

**Canadian Rental Development Services Inc.**

**910 March Road**

**Transportation  
Impact  
Assessment**



# 910 March Road

## Transportation Impact Assessment

Step 1 Screening Report

Step 2 Scoping Report

Step 3 Forecasting Report

Step 4 Strategy Report

Step 5 TIA Report

Prepared for:

Canadian Rental Development Services Inc.  
205-555 Legget Drive (Tower A)  
Ottawa, ON K2K 2X3

Prepared by:



6 Plaza Court  
Ottawa, ON K2H 7W1

January 2024

PN: 2021-073

## Table of Contents

1	Screening.....	1
2	Existing and Planned Conditions.....	1
2.1	Proposed Development.....	1
2.2	Existing Conditions.....	4
2.2.1	Area Road Network.....	4
2.2.2	Existing Intersections.....	4
2.2.3	Existing Driveways.....	4
2.2.4	Cycling and Pedestrian Facilities.....	5
2.2.5	Existing Transit.....	6
2.2.6	Existing Area Traffic Management Measures.....	7
2.2.7	Existing Peak Hour Travel Demand.....	8
2.2.8	Collision Analysis.....	10
2.3	Planned Conditions.....	13
2.3.1	Changes to the Area Transportation Network.....	13
2.3.2	Other Study Area Developments.....	14
3	Study Area and Time Periods.....	21
3.1	Study Area.....	21
3.2	Time Periods.....	22
3.3	Horizon Years.....	22
4	Exemption Review.....	22
5	Development-Generated Travel Demand.....	22
5.1	Mode Shares.....	22
5.2	Trip Generation.....	23
5.3	Trip Distribution.....	25
5.4	Trip Assignment.....	25
6	Background Network Travel Demands.....	29
6.1	Transportation Network Plans.....	29
6.2	Background Growth and Other Developments.....	29
7	Demand Rationalization.....	31
7.1	2028 Interim Year.....	34
8	Monitoring Plan.....	37
8.1	Rationale.....	37
8.2	Monitoring Activities.....	37
8.3	Evaluation.....	37
8.4	Remediation.....	37
9	Development Design.....	38
9.1	Design for Sustainable Modes.....	38
9.2	Circulation and Access.....	38
9.3	New Street Networks.....	39
10	Parking.....	39
10.1	Parking Supply.....	39
10.2	Spillover Parking.....	40

11	Boundary Street Design.....	40
12	Access Intersection Design.....	41
12.1	Location and Design of Access.....	41
12.2	Site Access Design.....	41
13	Transportation Demand Management.....	43
14	Neighbourhood Traffic Management.....	43
15	Transit.....	44
16	Review of Network Concept.....	44
17	Intersection Design.....	44
17.1	Intersection Control.....	44
17.2	Intersection Design.....	44
17.2.1	Existing Conditions.....	44
17.2.2	2028 Future Background.....	45
17.2.3	2033 Future Background.....	46
17.2.4	2028 Future Total.....	47
17.2.5	2028 Future Total – Interim Horizon.....	50
17.2.6	2033 Future Total.....	51
17.2.7	Intersection MMLOS.....	54
18	Conclusions.....	56

## List of Figures

Figure 1:	Area Context Plan.....	2
Figure 2:	Concept Plan.....	3
Figure 3:	Study Area Pedestrian Facilities.....	5
Figure 4:	Study Area Cycling Facilities.....	6
Figure 5:	Existing Study Area Transit Service.....	7
Figure 6:	Existing Study Area Transit Stops.....	7
Figure 7:	2022 Existing Traffic Volumes.....	8
Figure 8:	Existing Pedestrian Volumes.....	9
Figure 9:	Existing Cyclist Volumes.....	10
Figure 10:	Representation of Study Area Collision Records.....	11
Figure 11:	1055 Klondike Road Site Generated Primary Volumes.....	15
Figure 12:	1156 March Road Site Generated Primary Volumes.....	16
Figure 13:	788 March Road Site Generated Volumes-Phase 1 &2.....	17
Figure 14:	Kanata North Community Design Plan - 2026 Future Background Volumes.....	18
Figure 15:	Kanata North Community Design Plan - 2026 Future Total Volumes.....	19
Figure 16:	936 March Road Site Generated Traffic Volumes.....	20
Figure 17:	1020 / 1070 March Road Site Generated Volumes.....	21
Figure 18:	Pass-By Trip Volumes.....	26
Figure 19:	New Site Generation Auto Volumes.....	27
Figure 20:	Net New Site Generation Auto Volumes.....	28
Figure 21:	2028 Future Background Volumes.....	30
Figure 22:	2033 Future Background Volumes.....	31

Figure 23: 2028 Future Total Volumes .....	33
Figure 24: 2033 Future Total Volumes .....	34
Figure 25: 2028 Future Total Interim Volumes .....	36
Figure 26: 2028 Future Total Volumes - Right-In/Right-Out .....	50
Figure 27: 2033 Future Total Volumes - Right-in/Right-out.....	54

## Table of Tables

Table 1: Intersection Count Date.....	8
Table 2: Study Area Collision Summary, 2016-2020 .....	10
Table 3: Summary of Collision Locations, 2016-2020.....	11
Table 4: Klondike Road at March Road Collision Summary.....	12
Table 5: Segment of March Road between Halton Terrace / Maxwell Bridge Road and Klondike Road Collision Summary.....	12
Table 6: Halton Terrace / Maxwell Bridge Road at March Road Collision Summary .....	13
Table 7: Exemption Review .....	22
Table 8: TRANS Trip Generation Manual Recommended Mode Shares – Kanata/Stittsville.....	23
Table 9: TRANS Trip Generation Manual Recommended Mode Shares – Other Rural Districts .....	23
Table 10: Applied Mode Shares – Average.....	23
Table 11: Trip Generation Person Trip Rates by Peak Period.....	23
Table 12: Total Residential Person Trip Generation by Peak Hour .....	24
Table 13: Internal Capture Rates.....	24
Table 14: Land Use Pass-by Rates .....	24
Table 15: Trip Generation by Mode .....	25
Table 16: OD Survey Distribution – Kanata/Stittsville.....	25
Table 17: Parking Provisions.....	39
Table 18: Barrier-Free Parking Provisions .....	39
Table 19: Boundary Street MMLOS.....	40
Table 20: Interim and Ultimate SBL - Preliminary Minimum Design Criteria.....	42
Table 21: Throat Length by Land Use .....	43
Table 22: Trip Generation by Transit Mode – Multi-Unit (High-Rise) .....	44
Table 23: Trip Generation by Transit Mode - Strip Retail Plaza (<40k) .....	44
Table 24: Existing Intersection Operations.....	45
Table 25: 2028 Future Background Intersection Operations .....	46
Table 26: 2033 Future Background Intersection Operations .....	47
Table 27: 2028 Future Total Intersection Operations .....	48
Table 28: 2028 Future Total Interim Intersection Operations .....	51
Table 29: 2033 Future Total Intersection Operations .....	52
Table 30: Study Area Intersection MMLOS Analysis—All Horizons .....	55

## List of Appendices

- Appendix A – TIA Screening Form and Certification Form
- Appendix B – Traffic Data
- Appendix C – Collision Data
- Appendix D – March Road Widening Scenarios
- Appendix E – TDM Checklist
- Appendix F – Turning Templates
- Appendix G – Interim and Ultimate Access RMA Package
- Appendix H – Underground Parking
- Appendix I – MMLOS Worksheets
- Appendix J – Left-turn Lane Warrants
- Appendix K – Heavy Vehicle Percentage Calculations
- Appendix L – Synchro Intersection Worksheets – 2022 Existing Conditions
- Appendix M – Synchro Intersection Worksheets – 2028 Future Background Conditions
- Appendix N – Synchro Intersection Worksheets – 2033 Future Background Conditions
- Appendix O – Synchro Intersection Worksheets – 2028 Future Total Conditions
- Appendix P – Synchro Intersection Worksheets – 2028 Future Total Interim Conditions
- Appendix Q – Synchro Intersection Worksheets – 2033 Future Total Conditions

## 1 Screening

This study has been prepared according to the City of Ottawa's 2017 Transportation Impact Assessment (TIA) Guidelines. Accordingly, a Step 1 Screening Form has been prepared and is included as Appendix A, along with the Certification Form for the TIA Study PM. As shown in the Screening Form, a TIA is required including the Network Impact Component. This study has been prepared to support the zoning by-law amendment and site plan amendment application.

The previous outdated TIA completed for a commercial site application at 910 March Road, as well as traffic studies in this study area will be used as reference documents. Additionally, a TIA for 910 March Road, dated December 2022, has been submitted to support the zoning by-law amendment for this site. A subsequent submission in July 2023 report serves as an update to that document and addresses the received comments on the December 2022 submission from City of Ottawa staff. Comments dated October 11, 2023 were also received from City of Ottawa staff. As a result of the review process, additional comments and analysis have been produced for the City of Ottawa in the form of comment-response documents which have been submitted as a separate document. Additionally, an RMA was completed for the previous TIA produced for 910 March Road and has been updated appropriately to support this submission.

## 2 Existing and Planned Conditions

### 2.1 Proposed Development

The subject property, located at 910 March Road, is currently zoned as Rural [Ru] and Development Reserve [DR]. The proposed mixed-use development is multi-leveled with areas of one, two, three, four, five, six, seven, eight, and nine storeys. A total of 390 residential units and 501 square metres of ground floor commercial space over three units are proposed, and a total of 568 vehicle parking stalls will be provided, 541 spaces provided underground, and 27 spaces provided above ground. The proposed plan includes a full movement access on March Road located approximately 215 metres north of the signalized intersection of Maxwell Bridge Road. The anticipated full build-out and occupancy horizon is 2028 with construction occurring in a single phase. Figure 1 illustrates the study area context. Figure 2 illustrates the proposed concept plan.

Figure 1: Area Context Plan

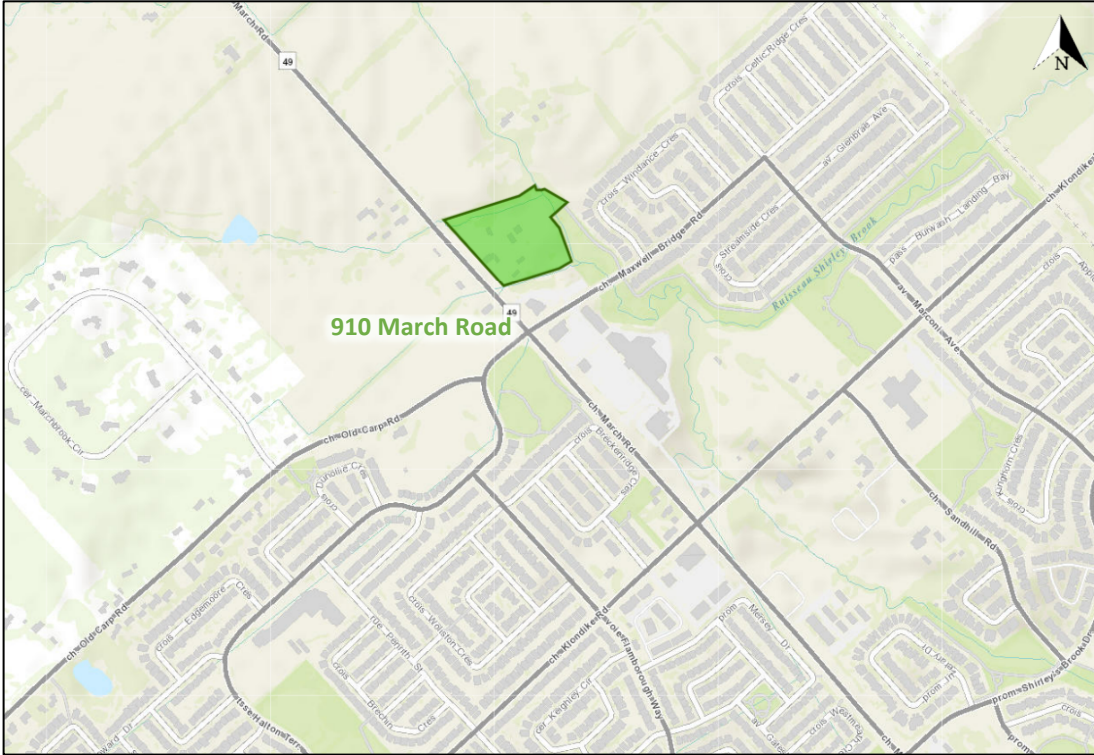

Source: <http://maps.ottawa.ca/geoOttawa/> Accessed: May 30, 2022



Figure 2: Concept Plan



NOTES GÉNÉRALES / General Notes

- Ces documents d'architecture sont la propriété exclusive de NEUF architectes et ne peuvent être utilisés, reproduits ou copiés sans autorisation écrite préalable. / These architectural documents are the exclusive property of NEUF architectes and cannot be used, copied or reproduced without written pre-authorization.
- Les dimensions apparaissant aux documents doivent être vérifiées par l'entrepreneur avant le début des travaux. / All dimensions which appear on the documents must be verified by the contractor before to start the work.
- Veuillez aviser l'architecte de toute dimension erreur et/ou divergence entre ces documents et ceux des autres professionnels. / The architect must be notified of all errors, omissions and discrepancies between these documents and those of the others professionals.
- Les dimensions sur ces documents doivent être lues et non mesurées. / The dimensions on these documents must be read and not measured.

ARCHITECTE PAYSAGER / Landscape Architect  
**Gino Aiello**  
 50 Camélot Drive, Nepean, ON K2G 5X8  
 T 613 852 1343

CIVIL CIVIL  
**NOVATECH**  
 240 Michael Cowpland Drive, Suite 200, Ottawa, ON K2M 1P6  
 T 613 254 9643 novatech-eng.com

INGÉNIEUR MÉCANIQUE / Mechanical Engineer  
**NATIONAL MULTI-RESIDENTIAL INNOVATIVE DESIGN**  
 555 Leggett Drive, Tower A, Suite 212, Ottawa, ON K2K 2X3  
 T 613 224 2761 Fax 613 951 0586

INGÉNIEUR EN STRUCTURE / Structural Engineer  
**CIMA+**  
 740, rue Notre-Dame O., Montréal, QC H3C 3X6  
 T 514 337 2462

ARCHITECTES ARCHITECT  
**NEUF architect(e)s**  
 630, boul. René-Lévesque O. 32e étage, Montréal QC H3B 1S6  
 T 514 847 1117 NEUFarchitectes.com

SCEAU / Seal

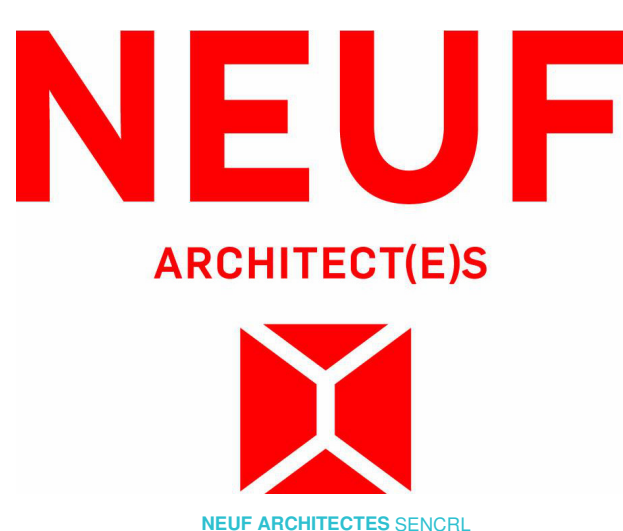

CLIENT / Client  
**LÉPINE**  
 206-555 Leggett Dr., Tower A, Ottawa, ON K2K 2X3  
 T 613 591 9090 F 613 591 9095

COMPANY NAME  
**910 MARCH ROAD**

EMPLACEMENT / Location NO PROJET / No.  
**910 MARCH ROAD 12712.00**

NO	RELEASE	DATE (aa-mm-ii)
0	ISSUED FOR ZONING	2023.01.26
1.A	ISSUED FOR SITE PLAN	2023.03.29
1.B	ISSUED FOR SITE PLAN REVISION 02	2023.12.22

*Preliminary  
DO NOT USE FOR  
CONSTRUCTION*

DESSIN PAR / Drawn by  
**Z.S** VÉRIFIÉ PAR / Checked  
**K.P.**

DATE (aa-mm-ii)  
**23/12/22** ÉCHELLE / Scale  
 As indicated

TITRE DU DESSIN / Drawing Title  
**1ST FLOOR SITE PLAN**

PREVIOUS REVISION: 1.5  
 CURRENT REVISION: 1.6  
 REVISION / Revision NO. DESSIN / Dwg Number

**1.6 A060**

Autodesk Docs://12712\_910 MARCH ROAD/MAM\_12712\_ARC\_BBD\_R22.rvt

## 2.2 Existing Conditions

### 2.2.1 Area Road Network

*March Road:* March Road is a City of Ottawa arterial road with a fluctuating cross-section and a posted speed limit of 80 km/h. South of Klondike Road, March Road has a six-lane cross-section with bike lanes, sidewalks, and curbs and gutters on both sides of the road. Approximately 125 metres north of Klondike Road, March Road becomes a five-lane road with bike lanes, sidewalks, and curbs and gutters on both sides of the road. Approximately 140 metres south of Halton Terrace / Maxwell Bridge Road, March Road becomes a four-lane road with bike lanes, sidewalks, and curbs and gutters on both sides of the road. March Road gradually decreases to a two-lane cross-section with gravel shoulders and no pedestrian or cycling infrastructure starting approximately 110 metres north of Halton Terrace / Maxwell Bridge Road. The Ottawa Official Plan reserves a 44.5 metre right of way. March Road is designated as a trucking route within the Study Area.

*Halton Terrace / Maxwell Bridge Road:* Halton Terrace / Maxwell Bridge Road is a City of Ottawa collector road that has a two-lane cross-section, and a posted speed-limit of 40 km/h. Halton Terrace / Maxwell Bridge Road has curbs and gutters, as well as sidewalks within the Study Area. Halton Terrace / Maxwell Bridge Road has a measured 24.5 metre right-of-way and is not designated as a trucking route.

*Klondike Road:* Klondike Road is a City of Ottawa collector road that has a three-lane cross-section to the west of March Road and a two-lane cross-section to the east of March Road, as well as a posted speed limit of 50 km/h. Sidewalks and curbs and gutters are present on both sides of the road. To the east of March Road, Klondike Road has bike lanes on the south side. The Ottawa Official Plan reserves a 24.0 metre right-of-way. Klondike Road is not a designated trucking route.

### 2.2.2 Existing Intersections

The existing key signalized intersections within one kilometre of the site have been summarized below:

*March Road at Halton Terrace / Maxwell Bridge Road* The intersection of Maxwell Bridge Road / Halton Terrace at March Road is a signalized intersection with auxiliary left-turn lanes on all four approaches. The northbound and southbound approaches both have two through lanes, an auxiliary right-turn lane and at grade cycling lanes between the through lane and the right turn lane. Both the eastbound and westbound approaches have a shared through / right-turn lane. Pedestrian crossings are provided at each leg. No turn restrictions were noted.

*March Road at Klondike Road* The intersection of Klondike Road at March Road is a signalized intersection. The northbound approach consists of two auxiliary left-turn lanes, two through lanes and a shared through / right-turn lane. The westbound approach is made up of an auxiliary left-turn lane and a shared through / right-turn lane. The southbound approach consists of an auxiliary left-turn lane, a through lane and a shared through / right-turn lane. The eastbound approach consists of an auxiliary left-turn lane, a through lane and a channelized right-turn lane. Pedestrian crossings are provided at each leg. No turn restrictions were noted.

### 2.2.3 Existing Driveways

Existing driveways are located along March Road within 200 metres of the proposed site access. All existing driveways are residential accesses and driveways to existing and future residential developments with the exception of the McDonald's driveway approximately 50 metres north of Maxwell Bridge Road / Halton Terrace.

2.2.4 Cycling and Pedestrian Facilities

Sidewalks are provided along both sides of Maxwell Bridge Road / Halton Terrace, on March Road with the exception of the two-lane cross-section segment, and Klondike Road west of March Road. A multi-use pathway is provided on Klondike Road east of March Road. The cycling network consists of bike lanes on March Road with the exception of the two-lane segment which has paved shoulders. Cycle tracks are provided along Maxwell Bridge Road between March Road and Sandhill Road.

March Road will be considered a spine route, and both Klondike Road and Halton Terrace will be considered local cycling routes within the Study Area during the ultimate horizon. A gravel pathway is anticipated to connect the northeast side of the proposed development to Maxwell Bridge Road and the adjacent residential development to the southeast.

Figure 3 illustrates the pedestrian facilities in the study area and Figure 4 illustrates the cycling facilities.

Figure 3: Study Area Pedestrian Facilities

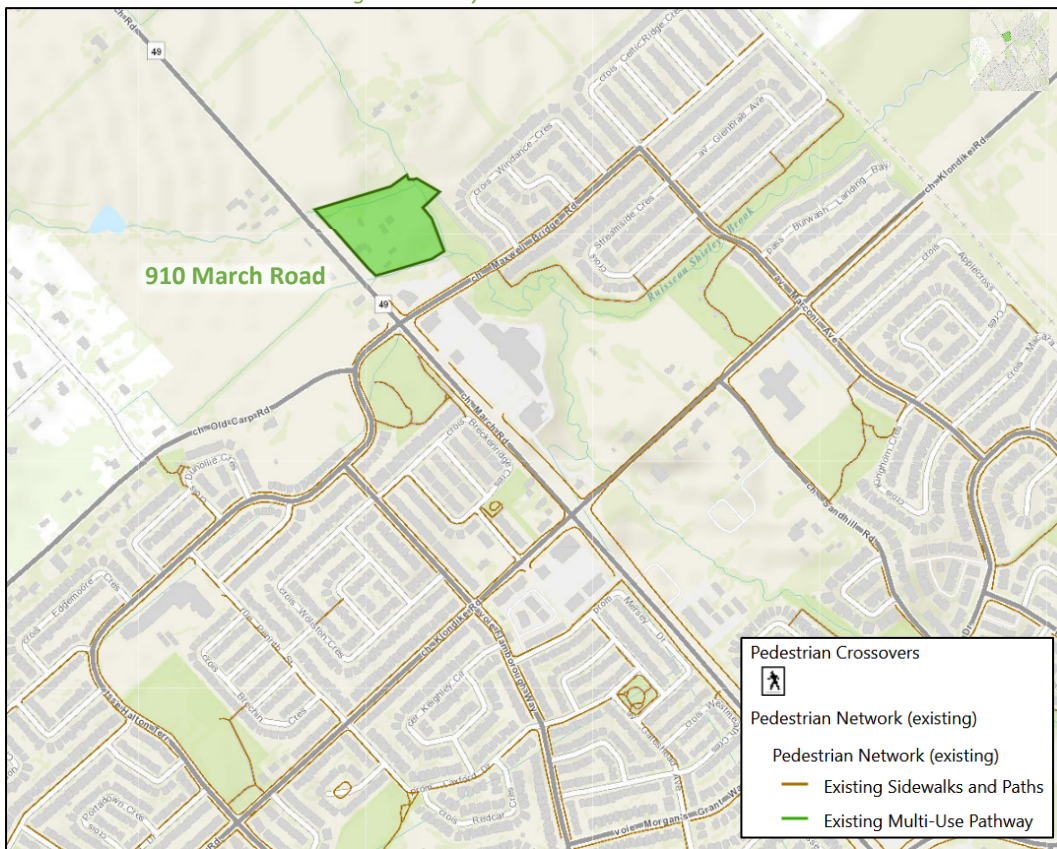

Source: <http://maps.ottawa.ca/geoOttawa/> Accessed: May 30, 2022

Figure 4: Study Area Cycling Facilities

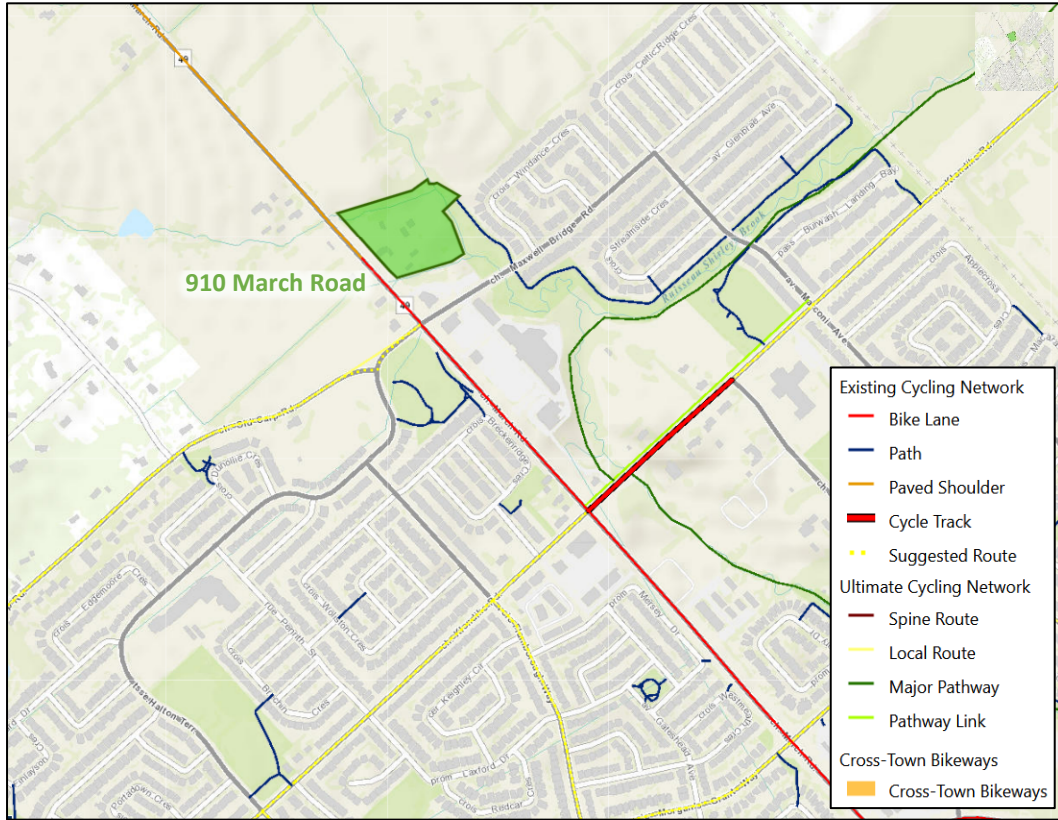

Source: <http://maps.ottawa.ca/geoOttawa/> Accessed: May 30, 2022

2.2.5 Existing Transit

Within the study area, the routes #63 and #165 are the only routes present within the Study Area. Route #63 has two stops on Maxwell Bridge Road, east of March Road and route #165 has two stops on Klondike Road to the east of March Road and two stops on Klondike Road to the west of March Road. The frequencies of these routes within the proximity of the proposed site currently are:

- Route #63— every 15 minutes in peak periods and every 30 minutes in off-peak periods.
- Route #165— every hour in the midday and evening

Figure 5 illustrates the transit system map in the study area and Figure 6 illustrates nearby transit stops.

Figure 5: Existing Study Area Transit Service

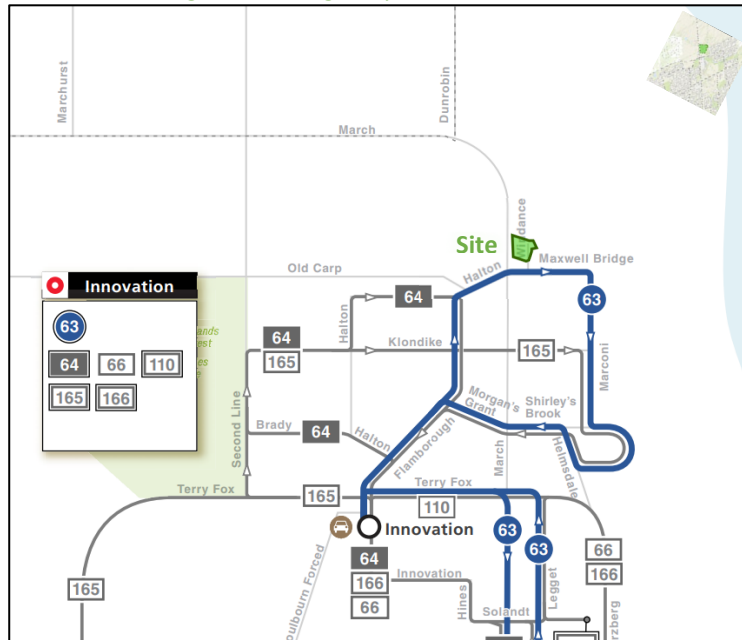

Source: <http://www.octranspo.com/> Accessed: May 30, 2022

Figure 6: Existing Study Area Transit Stops

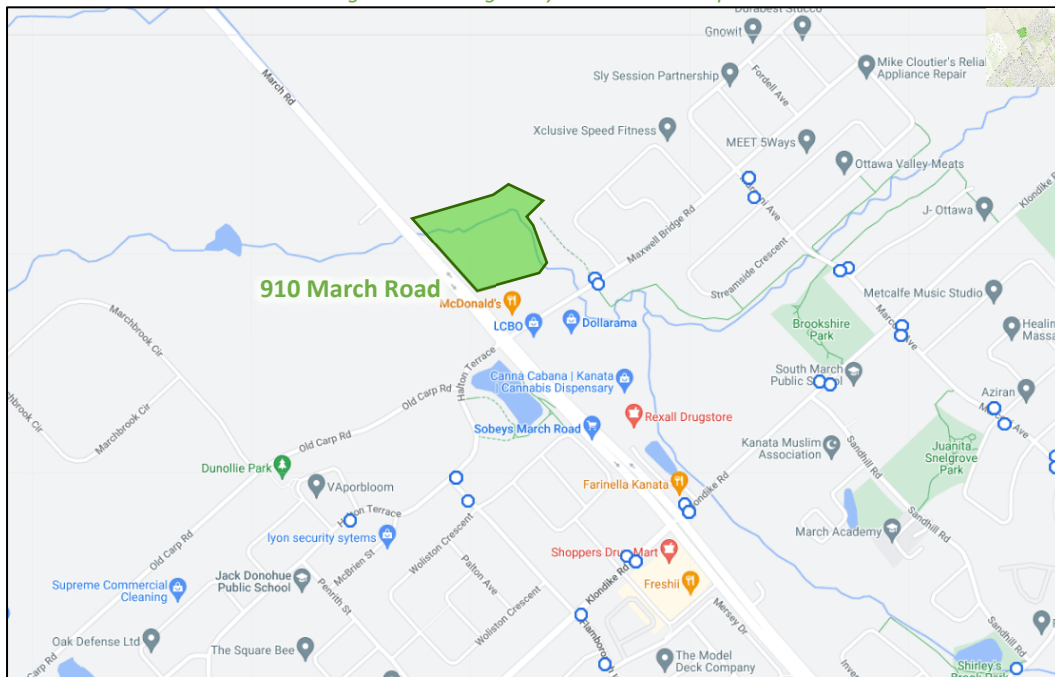

Source: <http://www.octranspo.com/> Accessed: Accessed: May 30, 2022

### 2.2.6 Existing Area Traffic Management Measures

Within the Study Area, traffic management measures are present on Maxwell Bridge Road approximately 200 metres east of March Road and on Halton Terrace beginning approximately 150 metres west of March Road. Both locations are designated as traffic calming zones using signage and pavement markings and is implemented via flexible in-road traffic calming signs.

2.2.7 Existing Peak Hour Travel Demand

Existing turning movement counts were acquired from the City of Ottawa for the existing study area key intersections. Turning movement count data can be found in Appendix B. Table 1 summarizes the intersection count dates.

Table 1: Intersection Count Date

Intersection	Count Date
March Road at Halton Terrace / Maxwell Bridge Road	Wednesday, March 4, 2020
March Road at Klondike Road	Wednesday, March 4, 2020

As shown above, the turning movement count data has been collected in 2020 and as such, a compound annual background growth rate of 0.50% has been applied to the northbound and southbound through movements along March Road in order to reflect a 2022 existing horizon. This growth rate is consistent with the Kanata North CDP TMP. Figure 7 illustrates the resulting 2022 existing horizon traffic volumes.

Figure 7: 2022 Existing Traffic Volumes

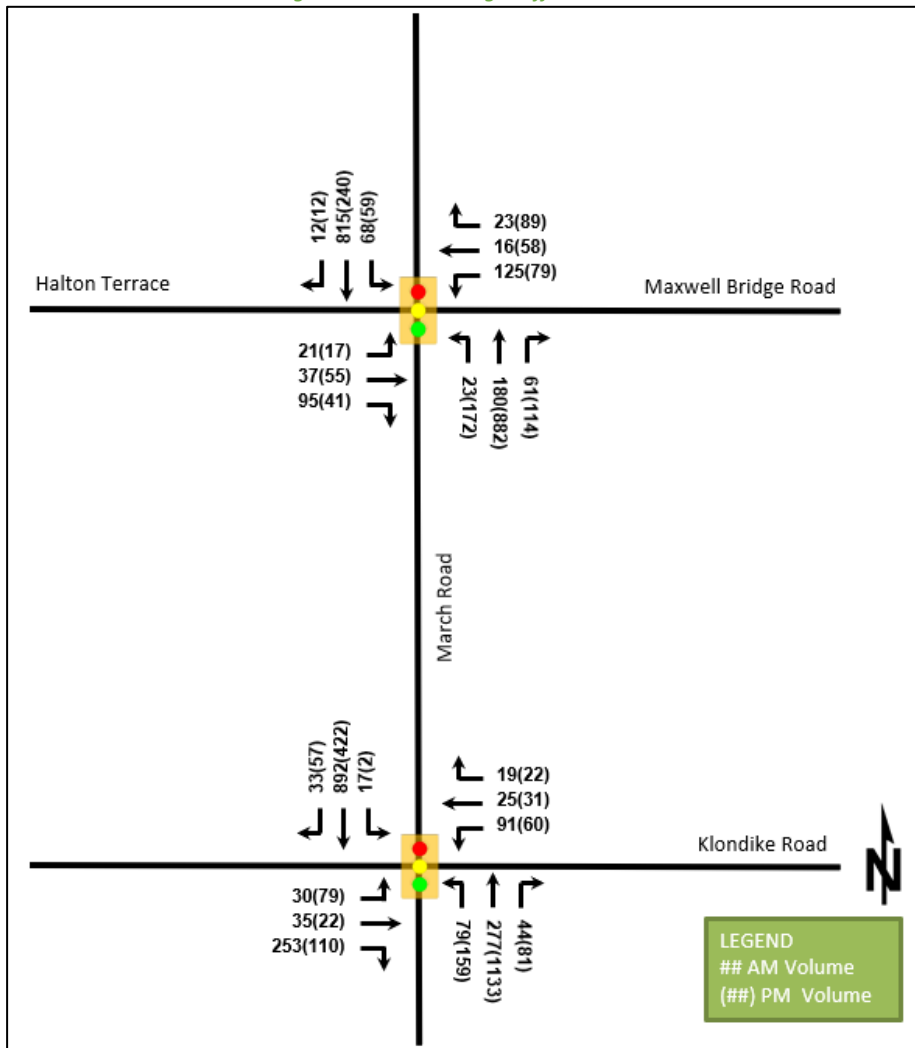

Additionally, as pedestrian and cyclist volumes were included in the study area intersection counts, these volumes have been compiled and are illustrated in Figure 8 and Figure 9, respectively.

Figure 8: Existing Pedestrian Volumes

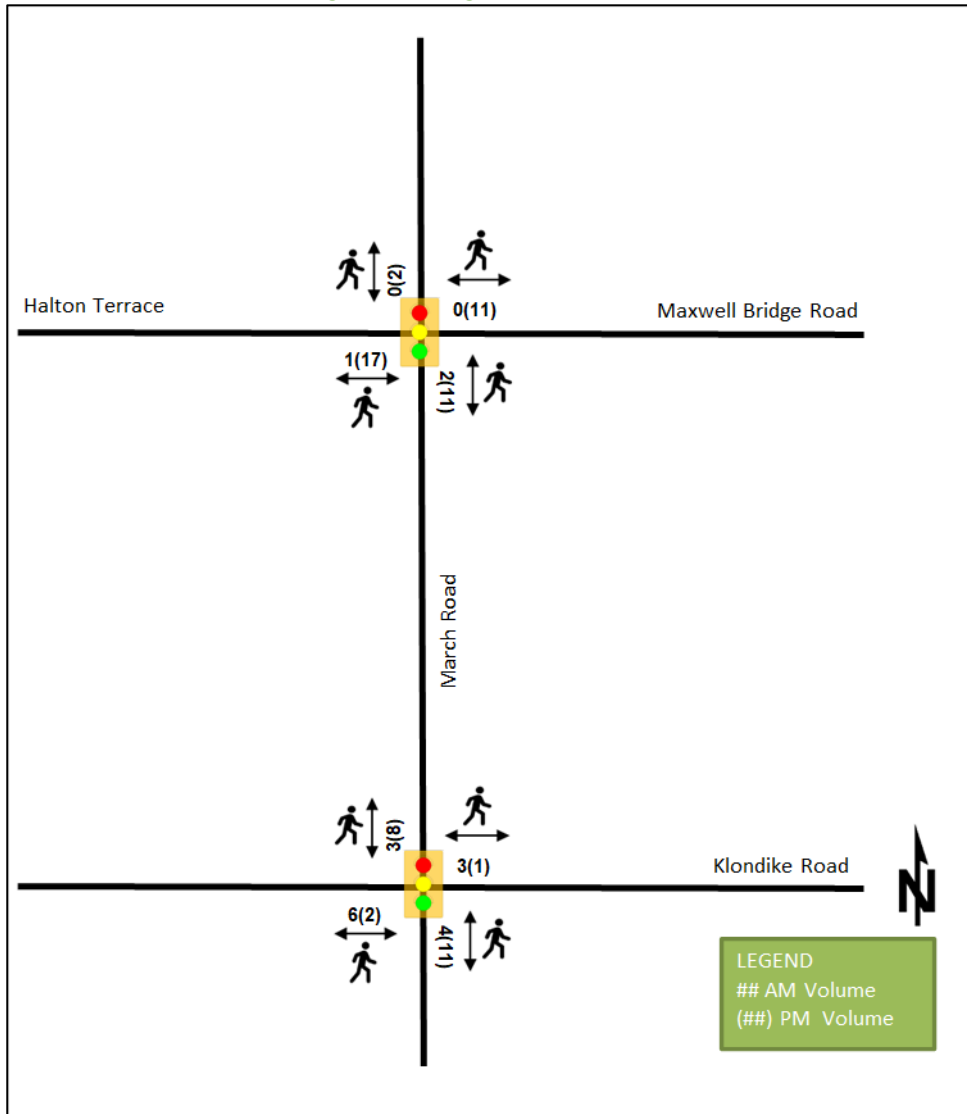
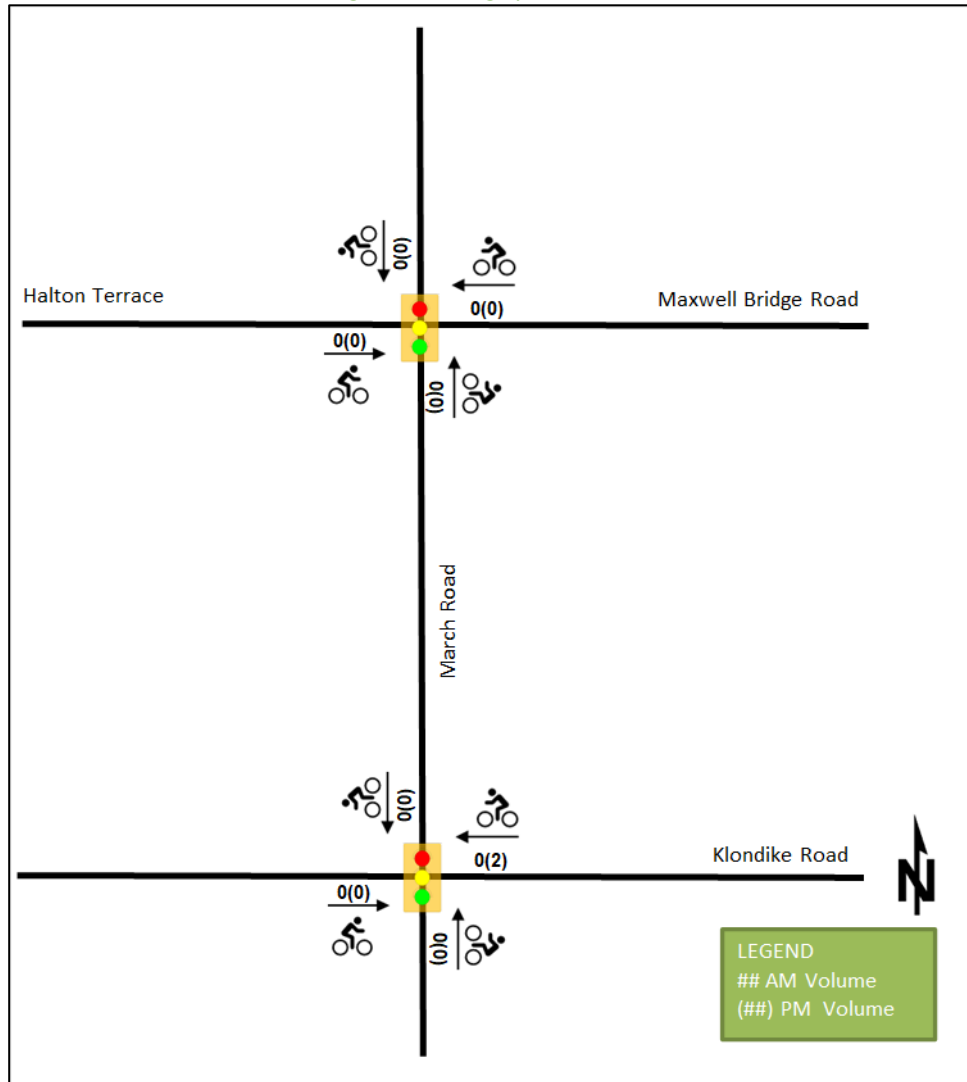

Figure 9: Existing Cyclist Volumes



2.2.8 Collision Analysis

Collision data have been acquired from the City of Ottawa open data website (data.ottawa.ca) for five years prior to the commencement of this TIA for the surrounding study area road network. Table 2 summarizes the collision types and conditions in the study area, Figure 10 illustrates the intersections and segments analyzed, and Table 3 summarizes the total collisions for each of these locations. Collision data is included in Appendix C.

Table 2: Study Area Collision Summary, 2016-2020

		Number	%
<b>Total Collisions</b>		<b>86</b>	<b>100%</b>
<b>Classification</b>	<b>Fatality</b>	0	0%
	<b>Non-Fatal Injury</b>	16	19%
	<b>Property Damage Only</b>	70	81%
<b>Initial Impact Type</b>	<b>Angle</b>	9	10%
	<b>Rear end</b>	23	27%
	<b>Sideswipe</b>	15	17%
	<b>Turning Movement</b>	12	14%
	<b>SMV Unattended</b>	1	1%



		Number	%
<b>Total Collisions</b>		<b>86</b>	<b>100%</b>
	SMV Other	25	29%
	Other	1	1%
<b>Road Surface Condition</b>	Dry	41	48%
	Wet	18	21%
	Loose Snow	13	15%
	Slush	5	6%
	Packed Snow	4	5%
	Ice	5	6%
<b>Pedestrian Involved</b>		<b>2</b>	<b>2%</b>
<b>Cyclists Involved</b>		<b>1</b>	<b>1%</b>

Figure 10: Representation of Study Area Collision Records

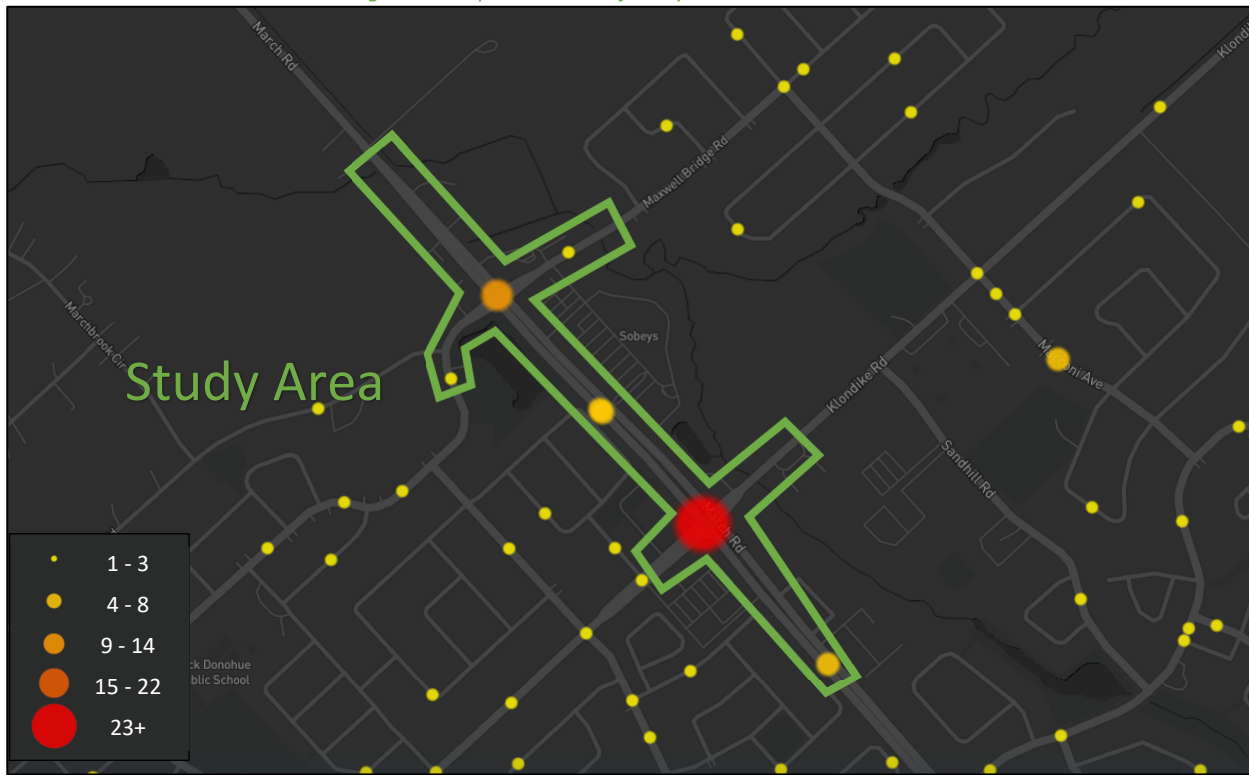

Table 3: Summary of Collision Locations, 2016-2020

Intersections / Segments	Number	%
	<b>86</b>	<b>100%</b>
Klondike Road @ March Road	26	30%
March Road btwn Halton Terrace / Maxwell Bridge Road & Maxwell Road	24	28%
Halton Terrace / Maxwell Bridge Road @ March Road	16	19%
March Road btwn Klondike Road & Morgan's Grant Way	7	8%
March Road btwn Halton Terrace / Maxwell Bridge Road & Klondike Road	5	6%
250 N of Klondike Road @ March Road	4	5%
Halton Terrace btwn continuation of Halton Terrace & Old Carp Road	2	2%
Maxwell Bridge Road btwn March Road & Windance Crescent	2	2%

Within the study area, the intersection of Klondike Road at March Road and Halton Terrace / Maxwell Bridge Road at March Road and segment of March Road between Halton Terrace / Maxwell Bridge Road and Maxwell Road

are noted to have experienced higher collisions than other locations. Table 4, Table 5, and Table 6 summarize the collision types and conditions for each location.

*Table 4: Klondike Road at March Road Collision Summary*

<b>Total Collisions</b>		<b>Number</b>	<b>%</b>
		<b>26</b>	<b>100%</b>
<b>Classification</b>	<b>Fatality</b>	0	0%
	<b>Non-Fatal Injury</b>	6	23%
	<b>Property Damage Only</b>	20	77%
<b>Initial Impact Type</b>	<b>Angle</b>	5	19%
	<b>Rear end</b>	9	35%
	<b>Sideswipe</b>	4	15%
	<b>Turning Movement</b>	3	12%
	<b>SMV Other</b>	5	19%
<b>Road Surface Condition</b>	<b>Dry</b>	14	54%
	<b>Wet</b>	2	8%
	<b>Loose Snow</b>	6	23%
	<b>Slush</b>	1	4%
	<b>Packed Snow</b>	1	4%
	<b>Ice</b>	2	8%
<b>Pedestrian Involved</b>		1	4%
<b>Cyclists Involved</b>		0	0%

The Klondike Road at March Road intersection had a total of 26 collisions during the 2016-2020 time period, with 20 involving property damage only and the remaining six having non-fatal injuries. The collision types are most represented by the rear end impact type with nine collisions, followed by five collisions each for the angle and SMV other and with the remaining four collision as sideswipe and three as turning movement. Weather/road conditions are considered to be a contributing factor for 46% of the collisions at this location.

*Table 5: Segment of March Road between Halton Terrace / Maxwell Bridge Road and Klondike Road Collision Summary*

<b>Total Collisions</b>		<b>Number</b>	<b>%</b>
		<b>24</b>	<b>100%</b>
<b>Classification</b>	<b>Fatality</b>	0	0%
	<b>Non-Fatal Injury</b>	2	8%
	<b>Property Damage Only</b>	22	92%
<b>Initial Impact Type</b>	<b>Rear end</b>	4	17%
	<b>Sideswipe</b>	3	13%
	<b>Turning Movement</b>	2	8%
	<b>SMV Other</b>	15	63%
<b>Road Surface Condition</b>	<b>Dry</b>	10	42%
	<b>Wet</b>	8	33%
	<b>Loose Snow</b>	4	17%
	<b>Slush</b>	1	4%
	<b>Packed Snow</b>	1	4%
<b>Pedestrian Involved</b>		0	0%
<b>Cyclists Involved</b>		0	0%

The segment of March Road between Halton Terrace / Maxwell Bridge Road and Maxwell Road had a total of 24 collisions during the 2016-2020 time period, with 22 involving property damage only and the remaining two having non-fatal injuries. The collision types are most represented by the SMV other impact type with 15 collisions, followed by rear end with four, sideswipe with three, and with the remaining collision types represented by the

turning movement impact type. Weather/road conditions are considered to be a contributing factor for 58% of the collisions at this location.

*Table 6: Halton Terrace / Maxwell Bridge Road at March Road Collision Summary*

<b>Total Collisions</b>		<b>Number</b>	<b>%</b>
		<b>16</b>	<b>100%</b>
<b>Classification</b>	<b>Fatality</b>	0	0%
	<b>Non-Fatal Injury</b>	4	25%
	<b>Property Damage Only</b>	12	75%
<b>Initial Impact Type</b>	<b>Angle</b>	3	19%
	<b>Rear end</b>	2	13%
	<b>Sideswipe</b>	3	19%
	<b>Turning Movement</b>	6	38%
	<b>SMV Other</b>	1	6%
	<b>Other</b>	1	6%
<b>Road Surface Condition</b>	<b>Dry</b>	6	38%
	<b>Wet</b>	5	31%
	<b>Loose Snow</b>	3	19%
	<b>Ice</b>	2	13%
<b>Pedestrian Involved</b>		1	6%
<b>Cyclists Involved</b>		1	6%

The Halton Terrace / Maxwell Bridge Road at March Road intersection had a total of 16 collisions during the 2016-2020 time period, with twelve involving property damage only and the remaining four having non-fatal injuries. The collision types are most represented by turning movement with six collisions, followed by sideswipe and angle each with three collisions, rear end with two, and with the remaining collision types represented by SMV other and other. Weather/road conditions are considered to be a contributing factor for 62% of the collisions at this location.

### 2.3 Planned Conditions

#### 2.3.1 Changes to the Area Transportation Network

The subject development is just outside the Kanata North CDP Urban Expansion Area, however March Road north of Maxwell Bridge Road / Halton Terrace is within the Kanata North CDP area. As such, this portion of March Road is subject to the planning policies outlined in the CDP. The CDP proposes that March Road remain an Arterial Road with a median Bus Rapid (BRT) facility, following the results of the Environmental Assessment (EA) completed for March Road. The widening of March Road, and the extension of a Bus Rapid Transit facility within the Study Area is considered in the City of Ottawa TMP Ultimate Network. Both interim and ultimate widening scenarios of March Road have been proposed in the Kanata North CDP and can be seen in Appendix D. The interim scenario is the widening of March Road to four lanes and the ultimate scenario considers the widening of March Road to accommodate the extension of the Median BRT system. As the timing of both of these improvements to March Road is unknown and neither transportation infrastructure upgrade is included in the City of Ottawa’s 2031 Affordable Network, it has been assumed that they will occur beyond the proposed development’s future analysis horizons. This assumption has been confirmed by the City of Ottawa as part of the comments provided on the former 910 March Road Forecasting Report for the previously proposed development. These comments have been included under a separate cover.

The Ottawa Official Plan, Ottawa Transportation Master Plan, Ottawa Pedestrian Plan, and the Ottawa Cycling Plan have also been used to identify changes to the area transportation network. The resulting changes to the road, pedestrian, and cycling network in the Study Area due to these plans are outlined below:

- As part of the 2031 Affordable Road Network, Klondike Road between March Road and Sandhill Road will be urbanized from a rural to an urban road cross-section. The original timing of this improvement was between 2014 to 2019. As these changes do not appear to be implemented, the timing of this is currently unknown.
- As part of the 2031 Affordable Network, March Road between Carling Avenue and Maxwell Bridge Road will be considered a Transit Signal Priority corridor (Isolated Measures). As a result, transit signal priority and queue jump lanes will be implemented. The exact timing of this is not clear.
- As part of the 2031 Ultimate Cycling Network, within the Study Area March Road will be considered a spine route, and both Klondike Road to the west of March Road, and Halton Terrace will be considered local routes. The exact timing of these have not been made clear.

Additionally, it is assumed that as part of the proposed development, the existing pedestrian facilities which terminate north of Maxwell Bridge Road / Halton Terrace will be extended along the frontage of the proposed development along the east side of March Road upon full-build out of the development. As per comments received from the City of Ottawa, no upgraded cycling infrastructure has been proposed along the frontage of the site. As such the existing paved shoulder that acts as a bike lane will be maintained and no protected crossings at the proposed site access intersection shall be provided.

### 2.3.2 Other Study Area Developments

A few development applications were available for the adjacent properties as listed on the City's Development Application Search tool:

- 1055 Klondike Road – A residential subdivision made up of 12 semi-detached dwellings, 46 townhouse units, 56 apartment units, and additional space designated for development. The development is anticipated to be built out in 2024 and the anticipated primary trip generation from this site can be seen in Figure 11 and is an excerpt from the 1055 Klondike Road Transportation Impact Assessment prepared by Novatech.

Figure 11: 1055 Klondike Road Site Generated Primary Volumes

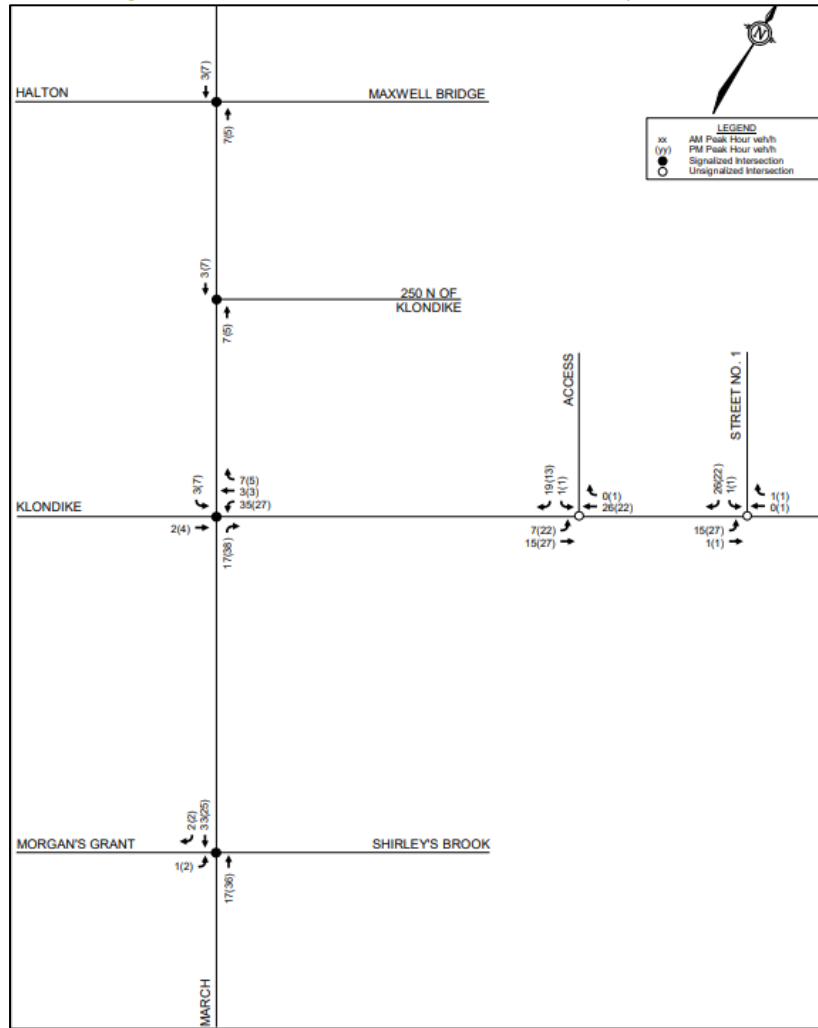

Source: 1055 Klondike Road TIA (Novatech., 2021)

- 1156 / 1170 March Road – A gasoline service centre with eight fuelling pumps and a convenience store. The originally anticipated full-build out year was 2017. As this construction on this development does not appear to have begun yet, it will be assumed to be built-out before the future horizon year of 2028 to ensure it is considered. The anticipated primary trip generation from this site can be seen in Figure 12 and is an excerpt from the Mr. Gas Service Centre-1156 March Road Transportation Brief prepared by D.J. Halpenny & Associates Ltd.

Figure 12: 1156 March Road Site Generated Primary Volumes

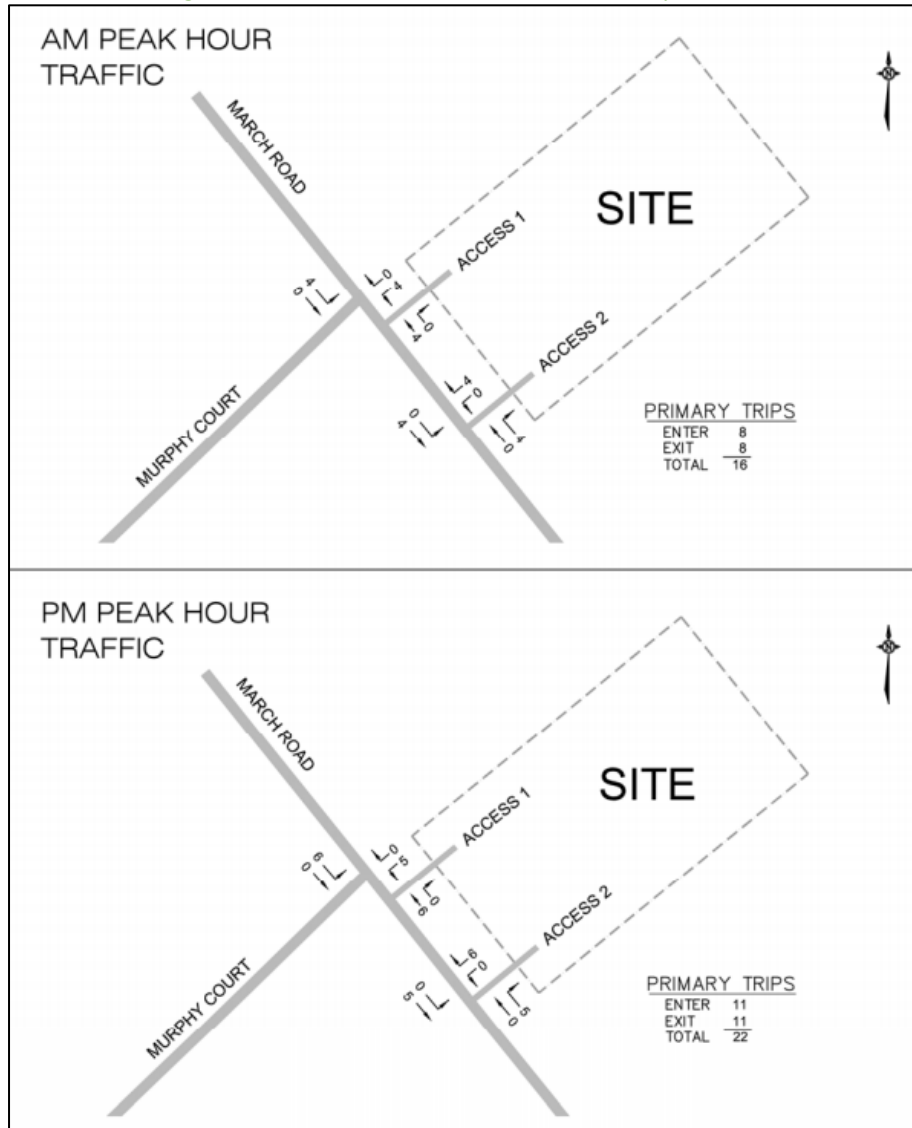

Source: 1156 March Road TIA Strategy Report (D.J. Halpenny & Associates Ltd., 2016)

- 1104 Halton Terrace – The proposed development includes 86 apartments. The development is anticipated to be built out in 2024 and is anticipated to generate 17AM and 17PM new two-way peak-hour auto trips. As such, the trip generation trigger for a full TIA was not met, and no volume figures were produced. The impact of the trips generated by this development is expected to be captured by the application of a background growth rate. (Novatech, 2021)
- 1050 Klondike Road – The proposed development includes a single residential stacked dwelling block composed of 9 dwelling units. No TIA is available at this time, however given the small number of proposed dwelling units, the impact of the trips generated by this development is expected to be captured by the application of a background growth rate.
- 788 March Road – A two-phase residential development proposing 95 residential units upon the completion of the first phase (2021) and an additional 101 residential units upon build-out of the second phase (2023). As this construction of the first phase of this development does not appear to have begun

yet, it will be assumed to be built-out before the future horizon year of 2028 to ensure it is considered. A total of approximately 270 vehicle parking spaces are proposed. The anticipated trip generation from this site for Phase 1 and Phase 2 can be seen in Figure 13, and is an excerpt from the 788 March Road Draft Transportation Impact Assessment prepared by Parsons. A final version of the report has not been made available.

Figure 13: 788 March Road Site Generated Volumes-Phase 1 & 2

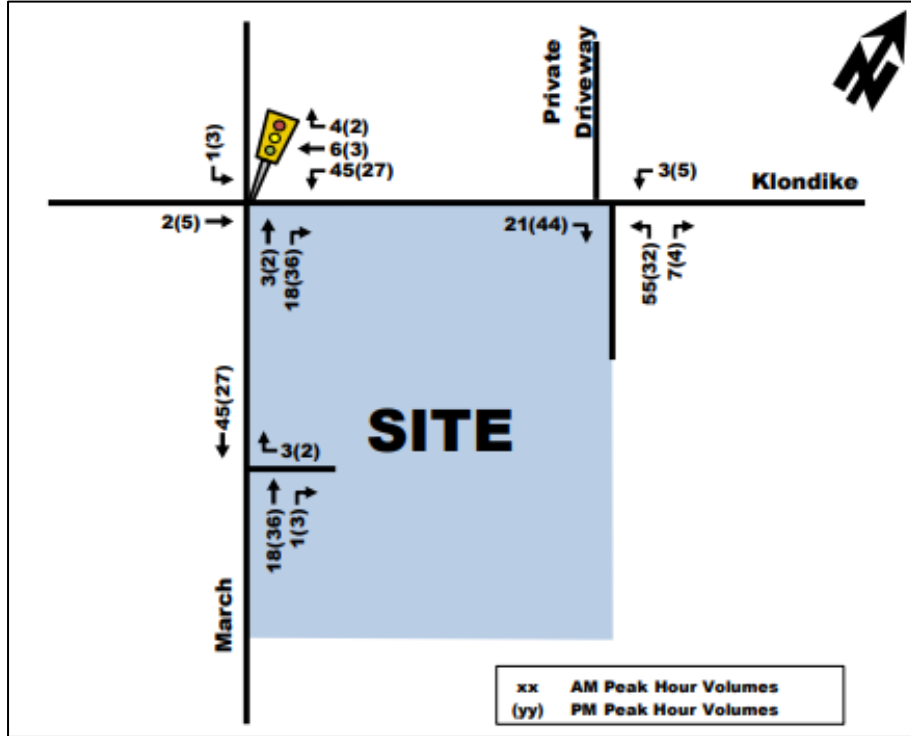

Source: 788 March Road TIA Strategy Report (Parsons, 2018)

- 1015 March Road –1015 March Road is proposed to subdivide the Subject Site to consist of one future mixed-use block, one future institutional block, and will extend a Street to March Road. No TIA is available at this time, and so the impact of the trips generated by this development is expected to be captured by the application of a background growth rate.

The Kanata North Community Design Plan outlines the proposed community-wide land-use framework for the Kanata North Urban Expansion Area. Various proposed developments are considered as part of the design plan and have been broken into four quadrants (northeastern, southeastern, southwestern, and northwestern). The Kanata North Community Design Plan -TMP – prepared by Novatech identifies the site-generated traffic of all four quadrants on the surrounding area road network and assumes a full build-out year of 2026. Excerpts from the TMP can be seen in Figure 14 and Figure 15 depicting the 2026 Future Background Volumes and the 2026 Future Total Volumes, respectively.

Figure 14: Kanata North Community Design Plan - 2026 Future Background Volumes

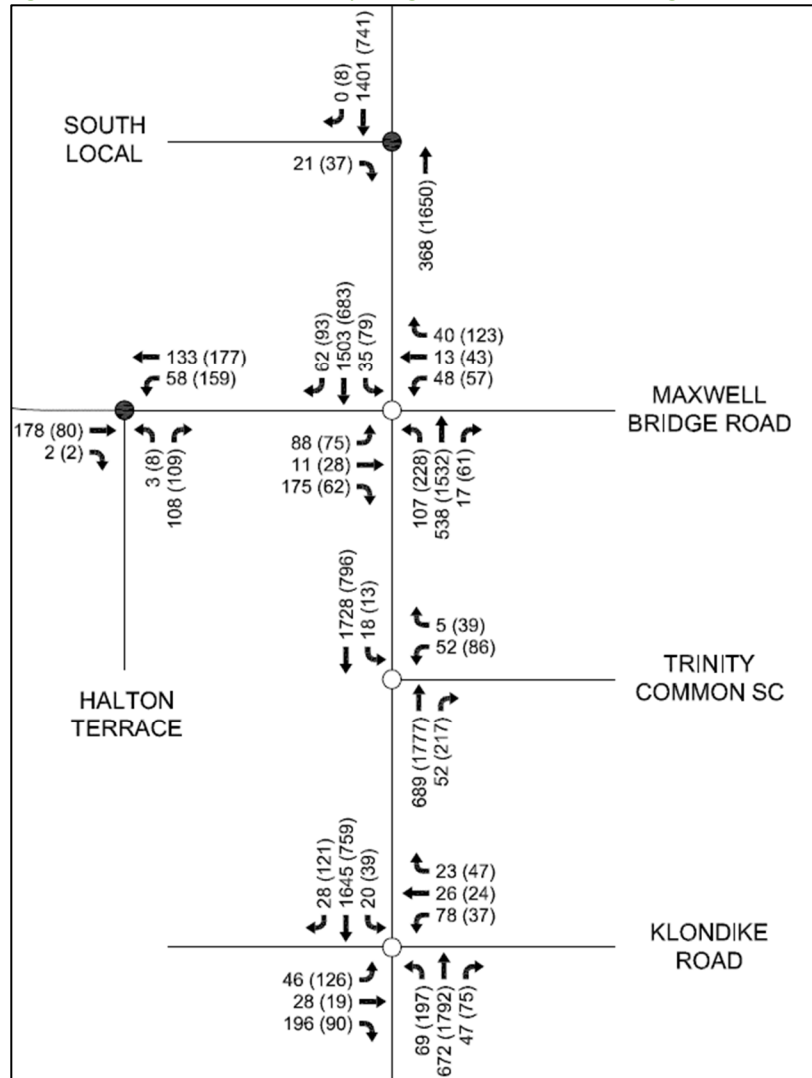

Source: Kanata North Community Design Plan - TMP (Novatech, 2016)



Figure 15: Kanata North Community Design Plan - 2026 Future Total Volumes

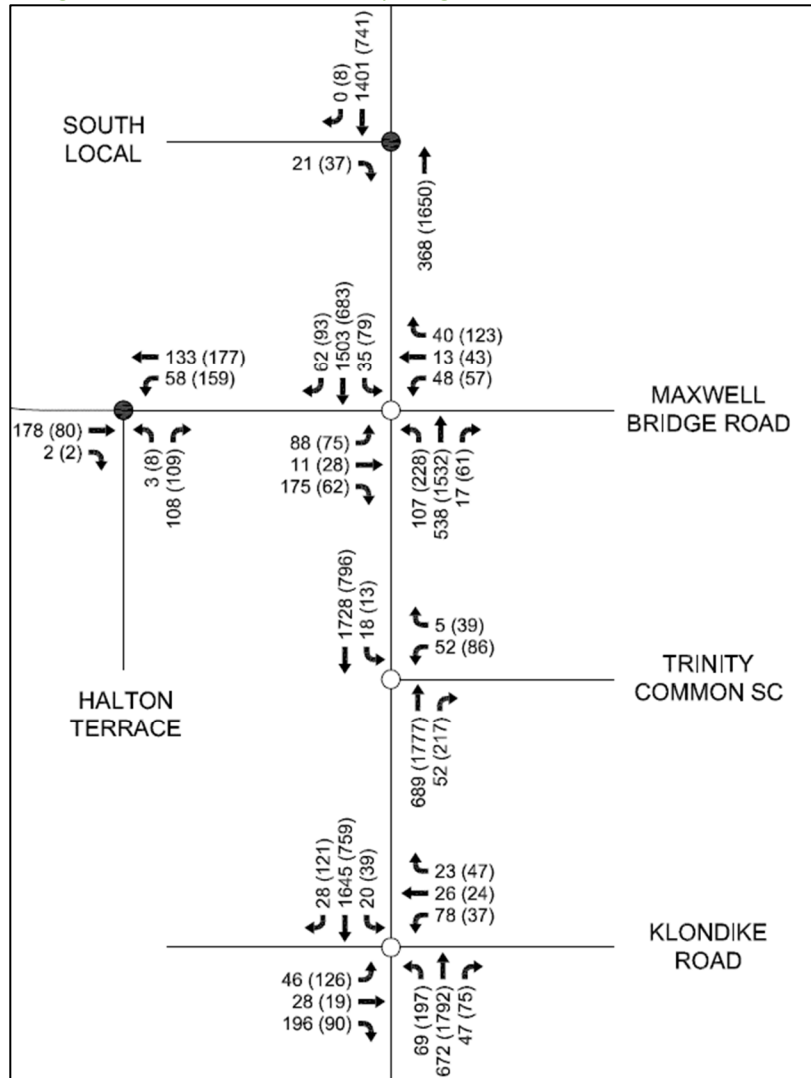

Source: Kanata North Community Design Plan - TMP (Novatech, 2016)

At this time, active development applications are available for all quadrants, and therefore the site generated traffic for these quadrants will be determined based on the Transportation Impact Assessments for these development areas where available.

The other development quadrants are explored in further detail below:

- 936 March Road - Considered the southeast portion of the Kanata North Urban Expansion Area Proposed to include approximately 900 residential units split between townhomes and detached units. The full build-out of this development is expected by 2023. The anticipated trip generation from this site can be seen in Figure 16 and is an excerpt from the 936 March Road Transportation Impact Assessment prepared by CGH Transportation.

Figure 16: 936 March Road Site Generated Traffic Volumes

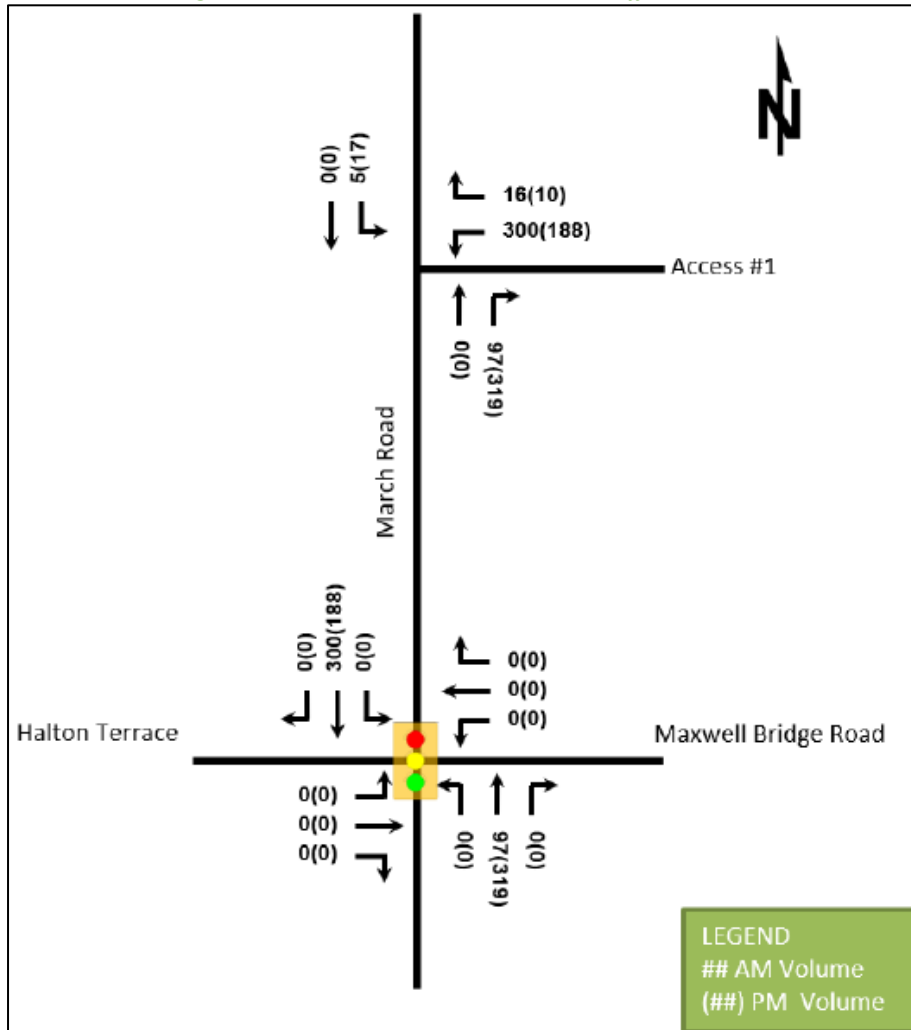

Source: 936 March Road (CGH Transportation, 2020)

- 1020 / 1070 March Road – Considered the northeast portion of the Kanata North Urban Expansion Area. A subdivision proposed to include 297 single family homes, 315 townhouses, 116 apartment units, an elementary school, and 80, 000 ft<sup>2</sup> of specialty retail. Full build-out of this development is expected by 2031. No phasing information is available. The anticipated trip generation from this site can be seen in Figure 17 and is an excerpt from 1020 and 1070 March Road Transportation Impact Assessment-Strategy Report prepared by Stantec.

Figure 17:1020 / 1070 March Road Site Generated Volumes

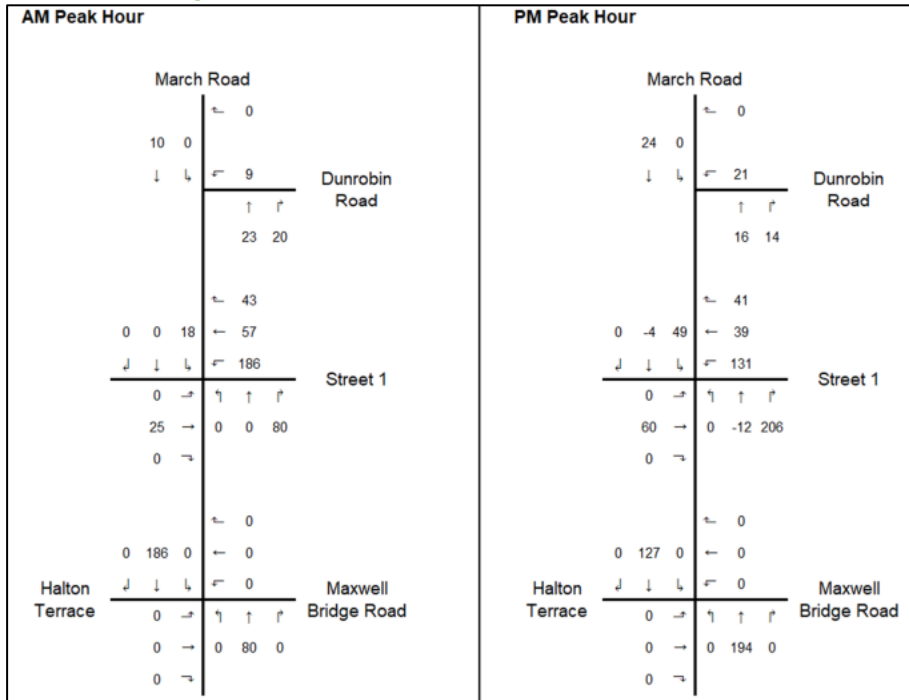

Source: 1020 and 1070 March Road TIA Strategy Report (Stantec, 2020)

- 1053 / 1075 / 1145 March Road – Considered the northwest portion of the Kanata North Urban Expansion Area. Proposed to include 295 single detached dwellings, 314 townhouse dwellings, 216 multi-unit dwellings. Full build-out of this development is expected by 2026. Site generated volumes diagrams are not available as part of the TIA, however the report indicates that the volumes presented in the Kanata North Community Design Plan – TMP prepared by Novatech can be used to determine a conservative estimate of the traffic generated by the proposed development at 1053 / 1075 / 1145 March Road. The 2026 future background volumes and the 2026 future total volumes seen in Figure 14 and Figure 15 will therefore be used to calculate the site generated traffic.
- 927 March Road – Considered the southwest portion of the Kanata North Urban Expansion Area. 927 March Road is proposed to be a residential subdivision with 35 single family homes, 78 townhouses, 1,838 apartment units, and 6,100 m<sup>2</sup> of specialty retail constructed in seven phases. Phase One to Phase Four is expected to be built by 2028, and it includes two mid-rise residential buildings with 600 units, SWM pond block, 33 townhouse units, 28 singles units, and three low-rise residential apartments with 336 units. Phase Five and Six is expected to be built by 2032, and it includes four low-rise residential apartments with 554 units. Full build-out of this development is expected by 2034. As such, the Phase One to Phase Four site traffic generated by 927 March Road will be considered in the future analysis horizons of 2028 and Phase One to Phase Six will be considered in the future analysis horizons of 2033 within this report. (Stantec, 2020)

### 3 Study Area and Time Periods

#### 3.1 Study Area

The study area will include the intersections of March Road at Halton Terrace / Maxwell Bridge Road, March Road at Klondike Road, and March Road at the site access.

The boundary road will be March Road and no screenlines are present within proximity to the site.

### 3.2 Time Periods

As the proposed development is composed of residential and commercial uses, the AM and PM peak hours will be examined.

### 3.3 Horizon Years

The anticipated build-out year is 2028. As a result, the full build-out plus five years horizon year is 2033.

## 4 Exemption Review

Table 7 summarizes the exemptions for this TIA.

*Table 7: Exemption Review*

Module	Element	Explanation	Exempt/Required
<b>Design Review Component</b>			
<b>4.1 Development Design</b>	4.1.2 Circulation and Access	Only required for site plans	Required.
	4.1.3 New Street Networks	Only required for plans of subdivision	Exempt
<b>4.2 Parking</b>	4.2.1 Parking Supply	Only required for site plans	Required.
	4.2.2 Spillover Parking	Only required for site plans where parking supply is 15% below unconstrained demand	Exempt.
<b>Network Impact Component</b>			
<b>4.5 Transportation Demand Management</b>	All Elements	Not required for site plans expected to have fewer than 60 employees and/or students on location at any given time	Required
<b>4.6 Neighbourhood Traffic Management</b>	4.6.1 Adjacent Neighbourhoods	Only required when the development relies on local or collector streets for access and total volumes exceed ATM capacity thresholds	Exempt
<b>4.8 Network Concept</b>		Only required when proposed development generates more than 200 person-trips during the peak hour in excess of equivalent volume permitted by established zoning	Exempt

## 5 Development-Generated Travel Demand

### 5.1 Mode Shares

Examining the mode shares recommended in the TRANS Trip Generation Manual (2020) for the subject district and derived from the most recent National Capital Region Origin-Destination survey (OD Survey), the existing average district mode shares by land use for Kanata/Stittsville and other rural districts have been summarized in Table 8 and Table 9, respectively. Since the development location is just above the Kanata/Stittsville district, an average mode share of Kanata/Stittsville and other rural districts was used and has been summarized in Table 10.

Table 8: TRANS Trip Generation Manual Recommended Mode Shares – Kanata/Stittsville

Travel Mode	Multi-Unit (High-Rise)		Commercial Generator	
	AM	PM	AM	PM
Auto Driver	43%	55%	81%	73%
Auto Passenger	26%	19%	12%	22%
Transit	28%	21%	5%	1%
Cycling	0%	0%	0%	0%
Walking	4%	5%	2%	4%
<b>Total</b>	<b>100%</b>	<b>100%</b>	<b>100%</b>	<b>100%</b>

Table 9: TRANS Trip Generation Manual Recommended Mode Shares – Other Rural Districts

Travel Mode	Multi-Unit (High-Rise)		Commercial Generator	
	AM	PM	AM	PM
Auto Driver	63%	64%	87%	80%
Auto Passenger	15%	18%	9%	14%
Transit	19%	16%	0%	1%
Cycling	0%	0%	0%	2%
Walking	3%	1%	3%	4%
<b>Total</b>	<b>100%</b>	<b>100%</b>	<b>100%</b>	<b>100%</b>

Table 10: Applied Mode Shares – Average

Travel Mode	Multi-Unit (High-Rise)		Commercial Generator	
	AM	PM	AM	PM
Auto Driver	53%	60%	84%	76%
Auto Passenger	20%	19%	11%	18%
Transit	24%	19%	3%	1%
Cycling	0%	0%	0%	1%
Walking	3%	2%	2%	4%
<b>Total</b>	<b>100%</b>	<b>100%</b>	<b>100%</b>	<b>100%</b>

## 5.2 Trip Generation

This TIA has been prepared using the vehicle and person trip rates for the residential dwellings using the TRANS Trip Generation Manual (2020) and the vehicle trip rates and derived person trip rates for commercial component from the ITE Trip Generation Manual 11th Edition using the City-prescribed conversion factor of 1.28. Table 11 summarizes the person trip rates for the proposed residential land uses for each peak period and the person trip rates for the non-residential land uses by peak hour.

Table 11: Trip Generation Person Trip Rates by Peak Period

Land Use	Land Use Code	Peak Period	Vehicle Trip Rate	Person Trip Rates
Multi-Unit (High-Rise)	221 & 222 (TRANS)	AM	-	0.80
		PM	-	0.90
Strip Retail Plaza (<40k)	822 (ITE)	AM	2.36	3.02
		PM	6.59	8.44

Using the above person trip rates, the total person trip generation has been estimated. Table 12 summarizes the total person trip generation for the residential land uses and for the non-residential land uses.

Table 12: Total Residential Person Trip Generation by Peak Hour

Land Use	Units/GFA	AM Peak Period			PM Peak Period		
		In	Out	Total	In	Out	Total
Multi-Unit (High-Rise)	390 units	48	107	155	90	65	155
Strip Retail Plaza (<40k)	5393 sq ft	10	7	17	24	24	48

Internal capture rates from the ITE Trip Generation Handbook 3<sup>rd</sup> Edition have been assigned to the development’s retail component for mixed-use developments. The rates summarized in Table 13 represent the percentage of trips to/from the retail use based on the residential component.

Table 13: Internal Capture Rates

Land Use	AM		PM	
	In	Out	In	Out
Residential to/from Strip Retail Plaza (<40k)	17%	14%	10%	26%

Where applicable, pass-by trips have been accounted for. The pass-by rate has been selected using ITE Trip Generation Manual 11th Edition. As land use 822 (Strip Retail Plaza) does not have a pass-by trip percentage provided, pass-by trip rates from land use 820 (Shopping Centre), and land use 821 (Shopping Plaza) were both considered. The pass-by rate for land use 821 was selected as it is more similar to land use 822. The average pass-by trip percentages for the PM peak period was taken from this table as pass-by trips are not expected in the AM peak period for retail land uses. For the residential land uses, a pass-by rate has not been applied as they are unlikely to attract pass-by trips. The rates used for the retail land use has been summarized in Table 14, as per the ITE Trip Generation Manual.

Table 14: Land Use Pass-by Rates

Land Use	Pass-by Rate	
	AM	PM
Strip Retail Plaza	-	40%

Using the above mode share targets for the internal capture and pass-by rates, and the person trip rates, the person trips by mode have been projected. Trip generation by peak hour has been forecasted using the prescribed peak period conversion factors presented in the TRANS Trip Generation Manual (2020) for the residential component. Table 15 summarizes the residential trip generation and the non-residential trip generation by mode and peak hour.

Table 15: Trip Generation by Mode

Travel Mode		AM Peak Hour				PM Peak Hour			
		Mode Share	In	Out	Total	Mode Share	In	Out	Total
Multi-Unit (High-Rise)	Auto Driver	53%	24	55	79	60%	53	38	91
	Auto Passenger	20%	9	21	30	19%	17	12	29
	Transit	24%	13	28	41	19%	18	13	31
	Cycling	0%	0	0	0	0%	0	0	0
	Walking	4%	2	3	5	3%	2	2	4
	<b>Total</b>	<b>100%</b>	<b>48</b>	<b>107</b>	<b>155</b>	<b>100%</b>	<b>90</b>	<b>65</b>	<b>155</b>
Strip Retail Plaza (<40k)	Auto Driver	84%	7	5	12	76%	7	4	11
	Auto Passenger	11%	1	1	2	18%	4	3	7
	Transit	3%	0	0	0	1%	0	0	0
	Cycling	0%	0	0	0	1%	0	0	0
	Walking	3%	0	0	0	4%	1	1	2
	Internal Capture	varies	-2	-1	-3	varies	-2	-6	-8
	Pass-by	0%	0	0	0	40%	-10	-10	-20
	<b>Total</b>	<b>100%</b>	<b>8</b>	<b>6</b>	<b>14</b>	<b>100%</b>	<b>12</b>	<b>8</b>	<b>20</b>
Total	Auto Driver	-	31	60	91	-	60	42	102
	Auto Passenger	-	10	22	32	-	21	15	36
	Transit	-	13	28	41	-	18	13	31
	Cycling	-	0	0	0	-	0	0	0
	Walking	-	2	3	5	-	3	3	6
	<b>Total</b>	<b>100%</b>	<b>56</b>	<b>113</b>	<b>169</b>	<b>100%</b>	<b>102</b>	<b>73</b>	<b>175</b>

As shown above, a total of 91 AM and 102 PM new peak hour two-way vehicle trips are projected as a result of the proposed development.

### 5.3 Trip Distribution

To understand the travel patterns of the subject development, the OD Survey has been reviewed to determine the travel patterns, and these patterns were applied based on the build-out of Kanata/Stittsville as it is considered reflective of future plans for the surrounding area. Table 16 below summarizes the distributions.

Table 16: OD Survey Distribution – Kanata/Stittsville

To/From	Residential % of Trips
North	5%
South	50%
East	40%
West	5%
<b>Total</b>	<b>100%</b>

### 5.4 Trip Assignment

Using the distribution outlined above, turning movement splits, and access to major transportation infrastructure, the pass-by trips and trips generated by the site have been assigned to the Study Area road network.

To assign the pass-by trips to the accesses, a ratio of southbound trips as a portion of all traffic on March Road, and northbound trips as a portion of all traffic on March Road was developed. It was determined that 72% of the total traffic is southbound and 28% is northbound in the AM peak period and 35% of the total traffic is southbound and 65% is northbound in the peak periods. Using these percentages, the traffic volumes have been logically

distributed to the access points. Figure 18 and Figure 19 illustrate the forecasted pass-by trip volumes and new site generation auto volumes, respectively.

Figure 18: Pass-By Trip Volumes





Figure 19: New Site Generation Auto Volumes

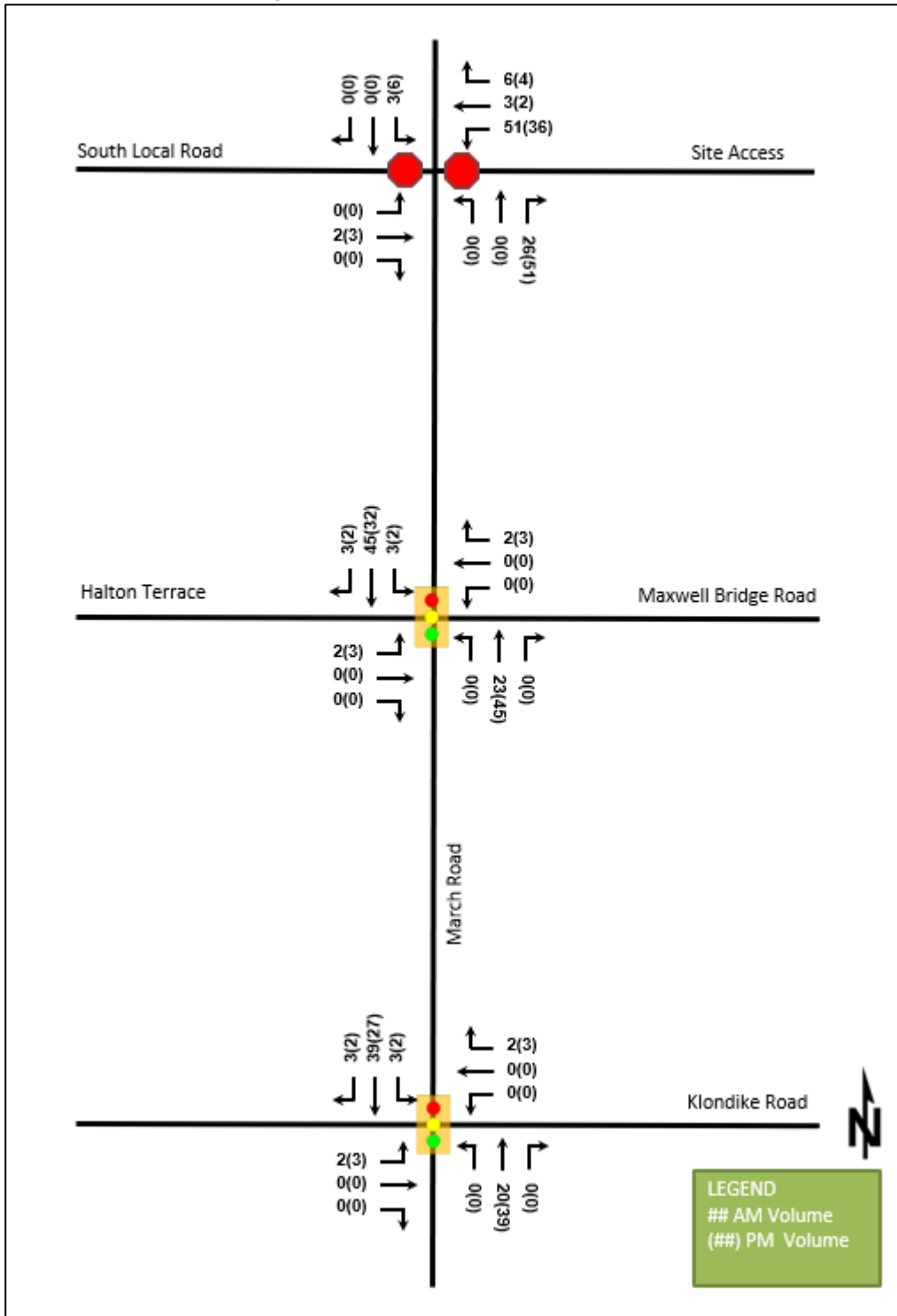
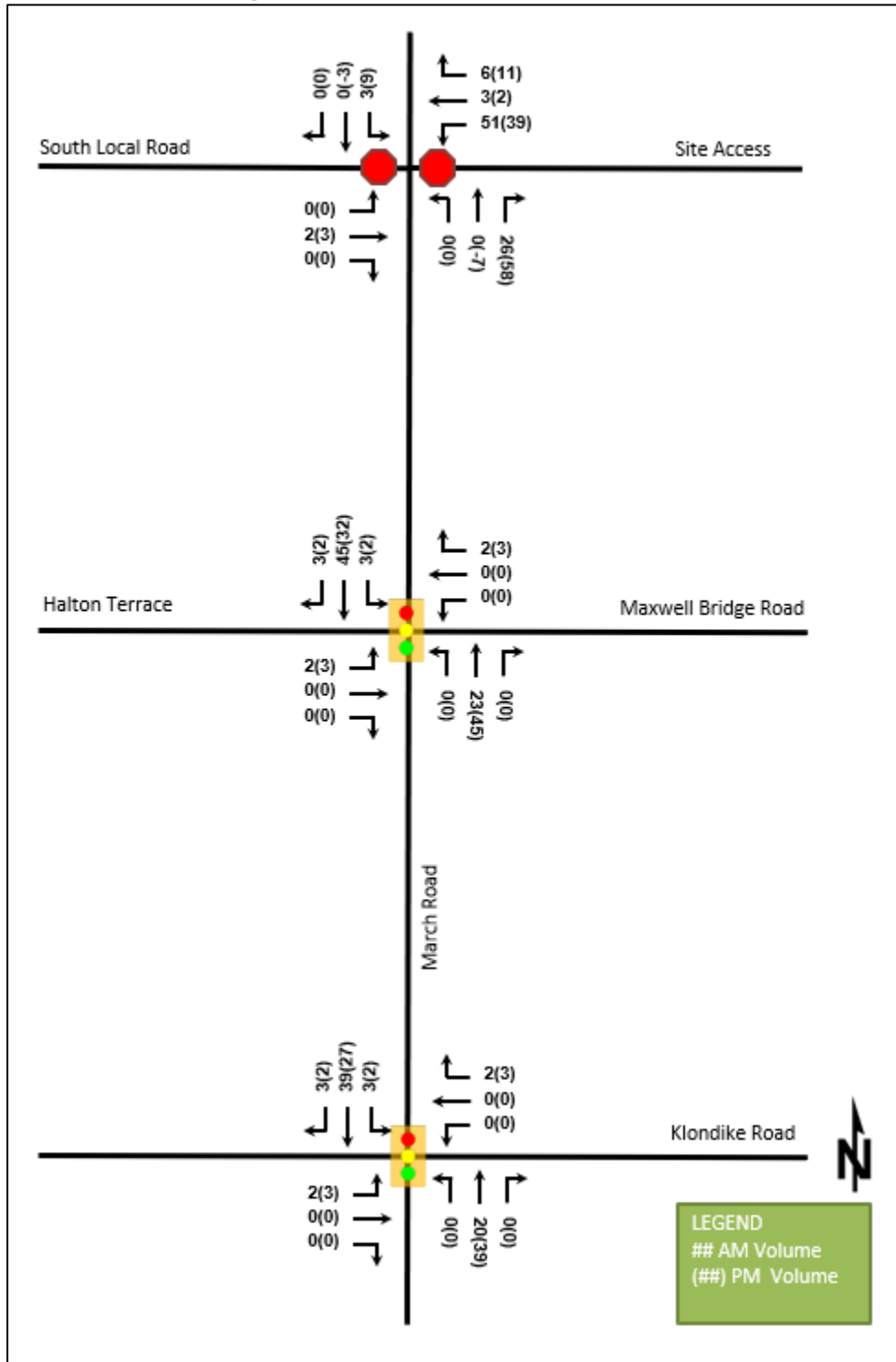

Figure 20: Net New Site Generation Auto Volumes



## 6 Background Network Travel Demands

### 6.1 Transportation Network Plans

The transportation network plans were discussed in Section 2.3.1. The Kanata North CDP has determined the required March Road interim and ultimate cross-sections. Both cross-sections, as shown in Appendix D, include two traffic lanes, cycling lanes, and sidewalks, both northbound and southbound. The ultimate cross-section also includes a centreline bus rapid transitway. Additionally, Klondike Road between March Road and Sandhill Road will be urbanized and the implementation of a Transit Signal Priority corridor (isolated measures) on March Road between Carling Avenue and Maxwell Bridge Road are indicated by the City of Ottawa 2031 Affordable Road Network. As the timing of this is currently unknown, this is assumed to occur beyond the proposed development's future analysis horizons.

The additional connectivity provided by the future bicycle spine route along March Road and the local routes along Klondike Road to the west of March Road and Halton Terrace will improve the active mode network but is not anticipated to significantly impact the modal shares used in the future trip generation.

It is noted that in the City of Ottawa 2021 Official Plan indicates a 48-metre right-of-way on March Road between Klondike Road and 230 metres north of Maxwell Bridge Road. As a result, a 48-metre right-of-way has been protected for on the updated plan.

### 6.2 Background Growth and Other Developments

An annual compound growth rate of 0.5% has been used to determine the background growth. The growth rate has been applied to the through volumes along March Road only. This growth rate is consistent with the Kanata North CDP TMP.

The background developments explicitly considered in the background conditions (Section 6.2) include:

- 1055 Klondike Road
- 1156/1170 March Road
- 788 March Road
- 936 March Road
- 1053/1075/1145 March Road
- 927 March Road

It is noted that these background development volumes are likely overstated and are actually lower than what has been used as the majority of background traffic volume projections considered were developed prior to the publishing of the TRANS Trip Generation Manual (2020). This is because the majority of the trip generation rates from the 2020 manual are lower than the TRANS trip generation rates previously used. No reductions to these volumes were applied.

Figure 21 illustrates the 2028 future background volumes, and Figure 22 illustrates the 2033 future background volumes.

Figure 21: 2028 Future Background Volumes

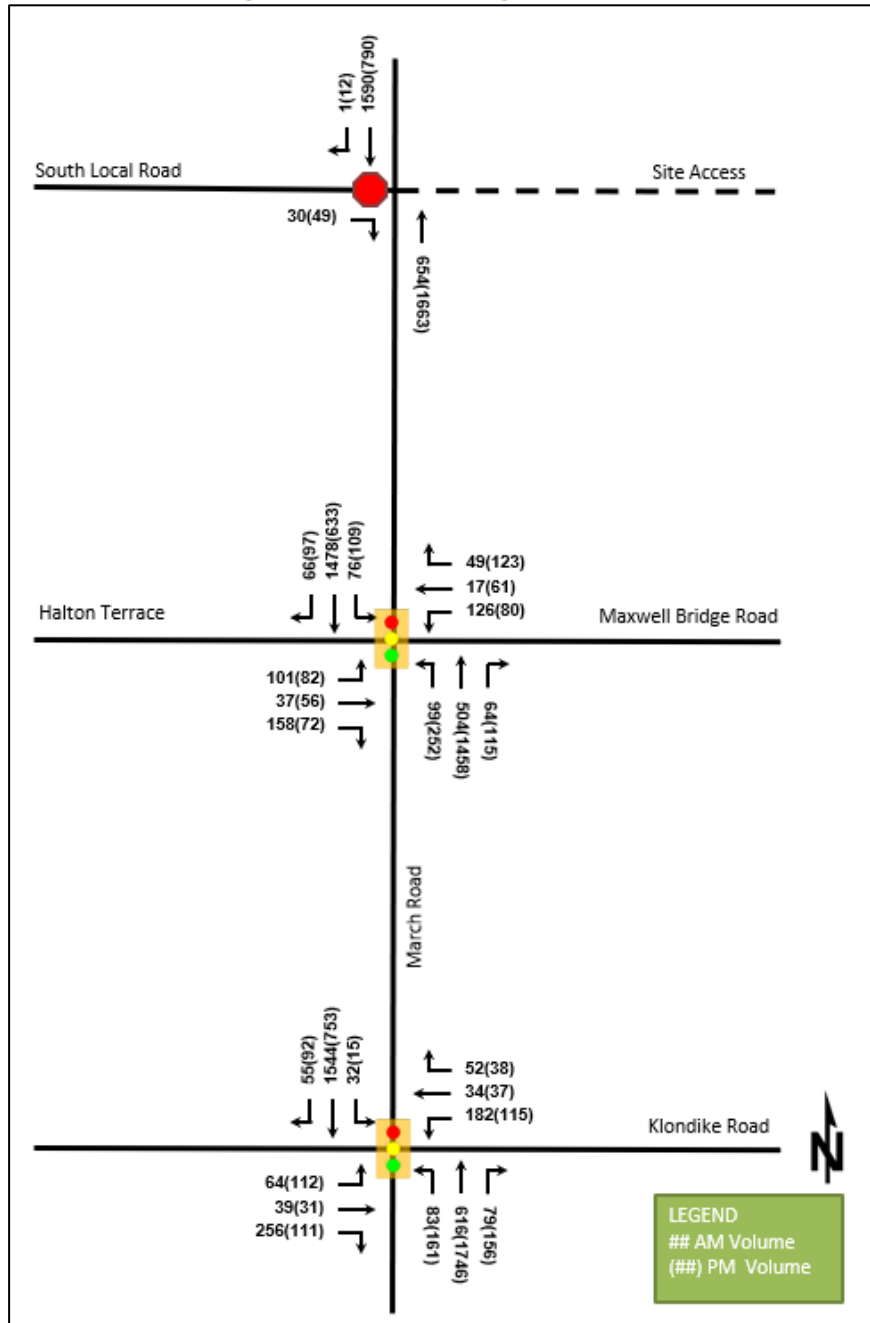
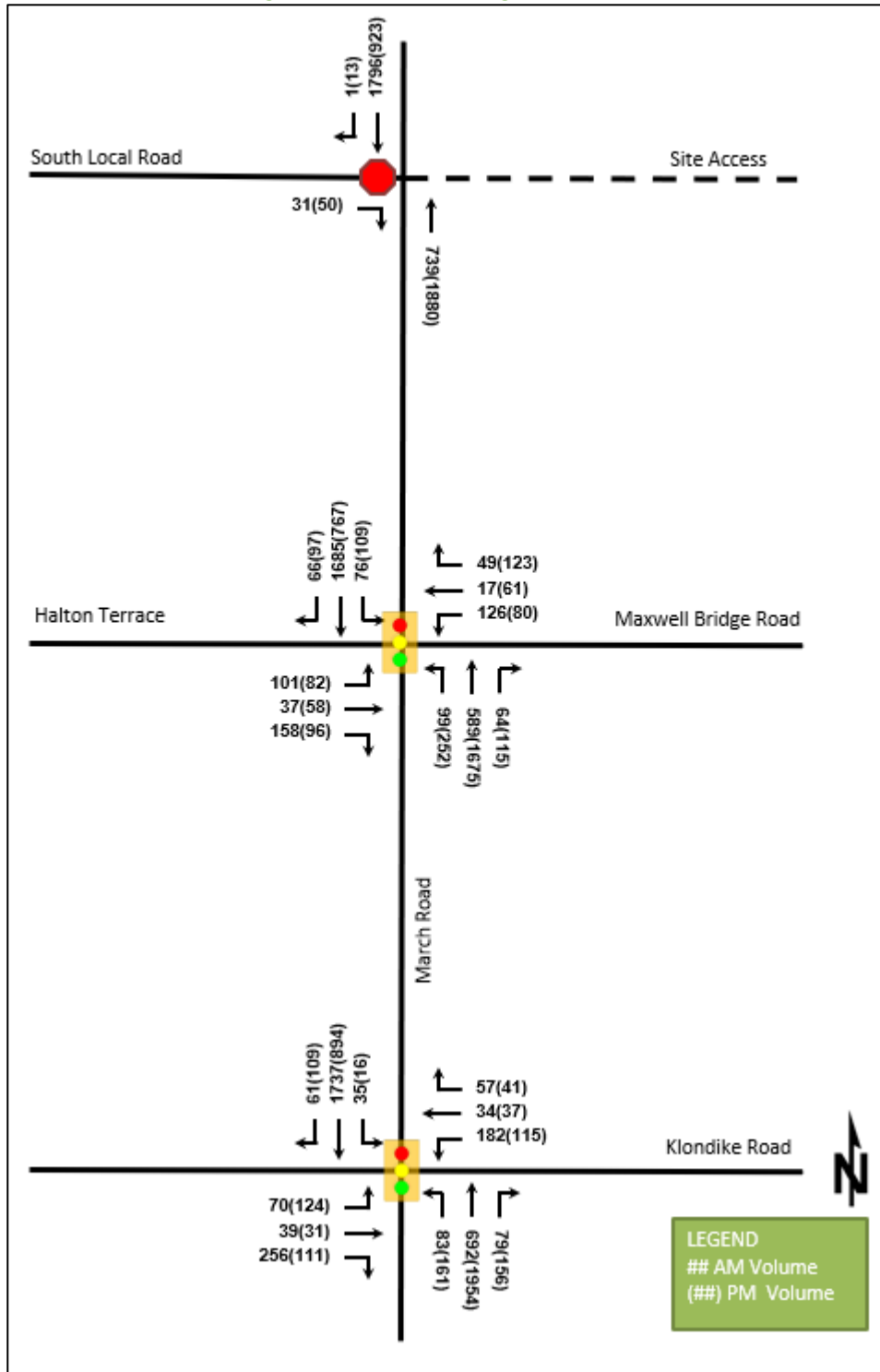

Figure 22: 2033 Future Background Volumes



## 7 Demand Rationalization

As documented in Section 17.2.1, the existing conditions within the Study Area are not indicative of any capacity issues. Changes in traffic volumes between existing and future conditions will come from the applied 0.5%

background growth rate, the 1055 Klondike Road development, the 1156/1170 March Road development, the 788 March Road development, the 936 March Road development, the 1053/1075/1145 March Road development, the southwestern development in the Kanata North Community Design Plan, and the net new auto trips from the proposed development within this report. The trip generation of this development is consistent with expected modal shares as can be seen in Section 5.1.

It is also noted that turning movements to and from the South Local Road change between future background and future total conditions as the South Local Road is expected to operate as a right-in / right-out access in the future background conditions and is expected to operate as a four-legged full movement intersection in the future total conditions.

The future total 2028 volumes are illustrated in Figure 23 and the future total 2033 volumes are illustrated in Figure 24.

Figure 23: 2028 Future Total Volumes

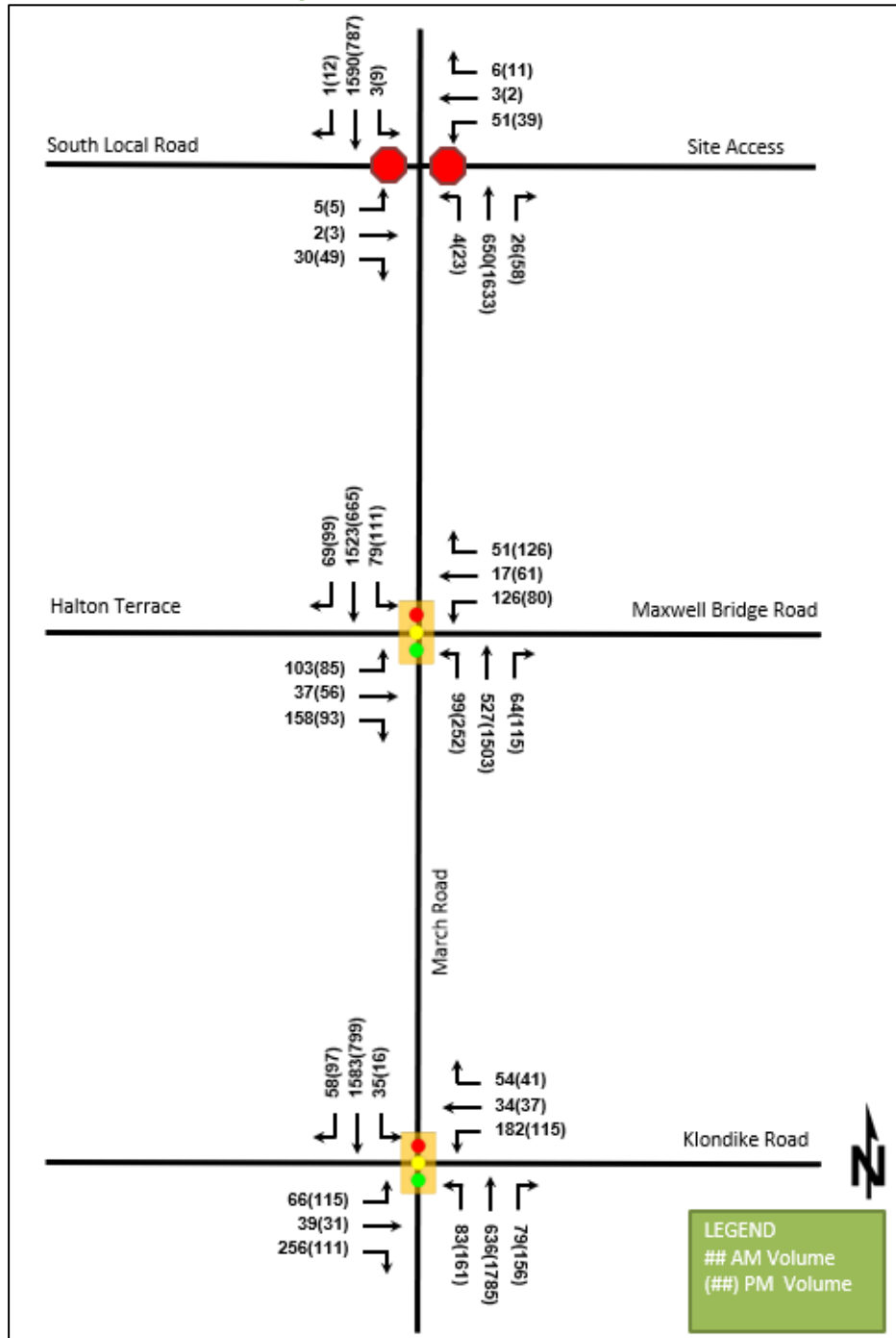
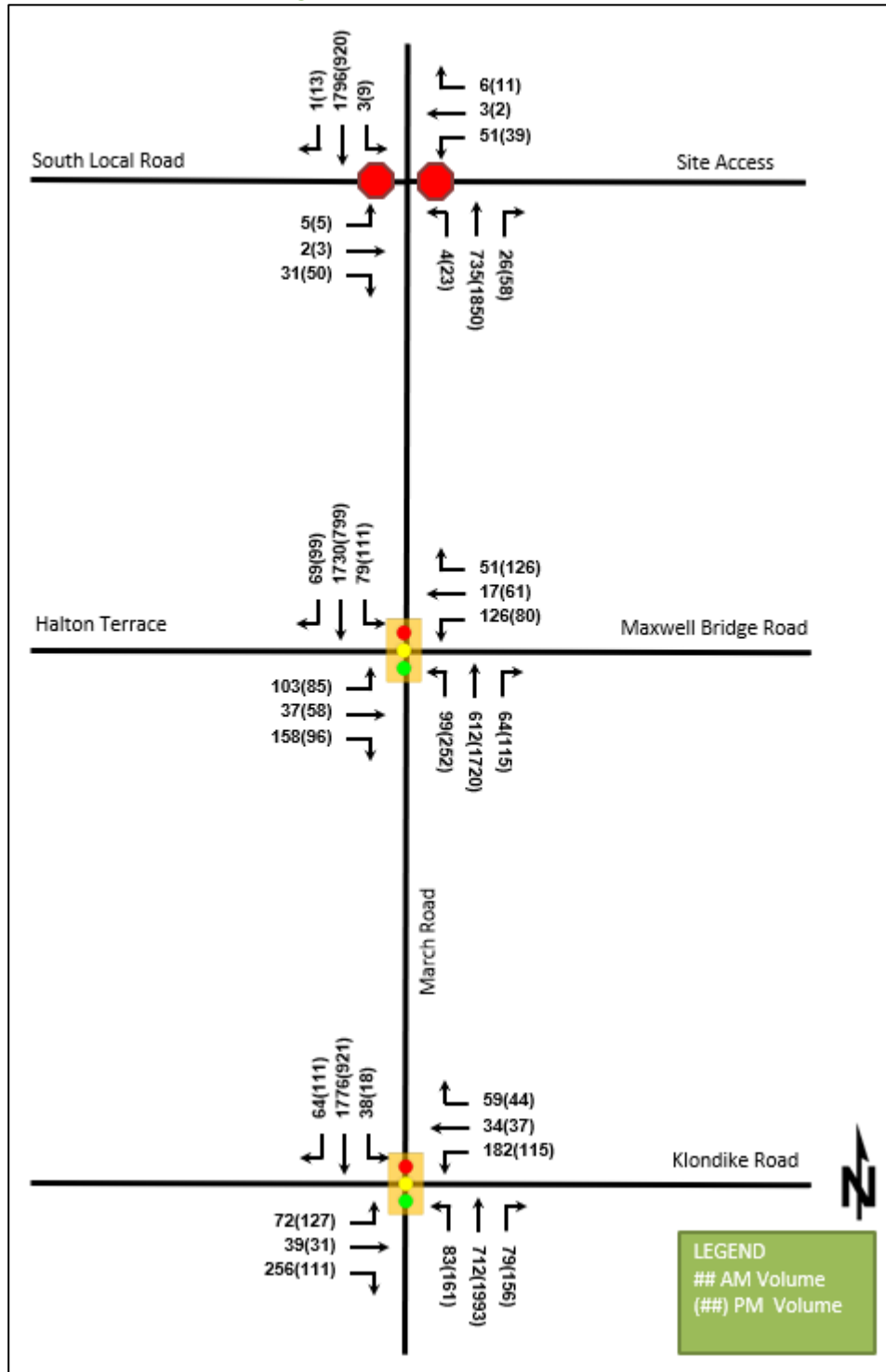

Figure 24: 2033 Future Total Volumes



7.1 2028 Interim Year

A significant increase in volumes at the Study Area intersections has been noted between the existing and future background analysis horizons as a result of the future background developments proposed as part of the Kanata North CDP area to the north of the subject development. While the build-out of the developments that make up this area have been accounted for based on build-out horizons indicated in their respective TIAs, as well as the



Kanata North CDP TMP, some of these horizons are not considered realistic. As such, a portion of the background development volumes considered in both the future analysis horizons may not actually be realized in these horizons. As mentioned in Section 6.2 above, it is also noted that these background development volumes are likely overstated and are actually lower than what has been used as the majority of background traffic volume projections considered were developed prior to the publishing of the TRANS Trip Generation Manual (2020). This is because the majority of the trip generation rates from the 2020 manual are lower than the TRANS trip generation rates previously used.

Given the uncertainty surrounding the timing of surrounding roadway developments, and the timing of future plans to widen March Road as well as to implement BRT facilities, an interim analysis horizon has been developed. This interim analysis horizon assumes no background developments have been built in the 2028 future analysis horizon, and as such consists of the 2022 existing volumes grown to a 2028 horizon, as well as the subject development's site generated traffic. Figure 25 illustrates the resulting 2028 interim future total volumes and Section 17.2.5 below summarizes the operational analysis of the site access intersection as an unsignalized intersection with stop-control on the east leg. As the site access is shown to operate well with no LOS F movements or v/c ratios greater than 1.0, should the surrounding background developments be built-out on a realistic timeline as opposed to what has been proposed in their respective TIA's, the access intersection will not require any intersection configuration changes from an operational perspective in the 2028 future analysis horizon. Based on the volumes and analysis of the 2028 future total interim horizons, a monitoring plan, summarized in Section 8 below, has been developed to identify when intersection configuration changes to the site access intersection will be required.

Figure 25: 2028 Future Total Interim Volumes

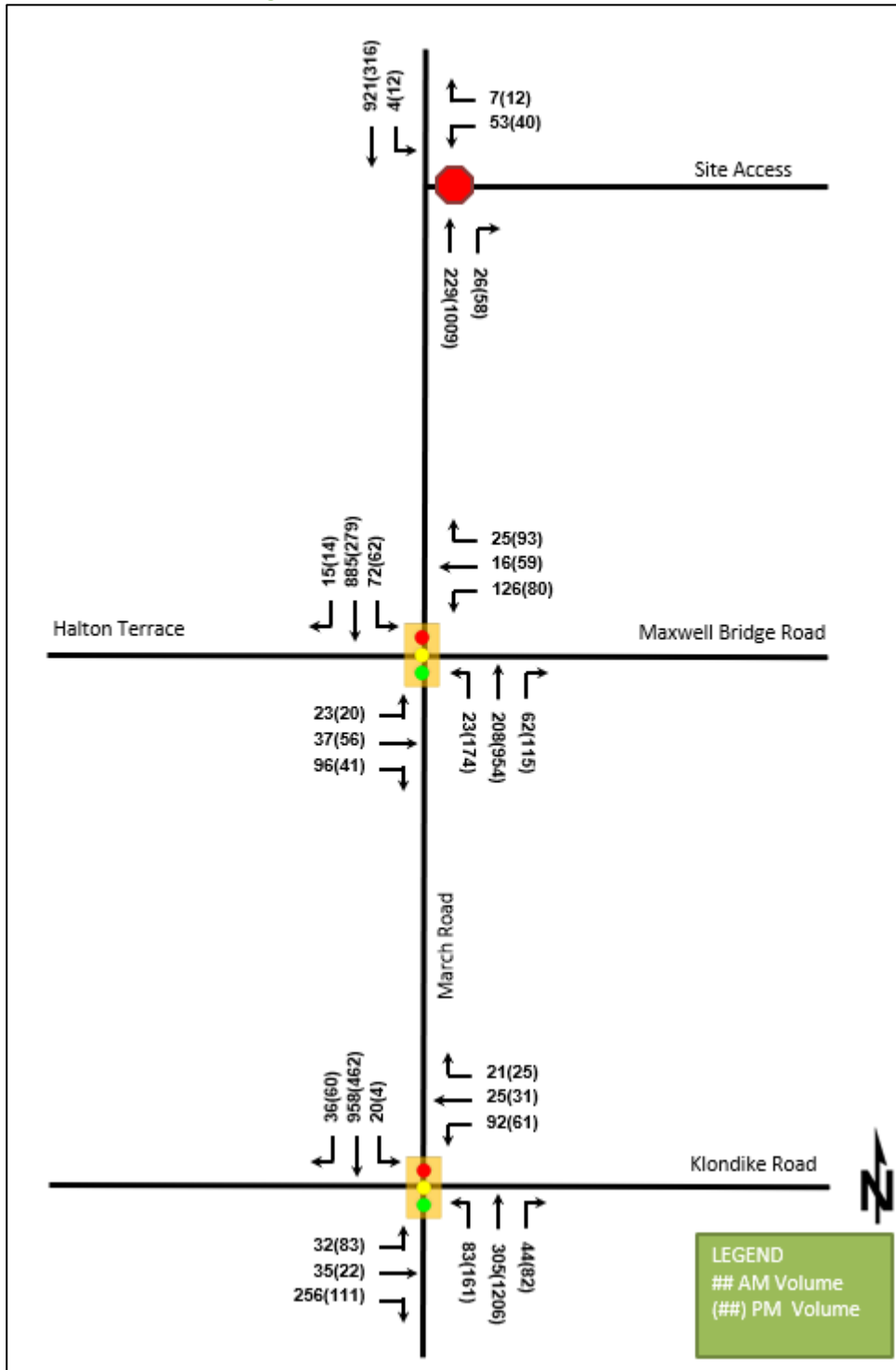

## 8 Monitoring Plan

### 8.1 Rationale

In order to determine when the site access should be reconfigured to become a right-in / right-out site access intersection on March Road, a monitoring plan to track on-site traffic volumes and determine on-site vehicle delays following the completion of the proposed development has been developed. Rather than immediately reconfiguring the site access as a right-in / right-out intersection, monitoring the level of service for the entire intersection will better determine when intersection reconfiguration is justified. As previously discussed, projected build-outs of the surrounding background developments may not be realistic, and the trips rates used to develop background development site generated traffic may be outdated and overly conservative. As such, the reconfiguration of the access intersection may not be required at the time of the subject development's build-out, and the access should be monitored to best determine when to modify the site access from the proposed full-movement stop-controlled access to a right-in right-out access.

### 8.2 Monitoring Activities

To monitor the traffic volumes and experienced level of service at the subject intersection, traffic count monitoring is to occur annually. Commencing the year of full build-out, the intersection traffic counts, and information will be collected over an eight-hour period on a weekday, recording both the AM and PM peak hours. Yearly monitoring is to occur for five years past the build-out (2028-2033), or until the completion of the proposed bus rapid transit (BRT) line currently planned for March Road, which will result in the implementation of a median along March Road, resulting in the site access intersection becoming a right-in/right-out intersection. The annual traffic volume monitoring is to be conducted by a third-party traffic monitoring company and paid for by the developer. Each year, the results of the monitoring activities will be submitted to the City of Ottawa in the form of a yearly memo, updated annually to determine when to reconfigure the intersection.

### 8.3 Evaluation

The expected timeline for the monitoring plan will be from the year of full build-out for the proposed development, currently estimated to be 2028, until the end of the five-year horizon of 2033, or until the completion of the proposed March Road BRT line should this occur prior to 2033. Upon the completion of the proposed BRT line, the intersection will be converted from a full-movement access to a right-in/right-out access. Should the monitoring plan annual memo determine the level of service at the intersection of March Road and Site Access / South Local Road to be a level of service of 'F' a right-in/right-out access will be recommended and deemed warranted. Ultimately, the decision of when to reconfigure the access intersection will be the responsibility of the City of Ottawa, should the annual memo identify that it is warranted. After the five-year horizon in 2033 is reached, if a level of service of F at the intersection is not reached, it is assumed that the monitoring of the intersection will become the responsibility of the City of Ottawa as part of ongoing monitoring and planning of the proposed March Road BRT line.

### 8.4 Remediation

If the outcome of the monitoring plan deems that the reconfiguration of the intersection is warranted within the five-year horizon period (2028-2033) in which the monitoring is the responsibility of the developer, the site access will be reconfigured to accommodate a right-in right-out movement by installing a concrete median along March Road at the site access intersection, along with appropriate signage. Should the level of service experienced at the intersection justify the intersection's reconfiguration, a concrete median and appropriate signage will be installed. If the previously mentioned condition is met within the five-year horizon period following the full build-out of the proposed development, the developer will assume responsibility for the installation of the median and signs, after

which it is assumed that responsibility will be transferred to the City of Ottawa. Following the five-year monitoring period by the developer, the responsibility for monitoring the intersection will become that of the City of Ottawa until reconfiguration is warranted, or until the completion of the proposed March Road BRT which will result in the intersection being reconfigured as a right-in/right-out intersection.

## 9 Development Design

### 9.1 Design for Sustainable Modes

The proposed development will provide both indoor garage vehicle and bicycle parking for residents and visitors, and outdoor vehicle parking for visitors and those utilizing the retail portion of the development.

The proposed development fronts directly onto future pedestrian and bicycle facilities on March Road. These facilities will provide access to the surrounding Study Area as well as the existing transit stops surrounding the proposed development.

Additionally, the planned future Bus Rapid Transit facilities along March Road is anticipated improve transit access to and from the proposed development beyond the future study horizons.

Based on the most recent site plan, the external access from the western main lobby doors and from the north commercial entrance have a minimum walking distance to the nearest existing transit stop of approximately 445 metres. The maximum walking distance from an external access, Stairwell F, is approximately 628 metres. Currently, no planned external access is within 400 metres of an existing transit stop. The minimum distance can be improved to 245 metres from the lobby and north commercial access, and between 385 and 430 metres from Stairwell F if a future transit stop were located at the intersection of March Road and Halton Terrace/Maxwell Bridge Road.

Additionally, facilities that are supportive of sustainable modes in the City of Ottawa's TDM-supportive Development Design and Infrastructure Checklist, which are required for zoning and standard site design, will be implemented. The following additional measures will also be implemented:

- Locate building close to the street, and do not locate parking areas between the street and building entrances.
- Locate building entrances in order to minimize walking distances to sidewalks and transit facilities.
- Locate building doors and entrances to ensure visibility of pedestrians from the building.
- Provide safe, direct, and attractive walking routes from the building entrances to nearby transit stops.
- Ensure that walking routes to transit stops are secure, visible, and lighted wherever possible.
- Provide wayfinding signage for site access and egress.
- Provide lighting, landscaping, and benches along walking and cycling routes between building entrances and streets, sidewalks and trails.
- Provide a permanent bike repair station for resident/private use only.

TDM Checklists for residential and non-residential land uses can be found in Appendix E.

### 9.2 Circulation and Access

A site circulation assessment was completed using AutoTURN 11.0 to develop turning templates for garbage trucks and loading trucks at the moving aisle/loading bay. An HSU vehicle was used to simulate the movements of these vehicles as they manoeuvre throughout the site with key areas of assessment being the March Road site access, and the moving aisle.

Loading vehicles will enter and exit the site in a forward motion using the site access on March Road and have been tested backing into the moving aisle.

Garbage trucks will enter and exit the site in a forward motion using the site access on March Road and have been tested pulling into the moving aisle. It is noted that while the garbage room is located on Parking Level 1, garbage pick-up will occur in the moving aisle. Garbage pick-up will be pre-scheduled at the same time each week, and building staff will transport the garbage bins from the garbage room to the loading bay using a tractor. These bins will be returned to the garbage room following garbage pick-up. Move-ins and move-outs will not be scheduled during this time. Turning templates showing internal site circulation can be found in Appendix F, and turning templates showing garbage and loading vehicles at the site access can be found in the RMA package in Appendix G.

Access configuration details are included in Section 12 below.

### 9.3 New Street Networks

This TIA is exempt from this Module (see Table 7).

## 10 Parking

### 10.1 Parking Supply

Using the City of Ottawa Zoning By-law 2008-250, Table 101 (By-law 2018-206, By-law 2016-249), and Table 102 (By-law 2016-249), the parking requirements and provisions for the proposed development are summarized in Table 17.

Table 17: Parking Provisions

Land Use	Parking Rate	Number of Units / Gross Floor Area	Parking Required	Parking Provided
<b>Residential</b>	1.0 spaces / unit	390 units	390	470
<b>Visitor</b>	0.2 spaces / unit		78	79
<b>Retail</b>	3.4 / 100 m <sup>2</sup> GFA	501 m <sup>2</sup>	18	19
<b>Total Vehicle Parking</b>			<b>486</b>	<b>568</b>
<b>Residential (bicycle)</b>	0.5 spaces / unit	390 units	195	195
<b>Retail Store (bicycle)</b>	1 / 250 m <sup>2</sup> GFA	501 m <sup>2</sup>	3	3
<b>Total Bicycle Parking</b>			<b>198</b>	<b>198</b>

Based on the City of Ottawa Zoning By-laws, a minimum of 486 automobile parking spaces and a minimum of 198 bicycle parking spaces are required. As can be seen in Table 17, automobile parking space requirements are met in excess of 82 spaces, and bicycle parking space requirements are met exactly.

Table 18: Barrier-Free Parking Provisions

Parking Rate		Provided Parking	Required Barrier-Free Parking	Provided Barrier-Free Parking
Number of Parking Spaces	Minimum Number of Barrier-Free Spaces			
500+	6	568	6	12

Based on the City of Ottawa Zoning By-law 2017-301, a minimum of six barrier-free parking spaces are required for the proposed development. As shown in Table 18 above, the barrier-free parking space requirement is met in excess of six spaces.

Underground parking levels are shown in Appendix H.

### 10.2 Spillover Parking

This TIA is exempt from this Module (see Table 7).

## 11 Boundary Street Design

March Road is noted as a boundary road for the site in both the 2028 and 2033 future horizons. March Road is not considered a Complete Street and no plans currently exist to upgrade March Road within the proposed development’s future analysis horizons. As discussed in Section 2.3.1, as part of the proposed development, the existing pedestrian facilities and bike lanes which terminate north of Maxwell Bridge Road / Halton Terrace will be extended along the frontage of the proposed development along the east side of March Road upon full-build out of the development. It is expected that the existing pedestrian facilities and bike lanes which terminate north of Maxwell Bridge Road / Halton Terrace will be extended along the frontage of the proposed development along the west side of March Road in conjunction with the development of the southwestern quadrant of the Kanata North Community Design Plan in time for the 2028 future horizon.

Additionally, future improvements on March Road north of Maxwell Bridge Road / Halton Terrace are expected in two stages. The first stage is the widening of March Road to four lanes and the second stage considers the widening of March Road to accommodate the extension of the Median BRT system as discussed in Section 2.3.1. These improvements have been proposed as part of the City of Ottawa’s TMP Ultimate Network and the Kanata North CDP. As the timing of both of these improvements to March Road is unknown and neither transportation infrastructure upgrade is included in the City of Ottawa’s 2031 Affordable Network, it has been assumed that they will occur beyond both of the proposed development’s future analysis horizons.

The Segment Multi-Modal Level of Service (MMLOS) is broken down into the Pedestrian Level of Service (PLOS), Bicycle Level of Service (BLOS), Transit Level of Service (TLOS) and Truck Level of Service (TkLOS) and are all recorded in Table 19. As the existing, future background and future total scenarios are all different, they have been evaluated in their own MMLOS worksheets. March Road has been evaluated against the target for a developing community. The MMLOS Worksheets for each horizon can be found in Appendix I.

Table 19: Boundary Street MMLOS

Road Segment	Horizon	MMLOS							
		PLOS		BLOS		TLOS		TkLOS	
		Actual	Target	Actual	Target	Actual	Target	Actual	Target
March Road	Existing								
	2028 FB			F					
	2033 FB	F	C		C	D	D	C	D
	2028 FT			F					
	2033 FT			E				A	

March Road will not meet its pedestrian LOS target due to small boulevard widths and high vehicle operating speeds, however, and will not meet its bicycle LOS target due to mixed traffic conditions on some segments of March Road and high operating speeds. Both the Transit LOS and Truck LOS targets have been met.

Future widening and transit improvements to March Road as mentioned above, are anticipated to increase connectivity, and improve the segment MMLOS along March Road. As such, no further improvements to March Road, beyond the extension of pedestrian and bicycle facilities along the frontage of the site, are recommended as a result of the boundary street MMLOS analysis.

## 12 Access Intersection Design

### 12.1 Location and Design of Access

The site is proposed to have one full-movement access on March Road located approximately 215 metres north of Maxwell Bridge Road/Halton Terrace, measured from intersection centreline to intersection centreline. As per the Transportation Association of Canada's Geometric Design Guide for Canadian Roads (TAC), typical minimum intersection spacing along minor arterials is 200 metres. This segment of March Road can be considered a minor arterial road within the Study Area as it currently has a narrow cross-section, and south of the Study Area it provides access directly to developments along March Road. Therefore, the distance between the intersection of March Road and Maxwell Bridge Road / Halton Terrace and the Site Access is acceptable. Additionally, this spacing is consistent with that of other intersections along March Road. As future infrastructure upgrades outside of the study horizons are implemented on March Road, including the implementation of the March Road BRT line, it will be upgraded to a major arterial road.

### 12.2 Site Access Design

An RMA and functional design are anticipated for the site access intersection. It is noted that the interim and ultimate intersection designs discussed below are based on the City of Ottawa's *Curb Return Entrances – Uncontrolled Intersections SC7.1* drawing. For the purposes of this report, the following assumptions surrounding the intersection design of the site access has been made:

Left-turn lane warrants for unsignalized intersections were examined at the site access for the 2028 interim horizon, and the 2028 and 2033 total future horizons using the MTO Geometric Design Standards for Ontario Highways, Section E. A southbound left-turn lane was found to be warranted for the 2028 future total interim horizon as well as the 2028 and 2033 future total horizons. A northbound left-turn lane at the site access intersection was also found to be warranted in the applicable 2028 and 2033 future total horizons. The left-turn lane warrant nomographs can be found in Appendix J.

For the 2028 future total interim analysis horizon, the intersection of the Site Access and March Road has been assumed to be a three-legged intersection. The northbound approach will consist of a through lane and an auxiliary right-turn lane, the westbound approach will be made up of a shared left-turn / right-turn lane, and the southbound approach will consist of an auxiliary left-turn lane and a through lane. Additionally, pedestrian facilities are anticipated to be extended along the proposed development's frontage on the east side of March Road, and cycling facilities are anticipated to use the existing paved shoulder that acts as a bike lane. This paved shoulder will be maintained and no protected crossings at the proposed site access intersection will be provided. This intersection configuration represents the interim access intersection design that will provide access to the subject development until the monitoring plan indicates reconfiguration is required, or until the March Road BRT is constructed.

For the ultimate intersection configuration, discussed in the 2028 and 2033 future total operational analysis below, the site access intersection has been assumed to be a right-in/right-out intersection with stop-control on the minor leg. The South Local Road will also become a right-in/right-out intersection with stop-control on the minor leg and will serve as an access to the southwestern development quadrant discussed in the Kanata North

Community Design Plan. The South Local Road is anticipated to have both pedestrian and cycling facilities. The northbound approach will consist of a through lane, and an auxiliary right-turn lane, the westbound approach will be made up of a right-turn lane, the southbound approach is assumed to consist of a shared through / right-turn lane, and the eastbound approach will consist of a right-turn lane. Additionally, pedestrian facilities are anticipated to be extended along the proposed development’s frontage on the east side of March Road, and cycling facilities are anticipated to use the existing paved shoulder that acts as a bike lane. This paved shoulder will be maintained and no protected crossings at the proposed site access intersection will be provided. Pedestrian and cycling lanes are anticipated to be extended along the west side of March Road in conjunction with the development of the southwestern quadrant of the Kanata North Community Design Plan. This intersection configuration represents the ultimate access intersection design. It is noted that the RMA does not consider the design of the South Local Road as the design of these elements should be determined as part of the development application process for the southwestern quadrant of the Kanata North Community Design Plan.

The preliminary minimum storage and taper lengths for the proposed southbound left-turn lane for the interim intersection design, using the Transportation Association of Canada’s (TAC) Geometric Design Guide, is summarized in Table 20 and further discussed below.

*Table 20: Interim and Ultimate SBL - Preliminary Minimum Design Criteria*

Design Standard	Design Speed	Storage	Parallel Lane	Taper Ratio	Taper	Total Lane Length
TAC	90 km/h	15 m (min.)	95 m	27:1	95 m	205 m

Using Transportation Association of Canada’s Geometric Design Guide for Canadian Roads (TAC) the storage, parallel lane, and taper lengths were determined for a 90 km/h design speed. For the purposes of determining the taper length it was assumed that this left-turn lane would be constructed as a left-turn on the left side of the centreline with a 3.5 metre turning lane width. The parallel lane length was calculated based on the following formula (TAC Formula 2.5.1):

$$d_b = 0.039 \frac{V^2}{a}$$

Where:

$$d_b = \text{Braking Distance (m)}$$

$$V = \text{Design Speed (km/h)}$$

$$a = \text{Deceleration rate (m/s}^2\text{)} = 3.4 \text{ m/s}^2$$

No intersections or driveways are currently planned within the parallel lane or taper length of the left-turn lane that will be negatively impacted by its implementation.

As such, based on TAC design guidelines, the southbound left-turn lane at the site access should be a minimum of 205 metres long with a storage lane of 15 metres, an approximate parallel lane of 95 metres and an approximate taper of 95 metres for the interim intersection design.

The northbound right-turn lane shown in both the interim and ultimate intersection design has been designed with a 15-metre storage, a 35-metre parallel lane length, and a 15 metre taper. As a result of the distance between



the site access intersection and Halton Terrace / Maxwell Bridge Road, the parallel lane length and the taper length are less than what would ideally be proposed.

The measured throat length of the site access intersection is approximately 32 metres. According to Transportation Association of Canada’s Geometric Design Guide for Canadian Roads (TAC), Table 8.9.3, the suggested minimum clear throat length for major driveways, for a development of this size, would require a throat length based on each land use and is summarized in the Table 21 below.

Table 21: Throat Length by Land Use

Land Use*	Development Size (units or sq.m.)	Required Clear Throat Length (m)
Apartments	390 units	40
Shopping Centre	501 sq.m.	15

\*Note: Not all land uses are represented in Table 8.9.3. Where an exact match was not available, a reasonable assumption of a comparable land use was used.

As shown above, the provided site access throat length is less than the required 40 metres of throat length. A throat length of 32 metres will accommodate approximately 4.5 queued passenger vehicles based on an assumed seven metre passenger vehicle. Additionally, it is noted that the first point of vehicle conflict within the site is an internal driveway to 13 outdoor vehicle parking spaces and is therefore not anticipated to have many vehicles turning into and out of this internal driveway. As such, vehicles are expected to be able to travel into the site without being impacted by the internal driveway. Given the ability for 4.5 queued passenger vehicles to be accommodated within the provided throat length, as well as the internal driveway having a low number of vehicles turning in and out of the driveway, the provided throat length of 32 metres is considered sufficient.

Further intersection geometry details for both the interim and ultimate intersection designs are shown in the RMA prepared to support the interim and ultimate intersection designs which can be found in Appendix G.

### 13 Transportation Demand Management

Transportation Demand Management measures are implemented to encourage the use of non-auto modes of travel. This is aimed at reducing the reliance on single occupant auto trips in the City of Ottawa. The proposed development adheres to the City’s TDM principles by facilitating connections to adjacent pedestrian, cycling, and transit facilities.

The following measures consistent with the TDM Checklists for non-residential land uses, included in Appendix E, could be implemented to ensure that the travel mode shares are achieved.

- Designate an internal coordinator, or contract with an external coordinator.
- Provide online links to local area maps with walking/cycling access routes, if available, on the building website.
- Provide online links to OC Transpo information on the building website.
- Offer PRESTO cards preloaded with one monthly transit pass on first round of resident move-in. Further details may be determined through Site Plan Conditions.
- Unbundle parking cost from monthly rent.
- Provide a multimodal travel option information package to new residents.

### 14 Neighbourhood Traffic Management

This TIA is exempt from this Module (see Table 7).

## 15 Transit

In Section 5.2, the trip generation by mode was estimated, including the number of transit trips that will be generated by the proposed development. Table 22 summarizes the transit trip generation for the multi-unit (high-rise) residential portion of the proposed development, and Table 23 summarizes the transit trip generation for the strip retail plaza portion of the proposed development.

*Table 22: Trip Generation by Transit Mode – Multi-Unit (High-Rise)*

Travel Mode	AM Peak Hour				PM Peak Hour			
	Mode Share	In	Out	Total	Mode Share	In	Out	Total
Transit	24%	13	28	41	19%	18	13	31

*Table 23: Trip Generation by Transit Mode - Strip Retail Plaza (<40k)*

Travel Mode	AM Peak Hour				PM Peak Hour			
	Mode Share	In	Out	Total	Mode Share	In	Out	Total
Transit	3%	0	0	0	1%	0	0	0

Route #63 and #165 are expected to provide adequate transit capacity to support the increase in travel demand by the proposed development. It is recommended that OC Transpo provide additional transit capacity only as needed once the development is completed. It is expected that once the March Road BRT is constructed, that the transit trips generated but the proposed development would increase. This change in transit mode share has not been examined herein as the BRT is not included in the City of Ottawa TMP 2031 Affordable Network.

## 16 Review of Network Concept

This TIA is exempt from this Module (see Table 7).

## 17 Intersection Design

### 17.1 Intersection Control

The intersection methods of control for March Road at Halton Terrace / Maxwell Bridge Road and March Road at Klondike Road will remain consistent with existing methods of control at both future horizons.

### 17.2 Intersection Design

To understand the intersection design, an MMLOS analysis of existing, 2028 future horizon, and 2033 future horizon demands is required. The existing and future segment MMLOS has been discussed in Section 11. The following sections will discuss the vehicle LOS at Study Area intersections. Synchro (Version 11) was used to model the Study Area intersections. This will be followed by a discussion of the intersection MMLOS for other modes.

As required by the City of Ottawa, the level of service at signalized intersections is based on the v/c ratio calculations for individual lane movements and HCM v/c calculations for the overall intersection, and average delay for unsignalized intersections. The Heavy Vehicle percentage (HV %) has been calculated for each turning movement at the Study Area intersection. All Heavy Vehicle percentages calculated to be less than 2% were entered into the Synchro model as 2% in order to produce a conservative analysis. These calculations are shown in Appendix K. All parameters have been coded using the City of Ottawa’s TIA Guidelines and default parameters.

#### 17.2.1 Existing Conditions

The existing intersection volumes have been analyzed to establish a baseline condition and determine the impact of the subject development as well as the surrounding background developments on the Study Area road network.

Table 24 summarizes the existing intersection operations. Appendix L contains the 2022 Existing Conditions Synchro Worksheets.

Table 24: Existing Intersection Operations

Intersection	Lane	AM Peak Hour				PM Peak Hour			
		LOS	V/C	Delay (s)	Q (95 <sup>th</sup> )	LOS	V/C	Delay (s)	Q (95 <sup>th</sup> )
<b>March Road at Halton Terrace / Maxwell Bridge Road</b> <i>Signalized</i>	EBL	A	0.11	40.0	11.1	A	0.18	48.5	10.8
	EBT/R	A	0.44	17.6	24.7	A	0.48	39.8	32.0
	WBL	D	0.81	80.0	50.7	B	0.61	66.7	35.3
	WBT/R	A	0.16	21.7	12.8	B	0.64	39.5	41.3
	NBL	A	0.07	7.2	5.3	A	0.25	5.4	21.4
	NBT	A	0.11	11.0	18.7	A	0.44	11.0	83.3
	NBR	A	0.08	1.2	3.1	A	0.13	2.0	7.7
	SBL	A	0.10	6.4	11.6	A	0.17	5.7	8.2
	SBT	A	0.42	12.8	87.7	A	0.13	10.4	22.9
	SBR	A	0.01	0.0	0.0	A	0.01	0.0	0.0
	<b>Overall</b>	<b>A</b>	<b>0.50</b>	<b>20.5</b>	<b>-</b>	<b>A</b>	<b>0.47</b>	<b>17.2</b>	<b>-</b>
<b>March Road at Klondike Road</b> <i>Signalized</i>	EBL	A	0.19	42.0	14.8	A	0.52	56.4	33.1
	EBT	A	0.13	41.1	16.7	A	0.08	42.3	12.2
	EBR	B	0.69	24.8	47.8	A	0.36	10.0	15.5
	WBL	B	0.66	73.6	41.7	A	0.56	72.7	30.8
	WBT/R	A	0.24	34.4	17.6	A	0.34	39.5	20.9
	NBL	A	0.41	63.0	19.5	A	0.57	63.4	33.6
	NBT/R	A	0.12	9.7	22.2	A	0.40	9.6	84.9
	SBL	A	0.24	64.9	12.8	A	0.03	60.0	3.3
	SBT/R	A	0.36	15.4	72.6	A	0.19	13.8	34.2
	<b>Overall</b>	<b>A</b>	<b>0.44</b>	<b>25.7</b>	<b>-</b>	<b>A</b>	<b>0.49</b>	<b>21.3</b>	<b>-</b>

Notes: Saturation flow rate of 1800 veh/h/lane  
Queue is measured in metres  
Peak Hour Factor = 0.90

m = metered queue  
# = volume for the 95th %ile cycle exceeds capacity

As shown above, during both the AM and PM peak hours, the study area intersections operate well with no capacity issues noted.

### 17.2.2 2028 Future Background

The 2028 future background intersection volumes and other development traffic has been analyzed to allow a comparison between the future volumes with and without the proposed development. Table 25 summarizes the 2028 background intersection operations. The intersection of the South Local Road and March Road is considered as part of the 2028 future background horizon and has been analyzed as a right-in right-out unsignalized intersection as indicated in the Kanata North Community Design Plan. The South Local Road will form the west leg of the site access intersection to be considered in the future total analysis horizons. Appendix M contains the 2028 Future Background Synchro sheets.

Table 25: 2028 Future Background Intersection Operations

Intersection	Lane	AM Peak Hour				PM Peak Hour			
		LOS	V/C	Delay	Q (95 <sup>th</sup> )	LOS	V/C	Delay	Q (95 <sup>th</sup> )
<b>March Road at Halton Terrace / Maxwell Bridge Road</b> <i>Signalized</i>	EBL	A	0.48	51.0	35.8	D	0.88	114.9	#39.0
	EBT/R	A	0.51	14.9	26.6	A	0.53	34.3	32.8
	WBL	E	0.93	109.8	#51.4	B	0.61	67.5	32.6
	WBT/R	A	0.23	16.8	14.3	B	0.67	36.7	42.4
	NBL	A	0.49	16.9	18.4	A	0.45	7.7	29.2
	NBT	A	0.27	12.3	46.8	B	0.70	18.5	176.8
	NBR	A	0.07	1.1	2.5	A	0.12	3.5	10.3
	SBL	A	0.13	7.0	11.8	A	0.42	10.6	12.9
	SBT	C	0.76	23.3	#218.9	A	0.31	13.1	59.3
	SBR	A	0.08	1.3	3.1	A	0.11	2.9	7.8
	<b>Overall</b>	<b>C</b>	<b>0.77</b>	<b>23.8</b>	<b>-</b>	<b>C</b>	<b>0.72</b>	<b>20.7</b>	<b>-</b>
<b>March Road at Klondike Road</b> <i>Signalized</i>	EBL	A	0.25	35.8	21.6	A	0.48	47.9	38.1
	EBT	A	0.09	32.5	14.7	A	0.08	37.9	13.7
	EBR	A	0.52	17.6	40.3	A	0.27	8.1	13.8
	WBL	C	0.78	71.4	65.5	B	0.68	73.3	46.1
	EBT/R	A	0.28	21.1	20.0	A	0.31	29.6	21.8
	NBL	A	0.39	63.0	18.8	A	0.55	63.5	31.2
	NBT/R	A	0.28	17.7	54.4	B	0.65	18.5	165.7
	SBL	A	0.35	67.5	18.3	A	0.17	62.9	11.0
	SBT/R	B	0.65	26.4	151.1	A	0.34	18.5	62.3
		<b>Overall</b>	<b>B</b>	<b>0.67</b>	<b>27.9</b>	<b>-</b>	<b>B</b>	<b>0.70</b>	<b>23.8</b>
<b>March Road at South Local Road</b> <i>Unsignalized</i>	EBR	E	0.23	40.1	6.0	C	0.13	15.7	3.0
	NBT	-	-	-	-	-	-	-	-
	SBT/R	-	-	-	-	-	-	-	-
		<b>Overall</b>	<b>A</b>	<b>-</b>	<b>0.5</b>	<b>-</b>	<b>A</b>	<b>-</b>	<b>0.3</b>

Notes: Saturation flow rate of 1800 veh/h/lane  
Queue is measured in metres  
Peak Hour Factor = 1.00

m = metered queue  
# = volume for the 95<sup>th</sup> %ile cycle exceeds capacity

With the background growth and background development volumes, the westbound left-turn movement at the intersection of March Road at Halton Terrace/Maxwell Bridge Road during the AM peak may be subject to high delays and extended queues. It is noted that at both the intersections of March Road at Halton Terrace/Maxwell Bridge Road and March Road at Klondike Road, extended southbound through queues may occur in the AM peak, and extended northbound queues may occur in the PM peak. At the intersection of March Road at the South Local Road, the eastbound right-turn is shown to operate with a LOS E in the AM peak. This can be attributed to the high delay on the eastbound right-turn resulting from the high southbound through volumes.

17.2.3 2033 Future Background

The 2033 future background intersection volumes and other development traffic has been analyzed to allow a comparison between the future volumes with and without the proposed development. Table 26 summarizes the 2033 background intersection operations. The intersection of the South Local Road and March Road is considered as part of the 2028 future background horizon and has been analyzed as a right-in right-out unsignalized intersection as indicated in the Kanata North Community Design Plan. The South Local Road will form the west leg of the site access intersection to be considered in the future total analysis horizons. Appendix N contains the 2033 Future Background Synchro sheets.

Table 26: 2033 Future Background Intersection Operations

Intersection	Lane	AM Peak Hour				PM Peak Hour			
		LOS	V/C	Delay	Q (95 <sup>th</sup> )	LOS	V/C	Delay	Q (95 <sup>th</sup> )
<b>March Road at Halton Terrace / Maxwell Bridge Road</b> <i>Signalized</i>	EBL	A	0.48	51.0	35.8	D	0.88	114.9	#39.0
	EBT/R	A	0.51	14.9	26.6	B	0.61	35.3	37.1
	WBL	E	0.93	109.8	#51.4	C	0.71	81.2	33.6
	WBT/R	A	0.23	16.8	14.3	B	0.67	36.7	42.4
	NBL	A	0.60	35.1	27.6	A	0.51	8.8	29.2
	NBT	A	0.31	12.7	55.8	C	0.80	22.1	#246.8
	NBR	A	0.07	1.1	2.5	A	0.12	3.5	10.3
	SBL	A	0.14	7.1	11.8	A	0.51	21.3	23.4
	SBT	D	0.86	28.0	#272.5	A	0.38	14.0	74.1
	SBR	A	0.08	1.3	3.1	A	0.11	2.9	7.8
<b>Overall</b>	<b>D</b>	<b>0.86</b>	<b>26.7</b>	-	-	<b>C</b>	<b>0.80</b>	<b>23.1</b>	-
<b>March Road at Klondike Road</b> <i>Signalized</i>	EBL	A	0.28	36.5	23.2	A	0.53	50.1	41.4
	EBT	A	0.09	32.5	14.7	A	0.08	37.9	13.7
	EBR	A	0.52	17.9	41.8	A	0.27	8.1	13.8
	WBL	C	0.78	71.4	65.5	B	0.68	73.3	46.1
	EBT/R	A	0.29	20.3	20.7	A	0.33	29.0	22.1
	NBL	A	0.39	63.0	18.8	A	0.55	63.5	31.8
	NBT/R	A	0.31	18.4	61.7	C	0.72	20.4	197.9
	SBL	A	0.37	67.9	19.2	A	0.18	63.2	11.5
	SBT/R	C	0.73	28.6	#180.5	A	0.40	19.5	76.0
	<b>Overall</b>	<b>C</b>	<b>0.72</b>	<b>29.0</b>	-	-	<b>C</b>	<b>0.76</b>	<b>24.8</b>
<b>March Road at South Local Road</b> <i>Unsignalized</i>	EBR	<b>F</b>	<b>0.31</b>	<b>57.1</b>	<b>9.1</b>	C	0.16	18.2	3.8
	NBT	-	-	-	-	-	-	-	-
	SBT/R	-	-	-	-	-	-	-	-
	<b>Overall</b>	<b>A</b>	-	<b>0.7</b>	-	-	<b>A</b>	-	<b>0.3</b>

Notes: Saturation flow rate of 1800 veh/h/lane  
 Queue is measured in metres  
 Peak Hour Factor = 1.00  
 m = metered queue  
 # = volume for the 95th %ile cycle exceeds capacity

With the addition of background growth and other development traffic to reflect the 2033 horizon, the existing intersections are anticipated to operate with similar operational characteristics to the 2028 future background conditions.

The westbound left-turn movement at the intersection of March Road at Halton Terrace/Maxwell Bridge Road during the AM peak may be subject to high delays and extended queues. It is noted that at both the intersections of March Road at Halton Terrace/Maxwell Bridge Road and March Road at Klondike Road, extended southbound through queues may occur in the AM peak, and extended northbound queues may occur in the PM peak.

With the additional background development traffic and growth, the eastbound right-turn at the intersection of March Road at the South Local Road, is shown to operate with a LOS F in the AM peak. This can be attributed to the high delay on the eastbound right-turn resulting from the high southbound through volumes.

17.2.4 2028 Future Total

The 2028 future total intersection volumes, including the site generated traffic and other development traffic, have been analyzed to understand the impact of the subject development in the Study Area intersections Table 27 summarizes the 2028 future total intersection operations. Appendix O contains the 2028 Future Total Synchro sheets.

Table 27: 2028 Future Total Intersection Operations

Intersection	Lane	AM Peak Hour				PM Peak Hour			
		LOS	V/C	Delay	Q (95 <sup>th</sup> )	LOS	V/C	Delay	Q (95 <sup>th</sup> )
<b>March Road at Halton Terrace / Maxwell Bridge Road</b> <i>Signalized</i>	EBL	A	0.49	51.5	36.3	D	0.89	116.5	#39.8
	EBT/R	A	0.51	14.9	26.6	A	0.58	33.2	35.3
	WBL	E	0.93	109.8	#51.4	B	0.67	74.3	33.1
	WBT/R	A	0.23	16.7	14.5	B	0.66	35.9	42.7
	NBL	A	0.51	19.4	20.6	A	0.47	8.1	29.8
	NBT	A	0.28	12.4	49.4	C	0.73	19.7	190.1
	NBR	A	0.07	1.1	2.5	A	0.12	3.6	10.5
	SBL	A	0.14	7.0	12.1	A	0.45	12.8	15.4
	SBT	C	0.78	24.1	#230.7	A	0.33	13.6	63.4
	SBR	A	0.08	1.5	3.7	A	0.11	3.1	8.3
<b>Overall</b>	<b>C</b>	<b>0.79</b>	<b>25.4</b>	-	-	<b>C</b>	<b>0.74</b>	<b>21.9</b>	-
<b>March Road at Klondike Road</b> <i>Signalized</i>	EBL	A	0.26	36.0	22.0	A	0.49	48.5	38.7
	EBT	A	0.09	32.5	14.7	A	0.08	37.9	13.7
	EBR	A	0.52	17.8	41.5	A	0.27	8.1	13.8
	WBL	C	0.78	71.4	65.5	B	0.68	73.3	46.1
	EBT/R	A	0.28	20.8	20.2	A	0.33	29.0	22.1
	NBL	A	0.39	63.0	18.8	A	0.55	63.5	31.2
	NBT/R	A	0.29	18.0	56.5	B	0.66	18.9	171.6
	SBL	A	0.37	67.9	19.2	A	0.18	63.2	11.5
	SBT/R	B	0.67	26.9	157.1	A	0.36	18.8	66.6
	<b>Overall</b>	<b>C</b>	<b>0.68</b>	<b>29.4</b>	-	-	<b>C</b>	<b>0.71</b>	<b>25.0</b>
<b>March Road at Site Access / South Local Road</b> <i>Unsignalized</i>	EBL/T/R	F	0.47	85.1	14.4	F	0.55	76.1	19.8
	WBL/T/R	F	2.50	1024.2	57.0	F	2.74	1206.6	52.4
	NBL	A	0.01	13.8	0.0	A	0.03	9.5	0.8
	NBT	-	-	-	-	-	-	-	-
	NBR	-	-	-	-	-	-	-	-
	SBL	A	0.00	8.9	0.0	B	0.02	14.8	0.8
	SBT/R	-	-	-	-	-	-	-	-
	<b>Overall</b>	<b>D</b>	-	<b>27.3</b>	-	-	<b>D</b>	-	<b>25.6</b>
<b>Mitigation – Right-In/Right-Out</b>									
<b>March Road at Site Access / South Local Road</b> <i>Right-In Right-Out</i>	EBR	E	0.28	42.2	8.4	C	0.15	16.1	3.8
	WBR	B	0.13	13.9	3.0	F	0.45	59.1	15.2
	NBT	-	-	-	-	-	-	-	-
	NBR	-	-	-	-	-	-	-	-
	SBT/R	-	-	-	-	-	-	-	-
	<b>Overall</b>	<b>A</b>	-	<b>1.0</b>	-	-	<b>A</b>	-	<b>1.5</b>

Notes: Saturation flow rate of 1800 veh/h/lane  
 Queue is measured in metres  
 Peak Hour Factor = 1.00

m = metered queue  
 # = volume for the 95th %ile cycle exceeds capacity

With the addition of site generated traffic, the network intersection operations for the 2028 future total horizon operate similarly to the 2028 future background conditions expect for the March Road at Site Access / South Local Road intersection.

The intersection of March Road at Site Access / South Local Road has been analyzed as a stop-controlled intersection. This intersection has a shared left-turn / through / right-turn lane on both the east and west legs of the intersection, the north leg of the intersection consist of an auxiliary left-turn lane and a through lane, and the south leg of the intersection consists of an auxiliary left-turn lane, aa through lane, and an auxiliary right-turn lane.

Multiple movements in both the AM and PM Peak hour may be subject to high delays and extended queues. As such, the reconfiguration of March Road at Site Access / South Local Road as a right-in/right-out intersection has been considered as a mitigation measure.

Upon reconfiguring the intersection as a right-in/right-out intersection, the intersection of March Road at Site Access / South Local Road operates well in both the AM and PM peak hours. The design of this intersection is consistent with ultimate intersection configuration discussed in Section 12.2 above. Based on the operational analysis, reconfiguring the site access intersection is recommended to improve the level of service at the intersection. This mitigation measure is consistent with the future geometry of the intersection following the completion of the March Road BRT or in the case that the monitoring plan identifies the need for this reconfiguration. The future total volumes for the 2028 horizon considering the right-in right-out mitigation measure are illustrated in Figure 26.

Figure 26: 2028 Future Total Volumes - Right-In/Right-Out

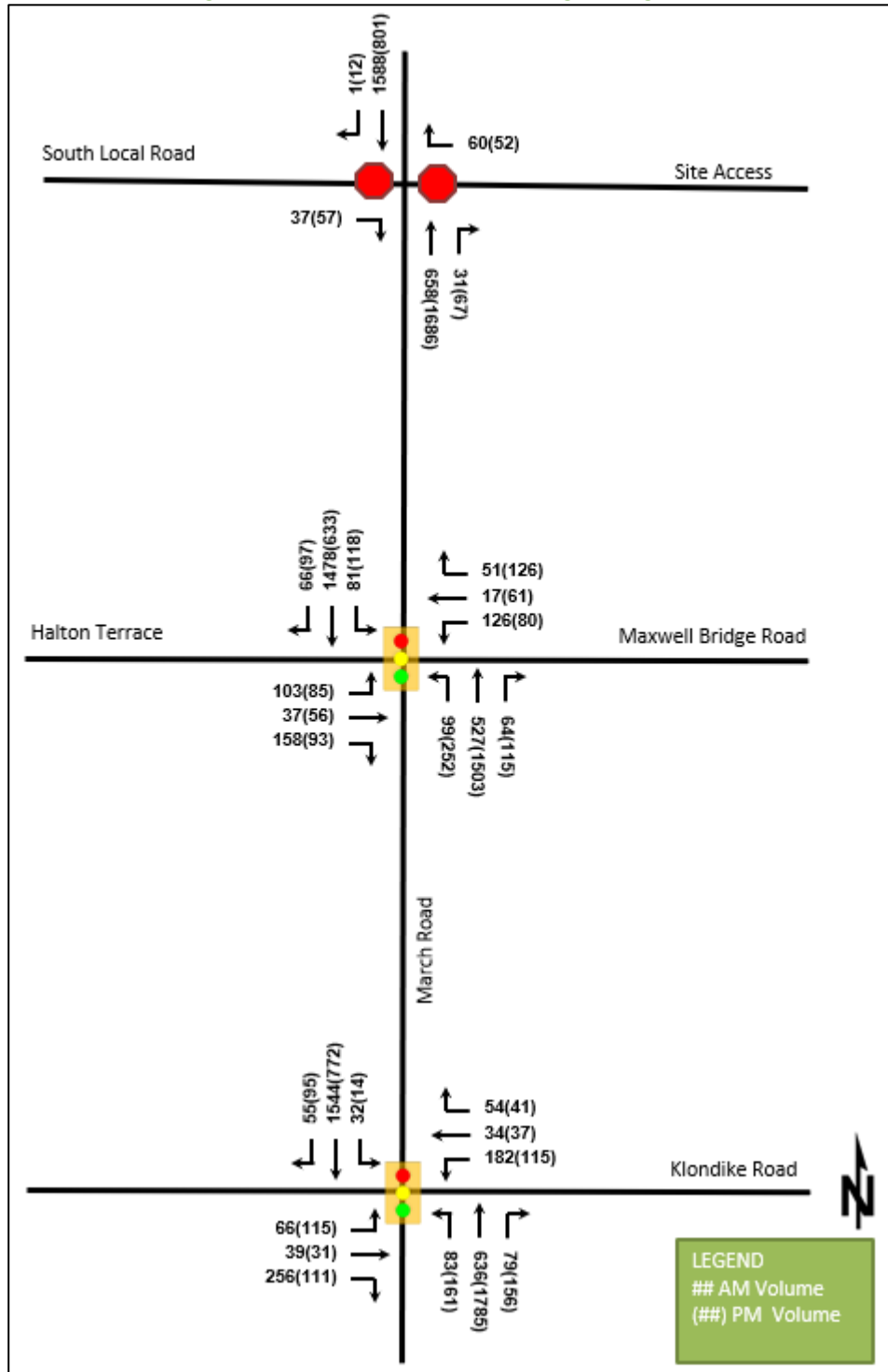

17.2.5 2028 Future Total – Interim Horizon

The 2028 future total interim intersection volumes, including the site generated traffic and excluding the other development traffic, have been analyzed to understand the impact of the subject development on the Study Area intersections. Table 28 summarizes the 2028 future total interim intersection operations. Appendix P contains the 2028 Future Total Interim Synchro sheets.



Table 28: 2028 Future Total Interim Intersection Operations

Intersection	Lane	AM Peak Hour				PM Peak Hour			
		LOS	V/C	Delay	Q (95 <sup>th</sup> )	LOS	V/C	Delay	Q (95 <sup>th</sup> )
<b>March Road at Halton Terrace / Maxwell Bridge Road</b> <i>Signalized</i>	EBL	A	0.12	41.9	11.4	A	0.19	50.5	11.5
	EBT/R	A	0.43	18.5	23.8	A	0.48	40.2	29.8
	WBL	C	0.77	76.0	46.5	A	0.57	65.5	32.8
	WBT/R	A	0.16	22.4	12.3	B	0.64	39.3	38.4
	NBL	A	0.06	6.5	4.5	A	0.24	5.0	18.5
	NBT	A	0.11	10.1	18.4	A	0.46	10.7	80.1
	NBR	A	0.07	0.8	2.1	A	0.12	1.9	7.0
	SBL	A	0.09	5.8	10.3	A	0.15	5.1	7.3
	SBT	A	0.40	11.6	80.8	A	0.13	9.7	22.6
	SBR	A	0.02	0.0	0.0	A	0.02	0.0	0.0
<b>Overall</b>	<b>B</b>	<b>0.47</b>	<b>19.0</b>	-	<b>B</b>	<b>0.48</b>	<b>16.7</b>	-	
<b>March Road at Klondike Road</b> <i>Signalized</i>	EBL	A	0.19	43.0	14.6	A	0.56	60.6	32.3
	EBT	A	0.12	41.7	15.4	A	0.08	42.8	11.8
	EBR	B	0.64	20.3	39.4	A	0.34	10.3	15.0
	WBL	B	0.64	73.6	39.1	A	0.54	72.5	28.8
	EBT/R	A	0.24	34.4	16.9	A	0.36	39.5	20.1
	NBL	A	0.39	63.0	18.8	A	0.56	63.7	31.2
	NBT/R	A	0.12	9.5	21.4	A	0.40	9.4	81.4
	SBL	A	0.25	65.1	13.3	A	0.06	60.8	4.8
	SBT/R	A	0.35	14.6	68.0	A	0.19	13.3	32.9
	<b>Overall</b>	<b>C</b>	<b>0.41</b>	<b>24.8</b>	-	<b>C</b>	<b>0.50</b>	<b>20.9</b>	-
<b>March Road at Site Access</b> <i>Unsignalized</i>	WBL/R	D	0.25	25.4	7.6	D	0.29	32.5	8.4
	NBT	-	-	-	-	-	-	-	-
	NBR	-	-	-	-	-	-	-	-
	SBL	A	0.00	7.8	0.0	A	0.02	10.6	0.8
	SBT	-	-	-	-	-	-	-	-
	<b>Overall</b>	<b>A</b>	-	<b>1.2</b>	-	<b>A</b>	-	<b>1.3</b>	-

Notes: Saturation flow rate of 1800 veh/h/lane  
 Queue is measured in metres  
 Peak Hour Factor = 1.00

m = metered queue  
 # = volume for the 95<sup>th</sup> %ile cycle exceeds capacity

With the addition of background growth, excluding explicit background development traffic, and the subject site generated trips to reflect the 2028 future total interim horizon, the study area intersections are anticipated to operate with similar operational characteristics to the existing conditions. The site access intersection has been analyzed as an unsignalized right-in/right-out intersection and is based on the interim intersection design discussed above. The site access intersection is shown to operate well without high delays or queues.

17.2.6 2033 Future Total

The 2033 future total intersection volumes, including the site generated traffic and other development traffic, have been analyzed to understand the impact of the subject development in the Study Area intersections. Table 29 summarizes the 2033 future total intersection operations. Appendix Q contains the 2033 Future Total Synchro sheets.

Table 29: 2033 Future Total Intersection Operations

Intersection	Lane	AM Peak Hour				PM Peak Hour			
		LOS	V/C	Delay	Q (95 <sup>th</sup> )	LOS	V/C	Delay	Q (95 <sup>th</sup> )
<b>March Road at Halton Terrace / Maxwell Bridge Road</b> <i>Signalized</i>	EBL	A	0.49	51.3	36.3	D	0.89	116.5	#39.8
	EBT/R	A	0.51	14.9	26.6	A	0.59	34.5	36.9
	WBL	E	0.93	109.8	#51.4	B	0.69	77.4	33.3
	WBT/R	A	0.23	16.7	14.5	B	0.66	35.9	42.7
	NBL	B	0.61	37.4	28.3	A	0.52	9.3	29.8
	NBT	A	0.32	12.9	58.5	D	0.83	23.7	#261.6
	NBR	A	0.07	1.1	2.5	A	0.12	3.6	10.5
	SBL	A	0.15	7.1	12.1	A	0.55	26.5	26.5
	SBT	D	0.88	29.5	#284.1	A	0.40	14.6	79.0
	SBR	A	0.08	1.5	3.7	A	0.11	3.1	8.3
<b>Overall</b>	<b>C</b>	<b>0.87</b>	<b>28.3</b>	-	-	<b>C</b>	<b>0.83</b>	<b>23.7</b>	-
<b>March Road at Klondike Road</b> <i>Signalized</i>	EBL	A	0.29	36.7	23.8	A	0.55	50.7	42.5
	EBT	A	0.09	32.5	14.7	A	0.08	37.9	13.7
	EBR	A	0.52	18.1	42.0	A	0.27	8.1	13.8
	WBL	C	0.78	71.4	65.5	B	0.68	73.3	46.1
	EBT/R	A	0.29	20.1	20.5	A	0.33	28.3	22.3
	NBL	A	0.39	63.0	18.8	A	0.55	63.5	31.2
	NBT/R	A	0.33	19.9	63.9	C	0.73	20.9	205.9
	SBL	A	0.39	68.5	20.5	A	0.20	63.4	12.5
	SBT/R	C	0.75	29.2	#197.9	A	0.41	19.7	78.8
	<b>Overall</b>	<b>C</b>	<b>0.73</b>	<b>30.6</b>	-	-	<b>C</b>	<b>0.77</b>	<b>26.1</b>
<b>March Road at Site Access / South Local Road</b> <i>Unsignalized</i>	EBL/T/R	F	0.70	164.9	22.0	F	0.98	226.1	35.0
	WBL/T/R	F	4.29	2022.4	63.8	F	5.2	2627.4	59.3
	NBL	C	0.01	15.6	0.0	B	0.03	10.1	0.8
	NBT	-	-	-	-	-	-	-	-
	NBR	-	-	-	-	-	-	-	-
	SBL	A	0.00	8.9	0.0	C	0.03	16.9	0.8
	SBT/R	-	-	-	-	-	-	-	-
	<b>Overall</b>	<b>E</b>	-	<b>47.9</b>	-	-	<b>F</b>	-	<b>50.3</b>
<b>Mitigation – Right-In Right-Out</b>									
<b>March Road at Site Access / South Local Road</b> <i>Right-In Right-Out</i>	EBR	F	0.38	61.6	11.4	C	0.18	18.8	5.3
	WBR	C	0.15	15.1	3.8	F	0.61	96.8	21.3
	NBT	-	-	-	-	-	-	-	-
	NBR	-	-	-	-	-	-	-	-
	SBT/R	-	-	-	-	-	-	-	-
	<b>Overall</b>	<b>A</b>	-	<b>1.2</b>	-	-	<b>A</b>	-	<b>2.0</b>

Notes: Saturation flow rate of 1800 veh/h/lane  
Queue is measured in metres  
Peak Hour Factor = 1.00

m = metered queue  
# = volume for the 95th %ile cycle exceeds capacity

With the addition of site generated traffic, the network intersection operations for the 2033 future total horizon operate similarly to the 2033 future background conditions expect for the March Road at Site Access / South Local Road intersection.

The intersection of March Road at Site Access / South Local Road has been analyzed as a stop-controlled intersection with a single outbound lane as the westbound leg of the intersection. This intersection has a shared left-turn / through / right-turn lane on both the east and west legs of the intersection, the north leg of the intersection consist of an auxiliary left-turn lane and a through lane, and the south leg of the intersection consists

of an auxiliary left-turn lane, a through lane, and an auxiliary right-turn lane. Multiple movements in both the AM and PM Peak hour may be subject to high delays and extended queues. As such, the reconfiguration of March Road at Site Access / South Local Road as a right-in/right-out intersection has been considered as a mitigation measure.

Upon reconfiguring the intersection as a right-in/right-out intersection, the intersection of March Road at Site Access / South Local Road operates well in both the AM and PM peak hours. The design of this intersection is consistent with ultimate intersection configuration discussed in Section 12.2 above. Based on the operational analysis, reconfiguring the site access intersection is recommended to improve the level of service at the intersection. This mitigation measure is consistent with the future geometry of the intersection following the completion of the March Road BRT or in the case that the monitoring plan identifies the need for this reconfiguration. The future total volumes for the 2033 horizon considering the right-in/right-out mitigation measure is illustrated in Figure 27.

Figure 27: 2033 Future Total Volumes - Right-in/Right-out

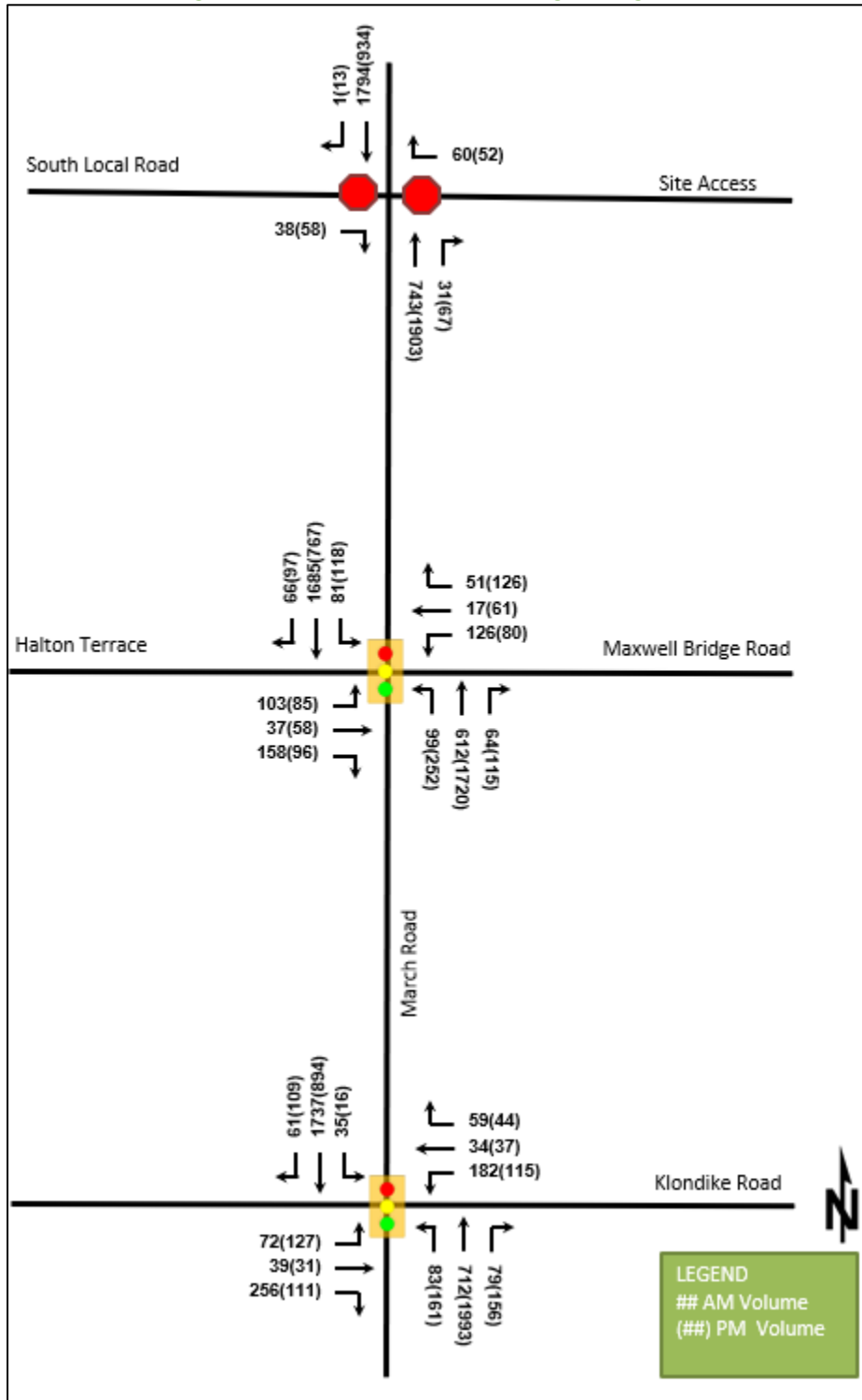

17.2.7 Intersection MMLOS

Intersection MMLOS is only undertaken at signalized intersections. The two signalized intersections considered in this study are March Road at Halton Terrace / Maxwell Bridge Road, and March Road at Klondike Road.

Table 30 summarizes the MMLOS analysis for these two signalized intersections in the Study Area for the existing and future horizons. The analysis is based on the developing community policy area. The MMLOS worksheets have been provided in Appendix I.

Table 30: Study Area Intersection MMLOS Analysis—All Horizons

Intersection	Horizon	Pedestrian LOS		Bicycle LOS		Transit LOS		Truck LOS		Auto LOS	
		PLOS	Target	BLOS	Target	TLOS	Target	TrLOS	Target	ALOS	Target
March Road & Halton Terrace / Maxwell Bridge Road	Existing	F	C	F	B	F	D	E	D	C	D
	2028 FB									C	
	2028 FT									C	
	2033 FT									C	
March Road & Klondike Road	Existing	F	C	F	B	F	D	E	D	B	D
	2028 FB									C	
	2028 FT									C	
	2033 FT									C	

The pedestrian and bicycle LOS targets are not met at the network intersections due to crossing distances, permissive left and right-turns, and lack of cycling facilities in the Study Area. The bicycle LOS is not met as a result of mixed traffic conditions on some intersection legs as well as high operating speeds. The transit LOS generally fails to meet the targets at some intersections due to the intersection delays. Truck LOS is not met at most intersections due to the low number of receiving lanes, and the smaller curb radius found at the site access. Auto LOS targets are met in all analyzed horizons. This is due to the high volume to capacity ratio experienced at the intersection.

The future widening and transit improvements to March Road, are anticipated to increase connectivity and improve the segment MMLOS along March Road. As such, no further intersection improvements are recommended, beyond the extension of pedestrian and bicycle facilities along the frontage of the site, as a result of the intersection MMLOS analysis.

## 18 Conclusions

- A. It is noted that a TIA for 910 March Road, dated July 2023, was previously submitted to support the zoning by-law amendment for this site. This report serves as an update to that submission and incorporates the received City of Ottawa comments on the July 2023 report.
- B. The proposed development, located at 910 March Road, is a mixed-use development with 390 residential units and 501 square metres of ground floor commercial space. A total of 568 vehicle parking stalls and 198 bicycle parking spaces will be provided.
- C. The site is proposed to have one access. The site access is located on March Road and is a full-movement access approximately 215 metres north of Maxwell Bridge Road, measured from intersection centreline to intersection centreline.
- D. The site access intersection is subject to an RMA and functional design for both the interim and ultimate configurations.
- E. The existing Study Area is currently served by bus routes #63, and 165.
- F. The previous five years of collision history at the existing Study Area intersections has been reviewed. No patterns emerged that indicated that mitigation measures or further monitoring was required.
- G. It was found that the proposed development can be anticipated to generate 91 AM, and 102 PM net new peak hour two-way vehicle trips.
- H. Minimum vehicle and bicycle parking space requirements are met.
- I. It was found that the road segments of March Road do not meet the majority of its MMLOS targets. As future changes to the road network are anticipated to improve the MMLOS of these segments, no resulting improvements to the boundary road is recommended.
- J. Left-turn lane warrants were evaluated at the site access intersection. A southbound left-turn lane was warranted for all future total horizons. Preliminary storage and taper lengths have been designed for the southbound left-turn lane for operational analysis purposes, and have been further refined in the RMA and functional design.
- K. A 2022 Existing, 2028 future background, 2033 future background, 2028 future total, 2028 future total interim, and a 2033 future total analysis horizon has been developed.
  - 1. The 2028 future total interim analysis horizon assumes no background developments have been built in the 2028 future analysis horizon, and as such consists of the 2022 existing volumes grown to a 2028 horizon, as well as the subject development's site generated traffic. The interim analysis horizon assumes the site access is a three-legged unsignalized intersection with stop-control on the east leg.
  - 2. The 2028 future total interim analysis horizon has been developed and analyzed as the surrounding background development site generated volumes are considered to be inflated and the build-out horizons are assumed to be unrealistic.
- L. A monitoring plan has been developed to identify the need for reconfiguration of the site access intersection to a right-in/right-out intersection based on the overall intersection level of service, based on AM and PM peak hour traffic volumes.
- M. The existing Study Area intersections operate satisfactorily during the peak hours in the existing conditions operational analysis.
- N. The Study Area intersections generally operate satisfactorily during the peak hours in the 2028 future background operational analysis.
- O. The Study Area intersections operate satisfactorily during the peak hours in the 2028 future total operational analysis with similar operational characteristics as the 2028 future background conditions.

The site access is shown to operate with high delays and queues. The following recommendation is the result of this analysis:

1. Reconfiguration of the site access intersection to a right-in/right-out intersection
- P. The Study Area intersections operate satisfactorily during the peak hours in the 2028 future total interim analysis horizon.
1. The 2028 future total interim analysis results were used to inform the interim functional design and RMA design of the access intersection and is recommended until reconfiguration of the access is considered warranted as a result of the monitoring plan, or BRT facilities are implemented along March Road.
- Q. The existing Study Area intersections generally operate satisfactorily during the peak hours in the 2033 future background operational analysis.
- R. The Study Area intersections operate satisfactorily during the peak hours in the 2033 future total operational analysis with similar operational characteristics as the 2033 future background conditions. The site access is shown to operate with high delays and queues. The following recommendation is the result of this analysis:
1. Reconfiguration of the site access intersection to a right-in right-out intersection
- S. The mitigation measures proposed in the 2028 and 2033 future total analysis results were used to inform the ultimate functional design and RMA design of the access intersection and is recommended when reconfiguration of the access is considered warranted as a result of the monitoring plan.
- T. The PLOS, BLOS, TLOS, and TkLOS were evaluated at both of the signalized Study Area intersections. In most cases, the MMLoS targets were not met. No intersection alterations or mitigation measures are suggested as changes to these intersections as future improvements along March Road are expected to improve the intersection MMLoS at these locations.

The proposed development will function within the Study Area Road Network. It is recommended that, from a transportation perspective, the proposed development application process proceed.

Prepared By:



Robin Marinac, P. Eng.  
437-242-5183  
[Robin.marinac@CGHTransportation.com](mailto:Robin.marinac@CGHTransportation.com)

Reviewed By:



Mark Crockford, P. Eng.  
905-251-4070  
[Mark.Crockford@CGHTransportation.com](mailto:Mark.Crockford@CGHTransportation.com)

# Appendix A

TIA Screening Form and PM Certification Form



City of Ottawa 2017 TIA Guidelines  
Step 1 - Screening Form

Date: 06-Jul-23  
Project Number: 2021-073  
Project Reference: 910 March Road

1.1 Description of Proposed Development	
Municipal Address	910 March Road
Description of Location	Ward 5. On the east side of March Road approximately 150 metres north of Maxwell Bridge Road
Land Use Classification	Development Reserve Zone [DR] and Rural Zone [RU]
Development Size	390 residential units and 501 square metres of ground floor commercial space
Accesses	One full-movement access on March Road. Ultimate intersection configuration will be a right-in/right-out access
Phase of Development	Single Phase
Buildout Year	2028
TIA Requirement	Full TIA Required

1.2 Trip Generation Trigger	
Land Use Type	Townhomes or apartments
Development Size	390 Units
Trip Generation Trigger	Yes

1.3 Location Triggers	
Does the development propose a new driveway to a boundary street that is designated as part of the City's Transit Priority, Rapid Transit or Spine Bicycle Networks?	Yes
Is the development in a Design Priority Area (DPA) or Transit-oriented Development (TOD) zone?	No
Location Trigger	Yes

1.4. Safety Triggers	
Are posted speed limits on a boundary street 80 km/hr or greater?	Yes
Are there any horizontal/vertical curvatures on a boundary street limits sight lines at a proposed driveway?	No
Is the proposed driveway within the area of influence of an adjacent traffic signal or roundabout (i.e. within 300 m of intersection in rural conditions, or within 150 m of intersection in urban/ suburban conditions)?	Yes
Is the proposed driveway within auxiliary lanes of an intersection?	No
Does the proposed driveway make use of an existing median break that serves an existing site?	No
Is there is a documented history of traffic operations or safety concerns on the boundary streets within 500 m of the development?	No
Does the development include a drive-thru facility?	No
Safety Trigger	Yes



## **TIA Plan Reports**

On 14 June 2017, the Council of the City of Ottawa adopted new Transportation Impact Assessment (TIA) Guidelines. In adopting the guidelines, Council established a requirement for those preparing and delivering transportation impact assessments and reports to sign a letter of certification.

Individuals submitting TIA reports will be responsible for all aspects of development-related transportation assessment and reporting, and undertaking such work, in accordance and compliance with the City of Ottawa's Official Plan, the Transportation Master Plan and the Transportation Impact Assessment (2017) Guidelines.

By submitting the attached TIA report (and any associated documents) and signing this document, the individual acknowledges that s/he meets the four criteria listed below.

### **CERTIFICATION**

1. I have reviewed and have a sound understanding of the objectives, needs and requirements of the City of Ottawa's Official Plan, Transportation Master Plan and the Transportation Impact Assessment (2017) Guidelines;
2. I have a sound knowledge of industry standard practice with respect to the preparation of transportation impact assessment reports, including multi modal level of service review;
3. I have substantial experience (more than 5 years) in undertaking and delivering transportation impact studies (analysis, reporting and geometric design) with strong background knowledge in transportation planning, engineering or traffic operations; and
4. I am either a licensed<sup>1</sup> or registered<sup>2</sup> professional in good standing, whose field of expertise [check  appropriate field(s)] is either transportation engineering  or transportation planning .

**1,2 License of registration body that oversees the profession is required to have a code of conduct and ethics guidelines that will ensure appropriate conduct and representation for transportation planning and/or transportation engineering works.**

City Of Ottawa  
Infrastructure Services and Community  
Sustainability  
Planning and Growth Management  
110 Laurier Avenue West, 4th fl.  
Ottawa, ON K1P 1J1  
Tel. : 613-580-2424  
Fax: 613-560-6006

Ville d'Ottawa  
Services d'infrastructure et Viabilité des  
collectivités  
Urbanisme et Gestion de la croissance  
110, avenue Laurier Ouest  
Ottawa (Ontario) K1P 1J1  
Tél. : 613-580-2424  
Télécopieur: 613-560-6006

Dated at Newmarket this 22 day of April, 2020.  
(City)

Name: Mark Crockford  
(Please Print)

Professional Title: Professional Engineer

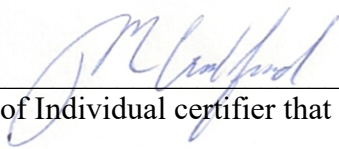
  
Signature of Individual certifier that s/he meets the above four criteria

<b>Office Contact Information (Please Print)</b>
Address: 628 Haines Road
City / Postal Code: Newmarket / L3Y 6V5
Telephone / Extension: (905) 251-4070
E-Mail Address: Mark.Crockford@CGHTransportation.com



# Appendix B

Traffic Data

**Survey Date:** Wednesday, March 04, 2020

**WO No:** 39372

**Start Time:** 07:00

**Device:** Miovision

### Full Study Diagram

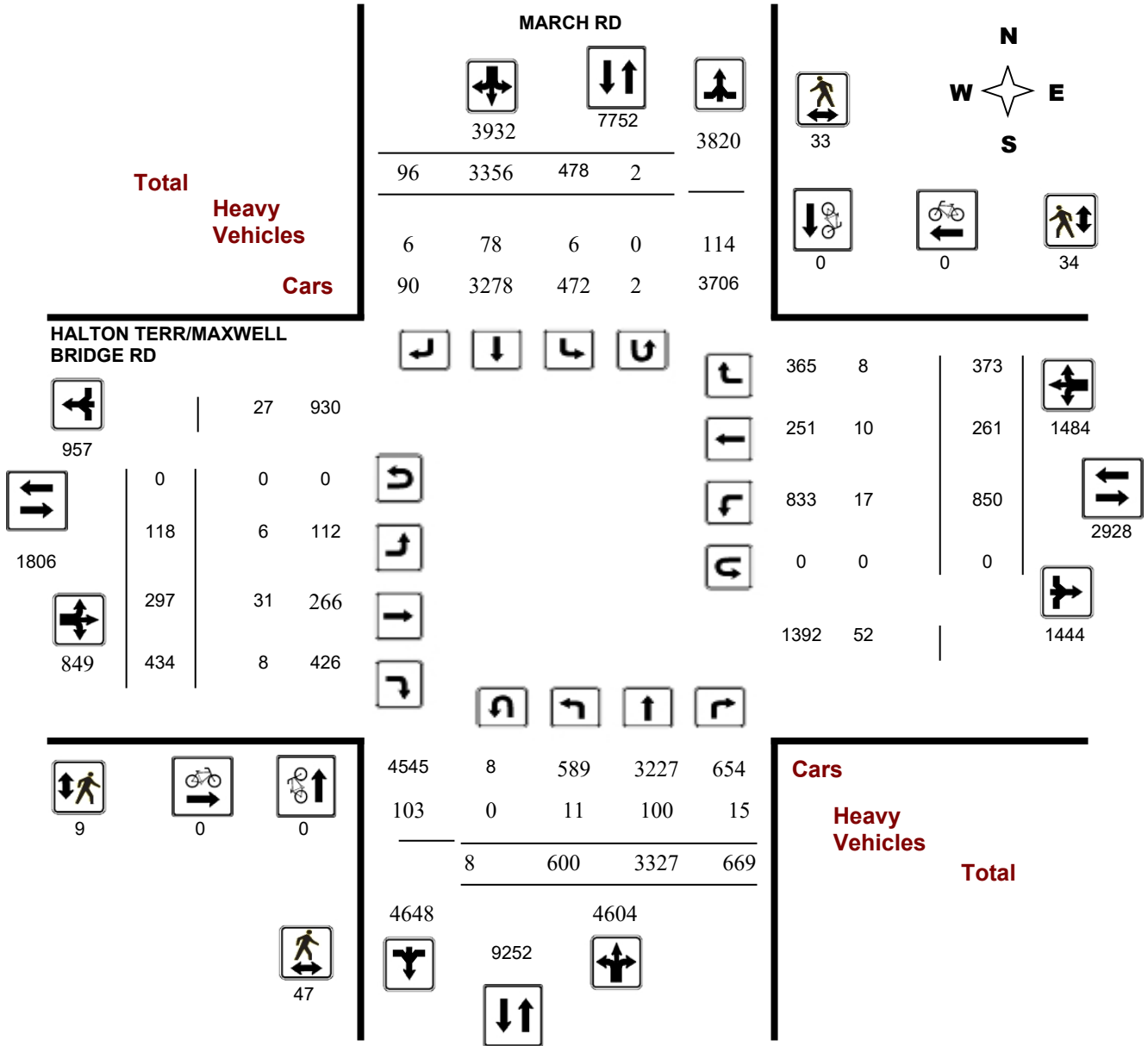

5472187 - WED JAN 22, 2020 - 8HRS - LORETTA

## Turning Movement Count - Study Results

### HALTON TERR/MAXWELL BRIDGE RD @ MARCH RD

**Survey Date:** Wednesday, March 04, 2020

**WO No:** 39372

**Start Time:** 07:00

**Device:** Miovision

### Full Study Peak Hour Diagram

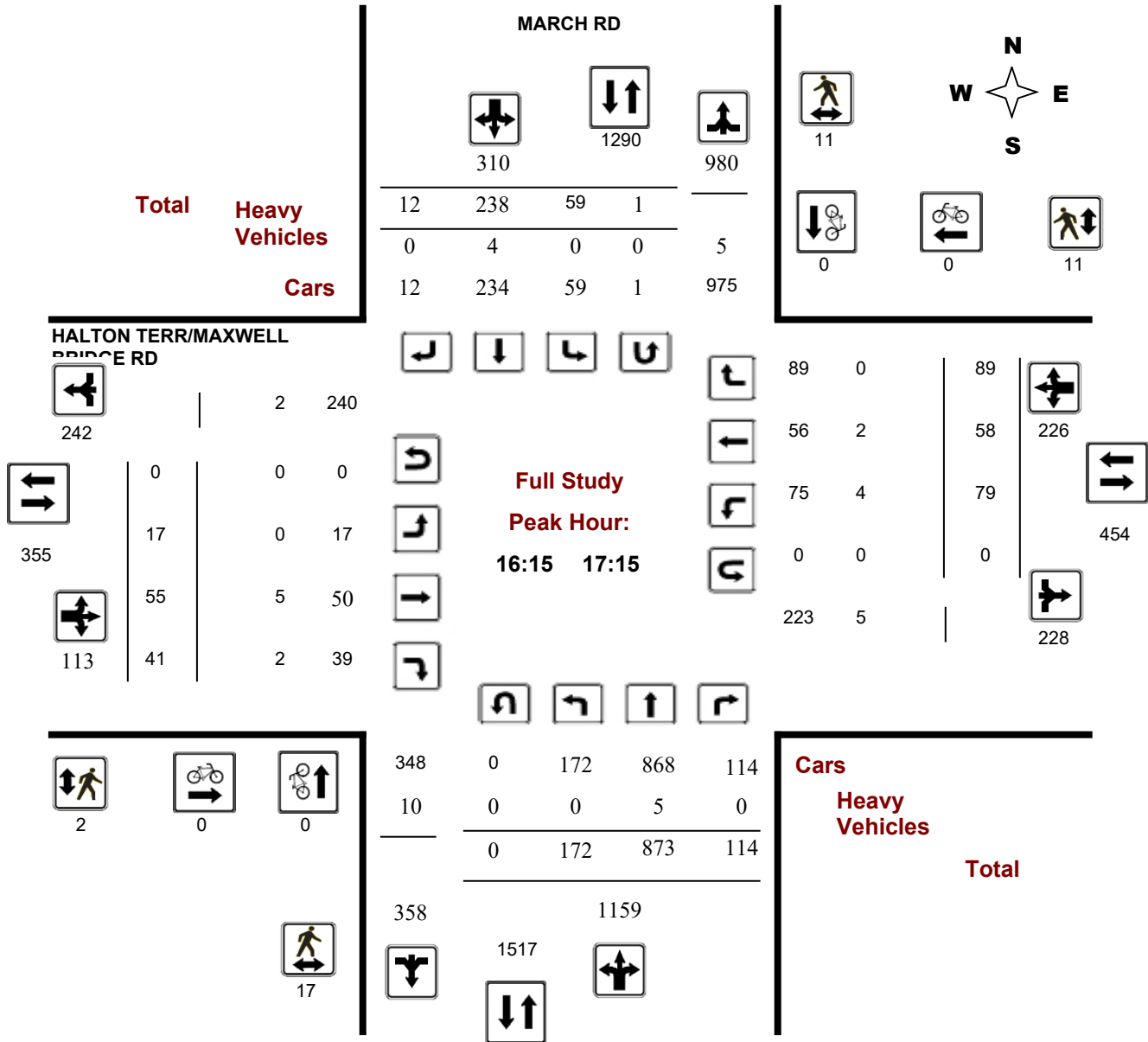

5472187 - WED JAN 22, 2020 - 8HRS - LORETTA



# Transportation Services - Traffic Services

## Turning Movement Count - Peak Hour Diagram

### HALTON TERR/MAXWELL BRIDGE RD @ MARCH RD

**Survey Date:** Wednesday, March 04, 2020

**Start Time:** 07:00

**WO No:** 39372

**Device:** Miovision

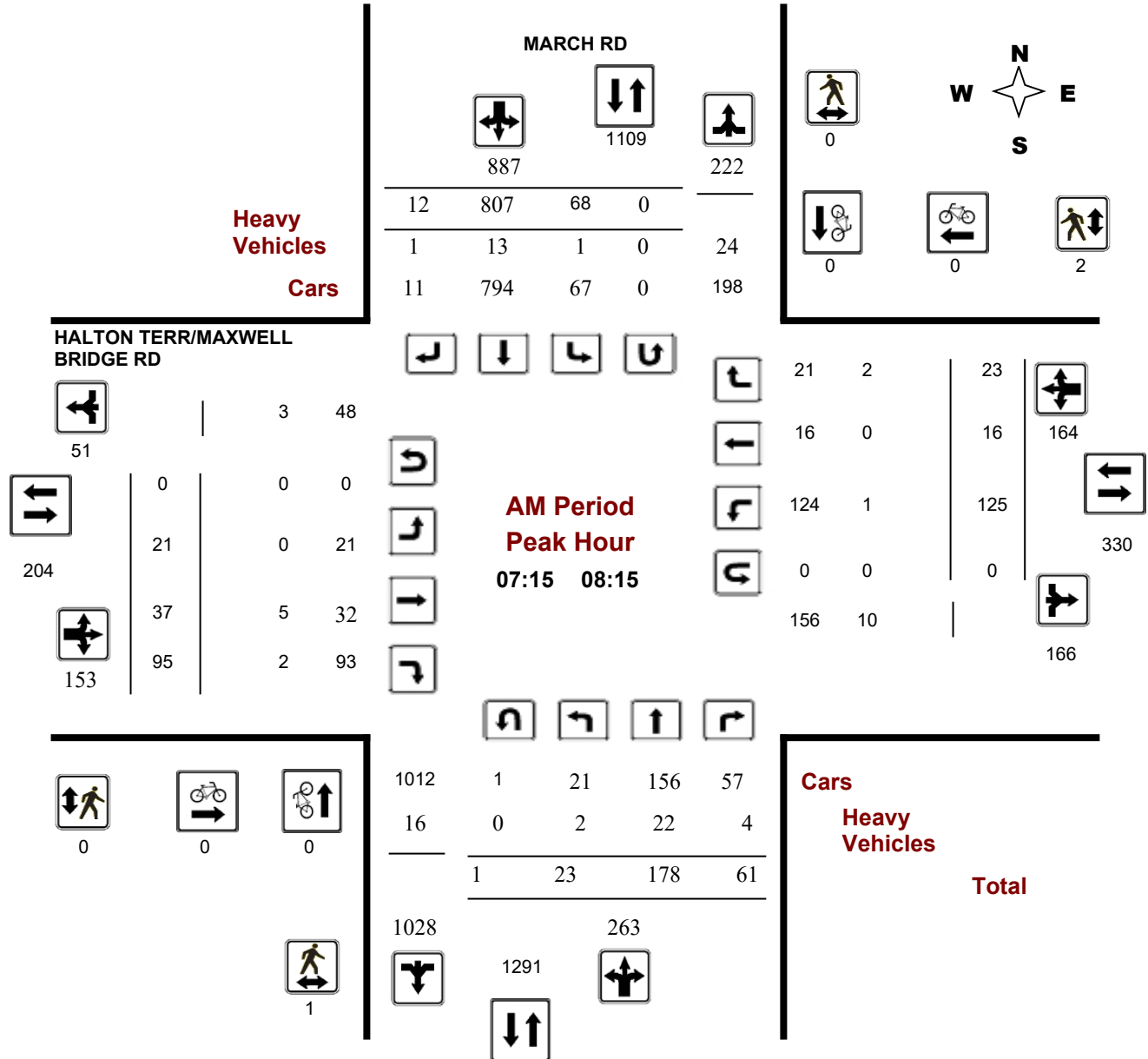

**Comments** 5472187 - WED JAN 22, 2020 - 8HRS - LORETTA



# Transportation Services - Traffic Services

## Turning Movement Count - Peak Hour Diagram

### HALTON TERR/MAXWELL BRIDGE RD @ MARCH RD

**Survey Date:** Wednesday, March 04, 2020

**Start Time:** 07:00

**WO No:** 39372

**Device:** Miovision

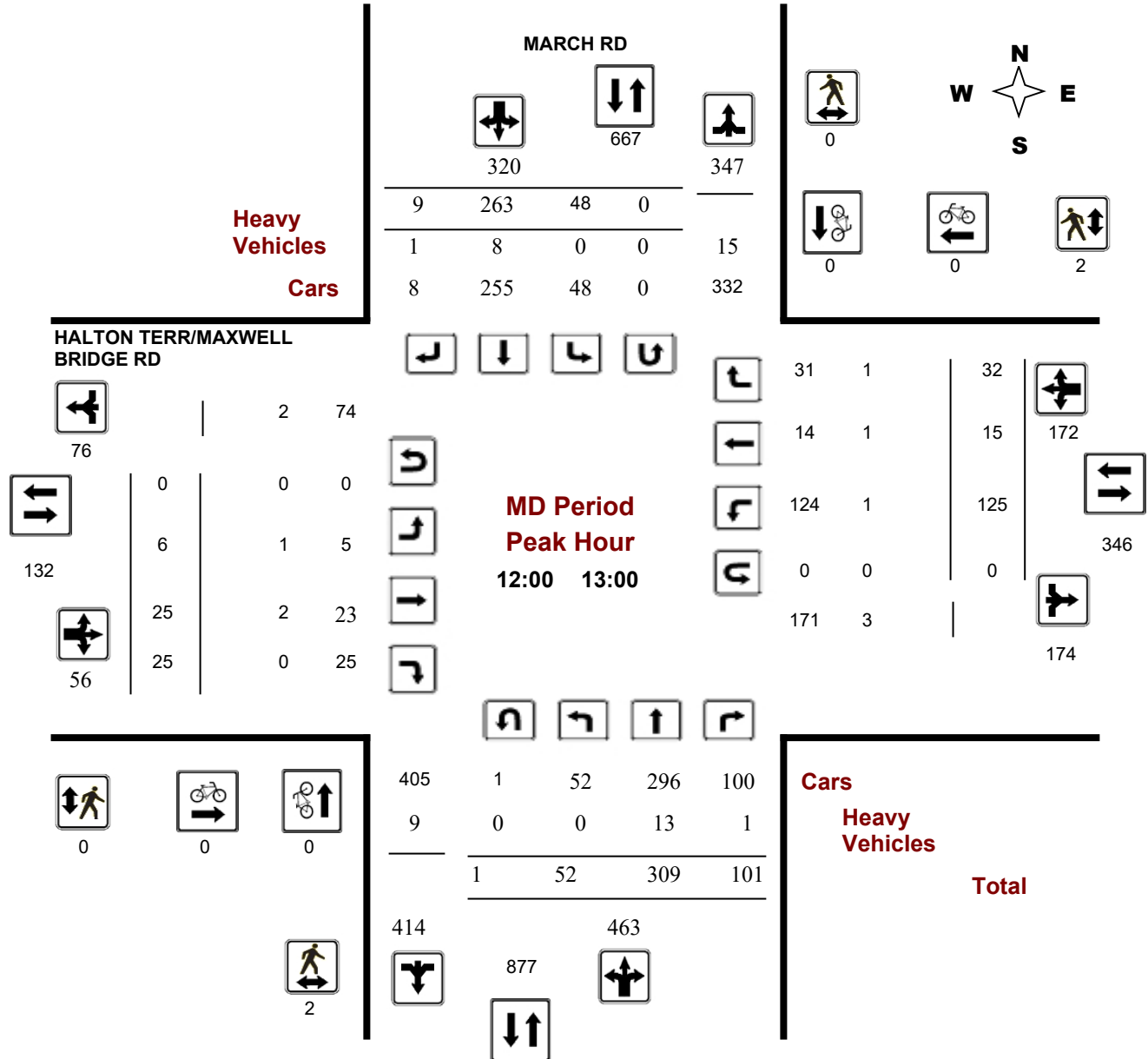

**Comments** 5472187 - WED JAN 22, 2020 - 8HRS - LORETTA



## Turning Movement Count - Peak Hour Diagram

### HALTON TERR/MAXWELL BRIDGE RD @ MARCH RD

**Survey Date:** Wednesday, March 04, 2020

**Start Time:** 07:00

**WO No:** 39372

**Device:** Miovision

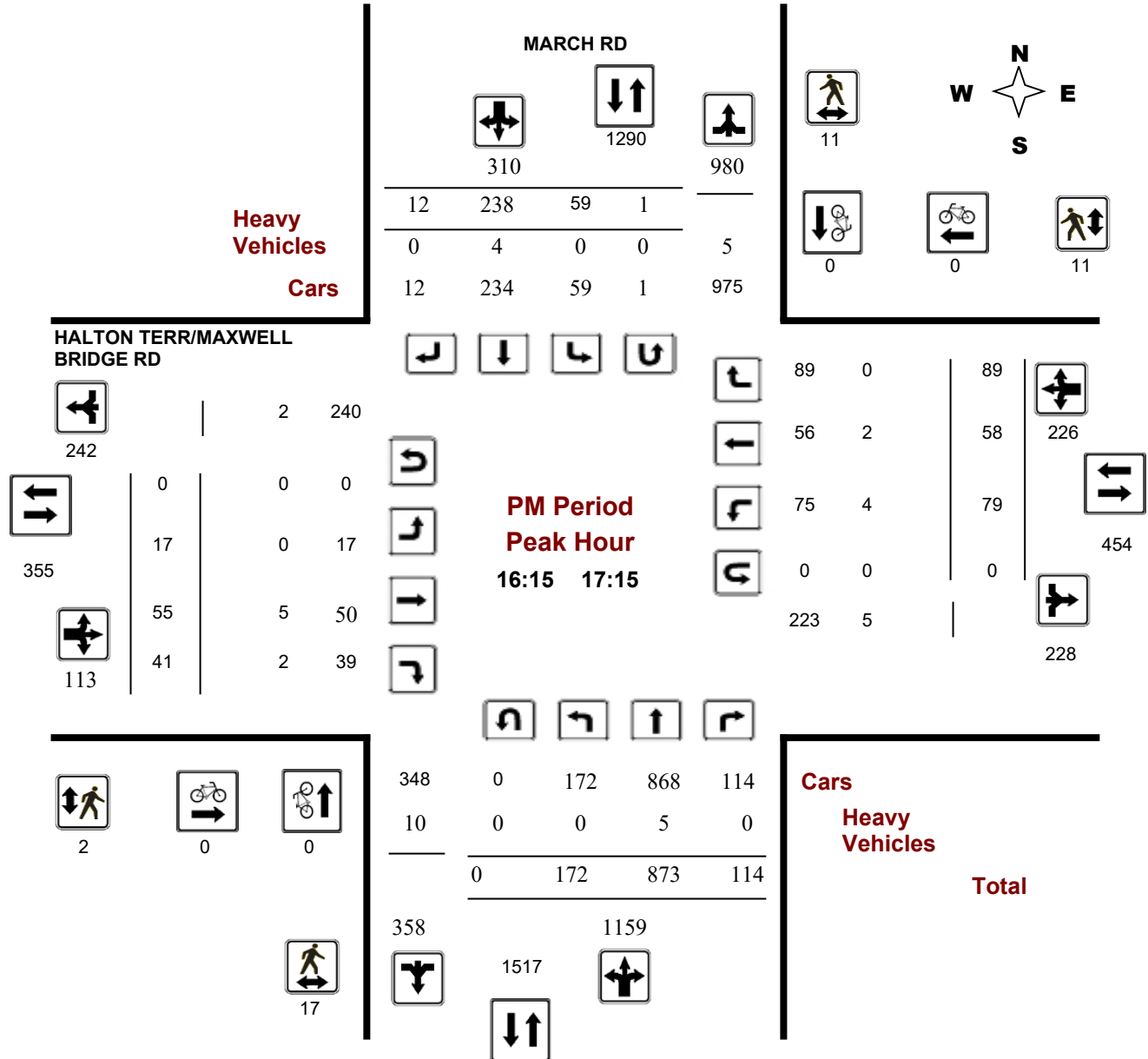

**Comments** 5472187 - WED JAN 22, 2020 - 8HRS - LORETTA



# Transportation Services - Traffic Services

## Turning Movement Count - Study Results

### HALTON TERR/MAXWELL BRIDGE RD @ MARCH RD

**Survey Date:** Wednesday, March 04, 2020

**WO No:** 39372

**Start Time:** 07:00

**Device:** Miovision

### Full Study Summary (8 HR Standard)

**Survey Date:** Wednesday, March 04, 2020

**Total Observed U-Turns**  
 Northbound: 8      Southbound: 2  
 Eastbound: 0      Westbound: 0

**AADT Factor**  
 1.00

Period	MARCH RD										HALTON TERR/MAXWELL BRIDGE RD										
	Northbound					Southbound					Eastbound					Westbound					Grand Total
	LT	ST	RT	NB TOT	LT	ST	RT	SB TOT	STR TOT	LT	ST	RT	EB TOT	LT	ST	RT	WB TOT	STR TOT			
07:00 08:00	21	180	50	251	56	785	10	851	1102	18	36	90	144	122	16	23	161	305	1407		
08:00 09:00	35	152	76	263	78	758	10	846	1109	21	32	83	136	141	24	19	184	320	1429		
09:00 10:00	28	208	62	298	69	517	13	599	897	21	42	87	150	120	28	29	177	327	1224		
11:30 12:30	58	268	85	411	52	283	9	344	755	3	24	28	55	115	18	27	160	215	970		
12:30 13:30	47	287	86	420	43	266	7	316	736	8	21	34	63	109	15	28	152	215	951		
15:00 16:00	96	608	104	808	58	265	19	342	1150	18	41	36	95	59	50	73	182	277	1427		
16:00 17:00	156	867	101	1124	63	246	11	320	1444	18	51	39	108	70	52	88	210	318	1762		
17:00 18:00	159	757	105	1021	59	236	17	312	1333	11	50	37	98	114	58	86	258	356	1689		
<b>Sub Total</b>	600	3327	669	4596	478	3356	96	3930	8526	118	297	434	849	850	261	373	1484	2333	10859		
<b>U Turns</b>				8				2	10				0				0	0	10		
<b>Total</b>	600	3327	669	4604	478	3356	96	3932	8536	118	297	434	849	850	261	373	1484	2333	10869		
<b>EQ 12Hr</b>	834	4625	930	6400	664	4665	133	5465	11865	164	413	603	1180	1182	363	518	2063	3243	15108		
Note: These values are calculated by multiplying the totals by the appropriate expansion factor.																	<b>1.39</b>				
<b>AVG 12Hr</b>	786	4358	876	6031	626	4396	126	5151	11865	155	389	569	1112	1114	342	489	1944	3243	15108		
Note: These volumes are calculated by multiplying the Equivalent 12 hr. totals by the AADT factor.																	<b>1</b>				
<b>AVG 24Hr</b>	1030	5709	1148	7901	820	5759	165	6748	14649	202	510	745	1457	1459	448	640	2547	4004	18653		
Note: These volumes are calculated by multiplying the Average Daily 12 hr. totals by 12 to 24 expansion factor.																	<b>1.31</b>				
Note: U-Turns provided for approach totals. Refer to 'U-Turn' Report for specific breakdown.																					



# Transportation Services - Traffic Services

## Turning Movement Count - Study Results

### HALTON TERR/MAXWELL BRIDGE RD @ MARCH RD

**Survey Date:** Wednesday, March 04, 2020

**WO No:** 39372

**Start Time:** 07:00

**Device:** Miovision

### Full Study 15 Minute Increments

#### MARCH RD

#### HALTON TERR/MAXWELL BRIDGE RD

Northbound

Southbound

Eastbound

Westbound

Time Period	LT	ST	RT	N TOT	LT	ST	RT	S TOT	STR TOT	LT	ST	RT	E TOT	LT	ST	RT	W TOT	STR TOT	Grand Total
07:00 07:15	6	45	14	65	9	179	0	188	15	2	8	19	29	36	4	6	46	15	328
07:15 07:30	8	54	12	74	14	224	1	239	17	5	6	27	38	29	4	3	36	17	387
07:30 07:45	4	54	16	75	12	183	5	200	7	8	10	25	43	25	3	4	32	7	350
07:45 08:00	3	27	8	38	21	199	4	224	7	3	12	19	34	32	5	10	47	7	343
08:00 08:15	8	43	25	76	21	201	2	224	12	5	9	24	38	39	4	6	49	12	387
08:15 08:30	6	32	18	56	20	182	1	203	5	5	8	18	31	37	3	5	45	5	335
08:30 08:45	11	42	22	76	15	189	3	207	9	7	7	27	41	26	6	5	37	9	361
08:45 09:00	10	35	11	56	22	186	4	212	6	4	8	14	26	39	11	3	53	6	347
09:00 09:15	7	52	23	82	23	166	8	197	16	8	18	37	63	40	10	9	59	16	401
09:15 09:30	8	54	17	79	17	126	1	144	10	7	9	33	49	30	10	10	50	10	322
09:30 09:45	7	55	11	74	17	125	2	144	5	4	6	13	23	27	3	4	34	5	275
09:45 10:00	6	47	11	65	12	100	2	114	4	2	9	4	15	23	5	6	34	4	228
11:30 11:45	17	55	19	92	14	77	4	95	5	1	6	10	17	35	5	8	48	5	252
11:45 12:00	15	57	20	94	10	70	1	81	10	2	6	10	18	25	6	3	34	10	227
12:00 12:15	16	84	26	126	12	70	3	85	3	0	4	3	7	30	2	8	40	3	258
12:15 12:30	10	72	20	103	16	66	1	83	3	0	8	5	13	25	5	8	38	3	237
12:30 12:45	15	79	28	122	8	56	2	66	7	3	6	8	17	37	5	9	51	7	256
12:45 13:00	11	74	27	112	12	71	3	86	10	3	7	9	19	33	3	7	43	10	260
13:00 13:15	11	83	10	104	8	71	1	80	4	1	6	13	20	18	2	6	26	4	230
13:15 13:30	10	51	21	82	15	68	1	85	6	1	2	4	7	21	5	6	32	6	206
15:00 15:15	13	130	25	168	10	63	4	77	1	2	5	7	14	15	9	19	43	1	302
15:15 15:30	29	129	33	191	13	56	6	75	9	2	11	8	21	16	15	15	46	9	333
15:30 15:45	24	163	16	203	13	65	4	82	10	7	9	5	21	13	16	23	52	10	358
15:45 16:00	30	186	30	246	22	81	5	108	9	7	16	16	39	15	10	16	41	9	434
16:00 16:15	27	202	22	251	17	62	3	82	7	4	12	11	27	17	9	25	51	7	411
16:15 16:30	40	251	17	308	16	64	1	81	3	6	13	11	30	14	11	18	43	3	462
16:30 16:45	43	214	32	289	10	50	4	65	1	2	11	8	21	20	14	27	61	1	436
16:45 17:00	46	200	30	276	20	70	3	93	3	6	15	9	30	19	18	18	55	3	454
17:00 17:15	43	208	35	286	13	54	4	71	2	3	16	13	32	26	15	26	67	2	456
17:15 17:30	32	217	18	267	17	65	1	83	1	3	10	5	18	30	14	21	65	1	433
17:30 17:45	37	173	26	236	21	50	3	74	9	5	15	7	27	37	11	27	75	9	412
17:45 18:00	47	159	26	232	8	67	9	84	0	0	9	12	21	21	18	12	51	0	388
Total:	600	3327	669	4604	478	3356	96	3932	216	118	297	434	849	850	261	373	1484	216	10,869

Note: U-Turns are included in Totals.



# Transportation Services - Traffic Services

## Turning Movement Count - Study Results

### HALTON TERR/MAXWELL BRIDGE RD @ MARCH RD

**Survey Date:** Wednesday, March 04, 2020

**WO No:** 39372

**Start Time:** 07:00

**Device:** Miovision

### Full Study Cyclist Volume

Time Period	MARCH RD			HALTON TERR/MAXWELL BRIDGE RD			Grand Total
	Northbound	Southbound	Street Total	Eastbound	Westbound	Street Total	
07:00 07:15	0	0	0	0	0	0	0
07:15 07:30	0	0	0	0	0	0	0
07:30 07:45	0	0	0	0	0	0	0
07:45 08:00	0	0	0	0	0	0	0
08:00 08:15	0	0	0	0	0	0	0
08:15 08:30	0	0	0	0	0	0	0
08:30 08:45	0	0	0	0	0	0	0
08:45 09:00	0	0	0	0	0	0	0
09:00 09:15	0	0	0	0	0	0	0
09:15 09:30	0	0	0	0	0	0	0
09:30 09:45	0	0	0	0	0	0	0
09:45 10:00	0	0	0	0	0	0	0
11:30 11:45	0	0	0	0	0	0	0
11:45 12:00	0	0	0	0	0	0	0
12:00 12:15	0	0	0	0	0	0	0
12:15 12:30	0	0	0	0	0	0	0
12:30 12:45	0	0	0	0	0	0	0
12:45 13:00	0	0	0	0	0	0	0
13:00 13:15	0	0	0	0	0	0	0
13:15 13:30	0	0	0	0	0	0	0
15:00 15:15	0	0	0	0	0	0	0
15:15 15:30	0	0	0	0	0	0	0
15:30 15:45	0	0	0	0	0	0	0
15:45 16:00	0	0	0	0	0	0	0
16:00 16:15	0	0	0	0	0	0	0
16:15 16:30	0	0	0	0	0	0	0
16:30 16:45	0	0	0	0	0	0	0
16:45 17:00	0	0	0	0	0	0	0
17:00 17:15	0	0	0	0	0	0	0
17:15 17:30	0	0	0	0	0	0	0
17:30 17:45	0	0	0	0	0	0	0
17:45 18:00	0	0	0	0	0	0	0
Total	0	0	0	0	0	0	0



# Transportation Services - Traffic Services

## Turning Movement Count - Study Results

### HALTON TERR/MAXWELL BRIDGE RD @ MARCH RD

**Survey Date:** Wednesday, March 04, 2020

**WO No:** 39372

**Start Time:** 07:00

**Device:** Miovision

### Full Study Pedestrian Volume

#### MARCH RD

#### HALTON TERR/MAXWELL BRIDGE RD

Time Period	NB Approach (E or W Crossing)	SB Approach (E or W Crossing)	Total	EB Approach (N or S Crossing)	WB Approach (N or S Crossing)	Total	Grand Total
07:00 07:15	0	1	1	0	0	0	1
07:15 07:30	0	0	0	0	1	1	1
07:30 07:45	0	0	0	0	0	0	0
07:45 08:00	1	0	1	0	1	1	2
08:00 08:15	0	0	0	0	0	0	0
08:15 08:30	0	0	0	0	0	0	0
08:30 08:45	0	0	0	0	1	1	1
08:45 09:00	1	2	3	0	1	1	4
09:00 09:15	1	0	1	0	0	0	1
09:15 09:30	0	1	1	1	1	2	3
09:30 09:45	0	0	0	0	0	0	0
09:45 10:00	0	0	0	1	0	1	1
11:30 11:45	2	0	2	0	1	1	3
11:45 12:00	2	0	2	0	0	0	2
12:00 12:15	0	0	0	0	2	2	2
12:15 12:30	1	0	1	0	0	0	1
12:30 12:45	1	0	1	0	0	0	1
12:45 13:00	0	0	0	0	0	0	0
13:00 13:15	2	0	2	0	0	0	2
13:15 13:30	2	0	2	0	0	0	2
15:00 15:15	0	5	5	0	4	4	9
15:15 15:30	4	2	6	0	6	6	12
15:30 15:45	1	0	1	0	0	0	1
15:45 16:00	0	1	1	1	0	1	2
16:00 16:15	3	5	8	1	1	2	10
16:15 16:30	6	0	6	1	6	7	13
16:30 16:45	4	8	12	0	1	1	13
16:45 17:00	6	2	8	1	2	3	11
17:00 17:15	1	1	2	0	2	2	4
17:15 17:30	3	1	4	0	1	1	5
17:30 17:45	3	4	7	0	3	3	10
17:45 18:00	3	0	3	3	0	3	6
<b>Total .....</b>	<b>47</b>	<b>33</b>	<b>80</b>	<b>9</b>	<b>34</b>	<b>43</b>	<b>123</b>

5472187 - WED JAN 22, 2020 - 8HRS - LORETTA



# Transportation Services - Traffic Services

## Turning Movement Count - Study Results

### HALTON TERR/MAXWELL BRIDGE RD @ MARCH RD

**Survey Date:** Wednesday, March 04, 2020

**WO No:** 39372

**Start Time:** 07:00

**Device:** Miovision

### Full Study Heavy Vehicles

**MARCH RD**

**HALTON TERR/MAXWELL BRIDGE RD**

Northbound

Southbound

Eastbound

Westbound

Time Period	Northbound			N TOT	Southbound			S TOT	STR TOT	Eastbound			E TOT	Westbound			W TOT	STR TOT	Grand Total
	LT	ST	RT		LT	ST	RT			LT	ST	RT		LT	ST	RT			
07:00 07:15	1	5	3	9	0	6	0	6	15	0	2	0	2	0	0	0	0	2	17
07:15 07:30	2	9	2	13	1	3	0	4	17	0	1	2	3	0	0	2	2	5	22
07:30 07:45	0	3	1	4	0	3	0	3	7	0	1	0	1	0	0	0	0	1	8
07:45 08:00	0	2	0	2	0	4	1	5	7	0	1	0	1	1	0	0	1	2	9
08:00 08:15	0	8	1	9	0	3	0	3	12	0	2	0	2	0	0	0	0	2	14
08:15 08:30	0	2	0	2	1	2	0	3	5	0	1	0	1	0	0	0	0	1	6
08:30 08:45	0	5	1	6	0	3	0	3	9	0	0	0	0	0	1	0	1	1	10
08:45 09:00	0	2	0	2	1	3	0	4	6	0	1	0	1	1	1	0	2	3	9
09:00 09:15	2	6	0	8	0	7	1	8	16	1	2	2	5	0	1	1	2	7	23
09:15 09:30	1	6	1	8	0	2	0	2	10	1	2	2	5	0	0	1	1	6	16
09:30 09:45	0	2	0	2	0	3	0	3	5	0	0	0	0	0	0	0	0	0	5
09:45 10:00	0	2	0	2	0	2	0	2	4	0	2	0	2	0	0	0	0	2	6
11:30 11:45	0	2	0	2	2	1	0	3	5	0	1	0	1	0	1	1	2	3	8
11:45 12:00	0	7	1	8	0	2	0	2	10	0	0	0	0	1	0	0	1	1	11
12:00 12:15	0	0	0	0	0	3	0	3	3	0	0	0	0	0	0	0	0	0	3
12:15 12:30	0	2	0	2	0	1	0	1	3	0	1	0	1	1	0	0	1	2	5
12:30 12:45	0	4	1	5	0	2	0	2	7	0	1	0	1	0	1	1	2	3	10
12:45 13:00	0	7	0	7	0	2	1	3	10	1	0	0	1	0	0	0	0	1	11
13:00 13:15	1	1	0	2	0	2	0	2	4	1	1	0	2	0	0	0	0	2	6
13:15 13:30	1	2	0	3	0	2	1	3	6	0	1	0	1	0	0	0	0	1	7
15:00 15:15	0	0	0	0	0	1	0	1	1	0	0	0	0	2	0	0	2	2	3
15:15 15:30	0	3	1	4	0	5	0	5	9	0	1	0	1	0	1	0	1	2	11
15:30 15:45	1	5	1	7	0	3	0	3	10	1	1	0	2	1	1	0	2	4	14
15:45 16:00	1	2	1	4	1	2	2	5	9	0	1	0	1	0	0	0	0	1	10
16:00 16:15	1	3	0	4	0	3	0	3	7	1	1	0	2	1	1	2	4	6	13
16:15 16:30	0	3	0	3	0	0	0	0	3	0	1	0	1	2	2	0	4	5	8
16:30 16:45	0	0	0	0	0	1	0	1	1	0	2	1	3	0	0	0	0	3	4
16:45 17:00	0	0	0	0	0	3	0	3	3	0	1	0	1	1	0	0	1	2	5
17:00 17:15	0	2	0	2	0	0	0	0	2	0	1	1	2	1	0	0	1	3	5
17:15 17:30	0	1	0	1	0	0	0	0	1	0	1	0	1	1	0	0	1	2	3
17:30 17:45	0	4	1	5	0	4	0	4	9	0	0	0	0	3	0	0	3	3	12
17:45 18:00	0	0	0	0	0	0	0	0	0	0	1	0	1	1	0	0	1	2	2
Total: None	11	100	15	126	6	78	6	90	216	6	31	8	45	17	10	8	35	80	296



# Transportation Services - Traffic Services

## Turning Movement Count - Study Results

### HALTON TERR/MAXWELL BRIDGE RD @ MARCH RD

**Survey Date:** Wednesday, March 04, 2020

**WO No:** 39372

**Start Time:** 07:00

**Device:** Miovision

### Full Study 15 Minute U-Turn Total

Time Period	MARCH RD		HALTON TERR/MAXWELL BRIDGE RD		Total
	Northbound U-Turn Total	Southbound U-Turn Total	Eastbound U-Turn Total	Westbound U-Turn Total	
07:00 - 07:15	0	0	0	0	0
07:15 - 07:30	0	0	0	0	0
07:30 - 07:45	1	0	0	0	1
07:45 - 08:00	0	0	0	0	0
08:00 - 08:15	0	0	0	0	0
08:15 - 08:30	0	0	0	0	0
08:30 - 08:45	1	0	0	0	1
08:45 - 09:00	0	0	0	0	0
09:00 - 09:15	0	0	0	0	0
09:15 - 09:30	0	0	0	0	0
09:30 - 09:45	1	0	0	0	1
09:45 - 10:00	1	0	0	0	1
11:30 - 11:45	1	0	0	0	1
11:45 - 12:00	2	0	0	0	2
12:00 - 12:15	0	0	0	0	0
12:15 - 12:30	1	0	0	0	1
12:30 - 12:45	0	0	0	0	0
12:45 - 13:00	0	0	0	0	0
13:00 - 13:15	0	0	0	0	0
13:15 - 13:30	0	1	0	0	1
15:00 - 15:15	0	0	0	0	0
15:15 - 15:30	0	0	0	0	0
15:30 - 15:45	0	0	0	0	0
15:45 - 16:00	0	0	0	0	0
16:00 - 16:15	0	0	0	0	0
16:15 - 16:30	0	0	0	0	0
16:30 - 16:45	0	1	0	0	1
16:45 - 17:00	0	0	0	0	0
17:00 - 17:15	0	0	0	0	0
17:15 - 17:30	0	0	0	0	0
17:30 - 17:45	0	0	0	0	0
17:45 - 18:00	0	0	0	0	0
<b>Total</b>	<b>8</b>	<b>2</b>	<b>0</b>	<b>0</b>	<b>10</b>

## Turning Movement Count - Study Results

### KLONDIKE RD @ MARCH RD

**Survey Date:** Wednesday, March 04, 2020

**WO No:** 39371

**Start Time:** 07:00

**Device:** Miovision

### Full Study Diagram

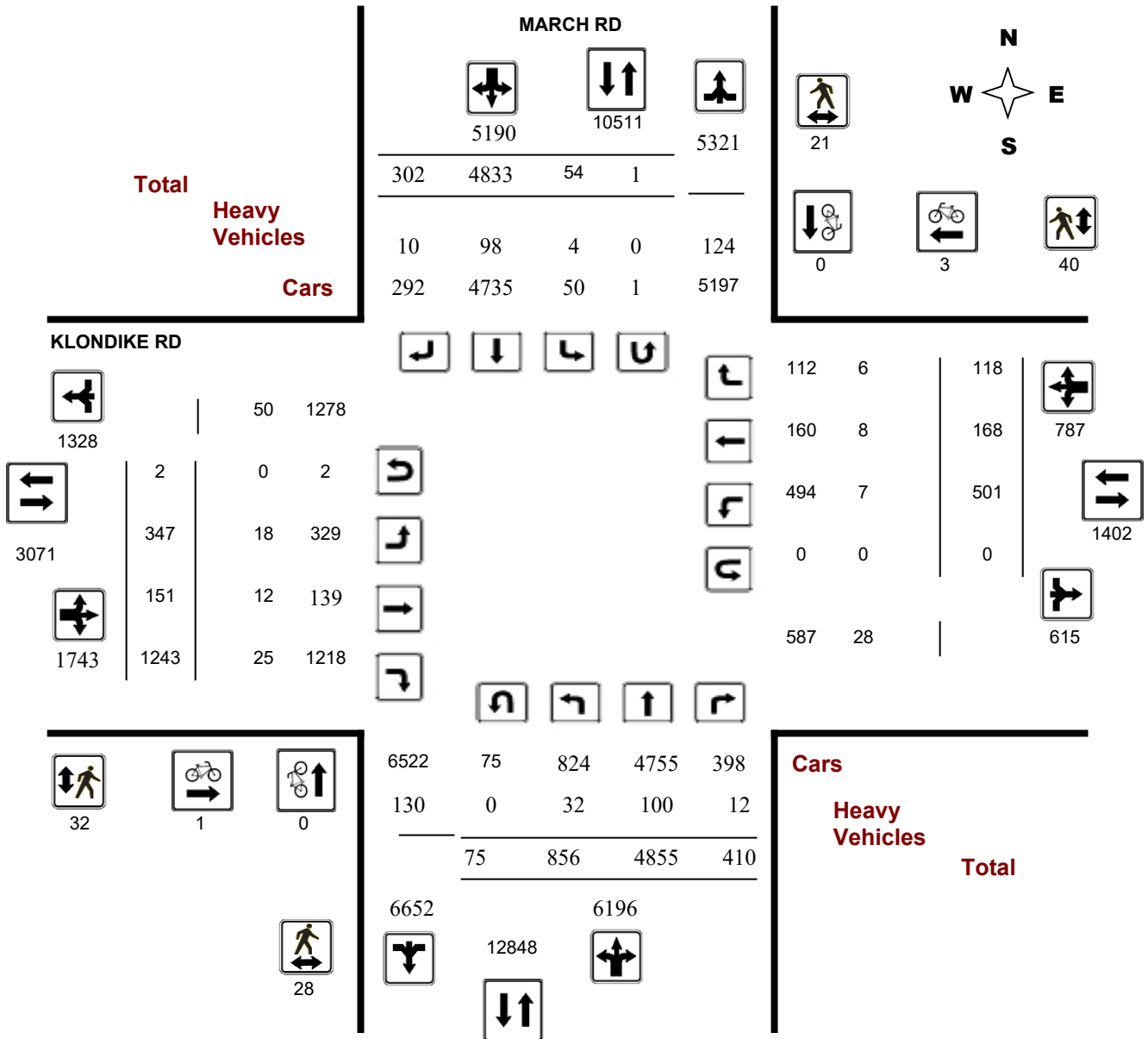

5472186 - WED JAN 22, 2020 - 8HRS - LORETTA



## Turning Movement Count - Study Results

### KLONDIKE RD @ MARCH RD

**Survey Date:** Wednesday, March 04, 2020

**WO No:** 39371

**Start Time:** 07:00

**Device:** Miovision

### Full Study Peak Hour Diagram

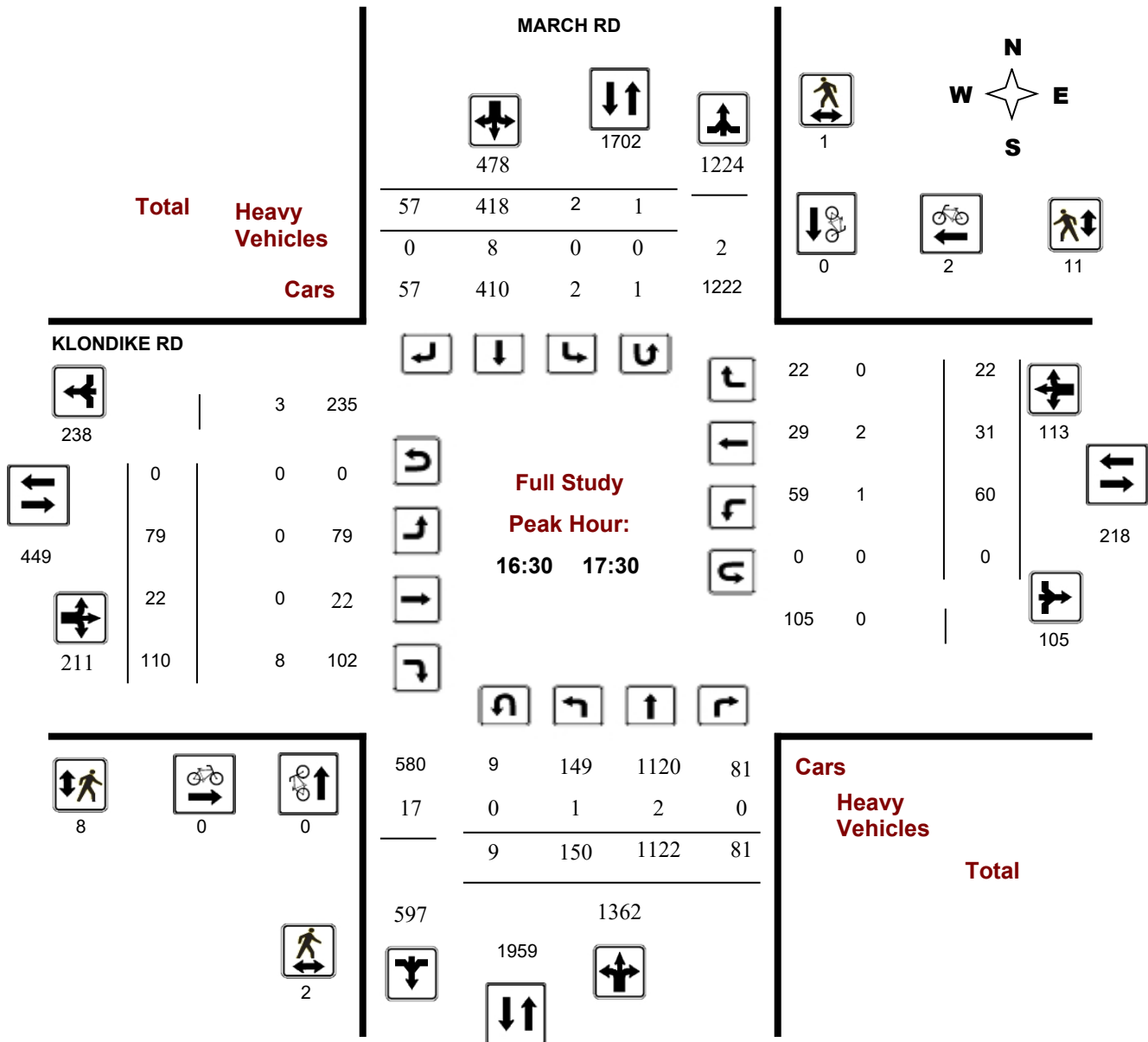

5472186 - WED JAN 22, 2020 - 8HRS - LORETTA



# Transportation Services - Traffic Services

## Turning Movement Count - Peak Hour Diagram

### KLONDIKE RD @ MARCH RD

**Survey Date:** Wednesday, March 04, 2020

**Start Time:** 07:00

**WO No:** 39371

**Device:** Miovision

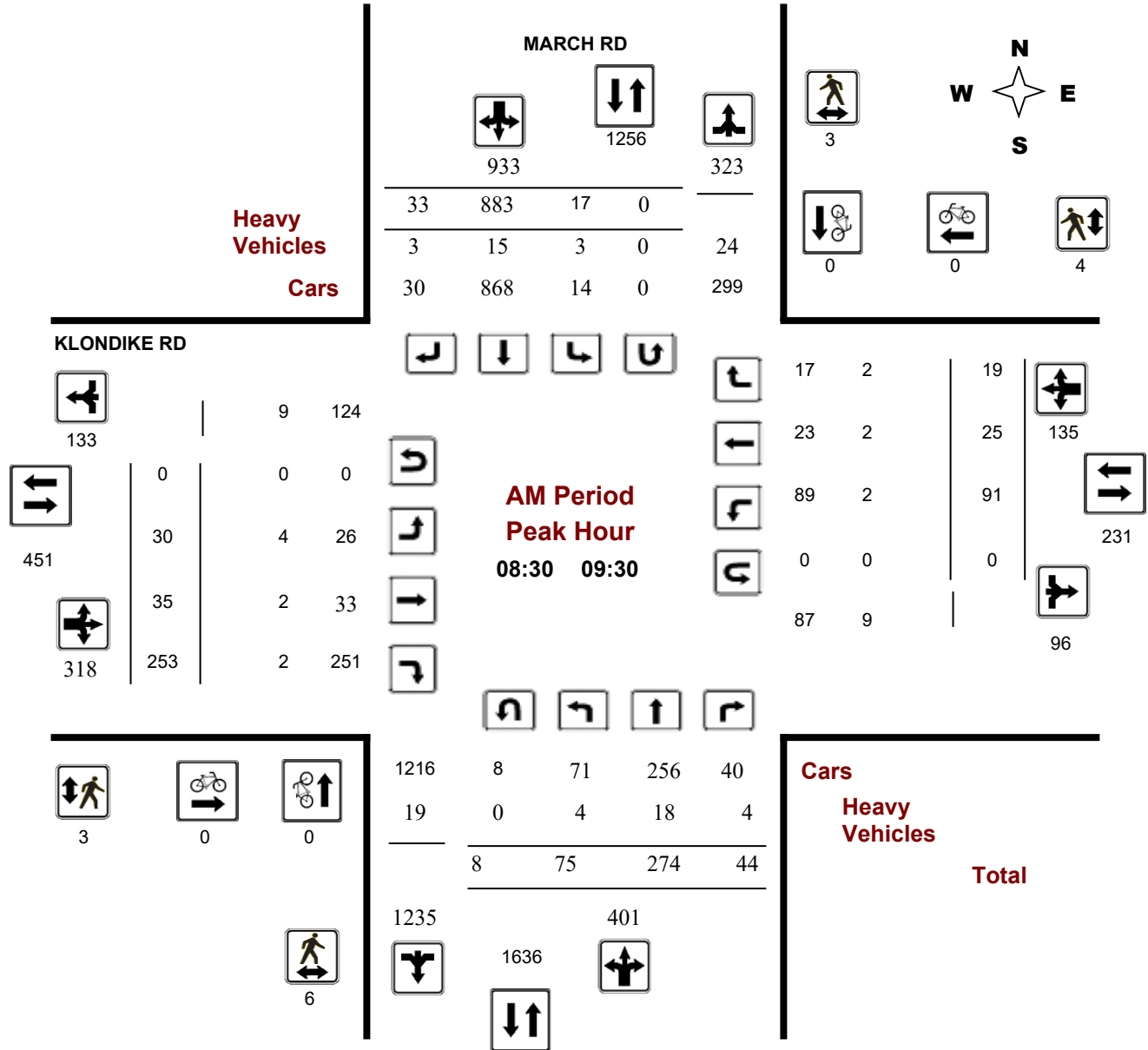

**Comments** 5472186 - WED JAN 22, 2020 - 8HRS - LORETTA



# Transportation Services - Traffic Services

## Turning Movement Count - Peak Hour Diagram

### KLONDIKE RD @ MARCH RD

**Survey Date:** Wednesday, March 04, 2020

**Start Time:** 07:00

**WO No:** 39371

**Device:** Miovision

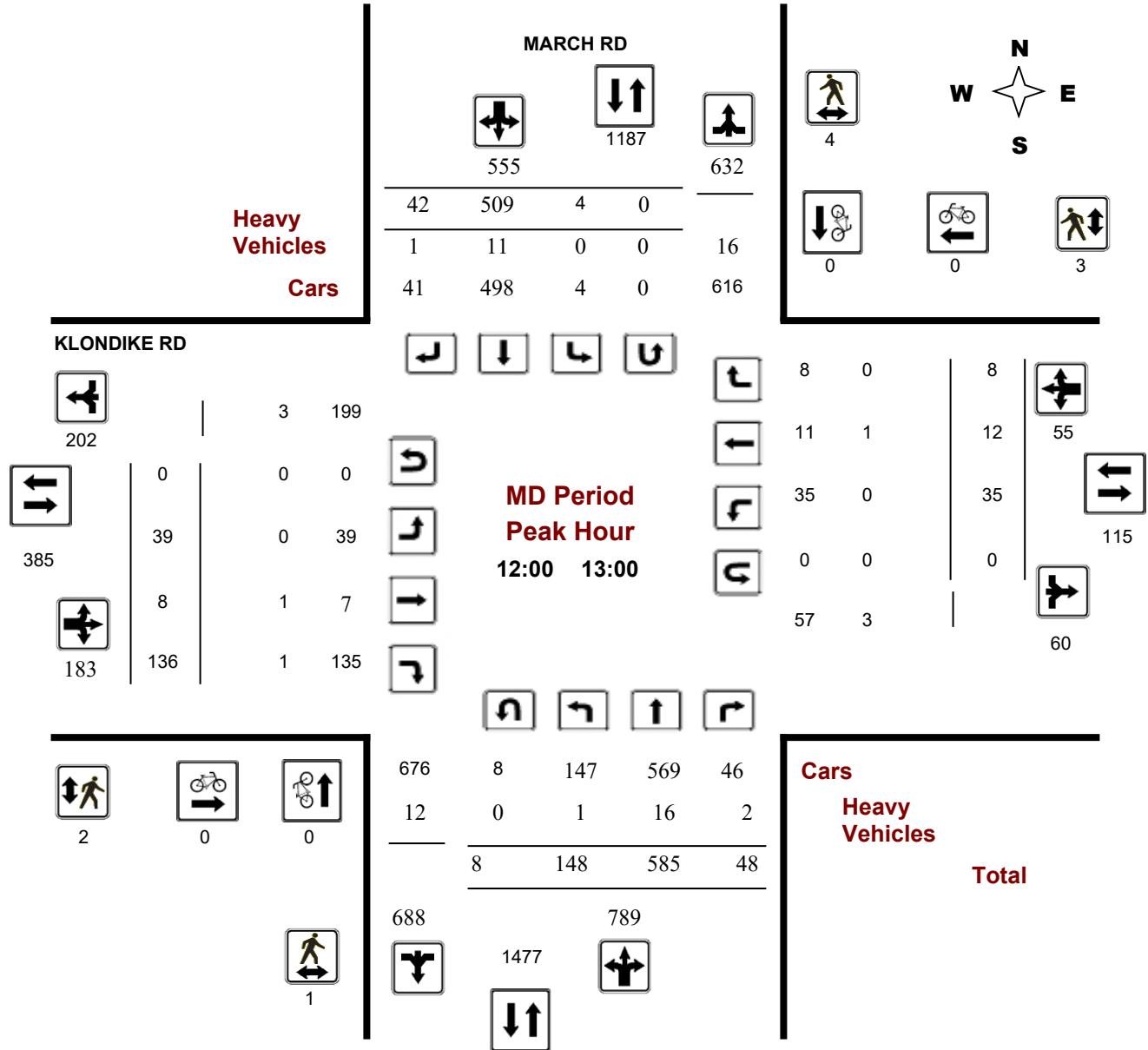

**Comments** 5472186 - WED JAN 22, 2020 - 8HRS - LORETTA

# Transportation Services - Traffic Services

## Turning Movement Count - Peak Hour Diagram

### KLONDIKE RD @ MARCH RD

**Survey Date:** Wednesday, March 04, 2020

**Start Time:** 07:00

**WO No:** 39371

**Device:** Miovision

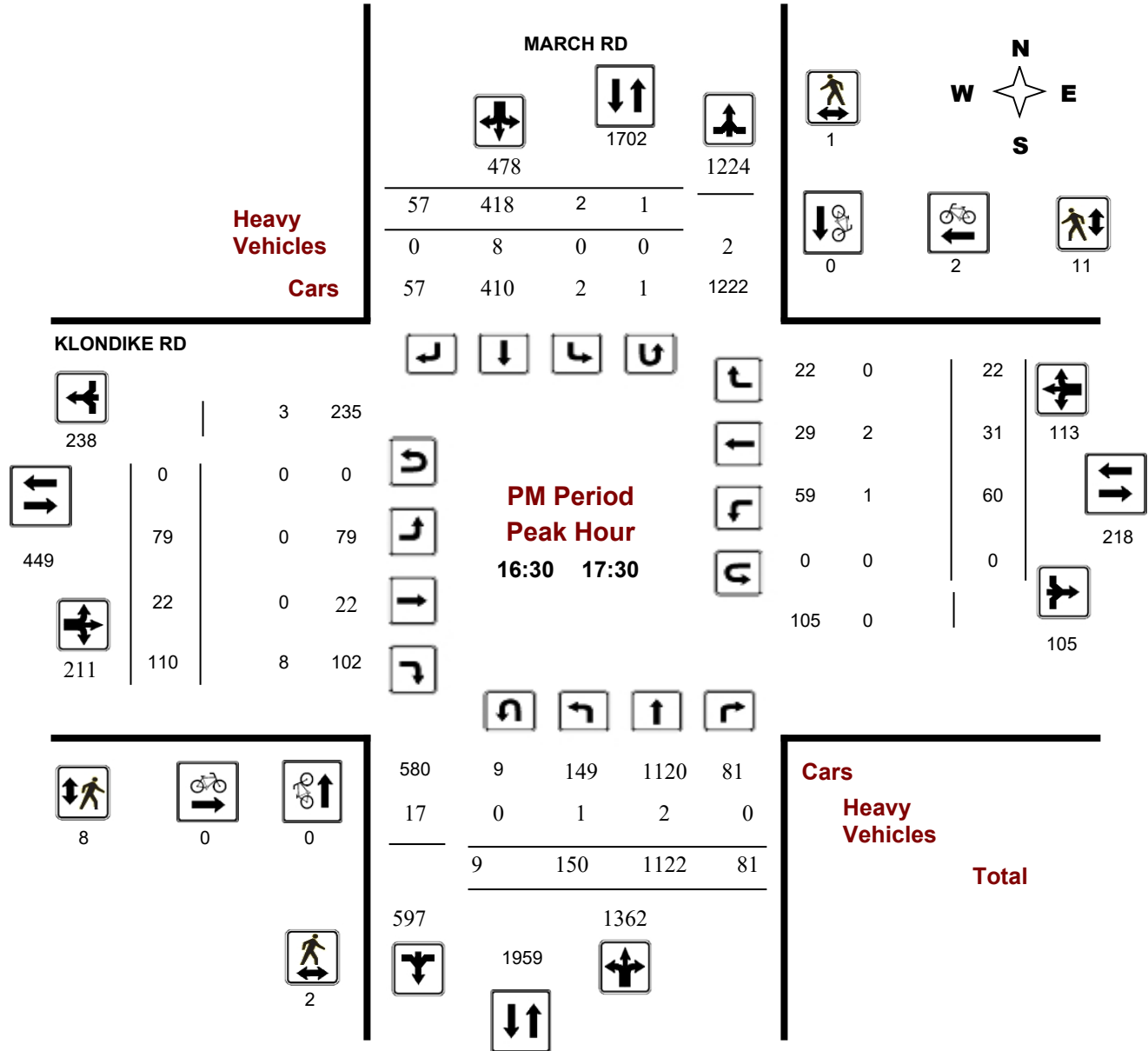

**Comments** 5472186 - WED JAN 22, 2020 - 8HRS - LORETTA



# Transportation Services - Traffic Services

## Turning Movement Count - Study Results

### KLONDIKE RD @ MARCH RD

**Survey Date:** Wednesday, March 04, 2020

**WO No:** 39371

**Start Time:** 07:00

**Device:** Miovision

### Full Study Summary (8 HR Standard)

**Survey Date:** Wednesday, March 04, 2020

**Total Observed U-Turns**

**AADT Factor**

Northbound: 75      Southbound: 1  
 Eastbound: 2      Westbound: 0

1.00

Period	MARCH RD										KLONDIKE RD										Grand Total
	Northbound					Southbound					Eastbound					Westbound					
	LT	ST	RT	NB TOT	STR TOT	LT	ST	RT	SB TOT	STR TOT	LT	ST	RT	EB TOT	STR TOT	LT	ST	RT	WB TOT	STR TOT	
07:00 08:00	42	268	31	341	6	966	16	988	1329	11	12	217	240	79	9	10	98	338	1667		
08:00 09:00	65	232	38	335	8	954	31	993	1328	22	27	221	270	49	21	8	78	348	1676		
09:00 10:00	70	320	40	430	13	720	27	760	1190	27	18	211	256	100	18	15	133	389	1579		
11:30 12:30	129	567	42	738	3	485	40	528	1266	32	10	125	167	43	13	4	60	227	1493		
12:30 13:30	134	473	42	649	1	492	42	535	1184	50	12	159	221	32	13	10	55	276	1460		
15:00 16:00	126	804	58	988	11	391	34	436	1424	62	28	100	190	62	26	32	120	310	1734		
16:00 17:00	152	1123	74	1349	5	383	55	443	1792	65	20	112	197	76	36	24	136	333	2125		
17:00 18:00	138	1068	85	1291	7	442	57	506	1797	78	24	98	200	60	32	15	107	307	2104		
<b>Sub Total</b>	856	4855	410	6121	54	4833	302	5189	11310	347	151	1243	1741	501	168	118	787	2528	13838		
<b>U Turns</b>				75				1	76				2				0	2	78		
<b>Total</b>	856	4855	410	6196	54	4833	302	5190	11386	347	151	1243	1743	501	168	118	787	2530	13916		
<b>EQ 12Hr</b>	1190	6748	570	8612	75	6718	420	7214	15827	482	210	1728	2423	696	234	164	1094	3517	19343		
Note: These values are calculated by multiplying the totals by the appropriate expansion factor.																	<b>1.39</b>				
<b>AVG 12Hr</b>	1121	6360	537	8117	71	6331	396	6799	15827	455	198	1628	2283	656	220	155	1031	3517	19343		
Note: These volumes are calculated by multiplying the Equivalent 12 hr. totals by the AADT factor.																	<b>1</b>				
<b>AVG 24Hr</b>	1469	8332	704	10633	93	8294	518	8907	19540	595	259	2133	2991	860	288	202	1351	4342	23882		
Note: These volumes are calculated by multiplying the Average Daily 12 hr. totals by 12 to 24 expansion factor.																	<b>1.31</b>				
Note: U-Turns provided for approach totals. Refer to 'U-Turn' Report for specific breakdown.																					



# Transportation Services - Traffic Services

## Turning Movement Count - Study Results

### KLONDIKE RD @ MARCH RD

**Survey Date:** Wednesday, March 04, 2020

**WO No:** 39371

**Start Time:** 07:00

**Device:** Miovision

### Full Study 15 Minute Increments

#### MARCH RD

#### KLONDIKE RD

Northbound

Southbound

Eastbound

Westbound

Time Period	LT	ST	RT	N TOT	LT	ST	RT	S TOT	STR TOT	LT	ST	RT	E TOT	LT	ST	RT	W TOT	STR TOT	Grand Total
07:00 07:15	3	66	8	84	3	229	6	238	13	2	0	59	61	21	1	2	24	13	407
07:15 07:30	15	76	5	99	0	276	3	279	16	6	5	53	64	17	1	3	21	16	463
07:30 07:45	9	68	9	89	0	225	3	228	6	1	2	46	49	21	4	5	30	6	396
07:45 08:00	15	58	9	84	3	236	4	243	11	2	5	59	66	20	3	0	23	11	416
08:00 08:15	14	60	7	84	0	265	7	272	14	2	4	45	51	21	5	1	27	14	434
08:15 08:30	13	52	9	79	3	230	5	238	7	4	5	51	60	8	4	2	14	7	391
08:30 08:45	23	73	10	110	3	223	8	234	8	3	7	62	72	13	1	0	14	8	430
08:45 09:00	15	47	12	74	2	236	11	249	11	13	11	63	87	7	11	5	23	11	433
09:00 09:15	19	72	14	106	10	235	7	252	18	9	12	69	90	31	6	10	47	18	495
09:15 09:30	18	82	8	111	2	189	7	198	10	5	5	59	69	40	7	4	51	10	429
09:30 09:45	20	85	8	115	0	169	5	174	6	3	1	42	46	12	2	1	15	6	350
09:45 10:00	13	81	10	106	1	127	8	136	2	10	0	41	51	17	3	0	20	2	313
11:30 11:45	23	123	9	158	0	129	11	140	9	8	3	26	37	10	4	0	14	9	349
11:45 12:00	23	128	7	160	0	108	15	123	8	9	1	35	45	12	4	2	18	8	346
12:00 12:15	51	179	16	251	1	131	2	134	6	8	2	28	38	11	2	0	13	6	436
12:15 12:30	32	137	10	180	2	117	12	131	8	7	4	36	47	10	3	2	15	8	373
12:30 12:45	38	143	7	189	0	128	12	140	7	11	1	38	50	11	4	4	19	7	398
12:45 13:00	27	126	15	169	1	133	16	150	10	13	1	34	48	3	3	2	8	10	375
13:00 13:15	28	108	8	146	0	126	6	132	5	10	3	53	66	8	2	2	12	5	356
13:15 13:30	41	96	12	151	0	105	8	113	7	16	7	34	57	10	4	2	16	7	337
15:00 15:15	19	164	13	197	2	101	9	112	5	17	3	18	40	10	5	3	18	5	367
15:15 15:30	32	209	15	257	3	89	9	101	13	15	8	23	46	13	9	3	25	13	429
15:30 15:45	37	201	19	257	5	84	5	94	13	14	10	27	51	15	4	5	24	13	426
15:45 16:00	38	230	11	282	1	117	11	129	7	16	7	32	55	24	8	21	53	7	519
16:00 16:15	38	262	21	323	3	96	11	110	7	14	4	31	49	31	11	4	46	7	528
16:15 16:30	39	307	12	361	1	100	10	111	7	16	5	25	46	13	8	6	27	7	545
16:30 16:45	38	283	24	346	0	87	18	106	2	18	5	24	47	15	14	7	36	2	535
16:45 17:00	37	271	17	327	1	100	16	117	4	17	6	32	55	17	3	7	27	4	526
17:00 17:15	26	279	19	325	0	109	8	117	2	21	5	21	47	13	7	2	22	2	511
17:15 17:30	49	289	21	364	1	122	15	138	3	23	6	33	62	15	7	6	28	3	592
17:30 17:45	36	266	22	324	2	102	17	121	10	13	5	21	39	19	8	3	30	10	514
17:45 18:00	27	234	23	288	4	109	17	130	1	21	8	23	52	13	10	4	27	1	497
<b>Total:</b>	<b>856</b>	<b>4855</b>	<b>410</b>	<b>6196</b>	<b>54</b>	<b>4833</b>	<b>302</b>	<b>5190</b>	<b>256</b>	<b>347</b>	<b>151</b>	<b>1243</b>	<b>1743</b>	<b>501</b>	<b>168</b>	<b>118</b>	<b>787</b>	<b>256</b>	<b>13,916</b>

Note: U-Turns are included in Totals.



# Transportation Services - Traffic Services

## Turning Movement Count - Study Results

### KLONDIKE RD @ MARCH RD

**Survey Date:** Wednesday, March 04, 2020

**WO No:** 39371

**Start Time:** 07:00

**Device:** Miovision

### Full Study Cyclist Volume

Time Period	MARCH RD			KLONDIKE RD			Grand Total
	Northbound	Southbound	Street Total	Eastbound	Westbound	Street Total	
07:00 07:15	0	0	0	0	0	0	0
07:15 07:30	0	0	0	0	0	0	0
07:30 07:45	0	0	0	0	0	0	0
07:45 08:00	0	0	0	0	0	0	0
08:00 08:15	0	0	0	0	0	0	0
08:15 08:30	0	0	0	0	0	0	0
08:30 08:45	0	0	0	0	0	0	0
08:45 09:00	0	0	0	0	0	0	0
09:00 09:15	0	0	0	0	0	0	0
09:15 09:30	0	0	0	0	0	0	0
09:30 09:45	0	0	0	0	0	0	0
09:45 10:00	0	0	0	0	0	0	0
11:30 11:45	0	0	0	0	0	0	0
11:45 12:00	0	0	0	0	0	0	0
12:00 12:15	0	0	0	0	0	0	0
12:15 12:30	0	0	0	0	0	0	0
12:30 12:45	0	0	0	0	0	0	0
12:45 13:00	0	0	0	0	0	0	0
13:00 13:15	0	0	0	0	0	0	0
13:15 13:30	0	0	0	0	0	0	0
15:00 15:15	0	0	0	0	0	0	0
15:15 15:30	0	0	0	0	1	1	1
15:30 15:45	0	0	0	0	0	0	0
15:45 16:00	0	0	0	1	0	1	1
16:00 16:15	0	0	0	0	0	0	0
16:15 16:30	0	0	0	0	0	0	0
16:30 16:45	0	0	0	0	1	1	1
16:45 17:00	0	0	0	0	0	0	0
17:00 17:15	0	0	0	0	0	0	0
17:15 17:30	0	0	0	0	1	1	1
17:30 17:45	0	0	0	0	0	0	0
17:45 18:00	0	0	0	0	0	0	0
Total	0	0	0	1	3	4	4



# Transportation Services - Traffic Services

## Turning Movement Count - Study Results

### KLONDIKE RD @ MARCH RD

**Survey Date:** Wednesday, March 04, 2020

**WO No:** 39371

**Start Time:** 07:00

**Device:** Miovision

### Full Study Pedestrian Volume

#### MARCH RD

#### KLONDIKE RD

Time Period	NB Approach (E or W Crossing)	SB Approach (E or W Crossing)	Total	EB Approach (N or S Crossing)	WB Approach (N or S Crossing)	Total	Grand Total
07:00 07:15	1	0	1	0	1	1	2
07:15 07:30	1	0	1	0	2	2	3
07:30 07:45	0	0	0	0	0	0	0
07:45 08:00	0	0	0	0	0	0	0
08:00 08:15	3	0	3	0	0	0	3
08:15 08:30	1	0	1	0	0	0	1
08:30 08:45	0	0	0	1	0	1	1
08:45 09:00	3	0	3	1	2	3	6
09:00 09:15	1	2	3	1	0	1	4
09:15 09:30	2	1	3	0	2	2	5
09:30 09:45	0	2	2	1	0	1	3
09:45 10:00	0	0	0	1	0	1	1
11:30 11:45	0	1	1	0	0	0	1
11:45 12:00	1	2	3	3	0	3	6
12:00 12:15	0	0	0	0	1	1	1
12:15 12:30	1	1	2	0	1	1	3
12:30 12:45	0	1	1	1	1	2	3
12:45 13:00	0	2	2	1	0	1	3
13:00 13:15	1	0	1	1	3	4	5
13:15 13:30	0	0	0	0	0	0	0
15:00 15:15	2	1	3	2	4	6	9
15:15 15:30	2	3	5	2	1	3	8
15:30 15:45	1	1	2	1	2	3	5
15:45 16:00	2	0	2	0	1	1	3
16:00 16:15	2	2	4	1	1	2	6
16:15 16:30	0	1	1	0	1	1	2
16:30 16:45	0	0	0	1	2	3	3
16:45 17:00	1	1	2	2	1	3	5
17:00 17:15	1	0	1	2	5	7	8
17:15 17:30	0	0	0	3	3	6	6
17:30 17:45	1	0	1	3	6	9	10
17:45 18:00	1	0	1	4	0	4	5
<b>Total</b> .....	<b>28</b>	<b>21</b>	<b>49</b>	<b>32</b>	<b>40</b>	<b>72</b>	<b>121</b>

5472186 - WED JAN 22, 2020 - 8HRS - LORETTA





# Transportation Services - Traffic Services

## Turning Movement Count - Study Results

### KLONDIKE RD @ MARCH RD

**Survey Date:** Wednesday, March 04, 2020

**WO No:** 39371

**Start Time:** 07:00

**Device:** Miovision

### Full Study Heavy Vehicles

#### MARCH RD

#### KLONDIKE RD

Northbound

Southbound

Eastbound

Westbound

Time Period	Northbound			N TOT	Southbound			S TOT	STR TOT	Eastbound			E TOT	Westbound			W TOT	STR TOT	Grand Total	
	LT	ST	RT		LT	ST	RT			LT	ST	RT		LT	ST	RT				
07:00 07:15	0	5	0	5	0	6	2	8	13	0	0	0	0	0	0	0	0	0	13	
07:15 07:30	2	10	0	12	0	3	1	4	16	3	2	0	5	0	0	2	2	7	23	
07:30 07:45	1	2	0	3	0	3	0	3	6	0	1	0	1	0	0	0	0	1	7	
07:45 08:00	3	3	1	7	0	4	0	4	11	0	0	0	0	0	0	0	0	0	11	
08:00 08:15	3	7	0	10	0	4	0	4	14	1	1	0	2	0	0	0	0	2	16	
08:15 08:30	2	2	1	5	0	2	0	2	7	0	0	0	0	0	0	0	0	0	7	
08:30 08:45	1	4	0	5	0	2	1	3	8	1	0	2	3	0	0	0	0	3	11	
08:45 09:00	2	1	2	5	0	4	2	6	11	1	1	0	2	0	0	0	0	2	13	
09:00 09:15	1	6	2	9	2	7	0	9	18	2	0	0	2	1	1	2	4	6	24	
09:15 09:30	0	7	0	7	1	2	0	3	10	0	1	0	1	1	1	0	2	3	13	
09:30 09:45	1	1	0	2	0	4	0	4	6	0	0	0	0	0	0	0	0	0	6	
09:45 10:00	0	1	0	1	0	1	0	1	2	1	0	0	1	0	0	0	0	1	3	
11:30 11:45	0	7	0	7	0	1	1	2	9	1	0	1	2	0	0	0	0	2	11	
11:45 12:00	0	3	0	3	0	4	1	5	8	1	0	0	1	0	0	0	0	1	9	
12:00 12:15	1	0	2	3	0	3	0	3	6	0	0	0	0	0	0	0	0	0	6	
12:15 12:30	0	4	0	4	0	4	0	4	8	0	1	0	1	0	0	0	0	1	9	
12:30 12:45	0	5	0	5	0	2	0	2	7	0	0	1	1	0	1	0	1	2	9	
12:45 13:00	0	7	0	7	0	2	1	3	10	0	0	0	0	0	0	0	0	0	10	
13:00 13:15	1	1	0	2	0	3	0	3	5	0	0	2	2	0	0	0	0	2	7	
13:15 13:30	2	3	0	5	0	2	0	2	7	0	1	1	2	0	0	0	0	2	9	
15:00 15:15	2	0	0	2	0	3	0	3	5	0	0	2	2	0	1	0	1	3	8	
15:15 15:30	3	4	1	8	0	5	0	5	13	2	0	1	3	0	0	0	0	3	16	
15:30 15:45	1	7	0	8	0	5	0	5	13	0	1	2	3	0	0	0	0	3	16	
15:45 16:00	1	1	2	4	1	2	0	3	7	2	3	1	6	0	1	2	3	9	16	
16:00 16:15	1	2	0	3	0	3	1	4	7	1	0	1	2	4	1	0	5	7	14	
16:15 16:30	3	1	1	5	0	2	0	2	7	1	0	1	2	0	0	0	0	2	9	
16:30 16:45	0	0	0	0	0	2	0	2	2	0	0	3	3	0	1	0	1	4	6	
16:45 17:00	0	0	0	0	0	4	0	4	4	0	0	4	4	0	0	0	0	4	8	
17:00 17:15	0	1	0	1	0	1	0	1	2	0	0	0	0	1	0	0	1	1	3	
17:15 17:30	1	1	0	2	0	1	0	1	3	0	0	1	1	0	1	0	1	2	5	
17:30 17:45	0	4	0	4	0	6	0	6	10	1	0	1	2	0	0	0	0	2	12	
17:45 18:00	0	0	0	0	0	1	0	1	1	0	0	1	1	0	0	0	0	1	2	
<b>Total:</b>	None	32	100	12	144	4	98	10	112	256	18	12	25	55	7	8	6	21	76	332



# Transportation Services - Traffic Services

## Turning Movement Count - Study Results

### KLONDIKE RD @ MARCH RD

**Survey Date:** Wednesday, March 04, 2020

**WO No:** 39371

**Start Time:** 07:00

**Device:** Miovision

### Full Study 15 Minute U-Turn Total

MARCH RD

KLONDIKE RD

Time Period		Northbound U-Turn Total	Southbound U-Turn Total	Eastbound U-Turn Total	Westbound U-Turn Total	Total
07:00	07:15	7	0	0	0	7
07:15	07:30	3	0	0	0	3
07:30	07:45	3	0	0	0	3
07:45	08:00	2	0	0	0	2
08:00	08:15	3	0	0	0	3
08:15	08:30	5	0	0	0	5
08:30	08:45	4	0	0	0	4
08:45	09:00	0	0	0	0	0
09:00	09:15	1	0	0	0	1
09:15	09:30	3	0	0	0	3
09:30	09:45	2	0	0	0	2
09:45	10:00	2	0	0	0	2
11:30	11:45	3	0	0	0	3
11:45	12:00	2	0	0	0	2
12:00	12:15	5	0	0	0	5
12:15	12:30	1	0	0	0	1
12:30	12:45	1	0	0	0	1
12:45	13:00	1	0	0	0	1
13:00	13:15	2	0	0	0	2
13:15	13:30	2	0	0	0	2
15:00	15:15	1	0	2	0	3
15:15	15:30	1	0	0	0	1
15:30	15:45	0	0	0	0	0
15:45	16:00	3	0	0	0	3
16:00	16:15	2	0	0	0	2
16:15	16:30	3	0	0	0	3
16:30	16:45	1	1	0	0	2
16:45	17:00	2	0	0	0	2
17:00	17:15	1	0	0	0	1
17:15	17:30	5	0	0	0	5
17:30	17:45	0	0	0	0	0
17:45	18:00	4	0	0	0	4
Total		75	1	2	0	78

# Traffic Signal Timing

City of Ottawa, Transportation Services Department

## Traffic Signal Operations Unit

<b>Intersection:</b>	Main: March	Side: Maxwell Bridge
<b>Controller:</b>	MS-3200	<b>TSD:</b> 5963
<b>Author:</b>	Sarah Saade	<b>Date:</b> 25-Jul-2018

### Existing Timing Plans<sup>†</sup>

	Plan				Ped Minimum Time				
	AM Peak 1	Off Peak 2	PM Peak 3	Night 4	AM Peak 11	PM Peak 13	Walk	DW	A+R
<b>Cycle</b>	110	95	120	95	120	120			
<b>Offset</b>	90	11	50	X	99	50			
NB Thru	56	56	66	56	52	55	7	21	4.6+2.0
SB Thru	56	56	66	56	52	55	7	21	4.6+2.0
EB Thru	39	39	39	39	48	45	7	25	3.3+3.3
WB Thru	39	39	39	39	48	45	7	25	3.3+3.3
NB Left	15	-	15	-	20	20	-	-	4.6+1.8
SB Left	15	-	15	-	20	20	-	-	4.6+1.8

### Phasing Sequence<sup>‡</sup>

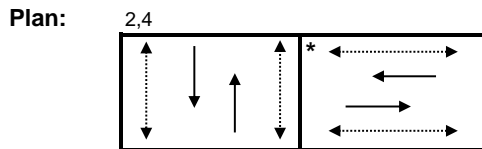
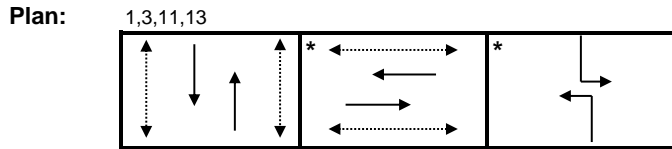

### Schedule

Weekday		Weekend	
Time	Plan	Time	Plan
0:10	4	0:10	4
6:20	1	8:00	2
7:30	11	22:30	4
9:50	2		
15:00	3		
16:30	13		
18:30	3		
19:00	2		
23:00	4		

### Notes

- †: Time for each direction includes amber and all red intervals
- ‡: Start of first phase should be used as reference point for offset
- Asterisk (\*) Indicates actuated phase
- (fp): Fully Protected Left Turn
- ◄.....► Pedestrian signal

Cost is \$56.50 (\$50 + HST)

# Traffic Signal Timing

City of Ottawa, Transportation Services Department

## Traffic Signal Operations Unit

<b>Intersection:</b>	Main: March	Side: Klondike
<b>Controller:</b>	MS-3200	<b>TSD:</b> 6742
<b>Author:</b>	Matthew Anderson	<b>Date:</b> 08-May-2020

### Existing Timing Plans†

	Plan					Ped Minimum Time		
	AM Peak 1	Off Peak 2	PM Peak 3	Night 4	PM Heavy 13	Walk	DW	A+R
<b>Cycle</b>	130	110	120	110	130			
<b>Offset</b>	64	16	8	X	20			
NB Thru	58	49	43	47	51	7	19	4.6+1.8
SB Thru	58	49	43	47	51	7	19	4.6+1.8
EB Left	12	-	12	-	12	-	-	3.3+3.3
EB Thru	57	45	57	46	57	7	30	3.3+3.8
WB Thru	45	45	45	46	45	7	30	3.3+3.8
NB Left (fp)	15	16	20	17	22	-	-	4.6+2.0
SB Left (fp)	15	16	20	17	22	-	-	4.6+2.0

### Phasing Sequence‡

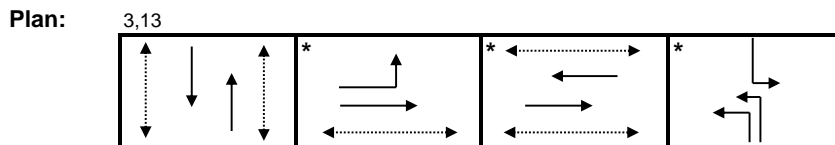
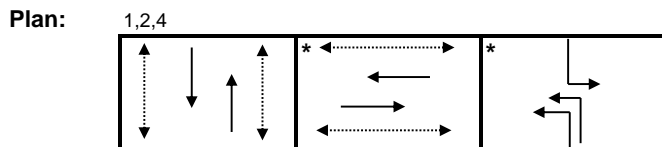

### Schedule

#### Weekday

Time	Plan
0:10	4
6:30	1
9:30	2
15:00	3
16:30	13
18:00	3
18:30	2
23:00	4

#### Weekend

Time	Plan
0:10	4
8:00	2
22:30	4

### Notes

- †: Time for each direction includes amber and all red intervals
- ‡: Start of first phase should be used as reference point for offset
- Asterisk (\*) Indicates actuated phase
- (fp): Fully Protected Left Turn
- ◄.....► Pedestrian signal

Cost is \$58.78 (\$52.02 + HST)

# Appendix C

Collision Data



2019-12-14	2019	23:30	KLONDIKE RD @ MARCH RD (0003096)	03 - Snow	07 - Dark	01 - Traffic signal	01 - Functioning	03 - P.D. only	07 - SMV other	03 - Loose snow	1	0
2019-12-30	2019	21:38	KLONDIKE RD @ MARCH RD (0003096)	03 - Snow	07 - Dark	01 - Traffic signal	01 - Functioning	03 - P.D. only	04 - Sideswipe	05 - Packed snow	2	0
2016-02-11	2016	7:32	MARCH RD btwn KLONDIKE RD & MORGAN'S GRANT WAY (__3ZA2EW)	03 - Snow	01 - Daylight	10 - No control	0	02 - Non-fatal injury	04 - Sideswipe	04 - Slush	2	0
2017-07-28	2017	9:20	MARCH RD btwn KLONDIKE RD & MORGAN'S GRANT WAY (__3ZA2EW)	01 - Clear	01 - Daylight	10 - No control	0	02 - Non-fatal injury	03 - Rear end	01 - Dry	2	0
2017-09-07	2017	19:47	MARCH RD btwn KLONDIKE RD & MORGAN'S GRANT WAY (__3ZA2EW)	02 - Rain	07 - Dark	10 - No control	0	03 - P.D. only	07 - SMV other	02 - Wet	1	0
2018-12-03	2018	9:24	MARCH RD btwn KLONDIKE RD & MORGAN'S GRANT WAY (__3ZA2EW)	03 - Snow	01 - Daylight	10 - No control	0	03 - P.D. only	07 - SMV other	06 - Ice	1	0
2019-12-02	2019	8:22	MARCH RD btwn KLONDIKE RD & MORGAN'S GRANT WAY (__3ZA2EW)	01 - Clear	01 - Daylight	10 - No control	0	03 - P.D. only	03 - Rear end	01 - Dry	2	0
2020-04-25	2020	9:33	MARCH RD btwn KLONDIKE RD & MORGAN'S GRANT WAY (__3ZA2EW)	01 - Clear	01 - Daylight	10 - No control	0	03 - P.D. only	06 - SMV unattended vehicle	01 - Dry	1	0
2020-01-13	2020	6:14	MARCH RD btwn KLONDIKE RD & MORGAN'S GRANT WAY (__3ZA2EW)	01 - Clear	07 - Dark	10 - No control	0	03 - P.D. only	04 - Sideswipe	02 - Wet	2	0

# Appendix D

March Road Widening Scenarios



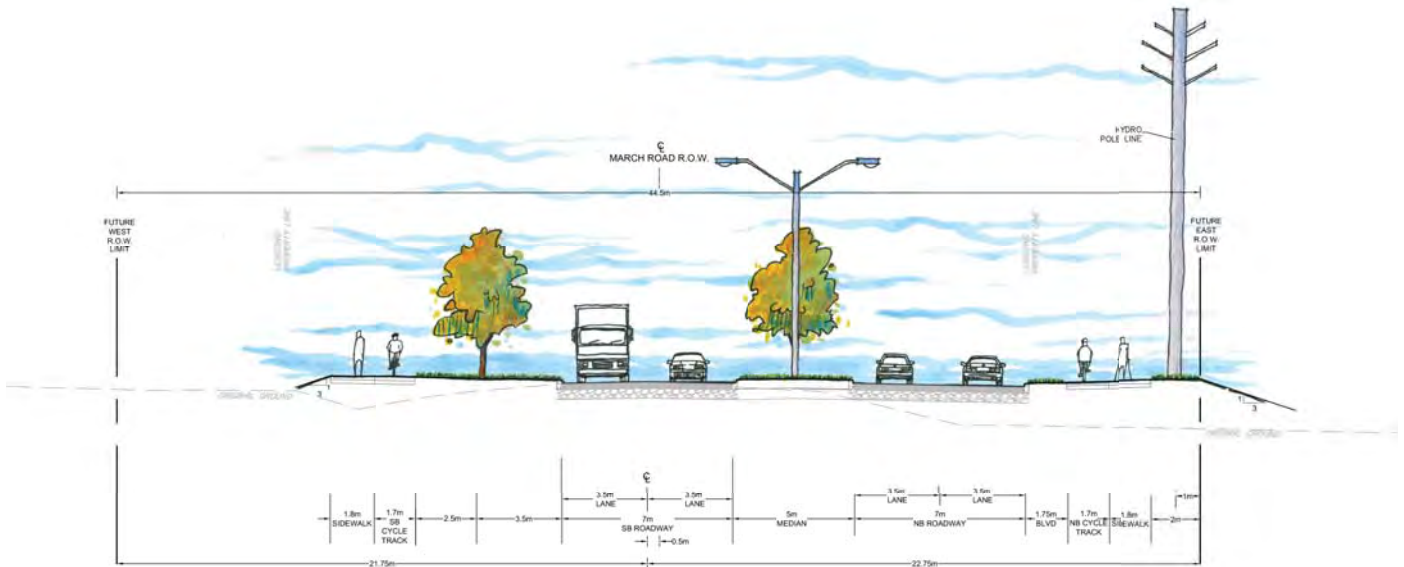

**FIGURE 27** | Cross-Section for March Road - Interim

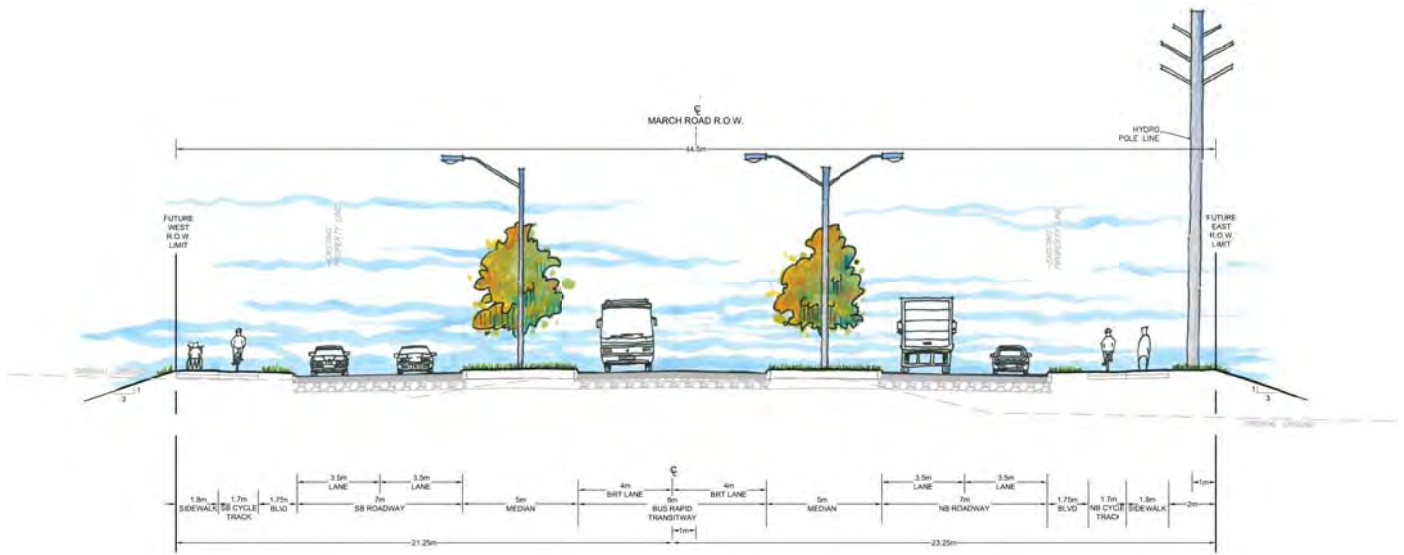

**FIGURE 28** | Cross-Section for March Road - Ultimate

# Appendix E

TDM Checklist

**TDM-Supportive Development Design and Infrastructure Checklist:**  
*Non-Residential Developments (office, institutional, retail or industrial)*

<b>Legend</b>	
<b>REQUIRED</b>	The Official Plan or Zoning By-law provides related guidance that must be followed
<b>BASIC</b>	The measure is generally feasible and effective, and in most cases would benefit the development and its users
<b>BETTER</b>	The measure could maximize support for users of sustainable modes, and optimize development performance

TDM-supportive design & infrastructure measures: <i>Non-residential developments</i>		Check if completed & add descriptions, explanations or plan/drawing references
<b>1. WALKING &amp; CYCLING: ROUTES</b>		
<b>1.1 Building location &amp; access points</b>		
BASIC	1.1.1 Locate building close to the street, and do not locate parking areas between the street and building entrances	<input checked="" type="checkbox"/>
BASIC	1.1.2 Locate building entrances in order to minimize walking distances to sidewalks and transit stops/stations	<input checked="" type="checkbox"/>
BASIC	1.1.3 Locate building doors and windows to ensure visibility of pedestrians from the building, for their security and comfort	<input checked="" type="checkbox"/>
<b>1.2 Facilities for walking &amp; cycling</b>		
REQUIRED	1.2.1 Provide convenient, direct access to stations or major stops along rapid transit routes within 600 metres; minimize walking distances from buildings to rapid transit; provide pedestrian-friendly, weather-protected (where possible) environment between rapid transit accesses and building entrances; ensure quality linkages from sidewalks through building entrances to integrated stops/stations ( <i>see Official Plan policy 4.3.3</i> )	<input checked="" type="checkbox"/>
REQUIRED	1.2.2 Provide safe, direct and attractive pedestrian access from public sidewalks to building entrances through such measures as: reducing distances between public sidewalks and major building entrances; providing walkways from public streets to major building entrances; within a site, providing walkways along the front of adjoining buildings, between adjacent buildings, and connecting areas where people may congregate, such as courtyards and transit stops; and providing weather protection through canopies, colonnades, and other design elements wherever possible ( <i>see Official Plan policy 4.3.12</i> )	<input checked="" type="checkbox"/>

<b>TDM-supportive design &amp; infrastructure measures: Non-residential developments</b>		<b>Check if completed &amp; add descriptions, explanations or plan/drawing references</b>
<b>REQUIRED</b>	1.2.3 Provide sidewalks of smooth, well-drained walking surfaces of contrasting materials or treatments to differentiate pedestrian areas from vehicle areas, and provide marked pedestrian crosswalks at intersection sidewalks (see <i>Official Plan policy 4.3.10</i> )	<input checked="" type="checkbox"/>
<b>REQUIRED</b>	1.2.4 Make sidewalks and open space areas easily accessible through features such as gradual grade transition, depressed curbs at street corners and convenient access to extra-wide parking spaces and ramps (see <i>Official Plan policy 4.3.10</i> )	<input checked="" type="checkbox"/>
<b>REQUIRED</b>	1.2.5 Include adequately spaced inter-block/street cycling and pedestrian connections to facilitate travel by active transportation. Provide links to the existing or planned network of public sidewalks, multi-use pathways and on-road cycle routes. Where public sidewalks and multi-use pathways intersect with roads, consider providing traffic control devices to give priority to cyclists and pedestrians (see <i>Official Plan policy 4.3.11</i> )	<input checked="" type="checkbox"/>
<b>BASIC</b>	1.2.6 Provide safe, direct and attractive walking routes from building entrances to nearby transit stops	<input checked="" type="checkbox"/>
<b>BASIC</b>	1.2.7 Ensure that walking routes to transit stops are secure, visible, lighted, shaded and wind-protected wherever possible	<input checked="" type="checkbox"/>
<b>BASIC</b>	1.2.8 Design roads used for access or circulation by cyclists using a target operating speed of no more than 30 km/h, or provide a separated cycling facility	<input type="checkbox"/>
<b>1.3 Amenities for walking &amp; cycling</b>		
<b>BASIC</b>	1.3.1 Provide lighting, landscaping and benches along walking and cycling routes between building entrances and streets, sidewalks and trails	<input checked="" type="checkbox"/>
<b>BASIC</b>	1.3.2 Provide wayfinding signage for site access (where required, e.g. when multiple buildings or entrances exist) and egress (where warranted, such as when directions to reach transit stops/stations, trails or other common destinations are not obvious)	<input type="checkbox"/>

TDM-supportive design & infrastructure measures: <i>Non-residential developments</i>		Check if completed & add descriptions, explanations or plan/drawing references
<b>2. WALKING &amp; CYCLING: END-OF-TRIP FACILITIES</b>		
<b>2.1 Bicycle parking</b>		
REQUIRED	2.1.1 Provide bicycle parking in highly visible and lighted areas, sheltered from the weather wherever possible (see <i>Official Plan policy 4.3.6</i> )	<input checked="" type="checkbox"/>
REQUIRED	2.1.2 Provide the number of bicycle parking spaces specified for various land uses in different parts of Ottawa; provide convenient access to main entrances or well-used areas (see <i>Zoning By-law Section 111</i> )	<input checked="" type="checkbox"/>
REQUIRED	2.1.3 Ensure that bicycle parking spaces and access aisles meet minimum dimensions; that no more than 50% of spaces are vertical spaces; and that parking racks are securely anchored (see <i>Zoning By-law Section 111</i> )	<input checked="" type="checkbox"/>
BASIC	2.1.4 Provide bicycle parking spaces equivalent to the expected number of commuter cyclists (assuming the cycling mode share target is met), plus the expected peak number of customer/visitor cyclists	<input type="checkbox"/>
BETTER	2.1.5 Provide bicycle parking spaces equivalent to the expected number of commuter and customer/visitor cyclists, plus an additional buffer (e.g. 25 percent extra) to encourage other cyclists and ensure adequate capacity in peak cycling season	<input type="checkbox"/>
<b>2.2 Secure bicycle parking</b>		
REQUIRED	2.2.1 Where more than 50 bicycle parking spaces are provided for a single office building, locate at least 25% of spaces within a building/structure, a secure area (e.g. supervised parking lot or enclosure) or bicycle lockers (see <i>Zoning By-law Section 111</i> )	<input type="checkbox"/>
BETTER	2.2.2 Provide secure bicycle parking spaces equivalent to the expected number of commuter cyclists (assuming the cycling mode share target is met)	<input type="checkbox"/>
<b>2.3 Shower &amp; change facilities</b>		
BASIC	2.3.1 Provide shower and change facilities for the use of active commuters	<input type="checkbox"/>
BETTER	2.3.2 In addition to shower and change facilities, provide dedicated lockers, grooming stations, drying racks and laundry facilities for the use of active commuters	<input type="checkbox"/>
<b>2.4 Bicycle repair station</b>		
BETTER	2.4.1 Provide a permanent bike repair station, with commonly used tools and an air pump, adjacent to the main bicycle parking area (or secure bicycle parking area, if provided)	<input type="checkbox"/>

TDM-supportive design & infrastructure measures: <i>Non-residential developments</i>		Check if completed & add descriptions, explanations or plan/drawing references
<b>3. TRANSIT</b>		
<b>3.1 Customer amenities</b>		
BASIC	3.1.1 Provide shelters, lighting and benches at any on-site transit stops	<input type="checkbox"/>
BASIC	3.1.2 Where the site abuts an off-site transit stop and insufficient space exists for a transit shelter in the public right-of-way, protect land for a shelter and/or install a shelter	<input type="checkbox"/>
BETTER	3.1.3 Provide a secure and comfortable interior waiting area by integrating any on-site transit stops into the building	<input type="checkbox"/>
<b>4. RIDESHARING</b>		
<b>4.1 Pick-up &amp; drop-off facilities</b>		
BASIC	4.1.1 Provide a designated area for carpool drivers (plus taxis and ride-hailing services) to drop off or pick up passengers without using fire lanes or other no-stopping zones	<input type="checkbox"/>
<b>4.2 Carpool parking</b>		
BASIC	4.2.1 Provide signed parking spaces for carpools in a priority location close to a major building entrance, sufficient in number to accommodate the mode share target for carpools	<input type="checkbox"/>
BETTER	4.2.2 At large developments, provide spaces for carpools in a separate, access-controlled parking area to simplify enforcement	<input type="checkbox"/>
<b>5. CARSHARING &amp; BIKESHARING</b>		
<b>5.1 Carshare parking spaces</b>		
BETTER	5.1.1 Provide carshare parking spaces in permitted non-residential zones, occupying either required or provided parking spaces ( <i>see Zoning By-law Section 94</i> )	<input type="checkbox"/>
<b>5.2 Bikeshare station location</b>		
BETTER	5.2.1 Provide a designated bikeshare station area near a major building entrance, preferably lighted and sheltered with a direct walkway connection	<input type="checkbox"/>

TDM-supportive design & infrastructure measures: <i>Non-residential developments</i>		Check if completed & add descriptions, explanations or plan/drawing references
<b>6. PARKING</b>		
<b>6.1 Number of parking spaces</b>		
<b>REQUIRED</b>	6.1.1 Do not provide more parking than permitted by zoning, nor less than required by zoning, unless a variance is being applied for	<input checked="" type="checkbox"/>
<b>BASIC</b>	6.1.2 Provide parking for long-term and short-term users that is consistent with mode share targets, considering the potential for visitors to use off-site public parking	<input type="checkbox"/>
<b>BASIC</b>	6.1.3 Where a site features more than one use, provide shared parking and reduce the cumulative number of parking spaces accordingly ( <i>see Zoning By-law Section 104</i> )	<input type="checkbox"/>
<b>BETTER</b>	6.1.4 Reduce the minimum number of parking spaces required by zoning by one space for each 13 square metres of gross floor area provided as shower rooms, change rooms, locker rooms and other facilities for cyclists in conjunction with bicycle parking ( <i>see Zoning By-law Section 111</i> )	<input type="checkbox"/>
<b>6.2 Separate long-term &amp; short-term parking areas</b>		
<b>BETTER</b>	6.2.1 Separate short-term and long-term parking areas using signage or physical barriers, to permit access controls and simplify enforcement (i.e. to discourage employees from parking in visitor spaces, and vice versa)	<input type="checkbox"/>
<b>7. OTHER</b>		
<b>7.1 On-site amenities to minimize off-site trips</b>		
<b>BETTER</b>	7.1.1 Provide on-site amenities to minimize mid-day or mid-commute errands	<input type="checkbox"/>

## TDM-Supportive Development Design and Infrastructure Checklist: *Residential Developments (multi-family or condominium)*

<b>Legend</b>	
<b>REQUIRED</b>	The Official Plan or Zoning By-law provides related guidance that must be followed
<b>BASIC</b>	The measure is generally feasible and effective, and in most cases would benefit the development and its users
<b>BETTER</b>	The measure could maximize support for users of sustainable modes, and optimize development performance

TDM-supportive design & infrastructure measures: <i>Residential developments</i>		Check if completed & add descriptions, explanations or plan/drawing references
<b>1. WALKING &amp; CYCLING: ROUTES</b>		
<b>1.1 Building location &amp; access points</b>		
<b>BASIC</b>	1.1.1 Locate building close to the street, and do not locate parking areas between the street and building entrances	<input checked="" type="checkbox"/>
<b>BASIC</b>	1.1.2 Locate building entrances in order to minimize walking distances to sidewalks and transit stops/stations	<input checked="" type="checkbox"/>
<b>BASIC</b>	1.1.3 Locate building doors and windows to ensure visibility of pedestrians from the building, for their security and comfort	<input checked="" type="checkbox"/>
<b>1.2 Facilities for walking &amp; cycling</b>		
<b>REQUIRED</b>	1.2.1 Provide convenient, direct access to stations or major stops along rapid transit routes within 600 metres; minimize walking distances from buildings to rapid transit; provide pedestrian-friendly, weather-protected (where possible) environment between rapid transit accesses and building entrances; ensure quality linkages from sidewalks through building entrances to integrated stops/stations ( <i>see Official Plan policy 4.3.3</i> )	<input checked="" type="checkbox"/>
<b>REQUIRED</b>	1.2.2 Provide safe, direct and attractive pedestrian access from public sidewalks to building entrances through such measures as: reducing distances between public sidewalks and major building entrances; providing walkways from public streets to major building entrances; within a site, providing walkways along the front of adjoining buildings, between adjacent buildings, and connecting areas where people may congregate, such as courtyards and transit stops; and providing weather protection through canopies, colonnades, and other design elements wherever possible ( <i>see Official Plan policy 4.3.12</i> )	<input checked="" type="checkbox"/>



<b>TDM-supportive design &amp; infrastructure measures: <i>Residential developments</i></b>		<b>Check if completed &amp; add descriptions, explanations or plan/drawing references</b>
<b>REQUIRED</b>	1.2.3 Provide sidewalks of smooth, well-drained walking surfaces of contrasting materials or treatments to differentiate pedestrian areas from vehicle areas, and provide marked pedestrian crosswalks at intersection sidewalks ( <i>see Official Plan policy 4.3.10</i> )	<input checked="" type="checkbox"/>
<b>REQUIRED</b>	1.2.4 Make sidewalks and open space areas easily accessible through features such as gradual grade transition, depressed curbs at street corners and convenient access to extra-wide parking spaces and ramps ( <i>see Official Plan policy 4.3.10</i> )	<input checked="" type="checkbox"/>
<b>REQUIRED</b>	1.2.5 Include adequately spaced inter-block/street cycling and pedestrian connections to facilitate travel by active transportation. Provide links to the existing or planned network of public sidewalks, multi-use pathways and on-road cycle routes. Where public sidewalks and multi-use pathways intersect with roads, consider providing traffic control devices to give priority to cyclists and pedestrians ( <i>see Official Plan policy 4.3.11</i> )	<input checked="" type="checkbox"/>
<b>BASIC</b>	1.2.6 Provide safe, direct and attractive walking routes from building entrances to nearby transit stops	<input checked="" type="checkbox"/>
<b>BASIC</b>	1.2.7 Ensure that walking routes to transit stops are secure, visible, lighted, shaded and wind-protected wherever possible	<input checked="" type="checkbox"/>
<b>BASIC</b>	1.2.8 Design roads used for access or circulation by cyclists using a target operating speed of no more than 30 km/h, or provide a separated cycling facility	<input type="checkbox"/>
<b>1.3 Amenities for walking &amp; cycling</b>		
<b>BASIC</b>	1.3.1 Provide lighting, landscaping and benches along walking and cycling routes between building entrances and streets, sidewalks and trails	<input type="checkbox"/>
<b>BASIC</b>	1.3.2 Provide wayfinding signage for site access (where required, e.g. when multiple buildings or entrances exist) and egress (where warranted, such as when directions to reach transit stops/stations, trails or other common destinations are not obvious)	<input type="checkbox"/>

TDM-supportive design & infrastructure measures: <i>Residential developments</i>		Check if completed & add descriptions, explanations or plan/drawing references
<b>2. WALKING &amp; CYCLING: END-OF-TRIP FACILITIES</b>		
<b>2.1 Bicycle parking</b>		
REQUIRED	2.1.1 Provide bicycle parking in highly visible and lighted areas, sheltered from the weather wherever possible (see <i>Official Plan policy 4.3.6</i> )	<input checked="" type="checkbox"/>
REQUIRED	2.1.2 Provide the number of bicycle parking spaces specified for various land uses in different parts of Ottawa; provide convenient access to main entrances or well-used areas (see <i>Zoning By-law Section 111</i> )	<input checked="" type="checkbox"/>
REQUIRED	2.1.3 Ensure that bicycle parking spaces and access aisles meet minimum dimensions; that no more than 50% of spaces are vertical spaces; and that parking racks are securely anchored (see <i>Zoning By-law Section 111</i> )	<input checked="" type="checkbox"/>
BASIC	2.1.4 Provide bicycle parking spaces equivalent to the expected number of resident-owned bicycles, plus the expected peak number of visitor cyclists	<input type="checkbox"/>
<b>2.2 Secure bicycle parking</b>		
REQUIRED	2.2.1 Where more than 50 bicycle parking spaces are provided for a single residential building, locate at least 25% of spaces within a building/structure, a secure area (e.g. supervised parking lot or enclosure) or bicycle lockers (see <i>Zoning By-law Section 111</i> )	<input checked="" type="checkbox"/>
BETTER	2.2.2 Provide secure bicycle parking spaces equivalent to at least the number of units at condominiums or multi-family residential developments	<input type="checkbox"/>
<b>2.3 Bicycle repair station</b>		
BETTER	2.3.1 Provide a permanent bike repair station, with commonly used tools and an air pump, adjacent to the main bicycle parking area (or secure bicycle parking area, if provided)	<input checked="" type="checkbox"/>
<b>3. TRANSIT</b>		
<b>3.1 Customer amenities</b>		
BASIC	3.1.1 Provide shelters, lighting and benches at any on-site transit stops	<input type="checkbox"/>
BASIC	3.1.2 Where the site abuts an off-site transit stop and insufficient space exists for a transit shelter in the public right-of-way, protect land for a shelter and/or install a shelter	<input type="checkbox"/>
BETTER	3.1.3 Provide a secure and comfortable interior waiting area by integrating any on-site transit stops into the building	<input type="checkbox"/>

TDM-supportive design & infrastructure measures: <i>Residential developments</i>		Check if completed & add descriptions, explanations or plan/drawing references
<b>4. RIDESHARING</b>		
<b>4.1 Pick-up &amp; drop-off facilities</b>		
BASIC	4.1.1 Provide a designated area for carpool drivers (plus taxis and ride-hailing services) to drop off or pick up passengers without using fire lanes or other no-stopping zones	<input type="checkbox"/>
<b>5. CARSHARING &amp; BIKESHARING</b>		
<b>5.1 Carshare parking spaces</b>		
BETTER	5.1.1 Provide up to three carshare parking spaces in an R3, R4 or R5 Zone for specified residential uses (see <i>Zoning By-law Section 94</i> )	<input type="checkbox"/>
<b>5.2 Bikeshare station location</b>		
BETTER	5.2.1 Provide a designated bikeshare station area near a major building entrance, preferably lighted and sheltered with a direct walkway connection	<input type="checkbox"/>
<b>6. PARKING</b>		
<b>6.1 Number of parking spaces</b>		
REQUIRED	6.1.1 Do not provide more parking than permitted by zoning, nor less than required by zoning, unless a variance is being applied for	<input checked="" type="checkbox"/>
BASIC	6.1.2 Provide parking for long-term and short-term users that is consistent with mode share targets, considering the potential for visitors to use off-site public parking	<input type="checkbox"/>
BASIC	6.1.3 Where a site features more than one use, provide shared parking and reduce the cumulative number of parking spaces accordingly (see <i>Zoning By-law Section 104</i> )	<input type="checkbox"/>
BETTER	6.1.4 Reduce the minimum number of parking spaces required by zoning by one space for each 13 square metres of gross floor area provided as shower rooms, change rooms, locker rooms and other facilities for cyclists in conjunction with bicycle parking (see <i>Zoning By-law Section 111</i> )	<input type="checkbox"/>
<b>6.2 Separate long-term &amp; short-term parking areas</b>		
BETTER	6.2.1 Provide separate areas for short-term and long-term parking (using signage or physical barriers) to permit access controls and simplify enforcement (i.e. to discourage residents from parking in visitor spaces, and vice versa)	<input type="checkbox"/>

**TDM Measures Checklist:**  
*Non-Residential Developments (office, institutional, retail or industrial)*

<b>Legend</b>	
<b>BASIC</b>	The measure is generally feasible and effective, and in most cases would benefit the development and its users
<b>BETTER</b>	The measure could maximize support for users of sustainable modes, and optimize development performance
★	The measure is one of the most dependably effective tools to encourage the use of sustainable modes

TDM measures: <i>Non-residential developments</i>		Check if proposed & add descriptions
<b>1. TDM PROGRAM MANAGEMENT</b>		
<b>1.1 Program coordinator</b>		
<b>BASIC</b>	★ 1.1.1 Designate an internal coordinator, or contract with an external coordinator	<input type="checkbox"/>
<b>1.2 Travel surveys</b>		
<b>BETTER</b>	1.2.1 Conduct periodic surveys to identify travel-related behaviours, attitudes, challenges and solutions, and to track progress	<input type="checkbox"/>
<b>2. WALKING AND CYCLING</b>		
<b>2.1 Information on walking/cycling routes &amp; destinations</b>		
<b>BASIC</b>	2.1.1 Display local area maps with walking/cycling access routes and key destinations at major entrances	<input checked="" type="checkbox"/>
<b>2.2 Bicycle skills training</b>		
<i>Commuter travel</i>		
<b>BETTER</b>	★ 2.2.1 Offer on-site cycling courses for commuters, or subsidize off-site courses	<input type="checkbox"/>
<b>2.3 Valet bike parking</b>		
<i>Visitor travel</i>		
<b>BETTER</b>	2.3.1 Offer secure valet bike parking during public events when demand exceeds fixed supply (e.g. for festivals, concerts, games)	<input type="checkbox"/>

TDM measures: <i>Non-residential developments</i>		Check if proposed & add descriptions
<b>3. TRANSIT</b>		
<b>3.1 Transit information</b>		
BASIC	3.1.1 Display relevant transit schedules and route maps at entrances	<input type="checkbox"/>
BASIC	3.1.2 Provide online links to OC Transpo and STO information	<input checked="" type="checkbox"/>
BETTER	3.1.3 Provide real-time arrival information display at entrances	<input type="checkbox"/>
<b>3.2 Transit fare incentives</b>		
<i>Commuter travel</i>		
BETTER	3.2.1 Offer preloaded PRESTO cards to encourage commuters to use transit	<input type="checkbox"/>
BETTER ★	3.2.2 Subsidize or reimburse monthly transit pass purchases by employees	<input type="checkbox"/>
<i>Visitor travel</i>		
BETTER	3.2.3 Arrange inclusion of same-day transit fare in price of tickets (e.g. for festivals, concerts, games)	<input type="checkbox"/>
<b>3.3 Enhanced public transit service</b>		
<i>Commuter travel</i>		
BETTER	3.3.1 Contract with OC Transpo to provide enhanced transit services (e.g. for shift changes, weekends)	<input type="checkbox"/>
<i>Visitor travel</i>		
BETTER	3.3.2 Contract with OC Transpo to provide enhanced transit services (e.g. for festivals, concerts, games)	<input type="checkbox"/>
<b>3.4 Private transit service</b>		
<i>Commuter travel</i>		
BETTER	3.4.1 Provide shuttle service when OC Transpo cannot offer sufficient quality or capacity to serve demand (e.g. for shift changes, weekends)	<input type="checkbox"/>
<i>Visitor travel</i>		
BETTER	3.4.2 Provide shuttle service when OC Transpo cannot offer sufficient quality or capacity to serve demand (e.g. for festivals, concerts, games)	<input type="checkbox"/>

TDM measures: <i>Non-residential developments</i>		Check if proposed & add descriptions
<b>4. RIDESHARING</b>		
<b>4.1 Ridematching service</b>		
<i>Commuter travel</i>		
BASIC ★	4.1.1 Provide a dedicated ridematching portal at OttawaRideMatch.com	<input type="checkbox"/>
<b>4.2 Carpool parking price incentives</b>		
<i>Commuter travel</i>		
BETTER	4.2.1 Provide discounts on parking costs for registered carpools	<input type="checkbox"/>
<b>4.3 Vanpool service</b>		
<i>Commuter travel</i>		
BETTER	4.3.1 Provide a vanpooling service for long-distance commuters	<input type="checkbox"/>
<b>5. CARSHARING &amp; BIKESHARING</b>		
<b>5.1 Bikeshare stations &amp; memberships</b>		
BETTER	5.1.1 Contract with provider to install on-site bikeshare station for use by commuters and visitors	<input type="checkbox"/>
<i>Commuter travel</i>		
BETTER	5.1.2 Provide employees with bikeshare memberships for local business travel	<input type="checkbox"/>
<b>5.2 Carshare vehicles &amp; memberships</b>		
<i>Commuter travel</i>		
BETTER	5.2.1 Contract with provider to install on-site carshare vehicles and promote their use by tenants	<input type="checkbox"/>
BETTER	5.2.2 Provide employees with carshare memberships for local business travel	<input type="checkbox"/>
<b>6. PARKING</b>		
<b>6.1 Priced parking</b>		
<i>Commuter travel</i>		
BASIC ★	6.1.1 Charge for long-term parking (daily, weekly, monthly)	<input checked="" type="checkbox"/>
BASIC	6.1.2 Unbundle parking cost from lease rates at multi-tenant sites	<input type="checkbox"/>
<i>Visitor travel</i>		
BETTER	6.1.3 Charge for short-term parking (hourly)	<input type="checkbox"/>

TDM measures: <i>Non-residential developments</i>		Check if proposed & add descriptions
<b>7. TDM MARKETING &amp; COMMUNICATIONS</b>		
<b>7.1 Multimodal travel information</b>		
<i>Commuter travel</i>		
BASIC ★	7.1.1 Provide a multimodal travel option information package to new/relocating employees and students	<input checked="" type="checkbox"/>
<i>Visitor travel</i>		
BETTER ★	7.1.2 Include multimodal travel option information in invitations or advertising that attract visitors or customers (e.g. for festivals, concerts, games)	<input type="checkbox"/>
<b>7.2 Personalized trip planning</b>		
<i>Commuter travel</i>		
BETTER ★	7.2.1 Offer personalized trip planning to new/relocating employees	<input type="checkbox"/>
<b>7.3 Promotions</b>		
<i>Commuter travel</i>		
BETTER	7.3.1 Deliver promotions and incentives to maintain awareness, build understanding, and encourage trial of sustainable modes	<input type="checkbox"/>
<b>8. OTHER INCENTIVES &amp; AMENITIES</b>		
<b>8.1 Emergency ride home</b>		
<i>Commuter travel</i>		
BETTER ★	8.1.1 Provide emergency ride home service to non-driving commuters	<input type="checkbox"/>
<b>8.2 Alternative work arrangements</b>		
<i>Commuter travel</i>		
BASIC ★	8.2.1 Encourage flexible work hours	<input checked="" type="checkbox"/>
BETTER	8.2.2 Encourage compressed workweeks	<input type="checkbox"/>
BETTER ★	8.2.3 Encourage telework	<input checked="" type="checkbox"/>
<b>8.3 Local business travel options</b>		
<i>Commuter travel</i>		
BASIC ★	8.3.1 Provide local business travel options that minimize the need for employees to bring a personal car to work	<input type="checkbox"/>
<b>8.4 Commuter incentives</b>		
<i>Commuter travel</i>		
BETTER	8.4.1 Offer employees a taxable, mode-neutral commuting allowance	<input type="checkbox"/>
<b>8.5 On-site amenities</b>		
<i>Commuter travel</i>		
BETTER	8.5.1 Provide on-site amenities/services to minimize mid-day or mid-commute errands	<input type="checkbox"/>

**TDM Measures Checklist:**  
*Residential Developments (multi-family, condominium or subdivision)*

<b>Legend</b>	
<b>BASIC</b>	The measure is generally feasible and effective, and in most cases would benefit the development and its users
<b>BETTER</b>	The measure could maximize support for users of sustainable modes, and optimize development performance
★	The measure is one of the most dependably effective tools to encourage the use of sustainable modes

TDM measures: <i>Residential developments</i>		Check if proposed & add descriptions
<b>1. TDM PROGRAM MANAGEMENT</b>		
<b>1.1 Program coordinator</b>		
<b>BASIC</b>	★ 1.1.1 Designate an internal coordinator, or contract with an external coordinator	<input checked="" type="checkbox"/>
<b>1.2 Travel surveys</b>		
<b>BETTER</b>	1.2.1 Conduct periodic surveys to identify travel-related behaviours, attitudes, challenges and solutions, and to track progress	<input type="checkbox"/>
<b>2. WALKING AND CYCLING</b>		
<b>2.1 Information on walking/cycling routes &amp; destinations</b>		
<b>BASIC</b>	2.1.1 Display local area maps with walking/cycling access routes and key destinations at major entrances ( <i>multi-family, condominium</i> )	<input checked="" type="checkbox"/>
<b>2.2 Bicycle skills training</b>		
<b>BETTER</b>	2.2.1 Offer on-site cycling courses for residents, or subsidize off-site courses	<input type="checkbox"/>



TDM measures: <i>Residential developments</i>		Check if proposed & add descriptions
<b>3. TRANSIT</b>		
<b>3.1 Transit information</b>		
BASIC	3.1.1 Display relevant transit schedules and route maps at entrances ( <i>multi-family, condominium</i> )	<input type="checkbox"/>
BETTER	3.1.2 Provide real-time arrival information display at entrances ( <i>multi-family, condominium</i> )	<input type="checkbox"/>
<b>3.2 Transit fare incentives</b>		
BASIC ★	3.2.1 Offer PRESTO cards preloaded with one monthly transit pass on residence purchase/move-in, to encourage residents to use transit	<input checked="" type="checkbox"/>
BETTER	3.2.2 Offer at least one year of free monthly transit passes on residence purchase/move-in	<input type="checkbox"/>
<b>3.3 Enhanced public transit service</b>		
BETTER ★	3.3.1 Contract with OC Transpo to provide early transit services until regular services are warranted by occupancy levels ( <i>subdivision</i> )	<input type="checkbox"/>
<b>3.4 Private transit service</b>		
BETTER	3.4.1 Provide shuttle service for seniors homes or lifestyle communities (e.g. scheduled mall or supermarket runs)	<input type="checkbox"/>
<b>4. CARSHARING &amp; BIKESHARING</b>		
<b>4.1 Bikeshare stations &amp; memberships</b>		
BETTER	4.1.1 Contract with provider to install on-site bikeshare station ( <i>multi-family</i> )	<input type="checkbox"/>
BETTER	4.1.2 Provide residents with bikeshare memberships, either free or subsidized ( <i>multi-family</i> )	<input type="checkbox"/>
<b>4.2 Carshare vehicles &amp; memberships</b>		
BETTER	4.2.1 Contract with provider to install on-site carshare vehicles and promote their use by residents	<input type="checkbox"/>
BETTER	4.2.2 Provide residents with carshare memberships, either free or subsidized	<input type="checkbox"/>
<b>5. PARKING</b>		
<b>5.1 Priced parking</b>		
BASIC ★	5.1.1 Unbundle parking cost from purchase price ( <i>condominium</i> )	<input type="checkbox"/>
BASIC ★	5.1.2 Unbundle parking cost from monthly rent ( <i>multi-family</i> )	<input checked="" type="checkbox"/>

TDM measures: <i>Residential developments</i>		Check if proposed & add descriptions
<b>6. TDM MARKETING &amp; COMMUNICATIONS</b>		
<b>6.1 Multimodal travel information</b>		
<b>BASIC</b> ★	6.1.1 Provide a multimodal travel option information package to new residents	<input checked="" type="checkbox"/>
<b>6.2 Personalized trip planning</b>		
<b>BETTER</b> ★	6.2.1 Offer personalized trip planning to new residents	<input type="checkbox"/>

# Appendix F

Turning Templates

# HSU Inbound Movement

# HSU Outbound Movement

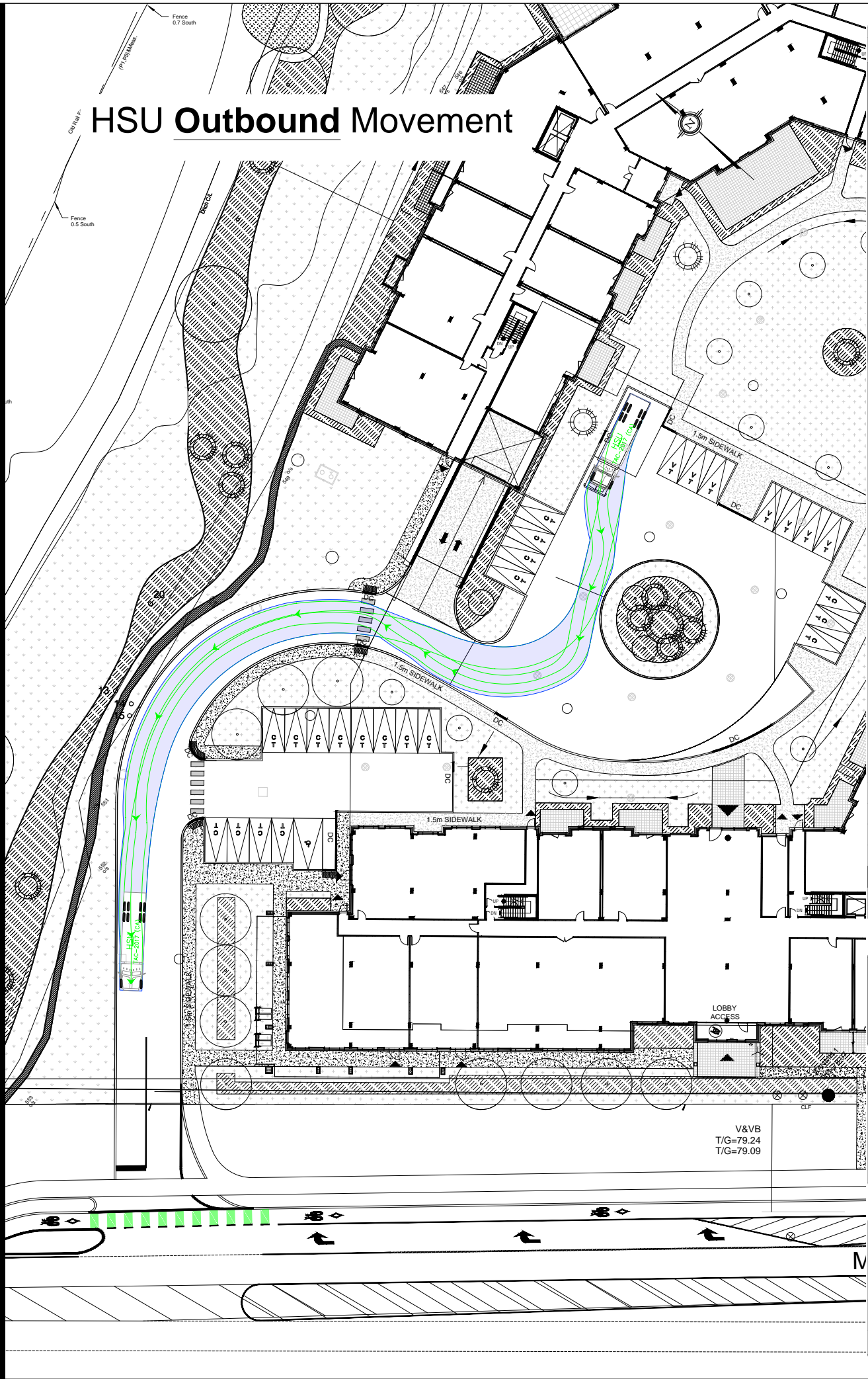
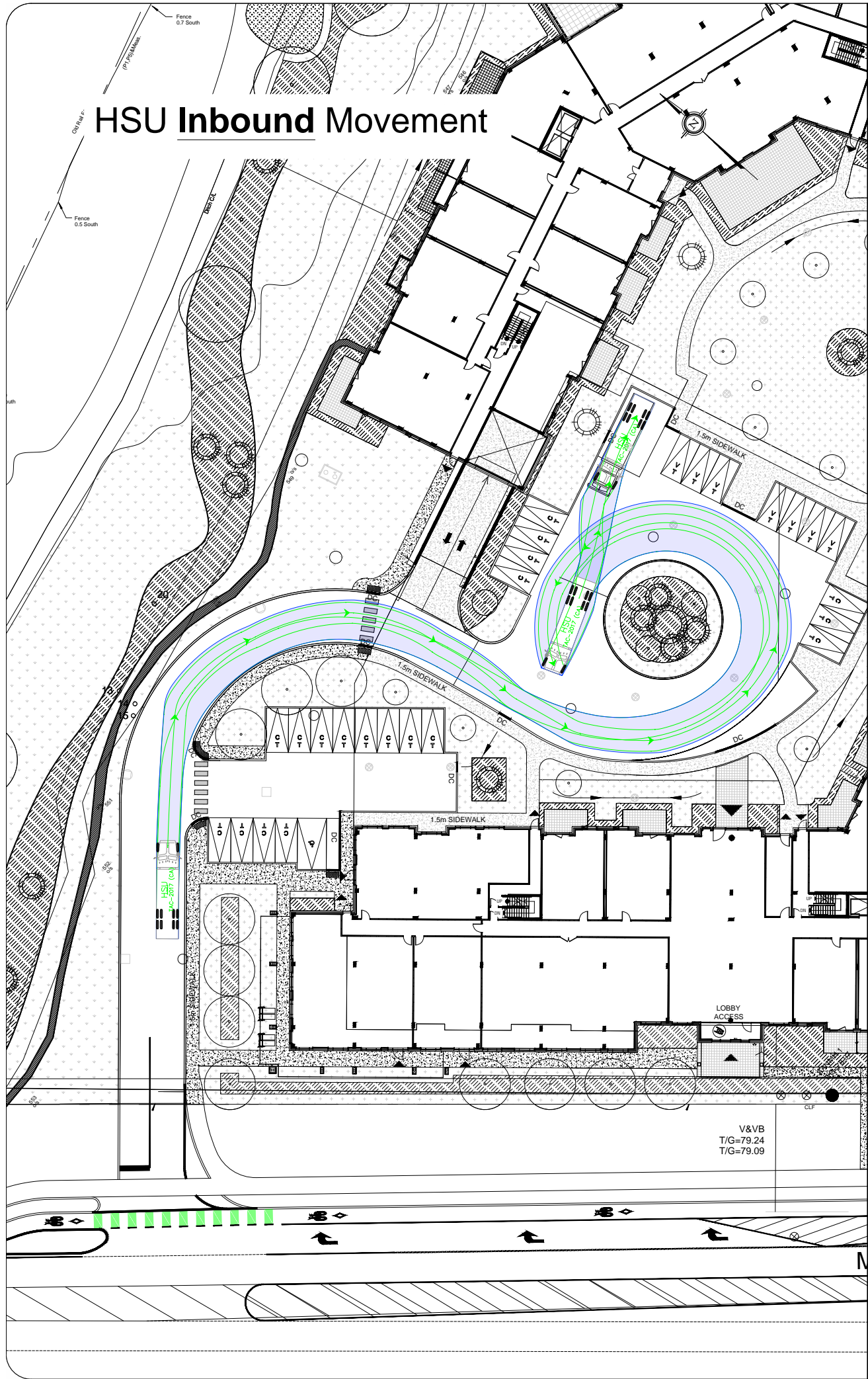

Notes:

Key Map:

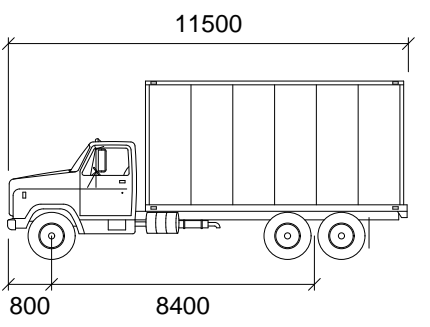
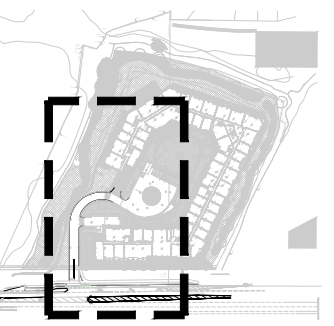

**HSU**

mm

Width : 2600  
 Track : 2600  
 Lock to Lock Time : 6.0  
 Steering Angle : 40.0

05	Updated Site Plan	BB	2024-01-17
04	Updated Site Plan	AN	2023-07-27
03	Updated Site Plan	AN	2023-03-30
02	Updated Site Plan	AN	2023-03-29
01	Issued for Review	AN	2023-03-14
REV:	DESCRIPTION:	BY:	DATE:
STATUS:			

**CGH Transportation**  
 6 Plaza Court  
 Ottawa, ON  
 K2H 7W1  
 (343) 999-9117

CLIENT: Lepine Corp.

ARCHITECT:

SITE:  
 910 March Road

TITLE:  
 Turning Movement Analysis  
 HSU Turning Movements

SCALE AT A3: NTS	DATE: 2024-01-17	DRAWN: AN	CHECKED: AL
PROJECT NO: 2021-073	DRAWING NO: 001	REVISION: 05	

# Garbage Inbound Movement

# Garbage Outbound Movement

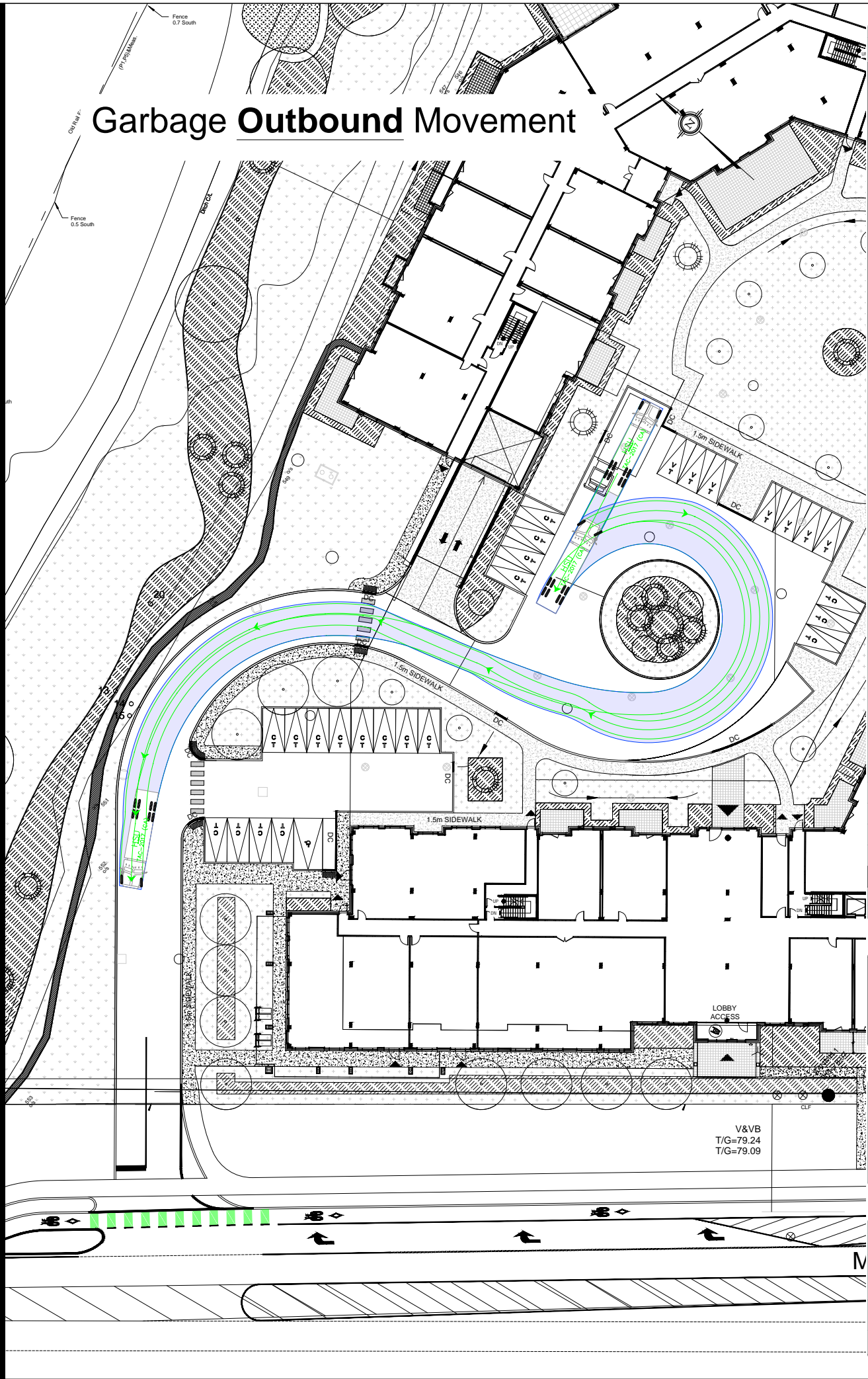
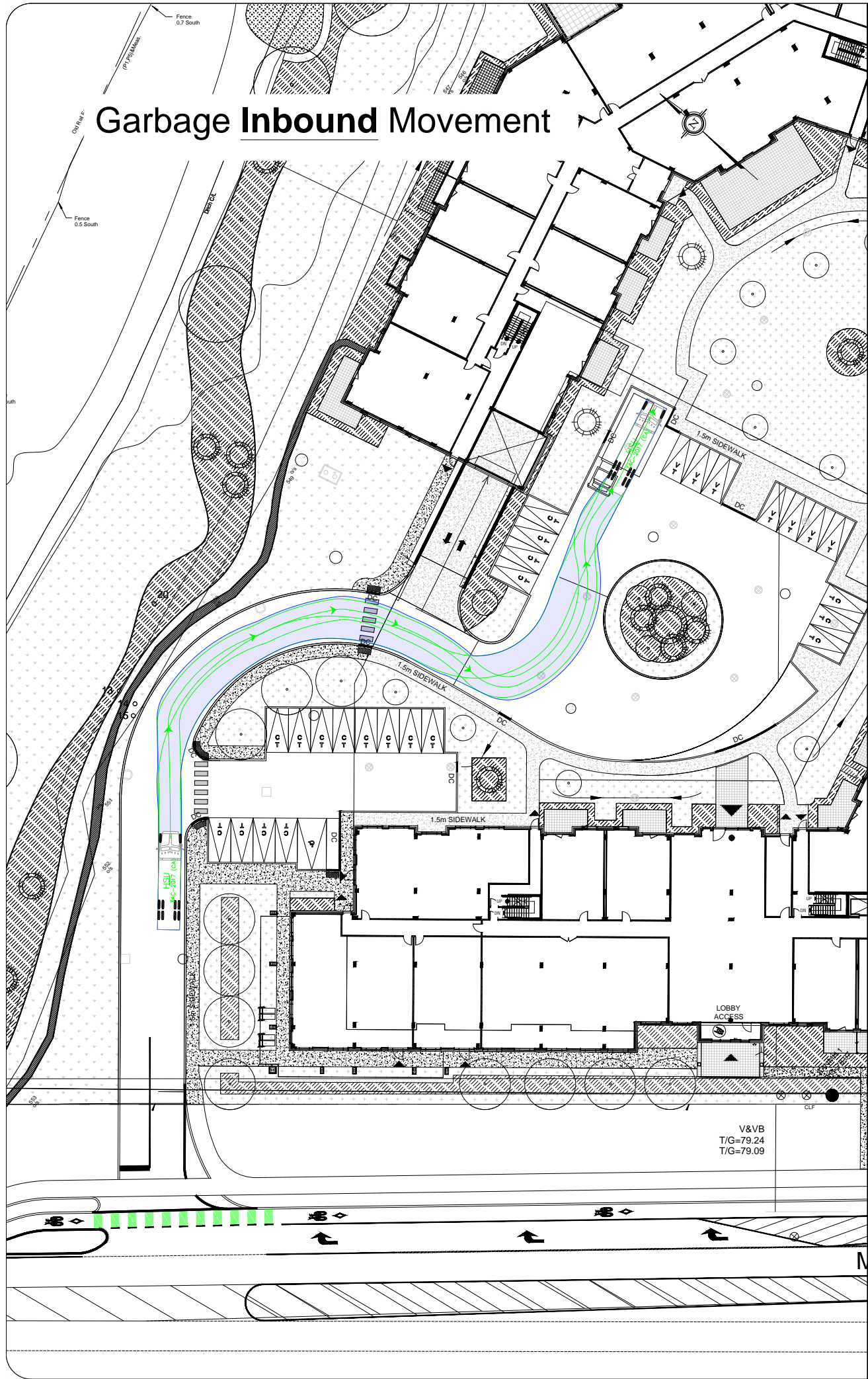

Notes:

Key Map:

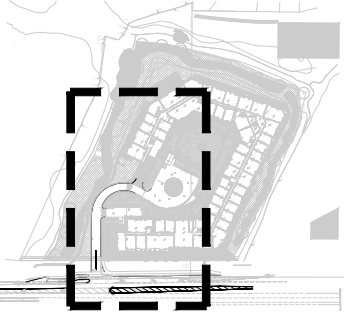

11500

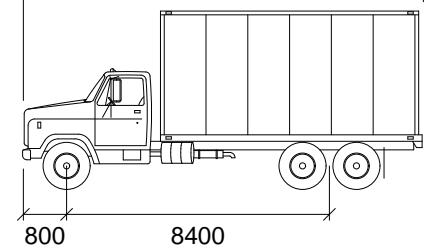

HSU

mm  
 Width : 2600  
 Track : 2600  
 Lock to Lock Time : 6.0  
 Steering Angle : 40.0

05	Updated Site Plan	BB	2024-01-17
04	Updated Site Plan	AN	2023-07-27
03	Updated Site Plan	AN	2023-03-30
02	Updated Site Plan	AN	2023-03-29
01	Issued for Review	AN	2023-03-14
REV:	DESCRIPTION:	BY:	DATE:
STATUS:			

**CGH Transportation**  
 6 Plaza Court  
 Ottawa, ON  
 K2H 7W1  
 (343) 999-9117

CLIENT: Lepine Corp.  
 ARCHITECT:

SITE:  
 910 March Road  
 TITLE:  
 Turning Movement Analysis  
 Garbage Turning Movements

SCALE AT A3:	DATE:	DRAWN:	CHECKED:
NTS	2024-01-17	BB	AL
PROJECT NO:	DRAWING NO:	REVISION:	
2021-073	002	05	

V&VB  
 T/G=79.24  
 T/G=79.09

V&VB  
 T/G=79.24  
 T/G=79.09

# Appendix G

Interim and Ultimate Access RMA Package

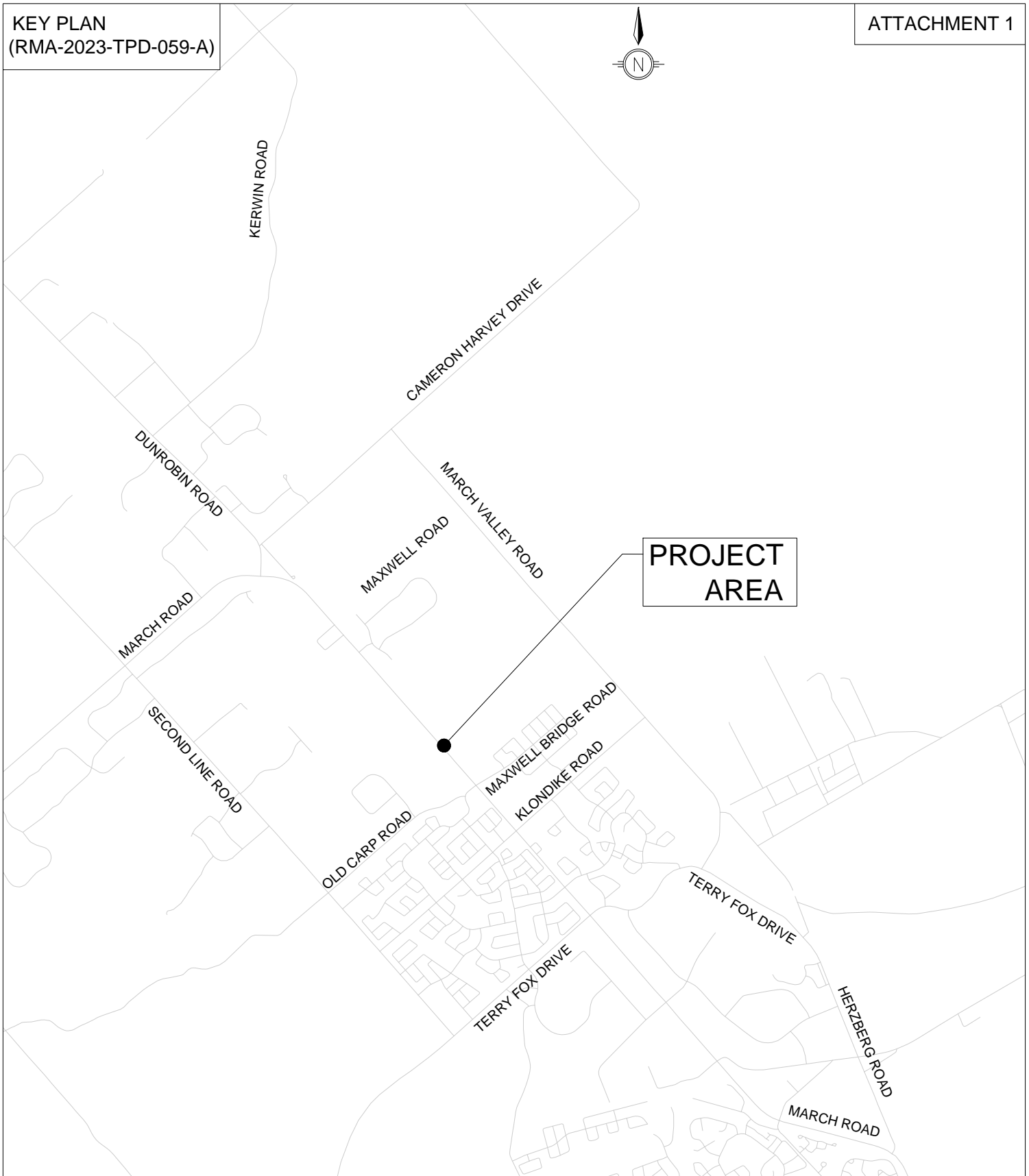

**PROJECT  
AREA**



TRANSPORTATION  
PLANNING DEPT.

**LEPINE  
910 MARCH ROAD**

**KEY PLAN**

**Transportation Engineering Services**

Approved By:  
TBD

Completed By:  
CGH

Scale:  
N.T.S.

Date:  
JAN.  
2024

Drawing No.:

**RMA-2023  
-TPD-059-A**

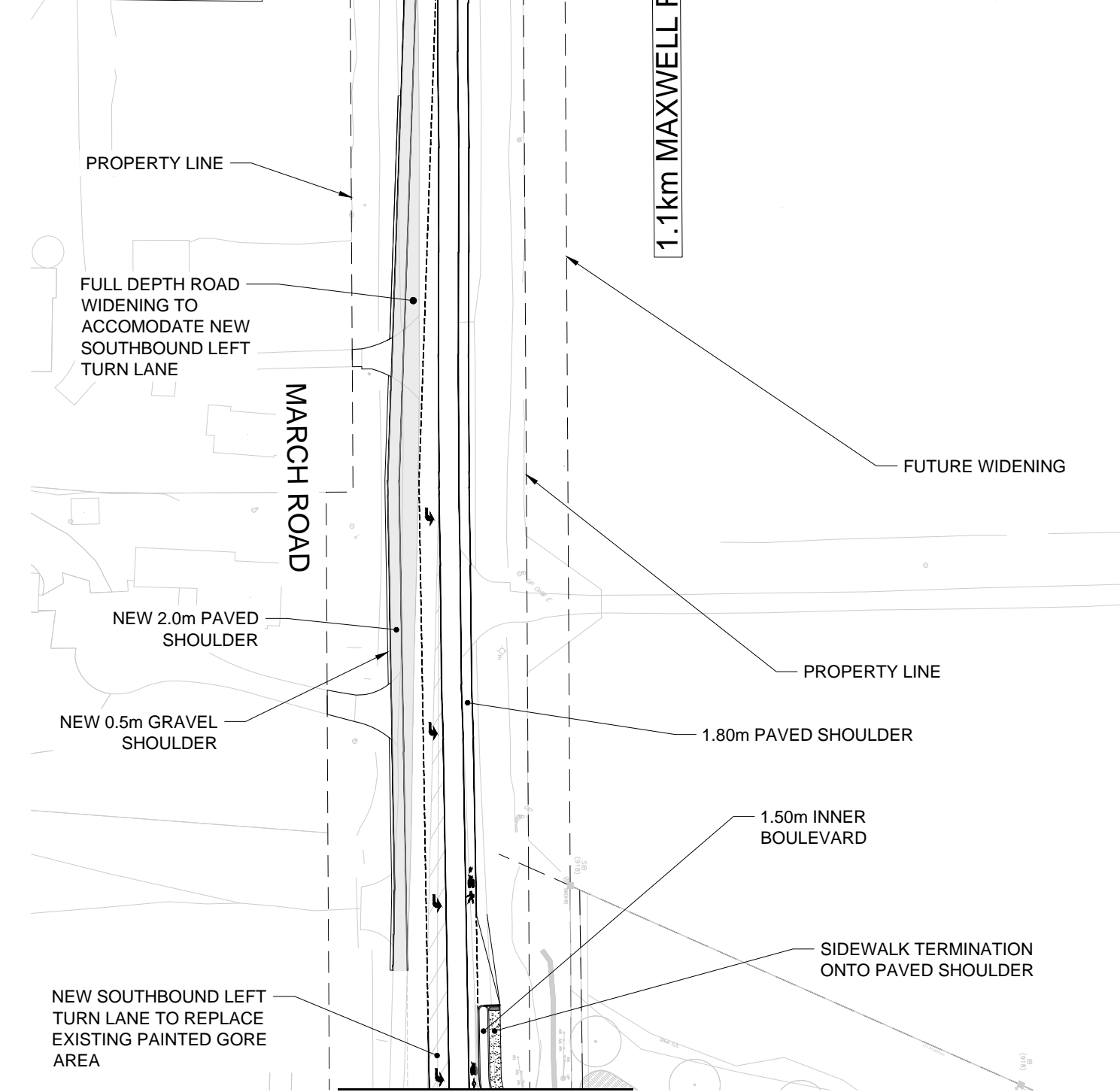
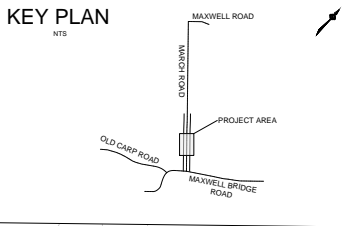

REFER TO ATTACHMENT 3

 TRANSPORTATION PLANNING DEPT.	<b>LEPINE</b> <b>910 MARCH ROAD</b>	Transportation Engineering Services		
	<b>MARCH ROAD</b> <b>MODIFICATIONS</b> <b>INTERIM CONDITION</b>	Approved By: TBD	Drawing No.:	
		Completed By: CGH	<b>RMA-2023</b> <b>-TPD-059-B</b>	
		Scale: 1:1000		



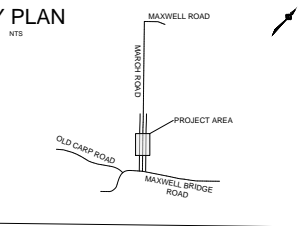

REFER TO ATTACHMENT 2



1.50m TOP SOIL AND SOD BOULEVARD

MOUNTABLE CONCRETE APRON WITH RIPPLE STRIP

PAINTED GORE AREA

REPURPOSE EXISTING EASTERMOST NORTHBOUND RUNOUT LANE TO RIGHT TURN LANE

0.1km MAXWELL BRIDGE ROAD

MARCH ROAD

LIMIT OF PROJECT

1.80m CYCLE LANE WITH 1-1-1 DASHED GREEN THERMOPLAST AT CROSSING

FULL MOVEMENT ACCESS

2.00m DEPRESSED CONCRETE SIDEWALK PER SC7.1

FULL DEPTH ROADWAY WIDENING FOR NORTHBOUND RIGHT TURN LANE.

1.50m TOPSOIL AND SOD BOULEVARD

CYCLING LANE EXTENSION

2.00m EXISTING CONCRETE SIDEWALK EXTENSION

PROPERTY LINE

FUTURE WIDENING

EXISTING LANE TERMINATION SHIFTED SOUTH OF NEW ACCESS AND RIGHT TURN LANE



TRANSPORTATION PLANNING DEPT.

LEPINE  
910 MARCH ROAD

MARCH ROAD  
MODIFICATIONS  
INTERIM CONDITION

Transportation Engineering Services

Approved By:  
TBD

Completed By:  
CGH

Scale:  
1:1000

Date:  
JAN.  
2024

Drawing No.:

RMA-2023  
-TPD-059-C



# INFRASTRUCTURE SERVICES DEPARTMENT

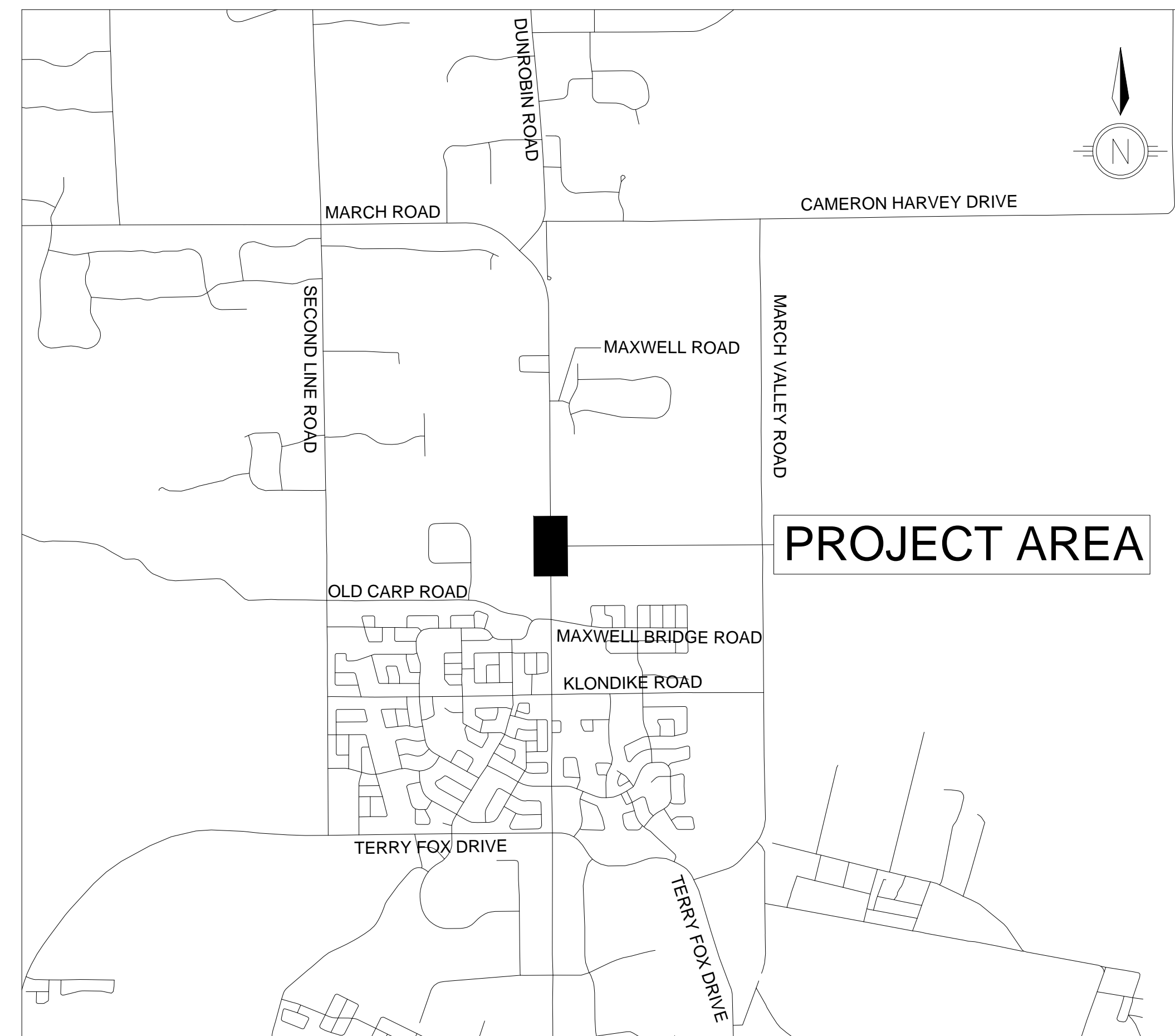

## 910 MARCH ROAD ROADWAY MODIFICATION INTERIM CONFIGURATION

CONTRACT NO. D07-12-22-0050

FUNCTIONAL DESIGN  
NOT FOR CONSTRUCTION  
JANUARY, 2024

# KEY PLAN

NTS

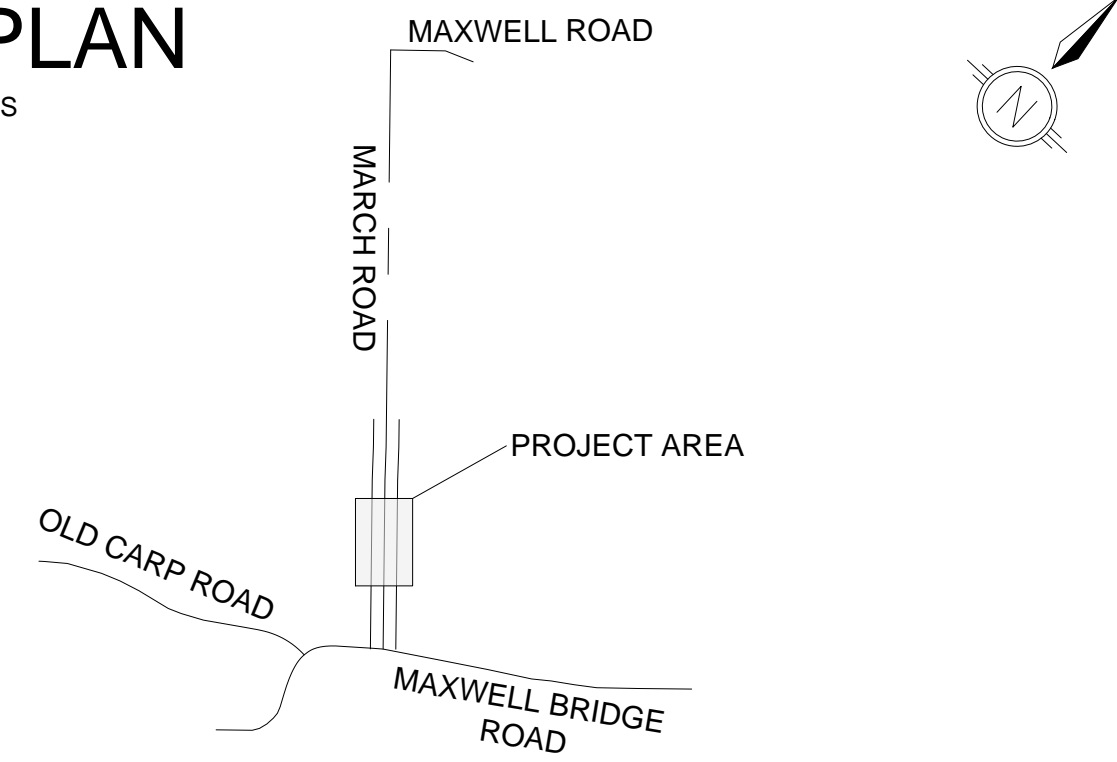

## LEGEND

- |  |  |  |                                     |
|--|--|--|-------------------------------------|
|  | CONCRETE SIDEWALK                                  |  | ASPHALT SHOULDER STRUCTURE          |
|  | MOUNTABLE CONCRETE APRON WITH RIPPLE STRIP         |  | PARTIAL DEPTH ASPHALT REINSTATEMENT |
|  | TACTILE WALKING SURFACE INDICATORS                 |  | GRANULAR SHOULDER                   |
|  | FULL DEPTH ROAD STRUCTURE REINSTATEMENT & WIDENING |  | TOPSOIL AND SOD                     |

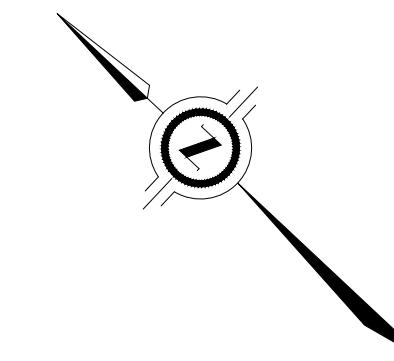

910 MARCH ROAD  
ROAD WIDENING



GEOMETRY & GENERAL LAYOUT  
MARCH ROAD  
STA 9+775 TO 9+960

Contract No. D07-12-22-0050 Dwg. No. G01  
Sheet - of -

Asset No.

Asset Group



Des. B.B Chk'd. M.C

Dwn. B.B Chk'd. M.C

Utility Circ. No. Index No.

Const. Inspector

Scale: HORIZONTAL  
0m 5 10

NOTE: The location of utilities is approximate only, the exact location should be determined by consulting the municipal authorities and utility companies concerned. The contractor shall prove the location of utilities and shall be responsible for adequate protection from damage.

No.	Description	By	Date (dd/mm/yy)
1.	ISSUED FOR FUNCTIONAL DESIGN REVIEW	M.C	25/01/23
2.	ISSUED FOR FUNCTIONAL DESIGN REVIEW	M.C	27/07/23
3.	ISSUED FOR FUNCTIONAL DESIGN REVIEW	M.C	20/10/23
4.	ISSUED FOR FUNCTIONAL DESIGN REVIEW	M.C	17/01/24

## FUNCTIONAL DESIGN NOT FOR CONSTRUCTION

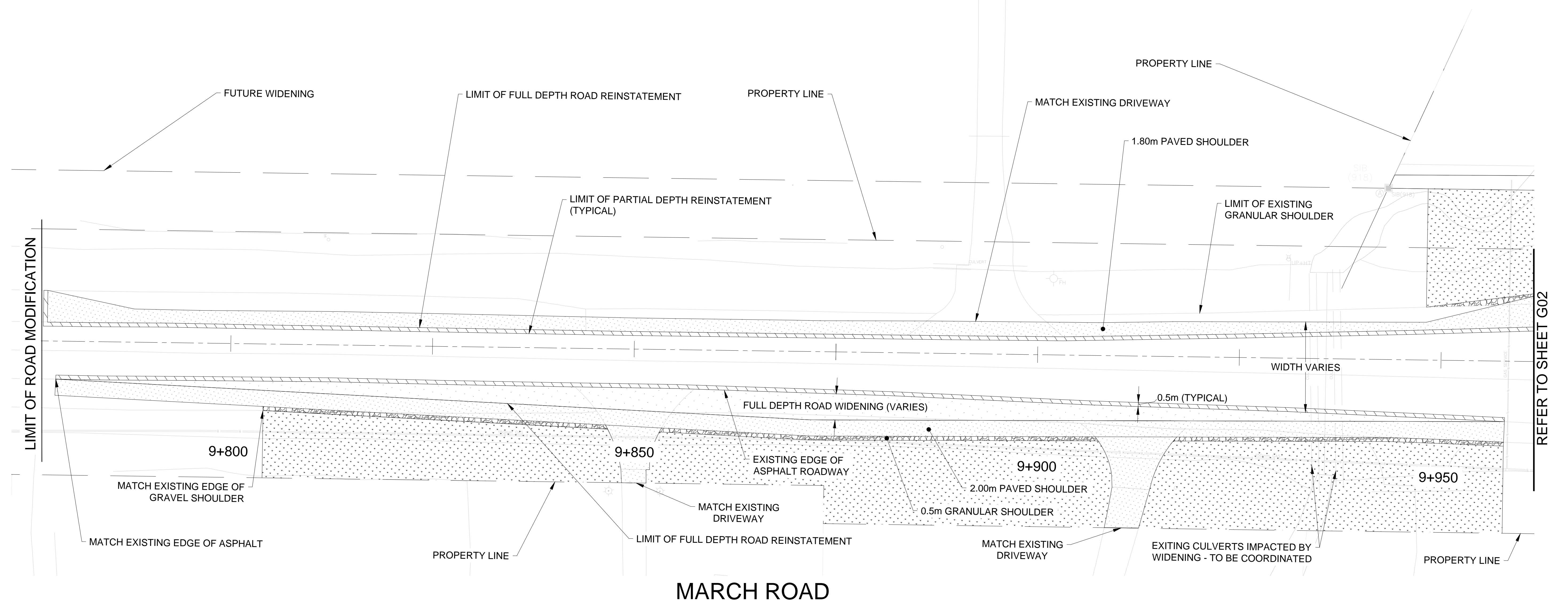

NOTE: The location of utilities is approximate only, the exact location should be determined by consulting the municipal authorities and utility companies concerned. The contractor shall prove the location of utilities and shall be responsible for adequate protection from damage.

No.	Description	By	Date (dd/mm/yy)
1.	ISSUED FOR FUNCTIONAL DESIGN REVIEW	M.C.	25/01/23
2.	ISSUED FOR FUNCTIONAL DESIGN REVIEW	M.C.	27/07/23
3.	ISSUED FOR FUNCTIONAL DESIGN REVIEW	M.C.	20/10/23
4.	ISSUED FOR FUNCTIONAL DESIGN REVIEW	M.C.	17/01/24

FUNCTIONAL DESIGN  
NOT FOR CONSTRUCTION

### KEY PLAN

NTS

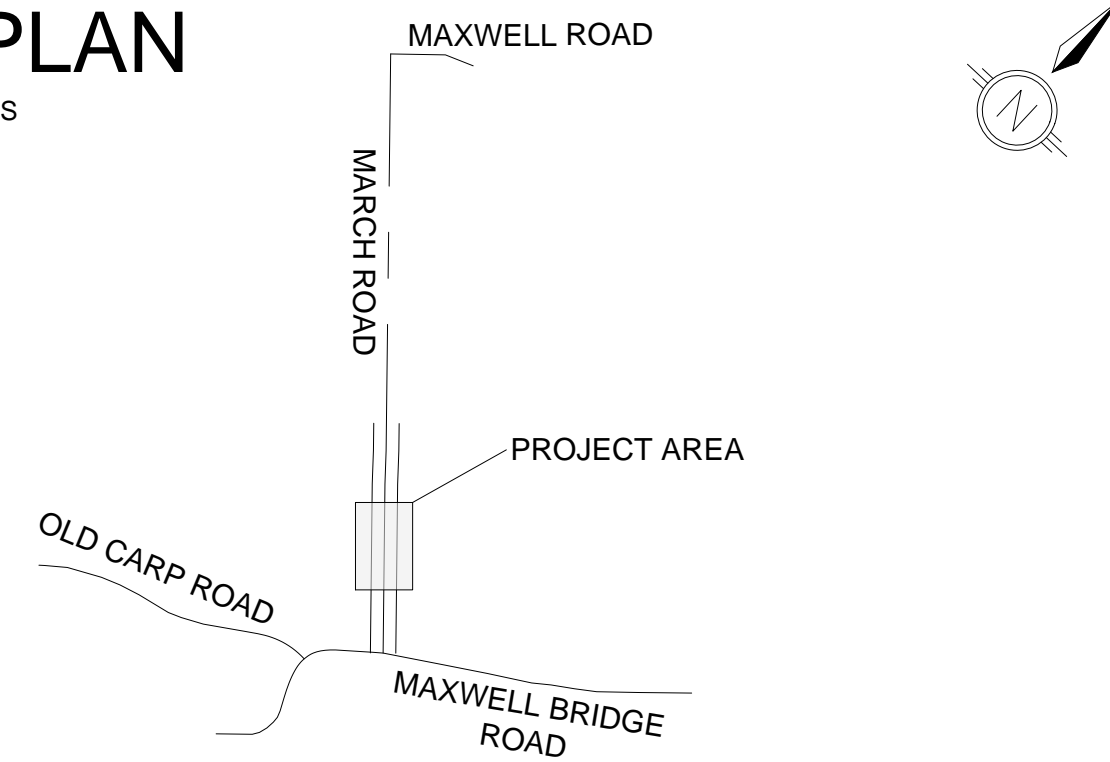

### LEGEND

- CONCRETE SIDEWALK
- MOUNTABLE CONCRETE APRON WITH RIPPLE STRIP
- TACTILE WALKING SURFACE INDICATORS
- FULL DEPTH ROAD STRUCTURE REINSTATEMENT & WIDENING
- ASPHALT SHOULDER STRUCTURE
- PARTIAL DEPTH ASPHALT REINSTATEMENT
- GRANULAR SHOULDER
- TOPSOIL AND SOD

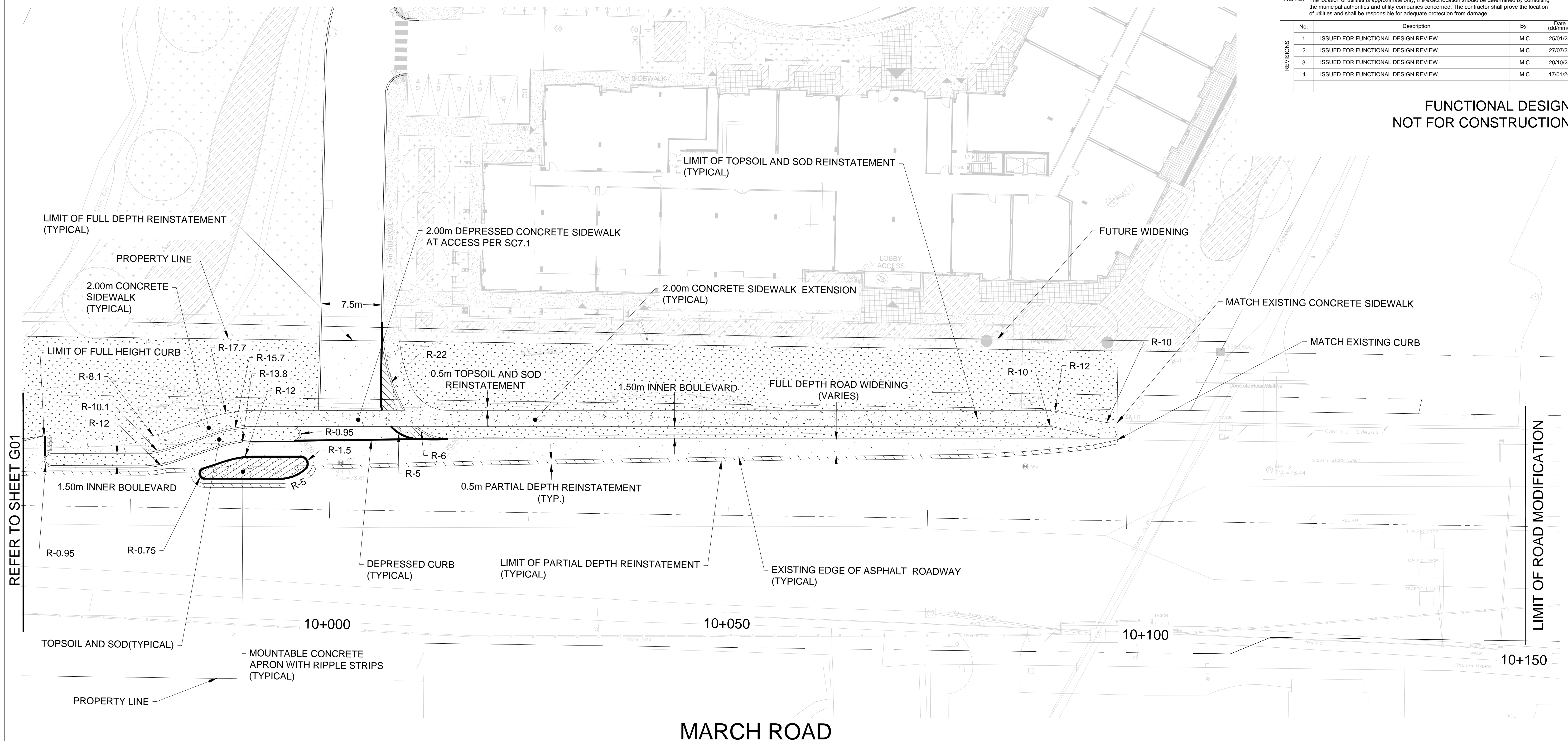
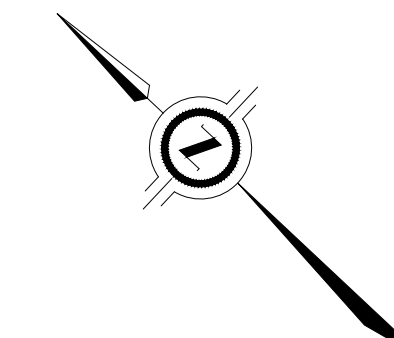

REFER TO SHEET G01

LIMIT OF ROAD MODIFICATION

## MARCH ROAD

# KEY PLAN

NTS

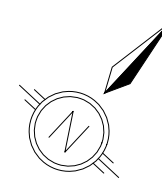
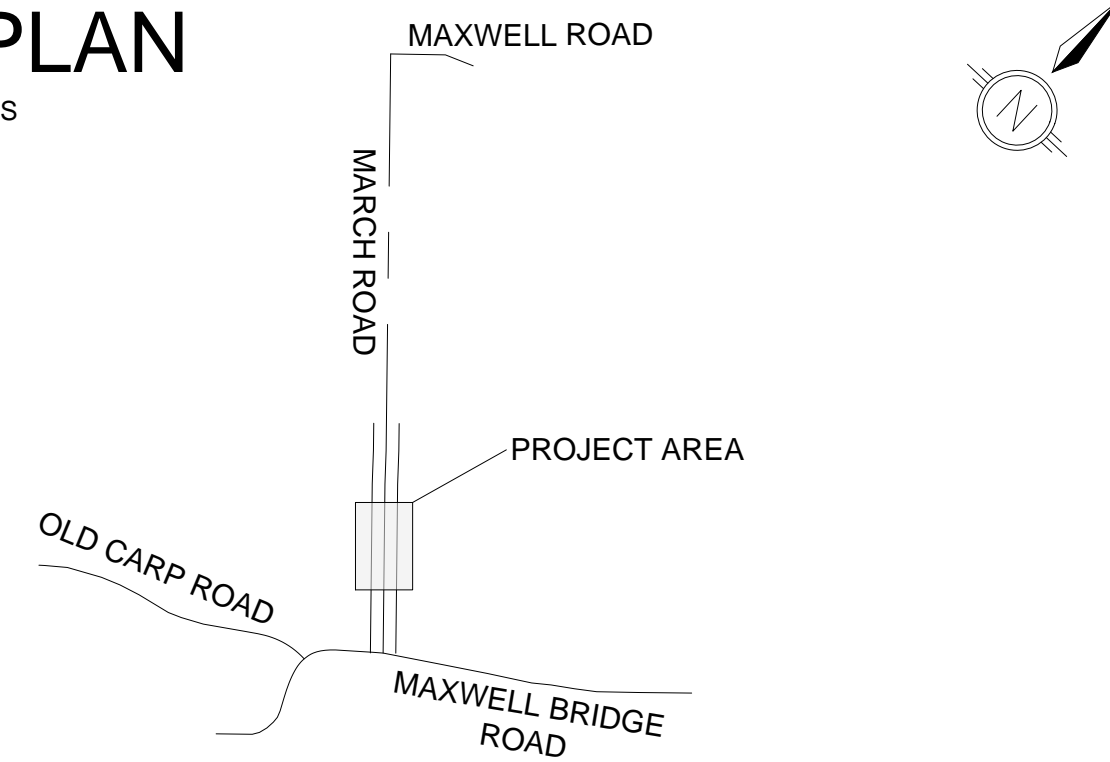

# SIGN LEGEND

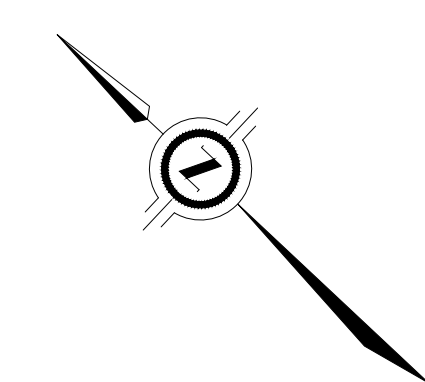
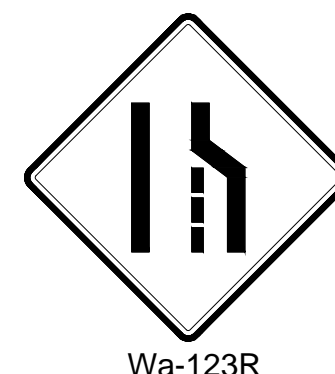
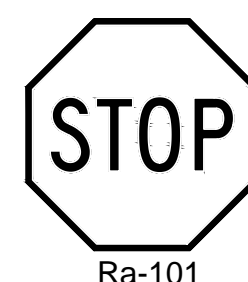
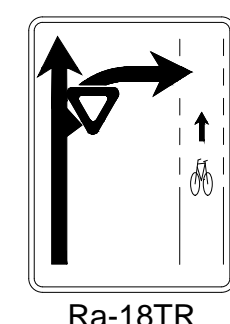
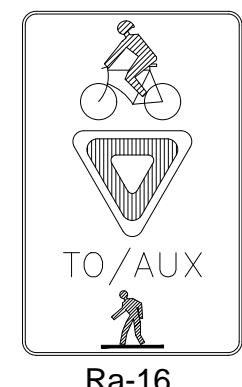

910 MARCH ROAD  
ROAD WIDENING



PAVEMENT MARKING AND SIGNAGE  
MARCH ROAD  
STA 9+775 TO 9+945

Contract No. D07-12-22-0050 Dwg. No. PMK01

Sheet - of -

Asset No.

Asset Group



Des. B.B Chk'd. M.C

Dwn. B.B Chk'd. M.C

Utility Circ. No. Index No.

Const. Inspector

Scale: HORIZONTAL

0m 5 10

NOTE: The location of utilities is approximate only, the exact location should be determined by consulting the municipal authorities and utility companies concerned. The contractor shall prove the location of utilities and shall be responsible for adequate protection from damage.

No.	Description	By	Date (dd/mm/yy)
1.	ISSUED FOR FUNCTIONAL DESIGN REVIEW	M.C	25/01/23
2.	ISSUED FOR FUNCTIONAL DESIGN REVIEW	M.C	27/07/23
3.	ISSUED FOR FUNCTIONAL DESIGN REVIEW	M.C	20/10/23
4.	ISSUED FOR FUNCTIONAL DESIGN REVIEW	M.C	17/01/24

FUNCTIONAL DESIGN  
NOT FOR CONSTRUCTION

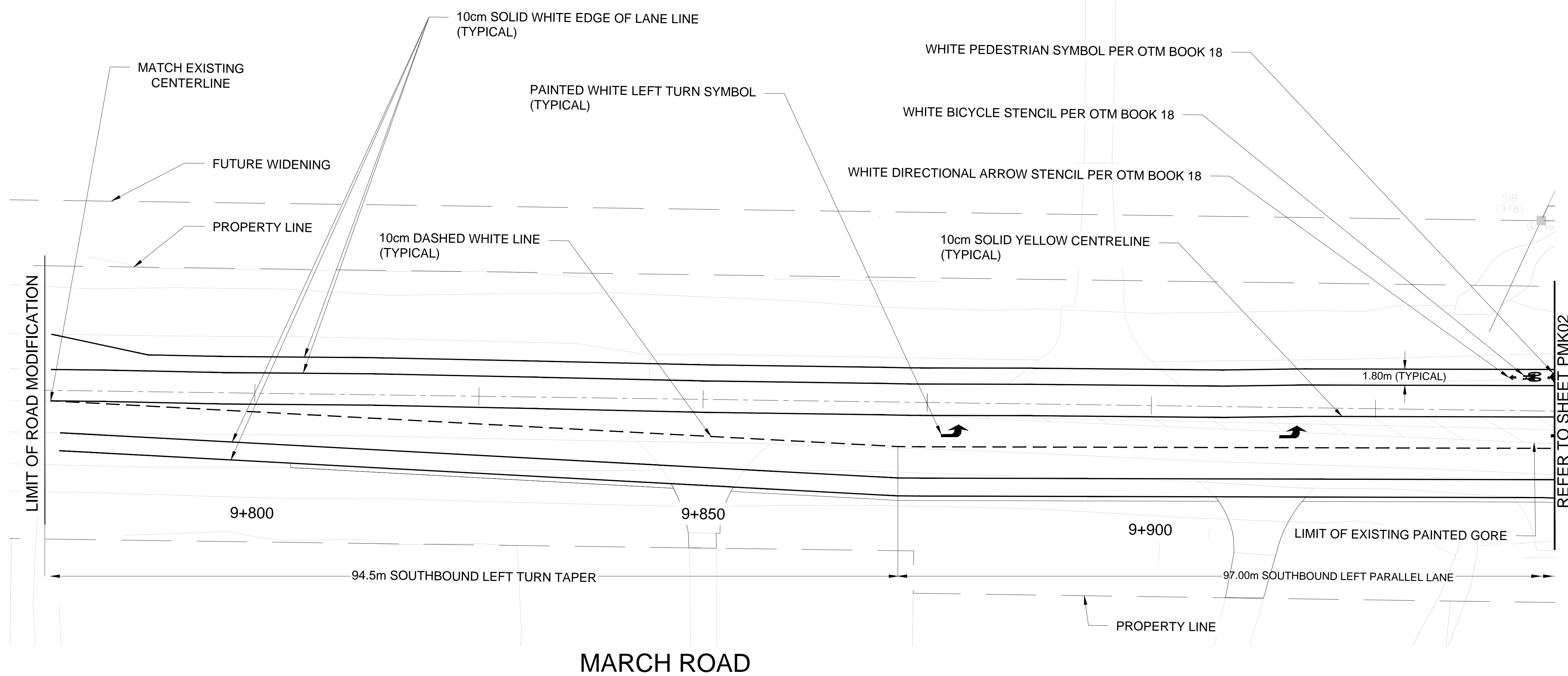

MARCH ROAD

REFER TO SHEET PMK02

# KEY PLAN

NTS

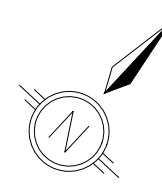
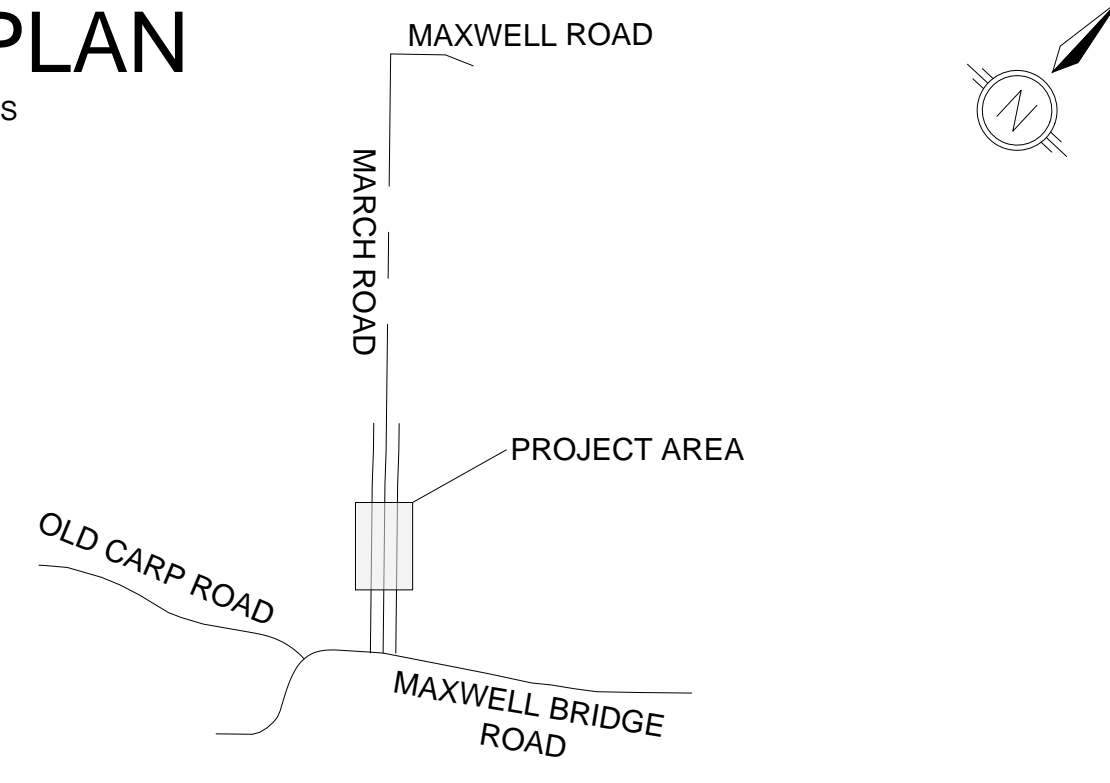

# SIGN LEGEND

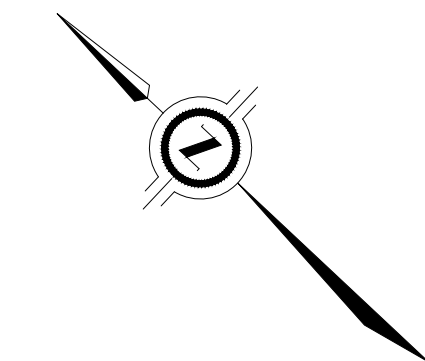
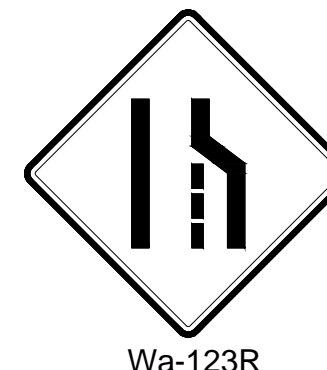
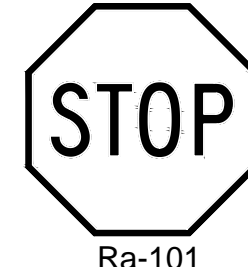
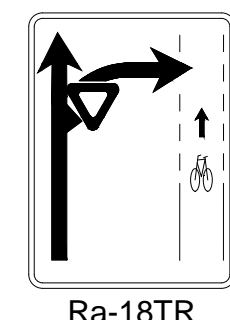
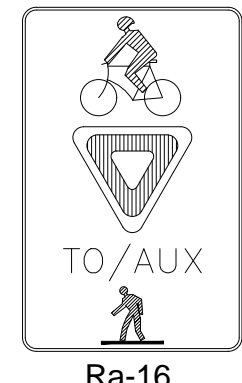

910 MARCH ROAD  
ROAD WIDENING



PAVEMENT MARKING AND SIGNAGE  
MARCH ROAD  
STA 9+945 TO 10+100

Contract No.	D07-12-22-0050	Dwg. No.	PMK02
Sheet	-	of	-
Asset No.			
Asset Group			
Des.	B.B	Chk'd.	M.C
Dwn.	B.B	Chk'd.	M.C
Utility Circ. No.		Index No.	
Const. Inspector			
Scale:	HORIZONTAL		
	0m	5	10

NOTE: The location of utilities is approximate only, the exact location should be determined by consulting the municipal authorities and utility companies concerned. The contractor shall prove the location of utilities and shall be responsible for adequate protection from damage.

No.	Description	By	Date (dd/mm/yy)
1.	ISSUED FOR FUNCTIONAL DESIGN REVIEW	M.C	25/01/23
2.	ISSUED FOR FUNCTIONAL DESIGN REVIEW	M.C	27/07/23
3.	ISSUED FOR FUNCTIONAL DESIGN REVIEW	M.C	20/10/23
4.	ISSUED FOR FUNCTIONAL DESIGN REVIEW	M.C	17/01/24

FUNCTIONAL DESIGN  
NOT FOR CONSTRUCTION

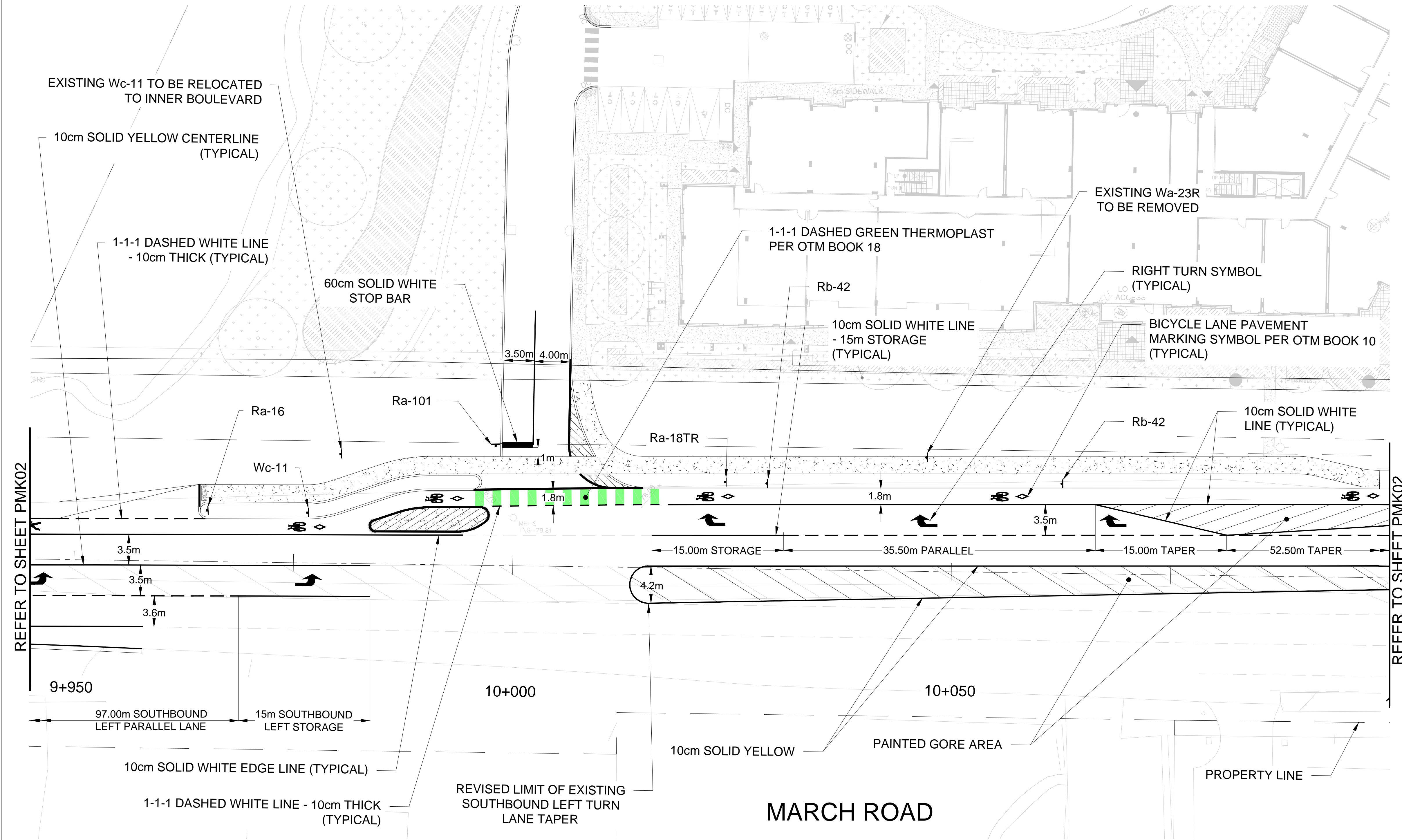

# KEY PLAN

NTS

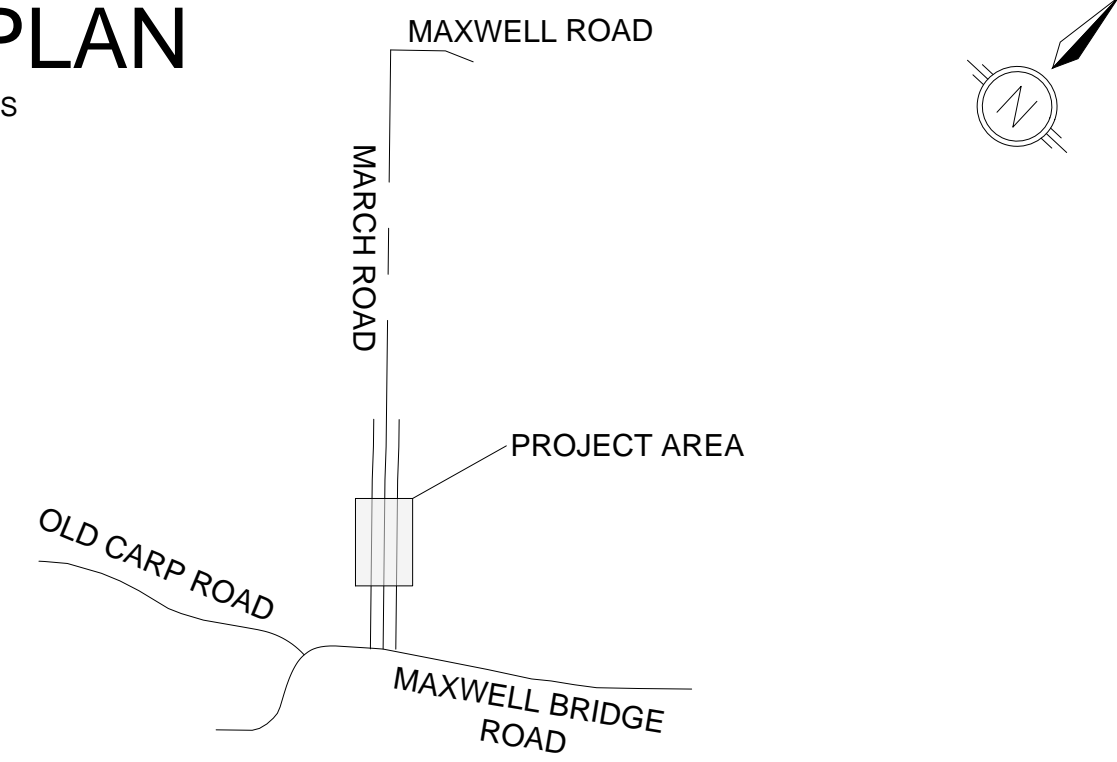

# SIGN LEGEND

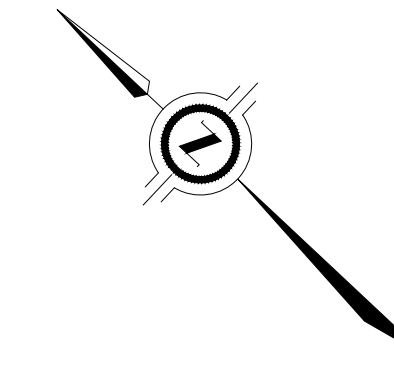
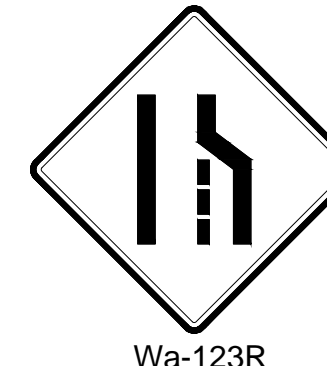
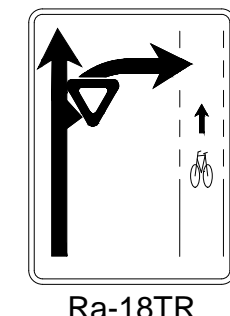
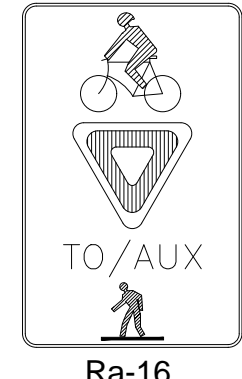

910 MARCH ROAD  
ROAD WIDENING



PAVEMENT MARKING AND SIGNAGE  
MARCH ROAD  
STA 10+100 TO 10+200

Contract No. D07-12-22-0050 Dwg. No. PMK03  
Sheet - of -

Asset No.

Asset Group



Des. B.B Chk'd. M.C

Dwn. B.B Chk'd. M.C

Utility Circ. No. Index No.

Const. Inspector

Scale: HORIZONTAL  
0m 5 10

NOTE: The location of utilities is approximate only, the exact location should be determined by consulting the municipal authorities and utility companies concerned. The contractor shall prove the location of utilities and shall be responsible for adequate protection from damage.

No.	Description	By	Date (dd/mm/yy)
1.	ISSUED FOR FUNCTIONAL DESIGN REVIEW	M.C	25/01/23
2.	ISSUED FOR FUNCTIONAL DESIGN REVIEW	M.C	27/07/23
3.	ISSUED FOR FUNCTIONAL DESIGN REVIEW	M.C	20/10/23
4.	ISSUED FOR FUNCTIONAL DESIGN REVIEW	M.C	17/01/24

FUNCTIONAL DESIGN  
NOT FOR CONSTRUCTION

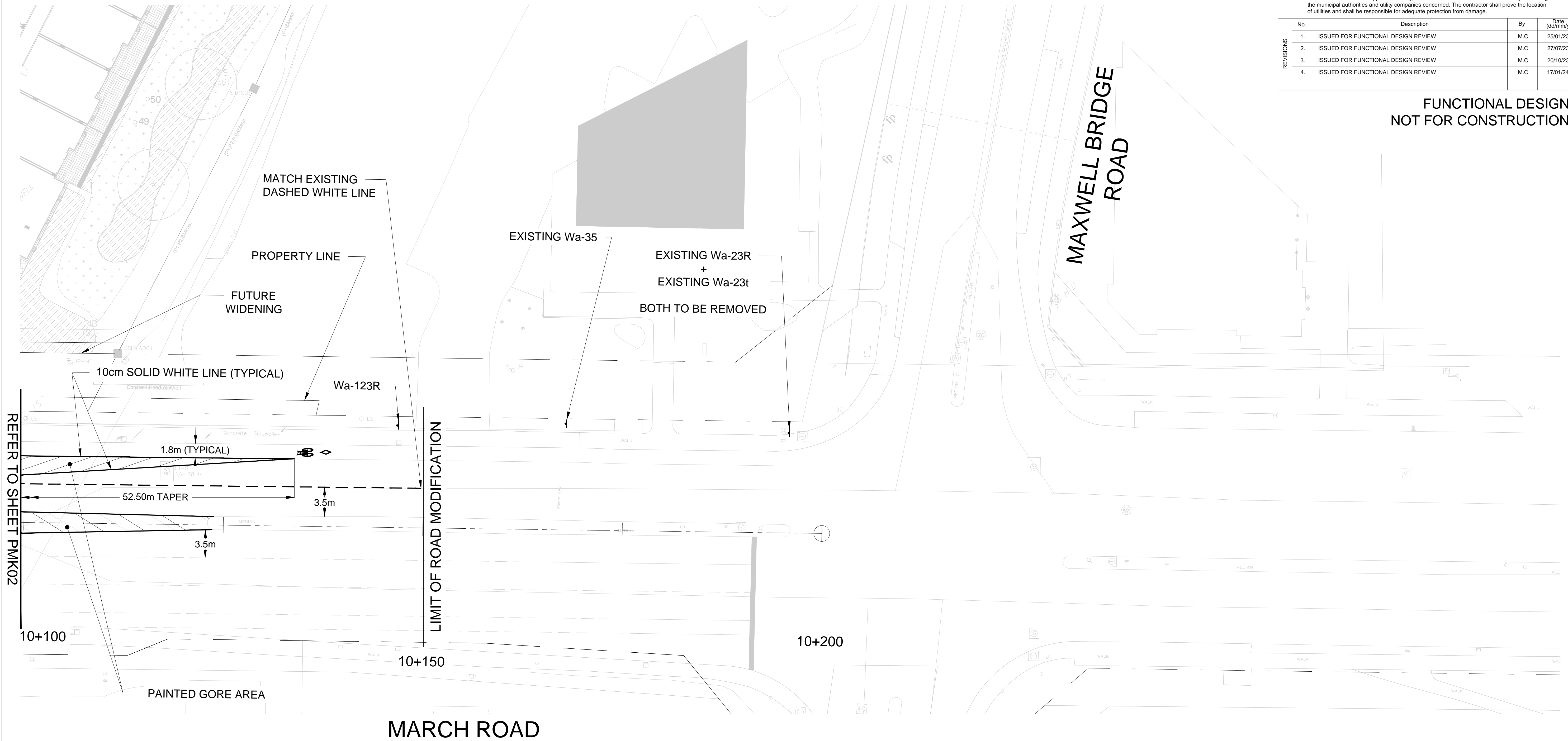

REFER TO SHEET PMK02

# KEY PLAN

NTS

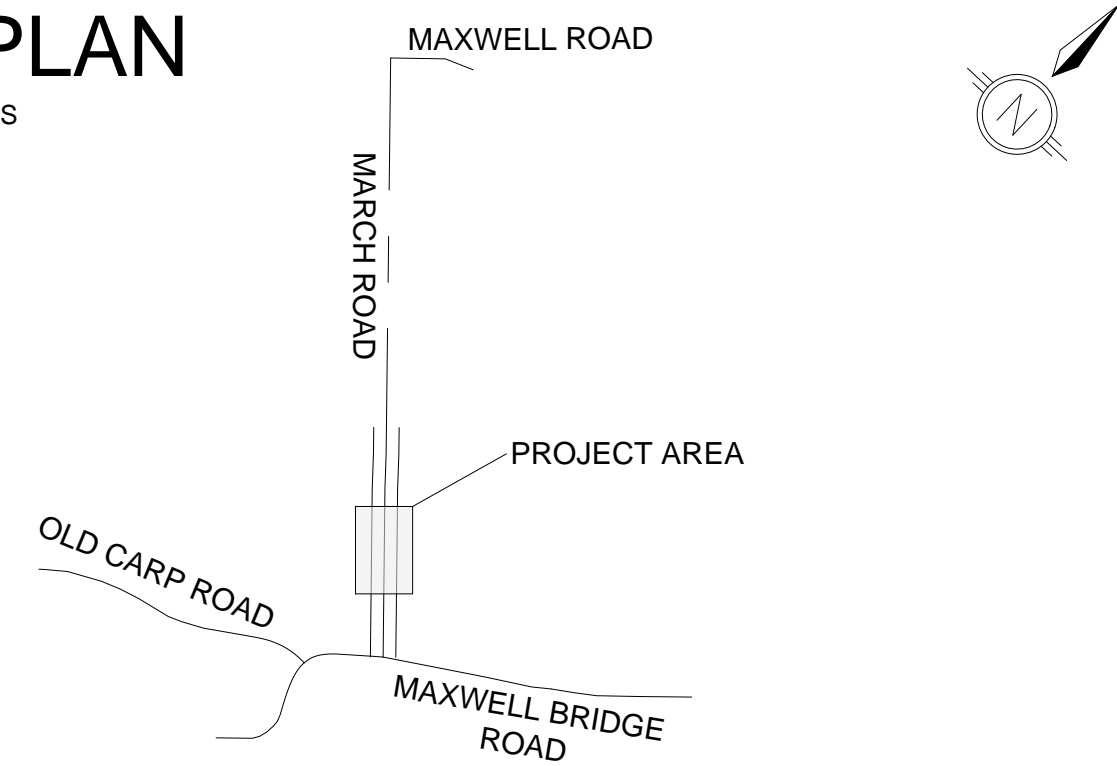

910 MARCH ROAD  
ROAD WIDENING



HSU DESIGN VEHICLE  
TURNING MOVEMENT ANALYSIS  
NEW SITE ACCESS

Contract No. D07-12-22-0050 Dwg. No. TT01  
Sheet - of -

Asset No.

Asset Group



Des. B.B Chk'd. M.C

Dwn. B.B Chk'd. M.C

Utility Circ. No. Index No.

Const. Inspector

Scale: HORIZONTAL  
0m 5 10

NOTE: The location of utilities is approximate only, the exact location should be determined by consulting the municipal authorities and utility companies concerned. The contractor shall prove the location of utilities and shall be responsible for adequate protection from damage.

No.	Description	By	Date (dd/mm/yy)
1.	ISSUED FOR FUNCTIONAL DESIGN REVIEW	M.C	25/01/23
2.	ISSUED FOR FUNCTIONAL DESIGN REVIEW	M.C	27/07/23
3.	ISSUED FOR FUNCTIONAL DESIGN REVIEW	M.C	20/10/23
4.	ISSUED FOR FUNCTIONAL DESIGN REVIEW	M.C	17/01/24

FUNCTIONAL DESIGN  
NOT FOR CONSTRUCTION

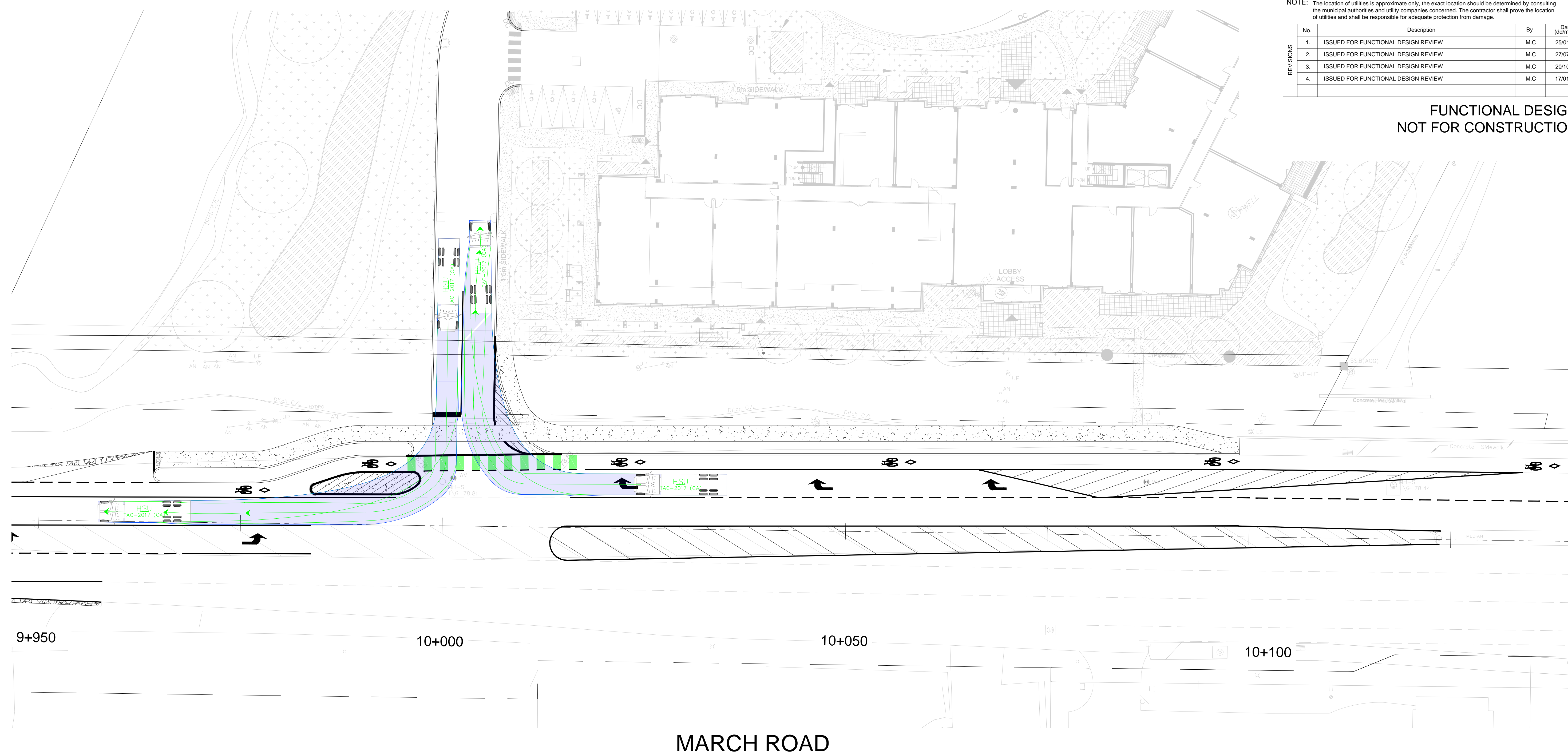

MARCH ROAD



# KEY PLAN

NTS

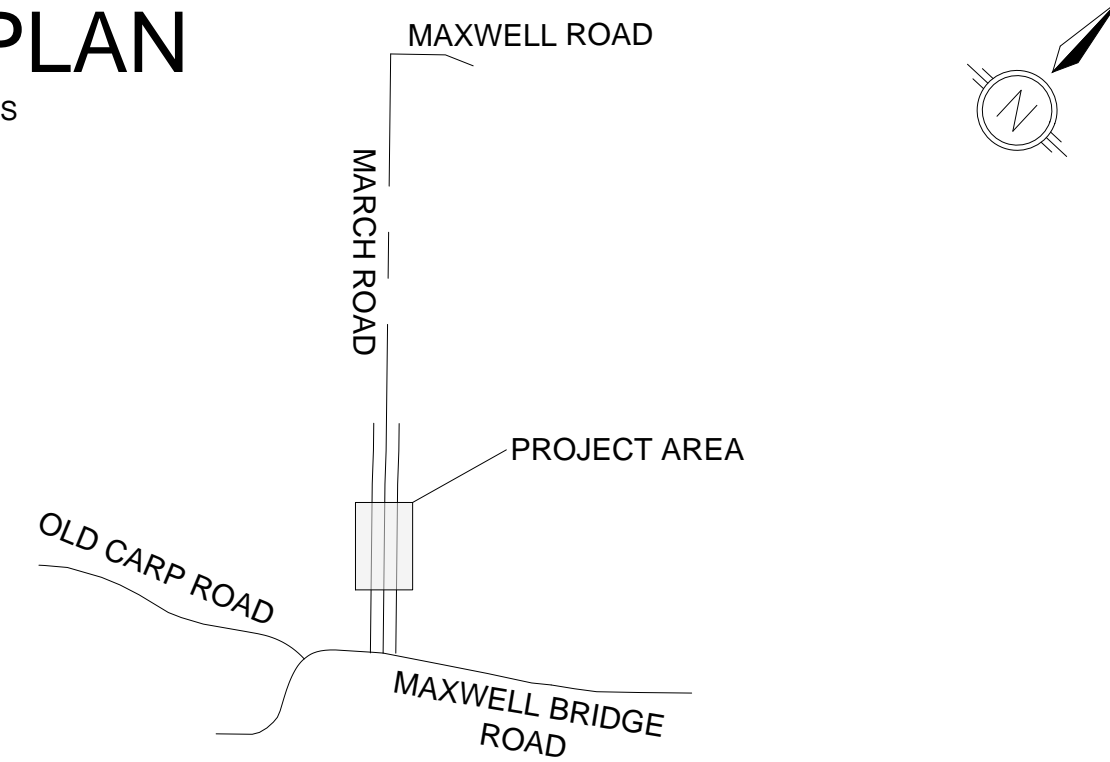

910 MARCH ROAD  
ROAD WIDENING



HSU DESIGN VEHICLE  
TURNING MOVEMENT ANALYSIS  
NEW SITE ACCESS

Contract No. D07-12-22-0050 Dwg. No. TT02  
Sheet - of -

Asset No.

Asset Group



Des. B.B Chk'd. M.C

Dwn. B.B Chk'd. M.C

Utility Circ. No. Index No.

Const. Inspector

Scale: HORIZONTAL  
0m 5 10

NOTE: The location of utilities is approximate only, the exact location should be determined by consulting the municipal authorities and utility companies concerned. The contractor shall prove the location of utilities and shall be responsible for adequate protection from damage.

No.	Description	By	Date (dd/mm/yy)
1.	ISSUED FOR FUNCTIONAL DESIGN REVIEW	M.C	25/01/23
2.	ISSUED FOR FUNCTIONAL DESIGN REVIEW	M.C	27/07/23
3.	ISSUED FOR FUNCTIONAL DESIGN REVIEW	M.C	20/10/23
4.	ISSUED FOR FUNCTIONAL DESIGN REVIEW	M.C	17/01/24

FUNCTIONAL DESIGN  
NOT FOR CONSTRUCTION

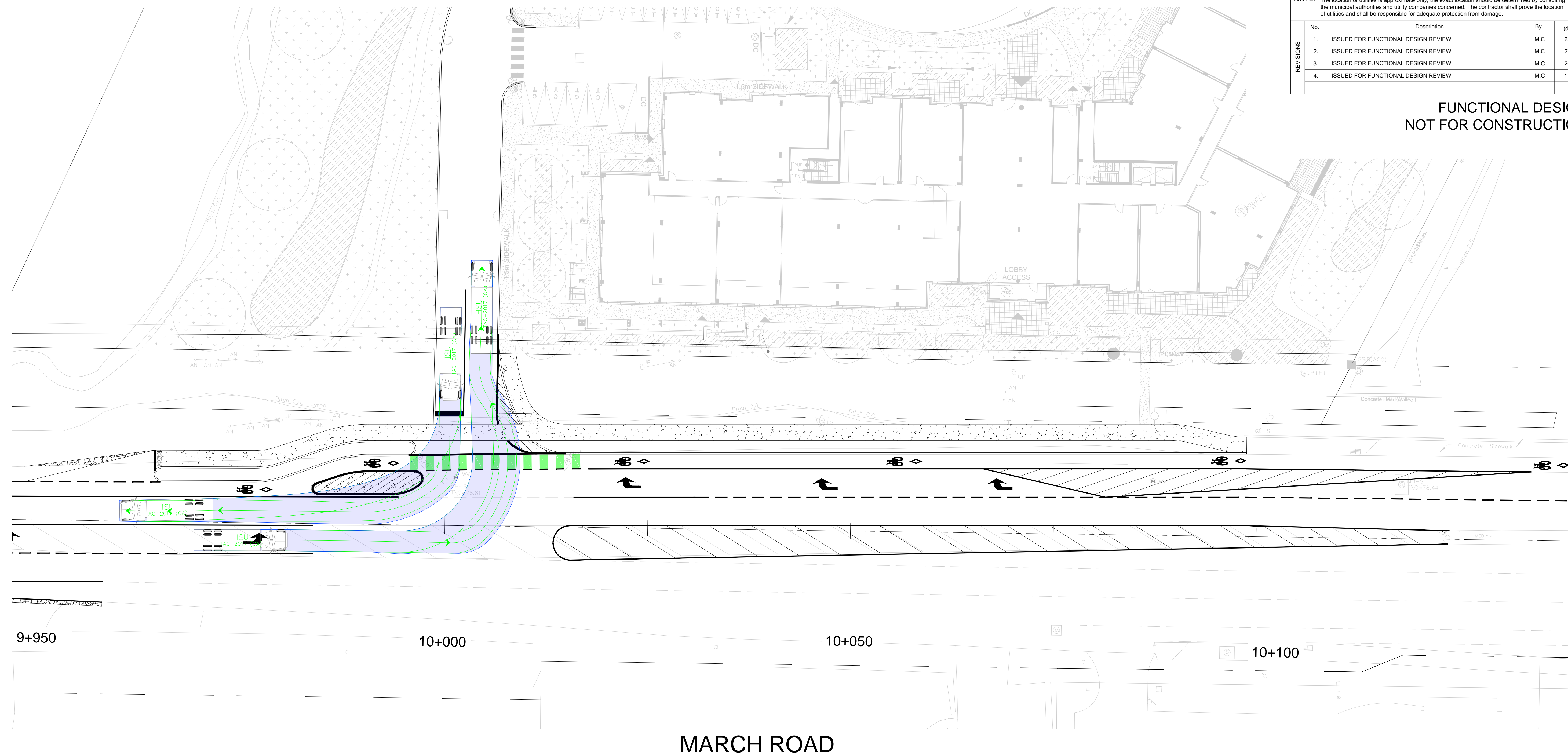

**910 March Road**  
**Intersection Modification Construction Costs**  
**Interim Condition**  
**Class 'D' Cost Estimate**  
**2024-01-17**



RMA-2023-TPD-059

Item	Description		Amount
<b>10</b>	<b>Construction</b>		<b>\$ 531,351.36</b>
10.00	Construction - General		\$ 4,500.00
10.01	Excavation and Removals		\$ 90,560.79
10.02	Concrete		\$ 109,881.48
10.03	Pavement Structure		\$ 169,862.82
10.04	Landscaping		\$ 104,076.29
10.05	Pavement Marking		\$ 6,500.00
10.06	Storm Sewer		\$ 44,569.98
10.07	Signage		\$ 1,400.00
20	Engineering and Architectural Services	15%	\$ 79,702.70
30	Contract Administration Fees (If Required)	10%	\$ 53,135.14
	<b>Sub Total</b>		<b>\$ 664,189.20</b>
40	Contingency	15%	\$ 79,702.70
	<b>GRAND TOTAL</b>		<b>\$ 743,891.91</b>

**910 March Road**  
**Intersection Modification Construction Costs**  
**Interim Condition**  
**Class 'D' Cost Estimate**  
**2024-01-17**



Item No.	Item Code	Description	Quantity	Units	Unit Price	Amount
<b>10.00</b>		<b>Construction General</b>				
	A020.01	Traffic Control Plan (includes Police assistance)	1	LS	\$ 3,500.00	\$ 3,500.00
	A030.01	Construction Site Pedestrian Control Plan	1	LS	\$ 1,000.00	\$ 1,000.00
<b>10.01</b>		<b>Excavation and Removals</b>				
	L040.35	Saw Cutting of Asphalt	1016	m	\$ 13.63	\$ 13,848.22
	L040.37	Remove Asphalt Pavement by Dry Grinding	255	m <sup>2</sup>	\$ 103.17	\$ 26,308.35
	L040.38	Remove Asphalt Pavement - Full Depth (Stripping)	11	m <sup>2</sup>	\$ 42.74	\$ 470.14
	L120.01	Earth Excavation (Includes stripping, Duct and Foundation Removals)	1662	m3	\$ 30.05	\$ 49,934.09
<b>10.02</b>		<b>Concrete</b>				
	L260.01	Concrete Barrier Curb as per SC1.1	238	m	\$ 160.65	\$ 38,234.70
	L250.06	Concrete Sidewalks, Boulevards and Islands	332	m <sup>2</sup>	\$ 211.74	\$ 70,297.68
	L250.11	TWSI	1	m <sup>2</sup>	\$ 1,309.81	\$ 1,349.10
<b>10.03</b>		<b>Pavement Structure</b>				
	L380.20	Superpave 12.5mm (50mm Depth)	194	t	\$ 341.39	\$ 66,275.75
	L390.05	Superpave 19.0mm (70mm Depth)	122	t	\$ 226.39	\$ 27,596.49
	L210.01	Granular 'A' (150mm Depth)	916	t	\$ 41.90	\$ 38,380.40
	L210.03	Granular 'B', Type II (450mm Depth)	806	t	\$ 28.89	\$ 23,270.90
	L190.09	Geotextile	400	m2	\$ 2.67	\$ 1,068.00
	-	Clean Fill	938	m3	\$ 14.15	\$ 13,271.29
<b>10.04</b>		<b>Landscaping</b>				
	T020.03	Top Soil, Imported (150mm Thick)	418	m3	\$ 91.84	\$ 38,359.73
	T030.05	Sod, Including Watering	2785	m2	\$ 23.60	\$ 65,716.56
<b>10.05</b>		<b>Pavement Markings</b>				
	-	Pavement Markings [Provisional]	1	LS	\$ 6,500.00	\$ 6,500.00
<b>10.06</b>		<b>Storm Sewer</b>				
	F010.05	Subdrains (includes connections)	146	m	\$ 41.93	\$ 6,121.78
	F040.01	600mm x 600mm PCC Catch Basin	4	ea	\$ 5,557.85	\$ 22,231.40
	F060.02	200mm dia. PVC Catch Basin Leads	30	m	\$ 540.56	\$ 16,216.80
<b>10.07</b>		<b>Signage</b>				
		Ra-101	1	ea	\$ 400.00	\$ 400.00
		Ra-16	1	ea	\$ 150.00	\$ 150.00
		Ra-18TR	1	ea	\$ 150.00	\$ 150.00
		Rb-42	2	ea	\$ 150.00	\$ 300.00
		Wa-123R	1	ea	\$ 400.00	\$ 400.00
<b>Total</b>						<b>\$ 531,351.36</b>

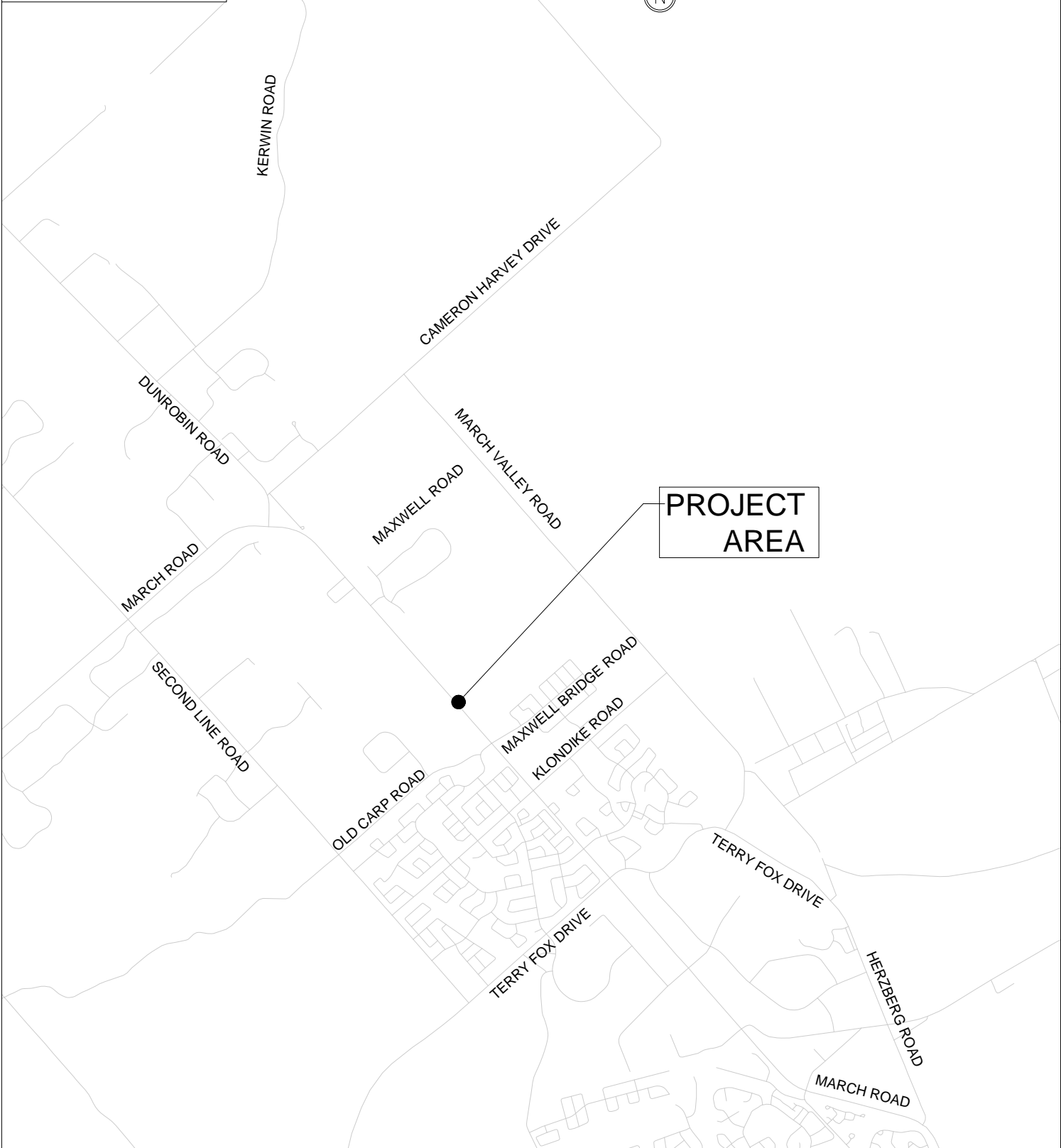

**PROJECT  
AREA**



TRANSPORTATION  
PLANNING DEPT.

**LEPINE  
910 MARCH ROAD**

**KEY PLAN**

**Transportation Engineering Services**

Approved By:  
N/A

Completed By:  
CGH

Scale:  
N.T.S.

Date:  
JAN.  
2024

Drawing No.:

**RMA-2023  
-TPD-060-A**

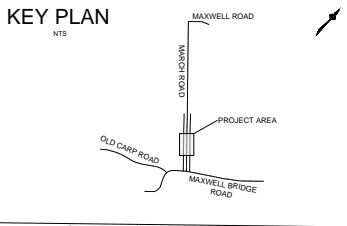

LIMIT OF PROJECT

0.9km MAXWELL ROAD



SOLID WHITE EDGE OF LANE MARKING

PROPERTY LINE

ASPHALT FROM INTERIM WIDENING TO ACCOMMODATE SBLTL TO REMAIN - SOUTHBOUND LANE MARKED WITH SOLID WHITE EDGE LINE

PROPERTY LINE

MARCH ROAD MEDIAN EXTENSION

REFER TO ATTACHMENT 3



TRANSPORTATION PLANNING DEPT.

LEPINE  
910 MARCH ROAD

MARCH ROAD  
MODIFICATIONS  
ULTIMATE CONDITION

Transportation Engineering Services

Approved By:  
N/A

Completed By:  
CGH

Scale:  
1:1000

Date:  
JAN.  
2024

Drawing No.:

RMA-2023  
-TPD-060-B

KEY PLAN

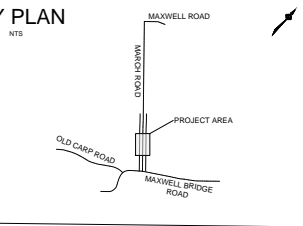

ATTACHMENT 3

REFER TO ATTACHMENT 2

RIGHT-IN RIGHT-OUT CONTROLLED ACCESS

PROPERTY LINE

GRASS TURF MEDIAN EXTENSION

0.1km MAXWELL BRIDGE ROAD

CONCRETE MEDIAN EXTENSION

MATCH EXISTING CONCRETE MEDIAN

LIMIT OF PROJECT

PROPERTY LINE



TRANSPORTATION PLANNING DEPT.

LEPINE  
910 MARCH ROAD

MARCH ROAD  
MODIFICATIONS  
ULTIMATE CONDITION

Transportation Engineering Services

Approved By:  
N/A

Completed By:  
CGH

Scale:  
1:1000

Date:  
JAN.  
2024

Drawing No.:

RMA-2023  
-TPD-060-B



# INFRASTRUCTURE SERVICES DEPARTMENT

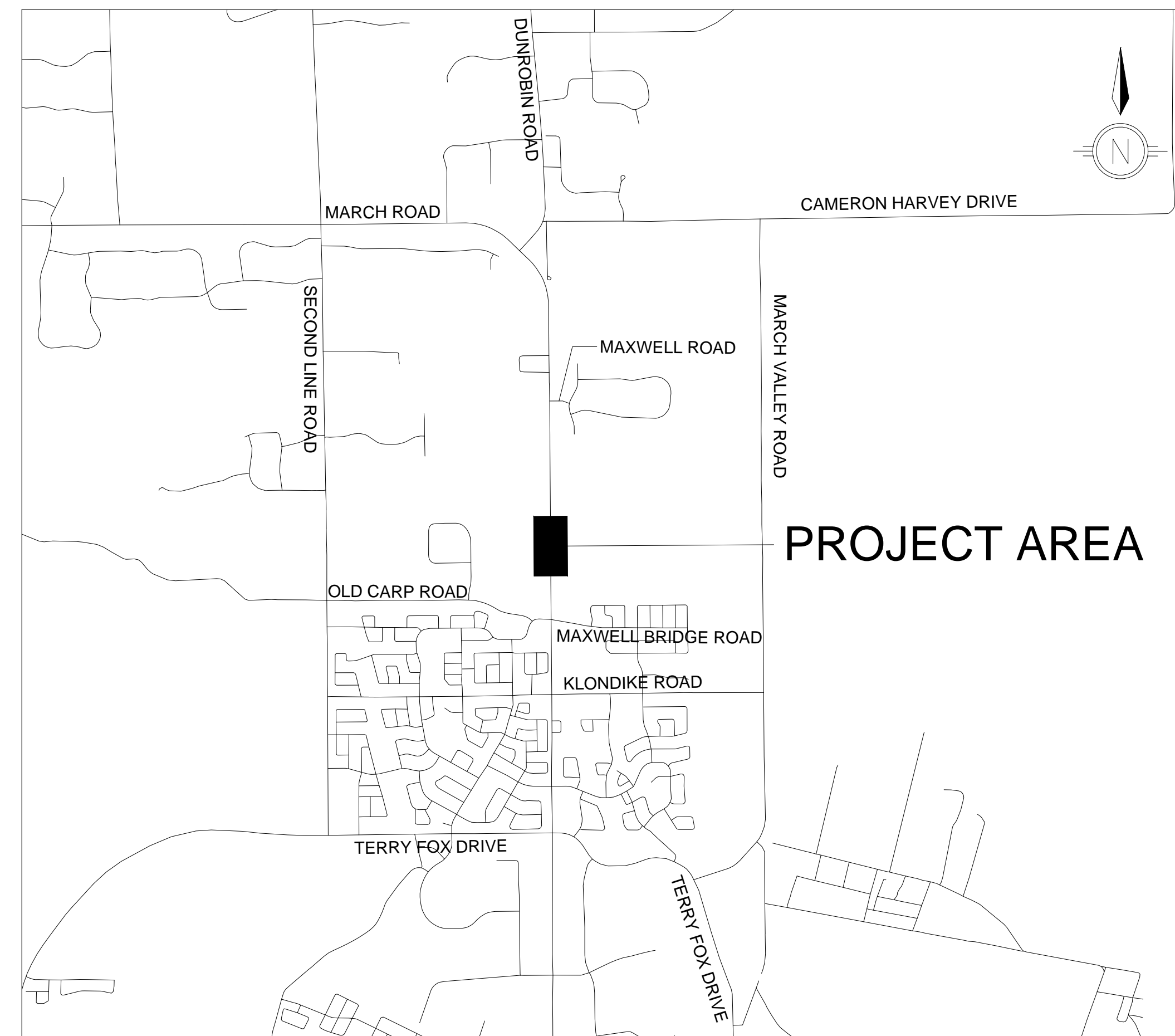

## 910 MARCH ROAD ROADWAY MODIFICATION ULTIMATE CONFIGURATION



CONTRACT NO. D07-12-22-0050

FUNCTIONAL DESIGN  
NOT FOR CONSTRUCTION  
JANUARY, 2024

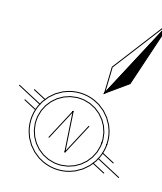
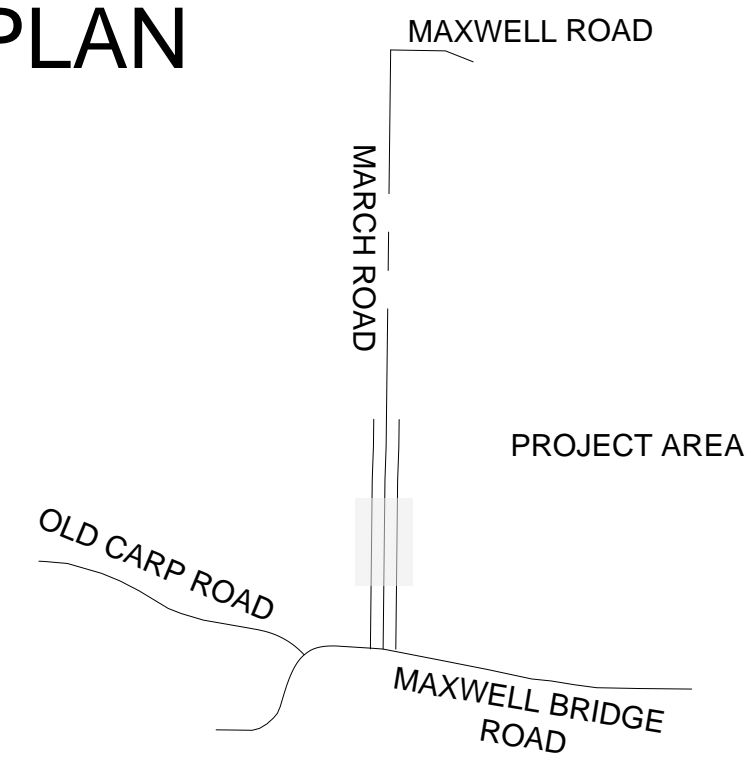
# KEY PLAN

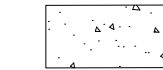
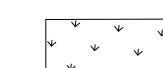
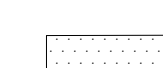

## LEGEND

-  CONCRETE MEDIAN
-  GRASS TURN MEDIAN
-  FULL DEPTH ASPHALT REINSTATEMENT
-  PARTIAL DEPTH ASPHALT REINSTATEMENT

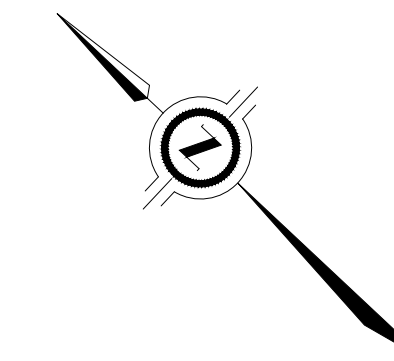

### 910 MARCH ROAD ROADWAY MODIFICATION ULTIMATE CONFIGURATION

GEOMETRY & GENERAL LAYOUT  
MARCH ROAD  
STA 9+950 TO 10+125

Contract No. D07-12-22-0050 Dwg. No. G01

Sheet - of -

Asset No.

Asset Group



Des. B.B Chk'd. M.C

Dwn. B.B Chk'd. M.C

Utility Circ. No. Index No.

Const. Inspector

Scale: HORIZONTAL  
0m 5 10

NOTE: The location of utilities is approximate only, the exact location should be determined by consulting the municipal authorities and utility companies concerned. The contractor shall prove the location of utilities and shall be responsible for adequate protection from damage.

REVISIONS	No.	Description	By	Date (dd/mm/yy)
	1.	ISSUED FOR FUNCTIONAL DESIGN REVIEW	M.C	25/01/23
	2.	ISSUED FOR FUNCTIONAL DESIGN REVIEW	M.C	27/07/23
	3.	ISSUED FOR FUNCTIONAL DESIGN REVIEW	M.C	20/10/23
	4.	ISSUED FOR FUNCTIONAL DESIGN REVIEW	M.C	17/01/24

## FUNCTIONAL DESIGN NOT FOR CONSTRUCTION

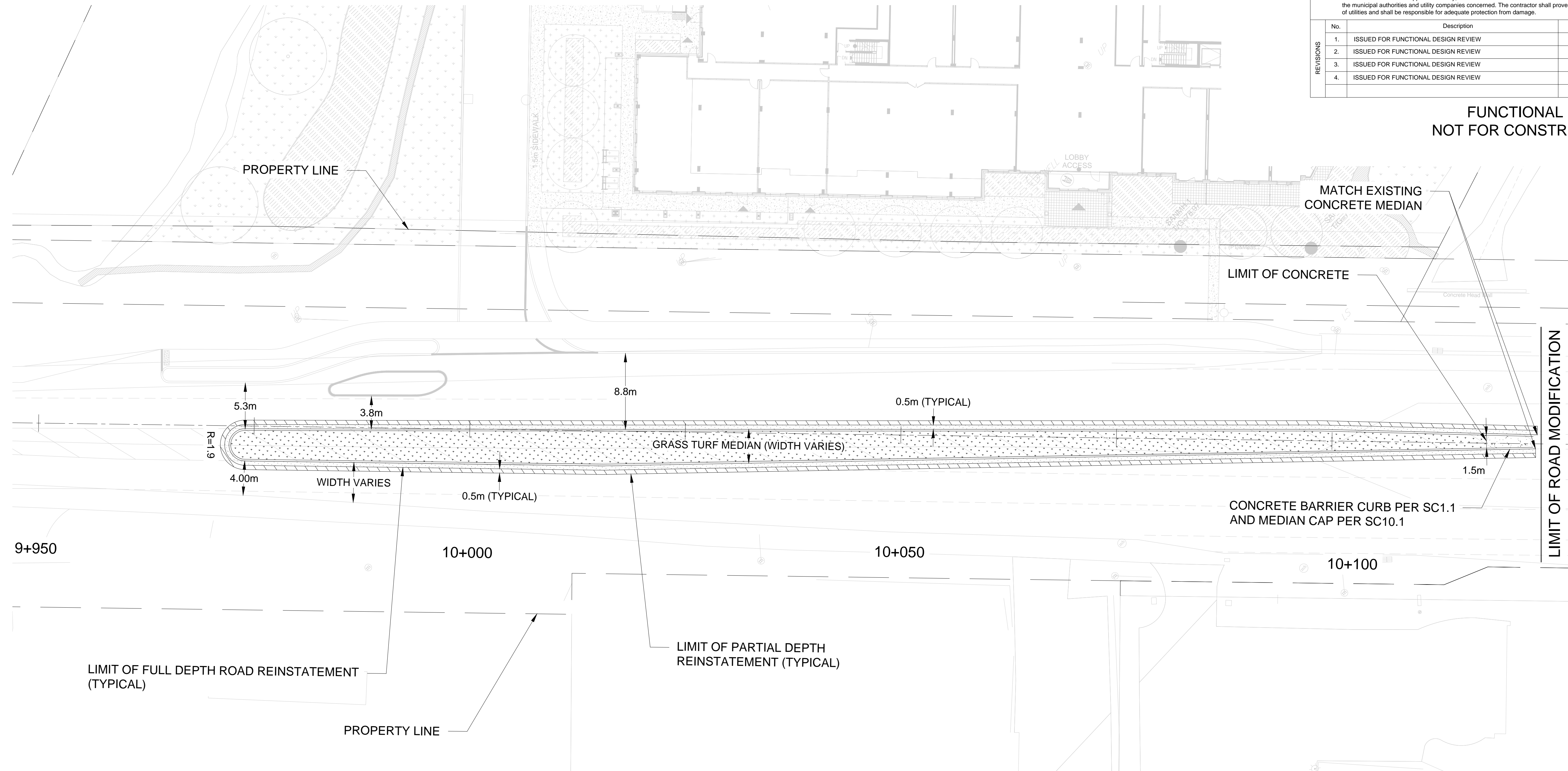



# KEY PLAN

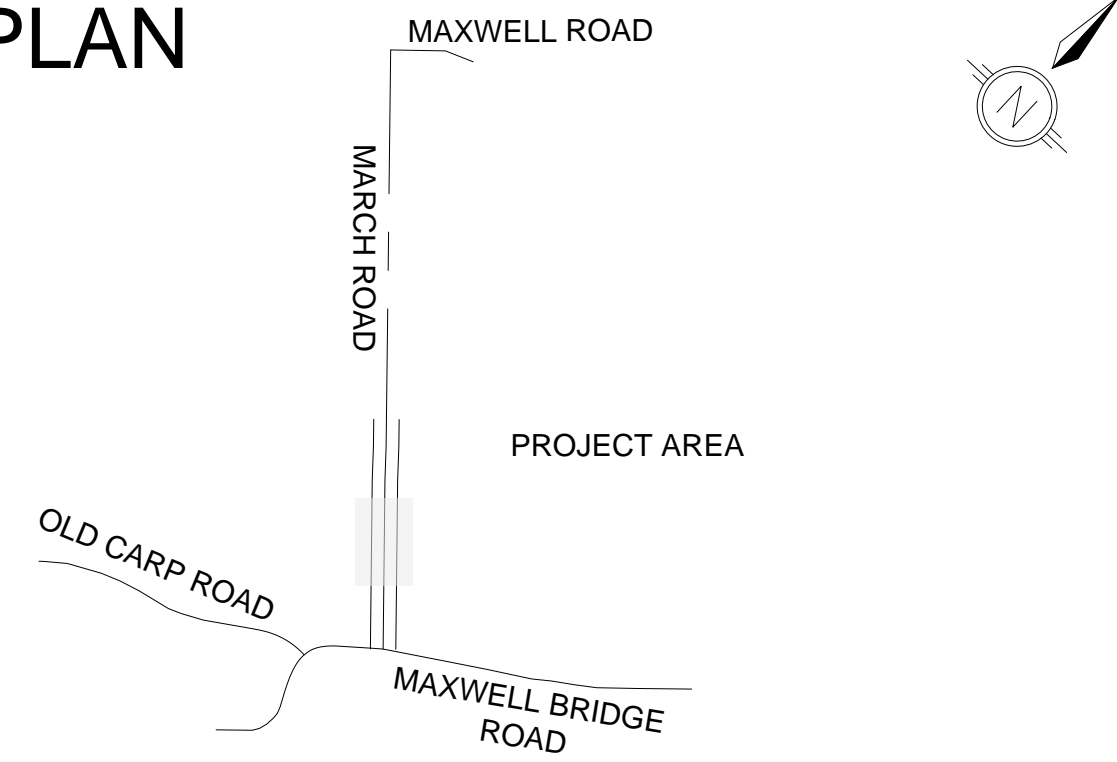

# SIGN LEGEND

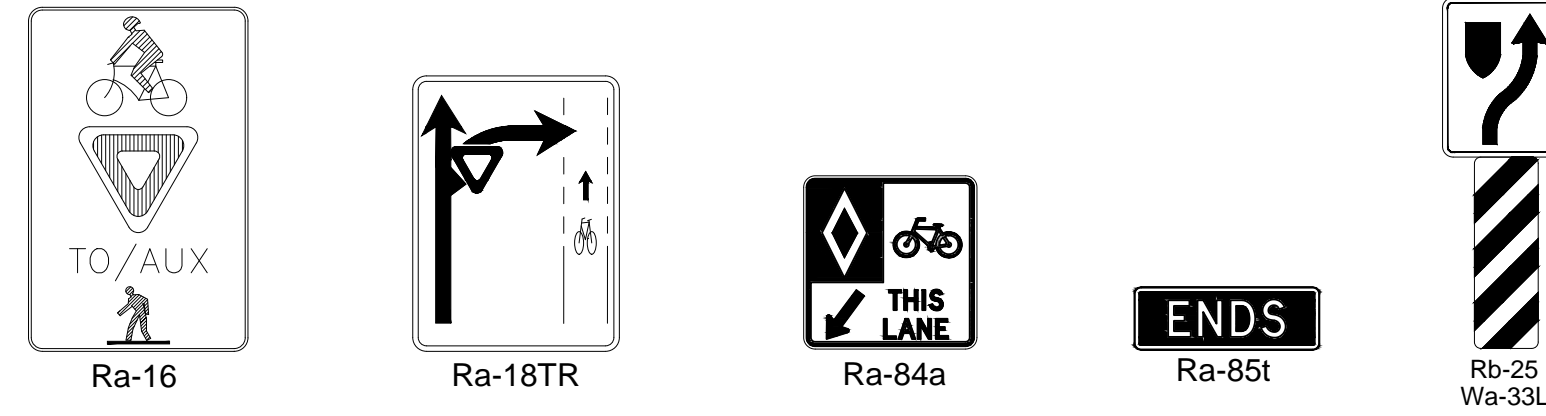

NOTES:  
ANY PROPOSED SIGNAGE FROM INTERIM RMA PACKAGE TO REMAIN UNLESS NOTED.

**910 MARCH ROAD  
ROADWAY MODIFICATION  
ULTIMATE CONFIGURATION**

PAVEMENT MARKING AND SIGNAGE MARCH ROAD 9+775 TO 9+935	Contract No. D07-12-22-0050	Dwg. No. <b>PMK01</b>
Asset No.	Sheet	of
Asset Group		
Des.		Chk'd.
Dwn.		Chk'd.
Utility Circ. No.	Index No.	
Const. Inspector		
Scale: HORIZONTAL		

NOTE: The location of utilities is approximate only, the exact location should be determined by consulting the municipal authorities and utility companies concerned. The contractor shall prove the location of utilities and shall be responsible for adequate protection from damage.

REVISIONS	No.	Description	By	Date (dd/mm/yy)
	1.	ISSUED FOR FUNCTIONAL DESIGN REVIEW	M.C	25/01/23
	2.	ISSUED FOR FUNCTIONAL DESIGN REVIEW	M.C	27/07/23
	3.	ISSUED FOR FUNCTIONAL DESIGN REVIEW	M.C	20/10/23
	4.	ISSUED FOR FUNCTIONAL DESIGN REVIEW	M.C	17/01/24

**FUNCTIONAL DESIGN  
NOT FOR CONSTRUCTION**

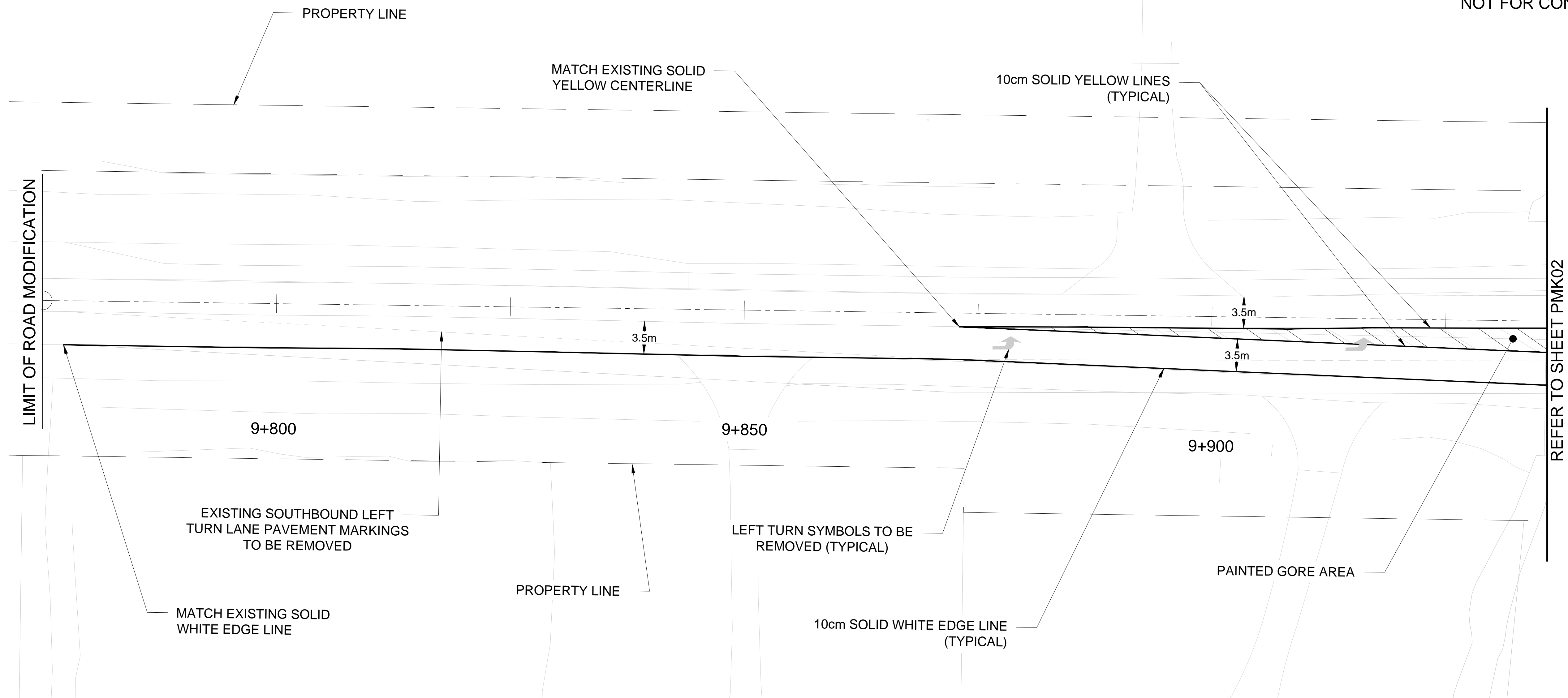

REFER TO SHEET PMK02

910 MARCH ROAD  
ROADWAY MODIFICATION  
ULTIMATE CONFIGURATION

PAVEMENT MARKING AND SIGNAGE  
MARCH ROAD  
STA 9+935 TO 10+125



Contract No. D07-12-22-0050	Dwg. No. PMK02
Sheet - of -	
Asset No.	
Asset Group	
Des. B.B	Chk'd. M.C
Dwn. B.B	Chk'd. M.C
Utility Circ. No.	Index No.
Const. Inspector	
Scale: 0m 5 10	HORIZONTAL

NOTE: The location of utilities is approximate only, the exact location should be determined by consulting the municipal authorities and utility companies concerned. The contractor shall prove the location of utilities and shall be responsible for adequate protection from damage.

No.	Description	By	Date (dd/mm/yy)
1.	ISSUED FOR FUNCTIONAL DESIGN REVIEW	M.C	25/01/23
2.	ISSUED FOR FUNCTIONAL DESIGN REVIEW	M.C	27/07/23
3.	ISSUED FOR FUNCTIONAL DESIGN REVIEW	M.C	20/10/23
4.	ISSUED FOR FUNCTIONAL DESIGN REVIEW	M.C	17/01/24

KEY PLAN

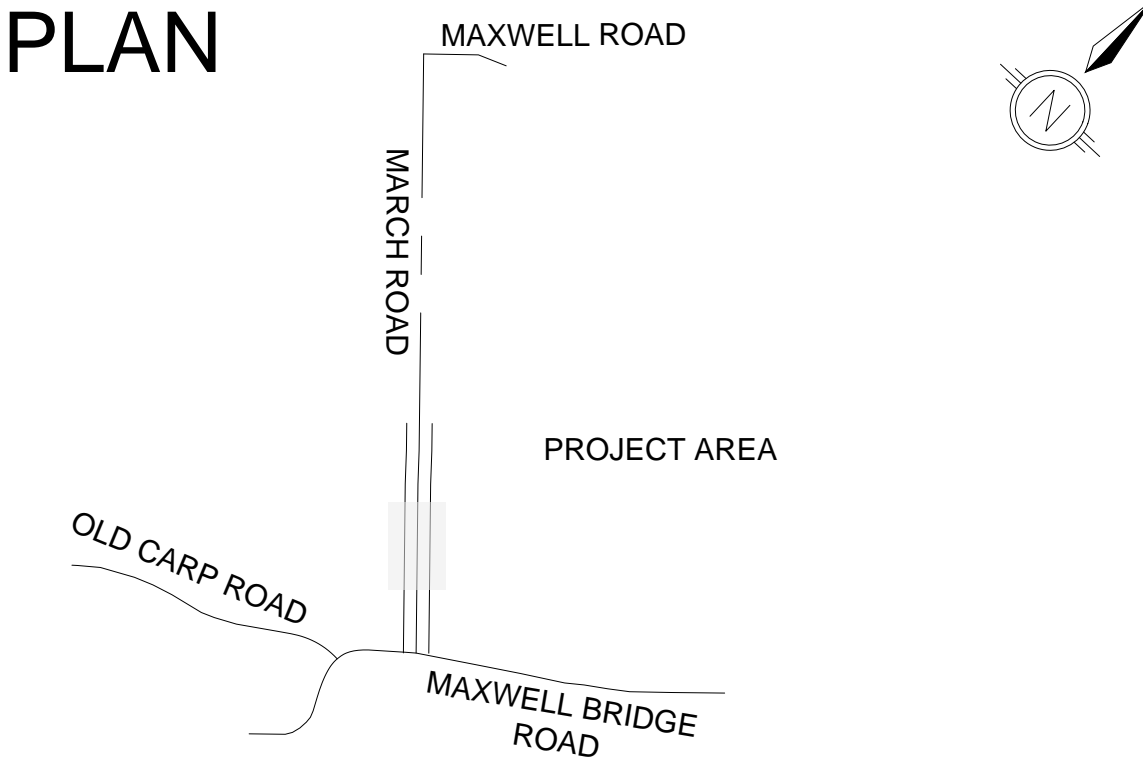

SIGN LEGEND

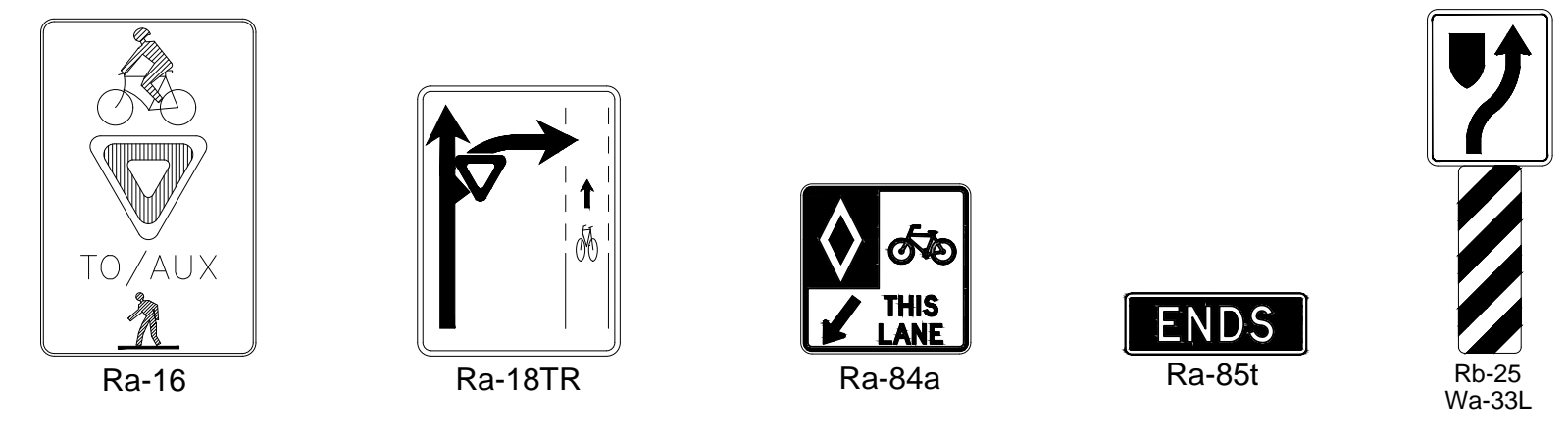

NOTES:  
ANY PROPOSED SIGNAGE FROM INTERIM RMA PACKAGE TO REMAIN UNLESS NOTED.

FUNCTIONAL DESIGN  
NOT FOR CONSTRUCTION

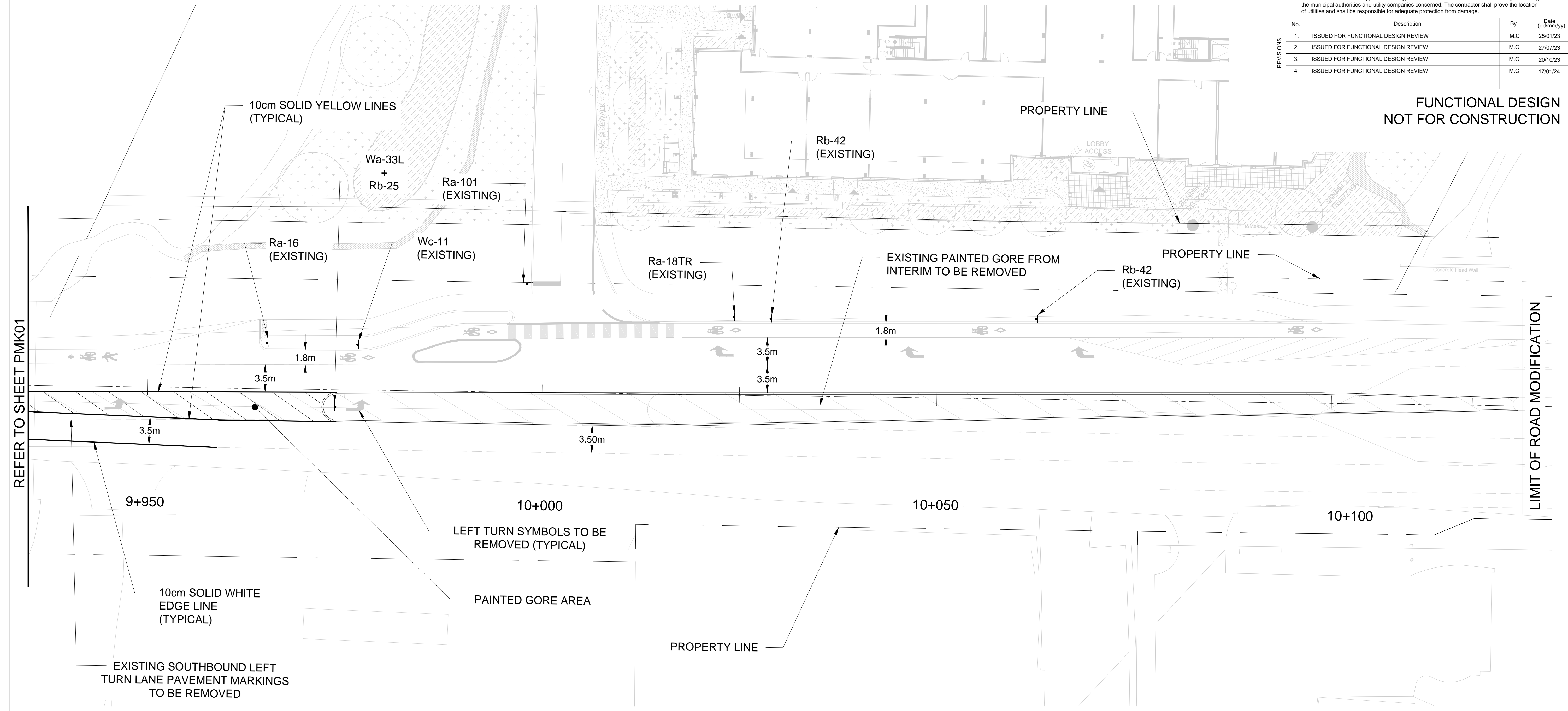

REFER TO SHEET PMK01

LIMIT OF ROAD MODIFICATION

# KEY PLAN

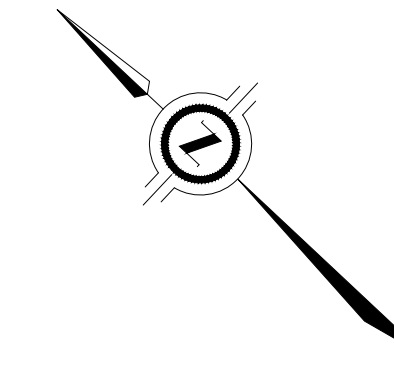
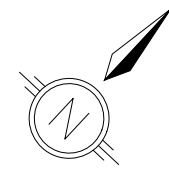
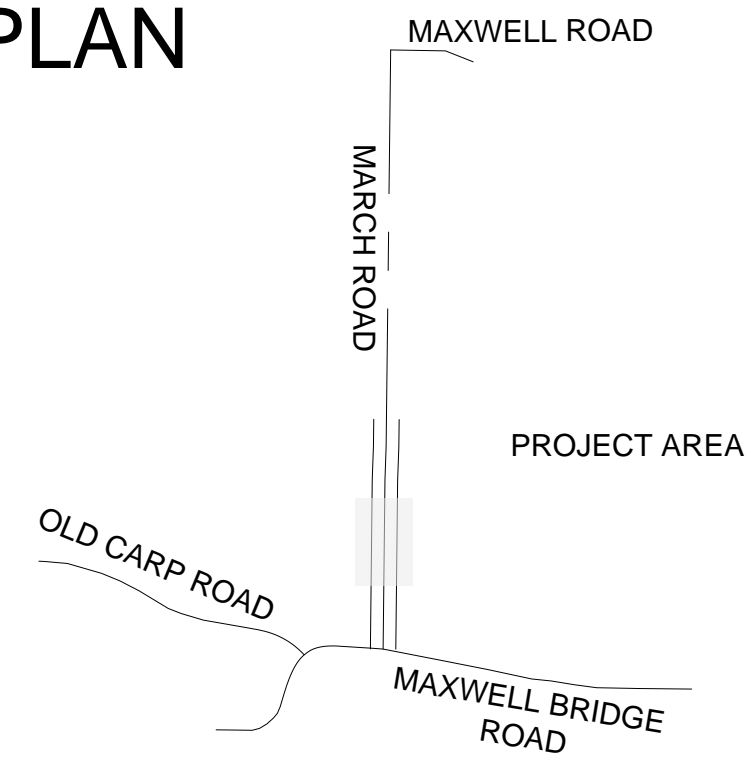

## 910 MARCH ROAD ROADWAY MODIFICATION ULTIMATE CONFIGURATION

TURNING MOVEMENT ANALYSIS  
MARCH ROAD  
STA 9+950 TO 10+125

Contract No. D07-12-22-0050	Dwg. No. TT01
Sheet - of -	
Asset No.	
Asset Group	
Des. B.B	Chk'd. M.C
Dwn. B.B	Chk'd. M.C
Utility Circ. No.	Index No.
Const. Inspector	
Scale: HORIZONTAL	
0m 5 10	



NOTE: The location of utilities is approximate only, the exact location should be determined by consulting the municipal authorities and utility companies concerned. The contractor shall prove the location of utilities and shall be responsible for adequate protection from damage.

No.	Description	By	Date (dd/mm/yy)
1.	ISSUED FOR FUNCTIONAL DESIGN REVIEW	M.C	25/01/23
2.	ISSUED FOR FUNCTIONAL DESIGN REVIEW	M.C	27/07/23
3.	ISSUED FOR FUNCTIONAL DESIGN REVIEW	M.C	20/10/23
4.	ISSUED FOR FUNCTIONAL DESIGN REVIEW	M.C	17/01/24

**FUNCTIONAL DESIGN  
NOT FOR CONSTRUCTION**



**910 March Road  
Intersection Modification Construction Costs  
Ultimate Condition  
Class 'D' Cost Estimate  
2024-01-17**



Item	Description		Amount
<b>10</b>	<b>Construction</b>		<b>\$ 110,744.65</b>
10.00	Construction - General		\$ 2,500.00
10.01	Excavation and Removals		\$ 52,859.34
10.02	Concrete		\$ 50,852.82
10.03	Pavement Structure		\$ 2,232.49
10.05	Pavement Marking		\$ 1,500.00
10.07	Signage		\$ 800.00
20	Engineering and Architectural Services	15%	\$ 16,611.70
30	Contract Administration Fees (If Required)	10%	\$ 11,074.46
	<b>Sub Total</b>		<b>\$ 138,430.81</b>
40	Contingency	15%	\$ 16,611.70
	<b>GRAND TOTAL</b>		<b>\$ 155,042.51</b>

**910 March Road**  
**Intersection Modification Construction Costs**  
**Ultimate Condition**  
**Class 'D' Cost Estimate**  
**2024-01-17**



Item No.	Item Code	Description	Quantity	Units	Unit Price	Amount
<b>10.00</b>		<b>Construction General</b>				
	A020.01	Traffic Control Plan (includes Police assistance)	1	LS	\$ 1,500.00	\$ 1,500.00
	A030.01	Construction Site Pedestrian Control Plan	1	LS	\$ 1,000.00	\$ 1,000.00
<b>10.01</b>		<b>Excavation and Removals</b>				
	L040.35	Saw Cutting of Asphalt	618	m	\$ 13.63	\$ 8,423.34
	L040.37	Remove Asphalt Pavement by Dry Grinding	154	m <sup>2</sup>	\$ 103.17	\$ 15,898.50
	L040.38	Remove Asphalt Pavement - Full Depth (Stripping)	668	m <sup>2</sup>	\$ 42.74	\$ 28,537.50
<b>10.02</b>		<b>Concrete</b>				
	L260.01	Concrete Barrier Curb as per SC1.1	306	m	\$ 160.65	\$ 49,158.90
	L250.06	Concrete Sidewalks, Boulevards and Islands	8	m <sup>2</sup>	\$ 211.74	\$ 1,693.92
<b>10.03</b>		<b>Pavement Structure</b>				
	L380.20	Superpave 12.5mm (50mm Depth)	5	t	\$ 341.39	\$ 1,553.32
	L390.05	Superpave 19.0mm (70mm Depth)	3	t	\$ 226.39	\$ 679.17
<b>10.04</b>		<b>Landscaping</b>				
	T020.03	Top Soil, Imported (150mm Thick)	67	m <sup>3</sup>	\$ 91.84	\$ 6,157.87
	T030.05	Sod, Including Watering	447	m <sup>2</sup>	\$ 23.60	\$ 10,549.20
<b>10.05</b>		<b>Pavement Markings</b>				
	-	Pavement Markings [Provisional]	1	LS	\$ 1,500.00	\$ 1,500.00
<b>10.07</b>		<b>Signage</b>				
		Wa-33L	1	ea	\$ 400.00	\$ 400.00
		Rb-25	1	ea	\$ 400.00	\$ 400.00
<b>Total</b>						<b>\$ 127,451.72</b>

# Appendix H

Underground Parking

Autodesk Docs://12712\_910 MARCH ROAD/M&M\_12712\_ARC\_BDD\_R22.rvt

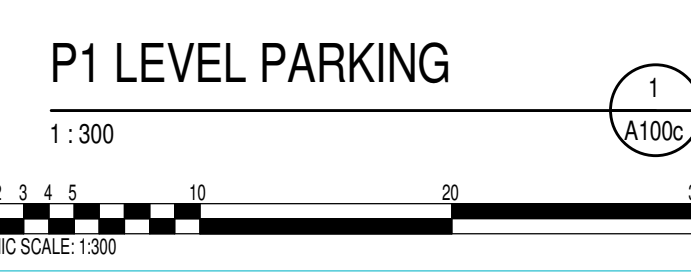

# NOTE	DESCRIPTION
1	TOP OF BANK ORDINARY HIGHT WATER MARK
2	EXISTING MUNICIPAL MUPITRAL
3	EXISTING UTILITY POLE TO BE REMOVED
4	UNDERGROUND PARKING P1 OUTLINE
5	GROUND FLOOR OUTLINE
6	2ND FLOOR - OUTLINE
7	NEW SIDEWALK
8	EXISTING TRIBUTARIES
9	RETAINING WALL
10	EXISTING UTILITY POLE
11	OVERHEAD WIRES
12	PRIVATE BALCONY
13	PRIVATE TERRACE
14	ELEVATOR MECHANICAL PENTHOUSE
15	BKE RACK
16	EXISTING FIRE HYDRANT
17	P2 LEVEL - OUTLINE
18	DEPRESSED CURB
20	EXIT STAIR
21	P3 LEVEL - OUTLINE
22	COMMERCIAL TERRACE
23	CANOPY PROFILE
24	WATER TANK ACCESS
25	PERGOLA
26	FIRE DEPARTMENT CONNECTION

LINE TYPE LEGEND	
	PROPERTY LINE
	REQUIRED SETBACKS
	SETBACKS AS PER PROPOSED ZONING

LOCKER SCHEDULE	
Description	Count
P3 PARKING LEVEL LOCKER	125
P2 PARKING LEVEL LOCKER	143
P1 PARKING LEVEL LOCKER	122
<b>GRAND TOTAL</b>	<b>390</b>

BIKE SCHEDULE	
Description	Count
P1 PARKING LEVEL BICYCLE RACK	192
1ST FLOOR LEVEL BICYCLE RACK	6
<b>GRAND TOTAL</b>	<b>198</b>

BICYCLE RACK LEGEND	
	F.M.S. - FLOOR MOUNTED SINGLE - 600 x 1800
	F.M.D. - FLOOR MOUNTED DOUBLE - 600 x 1800
	W.M.S. - WALL MOUNTED SINGLE - 500 x 1500

PARKING SPACE	
	COUNT
P3 PARKING LEVEL STANDARD SMALL: 2400mmx4600mm	15
STANDARD: 2600mmx5200mm	107
P2 PARKING LEVEL STANDARD SMALL: 2400mmx4600mm	42
STANDARD: 2600mmx5200mm	188
P1 PARKING LEVEL BARRIER FREE PARKING: 2400mmx5200mm	6
BARRIER FREE PARKING: 3400mmx5200mm	6
STANDARD SMALL: 2400mmx4600mm	19
STANDARD: 2600mmx5200mm	86
STANDARD: PARKING SPACE FOR VISITORS	66
1ST FLOOR LEVEL BARRIER FREE: REF. TYPE C (3400mmx6000mm)	1
STANDARD: PARKING SPACE FOR COMMERCIAL	19
STANDARD: PARKING SPACE FOR VISITORS	7
<b>GRAND TOTAL</b>	<b>568</b>

PARKING LEGEND	
	BARRIER FREE PARKING SPACE 5.2m X 3.4m (min.)
	BARRIER FREE PARKING SPACE 5.2m X 2.4m (min.)
	TYPICAL PARKING SPACE 5.2m X 2.6m (min.)
	TYPICAL PARKING SPACE FOR VISITORS 5.2m X 2.6m (min.)
	TYPICAL PARKING SPACE FOR SHOPPING CENTER 5.2m X 2.6m (min.)
	SMALL CAR PARKING SPACE 4.6m X 2.4m (min.)
	SMALL CAR PARKING SPACE FOR VISITORS 4.6m X 2.4m (min.)
	ZONE WITH A CLEAR HEIGHT OF 2300mm (min.)
	DRIVING AISLE IN GARAGE
	PEDESTRIAN TRAFFIC
	ZONES WHICH ARE CONSIDERED PART OF THE EXIT AND CANNOT BE PENETRATED BY ANY ELECTRICAL AND MECHANICAL NOT SERVICING THE EXIT

PLAN SYMBOL LEGEND	
	RAILING OR GUARDRAIL TYPE: SEE PAGE A330 FOR DETAILS
	GENERAL NOTES: SEE LEGEND FOR DESCRIPTION
	WINDOW OR CURTAIN WALL TYPE: SEE PAGE A004 & A005 FOR DETAILS
	WALL TYPE: SEE PAGE A800 FOR DETAILS
	ROOF TYPE: SEE PAGE A800 FOR DETAILS
	DOOR NUMBER: SEE PAGE A800 & A801 FOR DETAILS
	ROOM NUMBER: SEE PLANS FOR DETAILS
	MATERIAL TYPE: SEE PAGE A400 @ A404 FOR LEGEND

**NOTES LIST**

NOTES GÉNÉRALES / General Notes

- Ces documents d'architecture sont la propriété exclusive de NEUF architectes et ne peuvent être utilisés, reproduits ou copiés sans autorisation écrite préalable. / These architectural documents are the exclusive property of NEUF architectes and cannot be used, copied or reproduced without written pre-authorization.
- Les dimensions apparaissant aux documents doivent être vérifiées par l'entrepreneur avant le début des travaux. / All dimensions which appear on the documents must be verified by the contractor before to start the work.
- Veuillez aviser l'architecte de toute dimension erreur et/ou divergence entre ces documents et ceux des autres professionnels. / The architect must be notified of all errors, omissions and discrepancies between these documents and those of the others professionals.
- Les dimensions sur ces documents doivent être lues et non mesurées. / The dimensions on these documents must be read and not measured.

ARCHITECTE PAYSAGER / Landscape Architect  
**Gino Aiello**  
 50 Camelot Drive, Nepean, ON K2G 5X8  
 T 613 852 1343

CIVIL CIVIL  
**NOVATECH**  
 240 Michael Cowpland Drive, Suite 200, Ottawa, ON K2M 1P6  
 T 613 254 9643 novatech-eng.com

INGÉNIEUR MÉCANIQUE / Mechanical Engineer  
**NATIONAL MULTI-RESIDENTIAL INNOVATIVE DESIGN**  
 555 Legget Drive, Tower A, Suite 212, Ottawa, ON K2K 2X3  
 T 613 224 2761 Fax 613 951 0586

INGÉNIEUR EN STRUCTURE / Structural Engineer  
**CIMA+**  
 740, rue Notre-Dame O., Montréal, QC H3C 3X6  
 T 514 337 2462

ARCHITECTES / Architect  
**NEUF architect(e)s**  
 630, boul. René-Lévesque O. 32e étage, Montréal QC H3B 1S6  
 T 514 847 1117 NEUFarchitectes.com

SCEAU / Seal

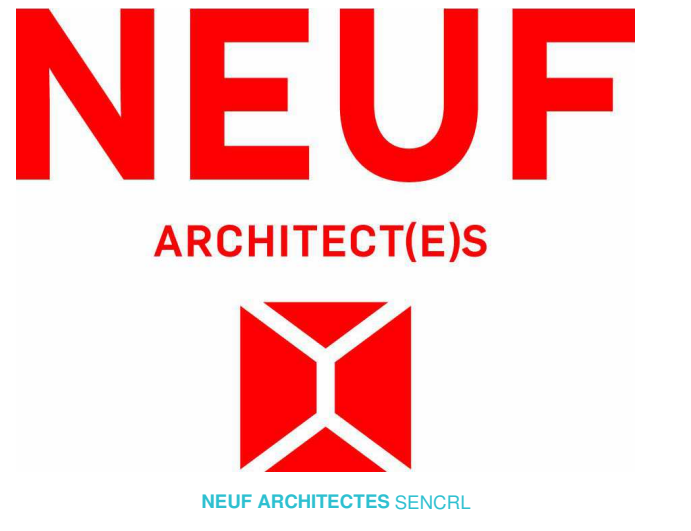

CLIENT / Client  
**LÉPINE**  
 206-555 Legget Dr., Tower A, Ottawa, ON K2K 2X3  
 T 613 591 9090 F 613 591 9095

COMPANY NAME  
**910 MARCH ROAD**

EMPLACEMENT / Location NO PROJECT No.  
**910 MARCH ROAD 12712.00**

NO	RELEASE	DATE (aa-mm-jj)
0	ISSUED FOR ZONING	2023.01.26
1A	ISSUED FOR SITE PLAN	2023.03.29

DESSIN PAR / Drawn by Z.S.  
 VÉRIFIÉ PAR / Checked by K.P.  
 DATE (aa-mm-jj) 23/03/29  
 ÉCHELLE / Scale As indicated  
 TITRE DU DESSIN / Drawing Title  
**P1 LEVEL PARKING**

PREVIOUS REVISION: 0.14  
 CURRENT REVISION: 1.0  
 REVISION / Revision NO. DESSIN / Dwg Number  
**1.0 A100c**

Preliminary  
DO NOT USE FOR  
CONSTRUCTION

# Appendix I

MMLOS Worksheets



**Multi-Modal Level of Service - Intersections Form**

Consultant  
Scenario  
Comments

<b>CGH Transportation</b>
<b>Existing Conditions</b>

Project  
Date

<b>2021-073</b>
<b>2022-11-03</b>

INTERSECTIONS		March Road & Halton Terrace / Maxwell Bridge Road				March Road & Klondike Road			
Crossing Side		NORTH	SOUTH	EAST	WEST	NORTH	SOUTH	EAST	WEST
<b>Pedestrian</b>	Lanes	6	6	3	3	7	8	3	4
	Median	No Median - 2.4 m	No Median - 2.4 m	No Median - 2.4 m	No Median - 2.4 m	No Median - 2.4 m	No Median - 2.4 m	No Median - 2.4 m	No Median - 2.4 m
	Conflicting Left Turns	Protected/ Permissive	Protected/ Permissive	Permissive	Permissive	Protected	Protected	Permissive	Protected/ Permissive
	Conflicting Right Turns	Permissive or yield control	Permissive or yield control	Permissive or yield control	Permissive or yield control	Permissive or yield control	Permissive or yield control	Permissive or yield control	Permissive or yield control
	Right Turns on Red (RTOR) ?	RTOR allowed	RTOR allowed	RTOR allowed	RTOR allowed	RTOR allowed	RTOR allowed	RTOR allowed	RTOR allowed
	Ped Signal Leading Interval?	No	No	No	No	No	No	No	No
	Right Turn Channel	No Channel	No Channel	No Channel	No Channel	No Channel	No Channel	No Channel	Conv'tl without Receiving Lane
	Corner Radius	15-25m	10-15m	10-15m	15-25m	10-15m	15-25m	10-15m	15-25m
	Crosswalk Type	Std transverse markings	Std transverse markings	Std transverse markings	Std transverse markings	Std transverse markings	Std transverse markings	Std transverse markings	Std transverse markings
	<b>PETSI Score</b>	<b>18</b>	<b>20</b>	<b>70</b>	<b>68</b>	<b>12</b>	<b>-6</b>	<b>70</b>	<b>55</b>
	<b>Ped. Exposure to Traffic LoS</b>	<b>F</b>	<b>F</b>	<b>C</b>	<b>C</b>	<b>F</b>	<b>F</b>	<b>C</b>	<b>D</b>
	Cycle Length	120				130			
	Effective Walk Time	7				7			
	<b>Average Pedestrian Delay</b>	<b>53</b>				<b>58</b>			
<b>Pedestrian Delay LoS</b>	<b>E</b>	<b>-</b>	<b>-</b>	<b>-</b>	<b>E</b>	<b>-</b>	<b>-</b>	<b>-</b>	
<b>Level of Service</b>	<b>F</b>	<b>F</b>	<b>C</b>	<b>C</b>	<b>F</b>	<b>F</b>	<b>C</b>	<b>D</b>	
	<b>F</b>				<b>F</b>				
Approach From		NORTH	SOUTH	EAST	WEST	NORTH	SOUTH	EAST	WEST
<b>Bicycle</b>	Bicycle Lane Arrangement on Approach	Pocket Bike Lane	Pocket Bike Lane	Mixed Traffic	Mixed Traffic	Curb Bike Lane, Cycletrack or MUP	Curb Bike Lane, Cycletrack or MUP	Mixed Traffic	Mixed Traffic
	Right Turn Lane Configuration	Bike lane shifts to the left of right turn	Bike lane shifts to the left of right turn	> 50 m	> 50 m	Not Applicable	Not Applicable	> 50 m	≤ 50 m
	Right Turning Speed	≤ 25 km/h	≤ 25 km/h	≤ 25 km/h	≤ 25 km/h	Not Applicable	Not Applicable	≤ 25 km/h	≤ 25 km/h
	<b>Cyclist relative to RT motorists</b>	<b>D</b>	<b>D</b>	<b>F</b>	<b>F</b>	<b>Not Applicable</b>	<b>Not Applicable</b>	<b>F</b>	<b>D</b>
	<b>Separated or Mixed Traffic</b>	<b>Separated</b>	<b>Separated</b>	<b>Mixed Traffic</b>	<b>Mixed Traffic</b>	<b>Separated</b>	<b>Separated</b>	<b>Mixed Traffic</b>	<b>Mixed Traffic</b>
	Left Turn Approach	≥ 2 lanes crossed	≥ 2 lanes crossed	No lane crossed	No lane crossed	≥ 2 lanes crossed	≥ 2 lanes crossed	No lane crossed	No lane crossed
	Operating Speed	≥ 60 km/h	≥ 60 km/h	≤ 40 km/h	≤ 40 km/h	≥ 60 km/h	≥ 60 km/h	> 40 to ≤ 50 km/h	> 40 to ≤ 50 km/h
	<b>Left Turning Cyclist</b>	<b>F</b>	<b>F</b>	<b>B</b>	<b>B</b>	<b>F</b>	<b>F</b>	<b>B</b>	<b>B</b>
<b>Level of Service</b>	<b>F</b>	<b>F</b>	<b>F</b>	<b>F</b>	<b>F</b>	<b>F</b>	<b>F</b>	<b>D</b>	
	<b>F</b>				<b>F</b>				
<b>Transit</b>	Average Signal Delay	≤ 30 sec	≤ 20 sec	> 40 sec	≤ 30 sec	≤ 30 sec	≤ 30 sec	> 40 sec	≤ 30 sec
	<b>Level of Service</b>	<b>D</b>	<b>C</b>	<b>F</b>	<b>D</b>	<b>D</b>	<b>D</b>	<b>F</b>	<b>D</b>
	<b>F</b>				<b>F</b>				
<b>Truck</b>	Effective Corner Radius	> 15 m	10 - 15 m	10 - 15 m	> 15 m	10 - 15 m	> 15 m	10 - 15 m	> 15 m
	Number of Receiving Lanes on Departure from Intersection	1	1	≥ 2	≥ 2	1	≥ 2	≥ 2	≥ 2
	<b>Level of Service</b>	<b>C</b>	<b>E</b>	<b>B</b>	<b>A</b>	<b>E</b>	<b>A</b>	<b>B</b>	<b>A</b>
	<b>E</b>				<b>E</b>				
<b>Auto</b>	Volume to Capacity Ratio	0.71 - 0.80				0.61 - 0.70			
	<b>Level of Service</b>	<b>C</b>				<b>B</b>			

# Multi-Modal Level of Service - Segments Form

Consultant	<b>CGH Transportation</b>
Scenario	<b>Existing Conditions</b>
Comments	

Project	<b>2021-073</b>
Date	<b>2022-12-16</b>

SEGMENTS		March Road	> 110 m N of Halton Terrace 1	10 m N of Halton Terrace & Kl 2	S of Klondike Road 3
<b>Pedestrian</b>	Sidewalk Width	<b>F</b>	no sidewalk	≥ 2 m	≥ 2 m
	Boulevard Width		n/a	< 0.5	< 0.5
	Avg Daily Curb Lane Traffic Volume		> 3000	> 3000	> 3000
	Operating Speed		> 60 km/h	> 60 km/h	> 60 km/h
	On-Street Parking		no	no	no
	<b>Exposure to Traffic PLoS</b>		<b>F</b>	<b>F</b>	<b>F</b>
	Effective Sidewalk Width			2.0 m	2.0 m
	Pedestrian Volume			250 ped/hr	250 ped/hr
<b>Crowding PLoS</b>	<b>-</b>	<b>B</b>	<b>B</b>		
<b>Level of Service</b>	<b>-</b>	<b>F</b>	<b>F</b>		
<b>Bicycle</b>	Type of Cycling Facility	<b>F</b>	Mixed Traffic	Curbside Bike Lane	Curbside Bike Lane
	Number of Travel Lanes		2-3 lanes total	2 ea. dir. (w median)	2 ea. dir. (w median)
	Operating Speed		≥ 60 km/h	> 70 km/h	> 70 km/h
	<b># of Lanes &amp; Operating Speed LoS</b>		<b>F</b>	<b>E</b>	<b>E</b>
	Bike Lane (+ Parking Lane) Width			≥ 1.8 m	≥ 1.8 m
	<b>Bike Lane Width LoS</b>		<b>-</b>	<b>A</b>	<b>A</b>
	Bike Lane Blockages			Rare	Rare
	<b>Blockage LoS</b>		<b>-</b>	<b>A</b>	<b>A</b>
	Median Refuge Width (no median = < 1.8 m)		< 1.8 m refuge	< 1.8 m refuge	< 1.8 m refuge
	No. of Lanes at Unsignalized Crossing		≤ 3 lanes	≤ 3 lanes	≤ 3 lanes
	Sidestreet Operating Speed		≤ 40 km/h	≤ 40 km/h	>40 to 50 km/h
<b>Unsignalized Crossing - Lowest LoS</b>	<b>A</b>	<b>A</b>	<b>A</b>		
<b>Level of Service</b>	<b>F</b>	<b>E</b>	<b>E</b>		
<b>Transit</b>	Facility Type	<b>D</b>	Mixed Traffic	Mixed Traffic	Mixed Traffic
	Friction or Ratio Transit:Posted Speed		Vt/Vp ≥ 0.8	Vt/Vp ≥ 0.8	Vt/Vp ≥ 0.8
	<b>Level of Service</b>		<b>D</b>	<b>D</b>	<b>D</b>
<b>Truck</b>	Truck Lane Width	<b>C</b>	≤ 3.5 m	≤ 3.5 m	≤ 3.5 m
	Travel Lanes per Direction		1	> 1	> 1
	<b>Level of Service</b>		<b>C</b>	<b>A</b>	<b>A</b>
<b>Auto</b>	<b>Level of Service</b>	<b>Not Applicable</b>			

**Multi-Modal Level of Service - Intersections Form**

Consultant  
Scenario  
Comments

<b>CGH Transportation</b>
<b>FB2028</b>

Project  
Date

<b>2021-073</b>
<b>2022-07-31</b>

INTERSECTIONS		March Road & Halton Terrace / Maxwell Bridge Road				March Road & Klondike Road			
Crossing Side		NORTH	SOUTH	EAST	WEST	NORTH	SOUTH	EAST	WEST
<b>Pedestrian</b>	Lanes	6	6	3	3	7	8	3	4
	Median	No Median - 2.4 m	No Median - 2.4 m	No Median - 2.4 m	No Median - 2.4 m	No Median - 2.4 m	No Median - 2.4 m	No Median - 2.4 m	No Median - 2.4 m
	Conflicting Left Turns	Protected/ Permissive	Protected/ Permissive	Permissive	Permissive	Protected	Protected	Permissive	Protected/ Permissive
	Conflicting Right Turns	Permissive or yield control	Permissive or yield control	Permissive or yield control	Permissive or yield control	Permissive or yield control	Permissive or yield control	Permissive or yield control	Permissive or yield control
	Right Turns on Red (RTOR) ?	RTOR allowed	RTOR allowed	RTOR allowed	RTOR allowed	RTOR allowed	RTOR allowed	RTOR allowed	RTOR allowed
	Ped Signal Leading Interval?	No	No	No	No	No	No	No	No
	Right Turn Channel	No Channel	No Channel	No Channel	No Channel	No Channel	No Channel	No Channel	Conv'tl without Receiving Lane
	Corner Radius	15-25m	10-15m	10-15m	15-25m	10-15m	15-25m	10-15m	15-25m
	Crosswalk Type	Std transverse markings	Std transverse markings	Std transverse markings	Std transverse markings	Std transverse markings	Std transverse markings	Std transverse markings	Std transverse markings
	<b>PETSI Score</b>	<b>18</b>	<b>20</b>	<b>70</b>	<b>68</b>	<b>12</b>	<b>-6</b>	<b>70</b>	<b>55</b>
	<b>Ped. Exposure to Traffic LoS</b>	<b>F</b>	<b>F</b>	<b>C</b>	<b>C</b>	<b>F</b>	<b>F</b>	<b>C</b>	<b>D</b>
	Cycle Length	120				130			
	Effective Walk Time	7				7			
	<b>Average Pedestrian Delay</b>	<b>53</b>				<b>58</b>			
<b>Pedestrian Delay LoS</b>	<b>E</b>	<b>-</b>	<b>-</b>	<b>-</b>	<b>E</b>	<b>-</b>	<b>-</b>	<b>-</b>	
<b>Level of Service</b>	<b>F</b>	<b>F</b>	<b>C</b>	<b>C</b>	<b>F</b>	<b>F</b>	<b>C</b>	<b>D</b>	
		<b>F</b>				<b>F</b>			
Approach From		NORTH	SOUTH	EAST	WEST	NORTH	SOUTH	EAST	WEST
<b>Bicycle</b>	Bicycle Lane Arrangement on Approach	Pocket Bike Lane	Pocket Bike Lane	Mixed Traffic	Mixed Traffic	Curb Bike Lane, Cycletrack or MUP	Curb Bike Lane, Cycletrack or MUP	Mixed Traffic	Mixed Traffic
	Right Turn Lane Configuration	Bike lane shifts to the left of right turn	Bike lane shifts to the left of right turn	> 50 m	> 50 m	Not Applicable	Not Applicable	> 50 m	≤ 50 m
	Right Turning Speed	≤ 25 km/h	≤ 25 km/h	≤ 25 km/h	≤ 25 km/h	Not Applicable	Not Applicable	≤ 25 km/h	≤ 25 km/h
	<b>Cyclist relative to RT motorists</b>	<b>D</b>	<b>D</b>	<b>F</b>	<b>F</b>	<b>Not Applicable</b>	<b>Not Applicable</b>	<b>F</b>	<b>D</b>
	<b>Separated or Mixed Traffic</b>	<b>Separated</b>	<b>Separated</b>	<b>Mixed Traffic</b>	<b>Mixed Traffic</b>	<b>Separated</b>	<b>Separated</b>	<b>Mixed Traffic</b>	<b>Mixed Traffic</b>
	Left Turn Approach	≥ 2 lanes crossed	≥ 2 lanes crossed	No lane crossed	No lane crossed	≥ 2 lanes crossed	≥ 2 lanes crossed	No lane crossed	No lane crossed
	Operating Speed	≥ 60 km/h	≥ 60 km/h	≤ 40 km/h	≤ 40 km/h	≥ 60 km/h	≥ 60 km/h	> 40 to ≤ 50 km/h	> 40 to ≤ 50 km/h
	<b>Left Turning Cyclist</b>	<b>F</b>	<b>F</b>	<b>B</b>	<b>B</b>	<b>F</b>	<b>F</b>	<b>B</b>	<b>B</b>
<b>Level of Service</b>	<b>F</b>	<b>F</b>	<b>F</b>	<b>F</b>	<b>F</b>	<b>F</b>	<b>F</b>	<b>D</b>	
		<b>F</b>				<b>F</b>			
<b>Transit</b>	Average Signal Delay	≤ 30 sec	≤ 20 sec	> 40 sec	≤ 30 sec	≤ 30 sec	≤ 30 sec	> 40 sec	≤ 30 sec
	<b>Level of Service</b>	<b>D</b>	<b>C</b>	<b>F</b>	<b>D</b>	<b>D</b>	<b>D</b>	<b>F</b>	<b>D</b>
		<b>F</b>				<b>F</b>			
<b>Truck</b>	Effective Corner Radius	> 15 m	10 - 15 m	10 - 15 m	> 15 m	10 - 15 m	> 15 m	10 - 15 m	> 15 m
	Number of Receiving Lanes on Departure from Intersection	1	1	≥ 2	≥ 2	1	≥ 2	≥ 2	≥ 2
	<b>Level of Service</b>	<b>C</b>	<b>E</b>	<b>B</b>	<b>A</b>	<b>E</b>	<b>A</b>	<b>B</b>	<b>A</b>
		<b>E</b>				<b>E</b>			
<b>Auto</b>	Volume to Capacity Ratio	0.71 - 0.80				0.61 - 0.70			
	<b>Level of Service</b>	<b>C</b>				<b>B</b>			

## Multi-Modal Level of Service - Segments Form

Consultant  
Scenario  
Comments

<b>CGH Transportation</b>
<b>FB2028</b>

Project  
Date

<b>2021-073</b>
<b>2022-07-31</b>

SEGMENTS		March Road	> 110 m N of Halton Terrace 1	in 110 m N of Halton Terrace & Klondike 2	S of Klondike Road 3
<b>Pedestrian</b>	Sidewalk Width	<b>F</b>	no sidewalk	≥ 2 m	≥ 2 m
	Boulevard Width		n/a	< 0.5	< 0.5
	Avg Daily Curb Lane Traffic Volume		> 3000	> 3000	> 3000
	Operating Speed		> 60 km/h	> 60 km/h	> 60 km/h
	On-Street Parking		no	no	no
	<b>Exposure to Traffic PLoS</b>		<b>F</b>	<b>F</b>	<b>F</b>
	Effective Sidewalk Width			2.0 m	2.0 m
	Pedestrian Volume			250 ped/hr	250 ped/hr
<b>Crowding PLoS</b>		<b>-</b>	<b>B</b>	<b>B</b>	
<b>Level of Service</b>		<b>-</b>	<b>F</b>	<b>F</b>	
<b>Bicycle</b>	Type of Cycling Facility	<b>F</b>	Mixed Traffic	Curbside Bike Lane	Curbside Bike Lane
	Number of Travel Lanes		2-3 lanes total	2 ea. dir. (w median)	2 ea. dir. (w median)
	Operating Speed		≥ 60 km/h	> 70 km/h	> 70 km/h
	<b># of Lanes &amp; Operating Speed LoS</b>		<b>F</b>	<b>E</b>	<b>E</b>
	Bike Lane (+ Parking Lane) Width			≥ 1.8 m	≥ 1.8 m
	<b>Bike Lane Width LoS</b>		<b>-</b>	<b>A</b>	<b>A</b>
	Bike Lane Blockages			Rare	Rare
	<b>Blockage LoS</b>		<b>-</b>	<b>A</b>	<b>A</b>
	Median Refuge Width (no median = < 1.8 m)		< 1.8 m refuge	< 1.8 m refuge	< 1.8 m refuge
	No. of Lanes at Unsignalized Crossing		≤ 3 lanes	≤ 3 lanes	≤ 3 lanes
	Sidestreet Operating Speed		≤ 40 km/h	≤ 40 km/h	>40 to 50 km/h
<b>Unsignalized Crossing - Lowest LoS</b>	<b>A</b>	<b>A</b>	<b>A</b>		
<b>Level of Service</b>	<b>F</b>	<b>E</b>	<b>E</b>		
<b>Transit</b>	Facility Type	<b>D</b>	Mixed Traffic	Mixed Traffic	Mixed Traffic
	Friction or Ratio Transit:Posted Speed		Vt/Vp ≥ 0.8	Vt/Vp ≥ 0.8	Vt/Vp ≥ 0.8
	<b>Level of Service</b>		<b>D</b>	<b>D</b>	<b>D</b>
<b>Truck</b>	Truck Lane Width	<b>C</b>	≤ 3.5 m	≤ 3.5 m	≤ 3.5 m
	Travel Lanes per Direction		1	> 1	> 1
	<b>Level of Service</b>		<b>C</b>	<b>A</b>	<b>A</b>
<b>Auto</b>	<b>Level of Service</b>	<b>Not Applicable</b>			

**Multi-Modal Level of Service - Intersections Form**

Consultant  
Scenario  
Comments

<b>CGH Transportation</b>
<b>FB2033</b>

Project  
Date

<b>2021-073</b>
<b>2023-07-31</b>

INTERSECTIONS		March Road & Halton Terrace / Maxwell Bridge Road				March Road & Klondike Road			
Crossing Side		NORTH	SOUTH	EAST	WEST	NORTH	SOUTH	EAST	WEST
Pedestrian	Lanes	6	6	3	3	7	8	3	4
	Median	No Median - 2.4 m	No Median - 2.4 m	No Median - 2.4 m	No Median - 2.4 m	No Median - 2.4 m	No Median - 2.4 m	No Median - 2.4 m	No Median - 2.4 m
	Conflicting Left Turns	Protected/ Permissive	Protected/ Permissive	Permissive	Permissive	Protected	Protected	Permissive	Protected/ Permissive
	Conflicting Right Turns	Permissive or yield control	Permissive or yield control	Permissive or yield control	Permissive or yield control	Permissive or yield control	Permissive or yield control	Permissive or yield control	Permissive or yield control
	Right Turns on Red (RTOR) ?	RTOR allowed	RTOR allowed	RTOR allowed	RTOR allowed	RTOR allowed	RTOR allowed	RTOR allowed	RTOR allowed
	Ped Signal Leading Interval?	No	No	No	No	No	No	No	No
	Right Turn Channel	No Channel	No Channel	No Channel	No Channel	No Channel	No Channel	No Channel	Conv'tl without Receiving Lane
	Corner Radius	15-25m	10-15m	10-15m	15-25m	10-15m	15-25m	10-15m	15-25m
	Crosswalk Type	Std transverse markings	Std transverse markings	Std transverse markings	Std transverse markings	Std transverse markings	Std transverse markings	Std transverse markings	Std transverse markings
	<b>PETSI Score</b>	<b>18</b>	<b>20</b>	<b>70</b>	<b>68</b>	<b>12</b>	<b>-6</b>	<b>70</b>	<b>55</b>
	<b>Ped. Exposure to Traffic LoS</b>	<b>F</b>	<b>F</b>	<b>C</b>	<b>C</b>	<b>F</b>	<b>F</b>	<b>C</b>	<b>D</b>
	Cycle Length								
	Effective Walk Time								
	<b>Average Pedestrian Delay</b>								
<b>Pedestrian Delay LoS</b>									
<b>Level of Service</b>	<b>F</b>	<b>F</b>	<b>C</b>	<b>C</b>	<b>F</b>	<b>F</b>	<b>C</b>	<b>D</b>	
	<b>F</b>				<b>F</b>				
Approach From		NORTH	SOUTH	EAST	WEST	NORTH	SOUTH	EAST	WEST
Bicycle	Bicycle Lane Arrangement on Approach	Pocket Bike Lane	Pocket Bike Lane	Mixed Traffic	Mixed Traffic	Curb Bike Lane, Cycletrack or MUP	Curb Bike Lane, Cycletrack or MUP	Mixed Traffic	Mixed Traffic
	Right Turn Lane Configuration	Bike lane shifts to the left of right turn	Bike lane shifts to the left of right turn	> 50 m	> 50 m	Not Applicable	Not Applicable	> 50 m	≤ 50 m
	Right Turning Speed	≤ 25 km/h	≤ 25 km/h	≤ 25 km/h	≤ 25 km/h	Not Applicable	Not Applicable	≤ 25 km/h	≤ 25 km/h
	<b>Cyclist relative to RT motorists</b>	<b>D</b>	<b>D</b>	<b>F</b>	<b>F</b>	<b>Not Applicable</b>	<b>Not Applicable</b>	<b>F</b>	<b>D</b>
	<b>Separated or Mixed Traffic</b>	<b>Separated</b>	<b>Separated</b>	<b>Mixed Traffic</b>	<b>Mixed Traffic</b>	<b>Separated</b>	<b>Separated</b>	<b>Mixed Traffic</b>	<b>Mixed Traffic</b>
	Left Turn Approach	≥ 2 lanes crossed	≥ 2 lanes crossed	No lane crossed	No lane crossed	≥ 2 lanes crossed	≥ 2 lanes crossed	No lane crossed	No lane crossed
	Operating Speed	≥ 60 km/h	≥ 60 km/h	≤ 40 km/h	≤ 40 km/h	≥ 60 km/h	≥ 60 km/h	> 40 to ≤ 50 km/h	> 40 to ≤ 50 km/h
	<b>Left Turning Cyclist</b>	<b>F</b>	<b>F</b>	<b>B</b>	<b>B</b>	<b>F</b>	<b>F</b>	<b>B</b>	<b>B</b>
<b>Level of Service</b>	<b>F</b>	<b>F</b>	<b>F</b>	<b>F</b>	<b>F</b>	<b>F</b>	<b>F</b>	<b>D</b>	
	<b>F</b>				<b>F</b>				
Transit	Average Signal Delay	≤ 30 sec	≤ 20 sec	> 40 sec	≤ 30 sec	≤ 30 sec	≤ 30 sec	> 40 sec	≤ 30 sec
	<b>Level of Service</b>	<b>D</b>	<b>C</b>	<b>F</b>	<b>D</b>	<b>D</b>	<b>D</b>	<b>F</b>	<b>D</b>
	<b>F</b>				<b>F</b>				
Truck	Effective Corner Radius	> 15 m	10 - 15 m	10 - 15 m	> 15 m	10 - 15 m	> 15 m	10 - 15 m	> 15 m
	Number of Receiving Lanes on Departure from Intersection	1	1	≥ 2	≥ 2	1	≥ 2	≥ 2	≥ 2
<b>Level of Service</b>	<b>C</b>	<b>E</b>	<b>B</b>	<b>A</b>	<b>E</b>	<b>A</b>	<b>B</b>	<b>A</b>	
	<b>E</b>				<b>E</b>				
Auto	Volume to Capacity Ratio	0.81 - 0.90				0.71 - 0.80			
	<b>Level of Service</b>	<b>D</b>				<b>C</b>			

# Multi-Modal Level of Service - Segments Form

Consultant	<b>CGH Transportation</b>
Scenario	<b>FB2033</b>
Comments	

Project	<b>2021-073</b>
Date	<b>2023-07-31</b>

SEGMENTS			> 110 m N of Halton Terrace	Btwn 110 m N of Halton Terrace & Klondike	S of Klondike Road
			1	2	3
<b>Pedestrian</b>	Sidewalk Width	<b>F</b>	no sidewalk	≥ 2 m	≥ 2 m
	Boulevard Width		n/a	< 0.5	< 0.5
	Avg Daily Curb Lane Traffic Volume		> 3000	> 3000	> 3000
	Operating Speed		> 60 km/h	> 60 km/h	> 60 km/h
	On-Street Parking		no	no	no
	<b>Exposure to Traffic PLoS</b>		<b>F</b>	<b>F</b>	<b>F</b>
	Effective Sidewalk Width		2.0 m	2.0 m	2.0 m
	Pedestrian Volume		250 ped/hr	250 ped/hr	250 ped/hr
<b>Crowding PLoS</b>	<b>B</b>	<b>B</b>	<b>B</b>		
<b>Level of Service</b>	<b>F</b>	<b>F</b>	<b>F</b>		
<b>Bicycle</b>	Type of Cycling Facility	<b>F</b>	Mixed Traffic	Curbside Bike Lane	Curbside Bike Lane
	Number of Travel Lanes		2-3 lanes total	2 ea. dir. (w median)	2 ea. dir. (w median)
	Operating Speed		≥ 60 km/h	> 70 km/h	> 70 km/h
	<b># of Lanes &amp; Operating Speed LoS</b>		<b>F</b>	<b>E</b>	<b>E</b>
	Bike Lane (+ Parking Lane) Width			≥ 1.8 m	≥ 1.8 m
	<b>Bike Lane Width LoS</b>		-	<b>A</b>	<b>A</b>
	Bike Lane Blockages			Rare	Rare
	<b>Blockage LoS</b>		-	<b>A</b>	<b>A</b>
	Median Refuge Width (no median = < 1.8 m)		< 1.8 m refuge	< 1.8 m refuge	< 1.8 m refuge
	No. of Lanes at Unsignalized Crossing		≤ 3 lanes	≤ 3 lanes	≤ 3 lanes
	Sidestreet Operating Speed		≤ 40 km/h	≤ 40 km/h	>50 to 60 km/h
<b>Unsignalized Crossing - Lowest LoS</b>	<b>A</b>	<b>A</b>	<b>B</b>		
<b>Level of Service</b>	<b>F</b>	<b>E</b>	<b>E</b>		
<b>Transit</b>	Facility Type	<b>D</b>	Mixed Traffic	Mixed Traffic	Mixed Traffic
	Friction or Ratio Transit:Posted Speed		Vt/Vp ≥ 0.8	Vt/Vp ≥ 0.8	Vt/Vp ≥ 0.8
	<b>Level of Service</b>		<b>D</b>	<b>D</b>	<b>D</b>
<b>Truck</b>	Truck Lane Width	<b>C</b>	≤ 3.5 m	≤ 3.5 m	≤ 3.5 m
	Travel Lanes per Direction		1	> 1	> 1
	<b>Level of Service</b>		<b>C</b>	<b>A</b>	<b>A</b>
<b>Auto</b>	<b>Level of Service</b>	<b>Not Applicable</b>			

**Multi-Modal Level of Service - Intersections Form**

Consultant  
Scenario  
Comments

<b>CGH Transportation</b>
<b>FT2028</b>

Project  
Date

<b>2021-073</b>
<b>2023-07-31</b>

INTERSECTIONS		March Road & Halton Terrace / Maxwell Bridge Road				March Road & Klondike Road			
Crossing Side		NORTH	SOUTH	EAST	WEST	NORTH	SOUTH	EAST	WEST
<b>Pedestrian</b>	Lanes	6	6	3	3	7	8	3	4
	Median	No Median - 2.4 m	No Median - 2.4 m	No Median - 2.4 m	No Median - 2.4 m	No Median - 2.4 m	No Median - 2.4 m	No Median - 2.4 m	No Median - 2.4 m
	Conflicting Left Turns	Protected/ Permissive	Protected/ Permissive	Permissive	Permissive	Protected	Protected	Permissive	Protected/ Permissive
	Conflicting Right Turns	Permissive or yield control	Permissive or yield control	Permissive or yield control	Permissive or yield control	Permissive or yield control	Permissive or yield control	Permissive or yield control	Permissive or yield control
	Right Turns on Red (RTor) ?	RTOR allowed	RTOR allowed	RTOR allowed	RTOR allowed	RTOR allowed	RTOR allowed	RTOR allowed	RTOR allowed
	Ped Signal Leading Interval?	No	No	No	No	No	No	No	No
	Right Turn Channel	No Channel	No Channel	No Channel	No Channel	No Channel	No Channel	No Channel	Conv'tl without Receiving Lane
	Corner Radius	15-25m	10-15m	10-15m	15-25m	10-15m	15-25m	10-15m	15-25m
	Crosswalk Type	Std transverse markings	Std transverse markings	Std transverse markings	Std transverse markings	Std transverse markings	Std transverse markings	Std transverse markings	Std transverse markings
	<b>PETSI Score</b>	<b>18</b>	<b>20</b>	<b>70</b>	<b>68</b>	<b>12</b>	<b>-6</b>	<b>70</b>	<b>55</b>
	<b>Ped. Exposure to Traffic LoS</b>	<b>F</b>	<b>F</b>	<b>C</b>	<b>C</b>	<b>F</b>	<b>F</b>	<b>C</b>	<b>D</b>
	Cycle Length								
Effective Walk Time									
<b>Average Pedestrian Delay</b>									
<b>Pedestrian Delay LoS</b>									
<b>Level of Service</b>	<b>F</b>	<b>F</b>	<b>C</b>	<b>C</b>	<b>F</b>	<b>F</b>	<b>C</b>	<b>D</b>	
	<b>F</b>				<b>F</b>				
Approach From		NORTH	SOUTH	EAST	WEST	NORTH	SOUTH	EAST	WEST
<b>Bicycle</b>	Bicycle Lane Arrangement on Approach	Pocket Bike Lane	Pocket Bike Lane	Mixed Traffic	Mixed Traffic	Curb Bike Lane, Cycletrack or MUP	Curb Bike Lane, Cycletrack or MUP	Mixed Traffic	Mixed Traffic
	Right Turn Lane Configuration	Bike lane shifts to the left of right turn	Bike lane shifts to the left of right turn	> 50 m	> 50 m	Not Applicable	Not Applicable	> 50 m	≤ 50 m
	Right Turning Speed	≤ 25 km/h	≤ 25 km/h	≤ 25 km/h	≤ 25 km/h	Not Applicable	Not Applicable	≤ 25 km/h	≤ 25 km/h
	<b>Cyclist relative to RT motorists</b>	<b>D</b>	<b>D</b>	<b>F</b>	<b>F</b>	<b>Not Applicable</b>	<b>Not Applicable</b>	<b>F</b>	<b>D</b>
	<b>Separated or Mixed Traffic</b>	<b>Separated</b>	<b>Separated</b>	<b>Mixed Traffic</b>	<b>Mixed Traffic</b>	<b>Separated</b>	<b>Separated</b>	<b>Mixed Traffic</b>	<b>Mixed Traffic</b>
	Left Turn Approach	≥ 2 lanes crossed	≥ 2 lanes crossed	No lane crossed	No lane crossed	≥ 2 lanes crossed	≥ 2 lanes crossed	No lane crossed	No lane crossed
	Operating Speed	≥ 60 km/h	≥ 60 km/h	≤ 40 km/h	≤ 40 km/h	≥ 60 km/h	≥ 60 km/h	> 40 to ≤ 50 km/h	> 40 to ≤ 50 km/h
	<b>Left Turning Cyclist</b>	<b>F</b>	<b>F</b>	<b>B</b>	<b>B</b>	<b>F</b>	<b>F</b>	<b>B</b>	<b>B</b>
<b>Level of Service</b>	<b>F</b>	<b>F</b>	<b>F</b>	<b>F</b>	<b>F</b>	<b>F</b>	<b>F</b>	<b>D</b>	
	<b>F</b>				<b>F</b>				
<b>Transit</b>	Average Signal Delay	≤ 30 sec	≤ 20 sec	> 40 sec	≤ 30 sec	≤ 30 sec	≤ 30 sec	> 40 sec	≤ 30 sec
	<b>Level of Service</b>	<b>D</b>	<b>C</b>	<b>F</b>	<b>D</b>	<b>D</b>	<b>D</b>	<b>F</b>	<b>D</b>
	<b>F</b>				<b>F</b>				
<b>Truck</b>	Effective Corner Radius	> 15 m	10 - 15 m	10 - 15 m	> 15 m	10 - 15 m	> 15 m	10 - 15 m	> 15 m
	Number of Receiving Lanes on Departure from Intersection	1	1	≥ 2	≥ 2	1	≥ 2	≥ 2	≥ 2
	<b>Level of Service</b>	<b>C</b>	<b>E</b>	<b>B</b>	<b>A</b>	<b>E</b>	<b>A</b>	<b>B</b>	<b>A</b>
	<b>E</b>				<b>E</b>				
<b>Auto</b>	Volume to Capacity Ratio	0.81 - 0.90				0.71 - 0.80			
	<b>Level of Service</b>	<b>D</b>				<b>C</b>			

# Multi-Modal Level of Service - Segments Form

Consultant Scenario Comments	<b>CGH Transportation</b>	Project Date	<b>2021-073</b>
	<b>FT2028</b>		<b>2023-07-31</b>

SEGMENTS			> 110 m N of Halton Terrace 1	Btwn 110 m N of Halton Terrace & Klondike 2	S of Klondike Road 3
<b>Pedestrian</b>	Sidewalk Width	<b>F</b>	≥ 2 m	≥ 2 m	≥ 2 m
	Boulevard Width		> 2 m	< 0.5	< 0.5
	Avg Daily Curb Lane Traffic Volume		> 3000	> 3000	> 3000
	Operating Speed		> 60 km/h	> 60 km/h	> 60 km/h
	On-Street Parking		no	no	no
	<b>Exposure to Traffic PLoS</b>		<b>D</b>	<b>F</b>	<b>F</b>
	Effective Sidewalk Width		2.0 m	2.0 m	2.0 m
	Pedestrian Volume		250 ped/hr	250 ped/hr	250 ped/hr
<b>Crowding PLoS</b>	<b>B</b>	<b>B</b>	<b>B</b>		
<b>Level of Service</b>	<b>D</b>	<b>F</b>	<b>F</b>		
<b>Bicycle</b>	Type of Cycling Facility	<b>E</b>	Curbside Bike Lane	Curbside Bike Lane	Curbside Bike Lane
	Number of Travel Lanes		2 ea. dir. (no median)	2 ea. dir. (w median)	2 ea. dir. (w median)
	Operating Speed		> 70 km/h	> 70 km/h	> 70 km/h
	<b># of Lanes &amp; Operating Speed LoS</b>		<b>E</b>	<b>E</b>	<b>E</b>
	Bike Lane (+ Parking Lane) Width		≥ 1.8 m	≥ 1.8 m	≥ 1.8 m
	<b>Bike Lane Width LoS</b>		<b>A</b>	<b>A</b>	<b>A</b>
	Bike Lane Blockages		Rare	Rare	Rare
	<b>Blockage LoS</b>		<b>A</b>	<b>A</b>	<b>A</b>
	Median Refuge Width (no median = < 1.8 m)		< 1.8 m refuge	< 1.8 m refuge	< 1.8 m refuge
	No. of Lanes at Unsignalized Crossing		≤ 3 lanes	≤ 3 lanes	≤ 3 lanes
	Sidestreet Operating Speed		≤ 40 km/h	≤ 40 km/h	>50 to 60 km/h
<b>Unsignalized Crossing - Lowest LoS</b>	<b>A</b>	<b>A</b>	<b>B</b>		
<b>Level of Service</b>	<b>E</b>	<b>E</b>	<b>E</b>		
<b>Transit</b>	Facility Type	<b>D</b>	Mixed Traffic	Mixed Traffic	Mixed Traffic
	Friction or Ratio Transit:Posted Speed		Vt/Vp ≥ 0.8	Vt/Vp ≥ 0.8	Vt/Vp ≥ 0.8
<b>Level of Service</b>	<b>D</b>	<b>D</b>	<b>D</b>		
<b>Truck</b>	Truck Lane Width	<b>C</b>	≤ 3.5 m	≤ 3.5 m	≤ 3.5 m
	Travel Lanes per Direction		1	> 1	> 1
<b>Level of Service</b>	<b>C</b>	<b>A</b>	<b>A</b>		
<b>Auto</b>	<b>Level of Service</b>	<b>Not Applicable</b>			



**Multi-Modal Level of Service - Intersections Form**

Consultant  
Scenario  
Comments

<b>CGH Transportation</b>
<b>FT2033</b>

Project  
Date

<b>2021-073</b>
<b>2023-07-31</b>

INTERSECTIONS		March Road & Halton Terrace / Maxwell Bridge Road				March Road & Klondike Road			
Crossing Side		NORTH	SOUTH	EAST	WEST	NORTH	SOUTH	EAST	WEST
Pedestrian	Lanes	6	6	3	3	7	8	3	4
	Median	No Median - 2.4 m	No Median - 2.4 m	No Median - 2.4 m	No Median - 2.4 m	No Median - 2.4 m	No Median - 2.4 m	No Median - 2.4 m	No Median - 2.4 m
	Conflicting Left Turns	Protected/ Permissive	Protected/ Permissive	Permissive	Permissive	Protected	Protected	Permissive	Protected/ Permissive
	Conflicting Right Turns	Permissive or yield control	Permissive or yield control	Permissive or yield control	Permissive or yield control	Permissive or yield control	Permissive or yield control	Permissive or yield control	Permissive or yield control
	Right Turns on Red (RTOR) ?	RTOR allowed	RTOR allowed	RTOR allowed	RTOR allowed	RTOR allowed	RTOR allowed	RTOR allowed	RTOR allowed
	Ped Signal Leading Interval?	No	No	No	No	No	No	No	No
	Right Turn Channel	No Channel	No Channel	No Channel	No Channel	No Channel	No Channel	No Channel	Conv'tl without Receiving Lane
	Corner Radius	15-25m	10-15m	10-15m	15-25m	10-15m	15-25m	10-15m	15-25m
	Crosswalk Type	Std transverse markings	Std transverse markings	Std transverse markings	Std transverse markings	Std transverse markings	Std transverse markings	Std transverse markings	Std transverse markings
	<b>PETSI Score</b>	<b>18</b>	<b>20</b>	<b>70</b>	<b>68</b>	<b>12</b>	<b>-6</b>	<b>70</b>	<b>55</b>
	<b>Ped. Exposure to Traffic LoS</b>	<b>F</b>	<b>F</b>	<b>C</b>	<b>C</b>	<b>F</b>	<b>F</b>	<b>C</b>	<b>D</b>
	Cycle Length								
	Effective Walk Time								
	<b>Average Pedestrian Delay</b>								
<b>Pedestrian Delay LoS</b>									
<b>Level of Service</b>	<b>F</b>	<b>F</b>	<b>C</b>	<b>C</b>	<b>F</b>	<b>F</b>	<b>C</b>	<b>D</b>	
	<b>F</b>				<b>F</b>				
Approach From		NORTH	SOUTH	EAST	WEST	NORTH	SOUTH	EAST	WEST
Bicycle	Bicycle Lane Arrangement on Approach	Pocket Bike Lane	Pocket Bike Lane	Mixed Traffic	Mixed Traffic	Curb Bike Lane, Cycletrack or MUP	Curb Bike Lane, Cycletrack or MUP	Mixed Traffic	Mixed Traffic
	Right Turn Lane Configuration	Bike lane shifts to the left of right turn	Bike lane shifts to the left of right turn	> 50 m	> 50 m	Not Applicable	Not Applicable	> 50 m	≤ 50 m
	Right Turning Speed	≤ 25 km/h	≤ 25 km/h	≤ 25 km/h	≤ 25 km/h	Not Applicable	Not Applicable	≤ 25 km/h	≤ 25 km/h
	<b>Cyclist relative to RT motorists</b>	<b>D</b>	<b>D</b>	<b>F</b>	<b>F</b>	<b>Not Applicable</b>	<b>Not Applicable</b>	<b>F</b>	<b>D</b>
	<b>Separated or Mixed Traffic</b>	<b>Separated</b>	<b>Separated</b>	<b>Mixed Traffic</b>	<b>Mixed Traffic</b>	<b>Separated</b>	<b>Separated</b>	<b>Mixed Traffic</b>	<b>Mixed Traffic</b>
	Left Turn Approach	≥ 2 lanes crossed	≥ 2 lanes crossed	No lane crossed	No lane crossed	≥ 2 lanes crossed	≥ 2 lanes crossed	No lane crossed	No lane crossed
	Operating Speed	≥ 60 km/h	≥ 60 km/h	≤ 40 km/h	≤ 40 km/h	≥ 60 km/h	≥ 60 km/h	> 40 to ≤ 50 km/h	> 40 to ≤ 50 km/h
	<b>Left Turning Cyclist</b>	<b>F</b>	<b>F</b>	<b>B</b>	<b>B</b>	<b>F</b>	<b>F</b>	<b>B</b>	<b>B</b>
<b>Level of Service</b>	<b>F</b>	<b>F</b>	<b>F</b>	<b>F</b>	<b>F</b>	<b>F</b>	<b>F</b>	<b>D</b>	
	<b>F</b>				<b>F</b>				
Transit	Average Signal Delay	≤ 30 sec	≤ 20 sec	> 40 sec	≤ 30 sec	≤ 30 sec	≤ 30 sec	> 40 sec	≤ 30 sec
	<b>Level of Service</b>	<b>D</b>	<b>C</b>	<b>F</b>	<b>D</b>	<b>D</b>	<b>D</b>	<b>F</b>	<b>D</b>
	<b>F</b>				<b>F</b>				
Truck	Effective Corner Radius	> 15 m	10 - 15 m	10 - 15 m	> 15 m	10 - 15 m	> 15 m	10 - 15 m	> 15 m
	Number of Receiving Lanes on Departure from Intersection	1	1	≥ 2	≥ 2	1	≥ 2	≥ 2	≥ 2
<b>Level of Service</b>	<b>C</b>	<b>E</b>	<b>B</b>	<b>A</b>	<b>E</b>	<b>A</b>	<b>B</b>	<b>A</b>	
	<b>E</b>				<b>E</b>				
Auto	Volume to Capacity Ratio	0.81 - 0.90				0.71 - 0.80			
	<b>Level of Service</b>	<b>D</b>				<b>C</b>			

# Multi-Modal Level of Service - Segments Form

Consultant	<b>CGH Transportation</b>
Scenario	<b>FT2033</b>
Comments	

Project	<b>2021-073</b>
Date	<b>2023-07-31</b>

SEGMENTS			> 110 m N of Halton Terrace	Btwn 110 m N of Halton Terrace & Klondike	S of Klondike Road
			1	2	3
<b>Pedestrian</b>	Sidewalk Width	<b>F</b>	≥ 2 m	≥ 2 m	≥ 2 m
	Boulevard Width		> 2 m	< 0.5	< 0.5
	Avg Daily Curb Lane Traffic Volume		> 3000	> 3000	> 3000
	Operating Speed		> 60 km/h	> 60 km/h	> 60 km/h
	On-Street Parking		no	no	no
	<b>Exposure to Traffic PLoS</b>		<b>D</b>	<b>F</b>	<b>F</b>
	Effective Sidewalk Width		2.0 m	2.0 m	2.0 m
	Pedestrian Volume		250 ped/hr	250 ped/hr	250 ped/hr
<b>Crowding PLoS</b>	<b>B</b>	<b>B</b>	<b>B</b>		
<b>Level of Service</b>	<b>D</b>	<b>F</b>	<b>F</b>		
<b>Bicycle</b>	Type of Cycling Facility	<b>E</b>	Curbside Bike Lane	Curbside Bike Lane	Curbside Bike Lane
	Number of Travel Lanes		2 ea. dir. (no median)	2 ea. dir. (w median)	2 ea. dir. (w median)
	Operating Speed		> 70 km/h	> 70 km/h	> 70 km/h
	<b># of Lanes &amp; Operating Speed LoS</b>		<b>E</b>	<b>E</b>	<b>E</b>
	Bike Lane (+ Parking Lane) Width		≥ 1.8 m	≥ 1.8 m	≥ 1.8 m
	<b>Bike Lane Width LoS</b>		<b>A</b>	<b>A</b>	<b>A</b>
	Bike Lane Blockages		Rare	Rare	Rare
	<b>Blockage LoS</b>		<b>A</b>	<b>A</b>	<b>A</b>
	Median Refuge Width (no median = < 1.8 m)		< 1.8 m refuge	< 1.8 m refuge	< 1.8 m refuge
	No. of Lanes at Unsignalized Crossing		≤ 3 lanes	≤ 3 lanes	≤ 3 lanes
Sidestreet Operating Speed	≤ 40 km/h	≤ 40 km/h	>50 to 60 km/h		
<b>Unsignalized Crossing - Lowest LoS</b>	<b>A</b>	<b>A</b>	<b>B</b>		
<b>Level of Service</b>	<b>E</b>	<b>E</b>	<b>E</b>		
<b>Transit</b>	Facility Type	<b>D</b>	Mixed Traffic	Mixed Traffic	Mixed Traffic
	Friction or Ratio Transit:Posted Speed		Vt/Vp ≥ 0.8	Vt/Vp ≥ 0.8	Vt/Vp ≥ 0.8
<b>Level of Service</b>	<b>D</b>	<b>D</b>	<b>D</b>		
<b>Truck</b>	Truck Lane Width	<b>A</b>	≤ 3.5 m	≤ 3.5 m	≤ 3.5 m
	Travel Lanes per Direction		> 1	> 1	> 1
<b>Level of Service</b>	<b>A</b>	<b>A</b>	<b>A</b>		
<b>Auto</b>	<b>Level of Service</b>	<b>Not Applicable</b>			

# Appendix J

Left-turn Lane Warrants

March Road/Site Access Design Speed 90 km/h	FT2028 Interim Southbound Left													%Left Turn	Volume Advancing	Volume Opposing
	EBL	EBT	EBR	WBL	WBT	WBR	NBL	NBT	NBR	Yes SBL	SBT	SBR				
AM	0	1	0	53	0	7	0	229	26	4	921	0	0.4%	925	255	
PM	0	0	0	40	0	12	0	1009	58	12	316	0	3.7%	328	1067	

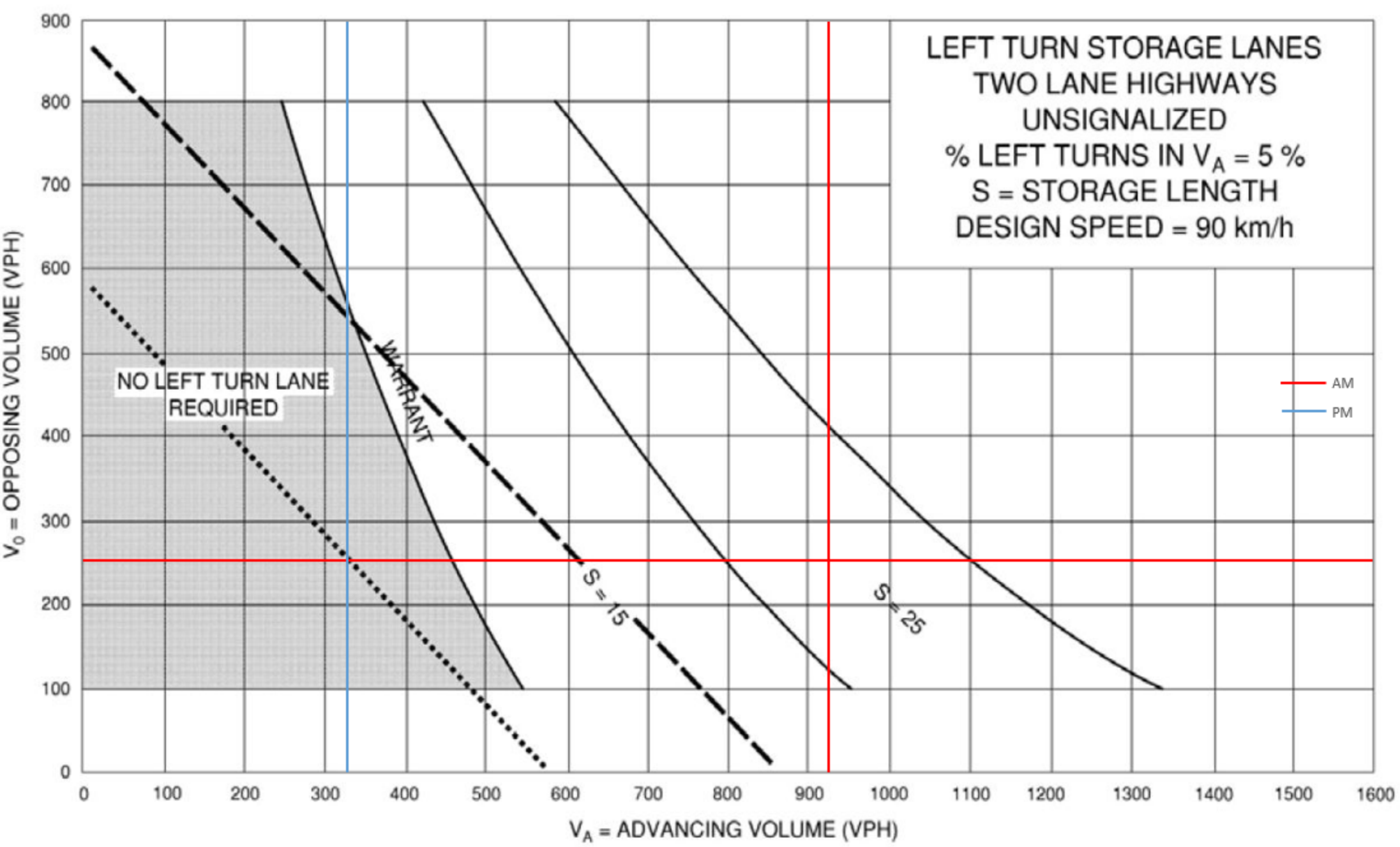

March Road/Site Access		FT2028															
Design Speed		Northbound Left															
90 km/h		EBL	EBT	EBR	WBL	WBT	WBR	Yes	NBL	NBT	NBR	SBL	SBT	SBR	%Left Turn	Volume Advancing	Volume Opposing
AM		5	2	30	51	3	6	4	650	26	3	1590	1	0.6%	680	1594	
PM		5	3	49	39	2	11	23	1633	58	9	787	12	1.3%	1714	808	

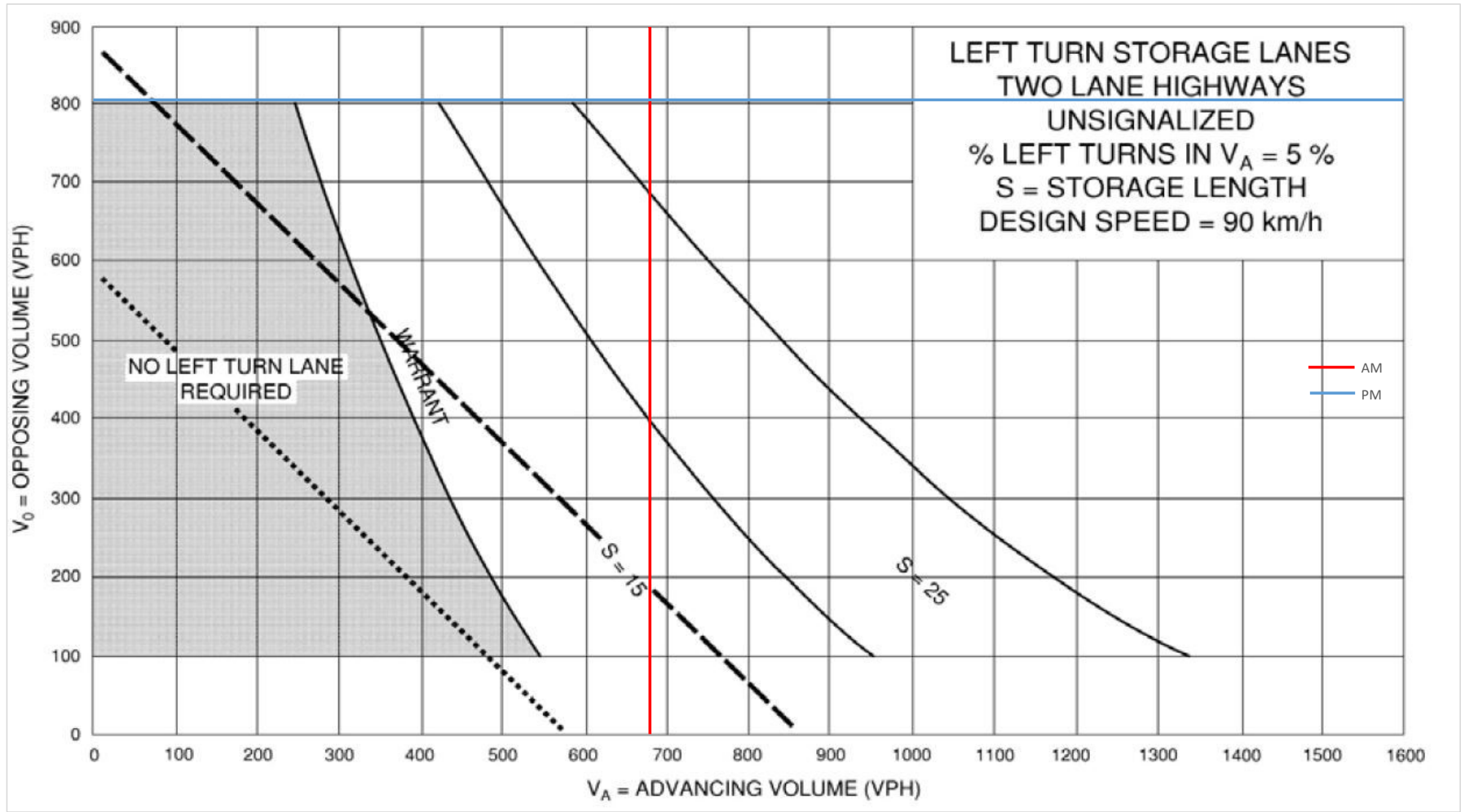

March Road/Site Access Design Speed 90 km/h	FT2028 Southbound Left											Yes		%Left Turn	Volume Advancing	Volume Opposing
	EBL	EBT	EBR	WBL	WBT	WBR	NBL	NBT	NBR	SBL	SBT	SBR				
AM	5	2	30	51	3	6	4	650	26	3	1590	1	0.2%	1594	680	
PM	5	3	49	39	2	11	23	1633	58	9	787	12	1.1%	808	1714	



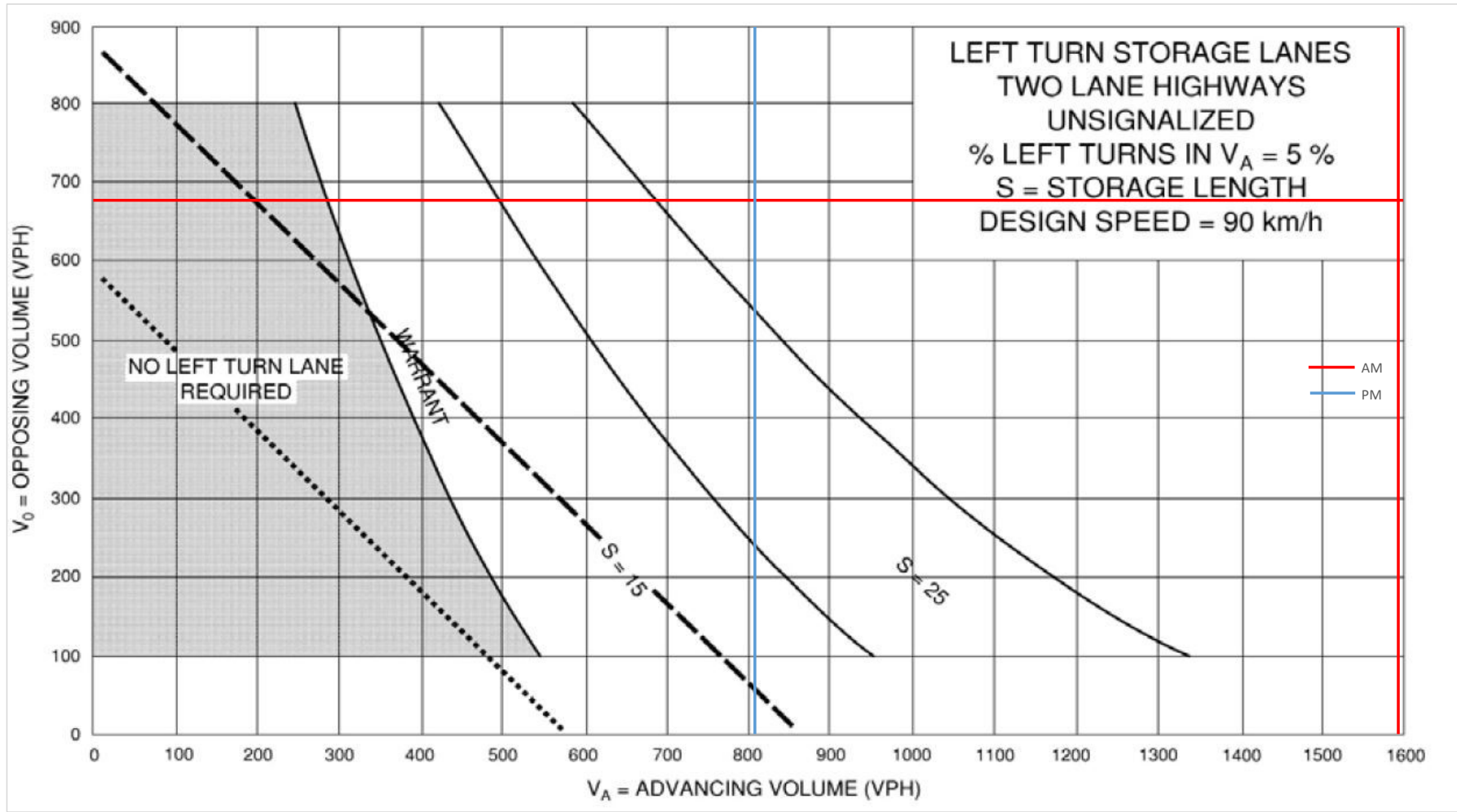

March Road/Site Access		FT2033															
Design Speed		Northbound Left															
90 km/h		EBL	EBT	EBR	WBL	WBT	WBR	Yes	NBL	NBT	NBR	SBL	SBT	SBR	%Left Turn	Volume Advancing	Volume Opposing
AM		5	2	31	51	3	6	4	735	26	3	1796	1	0.5%	765	1800	
PM		5	3	50	39	2	11	23	1850	58	9	920	13	1.2%	1931	942	

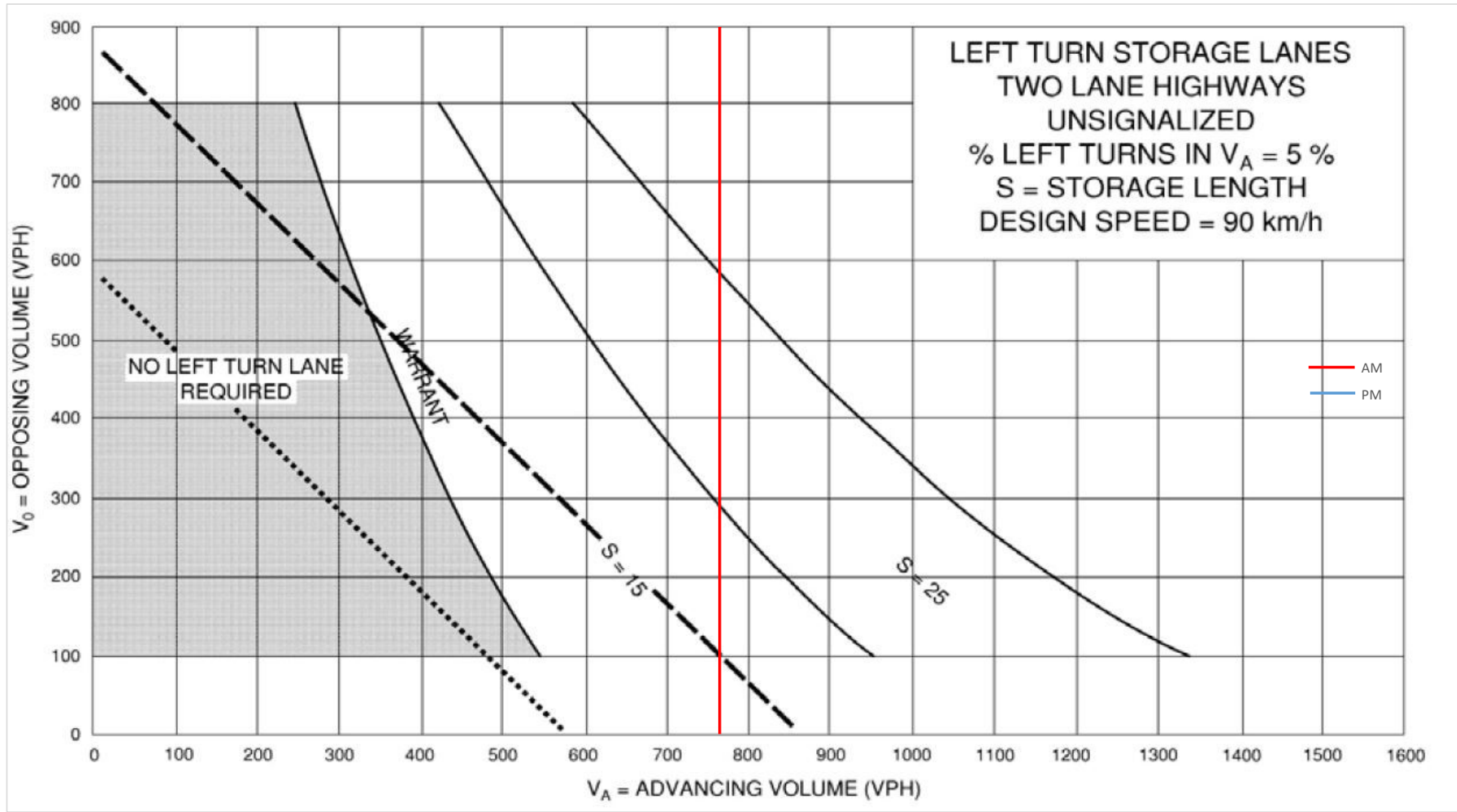

March Road/Site Access  
Design Speed  
90 km/h

FT2033  
Southbound Left

	EBL	EBT	EBR	WBL	WBT	WBR	NBL	NBT	NBR	Yes SBL	SBT	SBR	%Left Turn	Volume Advancing	Volume Opposing
AM	5	2	31	51	3	6	4	735	26	3	1796	1	0.2%	1800	765
PM	5	3	50	39	2	11	23	1850	58	9	920	13	1.0%	942	1931

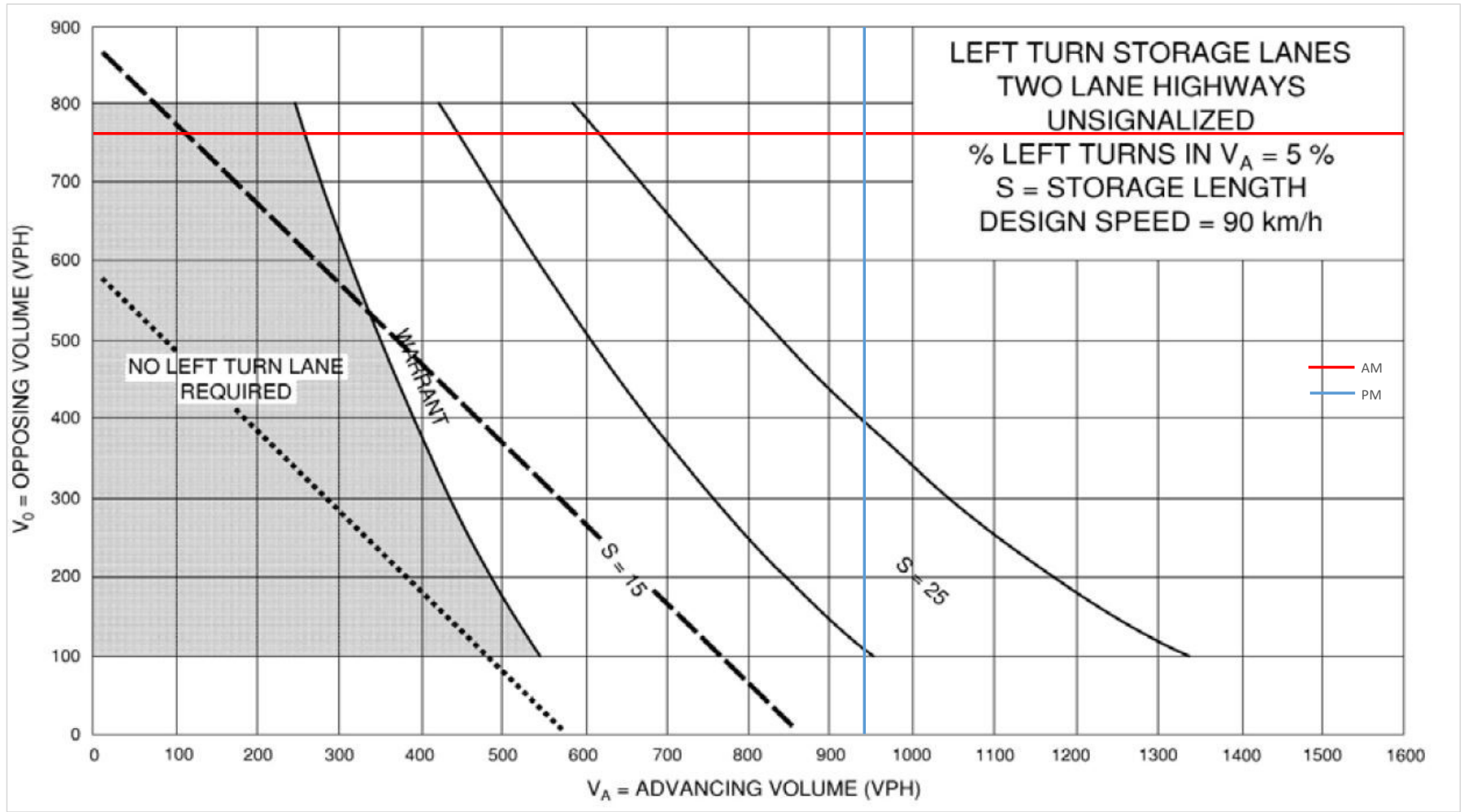

# Appendix K

Heavy Vehicle Percentage Calculations

[1] March Road at Halton Terrace / Maxwell Bridge Road												
AM												
	NBL	NBT	NBR	SBL	SBT	SBR	EBL	EBT	EBR	WBL	WBT	WBR
HV Volume	2	22	4	1	13	1	0	5	2	1	0	2
Total Volume	23	178	61	68	807	12	21	37	95	125	16	23
HV%	9%	12%	7%	1%	2%	8%	0%	14%	2%	1%	0%	9%
PM												
	NBL	NBT	NBR	SBL	SBT	SBR	EBL	EBT	EBR	WBL	WBT	WBR
HV Volume	0	5	0	0	4	0	0	5	2	4	2	0
Total Volume	172	873	114	59	238	12	17	55	41	79	58	89
HV%	0%	1%	0%	0%	2%	0%	0%	9%	5%	5%	3%	0%

[2] March Road at Klondike Road												
AM												
	NBL	NBT	NBR	SBL	SBT	SBR	EBL	EBT	EBR	WBL	WBT	WBR
HV Volume	4	18	4	3	15	3	4	2	2	2	2	2
Total Volume	83	274	44	17	883	33	30	35	253	91	25	19
HV%	5%	7%	9%	18%	2%	9%	13%	6%	1%	2%	8%	11%
PM												
	NBL	NBT	NBR	SBL	SBT	SBR	EBL	EBT	EBR	WBL	WBT	WBR
HV Volume	1	2	0	0	8	0	0	0	0	1	2	0
Total Volume	159	1122	81	2	418	57	79	22	110	60	31	22
HV%	1%	0%	0%	0%	2%	0%	0%	0%	0%	2%	6%	0%

# Appendix L

Synchro Intersection Worksheets – 2022 Existing Conditions



Lanes, Volumes, Timings  
 1: March Road & Halton Terrace/Maxwell Bridge Road

2022 Existing AM  
 910 March Road



Lane Group	EBL	EBT	EBR	WBL	WBT	WBR	NBL	NBT	NBR	SBL	SBT	SBR
Lane Configurations												
Traffic Volume (vph)	21	37	95	125	16	23	23	180	61	68	815	12
Future Volume (vph)	21	37	95	125	16	23	23	180	61	68	815	12
Lane Util. Factor	1.00	1.00	1.00	1.00	1.00	1.00	1.00	0.95	1.00	1.00	0.95	1.00
Ped Bike Factor		0.99		1.00					0.98	1.00		
Frt		0.892			0.911				0.850			0.850
Flt Protected	0.950			0.950			0.950			0.950		
Satd. Flow (prot)	1658	1493	0	1658	1528	0	1551	3020	1414	1658	3316	1401
Flt Permitted	0.728			0.588			0.280			0.616		
Satd. Flow (perm)	1270	1493	0	1025	1528	0	457	3020	1380	1071	3316	1401
Satd. Flow (RTOR)		106			26				100			100
Confl. Peds. (#/hr)			1	1					2	2		
Peak Hour Factor	0.90	0.90	0.90	0.90	0.90	0.90	0.90	0.90	0.90	0.90	0.90	0.90
Heavy Vehicles (%)	2%	14%	2%	2%	2%	9%	9%	12%	7%	2%	2%	8%
Adj. Flow (vph)	23	41	106	139	18	26	26	200	68	76	906	13
Shared Lane Traffic (%)												
Lane Group Flow (vph)	23	147	0	139	44	0	26	200	68	76	906	13
Enter Blocked Intersection	No	No	No	No	No	No	No	No	No	No	No	No
Lane Alignment	Left	Left	Right	Left	Left	Right	Left	Left	Right	Left	Left	Right
Median Width(m)		3.5			3.5			3.5			3.5	
Link Offset(m)		0.0			0.0			0.0			0.0	
Crosswalk Width(m)		3.0			3.0			3.0			3.0	
Two way Left Turn Lane												
Headway Factor	1.09	1.09	1.09	1.09	1.09	1.09	1.09	1.09	1.09	1.09	1.09	1.09
Turning Speed (k/h)	25		15	25		15	25		15	25		15
Number of Detectors	1	2		1	2		1	2	1	1	2	1
Detector Template	Left	Thru		Left	Thru		Left	Thru	Right	Left	Thru	Right
Leading Detector (m)	2.0	10.0		2.0	10.0		2.0	10.0	2.0	2.0	10.0	2.0
Trailing Detector (m)	0.0	0.0		0.0	0.0		0.0	0.0	0.0	0.0	0.0	0.0
Detector 1 Position(m)	0.0	0.0		0.0	0.0		0.0	0.0	0.0	0.0	0.0	0.0
Detector 1 Size(m)	2.0	0.6		2.0	0.6		2.0	0.6	2.0	2.0	0.6	2.0
Detector 1 Type	Cl+Ex	Cl+Ex		Cl+Ex	Cl+Ex		Cl+Ex	Cl+Ex	Cl+Ex	Cl+Ex	Cl+Ex	Cl+Ex
Detector 1 Channel												
Detector 1 Extend (s)	0.0	0.0		0.0	0.0		0.0	0.0	0.0	0.0	0.0	0.0
Detector 1 Queue (s)	0.0	0.0		0.0	0.0		0.0	0.0	0.0	0.0	0.0	0.0
Detector 1 Delay (s)	0.0	0.0		0.0	0.0		0.0	0.0	0.0	0.0	0.0	0.0
Detector 2 Position(m)		9.4			9.4			9.4			9.4	
Detector 2 Size(m)		0.6			0.6			0.6			0.6	
Detector 2 Type		Cl+Ex			Cl+Ex			Cl+Ex			Cl+Ex	
Detector 2 Channel												
Detector 2 Extend (s)		0.0			0.0			0.0			0.0	
Turn Type	Perm	NA		Perm	NA		pm+pt	NA	Perm	pm+pt	NA	Perm
Protected Phases		4			8		5	2		1	6	
Permitted Phases	4			8			2		2	6		6
Detector Phase	4	4		8	8		5	2	2	1	6	6
Switch Phase												
Minimum Initial (s)	10.0	10.0		10.0	10.0		5.0	10.0	10.0	5.0	10.0	10.0
Minimum Split (s)	38.6	38.6		38.6	38.6		12.4	34.6	34.6	11.4	34.6	34.6
Total Split (s)	48.0	48.0		48.0	48.0		20.0	52.0	52.0	20.0	52.0	52.0

Lanes, Volumes, Timings  
 1: March Road & Halton Terrace/Maxwell Bridge Road

2022 Existing AM  
 910 March Road



Lane Group	EBL	EBT	EBR	WBL	WBT	WBR	NBL	NBT	NBR	SBL	SBT	SBR
Total Split (%)	40.0%	40.0%		40.0%	40.0%		16.7%	43.3%	43.3%	16.7%	43.3%	43.3%
Maximum Green (s)	41.4	41.4		41.4	41.4		12.6	45.4	45.4	13.6	45.4	45.4
Yellow Time (s)	3.3	3.3		3.3	3.3		4.6	4.6	4.6	4.6	4.6	4.6
All-Red Time (s)	3.3	3.3		3.3	3.3		2.8	2.0	2.0	1.8	2.0	2.0
Lost Time Adjust (s)	0.0	0.0		0.0	0.0		0.0	0.0	0.0	0.0	0.0	0.0
Total Lost Time (s)	6.6	6.6		6.6	6.6		7.4	6.6	6.6	6.4	6.6	6.6
Lead/Lag							Lead	Lag	Lag	Lead	Lag	Lag
Lead-Lag Optimize?							Yes	Yes	Yes	Yes	Yes	Yes
Vehicle Extension (s)	3.0	3.0		3.0	3.0		3.0	3.0	3.0	3.0	3.0	3.0
Recall Mode	None	None		None	None		None	C-Max	C-Max	None	C-Max	C-Max
Walk Time (s)	7.0	7.0		7.0	7.0			7.0	7.0		7.0	7.0
Flash Dont Walk (s)	25.0	25.0		25.0	25.0			21.0	21.0		21.0	21.0
Pedestrian Calls (#/hr)	0	0		0	0			0	0		0	0
Act Effct Green (s)	20.1	20.1		20.1	20.1		79.8	75.5	75.5	83.4	78.4	78.4
Actuated g/C Ratio	0.17	0.17		0.17	0.17		0.66	0.63	0.63	0.70	0.65	0.65
v/c Ratio	0.11	0.44		0.81	0.16		0.07	0.11	0.08	0.10	0.42	0.01
Control Delay	40.0	17.6		80.0	21.7		7.2	11.0	1.2	6.4	12.8	0.0
Queue Delay	0.0	0.0		0.0	0.0		0.0	0.0	0.0	0.0	0.0	0.0
Total Delay	40.0	17.6		80.0	21.7		7.2	11.0	1.2	6.4	12.8	0.0
LOS	D	B		F	C		A	B	A	A	B	A
Approach Delay		20.6			66.0			8.4			12.1	
Approach LOS		C			E			A			B	
Queue Length 50th (m)	4.7	8.4		31.9	3.6		1.6	9.6	0.0	4.6	56.4	0.0
Queue Length 95th (m)	11.1	24.7		50.7	12.8		5.3	18.7	3.1	11.6	87.7	0.0
Internal Link Dist (m)		119.7			332.2			300.9			243.2	
Turn Bay Length (m)	30.0			30.0			60.0			70.0		15.0
Base Capacity (vph)	438	584		353	544		437	1900	905	840	2165	949
Starvation Cap Reductn	0	0		0	0		0	0	0	0	0	0
Spillback Cap Reductn	0	0		0	0		0	0	0	0	0	0
Storage Cap Reductn	0	0		0	0		0	0	0	0	0	0
Reduced v/c Ratio	0.05	0.25		0.39	0.08		0.06	0.11	0.08	0.09	0.42	0.01

Intersection Summary

Cycle Length: 120  
 Actuated Cycle Length: 120  
 Offset: 99 (83%), Referenced to phase 2:NBTL and 6:SBTL, Start of Green  
 Natural Cycle: 90  
 Control Type: Actuated-Coordinated  
 Maximum v/c Ratio: 0.81  
 Intersection Signal Delay: 18.4  
 Intersection Capacity Utilization 67.9%  
 Analysis Period (min) 15  
 Intersection LOS: B  
 ICU Level of Service C

Splits and Phases: 1: March Road & Halton Terrace/Maxwell Bridge Road



HCM Signalized Intersection Capacity Analysis  
 1: March Road & Halton Terrace/Maxwell Bridge Road

2022 Existing AM  
 910 March Road



Movement	EBL	EBT	EBR	WBL	WBT	WBR	NBL	NBT	NBR	SBL	SBT	SBR
Lane Configurations	↖	↗		↖	↗		↖	↑↑	↗	↖	↑↑	↗
Traffic Volume (vph)	21	37	95	125	16	23	23	180	61	68	815	12
Future Volume (vph)	21	37	95	125	16	23	23	180	61	68	815	12
Ideal Flow (vphp)	1800	1800	1800	1800	1800	1800	1800	1800	1800	1800	1800	1800
Total Lost time (s)	6.6	6.6		6.6	6.6		7.4	6.6	6.6	6.4	6.6	6.6
Lane Util. Factor	1.00	1.00		1.00	1.00		1.00	0.95	1.00	1.00	0.95	1.00
Frbp, ped/bikes	1.00	0.99		1.00	1.00		1.00	1.00	0.98	1.00	1.00	1.00
Flpb, ped/bikes	1.00	1.00		1.00	1.00		1.00	1.00	1.00	1.00	1.00	1.00
Frt	1.00	0.89		1.00	0.91		1.00	1.00	0.85	1.00	1.00	0.85
Flt Protected	0.95	1.00		0.95	1.00		0.95	1.00	1.00	0.95	1.00	1.00
Satd. Flow (prot)	1658	1493		1656	1528		1551	3020	1380	1655	3316	1401
Flt Permitted	0.73	1.00		0.59	1.00		0.28	1.00	1.00	0.62	1.00	1.00
Satd. Flow (perm)	1271	1493		1025	1528		457	3020	1380	1073	3316	1401
Peak-hour factor, PHF	0.90	0.90	0.90	0.90	0.90	0.90	0.90	0.90	0.90	0.90	0.90	0.90
Adj. Flow (vph)	23	41	106	139	18	26	26	200	68	76	906	13
RTOR Reduction (vph)	0	88	0	0	22	0	0	0	26	0	0	5
Lane Group Flow (vph)	23	59	0	139	22	0	26	200	42	76	906	8
Confl. Peds. (#/hr)			1	1					2	2		
Heavy Vehicles (%)	2%	14%	2%	2%	2%	9%	9%	12%	7%	2%	2%	8%
Turn Type	Perm	NA		Perm	NA		pm+pt	NA	Perm	pm+pt	NA	Perm
Protected Phases		4			8		5	2		1	6	
Permitted Phases	4			8			2		2	6		6
Actuated Green, G (s)	20.1	20.1		20.1	20.1		78.1	74.2	74.2	81.5	75.4	75.4
Effective Green, g (s)	20.1	20.1		20.1	20.1		78.1	74.2	74.2	81.5	75.4	75.4
Actuated g/C Ratio	0.17	0.17		0.17	0.17		0.65	0.62	0.62	0.68	0.63	0.63
Clearance Time (s)	6.6	6.6		6.6	6.6		7.4	6.6	6.6	6.4	6.6	6.6
Vehicle Extension (s)	3.0	3.0		3.0	3.0		3.0	3.0	3.0	3.0	3.0	3.0
Lane Grp Cap (vph)	212	250		171	255		332	1867	853	758	2083	880
v/s Ratio Prot		0.04			0.01		0.00	0.07		c0.01	c0.27	
v/s Ratio Perm	0.02			c0.14			0.05		0.03	0.06		0.01
v/c Ratio	0.11	0.24		0.81	0.09		0.08	0.11	0.05	0.10	0.43	0.01
Uniform Delay, d1	42.4	43.3		48.1	42.2		7.7	9.4	9.0	6.5	11.4	8.3
Progression Factor	1.00	1.00		1.00	1.00		1.00	1.00	1.00	1.00	1.00	1.00
Incremental Delay, d2	0.2	0.5		24.6	0.1		0.1	0.1	0.1	0.1	0.7	0.0
Delay (s)	42.6	43.8		72.8	42.4		7.8	9.5	9.1	6.5	12.1	8.4
Level of Service	D	D		E	D		A	A	A	A	B	A
Approach Delay (s)		43.6			65.4			9.2			11.6	
Approach LOS		D			E			A			B	
<b>Intersection Summary</b>												
HCM 2000 Control Delay			20.5				HCM 2000 Level of Service			C		
HCM 2000 Volume to Capacity ratio			0.50									
Actuated Cycle Length (s)			120.0				Sum of lost time (s)			20.6		
Intersection Capacity Utilization			67.9%				ICU Level of Service			C		
Analysis Period (min)			15									

c Critical Lane Group

Lanes, Volumes, Timings  
2: March Road & Klondike Road

2022 Existing AM  
910 March Road



Lane Group	EBL	EBT	EBR	WBL	WBT	WBR	NBL	NBT	NBR	SBL	SBT	SBR
Lane Configurations												
Traffic Volume (vph)	30	35	253	91	25	19	79	277	44	17	892	33
Future Volume (vph)	30	35	253	91	25	19	79	277	44	17	892	33
Lane Util. Factor	1.00	1.00	1.00	1.00	1.00	1.00	0.97	0.91	0.91	1.00	0.91	0.91
Ped Bike Factor	1.00		0.98	0.99	0.99		1.00	1.00		0.99	1.00	
Frt			0.850		0.936			0.979			0.995	
Flt Protected	0.950			0.950			0.950			0.950		
Satd. Flow (prot)	1496	1679	1483	1658	1515	0	3124	4417	0	1433	4726	0
Flt Permitted	0.510			0.732			0.950			0.950		
Satd. Flow (perm)	801	1679	1456	1270	1515	0	3119	4417	0	1424	4726	0
Satd. Flow (RTOR)			184		21			27			5	
Confl. Peds. (#/hr)	3		6	6		3	3		4	4		3
Peak Hour Factor	0.90	0.90	0.90	0.90	0.90	0.90	0.90	0.90	0.90	0.90	0.90	0.90
Heavy Vehicles (%)	13%	6%	2%	2%	8%	11%	5%	7%	9%	18%	2%	9%
Adj. Flow (vph)	33	39	281	101	28	21	88	308	49	19	991	37
Shared Lane Traffic (%)												
Lane Group Flow (vph)	33	39	281	101	49	0	88	357	0	19	1028	0
Enter Blocked Intersection	No	No	No	No	No	No	No	No	No	No	No	No
Lane Alignment	Left	Left	Right	Left	Left	Right	Left	Left	Right	Left	Left	Right
Median Width(m)		3.5			3.5			7.0			7.0	
Link Offset(m)		0.0			0.0			0.0			0.0	
Crosswalk Width(m)		3.0			3.0			3.0			3.0	
Two way Left Turn Lane												
Headway Factor	1.09	1.09	1.09	1.09	1.09	1.09	1.09	1.09	1.09	1.09	1.09	1.09
Turning Speed (k/h)	25		15	25		15	25		15	25		15
Number of Detectors	1	2	1	1	2		1	2		1	2	
Detector Template	Left	Thru	Right	Left	Thru		Left	Thru		Left	Thru	
Leading Detector (m)	2.0	10.0	2.0	2.0	10.0		2.0	10.0		2.0	10.0	
Trailing Detector (m)	0.0	0.0	0.0	0.0	0.0		0.0	0.0		0.0	0.0	
Detector 1 Position(m)	0.0	0.0	0.0	0.0	0.0		0.0	0.0		0.0	0.0	
Detector 1 Size(m)	2.0	0.6	2.0	2.0	0.6		2.0	0.6		2.0	0.6	
Detector 1 Type	Cl+Ex	Cl+Ex	Cl+Ex	Cl+Ex	Cl+Ex		Cl+Ex	Cl+Ex		Cl+Ex	Cl+Ex	
Detector 1 Channel												
Detector 1 Extend (s)	0.0	0.0	0.0	0.0	0.0		0.0	0.0		0.0	0.0	
Detector 1 Queue (s)	0.0	0.0	0.0	0.0	0.0		0.0	0.0		0.0	0.0	
Detector 1 Delay (s)	0.0	0.0	0.0	0.0	0.0		0.0	0.0		0.0	0.0	
Detector 2 Position(m)		9.4			9.4			9.4			9.4	
Detector 2 Size(m)		0.6			0.6			0.6			0.6	
Detector 2 Type		Cl+Ex			Cl+Ex			Cl+Ex			Cl+Ex	
Detector 2 Channel												
Detector 2 Extend (s)		0.0			0.0			0.0			0.0	
Turn Type	pm+pt	NA	Perm	Perm	NA		Prot	NA		Prot	NA	
Protected Phases	7	4			8		5	2		1	6	
Permitted Phases	4		4	8								
Detector Phase	7	4	4	8	8		5	2		1	6	
Switch Phase												
Minimum Initial (s)	5.0	5.0	5.0	5.0	5.0		5.0	5.0		5.0	5.0	
Minimum Split (s)	11.6	44.1	44.1	44.1	44.1		11.6	32.4		11.6	32.4	
Total Split (s)	12.0	57.0	57.0	45.0	45.0		15.0	58.0		15.0	58.0	

Lanes, Volumes, Timings  
2: March Road & Klondike Road

2022 Existing AM  
910 March Road



Lane Group	EBL	EBT	EBR	WBL	WBT	WBR	NBL	NBT	NBR	SBL	SBT	SBR
Total Split (%)	9.2%	43.8%	43.8%	34.6%	34.6%		11.5%	44.6%		11.5%	44.6%	
Maximum Green (s)	5.4	49.9	49.9	37.9	37.9		8.4	51.6		8.4	51.6	
Yellow Time (s)	3.3	3.3	3.3	3.3	3.3		4.6	4.6		4.6	4.6	
All-Red Time (s)	3.3	3.8	3.8	3.8	3.8		2.0	1.8		2.0	1.8	
Lost Time Adjust (s)	0.0	0.0	0.0	0.0	0.0		0.0	0.0		0.0	0.0	
Total Lost Time (s)	6.6	7.1	7.1	7.1	7.1		6.6	6.4		6.6	6.4	
Lead/Lag	Lead			Lag			Lead	Lag		Lead	Lag	
Lead-Lag Optimize?	Yes			Yes			Yes	Yes		Yes	Yes	
Vehicle Extension (s)	3.0	3.0	3.0	3.0	3.0		3.0	3.0		3.0	3.0	
Recall Mode	None	None	None	None	None		None	C-Max		None	C-Max	
Walk Time (s)		7.0	7.0	7.0	7.0			7.0			7.0	
Flash Dont Walk (s)		30.0	30.0	30.0	30.0			19.0			19.0	
Pedestrian Calls (#/hr)		0	0	0	0			0			0	
Act Effct Green (s)	23.4	22.9	22.9	15.7	15.7		9.0	87.4		7.3	77.9	
Actuated g/C Ratio	0.18	0.18	0.18	0.12	0.12		0.07	0.67		0.06	0.60	
v/c Ratio	0.19	0.13	0.69	0.66	0.24		0.41	0.12		0.24	0.36	
Control Delay	42.0	41.1	24.8	73.6	34.4		63.0	9.7		64.9	15.4	
Queue Delay	0.0	0.0	0.0	0.0	0.0		0.0	0.0		0.0	0.0	
Total Delay	42.0	41.1	24.8	73.6	34.4		63.0	9.7		64.9	15.4	
LOS	D	D	C	E	C		E	A		E	B	
Approach Delay		28.2				60.8		20.3			16.3	
Approach LOS		C				E		C			B	
Queue Length 50th (m)	6.8	8.1	21.6	25.1	6.5		11.3	9.7		4.8	51.4	
Queue Length 95th (m)	14.8	16.7	47.8	41.7	17.6		19.5	22.2		12.8	72.6	
Internal Link Dist (m)		93.7				322.6		237.8			118.1	
Turn Bay Length (m)	100.0		5.0	15.0			100.0			45.0		
Base Capacity (vph)	173	644	672	370	456		228	2976		95	2835	
Starvation Cap Reductn	0	0	0	0	0		0	0		0	0	
Spillback Cap Reductn	0	0	0	0	0		0	0		0	0	
Storage Cap Reductn	0	0	0	0	0		0	0		0	0	
Reduced v/c Ratio	0.19	0.06	0.42	0.27	0.11		0.39	0.12		0.20	0.36	

Intersection Summary

Cycle Length: 130  
 Actuated Cycle Length: 130  
 Offset: 64 (49%), Referenced to phase 2:NBT and 6:SBT, Start of Green  
 Natural Cycle: 100  
 Control Type: Actuated-Coordinated  
 Maximum v/c Ratio: 0.69  
 Intersection Signal Delay: 22.7  
 Intersection LOS: C  
 Intersection Capacity Utilization 63.8%  
 ICU Level of Service B  
 Analysis Period (min) 15

Splits and Phases: 2: March Road & Klondike Road



HCM Signalized Intersection Capacity Analysis  
2: March Road & Klondike Road

2022 Existing AM  
910 March Road



Movement	EBL	EBT	EBR	WBL	WBT	WBR	NBL	NBT	NBR	SBL	SBT	SBR
Lane Configurations	↖	↑	↗	↖	↗		↖↗	↑↑↑		↖	↑↑↑	
Traffic Volume (vph)	30	35	253	91	25	19	79	277	44	17	892	33
Future Volume (vph)	30	35	253	91	25	19	79	277	44	17	892	33
Ideal Flow (vphp)	1800	1800	1800	1800	1800	1800	1800	1800	1800	1800	1800	1800
Total Lost time (s)	6.6	7.1	7.1	7.1	7.1		6.6	6.4		6.6	6.4	
Lane Util. Factor	1.00	1.00	1.00	1.00	1.00		0.97	0.91		1.00	0.91	
Frpb, ped/bikes	1.00	1.00	0.98	1.00	0.99		1.00	1.00		1.00	1.00	
Flpb, ped/bikes	1.00	1.00	1.00	0.99	1.00		1.00	1.00		1.00	1.00	
Frt	1.00	1.00	0.85	1.00	0.94		1.00	0.98		1.00	0.99	
Flt Protected	0.95	1.00	1.00	0.95	1.00		0.95	1.00		0.95	1.00	
Satd. Flow (prot)	1495	1679	1456	1648	1514		3124	4418		1433	4724	
Flt Permitted	0.51	1.00	1.00	0.73	1.00		0.95	1.00		0.95	1.00	
Satd. Flow (perm)	803	1679	1456	1269	1514		3124	4418		1433	4724	
Peak-hour factor, PHF	0.90	0.90	0.90	0.90	0.90	0.90	0.90	0.90	0.90	0.90	0.90	0.90
Adj. Flow (vph)	33	39	281	101	28	21	88	308	49	19	991	37
RTOR Reduction (vph)	0	0	148	0	18	0	0	10	0	0	2	0
Lane Group Flow (vph)	33	39	133	101	31	0	88	347	0	19	1026	0
Confl. Peds. (#/hr)	3		6	6		3	3		4	4		3
Heavy Vehicles (%)	13%	6%	2%	2%	8%	11%	5%	7%	9%	18%	2%	9%
Turn Type	pm+pt	NA	Perm	Perm	NA		Prot	NA		Prot	NA	
Protected Phases	7	4			8		5	2		1	6	
Permitted Phases	4		4	8								
Actuated Green, G (s)	25.5	25.5	25.5	15.7	15.7		9.0	80.8		3.6	75.4	
Effective Green, g (s)	25.5	25.5	25.5	15.7	15.7		9.0	80.8		3.6	75.4	
Actuated g/C Ratio	0.20	0.20	0.20	0.12	0.12		0.07	0.62		0.03	0.58	
Clearance Time (s)	6.6	7.1	7.1	7.1	7.1		6.6	6.4		6.6	6.4	
Vehicle Extension (s)	3.0	3.0	3.0	3.0	3.0		3.0	3.0		3.0	3.0	
Lane Grp Cap (vph)	174	329	285	153	182		216	2745		39	2739	
v/s Ratio Prot	0.00	0.02			0.02		c0.03	c0.08		0.01	c0.22	
v/s Ratio Perm	0.03		c0.09	c0.08								
v/c Ratio	0.19	0.12	0.47	0.66	0.17		0.41	0.13		0.49	0.37	
Uniform Delay, d1	43.1	43.0	46.2	54.6	51.3		57.9	10.1		62.3	14.6	
Progression Factor	1.00	1.00	1.00	1.00	1.00		1.00	1.00		1.00	1.00	
Incremental Delay, d2	0.5	0.2	1.2	10.2	0.4		1.3	0.1		9.3	0.4	
Delay (s)	43.7	43.2	47.4	64.8	51.7		59.2	10.2		71.6	15.0	
Level of Service	D	D	D	E	D		E	B		E	B	
Approach Delay (s)		46.6			60.5			19.9			16.1	
Approach LOS		D			E			B			B	
<b>Intersection Summary</b>												
HCM 2000 Control Delay			25.7	HCM 2000 Level of Service				C				
HCM 2000 Volume to Capacity ratio			0.44									
Actuated Cycle Length (s)			130.0	Sum of lost time (s)				26.7				
Intersection Capacity Utilization			63.8%	ICU Level of Service				B				
Analysis Period (min)			15									

c Critical Lane Group

Lanes, Volumes, Timings  
 1: March Road & Halton Terrace/Maxwell Bridge Road

2022 Existing PM  
 910 March Road



Lane Group	EBL	EBT	EBR	WBL	WBT	WBR	NBL	NBT	NBR	SBL	SBT	SBR
Lane Configurations												
Traffic Volume (vph)	17	55	41	79	58	89	172	882	114	59	240	12
Future Volume (vph)	17	55	41	79	58	89	172	882	114	59	240	12
Lane Util. Factor	1.00	1.00	1.00	1.00	1.00	1.00	1.00	0.95	1.00	1.00	0.95	1.00
Ped Bike Factor	0.99	0.99		0.98	0.99		1.00		0.96	1.00		0.98
Frt		0.936			0.909				0.850			0.850
Flt Protected	0.950			0.950			0.950			0.950		
Satd. Flow (prot)	1658	1532	0	1610	1557	0	1658	3316	1483	1658	3316	1483
Flt Permitted	0.487			0.687			0.551			0.274		
Satd. Flow (perm)	842	1532	0	1145	1557	0	959	3316	1419	476	3316	1447
Satd. Flow (RTOR)		33			68				127			100
Confl. Peds. (#/hr)	11		17	17		11	2		11	11		2
Peak Hour Factor	0.90	0.90	0.90	0.90	0.90	0.90	0.90	0.90	0.90	0.90	0.90	0.90
Heavy Vehicles (%)	2%	9%	5%	5%	3%	2%	2%	2%	2%	2%	2%	2%
Adj. Flow (vph)	19	61	46	88	64	99	191	980	127	66	267	13
Shared Lane Traffic (%)												
Lane Group Flow (vph)	19	107	0	88	163	0	191	980	127	66	267	13
Enter Blocked Intersection	No	No	No	No	No	No	No	No	No	No	No	No
Lane Alignment	Left	Left	Right	Left	Left	Right	Left	Left	Right	Left	Left	Right
Median Width(m)		3.5			3.5			3.5			3.5	
Link Offset(m)		0.0			0.0			0.0			0.0	
Crosswalk Width(m)		3.0			3.0			3.0			3.0	
Two way Left Turn Lane												
Headway Factor	1.09	1.09	1.09	1.09	1.09	1.09	1.09	1.09	1.09	1.09	1.09	1.09
Turning Speed (k/h)	25		15	25		15	25		15	25		15
Number of Detectors	1	2		1	2		1	2	1	1	2	1
Detector Template	Left	Thru		Left	Thru		Left	Thru	Right	Left	Thru	Right
Leading Detector (m)	2.0	10.0		2.0	10.0		2.0	10.0	2.0	2.0	10.0	2.0
Trailing Detector (m)	0.0	0.0		0.0	0.0		0.0	0.0	0.0	0.0	0.0	0.0
Detector 1 Position(m)	0.0	0.0		0.0	0.0		0.0	0.0	0.0	0.0	0.0	0.0
Detector 1 Size(m)	2.0	0.6		2.0	0.6		2.0	0.6	2.0	2.0	0.6	2.0
Detector 1 Type	Cl+Ex	Cl+Ex		Cl+Ex	Cl+Ex		Cl+Ex	Cl+Ex	Cl+Ex	Cl+Ex	Cl+Ex	Cl+Ex
Detector 1 Channel												
Detector 1 Extend (s)	0.0	0.0		0.0	0.0		0.0	0.0	0.0	0.0	0.0	0.0
Detector 1 Queue (s)	0.0	0.0		0.0	0.0		0.0	0.0	0.0	0.0	0.0	0.0
Detector 1 Delay (s)	0.0	0.0		0.0	0.0		0.0	0.0	0.0	0.0	0.0	0.0
Detector 2 Position(m)		9.4			9.4			9.4			9.4	
Detector 2 Size(m)		0.6			0.6			0.6			0.6	
Detector 2 Type		Cl+Ex			Cl+Ex			Cl+Ex			Cl+Ex	
Detector 2 Channel												
Detector 2 Extend (s)		0.0			0.0			0.0			0.0	
Turn Type	Perm	NA		Perm	NA		pm+pt	NA	Perm	pm+pt	NA	Perm
Protected Phases		4			8		5	2		1	6	
Permitted Phases	4			8			2		2	6		6
Detector Phase	4	4		8	8		5	2	2	1	6	6
Switch Phase												
Minimum Initial (s)	10.0	10.0		10.0	10.0		5.0	10.0	10.0	5.0	10.0	10.0
Minimum Split (s)	38.6	38.6		38.6	38.6		12.4	34.6	34.6	11.4	34.6	34.6
Total Split (s)	45.0	45.0		45.0	45.0		20.0	55.0	55.0	20.0	55.0	55.0

Lanes, Volumes, Timings  
 1: March Road & Halton Terrace/Maxwell Bridge Road

2022 Existing PM  
 910 March Road



Lane Group	EBL	EBT	EBR	WBL	WBT	WBR	NBL	NBT	NBR	SBL	SBT	SBR
Total Split (%)	37.5%	37.5%		37.5%	37.5%		16.7%	45.8%	45.8%	16.7%	45.8%	45.8%
Maximum Green (s)	38.4	38.4		38.4	38.4		12.6	48.4	48.4	13.6	48.4	48.4
Yellow Time (s)	3.3	3.3		3.3	3.3		4.6	4.6	4.6	4.6	4.6	4.6
All-Red Time (s)	3.3	3.3		3.3	3.3		2.8	2.0	2.0	1.8	2.0	2.0
Lost Time Adjust (s)	0.0	0.0		0.0	0.0		0.0	0.0	0.0	0.0	0.0	0.0
Total Lost Time (s)	6.6	6.6		6.6	6.6		7.4	6.6	6.6	6.4	6.6	6.6
Lead/Lag							Lead	Lag	Lag	Lead	Lag	Lag
Lead-Lag Optimize?							Yes	Yes	Yes	Yes	Yes	Yes
Vehicle Extension (s)	3.0	3.0		3.0	3.0		3.0	3.0	3.0	3.0	3.0	3.0
Recall Mode	None	None		None	None		None	C-Max	C-Max	None	C-Max	C-Max
Walk Time (s)	7.0	7.0		7.0	7.0			7.0	7.0		7.0	7.0
Flash Dont Walk (s)	25.0	25.0		25.0	25.0			21.0	21.0		21.0	21.0
Pedestrian Calls (#/hr)	0	0		0	0			0	0		0	0
Act Effct Green (s)	15.1	15.1		15.1	15.1		88.3	81.0	81.0	81.7	74.8	74.8
Actuated g/C Ratio	0.13	0.13		0.13	0.13		0.74	0.68	0.68	0.68	0.62	0.62
v/c Ratio	0.18	0.48		0.61	0.64		0.25	0.44	0.13	0.17	0.13	0.01
Control Delay	48.5	39.8		66.7	39.5		5.4	11.0	2.0	5.7	10.4	0.0
Queue Delay	0.0	0.0		0.0	0.0		0.0	0.0	0.0	0.0	0.0	0.0
Total Delay	48.5	39.8		66.7	39.5		5.4	11.0	2.0	5.7	10.4	0.0
LOS	D	D		E	D		A	B	A	A	B	A
Approach Delay		41.1			49.1			9.3			9.2	
Approach LOS		D			D			A			A	
Queue Length 50th (m)	4.1	16.3		20.0	21.3		10.3	53.8	0.0	3.2	12.3	0.0
Queue Length 95th (m)	10.8	32.0		35.3	41.3		21.4	83.3	7.7	8.2	22.9	0.0
Internal Link Dist (m)		119.7			332.2			300.9			243.2	
Turn Bay Length (m)	30.0			30.0			60.0			70.0		15.0
Base Capacity (vph)	269	512		366	544		795	2236	998	485	2067	939
Starvation Cap Reductn	0	0		0	0		0	0	0	0	0	0
Spillback Cap Reductn	0	0		0	0		0	0	0	0	0	0
Storage Cap Reductn	0	0		0	0		0	0	0	0	0	0
Reduced v/c Ratio	0.07	0.21		0.24	0.30		0.24	0.44	0.13	0.14	0.13	0.01

Intersection Summary

Cycle Length: 120  
 Actuated Cycle Length: 120  
 Offset: 50 (42%), Referenced to phase 2:NBTL and 6:SBTL, Start of Green  
 Natural Cycle: 90  
 Control Type: Actuated-Coordinated  
 Maximum v/c Ratio: 0.64  
 Intersection Signal Delay: 16.2  
 Intersection LOS: B  
 Intersection Capacity Utilization 70.6%  
 ICU Level of Service C  
 Analysis Period (min) 15

Splits and Phases: 1: March Road & Halton Terrace/Maxwell Bridge Road





HCM Signalized Intersection Capacity Analysis  
 1: March Road & Halton Terrace/Maxwell Bridge Road

2022 Existing PM  
 910 March Road



Movement	EBL	EBT	EBR	WBL	WBT	WBR	NBL	NBT	NBR	SBL	SBT	SBR
Lane Configurations	↖	↗		↖	↗		↖	↑↑	↗	↖	↑↑	↗
Traffic Volume (vph)	17	55	41	79	58	89	172	882	114	59	240	12
Future Volume (vph)	17	55	41	79	58	89	172	882	114	59	240	12
Ideal Flow (vphp)	1800	1800	1800	1800	1800	1800	1800	1800	1800	1800	1800	1800
Total Lost time (s)	6.6	6.6		6.6	6.6		7.4	6.6	6.6	6.4	6.6	6.6
Lane Util. Factor	1.00	1.00		1.00	1.00		1.00	0.95	1.00	1.00	0.95	1.00
Frbp, ped/bikes	1.00	0.99		1.00	0.99		1.00	1.00	0.96	1.00	1.00	0.98
Flpb, ped/bikes	0.99	1.00		0.98	1.00		1.00	1.00	1.00	1.00	1.00	1.00
Frt	1.00	0.94		1.00	0.91		1.00	1.00	0.85	1.00	1.00	0.85
Flt Protected	0.95	1.00		0.95	1.00		0.95	1.00	1.00	0.95	1.00	1.00
Satd. Flow (prot)	1642	1532		1584	1557		1655	3316	1419	1656	3316	1447
Flt Permitted	0.49	1.00		0.69	1.00		0.55	1.00	1.00	0.27	1.00	1.00
Satd. Flow (perm)	843	1532		1145	1557		960	3316	1419	478	3316	1447
Peak-hour factor, PHF	0.90	0.90	0.90	0.90	0.90	0.90	0.90	0.90	0.90	0.90	0.90	0.90
Adj. Flow (vph)	19	61	46	88	64	99	191	980	127	66	267	13
RTOR Reduction (vph)	0	29	0	0	59	0	0	0	43	0	0	5
Lane Group Flow (vph)	19	78	0	88	104	0	191	980	84	66	267	8
Confl. Peds. (#/hr)	11		17	17		11	2		11	11		2
Heavy Vehicles (%)	2%	9%	5%	5%	3%	2%	2%	2%	2%	2%	2%	2%
Turn Type	Perm	NA		Perm	NA		pm+pt	NA	Perm	pm+pt	NA	Perm
Protected Phases		4			8		5	2		1	6	
Permitted Phases	4			8			2		2	6		6
Actuated Green, G (s)	15.1	15.1		15.1	15.1		89.2	79.7	79.7	80.4	74.8	74.8
Effective Green, g (s)	15.1	15.1		15.1	15.1		89.2	79.7	79.7	80.4	74.8	74.8
Actuated g/C Ratio	0.13	0.13		0.13	0.13		0.74	0.66	0.66	0.67	0.62	0.62
Clearance Time (s)	6.6	6.6		6.6	6.6		7.4	6.6	6.6	6.4	6.6	6.6
Vehicle Extension (s)	3.0	3.0		3.0	3.0		3.0	3.0	3.0	3.0	3.0	3.0
Lane Grp Cap (vph)	106	192		144	195		768	2202	942	375	2066	901
v/s Ratio Prot		0.05			0.07		c0.02	c0.30		0.01	0.08	
v/s Ratio Perm	0.02			c0.08			0.17		0.06	0.11		0.01
v/c Ratio	0.18	0.41		0.61	0.53		0.25	0.45	0.09	0.18	0.13	0.01
Uniform Delay, d1	46.9	48.3		49.7	49.1		4.6	9.6	7.2	6.9	9.3	8.6
Progression Factor	1.00	1.00		1.00	1.00		1.00	1.00	1.00	1.00	1.00	1.00
Incremental Delay, d2	0.8	1.4		7.5	2.8		0.2	0.7	0.2	0.2	0.1	0.0
Delay (s)	47.7	49.7		57.1	51.9		4.8	10.3	7.4	7.1	9.4	8.6
Level of Service	D	D		E	D		A	B	A	A	A	A
Approach Delay (s)		49.4			53.7			9.2			8.9	
Approach LOS		D			D			A			A	

Intersection Summary		
HCM 2000 Control Delay	17.2	HCM 2000 Level of Service
HCM 2000 Volume to Capacity ratio	0.47	B
Actuated Cycle Length (s)	120.0	Sum of lost time (s)
Intersection Capacity Utilization	70.6%	20.6
Analysis Period (min)	15	ICU Level of Service
		C

c Critical Lane Group

Lanes, Volumes, Timings  
2: March Road & Klondike Road

2022 Existing PM  
910 March Road



Lane Group	EBL	EBT	EBR	WBL	WBT	WBR	NBL	NBT	NBR	SBL	SBT	SBR
Lane Configurations												
Traffic Volume (vph)	79	22	110	60	31	22	159	1133	81	2	422	57
Future Volume (vph)	79	22	110	60	31	22	159	1133	81	2	422	57
Lane Util. Factor	1.00	1.00	1.00	1.00	1.00	1.00	0.97	0.91	0.91	1.00	0.91	0.91
Ped Bike Factor	1.00		0.99	1.00	0.99		0.99	1.00		1.00	1.00	
Frt			0.850		0.938			0.990			0.982	
Flt Protected	0.950			0.950			0.950			0.950		
Satd. Flow (prot)	1658	1745	1483	1658	1591	0	3216	4702	0	1658	4665	0
Flt Permitted	0.446			0.742			0.950			0.950		
Satd. Flow (perm)	778	1745	1462	1292	1591	0	3185	4702	0	1651	4665	0
Satd. Flow (RTOR)			122		24			9			20	
Confl. Peds. (#/hr)	1		2	2		1	8		11	11		8
Peak Hour Factor	0.90	0.90	0.90	0.90	0.90	0.90	0.90	0.90	0.90	0.90	0.90	0.90
Heavy Vehicles (%)	2%	2%	2%	2%	6%	2%	2%	2%	2%	2%	2%	2%
Adj. Flow (vph)	88	24	122	67	34	24	177	1259	90	2	469	63
Shared Lane Traffic (%)												
Lane Group Flow (vph)	88	24	122	67	58	0	177	1349	0	2	532	0
Enter Blocked Intersection	No	No	No	No	No	No	No	No	No	No	No	No
Lane Alignment	Left	Left	Right	Left	Left	Right	Left	Left	Right	Left	Left	Right
Median Width(m)		3.5			3.5			7.0			7.0	
Link Offset(m)		0.0			0.0			0.0			0.0	
Crosswalk Width(m)		3.0			3.0			3.0			3.0	
Two way Left Turn Lane												
Headway Factor	1.09	1.09	1.09	1.09	1.09	1.09	1.09	1.09	1.09	1.09	1.09	1.09
Turning Speed (k/h)	25		15	25		15	25		15	25		15
Number of Detectors	1	2	1	1	2		1	2		1	2	
Detector Template	Left	Thru	Right	Left	Thru		Left	Thru		Left	Thru	
Leading Detector (m)	2.0	10.0	2.0	2.0	10.0		2.0	10.0		2.0	10.0	
Trailing Detector (m)	0.0	0.0	0.0	0.0	0.0		0.0	0.0		0.0	0.0	
Detector 1 Position(m)	0.0	0.0	0.0	0.0	0.0		0.0	0.0		0.0	0.0	
Detector 1 Size(m)	2.0	0.6	2.0	2.0	0.6		2.0	0.6		2.0	0.6	
Detector 1 Type	Cl+Ex	Cl+Ex	Cl+Ex	Cl+Ex	Cl+Ex		Cl+Ex	Cl+Ex		Cl+Ex	Cl+Ex	
Detector 1 Channel												
Detector 1 Extend (s)	0.0	0.0	0.0	0.0	0.0		0.0	0.0		0.0	0.0	
Detector 1 Queue (s)	0.0	0.0	0.0	0.0	0.0		0.0	0.0		0.0	0.0	
Detector 1 Delay (s)	0.0	0.0	0.0	0.0	0.0		0.0	0.0		0.0	0.0	
Detector 2 Position(m)		9.4			9.4			9.4			9.4	
Detector 2 Size(m)		0.6			0.6			0.6			0.6	
Detector 2 Type		Cl+Ex			Cl+Ex			Cl+Ex			Cl+Ex	
Detector 2 Channel												
Detector 2 Extend (s)		0.0			0.0			0.0			0.0	
Turn Type	pm+pt	NA	Perm	Perm	NA		Prot	NA		Prot	NA	
Protected Phases	7	4			8		5	2		1	6	
Permitted Phases	4		4	8								
Detector Phase	7	4	4	8	8		5	2		1	6	
Switch Phase												
Minimum Initial (s)	5.0	5.0	5.0	5.0	5.0		5.0	5.0		5.0	5.0	
Minimum Split (s)	11.6	44.1	44.1	44.1	44.1		11.6	32.4		11.6	32.4	
Total Split (s)	12.0	57.0	57.0	45.0	45.0		22.0	51.0		22.0	51.0	

Lanes, Volumes, Timings  
2: March Road & Klondike Road

2022 Existing PM  
910 March Road



Lane Group	EBL	EBT	EBR	WBL	WBT	WBR	NBL	NBT	NBR	SBL	SBT	SBR
Total Split (%)	9.2%	43.8%	43.8%	34.6%	34.6%		16.9%	39.2%		16.9%	39.2%	
Maximum Green (s)	5.4	49.9	49.9	37.9	37.9		15.4	44.6		15.4	44.6	
Yellow Time (s)	3.3	3.3	3.3	3.3	3.3		4.6	4.6		4.6	4.6	
All-Red Time (s)	3.3	3.8	3.8	3.8	3.8		2.0	1.8		2.0	1.8	
Lost Time Adjust (s)	0.0	0.0	0.0	0.0	0.0		0.0	0.0		0.0	0.0	
Total Lost Time (s)	6.6	7.1	7.1	7.1	7.1		6.6	6.4		6.6	6.4	
Lead/Lag	Lead			Lag			Lead	Lag		Lead	Lag	
Lead-Lag Optimize?	Yes			Yes			Yes	Yes		Yes	Yes	
Vehicle Extension (s)	3.0	3.0	3.0	3.0	3.0		3.0	3.0		3.0	3.0	
Recall Mode	None	None	None	None	None		None	C-Max		None	C-Max	
Walk Time (s)		7.0	7.0	7.0	7.0			7.0			7.0	
Flash Dont Walk (s)		30.0	30.0	30.0	30.0			19.0			19.0	
Pedestrian Calls (#/hr)		0	0	0	0			0			0	
Act Effct Green (s)	22.0	21.5	21.5	12.1	12.1		12.5	92.4		5.8	75.9	
Actuated g/C Ratio	0.17	0.17	0.17	0.09	0.09		0.10	0.71		0.04	0.58	
v/c Ratio	0.52	0.08	0.36	0.56	0.34		0.57	0.40		0.03	0.19	
Control Delay	56.4	42.3	10.0	72.7	39.5		63.4	9.6		60.0	13.8	
Queue Delay	0.0	0.0	0.0	0.0	0.0		0.0	0.0		0.0	0.0	
Total Delay	56.4	42.3	10.0	72.7	39.5		63.4	9.6		60.0	13.8	
LOS	E	D	B	E	D		E	A		E	B	
Approach Delay		30.8				57.3		15.8			14.0	
Approach LOS		C				E		B			B	
Queue Length 50th (m)	19.5	5.1	0.0	16.7	8.2		22.7	45.8		0.5	22.5	
Queue Length 95th (m)	33.1	12.2	15.5	30.8	20.9		33.6	84.9		3.3	34.2	
Internal Link Dist (m)		93.7				322.6		237.8			118.1	
Turn Bay Length (m)	100.0			5.0	15.0		100.0			45.0		
Base Capacity (vph)	169	669	636	376	480		383	3344		196	2733	
Starvation Cap Reductn	0	0	0	0	0		0	0		0	0	
Spillback Cap Reductn	0	0	0	0	0		0	0		0	0	
Storage Cap Reductn	0	0	0	0	0		0	0		0	0	
Reduced v/c Ratio	0.52	0.04	0.19	0.18	0.12		0.46	0.40		0.01	0.19	

Intersection Summary

Cycle Length: 130  
 Actuated Cycle Length: 130  
 Offset: 20 (15%), Referenced to phase 2:NBT and 6:SBT, Start of Green  
 Natural Cycle: 100  
 Control Type: Actuated-Coordinated  
 Maximum v/c Ratio: 0.57  
 Intersection Signal Delay: 19.0  
 Intersection LOS: B  
 Intersection Capacity Utilization 58.5%  
 ICU Level of Service B  
 Analysis Period (min) 15

Splits and Phases: 2: March Road & Klondike Road



HCM Signalized Intersection Capacity Analysis  
2: March Road & Klondike Road

2022 Existing PM  
910 March Road



Movement	EBL	EBT	EBR	WBL	WBT	WBR	NBL	NBT	NBR	SBL	SBT	SBR
Lane Configurations	↖	↑	↗	↖	↗		↖↗	↑↑↑		↖	↑↑↑	
Traffic Volume (vph)	79	22	110	60	31	22	159	1133	81	2	422	57
Future Volume (vph)	79	22	110	60	31	22	159	1133	81	2	422	57
Ideal Flow (vphp)	1800	1800	1800	1800	1800	1800	1800	1800	1800	1800	1800	1800
Total Lost time (s)	6.6	7.1	7.1	7.1	7.1		6.6	6.4		6.6	6.4	
Lane Util. Factor	1.00	1.00	1.00	1.00	1.00		0.97	0.91		1.00	0.91	
Frpb, ped/bikes	1.00	1.00	0.99	1.00	0.99		1.00	1.00		1.00	1.00	
Flpb, ped/bikes	1.00	1.00	1.00	1.00	1.00		1.00	1.00		1.00	1.00	
Frt	1.00	1.00	0.85	1.00	0.94		1.00	0.99		1.00	0.98	
Flt Protected	0.95	1.00	1.00	0.95	1.00		0.95	1.00		0.95	1.00	
Satd. Flow (prot)	1657	1745	1462	1654	1591		3216	4702		1658	4666	
Flt Permitted	0.45	1.00	1.00	0.74	1.00		0.95	1.00		0.95	1.00	
Satd. Flow (perm)	779	1745	1462	1292	1591		3216	4702		1658	4666	
Peak-hour factor, PHF	0.90	0.90	0.90	0.90	0.90	0.90	0.90	0.90	0.90	0.90	0.90	0.90
Adj. Flow (vph)	88	24	122	67	34	24	177	1259	90	2	469	63
RTOR Reduction (vph)	0	0	101	0	22	0	0	3	0	0	9	0
Lane Group Flow (vph)	88	24	21	67	36	0	177	1346	0	2	523	0
Confl. Peds. (#/hr)	1		2	2		1	8		11	11		8
Heavy Vehicles (%)	2%	2%	2%	2%	6%	2%	2%	2%	2%	2%	2%	2%
Turn Type	pm+pt	NA	Perm	Perm	NA		Prot	NA		Prot	NA	
Protected Phases	7	4			8		5	2		1	6	
Permitted Phases	4		4	8								
Actuated Green, G (s)	22.9	22.9	22.9	10.8	10.8		12.5	85.7		1.3	74.5	
Effective Green, g (s)	22.9	22.9	22.9	10.8	10.8		12.5	85.7		1.3	74.5	
Actuated g/C Ratio	0.18	0.18	0.18	0.08	0.08		0.10	0.66		0.01	0.57	
Clearance Time (s)	6.6	7.1	7.1	7.1	7.1		6.6	6.4		6.6	6.4	
Vehicle Extension (s)	3.0	3.0	3.0	3.0	3.0		3.0	3.0		3.0	3.0	
Lane Grp Cap (vph)	174	307	257	107	132		309	3099		16	2673	
v/s Ratio Prot	c0.02	0.01			0.02		c0.06	c0.29		0.00	0.11	
v/s Ratio Perm	0.07		0.01	c0.05								
v/c Ratio	0.51	0.08	0.08	0.63	0.27		0.57	0.43		0.12	0.20	
Uniform Delay, d1	47.3	44.7	44.8	57.6	55.9		56.2	10.6		63.8	13.3	
Progression Factor	1.00	1.00	1.00	1.00	1.00		1.00	1.00		1.00	1.00	
Incremental Delay, d2	2.3	0.1	0.1	10.9	1.1		2.6	0.4		3.5	0.2	
Delay (s)	49.6	44.8	44.9	68.6	57.0		58.8	11.0		67.3	13.5	
Level of Service	D	D	D	E	E		E	B		E	B	
Approach Delay (s)		46.7			63.2			16.6			13.7	
Approach LOS		D			E			B			B	

Intersection Summary

HCM 2000 Control Delay	21.3	HCM 2000 Level of Service	C
HCM 2000 Volume to Capacity ratio	0.49		
Actuated Cycle Length (s)	130.0	Sum of lost time (s)	26.7
Intersection Capacity Utilization	58.5%	ICU Level of Service	B
Analysis Period (min)	15		

c Critical Lane Group

# Appendix M

Synchro Intersection Worksheets – 2028 Future Background Conditions

Lanes, Volumes, Timings  
 1: March Road & Halton Terrace/Maxwell Bridge Road

2028 Future Background AM  
 910 March Road



Lane Group	EBL	EBT	EBR	WBL	WBT	WBR	NBL	NBT	NBR	SBL	SBT	SBR
Lane Configurations												
Traffic Volume (vph)	101	37	158	126	17	49	99	504	64	76	1478	66
Future Volume (vph)	101	37	158	126	17	49	99	504	64	76	1478	66
Ideal Flow (vphpl)	1800	1800	1800	1800	1800	1800	1800	1800	1800	1800	1800	1800
Storage Length (m)	30.0		0.0	30.0		0.0	60.0		0.0	70.0		15.0
Storage Lanes	1		0	1		0	1		1	1		1
Taper Length (m)	60.0			60.0			70.0			100.0		
Lane Util. Factor	1.00	1.00	1.00	1.00	1.00	1.00	1.00	0.95	1.00	1.00	0.95	1.00
Ped Bike Factor		0.99		1.00					0.98	1.00		
Frt		0.878			0.889				0.850			0.850
Flt Protected	0.950			0.950			0.950			0.950		
Satd. Flow (prot)	1658	1483	0	1658	1476	0	1551	3020	1414	1658	3316	1401
Flt Permitted	0.714			0.461			0.096			0.467		
Satd. Flow (perm)	1246	1483	0	804	1476	0	157	3020	1380	813	3316	1401
Right Turn on Red			Yes			Yes			Yes			Yes
Satd. Flow (RTOR)		158			49				100			100
Link Speed (k/h)		40			40			80				80
Link Distance (m)		143.7			356.2			324.9				307.8
Travel Time (s)		12.9			32.1			14.6				13.9
Confl. Peds. (#/hr)			1	1					2	2		
Peak Hour Factor	1.00	1.00	1.00	1.00	1.00	1.00	1.00	1.00	1.00	1.00	1.00	1.00
Heavy Vehicles (%)	2%	14%	2%	2%	2%	9%	9%	12%	7%	2%	2%	8%
Adj. Flow (vph)	101	37	158	126	17	49	99	504	64	76	1478	66
Shared Lane Traffic (%)												
Lane Group Flow (vph)	101	195	0	126	66	0	99	504	64	76	1478	66
Enter Blocked Intersection	No	No	No	No	No	No	No	No	No	No	No	No
Lane Alignment	Left	Left	Right	Left	Left	Right	Left	Left	Right	Left	Left	Right
Median Width(m)		3.5			3.5			3.5				3.5
Link Offset(m)		0.0			0.0			0.0				0.0
Crosswalk Width(m)		3.0			3.0			3.0				3.0
Two way Left Turn Lane												
Headway Factor	1.09	1.09	1.09	1.09	1.09	1.09	1.09	1.09	1.09	1.09	1.09	1.09
Turning Speed (k/h)	25		15	25		15	25		15	25		15
Number of Detectors	1	2		1	2		1	2	1	1	2	1
Detector Template	Left	Thru		Left	Thru		Left	Thru	Right	Left	Thru	Right
Leading Detector (m)	2.0	10.0		2.0	10.0		2.0	10.0	2.0	2.0	10.0	2.0
Trailing Detector (m)	0.0	0.0		0.0	0.0		0.0	0.0	0.0	0.0	0.0	0.0
Detector 1 Position(m)	0.0	0.0		0.0	0.0		0.0	0.0	0.0	0.0	0.0	0.0
Detector 1 Size(m)	2.0	0.6		2.0	0.6		2.0	0.6	2.0	2.0	0.6	2.0
Detector 1 Type	Cl+Ex	Cl+Ex		Cl+Ex	Cl+Ex		Cl+Ex	Cl+Ex	Cl+Ex	Cl+Ex	Cl+Ex	Cl+Ex
Detector 1 Channel												
Detector 1 Extend (s)	0.0	0.0		0.0	0.0		0.0	0.0	0.0	0.0	0.0	0.0
Detector 1 Queue (s)	0.0	0.0		0.0	0.0		0.0	0.0	0.0	0.0	0.0	0.0
Detector 1 Delay (s)	0.0	0.0		0.0	0.0		0.0	0.0	0.0	0.0	0.0	0.0
Detector 2 Position(m)		9.4			9.4			9.4				9.4
Detector 2 Size(m)		0.6			0.6			0.6				0.6
Detector 2 Type		Cl+Ex			Cl+Ex			Cl+Ex				Cl+Ex
Detector 2 Channel												
Detector 2 Extend (s)		0.0			0.0			0.0				0.0

Lanes, Volumes, Timings  
1: March Road & Halton Terrace/Maxwell Bridge Road

2028 Future Background AM  
910 March Road



Lane Group	EBL	EBT	EBR	WBL	WBT	WBR	NBL	NBT	NBR	SBL	SBT	SBR
Turn Type	Perm	NA		Perm	NA		pm+pt	NA	Perm	pm+pt	NA	Perm
Protected Phases		4			8		5	2		1	6	
Permitted Phases	4			8			2		2	6		6
Detector Phase	4	4		8	8		5	2	2	1	6	6
Switch Phase												
Minimum Initial (s)	10.0	10.0		10.0	10.0		5.0	10.0	10.0	5.0	10.0	10.0
Minimum Split (s)	38.6	38.6		38.6	38.6		12.4	34.6	34.6	11.4	34.6	34.6
Total Split (s)	48.0	48.0		48.0	48.0		20.0	52.0	52.0	20.0	52.0	52.0
Total Split (%)	40.0%	40.0%		40.0%	40.0%		16.7%	43.3%	43.3%	16.7%	43.3%	43.3%
Maximum Green (s)	41.4	41.4		41.4	41.4		12.6	45.4	45.4	13.6	45.4	45.4
Yellow Time (s)	3.3	3.3		3.3	3.3		4.6	4.6	4.6	4.6	4.6	4.6
All-Red Time (s)	3.3	3.3		3.3	3.3		2.8	2.0	2.0	1.8	2.0	2.0
Lost Time Adjust (s)	0.0	0.0		0.0	0.0		0.0	0.0	0.0	0.0	0.0	0.0
Total Lost Time (s)	6.6	6.6		6.6	6.6		7.4	6.6	6.6	6.4	6.6	6.6
Lead/Lag							Lead	Lag	Lag	Lead	Lag	Lag
Lead-Lag Optimize?							Yes	Yes	Yes	Yes	Yes	Yes
Vehicle Extension (s)	3.0	3.0		3.0	3.0		3.0	3.0	3.0	3.0	3.0	3.0
Recall Mode	None	None		None	None		None	C-Max	C-Max	None	C-Max	C-Max
Walk Time (s)	7.0	7.0		7.0	7.0			7.0	7.0		7.0	7.0
Flash Dont Walk (s)	25.0	25.0		25.0	25.0			21.0	21.0		21.0	21.0
Pedestrian Calls (#/hr)	0	0		0	0			0	0		0	0
Act Effct Green (s)	20.2	20.2		20.2	20.2		81.8	75.4	75.4	78.3	70.8	70.8
Actuated g/C Ratio	0.17	0.17		0.17	0.17		0.68	0.63	0.63	0.65	0.59	0.59
v/c Ratio	0.48	0.51		0.93	0.23		0.49	0.27	0.07	0.13	0.76	0.08
Control Delay	51.0	14.9		109.8	16.8		16.9	12.3	1.1	7.0	23.3	1.3
Queue Delay	0.0	0.0		0.0	0.0		0.0	0.0	0.0	0.0	0.0	0.0
Total Delay	51.0	14.9		109.8	16.8		16.9	12.3	1.1	7.0	23.3	1.3
LOS	D	B		F	B		B	B	A	A	C	A
Approach Delay		27.3			77.9			11.9			21.6	
Approach LOS		C			E			B			C	
Queue Length 50th (m)	21.8	7.5		29.6	3.4		6.3	27.4	0.0	4.6	126.2	0.0
Queue Length 95th (m)	35.8	26.6		#51.4	14.3		18.4	46.8	2.5	11.8	#218.9	3.1
Internal Link Dist (m)		119.7			332.2			300.9			283.8	
Turn Bay Length (m)	30.0			30.0			60.0			70.0		15.0
Base Capacity (vph)	429	615		277	541		257	1896	903	668	1957	867
Starvation Cap Reductn	0	0		0	0		0	0	0	0	0	0
Spillback Cap Reductn	0	0		0	0		0	0	0	0	0	0
Storage Cap Reductn	0	0		0	0		0	0	0	0	0	0
Reduced v/c Ratio	0.24	0.32		0.45	0.12		0.39	0.27	0.07	0.11	0.76	0.08

Intersection Summary

Area Type: Other  
 Cycle Length: 120  
 Actuated Cycle Length: 120  
 Offset: 99 (83%), Referenced to phase 2:NBTL and 6:SBTL, Start of Green  
 Natural Cycle: 100  
 Control Type: Actuated-Coordinated  
 Maximum v/c Ratio: 0.93  
 Intersection Signal Delay: 23.8  
 Intersection LOS: C

Intersection Capacity Utilization 92.8% ICU Level of Service F

Analysis Period (min) 15

# 95th percentile volume exceeds capacity, queue may be longer.  
 Queue shown is maximum after two cycles.

Splits and Phases: 1: March Road & Halton Terrace/Maxwell Bridge Road





HCM Signalized Intersection Capacity Analysis  
 1: March Road & Halton Terrace/Maxwell Bridge Road

2028 Future Background AM  
 910 March Road



Movement	EBL	EBT	EBR	WBL	WBT	WBR	NBL	NBT	NBR	SBL	SBT	SBR
Lane Configurations												
Traffic Volume (vph)	101	37	158	126	17	49	99	504	64	76	1478	66
Future Volume (vph)	101	37	158	126	17	49	99	504	64	76	1478	66
Ideal Flow (vphpl)	1800	1800	1800	1800	1800	1800	1800	1800	1800	1800	1800	1800
Total Lost time (s)	6.6	6.6		6.6	6.6		7.4	6.6	6.6	6.4	6.6	6.6
Lane Util. Factor	1.00	1.00		1.00	1.00		1.00	0.95	1.00	1.00	0.95	1.00
Frbp, ped/bikes	1.00	0.99		1.00	1.00		1.00	1.00	0.98	1.00	1.00	1.00
Flpb, ped/bikes	1.00	1.00		1.00	1.00		1.00	1.00	1.00	1.00	1.00	1.00
Frt	1.00	0.88		1.00	0.89		1.00	1.00	0.85	1.00	1.00	0.85
Flt Protected	0.95	1.00		0.95	1.00		0.95	1.00	1.00	0.95	1.00	1.00
Satd. Flow (prot)	1658	1484		1657	1476		1551	3020	1380	1656	3316	1401
Flt Permitted	0.71	1.00		0.46	1.00		0.10	1.00	1.00	0.47	1.00	1.00
Satd. Flow (perm)	1246	1484		804	1476		156	3020	1380	814	3316	1401
Peak-hour factor, PHF	1.00	1.00	1.00	1.00	1.00	1.00	1.00	1.00	1.00	1.00	1.00	1.00
Adj. Flow (vph)	101	37	158	126	17	49	99	504	64	76	1478	66
RTOR Reduction (vph)	0	131	0	0	41	0	0	0	24	0	0	27
Lane Group Flow (vph)	101	64	0	126	25	0	99	504	40	76	1478	39
Confl. Peds. (#/hr)			1	1					2	2		
Heavy Vehicles (%)	2%	14%	2%	2%	2%	9%	9%	12%	7%	2%	2%	8%
Turn Type	Perm	NA		Perm	NA		pm+pt	NA	Perm	pm+pt	NA	Perm
Protected Phases		4			8		5	2		1	6	
Permitted Phases	4			8			2		2	6		6
Actuated Green, G (s)	20.2	20.2		20.2	20.2		82.5	74.1	74.1	76.9	70.8	70.8
Effective Green, g (s)	20.2	20.2		20.2	20.2		82.5	74.1	74.1	76.9	70.8	70.8
Actuated g/C Ratio	0.17	0.17		0.17	0.17		0.69	0.62	0.62	0.64	0.59	0.59
Clearance Time (s)	6.6	6.6		6.6	6.6		7.4	6.6	6.6	6.4	6.6	6.6
Vehicle Extension (s)	3.0	3.0		3.0	3.0		3.0	3.0	3.0	3.0	3.0	3.0
Lane Grp Cap (vph)	209	249		135	248		204	1864	852	564	1956	826
v/s Ratio Prot		0.04			0.02		c0.03	0.17		0.01	c0.45	
v/s Ratio Perm	0.08			c0.16			c0.30		0.03	0.08		0.03
v/c Ratio	0.48	0.26		0.93	0.10		0.49	0.27	0.05	0.13	0.76	0.05
Uniform Delay, d1	45.2	43.4		49.2	42.2		13.6	10.5	9.0	8.1	18.2	10.4
Progression Factor	1.00	1.00		1.00	1.00		1.00	1.00	1.00	1.00	1.00	1.00
Incremental Delay, d2	1.8	0.5		57.1	0.2		1.8	0.4	0.1	0.1	2.8	0.1
Delay (s)	46.9	43.9		106.3	42.4		15.5	10.9	9.1	8.2	21.0	10.5
Level of Service	D	D		F	D		B	B	A	A	C	B
Approach Delay (s)		44.9			84.4			11.4			19.9	
Approach LOS		D			F			B			B	
<b>Intersection Summary</b>												
HCM 2000 Control Delay			25.0				HCM 2000 Level of Service			C		
HCM 2000 Volume to Capacity ratio			0.77									
Actuated Cycle Length (s)			120.0				Sum of lost time (s)			20.6		
Intersection Capacity Utilization			92.8%				ICU Level of Service			F		
Analysis Period (min)			15									

c Critical Lane Group

Lanes, Volumes, Timings  
2: March Road & Klondike Road

2028 Future Background AM  
910 March Road



Lane Group	EBL	EBT	EBR	WBL	WBT	WBR	NBL	NBT	NBR	SBL	SBT	SBR
Lane Configurations												
Traffic Volume (vph)	64	39	256	182	34	52	83	616	79	32	1544	55
Future Volume (vph)	64	39	256	182	34	52	83	616	79	32	1544	55
Ideal Flow (vphpl)	1800	1800	1800	1800	1800	1800	1800	1800	1800	1800	1800	1800
Storage Length (m)	100.0		5.0	15.0		0.0	100.0		0.0	45.0		0.0
Storage Lanes	1		1	1		0	2		0	1		0
Taper Length (m)	0.0			30.0			100.0			85.0		
Lane Util. Factor	1.00	1.00	1.00	1.00	1.00	1.00	0.97	0.91	0.91	1.00	0.91	0.91
Ped Bike Factor	1.00		0.98	0.99	0.99		1.00	1.00		1.00	1.00	
Fr <sub>t</sub>			0.850		0.909			0.983			0.995	
Fl <sub>t</sub> Protected	0.950			0.950			0.950			0.950		
Satd. Flow (prot)	1496	1679	1483	1658	1460	0	3124	4440	0	1433	4726	0
Fl <sub>t</sub> Permitted	0.550			0.732			0.950			0.950		
Satd. Flow (perm)	864	1679	1456	1270	1460	0	3122	4440	0	1428	4726	0
Right Turn on Red			Yes			Yes			Yes			Yes
Satd. Flow (RTOR)			157		52			21			5	
Link Speed (k/h)		50			50			80			80	
Link Distance (m)		117.7			346.6			261.8			142.1	
Travel Time (s)		8.5			25.0			11.8			6.4	
Confl. Peds. (#/hr)	3		6	6		3	3		4	4		3
Peak Hour Factor	1.00	1.00	1.00	1.00	1.00	1.00	1.00	1.00	1.00	1.00	1.00	1.00
Heavy Vehicles (%)	13%	6%	2%	2%	8%	11%	5%	7%	9%	18%	2%	9%
Adj. Flow (vph)	64	39	256	182	34	52	83	616	79	32	1544	55
Shared Lane Traffic (%)												
Lane Group Flow (vph)	64	39	256	182	86	0	83	695	0	32	1599	0
Enter Blocked Intersection	No	No	No	No	No	No	No	No	No	No	No	No
Lane Alignment	Left	Left	Right	Left	Left	Right	Left	Left	Right	Left	Left	Right
Median Width(m)		3.5			3.5			7.0			7.0	
Link Offset(m)		0.0			0.0			0.0			0.0	
Crosswalk Width(m)		3.0			3.0			3.0			3.0	
Two way Left Turn Lane												
Headway Factor	1.09	1.09	1.09	1.09	1.09	1.09	1.09	1.09	1.09	1.09	1.09	1.09
Turning Speed (k/h)	25		15	25		15	25		15	25		15
Number of Detectors	1	2	1	1	2		1	2		1	2	
Detector Template	Left	Thru	Right	Left	Thru		Left	Thru		Left	Thru	
Leading Detector (m)	2.0	10.0	2.0	2.0	10.0		2.0	10.0		2.0	10.0	
Trailing Detector (m)	0.0	0.0	0.0	0.0	0.0		0.0	0.0		0.0	0.0	
Detector 1 Position(m)	0.0	0.0	0.0	0.0	0.0		0.0	0.0		0.0	0.0	
Detector 1 Size(m)	2.0	0.6	2.0	2.0	0.6		2.0	0.6		2.0	0.6	
Detector 1 Type	Cl+Ex	Cl+Ex	Cl+Ex	Cl+Ex	Cl+Ex		Cl+Ex	Cl+Ex		Cl+Ex	Cl+Ex	
Detector 1 Channel												
Detector 1 Extend (s)	0.0	0.0	0.0	0.0	0.0		0.0	0.0		0.0	0.0	
Detector 1 Queue (s)	0.0	0.0	0.0	0.0	0.0		0.0	0.0		0.0	0.0	
Detector 1 Delay (s)	0.0	0.0	0.0	0.0	0.0		0.0	0.0		0.0	0.0	
Detector 2 Position(m)		9.4			9.4			9.4			9.4	
Detector 2 Size(m)		0.6			0.6			0.6			0.6	
Detector 2 Type		Cl+Ex			Cl+Ex			Cl+Ex			Cl+Ex	
Detector 2 Channel												
Detector 2 Extend (s)		0.0			0.0			0.0			0.0	

Lanes, Volumes, Timings  
2: March Road & Klondike Road

2028 Future Background AM  
910 March Road



Lane Group	EBL	EBT	EBR	WBL	WBT	WBR	NBL	NBT	NBR	SBL	SBT	SBR
Turn Type	pm+pt	NA	Perm	Perm	NA		Prot	NA		Prot	NA	
Protected Phases	7	4			8		5	2		1	6	
Permitted Phases	4		4	8								
Detector Phase	7	4	4	8	8		5	2		1	6	
Switch Phase												
Minimum Initial (s)	5.0	5.0	5.0	5.0	5.0		5.0	5.0		5.0	5.0	
Minimum Split (s)	11.6	44.1	44.1	44.1	44.1		11.6	32.4		11.6	32.4	
Total Split (s)	12.0	57.0	57.0	45.0	45.0		15.0	58.0		15.0	58.0	
Total Split (%)	9.2%	43.8%	43.8%	34.6%	34.6%		11.5%	44.6%		11.5%	44.6%	
Maximum Green (s)	5.4	49.9	49.9	37.9	37.9		8.4	51.6		8.4	51.6	
Yellow Time (s)	3.3	3.3	3.3	3.3	3.3		4.6	4.6		4.6	4.6	
All-Red Time (s)	3.3	3.8	3.8	3.8	3.8		2.0	1.8		2.0	1.8	
Lost Time Adjust (s)	0.0	0.0	0.0	0.0	0.0		0.0	0.0		0.0	0.0	
Total Lost Time (s)	6.6	7.1	7.1	7.1	7.1		6.6	6.4		6.6	6.4	
Lead/Lag	Lead			Lag	Lag		Lead	Lag		Lead	Lag	
Lead-Lag Optimize?	Yes			Yes	Yes		Yes	Yes		Yes	Yes	
Vehicle Extension (s)	3.0	3.0	3.0	3.0	3.0		3.0	3.0		3.0	3.0	
Recall Mode	None	None	None	None	None		None	C-Max		None	C-Max	
Walk Time (s)		7.0	7.0	7.0	7.0			7.0			7.0	
Flash Dont Walk (s)		30.0	30.0	30.0	30.0			19.0			19.0	
Pedestrian Calls (#/hr)		0	0	0	0			0			0	
Act Effct Green (s)	34.1	33.6	33.6	24.0	24.0		8.8	73.0		8.4	67.5	
Actuated g/C Ratio	0.26	0.26	0.26	0.18	0.18		0.07	0.56		0.06	0.52	
v/c Ratio	0.25	0.09	0.52	0.78	0.28		0.39	0.28		0.35	0.65	
Control Delay	35.8	32.5	17.6	71.4	21.1		63.0	17.7		67.5	26.4	
Queue Delay	0.0	0.0	0.0	0.0	0.0		0.0	0.0		0.0	0.0	
Total Delay	35.8	32.5	17.6	71.4	21.1		63.0	17.7		67.5	26.4	
LOS	D	C	B	E	C		E	B		E	C	
Approach Delay		22.5			55.3			22.6			27.2	
Approach LOS		C			E			C			C	
Queue Length 50th (m)	12.3	7.4	19.9	44.8	7.4		10.6	36.0		8.0	110.0	
Queue Length 95th (m)	21.6	14.7	41.3	65.5	20.0		18.8	54.4		18.3	151.1	
Internal Link Dist (m)		93.7			322.6			237.8			118.1	
Turn Bay Length (m)	100.0		5.0	15.0			100.0			45.0		
Base Capacity (vph)	253	644	655	370	462		224	2503		102	2456	
Starvation Cap Reductn	0	0	0	0	0		0	0		0	0	
Spillback Cap Reductn	0	0	0	0	0		0	0		0	0	
Storage Cap Reductn	0	0	0	0	0		0	0		0	0	
Reduced v/c Ratio	0.25	0.06	0.39	0.49	0.19		0.37	0.28		0.31	0.65	

Intersection Summary

Area Type: Other  
 Cycle Length: 130  
 Actuated Cycle Length: 130  
 Offset: 64 (49%), Referenced to phase 2:NBT and 6:SBT, Start of Green  
 Natural Cycle: 110  
 Control Type: Actuated-Coordinated  
 Maximum v/c Ratio: 0.78  
 Intersection Signal Delay: 27.9  
 Intersection LOS: C

Intersection Capacity Utilization 80.4% ICU Level of Service D  
 Analysis Period (min) 15

Splits and Phases: 2: March Road & Klondike Road



HCM Signalized Intersection Capacity Analysis  
2: March Road & Klondike Road

2028 Future Background AM  
910 March Road



Movement	EBL	EBT	EBR	WBL	WBT	WBR	NBL	NBT	NBR	SBL	SBT	SBR
Lane Configurations												
Traffic Volume (vph)	64	39	256	182	34	52	83	616	79	32	1544	55
Future Volume (vph)	64	39	256	182	34	52	83	616	79	32	1544	55
Ideal Flow (vphpl)	1800	1800	1800	1800	1800	1800	1800	1800	1800	1800	1800	1800
Total Lost time (s)	6.6	7.1	7.1	7.1	7.1		6.6	6.4		6.6	6.4	
Lane Util. Factor	1.00	1.00	1.00	1.00	1.00		0.97	0.91		1.00	0.91	
Frpb, ped/bikes	1.00	1.00	0.98	1.00	0.99		1.00	1.00		1.00	1.00	
Flpb, ped/bikes	1.00	1.00	1.00	0.99	1.00		1.00	1.00		1.00	1.00	
Frt	1.00	1.00	0.85	1.00	0.91		1.00	0.98		1.00	0.99	
Flt Protected	0.95	1.00	1.00	0.95	1.00		0.95	1.00		0.95	1.00	
Satd. Flow (prot)	1494	1679	1456	1648	1460		3124	4440		1433	4726	
Flt Permitted	0.55	1.00	1.00	0.73	1.00		0.95	1.00		0.95	1.00	
Satd. Flow (perm)	865	1679	1456	1269	1460		3124	4440		1433	4726	
Peak-hour factor, PHF	1.00	1.00	1.00	1.00	1.00	1.00	1.00	1.00	1.00	1.00	1.00	1.00
Adj. Flow (vph)	64	39	256	182	34	52	83	616	79	32	1544	55
RTOR Reduction (vph)	0	0	115	0	42	0	0	10	0	0	2	0
Lane Group Flow (vph)	64	39	141	182	44	0	83	685	0	32	1597	0
Confl. Peds. (#/hr)	3		6	6		3	3		4	4		3
Heavy Vehicles (%)	13%	6%	2%	2%	8%	11%	5%	7%	9%	18%	2%	9%
Turn Type	pm+pt	NA	Perm	Perm	NA		Prot	NA		Prot	NA	
Protected Phases	7	4			8		5	2		1	6	
Permitted Phases	4		4	8								
Actuated Green, G (s)	34.9	34.9	34.9	24.0	24.0		8.8	69.1		5.9	66.2	
Effective Green, g (s)	34.9	34.9	34.9	24.0	24.0		8.8	69.1		5.9	66.2	
Actuated g/C Ratio	0.27	0.27	0.27	0.18	0.18		0.07	0.53		0.05	0.51	
Clearance Time (s)	6.6	7.1	7.1	7.1	7.1		6.6	6.4		6.6	6.4	
Vehicle Extension (s)	3.0	3.0	3.0	3.0	3.0		3.0	3.0		3.0	3.0	
Lane Grp Cap (vph)	253	450	390	234	269		211	2360		65	2406	
v/s Ratio Prot	0.01	0.02			0.03		c0.03	c0.15		0.02	c0.34	
v/s Ratio Perm	0.06		c0.10	c0.14								
v/c Ratio	0.25	0.09	0.36	0.78	0.16		0.39	0.29		0.49	0.66	
Uniform Delay, d1	36.5	35.6	38.5	50.5	44.5		58.0	16.9		60.6	23.6	
Progression Factor	1.00	1.00	1.00	1.00	1.00		1.00	1.00		1.00	1.00	
Incremental Delay, d2	0.5	0.1	0.6	14.9	0.3		1.2	0.3		5.8	1.5	
Delay (s)	37.0	35.7	39.1	65.4	44.8		59.3	17.2		66.3	25.1	
Level of Service	D	D	D	E	D		E	B		E	C	
Approach Delay (s)		38.4			58.8			21.7			25.9	
Approach LOS		D			E			C			C	
<b>Intersection Summary</b>												
HCM 2000 Control Delay			29.2			HCM 2000 Level of Service				C		
HCM 2000 Volume to Capacity ratio			0.67									
Actuated Cycle Length (s)			130.0			Sum of lost time (s)				26.7		
Intersection Capacity Utilization			80.4%			ICU Level of Service				D		
Analysis Period (min)			15									

c Critical Lane Group

Lanes, Volumes, Timings  
3: March Road & South Local Road

2028 Future Background AM  
910 March Road



Lane Group	EBL	EBR	NBL	NBT	SBT	SBR
Lane Configurations		↗		↑↑	↓	
Traffic Volume (vph)	0	30	0	654	1590	1
Future Volume (vph)	0	30	0	654	1590	1
Ideal Flow (vphpl)	1800	1800	1800	1800	1800	1800
Lane Util. Factor	1.00	1.00	1.00	0.95	1.00	1.00
Fr <sub>t</sub>	0.865					
Fl <sub>t</sub> Protected						
Satd. Flow (prot)	0	1510	0	3316	1745	0
Fl <sub>t</sub> Permitted						
Satd. Flow (perm)	0	1510	0	3316	1745	0
Link Speed (k/h)	50			80	80	
Link Distance (m)	136.5			307.8	144.0	
Travel Time (s)	9.8			13.9	6.5	
Peak Hour Factor	1.00	1.00	1.00	1.00	1.00	1.00
Adj. Flow (vph)	0	30	0	654	1590	1
Shared Lane Traffic (%)						
Lane Group Flow (vph)	0	30	0	654	1591	0
Enter Blocked Intersection	No	No	No	No	No	No
Lane Alignment	Left	Right	Left	Left	Left	Right
Median Width(m)	0.0			3.5	3.5	
Link Offset(m)	0.0			0.0	0.0	
Crosswalk Width(m)	3.0			3.0	3.0	
Two way Left Turn Lane						
Headway Factor	1.09	1.09	1.09	1.09	1.09	1.09
Turning Speed (k/h)	25	15	25			15
Sign Control	Stop			Free	Free	
<b>Intersection Summary</b>						
Area Type:	Other					
Control Type:	Unsignalized					
Intersection Capacity Utilization	98.4%			ICU Level of Service F		
Analysis Period (min)	15					

Intersection						
Int Delay, s/veh	0.5					
Movement	EBL	EBR	NBL	NBT	SBT	SBR
Lane Configurations		↗		↑↑	↘	
Traffic Vol, veh/h	0	30	0	654	1590	1
Future Vol, veh/h	0	30	0	654	1590	1
Conflicting Peds, #/hr	0	0	0	0	0	0
Sign Control	Stop	Stop	Free	Free	Free	Free
RT Channelized	-	None	-	None	-	None
Storage Length	-	0	-	-	-	-
Veh in Median Storage, #	0	-	-	0	0	-
Grade, %	0	-	-	0	0	-
Peak Hour Factor	100	100	100	100	100	100
Heavy Vehicles, %	2	2	2	2	2	2
Mvmt Flow	0	30	0	654	1590	1

Major/Minor	Minor2	Major1	Major2
Conflicting Flow All	- 1591	-	0 - 0
Stage 1	- -	-	- - -
Stage 2	- -	-	- - -
Critical Hdwy	- 6.23	-	- - -
Critical Hdwy Stg 1	- -	-	- - -
Critical Hdwy Stg 2	- -	-	- - -
Follow-up Hdwy	- 3.319	-	- - -
Pot Cap-1 Maneuver	0 132	0	- - -
Stage 1	0 -	0	- - -
Stage 2	0 -	0	- - -
Platoon blocked, %			- - -
Mov Cap-1 Maneuver	- 132	-	- - -
Mov Cap-2 Maneuver	- -	-	- - -
Stage 1	- -	-	- - -
Stage 2	- -	-	- - -

Approach	EB	NB	SB
HCM Control Delay, s	40.1	0	0
HCM LOS	E		

Minor Lane/Major Mvmt	NBT EBLn1	SBT	SBR
Capacity (veh/h)	- 132	-	-
HCM Lane V/C Ratio	- 0.227	-	-
HCM Control Delay (s)	- 40.1	-	-
HCM Lane LOS	- E	-	-
HCM 95th %tile Q(veh)	- 0.8	-	-

Lanes, Volumes, Timings  
 1: March Road & Halton Terrace/Maxwell Bridge Road

2028 Future Background PM  
 910 March Road



Lane Group	EBL	EBT	EBR	WBL	WBT	WBR	NBL	NBT	NBR	SBL	SBT	SBR
Lane Configurations												
Traffic Volume (vph)	82	56	72	80	61	123	252	1458	115	109	633	97
Future Volume (vph)	82	56	72	80	61	123	252	1458	115	109	633	97
Ideal Flow (vphpl)	1800	1800	1800	1800	1800	1800	1800	1800	1800	1800	1800	1800
Storage Length (m)	30.0		0.0	30.0		0.0	60.0		0.0	70.0		15.0
Storage Lanes	1		0	1		0	1		1	1		1
Taper Length (m)	60.0			60.0			70.0			100.0		
Lane Util. Factor	1.00	1.00	1.00	1.00	1.00	1.00	1.00	0.95	1.00	1.00	0.95	1.00
Ped Bike Factor	0.99	0.98		0.98	0.98		1.00		0.96			0.98
Fr <sub>t</sub>		0.916			0.900				0.850			0.850
Fl <sub>t</sub> Protected	0.950			0.950			0.950			0.950		
Satd. Flow (prot)	1658	1501	0	1610	1540	0	1658	3316	1483	1658	3316	1483
Fl <sub>t</sub> Permitted	0.422			0.614			0.374			0.122		
Satd. Flow (perm)	730	1501	0	1024	1540	0	652	3316	1419	213	3316	1447
Right Turn on Red			Yes			Yes			Yes			Yes
Satd. Flow (RTOR)		57			89				100			100
Link Speed (k/h)		40			40			80				80
Link Distance (m)		143.7			356.2			324.9				212.1
Travel Time (s)		12.9			32.1			14.6				9.5
Confl. Peds. (#/hr)	11		17	17		11	2		11	11		2
Peak Hour Factor	1.00	1.00	1.00	1.00	1.00	1.00	1.00	1.00	1.00	1.00	1.00	1.00
Heavy Vehicles (%)	2%	9%	5%	5%	3%	2%	2%	2%	2%	2%	2%	2%
Adj. Flow (vph)	82	56	72	80	61	123	252	1458	115	109	633	97
Shared Lane Traffic (%)												
Lane Group Flow (vph)	82	128	0	80	184	0	252	1458	115	109	633	97
Enter Blocked Intersection	No	No	No	No	No	No	No	No	No	No	No	No
Lane Alignment	Left	Left	Right	Left	Left	Right	Left	Left	Right	Left	Left	Right
Median Width(m)		3.5			3.5			3.5				3.5
Link Offset(m)		0.0			0.0			0.0				0.0
Crosswalk Width(m)		3.0			3.0			3.0				3.0
Two way Left Turn Lane												
Headway Factor	1.09	1.09	1.09	1.09	1.09	1.09	1.09	1.09	1.09	1.09	1.09	1.09
Turning Speed (k/h)	25		15	25		15	25		15	25		15
Number of Detectors	1	2		1	2		1	2	1	1	2	1
Detector Template	Left	Thru		Left	Thru		Left	Thru	Right	Left	Thru	Right
Leading Detector (m)	2.0	10.0		2.0	10.0		2.0	10.0	2.0	2.0	10.0	2.0
Trailing Detector (m)	0.0	0.0		0.0	0.0		0.0	0.0	0.0	0.0	0.0	0.0
Detector 1 Position(m)	0.0	0.0		0.0	0.0		0.0	0.0	0.0	0.0	0.0	0.0
Detector 1 Size(m)	2.0	0.6		2.0	0.6		2.0	0.6	2.0	2.0	0.6	2.0
Detector 1 Type	Cl+Ex	Cl+Ex		Cl+Ex	Cl+Ex		Cl+Ex	Cl+Ex	Cl+Ex	Cl+Ex	Cl+Ex	Cl+Ex
Detector 1 Channel												
Detector 1 Extend (s)	0.0	0.0		0.0	0.0		0.0	0.0	0.0	0.0	0.0	0.0
Detector 1 Queue (s)	0.0	0.0		0.0	0.0		0.0	0.0	0.0	0.0	0.0	0.0
Detector 1 Delay (s)	0.0	0.0		0.0	0.0		0.0	0.0	0.0	0.0	0.0	0.0
Detector 2 Position(m)		9.4			9.4			9.4				9.4
Detector 2 Size(m)		0.6			0.6			0.6				0.6
Detector 2 Type		Cl+Ex			Cl+Ex			Cl+Ex				Cl+Ex
Detector 2 Channel												
Detector 2 Extend (s)		0.0			0.0			0.0				0.0



Lanes, Volumes, Timings  
1: March Road & Halton Terrace/Maxwell Bridge Road

2028 Future Background PM  
910 March Road



Lane Group	EBL	EBT	EBR	WBL	WBT	WBR	NBL	NBT	NBR	SBL	SBT	SBR
Turn Type	Perm	NA		Perm	NA		pm+pt	NA	Perm	pm+pt	NA	Perm
Protected Phases		4			8		5	2		1	6	
Permitted Phases	4			8			2		2	6		6
Detector Phase	4	4		8	8		5	2	2	1	6	6
Switch Phase												
Minimum Initial (s)	10.0	10.0		10.0	10.0		5.0	10.0	10.0	5.0	10.0	10.0
Minimum Split (s)	38.6	38.6		38.6	38.6		12.4	34.6	34.6	11.4	34.6	34.6
Total Split (s)	45.0	45.0		45.0	45.0		20.0	55.0	55.0	20.0	55.0	55.0
Total Split (%)	37.5%	37.5%		37.5%	37.5%		16.7%	45.8%	45.8%	16.7%	45.8%	45.8%
Maximum Green (s)	38.4	38.4		38.4	38.4		12.6	48.4	48.4	13.6	48.4	48.4
Yellow Time (s)	3.3	3.3		3.3	3.3		4.6	4.6	4.6	4.6	4.6	4.6
All-Red Time (s)	3.3	3.3		3.3	3.3		2.8	2.0	2.0	1.8	2.0	2.0
Lost Time Adjust (s)	0.0	0.0		0.0	0.0		0.0	0.0	0.0	0.0	0.0	0.0
Total Lost Time (s)	6.6	6.6		6.6	6.6		7.4	6.6	6.6	6.4	6.6	6.6
Lead/Lag							Lead	Lag	Lag	Lead	Lag	Lag
Lead-Lag Optimize?							Yes	Yes	Yes	Yes	Yes	Yes
Vehicle Extension (s)	3.0	3.0		3.0	3.0		3.0	3.0	3.0	3.0	3.0	3.0
Recall Mode	None	None		None	None		None	C-Max	C-Max	None	C-Max	C-Max
Walk Time (s)	7.0	7.0		7.0	7.0			7.0	7.0		7.0	7.0
Flash Dont Walk (s)	25.0	25.0		25.0	25.0			21.0	21.0		21.0	21.0
Pedestrian Calls (#/hr)	0	0		0	0			0	0		0	0
Act Effct Green (s)	15.5	15.5		15.5	15.5		85.9	75.6	75.6	82.4	72.8	72.8
Actuated g/C Ratio	0.13	0.13		0.13	0.13		0.72	0.63	0.63	0.69	0.61	0.61
v/c Ratio	0.88	0.53		0.61	0.67		0.45	0.70	0.12	0.42	0.31	0.11
Control Delay	114.9	34.3		67.5	36.7		7.7	18.5	3.5	10.6	13.1	2.9
Queue Delay	0.0	0.0		0.0	0.0		0.0	0.0	0.0	0.0	0.0	0.0
Total Delay	114.9	34.3		67.5	36.7		7.7	18.5	3.5	10.6	13.1	2.9
LOS	F	C		E	D		A	B	A	B	B	A
Approach Delay		65.7			46.0			16.1			11.6	
Approach LOS		E			D			B			B	
Queue Length 50th (m)	19.3	15.6		18.2	21.3		14.4	108.3	1.2	5.4	34.8	0.0
Queue Length 95th (m)	#39.0	32.8		32.6	42.4		29.2	176.8	10.3	12.9	59.3	7.8
Internal Link Dist (m)		119.7			332.2			300.9			188.1	
Turn Bay Length (m)	30.0			30.0			60.0			70.0		15.0
Base Capacity (vph)	233	519		327	553		588	2089	930	318	2012	917
Starvation Cap Reductn	0	0		0	0		0	0	0	0	0	0
Spillback Cap Reductn	0	0		0	0		0	0	0	0	0	0
Storage Cap Reductn	0	0		0	0		0	0	0	0	0	0
Reduced v/c Ratio	0.35	0.25		0.24	0.33		0.43	0.70	0.12	0.34	0.31	0.11

Intersection Summary

Area Type: Other  
 Cycle Length: 120  
 Actuated Cycle Length: 120  
 Offset: 50 (42%), Referenced to phase 2:NBTL and 6:SBTL, Start of Green  
 Natural Cycle: 100  
 Control Type: Actuated-Coordinated  
 Maximum v/c Ratio: 0.88  
 Intersection Signal Delay: 20.7  
 Intersection LOS: C

Lanes, Volumes, Timings  
 1: March Road & Halton Terrace/Maxwell Bridge Road

2028 Future Background PM  
 910 March Road

Intersection Capacity Utilization 95.7% ICU Level of Service F

Analysis Period (min) 15

# 95th percentile volume exceeds capacity, queue may be longer.  
 Queue shown is maximum after two cycles.

Splits and Phases: 1: March Road & Halton Terrace/Maxwell Bridge Road



HCM Signalized Intersection Capacity Analysis  
 1: March Road & Halton Terrace/Maxwell Bridge Road

2028 Future Background PM  
 910 March Road



Movement	EBL	EBT	EBR	WBL	WBT	WBR	NBL	NBT	NBR	SBL	SBT	SBR
Lane Configurations	↗	↘		↗	↘		↗	↑↑	↗	↗	↑↑	↗
Traffic Volume (vph)	82	56	72	80	61	123	252	1458	115	109	633	97
Future Volume (vph)	82	56	72	80	61	123	252	1458	115	109	633	97
Ideal Flow (vphpl)	1800	1800	1800	1800	1800	1800	1800	1800	1800	1800	1800	1800
Total Lost time (s)	6.6	6.6		6.6	6.6		7.4	6.6	6.6	6.4	6.6	6.6
Lane Util. Factor	1.00	1.00		1.00	1.00		1.00	0.95	1.00	1.00	0.95	1.00
Frbp, ped/bikes	1.00	0.98		1.00	0.98		1.00	1.00	0.96	1.00	1.00	0.98
Flpb, ped/bikes	0.99	1.00		0.98	1.00		1.00	1.00	1.00	1.00	1.00	1.00
Frt	1.00	0.92		1.00	0.90		1.00	1.00	0.85	1.00	1.00	0.85
Flt Protected	0.95	1.00		0.95	1.00		0.95	1.00	1.00	0.95	1.00	1.00
Satd. Flow (prot)	1643	1500		1585	1540		1657	3316	1419	1658	3316	1447
Flt Permitted	0.42	1.00		0.61	1.00		0.37	1.00	1.00	0.12	1.00	1.00
Satd. Flow (perm)	730	1500		1025	1540		652	3316	1419	213	3316	1447
Peak-hour factor, PHF	1.00	1.00	1.00	1.00	1.00	1.00	1.00	1.00	1.00	1.00	1.00	1.00
Adj. Flow (vph)	82	56	72	80	61	123	252	1458	115	109	633	97
RTOR Reduction (vph)	0	50	0	0	78	0	0	0	37	0	0	38
Lane Group Flow (vph)	82	78	0	80	106	0	252	1458	78	109	633	59
Confl. Peds. (#/hr)	11		17	17		11	2		11	11		2
Heavy Vehicles (%)	2%	9%	5%	5%	3%	2%	2%	2%	2%	2%	2%	2%
Turn Type	Perm	NA		Perm	NA		pm+pt	NA	Perm	pm+pt	NA	Perm
Protected Phases		4			8		5	2		1	6	
Permitted Phases	4			8			2		2	6		6
Actuated Green, G (s)	15.5	15.5		15.5	15.5		86.7	75.6	75.6	82.1	72.8	72.8
Effective Green, g (s)	15.5	15.5		15.5	15.5		86.7	75.6	75.6	82.1	72.8	72.8
Actuated g/C Ratio	0.13	0.13		0.13	0.13		0.72	0.63	0.63	0.68	0.61	0.61
Clearance Time (s)	6.6	6.6		6.6	6.6		7.4	6.6	6.6	6.4	6.6	6.6
Vehicle Extension (s)	3.0	3.0		3.0	3.0		3.0	3.0	3.0	3.0	3.0	3.0
Lane Grp Cap (vph)	94	193		132	198		564	2089	893	257	2011	877
v/s Ratio Prot		0.05			0.07		c0.04	c0.44		0.03	0.19	
v/s Ratio Perm	c0.11			0.08			0.28		0.05	0.26		0.04
v/c Ratio	0.87	0.41		0.61	0.54		0.45	0.70	0.09	0.42	0.31	0.07
Uniform Delay, d1	51.3	48.0		49.4	48.9		5.8	14.7	8.7	9.9	11.5	9.7
Progression Factor	1.00	1.00		1.00	1.00		1.00	1.00	1.00	1.00	1.00	1.00
Incremental Delay, d2	53.6	1.4		7.6	2.8		0.6	2.0	0.2	1.1	0.4	0.1
Delay (s)	104.9	49.4		57.0	51.7		6.3	16.6	8.9	11.1	11.9	9.8
Level of Service	F	D		E	D		A	B	A	B	B	A
Approach Delay (s)		71.1			53.3			14.7			11.5	
Approach LOS		E			D			B			B	
<b>Intersection Summary</b>												
HCM 2000 Control Delay			20.9				HCM 2000 Level of Service			C		
HCM 2000 Volume to Capacity ratio			0.72									
Actuated Cycle Length (s)			120.0				Sum of lost time (s)			20.6		
Intersection Capacity Utilization			95.7%				ICU Level of Service			F		
Analysis Period (min)			15									

c Critical Lane Group

Lanes, Volumes, Timings  
2: March Road & Klondike Road

2028 Future Background PM  
910 March Road



Lane Group	EBL	EBT	EBR	WBL	WBT	WBR	NBL	NBT	NBR	SBL	SBT	SBR
Lane Configurations												
Traffic Volume (vph)	112	31	111	115	37	38	161	1746	156	15	753	92
Future Volume (vph)	112	31	111	115	37	38	161	1746	156	15	753	92
Ideal Flow (vphpl)	1800	1800	1800	1800	1800	1800	1800	1800	1800	1800	1800	1800
Storage Length (m)	100.0		5.0	15.0		0.0	100.0		0.0	45.0		0.0
Storage Lanes	1		1	1		0	2		0	1		0
Taper Length (m)	0.0			30.0			100.0			85.0		
Lane Util. Factor	1.00	1.00	1.00	1.00	1.00	1.00	0.97	0.91	0.91	1.00	0.91	0.91
Ped Bike Factor	1.00		0.99	1.00	0.99		0.99	1.00		1.00	1.00	
Frt			0.850		0.924			0.988			0.984	
Flt Protected	0.950			0.950			0.950			0.950		
Satd. Flow (prot)	1658	1745	1483	1658	1571	0	3216	4689	0	1658	4676	0
Flt Permitted	0.510			0.737			0.950			0.950		
Satd. Flow (perm)	889	1745	1462	1284	1571	0	3196	4689	0	1655	4676	0
Right Turn on Red			Yes			Yes			Yes			Yes
Satd. Flow (RTOR)			111		38			12			18	
Link Speed (k/h)		50			50			80			80	
Link Distance (m)		117.7			346.6			261.8			142.1	
Travel Time (s)		8.5			25.0			11.8			6.4	
Confl. Peds. (#/hr)	1		2	2		1	8		11	11		8
Peak Hour Factor	1.00	1.00	1.00	1.00	1.00	1.00	1.00	1.00	1.00	1.00	1.00	1.00
Heavy Vehicles (%)	2%	2%	2%	2%	6%	2%	2%	2%	2%	2%	2%	2%
Adj. Flow (vph)	112	31	111	115	37	38	161	1746	156	15	753	92
Shared Lane Traffic (%)												
Lane Group Flow (vph)	112	31	111	115	75	0	161	1902	0	15	845	0
Enter Blocked Intersection	No	No	No	No	No	No	No	No	No	No	No	No
Lane Alignment	Left	Left	Right	Left	Left	Right	Left	Left	Right	Left	Left	Right
Median Width(m)		3.5			3.5			7.0			7.0	
Link Offset(m)		0.0			0.0			0.0			0.0	
Crosswalk Width(m)		3.0			3.0			3.0			3.0	
Two way Left Turn Lane												
Headway Factor	1.09	1.09	1.09	1.09	1.09	1.09	1.09	1.09	1.09	1.09	1.09	1.09
Turning Speed (k/h)	25		15	25		15	25		15	25		15
Number of Detectors	1	2	1	1	2		1	2		1	2	
Detector Template	Left	Thru	Right	Left	Thru		Left	Thru		Left	Thru	
Leading Detector (m)	2.0	10.0	2.0	2.0	10.0		2.0	10.0		2.0	10.0	
Trailing Detector (m)	0.0	0.0	0.0	0.0	0.0		0.0	0.0		0.0	0.0	
Detector 1 Position(m)	0.0	0.0	0.0	0.0	0.0		0.0	0.0		0.0	0.0	
Detector 1 Size(m)	2.0	0.6	2.0	2.0	0.6		2.0	0.6		2.0	0.6	
Detector 1 Type	Cl+Ex	Cl+Ex	Cl+Ex	Cl+Ex	Cl+Ex		Cl+Ex	Cl+Ex		Cl+Ex	Cl+Ex	
Detector 1 Channel												
Detector 1 Extend (s)	0.0	0.0	0.0	0.0	0.0		0.0	0.0		0.0	0.0	
Detector 1 Queue (s)	0.0	0.0	0.0	0.0	0.0		0.0	0.0		0.0	0.0	
Detector 1 Delay (s)	0.0	0.0	0.0	0.0	0.0		0.0	0.0		0.0	0.0	
Detector 2 Position(m)		9.4			9.4			9.4			9.4	
Detector 2 Size(m)		0.6			0.6			0.6			0.6	
Detector 2 Type		Cl+Ex			Cl+Ex			Cl+Ex			Cl+Ex	
Detector 2 Channel												
Detector 2 Extend (s)		0.0			0.0			0.0			0.0	

Lanes, Volumes, Timings  
2: March Road & Klondike Road

2028 Future Background PM  
910 March Road



Lane Group	EBL	EBT	EBR	WBL	WBT	WBR	NBL	NBT	NBR	SBL	SBT	SBR
Turn Type	pm+pt	NA	Perm	Perm	NA		Prot	NA		Prot	NA	
Protected Phases	7	4			8		5	2		1	6	
Permitted Phases	4		4	8								
Detector Phase	7	4	4	8	8		5	2		1	6	
Switch Phase												
Minimum Initial (s)	5.0	5.0	5.0	5.0	5.0		5.0	5.0		5.0	5.0	
Minimum Split (s)	11.6	44.1	44.1	44.1	44.1		11.6	32.4		11.6	32.4	
Total Split (s)	12.0	57.0	57.0	45.0	45.0		22.0	51.0		22.0	51.0	
Total Split (%)	9.2%	43.8%	43.8%	34.6%	34.6%		16.9%	39.2%		16.9%	39.2%	
Maximum Green (s)	5.4	49.9	49.9	37.9	37.9		15.4	44.6		15.4	44.6	
Yellow Time (s)	3.3	3.3	3.3	3.3	3.3		4.6	4.6		4.6	4.6	
All-Red Time (s)	3.3	3.8	3.8	3.8	3.8		2.0	1.8		2.0	1.8	
Lost Time Adjust (s)	0.0	0.0	0.0	0.0	0.0		0.0	0.0		0.0	0.0	
Total Lost Time (s)	6.6	7.1	7.1	7.1	7.1		6.6	6.4		6.6	6.4	
Lead/Lag	Lead			Lag	Lag		Lead	Lag		Lead	Lag	
Lead-Lag Optimize?	Yes			Yes	Yes		Yes	Yes		Yes	Yes	
Vehicle Extension (s)	3.0	3.0	3.0	3.0	3.0		3.0	3.0		3.0	3.0	
Recall Mode	None	None	None	None	None		None	C-Max		None	C-Max	
Walk Time (s)		7.0	7.0	7.0	7.0			7.0			7.0	
Flash Dont Walk (s)		30.0	30.0	30.0	30.0			19.0			19.0	
Pedestrian Calls (#/hr)		0	0	0	0			0			0	
Act Effct Green (s)	29.5	29.0	29.0	17.0	17.0		11.8	81.6		6.8	69.1	
Actuated g/C Ratio	0.23	0.22	0.22	0.13	0.13		0.09	0.63		0.05	0.53	
v/c Ratio	0.48	0.08	0.27	0.68	0.31		0.55	0.65		0.17	0.34	
Control Delay	47.9	37.9	8.1	73.3	29.6		63.5	18.5		62.9	18.5	
Queue Delay	0.0	0.0	0.0	0.0	0.0		0.0	0.0		0.0	0.0	
Total Delay	47.9	37.9	8.1	73.3	29.6		63.5	18.5		62.9	18.5	
LOS	D	D	A	E	C		E	B		E	B	
Approach Delay		29.3			56.1			22.0			19.3	
Approach LOS		C			E			C			B	
Queue Length 50th (m)	24.0	6.3	0.0	28.5	8.6		20.7	89.7		3.8	42.7	
Queue Length 95th (m)	38.1	13.7	13.8	46.1	21.8		31.2	165.7		11.0	62.3	
Internal Link Dist (m)		93.7			322.6			237.8			118.1	
Turn Bay Length (m)	100.0		5.0	15.0			100.0			45.0		
Base Capacity (vph)	233	669	629	374	484		380	2948		196	2492	
Starvation Cap Reductn	0	0	0	0	0		0	0		0	0	
Spillback Cap Reductn	0	0	0	0	0		0	0		0	0	
Storage Cap Reductn	0	0	0	0	0		0	0		0	0	
Reduced v/c Ratio	0.48	0.05	0.18	0.31	0.15		0.42	0.65		0.08	0.34	

**Intersection Summary**

Area Type: Other

Cycle Length: 130

Actuated Cycle Length: 130

Offset: 20 (15%), Referenced to phase 2:NBT and 6:SBT, Start of Green

Natural Cycle: 120

Control Type: Actuated-Coordinated

Maximum v/c Ratio: 0.68

Intersection Signal Delay: 23.8

Intersection LOS: C

Intersection Capacity Utilization 74.6% ICU Level of Service D  
 Analysis Period (min) 15

Splits and Phases: 2: March Road & Klondike Road



HCM Signalized Intersection Capacity Analysis  
2: March Road & Klondike Road

2028 Future Background PM  
910 March Road



Movement	EBL	EBT	EBR	WBL	WBT	WBR	NBL	NBT	NBR	SBL	SBT	SBR
Lane Configurations	↙	↑	↗	↙	↗		↙↗	↑↑↑		↙	↑↑↑	
Traffic Volume (vph)	112	31	111	115	37	38	161	1746	156	15	753	92
Future Volume (vph)	112	31	111	115	37	38	161	1746	156	15	753	92
Ideal Flow (vphpl)	1800	1800	1800	1800	1800	1800	1800	1800	1800	1800	1800	1800
Total Lost time (s)	6.6	7.1	7.1	7.1	7.1		6.6	6.4		6.6	6.4	
Lane Util. Factor	1.00	1.00	1.00	1.00	1.00		0.97	0.91		1.00	0.91	
Frpb, ped/bikes	1.00	1.00	0.99	1.00	0.99		1.00	1.00		1.00	1.00	
Flpb, ped/bikes	1.00	1.00	1.00	1.00	1.00		1.00	1.00		1.00	1.00	
Frt	1.00	1.00	0.85	1.00	0.92		1.00	0.99		1.00	0.98	
Flt Protected	0.95	1.00	1.00	0.95	1.00		0.95	1.00		0.95	1.00	
Satd. Flow (prot)	1657	1745	1462	1654	1571		3216	4687		1658	4674	
Flt Permitted	0.51	1.00	1.00	0.74	1.00		0.95	1.00		0.95	1.00	
Satd. Flow (perm)	890	1745	1462	1283	1571		3216	4687		1658	4674	
Peak-hour factor, PHF	1.00	1.00	1.00	1.00	1.00	1.00	1.00	1.00	1.00	1.00	1.00	1.00
Adj. Flow (vph)	112	31	111	115	37	38	161	1746	156	15	753	92
RTOR Reduction (vph)	0	0	86	0	33	0	0	5	0	0	8	0
Lane Group Flow (vph)	112	31	25	115	42	0	161	1897	0	15	837	0
Confl. Peds. (#/hr)	1		2	2		1	8		11	11		8
Heavy Vehicles (%)	2%	2%	2%	2%	6%	2%	2%	2%	2%	2%	2%	2%
Turn Type	pm+pt	NA	Perm	Perm	NA		Prot	NA		Prot	NA	
Protected Phases	7	4			8		5	2		1	6	
Permitted Phases	4		4	8								
Actuated Green, G (s)	29.0	29.0	29.0	17.0	17.0		11.8	77.7		3.2	69.1	
Effective Green, g (s)	29.0	29.0	29.0	17.0	17.0		11.8	77.7		3.2	69.1	
Actuated g/C Ratio	0.22	0.22	0.22	0.13	0.13		0.09	0.60		0.02	0.53	
Clearance Time (s)	6.6	7.1	7.1	7.1	7.1		6.6	6.4		6.6	6.4	
Vehicle Extension (s)	3.0	3.0	3.0	3.0	3.0		3.0	3.0		3.0	3.0	
Lane Grp Cap (vph)	230	389	326	167	205		291	2801		40	2484	
v/s Ratio Prot	c0.02	0.02			0.03		c0.05	c0.40		0.01	0.18	
v/s Ratio Perm	0.09		0.02	c0.09								
v/c Ratio	0.49	0.08	0.08	0.69	0.20		0.55	0.68		0.38	0.34	
Uniform Delay, d1	43.8	39.9	39.9	54.0	50.5		56.6	17.7		62.4	17.4	
Progression Factor	1.00	1.00	1.00	1.00	1.00		1.00	1.00		1.00	1.00	
Incremental Delay, d2	1.6	0.1	0.1	11.2	0.5		2.3	1.3		5.8	0.4	
Delay (s)	45.4	40.0	40.0	65.2	51.0		58.8	19.0		68.2	17.7	
Level of Service	D	D	D	E	D		E	B		E	B	
Approach Delay (s)		42.4			59.6			22.1			18.6	
Approach LOS		D			E			C			B	
<b>Intersection Summary</b>												
HCM 2000 Control Delay			24.9			HCM 2000 Level of Service				C		
HCM 2000 Volume to Capacity ratio			0.70									
Actuated Cycle Length (s)			130.0			Sum of lost time (s)				26.7		
Intersection Capacity Utilization			74.6%			ICU Level of Service				D		
Analysis Period (min)			15									

c Critical Lane Group

Lanes, Volumes, Timings  
3: March Road & South Local Road

2028 Future Background PM  
910 March Road



Lane Group	EBL	EBR	NBL	NBT	SBT	SBR
Lane Configurations		↗		↕	↘	
Traffic Volume (vph)	0	49	0	1663	790	12
Future Volume (vph)	0	49	0	1663	790	12
Ideal Flow (vphpl)	1800	1800	1800	1800	1800	1800
Lane Util. Factor	1.00	1.00	1.00	0.95	1.00	1.00
Fr <sub>t</sub>		0.865			0.998	
Fl <sub>t</sub> Protected						
Satd. Flow (prot)	0	1510	0	3316	1742	0
Fl <sub>t</sub> Permitted						
Satd. Flow (perm)	0	1510	0	3316	1742	0
Link Speed (k/h)	50			80	80	
Link Distance (m)	120.2			212.1	95.6	
Travel Time (s)	8.7			9.5	4.3	
Peak Hour Factor	1.00	1.00	1.00	1.00	1.00	1.00
Adj. Flow (vph)	0	49	0	1663	790	12
Shared Lane Traffic (%)						
Lane Group Flow (vph)	0	49	0	1663	802	0
Enter Blocked Intersection	No	No	No	No	No	No
Lane Alignment	Left	Right	Left	Left	Left	Right
Median Width(m)	0.0			3.5	3.5	
Link Offset(m)	0.0			0.0	0.0	
Crosswalk Width(m)	3.0			3.0	3.0	
Two way Left Turn Lane						
Headway Factor	1.09	1.09	1.09	1.09	1.09	1.09
Turning Speed (k/h)	25	15	25			15
Sign Control	Stop			Free	Free	

Intersection Summary

Area Type:	Other
Control Type:	Unsignalized
Intersection Capacity Utilization	54.7%
ICU Level of Service	A
Analysis Period (min)	15



Intersection						
Int Delay, s/veh	0.3					
Movement	EBL	EBR	NBL	NBT	SBT	SBR
Lane Configurations		↗		↑↑	↑	
Traffic Vol, veh/h	0	49	0	1663	790	12
Future Vol, veh/h	0	49	0	1663	790	12
Conflicting Peds, #/hr	0	0	0	0	0	0
Sign Control	Stop	Stop	Free	Free	Free	Free
RT Channelized	-	None	-	None	-	None
Storage Length	-	0	-	-	-	-
Veh in Median Storage, #	0	-	-	0	0	-
Grade, %	0	-	-	0	0	-
Peak Hour Factor	100	100	100	100	100	100
Heavy Vehicles, %	2	2	2	2	2	2
Mvmt Flow	0	49	0	1663	790	12

Major/Minor	Minor2	Major1	Major2		
Conflicting Flow All	-	796	-	0	0
Stage 1	-	-	-	-	-
Stage 2	-	-	-	-	-
Critical Hdwy	-	6.23	-	-	-
Critical Hdwy Stg 1	-	-	-	-	-
Critical Hdwy Stg 2	-	-	-	-	-
Follow-up Hdwy	-	3.319	-	-	-
Pot Cap-1 Maneuver	0	386	0	-	-
Stage 1	0	-	0	-	-
Stage 2	0	-	0	-	-
Platoon blocked, %				-	-
Mov Cap-1 Maneuver	-	386	-	-	-
Mov Cap-2 Maneuver	-	-	-	-	-
Stage 1	-	-	-	-	-
Stage 2	-	-	-	-	-

Approach	EB	NB	SB
HCM Control Delay, s	15.7	0	0
HCM LOS	C		

Minor Lane/Major Mvmt	NBT	EBLn1	SBT	SBR
Capacity (veh/h)	-	386	-	-
HCM Lane V/C Ratio	-	0.127	-	-
HCM Control Delay (s)	-	15.7	-	-
HCM Lane LOS	-	C	-	-
HCM 95th %tile Q(veh)	-	0.4	-	-

# Appendix N

Synchro Intersection Worksheets – 2033 Future Background Conditions

Lanes, Volumes, Timings  
 1: March Road & Halton Terrace/Maxwell Bridge Road

2033 Future Background  
 910 March Road



Lane Group	EBL	EBT	EBR	WBL	WBT	WBR	NBL	NBT	NBR	SBL	SBT	SBR
Lane Configurations												
Traffic Volume (vph)	101	37	158	126	17	49	99	589	64	76	1685	66
Future Volume (vph)	101	37	158	126	17	49	99	589	64	76	1685	66
Ideal Flow (vphpl)	1800	1800	1800	1800	1800	1800	1800	1800	1800	1800	1800	1800
Storage Length (m)	30.0		0.0	30.0		0.0	60.0		0.0	70.0		15.0
Storage Lanes	1		0	1		0	1		1	1		1
Taper Length (m)	60.0			60.0			70.0			100.0		
Lane Util. Factor	1.00	1.00	1.00	1.00	1.00	1.00	1.00	0.95	1.00	1.00	0.95	1.00
Ped Bike Factor		0.99		1.00					0.98	1.00		
Fr <sub>t</sub>		0.878			0.889				0.850			0.850
Fl <sub>t</sub> Protected	0.950			0.950			0.950			0.950		
Satd. Flow (prot)	1658	1483	0	1658	1476	0	1551	3020	1414	1658	3316	1401
Fl <sub>t</sub> Permitted	0.714			0.461			0.057			0.430		
Satd. Flow (perm)	1246	1483	0	804	1476	0	93	3020	1380	749	3316	1401
Right Turn on Red			Yes			Yes			Yes			Yes
Satd. Flow (RTOR)		158			49				100			100
Link Speed (k/h)		40			40			80				80
Link Distance (m)		143.7			356.2			324.9				203.9
Travel Time (s)		12.9			32.1			14.6				9.2
Confl. Peds. (#/hr)			1	1					2	2		
Peak Hour Factor	1.00	1.00	1.00	1.00	1.00	1.00	1.00	1.00	1.00	1.00	1.00	1.00
Heavy Vehicles (%)	2%	14%	2%	2%	2%	9%	9%	12%	7%	2%	2%	8%
Adj. Flow (vph)	101	37	158	126	17	49	99	589	64	76	1685	66
Shared Lane Traffic (%)												
Lane Group Flow (vph)	101	195	0	126	66	0	99	589	64	76	1685	66
Enter Blocked Intersection	No	No	No	No	No	No	No	No	No	No	No	No
Lane Alignment	Left	Left	Right	Left	Left	Right	Left	Left	Right	Left	Left	Right
Median Width(m)		3.5			3.5			3.5				3.5
Link Offset(m)		0.0			0.0			0.0				0.0
Crosswalk Width(m)		3.0			3.0			3.0				3.0
Two way Left Turn Lane												
Headway Factor	1.09	1.09	1.09	1.09	1.09	1.09	1.09	1.09	1.09	1.09	1.09	1.09
Turning Speed (k/h)	25		15	25		15	25		15	25		15
Number of Detectors	1	2		1	2		1	2	1	1	2	1
Detector Template	Left	Thru		Left	Thru		Left	Thru	Right	Left	Thru	Right
Leading Detector (m)	2.0	10.0		2.0	10.0		2.0	10.0	2.0	2.0	10.0	2.0
Trailing Detector (m)	0.0	0.0		0.0	0.0		0.0	0.0	0.0	0.0	0.0	0.0
Detector 1 Position(m)	0.0	0.0		0.0	0.0		0.0	0.0	0.0	0.0	0.0	0.0
Detector 1 Size(m)	2.0	0.6		2.0	0.6		2.0	0.6	2.0	2.0	0.6	2.0
Detector 1 Type	Cl+Ex	Cl+Ex		Cl+Ex	Cl+Ex		Cl+Ex	Cl+Ex	Cl+Ex	Cl+Ex	Cl+Ex	Cl+Ex
Detector 1 Channel												
Detector 1 Extend (s)	0.0	0.0		0.0	0.0		0.0	0.0	0.0	0.0	0.0	0.0
Detector 1 Queue (s)	0.0	0.0		0.0	0.0		0.0	0.0	0.0	0.0	0.0	0.0
Detector 1 Delay (s)	0.0	0.0		0.0	0.0		0.0	0.0	0.0	0.0	0.0	0.0
Detector 2 Position(m)		9.4			9.4			9.4				9.4
Detector 2 Size(m)		0.6			0.6			0.6				0.6
Detector 2 Type		Cl+Ex			Cl+Ex			Cl+Ex				Cl+Ex
Detector 2 Channel												
Detector 2 Extend (s)		0.0			0.0			0.0				0.0

Lanes, Volumes, Timings  
1: March Road & Halton Terrace/Maxwell Bridge Road

2033 Future Background  
910 March Road



Lane Group	EBL	EBT	EBR	WBL	WBT	WBR	NBL	NBT	NBR	SBL	SBT	SBR
Turn Type	Perm	NA		Perm	NA		pm+pt	NA	Perm	pm+pt	NA	Perm
Protected Phases		4			8		5	2		1	6	
Permitted Phases	4			8			2		2	6		6
Detector Phase	4	4		8	8		5	2	2	1	6	6
Switch Phase												
Minimum Initial (s)	10.0	10.0		10.0	10.0		5.0	10.0	10.0	5.0	10.0	10.0
Minimum Split (s)	38.6	38.6		38.6	38.6		12.4	34.6	34.6	11.4	34.6	34.6
Total Split (s)	48.0	48.0		48.0	48.0		20.0	52.0	52.0	20.0	52.0	52.0
Total Split (%)	40.0%	40.0%		40.0%	40.0%		16.7%	43.3%	43.3%	16.7%	43.3%	43.3%
Yellow Time (s)	3.3	3.3		3.3	3.3		4.6	4.6	4.6	4.6	4.6	4.6
All-Red Time (s)	3.3	3.3		3.3	3.3		2.8	2.0	2.0	1.8	2.0	2.0
Lost Time Adjust (s)	0.0	0.0		0.0	0.0		0.0	0.0	0.0	0.0	0.0	0.0
Total Lost Time (s)	6.6	6.6		6.6	6.6		7.4	6.6	6.6	6.4	6.6	6.6
Lead/Lag							Lead	Lag	Lag	Lead	Lag	Lag
Lead-Lag Optimize?							Yes	Yes	Yes	Yes	Yes	Yes
Recall Mode	None	None		None	None		None	C-Max	C-Max	None	C-Max	C-Max
Act Effct Green (s)	20.2	20.2		20.2	20.2		81.8	75.4	75.4	78.3	70.8	70.8
Actuated g/C Ratio	0.17	0.17		0.17	0.17		0.68	0.63	0.63	0.65	0.59	0.59
v/c Ratio	0.48	0.51		0.93	0.23		0.60	0.31	0.07	0.14	0.86	0.08
Control Delay	51.0	14.9		109.8	16.8		35.1	12.7	1.1	7.1	28.0	1.3
Queue Delay	0.0	0.0		0.0	0.0		0.0	0.0	0.0	0.0	0.0	0.0
Total Delay	51.0	14.9		109.8	16.8		35.1	12.7	1.1	7.1	28.0	1.3
LOS	D	B		F	B		D	B	A	A	C	A
Approach Delay		27.3			77.9			14.7			26.2	
Approach LOS		C			E			B			C	
Queue Length 50th (m)	21.8	7.5		29.6	3.4		8.6	33.2	0.0	4.6	162.2	0.0
Queue Length 95th (m)	35.8	26.6		#51.4	14.3		27.6	55.8	2.5	11.8	#272.5	3.1
Internal Link Dist (m)		119.7			332.2			300.9			179.9	
Turn Bay Length (m)	30.0			30.0			60.0			70.0		15.0
Base Capacity (vph)	429	615		277	541		218	1896	903	630	1957	867
Starvation Cap Reductn	0	0		0	0		0	0	0	0	0	0
Spillback Cap Reductn	0	0		0	0		0	0	0	0	0	0
Storage Cap Reductn	0	0		0	0		0	0	0	0	0	0
Reduced v/c Ratio	0.24	0.32		0.45	0.12		0.45	0.31	0.07	0.12	0.86	0.08

Intersection Summary

Area Type: Other

Cycle Length: 120

Actuated Cycle Length: 120

Offset: 99 (83%), Referenced to phase 2:NBTL and 6:SBTL, Start of Green

Natural Cycle: 110

Control Type: Actuated-Coordinated

Maximum v/c Ratio: 0.93

Intersection Signal Delay: 26.7

Intersection LOS: C

Intersection Capacity Utilization 98.8%

ICU Level of Service F

Analysis Period (min) 15

# 95th percentile volume exceeds capacity, queue may be longer.

Queue shown is maximum after two cycles.

Splits and Phases: 1: March Road & Halton Terrace/Maxwell Bridge Road

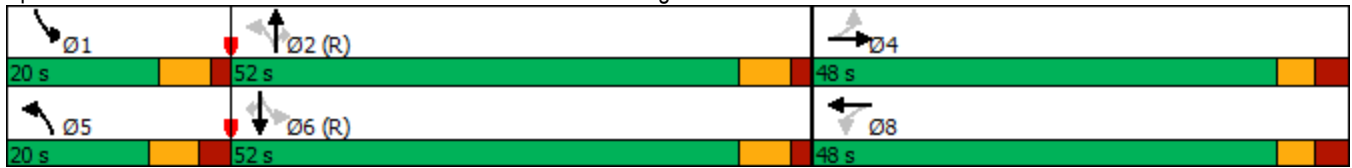

HCM Signalized Intersection Capacity Analysis  
 1: March Road & Halton Terrace/Maxwell Bridge Road

2033 Future Background  
 910 March Road



Movement	EBL	EBT	EBR	WBL	WBT	WBR	NBL	NBT	NBR	SBL	SBT	SBR
Lane Configurations												
Traffic Volume (vph)	101	37	158	126	17	49	99	589	64	76	1685	66
Future Volume (vph)	101	37	158	126	17	49	99	589	64	76	1685	66
Ideal Flow (vphpl)	1800	1800	1800	1800	1800	1800	1800	1800	1800	1800	1800	1800
Total Lost time (s)	6.6	6.6		6.6	6.6		7.4	6.6	6.6	6.4	6.6	6.6
Lane Util. Factor	1.00	1.00		1.00	1.00		1.00	0.95	1.00	1.00	0.95	1.00
Frbp, ped/bikes	1.00	0.99		1.00	1.00		1.00	1.00	0.98	1.00	1.00	1.00
Flpb, ped/bikes	1.00	1.00		1.00	1.00		1.00	1.00	1.00	1.00	1.00	1.00
Frt	1.00	0.88		1.00	0.89		1.00	1.00	0.85	1.00	1.00	0.85
Flt Protected	0.95	1.00		0.95	1.00		0.95	1.00	1.00	0.95	1.00	1.00
Satd. Flow (prot)	1658	1484		1657	1476		1551	3020	1380	1657	3316	1401
Flt Permitted	0.71	1.00		0.46	1.00		0.06	1.00	1.00	0.43	1.00	1.00
Satd. Flow (perm)	1246	1484		804	1476		94	3020	1380	749	3316	1401
Peak-hour factor, PHF	1.00	1.00	1.00	1.00	1.00	1.00	1.00	1.00	1.00	1.00	1.00	1.00
Adj. Flow (vph)	101	37	158	126	17	49	99	589	64	76	1685	66
RTOR Reduction (vph)	0	131	0	0	41	0	0	0	24	0	0	27
Lane Group Flow (vph)	101	64	0	126	25	0	99	589	40	76	1685	39
Confl. Peds. (#/hr)			1	1					2	2		
Heavy Vehicles (%)	2%	14%	2%	2%	2%	9%	9%	12%	7%	2%	2%	8%
Turn Type	Perm	NA		Perm	NA		pm+pt	NA	Perm	pm+pt	NA	Perm
Protected Phases		4			8		5	2		1	6	
Permitted Phases	4			8			2		2	6		6
Actuated Green, G (s)	20.2	20.2		20.2	20.2		82.5	74.1	74.1	76.9	70.8	70.8
Effective Green, g (s)	20.2	20.2		20.2	20.2		82.5	74.1	74.1	76.9	70.8	70.8
Actuated g/C Ratio	0.17	0.17		0.17	0.17		0.69	0.62	0.62	0.64	0.59	0.59
Clearance Time (s)	6.6	6.6		6.6	6.6		7.4	6.6	6.6	6.4	6.6	6.6
Vehicle Extension (s)	3.0	3.0		3.0	3.0		3.0	3.0	3.0	3.0	3.0	3.0
Lane Grp Cap (vph)	209	249		135	248		166	1864	852	526	1956	826
v/s Ratio Prot		0.04			0.02		c0.04	0.20		0.01	c0.51	
v/s Ratio Perm	0.08			c0.16			c0.37		0.03	0.09		0.03
v/c Ratio	0.48	0.26		0.93	0.10		0.60	0.32	0.05	0.14	0.86	0.05
Uniform Delay, d1	45.2	43.4		49.2	42.2		21.8	10.9	9.0	8.1	20.5	10.4
Progression Factor	1.00	1.00		1.00	1.00		1.00	1.00	1.00	1.00	1.00	1.00
Incremental Delay, d2	1.8	0.5		57.1	0.2		5.7	0.4	0.1	0.1	5.3	0.1
Delay (s)	46.9	43.9		106.3	42.4		27.5	11.4	9.1	8.2	25.8	10.5
Level of Service	D	D		F	D		C	B	A	A	C	B
Approach Delay (s)		44.9			84.4			13.3			24.5	
Approach LOS		D			F			B			C	
<b>Intersection Summary</b>												
HCM 2000 Control Delay			27.5				HCM 2000 Level of Service		C			
HCM 2000 Volume to Capacity ratio			0.86									
Actuated Cycle Length (s)			120.0				Sum of lost time (s)		20.6			
Intersection Capacity Utilization			98.8%				ICU Level of Service		F			
Analysis Period (min)			15									

c Critical Lane Group

Lanes, Volumes, Timings  
2: March Road & Klondike Road

2033 Future Background  
910 March Road



Lane Group	EBL	EBT	EBR	WBL	WBT	WBR	NBL	NBT	NBR	SBL	SBT	SBR
Lane Configurations												
Traffic Volume (vph)	70	39	256	182	34	57	83	692	79	35	1737	61
Future Volume (vph)	70	39	256	182	34	57	83	692	79	35	1737	61
Ideal Flow (vphpl)	1800	1800	1800	1800	1800	1800	1800	1800	1800	1800	1800	1800
Storage Length (m)	100.0		5.0	15.0		0.0	100.0		0.0	45.0		0.0
Storage Lanes	1		1	1		0	2		0	1		0
Taper Length (m)	0.0			30.0			100.0			85.0		
Lane Util. Factor	1.00	1.00	1.00	1.00	1.00	1.00	0.97	0.91	0.91	1.00	0.91	0.91
Ped Bike Factor	1.00		0.98	0.99	0.99		1.00	1.00		1.00	1.00	
Frt			0.850		0.906			0.985			0.995	
Flt Protected	0.950			0.950			0.950			0.950		
Satd. Flow (prot)	1496	1679	1483	1658	1454	0	3124	4451	0	1433	4727	0
Flt Permitted	0.547			0.732			0.950			0.950		
Satd. Flow (perm)	859	1679	1456	1270	1454	0	3122	4451	0	1428	4727	0
Right Turn on Red			Yes			Yes			Yes			Yes
Satd. Flow (RTOR)			155		57			18			5	
Link Speed (k/h)		50			50			80			80	
Link Distance (m)		117.7			346.6			261.8			142.1	
Travel Time (s)		8.5			25.0			11.8			6.4	
Confl. Peds. (#/hr)	3		6	6		3	3		4	4		3
Peak Hour Factor	1.00	1.00	1.00	1.00	1.00	1.00	1.00	1.00	1.00	1.00	1.00	1.00
Heavy Vehicles (%)	13%	6%	2%	2%	8%	11%	5%	7%	9%	18%	2%	9%
Adj. Flow (vph)	70	39	256	182	34	57	83	692	79	35	1737	61
Shared Lane Traffic (%)												
Lane Group Flow (vph)	70	39	256	182	91	0	83	771	0	35	1798	0
Enter Blocked Intersection	No	No	No	No	No	No	No	No	No	No	No	No
Lane Alignment	Left	Left	Right	Left	Left	Right	Left	Left	Right	Left	Left	Right
Median Width(m)		3.5			3.5			7.0			7.0	
Link Offset(m)		0.0			0.0			0.0			0.0	
Crosswalk Width(m)		3.0			3.0			3.0			3.0	
Two way Left Turn Lane												
Headway Factor	1.09	1.09	1.09	1.09	1.09	1.09	1.09	1.09	1.09	1.09	1.09	1.09
Turning Speed (k/h)	25		15	25		15	25		15	25		15
Number of Detectors	1	2	1	1	2		1	2		1	2	
Detector Template	Left	Thru	Right	Left	Thru		Left	Thru		Left	Thru	
Leading Detector (m)	2.0	10.0	2.0	2.0	10.0		2.0	10.0		2.0	10.0	
Trailing Detector (m)	0.0	0.0	0.0	0.0	0.0		0.0	0.0		0.0	0.0	
Detector 1 Position(m)	0.0	0.0	0.0	0.0	0.0		0.0	0.0		0.0	0.0	
Detector 1 Size(m)	2.0	0.6	2.0	2.0	0.6		2.0	0.6		2.0	0.6	
Detector 1 Type	Cl+Ex	Cl+Ex	Cl+Ex	Cl+Ex	Cl+Ex		Cl+Ex	Cl+Ex		Cl+Ex	Cl+Ex	
Detector 1 Channel												
Detector 1 Extend (s)	0.0	0.0	0.0	0.0	0.0		0.0	0.0		0.0	0.0	
Detector 1 Queue (s)	0.0	0.0	0.0	0.0	0.0		0.0	0.0		0.0	0.0	
Detector 1 Delay (s)	0.0	0.0	0.0	0.0	0.0		0.0	0.0		0.0	0.0	
Detector 2 Position(m)		9.4			9.4			9.4			9.4	
Detector 2 Size(m)		0.6			0.6			0.6			0.6	
Detector 2 Type		Cl+Ex			Cl+Ex			Cl+Ex			Cl+Ex	
Detector 2 Channel												
Detector 2 Extend (s)		0.0			0.0			0.0			0.0	

Lanes, Volumes, Timings  
2: March Road & Klondike Road

2033 Future Background  
910 March Road



Lane Group	EBL	EBT	EBR	WBL	WBT	WBR	NBL	NBT	NBR	SBL	SBT	SBR
Turn Type	pm+pt	NA	Perm	Perm	NA		Prot	NA		Prot	NA	
Protected Phases	7	4			8		5	2		1	6	
Permitted Phases	4		4	8								
Detector Phase	7	4	4	8	8		5	2		1	6	
Switch Phase												
Minimum Initial (s)	5.0	5.0	5.0	5.0	5.0		5.0	5.0		5.0	5.0	
Minimum Split (s)	11.6	44.1	44.1	44.1	44.1		11.6	32.4		11.6	32.4	
Total Split (s)	12.0	57.0	57.0	45.0	45.0		15.0	58.0		15.0	58.0	
Total Split (%)	9.2%	43.8%	43.8%	34.6%	34.6%		11.5%	44.6%		11.5%	44.6%	
Yellow Time (s)	3.3	3.3	3.3	3.3	3.3		4.6	4.6		4.6	4.6	
All-Red Time (s)	3.3	3.8	3.8	3.8	3.8		2.0	1.8		2.0	1.8	
Lost Time Adjust (s)	0.0	0.0	0.0	0.0	0.0		0.0	0.0		0.0	0.0	
Total Lost Time (s)	6.6	7.1	7.1	7.1	7.1		6.6	6.4		6.6	6.4	
Lead/Lag	Lead			Lag	Lag		Lead	Lag		Lead	Lag	
Lead-Lag Optimize?	Yes			Yes	Yes		Yes	Yes		Yes	Yes	
Recall Mode	None	None	None	None	None		None	C-Max		None	C-Max	
Act Effct Green (s)	34.1	33.6	33.6	24.0	24.0		8.8	72.8		8.7	67.5	
Actuated g/C Ratio	0.26	0.26	0.26	0.18	0.18		0.07	0.56		0.07	0.52	
v/c Ratio	0.28	0.09	0.52	0.78	0.29		0.39	0.31		0.37	0.73	
Control Delay	36.5	32.5	17.9	71.4	20.3		63.0	18.4		67.9	28.6	
Queue Delay	0.0	0.0	0.0	0.0	0.0		0.0	0.0		0.0	0.0	
Total Delay	36.5	32.5	17.9	71.4	20.3		63.0	18.4		67.9	28.6	
LOS	D	C	B	E	C		E	B		E	C	
Approach Delay		23.0			54.4			22.7			29.4	
Approach LOS		C			D			C			C	
Queue Length 50th (m)	13.6	7.4	20.4	44.8	7.4		10.6	41.3		8.7	132.0	
Queue Length 95th (m)	23.2	14.7	41.8	65.5	20.7		18.8	61.7		19.2	#180.5	
Internal Link Dist (m)		93.7			322.6			237.8			118.1	
Turn Bay Length (m)	100.0		5.0	15.0			100.0			45.0		
Base Capacity (vph)	251	644	654	370	464		224	2500		104	2457	
Starvation Cap Reductn	0	0	0	0	0		0	0		0	0	
Spillback Cap Reductn	0	0	0	0	0		0	0		0	0	
Storage Cap Reductn	0	0	0	0	0		0	0		0	0	
Reduced v/c Ratio	0.28	0.06	0.39	0.49	0.20		0.37	0.31		0.34	0.73	

Intersection Summary

Area Type: Other  
 Cycle Length: 130  
 Actuated Cycle Length: 130  
 Offset: 64 (49%), Referenced to phase 2:NBT and 6:SBT, Start of Green  
 Natural Cycle: 110  
 Control Type: Actuated-Coordinated  
 Maximum v/c Ratio: 0.78  
 Intersection Signal Delay: 29.0  
 Intersection LOS: C  
 Intersection Capacity Utilization 84.5%  
 ICU Level of Service E  
 Analysis Period (min) 15  
 # 95th percentile volume exceeds capacity, queue may be longer.  
 Queue shown is maximum after two cycles.



Splits and Phases: 2: March Road & Klondike Road



HCM Signalized Intersection Capacity Analysis  
2: March Road & Klondike Road

2033 Future Background  
910 March Road



Movement	EBL	EBT	EBR	WBL	WBT	WBR	NBL	NBT	NBR	SBL	SBT	SBR
Lane Configurations	↖	↑	↗	↖	↗		↖↗	↑↑↑		↖	↑↑↑	
Traffic Volume (vph)	70	39	256	182	34	57	83	692	79	35	1737	61
Future Volume (vph)	70	39	256	182	34	57	83	692	79	35	1737	61
Ideal Flow (vphpl)	1800	1800	1800	1800	1800	1800	1800	1800	1800	1800	1800	1800
Total Lost time (s)	6.6	7.1	7.1	7.1	7.1		6.6	6.4		6.6	6.4	
Lane Util. Factor	1.00	1.00	1.00	1.00	1.00		0.97	0.91		1.00	0.91	
Frpb, ped/bikes	1.00	1.00	0.98	1.00	0.99		1.00	1.00		1.00	1.00	
Flpb, ped/bikes	1.00	1.00	1.00	0.99	1.00		1.00	1.00		1.00	1.00	
Frt	1.00	1.00	0.85	1.00	0.91		1.00	0.98		1.00	0.99	
Flt Protected	0.95	1.00	1.00	0.95	1.00		0.95	1.00		0.95	1.00	
Satd. Flow (prot)	1494	1679	1456	1648	1454		3124	4450		1433	4726	
Flt Permitted	0.55	1.00	1.00	0.73	1.00		0.95	1.00		0.95	1.00	
Satd. Flow (perm)	861	1679	1456	1269	1454		3124	4450		1433	4726	
Peak-hour factor, PHF	1.00	1.00	1.00	1.00	1.00	1.00	1.00	1.00	1.00	1.00	1.00	1.00
Adj. Flow (vph)	70	39	256	182	34	57	83	692	79	35	1737	61
RTOR Reduction (vph)	0	0	113	0	46	0	0	8	0	0	2	0
Lane Group Flow (vph)	70	39	143	182	45	0	83	763	0	35	1796	0
Confl. Peds. (#/hr)	3		6	6		3	3		4	4		3
Heavy Vehicles (%)	13%	6%	2%	2%	8%	11%	5%	7%	9%	18%	2%	9%
Turn Type	pm+pt	NA	Perm	Perm	NA		Prot	NA		Prot	NA	
Protected Phases	7	4			8		5	2		1	6	
Permitted Phases	4		4	8								
Actuated Green, G (s)	34.9	34.9	34.9	24.0	24.0		8.8	68.9		6.1	66.2	
Effective Green, g (s)	34.9	34.9	34.9	24.0	24.0		8.8	68.9		6.1	66.2	
Actuated g/C Ratio	0.27	0.27	0.27	0.18	0.18		0.07	0.53		0.05	0.51	
Clearance Time (s)	6.6	7.1	7.1	7.1	7.1		6.6	6.4		6.6	6.4	
Vehicle Extension (s)	3.0	3.0	3.0	3.0	3.0		3.0	3.0		3.0	3.0	
Lane Grp Cap (vph)	252	450	390	234	268		211	2358		67	2406	
v/s Ratio Prot	0.01	0.02			0.03		c0.03	c0.17		0.02	c0.38	
v/s Ratio Perm	0.07		c0.10	c0.14								
v/c Ratio	0.28	0.09	0.37	0.78	0.17		0.39	0.32		0.52	0.75	
Uniform Delay, d1	37.1	35.6	38.6	50.5	44.6		58.0	17.3		60.5	25.3	
Progression Factor	1.00	1.00	1.00	1.00	1.00		1.00	1.00		1.00	1.00	
Incremental Delay, d2	0.6	0.1	0.6	14.9	0.3		1.2	0.4		7.2	2.2	
Delay (s)	37.7	35.7	39.2	65.4	44.9		59.3	17.7		67.7	27.4	
Level of Service	D	D	D	E	D		E	B		E	C	
Approach Delay (s)		38.5			58.6			21.7			28.2	
Approach LOS		D			E			C			C	
<b>Intersection Summary</b>												
HCM 2000 Control Delay			30.2			HCM 2000 Level of Service				C		
HCM 2000 Volume to Capacity ratio			0.72									
Actuated Cycle Length (s)			130.0			Sum of lost time (s)				26.7		
Intersection Capacity Utilization			84.5%			ICU Level of Service				E		
Analysis Period (min)			15									

c Critical Lane Group

Lanes, Volumes, Timings  
3: March Road & South Local Road

2033 Future Background  
910 March Road



Lane Group	EBL	EBR	NBL	NBT	SBT	SBR
Lane Configurations						
Traffic Volume (vph)	0	31	0	739	1796	1
Future Volume (vph)	0	31	0	739	1796	1
Ideal Flow (vphpl)	1800	1800	1800	1800	1800	1800
Lane Util. Factor	1.00	1.00	1.00	0.95	1.00	1.00
Fr <sub>t</sub>	0.865					
Fl <sub>t</sub> Protected						
Satd. Flow (prot)	0	1510	0	3316	1745	0
Fl <sub>t</sub> Permitted						
Satd. Flow (perm)	0	1510	0	3316	1745	0
Link Speed (k/h)	50			80	80	
Link Distance (m)	175.3			203.9	135.6	
Travel Time (s)	12.6			9.2	6.1	
Peak Hour Factor	1.00	1.00	1.00	1.00	1.00	1.00
Adj. Flow (vph)	0	31	0	739	1796	1
Shared Lane Traffic (%)						
Lane Group Flow (vph)	0	31	0	739	1797	0
Enter Blocked Intersection	No	No	No	No	No	No
Lane Alignment	Left	Right	Left	Left	Left	Right
Median Width(m)	0.0			3.5	3.5	
Link Offset(m)	0.0			0.0	0.0	
Crosswalk Width(m)	3.0			3.0	3.0	
Two way Left Turn Lane						
Headway Factor	1.09	1.09	1.09	1.09	1.09	1.09
Turning Speed (k/h)	25	15	25			15
Sign Control	Stop			Free	Free	
<b>Intersection Summary</b>						
Area Type:	Other					
Control Type:	Unsignalized					
Intersection Capacity Utilization	109.8%			ICU Level of Service H		
Analysis Period (min)	15					

Intersection						
Int Delay, s/veh	0.7					
Movement	EBL	EBR	NBL	NBT	SBT	SBR
Lane Configurations		↗		↑↑	↑	
Traffic Vol, veh/h	0	31	0	739	1796	1
Future Vol, veh/h	0	31	0	739	1796	1
Conflicting Peds, #/hr	0	0	0	0	0	0
Sign Control	Stop	Stop	Free	Free	Free	Free
RT Channelized	-	None	-	None	-	None
Storage Length	-	0	-	-	-	-
Veh in Median Storage, #	0	-	-	0	0	-
Grade, %	0	-	-	0	0	-
Peak Hour Factor	100	100	100	100	100	100
Heavy Vehicles, %	2	2	2	2	2	2
Mvmt Flow	0	31	0	739	1796	1

Major/Minor	Minor2	Major1	Major2		
Conflicting Flow All	-	1797	-	0	-
Stage 1	-	-	-	-	-
Stage 2	-	-	-	-	-
Critical Hdwy	-	6.23	-	-	-
Critical Hdwy Stg 1	-	-	-	-	-
Critical Hdwy Stg 2	-	-	-	-	-
Follow-up Hdwy	-	3.319	-	-	-
Pot Cap-1 Maneuver	0	99	0	-	-
Stage 1	0	-	0	-	-
Stage 2	0	-	0	-	-
Platoon blocked, %				-	-
Mov Cap-1 Maneuver	-	99	-	-	-
Mov Cap-2 Maneuver	-	-	-	-	-
Stage 1	-	-	-	-	-
Stage 2	-	-	-	-	-

Approach	EB	NB	SB
HCM Control Delay, s	57.1	0	0
HCM LOS	F		

Minor Lane/Major Mvmt	NBT	EBLn1	SBT	SBR
Capacity (veh/h)	-	99	-	-
HCM Lane V/C Ratio	-	0.313	-	-
HCM Control Delay (s)	-	57.1	-	-
HCM Lane LOS	-	F	-	-
HCM 95th %tile Q(veh)	-	1.2	-	-

Lanes, Volumes, Timings  
 1: March Road & Halton Terrace/Maxwell Bridge Road

2033 Future Background  
 910 March Road



Lane Group	EBL	EBT	EBR	WBL	WBT	WBR	NBL	NBT	NBR	SBL	SBT	SBR
Lane Configurations												
Traffic Volume (vph)	82	58	96	80	61	123	252	1675	115	109	767	97
Future Volume (vph)	82	58	96	80	61	123	252	1675	115	109	767	97
Ideal Flow (vphpl)	1800	1800	1800	1800	1800	1800	1800	1800	1800	1800	1800	1800
Storage Length (m)	30.0		0.0	30.0		0.0	60.0		0.0	70.0		15.0
Storage Lanes	1		0	1		0	1		1	1		1
Taper Length (m)	60.0			60.0			70.0			100.0		
Lane Util. Factor	1.00	1.00	1.00	1.00	1.00	1.00	1.00	0.95	1.00	1.00	0.95	1.00
Ped Bike Factor	0.99	0.98		0.98	0.98		1.00		0.96			0.98
Fr <sub>t</sub>		0.906			0.900				0.850			0.850
Fl <sub>t</sub> Protected	0.950			0.950			0.950			0.950		
Satd. Flow (prot)	1658	1485	0	1610	1540	0	1658	3316	1483	1658	3316	1483
Fl <sub>t</sub> Permitted	0.422			0.524			0.313			0.079		
Satd. Flow (perm)	730	1485	0	875	1540	0	546	3316	1419	138	3316	1447
Right Turn on Red			Yes			Yes			Yes			Yes
Satd. Flow (RTOR)		73			89				100			100
Link Speed (k/h)		40			40			80				80
Link Distance (m)		143.7			356.2			324.9				214.1
Travel Time (s)		12.9			32.1			14.6				9.6
Confl. Peds. (#/hr)	11		17	17		11	2		11	11		2
Peak Hour Factor	1.00	1.00	1.00	1.00	1.00	1.00	1.00	1.00	1.00	1.00	1.00	1.00
Heavy Vehicles (%)	2%	9%	5%	5%	3%	2%	2%	2%	2%	2%	2%	2%
Adj. Flow (vph)	82	58	96	80	61	123	252	1675	115	109	767	97
Shared Lane Traffic (%)												
Lane Group Flow (vph)	82	154	0	80	184	0	252	1675	115	109	767	97
Enter Blocked Intersection	No	No	No	No	No	No	No	No	No	No	No	No
Lane Alignment	Left	Left	Right	Left	Left	Right	Left	Left	Right	Left	Left	Right
Median Width(m)		3.5			3.5			3.5				3.5
Link Offset(m)		0.0			0.0			0.0				0.0
Crosswalk Width(m)		3.0			3.0			3.0				3.0
Two way Left Turn Lane												
Headway Factor	1.09	1.09	1.09	1.09	1.09	1.09	1.09	1.09	1.09	1.09	1.09	1.09
Turning Speed (k/h)	25		15	25		15	25		15	25		15
Number of Detectors	1	2		1	2		1	2	1	1	2	1
Detector Template	Left	Thru		Left	Thru		Left	Thru	Right	Left	Thru	Right
Leading Detector (m)	2.0	10.0		2.0	10.0		2.0	10.0	2.0	2.0	10.0	2.0
Trailing Detector (m)	0.0	0.0		0.0	0.0		0.0	0.0	0.0	0.0	0.0	0.0
Detector 1 Position(m)	0.0	0.0		0.0	0.0		0.0	0.0	0.0	0.0	0.0	0.0
Detector 1 Size(m)	2.0	0.6		2.0	0.6		2.0	0.6	2.0	2.0	0.6	2.0
Detector 1 Type	Cl+Ex	Cl+Ex		Cl+Ex	Cl+Ex		Cl+Ex	Cl+Ex	Cl+Ex	Cl+Ex	Cl+Ex	Cl+Ex
Detector 1 Channel												
Detector 1 Extend (s)	0.0	0.0		0.0	0.0		0.0	0.0	0.0	0.0	0.0	0.0
Detector 1 Queue (s)	0.0	0.0		0.0	0.0		0.0	0.0	0.0	0.0	0.0	0.0
Detector 1 Delay (s)	0.0	0.0		0.0	0.0		0.0	0.0	0.0	0.0	0.0	0.0
Detector 2 Position(m)		9.4			9.4			9.4				9.4
Detector 2 Size(m)		0.6			0.6			0.6				0.6
Detector 2 Type		Cl+Ex			Cl+Ex			Cl+Ex				Cl+Ex
Detector 2 Channel												
Detector 2 Extend (s)		0.0			0.0			0.0				0.0

Lanes, Volumes, Timings  
1: March Road & Halton Terrace/Maxwell Bridge Road

2033 Future Background  
910 March Road



Lane Group	EBL	EBT	EBR	WBL	WBT	WBR	NBL	NBT	NBR	SBL	SBT	SBR
Turn Type	Perm	NA		Perm	NA		pm+pt	NA	Perm	pm+pt	NA	Perm
Protected Phases		4			8		5	2		1	6	
Permitted Phases	4			8			2		2	6		6
Detector Phase	4	4		8	8		5	2	2	1	6	6
Switch Phase												
Minimum Initial (s)	10.0	10.0		10.0	10.0		5.0	10.0	10.0	5.0	10.0	10.0
Minimum Split (s)	38.6	38.6		38.6	38.6		12.4	34.6	34.6	11.4	34.6	34.6
Total Split (s)	45.0	45.0		45.0	45.0		20.0	55.0	55.0	20.0	55.0	55.0
Total Split (%)	37.5%	37.5%		37.5%	37.5%		16.7%	45.8%	45.8%	16.7%	45.8%	45.8%
Maximum Green (s)	38.4	38.4		38.4	38.4		12.6	48.4	48.4	13.6	48.4	48.4
Yellow Time (s)	3.3	3.3		3.3	3.3		4.6	4.6	4.6	4.6	4.6	4.6
All-Red Time (s)	3.3	3.3		3.3	3.3		2.8	2.0	2.0	1.8	2.0	2.0
Lost Time Adjust (s)	0.0	0.0		0.0	0.0		0.0	0.0	0.0	0.0	0.0	0.0
Total Lost Time (s)	6.6	6.6		6.6	6.6		7.4	6.6	6.6	6.4	6.6	6.6
Lead/Lag							Lead	Lag	Lag	Lead	Lag	Lag
Lead-Lag Optimize?							Yes	Yes	Yes	Yes	Yes	Yes
Vehicle Extension (s)	3.0	3.0		3.0	3.0		3.0	3.0	3.0	3.0	3.0	3.0
Recall Mode	None	None		None	None		None	C-Max	C-Max	None	C-Max	C-Max
Walk Time (s)	7.0	7.0		7.0	7.0			7.0	7.0		7.0	7.0
Flash Dont Walk (s)	25.0	25.0		25.0	25.0			21.0	21.0		21.0	21.0
Pedestrian Calls (#/hr)	0	0		0	0			0	0		0	0
Act Effct Green (s)	15.5	15.5		15.5	15.5		86.1	75.6	75.6	82.2	72.6	72.6
Actuated g/C Ratio	0.13	0.13		0.13	0.13		0.72	0.63	0.63	0.68	0.60	0.60
v/c Ratio	0.88	0.61		0.71	0.67		0.51	0.80	0.12	0.51	0.38	0.11
Control Delay	114.9	35.3		81.2	36.7		8.8	22.1	3.5	21.3	14.0	2.9
Queue Delay	0.0	0.0		0.0	0.0		0.0	0.0	0.0	0.0	0.0	0.0
Total Delay	114.9	35.3		81.2	36.7		8.8	22.1	3.5	21.3	14.0	2.9
LOS	F	D		F	D		A	C	A	C	B	A
Approach Delay		62.9			50.2			19.4			13.7	
Approach LOS		E			D			B			B	
Queue Length 50th (m)	19.3	17.9		18.4	21.3		14.4	140.7	1.2	5.4	44.7	0.0
Queue Length 95th (m)	#39.0	37.1		33.6	42.4		29.2	#246.8	10.3	23.4	74.1	7.8
Internal Link Dist (m)		119.7			332.2			300.9			190.1	
Turn Bay Length (m)	30.0			30.0			60.0			70.0		15.0
Base Capacity (vph)	233	524		280	553		523	2089	930	272	2006	915
Starvation Cap Reductn	0	0		0	0		0	0	0	0	0	0
Spillback Cap Reductn	0	0		0	0		0	0	0	0	0	0
Storage Cap Reductn	0	0		0	0		0	0	0	0	0	0
Reduced v/c Ratio	0.35	0.29		0.29	0.33		0.48	0.80	0.12	0.40	0.38	0.11

Intersection Summary

Area Type: Other  
 Cycle Length: 120  
 Actuated Cycle Length: 120  
 Offset: 50 (42%), Referenced to phase 2:NBT and 6:SBT, Start of Green  
 Natural Cycle: 110  
 Control Type: Actuated-Coordinated  
 Maximum v/c Ratio: 0.88  
 Intersection Signal Delay: 23.1  
 Intersection LOS: C

Lanes, Volumes, Timings  
 1: March Road & Halton Terrace/Maxwell Bridge Road

2033 Future Background  
 910 March Road

Intersection Capacity Utilization 102.9%      ICU Level of Service G

Analysis Period (min) 15

# 95th percentile volume exceeds capacity, queue may be longer.

Queue shown is maximum after two cycles.

Splits and Phases: 1: March Road & Halton Terrace/Maxwell Bridge Road



HCM Signalized Intersection Capacity Analysis  
 1: March Road & Halton Terrace/Maxwell Bridge Road

2033 Future Background  
 910 March Road



Movement	EBL	EBT	EBR	WBL	WBT	WBR	NBL	NBT	NBR	SBL	SBT	SBR
Lane Configurations												
Traffic Volume (vph)	82	58	96	80	61	123	252	1675	115	109	767	97
Future Volume (vph)	82	58	96	80	61	123	252	1675	115	109	767	97
Ideal Flow (vphpl)	1800	1800	1800	1800	1800	1800	1800	1800	1800	1800	1800	1800
Total Lost time (s)	6.6	6.6		6.6	6.6		7.4	6.6	6.6	6.4	6.6	6.6
Lane Util. Factor	1.00	1.00		1.00	1.00		1.00	0.95	1.00	1.00	0.95	1.00
Frbp, ped/bikes	1.00	0.98		1.00	0.98		1.00	1.00	0.96	1.00	1.00	0.98
Flpb, ped/bikes	0.99	1.00		0.99	1.00		1.00	1.00	1.00	1.00	1.00	1.00
Frt	1.00	0.91		1.00	0.90		1.00	1.00	0.85	1.00	1.00	0.85
Flt Protected	0.95	1.00		0.95	1.00		0.95	1.00	1.00	0.95	1.00	1.00
Satd. Flow (prot)	1643	1486		1587	1540		1657	3316	1419	1658	3316	1447
Flt Permitted	0.42	1.00		0.52	1.00		0.31	1.00	1.00	0.08	1.00	1.00
Satd. Flow (perm)	730	1486		875	1540		545	3316	1419	138	3316	1447
Peak-hour factor, PHF	1.00	1.00	1.00	1.00	1.00	1.00	1.00	1.00	1.00	1.00	1.00	1.00
Adj. Flow (vph)	82	58	96	80	61	123	252	1675	115	109	767	97
RTOR Reduction (vph)	0	64	0	0	78	0	0	0	37	0	0	38
Lane Group Flow (vph)	82	90	0	80	106	0	252	1675	78	109	767	59
Confl. Peds. (#/hr)	11		17	17		11	2		11	11		2
Heavy Vehicles (%)	2%	9%	5%	5%	3%	2%	2%	2%	2%	2%	2%	2%
Turn Type	Perm	NA		Perm	NA		pm+pt	NA	Perm	pm+pt	NA	Perm
Protected Phases		4			8		5	2		1	6	
Permitted Phases	4			8			2		2	6		6
Actuated Green, G (s)	15.5	15.5		15.5	15.5		86.9	75.6	75.6	81.9	72.6	72.6
Effective Green, g (s)	15.5	15.5		15.5	15.5		86.9	75.6	75.6	81.9	72.6	72.6
Actuated g/C Ratio	0.13	0.13		0.13	0.13		0.72	0.63	0.63	0.68	0.60	0.60
Clearance Time (s)	6.6	6.6		6.6	6.6		7.4	6.6	6.6	6.4	6.6	6.6
Vehicle Extension (s)	3.0	3.0		3.0	3.0		3.0	3.0	3.0	3.0	3.0	3.0
Lane Grp Cap (vph)	94	191		113	198		499	2089	893	211	2006	875
v/s Ratio Prot		0.06			0.07		c0.05	c0.51		0.04	0.23	
v/s Ratio Perm	c0.11			0.09			0.32		0.05	0.31		0.04
v/c Ratio	0.87	0.47		0.71	0.54		0.51	0.80	0.09	0.52	0.38	0.07
Uniform Delay, d1	51.3	48.5		50.1	48.9		6.1	16.6	8.7	14.5	12.2	9.8
Progression Factor	1.00	1.00		1.00	1.00		1.00	1.00	1.00	1.00	1.00	1.00
Incremental Delay, d2	53.6	1.8		18.3	2.8		0.8	3.4	0.2	2.1	0.6	0.1
Delay (s)	104.9	50.3		68.4	51.7		6.9	20.0	8.9	16.6	12.7	9.9
Level of Service	F	D		E	D		A	B	A	B	B	A
Approach Delay (s)		69.3			56.8			17.7			12.9	
Approach LOS		E			E			B			B	
<b>Intersection Summary</b>												
HCM 2000 Control Delay			22.8			HCM 2000 Level of Service		C				
HCM 2000 Volume to Capacity ratio			0.80									
Actuated Cycle Length (s)			120.0			Sum of lost time (s)		20.6				
Intersection Capacity Utilization			102.9%			ICU Level of Service		G				
Analysis Period (min)			15									

c Critical Lane Group



Lanes, Volumes, Timings  
2: March Road & Klondike Road

2033 Future Background  
910 March Road



Lane Group	EBL	EBT	EBR	WBL	WBT	WBR	NBL	NBT	NBR	SBL	SBT	SBR
Lane Configurations												
Traffic Volume (vph)	124	31	111	115	37	41	161	1954	156	16	894	109
Future Volume (vph)	124	31	111	115	37	41	161	1954	156	16	894	109
Ideal Flow (vphpl)	1800	1800	1800	1800	1800	1800	1800	1800	1800	1800	1800	1800
Storage Length (m)	100.0		5.0	15.0		0.0	100.0		0.0	45.0		0.0
Storage Lanes	1		1	1		0	2		0	1		0
Taper Length (m)	0.0			30.0			100.0			85.0		
Lane Util. Factor	1.00	1.00	1.00	1.00	1.00	1.00	0.97	0.91	0.91	1.00	0.91	0.91
Ped Bike Factor	1.00		0.99	1.00	0.99		1.00	1.00		1.00	1.00	
Fr <sub>t</sub>			0.850		0.921			0.989			0.984	
Fl <sub>t</sub> Protected	0.950			0.950			0.950			0.950		
Satd. Flow (prot)	1658	1745	1483	1658	1567	0	3216	4695	0	1658	4676	0
Fl <sub>t</sub> Permitted	0.509			0.737			0.950			0.950		
Satd. Flow (perm)	887	1745	1462	1284	1567	0	3200	4695	0	1655	4676	0
Right Turn on Red			Yes			Yes			Yes			Yes
Satd. Flow (RTOR)			111		41			11			18	
Link Speed (k/h)		50			50			80			80	
Link Distance (m)		117.7			346.6			261.8			142.1	
Travel Time (s)		8.5			25.0			11.8			6.4	
Confl. Peds. (#/hr)	1		2	2		1	8		11	11		8
Peak Hour Factor	1.00	1.00	1.00	1.00	1.00	1.00	1.00	1.00	1.00	1.00	1.00	1.00
Heavy Vehicles (%)	2%	2%	2%	2%	6%	2%	2%	2%	2%	2%	2%	2%
Adj. Flow (vph)	124	31	111	115	37	41	161	1954	156	16	894	109
Shared Lane Traffic (%)												
Lane Group Flow (vph)	124	31	111	115	78	0	161	2110	0	16	1003	0
Enter Blocked Intersection	No	No	No	No	No	No	No	No	No	No	No	No
Lane Alignment	Left	Left	Right	Left	Left	Right	Left	Left	Right	Left	Left	Right
Median Width(m)		3.5			3.5			7.0			7.0	
Link Offset(m)		0.0			0.0			0.0			0.0	
Crosswalk Width(m)		3.0			3.0			3.0			3.0	
Two way Left Turn Lane												
Headway Factor	1.09	1.09	1.09	1.09	1.09	1.09	1.09	1.09	1.09	1.09	1.09	1.09
Turning Speed (k/h)	25		15	25		15	25		15	25		15
Number of Detectors	1	2	1	1	2		1	2		1	2	
Detector Template	Left	Thru	Right	Left	Thru		Left	Thru		Left	Thru	
Leading Detector (m)	2.0	10.0	2.0	2.0	10.0		2.0	10.0		2.0	10.0	
Trailing Detector (m)	0.0	0.0	0.0	0.0	0.0		0.0	0.0		0.0	0.0	
Detector 1 Position(m)	0.0	0.0	0.0	0.0	0.0		0.0	0.0		0.0	0.0	
Detector 1 Size(m)	2.0	0.6	2.0	2.0	0.6		2.0	0.6		2.0	0.6	
Detector 1 Type	Cl+Ex	Cl+Ex	Cl+Ex	Cl+Ex	Cl+Ex		Cl+Ex	Cl+Ex		Cl+Ex	Cl+Ex	
Detector 1 Channel												
Detector 1 Extend (s)	0.0	0.0	0.0	0.0	0.0		0.0	0.0		0.0	0.0	
Detector 1 Queue (s)	0.0	0.0	0.0	0.0	0.0		0.0	0.0		0.0	0.0	
Detector 1 Delay (s)	0.0	0.0	0.0	0.0	0.0		0.0	0.0		0.0	0.0	
Detector 2 Position(m)		9.4			9.4			9.4			9.4	
Detector 2 Size(m)		0.6			0.6			0.6			0.6	
Detector 2 Type		Cl+Ex			Cl+Ex			Cl+Ex			Cl+Ex	
Detector 2 Channel												
Detector 2 Extend (s)		0.0			0.0			0.0			0.0	

Lanes, Volumes, Timings  
2: March Road & Klondike Road

2033 Future Background  
910 March Road



Lane Group	EBL	EBT	EBR	WBL	WBT	WBR	NBL	NBT	NBR	SBL	SBT	SBR
Turn Type	pm+pt	NA	Perm	Perm	NA		Prot	NA		Prot	NA	
Protected Phases	7	4			8		5	2		1	6	
Permitted Phases	4		4	8								
Detector Phase	7	4	4	8	8		5	2		1	6	
Switch Phase												
Minimum Initial (s)	5.0	5.0	5.0	5.0	5.0		5.0	5.0		5.0	5.0	
Minimum Split (s)	11.6	44.1	44.1	44.1	44.1		11.6	32.4		11.6	32.4	
Total Split (s)	12.0	57.0	57.0	45.0	45.0		22.0	51.0		22.0	51.0	
Total Split (%)	9.2%	43.8%	43.8%	34.6%	34.6%		16.9%	39.2%		16.9%	39.2%	
Maximum Green (s)	5.4	49.9	49.9	37.9	37.9		15.4	44.6		15.4	44.6	
Yellow Time (s)	3.3	3.3	3.3	3.3	3.3		4.6	4.6		4.6	4.6	
All-Red Time (s)	3.3	3.8	3.8	3.8	3.8		2.0	1.8		2.0	1.8	
Lost Time Adjust (s)	0.0	0.0	0.0	0.0	0.0		0.0	0.0		0.0	0.0	
Total Lost Time (s)	6.6	7.1	7.1	7.1	7.1		6.6	6.4		6.6	6.4	
Lead/Lag	Lead			Lag	Lag		Lead	Lag		Lead	Lag	
Lead-Lag Optimize?	Yes			Yes	Yes		Yes	Yes		Yes	Yes	
Vehicle Extension (s)	3.0	3.0	3.0	3.0	3.0		3.0	3.0		3.0	3.0	
Recall Mode	None	None	None	None	None		None	C-Max		None	C-Max	
Walk Time (s)		7.0	7.0	7.0	7.0			7.0			7.0	
Flash Dont Walk (s)		30.0	30.0	30.0	30.0			19.0			19.0	
Pedestrian Calls (#/hr)		0	0	0	0			0			0	
Act Effct Green (s)	29.5	29.0	29.0	17.0	17.0		11.8	81.6		6.8	69.1	
Actuated g/C Ratio	0.23	0.22	0.22	0.13	0.13		0.09	0.63		0.05	0.53	
v/c Ratio	0.53	0.08	0.27	0.68	0.33		0.55	0.72		0.18	0.40	
Control Delay	50.1	37.9	8.1	73.3	29.0		63.5	20.4		63.2	19.5	
Queue Delay	0.0	0.0	0.0	0.0	0.0		0.0	0.0		0.0	0.0	
Total Delay	50.1	37.9	8.1	73.3	29.0		63.5	20.4		63.2	19.5	
LOS	D	D	A	E	C		E	C		E	B	
Approach Delay		31.1			55.4			23.5			20.2	
Approach LOS		C			E			C			C	
Queue Length 50th (m)	26.8	6.3	0.0	28.5	8.6		20.7	107.5		4.0	53.1	
Queue Length 95th (m)	41.4	13.7	13.8	46.1	22.1		31.2	197.9		11.5	76.0	
Internal Link Dist (m)		93.7			322.6			237.8			118.1	
Turn Bay Length (m)	100.0		5.0	15.0			100.0			45.0		
Base Capacity (vph)	233	669	629	374	485		380	2950		196	2492	
Starvation Cap Reductn	0	0	0	0	0		0	0		0	0	
Spillback Cap Reductn	0	0	0	0	0		0	0		0	0	
Storage Cap Reductn	0	0	0	0	0		0	0		0	0	
Reduced v/c Ratio	0.53	0.05	0.18	0.31	0.16		0.42	0.72		0.08	0.40	

Intersection Summary

Area Type: Other  
 Cycle Length: 130  
 Actuated Cycle Length: 130  
 Offset: 20 (15%), Referenced to phase 2:NBT and 6:SBT, Start of Green  
 Natural Cycle: 130  
 Control Type: Actuated-Coordinated  
 Maximum v/c Ratio: 0.72  
 Intersection Signal Delay: 24.8  
 Intersection LOS: C

Intersection Capacity Utilization 79.5% ICU Level of Service D  
 Analysis Period (min) 15

Splits and Phases: 2: March Road & Klondike Road



HCM Signalized Intersection Capacity Analysis  
2: March Road & Klondike Road

2033 Future Background  
910 March Road



Movement	EBL	EBT	EBR	WBL	WBT	WBR	NBL	NBT	NBR	SBL	SBT	SBR
Lane Configurations												
Traffic Volume (vph)	124	31	111	115	37	41	161	1954	156	16	894	109
Future Volume (vph)	124	31	111	115	37	41	161	1954	156	16	894	109
Ideal Flow (vphpl)	1800	1800	1800	1800	1800	1800	1800	1800	1800	1800	1800	1800
Total Lost time (s)	6.6	7.1	7.1	7.1	7.1		6.6	6.4		6.6	6.4	
Lane Util. Factor	1.00	1.00	1.00	1.00	1.00		0.97	0.91		1.00	0.91	
Frpb, ped/bikes	1.00	1.00	0.99	1.00	0.99		1.00	1.00		1.00	1.00	
Flpb, ped/bikes	1.00	1.00	1.00	1.00	1.00		1.00	1.00		1.00	1.00	
Frt	1.00	1.00	0.85	1.00	0.92		1.00	0.99		1.00	0.98	
Flt Protected	0.95	1.00	1.00	0.95	1.00		0.95	1.00		0.95	1.00	
Satd. Flow (prot)	1657	1745	1462	1654	1567		3216	4695		1658	4674	
Flt Permitted	0.51	1.00	1.00	0.74	1.00		0.95	1.00		0.95	1.00	
Satd. Flow (perm)	887	1745	1462	1283	1567		3216	4695		1658	4674	
Peak-hour factor, PHF	1.00	1.00	1.00	1.00	1.00	1.00	1.00	1.00	1.00	1.00	1.00	1.00
Adj. Flow (vph)	124	31	111	115	37	41	161	1954	156	16	894	109
RTOR Reduction (vph)	0	0	86	0	36	0	0	4	0	0	8	0
Lane Group Flow (vph)	124	31	25	115	42	0	161	2106	0	16	995	0
Confl. Peds. (#/hr)	1		2	2		1	8		11	11		8
Heavy Vehicles (%)	2%	2%	2%	2%	6%	2%	2%	2%	2%	2%	2%	2%
Turn Type	pm+pt	NA	Perm	Perm	NA		Prot	NA		Prot	NA	
Protected Phases	7	4			8		5	2		1	6	
Permitted Phases	4		4	8								
Actuated Green, G (s)	29.0	29.0	29.0	17.0	17.0		11.8	77.7		3.2	69.1	
Effective Green, g (s)	29.0	29.0	29.0	17.0	17.0		11.8	77.7		3.2	69.1	
Actuated g/C Ratio	0.22	0.22	0.22	0.13	0.13		0.09	0.60		0.02	0.53	
Clearance Time (s)	6.6	7.1	7.1	7.1	7.1		6.6	6.4		6.6	6.4	
Vehicle Extension (s)	3.0	3.0	3.0	3.0	3.0		3.0	3.0		3.0	3.0	
Lane Grp Cap (vph)	229	389	326	167	204		291	2806		40	2484	
v/s Ratio Prot	c0.02	0.02			0.03		c0.05	c0.45		0.01	0.21	
v/s Ratio Perm	0.10		0.02	c0.09								
v/c Ratio	0.54	0.08	0.08	0.69	0.21		0.55	0.75		0.40	0.40	
Uniform Delay, d1	44.7	39.9	39.9	54.0	50.5		56.6	19.1		62.5	18.1	
Progression Factor	1.00	1.00	1.00	1.00	1.00		1.00	1.00		1.00	1.00	
Incremental Delay, d2	2.6	0.1	0.1	11.2	0.5		2.3	1.9		6.4	0.5	
Delay (s)	47.3	40.0	40.0	65.2	51.0		58.8	21.0		68.9	18.6	
Level of Service	D	D	D	E	D		E	C		E	B	
Approach Delay (s)		43.4			59.4			23.7			19.4	
Approach LOS		D			E			C			B	
<b>Intersection Summary</b>												
HCM 2000 Control Delay			25.7				HCM 2000 Level of Service			C		
HCM 2000 Volume to Capacity ratio			0.76									
Actuated Cycle Length (s)			130.0				Sum of lost time (s)			26.7		
Intersection Capacity Utilization			79.5%				ICU Level of Service			D		
Analysis Period (min)			15									

c Critical Lane Group

Lanes, Volumes, Timings  
3: March Road & South Local Road

2033 Future Background  
910 March Road



Lane Group	EBL	EBR	NBL	NBT	SBT	SBR
Lane Configurations						
Traffic Volume (vph)	0	50	0	1880	923	13
Future Volume (vph)	0	50	0	1880	923	13
Ideal Flow (vphpl)	1800	1800	1800	1800	1800	1800
Lane Util. Factor	1.00	1.00	1.00	0.95	1.00	1.00
Fr <sub>t</sub>		0.865			0.998	
Fl <sub>t</sub> Protected						
Satd. Flow (prot)	0	1510	0	3316	1742	0
Fl <sub>t</sub> Permitted						
Satd. Flow (perm)	0	1510	0	3316	1742	0
Link Speed (k/h)	50			80	80	
Link Distance (m)	136.6			214.1	120.6	
Travel Time (s)	9.8			9.6	5.4	
Peak Hour Factor	1.00	1.00	1.00	1.00	1.00	1.00
Adj. Flow (vph)	0	50	0	1880	923	13
Shared Lane Traffic (%)						
Lane Group Flow (vph)	0	50	0	1880	936	0
Enter Blocked Intersection	No	No	No	No	No	No
Lane Alignment	Left	Right	Left	Left	Left	Right
Median Width(m)	0.0			3.5	3.5	
Link Offset(m)	0.0			0.0	0.0	
Crosswalk Width(m)	3.0			3.0	3.0	
Two way Left Turn Lane						
Headway Factor	1.09	1.09	1.09	1.09	1.09	1.09
Turning Speed (k/h)	25	15	25			15
Sign Control	Stop			Free	Free	

Intersection Summary

Area Type:	Other
Control Type:	Unsignalized
Intersection Capacity Utilization	62.1%
ICU Level of Service	B
Analysis Period (min)	15

Intersection						
Int Delay, s/veh	0.3					
Movement	EBL	EBR	NBL	NBT	SBT	SBR
Lane Configurations		↗		↑↑	↑	
Traffic Vol, veh/h	0	50	0	1880	923	13
Future Vol, veh/h	0	50	0	1880	923	13
Conflicting Peds, #/hr	0	0	0	0	0	0
Sign Control	Stop	Stop	Free	Free	Free	Free
RT Channelized	-	None	-	None	-	None
Storage Length	-	0	-	-	-	-
Veh in Median Storage, #	0	-	-	0	0	-
Grade, %	0	-	-	0	0	-
Peak Hour Factor	100	100	100	100	100	100
Heavy Vehicles, %	2	2	2	2	2	2
Mvmt Flow	0	50	0	1880	923	13

Major/Minor	Minor2	Major1	Major2		
Conflicting Flow All	-	930	-	0	-
Stage 1	-	-	-	-	-
Stage 2	-	-	-	-	-
Critical Hdwy	-	6.23	-	-	-
Critical Hdwy Stg 1	-	-	-	-	-
Critical Hdwy Stg 2	-	-	-	-	-
Follow-up Hdwy	-	3.319	-	-	-
Pot Cap-1 Maneuver	0	323	0	-	-
Stage 1	0	-	0	-	-
Stage 2	0	-	0	-	-
Platoon blocked, %				-	-
Mov Cap-1 Maneuver	-	323	-	-	-
Mov Cap-2 Maneuver	-	-	-	-	-
Stage 1	-	-	-	-	-
Stage 2	-	-	-	-	-

Approach	EB	NB	SB
HCM Control Delay, s	18.2	0	0
HCM LOS	C		

Minor Lane/Major Mvmt	NBT	EBLn1	SBT	SBR
Capacity (veh/h)	-	323	-	-
HCM Lane V/C Ratio	-	0.155	-	-
HCM Control Delay (s)	-	18.2	-	-
HCM Lane LOS	-	C	-	-
HCM 95th %tile Q(veh)	-	0.5	-	-

# Appendix O

Synchro Intersection Worksheets – 2028 Future Total Conditions

Lanes, Volumes, Timings  
 1: March Road & Halton Terrace/Maxwell Bridge Road

2028 Future Total - AM  
 910 March Road



Lane Group	EBL	EBT	EBR	WBL	WBT	WBR	NBL	NBT	NBR	SBL	SBT	SBR
Lane Configurations												
Traffic Volume (vph)	103	37	158	126	17	51	99	527	64	79	1523	69
Future Volume (vph)	103	37	158	126	17	51	99	527	64	79	1523	69
Ideal Flow (vphpl)	1800	1800	1800	1800	1800	1800	1800	1800	1800	1800	1800	1800
Storage Length (m)	30.0		0.0	30.0		0.0	60.0		0.0	70.0		15.0
Storage Lanes	1		0	1		0	1		1	1		1
Taper Length (m)	60.0			60.0			70.0			100.0		
Lane Util. Factor	1.00	1.00	1.00	1.00	1.00	1.00	1.00	0.95	1.00	1.00	0.95	1.00
Ped Bike Factor		0.99		1.00					0.98	1.00		
Frt		0.878			0.887				0.850			0.850
Flt Protected	0.950			0.950			0.950			0.950		
Satd. Flow (prot)	1658	1483	0	1658	1472	0	1551	3020	1414	1658	3316	1401
Flt Permitted	0.713			0.461			0.087			0.456		
Satd. Flow (perm)	1244	1483	0	804	1472	0	142	3020	1380	794	3316	1401
Right Turn on Red			Yes			Yes			Yes			Yes
Satd. Flow (RTOR)		158			51				100			100
Link Speed (k/h)		40			40			80				80
Link Distance (m)		143.7			356.2			324.9				135.7
Travel Time (s)		12.9			32.1			14.6				6.1
Confl. Peds. (#/hr)			1	1					2	2		
Peak Hour Factor	1.00	1.00	1.00	1.00	1.00	1.00	1.00	1.00	1.00	1.00	1.00	1.00
Heavy Vehicles (%)	2%	14%	2%	2%	2%	9%	9%	12%	7%	2%	2%	8%
Adj. Flow (vph)	103	37	158	126	17	51	99	527	64	79	1523	69
Shared Lane Traffic (%)												
Lane Group Flow (vph)	103	195	0	126	68	0	99	527	64	79	1523	69
Enter Blocked Intersection	No	No	No	No	No	No	No	No	No	No	No	No
Lane Alignment	Left	Left	Right	Left	Left	Right	Left	Left	Right	Left	Left	Right
Median Width(m)		3.5			3.5			3.5				3.5
Link Offset(m)		0.0			0.0			0.0				0.0
Crosswalk Width(m)		3.0			3.0			3.0				3.0
Two way Left Turn Lane												
Headway Factor	1.09	1.09	1.09	1.09	1.09	1.09	1.09	1.09	1.09	1.09	1.09	1.09
Turning Speed (k/h)	25		15	25		15	25		15	25		15
Number of Detectors	1	2		1	2		1	2	1	1	2	1
Detector Template	Left	Thru		Left	Thru		Left	Thru	Right	Left	Thru	Right
Leading Detector (m)	2.0	10.0		2.0	10.0		2.0	10.0	2.0	2.0	10.0	2.0
Trailing Detector (m)	0.0	0.0		0.0	0.0		0.0	0.0	0.0	0.0	0.0	0.0
Detector 1 Position(m)	0.0	0.0		0.0	0.0		0.0	0.0	0.0	0.0	0.0	0.0
Detector 1 Size(m)	2.0	0.6		2.0	0.6		2.0	0.6	2.0	2.0	0.6	2.0
Detector 1 Type	Cl+Ex	Cl+Ex		Cl+Ex	Cl+Ex		Cl+Ex	Cl+Ex	Cl+Ex	Cl+Ex	Cl+Ex	Cl+Ex
Detector 1 Channel												
Detector 1 Extend (s)	0.0	0.0		0.0	0.0		0.0	0.0	0.0	0.0	0.0	0.0
Detector 1 Queue (s)	0.0	0.0		0.0	0.0		0.0	0.0	0.0	0.0	0.0	0.0
Detector 1 Delay (s)	0.0	0.0		0.0	0.0		0.0	0.0	0.0	0.0	0.0	0.0
Detector 2 Position(m)		9.4			9.4			9.4				9.4
Detector 2 Size(m)		0.6			0.6			0.6				0.6
Detector 2 Type		Cl+Ex			Cl+Ex			Cl+Ex				Cl+Ex
Detector 2 Channel												
Detector 2 Extend (s)		0.0			0.0			0.0				0.0



Lanes, Volumes, Timings  
1: March Road & Halton Terrace/Maxwell Bridge Road

2028 Future Total - AM  
910 March Road



Lane Group	EBL	EBT	EBR	WBL	WBT	WBR	NBL	NBT	NBR	SBL	SBT	SBR
Turn Type	Perm	NA		Perm	NA		pm+pt	NA	Perm	pm+pt	NA	Perm
Protected Phases		4			8		5	2		1	6	
Permitted Phases	4			8			2		2	6		6
Detector Phase	4	4		8	8		5	2	2	1	6	6
Switch Phase												
Minimum Initial (s)	10.0	10.0		10.0	10.0		5.0	10.0	10.0	5.0	10.0	10.0
Minimum Split (s)	38.6	38.6		38.6	38.6		12.4	34.6	34.6	11.4	34.6	34.6
Total Split (s)	48.0	48.0		48.0	48.0		20.0	52.0	52.0	20.0	52.0	52.0
Total Split (%)	40.0%	40.0%		40.0%	40.0%		16.7%	43.3%	43.3%	16.7%	43.3%	43.3%
Maximum Green (s)	41.4	41.4		41.4	41.4		12.6	45.4	45.4	13.6	45.4	45.4
Yellow Time (s)	3.3	3.3		3.3	3.3		4.6	4.6	4.6	4.6	4.6	4.6
All-Red Time (s)	3.3	3.3		3.3	3.3		2.8	2.0	2.0	1.8	2.0	2.0
Lost Time Adjust (s)	0.0	0.0		0.0	0.0		0.0	0.0	0.0	0.0	0.0	0.0
Total Lost Time (s)	6.6	6.6		6.6	6.6		7.4	6.6	6.6	6.4	6.6	6.6
Lead/Lag							Lead	Lag	Lag	Lead	Lag	Lag
Lead-Lag Optimize?							Yes	Yes	Yes	Yes	Yes	Yes
Vehicle Extension (s)	3.0	3.0		3.0	3.0		3.0	3.0	3.0	3.0	3.0	3.0
Recall Mode	None	None		None	None		None	C-Max	C-Max	None	C-Max	C-Max
Walk Time (s)	7.0	7.0		7.0	7.0			7.0	7.0		7.0	7.0
Flash Dont Walk (s)	25.0	25.0		25.0	25.0			21.0	21.0		21.0	21.0
Pedestrian Calls (#/hr)	0	0		0	0			0	0		0	0
Act Effct Green (s)	20.2	20.2		20.2	20.2		81.7	75.3	75.3	78.3	70.8	70.8
Actuated g/C Ratio	0.17	0.17		0.17	0.17		0.68	0.63	0.63	0.65	0.59	0.59
v/c Ratio	0.49	0.51		0.93	0.23		0.51	0.28	0.07	0.14	0.78	0.08
Control Delay	51.5	14.9		109.8	16.7		19.4	12.4	1.1	7.0	24.1	1.5
Queue Delay	0.0	0.0		0.0	0.0		0.0	0.0	0.0	0.0	0.0	0.0
Total Delay	51.5	14.9		109.8	16.7		19.4	12.4	1.1	7.0	24.1	1.5
LOS	D	B		F	B		B	B	A	A	C	A
Approach Delay		27.6			77.2			12.4			22.4	
Approach LOS		C			E			B			C	
Queue Length 50th (m)	22.3	7.5		29.6	3.4		6.3	29.0	0.0	4.8	133.2	0.0
Queue Length 95th (m)	36.3	26.6		#51.4	14.5		20.6	49.4	2.5	12.1	#230.7	3.7
Internal Link Dist (m)		119.7			332.2			300.9			111.7	
Turn Bay Length (m)	30.0			30.0			60.0			70.0		15.0
Base Capacity (vph)	429	615		277	541		247	1895	903	657	1957	867
Starvation Cap Reductn	0	0		0	0		0	0	0	0	0	0
Spillback Cap Reductn	0	0		0	0		0	0	0	0	0	0
Storage Cap Reductn	0	0		0	0		0	0	0	0	0	0
Reduced v/c Ratio	0.24	0.32		0.45	0.13		0.40	0.28	0.07	0.12	0.78	0.08

Intersection Summary

Area Type: Other  
 Cycle Length: 120  
 Actuated Cycle Length: 120  
 Offset: 99 (83%), Referenced to phase 2:NBTL and 6:SBTL, Start of Green  
 Natural Cycle: 100  
 Control Type: Actuated-Coordinated  
 Maximum v/c Ratio: 0.93  
 Intersection Signal Delay: 24.2  
 Intersection LOS: C

Lanes, Volumes, Timings  
 1: March Road & Halton Terrace/Maxwell Bridge Road

2028 Future Total - AM  
 910 March Road

Intersection Capacity Utilization 94.1% ICU Level of Service F

Analysis Period (min) 15

# 95th percentile volume exceeds capacity, queue may be longer.  
 Queue shown is maximum after two cycles.

Splits and Phases: 1: March Road & Halton Terrace/Maxwell Bridge Road



HCM Signalized Intersection Capacity Analysis  
 1: March Road & Halton Terrace/Maxwell Bridge Road

2028 Future Total - AM  
 910 March Road



Movement	EBL	EBT	EBR	WBL	WBT	WBR	NBL	NBT	NBR	SBL	SBT	SBR
Lane Configurations												
Traffic Volume (vph)	103	37	158	126	17	51	99	527	64	79	1523	69
Future Volume (vph)	103	37	158	126	17	51	99	527	64	79	1523	69
Ideal Flow (vphpl)	1800	1800	1800	1800	1800	1800	1800	1800	1800	1800	1800	1800
Total Lost time (s)	6.6	6.6		6.6	6.6		7.4	6.6	6.6	6.4	6.6	6.6
Lane Util. Factor	1.00	1.00		1.00	1.00		1.00	0.95	1.00	1.00	0.95	1.00
Frbp, ped/bikes	1.00	0.99		1.00	1.00		1.00	1.00	0.98	1.00	1.00	1.00
Flpb, ped/bikes	1.00	1.00		1.00	1.00		1.00	1.00	1.00	1.00	1.00	1.00
Frt	1.00	0.88		1.00	0.89		1.00	1.00	0.85	1.00	1.00	0.85
Flt Protected	0.95	1.00		0.95	1.00		0.95	1.00	1.00	0.95	1.00	1.00
Satd. Flow (prot)	1658	1484		1657	1473		1551	3020	1380	1656	3316	1401
Flt Permitted	0.71	1.00		0.46	1.00		0.09	1.00	1.00	0.46	1.00	1.00
Satd. Flow (perm)	1244	1484		804	1473		142	3020	1380	796	3316	1401
Peak-hour factor, PHF	1.00	1.00	1.00	1.00	1.00	1.00	1.00	1.00	1.00	1.00	1.00	1.00
Adj. Flow (vph)	103	37	158	126	17	51	99	527	64	79	1523	69
RTOR Reduction (vph)	0	131	0	0	42	0	0	0	25	0	0	28
Lane Group Flow (vph)	103	64	0	126	26	0	99	527	39	79	1523	41
Confl. Peds. (#/hr)			1	1					2	2		
Heavy Vehicles (%)	2%	14%	2%	2%	2%	9%	9%	12%	7%	2%	2%	8%
Turn Type	Perm	NA		Perm	NA		pm+pt	NA	Perm	pm+pt	NA	Perm
Protected Phases		4			8		5	2		1	6	
Permitted Phases	4			8			2		2	6		6
Actuated Green, G (s)	20.2	20.2		20.2	20.2		82.4	74.0	74.0	77.0	70.8	70.8
Effective Green, g (s)	20.2	20.2		20.2	20.2		82.4	74.0	74.0	77.0	70.8	70.8
Actuated g/C Ratio	0.17	0.17		0.17	0.17		0.69	0.62	0.62	0.64	0.59	0.59
Clearance Time (s)	6.6	6.6		6.6	6.6		7.4	6.6	6.6	6.4	6.6	6.6
Vehicle Extension (s)	3.0	3.0		3.0	3.0		3.0	3.0	3.0	3.0	3.0	3.0
Lane Grp Cap (vph)	209	249		135	247		196	1862	851	555	1956	826
v/s Ratio Prot		0.04			0.02		c0.04	0.17		0.01	c0.46	
v/s Ratio Perm	0.08			c0.16			c0.31		0.03	0.08		0.03
v/c Ratio	0.49	0.26		0.93	0.10		0.51	0.28	0.05	0.14	0.78	0.05
Uniform Delay, d1	45.3	43.4		49.2	42.2		14.7	10.7	9.1	8.1	18.7	10.4
Progression Factor	1.00	1.00		1.00	1.00		1.00	1.00	1.00	1.00	1.00	1.00
Incremental Delay, d2	1.8	0.5		57.1	0.2		2.0	0.4	0.1	0.1	3.1	0.1
Delay (s)	47.1	43.9		106.3	42.4		16.8	11.1	9.2	8.2	21.8	10.5
Level of Service	D	D		F	D		B	B	A	A	C	B
Approach Delay (s)		45.0			83.9			11.7			20.7	
Approach LOS		D			F			B			C	
<b>Intersection Summary</b>												
HCM 2000 Control Delay			25.4				HCM 2000 Level of Service			C		
HCM 2000 Volume to Capacity ratio			0.79									
Actuated Cycle Length (s)			120.0				Sum of lost time (s)			20.6		
Intersection Capacity Utilization			94.1%				ICU Level of Service			F		
Analysis Period (min)			15									

c Critical Lane Group

Lanes, Volumes, Timings  
2: March Road & Klondike Road

2028 Future Total - AM  
910 March Road



Lane Group	EBL	EBT	EBR	WBL	WBT	WBR	NBL	NBT	NBR	SBL	SBT	SBR
Lane Configurations												
Traffic Volume (vph)	66	39	256	182	34	54	83	636	79	35	1583	58
Future Volume (vph)	66	39	256	182	34	54	83	636	79	35	1583	58
Ideal Flow (vphpl)	1800	1800	1800	1800	1800	1800	1800	1800	1800	1800	1800	1800
Storage Length (m)	100.0		5.0	15.0		0.0	100.0		0.0	45.0		0.0
Storage Lanes	1		1	1		0	2		0	1		0
Taper Length (m)	0.0			30.0			100.0			85.0		
Lane Util. Factor	1.00	1.00	1.00	1.00	1.00	1.00	0.97	0.91	0.91	1.00	0.91	0.91
Ped Bike Factor	1.00		0.98	0.99	0.99		1.00	1.00		1.00	1.00	
Fr <sub>t</sub>			0.850		0.908			0.983			0.995	
Fl <sub>t</sub> Protected	0.950			0.950			0.950			0.950		
Satd. Flow (prot)	1496	1679	1483	1658	1458	0	3124	4440	0	1433	4726	0
Fl <sub>t</sub> Permitted	0.549			0.732			0.950			0.950		
Satd. Flow (perm)	863	1679	1456	1270	1458	0	3122	4440	0	1428	4726	0
Right Turn on Red			Yes			Yes			Yes			Yes
Satd. Flow (RTOR)			156		54			20			5	
Link Speed (k/h)		50			50			80			80	
Link Distance (m)		117.7			346.6			261.8			142.1	
Travel Time (s)		8.5			25.0			11.8			6.4	
Confl. Peds. (#/hr)	3		6	6		3	3		4	4		3
Peak Hour Factor	1.00	1.00	1.00	1.00	1.00	1.00	1.00	1.00	1.00	1.00	1.00	1.00
Heavy Vehicles (%)	13%	6%	2%	2%	8%	11%	5%	7%	9%	18%	2%	9%
Adj. Flow (vph)	66	39	256	182	34	54	83	636	79	35	1583	58
Shared Lane Traffic (%)												
Lane Group Flow (vph)	66	39	256	182	88	0	83	715	0	35	1641	0
Enter Blocked Intersection	No	No	No	No	No	No	No	No	No	No	No	No
Lane Alignment	Left	Left	Right	Left	Left	Right	Left	Left	Right	Left	Left	Right
Median Width(m)		3.5			3.5			7.0			7.0	
Link Offset(m)		0.0			0.0			0.0			0.0	
Crosswalk Width(m)		3.0			3.0			3.0			3.0	
Two way Left Turn Lane												
Headway Factor	1.09	1.09	1.09	1.09	1.09	1.09	1.09	1.09	1.09	1.09	1.09	1.09
Turning Speed (k/h)	25		15	25		15	25		15	25		15
Number of Detectors	1	2	1	1	2		1	2		1	2	
Detector Template	Left	Thru	Right	Left	Thru		Left	Thru		Left	Thru	
Leading Detector (m)	2.0	10.0	2.0	2.0	10.0		2.0	10.0		2.0	10.0	
Trailing Detector (m)	0.0	0.0	0.0	0.0	0.0		0.0	0.0		0.0	0.0	
Detector 1 Position(m)	0.0	0.0	0.0	0.0	0.0		0.0	0.0		0.0	0.0	
Detector 1 Size(m)	2.0	0.6	2.0	2.0	0.6		2.0	0.6		2.0	0.6	
Detector 1 Type	Cl+Ex	Cl+Ex	Cl+Ex	Cl+Ex	Cl+Ex		Cl+Ex	Cl+Ex		Cl+Ex	Cl+Ex	
Detector 1 Channel												
Detector 1 Extend (s)	0.0	0.0	0.0	0.0	0.0		0.0	0.0		0.0	0.0	
Detector 1 Queue (s)	0.0	0.0	0.0	0.0	0.0		0.0	0.0		0.0	0.0	
Detector 1 Delay (s)	0.0	0.0	0.0	0.0	0.0		0.0	0.0		0.0	0.0	
Detector 2 Position(m)		9.4			9.4			9.4			9.4	
Detector 2 Size(m)		0.6			0.6			0.6			0.6	
Detector 2 Type		Cl+Ex			Cl+Ex			Cl+Ex			Cl+Ex	
Detector 2 Channel												
Detector 2 Extend (s)		0.0			0.0			0.0			0.0	

Lanes, Volumes, Timings  
2: March Road & Klondike Road

2028 Future Total - AM  
910 March Road



Lane Group	EBL	EBT	EBR	WBL	WBT	WBR	NBL	NBT	NBR	SBL	SBT	SBR
Turn Type	pm+pt	NA	Perm	Perm	NA		Prot	NA		Prot	NA	
Protected Phases	7	4			8		5	2		1	6	
Permitted Phases	4		4	8								
Detector Phase	7	4	4	8	8		5	2		1	6	
Switch Phase												
Minimum Initial (s)	5.0	5.0	5.0	5.0	5.0		5.0	5.0		5.0	5.0	
Minimum Split (s)	11.6	44.1	44.1	44.1	44.1		11.6	32.4		11.6	32.4	
Total Split (s)	12.0	57.0	57.0	45.0	45.0		15.0	58.0		15.0	58.0	
Total Split (%)	9.2%	43.8%	43.8%	34.6%	34.6%		11.5%	44.6%		11.5%	44.6%	
Maximum Green (s)	5.4	49.9	49.9	37.9	37.9		8.4	51.6		8.4	51.6	
Yellow Time (s)	3.3	3.3	3.3	3.3	3.3		4.6	4.6		4.6	4.6	
All-Red Time (s)	3.3	3.8	3.8	3.8	3.8		2.0	1.8		2.0	1.8	
Lost Time Adjust (s)	0.0	0.0	0.0	0.0	0.0		0.0	0.0		0.0	0.0	
Total Lost Time (s)	6.6	7.1	7.1	7.1	7.1		6.6	6.4		6.6	6.4	
Lead/Lag	Lead			Lag	Lag		Lead	Lag		Lead	Lag	
Lead-Lag Optimize?	Yes			Yes	Yes		Yes	Yes		Yes	Yes	
Vehicle Extension (s)	3.0	3.0	3.0	3.0	3.0		3.0	3.0		3.0	3.0	
Recall Mode	None	None	None	None	None		None	C-Max		None	C-Max	
Walk Time (s)		7.0	7.0	7.0	7.0			7.0			7.0	
Flash Dont Walk (s)		30.0	30.0	30.0	30.0			19.0			19.0	
Pedestrian Calls (#/hr)		0	0	0	0			0			0	
Act Effct Green (s)	34.1	33.6	33.6	24.0	24.0		8.8	72.8		8.7	67.5	
Actuated g/C Ratio	0.26	0.26	0.26	0.18	0.18		0.07	0.56		0.07	0.52	
v/c Ratio	0.26	0.09	0.52	0.78	0.28		0.39	0.29		0.37	0.67	
Control Delay	36.0	32.5	17.8	71.4	20.8		63.0	18.0		67.9	26.9	
Queue Delay	0.0	0.0	0.0	0.0	0.0		0.0	0.0		0.0	0.0	
Total Delay	36.0	32.5	17.8	71.4	20.8		63.0	18.0		67.9	26.9	
LOS	D	C	B	E	C		E	B		E	C	
Approach Delay		22.7			54.9			22.7			27.7	
Approach LOS		C			D			C			C	
Queue Length 50th (m)	12.7	7.4	20.1	44.8	7.4		10.6	37.5		8.7	114.2	
Queue Length 95th (m)	22.0	14.7	41.5	65.5	20.2		18.8	56.5		19.2	157.1	
Internal Link Dist (m)		93.7			322.6			237.8			118.1	
Turn Bay Length (m)	100.0		5.0	15.0			100.0			45.0		
Base Capacity (vph)	252	644	655	370	463		224	2495		104	2456	
Starvation Cap Reductn	0	0	0	0	0		0	0		0	0	
Spillback Cap Reductn	0	0	0	0	0		0	0		0	0	
Storage Cap Reductn	0	0	0	0	0		0	0		0	0	
Reduced v/c Ratio	0.26	0.06	0.39	0.49	0.19		0.37	0.29		0.34	0.67	

Intersection Summary

Area Type: Other  
 Cycle Length: 130  
 Actuated Cycle Length: 130  
 Offset: 64 (49%), Referenced to phase 2:NBT and 6:SBT, Start of Green  
 Natural Cycle: 110  
 Control Type: Actuated-Coordinated  
 Maximum v/c Ratio: 0.78  
 Intersection Signal Delay: 28.2  
 Intersection LOS: C

Intersection Capacity Utilization 81.3% ICU Level of Service D  
 Analysis Period (min) 15

Splits and Phases: 2: March Road & Klondike Road



# HCM Signalized Intersection Capacity Analysis

2028 Future Total - AM

## 2: March Road & Klondike Road

910 March Road



Movement	EBL	EBT	EBR	WBL	WBT	WBR	NBL	NBT	NBR	SBL	SBT	SBR
Lane Configurations	↖	↑	↗	↖	↗		↖↗	↑↑↑		↖	↑↑↑	
Traffic Volume (vph)	66	39	256	182	34	54	83	636	79	35	1583	58
Future Volume (vph)	66	39	256	182	34	54	83	636	79	35	1583	58
Ideal Flow (vphpl)	1800	1800	1800	1800	1800	1800	1800	1800	1800	1800	1800	1800
Total Lost time (s)	6.6	7.1	7.1	7.1	7.1		6.6	6.4		6.6	6.4	
Lane Util. Factor	1.00	1.00	1.00	1.00	1.00		0.97	0.91		1.00	0.91	
Frpb, ped/bikes	1.00	1.00	0.98	1.00	0.99		1.00	1.00		1.00	1.00	
Flpb, ped/bikes	1.00	1.00	1.00	0.99	1.00		1.00	1.00		1.00	1.00	
Frt	1.00	1.00	0.85	1.00	0.91		1.00	0.98		1.00	0.99	
Flt Protected	0.95	1.00	1.00	0.95	1.00		0.95	1.00		0.95	1.00	
Satd. Flow (prot)	1494	1679	1456	1648	1458		3124	4442		1433	4725	
Flt Permitted	0.55	1.00	1.00	0.73	1.00		0.95	1.00		0.95	1.00	
Satd. Flow (perm)	864	1679	1456	1269	1458		3124	4442		1433	4725	
Peak-hour factor, PHF	1.00	1.00	1.00	1.00	1.00	1.00	1.00	1.00	1.00	1.00	1.00	1.00
Adj. Flow (vph)	66	39	256	182	34	54	83	636	79	35	1583	58
RTOR Reduction (vph)	0	0	114	0	44	0	0	9	0	0	2	0
Lane Group Flow (vph)	66	39	142	182	44	0	83	706	0	35	1639	0
Confl. Peds. (#/hr)	3		6	6		3	3		4	4		3
Heavy Vehicles (%)	13%	6%	2%	2%	8%	11%	5%	7%	9%	18%	2%	9%
Turn Type	pm+pt	NA	Perm	Perm	NA		Prot	NA		Prot	NA	
Protected Phases	7	4			8		5	2		1	6	
Permitted Phases	4		4	8								
Actuated Green, G (s)	34.9	34.9	34.9	24.0	24.0		8.8	68.9		6.1	66.2	
Effective Green, g (s)	34.9	34.9	34.9	24.0	24.0		8.8	68.9		6.1	66.2	
Actuated g/C Ratio	0.27	0.27	0.27	0.18	0.18		0.07	0.53		0.05	0.51	
Clearance Time (s)	6.6	7.1	7.1	7.1	7.1		6.6	6.4		6.6	6.4	
Vehicle Extension (s)	3.0	3.0	3.0	3.0	3.0		3.0	3.0		3.0	3.0	
Lane Grp Cap (vph)	252	450	390	234	269		211	2354		67	2406	
v/s Ratio Prot	0.01	0.02			0.03		c0.03	c0.16		0.02	c0.35	
v/s Ratio Perm	0.06		c0.10	c0.14								
v/c Ratio	0.26	0.09	0.36	0.78	0.16		0.39	0.30		0.52	0.68	
Uniform Delay, d1	36.7	35.6	38.5	50.5	44.6		58.0	17.1		60.5	24.0	
Progression Factor	1.00	1.00	1.00	1.00	1.00		1.00	1.00		1.00	1.00	
Incremental Delay, d2	0.6	0.1	0.6	14.9	0.3		1.2	0.3		7.2	1.6	
Delay (s)	37.2	35.7	39.1	65.4	44.8		59.3	17.4		67.7	25.5	
Level of Service	D	D	D	E	D		E	B		E	C	
Approach Delay (s)		38.4			58.7			21.8			26.4	
Approach LOS		D			E			C			C	



















### Intersection Summary

HCM 2000 Control Delay	29.4	HCM 2000 Level of Service	C
HCM 2000 Volume to Capacity ratio	0.68		
Actuated Cycle Length (s)	130.0	Sum of lost time (s)	26.7
Intersection Capacity Utilization	81.3%	ICU Level of Service	D
Analysis Period (min)	15		

c Critical Lane Group

Lanes, Volumes, Timings  
3: March Road & South Local Road/Site Access

2028 Future Total - AM  
910 March Road

												
Lane Group	EBL	EBT	EBR	WBL	WBT	WBR	NBL	NBT	NBR	SBL	SBT	SBR
Lane Configurations												
Traffic Volume (vph)	5	2	30	51	3	6	4	650	26	3	1590	1
Future Volume (vph)	5	2	30	51	3	6	4	650	26	3	1590	1
Ideal Flow (vphpl)	1800	1800	1800	1800	1800	1800	1800	1800	1800	1800	1800	1800
Storage Length (m)	0.0		0.0	0.0		0.0	30.0		50.0	110.0		0.0
Storage Lanes	0		0	0		0	1		1	1		0
Taper Length (m)	15.0			15.0			15.0			95.0		
Lane Util. Factor	1.00	1.00	1.00	1.00	1.00	1.00	1.00	1.00	1.00	1.00	1.00	1.00
Frt		0.891			0.986				0.850			
Flt Protected		0.993			0.959		0.950			0.950		
Satd. Flow (prot)	0	1544	0	0	1650	0	1658	1745	1483	1658	1745	0
Flt Permitted		0.993			0.959		0.950			0.950		
Satd. Flow (perm)	0	1544	0	0	1650	0	1658	1745	1483	1658	1745	0
Link Speed (k/h)		50			30			80			80	
Link Distance (m)		84.7			77.2			78.1			262.6	
Travel Time (s)		6.1			9.3			3.5			11.8	
Peak Hour Factor	1.00	1.00	1.00	1.00	1.00	1.00	1.00	1.00	1.00	1.00	1.00	1.00
Adj. Flow (vph)	5	2	30	51	3	6	4	650	26	3	1590	1
Shared Lane Traffic (%)												
Lane Group Flow (vph)	0	37	0	0	60	0	4	650	26	3	1591	0
Enter Blocked Intersection	No	No	No	No	No	No	No	No	No	No	No	No
Lane Alignment	Left	Left	Right	Left	Left	Right	Left	Left	Right	Left	Left	Right
Median Width(m)		0.0			0.0			3.5			3.5	
Link Offset(m)		0.0			0.0			0.0			0.0	
Crosswalk Width(m)		3.0			3.0			3.0			3.0	
Two way Left Turn Lane												
Headway Factor	1.09	1.09	1.09	1.09	1.09	1.09	1.09	1.09	1.09	1.09	1.09	1.09
Turning Speed (k/h)	25		15	25		15	25		15	25		15
Sign Control		Stop			Stop			Free			Free	

Intersection Summary

Area Type:	Other
Control Type:	Unsignalized
Intersection Capacity Utilization	105.3%
ICU Level of Service	G
Analysis Period (min)	15



Intersection												
Int Delay, s/veh	27.3											
Movement	EBL	EBT	EBR	WBL	WBT	WBR	NBL	NBT	NBR	SBL	SBT	SBR
Lane Configurations		↕			↕		↑	↑	↑	↑	↑	
Traffic Vol, veh/h	5	2	30	51	3	6	4	650	26	3	1590	1
Future Vol, veh/h	5	2	30	51	3	6	4	650	26	3	1590	1
Conflicting Peds, #/hr	0	0	0	0	0	0	0	0	0	0	0	0
Sign Control	Stop	Stop	Stop	Stop	Stop	Stop	Free	Free	Free	Free	Free	Free
RT Channelized	-	-	None	-	-	None	-	-	None	-	-	None
Storage Length	-	-	-	-	-	-	30	-	50	110	-	-
Veh in Median Storage, #	-	0	-	-	0	-	-	0	-	-	0	-
Grade, %	-	0	-	-	0	-	-	0	-	-	0	-
Peak Hour Factor	100	100	100	100	100	100	100	100	100	100	100	100
Heavy Vehicles, %	2	2	2	2	2	2	2	2	2	2	2	2
Mvmt Flow	5	2	30	51	3	6	4	650	26	3	1590	1

Major/Minor	Minor2		Minor1		Major1		Major2					
Conflicting Flow All	2273	2281	1591	2271	2255	650	1591	0	0	676	0	0
Stage 1	1597	1597	-	658	658	-	-	-	-	-	-	-
Stage 2	676	684	-	1613	1597	-	-	-	-	-	-	-
Critical Hdwy	7.12	6.52	6.22	7.12	6.52	6.22	4.12	-	-	4.12	-	-
Critical Hdwy Stg 1	6.12	5.52	-	6.12	5.52	-	-	-	-	-	-	-
Critical Hdwy Stg 2	6.12	5.52	-	6.12	5.52	-	-	-	-	-	-	-
Follow-up Hdwy	3.518	4.018	3.318	3.518	4.018	3.318	2.218	-	-	2.218	-	-
Pot Cap-1 Maneuver	28	40	132	~29	41	469	412	-	-	915	-	-
Stage 1	134	166	-	453	461	-	-	-	-	-	-	-
Stage 2	443	449	-	131	166	-	-	-	-	-	-	-
Platoon blocked, %								-	-	-	-	-
Mov Cap-1 Maneuver	26	39	132	~21	40	469	412	-	-	915	-	-
Mov Cap-2 Maneuver	26	39	-	~21	40	-	-	-	-	-	-	-
Stage 1	133	166	-	448	456	-	-	-	-	-	-	-
Stage 2	430	445	-	100	166	-	-	-	-	-	-	-

Approach	EB	WB	NB	SB
HCM Control Delay, s	85.6	\$ 1024.2	0.1	0
HCM LOS	F	F		

Minor Lane/Major Mvmt	NBL	NBT	NBR	EBLn1WBLn1	SBL	SBT	SBR
Capacity (veh/h)	412	-	-	79	24	915	-
HCM Lane V/C Ratio	0.01	-	-	0.468	2.5	0.003	-
HCM Control Delay (s)	13.8	-	-	85.6	\$ 1024.2	8.9	-
HCM Lane LOS	B	-	-	F	F	A	-
HCM 95th %tile Q(veh)	0	-	-	1.9	7.5	0	-

Notes  
 ~: Volume exceeds capacity    \$: Delay exceeds 300s    +: Computation Not Defined    \*: All major volume in platoon

Lanes, Volumes, Timings  
 1: March Road & Halton Terrace/Maxwell Bridge Road

2028 Future Total - PM  
 910 March Road



Lane Group	EBL	EBT	EBR	WBL	WBT	WBR	NBL	NBT	NBR	SBL	SBT	SBR
Lane Configurations												
Traffic Volume (vph)	85	56	93	80	61	126	252	1503	115	111	665	99
Future Volume (vph)	85	56	93	80	61	126	252	1503	115	111	665	99
Ideal Flow (vphpl)	1800	1800	1800	1800	1800	1800	1800	1800	1800	1800	1800	1800
Storage Length (m)	30.0		0.0	30.0		0.0	60.0		0.0	70.0		15.0
Storage Lanes	1		0	1		0	1		1	1		1
Taper Length (m)	60.0			60.0			70.0			100.0		
Lane Util. Factor	1.00	1.00	1.00	1.00	1.00	1.00	1.00	0.95	1.00	1.00	0.95	1.00
Ped Bike Factor	0.99	0.98		0.98	0.98		1.00		0.96			0.98
Frt		0.906			0.899				0.850			0.850
Flt Protected	0.950			0.950			0.950			0.950		
Satd. Flow (prot)	1658	1485	0	1610	1538	0	1658	3316	1483	1658	3316	1483
Flt Permitted	0.420			0.546			0.358			0.111		
Satd. Flow (perm)	726	1485	0	911	1538	0	624	3316	1419	194	3316	1447
Right Turn on Red			Yes			Yes			Yes			Yes
Satd. Flow (RTOR)		73			91				100			100
Link Speed (k/h)		40			40			80				80
Link Distance (m)		143.7			356.2			324.9				231.3
Travel Time (s)		12.9			32.1			14.6				10.4
Confl. Peds. (#/hr)	11		17	17		11	2		11	11		2
Peak Hour Factor	1.00	1.00	1.00	1.00	1.00	1.00	1.00	1.00	1.00	1.00	1.00	1.00
Heavy Vehicles (%)	2%	9%	5%	5%	3%	2%	2%	2%	2%	2%	2%	2%
Adj. Flow (vph)	85	56	93	80	61	126	252	1503	115	111	665	99
Shared Lane Traffic (%)												
Lane Group Flow (vph)	85	149	0	80	187	0	252	1503	115	111	665	99
Enter Blocked Intersection	No	No	No	No	No	No	No	No	No	No	No	No
Lane Alignment	Left	Left	Right	Left	Left	Right	Left	Left	Right	Left	Left	Right
Median Width(m)		3.5			3.5			3.5				3.5
Link Offset(m)		0.0			0.0			0.0				0.0
Crosswalk Width(m)		3.0			3.0			3.0				3.0
Two way Left Turn Lane												
Headway Factor	1.09	1.09	1.09	1.09	1.09	1.09	1.09	1.09	1.09	1.09	1.09	1.09
Turning Speed (k/h)	25		15	25		15	25		15	25		15
Number of Detectors	1	2		1	2		1	2	1	1	2	1
Detector Template	Left	Thru		Left	Thru		Left	Thru	Right	Left	Thru	Right
Leading Detector (m)	2.0	10.0		2.0	10.0		2.0	10.0	2.0	2.0	10.0	2.0
Trailing Detector (m)	0.0	0.0		0.0	0.0		0.0	0.0	0.0	0.0	0.0	0.0
Detector 1 Position(m)	0.0	0.0		0.0	0.0		0.0	0.0	0.0	0.0	0.0	0.0
Detector 1 Size(m)	2.0	0.6		2.0	0.6		2.0	0.6	2.0	2.0	0.6	2.0
Detector 1 Type	Cl+Ex	Cl+Ex		Cl+Ex	Cl+Ex		Cl+Ex	Cl+Ex	Cl+Ex	Cl+Ex	Cl+Ex	Cl+Ex
Detector 1 Channel												
Detector 1 Extend (s)	0.0	0.0		0.0	0.0		0.0	0.0	0.0	0.0	0.0	0.0
Detector 1 Queue (s)	0.0	0.0		0.0	0.0		0.0	0.0	0.0	0.0	0.0	0.0
Detector 1 Delay (s)	0.0	0.0		0.0	0.0		0.0	0.0	0.0	0.0	0.0	0.0
Detector 2 Position(m)		9.4			9.4			9.4				9.4
Detector 2 Size(m)		0.6			0.6			0.6				0.6
Detector 2 Type		Cl+Ex			Cl+Ex			Cl+Ex				Cl+Ex
Detector 2 Channel												
Detector 2 Extend (s)		0.0			0.0			0.0				0.0

Lanes, Volumes, Timings  
 1: March Road & Halton Terrace/Maxwell Bridge Road

2028 Future Total - PM  
 910 March Road



Lane Group	EBL	EBT	EBR	WBL	WBT	WBR	NBL	NBT	NBR	SBL	SBT	SBR
Turn Type	Perm	NA		Perm	NA		pm+pt	NA	Perm	pm+pt	NA	Perm
Protected Phases		4			8		5	2		1	6	
Permitted Phases	4			8			2		2	6		6
Detector Phase	4	4		8	8		5	2	2	1	6	6
Switch Phase												
Minimum Initial (s)	10.0	10.0		10.0	10.0		5.0	10.0	10.0	5.0	10.0	10.0
Minimum Split (s)	38.6	38.6		38.6	38.6		12.4	34.6	34.6	11.4	34.6	34.6
Total Split (s)	45.0	45.0		45.0	45.0		20.0	55.0	55.0	20.0	55.0	55.0
Total Split (%)	37.5%	37.5%		37.5%	37.5%		16.7%	45.8%	45.8%	16.7%	45.8%	45.8%
Maximum Green (s)	38.4	38.4		38.4	38.4		12.6	48.4	48.4	13.6	48.4	48.4
Yellow Time (s)	3.3	3.3		3.3	3.3		4.6	4.6	4.6	4.6	4.6	4.6
All-Red Time (s)	3.3	3.3		3.3	3.3		2.8	2.0	2.0	1.8	2.0	2.0
Lost Time Adjust (s)	0.0	0.0		0.0	0.0		0.0	0.0	0.0	0.0	0.0	0.0
Total Lost Time (s)	6.6	6.6		6.6	6.6		7.4	6.6	6.6	6.4	6.6	6.6
Lead/Lag							Lead	Lag	Lag	Lead	Lag	Lag
Lead-Lag Optimize?							Yes	Yes	Yes	Yes	Yes	Yes
Vehicle Extension (s)	3.0	3.0		3.0	3.0		3.0	3.0	3.0	3.0	3.0	3.0
Recall Mode	None	None		None	None		None	C-Max	C-Max	None	C-Max	C-Max
Walk Time (s)	7.0	7.0		7.0	7.0			7.0	7.0		7.0	7.0
Flash Dont Walk (s)	25.0	25.0		25.0	25.0			21.0	21.0		21.0	21.0
Pedestrian Calls (#/hr)	0	0		0	0			0	0		0	0
Act Effct Green (s)	15.9	15.9		15.9	15.9		85.4	75.0	75.0	82.0	72.3	72.3
Actuated g/C Ratio	0.13	0.13		0.13	0.13		0.71	0.62	0.62	0.68	0.60	0.60
v/c Ratio	0.89	0.58		0.67	0.66		0.47	0.73	0.12	0.45	0.33	0.11
Control Delay	116.5	33.2		74.3	35.9		8.1	19.7	3.6	12.8	13.6	3.1
Queue Delay	0.0	0.0		0.0	0.0		0.0	0.0	0.0	0.0	0.0	0.0
Total Delay	116.5	33.2		74.3	35.9		8.1	19.7	3.6	12.8	13.6	3.1
LOS	F	C		E	D		A	B	A	B	B	A
Approach Delay		63.4			47.4			17.1			12.3	
Approach LOS		E			D			B			B	
Queue Length 50th (m)	20.0	16.7		18.3	21.5		14.7	116.4	1.2	5.6	37.6	0.0
Queue Length 95th (m)	#39.8	35.3		33.1	42.7		29.8	190.1	10.5	15.4	63.4	8.3
Internal Link Dist (m)		119.7			332.2			300.9			207.3	
Turn Bay Length (m)	30.0			30.0			60.0			70.0		15.0
Base Capacity (vph)	232	524		291	554		568	2073	924	307	1998	912
Starvation Cap Reductn	0	0		0	0		0	0	0	0	0	0
Spillback Cap Reductn	0	0		0	0		0	0	0	0	0	0
Storage Cap Reductn	0	0		0	0		0	0	0	0	0	0
Reduced v/c Ratio	0.37	0.28		0.27	0.34		0.44	0.73	0.12	0.36	0.33	0.11

Intersection Summary

Area Type: Other  
 Cycle Length: 120  
 Actuated Cycle Length: 120  
 Offset: 50 (42%), Referenced to phase 2:NBT and 6:SBT, Start of Green  
 Natural Cycle: 100  
 Control Type: Actuated-Coordinated  
 Maximum v/c Ratio: 0.89  
 Intersection Signal Delay: 21.7  
 Intersection LOS: C

Lanes, Volumes, Timings  
 1: March Road & Halton Terrace/Maxwell Bridge Road

2028 Future Total - PM  
 910 March Road

Intersection Capacity Utilization 97.8% ICU Level of Service F

Analysis Period (min) 15

# 95th percentile volume exceeds capacity, queue may be longer.  
 Queue shown is maximum after two cycles.

Splits and Phases: 1: March Road & Halton Terrace/Maxwell Bridge Road



HCM Signalized Intersection Capacity Analysis  
 1: March Road & Halton Terrace/Maxwell Bridge Road

2028 Future Total - PM  
 910 March Road



Movement	EBL	EBT	EBR	WBL	WBT	WBR	NBL	NBT	NBR	SBL	SBT	SBR
Lane Configurations												
Traffic Volume (vph)	85	56	93	80	61	126	252	1503	115	111	665	99
Future Volume (vph)	85	56	93	80	61	126	252	1503	115	111	665	99
Ideal Flow (vphpl)	1800	1800	1800	1800	1800	1800	1800	1800	1800	1800	1800	1800
Total Lost time (s)	6.6	6.6		6.6	6.6		7.4	6.6	6.6	6.4	6.6	6.6
Lane Util. Factor	1.00	1.00		1.00	1.00		1.00	0.95	1.00	1.00	0.95	1.00
Frpb, ped/bikes	1.00	0.98		1.00	0.98		1.00	1.00	0.96	1.00	1.00	0.98
Flpb, ped/bikes	0.99	1.00		0.99	1.00		1.00	1.00	1.00	1.00	1.00	1.00
Frt	1.00	0.91		1.00	0.90		1.00	1.00	0.85	1.00	1.00	0.85
Flt Protected	0.95	1.00		0.95	1.00		0.95	1.00	1.00	0.95	1.00	1.00
Satd. Flow (prot)	1643	1486		1587	1538		1657	3316	1419	1658	3316	1447
Flt Permitted	0.42	1.00		0.55	1.00		0.36	1.00	1.00	0.11	1.00	1.00
Satd. Flow (perm)	726	1486		912	1538		625	3316	1419	193	3316	1447
Peak-hour factor, PHF	1.00	1.00	1.00	1.00	1.00	1.00	1.00	1.00	1.00	1.00	1.00	1.00
Adj. Flow (vph)	85	56	93	80	61	126	252	1503	115	111	665	99
RTOR Reduction (vph)	0	63	0	0	79	0	0	0	38	0	0	39
Lane Group Flow (vph)	85	86	0	80	108	0	252	1503	78	111	665	60
Confl. Peds. (#/hr)	11		17	17		11	2		11	11		2
Heavy Vehicles (%)	2%	9%	5%	5%	3%	2%	2%	2%	2%	2%	2%	2%
Turn Type	Perm	NA		Perm	NA		pm+pt	NA	Perm	pm+pt	NA	Perm
Protected Phases		4			8		5	2		1	6	
Permitted Phases	4			8			2		2	6		6
Actuated Green, G (s)	15.9	15.9		15.9	15.9		86.2	75.0	75.0	81.8	72.3	72.3
Effective Green, g (s)	15.9	15.9		15.9	15.9		86.2	75.0	75.0	81.8	72.3	72.3
Actuated g/C Ratio	0.13	0.13		0.13	0.13		0.72	0.62	0.62	0.68	0.60	0.60
Clearance Time (s)	6.6	6.6		6.6	6.6		7.4	6.6	6.6	6.4	6.6	6.6
Vehicle Extension (s)	3.0	3.0		3.0	3.0		3.0	3.0	3.0	3.0	3.0	3.0
Lane Grp Cap (vph)	96	196		120	203		545	2072	886	247	1997	871
v/s Ratio Prot		0.06			0.07		c0.04	c0.45		0.04	0.20	
v/s Ratio Perm	c0.12			0.09			0.29		0.05	0.27		0.04
v/c Ratio	0.89	0.44		0.67	0.53		0.46	0.73	0.09	0.45	0.33	0.07
Uniform Delay, d1	51.2	47.9		49.5	48.6		6.0	15.4	8.9	11.0	11.9	9.9
Progression Factor	1.00	1.00		1.00	1.00		1.00	1.00	1.00	1.00	1.00	1.00
Incremental Delay, d2	56.1	1.6		13.1	2.7		0.6	2.3	0.2	1.3	0.4	0.2
Delay (s)	107.2	49.5		62.7	51.3		6.6	17.7	9.1	12.3	12.3	10.0
Level of Service	F	D		E	D		A	B	A	B	B	B
Approach Delay (s)		70.5			54.7			15.7			12.0	
Approach LOS		E			D			B			B	
<b>Intersection Summary</b>												
HCM 2000 Control Delay			21.9				HCM 2000 Level of Service				C	
HCM 2000 Volume to Capacity ratio			0.74									
Actuated Cycle Length (s)			120.0				Sum of lost time (s)				20.6	
Intersection Capacity Utilization			97.8%				ICU Level of Service				F	
Analysis Period (min)			15									

c Critical Lane Group

Lanes, Volumes, Timings  
2: March Road & Klondike Road

2028 Future Total - PM  
910 March Road



Lane Group	EBL	EBT	EBR	WBL	WBT	WBR	NBL	NBT	NBR	SBL	SBT	SBR
Lane Configurations												
Traffic Volume (vph)	115	31	111	115	37	41	161	1785	156	16	799	97
Future Volume (vph)	115	31	111	115	37	41	161	1785	156	16	799	97
Ideal Flow (vphpl)	1800	1800	1800	1800	1800	1800	1800	1800	1800	1800	1800	1800
Storage Length (m)	100.0		5.0	15.0		0.0	100.0		0.0	45.0		0.0
Storage Lanes	1		1	1		0	2		0	1		0
Taper Length (m)	0.0			30.0			100.0			85.0		
Lane Util. Factor	1.00	1.00	1.00	1.00	1.00	1.00	0.97	0.91	0.91	1.00	0.91	0.91
Ped Bike Factor	1.00		0.99	1.00	0.99		0.99	1.00		1.00	1.00	
Frt			0.850		0.921			0.988			0.984	
Flt Protected	0.950			0.950			0.950			0.950		
Satd. Flow (prot)	1658	1745	1483	1658	1567	0	3216	4689	0	1658	4676	0
Flt Permitted	0.509			0.737			0.950			0.950		
Satd. Flow (perm)	887	1745	1462	1284	1567	0	3198	4689	0	1655	4676	0
Right Turn on Red			Yes			Yes			Yes			Yes
Satd. Flow (RTOR)			111		41			12			18	
Link Speed (k/h)		50			50			80			80	
Link Distance (m)		117.7			346.6			261.8			142.1	
Travel Time (s)		8.5			25.0			11.8			6.4	
Confl. Peds. (#/hr)	1		2	2		1	8		11	11		8
Peak Hour Factor	1.00	1.00	1.00	1.00	1.00	1.00	1.00	1.00	1.00	1.00	1.00	1.00
Heavy Vehicles (%)	2%	2%	2%	2%	6%	2%	2%	2%	2%	2%	2%	2%
Adj. Flow (vph)	115	31	111	115	37	41	161	1785	156	16	799	97
Shared Lane Traffic (%)												
Lane Group Flow (vph)	115	31	111	115	78	0	161	1941	0	16	896	0
Enter Blocked Intersection	No	No	No	No	No	No	No	No	No	No	No	No
Lane Alignment	Left	Left	Right	Left	Left	Right	Left	Left	Right	Left	Left	Right
Median Width(m)		3.5			3.5			7.0			7.0	
Link Offset(m)		0.0			0.0			0.0			0.0	
Crosswalk Width(m)		3.0			3.0			3.0			3.0	
Two way Left Turn Lane												
Headway Factor	1.09	1.09	1.09	1.09	1.09	1.09	1.09	1.09	1.09	1.09	1.09	1.09
Turning Speed (k/h)	25		15	25		15	25		15	25		15
Number of Detectors	1	2	1	1	2		1	2		1	2	
Detector Template	Left	Thru	Right	Left	Thru		Left	Thru		Left	Thru	
Leading Detector (m)	2.0	10.0	2.0	2.0	10.0		2.0	10.0		2.0	10.0	
Trailing Detector (m)	0.0	0.0	0.0	0.0	0.0		0.0	0.0		0.0	0.0	
Detector 1 Position(m)	0.0	0.0	0.0	0.0	0.0		0.0	0.0		0.0	0.0	
Detector 1 Size(m)	2.0	0.6	2.0	2.0	0.6		2.0	0.6		2.0	0.6	
Detector 1 Type	Cl+Ex	Cl+Ex	Cl+Ex	Cl+Ex	Cl+Ex		Cl+Ex	Cl+Ex		Cl+Ex	Cl+Ex	
Detector 1 Channel												
Detector 1 Extend (s)	0.0	0.0	0.0	0.0	0.0		0.0	0.0		0.0	0.0	
Detector 1 Queue (s)	0.0	0.0	0.0	0.0	0.0		0.0	0.0		0.0	0.0	
Detector 1 Delay (s)	0.0	0.0	0.0	0.0	0.0		0.0	0.0		0.0	0.0	
Detector 2 Position(m)		9.4			9.4			9.4			9.4	
Detector 2 Size(m)		0.6			0.6			0.6			0.6	
Detector 2 Type		Cl+Ex			Cl+Ex			Cl+Ex			Cl+Ex	
Detector 2 Channel												
Detector 2 Extend (s)		0.0			0.0			0.0			0.0	

Lanes, Volumes, Timings  
2: March Road & Klondike Road

2028 Future Total - PM  
910 March Road



Lane Group	EBL	EBT	EBR	WBL	WBT	WBR	NBL	NBT	NBR	SBL	SBT	SBR
Turn Type	pm+pt	NA	Perm	Perm	NA		Prot	NA		Prot	NA	
Protected Phases	7	4			8		5	2		1	6	
Permitted Phases	4		4	8								
Detector Phase	7	4	4	8	8		5	2		1	6	
Switch Phase												
Minimum Initial (s)	5.0	5.0	5.0	5.0	5.0		5.0	5.0		5.0	5.0	
Minimum Split (s)	11.6	44.1	44.1	44.1	44.1		11.6	32.4		11.6	32.4	
Total Split (s)	12.0	57.0	57.0	45.0	45.0		22.0	51.0		22.0	51.0	
Total Split (%)	9.2%	43.8%	43.8%	34.6%	34.6%		16.9%	39.2%		16.9%	39.2%	
Maximum Green (s)	5.4	49.9	49.9	37.9	37.9		15.4	44.6		15.4	44.6	
Yellow Time (s)	3.3	3.3	3.3	3.3	3.3		4.6	4.6		4.6	4.6	
All-Red Time (s)	3.3	3.8	3.8	3.8	3.8		2.0	1.8		2.0	1.8	
Lost Time Adjust (s)	0.0	0.0	0.0	0.0	0.0		0.0	0.0		0.0	0.0	
Total Lost Time (s)	6.6	7.1	7.1	7.1	7.1		6.6	6.4		6.6	6.4	
Lead/Lag	Lead			Lag	Lag		Lead	Lag		Lead	Lag	
Lead-Lag Optimize?	Yes			Yes	Yes		Yes	Yes		Yes	Yes	
Vehicle Extension (s)	3.0	3.0	3.0	3.0	3.0		3.0	3.0		3.0	3.0	
Recall Mode	None	None	None	None	None		None	C-Max		None	C-Max	
Walk Time (s)		7.0	7.0	7.0	7.0			7.0			7.0	
Flash Dont Walk (s)		30.0	30.0	30.0	30.0			19.0			19.0	
Pedestrian Calls (#/hr)		0	0	0	0			0			0	
Act Effct Green (s)	29.5	29.0	29.0	17.0	17.0		11.8	81.6		6.8	69.1	
Actuated g/C Ratio	0.23	0.22	0.22	0.13	0.13		0.09	0.63		0.05	0.53	
v/c Ratio	0.49	0.08	0.27	0.68	0.33		0.55	0.66		0.18	0.36	
Control Delay	48.5	37.9	8.1	73.3	29.0		63.5	18.9		63.2	18.8	
Queue Delay	0.0	0.0	0.0	0.0	0.0		0.0	0.0		0.0	0.0	
Total Delay	48.5	37.9	8.1	73.3	29.0		63.5	18.9		63.2	18.8	
LOS	D	D	A	E	C		E	B		E	B	
Approach Delay		29.8			55.4			22.3			19.6	
Approach LOS		C			E			C			B	
Queue Length 50th (m)	24.7	6.3	0.0	28.5	8.6		20.7	92.8		4.0	46.0	
Queue Length 95th (m)	38.7	13.7	13.8	46.1	22.1		31.2	171.6		11.5	66.6	
Internal Link Dist (m)		93.7			322.6			237.8			118.1	
Turn Bay Length (m)	100.0		5.0	15.0			100.0			45.0		
Base Capacity (vph)	233	669	629	374	485		380	2946		196	2492	
Starvation Cap Reductn	0	0	0	0	0		0	0		0	0	
Spillback Cap Reductn	0	0	0	0	0		0	0		0	0	
Storage Cap Reductn	0	0	0	0	0		0	0		0	0	
Reduced v/c Ratio	0.49	0.05	0.18	0.31	0.16		0.42	0.66		0.08	0.36	

Intersection Summary

Area Type: Other  
 Cycle Length: 130  
 Actuated Cycle Length: 130  
 Offset: 20 (15%), Referenced to phase 2:NBT and 6:SBT, Start of Green  
 Natural Cycle: 120  
 Control Type: Actuated-Coordinated  
 Maximum v/c Ratio: 0.68  
 Intersection Signal Delay: 24.0  
 Intersection LOS: C

Intersection Capacity Utilization 75.6% ICU Level of Service D  
 Analysis Period (min) 15

Splits and Phases: 2: March Road & Klondike Road





HCM Signalized Intersection Capacity Analysis  
2: March Road & Klondike Road

2028 Future Total - PM  
910 March Road



Movement	EBL	EBT	EBR	WBL	WBT	WBR	NBL	NBT	NBR	SBL	SBT	SBR
Lane Configurations												
Traffic Volume (vph)	115	31	111	115	37	41	161	1785	156	16	799	97
Future Volume (vph)	115	31	111	115	37	41	161	1785	156	16	799	97
Ideal Flow (vphpl)	1800	1800	1800	1800	1800	1800	1800	1800	1800	1800	1800	1800
Total Lost time (s)	6.6	7.1	7.1	7.1	7.1		6.6	6.4		6.6	6.4	
Lane Util. Factor	1.00	1.00	1.00	1.00	1.00		0.97	0.91		1.00	0.91	
Frpb, ped/bikes	1.00	1.00	0.99	1.00	0.99		1.00	1.00		1.00	1.00	
Flpb, ped/bikes	1.00	1.00	1.00	1.00	1.00		1.00	1.00		1.00	1.00	
Frt	1.00	1.00	0.85	1.00	0.92		1.00	0.99		1.00	0.98	
Flt Protected	0.95	1.00	1.00	0.95	1.00		0.95	1.00		0.95	1.00	
Satd. Flow (prot)	1657	1745	1462	1654	1567		3216	4689		1658	4675	
Flt Permitted	0.51	1.00	1.00	0.74	1.00		0.95	1.00		0.95	1.00	
Satd. Flow (perm)	887	1745	1462	1283	1567		3216	4689		1658	4675	
Peak-hour factor, PHF	1.00	1.00	1.00	1.00	1.00	1.00	1.00	1.00	1.00	1.00	1.00	1.00
Adj. Flow (vph)	115	31	111	115	37	41	161	1785	156	16	799	97
RTOR Reduction (vph)	0	0	86	0	36	0	0	5	0	0	8	0
Lane Group Flow (vph)	115	31	25	115	42	0	161	1936	0	16	888	0
Confl. Peds. (#/hr)	1		2	2		1	8		11	11		8
Heavy Vehicles (%)	2%	2%	2%	2%	6%	2%	2%	2%	2%	2%	2%	2%
Turn Type	pm+pt	NA	Perm	Perm	NA		Prot	NA		Prot	NA	
Protected Phases	7	4			8		5	2		1	6	
Permitted Phases	4		4	8								
Actuated Green, G (s)	29.0	29.0	29.0	17.0	17.0		11.8	77.7		3.2	69.1	
Effective Green, g (s)	29.0	29.0	29.0	17.0	17.0		11.8	77.7		3.2	69.1	
Actuated g/C Ratio	0.22	0.22	0.22	0.13	0.13		0.09	0.60		0.02	0.53	
Clearance Time (s)	6.6	7.1	7.1	7.1	7.1		6.6	6.4		6.6	6.4	
Vehicle Extension (s)	3.0	3.0	3.0	3.0	3.0		3.0	3.0		3.0	3.0	
Lane Grp Cap (vph)	229	389	326	167	204		291	2802		40	2484	
v/s Ratio Prot	c0.02	0.02			0.03		c0.05	c0.41		0.01	0.19	
v/s Ratio Perm	0.09		0.02	c0.09								
v/c Ratio	0.50	0.08	0.08	0.69	0.21		0.55	0.69		0.40	0.36	
Uniform Delay, d1	44.0	39.9	39.9	54.0	50.5		56.6	17.9		62.5	17.6	
Progression Factor	1.00	1.00	1.00	1.00	1.00		1.00	1.00		1.00	1.00	
Incremental Delay, d2	1.7	0.1	0.1	11.2	0.5		2.3	1.4		6.4	0.4	
Delay (s)	45.8	40.0	40.0	65.2	51.0		58.8	19.3		68.9	18.0	
Level of Service	D	D	D	E	D		E	B		E	B	
Approach Delay (s)		42.6			59.4			22.4			18.9	
Approach LOS		D			E			C			B	
<b>Intersection Summary</b>												
HCM 2000 Control Delay			25.0				HCM 2000 Level of Service			C		
HCM 2000 Volume to Capacity ratio			0.71									
Actuated Cycle Length (s)			130.0				Sum of lost time (s)			26.7		
Intersection Capacity Utilization			75.6%				ICU Level of Service			D		
Analysis Period (min)			15									

c Critical Lane Group

Lanes, Volumes, Timings  
3: March Road & South Local Road/Site Access

2028 Future Total - PM  
910 March Road



Lane Group	EBL	EBT	EBR	WBL	WBT	WBR	NBL	NBT	NBR	SBL	SBT	SBR
Lane Configurations		↕			↕		↗	↑	↗	↗	↗	↗
Traffic Volume (vph)	5	3	49	39	2	11	23	1633	58	9	787	12
Future Volume (vph)	5	3	49	39	2	11	23	1633	58	9	787	12
Ideal Flow (vphpl)	1800	1800	1800	1800	1800	1800	1800	1800	1800	1800	1800	1800
Storage Length (m)	0.0		0.0	0.0		0.0	30.0		50.0	110.0		0.0
Storage Lanes	0		0	0		0	1		1	1		0
Taper Length (m)	15.0			15.0			15.0			95.0		
Lane Util. Factor	1.00	1.00	1.00	1.00	1.00	1.00	1.00	1.00	1.00	1.00	1.00	1.00
Frt		0.884			0.971				0.850		0.998	
Flt Protected		0.996			0.964		0.950			0.950		
Satd. Flow (prot)	0	1536	0	0	1633	0	1658	1745	1483	1658	1742	0
Flt Permitted		0.996			0.964		0.950			0.950		
Satd. Flow (perm)	0	1536	0	0	1633	0	1658	1745	1483	1658	1742	0
Link Speed (k/h)		50			30			80			80	
Link Distance (m)		100.3			69.7			80.8			213.6	
Travel Time (s)		7.2			8.4			3.6			9.6	
Peak Hour Factor	1.00	1.00	1.00	1.00	1.00	1.00	1.00	1.00	1.00	1.00	1.00	1.00
Adj. Flow (vph)	5	3	49	39	2	11	23	1633	58	9	787	12
Shared Lane Traffic (%)												
Lane Group Flow (vph)	0	57	0	0	52	0	23	1633	58	9	799	0
Enter Blocked Intersection	No	No	No	No	No	No	No	No	No	No	No	No
Lane Alignment	Left	Left	Right	Left	Left	Right	Left	Left	Right	Left	Left	Right
Median Width(m)		0.0			0.0			3.5			3.5	
Link Offset(m)		0.0			0.0			0.0			0.0	
Crosswalk Width(m)		3.0			3.0			3.0			3.0	
Two way Left Turn Lane												
Headway Factor	1.09	1.09	1.09	1.09	1.09	1.09	1.09	1.09	1.09	1.09	1.09	1.09
Turning Speed (k/h)	25		15	25		15	25		15	25		15
Sign Control		Stop			Stop			Free			Free	

Intersection Summary	
Area Type:	Other
Control Type:	Unsignalized
Intersection Capacity Utilization	107.2%
ICU Level of Service	G
Analysis Period (min)	15

Intersection												
Int Delay, s/veh	25.6											
Movement	EBL	EBT	EBR	WBL	WBT	WBR	NBL	NBT	NBR	SBL	SBT	SBR
Lane Configurations		↕			↕		↕	↑	↑	↕	↕	↕
Traffic Vol, veh/h	5	3	49	39	2	11	23	1633	58	9	787	12
Future Vol, veh/h	5	3	49	39	2	11	23	1633	58	9	787	12
Conflicting Peds, #/hr	0	0	0	0	0	0	0	0	0	0	0	0
Sign Control	Stop	Stop	Stop	Stop	Stop	Stop	Free	Free	Free	Free	Free	Free
RT Channelized	-	-	None	-	-	None	-	-	None	-	-	None
Storage Length	-	-	-	-	-	-	30	-	50	110	-	-
Veh in Median Storage, #	-	0	-	-	0	-	-	0	-	-	0	-
Grade, %	-	0	-	-	0	-	-	0	-	-	0	-
Peak Hour Factor	100	100	100	100	100	100	100	100	100	100	100	100
Heavy Vehicles, %	2	2	2	2	2	2	2	2	2	2	2	2
Mvmt Flow	5	3	49	39	2	11	23	1633	58	9	787	12

Major/Minor	Minor2		Minor1		Major1			Major2				
Conflicting Flow All	2526	2548	793	2516	2496	1633	799	0	0	1691	0	0
Stage 1	811	811	-	1679	1679	-	-	-	-	-	-	-
Stage 2	1715	1737	-	837	817	-	-	-	-	-	-	-
Critical Hdwy	7.12	6.52	6.22	7.12	6.52	6.22	4.12	-	-	4.12	-	-
Critical Hdwy Stg 1	6.12	5.52	-	6.12	5.52	-	-	-	-	-	-	-
Critical Hdwy Stg 2	6.12	5.52	-	6.12	5.52	-	-	-	-	-	-	-
Follow-up Hdwy	3.518	4.018	3.318	3.518	4.018	3.318	2.218	-	-	2.218	-	-
Pot Cap-1 Maneuver	19	27	389	~ 19	29	125	824	-	-	377	-	-
Stage 1	373	393	-	120	151	-	-	-	-	-	-	-
Stage 2	114	141	-	361	390	-	-	-	-	-	-	-
Platoon blocked, %								-	-	-	-	-
Mov Cap-1 Maneuver	16	26	389	~ 15	28	125	824	-	-	377	-	-
Mov Cap-2 Maneuver	16	26	-	~ 15	28	-	-	-	-	-	-	-
Stage 1	363	384	-	117	147	-	-	-	-	-	-	-
Stage 2	100	137	-	306	381	-	-	-	-	-	-	-

Approach	EB	WB	NB	SB
HCM Control Delay, s	76.6	\$ 1206.6	0.1	0.2
HCM LOS	F	F		

Minor Lane/Major Mvmt	NBL	NBT	NBR	EBLn1WBLn1	SBL	SBT	SBR
Capacity (veh/h)	824	-	-	103	19	377	-
HCM Lane V/C Ratio	0.028	-	-	0.553	2.737	0.024	-
HCM Control Delay (s)	9.5	-	-	76.6	1206.6	14.8	-
HCM Lane LOS	A	-	-	F	F	B	-
HCM 95th %tile Q(veh)	0.1	-	-	2.6	6.9	0.1	-

Notes  
 ~: Volume exceeds capacity    \$: Delay exceeds 300s    +: Computation Not Defined    \*: All major volume in platoon

Lanes, Volumes, Timings  
 3: March Road & South Local Road/Site Access

2028 Future Total AM - RIRO  
 910 March Road



Lane Group	EBL	EBT	EBR	WBL	WBT	WBR	NBL	NBT	NBR	SBL	SBT	SBR
Lane Configurations												
Traffic Volume (vph)	0	0	37	0	0	60	0	658	31	0	1588	1
Future Volume (vph)	0	0	37	0	0	60	0	658	31	0	1588	1
Ideal Flow (vphpl)	1800	1800	1800	1800	1800	1800	1800	1800	1800	1800	1800	1800
Storage Length (m)	0.0		0.0	0.0		0.0	0.0		50.0	110.0		0.0
Storage Lanes	0		1	0		1	0		1	0		0
Taper Length (m)	15.0			15.0			15.0			95.0		
Lane Util. Factor	1.00	1.00	1.00	1.00	1.00	1.00	1.00	1.00	1.00	1.00	1.00	1.00
Frt			0.865			0.865			0.850			
Flt Protected												
Satd. Flow (prot)	0	0	1510	0	0	1510	0	1745	1483	0	1745	0
Flt Permitted												
Satd. Flow (perm)	0	0	1510	0	0	1510	0	1745	1483	0	1745	0
Link Speed (k/h)		50			30			80			80	
Link Distance (m)		84.7			77.2			81.6			262.6	
Travel Time (s)		6.1			9.3			3.7			11.8	
Peak Hour Factor	1.00	1.00	1.00	1.00	1.00	1.00	1.00	1.00	1.00	1.00	1.00	1.00
Adj. Flow (vph)	0	0	37	0	0	60	0	658	31	0	1588	1
Shared Lane Traffic (%)												
Lane Group Flow (vph)	0	0	37	0	0	60	0	658	31	0	1589	0
Enter Blocked Intersection	No	No	No	No	No	No	No	No	No	No	No	No
Lane Alignment	Left	Left	Right	Left	Left	Right	Left	Left	Right	Left	Left	Right
Median Width(m)		0.0			0.0			0.0			0.0	
Link Offset(m)		0.0			0.0			0.0			0.0	
Crosswalk Width(m)		3.0			3.0			3.0			3.0	
Two way Left Turn Lane												
Headway Factor	1.09	1.09	1.09	1.09	1.09	1.09	1.09	1.09	1.09	1.09	1.09	1.09
Turning Speed (k/h)	25		15	25		15	25		15	25		15
Sign Control		Stop			Stop			Free			Free	

Intersection Summary

Area Type:	Other
Control Type:	Unsignalized
Intersection Capacity Utilization	98.3%
ICU Level of Service	F
Analysis Period (min)	15

Intersection												
Int Delay, s/veh	1											
Movement	EBL	EBT	EBR	WBL	WBT	WBR	NBL	NBT	NBR	SBL	SBT	SBR
Lane Configurations			↗			↗		↖	↗		↖	
Traffic Vol, veh/h	0	0	37	0	0	60	0	658	31	0	1588	1
Future Vol, veh/h	0	0	37	0	0	60	0	658	31	0	1588	1
Conflicting Peds, #/hr	0	0	0	0	0	0	0	0	0	0	0	0
Sign Control	Stop	Stop	Stop	Stop	Stop	Stop	Free	Free	Free	Free	Free	Free
RT Channelized	-	-	None	-	-	None	-	-	None	-	-	None
Storage Length	-	-	0	-	-	0	-	-	50	-	-	-
Veh in Median Storage, #	-	0	-	-	0	-	-	0	-	-	0	-
Grade, %	-	0	-	-	0	-	-	0	-	-	0	-
Peak Hour Factor	100	100	100	100	100	100	100	100	100	100	100	100
Heavy Vehicles, %	2	2	2	2	2	2	2	2	2	2	2	2
Mvmt Flow	0	0	37	0	0	60	0	658	31	0	1588	1

















Major/Minor	Minor2		Minor1		Major1		Major2					
Conflicting Flow All	-	-	1589	-	-	658	-	0	0	-	-	0
Stage 1	-	-	-	-	-	-	-	-	-	-	-	-
Stage 2	-	-	-	-	-	-	-	-	-	-	-	-
Critical Hdwy	-	-	6.22	-	-	6.22	-	-	-	-	-	-
Critical Hdwy Stg 1	-	-	-	-	-	-	-	-	-	-	-	-
Critical Hdwy Stg 2	-	-	-	-	-	-	-	-	-	-	-	-
Follow-up Hdwy	-	-	3.318	-	-	3.318	-	-	-	-	-	-
Pot Cap-1 Maneuver	0	0	133	0	0	464	0	-	-	0	-	-
Stage 1	0	0	-	0	0	-	0	-	-	0	-	-
Stage 2	0	0	-	0	0	-	0	-	-	0	-	-
Platoon blocked, %	-	-	-	-	-	-	-	-	-	-	-	-
Mov Cap-1 Maneuver	-	-	133	-	-	464	-	-	-	-	-	-
Mov Cap-2 Maneuver	-	-	-	-	-	-	-	-	-	-	-	-
Stage 1	-	-	-	-	-	-	-	-	-	-	-	-
Stage 2	-	-	-	-	-	-	-	-	-	-	-	-

Approach	EB		WB		NB		SB	
HCM Control Delay, s	42.2		13.9		0		0	
HCM LOS	E		B					

Minor Lane/Major Mvmt	NBT	NBR	EBLn1	WBLn1	SBT	SBR
Capacity (veh/h)	-	-	133	464	-	-
HCM Lane V/C Ratio	-	-	0.278	0.129	-	-
HCM Control Delay (s)	-	-	42.2	13.9	-	-
HCM Lane LOS	-	-	E	B	-	-
HCM 95th %tile Q(veh)	-	-	1.1	0.4	-	-

Lanes, Volumes, Timings  
3: March Road & South Local Road/Site Access

2028 Future Total PM - RIRO  
910 March Road

												
Lane Group	EBL	EBT	EBR	WBL	WBT	WBR	NBL	NBT	NBR	SBL	SBT	SBR
Lane Configurations												
Traffic Volume (vph)	0	0	57	0	0	52	0	1686	67	0	801	12
Future Volume (vph)	0	0	57	0	0	52	0	1686	67	0	801	12
Ideal Flow (vphpl)	1800	1800	1800	1800	1800	1800	1800	1800	1800	1800	1800	1800
Storage Length (m)	0.0		0.0	20.0		0.0	0.0		50.0	110.0		0.0
Storage Lanes	0		1	0		1	0		1	0		0
Taper Length (m)	15.0			15.0			15.0			95.0		
Lane Util. Factor	1.00	1.00	1.00	1.00	1.00	1.00	1.00	1.00	1.00	1.00	1.00	1.00
Frt			0.865			0.865			0.850		0.998	
Flt Protected												
Satd. Flow (prot)	0	0	1510	0	0	1510	0	1745	1483	0	1742	0
Flt Permitted												
Satd. Flow (perm)	0	0	1510	0	0	1510	0	1745	1483	0	1742	0
Link Speed (k/h)		50			30			80			80	
Link Distance (m)		100.3			69.7			75.7			213.6	
Travel Time (s)		7.2			8.4			3.4			9.6	
Peak Hour Factor	1.00	1.00	1.00	1.00	1.00	1.00	1.00	1.00	1.00	1.00	1.00	1.00
Adj. Flow (vph)	0	0	57	0	0	52	0	1686	67	0	801	12
Shared Lane Traffic (%)												
Lane Group Flow (vph)	0	0	57	0	0	52	0	1686	67	0	813	0
Enter Blocked Intersection	No	No	No	No	No	No	No	No	No	No	No	No
Lane Alignment	Left	Left	Right	Left	Left	Right	Left	Left	Right	Left	Left	Right
Median Width(m)		0.0			0.0			0.0			0.0	
Link Offset(m)		0.0			0.0			0.0			0.0	
Crosswalk Width(m)		3.0			3.0			3.0			3.0	
Two way Left Turn Lane												
Headway Factor	1.09	1.09	1.09	1.09	1.09	1.09	1.09	1.09	1.09	1.09	1.09	1.09
Turning Speed (k/h)	25		15	25		15	25		15	25		15
Sign Control		Stop			Stop			Free			Free	
<b>Intersection Summary</b>												
Area Type:	Other											
Control Type:	Unsignalized											
Intersection Capacity Utilization	103.7%						ICU Level of Service G					
Analysis Period (min)	15											

Intersection												
Int Delay, s/veh	1.5											
Movement	EBL	EBT	EBR	WBL	WBT	WBR	NBL	NBT	NBR	SBL	SBT	SBR
Lane Configurations			↗			↗		↖	↗		↖	
Traffic Vol, veh/h	0	0	57	0	0	52	0	1686	67	0	801	12
Future Vol, veh/h	0	0	57	0	0	52	0	1686	67	0	801	12
Conflicting Peds, #/hr	0	0	0	0	0	0	0	0	0	0	0	0
Sign Control	Stop	Stop	Stop	Stop	Stop	Stop	Free	Free	Free	Free	Free	Free
RT Channelized	-	-	None	-	-	None	-	-	None	-	-	None
Storage Length	-	-	0	-	-	0	-	-	50	-	-	-
Veh in Median Storage, #	-	0	-	-	0	-	-	0	-	-	0	-
Grade, %	-	0	-	-	0	-	-	0	-	-	0	-
Peak Hour Factor	100	100	100	100	100	100	100	100	100	100	100	100
Heavy Vehicles, %	2	2	2	2	2	2	2	2	2	2	2	2
Mvmt Flow	0	0	57	0	0	52	0	1686	67	0	801	12

Major/Minor	Minor2		Minor1		Major1		Major2	
Conflicting Flow All	-	-	807	-	-	1686	-	0
Stage 1	-	-	-	-	-	-	-	-
Stage 2	-	-	-	-	-	-	-	-
Critical Hdwy	-	-	6.22	-	-	6.22	-	-
Critical Hdwy Stg 1	-	-	-	-	-	-	-	-
Critical Hdwy Stg 2	-	-	-	-	-	-	-	-
Follow-up Hdwy	-	-	3.318	-	-	3.318	-	-
Pot Cap-1 Maneuver	0	0	381	0	0	116	0	-
Stage 1	0	0	-	0	0	-	0	-
Stage 2	0	0	-	0	0	-	0	-
Platoon blocked, %	-	-	-	-	-	-	-	-
Mov Cap-1 Maneuver	-	-	381	-	-	116	-	-
Mov Cap-2 Maneuver	-	-	-	-	-	-	-	-
Stage 1	-	-	-	-	-	-	-	-
Stage 2	-	-	-	-	-	-	-	-

Approach	EB	WB	NB	SB
HCM Control Delay, s	16.1	59.1	0	0
HCM LOS	C	F		

Minor Lane/Major Mvmt	NBT	NBR	EBLn1WBLn1	SBT	SBR
Capacity (veh/h)	-	-	381	116	-
HCM Lane V/C Ratio	-	-	0.15	0.448	-
HCM Control Delay (s)	-	-	16.1	59.1	-
HCM Lane LOS	-	-	C	F	-
HCM 95th %tile Q(veh)	-	-	0.5	2	-

# Appendix P

Synchro Intersection Worksheets – 2028 Future Total Interim Conditions



Lanes, Volumes, Timings  
 1: March Road & Halton Terrace/Maxwell Bridge Road

2028 FT AM - Interim  
 910 March Road



Lane Group	EBL	EBT	EBR	WBL	WBT	WBR	NBL	NBT	NBR	SBL	SBT	SBR
Lane Configurations												
Traffic Volume (vph)	23	37	96	126	16	25	23	208	62	72	885	15
Future Volume (vph)	23	37	96	126	16	25	23	208	62	72	885	15
Ideal Flow (vphpl)	1800	1800	1800	1800	1800	1800	1800	1800	1800	1800	1800	1800
Storage Length (m)	30.0		0.0	30.0		0.0	60.0		0.0	70.0		15.0
Storage Lanes	1		0	1		0	1		1	1		1
Taper Length (m)	60.0			60.0			70.0			100.0		
Lane Util. Factor	1.00	1.00	1.00	1.00	1.00	1.00	1.00	0.95	1.00	1.00	0.95	1.00
Ped Bike Factor		0.99		1.00					0.98	1.00		
Fr <sub>t</sub>		0.892			0.909				0.850			0.850
Fl <sub>t</sub> Protected	0.950			0.950			0.950			0.950		
Satd. Flow (prot)	1658	1493	0	1658	1523	0	1551	3020	1414	1658	3316	1401
Fl <sub>t</sub> Permitted	0.730			0.617			0.291			0.613		
Satd. Flow (perm)	1274	1493	0	1076	1523	0	475	3020	1380	1066	3316	1401
Right Turn on Red			Yes			Yes			Yes			Yes
Satd. Flow (RTOR)		96			25				100			100
Link Speed (k/h)		40			40			80			80	
Link Distance (m)		143.7			356.2			324.9			130.5	
Travel Time (s)		12.9			32.1			14.6			5.9	
Confl. Peds. (#/hr)			1	1					2	2		
Peak Hour Factor	1.00	1.00	1.00	1.00	1.00	1.00	1.00	1.00	1.00	1.00	1.00	1.00
Heavy Vehicles (%)	2%	14%	2%	2%	2%	9%	9%	12%	7%	2%	2%	8%
Adj. Flow (vph)	23	37	96	126	16	25	23	208	62	72	885	15
Shared Lane Traffic (%)												
Lane Group Flow (vph)	23	133	0	126	41	0	23	208	62	72	885	15
Enter Blocked Intersection	No	No	No	No	No	No	No	No	No	No	No	No
Lane Alignment	Left	Left	Right	Left	Left	Right	Left	Left	Right	Left	Left	Right
Median Width(m)		3.5			3.5			3.5			3.5	
Link Offset(m)		0.0			0.0			0.0			0.0	
Crosswalk Width(m)		3.0			3.0			3.0			3.0	
Two way Left Turn Lane												
Headway Factor	1.09	1.09	1.09	1.09	1.09	1.09	1.09	1.09	1.09	1.09	1.09	1.09
Turning Speed (k/h)	25		15	25		15	25		15	25		15
Number of Detectors	1	2		1	2		1	2	1	1	2	1
Detector Template	Left	Thru		Left	Thru		Left	Thru	Right	Left	Thru	Right
Leading Detector (m)	2.0	10.0		2.0	10.0		2.0	10.0	2.0	2.0	10.0	2.0
Trailing Detector (m)	0.0	0.0		0.0	0.0		0.0	0.0	0.0	0.0	0.0	0.0
Detector 1 Position(m)	0.0	0.0		0.0	0.0		0.0	0.0	0.0	0.0	0.0	0.0
Detector 1 Size(m)	2.0	0.6		2.0	0.6		2.0	0.6	2.0	2.0	0.6	2.0
Detector 1 Type	Cl+Ex	Cl+Ex		Cl+Ex	Cl+Ex		Cl+Ex	Cl+Ex	Cl+Ex	Cl+Ex	Cl+Ex	Cl+Ex
Detector 1 Channel												
Detector 1 Extend (s)	0.0	0.0		0.0	0.0		0.0	0.0	0.0	0.0	0.0	0.0
Detector 1 Queue (s)	0.0	0.0		0.0	0.0		0.0	0.0	0.0	0.0	0.0	0.0
Detector 1 Delay (s)	0.0	0.0		0.0	0.0		0.0	0.0	0.0	0.0	0.0	0.0
Detector 2 Position(m)		9.4			9.4			9.4			9.4	
Detector 2 Size(m)		0.6			0.6			0.6			0.6	
Detector 2 Type		Cl+Ex			Cl+Ex			Cl+Ex			Cl+Ex	
Detector 2 Channel												
Detector 2 Extend (s)		0.0			0.0			0.0			0.0	

Lanes, Volumes, Timings  
1: March Road & Halton Terrace/Maxwell Bridge Road

2028 FT AM - Interim  
910 March Road



Lane Group	EBL	EBT	EBR	WBL	WBT	WBR	NBL	NBT	NBR	SBL	SBT	SBR
Turn Type	Perm	NA		Perm	NA		pm+pt	NA	Perm	pm+pt	NA	Perm
Protected Phases		4			8		5	2		1	6	
Permitted Phases	4			8			2		2	6		6
Detector Phase	4	4		8	8		5	2	2	1	6	6
Switch Phase												
Minimum Initial (s)	10.0	10.0		10.0	10.0		5.0	10.0	10.0	5.0	10.0	10.0
Minimum Split (s)	38.6	38.6		38.6	38.6		12.4	34.6	34.6	11.4	34.6	34.6
Total Split (s)	48.0	48.0		48.0	48.0		20.0	52.0	52.0	20.0	52.0	52.0
Total Split (%)	40.0%	40.0%		40.0%	40.0%		16.7%	43.3%	43.3%	16.7%	43.3%	43.3%
Maximum Green (s)	41.4	41.4		41.4	41.4		12.6	45.4	45.4	13.6	45.4	45.4
Yellow Time (s)	3.3	3.3		3.3	3.3		4.6	4.6	4.6	4.6	4.6	4.6
All-Red Time (s)	3.3	3.3		3.3	3.3		2.8	2.0	2.0	1.8	2.0	2.0
Lost Time Adjust (s)	0.0	0.0		0.0	0.0		0.0	0.0	0.0	0.0	0.0	0.0
Total Lost Time (s)	6.6	6.6		6.6	6.6		7.4	6.6	6.6	6.4	6.6	6.6
Lead/Lag							Lead	Lag	Lag	Lead	Lag	Lag
Lead-Lag Optimize?							Yes	Yes	Yes	Yes	Yes	Yes
Vehicle Extension (s)	3.0	3.0		3.0	3.0		3.0	3.0	3.0	3.0	3.0	3.0
Recall Mode	None	None		None	None		None	C-Max	C-Max	None	C-Max	C-Max
Walk Time (s)	7.0	7.0		7.0	7.0			7.0	7.0		7.0	7.0
Flash Dont Walk (s)	25.0	25.0		25.0	25.0			21.0	21.0		21.0	21.0
Pedestrian Calls (#/hr)	0	0		0	0			0	0		0	0
Act Effct Green (s)	18.4	18.4		18.4	18.4		81.5	77.4	77.4	85.0	80.1	80.1
Actuated g/C Ratio	0.15	0.15		0.15	0.15		0.68	0.64	0.64	0.71	0.67	0.67
v/c Ratio	0.12	0.43		0.77	0.16		0.06	0.11	0.07	0.09	0.40	0.02
Control Delay	41.9	18.5		76.0	22.4		6.5	10.1	0.8	5.8	11.6	0.0
Queue Delay	0.0	0.0		0.0	0.0		0.0	0.0	0.0	0.0	0.0	0.0
Total Delay	41.9	18.5		76.0	22.4		6.5	10.1	0.8	5.8	11.6	0.0
LOS	D	B		E	C		A	B	A	A	B	A
Approach Delay		22.0			62.9			7.9			11.0	
Approach LOS		C			E			A			B	
Queue Length 50th (m)	4.7	7.7		28.8	3.3		1.3	9.6	0.0	4.1	52.1	0.0
Queue Length 95th (m)	11.4	23.8		46.5	12.3		4.5	18.4	2.1	10.3	80.8	0.0
Internal Link Dist (m)		119.7			332.2			300.9			106.5	
Turn Bay Length (m)	30.0			30.0			60.0			70.0		15.0
Base Capacity (vph)	439	577		371	541		455	1947	925	852	2214	969
Starvation Cap Reductn	0	0		0	0		0	0	0	0	0	0
Spillback Cap Reductn	0	0		0	0		0	0	0	0	0	0
Storage Cap Reductn	0	0		0	0		0	0	0	0	0	0
Reduced v/c Ratio	0.05	0.23		0.34	0.08		0.05	0.11	0.07	0.08	0.40	0.02

Intersection Summary

Area Type: Other  
 Cycle Length: 120  
 Actuated Cycle Length: 120  
 Offset: 99 (83%), Referenced to phase 2:NBTL and 6:SBTL, Start of Green  
 Natural Cycle: 90  
 Control Type: Actuated-Coordinated  
 Maximum v/c Ratio: 0.77  
 Intersection Signal Delay: 17.0  
 Intersection LOS: B

Intersection Capacity Utilization 70.0% ICU Level of Service C  
 Analysis Period (min) 15

Splits and Phases: 1: March Road & Halton Terrace/Maxwell Bridge Road

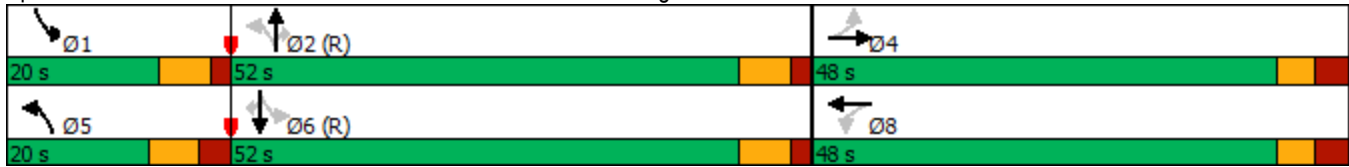

HCM Signalized Intersection Capacity Analysis  
 1: March Road & Halton Terrace/Maxwell Bridge Road

2028 FT AM - Interim  
 910 March Road



Movement	EBL	EBT	EBR	WBL	WBT	WBR	NBL	NBT	NBR	SBL	SBT	SBR
Lane Configurations	↖	↗		↖	↗		↖	↑↑	↗	↖	↑↑	↗
Traffic Volume (vph)	23	37	96	126	16	25	23	208	62	72	885	15
Future Volume (vph)	23	37	96	126	16	25	23	208	62	72	885	15
Ideal Flow (vphpl)	1800	1800	1800	1800	1800	1800	1800	1800	1800	1800	1800	1800
Total Lost time (s)	6.6	6.6		6.6	6.6		7.4	6.6	6.6	6.4	6.6	6.6
Lane Util. Factor	1.00	1.00		1.00	1.00		1.00	0.95	1.00	1.00	0.95	1.00
Frbp, ped/bikes	1.00	0.99		1.00	1.00		1.00	1.00	0.98	1.00	1.00	1.00
Flpb, ped/bikes	1.00	1.00		1.00	1.00		1.00	1.00	1.00	1.00	1.00	1.00
Frt	1.00	0.89		1.00	0.91		1.00	1.00	0.85	1.00	1.00	0.85
Flt Protected	0.95	1.00		0.95	1.00		0.95	1.00	1.00	0.95	1.00	1.00
Satd. Flow (prot)	1658	1493		1656	1522		1551	3020	1380	1655	3316	1401
Flt Permitted	0.73	1.00		0.62	1.00		0.29	1.00	1.00	0.61	1.00	1.00
Satd. Flow (perm)	1274	1493		1076	1522		475	3020	1380	1067	3316	1401
Peak-hour factor, PHF	1.00	1.00	1.00	1.00	1.00	1.00	1.00	1.00	1.00	1.00	1.00	1.00
Adj. Flow (vph)	23	37	96	126	16	25	23	208	62	72	885	15
RTOR Reduction (vph)	0	81	0	0	21	0	0	0	23	0	0	5
Lane Group Flow (vph)	23	52	0	126	20	0	23	208	39	72	885	10
Confl. Peds. (#/hr)			1	1					2	2		
Heavy Vehicles (%)	2%	14%	2%	2%	2%	9%	9%	12%	7%	2%	2%	8%
Turn Type	Perm	NA		Perm	NA		pm+pt	NA	Perm	pm+pt	NA	Perm
Protected Phases		4			8		5	2		1	6	
Permitted Phases	4			8			2		2	6		6
Actuated Green, G (s)	18.4	18.4		18.4	18.4		79.9	76.1	76.1	83.1	77.2	77.2
Effective Green, g (s)	18.4	18.4		18.4	18.4		79.9	76.1	76.1	83.1	77.2	77.2
Actuated g/C Ratio	0.15	0.15		0.15	0.15		0.67	0.63	0.63	0.69	0.64	0.64
Clearance Time (s)	6.6	6.6		6.6	6.6		7.4	6.6	6.6	6.4	6.6	6.6
Vehicle Extension (s)	3.0	3.0		3.0	3.0		3.0	3.0	3.0	3.0	3.0	3.0
Lane Grp Cap (vph)	195	228		164	233		350	1915	875	767	2133	901
v/s Ratio Prot		0.03			0.01		0.00	0.07		c0.00	c0.27	
v/s Ratio Perm	0.02			c0.12			0.04		0.03	0.06		0.01
v/c Ratio	0.12	0.23		0.77	0.09		0.07	0.11	0.04	0.09	0.41	0.01
Uniform Delay, d1	43.8	44.6		48.8	43.6		7.0	8.6	8.3	5.9	10.4	7.7
Progression Factor	1.00	1.00		1.00	1.00		1.00	1.00	1.00	1.00	1.00	1.00
Incremental Delay, d2	0.3	0.5		19.2	0.2		0.1	0.1	0.1	0.1	0.6	0.0
Delay (s)	44.1	45.1		67.9	43.7		7.1	8.7	8.4	6.0	11.0	7.7
Level of Service	D	D		E	D		A	A	A	A	B	A
Approach Delay (s)		44.9			62.0			8.5			10.6	
Approach LOS		D			E			A			B	

Intersection Summary		
HCM 2000 Control Delay	19.0	HCM 2000 Level of Service
HCM 2000 Volume to Capacity ratio	0.47	B
Actuated Cycle Length (s)	120.0	Sum of lost time (s)
Intersection Capacity Utilization	70.0%	20.6
Analysis Period (min)	15	ICU Level of Service
		C

c Critical Lane Group

Lanes, Volumes, Timings  
2: March Road & Klondike Road

2028 FT AM - Interim  
910 March Road



Lane Group	EBL	EBT	EBR	WBL	WBT	WBR	NBL	NBT	NBR	SBL	SBT	SBR
Lane Configurations												
Traffic Volume (vph)	32	35	256	92	25	21	83	305	44	20	958	36
Future Volume (vph)	32	35	256	92	25	21	83	305	44	20	958	36
Ideal Flow (vphpl)	1800	1800	1800	1800	1800	1800	1800	1800	1800	1800	1800	1800
Storage Length (m)	100.0		5.0	15.0		0.0	100.0		0.0	45.0		0.0
Storage Lanes	1		1	1		0	2		0	1		0
Taper Length (m)	0.0			30.0			100.0			85.0		
Lane Util. Factor	1.00	1.00	1.00	1.00	1.00	1.00	0.97	0.91	0.91	1.00	0.91	0.91
Ped Bike Factor	1.00		0.98	0.99	0.99		1.00	1.00		0.99	1.00	
Fr <sub>t</sub>			0.850		0.932			0.981			0.995	
Fl <sub>t</sub> Protected	0.950			0.950			0.950			0.950		
Satd. Flow (prot)	1496	1679	1483	1658	1506	0	3124	4428	0	1433	4726	0
Fl <sub>t</sub> Permitted	0.503			0.734			0.950			0.950		
Satd. Flow (perm)	790	1679	1456	1273	1506	0	3118	4428	0	1424	4726	0
Right Turn on Red			Yes			Yes			Yes			Yes
Satd. Flow (RTOR)			188		21			24			5	
Link Speed (k/h)		50			50			80			80	
Link Distance (m)		117.7			346.6			261.8			142.1	
Travel Time (s)		8.5			25.0			11.8			6.4	
Confl. Peds. (#/hr)	3		6	6		3	3		4	4		3
Peak Hour Factor	1.00	1.00	1.00	1.00	1.00	1.00	1.00	1.00	1.00	1.00	1.00	1.00
Heavy Vehicles (%)	13%	6%	2%	2%	8%	11%	5%	7%	9%	18%	2%	9%
Adj. Flow (vph)	32	35	256	92	25	21	83	305	44	20	958	36
Shared Lane Traffic (%)												
Lane Group Flow (vph)	32	35	256	92	46	0	83	349	0	20	994	0
Enter Blocked Intersection	No	No	No	No	No	No	No	No	No	No	No	No
Lane Alignment	Left	Left	Right	Left	Left	Right	Left	Left	Right	Left	Left	Right
Median Width(m)		3.5			3.5			7.0			7.0	
Link Offset(m)		0.0			0.0			0.0			0.0	
Crosswalk Width(m)		3.0			3.0			3.0			3.0	
Two way Left Turn Lane												
Headway Factor	1.09	1.09	1.09	1.09	1.09	1.09	1.09	1.09	1.09	1.09	1.09	1.09
Turning Speed (k/h)	25		15	25		15	25		15	25		15
Number of Detectors	1	2	1	1	2		1	2		1	2	
Detector Template	Left	Thru	Right	Left	Thru		Left	Thru		Left	Thru	
Leading Detector (m)	2.0	10.0	2.0	2.0	10.0		2.0	10.0		2.0	10.0	
Trailing Detector (m)	0.0	0.0	0.0	0.0	0.0		0.0	0.0		0.0	0.0	
Detector 1 Position(m)	0.0	0.0	0.0	0.0	0.0		0.0	0.0		0.0	0.0	
Detector 1 Size(m)	2.0	0.6	2.0	2.0	0.6		2.0	0.6		2.0	0.6	
Detector 1 Type	Cl+Ex	Cl+Ex	Cl+Ex	Cl+Ex	Cl+Ex		Cl+Ex	Cl+Ex		Cl+Ex	Cl+Ex	
Detector 1 Channel												
Detector 1 Extend (s)	0.0	0.0	0.0	0.0	0.0		0.0	0.0		0.0	0.0	
Detector 1 Queue (s)	0.0	0.0	0.0	0.0	0.0		0.0	0.0		0.0	0.0	
Detector 1 Delay (s)	0.0	0.0	0.0	0.0	0.0		0.0	0.0		0.0	0.0	
Detector 2 Position(m)		9.4			9.4			9.4			9.4	
Detector 2 Size(m)		0.6			0.6			0.6			0.6	
Detector 2 Type		Cl+Ex			Cl+Ex			Cl+Ex			Cl+Ex	
Detector 2 Channel												
Detector 2 Extend (s)		0.0			0.0			0.0			0.0	

Lanes, Volumes, Timings  
2: March Road & Klondike Road

2028 FT AM - Interim  
910 March Road



Lane Group	EBL	EBT	EBR	WBL	WBT	WBR	NBL	NBT	NBR	SBL	SBT	SBR
Turn Type	pm+pt	NA	Perm	Perm	NA		Prot	NA		Prot	NA	
Protected Phases	7	4			8		5	2		1	6	
Permitted Phases	4		4	8								
Detector Phase	7	4	4	8	8		5	2		1	6	
Switch Phase												
Minimum Initial (s)	5.0	5.0	5.0	5.0	5.0		5.0	5.0		5.0	5.0	
Minimum Split (s)	11.6	44.1	44.1	44.1	44.1		11.6	32.4		11.6	32.4	
Total Split (s)	12.0	57.0	57.0	45.0	45.0		15.0	58.0		15.0	58.0	
Total Split (%)	9.2%	43.8%	43.8%	34.6%	34.6%		11.5%	44.6%		11.5%	44.6%	
Maximum Green (s)	5.4	49.9	49.9	37.9	37.9		8.4	51.6		8.4	51.6	
Yellow Time (s)	3.3	3.3	3.3	3.3	3.3		4.6	4.6		4.6	4.6	
All-Red Time (s)	3.3	3.8	3.8	3.8	3.8		2.0	1.8		2.0	1.8	
Lost Time Adjust (s)	0.0	0.0	0.0	0.0	0.0		0.0	0.0		0.0	0.0	
Total Lost Time (s)	6.6	7.1	7.1	7.1	7.1		6.6	6.4		6.6	6.4	
Lead/Lag	Lead			Lag	Lag		Lead	Lag		Lead	Lag	
Lead-Lag Optimize?	Yes			Yes	Yes		Yes	Yes		Yes	Yes	
Vehicle Extension (s)	3.0	3.0	3.0	3.0	3.0		3.0	3.0		3.0	3.0	
Recall Mode	None	None	None	None	None		None	C-Max		None	C-Max	
Walk Time (s)		7.0	7.0	7.0	7.0			7.0			7.0	
Flash Dont Walk (s)		30.0	30.0	30.0	30.0			19.0			19.0	
Pedestrian Calls (#/hr)		0	0	0	0			0			0	
Act Effct Green (s)	22.5	22.0	22.0	14.8	14.8		8.8	88.2		7.4	79.1	
Actuated g/C Ratio	0.17	0.17	0.17	0.11	0.11		0.07	0.68		0.06	0.61	
v/c Ratio	0.19	0.12	0.64	0.64	0.24		0.39	0.12		0.25	0.35	
Control Delay	43.0	41.7	20.3	73.6	34.4		63.0	9.5		65.1	14.6	
Queue Delay	0.0	0.0	0.0	0.0	0.0		0.0	0.0		0.0	0.0	
Total Delay	43.0	41.7	20.3	73.6	34.4		63.0	9.5		65.1	14.6	
LOS	D	D	C	E	C		E	A		E	B	
Approach Delay		24.9			60.5			19.7			15.6	
Approach LOS		C			E			B			B	
Queue Length 50th (m)	6.7	7.3	14.7	22.9	5.9		10.6	9.3		5.0	48.0	
Queue Length 95th (m)	14.6	15.4	39.4	39.1	16.9		18.8	21.4		13.3	68.0	
Internal Link Dist (m)		93.7			322.6			237.8			118.1	
Turn Bay Length (m)	100.0		5.0	15.0			100.0			45.0		
Base Capacity (vph)	166	644	674	371	453		224	3013		95	2878	
Starvation Cap Reductn	0	0	0	0	0		0	0		0	0	
Spillback Cap Reductn	0	0	0	0	0		0	0		0	0	
Storage Cap Reductn	0	0	0	0	0		0	0		0	0	
Reduced v/c Ratio	0.19	0.05	0.38	0.25	0.10		0.37	0.12		0.21	0.35	

Intersection Summary

Area Type: Other  
 Cycle Length: 130  
 Actuated Cycle Length: 130  
 Offset: 64 (49%), Referenced to phase 2:NBT and 6:SBT, Start of Green  
 Natural Cycle: 100  
 Control Type: Actuated-Coordinated  
 Maximum v/c Ratio: 0.64  
 Intersection Signal Delay: 21.4  
 Intersection LOS: C

Intersection Capacity Utilization 64.0% ICU Level of Service C  
 Analysis Period (min) 15

Splits and Phases: 2: March Road & Klondike Road



HCM Signalized Intersection Capacity Analysis  
2: March Road & Klondike Road

2028 FT AM - Interim  
910 March Road



Movement	EBL	EBT	EBR	WBL	WBT	WBR	NBL	NBT	NBR	SBL	SBT	SBR
Lane Configurations	↘	↑	↗	↘	↗		↘↗	↑↑↑		↘	↑↑↑	
Traffic Volume (vph)	32	35	256	92	25	21	83	305	44	20	958	36
Future Volume (vph)	32	35	256	92	25	21	83	305	44	20	958	36
Ideal Flow (vphpl)	1800	1800	1800	1800	1800	1800	1800	1800	1800	1800	1800	1800
Total Lost time (s)	6.6	7.1	7.1	7.1	7.1		6.6	6.4		6.6	6.4	
Lane Util. Factor	1.00	1.00	1.00	1.00	1.00		0.97	0.91		1.00	0.91	
Frpb, ped/bikes	1.00	1.00	0.98	1.00	0.99		1.00	1.00		1.00	1.00	
Flpb, ped/bikes	1.00	1.00	1.00	0.99	1.00		1.00	1.00		1.00	1.00	
Frt	1.00	1.00	0.85	1.00	0.93		1.00	0.98		1.00	0.99	
Flt Protected	0.95	1.00	1.00	0.95	1.00		0.95	1.00		0.95	1.00	
Satd. Flow (prot)	1495	1679	1456	1648	1506		3124	4428		1433	4724	
Flt Permitted	0.50	1.00	1.00	0.73	1.00		0.95	1.00		0.95	1.00	
Satd. Flow (perm)	791	1679	1456	1274	1506		3124	4428		1433	4724	
Peak-hour factor, PHF	1.00	1.00	1.00	1.00	1.00	1.00	1.00	1.00	1.00	1.00	1.00	1.00
Adj. Flow (vph)	32	35	256	92	25	21	83	305	44	20	958	36
RTOR Reduction (vph)	0	0	152	0	19	0	0	9	0	0	2	0
Lane Group Flow (vph)	32	35	104	92	27	0	83	340	0	20	992	0
Confl. Peds. (#/hr)	3		6	6		3	3		4	4		3
Heavy Vehicles (%)	13%	6%	2%	2%	8%	11%	5%	7%	9%	18%	2%	9%
Turn Type	pm+pt	NA	Perm	Perm	NA		Prot	NA		Prot	NA	
Protected Phases	7	4			8		5	2		1	6	
Permitted Phases	4		4	8								
Actuated Green, G (s)	24.6	24.6	24.6	14.8	14.8		8.8	81.7		3.6	76.5	
Effective Green, g (s)	24.6	24.6	24.6	14.8	14.8		8.8	81.7		3.6	76.5	
Actuated g/C Ratio	0.19	0.19	0.19	0.11	0.11		0.07	0.63		0.03	0.59	
Clearance Time (s)	6.6	7.1	7.1	7.1	7.1		6.6	6.4		6.6	6.4	
Vehicle Extension (s)	3.0	3.0	3.0	3.0	3.0		3.0	3.0		3.0	3.0	
Lane Grp Cap (vph)	167	317	275	145	171		211	2782		39	2779	
v/s Ratio Prot	0.00	0.02			0.02		c0.03	c0.08		0.01	c0.21	
v/s Ratio Perm	0.03		c0.07	c0.07								
v/c Ratio	0.19	0.11	0.38	0.63	0.16		0.39	0.12		0.51	0.36	
Uniform Delay, d1	43.8	43.6	46.0	55.0	52.0		58.0	9.7		62.3	13.9	
Progression Factor	1.00	1.00	1.00	1.00	1.00		1.00	1.00		1.00	1.00	
Incremental Delay, d2	0.6	0.2	0.9	8.8	0.4		1.2	0.1		10.9	0.4	
Delay (s)	44.4	43.8	46.9	63.8	52.4		59.3	9.8		73.3	14.3	
Level of Service	D	D	D	E	D		E	A		E	B	
Approach Delay (s)		46.3			60.0			19.3			15.5	
Approach LOS		D			E			B			B	

Intersection Summary











HCM 2000 Control Delay	24.8	HCM 2000 Level of Service	C
HCM 2000 Volume to Capacity ratio	0.41		
Actuated Cycle Length (s)	130.0	Sum of lost time (s)	26.7
Intersection Capacity Utilization	64.0%	ICU Level of Service	C
Analysis Period (min)	15		

c Critical Lane Group



Lanes, Volumes, Timings  
3: March Road & Site Access

2028 FT AM - Interim  
910 March Road

						
Lane Group	WBL	WBR	NBT	NBR	SBL	SBT
Lane Configurations						
Traffic Volume (vph)	53	7	229	26	4	921
Future Volume (vph)	53	7	229	26	4	921
Ideal Flow (vphpl)	1800	1800	1800	1800	1800	1800
Storage Length (m)	0.0	0.0		50.0	110.0	
Storage Lanes	1	0		1	1	
Taper Length (m)	15.0				95.0	
Lane Util. Factor	1.00	1.00	1.00	1.00	1.00	1.00
Frt	0.984			0.850		
Flt Protected	0.958				0.950	
Satd. Flow (prot)	1645	0	1745	1483	1658	1745
Flt Permitted	0.958				0.950	
Satd. Flow (perm)	1645	0	1745	1483	1658	1745
Link Speed (k/h)	30		80			80
Link Distance (m)	77.2		83.4			262.6
Travel Time (s)	9.3		3.8			11.8
Peak Hour Factor	1.00	1.00	1.00	1.00	1.00	1.00
Adj. Flow (vph)	53	7	229	26	4	921
Shared Lane Traffic (%)						
Lane Group Flow (vph)	60	0	229	26	4	921
Enter Blocked Intersection	No	No	No	No	No	No
Lane Alignment	Left	Right	Left	Right	Left	Left
Median Width(m)	3.5		3.5			3.5
Link Offset(m)	0.0		0.0			0.0
Crosswalk Width(m)	3.0		3.0			3.0
Two way Left Turn Lane						
Headway Factor	1.09	1.09	1.09	1.09	1.09	1.09
Turning Speed (k/h)	25	15		15	25	
Sign Control	Stop		Free			Free
<b>Intersection Summary</b>						
Area Type:	Other					
Control Type:	Unsignalized					
Intersection Capacity Utilization	61.4%			ICU Level of Service B		
Analysis Period (min)	15					

Intersection						
Int Delay, s/veh	1.2					
Movement	WBL	WBR	NBT	NBR	SBL	SBT
Lane Configurations	↔		↑	↑	↔	↑
Traffic Vol, veh/h	53	7	229	26	4	921
Future Vol, veh/h	53	7	229	26	4	921
Conflicting Peds, #/hr	0	0	0	0	0	0
Sign Control	Stop	Stop	Free	Free	Free	Free
RT Channelized	-	None	-	None	-	None
Storage Length	0	-	-	50	110	-
Veh in Median Storage, #	0	-	0	-	-	0
Grade, %	0	-	0	-	-	0
Peak Hour Factor	100	100	100	100	100	100
Heavy Vehicles, %	2	2	2	2	2	2
Mvmt Flow	53	7	229	26	4	921

Major/Minor	Minor1	Major1	Major2		
Conflicting Flow All	1158	229	0	0	255
Stage 1	229	-	-	-	-
Stage 2	929	-	-	-	-
Critical Hdwy	6.42	6.22	-	-	4.12
Critical Hdwy Stg 1	5.42	-	-	-	-
Critical Hdwy Stg 2	5.42	-	-	-	-
Follow-up Hdwy	3.518	3.318	-	-	2.218
Pot Cap-1 Maneuver	217	810	-	-	1310
Stage 1	809	-	-	-	-
Stage 2	385	-	-	-	-
Platoon blocked, %			-	-	-
Mov Cap-1 Maneuver	216	810	-	-	1310
Mov Cap-2 Maneuver	216	-	-	-	-
Stage 1	809	-	-	-	-
Stage 2	384	-	-	-	-

Approach	WB	NB	SB
HCM Control Delay, s	25.4	0	0
HCM LOS	D		

Minor Lane/Major Mvmt	NBT	NBRWBLn1	SBL	SBT
Capacity (veh/h)	-	-	236	1310
HCM Lane V/C Ratio	-	-	0.254	0.003
HCM Control Delay (s)	-	-	25.4	7.8
HCM Lane LOS	-	-	D	A
HCM 95th %tile Q(veh)	-	-	1	0

Lanes, Volumes, Timings  
 1: March Road & Halton Terrace/Maxwell Bridge Road

2028 FT PM - Interim  
 910 March Road



Lane Group	EBL	EBT	EBR	WBL	WBT	WBR	NBL	NBT	NBR	SBL	SBT	SBR
Lane Configurations												
Traffic Volume (vph)	20	56	41	80	59	93	174	954	115	62	279	14
Future Volume (vph)	20	56	41	80	59	93	174	954	115	62	279	14
Ideal Flow (vphpl)	1800	1800	1800	1800	1800	1800	1800	1800	1800	1800	1800	1800
Storage Length (m)	30.0		0.0	30.0		0.0	60.0		0.0	70.0		15.0
Storage Lanes	1		0	1		0	1		1	1		1
Taper Length (m)	60.0			60.0			70.0			100.0		
Lane Util. Factor	1.00	1.00	1.00	1.00	1.00	1.00	1.00	0.95	1.00	1.00	0.95	1.00
Ped Bike Factor		0.99		1.00					0.98	1.00		
Fr <sub>t</sub>		0.937			0.908				0.850			0.850
Fl <sub>t</sub> Protected	0.950			0.950			0.950			0.950		
Satd. Flow (prot)	1658	1523	0	1658	1521	0	1551	3020	1414	1658	3316	1401
Fl <sub>t</sub> Permitted	0.509			0.694			0.547			0.285		
Satd. Flow (perm)	888	1523	0	1210	1521	0	893	3020	1380	497	3316	1401
Right Turn on Red			Yes			Yes			Yes			Yes
Satd. Flow (RTOR)		32			70				115			100
Link Speed (k/h)		40			40			80				80
Link Distance (m)		143.7			356.2			324.9				133.9
Travel Time (s)		12.9			32.1			14.6				6.0
Confl. Peds. (#/hr)			1	1					2	2		
Peak Hour Factor	1.00	1.00	1.00	1.00	1.00	1.00	1.00	1.00	1.00	1.00	1.00	1.00
Heavy Vehicles (%)	2%	14%	2%	2%	2%	9%	9%	12%	7%	2%	2%	8%
Adj. Flow (vph)	20	56	41	80	59	93	174	954	115	62	279	14
Shared Lane Traffic (%)												
Lane Group Flow (vph)	20	97	0	80	152	0	174	954	115	62	279	14
Enter Blocked Intersection	No	No	No	No	No	No	No	No	No	No	No	No
Lane Alignment	Left	Left	Right	Left	Left	Right	Left	Left	Right	Left	Left	Right
Median Width(m)		3.5			3.5			3.5				3.5
Link Offset(m)		0.0			0.0			0.0				0.0
Crosswalk Width(m)		3.0			3.0			3.0				3.0
Two way Left Turn Lane												
Headway Factor	1.09	1.09	1.09	1.09	1.09	1.09	1.09	1.09	1.09	1.09	1.09	1.09
Turning Speed (k/h)	25		15	25		15	25		15	25		15
Number of Detectors	1	2		1	2		1	2	1	1	2	1
Detector Template	Left	Thru		Left	Thru		Left	Thru	Right	Left	Thru	Right
Leading Detector (m)	2.0	10.0		2.0	10.0		2.0	10.0	2.0	2.0	10.0	2.0
Trailing Detector (m)	0.0	0.0		0.0	0.0		0.0	0.0	0.0	0.0	0.0	0.0
Detector 1 Position(m)	0.0	0.0		0.0	0.0		0.0	0.0	0.0	0.0	0.0	0.0
Detector 1 Size(m)	2.0	0.6		2.0	0.6		2.0	0.6	2.0	2.0	0.6	2.0
Detector 1 Type	Cl+Ex	Cl+Ex		Cl+Ex	Cl+Ex		Cl+Ex	Cl+Ex	Cl+Ex	Cl+Ex	Cl+Ex	Cl+Ex
Detector 1 Channel												
Detector 1 Extend (s)	0.0	0.0		0.0	0.0		0.0	0.0	0.0	0.0	0.0	0.0
Detector 1 Queue (s)	0.0	0.0		0.0	0.0		0.0	0.0	0.0	0.0	0.0	0.0
Detector 1 Delay (s)	0.0	0.0		0.0	0.0		0.0	0.0	0.0	0.0	0.0	0.0
Detector 2 Position(m)		9.4			9.4			9.4			9.4	
Detector 2 Size(m)		0.6			0.6			0.6			0.6	
Detector 2 Type		Cl+Ex			Cl+Ex			Cl+Ex			Cl+Ex	
Detector 2 Channel												
Detector 2 Extend (s)		0.0			0.0			0.0			0.0	

Lanes, Volumes, Timings  
 1: March Road & Halton Terrace/Maxwell Bridge Road

2028 FT PM - Interim  
 910 March Road



Lane Group	EBL	EBT	EBR	WBL	WBT	WBR	NBL	NBT	NBR	SBL	SBT	SBR
Turn Type	Perm	NA		Perm	NA		pm+pt	NA	Perm	pm+pt	NA	Perm
Protected Phases		4			8		5	2		1	6	
Permitted Phases	4			8			2		2	6		6
Detector Phase	4	4		8	8		5	2	2	1	6	6
Switch Phase												
Minimum Initial (s)	10.0	10.0		10.0	10.0		5.0	10.0	10.0	5.0	10.0	10.0
Minimum Split (s)	38.6	38.6		38.6	38.6		12.4	34.6	34.6	11.4	34.6	34.6
Total Split (s)	45.0	45.0		45.0	45.0		20.0	55.0	55.0	20.0	55.0	55.0
Total Split (%)	37.5%	37.5%		37.5%	37.5%		16.7%	45.8%	45.8%	16.7%	45.8%	45.8%
Maximum Green (s)	38.4	38.4		38.4	38.4		12.6	48.4	48.4	13.6	48.4	48.4
Yellow Time (s)	3.3	3.3		3.3	3.3		4.6	4.6	4.6	4.6	4.6	4.6
All-Red Time (s)	3.3	3.3		3.3	3.3		2.8	2.0	2.0	1.8	2.0	2.0
Lost Time Adjust (s)	0.0	0.0		0.0	0.0		0.0	0.0	0.0	0.0	0.0	0.0
Total Lost Time (s)	6.6	6.6		6.6	6.6		7.4	6.6	6.6	6.4	6.6	6.6
Lead/Lag							Lead	Lag	Lag	Lead	Lag	Lag
Lead-Lag Optimize?							Yes	Yes	Yes	Yes	Yes	Yes
Vehicle Extension (s)	3.0	3.0		3.0	3.0		3.0	3.0	3.0	3.0	3.0	3.0
Recall Mode	None	None		None	None		None	C-Max	C-Max	None	C-Max	C-Max
Walk Time (s)	7.0	7.0		7.0	7.0			7.0	7.0		7.0	7.0
Flash Dont Walk (s)	25.0	25.0		25.0	25.0			21.0	21.0		21.0	21.0
Pedestrian Calls (#/hr)	0	0		0	0			0	0		0	0
Act Effct Green (s)	13.9	13.9		13.9	13.9		89.4	82.3	82.3	83.1	76.3	76.3
Actuated g/C Ratio	0.12	0.12		0.12	0.12		0.74	0.69	0.69	0.69	0.64	0.64
v/c Ratio	0.19	0.48		0.57	0.64		0.24	0.46	0.12	0.15	0.13	0.02
Control Delay	50.5	40.2		65.5	39.3		5.0	10.7	1.9	5.1	9.7	0.0
Queue Delay	0.0	0.0		0.0	0.0		0.0	0.0	0.0	0.0	0.0	0.0
Total Delay	50.5	40.2		65.5	39.3		5.0	10.7	1.9	5.1	9.7	0.0
LOS	D	D		E	D		A	B	A	A	A	A
Approach Delay		42.0			48.3			9.1			8.5	
Approach LOS		D			D			A			A	
Queue Length 50th (m)	4.4	14.4		18.2	18.4		8.8	51.7	0.0	2.8	12.4	0.0
Queue Length 95th (m)	11.5	29.8		32.8	38.4		18.5	80.1	7.0	7.3	22.6	0.0
Internal Link Dist (m)		119.7			332.2			300.9			109.9	
Turn Bay Length (m)	30.0			30.0			60.0			70.0		15.0
Base Capacity (vph)	284	509		387	534		750	2071	982	504	2107	926
Starvation Cap Reductn	0	0		0	0		0	0	0	0	0	0
Spillback Cap Reductn	0	0		0	0		0	0	0	0	0	0
Storage Cap Reductn	0	0		0	0		0	0	0	0	0	0
Reduced v/c Ratio	0.07	0.19		0.21	0.28		0.23	0.46	0.12	0.12	0.13	0.02

Intersection Summary

Area Type: Other  
 Cycle Length: 120  
 Actuated Cycle Length: 120  
 Offset: 50 (42%), Referenced to phase 2:NBTL and 6:SBTL, Start of Green  
 Natural Cycle: 90  
 Control Type: Actuated-Coordinated  
 Maximum v/c Ratio: 0.64  
 Intersection Signal Delay: 15.6  
 Intersection LOS: B

Intersection Capacity Utilization 66.2%      ICU Level of Service C  
 Analysis Period (min) 15

Splits and Phases: 1: March Road & Halton Terrace/Maxwell Bridge Road



HCM Signalized Intersection Capacity Analysis  
 1: March Road & Halton Terrace/Maxwell Bridge Road

2028 FT PM - Interim  
 910 March Road



Movement	EBL	EBT	EBR	WBL	WBT	WBR	NBL	NBT	NBR	SBL	SBT	SBR
Lane Configurations												
Traffic Volume (vph)	20	56	41	80	59	93	174	954	115	62	279	14
Future Volume (vph)	20	56	41	80	59	93	174	954	115	62	279	14
Ideal Flow (vphpl)	1800	1800	1800	1800	1800	1800	1800	1800	1800	1800	1800	1800
Total Lost time (s)	6.6	6.6		6.6	6.6		7.4	6.6	6.6	6.4	6.6	6.6
Lane Util. Factor	1.00	1.00		1.00	1.00		1.00	0.95	1.00	1.00	0.95	1.00
Frbp, ped/bikes	1.00	0.99		1.00	1.00		1.00	1.00	0.98	1.00	1.00	1.00
Flpb, ped/bikes	1.00	1.00		1.00	1.00		1.00	1.00	1.00	1.00	1.00	1.00
Frt	1.00	0.94		1.00	0.91		1.00	1.00	0.85	1.00	1.00	0.85
Flt Protected	0.95	1.00		0.95	1.00		0.95	1.00	1.00	0.95	1.00	1.00
Satd. Flow (prot)	1658	1522		1656	1521		1551	3020	1380	1657	3316	1401
Flt Permitted	0.51	1.00		0.69	1.00		0.55	1.00	1.00	0.29	1.00	1.00
Satd. Flow (perm)	888	1522		1210	1521		893	3020	1380	497	3316	1401
Peak-hour factor, PHF	1.00	1.00	1.00	1.00	1.00	1.00	1.00	1.00	1.00	1.00	1.00	1.00
Adj. Flow (vph)	20	56	41	80	59	93	174	954	115	62	279	14
RTOR Reduction (vph)	0	28	0	0	62	0	0	0	37	0	0	5
Lane Group Flow (vph)	20	69	0	80	90	0	174	954	78	62	279	9
Confl. Peds. (#/hr)			1	1					2	2		
Heavy Vehicles (%)	2%	14%	2%	2%	2%	9%	9%	12%	7%	2%	2%	8%
Turn Type	Perm	NA		Perm	NA		pm+pt	NA	Perm	pm+pt	NA	Perm
Protected Phases		4			8		5	2		1	6	
Permitted Phases	4			8			2		2	6		6
Actuated Green, G (s)	13.9	13.9		13.9	13.9		90.2	81.0	81.0	81.8	76.3	76.3
Effective Green, g (s)	13.9	13.9		13.9	13.9		90.2	81.0	81.0	81.8	76.3	76.3
Actuated g/C Ratio	0.12	0.12		0.12	0.12		0.75	0.68	0.68	0.68	0.64	0.64
Clearance Time (s)	6.6	6.6		6.6	6.6		7.4	6.6	6.6	6.4	6.6	6.6
Vehicle Extension (s)	3.0	3.0		3.0	3.0		3.0	3.0	3.0	3.0	3.0	3.0
Lane Grp Cap (vph)	102	176		140	176		721	2038	931	391	2108	890
v/s Ratio Prot		0.05			0.06		c0.02	c0.32		0.01	0.08	
v/s Ratio Perm	0.02			c0.07			0.16		0.06	0.10		0.01
v/c Ratio	0.20	0.39		0.57	0.51		0.24	0.47	0.08	0.16	0.13	0.01
Uniform Delay, d1	48.0	49.1		50.2	49.9		4.3	9.3	6.7	6.4	8.7	8.0
Progression Factor	1.00	1.00		1.00	1.00		1.00	1.00	1.00	1.00	1.00	1.00
Incremental Delay, d2	0.9	1.4		5.5	2.5		0.2	0.8	0.2	0.2	0.1	0.0
Delay (s)	48.9	50.6		55.8	52.4		4.5	10.0	6.9	6.6	8.8	8.0
Level of Service	D	D		E	D		A	B	A	A	A	A
Approach Delay (s)		50.3			53.5			9.0			8.4	
Approach LOS		D			D			A			A	

Intersection Summary		
HCM 2000 Control Delay	16.7	HCM 2000 Level of Service
HCM 2000 Volume to Capacity ratio	0.48	B
Actuated Cycle Length (s)	120.0	Sum of lost time (s)
Intersection Capacity Utilization	66.2%	20.6
Analysis Period (min)	15	ICU Level of Service
		C

c Critical Lane Group

Lanes, Volumes, Timings  
2: March Road & Klondike Road

2028 FT PM - Interim  
910 March Road



Lane Group	EBL	EBT	EBR	WBL	WBT	WBR	NBL	NBT	NBR	SBL	SBT	SBR
Lane Configurations												
Traffic Volume (vph)	83	22	111	61	31	25	161	1206	82	4	462	60
Future Volume (vph)	83	22	111	61	31	25	161	1206	82	4	462	60
Ideal Flow (vphpl)	1800	1800	1800	1800	1800	1800	1800	1800	1800	1800	1800	1800
Storage Length (m)	100.0		5.0	15.0		0.0	100.0		0.0	45.0		0.0
Storage Lanes	1		1	1		0	2		0	1		0
Taper Length (m)	0.0			30.0			100.0			85.0		
Lane Util. Factor	1.00	1.00	1.00	1.00	1.00	1.00	0.97	0.91	0.91	1.00	0.91	0.91
Ped Bike Factor	1.00		0.98	0.99	0.99		1.00	1.00		1.00	1.00	
Fr <sub>t</sub>			0.850		0.933			0.990			0.983	
Fl <sub>t</sub> Protected	0.950			0.950			0.950			0.950		
Satd. Flow (prot)	1496	1679	1483	1658	1509	0	3124	4482	0	1433	4638	0
Fl <sub>t</sub> Permitted	0.439			0.743			0.950			0.950		
Satd. Flow (perm)	690	1679	1456	1289	1509	0	3113	4482	0	1431	4638	0
Right Turn on Red			Yes			Yes			Yes			Yes
Satd. Flow (RTOR)			111		25			9			19	
Link Speed (k/h)		50			50			80			80	
Link Distance (m)		117.7			346.6			261.8			142.1	
Travel Time (s)		8.5			25.0			11.8			6.4	
Confl. Peds. (#/hr)	3		6	6		3	3		4	4		3
Peak Hour Factor	1.00	1.00	1.00	1.00	1.00	1.00	1.00	1.00	1.00	1.00	1.00	1.00
Heavy Vehicles (%)	13%	6%	2%	2%	8%	11%	5%	7%	9%	18%	2%	9%
Adj. Flow (vph)	83	22	111	61	31	25	161	1206	82	4	462	60
Shared Lane Traffic (%)												
Lane Group Flow (vph)	83	22	111	61	56	0	161	1288	0	4	522	0
Enter Blocked Intersection	No	No	No	No	No	No	No	No	No	No	No	No
Lane Alignment	Left	Left	Right	Left	Left	Right	Left	Left	Right	Left	Left	Right
Median Width(m)		3.5			3.5			7.0			7.0	
Link Offset(m)		0.0			0.0			0.0			0.0	
Crosswalk Width(m)		3.0			3.0			3.0			3.0	
Two way Left Turn Lane												
Headway Factor	1.09	1.09	1.09	1.09	1.09	1.09	1.09	1.09	1.09	1.09	1.09	1.09
Turning Speed (k/h)	25		15	25		15	25		15	25		15
Number of Detectors	1	2	1	1	2		1	2		1	2	
Detector Template	Left	Thru	Right	Left	Thru		Left	Thru		Left	Thru	
Leading Detector (m)	2.0	10.0	2.0	2.0	10.0		2.0	10.0		2.0	10.0	
Trailing Detector (m)	0.0	0.0	0.0	0.0	0.0		0.0	0.0		0.0	0.0	
Detector 1 Position(m)	0.0	0.0	0.0	0.0	0.0		0.0	0.0		0.0	0.0	
Detector 1 Size(m)	2.0	0.6	2.0	2.0	0.6		2.0	0.6		2.0	0.6	
Detector 1 Type	Cl+Ex	Cl+Ex	Cl+Ex	Cl+Ex	Cl+Ex		Cl+Ex	Cl+Ex		Cl+Ex	Cl+Ex	
Detector 1 Channel												
Detector 1 Extend (s)	0.0	0.0	0.0	0.0	0.0		0.0	0.0		0.0	0.0	
Detector 1 Queue (s)	0.0	0.0	0.0	0.0	0.0		0.0	0.0		0.0	0.0	
Detector 1 Delay (s)	0.0	0.0	0.0	0.0	0.0		0.0	0.0		0.0	0.0	
Detector 2 Position(m)		9.4			9.4			9.4			9.4	
Detector 2 Size(m)		0.6			0.6			0.6			0.6	
Detector 2 Type		Cl+Ex			Cl+Ex			Cl+Ex			Cl+Ex	
Detector 2 Channel												
Detector 2 Extend (s)		0.0			0.0			0.0			0.0	

Lanes, Volumes, Timings  
2: March Road & Klondike Road

2028 FT PM - Interim  
910 March Road



Lane Group	EBL	EBT	EBR	WBL	WBT	WBR	NBL	NBT	NBR	SBL	SBT	SBR
Turn Type	pm+pt	NA	Perm	Perm	NA		Prot	NA		Prot	NA	
Protected Phases	7	4			8		5	2		1	6	
Permitted Phases	4		4	8								
Detector Phase	7	4	4	8	8		5	2		1	6	
Switch Phase												
Minimum Initial (s)	5.0	5.0	5.0	5.0	5.0		5.0	5.0		5.0	5.0	
Minimum Split (s)	11.6	44.1	44.1	44.1	44.1		11.6	32.4		11.6	32.4	
Total Split (s)	12.0	57.0	57.0	45.0	45.0		22.0	51.0		22.0	51.0	
Total Split (%)	9.2%	43.8%	43.8%	34.6%	34.6%		16.9%	39.2%		16.9%	39.2%	
Maximum Green (s)	5.4	49.9	49.9	37.9	37.9		15.4	44.6		15.4	44.6	
Yellow Time (s)	3.3	3.3	3.3	3.3	3.3		4.6	4.6		4.6	4.6	
All-Red Time (s)	3.3	3.8	3.8	3.8	3.8		2.0	1.8		2.0	1.8	
Lost Time Adjust (s)	0.0	0.0	0.0	0.0	0.0		0.0	0.0		0.0	0.0	
Total Lost Time (s)	6.6	7.1	7.1	7.1	7.1		6.6	6.4		6.6	6.4	
Lead/Lag	Lead			Lag	Lag		Lead	Lag		Lead	Lag	
Lead-Lag Optimize?	Yes			Yes	Yes		Yes	Yes		Yes	Yes	
Vehicle Extension (s)	3.0	3.0	3.0	3.0	3.0		3.0	3.0		3.0	3.0	
Recall Mode	None	None	None	None	None		None	C-Max		None	C-Max	
Walk Time (s)		7.0	7.0	7.0	7.0			7.0			7.0	
Flash Dont Walk (s)		30.0	30.0	30.0	30.0			19.0			19.0	
Pedestrian Calls (#/hr)		0	0	0	0			0			0	
Act Effct Green (s)	21.5	21.0	21.0	11.5	11.5		12.0	92.8		6.0	76.9	
Actuated g/C Ratio	0.17	0.16	0.16	0.09	0.09		0.09	0.71		0.05	0.59	
v/c Ratio	0.56	0.08	0.34	0.54	0.36		0.56	0.40		0.06	0.19	
Control Delay	60.6	42.8	10.3	72.5	39.5		63.7	9.4		60.8	13.3	
Queue Delay	0.0	0.0	0.0	0.0	0.0		0.0	0.0		0.0	0.0	
Total Delay	60.6	42.8	10.3	72.5	39.5		63.7	9.4		60.8	13.3	
LOS	E	D	B	E	D		E	A		E	B	
Approach Delay		33.0			56.7			15.5			13.7	
Approach LOS		C			E			B			B	
Queue Length 50th (m)	18.6	4.7	0.0	15.2	7.5		20.7	43.0		1.0	21.6	
Queue Length 95th (m)	32.3	11.8	15.0	28.8	20.1		31.2	81.4		4.8	32.9	
Internal Link Dist (m)		93.7			322.6			237.8			118.1	
Turn Bay Length (m)	100.0		5.0	15.0			100.0			45.0		
Base Capacity (vph)	148	644	627	375	457		370	3202		169	2752	
Starvation Cap Reductn	0	0	0	0	0		0	0		0	0	
Spillback Cap Reductn	0	0	0	0	0		0	0		0	0	
Storage Cap Reductn	0	0	0	0	0		0	0		0	0	
Reduced v/c Ratio	0.56	0.03	0.18	0.16	0.12		0.44	0.40		0.02	0.19	

Intersection Summary

Area Type: Other  
 Cycle Length: 130  
 Actuated Cycle Length: 130  
 Offset: 64 (49%), Referenced to phase 2:NBT and 6:SBT, Start of Green  
 Natural Cycle: 100  
 Control Type: Actuated-Coordinated  
 Maximum v/c Ratio: 0.56  
 Intersection Signal Delay: 18.8  
 Intersection LOS: B



Intersection Capacity Utilization 62.5% ICU Level of Service B  
 Analysis Period (min) 15

Splits and Phases: 2: March Road & Klondike Road



HCM Signalized Intersection Capacity Analysis  
2: March Road & Klondike Road

2028 FT PM - Interim  
910 March Road



Movement	EBL	EBT	EBR	WBL	WBT	WBR	NBL	NBT	NBR	SBL	SBT	SBR
Lane Configurations	↖	↑	↗	↖	↗		↖↗	↑↑↑		↖	↑↑↑	
Traffic Volume (vph)	83	22	111	61	31	25	161	1206	82	4	462	60
Future Volume (vph)	83	22	111	61	31	25	161	1206	82	4	462	60
Ideal Flow (vphpl)	1800	1800	1800	1800	1800	1800	1800	1800	1800	1800	1800	1800
Total Lost time (s)	6.6	7.1	7.1	7.1	7.1		6.6	6.4		6.6	6.4	
Lane Util. Factor	1.00	1.00	1.00	1.00	1.00		0.97	0.91		1.00	0.91	
Frpb, ped/bikes	1.00	1.00	0.98	1.00	0.99		1.00	1.00		1.00	1.00	
Flpb, ped/bikes	1.00	1.00	1.00	0.99	1.00		1.00	1.00		1.00	1.00	
Frt	1.00	1.00	0.85	1.00	0.93		1.00	0.99		1.00	0.98	
Flt Protected	0.95	1.00	1.00	0.95	1.00		0.95	1.00		0.95	1.00	
Satd. Flow (prot)	1495	1679	1456	1648	1509		3124	4484		1433	4637	
Flt Permitted	0.44	1.00	1.00	0.74	1.00		0.95	1.00		0.95	1.00	
Satd. Flow (perm)	691	1679	1456	1289	1509		3124	4484		1433	4637	
Peak-hour factor, PHF	1.00	1.00	1.00	1.00	1.00	1.00	1.00	1.00	1.00	1.00	1.00	1.00
Adj. Flow (vph)	83	22	111	61	31	25	161	1206	82	4	462	60
RTOR Reduction (vph)	0	0	92	0	23	0	0	3	0	0	8	0
Lane Group Flow (vph)	83	22	19	61	33	0	161	1285	0	4	514	0
Confl. Peds. (#/hr)	3		6	6		3	3		4	4		3
Heavy Vehicles (%)	13%	6%	2%	2%	8%	11%	5%	7%	9%	18%	2%	9%
Turn Type	pm+pt	NA	Perm	Perm	NA		Prot	NA		Prot	NA	
Protected Phases	7	4			8		5	2		1	6	
Permitted Phases	4		4	8								
Actuated Green, G (s)	22.4	22.4	22.4	10.3	10.3		12.0	86.1		1.4	75.5	
Effective Green, g (s)	22.4	22.4	22.4	10.3	10.3		12.0	86.1		1.4	75.5	
Actuated g/C Ratio	0.17	0.17	0.17	0.08	0.08		0.09	0.66		0.01	0.58	
Clearance Time (s)	6.6	7.1	7.1	7.1	7.1		6.6	6.4		6.6	6.4	
Vehicle Extension (s)	3.0	3.0	3.0	3.0	3.0		3.0	3.0		3.0	3.0	
Lane Grp Cap (vph)	153	289	250	102	119		288	2969		15	2693	
v/s Ratio Prot	c0.02	0.01			0.02		c0.05	c0.29		0.00	0.11	
v/s Ratio Perm	c0.07		0.01	0.05								
v/c Ratio	0.54	0.08	0.08	0.60	0.28		0.56	0.43		0.27	0.19	
Uniform Delay, d1	48.1	45.1	45.1	57.8	56.3		56.5	10.4		63.8	12.8	
Progression Factor	1.00	1.00	1.00	1.00	1.00		1.00	1.00		1.00	1.00	
Incremental Delay, d2	3.9	0.1	0.1	9.1	1.3		2.3	0.5		9.3	0.2	
Delay (s)	52.0	45.2	45.3	66.9	57.6		58.8	10.9		73.1	13.0	
Level of Service	D	D	D	E	E		E	B		E	B	
Approach Delay (s)		47.8			62.5			16.2			13.5	
Approach LOS		D			E			B			B	











Intersection Summary

HCM 2000 Control Delay	20.9	HCM 2000 Level of Service	C
HCM 2000 Volume to Capacity ratio	0.50		
Actuated Cycle Length (s)	130.0	Sum of lost time (s)	26.7
Intersection Capacity Utilization	62.5%	ICU Level of Service	B
Analysis Period (min)	15		

c Critical Lane Group

Lanes, Volumes, Timings  
3: March Road & Site Access

2028 FT PM - Interim  
910 March Road

						
Lane Group	WBL	WBR	NBT	NBR	SBL	SBT
Lane Configurations						
Traffic Volume (vph)	40	12	1009	58	12	316
Future Volume (vph)	40	12	1009	58	12	316
Ideal Flow (vphpl)	1800	1800	1800	1800	1800	1800
Storage Length (m)	0.0	0.0		50.0	110.0	
Storage Lanes	1	0		1	1	
Taper Length (m)	15.0				95.0	
Lane Util. Factor	1.00	1.00	1.00	1.00	1.00	1.00
Frt	0.969			0.850		
Flt Protected	0.963				0.950	
Satd. Flow (prot)	1628	0	1745	1483	1658	1745
Flt Permitted	0.963				0.950	
Satd. Flow (perm)	1628	0	1745	1483	1658	1745
Link Speed (k/h)	30		80			80
Link Distance (m)	77.2		79.9			262.6
Travel Time (s)	9.3		3.6			11.8
Peak Hour Factor	1.00	1.00	1.00	1.00	1.00	1.00
Adj. Flow (vph)	40	12	1009	58	12	316
Shared Lane Traffic (%)						
Lane Group Flow (vph)	52	0	1009	58	12	316
Enter Blocked Intersection	No	No	No	No	No	No
Lane Alignment	Left	Right	Left	Right	Left	Left
Median Width(m)	3.5		3.5			3.5
Link Offset(m)	0.0		0.0			0.0
Crosswalk Width(m)	3.0		3.0			3.0
Two way Left Turn Lane						
Headway Factor	1.09	1.09	1.09	1.09	1.09	1.09
Turning Speed (k/h)	25	15		15	25	
Sign Control	Stop		Free			Free
<b>Intersection Summary</b>						
Area Type:	Other					
Control Type:	Unsignalized					
Intersection Capacity Utilization	66.1%			ICU Level of Service C		
Analysis Period (min)	15					

Intersection						
Int Delay, s/veh	1.3					
Movement	WBL	WBR	NBT	NBR	SBL	SBT
Lane Configurations	↔		↑	↑	↔	↑
Traffic Vol, veh/h	40	12	1009	58	12	316
Future Vol, veh/h	40	12	1009	58	12	316
Conflicting Peds, #/hr	0	0	0	0	0	0
Sign Control	Stop	Stop	Free	Free	Free	Free
RT Channelized	-	None	-	None	-	None
Storage Length	0	-	-	50	110	-
Veh in Median Storage, #	0	-	0	-	-	0
Grade, %	0	-	0	-	-	0
Peak Hour Factor	100	100	100	100	100	100
Heavy Vehicles, %	2	2	2	2	2	2
Mvmt Flow	40	12	1009	58	12	316

Major/Minor	Minor1	Major1	Major2		
Conflicting Flow All	1349	1009	0	0	1067
Stage 1	1009	-	-	-	-
Stage 2	340	-	-	-	-
Critical Hdwy	6.42	6.22	-	-	4.12
Critical Hdwy Stg 1	5.42	-	-	-	-
Critical Hdwy Stg 2	5.42	-	-	-	-
Follow-up Hdwy	3.518	3.318	-	-	2.218
Pot Cap-1 Maneuver	166	292	-	-	653
Stage 1	352	-	-	-	-
Stage 2	721	-	-	-	-
Platoon blocked, %			-	-	-
Mov Cap-1 Maneuver	163	292	-	-	653
Mov Cap-2 Maneuver	163	-	-	-	-
Stage 1	352	-	-	-	-
Stage 2	708	-	-	-	-

Approach	WB	NB	SB
HCM Control Delay, s	32.5	0	0.4
HCM LOS	D		

Minor Lane/Major Mvmt	NBT	NBRWBLn1	SBL	SBT
Capacity (veh/h)	-	-	182	653
HCM Lane V/C Ratio	-	-	0.286	0.018
HCM Control Delay (s)	-	-	32.5	10.6
HCM Lane LOS	-	-	D	B
HCM 95th %tile Q(veh)	-	-	1.1	0.1

# Appendix Q

Synchro Intersection Worksheets – 2033 Future Total Conditions

Lanes, Volumes, Timings  
 1: March Road & Halton Terrace/Maxwell Bridge Road

2033 Future Total AM  
 910 March Road



Lane Group	EBL	EBT	EBR	WBL	WBT	WBR	NBL	NBT	NBR	SBL	SBT	SBR
Lane Configurations												
Traffic Volume (vph)	103	37	158	126	17	51	99	612	64	79	1730	69
Future Volume (vph)	103	37	158	126	17	51	99	612	64	79	1730	69
Ideal Flow (vphpl)	1800	1800	1800	1800	1800	1800	1800	1800	1800	1800	1800	1800
Storage Length (m)	30.0		0.0	30.0		0.0	60.0		0.0	70.0		15.0
Storage Lanes	1		0	1		0	1		1	1		1
Taper Length (m)	60.0			60.0			70.0			100.0		
Lane Util. Factor	1.00	1.00	1.00	1.00	1.00	1.00	1.00	0.95	1.00	1.00	0.95	1.00
Ped Bike Factor		0.99		1.00					0.98	1.00		
Fr <sub>t</sub>		0.878			0.887				0.850			0.850
Fl <sub>t</sub> Protected	0.950			0.950			0.950			0.950		
Satd. Flow (prot)	1658	1483	0	1658	1472	0	1551	3020	1414	1658	3316	1401
Fl <sub>t</sub> Permitted	0.713			0.461			0.054			0.419		
Satd. Flow (perm)	1244	1483	0	804	1472	0	88	3020	1380	730	3316	1401
Right Turn on Red			Yes			Yes			Yes			Yes
Satd. Flow (RTOR)		158			51				100			100
Link Speed (k/h)		40			40			80			80	
Link Distance (m)		143.7			356.2			324.9			132.4	
Travel Time (s)		12.9			32.1			14.6			6.0	
Confl. Peds. (#/hr)			1	1					2	2		
Peak Hour Factor	1.00	1.00	1.00	1.00	1.00	1.00	1.00	1.00	1.00	1.00	1.00	1.00
Heavy Vehicles (%)	2%	14%	2%	2%	2%	9%	9%	12%	7%	2%	2%	8%
Adj. Flow (vph)	103	37	158	126	17	51	99	612	64	79	1730	69
Shared Lane Traffic (%)												
Lane Group Flow (vph)	103	195	0	126	68	0	99	612	64	79	1730	69
Enter Blocked Intersection	No	No	No	No	No	No	No	No	No	No	No	No
Lane Alignment	Left	Left	Right	Left	Left	Right	Left	Left	Right	Left	Left	Right
Median Width(m)		3.5			3.5			3.5			3.5	
Link Offset(m)		0.0			0.0			0.0			0.0	
Crosswalk Width(m)		3.0			3.0			3.0			3.0	
Two way Left Turn Lane												
Headway Factor	1.09	1.09	1.09	1.09	1.09	1.09	1.09	1.09	1.09	1.09	1.09	1.09
Turning Speed (k/h)	25		15	25		15	25		15	25		15
Number of Detectors	1	2		1	2		1	2	1	1	2	1
Detector Template	Left	Thru		Left	Thru		Left	Thru	Right	Left	Thru	Right
Leading Detector (m)	2.0	10.0		2.0	10.0		2.0	10.0	2.0	2.0	10.0	2.0
Trailing Detector (m)	0.0	0.0		0.0	0.0		0.0	0.0	0.0	0.0	0.0	0.0
Detector 1 Position(m)	0.0	0.0		0.0	0.0		0.0	0.0	0.0	0.0	0.0	0.0
Detector 1 Size(m)	2.0	0.6		2.0	0.6		2.0	0.6	2.0	2.0	0.6	2.0
Detector 1 Type	Cl+Ex	Cl+Ex		Cl+Ex	Cl+Ex		Cl+Ex	Cl+Ex	Cl+Ex	Cl+Ex	Cl+Ex	Cl+Ex
Detector 1 Channel												
Detector 1 Extend (s)	0.0	0.0		0.0	0.0		0.0	0.0	0.0	0.0	0.0	0.0
Detector 1 Queue (s)	0.0	0.0		0.0	0.0		0.0	0.0	0.0	0.0	0.0	0.0
Detector 1 Delay (s)	0.0	0.0		0.0	0.0		0.0	0.0	0.0	0.0	0.0	0.0
Detector 2 Position(m)		9.4			9.4			9.4			9.4	
Detector 2 Size(m)		0.6			0.6			0.6			0.6	
Detector 2 Type		Cl+Ex			Cl+Ex			Cl+Ex			Cl+Ex	
Detector 2 Channel												
Detector 2 Extend (s)		0.0			0.0			0.0			0.0	

Lanes, Volumes, Timings  
 1: March Road & Halton Terrace/Maxwell Bridge Road

2033 Future Total AM  
 910 March Road



Lane Group	EBL	EBT	EBR	WBL	WBT	WBR	NBL	NBT	NBR	SBL	SBT	SBR
Turn Type	Perm	NA		Perm	NA		pm+pt	NA	Perm	pm+pt	NA	Perm
Protected Phases		4			8		5	2		1	6	
Permitted Phases	4			8			2		2	6		6
Detector Phase	4	4		8	8		5	2	2	1	6	6
Switch Phase												
Minimum Initial (s)	10.0	10.0		10.0	10.0		5.0	10.0	10.0	5.0	10.0	10.0
Minimum Split (s)	38.6	38.6		38.6	38.6		12.4	34.6	34.6	11.4	34.6	34.6
Total Split (s)	48.0	48.0		48.0	48.0		20.0	52.0	52.0	20.0	52.0	52.0
Total Split (%)	40.0%	40.0%		40.0%	40.0%		16.7%	43.3%	43.3%	16.7%	43.3%	43.3%
Maximum Green (s)	41.4	41.4		41.4	41.4		12.6	45.4	45.4	13.6	45.4	45.4
Yellow Time (s)	3.3	3.3		3.3	3.3		4.6	4.6	4.6	4.6	4.6	4.6
All-Red Time (s)	3.3	3.3		3.3	3.3		2.8	2.0	2.0	1.8	2.0	2.0
Lost Time Adjust (s)	0.0	0.0		0.0	0.0		0.0	0.0	0.0	0.0	0.0	0.0
Total Lost Time (s)	6.6	6.6		6.6	6.6		7.4	6.6	6.6	6.4	6.6	6.6
Lead/Lag							Lead	Lag	Lag	Lead	Lag	Lag
Lead-Lag Optimize?							Yes	Yes	Yes	Yes	Yes	Yes
Vehicle Extension (s)	3.0	3.0		3.0	3.0		3.0	3.0	3.0	3.0	3.0	3.0
Recall Mode	None	None		None	None		None	C-Max	C-Max	None	C-Max	C-Max
Walk Time (s)	7.0	7.0		7.0	7.0			7.0	7.0		7.0	7.0
Flash Dont Walk (s)	25.0	25.0		25.0	25.0			21.0	21.0		21.0	21.0
Pedestrian Calls (#/hr)	0	0		0	0			0	0		0	0
Act Effct Green (s)	20.2	20.2		20.2	20.2		81.7	75.3	75.3	78.3	70.8	70.8
Actuated g/C Ratio	0.17	0.17		0.17	0.17		0.68	0.63	0.63	0.65	0.59	0.59
v/c Ratio	0.49	0.51		0.93	0.23		0.61	0.32	0.07	0.15	0.88	0.08
Control Delay	51.5	14.9		109.8	16.7		37.4	12.9	1.1	7.1	29.5	1.5
Queue Delay	0.0	0.0		0.0	0.0		0.0	0.0	0.0	0.0	0.0	0.0
Total Delay	51.5	14.9		109.8	16.7		37.4	12.9	1.1	7.1	29.5	1.5
LOS	D	B		F	B		D	B	A	A	C	A
Approach Delay		27.6			77.2			15.1			27.5	
Approach LOS		C			E			B			C	
Queue Length 50th (m)	22.3	7.5		29.6	3.4		9.4	34.9	0.0	4.8	171.3	0.0
Queue Length 95th (m)	36.3	26.6		#51.4	14.5		28.3	58.5	2.5	12.1	#284.1	3.7
Internal Link Dist (m)		119.7			332.2			300.9			108.4	
Turn Bay Length (m)	30.0			30.0			60.0			70.0		15.0
Base Capacity (vph)	429	615		277	541		215	1895	903	619	1957	867
Starvation Cap Reductn	0	0		0	0		0	0	0	0	0	0
Spillback Cap Reductn	0	0		0	0		0	0	0	0	0	0
Storage Cap Reductn	0	0		0	0		0	0	0	0	0	0
Reduced v/c Ratio	0.24	0.32		0.45	0.13		0.46	0.32	0.07	0.13	0.88	0.08

**Intersection Summary**

Area Type: Other

Cycle Length: 120

Actuated Cycle Length: 120

Offset: 99 (83%), Referenced to phase 2:NBTL and 6:SBTL, Start of Green

Natural Cycle: 120

Control Type: Actuated-Coordinated

Maximum v/c Ratio: 0.93

Intersection Signal Delay: 27.5

Intersection LOS: C

Lanes, Volumes, Timings  
 1: March Road & Halton Terrace/Maxwell Bridge Road

2033 Future Total AM  
 910 March Road

Intersection Capacity Utilization 100.2%      ICU Level of Service G

Analysis Period (min) 15

# 95th percentile volume exceeds capacity, queue may be longer.  
 Queue shown is maximum after two cycles.

Splits and Phases: 1: March Road & Halton Terrace/Maxwell Bridge Road





HCM Signalized Intersection Capacity Analysis  
 1: March Road & Halton Terrace/Maxwell Bridge Road

2033 Future Total AM  
 910 March Road



Movement	EBL	EBT	EBR	WBL	WBT	WBR	NBL	NBT	NBR	SBL	SBT	SBR
Lane Configurations	↖	↗		↖	↗		↖	↑↑	↗	↖	↑↑	↗
Traffic Volume (vph)	103	37	158	126	17	51	99	612	64	79	1730	69
Future Volume (vph)	103	37	158	126	17	51	99	612	64	79	1730	69
Ideal Flow (vphpl)	1800	1800	1800	1800	1800	1800	1800	1800	1800	1800	1800	1800
Total Lost time (s)	6.6	6.6		6.6	6.6		7.4	6.6	6.6	6.4	6.6	6.6
Lane Util. Factor	1.00	1.00		1.00	1.00		1.00	0.95	1.00	1.00	0.95	1.00
Frbp, ped/bikes	1.00	0.99		1.00	1.00		1.00	1.00	0.98	1.00	1.00	1.00
Flpb, ped/bikes	1.00	1.00		1.00	1.00		1.00	1.00	1.00	1.00	1.00	1.00
Frt	1.00	0.88		1.00	0.89		1.00	1.00	0.85	1.00	1.00	0.85
Flt Protected	0.95	1.00		0.95	1.00		0.95	1.00	1.00	0.95	1.00	1.00
Satd. Flow (prot)	1658	1484		1657	1473		1551	3020	1380	1657	3316	1401
Flt Permitted	0.71	1.00		0.46	1.00		0.05	1.00	1.00	0.42	1.00	1.00
Satd. Flow (perm)	1244	1484		804	1473		88	3020	1380	730	3316	1401
Peak-hour factor, PHF	1.00	1.00	1.00	1.00	1.00	1.00	1.00	1.00	1.00	1.00	1.00	1.00
Adj. Flow (vph)	103	37	158	126	17	51	99	612	64	79	1730	69
RTOR Reduction (vph)	0	131	0	0	42	0	0	0	25	0	0	28
Lane Group Flow (vph)	103	64	0	126	26	0	99	612	39	79	1730	41
Confl. Peds. (#/hr)			1	1					2	2		
Heavy Vehicles (%)	2%	14%	2%	2%	2%	9%	9%	12%	7%	2%	2%	8%
Turn Type	Perm	NA		Perm	NA		pm+pt	NA	Perm	pm+pt	NA	Perm
Protected Phases		4			8		5	2		1	6	
Permitted Phases	4			8			2		2	6		6
Actuated Green, G (s)	20.2	20.2		20.2	20.2		82.4	74.0	74.0	77.0	70.8	70.8
Effective Green, g (s)	20.2	20.2		20.2	20.2		82.4	74.0	74.0	77.0	70.8	70.8
Actuated g/C Ratio	0.17	0.17		0.17	0.17		0.69	0.62	0.62	0.64	0.59	0.59
Clearance Time (s)	6.6	6.6		6.6	6.6		7.4	6.6	6.6	6.4	6.6	6.6
Vehicle Extension (s)	3.0	3.0		3.0	3.0		3.0	3.0	3.0	3.0	3.0	3.0
Lane Grp Cap (vph)	209	249		135	247		162	1862	851	516	1956	826
v/s Ratio Prot		0.04			0.02		c0.04	0.20		0.01	c0.52	
v/s Ratio Perm	0.08			c0.16			c0.37		0.03	0.09		0.03
v/c Ratio	0.49	0.26		0.93	0.10		0.61	0.33	0.05	0.15	0.88	0.05
Uniform Delay, d1	45.3	43.4		49.2	42.2		24.4	11.1	9.1	8.1	21.1	10.4
Progression Factor	1.00	1.00		1.00	1.00		1.00	1.00	1.00	1.00	1.00	1.00
Incremental Delay, d2	1.8	0.5		57.1	0.2		6.7	0.5	0.1	0.1	6.3	0.1
Delay (s)	47.1	43.9		106.3	42.4		31.0	11.5	9.2	8.2	27.4	10.5
Level of Service	D	D		F	D		C	B	A	A	C	B
Approach Delay (s)		45.0			83.9			13.8			26.0	
Approach LOS		D			F			B			C	
<b>Intersection Summary</b>												
HCM 2000 Control Delay			28.3				HCM 2000 Level of Service			C		
HCM 2000 Volume to Capacity ratio			0.87									
Actuated Cycle Length (s)			120.0				Sum of lost time (s)			20.6		
Intersection Capacity Utilization			100.2%				ICU Level of Service			G		
Analysis Period (min)			15									

c Critical Lane Group

Lanes, Volumes, Timings  
2: March Road & Klondike Road

2033 Future Total AM  
910 March Road



Lane Group	EBL	EBT	EBR	WBL	WBT	WBR	NBL	NBT	NBR	SBL	SBT	SBR
Lane Configurations												
Traffic Volume (vph)	72	39	256	182	34	59	83	712	79	38	1776	64
Future Volume (vph)	72	39	256	182	34	59	83	712	79	38	1776	64
Ideal Flow (vphpl)	1800	1800	1800	1800	1800	1800	1800	1800	1800	1800	1800	1800
Storage Length (m)	100.0		5.0	15.0		0.0	100.0		0.0	45.0		0.0
Storage Lanes	1		1	1		0	2		0	1		0
Taper Length (m)	0.0			30.0			100.0			85.0		
Lane Util. Factor	1.00	1.00	1.00	1.00	1.00	1.00	0.97	0.91	0.91	1.00	0.91	0.91
Ped Bike Factor	1.00		0.98	0.99	0.99		1.00	1.00		1.00	1.00	
Fr <sub>t</sub>			0.850		0.905			0.985			0.995	
Fl <sub>t</sub> Protected	0.950			0.950			0.950			0.950		
Satd. Flow (prot)	1496	1679	1483	1658	1452	0	3124	4452	0	1433	4726	0
Fl <sub>t</sub> Permitted	0.546			0.732			0.950			0.950		
Satd. Flow (perm)	858	1679	1456	1270	1452	0	3122	4452	0	1428	4726	0
Right Turn on Red			Yes			Yes			Yes			Yes
Satd. Flow (RTOR)			154		59			17			5	
Link Speed (k/h)		50			50			80			80	
Link Distance (m)		117.7			346.6			261.8			142.1	
Travel Time (s)		8.5			25.0			11.8			6.4	
Confl. Peds. (#/hr)	3		6	6		3	3		4	4		3
Peak Hour Factor	1.00	1.00	1.00	1.00	1.00	1.00	1.00	1.00	1.00	1.00	1.00	1.00
Heavy Vehicles (%)	13%	6%	2%	2%	8%	11%	5%	7%	9%	18%	2%	9%
Adj. Flow (vph)	72	39	256	182	34	59	83	712	79	38	1776	64
Shared Lane Traffic (%)												
Lane Group Flow (vph)	72	39	256	182	93	0	83	791	0	38	1840	0
Enter Blocked Intersection	No	No	No	No	No	No	No	No	No	No	No	No
Lane Alignment	Left	Left	Right	Left	Left	Right	Left	Left	Right	Left	Left	Right
Median Width(m)		3.5			3.5			7.0			7.0	
Link Offset(m)		0.0			0.0			0.0			0.0	
Crosswalk Width(m)		3.0			3.0			3.0			3.0	
Two way Left Turn Lane												
Headway Factor	1.09	1.09	1.09	1.09	1.09	1.09	1.09	1.09	1.09	1.09	1.09	1.09
Turning Speed (k/h)	25		15	25		15	25		15	25		15
Number of Detectors	1	2	1	1	2		1	2		1	2	
Detector Template	Left	Thru	Right	Left	Thru		Left	Thru		Left	Thru	
Leading Detector (m)	2.0	10.0	2.0	2.0	10.0		2.0	10.0		2.0	10.0	
Trailing Detector (m)	0.0	0.0	0.0	0.0	0.0		0.0	0.0		0.0	0.0	
Detector 1 Position(m)	0.0	0.0	0.0	0.0	0.0		0.0	0.0		0.0	0.0	
Detector 1 Size(m)	2.0	0.6	2.0	2.0	0.6		2.0	0.6		2.0	0.6	
Detector 1 Type	Cl+Ex	Cl+Ex	Cl+Ex	Cl+Ex	Cl+Ex		Cl+Ex	Cl+Ex		Cl+Ex	Cl+Ex	
Detector 1 Channel												
Detector 1 Extend (s)	0.0	0.0	0.0	0.0	0.0		0.0	0.0		0.0	0.0	
Detector 1 Queue (s)	0.0	0.0	0.0	0.0	0.0		0.0	0.0		0.0	0.0	
Detector 1 Delay (s)	0.0	0.0	0.0	0.0	0.0		0.0	0.0		0.0	0.0	
Detector 2 Position(m)		9.4			9.4			9.4			9.4	
Detector 2 Size(m)		0.6			0.6			0.6			0.6	
Detector 2 Type		Cl+Ex			Cl+Ex			Cl+Ex			Cl+Ex	
Detector 2 Channel												
Detector 2 Extend (s)		0.0			0.0			0.0			0.0	

Lanes, Volumes, Timings  
2: March Road & Klondike Road

2033 Future Total AM  
910 March Road



Lane Group	EBL	EBT	EBR	WBL	WBT	WBR	NBL	NBT	NBR	SBL	SBT	SBR
Turn Type	pm+pt	NA	Perm	Perm	NA		Prot	NA		Prot	NA	
Protected Phases	7	4			8		5	2		1	6	
Permitted Phases	4		4	8								
Detector Phase	7	4	4	8	8		5	2		1	6	
Switch Phase												
Minimum Initial (s)	5.0	5.0	5.0	5.0	5.0		5.0	5.0		5.0	5.0	
Minimum Split (s)	11.6	44.1	44.1	44.1	44.1		11.6	32.4		11.6	32.4	
Total Split (s)	12.0	57.0	57.0	45.0	45.0		15.0	58.0		15.0	58.0	
Total Split (%)	9.2%	43.8%	43.8%	34.6%	34.6%		11.5%	44.6%		11.5%	44.6%	
Maximum Green (s)	5.4	49.9	49.9	37.9	37.9		8.4	51.6		8.4	51.6	
Yellow Time (s)	3.3	3.3	3.3	3.3	3.3		4.6	4.6		4.6	4.6	
All-Red Time (s)	3.3	3.8	3.8	3.8	3.8		2.0	1.8		2.0	1.8	
Lost Time Adjust (s)	0.0	0.0	0.0	0.0	0.0		0.0	0.0		0.0	0.0	
Total Lost Time (s)	6.6	7.1	7.1	7.1	7.1		6.6	6.4		6.6	6.4	
Lead/Lag	Lead			Lag	Lag		Lead	Lag		Lead	Lag	
Lead-Lag Optimize?	Yes			Yes	Yes		Yes	Yes		Yes	Yes	
Vehicle Extension (s)	3.0	3.0	3.0	3.0	3.0		3.0	3.0		3.0	3.0	
Recall Mode	None	None	None	None	None		None	C-Max		None	C-Max	
Walk Time (s)		7.0	7.0	7.0	7.0			7.0			7.0	
Flash Dont Walk (s)		30.0	30.0	30.0	30.0			19.0			19.0	
Pedestrian Calls (#/hr)		0	0	0	0			0			0	
Act Effct Green (s)	34.1	33.6	33.6	24.0	24.0		8.8	69.8		8.9	67.5	
Actuated g/C Ratio	0.26	0.26	0.26	0.18	0.18		0.07	0.54		0.07	0.52	
v/c Ratio	0.29	0.09	0.52	0.78	0.29		0.39	0.33		0.39	0.75	
Control Delay	36.7	32.5	18.1	71.4	20.1		63.0	19.9		68.5	29.2	
Queue Delay	0.0	0.0	0.0	0.0	0.0		0.0	0.0		0.0	0.0	
Total Delay	36.7	32.5	18.1	71.4	20.1		63.0	19.9		68.5	29.2	
LOS	D	C	B	E	C		E	B		E	C	
Approach Delay		23.2			54.1			24.0			30.0	
Approach LOS		C			D			C			C	
Queue Length 50th (m)	14.0	7.4	20.6	44.8	7.3		10.6	42.8		9.5	137.1	
Queue Length 95th (m)	23.8	14.7	42.0	65.5	20.5		18.8	63.9		20.5	#197.9	
Internal Link Dist (m)		93.7			322.6			237.8			118.1	
Turn Bay Length (m)	100.0		5.0	15.0			100.0			45.0		
Base Capacity (vph)	251	644	653	370	465		224	2399		106	2456	
Starvation Cap Reductn	0	0	0	0	0		0	0		0	0	
Spillback Cap Reductn	0	0	0	0	0		0	0		0	0	
Storage Cap Reductn	0	0	0	0	0		0	0		0	0	
Reduced v/c Ratio	0.29	0.06	0.39	0.49	0.20		0.37	0.33		0.36	0.75	

**Intersection Summary**

Area Type: Other

Cycle Length: 130

Actuated Cycle Length: 130

Offset: 64 (49%), Referenced to phase 2:NBT and 6:SBT, Start of Green

Natural Cycle: 120

Control Type: Actuated-Coordinated

Maximum v/c Ratio: 0.78

Intersection Signal Delay: 29.7

Intersection LOS: C

Intersection Capacity Utilization 85.4% ICU Level of Service E

Analysis Period (min) 15

# 95th percentile volume exceeds capacity, queue may be longer.  
 Queue shown is maximum after two cycles.

Splits and Phases: 2: March Road & Klondike Road



HCM Signalized Intersection Capacity Analysis  
2: March Road & Klondike Road

2033 Future Total AM  
910 March Road





















Movement	EBL	EBT	EBR	WBL	WBT	WBR	NBL	NBT	NBR	SBL	SBT	SBR
Lane Configurations	↖	↑	↗	↖	↗		↖↗	↑↑↑		↖	↑↑↑	
Traffic Volume (vph)	72	39	256	182	34	59	83	712	79	38	1776	64
Future Volume (vph)	72	39	256	182	34	59	83	712	79	38	1776	64
Ideal Flow (vphpl)	1800	1800	1800	1800	1800	1800	1800	1800	1800	1800	1800	1800
Total Lost time (s)	6.6	7.1	7.1	7.1	7.1		6.6	6.4		6.6	6.4	
Lane Util. Factor	1.00	1.00	1.00	1.00	1.00		0.97	0.91		1.00	0.91	
Frpb, ped/bikes	1.00	1.00	0.98	1.00	0.99		1.00	1.00		1.00	1.00	
Flpb, ped/bikes	1.00	1.00	1.00	0.99	1.00		1.00	1.00		1.00	1.00	
Frt	1.00	1.00	0.85	1.00	0.90		1.00	0.99		1.00	0.99	
Flt Protected	0.95	1.00	1.00	0.95	1.00		0.95	1.00		0.95	1.00	
Satd. Flow (prot)	1494	1679	1456	1648	1451		3124	4452		1433	4725	
Flt Permitted	0.55	1.00	1.00	0.73	1.00		0.95	1.00		0.95	1.00	
Satd. Flow (perm)	860	1679	1456	1269	1451		3124	4452		1433	4725	
Peak-hour factor, PHF	1.00	1.00	1.00	1.00	1.00	1.00	1.00	1.00	1.00	1.00	1.00	1.00
Adj. Flow (vph)	72	39	256	182	34	59	83	712	79	38	1776	64
RTOR Reduction (vph)	0	0	113	0	48	0	0	8	0	0	2	0
Lane Group Flow (vph)	72	39	143	182	45	0	83	783	0	38	1838	0
Confl. Peds. (#/hr)	3		6	6		3	3		4	4		3
Heavy Vehicles (%)	13%	6%	2%	2%	8%	11%	5%	7%	9%	18%	2%	9%
Turn Type	pm+pt	NA	Perm	Perm	NA		Prot	NA		Prot	NA	
Protected Phases	7	4			8		5	2		1	6	
Permitted Phases	4		4	8								
Actuated Green, G (s)	34.9	34.9	34.9	24.0	24.0		8.8	67.2		7.8	66.2	
Effective Green, g (s)	34.9	34.9	34.9	24.0	24.0		8.8	67.2		7.8	66.2	
Actuated g/C Ratio	0.27	0.27	0.27	0.18	0.18		0.07	0.52		0.06	0.51	
Clearance Time (s)	6.6	7.1	7.1	7.1	7.1		6.6	6.4		6.6	6.4	
Vehicle Extension (s)	3.0	3.0	3.0	3.0	3.0		3.0	3.0		3.0	3.0	
Lane Grp Cap (vph)	251	450	390	234	267		211	2301		85	2406	
v/s Ratio Prot	0.01	0.02			0.03		c0.03	0.18		0.03	c0.39	
v/s Ratio Perm	0.07		c0.10	c0.14								
v/c Ratio	0.29	0.09	0.37	0.78	0.17		0.39	0.34		0.45	0.76	
Uniform Delay, d1	37.3	35.6	38.6	50.5	44.6		58.0	18.4		59.0	25.6	
Progression Factor	1.00	1.00	1.00	1.00	1.00		1.00	1.00		1.00	1.00	
Incremental Delay, d2	0.6	0.1	0.6	14.9	0.3		1.2	0.4		3.7	2.4	
Delay (s)	37.9	35.7	39.2	65.4	44.9		59.3	18.8		62.7	28.0	
Level of Service	D	D	D	E	D		E	B		E	C	
Approach Delay (s)		38.6			58.5			22.6			28.7	
Approach LOS		D			E			C			C	
<b>Intersection Summary</b>												
HCM 2000 Control Delay			30.6				HCM 2000 Level of Service			C		
HCM 2000 Volume to Capacity ratio			0.73									
Actuated Cycle Length (s)			130.0				Sum of lost time (s)			26.7		
Intersection Capacity Utilization			85.4%				ICU Level of Service			E		
Analysis Period (min)			15									

c Critical Lane Group

Lanes, Volumes, Timings  
3: March Road & South Local Road/Site Access

2033 Future Total AM  
910 March Road

												
Lane Group	EBL	EBT	EBR	WBL	WBT	WBR	NBL	NBT	NBR	SBL	SBT	SBR
Lane Configurations												
Traffic Volume (vph)	5	2	31	51	3	6	4	735	26	3	1796	1
Future Volume (vph)	5	2	31	51	3	6	4	735	26	3	1796	1
Ideal Flow (vphpl)	1800	1800	1800	1800	1800	1800	1800	1800	1800	1800	1800	1800
Storage Length (m)	0.0		0.0	0.0		0.0	30.0		50.0	110.0		0.0
Storage Lanes	0		0	0		0	1		1	1		0
Taper Length (m)	15.0			15.0			15.0			95.0		
Lane Util. Factor	1.00	1.00	1.00	1.00	1.00	1.00	1.00	1.00	1.00	1.00	1.00	1.00
Frt		0.890			0.986				0.850			
Flt Protected		0.993			0.959		0.950			0.950		
Satd. Flow (prot)	0	1542	0	0	1650	0	1658	1745	1483	1658	1745	0
Flt Permitted		0.993			0.959		0.950			0.950		
Satd. Flow (perm)	0	1542	0	0	1650	0	1658	1745	1483	1658	1745	0
Link Speed (k/h)		50			30			80			80	
Link Distance (m)		84.7			77.2			81.5			262.6	
Travel Time (s)		6.1			9.3			3.7			11.8	
Peak Hour Factor	1.00	1.00	1.00	1.00	1.00	1.00	1.00	1.00	1.00	1.00	1.00	1.00
Adj. Flow (vph)	5	2	31	51	3	6	4	735	26	3	1796	1
Shared Lane Traffic (%)												
Lane Group Flow (vph)	0	38	0	0	60	0	4	735	26	3	1797	0
Enter Blocked Intersection	No	No	No	No	No	No	No	No	No	No	No	No
Lane Alignment	Left	Left	Right	Left	Left	Right	Left	Left	Right	Left	Left	Right
Median Width(m)		0.0			0.0			3.5			3.5	
Link Offset(m)		0.0			0.0			0.0			0.0	
Crosswalk Width(m)		3.0			3.0			3.0			3.0	
Two way Left Turn Lane												
Headway Factor	1.09	1.09	1.09	1.09	1.09	1.09	1.09	1.09	1.09	1.09	1.09	1.09
Turning Speed (k/h)	25		15	25		15	25		15	25		15
Sign Control		Stop			Stop			Free			Free	

Intersection Summary

Area Type:	Other
Control Type:	Unsignalized
Intersection Capacity Utilization	116.7%
ICU Level of Service	H
Analysis Period (min)	15

Intersection												
Int Delay, s/veh	47.9											
Movement	EBL	EBT	EBR	WBL	WBT	WBR	NBL	NBT	NBR	SBL	SBT	SBR
Lane Configurations		↕			↕		↕	↑	↑	↕	↕	↕
Traffic Vol, veh/h	5	2	31	51	3	6	4	735	26	3	1796	1
Future Vol, veh/h	5	2	31	51	3	6	4	735	26	3	1796	1
Conflicting Peds, #/hr	0	0	0	0	0	0	0	0	0	0	0	0
Sign Control	Stop	Stop	Stop	Stop	Stop	Stop	Free	Free	Free	Free	Free	Free
RT Channelized	-	-	None	-	-	None	-	-	None	-	-	None
Storage Length	-	-	-	-	-	-	30	-	50	110	-	-
Veh in Median Storage, #	-	0	-	-	0	-	-	0	-	-	0	-
Grade, %	-	0	-	-	0	-	-	0	-	-	0	-
Peak Hour Factor	100	100	100	100	100	100	100	100	100	100	100	100
Heavy Vehicles, %	2	2	2	2	2	2	2	2	2	2	2	2
Mvmt Flow	5	2	31	51	3	6	4	735	26	3	1796	1

Major/Minor	Minor2		Minor1		Major1		Major2					
Conflicting Flow All	2564	2572	1797	2562	2546	735	1797	0	0	761	0	0
Stage 1	1803	1803	-	743	743	-	-	-	-	-	-	-
Stage 2	761	769	-	1819	1803	-	-	-	-	-	-	-
Critical Hdwy	7.12	6.52	6.22	7.12	6.52	6.22	4.12	-	-	4.12	-	-
Critical Hdwy Stg 1	6.12	5.52	-	6.12	5.52	-	-	-	-	-	-	-
Critical Hdwy Stg 2	6.12	5.52	-	6.12	5.52	-	-	-	-	-	-	-
Follow-up Hdwy	3.518	4.018	3.318	3.518	4.018	3.318	2.218	-	-	2.218	-	-
Pot Cap-1 Maneuver	18	26	100	~ 18	27	420	343	-	-	851	-	-
Stage 1	102	131	-	407	422	-	-	-	-	-	-	-
Stage 2	398	411	-	99	131	-	-	-	-	-	-	-
Platoon blocked, %								-	-	-	-	-
Mov Cap-1 Maneuver	16	26	100	~ 12	27	420	343	-	-	851	-	-
Mov Cap-2 Maneuver	16	26	-	~ 12	27	-	-	-	-	-	-	-
Stage 1	101	130	-	402	417	-	-	-	-	-	-	-
Stage 2	385	406	-	67	130	-	-	-	-	-	-	-

Approach	EB	WB	NB	SB
HCM Control Delay, s	164.9	\$ 2022.4	0.1	0
HCM LOS	F	F		

Minor Lane/Major Mvmt	NBL	NBT	NBR	EBLn1WBLn1	SBL	SBT	SBR
Capacity (veh/h)	343	-	-	54	14	851	-
HCM Lane V/C Ratio	0.012	-	-	0.704	4.286	0.004	-
HCM Control Delay (s)	15.6	-	-	164.9	\$ 2022.4	9.2	-
HCM Lane LOS	C	-	-	F	F	A	-
HCM 95th %tile Q(veh)	0	-	-	2.9	8.4	0	-

Notes  
 ~: Volume exceeds capacity    \$: Delay exceeds 300s    +: Computation Not Defined    \*: All major volume in platoon

Lanes, Volumes, Timings  
 1: March Road & Halton Terrace/Maxwell Bridge Road

2033 Future Total PM  
 910 March Road



Lane Group	EBL	EBT	EBR	WBL	WBT	WBR	NBL	NBT	NBR	SBL	SBT	SBR
Lane Configurations												
Traffic Volume (vph)	85	58	96	80	61	126	252	1720	115	111	799	99
Future Volume (vph)	85	58	96	80	61	126	252	1720	115	111	799	99
Ideal Flow (vphpl)	1800	1800	1800	1800	1800	1800	1800	1800	1800	1800	1800	1800
Storage Length (m)	30.0		0.0	30.0		0.0	60.0		0.0	70.0		15.0
Storage Lanes	1		0	1		0	1		1	1		1
Taper Length (m)	60.0			60.0			70.0			100.0		
Lane Util. Factor	1.00	1.00	1.00	1.00	1.00	1.00	1.00	0.95	1.00	1.00	0.95	1.00
Ped Bike Factor	0.99	0.98		0.98	0.98		1.00		0.96			0.98
Fr <sub>t</sub>		0.906			0.899				0.850			0.850
Fl <sub>t</sub> Protected	0.950			0.950			0.950			0.950		
Satd. Flow (prot)	1658	1485	0	1610	1538	0	1658	3316	1483	1658	3316	1483
Fl <sub>t</sub> Permitted	0.420			0.529			0.298			0.069		
Satd. Flow (perm)	726	1485	0	883	1538	0	520	3316	1419	120	3316	1447
Right Turn on Red			Yes			Yes			Yes			Yes
Satd. Flow (RTOR)		73			91				100			100
Link Speed (k/h)		40			40			80				80
Link Distance (m)		143.7			356.2			324.9				233.0
Travel Time (s)		12.9			32.1			14.6				10.5
Confl. Peds. (#/hr)	11		17	17		11	2		11	11		2
Peak Hour Factor	1.00	1.00	1.00	1.00	1.00	1.00	1.00	1.00	1.00	1.00	1.00	1.00
Heavy Vehicles (%)	2%	9%	5%	5%	3%	2%	2%	2%	2%	2%	2%	2%
Adj. Flow (vph)	85	58	96	80	61	126	252	1720	115	111	799	99
Shared Lane Traffic (%)												
Lane Group Flow (vph)	85	154	0	80	187	0	252	1720	115	111	799	99
Enter Blocked Intersection	No	No	No	No	No	No	No	No	No	No	No	No
Lane Alignment	Left	Left	Right	Left	Left	Right	Left	Left	Right	Left	Left	Right
Median Width(m)		3.5			3.5			3.5				3.5
Link Offset(m)		0.0			0.0			0.0				0.0
Crosswalk Width(m)		3.0			3.0			3.0				3.0
Two way Left Turn Lane												
Headway Factor	1.09	1.09	1.09	1.09	1.09	1.09	1.09	1.09	1.09	1.09	1.09	1.09
Turning Speed (k/h)	25		15	25		15	25		15	25		15
Number of Detectors	1	2		1	2		1	2	1	1	2	1
Detector Template	Left	Thru		Left	Thru		Left	Thru	Right	Left	Thru	Right
Leading Detector (m)	2.0	10.0		2.0	10.0		2.0	10.0	2.0	2.0	10.0	2.0
Trailing Detector (m)	0.0	0.0		0.0	0.0		0.0	0.0	0.0	0.0	0.0	0.0
Detector 1 Position(m)	0.0	0.0		0.0	0.0		0.0	0.0	0.0	0.0	0.0	0.0
Detector 1 Size(m)	2.0	0.6		2.0	0.6		2.0	0.6	2.0	2.0	0.6	2.0
Detector 1 Type	Cl+Ex	Cl+Ex		Cl+Ex	Cl+Ex		Cl+Ex	Cl+Ex	Cl+Ex	Cl+Ex	Cl+Ex	Cl+Ex
Detector 1 Channel												
Detector 1 Extend (s)	0.0	0.0		0.0	0.0		0.0	0.0	0.0	0.0	0.0	0.0
Detector 1 Queue (s)	0.0	0.0		0.0	0.0		0.0	0.0	0.0	0.0	0.0	0.0
Detector 1 Delay (s)	0.0	0.0		0.0	0.0		0.0	0.0	0.0	0.0	0.0	0.0
Detector 2 Position(m)		9.4			9.4			9.4				9.4
Detector 2 Size(m)		0.6			0.6			0.6				0.6
Detector 2 Type		Cl+Ex			Cl+Ex			Cl+Ex				Cl+Ex
Detector 2 Channel												
Detector 2 Extend (s)		0.0			0.0			0.0				0.0



Lanes, Volumes, Timings  
 1: March Road & Halton Terrace/Maxwell Bridge Road

2033 Future Total PM  
 910 March Road



Lane Group	EBL	EBT	EBR	WBL	WBT	WBR	NBL	NBT	NBR	SBL	SBT	SBR
Turn Type	Perm	NA		Perm	NA		pm+pt	NA	Perm	pm+pt	NA	Perm
Protected Phases		4			8		5	2		1	6	
Permitted Phases	4			8			2		2	6		6
Detector Phase	4	4		8	8		5	2	2	1	6	6
Switch Phase												
Minimum Initial (s)	10.0	10.0		10.0	10.0		5.0	10.0	10.0	5.0	10.0	10.0
Minimum Split (s)	38.6	38.6		38.6	38.6		12.4	34.6	34.6	11.4	34.6	34.6
Total Split (s)	45.0	45.0		45.0	45.0		20.0	55.0	55.0	20.0	55.0	55.0
Total Split (%)	37.5%	37.5%		37.5%	37.5%		16.7%	45.8%	45.8%	16.7%	45.8%	45.8%
Maximum Green (s)	38.4	38.4		38.4	38.4		12.6	48.4	48.4	13.6	48.4	48.4
Yellow Time (s)	3.3	3.3		3.3	3.3		4.6	4.6	4.6	4.6	4.6	4.6
All-Red Time (s)	3.3	3.3		3.3	3.3		2.8	2.0	2.0	1.8	2.0	2.0
Lost Time Adjust (s)	0.0	0.0		0.0	0.0		0.0	0.0	0.0	0.0	0.0	0.0
Total Lost Time (s)	6.6	6.6		6.6	6.6		7.4	6.6	6.6	6.4	6.6	6.6
Lead/Lag							Lead	Lag	Lag	Lead	Lag	Lag
Lead-Lag Optimize?							Yes	Yes	Yes	Yes	Yes	Yes
Vehicle Extension (s)	3.0	3.0		3.0	3.0		3.0	3.0	3.0	3.0	3.0	3.0
Recall Mode	None	None		None	None		None	C-Max	C-Max	None	C-Max	C-Max
Walk Time (s)	7.0	7.0		7.0	7.0			7.0	7.0		7.0	7.0
Flash Dont Walk (s)	25.0	25.0		25.0	25.0			21.0	21.0		21.0	21.0
Pedestrian Calls (#/hr)	0	0		0	0			0	0		0	0
Act Effct Green (s)	15.9	15.9		15.9	15.9		85.8	75.0	75.0	81.6	71.9	71.9
Actuated g/C Ratio	0.13	0.13		0.13	0.13		0.72	0.62	0.62	0.68	0.60	0.60
v/c Ratio	0.89	0.59		0.69	0.66		0.52	0.83	0.12	0.55	0.40	0.11
Control Delay	116.5	34.5		77.4	35.9		9.3	23.7	3.6	26.5	14.6	3.1
Queue Delay	0.0	0.0		0.0	0.0		0.0	0.0	0.0	0.0	0.0	0.0
Total Delay	116.5	34.5		77.4	35.9		9.3	23.7	3.6	26.5	14.6	3.1
LOS	F	C		E	D		A	C	A	C	B	A
Approach Delay		63.6			48.3			20.9			14.8	
Approach LOS		E			D			C			B	
Queue Length 50th (m)	20.0	17.8		18.3	21.5		14.7	151.2	1.2	6.3	48.1	0.0
Queue Length 95th (m)	#39.8	36.9		33.3	42.7		29.8	#261.6	10.5	26.5	79.0	8.3
Internal Link Dist (m)		119.7			332.2			300.9			209.0	
Turn Bay Length (m)	30.0			30.0			60.0			70.0		15.0
Base Capacity (vph)	232	524		282	554		505	2073	924	261	1987	907
Starvation Cap Reductn	0	0		0	0		0	0	0	0	0	0
Spillback Cap Reductn	0	0		0	0		0	0	0	0	0	0
Storage Cap Reductn	0	0		0	0		0	0	0	0	0	0
Reduced v/c Ratio	0.37	0.29		0.28	0.34		0.50	0.83	0.12	0.43	0.40	0.11

Intersection Summary

Area Type: Other  
 Cycle Length: 120  
 Actuated Cycle Length: 120  
 Offset: 50 (42%), Referenced to phase 2:NBT and 6:SBT, Start of Green  
 Natural Cycle: 120  
 Control Type: Actuated-Coordinated  
 Maximum v/c Ratio: 0.89  
 Intersection Signal Delay: 24.0  
 Intersection LOS: C

Lanes, Volumes, Timings  
 1: March Road & Halton Terrace/Maxwell Bridge Road

2033 Future Total PM  
 910 March Road

Intersection Capacity Utilization 104.3%      ICU Level of Service G

Analysis Period (min) 15

# 95th percentile volume exceeds capacity, queue may be longer.  
 Queue shown is maximum after two cycles.

Splits and Phases: 1: March Road & Halton Terrace/Maxwell Bridge Road



HCM Signalized Intersection Capacity Analysis  
 1: March Road & Halton Terrace/Maxwell Bridge Road

2033 Future Total PM  
 910 March Road



Movement	EBL	EBT	EBR	WBL	WBT	WBR	NBL	NBT	NBR	SBL	SBT	SBR
Lane Configurations	↖	↗		↖	↗		↖	↑↑	↗	↖	↑↑	↗
Traffic Volume (vph)	85	58	96	80	61	126	252	1720	115	111	799	99
Future Volume (vph)	85	58	96	80	61	126	252	1720	115	111	799	99
Ideal Flow (vphpl)	1800	1800	1800	1800	1800	1800	1800	1800	1800	1800	1800	1800
Total Lost time (s)	6.6	6.6		6.6	6.6		7.4	6.6	6.6	6.4	6.6	6.6
Lane Util. Factor	1.00	1.00		1.00	1.00		1.00	0.95	1.00	1.00	0.95	1.00
Frbp, ped/bikes	1.00	0.98		1.00	0.98		1.00	1.00	0.96	1.00	1.00	0.98
Flpb, ped/bikes	0.99	1.00		0.99	1.00		1.00	1.00	1.00	1.00	1.00	1.00
Frt	1.00	0.91		1.00	0.90		1.00	1.00	0.85	1.00	1.00	0.85
Flt Protected	0.95	1.00		0.95	1.00		0.95	1.00	1.00	0.95	1.00	1.00
Satd. Flow (prot)	1643	1486		1587	1538		1657	3316	1419	1658	3316	1447
Flt Permitted	0.42	1.00		0.53	1.00		0.30	1.00	1.00	0.07	1.00	1.00
Satd. Flow (perm)	726	1486		884	1538		519	3316	1419	121	3316	1447
Peak-hour factor, PHF	1.00	1.00	1.00	1.00	1.00	1.00	1.00	1.00	1.00	1.00	1.00	1.00
Adj. Flow (vph)	85	58	96	80	61	126	252	1720	115	111	799	99
RTOR Reduction (vph)	0	63	0	0	79	0	0	0	38	0	0	40
Lane Group Flow (vph)	85	91	0	80	108	0	252	1720	78	111	799	59
Confl. Peds. (#/hr)	11		17	17		11	2		11	11		2
Heavy Vehicles (%)	2%	9%	5%	5%	3%	2%	2%	2%	2%	2%	2%	2%
Turn Type	Perm	NA		Perm	NA		pm+pt	NA	Perm	pm+pt	NA	Perm
Protected Phases		4			8		5	2		1	6	
Permitted Phases	4			8			2		2	6		6
Actuated Green, G (s)	15.9	15.9		15.9	15.9		86.6	75.0	75.0	81.4	71.9	71.9
Effective Green, g (s)	15.9	15.9		15.9	15.9		86.6	75.0	75.0	81.4	71.9	71.9
Actuated g/C Ratio	0.13	0.13		0.13	0.13		0.72	0.62	0.62	0.68	0.60	0.60
Clearance Time (s)	6.6	6.6		6.6	6.6		7.4	6.6	6.6	6.4	6.6	6.6
Vehicle Extension (s)	3.0	3.0		3.0	3.0		3.0	3.0	3.0	3.0	3.0	3.0
Lane Grp Cap (vph)	96	196		117	203		484	2072	886	203	1986	866
v/s Ratio Prot		0.06			0.07		c0.05	c0.52		0.04	0.24	
v/s Ratio Perm	c0.12			0.09			0.32		0.05	0.33		0.04
v/c Ratio	0.89	0.46		0.68	0.53		0.52	0.83	0.09	0.55	0.40	0.07
Uniform Delay, d1	51.2	48.1		49.7	48.6		6.4	17.5	8.9	16.5	12.7	10.1
Progression Factor	1.00	1.00		1.00	1.00		1.00	1.00	1.00	1.00	1.00	1.00
Incremental Delay, d2	56.1	1.7		15.3	2.7		1.0	4.0	0.2	3.0	0.6	0.2
Delay (s)	107.2	49.8		64.9	51.3		7.4	21.6	9.1	19.5	13.3	10.2
Level of Service	F	D		E	D		A	C	A	B	B	B
Approach Delay (s)		70.2			55.3			19.2			13.7	
Approach LOS		E			E			B			B	
<b>Intersection Summary</b>												
HCM 2000 Control Delay			23.7				HCM 2000 Level of Service			C		
HCM 2000 Volume to Capacity ratio			0.83									
Actuated Cycle Length (s)			120.0				Sum of lost time (s)			20.6		
Intersection Capacity Utilization			104.3%				ICU Level of Service			G		
Analysis Period (min)			15									

c Critical Lane Group

Lanes, Volumes, Timings  
2: March Road & Klondike Road

2033 Future Total PM  
910 March Road



Lane Group	EBL	EBT	EBR	WBL	WBT	WBR	NBL	NBT	NBR	SBL	SBT	SBR
Lane Configurations												
Traffic Volume (vph)	127	31	111	115	37	44	161	1993	156	18	921	111
Future Volume (vph)	127	31	111	115	37	44	161	1993	156	18	921	111
Ideal Flow (vphpl)	1800	1800	1800	1800	1800	1800	1800	1800	1800	1800	1800	1800
Storage Length (m)	100.0		5.0	15.0		0.0	100.0		0.0	45.0		0.0
Storage Lanes	1		1	1		0	2		0	1		0
Taper Length (m)	0.0			30.0			100.0			85.0		
Lane Util. Factor	1.00	1.00	1.00	1.00	1.00	1.00	0.97	0.91	0.91	1.00	0.91	0.91
Ped Bike Factor	1.00		0.99	1.00	0.99		1.00	1.00		1.00	1.00	
Fr <sub>t</sub>			0.850		0.919			0.989			0.984	
Fl <sub>t</sub> Protected	0.950			0.950			0.950			0.950		
Satd. Flow (prot)	1658	1745	1483	1658	1564	0	3216	4696	0	1658	4676	0
Fl <sub>t</sub> Permitted	0.507			0.737			0.950			0.950		
Satd. Flow (perm)	884	1745	1462	1284	1564	0	3201	4696	0	1656	4676	0
Right Turn on Red			Yes			Yes			Yes			Yes
Satd. Flow (RTOR)			111		44			10			18	
Link Speed (k/h)		50			50			80			80	
Link Distance (m)		117.7			346.6			261.8			142.1	
Travel Time (s)		8.5			25.0			11.8			6.4	
Confl. Peds. (#/hr)	1		2	2		1	8		11	11		8
Peak Hour Factor	1.00	1.00	1.00	1.00	1.00	1.00	1.00	1.00	1.00	1.00	1.00	1.00
Heavy Vehicles (%)	2%	2%	2%	2%	6%	2%	2%	2%	2%	2%	2%	2%
Adj. Flow (vph)	127	31	111	115	37	44	161	1993	156	18	921	111
Shared Lane Traffic (%)												
Lane Group Flow (vph)	127	31	111	115	81	0	161	2149	0	18	1032	0
Enter Blocked Intersection	No	No	No	No	No	No	No	No	No	No	No	No
Lane Alignment	Left	Left	Right	Left	Left	Right	Left	Left	Right	Left	Left	Right
Median Width(m)		3.5			3.5			7.0			7.0	
Link Offset(m)		0.0			0.0			0.0			0.0	
Crosswalk Width(m)		3.0			3.0			3.0			3.0	
Two way Left Turn Lane												
Headway Factor	1.09	1.09	1.09	1.09	1.09	1.09	1.09	1.09	1.09	1.09	1.09	1.09
Turning Speed (k/h)	25		15	25		15	25		15	25		15
Number of Detectors	1	2	1	1	2		1	2		1	2	
Detector Template	Left	Thru	Right	Left	Thru		Left	Thru		Left	Thru	
Leading Detector (m)	2.0	10.0	2.0	2.0	10.0		2.0	10.0		2.0	10.0	
Trailing Detector (m)	0.0	0.0	0.0	0.0	0.0		0.0	0.0		0.0	0.0	
Detector 1 Position(m)	0.0	0.0	0.0	0.0	0.0		0.0	0.0		0.0	0.0	
Detector 1 Size(m)	2.0	0.6	2.0	2.0	0.6		2.0	0.6		2.0	0.6	
Detector 1 Type	Cl+Ex	Cl+Ex	Cl+Ex	Cl+Ex	Cl+Ex		Cl+Ex	Cl+Ex		Cl+Ex	Cl+Ex	
Detector 1 Channel												
Detector 1 Extend (s)	0.0	0.0	0.0	0.0	0.0		0.0	0.0		0.0	0.0	
Detector 1 Queue (s)	0.0	0.0	0.0	0.0	0.0		0.0	0.0		0.0	0.0	
Detector 1 Delay (s)	0.0	0.0	0.0	0.0	0.0		0.0	0.0		0.0	0.0	
Detector 2 Position(m)		9.4			9.4			9.4			9.4	
Detector 2 Size(m)		0.6			0.6			0.6			0.6	
Detector 2 Type		Cl+Ex			Cl+Ex			Cl+Ex			Cl+Ex	
Detector 2 Channel												
Detector 2 Extend (s)		0.0			0.0			0.0			0.0	

Lanes, Volumes, Timings  
2: March Road & Klondike Road

2033 Future Total PM  
910 March Road



Lane Group	EBL	EBT	EBR	WBL	WBT	WBR	NBL	NBT	NBR	SBL	SBT	SBR
Turn Type	pm+pt	NA	Perm	Perm	NA		Prot	NA		Prot	NA	
Protected Phases	7	4			8		5	2		1	6	
Permitted Phases	4		4	8								
Detector Phase	7	4	4	8	8		5	2		1	6	
Switch Phase												
Minimum Initial (s)	5.0	5.0	5.0	5.0	5.0		5.0	5.0		5.0	5.0	
Minimum Split (s)	11.6	44.1	44.1	44.1	44.1		11.6	32.4		11.6	32.4	
Total Split (s)	12.0	57.0	57.0	45.0	45.0		22.0	51.0		22.0	51.0	
Total Split (%)	9.2%	43.8%	43.8%	34.6%	34.6%		16.9%	39.2%		16.9%	39.2%	
Maximum Green (s)	5.4	49.9	49.9	37.9	37.9		15.4	44.6		15.4	44.6	
Yellow Time (s)	3.3	3.3	3.3	3.3	3.3		4.6	4.6		4.6	4.6	
All-Red Time (s)	3.3	3.8	3.8	3.8	3.8		2.0	1.8		2.0	1.8	
Lost Time Adjust (s)	0.0	0.0	0.0	0.0	0.0		0.0	0.0		0.0	0.0	
Total Lost Time (s)	6.6	7.1	7.1	7.1	7.1		6.6	6.4		6.6	6.4	
Lead/Lag	Lead			Lag	Lag		Lead	Lag		Lead	Lag	
Lead-Lag Optimize?	Yes			Yes	Yes		Yes	Yes		Yes	Yes	
Vehicle Extension (s)	3.0	3.0	3.0	3.0	3.0		3.0	3.0		3.0	3.0	
Recall Mode	None	None	None	None	None		None	C-Max		None	C-Max	
Walk Time (s)		7.0	7.0	7.0	7.0			7.0			7.0	
Flash Dont Walk (s)		30.0	30.0	30.0	30.0			19.0			19.0	
Pedestrian Calls (#/hr)		0	0	0	0			0			0	
Act Effct Green (s)	29.5	29.0	29.0	17.0	17.0		11.8	81.4		7.0	69.1	
Actuated g/C Ratio	0.23	0.22	0.22	0.13	0.13		0.09	0.63		0.05	0.53	
v/c Ratio	0.55	0.08	0.27	0.68	0.33		0.55	0.73		0.20	0.41	
Control Delay	50.7	37.9	8.1	73.3	28.3		63.5	20.9		63.4	19.7	
Queue Delay	0.0	0.0	0.0	0.0	0.0		0.0	0.0		0.0	0.0	
Total Delay	50.7	37.9	8.1	73.3	28.3		63.5	20.9		63.4	19.7	
LOS	D	D	A	E	C		E	C		E	B	
Approach Delay		31.7			54.7			23.9			20.4	
Approach LOS		C			D			C			C	
Queue Length 50th (m)	27.5	6.3	0.0	28.5	8.6		20.7	111.2		4.5	55.1	
Queue Length 95th (m)	42.5	13.7	13.8	46.1	22.3		31.2	205.9		12.5	78.8	
Internal Link Dist (m)		93.7			322.6			237.8			118.1	
Turn Bay Length (m)	100.0		5.0	15.0			100.0			45.0		
Base Capacity (vph)	233	669	629	374	487		380	2945		196	2492	
Starvation Cap Reductn	0	0	0	0	0		0	0		0	0	
Spillback Cap Reductn	0	0	0	0	0		0	0		0	0	
Storage Cap Reductn	0	0	0	0	0		0	0		0	0	
Reduced v/c Ratio	0.55	0.05	0.18	0.31	0.17		0.42	0.73		0.09	0.41	

Intersection Summary

Area Type: Other  
 Cycle Length: 130  
 Actuated Cycle Length: 130  
 Offset: 20 (15%), Referenced to phase 2:NBT and 6:SBT, Start of Green  
 Natural Cycle: 130  
 Control Type: Actuated-Coordinated  
 Maximum v/c Ratio: 0.73  
 Intersection Signal Delay: 25.1  
 Intersection LOS: C

Intersection Capacity Utilization 80.5% ICU Level of Service D  
 Analysis Period (min) 15

Splits and Phases: 2: March Road & Klondike Road



HCM Signalized Intersection Capacity Analysis  
2: March Road & Klondike Road

2033 Future Total PM  
910 March Road



Movement	EBL	EBT	EBR	WBL	WBT	WBR	NBL	NBT	NBR	SBL	SBT	SBR
Lane Configurations	↖	↑	↗	↖	↗		↖↗	↑↑↑		↖	↑↑↑	
Traffic Volume (vph)	127	31	111	115	37	44	161	1993	156	18	921	111
Future Volume (vph)	127	31	111	115	37	44	161	1993	156	18	921	111
Ideal Flow (vphpl)	1800	1800	1800	1800	1800	1800	1800	1800	1800	1800	1800	1800
Total Lost time (s)	6.6	7.1	7.1	7.1	7.1		6.6	6.4		6.6	6.4	
Lane Util. Factor	1.00	1.00	1.00	1.00	1.00		0.97	0.91		1.00	0.91	
Frpb, ped/bikes	1.00	1.00	0.99	1.00	0.99		1.00	1.00		1.00	1.00	
Flpb, ped/bikes	1.00	1.00	1.00	1.00	1.00		1.00	1.00		1.00	1.00	
Frt	1.00	1.00	0.85	1.00	0.92		1.00	0.99		1.00	0.98	
Flt Protected	0.95	1.00	1.00	0.95	1.00		0.95	1.00		0.95	1.00	
Satd. Flow (prot)	1657	1745	1462	1654	1564		3216	4696		1658	4675	
Flt Permitted	0.51	1.00	1.00	0.74	1.00		0.95	1.00		0.95	1.00	
Satd. Flow (perm)	885	1745	1462	1283	1564		3216	4696		1658	4675	
Peak-hour factor, PHF	1.00	1.00	1.00	1.00	1.00	1.00	1.00	1.00	1.00	1.00	1.00	1.00
Adj. Flow (vph)	127	31	111	115	37	44	161	1993	156	18	921	111
RTOR Reduction (vph)	0	0	86	0	38	0	0	4	0	0	8	0
Lane Group Flow (vph)	127	31	25	115	43	0	161	2145	0	18	1024	0
Confl. Peds. (#/hr)	1		2	2		1	8		11	11		8
Heavy Vehicles (%)	2%	2%	2%	2%	6%	2%	2%	2%	2%	2%	2%	2%
Turn Type	pm+pt	NA	Perm	Perm	NA		Prot	NA		Prot	NA	
Protected Phases	7	4			8		5	2		1	6	
Permitted Phases	4		4	8								
Actuated Green, G (s)	29.0	29.0	29.0	17.0	17.0		11.8	77.5		3.4	69.1	
Effective Green, g (s)	29.0	29.0	29.0	17.0	17.0		11.8	77.5		3.4	69.1	
Actuated g/C Ratio	0.22	0.22	0.22	0.13	0.13		0.09	0.60		0.03	0.53	
Clearance Time (s)	6.6	7.1	7.1	7.1	7.1		6.6	6.4		6.6	6.4	
Vehicle Extension (s)	3.0	3.0	3.0	3.0	3.0		3.0	3.0		3.0	3.0	
Lane Grp Cap (vph)	229	389	326	167	204		291	2799		43	2484	
v/s Ratio Prot	c0.02	0.02			0.03		c0.05	c0.46		0.01	0.22	
v/s Ratio Perm	0.10		0.02	c0.09								
v/c Ratio	0.55	0.08	0.08	0.69	0.21		0.55	0.77		0.42	0.41	
Uniform Delay, d1	44.9	39.9	39.9	54.0	50.5		56.6	19.5		62.3	18.3	
Progression Factor	1.00	1.00	1.00	1.00	1.00		1.00	1.00		1.00	1.00	
Incremental Delay, d2	2.9	0.1	0.1	11.2	0.5		2.3	2.1		6.5	0.5	
Delay (s)	47.8	40.0	40.0	65.2	51.0		58.8	21.6		68.8	18.8	
Level of Service	D	D	D	E	D		E	C		E	B	
Approach Delay (s)		43.7			59.3			24.2			19.6	
Approach LOS		D			E			C			B	
<b>Intersection Summary</b>												
HCM 2000 Control Delay			26.1	HCM 2000 Level of Service				C				
HCM 2000 Volume to Capacity ratio			0.77									
Actuated Cycle Length (s)			130.0	Sum of lost time (s)				26.7				
Intersection Capacity Utilization			80.5%	ICU Level of Service				D				
Analysis Period (min)			15									

c Critical Lane Group

Lanes, Volumes, Timings  
3: March Road & South Local Road/Site Access

2033 Future Total PM  
910 March Road



Lane Group	EBL	EBT	EBR	WBL	WBT	WBR	NBL	NBT	NBR	SBL	SBT	SBR
Lane Configurations		↕			↕		↗	↑	↗	↗	↗	↗
Traffic Volume (vph)	5	3	50	39	2	11	23	1850	58	9	920	13
Future Volume (vph)	5	3	50	39	2	11	23	1850	58	9	920	13
Ideal Flow (vphpl)	1800	1800	1800	1800	1800	1800	1800	1800	1800	1800	1800	1800
Storage Length (m)	0.0		0.0	0.0		0.0	30.0		50.0	110.0		0.0
Storage Lanes	0		0	0		0	1		1	1		0
Taper Length (m)	15.0			15.0			15.0			95.0		
Lane Util. Factor	1.00	1.00	1.00	1.00	1.00	1.00	1.00	1.00	1.00	1.00	1.00	1.00
Frt		0.884			0.971				0.850		0.998	
Flt Protected		0.996			0.964		0.950			0.950		
Satd. Flow (prot)	0	1536	0	0	1633	0	1658	1745	1483	1658	1742	0
Flt Permitted		0.996			0.964		0.950			0.950		
Satd. Flow (perm)	0	1536	0	0	1633	0	1658	1745	1483	1658	1742	0
Link Speed (k/h)		50			30			80			80	
Link Distance (m)		100.3			69.7			79.0			213.6	
Travel Time (s)		7.2			8.4			3.6			9.6	
Peak Hour Factor	1.00	1.00	1.00	1.00	1.00	1.00	1.00	1.00	1.00	1.00	1.00	1.00
Adj. Flow (vph)	5	3	50	39	2	11	23	1850	58	9	920	13
Shared Lane Traffic (%)												
Lane Group Flow (vph)	0	58	0	0	52	0	23	1850	58	9	933	0
Enter Blocked Intersection	No	No	No	No	No	No	No	No	No	No	No	No
Lane Alignment	Left	Left	Right	Left	Left	Right	Left	Left	Right	Left	Left	Right
Median Width(m)		0.0			0.0			3.5			3.5	
Link Offset(m)		0.0			0.0			0.0			0.0	
Crosswalk Width(m)		3.0			3.0			3.0			3.0	
Two way Left Turn Lane												
Headway Factor	1.09	1.09	1.09	1.09	1.09	1.09	1.09	1.09	1.09	1.09	1.09	1.09
Turning Speed (k/h)	25		15	25		15	25		15	25		15
Sign Control		Stop			Stop			Free			Free	

Intersection Summary	
Area Type:	Other
Control Type:	Unsignalized
Intersection Capacity Utilization	119.2%
ICU Level of Service	H
Analysis Period (min)	15



Intersection												
Int Delay, s/veh	50.3											
Movement	EBL	EBT	EBR	WBL	WBT	WBR	NBL	NBT	NBR	SBL	SBT	SBR
Lane Configurations		↕			↕		↕	↑	↑	↕	↕	↕
Traffic Vol, veh/h	5	3	50	39	2	11	23	1850	58	9	920	13
Future Vol, veh/h	5	3	50	39	2	11	23	1850	58	9	920	13
Conflicting Peds, #/hr	0	0	0	0	0	0	0	0	0	0	0	0
Sign Control	Stop	Stop	Stop	Stop	Stop	Stop	Free	Free	Free	Free	Free	Free
RT Channelized	-	-	None	-	-	None	-	-	None	-	-	None
Storage Length	-	-	-	-	-	-	30	-	50	110	-	-
Veh in Median Storage, #	-	0	-	-	0	-	-	0	-	-	0	-
Grade, %	-	0	-	-	0	-	-	0	-	-	0	-
Peak Hour Factor	100	100	100	100	100	100	100	100	100	100	100	100
Heavy Vehicles, %	2	2	2	2	2	2	2	2	2	2	2	2
Mvmt Flow	5	3	50	39	2	11	23	1850	58	9	920	13

Major/Minor	Minor2		Minor1		Major1			Major2				
Conflicting Flow All	2877	2899	927	2867	2847	1850	933	0	0	1908	0	0
Stage 1	945	945	-	1896	1896	-	-	-	-	-	-	-
Stage 2	1932	1954	-	971	951	-	-	-	-	-	-	-
Critical Hdwy	7.12	6.52	6.22	7.12	6.52	6.22	4.12	-	-	4.12	-	-
Critical Hdwy Stg 1	6.12	5.52	-	6.12	5.52	-	-	-	-	-	-	-
Critical Hdwy Stg 2	6.12	5.52	-	6.12	5.52	-	-	-	-	-	-	-
Follow-up Hdwy	3.518	4.018	3.318	3.518	4.018	3.318	2.218	-	-	2.218	-	-
Pot Cap-1 Maneuver	10	16	325	~ 11	17	92	734	-	-	311	-	-
Stage 1	314	340	-	90	118	-	-	-	-	-	-	-
Stage 2	85	110	-	304	338	-	-	-	-	-	-	-
Platoon blocked, %								-	-	-	-	-
Mov Cap-1 Maneuver	8	15	325	~ 8	16	92	734	-	-	311	-	-
Mov Cap-2 Maneuver	8	15	-	~ 8	16	-	-	-	-	-	-	-
Stage 1	304	330	-	87	114	-	-	-	-	-	-	-
Stage 2	71	107	-	248	328	-	-	-	-	-	-	-

















Approach	EB		WB		NB		SB	
HCM Control Delay, s	226.5		\$ 2627.4		0.1		0.2	
HCM LOS	F		F					

Minor Lane/Major Mvmt	NBL	NBT	NBR	EBLn1WBLn1	SBL	SBT	SBR
Capacity (veh/h)	734	-	-	59	10	311	-
HCM Lane V/C Ratio	0.031	-	-	0.983	5.2	0.029	-
HCM Control Delay (s)	10.1	-	-	226.5	\$ 2627.4	16.9	-
HCM Lane LOS	B	-	-	F	F	C	-
HCM 95th %tile Q(veh)	0.1	-	-	4.6	7.8	0.1	-

Notes  
 ~: Volume exceeds capacity    \$: Delay exceeds 300s    +: Computation Not Defined    \*: All major volume in platoon

Lanes, Volumes, Timings  
3: March Road & South Local Road/Site Access

2033 Future Total AM - RIRO  
910 March Road

												
Lane Group	EBL	EBT	EBR	WBL	WBT	WBR	NBL	NBT	NBR	SBL	SBT	SBR
Lane Configurations												
Traffic Volume (vph)	0	0	38	0	0	60	0	743	31	0	1794	1
Future Volume (vph)	0	0	38	0	0	60	0	743	31	0	1794	1
Ideal Flow (vphpl)	1800	1800	1800	1800	1800	1800	1800	1800	1800	1800	1800	1800
Storage Length (m)	0.0		0.0	0.0		0.0	0.0		50.0	110.0		0.0
Storage Lanes	0		1	0		1	0		1	0		0
Taper Length (m)	15.0			15.0			15.0			95.0		
Lane Util. Factor	1.00	1.00	1.00	1.00	1.00	1.00	1.00	1.00	1.00	1.00	1.00	1.00
Frt			0.865			0.865			0.850			
Flt Protected												
Satd. Flow (prot)	0	0	1510	0	0	1510	0	1745	1483	0	1745	0
Flt Permitted												
Satd. Flow (perm)	0	0	1510	0	0	1510	0	1745	1483	0	1745	0
Link Speed (k/h)		50			30			80			80	
Link Distance (m)		84.7			77.2			81.1			262.6	
Travel Time (s)		6.1			9.3			3.6			11.8	
Peak Hour Factor	1.00	1.00	1.00	1.00	1.00	1.00	1.00	1.00	1.00	1.00	1.00	1.00
Adj. Flow (vph)	0	0	38	0	0	60	0	743	31	0	1794	1
Shared Lane Traffic (%)												
Lane Group Flow (vph)	0	0	38	0	0	60	0	743	31	0	1795	0
Enter Blocked Intersection	No	No	No	No	No	No	No	No	No	No	No	No
Lane Alignment	Left	Left	Right	Left	Left	Right	Left	Left	Right	Left	Left	Right
Median Width(m)		0.0			0.0			0.0			0.0	
Link Offset(m)		0.0			0.0			0.0			0.0	
Crosswalk Width(m)		3.0			3.0			3.0			3.0	
Two way Left Turn Lane												
Headway Factor	1.09	1.09	1.09	1.09	1.09	1.09	1.09	1.09	1.09	1.09	1.09	1.09
Turning Speed (k/h)	25		15	25		15	25		15	25		15
Sign Control		Stop			Stop			Free			Free	
<b>Intersection Summary</b>												
Area Type:	Other											
Control Type:	Unsignalized											
Intersection Capacity Utilization	109.7%						ICU Level of Service H					
Analysis Period (min)	15											

Intersection												
Int Delay, s/veh	1.2											
Movement	EBL	EBT	EBR	WBL	WBT	WBR	NBL	NBT	NBR	SBL	SBT	SBR
Lane Configurations			↗			↗		↑	↗		↘	
Traffic Vol, veh/h	0	0	38	0	0	60	0	743	31	0	1794	1
Future Vol, veh/h	0	0	38	0	0	60	0	743	31	0	1794	1
Conflicting Peds, #/hr	0	0	0	0	0	0	0	0	0	0	0	0
Sign Control	Stop	Stop	Stop	Stop	Stop	Stop	Free	Free	Free	Free	Free	Free
RT Channelized	-	-	None	-	-	None	-	-	None	-	-	None
Storage Length	-	-	0	-	-	0	-	-	50	-	-	-
Veh in Median Storage, #	-	0	-	-	0	-	-	0	-	-	0	-
Grade, %	-	0	-	-	0	-	-	0	-	-	0	-
Peak Hour Factor	100	100	100	100	100	100	100	100	100	100	100	100
Heavy Vehicles, %	2	2	2	2	2	2	2	2	2	2	2	2
Mvmt Flow	0	0	38	0	0	60	0	743	31	0	1794	1

Major/Minor	Minor2		Minor1		Major1		Major2					
Conflicting Flow All	-	-	1795	-	-	743	-	0	0	-	-	0
Stage 1	-	-	-	-	-	-	-	-	-	-	-	-
Stage 2	-	-	-	-	-	-	-	-	-	-	-	-
Critical Hdwy	-	-	6.22	-	-	6.22	-	-	-	-	-	-
Critical Hdwy Stg 1	-	-	-	-	-	-	-	-	-	-	-	-
Critical Hdwy Stg 2	-	-	-	-	-	-	-	-	-	-	-	-
Follow-up Hdwy	-	-	3.318	-	-	3.318	-	-	-	-	-	-
Pot Cap-1 Maneuver	0	0	100	0	0	415	0	-	-	0	-	-
Stage 1	0	0	-	0	0	-	0	-	-	0	-	-
Stage 2	0	0	-	0	0	-	0	-	-	0	-	-
Platoon blocked, %	-	-	-	-	-	-	-	-	-	-	-	-
Mov Cap-1 Maneuver	-	-	100	-	-	415	-	-	-	-	-	-
Mov Cap-2 Maneuver	-	-	-	-	-	-	-	-	-	-	-	-
Stage 1	-	-	-	-	-	-	-	-	-	-	-	-
Stage 2	-	-	-	-	-	-	-	-	-	-	-	-

Approach	EB		WB		NB		SB	
HCM Control Delay, s	61.6		15.1		0		0	
HCM LOS	F		C					

Minor Lane/Major Mvmt	NBT	NBR	EBLn1	WBLn1	SBT	SBR
Capacity (veh/h)	-	-	100	415	-	-
HCM Lane V/C Ratio	-	-	0.38	0.145	-	-
HCM Control Delay (s)	-	-	61.6	15.1	-	-
HCM Lane LOS	-	-	F	C	-	-
HCM 95th %tile Q(veh)	-	-	1.5	0.5	-	-

Lanes, Volumes, Timings  
 3: March Road & South Local Road/Site Access

2033 Future Total PM - RIRO  
 910 March Road



Lane Group	EBL	EBT	EBR	WBL	WBT	WBR	NBL	NBT	NBR	SBL	SBT	SBR
Lane Configurations												
Traffic Volume (vph)	0	0	58	0	0	52	0	1903	67	0	934	13
Future Volume (vph)	0	0	58	0	0	52	0	1903	67	0	934	13
Ideal Flow (vphpl)	1800	1800	1800	1800	1800	1800	1800	1800	1800	1800	1800	1800
Storage Length (m)	0.0		0.0	0.0		0.0	0.0		50.0	110.0		0.0
Storage Lanes	0		1	0		1	0		1	0		0
Taper Length (m)	15.0			15.0			15.0			95.0		
Lane Util. Factor	1.00	1.00	1.00	1.00	1.00	1.00	1.00	1.00	1.00	1.00	1.00	1.00
Frt			0.865			0.865			0.850		0.998	
Flt Protected												
Satd. Flow (prot)	0	0	1510	0	0	1510	0	1745	1483	0	1742	0
Flt Permitted												
Satd. Flow (perm)	0	0	1510	0	0	1510	0	1745	1483	0	1742	0
Link Speed (k/h)		50			30			80			80	
Link Distance (m)		100.3			69.7			88.6			213.6	
Travel Time (s)		7.2			8.4			4.0			9.6	
Peak Hour Factor	1.00	1.00	1.00	1.00	1.00	1.00	1.00	1.00	1.00	1.00	1.00	1.00
Adj. Flow (vph)	0	0	58	0	0	52	0	1903	67	0	934	13
Shared Lane Traffic (%)												
Lane Group Flow (vph)	0	0	58	0	0	52	0	1903	67	0	947	0
Enter Blocked Intersection	No	No	No	No	No	No	No	No	No	No	No	No
Lane Alignment	Left	Left	Right	Left	Left	Right	Left	Left	Right	Left	Left	Right
Median Width(m)		0.0			0.0			0.0			0.0	
Link Offset(m)		0.0			0.0			0.0			0.0	
Crosswalk Width(m)		3.0			3.0			3.0			3.0	
Two way Left Turn Lane												
Headway Factor	1.09	1.09	1.09	1.09	1.09	1.09	1.09	1.09	1.09	1.09	1.09	1.09
Turning Speed (k/h)	25		15	25		15	25		15	25		15
Sign Control		Stop			Stop			Free			Free	

Intersection Summary

Area Type:	Other
Control Type:	Unsignalized
Intersection Capacity Utilization	115.8%
ICU Level of Service	H
Analysis Period (min)	15

Intersection												
Int Delay, s/veh	2											
Movement	EBL	EBT	EBR	WBL	WBT	WBR	NBL	NBT	NBR	SBL	SBT	SBR
Lane Configurations			↗			↗		↖	↗		↖	
Traffic Vol, veh/h	0	0	58	0	0	52	0	1903	67	0	934	13
Future Vol, veh/h	0	0	58	0	0	52	0	1903	67	0	934	13
Conflicting Peds, #/hr	0	0	0	0	0	0	0	0	0	0	0	0
Sign Control	Stop	Stop	Stop	Stop	Stop	Stop	Free	Free	Free	Free	Free	Free
RT Channelized	-	-	None	-	-	None	-	-	None	-	-	None
Storage Length	-	-	0	-	-	0	-	-	50	-	-	-
Veh in Median Storage, #	-	0	-	-	0	-	-	0	-	-	0	-
Grade, %	-	0	-	-	0	-	-	0	-	-	0	-
Peak Hour Factor	100	100	100	100	100	100	100	100	100	100	100	100
Heavy Vehicles, %	2	2	2	2	2	2	2	2	2	2	2	2
Mvmt Flow	0	0	58	0	0	52	0	1903	67	0	934	13

Major/Minor	Minor2		Minor1		Major1		Major2	
Conflicting Flow All	-	-	941	-	-	1903	-	0
Stage 1	-	-	-	-	-	-	-	-
Stage 2	-	-	-	-	-	-	-	-
Critical Hdwy	-	-	6.22	-	-	6.22	-	-
Critical Hdwy Stg 1	-	-	-	-	-	-	-	-
Critical Hdwy Stg 2	-	-	-	-	-	-	-	-
Follow-up Hdwy	-	-	3.318	-	-	3.318	-	-
Pot Cap-1 Maneuver	0	0	319	0	0	86	0	-
Stage 1	0	0	-	0	0	-	0	-
Stage 2	0	0	-	0	0	-	0	-
Platoon blocked, %	-	-	-	-	-	-	-	-
Mov Cap-1 Maneuver	-	-	319	-	-	86	-	-
Mov Cap-2 Maneuver	-	-	-	-	-	-	-	-
Stage 1	-	-	-	-	-	-	-	-
Stage 2	-	-	-	-	-	-	-	-

Approach	EB	WB	NB	SB
HCM Control Delay, s	18.8	96.8	0	0
HCM LOS	C	F		

Minor Lane/Major Mvmt	NBT	NBR	EBLn1WBLn1	SBT	SBR
Capacity (veh/h)	-	-	319	86	-
HCM Lane V/C Ratio	-	-	0.182	0.605	-
HCM Control Delay (s)	-	-	18.8	96.8	-
HCM Lane LOS	-	-	C	F	-
HCM 95th %tile Q(veh)	-	-	0.7	2.8	-