

LT. COL. WILLIAM G. BARKER PARK



Canada Lands Company
Société immobilière du Canada

NAK PROJECT NO. 21-112

WATERIDGE VILLAGE
LT. COL. WILLIAM G. BARKER VC PARK
PARK 8 - BLOCK 20

ISSUED FOR CONSTRUCTION
OCTOBER 20, 2023

LIST OF DRAWINGS:

<u>NAK</u>	
L01	- SITE PLAN
L02	- LAYOUT PLAN
L03	- PLANTING PLAN
L04	- GRADING PLAN
<u>DETAILS</u>	
D01	- DETAILS
D02	- DETAILS
D03	- DETAILS
<u>CIVIL</u>	
C401	- SERVICING PLAN
<u>ELECTRICAL</u>	
E000	- ELECTRICAL SPECIFICATIONS
E001	- ELECTRICAL DETAILS
E002	- ELECTRICAL DETAILS
E100	- ELECTRICAL SITE PLAN

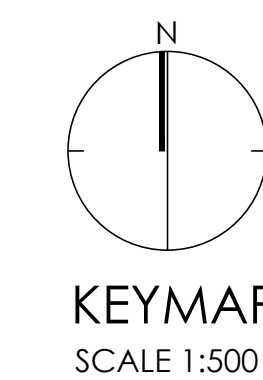

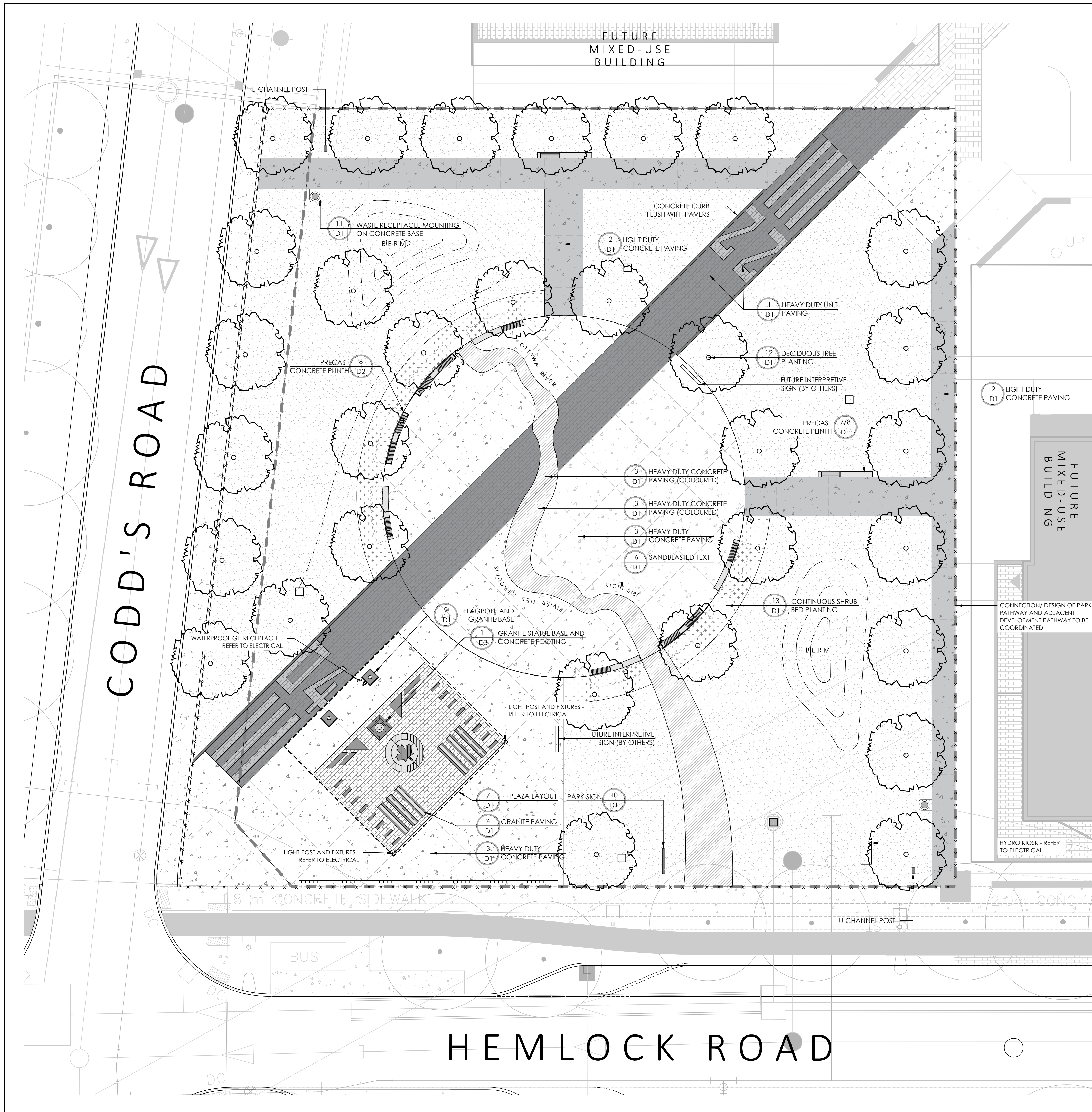

SITE NOTES:

- REPORT ANY DISCREPANCIES TO THE LANDSCAPE ARCHITECT PRIOR TO COMMENCING WORK. NO RESPONSIBILITY IS BORNE BY THE CONSULTANT FOR UNKNOWN SURFACE CONDITIONS.
- REINSTATE ALL AREAS AND ITEMS DAMAGED ON SITE AND REPORT ANY ERRORS AND/OR OMISSIONS TO LANDSCAPE ARCHITECT. ANY AREAS BEYOND THE LIMIT OF THE SITE DISTURBED DURING CONSTRUCTION SHALL BE RESTORED TO ORIGINAL CONDITION OR BETTER TO THE SATISFACTION OF THE AUTHORITY HAVING JURISDICTION AT THE CONTRACTOR'S EXPENSE.
- ALL DIMENSIONS SHALL BE CHECKED AND VERIFIED IN THE FIELD BY THE CONTRACTOR PRIOR TO THE START OF CONSTRUCTION. ANY DISCREPANCIES SHALL BE REPORTED IMMEDIATELY TO THE CONSULTANT. LOST TIME DUE TO FAILURE OF THE CONTRACTOR TO CONFIRM UTILITY LOCATIONS AND NOTIFY CONSULTANT OF POSSIBLE CONFLICTS PRIOR TO CONSTRUCTION WILL BE AT THE CONTRACTOR'S EXPENSE.
- ALL DIMENSIONS ARE IN METERS UNLESS SPECIFIED OTHERWISE.
- ALL WORKS AND MATERIALS SHALL CONFORM TO THE LATEST REVISION OF THE STANDARDS AND SPECIFICATIONS FOR THE CITY OF OTTAWA, ONTARIO PROVINCIAL STANDARD DRAWINGS (OPSD) AND SPECIFICATIONS (OPSS), WHERE APPLICABLE. LOCAL UTILITY STANDARDS AND MINISTRY OF TRANSPORTATION STANDARDS WILL APPLY WHERE REQUIRED.
- ALL CONSTRUCTION SIGNAGE MUST CONFORM TO THE MINISTRY OF TRANSPORTATION OF ONTARIO MANUAL OF UNIFORM TRAFFIC CONTROL DEVICES PER LATEST AMENDMENT.
- CITY OF OTTAWA TO APPROVE FINAL PARK SIGN LOCATION ON SITE PRIOR TO EXCAVATION OR INSTALLATION.
- A CERTIFIED INDEPENDENT PLAYGROUND INSPECTOR MUST INSPECT THE INSTALLED STRUCTURES, COMPONENTS AND THEIR LAYOUTS AND PROVIDE WRITTEN DOCUMENTATION TO THE CITY THAT THEY MEET OR EXCEED THE LATEST CSA STANDARDS (CAN/CSA Z614-14), ANNEK B REQUIREMENTS, AODA, AND CITY OF OTTAWA ACCESSIBILITY STANDARDS.
- THE CONTRACTOR IS ADVISED THAT WORKS BY OTHERS MAY BE ONGOING DURING THE PERIOD OF THIS CONTRACT. THE CONTRACTOR SHALL COORDINATE CONSTRUCTION ACTIVITIES TO PREVENT CONFLICTS.
- THERE WILL BE NO SUBSTITUTION OF MATERIALS UNLESS PRIOR WRITTEN APPROVAL IS RECEIVED FROM THE CONSULTANT.
- ALL CONSTRUCTION SHALL BE CARRIED OUT IN ACCORDANCE WITH THE RECOMMENDATIONS MADE IN THE GEOTECHNICAL REPORT.
- THE CONTRACTOR IS RESPONSIBLE FOR OBTAINING ALL PERMITS REQUIRED AND TO BEAR THE COST OF THE SAME.
- ALL WORK SHALL BE COMPLETED IN ACCORDANCE WITH THE OCCUPATIONAL HEALTH AND SAFETY ACT AND REGULATIONS FOR CONSTRUCTION PROJECT. THE GENERAL CONTRACTOR SHALL BE DEEMED TO BE THE 'CONTRACTOR' AS DEFINED IN THE ACT.
- CONTRACTOR TO ARRANGE A SITE REVIEW FOR PRELIMINARY ACCEPTANCE OF THE WORKS BY THE CITY. PROVIDED THAT THE WORKS ARE COMPLETED IN STRICT COMPLIANCE WITH THE DRAWING SPECIFICATIONS. PRELIMINARY ACCEPTANCE MAY BE GRANTED SUBJECT TO CORRECTION OF ANY NOTED DEFICIENCIES WITHIN 21 CALENDAR DAYS FROM THE DATE OF PRELIMINARY ACCEPTANCE. 3 YEAR WARRANTY PERIOD TO COMMENCE FROM THEN ON.

Contractor shall check all dimensions on the work and report any discrepancy to the Landscape Architect before proceeding. All drawings and specifications are the property of the Landscape Architect and must be returned at the completion of the work. This drawing is not to be used for construction until signed by the Landscape Architect.

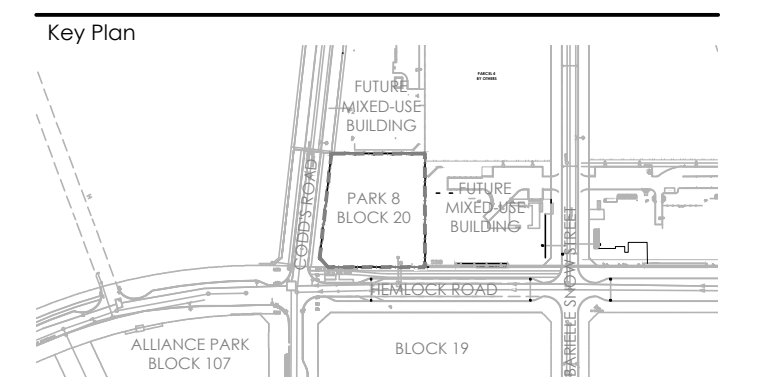

LEGEND

PROPERTY LINE

FENCING

TEMP. CONSTRUCTION FENCE

PLANTING

STREET TREE (BY OTHERS)

LARGE DECIDUOUS TREE

SODDING

SHRUB BED

SURFACING

C.I.P. CONCRETE (LIGHT DUTY)

C.I.P. CONCRETE (HEAVY DUTY)

C.I.P. CONCRETE - COLOURED (HEAVY DUTY)

HEAVY DUTY UNIT PAVERS (BLACK/GREY/WHITE)

GRANITE INLAY (BLACK)

GRANITE INLAY (WHITE)

GRANITE INLAY (RED)

GRANITE INLAY (GREY)

SAWCUT

EXPANSION JOINT

AMENITIES

BENCH TOPPERS (ACCESSIBLE/STANDARD)

WASTE RECEPTACLE

PARK SIGN

U-CHANNEL SIGN POST

CONCRETE PLINTH - CURVED

CONCRETE PLINTH - STRAIGHT

DETAIL KEY

DETAIL NO.

SHEET NO.

No.	Description	Date
11	Issued for Construction	Oct 20/23
10	Issued for Addendum 06	Mar 13/23
9	Issued for Addendum 03	Feb 6/23
8	Issued for Tender	Jan 10/23
7	Issued for 100% Submission	Dec 14/22
6	Issued for Client Review	Dec 05/22
5	Issued for 90% Submission	Oct 12/22
4	Issued for 90% - Client Review	Oct 06/22
3	Issued for Client Review	Sep. 21/22
2	Issued for 60% Submission	May 21/22
1	Issued for 60% Submission - Client Review	Apr. 22/22

Revision
City Approval Stamp

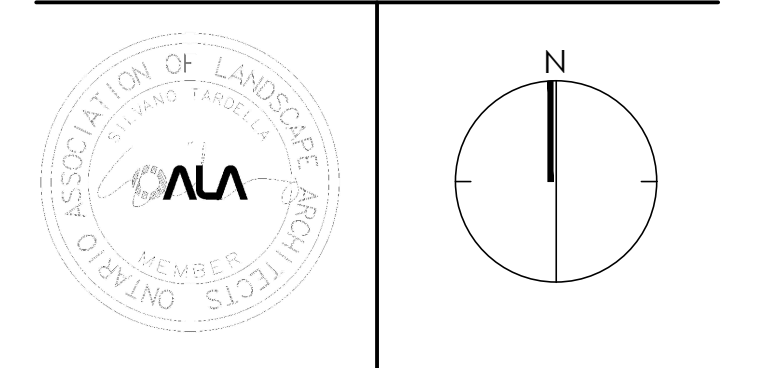

NAK
design strategies

1285 Wellington St. W. OTTAWA, ON K1N 6B3 CANADA
T 613.237.2345 F 613.237.6423 NAKDESIGNSTRATEGIES.COM

Project
WATERIDGE VILLAGE
LT. COL. WILLIAM G. BARKER VC PARK
PARK 8 - BLOCK 20

Title
SITE PLAN

Date APRIL 2022
Scale 1:150 @ ARCH D
Drawn EL
CheckedJSC
Job No. 21-112

Sheet
L-01

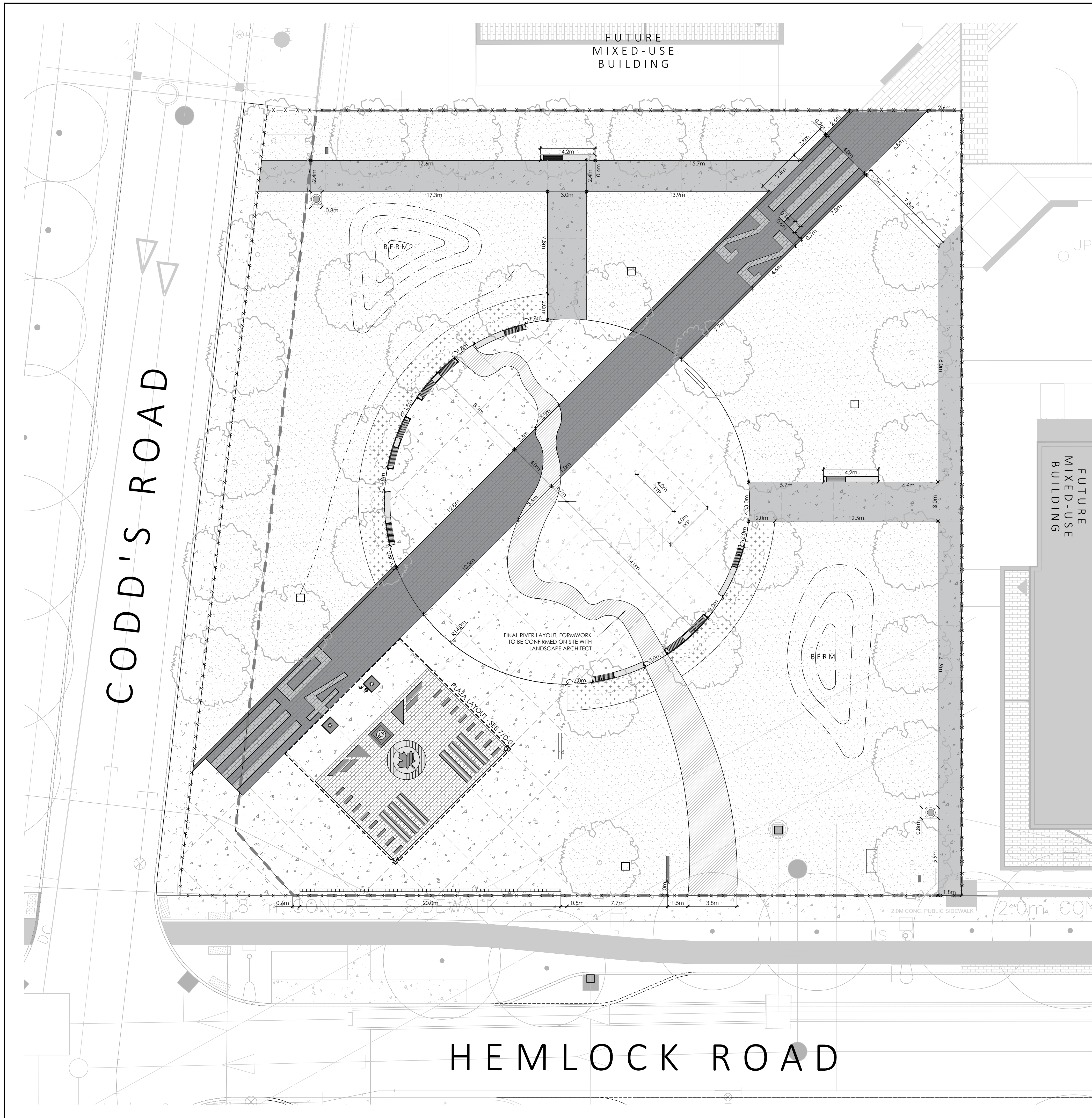

GENERAL NOTES:

1. ALL WORKS AND MATERIALS SHALL CONFORM TO THE LATEST REVISION OF THE STANDARDS AND SPECIFICATIONS FOR THE CITY OF OTTAWA, ONTARIO PROVINCIAL STANDARD DRAWINGS (OPSD) AND SPECIFICATIONS (OPSS) WHERE APPLICABLE. LOCAL UTILITY STANDARDS AND MINISTRY OF TRANSPORTATION STANDARDS WILL APPLY WHERE REQUIRED.
2. THE CONTRACTOR SHALL CONFIRM THE LOCATION OF ALL EXISTING UTILITIES WITHIN THE SITE AND ADJACENT WORK AREAS. THE CONTRACTOR SHALL BE RESPONSIBLE FOR PROTECTING ALL EXISTING UTILITIES TO THE SATISFACTION OF THE AUTHORITY HAVING JURISDICTION. THE CONTRACTOR SHALL BE RESPONSIBLE FOR THE REPAIR OR REPLACEMENT OF ANY SERVICES OR UTILITIES DISTURBED DURING CONSTRUCTION, TO THE SATISFACTION OF THE AUTHORITY HAVING JURISDICTION.
3. ALL DIMENSIONS SHALL BE CHECKED AND VERIFIED IN THE FIELD BY THE CONTRACTOR PRIOR TO THE START OF CONSTRUCTION. ANY DISCREPANCIES SHALL BE REPORTED IMMEDIATELY TO THE CONSULTANT. LOST TIME DUE TO FAILURE OF THE CONTRACTOR TO CONFIRM UTILITY LOCATIONS AND NOTIFY CONSULTANT OF POSSIBLE CONFLICTS PRIOR TO CONSTRUCTION WILL BE AT THE CONTRACTORS EXPENSE.
4. ANY AREAS BEYOND THE LIMIT OF THE SITE DISTURBED DURING CONSTRUCTION SHALL BE RESTORED TO ORIGINAL CONDITION OR BETTER TO THE SATISFACTION OF THE AUTHORITY HAVING JURISDICTION AT THE CONTRACTORS EXPENSE.
5. ALL WORK SHALL BE COMPLETED IN ACCORDANCE WITH THE OCCUPATIONAL HEALTH AND SAFETY ACT AND REGULATIONS FOR CONSTRUCTION PROJECTS. THE GENERAL CONTRACTOR SHALL BE DEEMED TO BE THE 'CONTRACTOR' AS DEFINED IN THE ACT.
6. ALL CONSTRUCTION SIGNAGE MUST CONFORM TO THE MINISTRY OF TRANSPORTATION OF ONTARIO MANUAL OF UNIFORM TRAFFIC CONTROL DEVICES PER LATEST AMENDMENT.
7. THE CONTRACTOR IS ADVISED THAT WORKS BY OTHERS MAY BE ONGOING DURING THE PERIOD OF THIS CONTRACT. THE CONTRACTOR SHALL COORDINATE CONSTRUCTION ACTIVITIES TO PREVENT CONFLICTS.
8. ALL DIMENSIONS ARE IN METERS UNLESS SPECIFIED OTHERWISE.
9. THERE WILL BE NO SUBSTITUTION OF MATERIALS UNLESS PRIOR WRITTEN APPROVAL IS RECEIVED FROM THE CONSULTANT.
10. ALL CONSTRUCTION SHALL BE CARRIED OUT IN ACCORDANCE WITH THE RECOMMENDATIONS MADE IN THE GEOTECHNICAL REPORT.
11. ALL SEWERS CONSTRUCTED WITH GRADES LESS THAN 1.0% SHALL BE INSTALLED USING LASER ALIGNMENT AND CHECKED WITH LEVEL INSTRUMENT PRIOR TO BACKFILLING.
12. THE CONTRACTOR IS RESPONSIBLE FOR OBTAINING ALL PERMITS REQUIRED AND TO BEAR THE COST OF THE SAME.
13. THE CONTRACTOR WILL BE RESPONSIBLE FOR ADDITIONAL BEDDING, OR ADDITIONAL STRENGTH PIPE IF THE MAXIMUM TRENCH WIDTH AS SPECIFIED BY OPSD IS EXCEEDED.
14. ALL PIPE / CULVERT SECTION SIZES REFER TO INSIDE DIMENSIONS.
15. SHOULD DEEPLY BURIED ARCHAEOLOGICAL REMAINS BE FOUND ON THE PROPERTY DURING CONSTRUCTION ACTIVITIES, THE HERITAGE OPERATIONS UNIT OF THE ONTARIO MINISTRY OF CULTURE MUST BE NOTIFIED IMMEDIATELY.
16. ALL NECESSARY CLEARING AND GRUBBING SHALL BE COMPLETED BY THE CONTRACTOR. REVIEW WITH CONSULTANT AND THE CITY OF OTTAWA PRIOR TO ANY TREE CUTTING / REMOVAL.
17. DRAWINGS SHALL BE READ IN CONJUNCTION WITH THE SITE PLAN.
18. THE CONTRACTOR SHALL PROVIDE THE CONSULTANT ONE SET OF AS CONSTRUCTED SITE SERVICING AND GRADING DRAWINGS.
19. BENCHMARKS: IT IS THE RESPONSIBILITY OF THE CONTRACTOR TO VERIFY THAT THE SITE BENCHMARK(S) HAS NOT BEEN ALTERED OR DISTURBED AND THAT ITS RELATIVE ELEVATION AND DESCRIPTION AGREES WITH THE INFORMATION DEPICTED ON THIS PLAN.

GRADING NOTES:

1. PRIOR TO THE COMMENCEMENT OF THE SITE GRADING WORKS, ALL SITUATION CONTROL DEVICES SHALL BE INSTALLED AND OPERATIONAL PER EROSION CONTROL PLAN.
2. ASPHALT SIDEWALK SHALL BE IN ACCORDANCE WITH CITY OF OTTAWA STD. SC20. ALL CURBS, CONCRETE ISLANDS, AND SIDEWALKS SHOWN ON THIS DRAWING ARE TO BE PRICED IN THE SITE WORKS PORTION OF THE CONTRACT.
3. PAVEMENT REINSTATEMENT FOR SERVICE AND UTILITY CUTS SHALL BE IN ACCORDANCE WITH THE CITY OF OTTAWA STD. R10 AND OPSD 509.010, AND OPSD 310.
4. SUB-EXCAVATE SOFT AREAS AND FILL WITH GRANULAR 'B' COMPACTED IN MAXIMUM 300mm LIFTS.
5. ALL WORK ON THE MUNICIPAL RIGHT OF WAY AND EASEMENTS TO BE INSPECTED BY THE MUNICIPALITY PRIOR TO BACKFILLING.
6. REFER TO SITE PLAN FOR DIMENSIONS AND SITE DETAILS.
7. STEP JOINTS ARE TO BE USED WHERE PROPOSED ASPHALT MEETS EXISTING ASPHALT. ALL JOINTS MUST BE SEALED.

Contractor shall check all dimensions on the work and report any discrepancy to the Landscape Architect before proceeding. All drawings and specifications are the property of the Landscape Architect and must be returned at the completion of the work. This drawing is not to be used for construction until signed by the Landscape Architect.

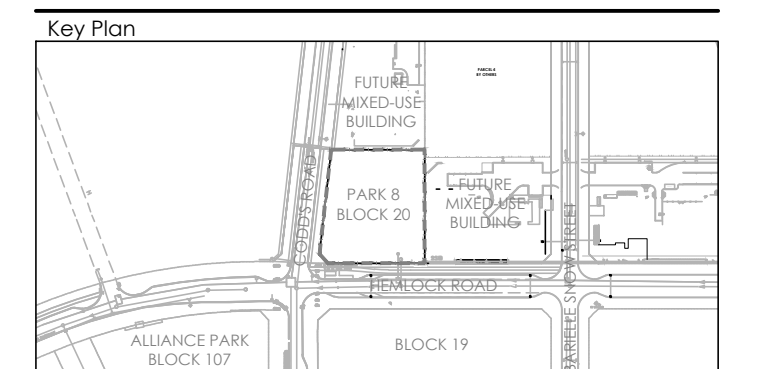

LEGEND

— — — — — PROPERTY LINE

— X — X — X — TEMP. CONSTRUCTION FENCE

PLANTING

- (+ symbol) STREET TREE (BY OTHERS)
- (Large circle symbol) LARGE DECIDUOUS TREE
- (Stippled pattern) SODDING
- (Dotted pattern) SHRUB BED

SURFACING

- (Light grey pattern) C.I.P. CONCRETE (LIGHT DUTY)
- (Medium grey pattern) C.I.P. CONCRETE (HEAVY DUTY)
- (Dark grey pattern) C.I.P. CONCRETE - COLOURED (HEAVY DUTY)
- (Diagonal lines) HEAVY DUTY UNIT PAVERS (BLACK/GREY/WHITE)
- (Solid black) GRANITE INLAY (BLACK)
- (Solid white) GRANITE INLAY (WHITE)
- (Diagonal lines) GRANITE INLAY (RED)
- (Diagonal lines) GRANITE INLAY (GREY)
- (Dashed line) SAWCUT
- (Dashed line) EXPANSION JOINT

AMENITIES

- (Square symbol) BENCH TOPPERS (ACCESSIBLE/STANDARD)
- (Circle symbol) WASTE RECEPTACLE
- (Square symbol) PARK SIGN
- (Square symbol) U-CHANNEL SIGN POST
- (Rectangular symbol) CONCRETE PLINTH - CURVED
- (Rectangular symbol) CONCRETE PLINTH - STRAIGHT

9	Issued for Construction	Oct 20/22
8	Issued for Tender	Jan 10/23
7	Issued for 100% Submission	Dec 14/22
6	Issued for Client Review	Dec 05/22
5	Issued for 90% Submission	Oct 12/22
4	Issued for 90% - Client Review	Oct 06/22
3	Issued for Client Review	Sep. 21/22
2	Issued for 60% Submission	May 9/22
1	Issued for 60% Submission - Client Review	Apr.22/22
No.	Description	Date

Revision

No.	Description	Date

City Approval Stamp

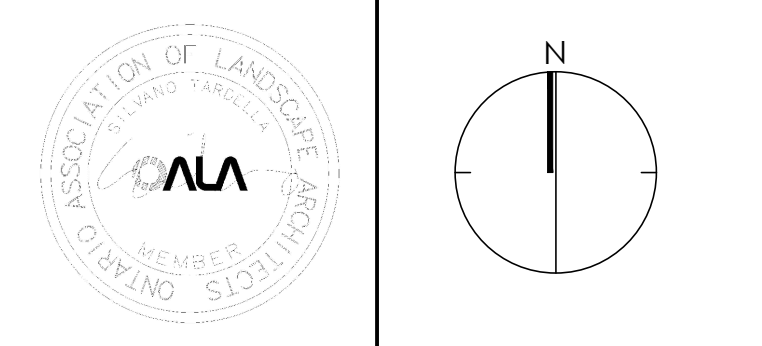

NAK
design strategies

1285 Wellington St. W. OTTAWA, ON K1N 6B3 CANADA
T 613.237.2345 F 613.237.6423 NAKDESIGNSTRATEGIES.COM

Project

WATERIDGE VILLAGE
LT. COL. WILLIAM G. BARKER VC PARK
PARK 8 - BLOCK 20

Title

LAYOUT PLAN

Date: APRIL 2022
Scale: 1:150 @ ARCH D
Drawn: EL
Checked: JSC
Job No.: 21-112

Sheet

L-02

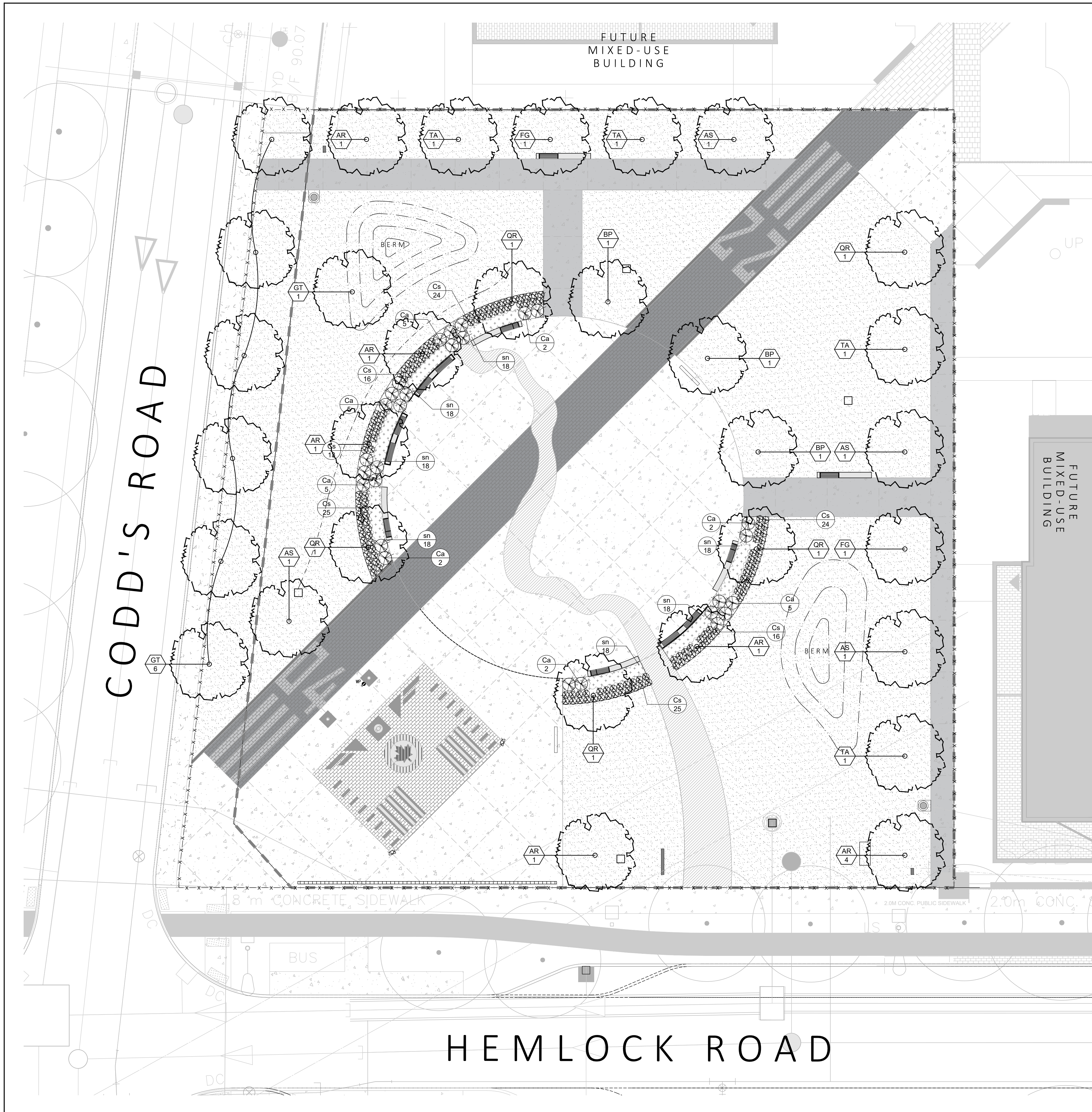

PLANT LIST

KEY	QTY.	BOTANICAL NAME	COMMON NAME	SIZE (mm)	ROOT
DECIDUOUS TREES					
AR	6	ACER RUBRUM	RED MAPLE	60	W.B.
AS	4	ACER SACCHARUM	SUGAR MAPLE	60	W.B.
BP	3	BETULA PAPERIFERA	PAPER BIRCH	60	W.B.
FG	2	FAGUS GRANIFICOLA	AMERICAN BIRCH	60	W.B.
GT	7	GLEDITSIA TRIACANTHOS 'VAR INERMIS'	THORNLESS HONEYLOCUST	60	W.B.
QR	5	QUERCUS RUBRA	RED OAK	60	W.B.
TA	4	TILIA AMERICANA	AMERICAN LINDEN	60	W.B.
DECIDUOUS SHRUBS					
Ca	28	CEANOTHUS AMERICANUS	NEW JERSEY TEA	3 GAL.	POT
Cs	143	CORNUS SERICEA 'KELSEY'	REDTWIG DOGWOOD	3 GAL.	POT
ORNAMENTAL GRASSES					
sn	126	SORGHASTRUM NUTANS	INDIAN GRASS	2 GAL.	POT

- PLANTING NOTES:**
- CONTRACTOR TO VERIFY LOCATION OF ALL SERVICES PRIOR TO ANY EXCAVATION.
 - LOCATIONS OF ALL PLANT MATERIALS TO BE STAKED BY THE CONTRACTOR AND VERIFIED IN THE FIELD BY THE CONSULTANT PRIOR TO THE EXCAVATION OF PITS.
 - ALL PLANT MATERIAL SHALL BE NURSERY GROWN STOCK UNLESS OTHERWISE NOTED.
 - DECIDUOUS TREES TO HAVE A MINIMUM 1800 CLEAR STEM ABOVE GRADE.
 - ALL PLANT MATERIAL SHALL BE WARRANTED FOR TWO YEARS FROM THE DATE OF SUBSTANTIAL COMPLETION AS DETERMINED BY THE CONSULTANT, UNLESS OTHERWISE NOTED.
 - ALL STEEL T-BARS TO BE REMOVED AT THE ONE YEAR INTERIM INSPECTION UNLESS OTHERWISE DIRECTED BY THE CONSULTANT.
 - CONTRACTOR TO REINSTATE ALL EXISTING AREAS DAMAGED BY HIS WORK TO THE SATISFACTION OF THE CONSULTANT.
 - PERIODIC REVIEWS OF PLANTING SHALL BE CARRIED OUT BY THE CONSULTANT.
 - ACER RUBRUM, QUERCUS RUBRA AND CELIS OCCIDENTALIS TO BE SPRING DUG SPECIMENS AND PLANTING IN THE SPRING ONLY.
 - ANY PROPOSED SUBSTITUTIONS OF PLANT SPECIES SHALL BE MADE WITH PLANTS OF EQUIVALENT OVERALL FORM, HEIGHT, BRANCHING HABIT, FLOWER, LEAF, COLOR, FRUIT AND CULTURE AND ONLY AFTER APPROVAL OF THE CONSULTANT.
 - TREE STAKING IS NOT RECOMMENDED WITHIN A 10m RADIUS OF THE PLAY EQUIPMENT.

Contractor shall check all dimensions on the work and report any discrepancy to the Landscape Architect before proceeding. All drawings and specifications are the property of the Landscape Architect and must be returned at the completion of the work. This drawing is not to be used for construction until signed by the Landscape Architect.

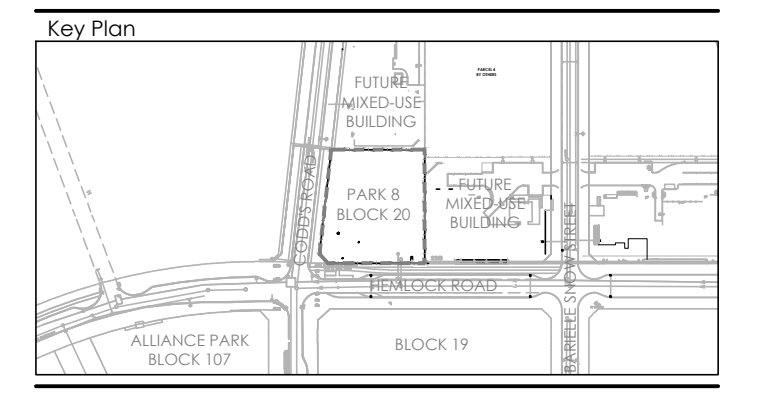

LEGEND

—	PROPERTY LINE
— X — X — X — X —	TEMP. CONSTRUCTION FENCE
PLANTING	
(+)	STREET TREE (BY OTHERS)
(Large tree symbol)	LARGE DECIDUOUS TREE
(Hatched box)	SODDING
(Dotted box)	SHRUB BED
PLANTING KEY	
(XX/00)	TREE SPECIES QUANTITY
(XX/00)	SHRUB SPECIES QUANTITY

9	Issued for Construction	Oct 20/22
8	Issued for Tender	Jan 10/23
7	Issued for 100% Submission	Dec 14/22
6	Issued for Client Review	Dec 05/22
5	Issued for 90% Submission	Oct 12/22
4	Issued for 90% - Client Review	Oct 06/22
3	Issued for Client Review	Sep. 21/22
2	Issued for 60% Submission	May 9/22
1	Issued for 60% Submission - Client Review	Apr. 22/22
No.	Description	Date

Revision
City Approval Stamp

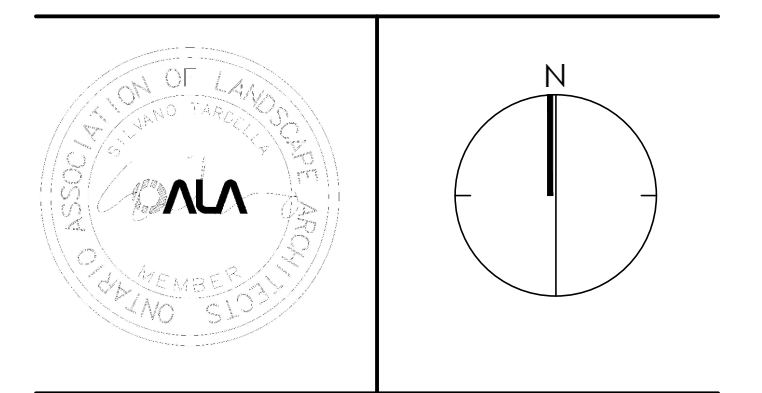

NAK
design strategies

1285 Wellington St. W. OTTAWA, ON K1N 6S3 CANADA
T 613.237.2345 F 613.237.6423 NAKDESIGNSTRATEGIES.COM

Project
WATERIDGE VILLAGE
LT. COL. WILLIAM G. BARKER VC PARK
PARK 8 - BLOCK 20

Title
PLANTING PLAN

Date	APRIL 2022	Sheet	L-03
Scale	1:150 @ ARCH D		
Drawn	JC		
Checked	MK		
Job No.	21-112		

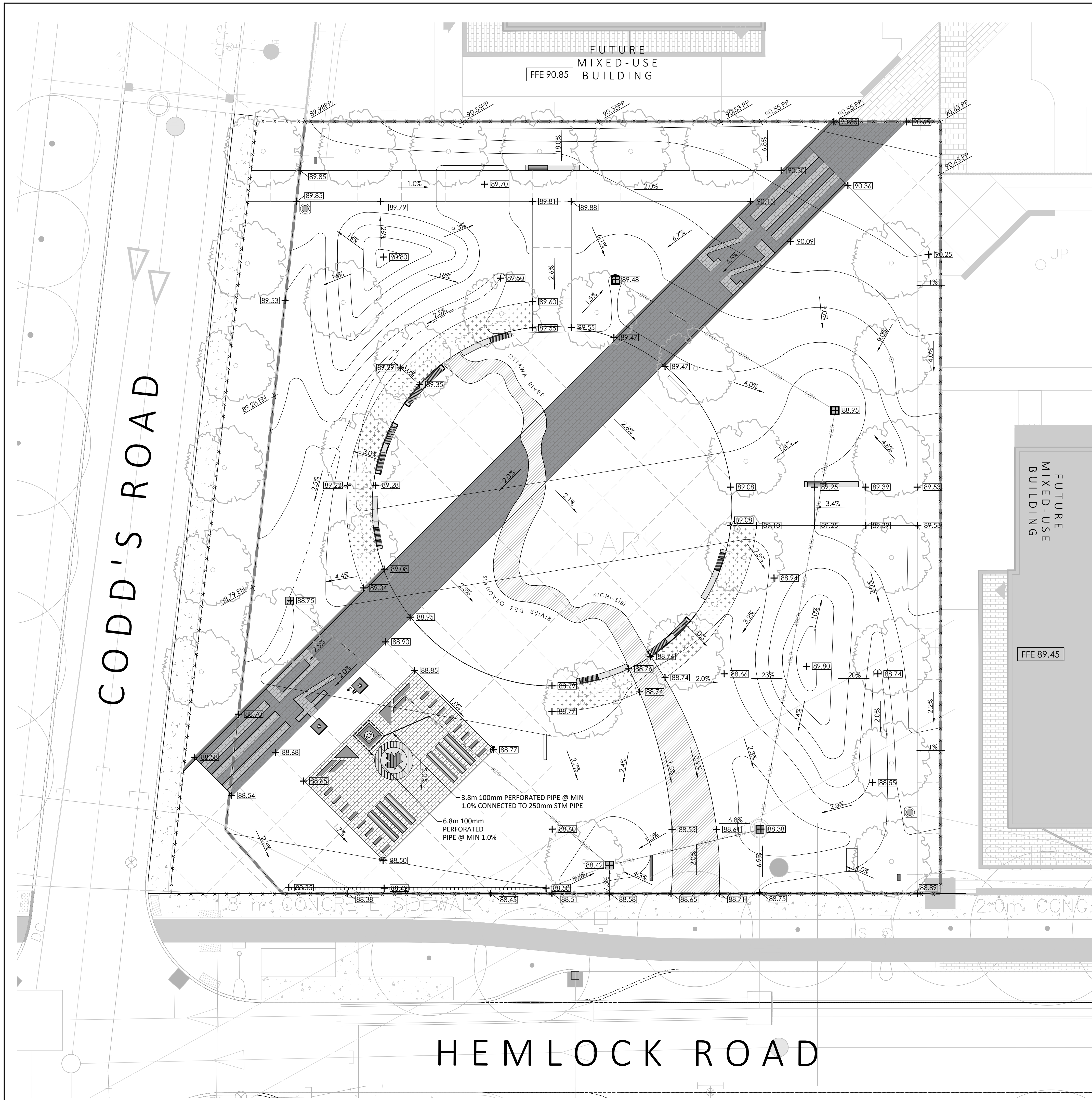

GENERAL NOTES:

1. ALL WORKS AND MATERIALS SHALL CONFORM TO THE LATEST REVISION OF THE STANDARDS AND SPECIFICATIONS FOR THE CITY OF OTTAWA, ONTARIO PROVINCIAL STANDARD DRAWINGS (OPSD) AND SPECIFICATIONS (OPSS), WHERE APPLICABLE. LOCAL UTILITY STANDARDS AND MINISTRY OF TRANSPORTATION STANDARDS WILL APPLY WHERE REQUIRED.
2. THE CONTRACTOR SHALL CONFIRM THE LOCATION OF ALL EXISTING UTILITIES WITHIN THE SITE AND ADJACENT WORK AREAS. THE CONTRACTOR SHALL BE RESPONSIBLE FOR PROTECTING ALL EXISTING UTILITIES TO THE SATISFACTION OF THE AUTHORITY HAVING JURISDICTION. THE CONTRACTOR SHALL BE RESPONSIBLE FOR THE REPAIR OR REPLACEMENT OF ANY SERVICES OR UTILITIES DISTURBED DURING CONSTRUCTION, TO THE SATISFACTION OF THE AUTHORITY HAVING JURISDICTION.
3. ALL DIMENSIONS SHALL BE CHECKED AND VERIFIED IN THE FIELD BY THE CONTRACTOR PRIOR TO THE START OF CONSTRUCTION. ANY DISCREPANCIES SHALL BE REPORTED IMMEDIATELY TO THE CONSULTANT. LOST TIME DUE TO FAILURE OF THE CONTRACTOR TO CONFIRM UTILITY LOCATIONS AND NOTIFY CONSULTANT OF POSSIBLE CONFLICTS PRIOR TO CONSTRUCTION WILL BE AT THE CONTRACTOR'S EXPENSE.
4. ANY AREAS BEYOND THE LIMIT OF THE SITE DISTURBED DURING CONSTRUCTION SHALL BE RESTORED TO ORIGINAL CONDITION OR BETTER TO THE SATISFACTION OF THE AUTHORITY HAVING JURISDICTION AT THE CONTRACTOR'S EXPENSE.
5. ALL WORK SHALL BE COMPLETED IN ACCORDANCE WITH THE OCCUPATIONAL HEALTH AND SAFETY ACT AND REGULATIONS FOR CONSTRUCTION PROJECTS. THE GENERAL CONTRACTOR SHALL BE DEEMED TO BE THE 'CONTRACTOR' AS DEFINED IN THE ACT.
6. ALL CONSTRUCTION SIGNAGE MUST CONFORM TO THE MINISTRY OF TRANSPORTATION OF ONTARIO MANUAL OF UNIFORM TRAFFIC CONTROL DEVICES PER LATEST AMENDMENT.
7. THE CONTRACTOR IS ADVISED THAT WORKS BY OTHERS MAY BE ONGOING DURING THE PERIOD OF THIS CONTRACT. THE CONTRACTOR SHALL COORDINATE CONSTRUCTION ACTIVITIES TO PREVENT CONFLICTS.
8. ALL DIMENSIONS ARE IN METERS UNLESS SPECIFIED OTHERWISE.
9. THERE WILL BE NO SUBSTITUTION OF MATERIALS UNLESS PRIOR WRITTEN APPROVAL IS RECEIVED FROM THE CONSULTANT.
10. ALL CONSTRUCTION SHALL BE CARRIED OUT IN ACCORDANCE WITH THE RECOMMENDATIONS MADE IN THE GEOTECHNICAL REPORT.
11. ALL SEWERS CONSTRUCTED WITH GRADES LESS THAN 1.0% SHALL BE INSTALLED USING LASER ALIGNMENT AND CHECKED WITH LEVEL INSTRUMENT PRIOR TO BACKFILLING.
12. THE CONTRACTOR IS RESPONSIBLE FOR OBTAINING ALL PERMITS REQUIRED AND TO BEAR THE COST OF THE SAME.
13. THE CONTRACTOR WILL BE RESPONSIBLE FOR ADDITIONAL BEDDING, OR ADDITIONAL STRENGTH PIPE IF THE MAXIMUM TRENCH WIDTH AS SPECIFIED BY OPSD IS EXCEEDED.
14. ALL PIPE / CULVERT SECTION SIZES REFER TO INSIDE DIMENSIONS.
15. SHOULD DEEPLY BURIED ARCHAEOLOGICAL REMAINS BE FOUND ON THE PROPERTY DURING CONSTRUCTION ACTIVITIES, THE HERITAGE OPERATIONS UNIT OF THE ONTARIO MINISTRY OF CULTURE MUST BE NOTIFIED IMMEDIATELY.
16. ALL NECESSARY CLEARING AND GRUBBING SHALL BE COMPLETED BY THE CONTRACTOR. REVIEW WITH CONSULTANT AND THE CITY OF OTTAWA PRIOR TO ANY TREE CUTTING / REMOVAL.
17. DRAWINGS SHALL BE READ IN CONJUNCTION WITH THE SITE PLAN.
18. THE CONTRACTOR SHALL PROVIDE THE CONSULTANT ONE SET OF AS CONSTRUCTED SITE SERVICING AND GRADING DRAWINGS.
19. BENCHMARKS: IT IS THE RESPONSIBILITY OF THE CONTRACTOR TO VERIFY THAT THE SITE BENCHMARK(S) HAS NOT BEEN ALTERED OR DISTURBED AND THAT ITS RELATIVE ELEVATION AND DESCRIPTION AGREES WITH THE INFORMATION DEPICTED ON THIS PLAN.

GRADING NOTES:

1. PRIOR TO THE COMMENCEMENT OF THE SITE GRADING WORKS, ALL SILTATION CONTROL DEVICES SHALL BE INSTALLED AND OPERATIONAL PER EROSION CONTROL PLAN.
2. ASPHALT SIDEWALK SHALL BE IN ACCORDANCE WITH CITY OF OTTAWA STD SC20. ALL CURBS, CONCRETE ISLANDS, AND SIDEWALKS SHOWN ON THIS DRAWING ARE TO BE PRICED IN THE SITE WORKS PORTION OF THE CONTRACT.
3. PAVEMENT REINSTATEMENT FOR SERVICE AND UTILITY CUTS SHALL BE IN ACCORDANCE WITH THE CITY OF OTTAWA STD, R10 AND OPSD S09.010, AND OPSS 310.
4. SUB-EXCAVATE SOFT AREAS AND FILL WITH GRANULAR 'B' COMPACTED IN MAXIMUM 300mm LIFTS.
5. ALL WORK ON THE MUNICIPAL RIGHT OF WAY AND EASEMENTS TO BE INSPECTED BY THE MUNICIPALITY PRIOR TO BACKFILLING.
6. REFER TO SITE PLAN FOR DIMENSIONS AND SITE DETAILS.
7. STEP JOINTS ARE TO BE USED WHERE PROPOSED ASPHALT MEETS EXISTING ASPHALT. ALL JOINTS MUST BE SEALED.

Contractor shall check all dimensions on the work and report any discrepancy to the Landscape Architect before proceeding. All drawings and specifications are the property of the Landscape Architect and must be returned at the completion of the work. This drawing is not to be used for construction until signed by the Landscape Architect.

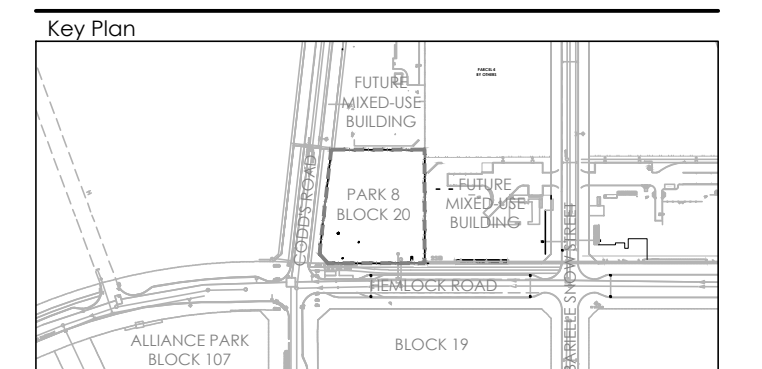

LEGEND

--- PROPERTY LINE

GRADING

- X 89.90 EA EXISTING GRADES
- + 89.90 EN ENGINEERED GRADES
- + 89.90 PROPOSED GRADES
- + 89.90 HP PROPOSED HIGH POINT
- + 89.90 LP PROPOSED LOW POINT
- 2.0% PROPOSED SLOPE
- SWALE CENTRE LINE
- BERM CENTRE LINE
- 93.00 PROPOSED CONTOURS
- 93.00 EXISTING CONTOURS
- 100mm PERFORATED STORM PIPE
- 150mm SOLID PVC STORM PIPE

SERVICING - REFER TO C401

- EX. CATCH BASIN MANHOLE
- EX. SAN MANHOLE
- RYCB: CATCH BASIN
- STM PROPOSED STORM SEWER

10	Issued for Construction	Oct 20/23
9	Issued for Addendum 6	Mar 13/23
8	Issued for Tender	Jan 10/23
7	Issued for 100% Submission	Dec 14/22
6	Issued for Client Review	Dec 05/22
5	Issued for 90% Submission	Oct 12/22
4	Issued for 90% - Client Review	Oct 06/22
3	Issued for Client Review	Sep. 21/22
2	Issued for 60% Submission	May 9/22
1	Issued for 60% Submission - Client Review	Apr. 22/22
No.	Description	Date

Revision		
City Approval Stamp		

design strategies

1285 Wellington St. W. OTTAWA, ON K1N 6B3 CANADA
 T 613.237.2345 F 613.237.6423 NAKDESIGNSTRATEGIES.COM

WATERIDGE VILLAGE
 LT. COL. WILLIAM G. BARKER VC PARK
 PARK 8 - BLOCK 20

Title	
GRADING PLAN	
Date	APRIL 2022
Scale	1:150 @ ARCH D
Drawn	JK
Checked	MK
Job No.	21-112
Sheet	
L-04	

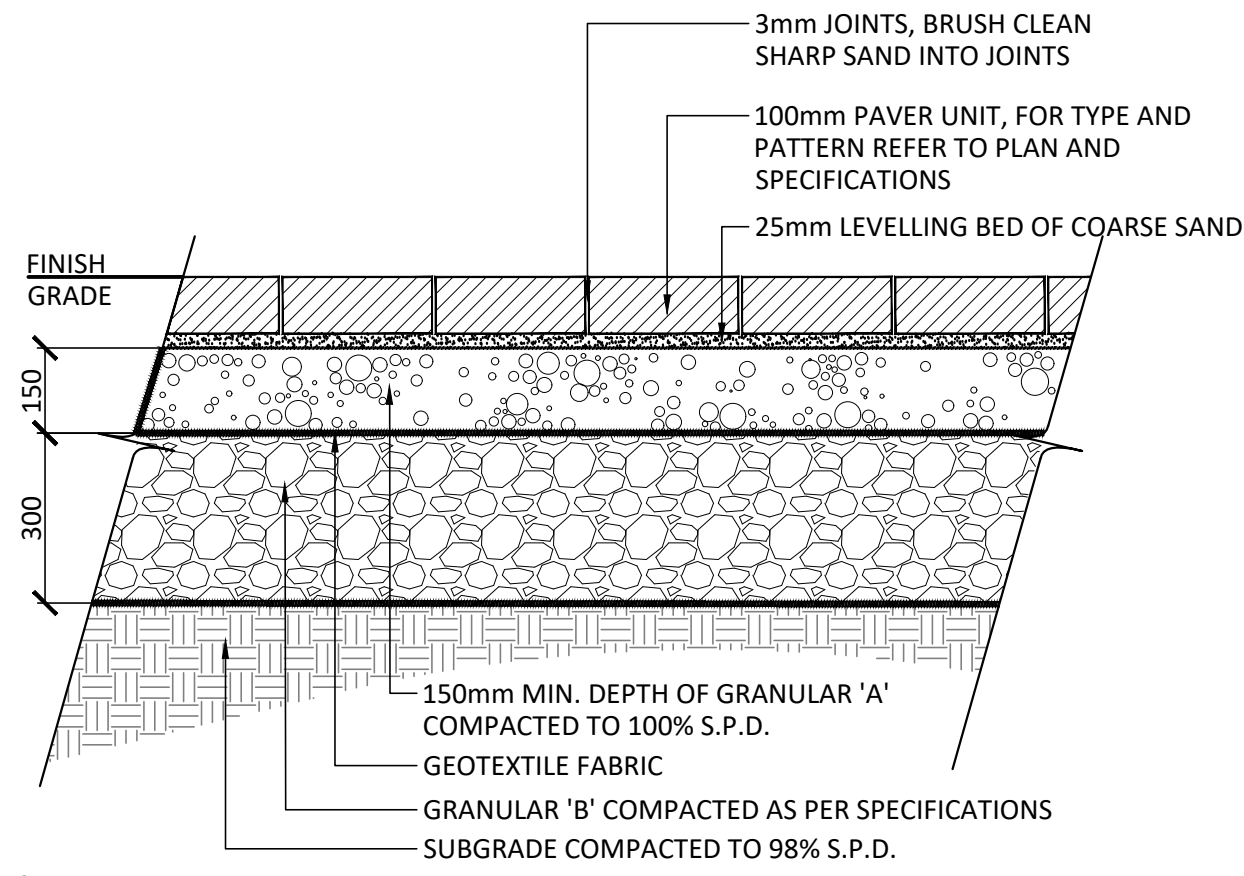

- NOTES:**
- FOR PAVEMENT TYPE REFER TO SPECIFICATIONS. PAVERS SHALL BE INSTALLED IN STRICT ACCORDANCE WITH THE MANUFACTURER'S RECOMMENDATIONS WITH TIGHT BUTT JOINTS OF APPROXIMATELY 3mm, ON A SAND BASE. SAW CUT PAVERS AS REQUIRED. USE AN APPROVED VIBRATORY COMPACTOR IN A CIRCULAR PATTERN.
 - ALL DAMAGED OR CHIPPED PAVERS MUST BE REPLACED AT THE CONTRACTOR'S COST.
 - EXCAVATE AND REMOVE ALL TOPSOIL AND UNSTABLE MATERIALS OFF SITE. SUBGRADE TO BE GRADED TO SIMILAR CONTOURS AS FINISH GRADE. COMPACT SUBGRADE TO 95% S.P.D. PLACE 150mm LAYER OF GRANULAR 'A' COMPACTED TO 100% S.P.D.
 - PLACE MAXIMUM 25mm UNCOMPACTED SAND FOR LEVELLING COURSE.
 - INSTALL PAVING UNITS IN THE PATTERN AS SPECIFIED PER MANUFACTURER'S PATTERN RECOMMENDATION AND SPECIFICATIONS.
 - WHERE THE PAVEMENT STRUCTURE THICKNESSES ARE DIFFERENT BETWEEN THE TWO ABUTTING STRUCTURES, SUB-EXCAVATE A 1 M LONG HORIZONTAL BENCH BELOW THE LESSER PAVEMENT STRUCTURE WITH THE BOTTOM OF THE EXCAVATION TO MATCH THE BASE/SUBBASE OF THE THICKER PAVEMENT STRUCTURE. THIS WILL ALLOW FOR THE INSTALLATION OF A FROST TAPER BETWEEN THE TWO STRUCTURES.
 - THE SUB-EXCAVATED AREA SHOULD EXTEND A MINIMUM OF 1 M LATERALLY BEYOND THE BOUNDARY OF THE TRANSITION AREA FOLLOWED BY A MINIMUM OF 3H:1V UPWARD SLOPE TOWARDS THE BASE/SUBBASE OF THE WEAKER PAVEMENT STRUCTURE.
 - THE FROST TAPER SHOULD BE BACKFILLED WITH A FREE DRAINING, NON-FROST SUSCEPTIBLE WELL-GRADE CRUSHED STONE FILL SUCH AS OPSS GRANULAR A OR OPSS GRANULAR B TYPE II COMPACTED TO A MINIMUM OF 98% OF THE MATERIALS SPMD.

1 HEAVY DUTY UNIT PAVING
1:10

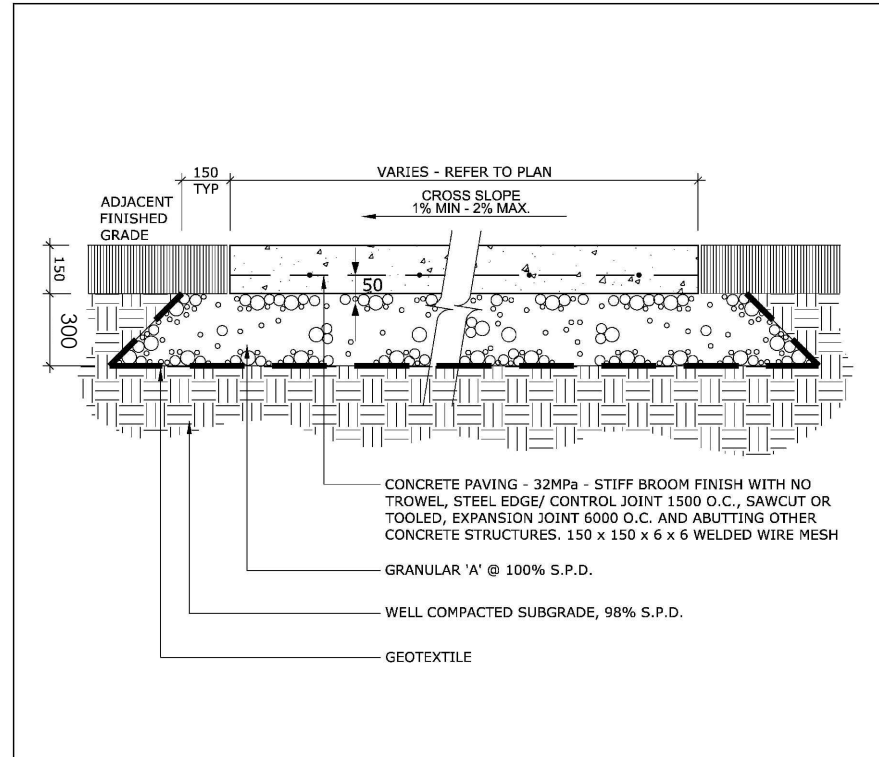

- NOTES:**
- ALL MEASUREMENTS ARE IN MILLIMETRES UNLESS OTHERWISE NOTED.
 - CONCRETE SHALL BE 32MPa CLASS C-2 MEETING THE REQUIREMENTS OF S.P. F-3510 AND PLACED IN ACCORDANCE WITH S.P. F-9040.
 - GRANULAR 'A' SHALL MEET THE REQUIREMENTS OF OPSS 1010.
 - APPROVED NON-WOVEN CLASS 1 GEOTEXTILE AS PER MS-22.15 WHEN WARRANTED BY SOIL CONDITION, SUBJECT TO APPROVAL BY THE CONTRACT ADMINISTRATOR.

2 LIGHT DUTY CONCRETE PAVING
N.T.S.

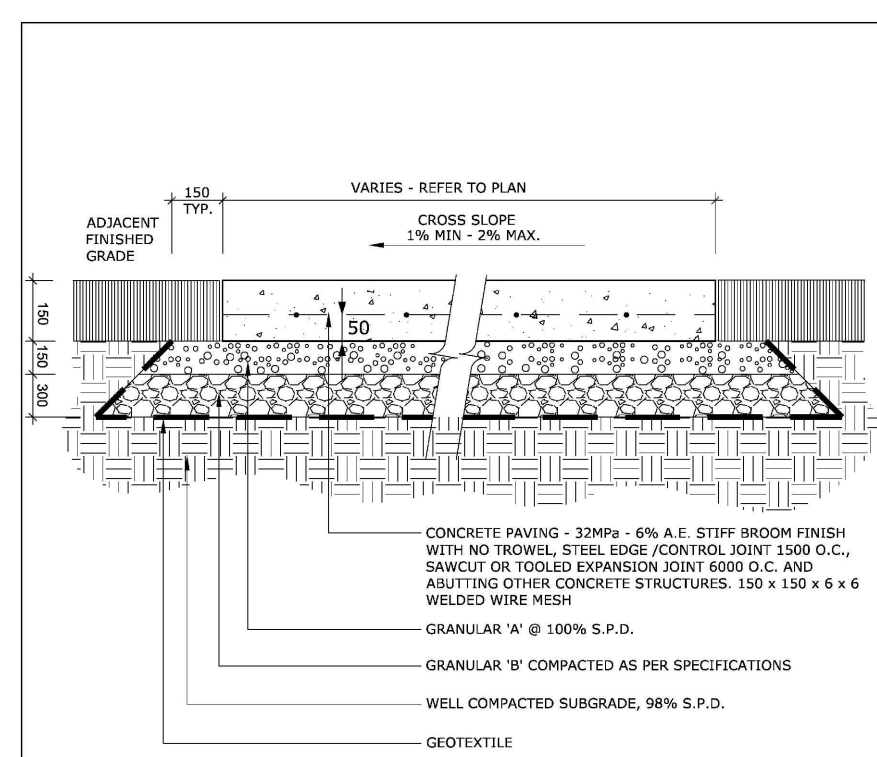

- NOTES:**
- ALL MEASUREMENTS ARE IN MILLIMETRES UNLESS OTHERWISE NOTED.
 - CONCRETE SHALL BE 32MPa CLASS C-2 MEETING THE REQUIREMENTS OF S.P. F-3510 AND PLACED IN ACCORDANCE WITH S.P. F-9040.
 - GRANULAR 'A' SHALL MEET THE REQUIREMENTS OF OPSS 1010.
 - APPROVED NON-WOVEN CLASS 1 GEOTEXTILE AS PER MS-22.15 WHEN WARRANTED BY SOIL CONDITION, SUBJECT TO APPROVAL BY THE CONTRACT ADMINISTRATOR.

3 HEAVY DUTY CONCRETE PAVING
N.T.S.

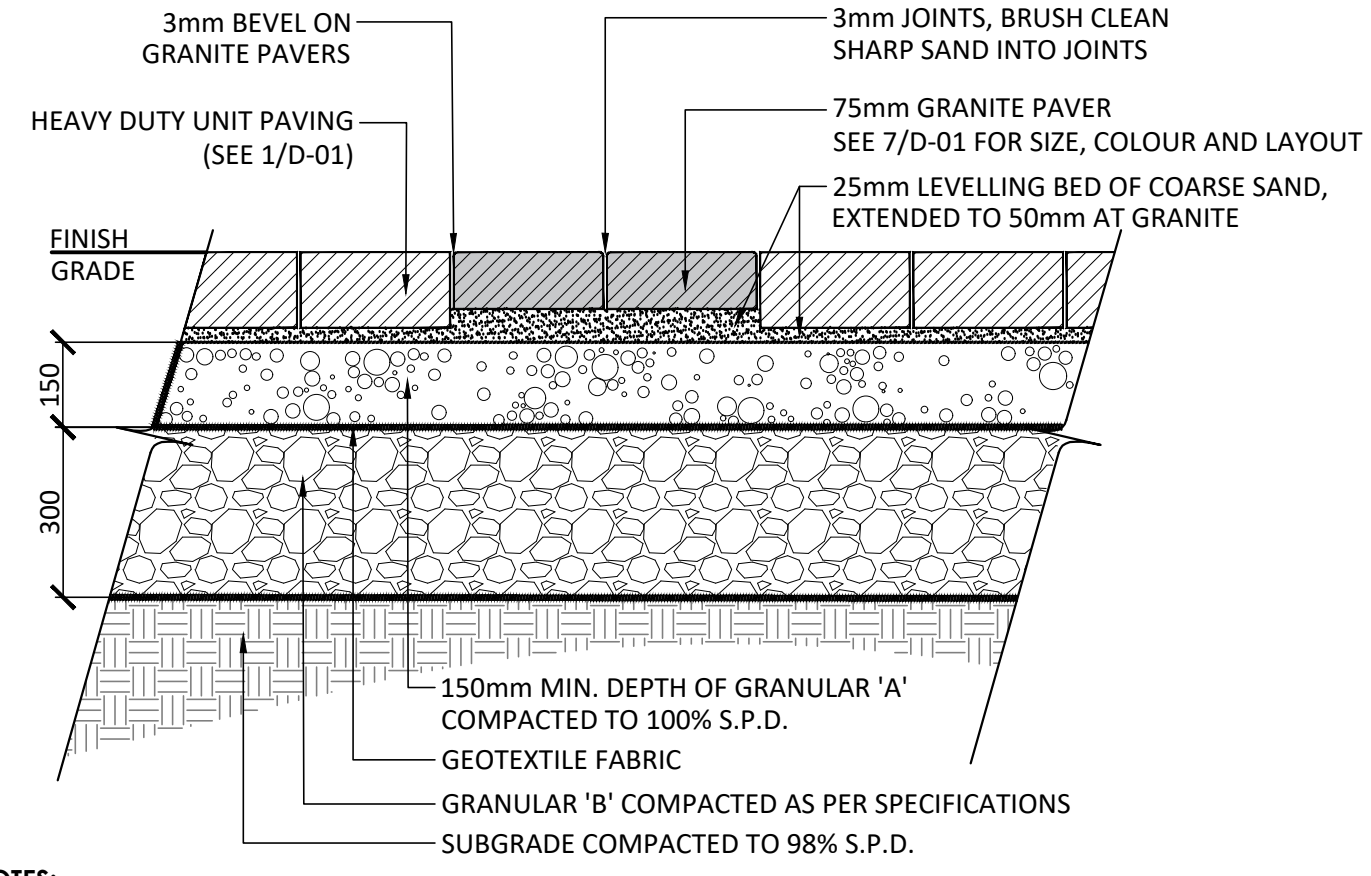

- NOTES:**
- FOR PAVEMENT TYPE REFER TO SPECIFICATIONS. PAVERS SHALL BE INSTALLED IN STRICT ACCORDANCE WITH THE MANUFACTURER'S RECOMMENDATIONS WITH TIGHT BUTT JOINTS OF APPROXIMATELY 3mm, ON A SAND BASE. SAW CUT PAVERS AS REQUIRED. USE AN APPROVED VIBRATORY COMPACTOR IN A CIRCULAR PATTERN.
 - ALL DAMAGED OR CHIPPED PAVERS MUST BE REPLACED AT THE CONTRACTOR'S COST.
 - EXCAVATE AND REMOVE ALL TOPSOIL AND UNSTABLE MATERIALS OFF SITE. SUBGRADE TO BE GRADED TO SIMILAR CONTOURS AS FINISH GRADE. COMPACT SUBGRADE TO 95% S.P.D. PLACE 150mm LAYER OF GRANULAR 'A' COMPACTED TO 100% S.P.D.
 - PLACE MAXIMUM 25mm UNCOMPACTED SAND FOR LEVELLING COURSE.
 - INSTALL PAVING UNITS IN THE PATTERN AS SPECIFIED PER MANUFACTURER'S PATTERN RECOMMENDATION AND SPECIFICATIONS.
 - WHERE THE PAVEMENT STRUCTURE THICKNESSES ARE DIFFERENT BETWEEN THE TWO ABUTTING STRUCTURES, SUB-EXCAVATE A 1 M LONG HORIZONTAL BENCH BELOW THE LESSER PAVEMENT STRUCTURE WITH THE BOTTOM OF THE EXCAVATION TO MATCH THE BASE/SUBBASE OF THE THICKER PAVEMENT STRUCTURE. THIS WILL ALLOW FOR THE INSTALLATION OF A FROST TAPER BETWEEN THE TWO STRUCTURES.
 - THE SUB-EXCAVATED AREA SHOULD EXTEND A MINIMUM OF 1 M LATERALLY BEYOND THE BOUNDARY OF THE TRANSITION AREA FOLLOWED BY A MINIMUM OF 3H:1V UPWARD SLOPE TOWARDS THE BASE/SUBBASE OF THE WEAKER PAVEMENT STRUCTURE.
 - THE FROST TAPER SHOULD BE BACKFILLED WITH A FREE DRAINING, NON-FROST SUSCEPTIBLE WELL-GRADE CRUSHED STONE FILL SUCH AS OPSS GRANULAR A OR OPSS GRANULAR B TYPE II COMPACTED TO A MINIMUM OF 98% OF THE MATERIALS SPMD.

4 HEAVY DUTY GRANITE PAVING
N.T.S.

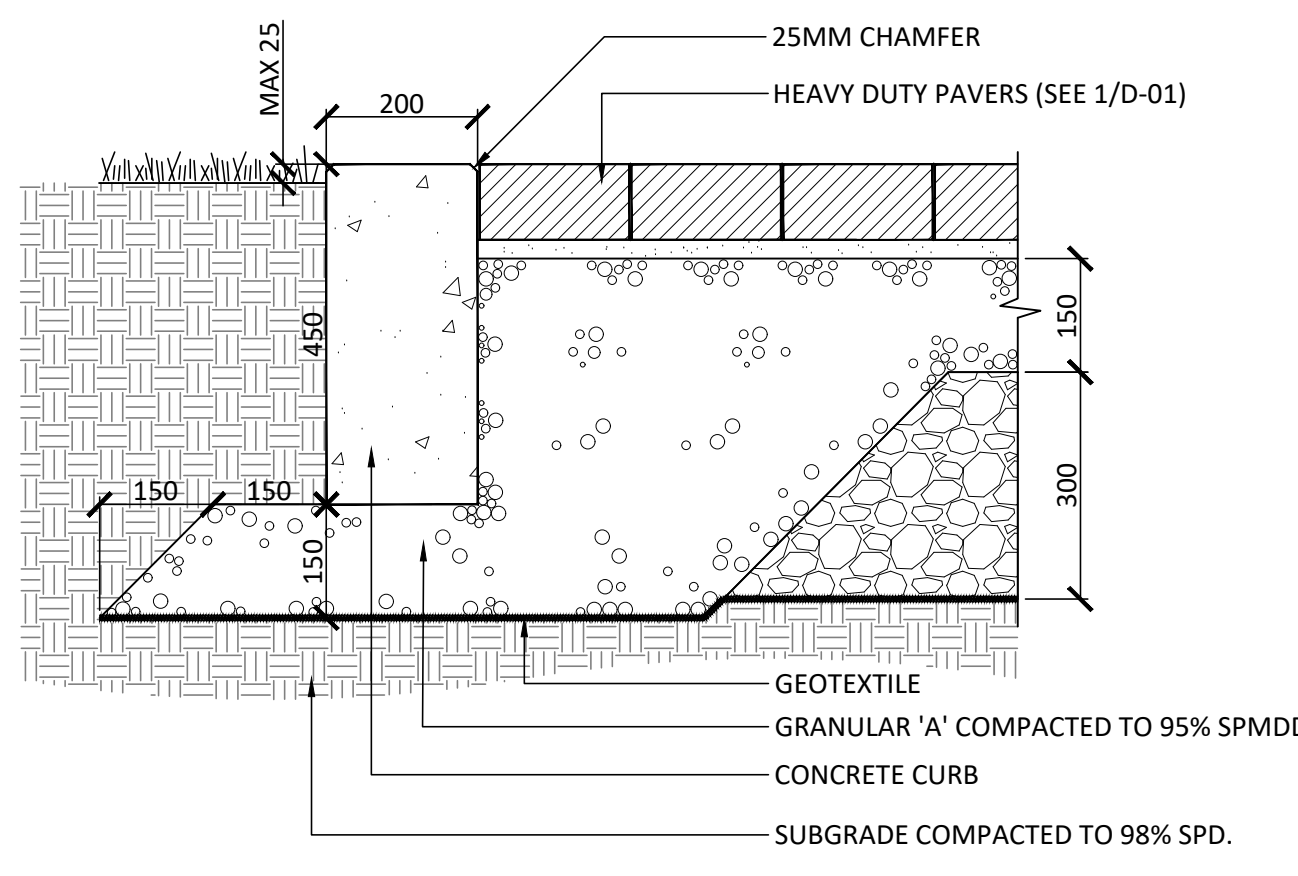

- NOTES:**
- ALL DIMENSIONS IN MILLIMETRES UNLESS OTHERWISE NOTED.
 - CONCRETE SHALL BE 32MPa CLASS C-2 MEETING THE REQUIREMENTS OF S.P. F-3510 AND PLACED IN ACCORDANCE WITH S.P. F-9040.
 - GRANULAR 'A' SHALL MEET THE REQUIREMENTS OF OPSS 1010.
 - APPROVED NON-WOVEN CLASS 1 GEOTEXTILE AS PER MS-22.15.

5 CONCRETE CURB @ HEAVY DUTY UNIT PAVING
1:10

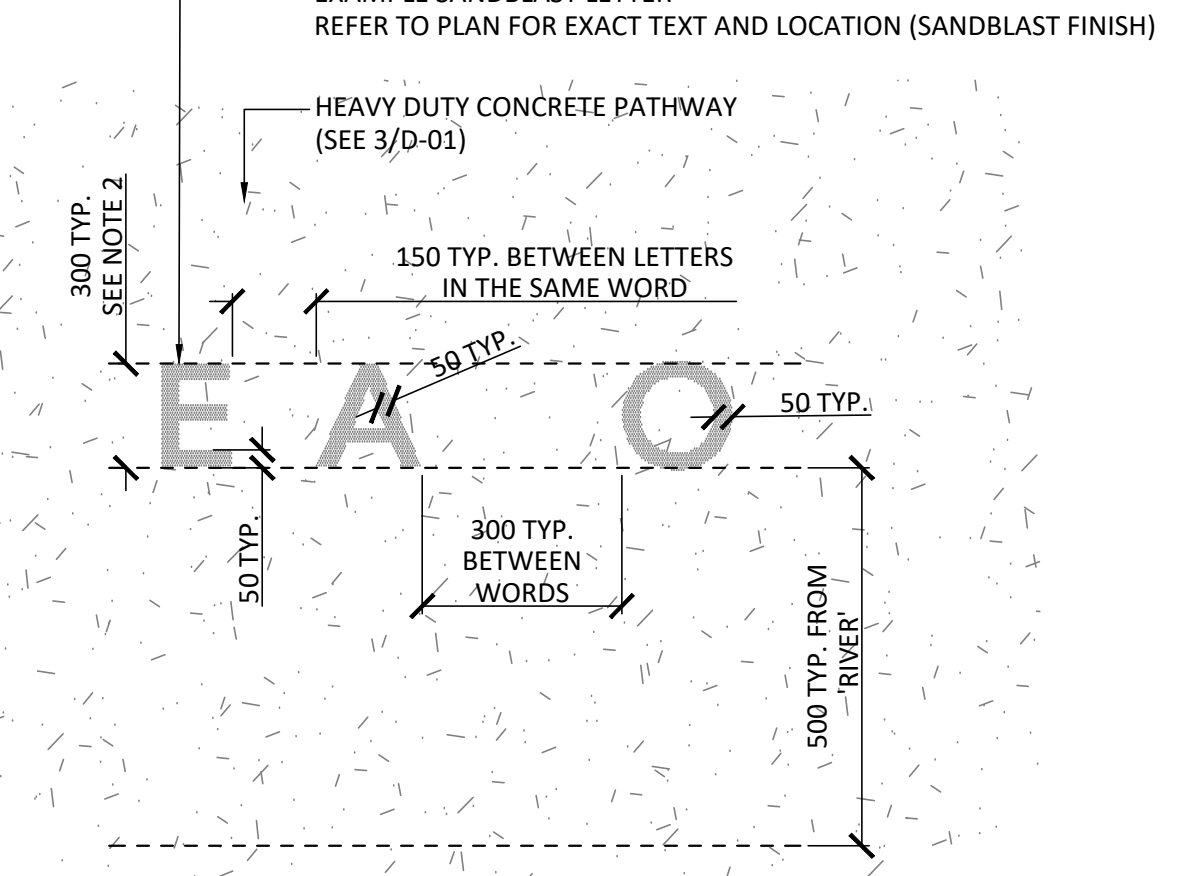

- NOTES:**
- FONT SHALL BE 'AVENIR BOOK', SIZE AS PER ABOVE.
 - REFER TO PLAN FOR CONTENT AND RADII OF INDIVIDUAL TEXT ARCS.
 - ALL DIMENSIONS IN MILLIMETRES UNLESS OTHERWISE NOTED.
 - FINAL LETTER PLACEMENT TO BE CONFIRMED ON SITE WITH CONSULTANT.

6 SANDBLASTED TEXT
1:10

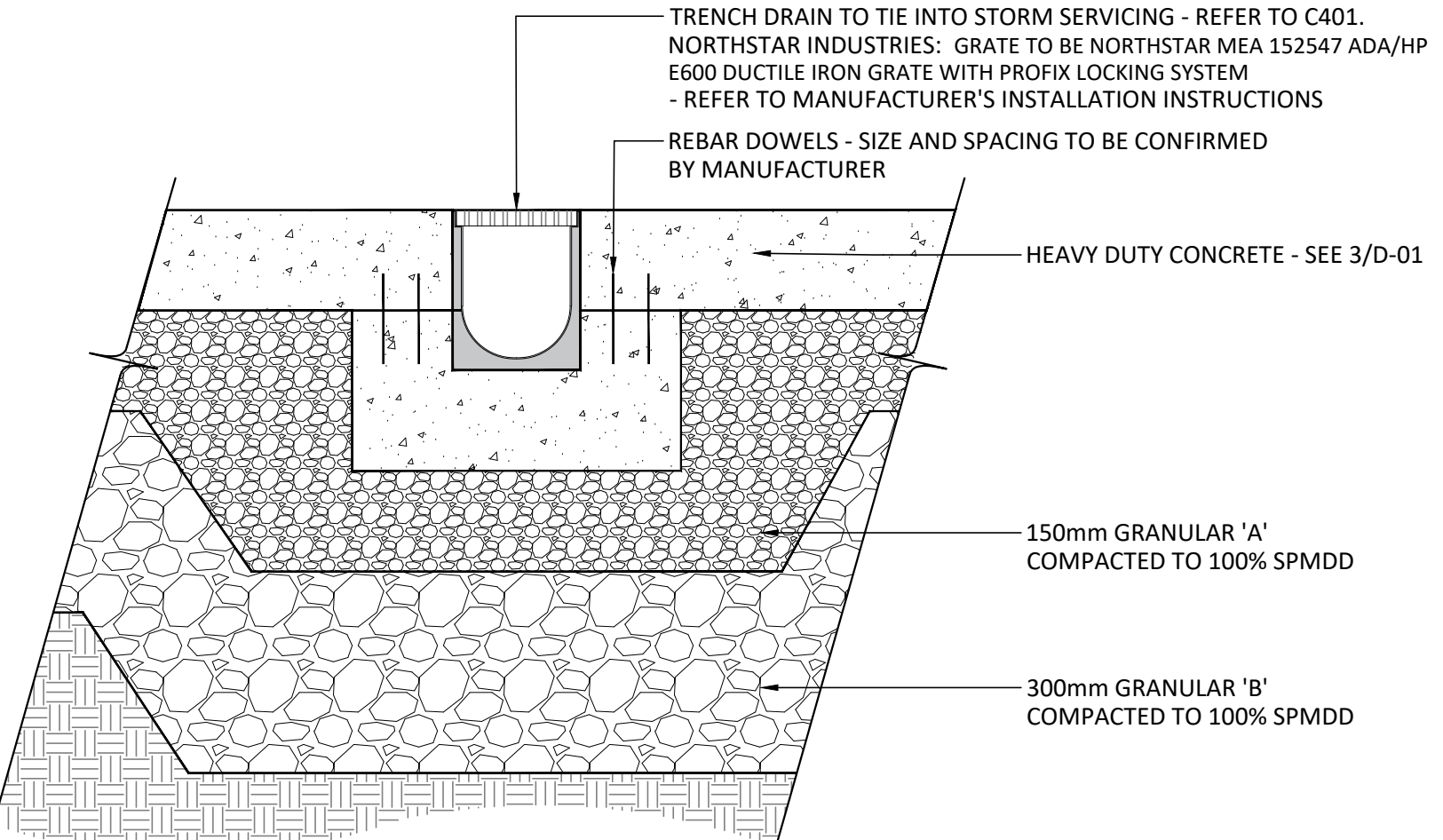

8 TRENCH DRAIN @ HEAVY DUTY CONCRETE
1:10

SPECIFICATION NOTES:

GENERAL
THE SURFACE DRAINAGE SYSTEM TO BE MEADRAIN EN1500 WITH IN-LINE CATCH BASIN COMPLETE WITH D400 SLOTTED DUCTILE IRON GRATING

CHANNEL
THE CLEAR OPENING SHALL BE 150MM HAVING OVERALL WIDTH OF 190MM. EACH UNIT WILL FEATURE A FULL RADIUS IN THE TRENCH BOTTOM AND A MALE-FEMALE INTERCONNECTING END PROFILE. STEPPED CHANNELS WITH BUILT-IN 5% INVERT. UNITS SHALL HAVE CAST-IN ANCHORING FEATURES ON THE OUTSIDE WALL TO ENSURE MAXIMUM MECHANICAL BOND TO THE SURROUNDING MATERIAL AND PAVEMENT SURFACE. EDGE RAIL TO BE CAST IRON WITH A KTL-COATING (CATAPHORETIC PAINTING). THE RAIL SYSTEM WILL BE CAST IN BY THE MANUFACTURER TO ENSURE MAXIMUM STRENGTH BETWEEN POLYMER CONCRETE BODY AND EDGE RAIL.

CATCH BASIN
EN1500 850MM DEEP IN-LINE CATCH BASIN SHALL BE MADE OF POLYMER CONCRETE WITH INTEGRATED CAST IRON EDGE RAILS AND 160MM/200MM DIA. PRE-FORMED KNOCKOUT FOR CONNECTIONS. GRATES AND LOCKING MECHANISM TO MATCH TRENCH SYSTEM UNLESS NOTED OTHERWISE.

GRATES
GRATE TO BE NORTHSTAR MEA 152547 ADA/HP E600 DUCTILE IRON GRATE WITH PROFIX LOCKING SYSTEM. GRATES TO BE 499 MM LONG BY 173 MM WIDE. AFTER GRATE REMOVAL, THERE SHALL BE UNINTERRUPTED ACCESS IN THE TRENCH FOR CLEANING AND MAINTENANCE.

INSTALLATION
SEALANT SHALL BE USED DURING INSTALLATION TO BE PLACED BETWEEN JOINTS BEFORE FINAL PLACEMENT. THE TRENCH DRAIN SYSTEM SHALL BE INSTALLED IN ACCORDANCE WITH THE MANUFACTURER'S INSTALLATION INSTRUCTIONS AND RECOMMENDATIONS. SYSTEM TO BE SUPPLIED BY NORTHSTAR INDUSTRIES @ 1-877-385-5130* CONTRACTOR TO PROVIDE MANUFACTURER SHOP DRAWINGS.

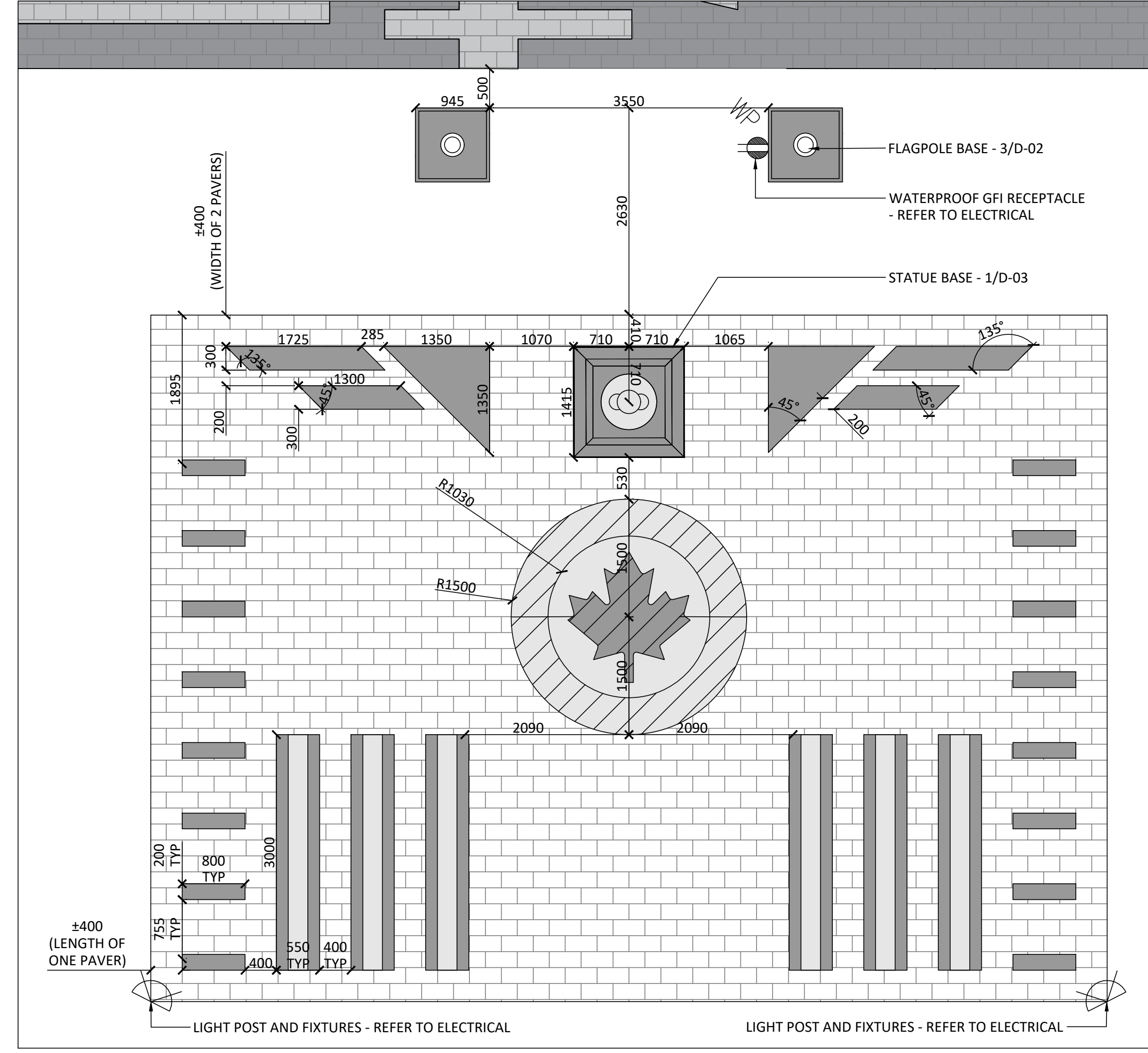

7 PLAZA LAYOUT
1:10

- SURFACING**
- HEAVY DUTY UNIT PAVERS (BLACK/GREY/WHITE)
 - GRANITE INLAY (BLACK)
 - GRANITE INLAY (WHITE)
 - GRANITE INLAY (RED)
 - GRANITE INLAY (GREY)

Contractor shall check all dimensions on the work and report any discrepancy to the Landscape Architect before proceeding. All drawings and specifications are the property of the Landscape Architect and must be returned at the completion of the work. This drawing is not to be used for construction until signed by the Landscape Architect.

11	Issued for Construction	Oct 20/23
10	Issued for Addendum 04	Mar 13/23
9	Issued for Addendum 03	Feb 04/23
8	Issued for Tender	Jan 10/23
7	Issued for 100% Submission	Dec 14/22
6	Issued for Client Review	Dec 05/22
5	Issued for 90% Submission	Oct 12/22
4	Issued for 90% - Client Review	Oct 06/22
3	Issued for Client Review	Sep. 21/22
2	Issued for 60% Submission	May 9/22
1	Issued for 60% Submission - Client Review	Apr.22/22
No.	Description	Date
Revision		
City Approval Stamp		



NAK design strategies
1285 Wellington St. W. OTTAWA, ON K1N 6B3 CANADA
T 613.237.2345 F 613.237.6423 NAKDESIGNSTRATEGIES.COM

Project
WATERIDGE VILLAGE
LT. COL. WILLIAM G. BARKER VC PARK
PARK 8 - BLOCK 20

Date	APRIL 2022	Sheet	
Scale	1:200 @ ARCH D	Checked	MK
Drawn	JC	Job No.	21-112
		D-01	

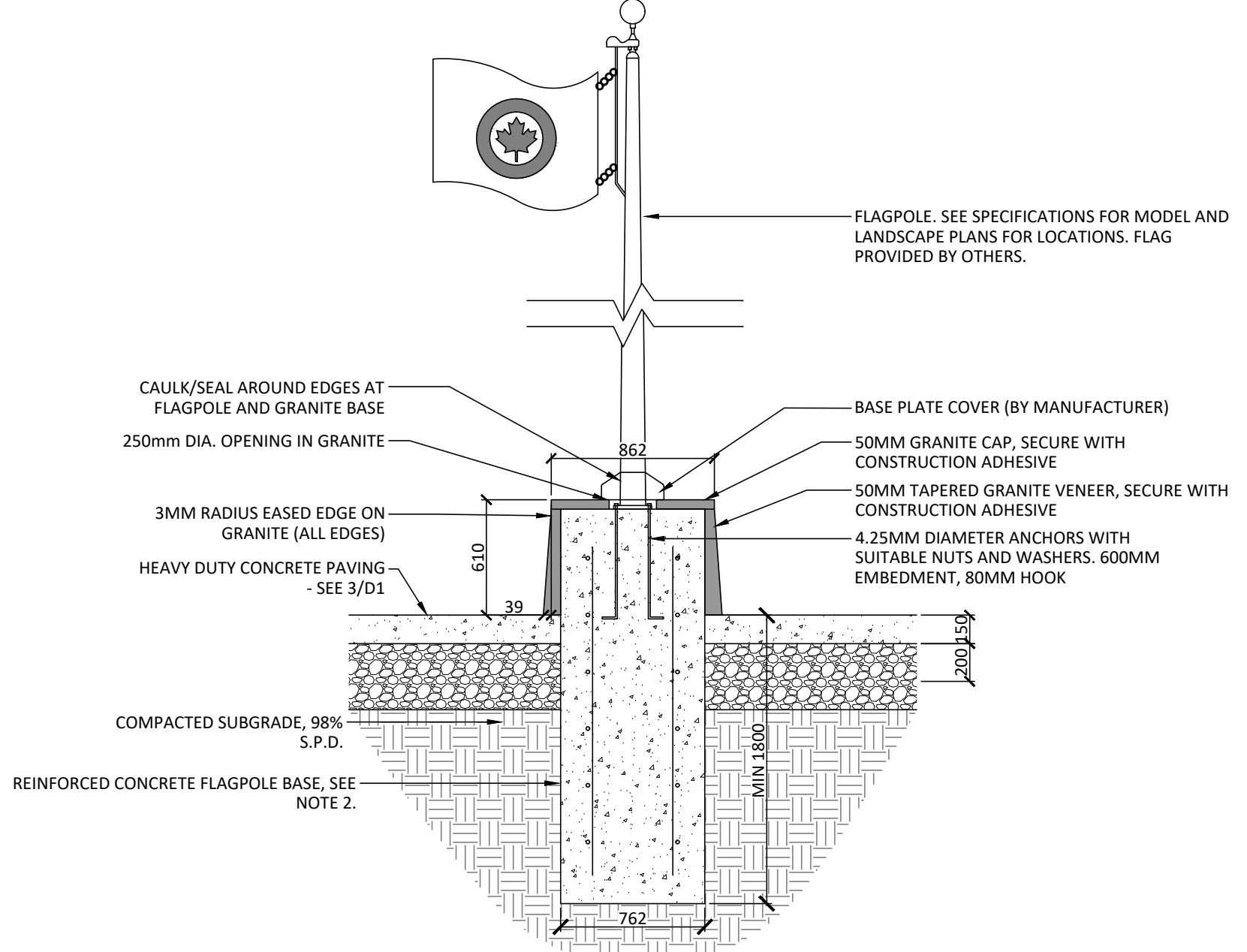
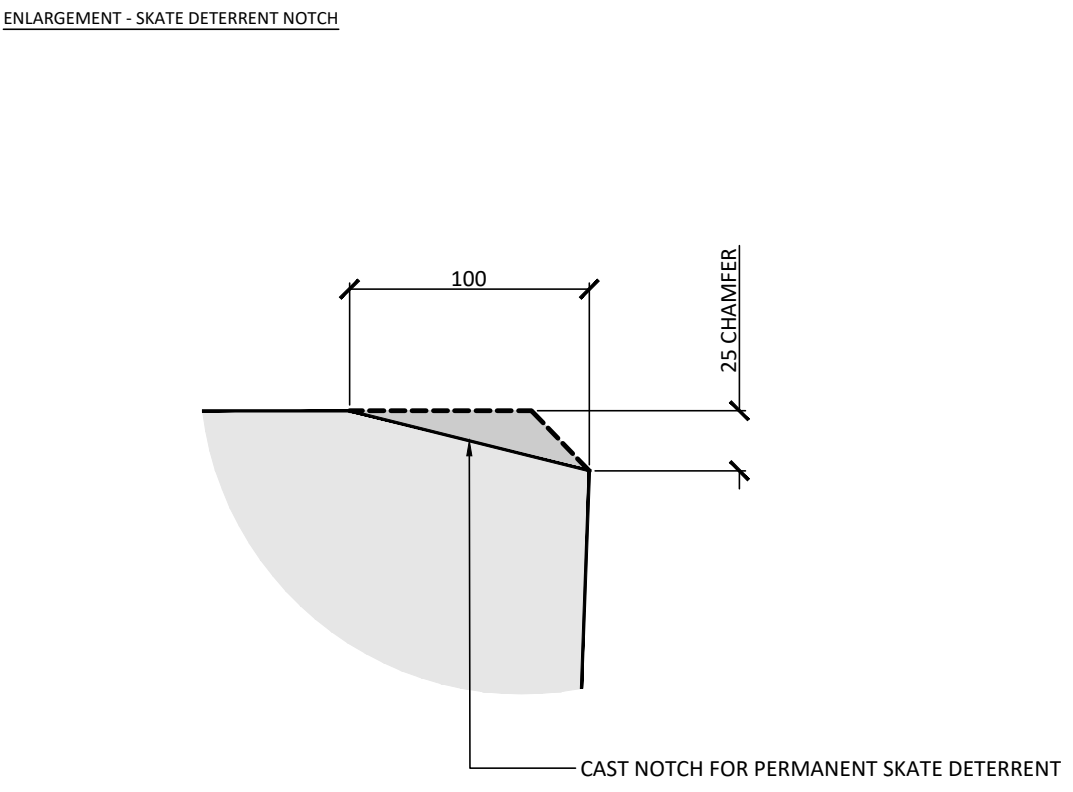
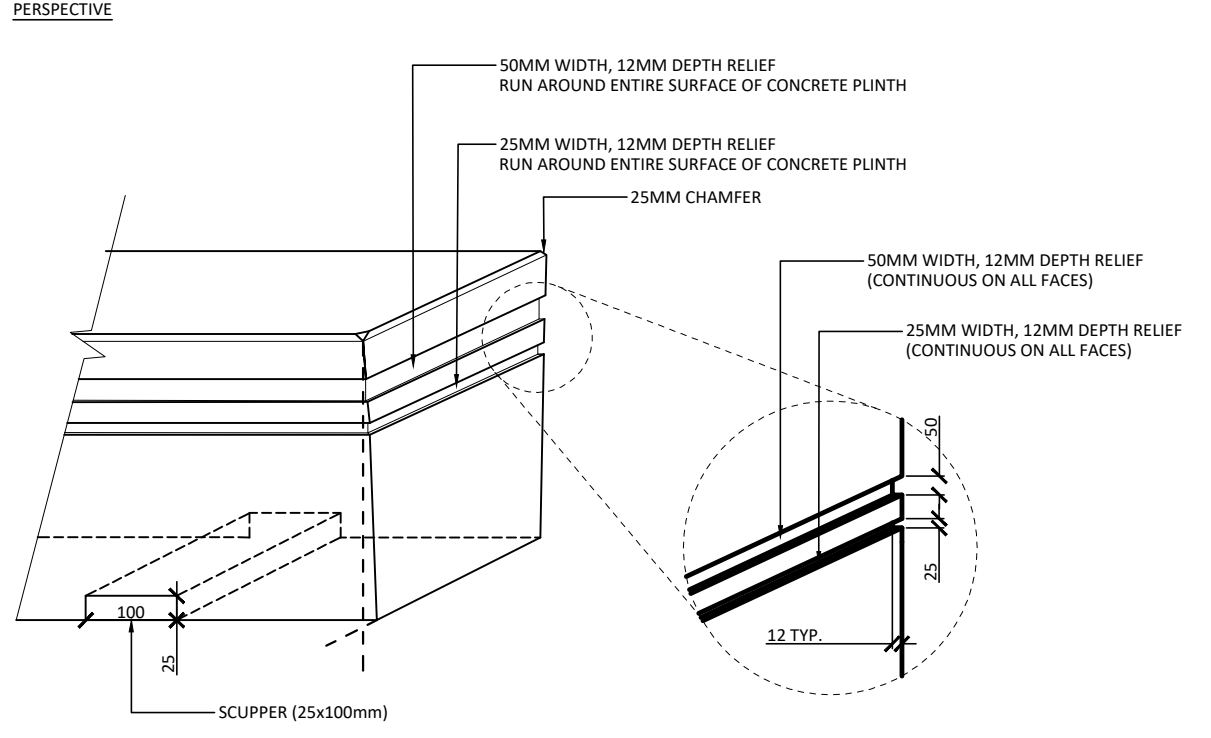
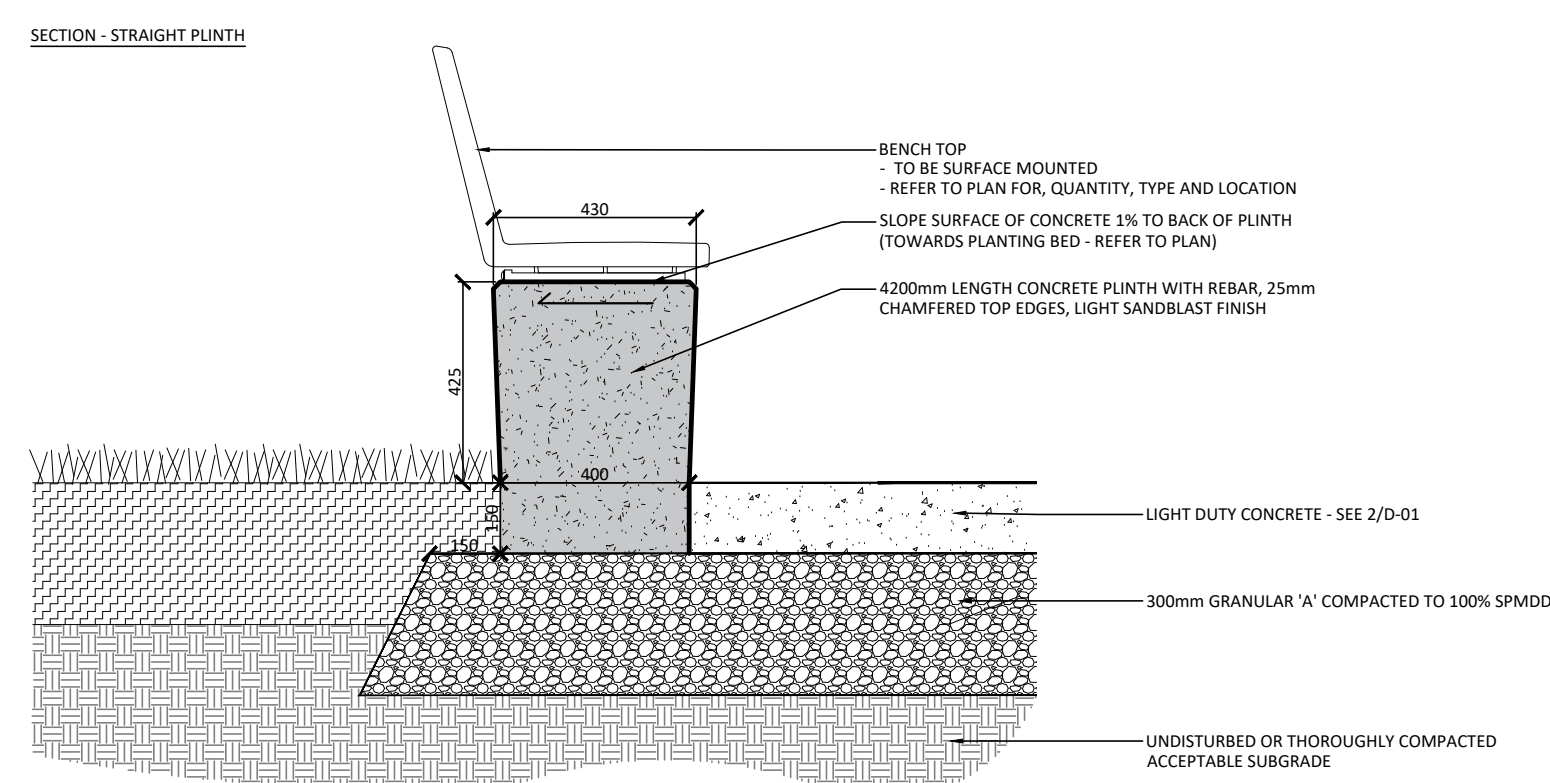
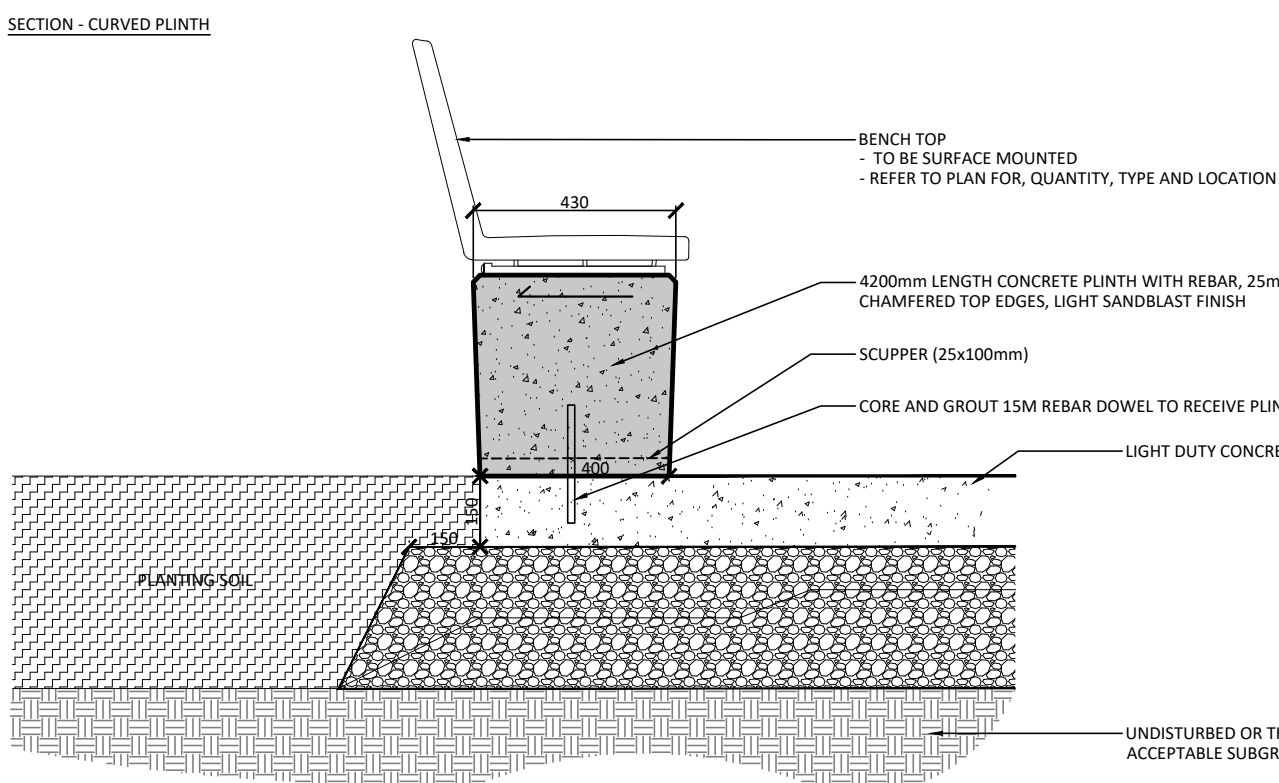
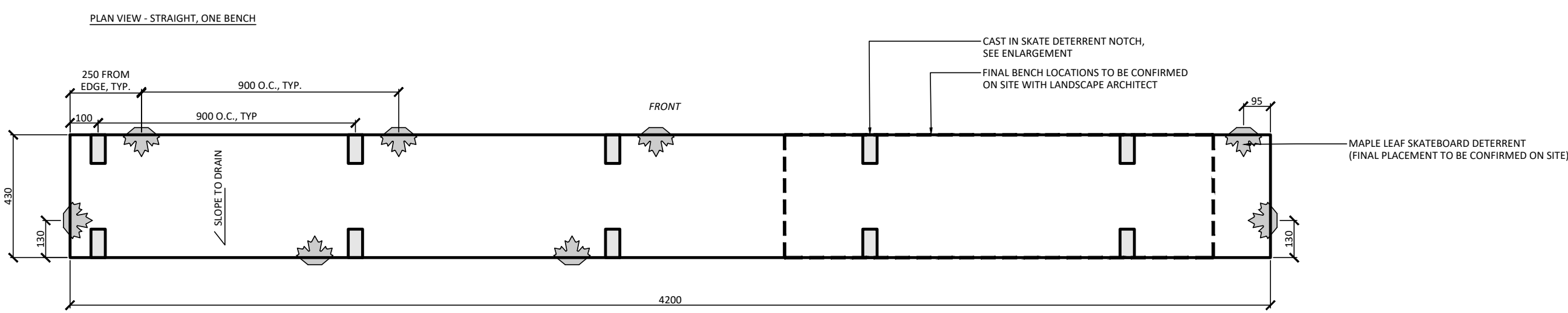
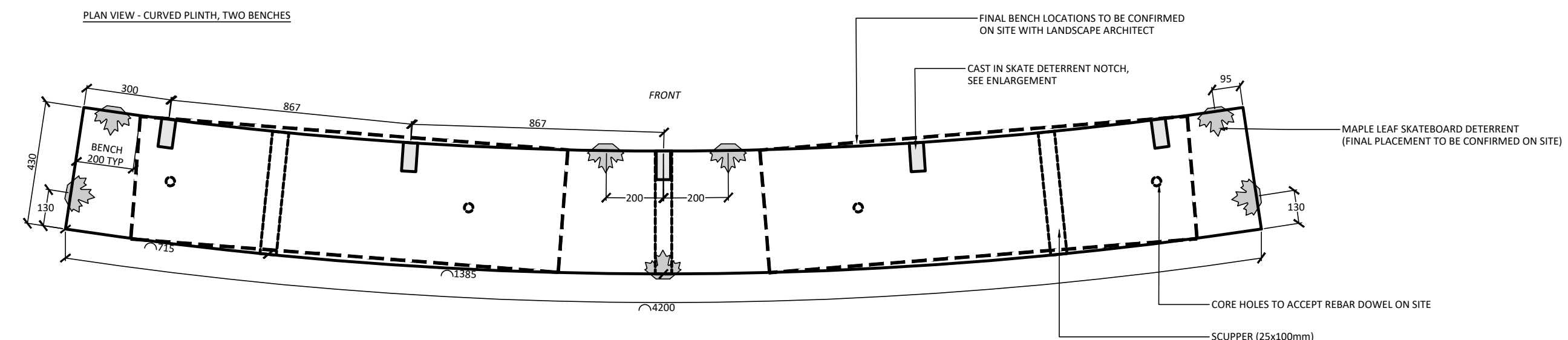
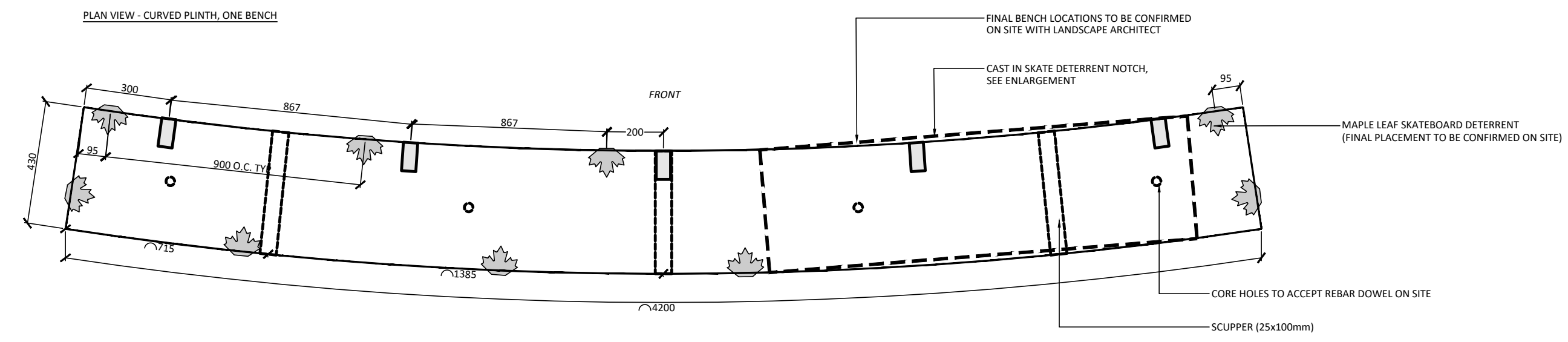

- NOTES:**
- SPECIFIED FLAGPOLE FOUNDATION DIMENSIONS AND REINFORCEMENT ARE MINIMUM REQUIREMENTS TO BE USED FOR PRICING ONLY.
 - CONTRACTOR TO RETAIN THE SERVICES OF A PROFESSIONAL ENGINEER REGISTERED IN THE PROVINCE OF ONTARIO TO DESIGN AND DETAIL THE FLAGPOLE FOUNDATION AND REQUIRED ANCHORAGES. PROVIDE STAMPED SHOP DRAWINGS FOR OUR REVIEW PRIOR TO FABRICATION.
 - EXPOSED ANCHORS, BOLTS AND WASHERS TO BE HOT DIPPED GALVANIZED.
 - ALL FASTENING TO BE SELECTED TO AVOID VOLCANIC ACTION BETWEEN DISSIMILAR METALS.

9 FLAGPOLE
1:30

Contractor shall check all dimensions on the work and report any discrepancy to the Landscape Architect before proceeding. All drawings and specifications are the property of the Landscape Architect and must be returned at the completion of the work. This drawing is not to be used for construction until signed by the Landscape Architect.

No.	Description	Date
10	Issued for Construction	Oct 20/23
9	Issued for Addendum 06	Mar 13/23
8	Issued for Tender	Jan 10/23
7	Issued for 100% Submission	Dec 14/22
6	Issued for Client Review	Dec 05/22
5	Issued for 90% Submission	Oct 12/22
4	Issued for Client Review	Oct 06/22
3	Issued for Client Review	Sep. 21/22
2	Issued for 60% Submission	May 9/22
1	Issued for 60% Submission - Client Review	Apr.22/22

Revision
City Approval Stamp

8 PRECAST CONCRETE PLINTHS
1:16

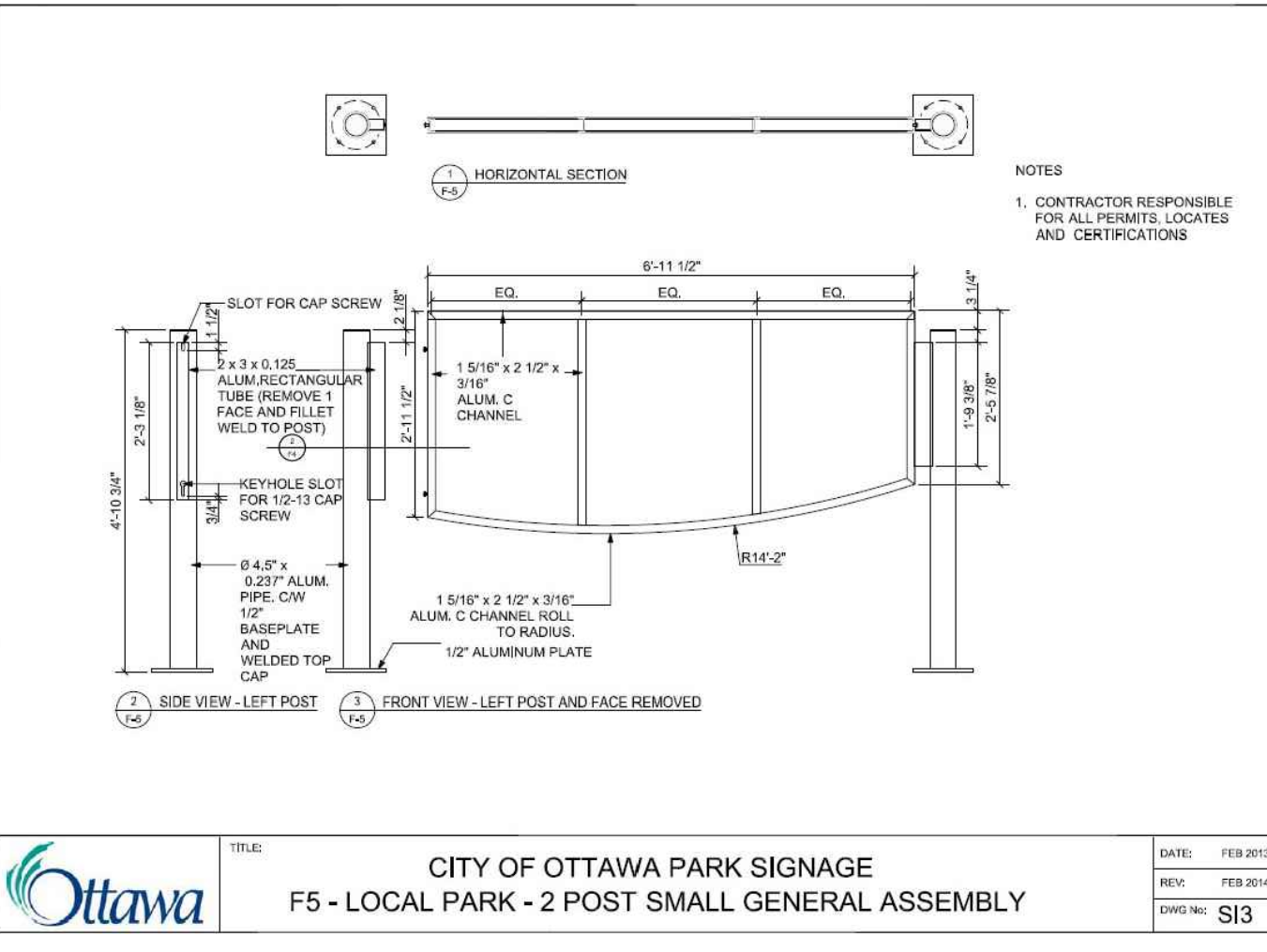

10 LOCAL PARK - 2 POST SMALL GENERAL ASSEMBLY AND INSTALLATION
N.T.S.

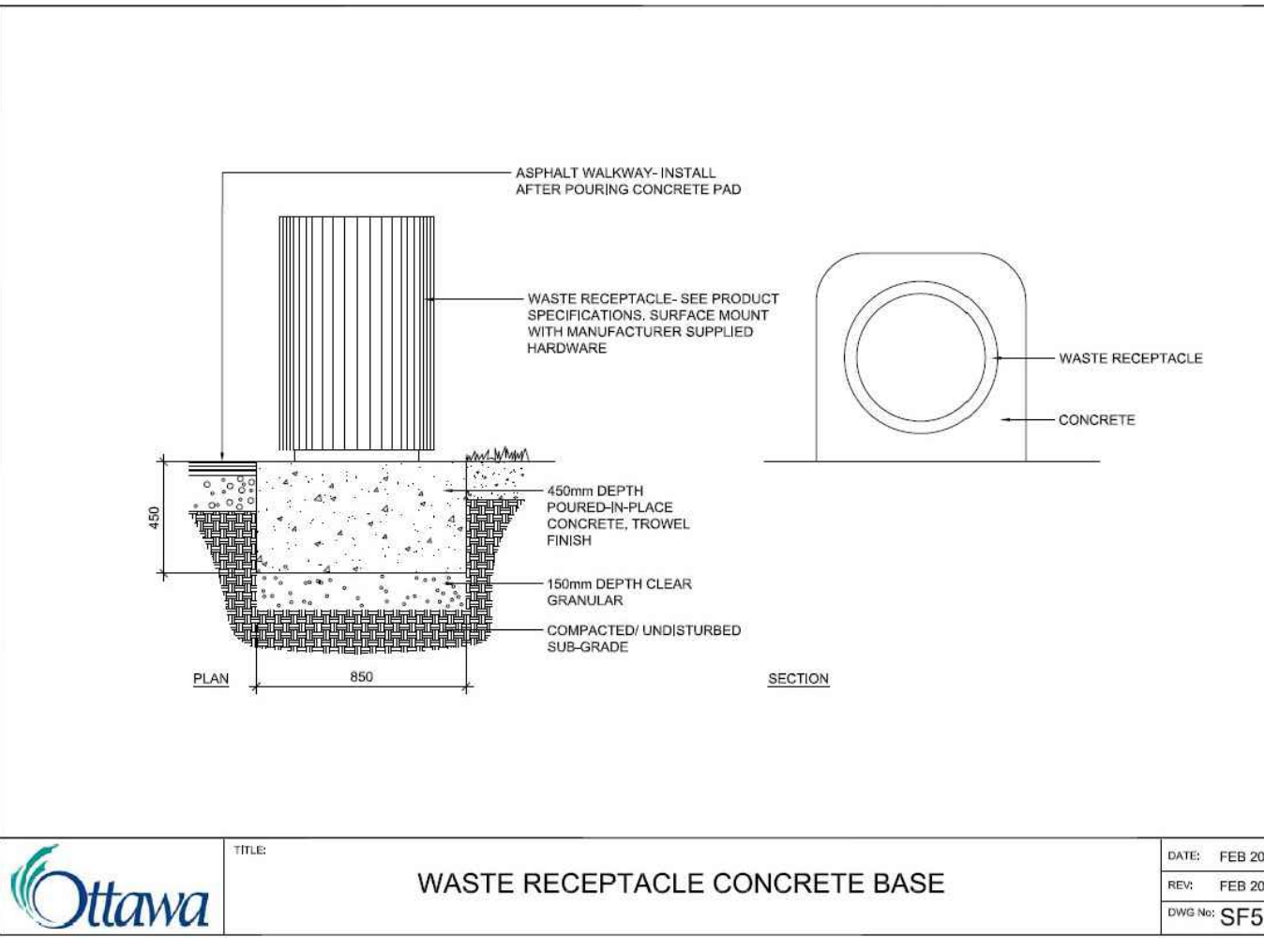

11 WASTE RECEPTACLE MOUNTING ON CONCRETE BASE
N.T.S.

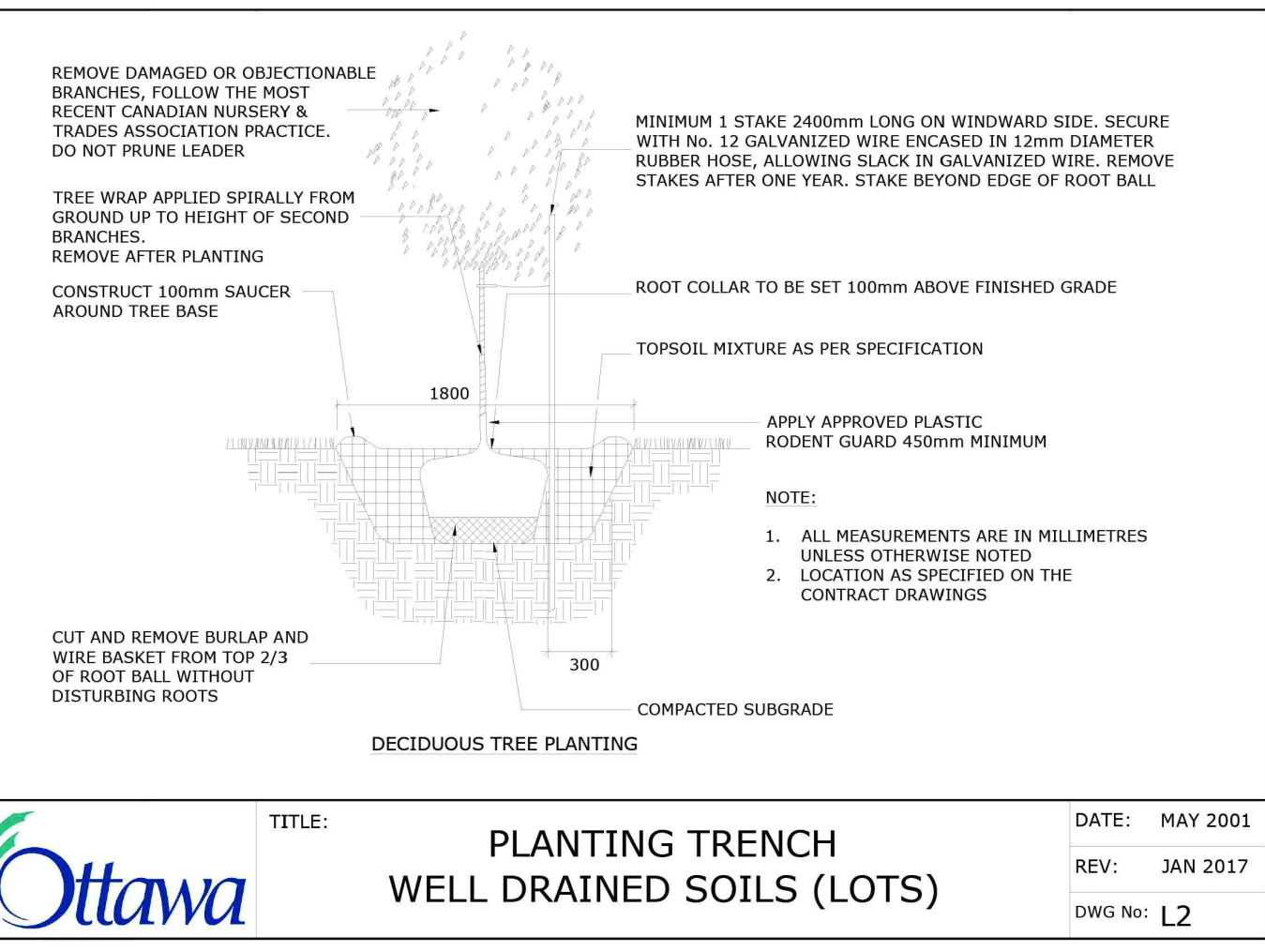

12 DECIDUOUS TREE PLANTING
N.T.S.

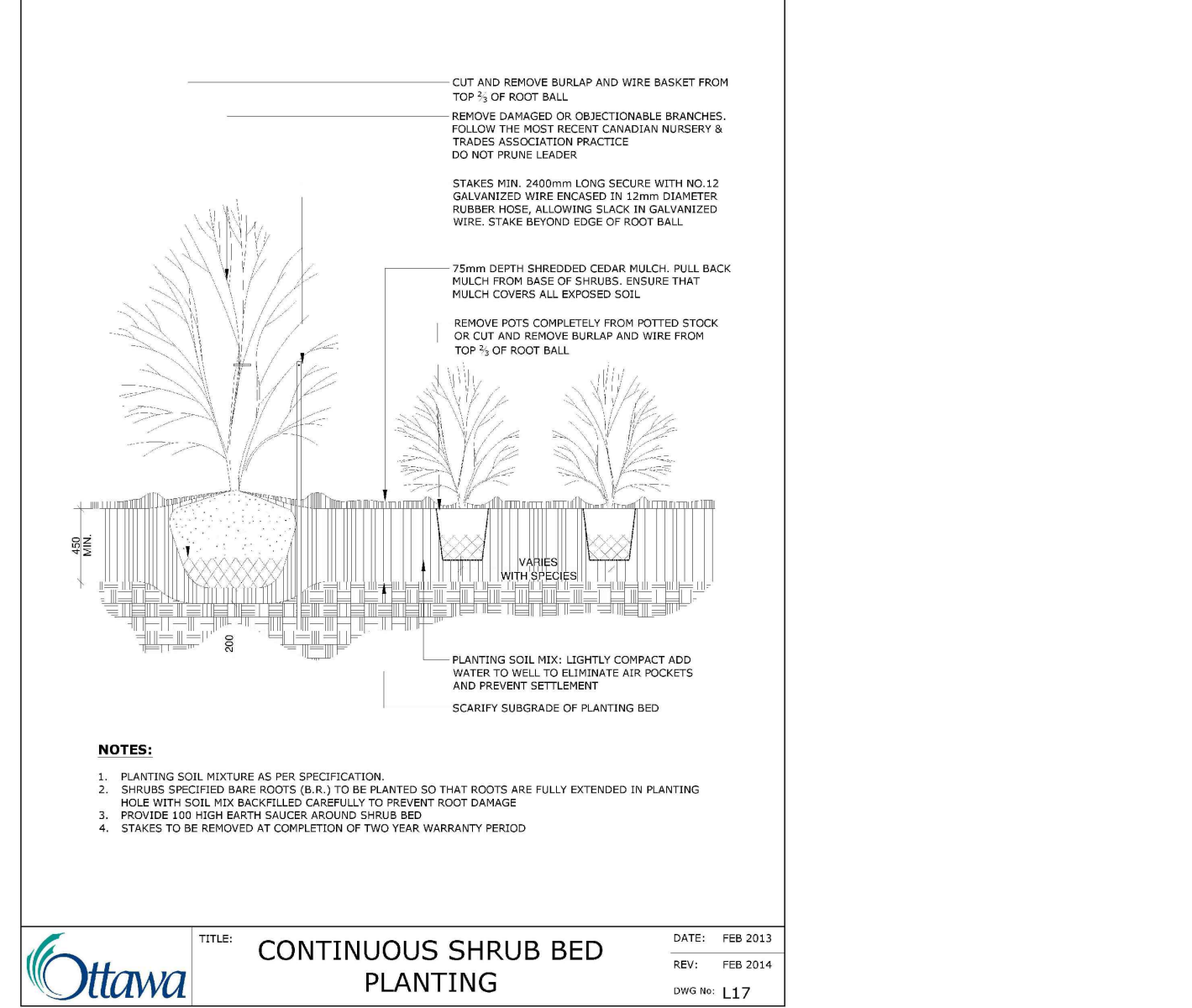

13 CONTINUOUS SHRUB BED PLANTING
N.T.S.

ASSOCIATION OF LANDSCAPE ARCHITECTS (ONTARIO) MEMBER

NAK
design strategies

1285 Wellington St. W. OTTAWA, ON K1N 6B3 CANADA
T 613.237.2345 F 613.237.6423 NAKDESIGNSTRATEGIES.COM

Project

WATERIDGE VILLAGE
LT. COL. WILLIAM G. BARKER VC PARK
PARK 8 - BLOCK 20

Title

DETAILS

Date APRIL 2022
Scale 1:200 @ ARCH D
Drawn JC
Checked MK
Job No. 21-112

Sheet
D-02

Contractor shall check all dimensions on the work and report any discrepancy to the Landscape Architect before proceeding. All drawings and specifications are the property of the Landscape Architect and must be returned at the completion of the work. This drawing is not to be used for construction until signed by the Landscape Architect.

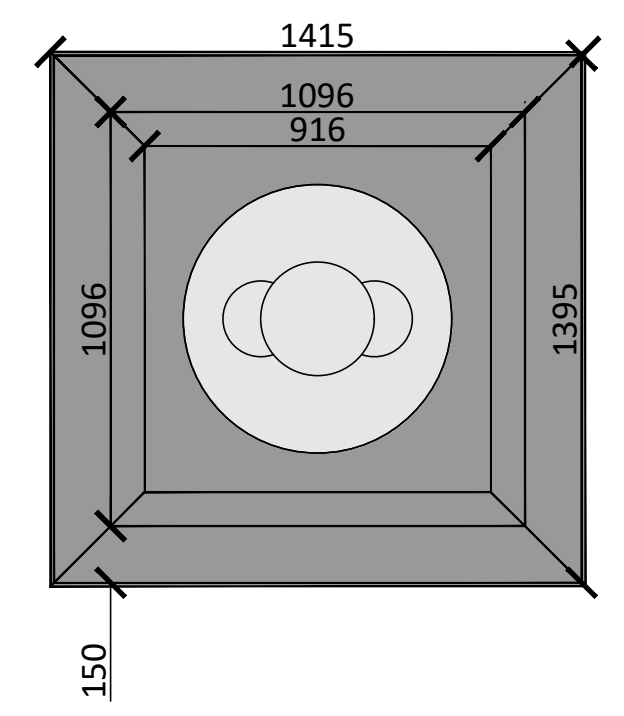

ELEVATION

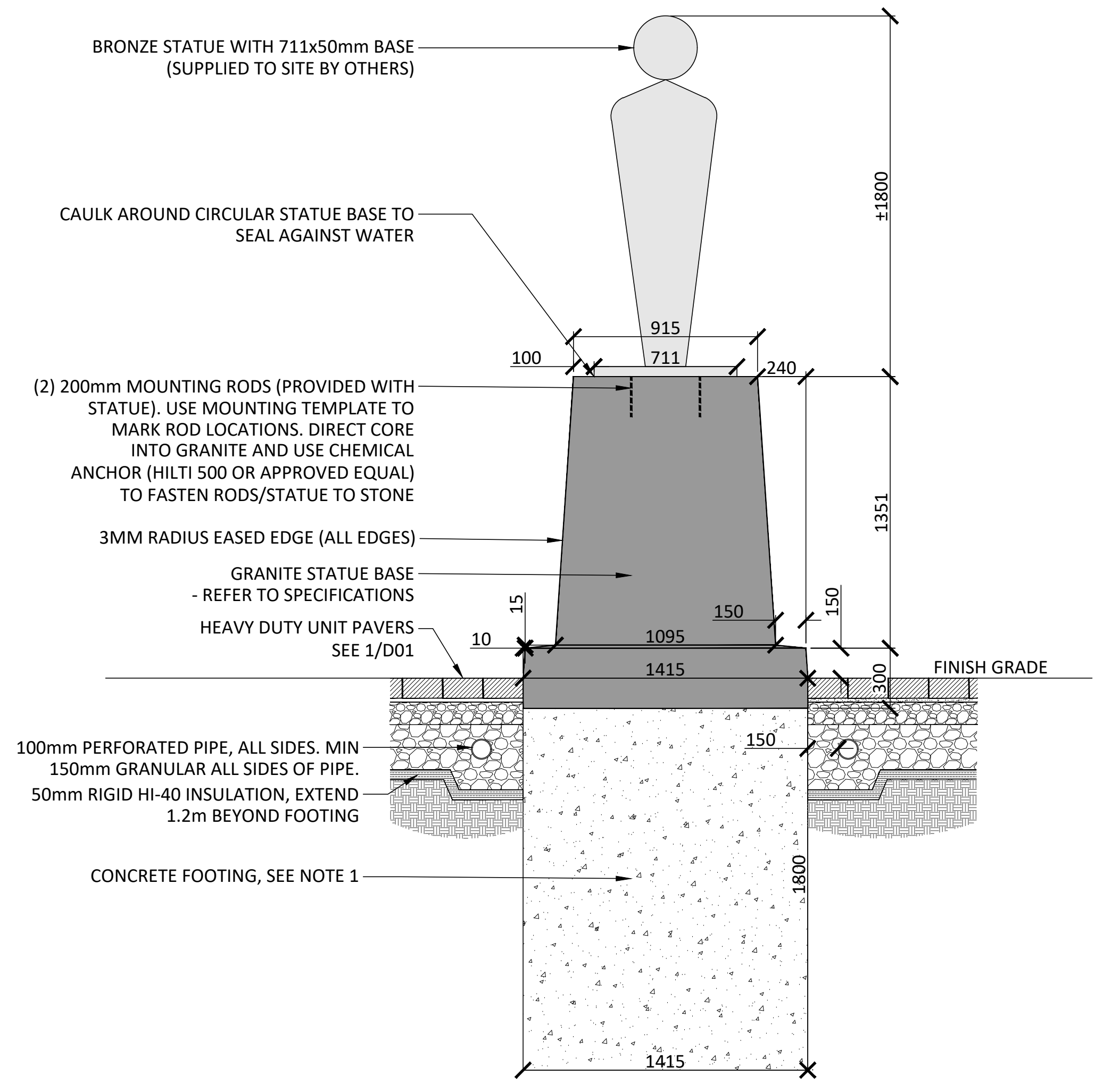

BRONZE STATUE WITH 711x50mm BASE (SUPPLIED TO SITE BY OTHERS)

CAULK AROUND CIRCULAR STATUE BASE TO SEAL AGAINST WATER

(2) 200mm MOUNTING RODS (PROVIDED WITH STATUE). USE MOUNTING TEMPLATE TO MARK ROD LOCATIONS. DIRECT CORE INTO GRANITE AND USE CHEMICAL ANCHOR (HILTI 500 OR APPROVED EQUAL) TO FASTEN RODS/STATUE TO STONE

3MM RADIUS EASED EDGE (ALL EDGES)

GRANITE STATUE BASE - REFER TO SPECIFICATIONS

HEAVY DUTY UNIT PAVERS SEE 1/D01

100mm PERFORATED PIPE, ALL SIDES. MIN 150mm GRANULAR ALL SIDES OF PIPE. 50mm RIGID HI-40 INSULATION, EXTEND 1.2m BEYOND FOOTING

CONCRETE FOOTING, SEE NOTE 1

NOTES:

- CONTRACTOR TO RETAIN THE SERVICES OF A PROFESSIONAL ENGINEER REGISTERED IN THE PROVINCE OF ONTARIO TO DESIGN AND DETAIL THE STATUE FOUNDATION INCLUDING REQUIRED ANCHORAGES, REINFORCEMENT, AND CONCRETE DESIGN. PROVIDE STAMPED SHOP DRAWINGS FOR OUR REVIEW PRIOR TO FABRICATION.

1 GRANITE STATUE BASE AND CONCRETE FOOTING
1:20

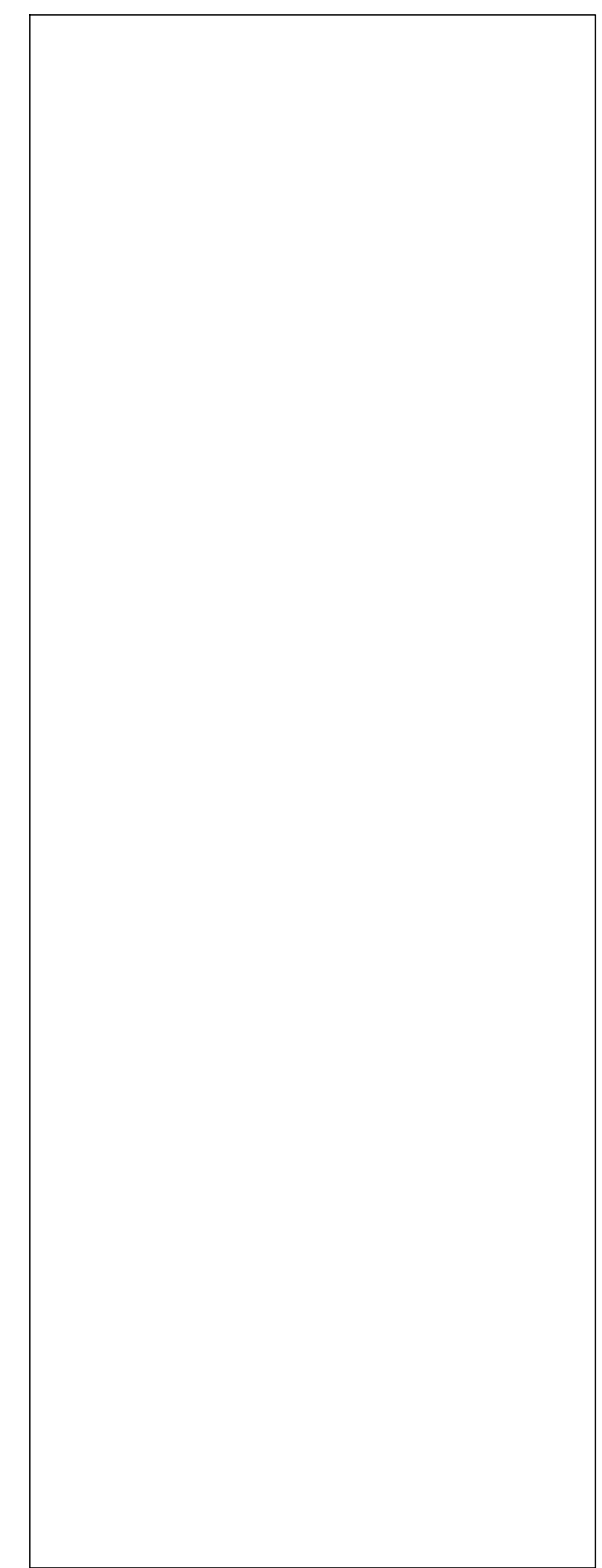

No.	Description	Date
2	Issued for Construction	Mar 20/23
1	Issued for Addenda 06	Mar 13/23

Revision

City Approval Stamp

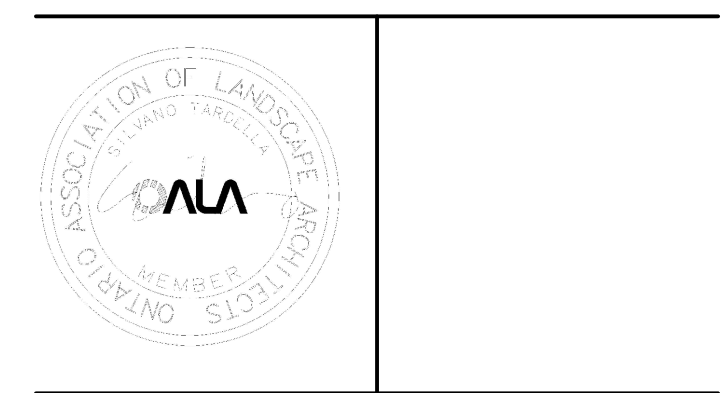

NAK
design strategies
1285 Wellington St. W. OTTAWA, ON K1H 4B3 CANADA
T 613.237.2345 F 613.237.6423 NAKDESIGNSTRATEGIES.COM

Project
WATERIDGE VILLAGE
LT. COL. WILLIAM G. BARKER VC PARK
PARK 8 - BLOCK 20

Title
DETAILS

Date APRIL 2022
Scale 1:200 @ ARCH D
Drawn JC
Checked MK
Job No. 21-112

Sheet
D-03

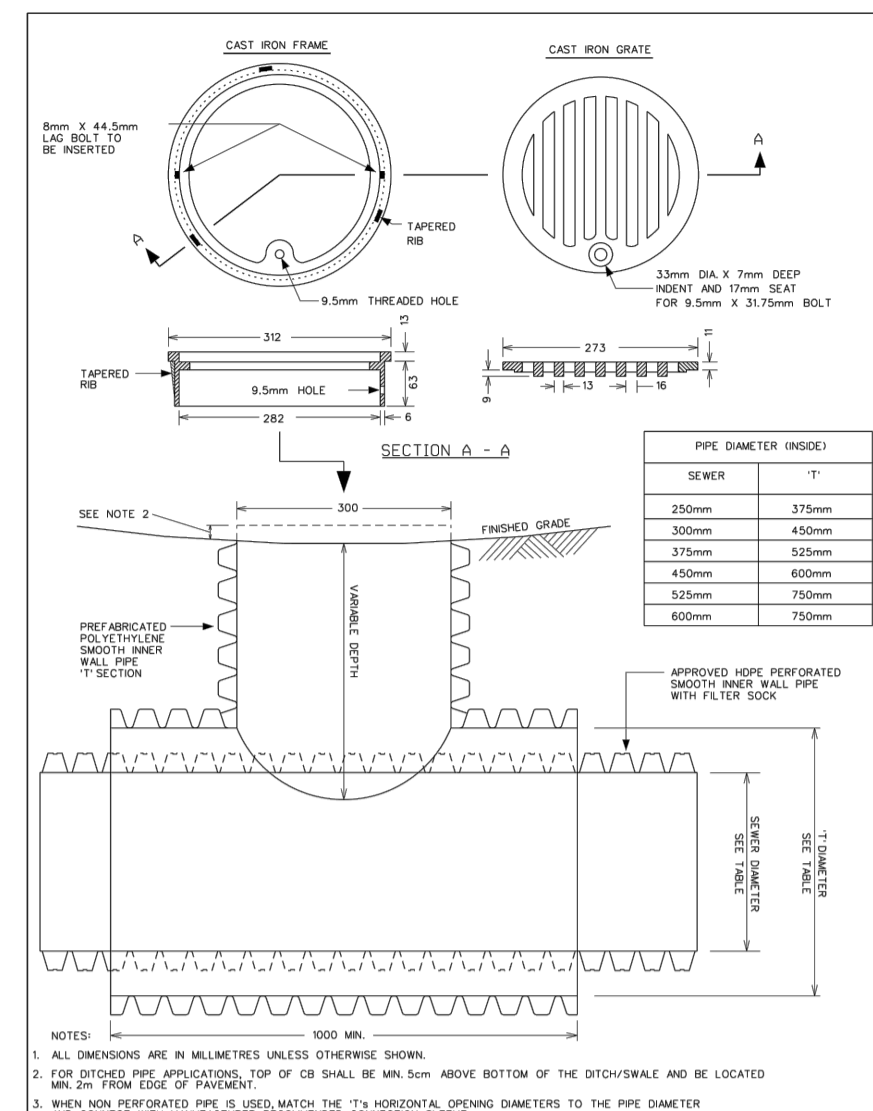

CATCH BASIN - T
FOR REAR YARD, DITCHED PIPE AND LANDSCAPING APPLICATIONS

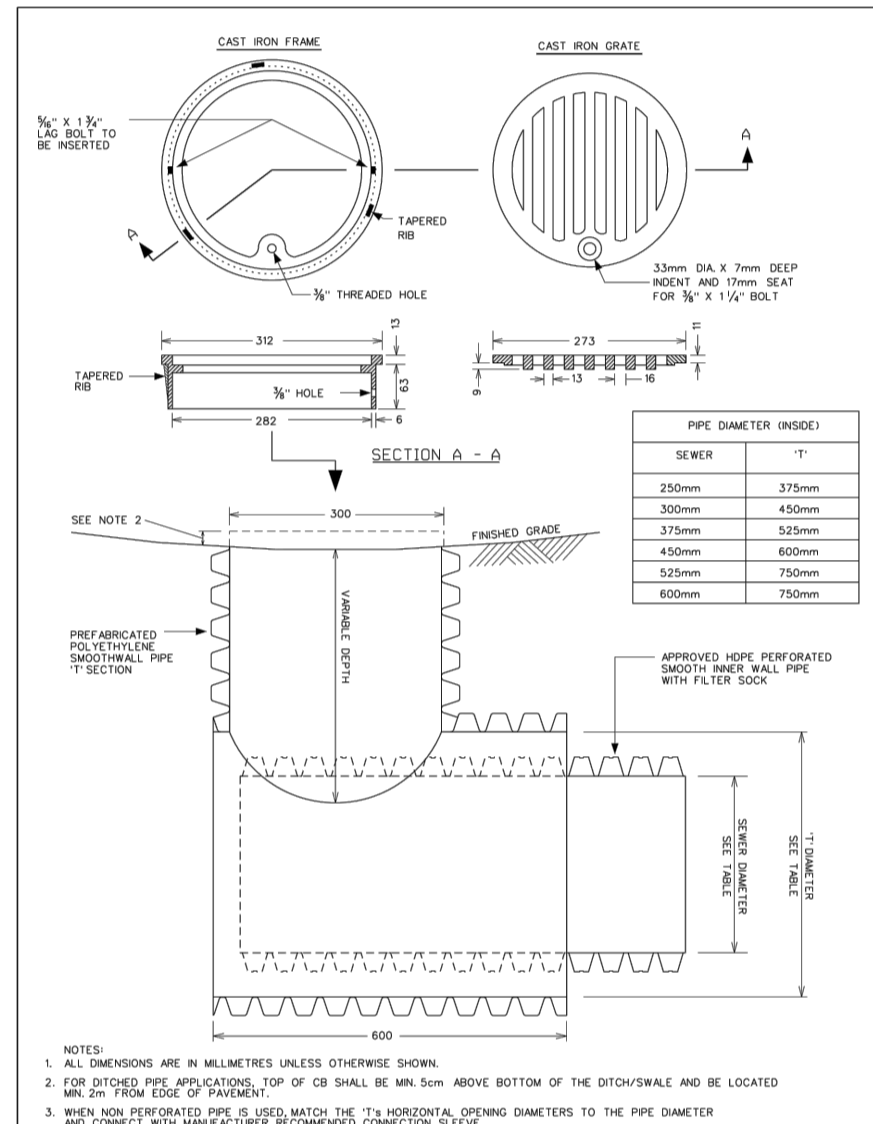

CATCH BASIN - ELBOW
FOR REAR YARD, DITCHED PIPE AND LANDSCAPING APPLICATIONS

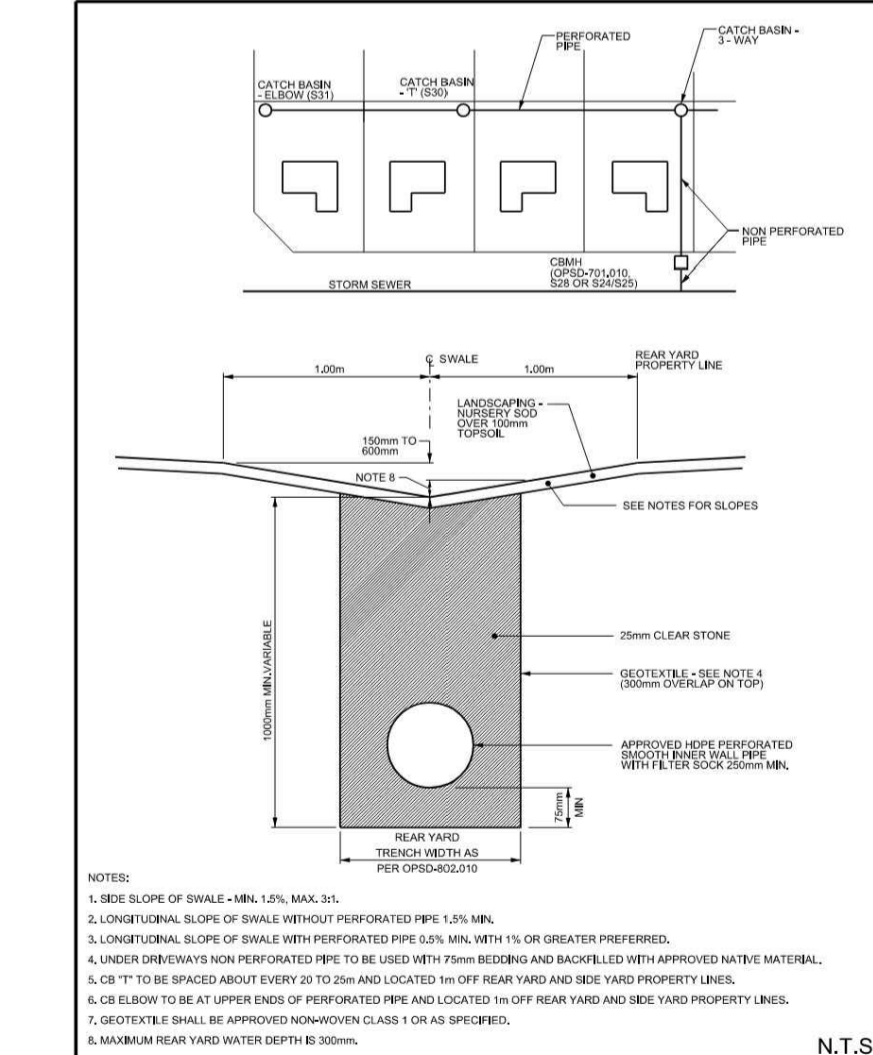

PERFORATED PIPE INSTALLATION
FOR REAR YARD AND LANDSCAPING APPLICATIONS

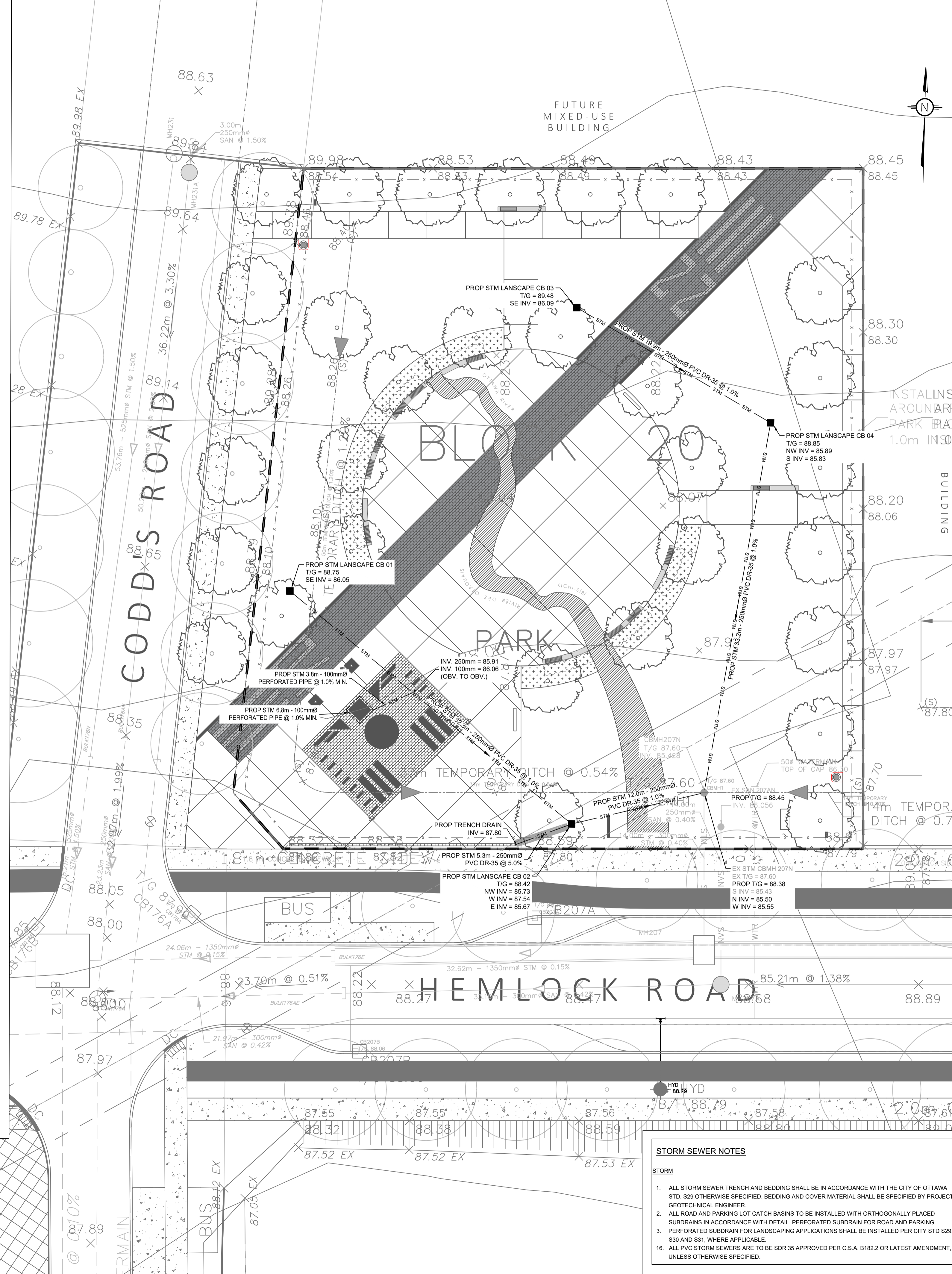

LEGEND:

	EXISTING PROPERTY LINE TO REMAIN
	PROPOSED CURB
	PROPOSED DEPRESSED CURB
	PROPOSED TRENCHING (3:1 MIN.)
	PROPOSED BERM CONTOUR
	PROPOSED TEMP CONSTRUCTION FENCE
	PROPOSED DOOR ENTRANCE/EXIST
	PROPOSED GRASS AREA (100mm TOP SOIL & SOD)
	PROPOSED CONCRETE FEATURES/SLAB
	PROPOSED SHRUB BED
	PROPOSED UNIT PAVERS
	PROPOSED ELEVATION
	PROPOSED HIGH POINT ELEVATION
	PROPOSED SWALE ELEVATION
	PROPOSED BOTTOM OF CURB / ASPHALT ELEVATION
	PROPOSED TOP OF CURB ELEVATION
	PROPOSED EXPOSED BOTTOM OF RETAINING WALL
	PROPOSED TOP OF RETAINING WALL
	MATCH INTO EXISTING ELEVATION
	EXISTING ELEVATION
	PROPOSED STORM SEWER
	PROPOSED SANITARY SEWER
	PROPOSED WATERMAIN
	EXISTING STORM SEWER
	EXISTING SANITARY SEWER
	EXISTING WATERMAIN
	EXISTING MANHOLE
	EXISTING CATCHBASIN
	PROPOSED CATCHBASIN-MANHOLE/CATCHBASIN
	PROPOSED MANHOLE
	PROPOSED CURB STOP
	PROPOSED PIPE INSULATION
	PROPOSED STREET TREES (BY OTHERS)
	PROPOSED LARGE DECIDUOUS TREES

USE AND INTERPRETATION OF DRAWINGS

GENERAL CONDITIONS OF THE CONTRACT FOR CONSTRUCTION ARE PART OF THE CONTRACT DOCUMENTS AND DESCRIBE USE AND INTENT OF THE DRAWING. THE CONTRACTOR SHALL BE RESPONSIBLE FOR OBTAINING ALL NECESSARY PERMITS AND APPROVALS FROM THE CITY OF OTTAWA AND THE LOCAL CONDITIONS, VERIFIED FIELD DIMENSIONS AND CORRELATED HIS OBSERVATIONS WITH THE REQUIREMENTS OF THE CONTRACT DOCUMENTS.

BY USE OF THE DRAWINGS FOR CONSTRUCTION OF THE PROJECT, THE OWNER CONFIRMS THAT HE HAS REVIEWED AND APPROVED THE DRAWINGS. THE CONTRACTOR CONFIRMS THAT HE HAS VISITED THE SITE, FAMILIARIZED HIMSELF WITH THE LOCAL CONDITIONS, VERIFIED FIELD DIMENSIONS AND CORRELATED HIS OBSERVATIONS WITH THE REQUIREMENTS OF THE CONTRACT DOCUMENTS.

AS INSTRUMENTS OF SERVICE, ALL DRAWINGS, SPECIFICATIONS, CAD FILES OR OTHER ELECTRONIC MEDIA AND COPIES THERE OF FURNISHED BY THE ENGINEER ARE HIS PROPERTY. THEY ARE TO BE USED ONLY FOR THIS PROJECT AND ARE NOT TO BE USED ON ANY OTHER PROJECT, INCLUDING REPEATS OF THE PROJECT. CHANGES TO THE DRAWINGS MAY ONLY BE MADE BY THE ENGINEER.

UNLESS THE REVISION TITLE IS ISSUED FOR CONSTRUCTION, THESE DRAWINGS SHALL BE CONSIDERED PRELIMINARY AND SHALL NOT BE USED AS A CONSTRUCTION DOCUMENT.

THESE DRAWINGS ILLUSTRATE THE WORK TO BE DONE. THE ENGINEER IS NOT RESPONSIBLE FOR THE MEANS, METHODS, TECHNIQUES, SEQUENCES, AND PROCEDURES USED TO DO THE WORK, OR THE SAFETY ASPECTS OF CONSTRUCTION, AND NOTHING ON THESE DRAWINGS EXPRESSED OR IMPLIED CHANGES THIS CONDITION. CONTRACTOR SHALL DETERMINE ALL CONDITIONS AT THE SITE AND SHALL BE RESPONSIBLE FOR KNOWING HOW THEY AFFECT THE WORK. SUBMITTAL OF A BID TO PERFORM THIS WORK IS ACKNOWLEDGEMENT OF THE RESPONSIBILITIES, AND THAT THEY HAVE BEEN FULLY CONSIDERED IN PLANNING OF THE WORK AND THE BID PRICE. NO CLAIMS FOR EXTRA CHARGES DUE TO THESE CONDITIONS WILL BE FORTHCOMING.

UNAUTHORIZED CHANGES:

IN THE EVENT THE CLIENT, THE CLIENT'S CONTRACTORS OR SUBCONTRACTORS, OR ANYONE FOR WHOM THE CLIENT IS LEGALLY LIABLE MAKES OR PERMITS TO BE MADE ANY CHANGES TO ANY REPORTS, PLANS, SPECIFICATIONS OR OTHER CONSTRUCTION DOCUMENTS PREPARED BY LRI ASSOCIATES LTD. (LRI) WITHOUT OBTAINING LRI'S PRIOR WRITTEN CONSENT, THE CLIENT SHALL ASSUME FULL RESPONSIBILITY FOR THE RESULTS OF SUCH CHANGES. THEREFORE THE CLIENT AGREES TO WAIVE ANY CLAIM AGAINST LRI AND TO RELEASE LRI FROM ANY LIABILITY ARISING DIRECTLY OR INDIRECTLY FROM SUCH UNAUTHORIZED CHANGES.

IN ADDITION, THE CLIENT AGREES, TO THE FULLEST EXTENT PERMITTED BY LAW, TO INDEMNIFY AND HOLD HARMLESS LRI FROM ANY DAMAGES, LIABILITIES OR COST, INCLUDING REASONABLE ATTORNEY'S FEES AND COST OF DEFENSE, ARISING FROM SUCH CHANGES.

IN ADDITION, THE CLIENT AGREES TO INCLUDE IN ANY CONTRACTS FOR CONSTRUCTION APPROPRIATE LANGUAGE THAT PROHIBITS THE CONTRACTOR OR ANY SUBCONTRACTORS OF ANY TIER FROM MAKING ANY CHANGES OR MODIFICATIONS TO LRI'S CONSTRUCTION DOCUMENTS WITHOUT THE PRIOR WRITTEN APPROVAL OF LRI AND THAT FURTHER REQUIRES THE CONTRACTOR TO INDEMNIFY BOTH LRI AND THE CLIENT FROM ANY LIABILITY OR COST ARISING FROM SUCH CHANGES MADE WITHOUT SUCH PROPER AUTHORIZATION.

EXISTING SERVICES AND UTILITIES SHOWN ON THESE DRAWINGS ARE TAKEN FROM THE BEST AVAILABLE RECORDS, BUT MAY NOT BE COMPLETE OR TO DATE. CONTRACTOR SHALL VERIFY LOCATION AND DEPTH OF ALL EXISTING SERVICES AND CHECK WITH THE UTILITY COMPANIES BEFORE DIGGING OR PERFORMING WORK.

CONTRACTOR IS ADVISED TO COLLECT INFORMATION ON SOIL CONDITIONS BEFORE START OF CONSTRUCTION.

THE ENGINEER WAIVES ANY AND ALL RESPONSIBILITY AND LIABILITY FOR PROBLEMS WHICH ARISE FROM FAILURE TO FOLLOW THESE PLANS, SPECIFICATIONS AND CONDITIONS. THE CLIENT SHALL ASSUME FULL RESPONSIBILITY FOR ANY ERRORS, OMISSIONS, INCONSISTENCIES, AMBIGUITIES OR CONFLICTS WHICH ARE ALLEGED.

CONTRACTOR TO VERIFY ALL DIMENSIONS AND NOTIFY THE ENGINEER OF ANY DISCREPANCIES BEFORE WORK COMMENCES. DO NOT SCALE DRAWINGS.

SCALE: 1:200

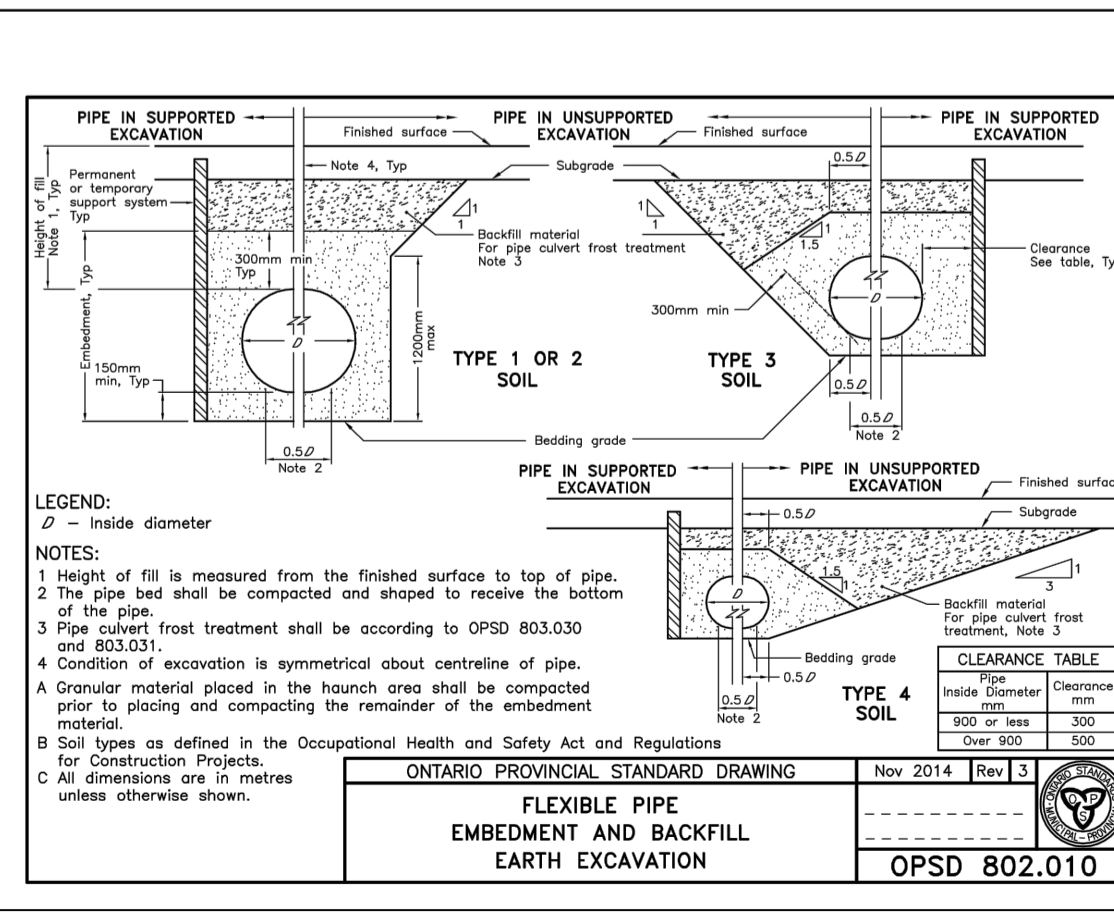
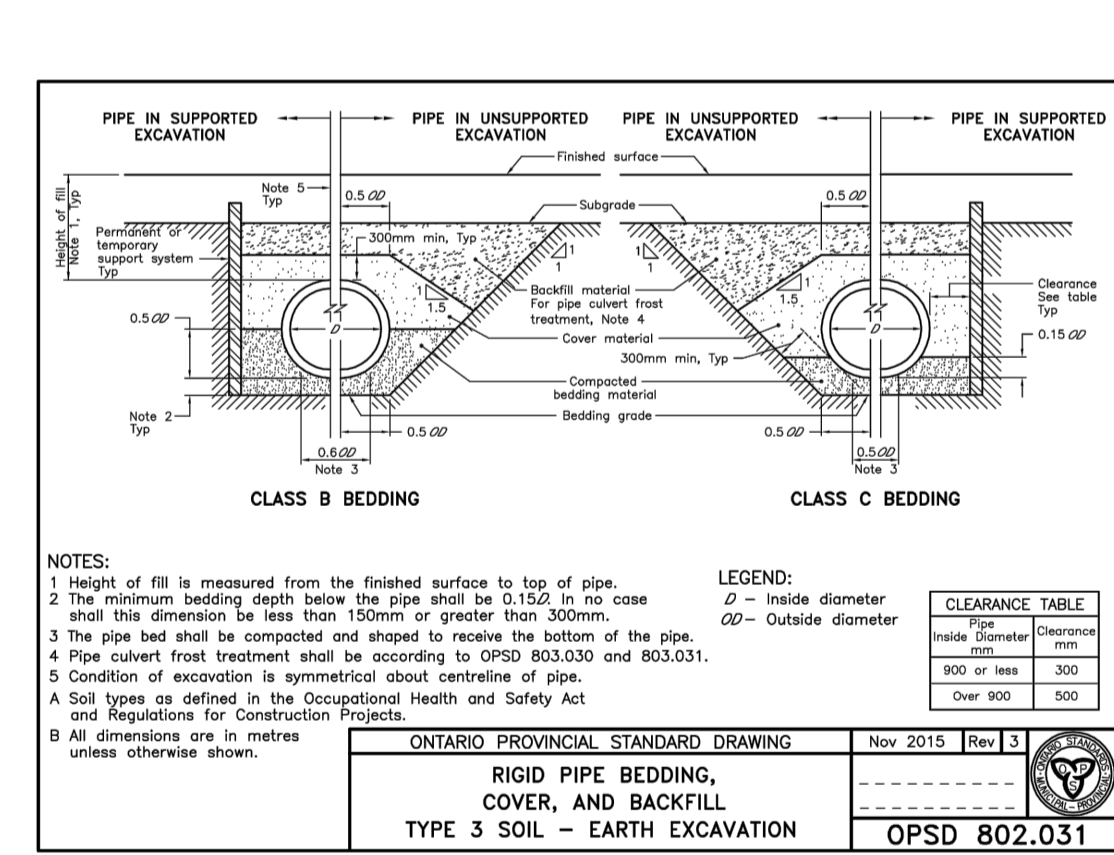

No.	REVISIONS	BY	DATE
03	ISSUED FOR CONSTRUCTION	M.L.	27 OCT 2023
02	ISSUED FOR APPROVAL	M.L.	27 OCT 2023
01	ISSUED FOR APPROVAL	M.L.	04 OCT 2022



CLIENT: NAK Design Strategies

DESIGNED BY: M.L. DRAWN BY: A.O. APPROVED BY: V.J.

PROJECT: WATERIDGE VILLAGE PARK 8 - BLOCK 20

DRAWING TITLE: SERVICING PLAN

PROJECT NO: 210126
DATE: AUG 2022

