



## **Transportation Noise Assessment**

**Salvation Army Multi Purpose Building  
102 Bill Leathem Drive**

**Ottawa, Ontario**

REPORT: GWE15-009 - Transportation Noise R2

### **Prepared For:**

Michaela Jones  
**The Salvation Army**  
2 Overlea Boulevard  
Toronto, Ontario  
M4H 1P4

### **Prepared By:**

Michael Lafortune, Environmental Technologist  
Joshua Foster, P.Eng., Partner

October 20, 2016

---

## EXECUTIVE SUMMARY

This document describes a transportation noise assessment performed for a proposed multi purpose single-storey development at 102 Bill Leathem Drive in Ottawa, Ontario. Phases 1 and 2 will rise approximately 9.5 and 10.5 meters above local grade respectively. Figure 1 illustrates a site plan with surrounding context. The major sources of roadway noise are Bill Leathem Drive and Leikin Drive. The site is also situated inside the Airport Operating Influence Zone [Noise Exposure Forecast (NEF) or Noise Prediction Forecast (NEP) 30]. The project represents an infill project on a severed lot in an established business park.

The assessment is based on: (i) theoretical noise prediction methods that conform to the Ontario Ministry of the Environment and Climate Change (MOECC) and City of Ottawa requirements; (ii) noise level criteria as specified by the City of Ottawa's Environmental Noise Control Guidelines (ENCG); (iii) future vehicular traffic volumes based on the City of Ottawa's Official Plan roadway classifications; (iv) future airport operation composite NEF and NEP contours, and (v) architectural drawings received from Vandenberg & Wildeboer Architects.

The results of the current study indicate that predicted noise levels due to roadway traffic over the site will range between 60 and 68 dBA during the daytime period (07:00-23:00) and between 53 and 60 dBA during the nighttime period (23:00-07:00). The highest predicted noise level (i.e. 68 dBA) occurs on the south façade of Phase 1 (Receptor 3), which is nearest and most exposed to Leikin Drive.

In addition to surface transportation, the site is also impacted by aircraft noise. The site is situated between NEF/NEP contours of 30 and 35, just inside the NEF/NEP 30 contour (corresponding to a 24-hour equivalent sound pressure level ( $L_{EQ}$ ) or 62 dBA. To verify predicted noise levels, on site monitoring was conducted 24-hours a day for a period of one month. Results of on site monitoring indicate existing noise levels from airport operations are below an equivalent of the NEF 30 contour (62 dBA 24-hour  $L_{EQ}$ ). The onsite monitoring also accounted for impacts of roadway traffic. To protect the building from possible future increases in airport noise, the building components were designed to a maximum predicted 24-hour equivalent sound pressure level of 67 dBA, due to aircraft flyovers, corresponding to the NEF/NEP 35 contour. This is a conservative approach as the NEF/NEP 35 contour is more than one kilometer from the site.

---

For noise control measures, upgraded Sound Transmission Class (STC) ratings are required for building components as predicted noise levels are above the ENCG criteria for roadway traffic and aircraft traffic noise respectively, as per Section 5. In addition to upgraded building components, the installation of central air conditioning (or similar mechanical system) will be required for the development. Furthermore, Warning Clauses will be required on all purchase, sale, and lease agreements, as per Section 6.

According to the Provincial Policy Statement, noise sensitive land uses may be considered above the NEF/NEP 30 where it is demonstrated that there will be no negative impact on long term function of the airport, for infill and redevelopment developments. Based on the proposed architectural drawings, building components are expected to achieve the required sound transmission ratings to control indoor noise levels to below ENCG criteria for places of worship at the proposed site. Furthermore, on site monitoring shows existing noise levels at the site are well below predicted sound levels. Therefore, no long-term impact on airport operations are anticipated.

## TABLE OF CONTENTS

		<b>PAGE</b>
1.	<b>INTRODUCTION</b>	<b>1</b>
2.	<b>TERMS OF REFERENCE</b>	<b>1</b>
3.	<b>OBJECTIVES</b>	<b>2</b>
4.	<b>METHODOLOGY</b>	<b>2</b>
4.1	Background	2
4.2	Roadway Traffic Noise	2
	4.2.1 Criteria for Roadway Traffic Noise	2
	4.2.2 Roadway Traffic Volumes	5
	4.2.3 Theoretical Roadway Noise Predictions	5
	4.2.4 Indoor Noise Calculations Roadway	6
4.3	Aircraft Traffic Noise	7
	4.3.1 Criteria for Aircraft Traffic Noise	7
	4.3.2 Theoretical Aircraft Noise Predictions	8
	4.3.3 Noise Monitoring	9
5.	<b>RESULTS AND DISCUSSION</b>	<b>11</b>
5.1	Roadway Traffic Noise Levels	11
	5.1.1 Roadway Traffic Noise STC Requirements	12
5.2	Noise Monitoring Results	14
	5.2.1 Aircraft Noise STC Requirements	17
6.	<b>CONCLUSIONS AND RECOMMENDATIONS</b>	<b>18</b>

### FIGURES

### APPENDICES:

**Appendix A – Architectural Drawings and Assemblies**

**Appendix B – STAMSON 5.04 Input and Output Data**

**Appendix C – Detailed STC Calculations Roadway**

**Appendix D – INSUL and IBANA-Calc Calculations for Aircraft**

**Appendix E – Ottawa International Airport Authority Correspondence**

---

## 1. INTRODUCTION

Gradient Wind Engineering Inc. (GWE) was retained by The Salvation Army to undertake a transportation noise study of a proposed multi purpose single floor building development at 102 Bill Leathem Drive in Ottawa, Ontario. This report summarizes the methodology, results, and recommendations related to a transportation noise assessment. GWE's scope of work involved assessing exterior and interior noise levels generated by local roadway traffic and aircraft. The assessment was performed on the basis of theoretical noise calculation methods conforming to the City of Ottawa<sup>1</sup> and Ontario Ministry of the Environment and Climate Change<sup>2</sup> guidelines as well as on-site monitoring of roadway traffic and aircraft flyovers. Noise calculations were based on architectural drawings received from Vandenberg & Wildeboer Architects (see Appendix A), with future roadway traffic volumes corresponding to the City of Ottawa's Official Plan (OP) roadway classifications.

## 2. TERMS OF REFERENCE

The focus of this transportation noise assessment is a proposed single-storey, two-phase, multi purpose building, to be used as a place of worship and a community centre. The development is located on the northwest corner of the Bill Leathem Drive & Leikin Drive intersection on vacant land and as such is considered an infill development. The Ottawa International Airport is located approximately 4 km to the northeast. The major sources of roadway noise are Bill Leathem Drive and Leikin Drive. The site is surrounded on all sides with mixed-use land, specifically Light Industrial and Parks and Open Space zones. Figure 1 illustrates a complete site plan with surrounding context.

Upon completion, Phases 1 and 2 will rise approximately 9.5 and 10.5 meters above local grade respectively. No passive recreational Outdoor Living Areas (OLAs) are currently located on, or proposed for the site.

---

<sup>1</sup> City of Ottawa, Environmental Noise Control Guidelines, January 2016

<sup>2</sup> Ontario Ministry of the Environment and Climate Change, Environmental Noise Guideline – Publication NPC-300, August 2013

---

### **3. OBJECTIVES**

The main goals of this work are to: (i) calculate the future noise levels on the study building produced by local roadway traffic and aircraft traffic, (ii) determine the feasibility of incorporating noise sensitive land uses, such as places of worship and gathering centres, within the site, (iii) ensure that interior noise levels do not exceed the allowable limits specified by the City of Ottawa's Environmental Noise Control Guidelines (ENCG) as outlined in Section 4 of this report, and (iv) demonstrate that there will be no negative impacts on the long-term function of the airport.

### **4. METHODOLOGY**

#### **4.1 Background**

Noise can be defined as any obtrusive sound. It is created at a source, transmitted through a medium, such as air, and intercepted by a receiver. Noise may be characterized in terms of the power of the source or the sound pressure at a specific distance. While the power of a source is characteristic of that particular source, the sound pressure depends on the location of the receiver and the path that the noise takes to reach the receiver. Measurement of noise is based on the decibel unit, dBA, which is a logarithmic ratio referenced to a standard noise level ( $2 \times 10^{-5}$  Pascals). The 'A' suffix refers to a weighting scale, which better represents how the noise is perceived by the human ear. With this scale, a doubling of power results in a 3 dBA increase in measured noise levels and is just perceptible to most people. An increase of 10 dBA is often perceived to be twice as loud.

The ENCG specifies that surface transportation (road and rail) noise and airport noise should be evaluated separately. The overall building attenuation parameters are then combined. Section 4.2 and 4.3 address the methodology for the evaluation of roadway and aircraft noise respectively. Section 4.2 also provides criteria for railway noise as background information, there is however no railway noise influencing the site.

#### **4.2 Roadway Traffic Noise**

##### **4.2.1 Criteria for Roadway Traffic Noise**

For vehicle traffic, the equivalent sound energy level,  $L_{EQ}$ , provides a measure of the time varying noise levels, which is well correlated with the annoyance of sound. It is defined as the continuous sound level,

which has the same energy as a time varying noise level over a period of time. For roadways, the  $L_{EQ}$  is commonly calculated on the basis of a 16-hour ( $L_{EQ16}$ ) daytime (07:00-23:00) / 8-hour ( $L_{EQ8}$ ) nighttime (23:00-07:00) split to assess its impact on residential buildings. The City of Ottawa’s Environmental Noise Control Guidelines (ENCG) specifies that the recommended indoor noise limit range (that is relevant to this study) is 45 dBA for conference rooms and places of worship, as listed in Table 1.

**TABLE 1: INDOOR SOUND LEVEL CRITERIA (ROAD & RAIL)<sup>3</sup>**

Type of Space	Time Period	$L_{EQ}$ (dBA)	
		Road	Rail
General offices, reception areas, retail stores, etc.	07:00 – 23:00	50	45
Living/dining/den areas of residences, hospitals, schools, nursing/retirement homes, day-care centres, theatres, <b>places of worship</b> , libraries, individual or semi-private offices, conference rooms, etc.	07:00 – 23:00	45	40
Sleeping quarters of hotels/motels	23:00 – 07:00	45	40
Sleeping quarters of residences, hospitals, nursing/retirement homes, etc.	23:00 – 07:00	40	35

Predicted noise levels at the plane of window (POW) and outdoor living area (OLA) dictate the action required to achieve the recommended sound levels. When noise levels at these areas exceed the criteria outlined in Table 2, specific outdoor, ventilation and Warning Clause requirements may apply. In addition, when noise levels exceed the criteria outlined in Table 3, upgraded building components must be designed.

<sup>3</sup> Adapted from ENCG 2016 – Table 2.2b,c

**TABLE 2: ROAD & RAIL NOISE COMBINED – OUTDOOR NOISE, VENTILATION AND WARNING CLAUSE REQUIREMENTS<sup>4</sup>**

Time Period	L <sub>EQ</sub> (dBA)	Ventilation Requirements	Outdoor Noise Control Measures	Warning Clause
<b>Outdoor Living Area (OLA)</b>				
Daytime (07:00 – 23:00)	L <sub>EQ(16hr)</sub> < 55	N/A	Not required	Not required
	55 < L <sub>EQ(16hr)</sub> ≤ 60	N/A	Required to reduce the L <sub>EQ</sub> to as close to 55 dBA as administratively, economically and/or technically feasible	Generic <sup>†</sup>
	L <sub>EQ(16hr)</sub> > 60	N/A		Extensive Mitigation <sup>†</sup>
<b>Plane of Window (POW)</b>				
Daytime (07:00 – 23:00)	L <sub>EQ(16hr)</sub> < 55	Not required	N/A	Not required
	55 < L <sub>EQ(16hr)</sub> ≤ 65	Forced air heating with provision for central air conditioning	N/A	Generic
	L <sub>EQ(16hr)</sub> > 65	Central air conditioning	N/A	Extensive Mitigation
Nighttime (23:00 – 07:00)	L <sub>EQ(8hr)</sub> < 50	Not required	N/A	Not required
	50 < L <sub>EQ(8hr)</sub> ≤ 60	Forced air heating with provision for central air conditioning	N/A	Generic
	L <sub>EQ(8hr)</sub> > 60	Central air conditioning	N/A	Extensive Mitigation

† - Required if resultant L<sub>EQ</sub> exceeds 55 dBA

**TABLE 3: ROAD & RAIL NOISE BUILDING COMPONENT REQUIREMENTS<sup>5</sup>**

Source	L <sub>EQ</sub> (dBA)	Building Component Requirements
Road	L <sub>EQ(16hr)</sub> > 65 (Daytime)	Building components (walls, windows, etc.) must be designed to achieve indoor sound level criteria
	L <sub>EQ(8hr)</sub> > 60 (Nighttime)	
Rail	L <sub>EQ(16hr)</sub> > 60 (Daytime)	
	L <sub>EQ(8hr)</sub> > 55 (Nighttime)	

<sup>4</sup> Adapted from ENCG 2016 / 2006 – Table 1.10

<sup>5</sup> Adapted from ENCG 2016 / 2006 – Table 1.8



## 4.2.2 Roadway Traffic Volumes

The ENCG dictates that noise calculations should consider future sound levels based on a roadway's classification at the mature state of development. Therefore, traffic volumes are based on the roadway classifications outlined in the City of Ottawa's Official Plan (OP) and Transportation Master Plan<sup>6</sup> which provides additional details on future roadway expansions. Average Annual Daily Traffic (AADT) volumes are then based on data in Table B1 of the ENCG for each roadway classification. Table 4 (below) summarizes the AADT values used for each roadway included in this assessment.

**TABLE 4: ROADWAY TRAFFIC DATA**

Roadway	Roadway Class	Speed Limit (km/h)	Official Plan AADT
Bill Leathem Drive	2-UMCU	60	<b>12,000</b>
Leikin Drive	2-UMCU	60	<b>12,000</b>

## 4.2.3 Theoretical Roadway Noise Predictions

Noise predictions were performed with the aid of the Ontario Ministry of the Environment and Climate Change (MOECC) computerized noise assessment program, STAMSON 5.04, for road and rail analysis. Appendix B includes the STAMSON 5.04 input and output data.

Roadway noise calculations were performed by treating each road segment as separate line sources of noise, and by using existing building locations as noise barriers. In addition to the traffic volumes summarized in Table 4, theoretical noise predictions were based on the following parameters:

- Truck traffic on all roadways was taken to comprise 5% heavy trucks and 7% medium trucks, as per ENCG requirements for noise level predictions
- The day/night split was taken to be 92% / 8% respectively for all streets
- Absorptive and reflective intermediate ground surfaces based on specific source-receiver path ground characteristics
- The study site was treated as having flat topography

<sup>6</sup> City of Ottawa Transportation Master Plan, November 2013

---

Noise receptors were strategically placed at seven locations around the study area (see Figure 2).

#### **4.2.4 Indoor Noise Calculations Roadway**

When calculations reveal that outdoor noise levels are sufficiently high as to require investigation of indoor noise levels, calculations are performed to verify the Sound Transmission Class (STC) requirements for building components. The difference between outdoor and indoor noise levels is the noise attenuation provided by the building envelope. According to common industry practice, complete walls and individual wall elements are rated according to the Sound Transmission Class (STC). The STC ratings of common residential walls built in conformance with the Ontario Building Code (2012) typically exceed STC 35, depending on exterior cladding, thickness and interior finish details. For example, brick veneered walls can achieve STC 55. Standard good quality double-glazed non-operable windows can have STC ratings ranging from 25 to 40 depending on the window manufacturer, pane thickness and inter-pane spacing. As previously mentioned, the windows are the known weak point in a partition, according to the ENCG, when daytime noise levels (from road and rail sources) at the plane of the window exceed 65 dBA, calculations must be performed to evaluate the sound transmission quality of the building components to ensure acceptable indoor noise levels. The calculation procedure<sup>7</sup> considers:

- Window type and total area as a percentage of total room floor area
- Exterior wall type and total area as a percentage of the total room floor area
- Acoustic absorption characteristics of the room
- Outdoor noise source type and approach geometry
- Indoor sound level criteria, which varies according to the intended use of a space

Based on published research<sup>8</sup>, exterior walls and windows possess specific sound attenuation characteristics that are used as a basis for calculating the indoor noise levels to ensure compliance with ENCG criteria. Calculations were based on the architectural assemblies and are available in Appendix C.

---

<sup>7</sup> Building Practice Note: Controlling Sound Transmission into Buildings by J.D. Quirt, National Research Council of Canada, September 1985

<sup>8</sup> CMHC, Road & Rail Noise: Effects on Housing

---

## 4.3 Aircraft Traffic Noise

### 4.3.1 Criteria for Aircraft Traffic Noise

The ENCG outlines the sound level criteria for aircraft noise based on a site's location near the Ottawa International Airport. The Ottawa Airport Vicinity Development Zone (OAVDZ) is a zone around the airport defined by Noise Exposure Forecast (NEF) or Noise Exposure Projections (NEP) contour lines that follow fixed features, such as roads or lot boundaries. NEF/NEP contours reflect the predetermined noise levels which would impact sensitive areas around airports. These contours include the influences of noise levels from aircraft flight, take-off, and ground operations to specific urban areas. Noise generated from aircraft traffic is represented as Effective Perceived Noise Levels (EPNL), a unit of noise measurement that accounts for variations in the human perception of pure tones and noise duration. Recorded noise levels are plotted geographically to generate NEF/NEP contour maps, where lower NEF/NEP levels correspond to lower average outdoor noise levels. The OAVDZ represents the 25 NEF/NEP contour. The Ottawa Airport Operating Influence Zone (OAOIZ) represents the NEF/NEP 30 contour, where commercial aircraft traffic may negatively influence noise-sensitive developments. Within the OAOIZ, noise-sensitive development is not permitted, although infill and redevelopment may occur in specific areas within the zone in keeping with the criteria set out in the Official Plan, and subject to detailed studies to demonstrate there will be no negative impact on long term airport operations.

According to accepted research<sup>9</sup>, Health and Welfare Canada states that people continuously exposed to NEF/NEP values less than 35 will not suffer adverse physical or psychological effects. Sociological surveys<sup>10</sup> have indicated that negative community reactions to noise levels may start at about 25 NEF/NEP. Table 5 identifies the sound level criteria for relevant outdoor and indoor living spaces exposed to aircraft noise. Transport Canada guidelines related to aircraft noise indicated churches and other places of worship can tolerate noise levels up to NEF/NEP 35 where noise attenuation is considered in the building construction<sup>11</sup>. Where developments are within the OAVDZ, building components must be designed to achieve the indoor criteria outlined in Table 5.

---

<sup>9</sup> Report of the Special Meeting on Aircraft Noise in the Vicinity of Aerodromes, Montreal ICAO, 1969.

<sup>10</sup> Noise in Urban and Suburban Areas. Bolt, Beanik and Newman, Inc., Washington, January 1967.

<sup>11</sup> <https://www.tc.gc.ca/eng/civilaviation/publications/tp1247-part4-1436.htm>

**TABLE 5: OUTDOOR AND INDOOR AIRCRAFT SOUND LEVEL CRITERIA<sup>12</sup>**

Type of Space	NEF/NEP	Approximate L <sub>EQ(24Hr)</sub>
Outdoor Point of Reception	30	61-64 dBA
General offices, reception areas, retail stores, etc.	15	46-49 dBA
Individual or semi-private offices, conference rooms, etc.	10	41-44 dBA
Living/dining areas of residences, sleeping quarters in hotels/motels, theatres, libraries, schools, day-care centres, <b>places of worship</b> , etc.	5	36 - 39 dBA
Sleeping quarters of residences, hospitals, nursing/retirement homes, etc.	0	31-34 dBA

### 4.3.2 Theoretical Aircraft Noise Predictions

The impact of aircraft noise on the indoor environment was determined using IBANA-CALC, a software package developed by the National Research Council of Canada. This software calculates indoor noise levels for standard roof, wall and window construction details for appropriate aircraft noise source spectra. Since aircraft produce uniform noise levels over large areas, building construction is more carefully considered than specific building location for interior noise level calculations. For this project, the building components were designed to an NEF value of 35 due to the study site location, which is just inside the NEF contour 30 as illustrated in Figure 1. This is considered a conservative approach as the NEF 35 contour is situated more than one kilometer from the site and noise levels are expected to be closer to NEF 30. No Outdoor Living Areas (OLAs) are currently located on, or proposed for the site.

The influence of aircraft noise is based on NEF/NEP contours, geographically plotted values that quantify the noise levels from airport traffic on adjacent properties. The ENCG guidelines state that locations corresponding to NEF/NEP 25 or greater require improvements to the typical building envelope components, including exterior walls, roofs, windows and doors, to ensure adequate noise attenuation by the building envelope. In IBANA-CALC, construction elements are rated on the basis of Outdoor-Indoor Transmission Class (OITC). The OITC is a single number rating of the sound insulation (similar to Acoustic Insulation Factor values referred to in the ENCG document) of an exterior partition against typical outdoor noises defined in the ASTM standard E1332. The procedure for determining OITC ratings includes specifying a standard source spectrum corresponding to an NEF/NEP and calculation of the reduction in

<sup>12</sup> Adapted from ENCG 2016 – Tables 4.2a and b

noise levels to the interior across the wall components. OTIC ratings of the proposed wall assemblies were predicted using INSUL software, which is based on extensive empirical data from countries around the world.

To model the study building using the IBANA-CALC software, building elements with the lowest OTIC rating of the proposed assemblies were selected as a worst case approach. The resulting interior noise level was then determined using similar construction elements and room dimensions. Calculations were based on a worst-case representation of the most sensitive rooms, comprising the following construction elements: metal sided 2" × 6" walls, wood truss roof, and standard glazing elements. Details of the wall assemblies proposed are included in Appendix A. Acoustically equivalent assemblies which match the available assemblies in IBANA-CALC were chosen for calculations for worship spaces and meeting rooms. OTIC ratings of the proposed assemblies were estimated using INSUL software, which uses a database of empirical data to estimate OTIC and STC ratings of various building assemblies. Details of the calculations are provided in Appendix D.

### **4.3.3 Noise Monitoring**

In addition to theoretical calculations, assessment of aircraft and roadway noise across the site was also determined through on-site noise monitoring over a period of four weeks. Noise levels were measured using a single Brüel and Kjær (B&K) noise monitoring station, model 365-C-DMO. The unit consists of an integrating sound level meter (Type 2250), a weather-proof microphone (Type 4952), wireless modem, power pack and batteries. Because there was no power at the site the unit was powered by a solar panel and 12-volt marine battery. The monitoring station setup is illustrated in Photograph 1. The station monitored continuously 24 hours per day with data sent wirelessly over an LTE / 3G network to B&K's cloud storage service, "Noise Sentinel on Demand". Noise measurements were conducted from August 23 through to September 19, 2016. A four-week time frame was selected to capture a statistically relevant set of data, allowing for daily changes in airport operations and meteorological conditions. Meteorological data showed that during the testing period, wind directions were such that the majority of planes would be taking off and landing on Runway 07-25, the approach path for which is aligned with the 102 Bill Leathem Drive site. The consistency within the data set proved the four-week measurement period was sufficient. The location of the noise monitoring station is illustrated in Figure 1 and Photographs 1 to 3 below.



**PHOTOGRAPH 1: NOISE MONITOR STATION**



**PHOTOGRAPH 2: NOISE MONITOR STATION**



**PHOTOGRAPH 3: NOISE MONITOR STATION**

## 5. RESULTS AND DISCUSSION

### 5.1 Roadway Traffic Noise Levels

Appendix B contains the complete set of input and output data from all STAMSON 5.04 calculations. The results of the roadway noise calculations are summarized in Table 6 below.

**TABLE 6: EXTERIOR NOISE LEVELS DUE TO ROADWAY TRAFFIC**

Receptor Number	Plane of Window	Noise Level (dBA)	
		Day	Night
1	POW – Phase 1 – 7 m – North Façade	63	56
2	POW – Phase 1 – 3.2 m – East Façade	66	58
3	POW – Phase 1 – 7 m – South Façade	68	60
4	POW – Phase 1 – 1.5 m – West Façade	62	55
5	POW – Phase 1 – 1.5 m – West Façade	62	54
6	POW – Phase 2 – 1.5 m – West Façade	60	53
7	POW – Phase 2 – 7 m – South Façade	65	57

The results of the current analysis indicate that noise levels will range between 60 and 68 dBA during the daytime period (07:00-23:00) and between 53 and 60 dBA during the nighttime period (23:00-07:00). The

---

highest noise level (i.e. 68 dBA) occurs on the south façade of Phase 1 (Receptor 3), which is nearest and most exposed to Leikin Drive.

Because of elevated noise levels from traffic, central air conditioning (or similar mechanical system) will be required to allow windows and doors to remain closed to maintain a comfortable and quiet indoor environment.

Under the ENCG guidelines, surface transportation and aircraft noise are evaluated separately and aircraft noise was found to be the governing source when considering a 24-hour  $L_{EQ}$  up to 67 dBA for design of the building components. It should also be noted that the indoor criteria for aircraft is more stringent, see section 5.2.1. as well as Table 1 and 5.

### **5.1.1 Roadway Traffic Noise STC Requirements**

The current selected exterior wall and window assemblies for the development, as described below, have been rated for a particular STC rating based on the performance evaluated using INSUL software, which has a similar methodology outlined in the National Research Council (NRC) Building Practice Note<sup>13</sup>. As a conservative approach, the exterior wall assembly with the lowest STC rating was considered in our analysis and consisted of the following.

#### **Typical Exterior Wall Construction (EX2):**

- Pre-Finished Metal Siding
- 25 mm XPS Insul. On Horiz. Z-bar
- 25 mm XPS Insul. On Vert. Z-bar
- Sheathing Membrane (No Acoustic Value)
- 13 mm Exterior Sheathing (OSB)
- Wood Sheathing
- 140 mm Wood Stud
- Batt Insulation
- Vapour Barrier (No Acoustic Value)
- 16 mm Type X Gypsum Board

(STC 48) INSUL Test Data

---

<sup>13</sup> Building Practice Note: Controlling Sound Transmission into Buildings by J.D. Quirt, National Research Council of Canada, September 1985



**Typical Glazing Construction:**

- 6 mm Inner Pane
- 13 mm Air Space
- 8 mm Outer Pane

(STC 34) IBANA Calc Test Data

Note: Glazing elements assumed based on STC 34 (OTIC) 29 requirements. Window assembly may vary provided STC requirements are maintained.

The noise levels predicted due to roadway traffic exceed the criteria listed in the ENCG for building components. As discussed in Section 4.3 the anticipated indoor noise levels in various sensitive rooms have been estimated based on the methodology developed by the National Research Council. Appendix C contains the complete set of calculations performed to verify the required exterior wall and window STC performance. Detailed STC calculations show that key façades, built to a typical EX2 wall construction or better with STC 34 rated windows, would provide the necessary attenuation to control interior noise levels. The indoor noise level results are summarized in Table 7 below.

**TABLE 7: INDOOR NOISE LEVELS DUE TO ROADWAY TRAFFIC**

Room Location	Indoor Noise Level $L_{EQ(24 \text{ Hr})}$ (dBA)	
	NRC Calculation	ENCG Criteria
Worship / Gymnasium (Phase 1)	38	45
Sanctuary (Phase 2)	34	45
Multi-Purpose Room	34	45

---

## 5.2 Noise Monitoring Results

Based on the on-site monitoring, the equivalent sound pressure levels ( $L_{EQ}$ ) for each day are presented as 24-hour daily averages ( $L_{EQ(24HR)}$ ), 16-hour daytime averages ( $L_{EQ(16HR)}$ ) and 8-hour nighttime averages ( $L_{EQ(8HR)}$ ). The daytime period is defined between 07:00 and 23:00 and the nighttime period from 23:00 to 07:00.

Following the monitoring period, it was brought to GWE's attention by the Ottawa International Airport Authority, that Runway 07-25 saw limited operations due to construction on Taxiway Bravo during the month of August, as noted in Table 8. In addition, Runway 07-25 was closed on August 31 and September 2 for rubber removal maintenance. Comparing  $L_{EQ 24}$  noise levels on days with regular operations suggests that aircraft noise is not the primary influence on ambient noise on site, as in most instances the variance is less than 3 dBA which is imperceptible to human hearing. Correspondence from the Ottawa International Airport Authority can be found in Appendix E.

As can be seen from Table 8, the average  $LEQ 24$  was found to be 56 dBA which is below the predicted aircraft noise exposure NEF /NEP 30 contours equivalent to 62 dBA. Additionally, the standard deviation in noise levels is no greater than 3 dBA. This change is barely perceptible to most human observers and the quality of the data is proven to be reliable and relevant. It can therefore be concluded that the assumptions of the theoretical analysis are acceptable, and that the proposed wall and window assemblies will be adequate to ensure ENCG compliance for indoor sound levels and maintaining compatibility with adjacent land uses. A sample of the time history of hourly and daily  $LEQ$  is presented in Charts 1 and 2 below. The highest noise levels occur on the first day of monitoring and are likely due to setting up the instrument versus environmental noise.

**TABLE 8: MEASURED EQUIVALENT SOUND PRESSURE LEVELS (dBA)**

Date	L <sub>EQ</sub> (24HR)	L <sub>EQ</sub> (8HR)	L <sub>EQ</sub> (16HR)	Wind Speed (km/h)	Temperature (°C)	Weather
23-Aug*	61	54	62	10 - 30	10-27	Clear
24-Aug*	57	55	58	6 - 22	17-29	Cloudy
25-Aug*	59	56	60	6 - 23	20-29	Cloudy and shower
26-Aug*	58	60	57	3 - 22	21 - 28	Clear
27-Aug*	55	52	56	9 - 18	17 - 27	Clear and cloudy
28-Aug*	55	54	55	9 - 24	18 - 28	Cloudy and thunderstorm
29-Aug*	56	52	58	7 - 29	17 - 25	Clear
30-Aug*	57	52	58	5 - 21	13 - 25	Cloudy
31-Aug†	56	54	57	7 - 22	19 - 26	Cloudy
01-Sep	56	48	57	9 - 27	12 - 22	Clear
02-Sep†	57	N/A	57	10 - 24	11 - 20	Clear
03-Sep	N/A	N/A	N/A	2 - 11	8 - 23	Clear
04-Sep	54	51	55	3 - 9	11 - 26	Cloudy
05-Sep	55	47	57	2 - 11	12 - 28	Clear
06-Sep	54	48	55	4 - 16	13 - 29	Clear
07-Sep	54	50	56	6 - 12	16 - 28	Cloudy
08-Sep	57	N/A	57	5 - 17	21 - 25	Cloudy and fog
09-Sep	54	46	55	7 - 22	15 - 20	Clear
10-Sep	52	52	52	1 - 30	17 - 25	Cloudy
11-Sep	54	53	55	19 - 36	11 - 21	Cloudy
12-Sep	54	53	56	5 - 16	9 - 23	Clear
13-Sep	56	48	57	4-27	10-27	Clear and cloudy
14-Sep	53	49	54	9-33	11-20	Cloudy and rain
15-Sep	55	50	56	4-12	6-17	Clear
16-Sep	53	50	54	1-16	6-22	Clear and cloudy
17-Sep	52	48	53	4-26	10-21	Cloudy and rain
18-Sep	52	45	53	7-23	17-26	Cloudy
Average	56	52	57			
Max	61	60	62			
Min	52	45	52			
Std Dev	2	3	2			
L10	57					
L95	38					

Note: Average is a logarithmic average of values, Std Dev = standard deviation

\*- Limited activity of runway 07-25 due to closure of taxiway Bravo

†- No activity on runway 07-25 due to rubber removal maintenance

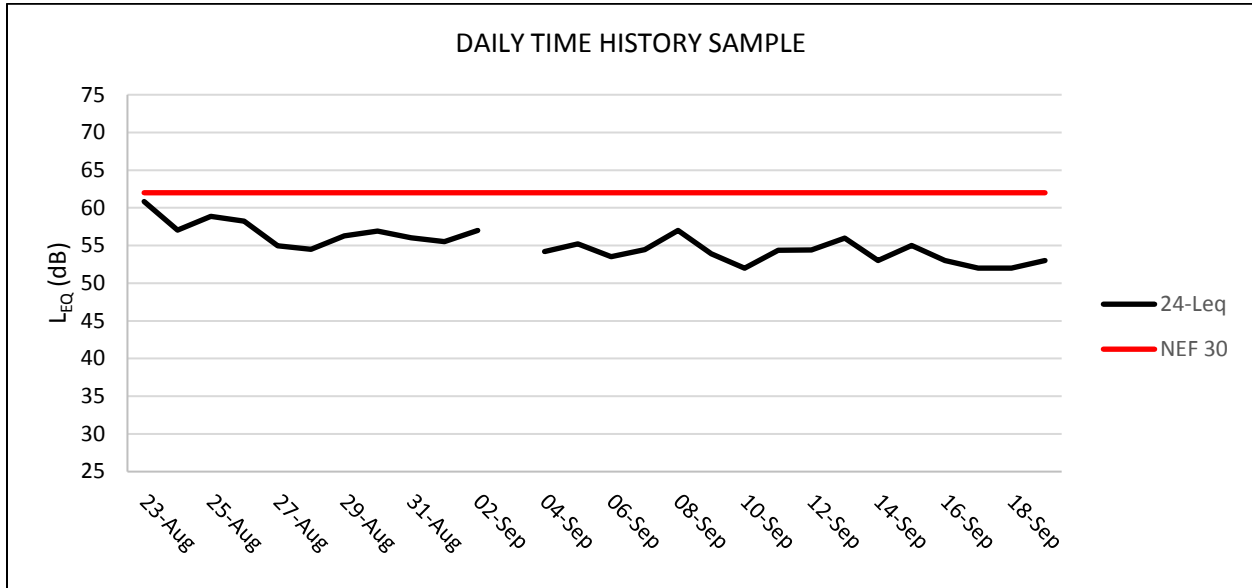

**CHART 1: DAILY TIME HISTORY**

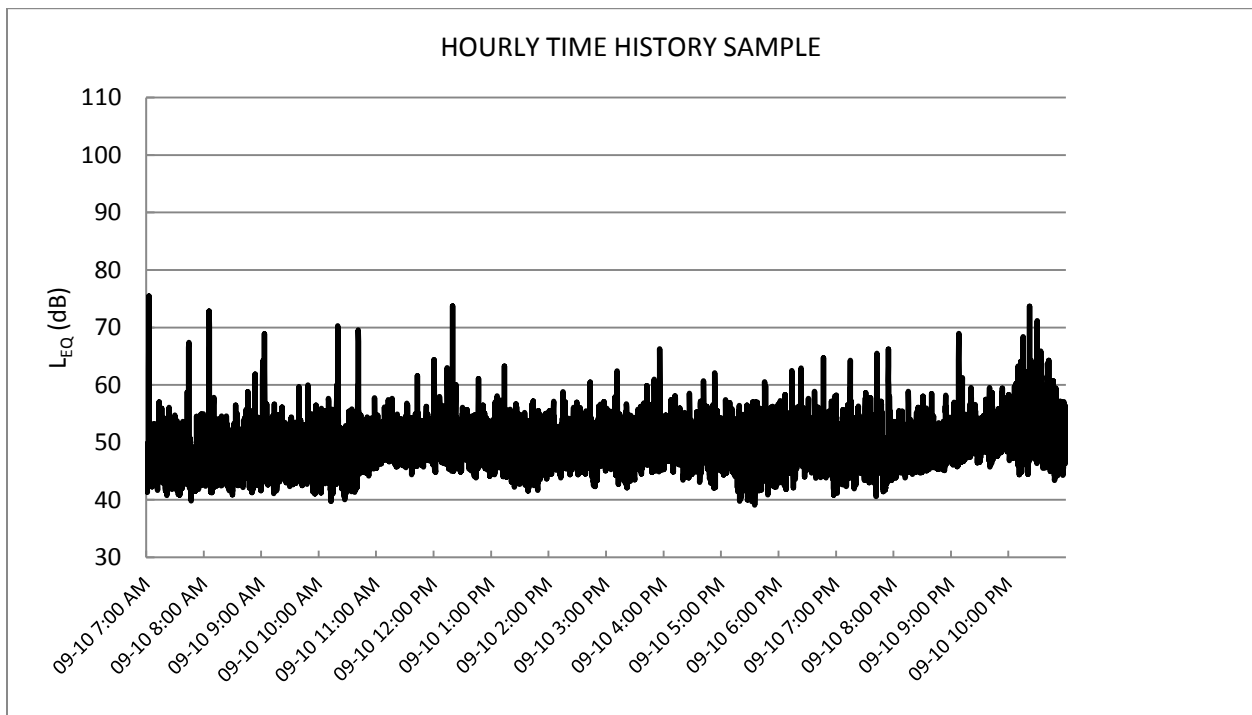

**CHART 2: HOURLY TIME HISTORY**

## 5.2.1 Aircraft Noise STC Requirements

The current selected roof assembly for the development, as described below, has been rated for a particular STC rating based on the performance evaluated using INSUL software, which has a similar methodology outlined in the National Research Council (NRC) Building Practice Note<sup>14</sup>. As a conservative approach, the roof assembly with the lowest STC rating is considered as a worst case example.

### Typical Roof Assembly Construction:

- Asphalt Shingles (no acoustic value)
- Synthetic Felt Sheet Underlayment (no acoustic value)
- Rubberized Membrane (no acoustic value)
- Wood Roof Sheathing
- 400 mm Sloped Roof Trusses w/ 600 mm Spacing
- Spray Foam Insulation (no acoustic value)
- Resilient Channel @ 400 mm O.C.
- 2 Layers 16 mm Type X Gypsum Board  
(STC 48) INSUL Test Data

The window and wall assemblies in Section 5.1.1 were also considered in the IBANA-Calc calculations. Appendix D contains the complete set of input and output data from all IBANA-Calc calculations. The results of the aircraft noise assessment are summarized in Table 9 below.

**TABLE 9: INDOOR NOISE LEVELS DUE TO AIRCRAFT**

Room Location	Indoor Noise Level $L_{EQ(24\text{ Hr})}$ (dBA)	
	IBANA-Calc	ENCG Criteria
Worship / Gymnasium (Phase 1)	37	36 - 39
Sanctuary (Phase 2)	36	36 - 39
Multi-Purpose Room	35	41 - 44

The results of the current analysis indicate that with the proposed wall and window assemblies predicted noise levels will be compliant to the ENCG criteria for aircraft noise. Due to aircraft noise, central air conditioning (or similar mechanical system) will be required to allow windows and doors to remain closed to maintain a comfortable and quiet indoor environment.

<sup>14</sup> Building Practice Note: Controlling Sound Transmission into Buildings by J.D. Quirt, National Research Council of Canada, September 1985

## 6. CONCLUSIONS AND RECOMMENDATIONS

The results of the current study indicate that predicted noise levels due to roadway traffic over the site will range between 60 and 68 dBA during the daytime period (07:00-23:00) and between 53 and 60 dBA during the nighttime period (23:00-07:00). The highest predicted noise level (i.e. 68 dBA) occurs on the south façade of Phase 1 (Receptor 3), which is nearest and most exposed to Leikin Drive.

In addition to surface transportation, the site is also impacted by aircraft noise. The site is situated between NEF/NEP contours of 30 and 35, just inside the NEF/NEP 30 contour (corresponding to a 24-hour equivalent sound pressure level ( $L_{EQ}$ ) of 62 dBA. To verify predicted noise levels, on site monitoring was conducted 24-hours a day for a period of one month. Results of on site monitoring indicate existing noise levels from airport operations are below an equivalent of the NEF 30 contour (62 dBA 24-hour  $L_{EQ}$ ). The onsite monitoring also accounted for impacts of roadway traffic. To protect the building from possible future increases in airport noise, the building components were designed to a maximum predicted 24-hour equivalent sound pressure level of 67 dBA, due to aircraft flyovers, corresponding to the NEF/NEP 35 contour. This is a conservative approach as the NEF/NEP 35 contour is more than one kilometer from the site.

For noise control measures for the building, upgraded Sound Transmission Class (STC) ratings are required for building components where noise levels are above the ENCG criteria for roadway traffic and aircraft traffic noise respectively, as per Section 5. The commercial space will be serviced with central air conditioning, which meet the ventilation requirements for noise control. As per ENCG requirements, the following Warning Clause<sup>15</sup> in all Agreements of Lease, Purchase and Sale will be required for commercial space:

*“Purchasers/tenants are advised that despite the inclusion of noise control features in the development and within the building units, sound levels due to increasing roadway traffic may, on occasion, interfere with some activities of the dwelling occupants as the sound levels exceed the sound level limits of the City and Ministry of the Environment*

*To help address the need for sound attenuation, this development includes:*

---

<sup>15</sup> City of Ottawa, Environmental Noise Control Guidelines, January 2016

**Upgraded exterior walls comprising the following features or brick veneer:**

*Typical Exterior Wall Construction:*

- 38 mm Pre-Finished Metal Siding
- 25 mm XPS Insul. On Horiz. Z-bar
- 25 mm XPS Insul. On Vert. Z-bar
- 13 mm Exterior Sheathing
- Wood Sheathing
- 140 mm Wood Stud
- Batt Insulation
- Vapour Barrier
- 16 mm Type X Gypsum Board

*Minimum STC 48*

**Upgraded glazing elements comprising the following features:**

*Minimum STC 35*

**Typical Roof Assembly Construction or higher rated assembly:**

- Asphalt Shingles
- Synthetic Felt Sheet Underlayment
- Rubberized Membrane
- Wood Roof Sheathing
- 400 mm Sloped Roof Trusses w/ 600 mm Spacing
- Spray Foam Insulation
- Resilient Channel @ 400 mm O.C.
- 2 Layers 16 mm Type X Gypsum Board

*Minimum STC 48*

*To ensure that provincial sound level limits are not exceeded, it is important to maintain these sound attenuation features.*

*This development has also been designed with central air condition (or similar mechanical system) for all units. Installation of central air conditioning will allow windows and exterior doors to remain closed, thereby ensuring that the indoor sound levels are within the sound level limits of the City and the Ministry of the Environment.”*

Also, because the development is noise sensitive, and is located inside the Airport Operating Influence Zone (AOIZ) but outside the NEP 35 contour, the following Warning Clause related to aircraft noise influence on site will be required for all commercial space:

---

*“Purchasers/building occupants are forewarned that this property/commercial unit is located in a noise sensitive area due to its proximity to Ottawa Macdonald-Cartier International Airport.*

*In order to reduce the impact of aircraft noise in the indoor spaces, the unit has been designed and built to meet provincial standards for noise control by the use of components and building systems that provide sound attenuation. In addition to the building components (i.e. walls, windows, doors, ceiling-roof), since the benefit of sound attenuation is lost when windows or doors are left open, this unit has been fitted with central air conditioning (or similar mechanical system).*

*Despite the inclusion of noise control features within the commercial unit, noise due to aircraft operations may continue to interfere with some indoor activities and with outdoor activities, particularly during the summer months. The purchaser/building occupant is further advised that the Airport is open and operates 24 hours a day, and that changes to operations or expansion of the airport facilities, including the construction of new runways, may affect the living environment of the residents of this property/area.*

*The Ottawa Macdonald-Cartier International Airport Authority, its acoustical consultants and the City of Ottawa are not responsible if, regardless of the implementation of noise control features, the purchaser/occupant of this commercial unit finds that the indoor and/or outdoor noise levels due to aircraft operations are of or are offensive.”*

According to the Provincial Policy Statement noise sensitive land uses maybe considered above the NEF/NEP 30 where it is demonstrated that there will be no negative impact on long term function of the airport, for infill and redevelopment type developments. Based on the proposed architectural drawings, building components are expected to achieve the required sound transmission ratings to control indoor noise levels to below ENCG criteria for conference rooms and places of worship. Furthermore, on site monitoring shows existing noise levels at the site are well below predicted sound levels, therefore, no long-term impact on airport operations are anticipated.



---

This concludes our assessment and report. If you have any questions or wish to discuss our findings please advise us. In the interim, we thank you for the opportunity to be of service.

Yours truly,

**Gradient Wind Engineering Inc.**

A handwritten signature in blue ink, appearing to read 'M. Lafortune'.

Michael Lafortune  
Environmental Technologist  
GWE15-009 - Transportation Noise R2



Joshua Foster, P.Eng.  
Partner

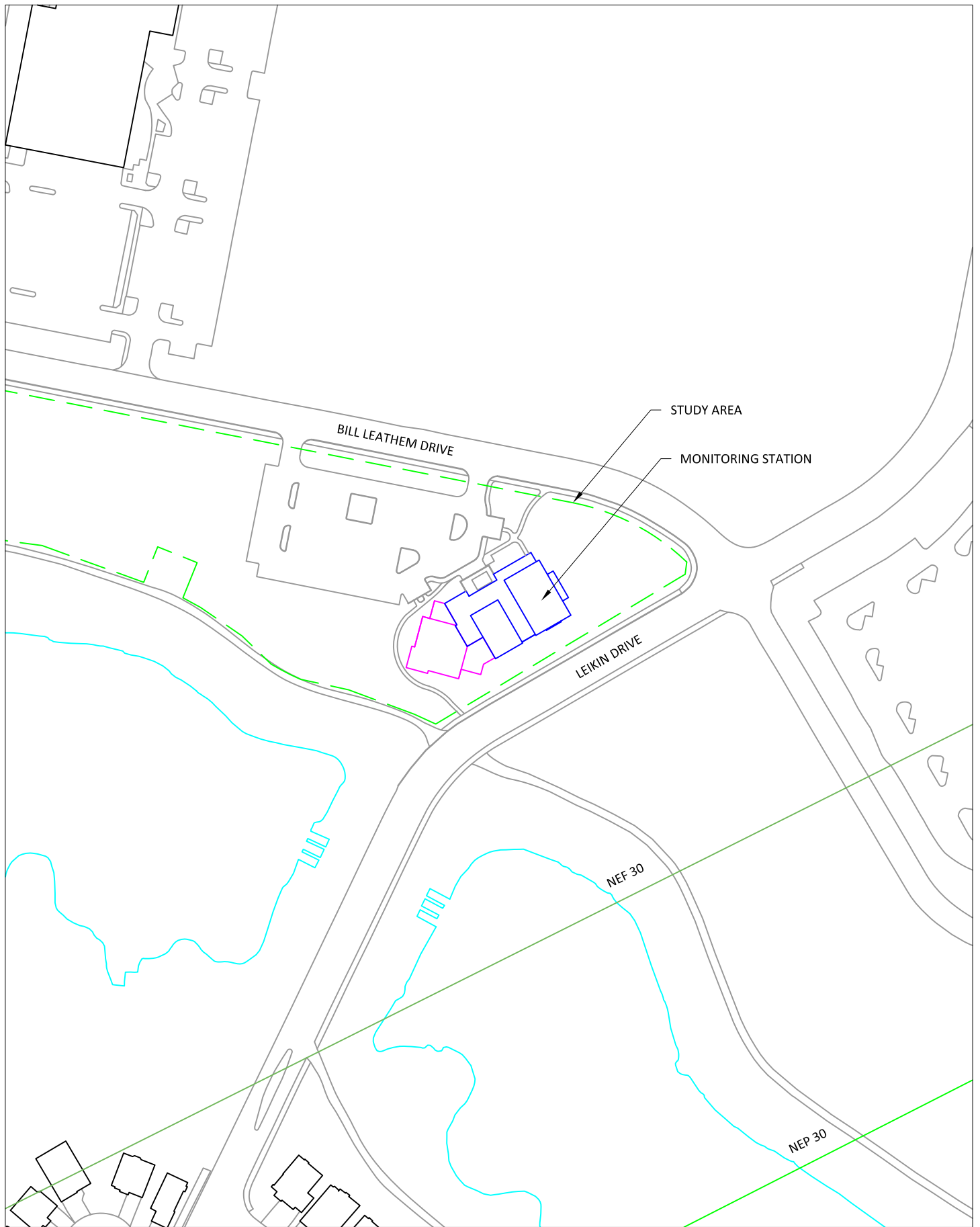



PROJECT		SALVATION ARMY CHURCH - TRANSPORTATION NOISE STUDY	
SCALE	1:2000 (APPROX.)	DRAWING NO.	GWE15-009-2
DATE	OCTOBER 20, 2016	DRAWN BY	M.L.

DESCRIPTION	FIGURE 2: RECEPTOR LOCATIONS
-------------	---------------------------------



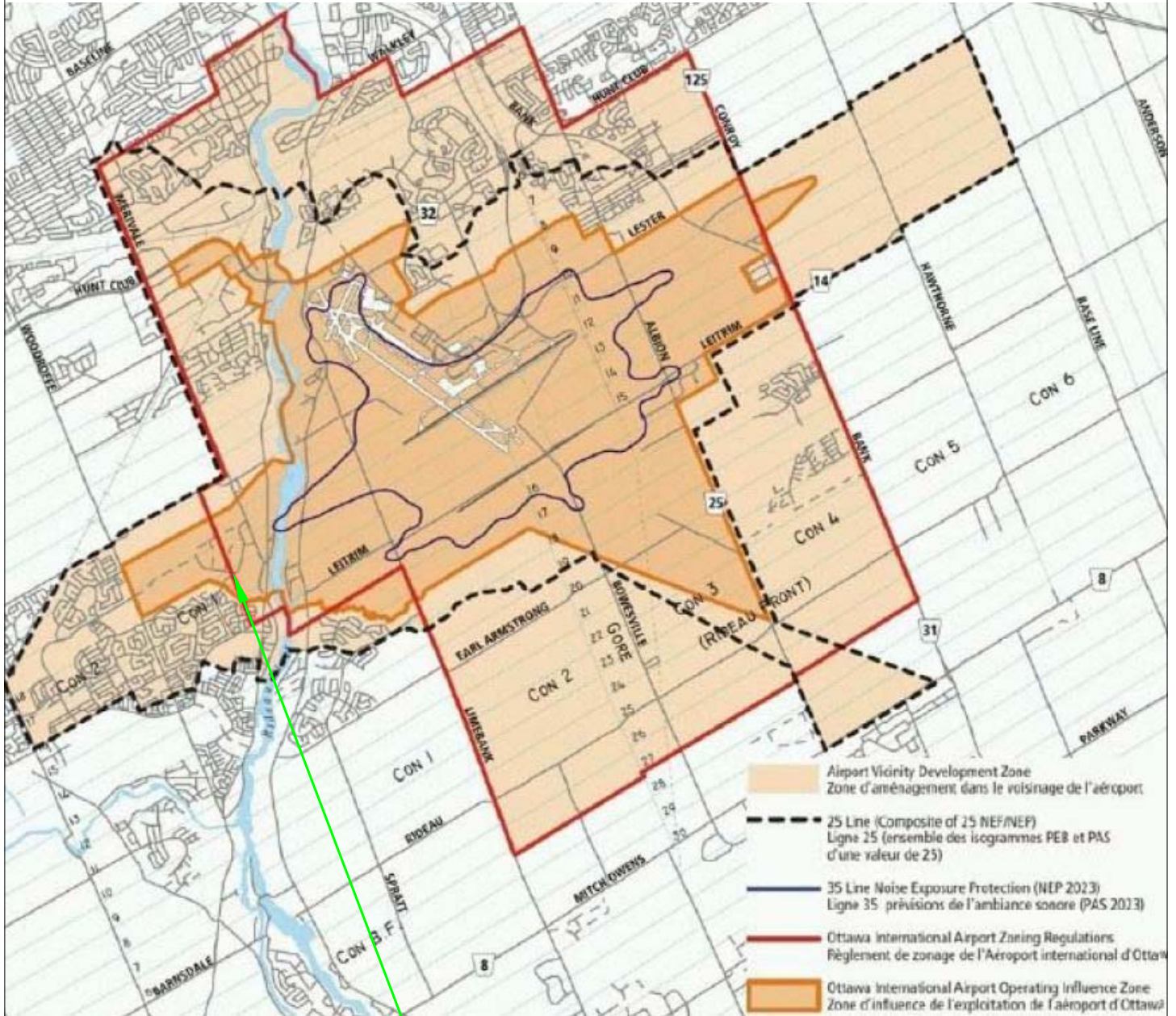

STUDY AREA

PROJECT		SALVATION ARMY CHURCH - TRANSPORTATION NOISE STUDY	
SCALE	NTS	DRAWING NO.	GWE15-009-3
DATE	OCTOBER 20, 2016	DRAWN BY	M.L

DESCRIPTION  
 FIGURE 3:  
 DEVELOPMENT LOCATION IN REFERENCE TO THE  
 OTTAWA AIRPORT OPERATING INFLUENCE ZONE



## **APPENDIX A**

### **Architectural Drawings and Assemblies**

NO.	REVISION	DATE
1	ISSUED FOR SITE PLAN APPLICATION	

**KEY PLAN**

**Property Information:**

**Legal Description:**  
 PART OF LOTS 17 & 18  
 Concession 1 (Rideau Front)  
 (Geographic Township of Nepean)  
 City of Ottawa



- GENERAL NOTES:**
1. ALL WALKWAYS TO BE ASPHALT PAVING UNLESS NOTED OTHERWISE.
  2. ALL NEW PARKING AREAS TO BE ASPHALT UNLESS NOTED OTHERWISE.
  3. REFER TO LEGAL SURVEY FOR SITE SPECIFIC LEGAL INFORMATION.
  4. REFER TO CIVIL FOR COMPLETE GRADE INFORMATION.

**BUILDING AREA (FOOTPRINT):** 1696.2 m<sup>2</sup>  
**LOT AREA:** 19578 m<sup>2</sup>  
**ZONE:** IL9 - LIGHT INDUSTRIAL

MECHANISM	REQUIRED	PROVIDED
MINIMUM LOT AREA	3000 m <sup>2</sup>	1672.2 m <sup>2</sup>
MINIMUM LOT WIDTH	50 m	± 89.2 m
MINIMUM FRONT YARD SETBACK	6 m	6 m
MINIMUM CORNER SIDE YARD SETBACK	6 m	22.4 m
MINIMUM REAR YARD SETBACK	6 m	104.7 m
MAXIMUM LOT COVERAGE	60 %	8.66 %
MAXIMUM BUILDING HEIGHT	22 m	10.5 m
MAXIMUM FLOOR SPACE INDEX	2	0.087
MAX. WIDTH LANDSCAPE AREA (AROUND PARKING LOT)	NO MIN.	N.A.
MIN. WIDTH OF LANDSCAPE AREA	3 m	6.5 m
MIN. # BICYCLE PARKING SPACES	1 PER 1500 m <sup>2</sup> GFA	6
MIN. # BICYCLE PARKING SPACES	1 PER 1500 m <sup>2</sup> GFA	6
BICYCLE PARKING SPACE SIZE PROVISIONS	0.6m x 1.8m	0.6 m x 1.8 m
LOADING SPACE	1: 3.5m x 9m	1

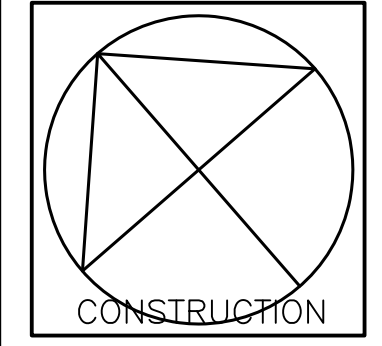

**Vandenberg & Wildeboer**  
 A.R.C.H.I.T.E.C.T.S

www.vandenberg-wildeboer.com Telephone: 613.287.2166 Fax: 613.271.3609 mail@vandenberg-wildeboer.com  
 • THE OLD STONE LODGE • 140 PLAINBOURNE WAY • OTTAWA, ONTARIO • K2H 1P9 •

**PROJECT TITLE**  
 SALVATION ARMY  
 BARRHAVEN, NAPEAN

**DRAWING TITLE**  
 PHASE 2: SITE PLAN

**DESIGNED BY:** RALPH VANDENBERG  
**DRAWN BY:** LV  
**START DATE:** 2015  
**SCALE:** 1:500  
**PROJECT NO.:** 1502

**A100**

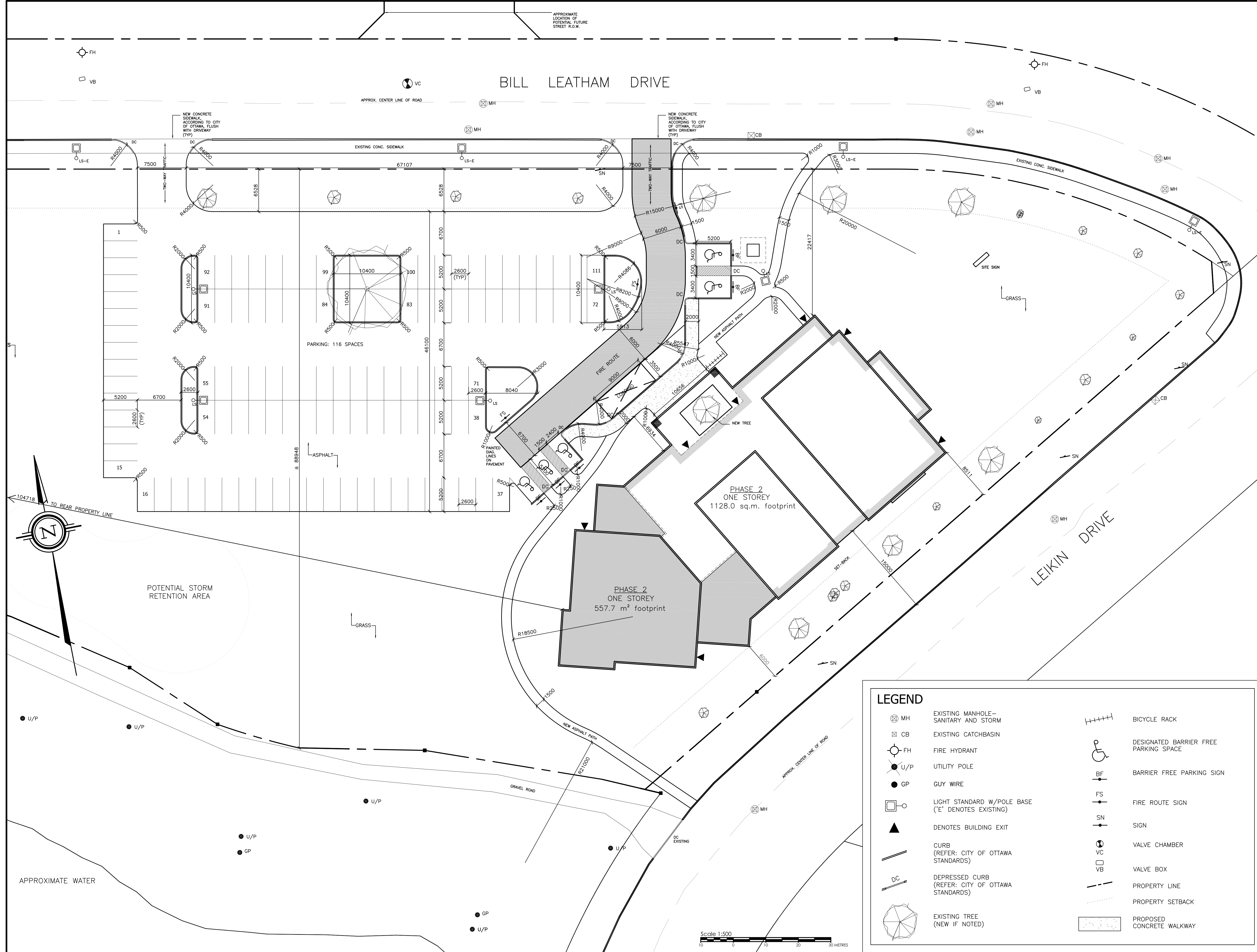

**LEGEND**

EXISTING MANHOLE—SANITARY AND STORM	BICYCLE RACK
EXISTING CATCHBASIN	DESIGNATED BARRIER FREE PARKING SPACE
FIRE HYDRANT	BARRIER FREE PARKING SIGN
UTILITY POLE	FIRE ROUTE SIGN
GUY WIRE	SIGN
LIGHT STANDARD W/POLE BASE ('E' DENOTES EXISTING)	VALVE CHAMBER
DENOTES BUILDING EXIT	VALVE BOX
CURB (REFER: CITY OF OTTAWA STANDARDS)	PROPERTY LINE
DEPRESSED CURB (REFER: CITY OF OTTAWA STANDARDS)	PROPERTY SETBACK
EXISTING TREE (NEW IF NOTED)	PROPOSED CONCRETE WALKWAY

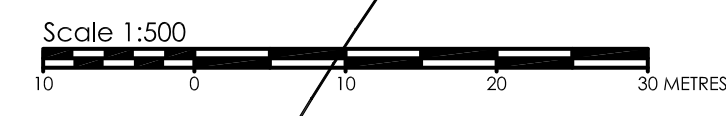

NO.	REVISION	DATE
1	ISSUED FOR SITE PLAN APPLICATION	

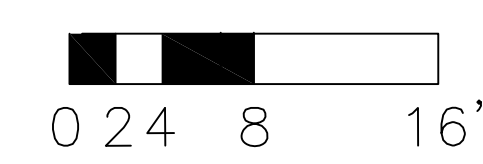
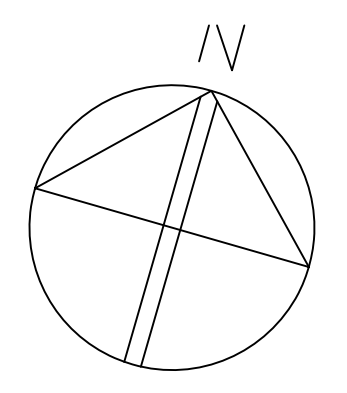
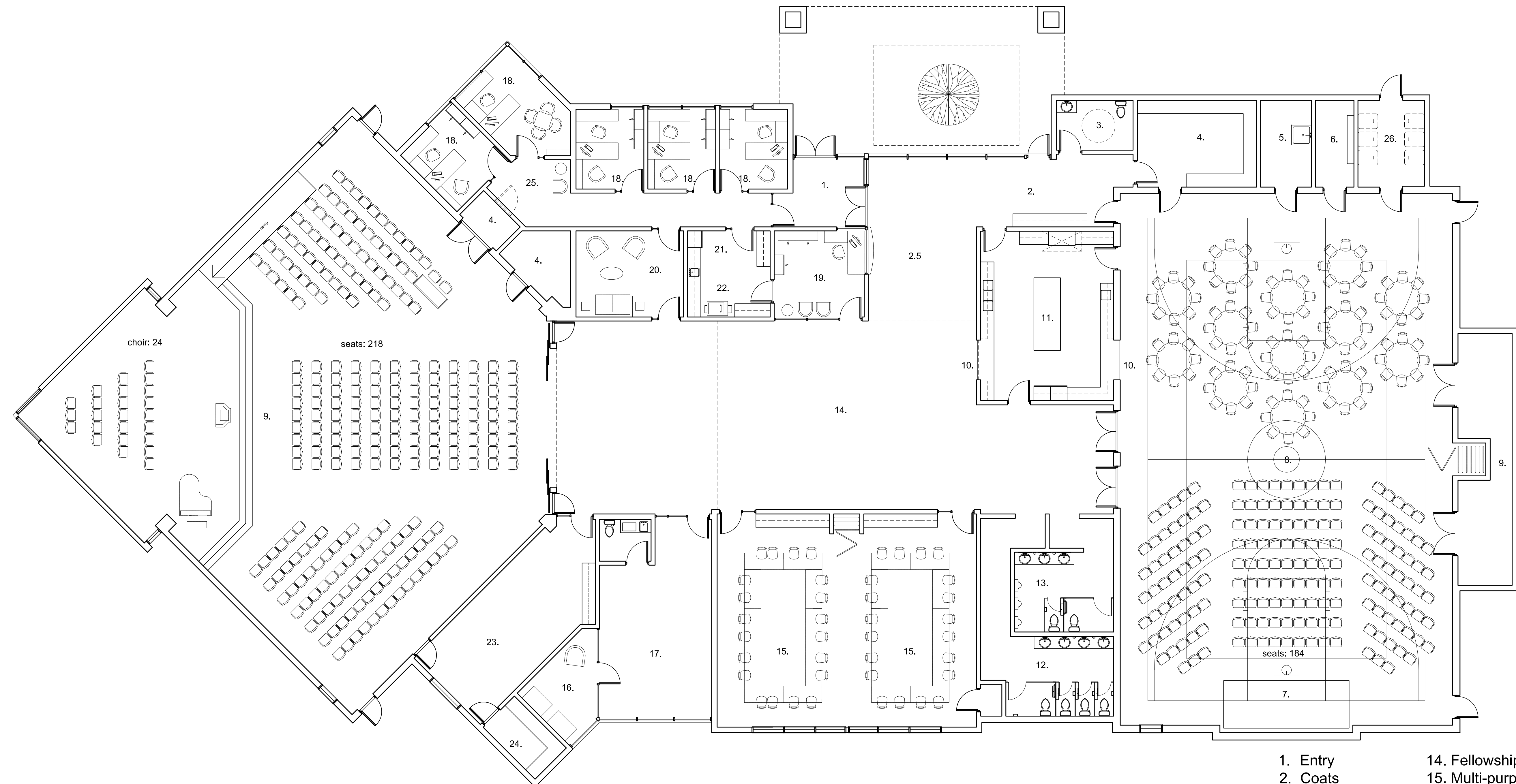

AREA: 18139.7 sq. ft.  
1685.2 sq. m.

- |                           |                                       |
|---------------------------|---------------------------------------|
| 1. Entry                  | 14. Fellowship                        |
| 2. Coats                  | 15. Multi-purpose                     |
| 2.5 Lobby                 | 16.                                   |
| 3. Universal w/c          | 17.                                   |
| 4. Storage                | 18. Office                            |
| 5. Janitorial             | 18.5 Work Station                     |
| 6. Electrical             | 19. Reception                         |
| 7. Platform               | 20. Waiting, Prayer<br>& Meeting Room |
| 8. Worship &<br>Gymnasium | 21. Kitchenette                       |
| 9. Sanctuary              | 22. Work Room                         |
| 10. Pass Thru             | 23. Music                             |
| 11. Kitchen               | 24. Music Storage                     |
| 12. Women's               | 25. Waiting                           |
| 13. Men's                 | 26. Recycling/<br>Refuse              |

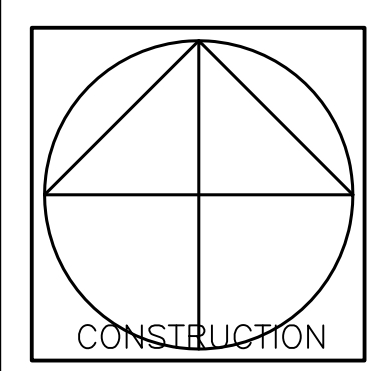

**Vandenberg & Wildeboer**  
A · R · C · H · I · T · E · C · T · S

www.vandenberg-wildeboer.com Telephone: 613.287.2144 Fax: 613.271.3609 email: info@vandenberg-wildeboer.com  
• THE OLD STONE LODGE • 140 PLAINFIELD ROAD • OTTAWA, ONTARIO • ONTARIO • K2E 9B9 •

PROJECT TITLE  
SALVATION ARMY  
BARRHAVEN, NAPEAN

DRAWING TITLE  
PHASE 2: PLAN

DESIGNED BY: RALPH VANDENBERG  
DRAWN BY: LV  
START DATE: 2015  
SCALE: 1:100  
PROJECT NO. 1502

**A101**

NO.	REVISION	DATE
1	ISSUED FOR SITE PLAN APPLICATION	



NORTH



SOUTH

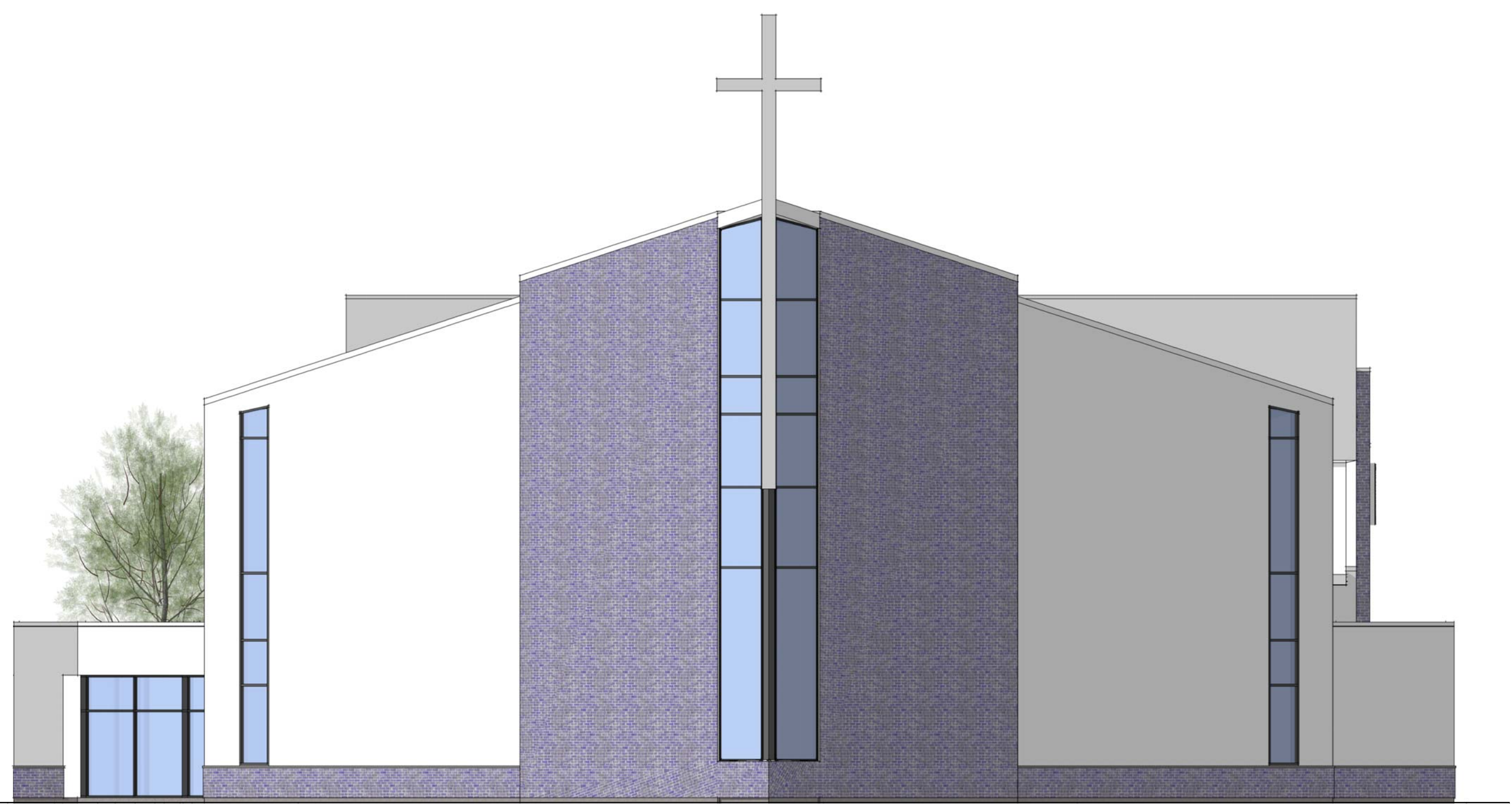

WEST

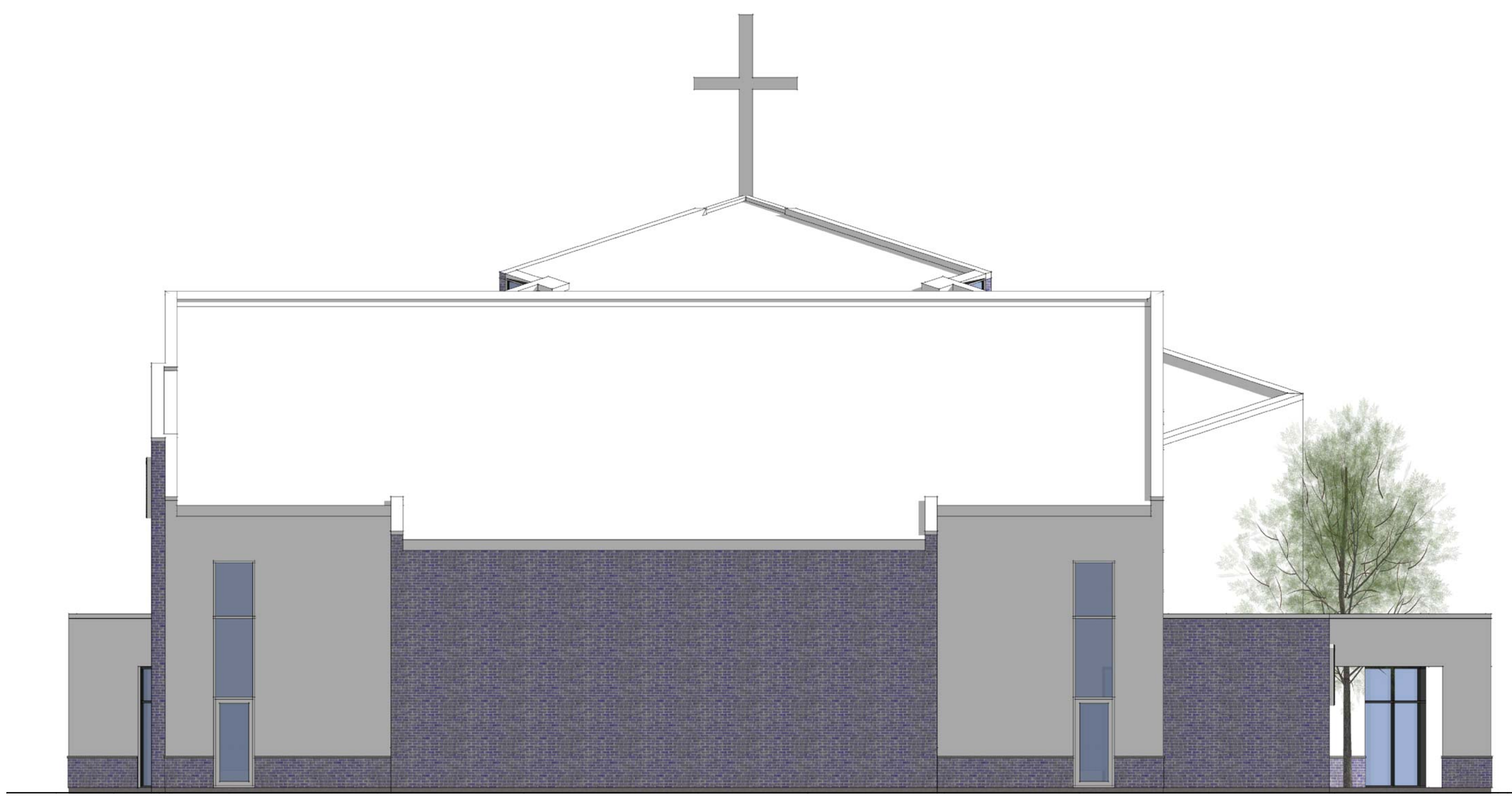

EAST

CONSTRUCTION

**Vandenberg & Wildeboer**  
A·R·C·H·I·T·E·C·T·S

www.vandenberg-wildeboer.com Telephone: 613.287.2144 Fax: 613.271.8699 email: info@vandenberg-wildeboer.com  
• THE OLD STONE LODGE • 140 PLAINBOURNE WAY • OTTAWA, ONTARIO • K2E 9B9 •

PROJECT TITLE  
SALVATION ARMY BARRHAVEN  
NAPEAN

DRAWING TITLE  
PHASE 2: ELEVATIONS

DESIGNED BY: RALPH VANDENBERG  
DRAWN BY: LV  
START DATE: 2015  
SCALE: 1:100  
PROJECT NO. 1502

**A102**



**TYPICAL CONSTRUCTION ASSEMBLIES**  
**SALVATION ARMY - BARRHAVEN**  
**APRIL 05, 2016**

**EXTERIOR WALLS:**

EX1

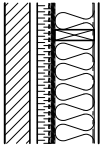

MASONRY VENEER/WOOD STUD  
 1 HR FRR PER SB-2 TABLES 2.3.4.A & C

- MASONRY VENEER (SEE ELEVS.)
- AIR SPACE (W/MORTAR CONTROL)
- 50 XPS INSULATION (RSI 1.8 c.i.)
- SHEATHING MEMBRANE (AIR BARRIER-VAPOUR PERMEABLE)
- WOOD SHEATHING (SEE STRUCT.)
- 140 WOOD STUD @ 400 O.C.
- BATT INSULATION (RSI 3.88)
- SHEET POLY VAPOUR BARRIER
- 16 TYPE X GYPSUM BOARD (FRR)

MIN. RSI 2.3+1.8 ci  
 (ENERGY EFFICIENCY per SB-10, DIVISION 2, TABLE 5.5-6, WOOD FRAMED/NON-RESIDENTIAL)

EX2

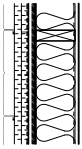

METAL SIDING/WOOD STUD  
 1 HR FRR PER SB-2 TABLES 2.3.4.A & C

- 38 PREFIN. METAL SIDING
- 25 XPS INSUL. ON HORIZ. Z-BAR (RSI .9 c.i.)
- 25 XPS INSUL. ON VERT. Z-BAR (RSI .9 c.i.)
- SHEATHING MEMBRANE (AIR BARRIER-VAPOUR PERMEABLE)
- 13 EXT. GYPSUM SHEATHING (STC)
- WOOD SHEATHING (REFER TO STRUCT.)
- 140 WOOD STUD @ 400 O.C.
- BATT INSULATION (RSI 3.88)
- SHEET POLY VAPOUR BARRIER
- 16 TYPE X GYPSUM BOARD (FRR)

MIN. RSI 2.3+1.8 ci  
 (ENERGY EFFICIENCY per SB-10, DIVISION 2, TABLE 5.5-6, WOOD FRAMED/(NON-RESIDENTIAL)

EX3

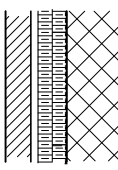

METAL SIDING - CONCRETE BLOCK

- 90 BRICK VENEER
- AIR SPACE
- 50 SEMI-RIGID INSUL. (RSI 1.48 c.i.) ON HORIZ. Z-GIRTS
- 50 XPS INSULATION (RSI 1.48 c.i.) ON VERT. Z-GIRTS
- LIQUID OR MEMBRANE MOISTURE BARRIER (AIR/VAPOUR BARRIER)
- 190 REINFORCED CMU (SEE STRUCT.)

MIN. RSI 2.7ci  
 (ENERGY EFFICIENCY per SB-10, DIVISION 2, TABLE 5.5-6, (WALL/MASS/NON-RESIDENTIAL)

EX4

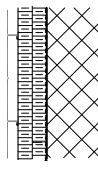

METAL SIDING - CONCRETE BLOCK

- 38 PREFIN. METAL SIDING
- HORIZ. Z-BAR METAL FURRING
- 50 SEMI-RIGID INSUL. (RSI 1.48 c.i.) ON HORIZ. Z-GIRTS
- 50 XPS INSULATION (RSI 1.48 c.i.) ON VERT. Z-GIRTS
- LIQUID OR MEMBRANE MOISTURE BARRIER (AIR/VAPOUR BARRIER)
- 190 REINFORCED CMU (SEE STRUCT.)

MIN. RSI 2.7ci  
 (ENERGY EFFICIENCY per SB-10, DIVISION 2, TABLE 5.5-6, (WALL/MASS/NON-RESIDENTIAL)

**ROOFS:**

R1

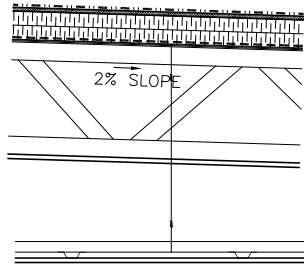

LOW SLOPE - WOOD  
 1 HR FRR PER SB-2 TABLES 2.3.4.A & C

- 2 PLY MOD. BIT MEMBRANE ROOFING
- PROTECTION BOARD UNDERLAY
- ROOF INSULATION BD (MIN. RSI 5.3 AGED)
- VAPOUR RETARDER
- WOOD ROOF SHEATHING (SEE STRUCT)
- 2% SLOPED STRUCTURE (SEE STRUCT)
- 16 TYPE X GYPSUM BOARD (FRR)
- SUSPENDED CEILING (ACOUSTIC TILE OR GYPSUM BOARD - SEE REFLECTED CEILING)

MIN. RSI 5.3 ci  
 (ENERGY EFFICIENCY per SB-10, DIVISION 2, TABLE 5.5-6, (ROOFS/INSUL ABOVE DECK/NON-RESIDENTIAL)

R2

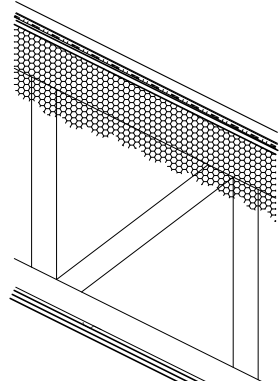

SLOPING FLAT ROOF - WOOD  
 1 HR FRR PER SB-2 TABLES 2.3.4.A & C

- PRE-FINISHED METAL ROOFING
- SYNTHETIC FELT SHEET UNDERLAYMENT
- SELF-ADHERED RUBBERIZED MEMBRANE (EAVE PROTECTION, VALLEYS, PENETRATIONS)
- WOOD ROOF SHEATHING (SEE STRUCT)
- SLOPED ROOF TRUSSES (SEE STRUCT)
- TYPE 2 SPRAY FOAM POLYURETHANE INSULATION (MIN. RSI 8.6 AGED)
- RESILIENT CHANNEL @ 400 O.C. (STC)
- 16 TYPE X GYPSUM BOARD (FRR & STC)
- 16 TYPE X GYPSUM BOARD (FRR)

MIN. RSI 8.6  
 (ENERGY EFFICIENCY per SB-10, DIVISION 2, TABLE 5.5-6, (ROOFS/OTHER/NON-RESIDENTIAL)

## **APPENDIX B**

### **STAMSON 5.04 - INPUT AND OUTPUT DATA**



STAMSON 5.0                      NORMAL REPORT                      Date: 01-04-2016 10:20:10  
 MINISTRY OF ENVIRONMENT AND ENERGY / NOISE ASSESSMENT

Filename: rl.te    Time Period: Day/Night 16/8 hours  
 Description:

Road data, segment # 1: Bill (day/night)

-----  
 Car traffic volume : 9715/845 veh/TimePeriod \*  
 Medium truck volume : 773/67 veh/TimePeriod \*  
 Heavy truck volume : 552/48 veh/TimePeriod \*  
 Posted speed limit : 60 km/h  
 Road gradient : 0 %  
 Road pavement : 1 (Typical asphalt or concrete)

\* Refers to calculated road volumes based on the following input:

24 hr Traffic Volume (AADT or SADT): 12000  
 Percentage of Annual Growth : 0.00  
 Number of Years of Growth : 0.00  
 Medium Truck % of Total Volume : 7.00  
 Heavy Truck % of Total Volume : 5.00  
 Day (16 hrs) % of Total Volume : 92.00

Data for Segment # 1: Bill (day/night)

-----  
 Angle1 Angle2 : -90.00 deg 49.00 deg  
 Wood depth : 0 (No woods.)  
 No of house rows : 0 / 0  
 Surface : 2 (Reflective ground surface)  
 Receiver source distance : 43.00 / 43.00 m  
 Receiver height : 7.00 / 7.00 m  
 Topography : 1 (Flat/gentle slope; no barrier)  
 Reference angle : 0.00



Results segment # 1: Bill (day)

Source height = 1.50 m

ROAD (0.00 + 63.33 + 0.00) = 63.33 dBA

Angle1	Angle2	Alpha	RefLeq	P.Adj	D.Adj	F.Adj	W.Adj	H.Adj	B.Adj
--------	--------	-------	--------	-------	-------	-------	-------	-------	-------

SubLeq

-90	49	0.00	69.03	0.00	-4.57	-1.12	0.00	0.00	0.00
-----	----	------	-------	------	-------	-------	------	------	------

63.33

Segment Leq : 63.33 dBA

Total Leq All Segments: 63.33 dBA

Results segment # 1: Bill (night)

Source height = 1.50 m

ROAD (0.00 + 55.73 + 0.00) = 55.73 dBA

Angle1	Angle2	Alpha	RefLeq	P.Adj	D.Adj	F.Adj	W.Adj	H.Adj	B.Adj
--------	--------	-------	--------	-------	-------	-------	-------	-------	-------

SubLeq

-90	49	0.00	61.43	0.00	-4.57	-1.12	0.00	0.00	0.00
-----	----	------	-------	------	-------	-------	------	------	------

55.73

Segment Leq : 55.73 dBA

Total Leq All Segments: 55.73 dBA

TOTAL Leq FROM ALL SOURCES (DAY) : 63.33  
(NIGHT) : 55.73



STAMSON 5.0                    NORMAL REPORT                    Date: 01-04-2016 10:20:17  
MINISTRY OF ENVIRONMENT AND ENERGY / NOISE ASSESSMENT

Filename: r2.te    Time Period: Day/Night 16/8 hours  
Description:

Road data, segment # 1: BillL (day/night)  
-----

Car traffic volume : 9715/845    veh/TimePeriod    \*  
Medium truck volume : 773/67    veh/TimePeriod    \*  
Heavy truck volume : 552/48    veh/TimePeriod    \*  
Posted speed limit : 60 km/h  
Road gradient : 0 %  
Road pavement : 1 (Typical asphalt or concrete)

\* Refers to calculated road volumes based on the following input:

24 hr Traffic Volume (AADT or SADT): 12000  
Percentage of Annual Growth : 0.00  
Number of Years of Growth : 0.00  
Medium Truck % of Total Volume : 7.00  
Heavy Truck % of Total Volume : 5.00  
Day (16 hrs) % of Total Volume : 92.00

Data for Segment # 1: BillL (day/night)  
-----

Angle1    Angle2                    : -41.00 deg    30.00 deg  
Wood depth : 0    (No woods.)  
No of house rows : 0 / 0  
Surface : 1    (Absorptive ground surface)  
Receiver source distance : 52.00 / 52.00    m  
Receiver height : 3.20 / 3.20    m  
Topography : 1    (Flat/gentle slope; no barrier)  
Reference angle : 0.00



Road data, segment # 2: BillR (day/night)

-----  
Car traffic volume : 9715/845 veh/TimePeriod \*  
Medium truck volume : 773/67 veh/TimePeriod \*  
Heavy truck volume : 552/48 veh/TimePeriod \*  
Posted speed limit : 60 km/h  
Road gradient : 0 %  
Road pavement : 1 (Typical asphalt or concrete)

\* Refers to calculated road volumes based on the following input:

24 hr Traffic Volume (AADT or SADT): 12000  
Percentage of Annual Growth : 0.00  
Number of Years of Growth : 0.00  
Medium Truck % of Total Volume : 7.00  
Heavy Truck % of Total Volume : 5.00  
Day (16 hrs) % of Total Volume : 92.00

Data for Segment # 2: BillR (day/night)

-----  
Angle1 Angle2 : -15.00 deg 73.00 deg  
Wood depth : 0 (No woods.)  
No of house rows : 0 / 0  
Surface : 2 (Reflective ground surface)  
Receiver source distance : 58.00 / 58.00 m  
Receiver height : 3.20 / 3.20 m  
Topography : 1 (Flat/gentle slope; no barrier)  
Reference angle : 0.00



Road data, segment # 3: Leikin (day/night)

-----  
Car traffic volume : 9715/845 veh/TimePeriod \*  
Medium truck volume : 773/67 veh/TimePeriod \*  
Heavy truck volume : 552/48 veh/TimePeriod \*  
Posted speed limit : 60 km/h  
Road gradient : 0 %  
Road pavement : 1 (Typical asphalt or concrete)

\* Refers to calculated road volumes based on the following input:

24 hr Traffic Volume (AADT or SADT): 12000  
Percentage of Annual Growth : 0.00  
Number of Years of Growth : 0.00  
Medium Truck % of Total Volume : 7.00  
Heavy Truck % of Total Volume : 5.00  
Day (16 hrs) % of Total Volume : 92.00

Data for Segment # 3: Leikin (day/night)

-----  
Angle1 Angle2 : -81.00 deg 0.00 deg  
Wood depth : 0 (No woods.)  
No of house rows : 0 / 0  
Surface : 2 (Reflective ground surface)  
Receiver source distance : 23.00 / 23.00 m  
Receiver height : 3.20 / 3.20 m  
Topography : 1 (Flat/gentle slope; no barrier)  
Reference angle : 0.00



Results segment # 1: BillL (day)

Source height = 1.50 m

ROAD (0.00 + 56.11 + 0.00) = 56.11 dBA

Angle1	Angle2	Alpha	RefLeq	P.Adj	D.Adj	F.Adj	W.Adj	H.Adj	B.Adj
--------	--------	-------	--------	-------	-------	-------	-------	-------	-------

-41	30	0.61	69.03	0.00	-8.69	-4.23	0.00	0.00	0.00
-----	----	------	-------	------	-------	-------	------	------	------

Segment Leq : 56.11 dBA

Results segment # 2: BillR (day)

Source height = 1.50 m

ROAD (0.00 + 60.05 + 0.00) = 60.05 dBA

Angle1	Angle2	Alpha	RefLeq	P.Adj	D.Adj	F.Adj	W.Adj	H.Adj	B.Adj
--------	--------	-------	--------	-------	-------	-------	-------	-------	-------

-15	73	0.00	69.03	0.00	-5.87	-3.11	0.00	0.00	0.00
-----	----	------	-------	------	-------	-------	------	------	------

Segment Leq : 60.05 dBA

Results segment # 3: Leikin (day)

Source height = 1.50 m

ROAD (0.00 + 63.70 + 0.00) = 63.70 dBA

Angle1	Angle2	Alpha	RefLeq	P.Adj	D.Adj	F.Adj	W.Adj	H.Adj	B.Adj
--------	--------	-------	--------	-------	-------	-------	-------	-------	-------

-81	0	0.00	69.03	0.00	-1.86	-3.47	0.00	0.00	0.00
-----	---	------	-------	------	-------	-------	------	------	------

Segment Leq : 63.70 dBA





Total Leq All Segments: 65.76 dBA

Results segment # 1: BillL (night)

Source height = 1.50 m

ROAD (0.00 + 48.51 + 0.00) = 48.51 dBA

Angle1	Angle2	Alpha	RefLeq	P.Adj	D.Adj	F.Adj	W.Adj	H.Adj	B.Adj
--------	--------	-------	--------	-------	-------	-------	-------	-------	-------

SubLeq

-41	30	0.61	61.43	0.00	-8.69	-4.23	0.00	0.00	0.00
48.51									

Segment Leq : 48.51 dBA

Results segment # 2: BillR (night)

Source height = 1.50 m

ROAD (0.00 + 52.45 + 0.00) = 52.45 dBA

Angle1	Angle2	Alpha	RefLeq	P.Adj	D.Adj	F.Adj	W.Adj	H.Adj	B.Adj
--------	--------	-------	--------	-------	-------	-------	-------	-------	-------

SubLeq

-15	73	0.00	61.43	0.00	-5.87	-3.11	0.00	0.00	0.00
52.45									

Segment Leq : 52.45 dBA



Results segment # 3: Leikin (night)

-----  
Source height = 1.50 m

ROAD (0.00 + 56.10 + 0.00) = 56.10 dBA

Angle1	Angle2	Alpha	RefLeq	P.Adj	D.Adj	F.Adj	W.Adj	H.Adj	B.Adj
--------	--------	-------	--------	-------	-------	-------	-------	-------	-------

SubLeq

-----  
--  
-81            0    0.00   61.43    0.00   -1.86   -3.47    0.00    0.00    0.00  
56.10  
-----  
--

Segment Leq : 56.10 dBA

Total Leq All Segments: 58.16 dBA

TOTAL Leq FROM ALL SOURCES (DAY): 65.76  
(NIGHT): 58.16



STAMSON 5.0                      NORMAL REPORT                      Date: 01-04-2016 10:20:23  
MINISTRY OF ENVIRONMENT AND ENERGY / NOISE ASSESSMENT

Filename: r3.te                      Time Period: Day/Night 16/8 hours  
Description:

Road data, segment # 1: Bill (day/night)

-----  
Car traffic volume : 9715/845    veh/TimePeriod \*  
Medium truck volume : 773/67    veh/TimePeriod \*  
Heavy truck volume : 552/48    veh/TimePeriod \*  
Posted speed limit : 60 km/h  
Road gradient : 0 %  
Road pavement : 1 (Typical asphalt or concrete)

\* Refers to calculated road volumes based on the following input:

24 hr Traffic Volume (AADT or SADT): 12000  
Percentage of Annual Growth : 0.00  
Number of Years of Growth : 0.00  
Medium Truck % of Total Volume : 7.00  
Heavy Truck % of Total Volume : 5.00  
Day (16 hrs) % of Total Volume : 92.00

Data for Segment # 1: Bill (day/night)

-----  
Angle1    Angle2                      : 0.00 deg    66.00 deg  
Wood depth : 0    (No woods.)  
No of house rows : 0 / 0  
Surface : 2    (Reflective ground surface)  
Receiver source distance : 72.00 / 72.00 m  
Receiver height : 7.00 / 7.00 m  
Topography : 1    (Flat/gentle slope; no barrier)  
Reference angle : 0.00



Road data, segment # 2: LeikinL (day/night)

-----  
Car traffic volume : 9715/845 veh/TimePeriod \*  
Medium truck volume : 773/67 veh/TimePeriod \*  
Heavy truck volume : 552/48 veh/TimePeriod \*  
Posted speed limit : 60 km/h  
Road gradient : 0 %  
Road pavement : 1 (Typical asphalt or concrete)

\* Refers to calculated road volumes based on the following input:

24 hr Traffic Volume (AADT or SADT): 12000  
Percentage of Annual Growth : 0.00  
Number of Years of Growth : 0.00  
Medium Truck % of Total Volume : 7.00  
Heavy Truck % of Total Volume : 5.00  
Day (16 hrs) % of Total Volume : 92.00

Data for Segment # 2: LeikinL (day/night)

-----  
Angle1 Angle2 : -83.00 deg 69.00 deg  
Wood depth : 0 (No woods.)  
No of house rows : 0 / 0  
Surface : 2 (Reflective ground surface)  
Receiver source distance : 21.00 / 21.00 m  
Receiver height : 7.00 / 7.00 m  
Topography : 1 (Flat/gentle slope; no barrier)  
Reference angle : 0.00

Road data, segment # 3: LeikinR (day/night)

-----  
Car traffic volume : 9715/845 veh/TimePeriod \*  
Medium truck volume : 773/67 veh/TimePeriod \*  
Heavy truck volume : 552/48 veh/TimePeriod \*  
Posted speed limit : 60 km/h  
Road gradient : 0 %  
Road pavement : 1 (Typical asphalt or concrete)

\* Refers to calculated road volumes based on the following input:

24 hr Traffic Volume (AADT or SADT): 12000  
Percentage of Annual Growth : 0.00  
Number of Years of Growth : 0.00  
Medium Truck % of Total Volume : 7.00  
Heavy Truck % of Total Volume : 5.00  
Day (16 hrs) % of Total Volume : 92.00



Data for Segment # 3: LeikinR (day/night)

```

-----
Angle1   Angle2           : -90.00 deg   -79.00 deg
Wood depth           :           0       (No woods.)
No of house rows     :           0 / 0
Surface              :           2       (Reflective ground surface)
Receiver source distance : 15.00 / 15.00 m
Receiver height      :   7.00 / 7.00 m
Topography           :           1       (Flat/gentle slope; no barrier)
Reference angle      :           0.00

```

Results segment # 1: Bill (day)

Source height = 1.50 m

ROAD (0.00 + 57.86 + 0.00) = 57.86 dBA

Angle1	Angle2	Alpha	RefLeq	P.Adj	D.Adj	F.Adj	W.Adj	H.Adj	B.Adj
SubLeq									

```

-----
--
--
0      66    0.00  69.03    0.00  -6.81  -4.36    0.00    0.00    0.00
57.86
-----
--

```

Segment Leq : 57.86 dBA

Results segment # 2: LeikinL (day)

Source height = 1.50 m

ROAD (0.00 + 66.83 + 0.00) = 66.83 dBA

Angle1	Angle2	Alpha	RefLeq	P.Adj	D.Adj	F.Adj	W.Adj	H.Adj	B.Adj
SubLeq									

```

-----
--
--
-83    69    0.00  69.03    0.00  -1.46  -0.73    0.00    0.00    0.00
66.83
-----
--

```

Segment Leq : 66.83 dBA



Results segment # 3: LeikinR (day)

Source height = 1.50 m

ROAD (0.00 + 56.89 + 0.00) = 56.89 dBA

Angle1	Angle2	Alpha	RefLeq	P.Adj	D.Adj	F.Adj	W.Adj	H.Adj	B.Adj
--------	--------	-------	--------	-------	-------	-------	-------	-------	-------

SubLeq

-90	-79	0.00	69.03	0.00	0.00	-12.14	0.00	0.00	0.00
-----	-----	------	-------	------	------	--------	------	------	------

56.89

Segment Leq : 56.89 dBA

Total Leq All Segments: 67.72 dBA

Results segment # 1: Bill (night)

Source height = 1.50 m

ROAD (0.00 + 50.26 + 0.00) = 50.26 dBA

Angle1	Angle2	Alpha	RefLeq	P.Adj	D.Adj	F.Adj	W.Adj	H.Adj	B.Adj
--------	--------	-------	--------	-------	-------	-------	-------	-------	-------

SubLeq

0	66	0.00	61.43	0.00	-6.81	-4.36	0.00	0.00	0.00
---	----	------	-------	------	-------	-------	------	------	------

50.26

Segment Leq : 50.26 dBA

Results segment # 2: LeikinL (night)

Source height = 1.50 m

ROAD (0.00 + 59.23 + 0.00) = 59.23 dBA

Angle1	Angle2	Alpha	RefLeq	P.Adj	D.Adj	F.Adj	W.Adj	H.Adj	B.Adj
--------	--------	-------	--------	-------	-------	-------	-------	-------	-------

SubLeq

-83	69	0.00	61.43	0.00	-1.46	-0.73	0.00	0.00	0.00
-----	----	------	-------	------	-------	-------	------	------	------

59.23



---

Segment Leq : 59.23 dBA

Results segment # 3: LeikinR (night)

-----  
Source height = 1.50 m

ROAD (0.00 + 49.29 + 0.00) = 49.29 dBA

Angle1	Angle2	Alpha	RefLeq	P.Adj	D.Adj	F.Adj	W.Adj	H.Adj	B.Adj
--------	--------	-------	--------	-------	-------	-------	-------	-------	-------

SubLeq

-----  
--  
-90      -79      0.00    61.43    0.00    0.00    -12.14    0.00    0.00    0.00  
49.29  
-----  
--

Segment Leq : 49.29 dBA

Total Leq All Segments: 60.12 dBA

TOTAL Leq FROM ALL SOURCES (DAY) : 67.72  
(NIGHT) : 60.12



STAMSON 5.0                      NORMAL REPORT                      Date: 01-04-2016 10:20:33  
MINISTRY OF ENVIRONMENT AND ENERGY / NOISE ASSESSMENT

Filename: r4.te                      Time Period: Day/Night 16/8 hours  
Description:

Road data, segment # 1: Bill (day/night)

-----  
Car traffic volume : 9715/845    veh/TimePeriod \*  
Medium truck volume : 773/67    veh/TimePeriod \*  
Heavy truck volume : 552/48    veh/TimePeriod \*  
Posted speed limit : 60 km/h  
Road gradient : 0 %  
Road pavement : 1 (Typical asphalt or concrete)

\* Refers to calculated road volumes based on the following input:

24 hr Traffic Volume (AADT or SADT): 12000  
Percentage of Annual Growth : 0.00  
Number of Years of Growth : 0.00  
Medium Truck % of Total Volume : 7.00  
Heavy Truck % of Total Volume : 5.00  
Day (16 hrs) % of Total Volume : 92.00

Data for Segment # 1: Bill (day/night)

-----  
Angle1    Angle2                      : -90.00 deg    -41.00 deg  
Wood depth                            : 0                      (No woods.)  
No of house rows                      : 0 / 0  
Surface                                : 2                      (Reflective ground surface)  
Receiver source distance : 74.00 / 74.00    m  
Receiver height                        : 1.50 / 1.50    m  
Topography                            : 2                      (Flat/gentle slope; with barrier)  
Barrier angle1                        : -84.00 deg    Angle2 : -41.00 deg  
Barrier height                         : 4.20 m  
Barrier receiver distance : 1.00 / 1.00    m  
Source elevation                        : 0.00 m  
Receiver elevation                      : 0.00 m  
Barrier elevation                       : 0.00 m  
Reference angle                        : 0.00





Road data, segment # 2: LeikinL (day/night)

-----  
Car traffic volume : 9715/845 veh/TimePeriod \*  
Medium truck volume : 773/67 veh/TimePeriod \*  
Heavy truck volume : 552/48 veh/TimePeriod \*  
Posted speed limit : 60 km/h  
Road gradient : 0 %  
Road pavement : 1 (Typical asphalt or concrete)

\* Refers to calculated road volumes based on the following input:

24 hr Traffic Volume (AADT or SADT): 12000  
Percentage of Annual Growth : 0.00  
Number of Years of Growth : 0.00  
Medium Truck % of Total Volume : 7.00  
Heavy Truck % of Total Volume : 5.00  
Day (16 hrs) % of Total Volume : 92.00

Data for Segment # 2: LeikinL (day/night)

-----  
Angle1 Angle2 : 0.00 deg 56.00 deg  
Wood depth : 0 (No woods.)  
No of house rows : 0 / 0  
Surface : 2 (Reflective ground surface)  
Receiver source distance : 24.00 / 24.00 m  
Receiver height : 1.50 / 1.50 m  
Topography : 1 (Flat/gentle slope; no barrier)  
Reference angle : 0.00



Road data, segment # 3: LeikinR (day/night)

-----  
Car traffic volume : 9715/845 veh/TimePeriod \*  
Medium truck volume : 773/67 veh/TimePeriod \*  
Heavy truck volume : 552/48 veh/TimePeriod \*  
Posted speed limit : 60 km/h  
Road gradient : 0 %  
Road pavement : 1 (Typical asphalt or concrete)

\* Refers to calculated road volumes based on the following input:

24 hr Traffic Volume (AADT or SADT): 12000  
Percentage of Annual Growth : 0.00  
Number of Years of Growth : 0.00  
Medium Truck % of Total Volume : 7.00  
Heavy Truck % of Total Volume : 5.00  
Day (16 hrs) % of Total Volume : 92.00

Data for Segment # 3: LeikinR (day/night)

-----  
Angle1 Angle2 : 88.00 deg 90.00 deg  
Wood depth : 0 (No woods.)  
No of house rows : 0 / 0  
Surface : 2 (Reflective ground surface)  
Receiver source distance : 15.00 / 15.00 m  
Receiver height : 1.50 / 1.50 m  
Topography : 1 (Flat/gentle slope; no barrier)  
Reference angle : 0.00



Results segment # 1: Bill (day)

Source height = 1.50 m

Barrier height for grazing incidence

Source Height (m)	Receiver Height (m)	Barrier Height (m)	Elevation of Barrier Top (m)
1.50	1.50	1.50	1.50

ROAD (47.32 + 39.92 + 0.00) = 48.05 dBA

Angle1	Angle2	Alpha	RefLeq	P.Adj	D.Adj	F.Adj	W.Adj	H.Adj	B.Adj
SubLeq									

-90	-84	0.00	69.03	0.00	-6.93	-14.77	0.00	0.00	0.00
47.32									

-84	-41	0.00	69.03	0.00	-6.93	-6.22	0.00	0.00	-15.96
39.92									

Segment Leq : 48.05 dBA

Results segment # 2: LeikinL (day)

Source height = 1.50 m

ROAD (0.00 + 61.92 + 0.00) = 61.92 dBA

Angle1	Angle2	Alpha	RefLeq	P.Adj	D.Adj	F.Adj	W.Adj	H.Adj	B.Adj
SubLeq									

0	56	0.00	69.03	0.00	-2.04	-5.07	0.00	0.00	0.00
61.92									

Segment Leq : 61.92 dBA



Results segment # 3: LeikinR (day)

Source height = 1.50 m

ROAD (0.00 + 49.48 + 0.00) = 49.48 dBA

Angle1	Angle2	Alpha	RefLeq	P.Adj	D.Adj	F.Adj	W.Adj	H.Adj	B.Adj
88	90	0.00	69.03	0.00	0.00	-19.54	0.00	0.00	0.00

SubLeq
49.48

Segment Leq : 49.48 dBA

Total Leq All Segments: 62.33 dBA

Results segment # 1: Bill (night)

Source height = 1.50 m

Barrier height for grazing incidence

Source Height (m)	Receiver Height (m)	Barrier Height (m)	Elevation of Barrier Top (m)
1.50	1.50	1.50	1.50

ROAD (39.73 + 32.32 + 0.00) = 40.45 dBA

Angle1	Angle2	Alpha	RefLeq	P.Adj	D.Adj	F.Adj	W.Adj	H.Adj	B.Adj
-90	-84	0.00	61.43	0.00	-6.93	-14.77	0.00	0.00	0.00

SubLeq
39.73

-84	-41	0.00	61.43	0.00	-6.93	-6.22	0.00	0.00	-15.96
-----	-----	------	-------	------	-------	-------	------	------	--------

32.32

Segment Leq : 40.45 dBA



Results segment # 2: LeikinL (night)

Source height = 1.50 m

ROAD (0.00 + 54.32 + 0.00) = 54.32 dBA

Angle1	Angle2	Alpha	RefLeq	P.Adj	D.Adj	F.Adj	W.Adj	H.Adj	B.Adj
--------	--------	-------	--------	-------	-------	-------	-------	-------	-------

SubLeq

0	56	0.00	61.43	0.00	-2.04	-5.07	0.00	0.00	0.00
---	----	------	-------	------	-------	-------	------	------	------

54.32

Segment Leq : 54.32 dBA

Results segment # 3: LeikinR (night)

Source height = 1.50 m

ROAD (0.00 + 41.89 + 0.00) = 41.89 dBA

Angle1	Angle2	Alpha	RefLeq	P.Adj	D.Adj	F.Adj	W.Adj	H.Adj	B.Adj
--------	--------	-------	--------	-------	-------	-------	-------	-------	-------

SubLeq

88	90	0.00	61.43	0.00	0.00	-19.54	0.00	0.00	0.00
----	----	------	-------	------	------	--------	------	------	------

41.89

Segment Leq : 41.89 dBA

Total Leq All Segments: 54.73 dBA

TOTAL Leq FROM ALL SOURCES (DAY): 62.33  
(NIGHT): 54.73



STAMSON 5.0                      NORMAL REPORT                      Date: 01-04-2016 10:20:41  
MINISTRY OF ENVIRONMENT AND ENERGY / NOISE ASSESSMENT

Filename: r5.te                                      Time Period: Day/Night 16/8 hours  
Description:

Road data, segment # 1: Bill (day/night)

-----  
Car traffic volume : 9715/845    veh/TimePeriod \*  
Medium truck volume : 773/67    veh/TimePeriod \*  
Heavy truck volume : 552/48    veh/TimePeriod \*  
Posted speed limit : 60 km/h  
Road gradient : 0 %  
Road pavement : 1 (Typical asphalt or concrete)

\* Refers to calculated road volumes based on the following input:

24 hr Traffic Volume (AADT or SADT): 12000  
Percentage of Annual Growth : 0.00  
Number of Years of Growth : 0.00  
Medium Truck % of Total Volume : 7.00  
Heavy Truck % of Total Volume : 5.00  
Day (16 hrs) % of Total Volume : 92.00

Data for Segment # 1: Bill (day/night)

-----  
Angle1    Angle2                      : -90.00 deg    -41.00 deg  
Wood depth : 0                                      (No woods.)  
No of house rows : 0 / 0  
Surface : 2                                      (Reflective ground surface)  
Receiver source distance : 60.00 / 60.00 m  
Receiver height : 1.50 / 1.50 m  
Topography : 1                                      (Flat/gentle slope; no barrier)  
Reference angle : 0.00



Road data, segment # 2: LeikinL (day/night)

-----  
Car traffic volume : 9715/845 veh/TimePeriod \*  
Medium truck volume : 773/67 veh/TimePeriod \*  
Heavy truck volume : 552/48 veh/TimePeriod \*  
Posted speed limit : 60 km/h  
Road gradient : 0 %  
Road pavement : 1 (Typical asphalt or concrete)

\* Refers to calculated road volumes based on the following input:

24 hr Traffic Volume (AADT or SADT): 12000  
Percentage of Annual Growth : 0.00  
Number of Years of Growth : 0.00  
Medium Truck % of Total Volume : 7.00  
Heavy Truck % of Total Volume : 5.00  
Day (16 hrs) % of Total Volume : 92.00

Data for Segment # 2: LeikinL (day/night)

-----  
Angle1 Angle2 : 0.00 deg 31.00 deg  
Wood depth : 0 (No woods.)  
No of house rows : 0 / 0  
Surface : 2 (Reflective ground surface)  
Receiver source distance : 49.00 / 49.00 m  
Receiver height : 1.50 / 1.50 m  
Topography : 2 (Flat/gentle slope; with barrier)  
Barrier angle1 : 0.00 deg Angle2 : 6.00 deg  
Barrier height : 4.20 m  
Barrier receiver distance : 8.00 / 8.00 m  
Source elevation : 0.00 m  
Receiver elevation : 0.00 m  
Barrier elevation : 0.00 m  
Reference angle : 0.00



Road data, segment # 3: LeikinR (day/night)

```

-----
Car traffic volume : 9715/845 veh/TimePeriod *
Medium truck volume : 773/67 veh/TimePeriod *
Heavy truck volume : 552/48 veh/TimePeriod *
Posted speed limit : 60 km/h
Road gradient : 0 %
Road pavement : 1 (Typical asphalt or concrete)

```

\* Refers to calculated road volumes based on the following input:

```

24 hr Traffic Volume (AADT or SADT): 12000
Percentage of Annual Growth : 0.00
Number of Years of Growth : 0.00
Medium Truck % of Total Volume : 7.00
Heavy Truck % of Total Volume : 5.00
Day (16 hrs) % of Total Volume : 92.00

```

Data for Segment # 3: LeikinR (day/night)

```

-----
Angle1 Angle2 : 63.00 deg 90.00 deg
Wood depth : 0 (No woods.)
No of house rows : 0 / 0
Surface : 2 (Reflective ground surface)
Receiver source distance : 26.00 / 26.00 m
Receiver height : 1.50 / 1.50 m
Topography : 1 (Flat/gentle slope; no barrier)
Reference angle : 0.00

```

Results segment # 1: Bill (day)

Source height = 1.50 m

ROAD (0.00 + 57.36 + 0.00) = 57.36 dBA

```

Angle1 Angle2 Alpha RefLeq P.Adj D.Adj F.Adj W.Adj H.Adj B.Adj
SubLeq

```

```

-----
--
-90 -41 0.00 69.03 0.00 -6.02 -5.65 0.00 0.00 0.00
57.36
-----
--

```

Segment Leq : 57.36 dBA





Results segment # 2: LeikinL (day)

Source height = 1.50 m

Barrier height for grazing incidence

Source Height (m)	Receiver Height (m)	Barrier Height (m)	Elevation of Barrier Top (m)
1.50	1.50	1.50	1.50

ROAD (0.00 + 34.20 + 55.31) = 55.35 dBA

Angle1	Angle2	Alpha	RefLeq	P.Adj	D.Adj	F.Adj	W.Adj	H.Adj	B.Adj
SubLeq									

0	6	0.00	69.03	0.00	-5.14	-14.77	0.00	0.00	-14.92
---	---	------	-------	------	-------	--------	------	------	--------

6	31	0.00	69.03	0.00	-5.14	-8.57	0.00	0.00	0.00
---	----	------	-------	------	-------	-------	------	------	------

Segment Leq : 55.35 dBA

Results segment # 3: LeikinR (day)

Source height = 1.50 m

ROAD (0.00 + 58.40 + 0.00) = 58.40 dBA

Angle1	Angle2	Alpha	RefLeq	P.Adj	D.Adj	F.Adj	W.Adj	H.Adj	B.Adj
SubLeq									

63	90	0.00	69.03	0.00	-2.39	-8.24	0.00	0.00	0.00
----	----	------	-------	------	-------	-------	------	------	------

Segment Leq : 58.40 dBA

Total Leq All Segments: 61.98 dBA



Results segment # 1: Bill (night)

Source height = 1.50 m

ROAD (0.00 + 49.76 + 0.00) = 49.76 dBA

Angle1	Angle2	Alpha	RefLeq	P.Adj	D.Adj	F.Adj	W.Adj	H.Adj	B.Adj
-90	-41	0.00	61.43	0.00	-6.02	-5.65	0.00	0.00	0.00

SubLeq
49.76

Segment Leq : 49.76 dBA

Results segment # 2: LeikinL (night)

Source height = 1.50 m

Barrier height for grazing incidence

Source Height (m)	Receiver Height (m)	Barrier Height (m)	Elevation of Barrier Top (m)
1.50	1.50	1.50	1.50

ROAD (0.00 + 26.60 + 47.71) = 47.75 dBA

Angle1	Angle2	Alpha	RefLeq	P.Adj	D.Adj	F.Adj	W.Adj	H.Adj	B.Adj
0	6	0.00	61.43	0.00	-5.14	-14.77	0.00	0.00	-14.92

SubLeq
26.60

SubLeq
47.71

Segment Leq : 47.75 dBA



Results segment # 3: LeikinR (night)

Source height = 1.50 m

ROAD (0.00 + 50.80 + 0.00) = 50.80 dBA

Angle1	Angle2	Alpha	RefLeq	P.Adj	D.Adj	F.Adj	W.Adj	H.Adj	B.Adj
--------	--------	-------	--------	-------	-------	-------	-------	-------	-------

SubLeq

63	90	0.00	61.43	0.00	-2.39	-8.24	0.00	0.00	0.00
50.80									

Segment Leq : 50.80 dBA

Total Leq All Segments: 54.38 dBA

TOTAL Leq FROM ALL SOURCES (DAY) : 61.98  
(NIGHT) : 54.38



STAMSON 5.0                      NORMAL REPORT                      Date: 01-04-2016 10:20:46  
MINISTRY OF ENVIRONMENT AND ENERGY / NOISE ASSESSMENT

Filename: r6.te                      Time Period: Day/Night 16/8 hours  
Description:

Road data, segment # 1: Bill (day/night)

-----  
Car traffic volume : 9715/845    veh/TimePeriod \*  
Medium truck volume : 773/67    veh/TimePeriod \*  
Heavy truck volume : 552/48    veh/TimePeriod \*  
Posted speed limit : 60 km/h  
Road gradient : 0 %  
Road pavement : 1 (Typical asphalt or concrete)

\* Refers to calculated road volumes based on the following input:

24 hr Traffic Volume (AADT or SADT): 12000  
Percentage of Annual Growth : 0.00  
Number of Years of Growth : 0.00  
Medium Truck % of Total Volume : 7.00  
Heavy Truck % of Total Volume : 5.00  
Day (16 hrs) % of Total Volume : 92.00

Data for Segment # 1: Bill (day/night)

-----  
Angle1    Angle2                      : -90.00 deg    4.00 deg  
Wood depth : 0    (No woods.)  
No of house rows : 0 / 0  
Surface : 2    (Reflective ground surface)  
Receiver source distance : 60.00 / 60.00 m  
Receiver height : 1.50 / 1.50 m  
Topography : 1    (Flat/gentle slope; no barrier)  
Reference angle : 0.00



Results segment # 1: Bill (day)

-----

Source height = 1.50 m

ROAD (0.00 + 60.19 + 0.00) = 60.19 dBA

Angle1	Angle2	Alpha	RefLeq	P.Adj	D.Adj	F.Adj	W.Adj	H.Adj	B.Adj
--------	--------	-------	--------	-------	-------	-------	-------	-------	-------

SubLeq

-----

--

-90	4	0.00	69.03	0.00	-6.02	-2.82	0.00	0.00	0.00
-----	---	------	-------	------	-------	-------	------	------	------

60.19

-----

--

Segment Leq : 60.19 dBA

Total Leq All Segments: 60.19 dBA

Results segment # 1: Bill (night)

-----

Source height = 1.50 m

ROAD (0.00 + 52.59 + 0.00) = 52.59 dBA

Angle1	Angle2	Alpha	RefLeq	P.Adj	D.Adj	F.Adj	W.Adj	H.Adj	B.Adj
--------	--------	-------	--------	-------	-------	-------	-------	-------	-------

SubLeq

-----

--

-90	4	0.00	61.43	0.00	-6.02	-2.82	0.00	0.00	0.00
-----	---	------	-------	------	-------	-------	------	------	------

52.59

-----

--

Segment Leq : 52.59 dBA

Total Leq All Segments: 52.59 dBA

TOTAL Leq FROM ALL SOURCES (DAY): 60.19  
(NIGHT): 52.59



STAMSON 5.0            NORMAL REPORT            Date: 01-04-2016 10:20:52  
 MINISTRY OF ENVIRONMENT AND ENERGY / NOISE ASSESSMENT

Filename: r7.te                                    Time Period: Day/Night 16/8 hours  
 Description:

Road data, segment # 1: LeikinL (day/night)

-----  
 Car traffic volume : 9715/845     veh/TimePeriod \*  
 Medium truck volume : 773/67     veh/TimePeriod \*  
 Heavy truck volume : 552/48     veh/TimePeriod \*  
 Posted speed limit : 60 km/h  
 Road gradient : 0 %  
 Road pavement : 1 (Typical asphalt or concrete)

\* Refers to calculated road volumes based on the following input:

24 hr Traffic Volume (AADT or SADT): 12000  
 Percentage of Annual Growth : 0.00  
 Number of Years of Growth : 0.00  
 Medium Truck % of Total Volume : 7.00  
 Heavy Truck % of Total Volume : 5.00  
 Day (16 hrs) % of Total Volume : 92.00

Data for Segment # 1: LeikinL (day/night)

-----  
 Angle1   Angle2                                 : -44.00 deg     37.00 deg  
 Wood depth                                    : 0                (No woods.)  
 No of house rows                             : 0 / 0  
 Surface                                         : 2                (Reflective ground surface)  
 Receiver source distance : 24.00 / 24.00    m  
 Receiver height                               : 7.00 / 7.00     m  
 Topography                                    : 1                (Flat/gentle slope; no barrier)  
 Reference angle                               : 0.00



Road data, segment # 2: LeikinR (day/night)

```

-----
Car traffic volume : 9715/845 veh/TimePeriod *
Medium truck volume : 773/67 veh/TimePeriod *
Heavy truck volume : 552/48 veh/TimePeriod *
Posted speed limit : 60 km/h
Road gradient : 0 %
Road pavement : 1 (Typical asphalt or concrete)

```

\* Refers to calculated road volumes based on the following input:

```

24 hr Traffic Volume (AADT or SADT): 12000
Percentage of Annual Growth : 0.00
Number of Years of Growth : 0.00
Medium Truck % of Total Volume : 7.00
Heavy Truck % of Total Volume : 5.00
Day (16 hrs) % of Total Volume : 92.00

```

Data for Segment # 2: LeikinR (day/night)

```

-----
Angle1 Angle2 : 68.00 deg 90.00 deg
Wood depth : 0 (No woods.)
No of house rows : 0 / 0
Surface : 2 (Reflective ground surface)
Receiver source distance : 15.00 / 15.00 m
Receiver height : 7.00 / 7.00 m
Topography : 1 (Flat/gentle slope; no barrier)
Reference angle : 0.00

```

Results segment # 1: LeikinL (day)

Source height = 1.50 m

ROAD (0.00 + 63.52 + 0.00) = 63.52 dBA

```

Angle1 Angle2 Alpha RefLeq P.Adj D.Adj F.Adj W.Adj H.Adj B.Adj
SubLeq

```

```

-----
--
-44 37 0.00 69.03 0.00 -2.04 -3.47 0.00 0.00 0.00
63.52
-----
--

```

Segment Leq : 63.52 dBA



Results segment # 2: LeikinR (day)

Source height = 1.50 m

ROAD (0.00 + 59.90 + 0.00) = 59.90 dBA

Angle1	Angle2	Alpha	RefLeq	P.Adj	D.Adj	F.Adj	W.Adj	H.Adj	B.Adj
--------	--------	-------	--------	-------	-------	-------	-------	-------	-------

SubLeq

68	90	0.00	69.03	0.00	0.00	-9.13	0.00	0.00	0.00
----	----	------	-------	------	------	-------	------	------	------

59.90

Segment Leq : 59.90 dBA

Total Leq All Segments: 65.09 dBA

Results segment # 1: LeikinL (night)

Source height = 1.50 m

ROAD (0.00 + 55.92 + 0.00) = 55.92 dBA

Angle1	Angle2	Alpha	RefLeq	P.Adj	D.Adj	F.Adj	W.Adj	H.Adj	B.Adj
--------	--------	-------	--------	-------	-------	-------	-------	-------	-------

SubLeq

-44	37	0.00	61.43	0.00	-2.04	-3.47	0.00	0.00	0.00
-----	----	------	-------	------	-------	-------	------	------	------

55.92

Segment Leq : 55.92 dBA





Results segment # 2: LeikinR (night)

Source height = 1.50 m

ROAD (0.00 + 52.30 + 0.00) = 52.30 dBA

Angle1	Angle2	Alpha	RefLeq	P.Adj	D.Adj	F.Adj	W.Adj	H.Adj	B.Adj
--------	--------	-------	--------	-------	-------	-------	-------	-------	-------

SubLeq

68	90	0.00	61.43	0.00	0.00	-9.13	0.00	0.00	0.00
----	----	------	-------	------	------	-------	------	------	------

52.30

Segment Leq : 52.30 dBA

Total Leq All Segments: 57.49 dBA

TOTAL Leq FROM ALL SOURCES (DAY) : 65.09

(NIGHT) : 57.49

## **APPENDIX C**

### **Detailed STC Calculations**

**WORSHIP / GYM REQUIRED STC**

Outdoor Sound Level	=	<b>68</b>	<b>dB A</b>
Source Geometry Correction:	=	<b>0</b>	<b>dB A</b>
Correction For Surface Reflection:	=	<b>3</b>	<b>dB A</b>
Target Indoor Noise Level:	=	<b>38.2</b>	<b>dB A</b>
Required Noise Reduction:	=	<b>32.8</b>	<b>dB A</b>

<b><u>COMPONENT: Wall</u></b>			STC Is:	<b>48</b>
Noise Spectrum Type	<b>D</b>		Correction:	<b>7 dB A</b>
Component Category	<b>d</b>			
Room Floor Area:	<b>360 m<sup>2</sup></b>			
Component Area:	<b>691 m<sup>2</sup></b>		Correction:	
Component / Floor (%):	<b>192 %</b>			
Room Absorption Category:	<b>intermediate</b>			<b>6 dB A</b>
Noise Reduction If Only This Component Transmits Sound Energy:				<b>35 dB A</b>
Component Transmits	<b>58 % Of Sound</b>		<b>Required Noise Reduction:</b>	<b>32.8 dB A</b>

<b><u>COMPONENT: Window</u></b>			Required Noise Reduction Is:	<b>32.8 dB A</b>
Percentage Of Sound Energy Transmitted:				<b>42 %</b>
Room Floor Area:	<b>360 m<sup>2</sup></b>		Correction:	<b>4</b>
Component Area:	<b>50 m<sup>2</sup></b>			
Component / Floor (%):	<b>14 %</b>			
Room Absorption Category:	<b>intermediate</b>		Correction:	<b>-6 dB A</b>
Noise Spectrum	<b>D</b>			
Component Category	<b>c</b>		Correction:	<b>4 dB A</b>
			<b>Required STC Is:</b>	<b>35</b>

**MULTI-PURPOSE ROOM REQUIRED STC**

Outdoor Sound Level	=	<b>63</b>	<b>dB A</b>
Source Geometry Correction:	=	<b>0</b>	<b>dB A</b>
Correction For Surface Reflection:	=	<b>3</b>	<b>dB A</b>
Target Indoor Noise Level:	=	<b>34</b>	<b>dB A</b>
Required Noise Reduction:	=	<b>32</b>	<b>dB A</b>

<b><u>COMPONENT: Wall</u></b>		STC Is:	<b>48</b>
Noise Spectrum Type	<b>D</b>	Correction:	<b>7 dB A</b>
Component Category	<b>d</b>		
Room Floor Area:	<b>114 m<sup>2</sup></b>		
Component Area:	<b>77.25 m<sup>2</sup></b>	Correction:	
Component / Floor (%):	<b>68 %</b>		
Room Absorption Category:	<b>intermediate</b>		<b>1 dB A</b>
Noise Reduction If Only This Component Transmits Sound Energy:			<b>40 dB A</b>
Component Transmits	<b>17 % Of Sound</b>	<b>Required Noise Reduction:</b>	<b>32 dB A</b>

<b><u>COMPONENT: Window</u></b>		Required Noise Reduction Is:	<b>32 dB A</b>
Percentage Of Sound Energy Transmitted:			<b>83 %</b>
Room Floor Area:	<b>114 m<sup>2</sup></b>	Correction:	<b>1</b>
Component Area:	<b>41 m<sup>2</sup></b>		
Component / Floor (%):	<b>36 %</b>		
Room Absorption Category:	<b>intermediate</b>	Correction:	<b>-1 dB A</b>
Noise Spectrum	<b>D</b>		
Component Category	<b>c</b>	Correction:	<b>4 dB A</b>
		<b>Required STC Is:</b>	<b>35</b>

### SANCTUARY REQUIRED STC

Outdoor Sound Level	=	<b>65</b>	<b>dB A</b>
Source Geometry Correction:	=	<b>0</b>	<b>dB A</b>
Correction For Surface Reflection:	=	<b>3</b>	<b>dB A</b>
Target Indoor Noise Level:	=	<b>34</b>	<b>dB A</b>
Required Noise Reduction:	=	<b>34</b>	<b>dB A</b>

<b><u>COMPONENT: Wall</u></b>			STC Is: <b>48</b>
Noise Spectrum Type	<b>D</b>		Correction: <b>7 dB A</b>
Component Category	<b>d</b>		
Room Floor Area:	<b>441 m<sup>2</sup></b>		
Component Area:	<b>454.5 m<sup>2</sup></b>		Correction:
Component / Floor (%):	<b>103 %</b>		
Room Absorption Category:	<b>intermediate</b>		<b>3 dB A</b>
Noise Reduction If Only This Component Transmits Sound Energy:			<b>38 dB A</b>
Component Transmits	<b>41 % Of Sound</b>	<b>Required Noise Reduction:</b>	<b>34 dB A</b>

<b><u>COMPONENT: Window</u></b>			Required Noise Reduction Is: <b>34 dB A</b>
Percentage Of Sound Energy Transmitted:			<b>59 %</b>
Room Floor Area:	<b>441 m<sup>2</sup></b>		Correction: <b>2</b>
Component Area:	<b>60 m<sup>2</sup></b>		
Component / Floor (%):	<b>14 %</b>		
Room Absorption Category:	<b>intermediate</b>		Correction: <b>-6 dB A</b>
Noise Spectrum	<b>D</b>		
Component Category	<b>c</b>		Correction: <b>4 dB A</b>
		<b>Required STC Is:</b>	<b>35</b>

## **APPENDIX D**

### **INSUL and IBANA-Calc Calculations**

## Aircraft Noise Sound Insulation - Scenario Calculation Results

**Project:** Salvation Army - Worship and Gym

**Date:** 9/23/2016 | **ProjectID:** GWE15-009

**Outdoor level:** NEF 35 or Leq24 67 or Ldn 68 dBA

### Source Spectrum details:

100% Standard Aircraft

### Corrections:

### Receiving room:

Floor Area: 360 m<sup>2</sup>

Absorbtion: 90% of floor area

### Construction Description:

Element 1: EX2

Construction Type: Custom Wall

Area: 691.00 m<sup>2</sup>

Test ID: EX2

Test Date: 4/4/2016

Element 2: GL6\_AIR9\_GL8

Construction Type: Glazing

Area: 50.00 m<sup>2</sup>

Test ID: CMHC177.961.6

Test Date: 11/1/1996

Thermopane only

Element 3: R2

Construction Type: Custom Roof-ceiling

Area: 360.00 m<sup>2</sup>

Test ID: InsulR2

Test Date: 9/23/2016



# Aircraft Noise Sound Insulation - Scenario Calculation Results

**Project:** Salvation Army - Worship and Gym

**Date:** 9/23/2016    **ProjectID:** GWE15-009

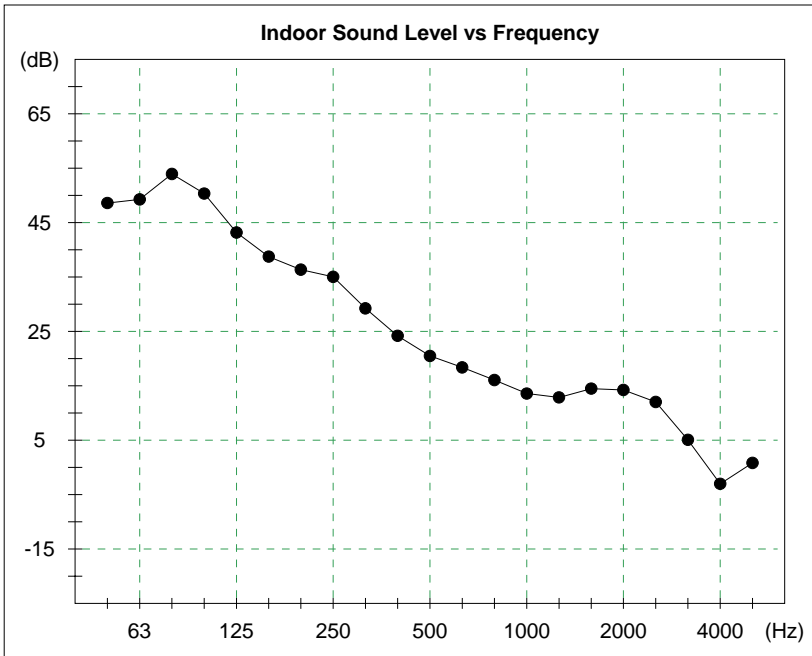

Frequency (Hz)	Sound Level (dB)
50	48.6
63	49.3
80	53.9
100	50.3
125	43.2
160	38.7
200	36.3
250	35.0
315	29.2
400	24.2
500	20.5
630	18.4
800	16.1
1000	13.6
1250	12.9
1600	14.5
2000	14.2
2500	12.0
3150	5.1
4000	-3.0
5000	0.8

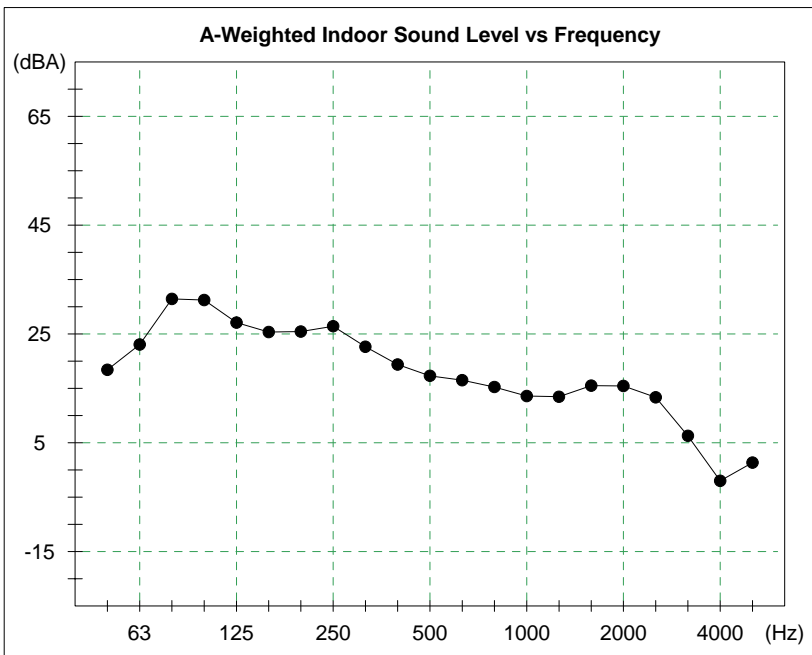

Frequency (Hz)	Sound Level (dBA)
50	18.4
63	23.1
80	31.4
100	31.2
125	27.1
160	25.3
200	25.4
250	26.4
315	22.6
400	19.4
500	17.3
630	16.5
800	15.3
1000	13.6
1250	13.5
1600	15.5
2000	15.4
2500	13.3
3150	6.3
4000	-2.0
5000	1.3



# Aircraft Noise Sound Insulation - Scenario Calculation Results

**Project:** Salvation Army - Worship and Gym

**Date:** 9/23/2016    **ProjectID:** GWE15-009

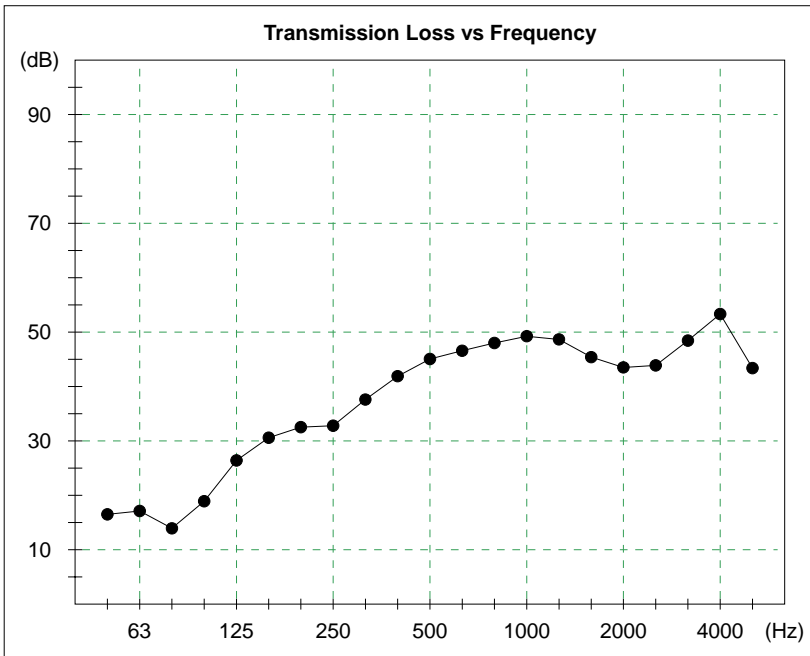

Frequency (Hz)	TL (dB)
50	17
63	17
80	14
100	19
125	26
160	31
200	33
250	33
315	38
400	42
500	45
630	47
800	48
1000	49
1250	49
1600	45
2000	44
2500	44
3150	48
4000	53
5000	43

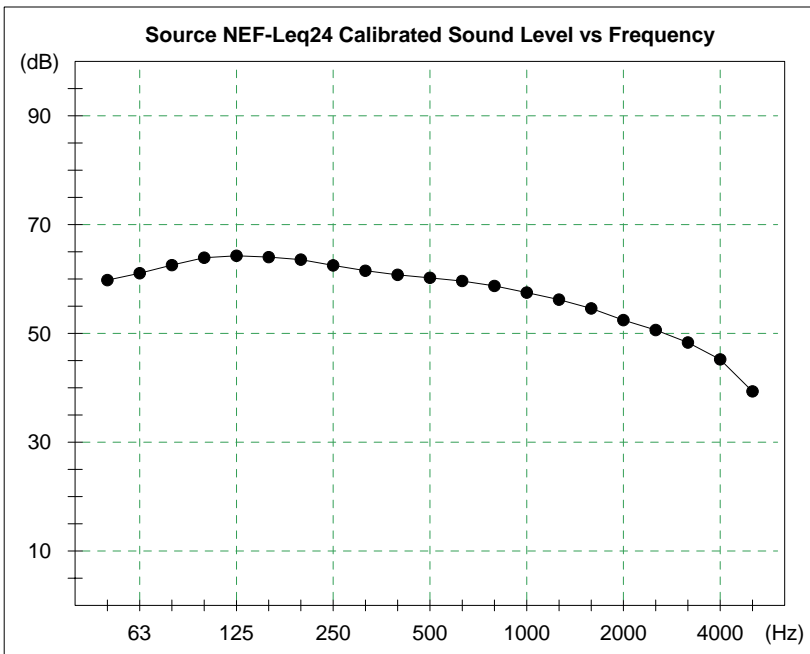

Frequency (Hz)	Sound Level (dB)
50	59.8
63	61.0
80	62.5
100	63.9
125	64.3
160	64.0
200	63.5
250	62.5
315	61.5
400	60.8
500	60.2
630	59.6
800	58.7
1000	57.5
1250	56.2
1600	54.6
2000	52.4
2500	50.6
3150	48.3
4000	45.2
5000	39.3

**Single Number Ratings:**

Outdoor Sound Level:	67 dBA
Indoor Sound Level:	37 dBA
A-wtd Level Reduction:	30 dB
A-wtd Reduction re Standard Source:	30 dB
OITC Rating:	31 dB

## Aircraft Noise Sound Insulation - Scenario Calculation Results

**Project:** Salvation Army - Sanctuary

**Date:** 9/23/2016 | **ProjectID:** GWE15-009

**Outdoor level:** NEF 35 or Leq24 67 or Ldn 68 dBA

### Source Spectrum details:

100% Standard Aircraft

### Corrections:

### Receiving room:

Floor Area: 441 m<sup>2</sup>

Absorbtion: 80% of floor area

### Construction Description:

Element 1: EX2

Construction Type: Custom Wall

Area: 394.00 m<sup>2</sup>

Test ID: EX2

Test Date: 4/4/2016

Element 2: GL3\_AIR13\_GL6

Construction Type: Window

Area: 60.00 m<sup>2</sup>

Test ID: CMHC177.961.13

Test Date: 11/1/1996

Wood casement

Element 3: R2

Construction Type: Custom Roof-ceiling

Area: 441.00 m<sup>2</sup>

Test ID: InsulR2

Test Date: 9/23/2016



# Aircraft Noise Sound Insulation - Scenario Calculation Results

**Project:** Salvation Army - Sanctuary

**Date:** 9/23/2016    **ProjectID:** GWE15-009

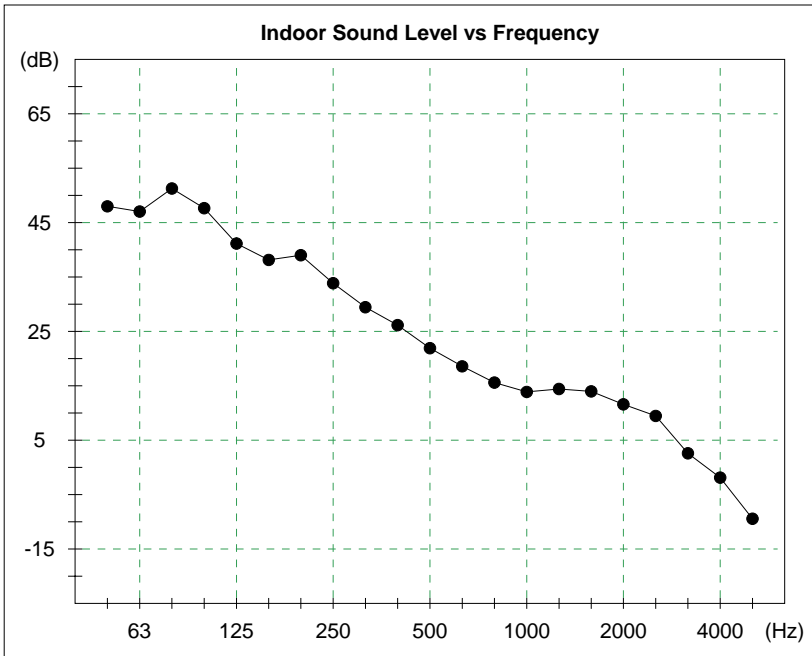

Frequency (Hz)	Sound Level (dB)
50	48.0
63	47.0
80	51.3
100	47.7
125	41.1
160	38.1
200	39.0
250	33.9
315	29.4
400	26.2
500	21.9
630	18.6
800	15.6
1000	13.9
1250	14.4
1600	14.0
2000	11.6
2500	9.5
3150	2.6
4000	-1.9
5000	-9.4

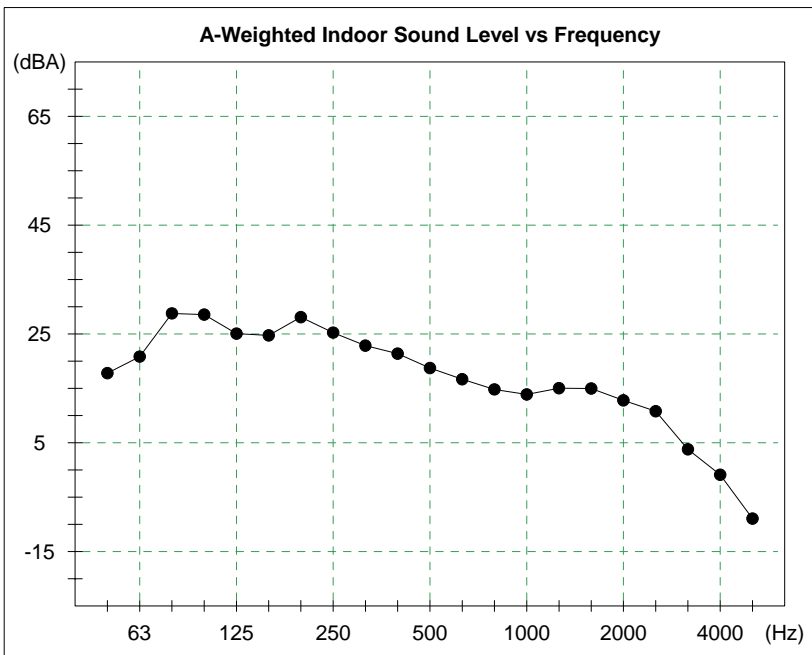

Frequency (Hz)	Sound Level (dBA)
50	17.8
63	20.8
80	28.8
100	28.6
125	25.0
160	24.7
200	28.1
250	25.3
315	22.8
400	21.4
500	18.7
630	16.7
800	14.8
1000	13.9
1250	15.0
1600	15.0
2000	12.8
2500	10.8
3150	3.8
4000	-0.9
5000	-8.9

# Aircraft Noise Sound Insulation - Scenario Calculation Results

**Project:** Salvation Army - Sanctuary

**Date:** 9/23/2016    **ProjectID:** GWE15-009

**Transmission Loss vs Frequency**

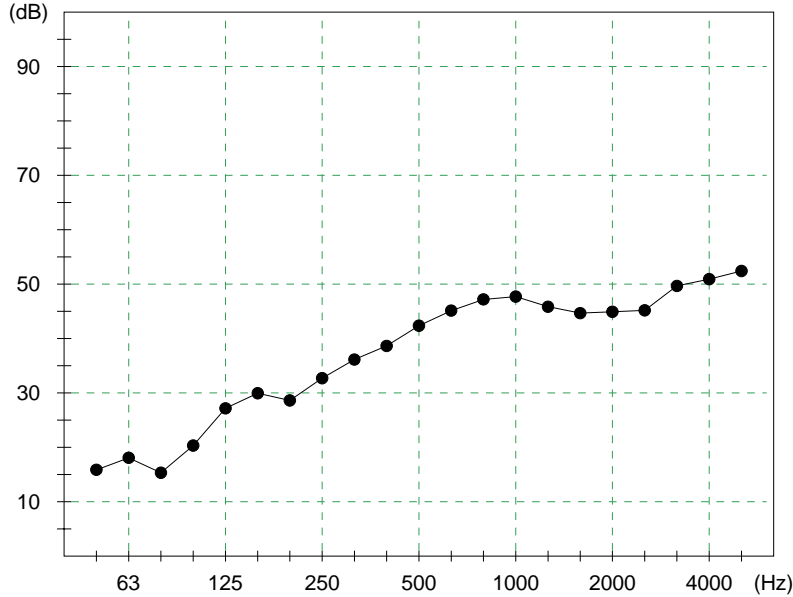

Frequency (Hz)	TL (dB)
50	16
63	18
80	15
100	20
125	27
160	30
200	29
250	33
315	36
400	39
500	42
630	45
800	47
1000	48
1250	46
1600	45
2000	45
2500	45
3150	50
4000	51
5000	52

**Source NEF-Leq24 Calibrated Sound Level vs Frequency**

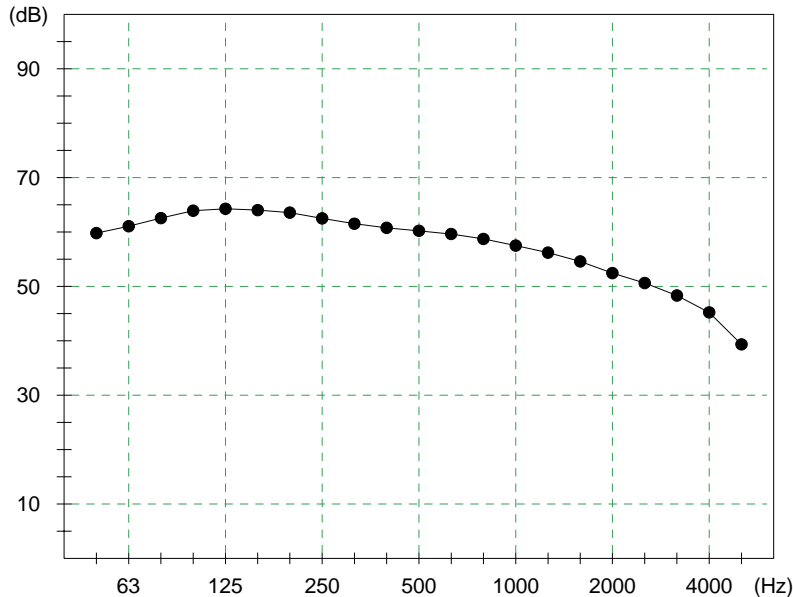

Frequency (Hz)	Sound Level (dB)
50	59.8
63	61.0
80	62.5
100	63.9
125	64.3
160	64.0
200	63.5
250	62.5
315	61.5
400	60.8
500	60.2
630	59.6
800	58.7
1000	57.5
1250	56.2
1600	54.6
2000	52.4
2500	50.6
3150	48.3
4000	45.2
5000	39.3

**Single Number Ratings:**

Outdoor Sound Level:	67 dBA
Indoor Sound Level:	36 dBA
A-wtd Level Reduction:	31 dB
A-wtd Reduction re Standard Source:	31 dB
OITC Rating:	32 dB

## Aircraft Noise Sound Insulation - Scenario Calculation Results

**Project:** Salvation Army - Multi-Purpose

**Date:** 9/23/2016 | **ProjectID:** GWE15-009

**Outdoor level:** NEF 35 or Leq24 67 or Ldn 68 dBA

### Source Spectrum details:

100% Standard Aircraft

### Corrections:

### Receiving room:

Floor Area: 120 m<sup>2</sup>

Absorbtion: 80% of floor area

### Construction Description:

Element 1: EX2

Construction Type: Custom Wall

Area: 5.00 m<sup>2</sup>

Test ID: EX2

Test Date: 4/4/2016

Element 2: GL3\_AIR13\_GL6

Construction Type: Window

Area: 30.00 m<sup>2</sup>

Test ID: CMHC177.961.13

Test Date: 11/1/1996

Wood casement

Element 3: R2

Construction Type: Custom Roof-ceiling

Area: 120.00 m<sup>2</sup>

Test ID: InsulR2

Test Date: 9/23/2016



# Aircraft Noise Sound Insulation - Scenario Calculation Results

**Project:** Salvation Army - Multi-Purpose

**Date:** 9/23/2016    **ProjectID:** GWE15-009

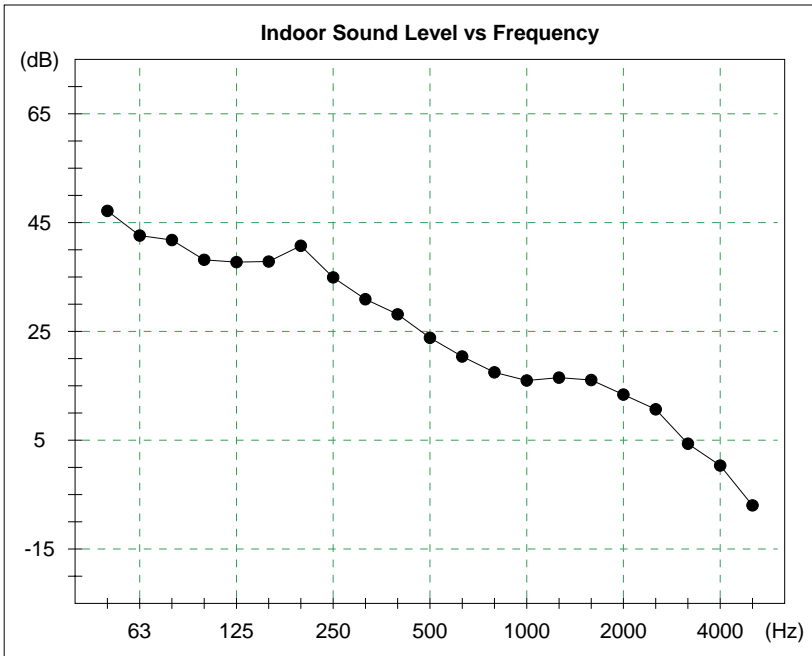

Frequency (Hz)	Sound Level (dB)
50	47.2
63	42.6
80	41.8
100	38.2
125	37.7
160	37.8
200	40.7
250	34.9
315	30.9
400	28.1
500	23.8
630	20.4
800	17.5
1000	16.0
1250	16.5
1600	16.0
2000	13.4
2500	10.7
3150	4.4
4000	0.3
5000	-7.0

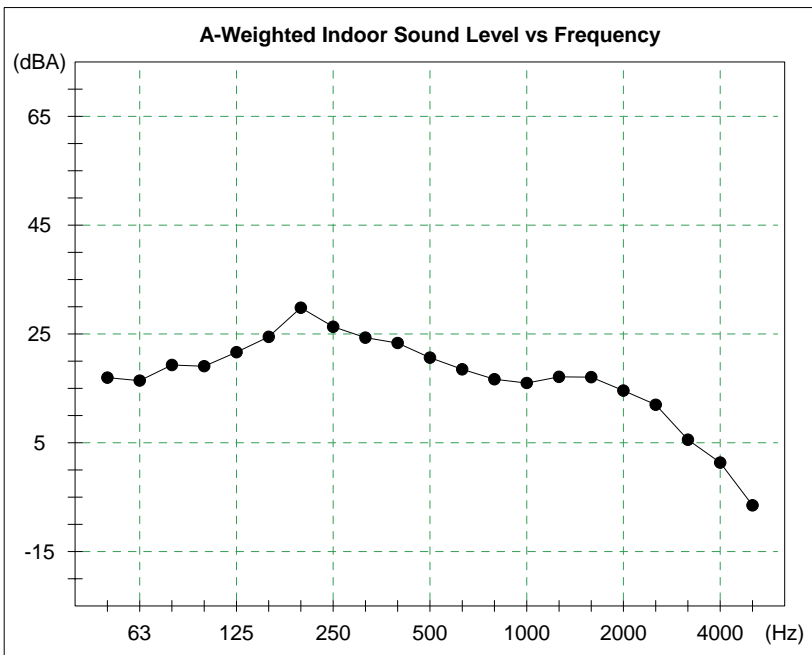

Frequency (Hz)	Sound Level (dBA)
50	17.0
63	16.4
80	19.3
100	19.1
125	21.6
160	24.4
200	29.8
250	26.3
315	24.3
400	23.3
500	20.6
630	18.5
800	16.7
1000	16.0
1250	17.1
1600	17.0
2000	14.6
2500	12.0
3150	5.6
4000	1.3
5000	-6.5

# Aircraft Noise Sound Insulation - Scenario Calculation Results

**Project:** Salvation Army - Multi-Purpose

**Date:** 9/23/2016    **ProjectID:** GWE15-009

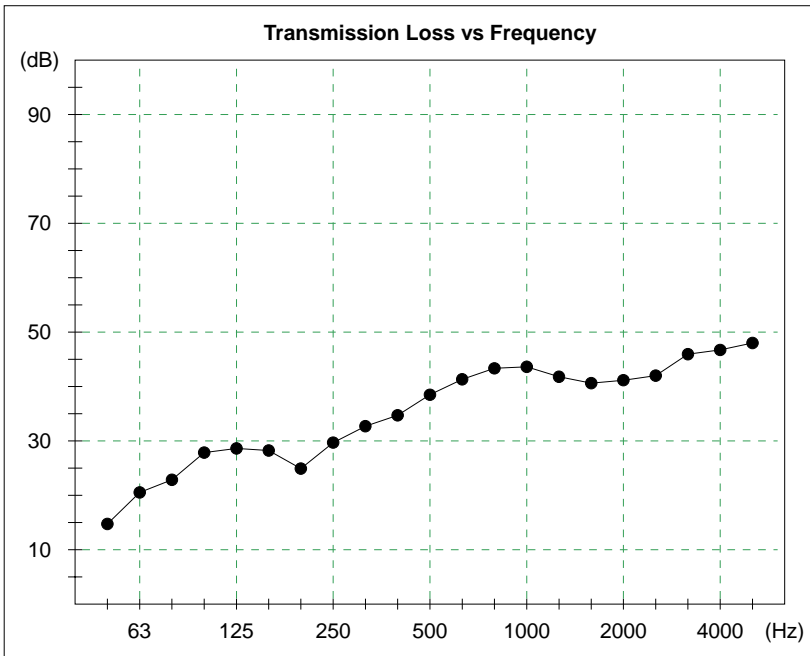

Frequency (Hz)	TL (dB)
50	15
63	21
80	23
100	28
125	29
160	28
200	25
250	30
315	33
400	35
500	38
630	41
800	43
1000	44
1250	42
1600	41
2000	41
2500	42
3150	46
4000	47
5000	48

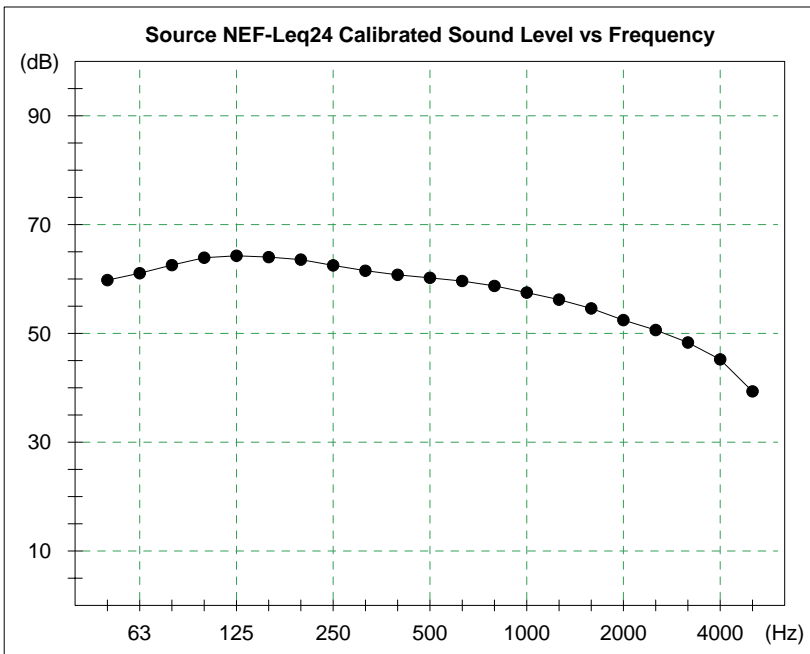

Frequency (Hz)	Sound Level (dB)
50	59.8
63	61.0
80	62.5
100	63.9
125	64.3
160	64.0
200	63.5
250	62.5
315	61.5
400	60.8
500	60.2
630	59.6
800	58.7
1000	57.5
1250	56.2
1600	54.6
2000	52.4
2500	50.6
3150	48.3
4000	45.2
5000	39.3

**Single Number Ratings:**

Outdoor Sound Level:	67 dBA
Indoor Sound Level:	35 dBA
A-wtd Level Reduction:	32 dB
A-wtd Reduction re Standard Source:	32 dB
OITC Rating:	34 dB

# Sound Insulation Prediction (v8.0.9)

Program copyright Marshall Day Acoustics 2015

- Key No. 4807

Margin of error is generally within STC +/- 3 dB

Job Name: Salvation Army

Job No.: 15-009

Page No.:

Notes:

Date: 4 Apr 16

Initials: JF

EX1

File Name: insul

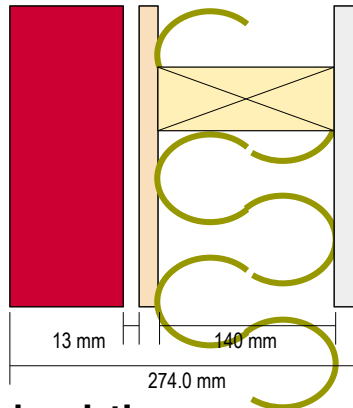

STC 66  
OITC 49

## System description

Panel 1 : 1 x 90.0 mm Brick ( $\rho$ :1600 kg/m<sup>3</sup>, $E$ :8.9GPa, $\eta$ :0.02)

Cavity: None: Stud spacing 600 mm

Panel 2 + 1 x 15.1 mm OSB (Oriented Strand Board) ( $\rho$ :562 kg/m<sup>3</sup>, $E$ :3.2GPa, $\eta$ :0.02)

Cavity: Timber stud: Stud spacing 400 mm , Infill Fibreglass (10kg/m<sup>3</sup>) Thickness 140 mm ( $\rho$ :10 kg/m<sup>3</sup>,  $R_f$ :4000 Pa.s/m<sup>2</sup>)

Panel 3 + 1 x 15.9 mm Type X Gypsum Board ( $\rho$ :690 kg/m<sup>3</sup>, $E$ :1.8GPa, $\eta$ :0.01)

Mass-air-mass resonant frequency =49 Hz , 227 Hz

Panel Size 2.7x4 m; Mass 164.9 kg/m<sup>2</sup>

frequency (Hz)	TL(dB)	TL(dB)
50	29	
63	24	27
80	31	
100	40	
125	46	44
160	49	
200	50	
250	51	51
315	54	
400	64	
500	71	68
630	77	
800	83	
1000	90	87
1250	97	
1600	99	
2000	101	100
2500	102	
3150	111	
4000	119	115
5000	125	

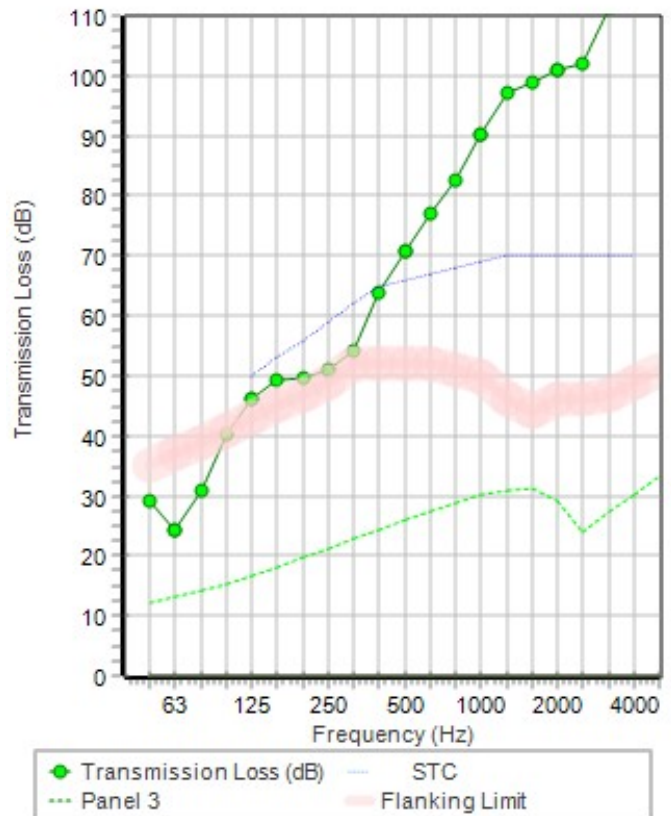



# Sound Insulation Prediction (v8.0.9)

Program copyright Marshall Day Acoustics 2015



- Key No. 4807

Margin of error is generally within STC +/- 3 dB

Job Name: Salvation Army

Job No.: 15-009

Page No.:

Notes:

Date: 4 Apr 16

Initials: JF

EX2

File Name: insul

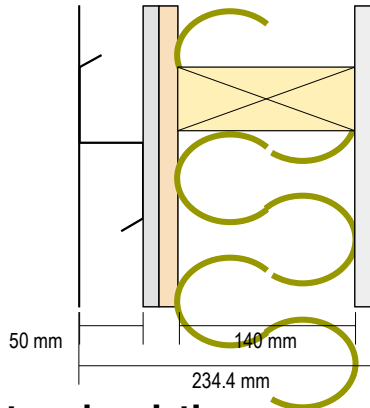

STC 48

OITC 29

## System description

Panel 1 : 1 x 0.7 mm Aluminium ( $\rho$ :2900 kg/m<sup>3</sup>, $E$ :85GPa, $\eta$ :0.01)

Cavity: Z Girt: Stud spacing 600 mm

Panel 2 + 1 x 12.7 mm DensGlass® Sheathing Georgia Pa ( $\rho$ :710 kg/m<sup>3</sup>, $E$ :2GPa, $\eta$ :0.01) + 1 x 15.1 mm OSB (Oriented Strand Board) ( $\rho$ :562 kg/m<sup>3</sup>, $E$ :3.2GPa, $\eta$ :0.02)

Cavity: Timber stud: Stud spacing 400 mm , Infill Fibreglass (10kg/m<sup>3</sup>) Thickness 140 mm ( $\rho$ :10 kg/m<sup>3</sup>, $R_f$ :4000 Pa.s/m<sup>2</sup>)

Panel 3 + 1 x 15.9 mm Type X Gypsum Board ( $\rho$ :690 kg/m<sup>3</sup>, $E$ :1.8GPa, $\eta$ :0.01)

Mass-air-mass resonant frequency =60 Hz , 236 Hz

Panel Size 2.7x4 m; Mass 31.9 kg/m<sup>2</sup>

frequency (Hz)	TL(dB)	TL(dB)
50	19	
63	16	15
80	12	
100	17	
125	25	21
160	30	
200	33	
250	35	35
315	40	
400	46	
500	51	49
630	54	
800	57	
1000	59	56
1250	54	
1600	55	
2000	55	55
2500	55	
3150	63	
4000	64	64
5000	66	

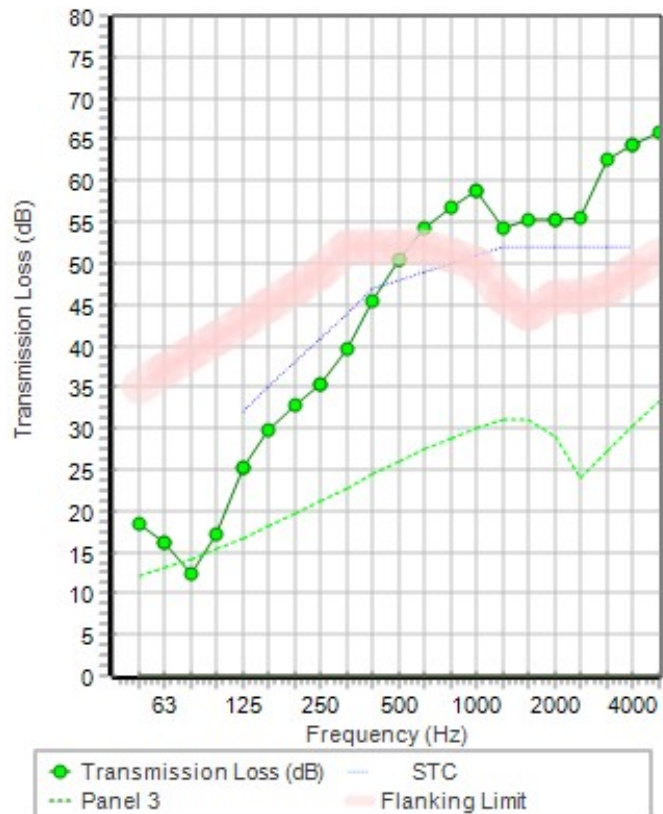

# Sound Insulation Prediction (v8.0.9)

Program copyright Marshall Day Acoustics 2015

- Key No. 4807

Margin of error is generally within STC +/- 3 dB

Job Name: Salvation Army

Job No.: 15-009

Page No.:

Notes:

Date: 4 Apr 16

Initials: JF

EX3

File Name: insul

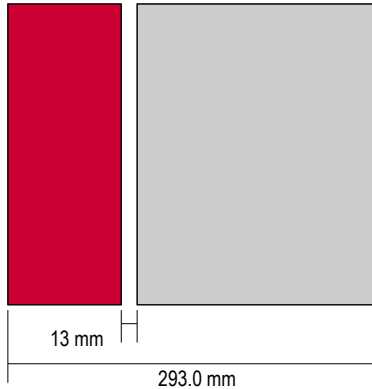

STC 64

OITC 45

## System description

Panel 1 : 1 x 90.0 mm Brick ( $\rho$ :1600 kg/m<sup>3</sup>, $E$ :8.9GPa, $\eta$ :0.02)

Cavity: None: Stud spacing 600 mm

Panel 2 + 1 x 190.0 mm CMU Hollow (95 lb/ft<sup>3</sup>) ( $\rho$ :775 kg/m<sup>3</sup>, $E$ :1.9GPa, $\eta$ :0.02)

Mass-air-mass resonant frequency =60 Hz

Panel Size 2.7x4 m; Mass 291.3 kg/m<sup>2</sup>

frequency (Hz)	TL(dB)	TL(dB)
50	33	
63	19	23
80	27	
100	35	
125	41	39
160	46	
200	49	
250	50	50
315	53	
400	65	
500	69	68
630	73	
800	76	
1000	80	79
1250	84	
1600	88	
2000	92	91
2500	96	
3150	100	
4000	101	100
5000	100	

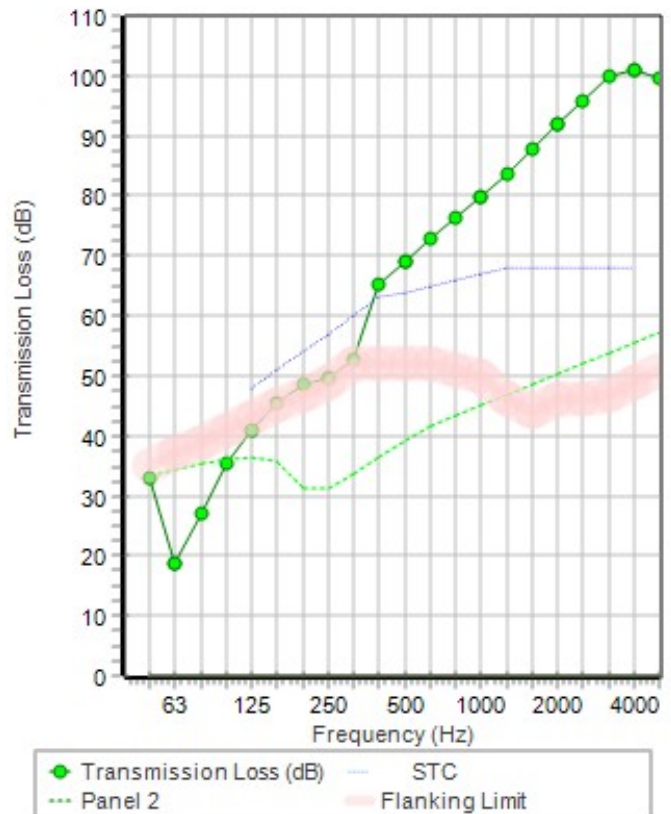

# Sound Insulation Prediction (v8.0.9)

Program copyright Marshall Day Acoustics 2015

- Key No. 4807

Margin of error is generally within STC +/- 3 dB

Job Name: Salvation Army

Job No.: 15-00

Page No.:

Notes:

Date: 5 Apr 16

Initials: JF

R1

File Name: insul

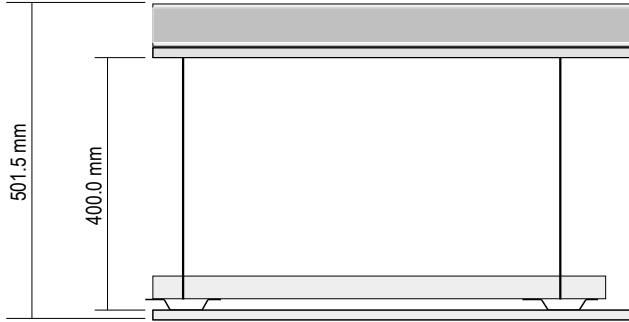

STC 50  
OITC 44

## System description

Panel 1 : 1 x 69.7 mm DensDeck Roof Board-Polyiso-DensDeck Roof Boa

+ 1 x 15.9 mm DensDeck Roof Board® Georgia Pa (p:767 kg/m<sup>3</sup>,E:2.3GPa,η:0.01)

Cavity: Suspended light steel grid: Stud spacing 600 mm

Panel 2 + 1 x 15.9 mm Type X Gypsum Board (p:690 kg/m<sup>3</sup>,E:1.8GPa,η:0.01)

Mass-air-mass resonant frequency =33 Hz

Panel Size 2.7x4 m; Mass 38.0 kg/m<sup>2</sup>

frequency (Hz)	TL(dB)	TL(dB)
50	19	
63	25	23
80	30	
100	35	
125	38	37
160	39	
200	41	
250	43	43
315	45	
400	47	
500	48	48
630	49	
800	50	
1000	49	48
1250	47	
1600	47	
2000	53	50
2500	58	
3150	63	
4000	68	66
5000	72	

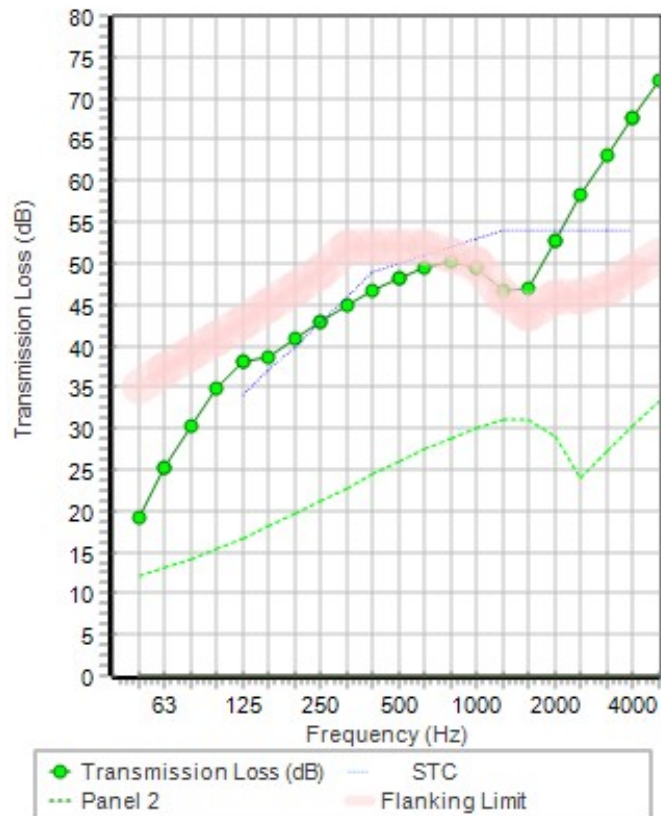

# Sound Insulation Prediction (v8.0.9)

Program copyright Marshall Day Acoustics 2015

- Key No. 4807

Margin of error is generally within STC +/- 3 dB

Job Name: Salvation Army

Job No.: 15-00

Page No.:

Notes:

Date: 5 Apr 16

Initials: JF

R2

File Name: insul

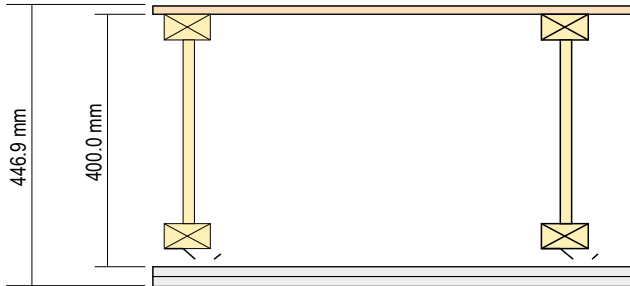

STC 48

OITC 40

## System description

Panel 1 : 1 x 15.1 mm OSB (Oriented Strand Board) ( $\rho$ :562 kg/m<sup>3</sup>,E:3.2GPa, $\eta$ :0.02)

Cavity: Resilient clip or channel: Stud spacing 600 mm

Panel 2 + 2 x 15.9 mm Type X Gypsum Board ( $\rho$ :690 kg/m<sup>3</sup>,E:1.8GPa, $\eta$ :0.01)

Mass-air-mass resonant frequency =37 Hz

Panel Size 2.7x4 m; Mass 30.4 kg/m<sup>2</sup>

frequency (Hz)	TL(dB)	TL(dB)
50	14	
63	21	18
80	26	
100	31	
125	34	33
160	35	
200	37	
250	39	39
315	42	
400	44	
500	46	46
630	48	
800	50	
1000	52	51
1250	52	
1600	49	
2000	47	47
2500	45	
3150	51	
4000	56	54
5000	62	

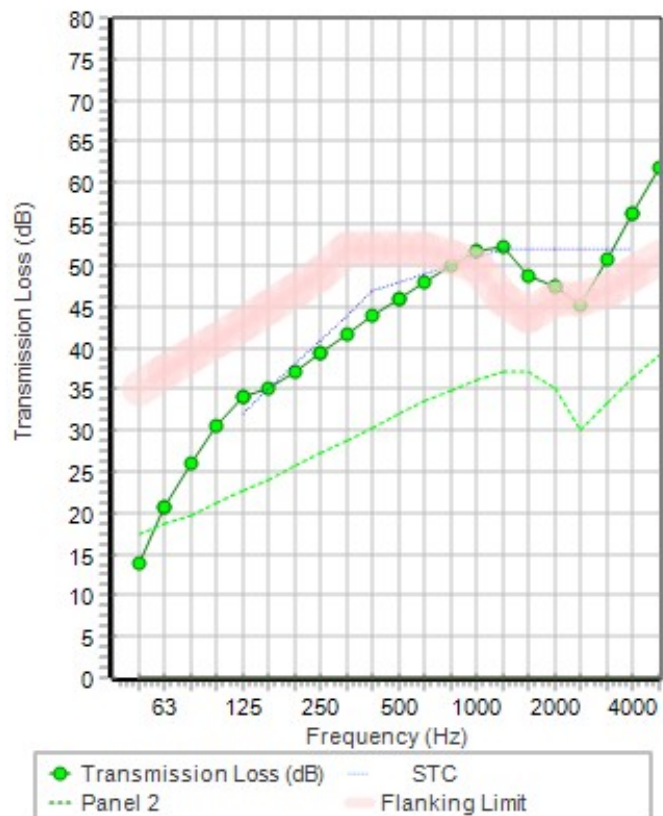

# Sound Insulation Prediction (v8.0.9)

Program copyright Marshall Day Acoustics 2015

- Key No. 4807

Margin of error is generally within STC +/- 3 dB

Job Name: Salvation Army

Job No.: 15-00

Page No.:

Notes:

Date: 5 Apr 16

Initials: JF

R3

File Name: insul

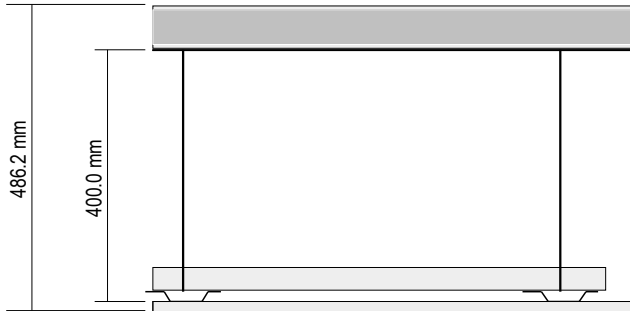

STC 48  
OITC 41

## System description

Panel 1 : 1 x 69.7 mm DensDeck Roof Board-Polyiso-DensDeck Roof Boa

+ 1 x 0.6 mm Steel Roofing (PBR Panels) (p:7800 kg/m<sup>3</sup>,E:2.1E02GPa,η:0.01)

Cavity: Suspended light steel grid: Stud spacing 600 mm

Panel 2 + 1 x 15.9 mm Type X Gypsum Board (p:690 kg/m<sup>3</sup>,E:1.8GPa,η:0.01)

Mass-air-mass resonant frequency =34 Hz

Panel Size 2.7x4 m; Mass 31.1 kg/m<sup>2</sup>

frequency (Hz)	TL(dB)	TL(dB)
50	16	
63	23	20
80	28	
100	32	
125	36	34
160	36	
200	38	
250	41	40
315	43	
400	44	
500	46	46
630	47	
800	48	
1000	47	46
1250	45	
1600	46	
2000	53	50
2500	56	
3150	62	
4000	66	65
5000	71	

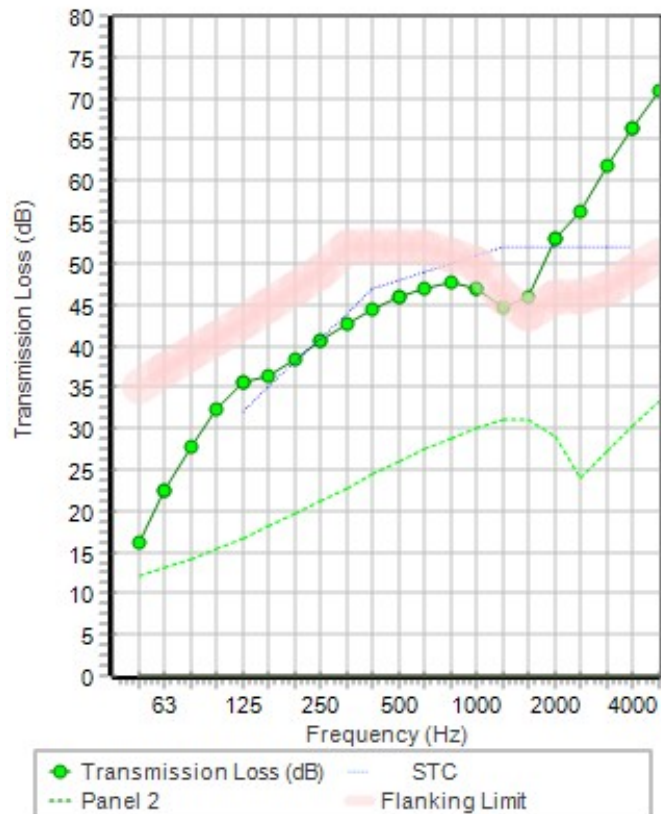

# Sound Insulation Prediction (v8.0.9)

Program copyright Marshall Day Acoustics 2015

- Key No. 4807

Margin of error is generally within STC +/- 3 dB

Job Name: Salvation Army

Job No.: 15-00

Page No.:

Notes:

Date: 5 Apr 16

Initials: JF

R4

File Name: insul

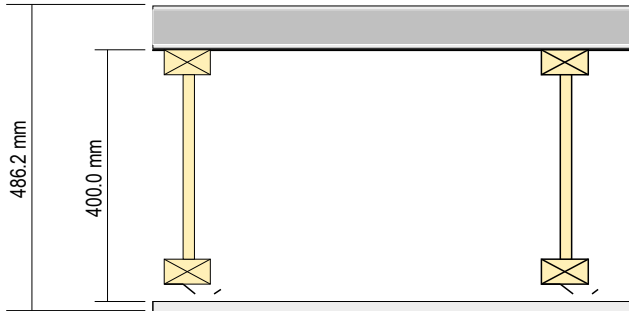

STC 48  
OITC 41

## System description

Panel 1 : 1 x 69.7 mm DensDeck Roof Board-Polyiso-DensDeck Roof Boa

+ 1 x 0.6 mm Steel Roofing (PBR Panels) ( $\rho$ :7800 kg/m<sup>3</sup>, $E$ :2.1E02GPa, $\eta$ :0.01)

Cavity: Resilient clip or channel: Stud spacing 600 mm

Panel 2 + 1 x 15.9 mm Type X Gypsum Board ( $\rho$ :690 kg/m<sup>3</sup>, $E$ :1.8GPa, $\eta$ :0.01)

Mass-air-mass resonant frequency =34 Hz

Panel Size 2.7x4 m; Mass 31.1 kg/m<sup>2</sup>

frequency (Hz)	TL(dB)	TL(dB)
50	16	
63	22	20
80	28	
100	32	
125	35	34
160	36	
200	38	
250	40	40
315	42	
400	44	
500	46	45
630	47	
800	48	
1000	47	46
1250	45	
1600	46	
2000	53	50
2500	56	
3150	62	
4000	67	65
5000	72	

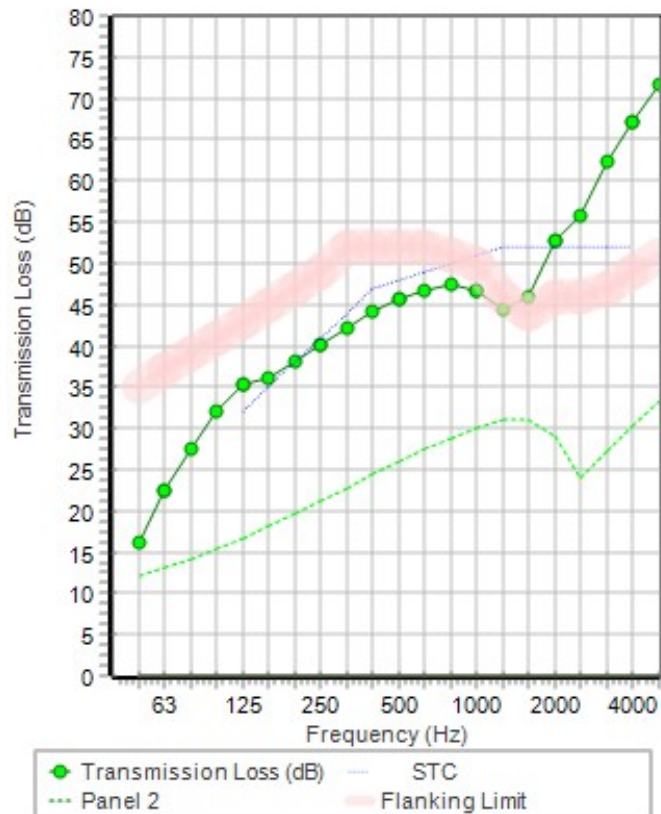

## **APPENDIX E**

### **Ottawa International Airport Authority Correspondence**

## Michael Lafortune

---

**From:** Stecky-Efantis, Alexander <alexander.stecky-efantis@yow.ca>  
**Sent:** October-04-16 3:24 PM  
**To:** Beth Henderson; Kealey, Krista  
**Cc:** Joshua Foster  
**Subject:** RE: Barrhaven Salvation Army proposal

Hi Beth,

Thank you for coming to the airport last week to meet with us regarding the development proposal and for your follow-up call.

As requested, I would like to provide some additional information on the limited operations on runway 07/25 this August. There were three weeks when the runway was open; however, taxiway bravo, which is one of the ways to access runway 07/25 was restricted to certain size aircraft due to construction. During this time from August 6<sup>th</sup> to the end of the month, aircraft movement on runway 07/25 were limited. There were also two days (August 9<sup>th</sup> and 10<sup>th</sup>) where the runway was closed for pest control. Finally, the runway was also closed on August 31<sup>st</sup> and September 2<sup>nd</sup> for rubber removal maintenance.

Please let me know if you have any questions or require additional information.

Regards,  
Alex

### Alexander Stecky-Efantis

Manager, Airport Planning and Municipal Affairs  
Ottawa International Airport Authority  
Gestionnaire, Planification aéroportuaire et affaires municipales  
Administration de l'aéroport international d'Ottawa

Tel. / Tél. : 613-248-2000x1909  
Fax / Téléc. : 613-248-2021



---

**From:** Beth Henderson [<mailto:bethhenderson@bell.net>]  
**Sent:** September-28-16 3:57 PM  
**To:** Stecky-Efantis, Alexander; Kealey, Krista



Cc: [Jeff Barrett@can.salvationarmy.org](mailto:Jeff_Barrett@can.salvationarmy.org); [James Mercer@can.salvationarmy.org](mailto:James_Mercer@can.salvationarmy.org); 'Joshua Foster'; Miguel Tremblay; [Michaela Jones@can.salvationarmy.org](mailto:Michaela_Jones@can.salvationarmy.org)

**Subject:** Barrhaven Salvation Army proposal

Good afternoon Krista and Alex

Thank you for taking the time to meet with us today to discuss the Salvation Army Church's proposal at 102 Bill Leathem Drive. I believe the exchange of information and ideas was constructive and beneficial as we move forward in the development application process.

Through this email I will request that Joshua Foster contact Alex to obtain the dates that the main east west runway was not active or significantly below the normal usage due to the resurfacing during the on site monitoring that was conducted by Gradient engineering on the proposed site.

Also it would be great if you could send the proposed 2043 contour mapping that was discussed.

As discussed I will contact the city planner on this file and ensure that the airport authority is circulated on the next submission.

Thank you again for your time and consideration and we look forward to discussing the application with you or answering any of your questions that may arise upon review of the second submission.

Sincerely,  
Beth Henderson