

FREEFIELD LTD.

Ottawa, Ontario, Canada

**TRAFFIC NOISE IMPACT
ASSESSMENT
FOR THE
PROPOSED RESIDENTIAL
DEVELOPMENT
AT
211 CLARENCE STREET**

CITY OF OTTAWA



Prepared for

Clarence Gate Holdings Inc.

Prepared by

Freefield Ltd.

25th February 2022

TRAFFIC NOISE IMPACT ASSESSMENT FOR THE PROPOSED RESIDENTIAL DEVELOPMENT AT 211 CLARENCE STREET CITY OF OTTAWA

Table of Contents

Section		Page
Table of Contents		i
1.	Introduction	1
2.	Methodology and Assessment Criteria	3
3.	Points of Reception	5
4.	Noise Source Modeling and Data	6
5.	Noise Impact Assessment	7
6.	Conclusions and Recommendations	10
References		12
Figures		13
Tables		21
Appendix 1	City of Ottawa Noise Criteria and Warning Clauses	28
Appendix 2	Calculation Details and Software Outputs	34
Resumes	Dr. Hugh Williamson, Michael Wells	

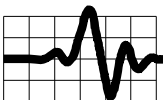

TRAFFIC NOISE IMPACT ASSESSMENT FOR THE PROPOSED RESIDENTIAL DEVELOPMENT AT 211 CLARENCE STREET CITY OF OTTAWA

1.0 Introduction

Freefield Ltd. has been retained by Clarence Gate Holdings Inc. to undertake a traffic noise impact assessment in relation to satisfying the City of Ottawa Environmental Noise Control Guidelines (ENCG) for the proposed nine storey multi-unit residential condominium building to be located at 211 Clarence Street, City of Ottawa, Ontario.

This report describes an assessment of noise impacts from surface transportation including road traffic on Murray Street and King Edward Avenue at the interior and exterior noise sensitive areas of the proposed development.

This assessment has been carried out in accordance with the City of Ottawa *Environmental Noise Control Guidelines, January 2016* (ENCG)¹ and Ministry of Environment, Conservation and Parks (MECP) publication, *NPC-300*² by Freefield Ltd.

This analysis is based on drawings and information received electronically from Art House Developments.

General Description of the Site

Directions in this report refer to site north as shown on Figure 1.

The site is on the north side of Clarence Street located at an approximate distance of 42.5 m south of Murray Street and 110 m west of King Edward Avenue.

The site and surrounding area are zoned Residential Fourth Density (R4) and consists of relatively flat topography with no significant changes in elevation.

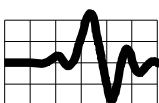

The primary source of environmental noise impacting the site is vehicular traffic on Murray Street and King Edward Avenue.

St. Patrick Avenue located in a northerly direction, Rideau Street located in a southerly direction and Dalhousie Street, located in a westerly direction, are greater than 100 m from the site, hence, noise from these roads is not required to be assessed as per ENCG criteria.

Refer to Figure 1 showing the location of the site with respect to the surrounding area.

General Description of the Proposed Development

The proposed development comprises a nine storey multi-unit residential condominium building rising to approximately 25.98 m above grade. The building will comprise of 34 residential condominiums.

The building consists of one basement level approximately 2.6 m below grade, with the ground to the ninth-floor levels elevated. Residential condominiums are located on each level of the proposed development.

The development includes a common outdoor amenity area (outdoor living area) located on the ninth floor of the building.

Refer to Figures 2 to 7.

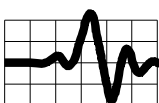

2.0 Methodology and Assessment Criteria

The outdoor and indoor noise criteria, sound level limits, are provided in Appendix 1. These limits are to be met by proposed noise sensitive developments using control measures such as site design, set-backs, noise barriers, acoustical requirements for building components and ventilation requirements. In some circumstances, warning clauses related to noise are required on titles, leases and sale agreements.

The noise assessment methodology is summarised as follows:

- Noise generated by road traffic is predicted using STAMSON^{3,4}, a traffic noise model developed by the MECP. STAMSON takes into account such factors as distance from the road, height, nature of the intervening buildings and terrain, ground absorption, and noise barriers, if present.
- Noise from future road traffic is predicted using STAMSON at critical points of reception at the proposed development. Locations to be considered include outdoor living areas (OLA) as well as ‘plane of window’ (POW) locations, where rooms for living or sleeping are provided. Noise levels are predicted as A-weighted equivalent sound levels, L_{EQ} , (i.e. average levels) for various periods such as Day (07:00 to 23:00) and Night (23:00 to 07:00) periods. A-weighting is a frequency correction to sound pressure levels which approximates the response of the human ear and is used extensively for environmental noise assessments. Results are expressed in dBA, A-weighted decibels.
- Based on the predicted sound levels, the specifications for mitigation measures such as noise barriers, building component requirements, ventilation requirements and warning clauses, are determined according to criteria established by the City of Ottawa ENCG and MECP guidelines including NPC-300.

The noise criteria for outdoor living areas and indoor living areas are set out in Tables A1.1 and A1.2, Appendix 1.

Where building components need to be designed to achieve specific indoor sound levels, restrictions apply such as the construction assembly and areas of walls, windows, and doors.

The City of Ottawa ENCG requires indoor noise impacts to be calculated based on the proposed construction assembly of the building to ensure compliance to the applicable indoor noise criteria. The MECP criteria contained in NPC-300 set outdoor noise thresholds to determine the need for building component design.

Based on the predicted exterior noise levels indoors noise levels have been calculated at worst case living room and bedroom locations for both daytime and nighttime periods. Refer section 5.0 and a summary of the provincial criteria in Table A1.3, Appendix 1.

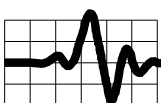

The ventilation requirements, outdoor noise control measures and warning clause requirements are dependent on predicted outdoor noise levels. Warning clauses, when required, are to be placed on title documents, sale agreements, and lease agreements. Refer ENCG Table A1 Surface Transportation Warning Clauses and the more specific provincial warning clauses taken from NPC-300² Section C8 Warning Clauses that are summarised in Appendix 1.

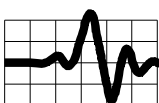

3.0 Points of Reception

For the evaluation of noise impacts, the critical points of reception, POR 1 to POR 4, were chosen at the north and eastern facades of the residential development, facing Murray Street and King Edward Avenue, and at the developments outdoor living area located on the ninth floor of the building. These locations represent worst case noise impacts at the proposed development, hence, compliance at these locations will ensure compliance at all other locations on the development.

POR 1 is located at the fourth-floor level plane of window location representing a living / bedroom location with 180 degrees exposure to Murray Street and 90 degrees exposure to King Edward Avenue.

POR 2 is located at the ninth-floor level plane of window location representing a living / bedroom location with 180 degrees exposure to Murray Street and 90 degrees exposure to King Edward Avenue.

POR 3 is located at the ninth-floor level, centre of exterior wall, representing a living / bedroom location with 90 degrees exposure to Murray Street and 180 degrees exposure to King Edward Avenue.

POR 4 was assessed at the developments outdoor living area, located on the ninth floor of the building of the building facing Clarence Street, with 180 degrees exposure to Murray Street and 180 degrees exposure to King Edward Avenue. Shielding by the proposed ninth floor of the building located north of the proposed OLA has been incorporated into the modelling.

The points of reception are listed in Table 1 and shown in Figures 2 to 7.

Outdoor sound levels are predicted at the critical points of reception. The predicted sound levels at each point of reception are then used to determine the requirements for mitigation needed to achieve the complying indoor sound levels as set out in in Appendix 1.

For assessment of indoor sound levels, point of reception, POR 1 was selected at location on the building most exposed to noise for daytime and nighttime periods at the worst-case living and bedroom location on the fourth floor. Levels at POR 3, located on the ninth floor, were used to calculate indoor noise impacts at the fourth floor living and bedroom location. This is a conservative approach as upper floors tend to be more exposed to environmental noise. Points of reception, POR 2 and POR 3, were selected at locations on the building most exposed to noise for daytime and nighttime periods at the developments worst-case living and bedroom location on the ninth floor.

Outdoor sound levels were calculated at these worst-case locations, 10.1 m above grade on the fourth-floor level and 24.3 m above grade on the ninth floor, representing the approximate centre of the windows located on each of these levels. Plane of window locations are used as windows represent the least ‘sound attenuating’ building component of the exterior partition. Refer to Table 1 and Figures 2 to 7.

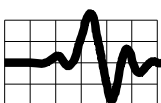

4.0 Noise Source Modelling and Data

The following road traffic data was used to assess the traffic noise impacts at each point of reception on the development. The data was taken from the City of Ottawa ENCG which provides ultimate future traffic volume data for various roadways based on roadway class and number of lanes. The traffic data used represents future traffic volumes and correspond to a 'mature state of development', in the City's Official Plan.¹

- Murray Street is assessed as a 2-Lane Urban Arterial (2-UAU) with 15,000 AADT, posted speed limit of 50 km/hr. Murray Street is assessed as a single two-lane segment, S1.
- King Edward Avenue is assessed as a 6-Lane Urban Arterial Divided (6-UAD) with 50,000 AADT, posted speed limit of 60 km/hr. King Edward Avenue is assessed as three two-lane segments, S2, S3 and S4.

The proportion of traffic type and times used to develop the traffic data for the road segment consists of a 92/8 day/night split with 7% medium trucks and 5% heavy trucks by volume as set out in Appendix B, City of Ottawa Environmental Noise Control Guidelines.¹

The surrounding topography was assessed as a generally flat, reflective surface.

Refer to Table 2: Future Traffic Volumes and Posted Speed Limits.

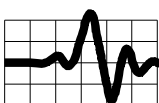

5.0 Noise Impact Assessment

Based on the future traffic projections, sound levels were predicted at each of the worst-case points of reception, POR 1 to POR 4, using the MECP STAMSON noise modelling software. The results of predictions are contained in Tables 1 to 6. Samples of the outputs of the STAMSON software are provided in Appendix 2.

In the following, the implications of the estimated future noise levels in relation to ENCG and NPC-300 criteria, as set out in Appendix 1, are discussed.

The requirement for building components, ventilation, and warning clauses, as noted below, apply to the development.

Building Components

The City of Ottawa ENCG provides indoor sound level criteria for noise sensitive spaces including living, dining, and sleeping areas of residences. This criterion is based on the provincial guideline, NPC-300, and is to be met by the design of building components including the walls, windows and doors of the proposed development.

To assess compliance POR 1, POR 2 and POR 3 were selected at locations which represent the worst-case noise impact, that is, the part of the building most exposed to road traffic noise, hence, the building components designed for these locations are sufficient to meet the indoor sound level criteria at all locations on the building.

Indoor sound levels in the developments worst case fourth floor bedroom and ninth floor living room have been estimated using standard acoustical procedures, see IBANA-Calculation output in Appendix 2, which takes into account window areas, wall areas, room sizes and room absorption, as well as the sound transmission characteristic of the external walls and windows and the proposed construction assembly of the building.

The proposed construction assembly of the building will consist of the following assemblies:

EXTERIOR WALLS

- Exterior walls, Ground to Level 6, will be 8" concrete with insulated concrete form (ICF) constructed with 2.5" Styrofoam, 8" concrete, 2.5" Styrofoam with 1 x layer minimum 13 mm gypsum board interior side. Exterior cladding to be determined.
- Exterior walls, Level 7 to Level 9, will be 6" concrete with insulated concrete form (ICF) constructed with 2.5" Styrofoam, 8" concrete, 2.5" Styrofoam with 1 x layer minimum 13 mm gypsum board interior side. Exterior cladding to be determined.

WINDOWS AND PATIO DOORS:

- Thermally broken double-glazed fiberglass sliding patio doors fixed windows.

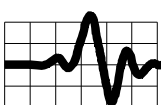

In order to consider worst case interior noise impacts the following construction assemblies where considered:

- External walls have been modelled as stucco, on concrete filled ICF including 6” thick concrete core, with 1 layer of 13 mm gypsum board attached to web interior side with a minimum STC rating of 48.
- Windows have been modelled as Vinyl, double pane sliding windows, with 3 mm glass, 13 mm air gap and 3 mm glass (seals not taped), with minimum STC rating of 27.

Sound transmission characteristics used in this analysis are based on National Research Council (NRC) and Intertek test report for ICF, as shown in Appendix 2.

As shown in Table 5 the resulting estimates of indoor sound levels comply with the daytime and nighttime sound level criteria. As such, with the proposed wall and window construction indoor sound levels will meet the indoor sound level criteria set out in Table A1.2.

Comparing the predicted outdoor sound level to provincial criteria² indicates that compliance with the Ontario Building Code is sufficient. Refer MECP publication, NPC-300, Section 7.4.

Outdoor Noise Control Measures

As shown in Table 4, future outdoor daytime noise levels at the Outdoor Living Area (OLA) Point of Reception, POR 4, are 57.8 dBA during the daytime period. As such Control Measures (such as barriers) are not required but should be considered i.e. Resultant Leq greater than 55 dBA and less than 60 dBA.

Control measures were considered, however, were considered infeasible due to significant shielding already provided by the building at the location of the OLA and the minimal benefit additional shielding provides at this location.

As future outdoor daytime noise levels at the Outdoor Living Area (OLA) Point of Reception, POR 4, are greater than 55 dBA and less than 60 dBA, the warning clause, as noted below, is required to meet City of Ottawa and MECP requirements. Refer Table 4.

Ventilation Requirements & Warning Clauses

The predicted plane of window noise levels, shown in Table 4, indicate that there is a provincial requirement in NPC-300 that the dwellings be fitted with forced air heating with the ducting etc. sized to accommodate central air-conditioning. Installation of central air-conditioning by the occupant will allow windows and exterior doors to remain closed, thereby ensuring that the indoor sound levels are within the City's and the Ministry of Environment, Conservation and Parks noise criteria.

The building is being constructed with air conditioning, hence, exceeds the minimum City of Ottawa and provincial requirement

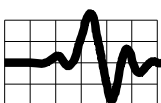

The predicted plane of window noise levels, shown in Table 4, indicate that the Warning Clause, as noted below, adapted from the ENCG and provincial guidelines, be applied.

“Purchasers/tenants are advised that sound levels due to increasing road traffic may occasionally interfere with some indoor activities when doors and windows are open as the outdoor sound levels may exceed the sound level limits of the City and the Ministry of the Environment, Conservation and Parks. To help address the need for sound attenuation this dwelling has been fitted with air conditioning which will allow windows and exterior doors to remain closed, thereby ensuring that the indoor sound levels are within the City's and the Ministry of Environment, Conservation and Parks noise criteria.

Measures for sound attenuation include:

- ***Multi-pane glass;***
- ***Provision of air conditioning.”***

In addition, Purchasers/Tenants are advised that sound levels due to increasing road traffic may occasionally interfere with outdoor activities of the dwelling occupants as the sound levels exceed the City's and the Ministry of Environment, Conservation and Parks noise criteria.”

This clause should be included in Agreements of Purchase and Sale or Lease Agreements and incorporated into the relevant Development Agreements which are registered on title of the property.

The above warning clauses are an adaptation of the “Generic” Warning Clause presented in the ENCG and the applicable provincial warning clause, Type A and Type D, required for this project. Refer Table 4.

The development is being constructed with air conditioning at units, hence, meets the minimum City of Ottawa and provincial requirement.

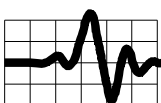

6.0 Conclusions and Recommendations

A detailed traffic noise impact assessment has been conducted for the proposed nine-storey multi-unit residential condominium building to be located at 211 Clarence Street in the City of Ottawa, Ontario.

The assessment has been carried out according to City of Ottawa Environmental Noise Control Guidelines and MECP NPC-300 taking into account future road traffic noise from Murray Street and King Edward Avenue.

The assessment has led to the following recommendations and conclusions:

- 6.1 It has been found that MECP criteria for surface transportation noise impacts can be met for the proposed development provided that the building components are constructed as noted in Section 5.0. The proposed assemblies as noted in this report meet the City of Ottawa ENCG requirement for building component design. Alternative construction is permissible providing it complies with the Ontario Building Code.
- 6.2 Future outdoor daytime noise levels at the proposed Outdoor Living Area (OLA) Point of Reception, POR 4 are greater than 55 dBA and less than 60 dBA, hence, control Measures (such as barriers) are not required but should be considered. Control measures were considered, however, were considered infeasible due to significant shielding already provided by the building at the location of the OLA and the minimal benefit additional shielding provides at this location. As the future outdoor daytime noise level at the proposed Outdoor Living Area is greater than 55 dBA, the warning clause, as noted below, is required to meet City of Ottawa and MECP requirements.
- 6.3 Outdoor sound levels exceed various thresholds for ventilation and warning clause requirements. The development is being constructed with air conditioning in all dwelling units which exceed the minimum City of Ottawa and MECP requirements.

It is recommended that the Warning Clause, as noted below, adapted from the ENCG and provincial guidelines, be applied all units.

“Purchasers/tenants are advised that sound levels due to increasing road traffic may occasionally interfere with some indoor activities when doors and windows are open as the outdoor sound levels may exceed the sound level limits of the City and the Ministry of the Environment, Conservation and Parks. To help address the need for sound attenuation this dwelling has been fitted with air conditioning which will allow windows and exterior doors to remain closed, thereby ensuring that the indoor sound levels are within the City's and the Ministry of Environment, Conservation and Parks noise criteria.

Measures for sound attenuation include:

- ***Multi-pane glass;***
- ***Provision of air conditioning.”***

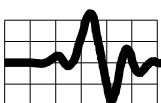

In addition, Purchasers/Tenants are advised that sound levels due to increasing road traffic may occasionally interfere with outdoor activities of the dwelling occupants as the sound levels exceed the City's and the Ministry of Environment, Conservation and Parks noise criteria."

This clause should be included in Agreements of Purchase and Sale or Lease Agreements and incorporated into the relevant Development Agreements which are registered on title of the property.



Michael Wells, B. Architecture (Hons), B.Sc. Arch. Registered Architect of NSW, ARN: 8111
Member, Canadian Acoustical Society, Member, Australian Acoustical Society, Associate Member,
INCE-USA

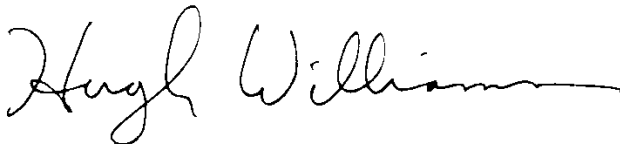

Hugh Williamson, Ph.D., P.Eng.
Member, Canadian Acoustical Society

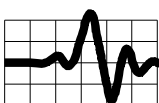

References

1. City of Ottawa *Environmental Noise Control Guidelines, January 2016.*
2. Ministry of Environment, Conservation and Parks, Publication NPC-300, *Environmental Noise Guideline Stationary and Transportation Sources - Approval and Planning*, August 2013.
3. Ministry of Environment, Conservation and Parks, *Sample Application Package, Basic Comprehensive Certificate of Approval (Air and Noise)*, July 2009.
4. Ministry of Environment, Conservation and Parks, Road Noise Analysis Method for Environment and Transportation (ORNAMENT), 1989.
5. Ministry of Environment, Conservation and Parks, STAMSON Software, Version 5.04, 1996. (Software version of References 5 and 6.)
6. City of Ottawa "*Official Plan - Annex 10*", 2011.

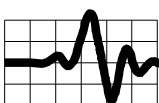

FIGURES

Contents:

- Figure 1: Area Plan, Proposed Development at 211 Clarence Street (Source: geoOttawa)**
- Figure 2: Site Plan showing Points of Reception (Source: Art House Developments)**
- Figure 3: Building Floor Plans showing Points of Reception (Source: Art House Developments)**
- Figure 4: Rear Elevation (facing Murray Street) showing Points of Reception**
- Figure 5: East Elevation (facing King Edward) showing Points of Reception**
- Figure 6: Layout of Worst Case Living and Bedroom Location (Fourth Floor)**
- Figure 7: Layout of Worst Case Living and Bedroom Location (Ninth Floor)**

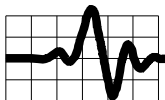

Figure 1: Area Plan, Proposed Development at 211 Clarence Street (Source: geoOttawa)

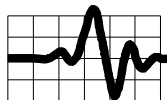
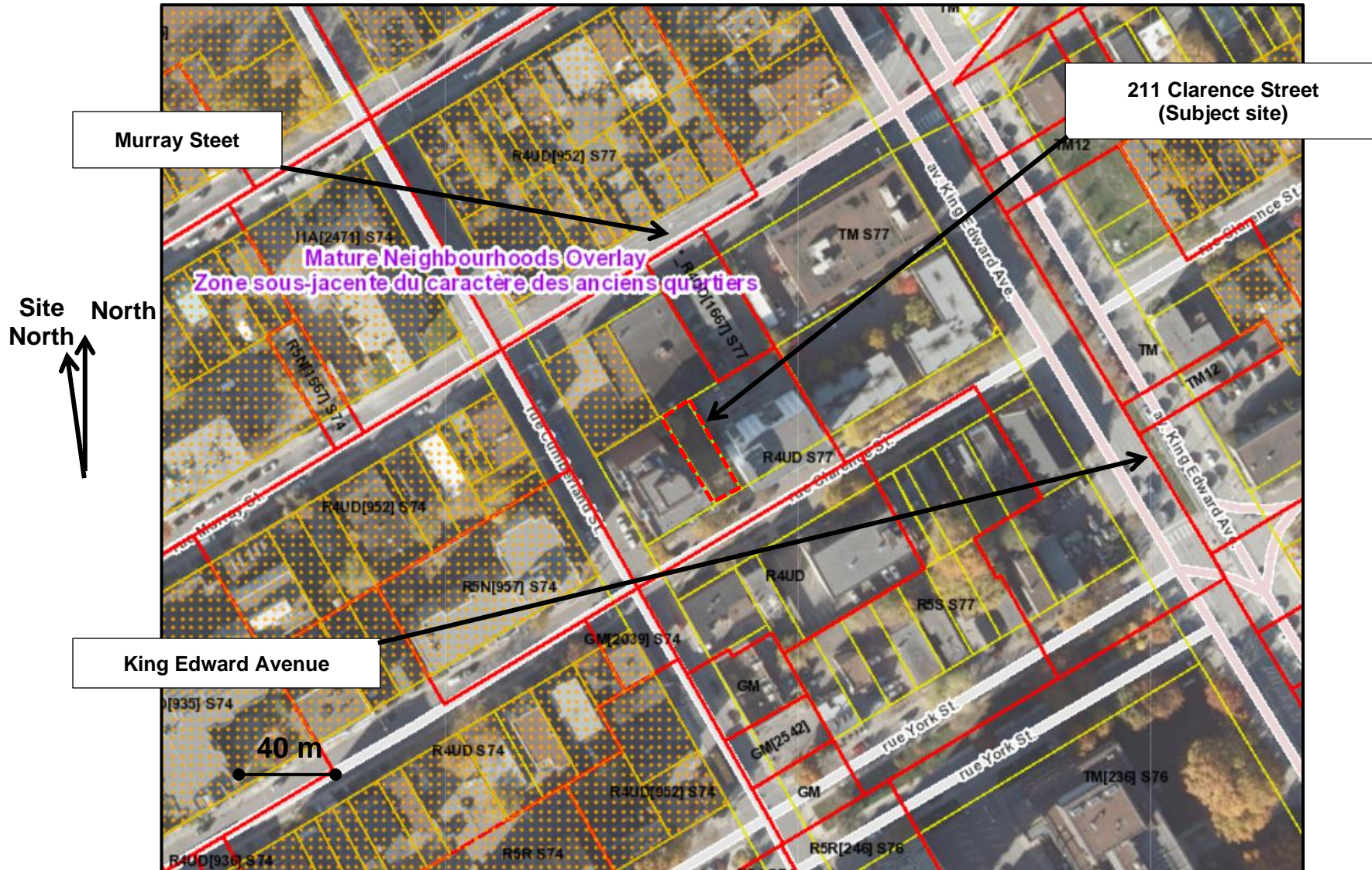

Figure 2: Site Plan showing Points of Reception (Source: Art House Developments)
Refer Table 1 for distance and angle of exposure to Murray Street & King Edward Avenue

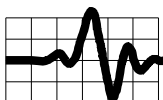
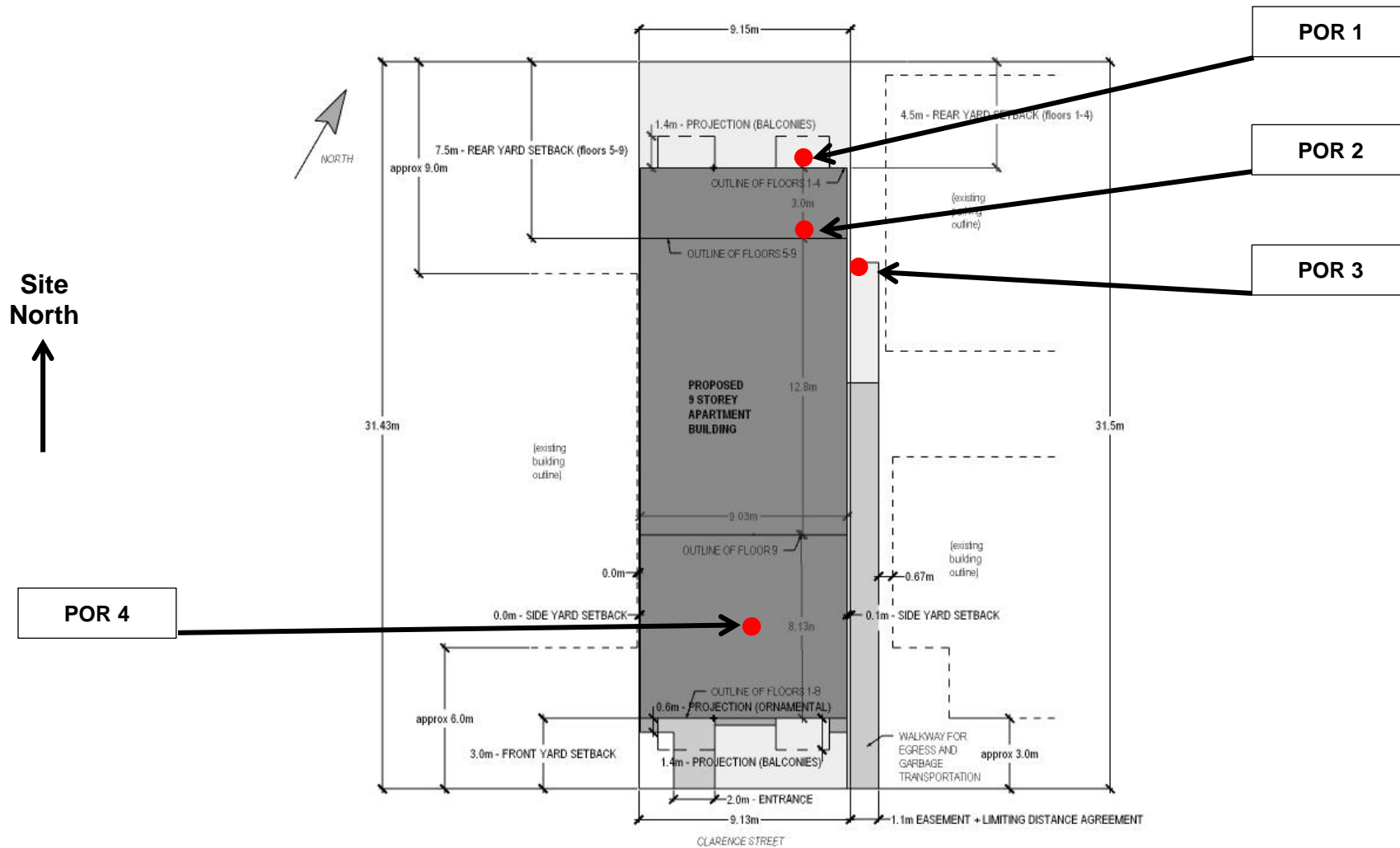

Figure 3: Building Floor Plans showing Points of Reception (Source: Art House Developments)

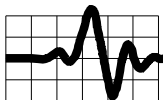
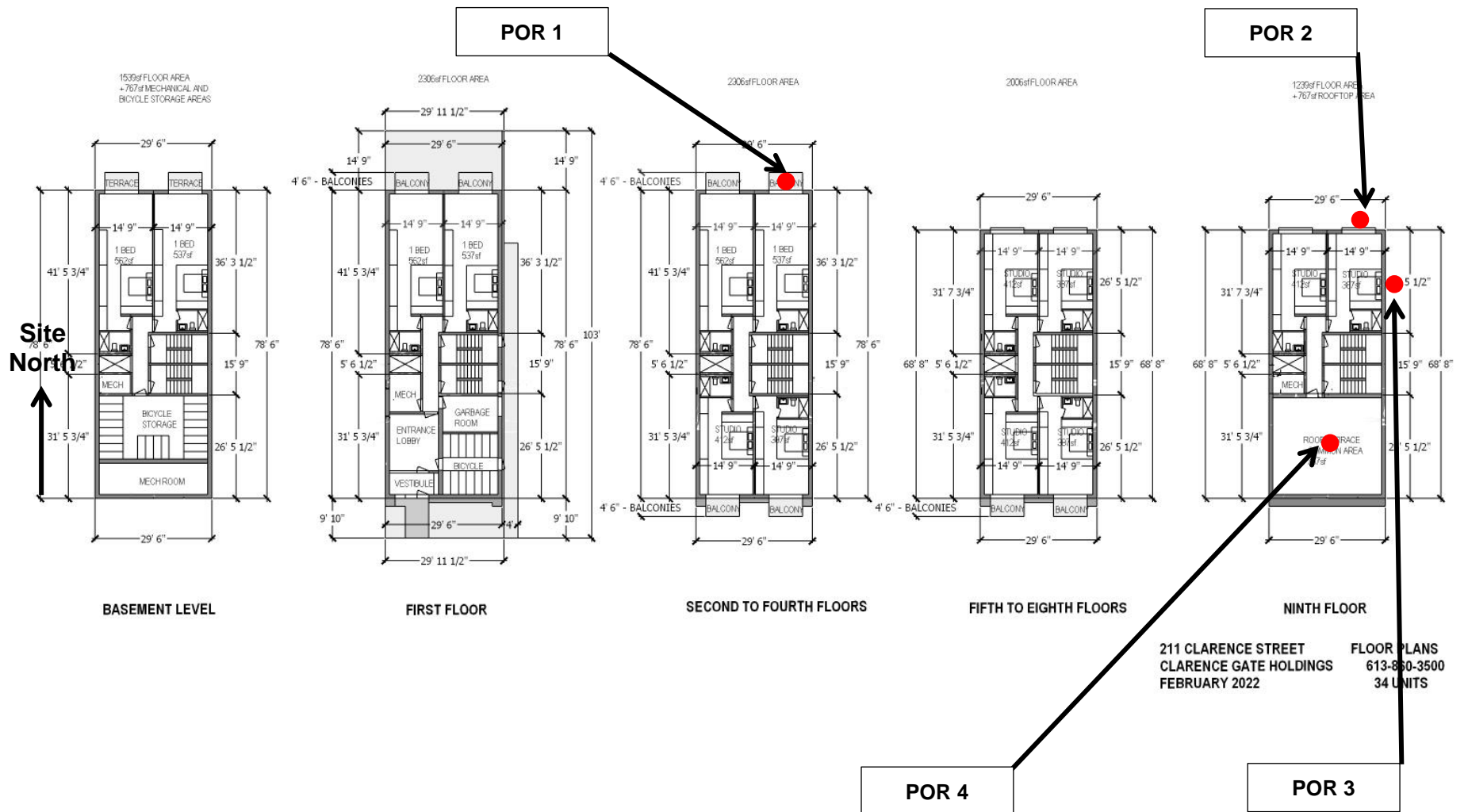

Figure 4: Rear Elevation (facing Murray Street) showing Points of Reception

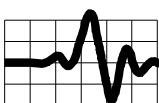
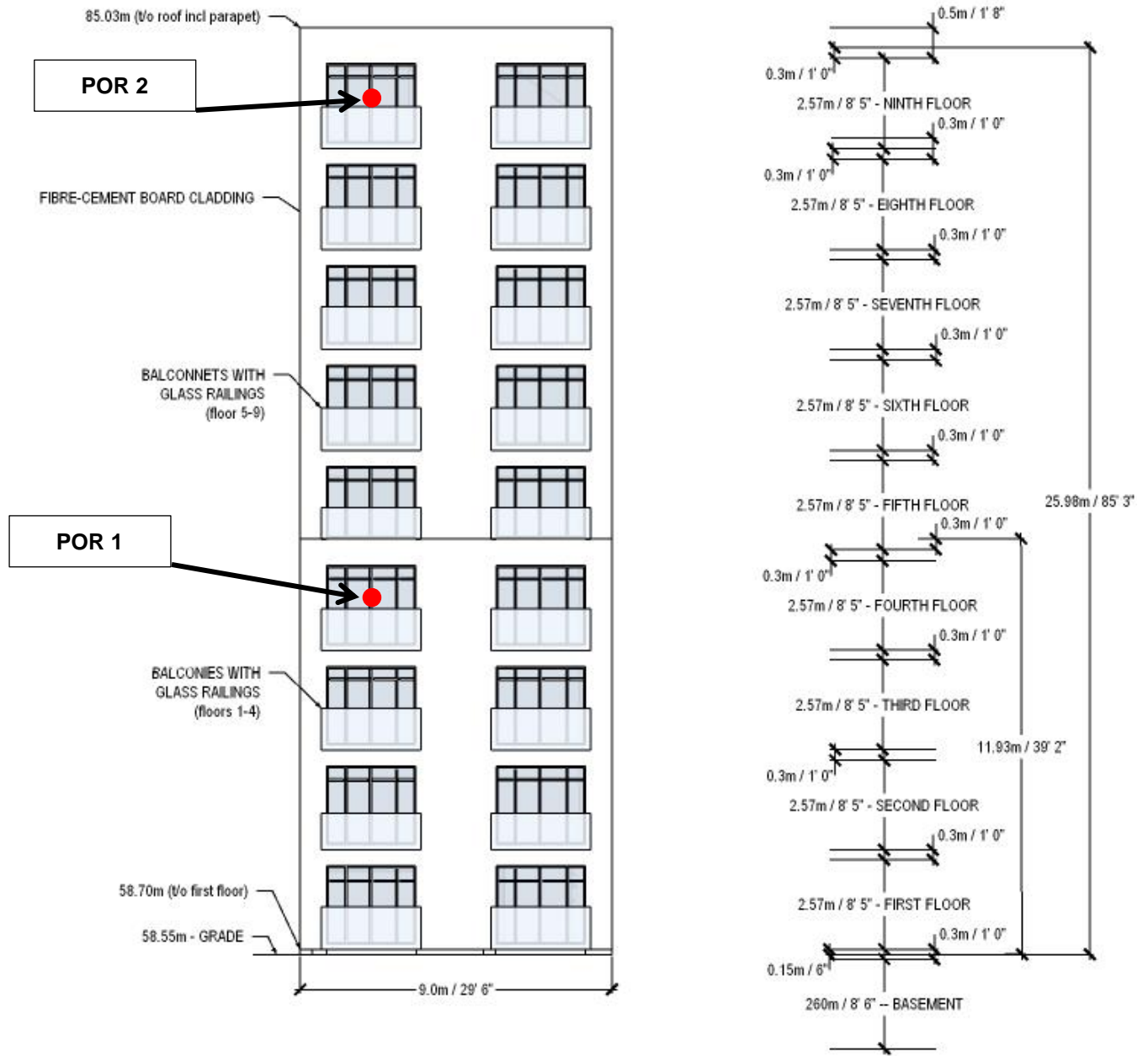

Figure 5: East Elevation (facing King Edward) showing Points of Reception

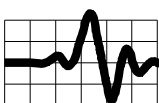
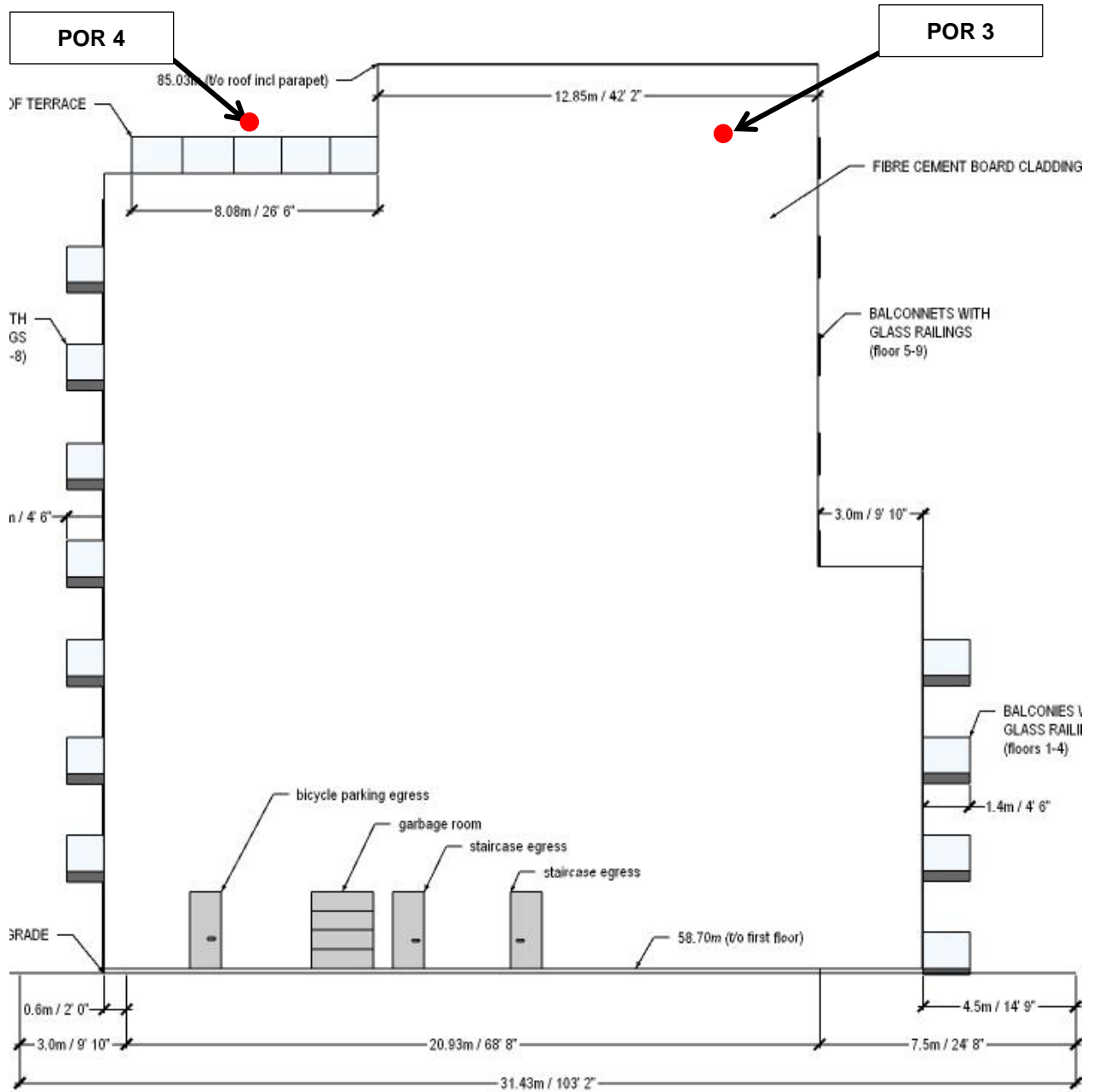

Figure 6: Layout of Worst Case Living and Bedroom Location (Fourth Floor)

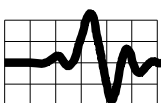
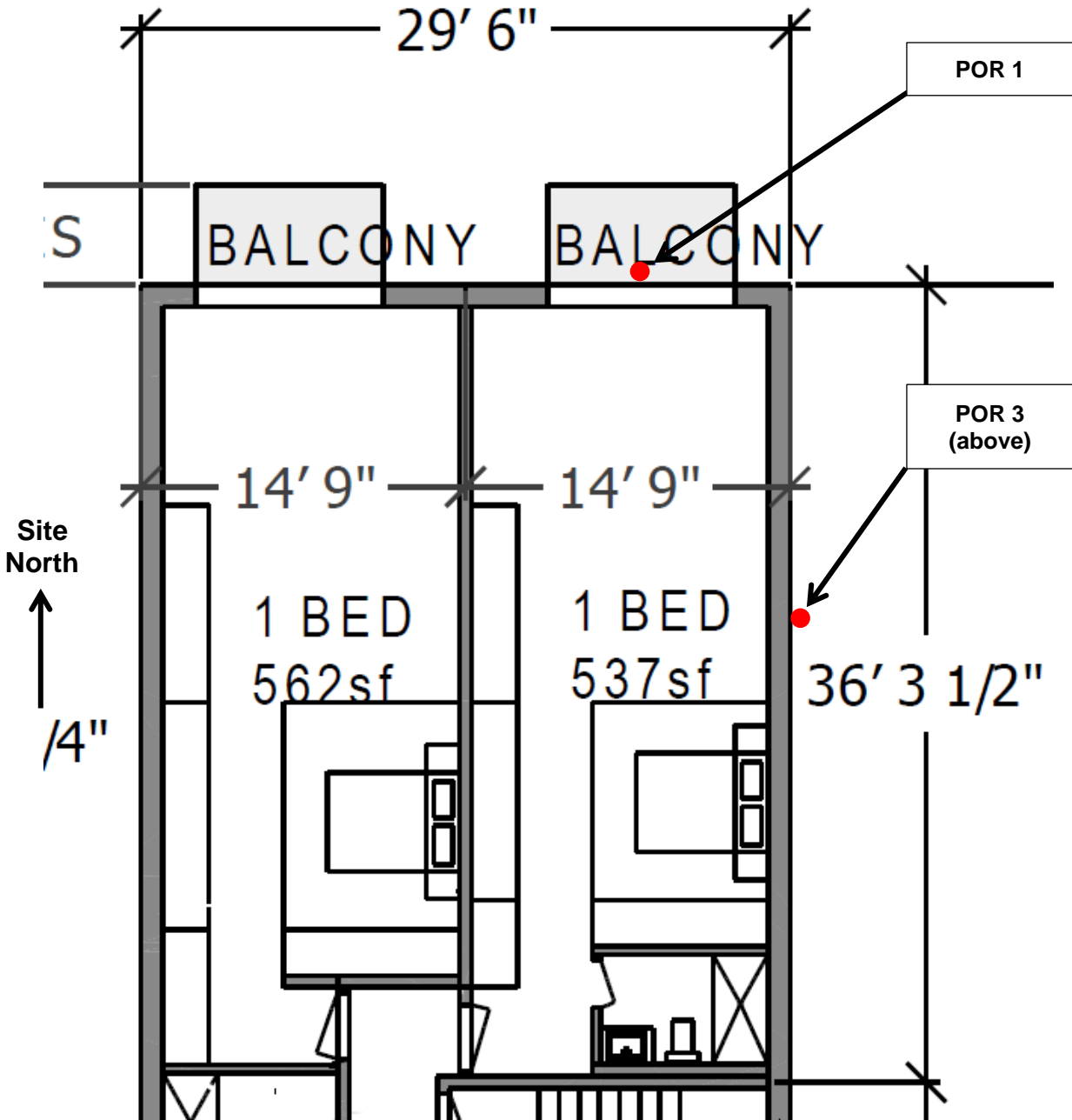
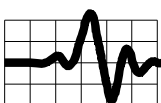
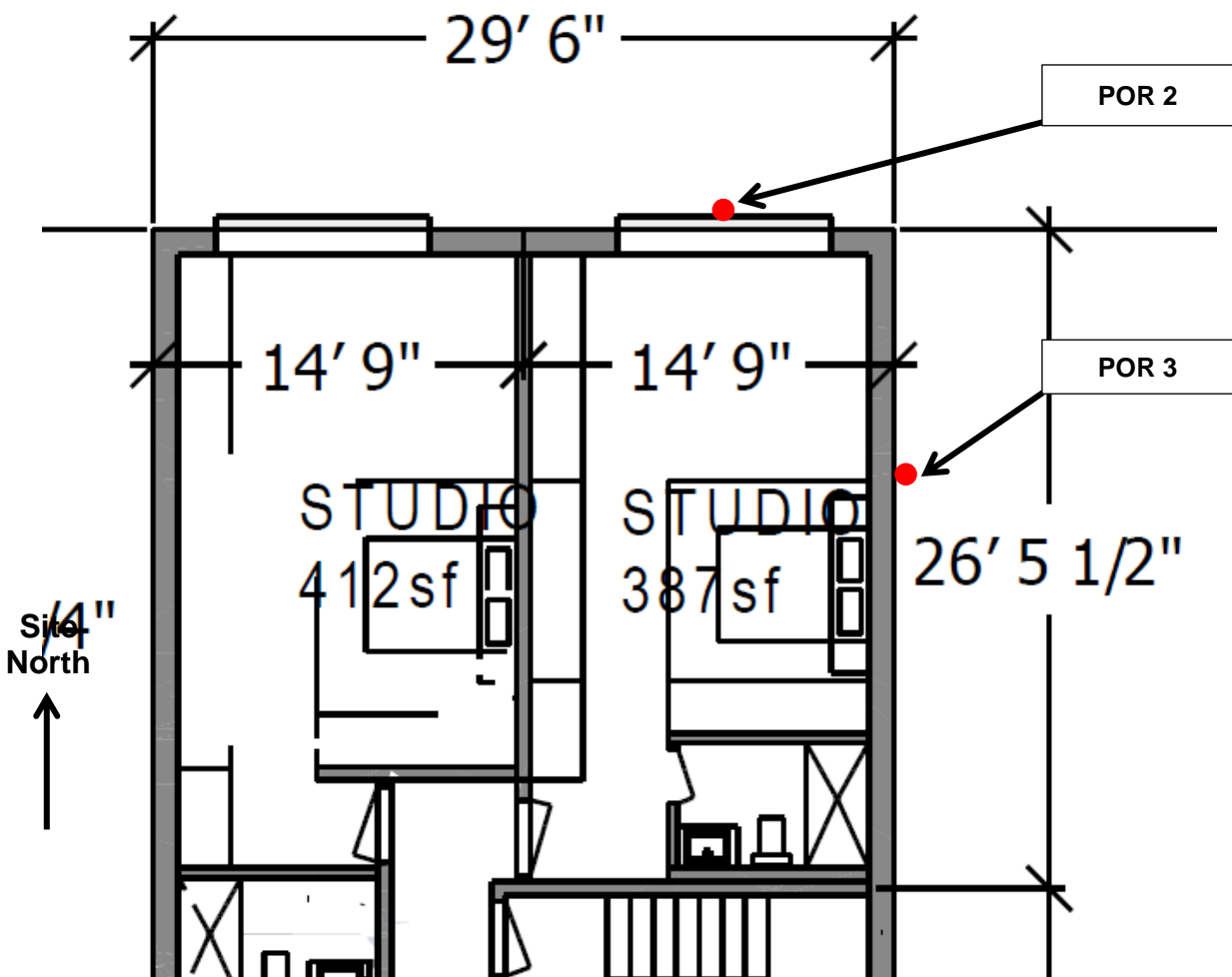

Figure 7: Layout of Worst Case Living and Bedroom Location (Ninth Floor)



TABLES

Contents:

- Table 1: Modelled Points of Reception**
- Table 2: Future Traffic Volumes and Posted Speed Limits**
- Table 3: Traffic Noise Impacts for Building Component Requirements**
- Table 4: Traffic Noise Impacts for Ventilation and Warning Clause Requirements**
- Table 5: Predicted Indoor Sound Levels**
- Table 6: Traffic Noise Impacts for Outdoor Living Area (OLA)**

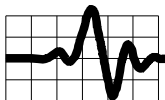

Table 1: Modelled Points of Reception

Symbol	Location	Murray Street (S1)		King Edward Avenue (S2)		King Edward Avenue (S3)		King Edward Avenue (S4)		Height (m)	Description
		Distance (m)	Angle (deg)	Distance (m)	Angle (deg)	Distance (m)	Angle (deg)	Distance (m)	Angle (deg)		
POR 1	Fourth floor level window – Northern Facade	47	180	103.1	90	113.1	90	123.1	90	10.1	Plane of window (living room)
POR 2	Ninth floor level window – Northern Facade	50	180	105.5	90	115.5	90	125.5	90	24.3	Plane of window (bedroom)
POR 3	Ninth floor level wall – Western Facade	51.5	90	101.6	180	111.6	180	115.5	180	24.3	Exterior Wall (bedroom)
POR 4	Outdoor Living Area (rooftop amenity area)	123.1	90	125.5	90	121.6	180	125.5	180	1.5*	Outdoor Living Area (Common Amenity Area)

*Height measured from finished floor level at outdoor terrace on the ninth floor of the building 23.1 m above grade.

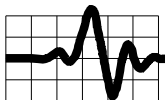

Table 2: Future Traffic Volumes and Posted Speed Limits

Road Segment	Input Data							Day Volumes, 7:00 - 23:00			Night Volumes, 23:00 - 7:00		
	Segment	AADT (24 hours)	Posted Speed	Split Day	Split Night	Medium Trucks	Heavy Trucks	Cars	Medium Trucks	Heavy Trucks	Cars	Medium Trucks	Heavy Trucks
	Type		kph	7:00-23:00	23:00-7:00	%	%	no.	no.	no.	no.	no.	no.
Murray Street, 2 Lane, 2-Lane Urban Arterial Undivided (2-UAU) - Future Mature Traffic Volumes from City of Ottawa Guidelines													
East / West	S1	15,000	50	0.92	0.08	7	5	12144	966	690	1056	84	60
King Edward Avenue, 6 Lane Urban Arterial Divided (6-UAD) - Future Mature Traffic Volumes from City of Ottawa Guidelines													
South	S2	16,667	40	0.92	0.08	7	5	13493	1073	767	1173	93	67
King Edward Avenue, 6 Lane Urban Arterial Divided (6-UAD) - Future Mature Traffic Volumes from City of Ottawa Guidelines													
North / South	S3	16,667	40	0.92	0.08	7	5	13493	1073	767	1173	93	67
King Edward Avenue, 6 Lane Urban Arterial Divided (6-UAD) - Future Mature Traffic Volumes from City of Ottawa Guidelines													
North	S4	16,667	40	0.92	0.08	7	5	13493	1073	767	1173	93	67

*Future Mature State Traffic Volume Data for roads are based on City of Ottawa Guidelines. Traffic Data for King Edward Avenue based on three 2 - two lane segments each with 16,667 AADT Volume. Total of three segments combined 50,000 AADT as per City of Ottawa Guidelines.

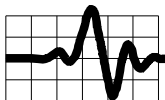

Table 3: Traffic Noise Impacts for Building Component Requirements

Point of Reception	Location	Estimated Future Noise Level* (dBA)		Building Component Requirement
		Day (Living Room - 7:00 to 23:00)	Night (Bedroom – 23:00 to 07:00)	
POR 1	Fourth floor level wall – Northern Facade (Living Room / Bedroom)	58.8	50.2	Building compliant with Ontario Building Code
POR 2	Ninth floor level wall – Northern Facade (Living Room / Bedroom)	58.6	50	Building compliant with Ontario Building Code
POR 3	Ninth floor level wall – Eastern Facade (Living Room / Bedroom)	58.2	50.1	Building compliant with Ontario Building Code

*Daytime Noise Impacts based on Leq 16 h (07:00 – 23:00), Nighttime Noise Impacts based on Leq 8 h (23:00 – 07:00). Refer Table A1.3.

** Analysis shows that the proposed construction of external walls and windows is sufficient to meet City of Ottawa ENCG indoor sound level criteria, see discussion in Section 5.0.

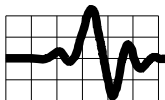

Table 4: Traffic Noise Impacts for Ventilation and Warning Clause Requirements

Point of Reception (POR)	Location (see Figures 1 to 7)	Sound Levels due to Road Traffic*		Ventilation Requirements ⁽¹⁾	Warning Clauses ⁽²⁾
		Day (dBA)	Night (dBA)		
POR 1	Fourth floor level wall – Northern Facade (Living Room / Bedroom)	58.8	50.2	Forced air heating with provision for central air-conditioning	Required Type C
POR 2	Ninth floor level wall – Northern Facade (Living Room / Bedroom)	58.6	50	Forced air heating with provision for central air-conditioning	Required Type C
POR 3	Ninth floor level wall – Eastern Facade (Living Room / Bedroom)	58.2	50.1	Forced air heating with provision for central air-conditioning	Required Type C
POR 4	Outdoor Living Area**	57.8	-	Control Measures (barriers) not required but should be considered.	Required Type A***

*Daytime Noise Impacts based on Leq 16 h (07:00 – 23:00), Night Impacts based on Leq 8 h (23:00 – 07:00).

** Resultant Leq includes shielding provided by the proposed buildings ninth floor located to the north of the Outdoor Living Area modelled as a barrier 3 m high in this analysis.

***Resultant Leq exceeds 55 dBA

- Notes: 1. Ventilation Requirements - Refer Table A1.5, Appendix 1
2. Warning Clause Requirements - Refer Tables A1.5 and A1.6, Appendix 1(

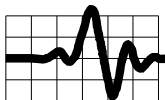

Table 5: Predicted Indoor Sound Levels*

Room	Period	Area (m2)	Facade 1 (POR 1 / POR 2)			Facade 2 (POR 3)			Combined Indoor Sound Level (dBA) Day / Night	City Criterion (dBA)	Complies (Yes/No)
			Window ³ (m2)	Wall ¹ (m2)	Indoor Sound Level (dBA) Day / Night	Window ³ (m2)	Wall ² (m2)	Indoor Sound Level Day / Night			
Living / Bedroom	Day / Night	40.1	6.1	5.5	36 / 28	-	23.4	14 / 6	36 / 28	45 / 40	Yes
Living / Bedroom	Day / Night	29.7	6.1	5.5	38 / 29	-	17	14 / 6	38 / 29	45 / 40	Yes

*Prediction Method: IBANA Calculations Refer to Appendix 2.

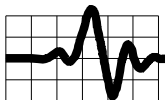
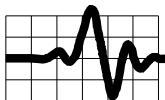

Table 6: Traffic Noise Impacts for Outdoor Living Area (OLA)

Point of Reception	Location	Estimated Future Day Noise Level* (dBA)		Description of Recommendations and Mitigation
		Day	Night	
POR 4	Outdoor Living Area	57.8	-	Control Measures (barriers) not required but should be considered. **

* Daytime Noise Impacts based on Leq 16 h (07:00 – 23:00). Result less than 55 dBA, hence, outdoor noise control measures not required. Refer Table A1.1 and A1.5.

**Note location assessed takes into consideration the shielding provided by the proposed building assessed as a 3 m high barrier (located on the north side of the Outdoor Living Area).



Appendix 1

City of Ottawa Noise Criteria and Warning Clauses

For further information refer to:

City of Ottawa Environmental Noise Control Guidelines¹ (ENCG)

MECP Documents, NPC-300^{5, 6, 7}

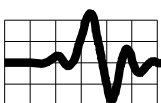

**Table A1.1 Summary of Sound Level Criteria for Outdoor Living Areas*
Surface Transportation (Road and Rail)**

Time Period	Leq 16 hr (dBA)
16 hr, 07:00 – 23:00	55

*Reference: ENCG¹ Table 2.2a and NPC-300², Table C-1.

**Table A1.2 Summary of Indoor Sound Level Criteria*
Surface Transportation (Road and Rail)**

Type of Space	Leq (Time Period (dBA))	
	Roadways, Transitways and LRT	Rail (diesel engines/ locomotives)
General offices, reception areas, retail stores, etc. (Time period: 16 hr., 07:00 – 23:00)	50	45
Living/dining areas of residences, hospitals, schools, nursing/retirement homes, day-care centres, theatres, places of worship, libraries, individual semi-private offices, conference rooms, reading rooms, etc. (Time period: 16 hr., 07:00 – 23:00)	45	40
Sleeping quarters of hotels/motels (Time period: 8 hr., 23:00 – 07:00)	45	40
Sleeping Quarters of residences, hospitals, nursing/retirement homes, etc. (Time period: 8 hr., 23:00 – 07:00)	40	35

*Reference: ENCG¹ Table 2.2b and 2.2c and NPC-300², Table C-1 and table C-9.

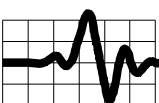

**Table A1.3: Summary of Road and Rail Noise*
Daytime (07:00 – 23:00) & Nighttime (23:00 – 07:00)
Building Component Requirements**

Assessment Location & Time		Outdoor Leq (dBA)	Building Component Requirements
Plane of the Living/Dining Room Windows ♦ Daytime (07:00 – 23:00)	Road	Less than or equal to 65	Building compliant with Ontario Building Code
		Greater than 65	Building components (walls, windows, etc.) must be designed to achieve indoor sound level criteria in Table A1.2.
	Rail	Less than or equal to 60	Building compliant with Ontario Building Code
		Greater than 60	Building components (walls, windows, etc.) must be designed to achieve indoor sound level criteria in Table A1.2.
Plane of Bedroom Window ♦ Nighttime (23:00 – 07:00)	Road	Less than or equal to 60	Building compliant with Ontario Building Code
		Greater than 60	Building components (walls, windows, etc.) must be designed to achieve indoor sound level criteria in Table A1.2.
	Rail	Less than or equal to 55	Building compliant with Ontario Building Code
		Greater than 55	Building components (walls, windows, etc.) must be designed to achieve indoor sound level criteria in Table A1.2.

*Reference: NPC-300, Section C7.1 Road Noise Control Measures

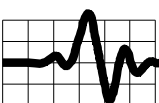
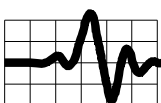

Table A1.4: Summary of Facade Material Requirement for Rail Noise Only*

Assessment Location	Distance to Railway	Sound Level dBA	Facade Material Requirement
Plane of Bedroom Window ◆ 24 hr.	Less than 100 m	Leq _{24 hr} less than or equal to 60	No additional requirement
		Leq _{24 hr} greater than 60	Brick veneer or acoustically equivalent
	Greater than 100 m	Leq _{24 hr} less than or equal to 60	No additional requirement
		Leq _{24 hr} greater than 60	No additional requirement

*Reference: NPC-300, Section C7.2 Rail Noise Control Measures.



**Table A1.5: Summary of Combination of Road and Rail Noise*
Day-time (07:00 – 23:00) & Night-time (23:00 – 07:00)
Outdoor, Ventilation and Warning Clause Requirements**

Assessment Location & Time	Outdoor Leq (dBA)	Ventilation Requirements	Outdoor Control Measures	Warning Clauses (see Table A1.6)
Outdoor Living Area (OLA) ◆ Day-time (07:00 – 23:00)	Less than or equal to 55	N/A	None Required	Not Required
	Greater than 55 to less than 60	N/A	Control Measures (barriers) not required but should be considered.	Type A required if resultant Leq exceeds 55 dBA
	Greater than 60	N/A	Control measures (barriers) required to reduce the Leq to below 60 dBA and as close to 55 dBA as technically, economically and administratively feasible.	Type B required if resultant Leq exceeds 55 dBA
Plane of the Living/Dining Room Windows ◆ Day-time (07:00 – 23:00)	Less than or equal to 55	None Required	N/A	Not Required
	Greater than 55 to less than or equal to 65	Forced air heating with provision for central air-conditioning	N/A	Required Type C
	Greater than 65	Central ducted air-conditioning	N/A	Required Type D
Plane of Bedroom Window ◆ Night-time (23:00 – 07:00)	Less than or equal to 50	None Required	N/A	Not Required
	Greater than 50 to less than or equal to 60	Forced air heating with provision for central ducted air-conditioning	N/A	Required Type C
	Greater than 60	Central ducted air-conditioning	N/A	Required Type D

*Reference: NPC-300, Section C7.1 and C7.2.

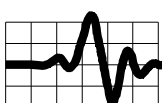
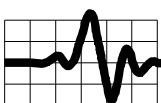

Table A1.6: Summary of Provincial Warning Type Clauses (may be used individually or in combination)*

Type	Warning Clause
Type A	"Purchasers/Tenants are advised that sound levels due to increasing (road) (transitway) (rail) (air) traffic may occasionally interfere with some activities of the dwelling occupants as the sound levels exceed the City's and the Ministry of Environment, Parks and Conservation noise criteria."
Type B	"Purchasers/Tenants are advised that despite the inclusion of noise control features in the development and within the building units, sound levels due to increasing (road) (transitway) (rail) (air) traffic may on occasions interfere with some activities of the dwelling occupants as the sound levels exceed the City's and the Ministry of Environment, Parks and Conservation noise criteria."
Type C	"This dwelling unit has been fitted with a forced air heating system and the ducting etc. was sized to accommodate central air-conditioning. Installation of central air-conditioning by the occupant will allow windows and exterior doors to remain closed, thereby ensuring that the indoor sound levels are within the City's and the Ministry of Environment, Parks and Conservation noise criteria. (Note: The location and installation of the outdoor air conditioning device should be done so as to comply with the noise criteria of MECP Publication NPC-216, Residential Air Conditioning Devices and thus minimize the noise impacts on and in the immediate vicinity of the subject property."
Type D	"This dwelling unit has been supplied with a central air-conditioning system which will allow windows and exterior doors to remain closed, thereby ensuring that the indoor sound levels are within the City's and the Ministry of Environment, Parks and Conservation noise criteria."
Type E	"Purchasers/tenants are advised that due to the proximity of the adjacent industry (facility) (utility), sound levels from the industry (facility) (utility) may at times be audible."

*Reference: NPC-300² Section C8 Warning Clauses. Refer ENCG Table A1 Surface Transportation Warning Clauses for example of applicable "no outdoor amenity area provided" type warning clause.



Appendix 2

Calculation Details and Software Outputs

Contents:

Sample outputs from STAMSON:

- POR 1: Fourth Floor Living / Bedroom (Day / Night)
- POR 2: Ninth Floor Living / Bedroom (Day / Night)
- POR 3: Ninth Floor Living / Bedroom (Day / Night)
- POR 4: Outdoor Living Area (Daytime)
- Indoor Noise Calculations – Living Room - POR 1 – (Day)
- Indoor Noise Calculations – Living Room - POR 1 – (Night)
- Indoor Noise Calculations – Living Room - POR 2 – (Day)
- Indoor Noise Calculations – Living Room - POR 2 – (Night)
- Indoor Noise Calculations – Living Room - POR 3 – Level 4 (Day)
- Indoor Noise Calculations – Living Room - POR 3 – Level 4 (Night)
- Indoor Noise Calculations – Living Room - POR 3 – Level 9 (Day)
- Indoor Noise Calculations – Living Room - POR 3 – Level 9 (Night)

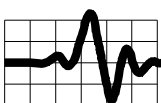

STAMSON 5.0 NORMAL REPORT Date: 10-02-2022 11:44:44
MINISTRY OF ENVIRONMENT AND ENERGY / NOISE ASSESSMENT

Filename: por1.te Time Period: Day/Night 16/8 hours
Description: POR 1 - Plane of Window - Day and Night

Road data, segment # 1: Murray S1 (day/night)

Car traffic volume : 12144/1056 veh/TimePeriod
Medium truck volume : 966/84 veh/TimePeriod
Heavy truck volume : 690/60 veh/TimePeriod
Posted speed limit : 50 km/h
Road gradient : 0 %
Road pavement : 1 (Typical asphalt or concrete)

Data for Segment # 1: Murray S1 (day/night)

Angle1 Angle2 : -90.00 deg 90.00 deg
Wood depth : 0 (No woods.)
No of house rows : 1 / 2
House density : 80 %
Surface : 2 (Reflective ground surface)
Receiver source distance : 47.00 / 47.00 m
Receiver height : 10.10 / 10.10 m
Topography : 1 (Flat/gentle slope; no barrier)
Reference angle : 0.00

Road data, segment # 2: King Ed S2 (day/night)

Car traffic volume : 13493/1173 veh/TimePeriod
Medium truck volume : 1073/93 veh/TimePeriod
Heavy truck volume : 767/67 veh/TimePeriod
Posted speed limit : 40 km/h
Road gradient : 0 %
Road pavement : 1 (Typical asphalt or concrete)

Data for Segment # 2: King Ed S2 (day/night)

Angle1 Angle2 : 0.00 deg 90.00 deg
Wood depth : 0 (No woods.)
No of house rows : 2 / 2
House density : 80 %
Surface : 2 (Reflective ground surface)
Receiver source distance : 103.10 / 103.10 m
Receiver height : 10.10 / 10.10 m
Topography : 1 (Flat/gentle slope; no barrier)
Reference angle : 0.00

Road data, segment # 3: King Ed S3 (day/night)

Car traffic volume : 13493/1173 veh/TimePeriod
Medium truck volume : 1073/93 veh/TimePeriod
Heavy truck volume : 767/67 veh/TimePeriod
Posted speed limit : 40 km/h
Road gradient : 0 %
Road pavement : 1 (Typical asphalt or concrete)

Data for Segment # 3: King Ed S3 (day/night)

Angle1 Angle2 : 0.00 deg 90.00 deg
Wood depth : 0 (No woods.)
No of house rows : 2 / 2
House density : 80 %
Surface : 2 (Reflective ground surface)
Receiver source distance : 113.10 / 113.10 m
Receiver height : 10.10 / 10.10 m
Topography : 1 (Flat/gentle slope; no barrier)
Reference angle : 0.00

Road data, segment # 4: King Ed S4 (day/night)

Car traffic volume : 13493/1173 veh/TimePeriod
Medium truck volume : 1073/93 veh/TimePeriod
Heavy truck volume : 767/67 veh/TimePeriod
Posted speed limit : 40 km/h
Road gradient : 0 %
Road pavement : 1 (Typical asphalt or concrete)

Data for Segment # 4: King Ed S4 (day/night)

Angle1 Angle2 : 0.00 deg 90.00 deg
Wood depth : 0 (No woods.)
No of house rows : 2 / 2
House density : 80 %
Surface : 2 (Reflective ground surface)
Receiver source distance : 123.10 / 123.10 m
Receiver height : 10.10 / 10.10 m
Topography : 1 (Flat/gentle slope; no barrier)
Reference angle : 0.00

Results segment # 1: Murray S1 (day)

Source height = 1.50 m

ROAD (0.00 + 57.49 + 0.00) = 57.49 dBA

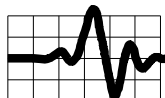

Angle1 Angle2 Alpha RefLeq P.Adj D.Adj F.Adj W.Adj H.Adj B.Adj SubLeq

-90 90 0.00 68.48 0.00 -4.96 0.00 0.00 -6.03 0.00 57.49

Segment Leq : 57.49 dBA

Results segment # 2: King Ed S2 (day)

Source height = 1.50 m

ROAD (0.00 + 48.58 + 0.00) = 48.58 dBA
Angle1 Angle2 Alpha RefLeq P.Adj D.Adj F.Adj W.Adj H.Adj B.Adj SubLeq

0 90 0.00 67.14 0.00 -8.37 -3.01 0.00 -7.18 0.00 48.58

Segment Leq : 48.58 dBA

Results segment # 3: King Ed S3 (day)

Source height = 1.50 m

ROAD (0.00 + 48.23 + 0.00) = 48.23 dBA
Angle1 Angle2 Alpha RefLeq P.Adj D.Adj F.Adj W.Adj H.Adj B.Adj SubLeq

0 90 0.00 67.14 0.00 -8.77 -3.01 0.00 -7.13 0.00 48.23

Segment Leq : 48.23 dBA

Results segment # 4: King Ed S4 (day)

Source height = 1.50 m

ROAD (0.00 + 47.90 + 0.00) = 47.90 dBA
Angle1 Angle2 Alpha RefLeq P.Adj D.Adj F.Adj W.Adj H.Adj B.Adj SubLeq

0 90 0.00 67.14 0.00 -9.14 -3.01 0.00 -7.09 0.00 47.90

Segment Leq : 47.90 dBA

Total Leq All Segments: 58.82 dBA

Results segment # 1: Murray S1 (night)

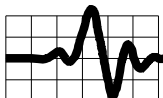

Source height = 1.50 m

ROAD (0.00 + 48.39 + 0.00) = 48.39 dBA
Angle1 Angle2 Alpha RefLeq P.Adj D.Adj F.Adj W.Adj H.Adj B.Adj SubLeq

-90 90 0.00 60.88 0.00 -4.96 0.00 0.00 -7.53 0.00 48.39

Segment Leq : 48.39 dBA

Results segment # 2: King Ed S2 (night)

Source height = 1.50 m

ROAD (0.00 + 40.99 + 0.00) = 40.99 dBA
Angle1 Angle2 Alpha RefLeq P.Adj D.Adj F.Adj W.Adj H.Adj B.Adj SubLeq

0 90 0.00 59.56 0.00 -8.37 -3.01 0.00 -7.18 0.00 40.99

Segment Leq : 40.99 dBA

Results segment # 3: King Ed S3 (night)

Source height = 1.50 m

ROAD (0.00 + 40.64 + 0.00) = 40.64 dBA
Angle1 Angle2 Alpha RefLeq P.Adj D.Adj F.Adj W.Adj H.Adj B.Adj SubLeq

0 90 0.00 59.56 0.00 -8.77 -3.01 0.00 -7.13 0.00 40.64

Segment Leq : 40.64 dBA

Results segment # 4: King Ed S4 (night)

Source height = 1.50 m

ROAD (0.00 + 40.31 + 0.00) = 40.31 dBA
Angle1 Angle2 Alpha RefLeq P.Adj D.Adj F.Adj W.Adj H.Adj B.Adj SubLeq

0 90 0.00 59.56 0.00 -9.14 -3.01 0.00 -7.09 0.00 40.31

Segment Leq : 40.31 dBA

Total Leq All Segments: 50.17 dBA

TOTAL Leq FROM ALL SOURCES (DAY): 58.82
(NIGHT): 50.17

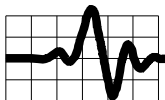

STAMSON 5.0 NORMAL REPORT Date: 10-02-2022 11:46:20
MINISTRY OF ENVIRONMENT AND ENERGY / NOISE ASSESSMENT

Filename: por2.te Time Period: Day/Night 16/8 hours
Description: POR 2 - Plane of Window - Day and Night

Road data, segment # 1: Murray S1 (day/night)

Car traffic volume : 12144/1056 veh/TimePeriod
Medium truck volume : 966/84 veh/TimePeriod
Heavy truck volume : 690/60 veh/TimePeriod
Posted speed limit : 50 km/h
Road gradient : 0 %
Road pavement : 1 (Typical asphalt or concrete)

Data for Segment # 1: Murray S1 (day/night)

Angle1 Angle2 : -90.00 deg 90.00 deg
Wood depth : 0 (No woods.)
No of house rows : 1 / 2
House density : 80 %
Surface : 2 (Reflective ground surface)
Receiver source distance : 50.00 / 50.00 m
Receiver height : 24.30 / 24.30 m
Topography : 1 (Flat/gentle slope; no barrier)
Reference angle : 0.00

Road data, segment # 2: King Ed S2 (day/night)

Car traffic volume : 13493/1173 veh/TimePeriod
Medium truck volume : 1073/93 veh/TimePeriod
Heavy truck volume : 767/67 veh/TimePeriod
Posted speed limit : 40 km/h
Road gradient : 0 %
Road pavement : 1 (Typical asphalt or concrete)

Data for Segment # 2: King Ed S2 (day/night)

Angle1 Angle2 : 0.00 deg 90.00 deg
Wood depth : 0 (No woods.)
No of house rows : 2 / 2
House density : 80 %
Surface : 2 (Reflective ground surface)
Receiver source distance : 105.50 / 105.50 m
Receiver height : 24.30 / 24.30 m
Topography : 1 (Flat/gentle slope; no barrier)
Reference angle : 0.00

Road data, segment # 3: King Ed S3 (day/night)

Car traffic volume : 13493/1173 veh/TimePeriod
Medium truck volume : 1073/93 veh/TimePeriod
Heavy truck volume : 767/67 veh/TimePeriod
Posted speed limit : 40 km/h
Road gradient : 0 %
Road pavement : 1 (Typical asphalt or concrete)

Data for Segment # 3: King Ed S3 (day/night)

Angle1 Angle2 : 0.00 deg 90.00 deg
Wood depth : 0 (No woods.)
No of house rows : 2 / 2
House density : 80 %
Surface : 2 (Reflective ground surface)
Receiver source distance : 115.50 / 115.50 m
Receiver height : 24.30 / 24.30 m
Topography : 1 (Flat/gentle slope; no barrier)
Reference angle : 0.00

Road data, segment # 4: King Ed S4 (day/night)

Car traffic volume : 13493/1173 veh/TimePeriod
Medium truck volume : 1073/93 veh/TimePeriod
Heavy truck volume : 767/67 veh/TimePeriod
Posted speed limit : 40 km/h
Road gradient : 0 %
Road pavement : 1 (Typical asphalt or concrete)

Data for Segment # 4: King Ed S4 (day/night)

Angle1 Angle2 : 0.00 deg 90.00 deg
Wood depth : 0 (No woods.)
No of house rows : 2 / 2
House density : 80 %
Surface : 2 (Reflective ground surface)
Receiver source distance : 125.50 / 125.50 m
Receiver height : 24.30 / 24.30 m
Topography : 1 (Flat/gentle slope; no barrier)
Reference angle : 0.00

Results segment # 1: Murray S1 (day)

Source height = 1.50 m

ROAD (0.00 + 57.25 + 0.00) = 57.25 dBA

Angle1 Angle2 Alpha RefLeq P.Adj D.Adj F.Adj W.Adj H.Adj B.Adj SubLeq

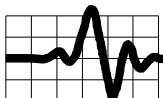

-90 90 0.00 68.48 0.00 -5.23 0.00 0.00 -6.00 0.00 57.25

Segment Leq : 57.25 dBA

Results segment # 2: King Ed S2 (day)

Source height = 1.50 m

ROAD (0.00 + 48.49 + 0.00) = 48.49 dBA
Angle1 Angle2 Alpha RefLeq P.Adj D.Adj F.Adj W.Adj H.Adj B.Adj SubLeq

0 90 0.00 67.14 0.00 -8.47 -3.01 0.00 -7.17 0.00 48.49

Segment Leq : 48.49 dBA

Results segment # 3: King Ed S3 (day)

Source height = 1.50 m

ROAD (0.00 + 48.15 + 0.00) = 48.15 dBA
Angle1 Angle2 Alpha RefLeq P.Adj D.Adj F.Adj W.Adj H.Adj B.Adj SubLeq

0 90 0.00 67.14 0.00 -8.86 -3.01 0.00 -7.12 0.00 48.15

Segment Leq : 48.15 dBA

Results segment # 4: King Ed S4 (day)

Source height = 1.50 m

ROAD (0.00 + 47.82 + 0.00) = 47.82 dBA
Angle1 Angle2 Alpha RefLeq P.Adj D.Adj F.Adj W.Adj H.Adj B.Adj SubLeq

0 90 0.00 67.14 0.00 -9.23 -3.01 0.00 -7.09 0.00 47.82

Segment Leq : 47.82 dBA

Total Leq All Segments: 58.62 dBA

Results segment # 1: Murray S1 (night)

Source height = 1.50 m

ROAD (0.00 + 48.15 + 0.00) = 48.15 dBA
Angle1 Angle2 Alpha RefLeq P.Adj D.Adj F.Adj W.Adj H.Adj B.Adj SubLeq

-90 90 0.00 60.88 0.00 -5.23 0.00 0.00 -7.50 0.00 48.15

Segment Leq : 48.15 dBA

Results segment # 2: King Ed S2 (night)

Source height = 1.50 m

ROAD (0.00 + 40.90 + 0.00) = 40.90 dBA
Angle1 Angle2 Alpha RefLeq P.Adj D.Adj F.Adj W.Adj H.Adj B.Adj SubLeq

0 90 0.00 59.56 0.00 -8.47 -3.01 0.00 -7.17 0.00 40.90

Segment Leq : 40.90 dBA

Results segment # 3: King Ed S3 (night)

Source height = 1.50 m

ROAD (0.00 + 40.56 + 0.00) = 40.56 dBA
Angle1 Angle2 Alpha RefLeq P.Adj D.Adj F.Adj W.Adj H.Adj B.Adj SubLeq

0 90 0.00 59.56 0.00 -8.86 -3.01 0.00 -7.12 0.00 40.56

Segment Leq : 40.56 dBA

Results segment # 4: King Ed S4 (night)

Source height = 1.50 m

ROAD (0.00 + 40.24 + 0.00) = 40.24 dBA
Angle1 Angle2 Alpha RefLeq P.Adj D.Adj F.Adj W.Adj H.Adj B.Adj SubLeq

0 90 0.00 59.56 0.00 -9.23 -3.01 0.00 -7.09 0.00 40.24

Segment Leq : 40.24 dBA

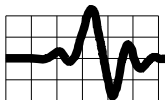

Total Leq All Segments: 49.98 dBA

TOTAL Leq FROM ALL SOURCES (DAY): 58.62
(NIGHT): 49.98

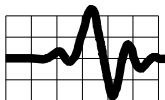

STAMSON 5.0 NORMAL REPORT Date: 10-02-2022 11:47:36
MINISTRY OF ENVIRONMENT AND ENERGY / NOISE ASSESSMENT

Filename: por3.te Time Period: Day/Night 16/8 hours
Description: POR 3 - Plane of Window - Day and Night

Road data, segment # 1: Murray S1 (day/night)

Car traffic volume : 12144/1056 veh/TimePeriod
Medium truck volume : 966/84 veh/TimePeriod
Heavy truck volume : 690/60 veh/TimePeriod
Posted speed limit : 50 km/h
Road gradient : 0 %
Road pavement : 1 (Typical asphalt or concrete)

Data for Segment # 1: Murray S1 (day/night)

Angle1 Angle2 : 0.00 deg 90.00 deg
Wood depth : 0 (No woods.)
No of house rows : 1 / 2
House density : 80 %
Surface : 2 (Reflective ground surface)
Receiver source distance : 51.50 / 51.50 m
Receiver height : 24.30 / 24.30 m
Topography : 1 (Flat/gentle slope; no barrier)
Reference angle : 0.00

Road data, segment # 2: King Ed S2 (day/night)

Car traffic volume : 13493/1173 veh/TimePeriod
Medium truck volume : 1073/93 veh/TimePeriod
Heavy truck volume : 767/67 veh/TimePeriod
Posted speed limit : 40 km/h
Road gradient : 0 %
Road pavement : 1 (Typical asphalt or concrete)

Data for Segment # 2: King Ed S2 (day/night)

Angle1 Angle2 : -90.00 deg 90.00 deg
Wood depth : 0 (No woods.)
No of house rows : 2 / 2
House density : 80 %
Surface : 2 (Reflective ground surface)
Receiver source distance : 101.60 / 101.60 m
Receiver height : 24.30 / 24.30 m
Topography : 1 (Flat/gentle slope; no barrier)
Reference angle : 0.00

Road data, segment # 3: King Ed S3 (day/night)

Car traffic volume : 13493/1173 veh/TimePeriod
Medium truck volume : 1073/93 veh/TimePeriod
Heavy truck volume : 767/67 veh/TimePeriod
Posted speed limit : 40 km/h
Road gradient : 0 %
Road pavement : 1 (Typical asphalt or concrete)

Data for Segment # 3: King Ed S3 (day/night)

Angle1 Angle2 : -90.00 deg 90.00 deg
Wood depth : 0 (No woods.)
No of house rows : 2 / 2
House density : 80 %
Surface : 2 (Reflective ground surface)
Receiver source distance : 111.60 / 111.60 m
Receiver height : 24.30 / 24.30 m
Topography : 1 (Flat/gentle slope; no barrier)
Reference angle : 0.00

Road data, segment # 4: King Ed S4 (day/night)

Car traffic volume : 13493/1173 veh/TimePeriod
Medium truck volume : 1073/93 veh/TimePeriod
Heavy truck volume : 767/67 veh/TimePeriod
Posted speed limit : 40 km/h
Road gradient : 0 %
Road pavement : 1 (Typical asphalt or concrete)

Data for Segment # 4: King Ed S4 (day/night)

Angle1 Angle2 : -90.00 deg 90.00 deg
Wood depth : 0 (No woods.)
No of house rows : 2 / 2
House density : 80 %
Surface : 2 (Reflective ground surface)
Receiver source distance : 121.60 / 121.60 m
Receiver height : 24.30 / 24.30 m
Topography : 1 (Flat/gentle slope; no barrier)
Reference angle : 0.00

Results segment # 1: Murray S1 (day)

Source height = 1.50 m

ROAD (0.00 + 54.13 + 0.00) = 54.13 dBA

Angle1 Angle2 Alpha RefLeq P.Adj D.Adj F.Adj W.Adj H.Adj B.Adj SubLeq

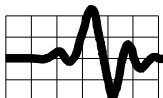

0 90 0.00 68.48 0.00 -5.36 -3.01 0.00 -5.99 0.00 54.13

Segment Leq : 54.13 dBA

Results segment # 2: King Ed S2 (day)

Source height = 1.50 m

ROAD (0.00 + 51.64 + 0.00) = 51.64 dBA
Angle1 Angle2 Alpha RefLeq P.Adj D.Adj F.Adj W.Adj H.Adj B.Adj SubLeq

-90 90 0.00 67.14 0.00 -8.31 0.00 0.00 -7.19 0.00 51.64

Segment Leq : 51.64 dBA

Results segment # 3: King Ed S3 (day)

Source height = 1.50 m

ROAD (0.00 + 51.29 + 0.00) = 51.29 dBA
Angle1 Angle2 Alpha RefLeq P.Adj D.Adj F.Adj W.Adj H.Adj B.Adj SubLeq

-90 90 0.00 67.14 0.00 -8.72 0.00 0.00 -7.14 0.00 51.29

Segment Leq : 51.29 dBA

Results segment # 4: King Ed S4 (day)

Source height = 1.50 m

ROAD (0.00 + 50.96 + 0.00) = 50.96 dBA
Angle1 Angle2 Alpha RefLeq P.Adj D.Adj F.Adj W.Adj H.Adj B.Adj SubLeq

-90 90 0.00 67.14 0.00 -9.09 0.00 0.00 -7.10 0.00 50.96

Segment Leq : 50.96 dBA

Total Leq All Segments: 58.22 dBA

Results segment # 1: Murray S1 (night)

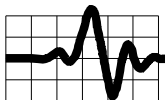

Source height = 1.50 m

ROAD (0.00 + 45.03 + 0.00) = 45.03 dBA
Angle1 Angle2 Alpha RefLeq P.Adj D.Adj F.Adj W.Adj H.Adj B.Adj SubLeq

0 90 0.00 60.88 0.00 -5.36 -3.01 0.00 -7.49 0.00 45.03

Segment Leq : 45.03 dBA

Results segment # 2: King Ed S2 (night)

Source height = 1.50 m

ROAD (0.00 + 44.06 + 0.00) = 44.06 dBA
Angle1 Angle2 Alpha RefLeq P.Adj D.Adj F.Adj W.Adj H.Adj B.Adj SubLeq

-90 90 0.00 59.56 0.00 -8.31 0.00 0.00 -7.19 0.00 44.06

Segment Leq : 44.06 dBA

Results segment # 3: King Ed S3 (night)

Source height = 1.50 m

ROAD (0.00 + 43.70 + 0.00) = 43.70 dBA
Angle1 Angle2 Alpha RefLeq P.Adj D.Adj F.Adj W.Adj H.Adj B.Adj SubLeq

-90 90 0.00 59.56 0.00 -8.72 0.00 0.00 -7.14 0.00 43.70

Segment Leq : 43.70 dBA

Results segment # 4: King Ed S4 (night)

Source height = 1.50 m

ROAD (0.00 + 43.37 + 0.00) = 43.37 dBA
Angle1 Angle2 Alpha RefLeq P.Adj D.Adj F.Adj W.Adj H.Adj B.Adj SubLeq

-90 90 0.00 59.56 0.00 -9.09 0.00 0.00 -7.10 0.00 43.37

Segment Leq : 43.37 dBA

Total Leq All Segments: 50.11 dBA

TOTAL Leq FROM ALL SOURCES (DAY): 58.22
(NIGHT): 50.11

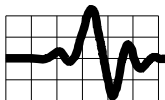

STAMSON 5.0 NORMAL REPORT Date: 10-02-2022 11:49:15
MINISTRY OF ENVIRONMENT AND ENERGY / NOISE ASSESSMENT

Filename: por4.te Time Period: 16 hours
Description: POR 4 - Outdoor Living Area - Day

Road data, segment # 1: Murray S1

Car traffic volume : 12144 veh/TimePeriod
Medium truck volume : 966 veh/TimePeriod
Heavy truck volume : 690 veh/TimePeriod
Posted speed limit : 50 km/h
Road gradient : 0 %
Road pavement : 1 (Typical asphalt or concrete)

Data for Segment # 1: Murray S1

Angle1 Angle2 : -90.00 deg 90.00 deg
Wood depth : 0 (No woods.)
No of house rows : 1
House density : 80 %
Surface : 2 (Reflective ground surface)
Receiver source distance : 70.70 m
Receiver height : 1.50 m
Topography : 4 (Elevated; with barrier)
Barrier angle1 : -45.00 deg Angle2 : 45.00 deg
Barrier height : 3.00 m
Elevation : 23.10 m
Barrier receiver distance : 3.00 m
Source elevation : 0.00 m
Receiver elevation : 23.10 m
Barrier elevation : 23.10 m
Reference angle : 0.00

Road data, segment # 2: King Ed S2

Car traffic volume : 13493 veh/TimePeriod
Medium truck volume : 1073 veh/TimePeriod
Heavy truck volume : 767 veh/TimePeriod
Posted speed limit : 40 km/h
Road gradient : 0 %
Road pavement : 1 (Typical asphalt or concrete)

Data for Segment # 2: King Ed S2

Angle1 Angle2 : -90.00 deg 90.00 deg
Wood depth : 0 (No woods.)
No of house rows : 2

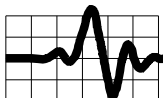

House density : 80 %
Surface : 2 (Reflective ground surface)
Receiver source distance : 105.50 m
Receiver height : 1.50 m
Topography : 3 (Elevated; no barrier)
Elevation : 23.10 m
Reference angle : 0.00

Road data, segment # 3: King Ed S3

Car traffic volume : 13493 veh/TimePeriod
Medium truck volume : 1073 veh/TimePeriod
Heavy truck volume : 767 veh/TimePeriod
Posted speed limit : 40 km/h
Road gradient : 0 %
Road pavement : 1 (Typical asphalt or concrete)

Data for Segment # 3: King Ed S3

Angle1 Angle2 : -90.00 deg 90.00 deg
Wood depth : 0 (No woods.)
No of house rows : 2
House density : 80 %
Surface : 2 (Reflective ground surface)
Receiver source distance : 115.50 m
Receiver height : 1.50 m
Topography : 3 (Elevated; no barrier)
Elevation : 23.10 m
Reference angle : 0.00

Road data, segment # 4: King Ed S4

Car traffic volume : 13493 veh/TimePeriod
Medium truck volume : 1073 veh/TimePeriod
Heavy truck volume : 767 veh/TimePeriod
Posted speed limit : 40 km/h
Road gradient : 0 %
Road pavement : 1 (Typical asphalt or concrete)

Data for Segment # 4: King Ed S4

Angle1 Angle2 : -90.00 deg 90.00 deg
Wood depth : 0 (No woods.)
No of house rows : 2
House density : 80 %
Surface : 2 (Reflective ground surface)
Receiver source distance : 125.50 m
Receiver height : 1.50 m
Topography : 3 (Elevated; no barrier)

Elevation : 23.10 m
Reference angle : 0.00

-90 90 0.00 67.14 0.00 -8.86 0.00 0.00 -7.12 0.00 51.16

Results segment # 1: Murray S1

Segment Leq : 51.16 dBA

Source height = 1.50 m

Results segment # 4: King Ed S4

Barrier height for grazing incidence

Source height = 1.50 m

Source Height (m)	Receiver Height (m)	Barrier Height (m)	Elevation of Barrier Top (m)
1.50	1.50	0.52	23.62

ROAD (0.00 + 50.83 + 0.00) = 50.83 dBA
Angle1 Angle2 Alpha RefLeq P.Adj D.Adj F.Adj W.Adj H.Adj B.Adj SubLeq

-90	90	0.00	67.14	0.00	-9.23	0.00	0.00	-7.09	0.00	50.83
-----	----	------	-------	------	-------	------	------	-------	------	-------

ROAD (49.88 + 41.57 + 49.88) = 53.20 dBA

Angle1 Angle2 Alpha RefLeq P.Adj D.Adj F.Adj W.Adj H.Adj B.Adj SubLeq

Segment Leq : 50.83 dBA

-90	-45	0.00	68.48	0.00	-6.73	-6.02	0.00	-5.85	0.00	49.88
-45	45	0.00	68.48	0.00	-6.73	-3.01	0.00	-5.85	0.00	52.89
-45	45	0.00	68.48	0.00	-6.73	-3.01	0.00	0.00	-17.16	41.57
45	90	0.00	68.48	0.00	-6.73	-6.02	0.00	-5.85	0.00	49.88

Total Leq All Segments: 57.79 dBA

TOTAL Leq FROM ALL SOURCES: 57.79

Segment Leq : 53.20 dBA

Results segment # 2: King Ed S2

Source height = 1.50 m

ROAD (0.00 + 51.50 + 0.00) = 51.50 dBA

Angle1 Angle2 Alpha RefLeq P.Adj D.Adj F.Adj W.Adj H.Adj B.Adj SubLeq

-90	90	0.00	67.14	0.00	-8.47	0.00	0.00	-7.17	0.00	51.50
-----	----	------	-------	------	-------	------	------	-------	------	-------

Segment Leq : 51.50 dBA

Results segment # 3: King Ed S3

Source height = 1.50 m

ROAD (0.00 + 51.16 + 0.00) = 51.16 dBA

Angle1 Angle2 Alpha RefLeq P.Adj D.Adj F.Adj W.Adj H.Adj B.Adj SubLeq

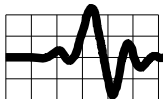

Noise Sound Insulation Scenario Calculation Results

Project: POR 1 Day

ProjectID:

Date:2022-02-10

Outdoor level: NEF 27 or Leq24 59 or Ldn 60 dBA

Source Spectrum details:

100% ISO 717 Road Traffic

Corrections:

Receiving room:

Floor Area: 40.10 ft²

Absorbtion: 120% of floor area

Construction Description:

Element 1: GL3_AIR13_GL3

Construction Type: Window

Area: 6.10 m²

Test ID: TLA-99-157a

Test Date: 1999-04-16

Vinyl double slider window (seals not taped).

Element 2: 6" thick ICF

Construction Type: Custom Wall

Area: 5.50 m²

Test ID: Intertek

Test Date: 2022-02-10

Stucco, on concrete filled ICF including 6" thick concrete core, with 1 layer of 13 mm gypsum board attached to web interior side with a minimum STC rating of 48.

Sound Level vs. Frequency - Spectrum Values:

Frequency(Hz) Indoor Sound Level(dB)

50	54.6
63	52.6
80	50.9

100	48.5
125	26.6
160	27.1
200	24.6
250	25.2
315	25.2
400	20.2
500	16.2
630	12.0
800	12.7
1000	11.7
1250	8.9
1600	8.5
2000	7.3
2500	6.2
3150	4.5
4000	3.6
5000	30.4

A-Weighted Sound Level vs. Frequency - Spectrum Values:

Frequency(Hz) A-Wtd Sound Level(dBA)

50	24.4
63	26.4
80	28.4
100	29.4
125	10.5
160	13.7
200	13.7
250	16.6
315	18.6
400	15.4
500	13.0
630	10.1
800	11.9
1000	11.7
1250	9.5
1600	9.5
2000	8.5
2500	7.5
3150	5.7
4000	4.6
5000	30.9

Transmission Loss vs. Frequency - Spectrum Values:

Frequency(Hz) Transmission Loss(dB)

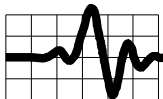

50	3.2
63	3.2
80	3.2
100	3.2
125	22.1
160	20.9
200	22.9
250	20.9
315	20.0
400	24.2
500	27.6
630	31.5
800	31.7
1000	32.9
1250	34.1
1600	33.1
2000	33.1
2500	32.1
3150	31.8
4000	31.8
5000	3.2

5000 40.3

Single Number Ratings

Outdoor Sound Level:	59 dBA
Indoor Sound Level:	36 dBA
A-wtd Level Reduction:	23 dB
A-wtd Reduction re Standard Source:	27 dB
OITC Rating:	18 dB

Source Sound Level vs. Frequency - Spectrum Values:

Frequency(Hz) Source Sound Level(dB)

50	64.0
63	62.0
80	60.3
100	57.9
125	54.9
160	54.2
200	53.7
250	52.4
315	51.4
400	50.6
500	50.0
630	49.7
800	50.6
1000	50.8
1250	49.2
1600	47.8
2000	46.6
2500	44.5
3150	42.6
4000	41.8

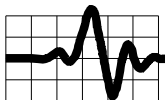

Noise Sound Insulation Scenario Calculation Results

Project: POR 1 Night
ProjectID:
Date:2022-02-10
Outdoor level: NEF 19 or Leq24 51 or Ldn 52 dBA

Source Spectrum details:

100% ISO 717 Road Traffic
Corrections:

Receiving room:

Floor Area: 40.10 ft²
Absorbtion: 120% of floor area

100	40.5
125	18.6
160	19.1
200	16.6
250	17.2
315	17.2
400	12.2
500	8.2
630	4.0
800	4.7
1000	3.7
1250	0.9
1600	0.5
2000	-0.7
2500	-1.8
3150	-3.5
4000	-4.4
5000	22.4

Construction Description:

Element 1: GL3_AIR13_GL3

Construction Type: Window
Area: 6.10 m²
Test ID: TLA-99-157a
Test Date: 1999-04-16

Vinyl double slider window (seals not taped).

Element 2: 6" thick ICF

Construction Type: Custom Wall
Area: 5.50 m²
Test ID: Intertek
Test Date: 2022-02-10

Stucco, on concrete filled ICF including 6" thick concrete core, with 1 layer of 13 mm gypsum board attached to web interior side with a minimum STC rating of 48.

Sound Level vs. Frequency - Spectrum Values:

Frequency(Hz) Indoor Sound Level(dB)

50	46.6
63	44.6
80	42.9

A-Weighted Sound Level vs. Frequency - Spectrum Values:

Frequency(Hz) A-Wtd Sound Level(dBA)

50	16.4
63	18.4
80	20.4
100	21.4
125	2.5
160	5.7
200	5.7
250	8.6
315	10.6
400	7.4
500	5.0
630	2.1
800	3.9
1000	3.7
1250	1.5
1600	1.5
2000	0.5
2500	-0.5
3150	-2.3
4000	-3.4
5000	22.9

Transmission Loss vs. Frequency - Spectrum Values:

Frequency(Hz) Transmission Loss(dB)

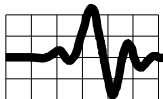

50	3.2
63	3.2
80	3.2
100	3.2
125	22.1
160	20.9
200	22.9
250	20.9
315	20.0
400	24.2
500	27.6
630	31.5
800	31.7
1000	32.9
1250	34.1
1600	33.1
2000	33.1
2500	32.1
3150	31.8
4000	31.8
5000	3.2

5000 32.3

Single Number Ratings

Outdoor Sound Level:	51 dBA
Indoor Sound Level:	28 dBA
A-wtd Level Reduction:	23 dB
A-wtd Reduction re Standard Source:	27 dB
OITC Rating:	18 dB

Source Sound Level vs. Frequency - Spectrum Values:

Frequency(Hz) Source Sound Level(dB)

50	56.0
63	54.0
80	52.3
100	49.9
125	46.9
160	46.2
200	45.7
250	44.4
315	43.4
400	42.6
500	42.0
630	41.7
800	42.6
1000	42.8
1250	41.2
1600	39.8
2000	38.6
2500	36.5
3150	34.6
4000	33.8

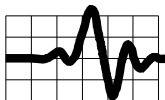

Noise Sound Insulation Scenario Calculation Results

Project: POR 2 Day
ProjectID:
Date:2022-02-10
Outdoor level: NEF 27 or Leq24 59 or Ldn 60 dBA

Source Spectrum details:

100% ISO 717 Road Traffic
Corrections:

Receiving room:

Floor Area: 29.70 ft²
Absorbtion: 100% of floor area

100	50.6
125	28.7
160	29.2
200	26.7
250	27.3
315	27.3
400	22.3
500	18.3
630	14.1
800	14.8
1000	13.8
1250	11.0
1600	10.5
2000	9.4
2500	8.3
3150	6.6
4000	5.7
5000	32.5

Construction Description:

Element 1: GL3_AIR13_GL3

Construction Type: Window
Area: 6.10 m²
Test ID: TLA-99-157a
Test Date: 1999-04-16

Vinyl double slider window (seals not taped).

Element 2: 6" thick ICF

Construction Type: Custom Wall
Area: 5.50 m²
Test ID: Intertek
Test Date: 2022-02-10

Stucco, on concrete filled ICF including 6" thick concrete core, with 1 layer of 13 mm gypsum board attached to web interior side with a minimum STC rating of 48.

Sound Level vs. Frequency - Spectrum Values:

Frequency(Hz) Indoor Sound Level(dB)

50	56.7
63	54.7
80	53.0

A-Weighted Sound Level vs. Frequency - Spectrum Values:

Frequency(Hz) A-Wtd Sound Level(dBA)

50	26.5
63	28.5
80	30.5
100	31.5
125	12.6
160	15.8
200	15.8
250	18.7
315	20.7
400	17.5
500	15.1
630	12.2
800	14.0
1000	13.8
1250	11.6
1600	11.5
2000	10.6
2500	9.6
3150	7.8
4000	6.7
5000	33.0

Transmission Loss vs. Frequency - Spectrum Values:

Frequency(Hz) Transmission Loss(dB)

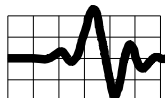

50	3.2
63	3.2
80	3.2
100	3.2
125	22.1
160	20.9
200	22.9
250	20.9
315	20.0
400	24.2
500	27.6
630	31.5
800	31.7
1000	32.9
1250	34.1
1600	33.1
2000	33.1
2500	32.1
3150	31.8
4000	31.8
5000	3.2

5000 40.3

Single Number Ratings

Outdoor Sound Level:	59 dBA
Indoor Sound Level:	38 dBA
A-wtd Level Reduction:	21 dB
A-wtd Reduction re Standard Source:	25 dB
OITC Rating:	18 dB

Source Sound Level vs. Frequency - Spectrum Values:

Frequency(Hz) Source Sound Level(dB)

50	64.0
63	62.0
80	60.3
100	57.9
125	54.9
160	54.2
200	53.7
250	52.4
315	51.4
400	50.6
500	50.0
630	49.7
800	50.6
1000	50.8
1250	49.2
1600	47.8
2000	46.6
2500	44.5
3150	42.6
4000	41.8

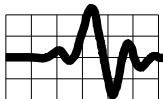

Noise Sound Insulation Scenario Calculation Results

	100	41.6
	125	19.7
	160	20.2
Project: POR 2 Night	200	17.7
ProjectID:	250	18.3
Date:2022-02-10	315	18.3
Outdoor level: NEF 18 or Leq24 50 or Ldn 51 dBA	400	13.3
	500	9.3
Source Spectrum details:	630	5.1
	800	5.8
100% ISO 717 Road Traffic	1000	4.8
Corrections:	1250	2.0
	1600	1.5
	2000	0.4
Receiving room:	2500	-0.7
	3150	-2.4
Floor Area: 29.70 ft ²	4000	-3.3
Absorbtion: 100% of floor area	5000	23.5

Construction Description:

Element 1: GL3_AIR13_GL3

Construction Type: Window
Area: 6.10 m²
Test ID: TLA-99-157a
Test Date: 1999-04-16

Vinyl double slider window (seals not taped).

Element 2: 6" thick ICF

Construction Type: Custom Wall
Area: 5.50 m²
Test ID: Intertek
Test Date: 2022-02-10

Stucco, on concrete filled ICF including 6" thick concrete core, with 1 layer of 13 mm gypsum board attached to web interior side with a minimum STC rating of 48.

Sound Level vs. Frequency - Spectrum Values:

Frequency(Hz) Indoor Sound Level(dB)

50	47.7
63	45.7
80	44.0

A-Weighted Sound Level vs. Frequency - Spectrum Values:

Frequency(Hz) A-Wtd Sound Level(dBA)

50	17.5
63	19.5
80	21.5
100	22.5
125	3.6
160	6.8
200	6.8
250	9.7
315	11.7
400	8.5
500	6.1
630	3.2
800	5.0
1000	4.8
1250	2.6
1600	2.5
2000	1.6
2500	0.6
3150	-1.2
4000	-2.3
5000	24.0

Transmission Loss vs. Frequency - Spectrum Values:

Frequency(Hz) Transmission Loss(dB)

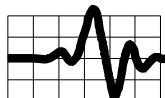

50	3.2
63	3.2
80	3.2
100	3.2
125	22.1
160	20.9
200	22.9
250	20.9
315	20.0
400	24.2
500	27.6
630	31.5
800	31.7
1000	32.9
1250	34.1
1600	33.1
2000	33.1
2500	32.1
3150	31.8
4000	31.8
5000	3.2

5000 31.3

Single Number Ratings

Outdoor Sound Level:	50 dBA
Indoor Sound Level:	29 dBA
A-wtd Level Reduction:	21 dB
A-wtd Reduction re Standard Source:	25 dB
OITC Rating:	18 dB

Source Sound Level vs. Frequency - Spectrum Values:

Frequency(Hz) Source Sound Level(dB)

50	55.0
63	53.0
80	51.3
100	48.9
125	45.9
160	45.2
200	44.7
250	43.4
315	42.4
400	41.6
500	41.0
630	40.7
800	41.6
1000	41.8
1250	40.2
1600	38.8
2000	37.6
2500	35.5
3150	33.6
4000	32.8

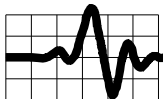

Moise Sound Insulation Scenario Calculation Results

Project: POR 3 Day L4
ProjectID:
Date:2022-02-10
Outdoor level: NEF 27 or Leq24 59 or Ldn 60 dBA
Source Spectrum details:

800	4.2
1000	-6.6
1250	-20.2
1600	-25.6
2000	-27.8
2500	-26.9
3150	-19.9
4000	-22.8
5000	-24.5

100% ISO 717 Road Traffic
Corrections:

A-Weighted Sound Level vs. Frequency - Spectrum Values:

Frequency(Hz) A-Wtd Sound Level(dBA)

Receiving room:

Floor Area: 40.1 ft²
Absorbtion: 100% of floor area

Construction Description:

Element 1: 6" thick ICF

Construction Type: Custom Wall
Area: 23.40 m²
Test ID: Intertek
Test Date: 2022-02-10

Stucco, on concrete filled ICF including 6" thick concrete core, with 1 lay
er of 13 mm gypsum board attached to web interior side with a minimum STC rating
of 48.

Sound Level vs. Frequency - Spectrum Values:

Frequency(Hz) Indoor Sound Level(dB)

50	19.6
63	17.6
80	15.9
100	13.5
125	10.5
160	17.8
200	20.3
250	16.0
315	6.0
400	-1.8
500	-1.4
630	3.3

50	-10.6
63	-8.6
80	-6.6
100	-5.6
125	-5.6
160	4.4
200	9.4
250	7.4
315	-0.6
400	-6.6
500	-4.6
630	1.4
800	3.4
1000	-6.6
1250	-19.6
1600	-24.6
2000	-26.6
2500	-25.6
3150	-18.7
4000	-21.8
5000	-24.0

Transmission Loss vs. Frequency - Spectrum Values:

Frequency(Hz) Transmission Loss(dB)

50	42.0
63	42.0
80	42.0
100	42.0
125	42.0
160	34.0
200	31.0

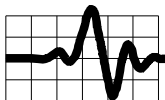

250	34.0
315	43.0
400	50.0
500	49.0
630	44.0
800	44.0
1000	55.0
1250	67.0
1600	71.0
2000	72.0
2500	69.0
3150	60.0
4000	62.0
5000	62.0

Source Sound Level vs. Frequency - Spectrum Values:

Frequency(Hz) Source Sound Level(dB)

50	64.0
63	62.0
80	60.3
100	57.9
125	54.9
160	54.2
200	53.7
250	52.4
315	51.4
400	50.6
500	50.0
630	49.7
800	50.6
1000	50.8
1250	49.2
1600	47.8
2000	46.6
2500	44.5
3150	42.6
4000	41.8
5000	40.3

Single Number Ratings

Outdoor Sound Level: 59 dBA
 Indoor Sound Level: 14 dBA
 A-wtd Level Reduction: 45 dB
 A-wtd Reduction re Standard Source: 44 dB
 OITC Rating: 41 dB

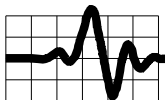

Noise Sound Insulation Scenario Calculation Results

Project: POR 3 Night L4
ProjectID:
Date:2022-02-10
Outdoor level: NEF 19 or Leq24 51 or Ldn 52 dBA
Source Spectrum details:

800	-3.8
1000	-14.6
1250	-28.2
1600	-33.6
2000	-35.8
2500	-34.9
3150	-27.9
4000	-30.8
5000	-32.5

100% ISO 717 Road Traffic
Corrections:

A-Weighted Sound Level vs. Frequency - Spectrum Values:

Frequency(Hz) A-Wtd Sound Level(dBA)

Receiving room:

Floor Area: 40.1 ft²
Absorbtion: 100% of floor area

Construction Description:

Element 1: 6" thick ICF

Construction Type: Custom Wall
Area: 23.40 m²
Test ID: Intertek
Test Date: 2022-02-10

Stucco, on concrete filled ICF including 6" thick concrete core, with 1 lay
er of 13 mm gypsum board attached to web interior side with a minimum STC rating
of 48.

Sound Level vs. Frequency - Spectrum Values:

Frequency(Hz) Indoor Sound Level(dB)

50	11.6
63	9.6
80	7.9
100	5.5
125	2.5
160	9.8
200	12.3
250	8.0
315	-2.0
400	-9.8
500	-9.4
630	-4.7

50	-18.6
63	-16.6
80	-14.6
100	-13.6
125	-13.6
160	-3.6
200	1.4
250	-0.6
315	-8.6
400	-14.6
500	-12.6
630	-6.6
800	-4.6
1000	-14.6
1250	-27.6
1600	-32.6
2000	-34.6
2500	-33.6
3150	-26.7
4000	-29.8
5000	-32.0

Transmission Loss vs. Frequency - Spectrum Values:

Frequency(Hz) Transmission Loss(dB)

50	42.0
63	42.0
80	42.0
100	42.0
125	42.0
160	34.0
200	31.0

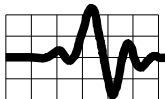

250	34.0
315	43.0
400	50.0
500	49.0
630	44.0
800	44.0
1000	55.0
1250	67.0
1600	71.0
2000	72.0
2500	69.0
3150	60.0
4000	62.0
5000	62.0

Source Sound Level vs. Frequency - Spectrum Values:

Frequency(Hz) Source Sound Level(dB)

50	56.0
63	54.0
80	52.3
100	49.9
125	46.9
160	46.2
200	45.7
250	44.4
315	43.4
400	42.6
500	42.0
630	41.7
800	42.6
1000	42.8
1250	41.2
1600	39.8
2000	38.6
2500	36.5
3150	34.6
4000	33.8
5000	32.3

Single Number Ratings

Outdoor Sound Level: 51 dBA
 Indoor Sound Level: 6 dBA
 A-wtd Level Reduction: 45 dB
 A-wtd Reduction re Standard Source: 44 dB
 OITC Rating: 41 dB

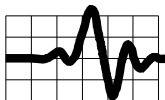

Noise Sound Insulation Scenario Calculation Results

Project: POR 3 Day L9
ProjectID:
Date:2022-02-10
Outdoor level: NEF 27 or Leq24 59 or Ldn 60 dBA
Source Spectrum details:

800	4.2
1000	-6.6
1250	-20.2
1600	-25.6
2000	-27.8
2500	-26.9
3150	-20.0
4000	-22.9
5000	-24.6

100% ISO 717 Road Traffic
Corrections:

A-Weighted Sound Level vs. Frequency - Spectrum Values:

Frequency(Hz) A-Wtd Sound Level(dBA)

Receiving room:

Floor Area: 29.70 ft²
Absorbtion: 100% of floor area

50	-10.6
63	-8.6
80	-6.6
100	-5.6
125	-5.6
160	4.4
200	9.4
250	7.4
315	-0.6
400	-6.6
500	-4.6
630	1.4
800	3.4
1000	-6.6
1250	-19.6
1600	-24.6
2000	-26.6
2500	-25.6
3150	-18.8
4000	-21.9
5000	-24.1

Construction Description:

Element 1: 6" thick ICF

Construction Type: Custom Wall
Area: 17.00 m²
Test ID: Intertek
Test Date: 2022-02-10

Stucco, on concrete filled ICF including 6" thick concrete core, with 1 lay
er of 13 mm gypsum board attached to web interior side with a minimum STC rating
of 48.

Sound Level vs. Frequency - Spectrum Values:

Frequency(Hz) Indoor Sound Level(dB)

50	19.6
63	17.6
80	15.9
100	13.5
125	10.5
160	17.8
200	20.3
250	16.0
315	6.0
400	-1.8
500	-1.4
630	3.3

Transmission Loss vs. Frequency - Spectrum Values:

Frequency(Hz) Transmission Loss(dB)

50	42.0
63	42.0
80	42.0
100	42.0
125	42.0
160	34.0
200	31.0

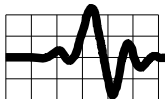

250	34.0
315	43.0
400	50.0
500	49.0
630	44.0
800	44.0
1000	55.0
1250	67.0
1600	71.0
2000	72.0
2500	69.0
3150	60.0
4000	62.0
5000	62.0

Source Sound Level vs. Frequency - Spectrum Values:

Frequency(Hz) Source Sound Level(dB)

50	64.0
63	62.0
80	60.3
100	57.9
125	54.9
160	54.2
200	53.7
250	52.4
315	51.4
400	50.6
500	50.0
630	49.7
800	50.6
1000	50.8
1250	49.2
1600	47.8
2000	46.6
2500	44.5
3150	42.6
4000	41.8
5000	40.3

Single Number Ratings

Outdoor Sound Level: 59 dBA
 Indoor Sound Level: 14 dBA
 A-wtd Level Reduction: 45 dB
 A-wtd Reduction re Standard Source: 44 dB
 OITC Rating: 41 dB

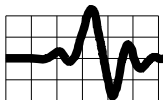

Noise Sound Insulation Scenario Calculation Results

Project: POR 3 Night L9
ProjectID:
Date:2022-02-10
Outdoor level: NEF 19 or Leq24 51 or Ldn 52 dBA
Source Spectrum details:

800	-3.8
1000	-14.6
1250	-28.2
1600	-33.6
2000	-35.8
2500	-34.9
3150	-28.0
4000	-30.9
5000	-32.6

100% ISO 717 Road Traffic
Corrections:

A-Weighted Sound Level vs. Frequency - Spectrum Values:

Frequency(Hz) A-Wtd Sound Level(dBA)

Receiving room:

Floor Area: 29.70 ft²
Absorbtion: 100% of floor area

Construction Description:

Element 1: 6" thick ICF

Construction Type: Custom Wall
Area: 17.00 m²
Test ID: Intertek
Test Date: 2022-02-10

Stucco, on concrete filled ICF including 6" thick concrete core, with 1 lay
er of 13 mm gypsum board attached to web interior side with a minimum STC rating
of 48.

Sound Level vs. Frequency - Spectrum Values:

Frequency(Hz) Indoor Sound Level(dB)

50	11.6
63	9.6
80	7.9
100	5.5
125	2.5
160	9.8
200	12.3
250	8.0
315	-2.0
400	-9.8
500	-9.4
630	-4.7

50	-18.6
63	-16.6
80	-14.6
100	-13.6
125	-13.6
160	-3.6
200	1.4
250	-0.6
315	-8.6
400	-14.6
500	-12.6
630	-6.6
800	-4.6
1000	-14.6
1250	-27.6
1600	-32.6
2000	-34.6
2500	-33.6
3150	-26.8
4000	-29.9
5000	-32.1

Transmission Loss vs. Frequency - Spectrum Values:

Frequency(Hz) Transmission Loss(dB)

50	42.0
63	42.0
80	42.0
100	42.0
125	42.0
160	34.0
200	31.0

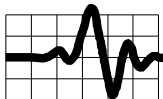

250	34.0
315	43.0
400	50.0
500	49.0
630	44.0
800	44.0
1000	55.0
1250	67.0
1600	71.0
2000	72.0
2500	69.0
3150	60.0
4000	62.0
5000	62.0

Source Sound Level vs. Frequency - Spectrum Values:

Frequency(Hz) Source Sound Level(dB)

50	56.0
63	54.0
80	52.3
100	49.9
125	46.9
160	46.2
200	45.7
250	44.4
315	43.4
400	42.6
500	42.0
630	41.7
800	42.6
1000	42.8
1250	41.2
1600	39.8
2000	38.6
2500	36.5
3150	34.6
4000	33.8
5000	32.3

Single Number Ratings

Outdoor Sound Level: 51 dBA
 Indoor Sound Level: 6 dBA
 A-wtd Level Reduction: 45 dB
 A-wtd Reduction re Standard Source: 44 dB
 OITC Rating: 41 dB

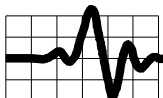

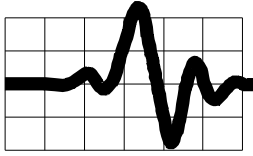
**RESUMÉ: Dr. HUGH WILLIAMSON, P.Eng.**

QUALIFICATIONS: Ph.D. Mechanical Engineering, University of New South Wales, 1972
B.Sc. Mechanical Engineering, (with Distinction), University of Alberta, 1967
Member, Professional Engineers, Ontario
Member, Canadian Acoustical Association

- KEY COMPETENCIES:**
- Environmental noise and vibration assessments, Environmental Compliance Approval (ECA). Noise assessment for land use planning
 - Architectural and building acoustics, acoustics of office spaces, meeting rooms, auditoriums and studios, noise and vibration control of building mechanical services.
 - Industrial noise and vibration assessment and control.
 - Transportation noise and vibration.

PROFESSIONAL EXPERIENCE:

Hugh Williamson is a professional engineer with many years of experience in the measurement, analysis and control of noise and vibration. Freefield Ltd. was incorporated in 2017 and provides consulting services in architectural, building, industrial, transportation and environmental acoustics and vibration. Clients include architects, engineering firms, industrial firms and government departments. Prior to joining Freefield Ltd. Hugh Williamson founded and directed Hugh Williamson Associates Inc. which specialized in consulting services in architectural, building, industrial, transportation and environmental acoustics and vibration. His career included extensive periods in industry as well as university level research and teaching. He is a former Director of the Acoustics and Vibration Unit at the Australian Defence Force Academy. He has published over 50 engineering and scientific papers and has been an invited speaker on noise and vibration at national and international conferences. He has more than 25 years of experience as a consultant.

CLIENT LIST:

Hugh Williamson has provided consulting services to large and small clients including: National Research Council, J. L. Richards & Associates, Barry Padolsky Associates, Atkinson Schroeter Design Group, R. W. Tomlinson Limited, Geo. Tackaberry Construction, Miller Paving, City of Ottawa.

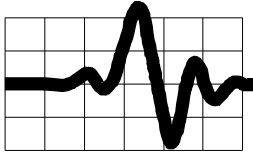

RESUMÉ: MICHAEL WELLS

QUALIFICATIONS: Registered Architect of NSW, Registration Number: 8111

B. Architecture (Hons), University of Sydney, 2002

B.Sc. Architecture, University of Sydney, 1999

Member, Canadian Acoustical Association

Member, Australian Acoustical Society

Associate Member, INCE-USA

**KEY
COMPETENCIES:**

- Environmental noise and vibration assessments, Environmental Compliance Approval (ECA). Noise assessment for land use planning.
- Architectural and building acoustics, acoustics of office spaces, meeting rooms, auditoriums and studios, noise and vibration control of building mechanical services.
- Industrial noise and vibration assessment and control.
- Transportation noise and vibration.
- Design services including sketch design, design development (development / permit applications), contract documents, tendering and contract administration.

PROFESSIONAL EXPERIENCE:

Michael Wells is a professional Architect registered in NSW, Australia, with many years of experience in the measurement, analysis and control of noise and vibration. Michael Wells is a founding Director of Freefield Ltd. which was incorporated in 2017, and provides consulting services in architectural, building, industrial, transportation and environmental acoustics and vibration. Clients include architects, engineering firms, industrial firms and government departments. Prior to establishing Freefield Ltd., his career included working for Hugh Williamson Associates Inc. specializing in acoustics, noise and vibration consulting services, and, the founding of Michael Wells Architect in Sydney, Australia, specializing in the design of institutional, commercial and residential projects. He is the former Director of Architectural Workshops Australia and Vision Blue Pty Ltd. He has more than 15 years of experience as a consultant.

CLIENT LIST:

Michael Wells has provided consulting services to large and small clients including: National Research Council, R. W. Tomlinson, G. Tackaberry & Sons Construction, Miller Paving, J. L. Richards & Associates, Barry Padolsky Associates, Atkinson Schroeter Design Group and Industry Canada.