



Preliminary Geotechnical Investigation

Client:

Katasa Groupe
69 rue Jean-Proulx, Unit 301
Gatineau, QC
J8Z 1W2

Attn: Chaxu Baria, Project Management Assistant

Type of Document:

FINAL

Project Name:

Proposed High Rise Development
381 Kent Street,
Ottawa, Ontario

Project Number:

OTT-21019154-A0

EXP Services Inc.

100-2650 Queensview Drive
Ottawa, Ontario K2B 8H6

t: +1.613.688.1899

f: +1.613.225.7337

Date Submitted: 2023.02.22

*Project Name: Proposed High Rise Development
Preliminary Geotechnical Investigation
381 Kent Street, Ottawa, Ontario
Project Number: OTT-21019154-A0
February 22, 2023
Final Report*

Table of Contents

| | |
|--|----|
| Executive Summary | 1 |
| 1. Introduction | 3 |
| 2. Site Description..... | 4 |
| 3. Geology of the Site | 5 |
| 3.1 Surficial Geology..... | 5 |
| 3.2 Bedrock Geology | 5 |
| 4. Procedure | 6 |
| 4.1 Fieldwork..... | 6 |
| 4.2 Laboratory Testing Program..... | 6 |
| 4.3 Multi-channel Analysis of Surface Waves (MASW) Survey | 7 |
| 5. Subsurface Conditions and Groundwater Levels..... | 8 |
| 5.1 Asphaltic Concrete | 8 |
| 5.2 Fill | 8 |
| 5.3 Silty clay..... | 8 |
| 5.4 Clayey Sand with Gravel Glacial Till..... | 9 |
| 5.5 Shale Bedrock..... | 9 |
| 5.6 Groundwater Level Measurements | 11 |
| 6. Site Classification for Seismic Site Response and Liquefaction Potential of Soils | 12 |
| 6.1 Site Classification for Seismic Site Response..... | 12 |
| 6.2 Liquefaction Potential of Soils..... | 12 |
| 7. Grade Raise Restrictions | 13 |
| 8. Foundation Considerations..... | 14 |
| 8.1 Footings..... | 14 |
| 8.2 Pile Foundation | 14 |
| 8.3 Caisson Foundation | 16 |
| 8.4 General Comments for Foundations..... | 16 |
| 9. Floor Slab and Drainage Requirements | 17 |

*Project Name: Proposed High Rise Development
 Preliminary Geotechnical Investigation
 381 Kent Street, Ottawa, Ontario
 Project Number: OTT-21019154-A0
 February 22, 2023
 Final Report*

9.1 Lowest Floor Level as a Concrete Surface 17

9.2 Lowest Floor Level as a Paved Surface 17

10. Lateral Earth Pressures Against Basement Walls 19

11. Excavations and De-Watering Requirements 20

 11.1 Excess Soil Management 20

 11.2 Excavations 20

 11.3 De-Watering Requirements and Impact of Groundwater Lowering on Adjacent Structures 21

12. Pipe Bedding Requirements 23

13. Backfilling Requirements and Suitability of On-Site Soils for Backfilling Purposes 24

14. Tree Planting Restrictions 25

15. Earthworks Quality Control During Construction 26

16. General Comments 27

List of Tables

| | |
|--|----|
| Table I: Summary of Laboratory Testing Program | 7 |
| Table II: Summary of Results from Grain-Size Analysis and Atterberg Limit Determination - Silty clay Samples..... | 9 |
| Table III: Summary of Results from Grain-Size Analysis and Atterberg Limit Determination - Glacial Till Samples..... | 9 |
| Table IV: Summary of Auger and Soil Sampler Refusal and Bedrock Depths (Elevations) in Boreholes | 10 |
| Table V: Summary of Unconfined Compressive Strength Test Results – Bedrock Cores | 10 |
| Table VI: Summary of Groundwater level Measurements | 11 |
| Table VII: Factored Geotechnical Resistance at Ultimate Limit State (ULS) for Steel Pipe and H-Piles | 15 |

List of Figures

| | | |
|----------------|---|--------------------------------|
| Figure 1 | – | Site Location Plan |
| Figures 2 | – | Borehole Location Plan |
| Figures 3 to 6 | – | Borehole Logs |
| Figures 7 to 9 | – | Grain-size Distribution Curves |

Appendices

| | |
|-------------|--|
| Appendix A: | Multi-channel Analysis of Surface Waves Survey Report by GPR |
| Appendix B: | Bedrock Core Photographs |
| Appendix C: | Ontario Provincial Standard Drawing (OPSD) 3001.100 |

Executive Summary

EXP Services Inc. (EXP) is pleased to present the results of the geotechnical investigation completed for the proposed development to be located at 381 Kent Street in Ottawa, Ontario.

It is understood that the site is to be redeveloped with two (2), nine (9) storey residential towers with two basement levels. EXP understands that Katasa Groupe is completing this work for due diligence purposes in support of site plan approval with the City of Ottawa.

Phase One and Two Environmental Site Assessments (ESAs) were conducted by EXP concurrently with this geotechnical investigation and the results of these assessments are reported in separate documents.

The fieldwork for this geotechnical investigation was undertaken between November 29 and December 2, 2021 and consists of four (4) boreholes (Borehole Nos. 1 to 4) advanced to auger refusal/DCPT refusal and termination depths ranging from 7.6 m to 20.9 m below existing grade. Nineteen (19) mm standpipes and thirty-eight (38) mm monitoring wells, with slotted sections, were installed in all the boreholes for long-term monitoring of the groundwater levels and for the sampling of the groundwater as part of the Phase Two ESA. The monitoring wells and standpipes were installed in accordance with EXP standard practice, and the installation configuration is documented on the respective borehole log.

The boreholes indicate the site is underlain by an asphaltic concrete layer underlain by loose to dense fill that extends to depths of 0.9 m to 1.7 m (Elevation 71.4 m to Elevation 71.0 m). Beneath the fill is a layer of firm to hard silty clay extending to the compact glacial till contacted at 6.0 m to 6.6 m depths (Elevation 66.7 m to Elevation 65.4 m). The glacial till was proven to overlie shale bedrock contacted at 9.6 m and 10.1 m depths (Elevation 62.9 m and Elevation 61.9 m) in Borehole Nos. 1 and 4. Auger refusal and DCPT refusal was encountered at 12.6 m (Elevation 60.1 m) and 7.6 m (Elevation 64.8 m) in Borehole Nos. 2 and 4, respectively, which may indicate the bedrock surface or cobbles/boulders within the glacial till. The groundwater level ranges from 2.8 m to 5.8 m (Elevation 69.9 m to Elevation 66.2 m) in the overburden wells. The groundwater within the shale was found to be 2.1 m (Elevation 70.4 m) and 8.2 m depth (Elevation 63.8 m) in Borehole Nos. 1 and 4, respectively.

The results of the shear wave velocity sounding survey (seismic shear wave survey) conducted by GPR is shown in Appendix C. Based on the results of the survey and the recommendation that the proposed buildings be supported by footings founded on the sound bedrock, the shear wave velocity for footings founded on sound bedrock was determined to be 515.4 m/s. For a shear wave velocity of 515.4 m/s, Table 4.1.8.4.A of the 2012 Ontario Building Code (as amended May 2, 2019) indicates the site classification for seismic site response is **Class A** for foundations placed on bedrock or within 3 m of the bedrock surface. For footings founded on the glacial till, more than 3.0 m from the bedrock surface, the site classification for seismic site response is **Class C**.

The subsurface soils are not considered to be liquefiable during a seismic event.

With this foundation option, it is anticipated that the footings will be founded on the native glacial till contacted at 6.0 m to 6.6 m depths (Elevation 66.7 m to Elevation 65.4 m) at Borehole Nos. 1, 2 and 4. Strip footings having a maximum width of 1.5 m and square pad footings having a width and length of 3.0 m and founded on the glacial till may be designed for a bearing pressure at serviceability limit state (SLS) of 150 kPa and factored geotechnical resistance at ultimate limit state (ULS) of 225 kPa. The factored geotechnical resistance at ULS includes a geotechnical resistance factor of 0.5. Any loose zones of the glacial till noted in the footing beds should be removed and replaced with Ontario Provincial Standard Specification (OPSS) Granular B Type II material compacted to 100 percent standard Proctor maximum dry density (SPMDD). Settlement of footings designed for the above SLS bearing pressure are expected to be within tolerable limits of 25 mm total and 19 differential movement.

If it is not feasible to support the proposed structure by shallow footings, the proposed structure may be supported by closed end steel pipe or steel H-piles driven to practical refusal in the shale bedrock confirmed at 9.6 m and 10.1 m depths (Elevation 62.9 m and Elevation 61.9 m). Sound shale bedrock was encountered in Boreholes Nos 1 and 4 at 10.1 m (Elevation 62.4 m) and 10.8 m (Elevation 61.2 m), respectively. Auger refusal and DCPT refusal was encountered at 12.6 m (Elevation 60.1 m) and 7.6 m (Elevation 64.8 m) in Boreholes Nos. 2 and 4, respectively, and may indicate the bedrock surface or cobbles/boulders within the glacial till or the bedrock surface. Closed end pipe piles are typically used in the Ottawa area and can be more economical

*Project Name: Proposed High Rise Development
Preliminary Geotechnical Investigation
381 Kent Street, Ottawa, Ontario
Project Number: OTT-21019154-A0
February 22, 2023
Final Report*

compared to H-piles. Further, H-piles tend to extend deeper into the shale bedrock to achieve practical refusal and required set compared with closed end pipe piles. Therefore, closed end pipe piles are recommended for this project.

The lowest floor level of the parking garages for the proposed buildings will be located at an approximate 6.0 m depth below the existing grade. Based on the borehole information, the lowest floor slabs of the buildings will be founded on, or just above the glacial till and may be constructed as a concrete slab-on-grade or as a paved surface.

The lowest floor level for the parking garages is anticipated to be located below the groundwater level. Therefore, underfloor and perimeter drainage systems will be required for the proposed below grade parking garages.

Excavation of the soils may be undertaken using heavy equipment capable of removing debris within the fill as well as cobbles, boulders and slabs of shale bedrock within the glacial till.

All excavations must be undertaken in accordance with the Occupational Health and Safety Act (OHSA), Ontario Reg. 213/91. Based on the definitions provided in OHSA, the subsurface soils on site are considered to be Type 3 and as such must be cut back at 1H:1V from the bottom of the excavation above the groundwater level. Within zones of persistent seepage and below the groundwater level in the soils, the excavation side slopes are expected to slough and eventually stabilize at a slope of 2H:1V to 3H:1V.

It is anticipated that due to the significant depth of the excavation for the proposed buildings and the proximity of the excavation to existing buildings and infrastructure, the excavations will likely have to be undertaken within the confines of a shoring system. The shoring system may consist of steel H soldier pile and timber lagging system, interlocking sheeting system and/or secant pile shoring system.

It is anticipated that the majority of the material required for backfilling purposes in the interior and exterior of the proposed buildings will need to be imported and should preferably conform to OPSS 1010 (as amended by SSP110S13) for Granular B Type II.

A hydrogeological study must be completed as part of the final design to establish the quantity of water to be pumped as well as any potential influence of the construction on neighboring properties so appropriate design steps can be implemented as part of the construction and design, i.e. shoring, drainage, etc.

The above and other related considerations are discussed in greater detail in the main body of this report.

*Project Name: Proposed High Rise Development
Preliminary Geotechnical Investigation
381 Kent Street, Ottawa, Ontario
Project Number: OTT-21019154-A0
February 22, 2023
Final Report*

1. Introduction

EXP Services Inc. (EXP) is pleased to present the results of the geotechnical investigation completed for the proposed development to be located at 381 Kent Street in Ottawa, Ontario.

It is understood that the site is to be redeveloped with two (2), nine (9) storey residential towers with two basement levels. EXP understands that Katasa Groupe is completing this work for due diligence purposes in support of site plan approval with the City of Ottawa.

Phase One and Two Environmental Site Assessments (ESAs) were conducted by EXP concurrently with this geotechnical investigation and the results of these assessments are reported in separate documents.

This geotechnical investigation was undertaken to:

- a) Establish the subsurface soil, bedrock and groundwater conditions at the four (4) borehole locations;
- b) Classify the site for seismic site response in accordance with the requirements of the 2012 Ontario Building Code (as amended May 2, 2019) and assess the potential for liquefaction of the subsurface soils during a seismic event;
- c) Comment on grade-raise restrictions;
- d) Make recommendations regarding the most suitable type of foundations, founding depth and bearing pressure at serviceability limit state (SLS) and factored geotechnical resistance at ultimate limit state (ULS) of the founding strata and comment on the anticipated total and differential settlements of the recommended foundation type;
- e) Discuss the feasibility of constructing the lowest floor slab as a slab on grade and provide comments regarding perimeter and underfloor drainage systems;
- f) Provide lateral earth pressure parameters (for static and seismic conditions) for the subsurface (basement) walls; and
- g) Comment on excavation conditions and de-watering requirements during construction;

The comments and recommendations given in this report are based on the assumption that the above-described design concepts will proceed into construction. If changes are made either in the design phase or during construction, this office must be retained to review these modifications. The result of this review may be a modification of our recommendations, or it may require additional field or laboratory work to check whether the changes are acceptable from a geotechnical viewpoint.

*Project Name: Proposed High Rise Development
Preliminary Geotechnical Investigation
381 Kent Street, Ottawa, Ontario
Project Number: OTT-21019154-A0
February 22, 2023
Final Report*

2. Site Description

The Site is located on the northeast corner of the intersection of Kent Street and James Street. The Site is irregular in shape with an approximate area of 0.4 hectares (1.0 acres) and is currently occupied by a five-storey commercial building with surface parking. A Site Location Plan is provided as Figure 1.

The topography of the site gradually slopes down to the south and to the west. The ground surface elevations at the borehole locations ranges from 72.00 m to 72.66 m.

3. Geology of the Site

3.1 Surficial Geology

The surficial geology was reviewed via the Google Earth applications published by the Ontario Ministry of Energy, Northern Development and Mines available via www.mndm.gov.on.ca/en/mines-and-minerals/applications/ogsearth/surficial-geology and was last modified on May 23, 2017. The map indicates that beneath any fill the site is underlain by fine-textured glaciolacustrine deposits consisting of silt and silty clay, minor sand and gravel. Underlying the glaciolacustrine deposits is a glacial till deposit. Older alluvial deposits are indicated to the southwest of the site. The surficial deposits are shown in Image 1 below.



Image 1 – Surficial Geology

3.2 Bedrock Geology

The bedrock geology was reviewed via the Google Earth applications published by the Ontario Ministry of Energy, Northern Development and Mines available via <http://www.geologyontario.mndm.gov.on.ca/mines/data/google/MRD219/geology/doc.kml> and published in 2007. The map indicates Limestone of the Lindsay formation. Near the site shale and minor limestone of the Billings Formation is indicated. The bedrock deposits are shown in Image 2 below.

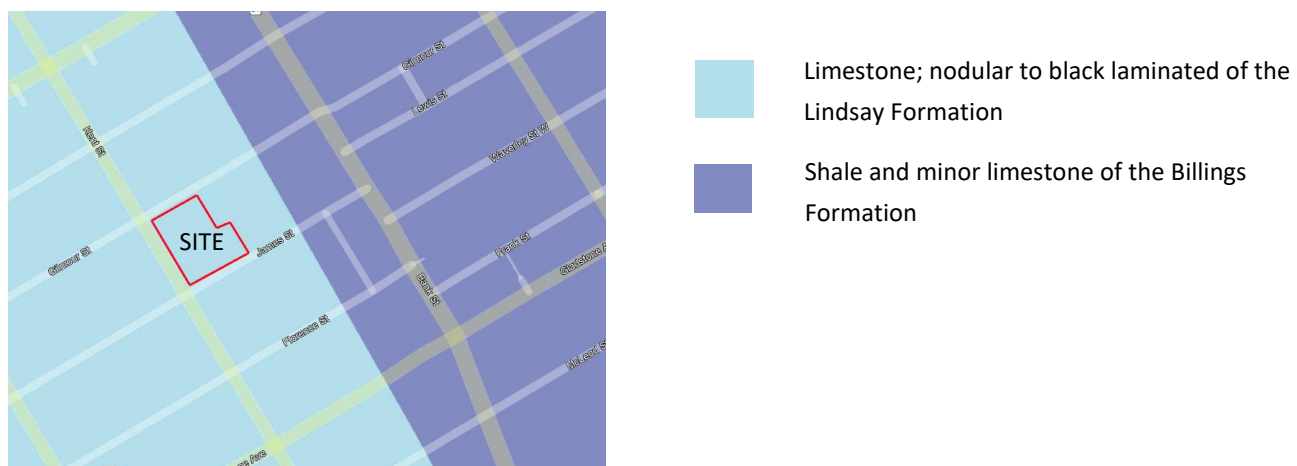

Image 2 – Bedrock Geology

4. Procedure

4.1 Fieldwork

The fieldwork for this geotechnical investigation was undertaken between November 29 and December 2, 2021 and consists of four (4) boreholes (Borehole Nos. 1 to 4) advanced to auger refusal/DCPT refusal and termination depths ranging from 7.6 m to 20.9 m below the existing grade.

The locations and geodetic elevations of the boreholes were surveyed by EXP. Prior to the fieldwork, the locations of the boreholes were cleared of any public and private underground services.

The boreholes were drilled using a CME-55 truck mounted drill rig equipped with continuous flight hollow stem augers and the capability to sample soil and bedrock. Standard penetration tests (SPTs) were performed in the boreholes at generally 0.8 m to 1.5 m depth intervals with soil samples retrieved by the split-barrel sampler. One sample was taken at an interval of 2.5 m and one sample taken at a 3.8 m interval in Boreholes Nos. 2 and 3, respectively. Borehole No. 2 was advanced from a 6.4 m depth to a cone refusal depth of 7.6 m by conducting a dynamic cone penetration test (DCPT). The undrained shear strength of the clayey soil was measured by conducting pocket penetrometer and in-situ vane tests. The bedrock was cored in Borehole Nos. 1 and 4 by conventional rock coring method. A careful record of any sudden drops of the core barrel, colour of the wash water and wash water return were recorded during the rock coring operation.

Nineteen (19) mm standpipes and thirty-eight (38) mm monitoring wells, with slotted sections, were installed in all the boreholes for long-term monitoring of the groundwater levels and for the sampling of the groundwater as part of the Phase Two ESA. The monitoring wells and standpipes were installed in accordance with EXP standard practice, and the installation configuration is documented on the respective borehole log. The boreholes were backfilled upon completion of the field work and the installation of the monitoring wells.

On completion of the fieldwork, the soil and rock samples were transported to the EXP laboratory in Ottawa. The soil and rock samples were visually examined in the laboratory by a senior geotechnical engineer and logs of boreholes prepared. All soil samples were classified in accordance with the Unified Soil Classification System (USCS) and the modified Burmeister System (as per the 2006 Fourth Edition Canadian Foundation Engineering Manual (CFEM)).

4.2 Laboratory Testing Program

The soil samples were visually examined in the laboratory by a geotechnical engineer. The soil samples were classified in accordance with the Unified Soil Classification System (USCS) and the modified Burmeister System (as per the 2006 Fourth Edition Canadian Foundation Engineering Manual (CFEM)).

A summary of the soil laboratory testing program is shown in Table I

*Project Name: Proposed High Rise Development
Preliminary Geotechnical Investigation
381 Kent Street, Ottawa, Ontario
Project Number: OTT-21019154-A0
February 22, 2023
Final Report*

| Table I: Summary of Laboratory Testing Program | |
|--|---------------------------|
| Type of Test | Number of Tests Completed |
| Soil Samples | |
| Moisture Content Determination | 29 |
| Unit Weight Determination | 7 |
| Grain Size Analysis | 3 |
| Atterberg Limit Determination | 3 |
| Bedrock Cores | |
| Unit Weight Determination | 8 |
| Unconfined Compressive Strength Test | 8 |

4.3 Multi-channel Analysis of Surface Waves (MASW) Survey

A seismic shear wave velocity sounding survey was conducted at the site on January 6, 2022 by Geophysics GPR International Inc. (GPR). The survey line is located along the north side of the site, as shown in Figure 2. The survey was undertaken using the multi-channel analysis of surface waves (MASW), spatial auto correlation (SPAC) and seismic refraction methods. The seismic shear wave velocity sounding survey report is shown in Appendix A.

5. Subsurface Conditions and Groundwater Levels

A detailed description of the subsurface conditions and groundwater levels from this geotechnical investigation are given on the attached Borehole Logs, Figure Nos. 3 to 6 inclusive. The borehole logs and related information depict subsurface conditions only at the specific locations and times indicated. Subsurface conditions and water levels at other locations may differ from conditions at the locations where sampling was conducted. The passage of time also may result in changes in the conditions interpreted to exist at the locations where sampling was conducted.

Boreholes were drilled to provide representation of subsurface conditions as part of a geotechnical exploration program and are not intended to provide evidence of potential environmental conditions.

It should be noted that the soil and rock boundaries indicated on the borehole logs are inferred from non-continuous sampling and observations during drilling operations. These boundaries are intended to reflect approximate transition zones for the purpose of geotechnical design and should not be interpreted as exact planes of geological change. The "Note on Sample Descriptions" preceding the borehole logs form an integral part of this report and should be read in conjunction with this report.

A review of the borehole logs indicates the following subsurface conditions with depth and groundwater levels.

5.1 Asphaltic Concrete

A 50 to 60 mm thick asphaltic concrete layer was contacted at the surface of all four (4) boreholes.

5.2 Fill

The asphaltic concrete in all four (4) boreholes is underlain by fill which extends to depths of 0.9 m to 1.7 m (Elevation 71.4 m to Elevation 71.0 m) and ranges in consistency from silty sand with gravel to gravel with sand. The fill contains brick fragments in Boreholes Nos. 1 and 3. The SPT N-values of 7 to 45 indicates a loose to dense state. The moisture content of the fill ranges from 6 percent to 17 percent.

5.3 Silty clay

Native silty clay was encountered below the fill in all the boreholes. The silty clay extends to depths of 6.0 m to 6.6 m (Elevation 66.7 m to Elevation 65.4 m). The silty clay has an upper brown to brownish grey desiccated crust to depths of 3.0 m to 4.1 m (Elevation 69.0 m to Elevation 68.4 m) underlain by a lower unweathered grey silty clay. The undrained shear strength of the upper brown silty clay ranges from 144 kPa to greater than 250 kPa indicating a very stiff to hard consistency. The undrained shear strength of the lower grey silty clay ranges from 60 kPa to 96 kPa indicating a stiff consistency.

Augering and sampling of Borehole No. 3 terminated within the silty clay layer.

The natural moisture content and unit weight of the upper brown crust ranges from 39 percent to 64 percent and 16.7 kN/m^3 to 18.4 kN/m^3 , respectively. The natural moisture content of the lower grey silty clay ranges from 39 percent to 75 percent.

The results from the grain-size analysis and Atterberg limit determination conducted on one (1) sample of the upper brown crust and one (1) sample of the lower grey silty clay are summarized in Table II. The grain-size distribution curves are shown in Figures 7 and 8.

Table II: Summary of Results from Grain-Size Analysis and Atterberg Limit Determination - Silty clay Samples

| Borehole (BH) No. – Sample (SS) No. | Depth (m) | Grain-Size Analysis (%) | | | | Atterberg Limits (%) | | | | Soil Classification (USCS) |
|-------------------------------------|-----------|-------------------------|------|------|------|----------------------|--------------|---------------|------------------|--|
| | | Gravel | Sand | Silt | Clay | Moisture Content | Liquid Limit | Plastic Limit | Plasticity Index | |
| BH 3 - SS4 | 2.3 - 2.9 | 0 | 2 | 30 | 68 | 39 | 78 | 31 | 47 | Upper Brown Crust: Silty Clay of High Plasticity (CH) |
| BH 1 - SS4 | 4.6 - 5.2 | 0 | 0 | 36 | 64 | 75 | 65 | 25 | 40 | Lower Grey Clay: Silty clay of High Plasticity (CH) |

Based on a review of the results of the grain-size analysis and Atterberg limits, the upper brown crust and lower grey silty clay may be classified as silty clays of high plasticity (CH) in accordance with the USCS.

5.4 Clayey Sand with Gravel Glacial Till

Glacial till was contacted below the silty clay in Borehole Nos. 1, 2 and 4 at depths of 6.0 m to 6.6 m (Elevation 66.7 m to Elevation 65.4 m). The composition of the glacial till contains varying amounts of gravel, sand, silt and clay. The glacial till contains cobbles, boulders and possible large slab pieces of shale. The SPT N-values of with the glacial till ranges from 11 to 77 indicating a compact to very dense condition. The natural moisture content of the glacial till ranges from 7 percent to 12 percent.

The results from the grain-size analysis and Atterberg limit determination conducted on one (1) sample of the glacial till are summarized in Table III. The grain-size distribution curves are shown in Figure 9.

Table III: Summary of Results from Grain-Size Analysis and Atterberg Limit Determination - Glacial Till Samples

| Borehole (BH) No. – Sample (SS) No. | Depth (m) | Grain-Size Analysis (%) | | | | Atterberg Limits (%) | | | | Soil Classification (USCS) |
|-------------------------------------|-----------|-------------------------|------|------|------|----------------------|--------------|---------------|------------------|------------------------------|
| | | Gravel | Sand | Silt | Clay | Moisture Content | Liquid Limit | Plastic Limit | Plasticity Index | |
| BH4 - SS11 | 4.6 - 5.2 | 32 | 34 | 21 | 13 | 10 | 22 | 11 | 11 | Clayey Sand with Gravel (SC) |

Based on a review of the results of the grain-size analysis and Atterberg limits, the glacial till may be classified as a Clayey sand with gravel (SC) in accordance with the USCS.

5.5 Shale Bedrock

Auger refusal was met in Boreholes Nos. 1, 2 and 4 at 9.6 m to 12.6 m depths (Elevation 62.9 m to Elevation 60.1 m). DCPT refusal was encountered in Borehole No. 3 at 7.6 m depth (Elevation 64.8 m).

A summary of the auger and DCPT refusal depths as well as the depth of bedrock confirmed by coring are shown in Table IV.

Project Name: Proposed High Rise Development
Preliminary Geotechnical Investigation
381 Kent Street, Ottawa, Ontario
Project Number: OTT-21019154-A0
February 22, 2023
Final Report

Table IV: Summary of Auger and Soil Sampler Refusal and Bedrock Depths (Elevations) in Boreholes

| Borehole (BH) No. | Ground Surface Elevation (m) | Refusal Depth (Elevation) | Depth (Elevation) of Proven Bedrock (m) | Comment wrt to Depth (Elevation) of Bedrock Surface |
|-------------------|------------------------------|---------------------------|---|---|
| BH-01 | 72.47 | 9.6 (62.9) | 9.6 (62.9) | Weathered bedrock from 9.6 to 9.9 m depth. 10.4 m length of bedrock cored below 9.9 m depth |
| BH-02 | 72.66 | 12.6 (60.1) | -- | Auger refusal at 12.6 m |
| BH-03 | 72.44 | 7.6 (64.8) | -- | DCPT refusal at 7.6 m on bedrock or cobble/boulder within the glacial till |
| BH-04 | 72.00 | 10.1 (61.9) | 10.1 (61.9) | 10.8 m length of bedrock cored below 10.1 m depth |

A review of Table IV indicates the depth of auger refusal ranges from 9.6 m to 12.6 m (Elevation 62.9 m to Elevation 60.1 m) below existing grade. DCPT refusal in Borehole No. 3 a depth of 7.6 m (Elevation 64.8 m) may indicate cobble/boulder within the glacial till layer or the bedrock surface.

The presence of the bedrock was proven in Borehole Nos. 1 and 4 by coring the bedrock. Based on a review of the bedrock cores, the bedrock is considered to be shale with limestone partings. In Borehole No. 1, between the depth of auger refusal, 9.6 m (Elevation 62.9 m) and 10.1 m (Elevation 62.4 m), weathered shale bedrock was encountered. In Borehole No. 4 between the depth of 10.1 m to 10.8 m (Elevation 61.9 m to 61.2 m) the bedrock is highly weathered and contained layers of sandy silty clay with gravel.

Based on the bedrock coring results, the total core recovery (TCR) generally ranges from 97 percent to 100 percent. The exception to this the first coring run of Borehole No. 4 which had a TCR value of 57. The rock quality designation (RQD) generally ranges from 28 percent to 99 percent indicating a bedrock quality ranging from poor to excellent. Lower RQD values were encountered in the first coring runs of Borehole Nos. 1 and 4 with RQD values of 14 and 8, respectively, indicating a weathered bedrock of very poor quality.

Unit weight determination and unconfined compressive strength tests were conducted on eight (8) rock core sections and the results are summarized in Table V. Photographs of the rock cores are shown in Appendix B.

Table V: Summary of Unconfined Compressive Strength Test Results – Bedrock Cores

| Borehole (BH) No. – Run No. | Depth (m) | Unit Weight (kN/m ³) | Unconfined Compressive Strength (MPa) | Classification of Rock with respect to Strength |
|-----------------------------|-------------|----------------------------------|---------------------------------------|---|
| BH1 – Run 2 | 9.6 – 9.7 | 24.3 | 38.8 | Medium Strong |
| BH1 – Run 3 | 13.0 – 13.1 | 24.2 | 31.6 | Medium Strong |
| BH1 – Run 4 | 16.5 – 16.6 | 24.9 | 38.4 | Medium Strong |
| BH1 – Run 6 | 16.4 – 16.5 | 24.9 | 48.6 | Medium Strong |
| BH4 – Run 2 | 8.8 – 8.9 | 24.6 | 52.0 | Strong |
| BH4 – Run 3 | 13.7 – 13.9 | 25.0 | 44.0 | Medium Strong |
| BH4 – Run 4 | 10.8 – 10.9 | 25.1 | 35.9 | Medium Strong |
| BH4 – Run 7 | 16.1 – 16.2 | 25.1 | 50.3 | Strong |

A review of the test results in Table V indicates the strength of the rock may be classified as medium strong to strong in accordance with the Canadian Foundation Engineering Manual (CFEM), Fourth Edition, 2006.

As previously mentioned, the site is underlain by shale bedrock of the Billings formation. This type of shale is prone to deterioration when exposed to the elements. It also heaves due to a complex mechanism caused in part from the bio-oxidation of the sulphides in the rock, which react with calcite seams to form expanding gypsum. This occurs when oxygen is permitted to enter the rock, usually by lowering of the water table and this process is accelerated by the presence of heat. Therefore, special treatment of the Billings shale bedrock will need to be incorporated into the design and construction of the proposed buildings if excavations will extend to the bedrock.

5.6 Groundwater Level Measurements

A summary of the groundwater level measurements taken in the monitoring wells are shown in Table VI. In Borehole Nos. 1 and 4, two (2) monitoring wells were installed within the borehole; a shallow well installed within the overburden and a deep well within the shale bedrock, indicated as (shallow) and (deep).

| Table VI: Summary of Groundwater level Measurements | | | | |
|---|------------------------------|--|-------------------|---|
| Borehole (BH) /Monitoring Well (MW) No. | Ground Surface Elevation (m) | Date of Measurement (Elapsed Time in Days from Date of Installation) | Screened Material | Groundwater Depth Below Ground Surface (Elevation), m |
| BH1 (Shallow) | 72.47 | December 8, 2022 (6 days) | Silty clay | 2.8 (66.7) |
| BH1 (Deep) | 72.47 | December 8, 2022 (6 days) | Shale | 2.1 (70.4) |
| BH2 | 72.66 | December 8, 2022 (7 days) | Silty clay | 2.8 (69.9) |
| BH3 | 72.44 | December 8, 2022 (7 days) | Silty clay | 5.6 (66.8) |
| BH4 (Shallow) | 72.00 | December 8, 2022 (8 days) | Silty clay/Till | 5.8 (66.2) |
| BH4 (Deep) | 72.00 | December 8, 2022 (8 days) | Shale | 8.2 (63.8) |

The groundwater level ranges from 2.8 m to 5.8 m (Elevation 69.9 m to Elevation 66.2 m) in the overburden wells. The groundwater within the shale was found to be 2.1 m (Elevation 70.4 m) and 8.2 m depth (Elevation 63.8 m) in Borehole Nos. 1 and 4, respectively.

Water levels were determined in the boreholes and monitoring wells at the times and under the conditions noted above. Note that fluctuations in the level of groundwater may occur due to a seasonal variation such as precipitation, snowmelt, rainfall activities, and other factors not evident at the time of measurement and therefore may be at a higher level during wet weather periods.

6. Site Classification for Seismic Site Response and Liquefaction Potential of Soils

6.1 Site Classification for Seismic Site Response

The borehole information indicates that the subsurface conditions at the site consist of a surficial asphaltic concrete layer underlain by fill which in turn is underlain by silty clay and then glacial till. Shale bedrock was contacted at 9.6 m and 10.3 m (Elevation 62.9 m to Elevation 61.7 m) below existing grade. The groundwater level ranges from 2.8 m to 5.8 m (Elevation 69.9 m to Elevation 66.2 m) in the overburn wells. The groundwater within the shale was found to be at 8.2 m depth (Elevation 63.8 m).

Based on a review of the available design information and borehole data, it is considered that the appropriate foundation to support the proposed buildings is spread and strip footings founded on the glacial till or deep foundations extending to the sound shale bedrock, depending on the required bearing capacity. The anticipated shallow founding depth of the footing is assumed to be approximately at a 6.0 m depth.

The results of the shear wave velocity sounding survey (seismic shear wave survey) conducted by GPR is shown in Appendix A. Based on the results of the survey and the recommendation that the proposed buildings be supported by footings founded on the sound bedrock, the shear wave velocity for footings founded on sound bedrock was determined to be 515.4 m/s. For a shear wave velocity of 515.4 m/s, Table 4.1.8.4.A of the 2012 Ontario Building Code (as amended May 2, 2019) indicates the site classification for seismic site response is **Class C** for foundations placed on glacial till, more than 3.0 m from the bedrock surface.

6.2 Liquefaction Potential of Soils

The subsurface soils are not considered to be liquefiable during a seismic event.

*Project Name: Proposed High Rise Development
Preliminary Geotechnical Investigation
381 Kent Street, Ottawa, Ontario
Project Number: OTT-21019154-A0
February 22, 2023
Final Report*

7. Grade Raise Restrictions

Since the site is located in a well-established developed area of the city of Ottawa and the current grades of the site are near those of the adjacent roadways, major grade raise is not anticipated to be required at the site as part of the proposed development. However, for purposes of this geotechnical investigation, a maximum permissible grade raise of 0.5 m may be used for design purposes.

8. Foundation Considerations

The boreholes indicate the site is underlain by an asphaltic concrete layer underlain by loose to dense fill that extends to depths of 0.9 m to 1.7 m (Elevation 71.4 m to Elevation 71.0 m). Beneath the fill is a layer of firm to hard silty clay extending to the compact glacial till contacted at 6.0 m to 6.6 m depths (Elevation 66.7 m to Elevation 65.4 m). The glacial till overlies shale bedrock contacted at 9.6 m and 10.1 m depths (Elevation 62.9 m and Elevation 61.9 m) in Borehole Nos. 1 and 4. Sound shale bedrock was encountered in Boreholes Nos 1 and 4 at 10.1 m (Elevation 62.4 m) and 10.8 m (Elevation 61.2 m), respectively. Auger refusal and DCPT refusal was encountered at 12.6 m (Elevation 60.1 m) and 7.6 m (Elevation 64.8 m) in Borehole Nos. 2 and 4, respectively, which may indicate the bedrock surface or cobbles/boulders within the glacial till.

Based on a review of the borehole information, for a two (2) level underground parking garage with an assumed lowest floor slab elevation of 6.0 m below existing grade, the lowest slab will be founded on the glacial till contacted in Borehole Nos. 1, 2 and 4.

The building can be supported on shallow foundations if the bearing capacity of the glacial till is sufficient. If it is insufficient, the proposed buildings may be supported by a pile or caisson foundation founded in the shale bedrock. Caissons are generally considered to be less desirable compared with pile foundations due to cave-in potential of the subsurface soils, difficulties in advancing the caissons through cobbles and boulders within the glacial till and difficulties in dewatering the caisson holes.

Each foundation alternative is discussed in the following sections of this report.

8.1 Footings

With this foundation option, it is anticipated that the footings will be founded on the native glacial till contacted at 6.0 m to 6.6 m depths (Elevation 66.7 m to Elevation 65.4 m) in Borehole Nos. 1, 2 and 4. Strip footings having a maximum width of 1.5 m and square pad footings having a width and length of 3.0 m and founded on the glacial till may be designed for a bearing pressure at serviceability limit state (SLS) of 150 kPa and factored geotechnical resistance at ultimate limit state (ULS) of 225 kPa. The factored geotechnical resistance at ULS includes a geotechnical resistance factor of 0.5. Any loose zones of the glacial till noted in the footing beds should be removed and replaced with Ontario Provincial Standard Specification (OPSS) Granular B Type II material compacted to 100 percent standard Proctor maximum dry density (SPMDD). Settlement of footings designed for the above SLS bearing pressure are expected to be within tolerable limits of 25 mm total and 19 differential movement.

If the founding depth of the footings in the glacial till be different than noted above, EXP should be contacted to provide updated SLS and factored ULS values.

All footing beds should be examined by a geotechnical engineer to ensure that the founding surfaces are capable of supporting the design bearing pressure at SLS and the footing beds have been properly prepared.

It is recommended that a 50 mm thick concrete mud slab be placed on the approved glacial till subgrade to protect the subgrade from disturbance by construction equipment, workers (foot traffic) and the effects of the weather (such as precipitation).

8.2 Pile Foundation

If it is not feasible to support the proposed structure by shallow footings, the proposed structure may be supported by closed end steel pipe or steel H-piles driven to practical refusal in the shale bedrock confirmed at 9.6 m and 10.1 m depths (Elevation 62.9 m and Elevation 61.9 m). Sound shale bedrock was encountered in Boreholes Nos 1 and 4 at 10.1 m (Elevation 62.4 m) and 10.8 m (Elevation 61.2 m), respectively. Auger refusal and DCPT refusal was encountered at 12.6 m (Elevation 60.1 m) and 7.6 m (Elevation 64.8 m) in Boreholes Nos. 2 and 4, respectively, and may indicate the bedrock surface or cobbles/boulders within the glacial till or the bedrock surface. Closed end pipe piles are typically used in the Ottawa area and can be more economical compared to H-piles. Further, H-piles tend to extend deeper into the shale bedrock to achieve practical refusal and required set compared with closed end pipe piles. Therefore, closed end pipe piles are recommended for this project.

The factored geotechnical resistance at ULS for various pile sections is shown in Table VII. The factored geotechnical resistance values at ULS are based on steel piles with a yield strength of 350 MPa and concrete compressive strength of 35 MPa and includes

*Project Name: Proposed High Rise Development
Preliminary Geotechnical Investigation
381 Kent Street, Ottawa, Ontario
Project Number: OTT-21019154-A0
February 22, 2023
Final Report*

a geotechnical resistance factor of 0.4. Since the piles are expected to meet refusal within the shale bedrock, the factored geotechnical resistance at ULS will govern the design, since the bearing pressure at SLS for 25 mm of settlement will be greater than the factored geotechnical resistance at ULS.

Table VII: Factored Geotechnical Resistance at Ultimate Limit State (ULS) for Steel Pipe and H-Piles

| Pile Section | Pile Section Size | Factored Geotechnical Resistance at ULS (kN) |
|--------------|-------------------------------------|--|
| Steel Pipe | 245 mm O.D. by 10 mm wall thickness | 1275 |
| | 245 mm O.D. by 12 mm wall thickness | 1445 |
| | 324 mm O.D. by 12 mm wall thickness | 2120 |
| Steel H | HP 310 x 79 | 1260 |
| | HP 310 x 110 | 1775 |
| | HP 310 x 125 | 2000 |

Total settlement of piles designed for the above recommended factored geotechnical resistance at ULS are expected to be less than 10 mm.

To achieve the capacity given previously, the pile driving hammer must seat the pile into shale bedrock without overstressing the pile material. For guidance purposes, it is estimated that a hammer with rated energy of 54 kJ to 70 kJ (40,000 to 52,000 ft. lbs.) per blow would be required to drive the piles to practical refusal in the shale bedrock. Practical refusal is considered to have been achieved at a set of 5 blows for 6 mm or less of pile penetration. However, the driving criteria for a particular hammer-pile system must be established at the beginning of the project. This may be achieved with a Pile Driving Analyzer.

The glacial till is expected to contain cobbles and boulders. It is therefore recommended that the pile tips should be reinforced with a 25-mm thick steel plate and equipped with a driving shoe in accordance with Ontario Provincial Standard Drawing (OPSD) 3001.100, Type II, dated November 2017 and shown in Appendix C.

A number of test piles should be monitored with the Pile Driving Analyzer (PDA) during the initial driving and re-striking at the beginning of the project and 3 percent of the piles tested should be subjected to CAPWAP analysis. This monitoring will allow for the evaluation of transferred energy into the pile from the hammer, determination of driving criteria and an evaluation of the geotechnical resistance at ULS of the piles. Depending on the results of the pile driving analysis, the pile capacity may have to be proven by at least one pile load test for each pile type before production piling begins. If necessary, the pile load test should be performed in accordance with American Society for Testing and Materials (ASTM) D 1143.

Closed-end pipe piles tend to displace a relatively large volume of soil. When driven in a cluster or group, they may tend to jack up the adjacent piles in the group. Consequently, the elevation of the top of each pile in a group should be monitored immediately after driving and after all the piles in the group have been driven. This is to ensure that the piles are not heaving. Any piles found to heave more than 3 mm should be re-tapped.

Piles driven at the site may be subject to relaxation, i.e. loss of load carrying capacity with time. Therefore, it is recommended that the piles should be re-struck, minimum of 24 hours after initial driving to determine if the piles have relaxed. If relaxation is observed, this procedure should be repeated every 24 hours until it can be proven that relaxation is no longer a problem.

The installation of the piles at the site should be monitored on a full-time basis by a geotechnician working under the direction and supervision of a qualified geotechnical engineer to verify that the piles are driven in accordance with the project specifications.

The concrete grade beams and pile caps for heated structures should be protected from frost action by providing the beams and caps with 1.5 m of earth cover. For non-heated structures, the pile caps and beams should be provided with 2.4 m of earth cover in areas where the snow will be removed and 2.1 m of cover in areas where the snow will not be removed. Alternatively, frost protection may be provided by rigid insulation or a combination of earth cover and rigid insulation.

8.3 Caisson Foundation

The proposed structure may be supported by caissons founded within the sound shale bedrock encountered in Boreholes Nos 1 and 4 at 10.1 m (Elevation 62.4 m) and 10.8 m (Elevation 61.2 m), respectively. Auger refusal or DCPT refusal was encountered at 12.6 m (Elevation 60.1 m) and 7.6 m (Elevation 64.8 m) and may indicate the bedrock surface or cobbles or boulders within the glacial till. The axial capacity of the caisson may be developed from shaft resistance between the concrete and the sound shale bedrock and ignoring end bearing capacity of the caisson. The caissons socketed into the sound shale bedrock may be designed for a factored shaft (sidewall) resistance at ULS of 600 kPa. The factored resistance at ULS includes a geotechnical resistance of 0.4. The caisson should have a minimum diameter of 760 mm and the depth of the socket (socket length) into the bedrock should be a minimum of two (2) diameters of the caisson. The factored geotechnical resistance at ULS will govern the caisson design since the bearing pressure at SLS for 25 mm of settlement will be greater than the factored geotechnical axial resistance at ULS.

It is imperative that the sidewalls of the portion of the caisson socketed into the bedrock be cleaned of any soil smearing, to ensure the concrete is in contact with the clean bedrock surface.

Installation of the caissons will require the use of at least one liner to minimize soil losses when penetrating the fill, layers of silty clay and the glacial till (contains cobbles and boulders). The liner should be driven to the shale bedrock surface. It may be necessary to loosen the overburden soil by augering through to the bedrock. The liner may then be advanced through the soil slurry to the bedrock. It is note that the caissons would require extensive and continuous dewatering since the groundwater level is up to approximately 9.0 m above the bedrock surface. If the caisson cannot be dewatered, the concrete may have to be placed by 'tremie' method.

All caissons must be inspected by a geotechnician under the supervision of the of a geotechnical engineer to confirm the ULS value of the bedrock, the required socket depth into the sound bedrock and that the surface of the bedrock along the length of the portion of the caisson socketed into the bedrock has been prepared satisfactorily and properly cleaned.

The caisson caps for heated structures should be protected from frost action by providing the beams and caps with 1.5 m of earth cover. For non-heated structures, the pile caps and beams should be provided with 2.4 m of earth cover in areas where the snow will be removed and 2.1 m of cover in areas where the snow will not be removed. Alternatively, frost protection may be provided by rigid insulation or a combination of earth cover and rigid insulation.

8.4 General Comments for Foundations

The recommended bearing pressure at SLS for footings and the raft foundation and the factored geotechnical resistances at ULS for all foundation options considered for this project have been calculated by EXP from the borehole information for the design stage only. The investigation and comments are necessarily on-going as new information of underground conditions becomes available. For example, more specific information is available with respect to conditions between boreholes, when foundation construction is underway. The interpretation between boreholes and the recommendations of this report must therefore be checked through field monitoring provided by an experienced geotechnical engineer to validate the information for use during the construction stage.

9. Floor Slab and Drainage Requirements

The lowest floor level of the parking garages for the proposed buildings will be located at an approximate 6.0 m depth below the existing grade. Based on the borehole information, the lowest floor slabs of the buildings will be founded on, or just above the glacial till and may be constructed as a concrete slab-on-grade or as a paved surface. The concrete and asphalt pavement structures indicated below are for light duty traffic only (cars). EXP can provide concrete and asphalt pavement structures for heavy duty traffic (cars and trucks), if required.

The lowest floor level for the parking garages is anticipated to be located below the groundwater level. Therefore, underfloor and perimeter drainage systems will be required for the proposed below grade parking garages.

The underfloor drainage system may consist of 100 mm diameter perforated pipe or equivalent placed in parallel rows at 5 m to 6 m centres and at least 300 mm below the underside of the floor slab. The drains should be set on 100 mm of pea-gravel and covered on top and sides with 150 mm of pea-gravel and 300 mm of CSA Fine Concrete Aggregate. The CSA Fine Concrete Aggregate may be replaced by an approved porous geotextile membrane, such as Terrafix 270R or equivalent. The perimeter drains may also consist of 100 mm diameter perforated pipe set on the footings and surrounded with 150 mm of pea-gravel and 300 mm of CSA Concrete Aggregate. The perimeter and underfloor drains should be connected to separate sumps equipped with backup pumps and generators in case of mechanical failure and/or power outage, so that at least one system would be operational should the other fail.

The finished exterior grade should be sloped away from the buildings to prevent ponding of surface water close to the exterior walls of the buildings.

9.1 Lowest Floor Level as a Concrete Surface

The subgrade is anticipated to consist of glacial till. The glacial till should be examined by a geotechnical engineer and any loose/soft zones of the bedrock should be excavated and removed. Upon approval, the bedrock subgrade should be prepared as noted above.

Following approval and preparation of the bedrock subgrade, the concrete slab for light duty traffic (cars only) may be constructed as follows:

- 150 mm thick concrete with 32 MPa compressive strength and air content of 5 percent to 8 percent; over
- 150 mm thick layer of OPSS 1010 Granular A compacted to 100 percent standard Proctor maximum dry density (SPMDD); over
- 300 mm minimum thick layer of OPSS 1010 Granular B Type II compacted to 100 percent SMPDD.

The concrete slab should be reinforced and adequate saw cuts should be provided in the floor slab to control cracking. Additional recommendations can be provided once the final design of the lower floor level has been determined.

9.2 Lowest Floor Level as a Paved Surface

The subgrade is anticipated to consist of shale bedrock. The exposed shale bedrock should be examined by a geotechnical engineer and any loose/soft zones of the glacial till noted in the footing beds should be excavated and replaced with Ontario Provincial Standard Specification (OPSS) Granular B Type II compacted to 95 percent SPMDD.

Following approval and preparation of the bedrock subgrade, the asphalt pavement structure for light duty traffic (cars only) may be constructed on the bedrock subgrade as follow:

- 65 mm thick layer of asphaltic concrete consisting of HL3/SP12.5 – The asphaltic concrete should be placed and compacted as per OPSS 310 and 313 and should be designed in accordance with OPSS 1150/1151; over
- 150 mm thick layer of OPSS Granular A compacted to 100 percent SPMDD; over

*Project Name: Proposed High Rise Development
Preliminary Geotechnical Investigation
381 Kent Street, Ottawa, Ontario
Project Number: OTT-21019154-A0
February 22, 2023
Final Report*

- 450 mm thick layer of OPSS Granular B Type II compacted to 100 percent SPMDD.

10. Lateral Earth Pressures Against Basement Walls

The subsurface basement walls of the proposed new building should be backfilled with free draining material, such as OPSS Granular B Type II compacted to 95 percent SPMD and equipped with a perimeter drainage system to prevent the buildup of hydrostatic pressure behind the walls. The walls will be subjected to lateral static and dynamic (seismic) earth forces. The expressions below assume free draining backfill material, a perimeter drainage system, level backfill surface behind the wall and vertical face on the back side of the wall.

For design purposes, the lateral static earth thrust against the subsurface walls may be computed from the following equation:

$$P = K_0 h (\frac{1}{2} \gamma h + q)$$

- where
- P = lateral earth thrust acting on the subsurface wall, kN/m
 - K_0 = lateral earth pressure at rest coefficient, assumed to be 0.5 for Granular B Type II backfill material
 - γ = unit weight of free draining granular backfill; Granular B Type II = 22 kN/m³
 - h = depth of point of interest below top of backfill, m
 - q = surcharge load stress, kPa

The lateral dynamic thrust may be computed from the equation given below:

$$\Delta_{pe} = \gamma H^2 \frac{a_h}{g} F_b$$

- where
- Δ_{pe} = dynamic thrust in kN/m of wall
 - H = height of wall, m
 - γ = unit weight of backfill material = 22 kN/m³
 - $\frac{a_h}{g}$ = earth pressure coefficient = 0.32 for Ottawa area
 - F_b = thrust factor = 1.0

The dynamic thrust does not take into account the surcharge load. The resultant force acts approximately at 0.63H above the base of the wall.

All subsurface walls should be properly waterproofed.

11. Excavations and De-Watering Requirements

11.1 Excess Soil Management

A new Ontario Regulation 406/19 made under the Environmental Protection Act (November 28, 2019) was implemented as of January 1, 2021. The new regulation dictates the testing protocol that will be required for the management and disposal of excess soils. As set forth in the regulation, specific analytical testing protocols will need to be implemented and followed based on the volume of soil to be managed. The testing protocols are specific as to whether the soils are stockpiled or in situ. In either scenario, the testing protocols are far more onerous than have been historically carried out as part of standard industry practices. These decisions should be factored in and accounted for prior to the initiation of the project-defined scope of work. EXP would be pleased to assist with the implementation of a soil management and testing program that would satisfy the requirements of Ontario Regulation 406/19.

11.2 Excavations

Excavation of the soils may be undertaken using heavy equipment capable of removing debris within the fill as well as cobbles, boulders and slabs of shale bedrock within the glacial till.

All excavations must be undertaken in accordance with the Occupational Health and Safety Act (OHS), Ontario Reg. 213/91. Based on the definitions provided in OHS, the subsurface soils on site are considered to be Type 3 and as such must be cut back at 1H:1V from the bottom of the excavation above the groundwater level. Within zones of persistent seepage and below the groundwater level in the soils, the excavation side slopes are expected to slough and eventually stabilize at a slope of 2H:1V to 3H:1V.

It is anticipated that due to the significant depth of the excavation for the proposed buildings and the proximity of the excavation to existing infrastructure, the excavations will likely have to be undertaken within the confines of a shoring system. The shoring system may consist of steel H soldier pile and timber lagging system, interlocking sheeting system and/or secant pile shoring system. A hydrogeological study must be completed at the site as part of the detail design, in order to establish the quantity of water to be removed from the site as well as potential impact on the neighboring properties as the results of the dewatering activities.

The type of shoring system required would depend on a number of factors including:

- Proximity of the excavation to existing structures and infrastructure;
- Type of foundations of the existing adjacent buildings and the difference in founding levels between the foundations of new buildings and existing adjacent buildings;
- The subsurface soil, bedrock and groundwater conditions; and
- Potential effect of temporary (during construction) and permanent dewatering (building dewatering) on neighboring properties

A conventional shoring system consisting of soldier pile and timber lagging is more flexible compared to the interlocking steel sheeting system and the secant pile shoring system. In areas where there is concern for lateral yielding of the soils and the potential of settlement of nearby structures and infrastructure, the use of a steel interlocking sheeting system or secant pile system can be considered. The shoring system will require lateral restraint provided by tiebacks consisting of rock anchors. Due to the presence of cobbles and boulders in the subsurface soils, pre-drilling may be required for the installation of the soldier piles. The presence of cobbles and boulders in the subsurface soils should also be taken into consideration for other contemplated shoring systems.

The need for a shoring system, the most appropriate shoring system and the design and installation of the shoring system should be determined by the contractors bidding on this project. The design and installation of the shoring system should be undertaken by a professional engineer experienced in shoring design and by a contractor experienced in the installation of shoring systems.

The shoring system should be designed and installed in accordance with OHSA and the 2006 CFEM (Canadian Foundation Engineering Manual (Fourth Edition)).

Soldier Pile and Timber Lagging System

A conventional steel H soldier pile and timber lagging shoring system must be designed to support the lateral earth pressure given by the expression below:

$$P = k (\gamma h + q)$$

- where
- P = the pressure, at any depth, h, below the ground surface
 - k = applicable earth pressure coefficient; active lateral earth pressure coefficient = 0.33
'at rest' lateral earth pressure coefficient = 0.50
 - γ = unit weight of soil to be retained, estimated at 22 kN/m³
 - h = the depth, in metres, at which pressure, P, is being computed
 - q = the equivalent surcharge acting on the ground surface adjacent to the shoring system

The resultant force from the lateral earth pressure will act one-third from the bottom of the shored wall and the resultant from adjacent surcharge at ground surface will act at one-half from bottom of the wall. The pressure distribution assumes that drainage is permitted between the lagging boards and that no build-up of hydrostatic pressure may occur.

The shoring should be designed using appropriate 'k' values depending on the location of any settlement-sensitive infrastructure (roadways and underground services) and building structures. The traffic loads on the streets should be considered as surcharge. It may be necessary to toe the soldier piles into the sound rock below the soils.

The shoring system as well as adjacent settlement sensitive structures and infrastructure should be monitored for movement (deflection) on a periodic basis during construction operations.

Many geologic materials deteriorate rapidly upon exposure to meteorological elements. Unless otherwise specifically indicated in this report, walls and floors of excavations must be protected from moisture, desiccation, and frost action throughout the course of construction.

11.3 De-Watering Requirements and Impact of Groundwater Lowering on Adjacent Structures

Excavations above the groundwater may be dewatered by conventional sump pumping techniques. Excavations below the groundwater level are expected to be more problematic and may result in greater water seepage, loss of ground and disturbance of the soils. Under these conditions, it is recommended that these excavations should be undertaken within the confines of a shoring system as previously discussed. In this regard, seepage of groundwater into the shored excavation should still be anticipated but may be removed by collecting the water at low points within the excavation and pumping from sumps. In areas of high infiltration, a higher seepage rate should be anticipated and the need for high-capacity pumps to keep the excavation dry should not be ignored.

It is recommended that a hydrogeological study (with a geotechnical component) be undertaken for the purpose of estimating the volume of groundwater anticipated to enter the unshored (worst case) and shored excavation (which permits drainage) and the zone of influence resulting from dewatering of the excavation. The zone of influence may be used to determine the impact, if any, dewatering of the excavation may have on nearby existing infrastructure and buildings. If it is determined that the zone of influence extends to nearby existing infrastructure and buildings, the geotechnical component of the hydrogeological study would involve estimating settlements of the nearby existing infrastructure and buildings as a result of lowering the groundwater table at the site and providing recommendations to minimize the estimated settlements.

The excavation depth for the proposed buildings will extend below the groundwater level and would necessitate groundwater removal from the site. It is noteworthy to mention that new legislation came into force in Ontario on March 29, 2016 to regulate groundwater takings for construction dewatering purposes. Prior to March 29, 2016, a Category 2 Permit to Take Water (PTTW) was required from the Ontario Ministry of the Environment and Climate Change (MOECC) for groundwater takings related to

*Project Name: Proposed High Rise Development
Preliminary Geotechnical Investigation
381 Kent Street, Ottawa, Ontario
Project Number: OTT-21019154-A0
February 22, 2023
Final Report*

construction dewatering, where taking volumes in excess of 50 m³/day, but less than 400 m³/day, and the taking duration was no more than 30 consecutive days. The new legislation replaces the Category 2 PTTW for construction dewatering with a new process under the Environmental Activity and Sector Registry (EASR). The EASR is an on-line registry, which allows persons engaged in prescribed activities, such as water takings, to register with the (now) Ministry of the Environment, Conservation and Parks (MECP) instead of applying for a PTTW.

To be eligible for the new EASR process, the construction dewatering taking must be less than 400 m³/day under normal conditions. The water taking can be groundwater, storm water, or a combination of both. It should be noted that the 30-consecutive day limit on the water taking under the old Category 2 PTTW process has been removed in the new EASR process. Also, it should be noted that the EASR process requires two technical studies be prepared by a Qualified Person, prior to any water taking. These studies include a Water Taking Report, which provides assurance that the taking will not cause any unacceptable impacts, and a Discharge Plan, which provides assurance that the discharge will not result in any adverse impacts to the environment. EXP has qualified persons who can prepare these types of reports, if required. A significant advantage of the new EASR process over the former Category 2 PTTW process, is that the groundwater taking may begin immediately after completing the on-line registration of the taking and paying the applicable fee, assuming the accompanying technical studies have been completed. The former PTTW process typically took more than 90 days, which had the potential to impact construction schedules.

Although this investigation has estimated the groundwater levels at the time of the fieldwork, and commented on dewatering and general construction problems, conditions may be present which are difficult to establish from standard boring and excavating techniques and which may affect the type and nature of dewatering procedures used by the contractor in practice. These conditions include local and seasonal fluctuations in the groundwater table, erratic changes in the soil profile, thin layers of soil with large or small permeabilities compared with the soil mass, etc. Only carefully controlled tests using pumped wells and observation wells will yield the quantitative data on groundwater volumes and pressures that are necessary to adequately engineer construction dewatering systems.

12. Pipe Bedding Requirements

For site servicing, it is anticipated that the subgrade for the proposed municipal services may consist of fill, silty clay and glacial till. The pipe bedding for the municipal services should be in accordance with City of Ottawa specifications, drawings and special provisions. The bedding and cover material should be compacted to a minimum of 95 percent standard Proctor maximum dry density (SPMDD).

The bedding for the underground services including material specifications, thickness of cover material and compaction requirements should conform to the City of Ottawa requirements and/or Ontario Provincial Standard Specification and Drawings (OPSS and OPSD).

It is recommended the pipe bedding consist of 300 mm thick OPSS Granular B Type II sub-bedding material overlain by 150 mm thick OPSS Granular A bedding material. The bedding and surround materials should be compacted to at least 95 percent SPMDD.

The bedding thickness may be further increased in areas where the subgrade is wet, soft/loose or becomes disturbed. Trench base stabilization techniques, such as removal of loose/soft material, placement of crushed stone sub-bedding (Granular B Type II), completely wrapped in a non-woven geotextile, may also be used if trench base disturbance becomes a problem in wet or soft areas.

The municipal services should be installed in short open trench sections that are excavated and backfilled the same day.

13. Backfilling Requirements and Suitability of On-Site Soils for Backfilling Purposes

The soils to be excavated from the site will comprise of fill, silty clay and glacial till. From a geotechnical perspective, these soils are not considered suitable for reuse as backfill material in the interior or exterior of the building. Therefore, it is anticipated that the majority of the material required for backfilling purposes in the interior and exterior of the proposed buildings will need to be imported and should preferably conform to OPSS 1010 (as amended by SSP110S13) for Granular B Type II. The backfill should be placed in 300 mm thick lifts compacted to 95 percent standard Proctor maximum dry density (SPMDD) outside the building and to 98 percent SPMDD inside the building.

14. Tree Planting Restrictions

The site is underlain by a sensitive marine silty clay that consists of an upper brown desiccated silty clay crust 3.0 m to 4.1 m (Elevation 69.0 m to Elevation 68.4 m) underlain by a grey silty clay which extends to depths of 6.0 m to 6.6 m (Elevation 66.7 m to Elevation 65.4 m).

The City of Ottawa document titled, "Tree Planting in Sensitive Marine Silty Clay Soils – 2017 Guidelines," was used as reference to provide guidance regarding tree planting at the site.

The modified plasticity index of the brown silty clay was estimated at 47 for the brown silty clay crust and 40 for the grey silty clay indicating a high potential for soil volume change.

For high potential volume change soil types, the tree planting restrictions and setbacks from structures should follow the above noted 2017 guidelines.

If the silty clay is to remain in areas where trees are to be planted a landscape architect should be consulted to ensure the applicable tree planting restrictions and setbacks for the development of this site are in accordance with the above referenced City of Ottawa guideline and policy.

*Project Name: Proposed High Rise Development
Preliminary Geotechnical Investigation
381 Kent Street, Ottawa, Ontario
Project Number: OTT-21019154-A0
February 22, 2023
Final Report*

15. Earthworks Quality Control During Construction

All earthworks activities from construction of footing foundations to subgrade preparation to the placement and compaction of fill soils should be inspected by geotechnical personnel to ensure that construction proceeds in accordance with the project specifications.

*Project Name: Proposed High Rise Development
Preliminary Geotechnical Investigation
381 Kent Street, Ottawa, Ontario
Project Number: OTT-21019154-A0
February 22, 2023
Final Report*

16. General Comments

The comments and recommendations given in this report are preliminary in nature as they are based on the assumption that the above-described design concepts will proceed into construction. If changes are made either in the design phase or during construction, this office must be retained to review these modifications. The result of this review may be a modification of our recommendations, or it may require additional field or laboratory work to check whether the changes are acceptable from a geotechnical viewpoint. This preliminary geotechnical report should be updated once final design for the proposed development is available.

The information contained in this report is not intended to reflect on environmental aspects of the soils and groundwater. Reference is made to the Phase One and Two Environmental Site Assessment (ESAs) reports completed by EXP for the site regarding the environmental aspects of the soil and groundwater.

We trust that the information contained in this report will be satisfactory for your purposes. Should you have any questions, please do not hesitate to contact this office.



Daniel Wall, M. Eng., P.Eng.
Geotechnical Engineer
Earth and Environment



Ismail M. Taki, M.Eng., P.Eng.
Senior Manager, Eastern Region
Earth and Environment

EXP Services Inc.

*Project Name: Proposed High Rise Development
Preliminary Geotechnical Investigation
381 Kent Street, Ottawa, Ontario
Project Number: OTT-21019154-A0
February 22, 2023
Final Report*

Figures

Filename: E:\OTT-21019154-A0_60_Execution\65 Drawings\env\ph1\21019154-A0_ph1_JAN22.dwg
 Last Saved: Jan. 27, 2022 10:33 AM Last Plotted: Mar. 18, 2022 3:09 PM Plotted by: #####



SITE LOCATION

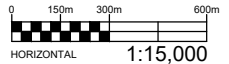

EXP Services Inc. www.exp.com
 t: +1.613.688.1899 | f: +1.613.225.7337
 2650 Queensview Drive, Suite 100
 Ottawa, ON K2B 8H6, Canada

| | | | |
|-----------------------------|----------------------|---|---------------------------------------|
| DATE OCTOBER 2021 | | CLIENT: KATASA GROUPE | project no. OTT-21019154-A0 |
| DESIGN LW | CHECKED LW | TITLE: SITE LOCATION PLAN | scale 1:15,000 |
| DRAWN BY TM | | 381 KENT STREET, STREET, ONTARIO | FIG 1 |

File name: E:\OTT\OTT-21019154-A0\60_Execution\62_Reports\62-6_Geotechnical Report\Draft Report\CAD files and drawings\21019154-A0_Figures-Edit.dwg
 Last Saved: Feb 22, 2023 2:54 PM
 Last Plotted: Feb 22, 2023 2:54 PM
 Plotted By: Severin

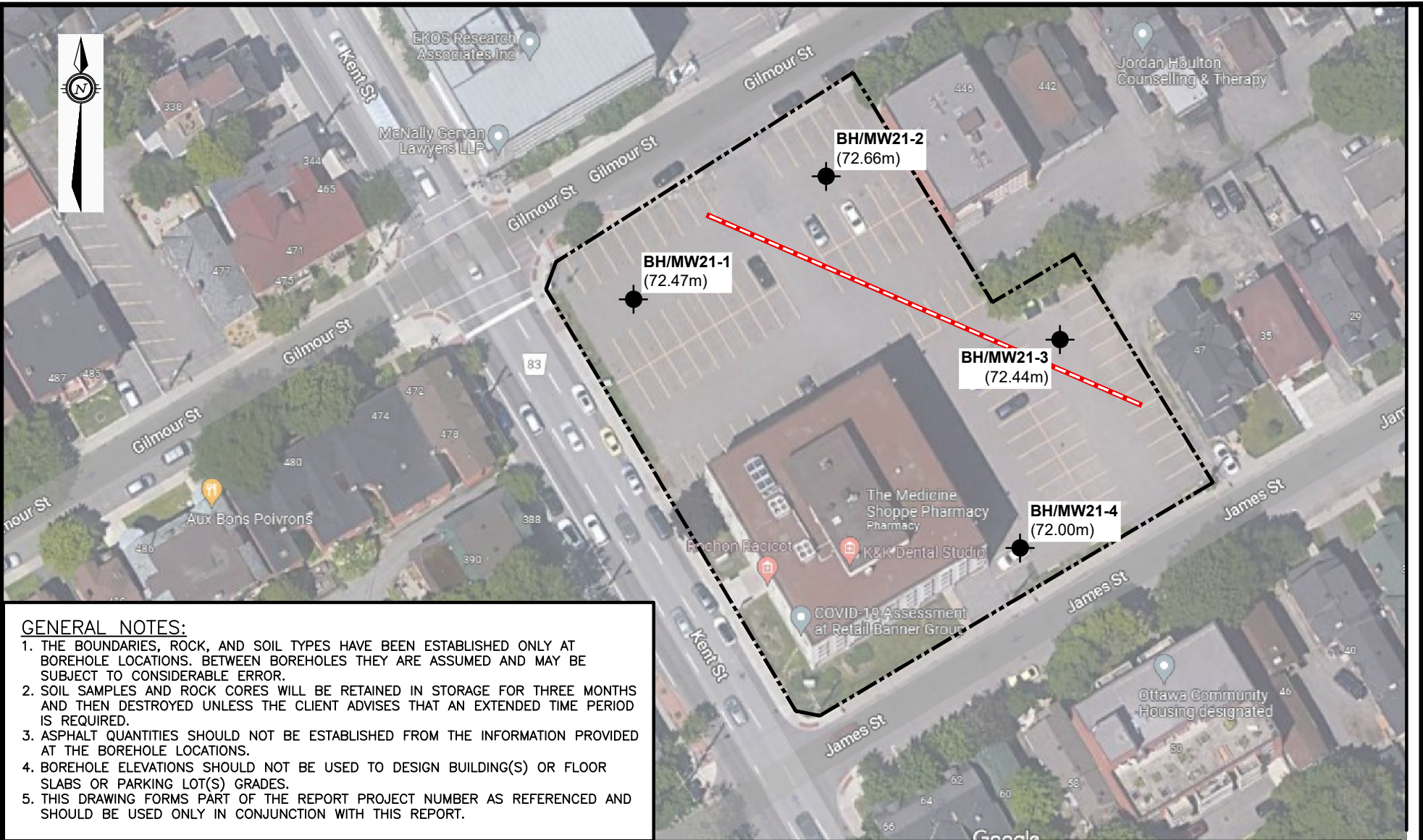

GENERAL NOTES:

1. THE BOUNDARIES, ROCK, AND SOIL TYPES HAVE BEEN ESTABLISHED ONLY AT BOREHOLE LOCATIONS. BETWEEN BOREHOLES THEY ARE ASSUMED AND MAY BE SUBJECT TO CONSIDERABLE ERROR.
2. SOIL SAMPLES AND ROCK CORES WILL BE RETAINED IN STORAGE FOR THREE MONTHS AND THEN DESTROYED UNLESS THE CLIENT ADVISES THAT AN EXTENDED TIME PERIOD IS REQUIRED.
3. ASPHALT QUANTITIES SHOULD NOT BE ESTABLISHED FROM THE INFORMATION PROVIDED AT THE BOREHOLE LOCATIONS.
4. BOREHOLE ELEVATIONS SHOULD NOT BE USED TO DESIGN BUILDING(S) OR FLOOR SLABS OR PARKING LOT(S) GRADES.
5. THIS DRAWING FORMS PART OF THE REPORT PROJECT NUMBER AS REFERENCED AND SHOULD BE USED ONLY IN CONJUNCTION WITH THIS REPORT.

LEGEND

SITE BOUNDARY
MASW STUDY AREA
BOREHOLE WITH MONITORING WELL
 BH/MW21-1 (72.47m)

HORIZONTAL 1:750



EXP Services Inc. www.exp.com
 t: +1.613.688.1899 | f: +1.613.225.7337
 2650 Queensview Drive, Suite 100
 Ottawa, ON K2B 8H6, Canada

| | | |
|--------------------------------------|---|---|
| <small>DATE</small> FEBRUARY 2023 | PROPOSED HIGH-RISE DEVELOPMENT 381 KENT STREET, OTTAWA, ONTARIO | <small>project no.</small> OTT-21019154-A0 |
| <small>DESIGN</small> DW | <small>CHECKED</small> IT | <small>scale</small> 1:750 |
| <small>DRAWN BY</small> AS | | BOREHOLE LOCATION PLAN |
| | | FIG 2 |

Notes On Sample Descriptions

1. All sample descriptions included in this report follow the Canadian Foundations Engineering Manual soil classification system. This system follows the standard proposed by the International Society for Soil Mechanics and Foundation Engineering. Laboratory grain size analyses provided by **exp** Services Inc. also follow the same system. Different classification systems may be used by others; one such system is the Unified Soil Classification. Please note that, with the exception of those samples where a grain size analysis has been made, all samples are classified visually. Visual classification is not sufficiently accurate to provide exact grain sizing or precise differentiation between size classification systems.

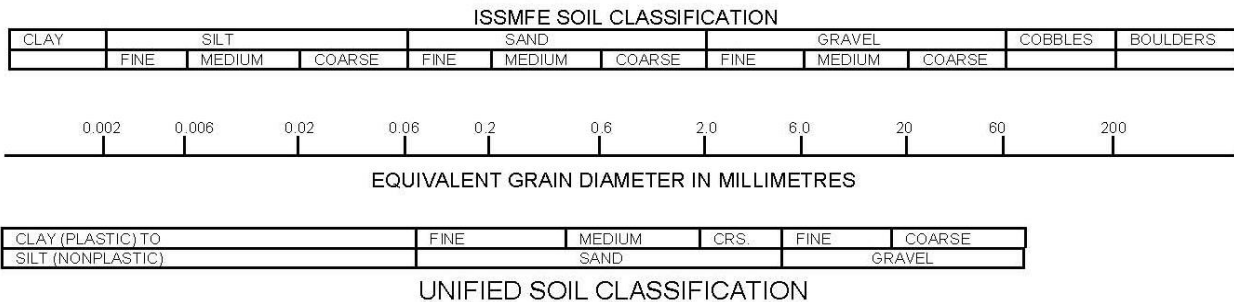

2. **Fill:** Where fill is designated on the borehole log it is defined as indicated by the sample recovered during the boring process. The reader is cautioned that fills are heterogeneous in nature and variable in density or degree of compaction. The borehole description may therefore not be applicable as a general description of site fill materials. All fills should be expected to contain obstruction such as wood, large concrete pieces or subsurface basements, floors, tanks, etc., none of these may have been encountered in the boreholes. Since boreholes cannot accurately define the contents of the fill, test pits are recommended to provide supplementary information. Despite the use of test pits, the heterogeneous nature of fill will leave some ambiguity as to the exact composition of the fill. Most fills contain pockets, seams, or layers of organically contaminated soil. This organic material can result in the generation of methane gas and/or significant ongoing and future settlements. Fill at this site may have been monitored for the presence of methane gas and, if so, the results are given on the borehole logs. The monitoring process does not indicate the volume of gas that can be potentially generated nor does it pinpoint the source of the gas. These readings are to advise of the presence of gas only, and a detailed study is recommended for sites where any explosive gas/methane is detected. Some fill material may be contaminated by toxic/hazardous waste that renders it unacceptable for deposition in any but designated land fill sites; unless specifically stated the fill on this site has not been tested for contaminants that may be considered toxic or hazardous. This testing and a potential hazard study can be undertaken if requested. In most residential/commercial areas undergoing reconstruction, buried oil tanks are common and are generally not detected in a conventional geotechnical site investigation.
3. **Till:** The term till on the borehole logs indicates that the material originates from a geological process associated with glaciation. Because of this geological process the till must be considered heterogeneous in composition and as such may contain pockets and/or seams of material such as sand, gravel, silt or clay. Till often contains cobbles (60 to 200 mm) or boulders (over 200 mm). Contractors may therefore encounter cobbles and boulders during excavation, even if they are not indicated by the borings. It should be appreciated that normal sampling equipment cannot differentiate the size or type of any obstruction. Because of the horizontal and vertical variability of till, the sample description may be applicable to a very limited zone; caution is therefore essential when dealing with sensitive excavations or dewatering programs in till materials.

Log of Borehole BH/MW21-1



Project No: OTT-21019154-A0

Figure No. 3

Project: Proposed High-Rise Development - Preliminary Investigation

Page. 1 of 2

Location: 381 Kent Street, Ottawa, Ontario

Date Drilled: December 2, 2021

Split Spoon Sample

Combustible Vapour Reading

Drill Type: CME-55 Truck Mounted Drill-Rig

Auger Sample

Natural Moisture Content

SPT (N) Value

Atterberg Limits

Datum: Geodetic Elevation

Dynamic Cone Test

Undrained Triaxial at

Shelby Tube

% Strain at Failure

Logged by: MAD Checked by: MGM/SMP

Shear Strength by Vane Test

Shear Strength by Penetrometer Test

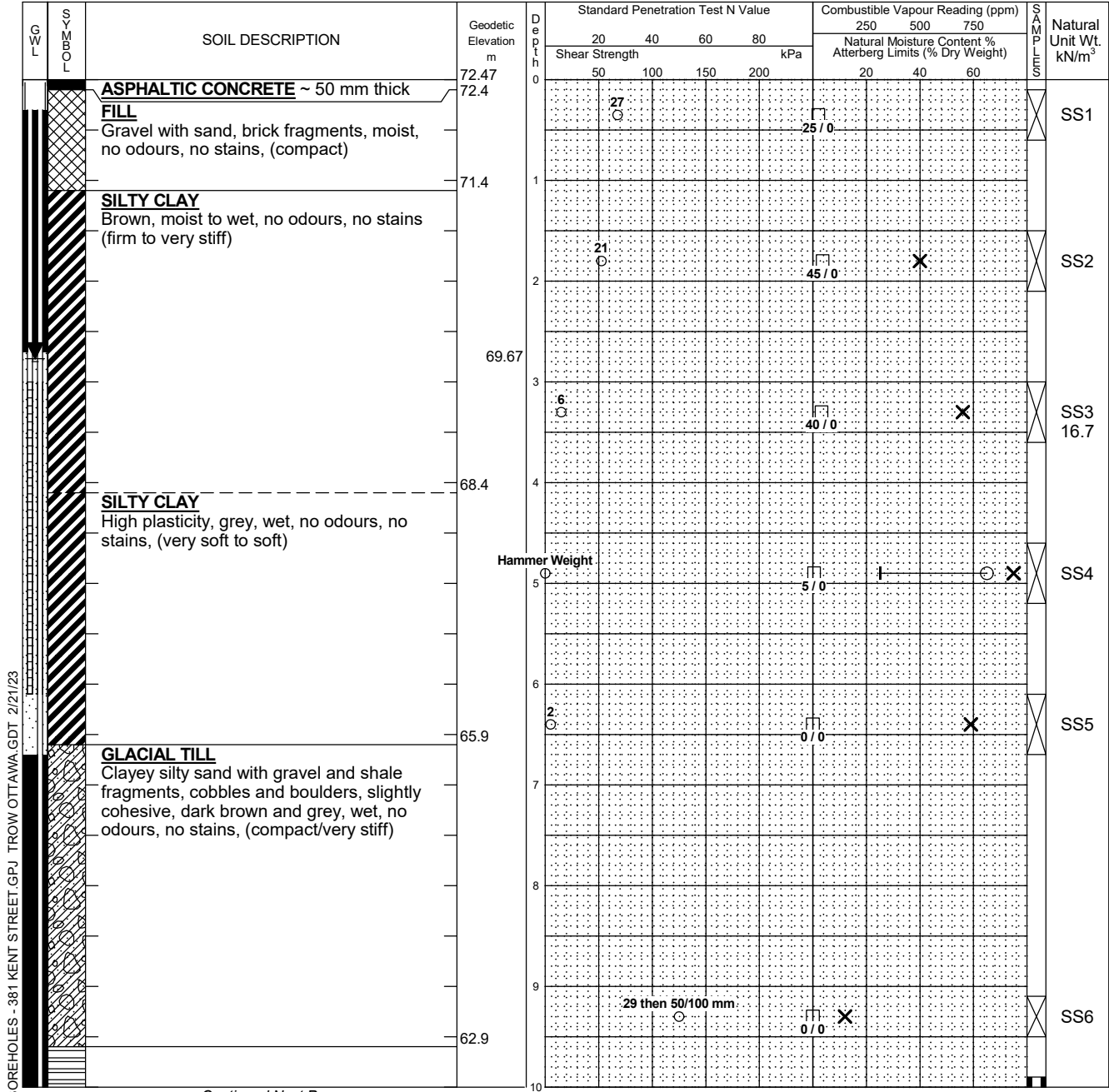

Continued Next Page

- NOTES:
- Borehole data requires interpretation by EXP before use by others
 - 19 mm diameter standpipe and 38 mm diameter monitoring well installed as shown upon completion of drilling.
 - Field work was supervised by an EXP representative.
 - See Notes on Sample Descriptions
 - Log to be read with EXP Report OTT-21019154-A0

| WATER LEVEL RECORDS | | |
|----------------------------|-----------------|------------------|
| Date | Water Level (m) | Hole Open To (m) |
| December 8, 2021 (Shallow) | 2.8 | - |
| December 8, 2021 (Deep) | 2.1 | - |

| CORE DRILLING RECORD | | | |
|----------------------|-------------|--------|-------|
| Run No. | Depth (m) | % Rec. | RQD % |
| 1 | 9.9 - 11.5 | 100 | 14 |
| 2 | 11.5 - 13.1 | 100 | 30 |
| 3 | 13.1 - 14.6 | 100 | 28 |
| 4 | 14.6 - 16.1 | 100 | 36 |
| 5 | 16.1 - 17.7 | 100 | 47 |
| 6 | 17.7 - 19.2 | 95 | 85 |
| 7 | 19.2 - 20.3 | 95 | 93 |

LOG OF BOREHOLE - 381 KENT STREET, GPJ TROW OTTAWA GDT 2/21/23

Log of Borehole BH/MW21-1



Project No: OTT-21019154-A0

Figure No. 3

Project: Proposed High-Rise Development - Preliminary Investigation

Page. 2 of 2

| G W L | SOIL DESCRIPTION | Geodetic Elevation m | Standard Penetration Test N Value | | | | Combustible Vapour Reading (ppm) | | | Natural Unit Wt. kN/m ³ |
|-------------|--|----------------------------|-----------------------------------|----|----|----|---|-----|-----|--|
| | | | Shear Strength | | | | Natural Moisture Content % Atterberg Limits (% Dry Weight) | | | |
| | | | 20 | 40 | 60 | 80 | 250 | 500 | 750 | |
| | WEATHERED SHALE BEDROCK With sandy silty clay, dark grey to black, wet (<i>continued</i>) | 62.47 62.4 | | | | | | | | |
| | SHALE BEDROCK With limestone partings, black, (poor to excellent quality) | | | | | | | | | RUN1 |
| | | | | | | | | | | RUN2 |
| | | | | | | | | | | RUN3 |
| | | | | | | | | | | RUN4 |
| | | | | | | | | | | RUN5 |
| | | | | | | | | | | RUN6 |
| | | | | | | | | | | RUN7 |
| | Borehole Terminated at 20.3 m Depth | 52.2 | | | | | | | | |

LOG OF BOREHOLE LOGS OF BOREHOLES - 381 KENT STREET GPJ TROW OTTAWA GDT 2/21/23

- NOTES:
- Borehole data requires interpretation by EXP before use by others
 - 19 mm diameter standpipe and 38 mm diameter monitoring well installed as shown upon completion of drilling.
 - Field work was supervised by an EXP representative.
 - See Notes on Sample Descriptions
 - Log to be read with EXP Report OTT-21019154-A0

| WATER LEVEL RECORDS | | |
|----------------------------|-----------------|------------------|
| Date | Water Level (m) | Hole Open To (m) |
| December 8, 2021 (Shallow) | 2.8 | - |
| December 8, 2021 (Deep) | 2.1 | - |

| CORE DRILLING RECORD | | | |
|----------------------|-------------|--------|-------|
| Run No. | Depth (m) | % Rec. | RQD % |
| 1 | 9.9 - 11.5 | 100 | 14 |
| 2 | 11.5 - 13.1 | 100 | 30 |
| 3 | 13.1 - 14.6 | 100 | 28 |
| 4 | 14.6 - 16.1 | 100 | 36 |
| 5 | 16.1 - 17.7 | 100 | 47 |
| 6 | 17.7 - 19.2 | 95 | 85 |
| 7 | 19.2 - 20.3 | 95 | 93 |

Log of Borehole BH/MW21-2



Project No: OTT-21019154-A0
 Project: Proposed High-Rise Development - Preliminary Investigation
 Location: 381 Kent Street, Ottawa, Ontario
 Date Drilled: December 1, 2021
 Drill Type: CME-55 Truck Mounted Drill-Rig
 Datum: Geodetic Elevation
 Logged by: MAD Checked by: MGM/SMP

Figure No. 4
 Page. 1 of 2

- Split Spoon Sample
- Auger Sample
- SPT (N) Value
- Dynamic Cone Test
- Shelby Tube
- Shear Strength by Vane Test
- Combustible Vapour Reading
- Natural Moisture Content
- Atterberg Limits
- Undrained Triaxial at % Strain at Failure
- Shear Strength by Penetrometer Test

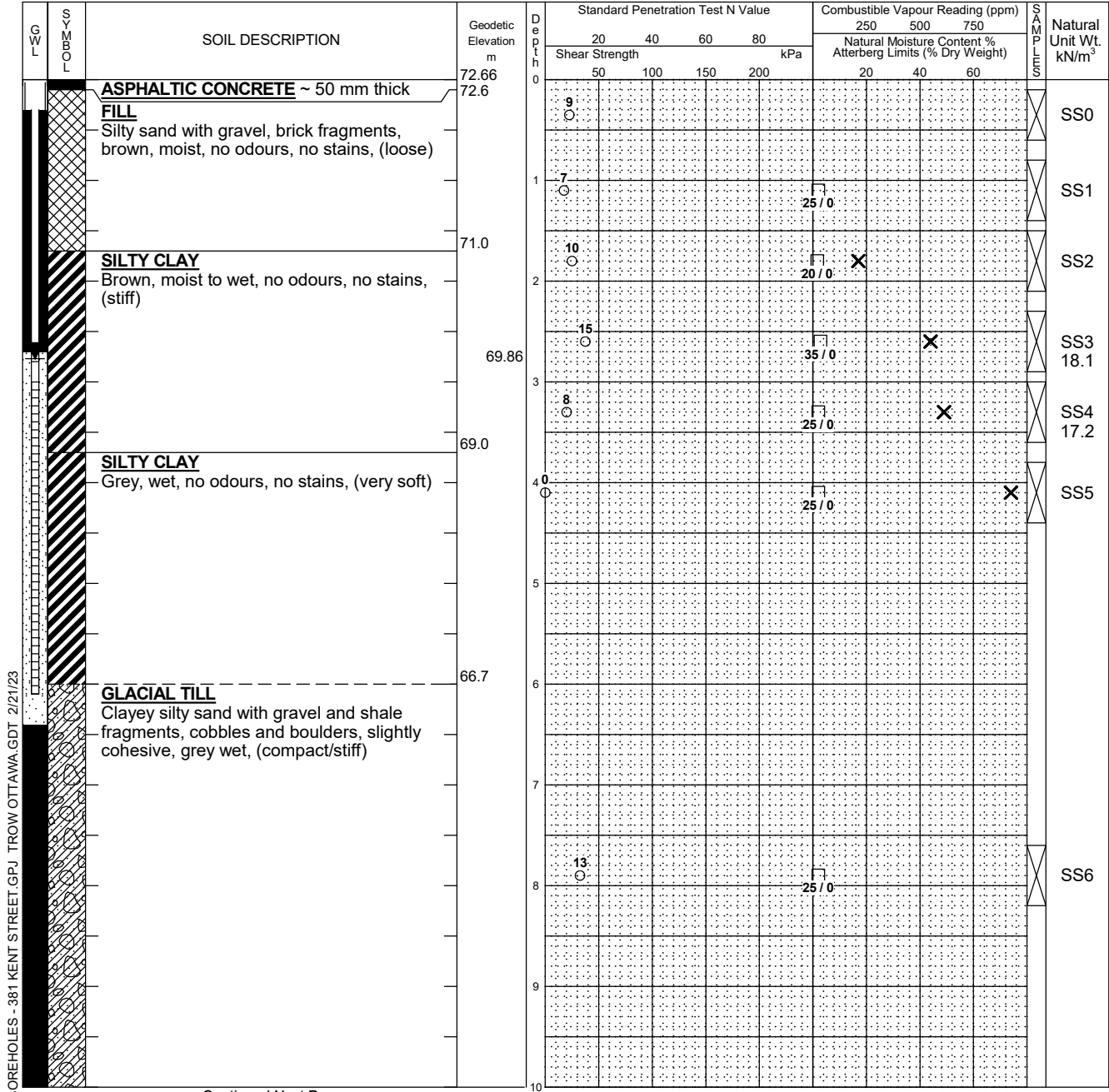

LOG OF BOREHOLE LOGS OF BOREHOLES - 381 KENT STREET.GPJ TROW OTTAWA.GDT 2/21/23

Continued Next Page

- NOTES:
- Borehole data requires interpretation by EXP before use by others
 - A 38 mm diameter monitoring well installed as shown upon completion of drilling.
 - Field work was supervised by an EXP representative.
 - See Notes on Sample Descriptions
 - Log to be read with EXP Report OTT-21019154-A0

| WATER LEVEL RECORDS | | |
|---------------------|-----------------|------------------|
| Date | Water Level (m) | Hole Open To (m) |
| December 8, 2021 | 2.8 | - |

| CORE DRILLING RECORD | | | |
|----------------------|-----------|--------|-------|
| Run No. | Depth (m) | % Rec. | RQD % |
| | | | |

Log of Borehole BH/MW21-2



Project No: OTT-21019154-A0

Figure No. 4

Project: Proposed High-Rise Development - Preliminary Investigation

Page. 2 of 2

| SOIL TYPE | SOIL DESCRIPTION | Geodetic Elevation m | Standard Penetration Test N Value | | | | Combustible Vapour Reading (ppm) | | | Natural Unit Wt. kN/m ³ |
|--------------|---|----------------------|-----------------------------------|-----|----|----|---|-----|-----|------------------------------------|
| | | | 20 | 40 | 60 | 80 | 250 | 500 | 750 | |
| | | | Shear Strength kPa | | | | Natural Moisture Content % Atterberg Limits (% Dry Weight) | | | |
| Depth | 50 | 100 | 150 | 200 | 20 | 40 | 60 | | | |
| GLACIAL TILL | Clayey silty sand with gravel and shale fragments, cobbles and boulders, slightly cohesive, grey wet, (compact/stiff) (continued) | 62.66 | 10 | | | | | | | |
| | | | 11 | | | | | | | |
| | | | 12 | | | | | | | |
| | Auger Refusal at 12.6 m Depth | 60.1 | | | | | | | | |

LOG OF BOREHOLE LOGS OF BOREHOLES - 381 KENT STREET.GPJ TROW OTTAWA.GDT 2/21/23

- NOTES:
- Borehole data requires interpretation by EXP before use by others
 - A 38 mm diameter monitoring well installed as shown upon completion of drilling.
 - Field work was supervised by an EXP representative.
 - See Notes on Sample Descriptions
 - Log to be read with EXP Report OTT-21019154-A0

| WATER LEVEL RECORDS | | |
|---------------------|-----------------|------------------|
| Date | Water Level (m) | Hole Open To (m) |
| December 8, 2021 | 2.8 | - |

| CORE DRILLING RECORD | | | |
|----------------------|-----------|--------|-------|
| Run No. | Depth (m) | % Rec. | RQD % |
| | | | |

Log of Borehole BH/MW21-3



Project No: OTT-21019154-A0
 Project: Proposed High-Rise Development - Preliminary Investigation
 Location: 381 Kent Street, Ottawa, Ontario
 Date Drilled: December 1, 2021
 Drill Type: CME-55 Truck Mounted Drill-Rig
 Datum: Geodetic Elevation
 Logged by: MAD Checked by: MGM/SMP

Figure No. 5
 Page. 1 of 1

- Split Spoon Sample
- Auger Sample
- SPT (N) Value
- Dynamic Cone Test
- Shelby Tube
- Shear Strength by Vane Test
- Combustible Vapour Reading
- Natural Moisture Content
- Atterberg Limits
- Undrained Triaxial at % Strain at Failure
- Shear Strength by Penetrometer Test

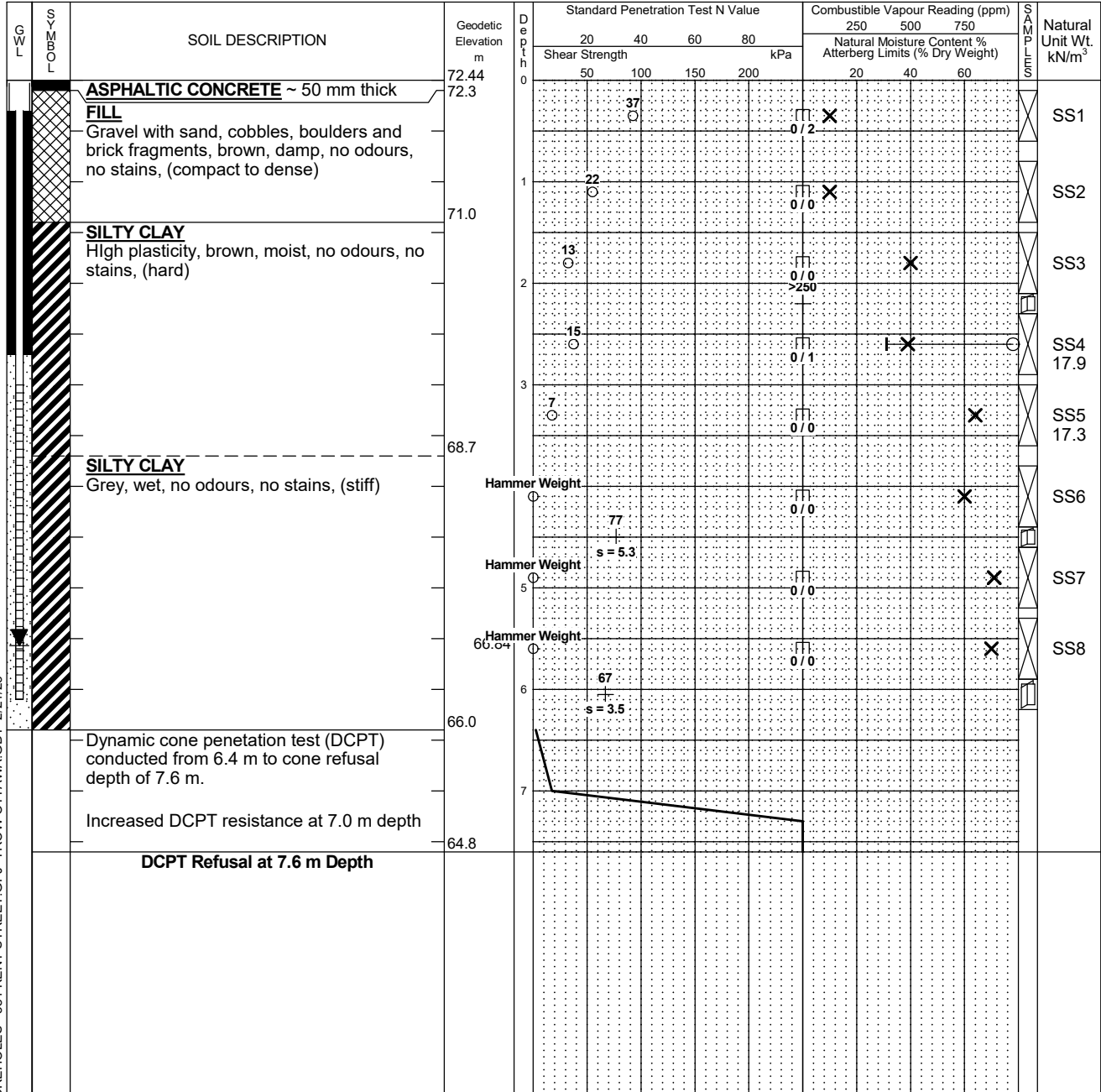

LOG OF BOREHOLE LOGS OF BOREHOLES - 381 KENT STREET.GPJ TROW OTTAWA.GDT 2/21/23

- NOTES:
- Borehole data requires interpretation by EXP before use by others
 - A 38 mm diameter monitoring well installed as shown upon completion of drilling.
 - Field work was supervised by an EXP representative.
 - See Notes on Sample Descriptions
 - Log to be read with EXP Report OTT-21019154-A0

| WATER LEVEL RECORDS | | |
|---------------------|-----------------|------------------|
| Date | Water Level (m) | Hole Open To (m) |
| December 8, 2021 | 5.6 | - |

| CORE DRILLING RECORD | | | |
|----------------------|-----------|--------|-------|
| Run No. | Depth (m) | % Rec. | RQD % |
| | | | |

Log of Borehole BH/MW21-4



Project No: OTT-21019154-A0

Figure No. 6

Project: Proposed High-Rise Development - Preliminary Investigation

Page. 1 of 2

Location: 381 Kent Street, Ottawa, Ontario

Date Drilled: November 29 and 30, 2021

Split Spoon Sample

Combustible Vapour Reading

Drill Type: CME-55 Truck Mounted Drill-Rig

Auger Sample

Natural Moisture Content

SPT (N) Value

Atterberg Limits

Datum: Geodetic Elevation

Dynamic Cone Test

Undrained Triaxial at % Strain at Failure

Shelby Tube

Shear Strength by Penetrometer Test

Logged by: MAD Checked by: MGM/SMP

Shear Strength by Vane Test

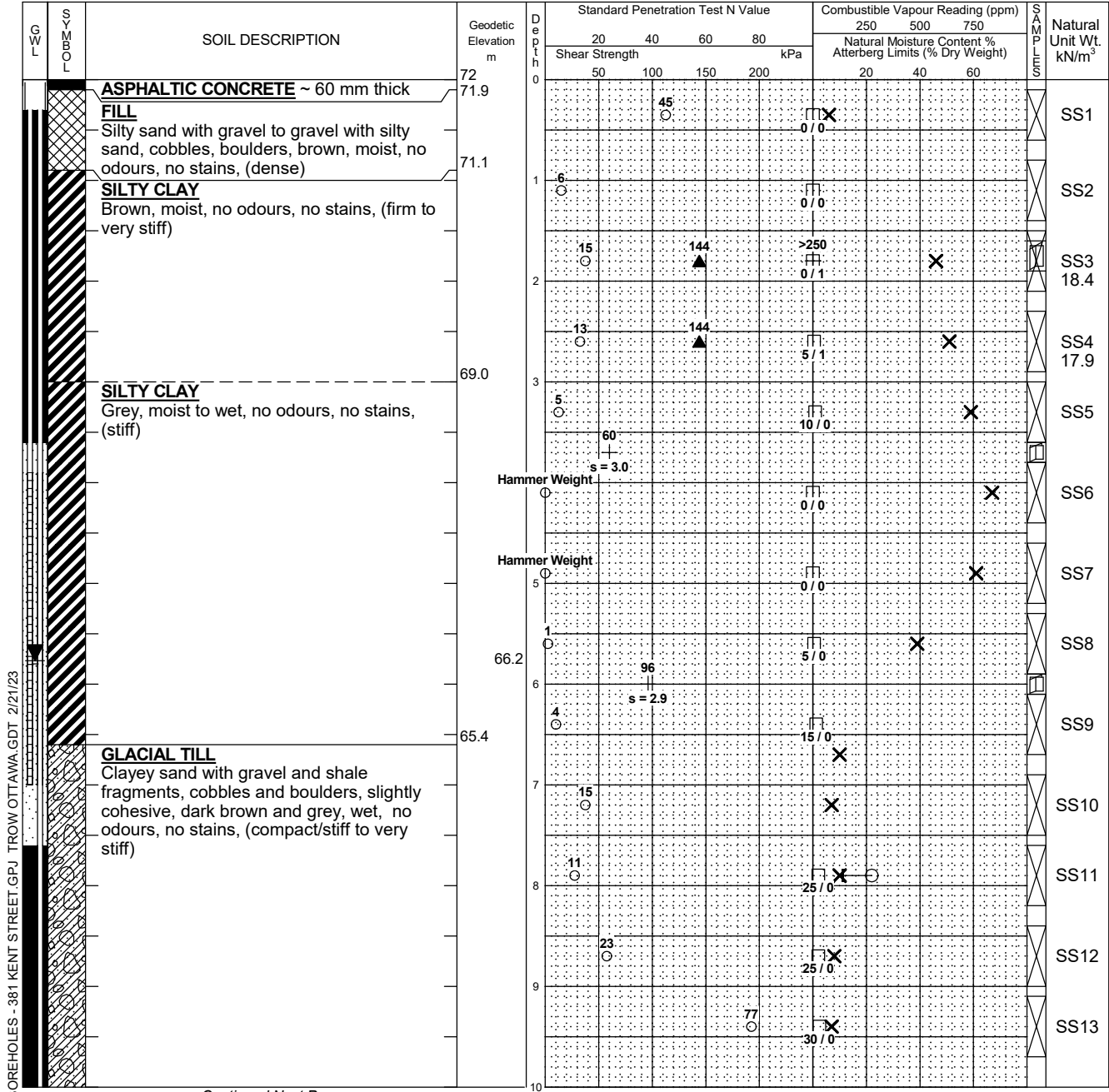

Continued Next Page

NOTES:

- Borehole data requires interpretation by EXP before use by others
- 19 mm diameter standpipe and 38 mm diameter monitoring well installed as shown upon completion of drilling.
- Field work was supervised by an EXP representative.
- See Notes on Sample Descriptions
- Log to be read with EXP Report OTT-21019154-A0

WATER LEVEL RECORDS

| Date | Water Level (m) | Hole Open To (m) |
|----------------------------|-----------------|------------------|
| December 8, 2021 (Shallow) | 5.8 | - |
| December 8, 2021 (Deep) | 8.2 | - |

CORE DRILLING RECORD

| Run No. | Depth (m) | % Rec. | RQD % |
|---------|-------------|--------|-------|
| 1 | 10.1 - 11.7 | 57 | 8 |
| 2 | 11.7 - 13.2 | 100 | 49 |
| 3 | 13.2 - 14.8 | 97 | 57 |
| 4 | 14.8 - 16.3 | 100 | 73 |
| 5 | 16.3 - 17.8 | 100 | 99 |
| 6 | 17.8 - 19.3 | 100 | 91 |
| 7 | 19.3 - 20.9 | 97 | 95 |

LOG OF BOREHOLE BH/MW21-4 - 381 KENT STREET, GPJ TROW OTTAWA GDT 2/21/23



Grain-Size Distribution Curve Method of Test For Particle Size Analysis of Soil ASTM C-136/ASTM D422

EXP Services Inc.
100-2650 Queensview Drive
Ottawa, ON K2B 8H6

Unified Soil Classification System

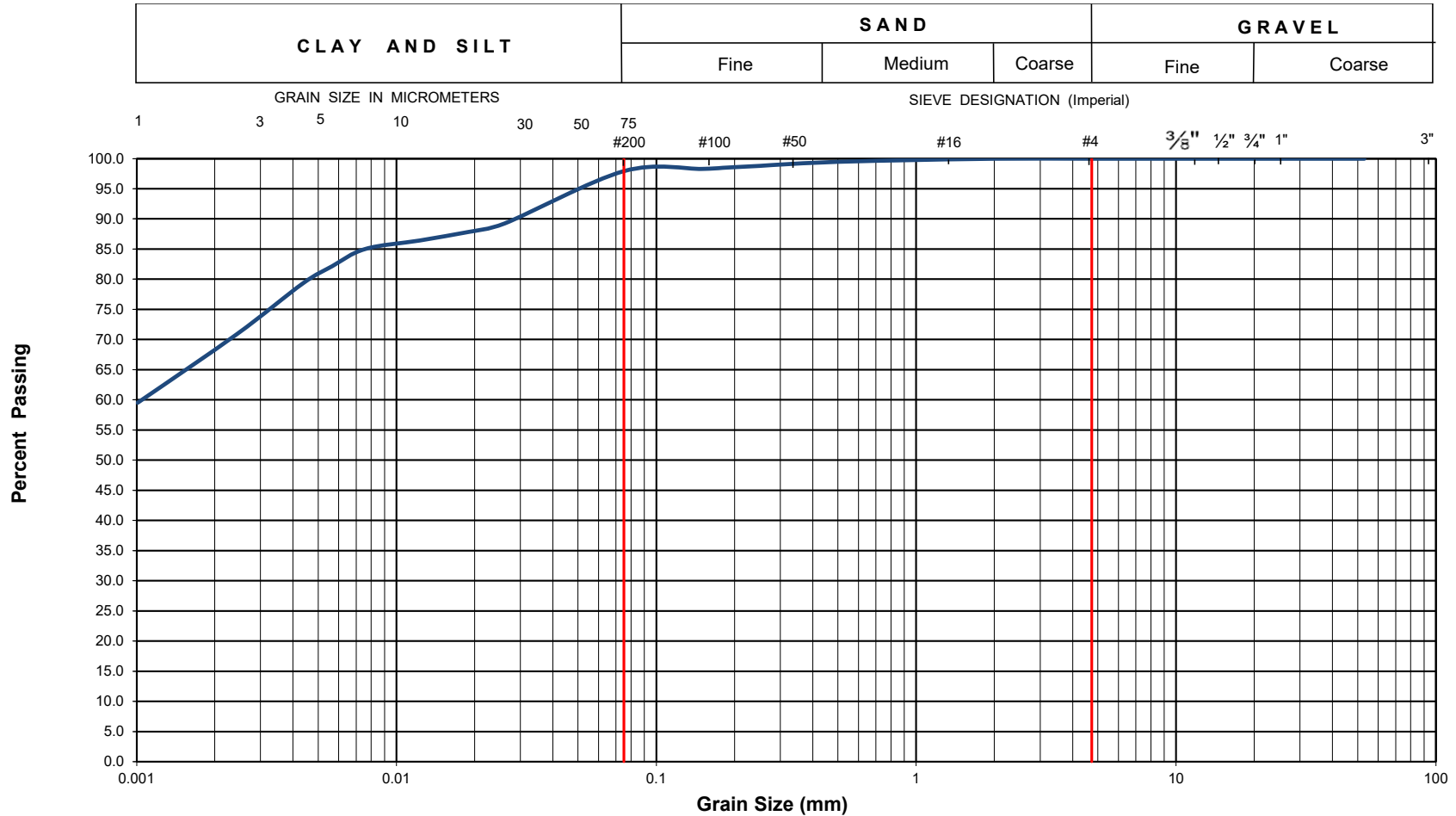

| | | | | | |
|----------------------|------------------------------------|--------------------|---|-----------------|---|
| EXP Project No.: | OTT-210195154-A0 | Project Name : | Geotechnical Investigation - Proposed High Rise Development | | |
| Client : | Katasa Groupe | Project Location : | 381 Kent Street, Ottawa, Ontario | | |
| Date Sampled : | December 1, 2021 | Borehole No: | BH21-3 | Sample No.: SS4 | |
| Sample Description : | % Silt and Clay | 98 | % Sand | 2 | |
| Sample Description : | | | % Gravel | 0 | |
| Sample Description : | Silty clay of High Plasticity (CH) | | | Figure : | 7 |



Grain-Size Distribution Curve Method of Test For Particle Size Analysis of Soil ASTM C-136/ASTM D422

EXP Services Inc.
100-2650 Queensview Drive
Ottawa, ON K2B 8H6

Unified Soil Classification System

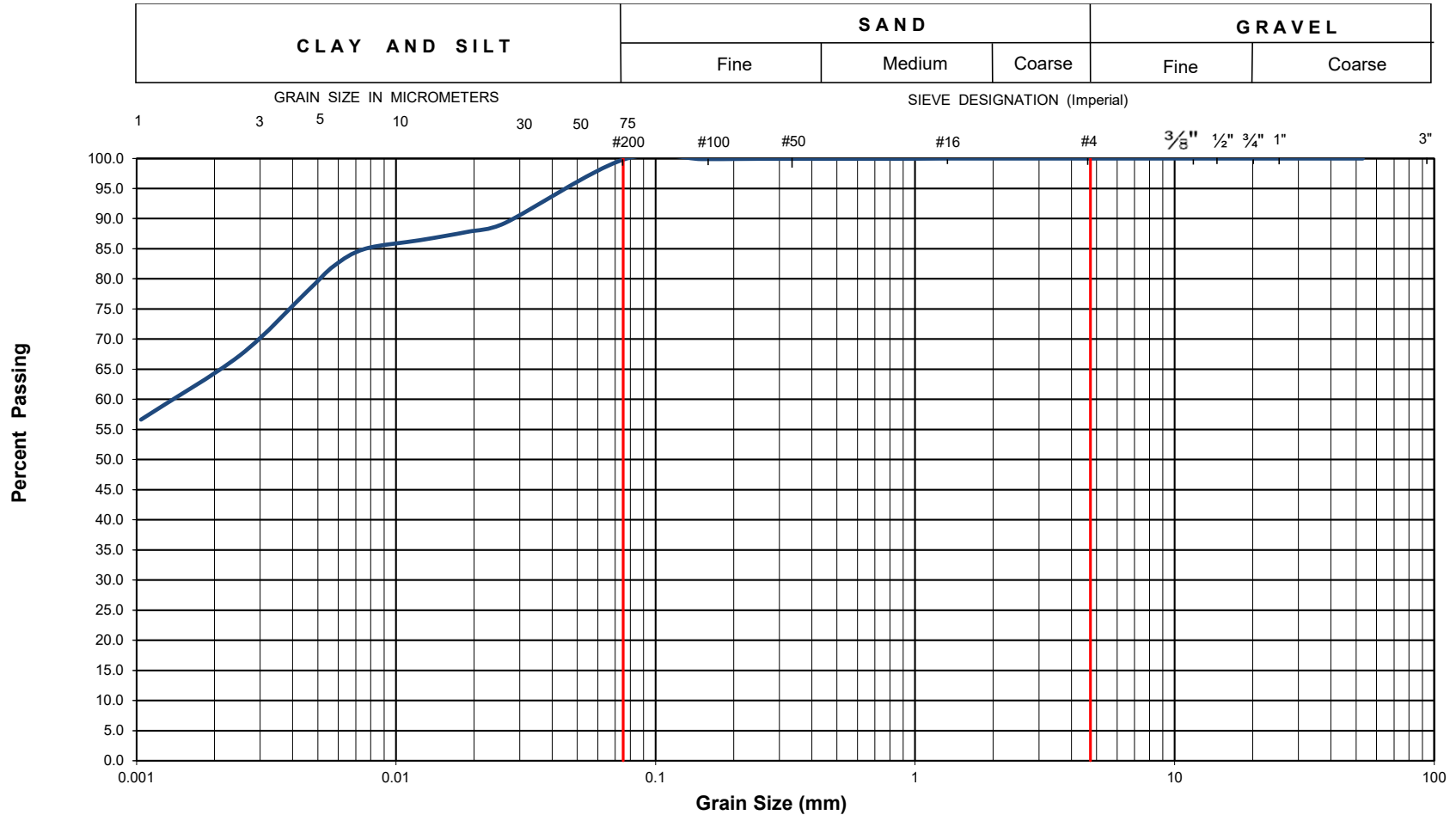

| | | | | | |
|----------------------|---|--------------------|---|-----------------|---|
| EXP Project No.: | OTT-210195154-A0 | Project Name : | Geotechnical Investigation - Proposed High Rise Development | | |
| Client : | Katasa Groupe | Project Location : | 381 Kent Street, Ottawa, Ontario | | |
| Date Sampled : | December 2, 2021 | Borehole No: | BH21-1 | Sample No.: SS4 | |
| Sample Description : | % Silt and Clay | 100 | % Sand | 0 | |
| Sample Description : | | | % Gravel | 0 | |
| Sample Description : | Silty clay of High Plasticity (CH) | | | Figure : | 8 |



Grain-Size Distribution Curve Method of Test For Particle Size Analysis of Soil ASTM C-136/ASTM D422

EXP Services Inc.
100-2650 Queensview Drive
Ottawa, ON K2B 8H6

Unified Soil Classification System

| | | | | | |
|----------------------|-------------|--------|--------|---------------|--------|
| CLAY AND SILT | SAND | | | GRAVEL | |
| | Fine | Medium | Coarse | Fine | Coarse |

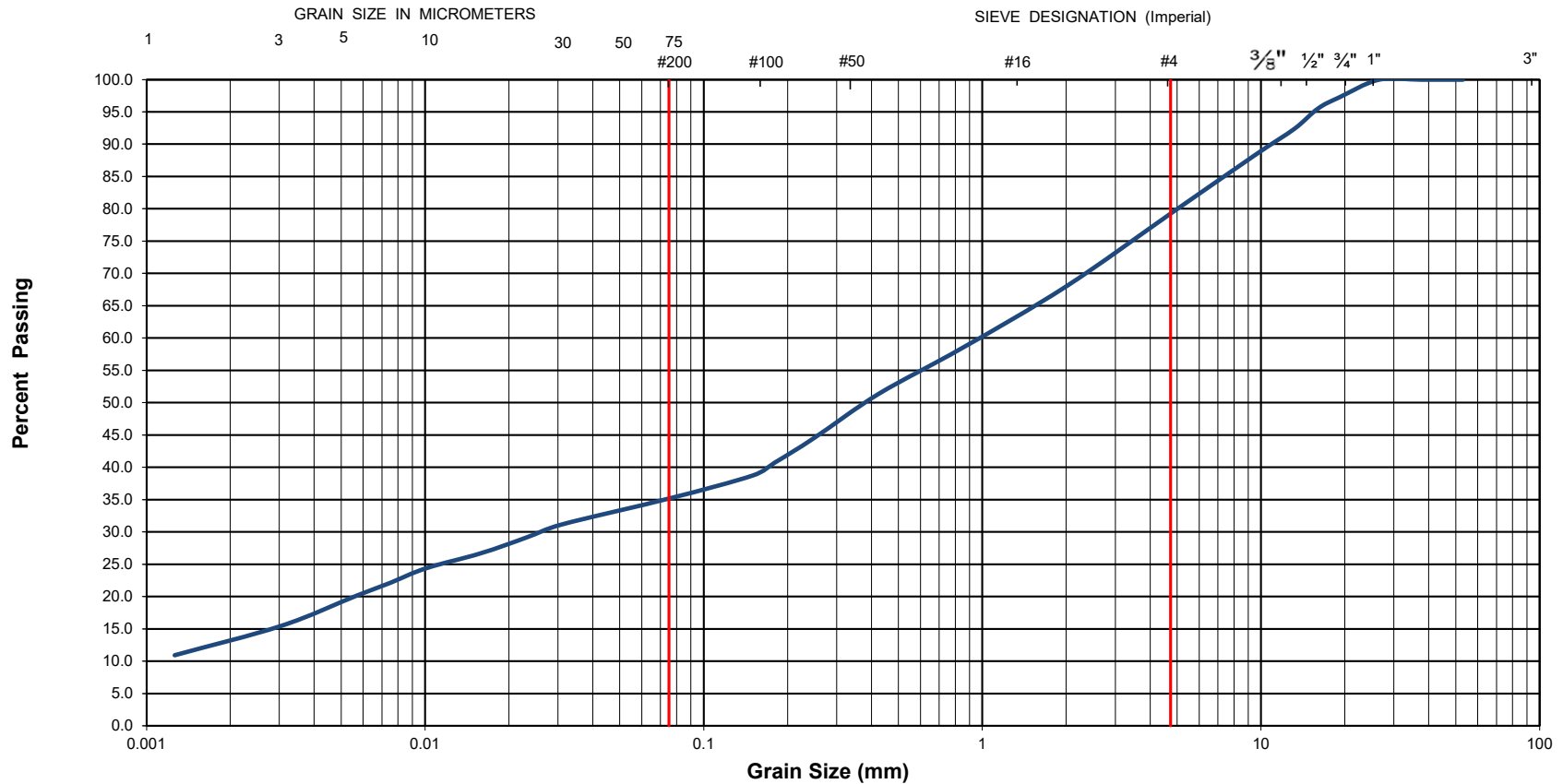

| | | | | | |
|----------------------|--|--------------------|---|------------------|---|
| EXP Project No.: | OTT-210195154-A0 | Project Name : | Geotechnical Investigation - Proposed High Rise Development | | |
| Client : | Katasa Groupe | Project Location : | 381 Kent Street, Ottawa, Ontario | | |
| Date Sampled : | December 2, 2021 | Borehole No: | BH21-4 | Sample No.: SS11 | |
| Sample Description : | % Silt and Clay | 35 | % Sand | 44 | |
| | | | % Gravel | 21 | |
| Sample Description : | GLACIAL TILL: Clayey sand with gravel (SC) | | | Figure : | 9 |

EXP Services Inc.

*Project Name: Proposed High Rise Development
Preliminary Geotechnical Investigation
381 Kent Street, Ottawa, Ontario
Project Number: OTT-21019154-A0
February 22, 2023
Final Report*

Appendix A – Multi-channel Analysis of Surface Waves Survey Report by GPR



GEOPHYSICS GPR INTERNATIONAL INC.

100 – 2545 Delorimier Street Tel. : (450) 679-2400
Longueuil (Québec) Fax : (514) 521-4128
Canada J4K 3P7 info@geophysicsgpr.com
www.geophysicsgpr.com

January 6th, 2022

Transmitted by email: Ismail.Taki@exp.com
Our Ref.: GPR-21-03517a

Mr. Ismail Taki, M.Eng., P.Eng.
Senior Manager, Earth & Environment, Eastern Region
exp Services inc.
100 – 2650 Queensview Drive
Ottawa ON K2B 8H6

Subject: Shear Wave Velocity Sounding for the Site Class Determination
381 Kent Street, Ottawa (ON)

[Project: OTT-21019154-A0]

Dear Sir,

Geophysics GPR International inc. has been mandated by **exp** Services inc. to carry out seismic shear wave surveys at 381 Kent Street, in Ottawa (ON). The geophysical investigation used the Multi-channel Analysis of Surface Waves (MASW), the Spatial AutoCorrelation (SPAC), and the seismic refraction methods. From the subsequent results, the seismic shear wave velocity values were calculated for the soil and the rock, to determine the Site Class.

The surveys were carried out on December 14th, 2021, by Mrs. Karyne Faguy, B.Sc. geoph. and Mr. Jérémie Thiffault, trainee. Figure 1 shows the regional location of the site and Figure 2 illustrates the location of the seismic spreads. Both figures are presented in the Appendix.

The following paragraphs briefly describe the survey design, the principles of the testing methods, and the results presented in tables and graphs.

MASW PRINCIPLE

The *Multi-channel Analysis of Surface Waves* (MASW) and the *SPatial AutoCorrelation* (SPAC or MAM for *Microtremors Array Method*) are seismic methods used to evaluate the shear wave velocities of subsurface materials through the analysis of the dispersion properties of the Rayleigh surface waves ("ground roll"). The MASW is considered an "active" method, as the seismic signal is induced at known location and time in the geophones' spread axis. Conversely, the SPAC is considered a "passive" method, using the low frequency "signals" produced far away. The method can also be used with "active" seismic source records. The SPAC method allows deeper V_s soundings, but generally with a lower resolution for the surface portion. Its dispersion curve can then be merged with the one of higher frequency from the MASW to calculate a more complete inversion. The dispersion properties are expressed as a change of phase velocities with respect to frequencies. Surface wave energy will decay exponentially with depth. Lower frequency surface waves will travel deeper and thus be more influenced by deeper velocity layering than the shallow higher frequency waves. The inversion of the Rayleigh wave dispersion curve yields a shear wave (V_s) velocity depth profile (sounding).

Figure 3 schematically outlines the basic operating procedure for the MASW method. Figure 4 illustrates an example of one of the MASW/SPAC records, the corresponding spectrogram analysis and resulting 1D V_s model.

INTERPRETATION

The main processing sequence involved data inspection and edition when required; spectral analysis ("phase shift" for MASW, and "cross-correlation" for SPAC); picking the fundamental mode; and 1D inversion of the MASW and SPAC shot records using the SeisImagerSW™ software. The data inversions used a nonlinear least squares algorithm.

In theory, all the shot records for a given seismic spread should produce a similar shear-wave velocity profile. In practice, however, differences can arise due to energy dissipation, local surface seismic velocities variations, and/or dipping of overburden layers or rock. In general, the precision of the calculated seismic shear wave velocities (V_s) is of the order of 15% or better.

More detailed descriptions of these methods are presented in *Shear Wave Velocity Measurement Guidelines for Canadian Seismic Site Characterization in Soil and Rock*, Hunter, J.A., Crow, H.L., et al., Geological Surveys of Canada, General Information Product 110, 2015.



SURVEY DESIGN

The seismic acquisition spreads were laid across the parking lot of the property, with a geophone spacing of 3.0 metres for the main spread, using 24 geophones (Figure 2). A shorter seismic spread, with geophone spacing of 1.0 metre, was dedicated to the near surface materials. The seismic records were produced with a seismograph Terraloc Pro 2 (from ABEM Instrument), and the geophones were 4.5 Hz. An 8 kg sledgehammer was used as the energy source with impacts being recorded off both ends of the seismic spreads.

The seismic records counted 4096 data, sampled at 1000 μ s for the MASW surveys, and 40 μ s for the seismic refraction. The records included a pre-triggered portion of 10 ms. A stacking procedure was also used to improve the Signal / Noise ratio for the seismic records.

The shear wave depth sounding can be considered as the average of the bulk area within the geophone spread, especially for its central half-length.

RESULTS

From seismic refraction (V_p), the rock depth was calculated between 9.1 and 11.6 metres (± 1 metre). The MASW calculated V_s results are illustrated at Figure 5. Some low velocities were calculated from approximately 0.7 to 4.7 metres deep.

The \bar{V}_{S30} value results from the harmonic mean of the shear wave velocities, from the surface to 30 metres deep. It is calculated by dividing the total depth of interest (30 metres) by the sum of the time spent in each velocity layer from the surface down to 30 metres, as:

$$\bar{V}_{S30} = \frac{\sum_{i=1}^N H_i}{\sum_{i=1}^N H_i / V_i} \quad | \quad \sum_{i=1}^N H_i = 30 \text{ m}$$

(N: number of layers; H_i : thickness of layer "i" ; V_i : V_s of layer "i")

Thus, the \bar{V}_{S30} value represents the seismic shear wave velocity of an equivalent homogeneous single layer response, between the surface and 30 metres deep.

The calculated \bar{V}_{S30} value of the actual site is 515.4 m/s (Table 1), corresponding to the Site Class "C". In the case the bottom of the foundations would be at 12 metres deep, the \bar{V}_{S30}^* value would be 2102.5 m/s (Table 2), corresponding to the Site Class "A".



CONCLUSION

Geophysical surveys were carried out to identify the Site Class at 381 Kent Street, in Ottawa (ON). The seismic surveys used the MASW and the SPAC analysis, and the seismic refraction method to calculate the \bar{V}_{S30} value. Its calculation is presented at Table 1.

The \bar{V}_{S30} value of the actual site is 515 m/s, corresponding to the Site Class "C" ($360 < \bar{V}_{S30} \leq 760$ m/s), as determined through the MASW and SPAC methods, Table 4.1.8.4.A of the NBC, and the Building Code, O. Reg. 332/12. Some low seismic velocities were calculated from approximately 0.7 to 4.7 metres deep. A geotechnical assessment of the corresponding materials could be required.

In the case the bottom of the foundations would be at 12 metres deep, the \bar{V}_{S30}^* value would be 2103 m/s, corresponding to the Site Class "A" ($\bar{V}_{S30} > 1500$ m/s).

It must be noted that other geotechnical information gleaned on site; including the presence of liquefiable soils, very soft clays, high moisture content etc. (cf. Table 4.1.8.4.A of the NBC) can supersede the Site classification provided in this report based on the \bar{V}_{S30} value.

The V_s values calculated are representative of the in situ materials and are not corrected for the total and effective stresses.

Hoping the whole to your satisfaction, we remain yours truly,



Jean-Luc Arsenault, M.A.Sc., P.Eng.
Senior Project Manager



2022-01-06



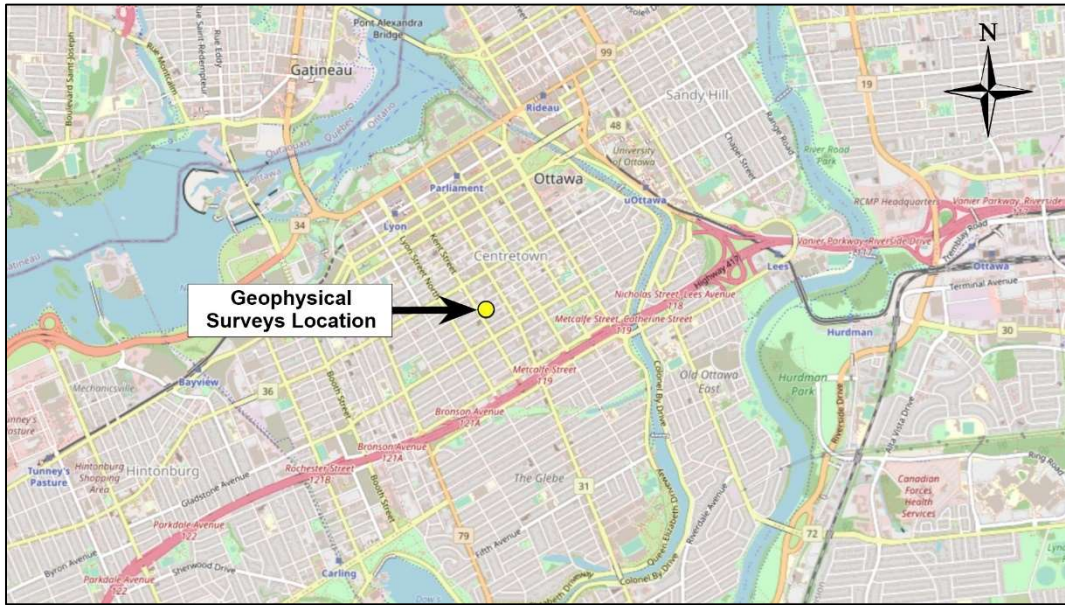

Figure 1: Regional location of the Site
(source: *OpenStreetMap*)

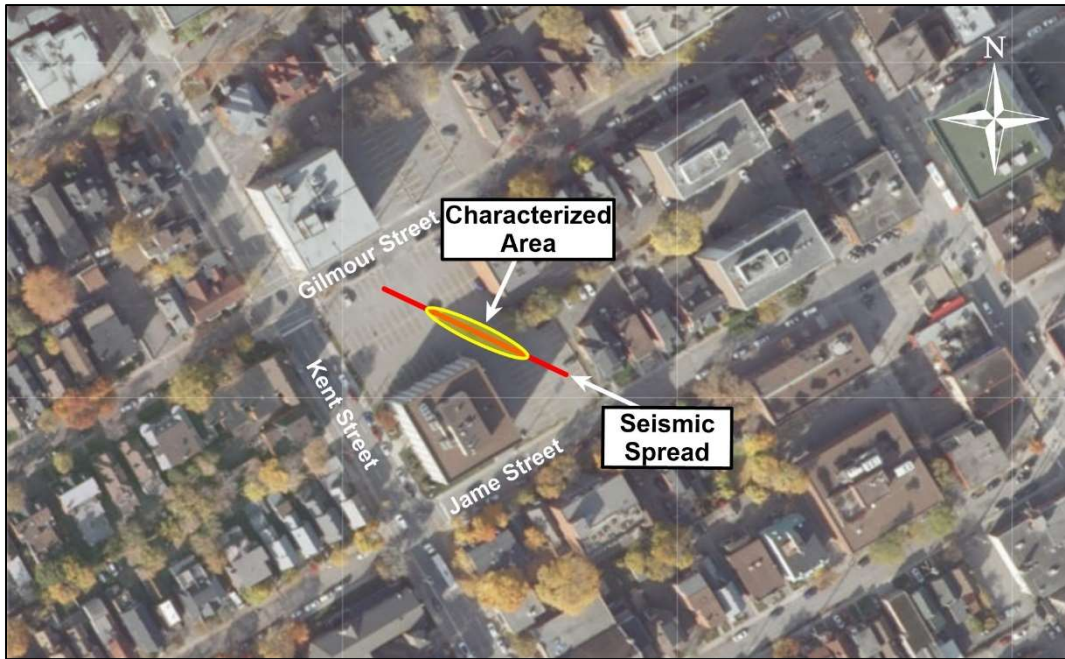

Figure 2: Location of the seismic spreads
(source: *geoOttawa*)



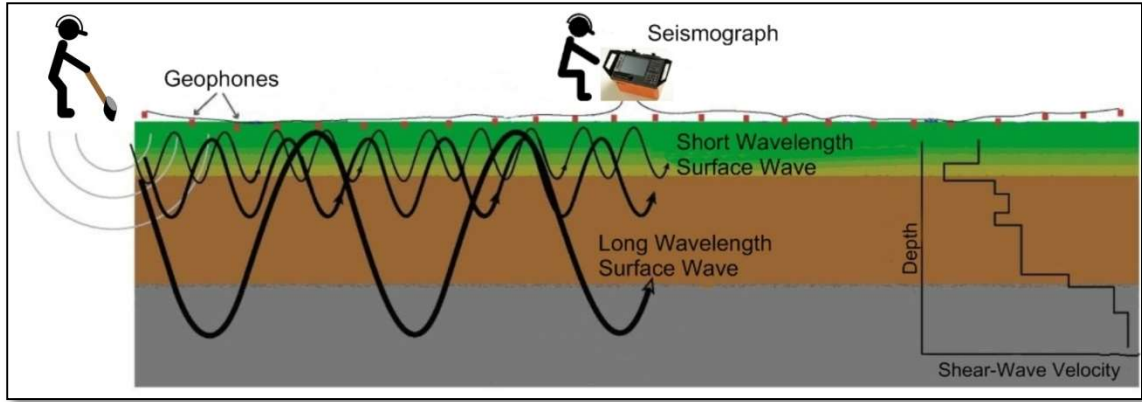

Figure 3: MASW Operating Principle

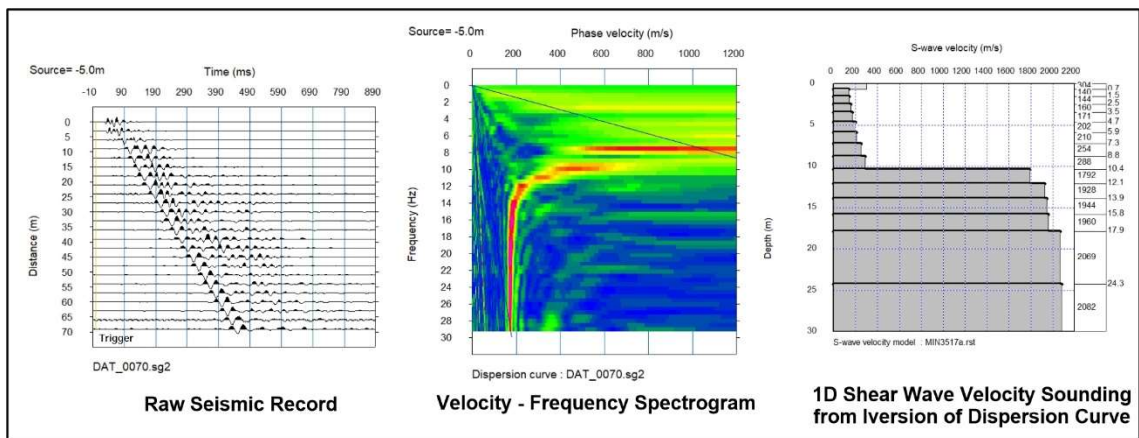

Figure 4: Example of a MASW/SPAC record, Phase Velocity - Frequency curve of the Rayleigh wave and resulting 1D Shear Wave Velocity Model



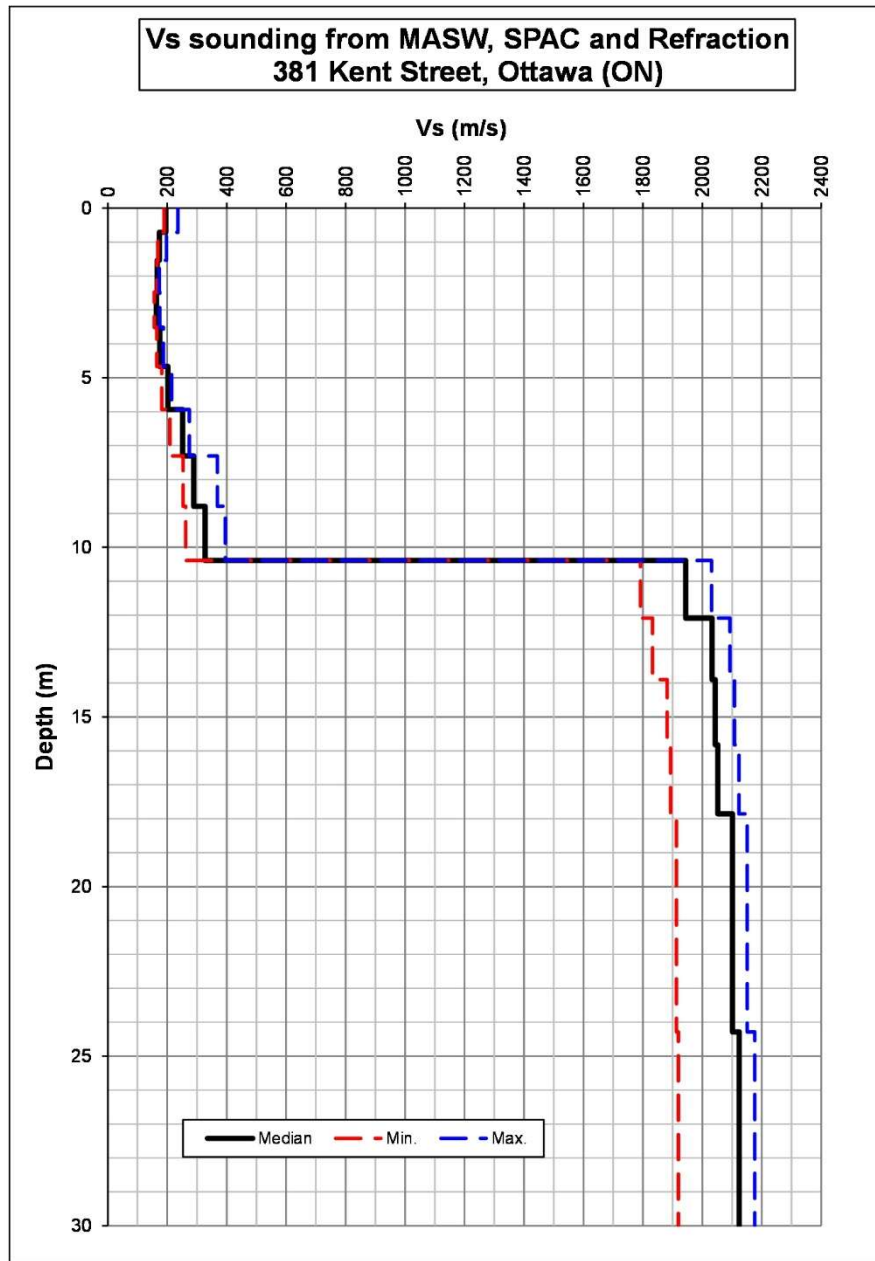

Figure 5: MASW Shear-Wave Velocity Sounding



TABLE 1
V_{S30} Calculation for the Site Class (actual site)

| Depth (m) | Vs | | | Thickness (m) | Cumulative Thickness (m) | Delay for Med. Vs (s) | Cumulative Delay (s) | Vs at given Depth (m/s) |
|--------------|---------------|-----------------|---------------|---|--------------------------------|-----------------------------|----------------------------|-------------------------------|
| | Min. (m/s) | Median (m/s) | Max. (m/s) | | | | | |
| 0 | 189.4 | 195.0 | 235.6 | Grade Level (December 14th, 2021) | | | | |
| 0.71 | 168.5 | 173.3 | 197.6 | 0.71 | 0.71 | 0.003664 | 0.003664 | 195.0 |
| 1.54 | 165.6 | 166.1 | 173.6 | 0.82 | 1.54 | 0.004755 | 0.008419 | 182.7 |
| 2.47 | 155.7 | 163.1 | 174.9 | 0.93 | 2.47 | 0.005622 | 0.014041 | 176.1 |
| 3.52 | 164.6 | 174.5 | 187.2 | 1.04 | 3.52 | 0.006402 | 0.020443 | 172.0 |
| 4.67 | 181.5 | 202.7 | 215.0 | 1.15 | 4.67 | 0.006612 | 0.027055 | 172.6 |
| 5.93 | 209.1 | 251.5 | 274.2 | 1.26 | 5.93 | 0.006235 | 0.033290 | 178.3 |
| 7.31 | 253.0 | 288.4 | 368.8 | 1.37 | 7.31 | 0.005461 | 0.038751 | 188.6 |
| 8.79 | 261.8 | 327.3 | 395.1 | 1.48 | 8.79 | 0.005145 | 0.043896 | 200.3 |
| 10.38 | 1791.9 | 1944.2 | 2030.9 | 1.59 | 10.38 | 0.004868 | 0.048763 | 213.0 |
| 12.09 | 1832.2 | 2032.5 | 2093.1 | 1.70 | 12.09 | 0.000876 | 0.049640 | 243.5 |
| 13.90 | 1881.8 | 2043.3 | 2108.3 | 1.81 | 13.90 | 0.000892 | 0.050532 | 275.1 |
| 15.82 | 1893.3 | 2051.9 | 2123.2 | 1.92 | 15.82 | 0.000941 | 0.051473 | 307.4 |
| 17.86 | 1912.9 | 2101.7 | 2151.0 | 2.03 | 17.86 | 0.000991 | 0.052464 | 340.4 |
| 24.29 | 1918.9 | 2123.9 | 2176.2 | 6.43 | 24.29 | 0.003059 | 0.055522 | 437.4 |
| 30 | | | | 5.71 | 30.00 | 0.002690 | 0.058213 | 515.4 |

| | |
|-------------------|------------------------|
| Vs30 (m/s) | 515.4 |
| Class | C⁽¹⁾ |

(1) A geotechnical assessment could be required for the low seismic velocity materials, from 0.7 to 4.7 metres deep.

TABLE 2
Considering the foundations at 12 metres deep

| Depth (m) | Vs | | | Thickness (m) | Cumulative Thickness (m) | Delay for Med. Vs (s) | Cumulative Delay (s) | Vs at given Depth (m/s) |
|--------------|---------------|-----------------|---------------|--|--------------------------------|-----------------------------|----------------------------|-------------------------------|
| | Min. (m/s) | Median (m/s) | Max. (m/s) | | | | | |
| 0 | 189.4 | 195.0 | 235.6 | Considering the foundations at 12 metres deep | | | | |
| 0.71 | 168.5 | 173.3 | 197.6 | | | | | |
| 1.54 | 165.6 | 166.1 | 173.6 | | | | | |
| 2.47 | 155.7 | 163.1 | 174.9 | | | | | |
| 3.52 | 164.6 | 174.5 | 187.2 | | | | | |
| 4.67 | 181.5 | 202.7 | 215.0 | | | | | |
| 5.93 | 209.1 | 251.5 | 274.2 | | | | | |
| 7.31 | 253.0 | 288.4 | 368.8 | | | | | |
| 8.79 | 261.8 | 327.3 | 395.1 | | | | | |
| 10.38 | 1791.9 | 1944.2 | 2030.9 | | | | | |
| 12 | 1791.9 | 1944.2 | 2030.9 | | | | | |
| 12.09 | 1832.2 | 2032.5 | 2093.1 | | | | | |
| 13.90 | 1881.8 | 2043.3 | 2108.3 | 1.81 | 1.90 | 0.000892 | 0.000937 | 2028.3 |
| 15.82 | 1893.3 | 2051.9 | 2123.2 | 1.92 | 3.82 | 0.000941 | 0.001878 | 2035.8 |
| 17.86 | 1912.9 | 2101.7 | 2151.0 | 2.03 | 5.86 | 0.000991 | 0.002869 | 2041.4 |
| 24.29 | 1918.9 | 2123.9 | 2176.2 | 6.43 | 12.29 | 0.003059 | 0.005928 | 2072.5 |
| 42 | | | | 17.71 | 30.00 | 0.008340 | 0.014268 | 2102.5 |

| | |
|--------------------|---------------|
| Vs30* (m/s) | 2102.5 |
| Class | A |



EXP Services Inc.

*Project Name: Proposed High Rise Development
Preliminary Geotechnical Investigation
381 Kent Street, Ottawa, Ontario
Project Number: OTT-21019154-A0
February 22, 2023
Final Report*

Appendix B – Bedrock Core Photographs

DRY BEDROCK CORES



WET BEDROCK CORES



EXP Services Inc. www.exp.com

t: +1.613.688.1899 | f: +1.613.225.7337

2650 Queensview Drive, Suite 100

Ottawa, ON K2B 8H6, Canada

| | | | |
|--------------------------------|--|--|------------------------------------|
| borehole no. BH21-1 | core runs Run 1: 9.9 m - 11.5 m Run 2: 11.5 m - 13.1 m | project Location: 381 Kent Street, Ottawa, ON | project no. OTT-21019154-A0 |
| date cored Dec 02, 2021 | | Rock Core Photographs | FIG B-1 |

13.1 m

DRY BEDROCK CORES



14.6 m

16.1 m

WET BEDROCK CORES

13.1m



14.6 m

16.1 m



EXP Services Inc. www.exp.com

t: +1.613.688.1899 | f: +1.613.225.7337

2650 Queensview Drive, Suite 100

Ottawa, ON K2B 8H6, Canada

| | | | |
|--------------------------------|---|--|------------------------------------|
| borehole no. BH21-1 | core runs Run 3: 13.1 m - 14.6 m Run 4: 14.6 m - 16.1 m | project Location: 381 Kent Street, Ottawa, ON | project no. OTT-21019154-A0 |
| date cored Dec 02, 2021 | | Rock Core Photographs | FIG B-2 |

16.1 m

DRY BEDROCK CORES

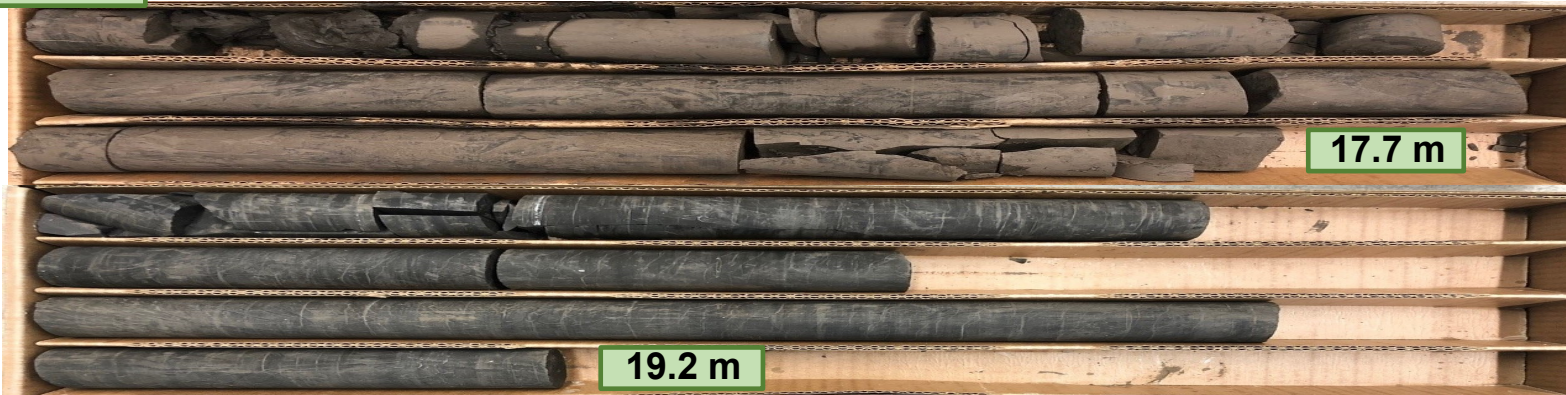

17.7 m

19.2 m

WET BEDROCK CORES

16.1 m

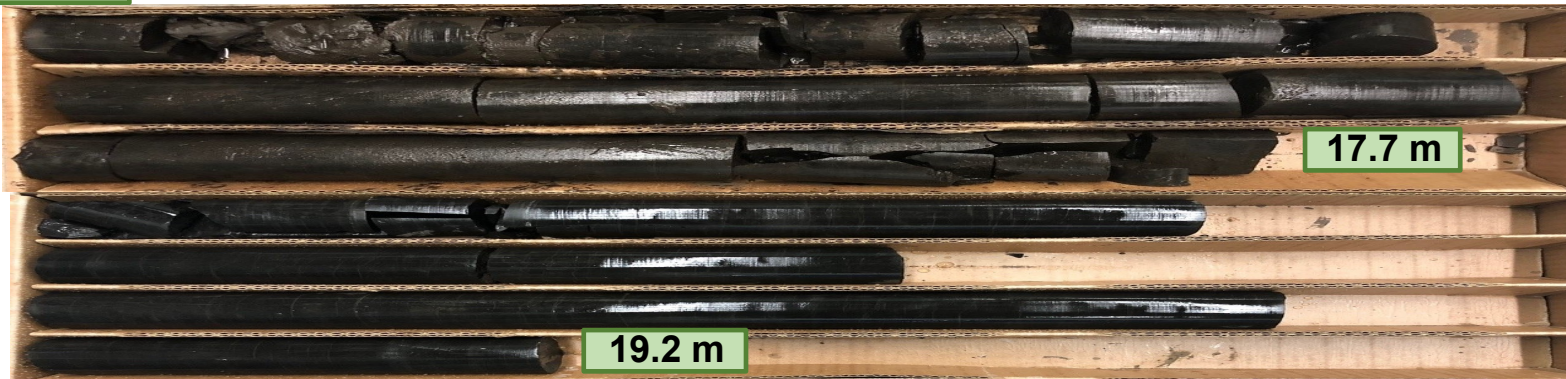

17.7 m

19.2 m



EXP Services Inc. www.exp.com

t: +1.613.688.1899 | f: +1.613.225.7337

2650 Queensview Drive, Suite 100

Ottawa, ON K2B 8H6, Canada

| | | | |
|--------------------------------|---|--|------------------------------------|
| borehole no. BH21-1 | core runs Run 5: 16.1 m - 17.7 m Run 6: 17.7 m - 19.2 m | project Location: 381 Kent Street, Ottawa, ON | project no. OTT-21019154-A0 |
| date cored Dec 02, 2021 | | Rock Core Photographs | FIG B-3 |

DRY BEDROCK CORES

19.2 m



20.3 m

WET BEDROCK CORES

19.2 m



20.3 m



EXP Services Inc. www.exp.com

t: +1.613.688.1899 | f: +1.613.225.7337

2650 Queensview Drive, Suite 100

Ottawa, ON K2B 8H6, Canada

| | | | |
|-------------------------------|-------------------------------------|--|--------------------------------|
| borehole no. BH21-1 | core runs Run 7: 19.2 m - 20.3 m | project Location: 381 Kent Street, Ottawa, ON | project no. OTT-21019154-A0 |
| date cored Dec 02, 2021 | | Rock Core Photographs | FIG B-4 |

DRY BEDROCK CORES

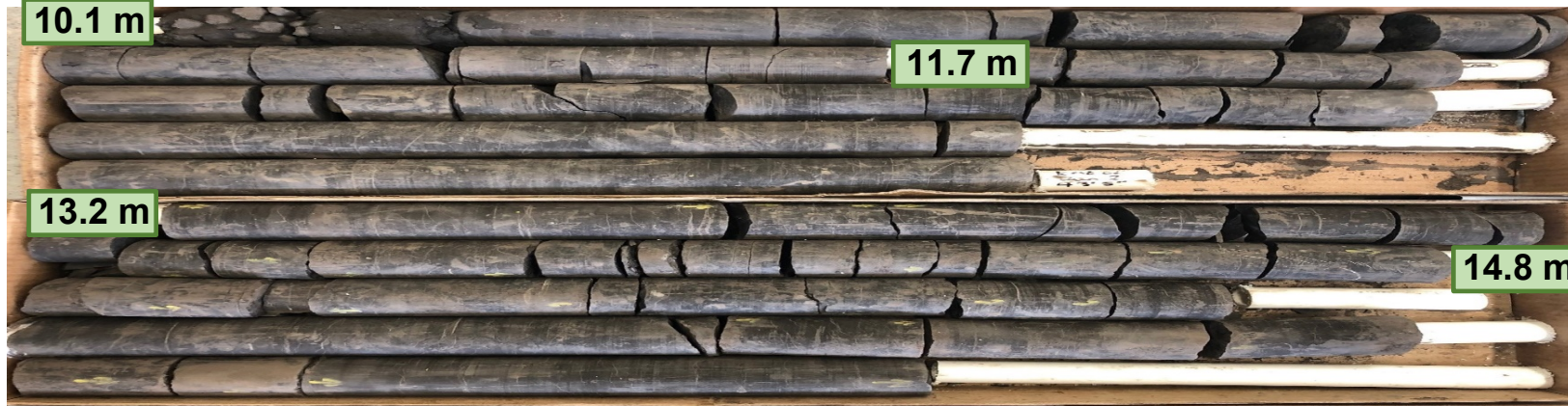

WET BEDROCK CORES

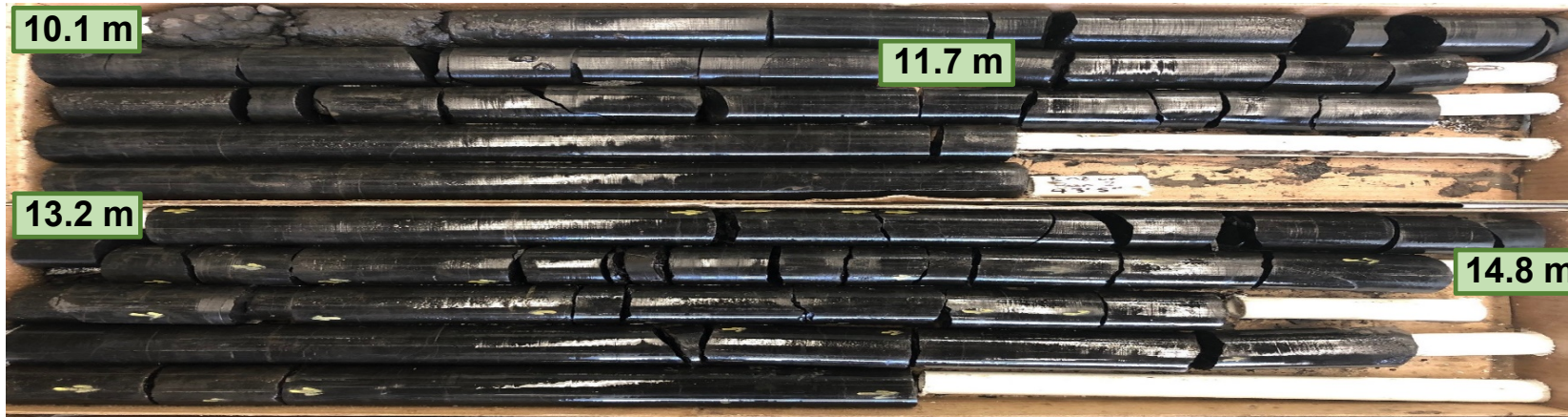

EXP Services Inc. www.exp.com

t: +1.613.688.1899 | f: +1.613.225.7337

2650 Queensview Drive, Suite 100

Ottawa, ON K2B 8H6, Canada

| | | | |
|-----------------------------------|---|--|------------------------------------|
| borehole no. BH21-4 | core runs Run 1: 10.1 m - 11.7 m Run 2: 11.7 m - 13.2 m Run 3: 13.2 m - 14.8 m Run 4: 14.8 m - 16.3m (continued) | project Location: 381 Kent Street, Ottawa, ON | project no. OTT-21019154-A0 |
| date cored Nov 30, 2021 | | Rock Core Photographs | FIG B-5 |

DRY BEDROCK CORES

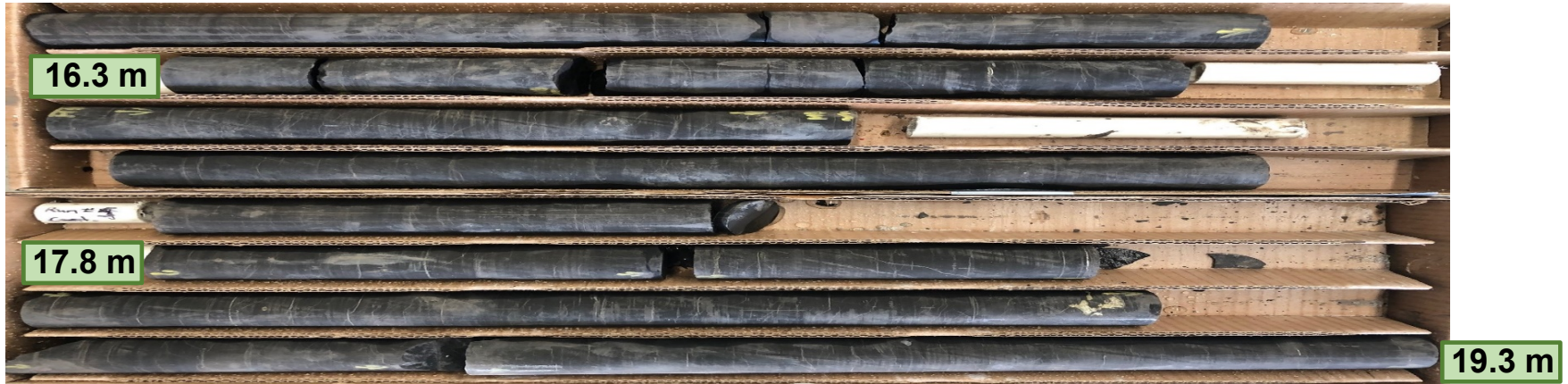

WET BEDROCK CORES



EXP Services Inc. www.exp.com

t: +1.613.688.1899 | f: +1.613.225.7337

2650 Queensview Drive, Suite 100

Ottawa, ON K2B 8H6, Canada

| | | | |
|-----------------------------------|---|--|------------------------------------|
| borehole no. BH21-4 | core runs Run 4: 14.8 m - 16.3 m Run 5: 16.3 m - 17.8 m Run 6: 17.8 m - 19.3 m | project Location: 381 Kent Street, Ottawa, ON | project no. OTT-21019154-A0 |
| date cored Nov 30, 2021 | | Rock Core Photographs | FIG B-6 |

DRY BEDROCK CORES

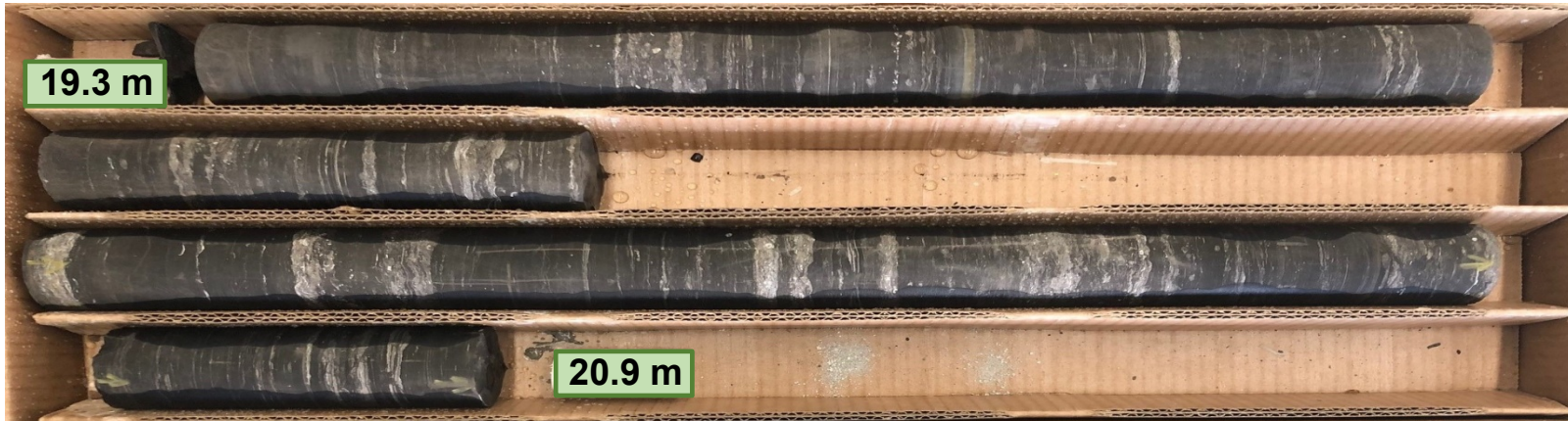

WET BEDROCK CORES

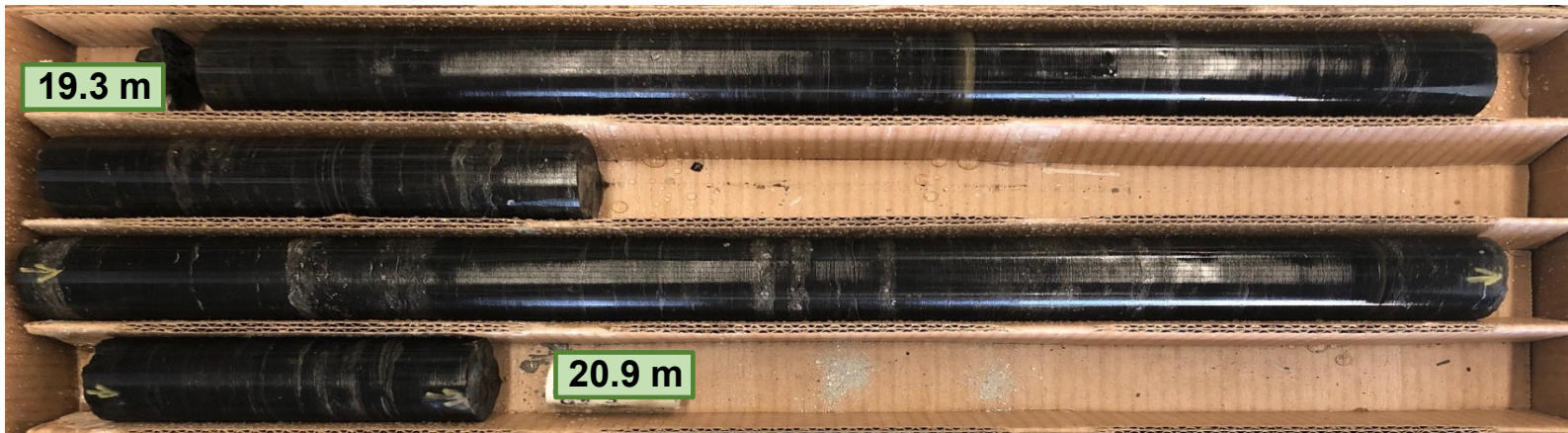

EXP Services Inc. www.exp.com

t: +1.613.688.1899 | f: +1.613.225.7337

2650 Queensview Drive, Suite 100

Ottawa, ON K2B 8H6, Canada

| | | | |
|-------------------------------|-------------------------------------|--|--------------------------------|
| borehole no. BH21-4 | core runs Run 7: 19.3 m - 20.9 m | project Location: 381 Kent Street, Ottawa, ON | project no. OTT-21019154-A0 |
| date cored Nov 30, 2021 | | Rock Core Photographs | FIG B-7 |

EXP Services Inc.

*Project Name: Proposed High Rise Development
Preliminary Geotechnical Investigation
381 Kent Street, Ottawa, Ontario
Project Number: OTT-21019154-A0
February 22, 2023
Final Report*

Appendix C – Ontario Provincial Standard Drawing (OPSD) 3001.100

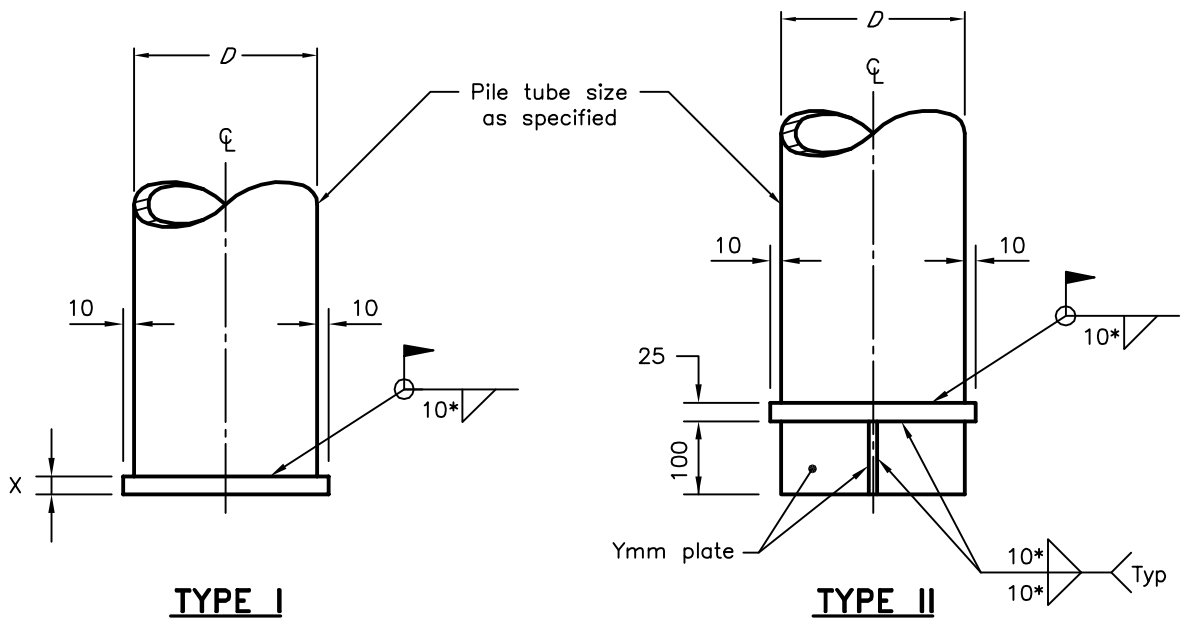

SHOE DETAILS

(*) or tube wall thickness whichever is smaller.

| Pipe Diameter (mm) | Plate Thickness | |
|-----------------------|-----------------|--------|
| | X (mm) | Y (mm) |
| $D < 324$ | 25 | 12 |
| $324 \leq D \leq 406$ | 40 | 15 |
| $406 < D \leq 610$ | 50 | 25 |

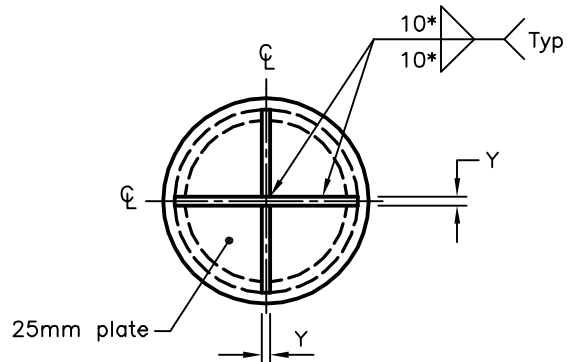

BOTTOM VIEW

NOTES:

- A Driving shoe Type I or II as specified.
- B Welding shall be according to CSA W59.
- C Steel plates shall be according to CSA G40.20/G40.21, Grade 300W/350W.
- D All dimensions are in millimeters unless otherwise shown.

| | | | |
|-------------------------------------|----------|-------|--|
| ONTARIO PROVINCIAL STANDARD DRAWING | Nov 2017 | Rev 2 | |
| FOUNDATION PILES | ----- | | |
| STEEL TUBE PILE DRIVING SHOE | ----- | | |
| OPSD 3001.100 | | | |

EXP Services Inc.

*Project Name: Proposed High Rise Development
Preliminary Geotechnical Investigation
381 Kent Street, Ottawa, Ontario
Project Number: OTT-21019154-A0
February 22, 2023
Final Report*

Legal Notification

This report was prepared by EXP Services for the account of Katasa Groupe.

Any use which a third party makes of this report, or any reliance on or decisions to be made based on it, are the responsibility of such third parties. EXP Services Inc. accepts no responsibility for damages, if any, suffered by any third party as a result of decisions made or actions based on this project.

EXP Services Inc.

*Project Name: Proposed High Rise Development
Preliminary Geotechnical Investigation
381 Kent Street, Ottawa, Ontario
Project Number: OTT-21019154-A0
February 22, 2023
Final Report*

List of Distribution

Report Distributed To:

Chaxu Baria <chaxu@katasa.ca>