

PROJECT INFORMATION	
ENGINEERED PRODUCT MANAGER:	CODY NEATH 519-465-9958 CODY.NEATH@ADSPIPE.COM
ADS SALES REP:	MICHAEL REID 613-882-4186 MICHAEL.REID@ADSPIPE.COM
PROJECT NO:	S312634
ONTARIO SITE COORDINATOR:	RYAN RUBENSTEIN 519-710-3687 RYAN.RUBENSTEIN@ADS-PIPE.COM



# ORLEANS LONG TERM CARE HOME

## ORLEANS, ON.

Resilient Consulting Corporation certifies the theoretical competence of the plans prepared by Advanced Drainage Systems, Inc. but cannot certify the integrity of the actual construction unless Resilient Consulting Corporation is retained to perform construction supervision of the project as works are being built.

Review is limited to the structural capacity of the chamber system to resist the applied dead load and live load only.

Review of ADS Drawings: S312634, revision date 09/07/22  
 Live load: CL-625-ONT  
 Dead Load: 47.1 KN/m<sup>2</sup> (SLS) and 91.8 KN/m<sup>2</sup> (ULS)  
 Pavement and Aggregate Cover: 2.13 m

Resilient Consulting Corporation takes no responsibility for the overall system design for hydraulic capacity, hydrologic function, soil conditions or bearing capacity, layout, locations, or elevations.

### MC-7200 STORMTECH CHAMBER SPECIFICATIONS

- CHAMBERS SHALL BE STORMTECH MC-7200.
- CHAMBERS SHALL BE ARCH-SHAPED AND SHALL BE MANUFACTURED FROM VIRGIN, IMPACT-MODIFIED POLYPROPYLENE COPOLYMERS.
- CHAMBERS SHALL BE CERTIFIED TO CSA B184, "POLYMERIC SUB-SURFACE STORMWATER MANAGEMENT STRUCTURES", AND MEET THE REQUIREMENTS OF ASTM F2418, "STANDARD SPECIFICATION FOR POLYPROPYLENE (PP) CORRUGATED WALL STORMWATER COLLECTION CHAMBERS" CHAMBER CLASSIFICATION 60x101.
- CHAMBER ROWS SHALL PROVIDE CONTINUOUS, UNOBSTRUCTED INTERNAL SPACE WITH NO INTERNAL SUPPORTS THAT WOULD IMPEDE FLOW OR LIMIT ACCESS FOR INSPECTION.
- THE STRUCTURAL DESIGN OF THE CHAMBERS, THE STRUCTURAL BACKFILL, AND THE INSTALLATION REQUIREMENTS SHALL ENSURE THAT THE LOAD FACTORS SPECIFIED IN THE AASHTO LRFD BRIDGE DESIGN SPECIFICATIONS, SECTION 12.12, ARE MET FOR: 1) LONG-DURATION DEAD LOADS AND 2) SHORT-DURATION LIVE LOADS, BASED ON THE CSA S6 CL-625 TRUCK AND THE AASHTO DESIGN TRUCK WITH CONSIDERATION FOR IMPACT AND MULTIPLE VEHICLE PRESENCES.
- CHAMBERS SHALL BE DESIGNED, TESTED AND ALLOWABLE LOAD CONFIGURATIONS DETERMINED IN ACCORDANCE WITH ASTM F2787, "STANDARD PRACTICE FOR STRUCTURAL DESIGN OF THERMOPLASTIC CORRUGATED WALL STORMWATER COLLECTION CHAMBERS". LOAD CONFIGURATIONS SHALL INCLUDE: 1) INSTANTANEOUS (<1 MIN) AASHTO DESIGN TRUCK LIVE LOAD ON MINIMUM COVER 2) MAXIMUM PERMANENT (75-YR) COVER LOAD AND 3) ALLOWABLE COVER WITH PARKED (1-WEEK) AASHTO DESIGN TRUCK.
- REQUIREMENTS FOR HANDLING AND INSTALLATION:
  - TO MAINTAIN THE WIDTH OF CHAMBERS DURING SHIPPING AND HANDLING, CHAMBERS SHALL HAVE INTEGRAL, INTERLOCKING STACKING LUGS.
  - TO ENSURE A SECURE JOINT DURING INSTALLATION AND BACKFILL, THE HEIGHT OF THE CHAMBER JOINT SHALL NOT BE LESS THAN 75 mm (3").
  - TO ENSURE THE INTEGRITY OF THE ARCH SHAPE DURING INSTALLATION, a) THE ARCH STIFFNESS CONSTANT SHALL BE GREATER THAN OR EQUAL TO 450 LBS/FT/%. THE ASC IS DEFINED IN SECTION 6.2.8 OF ASTM F2418. AND b) TO RESIST CHAMBER DEFORMATION DURING INSTALLATION AT ELEVATED TEMPERATURES (ABOVE 23° C / 73° F), CHAMBERS SHALL BE PRODUCED FROM REFLECTIVE GOLD OR YELLOW COLORS.
- ONLY CHAMBERS THAT ARE APPROVED BY THE SITE DESIGN ENGINEER WILL BE ALLOWED. UPON REQUEST BY THE SITE DESIGN ENGINEER OR OWNER, THE CHAMBER MANUFACTURER SHALL SUBMIT A STRUCTURAL EVALUATION FOR APPROVAL BEFORE DELIVERING CHAMBERS TO THE PROJECT SITE AS FOLLOWS:
  - THE STRUCTURAL EVALUATION SHALL BE SEALED BY A REGISTERED PROFESSIONAL ENGINEER.
  - THE STRUCTURAL EVALUATION SHALL DEMONSTRATE THAT THE SAFETY FACTORS ARE GREATER THAN OR EQUAL TO 1.95 FOR DEAD LOAD AND 1.75 FOR LIVE LOAD, THE MINIMUM REQUIRED BY ASTM F2787 AND BY SECTIONS 3 AND 12.12 OF THE AASHTO LRFD BRIDGE DESIGN SPECIFICATIONS FOR THERMOPLASTIC PIPE.
  - THE TEST DERIVED CREEP MODULUS AS SPECIFIED IN ASTM F2418 SHALL BE USED FOR PERMANENT DEAD LOAD DESIGN EXCEPT THAT IT SHALL BE THE 75-YEAR MODULUS USED FOR DESIGN.
- CHAMBERS AND END CAPS SHALL BE PRODUCED AT AN ISO 9001 CERTIFIED MANUFACTURING FACILITY.

### IMPORTANT - NOTES FOR THE BIDDING AND INSTALLATION OF MC-7200 CHAMBER SYSTEM

- STORMTECH MC-7200 CHAMBERS SHALL NOT BE INSTALLED UNTIL THE MANUFACTURER'S REPRESENTATIVE HAS COMPLETED A PRE-CONSTRUCTION MEETING WITH THE INSTALLERS.
- STORMTECH MC-7200 CHAMBERS SHALL BE INSTALLED IN ACCORDANCE WITH THE "STORMTECH MC-3500/MC-7200 CONSTRUCTION GUIDE".
- CHAMBERS ARE NOT TO BE BACKFILLED WITH A DOZER OR EXCAVATOR SITUATED OVER THE CHAMBERS. STORMTECH RECOMMENDS 3 BACKFILL METHODS:
  - STONESHOOTER LOCATED OFF THE CHAMBER BED.
  - BACKFILL AS ROWS ARE BUILT USING AN EXCAVATOR ON THE FOUNDATION STONE OR SUBGRADE.
  - BACKFILL FROM OUTSIDE THE EXCAVATION USING A LONG BOOM HOE OR EXCAVATOR.
- THE FOUNDATION STONE SHALL BE LEVELED AND COMPACTED PRIOR TO PLACING CHAMBERS.
- JOINTS BETWEEN CHAMBERS SHALL BE PROPERLY SEATED PRIOR TO PLACING STONE.
- MAINTAIN MINIMUM - 230 mm (9") SPACING BETWEEN THE CHAMBER ROWS.
- INLET AND OUTLET MANIFOLDS MUST BE INSERTED A MINIMUM OF 300 mm (12") INTO CHAMBER END CAPS.
- EMBEDMENT STONE SURROUNDING CHAMBERS MUST BE A CLEAN, CRUSHED, ANGULAR STONE WELL GRADED BETWEEN ¾" AND 2" (20-50 mm).
- STONE SHALL BE BROUGHT UP EVENLY AROUND CHAMBERS SO AS NOT TO DISTORT THE CHAMBER SHAPE. STONE DEPTHS SHOULD NEVER DIFFER BY MORE THAN 300 mm (12") BETWEEN ADJACENT CHAMBER ROWS.
- STONE MUST BE PLACED ON THE TOP CENTER OF THE CHAMBER TO ANCHOR THE CHAMBERS IN PLACE AND PRESERVE ROW SPACING.
- THE CONTRACTOR MUST REPORT ANY DISCREPANCIES WITH CHAMBER FOUNDATION MATERIAL BEARING CAPACITIES TO THE SITE DESIGN ENGINEER.
- ADS RECOMMENDS THE USE OF "FLEXSTORM CATCH IT" INSERTS DURING CONSTRUCTION FOR ALL INLETS TO PROTECT THE SUBSURFACE STORMWATER MANAGEMENT SYSTEM FROM CONSTRUCTION SITE RUNOFF.

### NOTES FOR CONSTRUCTION EQUIPMENT

- STORMTECH MC-7200 CHAMBERS SHALL BE INSTALLED IN ACCORDANCE WITH THE "STORMTECH MC-7200 CONSTRUCTION GUIDE".
- THE USE OF EQUIPMENT OVER MC-7200 CHAMBERS IS LIMITED:
  - NO EQUIPMENT IS ALLOWED ON BARE CHAMBERS.
  - NO RUBBER TIRE LOADER, DUMP TRUCK, OR EXCAVATORS ARE ALLOWED UNTIL PROPER FILL DEPTHS ARE REACHED IN ACCORDANCE WITH THE "STORMTECH MC-7200 CONSTRUCTION GUIDE".
  - WEIGHT LIMITS FOR CONSTRUCTION EQUIPMENT CAN BE FOUND IN THE "STORMTECH MC-7200 CONSTRUCTION GUIDE".
- FULL 900 mm (36") OF STABILIZED COVER MATERIALS OVER THE CHAMBERS IS REQUIRED FOR DUMP TRUCK TRAVEL OR DUMPING.

**USE OF A DOZER TO PUSH EMBEDMENT STONE BETWEEN THE ROWS OF CHAMBERS MAY CAUSE DAMAGE TO CHAMBERS AND IS NOT AN ACCEPTABLE BACKFILL METHOD. ANY CHAMBERS DAMAGED BY USING THE "DUMP AND PUSH" METHOD ARE NOT COVERED UNDER THE STORMTECH STANDARD WARRANTY.**

CONTACT STORMTECH AT 1-888-892-2694 WITH ANY QUESTIONS ON INSTALLATION REQUIREMENTS OR WEIGHT LIMITS FOR CONSTRUCTION EQUIPMENT.

**PROPOSED LAYOUT**

31	STORMTECH MC-7200 CHAMBERS
6	STORMTECH MC-7200 END CAPS
305	STONE ABOVE (mm)
229	STONE BELOW (mm)
40	% STONE VOID
<b>248.3</b>	<b>INSTALLED SYSTEM VOLUME (m<sup>3</sup>) ABOVE ELEVATION 63.861 (PERIMETER STONE INCLUDED)</b>
216.9	SYSTEM AREA (m <sup>2</sup> )
68.8	SYSTEM PERIMETER (m)

**PROPOSED ELEVATIONS**

67.480	MAXIMUM ALLOWABLE GRADE (TOP OF PAVEMENT/UNPAVED):
66.108	MINIMUM ALLOWABLE GRADE (UNPAVED WITH TRAFFIC):
65.956	MINIMUM ALLOWABLE GRADE (UNPAVED NO TRAFFIC):
65.956	MINIMUM ALLOWABLE GRADE (BASE OF FLEXIBLE PAVEMENT):
65.956	MINIMUM ALLOWABLE GRADE (TOP OF RIGID PAVEMENT):
65.651	TOP OF STONE:
65.346	TOP OF MC-7200 CHAMBER:
64.182	300 mm CUSTOM MANIFOLD INVERT:
64.025	300 mm CUSTOM MANIFOLD INVERT:
64.025	INSERTA TEE SIDE INLET CONNECTION INVERT:
63.880	600 mm ISOLATOR ROW PLUS INVERT:
63.872	450 mm BOTTOM CONNECTION INVERT:
63.861	300 mm BOTTOM MANIFOLD INVERT:
63.822	BOTTOM OF MC-7200 CHAMBER:
63.593	BOTTOM OF STONE:

**NOTES**

- MANIFOLD SIZE TO BE DETERMINED BY SITE DESIGN ENGINEER. SEE TECHNICAL NOTE 6.32 FOR MANIFOLD SIZING GUIDANCE.
- DUE TO THE ADAPTATION OF THIS CHAMBER SYSTEM TO SPECIFIC SITE AND DESIGN CONSTRAINTS, IT MAY BE NECESSARY TO CUT AND COUPLE ADDITIONAL PIPE TO STANDARD MANIFOLD COMPONENTS IN THE FIELD.
- THE SITE DESIGN ENGINEER MUST REVIEW ELEVATIONS AND IF NECESSARY ADJUST GRADING TO ENSURE THE CHAMBER COVER REQUIREMENTS ARE MET.
- THIS CHAMBER SYSTEM WAS DESIGNED WITHOUT SITE-SPECIFIC INFORMATION ON SOIL CONDITIONS OR BEARING CAPACITY. THE SITE DESIGN ENGINEER IS RESPONSIBLE FOR DETERMINING THE SUITABILITY OF THE SOIL AND PROVIDING THE BEARING CAPACITY OF THE INSITU SOILS. THE BASE STONE DEPTH MAY BE INCREASED OR DECREASED ONCE THIS INFORMATION IS PROVIDED.



**RESILIENT CONSULTING**

PO Box 643  
Whitby, ON L1N 5V3  
[info@resilientconsulting.ca](mailto:info@resilientconsulting.ca)

Resilient Consulting Corporation certifies the theoretical competence of the plans prepared by Advanced Drainage Systems, Inc. but cannot certify the integrity of the actual construction unless Resilient Consulting Corporation is retained to perform construction supervision of the project as works are being built.

Review is limited to the structural capacity of the chamber system to resist the applied dead load and live load only.

Review of ADS Drawings: S312634, revision date 09/07/22  
Live load: CL-625-ONT  
Dead Load: 47.1 KN/m<sup>2</sup> (SLS) and 91.8 KN/m<sup>2</sup> (ULS)  
Pavement and Aggregate Cover: 2.13 m

Resilient Consulting Corporation takes no responsibility for the overall system design for hydraulic capacity, hydrologic function, soil conditions or bearing capacity, layout, locations, or elevations.

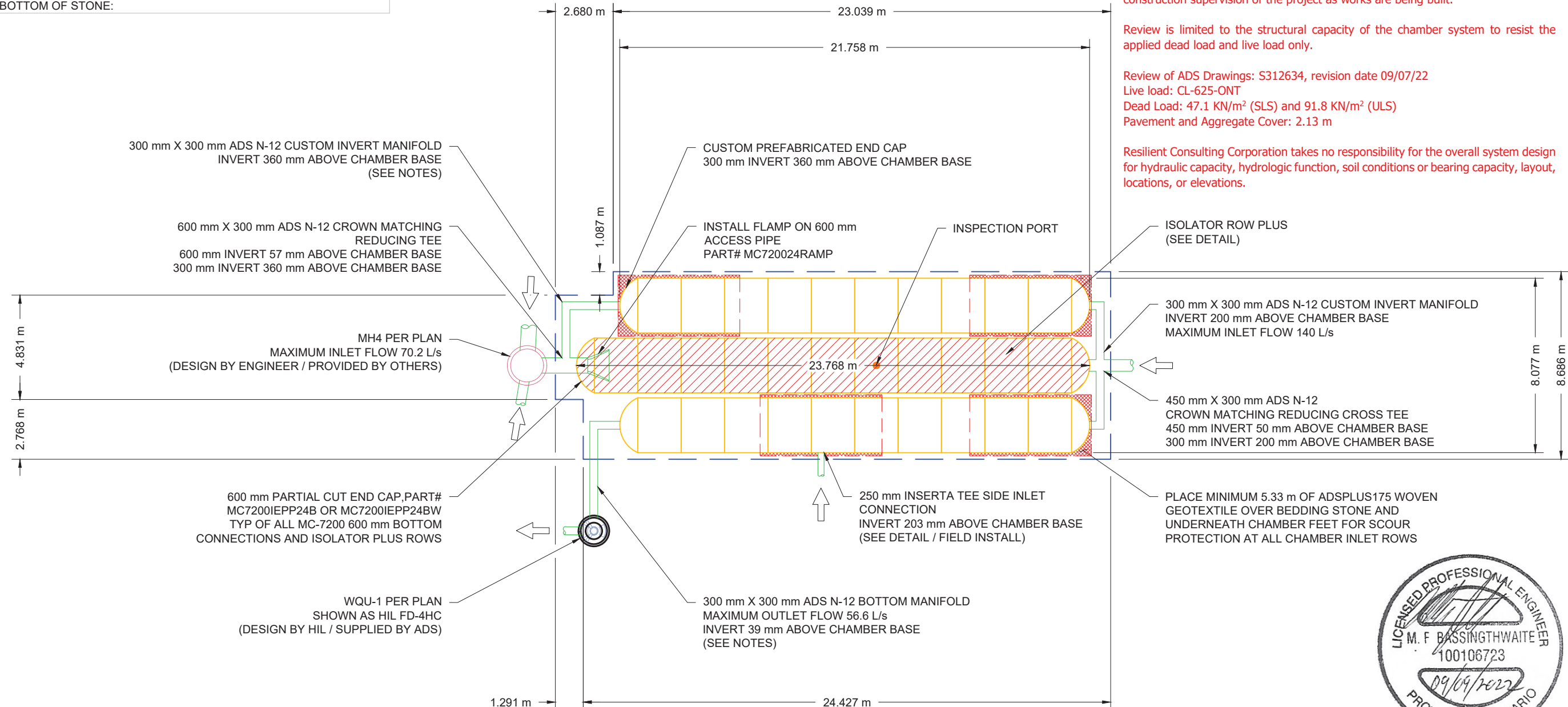

ORLEANS LONG TERM CARE HOME	
ORLEANS, ON.	
DATE: 08/23/22	DRAWN: JR
PROJECT #: S312634	CHECKED: AYT

REVISED PER NEW PLAN	DESCRIPTION
RCT	DRWN CHKD
97/22	DATE

**StormTech®**  
Chamber System  
888-892-2694 | WWW.STORMTECH.COM

4640 TRUEMAN BLVD  
HILLIARD, OH 43026

**SCALE = 1 : 200**



THIS DRAWING HAS BEEN PREPARED BASED ON INFORMATION PROVIDED TO ADS UNDER THE DIRECTION OF THE SITE DESIGN ENGINEER OR OTHER PROJECT REPRESENTATIVE. THE SITE DESIGN ENGINEER SHALL REVIEW THIS DRAWING PRIOR TO CONSTRUCTION. IT IS THE ULTIMATE RESPONSIBILITY OF THE SITE DESIGN ENGINEER TO ENSURE THAT THE PRODUCT(S) DEPICTED AND ALL ASSOCIATED DETAILS MEET ALL APPLICABLE LAWS, REGULATIONS, AND PROJECT REQUIREMENTS.



## ACCEPTABLE FILL MATERIALS: STORMTECH MC-7200 CHAMBER SYSTEMS

MATERIAL LOCATION	DESCRIPTION	AASHTO MATERIAL CLASSIFICATIONS	COMPACTION / DENSITY REQUIREMENT
D	<b>FINAL FILL:</b> FILL MATERIAL FOR LAYER 'D' STARTS FROM THE TOP OF THE 'C' LAYER TO THE BOTTOM OF FLEXIBLE PAVEMENT OR UNPAVED FINISHED GRADE ABOVE. NOTE THAT PAVEMENT SUBBASE MAY BE PART OF THE 'D' LAYER	N/A	PREPARE PER SITE DESIGN ENGINEER'S PLANS. PAVED INSTALLATIONS MAY HAVE STRINGENT MATERIAL AND PREPARATION REQUIREMENTS.
C	<b>INITIAL FILL:</b> FILL MATERIAL FOR LAYER 'C' STARTS FROM THE TOP OF THE EMBEDMENT STONE ('B' LAYER) TO 24" (600 mm) ABOVE THE TOP OF THE CHAMBER. NOTE THAT PAVEMENT SUBBASE MAY BE A PART OF THE 'C' LAYER.	AASHTO M145 <sup>1</sup> A-1, A-2-4, A-3  OR AASHTO M43 <sup>1</sup> 3, 357, 4, 467, 5, 56, 57, 6, 67, 68, 7, 78, 8, 89, 9, 10	BEGIN COMPACTIONS AFTER 24" (600 mm) OF MATERIAL OVER THE CHAMBERS IS REACHED. COMPACT ADDITIONAL LAYERS IN 12" (300 mm) MAX LIFTS TO A MIN. 95% PROCTOR DENSITY FOR WELL GRADED MATERIAL AND 95% RELATIVE DENSITY FOR PROCESSED AGGREGATE MATERIALS.
B	<b>EMBEDMENT STONE:</b> FILL SURROUNDING THE CHAMBERS FROM THE FOUNDATION STONE ('A' LAYER) TO THE 'C' LAYER ABOVE.	AASHTO M43 <sup>1</sup> 3, 4	NO COMPACTION REQUIRED.
A	<b>FOUNDATION STONE:</b> FILL BELOW CHAMBERS FROM THE SUBGRADE UP TO THE FOOT (BOTTOM) OF THE CHAMBER.	AASHTO M43 <sup>1</sup> 3, 4	PLATE COMPACT OR ROLL TO ACHIEVE A FLAT SURFACE. <sup>2,3</sup>

**PLEASE NOTE:**

- THE LISTED AASHTO DESIGNATIONS ARE FOR GRADATIONS ONLY. THE STONE MUST ALSO BE CLEAN, CRUSHED, ANGULAR. FOR EXAMPLE, A SPECIFICATION FOR #4 STONE WOULD STATE: "CLEAN, CRUSHED, ANGULAR NO. 4 (AASHTO M43) STONE".
- STORMTECH COMPACTION REQUIREMENTS ARE MET FOR 'A' LOCATION MATERIALS WHEN PLACED AND COMPACTED IN 9" (230 mm) (MAX) LIFTS USING TWO FULL COVERAGES WITH A VIBRATORY COMPACTOR.
- WHERE INFILTRATION SURFACES MAY BE COMPROMISED BY COMPACTION, FOR STANDARD DESIGN LOAD CONDITIONS, A FLAT SURFACE MAY BE ACHIEVED BY RAKING OR DRAGGING WITHOUT COMPACTION EQUIPMENT. FOR SPECIAL LOAD DESIGNS, CONTACT STORMTECH FOR COMPACTION REQUIREMENTS.
- ONCE LAYER 'C' IS PLACED, ANY SOIL/MATERIAL CAN BE PLACED IN LAYER 'D' UP TO THE FINISHED GRADE. MOST PAVEMENT SUBBASE SOILS CAN BE USED TO REPLACE THE MATERIAL REQUIREMENTS OF LAYER 'C' OR 'D' AT THE SITE DESIGN ENGINEER'S DISCRETION.

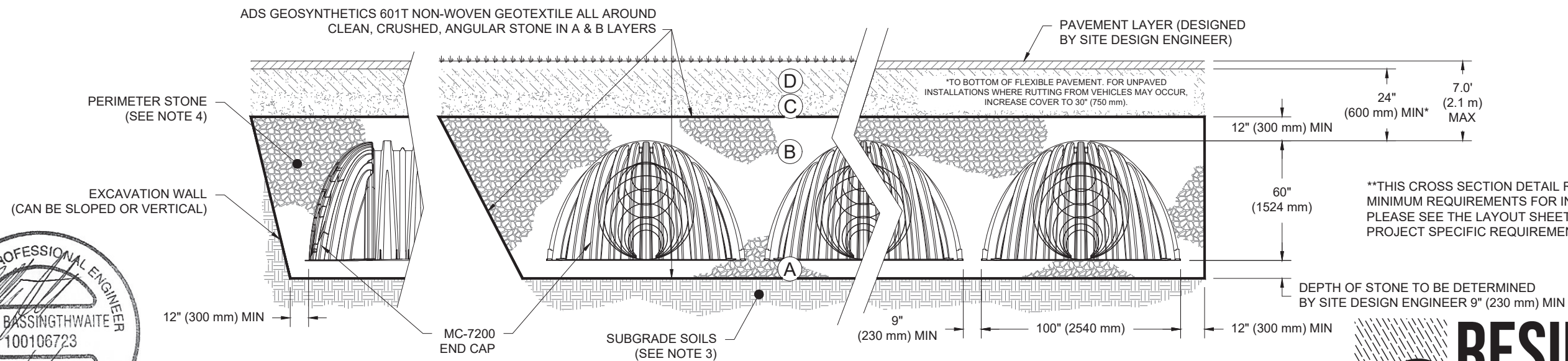

PO Box 643  
Whitby, ON L1N 5V3  
[info@resilientconsulting.ca](mailto:info@resilientconsulting.ca)

Resilient Consulting Corporation certifies the theoretical competence of the plans prepared by Advanced Drainage Systems, Inc. but cannot certify the integrity of the actual construction unless Resilient Consulting Corporation is retained to perform construction supervision of the project as works are being built.

Review is limited to the structural capacity of the chamber system to resist the applied dead load and live load only.

Review of ADS Drawings: S312634, revision date 09/07/22  
Live load: CL-625-ONT  
Dead Load: 47.1 kN/m<sup>2</sup> (SLS) and 91.8 kN/m<sup>2</sup> (ULS)  
Pavement and Aggregate Cover: 2.13 m

Resilient Consulting Corporation takes no responsibility for the overall system design for hydraulic capacity, hydrologic function, soil conditions or bearing capacity, layout, locations, or elevations.



**NOTES:**

- CHAMBERS SHALL MEET THE REQUIREMENTS OF ASTM F2418, "STANDARD SPECIFICATION FOR POLYPROPYLENE (PP) CORRUGATED WALL STORMWATER COLLECTION CHAMBERS" CHAMBER CLASSIFICATION 60x101
- MC-7200 CHAMBERS SHALL BE DESIGNED IN ACCORDANCE WITH ASTM F2787 "STANDARD PRACTICE FOR STRUCTURAL DESIGN OF THERMOPLASTIC CORRUGATED WALL STORMWATER COLLECTION CHAMBERS".
- THE SITE DESIGN ENGINEER IS RESPONSIBLE FOR ASSESSING THE BEARING RESISTANCE (ALLOWABLE BEARING CAPACITY) OF THE SUBGRADE SOILS AND THE DEPTH OF FOUNDATION STONE WITH CONSIDERATION FOR THE RANGE OF EXPECTED SOIL MOISTURE CONDITIONS.
- PERIMETER STONE MUST BE EXTENDED HORIZONTALLY TO THE EXCAVATION WALL FOR BOTH VERTICAL AND SLOPED EXCAVATION WALLS.
- REQUIREMENTS FOR HANDLING AND INSTALLATION:
  - TO MAINTAIN THE WIDTH OF CHAMBERS DURING SHIPPING AND HANDLING, CHAMBERS SHALL HAVE INTEGRAL, INTERLOCKING STACKING LUGS.
  - TO ENSURE A SECURE JOINT DURING INSTALLATION AND BACKFILL, THE HEIGHT OF THE CHAMBER JOINT SHALL NOT BE LESS THAN 3".
  - TO ENSURE THE INTEGRITY OF THE ARCH SHAPE DURING INSTALLATION, a) THE ARCH STIFFNESS CONSTANT AS DEFINED IN SECTION 6.2.8 OF ASTM F2418 SHALL BE GREATER THAN OR EQUAL TO 500 LBS/FT<sup>2</sup>%. AND b) TO RESIST CHAMBER DEFORMATION DURING INSTALLATION AT ELEVATED TEMPERATURES (ABOVE 73° F / 23° C), CHAMBERS SHALL BE PRODUCED FROM REFLECTIVE GOLD OR YELLOW COLORS.

ORLEANS LONG TERM CARE HOME

ORLEANS, ON.

DATE: 08/23/22

DRAWN: JR

PROJECT #: S312634

CHECKED: AYT

REVISION PER NEW PLAN

DESCRIPTION

DATE

97/22

RCT

DRWN

CHKD

StormTech®

Chamber System

888-892-2694 | WWW.STORMTECH.COM

4640 TRUJMAN BLVD  
HILLIARD, OH 43026

THIS DRAWING HAS BEEN PREPARED BASED ON INFORMATION PROVIDED TO ADS UNDER THE DIRECTION OF THE SITE DESIGN ENGINEER OR OTHER PROJECT REPRESENTATIVE. THE SITE DESIGN ENGINEER SHALL REVIEW THIS DRAWING PRIOR TO CONSTRUCTION. IT IS THE ULTIMATE RESPONSIBILITY OF THE SITE DESIGN ENGINEER TO ENSURE THAT THE PRODUCT(S) DEPICTED AND ALL ASSOCIATED DETAILS MEET ALL APPLICABLE LAWS, REGULATIONS, AND PROJECT REQUIREMENTS.

RESILIENT CONSULTING

3 SHEET OF 5

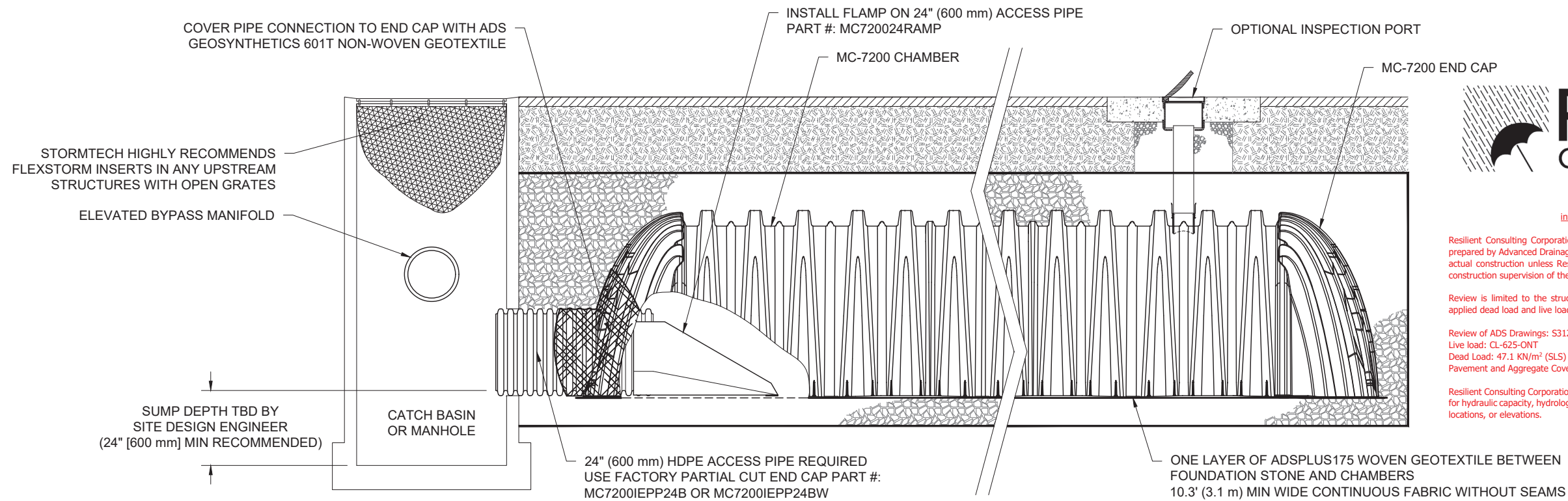

**MC-7200 ISOLATOR ROW PLUS DETAIL**  
NTS



PO Box 643  
Whitby, ON L1N 5V3  
info@resilientconsulting.ca

Resilient Consulting Corporation certifies the theoretical competence of the plans prepared by Advanced Drainage Systems, Inc. but cannot certify the integrity of the actual construction unless Resilient Consulting Corporation is retained to perform construction supervision of the project as works are being built.

Review is limited to the structural capacity of the chamber system to resist the applied dead load and live load only.

Review of ADS Drawings: S312634, revision date 09/07/22  
Live load: CL-625-ONT  
Dead Load: 47.1 kN/m<sup>2</sup> (SLS) and 91.8 kN/m<sup>2</sup> (ULS)  
Pavement and Aggregate Cover: 2.13 m

Resilient Consulting Corporation takes no responsibility for the overall system design for hydraulic capacity, hydrologic function, soil conditions or bearing capacity, layout, locations, or elevations.

**INSPECTION & MAINTENANCE**

- STEP 1) INSPECT ISOLATOR ROW PLUS FOR SEDIMENT
- A. INSPECTION PORTS (IF PRESENT)
    - A.1. REMOVE/OPEN LID ON NYLOPLAST INLINE DRAIN
    - A.2. REMOVE AND CLEAN FLEXSTORM FILTER IF INSTALLED
    - A.3. USING A FLASHLIGHT AND STADIA ROD, MEASURE DEPTH OF SEDIMENT AND RECORD ON MAINTENANCE LOG
    - A.4. LOWER A CAMERA INTO ISOLATOR ROW PLUS FOR VISUAL INSPECTION OF SEDIMENT LEVELS (OPTIONAL)
    - A.5. IF SEDIMENT IS AT, OR ABOVE, 3" (80 mm) PROCEED TO STEP 2. IF NOT, PROCEED TO STEP 3.
  - B. ALL ISOLATOR PLUS ROWS
    - B.1. REMOVE COVER FROM STRUCTURE AT UPSTREAM END OF ISOLATOR ROW PLUS
    - B.2. USING A FLASHLIGHT, INSPECT DOWN THE ISOLATOR ROW PLUS THROUGH OUTLET PIPE
      - i) MIRRORS ON POLES OR CAMERAS MAY BE USED TO AVOID A CONFINED SPACE ENTRY
      - ii) FOLLOW OSHA REGULATIONS FOR CONFINED SPACE ENTRY IF ENTERING MANHOLE
    - B.3. IF SEDIMENT IS AT, OR ABOVE, 3" (80 mm) PROCEED TO STEP 2. IF NOT, PROCEED TO STEP 3.
- STEP 2) CLEAN OUT ISOLATOR ROW PLUS USING THE JETVAC PROCESS
- A. A FIXED CULVERT CLEANING NOZZLE WITH REAR FACING SPREAD OF 45" (1.1 m) OR MORE IS PREFERRED
  - B. APPLY MULTIPLE PASSES OF JETVAC UNTIL BACKFLUSH WATER IS CLEAN
  - C. VACUUM STRUCTURE SUMP AS REQUIRED
- STEP 3) REPLACE ALL COVERS, GRATES, FILTERS, AND LIDS; RECORD OBSERVATIONS AND ACTIONS.
- STEP 4) INSPECT AND CLEAN BASINS AND MANHOLES UPSTREAM OF THE STORMTECH SYSTEM.

**NOTES**

1. INSPECT EVERY 6 MONTHS DURING THE FIRST YEAR OF OPERATION. ADJUST THE INSPECTION INTERVAL BASED ON PREVIOUS OBSERVATIONS OF SEDIMENT ACCUMULATION AND HIGH WATER ELEVATIONS.
2. CONDUCT JETTING AND VACTORING ANNUALLY OR WHEN INSPECTION SHOWS THAT MAINTENANCE IS NECESSARY.

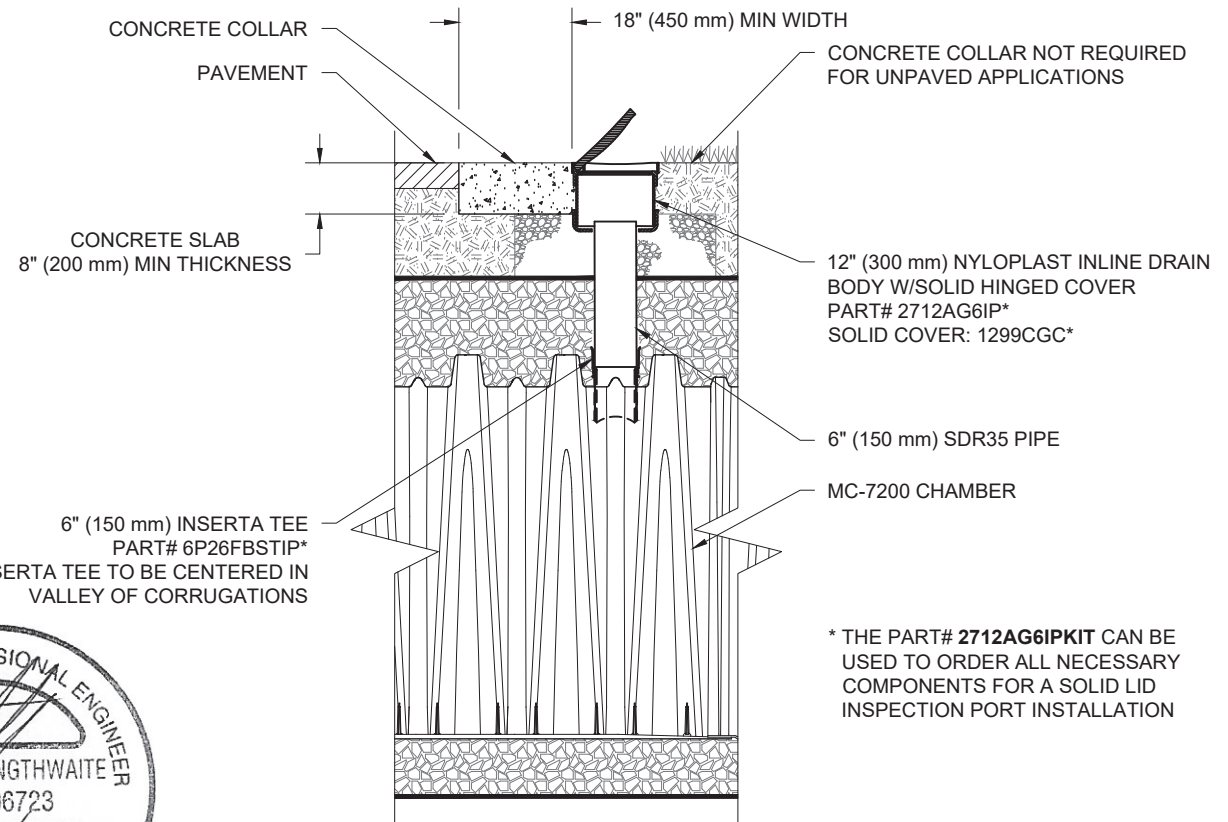

**MC-7200 6" (150 mm) INSPECTION PORT DETAIL**  
NTS

\* THE PART# 2712AG6IPKIT CAN BE USED TO ORDER ALL NECESSARY COMPONENTS FOR A SOLID LID INSPECTION PORT INSTALLATION

ORLEANS LONG TERM CARE HOME	
ORLEANS, ON.	
DATE: 08/23/22	DRAWN: JR
PROJECT #: S312634	CHECKED: AYT

DATE	DESCRIPTION
97/22	DRWN
	CHKD
	REVISD PER NEW PLAN

**StormTech®**  
Chamber System  
888-892-2694 | WWW.STORMTECH.COM

**ADS**  
4640 TRUEMAN BLVD  
HILLIARD, OH 43026

THIS DRAWING HAS BEEN PREPARED BASED ON INFORMATION PROVIDED TO ADS UNDER THE DIRECTION OF THE SITE DESIGN ENGINEER OR OTHER PROJECT REPRESENTATIVE. THE SITE DESIGN ENGINEER SHALL REVIEW THIS DRAWING PRIOR TO CONSTRUCTION. IT IS THE ULTIMATE RESPONSIBILITY OF THE SITE DESIGN ENGINEER TO ENSURE THAT THE PRODUCT(S) DEPICTED AND ALL ASSOCIATED DETAILS MEET ALL APPLICABLE LAWS, REGULATIONS, AND PROJECT REQUIREMENTS.



**INSERTA TEE DETAIL**

NTS

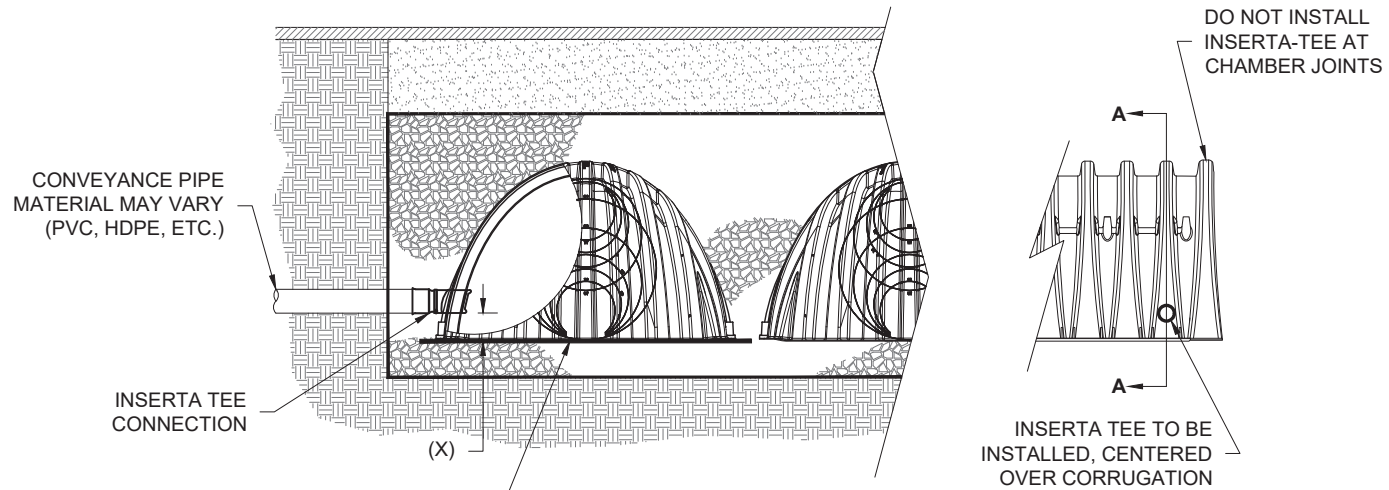

PLACE ADSPLUS WOVEN GEOTEXTILE (CENTERED ON INSERTA-TEE INLET) OVER BEDDING STONE FOR SCOUR PROTECTION AT SIDE INLET CONNECTIONS. GEOTEXTILE MUST EXTEND 6" (150 mm) PAST CHAMBER FOOT

**SECTION A-A**

**SIDE VIEW**

CHAMBER	MAX DIAMETER OF INSERTA TEE	HEIGHT FROM BASE OF CHAMBER (X)
SC-310	6" (150 mm)	4" (100 mm)
SC-740	10" (250 mm)	4" (100 mm)
DC-780	10" (250 mm)	4" (100 mm)
MC-3500	12" (300 mm)	6" (150 mm)
MC-4500	12" (300 mm)	8" (200 mm)
MC-7200	12" (300 mm)	8" (200 mm)

INSERTA TEE FITTINGS AVAILABLE FOR SDR 26, SDR 35, SCH 40 IPS GASKETED & SOLVENT WELD, N-12, HP STORM, C-900 OR DUCTILE IRON

**NOTES:**

- PART NUMBERS WILL VARY BASED ON INLET PIPE MATERIALS. CONTACT STORMTECH FOR MORE INFORMATION.
- CONTACT ADS ENGINEERING SERVICES IF INSERTA TEE INLET MUST BE RAISED AS NOT ALL INVERTS ARE POSSIBLE.

**MC-7200 TECHNICAL SPECIFICATION**

NTS

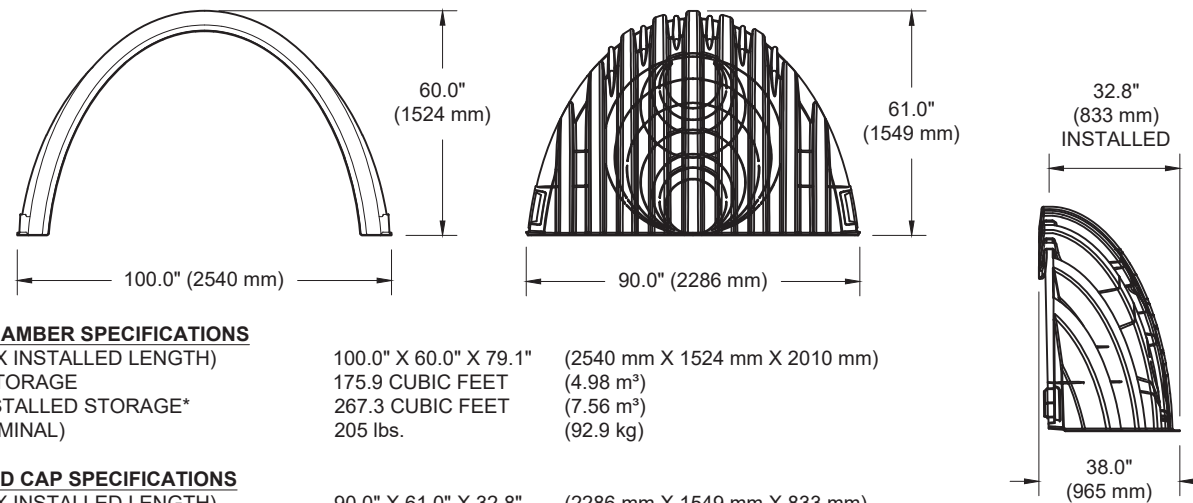
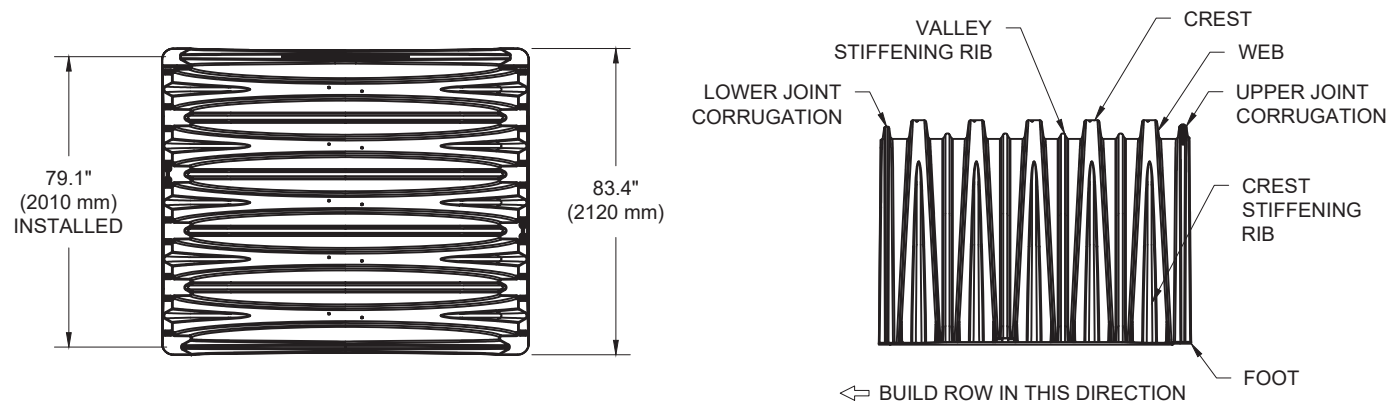

**NOMINAL CHAMBER SPECIFICATIONS**

SIZE (W X H X INSTALLED LENGTH)	100.0" X 60.0" X 79.1"	(2540 mm X 1524 mm X 2010 mm)
CHAMBER STORAGE	175.9 CUBIC FEET	(4.98 m³)
MINIMUM INSTALLED STORAGE*	267.3 CUBIC FEET	(7.56 m³)
WEIGHT (NOMINAL)	205 lbs.	(92.9 kg)

**NOMINAL END CAP SPECIFICATIONS**

SIZE (W X H X INSTALLED LENGTH)	90.0" X 61.0" X 32.8"	(2286 mm X 1549 mm X 833 mm)
END CAP STORAGE	39.5 CUBIC FEET	(1.12 m³)
MINIMUM INSTALLED STORAGE*	115.3 CUBIC FEET	(3.26 m³)
WEIGHT (NOMINAL)	90 lbs.	(40.8 kg)

\*ASSUMES 12" (305 mm) STONE ABOVE, 9" (229 mm) STONE FOUNDATION AND BETWEEN CHAMBERS, 12" (305 mm) STONE PERIMETER IN FRONT OF END CAPS AND 40% STONE POROSITY.

PARTIAL CUT HOLES AT BOTTOM OF END CAP FOR PART NUMBERS ENDING WITH "B"  
PARTIAL CUT HOLES AT TOP OF END CAP FOR PART NUMBERS ENDING WITH "T"  
END CAPS WITH A PREFABRICATED WELDED STUB END WITH "W"

PART #	STUB	B	C
MC7200IEPP06T	6" (150 mm)	42.54" (1081 mm)	---
MC7200IEPP06B		---	0.86" (22 mm)
MC7200IEPP08T	8" (200 mm)	40.50" (1029 mm)	---
MC7200IEPP08B		---	1.01" (26 mm)
MC7200IEPP10T	10" (250 mm)	38.37" (975 mm)	---
MC7200IEPP10B		---	1.33" (34 mm)
MC7200IEPP12T	12" (300 mm)	35.69" (907 mm)	---
MC7200IEPP12B		---	1.55" (39 mm)
MC7200IEPP15T	15" (375 mm)	32.72" (831 mm)	---
MC7200IEPP15B		---	1.70" (43 mm)
MC7200IEPP18T	18" (450 mm)	29.36" (746 mm)	---
MC7200IEPP18TW		---	1.97" (50 mm)
MC7200IEPP18B	24" (600 mm)	---	1.97" (50 mm)
MC7200IEPP18BW		23.05" (585 mm)	---
MC7200IEPP24T	24" (600 mm)	---	2.26" (57 mm)
MC7200IEPP24TW		---	2.26" (57 mm)
MC7200IEPP24B	30" (750 mm)	---	2.95" (75 mm)
MC7200IEPP24BW		---	2.95" (75 mm)
MC7200IEPP30BW	36" (900 mm)	---	3.25" (83 mm)
MC7200IEPP36BW		---	3.25" (83 mm)
MC7200IEPP42BW	42" (1050 mm)	---	3.55" (90 mm)

NOTE: ALL DIMENSIONS ARE NOMINAL

**MC-SERIES END CAP INSERTION DETAIL**

NTS

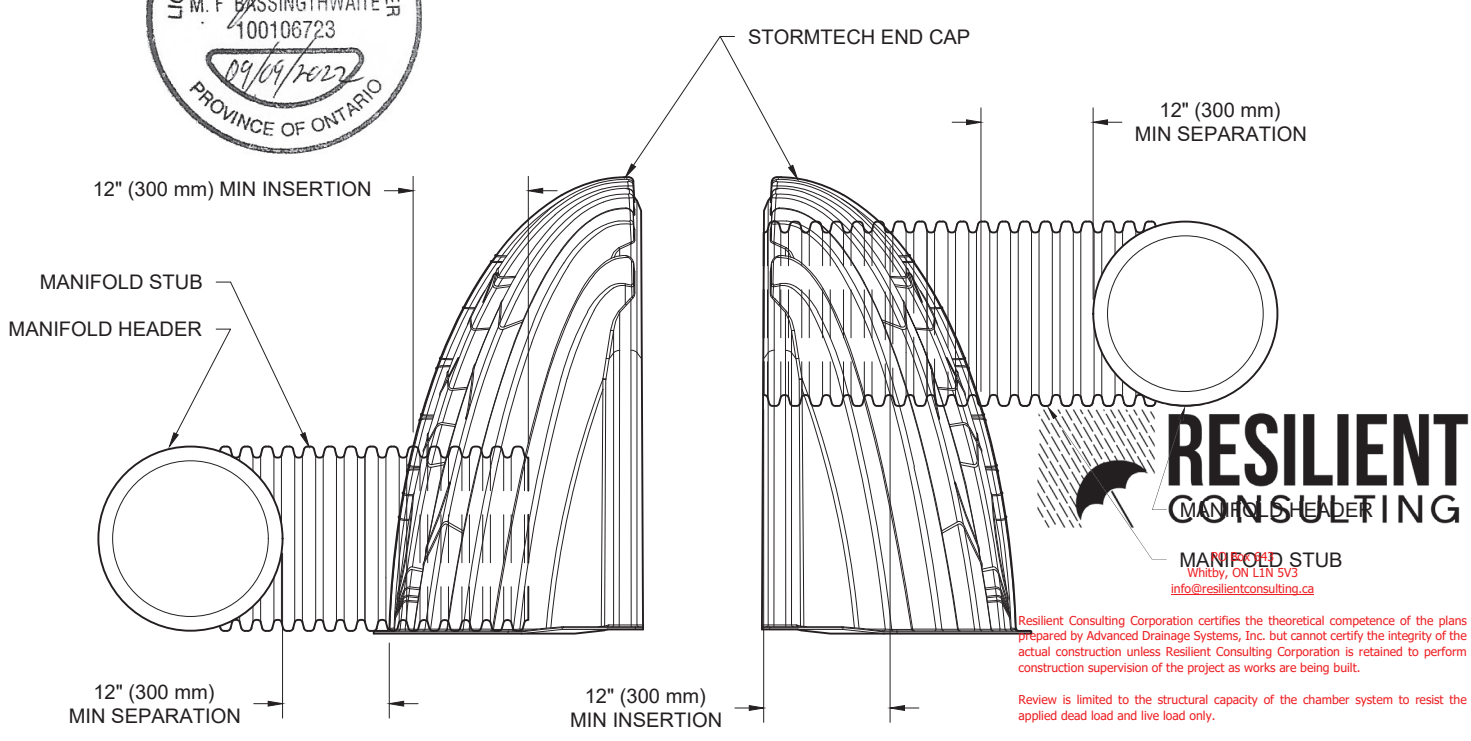

**RESILIENT CONSULTING**

Resilient Consulting Corporation certifies the theoretical competence of the plans prepared by Advanced Drainage Systems, Inc. but cannot certify the integrity of the actual construction unless Resilient Consulting Corporation is retained to perform construction supervision of the project as works are being built.

Review is limited to the structural capacity of the chamber system to resist the applied dead load and live load only.

Review of ADS Drawings: S312634, revision date 09/07/22  
Live load: CL-625-ONT  
Dead Load: 47.1 KN/m² (SLS) and 91.8 KN/m² (ULS)  
Pavement and Aggregate Cover: 2.13 m

Resilient Consulting Corporation takes no responsibility for the overall system design for hydraulic capacity, hydrologic function, soil conditions or bearing capacity, layout, locations, or elevations.

REVISED PER NEW PLAN	DESCRIPTION
RCT	DATE
RCT	DATE
97/22	DATE

**Inserta Tee®**  
Lateral Connection

4640 TRUEMAN BLVD  
HILLIARD, OH 43026  
**ADS**

THIS DRAWING HAS BEEN PREPARED BASED ON INFORMATION PROVIDED TO ADS UNDER THE DIRECTION OF THE SITE DESIGN ENGINEER OR OTHER PROJECT REPRESENTATIVE. THE SITE DESIGN ENGINEER SHALL REVIEW THIS DRAWING PRIOR TO CONSTRUCTION. IT IS THE ULTIMATE RESPONSIBILITY OF THE SITE DESIGN ENGINEER TO ENSURE THAT THE PRODUCT(S) DEPICTED AND ALL ASSOCIATED DETAILS MEET ALL APPLICABLE LAWS, REGULATIONS, AND PROJECT REQUIREMENTS.