

FORUM/SLP 15 OBLATS LIMITED PARTNERSHIP

**4-STOREY RESIDENTIAL DEVELOPMENT, 15 OBLATS  
AVENUE, OTTAWA, ON  
SITE SERVICING REPORT**

AUGUST 3, 2022







# 4-STOREY RESIDENTIAL DEVELOPMENT, 15 OBLATS AVENUE, OTTAWA, ON SITE SERVICING REPORT

FORUM/SLP 15 OBLATS LIMITED PARTNERSHIP

FOR SITE PLAN APPROVAL

PROJECT NO.: 221-02976-00

DATE: AUGUST 2022

WSP  
2611 QUEENSVIEW DRIVE, SUITE 300  
OTTAWA, ON, CANADA, K2B 8K2

WSP.COM





August 3, 2022

Forum/SLP 15 Oblats Limited Partnership  
226 Argyle Ave.  
Ottawa, ON K2P 1B9

**Attention: Andrew Levitan**

Dear Sir:

**Subject:** 15 Oblats Avenue, Ottawa, ON – Site Servicing and Stormwater Management Report

Please find attached our site servicing report issued for site plan approval application.

Yours sincerely,

A handwritten signature in blue ink, appearing to read 'Smc', with a long, sweeping flourish extending upwards and to the right.

Stephen McCaughey, P.Eng.  
Project Engineer

WSP ref.: 221-02976-00



---

# QUALITY MANAGEMENT

ISSUE/REVISION	FIRST ISSUE	REVISION 1	REVISION 2	REVISION 3
Remarks	Issued for Site Plan Approval Application			
Date	2022-08-03			
Prepared by	Erin Blanchette, P.Eng.			
Signature				
Checked by	Stephen McCaughey, P.Eng.			
Signature				
Authorised by				
Signature				
Project number	221-02976-00			
Report number				
File reference				





---

# SIGNATURES

PREPARED BY



---

Erin Blanchette, P.Eng.  
Project Engineer

REVIEWED BY



---

Stephen McCaughey, P.Eng.  
Project Engineer

This report was prepared by WSP Canada Inc. for the account of Forum/SLP 15 Oblats Limited Partnership, in accordance with the professional services agreement. The disclosure of any information contained in this report is the sole responsibility of the intended recipient. The material in it reflects WSP Canada Inc.'s best judgement in light of the information available to it at the time of preparation. Any use which a third party makes of this report, or any reliance on or decisions to be made based on it, are the responsibility of such third parties. WSP Canada Inc. accepts no responsibility for damages, if any, suffered by any third party as a result of decisions made or actions based on this report. This limitations statement is considered part of this report.

The original of the technology-based document sent herewith has been authenticated and will be retained by WSP for a minimum of ten years. Since the file transmitted is now out of WSP's control and its integrity can no longer be ensured, no guarantee may be given with regards to any modifications made to this document.





# TABLE OF CONTENTS

<b>1</b>	<b>INTRODUCTION .....</b>	<b>1</b>
<b>1.1</b>	<b>Executive Summary .....</b>	<b>1</b>
<b>1.2</b>	<b>Location Map and Plan.....</b>	<b>2</b>
<b>1.3</b>	<b>Higher Level Studies .....</b>	<b>2</b>
<b>1.4</b>	<b>Available Existing and Proposed Infrastructure.....</b>	<b>2</b>
<b>1.5</b>	<b>Geotechnical Study .....</b>	<b>3</b>
<b>2</b>	<b>WATER DISTRIBUTION .....</b>	<b>4</b>
<b>2.1</b>	<b>System Constraints and Boundary Conditions.....</b>	<b>4</b>
<b>2.2</b>	<b>Confirmation of Adequate Domestic Supply and Pressure.....</b>	<b>4</b>
<b>2.3</b>	<b>Confirmation of Adequate Fire Flow Protection.....</b>	<b>5</b>
<b>3</b>	<b>WASTEWATER DISPOSAL .....</b>	<b>7</b>
<b>3.1</b>	<b>Design Criteria .....</b>	<b>7</b>
<b>3.2</b>	<b>Calculations for Sanitary Demand .....</b>	<b>7</b>
<b>3.3</b>	<b>Verification of Available Capacity in Existing Sewer.....</b>	<b>7</b>
<b>4</b>	<b>SITE STORM SERVICING.....</b>	<b>8</b>
<b>4.1</b>	<b>Existing Condition .....</b>	<b>8</b>
<b>4.2</b>	<b>Drainage Drawings .....</b>	<b>8</b>
<b>4.3</b>	<b>Water Quantity Control Objective .....</b>	<b>8</b>
<b>4.4</b>	<b>Water Quality Control Objective .....</b>	<b>8</b>
<b>4.5</b>	<b>Proposed Minor System .....</b>	<b>8</b>
<b>4.6</b>	<b>Proposed Major System.....</b>	<b>8</b>
<b>5</b>	<b>SEDIMENT AND EROSION CONTROL .....</b>	<b>9</b>
<b>5.1</b>	<b>General.....</b>	<b>9</b>



<b>6</b>	<b>APPROVAL AND PERMIT REQUIREMENTS .....</b>	<b>11</b>
<b>6.1</b>	<b>General .....</b>	<b>11</b>
<b>7</b>	<b>CONCLUSION CHECKLIST .....</b>	<b>12</b>
<b>7.1</b>	<b>Conclusions and Recommendations.....</b>	<b>12</b>
<b>7.2</b>	<b>Comments Received from Review Agencies .....</b>	<b>12</b>

---

## **TABLES**

TABLE 2-1:	BOUNDARY CONDITIONS (CITY OF OTTAWA).....	4
TABLE 2-2:	SUMMARY OF WATER PRESSURE FROM EPANET RESULTS.....	5

---

## **FIGURES**

FIGURE 1-1	SITE LOCATION.....	2
FIGURE 2	- EXISTING FIRE HYDRANT LOCATIONS.....	6

---

## **APPENDICES**

<b>A</b>	WATER DEMAND
<b>B</b>	SANITARY DEMAND
<b>C</b>	SITE DRAWINGS
<b>D</b>	STORM SEWER DESIGN SHEET
<b>E</b>	CORRESPONDENCES



# 1 INTRODUCTION

---

## 1.1 EXECUTIVE SUMMARY

WSP was retained by Forum/SLP 15 Oblats Limited Partnership to provide servicing, grading and stormwater management design services in support of the site plan approval for the proposed residential development located at 15 Oblats Avenue, in the City of Ottawa. The proposed work consists of retrofit work to the current 4-storey residential building, and an expansion to the north-west which will also consist of residential units over 4 storeys plus a basement level. The existing building will be retrofitted to house 175 units while the proposed addition will house 109 units. This report will provide sufficient detail to demonstrate that the proposed development can be supported by the existing municipal infrastructure services (watermain, sanitary sewer, and storm sewer) and that the servicing design conforms to the applicable standards and guidelines. The report will also include measures to be taken during the construction to minimize erosion and sedimentation. A separate report (15 Oblats Avenue Stormwater Management Report) is provided detailing the stormwater management approach and addressing the quantity control and quality measures in accordance with the applicable guidelines.

Currently, the site is developed and houses a residential building for a former convent, and a small parking lot. The total property area is 0.677 ha in size. The site sits north-east of the Main St. and Oblats Ave. intersection and is bounded by residential buildings and single-family homes.

The subject site is a rectangular shaped property bounded by Springhurst Ave. and Oblats Ave. The site generally slopes south to north and for the most part drains onto Springhurst Ave. Flow also exits the site onto Oblats Ave. as well as into two catchbasins located on the western property line. The existing building is currently serviced for water, sanitary, and storm, however these services will be replaced with new services.

The City of Ottawa requires that the design of a drainage and stormwater management system in this development must be prepared in accordance with the following documents:

- Sewer Design Guidelines, City of Ottawa, October 2012;
- Stormwater Management Planning and Design Manual, Ministry of the Environment, March 2003; and
- Stormwater Management Facility Design Guidelines, City of Ottawa, April 2012

This report was prepared utilizing servicing design criteria obtained from the City of Ottawa and outlines the design for water, sanitary wastewater and stormwater facilities.

The format of this report matches that of the servicing study checklist found in Section 4 of the City of Ottawa's Servicing Study Guidelines for Development Applications, November 2009.

The following municipal services are available adjacent to the development as recorded from online resource GeoOttawa:

Springhurst Ave.

- ▶ 203 mm watermain, 450 mm sanitary sewer, and a 1350 mm storm sewer.

Oblats Ave.

- ▶ 250 mm watermain, 375 mm storm sewer, and a 250 mm sanitary sewer.

It is proposed that an on-site stormwater management system will be provided to collect and attenuate flow rates and control water quality leaving the site. Refer to stormwater management report for details.

---

## 1.2 LOCATION MAP AND PLAN

The site at 15 Oblats Ave. is shown in Figure 1-1 below as presented in the GeoOttawa website.



**Figure 1-1 Site Location**

The proposed development will consist of a 4-storey residential tower connected to the northwest side of the existing building. The existing building will be retrofitted to accommodate 175 units, while the proposed addition will house 109 units. The total approximate gross floor area of the retrofitted and new areas combined is 9,890m<sup>2</sup>.

---

## 1.3 HIGHER LEVEL STUDIES

The review for servicing has been undertaken in conformance with, and utilizing information from, the following documents:

- Ottawa Sewer Design Guidelines, Second Edition, Document SDG002, October 2012, City of Ottawa including all amendments issued as part of Technical Bulletins.
  - Ottawa Design Guidelines – Water Distribution, July 2010 (WDG001), including all amendments issued as part of Technical Bulletins.
  - Stormwater Management Planning and Design Manual, Ontario Ministry of the Environment and Climate Change, March 2003 (SMPDM).
  - Design Guidelines for Drinking-Water Systems, Ontario Ministry of the Environment and Climate Change, 2008 (GDWS).
  - Fire Underwriters Survey, Water Supply for Public Fire Protection (FUS), 2020.
- 

## 1.4 AVAILABLE EXISTING AND PROPOSED INFRASTRUCTURE

As described above, all municipal mains (watermains, storm sewers, and sanitary sewers) are available and located along both Springhurst Ave. and Oblats Ave. Two valved water services will be provided from Springhurst Ave. as well as a storm



and sanitary service with accompanying sanitary maintenance hole. Quantity and quality control is required to restrict the stormwater discharge leaving the site, thus the on-site storm runoff will be captured, detention storage provided, flow release restricted, treated for quality control requirements, and finally directed towards the existing storm sewer on Springhurst Ave. A fire hydrant is proposed on site adjacent to Springhurst Ave. to meet proximity requirements to the fire department connection as existing hydrants are more than 45m away.

---

## **1.5 GEOTECHNICAL STUDY**

Paterson Group provided a geotechnical investigation report of the subject property dated May 27, 2020. Based on the report, groundwater was measured between 2.67m to 3.83m below grade. The recommendations of the report have been considered for this design development.

## 2 WATER DISTRIBUTION

### 2.1 SYSTEM CONSTRAINTS AND BOUNDARY CONDITIONS

Boundary conditions have been provided by the City of Ottawa at the existing connection along the Springhurst Ave. 203mm watermain (Zone 1W). The City has additionally requested that hydrant flow test be conducted to validate the flow rates available.

**Table 2-1: Boundary Conditions (City of Ottawa)**

Scenario	Preston St. Connection
Average Day (MAX HGL)	115.0m
Peak Hour (MIN HGL)	105.6m
Max Day + Fire Flow	86.6m

### 2.2 CONFIRMATION OF ADEQUATE DOMESTIC SUPPLY AND PRESSURE

Water demands are based on Table 4.2 of the Ottawa Design Guidelines – Water Distribution for these residential demands based on the number of apartment units. A water demand calculation sheet is included in Appendix A, and the total water demands are summarized as follows:

	15 Oblats – Existing and Retrofitted
Average Day	0.93 L/s
Maximum Day	2.77 L/s
Peak Hour	12.43 L/s
Fire Flow	350.00 L/s

	15 Oblats - Proposed
Average Day	0.54 L/s
Maximum Day	1.62 L/s
Peak Hour	7.29 L/s
Fire Flow	100.00 L/s

	15 Oblats - TOTAL
Average Day	1.47 L/s
Maximum Day	4.39 L/s
Peak Hour	19.73 L/s
*Max Day + Fire Flow	354.39 L/s

\*note that the existing retrofitted building and the proposed addition will be separated by fire walls, thus the fire flows from the two buildings have been considered independently of each other.

Since the average day demand is more than 50,000 L/d (0.58 L/s), twin services will be required. The site servicing drawing is shown in Appendix C.

The pressure criteria identified in the guidelines are as follows:

Minimum Pressure	Minimum system pressure under peak hour demand conditions shall not be less than 276 kPa (40 psi)
Fire Flow	During the period of maximum day demand, the system pressure shall not be less than 140 kPa (20 psi) during a fire flow event.
Maximum Pressure	Maximum pressure at any point the distribution system shall not exceed 689 kPa (100 psi). In accordance with the Ontario Building/Plumbing Code, the maximum pressure should not exceed 552 kPa (80 psi). Pressure reduction controls may be required for buildings where it is not possible/feasible to maintain the system pressure below 552 kPa.

The site has been analyzed as summarized below and in Table 2-2 to ensure all the City of Ottawa minimum criteria for water pressures are met for the two conditions (maximum day + fire flow and peak hour). The analysis was carried out using EPANET, hydraulic and water quality analysis based on the boundary conditions provided by the City of Ottawa. The detailed EPANET output results are also included in the Appendix A.

With respect to an average day demand of 1.47 L/s, the model indicated that the pressure in the pipe was acceptable and within the City of Ottawa’s maximum pressure requirements.

With respect to a peak hour demand of 19.73 L/s, the model indicated that the pressure drop in the pipe was acceptable and within the City of Ottawa’s minimum pressure requirements.

With respect to a max day + fire flow of 354.39 L/s, the model indicated that the pressure drop in the pipe was acceptable and within the City of Ottawa’s minimum pressure requirements. Section 2.3 following details the fire flow estimation.

Refer to Appendix A for the detailed water distribution analysis output.

Additionally, flow tests were completed at four hydrants within proximity to the site. Results are included in Appendix A and indicate that there is sufficient pressure in the system to service the proposed development.

**Table 2-2: Summary of Water Pressure from EPANET results**

Scenario	Pressure at Building Connection	
	(psi)	(kPa)
Max Day + Fire Flow	21.1	145.5
Peak Hour (MIN HGL)	62.4	430.2
Average Day (Max HGL)	75.6	521.2

## 2.3 CONFIRMATION OF ADEQUATE FIRE FLOW PROTECTION

The fire flow rate has been calculated using the Fire Underwriters Survey (FUS, 2020) method. The method considers the type of building construction, the building occupancy, the use of sprinklers and the exposures to adjacent structures. The proposed building is classified as non-combustive construction where a reduced gross floor area is used such that only the single largest floor plus 25% of each of the two immediately adjoining floors are considered. The existing building is classified as ordinary construction where the entire gross floor area is considered, leading to the calculated fire flow demand of 21,000 L/min (350 L/s). A copy of the FUS calculations are included in Appendix A.

The maximum fire demand of 21,000 L/min can be delivered through the proposed twin 150mm services. There are several fire hydrants in proximity to the building as shown in the sketch below, and an additional hydrant is proposed to be within 45m of the fire hydrant connection. The fire department connection is located at the mechanical room adjacent to Springhurst Ave.

The boundary condition for Maximum Day and Fire Flow results in a pressure of 145.5kPa at the building. In the guidelines, a minimum residual pressure of 140 kPa must be maintained in the distribution system for a fire flow and maximum day event; therefore, the fire flow requirement is met.

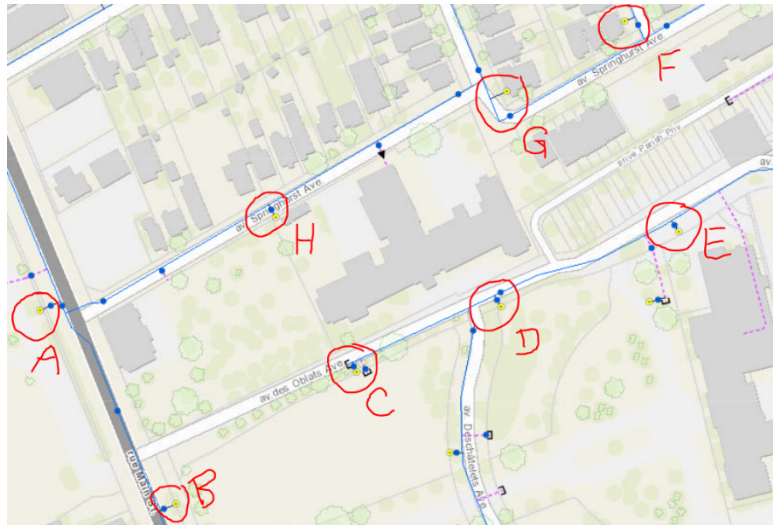

**Figure 2 - Existing Fire Hydrant Locations**

## 3 WASTEWATER DISPOSAL

---

### 3.1 DESIGN CRITERIA

In accordance with the City of Ottawa's Sewer Design Guidelines, the following design criteria have been utilized in order to estimate wastewater flows generated by the subject site and verify existing capacity;

- Average sanitary flow for residential use 280 L/c/d
  - Infiltration & Foundation Allowance (Total) 0.33 L/ha/s
- 

### 3.2 CALCULATIONS FOR SANITARY DEMAND

The criteria to determine anticipated peak flow based on site used as described in Ottawa Sewer Design Guidelines Appendix 4-A are as follows, refer to Appendix B for detailed calculation.

The demands below are a combined total of the existing retrofitted building and the proposed addition.

	<b>Total</b>
Average Day	1.47 L/s
Peak	4.99 L/s
Extraneous Day	0.22 L/s
<b>Total</b>	<b>5.21 L/s</b>

---

### 3.3 VERIFICATION OF AVAILABLE CAPACITY IN EXISTING SEWER

The sanitary demand will be serviced by a 150mm sewer with a minimum slope of 1% to the 450mm sewer on Springhurst Ave. A Sanitary Sewer Design Sheet is provided in Appendix B confirming capacity and minimum scouring velocity is achieved. The City has confirmed capacity in the existing sewer and correspondence is included in Appendix E.

## 4 SITE STORM SERVICING

---

### 4.1 EXISTING CONDITION

The site sits north-east of the Main St. and Oblats Ave. intersection and is bounded by residential buildings and single-family homes. The site is developed and houses a multi-unit residential building, and a small parking lot. The existing building is equipped with a storm service, however it will be replaced as part of the development. Most runoff from the subject site is ultimately directed to the 1350m diameter storm sewer, which runs west to east along Springhurst Ave.

---

### 4.2 DRAINAGE DRAWINGS

Site drawings are included in Appendix C including servicing, grading, drainage area, and erosion and sediment control.

---

### 4.3 WATER QUANTITY CONTROL OBJECTIVE

No roof storage is proposed for this site. Refer to the Stormwater Management Report for the water quantity objective for the site.

---

### 4.4 WATER QUALITY CONTROL OBJECTIVE

No water quality control is required for this site. Refer to the Stormwater Management Report for further details.

---

### 4.5 PROPOSED MINOR SYSTEM

The development will be serviced by a 250 mm storm service connection to the existing 1350 mm sewer on Springhurst Ave. As described in the Stormwater Management Report, runoff from the new building's roof will be directed to an underground cistern located within the parking lot footprint and will ultimately outlet to the storm sewer on Springhurst Ave. A flow restrictor will reduce post-development flows to the allowable rate. Flow from the parking area and courtyard will drain to on-site catchbasins which will be directed to the underground cistern. Flow generated from the area west of the development will drain into existing catchbasins which discharge per existing conditions. Finally, the area south of the development will remain uncontrolled. All other flow from the developed site will be left uncontrolled as is the existing condition and will be directed to either adjacent street. Refer to the Stormwater Management Report for more details on the uncontrolled areas. The sewer design sheet for the site storm system is provided in Appendix D.

---

### 4.6 PROPOSED MAJOR SYSTEM

For the overall ground-level drainage areas, the major overland flow routes lead out to the adjacent streets, with the overflow elevations at minimum 300mm below the building entrances. Additionally, the spillover points are less than 300mm from the surface inlet elevation so there will be no ponding greater than 300mm even in cases of blockage. The storm sewers are sized such that no ponding will occur during the 2-year. Due to the small drainage areas at-grade no ponding is expected during the 100-year nor 100-year + 20% stress test. The storm sewer design sheets are provided in Appendix D.

## 5 SEDIMENT AND EROSION CONTROL

---

### 5.1 GENERAL

Prior to topsoil stripping, earthworks or underground construction, erosion and sediment controls will be implemented and will be maintained throughout construction. Silt fences will be installed around the perimeter of the site and will be cleaned and maintained throughout construction. Silt fences will remain in place until the working areas have been stabilized or re-vegetated. Catch basins and manholes will have silt sack filters installed under the grate during construction to protect from silt entering the storm sewer system. A mud mat will be installed at the construction access to reduce risk of mud tracking onto adjacent roads.

Erosion and sediment controls must be in place during construction. Recommendations to the contractor will be included in the erosion and sediment control plan in Appendix C and are summarized below:

During all construction activities, erosion and sedimentation shall be controlled by the following techniques:

Prior to start of construction:

- ▶ Install silt fence along the perimeter of the property line.
- ▶ Install mud mat (gravel mat on geotextile) at construction site entrance to reduce mud tracking from site onto road.
- ▶ Install silt sack filters in all the catchbasins and manholes that capture runoff from the construction area.

During construction:

- ▶ Minimize the extent of disturbed areas and the duration of exposure and impacts to existing grading.
- ▶ Perimeter vegetation to remain in place until permanent storm water management is in place otherwise, immediately install silt fence when the existing site is disturbed at the perimeter.
- ▶ Protect disturbed areas from overland flow by providing temporary swales to the satisfaction of the field engineer. Tie-in temporary swale to existing catchbasins as required.
- ▶ During demolition of existing on-site storm infrastructure, protect downstream sewers from unfiltered flow.
- ▶ Provide temporary cover such as seeding or mulching if disturbed area will not be rehabilitated within 30 days.
- ▶ Inspect silt fences, filter fabric filters and catch basin sumps weekly and within 24 hours after a storm event. Clean and repair when necessary.
- ▶ Drawing to be reviewed and revised as required during construction.
- ▶ Erosion control fencing to be also installed around the base of all stockpiles.
- ▶ Do not locate topsoil piles and excavation material closer than 2.5m from any paved surface, or one which is to be paved before the pile is removed. All topsoil piles are to be seeded if they are to remain on site long enough for seeds to grow (longer than 30 days).
- ▶ Control dust blown off-site by seeding topsoil piles and other areas temporarily (provide watering as required and to the satisfaction of the engineer).
- ▶ No alternate methods of erosion protection shall be permitted unless approved by the field engineer.
- ▶ City roadway and sidewalk to be cleaned of all sediment from vehicular tracking as required.

- ▶ During wet conditions, tires of all vehicles/equipment leaving the site are to be scrapped.
- ▶ Any mud/material tracked onto the road shall be removed immediately by hand or rubber tire loader.
- ▶ Take all necessary steps to prevent building material, construction debris or waste being spilled or tracked onto abutting properties or public streets during construction and proceed immediately to clean up any areas so affected.
- ▶ All erosion control structure to remain in place until all disturbed ground surfaces have been stabilized either by paving or restoration of vegetative ground cover.
- ▶ During the course of construction, if the engineer believes that additional prevention methods are required to control erosion and sedimentation, the contractor will install additional silt fences or other methods as required to the satisfaction of the engineer.
- ▶ The contractor shall implement best management practices, to provide for protection of the area drainage system and the receiving watercourse, during construction activities. The contractor acknowledges that failure to implement appropriate erosion and sediment control measures may be subject to penalties imposed by any applicable regulatory agency.



## 6 APPROVAL AND PERMIT REQUIREMENTS

---

### 6.1 GENERAL

The proposed development is subject to City of Ottawa site plan approval and criteria from the Rideau Valley Conservation Authority.

No other permits or approvals are anticipated to be required from the Ontario Ministry of Environment, Conservation and Parks, Ontario Ministry of Transportation, National Capital Commission, Parks Canada, Public Works and Government Services Canada, or any other provincial or federal regulatory agency except those noted above.

## **7 CONCLUSION CHECKLIST**

---

### **7.1 CONCLUSIONS AND RECOMMENDATIONS**

It is concluded that the proposed development can meet all provided servicing constraints and associated requirements. It is recommended that this report be submitted to the City of Ottawa in support of the application for site plan approval.

---

### **7.2 COMMENTS RECEIVED FROM REVIEW AGENCIES**

Minutes from a pre-consultation meeting held with the City of Ottawa are provided in Appendix E.

# A WATER DEMAND

**WATER DISTRIBUTION - PROPOSED DOMESTIC DEMANDS**

Demand Type	Amount	Units
<b>Average Day Demand</b>		
Residential	= 280	L/c/d
Light Industrial	= 35000	L/gross ha/d
Heavy Industrial	= 55000	L/gross ha/d
Shopping Centres	= 2500	L/(1000m <sup>2</sup> /d)
Hospitals	= 900	L/(bed/d)
Schools	= 70	L/(Students/d)
Trailer Parks no Hook-Ups	= 340	L/(space/d)
Trailer Parks with Hook-Ups	= 800	L/(space/d)
Campgrounds	= 225	L/(campsite/d)
Mobile Home Parks	= 1000	L/(Space/d)
Hotels	= 150	L/(bed-space/d)
Hotels	= 225	L/(bed-space/d)
Tourist Commercial	= 28000	L/gross ha/d
Other Commercial	= 28000	L/gross ha/d

<b>Maximum Daily Demand:</b>			
Residential	=	2.5 x average day	L/c/d
Industrial	=	1.5 x average day	L/gross ha/d
Commercial	=	1.5 x average day	L/gross ha/d
Institutional	=	1.5 x average day	L/gross ha/d

<b>Maximum Hour Demand:</b>			
Residential	=	2.2 x maximum day	L/c/d
Industrial	=	1.8 x maximum day	L/gross ha/d
Commercial	=	1.8 x maximum day	L/gross ha/d
Institutional	=	1.8 x maximum day	L/gross ha/d

\* Maximum Daily Factor interpolated given fewer than 500 occupants 2.99

\*\* Maximum Hourly Factor interpolated given fewer than 500 occupants 4.49

<b>15 Oblats Existing</b>		
Demand Type	= Residential	
Average Day Demand	= 280	L/c/d
Population	= 286	
	= 280 x 286	
	= 80,024	L/day
Average Daily Flow	= 0.93	L/s
Daily Demand Type	= Residential	
Max. Daily Factor	= 3.0	L/c/d
	= 3.0 x Average Daily Flow	
	= 3.0 x 80,024	
	= 239,272	L/day
Maximum Daily Demand	= 2.77	L/s
Hour Demand Type	= Residential	
Max. Hour Factor	= 4.5	L/c/d
	= 4.5 x Maximum Daily Demand	
	= 4.5 x 239,272	
	= 1,074,330	L/day
Maximum Hour Demand	= 12.43	L/s

Unit Type	Person / Unit
Single Family	3.4
Semi-detached	2.7
Duplex	2.3
Townhouse (row)	2.7
<b>Apartments:</b>	
Bachelor	1.4
1 Bedroom	1.4
2 Bedroom	2.1
3 Bedroom	3.1
Average Apt.	1.8

15 Oblats Existing Units:	Person/Unit	Units
Studio	1.4	133
1 Bedroom	1.4	8
2 Bedroom	2.1	17
3 Bedroom	3.1	17
<b>Existing Population</b>		<b>285.8</b>

15 Oblats Porposed Units:	Person/Unit	Units
Studio	1.4	97
1 Bedroom	1.4	2
2 Bedroom	2.1	2
3 Bedroom	3.1	8
<b>Proposed Population</b>		<b>167.6</b>

<b>Total Population</b>	<b>453.4</b>
-------------------------	--------------

<b>15 Oblats Proposed</b>		
Demand Type	= Residential	
Average Day Demand	= 280	L/c/d
Population	= 168	
	= 280 x 168	
	= 46,928	L/day
Average Daily Flow	= 0.54	L/s
Daily Demand Type	= Residential	
Max. Daily Factor	= 3.0	L/c/d
	= 3.0 x Average Daily Flow	
	= 3.0 x 46,928	
	= 140,315	L/day
Maximum Daily Demand	= 1.62	L/s
Hour Demand Type	= Residential	
Max. Hour Factor	= 4.5	L/c/d
	= 4.5 x Maximum Daily Demand	
	= 4.5 x 140,315	
	= 630,013	L/day
Maximum Hour Demand	= 7.29	L/s

**WATER DISTRIBUTION - PROPOSED FIRE FLOW DEMANDS**

$F = 220 C \sqrt{A}$
----------------------

Type of Construction Coefficient:		Comments
Wood Frame	1.5	(all structurally combustible)
Ordinary	1.0	(brick, masonry wall, combustible floor and interior)
Non-Combustible	0.8	(unprotected metal structural component, masonry or metal walls)
Fire Resistive	0.6	(fully protected frame, floors and roof)

Combustibility:		
Non-Combustible	-25%	
Limited Combustible	-15%	
Combustible	0%	
Free Burning	15%	
Rapid Burning	25%	

Sprinkler Protection:		
Complete Sprinkler System	-50%	(max.)
NFPA 13 Conformed	-30%	(max.)
If Water Supply Standard for Both System and Fire Lines	-10%	additional (max.)
Fully Supervised System	-10%	additional (max.)
None	0%	

		15 Oblats Existing	
Type of Construction Coefficient	Ordinary		
		1.0	
Total Effective Floor Area (m <sup>2</sup> )		9,317	m2
Fire Flow, F		21,235	L/min
F(round)		21,000	L/min
Modification 1: Occupancy Combustibility	Limited Combustible		
		-15%	
Occupancy Credit		-3,150	L/min
F(mod1) = F(round) + Occupancy Credit		17,850	L/min
Modification 2: Sprinkler Protection	Complete Sprinkler System		
		-50%	
Additional Credit	If Water Supply Standard for Both System and Fire Lines		
		0	
Sprinkler Credit		-8,925	L/min
F(mod2) = F(mod1) + Sprinkler Credit		8,925	L/min
Modification 3: Exposure Distances			
North	20 m	15%	
South	20 m	15%	
East	19 m	15%	
West	0 m	25%	
		Total % =	70%
Exposure Credit		17,850 x	0.70
		12,495	L/min
F(mod3) = F(mod2) + Exposure Credit		21,420	L/min
<b>F(final) = F(mod3) rounded to nearest 1,000L/min</b>		<b>21,000</b>	<b>L/min</b>
<b>F(final)</b>		<b>350</b>	<b>L/s</b>

		15 Oblats Proposed	
Type of Construction Coefficient	Non-Combustible		
		0.8	
Total Effective Floor Area (m <sup>2</sup> )		1,270	m2
Fire Flow, F		6,271	L/min
F(round)		6,000	L/min
Modification 1: Occupancy Combustibility	Limited Combustible		
		-15%	
Occupancy Credit		-900	L/min
F(mod1) = F(round) + Occupancy Credit		5,100	L/min
Modification 2: Sprinkler Protection	Complete Sprinkler System		
		-50%	
Additional Credit	If Water Supply Standard for Both System and Fire Lines		
		0	
Sprinkler Credit		-2,550	L/min
F(mod2) = F(mod1) + Sprinkler Credit		2,550	L/min
Modification 3: Exposure Distances			
North	20 m	15%	
South	20 m	15%	
East	0 m	25%	
West	7 m	20%	
		Total % =	75%
Exposure Credit		5,100 x	0.75
		3,825	L/min
F(mod3) = F(mod2) + Exposure Credit		6,375	L/min
<b>F(final) = F(mod3) rounded to nearest 1,000L/min</b>		<b>6,000</b>	<b>L/min</b>
<b>F(final)</b>		<b>100</b>	<b>L/s</b>

	15 Oblats Existing	
<b>Average Daily Demand</b>	0.93	L/s
<b>Maximum Daily Demand</b>	2.77	L/s
<b>Peak Hour Demand</b>	12.43	L/s
<b>Fire Flow</b>	350.00	L/s

**Max Day + Fire Flow** 352.77 L/s

	15 Oblats Proposed	
<b>Average Daily Demand</b>	0.54	L/s
<b>Maximum Daily Demand</b>	1.62	L/s
<b>Peak Hour Demand</b>	7.29	L/s
<b>Fire Flow</b>	100.00	L/s

**Max Day + Fire Flow** 101.62 L/s

	15 Oblats Overall	
<b>Average Daily Demand</b>	1.47	L/s
<b>Maximum Daily Demand</b>	4.39	L/s
<b>Peak Hour Demand</b>	19.73	L/s
<b>Fire Flow</b>	350.00	L/s

**Max Day + Fire Flow** 354.39 L/s

```
*****
*                               E P A N E T                               *
*                               Hydraulic and Water Quality                 *
*                               Analysis for Pipe Networks                   *
*                               Version 2.2                                 *
*****
```

Input File: 15 Oblats - Model - SM.net

Link - Node Table:

Link ID	Start Node	End Node	Length m	Diameter mm
NelsonWM3	SiteConnect_1	SiteConnect_2	2	203
NelsonWM2	East	SiteConnect_2	10	203
BldgConnect_2	SiteConnect_2	Bldg	10	150
BldgConnect_1	SiteConnect_1	Bldg	10	150
1	ReservoirWest	SiteConnect_1	10	203

Node Results:

Node ID	Demand LPS	Head m	Pressure m	Quality
SiteConnect_1	0.00	115.00	54.00	0.00
SiteConnect_2	0.00	115.00	54.00	0.00
Bldg	1.47	115.00	54.00	0.00
East	-0.73	115.00	0.00	0.00 Reservoir
ReservoirWest	-0.73	115.00	0.00	0.00 Reservoir

Link Results:

Link ID	Flow LPS	VelocityUnit m/s	Headloss m/km	Status
NelsonWM3	0.00	0.00	0.00	Open
NelsonWM2	0.73	0.02	0.01	Open
BldgConnect_2	0.74	0.04	0.03	Open
BldgConnect_1	0.74	0.04	0.03	Open
1	0.73	0.02	0.01	Open

```
*****
*                               E P A N E T                               *
*                               Hydraulic and Water Quality                 *
*                               Analysis for Pipe Networks                   *
*                               Version 2.2                                 *
*****
```

Input File: 15 Oblats - Model - SM.net

Link - Node Table:

Link ID	Start Node	End Node	Length m	Diameter mm
NelsonWM3	SiteConnect_1	SiteConnect_2	2	203
NelsonWM2	East	SiteConnect_2	10	203
BldgConnect_2	SiteConnect_2	Bldg	10	150
BldgConnect_1	SiteConnect_1	Bldg	10	150
1	ReservoirWest	SiteConnect_1	10	203

Node Results:

Node ID	Demand LPS	Head m	Pressure m	Quality
SiteConnect_1	0.00	84.91	23.91	0.00
SiteConnect_2	0.00	84.91	23.91	0.00
Bldg	354.39	76.09	15.09	0.00
East	-177.19	86.60	0.00	0.00 Reservoir
ReservoirWest	-177.19	86.60	0.00	0.00 Reservoir

Link Results:

Link ID	Flow LPS	VelocityUnit m/s	Headloss m/km	Status
NelsonWM3	0.00	0.00	0.00	Open
NelsonWM2	177.19	5.47	169.31	Open
BldgConnect_2	177.19	10.03	881.91	Open
BldgConnect_1	177.19	10.03	881.91	Open
1	177.19	5.47	169.31	Open



```
*****
*                               E P A N E T                               *
*                               Hydraulic and Water Quality                *
*                               Analysis for Pipe Networks                  *
*                               Version 2.2                                *
*****
```

Input File: 15 Oblats - Model - SM.net

Link - Node Table:

Link ID	Start Node	End Node	Length m	Diameter mm
NelsonWM3	SiteConnect_1	SiteConnect_2	2	203
NelsonWM2	East	SiteConnect_2	10	203
BldgConnect_2	SiteConnect_2	Bldg	10	150
BldgConnect_1	SiteConnect_1	Bldg	10	150
1	ReservoirWest	SiteConnect_1	10	203

Node Results:

Node ID	Demand LPS	Head m	Pressure m	Quality
SiteConnect_1	0.00	105.59	44.59	0.00
SiteConnect_2	0.00	105.59	44.59	0.00
Bldg	19.73	105.55	44.55	0.00
East	-9.86	105.60	0.00	0.00 Reservoir
ReservoirWest	-9.86	105.60	0.00	0.00 Reservoir

Link Results:

Link ID	Flow LPS	VelocityUnit m/s	Headloss m/km	Status
NelsonWM3	0.00	0.00	0.00	Open
NelsonWM2	9.86	0.30	0.80	Open
BldgConnect_2	9.86	0.56	4.19	Open
BldgConnect_1	9.86	0.56	4.19	Open
1	9.86	0.30	0.80	Open



# LHS INC.

P.O. Box 712 Cobourg ON K9A 4R5

905-377-0715 / 1-866-622-4022

Email: info@lhsinc.com

<b>Client</b>	WSP Canada Inc (Test 1) 1224 Gardiners Rd. Kingston, On	<b>Site</b>	15 Oblats Ave
		<b>Site Contact Phone</b>	Utility

## FIRE FLOW TEST

Fire Flow Date **July 15, 2022 - 6:25 am**

Site **15 Oblats Ave**

Static Hydrant **1**

Flow Hydrant **2**

<b>Hydrant Colours</b>	RED - C	0-500
	ORANGE - B	500-1000
	GREEN - A	1000-1500
	BLUE - AA	>1500

### Single Port

Static	68 psi
Residual 1	67 psi
Flow	48 psi
Observed	<b>1162 US GPM</b> 968 IMP GPM 4399 L / MIN
Projected @ 20psi	<b>9399 US GPM</b> 7826 IMP GPM 35579 l/min.

### Two Port

Static	68 psi
Residual 2	66 psi
Flow 2 (x2)	35 psi
Observed	<b>1984 US GPM</b> 1652 IMP GPM 7512 L / MIN
Projected @ 20psi	<b>11040 US GPM</b> 9193 IMP GPM 41791 l/min.

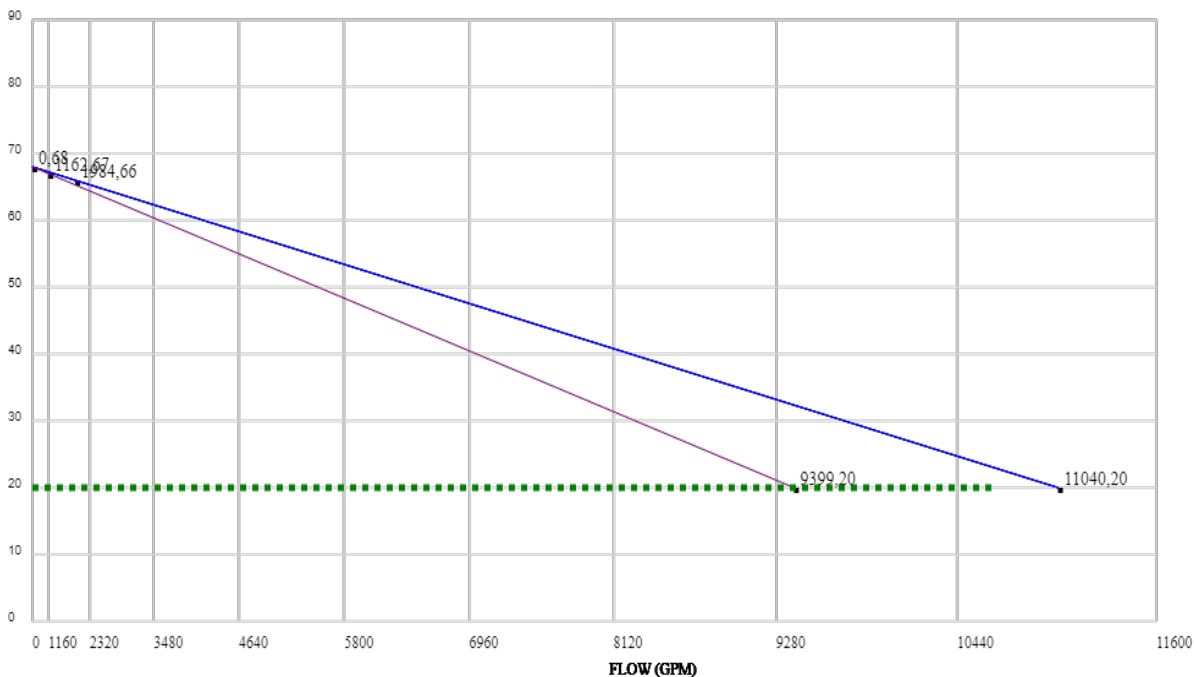



# LHS INC.

P.O. Box 712 Cobourg ON K9A 4R5

905-377-0715 / 1-866-622-4022

Email: info@lhsinc.com

<b>Client</b>	WSP Canada Inc (Test 2) 1224 Gardiners Rd. Kingston, On	<b>Site</b>	15 Oblats Ave
		<b>Site Contact Phone</b>	Utility

## FIRE FLOW TEST

Fire Flow Date **July 15, 2022 - 6:26 am**

Site **15 Oblats Ave**

Static Hydrant **1**

Flow Hydrant **2**

<b>Hydrant Colours</b>	RED - C	0-500
	ORANGE - B	500-1000
	GREEN - A	1000-1500
	BLUE - AA	>1500

### Single Port

Static	67 psi
Residual 1	66 psi
Flow	50 psi
Observed	<b>1186 US GPM</b> 988 IMP GPM 4489 L / MIN
Projected @ 20psi	<b>9484 US GPM</b> 7897 IMP GPM 35901 l/min.

### Two Port

Static	67 psi
Residual 2	62 psi
Flow 2 (x2)	38 psi
Observed	<b>2068 US GPM</b> 1722IMP GPM 7827 L / MIN
Projected @ 20psi	<b>6934 US GPM</b> 5774 IMP GPM 26248 l/min.

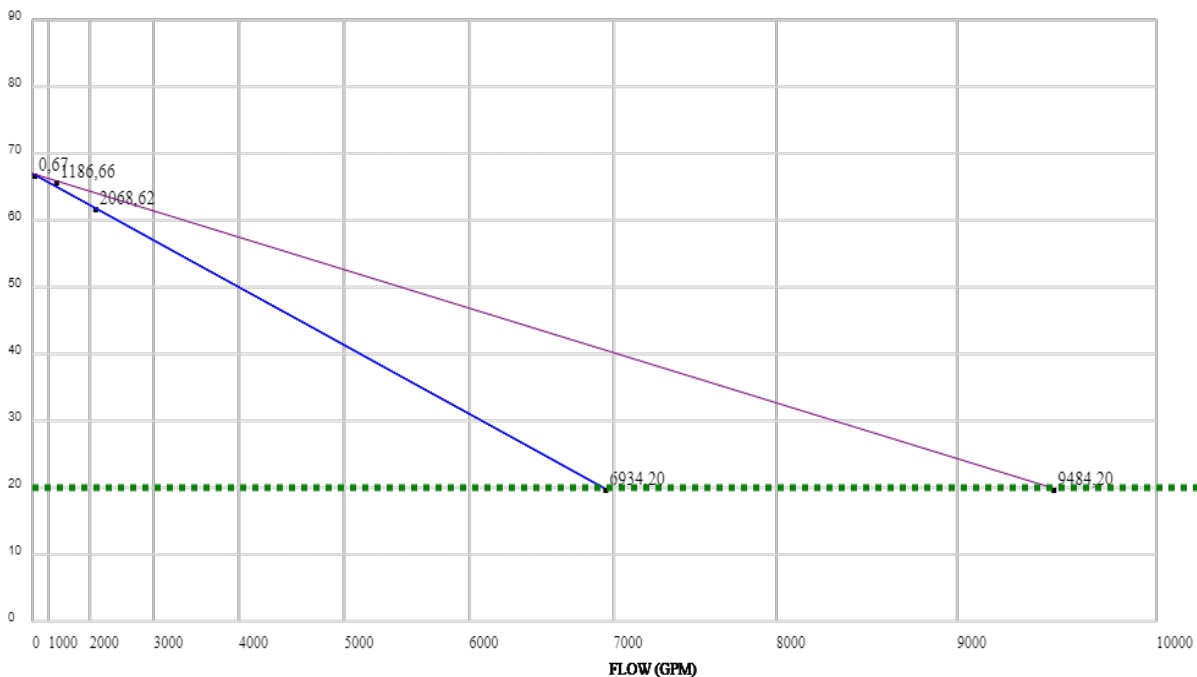



# LHS INC.

P.O. Box 712 Cobourg ON K9A 4R5

905-377-0715 / 1-866-622-4022

Email: info@lhsinc.com

<b>Client</b>	WSP Canada Inc (Test 3) 1224 Gardiners Rd. Kingston, On	<b>Site</b>	15 Oblats Ave
		<b>Site Contact Phone</b>	Utility

## FIRE FLOW TEST

Fire Flow Date	July 15, 2022 - 6:27 am	<b>Hydrant Colours</b>	RED - C	0-500
Site	15 Oblats Ave		ORANGE - B	500-1000
Static Hydrant	1		GREEN - A	1000-1500
Flow Hydrant	2		BLUE - AA	>1500

### Single Port

Static	68 psi
Residual 1	67 psi
Flow	60 psi
Observed	<b>1299 US GPM</b> 1082 IMP GPM 4918 L / MIN
Projected @ 20psi	<b>10508 US GPM</b> 8750 IMP GPM 39777 l/min.

### Two Port

Static	68 psi
Residual 2	66 psi
Flow 2 (x2)	40 psi
Observed	<b>2122 US GPM</b> 1767IMP GPM 8031 L / MIN
Projected @ 20psi	<b>11802 US GPM</b> 9827 IMP GPM 44675 l/min.

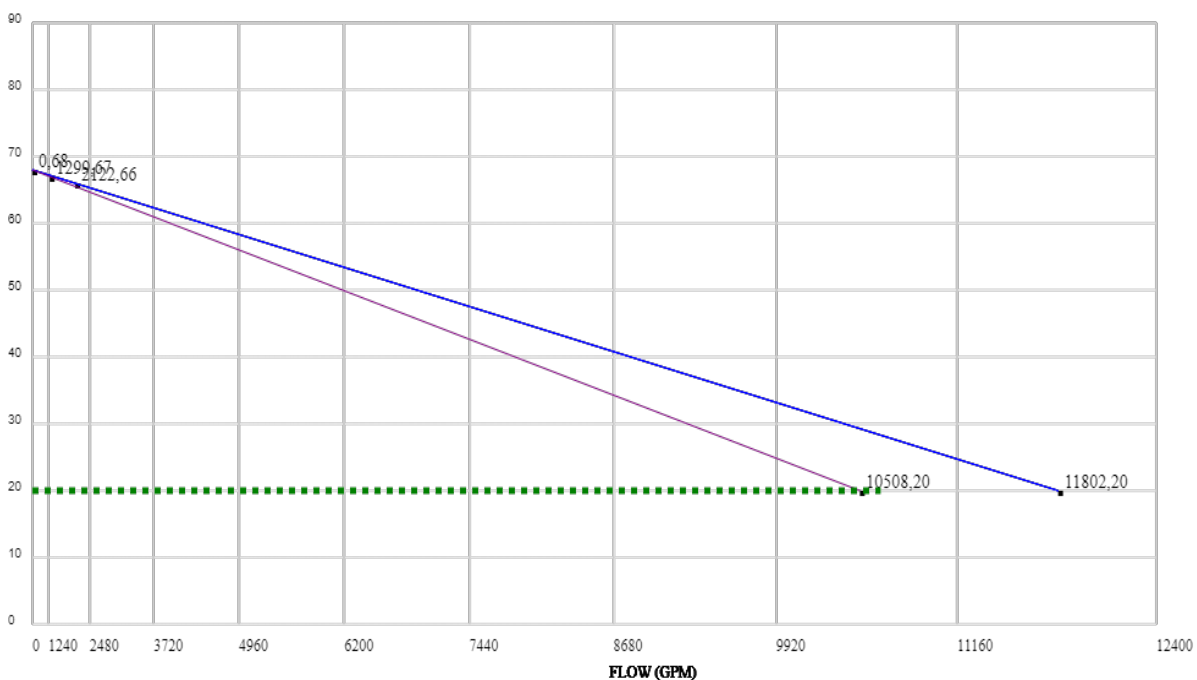



# LHS INC.

P.O. Box 712 Cobourg ON K9A 4R5

905-377-0715 / 1-866-622-4022

Email: info@lhsinc.com

<b>Client</b>	WSP Canada Inc. (Test 4) 1224 Gardiners Rd. Kingston, On	<b>Site</b>	15 Oblats Ave
		<b>Site Contact Phone</b>	Utility

## FIRE FLOW TEST

Fire Flow Date	July 15, 2022 - 6:28 am	<b>Hydrant Colours</b>	RED - C	0-500
Site	15 Oblats Ave		ORANGE - B	500-1000
Static Hydrant	1		GREEN - A	1000-1500
Flow Hydrant	2		BLUE - AA	>1500

### Single Port

Static	70 psi
Residual 1	69 psi
Flow	54 psi
Observed	<b>1232 US GPM</b> 1026 IMP GPM 4665 L / MIN
Projected @ 20psi	<b>10191 US GPM</b> 8486 IMP GPM 38577 l/min.

### Two Port

Static	70 psi
Residual 2	68 psi
Flow 2 (x2)	35 psi
Observed	<b>1984 US GPM</b> 1652 IMP GPM 7512 L / MIN
Projected @ 20psi	<b>11286 US GPM</b> 9398 IMP GPM 42722 l/min.

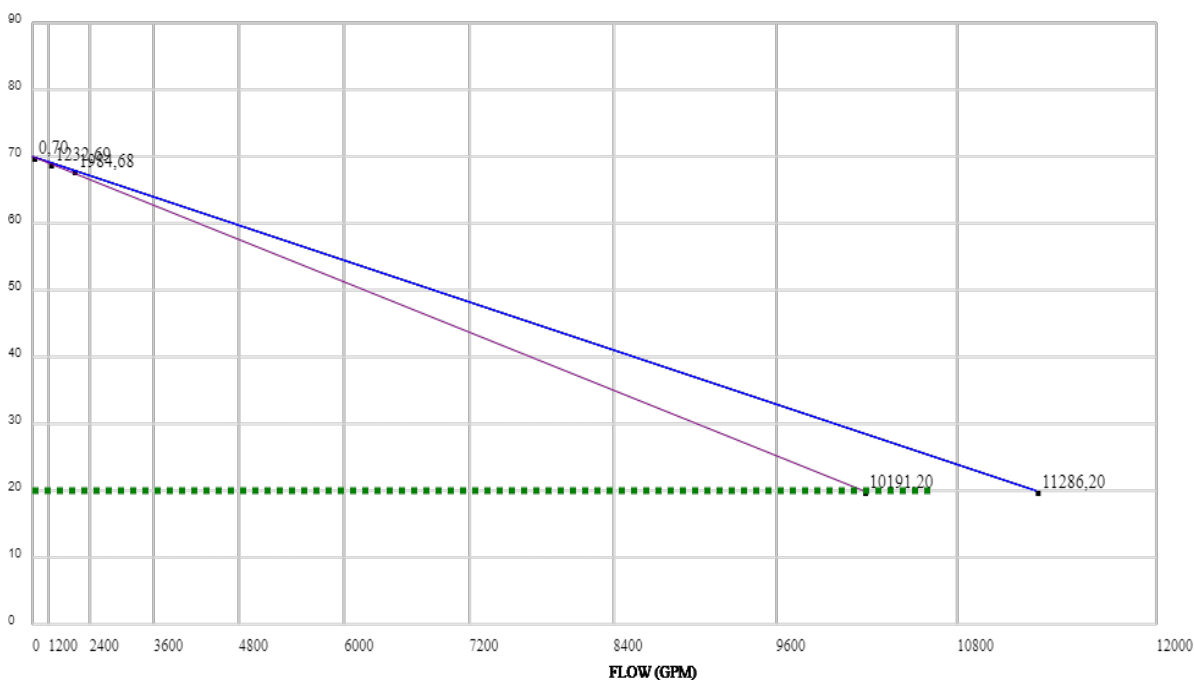

# B SANITARY DEMAND

### SANITARY SEWAGE - PROPOSED SANITARY FLOWS

<b>Average Wastewater Flows:</b>	
Residential	280 L/c/d
Commercial	28,000 L/gross ha/d
Institutional	28,000 L/gross ha/d
Light Industrial	35,000 L/gross ha/d
Heavy Industrial	55,000 L/gross ha/d

<b>Peaking Factors:</b>	
Residential	Harmon Equation
Commercial (>20% Area)	1.5
Commercial (<20% Area)	1.0
Institutional (>20% Area)	1.5
Institutional (<20% Area)	1.0
Industrial	Per Figure in Appendix 4-B

$$P.F. = 1 + \left( \frac{14}{4 + \left( \frac{P}{1000} \right)^{0.5}} \right) * K$$

where P = population  
K = correction factor = 0.8

<b>Peak Extraneous Flows:</b>	
Infiltration Allowance	0.33
<b>Less than 10 ha:</b>	
Foundation Drain Allowance	5.0
<b>10 ha - 100 ha:</b>	
Foundation Drain Allowance	3.0
<b>Greater than 100 ha:</b>	
Foundation Drain Allowance	2.0

Unit Type	Person Per Unit	Unit Count
Single Family	3.4	
Semi-detached	2.7	
Duplex	2.3	
Townhouse (row)	2.7	
<b>Apartments:</b>		
Bachelor	1.4	
1 Bedroom	1.4	
2 Bedroom	2.1	
3 Bedroom	3.1	
Average Apt.	1.8	
<b>15 Oblats Units:</b>		
Studio	1.4	230
1 Bedroom	1.4	10
2 Bedroom	2.1	19
3 Bedroom	3.1	25
<b>Total Population:</b>		<b>453</b>
<b>Total Area (ha):</b>		<b>0.7</b>

<b>15 Oblats</b>			
Demand Type=	<b>Residential</b>		
Average Day Demand=	280		L/c/d
Population	<b>453</b>		
Site Area (ha)	<b>0.677</b>		
	280	x	453
	126,952		L/day
<b>Average Daily Flow=</b>	<b>1.47</b>		<b>L/s</b>
Peaking Factor Type	Residential		
Peaking Factor	3.40		*Max=4
	3.40	x	average day
	3.40	x	126,952
	431,201		L/day
<b>Peak Daily Flow=</b>	<b>4.99</b>		<b>L/s</b>
Infiltration Allowance	0.33		
	0.33	x	lot area
	0.33	x	0.7
<b>Peak Extraneous Flow=</b>	<b>0.22</b>		<b>L/s</b>
	peak daily flow	+	extraneous flow
	4.99	+	0.22
<b>Total Peak Design Flow=</b>	<b>5.21</b>		<b>L/s</b>

<b>15 Oblats Ave.</b>	
<b>Peak Design Flow =</b>	<b>5.21 L/s</b>
<b>Total Peak Design Flow =</b>	<b>5.21 L/s</b>

**WSP Canada**  
Sanitary Sewer Design Sheet

LOCATION			RESIDENTIAL AREA AND POPULATION						INSTITUTIONAL	C+I+I	INFILTRATION			TOTAL FLOW (l/s)	PIPE					MANHOLE			
CONNECTIONS	FROM MH	TO MH	AREA (Ha)	POP.	CUMMULATIVE AREA (Ha) POP.		PEAK FACT.	PEAK FLOW (l/s)	AREA (Ha)	ACCU. AREA (Ha)	PEAK FLOW (l/s)	TOTAL AREA (Ha)	ACCU. AREA (Ha)		INFILT. FLOW (l/s)	LENGTH (m)	DIA. (mm)	SLOPE (%)	CAP. (FULL) (l/s)	PIPE CAPACITY USED (%)	VEL. (FULL) (m/s)	UP INVERT (m)	DOWN INVERT (m)
Building	Building	SAMH1	0.7	453	0.68	453	3.4	4.99	0.000	0.000	0.00	0.7	0.7	0.22	5.21	3.2	150	1.88%	20.89	25.0%	1.18	59.72	59.66
	SAMH1	Connect to 450mm	0.0	0	0.68	453	0.0	4.99	0.000	0.000	0.00	0.0	0.7	0.22	5.21	5.5	150	2.00%	21.52	24.2%	1.22	59.66	59.55
DESIGN PARAMETERS									Designed: Erin Blanchette, P.Eng			PROJECT: 15 Oblats Ave. Residential Building											
Residential: 280 L/cap/d Peak Factor = 3.4 Extraneous Flow = 0.33 l/s/ha Minimum Velocity = 0.60 m/s Manning's n = 0.013									Checked: Stephen McCaughey, P.Eng			LOCATION: 15 Oblats Ave, Ottawa, ON											
									Dwg. Reference:			File Ref.:			Date: July 2022			Sheet No. 1 of 1					



# C SITE DRAWINGS

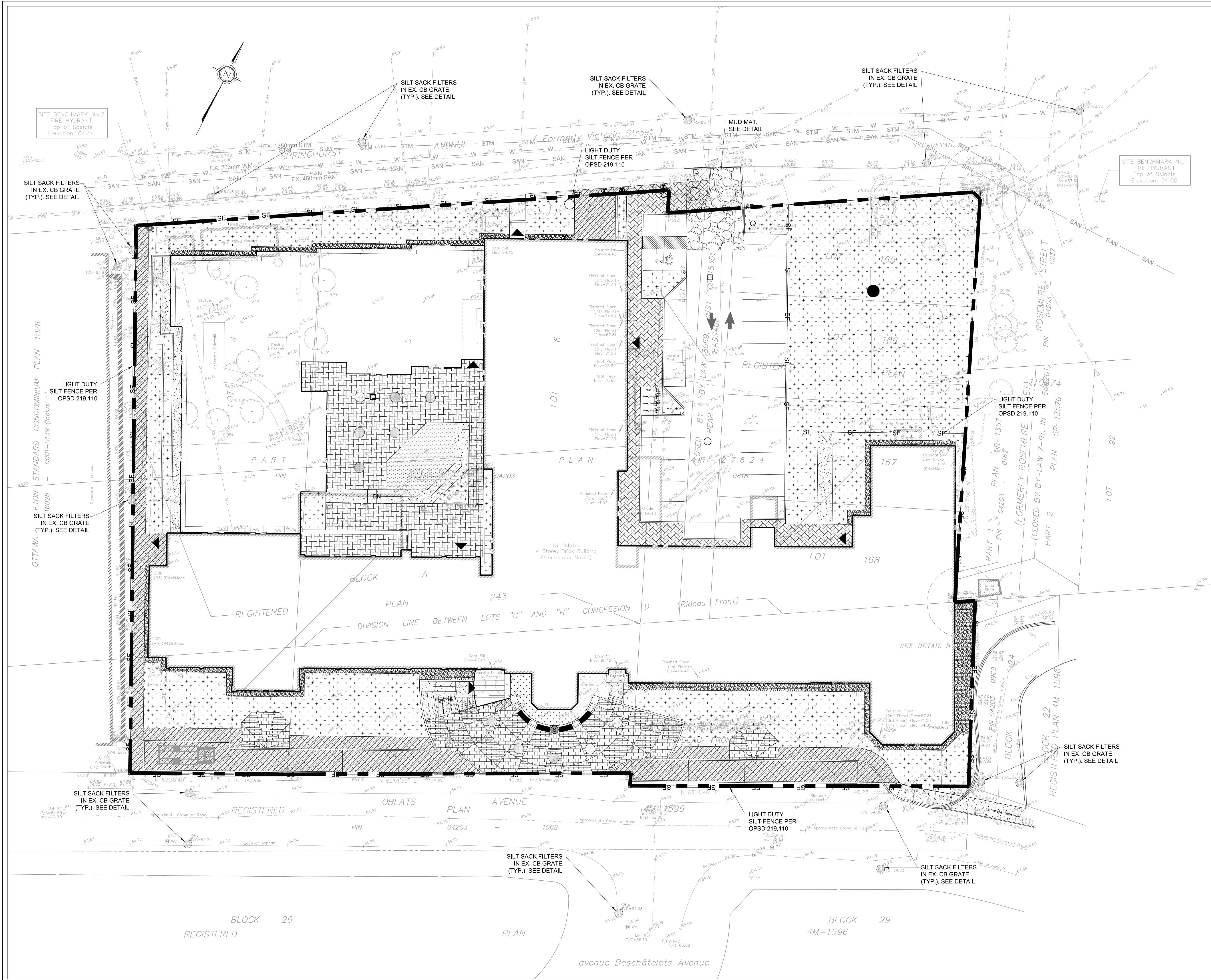

**LEGEND**

- ⊕ 64.99 EXISTING ELEVATION
- ⊕-ST-0 EXISTING STORM MANHOLE
- ⊕-C-0 EXISTING CATCHBASIN
- ⊕-S-0 EXISTING SANITARY MANHOLE
- ⊕-0 PROPOSED CATCHBASIN
- ⊕-0 PROPOSED STORM MANHOLE
- ⊕-0 PROPOSED SANITARY MANHOLE
- ⊕-0 PROPOSED VALVE AND BOX
- STM — PROPOSED STORM SEWER
- SAN — PROPOSED SANITARY SEWER
- W — PROPOSED WATER SERVICE
- ⊕ T/G 64.55 PROPOSED TOP OF GRATE
- ⊕ FFE 64.55 FINISH FLOOR ELEVATION
- ⊕ T/C 63.50 PROPOSED TOP AND BOTTOM OF CURB
- ⊕ B/C 63.45
- ⊕ T/L 63.55
- ⊕ B/L 63.45
- ⊕ T/S 64.60 PROPOSED TOP AND BOTTOM OF SLOPE
- ⊕ S/S 64.27
- ⊕ 63.25 PROPOSED ELEVATION
- 5.9% — PROPOSED SLOPE
- PROPOSED 3:1 SLOPE
- ⊕ SILT SACK FILTER
- SF — LIGHT DUTY SILT DENCE

- NOTES: EROSION AND SEDIMENT CONTROL**
- \*\* CONTRACTOR IS RESPONSIBLE FOR ALL INSTALLATION, MONITORING, REPAIR AND REMOVAL OF ALL EROSION AND SEDIMENT CONTROL FEATURES. \*\*
- PRIOR TO START OF CONSTRUCTION:
    - INSTALL SILT FENCE IN LOCATION SHOWN.
    - INSTALL FILTER FABRIC OR SILT SACK FILTERS IN ALL THE CATCHBASINS AND MANHOLES TO REMAIN DURING CONSTRUCTION WITHIN THE SITE.
    - INSPECT MEASURES IMMEDIATELY AFTER INSTALLATION.
    - INSTALL MUD MAT AT CONSTRUCTION ENTRANCES.
  - DURING CONSTRUCTION:
    - MINIMIZE THE EXTENT OF DISTURBED AREAS AND THE DURATION OF EXPOSURE AND IMPACTS TO EXISTING GRADING.
    - PERIMETER VEGETATION TO REMAIN IN PLACE UNTIL PERMANENT STORM WATER MANAGEMENT IS IN PLACE. OTHERWISE, IMMEDIATELY INSTALL SILT FENCE WHEN THE EXISTING SITE IS DISTURBED AT THE PERIMETER.
    - PROTECT DISTURBED AREAS FROM OVERLAND FLOW BY PROVIDING TEMPORARY SWALES TO THE SATISFACTION OF THE FIELD ENGINEER. TIE-IN TEMPORARY SWALE TO EXISTING CB'S AS REQUIRED.
    - PROVIDE TEMPORARY COVER SUCH AS SEEDING OR MULCHING IF DISTURBED AREA WILL NOT BE REHABILITATED WITHIN 30 DAYS.
    - INSPECT SILT FENCES, FILTER FABRIC FILTERS AND CATCH BASIN SUMPS WEEKLY AND WITHIN 24 HOURS AFTER A STORM EVENT. CLEAN AND REPAIR WHEN NECESSARY.
    - DOWNSTREAM STORM INFRASTRUCTURE SHALL BE PROTECTED FROM UNFILTERED RUNOFF DURING ON-SITE STORM INFRASTRUCTURE DEMOLITION.
    - DRAWING TO BE REVIEWED AND REVISED AS REQUIRED DURING CONSTRUCTION.
    - EROSION CONTROL FENCING TO BE ALSO INSTALLED AROUND THE BASE OF ALL STOCKPILES.
    - DO NOT LOCATE TOPSOIL PILES AND EXCAVATION MATERIAL CLOSER THAN 2.5m FROM ANY PAVED SURFACE, OR ONE WHICH IS TO BE PAVED BEFORE THE PILE IS REMOVED. ALL TOPSOIL PILES ARE TO BE SEEDED IF THEY ARE TO REMAIN ON SITE LONG ENOUGH FOR SEEDS TO GROW (LONGER THAN 30 DAYS).
    - CONTROL WIND-BLOWN DUST OFF SITE BY SEEDING TOPSOIL PILES AND OTHER AREAS TEMPORARILY (PROVIDE WATERING AS REQUIRED AND TO THE SATISFACTION OF THE ENGINEER).
    - NO ALTERNATE METHODS OF EROSION PROTECTION SHALL BE PERMITTED UNLESS APPROVED BY THE FIELD ENGINEER.
    - CITY ROADWAY AND SIDEWALK TO BE CLEANED OF ALL SEDIMENT FROM VEHICULAR TRACKING AS REQUIRED.
    - DURING WET CONDITIONS, TIRES OF ALL VEHICLES/EQUIPMENT LEAVING THE SITE ARE TO BE SCRAPPED.
    - ANY MULTIMATERIAL TRACKED ONTO THE ROAD SHALL BE REMOVED IMMEDIATELY BY HAND OR RUBBER TIRE LOADER.
    - TAKE ALL NECESSARY STEPS TO PREVENT BUILDING MATERIAL, CONSTRUCTION DEBRIS OR WASTE BEING SPILLED OR TRACKED ONTO ADJACENT PROPERTIES OR PUBLIC STREETS DURING CONSTRUCTION AND PROCEED IMMEDIATELY TO CLEAN UP ANY AREAS SO AFFECTED.
    - ALL EROSION CONTROL STRUCTURE TO REMAIN IN PLACE UNTIL ALL DISTURBED GROUND SURFACES HAVE BEEN STABILIZED EITHER BY PAVING OR RESTORATION OF VEGETATIVE GROUND COVER.
    - THE CONTRACTOR SHALL IMPLEMENT BEST MANAGEMENT PRACTICES, TO PROVIDE PROTECTION OF THE AREA DRAINAGE SYSTEM AND THE RECEIVING WATERCOURSE, DURING CONSTRUCTION ACTIVITIES. THE CONTRACTOR ACKNOWLEDGES THAT FAILURE TO IMPLEMENT APPROPRIATE EROSION AND SEDIMENT CONTROL MEASURES MAY BE SUBJECT TO PENALTIES IMPOSED BY ANY APPLICABLE REGULATORY AGENCY.

CLIENT  
FORUM/SLP 15 OBLATS LIMITED PARTNERSHIP  
226 ARGYLE AVE. OTTAWA, ON K2P 1B9

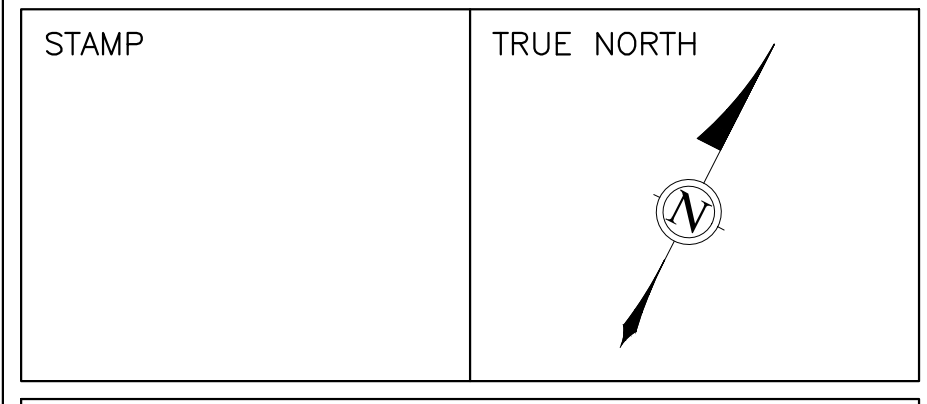
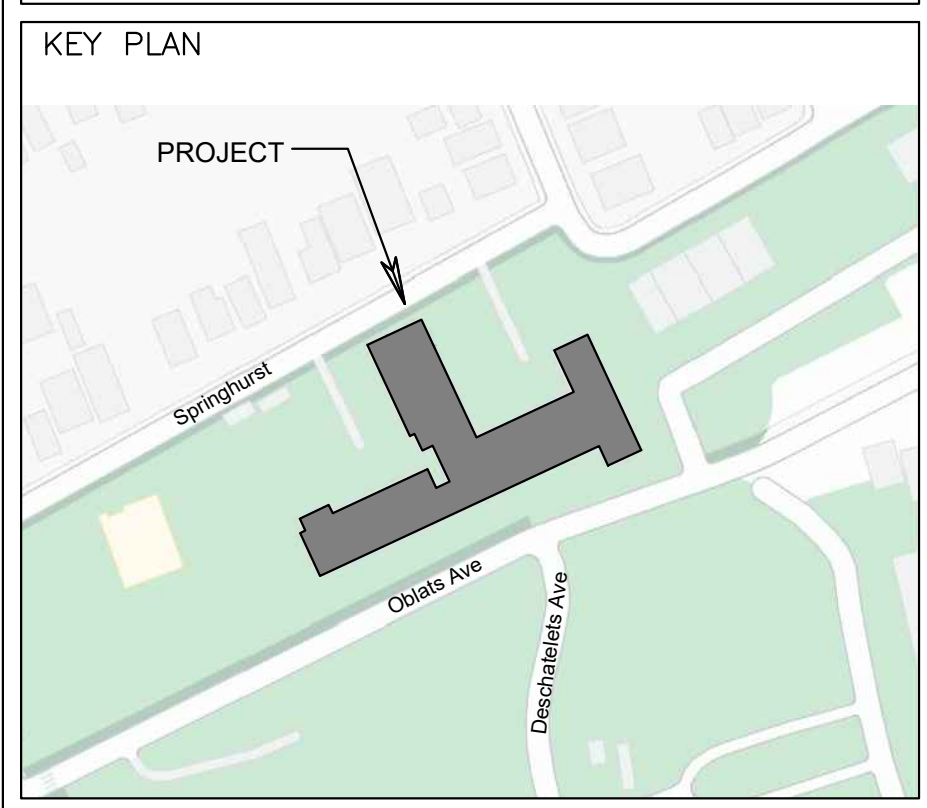

ALL CONTRACTORS TO VERIFY ALL DIMENSIONS ON SITE AND TO REPORT ALL ERRORS AND/OR OMISSIONS TO THE ARCHITECT.

ALL CONTRACTORS MUST COMPLY WITH ALL CODES AND BYLAWS AND OTHER AUTHORITIES HAVING JURISDICTION OVER THE WORK.

DO NOT SCALE DRAWINGS.

THIS DRAWING MAY NOT BE USED FOR CONSTRUCTION UNTIL SIGNED BY THE ARCHITECT. COPYRIGHT RESERVED.

NOT FOR CONSTRUCTION

1	ISSUED FOR SPA	2022-08-19
NO.	REVISION	DD/MM/YY DATE



CONSULTANTS:  
STRUCTURAL —  
MECHANICAL —  
ELECTRICAL —  
LANDSCAPING —

**15 OBLATS AVENUE  
OTTAWA**

**EROSION AND SEDIMENT  
CONTROL PLAN**

221-02976-00  
DRAWN BY: EB  
DESIGNED BY: EB  
CHECKED BY: SM

C003

**Typical SiltSack® Construction - Type B**

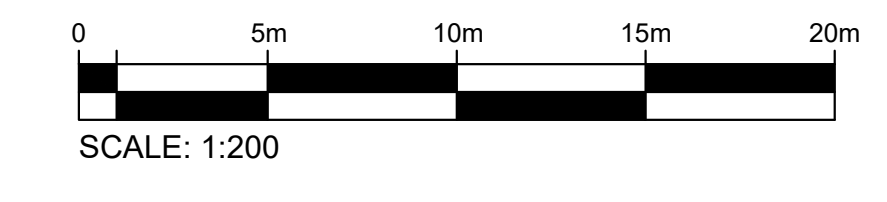
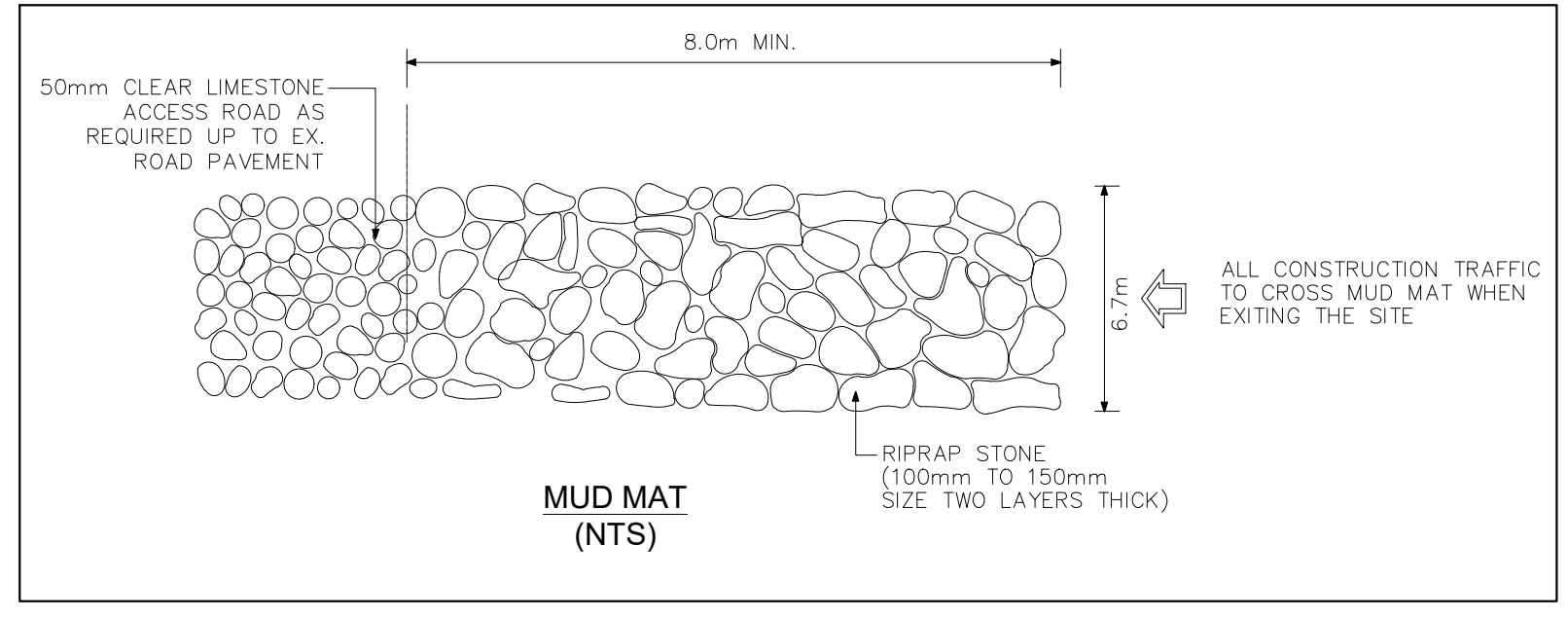
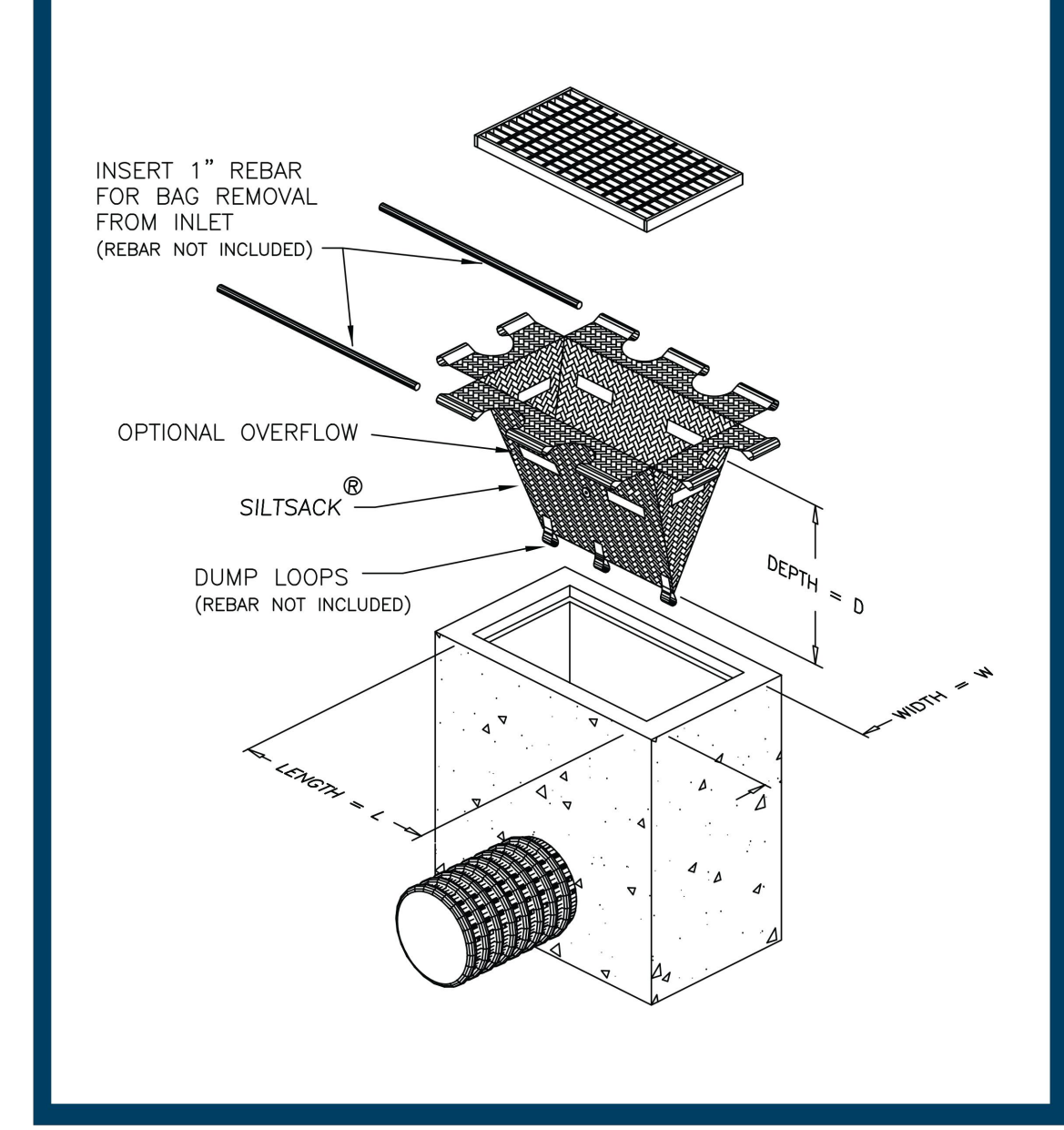

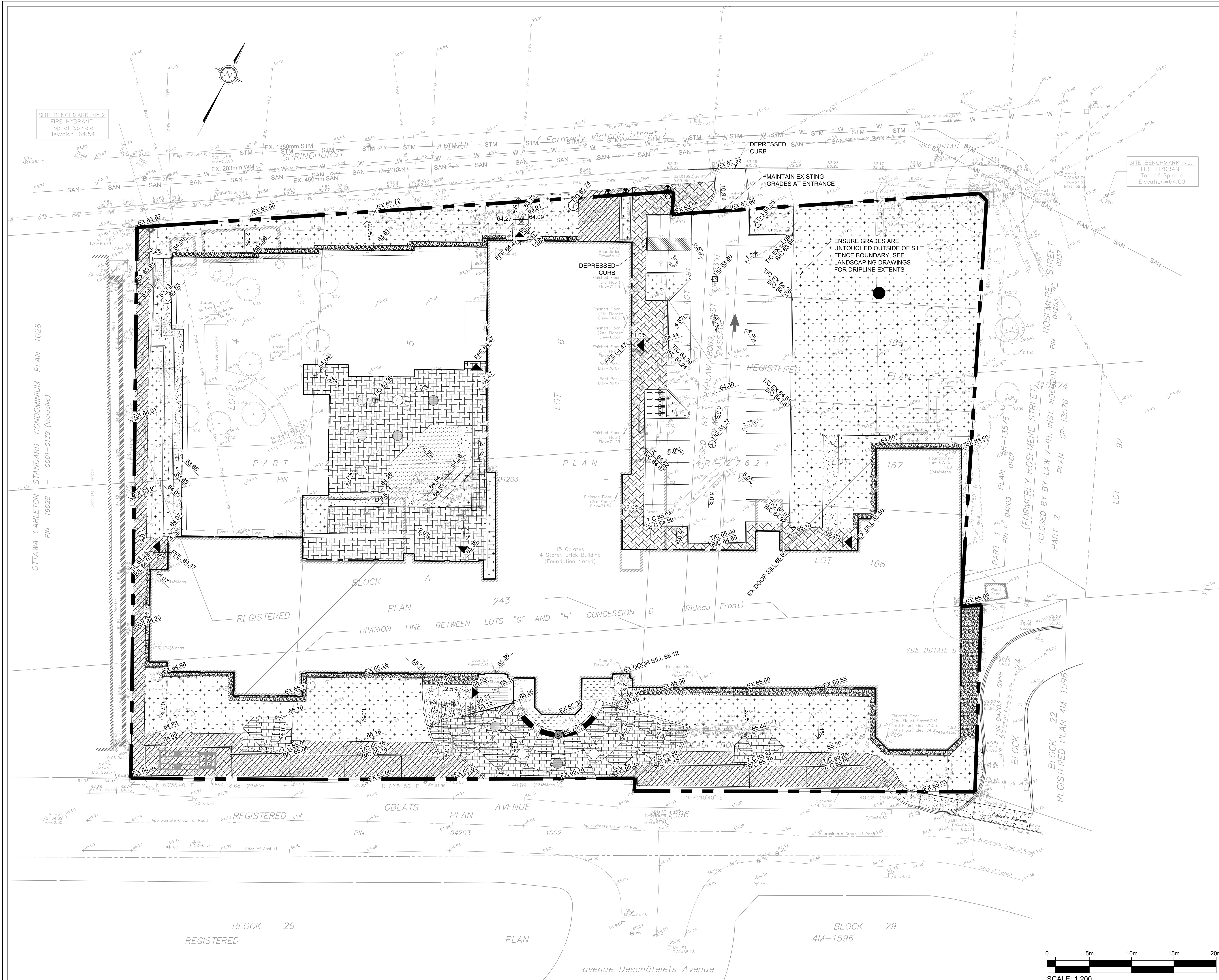

**LEGEND**

- 64.99 EXISTING ELEVATION
- 64.99 EXISTING STORM MANHOLE
- 64.99 EXISTING CATCHBASIN
- 64.99 EXISTING SANITARY MANHOLE
- 64.99 PROPOSED CATCHBASIN
- 64.99 PROPOSED STORM MANHOLE
- 64.99 PROPOSED SANITARY MANHOLE
- 64.99 PROPOSED VALVE AND BOX
- 64.99 PROPOSED STORM SEWER
- 64.99 PROPOSED SANITARY SEWER
- 64.99 PROPOSED WATER SERVICE
- 64.99 PROPOSED TOP OF GRATE
- 64.99 FINISH FLOOR ELEVATION
- 64.99 PROPOSED TOP AND BOTTOM OF CURB
- 64.99 PROPOSED TOP AND BOTTOM OF LANDING ELEVATION
- 64.99 PROPOSED TOP AND BOTTOM OF SLOPE
- 64.99 PROPOSED ELEVATION
- 64.99 PROPOSED SLOPE
- 64.99 PROPOSED 3:1 SLOPE
- 64.99 SILT SACK FILTER
- 64.99 LIGHT DUTY SILT DENCE

- NOTES:** PARKING LOT AND WORK IN PUBLIC RIGHTS OF WAY
- CONTRACTOR TO REINSTATE ROAD CUTS AS PER CITY OF OTTAWA DETAIL R10.
  - REFER TO GEOTECHNICAL INVESTIGATION REPORT PREPARED BY PATERSON GROUP DATED MAY 2020 FOR GEOTECHNICAL RECOMMENDATIONS.
  - CONTRACTOR TO PREPARE SUBGRADE, INCLUDING PROOFROLLING, TO THE SATISFACTION OF THE GEOTECHNICAL CONSULTANT PRIOR TO THE COMMENCEMENT OF PLACEMENT OF GRANULAR B MATERIAL.
  - FILL TO BE PLACED AND COMPACTED PER THE GEOTECHNICAL REPORT REQUIREMENTS.
  - CONTRACTOR TO SUPPLY, PLACE AND COMPACT GRANULAR B MATERIAL IN ACCORDANCE WITH THE RECOMMENDATIONS OF THE GEOTECHNICAL CONSULTANT. CONTRACTOR TO PROVIDE CONSULTANT WITH SAMPLES OF GRANULAR B MATERIAL FOR TESTING AND CERTIFICATION FROM THE GEOTECHNICAL CONSULTANT THAT THE MATERIAL MEETS THE GRADATION REQUIREMENTS SPECIFIED IN THE GEOTECHNICAL REPORT.
  - GRANULAR A MATERIAL TO BE PLACED ONLY UPON APPROVAL BY THE GEOTECHNICAL CONSULTANT OF GRANULAR B PLACEMENT.
  - CONTRACTOR TO SUPPLY, PLACE AND COMPACT GRANULAR A MATERIAL IN ACCORDANCE WITH THE RECOMMENDATIONS OF THE GEOTECHNICAL CONSULTANT. CONTRACTOR TO PROVIDE CONSULTANT WITH SAMPLES OF GRANULAR A MATERIAL FOR TESTING AND CERTIFICATION FROM THE GEOTECHNICAL CONSULTANT THAT THE MATERIAL MEETS THE GRADATION REQUIREMENTS SPECIFIED IN THE GEOTECHNICAL REPORT.
  - ASPHALT MATERIAL TO BE PLACED ONLY UPON APPROVAL BY THE GEOTECHNICAL CONSULTANT OF GRANULAR A PLACEMENT.
  - CONTRACTOR TO SUPPLY, PLACE AND COMPACT ASPHALT MATERIAL IN ACCORDANCE WITH THE RECOMMENDATIONS OF THE GEOTECHNICAL CONSULTANT. CONTRACTOR TO PROVIDE CONSULTANT WITH SAMPLES OF ASPHALT MATERIAL FOR TESTING AND CERTIFICATION FROM THE GEOTECHNICAL CONSULTANT THAT THE MATERIAL MEETS THE REQUIREMENTS SPECIFIED IN THE GEOTECHNICAL REPORT.
  - CONTRACTOR IS RESPONSIBLE FOR ESTABLISHING LINE AND GRADE IN ACCORDANCE WITH THE PLANS, AND FOR PROVIDING THE CONSULTANT WITH VERIFICATION PRIOR TO PLACEMENT.
  - ALL EXCESS MATERIAL TO BE HAULED OFFSITE AND DISPOSED OF AT AN APPROVED DUMP SITE. SHOULD THE CONTRACTOR DISCOVER ANY HAZARDOUS MATERIAL, CONTRACTOR IS TO NOTIFY CONSULTANT. CONSULTANT TO DETERMINE APPROPRIATE DISPOSAL METHOD/LOCATION.
  - PAVEMENT STRUCTURE (MATERIAL TYPES AND THICKNESS) TO BE AS SPECIFIED IN THE GEOTECHNICAL REPORT.

- NOTES: GENERAL**
- ALL SERVICES, MATERIALS, CONSTRUCTION METHODS AND INSTALLATIONS SHALL BE IN ACCORDANCE WITH THE LATEST STANDARDS AND REGULATIONS OF THE CITY OF OTTAWA STANDARD SPECIFICATIONS AND DRAWINGS, ONTARIO PROVINCIAL SPECIFICATION STANDARD SPECIFICATION (OPSS) AND ONTARIO PROVINCIAL STANDARD DRAWINGS (OPSD).
  - THE POSITION OF EXISTING POLE LINES, CONDUITS, WATERMANS, SEWERS AND OTHER UNDERGROUND AND ABOVEGROUND UTILITIES, STRUCTURES AND APPURTENANCES IS NOT NECESSARILY SHOWN ON THE CONTRACT DRAWING, AND WHERE SHOWN, THE ACCURACY OF THE POSITION OF SUCH UTILITIES AND STRUCTURES IS NOT GUARANTEED. PRIOR TO CONSTRUCTION, THE CONTRACTOR SHALL SATISFY HIMSELF OF THE EXACT LOCATION OF ALL SUCH UTILITIES AND STRUCTURES, AND SHALL ASSUME ALL LIABILITY FOR DAMAGE TO THEM DURING THE COURSE OF CONSTRUCTION, ANY RELOCATION OF EXISTING UTILITIES REQUIRED BY THE DEVELOPMENT OF SUBJECT LANDS IS TO BE UNDERTAKEN AT CONTRACTOR'S EXPENSE.
  - THE CONTRACTOR MUST NOTIFY ALL EXISTING UTILITY COMPANY OFFICIALS FIVE (5) BUSINESS DAYS PRIOR TO START OF CONSTRUCTION AND HAVE ALL EXISTING UTILITIES AND SERVICES LOCATED IN THE FIELD OR EXPOSED PRIOR TO THE START OF CONSTRUCTION, INCLUDING BUT NOT LIMITED TO HYDRO, BELL, CABLE TV, AND CONSUMERS GAS LINES.
  - ALL TRENCHING AND EXCAVATIONS TO BE IN ACCORDANCE WITH THE LATEST REVISIONS OF THE OCCUPATIONAL HEALTH AND SAFETY ACT AND REGULATIONS FOR CONSTRUCTION PROJECTS.
  - REFER TO ARCHITECTS PLANS FOR BUILDING DIMENSIONS, ELEVATIONS, LAYOUT AND DECK STRUCTURE. REFER TO LANDSCAPE PLAN FOR LANDSCAPED DETAILS AND OTHER RELEVANT INFORMATION. ALL INFORMATION SHALL BE CONFIRMED PRIOR TO COMMENCEMENT OF CONSTRUCTION.
  - TOPOGRAPHIC SURVEY COMPLETED AND PROVIDED BY ANNIS, O'SULLIVAN, VOLLEBEKK LTD. DATED JULY 2022. CONTRACTOR TO VERIFY IN THE FIELD PRIOR TO CONSTRUCTION OF ANY WORK AND NOTIFY THE ENGINEER OF ANY DISCREPANCIES.
  - ALL ELEVATIONS ARE GEODETIC AND UTILIZE METRIC UNITS.
  - ALL GROUND SURFACES SHALL BE EVENLY GRADED WITHOUT PONDING AREAS AND WITHOUT LOW POINTS EXCEPT WHERE APPROVED SWALE OR DRAIN OUTLETS ARE PROVIDED.
  - ALL EDGES OF DISTURBED PAVEMENT SHALL BE SAW CUT TO FORM A NEAT AND STRAIGHT LINE PRIOR TO PLACING NEW PAVEMENT. PAVEMENT REINSTATEMENT SHALL BE WITH STEP JOINTS OF 500mm WIDTH MINIMUM.
  - ALL DISTURBED AREAS OUTSIDE PROPOSED GRADING LIMITS TO BE RESTORED TO ORIGINAL ELEVATIONS AND CONDITIONS UNLESS OTHERWISE SPECIFIED. EXISTING PARKING LOT SHALL BE RE-ASPHALTED AT EXISTING GRADES EXCEPT AS NOTED TO EVEN OUT GRADES. ALL RESTORATION SHALL BE COMPLETED WITH THE GEOTECHNICAL REQUIREMENTS FOR BACKFILL AND COMPACTION.
  - ALL MATERIAL SUPPLIED AND PLACED FOR PARKING LOT AND ACCESS ROAD CONSTRUCTION SHALL BE TO OPSS STANDARDS AND SPECIFICATIONS UNLESS OTHERWISE NOTED. CONSTRUCTION TO OPSS 206, 310 & 314. MATERIALS TO OPSS 1001, 1003 & 1010.
  - RETAINING WALLS ARE TO BE CONSTRUCTED PER OPSS 3120.100 TYPE II.
  - ABUTTING PROPERTY GRADES TO BE MATCHED.
  - CONTRACTOR SHALL OBTAIN AND PAY FOR ALL NECESSARY PERMITS AND APPROVALS FROM THE MUNICIPAL AUTHORITIES PRIOR TO COMMENCING CONSTRUCTION.
  - MINIMIZE DISTURBANCE TO EXISTING VEGETATION DURING THE EXECUTION OF ALL WORKS.
  - REMOVE FROM SITE ALL EXCESS EXCAVATED MATERIAL UNLESS OTHERWISE DIRECTED FROM THE ENGINEER. EXCAVATE AND REMOVE ALL ORGANIC MATERIAL AND DEBRIS LOCATED WITHIN THE PROPOSED BUILDING, PARKING AND ROADWAY LOCATIONS.
  - AT PROPOSED UTILITY CONNECTION POINTS AND CROSSINGS (I.E. STORM SEWER, SANITARY SEWER, WATER, ETC.) THE CONTRACTOR SHALL DETERMINE THE PRECISE LOCATION AND DEPTH OF EXISTING UTILITIES AND REPORT ANY DISCREPANCIES OR CONFLICTS TO THE ENGINEER BEFORE COMMENCING WORK.
  - SERVICE TRENCHES ON MUNICIPAL RIGHT OF WAY TO BE REINSTATED AS PER CITY OF OTTAWA DETAIL R10.
  - PRIOR TO CONSTRUCTION, A GEOTECHNICAL ENGINEER REGISTERED IN THE PROVINCE OF ONTARIO IS TO INSPECT ALL SUB-SURFACES FOR FOOTINGS, SERVICES AND PAVEMENT STRUCTURES.
  - FOR ANY SOILS RELATED INFORMATION, REFER TO THE GEOTECHNICAL INVESTIGATION REPORT BY WSP CANADA INC.
  - CONTRACTOR TO OBTAIN POST-CONSTRUCTION TOPOGRAPHIC SURVEY PERFORMED BY CERTIFIED OLS OR P.ENG. CONFIRMING COMPLIANCE WITH DESIGN GRADING AND SERVICING. SURVEY IS TO INCLUDE LOCATION AND INVERTS FOR BURIED UTILITIES.
  - EXISTING STORM SEWER, SANITARY SEWER, AND WATERMAIN ALONG SPRINGHURST AVENUE WERE DRAWN IN BASED ON SURVEY. CONTRACTOR TO CONFIRM ON SITE PRIOR TO CONSTRUCTION.

CLIENT  
FORUM/SLP 15 OBLATS LIMITED PARTNERSHIP  
226 ARGYLE AVE. OTTAWA, ON K2P 1B9

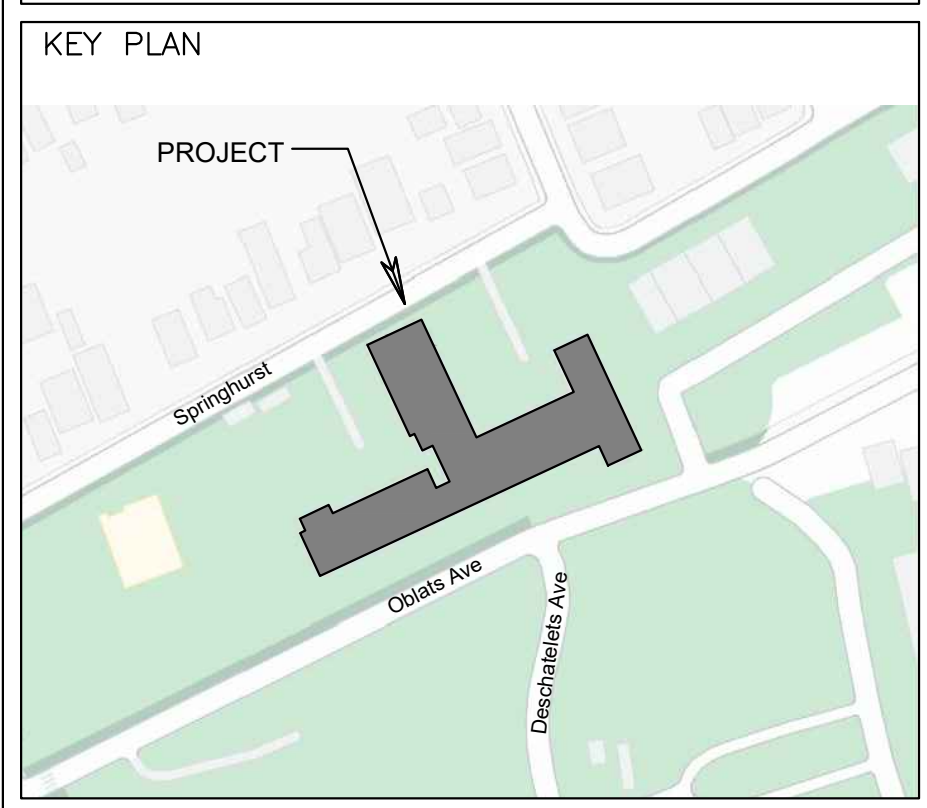

**STAMP**

TRUE NORTH

ALL CONTRACTORS TO VERIFY ALL DIMENSIONS ON SITE AND TO REPORT ALL ERRORS AND/OR OMISSIONS TO THE ARCHITECT.

ALL CONTRACTORS MUST COMPLY WITH ALL CODES AND BYLAWS AND OTHER AUTHORITIES HAVING JURISDICTION OVER THE WORK.

DO NOT SCALE DRAWINGS.

THIS DRAWING MAY NOT BE USED FOR CONSTRUCTION UNTIL SIGNED BY THE ARCHITECT.

COPYRIGHT RESERVED.

**NOT FOR CONSTRUCTION**

1	ISSUED FOR SPA	2022-08-19
NO.	REVISION	DD/MM/YY DATE



CONSULTANTS:  
STRUCTURAL —  
MECHANICAL —  
ELECTRICAL —  
LANDSCAPING —

**15 OBLATS AVENUE  
OTTAWA**

**GRADING PLAN**

221-02976-00  
DRAWN BY: EB  
DESIGNED BY: EB  
CHECKED BY: SM

**C001**

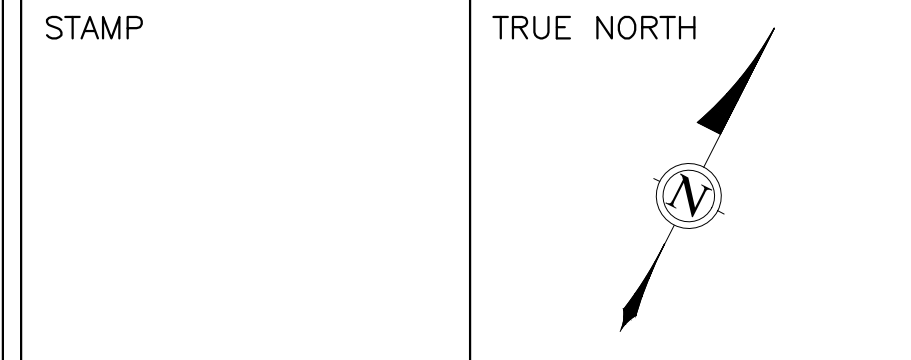
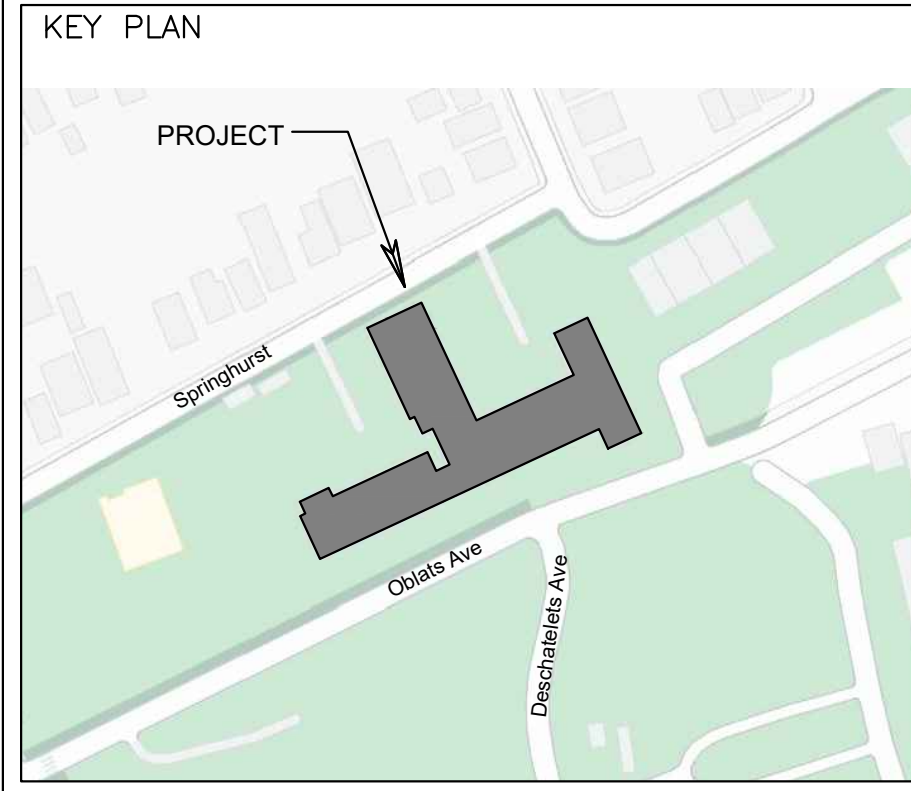

ALL CONTRACTORS TO VERIFY ALL DIMENSIONS ON SITE AND TO REPORT ALL ERRORS AND/OR OMISSIONS TO THE ARCHITECT.

ALL CONTRACTORS MUST COMPLY WITH ALL CODES AND BYLAWS AND OTHER AUTHORITIES HAVING JURISDICTION OVER THE WORK.

DO NOT SCALE DRAWINGS.

THIS DRAWING MAY NOT BE USED FOR CONSTRUCTION UNTIL SIGNED BY THE ARCHITECT. COPYRIGHT RESERVED.

NOT FOR CONSTRUCTION

1	ISSUED FOR SPA	2022-08-19
NO.	REVISION	DD/MM/YY DATE



CONSULTANTS:  
STRUCTURAL –  
MECHANICAL –  
ELECTRICAL –  
LANDSCAPING –

15 OBLATS AVENUE  
OTTAWA

SERVICING PLAN

221-02976-00	
DRAWN BY: EB	
DESIGNED BY: EB	
CHECKED BY: SM	C002

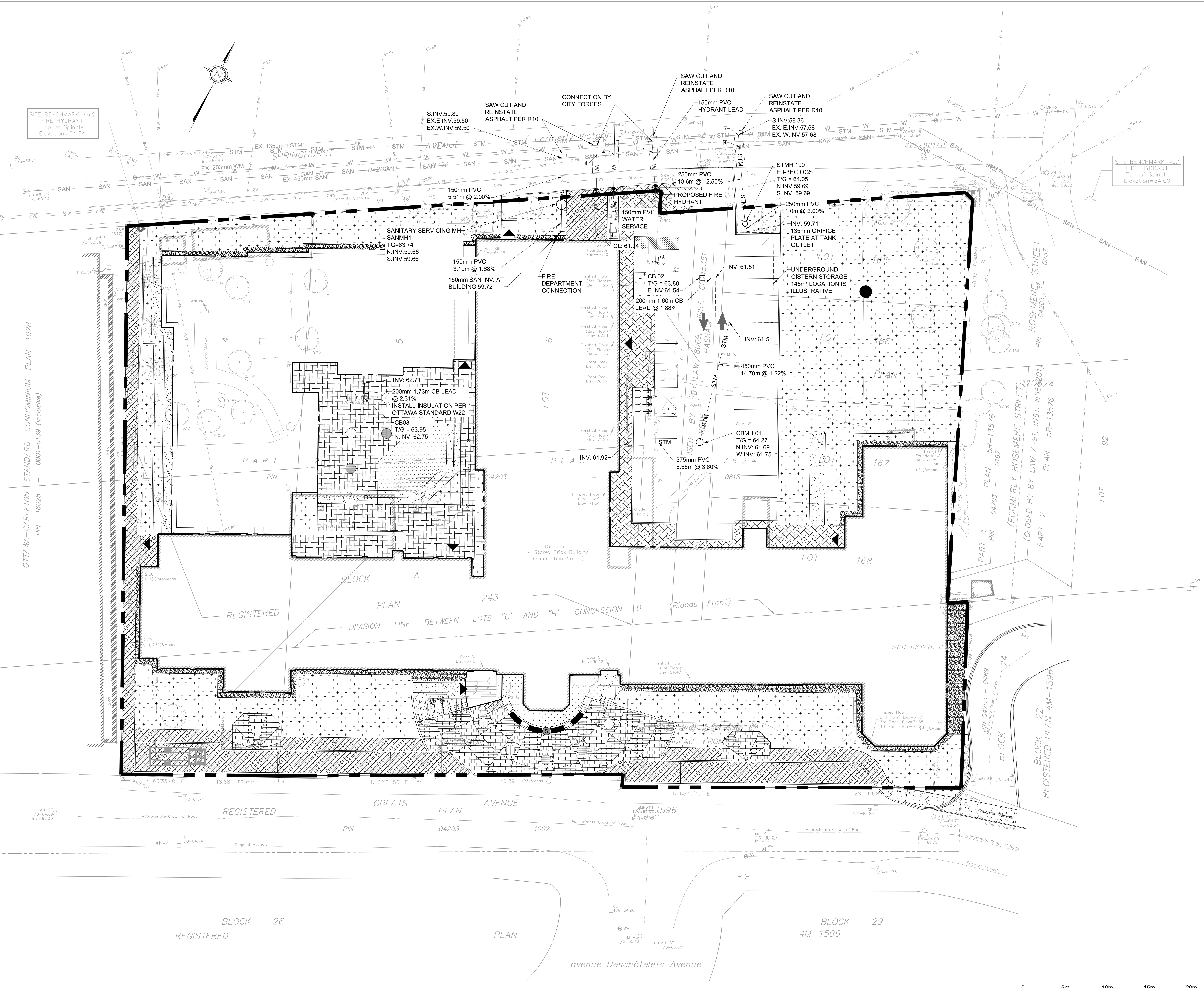

**LEGEND**

- EXISTING ELEVATION
- EXISTING STORM MANHOLE
- EXISTING CATCHBASIN
- EXISTING SANITARY MANHOLE
- PROPOSED CATCHBASIN
- PROPOSED STORM MANHOLE
- PROPOSED SANITARY MANHOLE
- PROPOSED VALVE AND BOX
- PROPOSED STORM SEWER
- PROPOSED SANITARY SEWER
- PROPOSED WATER SERVICE
- PROPOSED TOP OF GRATE
- FINISH FLOOR ELEVATION
- PROPOSED TOP AND BOTTOM OF CURB
- PROPOSED TOP AND BOTTOM OF LANDING ELEVATION
- PROPOSED TOP AND BOTTOM OF SLOPE
- PROPOSED ELEVATION
- PROPOSED SLOPE
- PROPOSED 3:1 SLOPE
- SILT SACK FILTER
- LIGHT DUTY SILT DENCE

- NOTES: STORM SEWERS AND STRUCTURES**
- ALL STORM SEWER MATERIALS AND CONSTRUCTION METHODS SHALL CONFORM TO THE CURRENT CITY OF OTTAWA STANDARDS AND SPECIFICATIONS. PROVIDE CITY INSPECTION REPORTS FOR ALL NEW STORM SEWERS, SERVICES AND CB LEADS.
  - STORM SEWERS 450mm DIAMETER AND SMALLER SHALL BE PVC SDR-35, WITH RUBBER GASKET PER CSA A-257.3.
  - STORM SEWER LARGER THAN 450mm SHALL BE REINFORCED CONCRETE CLASS 100.
  - SEWER BEDDING AS PER CITY OF OTTAWA DETAIL S6.
  - ALL STORM MANHOLES TO BE AS PER STORM STRUCTURE TABLE.
  - ANY NEW OR EXISTING STORM SEWER WITH LESS THAN 2.0m COVER REQUIRES THERMAL INSULATION AS PER CITY OF OTTAWA STANDARD W22, OR APPROVED BY THE ENGINEER.
  - ALL CATCHBASIN LEADS TO BE MINIMUM 200mm DIAMETER AT MINIMUM 1.0% SLOPE UNLESS OTHERWISE SPECIFIED.
  - STORM CATCHBASINS AS PER OPSD 705.010 AND FRAME/COVER AS PER CITY STANDARD DRAWINGS S19. STORM CBM'S AS INDICATED IN TABLE WITH SUMP, ADJUSTMENT SECTIONS SHALL BE AS PER OPSD 704.010.
  - INSTALLATION OF FLOW CONTROL ICD'S TO BE VERIFIED BY QUALITY VERIFICATION ENGINEER RETAINED BY CONTRACTOR.
  - PROVIDE BACKWATER VALVE ON FOUNDATION DRAIN, STORM DISCHARGE, AND OVERFLOW DISCHARGE PER S14

- NOTES: SANITARY SEWER AND MANHOLES**
- ALL SANITARY SEWER, SANITARY SEWER APPURTENANCES AND CONSTRUCTION METHODS SHALL CONFORM TO THE CURRENT CITY OF OTTAWA STANDARDS AND SPECIFICATIONS. PROVIDE CITY INSPECTION REPORTS FOR ALL NEW SANITARY PIPING.
  - SANITARY SEWER PIPE SIZE 150mm DIAMETER AND GREATER TO BE PVC SDR-35 (UNLESS SPECIFIED OTHERWISE) WITH RUBBER GASKET TYPE JOINTS IN CONFORMANCE WITH CSA B-182.2.3.4.
  - SEWER BEDDING AS PER CITY OF OTTAWA DETAIL S6.
  - ALL SANITARY MANHOLES 1200mm IN DIAMETER TO BE AS PER OPSD 701.01. FRAME AND COVER TO BE AS PER CITY OF OTTAWA STANDARD S25 AND S24.
  - MAINTENANCE HOLE BENCHING AND PIPE OPENING ALTERNATIVES AS PER THE OPSD 701.021
  - ANY SANITARY SEWER WITH LESS THAN 2.0m COVER REQUIRES THERMAL INSULATION AS PER CITY OF OTTAWA STANDARD W22, OR APPROVED BY THE ENGINEER.
  - PROVIDE BACKWATER VALVE PER S14.1

- NOTES: WATERMAIN**
- ALL WATERMAIN AND WATERMAIN APPURTENANCES, MATERIALS, CONSTRUCTION AND TESTING METHODS SHALL CONFORM TO THE CURRENT CITY OF OTTAWA AND MINISTRY OF ENVIRONMENT STANDARDS AND SPECIFICATIONS.
  - ALL WATERMAIN 300mm DIAMETER AND SMALLER TO BE POLY VINYL CHLORIDE (PVC) CLASS 150 DR 18 MEETING AWWA SPECIFICATION C900.
  - ALL WATERMAIN TO BE INSTALLED AT MINIMUM COVER OF 2.4m BELOW FINISHED GRADE. WHERE WATERMANS CROSS OVER OTHER UTILITIES, A MINIMUM 0.30m CLEARANCE SHALL BE MAINTAINED; WHERE WATERMANS CROSS UNDER OTHER UTILITIES, A MINIMUM 0.50m CLEARANCE SHALL BE MAINTAINED. WHERE THE MINIMUM SEPARATION CANNOT BE ACHIEVED, THE WATERMAIN SHALL BE INSTALLED AS PER CITY OF OTTAWA STANDARDS W25 AND W25.2. WHERE 2.4m MINIMUM DEPTH CANNOT BE ACHIEVED, THERMAL INSULATION SHALL BE PROVIDED AS PER CITY OF OTTAWA STANDARD W22. WHERE A WATERMAIN IS IN CLOSE PROXIMITY TO AN OPEN STRUCTURE, THERMAL INSULATION SHALL BE PROVIDED AS PER CITY OF OTTAWA STANDARD W25.3 & W25.4.
  - CONCRETE THRUST BLOCKS AND MECHANICAL RESTRAINTS ARE TO BE INSTALLED AT ALL TEES, BENDS, HYDRANTS, REDUCERS, ENDS OF MAINS AND CONNECTIONS 100mm AND LARGER, IN ACCORDANCE WITH CITY OF OTTAWA STANDARDS W25.3 & W25.4.
  - CATHODIC PROTECTION REQUIRED FOR ALL IRON FITTINGS AS PER CITY OF OTTAWA STANDARD W40 & W42.
  - ALL VALVES AND VALVE BOXES AND CHAMBERS, HYDRANTS, AND HYDRANT VALVES AND ASSEMBLES SHALL BE INSTALLED AS PER CITY OF OTTAWA STANDARD
  - FIRE HYDRANT LOCATION AND INSTALLATION AS PER CITY OF OTTAWA STANDARD W18 & W19. CONTRACTOR TO PROVIDE FLOW TEST AND PAINTING OF NEW HYDRANT IN ACCORDANCE WITH CITY STANDARDS.
  - IF WATER MAIN MUST BE DEFLECTED TO MEET ALIGNMENT, ENSURE THAT THE AMOUNT OF DEFLECTION USED IS LESS THAN HALF THAT RECOMMENDED BY THE MANUFACTURER.

**PIPE CROSSING TABLE**

	Obvert	Invert		
1	EX 450mm SAN 59.89	0.99	Clearance Under	60.88 150mm WM
2	EX 450mm SAN 59.86	1.02	Clearance Under	60.88 150mm WM
3	250mm STM 59.03	1.71	Clearance Under	60.74 EX 203mm WM
4	250mm STM 58.71	0.48	Clearance Under	59.19 EX 450mm SAN
5	EX 450mm SAN 59.79	1.04	Clearance Under	60.83 150mm FH lead

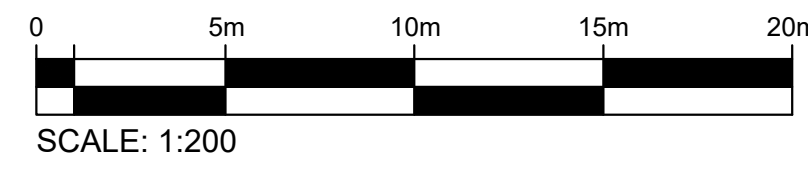

OTTAWA-CARLETON STANDARD CONDOMINIUM PLAN 1028  
PIN 0001-0139 (inclusive)

Min 51 1/2 @ 64.40  
Max 62.30

BLOCK 26 REGISTERED

BLOCK 29 REGISTERED

# D STORM SEWER DESIGN SHEET

**WSP Canada**  
Storm Sewer Design Sheet

2yr Storm Sewer Design

LOCATION			FLOW									PIPE						MANHOLE		
Catchment Area	FROM MH	TO MH	Coefficient	Area (m2)	Indiv. 2.78*AC	Cum. 2.78*AC	Time of Conc. (min.)	Rainfall Intensity (mm.hr)	Indiv. Area Flow (L/s)	Cum. Flow (L/s)	Controlled Cum. Flow (L/s)	Length (m)	Dia. (mm)	Slope (%)	Cap. (Full) (L/s)	Velocity (Full) (m/s)	Time of flow (min.)	Ratio (Q/Qfull)	UP INVERT (m)	DOWN INVERT (m)
PR-003	CB3	BLDG	0.8	50	0.012	0.012	10.00	76.81	0.89	0.89	0.89	1.73	200	2.31%	49.87	1.6	0.02	2%	62.75	62.71
PR-002 & PR-004	BLDG	CBMH1	0.9	3100	0.776	0.776	10.02	76.74	59.52	60.40	60.40	8.55	375	1.99%	247.23	2.2	0.06	24%	61.92	61.75
PR-005	CBMH1	TANK	0.7	500	0.103	0.103	10.08	76.49	7.87	68.27	68.27	14.70	450	1.22%	315.49	2.0	0.12	22%	61.69	61.51
PR-006	CB2	TANK	0.6	900	0.143	0.143	10.00	76.81	10.95	10.95	10.95	1.60	200	1.88%	44.91	1.4	0.02	24%	61.54	61.51
	TANK	OGS	0.9	0	0.000	0.000	10.08	76.49	0.00	79.23	52.25	1.00	250	2.00%	84.10	1.7	0.01	62%	59.71	59.69
	OGS	EX 1350mm	0.9	0	0.000	0.000	10.09	76.46	0.00	79.23	52.25	10.6	250	12.55%	210.65	4.3	0.04	25%	59.69	58.36
<b>DESIGN PARAMETERS</b> Q = 2.78CIA where, Q = Peak flow in L/s A = Drainage area in ha I = Rainfall intensity (mm/hr) C = Runoff coefficient Ottawa IDF Curve IDF Curve Equation (2yr storm) $I = 732.951/(T+6.199)^{0.81}$ Min. velocity = 0.8 m/s Manning 'n' = 0.013							Designed: Erin Blanchette, P.Eng.					PROJECT: 15 Oblats Ave. Residential Development								
							Checked: Stephen McCaughey, P.Eng.					LOCATION: 15 Oblats Ave., Ottawa, ON								
							Dwg. Reference:					File Ref.: 221-02976-00		Date: August 2022		Sheet No. 1 of 3				

Note:  
135mm orifice plate on TANK outlet controlled to 52.25 L/s

100yr Storm Sewer Design

LOCATION			FLOW									PIPE						MANHOLE					
Catchment Area	FROM MH	TO MH	Coefficient	Area (m2)	Indiv. 2.78*AC	Cum. 2.78*AC	Time of Conc. (min.)	Rainfall Intensity (mm.hr)	Indiv. Area Flow (L/s)	Cum. Flow (L/s)	Controlled Cum. Flow (L/s)	Length (m)	Dia. (mm)	Slope (%)	Cap. (Full) (L/s)	Velocity (Full) (m/s)	Time of flow (min.)	Ratio (Q/Qfull)	UP INVERT (m)	DOWN INVERT (m)			
PR-003	CB3	BLDG	1.0	50	0.014	0.014	10.00	178.56	2.48	2.48	2.48	1.73	200	2.31%	49.87	1.6	0.02	5%	62.75	62.71			
PR-002 & PR-004	BLDG	CBMH1	1.0	3100	0.862	0.862	10.02	178.39	153.74	156.22	156.22	8.55	375	1.99%	247.23	2.2	0.06	63%	61.92	61.75			
PR-005	CBMH1	TANK	0.9	500	0.129	0.129	10.08	177.81	22.86	179.08	179.08	14.70	450	1.22%	315.49	2.0	0.12	57%	61.69	61.51			
PR-006	CB2	TANK	0.7	900	0.178	0.178	10.00	178.56	31.83	31.83	31.83	1.60	200	1.88%	44.91	1.4	0.02	71%	61.54	61.51			
	TANK	OGS	1.0	0	0.000	0.000	10.08	177.81	0.00	210.91	52.25	1.00	250	2.00%	84.10	1.7	0.01	62%	59.71	59.69			
	OGS	EX 1350mm	1.0	0	0.000	0.000	10.09	177.73	0.00	210.91	52.25	10.6	250	12.55%	210.65	4.3	0.04	25%	59.69	58.36			
DESIGN PARAMETERS								Designed:				PROJECT:											
Q = 2.78CIA where, Q = Peak flow in L/s A = Drainage area in ha I = Rainfall intensity (mm/hr) C = Runoff coefficient								Ottawa IDF Curve IDF Curve Equation (100yr storm) $I = 1735.688/(T+6.014)^{0.82}$ Min. velocity = 0.8 m/s Manning 'n' = 0.013				Erin Blanchette, P.Eng.				15 Oblats Ave. Residential Development							
								Checked:				LOCATION:											
								Stephen McCaughey, P.Eng.				15 Oblats Ave., Ottawa, ON											
								Dwg. Reference:				File Ref.:		Date:		Sheet No.							
												221-02976-00		August 2022		2 of 3							

Note:  
135mm orifice plate on TANK outlet controlled to 52.25 L/s

100+20%yr Storm Sewer Design

LOCATION			FLOW									PIPE						MANHOLE		
Catchment Area	FROM MH	TO MH	Coefficient	Area (m2)	Indiv. 2.78*AC	Cum. 2.78*AC	Time of Conc. (min.)	Rainfall Intensity (mm.hr)	Indiv. Area Flow (L/s)	Cum. Flow (L/s)	Controlled Cum. Flow (L/s)	Length (m)	Dia. (mm)	Slope (%)	Cap. (Full) (L/s)	Velocity (Full) (m/s)	Time of flow (min.)	Ratio (Q/Qfull)	UP INVERT (m)	DOWN INVERT (m)
PR-003	CB3	BLDG	1.0	50	0.014	0.014	10.00	214.27	2.98	2.98	2.98	1.73	200	2.31%	49.87	1.6	0.02	6%	62.75	62.71
PR-002 & PR-004	BLDG	CBMH1	1.0	3100	0.862	0.862	10.02	214.07	184.49	187.47	187.47	8.55	375	1.99%	247.23	2.2	0.06	76%	61.92	61.75
PR-005	CBMH1	TANK	0.9	500	0.129	0.129	10.08	213.38	27.43	214.90	214.90	14.70	450	1.22%	315.49	2.0	0.12	68%	61.69	61.51
PR-006	CB2	TANK	0.7	900	0.178	0.178	10.00	214.27	38.20	38.20	38.20	1.60	200	1.88%	44.91	1.4	0.02	85%	61.54	61.51
	TANK	OGS	1.0	0	0.000	0.000	10.08	213.38	0.00	253.10	52.25	1.00	250	2.00%	84.10	1.7	0.01	62%	59.71	59.69
	OGS	EX 1350mm	1.0	0	0.000	0.000	10.09	213.27	0.00	253.10	52.25	10.6	250	12.55%	210.65	4.3	0.04	25%	59.69	58.36
DESIGN PARAMETERS								Designed:				PROJECT:								
Q = 2.78CIA where, Q = Peak flow in L/s A = Drainage area in ha I = Rainfall intensity (mm/hr) C = Runoff coefficient			Ottawa IDF Curve IDF Curve Equation (100yr storm) I = 1735.688/(T+6.014)^0.82 Min. velocity = 0.8 m/s Manning 'n' = 0.013					Erin Blanchette, P.Eng.				15 Oblats Ave. Residential Development								
								Checked:				LOCATION:								
								Stephen McCaughey, P.Eng.				15 Oblats Ave., Ottawa, ON								
								Dwg. Reference:				File Ref.:		Date:		Sheet No.				
												221-02976-00		August 2022		3 of 3				

Note:  
135mm orifice plate on TANK outlet controlled to 52.25 L/s



# E CORRESPONDENCES

**Pre-Application Consultation Meeting Notes**

**15 Oblats Avenue**

PC2021-0140

Thursday, May 27, 2021  
1:30-3pm via Microsoft Teams

---

**Attendees:**

*City of Ottawa:*

Andrew McCreight, File Lead  
Holly Newitt, Planning student  
Josiane Gervais, Transportation  
Luis Juarez, Heritage  
Mark Richardson, Forestry  
Nishant Jhamb, Engineering  
Randolph Wang, Urban Design

*Applicant Team:*

Lisa Dalla Rosa  
Brian Casagrande  
Jeremy Silburt  
Aly Damji  
Ryan Denyer  
Andrew Levitan

*Community Association Representative:*

Paul Goodkey  
Phyllis Odenbach-Sutton

---

**Subject: 15 Oblats**

**Meeting Notes:**

**Opening & attendee introduction**

- Introduction of meeting attendees
- Confirmation that the Community Association representatives are subject to Non-Disclaimer Agreements (NDA).
- If it is intended to speak with the broader Community Association or general public, please consider waiving the NDA requirements for this proposal.

## Proposal Overview (Applicant Team)

*Note: Presentation provided (requested for sharing post meeting)*

### Ryan Denver, Smart Living Properties & Aly Damji, Forum

- Introduction of Forum and Smart Living Properties
  - Forum Equity Partners = Toronto based private equity firm, private and public partnerships
  - Smart Living Properties = Ottawa-based real estate development company
    - Specialize in fully furnished, all-inclusive rental buildings
  - 3<sup>rd</sup> project of the partnership within Ottawa
    - Focused on adaptive reuse
    - Smaller than average units with larger amenity spaces that are more financially attainable

### Lisa Dalla Rosa, Fotenn

- Site history & context of the neighbourhood
  - Building not defined as historic but there are conditions regarding a statue
  - Highly walkable
  - Majority of surrounding options are condos and larger units that are more expensive
- Currently designated General Urban Area
  - Supports heights up to 4 storeys
- Subject to Old Ottawa East Secondary Plan
  - Residential low-rise on Springhurst
  - Residential mid-rise on Oblats
- Recent BHSC direction on the statue and heritage commemoration
- Split Zoning on site
  - R4-UD on Springhurst
  - R5 on Oblats
- Potential Development Options were created and debated
  - Proposed development is a hybrid
- 340 units, reduced parking, reduced 2-bedroom units (R4)
- Proposal will require zoning change for a reduction in parking spaces and reduction in provided 2-bedroom units (R4 requirement)
  - All parking is surface parking
  - Biking parking of .5 per unit
- Amenities intended for residents only; pool, gym, other co-living lifestyle features.
  - 87 Mann is Ottawa example of building type with furnished suites etc.
- Pathway / parkette will connect Springhurst and Oblats along the West side of the property
  - Including a new statue location and informative plaque
- Cantilevered units to complete Springhurst streetscape and reduce visual of surface parking
- Façade on Springhurst a mix of red brick and more modern materiality

- Limited changes to Oblats façade
- Timeline = Move-in 2024

### Clarification Questions (at meeting)

- Any non-residential uses proposed beyond amenities for tenants?
  - Tenants only.
- Did you mention a pathway connection?
  - Yes, along west side of property.
- Phyllis
  - Springhurst units – where are the basement suites in images?
    - Will need clarify on the basement units
  - Pool image shows basement windows
- Randolph
  - Parapet height – 2ft
  - Existing elevators? – yes, in middle of “T”
  - Setback on addition to west side. About 5m setback.
  - Parking along Oblates – existing? And expanding. For visitor or resident.... Intended for visitor use. 16 spaces current exist, we are adding 5.
  - Where is main entrance?
    - Oblates middle
- Luis
  - Is exterior architecture being retained. Yes, that is the intent. Some to be rpac

### Technical Comments

#### Luis Juarez, Heritage

##### Adaptive Reuse of the Convent

- Heritage staff are supportive of the adaptive reuse of the existing convent building for new residential and associated amenity uses.
- Staff do not object to new additions to the existing building subject to design refinements suggested by Urban Design and Development Review Staff. In any case, the additions should be located away from the Oblats frontage, complimentary and subordinate to the existing convent, and of their own time.
- Please indicate which (if any) architectural design features will be altered or removed as part of this development (i.e. confirm if windows/doors will be replaced, etc.).
- A conservation plan will be required to outline the conservation approach for the property. In addition to describing the conservation and relocation approach for the statue, the plan should also describe how the covenant building and its design features

will be preserved or restored, and outline recommendations for the long-term maintenance of the property's heritage value.

#### Proposed Statue and Garden Relocation and Commemoration

- Heritage staff are not opposed to the relocation of the statue along des Oblats Avenue as proposed, or along the Springhurst Avenue bend to facilitate the additions. In any case, the statue's location should be highly visible and accessible to the public.
- Ensure that the statue is protected during its relocation and that it be restored to its original condition once relocated if required. The relocation approach should be detailed in the conservation plan.
- The Ottawa East Secondary Plan mentions a grove of trees that were transplanted to the statue's current location. Clarify if these trees remain, and if so, if they can be transplanted to the statue's proposed location. The statue area shall be well landscaped to maintain the essence of the prayer garden that currently exists.
- The April 2021 BHSC motion requests a meaningful commemoration component be added to the property. A plaque and/or interpretation panel should be erected alongside the statue to commemorate the Order and their work in education, health care and social services in Ottawa East. Heritage Staff would like to work with the Applicant on the content of the commemoration component.

#### Nishant Jhamb, Engineering

Please forward the below information to the applicant regarding a development proposal at **15 Oblates Ave to convert the existing building to approximately 176 rental apartments and then construct 2 additions on to the north side for a further 158 units**. Note that the information is considered **preliminary** and the assigned Development Review Project Manager may modify and/or add additional requirements and conditions upon review of an application if deemed necessary.

#### **General:**

- It is the sole responsibility of the consultant to investigate the location of existing underground utilities in the proposed servicing area and submit a request for locates to avoid conflict(s). The location of existing utilities and services shall be documented on an **Existing Conditions Plan**.
- Any easements on the subject site shall be identified and respected by any development proposal and shall adhere to the conditions identified in the easement agreement. A **legal survey plan** shall be provided and all easements shall be shown on the engineering plans.
- A deep excavation and dewatering operations have the potential to cause damages to the neighboring adjacent buildings/ City infrastructure. Document that construction activities (excavation, dewatering, vibrations associated with construction, etc.) will not have an impact on any adjacent buildings and infrastructure.
- A **Record of Site Condition (RSC) in accordance with O.Reg. 153/04** will be required to be filed and acknowledged by the Ministry prior to issuance of a building permit due to a change to a more sensitive property use.
- Existing sanitary and storm service require a CCTV inspection and report to ensure existing services to be re-used are in good working order and meet current minimum size requirements. Located services to be placed on site servicing plans.

- All underground and above ground building footprints and permanent walls need to be shown on the plans to confirm that any permanent structure does not extend either above or below into the existing property lines and sight triangles.
- Reference documents for information purposes:
  - Ottawa Sewer Design Guidelines (October 2012)
  - Technical Bulletin PIEDTB-2016-01
  - Technical Bulletins ISTB-2018-01, ISTB-2018-02 and ISTB-2018-03.
  - Ottawa Design Guidelines - Water Distribution (2010)
  - Geotechnical Investigation and Reporting Guidelines for Development Applications in the City of Ottawa (2007)
  - City of Ottawa Slope Stability Guidelines for Development Applications (revised 2012)
  - City of Ottawa Environmental Noise Control Guidelines (January 2016)
  - City of Ottawa Accessibility Design Standards (2012) (City recommends development be in accordance with these standards on private property)
  - Ottawa Standard Tender Documents (latest version)
  - Ontario Provincial Standards for Roads & Public Works (2013)

Record drawings and utility plans are also available for purchase from the City (Contact the City's Information Centre by email at [InformationCentre@ottawa.ca](mailto:InformationCentre@ottawa.ca) or by phone at (613) 580-424 x.44455).

Please note that this is the applicant responsibility to refer to the latest applicable guidelines while preparing reports and studies.



**Disclaimer:**

*The City of Ottawa does not guarantee the accuracy or completeness of the data and information contained on the above image(s) and does not assume any responsibility or liability with respect to any damage or loss arising from the use or interpretation of the image(s) provided. This image is for schematic purposes only.*

**Stormwater Management Criteria and Information:**

- **Water Quantity Control:** In the absence of area specific SWM criteria please control post-development runoff from the subject site, up to and including the **100-year storm event**, to a **2-year pre-development level**. The pre-development runoff coefficient will need to be determined **as per existing conditions** but in no case more than 0.5. **[If 0.5 applies it needs to be clearly demonstrated in the report that the pre-development runoff coefficient is greater than 0.5]**. The time of concentration ( $T_c$ ) used to determine the pre-development condition should be calculated.  *$T_c$  should not be less than 10 min. since IDF curves become unrealistic at less than 10 min;  $T_c$  of 10 minutes shall be used for all post-development calculations*.
- Any storm events greater than the established **2-year allowable** release rate, up to and including the **100-year storm event**, shall be detained on-site. The SWM measures required to avoid impact on downstream sewer system will be subject to review.
- Document how any foundation drainage system will be integrated into the servicing design and show the positive outlet on the plan. Foundation drainage is to be independently connected to sewer main unless being pumped with appropriate back up power, sufficient sized pump and back flow prevention. **It is recommended that the foundation drainage system be drained by a sump pump connection to the storm sewer to minimize risk of basement flooding as it will provide the best protection from the uncontrolled sewer system compared to relying on the backwater valve.**
- **Water Quality Control:** Please consult with the local conservation authority (RVCA) regarding water quality criteria prior to submission of a Site Plan Control Proposal application to establish any water quality control restrictions, criteria and measures for the site. Correspondence and clearance shall be provided in the Appendix of the report.
- Please note that as per *Technical Bulletin PIEDTB-2016-01 section 8.3.11.1 (p.12 of 14)* **there shall be no surface ponding on private parking areas during the 5-year storm rainfall event.**
- **Underground Storage:** If underground storage is proposed please note that the Modified Rational Method for storage computation in the Sewer Design Guidelines was originally intended to be used for above ground storage (i.e. parking lot) where the change in head over the orifice varied from 1.5 m to 1.2 m (assuming a 1.2 m deep CB and a max ponding depth of 0.3 m). This change in head was small and hence the release rate fluctuated little, therefore there was no need to use an average release rate.
- When underground storage is used, the release rate fluctuates from a maximum peak flow based on maximum head down to a release rate of zero. This difference is large and has a significant impact on storage requirements. **We therefore require that an average release rate equal to 50% of the peak allowable rate shall be applied to estimate the required volume. Alternatively, the consultant may choose to use a submersible pump in the design to ensure a constant release rate.**
  - In the event that there is a disagreement from the designer regarding the required storage, The City will require that the designer demonstrate their rationale utilizing dynamic modelling, that will then be reviewed by City modellers in the Water Resources Group.
  - Provide information on type of underground storage system including product name and model, number of chambers, chamber configuration, confirm invert of chamber system, top of chamber system, required cover over system and details, interior bottom slope (for self-cleansing), chart of storage values, length, width and height, capacity, entry ports (maintenance) etc. UG storage to provide actual 2- and 100-year event storage requirements.

- In regard to all proposed UG storage, ground water levels (and in particular HGW levels) will need to be reviewed to ensure that the proposed system does not become surcharged and thereby ineffective.
- Modeling can be provided to ensure capacity for both storm and sanitary sewers for the proposed development by City's Water Distribution Dept. – Modeling Group, through PM and upon request.
- Minimum orifice dia. for a plug style **ICD is 83mm and the minimum flow rate from a vortex ICD is 6 L/s** in order to reduce the likelihood of plugging.
- Post-development site grading shall match existing property line grades in order to minimize disruption to the adjacent residential properties. A **topographical plan of survey** shall be provided as part of the submission and a note provided on the plans.
- Please provide a **Pre-Development Drainage Area Plan** to define the pre-development drainage areas/patterns. **Existing drainage patterns shall be maintained and discussed as part of the proposed SWM solution.**
- If **rooftop control** and storage is proposed as part of the SWM solutions sufficient details (Cl. 8.3.8.4) shall be discussed and document in the report and on the plans. Roof drains are to be connected downstream of any incorporated ICDs within the SWM system and not to the foundation drain system. Provide a **Roof Drain Plan** as part of the submission.
- If **Window wells** are proposed, they are to be indirectly connected to the footing drains. A detail of window well with indirect connection is required, as is a note at window well location speaking to indirect connection.
- There must be at least **15cm of vertical clearance** between the spill elevation and the ground elevation at the building envelope that is in proximity of the flow route or ponding area. The exception in this case would be at reverse sloped loading dock locations. At these locations, a minimum of 15cm of vertical clearance must be provided below loading dock openings. Ensure to provide discussion in report and ensure grading plan matches if applicable.
- Rear yard on grade parking to be permeable pavement. Refer to City Standard Detail Drawings SC26 (maintenance/temp parking areas), SC27 or permeable asphalt materials. No gravel or stone dust parking areas permitted.
- Street catchbasins are not to be located at any proposed entrances.

#### **Storm Sewer:**

- 1350mm Conc (1965) is available on Springhurst Ave. and 375mm PVC(2017) is available on Oblats Ave.
- A storm sewer monitoring maintenance hole is required to be installed at the property line (on the private side of the property) as per City of Ottawa Sewer-Use By-Law 2003-514 (14) *Monitoring Devices*.

#### **Sanitary Sewer**

- A 450mm Conc(1934) is present on Springhurst Ave. and 250mm PVC(2017) available on Oblats Ave.
- Please provide the new Sanitary sewer discharge and we confirm if sanitary sewer main has the capacity.
- Please apply the wastewater design flow parameters in *Technical Bulletin PIEDTB-2018-01*.



- Sanitary sewer monitoring maintenance hole is required to be installed at the property line (on the private side of the property) as per City of Ottawa Sewer-Use By-Law 2003-514 (14) *Monitoring Devices*.
- A backwater valve is required on the sanitary service for protection.
- Include correspondence from the Architect within the Appendix of the report confirming the number of residential units per building **and a unit type breakdown for each of the buildings** to support the calculated building populations.

### Water

- A 200 mm dia. PVC watermain (2011) is available within Springhurst Ave and 254mm PVC(2017) is available on Oblats
- Existing residential service to be blanked at the main.
- **Water Supply Redundancy:** Residential buildings with a basic day demand greater than 50m<sup>3</sup>/day (0.57 L/s) are required to be connected to a minimum of two water services separated by an isolation valve to avoid a vulnerable service area as per the *Ottawa Design Guidelines - Water Distribution, WDG001, July 2010 Clause 4.3.1 Configuration*. The basic day demand for this site not expected to exceed 50m<sup>3</sup>/day.
- Please **review Technical Bulletin ISTB-2018-0**, maximum fire flow hydrant capacity is provided in Section 3 Table 1 of Appendix I. A **hydrant coverage figure** shall be provided and **demonstrate there is adequate fire protection for the proposal**. Two or more public hydrants are anticipated to be required to handle fire flow.
- Boundary conditions are required to confirm that the require fire flows can be achieved as well as availability of the domestic water pressure on the City street in front of the development. Use Table 3-3 of the MOE Design Guidelines for Drinking-Water System to determine Maximum Day and Maximum Hour peaking factors for 0 to 500 persons and use Table 4.2 of the Ottawa Design Guidelines, Water Distribution for 501 to 3,000 persons. Please provide the following information to the City of Ottawa via email to request water distribution network boundary conditions for the subject site. Please note that once this information has been provided to the City of Ottawa it takes approximately 5-10 business days to receive boundary conditions.
  - Type of Development and Units
  - Site Address
  - A plan showing the proposed water service connection location.
  - **Average Daily Demand** (L/s)
  - **Maximum Daily Demand** (L/s)
  - **Peak Hour Demand** (L/s)
  - **Fire Flow** (L/min)
    - [*Fire flow demand requirements shall be based on **Fire Underwriters Survey (FUS) Water Supply for Public Fire Protection 1999***]
    - [*Exposure separation distances shall be defined on a figure to support the FUS calculation and required fore flow (RFF)*].
- **Hydrant capacity shall be assessed to demonstrate the RFF can be achieved.** Please identify which hydrants are being considered to meet the RFF on a fire hydrant coverage plan as part of the boundary conditions request.

### Snow Storage:

- Any portion of the subject property which is intended to be used for permanent or temporary snow storage shall be as shown on the approved site plan and grading plan. Snow storage shall not interfere with approved grading and drainage patters or

servicing. Snow storage areas shall be setback from the property lines, foundations, fencing or landscaping a minimum of 1.5m. Snow storage areas shall not occupy driveways, aisles, required parking spaces or any portion of a road allowance. If snow is to be removed from the site please indicate this on the plan(s).

**Wind impact on the pathway:**

- If the proposed building alignment is to stay the same as submitted during pre-consult meeting, please discuss the wind impacts on the proposed pathway on west side of the proposed building.

**Sensitive marine clay-**

- If Sensitive marine clay soils are present in this area that are susceptible to soil shrinkage that can lead to foundation and building damages. All six (6) conditions listed in the Tree Planting in Sensitive Marine Clay Soils-2017 Guidelines are required to be satisfied. Note that if the plasticity index of the soil is determined to be less than 40% a minimum separation between a street tree and the proposed building foundations of 4.5m will need to be achieved. A memorandum addressing the Tree in Clay Soil Guidelines prepared by a geotechnical engineer is required to be provided to the City. <https://ottawa.ca/en/city-hall/planning-and-development/community-plans-and-design-guidelines/design-and-planning/completed-guidelines/tree-planting-sensitive-marine-clay-soils-2017-guidelines>

**Severance:**

- If severance is planned, this needs to be addressed in servicing to satisfy severance requirements. Where a large parcel with multiple buildings is planned, City will require an ultimate servicing plan so as to appropriately understand how severance requirements are being met.

**Gas pressure regulating station**

- A gas pressure regulating station may be required depending on HVAC needs (typically for 12+ units). Be sure to include this on the Grading, Site Servicing, SWM and Landscape plans. This is to ensure that there are no barriers for overland flow routes (SWM) or conflicts with any proposed grading or landscape features with installed structures and has nothing to do with supply and demand of any product.



Gas Pressure  
Regulating Station.pdf

**Source Protection Policy Screening (SPPS):**

- Here is a summary of the Source Protection policy screening for 15 Oblats Ave.
  - The address lies within the Mississippi-Rideau Source Protection Region and is subject to the policies of the Mississippi-Rideau Source Protection Plan.
  - The area is not located within a Surface Water Intake Protection Zone (IPZ) where significant threat policies apply.
  - The area is not located within a Wellhead Protection Area (WHPA).
  - The area is not located within a Significant Groundwater Recharge Area (SGRA).

- The area is located within a Highly Vulnerable Aquifer (HVA). There are no legally-binding source protection policies related to activities within Highly Vulnerable Aquifers.
- In terms of the development application, please note that the address is not located in an area where activities could be considered a significant threat to drinking water sources and there are no legally-binding source protection policies

### **CCTV sewer inspection**

- CCTV sewer inspection required for pre and post construction conditions to ensure no damage to City Assets surrounding site.

### **Pre-Construction Survey**

- Pre-Construction (Piling/Hoe Ramming or close proximity to City Assets) and/or Pre-Blasting (if applicable) Survey required for any buildings/dwellings in proximity of 75m of site and circulation of notice of vibration/noise to residents within 150 m of site. Conditions for Pre-Construction/ Pre-Blast Survey & Use of Explosives will be applied to agreements. Refer to City's Standard S.P. No. F-1201 entitled Use of Explosives, as amended.

### **Road Reinstatement**

- Where servicing involves three or more service trenches, either a full road width or full lane width 40 mm asphalt overlay will be required, as per amended Road Activity By-Law 2003-445 and City Standard Detail Drawing R10. The amount of overlay will depend on condition of roadway and width of roadway(s).  
<https://ottawa.ca/en/business/permits-and-licenses/right-way/road-cut-permit#resurfacing-requirement>

### **Required Engineering Plans and Studies:**

- **Plans:**
  - Existing Conditions and Removals Plan
  - Site Servicing Plan
  - Grade Control and Drainage Plan
  - Erosion and Sediment Control Plan
  - Roof Drainage Plan
  - Foundation Drainage System Detail (if applicable)
  - Topographical survey
- **Reports:**
  - Site Servicing and Stormwater Management Report
  - Geotechnical Study/Investigation
  - Noise Control Study
  - Phase I ESA
  - Phase II ESA (Depending on recommendations of Phase I ESA)
  - RSC ( Record of the site Conditions)
  - Site lighting certificate
- Please refer to the **City of Ottawa Guide to Preparing Studies and Plans [Engineering]:**

- Specific information has been incorporated into both the [Guide to Preparing Studies and Plans](#) for a site plan. The guide outlines the requirement for a statement to be provided on the plan about where the property boundaries have been derived from.
- Added to the general information for servicing and grading plans is a note that an O.L.S. should be engaged when reporting on or relating information to property boundaries or existing conditions. The importance of engaging an O.L.S. for development projects is emphasized.

#### **Phase One Environmental Site Assessment:**

- A Phase I ESA is required to be completed in accordance with Ontario Regulation 153/04 in support of this development proposal to determine the potential for site contamination. Depending on the Phase I recommendations a Phase II ESA may be required.
- The Phase I ESA shall provide all the required Environmental Source Information as required by O. Reg. 153/04. ERIS records are available to public at a reasonable cost and need to be included in the ESA report to comply with O.Reg. 153/04 and the Official Plan. The City will not be in a position to approve the Phase I ESA without the inclusion of the ERIS reports.
- Official Plan Section 4.8.4: <https://ottawa.ca/en/city-hall/planning-and-development/official-plan-and-master-plans/official-plan/volume-1-official-plan/section-4-review-development-applications#4-8-protection-health-and-safety>

#### **RSC ( Record of the site Conditions)**

- A RSC is required when changing the land use (zoning) of a property to a more sensitive land use and **a memorandum prepared by an environmental consultant confirming that no potential contaminating activities have taken place within the RSC area since the filling of the RSC.**  
[Submitting a record of site condition | Ontario.ca](#)

#### **ECA application**

- The consultant shall determine if this project will be subject to an Environmental Compliance Approval (ECA) for Private Sewage Works. It shall be determined if the exemptions set out under Ontario Regulation 525/98: *Approval Exemptions* are satisfied. All regulatory approvals shall be documented and discussed in the report. If the SWM works and lateral are servicing one parcel of land under one ownership an ECA would not be required. Environmental Compliance Approval (ECA) for stormwater works the services more than one parcel of land.  
[Environmental Compliance Approval | Ontario.ca](#)

#### **Geotechnical Investigation:**

- A Geotechnical Study/Investigation shall be prepared in support of this development proposal.
- Reducing the groundwater level in this area can lead to potential damages to surrounding structures due to excessive differential settlements of the ground. The impact of groundwater lowering on adjacent properties needs to be discussed and investigated to ensure there will be no short term and long term damages associated with lowering the groundwater in this area.
- Geotechnical Study shall be consistent with the **Geotechnical Investigation and Reporting Guidelines for Development Applications.**

<https://documents.ottawa.ca/sites/default/files/documents/cap137602.pdf>

#### **Noise Study:**

- A **Transportation Noise Assessment** is required as the subject development is located within 100m proximity of Main street
- A **Stationary Noise Assessment** is required in order to assess the noise impact of the proposed sources of stationary noise (mechanical HVAC system/equipment) of the development onto the surrounding residential area to ensure the noise levels do not exceed allowable limits specified in the City Environmental Noise Control Guidelines. [https://documents.ottawa.ca/sites/default/files/documents/enviro\\_noise\\_guide\\_en.pdf](https://documents.ottawa.ca/sites/default/files/documents/enviro_noise_guide_en.pdf)

#### **Exterior Site Lighting:**

- Any proposed light fixtures (both pole-mounted and wall mounted) must be part of the approved Site Plan. All external light fixtures must meet the criteria for Full Cut-off Classification as recognized by the Illuminating Engineering Society of North America (IESNA or IES), and must result in minimal light spillage onto adjacent properties (as a guideline, 0.5 fc is normally the maximum allowable spillage). In order to satisfy these criteria, the please provide the City with a Certification (Statement) Letter from an acceptable professional engineer stating that the design is compliant.

#### **Fourth (4<sup>th</sup>) Review Charge:**

- Please be advised that additional charges for each review, after the 3<sup>rd</sup> review, will be applicable to each file. There will be no exceptions.

#### **Construction approach**

- Please contact the Right-of-Ways Permit Office [TMconstruction@ottawa.ca](mailto:TMconstruction@ottawa.ca) early in the Site Plan process to determine the ability to construct site and copy File Lead on this request.

Please note that these comments are considered preliminary based on the information available to date and therefore maybe amended as additional details become available and presented to the City. It is the responsibility of the applicant to verify the above information. The applicant may contact me for follow-up questions related to engineering/infrastructure prior to submission of an application if necessary.

#### Josiane Gervais, Transportation

- Follow Traffic Impact Assessment Guidelines
  - A full TIA is required. Please feel free to submit the Scoping report to [Josiane.Gervais@ottawa.ca](mailto:Josiane.Gervais@ottawa.ca) at your earliest convenience.
  - Start this process asap. The application will not be deemed complete until the submission of the draft step 1-4, including the functional draft RMA package (if applicable) and/or monitoring report (if applicable).
  - Request base mapping asap if RMA is required. Contact Engineering Services (<https://ottawa.ca/en/city-hall/planning-and-development/engineering-services>)
  - An update to the *TRANS Trip Generation Manual* has been completed (October 2020). This manual is to be utilized for this TIA. A copy of this document can be provided upon request.
- Sidewalks along Oblats and Springhurst are required.

- The parking on Oblats as shown would require a depressed sidewalk and depressed curb along a large portion of the frontage, which would not be supported. In addition, the parking stalls are across from the Oblats/Deschatelets intersection as presented and would result in vehicles having to back out of parking stalls through this intersection which is undesirable.
- Private accesses must meet the Private Approach Bylaw.
- Because a reduction in parking is sought, the TIA and application should clearly demonstrate if/how Transportation Demand Management measures are to be provided. As an example, providing 1 bike stall per unit would be encouraged.
- On site plan:
  - Show all details of the roads abutting the site up to and including the opposite curb; include such items as pavement markings, accesses and/or sidewalks.
  - Turning movement diagrams required for all accesses showing the largest vehicle to access/egress the site.
  - Turning movement diagrams required for internal movements (loading areas, garbage).
  - Show all curb radii measurements; ensure that all curb radii are reduced as much as possible.
  - Show lane/aisle widths.
  - Sidewalk is to be continuous across accesses as per City Specification 7.1.
  - Grey out any area that will not be impacted by this application.
- As the site proposed is residential, AODA legislation applies for all areas accessible to the public and visitors (i.e. outdoor pathways a minimum width of 1.5m, accessible parking stalls and access aisles, etc.). Consider using the City's Accessibility Design Standards.

#### Andrew McCreight, Planning

- Plan and study list combined for concurrent SPC and ZBLA submission.
- Site is split zoned – there is a holding symbol on the property that will not be lifted until a site plan application is approved. See urban exceptions 1848 and 1846
- There is a zoning provision that includes lands west to Main Street – One lot for zoning purposes causes some confusion – you may want to include more detail in your ZBLA to make it part of the review.
- Secondary Plan
  - Schedule A - Split designation – Res low-rise (Springhurst), Res mid-rise (Oblates)
  - 10.2.2 – “3.An architectural conservation study will be undertaken with respect to any proposal for redevelopment of a property that is included on the Heritage Reference List as shown on 3.11 Heritage Resource Strategy. The study will determine the suitability of the existing buildings and landscape features for conservation or adaptive reuse as part of any redevelopment proposal. This study will be submitted as part of a Site Plan Control application.” - Luis – apply?
  - Affordable Housing is encouraged. If rental, will some units be offered below AMR?
  - See 10.3.4 East side of Main Street Springhurst to Clegg, and as further detailed in the CDP.
  - Holding in SP

- Site Plan Control application is approved that includes this entire area and fulfils the following conditions:
    - Stormwater management for the subject lands;
    - Traffic impact analysis and management plan;
    - Water and sewer servicing design; and
    - Parkland and pathway dedication relative to the development of the subject site.
  - Locate parking for the medium-rise buildings primarily below grade. Where necessary, surface parking related to all development in this precinct should be obscured from view by means such as placement behind buildings and landscaping.
  - Retain the statue of the Blessed Virgin and associated grove of trees to commemorate the Sisters of the Sacred Heart.
  - Architecture and materiality should reflect the areas character and history.
- Planning rationale – amenities must remain private to not trigger an OPA and further ZBLA. Clarify intent of amenities areas within the building.
- Secondary Plan - see Policy 10.2.2 – architectural conservation study
- Affordable housing is encouraged in the secondary plan – integrate in planning rationale
- East side of Mainstreet in Secondary plan – is very detailed in CDP
  - Secondary plan details holding process in more detail, will naturally happen through SPC
  - Parking provisions in there as well (primarily below grade),
  - Is the parking along Oblates historical or legally established?
    - Will need confirmation that existing parking is legal-non conforming? Staff will be looking for its removal and recapture this public realm with proper sidewalks and landscaping.
- Happy to see mid-block connection – make sure walkway is wide enough to have public engagement, to be owned and maintained privately, public access easement. Room for snow removal.
- More clarify required on basement units and how they related to height (storeys) and unit functionality.
- Tight relationship to western property; This is creates an undesirable built form relationship, and current design is not sensitively done.
- Internal courtyards seem tight – would like to see them open to east/west instead through re-design.
  - Resulting in an H-shape building, but less of a massing along Springhurst with the corners opened.
- Further analysis on sighting of the building needs to be done
- Statue should stay in the public realm – lots of opportunities on site for relocation while satisfying heritage direction (BHSC).
- Consider integrating car share services for any surface parking spots that remain (see Secondary Plan policies on parking)
- Looking for proposal to include good bicycle infrastructure and design. Ground floor room, visitor parking etc.
- Should consider increased bike parking to support active transportation development

- Current reduction in parking requires further analysis and rationale before reduction would be supported. What is the parking strategy and active transit support strategy for this development?
- Encouraged to design building for City direction on waste collection – will send guidelines
- Will let Randolph elaborate further on Urban design concerns.
- The two mature trees at corner of Springhurst should be preserved.

#### Mark Richardson, Forest

- The City encourages the retention of healthy, structurally sound trees; please seek opportunities for retention of trees that will contribute to the design/function of the site.
- A Tree Conservation Report (TCR) must be supplied for review along with the suite of other plans/reports required by the City
  - an approved TCR is a requirement of Site Plan approval.
- As of January 1 2021, any removal of privately-owned trees 10cm or larger in diameter, or publicly (City) owned trees of any diameter requires a tree permit issued under the Tree Protection Bylaw (Bylaw 2020 – 340); the permit will be based on an approved TCR and made available at or near plan approval.
- The Planning Forester from Planning and Growth Management as well as foresters from Forestry Services will review the submitted TCR
  - If tree removal is required, both municipal and privately-owned trees will be addressed in a single permit issued through the Planning Forester
  - Compensation may be required for city owned trees – if so, it will need to be paid prior to the release of the tree permit
- The TCR must list all trees on site by species, diameter and health condition
- Please identify trees by ownership – private onsite, private on adjoining site, city owned, co-owned (trees on a property line)
- The TCR must list all trees on adjacent sites if they have a critical root zone that extends onto the development site
- If trees are to be removed, the TCR must clearly show where they are, and document the reason they cannot be retained
- All retained trees must be shown and all retained trees within the area impacted by the development process must be protected as per City guidelines available at [Tree Protection Specification](#) or by searching Ottawa.ca
  - the location of tree protection fencing must be shown on a plan
  - show the critical root zone of the retained trees
  - if excavation will occur within the critical root zone, please show the limits of excavation
- For more information on the process or help with tree retention options, contact Mark Richardson [mark.richardson@ottawa.ca](mailto:mark.richardson@ottawa.ca) or on [City of Ottawa](#)

#### **LP tree planting requirements:**

For additional information on the following please contact [tracy.smith@Ottawa.ca](mailto:tracy.smith@Ottawa.ca)

- Minimum Setbacks
  - Maintain 1.5m from sidewalk or MUP/cycle track.
  - Maintain 2.5m from curb
  - Coniferous species require a minimum 4.5m setback from curb, sidewalk or MUP/cycle track/pathway.



- Maintain 7.5m between large growing trees, and 4m between small growing trees. Park or open space planting should consider 10m spacing.
- Adhere to Ottawa Hydro’s planting guidelines (species and setbacks) when planting around overhead primary conductors.
- Tree specifications
  - Minimum stock size: 50mm tree caliper for deciduous, 200cm height for coniferous.
  - Maximize the use of large deciduous species wherever possible to maximize future canopy coverage
  - Tree planting on city property shall be in accordance with the City of Ottawa’s Tree Planting Specification; and include watering and warranty as described in the specification (can be provided by Forestry Services).
  - Plant native trees whenever possible
  - No root barriers, dead-man anchor systems, or planters are permitted.
  - No tree stakes unless necessary (and only 1 on the prevailing winds side of the tree)

**Hard surface planting**

- Curb style planter is highly recommended
- No grates are to be used and if guards are required, City of Ottawa standard (which can be provided) shall be used.
- Trees are to be planted at grade

**Soil Volume**

- Please ensure adequate soil volumes are met:

Tree Type/Size	Single Tree Soil Volume (m3)	Multiple Tree Soil Volume (m3/tree)
Ornamental	15	9
Columnar	15	9
Small	20	12
Medium	25	15
Large	30	18
Conifer	25	15

Please note that these soil volumes are not applicable in cases with Sensitive Marine Clay.

**Sensitive Marine Clay**

- Please follow the City’s 2017 Tree Planting in Sensitive Marine Clay guidelines

### Randolph Wang, Urban Design

- The applicants' efforts of early engagement, the base-middle-top approach to architecture design, as well as the retaining and relocation of the statue are appreciated.
- There are some significant concerns on the overall building massing and site plan (see attached diagrams for reference):
  - The conflict between the proposed building and the existing condo building to the west due to the extreme close proximity of the buildings;
  - The conflict between the proposed building and the existing trees at the north west corner of the site.
  - The extended area of surface parking on Oblats.
- Considerations should be given to developing different massing and site plan options. The attached diagram illustrates one of the possible options where the proposed development and the existing building will form a new H shape building with reasonable setbacks from interior lot line as well as the existing trees.
- The Oblats front should be as "green" as possible. Efforts should be made to minimize and eliminate surface parking.
- A Design Brief is required as part of the submission. The Terms of Reference of the Design Brief is attached for convenience.

### **Preliminary Comments from Community Association Representative**

#### Phyllis

- We really want to see that the statue is retained, and the history of the sisters shared
- Really don't like parking along Oblats. This is generally discouraged in the area.
- Would like to encourage retention of trees
- Would like to clarify the use of the rooftop
- Highlight high quality landscaping within secondary plan
- Importance of community feeling along the pathway
- Concerned re garbage and intensity of development (number of units)
- Would like to highlight newly built rental
- Would also like to raise wheelchair accessibility and affordability
- Are there full kitchens within the units?
- Is there going to be HVAC
- Expects push-back from the community due to number of units
- Agree with the thought of an "H" and more greenery on corners.

#### Paul

- Would like to see more landscaping on the east and west of the lot
- Secondary plan targets 1000 units within area and this will drastically increase that
- Would like to see a reduction in the number of units to be more palatable
- Concerned with projections above the height limit re rooftop mechanical room
- Happy to see retention of the heritage building
- Would like mechanical in building and nor projections

**Next steps:**

- We encourage the applicant to discuss the proposal with the local Councillor and the community association
- We will follow up with meeting minutes and a list of required documents for the submission

**From:** Jhamb, Nishant <nishant.jhamb@ottawa.ca>  
**Sent:** June 13, 2022 1:54 PM  
**To:** Blanchette, Erin  
**Cc:** McCaughey, Stephen  
**Subject:** RE: Boundary Conditions Request - 15 Oblats Ave  
**Attachments:** [15 Oblats Avenue June 2022.pdf](#)

Hi Erin

The following are boundary conditions, HGL, for hydraulic analysis at 15 Oblats Avenue (zone 1W) assumed to be connected to the 203 mm watermain on Springhurst Avenue (see attached PDF for location).

Both Connections

Minimum HGL: 105.6 m

Maximum HGL: 115.0 m

Max Day + FF (350 L/s): 86.6 m

**As the fire demand is very high, Please provide Hydrant flow test results to determine the actual flow rate at which the water is available at the hydrants specified below.**

These are for current conditions and are based on computer model simulation.

*Disclaimer: The boundary condition information is based on current operation of the city water distribution system. The computer model simulation is based on the best information available at the time. The operation of the water distribution system can change on a regular basis, resulting in a variation in boundary conditions. The physical properties of watermains deteriorate over time, as such must be assumed in the absence of actual field test data. The variation in physical watermain properties can therefore alter the results of the computer model simulation.*

Thanks  
Nishant

---

**From:** Jhamb, Nishant  
**Sent:** June 06, 2022 3:17 PM  
**To:** Blanchette, Erin <[Erin.Blanchette@wsp.com](mailto:Erin.Blanchette@wsp.com)>  
**Cc:** McCaughey, Stephen <[Stephen.McCaughey@wsp.com](mailto:Stephen.McCaughey@wsp.com)>  
**Subject:** RE: Boundary Conditions Request - 15 Oblats Ave

Hello Erin, Thank you for your patience .

We are considering the operational challenges in meeting such extreme fire demands. 21,000 L/Min is still very, very high and fire fighters would have to rely on a setup that would maximize the utilization from available 6 hydrants.

Please give some more time to respond to this request. Just a heads up that Hydrant flow testing on all 6 hydrants will be required as a second step. I will let you know when I receive an ok to proceed to the second step.

Thanks  
Nishant

---

**From:** Blanchette, Erin <[Erin.Blanchette@wsp.com](mailto:Erin.Blanchette@wsp.com)>  
**Sent:** June 02, 2022 11:24 AM  
**To:** Jhamb, Nishant <[nishant.jhamb@ottawa.ca](mailto:nishant.jhamb@ottawa.ca)>  
**Cc:** McCaughey, Stephen <[Stephen.McCaughey@wsp.com](mailto:Stephen.McCaughey@wsp.com)>  
**Subject:** RE: Boundary Conditions Request - 15 Oblats Ave

**CAUTION: This email originated from an External Sender. Please do not click links or open attachments unless you recognize the source.**

**ATTENTION : Ce courriel provient d'un expéditeur externe. Ne cliquez sur aucun lien et n'ouvrez pas de pièce jointe, excepté si vous connaissez l'expéditeur.**

Based on our original estimate using City of Ottawa guidelines (see below) we found there was sufficient capacity to meet our demands.

Could you please clarify how the Water Resource engineer is coming to a different conclusion?  
Additionally, could you please indicate what capacity is available?

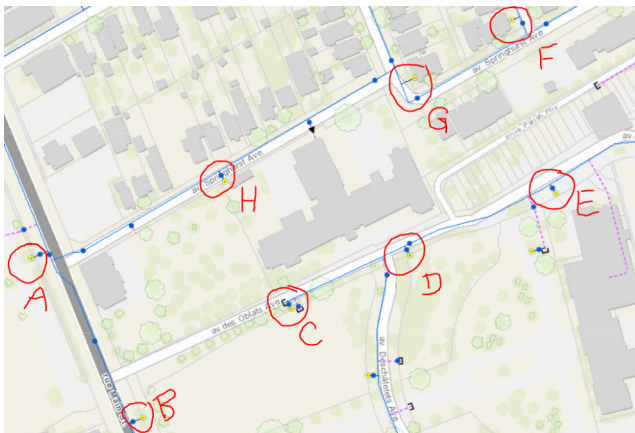

Hydrant	Dist. from bldg.	rating	rating est.	Flow contribution
A	168	AA		too far
B	154	X	AA	too far
C	59	X	AA	5700
D	46	X	AA	5700
E	117	AA		3800
F	138	AA		3800
G	80	AA		3800
H	65	X	AA	5700
<b>Total Flow Contribution (L/min)</b>				<b>28500</b>

Table 1. Maximum flow to be considered from a given hydrant

Hydrant Class	Distance to asset/structure/building (m) <sup>a</sup>	Contribution to required fire flow (L/min) <sup>b</sup>
AA	≤ 75	5,700
	> 75 and ≤ 150	3,800
A	≤ 75	3,800
	> 75 and ≤ 150	2,850
B	≤ 75	1,900
	> 75 and ≤ 150	1,500
C	≤ 75	800
	> 75 and ≤ 150	800

Thank you,  
Erin

---

**From:** Jhamb, Nishant <[nishant.jhamb@ottawa.ca](mailto:nishant.jhamb@ottawa.ca)>  
**Sent:** June 1, 2022 3:43 PM  
**To:** Blanchette, Erin <[Erin.Blanchette@wsp.com](mailto:Erin.Blanchette@wsp.com)>  
**Cc:** McCaughey, Stephen <[Stephen.McCaughey@wsp.com](mailto:Stephen.McCaughey@wsp.com)>  
**Subject:** RE: Boundary Conditions Request - 15 Oblats Ave

Hello Erin,

I have checked with the Water Resource engineer and they have confirmed that Fire request of 21000 L/min is way too much. Please look at ways to further reduce the fire demand.

Thanks  
Nishant

---

**From:** Blanchette, Erin <[Erin.Blanchette@wsp.com](mailto:Erin.Blanchette@wsp.com)>  
**Sent:** June 01, 2022 10:49 AM  
**To:** Jhamb, Nishant <[nishant.jhamb@ottawa.ca](mailto:nishant.jhamb@ottawa.ca)>  
**Cc:** McCaughey, Stephen <[Stephen.McCaughey@wsp.com](mailto:Stephen.McCaughey@wsp.com)>  
**Subject:** RE: Boundary Conditions Request - 15 Oblats Ave

**CAUTION: This email originated from an External Sender. Please do not click links or open attachments unless you recognize the source.**

**ATTENTION : Ce courriel provient d'un expéditeur externe. Ne cliquez sur aucun lien et n'ouvrez pas de pièce jointe, excepté si vous connaissez l'expéditeur.**

We recently received clarification of the construction types of the existing building and are now better able to estimate the fire flow demand.

Please see attached the updated calculations which show a decrease of 200L/s.

Please confirm the boundary conditions, and whether the existing hydrants in the area can accommodate this demand.

Let me know if you require any additional information.

Thank you,

Erin

---

**From:** Jhamb, Nishant <[nishant.jhamb@ottawa.ca](mailto:nishant.jhamb@ottawa.ca)>

**Sent:** May 11, 2022 1:27 PM

**To:** McCaughey, Stephen <[Stephen.McCaughey@wsp.com](mailto:Stephen.McCaughey@wsp.com)>

**Cc:** Blanchette, Erin <[Erin.Blanchette@wsp.com](mailto:Erin.Blanchette@wsp.com)>

**Subject:** RE: Boundary Conditions Request - 15 Oblats Ave

Hello Stephen

The following are boundary conditions, HGL, for hydraulic analysis at 15 Oblats Avenue (zone 1W) assumed to be connected to the 203 mm watermain on Springhurst Avenue (see attached PDF for location).

Both Connections

Minimum HGL: 105.6 m

Maximum HGL: 115.0 m

The hydrants provided below all flowing at full capacity can't meet the fire demand of 33,000 L/min.

*Disclaimer: The boundary condition information is based on current operation of the city water distribution system. The computer model simulation is based on the best information available at the time. The operation of the water distribution system can change on a regular basis, resulting in a variation in boundary conditions. The physical properties of watermains deteriorate over time, as such must be assumed in the absence of actual field test data. The variation in physical watermain properties can therefore alter the results of the computer model simulation.*

Thanks

Nishant

---

**From:** McCaughey, Stephen <[Stephen.McCaughey@wsp.com](mailto:Stephen.McCaughey@wsp.com)>

**Sent:** May 11, 2022 1:19 PM

**To:** Jhamb, Nishant <[nishant.jhamb@ottawa.ca](mailto:nishant.jhamb@ottawa.ca)>; Blanchette, Erin <[Erin.Blanchette@wsp.com](mailto:Erin.Blanchette@wsp.com)>

**Subject:** RE: Boundary Conditions Request - 15 Oblats Ave

**CAUTION: This email originated from an External Sender. Please do not click links or open attachments unless you recognize the source.**

**ATTENTION : Ce courriel provient d'un expéditeur externe. Ne cliquez sur aucun lien et n'ouvrez pas de pièce jointe, excepté si vous connaissez l'expéditeur.**

Note it was based on very conservative assumptions about the existing building.

In the meantime will the average day and peak hour boundary conditions still be provided, please?

Thank you,

**Stephen McCaughey, P.Eng., PMP**

T +1 613-690-3955 (Direct)

T +1 613-829-2800 (Office)



---

**From:** Jhamb, Nishant <[nishant.jhamb@ottawa.ca](mailto:nishant.jhamb@ottawa.ca)>

**Sent:** Tuesday, May 10, 2022 11:06 AM

**To:** Blanchette, Erin <[Erin.Blanchette@wsp.com](mailto:Erin.Blanchette@wsp.com)>

**Cc:** McCaughey, Stephen <[Stephen.McCaughey@wsp.com](mailto:Stephen.McCaughey@wsp.com)>

**Subject:** RE: Boundary Conditions Request - 15 Oblats Ave

Hello Erin,

The hydrants provided below all flowing at full capacity can't meet the fire demand of 33,000 L/min. Please look at ways of reducing the fire demand.

Regards

Nishant Jhamb, P.Eng

Project Manager | Gestionnaire de projet

Planning, Real Estate and Economic Development Department

Development Review - Central Branch

City of Ottawa | Ville d'Ottawa

110 Laurier Avenue West Ottawa, ON | 110, avenue. Laurier Ouest. Ottawa (Ontario) K1P 1J1

613.580.2424 ext./poste 23112, [nishant.jhamb@ottawa.ca](mailto:nishant.jhamb@ottawa.ca)



---

**From:** Jhamb, Nishant  
**Sent:** May 04, 2022 3:00 PM  
**To:** Blanchette, Erin <[Erin.Blanchette@wsp.com](mailto:Erin.Blanchette@wsp.com)>  
**Cc:** McCaughey, Stephen <[Stephen.Mccaughey@wsp.com](mailto:Stephen.Mccaughey@wsp.com)>  
**Subject:** RE: Boundary Conditions Request - 15 Oblats Ave

Hello Erin

Sanitary main has the capacity to take 5.59L/s from the proposed development.

I will get back to you with the boundary conditions. Please note it may take up to 2 weeks to get the boundary conditions.

Thanks  
Nishant

---

**From:** Blanchette, Erin <[Erin.Blanchette@wsp.com](mailto:Erin.Blanchette@wsp.com)>  
**Sent:** May 04, 2022 11:49 AM  
**To:** Jhamb, Nishant <[nishant.jhamb@ottawa.ca](mailto:nishant.jhamb@ottawa.ca)>  
**Cc:** McCaughey, Stephen <[Stephen.Mccaughey@wsp.com](mailto:Stephen.Mccaughey@wsp.com)>  
**Subject:** RE: Boundary Conditions Request - 15 Oblats Ave

**CAUTION: This email originated from an External Sender. Please do not click links or open attachments unless you recognize the source.**

**ATTENTION : Ce courriel provient d'un expéditeur externe. Ne cliquez sur aucun lien et n'ouvrez pas de pièce jointe, excepté si vous connaissez l'expéditeur.**

Thank you for making us aware of the updated FUS guide.

Our calculations are revised and attached to meet the new requirements. The revisions have increased the fire flow from 27,000 L/min to 33,000 L/min.

Please note that the proposed addition and the existing retrofitted buildings were treated separately since they are fire separated and are classified under different construction coefficients. You will notice that for the existing building 100% of all floor areas were considered, whereas for the addition, only the single largest floor plus 25% of each of the two immediately adjoining floors were considered, per the new FUS guide.

If you're also able to confirm that the sanitary sewer on Springhurst will have adequate downstream capacity given the estimated discharge provided in a previous email that would be much appreciated.

Please let me know if you have any questions/concerns, or if you require any additional information.

Thank you,  
Erin

---

**From:** Jhamb, Nishant <[nishant.jhamb@ottawa.ca](mailto:nishant.jhamb@ottawa.ca)>  
**Sent:** April 22, 2022 4:27 PM  
**To:** Blanchette, Erin <[Erin.Blanchette@wsp.com](mailto:Erin.Blanchette@wsp.com)>  
**Cc:** McCaughey, Stephen <[Stephen.McCaughey@wsp.com](mailto:Stephen.McCaughey@wsp.com)>  
**Subject:** RE: Boundary Conditions Request - 15 Oblats Ave

Hello Erin, As per the **new FUS guide** for Water supply for public fire protection, 100% of all floor areas are to be considered for this building . Can you please confirm that Gross area in your calculation includes all floor areas.

If not can you please resubmit the calculations.

Here is snip from FUS guideline

---

**Total Effective Area (A)**

To determine a required fire flow for an individual building, the Total Effective Area that would be affected during the design fire must be determined. The Total Effective Area is the largest Floor Area (in square metres) plus the following percentages of the total area of the other floors:

- 1) For a building classified with a Construction Coefficient from 1.0 to 1.5:
  - a) 100% of all Floor Areas are considered in determining the Total Effective Area to be used in the formula.

Thanks  
Nishant

---

**From:** Blanchette, Erin <[Erin.Blanchette@wsp.com](mailto:Erin.Blanchette@wsp.com)>  
**Sent:** April 11, 2022 11:28 AM  
**To:** Jhamb, Nishant <[nishant.jhamb@ottawa.ca](mailto:nishant.jhamb@ottawa.ca)>  
**Cc:** McCaughey, Stephen <[Stephen.McCaughey@wsp.com](mailto:Stephen.McCaughey@wsp.com)>  
**Subject:** RE: Boundary Conditions Request - 15 Oblats Ave

**CAUTION: This email originated from an External Sender. Please do not click links or open attachments unless you recognize the source.**

**ATTENTION : Ce courriel provient d'un expéditeur externe. Ne cliquez sur aucun lien et n'ouvrez pas de pièce jointe, excepté si vous connaissez l'expéditeur.**

From speaking with the architect the existing and proposed sections of the development will be separated by fire walls which is why we have considered the fire flows independent of each other.

The proposed water service will run parallel to, and within close proximity of the existing service as previously shown in the screen clip.

The estimated sanitary discharge from the existing building (including extraneous flow) is 3.44L/s while the sanitary discharge from the proposed addition (including extraneous flow) is 2.15L/s. Please note however that the calculation for existing discharge is only a rough estimate because I am not aware of the current number of units or their capacity. The proposed unit layout within the existing building was used to estimate the existing sanitary discharge.

Please let me know if any other clarifications are necessary.  
Thank you,  
Erin

---

**From:** Jhamb, Nishant <[nishant.jhamb@ottawa.ca](mailto:nishant.jhamb@ottawa.ca)>  
**Sent:** April 8, 2022 12:00 PM  
**To:** Blanchette, Erin <[Erin.Blanchette@wsp.com](mailto:Erin.Blanchette@wsp.com)>  
**Cc:** McCaughey, Stephen <[Stephen.McCaughey@wsp.com](mailto:Stephen.McCaughey@wsp.com)>  
**Subject:** FW: Boundary Conditions Request - 15 Oblats Ave

Hello Erin,

Can you please confirm the total fire flow demand ( existing + proposed ) ?  
As per the attached calculations overall fire demand should be 27,000L/min + 11,000L/min

Also Can you please include a plan showing both existing and proposed water service connection.

What is the net increase in Sanitary discharge ?

Regards

Nishant Jhamb, P.Eng  
Project Manager | Gestionnaire de projet  
Planning, Real Estate and Economic Development Department  
Development Review - Central Branch  
City of Ottawa | Ville d'Ottawa  
110 Laurier Avenue West Ottawa, ON | 110, avenue. Laurier Ouest. Ottawa (Ontario) K1P 1J1  
613.580.2424 ext./poste 23112, [nishant.jhamb@ottawa.ca](mailto:nishant.jhamb@ottawa.ca)

---

**From:** Blanchette, Erin <[Erin.Blanchette@wsp.com](mailto:Erin.Blanchette@wsp.com)>  
**Sent:** April 07, 2022 12:58 PM  
**To:** Jhamb, Nishant <[nishant.jhamb@ottawa.ca](mailto:nishant.jhamb@ottawa.ca)>  
**Cc:** McCaughey, Stephen <[Stephen.McCaughey@wsp.com](mailto:Stephen.McCaughey@wsp.com)>  
**Subject:** Boundary Conditions Request - 15 Oblats Ave

**CAUTION: This email originated from an External Sender. Please do not click links or open attachments unless you recognize the source.**

**ATTENTION : Ce courriel provient d'un expéditeur externe. Ne cliquez sur aucun lien et n'ouvrez pas de pièce jointe, excepté si vous connaissez l'expéditeur.**

I would like to request boundary conditions for the watermain on Springhurst Ave. facing our site, as well as confirmation that the sanitary sewer on Springhurst will have adequate downstream capacity. Attached are the water and sanitary calculations, and below are conceptual design demands and other relevant site information.

**Type of development and units:** 4 storey residential development with 284 units divided between the existing development and an extension

**Site Address:** 15 Oblats Ave.

**Plan showing proposed water service connection location:** It is proposed to maintain the current water service connection location to Springhurst Ave. A second service will be required.



**Average Daily Demand:** 1.47L/s

**Maximum Daily Demand:** 4.39L/s

**Peak Hour Demand:** 19.73L/s

**Fire Flow:** 27,000L/min

**Hydrant identification plan:**

Several hydrants in the area are unclassified, however given surrounding classifications it was assumed that a AA rating is expected. Sufficient flow contribution has been calculated. See table below for details.

Please confirm whether the AA rating assumptions are correct.

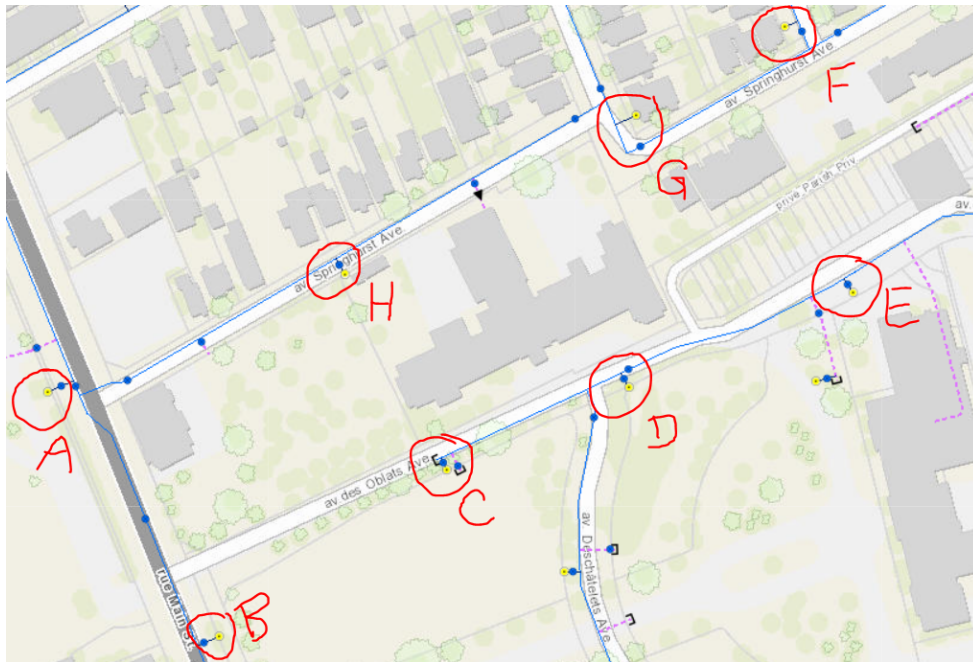

Hydrant	Dist. from bldg.	rating	rating est.	Flow contribution
A	168	AA		too far
B	154	X	AA	too far
C	59	X	AA	5700
D	46	X	AA	5700
E	117	AA		3800
F	138	AA		3800
G	80	AA		3800
H	65	X	AA	5700
<b>Total Flow Contribution (L/min)</b>				<b>28500</b>

Table 1. Maximum flow to be considered from a given hydrant

Hydrant Class	Distance to asset/structure/building (m) <sup>a</sup>	Contribution to required fire flow (L/min) <sup>b</sup>
AA	≤ 75	5,700
	> 75 and ≤ 150	3,800
A	≤ 75	3,800
	> 75 and ≤ 150	2,850
B	≤ 75	1,900
	> 75 and ≤ 150	1,500
C	≤ 75	800
	> 75 and ≤ 150	800

**Sanitary Demand:** Total peak Design Flow (for the existing and proposed developments combined) is calculated to be 5.21L/s. Please confirm the downstream sewer has the capacity for this flow.

Please let me know if any further details are required.

Thank you,

**Erin Blanchette, E.I.T.**  
Designer  
Municipal Engineering



T (613) 690-1087  
2611 Queensview Drive, Suite 300  
Ottawa, Ontario, Canada K2B 8K2

[erin.blanchette@wsp.com](mailto:erin.blanchette@wsp.com) | [wsp.com](http://wsp.com)

---

NOTICE: This communication and any attachments ("this message") may contain information which is privileged, confidential, proprietary or otherwise subject to restricted disclosure under applicable law. This message is for the sole use of the intended recipient(s). Any unauthorized use, disclosure, viewing, copying, alteration, dissemination or distribution of, or reliance on, this message is strictly prohibited. If you have received this message in error, or you are not an authorized or intended recipient, please notify the sender immediately by replying to this message, delete this message and all copies from your e-mail system and destroy any printed copies. You are receiving this communication because you are listed as a current WSP contact. Should you have any questions regarding WSP's electronic communications policy, please consult our Anti-Spam Commitment at [www.wsp.com/cas](http://www.wsp.com/cas). For any concern or if you believe you should not be receiving this message, please forward this message to [cascompliance@wsp.com](mailto:cascompliance@wsp.com) so that we can promptly address your request. Note that not all messages sent by WSP qualify as commercial electronic messages.

AVIS : Ce message, incluant tout fichier l'accompagnant (« le message »), peut contenir des renseignements ou de l'information privilégiés, confidentiels, propriétaires ou à divulgation restreinte en vertu de la loi. Ce message est destiné à l'usage exclusif du/des destinataire(s) voulu(s). Toute utilisation non permise, divulgation, lecture, reproduction, modification, diffusion ou distribution est interdite. Si vous avez reçu ce message par erreur, ou que vous n'êtes pas un destinataire autorisé ou voulu, veuillez en aviser l'expéditeur immédiatement et détruire le message et toute copie électronique ou imprimée. Vous recevez cette communication car vous faites partie des contacts de WSP. Si vous avez des questions concernant la politique de communications électroniques de WSP, veuillez consulter notre Engagement anti-pourriel au [www.wsp.com/lcap](http://www.wsp.com/lcap). Pour toute question ou si vous croyez que vous ne devriez pas recevoir ce message, prière de le transférer au [conformitecap@wsp.com](mailto:conformitecap@wsp.com) afin que nous puissions rapidement traiter votre demande. Notez que ce ne sont pas tous les messages transmis par WSP qui constituent des messages électroniques commerciaux.

-LAEmHhHzdJzBITWfa4Hgs7pbKl

This e-mail originates from the City of Ottawa e-mail system. Any distribution, use or copying of this e-mail or the information it contains by other than the intended recipient(s) is unauthorized. Thank you.

Le présent courriel a été expédié par le système de courriels de la Ville d'Ottawa. Toute distribution, utilisation ou reproduction du courriel ou des renseignements qui s'y trouvent par une personne autre que son destinataire prévu est interdite. Je vous remercie de votre collaboration.

This e-mail originates from the City of Ottawa e-mail system. Any distribution, use or copying of this e-mail or the information it contains by other than the intended recipient(s) is unauthorized. Thank you.

Le présent courriel a été expédié par le système de courriels de la Ville d'Ottawa. Toute distribution, utilisation ou reproduction du courriel ou des renseignements qui s'y trouvent par une personne autre que son destinataire prévu est interdite. Je vous remercie de votre collaboration.

'  
'  
This e-mail originates from the City of Ottawa e-mail system. Any distribution, use or copying of this e-mail or the information it contains by other than the intended recipient(s) is unauthorized. Thank you.

Le présent courriel a été expédié par le système de courriels de la Ville d'Ottawa. Toute distribution, utilisation ou reproduction du courriel ou des renseignements qui s'y trouvent par une personne autre que son destinataire prévu est interdite. Je vous remercie de votre collaboration.

'  
'  
This e-mail originates from the City of Ottawa e-mail system. Any distribution, use or copying of this e-mail or the information it contains by other than the intended recipient(s) is unauthorized. Thank you.

Le présent courriel a été expédié par le système de courriels de la Ville d'Ottawa. Toute distribution, utilisation ou reproduction du courriel ou des renseignements qui s'y trouvent par une personne autre que son destinataire prévu est interdite. Je vous remercie de votre collaboration.

'  
'  
This e-mail originates from the City of Ottawa e-mail system. Any distribution, use or copying of this e-mail or the information it contains by other than the intended recipient(s) is unauthorized. Thank you.

Le présent courriel a été expédié par le système de courriels de la Ville d'Ottawa. Toute distribution, utilisation ou reproduction du courriel ou des renseignements qui s'y trouvent par une personne autre que son destinataire prévu est interdite. Je vous remercie de votre collaboration.

'  
'  
This e-mail originates from the City of Ottawa e-mail system. Any distribution, use or copying of this e-mail or the information it contains by other than the intended recipient(s) is unauthorized. Thank you.

Le présent courriel a été expédié par le système de courriels de la Ville d'Ottawa. Toute distribution, utilisation ou reproduction du courriel ou des renseignements qui s'y trouvent par une personne autre que son destinataire prévu est interdite. Je vous remercie de votre collaboration.

'