

Engineering

- Land/Site Development
- Municipal Infrastructure
- Environmental/Water Resources
- Traffic/Transportation
- Recreational

Planning

- Land/Site Development
- Planning Application Management
- Municipal Planning
- Urban Design
- Expert Witness (LPAT)
- Wireless Industry

Landscape Architecture

- Streetscapes & Public Amenities
- Open Space, Parks & Recreation
- Community & Residential
- Commercial & Institutional
- Environmental Restoration



Stinson Lands 4386 Rideau Valley Drive Noise Control Feasibility Study

**STINSON LANDS
(4386 RIDEAU VALLEY DRIVE)**

NOISE CONTROL FEASIBILITY STUDY



Prepared for:

Uniform Urban Developments Ltd.
Suite 300, 117 Centrepointe Drive
Ottawa, Ontario
K2G 5X3

Prepared By:

NOVATECH
Suite 200, 240 Michael Cowpland Drive
Ottawa, Ontario
K2M 1P6

November 30, 2022

Novatech File: 121153
Ref: R-2022-144

August 19, 2022

City of Ottawa
Planning and Growth Management Department
Development Review (Urban Services - South) Branch
Infrastructure Approvals Division
110 Laurier Avenue West, 4th Floor
Ottawa, ON K1P 1J1

Attention: **Brian R. Morgan, CET**
 Project Manager

Mike Giampa
Senior Engineer

Reference: **Stinson Lands (4386 Rideau Valley Drive)**
 Noise Control Feasibility Study
 Novatech File No.: 121153

In support of the Draft Plan of Subdivision application for the above-noted site, you will find enclosed the Noise Control Feasibility Study for the Stinson Lands (4386 Rideau Valley Drive) development.

The study evaluates the environmental impact of noise to the proposed residential development, the feasibility of mitigation measures, and recommends the appropriate noise attenuation measures.

Should you have any questions, or require additional information, please contact me.

Yours truly,

NOVATECH

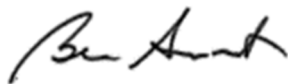

Ben Sweet, P. Eng.
Project Coordinator | Land Development

cc: Annibale Ferro, Uniform Urban Developments Ltd.

TABLE OF CONTENTS

1.0	INTRODUCTION.....	3
2.0	NOISE CONTROL CRITERIA AND GUIDELINES.....	3
2.1	SOUND LEVEL CRITERIA.....	3
2.2	NOISE ATTENUATION REQUIREMENTS.....	6
3.0	NOISE SOURCES	6
3.1	SURFACE TRANSPORTATION – RIDEAU VALLEY DRIVE / BANKFIELD ROAD (NC1).....	6
3.2	STATIONARY – MANOTICK PUMP STATION (NC2).....	6
4.0	NOISE LEVEL MODELLING AND PREDICTIONS.....	7
4.1	SURFACE TRANSPORTATION - ACOUSTIC MODELING.....	7
4.2	SURFACE TRANSPORTATION - NOISE LEVEL PREDICTIONS	9
4.3	STATIONARY – NOISE LEVEL PREDICTIONS	10
5.0	NOISE LEVEL ATTENUATION MEASURES	11
5.1	OUTDOOR – PROPOSED NOISE BARRIER	11
5.2	INDOOR – PROPOSED BUILDING COMPONENT ASSESSMENT.....	11
5.3	PROVISION FOR CENTRAL AIR CONDITIONING	12
5.4	PROPOSED WARNING CLAUSES.....	12
6.0	CONCLUSIONS AND RECOMMENDATIONS	12

LIST OF TABLES

- Table 2.1: Outdoor and Indoor Sound Level Criteria for Surface Transportation Noise
- Table 2.2: Outdoor and Indoor Sound Level Criteria for Stationary Noise
- Table 3.1: Rideau Valley Drive / Bankfield Road Traffic and Road Parameters
- Table 4.1: Road Segment / Receiver Parameters
- Table 4.2: OLA Noise Level Summary
- Table 4.3: ILE Noise Level Summary
- Table 4.4: Reference Distance / Noise Level Summary

LIST OF FIGURES

- Figure 1: Key Plan
- Figure 2: Site Plan

LIST OF APPENDICIES

- Appendix A – Official Plan and Environmental Noise Control Guideline Excerpts
- Appendix B – Manotick Pump Station Generator Specifications
- Appendix C – STAMSON Noise Modelling Results
- Appendix D – Sample Noise Barrier Drawings

LIST OF ENCLOSURES

- 118224-NC1 – Noise Control Plan (Surface Transportation Noise)
- 121153-NC2 – Noise Control Plan (Stationary Noise)

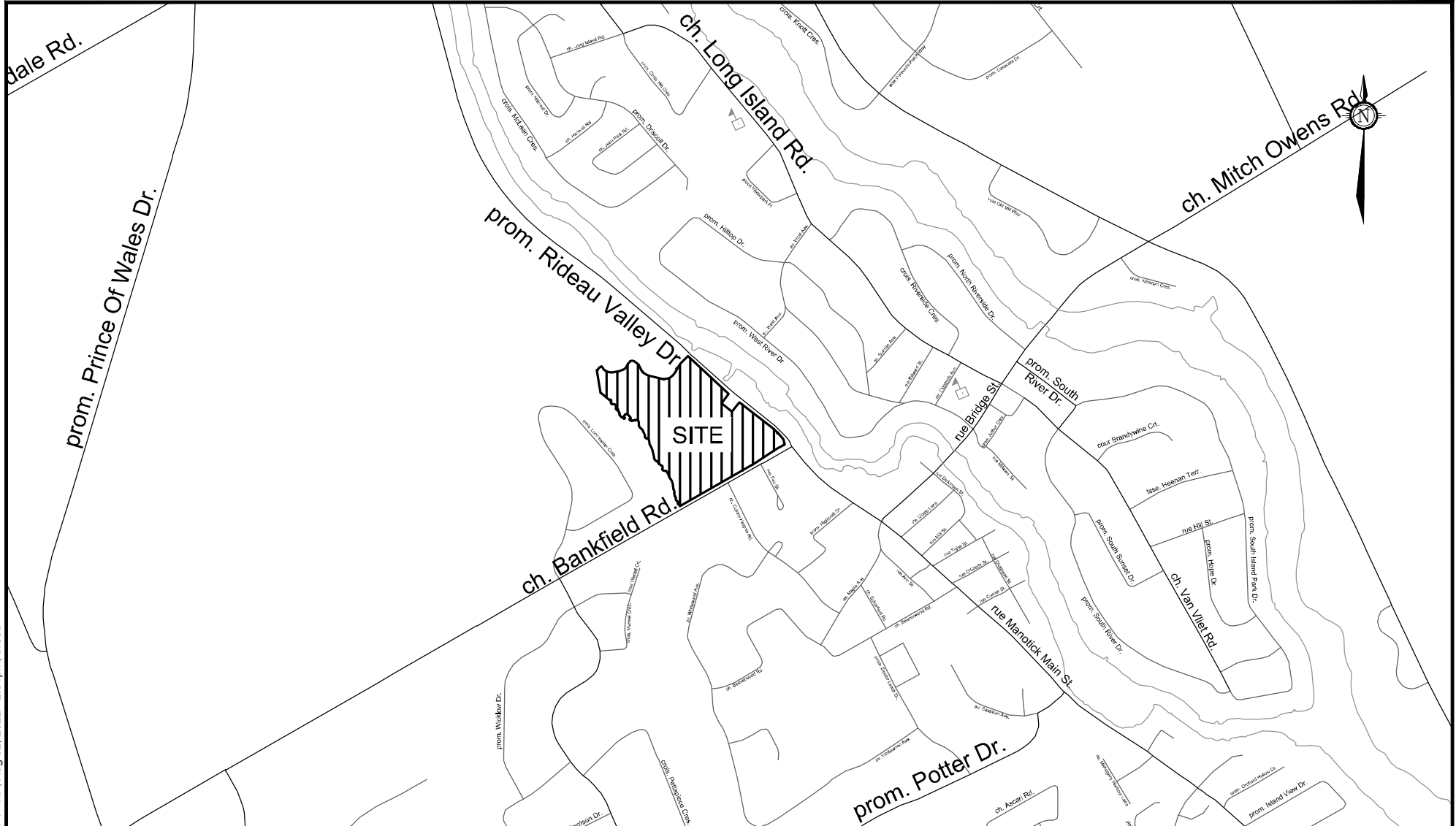

M:\2021\121153\CAD\Design\121153-BP.dwg, Fig. 1.1 - KP, Aug 02, 2022 - 2:04pm, breed



Engineers, Planners & Landscape Architects
 Suite 200, 240 Michael Cowpland Drive
 Ottawa, Ontario, Canada K2M 1P6

Telephone (613) 254-9643
 Facsimile (613) 254-5867
 Website www.novatech-eng.com

**CITY OF OTTAWA
 STINSON LANDS
 4386 RIVER ROAD**

KEY PLAN

SCALE **NOT TO SCALE**

DATE	JOB	FIGURE
AUG 2022	121153	1.1

M:\2021\121153\CAD\Planning\Concept Plans\121153-DCP.dwg, FIG 1.3 Site Plan, Nov 16, 2022 - 2:33pm, bruncle

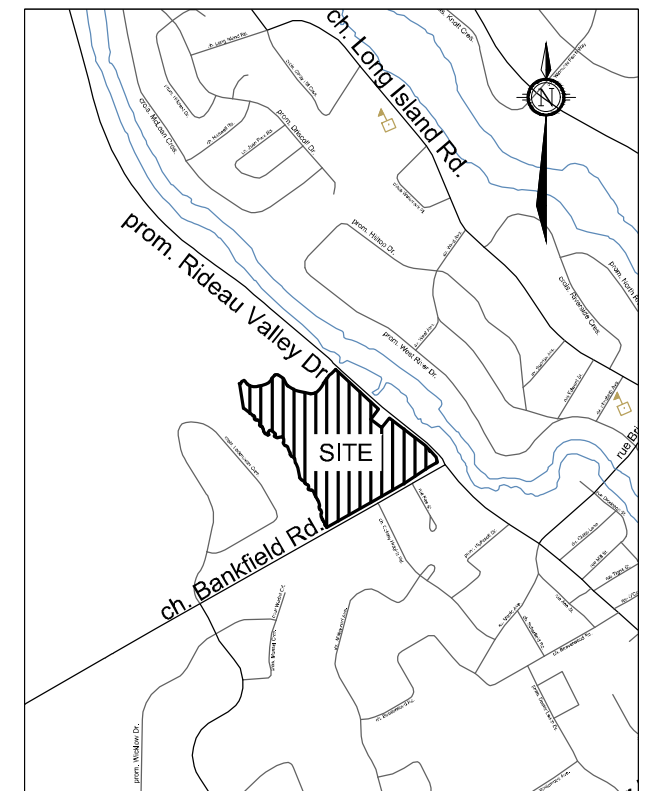
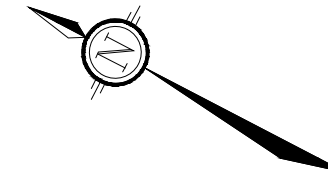
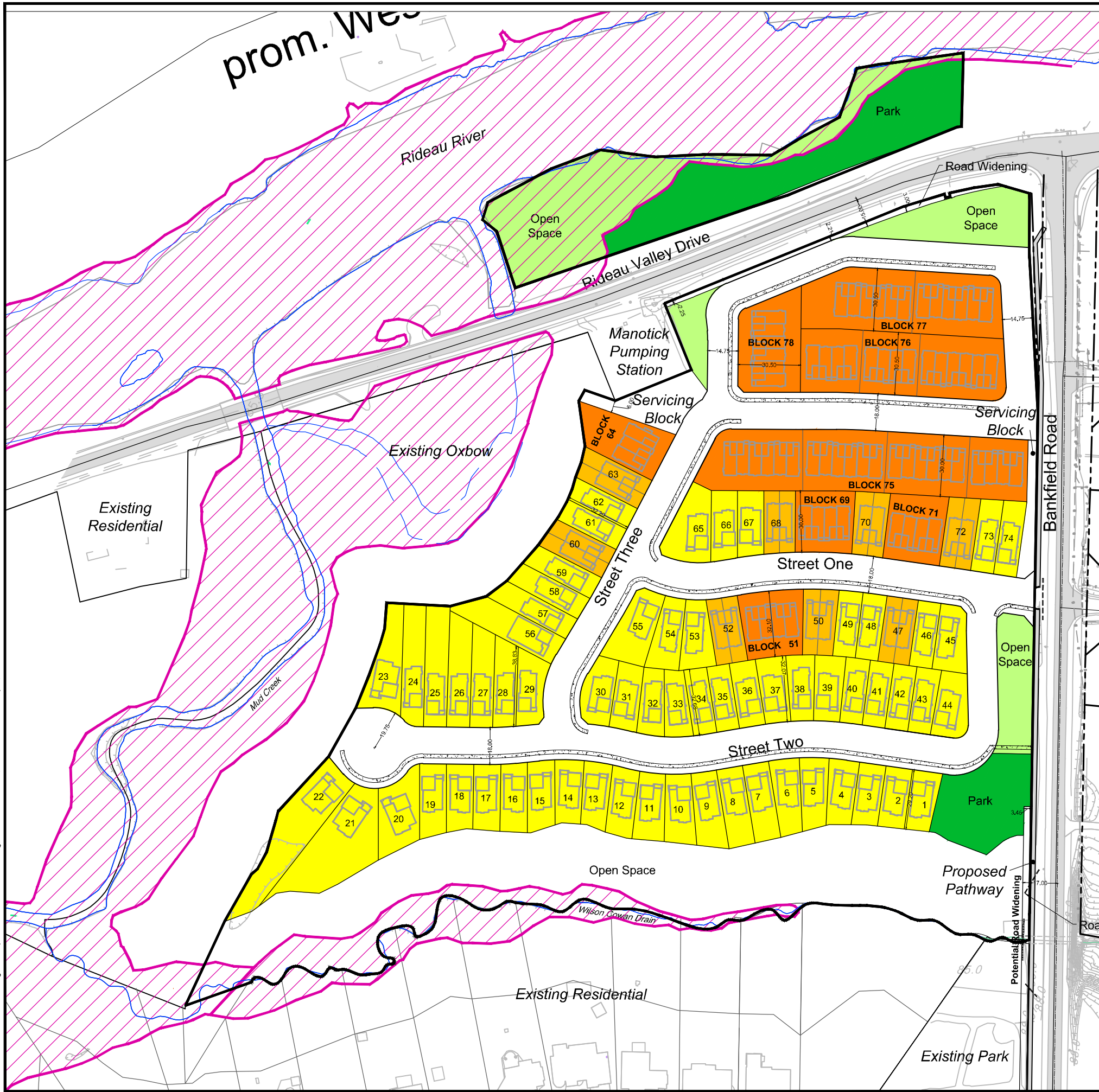

LEGEND

- Single Detached
- Semi Detached
- Townhome
- Park
- Open Space
- Floodplain

NOVATECH

Engineers, Planners & Landscape Architects
Suite 200, 240 Michael Cowpland Drive
Ottawa, Ontario, Canada K2M 1P6

Telephone (613) 254-9643
Facsimile (613) 254-5867
Website www.novatech-eng.com

CITY OF OTTAWA
STINSON LANDS
4386 RIDEAU VALLEY DRIVE

SITE PLAN

SCALE	1:2000	
DATE	AUG 2022	FIGURE 1.3
JOB	121153	

1.0 INTRODUCTION

The proposed development at 4386 Rideau Valley Drive (Subject Site) is located at the intersection of Rideau Valley Drive and Bankfield Road, as shown on **Figure 1.1** – Key Plan. The site is bound to the west by the Wilson-Cowan Drain, to the north by Mud Creek and an oxbow ditch, to the east by Rideau Valley Drive, and to the south by Bankfield Road.

The Subject Site has an area 10.28 ha, and the proposed subdivision will comprise of residential housing, public right-of-ways (ROW), open space blocks, two servicing blocks, and two park blocks. The development will contain City of Ottawa municipal road allowances of 14.0-18.0 metres wide. The proposed development is shown on **Figure 1.2** – Site Plan.

Novatech has been retained by Uniform Urban Developments Ltd. (Developer) to assess the environmental impact of noise for the Subject Site, the feasibility of mitigation measures, and recommend the appropriate noise attenuation measures to ensure compliance with the City of Ottawa Environmental Noise Control Guidelines, January 2016 (ENCG) and the Ministry of the Environment Environmental Noise Guideline, August 2013 (Provincial Guideline).

As per the ENCG, this report is considered a Phase 1 Noise Control Feasibility Study. A Phase 2 Noise Control Detailed Study will be included as part of the supporting documentation submitted in support of the Plan of Subdivision Application.

2.0 NOISE CONTROL CRITERIA AND GUIDELINES

2.1 Sound Level Criteria

The City of Ottawa is concerned with noise from aircraft, roads, transitways and railways as expressed in Section 4.8.7 of the Official Plan (OP). These policies are supported by the ENCG which is a technical document that outlines the specific sound level criteria, commonly referred to as the Logarithmic Energy Equivalent Continuous Sound Level (L_{eq}). The ENCG has been used as a guideline for this study. This study considers surface transportation noise from the surrounding arterial roads and stationary noise from a nearby pump station.

When considering surface transportation noise, proposed noise-sensitive developments must be evaluated within 100 m from the right-of-way of an existing or proposed arterial, collector, major collector, light rail transit, or bus transitway; 250 m from the right-of-way of an existing or proposed highway or a Secondary Main railway line; and 500 m from the right-of-way of a freeway, 400 series provincial highway, or Principle Main railway line. For the purposes of this study, Rideau Valley Drive and Bankfield Road are classified as rural arterial, thus requiring analysis.

For stationary noise, when developments are in proximity to existing noise sensitive receptors or lands designated for future development of noise sensitive receptors, noise sources must be evaluated. The Manotick Pump Station generator represents an individual stationary noise source which will combine sound and vibration levels emitted beyond the property boundary, thus also requiring analysis.

The mandate of acoustical engineering in respect to land-use planning is typically to analyze, and where required, design an acceptable acoustic environment that complies with the ENCG document to the extent that is both reasonable and practical. The areas which must be assessed

for acoustic protection include the Outdoor Living Area (OLA); and the Indoor Living Environment (ILE), for both living/dining area and sleeping quarters.

The OLA is defined as part of the outdoor amenity area provided for the quiet enjoyment of the outdoor environment during the day-time period. These amenity areas are typically backyards, gardens, terraces and patios.

The ILE is provided for the quiet enjoyment of the living/dining and sleeping quarters within a dwelling, during both the day-time and night-time periods.

Surface Transportation Noise

The OLA noise target for road surface transportation noise sources is 55 dBA. This criterion may be exceeded by an amount not greater than 5 dBA, subject to justification and the use of a warning clause.

The ILE sets noise target for road surface transportation noise sources at 45 dBA (day-time) and 40 dBA (night-time), respectively. If this criterion is exceeded, the property may be subject to building component analysis to ensure noise criteria are met and warning clauses.

The outdoor and indoor sound level criteria for surface transportation noise are summarized below in **Table 2.1**.

Table 2.1: Outdoor and Indoor Sound Level Criteria for Surface Transportation Noise

Environment	Receiver Location and Description	Time Period	Abbreviation for Report & Modelling	ENCG Equivalent Sound Level Criteria, L_{eq}
Outdoor	Outdoor Living Area	Day-time (07:00 - 23:00 hrs) 16 hour period	OLA-16	55 dBA
Indoor	Living/dining, den areas of residences, hospitals, nursing homes, schools, daycare centres, etc.	Day-time (07:00 - 23:00 hrs) 16 hour period	ILED-16	45 dBA
	Living/dining, den areas of residences, hospitals, nursing homes, etc. (except schools or daycare centres)	Night-time (23:00 - 07:00 hrs) 8 hour period	ILED-8 *	45 dBA
	Sleeping quarters	Day-time (07:00 - 23:00 hrs) 16 hour period	ILES-16	45 dBA
	Sleeping quarters	Night-time (23:00 - 07:00 hrs) 8 hour period	ILES-8	40 dBA

Notes:

(1) **ILED-8** has not been analysed or modelled in this study, as the noise levels would be governed by **ILES-8**.

Stationary Noise (Steady and Varying)

The impact of stationary noise on the community is largely dependent on its location in the City. For this reason, the ENCG and Provincial guidelines have established four community class areas which are defined by their ambient sound level. The Subject Site is classified as a Class 2 area.

The OLA noise target for steady and varying stationary noise sources is 50 dBA (day-time) and 45 dBA (night-time). This criterion may be exceeded by an amount not greater than 5 dBA, subject to justification and the use of a warning clause.

The ILE sets noise target for steady and varying stationary noise sources at 50 dBA (day-time) and 45 dBA (night-time), respectively. If this criterion is exceeded, the property may be subject to building component analysis, to ensure noise criteria are met, and warning clauses.

The outdoor and indoor sound level criteria for stationary noise are summarized below in **Table 2.2**.

Table 2.2: Outdoor and Indoor Sound Level Criteria for Stationary Noise

Environment	Receiver Location and Description	Time Period	Abbreviation for Report & Modelling	ENCG Equivalent Sound Level Criteria, L_{eq}
Outdoor	Outdoor Living Area	Day-time (07:00 - 19:00 hrs) 12 hour period	OLA-12	50 dBA
		Night-time (19:00 - 23:00 hrs) 4 hour period	OLA-4	45 dBA
Indoor	Living/dining, den areas of residences, hospitals, nursing homes, schools, daycare centres, etc.	Day-time (07:00 - 23:00 hrs) 16 hour period	ILED-16	50 dBA
	Living/dining, den areas of residences, hospitals, nursing homes, etc. (except schools or daycare centres)	Night-time (23:00 - 07:00 hrs) 8 hour period	ILED-8 *	45 dBA
	Sleeping quarters	Day-time (07:00 - 23:00 hrs) 16 hour period	ILES-16	50 dBA
	Sleeping quarters	Night-time (23:00 - 07:00 hrs) 8 hour period	ILES-8	45 dBA

Notes:

(1) **ILED-8** has not been analysed or modelled in this study, as the noise levels would be governed by **ILES-8**.

2.2 Noise Attenuation Requirements

When sound levels are predicted to be less than the specified criteria for the day-time and night-time conditions, no attenuation measures are required by the proponent. As the noise criteria is exceeded, a combination of attenuation measures is recommended by the City of Ottawa to modify the development environment. These attenuation measures may include:

- Adjusting the site layout to maximize noise insensitive land uses between the noise source and sensitive receptor;
- Orienting buildings to provide sheltered zones in rear yards;
- Constructing noise barriers and/or berms;
- Building component design for acoustic insulation;
- Installation of a forced air ventilation system with provision for central air conditioning;
- Warning Clauses within Subdivision Agreement and Agreement of Purchase and Sale of prospective home buyers, all of which will be registered on title.

In order to inform the purchasers, warning clauses will reference the specific mitigation measures utilized and state the need to maintain the specified noise mitigation measures.

3.0 NOISE SOURCES

3.1 Surface Transportation – Rideau Valley Drive / Bankfield Road (NC1)

Rideau Valley Drive and Bankfield Road are classified as a 2-Lane Rural Arterial (2-RAU) as per the 2013 Transportation Master Plan (TMP). As outlined in the ENCG (Appendix B, Table B1), this particular roadway class specifies an AADT of 15,000 vpd should be used for sound level predictions. See excerpts provided in **Appendix A**.

The roadway noise parameters are summarized below in **Table 3.1**.

Table 3.1: Rideau Valley Drive / Bankfield Road Traffic and Road Parameters

Roadway Parameters	Rideau Valley Drive / Bankfield Road
Roadway Classification	2 - Lane Rural Arterial
Annual Average Daily Traffic (AADT)	15,000 vehicles/day
Posted Speed	60 km/hr.
Day / Night Split (%)	92 / 8
Medium Trucks (%)	7
Heavy Trucks (%)	5

3.2 Stationary – Manotick Pump Station (NC2)

The Manotick Pump Station is fitted with a Kohler Industrial Diesel Generator with self-enclosed noise reduction measures. The generator yields a performance rating of 76 dBa at 7 meters at

full rated load. This will be the parameter used for the sound level predictions for this study. It should be noted that the self-enclosed noise reduction measures were not accounted for in the stationary noise calculations, therefore the results are found to be conservative. Further details and model specifications for the generator can be found in **Appendix B**.

4.0 NOISE LEVEL MODELLING AND PREDICTIONS

4.1 Surface Transportation - Acoustic Modeling

For surface transportation sources, noise levels were calculated using the STAMSON computer program, version 5.03. This program allows us to input variables of a road or railway such as traffic volume, types of vehicles, speed, barrier locations and topography to determine the environmental noise impact at a point of reception.

To analyze the noise impact on the Subject Site from the aforementioned surface transportation noise sources, six points of reception were implemented at the critical OLAs and eight points of reception were implemented at the critical ILEs. The noise control plan for surface transportation noise (Figure 121153-NC1) shows the receiver locations.

The parameters used in STAMSON to assess the noise impacts at the receiver locations can be found below in **Table 4.1**. It should be noted that, when practical and when the proposed layout of the Subject Site in relation to the existing and proposed residences permitted, screening was implemented to limit noise exposure from Rideau Valley Drive and Bankfield Road.

Noise modeling was undertaken for the following environments:

OLAs

For the purposes of this noise impact assessment, all receivers for the OLA-16 time period are located 3.0 meters from the building façade, 1.5 meters above grade, and aligned with the midpoint of the subject façade as per the ENCG.

ILEs

For the purposes of this noise impact assessment, all receivers for the ILED-16 time period are located at the plane of window, 1.5 meters above grade, and aligned in closest proximity to the noise source as per the ENCG.

All receivers for the ILES-16, and ILES-8 time periods are located at the plane of window, 4.5 meters above grade, and aligned in closest proximity to the noise source as per the ENCG.

Table 4.1: Road Segment / Receiver Parameters

Receiver	Segment Reference	Road Segment - Receiver Angles		Shielding - Barrier Angles		Shielding - Barrier Parameters				
		RØ1	RØ2	BØ1	BØ2	Receiver source distance (m)	Barrier receiver distance (m)	Source ground elevation (m)	Receiver ground elevation (m)	Barrier ground elevation (m)
Outdoor Living Areas										
R1	S1	-90	90	-90	90	62.1	3.0	85.05	86.50	86.60
R2	S1	-90	-21	-90	-21	42.2	3.0	87.20	88.00	88.82
	S2	-21	75	NA	NA		NA			NA
	S3	75	90	75	90		27.5			89.73
R3	S1	-90	48	NA	NA	35.8	NA	93.37	93.00	NA
	S2	48	90	48	90		3.0			94.12
R4	S1	-90	-43	-90	-43	23.7	3.5	92.08	91.40	91.24
	S2	-43	90	NA	NA		NA			NA
R5	S1	-90	-83	-90	-83	54.4	13.6	89.85	90.40	91.10
	S2	-83	45	NA	NA		NA			NA
	S3	45	90	45	90		3.0			91.50
R6	S1	-90	-23	-90	-23	71.0	3.0	88.82	88.40	88.50
	S2	-23	90	NA	NA		NA			NA
Indoor Living Environments										
R1	S1	-90	90	NA	NA	62.3	NA	84.75	86.55	NA
R2	S1	-90	90	NA	NA	32.4	NA	87.12	88.40	NA
R3	S1	-90	90	NA	NA	34.7	NA	87.82	90.20	NA
R4	S1	-90	90	NA	NA	35.2	NA	93.15	93.80	NA
R5	S1	-90	90	NA	NA	33.1	NA	93.39	93.00	NA
R6	S1	-90	90	NA	NA	20.9	NA	92.15	91.45	NA
R7	S1	-90	90	NA	NA	49.1	NA	89.77	90.40	NA
R8	S1	-90	-75	-90	-75	59.9	9.0	88.97	89.95	90.08
	S2	-75	90	NA	NA		NA			NA

Notes:

- (1) Refer to Figure 121153-NC1 for receiver and noise source locations.
- (2) All receiver angles are the same for both unattenuated and attenuated scenarios.
- (3) All receiver angles are the same for ILEs (i.e., ILED-16, ILES-16, and ILES-8).
- (4) Source height = source ground elevation + 1.5m.
- (5) Receiver height = receiver ground elevation + 1.5m (for all OLA and ILED-16 time periods); receiver ground elevation + 4.5m (for ILES-16, and ILES-8 time periods).

4.2 Surface Transportation - Noise Level Predictions

The following **Table 4.2** summarizes the predicted sound levels at the receiver locations based on the STAMSON noise modelling results. The complete modelling outputs can be found in **Appendix C**.

Table 4.2: OLA Noise Level Summary

Receiver	Unattenuated L_{eq} (15,000 vpd)	Attenuated L_{eq} (15,000 vpd)	Noise Barrier Reference
	OLA-16	OLA-16	
R1	58.88	-	Noise Barrier No.1 – 1.8 m Ht
R2	59.23	-	No action required.
R3	61.57	56.96	Noise Barrier No.2 – 1.8 m Ht
R4	64.40	59.58	Noise Barrier No.3 – 2.2 m Ht
R5	58.48	-	No action required.
R6	55.75	-	No action required.

Notes:

(1) Refer to Figure 121153-NC1 for receiver and noise source locations.

(2) Action required at receiver R1 to mitigate stationary noise from the Manotick Pump Station generator.

As outlined in **Table 2.1**, the target noise level for the OLA is 55 dBA, with a provision of an additional 5 dBA tolerance subject to justification and the use of a warning clause. For the established OLAs affected by the surface transportation noise within this proposed development, the day-time noise levels fall below the required OLA noise levels or maximum tolerable OLA noise levels when implementing the attenuated measures where required. Refer to further discussions in Section 5.1 of this report.

Table 4.3: ILE Noise Level Summary

Receiver	Unattenuated L_{eq} (15,000 vpd)		
	ILED-16	ILES-16	ILES-8
R1	58.85	59.56	51.97
R2	63.57	64.02	56.43
R3	62.49	62.97	55.38
R4	62.39	62.88	55.28
R5	62.83	63.30	55.70
R6	66.15	66.43	58.84
R7	59.89	60.61	53.01
R8	58.48	59.21	51.62

Notes:

(1) Refer to Figure 121153-NC1 for receiver and noise source locations.

The target noise levels for the ILE, also outlined in **Table 2.1**, for both living/dining area and sleeping quarters is 45 dBA and 40 dBA, respectively. To mitigate these sound levels, additional building component analysis is required to ensure noise criteria are met. Refer to further discussions in Section 5.2 of this report.

4.3 Stationary – Noise Level Predictions

The projected noise levels of the existing Manotick Pump Station generator are determined by a sound-distance correlation. Using the generators yield of 76 dBA at 7 meters at full rated load, noise levels of interest can be used to determine the distance corresponding to the aforementioned noise level. This can then be used to establish and analysis the critical zones for both the OLAs and ILEs.

The reference distance for the noise level of interest is calculated as follows:

$$R_2 = R_1 \times 10^{\{|L_1 - L_2| / 20\}}$$

Where, L_1 = Noise level at reference distance R_1 (76 dBA);
 R_1 = Reference distance for noise level L_1 (7.0 m);
 L_2 = Noise level at reference distance R_2 (noise level of interest).

Example – Noise Level L_2 = 55 dBA:

$$R_2 = 7.0 \text{ m} \times 10^{\{|76 \text{ dBA} - 55 \text{ dBA}| / 20\}} = 78.5 \text{ m}$$

The following **Table 4.4** summarizes the reference distance for the noise levels of interest from the results of the sound-distance calculation. The noise control plan for stationary noise (Drawing 121153-NC2) demonstrates the noise levels of interest in relation to the emergency generator.

Table 4.4: Reference Distance / Noise Level Summary

Noise Levels of Interest (dBA)	Reference Distance (m)
65	24.8
60	44.2
55	78.5
50	139.7
45	248.4

Notes:

- (1) Refer to Drawing 121153-NC2 for noise levels of interest in relation to the generator.
- (2) The noise levels of interest and the corresponding reference distances are unattenuated - no screening or noise exposure limitations have been applied.

As outlined in **Table 2.2**, the target noise level for the OLA is 50 dBA and 45 dBA for the day-time and night-time, respectively. This comes with a provision of an additional 5 dBA tolerance subject to justification and the use of a warning clause. For the established OLAs affected by the infrequent stationary noise within this proposed development, attenuated measures have been implemented in order to provide best efforts in reducing the noise levels to meet both the day-time and night-time criteria. Refer to further discussions in Section 5.1 of this report.

The target noise levels for the ILE, also outlined in **Table 2.2**, for both living/dining area and sleeping quarters is 50 dBA and 45 dBA, respectively. To mitigate these sound levels, additional building component analysis is required to ensure noise criteria are met. Refer to further discussions in Section 5.2 of this report.

To avoid the noise intrusion through open windows or doors due to summer heat, the installation of a forced air ventilation system with provisions for central air conditioning may be required. Refer to further discussions in Section 5.3 of this report.

Notwithstanding the outdoor and indoor mitigations, the inclusion of warning clauses within the Development Agreements, Agreements of Purchase and Sale, or Agreements of Lease of prospective home buyers/leases is recommended. Refer to further discussions in Section 5.4 of this report.

5.0 NOISE LEVEL ATTENUATION MEASURES

5.1 Outdoor – Proposed Noise Barrier

To meet the required OLA noise levels for both the surface transportation and stationary noise, three noise barriers are being proposed within the Subject Site. As shown in the tables in Section 4.2 and Section 4.3 of this report, with the proposed noise barriers being implemented, the noise levels at the specified OLAs provide adequate noise attenuation. The following outlines the proposed:

- Noise Barrier No.1 – 1.8 m high noise barrier, 38 m in length, within Block 64;
- Noise Barrier No.2 – 1.8 m high noise barrier, 29 m in length, within Blocks 76 and 77;
- Noise Barrier No.3 – 2.2 m high noise barrier, 30 m in length, within Block 75 and Lot 74;

The above is based on the current subdivision layout and conceptual grading. As part of Phase 2 Noise Control Detailed Study, further review of the detailed grading will be completed to confirm noise barrier heights and locations.

Sample noise barrier drawings have been provided in **Appendix D**. Additional details on the noise barriers will be provided as part of the Phase 2 Noise Control Detailed Study.

5.2 Indoor – Proposed Building Component Assessment

When ILE noise levels exceed the ENCG day-time or night-time criteria, the exterior shell system of the building envelope must be acoustically assessed to ensure the indoor noise criteria is achieved for the surface transportation and stationary noise. Based on the results in Section 4.2 and 4.3 of this report, in the proposed development the sound levels at the ILE receiver locations falls above the day-time and night-time allowances.

Notwithstanding the above, and per common industry practice, buildings built in conformance with the Ontario Building Code (OBC) typically provide a 25 dBA reduction to the noise levels. As such, if the buildings are built to provide exterior wall, window and patio door, roof and ceiling, and exterior door component assemblies to meet the prescribed requirements of the OBC, no further assessment on the building envelope is required.

Additional details and assessment of the proposed building components will be provided as part of the Phase 2 Noise Control Detailed Study. It is anticipated that the units adjacent to Rideau Valley Drive, Bankfield Road, and the Manotick Pump Station will require further assessment on the proposed building components.

5.3 Provision for Central Air Conditioning

To provide indoor isolation and avoid noise intrusion through open windows or doors, the installation of a forced air ventilation system with provisions for central air conditioning may be required.

Additional details on which lots may be required to implement provisions for central air conditioning will be provided as part of the Phase 2 Noise Control Detailed Study. It is anticipated that the units adjacent to Rideau Valley Drive, Bankfield Road, and the Manotick Pump Station will require provisions for central air conditioning.

5.4 Proposed Warning Clauses

If noise levels are expected to exceed the applicable ENCG sound level criteria, the City of Ottawa recommends a warning clause be registered on title and incorporated into the Subdivision Agreement and in the Agreement of Purchase and Sale. The warning clause serves to alert potential buyers and/or renters of the possible noise condition and of any limitations that may exist on his/her property rights.

Additional details on which lots will be required to apply warning clauses will be provided as part of the Phase 2 Noise Control Detailed Study. It is anticipated that the units adjacent to Rideau Valley Drive, Bankfield Road, and the Manotick Pump Station will be required to apply warning clauses.

6.0 CONCLUSIONS AND RECOMMENDATIONS

This study confirms the predicted noise levels for the units within the proposed residential development adjacent to Rideau Valley Drive, Bankfield Road, and the Manotick Pump Station are in excess of the ENCG criteria. The following outlines the summary of findings and recommendations being made:

- Based on the noise level results, it is anticipated that there will be a requirement for noise barriers within the Subject Site due to the surface transportation and stationary noise.
- A Phase 2 Noise Control Detailed Study will be required to provide:
 - Further review of the detailed grading for the Subject Site to confirm noise barrier heights and locations;
 - Additional details on the noise barriers;
 - Additional details and assessment of the proposed building components;
 - Additional details on which lots/blocks may be required to implement provisions for central air conditioning; and
 - Additional details on which lots/blocks will be required to apply Warning Clauses.

This study is respectfully submitted in support of the Draft Plan of Subdivision application. Please contact the undersigned should you have questions or require additional information.

NOVATECH

Prepared by:



Bradley Reed
E.I.T. | Land Development

Reviewed by:



Ben Sweet, P.Eng.
Project Coordinator | Land Development



Appendix A
Official Plan and Environmental Noise Control Guidelines Excerpts

McNAB/
BRAESIDE

CLARENCE-
ROCKLAND

THE NATION

MISSISSIPPI
MILLS

RUSSELL

NORTH
DUNDAS

NORTH
GRENVILLE

MONTAGUE

**City of Ottawa Official Plan
Consolidation and Amendments**

**Ville d'Ottawa Plan officiel
Amendement au plan directeur approuvé**

- # 14 (09/2004)
- # 50 (06/2006)
- # 76*

OMB decision/Décision de la CAMO - N° 2711

Note:
1) This schedule forms part of the Official Plan of the City of Ottawa and must be read in conjunction with the text.
2) This schedule is intended as a framework for planning and design; consequently alignments of proposed roads are approximate and subject to detailed study.
3) Reference should be made to Schedule H for clarity of road network in certain villages.

Note:
1) La présente annexe fait partie du Plan officiel de la Ville d'Ottawa et doit être consultée en se reportant au texte même du Plan officiel.
2) La présente annexe doit servir de guide en matière de planification et de conception; il s'ensuit que le tracé des routes proposées n'est qu'approximatif et donnera lieu à une étude plus approfondie.
3) On devrait faire référence à annexe H pour plus de détails sur le réseau routier dans certains villages.

**Official Plan - Schedule G
Rural Road Network**

Prepared by: Planning and Growth Management Department

**Plan officiel - Annexe G
Routes Rural**

Préparé par : Service de l'urbanisme et de la gestion de la croissance

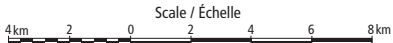

03/2012



SEE SCHEDULE E
VOIR ANNEXE E

SEE SCHEDULE E
VOIR ANNEXE E

4386 Rideau Valley
Drive (Stinson Lands)

Highway	Route
Existing	Établie
New Interchange	Nouvel échangeur
Arterial	Artère
Existing	Établie
Proposed (Alignment Defined)	Proposé (Alignement déterminée)
Conceptual (Alignment Undefined)	Conceptuelle (Alignement à déterminer)
Collector	Collectrice
Existing	Établie
Proposed	Proposé

Table 2.2a: Sound Level Limit for Outdoor Living Areas - Road and Rail
(from NPC-300, 2013 Table C-1)

Time Period	Required Leq (16) (dBA)
16-hour, 07:00 – 23:00	55

Table 2.2b: Sound Level Limit for Indoor Living Areas Road and Rail
(from NPC-300, 2013 Table C-2)

Type of Space	Time Period	Required Leq (dBA)	
		Road	Rail
Living/dining, den areas of residences, hospitals, nursing homes, schools, daycare centres, etc.	07:00 – 23:00	45	40
Living/dining, den areas of residences, hospitals, nursing homes, etc. (except schools or daycare centres)	23:00 – 07:00	45	40
Sleeping quarters	07:00 – 23:00	45	40
	23:00 – 07:00	40	35

The Province also provides for supplementary indoor sound level limits for land uses not generally considered noise sensitive (see Table 2.2c below). These good practice design objectives should be addressed in any noise study prepared for the City. These supplementary sound level limits are based on the windows and doors to an indoor space being closed.

Table 2.2c: Supplementary Sound Level Limits for Indoor Spaces - Road and Rail (adapted from NPC-300 Table C-9)

Type of Space	Time Period	Required Leq (dBA)	
		Road	Rail
General offices, reception areas, retail stores, etc.	16 hours between 07:00 – 23:00	50	45
Theatres, places of worship, libraries, individual or semi-private offices, conference rooms, reading rooms, etc.	16 hours between 07:00 – 23:00	45	40
Sleeping quarters of hotels/motels	8 hours between 23:00 – 07:00	45	40
Sleeping quarters of residences, hospitals, nursing/retirement homes, etc.	8 hours between 23:00 – 07:00	40	35



City Hall > » Planning and development > » Official Plan and master plans > » Official Plan
 > » Table 1- Road of Right-of-Way Protection

Table 1- Road of Right-of-Way Protection

Road	ROW to be Protected
Arterials in the rural area (as shown on Schedules G and H of the Official Plan)	ROW to be protected is 30 metres unless otherwise indicated
Collectors in the rural area (as shown on Schedules G and H of the Official Plan)	ROW to be protected is 26 metres unless otherwise indicated
Local roads in the rural area	ROW to be protected is 20 metres unless otherwise indicated

Road	From	To	ROW to be Protected	Classification	Sector
Abbott West	West Ridge	Main	24	collector	urban
Abbott East	Main	Iber	26	major collector	urban
Airport Parkway	Bronson	Airport Parkway Private	ECP	arterial	urban
Albert	Empress	Bronson	40 Note: Maximum land requirement from property abutting existing ROW (10.0 m).	arterial	urban
Albert	Bronson	Elgin	VRW Note: Maximum land requirement from property abutting existing ROW (1.25 m). Subject to widening/easement policy.	arterial	urban
Albert	Elgin	Mackenzie King Bridge	VRW Note: Maximum land requirement from property abutting existing ROW	arterial	urban

requirement from property abutting existing ROW (0.90m). Subject to widening/easement policy.

MacFarlane	Merivale	Deakin	24	collector	urban
MacKenzie	St. Patrick	Colonel By Drive	20 Note: Maximum land requirement from property abutting existing ROW (zero m). Subject to widening/easement policy	arterial	urban
MacKenzie King Bridge	Albert/Slater Connections	Waller	26	arterial	urban
Main	Echo	Highway 417	23	arterial	urban
Main	Highway 417	Clegg	20	arterial	urban
Main	Clegg	Riverside	23	arterial	urban
Main (Stittsville)	Hazeldean	Carp	37.5	arterial	urban
Main (Stittsville)	Carp	Etta	23	arterial	urban
Main (Stittsville)/ Huntley	Etta	Urban area limit	37.5 Note: An additional 5.0 m on the Rural side may be required to construct a rural cross-section.	arterial	urban
Maisonneuve	130 m north of St Joseph	St. Joseph	23	local	urban
Maitland	Carling	Woodward	26	arterial	urban
Majestic	New Haven	Woodroffe	24	collector	urban
Manotick Main	Bankfield	Century East	23	arterial	village
Maple Grove	Stittsville Main St.	Huntmar	26	collector and local	urban
Maple Grove	Huntmar	Terry Fox	37.5	arterial	urban
Maple Lane	Lisgar Road	Springfield	18 Note: unequal measured from north side	local	urban
March	Dunrobin	Urban Area Limit	34	arterial	rural
March	Urban area limit	Terry Fox	44.5 Note: Subject to unequal widenings outlined in MarchRoad ESR	arterial	urban



Appendix B
Manotick Pump Station Generator Specifications

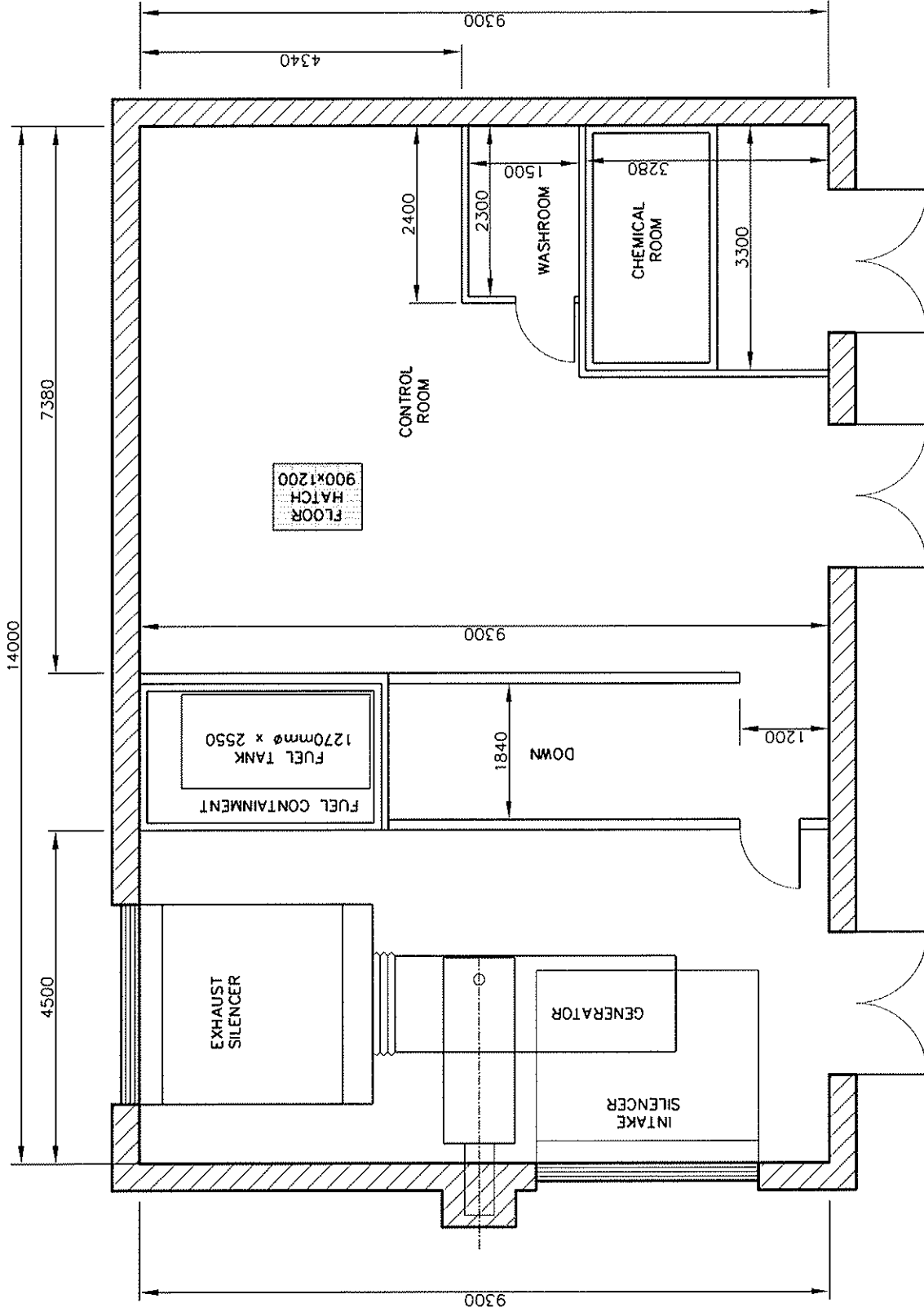

	Project Title DESIGN BRIEF MANOTICK MUNICIPAL SERVICING MAIN SANITARY SEWAGE PUMP STATION CITY OF OTTAWA	Drawing Title CONTROL BUILDING FLOOR PLAN	Project No. 11931
	Date SEPT. 2008		Date SEPT. 2008
			Figure FIGURE 9



RATINGS 480 V - 60 Hz		
Standby	kVA	625
	kWe	500
Prime	kVA	568
	kWe	454



Benefits & features

KOHLER premium quality

- Design offices using the latest technical innovations
- Modern fully certified factories
- A cutting edge laboratory
- The generating set, its components and a wide range of options have been fully developed, prototype tested, factory built, and production tested
- Approved for use with HVO (Hydrotreated Vegetable Oil) according to EN15940

KOHLER premium performances

- Optimized and certified sound levels
- Reliable power, even in extreme conditions
- Optimized fuel consumption
- Compact footprint
- Best quality of electricity, high starting and loading capacity, according to ISO8528-5
- Robust base frames and high-quality enclosures
- Protection of installations and people
- Approved in line with the most stringent standards

Engines

- Premium level engines, in-house or from strong partners
- High power density, small footprint
- Low temperature starting capability
- Long maintenance interval

Alternator

- Provide industry leading motor starting capability
- Made in Europe
- Built with a class H insulation and IP23

Cooling

- A compact and complete solution using a mechanically driven radiator fan
- Designed or optimized by KOHLER
- High temperature and altitude product capacity available

Base frame and enclosure

- High quality steel with enhanced corrosion resistance
- Highly durable QUALICOAT-certified epoxy paint
- Minimum 1000 hours of resistance to salt spray in accordance with ISO12944
- Ergonomic access to allow easy maintenance and connection of the generator
- Robust design optimized for transportation

GENERAL SPECIFICATIONS

Engine brand	VOLVO
Alternator commercial brand	KOHLER
Voltage (V)	480/277
Standard Control Panel	APM403
Optional control panel	APM802
Optional Control Panel	M80
Optional control panel	Terminal block
Consumption @ 100% load ESP (L/h)	132
Consumption @ 100% load PRP (L/h)	122
Emission level	Emission optimization - Stage II Compliant
Type of Cooling	Mechanical driven fan
Performance class	G3

GENERATOR SETS RATINGS

	Standby Rating						Prime Rating	
	Voltage	PH	Hz	kWe	kVA	Amps	kWe	kVA
V500UC2	480/277	3	60	500	625	752	454	568
	440/254	3	60	500	625	820	454	568
	220/127	3	60	500	625	1640	454	568
	208/120	3	60	500	625	1735	454	568

DIMENSIONS COMPACT VERSION

Length (mm)	3470
Width (mm)	1500
Height (mm)	2048
Tank capacity (L)	500
Dry weight (kg)	3660

DIMENSIONS SOUNDPROOFED VERSION

Type soundproofing	NOT AVAILABLE
Length (mm)	5031
Width (mm)	1560
Height (mm)	2435
Tank capacity (L)	500
Dry weight (kg)	4870
Acoustic pressure level @1m in dB(A) 60Hz (100% PRP)	87
Acoustic pressure level @7m in dB(A) 60Hz (100% PRP)	76

Reference Conditions: 25°C Air Inlet Temperature, 40°C Fuel Inlet Temperature, 100 kPa Barometric Pressure; 10.7 g/kg of dry air Humidity. Intake Restriction set to maximum allowable limit for clean filter; Exhaust Back pressure set to maximum allowable limit.

Data was taken from a single engine test according to the test methods, fuel specification and reference conditions stated above and is subjected to instrumentation and engine-to-engine variability. Test conducted with alternate test methods, instrumentation, fuel or reference conditions can yield different results. Data and specifications subject to change without notice.

Engine

General

Engine brand	VOLVO
Engine ref.	TAD1641GE-B *
Air inlet system	Turbo
Fuel	Diesel Fuel/HVO
Emission level	Emission optimization - Stage II Compliant
Cylinder configuration	L
Number of cylinders	6
Displacement (l)	16,12
Bore (mm) * Stroke (mm)	144 * 165
Compression ratio	16.5 : 1
Speed (RPM)	1800
Maximum stand-by power at rated RPM 60Hz (kW)	565
Charge Air coolant	Air/Air
Frequency regulation, steady state (%)	+/- 0.25%
Injection Type	Direct
Governor type	Electronic
Air cleaner type, models	Dry

Fuel system

Maximum fuel pump flow 60Hz (l/h)	190
Max head on fuel return line (m)	0

Consumption with cooling system

Fuel consumption @ ESP Max Power 60Hz (l/h)	135,60
Fuel consumption @ PRP Max Power 60Hz (l/h)	122,70
Fuel consumption @ 75% of PRP Power 60Hz (l/h)	91,20
Fuel consumption @ 50% of PRP Power 60Hz (l/h)	62,30

Emissions

Emission PM (g/kWh)	0,11
Emission CO (g/kW.h)	0,69
Emission NOx (g/kW.h) Diesel or NG	5,19
Emission HC (g/kW.h)	0,16

* Engine reference may be partially modified depending on genset application, options selected by the customer and lead time required.

** Fuel consumption is up to 4% higher when using HVO than Diesel Fuel

Lubrication System

Oil system capacity including filters (l)	48
Min. oil pressure (bar)	0,70
Max. oil pressure (bar)	6,50
Oil sump capacity (l)	42
Oil consumption 100% ESP 60Hz (l/h)	0,11

Air Intake system

Max. intake restriction (mm H2O)	500
Combustion air flow (l/s)	763

Exhaust system

	PRP	ESP
Heat rejection to exhaust (kW)		442
Exhaust gas temperature (°C)		479
Exhaust gas flow (L/s)		1840
Max. exhaust back pressure (mm H2O)	1000	

Cooling system

Radiator & Engine capacity (l)	60
Fan power 60Hz (kW)	19
Fan air flow w/o restriction (m3/s)	9,80
Available restriction on air flow (mm H2O)	25
Type of coolant	Glycol-Ethylene
Radiated heat to ambient (kW)	24
Heat rejection to coolant HT (kW)	231
Outlet coolant temperature (°C)	93
Max coolant temperature, Shutdown (°C)	103
Thermostat begin of opening HT (°C)	86
Thermostat end of opening HT (°C)	96

Alternator Specifications

Alternator commercial brand	KOHLER
Kohler Alternator description	KH02450T
Number of pole	4
Number of bearing	Single Bearing
Technology	Brushless
Indication of protection	IP23
Insulation class	H
Number of wires	12
AVR Regulation	Yes
Coupling	Direct
Capacity for maintaining short circuit at 3 In for 10 s	No

Application data

Overspeed (rpm)	2250
Power factor (Cos Phi)	0,80
Voltage regulation at established rating (+/- %)	0,50
Wave form : NEMA=TIF	<50
Wave form : CEI=FHT	<2
Total Harmonic Distortion in no-load DHT (%)	<2
Total Harmonic Distortion, on linear load DHT (%)	<2
Recovery time (Delta U = 20% transient) (ms)	500

Performance datas

Continuous Nominal Rating 40°C (kVA)	625
Unbalanced load acceptance ratio (%)	70

Peak motor starting (kVA) based on x% voltage dip power factor at 0.3

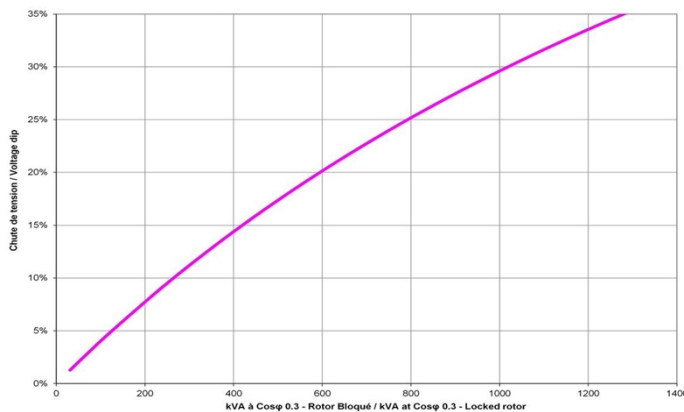

Alternator Standard Features

- All models are brushless, rotating-field alternators
- NEMA MG1, IEEE, and ANSI standards compliance for temperature rise and motor starting
- The AVR voltage regulator provides superior short circuit capability
- Self-ventilated and dip proof construction
- Superior voltage waveform

Note: See Alternator Data Sheets for alternator application data and ratings, efficiency curves, voltage dip with motor starting curves, and short circuit decrement curves.

Reference Conditions: 25°C Air Inlet Temperature, 40°C Fuel Inlet Temperature, 100 kPa Barometric Pressure; 10.7 g/kg of dry air Humidity. Intake Restriction set to maximum allowable limit for clean filter; Exhaust Back pressure set to maximum allowable limit.

Data was taken from a single engine test according to the test methods, fuel specification and reference conditions stated above and is subjected to instrumentation and engine-to-engine variability. Test conducted with alternate test methods, instrumentation, fuel or reference conditions can yield different results. Data and specifications subject to change without notice.

Dimensions compact version

Length (mm) * Width (mm) * Height (mm)	3470 * 1500 * 2048
Dry weight (kg)	3660
Tank capacity (L)	500

**M229 - Dimensions soundproofed version**

Length (mm) * Width (mm) * Height (mm)	5031 * 1560 * 2435
Dry weight (kg)	4870
Tank capacity (L)	500
Acoustic pressure level @1m in dB(A) 60Hz (100% PRP)	87
Acoustic pressure level @7m in dB(A) 60Hz (100% PRP)	76

**Dimensions DW compact version**

Length (mm) * Width (mm) * Height (mm)	5083 * 1560 * 2308
Dry weight (kg)	3490
Tank capacity (L)	1770

**M229 - Encombrement DW version insonorisée**

Length (mm) * Width (mm) * Height (mm)	5083 * 1560 * 2700
Dry weight (kg)	5590
Tank capacity (L)	1770
Acoustic pressure level @1m in dB(A) 60Hz (100% PRP)	87
Acoustic pressure level @7m in dB(A) 60Hz (100% PRP)	76



* dimensions and weight without options

Reference Conditions: 25°C Air Inlet Temperature, 40°C Fuel Inlet Temperature, 100 kPa Barometric Pressure; 10.7 g/kg of dry air Humidity. Intake Restriction set to maximum allowable limit for clean filter; Exhaust Back pressure set to maximum allowable limit.

Data was taken from a single engine test according to the test methods, fuel specification and reference conditions stated above and is subjected to instrumentation and engine-to-engine variability. Test conducted with alternate test methods, instrumentation, fuel or reference conditions can yield different results. Data and specifications subject to change without notice.

Basic terminal block

It is used as a basic terminal block for connecting a control unit. Offers the following functions:

- emergency stop button
- customer connection terminal block
- CE certified

M80

The M80 is a dual-function control panel. It can be used as a basic terminal block for connecting a control unit and as an instrument panel with a direct read facility, with displays giving a global view of your generating set's basic parameters. Offers the following functions:

- Engine parameters: tachometer, working hours counter, coolant temperature indicator, oil pressure indicator
- emergency stop button
- customer connection terminal block
- CE certified

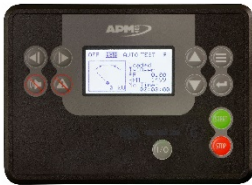
APM403**BASIC GENERATING SET AND POWER PLANT CONTROL**

The APM403 is a versatile control unit which allows operation in manual or automatic mode

- Measurements : voltage and current
- kW/kWh/kVA power meters
- Standard specifications: Voltmeter, Frequency meter.
- Optional : Battery ammeter.
- J1939 CAN ECU engine control
- Alarms and faults: Oil pressure, Coolant temperature, Overspeed, Start-up failure, alternator min/max, Emergency stop button.
- Engine parameters: Fuel level, hour counter, battery voltage.
- Optional (standard at 24V): Oil pressure, water temperature.
- Event log/ Management of the last 300 genset events.
- Mains and genset protection
- Clock management
- USB connections, USB Host and PC,
- Communications : RS485 INTERFACE
- ModBUS protocol /SNMP
- Optional : Ethernet, GPRS, remote control, 3G, 4G,
- Websupervisor, SMS, E-mails

APM802**ADVANCED POWER PLANT MANAGEMENT CONTROL**

Dedicated to power plant management APM802 provides advanced control, system monitoring, and system diagnostics for optimum performance and compatibility

- Graphic display with touchscreen
- User language selectable
- Specially researched ergonomics
- High level of equipment availability
- USB and Ethernet ports
- Modbus protocol
- Making it easy to extend the installation
- Complies with the international standard IEC 61131-3

STANDARD SCOPE OF SUPPLY

All our gensets are fitted with:

- Industrial water cooled DIESEL engine
- Electric starter & charge alternator
- Standard air filter
- Schneider or ABB electric circuit breaker, adapted to the short-circuit current of the generating set
- Single bearing alternator IP 23 T° rise/ insulation to class H/H
- Welded steel base frame with 85% vibration attenuation mounts
- 4 lifting points on the chassis, lifting bar on the top included from 165 kVA ESP or optional
- highly durable QUALICOAT certified epoxy paint
- frame height optimized to allow it to be moved safely by forklift
- enclosure made of new high-quality European steel with enhanced corrosion resistance
- IP 64 locks, made from stainless materials
- enclosures and base frames tested and analyzed by the French Corrosion Institut
- 100% of tanks tested for permeability
- Personal protection ensured by protective grilles on hot and rotating parts
- Separate 9 dB(A) silencer
- Fuel tank welded inside the genset frame
- Retention bund included for gensets up to 110 kVA ESP
- Charged DC starting battery with electrolyte
- Emergency stop button on the outside
- Flexible fuel lines & lub oil drain cock
- Exhaust outlet with flexible and flanges
- User's manual (1 copy)
- Packing under plastic film
- Delivered with oil and antifreeze liquid

STANDARD DELIVERY

All our gensets are fitted with:

- Industrial water-cooled DIESEL engine
- Electric starter & charge alternator
- Standard air filter
- Electric circuit breaker, adapted to the short-circuit current of the generating set
- Single bearing alternator IP 23 T° rise/ insulation to class H/H
- Welded steel base frame with 85% vibration attenuation mounts
- frame height optimized to allow it to be moved safely by forklift
- enclosure made of new high-quality European steel with enhanced corrosion resistance
- enclosures and base frames tested and analyzed by the French Corrosion Institut
- 100% of tanks tested for permeability
- Personal protection ensured by protective grilles on hot and rotating parts
- Separate 9 dB(A) silencer
- Fuel tank welded inside the genset frame
- Retention bund included for gensets up to 250 kVA ESP
- Charged DC starting battery with electrolyte
- Emergency stop button on the outside
- Flexible fuel lines & lub oil drain cock
- Exhaust outlet with flexible and flanges
- User's manual (1 copy)
- Packing under plastic film
- Delivered with oil and antifreeze liquid

CODES AND STANDARDS

Engine-generators set is designed and manufactured in facilities certified to standards ISO9001:2015 & ISO14001:2015. The generator sets and its components are prototype-tested, factory built and production tested and are in compliance with the relevant standards:

- Machinery Directive 2006/42/EC of May 17th 2006

Reference Conditions: 25°C Air Inlet Temperature, 40°C Fuel Inlet Temperature, 100 kPa Barometric Pressure; 10.7 g/kg of dry air Humidity. Intake Restriction set to maximum allowable limit for clean filter; Exhaust Back pressure set to maximum allowable limit.

Data was taken from a single engine test according to the test methods, fuel specification and reference conditions stated above and is subjected to instrumentation and engine-to-engine variability. Test conducted with alternate test methods, instrumentation, fuel or reference conditions can yield different results. Data and specifications subject to change without notice.

- EMC Directive 2014/30/UE
- Safety objectives set out in the Low Voltage Directive 2014/35/UE
- EN ISO 8528-13, EN 60034-1, EN 61000-6-1, EN 61000-6-2, EN 61000-6-3, EN 55011, EN 1679-1 et EN 60204-1

POWER RATINGS DEFINITION according to ISO8528-1 (2018-02 edition) and ISO-3046-1

Emergency Standby Power (ESP): The standby rating is applicable to varying loads for the duration of a power outage. There is no overload capability for this rating. Average load factor per 24 hours of operation is <70%.

Prime Power (PRP): At varying load, the number of generator set operating hours is unlimited. A 10% overload capacity is available for one hour within 12 hour of operation. Average load factor per 24 hours of operation is <70%.

TERMS OF USE

According to the standard, the nominal power assigned by the genset is given for 25°C Air Inlet Temperature, of a barometric pressure of 100 kPA (100 m A.S.L), and 30% relative humidity. For particular conditions in your installation, refer to the derating table.

WARRANTY INFORMATIONS

Standard Warranty Period:

- for Products in "back-up" service
 - o 30 months from the date the Product leaves the plant
 - o 24 months from the Product's commissioning date
 - o 1,000 running hours

The warranty expires when one of the above conditions is met.

- for Products in "prime" or "continuous" service (continuous supply of electricity, either in the absence of any normal electricity grid or to complement the grid),
 - o 18 months from the date the Product leaves the plant
 - o 12 months from the Product's commissioning date
 - o 2,500 running hours

The warranty expires when one of the above conditions is met.

For more details regarding conditions of application and scope of the warranty please refer to our General "terms & conditions of sales".

Appendix C
STAMSON Noise Modelling Results

STAMSON 5.0 NORMAL REPORT Date: 12-08-2022 10:12:22

MINISTRY OF ENVIRONMENT AND ENERGY / NOISE ASSESSMENT

Filename: iler1.te Time Period: Day/Night 16/8 hours

Description: Road data, segment # 1: RVDNOpem (day/night)

Car traffic volume : 12144/1056 veh/TimePeriod *

Medium truck volume : 966/84 veh/TimePeriod *

Heavy truck volume : 690/60 veh/TimePeriod *

Posted speed limit : 60 km/h

Road gradient : 3 %

Road pavement : 1 (Typical asphalt or concrete)

* Refers to calculated road volumes based on the following input:

24 hr Traffic Volume (AADT or SADT): 15000

Percentage of Annual Growth : 0.00

Number of Years of Growth : 0.00

Medium Truck % of Total Volume : 7.00

Heavy Truck % of Total Volume : 5.00

Day (16 hrs) % of Total Volume : 92.00

Data for Segment # 1: RVDNOpem (day/night)

Angle1 Angle2 : -90.00 deg 90.00 deg

Wood depth : 0 (No woods.)

No of house rows : 0 / 0

Surface : 1 (Absorptive ground surface)

Receiver source distance : 62.30 / 62.30 m

Receiver height : 1.50 / 4.50 m

Topography : 1 (Flat/gentle slope; no barrier)

Reference angle : 0.00

Results segment # 1: RVDNOpem (day)

Source height = 1.50 m

ROAD (0.00 + 58.85 + 0.00) = 58.85 dBA

Angle1 Angle2 Alpha RefLeq P.Adj D.Adj F.Adj W.Adj H.Adj B.Adj SubLeq

-90 90 0.66 70.58 0.00 -10.27 -1.46 0.00 0.00 0.00 58.85

Segment Leq : 58.85 dBA

Total Leq All Segments: 58.85 dBA

Results segment # 1: RVDNOpem (night)

Source height = 1.50 m

ROAD (0.00 + 51.97 + 0.00) = 51.97 dBA

Angle1 Angle2 Alpha RefLeq P.Adj D.Adj F.Adj W.Adj H.Adj B.Adj SubLeq

-90 90 0.57 62.98 0.00 -9.71 -1.30 0.00 0.00 0.00 51.97

Segment Leq : 51.97 dBA

Total Leq All Segments: 51.97 dBA

TOTAL Leq FROM ALL SOURCES (DAY): 58.85

(NIGHT): 51.97

STAMSON 5.0 NORMAL REPORT Date: 12-08-2022 10:14:41

MINISTRY OF ENVIRONMENT AND ENERGY / NOISE ASSESSMENT

Filename: iler2.te Time Period: Day/Night 16/8 hours

Description: Road data, segment # 1: RVDNOpem (day/night)

Car traffic volume : 12144/1056 veh/TimePeriod *

Medium truck volume : 966/84 veh/TimePeriod *

Heavy truck volume : 690/60 veh/TimePeriod *

Posted speed limit : 60 km/h

Road gradient : 3 %

Road pavement : 1 (Typical asphalt or concrete)

* Refers to calculated road volumes based on the following input:

24 hr Traffic Volume (AADT or SADT): 15000

Percentage of Annual Growth : 0.00

Number of Years of Growth : 0.00

Medium Truck % of Total Volume : 7.00

Heavy Truck % of Total Volume : 5.00

Day (16 hrs) % of Total Volume : 92.00

Data for Segment # 1: RVDNOpem (day/night)

Angle1 Angle2 : -90.00 deg 90.00 deg

Wood depth : 0 (No woods.)

No of house rows : 0 / 0

Surface : 1 (Absorptive ground surface)

Receiver source distance : 32.40 / 32.40 m

Receiver height : 1.50 / 4.50 m

Topography : 1 (Flat/gentle slope; no barrier)

Reference angle : 0.00

Results segment # 1: RVDNOpem (day)

Source height = 1.50 m

ROAD (0.00 + 63.57 + 0.00) = 63.57 dBA

Angle1 Angle2 Alpha RefLeq P.Adj D.Adj F.Adj W.Adj H.Adj B.Adj SubLeq

-90 90 0.66 70.58 0.00 -5.55 -1.46 0.00 0.00 0.00 63.57

Segment Leq : 63.57 dBA

Total Leq All Segments: 63.57 dBA

Results segment # 1: RVDNOpem (night)

Source height = 1.50 m

ROAD (0.00 + 56.43 + 0.00) = 56.43 dBA

Angle1 Angle2 Alpha RefLeq P.Adj D.Adj F.Adj W.Adj H.Adj B.Adj SubLeq

-90 90 0.57 62.98 0.00 -5.25 -1.30 0.00 0.00 0.00 56.43

Segment Leq : 56.43 dBA

Total Leq All Segments: 56.43 dBA

TOTAL Leq FROM ALL SOURCES (DAY): 63.57

(NIGHT): 56.43

STAMSON 5.0 NORMAL REPORT Date: 12-08-2022 10:15:43

MINISTRY OF ENVIRONMENT AND ENERGY / NOISE ASSESSMENT

Filename: iler3.te Time Period: Day/Night 16/8 hours

Description: Road data, segment # 1: RVDNOpem (day/night)

Car traffic volume : 12144/1056 veh/TimePeriod *

Medium truck volume : 966/84 veh/TimePeriod *

Heavy truck volume : 690/60 veh/TimePeriod *

Posted speed limit : 60 km/h

Road gradient : 2 %

Road pavement : 1 (Typical asphalt or concrete)

* Refers to calculated road volumes based on the following input:

24 hr Traffic Volume (AADT or SADT): 15000

Percentage of Annual Growth : 0.00

Number of Years of Growth : 0.00

Medium Truck % of Total Volume : 7.00

Heavy Truck % of Total Volume : 5.00

Day (16 hrs) % of Total Volume : 92.00

Data for Segment # 1: RVDNOpem (day/night)

Angle1 Angle2 : -90.00 deg 90.00 deg

Wood depth : 0 (No woods.)

No of house rows : 0 / 0

Surface : 1 (Absorptive ground surface)

Receiver source distance : 34.70 / 34.70 m

Receiver height : 1.50 / 4.50 m

Topography : 1 (Flat/gentle slope; no barrier)

Reference angle : 0.00

Results segment # 1: RVDNOpem (day)

Source height = 1.50 m

ROAD (0.00 + 62.49 + 0.00) = 62.49 dBA

Angle1 Angle2 Alpha RefLeq P.Adj D.Adj F.Adj W.Adj H.Adj B.Adj SubLeq

-90 90 0.66 70.00 0.00 -6.05 -1.46 0.00 0.00 0.00 62.49

Segment Leq : 62.49 dBA

Total Leq All Segments: 62.49 dBA

Results segment # 1: RVDNOpem (night)

Source height = 1.50 m

ROAD (0.00 + 55.38 + 0.00) = 55.38 dBA

Angle1 Angle2 Alpha RefLeq P.Adj D.Adj F.Adj W.Adj H.Adj B.Adj SubLeq

-90 90 0.57 62.40 0.00 -5.72 -1.30 0.00 0.00 0.00 55.38

Segment Leq : 55.38 dBA

Total Leq All Segments: 55.38 dBA

TOTAL Leq FROM ALL SOURCES (DAY): 62.49

(NIGHT): 55.38

STAMSON 5.0 NORMAL REPORT Date: 12-08-2022 10:17:00

MINISTRY OF ENVIRONMENT AND ENERGY / NOISE ASSESSMENT

Filename: iler4.te Time Period: Day/Night 16/8 hours

Description: Road data, segment # 1: RVDNOpem (day/night)

Car traffic volume : 12144/1056 veh/TimePeriod *

Medium truck volume : 966/84 veh/TimePeriod *

Heavy truck volume : 690/60 veh/TimePeriod *

Posted speed limit : 60 km/h

Road gradient : 2 %

Road pavement : 1 (Typical asphalt or concrete)

* Refers to calculated road volumes based on the following input:

24 hr Traffic Volume (AADT or SADT): 15000

Percentage of Annual Growth : 0.00

Number of Years of Growth : 0.00

Medium Truck % of Total Volume : 7.00

Heavy Truck % of Total Volume : 5.00

Day (16 hrs) % of Total Volume : 92.00

Data for Segment # 1: RVDNOpem (day/night)

Angle1 Angle2 : -90.00 deg 90.00 deg

Wood depth : 0 (No woods.)

No of house rows : 0 / 0

Surface : 1 (Absorptive ground surface)

Receiver source distance : 35.20 / 35.20 m

Receiver height : 1.50 / 4.50 m

Topography : 1 (Flat/gentle slope; no barrier)

Reference angle : 0.00

Results segment # 1: RVDNOpem (day)

Source height = 1.50 m

ROAD (0.00 + 62.39 + 0.00) = 62.39 dBA

Angle1 Angle2 Alpha RefLeq P.Adj D.Adj F.Adj W.Adj H.Adj B.Adj SubLeq

-90 90 0.66 70.00 0.00 -6.15 -1.46 0.00 0.00 0.00 62.39

Segment Leq : 62.39 dBA

Total Leq All Segments: 62.39 dBA

Results segment # 1: RVDNOpem (night)

Source height = 1.50 m

ROAD (0.00 + 55.28 + 0.00) = 55.28 dBA

Angle1 Angle2 Alpha RefLeq P.Adj D.Adj F.Adj W.Adj H.Adj B.Adj SubLeq

-90 90 0.57 62.40 0.00 -5.82 -1.30 0.00 0.00 0.00 55.28

Segment Leq : 55.28 dBA

Total Leq All Segments: 55.28 dBA

TOTAL Leq FROM ALL SOURCES (DAY): 62.39

(NIGHT): 55.28

STAMSON 5.0 NORMAL REPORT Date: 12-08-2022 10:18:04

MINISTRY OF ENVIRONMENT AND ENERGY / NOISE ASSESSMENT

Filename: iler5.te Time Period: Day/Night 16/8 hours

Description: Road data, segment # 1: RVDNOpem (day/night)

Car traffic volume : 12144/1056 veh/TimePeriod *

Medium truck volume : 966/84 veh/TimePeriod *

Heavy truck volume : 690/60 veh/TimePeriod *

Posted speed limit : 60 km/h

Road gradient : 1 %

Road pavement : 1 (Typical asphalt or concrete)

* Refers to calculated road volumes based on the following input:

24 hr Traffic Volume (AADT or SADT): 15000

Percentage of Annual Growth : 0.00

Number of Years of Growth : 0.00

Medium Truck % of Total Volume : 7.00

Heavy Truck % of Total Volume : 5.00

Day (16 hrs) % of Total Volume : 92.00

Data for Segment # 1: RVDNOpem (day/night)

Angle1 Angle2 : -90.00 deg 90.00 deg

Wood depth : 0 (No woods.)

No of house rows : 0 / 0

Surface : 1 (Absorptive ground surface)

Receiver source distance : 33.10 / 33.10 m

Receiver height : 1.50 / 4.50 m

Topography : 1 (Flat/gentle slope; no barrier)

Reference angle : 0.00

Results segment # 1: RVDNOpem (day)

Source height = 1.50 m

ROAD (0.00 + 62.83 + 0.00) = 62.83 dBA

Angle1 Angle2 Alpha RefLeq P.Adj D.Adj F.Adj W.Adj H.Adj B.Adj SubLeq

-90 90 0.66 70.00 0.00 -5.71 -1.46 0.00 0.00 0.00 62.83

Segment Leq : 62.83 dBA

Total Leq All Segments: 62.83 dBA

Results segment # 1: RVDNOpem (night)

Source height = 1.50 m

ROAD (0.00 + 55.70 + 0.00) = 55.70 dBA

Angle1 Angle2 Alpha RefLeq P.Adj D.Adj F.Adj W.Adj H.Adj B.Adj SubLeq

-90 90 0.57 62.40 0.00 -5.40 -1.30 0.00 0.00 0.00 55.70

Segment Leq : 55.70 dBA

Total Leq All Segments: 55.70 dBA

TOTAL Leq FROM ALL SOURCES (DAY): 62.83

(NIGHT): 55.70

STAMSON 5.0 NORMAL REPORT Date: 12-08-2022 10:19:08

MINISTRY OF ENVIRONMENT AND ENERGY / NOISE ASSESSMENT

Filename: iler6.te Time Period: Day/Night 16/8 hours

Description: Road data, segment # 1: RVDNOpem (day/night)

Car traffic volume : 12144/1056 veh/TimePeriod *

Medium truck volume : 966/84 veh/TimePeriod *

Heavy truck volume : 690/60 veh/TimePeriod *

Posted speed limit : 60 km/h

Road gradient : 2 %

Road pavement : 1 (Typical asphalt or concrete)

* Refers to calculated road volumes based on the following input:

24 hr Traffic Volume (AADT or SADT): 15000

Percentage of Annual Growth : 0.00

Number of Years of Growth : 0.00

Medium Truck % of Total Volume : 7.00

Heavy Truck % of Total Volume : 5.00

Day (16 hrs) % of Total Volume : 92.00

Data for Segment # 1: RVDNOpem (day/night)

Angle1 Angle2 : -90.00 deg 90.00 deg

Wood depth : 0 (No woods.)

No of house rows : 0 / 0

Surface : 1 (Absorptive ground surface)

Receiver source distance : 20.90 / 20.90 m

Receiver height : 1.50 / 4.50 m

Topography : 1 (Flat/gentle slope; no barrier)

Reference angle : 0.00

Results segment # 1: RVDNOpem (day)

Source height = 1.50 m

ROAD (0.00 + 66.15 + 0.00) = 66.15 dBA

Angle1 Angle2 Alpha RefLeq P.Adj D.Adj F.Adj W.Adj H.Adj B.Adj SubLeq

-90 90 0.66 70.00 0.00 -2.39 -1.46 0.00 0.00 0.00 66.15

Segment Leq : 66.15 dBA

Total Leq All Segments: 66.15 dBA

Results segment # 1: RVDNOpem (night)

Source height = 1.50 m

ROAD (0.00 + 58.84 + 0.00) = 58.84 dBA

Angle1 Angle2 Alpha RefLeq P.Adj D.Adj F.Adj W.Adj H.Adj B.Adj SubLeq

-90 90 0.57 62.40 0.00 -2.26 -1.30 0.00 0.00 0.00 58.84

Segment Leq : 58.84 dBA

Total Leq All Segments: 58.84 dBA

TOTAL Leq FROM ALL SOURCES (DAY): 66.15

(NIGHT): 58.84

STAMSON 5.0 NORMAL REPORT Date: 12-08-2022 10:20:15

MINISTRY OF ENVIRONMENT AND ENERGY / NOISE ASSESSMENT

Filename: iler7.te Time Period: Day/Night 16/8 hours

Description: Road data, segment # 1: RVDNOpem (day/night)

Car traffic volume : 12144/1056 veh/TimePeriod *

Medium truck volume : 966/84 veh/TimePeriod *

Heavy truck volume : 690/60 veh/TimePeriod *

Posted speed limit : 60 km/h

Road gradient : 0 %

Road pavement : 1 (Typical asphalt or concrete)

* Refers to calculated road volumes based on the following input:

24 hr Traffic Volume (AADT or SADT): 15000

Percentage of Annual Growth : 0.00

Number of Years of Growth : 0.00

Medium Truck % of Total Volume : 7.00

Heavy Truck % of Total Volume : 5.00

Day (16 hrs) % of Total Volume : 92.00

Data for Segment # 1: RVDNOpem (day/night)

Angle1 Angle2 : -90.00 deg 90.00 deg

Wood depth : 0 (No woods.)

No of house rows : 0 / 0

Surface : 1 (Absorptive ground surface)

Receiver source distance : 49.10 / 49.10 m

Receiver height : 1.50 / 4.50 m

Topography : 1 (Flat/gentle slope; no barrier)

Reference angle : 0.00

Results segment # 1: RVDNOpem (day)

Source height = 1.50 m

ROAD (0.00 + 59.99 + 0.00) = 59.99 dBA

Angle1 Angle2 Alpha RefLeq P.Adj D.Adj F.Adj W.Adj H.Adj B.Adj SubLeq

-90 90 0.66 70.00 0.00 -8.55 -1.46 0.00 0.00 0.00 59.99

Segment Leq : 59.99 dBA

Total Leq All Segments: 59.99 dBA

Results segment # 1: RVDNOpem (night)

Source height = 1.50 m

ROAD (0.00 + 53.01 + 0.00) = 53.01 dBA

Angle1 Angle2 Alpha RefLeq P.Adj D.Adj F.Adj W.Adj H.Adj B.Adj SubLeq

-90 90 0.57 62.40 0.00 -8.09 -1.30 0.00 0.00 0.00 53.01

Segment Leq : 53.01 dBA

Total Leq All Segments: 53.01 dBA

TOTAL Leq FROM ALL SOURCES (DAY): 59.99

(NIGHT): 53.01

STAMSON 5.0 NORMAL REPORT Date: 12-08-2022 10:21:43

MINISTRY OF ENVIRONMENT AND ENERGY / NOISE ASSESSMENT

Filename: iler8.te Time Period: Day/Night 16/8 hours

Description: Road data, segment # 1: House (day/night)

Car traffic volume : 12144/1056 veh/TimePeriod *

Medium truck volume : 966/84 veh/TimePeriod *

Heavy truck volume : 690/60 veh/TimePeriod *

Posted speed limit : 60 km/h

Road gradient : 0 %

Road pavement : 1 (Typical asphalt or concrete)

* Refers to calculated road volumes based on the following input:

24 hr Traffic Volume (AADT or SADT): 15000

Percentage of Annual Growth : 0.00

Number of Years of Growth : 0.00

Medium Truck % of Total Volume : 7.00

Heavy Truck % of Total Volume : 5.00

Day (16 hrs) % of Total Volume : 92.00

Data for Segment # 1: House (day/night)

Angle1 Angle2 : -90.00 deg -75.00 deg

Wood depth : 0 (No woods.)

No of house rows : 0 / 0

Surface : 1 (Absorptive ground surface)

Receiver source distance : 59.90 / 59.90 m

Receiver height : 1.50 / 4.50 m

Topography : 2 (Flat/gentle slope; with barrier)

Barrier angle1 : -90.00 deg Angle2 : -75.00 deg

Barrier height : 6.00 m Barrier receiver distance : 9.00 / 9.00 m

Source elevation : 88.97 m

Receiver elevation : 89.95 m

Barrier elevation : 90.08 m

Reference angle : 0.00

Road data, segment # 2: BFOpen (day/night)

Car traffic volume : 12144/1056 veh/TimePeriod *

Medium truck volume : 966/84 veh/TimePeriod *

Heavy truck volume : 690/60 veh/TimePeriod *

Posted speed limit : 60 km/h

Road gradient : 0 %

Road pavement : 1 (Typical asphalt or concrete)

* Refers to calculated road volumes based on the following input:

24 hr Traffic Volume (AADT or SADT): 15000

Percentage of Annual Growth : 0.00

Number of Years of Growth : 0.00

Medium Truck % of Total Volume : 7.00

Heavy Truck % of Total Volume : 5.00

Day (16 hrs) % of Total Volume : 92.00

Data for Segment # 2: BFOpen (day/night)

Angle1 Angle2 : -75.00 deg 90.00 deg

Wood depth : 0 (No woods.)

No of house rows : 0 / 0

Surface : 1 (Absorptive ground surface)

Receiver source distance : 59.90 / 59.90 m

Receiver height : 1.50 / 4.50 m

Topography : 1 (Flat/gentle slope; no barrier)

Reference angle : 0.00

Results segment # 1: House (day)

Source height = 1.50 m

Barrier height for grazing incidence

Source	Receiver	Barrier	Elevation of
Height (m)	Height (m)	Height (m)	Barrier Top (m)

-----+-----+-----+-----

1.50 ! 1.50 ! 1.22 ! 91.30

ROAD (0.00 + 38.87 + 0.00) = 38.87 dBA

Angle1	Angle2	Alpha	RefLeq	P.Adj	D.Adj	F.Adj	W.Adj	H.Adj	B.Adj	SubLeq
--------	--------	-------	--------	-------	-------	-------	-------	-------	-------	--------

-90 -75 0.30 70.00 0.00 -7.82 -13.68 0.00 0.00 -9.63 38.87

Segment Leq : 38.87 dBA

Results segment # 2: BFOpen (day)

Source height = 1.50 m

ROAD (0.00 + 58.43 + 0.00) = 58.43 dBA

Angle1	Angle2	Alpha	RefLeq	P.Adj	D.Adj	F.Adj	W.Adj	H.Adj	B.Adj	SubLeq
--------	--------	-------	--------	-------	-------	-------	-------	-------	-------	--------

-75 90 0.66 70.00 0.00 -9.98 -1.58 0.00 0.00 0.00 58.43

Segment Leq : 58.43 dBA

Total Leq All Segments: 58.48 dBA

Results segment # 1: House (night)

Source height = 1.50 m

Barrier height for grazing incidence

Source ! Receiver ! Barrier ! Elevation of
Height (m) ! Height (m) ! Height (m) ! Barrier Top (m)

-----+-----+-----+-----

1.50 ! 4.50 ! 3.77 ! 93.85

ROAD (0.00 + 35.56 + 0.00) = 35.56 dBA

Angle1 Angle2 Alpha RefLeq P.Adj D.Adj F.Adj W.Adj H.Adj B.Adj SubLeq

-90 -75 0.21 62.40 0.00 -7.28 -12.85 0.00 0.00 -6.72 35.56

Segment Leq : 35.56 dBA

Results segment # 2: BFOpen (night)

Source height = 1.50 m

ROAD (0.00 + 51.51 + 0.00) = 51.51 dBA

Angle1 Angle2 Alpha RefLeq P.Adj D.Adj F.Adj W.Adj H.Adj B.Adj SubLeq

-75 90 0.57 62.40 0.00 -9.44 -1.45 0.00 0.00 0.00 51.51

Segment Leq : 51.51 dBA

Total Leq All Segments: 51.62 dBA

TOTAL Leq FROM ALL SOURCES (DAY): 58.48

(NIGHT): 51.62

STAMSON 5.0 NORMAL REPORT Date: 12-08-2022 10:13:36

MINISTRY OF ENVIRONMENT AND ENERGY / NOISE ASSESSMENT

Filename: iler1.te Time Period: Day/Night 16/8 hours

Description: Road data, segment # 1: RVDNOpem (day/night)

Car traffic volume : 12144/1056 veh/TimePeriod *

Medium truck volume : 966/84 veh/TimePeriod *

Heavy truck volume : 690/60 veh/TimePeriod *

Posted speed limit : 60 km/h

Road gradient : 3 %

Road pavement : 1 (Typical asphalt or concrete)

* Refers to calculated road volumes based on the following input:

24 hr Traffic Volume (AADT or SADT): 15000

Percentage of Annual Growth : 0.00

Number of Years of Growth : 0.00

Medium Truck % of Total Volume : 7.00

Heavy Truck % of Total Volume : 5.00

Day (16 hrs) % of Total Volume : 92.00

Data for Segment # 1: RVDNOpem (day/night)

Angle1 Angle2 : -90.00 deg 90.00 deg

Wood depth : 0 (No woods.)

No of house rows : 0 / 0

Surface : 1 (Absorptive ground surface)

Receiver source distance : 62.30 / 62.30 m

Receiver height : 4.50 / 4.50 m

Topography : 1 (Flat/gentle slope; no barrier)

Reference angle : 0.00

Results segment # 1: RVDNOpem (day)

Source height = 1.50 m

ROAD (0.00 + 59.56 + 0.00) = 59.56 dBA

Angle1 Angle2 Alpha RefLeq P.Adj D.Adj F.Adj W.Adj H.Adj B.Adj SubLeq

-90 90 0.57 70.58 0.00 -9.71 -1.30 0.00 0.00 0.00 59.56

Segment Leq : 59.56 dBA

Total Leq All Segments: 59.56 dBA

Results segment # 1: RVDNOpem (night)

Source height = 1.50 m

ROAD (0.00 + 51.97 + 0.00) = 51.97 dBA

Angle1 Angle2 Alpha RefLeq P.Adj D.Adj F.Adj W.Adj H.Adj B.Adj SubLeq

-90 90 0.57 62.98 0.00 -9.71 -1.30 0.00 0.00 0.00 51.97

Segment Leq : 51.97 dBA

Total Leq All Segments: 51.97 dBA

TOTAL Leq FROM ALL SOURCES (DAY): 59.56

(NIGHT): 51.97

TAMSON 5.0 NORMAL REPORT Date: 12-08-2022 10:15:04

MINISTRY OF ENVIRONMENT AND ENERGY / NOISE ASSESSMENT

Filename: iler2.te Time Period: Day/Night 16/8 hours

Description: Road data, segment # 1: RVDNOpem (day/night)

Car traffic volume : 12144/1056 veh/TimePeriod *

Medium truck volume : 966/84 veh/TimePeriod *

Heavy truck volume : 690/60 veh/TimePeriod *

Posted speed limit : 60 km/h

Road gradient : 3 %

Road pavement : 1 (Typical asphalt or concrete)

* Refers to calculated road volumes based on the following input:

24 hr Traffic Volume (AADT or SADT): 15000

Percentage of Annual Growth : 0.00

Number of Years of Growth : 0.00

Medium Truck % of Total Volume : 7.00

Heavy Truck % of Total Volume : 5.00

Day (16 hrs) % of Total Volume : 92.00

Data for Segment # 1: RVDNOpem (day/night)

Angle1 Angle2 : -90.00 deg 90.00 deg

Wood depth : 0 (No woods.)

No of house rows : 0 / 0

Surface : 1 (Absorptive ground surface)

Receiver source distance : 32.40 / 32.40 m

Receiver height : 4.50 / 4.50 m

Topography : 1 (Flat/gentle slope; no barrier)

Reference angle : 0.00

Results segment # 1: RVDNOpem (day)

Source height = 1.50 m

ROAD (0.00 + 64.02 + 0.00) = 64.02 dBA

Angle1 Angle2 Alpha RefLeq P.Adj D.Adj F.Adj W.Adj H.Adj B.Adj SubLeq

-90 90 0.57 70.58 0.00 -5.25 -1.30 0.00 0.00 0.00 64.02

Segment Leq : 64.02 dBA

Total Leq All Segments: 64.02 dBA

Results segment # 1: RVDNOpem (night)

Source height = 1.50 m

ROAD (0.00 + 56.43 + 0.00) = 56.43 dBA

Angle1 Angle2 Alpha RefLeq P.Adj D.Adj F.Adj W.Adj H.Adj B.Adj SubLeq

-90 90 0.57 62.98 0.00 -5.25 -1.30 0.00 0.00 0.00 56.43

Segment Leq : 56.43 dBA

Total Leq All Segments: 56.43 dBA

TOTAL Leq FROM ALL SOURCES (DAY): 64.02

(NIGHT): 56.43

STAMSON 5.0 NORMAL REPORT Date: 12-08-2022 10:16:03

MINISTRY OF ENVIRONMENT AND ENERGY / NOISE ASSESSMENT

Filename: iler3.te Time Period: Day/Night 16/8 hours

Description: Road data, segment # 1: RVDNOpem (day/night)

Car traffic volume : 12144/1056 veh/TimePeriod *

Medium truck volume : 966/84 veh/TimePeriod *

Heavy truck volume : 690/60 veh/TimePeriod *

Posted speed limit : 60 km/h

Road gradient : 2 %

Road pavement : 1 (Typical asphalt or concrete)

* Refers to calculated road volumes based on the following input:

24 hr Traffic Volume (AADT or SADT): 15000

Percentage of Annual Growth : 0.00

Number of Years of Growth : 0.00

Medium Truck % of Total Volume : 7.00

Heavy Truck % of Total Volume : 5.00

Day (16 hrs) % of Total Volume : 92.00

Data for Segment # 1: RVDNOpem (day/night)

Angle1 Angle2 : -90.00 deg 90.00 deg

Wood depth : 0 (No woods.)

No of house rows : 0 / 0

Surface : 1 (Absorptive ground surface)

Receiver source distance : 34.70 / 34.70 m

Receiver height : 4.50 / 4.50 m

Topography : 1 (Flat/gentle slope; no barrier)

Reference angle : 0.00

Results segment # 1: RVDNOpem (day)

Source height = 1.50 m

ROAD (0.00 + 62.97 + 0.00) = 62.97 dBA

Angle1 Angle2 Alpha RefLeq P.Adj D.Adj F.Adj W.Adj H.Adj B.Adj SubLeq

-90 90 0.57 70.00 0.00 -5.72 -1.30 0.00 0.00 0.00 62.97

Segment Leq : 62.97 dBA

Total Leq All Segments: 62.97 dBA

Results segment # 1: RVDNOpem (night)

Source height = 1.50 m

ROAD (0.00 + 55.38 + 0.00) = 55.38 dBA

Angle1 Angle2 Alpha RefLeq P.Adj D.Adj F.Adj W.Adj H.Adj B.Adj SubLeq

-90 90 0.57 62.40 0.00 -5.72 -1.30 0.00 0.00 0.00 55.38

Segment Leq : 55.38 dBA

Total Leq All Segments: 55.38 dBA

TOTAL Leq FROM ALL SOURCES (DAY): 62.97

(NIGHT): 55.38

STAMSON 5.0 NORMAL REPORT Date: 12-08-2022 10:17:28

MINISTRY OF ENVIRONMENT AND ENERGY / NOISE ASSESSMENT

Filename: iler4.te Time Period: Day/Night 16/8 hours

Description: Road data, segment # 1: RVDNOpem (day/night)

Car traffic volume : 12144/1056 veh/TimePeriod *

Medium truck volume : 966/84 veh/TimePeriod *

Heavy truck volume : 690/60 veh/TimePeriod *

Posted speed limit : 60 km/h

Road gradient : 2 %

Road pavement : 1 (Typical asphalt or concrete)

* Refers to calculated road volumes based on the following input:

24 hr Traffic Volume (AADT or SADT): 15000

Percentage of Annual Growth : 0.00

Number of Years of Growth : 0.00

Medium Truck % of Total Volume : 7.00

Heavy Truck % of Total Volume : 5.00

Day (16 hrs) % of Total Volume : 92.00

Data for Segment # 1: RVDNOpem (day/night)

Angle1 Angle2 : -90.00 deg 90.00 deg

Wood depth : 0 (No woods.)

No of house rows : 0 / 0

Surface : 1 (Absorptive ground surface)

Receiver source distance : 35.20 / 35.20 m

Receiver height : 4.50 / 4.50 m

Topography : 1 (Flat/gentle slope; no barrier)

Reference angle : 0.00

Results segment # 1: RVDNOpem (day)

Source height = 1.50 m

ROAD (0.00 + 62.88 + 0.00) = 62.88 dBA

Angle1 Angle2 Alpha RefLeq P.Adj D.Adj F.Adj W.Adj H.Adj B.Adj SubLeq

-90 90 0.57 70.00 0.00 -5.82 -1.30 0.00 0.00 0.00 62.88

Segment Leq : 62.88 dBA

Total Leq All Segments: 62.88 dBA

Results segment # 1: RVDNOpem (night)

Source height = 1.50 m

ROAD (0.00 + 55.28 + 0.00) = 55.28 dBA

Angle1 Angle2 Alpha RefLeq P.Adj D.Adj F.Adj W.Adj H.Adj B.Adj SubLeq

-90 90 0.57 62.40 0.00 -5.82 -1.30 0.00 0.00 0.00 55.28

Segment Leq : 55.28 dBA

Total Leq All Segments: 55.28 dBA

TOTAL Leq FROM ALL SOURCES (DAY): 62.88

(NIGHT): 55.28

STAMSON 5.0 NORMAL REPORT Date: 12-08-2022 10:18:34

MINISTRY OF ENVIRONMENT AND ENERGY / NOISE ASSESSMENT

Filename: iler5.te Time Period: Day/Night 16/8 hours

Description: Road data, segment # 1: RVDNOpem (day/night)

Car traffic volume : 12144/1056 veh/TimePeriod *

Medium truck volume : 966/84 veh/TimePeriod *

Heavy truck volume : 690/60 veh/TimePeriod *

Posted speed limit : 60 km/h

Road gradient : 1 %

Road pavement : 1 (Typical asphalt or concrete)

* Refers to calculated road volumes based on the following input:

24 hr Traffic Volume (AADT or SADT): 15000

Percentage of Annual Growth : 0.00

Number of Years of Growth : 0.00

Medium Truck % of Total Volume : 7.00

Heavy Truck % of Total Volume : 5.00

Day (16 hrs) % of Total Volume : 92.00

Data for Segment # 1: RVDNOpem (day/night)

Angle1 Angle2 : -90.00 deg 90.00 deg

Wood depth : 0 (No woods.)

No of house rows : 0 / 0

Surface : 1 (Absorptive ground surface)

Receiver source distance : 33.10 / 33.10 m

Receiver height : 4.50 / 4.50 m

Topography : 1 (Flat/gentle slope; no barrier)

Reference angle : 0.00

Results segment # 1: RVDNOpem (day)

Source height = 1.50 m

ROAD (0.00 + 63.30 + 0.00) = 63.30 dBA

Angle1 Angle2 Alpha RefLeq P.Adj D.Adj F.Adj W.Adj H.Adj B.Adj SubLeq

-90 90 0.57 70.00 0.00 -5.40 -1.30 0.00 0.00 0.00 63.30

Segment Leq : 63.30 dBA

Total Leq All Segments: 63.30 dBA

Results segment # 1: RVDNOpem (night)

Source height = 1.50

ROAD (0.00 + 55.70 + 0.00) = 55.70 dBA

Angle1 Angle2 Alpha RefLeq P.Adj D.Adj F.Adj W.Adj H.Adj B.Adj SubLeq

-90 90 0.57 62.40 0.00 -5.40 -1.30 0.00 0.00 0.00 55.70

Segment Leq : 55.70 dBA

Total Leq All Segments: 55.70 dBA

TOTAL Leq FROM ALL SOURCES (DAY): 63.30

(NIGHT): 55.70

STAMSON 5.0 NORMAL REPORT Date: 12-08-2022 10:19:25

MINISTRY OF ENVIRONMENT AND ENERGY / NOISE ASSESSMENT

Filename: iler6.te Time Period: Day/Night 16/8 hours

Description: Road data, segment # 1: RVDNOpem (day/night)

Car traffic volume : 12144/1056 veh/TimePeriod *

Medium truck volume : 966/84 veh/TimePeriod *

Heavy truck volume : 690/60 veh/TimePeriod *

Posted speed limit : 60 km/h

Road gradient : 2 %

Road pavement : 1 (Typical asphalt or concrete)

* Refers to calculated road volumes based on the following input:

24 hr Traffic Volume (AADT or SADT): 15000

Percentage of Annual Growth : 0.00

Number of Years of Growth : 0.00

Medium Truck % of Total Volume : 7.00

Heavy Truck % of Total Volume : 5.00

Day (16 hrs) % of Total Volume : 92.00

Data for Segment # 1: RVDNOpem (day/night)

Angle1 Angle2 : -90.00 deg 90.00 deg

Wood depth : 0 (No woods.)

No of house rows : 0 / 0

Surface : 1 (Absorptive ground surface)

Receiver source distance : 20.90 / 20.90 m

Receiver height : 4.50 / 4.50 m

Topography : 1 (Flat/gentle slope; no barrier)

Reference angle : 0.00

Results segment # 1: RVDNOpem (day)

Source height = 1.50 m

ROAD (0.00 + 66.43 + 0.00) = 66.43 dBA

Angle1 Angle2 Alpha RefLeq P.Adj D.Adj F.Adj W.Adj H.Adj B.Adj SubLeq

-90 90 0.57 70.00 0.00 -2.26 -1.30 0.00 0.00 0.00 66.43

Segment Leq : 66.43 dBA

Total Leq All Segments: 66.43 dBA

Results segment # 1: RVDNOpem (night)

Source height = 1.50 m

ROAD (0.00 + 58.84 + 0.00) = 58.84 dBA

Angle1 Angle2 Alpha RefLeq P.Adj D.Adj F.Adj W.Adj H.Adj B.Adj SubLeq

-90 90 0.57 62.40 0.00 -2.26 -1.30 0.00 0.00 0.00 58.84

Segment Leq : 58.84 dBA

Total Leq All Segments: 58.84 dBA

TOTAL Leq FROM ALL SOURCES (DAY): 66.43

(NIGHT): 58.84

STAMSON 5.0 NORMAL REPORT Date: 12-08-2022 10:20:29

MINISTRY OF ENVIRONMENT AND ENERGY / NOISE ASSESSMENT

Filename: iler7.te Time Period: Day/Night 16/8 hours

Description: Road data, segment # 1: RVDNOpem (day/night)

Car traffic volume : 12144/1056 veh/TimePeriod *

Medium truck volume : 966/84 veh/TimePeriod *

Heavy truck volume : 690/60 veh/TimePeriod *

Posted speed limit : 60 km/h

Road gradient : 0 %

Road pavement : 1 (Typical asphalt or concrete)

* Refers to calculated road volumes based on the following input:

24 hr Traffic Volume (AADT or SADT): 15000

Percentage of Annual Growth : 0.00

Number of Years of Growth : 0.00

Medium Truck % of Total Volume : 7.00

Heavy Truck % of Total Volume : 5.00

Day (16 hrs) % of Total Volume : 92.00

Data for Segment # 1: RVDNOpem (day/night)

Angle1 Angle2 : -90.00 deg 90.00 deg

Wood depth : 0 (No woods.)

No of house rows : 0 / 0

Surface : 1 (Absorptive ground surface)

Receiver source distance : 49.10 / 49.10 m

Receiver height : 4.50 / 4.50 m

Topography : 1 (Flat/gentle slope; no barrier)

Reference angle : 0.00

Results segment # 1: RVDNOpem (day)

Source height = 1.50 m

ROAD (0.00 + 60.61 + 0.00) = 60.61 dBA

Angle1 Angle2 Alpha RefLeq P.Adj D.Adj F.Adj W.Adj H.Adj B.Adj SubLeq

-90 90 0.57 70.00 0.00 -8.09 -1.30 0.00 0.00 0.00 60.61

Segment Leq : 60.61 dBA

Total Leq All Segments: 60.61 dBA

Results segment # 1: RVDNOpem (night)

Source height = 1.50 m

ROAD (0.00 + 53.01 + 0.00) = 53.01 dBA

Angle1 Angle2 Alpha RefLeq P.Adj D.Adj F.Adj W.Adj H.Adj B.Adj SubLeq

-90 90 0.57 62.40 0.00 -8.09 -1.30 0.00 0.00 0.00 53.01

Segment Leq : 53.01 dBA

Total Leq All Segments: 53.01 dBA

TOTAL Leq FROM ALL SOURCES (DAY): 60.61

(NIGHT): 53.01

STAMSON 5.0 NORMAL REPORT Date: 12-08-2022 10:22:17

MINISTRY OF ENVIRONMENT AND ENERGY / NOISE ASSESSMENT

Filename: iler8.te Time Period: Day/Night 16/8 hours

Description: Road data, segment # 1: House (day/night)

Car traffic volume : 12144/1056 veh/TimePeriod *

Medium truck volume : 966/84 veh/TimePeriod *

Heavy truck volume : 690/60 veh/TimePeriod *

Posted speed limit : 60 km/h

Road gradient : 0 %

Road pavement : 1 (Typical asphalt or concrete)

* Refers to calculated road volumes based on the following input:

24 hr Traffic Volume (AADT or SADT): 15000

Percentage of Annual Growth : 0.00

Number of Years of Growth : 0.00

Medium Truck % of Total Volume : 7.00

Heavy Truck % of Total Volume : 5.00

Day (16 hrs) % of Total Volume : 92.00

Data for Segment # 1: House (day/night)

Angle1 Angle2 : -90.00 deg -75.00 deg

Wood depth : 0 (No woods.)

No of house rows : 0 / 0

Surface : 1 (Absorptive ground surface)

Receiver source distance : 59.90 / 59.90 m

Receiver height : 4.50 / 4.50 m

Topography : 2 (Flat/gentle slope; with barrier)

Barrier angle1 : -90.00 deg Angle2 : -75.00 deg

Barrier height : 6.00 m

Barrier receiver distance : 9.00 / 9.00 m

Source elevation : 88.97 m

Receiver elevation : 89.95 m

Barrier elevation : 90.08 m

Reference angle : 0.00

Road data, segment # 2: BFOpen (day/night)

Car traffic volume : 12144/1056 veh/TimePeriod *

Medium truck volume : 966/84 veh/TimePeriod *

Heavy truck volume : 690/60 veh/TimePeriod *

Posted speed limit : 60 km/h

Road gradient : 0 %

Road pavement : 1 (Typical asphalt or concrete)

* Refers to calculated road volumes based on the following input:

24 hr Traffic Volume (AADT or SADT): 15000

Percentage of Annual Growth : 0.00

Number of Years of Growth : 0.00

Medium Truck % of Total Volume : 7.00

Heavy Truck % of Total Volume : 5.00

Day (16 hrs) % of Total Volume : 92.00

Data for Segment # 2: BFOpen (day/night)

Angle1 Angle2 : -75.00 deg 90.00 deg

Wood depth : 0 (No woods.)

No of house rows : 0 / 0

Surface : 1 (Absorptive ground surface)

Receiver source distance : 59.90 / 59.90 m

Receiver height : 4.50 / 4.50 m

Topography : 1 (Flat/gentle slope; no barrier)

Reference angle : 0.00

Results segment # 1: House (day)

Source height = 1.50 m

Barrier height for grazing incidence

Source ! Receiver ! Barrier ! Elevation of
Height (m) ! Height (m) ! Height (m) ! Barrier Top (m)

-----+-----+-----+-----

1.50 ! 4.50 ! 3.77 ! 93.85

ROAD (0.00 + 43.16 + 0.00) = 43.16 dBA

Angle1 Angle2 Alpha RefLeq P.Adj D.Adj F.Adj W.Adj H.Adj B.Adj SubLeq

-90 -75 0.21 70.00 0.00 -7.28 -12.85 0.00 0.00 -6.72 43.16

Segment Leq : 43.16 dBA

Results segment # 2: BFOpen (day)

Source height = 1.50 m

ROAD (0.00 + 59.10 + 0.00) = 59.10 dBA

Angle1 Angle2 Alpha RefLeq P.Adj D.Adj F.Adj W.Adj H.Adj B.Adj SubLeq

-75 90 0.57 70.00 0.00 -9.44 -1.45 0.00 0.00 0.00 59.10

Segment Leq : 59.10 dBA

Total Leq All Segments: 59.21 dBA

Results segment # 1: House (night)

Source height = 1.50 m

Barrier height for grazing incidence

Source ! Receiver ! Barrier ! Elevation of
Height (m) ! Height (m) ! Height (m) ! Barrier Top (m)

-----+-----+-----+-----

1.50 ! 4.50 ! 3.77 ! 93.85

ROAD (0.00 + 35.56 + 0.00) = 35.56 dBA

Angle1 Angle2 Alpha RefLeq P.Adj D.Adj F.Adj W.Adj H.Adj B.Adj SubLeq

-90 -75 0.21 62.40 0.00 -7.28 -12.85 0.00 0.00 -6.72 35.56

Segment Leq : 35.56 dBA

Results segment # 2: BFOpen (night)

Source height = 1.50 m

ROAD (0.00 + 51.51 + 0.00) = 51.51 dBA

Angle1 Angle2 Alpha RefLeq P.Adj D.Adj F.Adj W.Adj H.Adj B.Adj SubLeq

-75 90 0.57 62.40 0.00 -9.44 -1.45 0.00 0.00 0.00 51.51

Segment Leq : 51.51 dBA

Total Leq All Segments: 51.62 dBA

TOTAL Leq FROM ALL SOURCES (DAY): 59.21

(NIGHT): 51.62

STAMSON 5.0 NORMAL REPORT Date: 12-08-2022 10:28:14

MINISTRY OF ENVIRONMENT AND ENERGY / NOISE ASSESSMENT

Filename: olar1.te Time Period: Day/Night 16/8 hours

Description: Road data, segment # 1: RVDNOpen (day/night)

Car traffic volume : 12144/1056 veh/TimePeriod *

Medium truck volume : 966/84 veh/TimePeriod *

Heavy truck volume : 690/60 veh/TimePeriod *

Posted speed limit : 60 km/h

Road gradient : 3 %

Road pavement : 1 (Typical asphalt or concrete)

* Refers to calculated road volumes based on the following input:

24 hr Traffic Volume (AADT or SADT): 15000

Percentage of Annual Growth : 0.00

Number of Years of Growth : 0.00

Medium Truck % of Total Volume : 7.00

Heavy Truck % of Total Volume : 5.00

Day (16 hrs) % of Total Volume : 92.00

Data for Segment # 1: RVDNOpen (day/night)

Angle1 Angle2 : -90.00 deg 90.00 deg

Wood depth : 0 (No woods.)

No of house rows : 0 / 0

Surface : 1 (Absorptive ground surface)

Receiver source distance : 62.10 / 62.10 m

Receiver height : 1.50 / 4.50 m

Topography : 1 (Flat/gentle slope; no barrier)

Reference angle : 0.00

Results segment # 1: RVDNOpen (day)

Source height = 1.50 m

ROAD (0.00 + 58.88 + 0.00) = 58.88 dBA

Angle1 Angle2 Alpha RefLeq P.Adj D.Adj F.Adj W.Adj H.Adj B.Adj SubLeq

-90 90 0.66 70.58 0.00 -10.24 -1.46 0.00 0.00 0.00 58.88

Segment Leq : 58.88 dBA

Total Leq All Segments: 58.88 dBA

Results segment # 1: RVDNOpen (night)

Source height = 1.50 m

ROAD (0.00 + 51.99 + 0.00) = 51.99 dBA

Angle1 Angle2 Alpha RefLeq P.Adj D.Adj F.Adj W.Adj H.Adj B.Adj SubLeq

-90 90 0.57 62.98 0.00 -9.69 -1.30 0.00 0.00 0.00 51.99

Segment Leq : 51.99 dBA

Total Leq All Segments: 51.99 dBA

TOTAL Leq FROM ALL SOURCES (DAY): 58.88

(NIGHT): 51.99

MINISTRY OF ENVIRONMENT AND ENERGY / NOISE ASSESSMENT

Filename: olar2.te Time Period: Day/Night 16/8 hours

Description: Road data, segment # 1: House (day/night)

Car traffic volume : 12144/1056 veh/TimePeriod *

Medium truck volume : 966/84 veh/TimePeriod *

Heavy truck volume : 690/60 veh/TimePeriod *

Posted speed limit : 60 km/h

Road gradient : 2 %

Road pavement : 1 (Typical asphalt or concrete)

* Refers to calculated road volumes based on the following input:

24 hr Traffic Volume (AADT or SADT): 15000

Percentage of Annual Growth : 0.00

Number of Years of Growth : 0.00

Medium Truck % of Total Volume : 7.00

Heavy Truck % of Total Volume : 5.00

Day (16 hrs) % of Total Volume : 92.00

Data for Segment # 1: House (day/night)

Angle1 Angle2 : -90.00 deg -21.00 deg

Wood depth : 0 (No woods.)

No of house rows : 0 / 0

Surface : 1 (Absorptive ground surface)

Receiver source distance : 42.20 / 42.20 m

Receiver height : 1.50 / 4.50 m

Topography : 2 (Flat/gentle slope; with barrier)

Barrier angle1 : -90.00 deg Angle2 : -21.00 deg

Barrier height : 6.00 m
Barrier receiver distance : 3.00 / 3.00 m
Source elevation : 87.20 m
Receiver elevation : 88.00 m
Barrier elevation : 88.82 m
Reference angle : 0.00
Road data, segment # 2: RVDNOpen (day/night)

Car traffic volume : 12144/1056 veh/TimePeriod *
Medium truck volume : 966/84 veh/TimePeriod *
Heavy truck volume : 690/60 veh/TimePeriod *
Posted speed limit : 60 km/h
Road gradient : 2 %
Road pavement : 1 (Typical asphalt or concrete)

* Refers to calculated road volumes based on the following input:

24 hr Traffic Volume (AADT or SADT): 15000
Percentage of Annual Growth : 0.00
Number of Years of Growth : 0.00
Medium Truck % of Total Volume : 7.00
Heavy Truck % of Total Volume : 5.00
Day (16 hrs) % of Total Volume : 92.00

Data for Segment # 2: RVDNOpen (day/night)

Angle1 Angle2 : -21.00 deg 75.00 deg
Wood depth : 0 (No woods.)
No of house rows : 0 / 0
Surface : 1 (Absorptive ground surface)
Receiver source distance : 42.20 / 42.20 m

Receiver height : 1.50 / 4.50 m
Topography : 1 (Flat/gentle slope; no barrier)
Reference angle : 0.00

Road data, segment # 3: House (day/night)

Car traffic volume : 12144/1056 veh/TimePeriod *
Medium truck volume : 966/84 veh/TimePeriod *
Heavy truck volume : 690/60 veh/TimePeriod *
Posted speed limit : 60 km/h
Road gradient : 2 %
Road pavement : 1 (Typical asphalt or concrete)

* Refers to calculated road volumes based on the following input:

24 hr Traffic Volume (AADT or SADT): 15000
Percentage of Annual Growth : 0.00
Number of Years of Growth : 0.00
Medium Truck % of Total Volume : 7.00
Heavy Truck % of Total Volume : 5.00
Day (16 hrs) % of Total Volume : 92.00

Data for Segment # 3: House (day/night)

Angle1 Angle2 : 75.00 deg 90.00 deg
Wood depth : 0 (No woods.)
No of house rows : 0 / 0
Surface : 1 (Absorptive ground surface)
Receiver source distance : 42.20 / 42.20 m
Receiver height : 1.50 / 4.50 m
Topography : 2 (Flat/gentle slope; with barrier)
Barrier angle1 : 75.00 deg Angle2 : 90.00 deg
Barrier height : 6.00 m

Barrier receiver distance : 27.50 / 27.50 m

Source elevation : 87.20 m

Receiver elevation : 88.00 m

Barrier elevation : 89.73 m

Reference angle : 0.00

Results segment # 1: House (day)

Source height = 1.50 m

Barrier height for grazing incidence

Source	Receiver	Barrier	Elevation of
Height (m)	Height (m)	Height (m)	Barrier Top (m)

-----+-----+-----+-----

1.50 ! 1.50 ! 0.62 ! 89.44

ROAD (0.00 + 42.31 + 0.00) = 42.31 dBA

Angle1	Angle2	Alpha	RefLeq	P.Adj	D.Adj	F.Adj	W.Adj	H.Adj	B.Adj	SubLeq
--------	--------	-------	--------	-------	-------	-------	-------	-------	-------	--------

-90 -21 0.30 70.00 0.00 -5.84 -5.19 0.00 0.00 -16.66 42.31

Segment Leq : 42.31 dBA

Results segment # 2: RVDNOpen (day)

Source height = 1.50 m

ROAD (0.00 + 59.09 + 0.00) = 59.09 dBA

Angle1	Angle2	Alpha	RefLeq	P.Adj	D.Adj	F.Adj	W.Adj	H.Adj	B.Adj	SubLeq
--------	--------	-------	--------	-------	-------	-------	-------	-------	-------	--------

-21 75 0.66 70.00 0.00 -7.46 -3.45 0.00 0.00 0.00 59.09

Segment Leq : 59.09 dBA

Results segment # 3: House (day)

Source height = 1.50 m

Barrier height for grazing incidence

Source ! Receiver ! Barrier ! Elevation of
Height (m) ! Height (m) ! Height (m) ! Barrier Top (m)

-----+-----+-----+-----

1.50 ! 1.50 ! -0.75 ! 88.98

ROAD (0.00 + 39.58 + 0.00) = 39.58 dBA

Angle1 Angle2 Alpha RefLeq P.Adj D.Adj F.Adj W.Adj H.Adj B.Adj SubLeq

75 90 0.30 70.00 0.00 -5.84 -13.68 0.00 0.00 -10.90 39.58

Segment Leq : 39.58 dBA

Total Leq All Segments: 59.23 dBA

Results segment # 1: House (night)

Source height = 1.50 m

Barrier height for grazing incidence

Source ! Receiver ! Barrier ! Elevation of
Height (m) ! Height (m) ! Height (m) ! Barrier Top (m)

-----+-----+-----+-----

1.50 ! 4.50 ! 3.41 ! 92.23

ROAD (0.00 + 38.94 + 0.00) = 38.94 dBA

Angle1 Angle2 Alpha RefLeq P.Adj D.Adj F.Adj W.Adj H.Adj B.Adj SubLeq

-90 -21 0.21 62.40 0.00 -5.44 -4.91 0.00 0.00 -13.12 38.94

Segment Leq : 38.94 dBA

Results segment # 2: RVDNOpen (night)

Source height = 1.50 m

ROAD (0.00 + 51.98 + 0.00) = 51.98 dBA

Angle1 Angle2 Alpha RefLeq P.Adj D.Adj F.Adj W.Adj H.Adj B.Adj SubLeq

-21 75 0.57 62.40 0.00 -7.05 -3.36 0.00 0.00 0.00 51.98

Segment Leq : 51.98 dBA

Results segment # 3: House (night)

Source height = 1.50 m

Barrier height for grazing incidence

Source ! Receiver ! Barrier ! Elevation of
Height (m) ! Height (m) ! Height (m) ! Barrier Top (m)

-----+-----+-----+-----
1.50 ! 4.50 ! 0.29 ! 90.02

ROAD (0.00 + 34.17 + 0.00) = 34.17 dBA

Angle1 Angle2 Alpha RefLeq P.Adj D.Adj F.Adj W.Adj H.Adj B.Adj SubLeq

75 90 0.21 62.40 0.00 -5.44 -12.85 0.00 0.00 -9.95 34.17

Segment Leq : 34.17 dBA

Total Leq All Segments: 52.26 dBA

TOTAL Leq FROM ALL SOURCES (DAY): 59.23

(NIGHT): 52.26

STAMSON 5.0 NORMAL REPORT Date: 12-08-2022 10:40:23

MINISTRY OF ENVIRONMENT AND ENERGY / NOISE ASSESSMENT

Filename: olar3.te Time Period: Day/Night 16/8 hours

Description: Road data, segment # 1: BFOpen (day/night)

Car traffic volume : 12144/1056 veh/TimePeriod *

Medium truck volume : 966/84 veh/TimePeriod *

Heavy truck volume : 690/60 veh/TimePeriod *

Posted speed limit : 60 km/h

Road gradient : 1 %

Road pavement : 1 (Typical asphalt or concrete)

* Refers to calculated road volumes based on the following input:

24 hr Traffic Volume (AADT or SADT): 15000

Percentage of Annual Growth : 0.00

Number of Years of Growth : 0.00

Medium Truck % of Total Volume : 7.00

Heavy Truck % of Total Volume : 5.00

Day (16 hrs) % of Total Volume : 92.00

Data for Segment # 1: BFOpen (day/night)

Angle1 Angle2 : -90.00 deg 48.00 deg

Wood depth : 0 (No woods.)

No of house rows : 0 / 0

Surface : 1 (Absorptive ground surface)

Receiver source distance : 35.80 / 35.80 m

Receiver height : 1.50 / 4.50 m

Topography : 2 (Flat/gentle slope; with barrier)

Barrier angle1 : -90.00 deg Angle2 : 48.00 deg

Barrier height : 1.80 m

Barrier receiver distance : 5.50 / 5.50 m

Source elevation : 93.37 m

Receiver elevation : 93.00 m

Barrier elevation : 93.00 m

Reference angle : 0.00

Road data, segment # 2: House (day/night)

Car traffic volume : 12144/1056 veh/TimePeriod *

Medium truck volume : 966/84 veh/TimePeriod *

Heavy truck volume : 690/60 veh/TimePeriod *

Posted speed limit : 60 km/h

Road gradient : 1 %

Road pavement : 1 (Typical asphalt or concrete)

* Refers to calculated road volumes based on the following input:

24 hr Traffic Volume (AADT or SADT): 15000

Percentage of Annual Growth : 0.00

Number of Years of Growth : 0.00

Medium Truck % of Total Volume : 7.00

Heavy Truck % of Total Volume : 5.00

Day (16 hrs) % of Total Volume : 92.00

Data for Segment # 2: House (day/night)

Angle1 Angle2 : 48.00 deg 90.00 deg

Wood depth : 0 (No woods.)

No of house rows : 0 / 0

Surface : 1 (Absorptive ground surface)

Receiver source distance : 35.80 / 35.80 m

Receiver height : 1.50 / 4.50 m

Topography : 2 (Flat/gentle slope; with barrier)

Barrier angle1 : 48.00 deg Angle2 : 90.00 deg

Barrier height : 6.00 m

Barrier receiver distance : 3.00 / 3.00 m

Source elevation : 93.37 m

Receiver elevation : 93.00 m

Barrier elevation : 94.12 m

Reference angle : 0.00

Results segment # 1: BFOpen (day)

Source height = 1.50 m

Barrier height for grazing incidence

Source	Receiver	Barrier	Elevation of
Height (m)	Height (m)	Height (m)	Barrier Top (m)

-----+-----+-----+-----

1.50 ! 1.50 ! 1.56 ! 94.56

ROAD (0.00 + 56.83 + 0.00) = 56.83 dBA

Angle1	Angle2	Alpha	RefLeq	P.Adj	D.Adj	F.Adj	W.Adj	H.Adj	B.Adj	SubLeq
--------	--------	-------	--------	-------	-------	-------	-------	-------	-------	--------

-90 48 0.55 70.00 0.00 -5.86 -2.06 0.00 0.00 -5.24 56.83

Segment Leq : 56.83 dBA

Results segment # 2: House (day)

Source height = 1.50 m

Barrier height for grazing incidence

Source	Receiver	Barrier	Elevation of
Height (m)	Height (m)	Height (m)	Barrier Top (m)

-----+-----+-----+-----
 1.50 ! 1.50 ! 0.41 ! 94.53

ROAD (0.00 + 41.64 + 0.00) = 41.64 dBA

Angle1 Angle2 Alpha RefLeq P.Adj D.Adj F.Adj W.Adj H.Adj B.Adj SubLeq

 48 90 0.30 70.00 0.00 -4.91 -7.91 0.00 0.00 -15.54 41.64

 Segment Leq : 41.64 dBA

Total Leq All Segments: 56.96 dBA

Results segment # 1: BFOpen (night)

 Source height = 1.50 m

Barrier height for grazing incidence

 Source ! Receiver ! Barrier ! Elevation of
 Height (m) ! Height (m) ! Height (m) ! Barrier Top (m)

-----+-----+-----+-----
 1.50 ! 4.50 ! 4.10 ! 97.10

ROAD (0.00 + 54.39 + 0.00) = 54.39 dBA

Angle1 Angle2 Alpha RefLeq P.Adj D.Adj F.Adj W.Adj H.Adj B.Adj SubLeq

 -90 48 0.46 62.40 0.00 -5.52 -1.94 0.00 0.00 -0.10 54.83*
 -90 48 0.57 62.40 0.00 -5.93 -2.08 0.00 0.00 0.00 54.39

 * Bright Zone !

Segment Leq : 54.39 dBA

Results segment # 2: House (night)

Source height = 1.50 m

Barrier height for grazing incidence

Source	Receiver	Barrier	Elevation of
Height (m)	Height (m)	Height (m)	Barrier Top (m)

-----+-----+-----+-----

1.50 ! 4.50 ! 3.16 ! 97.28

ROAD (0.00 + 38.15 + 0.00) = 38.15 dBA

Angle1	Angle2	Alpha	RefLeq	P.Adj	D.Adj	F.Adj	W.Adj	H.Adj	B.Adj	SubLeq
--------	--------	-------	--------	-------	-------	-------	-------	-------	-------	--------

48 90 0.21 62.40 0.00 -4.57 -7.46 0.00 0.00 -12.21 38.15

Segment Leq : 38.15 dBA

Total Leq All Segments: 54.49 dBA

TOTAL Leq FROM ALL SOURCES (DAY): 56.96

(NIGHT): 54.49

STAMSON 5.0 NORMAL REPORT Date: 12-08-2022 10:33:11

MINISTRY OF ENVIRONMENT AND ENERGY / NOISE ASSESSMENT

Filename: olar3.te Time Period: Day/Night 16/8 hours

Description: Road data, segment # 1: BFOpen (day/night)

Car traffic volume : 12144/1056 veh/TimePeriod *

Medium truck volume : 966/84 veh/TimePeriod *

Heavy truck volume : 690/60 veh/TimePeriod *

Posted speed limit : 60 km/h

Road gradient : 1 %

Road pavement : 1 (Typical asphalt or concrete)

* Refers to calculated road volumes based on the following input:

24 hr Traffic Volume (AADT or SADT): 15000

Percentage of Annual Growth : 0.00

Number of Years of Growth : 0.00

Medium Truck % of Total Volume : 7.00

Heavy Truck % of Total Volume : 5.00

Day (16 hrs) % of Total Volume : 92.00

Data for Segment # 1: BFOpen (day/night)

Angle1 Angle2 : -90.00 deg 48.00 deg

Wood depth : 0 (No woods.)

No of house rows : 0 / 0

Surface : 1 (Absorptive ground surface)

Receiver source distance : 35.80 / 35.80 m

Receiver height : 1.50 / 4.50 m

Topography : 1 (Flat/gentle slope; no barrier)

Reference angle : 0.00

Road data, segment # 2: House (day/night)

Car traffic volume : 12144/1056 veh/TimePeriod *

Medium truck volume : 966/84 veh/TimePeriod *

Heavy truck volume : 690/60 veh/TimePeriod *

Posted speed limit : 60 km/h

Road gradient : 1 %

Road pavement : 1 (Typical asphalt or concrete)

* Refers to calculated road volumes based on the following input:

24 hr Traffic Volume (AADT or SADT): 15000

Percentage of Annual Growth : 0.00

Number of Years of Growth : 0.00

Medium Truck % of Total Volume : 7.00

Heavy Truck % of Total Volume : 5.00

Day (16 hrs) % of Total Volume : 92.00

Data for Segment # 2: House (day/night)

Angle1 Angle2 : 48.00 deg 90.00 deg

Wood depth : 0 (No woods.)

No of house rows : 0 / 0

Surface : 1 (Absorptive ground surface)

Receiver source distance : 35.80 / 35.80 m

Receiver height : 1.50 / 4.50 m

Topography : 2 (Flat/gentle slope; with barrier)

Barrier angle1 : 48.00 deg Angle2 : 90.00 deg

Barrier height : 6.00 m

Barrier receiver distance : 3.00 / 3.00 m

Source elevation : 93.37 m

Receiver elevation : 93.00 m

Barrier elevation : 94.12 m

Reference angle : 0.00

Results segment # 1: BFOpen (day)

Source height = 1.50 m

ROAD (0.00 + 61.53 + 0.00) = 61.53 dBA

Angle1 Angle2 Alpha RefLeq P.Adj D.Adj F.Adj W.Adj H.Adj B.Adj SubLeq

-90 48 0.66 70.00 0.00 -6.27 -2.19 0.00 0.00 0.00 61.53

Segment Leq : 61.53 dBA

Results segment # 2: House (day)

Source height = 1.50 m

Barrier height for grazing incidence

Source ! Receiver ! Barrier ! Elevation of
Height (m) ! Height (m) ! Height (m) ! Barrier Top (m)

-----+-----+-----+-----

1.50 ! 1.50 ! 0.41 ! 94.53

ROAD (0.00 + 41.64 + 0.00) = 41.64 dBA

Angle1 Angle2 Alpha RefLeq P.Adj D.Adj F.Adj W.Adj H.Adj B.Adj SubLeq

48 90 0.30 70.00 0.00 -4.91 -7.91 0.00 0.00 -15.54 41.64

Segment Leq : 41.64 dBA

Total Leq All Segments: 61.57 dBA

Results segment # 1: BFOpen (night)

Source height = 1.50 m

ROAD (0.00 + 54.39 + 0.00) = 54.39 dBA

Angle1 Angle2 Alpha RefLeq P.Adj D.Adj F.Adj W.Adj H.Adj B.Adj SubLeq

-90 48 0.57 62.40 0.00 -5.93 -2.08 0.00 0.00 0.00 54.39

Segment Leq : 54.39 dBA

Results segment # 2: House (night)

Source height = 1.50 m

Barrier height for grazing incidence

Source ! Receiver ! Barrier ! Elevation of
Height (m) ! Height (m) ! Height (m) ! Barrier Top (m)

-----+-----+-----+-----

1.50 ! 4.50 ! 3.16 ! 97.28

ROAD (0.00 + 38.15 + 0.00) = 38.15 dBA

Angle1 Angle2 Alpha RefLeq P.Adj D.Adj F.Adj W.Adj H.Adj B.Adj SubLeq

48 90 0.21 62.40 0.00 -4.57 -7.46 0.00 0.00 -12.21 38.15

Segment Leq : 38.15 dBA

Total Leq All Segments: 54.49 dBA

TOTAL Leq FROM ALL SOURCES (DAY): 61.57

(NIGHT): 54.49

STAMSON 5.0 NORMAL REPORT Date: 12-08-2022 10:46:28

MINISTRY OF ENVIRONMENT AND ENERGY / NOISE ASSESSMENT

Filename: olar4.te Time Period: Day/Night 16/8 hours

Description: Road data, segment # 1: House (day/night)

Car traffic volume : 12144/1056 veh/TimePeriod *

Medium truck volume : 966/84 veh/TimePeriod *

Heavy truck volume : 690/60 veh/TimePeriod *

Posted speed limit : 60 km/h

Road gradient : 2 %

Road pavement : 1 (Typical asphalt or concrete)

* Refers to calculated road volumes based on the following input:

24 hr Traffic Volume (AADT or SADT): 15000

Percentage of Annual Growth : 0.00

Number of Years of Growth : 0.00

Medium Truck % of Total Volume : 7.00

Heavy Truck % of Total Volume : 5.00

Day (16 hrs) % of Total Volume : 92.00

Data for Segment # 1: House (day/night)

Angle1 Angle2 : -90.00 deg -43.00 deg

Wood depth : 0 (No woods.)

No of house rows : 0 / 0

Surface : 1 (Absorptive ground surface)

Receiver source distance : 23.70 / 23.70 m

Receiver height : 1.50 / 4.50 m

Topography : 2 (Flat/gentle slope; with barrier)

Barrier angle1 : -90.00 deg Angle2 : -43.00 deg

Barrier height : 6.00 m

Barrier receiver distance : 3.50 / 3.50 m

Source elevation : 92.08 m

Receiver elevation : 91.40 m

Barrier elevation : 91.24 m

Reference angle : 0.00

Road data, segment # 2: BFOpen (day/night)

Car traffic volume : 12144/1056 veh/TimePeriod *

Medium truck volume : 966/84 veh/TimePeriod *

Heavy truck volume : 690/60 veh/TimePeriod *

Posted speed limit : 60 km/h

Road gradient : 2 %

Road pavement : 1 (Typical asphalt or concrete)

* Refers to calculated road volumes based on the following input:

24 hr Traffic Volume (AADT or SADT): 15000

Percentage of Annual Growth : 0.00

Number of Years of Growth : 0.00

Medium Truck % of Total Volume : 7.00

Heavy Truck % of Total Volume : 5.00

Day (16 hrs) % of Total Volume : 92.00

Data for Segment # 2: BFOpen (day/night)

Angle1 Angle2 : -43.00 deg 90.00 deg

Wood depth : 0 (No woods.)

No of house rows : 0 / 0

Surface : 1 (Absorptive ground surface)

Receiver source distance : 23.70 / 23.70 m

Receiver height : 1.50 / 4.50 m

Topography : 2 (Flat/gentle slope; with barrier)

Barrier angle1 : -43.00 deg Angle2 : 90.00 deg

Barrier height : 2.10 m

Barrier receiver distance : 5.50 / 5.50 m

Source elevation : 92.08 m

Receiver elevation : 91.40 m

Barrier elevation : 91.24 m

Reference angle : 0.00

Results segment # 1: House (day)

Source height = 1.50 m

Barrier height for grazing incidence

Source	Receiver	Barrier	Elevation of
Height (m)	Height (m)	Height (m)	Barrier Top (m)

-----+-----+-----+-----

1.50 ! 1.50 ! 1.76 ! 93.00

ROAD (0.00 + 45.64 + 0.00) = 45.64 dBA

Angle1	Angle2	Alpha	RefLeq	P.Adj	D.Adj	F.Adj	W.Adj	H.Adj	B.Adj	SubLeq
--------	--------	-------	--------	-------	-------	-------	-------	-------	-------	--------

-90 -43 0.30 70.00 0.00 -2.58 -7.29 0.00 0.00 -14.48 45.64

Segment Leq : 45.64 dBA

Results segment # 2: BFOpen (day)

Source height = 1.50 m

Barrier height for grazing incidence

Source	Receiver	Barrier	Elevation of
Height (m)	Height (m)	Height (m)	Barrier Top (m)

-----+-----+-----+-----
1.50 ! 1.50 ! 1.82 ! 93.06

ROAD (0.00 + 59.40 + 0.00) = 59.40 dBA

Angle1 Angle2 Alpha RefLeq P.Adj D.Adj F.Adj W.Adj H.Adj B.Adj SubLeq

-43 90 0.53 70.00 0.00 -3.05 -2.20 0.00 0.00 -5.35 59.40

Segment Leq : 59.40 dBA

Total Leq All Segments: 59.58 dBA

Results segment # 1: House (night)

Source height = 1.50 m

Barrier height for grazing incidence

Source ! Receiver ! Barrier ! Elevation of
Height (m) ! Height (m) ! Height (m) ! Barrier Top (m)

-----+-----+-----+-----
1.50 ! 4.50 ! 4.32 ! 95.56

ROAD (0.00 + 43.51 + 0.00) = 43.51 dBA

Angle1 Angle2 Alpha RefLeq P.Adj D.Adj F.Adj W.Adj H.Adj B.Adj SubLeq

-90 -43 0.21 62.40 0.00 -2.40 -6.88 0.00 0.00 -9.61 43.51

Segment Leq : 43.51 dBA

Results segment # 2: BFOpen (night)

Source height = 1.50 m

Barrier height for grazing incidence

Source ! Receiver ! Barrier ! Elevation of
 Height (m) ! Height (m) ! Height (m) ! Barrier Top (m)

-----+-----+-----+-----

1.50 ! 4.50 ! 4.12 ! 95.36

ROAD (0.00 + 57.04 + 0.00) = 57.04 dBA

Angle1 Angle2 Alpha RefLeq P.Adj D.Adj F.Adj W.Adj H.Adj B.Adj SubLeq

-43 90 0.44 62.40 0.00 -2.87 -2.08 0.00 0.00 -0.12 57.33*

-43 90 0.57 62.40 0.00 -3.12 -2.24 0.00 0.00 0.00 57.04

* Bright Zone !

Segment Leq : 57.04 dBA

Total Leq All Segments: 57.23 dBA

TOTAL Leq FROM ALL SOURCES (DAY): 59.58

(NIGHT): 57.23

STAMSON 5.0 NORMAL REPORT Date: 12-08-2022 10:41:43

MINISTRY OF ENVIRONMENT AND ENERGY / NOISE ASSESSMENT

Filename: olar4.te Time Period: Day/Night 16/8 hours

Description: Road data, segment # 1: House (day/night)

Car traffic volume : 12144/1056 veh/TimePeriod *

Medium truck volume : 966/84 veh/TimePeriod *

Heavy truck volume : 690/60 veh/TimePeriod *

Posted speed limit : 60 km/h

Road gradient : 2 %

Road pavement : 1 (Typical asphalt or concrete)

* Refers to calculated road volumes based on the following input:

24 hr Traffic Volume (AADT or SADT): 15000

Percentage of Annual Growth : 0.00

Number of Years of Growth : 0.00

Medium Truck % of Total Volume : 7.00

Heavy Truck % of Total Volume : 5.00

Day (16 hrs) % of Total Volume : 92.00

Data for Segment # 1: House (day/night)

Angle1 Angle2 : -90.00 deg -43.00 deg

Wood depth : 0 (No woods.)

No of house rows : 0 / 0

Surface : 1 (Absorptive ground surface)

Receiver source distance : 23.70 / 23.70 m

Receiver height : 1.50 / 4.50 m

Topography : 2 (Flat/gentle slope; with barrier)

Barrier angle1 : -90.00 deg Angle2 : -43.00 deg

Barrier height : 6.00 m

Barrier receiver distance : 3.50 / 3.50 m

Source elevation : 92.08 m

Receiver elevation : 91.40 m

Barrier elevation : 91.24 m

Reference angle : 0.00

Road data, segment # 2: BFOpen (day/night)

Car traffic volume : 12144/1056 veh/TimePeriod *

Medium truck volume : 966/84 veh/TimePeriod *

Heavy truck volume : 690/60 veh/TimePeriod *

Posted speed limit : 60 km/h

Road gradient : 2 %

Road pavement : 1 (Typical asphalt or concrete)

* Refers to calculated road volumes based on the following input:

24 hr Traffic Volume (AADT or SADT): 15000

Percentage of Annual Growth : 0.00

Number of Years of Growth : 0.00

Medium Truck % of Total Volume : 7.00

Heavy Truck % of Total Volume : 5.00

Day (16 hrs) % of Total Volume : 92.00

Data for Segment # 2: BFOpen (day/night)

Angle1 Angle2 : -43.00 deg 90.00 deg

Wood depth : 0 (No woods.)

No of house rows : 0 / 0

Surface : 1 (Absorptive ground surface)

Receiver source distance : 23.70 / 23.70 m

Receiver height : 1.50 / 4.50 m

Topography : 1 (Flat/gentle slope; no barrier)

Reference angle : 0.00

Results segment # 1: House (day)

Source height = 1.50 m

Barrier height for grazing incidence

Source ! Receiver ! Barrier ! Elevation of
Height (m) ! Height (m) ! Height (m) ! Barrier Top (m)

-----+-----+-----+-----

1.50 ! 1.50 ! 1.76 ! 93.00

ROAD (0.00 + 45.64 + 0.00) = 45.64 dBA

Angle1 Angle2 Alpha RefLeq P.Adj D.Adj F.Adj W.Adj H.Adj B.Adj SubLeq

-90 -43 0.30 70.00 0.00 -2.58 -7.29 0.00 0.00 -14.48 45.64

Segment Leq : 45.64 dBA

Results segment # 2: BFOpen (day)

Source height = 1.50 m

ROAD (0.00 + 64.34 + 0.00) = 64.34 dBA

Angle1 Angle2 Alpha RefLeq P.Adj D.Adj F.Adj W.Adj H.Adj B.Adj SubLeq

-43 90 0.66 70.00 0.00 -3.30 -2.35 0.00 0.00 0.00 64.34

Segment Leq : 64.34 dBA

Total Leq All Segments: 64.40 dBA

Results segment # 1: House (night)

Source height = 1.50 m

Barrier height for grazing incidence

Source ! Receiver ! Barrier ! Elevation of
Height (m) ! Height (m) ! Height (m) ! Barrier Top (m)

-----+-----+-----+-----
1.50 ! 4.50 ! 4.32 ! 95.56

ROAD (0.00 + 43.51 + 0.00) = 43.51 dBA

Angle1 Angle2 Alpha RefLeq P.Adj D.Adj F.Adj W.Adj H.Adj B.Adj SubLeq

-90 -43 0.21 62.40 0.00 -2.40 -6.88 0.00 0.00 -9.61 43.51

Segment Leq : 43.51 dBA

Results segment # 2: BFOpen (night)

Source height = 1.50 m

ROAD (0.00 + 57.04 + 0.00) = 57.04 dBA

Angle1 Angle2 Alpha RefLeq P.Adj D.Adj F.Adj W.Adj H.Adj B.Adj SubLeq

-43 90 0.57 62.40 0.00 -3.12 -2.24 0.00 0.00 0.00 57.04

Segment Leq : 57.04 dBA

Total Leq All Segments: 57.23 dBA

TOTAL Leq FROM ALL SOURCES (DAY): 64.40

(NIGHT): 57.23

STAMSON 5.0 NORMAL REPORT Date: 12-08-2022 11:05:08

MINISTRY OF ENVIRONMENT AND ENERGY / NOISE ASSESSMENT

Filename: olar5.te Time Period: Day/Night 16/8 hours

Description: Road data, segment # 1: House (day/night)

Car traffic volume : 12144/1056 veh/TimePeriod *

Medium truck volume : 966/84 veh/TimePeriod *

Heavy truck volume : 690/60 veh/TimePeriod *

Posted speed limit : 60 km/h

Road gradient : 0 %

Road pavement : 1 (Typical asphalt or concrete)

* Refers to calculated road volumes based on the following input:

24 hr Traffic Volume (AADT or SADT): 15000

Percentage of Annual Growth : 0.00

Number of Years of Growth : 0.00

Medium Truck % of Total Volume : 7.00

Heavy Truck % of Total Volume : 5.00

Day (16 hrs) % of Total Volume : 92.00

Data for Segment # 1: House (day/night)

Angle1 Angle2 : -90.00 deg -83.00 deg

Wood depth : 0 (No woods.)

No of house rows : 0 / 0

Surface : 1 (Absorptive ground surface)

Receiver source distance : 54.40 / 54.40 m

Receiver height : 1.50 / 4.50 m

Topography : 2 (Flat/gentle slope; with barrier)

Barrier angle1 : -90.00 deg Angle2 : -83.00 deg

Barrier height : 6.00 m

Barrier receiver distance : 13.60 / 13.60 m

Source elevation : 89.85 m

Receiver elevation : 90.40 m

Barrier elevation : 91.10 m

Reference angle : 0.00

Road data, segment # 2: BFOpen (day/night)

Car traffic volume : 12144/1056 veh/TimePeriod *

Medium truck volume : 966/84 veh/TimePeriod *

Heavy truck volume : 690/60 veh/TimePeriod *

Posted speed limit : 60 km/h

Road gradient : 0 %

Road pavement : 1 (Typical asphalt or concrete)

* Refers to calculated road volumes based on the following input:

24 hr Traffic Volume (AADT or SADT): 15000

Percentage of Annual Growth : 0.00

Number of Years of Growth : 0.00

Medium Truck % of Total Volume : 7.00

Heavy Truck % of Total Volume : 5.00

Day (16 hrs) % of Total Volume : 92.00

Data for Segment # 2: BFOpen (day/night)

Angle1 Angle2 : -83.00 deg 45.00 deg

Wood depth : 0 (No woods.)

No of house rows : 0 / 0

Surface : 1 (Absorptive ground surface)

Receiver source distance : 54.40 / 54.40 m

Receiver height : 1.50 / 4.50 m

Topography : 1 (Flat/gentle slope; no barrier)

Reference angle : 0.00

Road data, segment # 3: House (day/night)

Car traffic volume : 12144/1056 veh/TimePeriod *

Medium truck volume : 966/84 veh/TimePeriod *

Heavy truck volume : 690/60 veh/TimePeriod *

Posted speed limit : 60 km/h

Road gradient : 0 %

Road pavement : 1 (Typical asphalt or concrete)

* Refers to calculated road volumes based on the following input:

24 hr Traffic Volume (AADT or SADT): 15000

Percentage of Annual Growth : 0.00

Number of Years of Growth : 0.00

Medium Truck % of Total Volume : 7.00

Heavy Truck % of Total Volume : 5.00

Day (16 hrs) % of Total Volume : 92.00

Data for Segment # 3: House (day/night)

Angle1 Angle2 : 45.00 deg 90.00 deg

Wood depth : 0 (No woods.)

No of house rows : 0 / 0

Surface : 1 (Absorptive ground surface)

Receiver source distance : 54.40 / 54.40 m

Receiver height : 1.50 / 4.50 m

Topography : 2 (Flat/gentle slope; with barrier)

Barrier angle1 : 45.00 deg Angle2 : 90.00 deg

Barrier height : 6.00 m

Barrier receiver distance : 3.00 / 3.00 m

Source elevation : 89.85 m

Receiver elevation : 91.40 m

Barrier elevation : 91.50 m

Reference angle : 0.00

Results segment # 1: House (day)

Source height = 1.50 m

Barrier height for grazing incidence

Source	Receiver	Barrier	Elevation of
Height (m)	Height (m)	Height (m)	Barrier Top (m)

-----+-----+-----+-----

1.50	1.50	0.66	91.76
------	------	------	-------

ROAD (0.00 + 36.91 + 0.00) = 36.91 dBA

Angle1	Angle2	Alpha	RefLeq	P.Adj	D.Adj	F.Adj	W.Adj	H.Adj	B.Adj	SubLeq
--------	--------	-------	--------	-------	-------	-------	-------	-------	-------	--------

-90	-83	0.30	70.00	0.00	-7.27	-17.98	0.00	0.00	-7.83	36.91
-----	-----	------	-------	------	-------	--------	------	------	-------	-------

Segment Leq : 36.91 dBA

Results segment # 2: BFOpen (day)

Source height = 1.50 m

ROAD (0.00 + 58.38 + 0.00) = 58.38 dBA

Angle1	Angle2	Alpha	RefLeq	P.Adj	D.Adj	F.Adj	W.Adj	H.Adj	B.Adj	SubLeq
--------	--------	-------	--------	-------	-------	-------	-------	-------	-------	--------

-83	45	0.66	70.00	0.00	-9.29	-2.33	0.00	0.00	0.00	58.38
-----	----	------	-------	------	-------	-------	------	------	------	-------

Segment Leq : 58.38 dBA

Results segment # 3: House (day)

Source height = 1.50 m

Barrier height for grazing incidence

Source	Receiver	Barrier	Elevation of
Height (m)	Height (m)	Height (m)	Barrier Top (m)

-----+-----+-----+-----

1.50	1.50	1.31	92.81
------	------	------	-------

ROAD (0.00 + 40.31 + 0.00) = 40.31 dBA

Angle1	Angle2	Alpha	RefLeq	P.Adj	D.Adj	F.Adj	W.Adj	H.Adj	B.Adj	SubLeq
--------	--------	-------	--------	-------	-------	-------	-------	-------	-------	--------

45	90	0.30	70.00	0.00	-7.27	-7.53	0.00	0.00	-14.88	40.31
----	----	------	-------	------	-------	-------	------	------	--------	-------

Segment Leq : 40.31 dBA

Total Leq All Segments: 58.48 dBA

Results segment # 1: House (night)

Source height = 1.50 m

Barrier height for grazing incidence

Source	Receiver	Barrier	Elevation of
Height (m)	Height (m)	Height (m)	Barrier Top (m)

-----+-----+-----+-----

1.50	4.50	2.91	94.01
------	------	------	-------

ROAD (0.00 + 32.53 + 0.00) = 32.53 dBA

Angle1	Angle2	Alpha	RefLeq	P.Adj	D.Adj	F.Adj	W.Adj	H.Adj	B.Adj	SubLeq
--------	--------	-------	--------	-------	-------	-------	-------	-------	-------	--------

-90	-83	0.21	62.40	0.00	-6.77	-16.85	0.00	0.00	-6.25	32.53
-----	-----	------	-------	------	-------	--------	------	------	-------	-------

Segment Leq : 32.53 dBA

Results segment # 2: BFOpen (night)

Source height = 1.50 m

ROAD (0.00 + 51.38 + 0.00) = 51.38 dBA

Angle1 Angle2 Alpha RefLeq P.Adj D.Adj F.Adj W.Adj H.Adj B.Adj SubLeq

-83 45 0.57 62.40 0.00 -8.79 -2.23 0.00 0.00 0.00 51.38

Segment Leq : 51.38 dBA

Results segment # 3: House (night)

Source height = 1.50 m

Barrier height for grazing incidence

Source ! Receiver ! Barrier ! Elevation of
Height (m) ! Height (m) ! Height (m) ! Barrier Top (m)

-----+-----+-----+-----

1.50 ! 4.50 ! 4.15 ! 95.65

ROAD (0.00 + 38.46 + 0.00) = 38.46 dBA

Angle1 Angle2 Alpha RefLeq P.Adj D.Adj F.Adj W.Adj H.Adj B.Adj SubLeq

45 90 0.21 62.40 0.00 -6.77 -7.10 0.00 0.00 -10.07 38.46

Segment Leq : 38.46 dBA

Total Leq All Segments: 51.65 dBA

TOTAL Leq FROM ALL SOURCES (DAY): 58.48

(NIGHT): 51.65

STAMSON 5.0 NORMAL REPORT Date: 12-08-2022 11:13:44

MINISTRY OF ENVIRONMENT AND ENERGY / NOISE ASSESSMENT

Filename: olar6.te Time Period: Day/Night 16/8 hours

Description: Road data, segment # 1: House (day/night)

Car traffic volume : 12144/1056 veh/TimePeriod *

Medium truck volume : 966/84 veh/TimePeriod *

Heavy truck volume : 690/60 veh/TimePeriod *

Posted speed limit : 60 km/h

Road gradient : 1 %

Road pavement : 1 (Typical asphalt or concrete)

* Refers to calculated road volumes based on the following input:

24 hr Traffic Volume (AADT or SADT): 15000

Percentage of Annual Growth : 0.00

Number of Years of Growth : 0.00

Medium Truck % of Total Volume : 7.00

Heavy Truck % of Total Volume : 5.00

Day (16 hrs) % of Total Volume : 92.00

Data for Segment # 1: House (day/night)

Angle1 Angle2 : -90.00 deg -23.00 deg

Wood depth : 0 (No woods.)

No of house rows : 0 / 0

Surface : 1 (Absorptive ground surface)

Receiver source distance : 71.00 / 71.00 m

Receiver height : 1.50 / 4.50 m

Topography : 2 (Flat/gentle slope; with barrier)

Barrier angle1 : -90.00 deg Angle2 : -23.00 deg

Barrier height : 6.00 m

Barrier receiver distance : 3.00 / 3.00 m

Source elevation : 88.82 m

Receiver elevation : 88.40 m

Barrier elevation : 88.50 m

Reference angle : 0.00

Road data, segment # 2: BFOpen (day/night)

Car traffic volume : 12144/1056 veh/TimePeriod *

Medium truck volume : 966/84 veh/TimePeriod *

Heavy truck volume : 690/60 veh/TimePeriod *

Posted speed limit : 60 km/h

Road gradient : 1 %

Road pavement : 1 (Typical asphalt or concrete)

* Refers to calculated road volumes based on the following input:

24 hr Traffic Volume (AADT or SADT): 15000

Percentage of Annual Growth : 0.00

Number of Years of Growth : 0.00

Medium Truck % of Total Volume : 7.00

Heavy Truck % of Total Volume : 5.00

Day (16 hrs) % of Total Volume : 92.00

Data for Segment # 2: BFOpen (day/night)

Angle1 Angle2 : -23.00 deg 90.00 deg

Wood depth : 0 (No woods.)

No of house rows : 0 / 0

Surface : 1 (Absorptive ground surface)

Receiver source distance : 71.00 / 71.00 m

Receiver height : 1.50 / 4.50 m

Topography : 1 (Flat/gentle slope; no barrier)

Reference angle : 0.00

Results segment # 1: House (day)

Source height = 1.50 m

Barrier height for grazing incidence

Source	Receiver	Barrier	Elevation of
Height (m)	Height (m)	Height (m)	Barrier Top (m)

-----+-----+-----+-----

1.50	1.50	1.42	89.92
------	------	------	-------

ROAD (0.00 + 40.09 + 0.00) = 40.09 dBA

Angle1	Angle2	Alpha	RefLeq	P.Adj	D.Adj	F.Adj	W.Adj	H.Adj	B.Adj	SubLeq
--------	--------	-------	--------	-------	-------	-------	-------	-------	-------	--------

-90	-23	0.30	70.00	0.00	-8.78	-5.35	0.00	0.00	-15.79	40.09
-----	-----	------	-------	------	-------	-------	------	------	--------	-------

Segment Leq : 40.09 dBA

Results segment # 2: BFOpen (day)

Source height = 1.50 m

ROAD (0.00 + 55.63 + 0.00) = 55.63 dBA

Angle1	Angle2	Alpha	RefLeq	P.Adj	D.Adj	F.Adj	W.Adj	H.Adj	B.Adj	SubLeq
--------	--------	-------	--------	-------	-------	-------	-------	-------	-------	--------

-23	90	0.66	70.00	0.00	-11.21	-3.16	0.00	0.00	0.00	55.63
-----	----	------	-------	------	--------	-------	------	------	------	-------

Segment Leq : 55.63 dBA

Total Leq All Segments: 55.75 dBA

Results segment # 1: House (night)

Source height = 1.50 m

Barrier height for grazing incidence

Source ! Receiver ! Barrier ! Elevation of
Height (m) ! Height (m) ! Height (m) ! Barrier Top (m)

-----+-----+-----+-----

1.50 ! 4.50 ! 4.29 ! 92.79

ROAD (0.00 + 38.61 + 0.00) = 38.61 dBA

Angle1 Angle2 Alpha RefLeq P.Adj D.Adj F.Adj W.Adj H.Adj B.Adj SubLeq

-90 -23 0.21 62.40 0.00 -8.17 -5.06 0.00 0.00 -10.57 38.61

Segment Leq : 38.61 dBA

Results segment # 2: BFOpen (night)

Source height = 1.50 m

ROAD (0.00 + 48.76 + 0.00) = 48.76 dBA

Angle1 Angle2 Alpha RefLeq P.Adj D.Adj F.Adj W.Adj H.Adj B.Adj SubLeq

-23 90 0.57 62.40 0.00 -10.60 -3.04 0.00 0.00 0.00 48.76

Segment Leq : 48.76 dBA

Total Leq All Segments: 49.16 dBA

TOTAL Leq FROM ALL SOURCES (DAY): 55.75

(NIGHT): 49.16

Appendix D
Sample Noise Barrier Drawings

End View

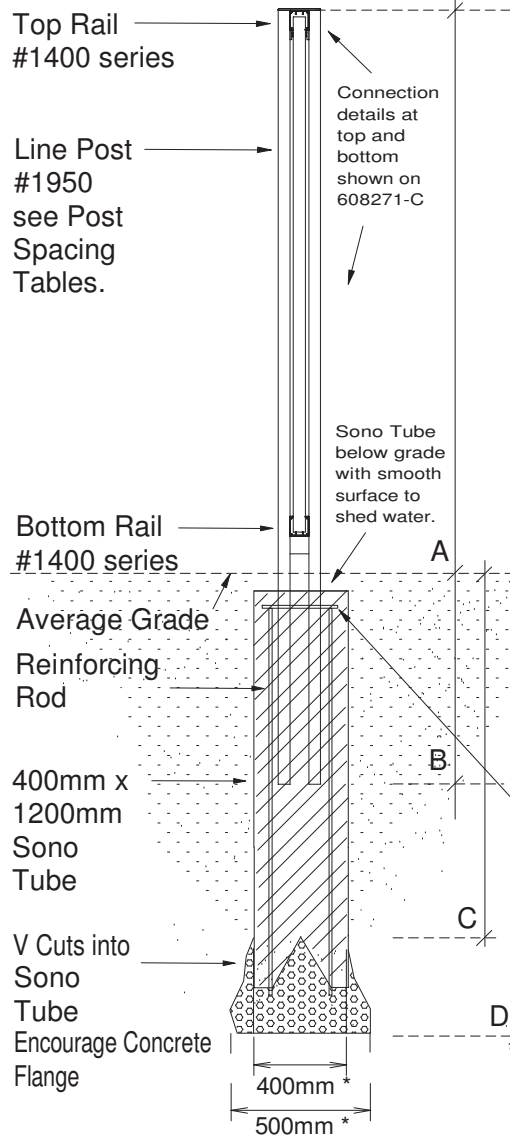

Top View

Infill is designed to fit into the Horizontal Rails for various widths.

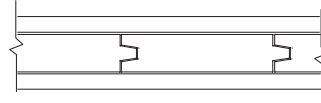

For Wood, the widths and species must provide adequate mass to achieve the intended noise transmission loss. Wood is typically a Vjoint with a 7/8" T&G at grade 3 or better, with a moisture content no greater than as required by the local building code for housing.

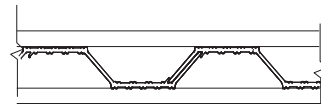

Alcuf Standard 8100 series aluminum continuous locked panels provide an STC rating of 20, and requires a 1.5" rail infill opening.

Rail sizes and dimensions are found on 608271-B. Infill openings range as follows;

.75", 1", 1.5", 1.75", 2" and 2.125".

2-10M closed circular ties @ 75mm o/c @ top of pier, when 400mm base used.

Side View

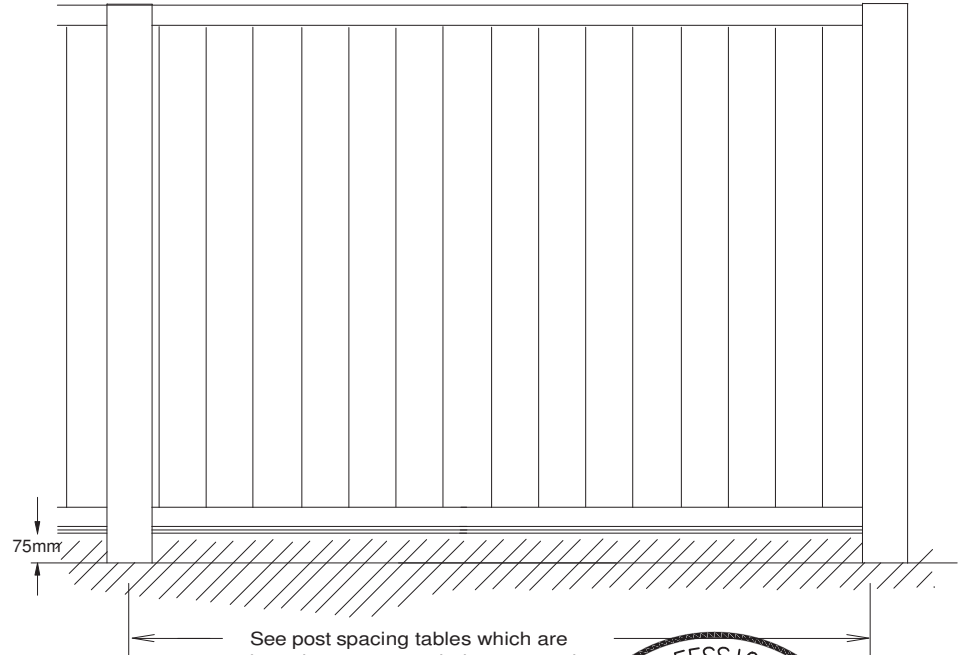

See post spacing tables which are based on average wind pressures in your region on drawing 608271-G.

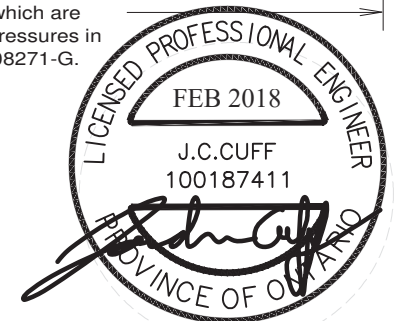

CUNLIFFE & ASSOCIATES

This drawing set consists of parts A to G.

FENCE HEIGHT (mm)	POST DEPTH IN FOOTING (mm)	TOP OF FOOTING (mm)	FOOTING DEPTH (mm)
"A" 1800 (6'-0")	"B" 750	"C" 1500	"D" 1800
"A" 2400 (8'-0")	"B" 800	"C" 1500	"D" 1800
"A" 3048 (10'-0")	"B" 800	"C" 1500	"D" 1800

NOTES:

Concrete strength @ 28 days: F_c=32 MPa - Class C2
Exposure 6% +/- 1% Air Entrainment.
Reinforcing Steel: G30.18M - Grade 400

The Cunliffe stamp is for aluminum structure only, consult Geotechnical Engineer for site specific foundation design.

* Footing dimensions shown are a minimum typical size for optimum Eastern Canadian soil conditions.
* Consult the Geotechnical Engineer for your specific site for confirmation, or specific requirements.

Alcuf DP2 Noise Barrier

DATE: 2018-01-29

DRAWING NUMBER:

REV: 3.0

SCALE: none

608271-A



Alcuf International Inc.
Ottawa, Ontario, Canada
www.alcuf.com

DRAWN BY:
designs@alcuf.com

DP2 Frameworks and Infill Options (up to 12' high)

This drawing set consists of parts A to G.

END VIEW

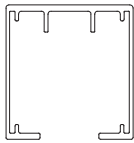

#1415 Rail for 1 1/2" infill

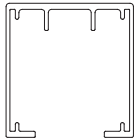

#1417 Rail for 1 3/4" infill

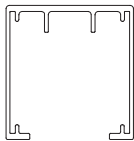

#1420 Rail for 2" infill

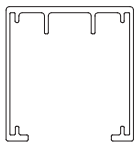

#1422 Rail for 2 1/8" infill

TOP VIEW

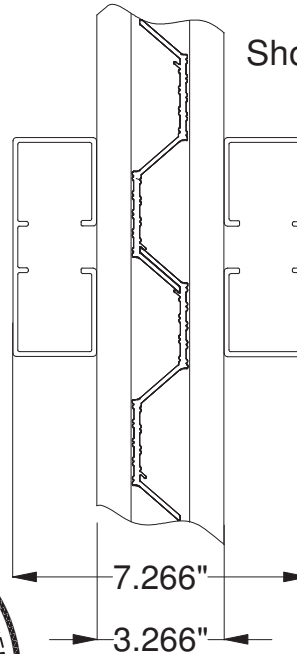

Shown: #1415 Rail with 1.5" #8100 Aluminum Panel infill

#1950 Post (2pc) for #1400 series rails

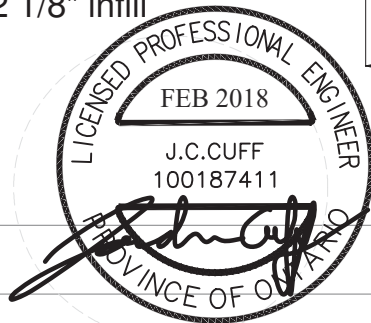

Infill Options

Infill can range in scope from wood, to composite panels, to high strength extruded 6005-T5 aluminum alloy. For Noise Barriers, typically 2 1/8" Western Red Cedar, 2" White Pine, 1 3/4" Yellow Cedar, or Alcuf 1 1/2" #8100 Extruded Aluminum Panels are used.

To create a continuous sound seal, Wood is typically shaped with an appropriate tongue and groove, and the Alcuf extruded aluminum panels are constructed in such a way as to lock panels together.

In addition, an optional sound seal should be constructed in areas where terrain is coarse, or on sites with open exposure.

Wood is best left unstained. Often stains will seal in more moisture than they keep out. If it is necessary to colour the wood, we recommend a breathable stain. In most cases, Alcuf Fencing is left unstained which provides a naturally weathered (and dry) wood infill, in a modern looking framework.

For colour, the Alcuf 1 1/2" #8100 Extruded Aluminum Panels are available in virtually any colour. Standard colours include White, Black, and a very earthy Bronze.

Optional Sound Seal

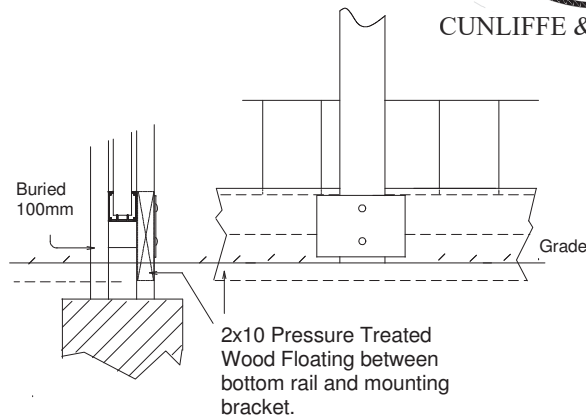

CUNLIFFE & ASSOCIATES

The OPTIONAL SOUND SEAL is used between posts and to the side of the bottom rail, where a 2x10 board is attached in such a way that it is free to float with ground movement without adding stress to the bottom rail. This does not interfere with the adjustable elevation of the bottom rail. The average grade is typically filled to meet the Sound Seal. The 2x10 board in this case is considered a sacrificial element that can be easily and economically replaced as it will deteriorate faster than other system components given its direct exposure to bacteria and oxygen at ground level, which will cause rot. However, this method is the most practical way to provide an effective sound seal between the earth, and the barrier.

Alcuf DP2 Noise Barrier

DATE: 2018-01-29

DRAWING NUMBER:

REV: 3.0

SCALE: none

608271-B



Alcuf International Inc.
Ottawa, Ontario, Canada
www.alcuf.com

DRAWN BY:
designs@alcuf.com

DP2 Connections and Assembly Details

This drawing set consists of parts A to G.

Figure 1 End View of assembled post with rails in place ready for infill.

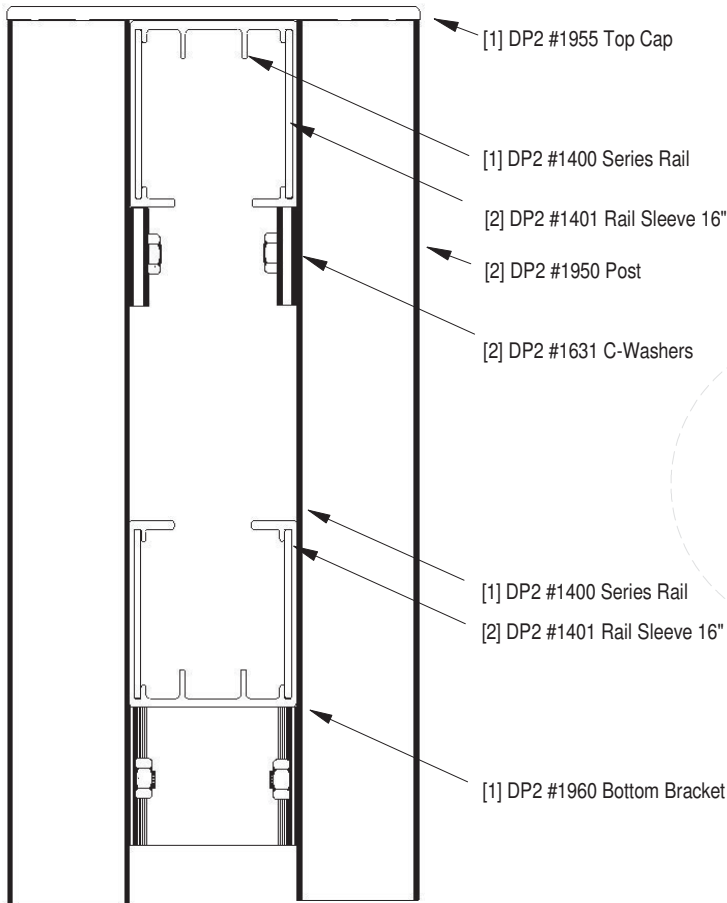

Figure 2 End View of assembled post ready to set in concrete

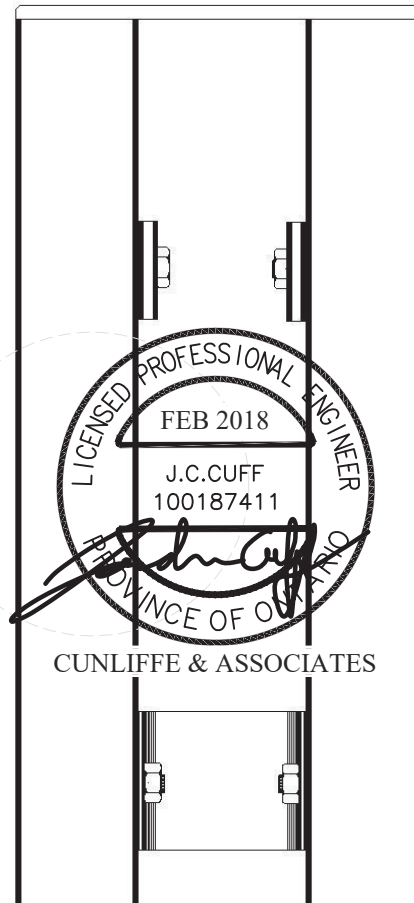

Figure 3 Post Cap slides down into top of posts

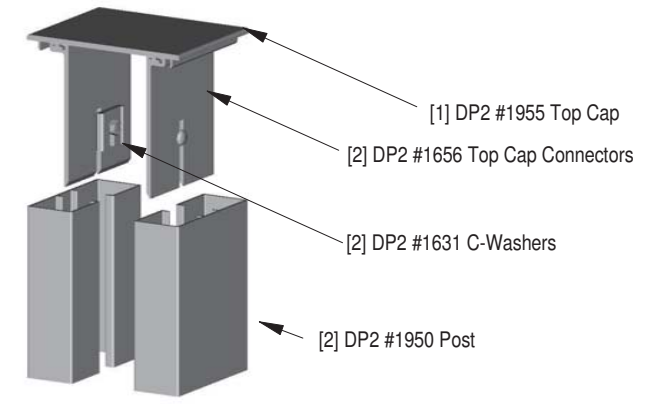
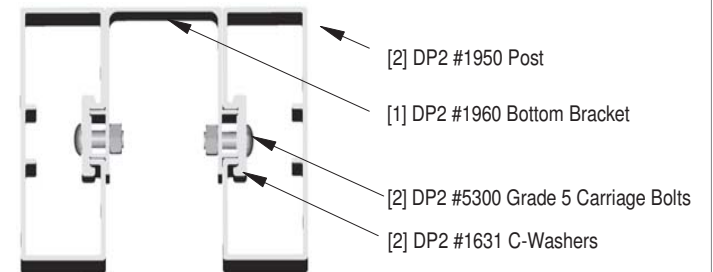

Figure 4 Top view of posts connected with Bottom Bracket



In Figure 1 we see an end view of the basic framework. Posts are assembled using the Post Cap shown in Figure 3, and the Bottom Bracket shown in Figure 4. Top Caps and Bottom Brackets are secured in place using grade 5 bolts and square washers shown in Figure 4. In Figure 4 we can see the Bottom Bracket in a top down view. Both the Bottom Bracket and the Post Cap insure that the two pieces are assembled at the right distance apart for setting in concrete, and then receiving top and bottom rails.

In Figure 2 we show an end view of the post assembly. Posts are assembled before they are set in concrete. Once set, the top cap is removed, and rails are mounted. Once the top cap is replaced and nuts are tightened using the C-Washer brackets that hold the rails in place locking the cap down, you're ready to insert infill. The bottom rail sits on the Bottom Bracket, and is held in place with the weight of the infill.

All bolts are 5/16" Grade 5 Carriage Bolts with a YELLOWTRICHROMATE coating ASTM B-117, with Stainless Steel Nuts.

Alcuf DP2 Noise Barrier

DATE: 2018-01-29

DRAWING NUMBER:

REV: 3.0

SCALE: none

608271-C



Alcuf International Inc.
Ottawa, Ontario, Canada
www.alcuf.com

DRAWN BY:
designs@alcuf.com

DP2 Other Rail Connections

This drawing set consists of parts A to G.

Figure 1

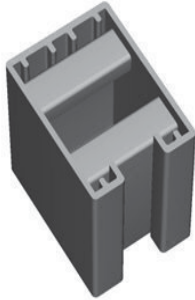

Figure 2

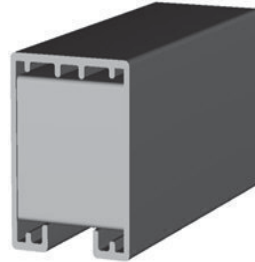

Figure 3

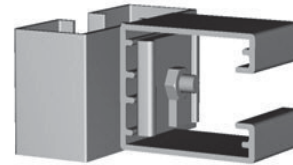
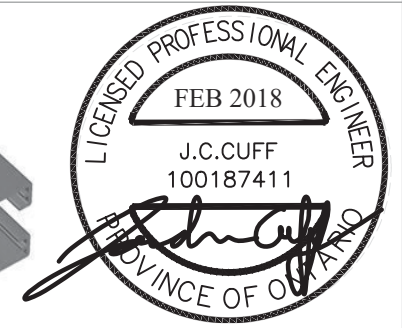
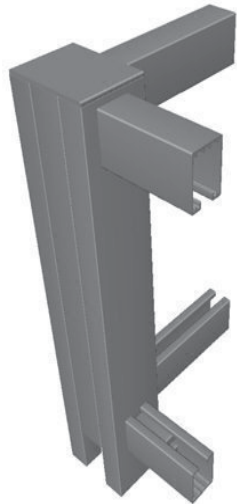

Figure 4



CUNLIFFE & ASSOCIATES

Connections: 2 way



3 way



4 way



4 way on an angle

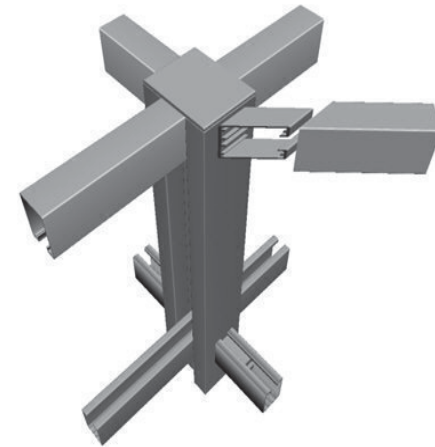

3 Way Connections and 4 Way Connections are easy. Brackets of the same high strength 6005 alloy can be cut from various 1100 series rails providing secure mounting points for rails to connect to the side of posts (F1 and F2). The Post and Rails both have two fins right at the point where a hole can be drilled, reinforcing the shape walls avoiding weakness which would result otherwise (F4). The bolt head would reside inside the Post where it will not interfere with the Post Cap, and the nut would be supported by a C-Washer inside the rail (F3).

Note these brackets can be mitred for angle connections.

Alcuf DP2 Noise Barrier

DATE: 2018-01-29

DRAWING NUMBER:

REV: 3.0

SCALE: none

608271-D



Alcuf International Inc.
Ottawa, Ontario, Canada
www.alcuf.com

DRAWN BY:
designs@alcuf.com

DP2 Sleeve Details and Expansion Gap Table

This drawing set consists of parts A to G.

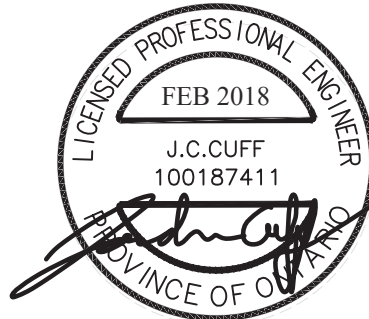
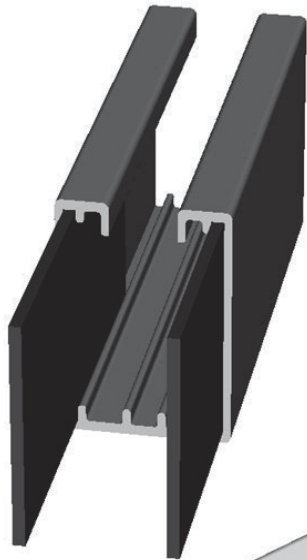

CUNLIFFE & ASSOCIATES

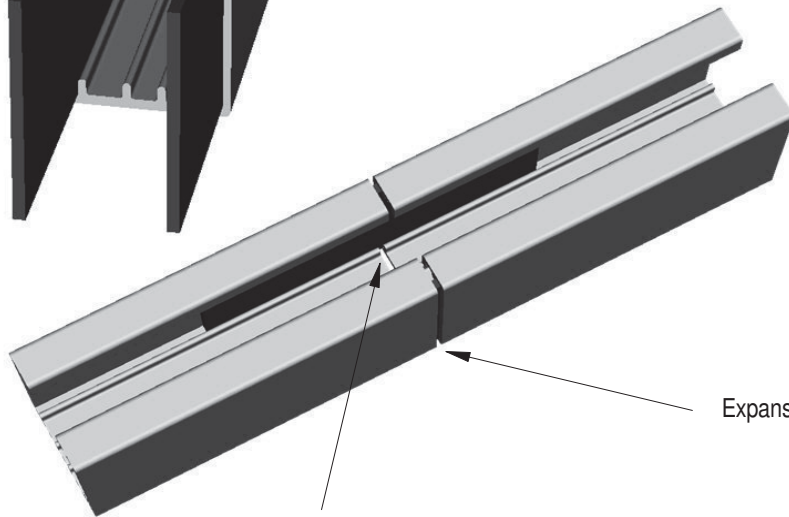

Drainage Point

Expansion Gap

Expansion Gap Table

Installation Temperature		Gap in inches
Celsius	Fahrenheit	(for 20' rails)
-20	-5	3/8
-15	0	3/8
-10	10	5/16
-5	20	5/16
0	30	1/4
5	40	1/4
10	50	1/4
15	60	3/16
20	70	3/16
25	80	3/16
30	90	1/8
35	100	1/8

Sleeve location and Rail Expansion

Rail sleeves must be no more than 12 inches from a post. The slip-fit between one half of the sleeve and the adjoining rail allows for the expansion and contraction that will occur. This is why the sleeve is fastened (riveted) to only one rail, and not both. The sleeve connection also provides an additional drainage point.

It is important to leave an expansion gap at each sleeve connection, to allow for expansion and contraction of the framework at different times of the year. The Expansion Gap Table provides the Gap required depending on the temperature at the time of installation.

Alcuf DP2 Noise Barrier

DATE: 2018-01-29

DRAWING NUMBER:

REV: 3.0

SCALE: none

608271-E



Alcuf International Inc.
Ottawa, Ontario, Canada
www.alcuf.com

DRAWN BY:
designs@alcuf.com

DP2 Post Finishing

This drawing set consists of parts A to G.



Long lengths of the bottom rail bracket extrusion can be used to block the end of posts. This caps the end of the post which is otherwise open. The bracket extrusion is the perfect fit to so this by knotching it at top and bottom to avoid the top and bottom rails mounted within the post.

The Bottom Bracket has a dual use

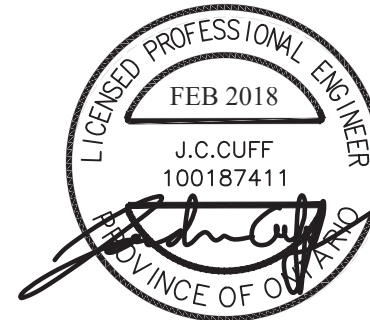
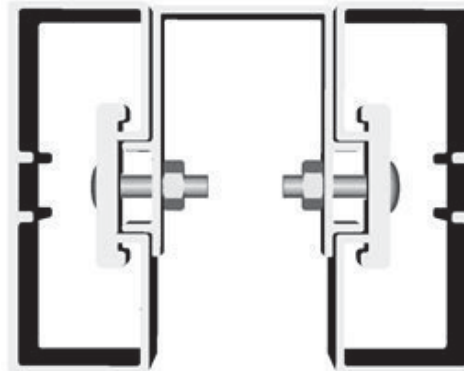

CUNLIFFE & ASSOCIATES

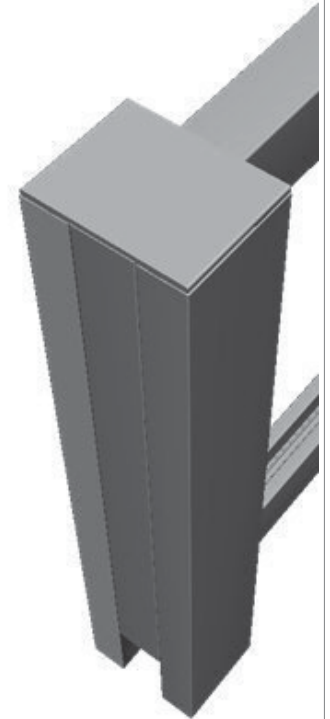

This figure shows the same post shown in Figure 1, which is a Line Post, but now as an End Post. Notice the Bottom Bracket shape is also used as an End Post Spacer. This basically covers the post at an end, where it terminates and the end post is visible. If the end post were butting up to a wall, this is not necessary. This option is for aesthetics, but this piece is also used to mount gate hinges - see Figure 8. Note that the End Post Spacer will need to be notched at the top and bottom allowing the rails to be inserted well into the post.

Alcuf DP2 Noise Barrier

DATE: 2018-01-29

DRAWING NUMBER:

REV: 3.0

SCALE: none

608271-F



Alcuf International Inc.
Ottawa, Ontario, Canada
www.alcuf.com

DRAWN BY:
designs@alcuf.com

DP2 Post Spacing Table

This drawing set consists of parts A to G.

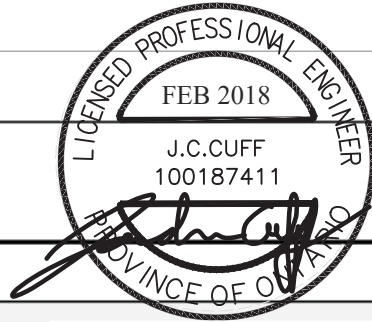

Location	Hourly Wind Pressure (kPa)	Design Wind Pressure (kPa)	DP2 Series						
			Minimum Rail/Post	8'=2.44m		10'=3.05m		12'=3.66m	
				Meter	Feet	Meter	Feet	Meter	Feet
Calgary	0.48	1.57	1400/1950	2.74	9	1.82	6	1.22	4
Edmonton	0.45	1.47	1400/1950	3.05	10	1.98	6.5	1.37	4.5
Halifax (Region)	0.58	1.9	1400/1950	2.44	8	1.52	5	1.07	3.5
Montreal (Region)	0.42	1.38	1400/1950	3.05	10	2.28	7.5	1.52	5
Ottawa (Metropolitan)	0.41	1.34	1400/1950	3.05	10	2.28	7.5	1.52	5
Quebec city (Region)	0.41	1.34	1400/1950	3.05	10	2.28	7.5	1.52	5
Saskatoon	0.43	1.41	1400/1950	3.05	10	2.13	7	1.52	5
Toronto (Metropolitan)	0.44	1.44	1400/1950	3.05	10	2.13	7	1.37	4.5
Toronto (Scarborough)	0.47	1.54	1400/1950	2.9	9.5	1.82	6	1.37	4.5
Vancouver (Burnaby)	0.47	1.54	1400/1950	2.9	9.5	1.82	6	1.37	4.5
Vancouver (Cloverdale, Haney, Langley, New Westminster, Surrey)	0.44	1.44	1400/1950	3.05	10	2.13	7	1.37	4.5
Vancouver (Ladner)	0.46	1.51	1400/1950	3.05	10	1.98	6.5	1.37	4.5
Vancouver (North Vancouver, Richmond, City Hall, Granville & 41 ave)	0.45	1.47	1400/1950	3.05	10	2.13	7	1.37	4.5
Vancouver (West Vancouver)	0.48	1.57	1400/1950	2.74	9	1.82	6	1.22	4
Winnipeg	0.45	1.47	1400/1950	3.05	10	2.13	7	1.37	4.5

- Hourly average wind pressure, in kPa are listed in the supplement to the National Building Code of Canada (2015) Climatic Information for building design in Canada, using the hourly wind pressure 1/50.
- Fence cover material has been assumed to be 2 1/8" wood panel, 100% solid infill.
- The design wind pressures are calculated using a load factor of 1.4, a gust effect factor of 2.5, an open terrain exposure factor of 0.9, a force coefficient of 1.3, and an importance factor of 0.8.
- Post and rail sections are extruded Aluminum shapes using alloy 6005, with a minimum yield strength of 240 MPa.
- Post (DP1 1650 series) and Rail (DP1 1100 series) sections checked for strength in accordance with S157-05/S157.1-05 (reaffirmed 2015), Strength design in Aluminum.
- Structural Engineering for the Alcuf Double Post Fence System (DP1 and DP2) to prepare these tables was performed by Cunliffe & Associates, Consulting Structural Engineers, Ottawa, Ontario, Canada (cunliffe.ca).

Alcuf DP2 Noise Barrier

DATE: 2018-01-29

DRAWING NUMBER:

REV: 3.0

SCALE: none

608271-G



Alcuf International Inc.
Ottawa, Ontario, Canada
www.alcuf.com

DRAWN BY:
designs@alcuf.com

DP2 Optional Sound Seal

This drawing set consists of parts A to I.

TOP VIEW

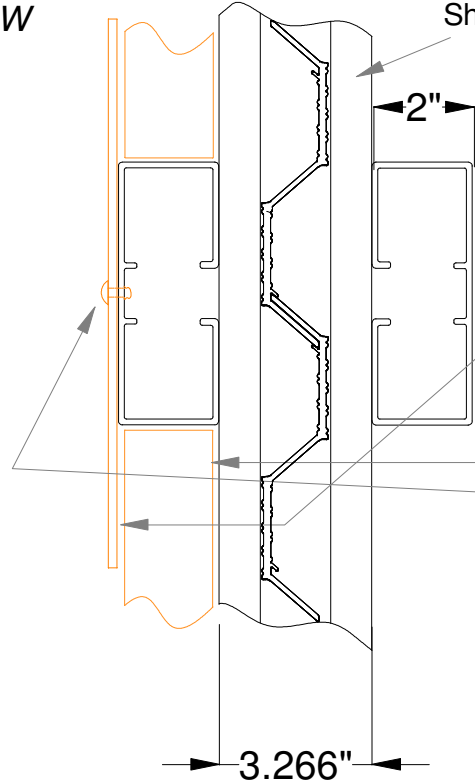

Shown: #1415 Rail with 1.5" #8100 Aluminum Panel infill

#1950 Post (2pc) for #1400 series rails

#1401: DP2 HD Rail Sleeve 16" (flat bar)
(This part can be cut to 10" long at the installers discretion)
(Two brackets may be used at the installers discretion)

2x10 Pressure Treated Wood Floating between bottom rail and mounting bracket.

#7233BSS: SSB68S SS Pop Rivet - 3/16" x 1/2"

SIDE VIEW

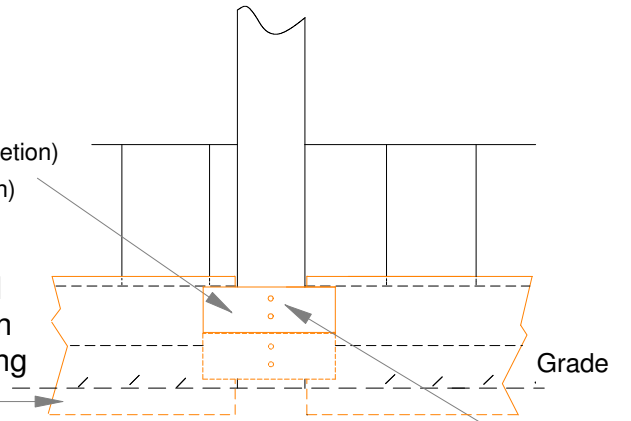

NOTES

A floating sound seal should be constructed in areas where terrain is coarse, and where a complete sound seal is desired.

To achieve this, a wood plank 2" wide x 8 to 10" tall (depending on the grade) is used between posts and to the side of the bottom rail. The plank is attached in such a way that it is free to float with ground movement without adding stress to the bottom rail.

The average grade is typically filled to meet the Sound Seal.

The sound seal plank is considered a sacrificial element that can be easily and economically replaced as it will deteriorate faster than other system components given its direct exposure to bacteria and oxygen at ground level, which will cause rot. However, this method remains the most practical way to provide an effective sound seal between the earth, and the barrier.

INLINE VIEW

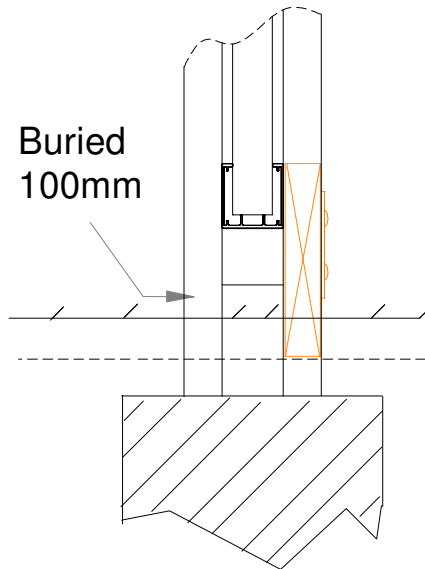

Buried
100mm

DP2 Optional Sound Seal

DATE: 2018-11-26

DRAWING NUMBER:

REV: 1.0

SCALE: none

608271-I



Alcuf International Inc.
Ottawa, Ontario, Canada
www.alcuf.com

DRAWN BY:
designs@alcuf.com

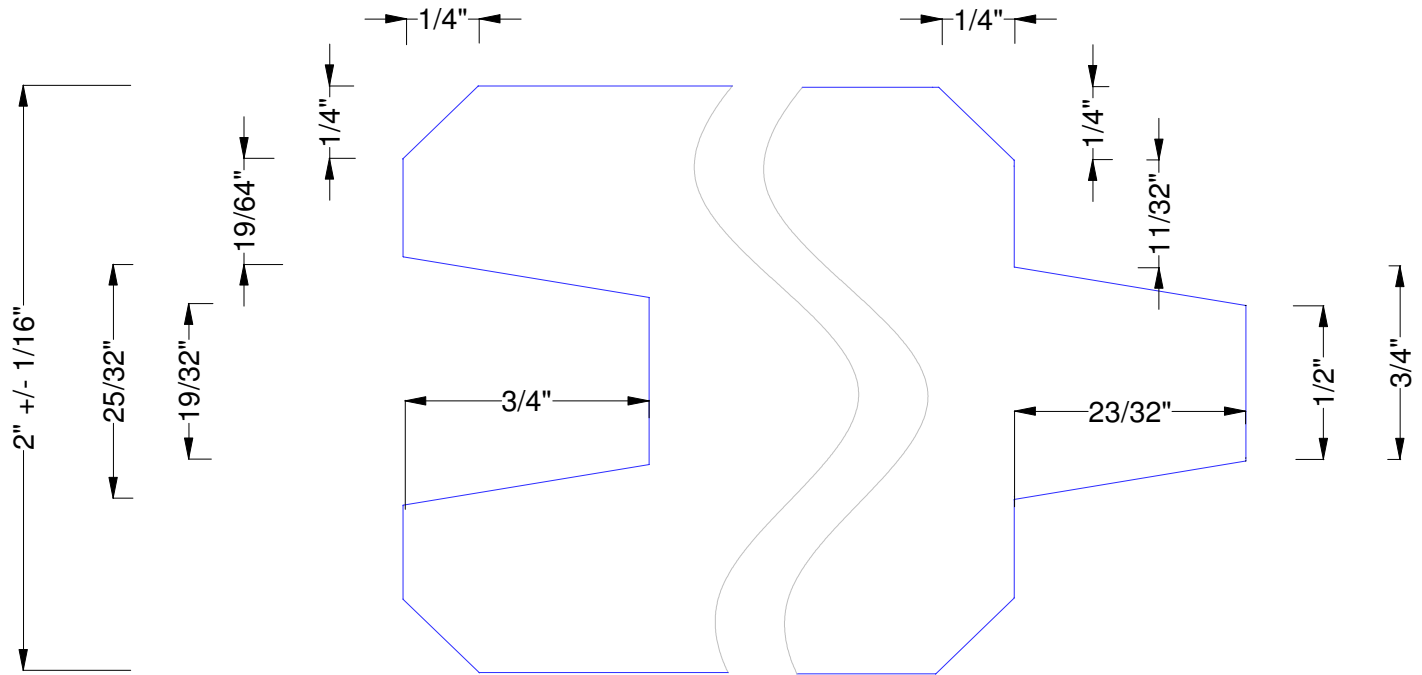
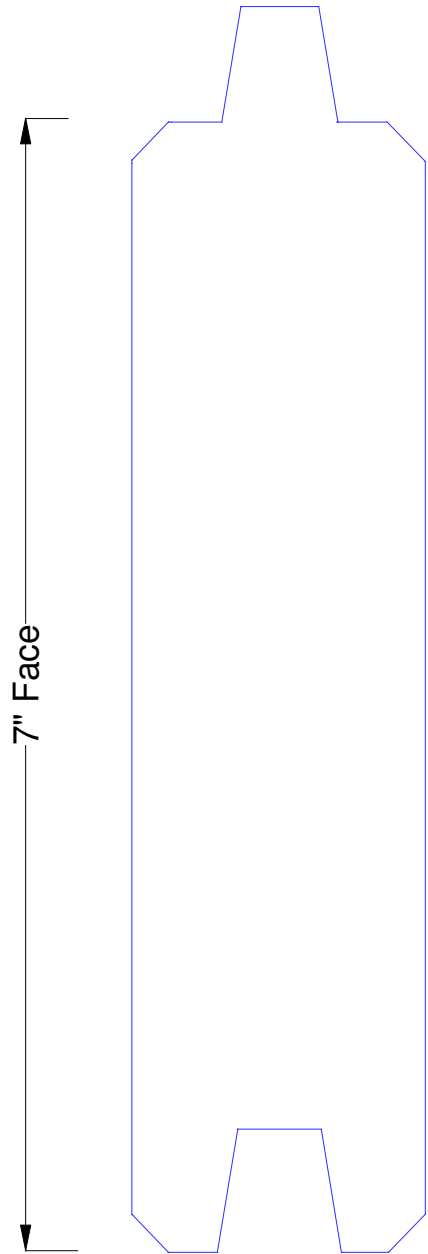

This shape is typically used with a White Pine for a 2" DP2 rail. In Ottawa, we see 35 year old jobs still looking great.

This wood is typically Kiln Dried to no more than 15% moisture. For maximum life expectancy, do not stain.

Alcuf DP2 Noise Barrier V-Joint Wood

DATE: 2018-09-03

DRAWING NUMBER:

REV: 1.0

SCALE: none

1809031



Alcuf International Inc.
Ottawa, Ontario, Canada
www.alcuf.com

DRAWN BY:
designs@alcuf.com

Enclosures

121153-NC1	Noise Control Plan (Surface Transportation Noise)
121153-NC2	Noise Control Plan (Stationary Noise)

M:\2021\121153 CAD\Design\Figures\Noise\121153-NC.dwg, NC1, Sep 07, 2022 - 9:34am, breed

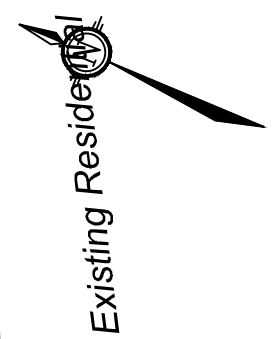
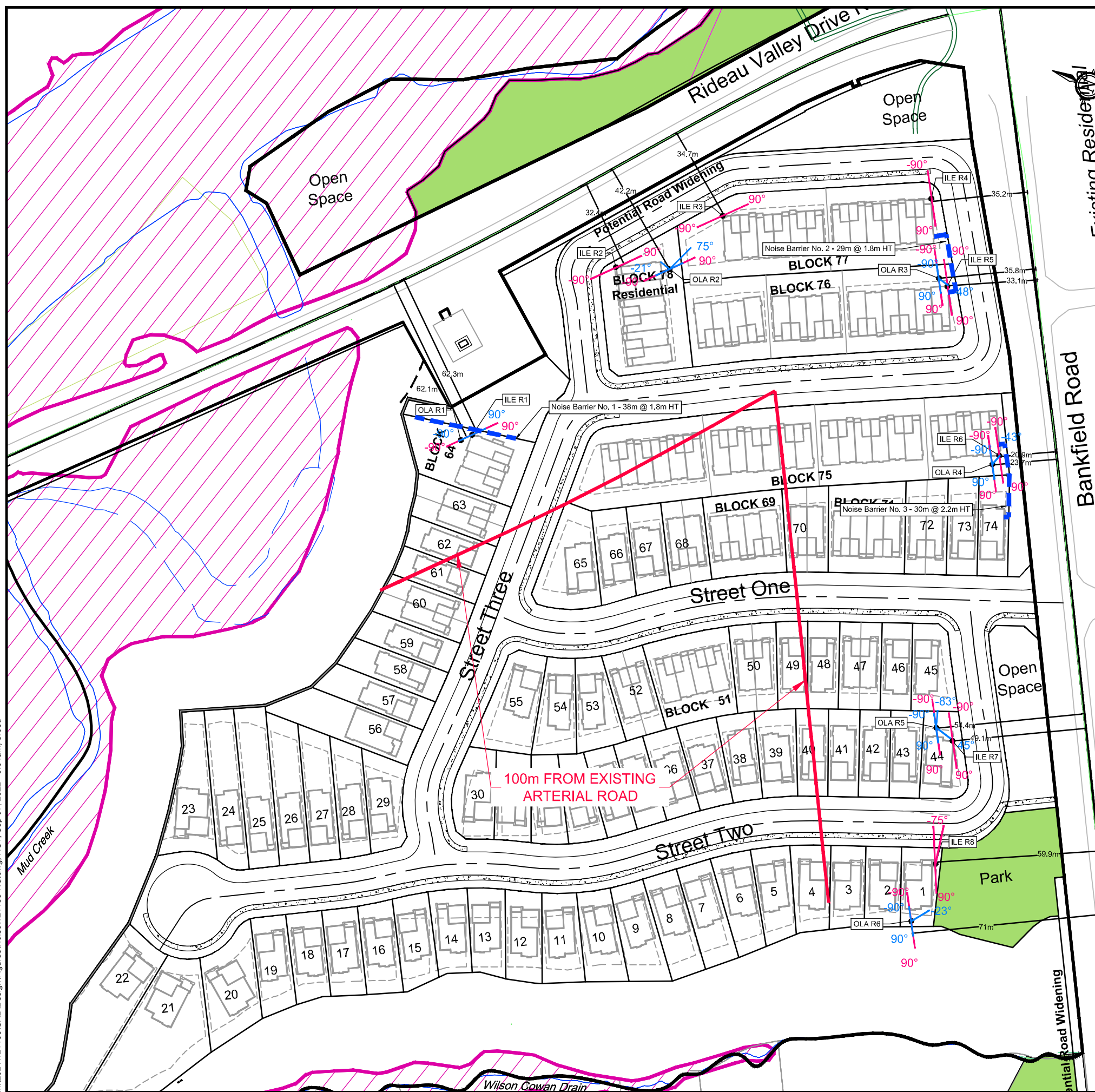

LEGEND

- OLA R1 ● PROPERTY LINE
- OLE R1 ● RECEIVER-OUTDOOR LIVING AREA (OLA)
- RECEIVER-INDOOR LIVING ENVIRONMENT (ILE)
- RECEIVER LOCATION
- 90° BARRIER ANGLES
- 90° RECEIVER ANGLES
- PROPOSED 2.4m NOISE BARRIER
- PROPOSED 2.2m NOISE BARRIER
- PROPOSED 1.8m NOISE BARRIER

RECEIVER DATA TABLE			
RECEIVER INFORMATION		DISTANCES TO NOISE SOURCE (m)	
RECEIVER	RECEIVER GROUND ELEVATION (m)	ROAD ELEVATION (m)	RIDEAU VALLY DRIVE / BANKFIELD ROAD
OLA R1	86.50	85.05	62.1
OLA R2	88.00	87.20	42.2
OLA R3	93.00	93.37	35.8
OLA R4	91.40	92.08	23.7
OLA R5	90.40	89.85	54.4
OLA R6	88.40	88.82	71.0
ILE R1	86.55	84.75	62.3
ILE R2	88.40	87.12	32.4
ILE R3	90.20	87.82	34.7
ILE R4	93.80	93.15	35.2
ILE R5	93.00	93.39	33.1
ILE R6	91.45	92.15	20.9
ILE R7	90.40	89.77	49.1
ILE R8	89.95	88.97	59.9



Engineers, Planners & Landscape Architects
 Suite 200, 240 Michael Cowpland Drive
 Ottawa, Ontario, Canada K2M 1P6

Telephone (613) 254-9643
 Facsimile (613) 254-5867
 Website www.novatech-eng.com

**CITY OF OTTAWA
 STINSON LANDS**

**NOISE CONTROL PLAN
 (SURFACE TRANSPORTATION NOISE)**



DATE NOV 2022 JOB 121153 FIGURE NC1

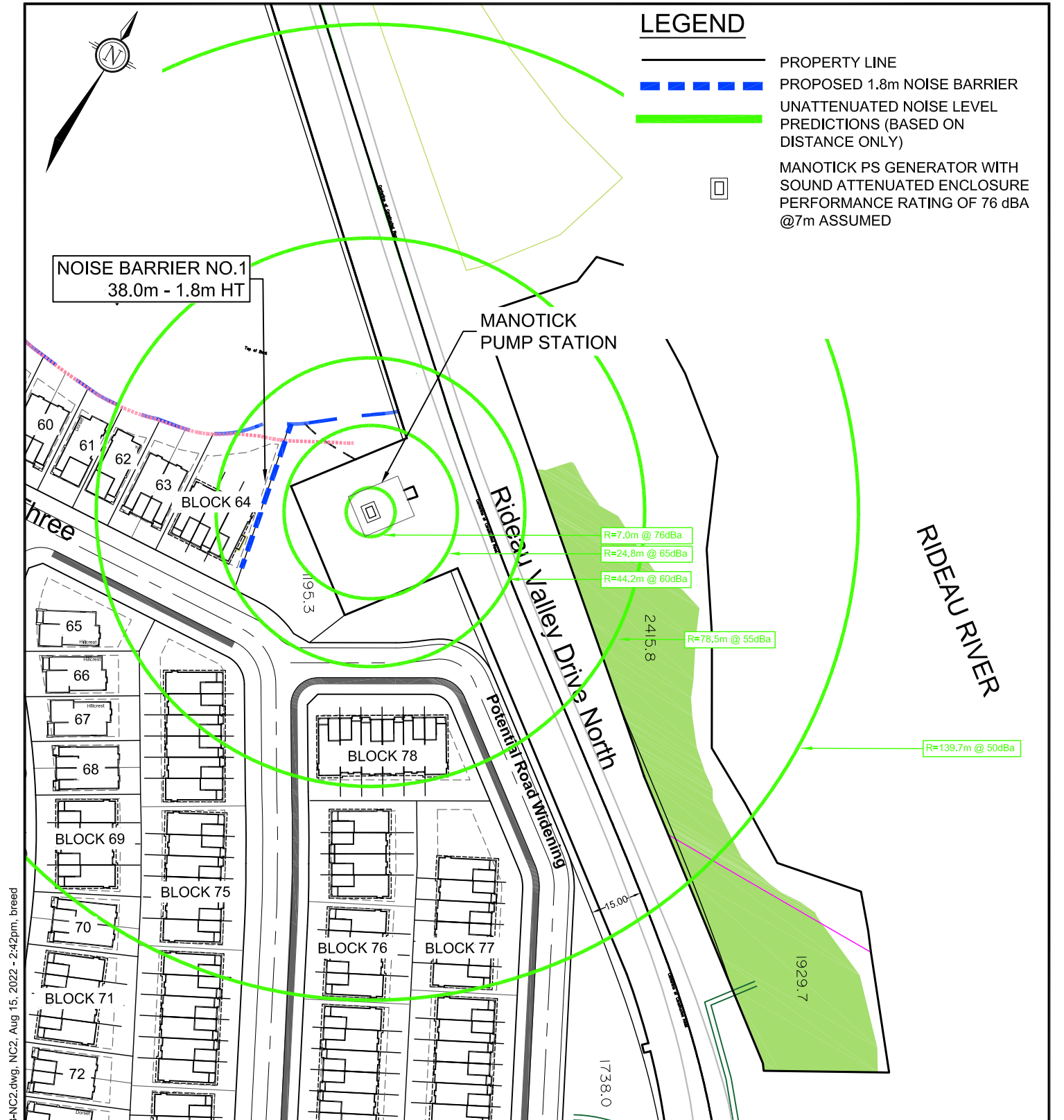

M:\2021\121153\CAD\Design\Figures\Noise\121153-NC2.dwg, NC2, Aug 15, 2022 - 2:42pm, breed



Engineers, Planners & Landscape Architects
 Suite 200, 240 Michael Cowpland Drive
 Ottawa, Ontario, Canada K2M 1P6

Telephone (613) 254-9643
 Facsimile (613) 254-5867
 Website www.novatech-eng.com

**CITY OF OTTAWA
 STINSON LANDS**

**NOISE CONTROL PLAN
 (STATIONARY NOISE)**

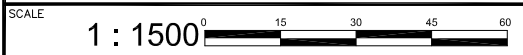

DATE	JOB	FIGURE
AUG 2022	121153	NC2