

100 Steacie Drive

Site Servicing and Stormwater Management Report



Stantec Consulting Ltd.

Prepared for:
11034936 Canada Inc.

Date:
June 15, 2026

Prepared by:
Stantec Consulting Ltd.

Project/File:
160401570

Revision Schedule

Revision	Description	Author	Date	Quality Check	Date	Independent Review	Date
0	1st Submission	Michael W.	2024-04-05	Dustin T.	2024-04-05	Kris K.	2024-04-05
1	2nd Submission	Michael W.	2024-07-29	Dustin T.	2024-08-09	Kris K.	2024-08-02
2	3 rd Submission	Michael W.	2025-07-10	Dustin T.	2025-07-11	Kris K.	2025-07-11
3	4 th Submission	Michael W.	2025-11-25	Dustin T.	2025-11-28	Kris K.	2025-11-28
4	5 th Submission	Michael W.	2026-02-09	Dustin T.	2026-03-02	Kris K.	2026-03-02
5	6 th Submission	Michael W.	2026-06-12	Dustin T.	2026-06-15	Kris K.	2026-06-15

Disclaimer

The conclusions in the Report titled 100 Steacie Drive are Stantec's professional opinion, as of the time of the Report, and concerning the scope described in the Report. The opinions in the document are based on conditions and information existing at the time the scope of work was conducted and do not take into account any subsequent changes. The Report relates solely to the specific project for which Stantec was retained and the stated purpose for which the Report was prepared. The Report is not to be used or relied on for any variation or extension of the project, or for any other project or purpose, and any unauthorized use or reliance is at the recipient's own risk.

Stantec has assumed all information received from 11034936 Canada Inc. (the "Client") and third parties in the preparation of the Report to be correct. While Stantec has exercised a customary level of judgment or due diligence in the use of such information, Stantec assumes no responsibility for the consequences of any error or omission contained therein.

This Report is intended solely for use by the Client in accordance with Stantec's contract with the Client. While the Report may be provided by the Client to applicable authorities having jurisdiction and to other third parties in connection with the project, Stantec disclaims any legal duty based upon warranty, reliance or any other theory to any third party, and will not be liable to such third party for any damages or losses of any kind that may result.

Prepared by:



Signature

Michael Wu, E.I.T.

Reviewed by:



Signature

Dustin Thiffault, P.Eng.

Approved by:



Signature

Kris Kilborn

Table of Contents

1	Introduction	1.1
1.1	Objective	1.2
2	Background	2.3
3	Water Servicing	3.1
3.1	Background	3.1
3.2	Design Criteria	3.1
3.2.1	Water Demand and Allowable Pressure	3.1
3.2.2	Fire Flow and Hydrant Capacity	3.1
3.3	Water Demands	3.2
3.3.1	Domestic Water Demands	3.2
3.3.2	Fire Flow Demands	3.2
3.4	Level of Servicing	3.2
3.4.1	Boundary Conditions	3.2
3.4.2	Allowable Domestic Pressures	3.3
3.4.3	Allowable Fire Flow Pressures	3.3
3.4.4	Fire Hydrant Coverage	3.3
3.5	Proposed Water Servicing	3.4
4	Wastewater Servicing	4.5
4.1	Background	4.5
4.2	Design Criteria	4.5
4.3	Wastewater Generation and Servicing Design	4.5
4.4	Proposed Servicing	4.6
5	Stormwater Management	5.7
5.1	Objectives	5.7
5.2	SWM Criteria and Constraints	5.7
5.3	Existing Conditions	5.8
5.4	Stormwater Management Design	5.9
5.4.1	Quantity Control: Storage Requirements	5.9
5.4.2	Results	5.14
5.4.3	Quality Control	5.14
6	Grading and Drainage	6.15
7	Utilities	7.15
8	Approvals	8.16
9	Erosion Control During Construction	9.17
10	Geotechnical Investigation	10.18
11	Conclusions	1
11.1	Water Servicing	1
11.2	Sanitary Servicing	1
11.3	Stormwater Servicing	1
11.4	Grading	1
11.5	Utilities	2
11.6	Approvals/Permits	2



List of Tables

Table 1.1: Unit Type Breakdown 1.2
Table 3.1: Estimated Water Demands 3.2
Table 3.2: Boundary Conditions 3.3
Table 4.1: Estimated Total Wastewater Peak Flow 4.5
Table 5.1: Summary of Existing Subcatchment Areas 5.8
Table 5.2: Target Release Rate 5.9
Table 5.3: 100 Year Summary of Roof Controls..... 5.10
Table 5.4: Surface Storage Areas - 100 Year Event 5.11
Table 5.5: Peak Post-Development Uncontrolled Surface Release Rates 5.11
Table 5.6: Comparison of Discharge Pre- to Post-Development..... 5.12
Table 5.7: Summary 5-Year and 100-Year Event Release Rates 5.14
Table 5.8: Surface Area and Runoff for Stormceptor Sizing 5.14
Table 10.1: Recommended Pavement Structure 10.18

List of Figures

Figure 1.1: Location Plan 1.1
Figure 3.4: Existing Fire Hydrant Coverage Map 3.4
Figure 5.1: Overall External Storm Conveyance Network 5.13

List of Appendices

Appendix A Background Correspondence

Appendix B Water Servicing

- B.1 Water Demands
- B.2 FUS Fire Flow Calculations
- B.3 Boundary Conditions
- B.4 Hydraulic Analysis Results

Appendix C Wastewater Servicing

Appendix D Stormwater Servicing and Management

- D.1 Storm Sewer Design Sheet
- D.2 MRM Sheet
- D.3 Stormceptor Sizing Report

Appendix E External Reports



1 Introduction

Stantec Consulting Ltd. has been commissioned by 11034936 Canada Inc. to prepare the following Site Servicing and Stormwater Management Report in support of a Site Plan Control application for the proposed development located at 100 Steacie Drive in the City of Ottawa.

The site is 2.2 ha in area and is situated approximately 250 m southwest from the March Road and Station Road intersection, on the west end of Steacie Drive and the south side of the Canadian National Railway Renfrew Subdivision. The site is currently zoned R4Y [2809] S463-h, O1, and O1R and is presently vacant. The site is bounded by the CN Rail Renfrew Subdivision to the north, Steacie Drive and existing commercial development to the east, greenspace, and existing residential development to the south and west, as shown on **Figure 1.1** below.

Figure 1.1: Location Plan

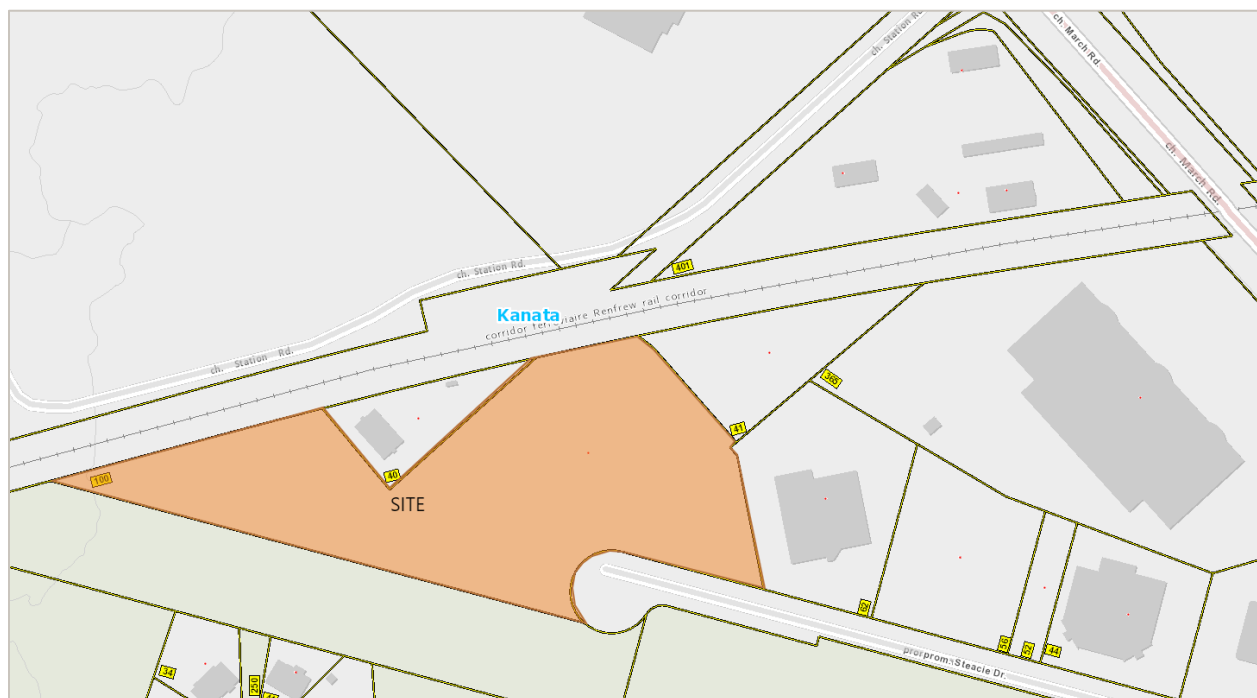

The proposed 2.2 ha site consists of two 4-storey medium rise residential buildings which would function as retirement facilities. Neuf has prepared a site plan and design brief dated May 25, 2026, while correspondence with Neuf (attached in **Appendix A**) confirmed the two buildings are proposed to have a total of 196 apartment units with the unit type breakdown summarized in **Table 1.1** below.



Table 1.1: Unit Type Breakdown

Unit Type	Number
Studio	2
One-bedroom	115
Two-bedroom	79
Total	196

1.1 Objective

This site servicing and stormwater management (SWM) report presents a servicing scheme that is free of conflicts, provides on-site servicing in accordance with City of Ottawa Design Guidelines, and uses the existing municipal infrastructure in accordance with any limitations communicated during consultation with the City of Ottawa staff. Details of the existing infrastructure located within Steacie Drive and Station Road right of ways (ROW) were obtained from available as-built drawings and site topographic survey.

Criteria and constraints provided by the City of Ottawa have been used as a basis for the detailed servicing design of the proposed development. Specific and potential development constraints to be addressed are as follows:

- Potable Water Servicing
 - Estimated water demands to characterize the proposed feed(s) for the proposed development which will be serviced from the 200 mm diameter watermains on Steacie Drive and Station Road.
 - Watermain servicing for the development is to be able to provide average day and maximum day (including peak hour) demands (i.e., non-emergency conditions) at pressures within the acceptable range of 345 to 552 kPa (50 to 80 psi)
 - Under fire flow (emergency) conditions, the water distribution system is to maintain a minimum pressure greater than 140 kPa (20 psi)
- Wastewater (Sanitary) Servicing
 - Define and size the on-site sanitary sewers which will be connected to the existing 250 mm diameter sanitary sewers within the Steacie Drive ROW.
- Storm Sewer Servicing
 - Define major and minor conveyance systems in conjunction with the proposed grading plan.
 - Determine the stormwater management storage requirements to meet the allowable release rate for the site.
 - Define and size the on-site storm sewers that will contribute to the existing ditches along the CN Rail Renfrew Subdivision.
- Prepare a grading plan in accordance with the proposed site plan and existing grades.

Drawing SSP-1 illustrate the proposed internal servicing scheme for the site.



2 Background

The following background studies have been referenced during the servicing and stormwater management design of the proposed site:

- City of Ottawa Design Guidelines – Water Distribution, Infrastructure Services Department, City of Ottawa, First Edition, July 2010
- City of Ottawa Sewer Design Guidelines, 2nd Ed., City of Ottawa, October 2012
- Technical Bulletin ISTB-2018-01 Revision to Ottawa Design Guidelines – Sewer, City of Ottawa, March 2018
- Technical Bulletin ISTB-2018-02 Revision to Ottawa Design Guidelines – Water Distribution, City of Ottawa, March 2018
- *Site Servicing and Stormwater Management Report – 100 Steacie Drive* (Functional), Revision 3, Stantec Consulting Ltd., March 2022
- *Geotechnical Investigation – Proposed Residential Development – 100 Steacie Drive, Paterson Drive*, December 2023



3 Water Servicing

3.1 Background

The proposed development is in Pressure Zone 2W2C of the City of Ottawa's Water Distribution System. The existing watermains within the vicinity of the site comprises of the 200 mm diameter watermain stub on Station Road and the existing 200 mm diameter watermain on Steacie Drive.

3.2 Design Criteria

3.2.1 Water Demand and Allowable Pressure

The domestic water demand and allowable water pressure are assessed using the City of Ottawa Water Distribution Guidelines (2025) as amended, and the ISTB 2021-03 Technical Bulletin.

Residential Apartment Population Rate

Bachelor and 1 Bedroom	1.4 persons / unit
2 Bedroom	2.1 persons / unit

Residential Apartment Demand

Average Daily (AVDY)	280 L/cap/day
Maximum Daily (MXDY)	2.5 x AVDY
Peak Hour (PKHR)	2.2 x MXDY

Allowable Water Pressure

MXDY Flow	345 kPa (50 psi) to 552 kPa (80 psi)
PKHR Flow Minimum	276 kPa (40 psi.)
MXDY + Fire Flow	140 kPa (20 psi.)
Maximum Allowable for Occupied Area	552 kPa (80 psi)

3.2.2 Fire Flow and Hydrant Capacity

Detailed fire flow requirements are assessed using the Fire Underwriters Survey (FUS) methodology (2020). Site specific criteria considered are noted in Section 2.3.2.

Fire hydrant capacity is assessed based on Table 18.5.4.3 of the National Fire Protection Agency (NFPA) Fire Code document. A hydrant situated less than 76 m away from a building can supply a maximum capacity of 5,678 L/min, and a hydrant 76 to less than 152 m away can supply a maximum capacity of 3,785 L/min.



3.3 Water Demands

3.3.1 Domestic Water Demands

Based on the unit type breakdown in **Table 1.1**, the proposed buildings are estimated to have a total population of 291 persons. The estimated demands are assessed based on the criteria described in **Section 3.2.1** and are summarized in **Table 3.1** and detailed in **Appendix B**.

Table 3.1: Estimated Water Demands

Total Apartment Units	Population	AVDY (L/s)	MXDY (L/s)	PKHR (L/s)
196	330	1.1	2.7	5.9

3.3.2 Fire Flow Demands

The fire flow requirement for the development was calculated in accordance with Fire Underwriters Survey (FUS) methodology. Per Section 3.2.2.48A of the Ontario Building Code, the building was assumed to be non-combustible construction in the assessment for fire flow requirements according to the Fire Underwriters Survey (FUS) Guidelines.

Required fire flows were estimated based on a building of non-combustible construction type without full protections of all vertical openings (one hour fire rating), and a final sprinkler design to conform to the NFPA 13 standard. The gross floor area of the two largest floors + 50 % of the gross floor area of the additional floors were used in the FUS calculation for the two high-rises, as per Page 22 of the *Fire Underwriters Survey's Water Supply for Public Fire Protection* (2020).

The building's minimum required fire flow was determined to be 150 L/s (9,000 L/min); however, as the water modelling indicated at development rezoning that the watermain would not be able to provide the fire flow, revised FUS calculations to account for the firewall splitting the building into two with footprints of 2250 m² were provided. Under this revised FUS calculation, the fire flow demand was reduced to 100 L/s (6,000 L/min). Detailed fire flow calculations per the FUS methodology are provided in **Appendix B**.

3.4 Level of Servicing

3.4.1 Boundary Conditions

The estimated domestic water demands, and fire flow demands were used to define the level of servicing required for the proposed development from the municipal watermain and hydrants within the Station Road and Steacie Drive ROWs. **Table 3.2** outlines the updated boundary conditions for the proposed connection at Steacie Drive servicing the site, with the future watermain connection between Steacie Drive and Station Road modelled and provided by the City of Ottawa on February 9, 2026, and shown in **Appendix B**.



Table 3.2: Boundary Conditions

Pressure Scenario	HGL (m)
Minimum HGL	125.7
Maximum HGL	130.2
Maximum Day + Fire Flow (150 L/s)	107.3

3.4.2 Allowable Domestic Pressures

The proposed finished floor elevation of the building is 92.23 m. This elevation serves as the first-floor elevation for the calculation of residual pressures at ground level. From the boundary condition HGL elevations, the pressures at the first-floor level are expected to range from 328 kPa to 372 kPa (47.6 psi to 54 psi) under normal operating conditions. The first-floor pressure is expected to be below the maximum allowable for occupied areas.

To ensure adequate water pressure above the first-floor elevation, booster pump requirements are to be confirmed by the mechanical engineering consultant during subsequent stages of the development application process.

3.4.3 Allowable Fire Flow Pressures

From the boundary condition HGL elevation provided, the watermains and nearby fire hydrants can provide the required fire flow while maintaining the minimum residual pressure of 138 kPa (20 psi).

3.4.4 Fire Hydrant Coverage

There is an existing fire hydrant in the proximity of the proposed development site, as shown in **Drawing SSP-1**. Additionally, a fire hydrant exists approximately 91 m east of the eastern site property boundary in front of the 56 Steacie Drive property as demonstrated in **Figure 3.4**.

According to the NFPA 1 Table 18.5.4.3 in Appendix I of the City of Ottawa Technical Bulletin ISTB-2018-02, a hydrant situated 75 m or less away from a building can supply a maximum capacity of 5,700 L/min whereas a hydrant between 75m and 150m away can supply 3,800 L/min. Hence, the site's RFF of 6,000 L/m can be met by the two fire hydrants in combination. Additionally, the closer hydrant is located within 45 m of the building fire department (Siamese) connection per Section 3.2.5.16 of the Ontario Building Code.



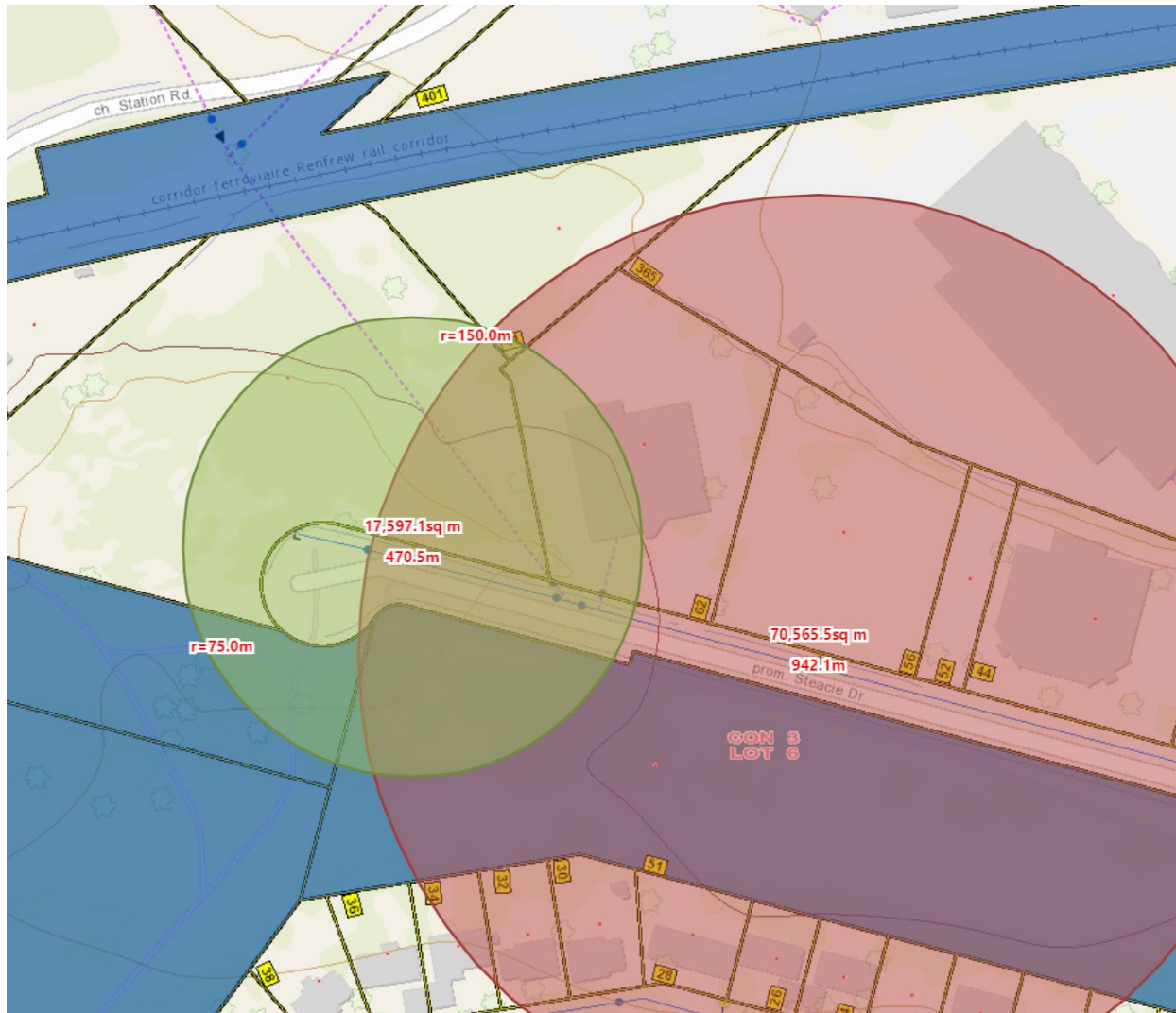

Figure 3.1: Existing Fire Hydrant Coverage Map

3.5 Proposed Water Servicing

The proposed development is to be serviced by a dual 150 mm service connection. The laterals and the municipal watermain are each to be equipped with an isolation valve.

The mechanical engineering consultant is responsible to confirm the water pressure within each building is adequate to meet building code requirements.



4 Wastewater Servicing

4.1 Background

The site will be serviced via a short extension of the existing 250 mm diameter sanitary sewer within the Steacie Drive ROW at the southern boundary of the site (see **Drawing SSP-1**). It is proposed to connect to the existing sewer via a 250 mm sanitary service line to service the proposed site.

4.2 Design Criteria

As outlined in the City of Ottawa Sewer Design Guidelines and the MECP's Design Guidelines for Sewage Works, the following criteria were used to calculate estimated wastewater flow rates and to determine the size and location of the sanitary service laterals:

- Minimum velocity = 0.6 m/s (0.8 m/s for upstream sections)
- Maximum velocity = 3.0 m/s
- Manning roughness coefficient for all smooth wall pipes = 0.013
- Minimum size of sanitary sewer service = 135 mm
- Minimum grade of sanitary sewer service = 1.0 % (2.0 % preferred)
- Average wastewater generation = 280 L/person/day (per City Design Guidelines)
- Peak Factor = based on Harmon Equation; maximum of 4.0 (residential)
- Harmon correction factor = 0.8
- Infiltration allowance = 0.33 L/s/ha (per City Design Guidelines)
- Minimum cover for sewer service connections = 2.0 m
- Average population density for studio and one-bedroom units – 1.4 persons/unit
- Average population density for two-bedroom units – 2.1 persons/unit

4.3 Wastewater Generation and Servicing Design

The estimated peak wastewater flow generated are based on the current site plan. The anticipated wastewater peak flow generated from the proposed development is summarized in **Table 4.1** below.

Table 4.1: Estimated Total Wastewater Peak Flow

Number of Units	Population	Peak Factor	Peak Flow (L/s)	Infiltration Flow (L/s)	Total Peak Flow (L/s)
196	330	3.45	3.7	0.8	4.5

1. Design residential flow based on 280 L/p/day.



100 Steacie Drive

Table of Contents

2. Peak factor for residential units calculated using Harmon's formula.
3. Average population estimated based on 1.8 persons/unit for apartments units.
4. Infiltration design flow equals 0.33 L/s/ha.

Detailed sanitary sewage calculations are included in **Appendix C**. A full port backwater valve will be required for the proposed building in accordance with the Sewer Design Guidelines and will be coordinated with the building mechanical engineers.

The peak estimated wastewater flow generation has been coordinated with City of Ottawa staff. City of Ottawa Water Resources team staff have confirmed that sufficient capacity exists within downstream sewer systems to accommodate the anticipated site plan development.

4.4 Proposed Servicing

A 250 mm diameter sanitary building service is proposed to service the development. The lateral will connect via a monitoring manhole to the proposed 250 mm diameter on-site private sanitary sewers, which will connect in turn to the existing 250 mm diameter sanitary sewer on Steacie Drive. The proposed sanitary servicing is shown on **Drawings SSP-1** and **SA-1**.

A full port backwater valve Per City Std S14.1 will be installed on the proposed sanitary service within the site to prevent any surcharge from the downstream sewer main from impacting the proposed property. A sump pump will be required for sewage discharge from the mechanical room. Sizing of the service laterals, sump pit, sump pump, and design of the internal plumbing and associated mechanical systems are to be confirmed by the mechanical consultant.



5 Stormwater Management

5.1 Objectives

The goal of this stormwater servicing and stormwater management (SWM) plan is to determine the measures necessary to control the quantity and quality of stormwater released from the proposed development to meet the criteria established during the consultation process with City of Ottawa staff, and to provide sufficient details required for approval.

5.2 SWM Criteria and Constraints

The Stormwater Management (SWM) criteria were established by combining current design practices outlined by the City of Ottawa Sewer Design Guidelines (SDG, October 2012), review of project pre-consultation notes with the City of Ottawa, the functional level *Site Servicing and Stormwater Management Report* previously prepared for the subject lands, and through consultation with City of Ottawa staff. The following summarizes the criteria, with the source of each criterion indicated in brackets:

General

- Use of the dual drainage principle (City of Ottawa).
- Wherever feasible and practical, site-level measures should be used to reduce and control the volume and rate of runoff. (City of Ottawa)
- Assess impact of 100-year event outlined in the City of Ottawa Sewer Design Guidelines on major & minor drainage system (City of Ottawa)
- Enhanced quality control (80% TSS removal) to be provided on-site for the development (MVCA/Kizell Drain).

Storm Sewer & Inlet Controls

- Discharge for each storm event to be restricted to pre-development levels with a maximum runoff coefficient of $C=0.50$. (City of Ottawa pre-consultation)
- Peak flows generated from events greater than the 5-year and including the 100-year storm must be detained on site (City of Ottawa pre-consultation)
- The foundation drainage system is to be independently connected to sewer main unless being pumped with appropriate back up power, sufficient sized pump, and backflow prevention. (City of Ottawa pre-consultation)
- T_c should be not less than 10 minutes (City of Ottawa SDG).
- Size storm sewers to convey at minimum the 5-year storm event under free-flow conditions using City of Ottawa I-D-F parameters (City of Ottawa)
- 100-year storm HGL to be a minimum of 0.30 m below building foundation footing (City of Ottawa).

Surface Storage & Overland Flow



- Building openings to be minimum of 0.30 m above the 100-year water level (City of Ottawa)
- Maximum depth of flow under either static or dynamic conditions shall be less than 0.35 m in the 100-year event (City of Ottawa)
- Provide adequate emergency overflow conveyance off-site with a minimum vertical clearance of 15 cm between the spill elevation and the ground elevation at the building envelope in the proximity of the flow route or ponding area (City of Ottawa)

5.3 Existing Conditions

The existing site (2.25 ha) is vacant with thick trees and greenspace. An area measuring approximately 2.33 ha corresponding to lands within the site for development and upstream offsite tributary areas have been used for determining the pre-development target release rate. Available topographic information for the site, of which the existing drainage conditions and grading for the site are derived from, are shown in **Drawing EX-1**.

Four sub-catchments were delineated in **Drawing EX-1** based on the existing topographic grading and outlets. As the existing site is undeveloped, the overall pre-development runoff coefficient was established to be C=0.20, below the maximum pre-development runoff coefficient of C=0.50 identified in consultation with City of Ottawa staff and summarized in **Table 5.1** below.

Table 5.1: Summary of Existing Subcatchment Areas

Catchment Areas	C	A (ha)	Outlet
EX-1	0.20	1.18	Ditch along rail line (West)
EX-2	0.20	0.11	Steacie ROW
EX-3	0.20	0.46	Ditch along rail line (North) via adjacent property
EX-4	0.20	0.58	Ditch along rail line (North)
Total	0.20	2.33	-

Note that area EX-1 includes upstream off-site tributary areas within the adjacent park land. Areas not proposed for development (Areas UNC-2 through UNC-4 as shown on **Drawing SD-1**) will continue to discharge overland on their existing drainage path. Area UNC-1 will continue to discharge uncontrolled to the Steacie Drive ROW and represents a marginal increase in runoff to the existing Steacie Drive roadside ditch.

The pre-development release rates for the site have been determined using the rational method and drainage characteristics identified above. A time of concentration for the predevelopment area (10 minutes) was assigned based on the relatively small site and its proximity to the existing drainage outlet for the site. C coefficient values have been increased by 25 % for the post-development 100-year storm event based on MTO Drainage Manual recommendations. Peak flow rates have been calculated using the rational method as follows:



100 Steacie Drive

Table of Contents

$$Q = 2.78 CiA$$

Where: Q = peak flow rate, L/s

A = drainage area, ha

I = rainfall intensity, mm/hr (per Ottawa IDF curves)

C = site runoff coefficient

The target release rate for the site is summarized in **Table 5.2** below:

Table 5.2: Target Release Rate

Design Storm	Target Flow Rate (L/s)
5-Year	135.1
100-Year	289.3

5.4 Stormwater Management Design

The proposed building will be serviced by a 250 mm diameter storm service lateral connected to a storm sewer network within the private driveways, which will collect stormwater discharge to a proposed stormwater dry pond, which ultimately discharges to the existing ditches along the north side of the existing rail corridor. The site has been subdivided into catchment areas to effectively collect, store, and convey runoff flowrates not exceeding the target release rate established in sections above.

Discharge from the building's rooftop, foundation drains, trench drain, and area drains are to be routed to the 250 mm diameter storm service lateral via the building's internal plumbing, which is to be designed by the mechanical consultant. On site catch basin(s) will collect additional drainage on site to the storm sewers for conveyance to the dry pond.

The proposed site plan, drainage areas and proposed storm sewer infrastructure are shown on **Drawing SD-1 and SSP-1**.

5.4.1 Quantity Control: Storage Requirements

The Modified Rational Method (MRM) was used to assess the flow rate and volume of runoff generated under post-development conditions. The site was subdivided into sub-catchments tributary to separate drainage outlets with most directed towards the dry pond. **Drawing SD-1** shows the delineated sub-catchment areas, while the MRM spreadsheet is included in **Appendix D**.

The following assumptions were made in the creation of the storm drainage plot and accompanying MRM spreadsheet:

- Excess run-off that cannot be captured as surface storage due to grading constraints is to sheet flow uncontrolled per existing conditions (areas UNC-1 to UNC-4).



- Area OFF-1 encompasses off-site runoff from the adjacent park which flows through the subject site. Area OFF-1 is tributary to the proposed dry pond and has been included in the overall pond discharge rate.
- An inlet control device (ICD) at the dry pond outlet manhole will be used to manage stormwater flows from the site.
- Restricted roof drains will be used to manage stormwater flows from the rooftop.

5.4.1.1 Rooftop Storage

It is proposed to retain stormwater on a portion of the building rooftop (Area R1A) to a maximum depth of 0.15 m by installing restricted flow roof drains and overflow scuppers. The MRM calculations assume the roof will be equipped with 10 standard Watts model roof drains complete with Adjustable Accutrol Weirs. Discharge from the controlled roof drains will be routed by the mechanical consultant through the building's internal plumbing to the storm service lateral.

Watts Drainage "Accutrol" roof drain weir data has been used to calculate a practical roof release rate and detention storage volume for the rooftops. It should be noted that the "Accutrol" weir has been used as an example only, and that other products may be specified for use, provided that the total roof drain release rate is restricted to match the maximum rate of release indicated in **Table 5.3**, and that sufficient roof storage is provided to meet (or exceed) the resulting volume of detained stormwater. Storage volume and controlled release rate are summarized in **Table 5.3**:

Table 5.3: 100 Year Summary of Roof Controls

Area ID	Depth (mm)	Discharge (L/s)	Volume Stored (m³)	Storage Provided (m³)
R1A	146	12.3	83.8	90.5

*Drainage from the roof is anticipated to enter the dry pond at the western boundary of the site.

5.4.1.2 Surface Storage

As part of the stormwater management design of the site development, a stormwater management dry pond is proposed to attenuate peak flows from the site. Per the modified rational method calculations included as part of **Appendix D**, discharge from the site is to be directed towards the proposed storm sewers on site, which ultimately convey discharge to the dry pond. The volume of storage proposed is sufficient to retain the stormwater generated by each storm event while not exceeding the allowable release rate. A large portion of the stormwater on the site (excluding some uncontrolled flows) will be directed towards the dry pond and ultimately discharge to Kizell Creek.

The reverse sloped ramp to the parking garage is to be equipped with a trench drain at the bottom of the ramp to provide an outlet for the driveway area (TRENCH subcatchment) with connection to the building storm service.



100 Steacie Drive

Table of Contents

Orifice discharge coefficients used for modified rational method calculations are 0.61 for circular orifice plates, and 0.572 for IPEX HF ICDs based on manufacturer supplied discharge curves included in **Appendix D**.

Runoff from areas POND-2 and POND-3 contributing to the pond is controlled via a 102mm diameter IPEX HF ICD to allow for use of surface ponding volume in that area. 100-year pond water elevations do not rise to the level of the proposed orifice control in this area, ensuring that orifice outflow calculations are not impacted by tailwater conditions.

The MRM sheet provided in **Appendix D** demonstrates that a volume of 233.3 m³ of storage is required in the proposed dry pond. Based on the proposed grading plan, dry pond storage is available to provide the necessary storage within the site.

Controlled release rates and storage volumes required are summarized in **Table 5.4**.

Table 5.4: Surface Storage Areas - 100 Year Event

Tributary Area	Design Storm	Design Head (m)	Discharge (L/s)	Orifice Type	V _{required} (m ³)	V _{provided} (m ³)
POND-2, POND-3	100-Year	2.09	29.9	IPEX HF ICD (102mm)	22.7	41.1
POND-1, POND-2, POND-3, R2A, R2B, TRENCH, OFF-1	100-Year	1.58 (elevation 87.04)	35.3	115 mm Circular Orifice	233.3	233.5

The proposed stormwater management pond is equipped with a 1.0 m wide spillway at elevation 87.40 to ensure that if the quantity control orifice is blocked, the pond may still safely discharge without impacting upstream USF elevations. As the proposed pond is oversized to meet storage requirements of the 100-year storm event, spillway use is not anticipated for design storm events up to and including the 100-year storm event.

5.4.1.3 Uncontrolled Areas

Uncontrolled areas represent drainage areas that cannot be graded to enter the storm sewer system due to grading restrictions. As such, they will sheet drain off the site to adjacent outlets per existing conditions.

Table 5.5: Peak Post-Development Uncontrolled Surface Release Rates

Design Storm	Release Rate (L/s)				
	UNC-1	UNC-2	UNC-3	UNC-4	Total
5-Year	6.6	12.3	24.1	31.7	74.7
100-Year	14.2	26.4	51.6	67.9	160.1



100 Steacie Drive

Table of Contents

Table 5.6 compares the pre- and post-development peak stormwater release rates from site areas to the existing outlets per existing conditions. The table below demonstrates that by developing the site, the overall stormwater release rate from the site will be reduced by as compared to existing conditions, as will the release rate from each individual discharge point under existing conditions.

Table 5.6: Comparison of Discharge Pre- to Post-Development

Outlet		A (ha)	C	5-Year (L/s)	5-Year Difference (L/s)	100-Year (L/s)	100-Year Difference (L/s)
Ditch along rail line (West) (EX-1)*	Pre-	1.18	0.20	68.4	-	146.4	-
	Post-	1.76	0.44	58.1	-10.3	103.2	-43.2
Steacie Drive ROW (EX-2)	Pre-	0.11	0.20	6.4	-	13.7	-
	Post-	0.06	0.40	6.6	0.2	14.2	0.5
Ditch along rail line (North) via Adjacent property (EX-3)	Pre-	0.46	0.20	26.6	-	57.1	-
	Post-	0.19	0.23	12.3	-14.3	26.4	-30.7
Ditch along rail line (North) (EX-4)	Pre-	0.58	0.20	33.6	-	72.0	-
	Post-	0.33	0.25	24.1	-9.5	51.6	-20.4
Difference		0.00	-	-	-33.9	-	-93.8

*Note: Includes controlled pond discharge & upstream drainage areas.



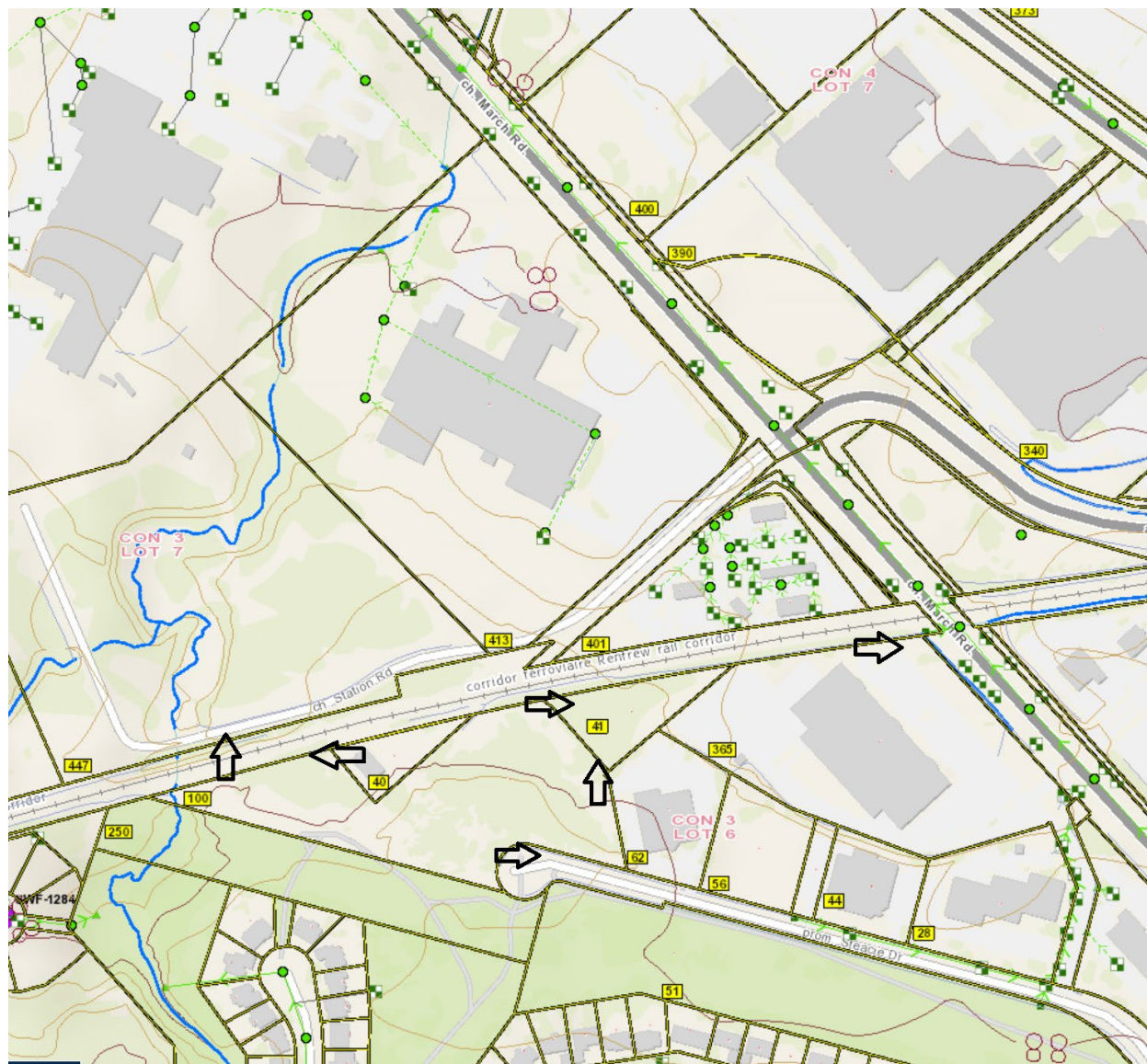

Figure 5.1: Overall External Storm Conveyance Network

It should be noted that all of the uncontrolled areas are tributary to the Kizell Creek, with area EX-1 contributing directly to the creek immediately north of Station Road, areas EX-3 and EX-4 progressing overland eastwards to capture to the storm sewer at March Road, which in turn discharges to Kizell Creek approximately 500m further north, and area EX-2 contributing to Steacie Drive sewers that also contribute to the March Road storm sewer system. As such, Table 5.6 above has been provided to identify impacts to the intermediate conveyance network, with overall contribution to the Kizell Drain maintained through summation of all post-development outflow in comparison to pre-development runoff described below.



5.4.2 Results

Table 5.7 identifies the release rates associated with the proposed stormwater management plan and demonstrates adherence to target peak outflow rates of the site.

Table 5.7: Summary 5-Year and 100-Year Event Release Rates

	Peak Discharge (L/s)	
	5-Year (L/s)	100-Year (L/s)
Total to Railway Ditch	94	181
Total to Steacie Drive ROW	7	14
Total	101	195
Target	135	289

5.4.3 Quality Control

On-site quality control measures are expected for the proposed development per pre-consultation with MVCA and City of Ottawa staff. It is assumed that enhanced protection (80 % removal of total suspended solids) will be required for the site before discharging to the Kizell Creek. As a result, an oil grit separator (OGS) has been proposed to treat runoff from impervious areas directed to the proposed dry pond.

The OGS unit will be privately maintained and located upstream of the dry pond as shown on **Drawing SD-1**. Using a fine particle size distribution and the Stormceptor Sizing Tool, a Stormceptor model EF05 has been selected for the proposed inlet manhole at the dry pond and will achieve 85 % TSS removal, exceeding the minimum required level of 80 %. The surface areas and runoff coefficient in which the sizing is based on is tabulated in **Table 5.8** below, while the detailed Stormceptor sizing report is included in **Appendix D**.

Table 5.8: Surface Area and Runoff for Stormceptor Sizing

Catchment Areas	A (ha)	C
R1A	0.23	0.90
R2B	0.22	0.90
TRENCH	0.05	0.67
POND-1	0.39	0.27
POND-2	0.14	0.29
POND-3	0.09	0.77
Total	1.12	0.58

The proposed OGS (Stormceptor) unit has been considered as an example only. Other OGS products or treatment systems with equivalent TSS removal capabilities may also be selected based on the input parameters noted within the Stormceptor sizing report.



6 Grading and Drainage

The proposed development site measures approximately 2.2 ha in area. The topography across the site is sloped with higher elevations near the southern boundary draining towards Kizell Creek located at the southwestern boundary of the site.

Detailed grading plans (see **Drawing GP-1, GP-2**) has been provided to satisfy the stormwater management requirements, adhere to any geotechnical restrictions for the site, and provide for minimum cover requirements for storm and sanitary sewers where possible. Site grading has been established to provide emergency overland flow routes required for stormwater management in accordance with City of Ottawa requirements.

The subject site maintains emergency overland flow routes for flows deriving from storm events in excess of the maximum design event to Kizell Creek as depicted in **Drawing GP-1**.

7 Utilities

Bell, Hydro and Rogers services exist in the vicinity of the proposed site. The site will be serviced through connection to these existing services.

As per our conversation with Enbridge, they have a plant within the vicinity of the site and will likely have sufficient capacity. However, only after receiving the detail loading criteria, will they be able to provide their final design.

Detailed design of the required utility services will be completed by the respective utility companies.

Hydro, Bell, Gas and Cable servicing for the proposed development should be readily available within subsurface utility infrastructure within the Steacie Drive ROW. Exact size, location and routing of utilities, along with determination of any off-site works required for redevelopment, will be finalized after design circulation.



8 Approvals

The proposed stormwater works comprises of a dry pond that ultimately discharges to Kizell Creek. As the site is of a single parcel under singular ownership, the site will not require an Environmental Compliance Approval (ECA) from the Ministry of the Environment, Conservation and Parks (MECP) under O.Reg. 525/98 for stormwater management works. An ECA will be required for municipally operated sanitary sewer works within the Steacie Drive ROW, to be processed under CLI-ECA for pre-approved works.

Requirement for a MECP Permit to Take Water (PTTW) for pumping during construction of the underground parking levels will be confirmed by the geotechnical consultant.

A Utilities Circulation and Approval is required for the proposed watermain and sanitary sewer extension within Station Road and Steacie Drive. The approval process will be completed as part of the circulation for the Site Plan Application. A Sewer Extension Agreement will be developed with City Staff for the proposed works. An MECP ECA is required for the sanitary sewer extension, expected under the City's existing CLI-ECA for sanitary sewer works.



9 Erosion Control During Construction

To protect downstream water quality and prevent sediment build-up in catch basins and storm sewers, erosion and sediment control measures must be implemented during construction. The following recommendations will be included in the contract documents and communicated to the Contractor.

1. Implement best management practices to provide appropriate protection of the existing and proposed drainage system and the receiving water course(s).
2. Limit the extent of the exposed soils at any given time.
3. Re-vegetate exposed areas as soon as possible.
4. Minimize the area to be cleared and grubbed.
5. Protect exposed slopes with geotextiles, geogrid, or synthetic mulches.
6. Install silt barriers/fencing around the perimeter of the site as indicated in **Drawing ECDS-1** to prevent the migration of sediment offsite.
7. Install trackout control mats (mud mats) at the entrance/egress to prevent migration of sediment into the public ROW.
8. Provide sediment traps and basins during dewatering works.
9. Install sediment traps (such as SiltSack® by Terrafix) between catch basins and frames.
10. Schedule the construction works at times which avoid flooding due to seasonal rains.

The Contractor will also be required to complete inspections and guarantee the proper performance of their erosion and sediment control measures at least after every rainfall. The inspections are to include:

- Verification that water is not flowing under silt barriers.
- Cleaning and changing the sediment traps placed on catch basins.

Refer to **Drawing ECDS-1** for the proposed location of silt fences, sediment traps, and other erosion control measures.



10 Geotechnical Investigation

A geotechnical investigation for the development was completed by Paterson Group Inc. in December 2023. The report summarizes the existing soil conditions within the site and construction recommendations. For details which are not summarized below, please see the Paterson report included in the submission package.

The subsurface profile encountered at the site is characterized primarily by a layer of 0.1 to 0.3 m thick topsoil, underlain by glacial till and/or hard brown silty clay and occasionally dark brown fill composed of silty clay with sand gravel and cobbles. In turn, the glacial till consists of a stiff to hard, brown silty clay mixed with silty sand with some cobbles, gravel, and boulders, and was observed to extend to the bedrock surface. From available geological mapping, the bedrock consists primarily of quartzite at depths ranging from 4.5 m to 5.7 m. Groundwater levels were measured from monitoring wells at all four boreholes in the November 2023 investigation and are expected to be 4 metres to 5 metres below the existing ground surface, though as groundwater levels are subject to seasonal fluctuations, they could vary at the time of construction.

Based on the results of the geotechnical investigation, the subject site is suitable for the proposed development. Bedrock removal is anticipated for completion of the underground parking level and site servicing work. Due to the presence of a silty clay deposit, the site is subject to a permissible grade raise restriction of 1.5 m above existing grade at the southwest corner of the site, by which the proposed grading plan adheres.

The recommended rigid pavement structure is further presented in **Table 10.1**.

Table 10.1: Recommended Pavement Structure

Material	Driveways and Car-only Parking Areas	Local Residential Roadways
Wear Course – HL-3 or Superpave 12.5 Asphaltic Concrete	50 mm	40 mm
Binder Course – HL-8 or Superpave 19.0 Asphaltic Concrete	-	50 mm
BASE – OPSS Granular A Crushed Stone	150 mm	150 mm
SUBBASE – OPSS Granular B Type II	300 mm	400 mm



11 Conclusions

11.1 Water Servicing

Based on the boundary conditions provided by the City of Ottawa, the adjacent watermains on Steacie Drive and Station Road can provide adequate flow and pressure to service the development. Pressure across the distribution system meets the pressure range as per the City of Ottawa Water Design guidelines under typical demand conditions (Average Day and Peak Hour).

The results also indicate that sufficient fire flows are available within the proposed watermain network under emergency fire demand conditions (maximum day + fire flow) while meeting the minimum requirements as per the City of Ottawa Water Design guidelines.

11.2 Sanitary Servicing

The proposed sanitary sewer service will consist of a sanitary service lateral, a 200 mm diameter sanitary sewer, a sanitary sump pit, monitoring ports, and sump pump(s) directing wastewater to the existing 250 mm diameter sanitary sewer on Steacie Drive. Full port backwater valves will be installed on the proposed sanitary service within the site to prevent any surcharge from the downstream sewer main from impacting the proposed property. A sump pump will be required for sewage discharge from the mechanical room. Sizing of the service lateral, sump pit, and sump pump are to be confirmed by the mechanical consultant.

11.3 Stormwater Servicing

Rooftop storage and a stormwater dry pond has been proposed to limit the stormwater discharge rates to the pre-development levels. The uncontrolled site areas continue to drain uncontrolled to the existing outlets, adjacent properties, and the Steacie Drive ROW as per existing conditions.

A 250 mm diameter storm service lateral is proposed for the building's foundation, roof drain, and internal storm drainage plumbing system, which will receive drainage from the area drains on site and will be equipped with a full port backwater valve. The on-site storm sewer conveys discharge from the building and the immediate areas to a proposed dry pond, which will be equipped with an inlet control device at the outlet for quantity control and outlet to the existing northern ditch within the existing rail corridor. Sizing of the service lateral, foundation, and area drains are to be confirmed by the mechanical consultant. Flood plain mapping provided by the MVCA for Kizell Creek has been incorporated in the site design.

11.4 Grading

Grading for the site has been designed to provide an emergency overland flow route as per City requirements and reflects the recommendations in the Geotechnical Investigation prepared by Paterson Group. Erosion



and sediment control measures will be implemented during construction to reduce the impact on existing facilities.

11.5 Utilities

Utility infrastructure exists within the Steacie Drive ROW at the southern boundary of the proposed site. It is anticipated that existing infrastructure will be sufficient to provide a means of distribution for the proposed site. Exact size, location and routing of utilities will be finalized after design circulation.

11.6 Approvals/Permits

The site will be subjected to Ministry of the Environment, Conservation and Parks (MECP) Environmental Compliance Approval (ECA) process under the City of Ottawa's current CLI-ECA for sanitary sewer works within Steacie Drive. Requirement for a MECP Permit to Take Water (PTTW) for sewer and building construction will be confirmed by the geotechnical consultant.



Appendices



Appendix A Background Correspondence



Wu, Michael

From: Sharp, Mike
Sent: June 3, 2026 16:05
To: Wu, Michael
Cc: Thiffault, Dustin; Kilborn, Kris
Subject: FW: 100 Steacie - Site Servicing Plan CAD File Request
Attachments: 26_05_25_STEACIE DRIVE_A101_SITE PLAN.dwg; 26_05_25_STEACIE DRIVE_A101_SITE PLAN.pdf

Hi Michael, please see below for Steacie new unit counts. I'm getting a new population count of 330 from the previous 291. Can you please revise in the report? The design sheet has been copied and revised with today's date. Thanks.
Mike

From: James Battison <jamesbattison@brigil.com>
Sent: Tuesday, May 26, 2026 8:08 AM
To: Kilborn, Kris <kris.kilborn@stantec.com>
Cc: Sharp, Mike <Mike.Sharp@stantec.com>; Jean-Luc Rivard <jlrivard@brigil.com>
Subject: RE: 100 Steacie - Site Servicing Plan CAD File Request

Hi Kris, Mike,

See attached updated Site Plan from Neuf yesterday. My understanding is the base was updated with the revised gas station (including removal of the old station location) and minor change to the garbage pad. Not s

Also, unit count final numbers to update the report and demand calcs.

Units

Studios: 2

1-bedroom (including 1bd+den): 115

2-bedroom: 79

Total: 196

Let me know if you have any comments or questions.

Thank you,

 Right-click or tap and hold here to download pictures. To help protect your privacy, Outlook prevented automatic download of this picture from the Internet.

ALMA TRALO, M. ARCH, PMP, LEED AP BD+C, MRAIC
Diplômée en Architecture, Graduate Architect
T 514 847 1117 F 514 847 2287
630, boul. René-Lévesque O, 32^e étage, Montréal (QC) H3B 1S6
NEUF ARCHITECTES INC. Confidentialité + Transmission
Montréal. Ottawa. Toronto

Let me know if we need anything else here to get the civil portion completed.

Thanks guys.

James Battison

Chargé de Projet – Développement des Terres
Project Manager – Land Development

C : 613 298-7752

brigil

101-425, boul. St-Joseph
Gatineau, QC J8Y 3Z8
brigil.com

From: Kilborn, Kris <kris.kilborn@stantec.com>
Sent: 25 mai 2026 11:36
To: James Battison <jamesbattison@brigil.com>
Subject: RE: 100 Steacie - Site Servicing Plan CAD File Request

Attention : L'émetteur est externe. | **Warning:** Sender is external.
[Any update on when we will have the final coordinated site plan / landscape plan for our civil updates.](#)

Sincerely

Kris Kilborn

Principal,
Community Development
Business Center Practice Lead (Ontario East)

Mobile: 613 297-0571
Fax: 613 722-2799
kris.kilborn@stantec.com
Stantec
300 - 1331 Clyde Avenue
Ottawa ON K2C 3G4



With every community, we redefine what's possible.

The content of this email is the confidential property of Stantec and should not be copied, modified, retransmitted, or used for any purpose except with Stantec's written authorization. If you are not the intended recipient, please delete all copies and notify us immediately. For a list of Stantec's operating entities with associated license and registration information, please visit stantec.com.

From: James Battison <jamesbattison@brigil.com>
Sent: Monday, May 25, 2026 11:35 AM
To: Kilborn, Kris <kris.kilborn@stantec.com>
Subject: RE: 100 Steacie - Site Servicing Plan CAD File Request

Tnx Kris!

James Battison

Chargé de Projet – Développement des Terres
Project Manager – Land Development

C : 613 298-7752

brigil

101-425, boul. St-Joseph
Gatineau, QC J8Y 3Z8
brigil.com

From: Kilborn, Kris <kris.kilborn@stantec.com>

Sent: 25 mai 2026 11:31

To: Roy, Jean-Miguel <Jean-Miguel.Roy@ottawa.ca>

Cc: James Battison <jamesbattison@brigil.com>; Gorni, Colette <colette.gorni@ottawa.ca>; Sharp, Mike <Mike.Sharp@stantec.com>; Thiffault, Dustin <Dustin.Thiffault@stantec.com>

Subject: RE: 100 Steacie - Site Servicing Plan CAD File Request

Attention : L'émetteur est externe. | **Warning:** Sender is external.

Good morning Jean-Miguel

Please see attached Stantec Site servicing drawing in acad format for your use.
Let me know if you are looking for anything else or have any trouble with the file.

Sincerely

Kris Kilborn

Principal,
Community Development
Business Center Practice Lead (Ontario East)

Mobile: 613 297-0571

Fax: 613 722-2799

kris.kilborn@stantec.com

Stantec

300 - 1331 Clyde Avenue

Ottawa ON K2C 3G4



With every community, we redefine what's possible.

The content of this email is the confidential property of Stantec and should not be copied, modified, retransmitted, or used for any purpose except with Stantec's written authorization. If you are not the intended recipient, please delete all copies and notify us immediately. For a list of Stantec's operating entities with associated license and registration information, please visit stantec.com.

From: Roy, Jean-Miguel <Jean-Miguel.Roy@ottawa.ca>

Sent: Friday, May 22, 2026 1:02 PM

To: Kilborn, Kris <kris.kilborn@stantec.com>; Thiffault, Dustin <Dustin.Thiffault@stantec.com>

Cc: James Battison <jamesbattison@brigil.com>; Gorni, Colette <colette.gorni@ottawa.ca>

Subject: 100 Steacie - Site Servicing Plan CAD File Request

Hi Kris and Dustin,

The City's Corporate Real Estate Office (CREO) is currently working on the required Crossing Agreement for the proposed watermain and sewer works for 100 Steacie within the rail corridor.

As part of this agreement, their mapping team is required to prepare a property sketch and has requested the site servicing plan in CAD format. Would you be able to share the CAD file with us to help facilitate the preparation of the sketch and assist in finalizing the Crossing Agreement?

Please let me know if you have any questions.

Have a great weekend.

Jean-Miguel Roy

Project Manager, Infrastructure Approvals

Development and Building Services |

Direction générale des services de la planification, de l'aménagement et du bâtiment

110 Laurier Avenue West | 110 avenue Laurier Ouest

City of Ottawa | Ville d'Ottawa

613.580.2424 x 30902

This e-mail originates from the City of Ottawa e-mail system. Any distribution, use or copying of this e-mail or the information it contains by other than the intended recipient(s) is unauthorized. Thank you.

Le présent courriel a été expédié par le système de courriels de la Ville d'Ottawa. Toute distribution, utilisation ou reproduction du courriel ou des renseignements qui s'y trouvent par une personne autre que son destinataire prévu est interdite. Je vous remercie de votre collaboration.

Classified as City of Ottawa - Internal / Ville d'Ottawa - classé interne

Caution: This email originated from outside of Stantec. Please take extra precaution.

Attention: Ce courriel provient de l'extérieur de Stantec. Veuillez prendre des précautions supplémentaires.

Atención: Este correo electrónico proviene de fuera de Stantec. Por favor, tome precauciones adicionales.

Caution: This email originated from outside of Stantec. Please take extra precaution.

Attention: Ce courriel provient de l'extérieur de Stantec. Veuillez prendre des précautions supplémentaires.

Atención: Este correo electrónico proviene de fuera de Stantec. Por favor, tome precauciones adicionales.

Caution: This email originated from outside of Stantec. Please take extra precaution.

Attention: Ce courriel provient de l'extérieur de Stantec. Veuillez prendre des précautions supplémentaires.

Atención: Este correo electrónico proviene de fuera de Stantec. Por favor, tome precauciones adicionales.

Appendix B Water Servicing

B.1 Water Demands



Domestic Water Demand Estimates - 100 Steacie Drive

Site Plan provided by Neuf dated 2026-05-25

Stantec Project No. 160401570 Designed by: MW

Revision Date: 23-March-2026 Checked by:

Revision: 01 City File No.: D07-12-24-0086



Population densities per Table 4.1 City of Ottawa Water Design Guidelines:		
1 Bedroom	1.4	ppu
2 Bedroom	2.1	ppu
Demand conversion factors per Table 4.2 of the City of Ottawa Water Design Guidelines and Technical Bulletin ISTB-2021-03:		
Residential	280	L/cap/day

Building ID	No. of Units	Population	Avg Day Demand		Max Day Demand ¹		Peak Hour Demand ¹	
			(L/min)	(L/s)	(L/min)	(L/s)	(L/min)	(L/s)
1 Bedroom	117	164	31.9	0.53	79.6	1.33	175.2	2.92
2 Bedroom	79	166	32.3	0.54	80.6	1.34	177.4	2.96
Total Site :	196	330	64.1	1.1	160.3	2.7	352.6	5.9

¹ The City of Ottawa water demand criteria used to estimate peak demand rates for residential areas are as follows:

maximum day demand rate = 2.5 × average day demand rate

peak hour demand rate = 2.2 × maximum day demand rate (as per Technical Bulletin ISD-2010-02)

B.2 FUS Fire Flow Calculations





FUS Fire Flow Calculation Sheet - 2020 FUS Guidelines

Stantec Project #: 160401570
 Project Name: 100 Steacie Drive
 Date: 2025-06-25

Fire Flow Calculation #: 2
 Description: 4-storey residential apartment

Notes: Site Plan and Design Brief provided by Neuf on 2025-05-29. OBC Section 3.2.2.48A Group C Sprinklered. Firewall reduces EFA to 2250 m².

Step	Task	Notes	Value Used	Req'd Fire Flow (L/min)						
1	Determine Type of Construction	Type II - Noncombustible Construction / Type IV-A - Mass Timber Construction	0.8	-						
2	Determine Effective Floor Area	Sum of Two Largest Floors + 50% of Eight Additional Floors	NO	-						
		Vertical Openings Protected?	6750	-						
3	Determine Required Fire Flow	(F = 220 x C x A ^{1/2}). Round to nearest 1000 L/min	-	14000						
4	Determine Occupancy Charge	Limited Combustible	-15%	11900						
5	Determine Sprinkler Reduction	Conforms to NFPA 13	-30%	-5950						
		Standard Water Supply	-10%							
		Fully Supervised	-10%							
		% Coverage of Sprinkler System	100%							
6	Determine Increase for Exposures (Max. 75%)	Direction	Exposure Distance (m)	Exposed Length (m)	Exposed Height (Stories)	Length-Height Factor (m x stories)	Construction of Adjacent Wall	Firewall / Sprinklered ?	-	-
		North	> 30	0	0	0-20	Type V	NO	0%	0
		East	0 to 3	28.5	4	> 100	Type I-II - Unprotected Openings	YES	0%	
		South	> 30	0	0	0-20	Type V	NO	0%	
		West	> 30	0	0	0-20	Type V	NO	0%	
7	Determine Final Required Fire Flow	Total Required Fire Flow in L/min, Rounded to Nearest 1000L/min			6000					
		Total Required Fire Flow in L/s			100.0					
		Required Duration of Fire Flow (hrs)			2.00					
		Required Volume of Fire Flow (m ³)			720					

B.3 Boundary Conditions



Boundary Conditions 100 Steacie

Provided Information

Scenario	Demand	
	L/min	L/s
Average Daily Demand	78	1.30
Maximum Daily Demand	186	3.10
Peak Hour	414	6.90
Fire Flow Demand #1	9,000	150.00

Location

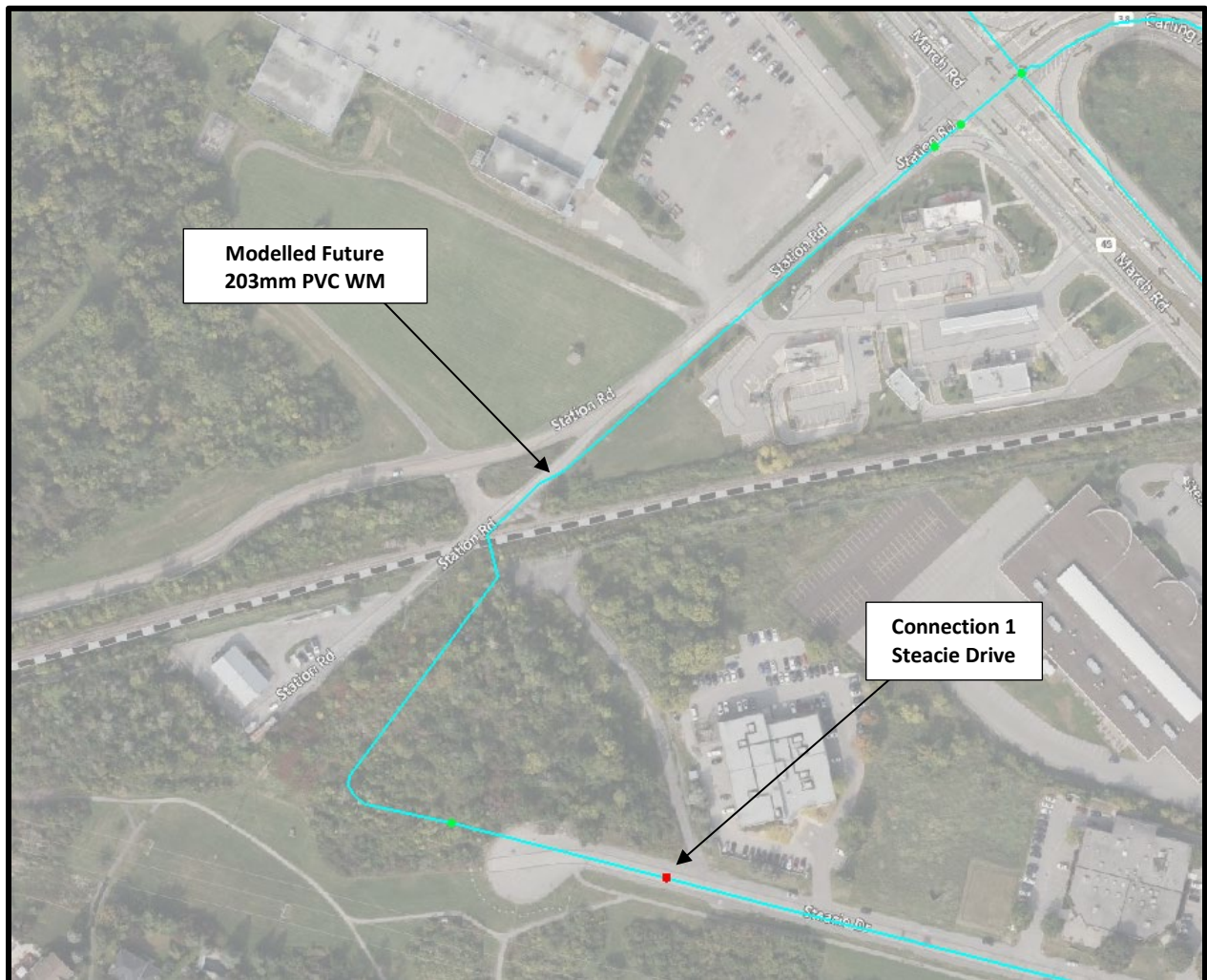

Results

Connection 1 – Steacie Drive

Demand Scenario	Head (m)	Pressure¹ (psi)
Maximum HGL	130.2	56.4
Peak Hour	125.7	49.9
Max Day plus Fire Flow #1	107.3	23.7

¹ Ground Elevation = 90.6 m

Notes

1. Industrial, commercial, institutional service areas with a basic day demand greater than 50 m³/day (0.58 L/s) and residential areas serving 50 or more dwellings shall be connected with a minimum of two watermains, separated by an isolation valve, to avoid the creation of a vulnerable service area. Individual residential facilities with a basic day demand greater than 50 m³/day shall be connected with a minimum of two water services, separated by an isolation valve, to avoid the creation of a vulnerable service area.

Disclaimer

The boundary condition information is based on current operation of the city water distribution system. The computer model simulation is based on the best information available at the time. The operation of the water distribution system can change on a regular basis, resulting in a variation in boundary conditions. The physical properties of watermains deteriorate over time, as such must be assumed in the absence of actual field test data. The variation in physical watermain properties can therefore alter the results of the computer model simulation. Fire Flow analysis is a reflection of available flow in the watermain; there may be additional restrictions that occur between the watermain and the hydrant that the model cannot take into account.

Appendix C Wastewater Servicing





SUBDIVISION:
100 Steacie Drive

DATE: 2026-06-03
REVISION: 4
DESIGNED BY: MJS
CHECKED BY: MW

**SANITARY SEWER
DESIGN SHEET
(City of Ottawa)**

FILE NUMBER: 160401570

DESIGN PARAMETERS			
MAX PEAK FACTOR (RES.)=	4.0	AVG. DAILY FLOW / PERSON	280 l/p/day
MIN PEAK FACTOR (RES.)=	2.0	COMMERCIAL	28,000 l/ha/day
PEAKING FACTOR (INDUSTRIAL):	2.4	INDUSTRIAL (HEAVY)	55,000 l/ha/day
PEAKING FACTOR (ICI >20%):	1.5	INDUSTRIAL (LIGHT)	35,000 l/ha/day
PERSONS / 1 BEDROOM	1.4	INSTITUTIONAL	28,000 l/ha/day
PERSONS / 2 BEDROOM	2.1	INFILTRATION	0.33 l/s/ha
PERSONS / APARTMENT	1.8		
		MINIMUM VELOCITY	0.60 m/s
		MAXIMUM VELOCITY	3.00 m/s
		MANNINGS n	0.013
		BEDDING CLASS	B
		MINIMUM COVER	2.50 m
		HARMON CORRECTION FACTOR	0.8

LOCATION			RESIDENTIAL AREA AND POPULATION								COMMERCIAL		INDUSTRIAL (L)		INDUSTRIAL (H)		INSTITUTIONAL		GREEN / UNUSED		C+H	INFILTRATION			TOTAL	PIPE								
AREA ID NUMBER	FROM M.H.	TO M.H.	AREA (ha)	UNITS 1 BEDROOM	UNITS 2 BEDROOM	UNITS APT	POP.	CUMULATIVE AREA (ha)	POP.	PEAK FACT.	PEAK FLOW (l/s)	AREA (ha)	ACCU. AREA (ha)	AREA (ha)	ACCU. AREA (ha)	AREA (ha)	ACCU. AREA (ha)	AREA (ha)	ACCU. AREA (ha)	AREA (ha)	ACCU. AREA (ha)	PEAK FLOW (l/s)	TOTAL AREA (ha)	ACCU. AREA (ha)	INFILT. FLOW (l/s)	FLOW (l/s)	LENGTH (m)	DIA (mm)	MATERIAL	CLASS	SLOPE (%)	CAP. (FULL) (l/s)	CAP. V PEAK FLOW (%)	VEL. (FULL) (m/s)
R101A, G101A	BLDG	101	0.45	117	79	0	330	0.45	330	3.45	3.7	0.00	0.00	0.00	0.00	0.00	0.00	0.00	0.00	1.80	1.80	0.0	2.25	2.25	0.7	4.4	2.0	200	PVC	SDR 35	2.00	47.3	9.36%	1.49
	101	100	0.00	0	0	0	0	0.45	330	3.45	3.7	0.00	0.00	0.00	0.00	0.00	0.00	0.00	0.00	0.00	1.80	0.0	0.00	2.25	0.7	4.4	16.9	200	PVC	SDR 35	0.50	23.6	18.72%	0.74
G101B	100	SAN OUTLET	0.00	0	0	0	0	0.45	330	3.45	3.7	0.00	0.00	0.00	0.00	0.00	0.00	0.15	1.95	0.0	0.15	2.40	0.8	4.5	28.7	200	PVC	SDR 35	0.50	23.6	18.93%	0.74		
																												250						

Appendix D Stormwater Servicing and Management

D.1 Storm Sewer Design Sheet





100 Steacie Drive

**STORM SEWER
DESIGN SHEET**
(City of Ottawa)

DESIGN PARAMETERS

$I = a / (t+b)^c$ (As per City of Ottawa Guidelines, 2012)

	1:2 yr	1:5 yr	1:10 yr	1:100 yr
a =	732.951	998.071	1174.184	1735.688
b =	6.199	6.053	6.014	6.014
c =	0.810	0.814	0.816	0.820

MANNING'S n = 0.013
 BEDDING CLASS = B
 MINIMUM COVER: 2.00 m
 TIME OF ENTRY: 10 min

DATE: 2026-06-17
 REVISION: 8
 DESIGNED BY: MW
 CHECKED BY: DT

FILE NUMBER: 160401570

LOCATION AREA ID NUMBER	FROM M.H.	TO M.H.	DRAINAGE AREA																PIPE SELECTION																			
			AREA (2-YEAR) (ha)	AREA (5-YEAR) (ha)	AREA (10-YEAR) (ha)	AREA (100-YEAR) (ha)	AREA (ROOF) (ha)	C (2-YEAR) (-)	C (5-YEAR) (-)	C (10-YEAR) (-)	C (100-YEAR) (-)	A x C (2-YEAR) (ha)	ACCUM (2YR) (ha)	A x C (5-YEAR) (ha)	ACCUM (5YR) (ha)	A x C (10-YEAR) (ha)	ACCUM (10YR) (ha)	A x C (100-YEAR) (ha)	ACCUM (100YR) (ha)	T of C (min)	I _{2-YEAR} (mm/h)	I _{5-YEAR} (mm/h)	I _{10-YEAR} (mm/h)	I _{100-YEAR} (mm/h)	Q _{CONTROL} (L/s)	ACCUM. Q _{CONTROL} (L/s)	Q _{ACT} (CIA/360) (L/s)	LENGTH (m)	PIPE WIDTH OR DIAMETER (mm)	PIPE HEIGHT (mm)	PIPE SHAPE (-)	MATERIAL (-)	CLASS (-)	SLOPE (%)	Q _{cap} (FULL) (L/s)	% FULL (-)	VEL. (FULL) (m/s)	
R1A	DG SERVII	1	0.00	0.00	0.00	0.00	0.23	0.00	0.00	0.00	0.00	0.000	0.000	0.000	0.000	0.000	0.000	0.000	0.000	0.000	10.00	76.81	104.19	122.14	178.56	12.3	12.3	12.3	2.7	250	250	CIRCULAR	PVC	-	1.00	60.4	20.36%	1.22
10.06																																						
R2B, TRENCH, POND-3	5	4	0.00	0.36	0.00	0.00	0.00	0.00	0.84	0.00	0.00	0.000	0.000	0.304	0.304	0.000	0.000	0.000	0.000	0.000	10.00	76.81	104.19	122.14	178.56	0.0	0.0	88.0	20.7	250	250	CIRCULAR	PVC	-	2.20	89.6	98.18%	1.80
POND-2	4	3	0.00	0.14	0.00	0.00	0.00	0.00	0.29	0.00	0.00	0.000	0.000	0.042	0.346	0.000	0.000	0.000	0.000	0.000	10.18	76.11	103.24	121.01	176.90	0.0	0.0	99.1	21.2	450	450	CIRCULAR	CONCRETE	-	0.25	148.7	66.63%	0.91
POND-1	3	2	0.00	0.39	0.00	0.00	0.00	0.00	0.27	0.00	0.00	0.000	0.000	0.105	0.451	0.000	0.000	0.000	0.000	0.000	10.60	74.56	101.11	118.51	173.23	0.0	0.0	126.6	29.0	450	450	CIRCULAR	CONCRETE	-	0.25	148.7	85.13%	0.91
	2	1	0.00	0.00	0.00	0.00	0.00	0.00	0.00	0.00	0.00	0.000	0.000	0.000	0.451	0.000	0.000	0.000	0.000	0.000	11.14	72.70	98.56	115.50	168.81	0.0	0.0	123.4	10.8	450	450	CIRCULAR	CONCRETE	-	0.25	148.7	82.98%	0.91
11.34																																						
	1	EF6	0.00	0.00	0.00	0.00	0.00	0.00	0.00	0.00	0.00	0.000	0.000	0.451	0.000	0.000	0.000	0.000	0.000	0.000	11.34	72.03	97.63	114.41	167.21	0.0	12.3	134.5	29.3	600	600	CIRCULAR	CONCRETE	-	0.25	320.3	42.01%	1.10
	EF6	POND IN	0.00	0.00	0.00	0.00	0.00	0.00	0.00	0.00	0.00	0.000	0.000	0.000	0.451	0.000	0.000	0.000	0.000	0.000	11.88	70.26	95.20	111.55	163.00	0.0	12.3	131.5	9.6	600	600	CIRCULAR	CONCRETE	-	0.20	286.5	45.90%	0.98
12.08																																						
	HWL	OUTLET	0.00	0.00	0.00	0.00	0.00	0.00	0.00	0.00	0.00	0.000	0.000	0.000	0.000	0.000	0.000	0.000	0.000	0.000	10.00	76.81	104.19	122.14	178.56	88.6	88.6	88.6	13.5	450	450	CIRCULAR	PVC	-	0.50	210.3	42.13%	1.28
	OUTLET	503	0.00	0.00	0.00	0.00	0.00	0.00	0.00	0.00	0.00	0.000	0.000	0.000	0.000	0.000	0.000	0.000	0.000	0.000	10.22	75.98	103.06	120.81	176.61	0.0	88.6	88.6	49.0	450	450	CIRCULAR	PVC	-	0.90	282.2	31.40%	1.72
	503	34	0.00	0.00	0.00	0.00	0.00	0.00	0.00	0.00	0.00	0.000	0.000	0.000	0.000	0.000	0.000	0.000	0.000	0.000	10.86	73.66	99.87	117.05	171.08	0.0	88.6	88.6	17.4	450	450	CIRCULAR	PVC	-	0.20	133.0	66.61%	0.81
11.24																																						

D.2 MRM Sheet



Stormwater Management Calculations

File No: 160401570
 Project: 100 Steacie Drive
 Date: 02-Mar-26

SWM Approach:
 Post-development to Pre-development flows

Post-Development Site Conditions:

Overall Runoff Coefficient for Site and Sub-Catchment Areas

Runoff Coefficient Table								
Sub-catchment Area	ID / Description		Area (ha) "A"	Runoff Coefficient "C"	"A x C"			Overall Runoff Coefficient
Catchment Type								
External - Tributary	OFF-1	Hard	0.000	0.9	0.000			
		Soft	0.086	0.2	0.017			
	Subtotal			0.09		0.017		0.200
Roof	R1A	Hard	0.226	0.9	0.204			
		Soft	0.000	0.2	0.000			
	Subtotal			0.23		0.204		0.900
Uncontrolled - Tributary to Pond	POND-1	Hard	0.039	0.9	0.035			
		Soft	0.351	0.2	0.070			
	Subtotal			0.39		0.105		0.270
Uncontrolled - Tributary to Pond	TRENCH, R2B	Hard	0.259	0.9	0.233			
		Soft	0.017	0.2	0.003			
	Subtotal			0.28		0.236		0.857
Controlled - Tributary to Pond	POND-3	Hard	0.071	0.9	0.064			
		Soft	0.016	0.2	0.003			
	Subtotal			0.09		0.067		0.770
Controlled - Tributary to Pond	POND-2	Hard	0.018	0.9	0.017			
		Soft	0.125	0.2	0.025			
	Subtotal			0.14		0.042		0.290
Uncontrolled - Towards Ditch (West)	UNC-4	Hard	0.000	0.9	0.000			
		Soft	0.547	0.2	0.109			
	Subtotal			0.55		0.109		0.200
Uncontrolled - Towards Ditch (North)	UNC-3	Hard	0.024	0.9	0.021			
		Soft	0.309	0.2	0.062			
	Subtotal			0.33		0.083		0.250
Uncontrolled - Towards Adjacent Property	UNC-2	Hard	0.008	0.9	0.007			
		Soft	0.177	0.2	0.035			
	Subtotal			0.19		0.043		0.230
Uncontrolled - Towards Steacie ROW	UNC-1	Hard	0.016	0.9	0.015			
		Soft	0.041	0.2	0.008			
	Subtotal			0.06		0.023		0.400
Total			2.331		0.930			0.40

Total Roof Areas	0.226 ha
Total Tributary Surface Areas (Controlled and Uncontrolled)	0.983 ha
Total Tributary Area to Outlet	1.209 ha
 Total Uncontrolled Areas (Non-Tributary)	 1.122 ha
 Total Site	 2.331 ha

Stormwater Management Calculations

Project #160401570, 100 Steacie Drive Modified Rational Method Calculations for Storage

5 yr Intensity City of Ottawa	$I = a/(t + b)$	a = 998.071	t (min)	I (mm/hr)
		b = 6.053		
		c = 0.814		
			10	104.2
			20	70.3
			30	53.9
			40	44.2
			50	37.7
			60	32.9
			70	29.4
			80	26.6
			90	24.3
			100	22.4
			110	20.8
			120	19.5

5 YEAR Predevelopment Target Release from Portion of Site

Subdrainage Area: Predevelopment Tributary Area to Outlet
 Area (ha): 2.33
 C: 0.20

Typical Time of Concentration

tc (min)	I (5 yr) (mm/hr)	Qtarget (L/s)
10	104.2	135.1

5 YEAR Modified Rational Method for Entire Site

Subdrainage Area: CBMH 4 Tributary to CBMH 4
 Area (ha): 0.23
 C: 0.47

tc (min)	I (5 yr) (mm/hr)	Qactual (L/s)	Qrelease (L/s)	Qstored (L/s)	Vstored (m ³)
10	104.2	31.6	28.2	3.4	2.0
20	70.3	21.3	21.3	0.0	0.0
30	53.9	16.4	16.4	0.0	0.0
40	44.2	13.4	13.4	0.0	0.0
50	37.7	11.4	11.4	0.0	0.0
60	32.9	10.0	10.0	0.0	0.0
70	29.4	8.9	8.9	0.0	0.0
80	26.6	8.1	8.1	0.0	0.0
90	24.3	7.4	7.4	0.0	0.0
100	22.4	6.8	6.8	0.0	0.0
110	20.8	6.3	6.3	0.0	0.0
120	19.5	5.9	5.9	0.0	0.0

Storage: Above CB

Orifice Equation: $Q = CdA(2gh)^{0.5}$ Where C = 0.57
 Orifice Diameter: 102.00 mm
 Invert Elevation: 89.58 m
 T/G Elevation: 91.47 m
 Max Ponding Depth: 0.02 m
 Downstream W/L: 86.27 m

Stage (m)	Head (m)	Discharge (L/s)	Vreq (cu. m)	Vavail (cu. m)	Volume Check
5-year Water Level	91.49	1.86	28.2	2.0	41.1 OK

Subdrainage Area: POND Pond

tc (min)	I (5 yr) (mm/hr)	Qactual (L/s)	Qrelease (L/s)	Qstored (L/s)	Vstored (m ³)
10	104.2	141.8	26.4	115.5	69.3
20	70.3	101.4	26.4	75.0	90.0
30	53.9	80.2	26.4	53.9	97.0
40	44.2	67.5	26.4	41.1	98.7
50	37.7	58.9	26.4	32.5	97.6
60	32.9	52.6	26.4	26.3	94.6
70	29.4	47.8	26.4	21.5	90.2
80	26.6	44.0	26.4	17.6	84.7
90	24.3	40.8	26.4	14.5	78.1
100	22.4	38.1	26.4	11.8	70.6
110	20.8	35.9	26.4	9.5	62.6
120	19.5	33.9	26.4	7.5	54.0

Storage: Above CB

Orifice Equation: $Q = CdA(2gh)^{0.5}$ Where C = 0.61
 Orifice Diameter: 115 mm
 Orifice CL Elevation: 85.33 m
 Spill Elevation: 87.40 m
 Max Ponding Depth: 0.94 m
 Downstream W/L: 85.40 m

Stage (m)	Head (m)	Discharge (L/s)	Vreq (cu. m)	Vavail (cu. m)	Volume Check
5-year Water Level	86.27	0.88	26.4	98.7	99.3 OK

Project #160401570, 100 Steacie Drive Modified Rational Method Calculations for Storage

100 yr Intensity City of Ottawa	$I = a/(t + b)$	a = 1735.688	t (min)	I (mm/hr)
		b = 6.014		
		c = 0.820		
			10	178.6
			20	120.0
			30	91.9
			40	75.1
			50	64.0
			60	55.9
			70	49.8
			80	45.0
			90	41.1
			100	37.9
			110	35.2
			120	32.9

100 YEAR Predevelopment Target Release from Portion of Site

Subdrainage Area: Predevelopment Tributary Area to Outlet
 Area (ha): 2.33
 C: 0.25

Estimated Time of Concentration after Development

tc (min)	I (100 yr) (mm/hr)	Q100yr (L/s)
10	178.6	289.3

100 YEAR Modified Rational Method for Entire Site

Subdrainage Area: CBMH 4 Tributary to CBMH 4
 Area (ha): 0.23
 C: 0.59

tc (min)	I (100 yr) (mm/hr)	Qactual (L/s)	Qrelease (L/s)	Qstored (L/s)	Vstored (m ³)
10	178.6	67.7	29.9	37.8	22.7
20	120.0	45.5	29.9	15.5	18.7
30	91.9	34.8	29.9	4.9	8.8
40	75.1	28.5	28.5	0.0	0.0
50	64.0	24.2	24.2	0.0	0.0
60	55.9	21.2	21.2	0.0	0.0
70	49.8	18.9	18.9	0.0	0.0
80	45.0	17.1	17.1	0.0	0.0
90	41.1	15.6	15.6	0.0	0.0
100	37.9	14.4	14.4	0.0	0.0
110	35.2	13.3	13.3	0.0	0.0
120	32.9	12.5	12.5	0.0	0.0

Storage: Surface Storage Above CB

Orifice Equation: $Q = CdA(2gh)^{0.5}$ Where C = 0.57
 Orifice Diameter: 102.00 mm
 Invert Elevation: 89.58 m
 T/G Elevation: 91.47 m
 Max Ponding Depth: 0.25 m
 Downstream W/L: 87.04 m

Stage (m)	Head (m)	Discharge (L/s)	Vreq (cu. m)	Vavail (cu. m)	Volume Check
100-year Water Level	91.72	2.09	29.9	22.7	41.1 OK

Subdrainage Area: POND Pond

tc (min)	I (100 yr) (mm/hr)	Qactual (L/s)	Qrelease (L/s)	Qstored (L/s)	Vstored (m ³)
10	178.6	254.3	35.3	219.0	131.4
20	120.0	185.0	35.3	149.7	179.6
30	91.9	151.8	35.3	116.4	209.6
40	75.1	130.5	35.3	95.1	228.3
50	64.0	112.9	35.3	77.5	232.6
60	55.9	100.1	35.3	64.8	233.3
70	49.8	90.5	35.3	55.1	231.6
80	45.0	82.8	35.3	47.5	228.0
90	41.1	76.6	35.3	41.3	222.9
100	37.9	71.4	35.3	36.1	216.6
110	35.2	67.0	35.3	31.7	209.4
120	32.9	63.3	35.3	28.0	201.4

Storage: Surface Storage Above CB

Orifice Equation: $Q = CdA(2gh)^{0.5}$ Where C = 0.61
 Orifice Diameter: 115 mm
 Orifice CL Elevation: 85.33 m
 Spill Elevation: 87.40 m
 Max Ponding Depth: 1.54 m
 Downstream W/L: 85.40 m

Stage (m)	Head (m)	Discharge (L/s)	Vreq (cu. m)	Vavail (cu. m)	Volume Check
100-year Water Level	87.04	1.58	35.3	233.3	233.5 OK

Stormwater Management Calculations

Project #160401570, 100 Steacie Drive
Modified Rational Method Calculations for Storage

Subdrainage Area: OFF-1		External - Tributary				
Area (ha): 0.09						
C: 0.20						
tc (min)	I (5 yr) (mm/hr)	Qactual (L/s)	Qrelease (L/s)	Qstored (L/s)	Vstored (m³)	
10	104.2	5.0				
20	70.3	3.4				
30	53.9	2.6				
40	44.2	2.1				
50	37.7	1.8				
60	32.9	1.6				
70	29.4	1.4				
80	26.6	1.3				
90	24.3	1.2				
100	22.4	1.1				
110	20.8	1.0				
120	19.5	0.9				

Subdrainage Area: R1A		Roof					
Area (ha): 0.23		Maximum Storage Depth: 150 mm					
C: 0.90							
tc (min)	I (5 yr) (mm/hr)	Qactual (L/s)	Qrelease (L/s)	Qstored (L/s)	Vstored (m³)	Depth (mm)	
10	104.2	59.0	9.6	49.3	29.6	102.7	0.00
20	70.3	39.7	10.0	29.7	35.7	108.7	0.00
30	53.9	30.5	10.1	20.4	36.8	109.8	0.00
40	44.2	25.0	10.0	15.0	35.9	108.9	0.00
50	37.7	21.3	9.9	11.4	34.2	107.2	0.00
60	32.9	18.6	9.8	8.9	31.9	105.0	0.00
70	29.4	16.6	9.6	7.0	29.4	102.5	0.00
80	26.6	15.0	9.5	5.6	26.7	99.9	0.00
90	24.3	13.7	9.2	4.5	24.4	96.2	0.00
100	22.4	12.7	9.0	3.7	22.1	92.5	0.00
110	20.8	11.8	8.8	3.0	19.9	88.9	0.00
120	19.5	11.0	8.5	2.5	17.8	85.4	0.00

Storage: Roof Storage

Depth (mm)	Head (m)	Discharge (L/s)	Vreq (cu. m)	Vavail (cu. m)	Discharge Check	
5-year Water Level	109.8	0.11	10.1	36.8	90.5	0.00

Project #160401570, 100 Steacie Drive
Modified Rational Method Calculations for Storage

Subdrainage Area: OFF-1		External - Tributary				
Area (ha): 0.09						
C: 0.25						
tc (min)	I (100 yr) (mm/hr)	Qactual (L/s)	Qrelease (L/s)	Qstored (L/s)	Vstored (m³)	
10	178.6	10.7				
20	120.0	7.2				
30	91.9	5.5				
40	75.1	4.5				
50	64.0	3.8				
60	55.9	3.3				
70	49.8	3.0				
80	45.0	2.7				
90	41.1	2.5				
100	37.9	2.3				
110	35.2	2.1				
120	32.9	2.0				

Subdrainage Area: R1A		Roof					
Area (ha): 0.23		Maximum Storage Depth: 150 mm					
C: 1.00							
tc (min)	I (100 yr) (mm/hr)	Qactual (L/s)	Qrelease (L/s)	Qstored (L/s)	Vstored (m³)	Depth (mm)	
10	178.6	112.3	11.4	100.9	60.5	130.4	0.00
20	120.0	75.4	12.0	63.4	76.1	140.6	0.00
30	91.9	57.8	12.3	45.5	81.9	144.4	0.00
40	75.1	47.2	12.3	34.9	83.8	145.6	0.00
50	64.0	40.2	12.3	27.9	83.6	145.5	0.00
60	55.9	35.1	12.3	22.9	82.3	144.6	0.00
70	49.8	31.3	12.2	19.1	80.2	143.3	0.00
80	45.0	28.3	12.1	16.2	77.7	141.7	0.00
90	41.1	25.8	12.0	13.9	74.9	139.8	0.00
100	37.9	23.8	11.8	12.0	71.9	137.8	0.00
110	35.2	22.1	11.7	10.4	68.7	135.7	0.00
120	32.9	20.7	11.6	9.1	65.5	133.6	0.00

Storage: Roof Storage

Depth (mm)	Head (m)	Discharge (L/s)	Vreq (cu. m)	Vavail (cu. m)	Discharge Check	
100-year Water Level	145.6	0.15	12.3	83.8	90.5	0.00

Stormwater Management Calculations

Project #160401570, 100 Steacie Drive
Modified Rational Method Calculations for Storage

Subdrainage Area: POND-1		Uncontrolled - Tributary to Pond				
Area (ha): 0.39						
C: 0.27						
tc (min)	I (5 yr) (mm/hr)	Qactual (L/s)	Qrelease (L/s)	Qstored (L/s)	Vstored (m ³)	
10	104.2	30.5	30.5			
20	70.3	20.5	20.5			
30	53.9	15.8	15.8			
40	44.2	12.9	12.9			
50	37.7	11.0	11.0			
60	32.9	9.6	9.6			
70	29.4	8.6	8.6			
80	26.6	7.8	7.8			
90	24.3	7.1	7.1			
100	22.4	6.6	6.6			
110	20.8	6.1	6.1			
120	19.5	5.7	5.7			

Subdrainage Area: RENCH, R2B		Uncontrolled - Tributary to Pond				
Area (ha): 0.28						
C: 0.86						
tc (min)	I (5 yr) (mm/hr)	Qactual (L/s)	Qrelease (L/s)	Qstored (L/s)	Vstored (m ³)	
10	104.2	68.5	68.5			
20	70.3	46.2	46.2			
30	53.9	35.4	35.4			
40	44.2	29.0	29.0			
50	37.7	24.8	24.8			
60	32.9	21.7	21.7			
70	29.4	19.3	19.3			
80	26.6	17.5	17.5			
90	24.3	16.0	16.0			
100	22.4	14.7	14.7			
110	20.8	13.7	13.7			
120	19.5	12.8	12.8			

Subdrainage Area: POND-3		Controlled - Tributary to Pond				
Area (ha): 0.09						
C: 0.77						
tc (min)	I (5 yr) (mm/hr)	Qactual (L/s)	Qrelease (L/s)	Qstored (L/s)	Vstored (m ³)	
10	104.2	19.5	19.5			
20	70.3	13.2	13.2			
30	53.9	10.1	10.1			
40	44.2	8.3	8.3			
50	37.7	7.1	7.1			
60	32.9	6.2	6.2			
70	29.4	5.5	5.5			
80	26.6	5.0	5.0			
90	24.3	4.6	4.6			
100	22.4	4.2	4.2			
110	20.8	3.9	3.9			
120	19.5	3.7	3.7			

Subdrainage Area: POND-2		Controlled - Tributary to Pond				
Area (ha): 0.14						
C: 0.29						
tc (min)	I (5 yr) (mm/hr)	Qactual (L/s)	Qrelease (L/s)	Qstored (L/s)	Vstored (m ³)	
10	104.2	12.1	12.1			
20	70.3	8.1	8.1			
30	53.9	6.2	6.2			
40	44.2	5.1	5.1			
50	37.7	4.4	4.4			
60	32.9	3.8	3.8			
70	29.4	3.4	3.4			
80	26.6	3.1	3.1			
90	24.3	2.8	2.8			
100	22.4	2.6	2.6			
110	20.8	2.4	2.4			
120	19.5	2.3	2.3			

Subdrainage Area: UNC-4		Uncontrolled - Towards Ditch (West)				
Area (ha): 0.55						
C: 0.20						
tc (min)	I (5 yr) (mm/hr)	Qactual (L/s)	Qrelease (L/s)	Qstored (L/s)	Vstored (m ³)	
10	104.2	31.7	31.7			
20	70.3	21.4	21.4			
30	53.9	16.4	16.4			
40	44.2	13.4	13.4			
50	37.7	11.4	11.4			
60	32.9	10.0	10.0			
70	29.4	8.9	8.9			
80	26.6	8.1	8.1			
90	24.3	7.4	7.4			
100	22.4	6.8	6.8			
110	20.8	6.3	6.3			
120	19.5	5.9	5.9			

Project #160401570, 100 Steacie Drive
Modified Rational Method Calculations for Storage

Subdrainage Area: POND-1		Uncontrolled - Tributary to Pond				
Area (ha): 0.39						
C: 0.34						
tc (min)	I (100 yr) (mm/hr)	Qactual (L/s)	Qrelease (L/s)	Qstored (L/s)	Vstored (m ³)	
10	178.6	65.3	65.3			
20	120.0	43.9	43.9			
30	91.9	33.6	33.6			
40	75.1	27.5	27.5			
50	64.0	23.4	23.4			
60	55.9	20.4	20.4			
70	49.8	18.2	18.2			
80	45.0	16.5	16.5			
90	41.1	15.0	15.0			
100	37.9	13.9	13.9			
110	35.2	12.9	12.9			
120	32.9	12.0	12.0			

Subdrainage Area: RENCH, R2B		Uncontrolled - Tributary to Pond				
Area (ha): 0.28						
C: 1.00						
tc (min)	I (100 yr) (mm/hr)	Qactual (L/s)	Qrelease (L/s)	Qstored (L/s)	Vstored (m ³)	
10	178.6	137.0	137.0			
20	120.0	92.0	92.0			
30	91.9	70.5	70.5			
40	75.1	57.7	57.7			
50	64.0	49.1	49.1			
60	55.9	42.9	42.9			
70	49.8	38.2	38.2			
80	45.0	34.5	34.5			
90	41.1	31.5	31.5			
100	37.9	29.1	29.1			
110	35.2	27.0	27.0			
120	32.9	25.2	25.2			

Subdrainage Area: POND-3		Controlled - Tributary to Pond				
Area (ha): 0.09						
C: 0.96						
tc (min)	I (100 yr) (mm/hr)	Qactual (L/s)	Qrelease (L/s)	Qstored (L/s)	Vstored (m ³)	
10	178.6	41.9	41.9			
20	120.0	28.1	28.1			
30	91.9	21.5	21.5			
40	75.1	17.6	17.6			
50	64.0	15.0	15.0			
60	55.9	13.1	13.1			
70	49.8	11.7	11.7			
80	45.0	10.5	10.5			
90	41.1	9.6	9.6			
100	37.9	8.9	8.9			
110	35.2	8.3	8.3			
120	32.9	7.7	7.7			

Subdrainage Area: POND-2		Controlled - Tributary to Pond				
Area (ha): 0.14						
C: 0.36						
tc (min)	I (100 yr) (mm/hr)	Qactual (L/s)	Qrelease (L/s)	Qstored (L/s)	Vstored (m ³)	
10	178.6	25.8	25.8			
20	120.0	17.3	17.3			
30	91.9	13.3	13.3			
40	75.1	10.9	10.9			
50	64.0	9.2	9.2			
60	55.9	8.1	8.1			
70	49.8	7.2	7.2			
80	45.0	6.5	6.5			
90	41.1	5.9	5.9			
100	37.9	5.5	5.5			
110	35.2	5.1	5.1			
120	32.9	4.8	4.8			

Subdrainage Area: UNC-4		Uncontrolled - Towards Ditch (West)				
Area (ha): 0.55						
C: 0.25						
tc (min)	I (100 yr) (mm/hr)	Qactual (L/s)	Qrelease (L/s)	Qstored (L/s)	Vstored (m ³)	
10	178.6	67.9	67.9			
20	120.0	45.6	45.6			
30	91.9	34.9	34.9			
40	75.1	28.6	28.6			
50	64.0	24.3	24.3			
60	55.9	21.2	21.2			
70	49.8	18.9	18.9			
80	45.0	17.1	17.1			
90	41.1	15.6	15.6			
100	37.9	14.4	14.4			
110	35.2	13.4	13.4			
120	32.9	12.5	12.5			

Roof Drain Design Calculation Sheet

**Project #160401570, 100 Steacie Drive
Roof Drain Design Sheet, Area R1A
Standard Watts Accutrol Weir - Single Notch Roof Drain**

Rating Curve				Volume Estimation				Water Depth (m)
Elevation (m)	Discharge Rate (cu.m/s)	Outlet Discharge (cu.m/s)	Storage (cu. m)	Elevation (m)	Area (sq. m)	Volume (cu. m)		
						Increment	Accumulated	
0.000	0.0000	0.0000	0	0.000	0	0	0	0.000
0.025	0.0003	0.0032	0	0.025	50	0	0	0.025
0.050	0.0006	0.0063	3	0.050	201	3	3	0.050
0.075	0.0008	0.0079	11	0.075	452	8	11	0.075
0.100	0.0009	0.0095	27	0.100	804	15	27	0.100
0.125	0.0011	0.0110	52	0.125	1256	26	52	0.125
0.150	0.0013	0.0126	90	0.150	1809	38	90	0.150

Drawdown Estimate			
Total Volume (cu.m)	Total Time (sec)	Vol (cu.m)	Detention Time (hr)
0.0	0.0	0.0	0
2.9	464.7	2.9	0.12908
10.9	1009.0	8.0	0.40936
26.4	1637.4	15.5	0.8642
51.9	2313.9	25.5	1.50695
90.0	3020.4	38.1	2.34594

Rooftop Storage Summary

Total Building Area (sq.m)		2261.31	
Assume Available Roof Area (sq. 80%)	80%	1809.048	
Roof Imperviousness		0.99	
Roof Drain Requirement (sq.m/Notch)		232	
Number of Roof Notches*		10	
Max. Allowable Depth of Roof Ponding (m)		0.15	* As per Ontario Building Code section OBC 7.4.10.4.(2)(c).
Max. Allowable Storage (cu.m)		90	
Estimated 100 Year Drawdown Time (h)		2.2	

* Note: Number of drains can be reduced if multiple-notch drain used.

Adjustable Accutrol Weir Flow Rate Settings From Watts Drain Catalogue					
Head (m)	L/s				
	Open	75%	50%	25%	Closed
0.025	0.3154	0.3154	0.3154	0.3154	0.3154
0.05	0.6308	0.6308	0.6308	0.6308	0.3154
0.075	0.9462	0.8674	0.7885	0.7097	0.3154
0.1	1.2617	1.104	0.9462	0.7885	0.3154
0.125	1.5771	1.3405	1.104	0.8674	0.3154
0.15	1.8925	1.5771	1.2617	0.9462	0.3154

Calculation Results

	5yr	100yr	Available
Qresult (cu.m/s)	0.010	0.012	-
Depth (m)	0.110	0.146	0.150
Volume (cu.m)	36.8	83.8	90.5
Drain time (hrs)	1.1	2.2	

Volume III: TEMPEST INLET CONTROL DEVICES

Municipal Technical
Manual Series



SECOND EDITION

LMF (Low to Medium Flow) ICD

HF (High Flow) ICD

MHF (Medium to High Flow) ICD



IPEX

by aliaxis

IPEX Tempest™ Inlet Control Devices

Municipal Technical Manual Series

Vol. I, 2nd Edition

© 2022 by IPEX. All rights reserved. No part of this book may be used or reproduced in any manner whatsoever without prior written permission.

For information contact: IPEX, Marketing,
1425 North Service Road East, Oakville, Ontario, Canada, L6H 1A7

The information contained here within is based on current information and product design at the time of publication and is subject to change without notification. IPEX does not guarantee or warranty the accuracy, suitability for particular applications, or results to be obtained therefrom.

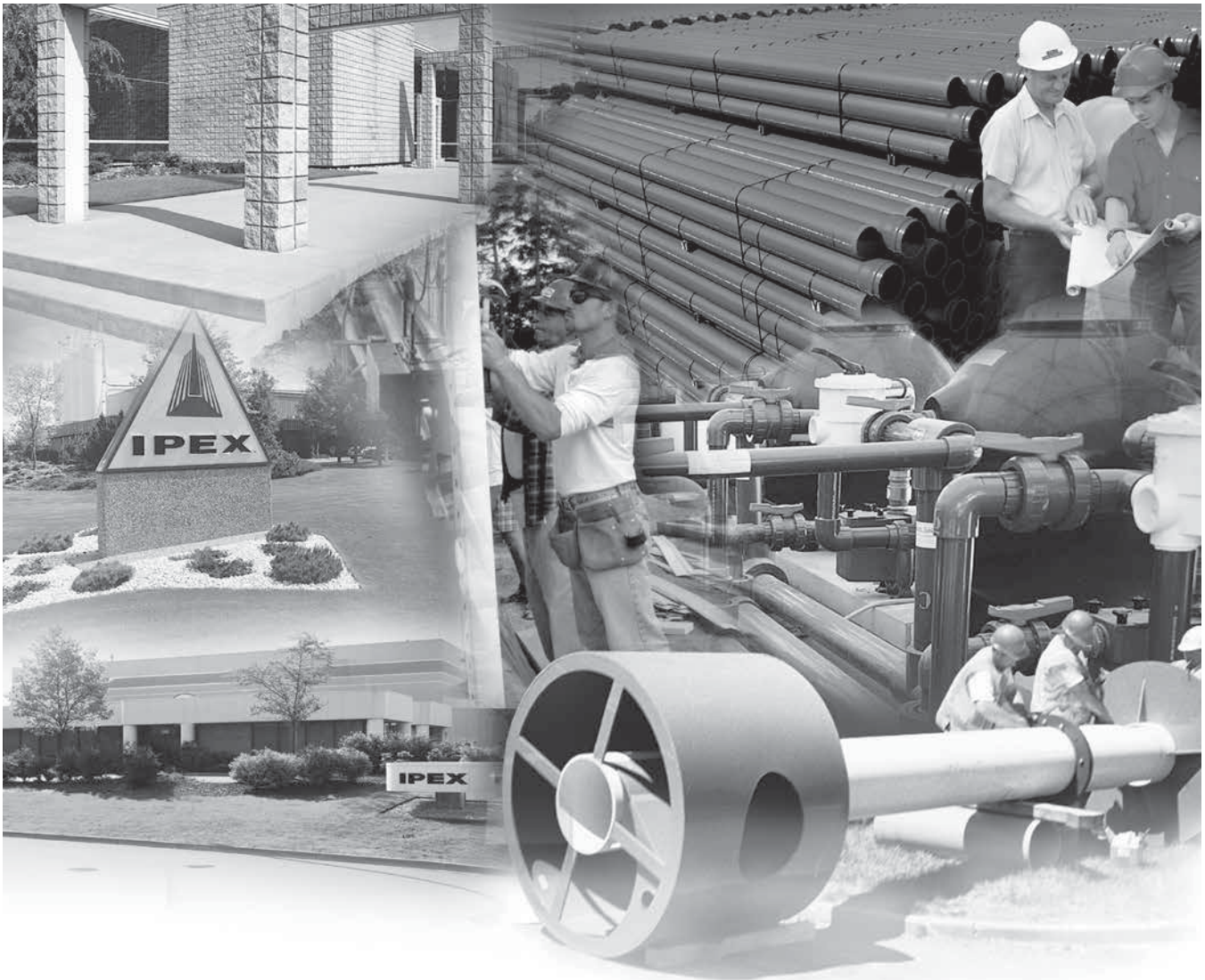

ABOUT IPEX

At IPEX, we have been manufacturing non-metallic pipe and fittings since 1951. We formulate our own compounds and maintain strict quality control during production. Our products are made available for customers thanks to a network of regional stocking locations throughout North America. We offer a wide variety of systems including complete lines of piping, fittings, valves and custom-fabricated items.

More importantly, we are committed to meeting our customers' needs. As a leader in the plastic piping industry, IPEX continually develops new products, modernizes manufacturing facilities and acquires innovative process technology. In addition, our staff take pride in their work, making available to customers their extensive thermoplastic knowledge and field experience. IPEX personnel are committed to improving the safety, reliability and performance of thermoplastic materials. We are involved in several standards committees and are members of and/or comply with the organizations listed on this page.

For specific details about any IPEX product, contact our customer service department.

CONTENTS

TEMPEST INLET CONTROL DEVICES Technical Manual

About IPEX

Section One:	Product Information: TEMPEST Low, Medium Flow (LMF) ICD	
	Purpose	4
	Product Description	4
	Product Function	4
	Product Construction	4
	Product Applications	4
	Chart 1: LMF 14 Preset Flow Curves	5
	Chart 2: LMF Flow Vs. ICD Alternatives	5
	Product Installation	
	Instructions to assemble a TEMPEST LMF ICD into a square catch basin:	6
	Instructions to assemble a TEMPEST LMF ICD into a round catch basin:	6
	Product Technical Specification	
	General	7
	Materials	7
	Dimensioning	7
	Installation	7
Section Two:	Product Information: TEMPEST High Flow (HF) & Medium, High Flow (MHF) ICD	
	Product Description	8
	Product Function	8
	Product Construction	8
	Product Applications	8
	Chart 3: HF & MHF Preset Flow Curves	9
	Product Installation	
	Instructions to assemble a TEMPEST HF or MHF ICD into a square catch basin:	10
	Instructions to assemble a TEMPEST HF or MHF ICD into a round catch basin:	10
	Instructions to assemble a TEMPEST HF Sump into a square or round catch basin: ...	11
	Product Technical Specification	
	General	11
	Materials	11
	Dimensioning	11
	Installation	11

PRODUCT INFORMATION: TEMPEST LOW, MEDIUM FLOW (LMF) ICD

Purpose

To control the amount of storm water runoff entering a sewer system by allowing a specified flow volume out of a catch basin or manhole at a specified head. This approach conserves pipe capacity so that catch basins downstream do not become uncontrollably surcharged, which can lead to basement floods, flash floods and combined sewer overflows.

Product Description

Our LMF ICD is designed to accommodate catch basins or manholes with sewer outlet pipes 6" in diameter and larger. Any storm sewer larger than 12" may require custom modification. However, IPEX can custom build a TEMPEST device to accommodate virtually any storm sewer size.

Available in 14 preset flow curves, the LMF ICD has the ability to provide flow rates: 2lps – 17lps (31gpm – 270gpm)

Product Function

The LMF ICD vortex flow action allows the LMF ICD to provide a narrower flow curve using a larger orifice than a conventional orifice plate ICD, making it less likely to clog. When comparing flows at the same head level, the LMF ICD has the ability to restrict more flow than a conventional ICD during a rain event, preserving greater sewer capacity.

Product Construction

Constructed from durable PVC, the LMF ICD is light weight 8.9 Kg (19.7 lbs).

Product Applications

Will accommodate both square and round applications:

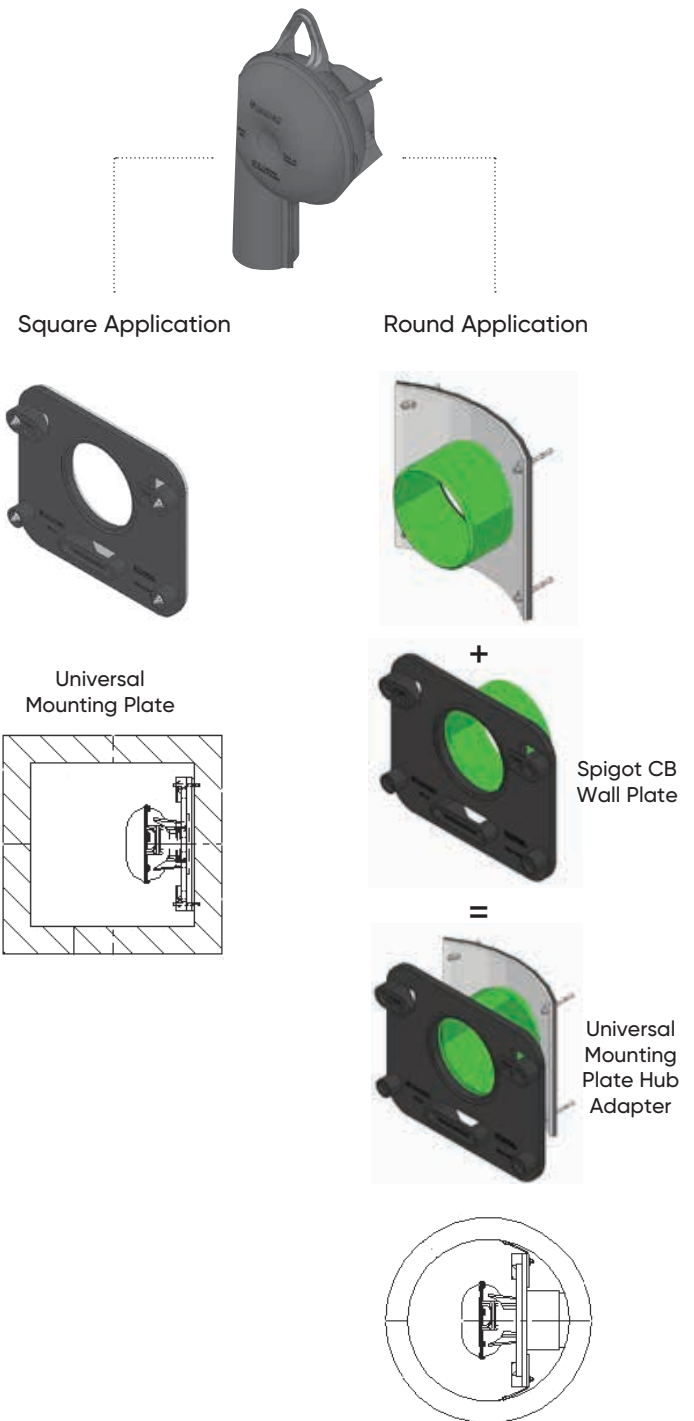

Chart 1: LMF 14 Preset Flow Curves

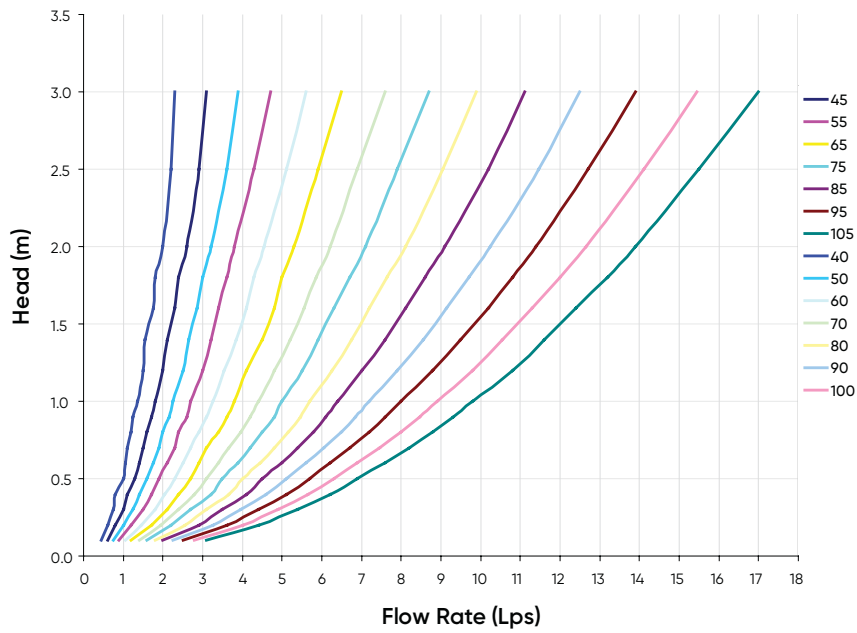
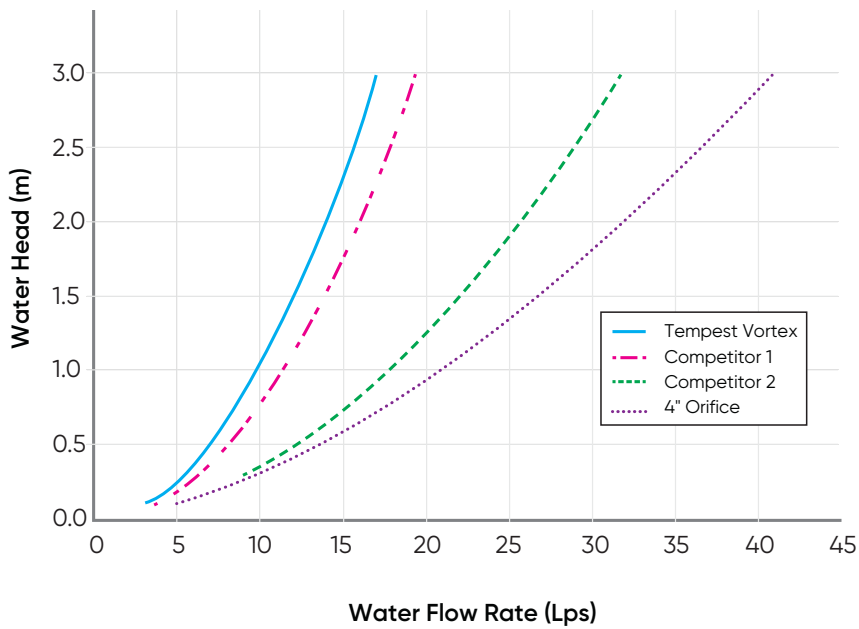

Chart 2: LMF Flow vs. ICD Alternatives



PRODUCT INSTALLATION

Instructions to assemble a TEMPEST LMF ICD into a Square Catch Basin:

STEPS:

1. Materials and tooling verification:
 - Tooling: impact drill, 3/8" concrete bit, torque wrench for 9/16" nut, hand hammer, level, and marker.
 - Material: (4) concrete anchor 3/8 x 3-1/2, (4) washers, (4) nuts, universal mounting plate, ICD device.
2. Use the mounting wall plate to locate and mark the hole (4) pattern on the catch basin wall. You should use a level to ensure that the plate is at the horizontal.
3. Use an impact drill with a 3/8" concrete bit to make the four holes at a minimum of 1-1/2" depth up to 2-1/2". Clean the concrete dust from the holes.
4. Install the anchors (4) in the holes by using a hammer. Thread the nuts on the top of the anchors to protect the threads when you hit the anchors with the hammer. Remove the nuts from the ends of the anchors.
5. Install the universal mounting plate on the anchors and screw the 4 nuts in place with a maximum torque of 40 N.m (30 lbf-ft). There should be no gap between the wall mounting plate and the catch basin wall.
6. From the ground above using a reach bar, lower the ICD device by hooking the end of the reach bar to the handle of the ICD device. Align the triangular plate portion into the mounting wall plate. Push down the device to be sure it has centered in to the universal mounting plate and has created a seal.



WARNING

- Verify that the outlet pipe doesn't protrude into the catch basin. If it does, cut down the pipe flush to the catch basin wall.
- Call your IPEX representative for more information or if you have any questions about our products.

Instructions to assemble a TEMPEST LMF ICD into a Round Catch Basin:

STEPS:

1. Materials and tooling verification.
 - Tooling: impact drill, 3/8" concrete bit, torque wrench for 9/16" nut, hand hammer, level and marker.
 - Material: (4) concrete anchor 3/8 x 3-1/2, (4) washers and (4) nuts, spigot CB wall plate, universal mounting plate hub adapter, ICD device.
2. Use the spigot catch basin wall plate to locate and mark the hole (4) pattern on the catch basin wall. You should use a level to ensure that the plate is at the horizontal.
3. Use an impact drill with a 3/8" concrete bit to make the four holes at a depth between 1-1/2" to 2-1/2". Clean the concrete dust from the holes.
4. Install the anchors (4) in the holes by using a hammer. Thread the nuts on the top of the anchors to protect the threads when you hit the anchors with the hammer. Remove the nuts from the ends of the anchors.
5. Install the CB spigot wall plate on the anchors and screw the 4 nuts in place with a maximum torque of 40 N.m (30 lbf-ft). There should be no gap between the spigot wall plate and the catch basin wall.
6. Apply solvent cement on the hub of the universal mounting plate, hub adapter and the spigot of the CB wall plate, then slide the hub over the spigot. Make sure the universal mounting plate is at the horizontal and its hub is completely inserted onto the spigot. Normally, the corners of the universal mounting plate hub adapter should touch the catch basin wall.
7. From ground above using a reach bar, lower the ICD device by hooking the end of the reach bar to the handle of the ICD device. Align the triangular plate portion into the mounting wall plate. Push down the device to be sure it has centered in to the mounting plate and has created a seal.



WARNING

- Verify that the outlet pipe doesn't protrude into the catch basin. If it does, cut back the pipe flush to the catch basin wall.
- The solvent cement which is used in this installation is to be approved for PVC.
- The solvent cement should not be used below 0°C (32°F) or in a high humidity environment. Refer to the IPEX solvent cement guide to confirm the required curing time or visit the IPEX Online Solvent Cement Training Course available at ipexna.com.
- Call your IPEX representative for more information or if you have any questions about our products.

PRODUCT TECHNICAL SPECIFICATION

General

Inlet control devices (ICD's) are designed to provide flow control at a specified rate for a given water head level and also provide odour and floatable control. All ICD's will be IPEX Tempest or approved equal.

All devices shall be removable from a universal mounting plate. An operator from street level using only a T-bar with a hook will be able to retrieve the device while leaving the universal mounting plate secured to the catch basin wall face. The removal of the TEMPEST devices listed above must not require any unbolting or special manipulation or any special tools.

High Flow (HF) Sump devices will consist of a removable threaded cap which can be accessible from street level with out entry into the catchbasin (CB). The removal of the threaded cap shall not require any special tools other than the operator's hand.

ICD's shall have no moving parts.

Materials

ICD's are to be manufactured from Polyvinyl Chloride (PVC) or Polyurethane material, designed to be durable enough to withstand multiple freeze-thaw cycles and exposure to harsh elements.

The inner ring seal will be manufactured using a Buna or Nitrile material with hardness between Duro 50 and Duro 70.

The wall seal is to be comprised of a 3/8" thick Neoprene Closed Cell Sponge gasket which is attached to the back of the wall plate.

All hardware will be made from 304 stainless steel.

Dimensioning

The Low Medium Flow (LMF), High Flow (HF) and the High Flow (HF) Sump shall allow for a minimum outlet pipe diameter of 200mm with a 600mm deep Catch Basin sump.

Installation

Contractor shall be responsible for securing, supporting and connecting the ICD's to the existing influent pipe and catchbasin/manhole structure as specified and designed by the Engineer.

PRODUCT INFORMATION: TEMPEST HF & MHF ICD

Product Description

Our HF, HF Sump and MHF ICD's are designed to accommodate catch basins or manholes with sewer outlet pipes 6" in diameter or larger. Any storm sewer larger than 12" may require custom modification. However, IPEX can custom build a TEMPEST device to accommodate virtually any storm sewer size.

Available in 5 preset flow curves, these ICDs have the ability to provide constant flow rates: 9lps (143 gpm) and greater

Product Function

TEMPEST HF (High Flow): designed to manage moderate to higher flows 15 L/s (240 gpm) or greater and prevent the propagation of odour and floatables. With this device, the cross-sectional area of the device is larger than the orifice diameter and has been designed to limit head losses. The HF ICD can also be ordered without flow control when only odour and floatable control is required.



TEMPEST HF (High Flow) Sump: The height of a sewer outlet pipe in a catch basin is not always conveniently located. At times it may be located very close to the catch basin floor, not providing enough sump for one of the other TEMPEST ICDs with universal back plate to be installed. In these applications, the HF Sump is offered. The HF Sump offers the same features and benefits as the HF ICD; however, is designed to raise the outlet in a square or round catch basin structure. When installed, the HF sump is fixed in place and not easily removed. Any required service to the device is performed through a clean-out located in the top of the device which can be often accessed from ground level.



TEMPEST MHF (Medium to High Flow): The MHF plate or plug is designed to control flow rates 9 L/s (143 gpm) or greater. It is not designed to prevent the propagation of odour and floatables.



Product Construction

The HF, HF Sump and MHF ICDs are built to be light weight at a maximum weight of 6.8 Kg (14.6 lbs).

Product Applications

The HF and MHF ICD's are available to accommodate both square and round applications:



Square Application

Universal Mounting Plate

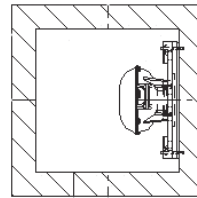

Round Application

Spigot CB Wall Plate



Universal Mounting Plate Hub Adapter



+

=

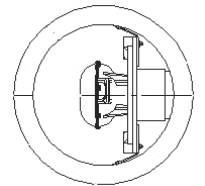
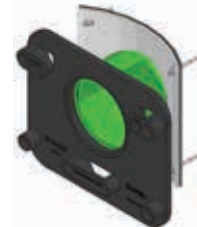

The HF Sump is available to accommodate low to no sump applications in both square and round catch basins:

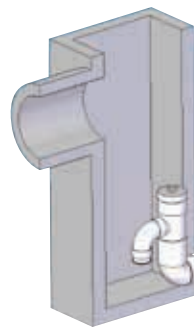

Square Catch Basin

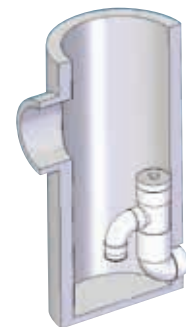

Round Catch Basin

Chart 3: HF & MHF Preset Flow Curves

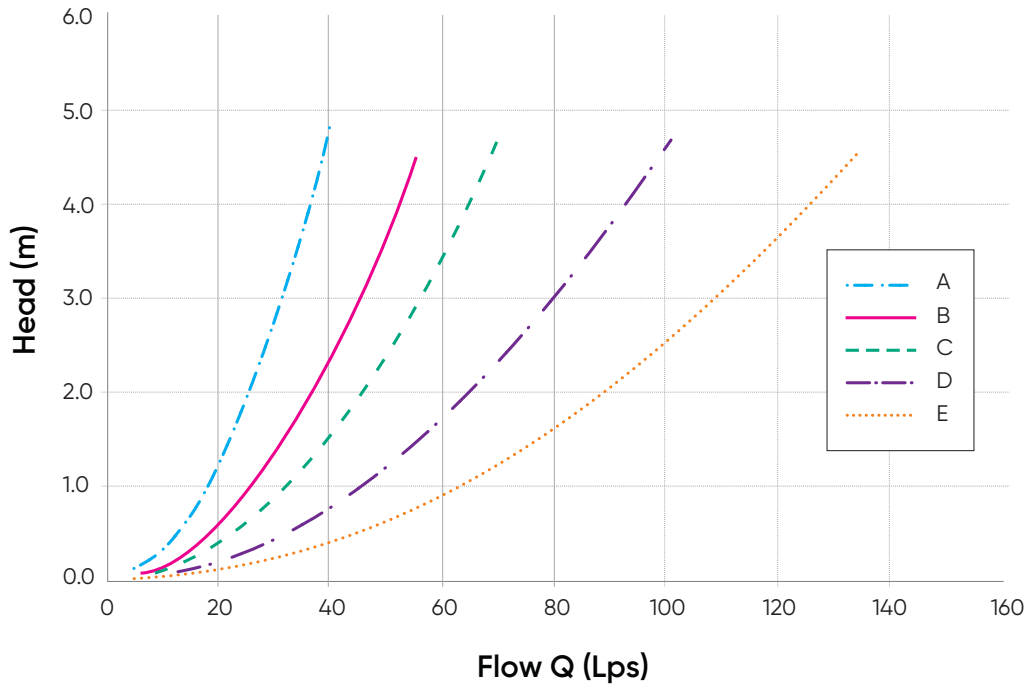

PRODUCT INSTALLATION

Instructions to assemble a TEMPEST HF or MHF ICD into a Square Catch Basin:

1. Materials and tooling verification:
 - Tooling: impact drill, 3/8" concrete bit, torque wrench for 9/16" nut, hand hammer, level, and marker.
 - Material: (4) concrete anchor 3/8 x 3-1/2, (4) washers, (4) nuts, universal mounting plate, ICD device
2. Use the mounting wall plate to locate and mark the hole (4) pattern on the catch basin wall. You should use a level to ensure that the plate is at the horizontal.
3. Use an impact drill with a 3/8" concrete bit to make the four holes at a minimum of 1-1/2" depth up to 2-1/2". Clean the concrete dust from the holes.
4. Install the anchors (4) in the holes by using a hammer. Thread the nuts on the top of the anchors to protect the threads when you hit the anchors with the hammer. Remove the nuts from the ends of the anchors.
5. Install the universal wall mounting plate on the anchors and screw the 4 nuts in place with a maximum torque of 40 N.m (30 lbf-ft). There should be no gap between the wall mounting plate and the catch basin wall.
6. From the ground above using a reach bar, lower the device by hooking the end of the reach bar to the handle of the ICD device. Align the triangular plate portion into the mounting wall plate. Push down the device to be sure it has centered in to the universal wall mounting plate and has created a seal.

WARNING

- Verify that the outlet pipe doesn't protrude into the catch basin. If it does, cut down the pipe flush to the catch basin wall.
- Call your IPEX representative for more information or if you have any questions about our products.

Instructions to assemble a TEMPEST HF or MHF ICD into a Round Catch Basin:

STEPS:

1. Materials and tooling verification.
 - Tooling: impact drill, 3/8" concrete bit, torque wrench for 9/16" nut, hand hammer, level and marker.
 - Material: (4) concrete anchor 3/8 x 3-1/2, (4) washers and (4) nuts, spigot CB wall plate, universal mounting plate hub adapter, ICD device.
2. Use the round catch basin spigot adaptor to locate and mark the hole (4) pattern on the catch basin wall. You should use a level to ensure that the plate is at the horizontal.
3. Use an impact drill with a 3/8" concrete bit to make the four holes at a depth between 1-1/2" to 2-1/2". Clean the concrete dust from the holes.
4. Install the anchors (4) in the holes by using a hammer. Thread the nuts on the top of the anchors to protect the threads when you hit the anchors with the hammer. Remove the nuts from the ends of the anchors.
5. Install the spigot CB wall plate on the anchors and screw the 4 nuts in place with a maximum torque of 40 N.m (30 lbf-ft). There should be no gap between the spigot CB wall plate and the catch basin wall.
6. Put solvent cement on the hub of the universal mounting plate, hub adapter and the spigot of the CB wall plate, then slide the hub over the spigot. Make sure the universal mounting plate is at the horizontal and its hub is completely inserted onto the spigot. Normally, the corners of the hub adapter should touch the catch basin wall.
7. From ground above using a reach bar, lower the device by hooking the end of the reach bar to the handle of the ICD device. Align the triangular plate portion into the mounting wall plate. Push down the device to be sure it has centered in to the wall mounting plate and has created a seal.

WARNING

- Verify that the outlet pipe doesn't protrude into the catch basin. If it does, cut down the pipe flush to the catch basin wall.
- The solvent cement which is used in this installation is to be approved for PVC.
- The solvent cement should not be used below 0°C (32°F) or in a high humidity environment. Refer to the IPEX solvent cement guide to confirm the required curing time or visit the IPEX Online Solvent Cement Training Course available at www.ipexinc.com.
- Call your IPEX representative for more information or if you have any questions about our products.

Instructions to assemble a TEMPEST HF Sump into a Square or Round Catch Basin:

STEPS:

1. Materials and tooling verification:
 - Tooling: impact drill, 3/8" concrete bit, torque wrench for 9/16" nut, hand hammer, level, mastic tape and metal strapping
 - Material: (2) concrete anchor 3/8 x 3-1/2, (2) washers, (2) nuts, HF Sump pieces (2).
2. Apply solvent cement to the spigot end of the top half of the sump. Apply solvent cement to the hub of the bottom half of the sump. Insert the spigot of the top half of the sump into the hub of the bottom half of the sump.
3. Install the 8" spigot of the device into the outlet pipe. Use the mastic tape to seal the device spigot into the outlet pipe. You should use a level to be sure that the fitting is standing at the vertical.
4. Use an impact drill with a 3/8" concrete bit to make a series of 2 holes along each side of the body throat. The depth of the hole should be between 1-1/2" to 2-1/2". Clean the concrete dust from the 2 holes.
5. Install the anchors (2) in the holes by using a hammer. Put the nuts on the top of the anchors to protect the threads when you hit the anchors. Remove the nuts from the ends of the anchors.
6. Cut the metal strapping to length and connect each end of the strapping to the anchors. Screw the nuts in place with a maximum torque of 40 N.m (30 lbf-ft). The device should be completely flush with the catch basin wall.



WARNING

- Verify that the outlet pipe doesn't protrude into the catch basin. If it does, cut down the pipe flush to the catch basin wall.
- The solvent cement which is used in this installation is to be approved for PVC.
- The solvent cement should not be used below 0°C (32°F) or in a high humidity environment. Refer to the IPEX solvent cement guide to confirm the required curing time or visit the IPEX Online Solvent Cement Training Course available at www.ipexinc.com.
- Call your IPEX representative for more information or if you have any questions about our products.

PRODUCT TECHNICAL SPECIFICATION

General

Inlet control devices (ICD's) are designed to provide flow control at a specified rate for a given water head level and also provide odour and floatable control where specified. All ICD's will be IPEX Tempest or approved equal.

All devices shall be removable from a universal mounting plate. An operator from street level using only a T-bar with a hook shall be able to retrieve the device while leaving the universal mounting plate secured to the catch basin wall face. The removal of the TEMPEST devices listed above shall not require any unbolting or special manipulation or any special tools.

High Flow (HF) Sump devices shall consist of a removable threaded cap which can be accessible from street level with out entry into the catchbasin (CB). The removal of the threaded cap shall not require any special tools other than the operator's hand.

ICD's shall have no moving parts.

Materials

ICD's are to be manufactured from Polyvinyl Chloride (PVC) or Polyurethane material, designed to be durable enough to withstand multiple freeze-thaw cycles and exposure to harsh elements.

The inner ring seal will be manufactured using a Buna or Nitrile material with hardness between Duro 50 and Duro 70.

The wall seal is to be comprised of a 3/8" thick Neoprene Closed Cell Sponge gasket which is attached to the back of the wall plate.

All hardware will be made from 304 stainless steel.

Dimensioning

The Low Medium Flow (LMF), High Flow (HF) and the High Flow (HF) Sump shall allow for a minimum outlet pipe diameter of 200mm with a 600mm deep Catch Basin sump.

Installation

Contractor shall be responsible for securing, supporting and connecting the ICD's to the existing influent pipe and catchbasin/manhole structure as specified and designed by the Engineer.

NOTES

SALES AND CUSTOMER SERVICE

IPEX Inc.

Toll Free: (866) 473-9462

ipexna.com

About the IPEX Group of Companies

As leading suppliers of thermoplastic piping systems, the IPEX Group of Companies provides our customers with some of the largest and most comprehensive product lines. All IPEX products are backed by more than 50 years of experience. With state-of-the-art manufacturing facilities and distribution centers across North America, we have established a reputation for product innovation, quality, end-user focus and performance.

Markets served by IPEX group products are:

- Electrical systems
- Telecommunications and utility piping systems
- PVC, CPVC, PP, ABS, PEX, FR-PVDF and PE pipe and fittings (1/4" to 48")
- Industrial process piping systems
- Municipal pressure and gravity piping systems
- Plumbing and mechanical piping systems
- PE Electrofusion systems for gas and water
- Industrial, plumbing and electrical cements
- Irrigation systems

Products manufactured by IPEX Inc.

Tempest™ is a trademark of IPEX Branding Inc.

This literature is published in good faith and is believed to be reliable. However it does not represent and/or warrant in any manner the information and suggestions contained in this brochure. Data presented is the result of laboratory tests and field experience.

A policy of ongoing product improvement is maintained. This may result in modifications of features and/or specifications without notice.



D.3 Stormceptor Sizing Report



Stormceptor® **EF** Sizing Report

Imbrium® Systems

ESTIMATED NET ANNUAL SEDIMENT (TSS) LOAD REDUCTION

07/04/2025

Province:	Ontario
City:	Ottawa
Nearest Rainfall Station:	OTTAWA CDA RCS
Climate Station Id:	6105978
Years of Rainfall Data:	20

Project Name:	100 Steacie Drive
Project Number:	160401570
Designer Name:	Michael Wu
Designer Company:	Stantec
Designer Email:	Michael.Wu@stantec.com
Designer Phone:	613-738-6033
EOR Name:	
EOR Company:	
EOR Email:	
EOR Phone:	

Site Name:	New
------------	-----

Drainage Area (ha):	1.12
---------------------	------

Runoff Coefficient 'c':	0.58
-------------------------	------

Particle Size Distribution:	Fine
-----------------------------	------

Target TSS Removal (%):	80.0
-------------------------	------

Required Water Quality Runoff Volume Capture (%):	90.00
Estimated Water Quality Flow Rate (L/s):	20.97
Oil / Fuel Spill Risk Site?	Yes
Upstream Flow Control?	No
Peak Conveyance (maximum) Flow Rate (L/s):	
Influent TSS Concentration (mg/L):	200
Estimated Average Annual Sediment Load (kg/yr):	605
Estimated Average Annual Sediment Volume (L/yr):	492

Net Annual Sediment (TSS) Load Reduction Sizing Summary	
Stormceptor Model	TSS Removal Provided (%)
EFO4	79
EFO5	85
EFO6	89
EFO8	94
EFO10	97
EFO12	98

Recommended Stormceptor EFO Model: EFO5

Estimated Net Annual Sediment (TSS) Load Reduction (%): 85

Water Quality Runoff Volume Capture (%): > 90



Stormceptor® **EF** Sizing Report

THIRD-PARTY TESTING AND VERIFICATION

► Stormceptor® EF and Stormceptor® EFO are the latest evolutions in the Stormceptor® oil-grit separator (OGS) technology series, and are designed to remove a wide variety of pollutants from stormwater and snowmelt runoff. These technologies have been third-party tested in accordance with the Canadian ETV **Procedure for Laboratory Testing of Oil-Grit Separators** and performance has been third-party verified in accordance with the **ISO 14034 Environmental Technology Verification (ETV)** protocol.

PERFORMANCE

► Stormceptor® EF and EFO remove stormwater pollutants through gravity separation and floatation, and feature a patent-pending design that generates positive removal of total suspended solids (TSS) throughout each storm event, including high-intensity storms. Captured pollutants include sediment, free oils, and sediment-bound pollutants such as nutrients, heavy metals, and petroleum hydrocarbons. Stormceptor is sized to remove a high level of TSS from the frequent rainfall events that contribute the vast majority of annual runoff volume and pollutant load. The technology incorporates an internal bypass to convey excessive stormwater flows from high-intensity storms through the device without resuspension and washout (scour) of previously captured pollutants. Proper routine maintenance ensures high pollutant removal performance and protection of downstream waterways.

PARTICLE SIZE DISTRIBUTION (PSD)

► The Canadian ETV PSD shown in the table below was used, or in part, for this sizing. This is the identical PSD that is referenced in the Canadian ETV **Procedure for Laboratory Testing of Oil-Grit Separators** for both sediment removal testing and scour testing. The Canadian ETV PSD contains a wide range of particle sizes in the sand and silt fractions, and is considered reasonably representative of the particle size fractions found in typical urban stormwater runoff.

Particle Size (µm)	Percent Less Than	Particle Size Fraction (µm)	Percent
1000	100	500-1000	5
500	95	250-500	5
250	90	150-250	15
150	75	100-150	15
100	60	75-100	10
75	50	50-75	5
50	45	20-50	10
20	35	8-20	15
8	20	5-8	10
5	10	2-5	5
2	5	<2	5



Stormceptor® EF Sizing Report

Rainfall Intensity (mm / hr)	Percent Rainfall Volume (%)	Cumulative Rainfall Volume (%)	Flow Rate (L/s)	Flow Rate (L/min)	Surface Loading Rate (L/min/m²)	Removal Efficiency (%)	Incremental Removal (%)	Cumulative Removal (%)
0.50	8.6	8.6	0.90	54.0	30.0	100	8.6	8.6
1.00	20.3	29.0	1.81	108.0	60.0	100	20.3	29.0
2.00	16.2	45.2	3.61	217.0	119.0	93	15.1	44.1
3.00	12.0	57.2	5.42	325.0	179.0	87	10.4	54.5
4.00	8.4	65.6	7.22	433.0	238.0	82	6.9	61.4
5.00	5.9	71.6	9.03	542.0	298.0	79	4.7	66.1
6.00	4.6	76.2	10.84	650.0	357.0	76	3.5	69.6
7.00	3.1	79.3	12.64	758.0	417.0	73	2.2	71.9
8.00	2.7	82.0	14.45	867.0	476.0	71	1.9	73.8
9.00	3.3	85.3	16.25	975.0	536.0	68	2.3	76.1
10.00	2.3	87.6	18.06	1084.0	595.0	65	1.5	77.6
11.00	1.6	89.2	19.86	1192.0	655.0	64	1.0	78.6
12.00	1.3	90.5	21.67	1300.0	714.0	64	0.8	79.4
13.00	1.7	92.2	23.48	1409.0	774.0	63	1.1	80.5
14.00	1.2	93.5	25.28	1517.0	833.0	63	0.8	81.3
15.00	1.2	94.6	27.09	1625.0	893.0	62	0.7	82.0
16.00	0.7	95.3	28.89	1734.0	953.0	62	0.4	82.4
17.00	0.7	96.1	30.70	1842.0	1012.0	61	0.5	82.9
18.00	0.4	96.5	32.51	1950.0	1072.0	60	0.2	83.1
19.00	0.4	96.9	34.31	2059.0	1131.0	59	0.2	83.4
20.00	0.2	97.1	36.12	2167.0	1191.0	57	0.1	83.5
21.00	0.5	97.5	37.92	2275.0	1250.0	56	0.3	83.8
22.00	0.2	97.8	39.73	2384.0	1310.0	54	0.1	83.9
23.00	1.0	98.8	41.54	2492.0	1369.0	53	0.5	84.4
24.00	0.3	99.1	43.34	2600.0	1429.0	52	0.1	84.6
25.00	0.0	99.1	45.15	2709.0	1488.0	49	0.0	84.6
30.00	0.9	100.0	54.18	3251.0	1786.0	41	0.4	84.9
35.00	0.0	100.0	63.21	3792.0	2084.0	35	0.0	84.9
40.00	0.0	100.0	72.24	4334.0	2381.0	31	0.0	84.9
45.00	0.0	100.0	81.26	4876.0	2679.0	28	0.0	84.9
Estimated Net Annual Sediment (TSS) Load Reduction =								85 %

Climate Station ID: 6105978 Years of Rainfall Data: 20



Stormceptor® EF Sizing Report

RAINFALL DATA FROM OTTAWA CDA RCS RAINFALL STATION

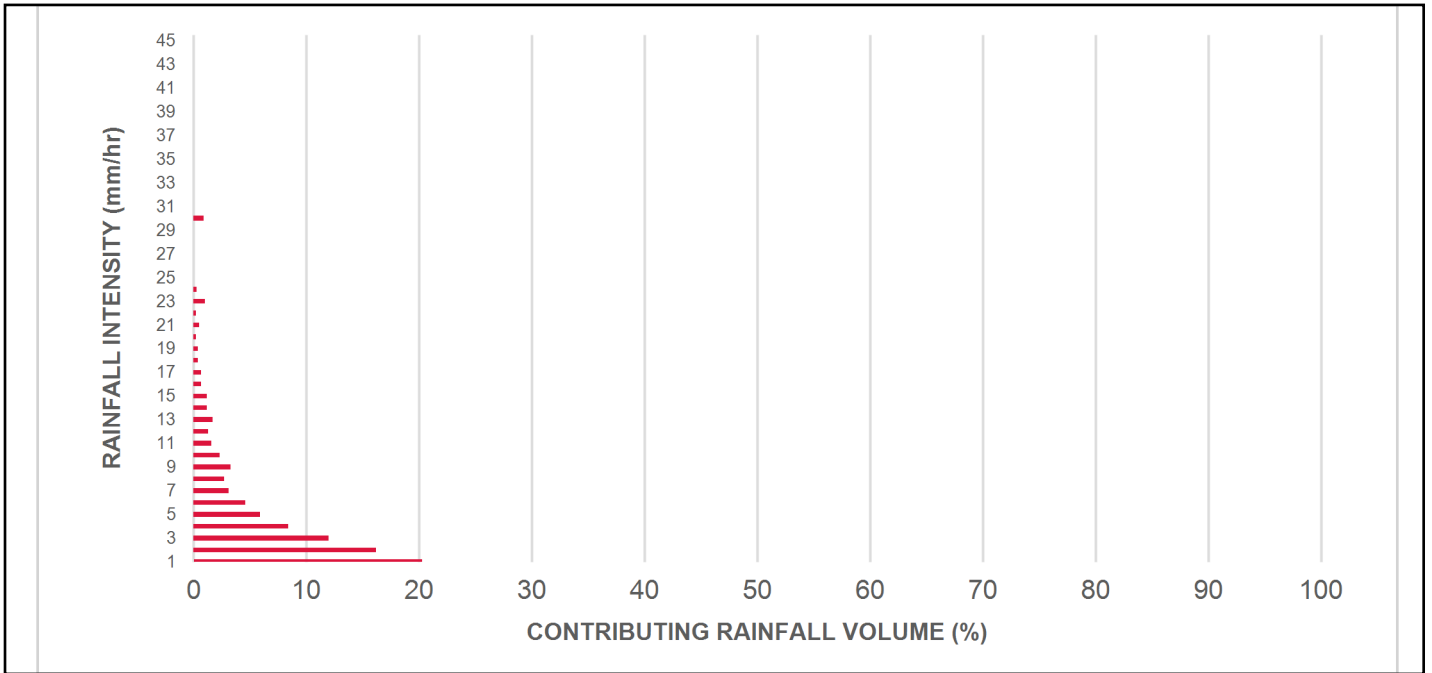

INCREMENTAL AND CUMULATIVE TSS REMOVAL FOR THE RECOMMENDED STORMCEPTOR® MODEL

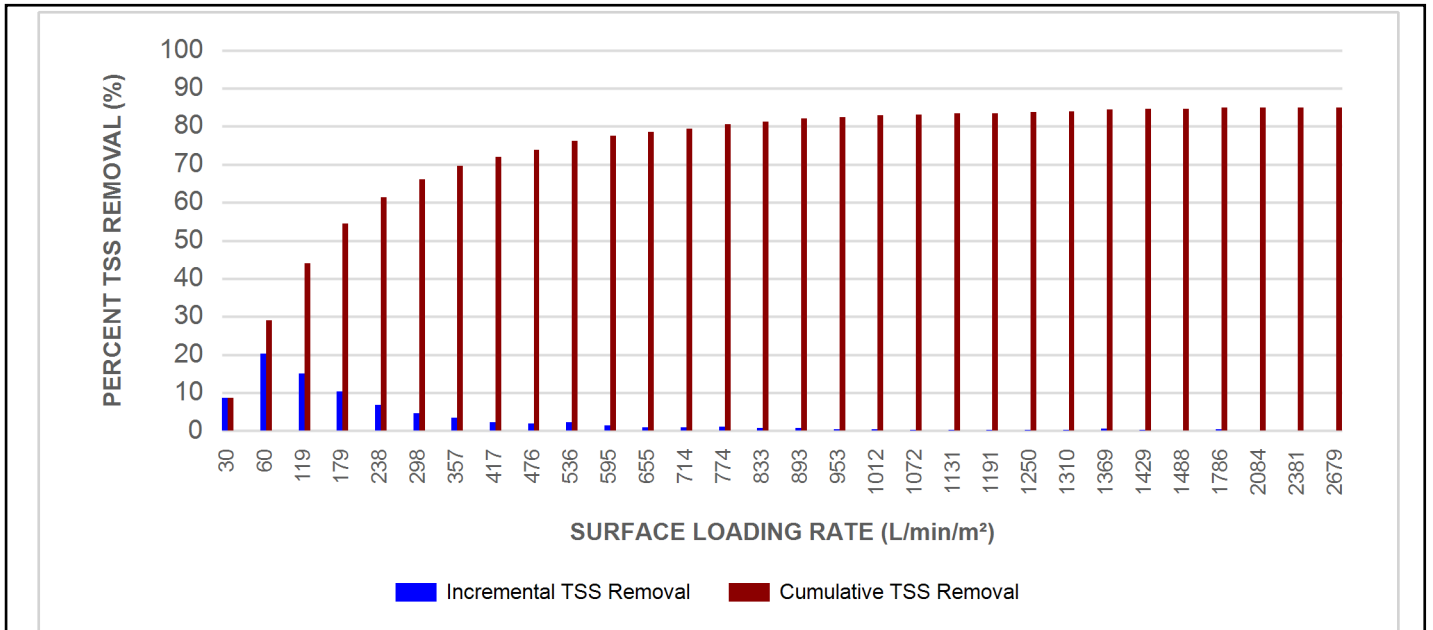

Stormceptor® EF Sizing Report

Maximum Pipe Diameter / Peak Conveyance

Stormceptor EF / EFO	Model Diameter		Min Angle Inlet / Outlet Pipes	Max Inlet Pipe Diameter		Max Outlet Pipe Diameter		Peak Conveyance Flow Rate	
	(m)	(ft)		(mm)	(in)	(mm)	(in)	(L/s)	(cfs)
EF4 / EFO4	1.2	4	90	609	24	609	24	425	15
EF5 / EFO5	1.5	5	90	762	30	762	30	710	25
EF6 / EFO6	1.8	6	90	914	36	914	36	990	35
EF8 / EFO8	2.4	8	90	1219	48	1219	48	1700	60
EF10 / EFO10	3.0	10	90	1828	72	1828	72	2830	100
EF12 / EFO12	3.6	12	90	1828	72	1828	72	2830	100

SCOUR PREVENTION AND ONLINE CONFIGURATION

► Stormceptor® EF and EFO feature an internal bypass and superior scour prevention technology that have been demonstrated in third-party testing according to the scour testing provisions of the Canadian ETV Procedure for Laboratory Testing of Oil-Grit Separators, and the exceptional scour test performance has been third-party verified in accordance with the ISO 14034 ETV protocol. As a result, Stormceptor EF and EFO are approved for online installation, eliminating the need for costly additional bypass structures, piping, and installation expense.

DESIGN FLEXIBILITY

► Stormceptor® EF and EFO offers design flexibility in one simplified platform, accepting stormwater flow from a single inlet pipe or multiple inlet pipes, and/or surface runoff through an inlet grate. The device can also serve as a junction structure, accommodate a 90-degree inlet-to-outlet bend angle, and can be modified to ensure performance in submerged conditions.

OIL CAPTURE AND RETENTION

► While Stormceptor® EF will capture and retain oil from dry weather spills and low intensity runoff, Stormceptor® EFO has demonstrated superior oil capture and greater than 99% oil retention in third-party testing according to the light liquid re-entrainment testing provisions of the Canadian ETV Procedure for Laboratory Testing of Oil-Grit Separators. Stormceptor EFO is recommended for sites where oil capture and retention is a requirement.

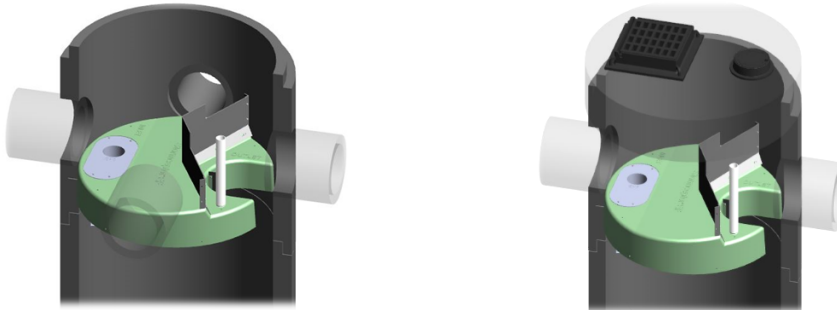

Stormceptor® EF Sizing Report

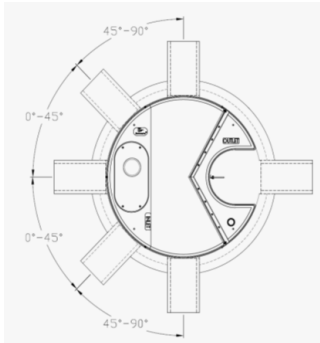

INLET-TO-OUTLET DROP

Elevation differential between inlet and outlet pipe inverts is dictated by the angle at which the inlet pipe(s) enters the unit.

0° - 45° : The inlet pipe is 1-inch (25mm) higher than the outlet pipe.

45° - 90° : The inlet pipe is 2-inches (50mm) higher than the outlet pipe.

HEAD LOSS

The head loss through Stormceptor EF is similar to that of a 60-degree bend structure. The applicable K value for calculating minor losses through the unit is 1.1. For submerged conditions the applicable K value is 3.0.

Pollutant Capacity

Stormceptor EF / EFO	Model Diameter		Depth (Outlet Pipe Invert to Sump Floor)		Oil Volume		Recommended Sediment Maintenance Depth *		Maximum Sediment Volume *		Maximum Sediment Mass **	
	(m)	(ft)	(m)	(ft)	(L)	(Gal)	(mm)	(in)	(L)	(ft³)	(kg)	(lb)
EF4 / EFO4	1.2	4	1.52	5.0	265	70	203	8	1190	42	1904	5250
EF5 / EFO5	1.5	5	1.62	5.3	420	111	305	10	2124	75	2612	5758
EF6 / EFO6	1.8	6	1.93	6.3	610	160	305	12	3470	123	5552	15375
EF8 / EFO8	2.4	8	2.59	8.5	1070	280	610	24	8780	310	14048	38750
EF10 / EFO10	3.0	10	3.25	10.7	1670	440	610	24	17790	628	28464	78500
EF12 / EFO12	3.6	12	3.89	12.8	2475	655	610	24	31220	1103	49952	137875

*Increased sump depth may be added to increase sediment storage capacity

** Average density of wet packed sediment in sump = 1.6 kg/L (100 lb/ft³)

Feature	Benefit	Feature Appeals To
Patent-pending enhanced flow treatment and scour prevention technology	Superior, verified third-party performance	Regulator, Specifying & Design Engineer
Third-party verified light liquid capture and retention for EFO version	Proven performance for fuel/oil hotspot locations	Regulator, Specifying & Design Engineer, Site Owner
Functions as bend, junction or inlet structure	Design flexibility	Specifying & Design Engineer
Minimal drop between inlet and outlet	Site installation ease	Contractor
Large diameter outlet riser for inspection and maintenance	Easy maintenance access from grade	Maintenance Contractor & Site Owner

STANDARD STORMCEPTOR EF/EFO DRAWINGS

For standard details, please visit <http://www.imbriumsystems.com/stormwater-treatment-solutions/stormceptor-ef>

STANDARD STORMCEPTOR EF/EFO SPECIFICATION

For specifications, please visit <http://www.imbriumsystems.com/stormwater-treatment-solutions/stormceptor-ef>

STANDARD PERFORMANCE SPECIFICATION FOR “OIL GRIT SEPARATOR” (OGS) STORMWATER QUALITY TREATMENT DEVICE

PART 1 – GENERAL

1.1 WORK INCLUDED

This section specifies requirements for selecting, sizing, and designing an underground Oil Grit Separator (OGS) device for stormwater quality treatment, with third-party testing results and a Statement of Verification in accordance with ISO 14034 Environmental Management – Environmental Technology Verification (ETV).

1.2 REFERENCE STANDARDS & PROCEDURES

ISO 14034:2016 Environmental management – Environmental technology verification (ETV)

Canadian Environmental Technology Verification (ETV) Program’s **Procedure for Laboratory Testing of Oil-Grit Separators**

1.3 SUBMITTALS

1.3.1 All submittals, including sizing reports & shop drawings, shall be submitted upon request with each order to the contractor then forwarded to the Engineer of Record for review and acceptance. Shop drawings shall detail all OGS components, elevations, and sequence of construction.

1.3.2 Alternative devices shall have features identical to or greater than the specified device, including: treatment chamber diameter, treatment chamber wet volume, sediment storage volume, and oil storage volume.

1.3.3 Unless directed otherwise by the Engineer of Record, OGS stormwater quality treatment product substitutions or alternatives submitted within ten days prior to project bid shall not be accepted. All alternatives or substitutions submitted shall be signed and sealed by a local registered Professional Engineer, based on the exact same criteria detailed in Section 3, in entirety, subject to review and approval by the Engineer of Record.

PART 2 – PRODUCTS

2.1 OGS POLLUTANT STORAGE

The OGS device shall include a sump for sediment storage, and a protected volume for the capture and storage of petroleum hydrocarbons and buoyant gross pollutants. The minimum sediment & petroleum hydrocarbon storage capacity shall be as follows:

2.1.1	4 ft (1219 mm) Diameter OGS Units:	1.19 m ³ sediment / 265 L oil
	5 ft (1524 mm) Diameter OGS Units:	1.95 m ³ sediment / 420 L oil
	6 ft (1829 mm) Diameter OGS Units:	3.48 m ³ sediment / 609 L oil
	8 ft (2438 mm) Diameter OGS Units:	8.78 m ³ sediment / 1,071 L oil
	10 ft (3048 mm) Diameter OGS Units:	17.78 m ³ sediment / 1,673 L oil
	12 ft (3657 mm) Diameter OGS Units:	31.23 m ³ sediment / 2,476 L oil

PART 3 – PERFORMANCE & DESIGN

Stormceptor® EF Sizing Report

3.1 GENERAL

The OGS stormwater quality treatment device shall be verified in accordance with ISO 14034:2016 Environmental management – Environmental technology verification (ETV). The OGS stormwater quality treatment device shall remove oil, sediment and gross pollutants from stormwater runoff during frequent wet weather events, and retain these pollutants during less frequent high flow wet weather events below the insert within the OGS for later removal during maintenance. The Manufacturer shall have at least ten (10) years of local experience, history and success in engineering design, manufacturing and production and supply of OGS stormwater quality treatment device systems, acceptable to the Engineer of Record.

3.2 SIZING METHODOLOGY

The OGS device shall be engineered, designed and sized to provide stormwater quality treatment based on treating a minimum of 90 percent of the average annual runoff volume and a minimum removal of an annual average 60% of the sediment (TSS) load based on the Particle Size Distribution (PSD) specified in the sizing report for the specified device. Sizing of the OGS shall be determined by use of a minimum ten (10) years of local historical rainfall data provided by Environment Canada. Sizing shall also be determined by use of the sediment removal performance data derived from the ISO 14034 ETV third-party verified laboratory testing data from testing conducted in accordance with the Canadian ETV protocol Procedure for Laboratory Testing of Oil-Grit Separators, as follows:

3.2.1 Sediment removal efficiency for a given surface loading rate and its associated flow rate shall be based on sediment removal efficiency demonstrated at the seven (7) tested surface loading rates specified in the protocol, ranging 40 L/min/m² to 1400 L/min/m², and as stated in the ISO 14034 ETV Verification Statement for the OGS device.

3.2.2 Sediment removal efficiency for surface loading rates between 40 L/min/m² and 1400 L/min/m² shall be based on linear interpolation of data between consecutive tested surface loading rates.

3.2.3 Sediment removal efficiency for surface loading rates less than the lowest tested surface loading rate of 40 L/min/m² shall be assumed to be identical to the sediment removal efficiency at 40 L/min/m². No extrapolation shall be allowed that results in a sediment removal efficiency that is greater than that demonstrated at 40 L/min/m².

3.2.4 Sediment removal efficiency for surface loading rates greater than the highest tested surface loading rate of 1400 L/min/m² shall assume zero sediment removal for the portion of flow that exceeds 1400 L/min/m², and shall be calculated using a simple proportioning formula, with 1400 L/min/m² in the numerator and the higher surface loading rate in the denominator, and multiplying the resulting fraction times the sediment removal efficiency at 1400 L/min/m².

The OGS device shall also have sufficient annual sediment storage capacity as specified and calculated in Section 2.1.

3.3 CANADIAN ETV or ISO 14034 ETV VERIFICATION OF SCOUR TESTING

The OGS device shall have Canadian ETV or ISO 14034 ETV Verification of third-party scour testing conducted in accordance with the Canadian ETV Program's **Procedure for Laboratory Testing of Oil-Grit Separators**.

3.3.1 To be acceptable for on-line installation, the OGS device must demonstrate an average scour test effluent concentration less than 10 mg/L at each surface loading rate tested, up to and including 2600 L/min/m².

3.4 LIGHT LIQUID RE-ENTRAINMENT SIMULATION TESTING

The OGS device shall have Canadian ETV or ISO 14034 ETV Verification of completed third-party Light Liquid

Stormceptor® **EF** Sizing Report

Re-entrainment Simulation Testing in accordance with the Canadian ETV **Program's Procedure for Laboratory Testing of Oil-Grit Separators**, with results reported within the Canadian ETV or ISO 14034 ETV verification. This re-entrainment testing is conducted with the device pre-loaded with low density polyethylene (LDPE) plastic beads as a surrogate for light liquids such as oil and fuel. Testing is conducted on the same OGS unit tested for sediment removal to assess whether light liquids captured after a spill are effectively retained at high flow rates.

3.4.1 For an OGS device to be an acceptable stormwater treatment device on a site where vehicular traffic occurs and the potential for an oil or fuel spill exists, the OGS device must have reported verified performance results of greater than 99% cumulative retention of LDPE plastic beads for the five specified surface loading rates (ranging 200 L/min/m² to 2600 L/min/m²) in accordance with the Light Liquid Re-entrainment Simulation Testing within the Canadian ETV Program's **Procedure for Laboratory Testing of Oil-Grit Separators**. However, an OGS device shall not be allowed if the Light Liquid Re-entrainment Simulation Testing was performed with screening components within the OGS device that are effective at retaining the LDPE plastic beads, but would not be expected to retain light liquids such as oil and fuel.

Appendix E External Reports



Geotechnical Investigation

Proposed Residential Development

100 Steacie Drive
Ottawa, Ontario

Prepared for Brigil.

Report PG5788-1 dated December 15, 2023

3.0 Method of Investigation

3.1 Field Investigation

Field Program

The field program for the current investigation was carried out on November 27, 2023. At that time, four (4) test pits were excavated to a maximum depth of 4.5 m below existing grade using an excavator. A previous investigation was conducted by others on site and consisted of sixteen (16) boreholes advanced to a maximum depth of 5.8 m below existing grade. The test hole locations from the current investigation were distributed in a manner to provide general coverage of the subject site and taking into consideration underground utilities and site features. The test hole locations are shown on Drawing PG5788-1 - Test Hole Location Plan included in Appendix 2.

All fieldwork was conducted under the full-time supervision of our personnel under the direction of a senior engineer from our geotechnical department. The test pitting procedure consisted of excavating to the required depths at the selected locations and sampling the overburden.

Sampling and In Situ Testing

Soil samples from the test pits from the current investigation were recovered from the side walls of the open excavation and all soil samples were initially classified on site. All samples were transported to our laboratory for further examination and classification. The depths at which the grab samples were recovered from the test pits are shown as 'G' on the Soil Profile and Test Data sheets in Appendix 1.

Undrained shear strength testing was carried out at regular depth intervals in cohesive soils using a vane apparatus.

The subsurface conditions observed in the test pits were recorded in detail in the field. The soil profiles are logged on the Soil Profile and Test Data sheets in Appendix 1 of this report.

Groundwater

The open hole groundwater infiltration levels were observed at the time of excavation at each test pit location. Our observations are presented in the Soil Profile and Test Data sheets in Appendix 1.

4.0 Observations

4.1 Surface Conditions

The subject site consists of an undeveloped site, characterized by dense vegetation and boulders and/or rock outcrops. It exhibits a gradual slope from north to south. Bedrock outcrop was observed in the center of the subjected site, within the footprint of the two buildings. To the north, the site is bordered by a railway, while an adjacent commercial building is situated to the east. To the west and south, the site is neighbored by a park and a residential development. Additionally, a high voltage overhead powerline traverses the southern portion of the site, and a multi-use pathway meanders between Steacie Drive, the park, and the residential development.

It should also be noted that an existing sanitary sewer crosses the site from south to north. Based on available information the sewer invert is located between 6.5 m to 8.0 m below ground surface.

4.2 Subsurface Profile

Overburden

Generally, the subsurface profile encountered at the test hole locations consists of a layer of 0.1 to 0.3 m thick topsoil, underlain by glacial till and/or hard brown silty clay, and occasionally dark brown fill composed of silty clay with sand gravel and cobbles. The glacial till generally consists of a stiff to hard, brown silty clay mixed with silty sand with some cobbles, gravel and boulders and was observed to extend to the bedrock surface.

Reference should be made to the Soil Profile and Test Data sheets in Appendix 1 for the details of the soil profile encountered at each test pits location.

Atterberg Limits Testing

Atterberg limits testing, as well as associated moisture content testing, was completed on select silty clay samples where encountered. The results of the Atterberg limits test are presented in Table 1 and on the Atterberg Limits Results sheet in Appendix 1. The results of the moisture content test are presented on the Soil Profile and Test Data Sheet in Appendix 1. The tested silty clay samples classify as inorganic silt of high plasticity (CL) in accordance with the Unified Soil Classification System.

Table 1 - Atterberg Limits Results						
Sample	Depth (m)	LL (%)	PL (%)	PI (%)	w (%)	Classification
TP 2-23 G6	2.3 to 2.4	46	21	25	46	CL
TP 3-23 G6	2.3 to 2.4	48	22	26	48	CL

Notes: LL: Liquid Limit; PL: Plastic Limit; PI: Plasticity Index; w: water content.
CL: Low-Plasticity Clay

Shrinkage Test

Linear shrinkage testing was completed on a sample recovered from 2.3 m depth from test pit TP 2-23 and yielded a shrinkage limit of 17.07 and a shrinkage ratio of 1.86.

Bedrock

Based on available geological mapping, the bedrock in the subject area consists primarily of quartzite, with an anticipated overburden thickness ranging across site from 1 to 10 m depth.

4.3 Groundwater

The groundwater infiltration was measured within the side walls of the test pits at the time of excavation on November 27, 2023. The measured open hole groundwater infiltration readings are presented in Table 2 below and in the Soil Profile and Test Data sheets in Appendix 1.

Table 2 - Summary of Groundwater Infiltration Readings				
Test Hole Number	Ground Surface Elevation (m)	Groundwater Level (m)	Groundwater Elevation (m)	Recording Date
TP 1-23	91.44	Dry	-	November 27, 2023
TP 2-23	87.13	2.5	84.63	
TP 3-23	86.99	4.0	82.99	
TP 4-23	87.50	1.4	86.10	

Note: Ground surface elevations at test hole locations are referenced to a geodetic datum.

It should be noted that the groundwater infiltration levels could be influenced by surface water infiltrating the upper soil profile. Long-term groundwater levels can also be estimated based on the observed colour and consistency of the recovered soil samples. Based on the groundwater infiltration readings and the soil sample observations, the long-term groundwater table can be expected at approximately 4 to 5 m below ground surface. Groundwater levels are subject to seasonal fluctuations and therefore may vary at the time of construction. The recorded groundwater infiltration levels are noted on the applicable Soil profile and Test Data sheets presented in Appendix 1.

5.0 Discussion

5.1 Geotechnical Assessment

From a geotechnical perspective, the subject site is suitable for the proposed development. The proposed multi-story residential building is anticipated to be founded over conventional shallow footings placed on an undisturbed, stiff silty clay bearing surface or on the bedrock surface.

Due to the presence of the bedrock outcrop observed in the middle of the subjected site, bedrock removal is anticipated to be required to complete the underground parking level and/or site servicing work. Line drilling and controlled blasting where large quantities of bedrock need to be removed may be required. The blasting operations should be planned and completed under the guidance of a professional engineer with experience in blasting operations.

Due to the presence of the silty clay layer, the subject site will have a permissible grade raise restriction. The permissible grade raise recommendations are discussed in Subsection 5.3.

The above and other considerations are discussed in the following sections.

5.2 Site Grading and Preparation

Stripping Depth

Topsoil and deleterious fill, such as those containing significant amounts of organic materials, should be stripped from under any buildings, paved areas, pipe bedding, and other settlement sensitive structures.

Bedrock Removal

Considering the bedrock composition found in that region, it is expected that line-drilling in conjunction with hoe-ramming and controlled blasting will be required to remove the bedrock. In areas of weathered bedrock and where only a small quantity of bedrock is to be removed, bedrock removal may be possible by hoe-ramming.

Adequate lateral support is provided to bedrock bearing medium when a plane extending down and out from the bottom edges of the footing at a minimum of 1H:6V (or flatter) passes only through sound bedrock or a material of the same or higher capacity as the bedrock, such as concrete.

A heavily fractured, weathered bedrock and/or overburden bearing medium will require a lateral support zone of 1H:1V (or flatter).

Permissible Grade Raise Restrictions

Based on the undrained shear strength values of the silty clay deposit encountered throughout the subject site, a permissible grade raise restriction of **1.5 m** is recommended in the immediate area of settlement sensitive structures and where silty clay is encountered at underside of footing elevations. A post-development groundwater lowering of 0.5 m was considered in our permissible grade raise restriction calculations.

If higher than permissible grade raises are required, preloading with or without a surcharge, lightweight fill and/or other measures should be investigated to reduce the risks of unacceptable long-term post construction total and differential settlements.

5.4 Design for Earthquakes

The site class for seismic site response can be taken as **Class C** for the foundations considered at this site. The soil underlying the subject site are not susceptible to liquefaction. A higher site class, such as Class A or B, may be achievable for foundations placed within 3 m of the bedrock surface. However, a site-specific shear wave velocity test is required to be completed to confirm the seismic site classification.

5.5 Slab-on-Grade and Basement Slab Construction

With the removal of all topsoil and deleterious materials within the footprint of the proposed buildings, an approved soil subgrade or bedrock surface, approved by Paterson personnel at the time of construction, is considered to be an acceptable subgrade surface on which to commence backfilling for the floor slab construction.

Where silty sand or glacial till is encountered below the slab, provisions should be made to proof-rolling the soil subgrade using heavy vibratory compaction equipment prior to placing any fill. Any soft areas should be removed and replaced with appropriate backfill material.

Flexible Pavement Structure

The flexible pavement structure presented in Table 5 and Table 6 should be used for driveways and car only parking areas and at grade access lanes and heavy loading parking areas.

Table 5 - Recommended Pavement Structure – Driveways Car Only Parking Areas	
Thickness (mm)	Material Description
50	Wear Course - HL-3 or Superpave 12.5 Asphaltic Concrete
150	BASE - OPSS Granular A Crushed Stone
300	SUBBASE - OPSS Granular B Type II
SUBGRADE - Either fill, in situ soil, or OPSS Granular B Type I or II material placed over in situ soil or fill	

Table 6 - Recommended Pavement Structure – Access Lanes	
Thickness (mm)	Material Description
40	Wear Course - HL-3 or Superpave 12.5 Asphaltic Concrete
50	Binder Course - HL-8 or Superpave 19.0 Asphaltic Concrete
150	BASE - OPSS Granular A Crushed Stone
400	SUBBASE - OPSS Granular B Type II
SUBGRADE - Either fill, in situ soil, select subgrade material or OPSS Granular B Type I or II material placed over in situ soil or fill	

Minimum Performance Graded (PG) 58-34 asphalt cement should be used for this project. If soft spots develop in the subgrade during compaction or due to construction traffic, the affected areas should be excavated and replaced with OPSS Granular B Type II material.

The pavement granular base and subbase should be placed in maximum 300 mm thick lifts and compacted to a minimum of 100% of the material's SPMDD using suitable compaction equipment.

7.0 Recommendations

For the foundation design data provided herein to be applicable that a material testing and observation services program is required to be completed.

The following aspects be performed by the geotechnical consultant:

- Review preliminary and detailed grading, servicing, and structural plan(s) from a geotechnical perspective.
- Review of the geotechnical aspects of the excavation contractor's shoring design, prior to construction, if applicable.
- Review of architectural plans pertaining to foundation and underfloor drainage systems and waterproofing details for elevator shafts.

For the foundation design data provided herein to be applicable, a material testing and observation services program is required to be completed. The following aspects be performed by Paterson:

- Review the bedrock stabilization and excavation requirements at the time of construction.
- Review and inspection of the installation of the foundation and underfloor drainage systems and elevator waterproofing.
- Observation of all bearing surfaces prior to the placement of concrete.
- Sampling and testing of the concrete and fill materials.
- Periodic observation of the condition of unsupported excavation side slopes in excess of 3 m in height, if applicable.
- Observation of all subgrades prior to backfilling.
- Field density tests to determine the level of compaction achieved.
- Sampling and testing of the bituminous concrete including mix design reviews.

A report confirming that these works have been conducted in general accordance with our recommendations could be issued upon the completion of a satisfactory inspection program by the geotechnical consultant. All excess soil must be handled as per *Ontario Regulation 406/19: On-Site and Excess Soil Management*.

8.0 Statement of Limitations

The recommendations made in this report are in accordance with our present understanding of the project. We request that we be permitted to review the grading plan once available and our recommendations when the drawings and specifications are complete.

A geotechnical investigation of this nature is a limited sampling of a site. The recommendations are based on information gathered at the specific test locations and can only be extrapolated to an undefined limited area around the test locations. The extent of the limited area depends on the soil, bedrock and groundwater conditions, as well the history of the site reflecting natural, construction, and other activities. Should any conditions at the site be encountered which differ from those at the test locations, we request notification immediately in order to permit reassessment of our recommendations.

The recommendations provided in this report are intended for the use of design professionals associated with this project. Contractors bidding on or undertaking the work should examine the factual information contained in this report and the site conditions, satisfy themselves as to the adequacy of the information provided for construction purposes, supplement the factual information if required, and develop their own interpretation of the factual information based on both their and their subcontractor's construction methods, equipment capabilities and schedules.

The present report applies only to the project described in this document. Use of this report for purposes other than those described herein or by person(s) other than Brigil or their agent(s) is not authorized without review by Paterson Group for the applicability of our recommendations to the altered use of the report.

Paterson Group Inc.



Fabrice Venadiambu, CPI, E.I.T.



Joey R. Villeneuve, M.A.Sc., P.Eng., ing.

Report Distribution:

- Brigil. (Digital copy)
- Paterson Group (1 copy)

With every community, we redefine what's possible.



Stantec is a global leader in sustainable engineering, architecture, and environmental consulting. The diverse perspectives of our partners and interested parties drive us to think beyond what's previously been done on critical issues like climate change, digital transformation, and future-proofing our cities and infrastructure. We innovate at the intersection of community, creativity, and client relationships to advance communities everywhere, so that together we can redefine what's possible.

Stantec Consulting Ltd.
300 - 1331 Clyde Avenue
Ottawa ON K2C 3G4
stantec.com