

Northwoods Phase 6 Transportation Impact Assessment

Step 1 Screening Report

Step 2 Scoping Report

Step 3 Strategy Report

Prepared for:

Mattamy Homes Ltd.
50 Hines Road, Suite 100
Ottawa ON K2K 2M5

Prepared by:



6 Plaza Court
Ottawa, ON K2H 7W1

March 2026

PN: 2025-017

Table of Contents

1	Screening	1
2	Existing and Planned Conditions	1
2.1	Proposed Development.....	1
2.2	Existing Conditions	3
2.2.1	Area Road Network.....	3
2.2.2	Existing Intersections.....	3
2.2.3	Existing Driveways	4
2.2.4	Cycling and Pedestrian Facilities.....	4
2.2.5	Existing Transit.....	7
2.2.6	Existing Area Traffic Management Measures.....	8
2.2.7	Existing Peak Hour Travel Demand.....	8
2.2.8	Collision Analysis.....	10
2.3	Planned Conditions.....	11
2.3.1	Changes to the Area Transportation Network	11
2.3.2	Other Study Area Developments.....	13
3	Study Area and Time Periods	14
3.1	Study Area	14
3.2	Time Periods.....	14
3.3	Horizon Years.....	14
4	Development-Generated Travel Demand	14
4.1	Mode Shares.....	14
4.2	Trip Generation	15
4.3	Trip Distribution.....	16
4.4	Trip Assignment.....	16
5	Exemption Review	18
6	Development Design	20
6.1	Design for Sustainable Modes.....	20
6.2	Circulation and Access.....	20
7	Parking.....	20
7.1	Parking Supply	20
8	Boundary Street Design.....	20
9	Transportation Demand Management	21
9.1	Context for TDM	21
9.2	Need and Opportunity.....	21
9.3	TDM Program	21
10	Access Intersection Design	21
10.1	Location and Design of Access.....	21
11	Summary of Improvements Indicated and Modifications Options.....	22
12	Conclusion	24

List of Figures

Figure 1: Area Context Plan	1
Figure 2: Concept Plan.....	2
Figure 3: Existing Driveways	4
Figure 4: Study Area Pedestrian Facilities	5
Figure 5: Study Area Cycling Facilities	5
Figure 6: Existing Pedestrian Volumes	6
Figure 7: Existing Cyclist Volumes	7
Figure 8: Existing Study Area Transit Service.....	8
Figure 9: Existing Study Area Transit Stops	8
Figure 10: Existing Traffic Counts	9
Figure 11: Study Area Collision Records.....	11
Figure 12: New Site Generation Auto Volumes.....	17
Figure 13: Pass-by Auto Volumes	18

Table of Tables

Table 1: Intersection Count Date.....	9
Table 2: Existing Intersection Operations.....	9
Table 3: Study Area Collision Summary, 2018-2022	10
Table 4: Summary of Collision Locations, 2018-2022.....	11
Table 5: TRANS Trip Generation Manual Recommended Mode Shares – Kanata/Stittsville.....	14
Table 6: Proposed Development Mode Shares.....	14
Table 7: Trip Generation Person Trip Rates by Peak Period.....	15
Table 8: Person Trip Generation by Peak Period.....	15
Table 9: Internal Capture Rates.....	15
Table 10: Trip Generation by Mode	16
Table 11: OD Survey Distribution – Kanata/Stittsville.....	16
Table 12: Trip Assignment	17
Table 13: Exemption Review	18
Table 14: Boundary Street MMLOS Analysis.....	21

List of Appendices

Appendix A – TIA Screening Form and Certification Form
Appendix B – Turning Movement Count Data
Appendix C – Synchro Intersection Worksheets – Existing Conditions
Appendix D – Collision Data
Appendix E – March Road at Buckbean Avenue Road Modification
Appendix F – TDM Checklist
Appendix G – Turning Templates
Appendix H – MMLOS Worksheets

1 Screening

This study has been prepared according to the City of Ottawa’s 2017 Transportation Impact Assessment (TIA) Guidelines, incorporating the 2023 Revision to Transportation Impact Assessment Guidelines. Accordingly, a Step 1 Screening Form has been prepared and is included as Appendix A, along with the Certification Form for the TIA Study PM. As shown in the Screening Form, a TIA is required, and this study has been prepared to support zoning bylaw amendment and site plan applications.

2 Existing and Planned Conditions

2.1 Proposed Development

The development site is located at 1020-1070 March Road and was recently rezoned General Mixed-Use (GM15). The subject site includes 48 townhome units and a mixed-use apartment dwelling containing 24 residential units and 7,585 sq. ft of commercial space, 110 vehicular parking spaces, and 39 bicycle parking spaces. Vehicular access is proposed on private access on Linseed Road. The anticipated full build-out horizon is 2029 with construction occurring in a single phase. The development is within the Kanata North Community Design Plan area. Figure 1 illustrates the study area context. Figure 2 illustrates the proposed concept plan.

Figure 1: Area Context Plan

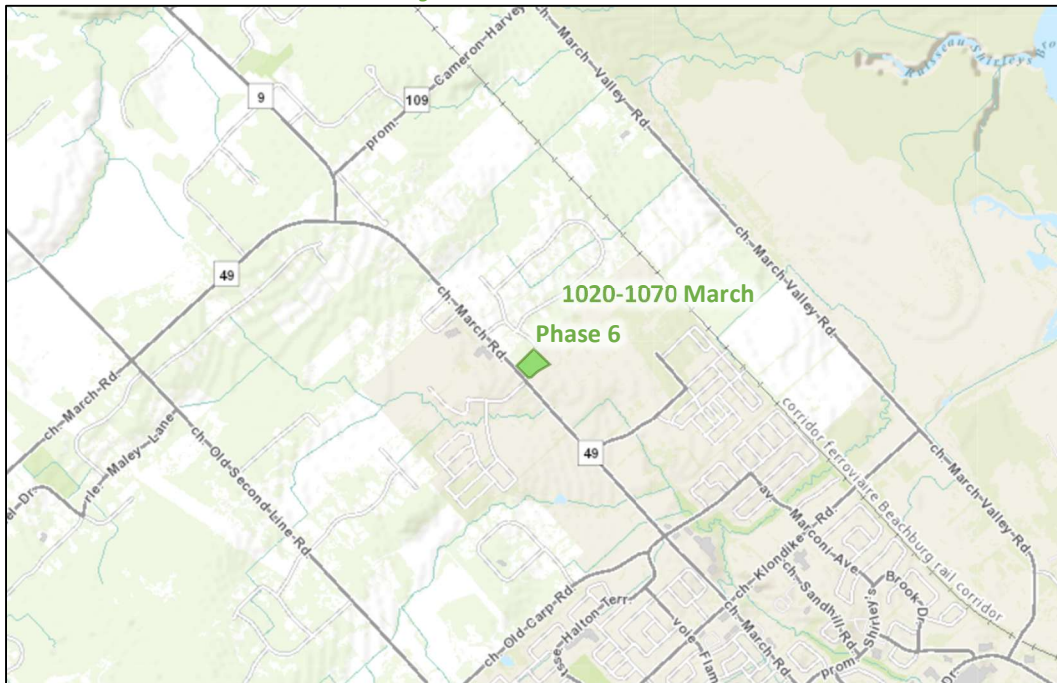

Source: <http://maps.ottawa.ca/geoOttawa/> Accessed: March 13, 2025

2.2 Existing Conditions

2.2.1 Area Road Network

March Road: March Road is a City of Ottawa arterial road with a two-lane rural cross-section with gravel shoulders and no pedestrian or cycling infrastructure approximately 260 metres north of Maxwell Bridge Road. The road widens to a four-lane road urban cross-section with bike lanes and sidewalks on both sides. The posted speed limit is 80 km/h and the City protected right-of-way is 46 meters from the northern limit of the urban area to Buckbean Avenue and 44.5 from Buckbean to 230 meters north of Maxwell Bridge Road, and 48.0 meters from that point to Klondike Road. March Road is designated as a trucking route within the Study Area.

Maxwell Bridge Road: Maxwell Bridge Road is a City of Ottawa collector road with a two-lane urban cross-section, including sidewalks on both sides of the road. The unposted limit is assumed to be 40 km/h based on the traffic calming design of new neighbourhoods, and the measured right-of-way is 24 meters.

Halton Terrace: Halton Terrace is a City of Ottawa collector road with a two-lane urban cross-section, including sidewalks on both sides of the road. The posted speed-limit is 40 km/h, and the measured right-of-way is 24.0 meters.

Invention Boulevard: Invention Boulevard is a City of Ottawa collector road with a two-lane cross-section, including a sidewalk on the south side and multi-use pathway on the north side of the road. The unposted limit is assumed to be 40 km/h based on the traffic calming design of new neighbourhoods, and the measured right-of-way is 26.0 meters.

Linseed Road: Linseed Road is a City of Ottawa collector road with a two-lane urban cross-section, including a sidewalk on the north side and a multi-use pathway on the south side of the road. The speed limit is assumed to be 40 km/h based on the traffic calming design of new neighbourhoods, and the measured right of way is 24.0 meters.

Buckbean Avenue: Buckbean Avenue is a City of Ottawa collector road with a two-lane urban cross-section, including a sidewalk on the north side and a multi-use pathway on the south side of the road. The unposted speed limit is assumed to be 40 km/h based on the traffic calming design of new neighbourhoods, and the measured right of way is 24.0 meters.

2.2.2 Existing Intersections

The existing intersections within one kilometre of the site have been summarized below:

<p>March Road at Invention Boulevard</p>	<p>The intersection of March Road at Invention Boulevard is currently an unsignalized intersection with stop control on the minor approach of Invention Boulevard. The northbound approach consists of a shared through/right-turn lane, and the southbound approach consists of a shared left-turn/through lane. The westbound approach consists of a shared left-turn/right-turn lane. No turn restrictions were noted.</p>
<p>March Road at Maxwell Bridge Road /Halton Terrace</p>	<p>The intersection of March Road at Maxwell Bridge Road/Halton Terrace at is a signalized intersection with auxiliary left-turn lanes on all four approaches. The northbound approach includes two through lanes, a bike lane, and a right-turn lane. The southbound approach includes a through lane, an auxiliary through lane, and an auxiliary right-turn lane. Both the eastbound and westbound approaches</p>

include a shared through/right-turn lane. No turn restrictions were noted.

2.2.3 Existing Driveways

Within 200 metres of the proposed site, driveways are present on the west side of March Road. Figure 3 illustrates the existing driveways.

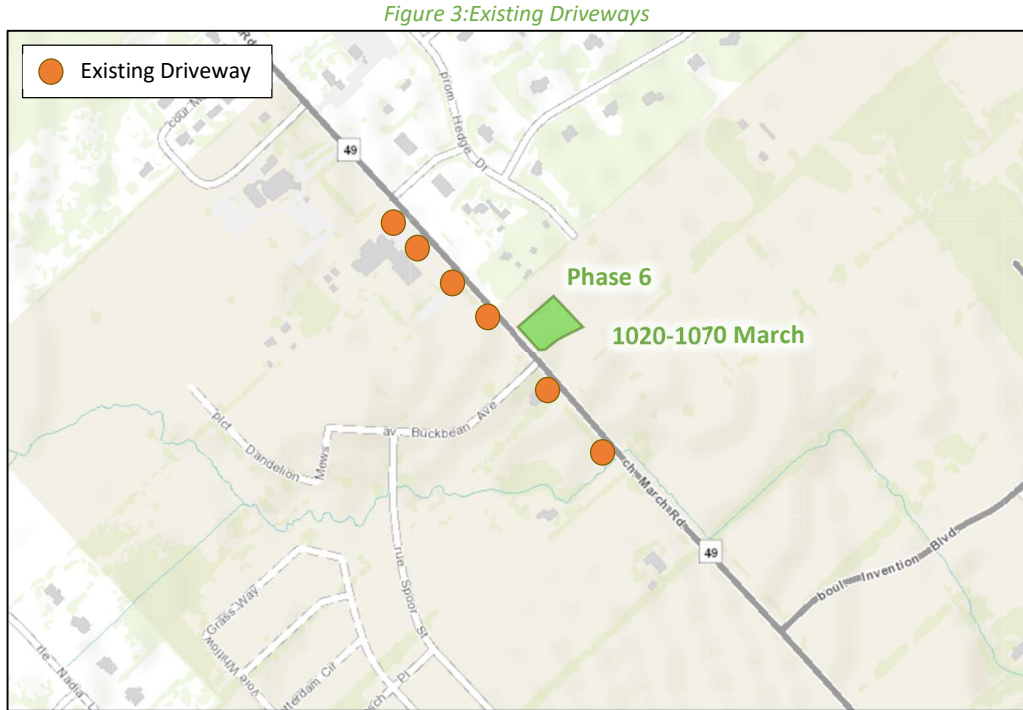

Source: <http://maps.ottawa.ca/geoOttawa/> Accessed: May 1, 2025

2.2.4 Cycling and Pedestrian Facilities

Figure 4 illustrates the pedestrian facilities in the study area and Figure 5 illustrates the cycling facilities.

Sidewalks are provided along both sides of Maxwell Bridge Road, Halton Terrace, and March Road from 110 metres north of Maxwell Bridge Road to the south, and along the east side of Invention Boulevard. Sidewalks are planned to be constructed on the north side of Buckbean Avenue and Linseed Road.

Cycling facilities include bike lanes are present on both sides of March Road from 110 metres north of Maxwell Bridge Road to the south and paved shoulders are present on both sides of March Road from that point to the north. March Road is identified as a spine route. A multi-use pathway is proposed to be constructed on the south side of Buckbean Avenue and Linseed Road.

Figure 6: Existing Pedestrian Volumes

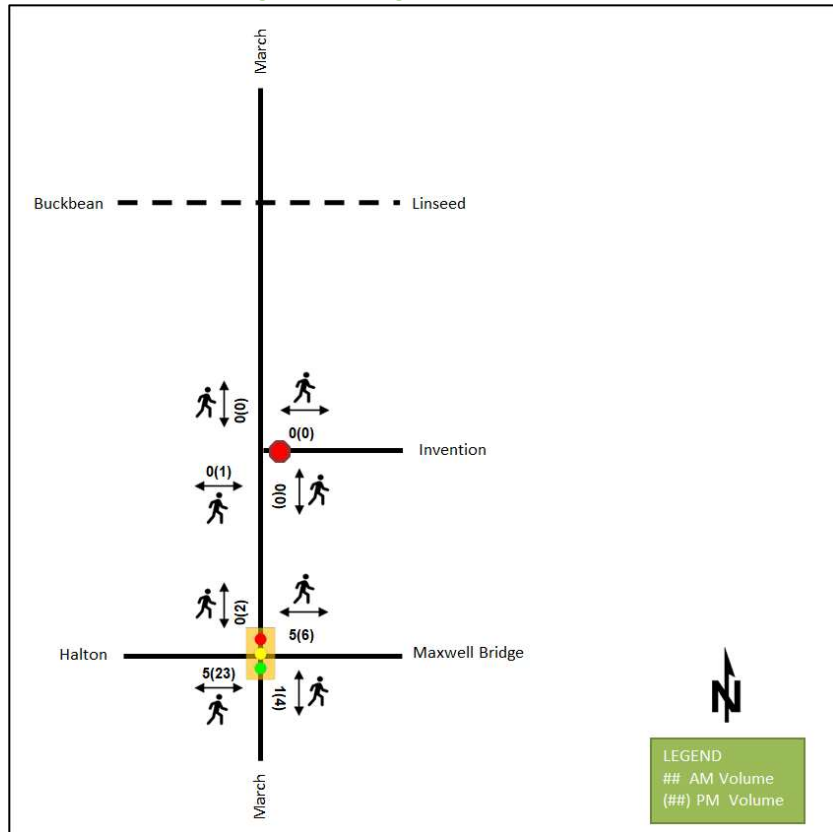
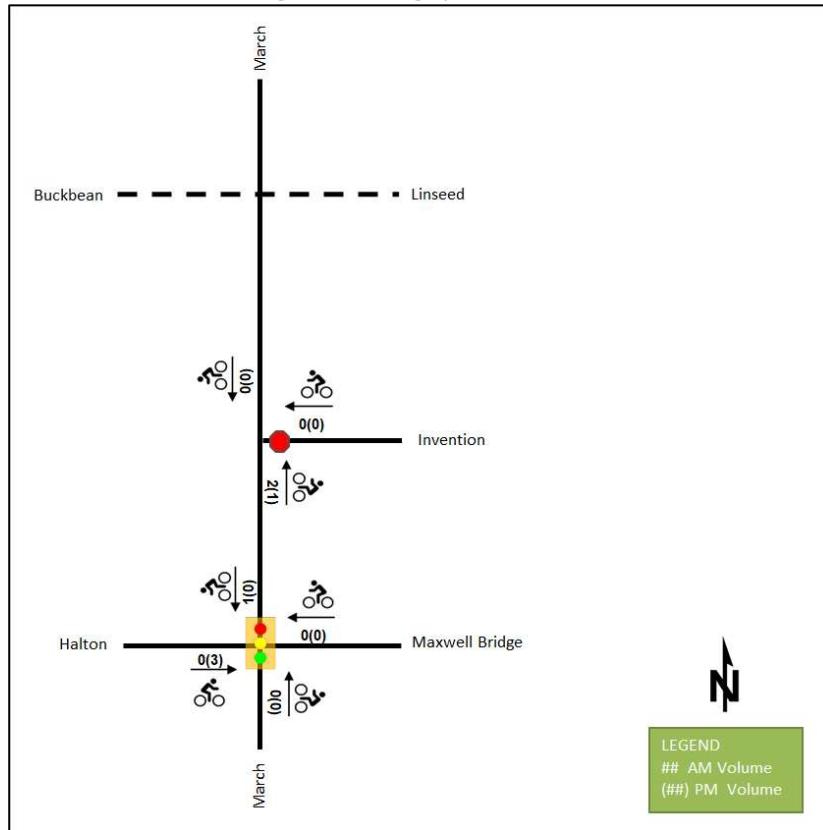

Figure 7: Existing Cyclist Volumes



2.2.5 Existing Transit

Figure 8 illustrates the transit system map in the study area and Figure 9 illustrates nearby transit stops. All transit information is from April 28, 2025, and is included for general information purposes and context to the surrounding area. Within the study area, the route #63 travels along Halton Terrace and Maxwell Bridge Road. The frequency of this route within proximity of the proposed site, based on April 28, 2025, is 15-minute service during peak hours, 30-minute service all day.

Figure 8: Existing Study Area Transit Service

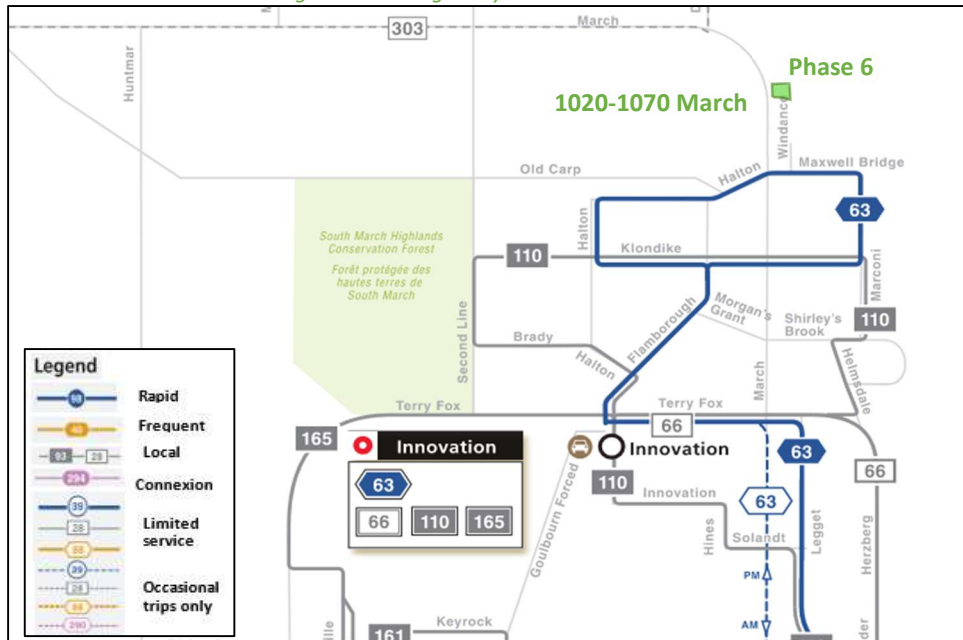

Source: <http://www.octranspo.com/> Accessed: April 28, 2025

Figure 9: Existing Study Area Transit Stops

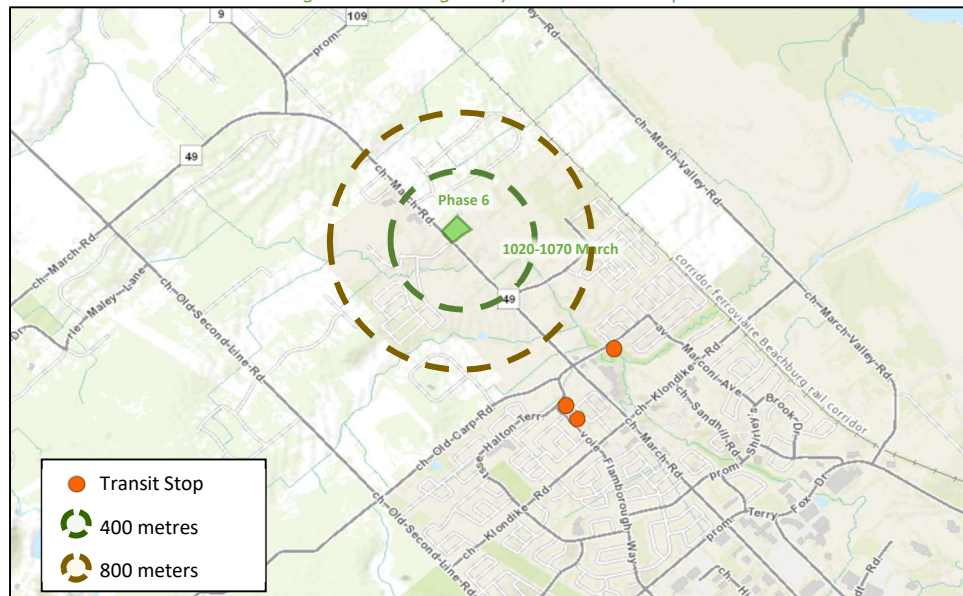

Source: <http://www.octranspo.com/> Accessed: March 13, 2025

2.2.6 Existing Area Traffic Management Measures

There are no existing area traffic management measures within the study area, however these will be included within the surrounding developing area.

2.2.7 Existing Peak Hour Travel Demand

Existing turning movement counts were acquired from the City of Ottawa, and third-party counts were collected by J & S Traffic Services. Table 1 summarizes the intersection count dates and sources.

Table 1: Intersection Count Date

Intersection	Count Date	Source
March Road at Invention Boulevard	Wednesday, February 05, 2025	City of Ottawa
March Road at Maxwell Bridge Road /Halton Terrace	Tuesday, March 18, 2025	J & S Traffic Services

Figure 10 illustrates the existing traffic counts and Table 2 summarizes the existing intersection operations. The level of service for signalized intersections is based on volume to capacity ratio (v/c) calculations for individual lane movements and MMLOS Guidelines weighted v/c methodology for the overall intersection, per direction from Transportation Engineering Services and average delay for unsignalized intersections. Detailed turning movement count data is included in Appendix B and the Synchro worksheets are provided in Appendix C.

Figure 10: Existing Traffic Counts

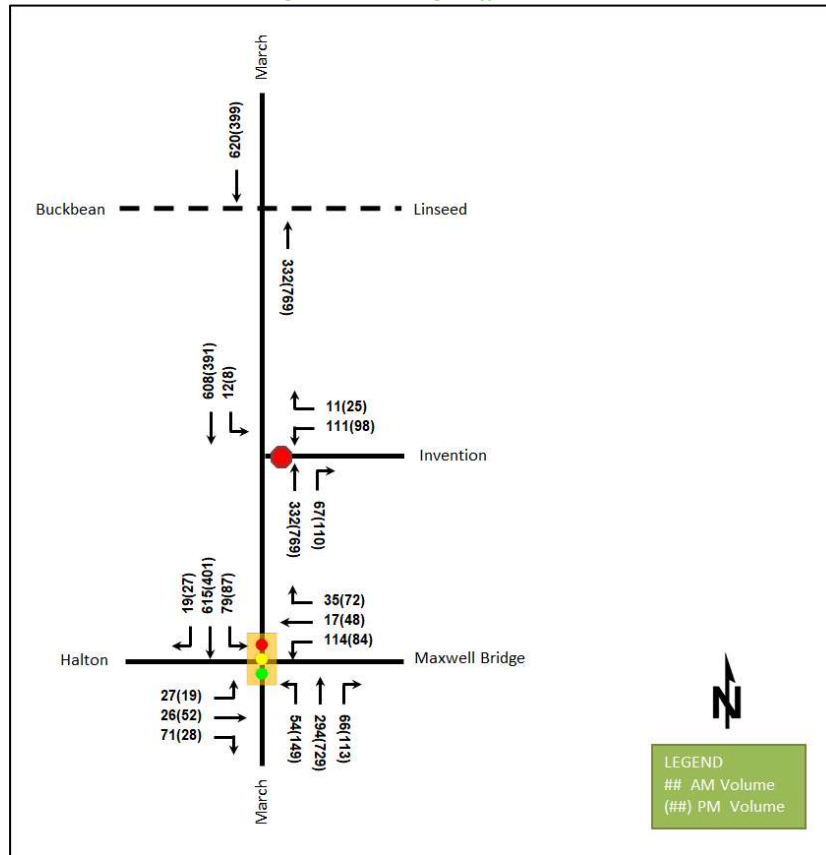

Table 2: Existing Intersection Operations

Intersection	Lane	AM Peak Hour				PM Peak Hour			
		LOS	V/C	Delay (s)	Q (95 th)	LOS	V/C	Delay (s)	Q (95 th)
March Road at Invention Boulevard <i>Unsignalized</i>	WB	A	0.07	8.7	1.5	F	0.77	71.6	37.5
	NBT/R	-	-	-	-	-	-	-	-
	SBT/L	A	0.04	7.3	0.8	B	0.01	10.2	0.0
	Overall	A	-	7.8	-	A	-	6.3	-

Intersection	Lane	AM Peak Hour				PM Peak Hour			
		LOS	V/C	Delay (s)	Q (95 th)	LOS	V/C	Delay (s)	Q (95 th)
March Road at Maxwell Bridge Road / Halton Terrace Signalized	EBL	B	0.64	72.7	39.5	A	0.17	51.4	12.4
	EBT/R	A	0.44	19.2	21.1	A	0.43	45.6	31.5
	WBL	A	0.40	58.8	26.7	B	0.65	74.0	39.0
	WBT/R	A	0.30	17.5	15.2	A	0.55	38.5	37.2
	NBL	A	0.06	4.6	6.4	A	0.25	5.5	19.3
	NBT	A	0.07	7.3	12.6	A	0.37	11.2	69.7
	NBR	A	0.03	0.0	0.0	A	0.13	2.1	7.9
	SBL	A	0.04	4.5	5.1	A	0.21	5.8	11.9
	SBT	A	0.10	8.0	18.0	A	0.21	10.4	37.6
	SBR	A	0.08	1.7	5.3	A	0.03	0.1	0.0
Overall	A	0.23	18.7	-	A	0.38	16.2	-	

Notes: Saturation flow rate of 1800 veh/h/lane
Queue is measured in metres
Peak Hour Factor = 0.90

Delay = average vehicle delay in seconds
m = metered queue
= volume for the 95th %ile cycle exceeds capacity

During both the AM and PM peak hours, the intersection of March Road at Maxwell Bridge Road/Halton Terrace operates well.

The intersection of March Road at Invention Boulevard operates well during the AM peak hour. During the PM peak hour, the westbound approach is subject to delays in excess of one minute.

Signalization warrants per OTM Book 12 – Traffic Signals were run for the intersection of March Road at Invention Boulevard for justifications 1-4 and the intersection did not meet the warrants for the existing conditions. It is understood that the signalization of this intersection is being explored by the City to address traffic safety concerns.

2.2.8 Collision Analysis

Collision data have been acquired from the City of Ottawa open data website (data.ottawa.ca) for five years prior to the commencement of this TIA for the surrounding study area road network. Table 3 summarizes the collision types and conditions in the study area, Figure 11 illustrates the area collisions, and Table 4 summarizes the total collisions for each of the locations analyzed. Collision data are included in Appendix D.

Table 3: Study Area Collision Summary, 2018-2022

		Number	%
Total Collisions		19	100%
Classification	Fatality	0	0%
	Non-Fatal Injury	0	0%
	Property Damage Only	19	100%
Initial Impact Type	Approaching	0	4%
	Angle	0	0%
	Rear end	5	30%
	Sideswipe	2	9%
	Turning Movement	1	4%
	SMV Unattended	0	0%
	SMV Other	11	52%
	Other	0	0%
Road Surface Condition	Dry	8	43%
	Wet	5	26%
	Loose Snow	3	17%
	Slush	0	0%

		Number	%
Total Collisions		19	100%
	Packed Snow	1	4%
	Ice	1	4%
	Loose sand or gravel	1	4%
	Unknown	0	0%
Pedestrian Involved		0	0%
Cyclists Involved		0	0%

Figure 11: Study Area Collision Records



Table 4: Summary of Collision Locations, 2018-2022

Intersections / Segments	Number	%
March Road between Maxwell Road & Maxwell Bridge Road	19	100%

The segment of March Road between Maxwell Road and Maxwell Bridge Road had a total of 19 collisions during the 2018-2022 time period, all of which involved property damage only. The collision types are most represented by SMV other with 11 collisions, rear end with five, sideswipe with two, and turning movement with one. Weather conditions are considered to be a contributing factor to the collisions as over 51% of the collisions on this segment occurred during non-day conditions. SMV other collisions are typical of rural arterial.

Road Safety Action Plan and the intersection RMA report (RMA-2022-TPD-051) noted the signalization of March Road and Buckbean Avenue is to address cycling safety.

2.3 Planned Conditions

2.3.1 Changes to the Area Transportation Network

2.3.1.1 Transportation Master Plan (2025)

The Transportation Master Plan (2025) includes a Capital Infrastructure Plan identifying transportation investment to support the forecasted growth and strategic connectivity and livability targets for the City. It also identifies

committed projects, and a subset of priority projects that are expected to be implemented by 2046 based on current affordability assumptions. Area projects anticipated to impact travel in the study area that are included within the Capital Infrastructure Plan are:

- Transit Network
 - Needs-Based
 - Median bus rapid transit from Eagleson-March Station to Buckbean Avenue (Kanata North Transitway)
- Road Network
 - Priority
 - March Road Widening from two to four lanes between Maxwell Bridge Road and Buckbean Avenue

2.3.1.2 Kanata North Urban Expansion Area Community Design Plan (CDP)

The Kanata North Urban Expansion Area CDP proposed that March Road will extend the median Bus Rapid (BRT) facility, following the results of the EA completed for March Road. The widening of March Road is included in the City of Ottawa's 2025 TMP within the Priority Road Network, and the extension of a Bus Rapid Transit facility is identified in the Need-Based Transit Network but is not included in the Priority Transit Network.

The ultimate and interim cross-sections for March Road considered in the CDP include northbound and southbound cycletracks.

2.3.1.3 Kanata North Transitway EA

The study of Kanata North Transitway was initially identified in 2008 TMP and envisioned to run along the March Road corridor from approximately Highway 417 to Maxwell Bridge Road. Council has since approved the functional design for the Kanata North Transitway between the March-Egleson Interchange at Highway 417 and 240 meters north of Maxwell Bridge Road, including a median Bus Rapid Transit (BRT) facility, transitway stations at major intersections, and connections to Park and Ride facilities. To proceed with the implementation of the project, the previously approved 2014 EA requires an EA Addendum to assess the validity of the original study's assumptions. This addendum is forthcoming and will include an assessment of connecting the median BRT facilities to the planned transit corridor through the Kanata North Urban Expansion Area (KNUEA) lands. The 2025 TMP includes a median BRT facility on March Road, from Corkstown Road to Terry Fox Drive, within the Priority Transit Network with implementation expected by 2046.

2.3.1.4 March Road and Buckbean Avenue Signalized Intersection

A roadway modification for the new signalized intersection at March Road and Buckbean Avenue was approved by Council in January 2025 with auxiliary left-turn lanes on all approaches and a northbound auxiliary right-turn lane with concrete sidewalks on all corners of the intersection with crosswalks on all sides. New one-way cycletracks on either side of March Road and one-way cross-rides on the east and west legs are proposed. New two-way multi-use pathway connections on the southeast and southwest corners of the intersection are also proposed. The project proposed new medians on the east and west legs of the intersection. Construction is scheduled for 2025/2026. The proposed road modification is included in Appendix E.

2.3.1.5 March Road and Invention Boulevard Intersection

It is understood that the March Road at Invention Boulevard intersection will be signalized to address existing safety concerns along March Road. It is anticipated that the design will be completed in 2026.

2.3.2 Other Study Area Developments

910 March Road

The proposed development application includes 390 residential units and 501 square meters of ground floor commercial space. The development is expected to generate 91 AM and 102 PM new peak hour two-way vehicle trips. The build-out horizon is assumed to be 2028. (CGH Transportation, 2024)

936 March Road

The proposed development application includes approximately 900 units, split between townhouse and detached units. The development was initially anticipated to be built out by 2023 and to generate 418 AM and 534 PM peak hour two-way auto trips. (CGH Transportation, 2020)

927 March Road

The proposed development application includes 19 single family homes, 32 townhomes, 1,857 apartment units and 4,253 square meters of commercial space constructed in seven phases. Phase 1 was initially anticipated to be built out by 2024 and includes three mid-rise residential buildings with 414 units, two high-rise residential buildings with 388 units, a SMW, and commercial space. Phase 2 is anticipated to be built out by 2025 and includes 32 townhomes and a park block. Phase 3 is expected to be built out by 2026 and includes 19 single family homes. Phase 4 is anticipated to be built out by 2028 and includes three low-rise residential buildings with 285 units. Phase 5 is expected to be built out by 2030 and includes two low-rise residential buildings with 206 units. Phase 6 is anticipated to be built out by 2032 and includes two low-rise residential buildings with 237 units, and Phase 7 is expected to be built out by 2034 and includes two low-rise residential buildings with 327 units. The development is expected to generate 630 AM and 722 PM new peak hour two-way vehicle trips. (Stantec, 2023)

1020 and 1070 March Road

The proposed development includes a plan of subdivision for 297 single family homes, 315 townhomes, 116 apartment units, one school, and two commercial parcels. The school and residential development are expected to generate 409 AM and 428 PM new peak hour two-way vehicle trips. The commercial parcels considered within the TIA (which includes the parcel considered within this study) were forecast to generate 64 PM new peak hour two-way trips. The build-out horizon is assumed to be 2031. (Stantec, 2020)

1015 March Road

The proposed development application includes a draft plan of subdivision and zoning bylaw amendment for a school and 15,000 square feet commercial space. The development is expected to generate 353 AM and 136 PM new peak hour two-way vehicle trips. The build-out horizon is assumed to be 2026. (Novatech, 2022)

1053, 1075, and 1145 March Road

The proposed development includes 295 single detached dwellings, 314 townhouse dwellings, and 216 multi-unit residential dwellings. The development is expected to generate 338 AM and 414 PM peak two-way vehicle trips. The build-out horizon is assumed to be 2026. (Novatech, 2018)

South March Urban Expansion Area

The proposed development includes 1,325 single detached homes, 1,325 townhomes, and 1,430 multi-unit residential. The development is estimated to generate 1,491 AM and 1,613 PM peak hour two-way vehicle trips. The build-out horizon is assumed to be 2046. (Novatech, 2025)

1104 Halton Terrace

The proposed development includes 103 apartment dwellings and is expected to generate 20 AM and 20 PM new peak hour two-way vehicle trips. The development was initially anticipated to be built out by 2024. (Novatech, 2021)

3 Study Area and Time Periods

3.1 Study Area

The study area will include the intersections of March Road at Invention Boulevard, March Road at Maxwell Bridge Road /Halton Terrace, and the intersection of site accesses at future Buckbean Avenue extension (Linseed Road).

The boundary road will be March Road, and no screenlines are present within proximity to the site and none will be evaluated as part of this study.

3.2 Time Periods

As the proposed development is primarily residential units within a larger residential context, the weekday AM and PM peak hours will be examined.

3.3 Horizon Years

The anticipated build-out year is 2029. As a result, the full build-out plus five years horizon year is 2034.

4 Development-Generated Travel Demand

4.1 Mode Shares

Examining the mode shares recommended in the TRANS Trip Generation Manual (2020) for the subject district, derived from the most recent National Capital Region Origin-Destination survey (OD Survey), the existing average district mode shares by land use for Kanata/Stittsville have been summarized in Table 5.

Table 5: TRANS Trip Generation Manual Recommended Mode Shares – Kanata/Stittsville

Travel Mode	Multi-Unit (Low-Rise)		Commercial Generator	
	AM	PM	AM	PM
Auto Driver	52%	58%	81%	73%
Auto Passenger	14%	17%	12%	22%
Transit	22%	17%	5%	1%
Cycling	0%	0%	0%	0%
Walking	11%	8%	2%	4%
Total	100%	100%	100%	100%

Given the implementation of the March Road BRT corridor from Terry Fox Drive to Maxwell Bridge Road is not included in the Priority Transit Network, current mode shares are proposed to be adjusted to reflect a 10% shift from transit mode to auto mode for the proposed residential land use. The proposed modified mode share targets are summarized in Table 6.

Table 6: Proposed Development Mode Shares

Travel Mode	Multi-Unit (Low-Rise)		Commercial Generator	
	AM	PM	AM	PM
Auto Driver	63%	68%	81%	73%
Auto Passenger	14%	17%	12%	22%
Transit	12%	7%	5%	1%
Cycling	0%	0%	0%	0%

Travel Mode	Multi-Unit (Low-Rise)		Commercial Generator	
	AM	PM	AM	PM
Walking	11%	8%	2%	4%
Total	100%	100%	100%	100%

4.2 Trip Generation

This TIA has been prepared using the vehicle and person trip rates for the residential dwellings using the TRANS Trip Generation Manual (2020) and the vehicle trip rates and derived person trip rates for commercial component from the ITE Trip Generation Manual 11th Edition (2021) using the City-prescribed conversion factor of 1.28. Table 7 summarizes the person trip rates for the proposed residential land uses for each peak period and the person trip rates for the non-residential land uses by peak hour.

Table 7: Trip Generation Person Trip Rates by Peak Period

Land Use	Land Use Code	Peak Period	Vehicle Trip Rate	Person Trip Rates
Multi-Unit Low-Rise	220 (TRANS)	AM	-	1.35
		PM	-	1.58
Land Use	Land Use Code	Peak Hour	Vehicle Trip Rate	Person Trip Rates
Strip Retail Plaza (<40k sq. ft.)	822 (ITE)	AM	2.36	3.02
		PM	6.59	8.44

Using the above person trip rates, the total person trip generation has been estimated. Table 8 summarizes the total person trip generation for the residential land uses and for the non-residential land uses.

Table 8: Person Trip Generation by Peak Period

Land Use	Units	AM Peak Period			PM Peak Period		
		In	Out	Total	In	Out	Total
Multi-Unit Low-Rise	72	29	68	97	64	50	114
Land Use	GFA	AM Peak Hour			PM Peak Hour		
		In	Out	Total	In	Out	Total
Strip Retail Plaza (<40k sq. ft.)	7,589 sq ft	14	9	23	32	32	64

Internal capture rates from the ITE Trip Generation Handbook 3rd Edition have been assigned to the development’s retail component for mixed-use developments. The rates summarized in Table 9 represent the percentage of trips to/from the retail use based on the residential component.

Table 9: Internal Capture Rates

Land Use	AM		PM	
	In	Out	In	Out
Residential to/from Shopping Centre	17%	14%	10%	26%

Typical pass-by reductions applied to the retail land use’s trip generation are 40%, which is derived from the recommended value presented in the ITE Trip Generation Manual 11th Edition (2021) for the most similar land use with a recommended rate, “Retail (40k – 150k sq. ft.)” The subject development is located on the northeast and southeast quadrants of the future arterial-collector intersection with access on the collector road. Given this proximity, and that the site access is onto the lower classification roadway, the application of the pass-by percentage to the future Linseed Road would not be considered to reflect the expected pass-by component of the site trips. Due to this context, the analysis will forgo the application of diverted trips and will apply the 40% pass-by to the major movements at the intersection of March Road at Buckbean Avenue/Linseed Road.

Using the above mode share targets, the internal capture and pass-by rates, and the person trip rates, the person trips by mode have been projected. Trip generation by peak hour has been forecasted using the prescribed peak

period conversion factors presented in the TRANS Trip Generation Manual (2020) for the residential component. Table 10 summarizes the residential trip generation and the non-residential trip generation by mode and peak hour.

Table 10: Trip Generation by Mode

Travel Mode		AM Peak Hour				PM Peak Hour			
		Mode Share	In	Out	Total	Mode Share	In	Out	Total
Multi-Unit (Low-Rise)	Auto Driver	63%	9	20	29	68%	19	15	34
	Auto Passenger	14%	2	5	7	17%	4	4	8
	Transit	12%	2	5	7	7%	2	2	4
	Cycling	0%	0	0	0	0%	0	0	0
	Walking	11%	2	4	6	8%	3	2	5
	Total	100%	15	34	49	100%	28	23	51
Strip Retail Plaza (<40k sq. ft.)	Auto Driver	81%	6	3	9	73%	13	11	24
	Auto Passenger	12%	1	1	2	22%	6	5	11
	Transit	5%	1	0	1	1%	0	0	0
	Cycling	0%	0	0	0	0%	0	0	0
	Walking	2%	0	0	0	4%	1	1	2
	Total	100%	8	4	12	100%	20	17	37
	Internal Capture	varies	-2	-1	-3	varies	-3	-8	-11
	Pass-by	40%	-4	-3	-7	40%	-8	-7	-15
Total	Auto Driver	-	15	23	38	-	32	26	58
	Auto Passenger	-	3	6	9	-	10	9	19
	Transit	-	3	5	8	-	2	2	4
	Cycling	-	0	0	0	-	0	0	0
	Walking	-	2	4	6	-	4	3	7
	Total	-	23	38	61	-	48	40	88
	Internal Capture	varies	-2	-1	-3	varies	-3	-8	-11
	Pass-by	40%	-4	-3	-7	40%	-8	-7	-15

As shown above, a total of 38 AM and 58 PM new peak hour two-way vehicle trips are projected as a result of the proposed development.

4.3 Trip Distribution

To understand the travel patterns of the subject development, the OD Survey has been reviewed to determine the travel for the residential component, and these patterns were applied based on the build-out of Kanata/Stittsville Table 11 below summarizes the distributions.

Table 11: OD Survey Distribution – Kanata/Stittsville

To/From	Residential % of Trips
North	5%
South	60%
East	30%
West	5%
Total	100%

4.4 Trip Assignment

Using the distribution outlined above, turning movement splits, and access to major transportation infrastructure, the trips generated by the site have been assigned to the study area road network. Table 12 summarizes the

proportional assignment to the study area roads, and Figure 12 illustrates the new site generated volumes. Figure 13 illustrates the pass-by volumes.

Table 12: Trip Assignment

To/From	Via
North	5% March Rd (N)
South	60% March Rd (S)
East	30% March Rd (S)
West	5% March Rd (N)
Total	100%

Figure 12: New Site Generation Auto Volumes

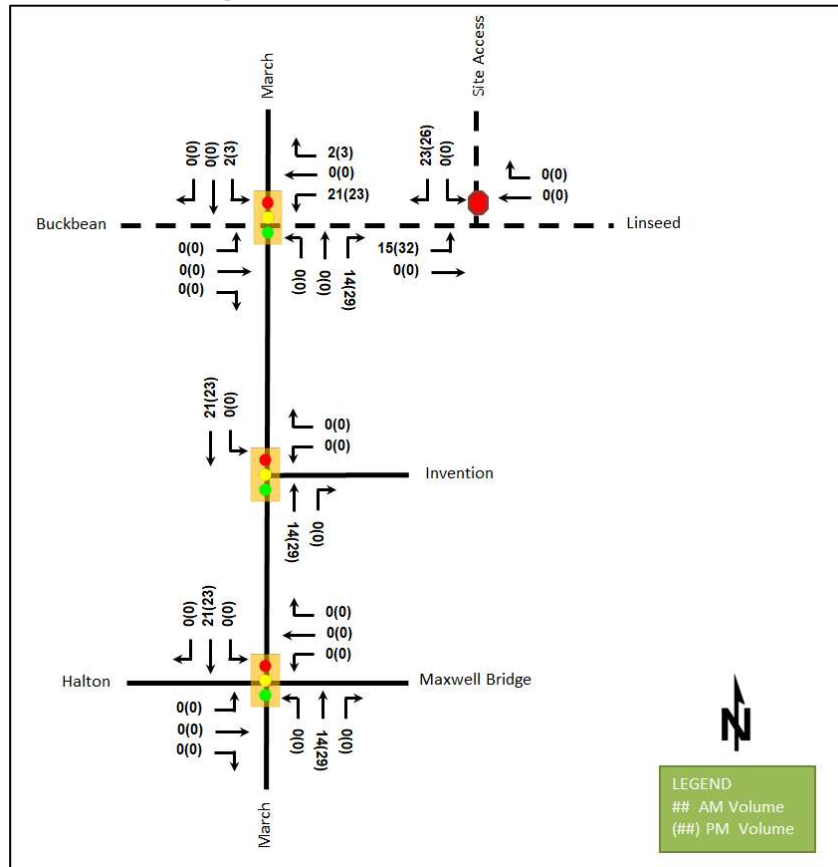
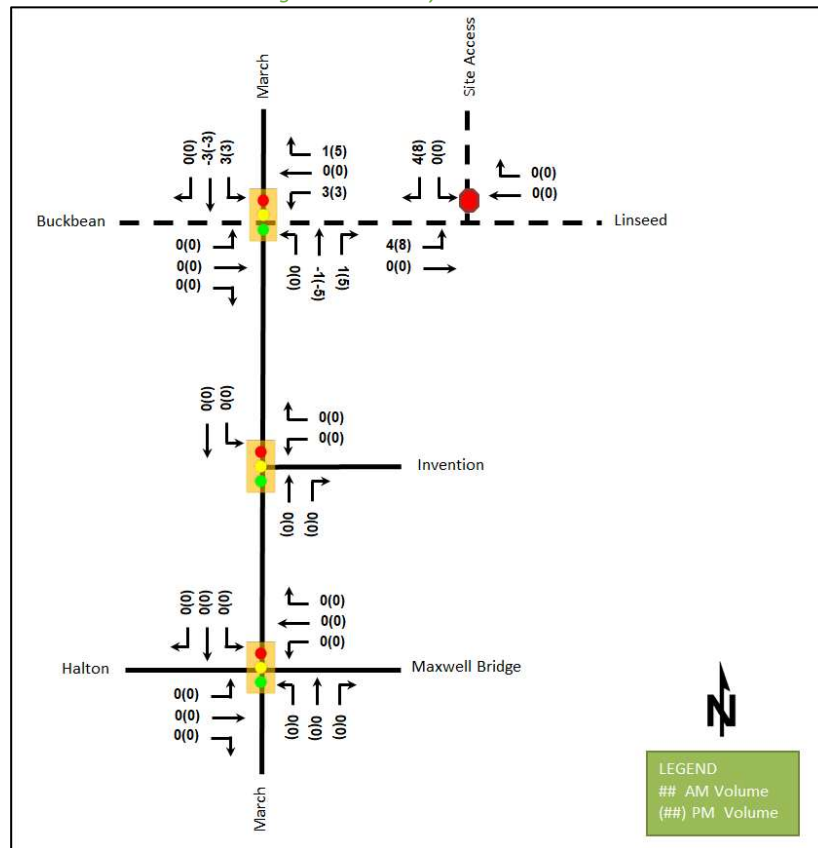

Figure 13: Pass-by Auto Volumes



5 Exemption Review

Table 13 summarizes the exemptions for this TIA.

Table 13: Exemption Review

Module	Element	Explanation	Exempt/Required
Site Design and TDM			
Development Design	4.1.2 Circulation and Access	Only required for site plan and zoning by-law applications	Required
	4.1.3 New Street Networks	Only required for plans of subdivision	Exempt
Parking	4.2.1 Parking Supply	Only required for site plan and zoning by-law applications	Required
Boundary Street Design		All applications	Required
Transportation Demand Management	All Elements	Only required when the development generates more than 60 person-trips	Required
Network Impact			
Background Network Travel Demand	All Elements	Only required when one or more other Network Impact Modules are triggered when the development generates more than 75 auto or transit trips	Exempt

Module	Element	Explanation	Exempt/Required
Demand Rationalization		Only required when one or more other Network Impact Modules when the development generates more than 75 auto trips	Exempt
Neighbourhood Traffic Calming	4.6.1 Adjacent Neighbourhoods	<p>If the development meets all of the following criteria along the route(s) site generated traffic is expected to utilize between an arterial road and the site's access:</p> <ol style="list-style-type: none"> 1. Access to Collector or Local; 2. "Significant sensitive land use presence" exists, where there is at least two of the following adjacent to the subject street segment: <ul style="list-style-type: none"> • School (within 250m walking distance); • Park; • Retirement / Older Adult Facility (i.e. long-term care and retirement homes); • Licenced Child Care Centre; • Community Centre; or • 50%, or greater, of adjacent property along the route(s) is occupied by residential lands and a minimum of 10 occupied residential units are present on the route. 3. Application is for Zoning By-Law Amendment or Draft Plan of Subdivision; 4. At least 75 site-generated auto trips; 5. Site Trip Infiltration is expected. Site traffic will increase peak hour vehicle volumes along the route by 50% or more. 	Exempt
Transit	4.7.1 Transit Route Capacity	Only required when the development generates more than 75 transit trips	Exempt
	4.7.2 Transit Priority Requirements	Only required when the development generates more than 75 auto trips	Exempt
Network Concept		Only required when proposed development generates more than 200 person-trips during the peak hour in excess of equivalent volume permitted by established zoning	Exempt
Intersection Design	4.4.1-2/4.9.1 Intersection Control	Only required when the development generates more than 75 auto trips	Exempt

Module	Element	Explanation	Exempt/Required
	4.4.3/4.9.2 Intersection Design	Only required when the development generates more than 75 auto trips	Exempt

6 Development Design

6.1 Design for Sustainable Modes

The proposed development consists of stacked townhome units and a residential building with a ground floor commercial component. A sidewalk is provided along the north side of Linseed Road, and bus stops are located approximately 50 metres east of the site access. Walkways with a width of 1.8-metres are proposed throughout the site to connect between the buildings, parking, and the surrounding pedestrian and transit facilities. The infrastructure TDM checklist is provided in Appendix F.

Bicycle parking is located in surface racks interspersed throughout the site and cycling access is via the drive aisles.

6.2 Circulation and Access

Vehicular and cycling access is provided via a 6.7-metre-wide two-way full-movement access on Linseed Road. Garbage facilities are located to the north of the surface parking lot. The Molok garbage collection truck can be accommodated on site and emergency services can access the site drive aisles. Turning templates are provided in Appendix G.

7 Parking

7.1 Parking Supply

A total of 110 vehicle parking spaces are proposed to serve the site, including 72 residential parking spaces, 14 residential visitor parking spaces and 24 commercial parking spaces. According to the parking provisions from the Zoning By-Law, 1.0 parking spaces per unit for residents, 0.2 parking spaces per unit for visitors and 3.4 per 100m² of commercial GFA are required, resulting in the minimum need for 110 vehicle parking spaces with 72 spaces for residents, 14 spaces for residential visitors and 24 commercial parking spaces. Therefore, the site meets the minimum requirements.

According to the Zoning By-Law, the minimum bicycle parking provision is 0.5 bike spaces per unit and 1 bike space per 250m² of GFA, requiring in 39 bicycle parking spaces. The site provides a total of 39 bicycle parking spaces, which meets the minimum bicycle parking requirement.

A total of 5 accessible parking spaces are required for the site, including two Type A and three Type B. These have been provided.

8 Boundary Street Design

Table 14 summarizes the MMLOS (2015 methodology) analysis for the boundary streets of March Road and Linseed Road. March Road has been considered with a median bus rapid transit in the future conditions and Linseed Road reflects the subdivision design. The boundary street analysis is based on the policy area of “Developing Community”. The MMLOS worksheets has been provided in Appendix H.

Table 14: Boundary Street MMLOS Analysis

Segment		Pedestrian LOS		Bicycle LOS		Transit LOS		Truck LOS	
		PLOS	Target	BLOS	Target	TLOS	Target	TrLOS	Target
March Road	Ex.	F	C	F	C	N/A	B	C	D
	Fut.	D	C	A	C	A	B	A	D
Linseed Road	Fut.	B	A	A	B	D	D	-	-

March Road will not meet the pedestrian LOS targets in the existing and future conditions. To meet the theoretical PLOS targets, the operating speed would need to be reduced to 50-60 km/h.

March Road will not meet the bicycle LOS targets in the existing conditions although the boundary street will meet the BLOS targets in the future conditions once the Kanata North Transitway is completed.

March Road will meet the transit LOS target in the future conditions.

Linseed Road will not meet the pedestrian LOS targets in the future conditions. To meet the theoretical PLOS targets, a speed reduction to 30 km/h is required. Linseed Road will meet the bicycle and transit LOS targets.

9 Transportation Demand Management

9.1 Context for TDM

The subject site has been assumed to rely predominantly on auto modes due to the implementation of bus rapid transit facilities beyond the study horizons. Overall, the modal shares are likely to be achieved and supporting TDM measures should be provided.

The subject site is within the Kanata North Community Design Plan area.

The total number of bedrooms within the development is subject to the finalized layouts of the stacked townhomes and the final unit breakdown of the mixed-use apartment building. No age restrictions are noted.

9.2 Need and Opportunity

The subject site has been assumed to rely predominantly on auto travel and those assumptions have been carried through the analysis. The risks of not meeting these mode shares are low due to the increased auto modes assumed.

9.3 TDM Program

The “suite of post occupancy TDM measures” has been summarized in the TDM checklists for the residential land uses. The checklist is provided in Appendix F. The key TDM measures recommended to be included is the unbundling of parking cost from purchase/rental costs. Given that bus service typically lags development and early servicing is not appropriate for the small scale of the subject development, no additional measures are considered applicable to the site. It is furthermore noted that the site will benefit from any TDM early servicing measures employed for the adjacent community.

10 Access Intersection Design

10.1 Location and Design of Access

The site access is proposed to be two-way and to permit full movements. The access is located approximately 37.0 metres from the eastern property line, and approximately 86.0 metres from March Road, and 106.0 metres from Tonic Crescent. The Geometric Design Guide for Canadian Roads (TAC, 2017) suggests a minimum corner clearance of 25.0 metres for driveways along collector roads from adjacent signalized intersections and 20.0 metres from

stop control intersection and thus the site access meets this guideline. The offset is furthermore measured to be approximately 70.0 metres from the intersecting March Road, and per the Private Approach By-Law, the site access is required to be 30.0 metres from this point, given the property is within 46 metres of an arterial, which is being met. The access also meets the 3.0-metre offset requirement from the adjacent property line.

The access is proposed to be 6.7 metres-wide at its typical width and 24.0 metres at the curb line with corner radii of 8.65 metres. The maximum width of a two-way access from the Private Approach By-Law is 9.0 metres, applied to both the street (right-of-way) line as well as the roadway edge. However, the application of this standard is not possible at the roadway edge given the minimum driveway width (6.0 metres from the Zoning By-Law) and minimum curb radii (standard 5.0 metres) would exceed this dimension. Therefore, the proposed driveway width is recommended to be approved, and 6.5 metres corner radii are recommended based on turning templates, resulting in an access width of 19.7 metres at the curb line.

The throat length to the first on-site conflict is approximately 32.0 metres. The TAC Geometric Design Guidelines requires a throat length of 8 metres for apartment land use with fewer than 100 units on a collector road. Therefore, the throat length requirement is met.

11 Summary of Improvements Indicated and Modifications Options

The following summarizes the analysis and results presented in this TIA report:

Proposed Site and Screening

- The proposed site includes 48 townhome units, a mixed-use apartment building with 24 units, 7,585 sq. ft of commercial space, 110 vehicle parking spaces, and 39 bicycle parking spaces
- The proposed access configuration comprises a two-way full-movement access on Linseed Road
- The development is proposed to be completed as a single phase by 2029
- The site is located within the Kanata North Community Design Plan area

TIA Screening and Exemptions

- The TIA Screening form indicated a design review component was required due to location and safety triggers
- The exemption review for the TIA did not require new street networks, background network travel demand, demand rationalization, neighbourhood traffic calming review, transit review, network concept review, intersection control review or intersection design review

Existing Conditions

- March Road is an arterial road, and Maxwell Bridge Road, Halton Terrace, and Invention Boulevard are collector roads in the study area
- Future roadways include Linseed Road and Buckbean Avenue as collector roads
- Sidewalks are provided on both sides of Maxwell Bridge Road, Halton Terrace, and March Road from 110 metres north of Maxwell Bridge Road to the south, and along the east side of Invention Boulevard
- Sidewalks are planned to be constructed on the north side of Buckbean Avenue and Linseed Road
- Bike lanes are present on both sides of March Road from 110 metres north of Maxwell Bridge Road to the south and paved shoulders are present on both sides of March Road from that point to the north
- A multi-use pathway is proposed to be constructed on the south side of Buckbean Avenue and Linseed Road

- During both the AM and PM peak hours, the study area intersections overall operations are acceptable with capacity issues noted at the intersection of March Road at Invention Boulevard
- The collisions are predominantly SMV other collisions, which are typical of rural arterials

Planned Conditions

- Median bus rapid transit from Eagleson-March Station to Buckbean Avenue (Kanata North Transitway) is identified as a needs-based project within the TMP Transit Network
- March Road Widening from two to four lanes between Maxwell Bridge Road and Buckbean Avenue is identified a road priority project within the TMP Road Network
- The construction of the signalized intersection of March Road at Buckbean Avenue is scheduled for 2025/2026
- The intersection of March Road at Invention Boulevard is anticipated to be signalized and the design will be completed in 2026

Development Generated Travel Demand

- The proposed development is forecasted produce 61 two-way people trips during the AM peak hour and 88 two-way people trips during the PM peak hour
- Of the forecasted people trips, 38 two-way trips will be vehicle trips during the AM peak hour, and 58 two-way trips will be vehicle trips during the PM peak
- Of the forecasted trips, 60% are anticipated to travel south, 30% to the east, and 5% to both the west and north

Development Design

- The proposed development consists of stacked townhome units and a residential building with a ground floor commercial component
- A sidewalk is provided along the north side of Linseed Road, and bus stops are located approximately 50 metres east of the site access
- Walkways are proposed throughout the site to connect between the buildings, parking, and connections to pedestrian and transit facilities
- Bicycle parking is located in surface racks interspersed throughout the site and cycling access is via the drive aisles
- Vehicular and cycling access is provided via a two-way full-movement access on Linseed Road
- The Molok garbage collection truck can be accommodated on site and emergency services can access the site drive aisles

Parking

- The site is proposed to include 110 vehicle parking spaces and 39 bicycle parking spaces
- The proposed development meets the minimum vehicle and bicycle parking requirements from the Zoning By-Law

Boundary Street Design

- March Road will not meet the pedestrian LOS targets in the existing and future conditions
- To meet the theoretical PLOS targets, a speed reduction to 50-60 km/h is required

- March Road will not meet the bicycle LOS targets in the existing conditions although the boundary street will meet the BLOS targets in the future conditions once the Kanata North Transitway is completed
- Linseed Road will not meet the pedestrian LOS targets in the future conditions and a speed reduction to 30 km/h is required to meet the theoretical PLOS targets
- Linseed Road will meet the bicycle and transit LOS targets

TDM

- Supportive TDM measures to be included within the proposed development should include:
 - Unbundle parking cost from purchase or rental costs

Intersection Design

- The access is proposed to be 6.7 metres-wide at its typical dimension and a minimum curb radius of 6.5 metres are recommended based on turning templates
- The access meets the offset requirement from the adjacent property line and from the adjacent road right-of-way from the Private Approach By-Law
- Throat length and corner clearance meet the TAC suggested minimum values

12 Conclusion

It is recommended that, from a transportation perspective, the proposed development applications proceed.

Prepared By:

Reihaneh Azhdar

Reihaneh Azhdar
Transportation Engineering, Intern

Reviewed By:



Andrew Harte, P.Eng.
Senior Transportation Engineer

Appendix A

TIA Screening Form and PM Certification Form

City of Ottawa 2023 Revisions to 2017 TIA Guidelines
Step 1 - Screening Form

Date: 2025-11-03
Project Number: 2025-017
Project Reference: Northwood Ph 6

1.1 Description of Proposed Development	
Municipal Address	1070 March Road
Description of Location	East side of March Road, block located to the north the future Linseed Road
Land Use Classification	Rural Countryside Zone (RU, RU[114r])
Development Size	48 stacked townhomes, 24 mixed-use residential units, and 7,585 sq.ft mixed-use retail
Accesses	One private access on Linseed Road
Phase of Development	Single
Buildout Year	2029 (estimated)
TIA Requirement	Design Review Component

1.2 Trip Generation Trigger	
Land Use Type	Multi-Family (Low-Rise)
Development Size	72 Units
Trip Generation Trigger	No

1.3 Location Triggers	
Does the development propose a new driveway to a boundary street that is designated as part of the Transit Priority Network, Rapid Transit network or Cross-Town Bikeways?	Yes
Is the development in a Hub, a Protected Major Transit Station Area (PMTSA), or a Design Priority Area (DPA)?	No
Location Trigger	Yes

1.4. Safety Triggers		
Are posted speed limits on a boundary street 80 km/hr or greater?	Yes	
Are there any horizontal/vertical curvatures on a boundary street limits sight lines at a proposed driveway?	No	
Is the proposed driveway within the area of influence of an adjacent traffic signal or roundabout (i.e. within 300 m of intersection in rural conditions, or within 150 m of intersection in urban/ suburban conditions)?	Yes	Accounting for the planned signalization of March Road and Buckbean Avenue, currently proceeding through RMA and design.
Is the proposed driveway within auxiliary lanes of an intersection?	Yes	Future westbound left-turn lane at March Road.
Does the proposed driveway make use of an existing median break that serves an existing site?	No	
Is there is a documented history of traffic operations or safety concerns on the boundary streets within 500 m of the development?	No	Road Safety Action Plan and the intersection RMA report (RMA-2022-TPD-051) note the signalization of March Road and Buckbean Avenue is to address cycling safety. No data is available for 2024, the City has noted concerns at the unsignalized intersection of March Road and Invention Boulevard
Does the development include a drive-thru facility?	No	
Safety Trigger	Yes	



Certification Form for TIA Study PM

TIA Plan Reports

On April 14, 2022, the Province's Bill 109 received Royal Assent providing legislative direction to implement the More Homes for Everyone Act, 2022 aiming to increase the supply of a range of housing options to make housing more affordable. Revisions have been made to the TIA guidelines to comply with Bill 109 and streamline the process for applicants and staff.

Individuals submitting TIA reports will be responsible for all aspects of development-related transportation assessment and reporting, and undertaking such work, in accordance and compliance with the City of Ottawa's Official Plan, the Transportation Master Plan and the Transportation Impact Assessment (2017) Guidelines.

By submitting the attached TIA report (and any associated documents) and signing this document, the individual acknowledges that they meet the four criteria listed below.

CERTIFICATION

I have reviewed and have a sound understanding of the objectives, needs and requirements of the City of Ottawa's Official Plan, Transportation Master Plan and the Transportation Impact Assessment (2017) Guidelines; (Update effective July 2023)

I have a sound knowledge of industry standard practice with respect to the preparation of transportation impact assessment reports, including multi modal level of service review;

I have substantial experience (more than 5 years) in undertaking and delivering transportation impact studies (analysis, reporting and geometric design) with strong background knowledge in transportation planning, engineering or traffic operations; and

I am either a licensed or registered¹ professional in good standing, whose field of expertise

is either transportation engineering

or transportation planning.

¹ License of registration body that oversees the profession is required to have a code of conduct and ethics guidelines that will ensure appropriate conduct and representation for transportation planning and/or transportation engineering works.

Dated at _____ this _____ day of _____, 20____.
(City)

Name :

Professional title:



Signature of individual certifier that s/he/they meet the above criteria

Office Contact Information (Please Print)

Address:

City / Postal Code:

Telephone / Extension:

Email Address:

Stamp



Revision Date: June 2023

Appendix B

Turning Movement Counts

Turning Movement Count - Study Results

INVENTION BLVD @ MARCH RD

Survey Date: Wednesday, February 05, 2025

WO No: 42560

Start Time: 07:00

Device: Miovision

Full Study Diagram

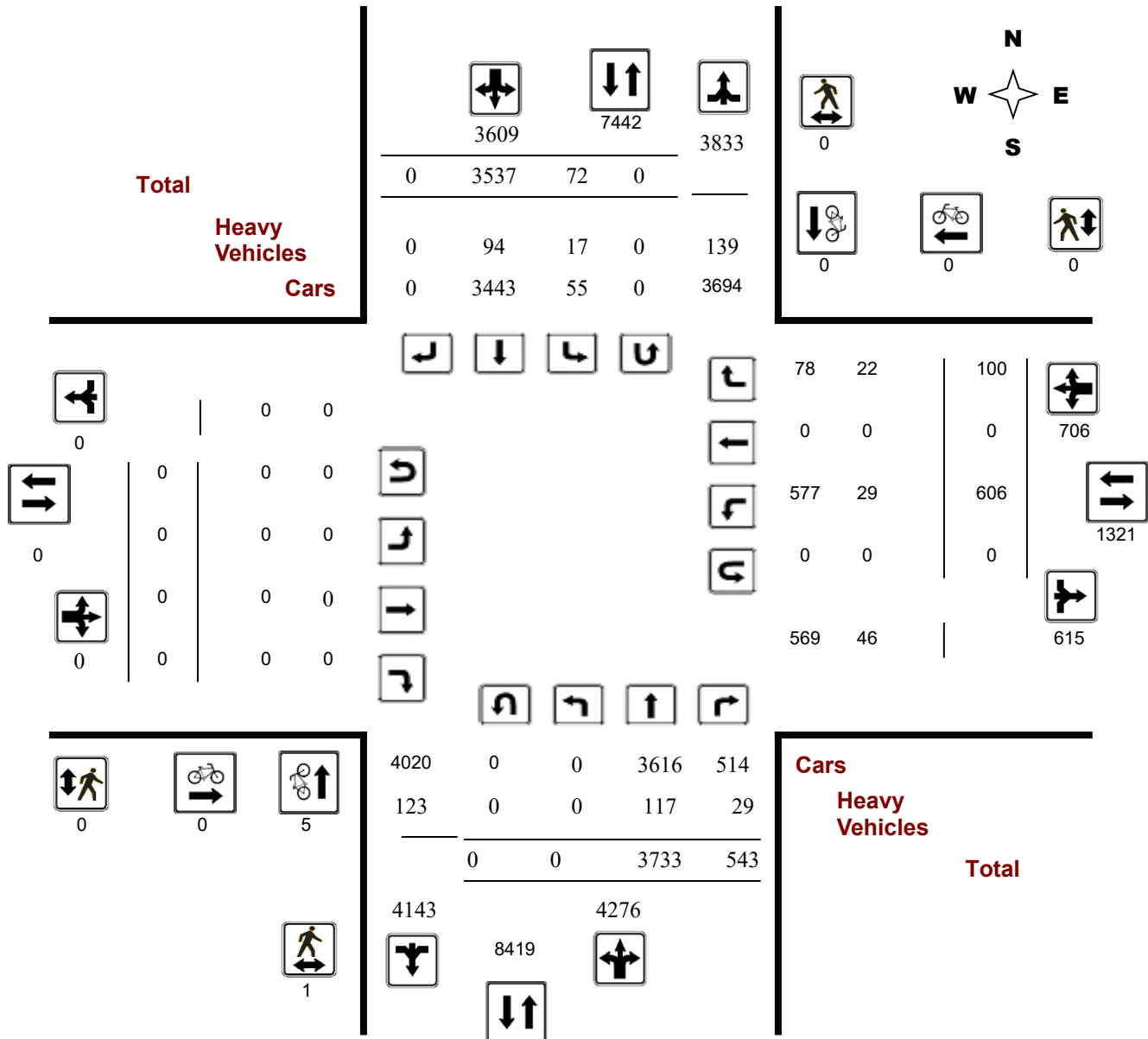

Turning Movement Count - Study Results

INVENTION BLVD @ MARCH RD

Survey Date: Wednesday, February 05, 2025

WO No: 42560

Start Time: 07:00

Device: Miovision

Full Study Peak Hour Diagram

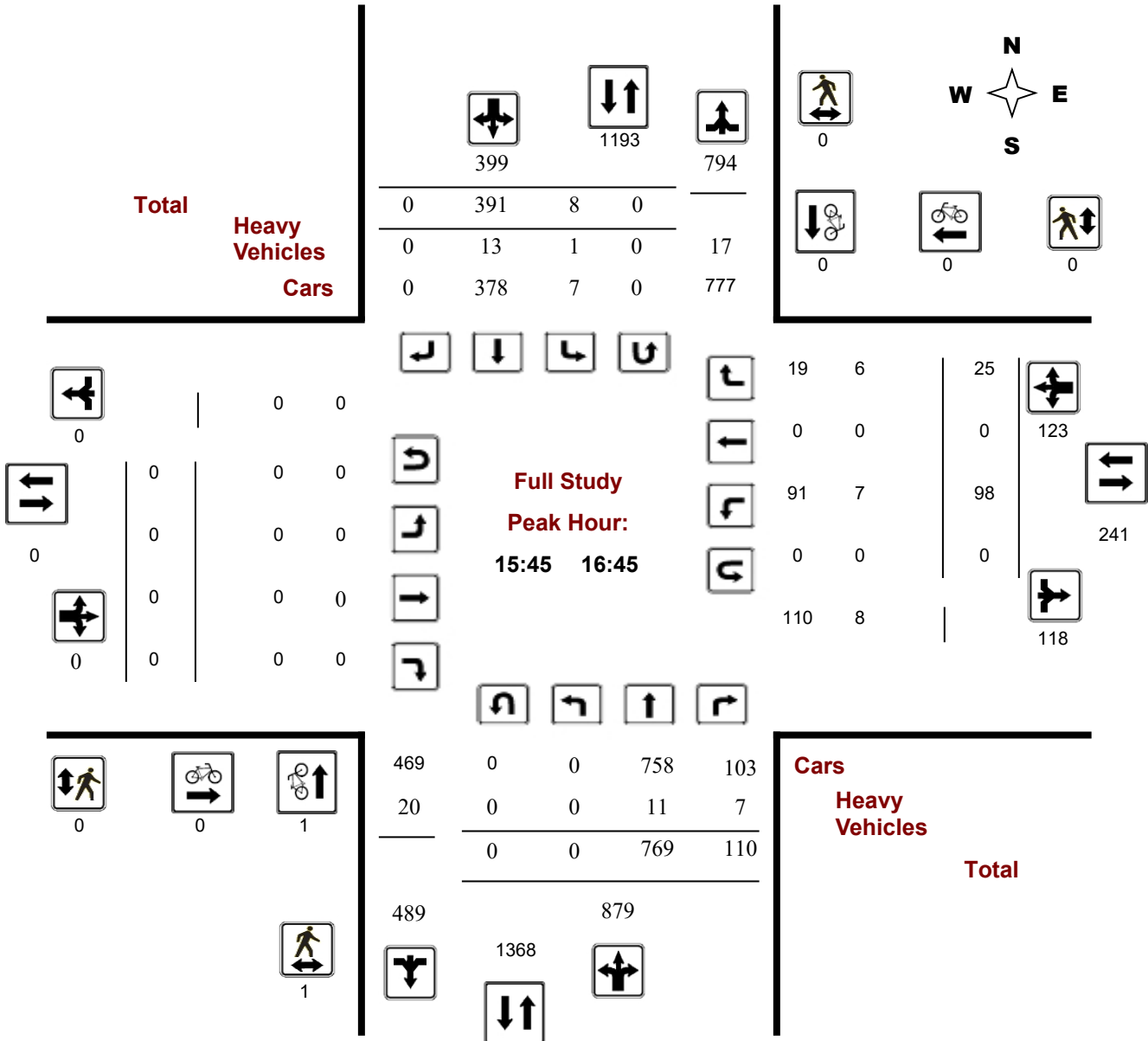

Turning Movement Count - Study Results

INVENTION BLVD @ MARCH RD

Survey Date: Wednesday, February 05, 2025

WO No: 42560

Start Time: 07:00

Device: Miovision

AM Period Peak Hour Diagram

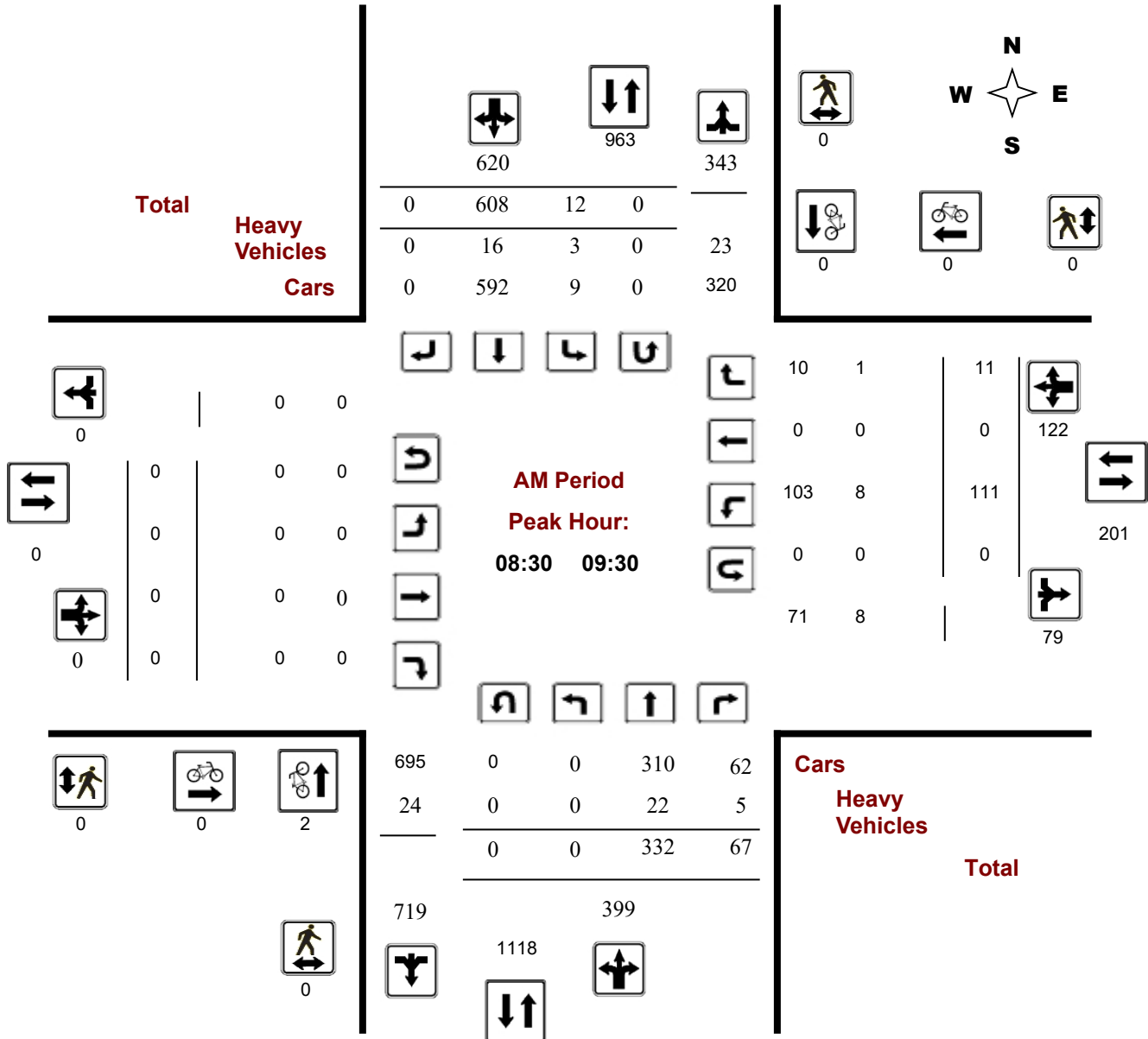

Turning Movement Count - Study Results

INVENTION BLVD @ MARCH RD

Survey Date: Wednesday, February 05, 2025

WO No: 42560

Start Time: 07:00

Device: Miovision

MD Period Peak Hour Diagram

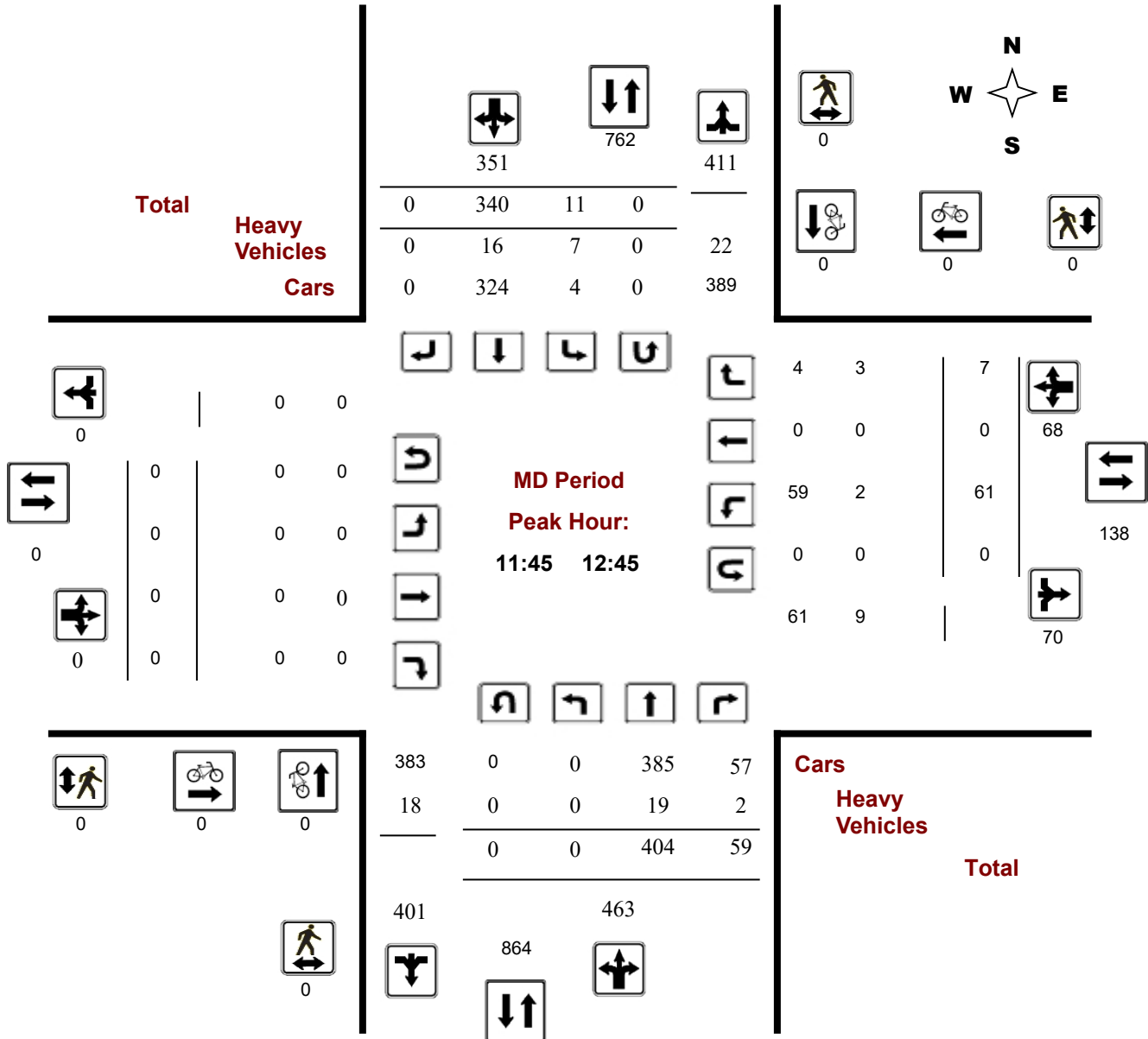

Turning Movement Count - Study Results

INVENTION BLVD @ MARCH RD

Survey Date: Wednesday, February 05, 2025

WO No: 42560

Start Time: 07:00

Device: Miovision

PM Period Peak Hour Diagram

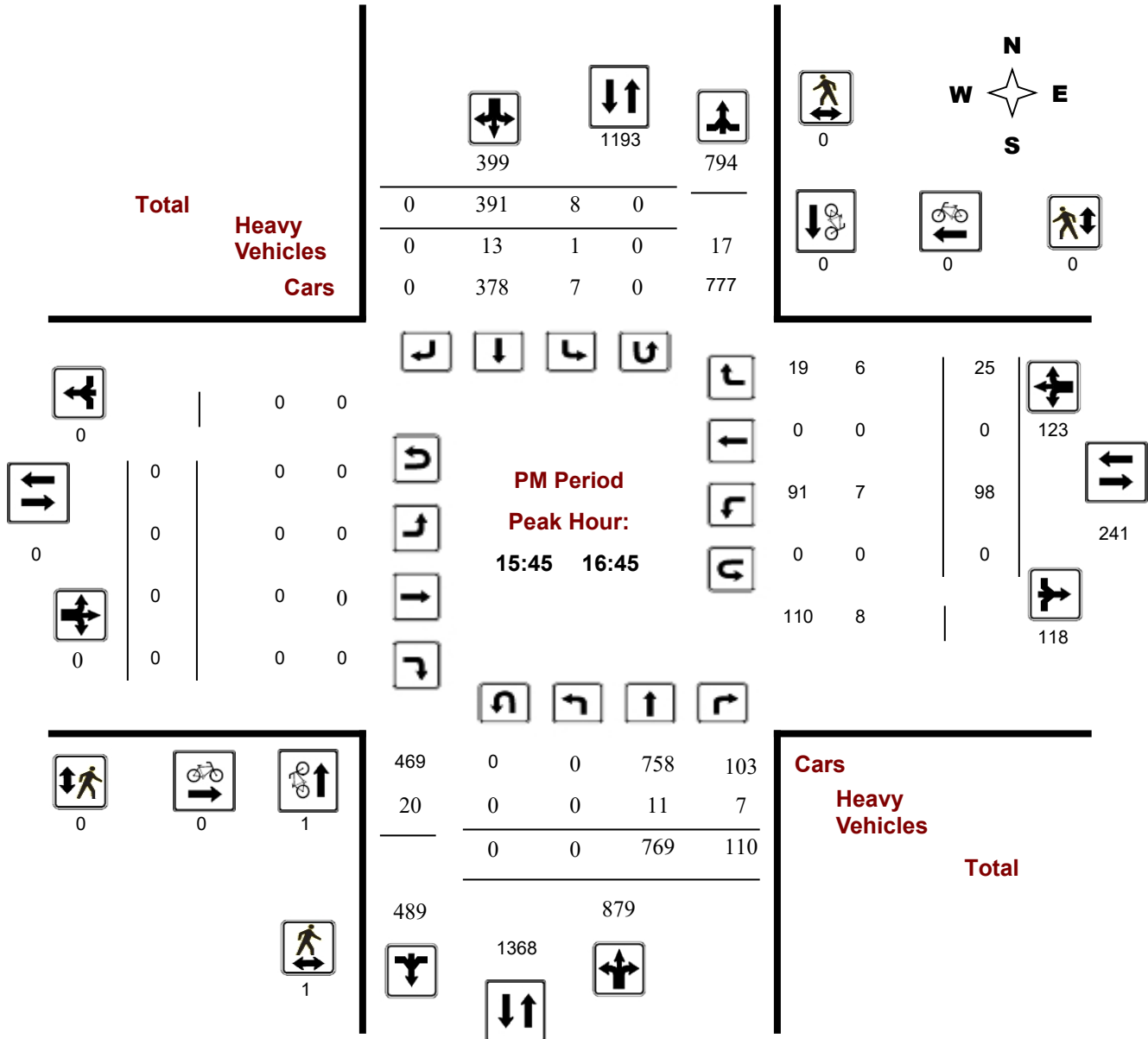



Transportation Services - Traffic Services

Turning Movement Count - Study Results

INVENTION BLVD @ MARCH RD

Survey Date: Wednesday, February 05, 2025

WO No: 42560

Start Time: 07:00

Device: Miovision

Full Study Summary (8 HR Standard)

Survey Date: Wednesday, February 05, 2025

Total Observed U-Turns
 Northbound: 0 Southbound: 0
 Eastbound: 0 Westbound: 0

AADT Factor
 1.00

Period	Northbound				Southbound				STR TOT	Eastbound				Westbound				STR TOT	Grand Total
	LT	ST	RT	NB TOT	LT	ST	RT	SB TOT		LT	ST	RT	EB TOT	LT	ST	RT	WB TOT		
07:00 08:00	0	248	41	289	11	607	0	618	907	0	0	0	0	63	0	9	72	72	979
08:00 09:00	0	273	48	321	8	620	0	628	949	0	0	0	0	85	0	12	97	97	1046
09:00 10:00	0	322	62	384	10	534	0	544	928	0	0	0	0	99	0	6	105	105	1033
11:30 12:30	0	373	49	422	10	343	0	353	775	0	0	0	0	54	0	7	61	61	836
12:30 13:30	0	375	57	432	8	333	0	341	773	0	0	0	0	43	0	12	55	55	828
15:00 16:00	0	636	93	729	10	379	0	389	1118	0	0	0	0	78	0	24	102	102	1220
16:00 17:00	0	773	95	868	8	363	0	371	1239	0	0	0	0	96	0	15	111	111	1350
17:00 18:00	0	733	98	831	7	358	0	365	1196	0	0	0	0	88	0	15	103	103	1299
Sub Total	0	3733	543	4276	72	3537	0	3609	7885	0	0	0	0	606	0	100	706	706	8591
U Turns				0				0	0				0				0	0	0
Total	0	3733	543	4276	72	3537	0	3609	7885	0	0	0	0	606	0	100	706	706	8591
EQ 12Hr	0	5189	755	5944	100	4916	0	5017	10960	0	0	0	0	842	0	139	981	981	11941
Note: These values are calculated by multiplying the totals by the appropriate expansion factor.													1.39						
AVG 12Hr	0	5189	755	5944	100	6441	0	5017	10960	0	0	0	0	842	0	139	981	981	11941
Note: These volumes are calculated by multiplying the Equivalent 12 hr. totals by the AADT factor.													1.00						
AVG 24Hr	0	6798	989	7787	131	8438	0	6572	14358	0	0	0	0	1103	0	182	1285	1285	15643
Note: These volumes are calculated by multiplying the Average Daily 12 hr. totals by 12 to 24 expansion factor.													1.31						
Note: U-Turns provided for approach totals. Refer to 'U-Turn' Report for specific breakdown.																			



Transportation Services - Traffic Services

Turning Movement Count - Study Results

INVENTION BLVD @ MARCH RD

Survey Date: Wednesday, February 05, 2025

WO No: 42560

Start Time: 07:00

Device: Miovision

Full Study 15 Minute Increments

Time Period	Northbound				Southbound				Eastbound				Westbound				Grand Total		
	LT	ST	RT	N TOT	LT	ST	RT	S TOT	STR TOT	LT	ST	RT	E TOT	LT	ST	RT		W TOT	STR TOT
07:00-07:15	0	45	4	49	3	142	0	145	194	0	0	0	0	12	0	3	15	15	209
07:15-07:30	0	63	17	80	3	136	0	139	219	0	0	0	0	24	0	2	26	26	245
07:30-07:45	0	76	15	91	3	163	0	166	257	0	0	0	0	11	0	4	15	15	272
07:45-08:00	0	64	5	69	2	166	0	168	237	0	0	0	0	16	0	0	16	16	253
08:00-08:15	0	69	9	78	1	180	0	181	259	0	0	0	0	13	0	2	15	15	274
08:15-08:30	0	57	14	71	2	124	0	126	197	0	0	0	0	23	0	3	26	26	223
08:30-08:45	0	71	14	85	2	158	0	160	245	0	0	0	0	15	0	3	18	18	263
08:45-09:00	0	76	11	87	3	158	0	161	248	0	0	0	0	34	0	4	38	38	286
09:00-09:15	0	96	15	111	4	165	0	169	280	0	0	0	0	36	0	1	37	37	317
09:15-09:30	0	89	27	116	3	127	0	130	246	0	0	0	0	26	0	3	29	29	275
09:30-09:45	0	69	14	83	3	131	0	134	217	0	0	0	0	22	0	2	24	24	241
09:45-10:00	0	68	6	74	0	111	0	111	185	0	0	0	0	15	0	0	15	15	200
11:30-11:45	0	72	8	80	1	81	0	82	162	0	0	0	0	11	0	3	14	14	176
11:45-12:00	0	101	12	113	1	66	0	67	180	0	0	0	0	15	0	2	17	17	197
12:00-12:15	0	105	11	116	3	102	0	105	221	0	0	0	0	16	0	1	17	17	238
12:15-12:30	0	95	18	113	5	94	0	99	212	0	0	0	0	12	0	1	13	13	225
12:30-12:45	0	103	18	121	2	78	0	80	201	0	0	0	0	18	0	3	21	21	222
12:45-13:00	0	74	16	90	1	86	0	87	177	0	0	0	0	10	0	1	11	11	188
13:00-13:15	0	111	16	127	2	83	0	85	212	0	0	0	0	7	0	3	10	10	222
13:15-13:30	0	87	7	94	3	86	0	89	183	0	0	0	0	8	0	5	13	13	196
15:00-15:15	0	146	19	165	2	78	0	80	245	0	0	0	0	18	0	5	23	23	268
15:15-15:30	0	149	17	166	4	95	0	99	265	0	0	0	0	14	0	6	20	20	285
15:30-15:45	0	168	22	190	2	94	0	96	286	0	0	0	0	19	0	2	21	21	307
15:45-16:00	0	173	35	208	2	112	0	114	322	0	0	0	0	27	0	11	38	38	360
16:00-16:15	0	202	21	223	1	88	0	89	312	0	0	0	0	17	0	5	22	22	334
16:15-16:30	0	192	27	219	3	104	0	107	326	0	0	0	0	30	0	6	36	36	362
16:30-16:45	0	202	27	229	2	87	0	89	318	0	0	0	0	24	0	3	27	27	345
16:45-17:00	0	177	20	197	2	84	0	86	283	0	0	0	0	25	0	1	26	26	309
17:00-17:15	0	183	23	206	1	91	0	92	298	0	0	0	0	25	0	6	31	31	329
17:15-17:30	0	233	27	260	1	92	0	93	353	0	0	0	0	21	0	7	28	28	381
17:30-17:45	0	172	20	192	3	91	0	94	286	0	0	0	0	18	0	1	19	19	305
17:45-18:00	0	145	28	173	2	84	0	86	259	0	0	0	0	24	0	1	25	25	284
Total:	0	3733	543	4276	72	3537	0	3609	7885	0	0	0	0	606	0	100	706	706	8,591

Note: U-Turns are included in Totals, cyclist volume is not included in totals. For cyclist volumes refer to Cyclist Volume report.



Transportation Services - Traffic Services

Turning Movement Count - Study Results

INVENTION BLVD @ MARCH RD

Survey Date: Wednesday, February 05, 2025

WO No: 42560

Start Time: 07:00

Device: Miovision

Full Study Cyclist Volume

Time Period	Northbound	Southbound	Street Total	Eastbound	Westbound	Street Total	Grand Total
07:00 07:15	0	0	0	0	0	0	0
07:15 07:30	1	0	1	0	0	0	1
07:30 07:45	1	0	1	0	0	0	1
07:45 08:00	0	0	0	0	0	0	0
08:00 08:15	0	0	0	0	0	0	0
08:15 08:30	0	0	0	0	0	0	0
08:30 08:45	0	0	0	0	0	0	0
08:45 09:00	0	0	0	0	0	0	0
09:00 09:15	2	0	2	0	0	0	2
09:15 09:30	0	0	0	0	0	0	0
09:30 09:45	0	0	0	0	0	0	0
09:45 10:00	0	0	0	0	0	0	0
11:30 11:45	0	0	0	0	0	0	0
11:45 12:00	0	0	0	0	0	0	0
12:00 12:15	0	0	0	0	0	0	0
12:15 12:30	0	0	0	0	0	0	0
12:30 12:45	0	0	0	0	0	0	0
12:45 13:00	0	0	0	0	0	0	0
13:00 13:15	0	0	0	0	0	0	0
13:15 13:30	0	0	0	0	0	0	0
15:00 15:15	0	0	0	0	0	0	0
15:15 15:30	0	0	0	0	0	0	0
15:30 15:45	0	0	0	0	0	0	0
15:45 16:00	1	0	1	0	0	0	1
16:00 16:15	0	0	0	0	0	0	0
16:15 16:30	0	0	0	0	0	0	0
16:30 16:45	0	0	0	0	0	0	0
16:45 17:00	0	0	0	0	0	0	0
17:00 17:15	0	0	0	0	0	0	0
17:15 17:30	0	0	0	0	0	0	0
17:30 17:45	0	0	0	0	0	0	0
17:45 18:00	0	0	0	0	0	0	0
Total	5	0	5	0	0	0	5



Transportation Services - Traffic Services

Turning Movement Count - Study Results

INVENTION BLVD @ MARCH RD

Survey Date: Wednesday, February 05, 2025

WO No: 42560

Start Time: 07:00

Device: Miovision

Full Study Pedestrian Volume

Time Period	NB Approach (E or W Crossing)	SB Approach (E or W Crossing)	Total	EB Approach (N or S Crossing)	WB Approach (N or S Crossing)	Total	Grand Total
07:00 07:15	0	0	0	0	0	0	0
07:15 07:30	0	0	0	0	0	0	0
07:30 07:45	0	0	0	0	0	0	0
07:45 08:00	0	0	0	0	0	0	0
08:00 08:15	0	0	0	0	0	0	0
08:15 08:30	0	0	0	0	0	0	0
08:30 08:45	0	0	0	0	0	0	0
08:45 09:00	0	0	0	0	0	0	0
09:00 09:15	0	0	0	0	0	0	0
09:15 09:30	0	0	0	0	0	0	0
09:30 09:45	0	0	0	0	0	0	0
09:45 10:00	0	0	0	0	0	0	0
11:30 11:45	0	0	0	0	0	0	0
11:45 12:00	0	0	0	0	0	0	0
12:00 12:15	0	0	0	0	0	0	0
12:15 12:30	0	0	0	0	0	0	0
12:30 12:45	0	0	0	0	0	0	0
12:45 13:00	0	0	0	0	0	0	0
13:00 13:15	0	0	0	0	0	0	0
13:15 13:30	0	0	0	0	0	0	0
15:00 15:15	0	0	0	0	0	0	0
15:15 15:30	0	0	0	0	0	0	0
15:30 15:45	0	0	0	0	0	0	0
15:45 16:00	1	0	1	0	0	0	1
16:00 16:15	0	0	0	0	0	0	0
16:15 16:30	0	0	0	0	0	0	0
16:30 16:45	0	0	0	0	0	0	0
16:45 17:00	0	0	0	0	0	0	0
17:00 17:15	0	0	0	0	0	0	0
17:15 17:30	0	0	0	0	0	0	0
17:30 17:45	0	0	0	0	0	0	0
17:45 18:00	0	0	0	0	0	0	0
Total	1	0	1	0	0	0	1



Transportation Services - Traffic Services

Turning Movement Count - Study Results

INVENTION BLVD @ MARCH RD

Survey Date: Wednesday, February 05, 2025

WO No: 42560

Start Time: 07:00

Device: Miovision

Full Study Heavy Vehicles

Time Period	Northbound				Southbound				Eastbound				Westbound				Grand Total		
	LT	ST	RT	N TOT	LT	ST	RT	S TOT	STR TOT	LT	ST	RT	E TOT	LT	ST	RT		W TOT	STR TOT
07:00 07:15	0	1	0	1	1	1	0	2	3	0	0	0	0	0	0	0	0	0	3
07:15 07:30	0	5	2	7	1	3	0	4	11	0	0	0	0	1	0	0	1	1	12
07:30 07:45	0	7	0	7	0	1	0	1	8	0	0	0	0	0	0	1	1	1	9
07:45 08:00	0	2	0	2	0	6	0	6	8	0	0	0	0	0	0	0	0	0	8
08:00 08:15	0	6	3	9	0	3	0	3	12	0	0	0	0	0	0	0	0	0	12
08:15 08:30	0	6	1	7	0	3	0	3	10	0	0	0	0	1	0	0	1	1	11
08:30 08:45	0	5	2	7	1	2	0	3	10	0	0	0	0	2	0	0	2	2	12
08:45 09:00	0	6	1	7	2	6	0	8	15	0	0	0	0	3	0	0	3	3	18
09:00 09:15	0	7	1	8	0	6	0	6	14	0	0	0	0	2	0	0	2	2	16
09:15 09:30	0	4	1	5	0	2	0	2	7	0	0	0	0	1	0	1	2	2	9
09:30 09:45	0	5	1	6	1	2	0	3	9	0	0	0	0	1	0	0	1	1	10
09:45 10:00	0	8	1	9	0	2	0	2	11	0	0	0	0	0	0	0	0	0	11
11:30 11:45	0	1	0	1	0	1	0	1	2	0	0	0	0	1	0	2	3	3	5
11:45 12:00	0	6	0	6	0	5	0	5	11	0	0	0	0	1	0	0	1	1	12
12:00 12:15	0	7	1	8	3	4	0	7	15	0	0	0	0	0	0	1	1	1	16
12:15 12:30	0	2	1	3	2	4	0	6	9	0	0	0	0	1	0	0	1	1	10
12:30 12:45	0	4	0	4	2	3	0	5	9	0	0	0	0	0	0	2	2	2	11
12:45 13:00	0	5	1	6	0	5	0	5	11	0	0	0	0	0	0	0	0	0	11
13:00 13:15	0	4	1	5	1	5	0	6	11	0	0	0	0	1	0	1	2	2	13
13:15 13:30	0	4	1	5	1	2	0	3	8	0	0	0	0	0	0	3	3	3	11
15:00 15:15	0	3	1	4	0	5	0	5	9	0	0	0	0	1	0	1	2	2	11
15:15 15:30	0	4	0	4	0	2	0	2	6	0	0	0	0	1	0	3	4	4	10
15:30 15:45	0	2	0	2	1	3	0	4	6	0	0	0	0	0	0	0	0	0	6
15:45 16:00	0	1	4	5	0	6	0	6	11	0	0	0	0	1	0	1	2	2	13
16:00 16:15	0	4	1	5	0	2	0	2	7	0	0	0	0	3	0	3	6	6	13
16:15 16:30	0	3	2	5	0	3	0	3	8	0	0	0	0	2	0	2	4	4	12
16:30 16:45	0	3	0	3	1	2	0	3	6	0	0	0	0	1	0	0	1	1	7
16:45 17:00	0	0	0	0	0	3	0	3	3	0	0	0	0	1	0	1	2	2	5
17:00 17:15	0	0	1	1	0	1	0	1	2	0	0	0	0	0	0	0	0	0	2
17:15 17:30	0	0	1	1	0	1	0	1	2	0	0	0	0	1	0	0	1	1	3
17:30 17:45	0	1	1	2	0	0	0	0	2	0	0	0	0	1	0	0	1	1	3
17:45 18:00	0	1	0	1	0	0	0	0	1	0	0	0	0	2	0	0	2	2	3
Total: None	0	117	29	146	17	94	0	111	257	0	0	0	0	29	0	22	51	51	308



Transportation Services - Traffic Services

Turning Movement Count - Study Results

INVENTION BLVD @ MARCH RD

Survey Date: Wednesday, February 05, 2025

WO No: 42560

Start Time: 07:00

Device: Miovision

Full Study 15 Minute U-Turn Total

Time Period		Northbound U-Turn Total	Southbound U-Turn Total	Eastbound U-Turn Total	Westbound U-Turn Total	Total
07:00	07:15	0	0	0	0	0
07:15	07:30	0	0	0	0	0
07:30	07:45	0	0	0	0	0
07:45	08:00	0	0	0	0	0
08:00	08:15	0	0	0	0	0
08:15	08:30	0	0	0	0	0
08:30	08:45	0	0	0	0	0
08:45	09:00	0	0	0	0	0
09:00	09:15	0	0	0	0	0
09:15	09:30	0	0	0	0	0
09:30	09:45	0	0	0	0	0
09:45	10:00	0	0	0	0	0
11:30	11:45	0	0	0	0	0
11:45	12:00	0	0	0	0	0
12:00	12:15	0	0	0	0	0
12:15	12:30	0	0	0	0	0
12:30	12:45	0	0	0	0	0
12:45	13:00	0	0	0	0	0
13:00	13:15	0	0	0	0	0
13:15	13:30	0	0	0	0	0
15:00	15:15	0	0	0	0	0
15:15	15:30	0	0	0	0	0
15:30	15:45	0	0	0	0	0
15:45	16:00	0	0	0	0	0
16:00	16:15	0	0	0	0	0
16:15	16:30	0	0	0	0	0
16:30	16:45	0	0	0	0	0
16:45	17:00	0	0	0	0	0
17:00	17:15	0	0	0	0	0
17:15	17:30	0	0	0	0	0
17:30	17:45	0	0	0	0	0
17:45	18:00	0	0	0	0	0
Total		0	0	0	0	0



Turning Movement Count Summary Report

Including AM and PM Peak Hours

All Vehicles Except Bicycles and Personal E-Transportation



Halton Terrace/Maxwell Bridge Road & March Road Kanata, ON

Survey Date: Tuesday, March 18, 2025 **Start Time:** 0700 **AADT Factor:** 1.0
Weather AM: Clear/Sunny +1° C **Survey Duration:** 6 Hrs. **Survey Hours:** 0700-1000 & 1500-1800
Weather PM: Clear/Sunny +8° C **Surveyor(s):** J. Mousseau

Halton Ter.	Maxwell Bridge Rd.	March Rd.	March Rd.
Eastbound	Westbound	Northbound	Southbound

Time Period	LT	ST	RT	UT	E/B Tot	LT	ST	RT	UT	W/B Tot	Street Total	LT	ST	RT	UT	N/B Tot	LT	ST	RT	UT	S/B Tot	Street Total	Grand Total
0700-0800	20	27	46	0	93	100	9	32	0	141	234	26	275	51	0	352	52	624	11	0	687	1039	1273
0800-0900	18	21	66	0	105	111	16	22	0	149	254	43	266	60	0	369	62	627	19	0	708	1077	1331
0900-1000	21	23	62	0	106	89	15	34	0	138	244	47	290	64	0	401	73	530	15	1	619	1020	1264
1500-1600	15	33	60	0	108	81	51	71	0	203	311	94	640	85	1	820	78	412	25	0	515	1335	1646
1600-1700	22	47	32	0	101	88	39	76	0	203	304	137	747	104	2	990	84	403	20	2	509	1499	1803
1700-1800	25	47	37	0	109	84	51	66	0	201	310	146	673	88	5	912	70	364	25	0	459	1371	1681
Totals	121	198	303	0	622	553	181	301	0	1035	1657	493	2891	452	8	3844	419	2960	115	3	3497	7341	8998

Equivalent 12 & 24-hour Vehicle Volumes Including the Annual Average Daily Traffic (AADT) Factor Applicable to the Day and Month of the Turning Movement Count

Expansion factors are applied exclusively to standard weekday 8-hour turning movement counts conducted during the hours of 0700h - 1000h, 1130h - 1330h and 1500h - 1800h

Equivalent 12-hour vehicle volumes. These volumes are calculated by multiplying the 8-hour totals by the 8 → 12 expansion factor of 1.39																							
Equ. 12 Hr	n/a	n/a	n/a	n/a	n/a	n/a	n/a	n/a	n/a	n/a	n/a	n/a	n/a	n/a	n/a	n/a	n/a	n/a	n/a	n/a	n/a	n/a	n/a
Average daily 12-hour vehicle volumes. These volumes are calculated by multiplying the equivalent 12-hour totals by the AADT factor of: 1.0																							
AADT 12-hr	n/a	n/a	n/a	n/a	n/a	n/a	n/a	n/a	n/a	n/a	n/a	n/a	n/a	n/a	n/a	n/a	n/a	n/a	n/a	n/a	n/a	n/a	n/a
24-Hour AADT. These volumes are calculated by multiplying the average daily 12-hour vehicle volumes by the 12 → 24 expansion factor of 1.31																							
AADT 24 Hr	n/a	n/a	n/a	n/a	n/a	n/a	n/a	n/a	n/a	n/a	n/a	n/a	n/a	n/a	n/a	n/a	n/a	n/a	n/a	n/a	n/a	n/a	n/a

AADT and expansion factors provided by the City of Ottawa

AM Peak Hour Factor → 0.93											Highest Hourly Vehicle Volume Between 0700h & 1000h												
AM Peak Hr	LT	ST	RT	UT	Total	LT	ST	RT	UT	Total	Str. Tot.	LT	ST	RT	UT	Total	LT	ST	RT	UT	Total	Str. Tot.	Gr. Tot.
0830-0930	27	26	71	0	124	114	17	35	0	166	290	54	294	66	0	414	78	615	19	1	713	1127	1417

PM Peak Hour Factor → 0.99											Highest Hourly Vehicle Volume Between 1500h & 1800h												
PM Peak Hr	LT	ST	RT	UT	Total	LT	ST	RT	UT	Total	Str. Tot.	LT	ST	RT	UT	Total	LT	ST	RT	UT	Total	Str. Tot.	Gr. Tot.
1615-1715	19	52	28	0	99	84	48	72	0	204	303	147	729	113	2	991	86	401	27	1	515	1506	1809

Comments:

OC Transpo and Para Transpo buses, private buses and school buses comprise 40.21% of the heavy vehicle traffic.

Notes:

1. Includes all vehicle types except bicycles, electric bicycles, and electric scooters.
2. When expansion and AADT factors are applied, the results will differ slightly due to rounding.



Turning Movement Count Summary, AM and PM Peak Hour Flow Diagrams



All Vehicles Except Bicycles and Personal E-Transportation

Halton Terrace/Maxwell Bridge Road & March Road

Kanata, ON

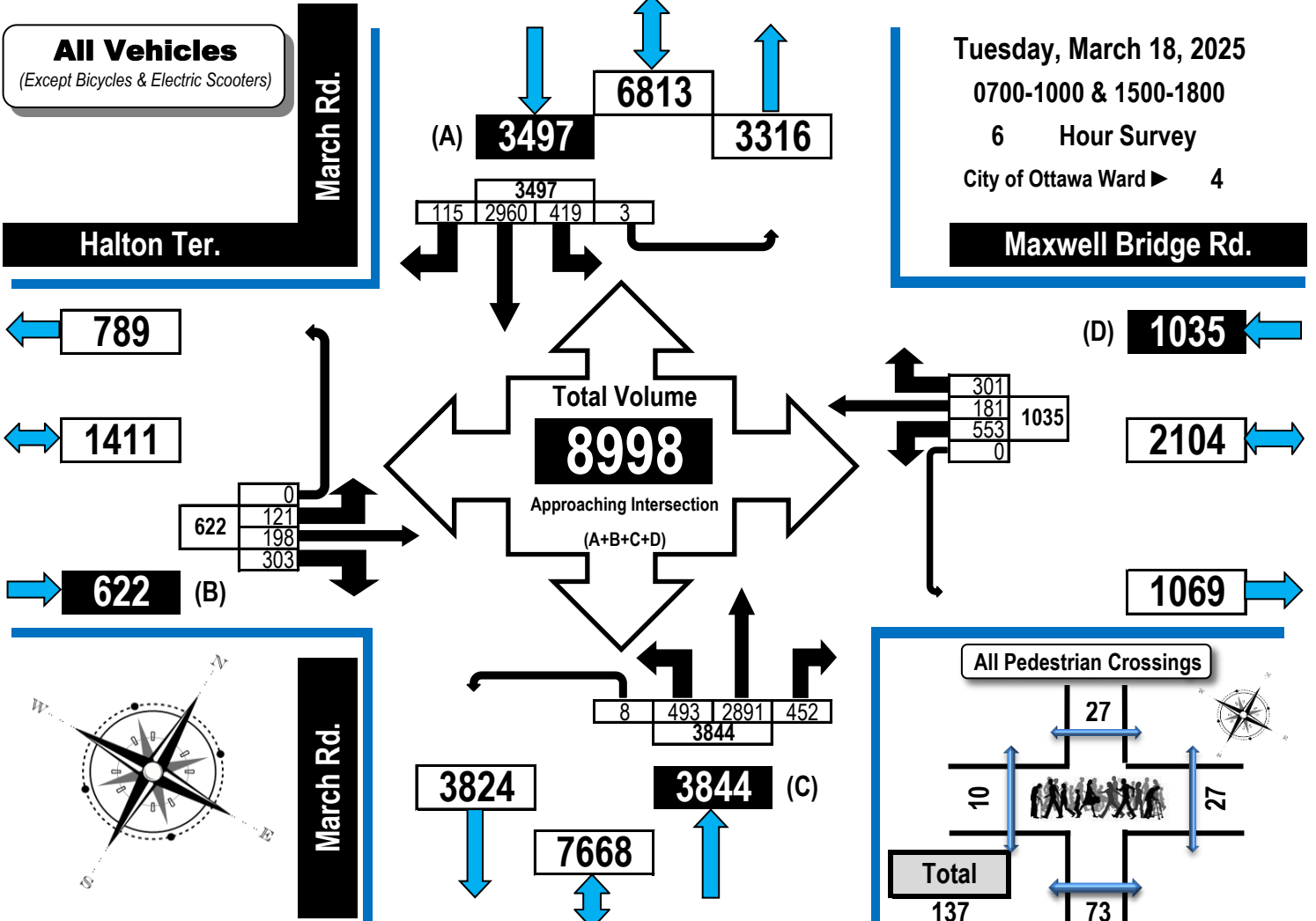

AM Peak Hour Flow Diagram PM Peak Hour Flow Diagram

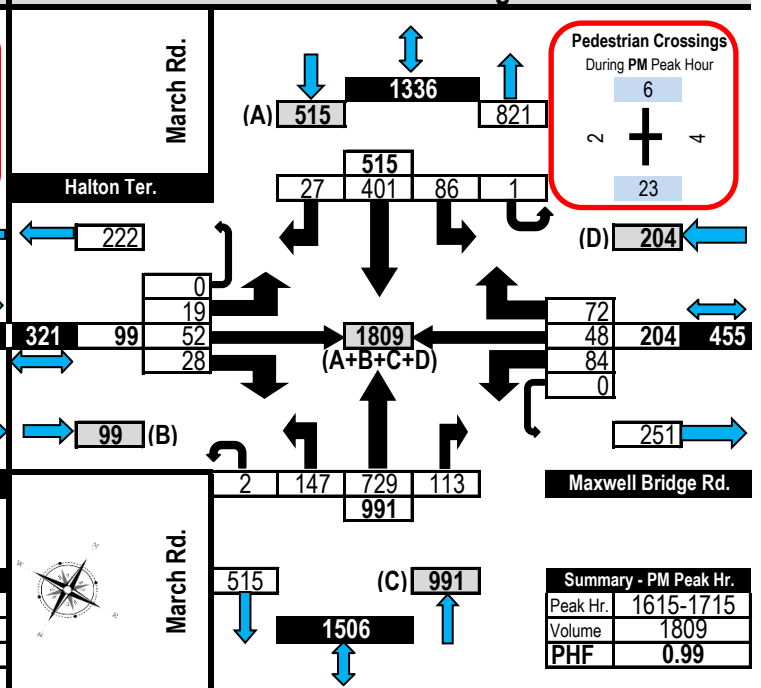
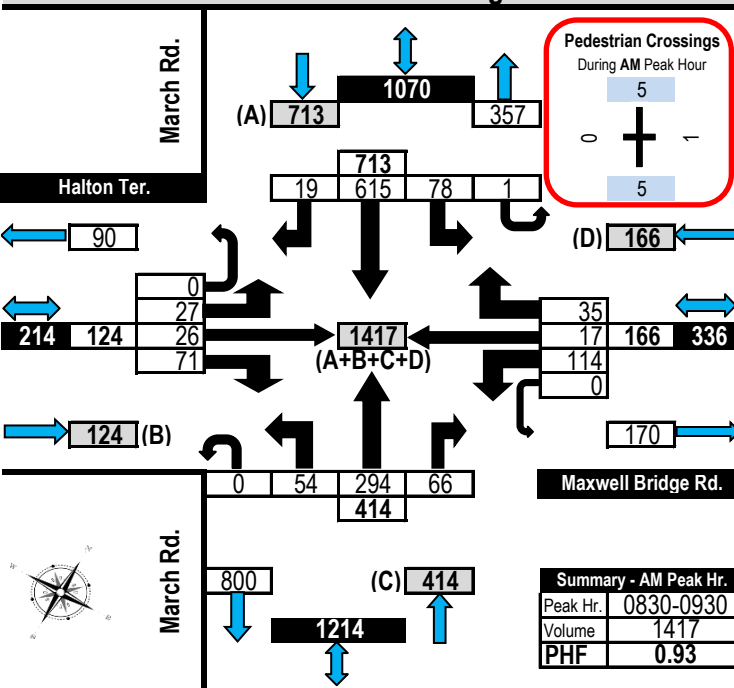

Summary - AM Peak Hr.

Peak Hr.	0830-0930
Volume	1417
PHF	0.93

Summary - PM Peak Hr.

Peak Hr.	1615-1715
Volume	1809
PHF	0.99



Turning Movement Count Heavy Vehicle Summary (FHWA Class 4-13) Flow Diagram



Halton Terrace/Maxwell Bridge Road & March Road Kanata, ON

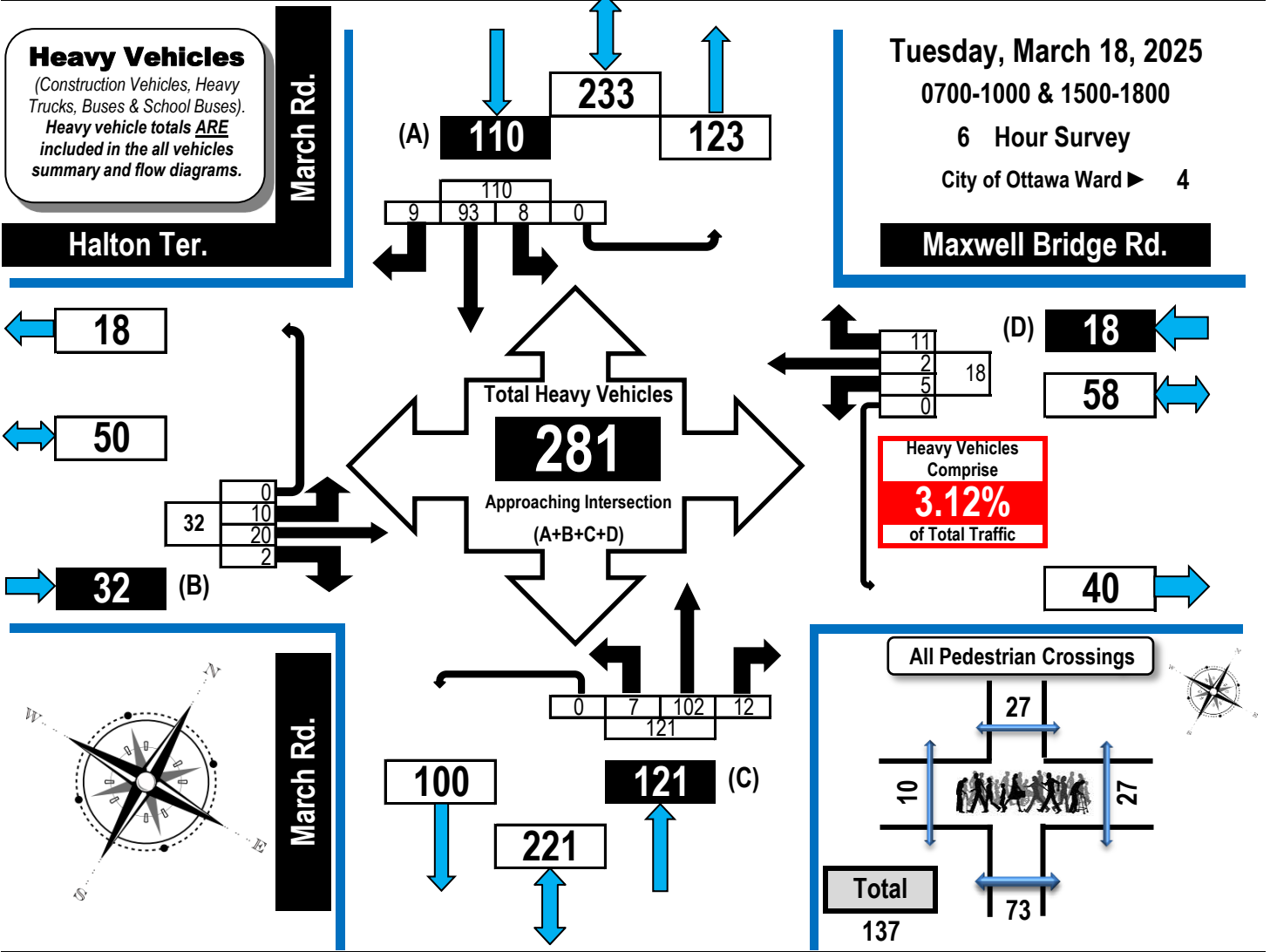

Halton Ter.	Maxwell Bridge Rd.	March Rd.	March Rd.
Eastbound	Westbound	Northbound	Southbound

Time Period	LT	ST	RT	UT	EB Tot	LT	ST	RT	UT	WB Tot	LT	ST	RT	UT	NB Tot	LT	ST	RT	UT	SB Tot	GR Tot
0700-0800	1	3	0	0	4	0	0	4	0	4	0	21	1	0	22	2	17	1	0	20	50
0800-0900	2	6	1	0	9	2	0	2	0	4	1	26	4	0	31	3	14	5	0	22	66
0900-1000	1	2	1	0	4	0	1	1	0	2	3	25	4	0	32	1	24	1	0	26	64
1500-1600	3	4	0	0	7	3	0	0	0	3	1	17	2	0	20	2	16	1	0	19	49
1600-1700	3	2	0	0	5	0	1	3	0	4	2	8	1	0	11	0	16	1	0	17	37
1700-1800	0	3	0	0	3	0	0	1	0	1	0	5	0	0	5	0	6	0	0	6	15
Totals	10	20	2	0	32	5	2	11	0	18	7	102	12	0	121	8	93	9	0	110	281

Comments:

OC Transpo and Para Transpo buses, private buses and school buses comprise 40.21% of the heavy vehicle traffic.



Turning Movement Count All Buses Summary (FHWA Class 4 ONLY) Flow Diagram



Halton Terrace/Maxwell Bridge Road & March Road

Kanata, ON

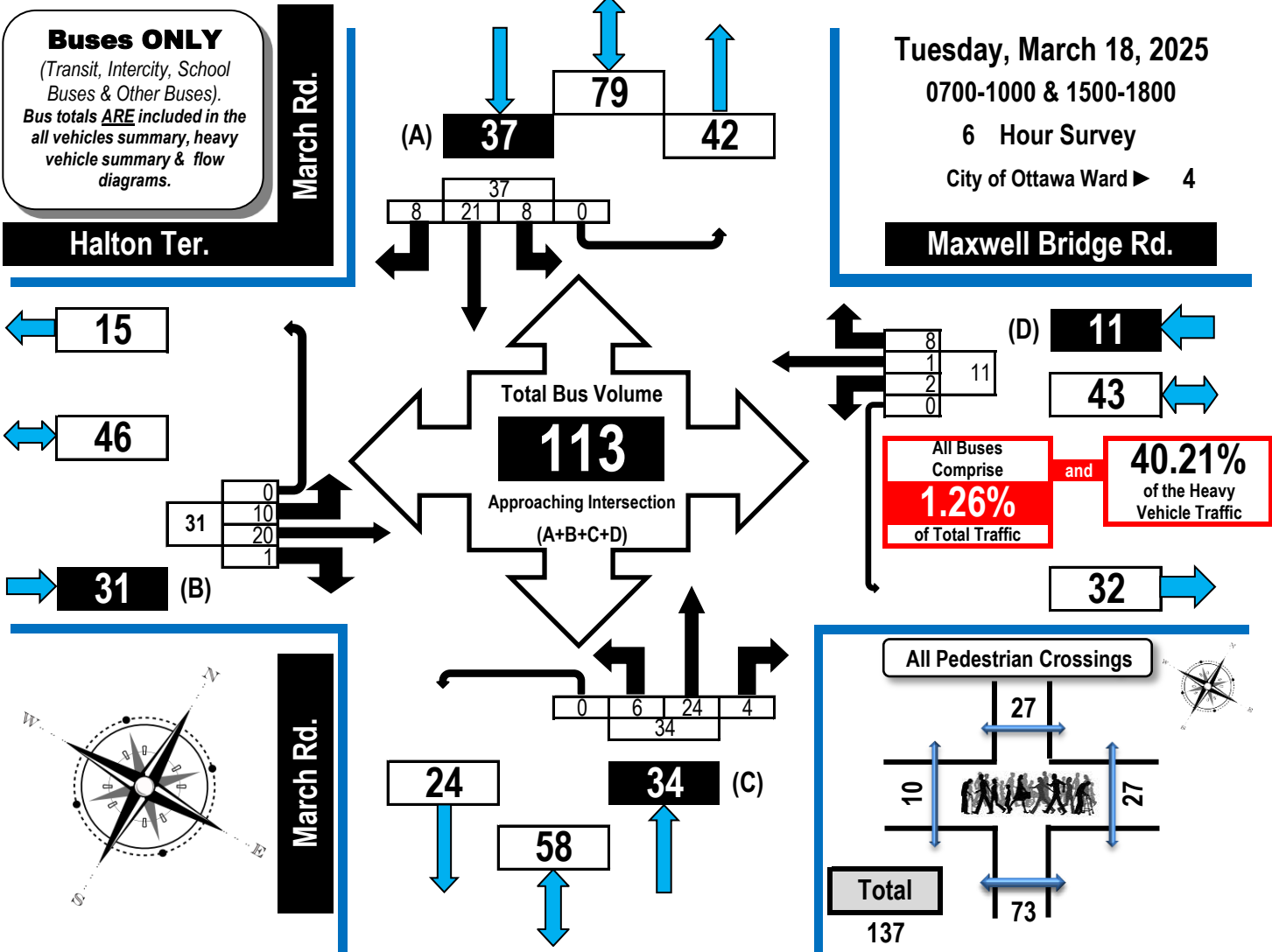

Halton Ter.	Maxwell Bridge Rd.	March Rd.	March Rd.
-------------	--------------------	-----------	-----------

Time Period	Eastbound				EB Tot	Westbound				WB Tot	Northbound				NB Tot	Southbound				SB Tot	GR Tot
	LT	ST	RT	UT		LT	ST	RT	UT		LT	ST	RT	UT		LT	ST	RT	UT		
0700-0800	1	3	0	0	4	0	0	3	0	3	0	6	0	0	6	2	4	1	0	7	20
0800-0900	2	6	1	0	9	1	0	1	0	2	1	6	2	0	9	3	3	5	0	11	31
0900-1000	1	2	0	0	3	0	0	1	0	1	2	6	0	0	8	1	5	1	0	7	19
1500-1600	3	4	0	0	7	1	0	0	0	1	1	3	1	0	5	2	3	0	0	5	18
1600-1700	3	2	0	0	5	0	1	3	0	4	2	3	1	0	6	0	3	1	0	4	19
1700-1800	0	3	0	0	3	0	0	0	0	0	0	0	0	0	0	0	3	0	0	3	6
Totals	10	20	1	0	31	2	1	8	0	11	6	24	4	0	34	8	21	8	0	37	113

Comments:
OC Transpo and Para Transpo buses, private buses and school buses comprise 40.21% of the heavy vehicle traffic.



Turning Movement Count Bicycles and Personal E-Transportation Summary Flow Diagram



Halton Terrace/Maxwell Bridge Road & March Road Kanata, ON

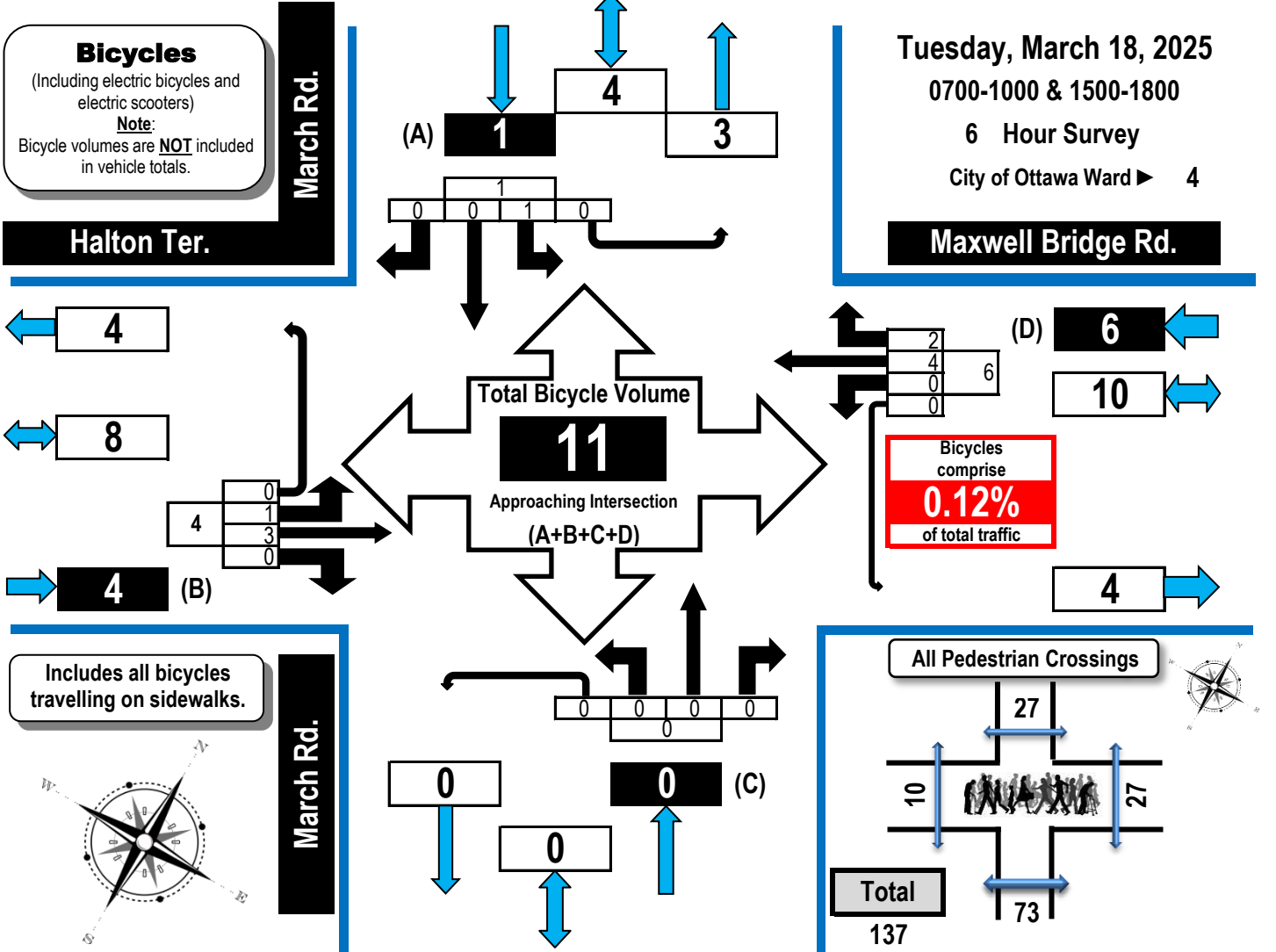

Time Period	Halton Ter.					Maxwell Bridge Rd.					March Rd.					March Rd.					
	LT	ST	RT	UT	EB Tot	LT	ST	RT	UT	WB Tot	LT	ST	RT	UT	NB Tot	LT	ST	RT	UT	SB Tot	GR Tot
0700-0800	0	0	0	0	0	0	0	0	0	0	0	0	0	0	0	1	0	0	0	1	1
0800-0900	0	0	0	0	0	0	1	0	0	1	0	0	0	0	0	0	0	0	0	0	1
0900-1000	0	0	0	0	0	0	0	0	0	0	0	0	0	0	0	0	0	0	0	0	0
1500-1600	0	0	0	0	0	0	0	0	0	0	0	0	0	0	0	0	0	0	0	0	0
1600-1700	1	2	0	0	3	0	0	0	0	0	0	0	0	0	0	0	0	0	0	0	3
1700-1800	0	1	0	0	1	0	3	2	0	5	0	0	0	0	0	0	0	0	0	0	6
Totals	1	3	0	0	4	0	4	2	0	6	0	0	0	0	0	1	0	0	0	1	11

Comments:
OC Transpo and Para Transpo buses, private buses and school buses comprise 40.21% of the heavy vehicle traffic.



Turning Movement Count Pedestrian Crossings Summary and Flow Diagram



Halton Terrace/Maxwell Bridge Road & March Road Kanata, ON

Pedestrian Crossings

Tuesday, March 18, 2025

0700-1000 & 1500-1800

6 Hour Survey

City of Ottawa Ward ► 4

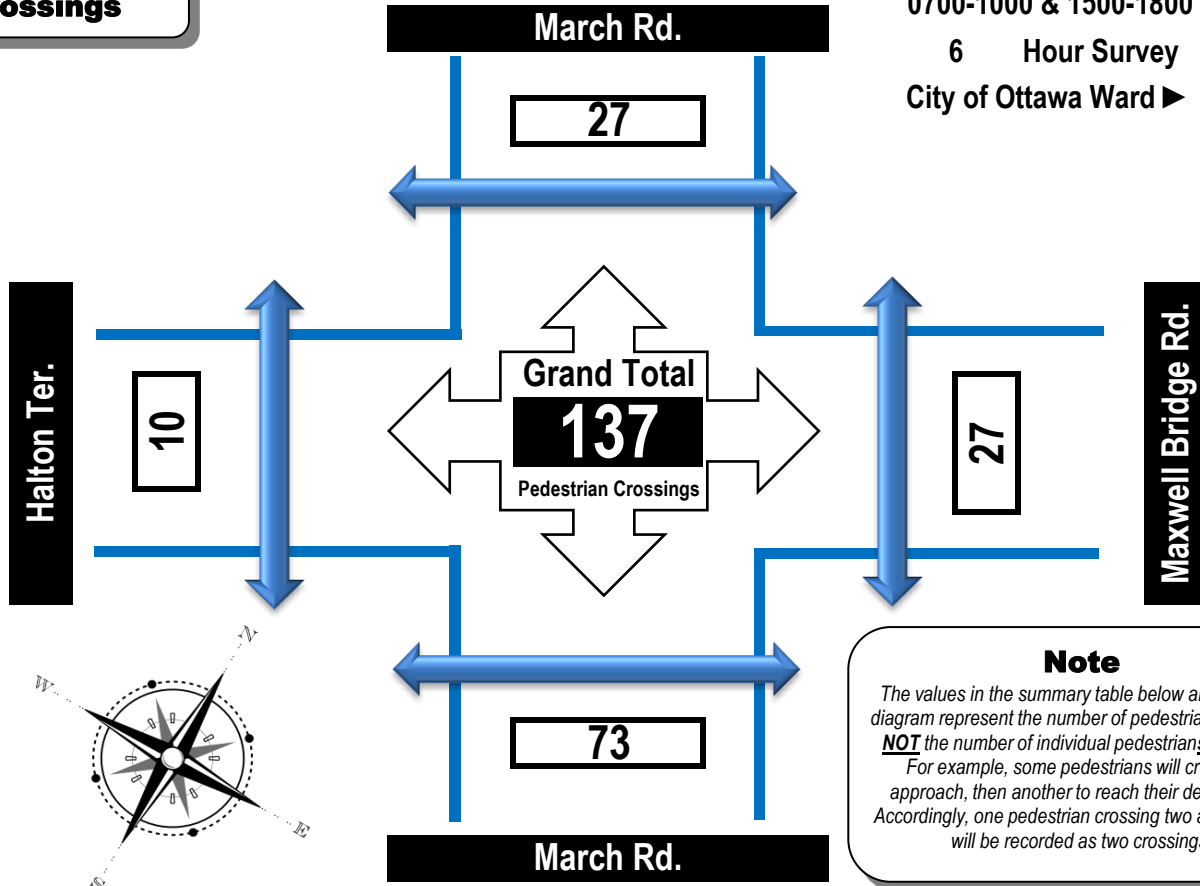

Note

The values in the summary table below and the flow diagram represent the number of pedestrian crossings **NOT** the number of individual pedestrians crossing. For example, some pedestrians will cross one approach, then another to reach their destination. Accordingly, one pedestrian crossing two approaches will be recorded as two crossings.

Time Period	West Side Crossing Halton Ter.	East Side Crossing Maxwell Bridge Rd.	Street Total	South Side Crossing March Rd.	North Side Crossing March Rd.	Street Total	Grand Total
0700-0800	0	1	1	0	2	2	3
0800-0900	1	0	1	2	0	2	3
0900-1000	0	3	3	7	6	13	16
1500-1600	1	9	10	21	6	27	37
1600-1700	7	5	12	15	12	27	39
1700-1800	1	9	10	28	1	29	39
Totals	10	27	37	73	27	100	137

Comments:









OC Transpo and Para Transpo buses, private buses and school buses comprise 40.21% of the heavy vehicle traffic.

Appendix C

Synchro Intersection Worksheets – Existing Conditions

Lanes, Volumes, Timings
1: March & Invention

2025 Existing AM
1020-1070 March Road

						
Lane Group	WBL	WBR	NBT	NBR	SBL	SBT
Lane Configurations						
Traffic Volume (vph)	9	52	1	1	63	2
Future Volume (vph)	9	52	1	1	63	2
Lane Util. Factor	1.00	1.00	1.00	1.00	1.00	1.00
Frt	0.885		0.932			
Flt Protected	0.993					0.954
Satd. Flow (prot)	1534	0	1626	0	0	1665
Flt Permitted	0.993					0.954
Satd. Flow (perm)	1534	0	1626	0	0	1665
Peak Hour Factor	0.90	0.90	0.90	0.90	0.90	0.90
Adj. Flow (vph)	10	58	1	1	70	2
Shared Lane Traffic (%)						
Lane Group Flow (vph)	68	0	2	0	0	72
Enter Blocked Intersection	No	No	No	No	No	No
Lane Alignment	Left	Right	Left	Right	Left	Left
Median Width(m)	3.5		0.0			0.0
Link Offset(m)	0.0		0.0			0.0
Crosswalk Width(m)	3.0		3.0			3.0
Two way Left Turn Lane						
Headway Factor	1.09	1.09	1.09	1.09	1.09	1.09
Turning Speed (k/h)	25	15		15	25	
Sign Control	Stop		Free			Free
Intersection Summary						
Control Type: Unsignalized						
Intersection Capacity Utilization 21.0%			ICU Level of Service A			
Analysis Period (min) 15						

Intersection						
Int Delay, s/veh	7.8					
Movement	WBL	WBR	NBT	NBR	SBL	SBT
Lane Configurations						
Traffic Vol, veh/h	9	52	1	1	63	2
Future Vol, veh/h	9	52	1	1	63	2
Conflicting Peds, #/hr	0	0	0	0	0	0
Sign Control	Stop	Stop	Free	Free	Free	Free
RT Channelized	-	None	-	None	-	None
Storage Length	0	-	-	-	-	-
Veh in Median Storage, #	0	-	0	-	-	0
Grade, %	0	-	0	-	-	0
Peak Hour Factor	90	90	90	90	90	90
Heavy Vehicles, %	2	2	2	2	2	2
Mvmt Flow	10	58	1	1	70	2

Major/Minor	Minor1	Major1	Major2		
Conflicting Flow All	144	2	0	0	2
Stage 1	2	-	-	-	-
Stage 2	142	-	-	-	-
Critical Hdwy	6.42	6.22	-	-	4.12
Critical Hdwy Stg 1	5.42	-	-	-	-
Critical Hdwy Stg 2	5.42	-	-	-	-
Follow-up Hdwy	3.518	3.318	-	-	2.218
Pot Cap-1 Maneuver	849	1082	-	-	1620
Stage 1	1021	-	-	-	-
Stage 2	885	-	-	-	-
Platoon blocked, %			-	-	-
Mov Cap-1 Maneuver	812	1082	-	-	1620
Mov Cap-2 Maneuver	812	-	-	-	-
Stage 1	1021	-	-	-	-
Stage 2	847	-	-	-	-

Approach	WB	NB	SB
HCM Control Delay, s	8.7	0	7.1
HCM LOS	A		

Minor Lane/Major Mvmt	NBT	NBRWBLn1	SBL	SBT
Capacity (veh/h)	-	-	1031	1620
HCM Lane V/C Ratio	-	-	0.066	0.043
HCM Control Delay (s)	-	-	8.7	7.3
HCM Lane LOS	-	-	A	A
HCM 95th %tile Q(veh)	-	-	0.2	0.1

Lanes, Volumes, Timings
 2: March Road & Halton Terrace/Maxwell Bridge Road

2025 Existing AM
 1020-1070 March Road

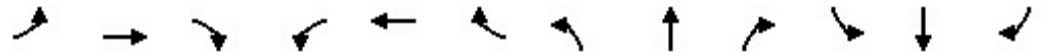

Lane Group	EBL	EBT	EBR	WBL	WBT	WBR	NBL	NBT	NBR	SBL	SBT	SBR
Lane Configurations												
Traffic Volume (vph)	85	18	85	53	8	56	41	142	26	31	210	75
Future Volume (vph)	85	18	85	53	8	56	41	142	26	31	210	75
Lane Util. Factor	1.00	1.00	1.00	1.00	1.00	1.00	1.00	0.95	1.00	1.00	0.95	1.00
Ped Bike Factor		0.99		1.00					0.98	1.00		
Frt		0.876			0.869				0.850			0.850
Flt Protected	0.950			0.950			0.950			0.950		
Satd. Flow (prot)	1658	1481	0	1658	1431	0	1551	3020	1414	1658	3316	1401
Flt Permitted	0.711			0.665			0.597			0.652		
Satd. Flow (perm)	1241	1481	0	1159	1431	0	975	3020	1379	1134	3316	1401
Satd. Flow (RTOR)		94			62				92			92
Confl. Peds. (#/hr)			1	1					2	2		
Peak Hour Factor	0.90	0.90	0.90	0.90	0.90	0.90	0.90	0.90	0.90	0.90	0.90	0.90
Heavy Vehicles (%)	2%	14%	2%	2%	2%	9%	9%	12%	7%	2%	2%	8%
Adj. Flow (vph)	94	20	94	59	9	62	46	158	29	34	233	83
Shared Lane Traffic (%)												
Lane Group Flow (vph)	94	114	0	59	71	0	46	158	29	34	233	83
Enter Blocked Intersection	No	No	No	No	No	No	No	No	No	No	No	No
Lane Alignment	Left	Left	Right	Left	Left	Right	Left	Left	Right	Left	Left	Right
Median Width(m)		3.5			3.5			3.5			3.5	
Link Offset(m)		0.0			0.0			0.0			0.0	
Crosswalk Width(m)		3.0			3.0			3.0			3.0	
Two way Left Turn Lane												
Headway Factor	1.09	1.09	1.09	1.09	1.09	1.09	1.09	1.09	1.09	1.09	1.09	1.09
Turning Speed (k/h)	25		15	25		15	25		15	25		15
Number of Detectors	1	2		1	2		1	2	1	1	2	1
Detector Template	Left	Thru		Left	Thru		Left	Thru	Right	Left	Thru	Right
Leading Detector (m)	2.0	10.0		2.0	10.0		2.0	10.0	2.0	2.0	10.0	2.0
Trailing Detector (m)	0.0	0.0		0.0	0.0		0.0	0.0	0.0	0.0	0.0	0.0
Detector 1 Position(m)	0.0	0.0		0.0	0.0		0.0	0.0	0.0	0.0	0.0	0.0
Detector 1 Size(m)	2.0	0.6		2.0	0.6		2.0	0.6	2.0	2.0	0.6	2.0
Detector 1 Type	Cl+Ex	Cl+Ex		Cl+Ex	Cl+Ex		Cl+Ex	Cl+Ex	Cl+Ex	Cl+Ex	Cl+Ex	Cl+Ex
Detector 1 Channel												
Detector 1 Extend (s)	0.0	0.0		0.0	0.0		0.0	0.0	0.0	0.0	0.0	0.0
Detector 1 Queue (s)	0.0	0.0		0.0	0.0		0.0	0.0	0.0	0.0	0.0	0.0
Detector 1 Delay (s)	0.0	0.0		0.0	0.0		0.0	0.0	0.0	0.0	0.0	0.0
Detector 2 Position(m)		9.4			9.4			9.4			9.4	
Detector 2 Size(m)		0.6			0.6			0.6			0.6	
Detector 2 Type		Cl+Ex			Cl+Ex			Cl+Ex			Cl+Ex	
Detector 2 Channel												
Detector 2 Extend (s)		0.0			0.0			0.0			0.0	
Turn Type	Perm	NA		Perm	NA		pm+pt	NA	Perm	pm+pt	NA	Perm
Protected Phases		4			8		5	2		1	6	
Permitted Phases	4			8			2		2	6		6
Detector Phase	4	4		8	8		5	2	2	1	6	6
Switch Phase												
Minimum Initial (s)	10.0	10.0		10.0	10.0		5.0	10.0	10.0	5.0	10.0	10.0
Minimum Split (s)	39.3	39.3		38.6	38.6		11.7	34.6	34.6	11.7	34.6	34.6
Total Split (s)	40.0	40.0		40.0	40.0		15.0	75.0	75.0	15.0	75.0	75.0

Lanes, Volumes, Timings
 2: March Road & Halton Terrace/Maxwell Bridge Road

2025 Existing AM
 1020-1070 March Road



Lane Group	EBL	EBT	EBR	WBL	WBT	WBR	NBL	NBT	NBR	SBL	SBT	SBR
Total Split (%)	30.8%	30.8%		30.8%	30.8%		11.5%	57.7%	57.7%	11.5%	57.7%	57.7%
Maximum Green (s)	32.7	32.7		33.7	33.7		8.3	68.4	68.4	8.3	68.4	68.4
Yellow Time (s)	3.0	3.0		3.0	3.0		4.6	4.6	4.6	4.6	4.6	4.6
All-Red Time (s)	4.3	4.3		3.3	3.3		2.1	2.0	2.0	2.1	2.0	2.0
Lost Time Adjust (s)	0.0	0.0		0.0	0.0		0.0	0.0	0.0	0.0	0.0	0.0
Total Lost Time (s)	7.3	7.3		6.3	6.3		6.7	6.6	6.6	6.7	6.6	6.6
Lead/Lag							Lead	Lag	Lag	Lead	Lag	Lag
Lead-Lag Optimize?							Yes	Yes	Yes	Yes	Yes	Yes
Vehicle Extension (s)	3.0	3.0		3.0	3.0		3.0	3.0	3.0	3.0	3.0	3.0
Recall Mode	None	None		None	None		None	C-Max	C-Max	None	C-Max	C-Max
Walk Time (s)	7.0	7.0		7.0	7.0			7.0	7.0		7.0	7.0
Flash Dont Walk (s)	25.0	25.0		25.0	25.0			21.0	21.0		21.0	21.0
Pedestrian Calls (#/hr)	0	0		0	0			0	0		0	0
Act Effct Green (s)	15.5	15.5		16.5	16.5		96.7	92.6	92.6	94.8	89.9	89.9
Actuated g/C Ratio	0.12	0.12		0.13	0.13		0.74	0.71	0.71	0.73	0.69	0.69
v/c Ratio	0.64	0.44		0.40	0.30		0.06	0.07	0.03	0.04	0.10	0.08
Control Delay	72.7	19.2		58.8	17.5		4.6	7.3	0.0	4.5	8.0	1.7
Queue Delay	0.0	0.0		0.0	0.0		0.0	0.0	0.0	0.0	0.0	0.0
Total Delay	72.7	19.2		58.8	17.5		4.6	7.3	0.0	4.5	8.0	1.7
LOS	E	B		E	B		A	A	A	A	A	A
Approach Delay		43.4			36.3			5.9			6.2	
Approach LOS		D			D			A			A	
Queue Length 50th (m)	23.4	4.7		14.2	2.1		2.3	6.6	0.0	1.7	10.0	0.0
Queue Length 95th (m)	39.5	21.1		26.7	15.2		6.4	12.6	0.0	5.1	18.0	5.3
Internal Link Dist (m)		105.3			242.3			231.0			179.5	
Turn Bay Length (m)	60.0			65.0			65.0			80.0		15.0
Base Capacity (vph)	312	442		300	416		768	2152	1009	874	2292	997
Starvation Cap Reductn	0	0		0	0		0	0	0	0	0	0
Spillback Cap Reductn	0	0		0	0		0	0	0	0	0	0
Storage Cap Reductn	0	0		0	0		0	0	0	0	0	0
Reduced v/c Ratio	0.30	0.26		0.20	0.17		0.06	0.07	0.03	0.04	0.10	0.08

Intersection Summary

Cycle Length: 130
 Actuated Cycle Length: 130
 Offset: 99 (76%), Referenced to phase 2:NBTL and 6:SBTL, Start of Green
 Natural Cycle: 90
 Control Type: Actuated-Coordinated
 Maximum v/c Ratio: 0.64
 Intersection Signal Delay: 18.7
 Intersection Capacity Utilization 56.8%
 Analysis Period (min) 15





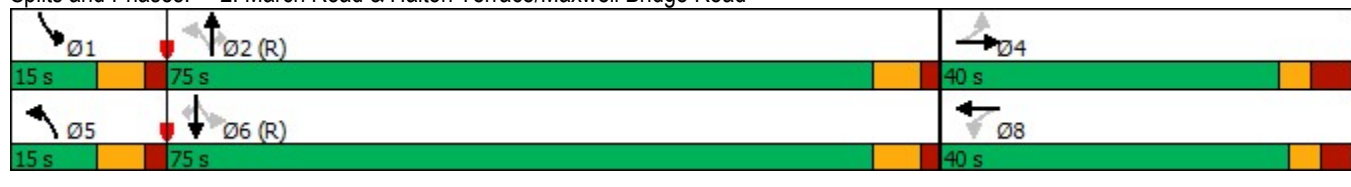



Intersection LOS: B
 ICU Level of Service B

Splits and Phases: 2: March Road & Halton Terrace/Maxwell Bridge Road



Lanes, Volumes, Timings
1: March & Invention

2025 Existing PM
1020-1070 March Road

						
Lane Group	WBL	WBR	NBT	NBR	SBL	SBT
Lane Configurations						
Traffic Volume (vph)	98	25	769	110	8	391
Future Volume (vph)	98	25	769	110	8	391
Lane Util. Factor	1.00	1.00	1.00	1.00	1.00	1.00
Frt	0.972		0.983			
Flt Protected	0.962					0.999
Satd. Flow (prot)	1632	0	1715	0	0	1743
Flt Permitted	0.962					0.999
Satd. Flow (perm)	1632	0	1715	0	0	1743
Peak Hour Factor	0.90	0.90	0.90	0.90	0.90	0.90
Adj. Flow (vph)	109	28	854	122	9	434
Shared Lane Traffic (%)						
Lane Group Flow (vph)	137	0	976	0	0	443
Enter Blocked Intersection	No	No	No	No	No	No
Lane Alignment	Left	Right	Left	Right	Left	Left
Median Width(m)	3.5		0.0			0.0
Link Offset(m)	0.0		0.0			0.0
Crosswalk Width(m)	3.0		3.0			3.0
Two way Left Turn Lane						
Headway Factor	1.09	1.09	1.09	1.09	1.09	1.09
Turning Speed (k/h)	25	15		15	25	
Sign Control	Stop		Free			Free
Intersection Summary						
Control Type: Unsignalized						
Intersection Capacity Utilization 63.8%			ICU Level of Service B			
Analysis Period (min) 15						

Intersection						
Int Delay, s/veh	6.3					
Movement	WBL	WBR	NBT	NBR	SBL	SBT
Lane Configurations	W	W	T	T	S	S
Traffic Vol, veh/h	98	25	769	110	8	391
Future Vol, veh/h	98	25	769	110	8	391
Conflicting Peds, #/hr	0	0	0	0	0	0
Sign Control	Stop	Stop	Free	Free	Free	Free
RT Channelized	-	None	-	None	-	None
Storage Length	0	-	-	-	-	-
Veh in Median Storage, #	0	-	0	-	-	0
Grade, %	0	-	0	-	-	0
Peak Hour Factor	90	90	90	90	90	90
Heavy Vehicles, %	2	2	2	2	2	2
Mvmt Flow	109	28	854	122	9	434

Major/Minor	Minor1	Major1	Major2		
Conflicting Flow All	1367	915	0	0	976
Stage 1	915	-	-	-	-
Stage 2	452	-	-	-	-
Critical Hdwy	6.42	6.22	-	-	4.12
Critical Hdwy Stg 1	5.42	-	-	-	-
Critical Hdwy Stg 2	5.42	-	-	-	-
Follow-up Hdwy	3.518	3.318	-	-	2.218
Pot Cap-1 Maneuver	162	331	-	-	707
Stage 1	390	-	-	-	-
Stage 2	641	-	-	-	-
Platoon blocked, %			-	-	-
Mov Cap-1 Maneuver	159	331	-	-	707
Mov Cap-2 Maneuver	159	-	-	-	-
Stage 1	390	-	-	-	-
Stage 2	630	-	-	-	-

Approach	WB	NB	SB
HCM Control Delay, s	71.6	0	0.2
HCM LOS	F		

Minor Lane/Major Mvmt	NBT	NBRWBLn1	SBL	SBT
Capacity (veh/h)	-	-	178	707
HCM Lane V/C Ratio	-	-	0.768	0.013
HCM Control Delay (s)	-	-	71.6	10.2
HCM Lane LOS	-	-	F	B
HCM 95th %tile Q(veh)	-	-	5	0

Lanes, Volumes, Timings
 2: March Road & Halton Terrace/Maxwell Bridge Road

2025 Existing PM
 1020-1070 March Road

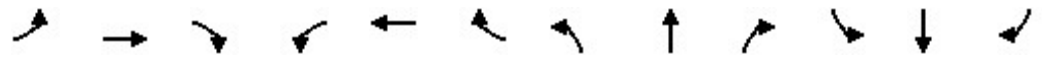

Lane Group	EBL	EBT	EBR	WBL	WBT	WBR	NBL	NBT	NBR	SBL	SBT	SBR
Lane Configurations												
Traffic Volume (vph)	19	52	28	84	48	72	149	729	113	87	401	27
Future Volume (vph)	19	52	28	84	48	72	149	729	113	87	401	27
Lane Util. Factor	1.00	1.00	1.00	1.00	1.00	1.00	1.00	0.95	1.00	1.00	0.95	1.00
Ped Bike Factor	0.99	0.99		0.98	0.98		1.00		0.95	0.99		0.98
Frt		0.948			0.910				0.850			0.850
Flt Protected	0.950			0.950			0.950			0.950		
Satd. Flow (prot)	1658	1551	0	1610	1558	0	1658	3316	1483	1658	3316	1483
Flt Permitted	0.597			0.699			0.483			0.323		
Satd. Flow (perm)	1031	1551	0	1163	1558	0	840	3316	1417	560	3316	1447
Satd. Flow (RTOR)		20			56				126			92
Confl. Peds. (#/hr)	11		17	17		11	2		11	11		2
Peak Hour Factor	0.90	0.90	0.90	0.90	0.90	0.90	0.90	0.90	0.90	0.90	0.90	0.90
Heavy Vehicles (%)	2%	9%	5%	5%	3%	2%	2%	2%	2%	2%	2%	2%
Adj. Flow (vph)	21	58	31	93	53	80	166	810	126	97	446	30
Shared Lane Traffic (%)												
Lane Group Flow (vph)	21	89	0	93	133	0	166	810	126	97	446	30
Enter Blocked Intersection	No	No	No	No	No	No	No	No	No	No	No	No
Lane Alignment	Left	Left	Right	Left	Left	Right	Left	Left	Right	Left	Left	Right
Median Width(m)		3.5			3.5			3.5			3.5	
Link Offset(m)		0.0			0.0			0.0			0.0	
Crosswalk Width(m)		3.0			3.0			3.0			3.0	
Two way Left Turn Lane												
Headway Factor	1.09	1.09	1.09	1.09	1.09	1.09	1.09	1.09	1.09	1.09	1.09	1.09
Turning Speed (k/h)	25		15	25		15	25		15	25		15
Number of Detectors	1	2		1	2		1	2	1	1	2	1
Detector Template	Left	Thru		Left	Thru		Left	Thru	Right	Left	Thru	Right
Leading Detector (m)	2.0	10.0		2.0	10.0		2.0	10.0	2.0	2.0	10.0	2.0
Trailing Detector (m)	0.0	0.0		0.0	0.0		0.0	0.0	0.0	0.0	0.0	0.0
Detector 1 Position(m)	0.0	0.0		0.0	0.0		0.0	0.0	0.0	0.0	0.0	0.0
Detector 1 Size(m)	2.0	0.6		2.0	0.6		2.0	0.6	2.0	2.0	0.6	2.0
Detector 1 Type	Cl+Ex	Cl+Ex		Cl+Ex	Cl+Ex		Cl+Ex	Cl+Ex	Cl+Ex	Cl+Ex	Cl+Ex	Cl+Ex
Detector 1 Channel												
Detector 1 Extend (s)	0.0	0.0		0.0	0.0		0.0	0.0	0.0	0.0	0.0	0.0
Detector 1 Queue (s)	0.0	0.0		0.0	0.0		0.0	0.0	0.0	0.0	0.0	0.0
Detector 1 Delay (s)	0.0	0.0		0.0	0.0		0.0	0.0	0.0	0.0	0.0	0.0
Detector 2 Position(m)		9.4			9.4			9.4			9.4	
Detector 2 Size(m)		0.6			0.6			0.6			0.6	
Detector 2 Type		Cl+Ex			Cl+Ex			Cl+Ex			Cl+Ex	
Detector 2 Channel												
Detector 2 Extend (s)		0.0			0.0			0.0			0.0	
Turn Type	Perm	NA		Perm	NA		pm+pt	NA	Perm	pm+pt	NA	Perm
Protected Phases		4			8		5	2		1	6	
Permitted Phases	4			8			2		2	6		6
Detector Phase	4	4		8	8		5	2	2	1	6	6
Switch Phase												
Minimum Initial (s)	10.0	10.0		10.0	10.0		5.0	10.0	10.0	5.0	10.0	10.0
Minimum Split (s)	39.3	39.3		39.3	39.3		11.7	34.6	34.6	11.7	34.6	34.6
Total Split (s)	40.0	40.0		40.0	40.0		15.0	75.0	75.0	15.0	75.0	75.0

Lanes, Volumes, Timings
 2: March Road & Halton Terrace/Maxwell Bridge Road

2025 Existing PM
 1020-1070 March Road

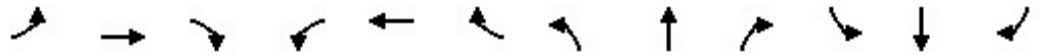

Lane Group	EBL	EBT	EBR	WBL	WBT	WBR	NBL	NBT	NBR	SBL	SBT	SBR
Total Split (%)	30.8%	30.8%		30.8%	30.8%		11.5%	57.7%	57.7%	11.5%	57.7%	57.7%
Maximum Green (s)	32.7	32.7		32.7	32.7		8.3	68.4	68.4	8.3	68.4	68.4
Yellow Time (s)	3.0	3.0		3.0	3.0		4.6	4.6	4.6	4.6	4.6	4.6
All-Red Time (s)	4.3	4.3		4.3	4.3		2.1	2.0	2.0	2.1	2.0	2.0
Lost Time Adjust (s)	0.0	0.0		0.0	0.0		0.0	0.0	0.0	0.0	0.0	0.0
Total Lost Time (s)	7.3	7.3		7.3	7.3		6.7	6.6	6.6	6.7	6.6	6.6
Lead/Lag							Lead	Lag	Lag	Lead	Lag	Lag
Lead-Lag Optimize?							Yes	Yes	Yes	Yes	Yes	Yes
Vehicle Extension (s)	3.0	3.0		3.0	3.0		3.0	3.0	3.0	3.0	3.0	3.0
Recall Mode	None	None		None	None		None	C-Max	C-Max	None	C-Max	C-Max
Walk Time (s)	7.0	7.0		7.0	7.0			7.0	7.0		7.0	7.0
Flash Dont Walk (s)	25.0	25.0		25.0	25.0			21.0	21.0		21.0	21.0
Pedestrian Calls (#/hr)	0	0		0	0			0	0		0	0
Act Effct Green (s)	16.0	16.0		16.0	16.0		94.8	85.9	85.9	91.7	84.3	84.3
Actuated g/C Ratio	0.12	0.12		0.12	0.12		0.73	0.66	0.66	0.71	0.65	0.65
v/c Ratio	0.17	0.43		0.65	0.55		0.25	0.37	0.13	0.21	0.21	0.03
Control Delay	51.4	45.6		74.0	38.5		5.5	11.2	2.1	5.8	10.4	0.1
Queue Delay	0.0	0.0		0.0	0.0		0.0	0.0	0.0	0.0	0.0	0.0
Total Delay	51.4	45.6		74.0	38.5		5.5	11.2	2.1	5.8	10.4	0.1
LOS	D	D		E	D		A	B	A	A	B	A
Approach Delay		46.7			53.1			9.3			9.1	
Approach LOS		D			D			A			A	
Queue Length 50th (m)	4.9	16.5		23.1	18.5		9.2	44.7	0.0	5.2	22.4	0.0
Queue Length 95th (m)	12.4	31.5		39.0	37.2		19.3	69.7	7.9	11.9	37.6	0.0
Internal Link Dist (m)		105.1			242.1			231.3			179.6	
Turn Bay Length (m)	60.0			65.0			65.0			80.0		15.0
Base Capacity (vph)	259	405		292	433		675	2190	978	471	2150	970
Starvation Cap Reductn	0	0		0	0		0	0	0	0	0	0
Spillback Cap Reductn	0	0		0	0		0	0	0	0	0	0
Storage Cap Reductn	0	0		0	0		0	0	0	0	0	0
Reduced v/c Ratio	0.08	0.22		0.32	0.31		0.25	0.37	0.13	0.21	0.21	0.03

Intersection Summary

Cycle Length: 130
 Actuated Cycle Length: 130
 Offset: 50 (38%), Referenced to phase 2:NBTL and 6:SBTL, Start of Green
 Natural Cycle: 90
 Control Type: Actuated-Coordinated
 Maximum v/c Ratio: 0.65
 Intersection Signal Delay: 16.2
 Intersection Capacity Utilization 65.5%
 Analysis Period (min) 15

Intersection LOS: B
 ICU Level of Service C

Splits and Phases: 2: March Road & Halton Terrace/Maxwell Bridge Road



Appendix D

Collision Data

Accident Date	Accident Year	Accident Time	Location	Environment Condition	Light	Traffic Control	Traffic Control Condition	Classification Of Accident	Initial Impact Type	Road Surface Condition	# Vehicles	# Motorcycles	# Bicycles	# Pedestrians
2018-02-01	2018	17:05	MARCH RD btwn MAXWELL RD & MAXWELL BRIDGE RD (320813)	03 - Snow	07 - Dark	10 - No control	0	03 - P.D. only	03 - Rear end	03 - Loose snow	3	0	0	0
2018-12-05	2018	16:50	MARCH RD btwn MAXWELL RD & MAXWELL BRIDGE RD (320813)	03 - Snow	07 - Dark	10 - No control	0	03 - P.D. only	07 - SMV other	03 - Loose snow	1	0	0	0
2019-05-26	2019	18:54	MARCH RD btwn MAXWELL RD & MAXWELL BRIDGE RD (320813)	01 - Clear	01 - Daylight	10 - No control	0	03 - P.D. only	05 - Turning movement	01 - Dry	2	0	0	0
2019-09-26	2019	16:40	MARCH RD btwn MAXWELL RD & MAXWELL BRIDGE RD (320813)	02 - Rain	01 - Daylight	10 - No control	0	03 - P.D. only	03 - Rear end	02 - Wet	2	0	0	0
2019-11-15	2019	22:25	MARCH RD btwn MAXWELL RD & MAXWELL BRIDGE RD (320813)	01 - Clear	07 - Dark	10 - No control	0	03 - P.D. only	07 - SMV other	01 - Dry	1	0	0	0
2019-12-18	2019	5:40	MARCH RD btwn MAXWELL RD & MAXWELL BRIDGE RD (320813)	01 - Clear	07 - Dark	10 - No control	0	03 - P.D. only	07 - SMV other	02 - Wet	1	0	0	0
2020-01-21	2020	14:45	MARCH RD btwn MAXWELL RD & MAXWELL BRIDGE RD (320813)	01 - Clear	01 - Daylight	10 - No control	0	03 - P.D. only	07 - SMV other	02 - Wet	1	0	0	0
2020-01-24	2020	19:30	MARCH RD btwn MAXWELL RD & MAXWELL BRIDGE RD (320813)	01 - Clear	07 - Dark	10 - No control	0	03 - P.D. only	04 - Sideswipe	01 - Dry	2	0	0	0
2020-02-28	2020	8:18	MARCH RD btwn MAXWELL RD & MAXWELL BRIDGE RD (320813)	01 - Clear	01 - Daylight	10 - No control	0	03 - P.D. only	07 - SMV other	05 - Packed snow	1	0	0	0
2020-04-16	2020	20:41	MARCH RD btwn MAXWELL RD & MAXWELL BRIDGE RD (320813)	01 - Clear	07 - Dark	10 - No control	0	03 - P.D. only	07 - SMV other	01 - Dry	1	0	0	0
2020-11-10	2020	19:09	MARCH RD btwn MAXWELL RD & MAXWELL BRIDGE RD (320813)	01 - Clear	07 - Dark	10 - No control	0	03 - P.D. only	07 - SMV other	01 - Dry	1	0	0	0
2020-11-10	2020	18:50	MARCH RD btwn MAXWELL RD & MAXWELL BRIDGE RD (320813)	01 - Clear	07 - Dark	10 - No control	0	03 - P.D. only	07 - SMV other	01 - Dry	1	0	0	0
2020-11-22	2020	17:57	MARCH RD btwn MAXWELL RD & MAXWELL BRIDGE RD (320813)	03 - Snow	07 - Dark	10 - No control	0	03 - P.D. only	07 - SMV other	03 - Loose snow	1	0	0	0
2020-12-26	2020	13:29	MARCH RD btwn MAXWELL RD & MAXWELL BRIDGE RD (320813)	01 - Clear	01 - Daylight	10 - No control	0	03 - P.D. only	07 - SMV other	02 - Wet	1	0	0	0
2021-01-09	2021	0:08	MARCH RD btwn MAXWELL RD & MAXWELL BRIDGE RD (320813)	01 - Clear	07 - Dark	10 - No control	0	03 - P.D. only	03 - Rear end	01 - Dry	2	0	0	0
2021-02-10	2021	16:24	MARCH RD btwn MAXWELL RD & MAXWELL BRIDGE RD (320813)	01 - Clear	01 - Daylight	10 - No control	0	03 - P.D. only	03 - Rear end	02 - Wet	2	0	0	0
2022-02-17	2022	21:02	MARCH RD btwn MAXWELL RD & MAXWELL BRIDGE RD (320813)	03 - Snow	07 - Dark	10 - No control	0	03 - P.D. only	07 - SMV other	06 - Ice	1	0	0	0
2022-03-29	2022	14:38	MARCH RD btwn MAXWELL RD & MAXWELL BRIDGE RD (320813)	01 - Clear	01 - Daylight	10 - No control	0	03 - P.D. only	04 - Sideswipe	08 - Loose sand or gravel	2	0	0	0
2022-05-03	2022	18:10	MARCH RD btwn MAXWELL RD & MAXWELL BRIDGE RD (320813)	01 - Clear	01 - Daylight	10 - No control	0	03 - P.D. only	03 - Rear end	01 - Dry	3	0	0	0

Appendix E

March Road at Buckbean Avenue Road Modification

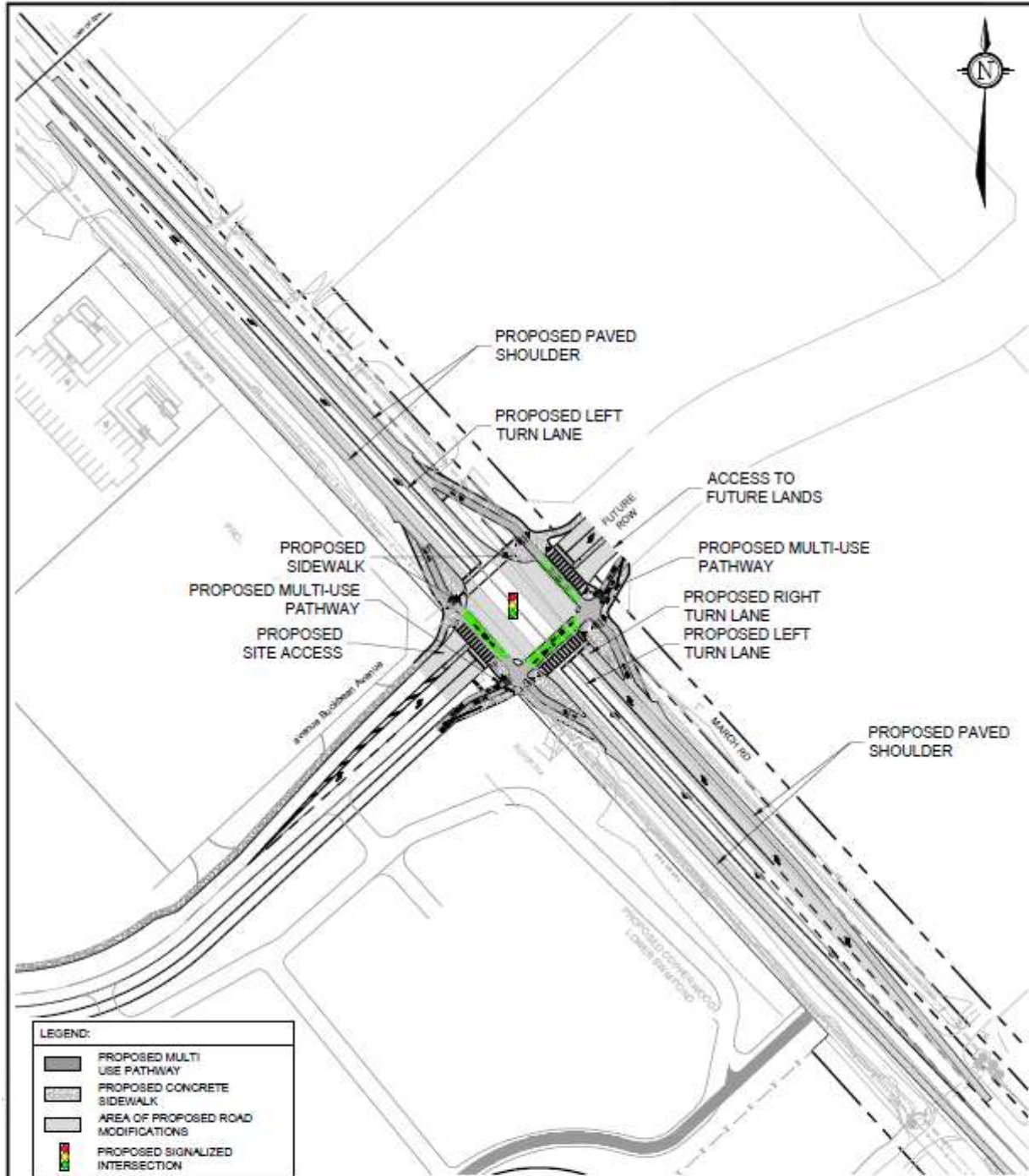

LEGEND:	
	PROPOSED MULTI-USE PATHWAY
	PROPOSED CONCRETE SIDEWALK
	AREA OF PROPOSED ROAD MODIFICATIONS
	PROPOSED SIGNALIZED INTERSECTION



PLANNING, DEVELOPMENT AND BUILDING SERVICES

PROPOSED ROADWAY MODIFICATIONS
MARCH ROAD AT STREET 1 (KANATA NORTH URBAN EXPANSION AREA)

Planning, Development & Building Services			
Approved By:	EMILY WANG	Drawing No.:	
Completed By:	NOVATECH	RMA-2022-TPD-051B	
Scale:	N.T.S.		
Date:	SEPTEMBER 2024		

Appendix F

TDM Checklist

TDM Measures Checklist:

Non-Residential Developments (office, institutional, retail or industrial)

Legend	
BASIC	The measure is generally feasible and effective, and in most cases would benefit the development and its users
BETTER	The measure could maximize support for users of sustainable modes, and optimize development performance
★	The measure is one of the most dependably effective tools to encourage the use of sustainable modes

TDM measures: <i>Non-residential developments</i>	Check if proposed & add descriptions
1. TDM PROGRAM MANAGEMENT	
1.1 Program coordinator	
BASIC	★ 1.1.1 Designate an internal coordinator, or contract with an external coordinator <input type="checkbox"/>
1.2 Travel surveys	
BETTER	1.2.1 Conduct periodic surveys to identify travel-related behaviours, attitudes, challenges and solutions, and to track progress <input type="checkbox"/>
2. WALKING AND CYCLING	
2.1 Information on walking/cycling routes & destinations	
BASIC	2.1.1 Display local area maps with walking/cycling access routes and key destinations at major entrances <input type="checkbox"/>
2.2 Bicycle skills training	
<i>Commuter travel</i>	
BETTER	★ 2.2.1 Offer on-site cycling courses for commuters, or subsidize off-site courses <input type="checkbox"/>
2.3 Valet bike parking	
<i>Visitor travel</i>	
BETTER	2.3.1 Offer secure valet bike parking during public events when demand exceeds fixed supply (e.g. for festivals, concerts, games) <input type="checkbox"/>

TDM measures: <i>Non-residential developments</i>		Check if proposed & add descriptions
3. TRANSIT		
3.1 Transit information		
BASIC	3.1.1 Display relevant transit schedules and route maps at entrances	<input type="checkbox"/>
BASIC	3.1.2 Provide online links to OC Transpo and STO information	<input type="checkbox"/>
BETTER	3.1.3 Provide real-time arrival information display at entrances	<input type="checkbox"/>
3.2 Transit fare incentives		
<i>Commuter travel</i>		
BETTER	3.2.1 Offer preloaded PRESTO cards to encourage commuters to use transit	<input type="checkbox"/>
BETTER ★	3.2.2 Subsidize or reimburse monthly transit pass purchases by employees	<input type="checkbox"/>
<i>Visitor travel</i>		
BETTER	3.2.3 Arrange inclusion of same-day transit fare in price of tickets (e.g. for festivals, concerts, games)	<input type="checkbox"/>
3.3 Enhanced public transit service		
<i>Commuter travel</i>		
BETTER	3.3.1 Contract with OC Transpo to provide enhanced transit services (e.g. for shift changes, weekends)	<input type="checkbox"/>
<i>Visitor travel</i>		
BETTER	3.3.2 Contract with OC Transpo to provide enhanced transit services (e.g. for festivals, concerts, games)	<input type="checkbox"/>
3.4 Private transit service		
<i>Commuter travel</i>		
BETTER	3.4.1 Provide shuttle service when OC Transpo cannot offer sufficient quality or capacity to serve demand (e.g. for shift changes, weekends)	<input type="checkbox"/>
<i>Visitor travel</i>		
BETTER	3.4.2 Provide shuttle service when OC Transpo cannot offer sufficient quality or capacity to serve demand (e.g. for festivals, concerts, games)	<input type="checkbox"/>

TDM measures: <i>Non-residential developments</i>		Check if proposed & add descriptions
4. RIDESHARING		
4.1 Ridematching service		
<i>Commuter travel</i>		
BASIC	★ 4.1.1 Provide a dedicated ridematching portal at OttawaRideMatch.com	<input type="checkbox"/>
4.2 Carpool parking price incentives		
<i>Commuter travel</i>		
BETTER	4.2.1 Provide discounts on parking costs for registered carpools	<input type="checkbox"/>
4.3 Vanpool service		
<i>Commuter travel</i>		
BETTER	4.3.1 Provide a vanpooling service for long-distance commuters	<input type="checkbox"/>
5. CARSHARING & BIKESHARING		
5.1 Bikeshare stations & memberships		
BETTER	5.1.1 Contract with provider to install on-site bikeshare station for use by commuters and visitors	<input type="checkbox"/>
<i>Commuter travel</i>		
BETTER	5.1.2 Provide employees with bikeshare memberships for local business travel	<input type="checkbox"/>
5.2 Carshare vehicles & memberships		
<i>Commuter travel</i>		
BETTER	5.2.1 Contract with provider to install on-site carshare vehicles and promote their use by tenants	<input type="checkbox"/>
BETTER	5.2.2 Provide employees with carshare memberships for local business travel	<input type="checkbox"/>
6. PARKING		
6.1 Priced parking		
<i>Commuter travel</i>		
BASIC	★ 6.1.1 Charge for long-term parking (daily, weekly, monthly)	<input type="checkbox"/>
BASIC	6.1.2 Unbundle parking cost from lease rates at multi-tenant sites	<input checked="" type="checkbox"/>
<i>Visitor travel</i>		
BETTER	6.1.3 Charge for short-term parking (hourly)	<input type="checkbox"/>

TDM measures: <i>Non-residential developments</i>		Check if proposed & add descriptions
7. TDM MARKETING & COMMUNICATIONS		
7.1 Multimodal travel information		
<i>Commuter travel</i>		
BASIC ★	7.1.1 Provide a multimodal travel option information package to new/relocating employees and students	<input type="checkbox"/>
<i>Visitor travel</i>		
BETTER ★	7.1.2 Include multimodal travel option information in invitations or advertising that attract visitors or customers (e.g. for festivals, concerts, games)	<input type="checkbox"/>
7.2 Personalized trip planning		
<i>Commuter travel</i>		
BETTER ★	7.2.1 Offer personalized trip planning to new/relocating employees	<input type="checkbox"/>
7.3 Promotions		
<i>Commuter travel</i>		
BETTER	7.3.1 Deliver promotions and incentives to maintain awareness, build understanding, and encourage trial of sustainable modes	<input type="checkbox"/>
8. OTHER INCENTIVES & AMENITIES		
8.1 Emergency ride home		
<i>Commuter travel</i>		
BETTER ★	8.1.1 Provide emergency ride home service to non-driving commuters	<input type="checkbox"/>
8.2 Alternative work arrangements		
<i>Commuter travel</i>		
BASIC ★	8.2.1 Encourage flexible work hours	<input type="checkbox"/>
BETTER	8.2.2 Encourage compressed workweeks	<input type="checkbox"/>
BETTER ★	8.2.3 Encourage telework	<input type="checkbox"/>
8.3 Local business travel options		
<i>Commuter travel</i>		
BASIC ★	8.3.1 Provide local business travel options that minimize the need for employees to bring a personal car to work	<input type="checkbox"/>
8.4 Commuter incentives		
<i>Commuter travel</i>		
BETTER	8.4.1 Offer employees a taxable, mode-neutral commuting allowance	<input type="checkbox"/>
8.5 On-site amenities		
<i>Commuter travel</i>		
BETTER	8.5.1 Provide on-site amenities/services to minimize mid-day or mid-commute errands	<input type="checkbox"/>

TDM Measures Checklist:
Residential Developments (multi-family, condominium or subdivision)

Legend	
BASIC	The measure is generally feasible and effective, and in most cases would benefit the development and its users
BETTER	The measure could maximize support for users of sustainable modes, and optimize development performance
★	The measure is one of the most dependably effective tools to encourage the use of sustainable modes

TDM measures: Residential developments		Check if proposed & add descriptions
1. TDM PROGRAM MANAGEMENT		
1.1 Program coordinator		
BASIC	★ 1.1.1 Designate an internal coordinator, or contract with an external coordinator	<input type="checkbox"/>
1.2 Travel surveys		
BETTER	1.2.1 Conduct periodic surveys to identify travel-related behaviours, attitudes, challenges and solutions, and to track progress	<input type="checkbox"/>
2. WALKING AND CYCLING		
2.1 Information on walking/cycling routes & destinations		
BASIC	2.1.1 Display local area maps with walking/cycling access routes and key destinations at major entrances (<i>multi-family, condominium</i>)	<input type="checkbox"/>
2.2 Bicycle skills training		
BETTER	2.2.1 Offer on-site cycling courses for residents, or subsidize off-site courses	<input type="checkbox"/>

TDM measures: <i>Residential developments</i>		Check if proposed & add descriptions
3. TRANSIT		
3.1 Transit information		
BASIC	3.1.1 Display relevant transit schedules and route maps at entrances (<i>multi-family, condominium</i>)	<input type="checkbox"/>
BETTER	3.1.2 Provide real-time arrival information display at entrances (<i>multi-family, condominium</i>)	<input type="checkbox"/>
3.2 Transit fare incentives		
BASIC ★	3.2.1 Offer PRESTO cards preloaded with one monthly transit pass on residence purchase/move-in, to encourage residents to use transit	<input type="checkbox"/>
BETTER	3.2.2 Offer at least one year of free monthly transit passes on residence purchase/move-in	<input type="checkbox"/>
3.3 Enhanced public transit service		
BETTER ★	3.3.1 Contract with OC Transpo to provide early transit services until regular services are warranted by occupancy levels (<i>subdivision</i>)	<input type="checkbox"/>
3.4 Private transit service		
BETTER	3.4.1 Provide shuttle service for seniors homes or lifestyle communities (e.g. scheduled mall or supermarket runs)	<input type="checkbox"/>
4. CARSHARING & BIKESHARING		
4.1 Bikeshare stations & memberships		
BETTER	4.1.1 Contract with provider to install on-site bikeshare station (<i>multi-family</i>)	<input type="checkbox"/>
BETTER	4.1.2 Provide residents with bikeshare memberships, either free or subsidized (<i>multi-family</i>)	<input type="checkbox"/>
4.2 Carshare vehicles & memberships		
BETTER	4.2.1 Contract with provider to install on-site carshare vehicles and promote their use by residents	<input type="checkbox"/>
BETTER	4.2.2 Provide residents with carshare memberships, either free or subsidized	<input type="checkbox"/>
5. PARKING		
5.1 Priced parking		
BASIC ★	5.1.1 Unbundle parking cost from purchase price (<i>condominium</i>)	<input checked="" type="checkbox"/>
BASIC ★	5.1.2 Unbundle parking cost from monthly rent (<i>multi-family</i>)	<input checked="" type="checkbox"/>

TDM measures: <i>Residential developments</i>		Check if proposed & add descriptions
6. TDM MARKETING & COMMUNICATIONS		
6.1 Multimodal travel information		
BASIC ★	6.1.1 Provide a multimodal travel option information package to new residents	<input type="checkbox"/>
6.2 Personalized trip planning		
BETTER ★	6.2.1 Offer personalized trip planning to new residents	<input type="checkbox"/>

TDM-Supportive Development Design and Infrastructure Checklist:
Non-Residential Developments (office, institutional, retail or industrial)

Legend	
REQUIRED	The Official Plan or Zoning By-law provides related guidance that must be followed
BASIC	The measure is generally feasible and effective, and in most cases would benefit the development and its users
BETTER	The measure could maximize support for users of sustainable modes, and optimize development performance

TDM-supportive design & infrastructure measures: <i>Non-residential developments</i>		Check if completed & add descriptions, explanations or plan/drawing references
1. WALKING & CYCLING: ROUTES		
1.1 Building location & access points		
BASIC	1.1.1 Locate building close to the street, and do not locate parking areas between the street and building entrances	<input checked="" type="checkbox"/>
BASIC	1.1.2 Locate building entrances in order to minimize walking distances to sidewalks and transit stops/stations	<input checked="" type="checkbox"/>
BASIC	1.1.3 Locate building doors and windows to ensure visibility of pedestrians from the building, for their security and comfort	<input checked="" type="checkbox"/>
1.2 Facilities for walking & cycling		
REQUIRED	1.2.1 Provide convenient, direct access to stations or major stops along rapid transit routes within 600 metres; minimize walking distances from buildings to rapid transit; provide pedestrian-friendly, weather-protected (where possible) environment between rapid transit accesses and building entrances; ensure quality linkages from sidewalks through building entrances to integrated stops/stations <i>(see Official Plan policy 4.3.3)</i>	<input checked="" type="checkbox"/>
REQUIRED	1.2.2 Provide safe, direct and attractive pedestrian access from public sidewalks to building entrances through such measures as: reducing distances between public sidewalks and major building entrances; providing walkways from public streets to major building entrances; within a site, providing walkways along the front of adjoining buildings, between adjacent buildings, and connecting areas where people may congregate, such as courtyards and transit stops; and providing weather protection through canopies, colonnades, and other design elements wherever possible <i>(see Official Plan policy 4.3.12)</i>	<input checked="" type="checkbox"/>

TDM-supportive design & infrastructure measures: <i>Non-residential developments</i>		Check if completed & add descriptions, explanations or plan/drawing references
REQUIRED	1.2.3 Provide sidewalks of smooth, well-drained walking surfaces of contrasting materials or treatments to differentiate pedestrian areas from vehicle areas, and provide marked pedestrian crosswalks at intersection sidewalks (<i>see Official Plan policy 4.3.10</i>)	<input checked="" type="checkbox"/>
REQUIRED	1.2.4 Make sidewalks and open space areas easily accessible through features such as gradual grade transition, depressed curbs at street corners and convenient access to extra-wide parking spaces and ramps (<i>see Official Plan policy 4.3.10</i>)	<input checked="" type="checkbox"/>
REQUIRED	1.2.5 Include adequately spaced inter-block/street cycling and pedestrian connections to facilitate travel by active transportation. Provide links to the existing or planned network of public sidewalks, multi-use pathways and on-road cycle routes. Where public sidewalks and multi-use pathways intersect with roads, consider providing traffic control devices to give priority to cyclists and pedestrians (<i>see Official Plan policy 4.3.11</i>)	<input checked="" type="checkbox"/>
BASIC	1.2.6 Provide safe, direct and attractive walking routes from building entrances to nearby transit stops	<input type="checkbox"/>
BASIC	1.2.7 Ensure that walking routes to transit stops are secure, visible, lighted, shaded and wind-protected wherever possible	<input type="checkbox"/>
BASIC	1.2.8 Design roads used for access or circulation by cyclists using a target operating speed of no more than 30 km/h, or provide a separated cycling facility	<input checked="" type="checkbox"/>
1.3 Amenities for walking & cycling		
BASIC	1.3.1 Provide lighting, landscaping and benches along walking and cycling routes between building entrances and streets, sidewalks and trails	<input type="checkbox"/>
BASIC	1.3.2 Provide wayfinding signage for site access (where required, e.g. when multiple buildings or entrances exist) and egress (where warranted, such as when directions to reach transit stops/stations, trails or other common destinations are not obvious)	<input type="checkbox"/>

TDM-supportive design & infrastructure measures: <i>Non-residential developments</i>		Check if completed & add descriptions, explanations or plan/drawing references
2. WALKING & CYCLING: END-OF-TRIP FACILITIES		
2.1 Bicycle parking		
REQUIRED	2.1.1 Provide bicycle parking in highly visible and lighted areas, sheltered from the weather wherever possible (see <i>Official Plan policy 4.3.6</i>)	<input checked="" type="checkbox"/>
REQUIRED	2.1.2 Provide the number of bicycle parking spaces specified for various land uses in different parts of Ottawa; provide convenient access to main entrances or well-used areas (see <i>Zoning By-law Section 111</i>)	<input checked="" type="checkbox"/>
REQUIRED	2.1.3 Ensure that bicycle parking spaces and access aisles meet minimum dimensions; that no more than 50% of spaces are vertical spaces; and that parking racks are securely anchored (see <i>Zoning By-law Section 111</i>)	<input checked="" type="checkbox"/>
BASIC	2.1.4 Provide bicycle parking spaces equivalent to the expected number of commuter cyclists (assuming the cycling mode share target is met), plus the expected peak number of customer/visitor cyclists	<input type="checkbox"/>
BETTER	2.1.5 Provide bicycle parking spaces equivalent to the expected number of commuter and customer/visitor cyclists, plus an additional buffer (e.g. 25 percent extra) to encourage other cyclists and ensure adequate capacity in peak cycling season	<input type="checkbox"/>
2.2 Secure bicycle parking		
REQUIRED	2.2.1 Where more than 50 bicycle parking spaces are provided for a single office building, locate at least 25% of spaces within a building/structure, a secure area (e.g. supervised parking lot or enclosure) or bicycle lockers (see <i>Zoning By-law Section 111</i>)	<input type="checkbox"/>
BETTER	2.2.2 Provide secure bicycle parking spaces equivalent to the expected number of commuter cyclists (assuming the cycling mode share target is met)	<input type="checkbox"/>
2.3 Shower & change facilities		
BASIC	2.3.1 Provide shower and change facilities for the use of active commuters	<input type="checkbox"/>
BETTER	2.3.2 In addition to shower and change facilities, provide dedicated lockers, grooming stations, drying racks and laundry facilities for the use of active commuters	<input type="checkbox"/>
2.4 Bicycle repair station		
BETTER	2.4.1 Provide a permanent bike repair station, with commonly used tools and an air pump, adjacent to the main bicycle parking area (or secure bicycle parking area, if provided)	<input type="checkbox"/>

TDM-supportive design & infrastructure measures: <i>Non-residential developments</i>		Check if completed & add descriptions, explanations or plan/drawing references
3. TRANSIT		
3.1 Customer amenities		
BASIC	3.1.1 Provide shelters, lighting and benches at any on-site transit stops	<input type="checkbox"/>
BASIC	3.1.2 Where the site abuts an off-site transit stop and insufficient space exists for a transit shelter in the public right-of-way, protect land for a shelter and/or install a shelter	<input type="checkbox"/>
BETTER	3.1.3 Provide a secure and comfortable interior waiting area by integrating any on-site transit stops into the building	<input type="checkbox"/>
4. RIDESHARING		
4.1 Pick-up & drop-off facilities		
BASIC	4.1.1 Provide a designated area for carpool drivers (plus taxis and ride-hailing services) to drop off or pick up passengers without using fire lanes or other no-stopping zones	<input type="checkbox"/>
4.2 Carpool parking		
BASIC	4.2.1 Provide signed parking spaces for carpools in a priority location close to a major building entrance, sufficient in number to accommodate the mode share target for carpools	<input type="checkbox"/>
BETTER	4.2.2 At large developments, provide spaces for carpools in a separate, access-controlled parking area to simplify enforcement	<input type="checkbox"/>
5. CARSHARING & BIKESHARING		
5.1 Carshare parking spaces		
BETTER	5.1.1 Provide carshare parking spaces in permitted non-residential zones, occupying either required or provided parking spaces (<i>see Zoning By-law Section 94</i>)	<input type="checkbox"/>
5.2 Bikeshare station location		
BETTER	5.2.1 Provide a designated bikeshare station area near a major building entrance, preferably lighted and sheltered with a direct walkway connection	<input type="checkbox"/>

TDM-supportive design & infrastructure measures: <i>Non-residential developments</i>		Check if completed & add descriptions, explanations or plan/drawing references
6. PARKING		
6.1 Number of parking spaces		
REQUIRED	6.1.1 Do not provide more parking than permitted by zoning, nor less than required by zoning, unless a variance is being applied for	<input checked="" type="checkbox"/>
BASIC	6.1.2 Provide parking for long-term and short-term users that is consistent with mode share targets, considering the potential for visitors to use off-site public parking	<input type="checkbox"/>
BASIC	6.1.3 Where a site features more than one use, provide shared parking and reduce the cumulative number of parking spaces accordingly (<i>see Zoning By-law Section 104</i>)	<input type="checkbox"/>
BETTER	6.1.4 Reduce the minimum number of parking spaces required by zoning by one space for each 13 square metres of gross floor area provided as shower rooms, change rooms, locker rooms and other facilities for cyclists in conjunction with bicycle parking (<i>see Zoning By-law Section 111</i>)	<input type="checkbox"/>
6.2 Separate long-term & short-term parking areas		
BETTER	6.2.1 Separate short-term and long-term parking areas using signage or physical barriers, to permit access controls and simplify enforcement (i.e. to discourage employees from parking in visitor spaces, and vice versa)	<input type="checkbox"/>
7. OTHER		
7.1 On-site amenities to minimize off-site trips		
BETTER	7.1.1 Provide on-site amenities to minimize mid-day or mid-commute errands	<input type="checkbox"/>

TDM-Supportive Development Design and Infrastructure Checklist:
Residential Developments (multi-family or condominium)

Legend	
REQUIRED	The Official Plan or Zoning By-law provides related guidance that must be followed
BASIC	The measure is generally feasible and effective, and in most cases would benefit the development and its users
BETTER	The measure could maximize support for users of sustainable modes, and optimize development performance

TDM-supportive design & infrastructure measures: <i>Residential developments</i>		Check if completed & add descriptions, explanations or plan/drawing references
1. WALKING & CYCLING: ROUTES		
1.1 Building location & access points		
BASIC	1.1.1 Locate building close to the street, and do not locate parking areas between the street and building entrances	<input checked="" type="checkbox"/>
BASIC	1.1.2 Locate building entrances in order to minimize walking distances to sidewalks and transit stops/stations	<input checked="" type="checkbox"/>
BASIC	1.1.3 Locate building doors and windows to ensure visibility of pedestrians from the building, for their security and comfort	<input checked="" type="checkbox"/>
1.2 Facilities for walking & cycling		
REQUIRED	1.2.1 Provide convenient, direct access to stations or major stops along rapid transit routes within 600 metres; minimize walking distances from buildings to rapid transit; provide pedestrian-friendly, weather-protected (where possible) environment between rapid transit accesses and building entrances; ensure quality linkages from sidewalks through building entrances to integrated stops/stations <i>(see Official Plan policy 4.3.3)</i>	<input checked="" type="checkbox"/>
REQUIRED	1.2.2 Provide safe, direct and attractive pedestrian access from public sidewalks to building entrances through such measures as: reducing distances between public sidewalks and major building entrances; providing walkways from public streets to major building entrances; within a site, providing walkways along the front of adjoining buildings, between adjacent buildings, and connecting areas where people may congregate, such as courtyards and transit stops; and providing weather protection through canopies, colonnades, and other design elements wherever possible <i>(see Official Plan policy 4.3.12)</i>	<input checked="" type="checkbox"/>

TDM-supportive design & infrastructure measures: <i>Residential developments</i>		Check if completed & add descriptions, explanations or plan/drawing references
REQUIRED	1.2.3 Provide sidewalks of smooth, well-drained walking surfaces of contrasting materials or treatments to differentiate pedestrian areas from vehicle areas, and provide marked pedestrian crosswalks at intersection sidewalks (<i>see Official Plan policy 4.3.10</i>)	<input checked="" type="checkbox"/>
REQUIRED	1.2.4 Make sidewalks and open space areas easily accessible through features such as gradual grade transition, depressed curbs at street corners and convenient access to extra-wide parking spaces and ramps (<i>see Official Plan policy 4.3.10</i>)	<input checked="" type="checkbox"/>
REQUIRED	1.2.5 Include adequately spaced inter-block/street cycling and pedestrian connections to facilitate travel by active transportation. Provide links to the existing or planned network of public sidewalks, multi-use pathways and on-road cycle routes. Where public sidewalks and multi-use pathways intersect with roads, consider providing traffic control devices to give priority to cyclists and pedestrians (<i>see Official Plan policy 4.3.11</i>)	<input checked="" type="checkbox"/>
BASIC	1.2.6 Provide safe, direct and attractive walking routes from building entrances to nearby transit stops	<input type="checkbox"/>
BASIC	1.2.7 Ensure that walking routes to transit stops are secure, visible, lighted, shaded and wind-protected wherever possible	<input type="checkbox"/>
BASIC	1.2.8 Design roads used for access or circulation by cyclists using a target operating speed of no more than 30 km/h, or provide a separated cycling facility	<input checked="" type="checkbox"/>
1.3 Amenities for walking & cycling		
BASIC	1.3.1 Provide lighting, landscaping and benches along walking and cycling routes between building entrances and streets, sidewalks and trails	<input type="checkbox"/>
BASIC	1.3.2 Provide wayfinding signage for site access (where required, e.g. when multiple buildings or entrances exist) and egress (where warranted, such as when directions to reach transit stops/stations, trails or other common destinations are not obvious)	<input type="checkbox"/>

TDM-supportive design & infrastructure measures: <i>Residential developments</i>		Check if completed & add descriptions, explanations or plan/drawing references
2. WALKING & CYCLING: END-OF-TRIP FACILITIES		
2.1 Bicycle parking		
REQUIRED	2.1.1 Provide bicycle parking in highly visible and lighted areas, sheltered from the weather wherever possible (see <i>Official Plan policy 4.3.6</i>)	<input checked="" type="checkbox"/>
REQUIRED	2.1.2 Provide the number of bicycle parking spaces specified for various land uses in different parts of Ottawa; provide convenient access to main entrances or well-used areas (see <i>Zoning By-law Section 111</i>)	<input checked="" type="checkbox"/>
REQUIRED	2.1.3 Ensure that bicycle parking spaces and access aisles meet minimum dimensions; that no more than 50% of spaces are vertical spaces; and that parking racks are securely anchored (see <i>Zoning By-law Section 111</i>)	<input checked="" type="checkbox"/>
BASIC	2.1.4 Provide bicycle parking spaces equivalent to the expected number of resident-owned bicycles, plus the expected peak number of visitor cyclists	<input type="checkbox"/>
2.2 Secure bicycle parking		
REQUIRED	2.2.1 Where more than 50 bicycle parking spaces are provided for a single residential building, locate at least 25% of spaces within a building/structure, a secure area (e.g. supervised parking lot or enclosure) or bicycle lockers (see <i>Zoning By-law Section 111</i>)	<input type="checkbox"/>
BETTER	2.2.2 Provide secure bicycle parking spaces equivalent to at least the number of units at condominiums or multi-family residential developments	<input type="checkbox"/>
2.3 Bicycle repair station		
BETTER	2.3.1 Provide a permanent bike repair station, with commonly used tools and an air pump, adjacent to the main bicycle parking area (or secure bicycle parking area, if provided)	<input type="checkbox"/>
3. TRANSIT		
3.1 Customer amenities		
BASIC	3.1.1 Provide shelters, lighting and benches at any on-site transit stops	<input type="checkbox"/>
BASIC	3.1.2 Where the site abuts an off-site transit stop and insufficient space exists for a transit shelter in the public right-of-way, protect land for a shelter and/or install a shelter	<input type="checkbox"/>
BETTER	3.1.3 Provide a secure and comfortable interior waiting area by integrating any on-site transit stops into the building	<input type="checkbox"/>

TDM-supportive design & infrastructure measures: <i>Residential developments</i>		Check if completed & add descriptions, explanations or plan/drawing references
4. RIDESHARING		
4.1 Pick-up & drop-off facilities		
BASIC	4.1.1 Provide a designated area for carpool drivers (plus taxis and ride-hailing services) to drop off or pick up passengers without using fire lanes or other no-stopping zones	<input type="checkbox"/>
5. CARSHARING & BIKESHARING		
5.1 Carshare parking spaces		
BETTER	5.1.1 Provide up to three carshare parking spaces in an R3, R4 or R5 Zone for specified residential uses (see <i>Zoning By-law Section 94</i>)	<input type="checkbox"/>
5.2 Bikeshare station location		
BETTER	5.2.1 Provide a designated bikeshare station area near a major building entrance, preferably lighted and sheltered with a direct walkway connection	<input type="checkbox"/>
6. PARKING		
6.1 Number of parking spaces		
REQUIRED	6.1.1 Do not provide more parking than permitted by zoning, nor less than required by zoning, unless a variance is being applied for	<input checked="" type="checkbox"/>
BASIC	6.1.2 Provide parking for long-term and short-term users that is consistent with mode share targets, considering the potential for visitors to use off-site public parking	<input type="checkbox"/>
BASIC	6.1.3 Where a site features more than one use, provide shared parking and reduce the cumulative number of parking spaces accordingly (see <i>Zoning By-law Section 104</i>)	<input type="checkbox"/>
BETTER	6.1.4 Reduce the minimum number of parking spaces required by zoning by one space for each 13 square metres of gross floor area provided as shower rooms, change rooms, locker rooms and other facilities for cyclists in conjunction with bicycle parking (see <i>Zoning By-law Section 111</i>)	<input type="checkbox"/>
6.2 Separate long-term & short-term parking areas		
BETTER	6.2.1 Provide separate areas for short-term and long-term parking (using signage or physical barriers) to permit access controls and simplify enforcement (i.e. to discourage residents from parking in visitor spaces, and vice versa)	<input checked="" type="checkbox"/>

Appendix G

Turning Templates

FIRE TRUCK INBOUND MOVEMENTS

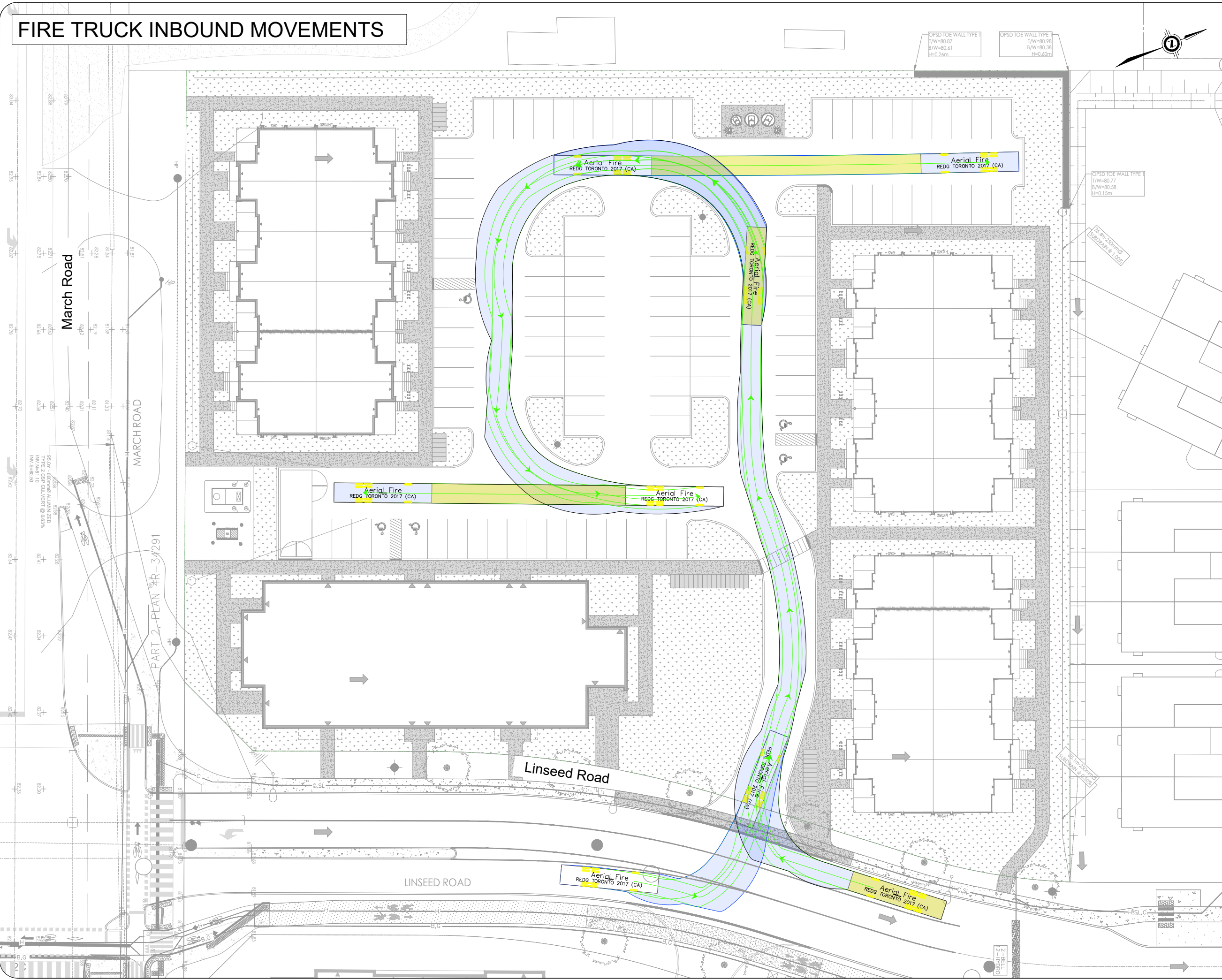

Notes:

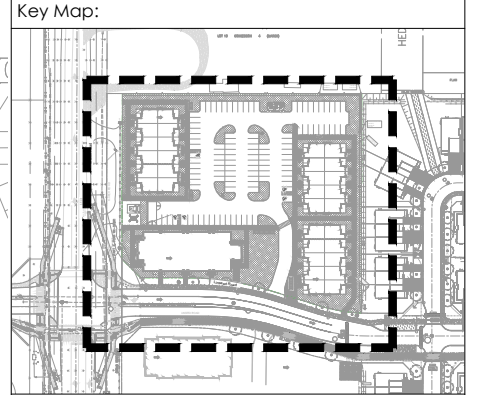

Legend:

- Forward Movement
- Reverse Movement
- Sanitary Maintenance Hole
- Storm Maintenance Hole
- Fire Hydrant
- Storm Catch Basin
- Street Light

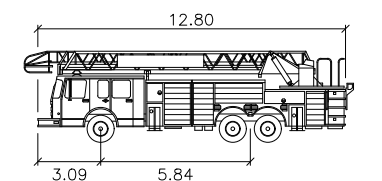

Aerial Fire

Width	: 2.54	units
Track	: 2.54	meters
Lock to Lock Time	: 6.0	seconds
Steering Angle	: 37.0	degrees

03	Issued for Review	EA	2026-03-09
REV:	DESCRIPTION:	BY:	DATE:
STATUS:			

CGH Transportation
6 Plaza Court
Ottawa, ON
K2H 7W1
(343) 999-9117

CLIENT:	Mattamy Homes Canada
ARCHITECT:	

SITE:	Mattamy Northwoods Phase 6 & 7
TITLE:	Turning Template Analysis

SCALE AT A3:	DATE:	DRAWN:	CHECKED:
NTS	2026-03-09	EA	AH
PROJECT NO:	DRAWING NO:	REVISION:	
2025-017	001	03	

FIRE TRUCK OUTBOUND MOVEMENTS

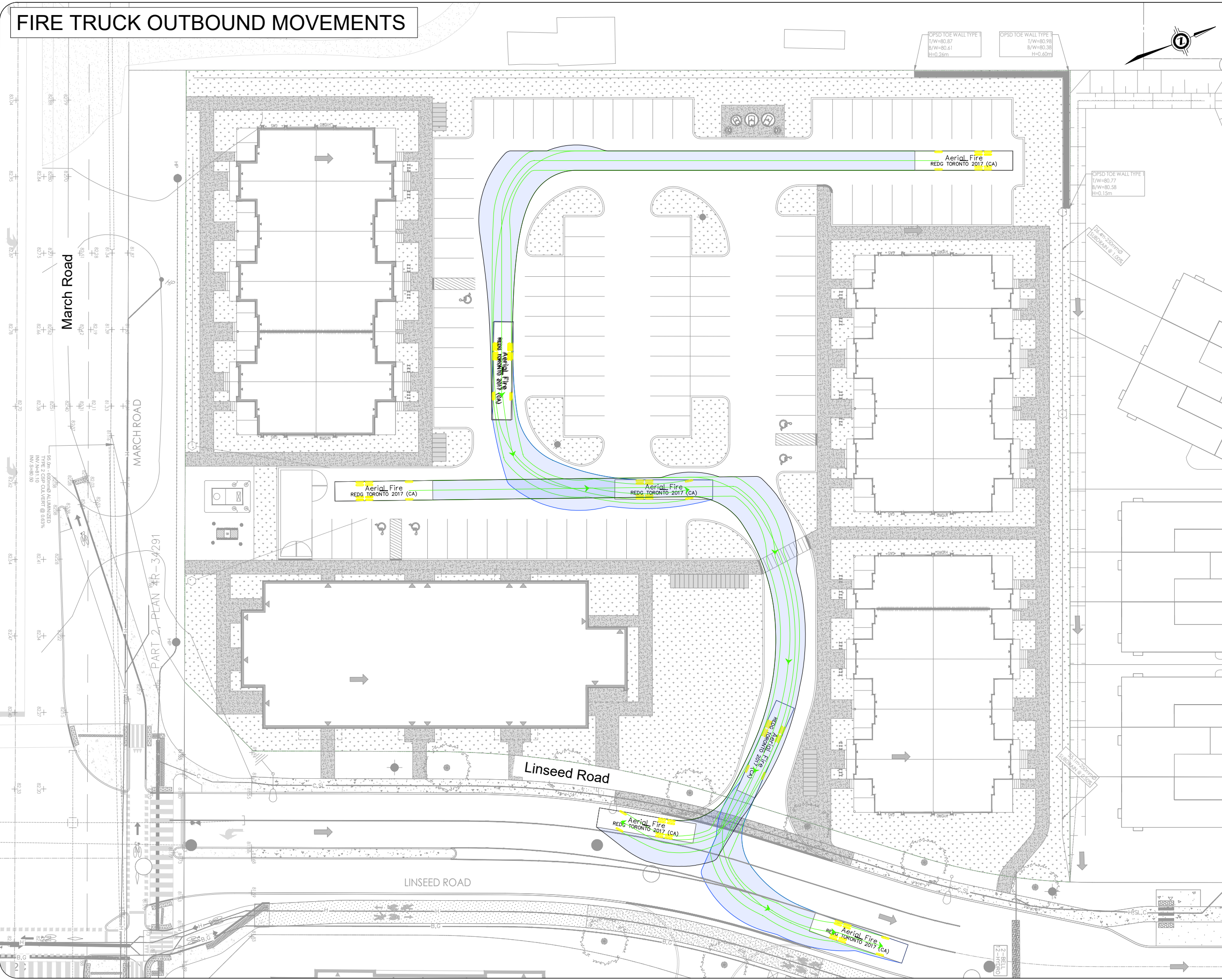

Notes:

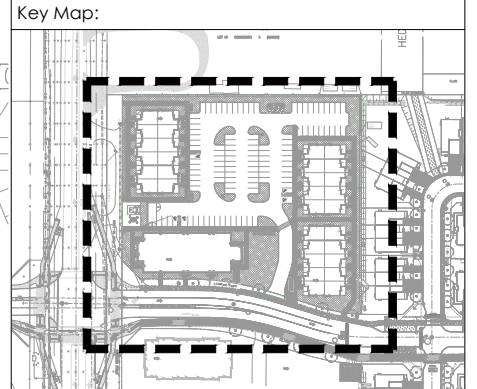

Legend:

- Forward Movement
- Reverse Movement
- Sanitary Maintenance Hole
- Storm Maintenance Hole
- Fire Hydrant
- Storm Catch Basin
- Street Light

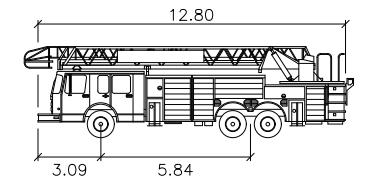

Aerial Fire		units
Width	: 2.54	meters
Track	: 2.54	meters
Lock to Lock Time	: 6.0	seconds
Steering Angle	: 37.0	degrees

03	Issued for Review	EA	2026-03-09
REV:	DESCRIPTION:	BY:	DATE:
STATUS:			

CGH Transportation
 6 Plaza Court
 Ottawa, ON
 K2H 7W1
 (343) 999-9117

CLIENT: **Mattamy Homes Canada**

ARCHITECT:

SITE: **Mattamy Northwoods Phase 6 & 7**

TITLE: **Turning Template Analysis**

SCALE AT A3:	DATE:	DRAWN:	CHECKED:
NTS	2026-03-09	EA	AH
PROJECT NO:	DRAWING NO:	REVISION:	
2025-017	002	03	

HSU INBOUND MOVEMENTS

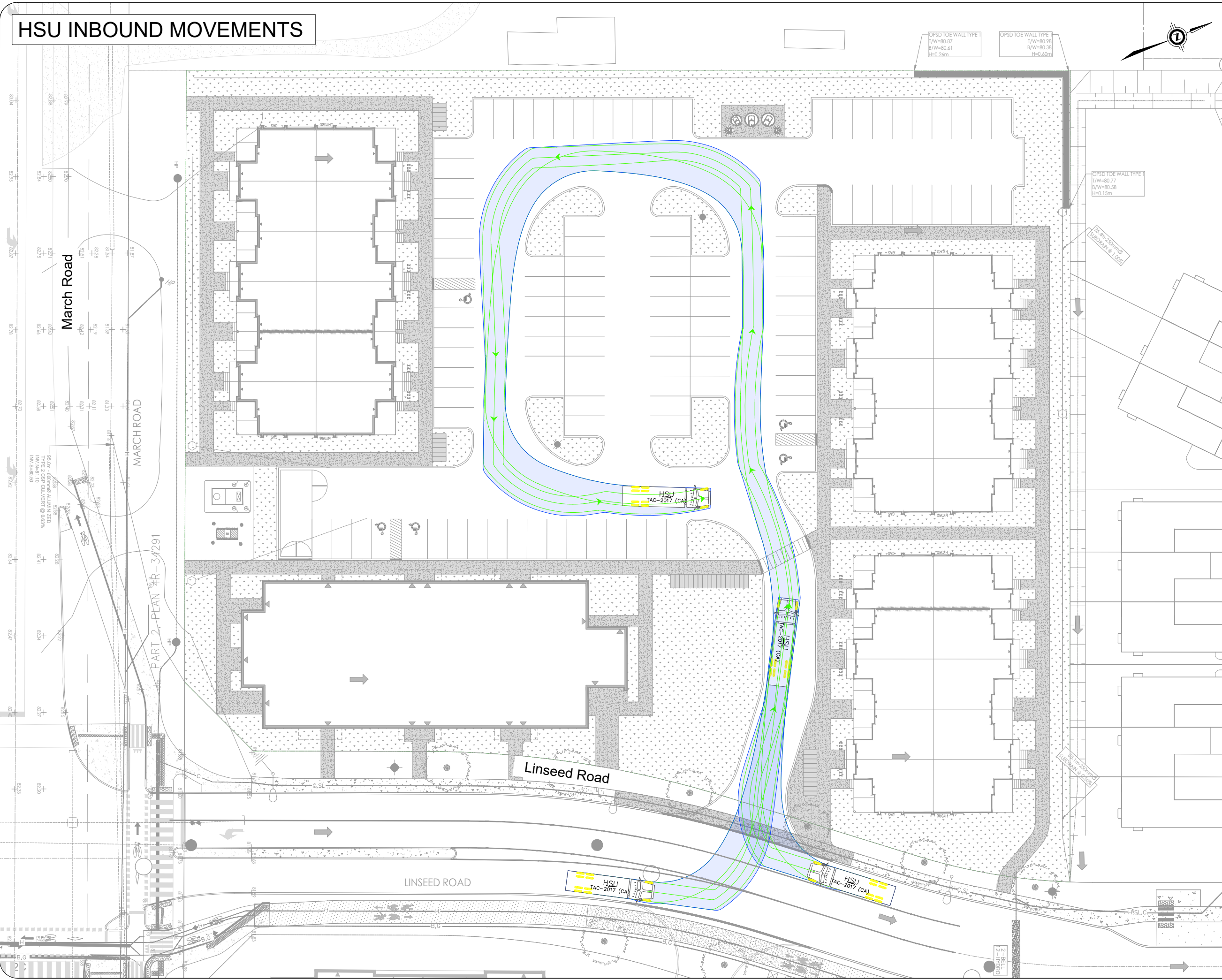

Notes:

Key Map:

Legend:

- Forward Movement
- Reverse Movement
- Sanitary Maintenance Hole
- Storm Maintenance Hole
- ⊕ Fire Hydrant
- Storm Catch Basin
- ⊗ Street Light

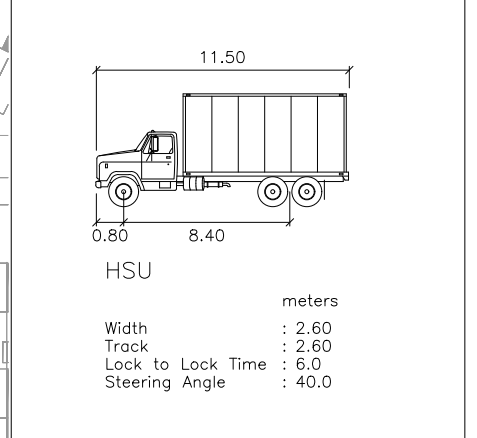

03	Issued for Review	EA	2026-03-09
REV:	DESCRIPTION:	BY:	DATE:
STATUS:			

CGH Transportation
6 Plaza Court
Ottawa, ON
K2H 7W1
(343) 999-9117

CLIENT: **Mattamy Homes Canada**

ARCHITECT:

SITE: **Mattamy Northwoods Phase 6 & 7**

TITLE: **Turning Template Analysis**

SCALE AT A3:	DATE:	DRAWN:	CHECKED:
NTS	2026-03-09	EA	AH
PROJECT NO:	DRAWING NO:	REVISION:	
2025-017	003	03	

HSU OUTBOUND MOVEMENTS

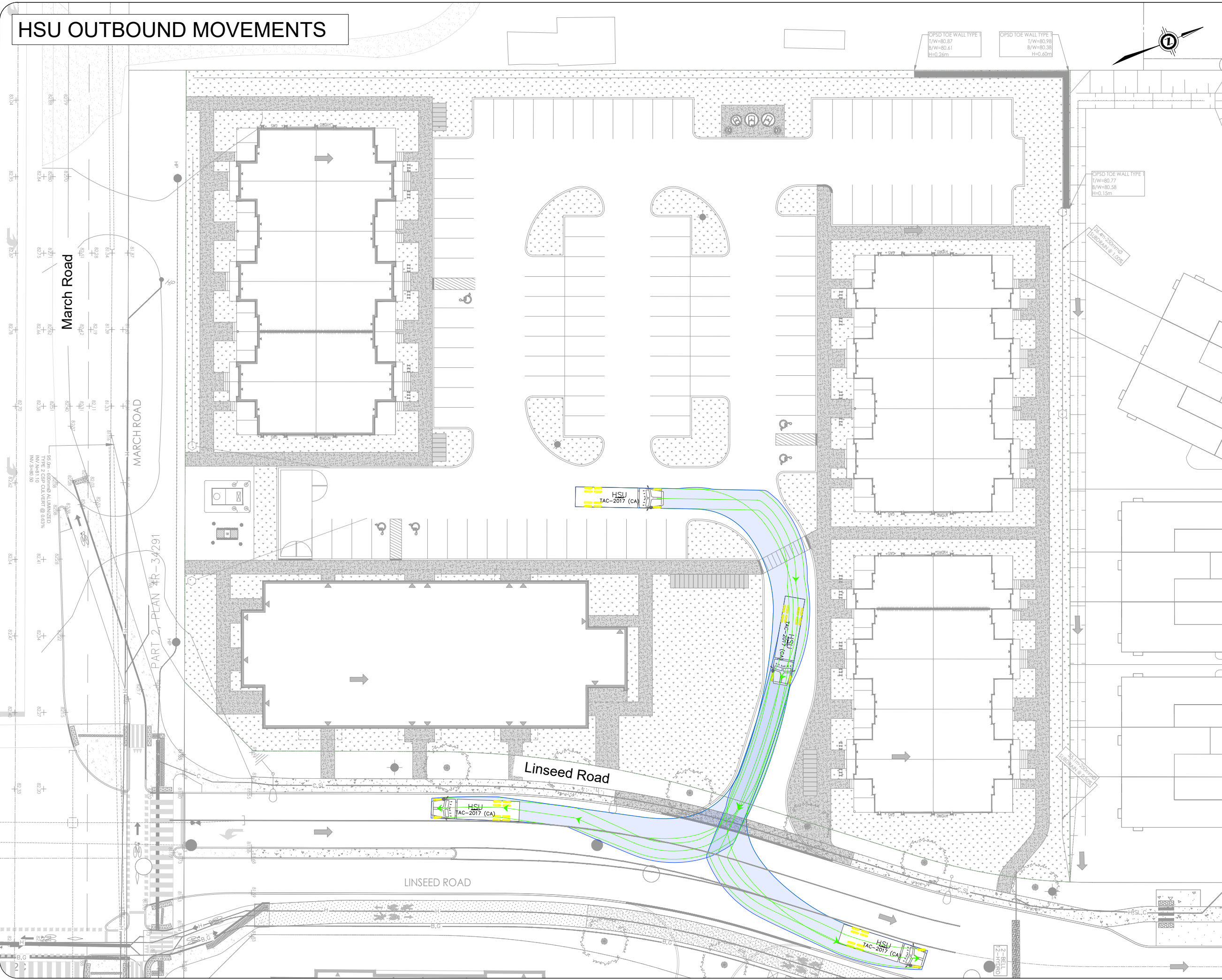

Notes:

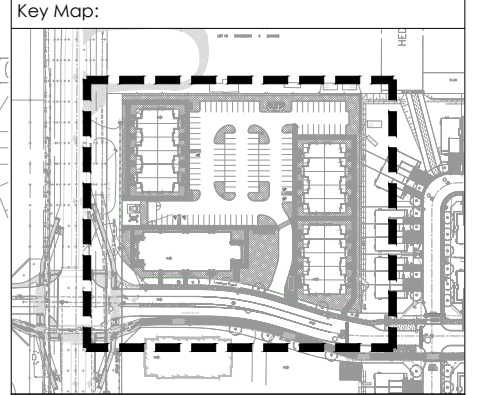

Legend:

- Forward Movement
- Reverse Movement
- Sanitary Maintenance Hole
- Storm Maintenance Hole
- FH Fire Hydrant
- Storm Catch Basin
- SL Street Light

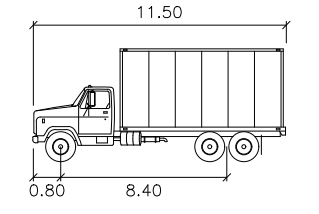

HSU

	meters
Width	: 11.50
Track	: 8.40
Lock to Lock Time	: 6.0
Steering Angle	: 40.0

03	Issued for Review	EA	2026-03-09
REV:	DESCRIPTION:	BY:	DATE:
STATUS:			

CGH Transportation
 6 Plaza Court
 Ottawa, ON
 K2H 7W1
 (343) 999-9117

CLIENT:	Mattamy Homes Canada
ARCHITECT:	

SITE:	Mattamy Northwoods Phase 6 & 7
TITLE:	Turning Template Analysis

SCALE AT A3:	DATE:	DRAWN:	CHECKED:
NTS	2026-03-09	EA	AH
PROJECT NO:	DRAWING NO:	REVISION:	
2025-017	004	03	

MOLOK GARBAGE TRUCK INBOUND MANEUVER

MOLOK GARBAGE TRUCK OUTBOUND MANEUVER

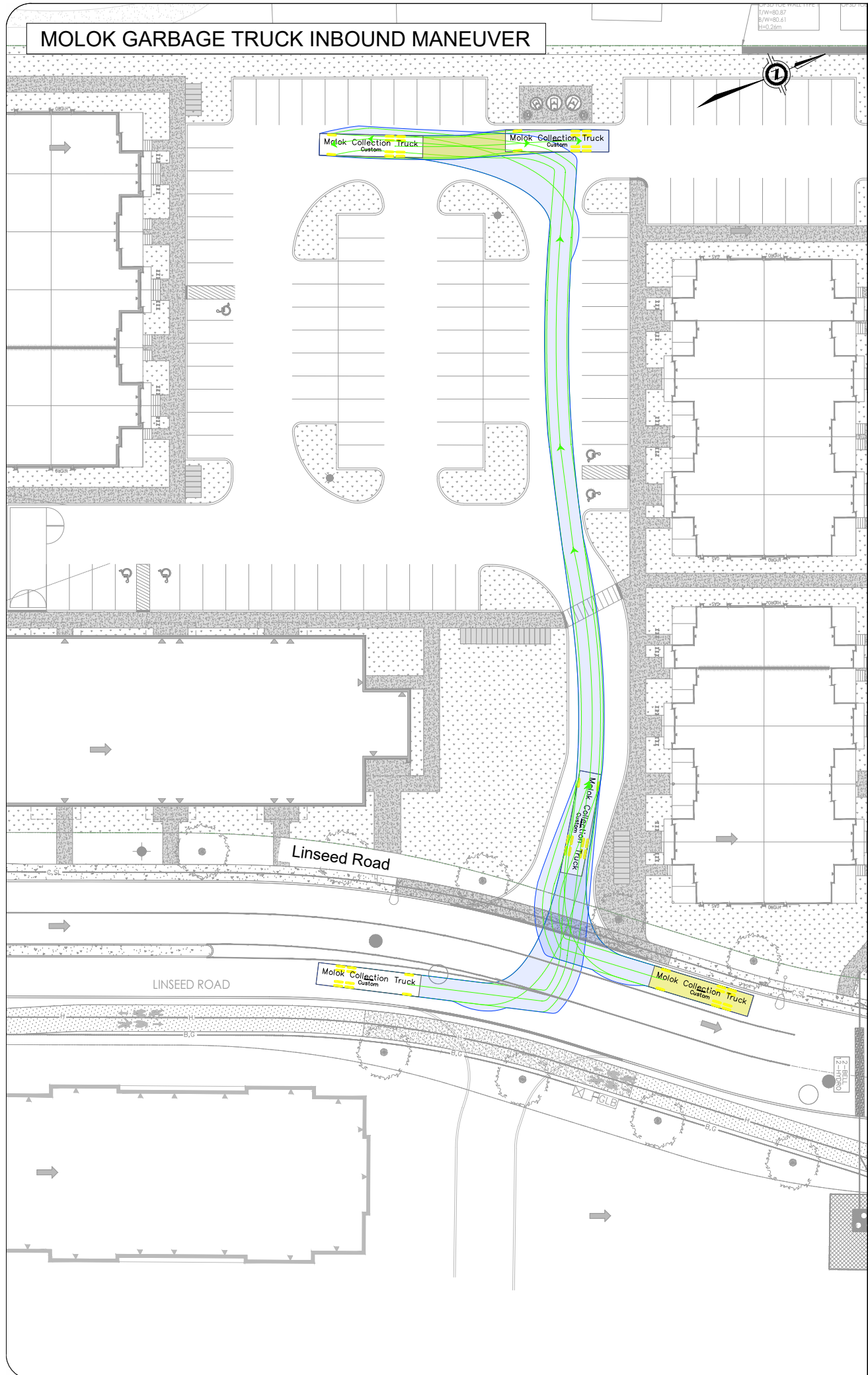

Notes:

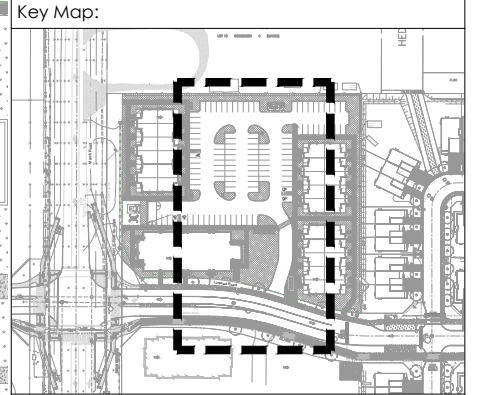

- Legend:
- Forward Movement
 - Reverse Movement
 - Sanitary Maintenance Hole
 - Storm Maintenance Hole
 - Fire Hydrant
 - Storm Catch Basin
 - Street Light

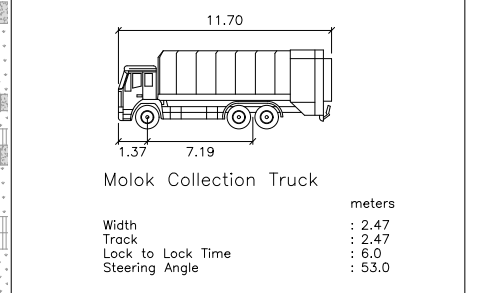

03	Issued for Review	EA	2026-03-09
REV:	DESCRIPTION:	BY:	DATE:
STATUS:			

CGH Transportation
 6 Plaza Court
 Ottawa, ON
 K2H 7W1
 (343) 999-9117

CLIENT: **Mattamy Homes Canada**

ARCHITECT:

SITE: **Mattamy Northwoods Phase 6 & 7**

TITLE: **Turning Template Analysis**

SCALE AT A3:	DATE:	DRAWN:	CHECKED:
NTS	2026-03-09	EA	AH
PROJECT NO:	DRAWING NO:	REVISION:	
2025-017	005	03	

Appendix H

MMLOS Worksheets

Multi-Modal Level of Service - Segments Form

Consultant	CGH Transportation Inc.	Project	Northwoods Phase 6
Scenario	Existing/Future	Date	2025-11-05
Comments			

SEGMENTS		March Ex.	March Fut. (Ultimate)	Linseed Fut.	
Pedestrian	Sidewalk Width	no sidewalk	≥ 2 m	≥ 2 m	
	Boulevard Width	n/a	< 0.5	< 0.5	
	Avg Daily Curb Lane Traffic Volume	> 3000	≤ 3000	≤ 3000	
	Operating Speed	> 60 km/h	> 60 km/h	> 30 to 50 km/h	
	On-Street Parking	no	no	yes	
	Exposure to Traffic PLoS	F	D	B	-
Pedestrian	Effective Sidewalk Width			2.0 m	
	Pedestrian Volume			250 ped/hr	
	Crowding PLoS	-	-	B	-
	Level of Service	-	-	B	-
Bicycle	Type of Cycling Facility	Mixed Traffic	Physically Separated	Physically Separated	
	Number of Travel Lanes	2-3 lanes total			
	Operating Speed	≥ 60 km/h			
	# of Lanes & Operating Speed LoS	F	-	-	-
	Bike Lane (+ Parking Lane) Width				
	Bike Lane Width LoS	-	-	-	-
	Bike Lane Blockages				
	Blockage LoS	-	-	-	-
	Median Refuge Width (no median = < 1.8 m)	< 1.8 m refuge			
	No. of Lanes at Unsignalized Crossing	≤ 3 lanes			
Sidestreet Operating Speed	>40 to 50 km/h				
	Unsignalized Crossing - Lowest LoS	B	A	A	-
	Level of Service	F	A	A	-
Transit	Facility Type		Segregated ROW	Mixed Traffic	
	Friction or Ratio Transit:Posted Speed			Vt/Vp ≥ 0.8	
	Level of Service	-	A	D	-
Truck	Truck Lane Width	≤ 3.5 m	≤ 3.5 m		
	Travel Lanes per Direction	1	> 1		
	Level of Service	C	A	-	-
Auto	Level of Service	Not Applicable			