

NOVATECH

Engineers, Planners & Landscape Architects

Engineering

Land/Site
Development

Municipal
Infrastructure

Environmental/
Water Resources

Traffic/
Transportation

Recreational

Planning

Land/Site
Development

Planning Application
Management

Municipal Planning

Urban Design

Expert Witness
(OLT)

Wireless Industry

Landscape Architecture

Streetscapes &
Public Amenities

Open Space, Parks &
Recreation

Community &
Residential

Commercial &
Institutional

Environmental
Restoration

**200 Baribeau Street
Ottawa, Ontario**

Servicing Design Brief

Engineering excellence.

Planning progress.

Liveable landscapes.

**200 BARIBEAU STREET
OTTAWA, ONTARIO**

SERVICING DESIGN BRIEF

Prepared For:

Baribeau Street Developments

Prepared By:



NOVATECH
Suite 200, 240 Michael Cowpland Drive
Ottawa, Ontario
K2M 1P6

March 13, 2026

Novatech File: 119068
Ref: R-2020-104

March 13, 2026

City of Ottawa
Infrastructure Services and Community Sustainability
110 Laurier Avenue West, 4th Floor
Ottawa, ON K1P 1J1

Attention: Jean-Charles Renaud, Planner II

**Reference: 200 Baribeau Street
Servicing Design Brief
Our File No.: 119068**

Enclosed for your review and approval is the Servicing Design Brief for the proposed 200 Baribeau Street development.

If you have any questions or comments, please do not hesitate to contact us.

Sincerely,

NOVATECH

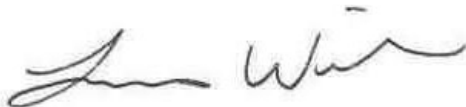

Lucas Wilson, P.Eng.
Project Engineer

TABLE OF CONTENTS

1.0	INTRODUCTION	1
1.1	BACKGROUND	1
1.2	LAND USE.....	2
2.0	ROADWAYS	3
2.1	EXISTING CONDITIONS.....	3
2.2	PROPOSED CONDITIONS.....	3
2.3	ROADWAY DESIGN	3
3.0	GRADING	3
3.1	EXISTING CONDITIONS.....	3
3.2	PROPOSED CONDITIONS.....	3
4.0	EROSION AND SEDIMENT CONTROL	4
5.0	SANITARY SEWERS	5
5.1	EXISTING CONDITIONS.....	5
5.2	PROPOSED CONDITIONS.....	5
6.0	STORMWATER MANAGEMENT	7
6.1	STORMWATER MANAGEMENT CRITERIA	7
6.1.1	<i>Allowable Release Rate</i>	7
6.2	EXISTING CONDITIONS.....	7
6.3	PROPOSED CONDITIONS.....	7
6.3.1	<i>Minor System Design</i>	8
6.3.2	<i>Major System Design</i>	10
6.4	HYDROLOGIC & HYDRAULIC MODELING	10
6.4.1	<i>Stormwater Storage</i>	13
6.5	RESULTS OF HYDROLOGIC / HYDRAULIC ANALYSIS.....	14
6.5.1	<i>Minor System</i>	14
6.5.2	<i>Major System</i>	15
6.5.3	<i>Hydraulic Grade Line</i>	16
6.5.4	<i>Peak Flows</i>	16
7.0	WATER	17
7.1	EXISTING CONDITIONS.....	17
7.2	PROPOSED CONDITIONS.....	17
8.0	CONCLUSIONS AND RECOMMENDATIONS	20

List of Tables

Table 2-1: Roadway Structure
Table 5-1: Proposed Sanitary Sewer Design Parameters
Table 6-1: Storm Sewer Design Parameters
Table 6-2: Runoff Coefficients
Table 6-3: Subcatchment Model Parameters
Table 6-4: Total Storage Provided (Surface and Underground)
Table 6-5: Inlet Control Devices & Design Flows
Table 6-6: Overland Flow Results (100-year Event)
Table 6-7: Summary of Peak Flows
Table 7-1: Watermain Design Criteria
Table 7-2: Water Flow Summary
Table 7-3: Summary of Hydraulic Model Results - Maximum Day + Fire Flow
Table 7-4: Summary of Hydraulic Model Results - Peak Hour Demand
Table 7-5: Summary of Hydraulic Model Results – Maximum Pressure Check

List of Figures

Figure 1: Key Plan
Figure 2: Site Plan
Figure 3: Sanitary Sewer Network
Figure 4: Storm Sewer Network
Figure 5: Watermain Layout

Appendices

Appendix A: Design Sheets
Appendix B: SWM Calculations
Appendix C: Drawings
Appendix D: DSS Checklist
Emergency Overland Flow Route Documentation

1.0 INTRODUCTION

1.1 Background

Novatech was retained by Baribeau Street Developments to prepare a Servicing Design Brief in support of a site plan application at 200 Baribeau Street.

The development is on the west side of Baribeau Street in Vanier and is shown on **Figure 1**.

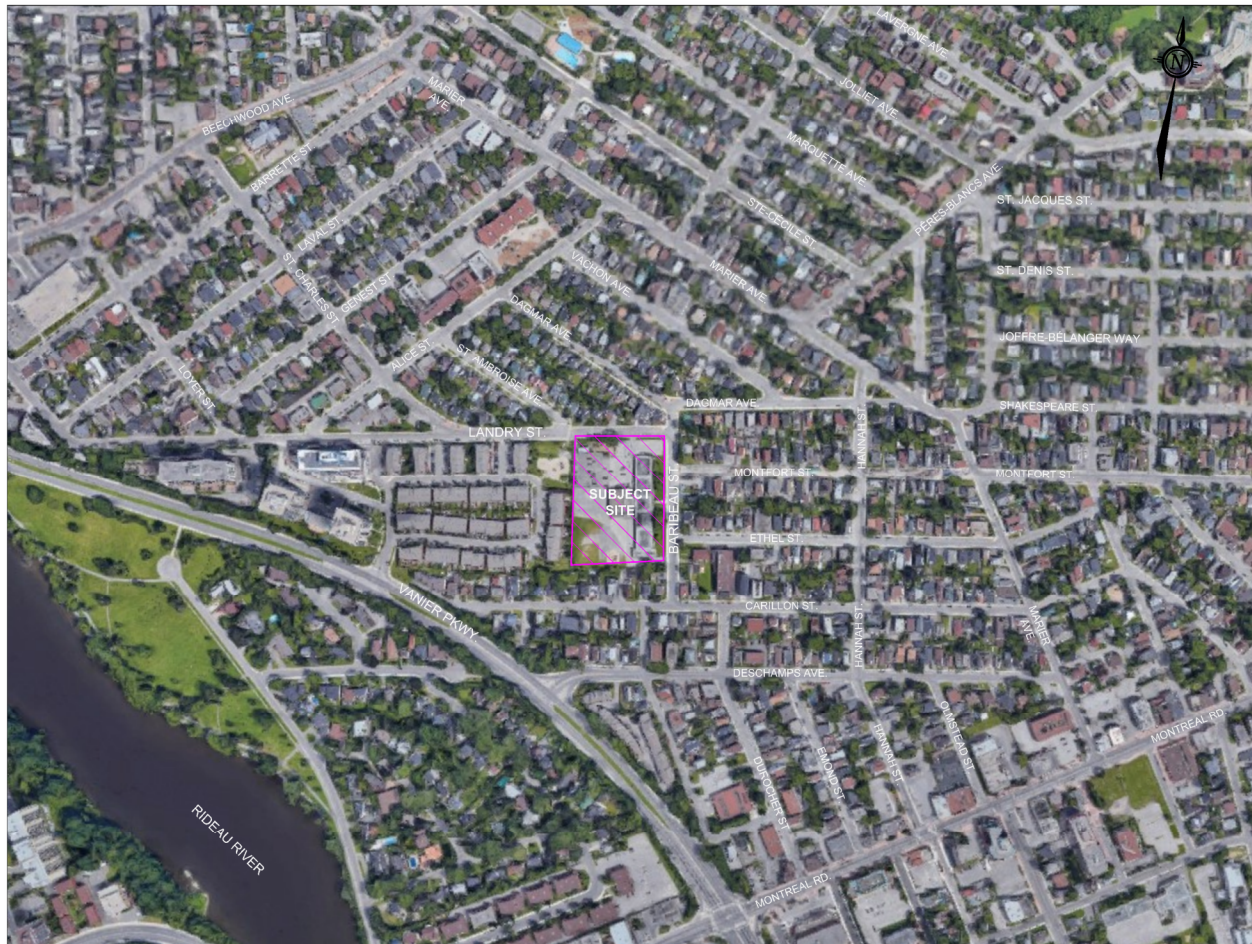

Figure 1: Key Plan

The site is approximately 1.27ha and is bordered by Landry Street to the north, Baribeau Street to the east and existing residential to the west and south.

This Servicing Design Brief provides the consideration and approach by which Novatech has analyzed the existing site information for the 200 Baribeau Street development, and details how the development lands will be serviced while meeting City requirements and other regulations.

This report should be read in conjunction with the following:

- Geotechnical Investigation, Proposed Residential Development, 200 Baribeau Street - Ottawa, Ontario prepared by Paterson Group, dated July 15, 2019 (Project:PG4951-1).

1.2 Land Use

The site is comprised of 9 buildings with a total of 282 rental units. The Site Plan is shown below in **Figure 2**.



Figure 2: Site Plan

2.0 ROADWAYS

2.1 Existing Conditions

The parcel was formerly a school site adjacent Landry Street and Baribeau Street, both classified as local roadways in the 2013 City of Ottawa Transportation Master Plan (TMP). The school site has since been demolished to prepare for planned development work.

2.2 Proposed Conditions

Site access via a 6.0m wide private road off Baribeau Street leads into the site parking lot.

2.3 Roadway Design

Paterson Group prepared a Geotechnical Investigation for the development (July 15th, 2019) with roadway structure recommendations as follows:

Table 2-1: Roadway Structure

Roadway Material Description	Road Structure
	Layer Thickness (mm)
Private Road	
Asphalt Wear Course: Superpave 12.5 (Class B)	40
Asphalt Binder Course: Superpave 19.0 (Class B)	50
Base: Granular A	150
Sub-Base: Granular B, Type II	400
Total	640

3.0 GRADING

3.1 Existing Conditions

When the site functioned as a school, lands along the north and east property lines sloped towards the adjacent public ROW (Landry Street and Baribeau Street). The remainder of the site drained to a catch basin in a playing field. These conditions no longer exist due to site demolition.

3.2 Proposed Conditions

The site will be graded to ensure the minimum clearances are provided per the City of Ottawa and RVCA policies listed below:

- Underside of slab must have a minimum of 0.30m clearance above the 100-year flood level of 56.44m;
- Building openings must be at least 0.30m above the 100-year flood level;
- Building terrace grades must be at least 0.15m above the 100-year flood level.

Landscape areas adjacent to Landry Street and Baribeau Street will tie into the back of curb and/or back of sidewalk elevation. Landscape areas adjacent to the west and south property lines,

including the park lands, will tie into the existing grades along the south and west property lines maintaining the existing emergency overland flow routes from Landry Street and Baribeau Street. For detailed grading, refer to drawing 119068-GR.

Design grading criteria follow:

- Landscape Area: 2% (min) - 6% (max)
- Rear Yard Swale: 1.5% (min); 1.0% (with subdrain)
- Maximum Terrace Grade: 3H:1V

4.0 EROSION AND SEDIMENT CONTROL

Erosion and sediment control measures will be implemented during construction in accordance with the "Guidelines on Erosion and Sediment Control for Urban Construction Sites" (Government of Ontario, May 1987). Typical erosion and sediment control measures include, but are not limited to, the use of silt fences around perimeter of site, filter fabric or inserts under catch basin/maintenance hole lids, heavy duty silt fence barrier, straw bale check dams, rock check dams, turbidity curtain, dewatering trap, temporary water passage system, riprap, mud mats, silt bags for dewatering operations, topsoil and sod to disturbed areas and natural grassed waterways. Dewatering and sediment control techniques will be developed for individual situations based on the above guidelines and utilize typical measures to ensure erosion and sediment control is applied in an acceptable manner and there is no negative impact to adjacent lands, water bodies or water treatment/conveyance facilities.

The following erosion and sediment control measures will be implemented during construction. Details are provided on the Erosion and Sediment Control Plan.

- All erosion and sediment control measures are to be installed to the satisfaction of the engineer, the municipality and the conservation authority prior to undertaking any site alterations (filling, grading, removal of vegetation, etc.) and remain present during all phases of site preparation and construction.
- A qualified inspector shall conduct routine visits to ensure the contractor is working in accordance with the design drawings and that mitigation measures are implemented as specified on the Erosion and Sediment Control & Removals Plan (**119068-ESC**), including:
 - Light duty silt fence barrier installation.
 - Geosynthetic silt sock placed at inlet structures.
 - Inspect, clean, and remove all ESC measures when no longer required.
- The contractor shall ensure that proper dust control is provided with the application of water (and if required, calcium chloride) during dry periods.
- The contractor shall immediately report to the engineer or inspector any accidental discharges of sediment material into any ditch or sewer system. Appropriate response measures shall be carried out by the contractor without delay.
- The contractor acknowledges that failure to implement erosion and sediment control measures may result in penalties imposed by any applicable regulatory agency.

Temporary erosion and sediment control measures would be implemented both prior to commencement and during construction in accordance with the "Guidelines on Erosion and Sediment Control for Urban Construction Sites", (Government of Ontario, May 1987).

5.0 SANITARY SEWERS

5.1 Existing Conditions

An existing 250mm diameter sanitary sewer runs along Baribeau Street and outlets to a 750mm trunk sanitary sewer in Carillon Street.

5.2 Proposed Conditions

The peak design flow parameters in **Table 5-1** are used in the sewer capacity analysis. Design criteria is referenced from the City of Ottawa Sewer Design Guidelines.

Sanitary flow from the site is proposed to connect into the 250mm diameter sanitary sewer in Baribeau Street at two separate connection points. The sanitary sewer layout is shown on 119068-GP (**Appendix C**), and the design sheet is attached in **Appendix A**. Peak wastewater design flow is listed below:

Outlet 1 (MH-6): 2.5 L/s
 Outlet 2 (MH-7): 3.4 L/s
 Entire Site = 5.9 L/s

Table 5-1: Proposed Sanitary Sewer Design Parameters

Parameter	Design Criteria
Apartment Unit Population	1.8 people/unit
Residential Flow Rate, Average Daily	280 L/cap/day
Residential Peaking Factor	Harmon Equation (min=2.0, max=4.0)
Infiltration Rate	0.33 L/s/ha
Minimum Pipe Size	200 mm
Minimum Velocity	0.6 m/s
Maximum Velocity	3.0 m/s

The existing school demand of 60 L/person/day was calculated using Appendix 4-A in the City of Ottawa Sewer Design Guidelines. The school contained 18 classrooms with 22 students per class (396 students). With one teacher per classroom, an estimate of 415 people was used to calculate peak wastewater flow from the school.

$$Q_{POP} = (415 \text{ ppl} * 60 \text{ L/day}) / 86400 = 0.29 \text{ L/s}$$

Adding infiltration, the peak design flow from the former school is calculated as:

$$Q_{PK \text{ DESIGN}} = (0.33 \text{ L/s/ha} * 1.27 \text{ ha}) + 0.29 \text{ L/s} = 0.71 \text{ L/s}$$

The proposed peak design flow of 5.9 L/s represents an increase of 5.2 L/s being directed to the existing 250mm diameter sanitary sewer in Baribeau Street. The attached sanitary design sheet in Appendix A shows the available capacity in the 250mm diameter sanitary sewer in Baribeau Street. With the additional flows from the site, there is still adequate capacity remaining in the existing sanitary sewer as the Q/Q_{FULL} is at 34%.

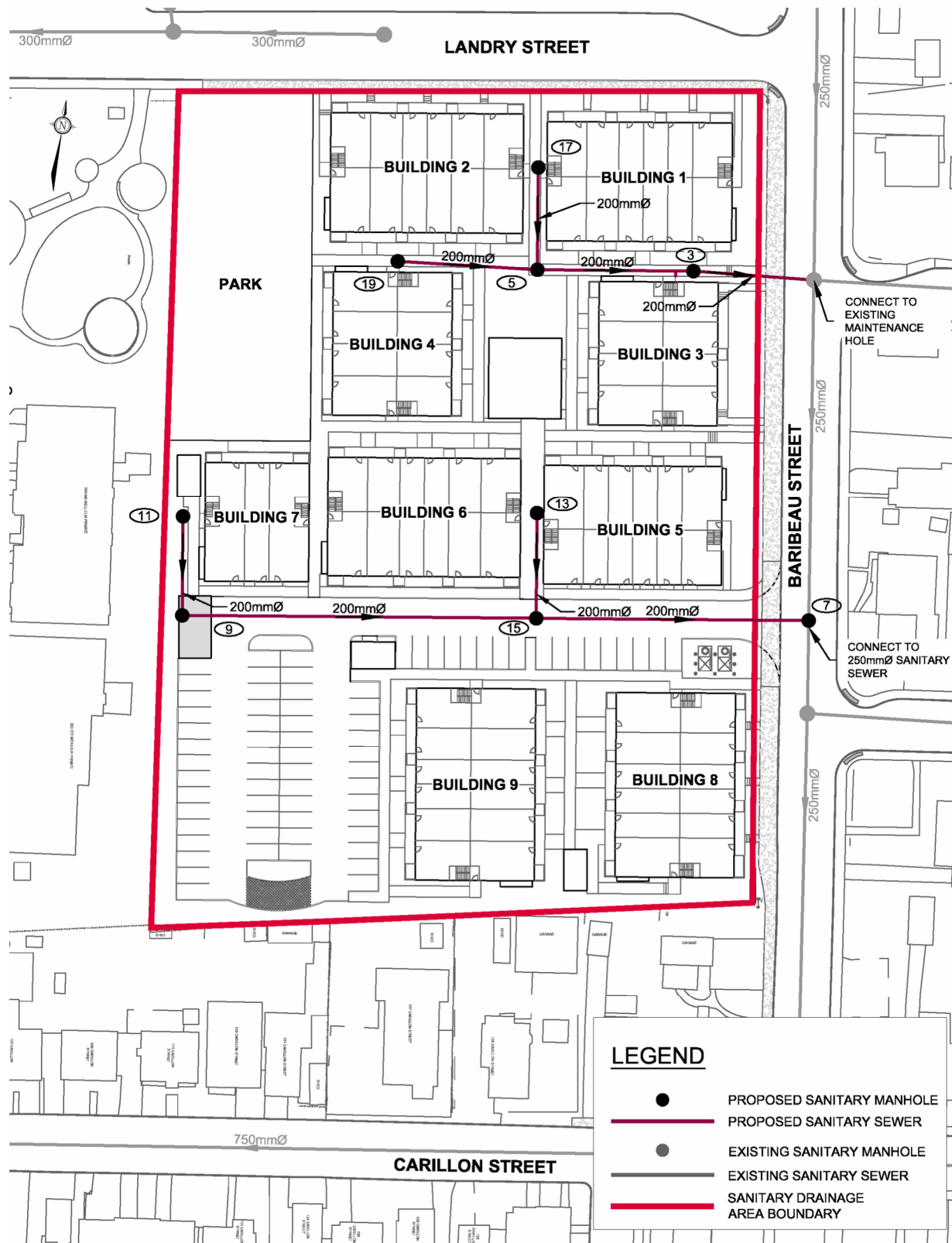

Figure 3: Sanitary Sewer Network

6.0 STORMWATER MANAGEMENT

6.1 Stormwater Management Criteria

The following stormwater management criteria for the proposed development were prepared in accordance with the City of Ottawa Sewer Design Guidelines (October 2012) and RVCA policies.

- Provide a dual drainage system (i.e. minor and major system flows);
- Control the runoff to the existing storm system in Carillon Street to the allowable release rates Specified in **Section 6.1.1** using on-site storage;
- Ensure that ponding is confined within the parking areas at a maximum depth of 0.35 m for both static ponding and dynamic flow;
- Ensure no surface ponding occurs during the 2-year storm event;
- Provide guidelines to ensure that site preparation and construction is in accordance with the current Best Management Practices for Erosion and Sediment Control.

6.1.1 Allowable Release Rate

The allowable release rate for the development has been calculated using the Rational Method with the following parameters:

- Drainage Area
 - 1.27 ha (site boundary)
- Runoff Coefficient
 - 0.50 (based on City of Ottawa criteria)
- Rainfall Intensity
 - Based on City of Ottawa IDF data (Ottawa Sewer Design Guidelines)
 - Time-of-Concentration = 10 minutes

The allowable release rate based on the above parameters is 135.6 L/s for all storms up to and including the 100-year storm event.

6.2 Existing Conditions

The development is located within the Rideau Valley Conservation Authority jurisdiction and is within the 100-year floodplain zone. Under existing conditions, the area fronting onto Baribeau Street and the parking area adjacent to Landry Street flow directly to the public roadways. The remainder of the site is directed to a catchbasin located within the playing field directing flows to the existing storm sewer system in the public roadways. A 525mm diameter storm sewer is located within Landry Street, storm sewers ranging from 600mm to 900mm are located within Baribeau Street and 1050mm diameter storm sewers are located within Carillon Street.

6.3 Proposed Conditions

Catch basins located within the private roadway and landscaped areas will be controlled with inlet control devices (ICDs). Runoff from the site will be routed to the 1050mm diameter storm sewer in Carillon Street through the property at 127 Carillon Street. A 6.0m easement will be provided through the property to access the existing 1050mm storm sewer. Catch basins located within the private roadway and landscaped areas will be controlled with inlet control devices (ICDs) to meet

the allowable release rate in **Section 6.1.1**. As there will be no foundation drain connections for the slab-on-grade buildings, the entire storm sewer network will act as underground storage during both the 2-year and 5-year storm events. Additional underground storage will be provided using StormTech STC-310 storage chambers to ensure the 100-year storm event is contained within the parking area.

The underside of slab elevation for each building has been set at least 300mm above the 100-year floodplain level of 56.44m. In addition, all building openings have been set at a minimum of 300mm above the 100-year floodplain level.

Figure 5 outlines the proposed storm sewer system layout, and how it will connect to the existing network along Carillon Street.

6.3.1 Minor System Design

The storm sewers comprising the minor system have been designed based on the criteria outlined in the Ottawa Sewer Design Guidelines using the principles of dual drainage. The design criteria used in sizing the storm sewers are summarized in **Table 6-1** and **Table 6-2**.

The proposed storm sewers are designed using the Rational Method to convey peak flow from a 2-year design storm. The storm sewer design sheets are provided in **Appendix A**. The corresponding Storm Drainage Area Plan (Drawing 119068-STM) is provided in **Appendix C**.

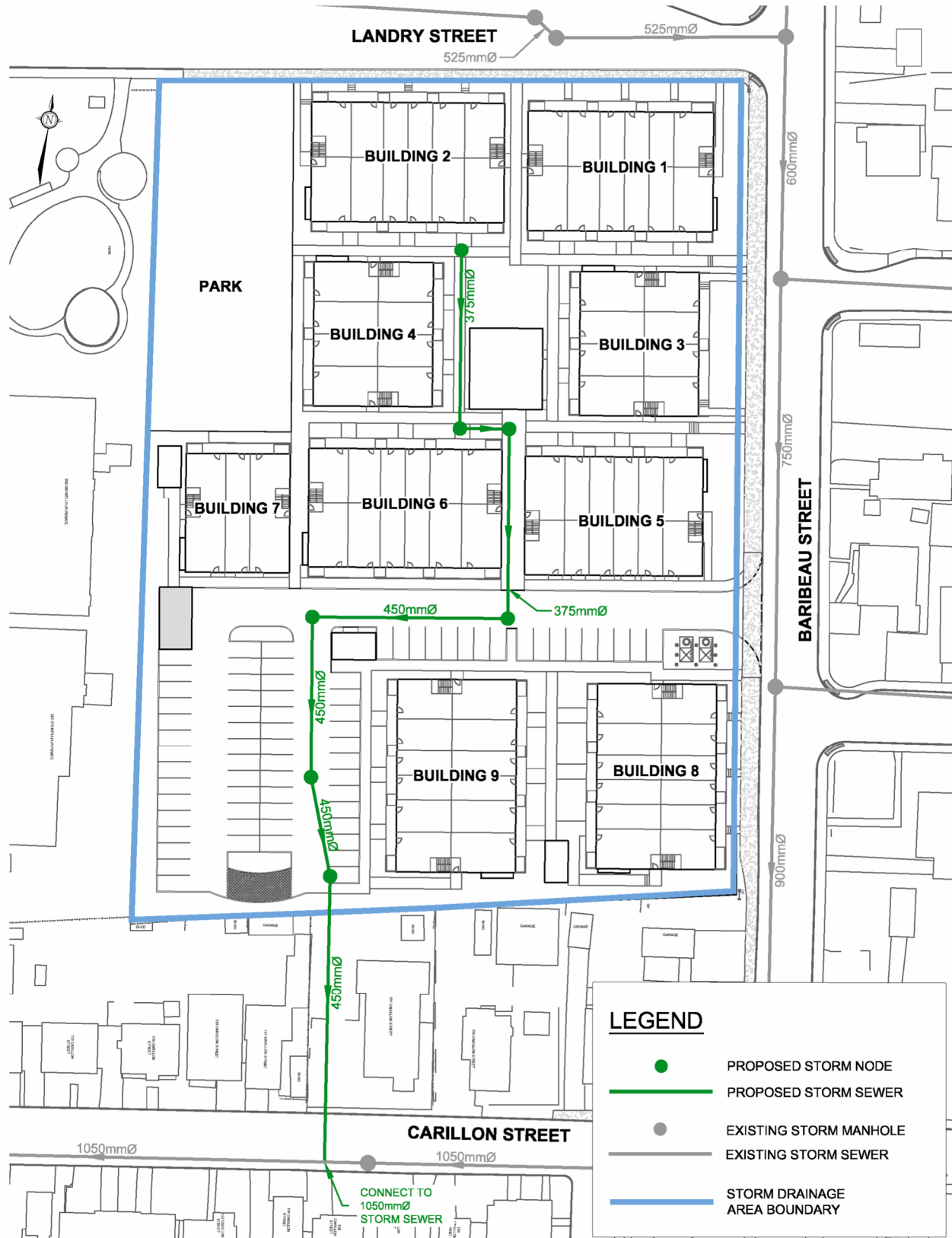

Figure 4: Storm Sewer Network

Table 6-1: Storm Sewer Design Parameters

Parameter	Design Criteria
Private Roads	2 Year Return Period
Storm Sewer Design	Rational Method/AutoDesk Storm Analysis
IDF Rainfall Data	Ottawa Sewer Design Guidelines
Initial Time of Concentration (T_c)	10 min
Minimum Velocity	0.8 m/s
Maximum Velocity	3.0 m/s
Minimum Diameter	250 mm

Table 6-2: Runoff Coefficients

Land Use	Runoff Coefficient
Hard Surface	0.90
Soft Surface	0.20

6.3.2 Major System Design

The site has been designed to convey runoff from storms that exceed the minor system capacity to the approved major system outlet within the existing pathway easement in the southwest corner of the site leading to Kipp Street. The roadway area has been graded to ensure that the 100-year peak overland flows are confined within the site at a maximum flow depth of 350mm. The design of the major system conforms to the design standards outlined in Section 5.5 (Major System Considerations) of the City of Ottawa Sewer Design Guidelines (October 2012).

The existing site provides an emergency overland flow route for Landry Street and Baribeau Street. The proposed site grading will maintain these emergency overland flow routes through the park land and along the south and west property lines. Prior discussion with the City of Ottawa regarding the design of the emergency overland flow routes is provided in **Appendix D**.

6.4 Hydrologic & Hydraulic Modeling

The *City of Ottawa Sewer Design Guidelines* (October 2012) require hydrologic modelling for all dual drainage systems. The performance of the proposed storm drainage system for the site was evaluated using the *PCWMM* hydrologic/hydraulic modeling software.

Design Storms

The hydrologic analysis was completed using the following synthetic design storms and historical storms. The IDF parameters used to generate design storms were taken from the Sewer Design Guidelines.

3 Hour Chicago Storms:

25mm 3-hr Chicago storm
 2-year 3hr Chicago storm
 5-year 3hr Chicago storm
 100-year 3hr Chicago storm

12 Hour SCS Storms:

2-year 12-hr SCS storm
 5-year 24hr Chicago storm
 100-year 24hr Chicago storm

The 3-hour Chicago distribution generates the highest peak flows for both the minor and major systems and was determined to be the critical storm distribution for the design of the storm drainage system.

The proposed drainage system has also been stress tested using a 3-hour Chicago design storm that has a 20% higher intensity and total volume compared to the 100-year event.

Model Development

The PCSWMM model accounts for both minor and major system flows (*dual drainage*), including the routing of flows through the storm sewer network (*minor system*), and overland along the road network (*major system*). The results of the analysis were used to;

- Determine the total major and minor system runoff from the site;
- Size the ICDs for each inlet to the storm sewer system;
- Calculate the storm sewer hydraulic grade line (HGL) for the 100-year storm event; and
- Ensure no ponding occurs during the 2-year storm event.

The model can account for both static and dynamic storage within the private roadways and landscaped areas, including the overland flow across all high points. The 100-year flow depths computed by the model represent the total (static + dynamic) ponding depths at low points for areas in road sags.

Storm Drainage Area Plan & Subcatchment Parameters

The development has been divided into subcatchments based on the drainage areas tributary to each inlet of the proposed storm sewer system. The catchment areas are shown on the Storm Drainage Area Plan provided as drawing **119068-STM** in **Appendix C**.

The hydrologic parameters for each subcatchment were developed based on the Site Plan (**Figure 2**) and the Storm Drainage Area Plan specified above. Subcatchment parameters are outlined in **Table 6-3**.

Table 6-3: Subcatchment Model Parameters

Area ID	Catchment Area (ha)	Runoff Coefficient (C)	Percent Impervious (%)	Zero Imperv. (%)	Flow Length (m)	Equivalent Width (m)	Average Slope (%)
Modelled Subcatchments							
A-01	0.062	0.22	2.9	0	25	24.8	4
A-02	0.085	0.31	15.7	0	25	34.0	4
A-03	0.019	0.50	42.9	0	5	38.0	1.5
A-04	0.017	0.51	44.3	0	5	34.0	1.5
A-05	0.031	0.42	31.4	0	15	20.7	1.5
A-06	0.023	0.50	42.9	0	15	15.3	1.5
A-07	0.034	0.44	34.3	0	10	34.0	1.5
A-08	0.046	0.86	94.3	0	15	30.7	1
A-09	0.044	0.30	14.3	0	5	88.0	0.5
A-10	0.013	0.40	28.6	0	5	26.0	2
A-11	0.039	0.43	32.9	0	15	26.0	2

Area ID	Catchment Area (ha)	Runoff Coefficient (C)	Percent Impervious (%)	Zero Imperv. (%)	Flow Length (m)	Equivalent Width (m)	Average Slope (%)
Modelled Subcatchments							
A-12	0.064	0.74	77.1	0	15	42.7	1.5
A-13	0.085	0.87	95.7	0	30	28.3	1.5
A-14	0.114	0.82	88.6	0	35	32.6	1.5
A-15	0.03	0.90	100	95	30	10.0	0.5
A-16	0.03	0.90	100	95	30	10.0	0.5
A-17	0.032	0.90	100	95	20	16.0	0.5
A-18	0.03	0.90	100	95	25	12.0	0.5
A-19	0.027	0.90	100	95	25	10.8	0.5
A-20	0.022	0.90	100	95	30	7.3	0.5
A-21	0.028	0.90	100	95	30	9.3	0.5
A-22	0.03	0.90	100	95	30	10.0	0.5
A-23	0.022	0.90	100	95	30	7.3	0.5
A-24	0.015	0.90	100	95	15	10.0	0.5
A-25	0.03	0.90	100	95	30	10.0	0.5
A-26	0.03	0.90	100	95	30	10.0	0.5
A-27	0.022	0.90	100	95	30	7.3	0.5
A-28	0.022	0.90	100	95	30	7.3	0.5
A-29	0.027	0.90	100	95	25	10.8	0.5
A-30	0.03	0.90	100	95	25	12.0	0.5
A-31	0.03	0.90	100	95	30	10.0	0.5
A-32	0.028	0.90	100	95	30	9.3	0.5
Uncontrolled Areas							
B-01*	0.036	0.47	38.6	-	-	-	-
B-02*	0.070	0.43	32.9	-	-	-	-
TOTAL	1.27 ha	0.69	70%	-	-	-	-

Note: * indicates peaks flows are calculated using Rationale Method and are not included in the PCSWMM model..

Infiltration

Infiltration losses for all catchment areas were modeled using Horton's infiltration equation, which defines the infiltration capacity of the soil over the duration of a precipitation event using a decay function that ranges from an initial maximum infiltration rate to a minimum rate as the storm progresses. The default values for the Sewer Design Guidelines were used for all catchments.

Horton's Equation:

$$f(t) = f_c + (f_o - f_c)e^{-k(t)}$$

Initial infiltration rate: $f_o = 76.2$ mm/hr
 Final infiltration rate: $f_c = 13.2$ mm/hr
 Decay Coefficient: $k = 4.14$ /hr

Depression Storage

The default values for depression storage in the Sewer Design Guidelines were used for all catchments. Residential rooftops were assumed to provide no depression storage.

- Depression Storage (pervious areas): 4.67 mm
- Depression Storage (impervious areas): 1.57 mm

Equivalent Width

Equivalent Width' refers to the width of the sub-catchment flow path. This parameter is calculated as described in the Sewer Design Guidelines, Section 5.4.5.6. The flow paths used to calculate the equivalent widths are shown on the PCSWMM schematics provided in **Appendix B**.

Impervious Values

Impervious (TIMP) values for each subcatchment area were calculated based on the proposed Site Plan (**Figure 2**) and correspond to the Runoff Coefficients used in the Rational Method calculations using the equation:

$$\%imp = \frac{C - 0.2}{0.7}$$

Boundary Conditions (Carillon Street Connection)

The Hydraulic Grade Line (HGL) elevations for the existing 1050mm storm sewer in Carillon Street was provided by the City of Ottawa (refer to existing HGL profile in Appendix B). The 2-year, 5-year and 100-year HGL elevations in the existing storm sewer at the proposed connection are 52.50m, 52.60m and 55.05m respectively.

6.4.1 Stormwater Storage

Surface storage is represented in the PCSWMM model using storage nodes and storage curves. Refer to **Appendix B** for additional details.

Underground Storage

Underground storage will be provided using a combination of the proposed storm sewer system and StormTech STC-310 storage chambers to ensure no 2-year ponding occurs and that the 100-year storm event is contained within the parking area.

The StormTech chambers have the following dimensions:

- Stone foundation depth = 150mm (min)
- Stone cover = 200mm
- Stone porosity = 40%
- Size (L x W x H) = 2170mm x 864mm x 406mm
- Chamber / minimum installed storage = 0.40m³ / 0.90m³

The storage volumes were determined using the StormTech design calculator based on the configurations shown on the General Plan of Services (Drawing 119068-GP). Documentation for the StormTech storage chambers is provided in **Appendix B**.

Surface Storage

In addition to the underground storage provided, surface storage will be provided to attenuate peak flows to the allowable release rates. Surface storage will consist of ponding above each catchbasin within the private roadways and landscaped areas.

A summary of the underground and surface storage is provided in **Table 6-4**. The extent of surface ponding is shown on the Storm Drainage Area Plan (119068-STM).

Table 6-4: Total Storage Provided (Surface and Underground)

Structure ID	Max Static Ponding Depth (m)	Storage Provided (m ³)		
		Underground	Surface	TOTAL
CB01	0.21	-	16.0	16.0
CB02	0.20	-	10.9	10.9
CB03	0.30	-	73.0	73.0
CBMH02	0.32	40.5	75.0	115.5
<i>Underground Storage (300mm to 450mm Pipes, 1200mm Structures)</i>				
MH02	-	46.6	-	46.6
TOTAL	-	87.1	174.9	262.0

Inlet Control Devices (ICDs)

ICDs will be located at maintenance hole MH02, controlling flows from the private roadway. RY01 and RY03 will also include an ICD, controlling flows from the swales located along the west and south property lines. ICDs are specified on the General Plan of Services (119068-GP).

6.5 Results of Hydrologic / Hydraulic Analysis

The model was used to evaluate the performance of the proposed storm drainage system for 200 Baribeau Street.

6.5.1 Minor System

Inflows to the storm sewer were modeled based on the characteristics of each inlet. All the catch basins in the roadways are located at low points. Inflows to the storm sewer are based on the ICD specified for the inlet and the maximum depth of ponding. ICDs have been sized to limit the outlet peak flows to the allowable release rate of 135.6 L/s. Details are outlined as follows in **Table 6.4**.

The Rational Method design sheets (**Appendix B**) were used to calculate the required storm sewer sizes based on capturing the peak flow at each inlet to the storm sewer for a 2-year design return period.

Table 6-5: Inlet Control Devices & Design Flows

Structure ID	ICD Size & Inlet Rate						
	ICD Type	T/G (m)	Orifice Invert (m)	100-year Head on Orifice (m)	2-year Orifice Peak Flow* (L/s)	5-year Orifice Peak Flow* (L/s)	100-year Orifice Peak Flow* (L/s)
MH02	152 mm	56.29	52.51	3.70	77.8	82.7	92.1
RY01	Tempest LMF	55.50	54.45	1.14	2.8	4.8	6.1
RY03	90 mm	55.84	55.30	0.71	12.2	12.9	14.0

*PCSWMM model results for a 3-hour Chicago storm distribution.

Note: Head and peak flow values are based on a normal outfall condition.

6.5.2 Major System

The major system network was evaluated using the PCSWMM model to ensure that the ponding depths conform to City standards. A summary of ponding depths at each inlet for the 2-year, 5-year, 100-year and 100-year (+20%) events are provided in **Appendix B**. The maximum static and dynamic ponding depths within the roadways are less than or equal to 0.35m during all events up to and including the 100-year event.

Table 6-6: Overland Flow Results (100-year Event)

Structure	T/G (m)	Max. Static Ponding (Spill Depth)		100-yr Event (3hr)			
		Elev. (m)	Depth (m)	Elev. (m)	Depth (m)	Cascading Flow?	Cascade Depth (m)
CB01	56.25	56.46	0.21	56.47	0.22	Y	0.01
CB02	56.25	56.45	0.20	56.44	0.19	N	0.00
CB03	56.06	56.36	0.30	56.36	0.30	N	0.00
CBMH01	56.57	56.65	0.08	56.58	0.01	N	0.00
CBMH02	56.06	56.38	0.32	56.36	0.30	N	0.00
LC01	56.58	56.69	0.11	56.62	0.04	N	0.00
LC02	56.57	56.67	0.10	56.62	0.05	N	0.00
LC03	56.55	56.66	0.11	56.66	0.11	N	0.00
LC04	55.69	55.76	0.07	55.82	0.13	Y	0.06
LC05	55.79	55.89	0.10	55.84	0.05	N	0.00
RY01	55.50	55.55	0.05	55.60	0.10	Y	0.05
RY02	56.55	56.67	0.12	56.66	0.11	N	0.00
RY03	55.84	55.91	0.07	56.01	0.17	Y	0.10
RY04	55.25	55.50	0.25	55.59	0.34	Y	0.09
RY05	56.00	56.00	0.00	56.01	0.01	Y	0.01
RY06	55.72	55.72	0.00	55.77	0.05	Y	0.05
RY07	56.56	56.61	0.05	56.59	0.03	N	0.00
RY08	56.55	56.63	0.08	56.59	0.04	N	0.00
RY09	56.55	56.68	0.13	56.66	0.11	N	0.00

Structure	T/G (m)	Max. Static Ponding (Spill Depth)		100-yr Event (3hr)			
		Elev. (m)	Depth (m)	Elev. (m)	Depth (m)	Cascading Flow?	Cascade Depth (m)
RY10	56.60	56.69	0.09	56.66	0.06	N	0.00
RY11	56.60	56.70	0.10	56.66	0.06	N	0.00

Note: Ponding elevations are taking from the PCSWMM model using a fixed boundary condition of 55.05m for the 100-yr storm event.

An expanded table of the ponding depths at low points in the roadway (including the stress-test event) is provided in **Appendix B**. Based on these results, the proposed storm drainage system will not experience any adverse flooding even with a 20% increase to the 100-year event.

6.5.3 Hydraulic Grade Line

Surcharging is occurring throughout the storm sewer system as the sewers are providing the required underground storage to ensure no 2-year ponding is occurring. Since there are no foundation drains being connected to the system for the slab-on-grade buildings, a hydraulic grade line analysis has not been provided.

6.5.4 Peak Flows

The overall release rates from the controlled and uncontrolled areas were added to determine the overall release rate from the site. The results of this analysis indicate that the allowable release rate will be met for each storm event. Refer to **Table 6-7** for the modelled peak flows for each storm event.

The results of the PCSWMM analysis indicate that outflows from the proposed development will not exceed the allowable release rate for all storm events.

Table 6-7: Summary of Peak Flows

Design Event	Allowable Release Rate (L/s)	Controlled Minor System Release Rate (L/s)	Uncontrolled Minor System Release Rate** (L/s)	Total Minor System Release Rate (L/s)
2-year	135.6	92.0	10.0	102.0
5-year		100.0	13.5	113.5
100-year		111.4	23.2	134.6

*PCSWMM Model results for a 3-hr Chicago storm distribution.

**Uncontrolled minor system release rates are calculated using design sheets located in Appendix B.

As mentioned above in **Section 6.3.2**, the existing site provides an emergency overland flow route for Landry Street and Baribeau Street, outletting to the pathway block connecting to Kipp Street. Through coordination with the City of Ottawa (**Appendix D**) Novatech has assumed potential 100-year overland flows of 190 L/s from Landry Street and 1,000 L/s from Baribeau Street. Most of the major system from the 100-year storm event is contained on-site. During the 100-year storm event 47.6 L/s of major system flow from the swale system is directed to Kipp Street at RY04. The overland flow at RY04 is the result of maintaining the grade of the existing overland flow route as we are unable to raise the existing grade enough to provide additional storage. The additional

47.6 L/s from the site is insignificant compared to the assumed flows from Landry Street and Baribeau Street.

7.0 WATER

7.1 Existing Conditions

The development is located within the 1E Pressure Zone. A 300mm diameter watermain runs along Landry Street and a 200mm diameter watermain runs along Baribeau Street.

7.2 Proposed Conditions

The site will have two connection points to the existing watermain on Baribeau Street. One at the site entrance and the other connection located between Building 1 and 4.

A 200mm diameter watermain is proposed and will provide capacity to maintain appropriate pressures and fire flows throughout the development. **Figure 5** provides a high-level schematic of the proposed water distribution system.

The watermain boundary conditions below were obtained from the City of Ottawa (July 2020) and are included in **Appendix A**:

Boundary Condition 1: Landry Street (300mm watermain)

Max Day + FF of 183 L/s = 110.0m

Max Day + FF of 333 L/s = 104.0m

Peak Hour = 109.5m

Maximum HGL = 118.5m

Boundary Condition 2: Baribeau Street (200mm watermain)

Max Day + FF of 183 L/s = 109.0m

Max Day + FF of 333 L/s = 101.0m

Peak Hour = 109.5m

Maximum HGL = 118.5m

City of Ottawa watermain design criteria are outlined in **Table 7.1**.

Table 7-1: Watermain Design Criteria

Parameter	Design Criteria
Apartment Population	1.8 people/unit
Residential Demand	280 L/c/d
Maximum Day Demand	2.5 x Average Day
Peak Hour Demand	2.2 x Maximum Day
Fire Demand	183 to 300 L/s
Maximum Pressure	690 kPa (100psi) unoccupied areas
Maximum Pressure	552 kPa (80psi) occupied areas outside of ROW
Minimum Pressure	275 kPa (40 psi) except during fire flow
Minimum Pressure	140 kPa (20 psi) fire flow conditions

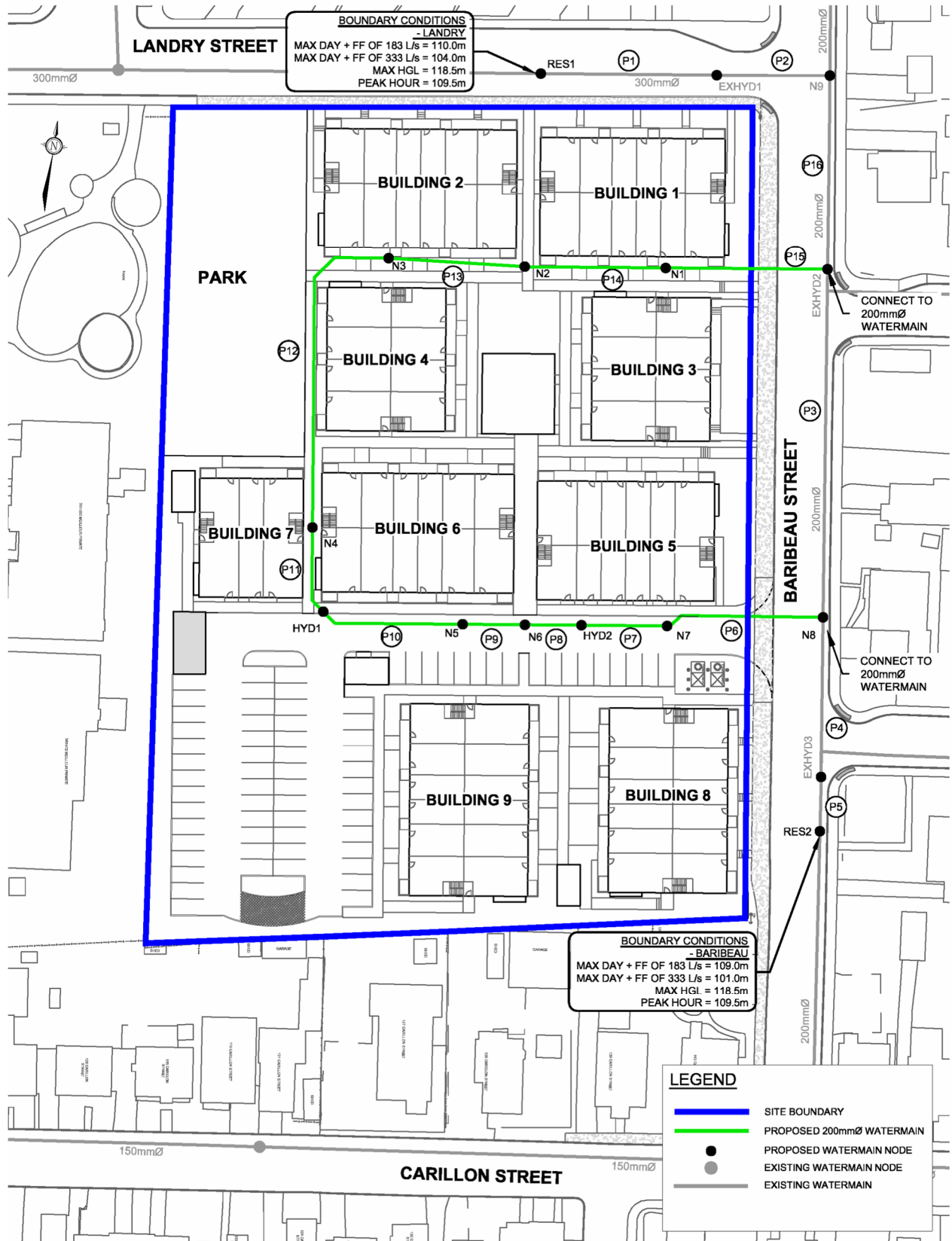

Figure 5: Watermain Layout

Table 7-2: Water Flow Summary

	Units	Population	Average Day Demand (L/s)	Maximum Day Demand (L/s)	Peak Hour Demand (L/s)
Apartments	282	508	1.645	4.113	9.048
Total	282	508	1.645	4.113	9.048

Based on the fire underwriters survey, the fire flows were calculated as 183 L/s (Building 7), 233 L/s (Building 4), 250 L/s (Building 3 & 9), 267 L/s (Buildings 2, 5 and 8), 283 L/s (Building 1) and 300 L/s (Building 6). Hydrant grades and distances to structures are illustrated on the Fire Hydrant Coverage Plan in **Appendix A**. Fire flow calculations are provided in **Appendix A**.

The proposed watermain was modeled using EPANET 2 (See 119068-GP for detailed watermain layout).

A summary of the model results is shown below in **Table 7.3**, **Table 7.4** and **Table 7.5**. Full model results are included in **Appendix A**.

Table 7-3: Summary of Hydraulic Model Results - Maximum Day + Fire Flow

Operating Condition	Minimum Pressure
300 L/s (95 L/s @ HYD 1 & 2, 55 L/s @ EXHYD 2 & 3)	385.43 kPa (HYD1) (55.9 psi)

Table 7-4: Summary of Hydraulic Model Results - Peak Hour Demand

Operating Condition	Maximum Pressure	Minimum Pressure
9.048 L/s through system	527.78 kPa (N8) (76.6 psi)	516.99 kPa (N3) (75.0 psi)

The hydraulic modelling summarized above highlights the maximum and minimum system pressures during Peak Hour conditions, and the minimum system pressures during Maximum Day + Fire condition. Since the Maximum Day + Fire Flow pressures are above the minimum 140 kPa, and the Peak Hour Pressures onsite fall within the normal operating pressure range (345 kPa to 552 kPa) we conclude the proposed water design will adequately service the development.

Table 7-5: Summary of Hydraulic Model Results – Maximum Pressure Check

Operating Condition	Maximum Pressure	Minimum Pressure
1.645 L/s through system	616.17 kPa (N8) (89.4 psi)	605.47 kPa (N3) (87.8 psi)

The average day pressures throughout the system are above 552 kPa, therefore pressure reducing valves are required.

Water retention was analyzed at each node during average day demand. The maximum age throughout the system is within City standards.

8.0 CONCLUSIONS AND RECOMMENDATIONS

The report conclusions follow:

- 1) The proposed storm system will control post-development flow to the allowable release rate of 135.6 L/s.
- 2) The proposed sanitary sewer conforms to City design criteria and provides a gravity outlet for the development site. There is capacity in the downstream sanitary sewers to accommodate the design flow into the Baribeau Street sanitary sewers.
- 3) Connection to the watermain in Baribeau Street will provide municipal water service to the development.
- 4) There is adequate fire protection for the proposed development, in accordance with the Fire Underwriter's Survey.
- 5) The proposed infrastructure (sanitary, storm and water) complies with City of Ottawa design standards.
- 6) The proposed grading provides a minimum 0.30m clearance between the RVCA regulatory flood level of 56.44m and the underside of slab of all living levels.

This report is respectfully submitted for review and approval. Please contact the undersigned should you have questions or require additional information.

Sincerely,

NOVATECH

Prepared By:



Lucas Wilson, P.Eng.
Project Engineer

Reviewed By:



Mark Bissett, P.Eng.
Senior Project Manager

APPENDIX A: Design Sheets

Storm Sewer Design Sheet (Rational Method)

Sanitary Sewer Design Sheet

Watermain Boundary Conditions

Watermain Modelling

Fire Flow Calculations

Fire Hydrant Coverage Plan

STORM SEWER DESIGN SHEET

FLOW RATES BASED ON RATIONAL METHOD



LOCATION				AREA (ha)			FLOW							TOTAL FLOW	SEWER DATA								
Street	Catchment ID	From Manhole	To Manhole	Area (ha)	C	AC (ha)	Indiv 2.78 AC	Accum 2.78 AC	Time of Concentration	Rainfall Intensity 2 Year (mm/hr)	Rainfall Intensity 5 Year (mm/hr)	Rainfall Intensity 100 Year (mm/hr)	Peak Flow (L/s)	Total Peak Flow, Q (L/s)	Dia. (m) Actual	Dia. (mm)	Type	Slope (%)	Length (m)	Capacity (L/s)	Velocity (m/s)	Flow Time (min)	Ratio Q/Q full
	A-04, A-07, A-20, A-21, A-23 to A-25	RY2	MH10	0.168	0.77	0.13	0.360	0.360	10.00	76.81			27.6	27.6	0.305	300	PVC	0.50	21.6	71.3	0.98	0.37	39%
						0.00	0.000	0.000	10.00														
						0.00	0.000	0.000	10.00														
	A-03, A-22, A-26	MH10	MH08	0.079	0.80	0.06	0.176	0.535	10.37	75.42			40.4	40.4	0.381	375	PVC	0.50	28.7	129.2	1.13	0.42	31%
						0.00	0.000	0.000	10.37														
						0.00	0.000	0.000	10.37														
	A-06, A-18, A-27, A-30	MH08	CBMH01	0.105	0.81	0.09	0.236	0.772	10.79	73.90			57.0	57.0	0.381	375	PVC	0.55	8.0	135.5	1.19	0.11	42%
						0.00	0.000	0.000	10.79														
						0.00	0.000	0.000	10.79														
	A-05, A-19, A-28, A-29	CBMH01	MH06	0.107	0.76	0.08	0.226	0.998	10.90	73.50			73.3	73.3	0.381	375	PVC	1.00	30.6	182.8	1.60	0.32	40%
						0.00	0.000	0.000	10.90														
						0.00	0.000	0.000	10.90														
	A-08, A-12, A-15, A-16	MH06	MH04	0.170	0.83	0.14	0.392	1.390	11.22	72.42			100.7	100.7	0.457	450	Conc	1.00	31.5	297.2	1.81	0.29	34%
						0.00	0.000	0.000	11.22														
						0.00	0.000	0.000	11.22														
		MH04	CBMH02	0.000	0.00	0.00	0.000	1.390	11.51	71.45			99.3	99.3	0.457	450	Conc	1.00	25.9	297.2	1.81	0.24	33%
						0.00	0.000	0.000	11.51														
						0.00	0.000	0.000	11.51														
	A-13, A-14, A-17	CBMH02	MH02	0.231	0.85	0.20	0.546	1.936	11.75	70.68			136.8	136.8	0.457	450	Conc	1.00	16.2	297.2	1.81	0.15	46%
						0.00	0.000	0.000	11.75														
						0.00	0.000	0.000	11.75														
	A-01, A-02, A-09 to A-11, A-31, A-32	MH02	EX. 1050	0.301	0.42	0.13	0.351	2.287	11.90	70.21			160.6	160.6	0.457	450	Conc	2.00	46.0	420.3	2.56	0.30	38%
						0.00	0.000	0.000	11.90														
						0.00	0.000	0.000	11.90														

Q = 2.78 AIC, where
 Q = Peak Flow in Litres per Second (L/s)
 A = Area in hectares (ha)
 I = Rainfall Intensity (mm/hr), 2 year storm
 C = Runoff Coefficient

Consultant:	Novatech
Date:	March 13, 2026
Design By:	Lucas Wilson
Client:	Dwg. Reference: 119068-STM
Parkriver Properties	Checked By: MAB



200 Baribeau Street - Sanitary Sewer Design Sheet

AREA			RESIDENTIAL					INFILTRATION				PIPE							
ID	From	To	Apartments		Accum. Pop.	Peak Factor	Peak Flow (l/s)	Total Area (ha)	Accum. Area (ha)	Infiltr. Flow (l/s)	Total Flow (l/s)	Size (mm)	Slope (%)	Length (m)	Capacity (l/s)	Full Flow Vel. (m/s)	Actual Vel. (m/s)	Q/Q _{full} (%)	d/D
			Units	Pop.															
200 BARIBEAU STREET																			
	9	7	162	291.6	291.6	3.5	3.3	0.31	0.31	0.1	3.4	200	0.35	101.0	20.2	0.62	0.38	16.7%	0.307
	5	3	120	216.0	216.0	3.5	2.5	0.24	0.24	0.1	2.5	200	0.65	25.2	27.6	0.85	0.44	9.2%	0.229
	3	6	0	0.0	216.0	3.5	2.5	0.00	0.24	0.1	2.5	200	0.35	19.5	20.2	0.62	0.36	12.5%	0.265
TOTAL			282	507.6	507.6	3.4	5.6	0.00	0.55	0.2	5.9								
Design Parameters: Avg Flow/Person = 280 l/day Comm./Inst. Flow = 28000 l/ha/day Infiltration = 0.33 l/s/ha Pipe Friction n = 0.013 Residential Peaking Factor = Harmon Equation (max 4, min 2)																			
Population Density: ppl/unit Apartment 1.80 units/net ha																			
Project: 200 Baribeau Street (119068) Designed: LRW Checked: MAB Date: March 13, 2026																			



200 Baribeau Street - Sanitary Sewer Design Sheet

AREA			RESIDENTIAL							ICI				INFILTRATION			PIPE											
Street	From	To	SINGLES		Apartments		Accum. Pop.	Peak Factor	Peak Flow (l/s)	Commercial Area (ha)	Institutional Area (ha)	Accum. Area (ha)	Peak Flow (l/s)	Total Area (ha)	Accum. Area (ha)	Infil. Flow (l/s)	Total Flow (l/s)	Size (mm)	Slope (%)	Length (m)	Capacity (l/s)	Full Flow Vel. (m/s)	Actual Vel. (m/s)	Q/Q _{full} (%)	d/D			
			Units	Pop.	Units	Pop.																						
Existing Sanitary Sewer																												
Dagmar Ave.	EXSANMH1	EXSANMH2	7	23.8	12	21.6	45.4	3.7	0.5	0.00	0.00	0.00	0.0	0.52	0.52	0.2	0.7	250	0.45	108.7	41.6	0.82	0.27	1.7%	0.077			
Dagmar Ave.	EXSANMH2	EXSANMH3	0	0.0		0.0	45.4	3.7	0.5	0.00	0.00	0.00	0.0	0.00	0.52	0.2	0.7	250	0.28	7.1	32.8	0.65	0.22	2.2%	0.108			
Dagmar Ave.	EXSANMH5	EXSANMH4	14	47.6	3	5.4	53.0	3.6	0.6	0.00	0.00	0.00	0.0	0.69	0.69	0.2	0.9	250	1.00	99.2	62.0	1.22	0.38	1.4%	0.077			
Dagmar Ave.	EXSANMH4	EXSANMH3	16	54.4		0.0	107.4	3.6	1.2	0.00	0.00	0.00	0.0	0.77	1.46	0.5	1.7	250	0.81	110.5	55.8	1.10	0.42	3.1%	0.132			
Baribeau St.	EXSANMH3	EXSANMH6	0	0.0	3	5.4	158.2	3.5	1.8	0.00	0.00	0.00	0.0	0.08	2.06	0.7	2.5	250	0.51	61.0	44.3	0.87	0.40	5.6%	0.171			
Montfort St.	EXSANMH8	EXSANMH7	11	37.4	15	27.0	64.4	3.6	0.8	0.00	0.00	0.00	0.0	0.65	0.65	0.2	1.0	250	0.39	86.6	38.7	0.76	0.28	2.5%	0.108			
Montfort St.	EXSANMH7	EXSANMH6	14	47.6		0.0	112.0	3.6	1.3	0.00	0.00	0.00	0.0	0.61	1.26	0.4	1.7	250	0.19	95.7	27.0	0.53	0.25	6.3%	0.077			
Baribeau St.	EXSANMH6	EXSANMH9	2	6.8	282	507.6	784.6	3.3	8.4	0.00	0.00	0.00	0.0	1.01	4.33	1.4	9.8	250	0.37	70.4	37.7	0.74	0.52	26.0%	0.077			
Ethel St.	EXSANMH11	EXSANMH10	11	37.4	5	9.0	46.4	3.7	0.5	0.00	0.00	0.00	0.0	0.58	0.58	0.2	0.7	250	0.40	84.7	39.2	0.77	0.25	1.9%	0.077			
Ethel St.	EXSANMH10	EXSANMH9	5	17.0	3	5.4	68.8	3.6	0.8	0.00	0.28	0.28	0.1	0.54	1.12	0.4	1.3	250	0.41	68.8	39.7	0.78	0.30	3.3%	0.077			
Baribeau St.	EXSANMH9	EXSANMH12	0	0.0		0.0	853.4	3.3	9.1	0.00	0.00	0.28	0.1	1.37	6.82	2.3	11.4	250	0.30	71.8	34.0	0.67	0.51	33.7%	0.077			
Design Parameters:			Population Density:										Project: 200 Baribeau Street (119068)															
Avg Flow/Person =			280 l/day					ppl/unit		units/net ha		Designed: LRW																
Comm./Inst. Flow =			28000 l/ha/day					Apartment 1.80		90		Checked: MAB																
Infiltration =			0.33 l/s/ha					Singles 3.40				Date: March 13, 2026																
Pipe Friction n =			0.013					Towns 2.70		60																		
Residential Peaking Factor = Harmon Equation (max 4, min 2)																												
Institutional Peaking Factor			1.5																									



M:\2019\119068\CAD\Design\Figures\Design Brief\119068-XSAN.dwg, 11x17 portrait, Mar 13, 2026 - 11:35am, IWilson

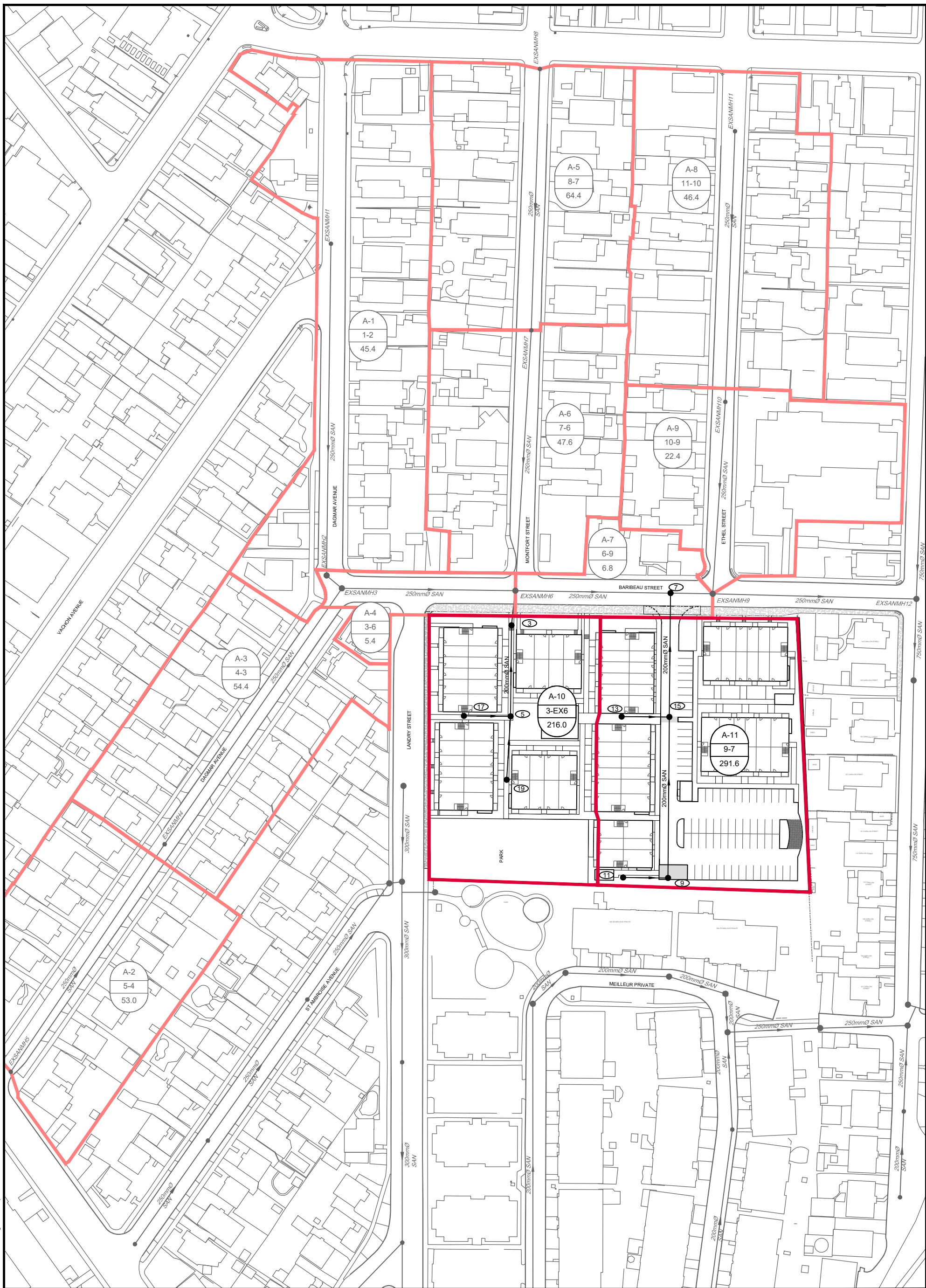









NOVATECH

Engineers, Planners & Landscape Architects
Suite 200, 240 Michael Cowpland Drive
Ottawa, Ontario, Canada K2M 1P6

Telephone (613) 254-9643
Facsimile (613) 254-5867
Website www.novatech-eng.com

LEGEND

-  EXISTING AREA I.D.
-  PROPOSED AREA I.D.
-  EXISTING MANHOLE RUN
-  PROPOSED MANHOLE RUN
-  EXISTING SANITARY NETWORK
-  PROPOSED SANITARY NETWORK
-  EXISTING SANITARY DRAINAGE AREA
-  PROPOSED SANITARY DRAINAGE AREA

CITY OF OTTAWA
200 BARIBEAU STREET

OFF-SITE SANITARY NETWORK

SCALE 1 : 1250

DATE MAR 13, 2026 JOB 119068 FIGURE SAN

Boundary Condition for 200 Baribeau

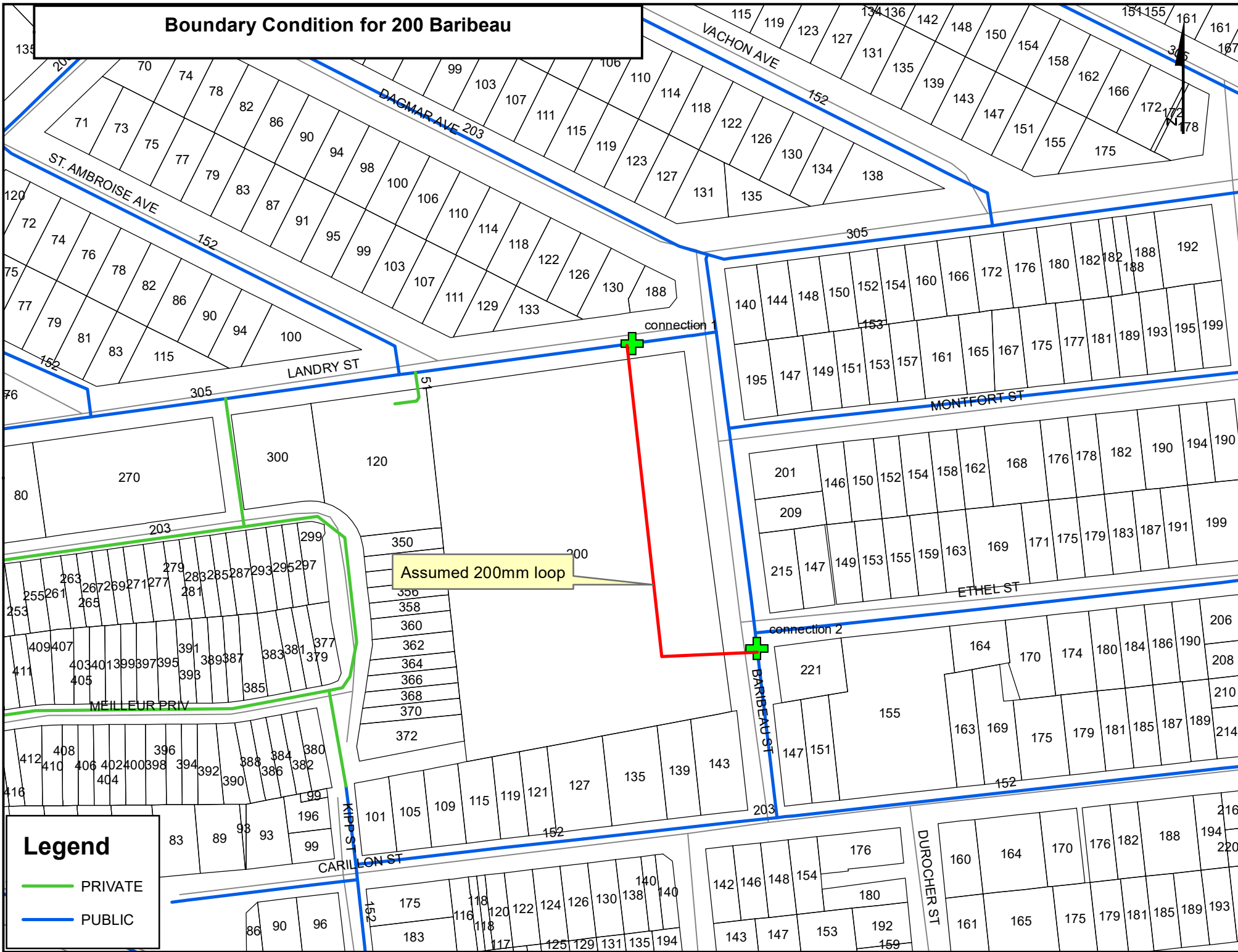

Legend

-  PRIVATE
-  PUBLIC

Lucas Wilson

From: Wu, John <John.Wu@ottawa.ca>
Sent: Monday, July 27, 2020 12:17 PM
To: Lucas Wilson
Subject: RE: Fir flow and boundary condition for 200 Baribeau
Attachments: 200 Baribeau July 2020.pdf

The following are boundary conditions, HGL, for hydraulic analysis at 200 Baribeau (zone 1E) assumed to be connected to the 305mm on Landry and 203mm on Baribeau (see attached PDF for location).

A 200mm private watermain was assumed between both connections as requested.

	305mm on Landry	203mm on Baribeau
Minimum HGL	109.5m	109.5m
Maximum HGL	118.5m*	118.5m*
MaxDay + Fireflow (183 L/s)	110.0m	109.0m
MaxDay + Fireflow (333L/s)	104.0m	101.0m

The maximum pressure is estimated to be above 80 psi. A pressure check at completion of construction is recommended to determine if pressure control is required.

These are for current conditions and are based on computer model simulation.

Disclaimer: The boundary condition information is based on current operation of the city water distribution system. The computer model simulation is based on the best information available at the time. The operation of the water distribution system can change on a regular basis, resulting in a variation in boundary conditions. The physical properties of watermains deteriorate over time, as such must be assumed in the absence of actual field test data. The variation in physical watermain properties can therefore alter the results of the computer model simulation.

John

From: Lucas Wilson <l.wilson@novatech-eng.com>
Sent: July 27, 2020 8:32 AM
To: Wu, John <John.Wu@ottawa.ca>
Subject: RE: Fir flow and boundary condition for 200 Baribeau

CAUTION: This email originated from an External Sender. Please do not click links or open attachments unless you recognize the source.

ATTENTION : Ce courriel provient d'un expéditeur externe. Ne cliquez sur aucun lien et n'ouvrez pas de pièce jointe, excepté si vous connaissez l'expéditeur.

Good morning John,

Just wanted to follow up on 200 Baribeau and if you've heard anything from water modelling in regards to the boundary conditions.

Thanks,

Lucas Wilson, P.Eng., Project Coordinator | Engineering

NOVATECH Engineers, Planners & Landscape Architects

240 Michael Cowpland Drive, Suite 200, Ottawa, ON K2M 1P6 | Tel: 613.254.9643 Ext: 282 | Fax: 613.254.5867

The information contained in this email message is confidential and is for exclusive use of the addressee.

From: Lucas Wilson

Sent: Monday, July 13, 2020 10:17 AM

To: 'John.Wu@ottawa.ca' <John.Wu@ottawa.ca>

Cc: Mark Bissett <m.bissett@novatech-eng.com>

Subject: RE: Fir flow and boundary condition for 200 Baribeau

John,

Thanks for the quick response. The link between the two connection points is a 200mm diameter watermain approximately 175m in length. We will be using a range of fire flows depending on the Block being modelled. Block 1 has the lowest fire flow of 183 L/s and Block 10 being the highest with a fire flow of 333 L/s. The City typically provides the pressures for the highest and lowest fire flows and requests that we interpolate for the remaining fire flows.

Thanks,

Lucas Wilson, P.Eng., Project Coordinator | Engineering

NOVATECH Engineers, Planners & Landscape Architects

240 Michael Cowpland Drive, Suite 200, Ottawa, ON K2M 1P6 | Tel: 613.254.9643 Ext: 282 | Fax: 613.254.5867

The information contained in this email message is confidential and is for exclusive use of the addressee.

From: Wu, John <John.Wu@ottawa.ca>

Sent: Monday, July 13, 2020 9:14 AM

To: Mark Bissett <m.bissett@novatech-eng.com>; Mark Bissett <m.bissett@novatech-eng.com>

Cc: Renaud, Jean-Charles <Jean-Charles.Renaud@ottawa.ca>

Subject: Fir flow and boundary condition for 200 Baribeau

Hi, Lucas:

Please let me know which Fire flow you try to use and what kind of link(size of water main and distance) between the two connection points

I can forward to City's Model group to do the boundary condition for you.

Thanks.

John Wu, P.Eng.

Project Manager, Infrastructure Approval

Development Review (Urban Services)

Gestionnaire de projet, Approbation de L'infrastructure
Examen des projets d'aménagement (Services urbains)
Planning, Infrastructure and Economic Development Department
Services de planification, d'infrastructure et de développement économique
City of Ottawa | Ville d'Ottawa
110 Laurier Avenue West. Ottawa, ON | 110, avenue. Laurier Ouest. Ottawa (Ontario) K1P 1J1
613.580.2424 ext./poste 27734, fax/télec:613-560-6006, john.wu@ottawa.ca

'

This e-mail originates from the City of Ottawa e-mail system. Any distribution, use or copying of this e-mail or the information it contains by other than the intended recipient(s) is unauthorized. Thank you.

Le présent courriel a été expédié par le système de courriels de la Ville d'Ottawa. Toute distribution, utilisation ou reproduction du courriel ou des renseignements qui s'y trouvent par une personne autre que son destinataire prévu est interdite. Je vous remercie de votre collaboration.

'

This e-mail originates from the City of Ottawa e-mail system. Any distribution, use or copying of this e-mail or the information it contains by other than the intended recipient(s) is unauthorized. Thank you.

Le présent courriel a été expédié par le système de courriels de la Ville d'Ottawa. Toute distribution, utilisation ou reproduction du courriel ou des renseignements qui s'y trouvent par une personne autre que son destinataire prévu est interdite. Je vous remercie de votre collaboration.

**200 Baribeau Street
Water Demand**

	Area (ha)	Units	Population	Average Day Demand (L/s)	Maximum Day Demand (L/s)	Peak Hour Demand (L/s)
Towns	N/A	282	508	1.645	4.113	9.048
Total	0.00	282	508	1.645	4.113	9.048

Water Demand Parameters

Apartment	1.8	ppl/unit
Residential Demand	280	L/c/day
Residential Max Day	2.5	x Avg Day
Residential Peak Hour	2.2	x Max Day
Residential Fire Flow	183 - 300	L/s

200 Baribeau Street - Watermain Demand

Node	Apartments	Total Population	Average Day Residential Demand (L/s)	Maximum Day Residential Demand (L/s)	Peak Hour Residential Demand (L/s)
HYD1	0	0	0.000	0.000	0.000
HYD2	0	0	0.000	0.000	0.000
EXHYD1	0	0	0.000	0.000	0.000
EXHYD2	0	0	0.000	0.000	0.000
EXHYD3	0	0	0.000	0.000	0.000
N1	24	43	0.140	0.350	0.770
N2	72	130	0.420	1.050	2.310
N3	24	43	0.140	0.350	0.770
N4	54	97	0.315	0.788	1.733
N5	36	65	0.210	0.525	1.155
N6	36	65	0.210	0.525	1.155
N7	36	65	0.210	0.525	1.155
N8	0	0	0.000	0.000	0.000
N9	0	0	0.000	0.000	0.000
Total	282	508	1.645	4.113	9.048

Water Demand Parameters

Towns	1.8	ppl/unit	Residential Max Day	2.5	x Avg Day
Residential Demand	280	ppl/unit	Residential Peak Hour	2.2	x Max Day
		L/c/day	Residential Fire Flow	183 - 300	L/s

200 Baribeau Street - Watermain Analysis

Network Table - Nodes - (Peak Hour)

Node ID	Elevation m	Demand LPS	Head m	Pressure m	Pressure kPa	Pressure psi
Junc EXHYD1	56.43	0	109.5	53.07	520.62	75.51
Junc EXHYD2	56.04	0	109.49	53.45	524.34	76.05
Junc EXHYD3	55.72	0	109.5	53.78	527.58	76.52
Junc HYD1	56.71	0	109.48	52.77	517.67	75.08
Junc HYD2	56.53	0	109.49	52.96	519.54	75.35
Junc N1	56.75	0.77	109.49	52.74	517.38	75.04
Junc N2	56.76	2.31	109.48	52.72	517.18	75.01
Junc N3	56.78	0.77	109.48	52.7	516.99	74.98
Junc N4	56.73	1.73	109.48	52.75	517.48	75.05
Junc N5	56.52	1.15	109.48	52.96	519.54	75.35
Junc N6	56.56	1.15	109.48	52.92	519.15	75.30
Junc N7	56.56	1.15	109.49	52.93	519.24	75.31
Junc N8	55.69	0	109.49	53.8	527.78	76.55
Junc N9	56.57	0	109.5	52.93	519.24	75.31
Resvr RES1	109.5	-4.39	109.5	0	0.00	0.00
Resvr RES2	109.5	-4.66	109.5	0	0.00	0.00

Network Table - Links - (Peak Hour)

Link ID	Length m	Diameter mm	Roughness	Flow LPS	Velocity m/s	Headloss m/km	Friction Factor
Pipe 1	28.5	300	120	4.39	0.06	0.02	0.035
Pipe 2	18.3	300	120	-4.39	0.06	0.02	0.035
Pipe 3	57.8	200	110	-0.1	0	0	0.063
Pipe 4	24.3	200	110	-4.66	0.15	0.22	0.039
Pipe 5	8.8	200	110	-4.66	0.15	0.22	0.039
Pipe 6	25.9	200	110	4.56	0.15	0.21	0.039
Pipe 7	14.5	200	110	3.4	0.11	0.12	0.04
Pipe 8	9.2	200	110	3.4	0.11	0.12	0.04
Pipe 9	10.1	200	110	2.25	0.07	0.06	0.042
Pipe 10	23.3	200	110	1.09	0.03	0.01	0.048
Pipe 11	14.3	200	110	1.09	0.03	0.01	0.049
Pipe 12	53.7	200	110	-0.64	0.02	0.01	0.052
Pipe 13	22	200	110	-1.41	0.04	0.02	0.046
Pipe 14	22.8	200	110	-3.72	0.12	0.14	0.04
Pipe 15	26.1	200	110	-4.49	0.14	0.2	0.039
Pipe 16	31.4	200	110	-4.39	0.14	0.19	0.039

200 Baribeau Street - Watermain Analysis

Network Table - Nodes - (Max Pressure Check)

Node ID	Elevation m	Demand LPS	Head m	Pressure m	Pressure kPa	Pressure psi	Age Hours
Junc EXHYD1	56.43	0	118.5	62.07	608.91	88.31	0.7
Junc EXHYD2	56.04	0	118.5	62.46	612.73	88.87	2.08
Junc EXHYD3	55.72	0	118.5	62.78	615.87	89.32	0.09
Junc HYD1	56.71	0	118.5	61.79	606.16	87.92	2.2
Junc HYD2	56.53	0	118.5	61.97	607.93	88.17	0.82
Junc N1	56.75	0.14	118.5	61.75	605.77	87.86	2.36
Junc N2	56.76	0.42	118.5	61.74	605.67	87.84	2.66
Junc N3	56.78	0.14	118.5	61.72	605.47	87.82	3.4
Junc N4	56.73	0.31	118.5	61.77	605.96	87.89	4.53
Junc N5	56.52	0.21	118.5	61.98	608.02	88.19	1.17
Junc N6	56.56	0.21	118.5	61.94	607.63	88.13	0.95
Junc N7	56.56	0.21	118.5	61.94	607.63	88.13	0.61
Junc N8	55.69	0	118.5	62.81	616.17	89.37	0.34
Junc N9	56.57	0	118.5	61.93	607.53	88.12	1.15
Resvr RES1	118.5	-0.8	118.5	0	0.00	0.00	0
Resvr RES2	118.5	-0.85	118.5	0	0.00	0.00	0

Network Table - Links - (Max Pressure Check)

Link ID	Length m	Diameter mm	Roughness	Flow LPS	Velocity m/s	Headloss m/km	Friction Factor
Pipe 1	29	300	120	0.80	0.01	0.00	0.045
Pipe 2	18	300	120	-0.80	0.01	0.00	0.047
Pipe 3	58	200	110	-0.02	0.00	0.00	0.000
Pipe 4	24	200	110	-0.85	0.03	0.01	0.050
Pipe 5	9	200	110	-0.85	0.03	0.01	0.051
Pipe 6	26	200	110	0.83	0.03	0.01	0.051
Pipe 7	15	200	110	0.62	0.02	0.00	0.046
Pipe 8	10	200	110	0.62	0.02	0.01	0.060
Pipe 9	10	200	110	0.41	0.01	0.00	0.043
Pipe 10	23	200	110	0.20	0.01	0.00	0.079
Pipe 11	14	200	110	0.20	0.01	0.00	0.064
Pipe 12	54	200	110	-0.12	0.00	0.00	0.098
Pipe 13	22	200	110	-0.26	0.01	0.00	0.050
Pipe 14	23	200	110	-0.68	0.02	0.01	0.052
Pipe 15	26	200	110	-0.82	0.03	0.01	0.050
Pipe 16	31	200	110	-0.80	0.03	0.01	0.050

200 Baribeau Street - Watermain Analysis

Network Table - Nodes (Max Day + FF '300 L/s')

Node ID	Elevation m	Demand LPS	Head m	Pressure m	Pressure kPa	Pressure psi
Junc EXHYD1	56.43	0	104.85	48.42	475.00	68.89
Junc EXHYD2	56.04	55	100.35	44.31	434.68	63.05
Junc EXHYD3	55.72	55	101.57	45.85	449.79	65.24
Junc HYD1	56.71	95	96	39.29	385.43	55.90
Junc HYD2	56.53	95	96.26	39.73	389.75	56.53
Junc N1	58.75	0.35	99.51	40.76	399.86	57.99
Junc N2	56.76	1.05	98.77	42.01	412.12	59.77
Junc N3	56.78	0.35	98.09	41.31	405.25	58.78
Junc N4	56.73	0.79	96.43	39.7	389.46	56.49
Junc N5	56.52	0.52	96.13	39.61	388.57	56.36
Junc N6	56.56	0.52	96.2	39.64	388.87	56.40
Junc N7	56.56	0.52	97.61	41.05	402.70	58.41
Junc N8	55.69	0	100.06	44.37	435.27	63.13
Junc N9	56.57	0	104.56	47.99	470.78	68.28
Resvr RES1	105.3	-150.18	105.3	0	0.00	0.00
Resvr RES2	102.8	-153.93	102.8	0	0.00	0.00

Network Table - Links (Max Day + FF '300 L/s')

Link ID	Length m	Diameter mm	Roughness	Flow LPS	Velocity m/s	Headloss m/km	Friction Factor
Pipe 1	29	300	120	150.18	2.12	15.83	0.021
Pipe 2	18	300	120	-150.18	2.12	15.83	0.021
Pipe 3	58	200	110	25.43	0.81	5.00	0.030
Pipe 4	24	200	110	-98.93	3.15	61.86	0.024
Pipe 5	9	200	110	-153.93	4.90	140.28	0.023
Pipe 6	26	200	110	124.36	3.96	94.49	0.024
Pipe 7	15	200	110	123.84	3.94	93.76	0.024
Pipe 8	10	200	110	28.84	0.92	6.31	0.029
Pipe 9	10	200	110	28.31	0.90	6.10	0.029
Pipe 10	23	200	110	27.79	0.88	5.89	0.030
Pipe 11	14	200	110	-67.21	2.14	30.24	0.026
Pipe 12	54	200	110	-68.00	2.16	30.90	0.026
Pipe 13	22	200	110	-68.35	2.18	31.19	0.026
Pipe 14	23	200	110	-69.40	2.21	32.08	0.026
Pipe 15	26	200	110	-69.75	2.22	32.38	0.026
Pipe 16	31	200	110	-150.18	4.78	134.01	0.023

FUS - Fire Flow Calculations

As per 2020 Fire Underwriter's Survey Guidelines



Engineers, Planners & Landscape Architects

Novatech Project #: 119068

Project Name: 200 Baribeau

Date: 3/13/2026

Input By: Lucas Wilson

Reviewed By: Mark Bissett

Legend

Building Description: Building #1 (36 Units)

Type V - Wood frame

Step	Input		Value Used	Total Fire Flow (L/min)		
Base Fire Flow						
1	Construction Material		Multiplier	1.5		
	Coefficient related to type of construction C	Type V - Wood frame	Yes		1.5	
		Type IV - Mass Timber			Varies	
		Type III - Ordinary construction			1	
		Type II - Non-combustible construction			0.8	
Type I - Fire resistive construction (2 hrs)			0.6			
2	Floor Area			14,000		
	A	Building Footprint (m ²)	574		1,722	
		Number of Floors/Storeys	3			
		Area of structure considered (m ²)				
F	Base fire flow without reductions $F = 220 C (A)^{0.5}$					
Reductions or Surcharges						
3	Occupancy hazard reduction or surcharge		FUS Table 3	Reduction/Surcharge		
	(1)	Non-combustible	Yes	-25%	-25%	
		Limited combustible		-15%		
		Combustible		0%		
		Free burning		15%		
Rapid burning			25%			
4	Sprinkler Reduction		FUS Table 4	Reduction		
	(2)	Adequately Designed System (NFPA 13)		-30%	0	
		Standard Water Supply		-10%		
		Fully Supervised System		-10%		
		Cumulative Sub-Total				0%
Area of Sprinklered Coverage (m²)		0	0%			
Cumulative Total			0%			
5	Exposure Surcharge		FUS Table 5	Surcharge		
	(3)	North Side	20.1 - 30 m	10%	6,300	
		East Side	20.1 - 30 m	10%		
		South Side	3.1 - 10 m	20%		
		West Side	3.1 - 10 m	20%		
Cumulative Total			60%			
Results						
6	(1) + (2) + (3)	Total Required Fire Flow, rounded to nearest 1000L/min		L/min	17,000	
		(2,000 L/min < Fire Flow < 45,000 L/min)		or	L/s	283
				or	USGPM	4,491

FUS - Fire Flow Calculations

As per 2020 Fire Underwriter's Survey Guidelines



Engineers, Planners & Landscape Architects

Novatech Project #: 119068
Project Name: 200 Baribeau
Date: 3/13/2026
Input By: Lucas Wilson
Reviewed By: Mark Bissett

Legend



Building Description: Building #2 (36 Units)
Type V - Wood frame

Step	Input		Value Used	Total Fire Flow (L/min)		
Base Fire Flow						
1	Construction Material		Multiplier	1.5		
	Coefficient related to type of construction C	Type V - Wood frame	Yes		1.5	
		Type IV - Mass Timber			Varies	
		Type III - Ordinary construction			1	
		Type II - Non-combustible construction			0.8	
Type I - Fire resistive construction (2 hrs)			0.6			
2	Floor Area			14,000		
	A	Building Footprint (m ²)	597		1,791	
		Number of Floors/Storeys	3			
		Area of structure considered (m ²)				
F	Base fire flow without reductions					
Reductions or Surcharges						
3	Occupancy hazard reduction or surcharge		FUS Table 3	Reduction/Surcharge		
	(1)	Non-combustible	Yes	-25%	-25%	
		Limited combustible		-15%		
		Combustible		0%		
		Free burning		15%		
Rapid burning			25%			
4	Sprinkler Reduction		FUS Table 4	Reduction		
	(2)	Adequately Designed System (NFPA 13)		-30%	0	
		Standard Water Supply		-10%		
		Fully Supervised System		-10%		
		Cumulative Sub-Total				0%
Area of Sprinklered Coverage (m²)		0	0%			
Cumulative Total			0%			
5	Exposure Surcharge		FUS Table 5	Surcharge		
	(3)	North Side	20.1 - 30 m	10%	5,250	
		East Side	3.1 - 10 m	20%		
		South Side	3.1 - 10 m	20%		
		West Side	>30m	0%		
Cumulative Total			50%			
Results						
6	(1) + (2) + (3)	Total Required Fire Flow, rounded to nearest 1000L/min		L/min	16,000	
		(2,000 L/min < Fire Flow < 45,000 L/min)		or	L/s	267
				or	USGPM	4,227

FUS - Fire Flow Calculations

As per 2020 Fire Underwriter's Survey Guidelines



Engineers, Planners & Landscape Architects

Novatech Project #: 119068

Project Name: 200 Baribeau

Date: 3/13/2026

Input By: Lucas Wilson

Reviewed By: Mark Bissett

Legend

Building Description: Building #3 (24 Units)

Type V - Wood frame

Step	Input		Value Used	Total Fire Flow (L/min)		
Base Fire Flow						
1	Construction Material		Multiplier	1.5		
	Coefficient related to type of construction C	Type V - Wood frame	Yes		1.5	
		Type IV - Mass Timber			Varies	
		Type III - Ordinary construction			1	
		Type II - Non-combustible construction			0.8	
Type I - Fire resistive construction (2 hrs)			0.6			
2	Floor Area			12,000		
	A	Building Footprint (m ²)	445			
		Number of Floors/Storeys	3			
		Area of structure considered (m ²)			1,335	
F	Base fire flow without reductions					
Reductions or Surcharges						
3	Occupancy hazard reduction or surcharge		FUS Table 3	Reduction/Surcharge		
	(1)	Non-combustible	Yes	-25%	-25%	
		Limited combustible		-15%		
		Combustible		0%		
		Free burning		15%		
Rapid burning			25%			
4	Sprinkler Reduction		FUS Table 4	Reduction		
	(2)	Adequately Designed System (NFPA 13)		-30%	0	
		Standard Water Supply		-10%		
		Fully Supervised System		-10%		
		Cumulative Sub-Total				0%
Area of Sprinklered Coverage (m²)		0	0%			
Cumulative Total			0%			
5	Exposure Surcharge		FUS Table 5	Surcharge		
	(3)	North Side	3.1 - 10 m		20%	
		East Side	20.1 - 30 m		10%	
		South Side	3.1 - 10 m		20%	
		West Side	3.1 - 10 m		20%	
Cumulative Total			70%			
Results						
6	(1) + (2) + (3)	Total Required Fire Flow, rounded to nearest 1000L/min		L/min	15,000	
		(2,000 L/min < Fire Flow < 45,000 L/min)		or	L/s	250
				or	USGPM	3,963

FUS - Fire Flow Calculations

As per 2020 Fire Underwriter's Survey Guidelines



Engineers, Planners & Landscape Architects

Novatech Project #: 119068
 Project Name: 200 Baribeau
 Date: 3/13/2026
 Input By: Lucas Wilson
 Reviewed By: Mark Bissett

Legend

Building Description: Building #4 (24 Units)
 Type V - Wood frame

Step	Input		Value Used	Total Fire Flow (L/min)	
Base Fire Flow					
1	Construction Material		Multiplier	1.5	
	Coefficient related to type of construction C	Type V - Wood frame	Yes		1.5
		Type IV - Mass Timber			Varies
		Type III - Ordinary construction			1
		Type II - Non-combustible construction			0.8
Type I - Fire resistive construction (2 hrs)			0.6		
2	Floor Area		1,335	12,000	
	A	Building Footprint (m ²)			445
		Number of Floors/Storeys			3
		Area of structure considered (m ²)			
F	Base fire flow without reductions				
Reductions or Surcharges					
3	Occupancy hazard reduction or surcharge		FUS Table 3	Reduction/Surcharge	
	(1)	Non-combustible	Yes	-25%	
		Limited combustible		-15%	
		Combustible		0%	
		Free burning		15%	
Rapid burning			25%		
4	Sprinkler Reduction		FUS Table 4	Reduction	
	(2)	Adequately Designed System (NFPA 13)		-30%	
		Standard Water Supply		-10%	
		Fully Supervised System		-10%	
		Cumulative Sub-Total		0%	
Area of Sprinklered Coverage (m²)		0	0%		
Cumulative Total		0%			
5	Exposure Surcharge		FUS Table 5	Surcharge	
	(3)	North Side	3.1 - 10 m	20%	
		East Side	3.1 - 10 m	20%	
		South Side	3.1 - 10 m	20%	
		West Side	>30m	0%	
Cumulative Total		60%			
Results					
6	(1) + (2) + (3)	Total Required Fire Flow, rounded to nearest 1000L/min		L/min	
		(2,000 L/min < Fire Flow < 45,000 L/min)		14,000	
		or		L/s	
		or		233	
		or		USGPM	
				3,699	

FUS - Fire Flow Calculations

As per 2020 Fire Underwriter's Survey Guidelines



Engineers, Planners & Landscape Architects

Novatech Project #: 119068

Project Name: 200 Baribeau

Date: 3/13/2026

Input By: Lucas Wilson

Reviewed By: Mark Bissett

Legend

Building Description: Building #5 (36 Units)

Type V - Wood frame

Step	Input		Value Used	Total Fire Flow (L/min)		
Base Fire Flow						
1	Construction Material		Multiplier	1.5		
	Coefficient related to type of construction C	Type V - Wood frame	Yes		1.5	
		Type IV - Mass Timber			Varies	
		Type III - Ordinary construction			1	
		Type II - Non-combustible construction			0.8	
Type I - Fire resistive construction (2 hrs)			0.6			
2	Floor Area		1,650	13,000		
	A	Building Footprint (m ²)			550	
		Number of Floors/Storeys			3	
		Area of structure considered (m ²)				
F	Base fire flow without reductions					
Reductions or Surcharges						
3	Occupancy hazard reduction or surcharge		FUS Table 3	Reduction/Surcharge		
	(1)	Non-combustible	Yes	-25%	-25%	
		Limited combustible		-15%		
		Combustible		0%		
		Free burning		15%		
Rapid burning			25%			
4	Sprinkler Reduction		FUS Table 4	Reduction		
	(2)	Adequately Designed System (NFPA 13)		-30%	0	
		Standard Water Supply		-10%		
		Fully Supervised System		-10%		
		Cumulative Sub-Total		0%		
Area of Sprinklered Coverage (m²)		0	0%			
Cumulative Total		0%				
5	Exposure Surcharge		FUS Table 5	Surcharge		
	(3)	North Side	3.1 - 10 m	20%	6,338	
		East Side	20.1 - 30 m	10%		
		South Side	10.1 - 20 m	15%		
		West Side	3.1 - 10 m	20%		
Cumulative Total		65%				
Results						
6	(1) + (2) + (3)	Total Required Fire Flow, rounded to nearest 1000L/min		L/min	16,000	
		(2,000 L/min < Fire Flow < 45,000 L/min)		or	L/s	267
				or	USGPM	4,227

FUS - Fire Flow Calculations

As per 2020 Fire Underwriter's Survey Guidelines



Engineers, Planners & Landscape Architects

Novatech Project #: 119068
 Project Name: 200 Baribeau
 Date: 3/13/2026
 Input By: Lucas Wilson
 Reviewed By: Mark Bissett

Legend

Building Description: Building #6 (36 Units)
 Type V - Wood frame

Step	Input		Value Used	Total Fire Flow (L/min)		
Base Fire Flow						
1	Construction Material		Multiplier	1.5		
	Coefficient related to type of construction C	Type V - Wood frame	Yes		1.5	
		Type IV - Mass Timber			Varies	
		Type III - Ordinary construction			1	
		Type II - Non-combustible construction			0.8	
Type I - Fire resistive construction (2 hrs)			0.6			
2	Floor Area			14,000		
	A	Building Footprint (m ²)	597		1,791	
		Number of Floors/Storeys	3			
		Area of structure considered (m ²)				
F	Base fire flow without reductions					
Reductions or Surcharges						
3	Occupancy hazard reduction or surcharge		FUS Table 3	Reduction/Surcharge		
	(1)	Non-combustible	Yes	-25%	-25%	
		Limited combustible		-15%		
		Combustible		0%		
		Free burning		15%		
Rapid burning			25%			
4	Sprinkler Reduction		FUS Table 4	Reduction		
	(2)	Adequately Designed System (NFPA 13)		-30%	0	
		Standard Water Supply		-10%		
		Fully Supervised System		-10%		
		Cumulative Sub-Total				0%
Area of Sprinklered Coverage (m²)		0	0%	0%		
Cumulative Total			0%			
5	Exposure Surcharge		FUS Table 5	Surcharge		
	(3)	North Side	3.1 - 10 m	20%	7,875	
		East Side	3.1 - 10 m	20%		
		South Side	10.1 - 20 m	15%		
		West Side	0 - 3 m	25%		
Cumulative Total			75%			
Results						
6	(1) + (2) + (3)	Total Required Fire Flow, rounded to nearest 1000L/min		L/min	18,000	
		(2,000 L/min < Fire Flow < 45,000 L/min)		or	L/s	300
				or	USGPM	4,756

FUS - Fire Flow Calculations

As per 2020 Fire Underwriter's Survey Guidelines



Engineers, Planners & Landscape Architects

Novatech Project #: 119068

Project Name: 200 Baribeau

Date: 3/13/2026

Input By: Lucas Wilson

Reviewed By: Mark Bissett

Legend

Building Description: Building #7 (18 Units)

Type V - Wood frame

Step	Input		Value Used	Total Fire Flow (L/min)		
Base Fire Flow						
1	Construction Material		Multiplier	1.5		
	Coefficient related to type of construction C	Type V - Wood frame	Yes		1.5	
		Type IV - Mass Timber			Varies	
		Type III - Ordinary construction			1	
		Type II - Non-combustible construction			0.8	
Type I - Fire resistive construction (2 hrs)			0.6			
2	Floor Area		966	10,000		
	A	Building Footprint (m ²)			322	
		Number of Floors/Storeys			3	
		Area of structure considered (m ²)				
F	Base fire flow without reductions					
Reductions or Surcharges						
3	Occupancy hazard reduction or surcharge		FUS Table 3	Reduction/Surcharge		
	(1)	Non-combustible	Yes	-25%	-25%	
		Limited combustible		-15%		
		Combustible		0%		
		Free burning		15%		
Rapid burning			25%			
4	Sprinkler Reduction		FUS Table 4	Reduction		
	(2)	Adequately Designed System (NFPA 13)		-30%	0	
		Standard Water Supply		-10%		
		Fully Supervised System		-10%		
		Cumulative Sub-Total		0%		
Area of Sprinklered Coverage (m²)		0	0%			
Cumulative Total		0%				
5	Exposure Surcharge		FUS Table 5	Surcharge		
	(3)	North Side	>30m	0%	3,000	
		East Side	0 - 3 m	25%		
		South Side	>30m	0%		
		West Side	10.1 - 20 m	15%		
Cumulative Total		40%				
Results						
6	(1) + (2) + (3)	Total Required Fire Flow, rounded to nearest 1000L/min		L/min	11,000	
		(2,000 L/min < Fire Flow < 45,000 L/min)		or	L/s	183
				or	USGPM	2,906

FUS - Fire Flow Calculations

As per 2020 Fire Underwriter's Survey Guidelines



Engineers, Planners & Landscape Architects

Novatech Project #: 119068

Project Name: 200 Baribeau

Date: 3/13/2026

Input By: Lucas Wilson

Reviewed By: Mark Bissett

Legend

Building Description: Building #8 (36 Units)

Type V - Wood frame

Step	Input		Value Used	Total Fire Flow (L/min)		
Base Fire Flow						
1	Construction Material		Multiplier	1.5		
	Coefficient related to type of construction C	Type V - Wood frame	Yes		1.5	
		Type IV - Mass Timber			Varies	
		Type III - Ordinary construction			1	
		Type II - Non-combustible construction			0.8	
Type I - Fire resistive construction (2 hrs)			0.6			
2	Floor Area			14,000		
	A	Building Footprint (m ²)	574			
		Number of Floors/Storeys	3			
		Area of structure considered (m ²)			1,722	
F	Base fire flow without reductions					
Reductions or Surcharges						
3	Occupancy hazard reduction or surcharge		FUS Table 3	Reduction/Surcharge		
	(1)	Non-combustible	Yes	-25%	-25%	
		Limited combustible		-15%		
		Combustible		0%		
		Free burning		15%		
Rapid burning			25%			
4	Sprinkler Reduction		FUS Table 4	Reduction		
	(2)	Adequately Designed System (NFPA 13)		-30%	0	
		Standard Water Supply		-10%		
		Fully Supervised System		-10%		
		Cumulative Sub-Total				0%
Area of Sprinklered Coverage (m²)		0	0%			
Cumulative Total			0%			
5	Exposure Surcharge		FUS Table 5	Surcharge		
	(3)	North Side	10.1 - 20 m	15%	5,775	
		East Side	20.1 - 30 m	10%		
		South Side	10.1 - 20 m	15%		
		West Side	10.1 - 20 m	15%		
Cumulative Total			55%			
Results						
6	(1) + (2) + (3)	Total Required Fire Flow, rounded to nearest 1000L/min		L/min	16,000	
		(2,000 L/min < Fire Flow < 45,000 L/min)		or	L/s	267
				or	USGPM	4,227

FUS - Fire Flow Calculations

As per 2020 Fire Underwriter's Survey Guidelines



Engineers, Planners & Landscape Architects

Novatech Project #: 119068

Project Name: 200 Baribeau

Date: 3/13/2026

Input By: Lucas Wilson

Reviewed By: Mark Bissett

Legend

Building Description: Building #9 (36 Units)

Type V - Wood frame

Step	Input		Value Used	Total Fire Flow (L/min)		
Base Fire Flow						
1	Construction Material		Multiplier	1.5		
	Coefficient related to type of construction C	Type V - Wood frame	Yes		1.5	
		Type IV - Mass Timber			Varies	
		Type III - Ordinary construction			1	
		Type II - Non-combustible construction			0.8	
Type I - Fire resistive construction (2 hrs)			0.6			
2	Floor Area			14,000		
	A	Building Footprint (m ²)	597		1,791	
		Number of Floors/Storeys	3			
		Area of structure considered (m ²)				
F	Base fire flow without reductions					
Reductions or Surcharges						
3	Occupancy hazard reduction or surcharge		FUS Table 3	Reduction/Surcharge		
	(1)	Non-combustible	Yes	-25%	-25%	
		Limited combustible		-15%		
		Combustible		0%		
		Free burning		15%		
Rapid burning			25%			
4	Sprinkler Reduction		FUS Table 4	Reduction		
	(2)	Adequately Designed System (NFPA 13)		-30%	0	
		Standard Water Supply		-10%		
		Fully Supervised System		-10%		
		Cumulative Sub-Total				0%
Area of Sprinklered Coverage (m²)		0	0%	0%		
Cumulative Total			0%			
5	Exposure Surcharge		FUS Table 5	Surcharge		
	(3)	North Side	10.1 - 20 m	15%	4,725	
		East Side	10.1 - 20 m	15%		
		South Side	10.1 - 20 m	15%		
		West Side	>30m	0%		
Cumulative Total			45%			
Results						
6	(1) + (2) + (3)	Total Required Fire Flow, rounded to nearest 1000L/min		L/min	15,000	
		(2,000 L/min < Fire Flow < 45,000 L/min)		or	L/s	250
				or	USGPM	3,963

LANDRY STREET

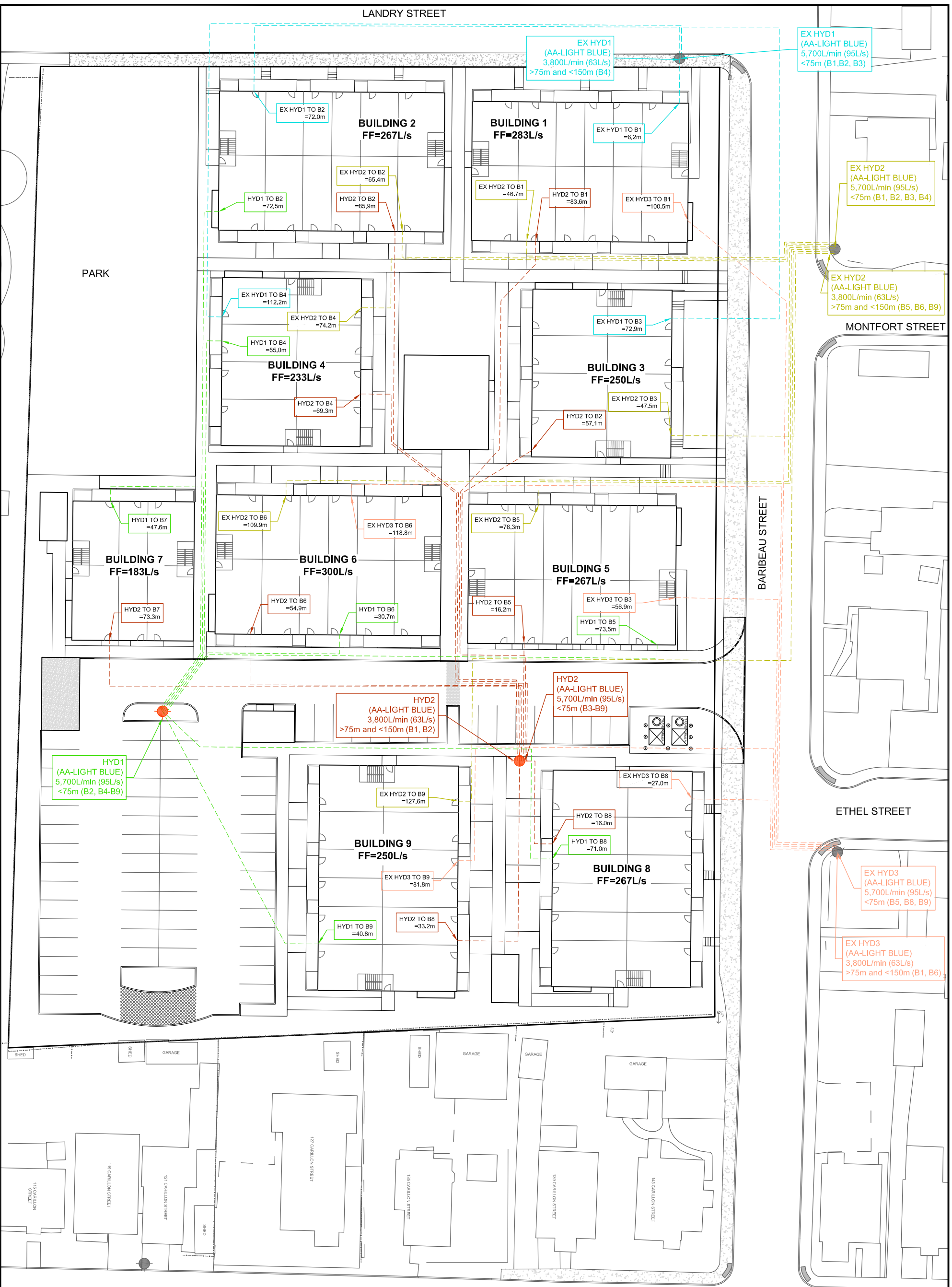

CARILLON STREET

LEGEND

- ROUTE FROM PROPOSED BUILDING TO HYD 1
- ROUTE FROM PROPOSED BUILDING TO HYD 2
- ROUTE FROM PROPOSED BUILDING TO EX HYD1
- ROUTE FROM PROPOSED BUILDING TO EX HYD2
- ROUTE FROM PROPOSED BUILDING TO EX HYD3
- FIRE HYDRANT



NOVATECH
 Engineers, Planners & Landscape Architects

Suite 200, 240 Michael Cowpland Drive
 Ottawa, Ontario, Canada K2M 1P6

Telephone (613) 254-9643
 Facsimile (613) 254-5867
 Website www.novatech-eng.com

CITY OF OTTAWA
 200 BARIBEAU STREET

**FIRE HYDRANT
 COVERAGE PLAN**

SCALE 1 : 500

DATE MAR 13, 2026 JOB 119068 FIGURE FIG-6

M:\2019\119068\CAD\Design\Figures\Design Brief\119068-HYD-Coverage.dwg, FIG-6, Mar 16, 2026 - 9:46am, IWilson

APPENDIX B

SWM Calculations

EXISTING CONDITIONS

Existing Catchment Parameters

Catchment ID	Areas (ha)	Runoff Coefficient
	Total	C
TOTAL	1.270	0.50

Pre-Development Peak Flows

Catchment ID	Rainfall Intensity (mm/hr) ¹	Peak Flows (L/s)
	2-year	2-year
Site Boundary (existing conditions)	76.81	135.6

¹ Tc is based on Uplands Method.

Notes:

Rainfall Intensity from City of Ottawa Sewer Design Guidelines (Oct. 2012)

- 100 year Intensity = $1735.688 / (Tc + 6.014)^{0.820}$
- 5 year Intensity = $998.071 / (Tc + 6.053)^{0.814}$
- 2 year Intensity = $732.951 / (Tc + 6.199)^{0.810}$

$Q(\text{peak flow}) = 2.78 \times C \times I \times A$

- C is the runoff coefficient
- I is the rainfall intensity
- A is the total drainage area

POST-DEVELOPMENT CONDITIONS

Uncontrolled Catchment Parameters

Catchment ID	Areas (ha)	Runoff Coefficient
	Total	C
TOTAL	0.106	0.44

Pre-Development Peak Flows

Catchment ID	Rainfall Intensity (mm/hr) ¹			Peak Flows (L/s)		
	2-year	5-year	100-year	2-year	5-year	100-year
Uncontrolled Areas (B-01, B-02)	76.81	104.19	178.56	10.0	13.5	23.2

¹ Tc is based on Uplands Method.

Notes:

Rainfall Intensity from City of Ottawa Sewer Design Guidelines (Oct. 2012)

- 100 year Intensity = $1735.688 / (Tc + 6.014^{0.820})$

- 5 year Intensity = $998.071 / (Tc + 6.053^{0.814})$

- 2 year Intensity = $732.951 / (Tc + 6.199^{0.810})$

$Q(\text{peak flow}) = 2.78 \times C \times I \times A$

- C is the runoff coefficient

- I is the rainfall intensity

- A is the total drainage area

CB1-Storage		
Depth (m)	Area (m ²)	Volume (m ³)
0.00	0.37	0.00
1.40	0.37	0.52
1.61	148.21	16.12
1.61	0.00	16.19
2.40	0.00	16.19

CB2-Storage		
Depth (m)	Area (m ²)	Volume (m ³)
0.00	0.37	0.00
1.40	0.37	0.52
1.60	109.00	11.46
1.60	0.00	11.51
2.40	0.00	11.51

CB3-Storage		
Depth (m)	Area (m ²)	Volume (m ³)
0.00	0.37	0.00
0.78	0.37	0.29
1.08	486.30	73.29
1.08	0.00	73.53
1.78	0.00	73.53

CBMH2-Storage		
Depth (m)	Area (m ²)	Volume (m ³)
0.00	1.17	0.00
2.78	1.17	3.25
3.10	467.60	78.26
3.10	0.00	78.49
3.78	0.00	78.49

200 Baribeau Street (119068)
 PCSWMM Model Results (Ponding)



CB ID	Invert Elev. (m)	Rim Elev. (m)	Spill Elev. (m)	Ponding Depth (m)	HGL Elev. (m) ¹				Ponding Depth (m)				Spill Depth (m)			
					2-yr	5-yr	100-yr	100-yr (+20%)	2-yr	5-yr	100-yr	100-yr (+20%)	2-yr	5-yr	100-yr	100-yr (+20%)
CB01	54.85	56.25	56.46	0.21	55.26	55.61	56.47	56.48	0.00	0.00	0.22	0.23	0.00	0.00	0.01	0.02
CB02	54.85	56.25	56.45	0.20	55.23	55.57	56.44	56.46	0.00	0.00	0.19	0.21	0.00	0.00	0.00	0.01
CB03	55.28	56.06	56.36	0.30	55.43	55.54	56.36	56.38	0.00	0.00	0.30	0.32	0.00	0.00	0.00	0.02
CBMH01	54.62	56.57	56.65	0.08	55.27	55.62	56.58	56.63	0.00	0.00	0.01	0.06	0.00	0.00	0.00	0.00
CBMH02	53.28	56.06	56.38	0.32	55.19	55.53	56.36	56.39	0.00	0.00	0.30	0.33	0.00	0.00	0.00	0.01
LC01	55.27	56.58	56.69	0.11	55.34	55.63	56.62	56.67	0.00	0.00	0.04	0.09	0.00	0.00	0.00	0.00
LC02	55.20	56.57	56.67	0.10	55.32	55.63	56.62	56.66	0.00	0.00	0.05	0.09	0.00	0.00	0.00	0.00
LC03	55.49	56.55	56.66	0.11	55.56	55.65	56.66	56.69	0.00	0.00	0.11	0.14	0.00	0.00	0.00	0.03
LC04	55.09	55.69	55.76	0.07	55.15	55.20	55.82	55.89	0.00	0.00	0.13	0.20	0.00	0.00	0.06	0.13
LC05	55.24	55.79	55.89	0.10	55.26	55.29	55.84	55.92	0.00	0.00	0.05	0.13	0.00	0.00	0.00	0.03
RY01	54.45	55.50	55.55	0.05	54.71	55.16	55.60	55.64	0.00	0.00	0.10	0.14	0.00	0.00	0.05	0.09
RY02	55.44	56.55	56.67	0.12	55.54	55.65	56.66	56.69	0.00	0.00	0.11	0.14	0.00	0.00	0.00	0.02
RY03	55.30	55.84	55.91	0.07	55.84	55.91	56.01	56.04	0.00	0.07	0.17	0.20	0.00	0.00	0.10	0.13
RY04	54.60	55.25	55.50	0.25	54.71	55.16	55.59	55.63	0.00	0.00	0.34	0.38	0.00	0.00	0.09	0.13
RY05	55.45	56.00	56.00	0.00	55.85	55.91	56.01	56.04	0.00	0.00	0.01	0.04	0.00	0.00	0.01	0.04
RY06	55.02	55.72	55.72	0.00	55.07	55.17	55.77	55.83	0.00	0.00	0.05	0.11	0.00	0.00	0.05	0.11
RY07	55.25	56.56	56.61	0.05	55.31	55.62	56.59	56.63	0.00	0.00	0.03	0.07	0.00	0.00	0.00	0.02
RY08	55.20	56.55	56.63	0.08	55.28	55.62	56.59	56.63	0.00	0.00	0.04	0.08	0.00	0.00	0.00	0.00
RY09	55.55	56.55	56.68	0.13	55.65	55.68	56.66	56.70	0.00	0.00	0.11	0.15	0.00	0.00	0.00	0.02
RY10	55.35	56.60	56.69	0.09	55.47	55.65	56.66	56.70	0.00	0.00	0.06	0.10	0.00	0.00	0.00	0.01
RY11	55.43	56.60	56.70	0.10	55.49	55.65	56.66	56.70	0.00	0.00	0.06	0.10	0.00	0.00	0.00	0.00

¹ 3-hour Chicago Storm.

200 Baribeau Street (119068)
PCSWMM Model Output
100yr 3-hour Chicago Storm (Fixed Outfall = 55.05m)



EPA STORM WATER MANAGEMENT MODEL - VERSION 5.2 (Build 5.2.4)

 Element Count

 Number of rain gages 1
 Number of subcatchments ... 32
 Number of nodes 70
 Number of links 87
 Number of pollutants 0
 Number of land uses 0

 Raingage Summary

Name	Data Source	Data Type	Recording Interval
RG-1	C3hr-100yr	INTENSITY	10 min.

 Subcatchment Summary

Name	Area	Width	%Imperv	%Slope	Rain Gage	Outlet
A-01	0.06	24.80	2.90	4.0000	RG-1	LC05
A-02	0.08	34.00	15.70	4.0000	RG-1	LC04
A-03	0.02	38.00	42.90	1.5000	RG-1	RY10
A-04	0.02	34.00	44.30	1.5000	RG-1	LC03
A-05	0.03	20.67	31.40	1.5000	RG-1	RY08
A-06	0.02	15.33	42.90	1.5000	RG-1	LC01
A-07	0.03	34.00	34.30	1.5000	RG-1	ry09
A-08	0.05	30.67	94.30	1.0000	RG-1	CB02
A-09	0.04	88.00	14.30	0.5000	RG-1	ms-ry06
A-10	0.01	26.00	28.60	2.0000	RG-1	RY01
A-11	0.04	26.00	32.90	2.0000	RG-1	RY03
A-12	0.06	42.67	77.10	1.5000	RG-1	CB01
A-13	0.08	28.33	95.70	1.5000	RG-1	CB03
A-14	0.11	32.57	88.60	1.5000	RG-1	CBMH02
A-15	0.03	10.00	100.00	0.5000	RG-1	B9_1
A-16	0.03	10.00	100.00	0.5000	RG-1	B8_1
A-17	0.03	16.00	100.00	0.5000	RG-1	B7
A-18	0.03	12.00	100.00	0.5000	RG-1	B6_2
A-19	0.03	10.80	100.00	0.5000	RG-1	B5_2
A-20	0.02	7.33	100.00	0.5000	RG-1	B3_1
A-21	0.03	9.33	100.00	0.5000	RG-1	B1_2
A-22	0.03	10.00	100.00	0.5000	RG-1	B2_1
A-23	0.02	7.33	100.00	0.5000	RG-1	B4_2
A-24	0.01	10.00	100.00	0.5000	RG-1	BICYCLE_GARBAGE
A-25	0.03	10.00	100.00	0.5000	RG-1	B1_1
A-26	0.03	10.00	100.00	0.5000	RG-1	B2_2
A-27	0.02	7.33	100.00	0.5000	RG-1	B4_1
A-28	0.02	7.33	100.00	0.5000	RG-1	B3_2
A-29	0.03	10.80	100.00	0.5000	RG-1	B5_1
A-30	0.03	12.00	100.00	0.5000	RG-1	B6_1
A-31	0.03	10.00	100.00	0.5000	RG-1	B9_2
A-32	0.03	9.33	100.00	0.5000	RG-1	B8_2

 Node Summary

Name	Type	Invert Elev.	Max. Depth	Ponded Area	External Inflow
B1_1	JUNCTION	56.78	1.00	0.0	
B1_2	JUNCTION	56.78	1.00	0.0	
B2_1	JUNCTION	56.78	1.00	0.0	
B2_2	JUNCTION	56.78	1.00	0.0	
B3_1	JUNCTION	56.79	1.00	0.0	
B3_2	JUNCTION	56.79	1.00	0.0	
B4_1	JUNCTION	56.82	1.00	0.0	
B4_2	JUNCTION	56.82	1.00	0.0	
B5_1	JUNCTION	56.80	1.00	0.0	
B5_2	JUNCTION	56.80	1.00	0.0	
B6_1	JUNCTION	56.85	1.00	0.0	
B6_2	JUNCTION	56.85	1.00	0.0	
B7	JUNCTION	56.80	1.00	0.0	

B8_1	JUNCTION	56.60	1.00	0.0
B8_2	JUNCTION	56.60	1.00	0.0
B9_1	JUNCTION	56.65	1.00	0.0
B9_2	JUNCTION	56.65	1.00	0.0
BICYCLE_GARBAGE	JUNCTION	56.80	1.00	0.0
HP-CB01	JUNCTION	56.46	1.00	0.0
HP-CB02	JUNCTION	56.45	1.00	0.0
HP-CB03	JUNCTION	56.36	1.00	0.0
HP-CBMH01	JUNCTION	56.65	1.00	0.0
HP-CBMH02	JUNCTION	56.38	1.00	0.0
HP-LC01(1)	JUNCTION	56.71	1.00	0.0
HP-LC01(2)	JUNCTION	56.69	1.00	0.0
HP-LC02	JUNCTION	56.67	1.00	0.0
HP-LC04	JUNCTION	55.76	1.00	0.0
HP-LC05(1)	JUNCTION	55.92	1.00	0.0
HP-LC05(2)	JUNCTION	55.89	1.00	0.0
HP-RY01	JUNCTION	55.55	1.00	0.0
HP-RY02	JUNCTION	56.67	1.00	0.0
HP-RY03	JUNCTION	55.91	1.00	0.0
HP-RY08	JUNCTION	56.63	1.00	0.0
HP-RY09	JUNCTION	56.68	1.00	0.0
HP-RY10	JUNCTION	56.69	1.00	0.0
HP-RY11(1)	JUNCTION	56.71	1.00	0.0
HP-RY11(2)	JUNCTION	56.70	1.00	0.0
ms-ry06	JUNCTION	55.47	1.00	0.0
Ex.1050	OUTFALL	51.05	1.00	0.0
HP-LC03	OUTFALL	56.66	1.00	0.0
HP-RY04	OUTFALL	55.50	1.00	0.0
HP-RY07	OUTFALL	56.61	1.00	0.0
CB01	STORAGE	54.85	2.40	0.0
CB02	STORAGE	54.85	2.40	0.0
CB03	STORAGE	55.28	1.78	0.0
CBMH01	STORAGE	54.62	2.95	0.0
CBMH02	STORAGE	53.28	3.78	0.0
Dummy_Chambers	STORAGE	55.10	1.40	0.0
Dummy-MH02	STORAGE	52.51	3.78	0.0
LC01	STORAGE	55.27	2.31	0.0
LC02	STORAGE	55.20	2.37	0.0
LC03	STORAGE	55.49	2.06	0.0
LC04	STORAGE	55.09	1.60	0.0
LC05	STORAGE	55.24	1.55	0.0
MH02	STORAGE	52.51	4.78	0.0
MH04	STORAGE	53.55	2.89	0.0
MH06	STORAGE	53.89	2.60	0.0
MH08	STORAGE	55.09	1.57	0.0
MH10	STORAGE	55.24	1.46	0.0
RY01	STORAGE	54.45	2.05	0.0
RY02	STORAGE	55.44	2.11	0.0
RY03	STORAGE	55.30	1.54	0.0
RY04	STORAGE	54.60	1.65	0.0
RY05	STORAGE	55.45	1.55	0.0
RY06	STORAGE	55.02	1.70	0.0
RY07	STORAGE	55.25	2.31	0.0
RY08	STORAGE	55.20	2.35	0.0
ry09	STORAGE	55.55	2.00	0.0
RY10	STORAGE	55.35	2.25	0.0
RY11	STORAGE	55.43	2.17	0.0

 Link Summary

Name	From Node	To Node	Type	Length	%Slope	Roughness
CB01-Lead	CB01	MH06	CONDUIT	18.6	0.9678	0.0130
CB02-Lead	CB02	MH06	CONDUIT	1.8	1.1112	0.0130
CB03-Lead	CB03	Dummy_Chambers	CONDUIT	5.7	0.5263	0.0130
CBMH01-MH06	CBMH01	MH06	CONDUIT	30.6	1.0131	0.0130
CBMH02-MH02	CBMH02	MH02	CONDUIT	16.2	1.0494	0.0130
LC01-LC02	LC01	LC02	CONDUIT	14.0	0.5000	0.0130
LC01-MH08	LC02	MH08	CONDUIT	6.0	0.5000	0.0130
LC03-RY02	LC03	RY02	CONDUIT	11.8	0.4237	0.0130
LC04-RY06	LC04	RY06	CONDUIT	25.4	0.2756	0.0130
LC05-LC04	LC05	LC04	CONDUIT	29.5	0.5085	0.0130
MH04-CBMH02	MH04	CBMH02	CONDUIT	25.9	1.0039	0.0130
MH04-Ex1050	Dummy-MH02	Ex.1050	CONDUIT	46.0	2.0004	0.0130
MH06-MH04	MH06	MH04	CONDUIT	31.5	0.9842	0.0130
MH08-CBMH01	MH08	CBMH01	CONDUIT	8.0	0.5000	0.0130
MH10-MH08	MH10	MH08	CONDUIT	28.7	0.4878	0.0130
MS-B1_1	B1_1	RY02	CONDUIT	11.4	2.0180	0.0350
MS-B1_2	B1_2	LC03	CONDUIT	5.0	4.6049	0.0350
MS-B2_1	B2_1	RY10	CONDUIT	9.0	2.0004	0.0350

200 Baribeau Street (119068)
PCSWMM Model Output
100yr 3-hour Chicago Storm (Fixed Outfall = 55.05m)

MS-B2_2	B2_2	RY11	CONDUIT	6.0	3.0014	0.0350
MS-B3_1	B3_1	ry09	CONDUIT	10.0	2.4007	0.0350
MS-B3_2	B3_2	CBMH01	CONDUIT	15.0	1.4668	0.0350
MS-B4_1	B4_1	LC02	CONDUIT	11.0	2.2733	0.0350
MS-B4_2	B4_2	ry09	CONDUIT	12.0	2.2506	0.0350
MS-B5_1	B5_1	CBMH01	CONDUIT	10.0	2.3006	0.0350
MS-B5_2	B5_2	RY07	CONDUIT	5.0	4.8055	0.0350
MS-B6_1	B6_1	LC01	CONDUIT	3.0	9.0367	0.0350
MS-B6_2	B6_2	CBMH01	CONDUIT	8.0	3.5021	0.0350
MS-B7	B7	CB03	CONDUIT	3.0	14.8270	0.0350
MS-B8_1	B8_1	CB01	CONDUIT	17.1	0.8187	0.0350
MS-B8_2	B8_2	RY03	CONDUIT	15.0	5.0063	0.0350
MS-B9_1	B9_1	CB01	CONDUIT	16.6	1.1447	0.0150
MS-B9_2	B9_2	RY03	CONDUIT	11.1	7.2260	0.0350
MS-BG	BICYCLE_GARBAGE	ry09	CONDUIT	6.0	4.1703	0.0350
MS-CB01 (1)	CB01	HP-CB01	CONDUIT	3.0	-7.0172	0.0150
MS-CB01 (2)	HP-CB01	CB02	CONDUIT	3.0	7.0172	0.0150
MS-CB02 (1)	CB02	HP-CB02	CONDUIT	3.0	-6.6815	0.0150
MS-CB02 (2)	HP-CB02	CBMH02	CONDUIT	3.0	13.1113	0.0150
MS-CB03 (1)	CB03	HP-CB03	CONDUIT	3.0	-10.0504	0.0150
MS-CB03 (2)	HP-CB03	ms-ry06	CONDUIT	3.0	31.0652	0.0150
MS-CBMH01 (1)	CBMH01	HP-CBMH01	CONDUIT	9.4	-0.8511	0.0350
MS-CBMH01 (2)	HP-CBMH01	RY08	CONDUIT	6.0	1.6669	0.0350
MS-CBMH02 (1)	CBMH02	HP-CBMH02	CONDUIT	3.0	-10.7279	0.0150
MS-CBMH02 (2)	HP-CBMH02	CB03	CONDUIT	3.0	10.7279	0.0150
MS-LC01 (1)	HP-LC01 (1)	LC01	CONDUIT	5.8	2.2419	0.0350
MS-LC01 (2)	LC01	HP-LC01 (2)	CONDUIT	6.9	-1.5944	0.0350
MS-LC01 (3)	HP-LC01 (2)	LC02	CONDUIT	6.5	1.8465	0.0350
MS-LC02 (1)	LC02	HP-LC02	CONDUIT	7.4	-1.3515	0.0350
MS-LC02 (2)	HP-LC02	CBMH01	CONDUIT	7.3	1.3700	0.0350
MS-LC03	LC03	HP-LC03	CONDUIT	5.9	-1.8647	0.0350
MS-LC04 (1)	LC04	HP-LC04	CONDUIT	4.4	-1.5911	0.0350
MS-LC04 (2)	HP-LC04	RY06	CONDUIT	9.3	0.4301	0.0350
MS-LC05 (1)	HP-LC05 (1)	LC05	CONDUIT	13.6	0.9559	0.0350
MS-LC05 (2)	LC05	HP-LC05 (2)	CONDUIT	10.1	-0.9901	0.0350
MS-LC05 (3)	HP-LC05 (2)	LC04	CONDUIT	19.4	1.0310	0.0350
MS-RY01 (1)	RY01	HP-RY01	CONDUIT	9.8	-0.5102	0.0350
MS-RY01 (2)	HP-RY01	RY04	CONDUIT	20.0	1.5002	0.0350
MS-RY02 (1)	RY02	HP-RY02	CONDUIT	8.1	-1.4816	0.0350
MS-RY02 (2)	HP-RY02	LC03	CONDUIT	3.8	3.1595	0.0350
MS-RY03 (1)	RY03	HP-RY03	CONDUIT	13.1	-0.5344	0.0350
MS-RY03 (2)	HP-RY03	RY01	CONDUIT	22.9	1.7907	0.0350
MS-RY04 (1)	RY04	HP-RY04	CONDUIT	3.0	-8.3624	0.0350
MS-RY05 (1)	RY05	RY03	CONDUIT	31.0	0.5161	0.0350
MS-RY06 (1)	RY06	ms-ry06	CONDUIT	39.2	0.6378	0.0350
MS-RY06 (2)	ms-ry06	RY04	CONDUIT	38.5	0.5714	0.0350
MS-RY07 (1)	RY07	HP-RY07	CONDUIT	5.5	-0.9091	0.0350
MS-RY08 (1)	RY08	HP-RY08	CONDUIT	7.9	-1.0127	0.0350
MS-RY08 (2)	HP-RY08	RY07	CONDUIT	4.1	1.7076	0.0350
MS-RY09 (1)	ry09	HP-RY09	CONDUIT	10.0	-1.3001	0.0350
MS-RY09 (2)	HP-RY09	RY02	CONDUIT	8.2	1.5856	0.0350
MS-RY10 (1)	RY10	HP-RY10	CONDUIT	6.5	-1.3847	0.0350
MS-RY10 (2)	HP-RY10	ry09	CONDUIT	10.3	1.3593	0.0350
MS-RY11 (1)	HP-RY11 (1)	RY11	CONDUIT	5.0	2.2005	0.0350
MS-RY11 (2)	RY11	HP-RY11 (2)	CONDUIT	8.8	-1.1364	0.0350
MS-RY11 (3)	HP-RY11 (2)	RY10	CONDUIT	7.4	1.3515	0.0350
RY02-MH10	RY02	MH10	CONDUIT	21.6	0.5556	0.0130
RY02-RY04	RY06	RY04	CONDUIT	77.7	0.5019	0.0130
RY04-RY01	RY04	RY01	CONDUIT	29.8	0.5034	0.0130
RY05-RY03	RY05	RY03	CONDUIT	30.1	0.4983	0.0130
RY07-RY08	RY07	RY08	CONDUIT	10.4	0.4808	0.0130
RY08-CBMH01	RY08	CBMH01	CONDUIT	16.2	0.4938	0.0130
RY09-Lead	ry09	MH10	CONDUIT	7.8	1.0257	0.0130
RY10-MH10	RY10	MH10	CONDUIT	6.0	0.5000	0.0130
RY11-RY10	RY11	RY10	CONDUIT	16.2	0.4938	0.0130
SC310_Chambers	MH02	Dummy_Chambers	CONDUIT	9.9	0.5051	0.0130
O-MH02	MH02	Dummy-MH02	ORIFICE			
O-RY01	RY01	Dummy-MH02	ORIFICE			
O-RY03	RY03	Dummy-MH02	ORIFICE			

Cross Section Summary

Conduit	Shape	Full Depth	Full Area	Hyd. Rad.	Max. Width	No. of Barrels	Full Flow
CB01-Lead	CIRCULAR	0.20	0.03	0.05	0.20	1	32.27
CB02-Lead	CIRCULAR	0.20	0.03	0.05	0.20	1	34.58
CB03-Lead	CIRCULAR	0.20	0.03	0.05	0.20	1	23.80
CBMH01-MH06	CIRCULAR	0.38	0.11	0.10	0.38	1	184.12
CBMH02-MH02	CIRCULAR	0.46	0.16	0.11	0.46	1	304.36

LC01-LC02	CIRCULAR	0.30	0.07	0.08	0.30	1	71.46
LC01-MH08	CIRCULAR	0.30	0.07	0.08	0.30	1	71.46
LC03-RY02	CIRCULAR	0.30	0.07	0.08	0.30	1	65.79
LC04-RY06	CIRCULAR	0.25	0.05	0.06	0.25	1	31.22
LC05-LC04	CIRCULAR	0.25	0.05	0.06	0.25	1	42.41
MH04-CBMH02	CIRCULAR	0.46	0.16	0.11	0.46	1	297.69
MH04-Ex1050	CIRCULAR	0.46	0.16	0.11	0.46	1	420.21
MH06-MH04	CIRCULAR	0.46	0.16	0.11	0.46	1	294.74
MH08-CBMH01	CIRCULAR	0.38	0.11	0.10	0.38	1	129.35
MH10-MH08	CIRCULAR	0.38	0.11	0.10	0.38	1	127.76
MS-B1_1	RECT_OPEN	1.00	3.00	0.60	3.00	1	8662.35
MS-B1_2	RECT_OPEN	1.00	3.00	0.60	3.00	1	13085.46
MS-B2_1	RECT_OPEN	1.00	3.00	0.60	3.00	1	8624.59
MS-B2_2	CIRCULAR	1.00	0.79	0.25	1.00	1	1542.88
MS-B3_1	RECT_OPEN	1.00	3.00	0.60	3.00	1	9448.18
MS-B3_2	RECT_OPEN	1.00	3.00	0.60	3.00	1	7385.32
MS-B4_1	RECT_OPEN	1.00	3.00	0.60	3.00	1	9194.12
MS-B4_2	RECT_OPEN	1.00	3.00	0.60	3.00	1	9148.01
MS-B5_1	RECT_OPEN	1.00	3.00	0.60	3.00	1	21581.34
MS-B5_2	RECT_OPEN	1.00	3.00	0.60	3.00	1	13367.53
MS-B6_1	RECT_OPEN	1.00	3.00	0.60	3.00	1	42772.17
MS-B6_2	RECT_OPEN	1.00	3.00	0.60	3.00	1	11411.62
MS-B7	RECT_OPEN	1.00	3.00	0.60	3.00	1	54787.78
MS-B8_1	RECT_OPEN	1.00	3.00	0.60	3.00	1	12874.50
MS-B8_2	RECT_OPEN	1.00	3.00	0.60	3.00	1	13643.85
MS-B9_1	RECT_OPEN	1.00	3.00	0.60	3.00	1	15222.78
MS-B9_2	RECT_OPEN	1.00	3.00	0.60	3.00	1	16391.89
MS-BG	RECT_OPEN	1.00	3.00	0.60	3.00	1	12452.69
MS-CB01 (1)	RECT_OPEN	1.00	3.00	0.60	3.00	1	37691.14
MS-CB01 (2)	RECT_OPEN	1.00	3.00	0.60	3.00	1	37691.14
MS-CB02 (1)	RECT_OPEN	1.00	6.00	0.75	6.00	1	8535.53
MS-CB02 (2)	RECT_OPEN	1.00	6.00	0.75	6.00	1	119568.26
MS-CB03 (1)	RECT_OPEN	1.00	3.00	0.60	3.00	1	45107.44
MS-CB03 (2)	RECT_OPEN	1.00	3.00	0.60	3.00	1	79303.79
MS-CBMH01 (1)	TRAPEZOIDAL	1.00	40.30	0.50	80.30	1	67074.12
MS-CBMH01 (2)	TRAPEZOIDAL	1.00	40.30	0.50	80.30	1	93868.65
MS-CBMH02 (1)	RECT_OPEN	1.00	6.00	0.75	6.00	1	108155.95
MS-CBMH02 (2)	RECT_OPEN	1.00	3.00	0.60	3.00	1	46602.99
MS-LC01 (1)	TRAPEZOIDAL	1.00	40.30	0.50	80.30	1	108862.49
MS-LC01 (2)	TRAPEZOIDAL	1.00	40.30	0.50	80.30	1	91804.81
MS-LC01 (3)	TRAPEZOIDAL	1.00	40.30	0.50	80.30	1	98795.46
MS-LC02 (1)	TRAPEZOIDAL	1.00	40.30	0.50	80.30	1	84522.05
MS-LC02 (2)	TRAPEZOIDAL	1.00	40.30	0.50	80.30	1	85099.10
MS-LC03	TRAPEZOIDAL	1.00	40.30	0.50	80.30	1	99282.82
MS-LC04 (1)	TRAPEZOIDAL	1.00	3.15	0.49	6.15	1	7022.94
MS-LC04 (2)	TRAPEZOIDAL	1.00	3.15	0.49	6.15	1	3651.40
MS-LC05 (1)	TRAPEZOIDAL	1.00	3.15	0.49	6.15	1	5443.54
MS-LC05 (2)	TRAPEZOIDAL	1.00	3.15	0.49	6.15	1	5540.12
MS-LC05 (3)	TRAPEZOIDAL	1.00	3.15	0.49	6.15	1	5653.21
MS-RY01 (1)	TRAPEZOIDAL	1.00	3.30	0.50	6.30	1	4232.38
MS-RY01 (2)	TRAPEZOIDAL	1.00	3.30	0.50	6.30	1	7257.39
MS-RY02 (1)	TRAPEZOIDAL	1.00	40.30	0.50	80.30	1	88498.92
MS-RY02 (2)	TRAPEZOIDAL	1.00	40.30	0.50	80.30	1	129232.93
MS-RY03 (1)	TRAPEZOIDAL	1.00	3.30	0.50	6.30	1	4331.38
MS-RY03 (2)	TRAPEZOIDAL	1.00	3.30	0.50	6.30	1	7929.01
MS-RY04 (1)	TRAPEZOIDAL	1.00	3.30	0.50	6.30	1	17134.69
MS-RY05 (1)	TRAPEZOIDAL	1.00	3.30	0.50	6.30	1	4256.89
MS-RY06 (1)	TRAPEZOIDAL	1.00	3.15	0.49	6.15	1	4446.32
MS-RY06 (2)	TRAPEZOIDAL	1.00	3.15	0.49	6.15	1	4208.75
MS-RY07 (1)	TRAPEZOIDAL	1.00	40.30	0.50	80.30	1	69323.21
MS-RY08 (1)	TRAPEZOIDAL	1.00	40.30	0.50	80.30	1	73165.88
MS-RY08 (2)	TRAPEZOIDAL	1.00	40.30	0.50	80.30	1	95006.82
MS-RY09 (1)	TRAPEZOIDAL	1.00	40.30	0.50	80.30	1	82900.29
MS-RY09 (2)	TRAPEZOIDAL	1.00	40.30	0.50	80.30	1	91549.94
MS-RY10 (1)	TRAPEZOIDAL	1.00	40.30	0.50	80.30	1	85556.19
MS-RY10 (2)	TRAPEZOIDAL	1.00	40.30	0.50	80.30	1	84767.92
MS-RY11 (1)	TRAPEZOIDAL	1.00	40.30	0.50	80.30	1	107852.43
MS-RY11 (2)	TRAPEZOIDAL	1.00	40.30	0.50	80.30	1	77506.61
MS-RY11 (3)	TRAPEZOIDAL	1.00	40.30	0.50	80.30	1	84522.05
RY02-MH10	CIRCULAR	0.30	0.07	0.08	0.30	1	75.33
RY02-RY04	CIRCULAR	0.25	0.05	0.06	0.25	1	42.13
RY04-RY01	CIRCULAR	0.25	0.05	0.06	0.25	1	42.19
RY05-RY03	CIRCULAR	0.25	0.05	0.06	0.25	1	41.98
RY07-RY08	CIRCULAR	0.30	0.07	0.08	0.30	1	70.08
RY08-CBMH01	CIRCULAR	0.30	0.07	0.08	0.30	1	71.02
RY09-Lead	CIRCULAR	0.25	0.05	0.06	0.25	1	60.23
RY10-MH10	CIRCULAR	0.30	0.07	0.08	0.30	1	71.46
RY11-RY10	CIRCULAR	0.30	0.07	0.08	0.30	1	71.02
SC310_Chambers	RECT_CLOSED	0.71	0.82	0.22	1.16	5	1635.94

200 Baribeau Street (119068)
PCSWMM Model Output
100yr 3-hour Chicago Storm (Fixed Outfall = 55.05m)



Analysis Options

 Flow Units LPS
 Process Models:
 Rainfall/Runoff YES
 RDII NO
 Snowmelt NO
 Groundwater NO
 Flow Routing YES
 Ponding Allowed NO
 Water Quality NO
 Infiltration Method HORTON
 Flow Routing Method DYNWAVE
 Surcharge Method EXTRAN
 Starting Date 04/29/2024 00:00:00
 Ending Date 04/30/2024 00:00:00
 Antecedent Dry Days 0.0
 Report Time Step 00:01:00
 Wet Time Step 00:05:00
 Dry Time Step 00:05:00
 Routing Time Step 1.00 sec
 Variable Time Step YES
 Maximum Trials 8
 Number of Threads 4
 Head Tolerance 0.001500 m

	Volume hectare-m	Depth mm
Runoff Quantity Continuity	-----	-----
Total Precipitation	0.083	71.667
Evaporation Loss	0.000	0.000
Infiltration Loss	0.014	12.184
Surface Runoff	0.069	59.743
Final Storage	0.001	0.520
Continuity Error (%)	-1.089	

	Volume hectare-m	Volume 10^6 ltr
Flow Routing Continuity	-----	-----
Dry Weather Inflow	0.000	0.000
Wet Weather Inflow	0.069	0.694
Groundwater Inflow	0.000	0.000
RDII Inflow	0.000	0.000
External Inflow	0.000	0.001
External Outflow	0.069	0.694
Flooding Loss	0.000	0.000
Evaporation Loss	0.000	0.000
Exfiltration Loss	0.000	0.000
Initial Stored Volume	0.004	0.037
Final Stored Volume	0.004	0.037
Continuity Error (%)	0.049	

 Time-Step Critical Elements

 None

 Highest Flow Instability Indexes

 Link O-MH02 (24)

 Most Frequent Nonconverging Nodes

 Convergence obtained at all time steps.

 Routing Time Step Summary

 Minimum Time Step : 0.49 sec
 Average Time Step : 1.00 sec
 Maximum Time Step : 1.00 sec
 % of Time in Steady State : 0.00
 Average Iterations per Step : 2.00
 % of Steps Not Converging : 0.00

Time Step Frequencies :
 1.000 - 0.871 sec : 99.98 %
 0.871 - 0.758 sec : 0.00 %
 0.758 - 0.660 sec : 0.00 %
 0.660 - 0.574 sec : 0.00 %
 0.574 - 0.500 sec : 0.00 %

 Subcatchment Runoff Summary

	Total Runoff 10^6 ltr	Peak Runoff LPS	Runoff Coeff	Total Precip mm	Total Runon mm	Total Evap mm	Total Infil mm	Imperv Runoff mm	Perv Runoff mm	Total Runoff mm
A-01	0.02	17.38	0.399	71.67	0.00	0.00	44.03	2.04	26.58	28.63
A-02	0.03	27.63	0.480	71.67	0.00	0.00	38.05	11.02	23.35	34.37
A-03	0.01	8.54	0.665	71.67	0.00	0.00	25.14	30.11	17.57	47.68
A-04	0.01	7.67	0.673	71.67	0.00	0.00	24.52	31.09	17.16	48.26
A-05	0.01	11.69	0.577	71.67	0.00	0.00	30.77	22.03	19.34	41.37
A-06	0.01	9.41	0.648	71.67	0.00	0.00	25.51	30.11	16.31	46.42
A-07	0.01	14.06	0.603	71.67	0.00	0.00	29.21	24.07	19.12	43.18
A-08	0.03	22.62	0.951	71.67	0.00	0.00	2.50	66.34	1.84	68.18
A-09	0.02	16.67	0.485	71.67	0.00	0.00	38.18	10.04	24.73	34.77
A-10	0.01	5.68	0.585	71.67	0.00	0.00	31.46	20.09	21.85	41.94
A-11	0.02	15.31	0.589	71.67	0.00	0.00	29.99	23.08	19.14	42.23
A-12	0.04	30.48	0.853	71.67	0.00	0.00	10.10	54.17	6.96	61.13
A-13	0.06	41.88	0.961	71.67	0.00	0.00	1.89	67.47	1.38	68.85
A-14	0.08	55.33	0.920	71.67	0.00	0.00	5.03	62.49	3.43	65.92
A-15	0.02	14.84	1.007	71.67	0.00	0.00	0.00	72.15	0.00	72.15
A-16	0.02	14.84	1.007	71.67	0.00	0.00	0.00	72.15	0.00	72.15
A-17	0.02	15.87	1.005	71.67	0.00	0.00	0.00	72.05	0.00	72.05
A-18	0.02	14.86	1.006	71.67	0.00	0.00	0.00	72.11	0.00	72.11
A-19	0.02	13.38	1.006	71.67	0.00	0.00	0.00	72.11	0.00	72.11
A-20	0.02	10.89	1.007	71.67	0.00	0.00	0.00	72.15	0.00	72.15
A-21	0.02	13.85	1.007	71.67	0.00	0.00	0.00	72.15	0.00	72.15
A-22	0.02	14.84	1.007	71.67	0.00	0.00	0.00	72.15	0.00	72.15
A-23	0.02	10.89	1.007	71.67	0.00	0.00	0.00	72.15	0.00	72.15
A-24	0.01	7.44	1.004	71.67	0.00	0.00	0.00	71.95	0.00	71.95
A-25	0.02	14.84	1.007	71.67	0.00	0.00	0.00	72.15	0.00	72.15
A-26	0.02	14.84	1.007	71.67	0.00	0.00	0.00	72.15	0.00	72.15
A-27	0.02	10.89	1.007	71.67	0.00	0.00	0.00	72.15	0.00	72.15
A-28	0.02	10.89	1.007	71.67	0.00	0.00	0.00	72.15	0.00	72.15
A-29	0.02	13.38	1.006	71.67	0.00	0.00	0.00	72.11	0.00	72.11
A-30	0.02	14.86	1.006	71.67	0.00	0.00	0.00	72.11	0.00	72.11

200 Baribeau Street (119068)
PCSWMM Model Output
100yr 3-hour Chicago Storm (Fixed Outfall = 55.05m)



A-31	14.84	1.007	71.67	0.00	0.00	0.00	72.15	0.00	72.15
0.02									
A-32	13.85	1.007	71.67	0.00	0.00	0.00	72.15	0.00	72.15
0.02									

ry09	STORAGE	0.08	1.11	56.66	0	01:15	1.11
RY10	STORAGE	0.10	1.31	56.66	0	01:13	1.31
RY11	STORAGE	0.09	1.23	56.66	0	01:13	1.23

Node Depth Summary

Node	Type	Average Depth Meters	Maximum Depth Meters	Maximum HGL Meters	Time of Max Occurrence days hr:min	Reported Max Depth Meters
B1_1	JUNCTION	0.00	0.02	56.80	0 01:07	0.02
B1_2	JUNCTION	0.00	0.01	56.79	0 01:10	0.01
B2_1	JUNCTION	0.00	0.02	56.80	0 01:08	0.02
B2_2	JUNCTION	0.00	0.07	56.85	0 01:10	0.07
B3_1	JUNCTION	0.00	0.02	56.81	0 01:06	0.02
B3_2	JUNCTION	0.00	0.02	56.81	0 01:10	0.02
B4_1	JUNCTION	0.00	0.02	56.84	0 01:08	0.02
B4_2	JUNCTION	0.00	0.02	56.84	0 01:06	0.02
B5_1	JUNCTION	0.00	0.01	56.81	0 01:10	0.01
B5_2	JUNCTION	0.00	0.01	56.81	0 01:09	0.01
B6_1	JUNCTION	0.00	0.01	56.86	0 01:10	0.01
B6_2	JUNCTION	0.00	0.02	56.87	0 01:10	0.02
B7	JUNCTION	0.00	0.01	56.81	0 01:10	0.01
B8_1	JUNCTION	0.00	0.01	56.61	0 01:10	0.01
B8_2	JUNCTION	0.00	0.01	56.61	0 01:10	0.01
B9_1	JUNCTION	0.00	0.01	56.66	0 01:10	0.01
B9_2	JUNCTION	0.00	0.01	56.66	0 01:10	0.01
BICYCLE_GARBAGE	JUNCTION	0.00	0.01	56.81	0 01:06	0.01
HP-CB01	JUNCTION	0.00	0.01	56.47	0 01:13	0.01
HP-CB02	JUNCTION	0.00	0.00	56.45	0 00:00	0.00
HP-CB03	JUNCTION	0.00	0.00	56.36	0 01:40	0.00
HP-CBMH01	JUNCTION	0.00	0.00	56.65	0 00:00	0.00
HP-CBMH02	JUNCTION	0.00	0.00	56.38	0 00:00	0.00
HP-LC01 (1)	JUNCTION	0.00	0.00	56.71	0 00:00	0.00
HP-LC01 (2)	JUNCTION	0.00	0.00	56.69	0 00:00	0.00
HP-LC02	JUNCTION	0.00	0.00	56.67	0 00:00	0.00
HP-LC04	JUNCTION	0.00	0.06	55.82	0 01:13	0.06
HP-LC05 (1)	JUNCTION	0.00	0.00	55.92	0 00:00	0.00
HP-LC05 (2)	JUNCTION	0.00	0.00	55.89	0 00:00	0.00
HP-RY01	JUNCTION	0.00	0.04	55.59	0 01:15	0.04
HP-RY02	JUNCTION	0.00	0.00	56.67	0 00:00	0.00
HP-RY03	JUNCTION	0.00	0.07	55.98	0 01:12	0.07
HP-RY08	JUNCTION	0.00	0.00	56.63	0 00:00	0.00
HP-RY09	JUNCTION	0.00	0.00	56.68	0 00:00	0.00
HP-RY10	JUNCTION	0.00	0.00	56.69	0 00:00	0.00
HP-RY11 (1)	JUNCTION	0.00	0.00	56.71	0 00:00	0.00
HP-RY11 (2)	JUNCTION	0.00	0.00	56.70	0 00:00	0.00
ms-ry06	JUNCTION	0.00	0.13	55.60	0 01:15	0.13
Ex-1050	OUTFALL	4.00	4.00	55.05	0 00:00	4.00
HP-LC03	OUTFALL	0.00	0.00	56.66	0 01:14	0.00
HP-RY04	OUTFALL	0.00	0.08	55.58	0 01:14	0.08
HP-RY07	OUTFALL	0.00	0.00	56.61	0 00:00	0.00
CB01	STORAGE	0.34	1.62	56.47	0 01:13	1.62
CB02	STORAGE	0.34	1.59	56.44	0 01:22	1.59
CB03	STORAGE	0.10	1.08	56.36	0 01:40	1.08
CBMH01	STORAGE	0.57	1.96	56.58	0 01:12	1.96
CBMH02	STORAGE	1.90	3.08	56.36	0 01:33	3.08
Dummy_Chambers	STORAGE	0.12	1.26	56.36	0 01:33	1.26
Dummy-MH02	STORAGE	2.54	2.58	55.09	0 01:23	2.58
LC01	STORAGE	0.11	1.35	56.62	0 01:12	1.35
LC02	STORAGE	0.12	1.42	56.62	0 01:13	1.42
LC03	STORAGE	0.08	1.17	56.66	0 01:14	1.17
LC04	STORAGE	0.04	0.73	55.82	0 01:13	0.73
LC05	STORAGE	0.02	0.60	55.84	0 01:12	0.60
MH02	STORAGE	2.67	3.85	56.36	0 01:33	3.85
MH04	STORAGE	1.63	2.83	56.38	0 01:31	2.83
MH06	STORAGE	1.29	2.55	56.44	0 01:22	2.55
MH08	STORAGE	0.13	1.53	56.62	0 01:13	1.53
MH10	STORAGE	0.11	1.41	56.65	0 01:14	1.41
RY01	STORAGE	0.64	1.15	55.60	0 01:14	1.15
RY02	STORAGE	0.09	1.22	56.66	0 01:14	1.22
RY03	STORAGE	0.02	0.71	56.01	0 01:12	0.71
RY04	STORAGE	0.49	0.99	55.59	0 01:14	0.99
RY05	STORAGE	0.01	0.56	56.01	0 01:12	0.56
RY06	STORAGE	0.07	0.75	55.77	0 01:14	0.75
RY07	STORAGE	0.11	1.34	56.59	0 01:12	1.34
RY08	STORAGE	0.12	1.39	56.59	0 01:12	1.39

Node Inflow Summary

Node	Type	Maximum Lateral Inflow LPS	Maximum Total Inflow LPS	Time of Max Occurrence days hr:min	Lateral Inflow Volume 10 ⁶ ltr	Total Inflow Volume 10 ⁶ ltr	Flow Balance Error Percent
B1_1	JUNCTION	14.84	14.84	0 01:10	0.0216	0.0216	1.065
B1_2	JUNCTION	13.85	13.85	0 01:10	0.0202	0.0202	0.308
B2_1	JUNCTION	14.84	14.84	0 01:10	0.0216	0.0216	0.766
B2_2	JUNCTION	14.84	14.84	0 01:10	0.0216	0.0216	0.116
B3_1	JUNCTION	10.89	10.89	0 01:10	0.0159	0.0159	1.001
B3_2	JUNCTION	10.89	10.89	0 01:10	0.0159	0.0159	0.993
B4_1	JUNCTION	10.89	10.89	0 01:10	0.0159	0.0159	0.931
B4_2	JUNCTION	10.89	10.89	0 01:10	0.0159	0.0159	1.253
B5_1	JUNCTION	13.38	13.38	0 01:10	0.0195	0.0195	0.247
B5_2	JUNCTION	13.38	13.38	0 01:10	0.0195	0.0195	0.223
B6_1	JUNCTION	14.86	14.86	0 01:10	0.0216	0.0216	0.041
B6_2	JUNCTION	14.86	14.86	0 01:10	0.0216	0.0216	0.202
B7	JUNCTION	15.87	15.87	0 01:10	0.0231	0.0231	-0.038
B8_1	JUNCTION	14.84	14.84	0 01:10	0.0216	0.0216	-0.021
B8_2	JUNCTION	13.85	13.85	0 01:10	0.0202	0.0202	0.796
B9_1	JUNCTION	14.84	14.84	0 01:10	0.0216	0.0216	-0.026
B9_2	JUNCTION	14.84	14.84	0 01:10	0.0216	0.0216	0.515
BICYCLE_GARBAGE	JUNCTION	7.44	7.44	0 01:10	0.0108	0.0108	0.551
HP-CB01	JUNCTION	0.00	19.12	0 01:13	0	0.00315	0.005
HP-CB02	JUNCTION	0.00	0.00	0 00:00	0	0	0.000 ltr
HP-CB03	JUNCTION	0.00	0.46	0 01:40	0	4.72e-05	0.579
HP-CBMH01	JUNCTION	0.00	0.00	0 00:00	0	0	0.000 ltr
HP-CBMH02	JUNCTION	0.00	0.00	0 00:00	0	0	0.000 ltr
HP-LC01 (1)	JUNCTION	0.00	0.00	0 00:00	0	0	0.000 ltr
HP-LC01 (2)	JUNCTION	0.00	0.00	0 00:00	0	0	0.000 ltr
HP-LC02	JUNCTION	0.00	0.00	0 00:00	0	0	0.000 ltr
HP-LC04	JUNCTION	0.00	3.68	0 01:13	0	0.00106	3.977
HP-LC05 (1)	JUNCTION	0.00	0.00	0 00:00	0	0	0.000 ltr
HP-LC05 (2)	JUNCTION	0.00	0.00	0 00:00	0	0	0.000 ltr
HP-RY01	JUNCTION	0.00	7.66	0 01:11	0	0.00157	0.430
HP-RY02	JUNCTION	0.00	0.00	0 00:00	0	0	0.000 ltr
HP-RY03	JUNCTION	0.00	18.05	0 01:12	0	0.0104	2.805
HP-RY08	JUNCTION	0.00	0.00	0 00:00	0	0	0.000 ltr
HP-RY09	JUNCTION	0.00	0.00	0 00:00	0	0	0.000 ltr
HP-RY10	JUNCTION	0.00	0.00	0 00:00	0	0	0.000 ltr
HP-RY11 (1)	JUNCTION	0.00	0.00	0 00:00	0	0	0.000 ltr
HP-RY11 (2)	JUNCTION	0.00	0.00	0 00:00	0	0	0.000 ltr
ms-ry06	JUNCTION	16.67	16.67	0 01:10	0.0153	0.0163	-0.633
Ex-1050	OUTFALL	0.00	71.94	0 01:24	0	0.649	0.000
HP-LC03	OUTFALL	0.00	0.00	0 01:14	0	0.000126	0.000
HP-RY04	OUTFALL	0.00	47.62	0 01:14	0	0.046	0.000
HP-RY07	OUTFALL	0.00	0.00	0 00:00	0	0	0.000 ltr
CB01	STORAGE	30.48	60.03	0 01:10	0.0391	0.0832	0.005
CB02	STORAGE	22.62	28.78	0 01:07	0.0314	0.0365	-0.037
CB03	STORAGE	41.88	75.57	0 01:10	0.0585	0.118	0.007
CBMH01	STORAGE	0.00	131.19	0 01:07	0	0.298	-0.056
CBMH02	STORAGE	55.33	185.29	0 01:08	0.0751	0.62	-0.009
Dummy_Chambers	STORAGE	0.00	75.89	0 01:05	0	0.167	-0.021
Dummy-MH02	STORAGE	0.00	71.94	0 01:24	0	0.649	0.031
LC01	STORAGE	9.41	24.27	0 01:10	0.0107	0.0323	-0.100
LC02	STORAGE	0.00	33.98	0 01:08	0	0.0481	-0.213
LC03	STORAGE	7.67	21.51	0 01:10	0.0082	0.0285	-0.355
LC04	STORAGE	27.63	42.75	0 01:10	0.0292	0.047	0.004
LC05	STORAGE	17.38	17.38	0 01:10	0.0177	0.0178	-0.152
MH02	STORAGE	0.00	55.22	0 01:32	0	0.571	-0.029
MH04	STORAGE	0.00	134.62	0 01:07	0	0.413	-0.000
MH06	STORAGE	0.00	149.57	0 01:06	0	0.416	-0.000
MH08	STORAGE	0.00	87.32	0 01:06	0	0.208	0.004
MH10	STORAGE	0.00	81.72	0 01:06	0	0.16	-0.104
RY01	STORAGE	5.68	21.59	0 01:12	0.00545	0.0411	-0.719
RY02	STORAGE	0.00	30.83	0 01:06	0	0.05	-0.214
RY03	STORAGE	15.31	45.53	0 01:09	0.0165	0.0602	-0.453
RY04	STORAGE	0.00	51.86	0 01:11	0	0.0713	0.251
RY05	STORAGE	0.00	8.11	0 01:03	0	0.00208	-0.441
RY06	STORAGE	0.00	33.01	0 01:12	0	0.0471	-0.021
RY07	STORAGE	0.00	13.40	0 01:09	0	0.0194	-0.264
RY08	STORAGE	11.69	23.48	0 01:08	0.0128	0.0323	0.063

**200 Baribeau Street (119068)
PCSWMM Model Output
100yr 3-hour Chicago Storm (Normal Outfall)**



EPA STORM WATER MANAGEMENT MODEL - VERSION 5.2 (Build 5.2.4)

WARNING 03: negative offset ignored for Link LC03-RY02
WARNING 03: negative offset ignored for Link RY02-MH10

Element Count

Number of rain gages 1
Number of subcatchments ... 32
Number of nodes 70
Number of links 87
Number of pollutants 0
Number of land uses 0

Raingage Summary

Name	Data Source	Data Type	Recording Interval
RG-1	C3hr-100yr	INTENSITY	10 min.

Subcatchment Summary

Name	Area	Width	%Imperv	%Slope	Rain Gage	Outlet
A-01	0.06	24.80	2.90	4.0000	RG-1	LC05
A-02	0.08	34.00	15.70	4.0000	RG-1	LC04
A-03	0.02	38.00	42.90	1.5000	RG-1	RY10
A-04	0.02	34.00	44.30	1.5000	RG-1	LC03
A-05	0.03	20.67	31.40	1.5000	RG-1	RY08
A-06	0.02	15.33	42.90	1.5000	RG-1	LC01
A-07	0.03	34.00	34.30	1.5000	RG-1	ry09
A-08	0.05	30.67	94.30	1.0000	RG-1	CB02
A-09	0.04	88.00	14.30	0.5000	RG-1	ms-ry06
A-10	0.01	26.00	28.60	2.0000	RG-1	RY01
A-11	0.04	26.00	32.90	2.0000	RG-1	RY03
A-12	0.06	42.67	77.10	1.5000	RG-1	CB01
A-13	0.08	28.33	95.70	1.5000	RG-1	CB03
A-14	0.11	32.57	88.60	1.5000	RG-1	CBMH02
A-15	0.03	10.00	100.00	0.5000	RG-1	B9_1
A-16	0.03	10.00	100.00	0.5000	RG-1	B8_1
A-17	0.03	16.00	100.00	0.5000	RG-1	B7
A-18	0.03	12.00	100.00	0.5000	RG-1	B6_2
A-19	0.03	10.80	100.00	0.5000	RG-1	B5_2
A-20	0.02	7.33	100.00	0.5000	RG-1	B3_1
A-21	0.03	9.33	100.00	0.5000	RG-1	B1_2
A-22	0.03	10.00	100.00	0.5000	RG-1	B2_1
A-23	0.02	7.33	100.00	0.5000	RG-1	B4_2
A-24	0.01	10.00	100.00	0.5000	RG-1	BICYCLE_GARBAGE
A-25	0.03	10.00	100.00	0.5000	RG-1	B1_1
A-26	0.03	10.00	100.00	0.5000	RG-1	B2_2
A-27	0.02	7.33	100.00	0.5000	RG-1	B4_1
A-28	0.02	7.33	100.00	0.5000	RG-1	B3_2
A-29	0.03	10.80	100.00	0.5000	RG-1	B5_1
A-30	0.03	12.00	100.00	0.5000	RG-1	B6_1
A-31	0.03	10.00	100.00	0.5000	RG-1	B9_2
A-32	0.03	9.33	100.00	0.5000	RG-1	B8_2

Node Summary

Name	Type	Invert Elev.	Max. Depth	Ponded Area	External Inflow
B1_1	JUNCTION	56.78	1.00	0.0	
B1_2	JUNCTION	56.78	1.00	0.0	
B2_1	JUNCTION	56.78	1.00	0.0	
B2_2	JUNCTION	56.78	1.00	0.0	
B3_1	JUNCTION	56.79	1.00	0.0	
B3_2	JUNCTION	56.79	1.00	0.0	
B4_1	JUNCTION	56.82	1.00	0.0	
B4_2	JUNCTION	56.82	1.00	0.0	
B5_1	JUNCTION	56.80	1.00	0.0	
B5_2	JUNCTION	56.80	1.00	0.0	

B6_1	JUNCTION	56.85	1.00	0.0
B6_2	JUNCTION	56.85	1.00	0.0
B7	JUNCTION	56.80	1.00	0.0
B8_1	JUNCTION	56.60	1.00	0.0
B8_2	JUNCTION	56.60	1.00	0.0
B9_1	JUNCTION	56.65	1.00	0.0
B9_2	JUNCTION	56.65	1.00	0.0
BICYCLE_GARBAGE	JUNCTION	56.80	1.00	0.0
HP-CB01	JUNCTION	56.46	1.00	0.0
HP-CB02	JUNCTION	56.45	1.00	0.0
HP-CB03	JUNCTION	56.36	1.00	0.0
HP-CBMH01	JUNCTION	56.65	1.00	0.0
HP-CBMH02	JUNCTION	56.38	1.00	0.0
HP-LC01 (1)	JUNCTION	56.71	1.00	0.0
HP-LC01 (2)	JUNCTION	56.69	1.00	0.0
HP-LC02	JUNCTION	56.67	1.00	0.0
HP-LC04	JUNCTION	55.76	1.00	0.0
HP-LC05 (1)	JUNCTION	55.92	1.00	0.0
HP-LC05 (2)	JUNCTION	55.89	1.00	0.0
HP-RY01	JUNCTION	55.55	1.00	0.0
HP-RY02	JUNCTION	56.67	1.00	0.0
HP-RY03	JUNCTION	55.91	1.00	0.0
HP-RY08	JUNCTION	56.63	1.00	0.0
HP-RY09	JUNCTION	56.68	1.00	0.0
HP-RY10	JUNCTION	56.69	1.00	0.0
HP-RY11 (1)	JUNCTION	56.71	1.00	0.0
HP-RY11 (2)	JUNCTION	56.70	1.00	0.0
ms-ry06	JUNCTION	55.47	1.00	0.0
Ex.1050	OUTFALL	51.05	1.00	0.0
HP-LC03	OUTFALL	56.66	1.00	0.0
HP-RY04	OUTFALL	55.50	1.00	0.0
HP-RY07	OUTFALL	56.61	1.00	0.0
CB01	STORAGE	54.85	2.40	0.0
CB02	STORAGE	54.85	2.40	0.0
CB03	STORAGE	55.28	1.78	0.0
CBMH01	STORAGE	54.62	2.95	0.0
CBMH02	STORAGE	53.28	3.78	0.0
Dummy_Chambers	STORAGE	55.10	1.40	0.0
Dummy-MH02	STORAGE	52.51	3.78	0.0
LC01	STORAGE	55.27	2.31	0.0
LC02	STORAGE	55.20	2.37	0.0
LC03	STORAGE	55.49	2.06	0.0
LC04	STORAGE	55.09	1.60	0.0
LC05	STORAGE	55.24	1.55	0.0
MH02	STORAGE	52.51	4.78	0.0
MH04	STORAGE	53.55	2.89	0.0
MH06	STORAGE	53.89	2.60	0.0
MH08	STORAGE	55.09	1.57	0.0
MH10	STORAGE	55.24	1.46	0.0
RY01	STORAGE	54.45	2.05	0.0
RY02	STORAGE	55.44	2.11	0.0
RY03	STORAGE	55.30	1.54	0.0
RY04	STORAGE	54.60	1.65	0.0
RY05	STORAGE	55.45	1.55	0.0
RY06	STORAGE	55.02	1.70	0.0
RY07	STORAGE	55.25	2.31	0.0
RY08	STORAGE	55.20	2.35	0.0
ry09	STORAGE	55.55	2.00	0.0
RY10	STORAGE	55.35	2.25	0.0
RY11	STORAGE	55.43	2.17	0.0

Link Summary

Name	From Node	To Node	Type	Length	%Slope	Roughness
CB01-Lead	CB01	MH06	CONDUIT	18.6	0.9678	0.0130
CB02-Lead	CB02	MH06	CONDUIT	1.8	1.1112	0.0130
CB03-Lead	CB03	Dummy_Chambers	CONDUIT	5.7	0.5263	0.0130
CBMH01-MH02	CBMH01	MH06	CONDUIT	30.6	1.0131	0.0130
CBMH02-MH02	CBMH02	MH02	CONDUIT	16.2	1.0494	0.0130
LC01-LC02	LC01	LC02	CONDUIT	14.0	0.5000	0.0130
LC01-MH08	LC02	MH08	CONDUIT	6.0	0.5000	0.0130
LC03-RY02	LC03	RY02	CONDUIT	11.8	0.4237	0.0130
LC04-RY06	LC04	RY06	CONDUIT	25.4	0.2756	0.0130
LC05-LC04	LC05	LC04	CONDUIT	29.5	0.5085	0.0130
MH04-CBMH02	MH04	CBMH02	CONDUIT	25.9	1.0039	0.0130
MH04-Ex1050	Dummy-MH02	Ex.1050	CONDUIT	46.0	2.0004	0.0130
MH06-MH04	MH06	MH04	CONDUIT	31.5	0.9842	0.0130
MH08-CBMH01	MH08	CBMH01	CONDUIT	8.0	0.5000	0.0130
MH10-MH08	MH10	MH08	CONDUIT	28.7	0.4878	0.0130

200 Baribeau Street (119068)
PCSWMM Model Output
100yr 3-hour Chicago Storm (Normal Outfall)



```

*****
Analysis Options
*****
Flow Units ..... LPS
Process Models:
  Rainfall/Runoff ..... YES
  RDII ..... NO
  Snowmelt ..... NO
  Groundwater ..... NO
  Flow Routing ..... YES
  Ponding Allowed ..... NO
  Water Quality ..... NO
  Infiltration Method ..... HORTON
  Flow Routing Method ..... DYNWAVE
  Surcharge Method ..... EXTRAN
Starting Date ..... 04/29/2024 00:00:00
Ending Date ..... 04/30/2024 00:00:00
Antecedent Dry Days ..... 0.0
Report Time Step ..... 00:01:00
Wet Time Step ..... 00:05:00
Dry Time Step ..... 00:05:00
Routing Time Step ..... 1.00 sec
Variable Time Step ..... YES
Maximum Trials ..... 8
Number of Threads ..... 4
Head Tolerance ..... 0.001500 m

```

```

*****
Volume      Depth
Runoff Quantity Continuity  hectare-m      mm
*****
Total Precipitation ..... 0.083      71.667
Evaporation Loss ..... 0.000      0.000
Infiltration Loss ..... 0.014      12.184
Surface Runoff ..... 0.069      59.743
Final Storage ..... 0.001      0.520
Continuity Error (%) ..... -1.089

```

```

*****
Volume      Volume
Flow Routing Continuity  hectare-m      10^6 ltr
*****
Dry Weather Inflow ..... 0.000      0.000
Wet Weather Inflow ..... 0.069      0.694
Groundwater Inflow ..... 0.000      0.000
RDII Inflow ..... 0.000      0.000
External Inflow ..... 0.000      0.000
External Outflow ..... 0.069      0.694
Flooding Loss ..... 0.000      0.000
Evaporation Loss ..... 0.000      0.000
Exfiltration Loss ..... 0.000      0.000
Initial Stored Volume ..... 0.000      0.000
Final Stored Volume ..... 0.000      0.000
Continuity Error (%) ..... -0.012

```

```

*****
Time-Step Critical Elements
*****
None

```

```

*****
Highest Flow Instability Indexes
*****
All links are stable.

```

```

*****
Most Frequent Nonconverging Nodes
*****
Convergence obtained at all time steps.

```

```

*****
Routing Time Step Summary
*****
Minimum Time Step : 0.12 sec
Average Time Step : 1.00 sec
Maximum Time Step : 1.00 sec

```

```

% of Time in Steady State : 0.00
Average Iterations per Step : 2.00
% of Steps Not Converging : 0.00
Time Step Frequencies :
1.000 - 0.871 sec : 99.70 %
0.871 - 0.758 sec : 0.15 %
0.758 - 0.660 sec : 0.10 %
0.660 - 0.574 sec : 0.02 %
0.574 - 0.500 sec : 0.03 %

```

Subcatchment Runoff Summary

Total Runoff Subcatchment 10^6 ltr	Peak Runoff LPS	Runoff Coeff	Total Precip mm	Total Runon mm	Total Evap mm	Total Infil mm	Imperv Runoff mm	Perv Runoff mm	Total Runoff mm
A-01	17.38	0.399	71.67	0.00	0.00	44.03	2.04	26.58	28.63
A-02	27.63	0.480	71.67	0.00	0.00	38.05	11.02	23.35	34.37
A-03	8.54	0.665	71.67	0.00	0.00	25.14	30.11	17.57	47.68
A-04	7.67	0.673	71.67	0.00	0.00	24.52	31.09	17.16	48.26
A-05	11.69	0.577	71.67	0.00	0.00	30.77	22.03	19.34	41.37
A-06	9.41	0.648	71.67	0.00	0.00	25.51	30.11	16.31	46.42
A-07	14.06	0.603	71.67	0.00	0.00	29.21	24.07	19.12	43.18
A-08	22.62	0.951	71.67	0.00	0.00	2.50	66.34	1.84	68.18
A-09	16.67	0.485	71.67	0.00	0.00	38.18	10.04	24.73	34.77
A-10	5.68	0.585	71.67	0.00	0.00	31.46	20.09	21.85	41.94
A-11	15.31	0.589	71.67	0.00	0.00	29.99	23.08	19.14	42.23
A-12	30.48	0.853	71.67	0.00	0.00	10.10	54.17	6.96	61.13
A-13	41.88	0.961	71.67	0.00	0.00	1.89	67.47	1.38	68.85
A-14	55.33	0.920	71.67	0.00	0.00	5.03	62.49	3.43	65.92
A-15	14.84	1.007	71.67	0.00	0.00	0.00	72.15	0.00	72.15
A-16	14.84	1.007	71.67	0.00	0.00	0.00	72.15	0.00	72.15
A-17	15.87	1.005	71.67	0.00	0.00	0.00	72.05	0.00	72.05
A-18	14.86	1.006	71.67	0.00	0.00	0.00	72.11	0.00	72.11
A-19	13.38	1.006	71.67	0.00	0.00	0.00	72.11	0.00	72.11
A-20	10.89	1.007	71.67	0.00	0.00	0.00	72.15	0.00	72.15
A-21	13.85	1.007	71.67	0.00	0.00	0.00	72.15	0.00	72.15
A-22	14.84	1.007	71.67	0.00	0.00	0.00	72.15	0.00	72.15
A-23	10.89	1.007	71.67	0.00	0.00	0.00	72.15	0.00	72.15
A-24	7.44	1.004	71.67	0.00	0.00	0.00	71.95	0.00	71.95
A-25	14.84	1.007	71.67	0.00	0.00	0.00	72.15	0.00	72.15
A-26	14.84	1.007	71.67	0.00	0.00	0.00	72.15	0.00	72.15
A-27	10.89	1.007	71.67	0.00	0.00	0.00	72.15	0.00	72.15
A-28	10.89	1.007	71.67	0.00	0.00	0.00	72.15	0.00	72.15

200 Baribeau Street (119068)
PCSWMM Model Output
100yr 3-hour Chicago Storm (Normal Outfall)



A-29			71.67	0.00	0.00	0.00	72.11	0.00	72.11
0.02	13.38	1.006							
A-30			71.67	0.00	0.00	0.00	72.11	0.00	72.11
0.02	14.86	1.006							
A-31			71.67	0.00	0.00	0.00	72.15	0.00	72.15
0.02	14.84	1.007							
A-32			71.67	0.00	0.00	0.00	72.15	0.00	72.15
0.02	13.85	1.007							

Node Depth Summary

Node	Type	Average Depth Meters	Maximum Depth Meters	Maximum HGL Meters	Time of Max Occurrence days hr:min	Reported Max Depth Meters
B1_1	JUNCTION	0.00	0.02	56.80	0 01:10	0.02
B1_2	JUNCTION	0.00	0.01	56.79	0 01:10	0.01
B2_1	JUNCTION	0.00	0.02	56.80	0 01:10	0.02
B2_2	JUNCTION	0.00	0.07	56.85	0 01:10	0.07
B3_1	JUNCTION	0.00	0.02	56.81	0 01:09	0.02
B3_2	JUNCTION	0.00	0.02	56.81	0 01:10	0.02
B4_1	JUNCTION	0.00	0.02	56.84	0 01:10	0.02
B4_2	JUNCTION	0.00	0.02	56.84	0 01:09	0.02
B5_1	JUNCTION	0.00	0.01	56.81	0 01:10	0.01
B5_2	JUNCTION	0.00	0.01	56.81	0 01:10	0.01
B6_1	JUNCTION	0.00	0.01	56.86	0 01:10	0.01
B6_2	JUNCTION	0.00	0.02	56.87	0 01:10	0.02
B7	JUNCTION	0.00	0.01	56.81	0 01:10	0.01
B8_1	JUNCTION	0.00	0.01	56.61	0 01:10	0.01
B8_2	JUNCTION	0.00	0.01	56.61	0 01:10	0.01
B9_1	JUNCTION	0.00	0.01	56.66	0 01:10	0.01
B9_2	JUNCTION	0.00	0.01	56.66	0 01:10	0.01
BICYCLE_GARBAGE	JUNCTION	0.00	0.01	56.81	0 01:09	0.01
HP-CB01	JUNCTION	0.00	0.00	56.46	0 00:00	0.00
HP-CB02	JUNCTION	0.00	0.00	56.45	0 00:00	0.00
HP-CB03	JUNCTION	0.00	0.00	56.36	0 00:00	0.00
HP-CBMH01	JUNCTION	0.00	0.00	56.65	0 00:00	0.00
HP-CBMH02	JUNCTION	0.00	0.00	56.38	0 00:00	0.00
HP-LC01 (1)	JUNCTION	0.00	0.00	56.71	0 00:00	0.00
HP-LC01 (2)	JUNCTION	0.00	0.00	56.69	0 00:00	0.00
HP-LC02	JUNCTION	0.00	0.00	56.67	0 00:00	0.00
HP-LC04	JUNCTION	0.00	0.03	55.79	0 01:14	0.03
HP-LC05 (1)	JUNCTION	0.00	0.00	55.92	0 00:00	0.00
HP-LC05 (2)	JUNCTION	0.00	0.00	55.89	0 00:00	0.00
HP-RY01	JUNCTION	0.00	0.03	55.58	0 01:15	0.03
HP-RY02	JUNCTION	0.00	0.00	56.67	0 00:00	0.00
HP-RY03	JUNCTION	0.00	0.07	55.98	0 01:12	0.07
HP-RY08	JUNCTION	0.00	0.00	56.63	0 00:00	0.00
HP-RY09	JUNCTION	0.00	0.00	56.68	0 00:00	0.00
HP-RY10	JUNCTION	0.00	0.00	56.69	0 00:00	0.00
HP-RY11 (1)	JUNCTION	0.00	0.00	56.71	0 00:00	0.00
HP-RY11 (2)	JUNCTION	0.00	0.00	56.70	0 00:00	0.00
ms-ry06	JUNCTION	0.00	0.11	55.58	0 01:15	0.11
Ex. 1050	OUTFALL	0.00	0.00	51.05	0 00:00	0.00
HP-LC03	OUTFALL	0.00	0.00	56.66	0 00:00	0.00
HP-RY04	OUTFALL	0.00	0.07	55.57	0 01:16	0.07
HP-RY07	OUTFALL	0.00	0.00	56.61	0 00:00	0.00
CB01	STORAGE	0.07	1.55	56.40	0 01:17	1.55
CB02	STORAGE	0.06	1.49	56.34	0 01:20	1.49
CB03	STORAGE	0.04	0.96	56.24	0 01:28	0.96
CBMH01	STORAGE	0.08	1.90	56.52	0 01:11	1.90
CBMH02	STORAGE	0.16	2.95	56.23	0 01:27	2.95
Dummy Chambers	STORAGE	0.04	1.13	56.23	0 01:26	1.13
Dummy-MH02	STORAGE	0.02	0.18	52.69	0 01:21	0.18
LC01	STORAGE	0.04	1.30	56.57	0 01:11	1.30
LC02	STORAGE	0.05	1.37	56.57	0 01:11	1.36
LC03	STORAGE	0.03	1.12	56.61	0 01:13	1.12
LC04	STORAGE	0.03	0.70	55.79	0 01:14	0.70
LC05	STORAGE	0.02	0.56	55.80	0 01:14	0.56
MH02	STORAGE	0.23	3.70	56.21	0 01:27	3.70
MH04	STORAGE	0.14	2.71	56.26	0 01:22	2.71
MH06	STORAGE	0.12	2.45	56.34	0 01:20	2.45
MH08	STORAGE	0.06	1.47	56.56	0 01:12	1.47
MH10	STORAGE	0.05	1.36	56.60	0 01:13	1.36
RY01	STORAGE	0.08	1.14	55.59	0 01:16	1.13
RY02	STORAGE	0.04	1.17	56.61	0 01:13	1.17
RY03	STORAGE	0.02	0.71	56.01	0 01:12	0.71
RY04	STORAGE	0.07	0.98	55.58	0 01:16	0.98

RY05	STORAGE	0.01	0.56	56.01	0 01:12	0.56
RY06	STORAGE	0.03	0.72	55.74	0 01:14	0.72
RY07	STORAGE	0.04	1.28	56.53	0 01:11	1.28
RY08	STORAGE	0.05	1.33	56.53	0 01:11	1.33
ry09	STORAGE	0.03	1.06	56.61	0 01:14	1.06
RY10	STORAGE	0.04	1.26	56.61	0 01:12	1.26
RY11	STORAGE	0.04	1.18	56.61	0 01:12	1.18

Node Inflow Summary

Node	Type	Maximum Lateral Inflow LPS	Maximum Total Inflow LPS	Time of Max Occurrence days hr:min	Lateral Inflow Volume 10 ⁶ ltr	Total Inflow Volume 10 ⁶ ltr	Flow Balance Error Percent
B1_1	JUNCTION	14.84	14.84	0 01:10	0.0216	0.0216	0.835
B1_2	JUNCTION	13.85	13.85	0 01:10	0.0202	0.0202	0.236
B2_1	JUNCTION	14.84	14.84	0 01:10	0.0216	0.0216	0.103
B2_2	JUNCTION	14.84	14.84	0 01:10	0.0216	0.0216	-0.003
B3_1	JUNCTION	10.89	10.89	0 01:10	0.0159	0.0159	0.848
B3_2	JUNCTION	10.89	10.89	0 01:10	0.0159	0.0159	-0.010
B4_1	JUNCTION	10.89	10.89	0 01:10	0.0159	0.0159	-0.013
B4_2	JUNCTION	10.89	10.89	0 01:10	0.0159	0.0159	1.065
B5_1	JUNCTION	13.38	13.38	0 01:10	0.0195	0.0195	-0.026
B5_2	JUNCTION	13.38	13.38	0 01:10	0.0195	0.0195	-0.016
B6_1	JUNCTION	14.86	14.86	0 01:10	0.0216	0.0216	-0.035
B6_2	JUNCTION	14.86	14.86	0 01:10	0.0216	0.0216	-0.013
B7	JUNCTION	15.87	15.87	0 01:10	0.0231	0.0231	-0.037
B8_1	JUNCTION	14.84	14.84	0 01:10	0.0216	0.0216	-0.021
B8_2	JUNCTION	13.85	13.85	0 01:10	0.0202	0.0202	0.797
B9_1	JUNCTION	14.84	14.84	0 01:10	0.0216	0.0216	-0.025
B9_2	JUNCTION	14.84	14.84	0 01:10	0.0216	0.0216	0.517
BICYCLE_GARBAGE	JUNCTION	7.44	7.44	0 01:10	0.0108	0.0108	0.457
HP-CB01	JUNCTION	0.00	0.00	0 00:00	0	0	0.000 ltr
HP-CB02	JUNCTION	0.00	0.00	0 00:00	0	0	0.000 ltr
HP-CB03	JUNCTION	0.00	0.00	0 00:00	0	0	0.000 ltr
HP-CBMH01	JUNCTION	0.00	0.00	0 00:00	0	0	0.000 ltr
HP-CBMH02	JUNCTION	0.00	0.00	0 00:00	0	0	0.000 ltr
HP-LC01 (1)	JUNCTION	0.00	0.00	0 00:00	0	0	0.000 ltr
HP-LC01 (2)	JUNCTION	0.00	0.00	0 00:00	0	0	0.000 ltr
HP-LC02	JUNCTION	0.00	0.00	0 00:00	0	0	0.000 ltr
HP-LC04	JUNCTION	0.00	1.34	0 01:12	0	0.000166	11.979
HP-LC05 (1)	JUNCTION	0.00	0.00	0 00:00	0	0	0.000 ltr
HP-LC05 (2)	JUNCTION	0.00	0.00	0 00:00	0	0	0.000 ltr
HP-RY01	JUNCTION	0.00	7.36	0 01:13	0	0.000735	0.732
HP-RY02	JUNCTION	0.00	0.00	0 00:00	0	0	0.000 ltr
HP-RY03	JUNCTION	0.00	17.83	0 01:12	0	0.0104	3.719
HP-RY08	JUNCTION	0.00	0.00	0 00:00	0	0	0.000 ltr
HP-RY09	JUNCTION	0.00	0.00	0 00:00	0	0	0.000 ltr
HP-RY10	JUNCTION	0.00	0.00	0 00:00	0	0	0.000 ltr
HP-RY11 (1)	JUNCTION	0.00	0.00	0 00:00	0	0	0.000 ltr
HP-RY11 (2)	JUNCTION	0.00	0.00	0 00:00	0	0	0.000 ltr
ms-ry06	JUNCTION	16.67	16.67	0 01:10	0.0153	0.0155	0.834
Ex. 1050	OUTFALL	0.00	111.39	0 01:21	0	0.66	0.000
HP-LC03	OUTFALL	0.00	0.00	0 00:00	0	0	0.000 ltr
HP-RY04	OUTFALL	0.00	39.24	0 01:16	0	0.035	0.000
HP-RY07	OUTFALL	0.00	0.00	0 00:00	0	0	0.000 ltr
CB01	STORAGE	30.48	60.03	0 01:10	0.0391	0.0824	0.377
CB02	STORAGE	22.62	22.62	0 01:10	0.0314	0.0314	-0.019
CB03	STORAGE	41.88	57.75	0 01:10	0.0585	0.0894	0.051
CBMH01	STORAGE	0.00	143.91	0 01:10	0	0.297	0.155
CBMH02	STORAGE	55.33	304.30	0 01:08	0.0752	0.605	-0.102
Dummy Chambers	STORAGE	0.00	199.40	0 01:08	0	0.128	0.366
Dummy-MH02	STORAGE	0.00	111.39	0 01:21	0	0.66	0.001
LC01	STORAGE	9.41	24.27	0 01:10	0.0107	0.0323	-0.029
LC02	STORAGE	0.00	33.81	0 01:05	0	0.0482	0.048
LC03	STORAGE	7.67	21.50	0 01:10	0.0082	0.0284	-0.204
LC04	STORAGE	27.63	43.00	0 01:09	0.0292	0.047	0.033
LC05	STORAGE	17.38	17.38	0 01:10	0.0177	0.0178	-0.109
MH02	STORAGE	0.00	101.68	0 01:05	0	0.568	-0.024
MH04	STORAGE	0.00	164.27	0 01:08	0	0.41	-0.128
MH06	STORAGE	0.00	182.89	0 01:08	0	0.41	-0.162
MH08	STORAGE	0.00	102.01	0 01:04	0	0.208	0.140
MH10	STORAGE	0.00	93.24	0 01:05	0	0.159	-0.159
RY01	STORAGE	5.68	22.26	0 01:12	0.00545	0.0495	-0.623
RY02	STORAGE	0.00	36.47	0 01:06	0	0.0499	-0.000
RY03	STORAGE	15.31	45.61	0 01:09	0.0165	0.0602	-0.450
RY04	STORAGE	0.00	53.37	0 01:11	0	0.0682	-0.718

200 Baribeau Street (119068)
PCSWMM Model Output
100yr 3-hour Chicago Storm (Normal Outfall)



RY05	STORAGE	0.00	8.11	0	01:03	0	0.00207	-0.698
RY06	STORAGE	0.00	35.36	0	01:10	0	0.047	0.650
RY07	STORAGE	0.00	34.90	0	01:05	0	0.0197	0.011
RY08	STORAGE	11.69	38.72	0	01:05	0.0128	0.033	0.432
ry09	STORAGE	14.06	45.64	0	01:10	0.0147	0.0569	-0.291
RY10	STORAGE	8.54	36.16	0	01:10	0.00906	0.0523	0.122
RY11	STORAGE	0.00	14.83	0	01:10	0	0.0217	-0.045

Node Surcharge Summary

No nodes were surcharged.

Node Flooding Summary

No nodes were flooded.

Storage Volume Summary

Storage Unit	Average Volume 1000 m ³	Avg Pcnt Full	Evap Pcnt Loss	Exfil Pcnt Loss	Maximum Volume 1000 m ³	Max Pcnt Full	Time of Max Occurrence days hr:min	Maximum Outflow LPS
CB01	0.000	0.7	0.0	0.0	0.008	52.3	0 01:17	54.14
CB02	0.000	0.4	0.0	0.0	0.003	24.7	0 01:20	20.67
CB03	0.000	0.7	0.0	0.0	0.025	34.3	0 01:28	57.06
CBMH01	0.000	2.8	0.0	0.0	0.002	64.4	0 01:11	131.71
CBMH02	0.001	0.7	0.0	0.0	0.025	31.9	0 01:27	238.71
Dummy Chambers	0.000	3.2	0.0	0.0	0.000	81.0	0 01:26	101.25
Dummy-MH02	0.000	0.0	0.0	0.0	0.000	0.0	0 00:00	111.39
LC01	0.000	1.9	0.0	0.0	0.000	56.3	0 01:11	23.54
LC02	0.000	2.0	0.0	0.0	0.001	57.6	0 01:11	32.72
LC03	0.000	1.6	0.0	0.0	0.000	54.6	0 01:13	22.25
LC04	0.000	1.7	0.0	0.0	0.000	43.7	0 01:14	35.36
LC05	0.000	1.0	0.0	0.0	0.000	36.1	0 01:14	15.91
MH02	0.000	4.7	0.0	0.0	0.004	77.5	0 01:27	92.07
MH04	0.000	5.0	0.0	0.0	0.003	93.9	0 01:22	148.70
MH06	0.000	4.8	0.0	0.0	0.003	94.2	0 01:20	164.27
MH08	0.000	3.7	0.0	0.0	0.002	93.7	0 01:12	92.04
MH10	0.000	3.4	0.0	0.0	0.002	93.2	0 01:13	80.91
RY01	0.000	4.0	0.0	0.0	0.000	55.4	0 01:16	18.40
RY02	0.000	1.8	0.0	0.0	0.000	55.6	0 01:13	31.07
RY03	0.000	1.5	0.0	0.0	0.000	46.2	0 01:12	32.35
RY04	0.000	4.0	0.0	0.0	0.000	59.6	0 01:16	39.24
RY05	0.000	0.8	0.0	0.0	0.000	36.3	0 01:12	5.75
RY06	0.000	1.8	0.0	0.0	0.000	42.4	0 01:14	26.33
RY07	0.000	1.9	0.0	0.0	0.000	55.6	0 01:11	28.07
RY08	0.000	2.0	0.0	0.0	0.000	56.7	0 01:11	28.74
ry09	0.000	0.4	0.0	0.0	0.002	44.1	0 01:14	38.85
RY10	0.000	1.9	0.0	0.0	0.000	56.0	0 01:12	35.22
RY11	0.000	1.7	0.0	0.0	0.000	54.5	0 01:12	14.03

Outfall Loading Summary

Outfall Node	Flow Freq Pcnt	Avg Flow LPS	Max Flow LPS	Total Volume 10 ⁶ ltr
Ex.1050	26.96	28.52	111.39	0.660
HP-LC03	0.00	0.00	0.00	0.000
HP-RY04	2.60	15.38	39.24	0.035
HP-RY07	0.00	0.00	0.00	0.000
System	7.39	43.90	150.53	0.695

Link Flow Summary

Link	Type	Maximum Flow LPS	Time of Max Occurrence days hr:min	Maximum Veloc m/sec	Max/ Full Flow	Max/ Full Depth
CB01-Lead	CONDUIT	54.14	0 01:07	1.72	1.68	1.00
CB02-Lead	CONDUIT	20.67	0 01:05	0.83	0.60	1.00
CB03-Lead	CONDUIT	57.06	0 01:06	1.83	2.40	1.00
CBMH01-MH06	CONDUIT	131.71	0 01:10	1.38	0.72	1.00
CBMH02-MH02	CONDUIT	101.68	0 01:05	1.27	0.33	1.00
LC01-LC02	CONDUIT	23.54	0 01:05	0.59	0.33	1.00
LC01-MH08	CONDUIT	32.72	0 01:05	0.62	0.46	1.00
LC03-RY02	CONDUIT	22.25	0 01:06	0.63	0.34	1.00
LC04-RY06	CONDUIT	35.36	0 01:10	0.86	1.13	1.00
LC05-LC04	CONDUIT	15.91	0 01:09	0.42	0.38	1.00
MH04-CBMH02	CONDUIT	148.70	0 01:09	1.13	0.50	1.00
MH04-Ex1050	CONDUIT	111.39	0 01:21	2.01	0.27	0.37
MH06-MH04	CONDUIT	164.27	0 01:08	1.26	0.56	1.00
MH08-CBMH01	CONDUIT	92.04	0 01:04	1.04	0.71	1.00
MH10-MH08	CONDUIT	80.91	0 01:04	0.83	0.63	1.00
MS-B1_1	CONDUIT	16.55	0 01:10	0.29	0.00	0.04
MS-B1_2	CONDUIT	13.90	0 01:10	0.35	0.00	0.04
MS-B2_1	CONDUIT	14.80	0 01:10	0.29	0.00	0.02
MS-B2_2	CONDUIT	14.83	0 01:10	0.66	0.01	0.07
MS-B3_1	CONDUIT	12.10	0 01:10	0.27	0.00	0.04
MS-B3_2	CONDUIT	10.81	0 01:10	0.23	0.00	0.02
MS-B4_1	CONDUIT	10.84	0 01:10	0.27	0.00	0.01
MS-B4_2	CONDUIT	12.29	0 01:10	0.27	0.00	0.04
MS-B5_1	CONDUIT	13.36	0 01:10	0.46	0.00	0.01
MS-B5_2	CONDUIT	13.36	0 01:10	0.35	0.00	0.01
MS-B6_1	CONDUIT	14.86	0 01:10	0.72	0.00	0.01
MS-B6_2	CONDUIT	14.84	0 01:10	0.34	0.00	0.01
MS-B7	CONDUIT	15.86	0 01:10	0.86	0.00	0.01
MS-B8_1	CONDUIT	14.78	0 01:10	0.36	0.00	0.01
MS-B8_2	CONDUIT	13.83	0 01:10	0.31	0.00	0.09
MS-B9_1	CONDUIT	14.78	0 01:10	0.39	0.00	0.01
MS-B9_2	CONDUIT	14.83	0 01:10	0.36	0.00	0.09
MS-BG	CONDUIT	7.71	0 01:09	0.27	0.00	0.03
MS-CB01 (1)	CONDUIT	0.00	0 00:00	0.00	0.00	0.07
MS-CB01 (2)	CONDUIT	0.00	0 00:00	0.00	0.00	0.05
MS-CB02 (1)	CONDUIT	0.00	0 00:00	0.00	0.00	0.05
MS-CB02 (2)	CONDUIT	0.00	0 00:00	0.00	0.00	0.09
MS-CB03 (1)	CONDUIT	0.00	0 00:00	0.00	0.00	0.09
MS-CB03 (2)	CONDUIT	0.00	0 00:00	0.00	0.00	0.06
MS-CBMH01 (1)	CONDUIT	0.00	0 00:00	0.00	0.00	0.00
MS-CBMH01 (2)	CONDUIT	0.00	0 00:00	0.00	0.00	0.00
MS-CBMH02 (1)	CONDUIT	0.00	0 00:00	0.00	0.00	0.09
MS-CBMH02 (2)	CONDUIT	0.00	0 00:00	0.00	0.00	0.09
MS-LC01 (1)	CONDUIT	0.00	0 00:00	0.00	0.00	0.00
MS-LC01 (2)	CONDUIT	0.00	0 00:00	0.00	0.00	0.00
MS-LC01 (3)	CONDUIT	0.00	0 00:00	0.00	0.00	0.00
MS-LC02 (1)	CONDUIT	0.00	0 00:00	0.00	0.00	0.00
MS-LC02 (2)	CONDUIT	0.00	0 00:00	0.00	0.00	0.00
MS-LC03	CONDUIT	0.00	0 00:00	0.00	0.00	0.03
MS-LC04 (1)	CONDUIT	1.34	0 01:12	0.09	0.00	0.06
MS-LC04 (2)	CONDUIT	0.75	0 01:14	0.14	0.00	0.02
MS-LC05 (1)	CONDUIT	0.00	0 00:00	0.00	0.00	0.00
MS-LC05 (2)	CONDUIT	0.00	0 00:00	0.00	0.00	0.00
MS-LC05 (3)	CONDUIT	0.00	0 00:00	0.00	0.00	0.05
MS-RY01 (1)	CONDUIT	2.41	0 01:14	0.09	0.00	0.06
MS-RY01 (2)	CONDUIT	5.61	0 01:13	0.04	0.00	0.18
MS-RY02 (1)	CONDUIT	0.00	0 00:00	0.00	0.00	0.03
MS-RY02 (2)	CONDUIT	0.00	0 00:00	0.00	0.00	0.03
MS-RY03 (1)	CONDUIT	17.83	0 01:12	0.22	0.00	0.12
MS-RY03 (2)	CONDUIT	16.91	0 01:12	0.53	0.00	0.08
MS-RY04 (1)	CONDUIT	39.24	0 01:16	0.21	0.00	0.20
MS-RY05 (1)	CONDUIT	0.42	0 01:12	0.01	0.00	0.09
MS-RY06 (1)	CONDUIT	0.65	0 01:14	0.03	0.00	0.07
MS-RY06 (2)	CONDUIT	16.59	0 01:09	0.33	0.00	0.22
MS-RY07 (1)	CONDUIT	0.00	0 00:00	0.00	0.00	0.00
MS-RY08 (1)	CONDUIT	0.00	0 00:00	0.00	0.00	0.00
MS-RY08 (2)	CONDUIT	0.00	0 00:00	0.00	0.00	0.00
MS-RY09 (1)	CONDUIT	0.00	0 00:00	0.00	0.00	0.03
MS-RY09 (2)	CONDUIT	0.00	0 00:00	0.00	0.00	0.03
MS-RY10 (1)	CONDUIT	0.00	0 00:00	0.00	0.00	0.01
MS-RY10 (2)	CONDUIT	0.00	0 00:00	0.00	0.00	0.03
MS-RY11 (1)	CONDUIT	0.00	0 00:00	0.00	0.00	0.01
MS-RY11 (2)	CONDUIT	0.00	0 00:00	0.00	0.00	0.01
MS-RY11 (3)	CONDUIT	0.00	0 00:00	0.00	0.00	0.01
RY02-MH10	CONDUIT	31.07	0 01:05	0.74	0.41	1.00
RY02-RY04	CONDUIT	25.71	0 01:12	0.66	0.61	1.00

200 Baribeau Street (119068)
PCSWMM Model Output
100yr 3-hour Chicago Storm (Normal Outfall)



RY04-RY01	CONDUIT	12.21	0	01:11	0.25	0.29	1.00
RY05-RY03	CONDUIT	8.11	0	01:03	0.17	0.19	1.00
RY07-RY08	CONDUIT	28.07	0	01:05	0.57	0.40	1.00
RY08-CBMH01	CONDUIT	26.14	0	01:05	0.71	0.37	1.00
RY09-Lead	CONDUIT	38.85	0	01:09	1.05	0.64	1.00
RY10-MH10	CONDUIT	35.22	0	01:10	0.70	0.49	1.00
RY11-RY10	CONDUIT	14.03	0	01:06	0.38	0.20	1.00
SC310_Chambers	CONDUIT	144.33	0	01:08	0.41	0.02	1.00
O-MH02	ORIFICE	92.07	0	01:27			1.00
O-RY01	ORIFICE	6.05	0	01:16			1.00
O-RY03	ORIFICE	14.04	0	01:12			1.00

Flow Classification Summary

Conduit	Adjusted /Actual Length	Fraction of Time in Flow Class									
		Dry	Up Dry	Down Dry	Sub Crit	Sup Crit	Up Crit	Down Norm	Inlet	Trl	Ctrl
CB01-Lead	1.00	0.01	0.00	0.00	0.06	0.00	0.00	0.94	0.00	0.00	
CB02-Lead	1.00	0.01	0.00	0.00	0.06	0.00	0.00	0.93	0.00	0.00	
CB03-Lead	1.00	0.01	0.00	0.00	0.05	0.00	0.00	0.94	0.00	0.00	
CBMH01-MH06	1.00	0.01	0.00	0.00	0.06	0.00	0.00	0.93	0.00	0.00	
CBMH02-MH02	1.00	0.01	0.00	0.00	0.07	0.00	0.00	0.92	0.00	0.00	
LC01-LC02	1.00	0.01	0.09	0.00	0.91	0.00	0.00	0.00	0.94	0.00	
LC01-MH08	1.00	0.01	0.00	0.00	0.06	0.00	0.00	0.93	0.00	0.00	
LC03-RY02	1.00	0.01	0.11	0.00	0.88	0.00	0.00	0.00	0.94	0.00	
LC04-RY06	1.00	0.01	0.02	0.00	0.96	0.00	0.00	0.00	0.88	0.00	
LC05-LC04	1.00	0.01	0.00	0.00	0.99	0.00	0.00	0.00	0.93	0.00	
MH04-CBMH02	1.00	0.01	0.00	0.00	0.07	0.02	0.00	0.90	0.00	0.00	
MH04-Ex1050	1.00	0.01	0.00	0.00	0.00	0.00	0.00	0.99	0.00	0.00	
MH06-MH04	1.00	0.01	0.00	0.00	0.07	0.00	0.00	0.92	0.00	0.00	
MH08-CBMH01	1.00	0.01	0.00	0.00	0.05	0.00	0.00	0.94	0.00	0.00	
MH10-MH08	1.00	0.01	0.00	0.00	0.12	0.00	0.00	0.87	0.00	0.00	
MS-B1_1	1.00	0.64	0.00	0.00	0.01	0.00	0.00	0.35	0.01	0.00	
MS-B1_2	1.00	0.71	0.00	0.00	0.01	0.00	0.00	0.28	0.01	0.00	
MS-B2_1	1.00	0.65	0.00	0.00	0.00	0.00	0.00	0.35	0.00	0.00	
MS-B2_2	1.00	0.01	0.00	0.00	0.00	0.00	0.00	0.99	0.00	0.00	
MS-B3_1	1.00	0.68	0.00	0.00	0.01	0.00	0.00	0.31	0.01	0.00	
MS-B3_2	1.00	0.62	0.00	0.00	0.00	0.00	0.00	0.38	0.00	0.00	
MS-B4_1	1.00	0.67	0.00	0.00	0.00	0.00	0.00	0.33	0.00	0.00	
MS-B4_2	1.00	0.67	0.00	0.00	0.01	0.00	0.00	0.32	0.01	0.00	
MS-B5_1	1.00	0.75	0.00	0.00	0.00	0.00	0.00	0.25	0.00	0.00	
MS-B5_2	1.00	0.73	0.00	0.00	0.00	0.00	0.00	0.27	0.00	0.00	
MS-B6_1	1.00	0.79	0.00	0.00	0.00	0.00	0.00	0.21	0.00	0.00	
MS-B6_2	1.00	0.70	0.00	0.00	0.00	0.00	0.00	0.30	0.00	0.00	
MS-B7	1.00	0.81	0.00	0.00	0.00	0.00	0.00	0.19	0.00	0.00	
MS-B8_1	1.00	0.64	0.00	0.00	0.00	0.00	0.00	0.36	0.00	0.00	
MS-B8_2	1.00	0.69	0.00	0.00	0.02	0.00	0.00	0.29	0.02	0.00	
MS-B9_1	1.00	0.66	0.00	0.00	0.00	0.00	0.00	0.34	0.00	0.00	
MS-B9_2	1.00	0.71	0.00	0.00	0.02	0.00	0.00	0.27	0.02	0.00	
MS-BG	1.00	0.78	0.00	0.00	0.01	0.00	0.00	0.21	0.01	0.00	
MS-CB01 (1)	1.00	0.98	0.02	0.00	0.00	0.00	0.00	0.00	0.00	0.00	
MS-CB01 (2)	1.00	0.98	0.02	0.00	0.00	0.00	0.00	0.00	0.00	0.00	
MS-CB02 (1)	1.00	0.98	0.02	0.00	0.00	0.00	0.00	0.00	0.00	0.00	
MS-CB02 (2)	1.00	0.97	0.03	0.00	0.00	0.00	0.00	0.00	0.00	0.00	
MS-CB03 (1)	1.00	0.97	0.03	0.00	0.00	0.00	0.00	0.00	0.00	0.00	
MS-CB03 (2)	1.00	0.01	0.99	0.00	0.00	0.00	0.00	0.00	0.00	0.00	
MS-CBMH01 (1)	1.00	1.00	0.00	0.00	0.00	0.00	0.00	0.00	0.00	0.00	
MS-CBMH01 (2)	1.00	1.00	0.00	0.00	0.00	0.00	0.00	0.00	0.00	0.00	
MS-CBMH02 (1)	1.00	0.97	0.03	0.00	0.00	0.00	0.00	0.00	0.00	0.00	
MS-CBMH02 (2)	1.00	0.97	0.03	0.00	0.00	0.00	0.00	0.00	0.00	0.00	
MS-LC01 (1)	1.00	1.00	0.00	0.00	0.00	0.00	0.00	0.00	0.00	0.00	
MS-LC01 (2)	1.00	1.00	0.00	0.00	0.00	0.00	0.00	0.00	0.00	0.00	
MS-LC01 (3)	1.00	1.00	0.00	0.00	0.00	0.00	0.00	0.00	0.00	0.00	
MS-LC02 (1)	1.00	1.00	0.00	0.00	0.00	0.00	0.00	0.00	0.00	0.00	
MS-LC02 (2)	1.00	1.00	0.00	0.00	0.00	0.00	0.00	0.00	0.00	0.00	
MS-LC03	1.00	0.99	0.01	0.00	0.00	0.00	0.00	0.00	0.00	0.00	
MS-LC04 (1)	1.00	0.05	0.00	0.00	0.01	0.00	0.00	0.94	0.00	0.00	
MS-LC04 (2)	1.00	0.05	0.00	0.00	0.00	0.00	0.00	0.95	0.00	0.00	
MS-LC05 (1)	1.00	1.00	0.00	0.00	0.00	0.00	0.00	0.00	0.00	0.00	
MS-LC05 (2)	1.00	1.00	0.00	0.00	0.00	0.00	0.00	0.00	0.00	0.00	
MS-LC05 (3)	1.00	0.99	0.01	0.00	0.00	0.00	0.00	0.00	0.00	0.00	
MS-RY01 (1)	1.00	0.92	0.00	0.00	0.02	0.00	0.00	0.05	0.02	0.00	
MS-RY01 (2)	1.00	0.92	0.00	0.00	0.06	0.00	0.00	0.02	0.05	0.00	
MS-RY02 (1)	1.00	0.99	0.01	0.00	0.00	0.00	0.00	0.00	0.00	0.00	
MS-RY02 (2)	1.00	0.99	0.01	0.00	0.00	0.00	0.00	0.00	0.00	0.00	
MS-RY03 (1)	1.00	0.92	0.00	0.00	0.02	0.00	0.00	0.05	0.01	0.00	
MS-RY03 (2)	1.00	0.92	0.00	0.00	0.02	0.00	0.00	0.05	0.02	0.00	

MS-RY04 (1)	1.00	0.05	0.00	0.00	0.06	0.00	0.00	0.89	0.03	0.00	
MS-RY05 (1)	1.00	0.98	0.02	0.00	0.00	0.00	0.00	0.00	0.95	0.00	
MS-RY06 (1)	1.00	0.01	0.98	0.00	0.00	0.00	0.00	0.00	0.95	0.00	
MS-RY06 (2)	1.00	0.01	0.00	0.00	0.06	0.00	0.00	0.00	0.93	0.03	0.00
MS-RY07 (1)	1.00	1.00	0.00	0.00	0.00	0.00	0.00	0.00	0.00	0.00	
MS-RY08 (1)	1.00	1.00	0.00	0.00	0.00	0.00	0.00	0.00	0.00	0.00	
MS-RY08 (2)	1.00	1.00	0.00	0.00	0.00	0.00	0.00	0.00	0.00	0.00	
MS-RY09 (1)	1.00	0.99	0.01	0.00	0.00	0.00	0.00	0.00	0.00	0.00	
MS-RY09 (2)	1.00	0.99	0.01	0.00	0.00	0.00	0.00	0.00	0.00	0.00	
MS-RY10 (1)	1.00	1.00	0.00	0.00	0.00	0.00	0.00	0.00	0.00	0.00	
MS-RY10 (2)	1.00	0.99	0.01	0.00	0.00	0.00	0.00	0.00	0.00	0.00	
MS-RY11 (1)	1.00	1.00	0.00	0.00	0.00	0.00	0.00	0.00	0.00	0.00	
MS-RY11 (2)	1.00	1.00	0.00	0.00	0.00	0.00	0.00	0.00	0.00	0.00	
MS-RY11 (3)	1.00	1.00	0.00	0.00	0.00	0.00	0.00	0.00	0.00	0.00	
RY02-MH10	1.00	0.01	0.00	0.00	0.05	0.00	0.00	0.94	0.00	0.00	
RY02-RY04	1.00	0.02	0.00	0.00	0.10	0.00	0.00	0.89	0.02	0.00	
RY04-RY01	1.00	0.01	0.00	0.00	0.98	0.00	0.00	0.00	0.06	0.00	
RY05-RY03	1.00	0.03	0.87	0.00	0.10	0.00	0.00	0.00	0.93	0.00	
RY07-RY08	1.00	0.01	0.11	0.00	0.88	0.00	0.00	0.00	0.93	0.00	
RY08-CBMH01	1.00	0.01	0.00	0.00	0.05	0.00	0.00	0.94	0.00	0.00	
RY09-Lead	1.00	0.01	0.00	0.00	0.05	0.00	0.00	0.95	0.00	0.00	
RY10-MH10	1.00	0.01	0.00	0.00	0.05	0.00	0.00	0.94	0.00	0.00	
RY11-RY10	1.00	0.01	0.08	0.00	0.91	0.00	0.00	0.00	0.94	0.00	
SC310_Chambers	1.00	0.55	0.00	0.00	0.05	0.00	0.00	0.39	0.00	0.00	

Conduit Surcharge Summary

Conduit	Hours Full			Hours Above Full Normal Flow	Hours Capacity Limited
	Both Ends	Upstream	Dnstream		
CB01-Lead	1.33	1.33	1.35	0.12	0.10
CB02-Lead	1.32	1.32	1.32	0.01	0.10
CB03-Lead	1.07	1.14	1.08	0.39	0.30
CBMH01-MH06	1.33	1.33	1.38	0.01	0.01
CBMH02-MH02	1.60	1.60	1.65	0.01	0.01
LC01-LC02	1.06	1.06	1.10	0.01	0.01
LC01-MH08	1.10	1.10	1.12	0.01	0.01
LC03-RY02	0.94	0.94	0.96	0.01	0.01
LC04-RY06	1.21	1.21	1.37	0.04	0.03
LC05-LC04	0.74	0.74	1.21	0.01	0.01
MH04-CBMH02	1.51	1.51	1.60	0.01	0.01
MH06-MH04	1.44	1.44	1.50	0.01	0.01
MH08-CBMH01	1.12	1.12	1.14	0.01	0.21
MH10-MH08	1.04	1.04	1.12	0.01	0.01
RY02-MH10	0.96	0.96	1.03	0.01	0.01
RY02-RY04	1.37	1.37	1.91	0.01	0.01
RY04-RY01	1.94	1.94	2.20	0.01	0.01
RY05-RY03	0.59	0.59	0.66	0.01	0.01
RY07-RY08	1.07	1.07	1.10	0.01	0.01
RY08-CBMH01	1.10	1.10	1.15	0.01	0.01
RY09-Lead	0.93	0.93	0.97	0.01	0.01
RY10-MH10	1.01	1.01	1.03	0.01	0.01
RY11-RY10	0.97	0.97	1.01	0.01	0.01
SC310_Chambers	0.86	0.86	0.89	0.01	0.01

Analysis begun on: Mon Mar 16 09:55:45 2026
Analysis ended on: Mon Mar 16 09:55:49 2026
Total elapsed time: 00:00:04

200 Baribeau Street (119068)
PCSWMM Model Output
100yr 3-hour Chicago Storm (Fixed Outfall = 55.05m)

ry09	STORAGE	14.06	43.22	0	01:10	0.0147	0.0569	-0.501
RY10	STORAGE	8.54	36.56	0	01:08	0.00906	0.0522	-0.179
RY11	STORAGE	0.00	14.83	0	01:10	0	0.0217	-0.156

Node Surcharge Summary

No nodes were surcharged.

Node Flooding Summary

No nodes were flooded.

Storage Volume Summary

Storage Unit	Average Volume 1000 m ³	Avg Pcnt Full	Evap Pcnt Loss	Exfil Pcnt Loss	Maximum Volume 1000 m ³	Max Pcnt Full	Time of Max Occurrence days hr:min	Maximum Outflow LPS
CB01	0.001	3.4	0.0	0.0	0.016	100.0	0 01:13	45.00
CB02	0.000	3.1	0.0	0.0	0.010	90.9	0 01:22	19.54
CB03	0.004	5.2	0.0	0.0	0.073	99.9	0 01:40	53.73
CBMH01	0.001	19.2	0.0	0.0	0.002	66.5	0 01:12	126.97
CBMH02	0.006	7.0	0.0	0.0	0.070	89.3	0 01:33	98.05
Dummy Chambers	0.000	8.9	0.0	0.0	0.000	90.2	0 01:33	24.31
Dummy-MH02	0.000	0.0	0.0	0.0	0.000	0.0	0 00:00	71.94
LC01	0.000	4.7	0.0	0.0	0.001	58.6	0 01:12	22.36
LC02	0.000	5.0	0.0	0.0	0.001	59.9	0 01:13	30.98
LC03	0.000	4.1	0.0	0.0	0.000	56.8	0 01:14	16.58
LC04	0.000	2.3	0.0	0.0	0.000	45.8	0 01:13	34.27
LC05	0.000	1.4	0.0	0.0	0.000	38.5	0 01:12	15.33
MH02	0.003	55.9	0.0	0.0	0.004	80.4	0 01:33	55.22
MH04	0.002	56.5	0.0	0.0	0.003	98.0	0 01:31	130.97
MH06	0.002	49.8	0.0	0.0	0.003	97.9	0 01:22	140.79
MH08	0.000	8.6	0.0	0.0	0.002	97.3	0 01:13	76.47
MH10	0.000	7.9	0.0	0.0	0.002	96.6	0 01:14	63.62
RY01	0.000	31.1	0.0	0.0	0.000	56.1	0 01:14	20.22
RY02	0.000	4.3	0.0	0.0	0.000	57.8	0 01:14	22.81
RY03	0.000	1.5	0.0	0.0	0.000	46.2	0 01:12	32.49
RY04	0.000	29.6	0.0	0.0	0.000	60.2	0 01:14	47.62
RY05	0.000	0.8	0.0	0.0	0.000	36.3	0 01:12	5.54
RY06	0.000	4.1	0.0	0.0	0.000	44.1	0 01:14	30.38
RY07	0.000	4.8	0.0	0.0	0.000	58.1	0 01:12	13.28
RY08	0.000	5.0	0.0	0.0	0.001	59.2	0 01:12	21.97
ry09	0.000	1.6	0.0	0.0	0.005	100.0	0 01:12	34.93
RY10	0.000	4.4	0.0	0.0	0.000	58.1	0 01:13	34.96
RY11	0.000	4.1	0.0	0.0	0.000	56.6	0 01:13	13.53

Outfall Loading Summary

Outfall Node	Flow Freq Pcnt	Avg Flow LPS	Max Flow LPS	Total Volume 10 ⁶ ltr
Ex-1050	34.29	21.88	71.94	0.649
HP-LC03	0.00	0.00	0.00	0.000
HP-RY04	3.25	16.21	47.62	0.046
HP-RY07	0.00	0.00	0.00	0.000
System	9.38	38.09	118.98	0.695

Link Flow Summary

Maximum Flow	Time of Max Occurrence	Maximum Veloc	Max/ Full	Max/ Full
---------------	------------------------	----------------	-----------	-----------

Link	Type	LPS	days hr:min	m/sec	Flow	Depth
CB01-Lead	CONDUIT	45.00	0 01:04	1.43	1.39	1.00
CB02-Lead	CONDUIT	19.54	0 01:06	0.62	0.57	1.00
CB03-Lead	CONDUIT	53.73	0 01:05	1.71	2.26	1.00
CBMH01-MH06	CONDUIT	126.97	0 01:07	1.11	0.69	1.00
CBMH02-MH02	CONDUIT	55.22	0 01:32	0.34	0.18	1.00
LC01-LC02	CONDUIT	22.36	0 01:07	0.42	0.31	1.00
LC01-MH08	CONDUIT	30.98	0 01:07	0.48	0.43	1.00
LC03-RY02	CONDUIT	16.58	0 01:06	0.55	0.25	1.00
LC04-RY06	CONDUIT	32.62	0 01:09	0.66	1.04	1.00
LC05-LC04	CONDUIT	15.33	0 01:10	0.31	0.36	1.00
MH04-CBMH02	CONDUIT	130.97	0 01:08	0.80	0.44	1.00
MH04-Ex1050	CONDUIT	71.94	0 01:24	0.44	0.17	1.00
MH06-MH04	CONDUIT	134.62	0 01:07	0.82	0.46	1.00
MH08-CBMH01	CONDUIT	76.47	0 01:07	0.67	0.59	1.00
MH10-MH08	CONDUIT	63.62	0 01:06	0.56	0.50	1.00
MS-B1_1	CONDUIT	16.50	0 01:07	0.29	0.00	0.06
MS-B1_2	CONDUIT	13.85	0 01:10	0.34	0.00	0.06
MS-B2_1	CONDUIT	16.13	0 01:08	0.29	0.00	0.04
MS-B2_2	CONDUIT	14.83	0 01:10	0.66	0.01	0.07
MS-B3_1	CONDUIT	11.80	0 01:07	0.27	0.00	0.06
MS-B3_2	CONDUIT	10.81	0 01:10	0.23	0.00	0.02
MS-B4_1	CONDUIT	11.90	0 01:08	0.27	0.00	0.03
MS-B4_2	CONDUIT	12.02	0 01:07	0.26	0.00	0.06
MS-B5_1	CONDUIT	13.36	0 01:10	0.46	0.00	0.01
MS-B5_2	CONDUIT	13.40	0 01:09	0.35	0.00	0.02
MS-B6_1	CONDUIT	14.86	0 01:10	0.72	0.00	0.02
MS-B6_2	CONDUIT	14.84	0 01:10	0.34	0.00	0.01
MS-B7	CONDUIT	15.86	0 01:10	0.86	0.00	0.01
MS-B8_1	CONDUIT	14.78	0 01:10	0.36	0.00	0.01
MS-B8_2	CONDUIT	13.83	0 01:10	0.31	0.00	0.09
MS-B9_1	CONDUIT	14.78	0 01:10	0.39	0.00	0.01
MS-B9_2	CONDUIT	14.83	0 01:10	0.36	0.00	0.09
MS-BG	CONDUIT	7.67	0 01:06	0.27	0.00	0.06
MS-CB01 (1)	CONDUIT	19.12	0 01:13	0.06	0.00	0.11
MS-CB01 (2)	CONDUIT	15.19	0 01:13	0.06	0.00	0.10
MS-CB02 (1)	CONDUIT	0.00	0 00:00	0.00	0.00	0.10
MS-CB02 (2)	CONDUIT	0.00	0 00:00	0.00	0.00	0.15
MS-CB03 (1)	CONDUIT	0.46	0 01:40	0.00	0.00	0.15
MS-CB03 (2)	CONDUIT	0.45	0 01:40	0.01	0.00	0.06
MS-CBMH01 (1)	CONDUIT	0.00	0 00:00	0.00	0.00	0.01
MS-CBMH01 (2)	CONDUIT	0.00	0 00:00	0.00	0.00	0.02
MS-CBMH02 (1)	CONDUIT	0.00	0 00:00	0.00	0.00	0.15
MS-CBMH02 (2)	CONDUIT	0.00	0 00:00	0.00	0.00	0.15
MS-LC01 (1)	CONDUIT	0.00	0 00:00	0.00	0.00	0.02
MS-LC01 (2)	CONDUIT	0.00	0 00:00	0.00	0.00	0.02
MS-LC01 (3)	CONDUIT	0.00	0 00:00	0.00	0.00	0.03
MS-LC02 (1)	CONDUIT	0.00	0 00:00	0.00	0.00	0.03
MS-LC02 (2)	CONDUIT	0.00	0 00:00	0.00	0.00	0.01
MS-LC03	CONDUIT	0.00	0 01:14	0.00	0.00	0.06
MS-LC04 (1)	CONDUIT	3.68	0 01:13	0.13	0.00	0.10
MS-LC04 (2)	CONDUIT	3.70	0 01:13	0.22	0.00	0.05
MS-LC05 (1)	CONDUIT	0.00	0 00:00	0.00	0.00	0.02
MS-LC05 (2)	CONDUIT	0.00	0 00:00	0.00	0.00	0.02
MS-LC05 (3)	CONDUIT	0.00	0 00:00	0.00	0.00	0.07
MS-RY01 (1)	CONDUIT	3.99	0 01:13	0.12	0.00	0.07
MS-RY01 (2)	CONDUIT	5.71	0 01:11	0.04	0.00	0.19
MS-RY02 (1)	CONDUIT	0.00	0 00:00	0.00	0.00	0.05
MS-RY02 (2)	CONDUIT	0.00	0 00:00	0.00	0.00	0.06
MS-RY03 (1)	CONDUIT	18.05	0 01:12	0.23	0.00	0.12
MS-RY03 (2)	CONDUIT	17.88	0 01:12	0.49	0.00	0.08
MS-RY04 (1)	CONDUIT	47.62	0 01:14	0.24	0.00	0.21
MS-RY05 (1)	CONDUIT	0.40	0 01:12	0.01	0.00	0.09
MS-RY06 (1)	CONDUIT	3.39	0 01:14	0.10	0.00	0.09
MS-RY06 (2)	CONDUIT	14.67	0 01:11	0.29	0.00	0.23
MS-RY07 (1)	CONDUIT	0.00	0 00:00	0.00	0.00	0.02
MS-RY08 (1)	CONDUIT	0.00	0 00:00	0.00	0.00	0.02
MS-RY08 (2)	CONDUIT	0.00	0 00:00	0.00	0.00	0.02
MS-RY09 (1)	CONDUIT	0.00	0 00:00	0.00	0.00	0.06
MS-RY09 (2)	CONDUIT	0.00	0 00:00	0.00	0.00	0.05
MS-RY10 (1)	CONDUIT	0.00	0 00:00	0.00	0.00	0.03
MS-RY10 (2)	CONDUIT	0.00	0 00:00	0.00	0.00	0.06
MS-RY11 (1)	CONDUIT	0.00	0 00:00	0.00	0.00	0.03
MS-RY11 (2)	CONDUIT	0.00	0 00:00	0.00	0.00	0.03
MS-RY11 (3)	CONDUIT	0.00	0 00:00	0.00	0.00	0.03
RY02-MH10	CONDUIT	22.81	0 01:06	0.61	0.30	1.00
RY02-RY04	CONDUIT	27.12	0 01:13	0.55	0.64	1.00
RY04-RY01	CONDUIT	12.25	0 01:13	0.25	0.29	1.00
RY05-RY03	CONDUIT	8.11	0 01:03	0.17	0.19	1.00
RY07-RY08	CONDUIT	13.28	0 01:08	0.37	0.19	1.00
RY08-CBMH01	CONDUIT	21.97	0 01:08	0.37	0.31	1.00

200 Baribeau Street (119068)
 PCSWMM Model Output
 100yr 3-hour Chicago Storm (Fixed Outfall = 55.05m)



RY09-Lead	CONDUIT	34.93	0	01:06	0.89	0.58	1.00
RY10-MH10	CONDUIT	34.96	0	01:07	0.56	0.49	1.00
RY11-RY10	CONDUIT	13.53	0	01:07	0.31	0.19	1.00
SC310_Chambers	CONDUIT	45.96	0	01:08	0.03	0.01	1.00
O-MH02	ORIFICE	55.22	0	01:42			1.00
O-RY01	ORIFICE	4.10	0	01:14			1.00
O-RY03	ORIFICE	14.04	0	01:12			1.00

 Flow Classification Summary

Conduit	Adjusted /Actual Length	Fraction of Time in Flow Class							
		Dry	Up Dry	Down Dry	Sub Crit	Sup Crit	Up Crit	Down Norm	Inlet
CB01-Lead	1.00	0.00	0.00	0.00	1.00	0.00	0.00	0.00	0.00
CB02-Lead	1.00	0.00	0.00	0.00	1.00	0.00	0.00	0.00	0.00
CB03-Lead	1.00	0.01	0.00	0.00	0.13	0.00	0.00	0.87	0.00
CBMH01-MH06	1.00	0.00	0.00	0.00	1.00	0.00	0.00	0.00	0.00
CBMH02-MH02	1.00	0.00	0.00	0.00	1.00	0.00	0.00	0.00	0.00
LC01-LC02	1.00	0.01	0.07	0.00	0.92	0.00	0.00	0.86	0.00
LC01-MH08	1.00	0.01	0.00	0.00	0.14	0.00	0.00	0.86	0.00
LC03-RY02	1.00	0.01	0.00	0.00	0.99	0.00	0.00	0.88	0.00
LC04-RY06	1.00	0.00	0.73	0.00	0.27	0.00	0.00	0.87	0.00
LC05-LC04	1.00	0.01	0.00	0.00	0.99	0.00	0.00	0.90	0.00
MH04-CBMH02	1.00	0.00	0.00	0.00	1.00	0.00	0.00	0.00	0.00
MH04-Ex1050	1.00	0.00	0.00	0.00	1.00	0.00	0.00	0.00	0.00
MH06-MH04	1.00	0.00	0.00	0.00	1.00	0.00	0.00	0.00	0.00
MH08-CBMH01	1.00	0.01	0.00	0.00	0.37	0.00	0.00	0.62	0.00
MH10-MH08	1.00	0.01	0.00	0.00	0.16	0.00	0.00	0.83	0.02
MS-B1_1	1.00	0.64	0.00	0.00	0.02	0.00	0.00	0.34	0.02
MS-B1_2	1.00	0.71	0.00	0.00	0.02	0.00	0.00	0.27	0.02
MS-B2_1	1.00	0.65	0.00	0.00	0.01	0.00	0.00	0.34	0.01
MS-B2_2	1.00	0.01	0.00	0.00	0.01	0.00	0.00	0.99	0.00
MS-B3_1	1.00	0.68	0.00	0.00	0.02	0.00	0.00	0.30	0.02
MS-B3_2	1.00	0.62	0.00	0.00	0.00	0.00	0.00	0.38	0.00
MS-B4_1	1.00	0.67	0.00	0.00	0.01	0.00	0.00	0.32	0.01
MS-B4_2	1.00	0.67	0.00	0.00	0.02	0.00	0.00	0.32	0.02
MS-B5_1	1.00	0.75	0.00	0.00	0.00	0.00	0.00	0.25	0.00
MS-B5_2	1.00	0.73	0.00	0.00	0.00	0.00	0.00	0.27	0.00
MS-B6_1	1.00	0.79	0.00	0.00	0.01	0.00	0.00	0.20	0.01
MS-B6_2	1.00	0.70	0.00	0.00	0.00	0.00	0.00	0.30	0.00
MS-B7	1.00	0.81	0.00	0.00	0.00	0.00	0.00	0.19	0.00
MS-B8_1	1.00	0.64	0.00	0.00	0.00	0.00	0.00	0.36	0.00
MS-B8_2	1.00	0.69	0.00	0.00	0.02	0.00	0.00	0.29	0.02
MS-B9_1	1.00	0.66	0.00	0.00	0.00	0.00	0.00	0.34	0.00
MS-B9_2	1.00	0.71	0.00	0.00	0.02	0.00	0.00	0.27	0.02
MS-BG	1.00	0.78	0.00	0.00	0.02	0.00	0.00	0.20	0.02
MS-CB01 (1)	1.00	0.94	0.06	0.00	0.01	0.00	0.00	0.94	0.00
MS-CB01 (2)	1.00	0.94	0.05	0.00	0.01	0.00	0.00	0.95	0.00
MS-CB02 (1)	1.00	0.94	0.06	0.00	0.00	0.00	0.00	0.94	0.00
MS-CB02 (2)	1.00	0.91	0.09	0.00	0.00	0.00	0.00	0.90	0.00
MS-CB03 (1)	1.00	0.91	0.09	0.00	0.00	0.00	0.00	0.93	0.00
MS-CB03 (2)	1.00	0.01	0.98	0.00	0.00	0.00	0.00	0.93	0.00
MS-CBMH01 (1)	1.00	1.00	0.00	0.00	0.00	0.00	0.00	0.00	0.00
MS-CBMH01 (2)	1.00	0.99	0.01	0.00	0.00	0.00	0.00	0.00	0.00
MS-CBMH02 (1)	1.00	0.91	0.09	0.00	0.00	0.00	0.00	0.90	0.00
MS-CBMH02 (2)	1.00	0.91	0.09	0.00	0.00	0.00	0.00	0.90	0.00
MS-LC01 (1)	1.00	0.99	0.01	0.00	0.00	0.00	0.00	0.00	0.00
MS-LC01 (2)	1.00	0.99	0.01	0.00	0.00	0.00	0.00	0.00	0.00
MS-LC01 (3)	1.00	0.99	0.01	0.00	0.00	0.00	0.00	0.00	0.00
MS-LC02 (1)	1.00	0.99	0.01	0.00	0.00	0.00	0.00	0.00	0.00
MS-LC02 (2)	1.00	1.00	0.00	0.00	0.00	0.00	0.00	0.00	0.00
MS-LC03	1.00	0.05	0.01	0.00	0.01	0.00	0.00	0.94	0.01
MS-LC04 (1)	1.00	0.05	0.00	0.00	0.01	0.00	0.00	0.94	0.00
MS-LC04 (2)	1.00	0.05	0.00	0.00	0.01	0.00	0.00	0.95	0.00
MS-LC05 (1)	1.00	0.99	0.01	0.00	0.00	0.00	0.00	0.90	0.00
MS-LC05 (2)	1.00	0.99	0.01	0.00	0.00	0.00	0.00	0.90	0.00
MS-LC05 (3)	1.00	0.99	0.01	0.00	0.00	0.00	0.00	0.90	0.00
MS-RY01 (1)	1.00	0.91	0.00	0.00	0.03	0.00	0.00	0.06	0.02
MS-RY01 (2)	1.00	0.91	0.00	0.00	0.08	0.00	0.00	0.07	0.00
MS-RY02 (1)	1.00	0.98	0.02	0.00	0.00	0.00	0.00	0.00	0.00
MS-RY02 (2)	1.00	0.98	0.02	0.00	0.00	0.00	0.00	0.00	0.00
MS-RY03 (1)	1.00	0.92	0.00	0.00	0.02	0.00	0.00	0.05	0.01
MS-RY03 (2)	1.00	0.92	0.00	0.00	0.03	0.00	0.00	0.04	0.03
MS-RY04 (1)	1.00	0.05	0.00	0.00	0.08	0.00	0.00	0.87	0.05
MS-RY05 (1)	1.00	0.98	0.02	0.00	0.00	0.00	0.00	0.95	0.00
MS-RY06 (1)	1.00	0.01	0.98	0.00	0.01	0.00	0.00	0.95	0.00
MS-RY06 (2)	1.00	0.01	0.00	0.00	0.09	0.00	0.00	0.90	0.05

MS-RY07 (1)	1.00	0.99	0.01	0.00	0.00	0.00	0.00	0.00	0.00	0.00
MS-RY08 (1)	1.00	0.99	0.01	0.00	0.00	0.00	0.00	0.00	0.00	0.00
MS-RY08 (2)	1.00	0.99	0.01	0.00	0.00	0.00	0.00	0.00	0.00	0.00
MS-RY09 (1)	1.00	0.98	0.02	0.00	0.00	0.00	0.00	0.00	0.00	0.00
MS-RY09 (2)	1.00	0.98	0.02	0.00	0.00	0.00	0.00	0.00	0.00	0.00
MS-RY10 (1)	1.00	0.99	0.01	0.00	0.00	0.00	0.00	0.00	0.00	0.00
MS-RY10 (2)	1.00	0.98	0.02	0.00	0.00	0.00	0.00	0.00	0.00	0.00
MS-RY11 (1)	1.00	0.99	0.01	0.00	0.00	0.00	0.00	0.00	0.00	0.00
MS-RY11 (2)	1.00	0.99	0.01	0.00	0.00	0.00	0.00	0.00	0.00	0.00
MS-RY11 (3)	1.00	0.99	0.01	0.00	0.00	0.00	0.00	0.00	0.00	0.00
RY02-MH10	1.00	0.01	0.00	0.00	0.12	0.00	0.00	0.87	0.01	0.00
RY02-RY04	1.00	0.00	0.00	0.00	1.00	0.00	0.00	0.00	0.00	0.00
RY04-RY01	1.00	0.00	0.00	0.00	1.00	0.00	0.00	0.00	0.00	0.00
RY05-RY03	1.00	0.03	0.87	0.00	0.10	0.00	0.00	0.00	0.93	0.00
RY07-RY08	1.00	0.01	0.07	0.00	0.92	0.00	0.00	0.00	0.86	0.00
RY08-CBMH01	1.00	0.01	0.00	0.00	0.14	0.00	0.00	0.85	0.01	0.00
RY09-Lead	1.00	0.01	0.00	0.00	0.11	0.00	0.00	0.88	0.00	0.00
RY10-MH10	1.00	0.01	0.00	0.00	0.12	0.00	0.00	0.87	0.00	0.00
RY11-RY10	1.00	0.01	0.06	0.00	0.93	0.00	0.00	0.00	0.87	0.00
SC310_Chambers	1.00	0.46	0.10	0.00	0.21	0.00	0.00	0.23	0.09	0.00

 Conduit Surcharge Summary

Conduit	Hours Full			Hours Above Full Capacity	
	Both Ends	Upstream	Dnstream	Normal Flow	Limited
CB01-Lead	14.15	14.15	24.00	0.05	0.05
CB02-Lead	14.27	14.27	24.00	0.01	0.05
CB03-Lead	2.68	2.68	2.72	0.19	0.09
CBMH01-MH06	24.00	24.00	24.00	0.01	0.01
CBMH02-MH02	24.00	24.00	24.00	0.01	0.01
LC01-LC02	2.57	2.57	2.66	0.01	0.01
LC01-MH08	2.66	2.66	2.70	0.01	0.01
LC03-RY02	2.36	2.36	2.40	0.01	0.01
LC04-RY06	1.71	1.71	2.01	0.03	0.03
LC05-LC04	0.93	0.93	1.71	0.01	0.01
MH04-CBMH02	24.00	24.00	24.00	0.01	0.01
MH04-Ex1050	24.00	24.00	24.00	0.01	0.01
MH06-MH04	24.00	24.00	24.00	0.01	0.01
MH08-CBMH01	2.70	2.70	2.76	0.01	0.03
MH10-MH08	2.52	2.52	2.69	0.01	0.01
RY02-MH10	2.40	2.40	2.52	0.01	0.01
RY02-RY04	2.01	2.01	24.00	0.01	0.01
RY04-RY01	24.00	24.00	24.00	0.01	0.01
RY05-RY03	0.59	0.59	0.66	0.01	0.01
RY07-RY08	2.59	2.59	2.66	0.01	0.01
RY08-CBMH01	2.66	2.66	2.77	0.01	0.01
RY09-Lead	2.36	2.36	2.42	0.01	0.01
RY10-MH10	2.49	2.49	2.52	0.01	0.01
RY11-RY10	2.41	2.41	2.49	0.01	0.01
SC310_Chambers	2.32	2.32	2.37	0.01	0.01

Analysis begun on: Fri Mar 13 15:05:37 2026
 Analysis ended on: Fri Mar 13 15:05:41 2026
 Total elapsed time: 00:00:04

Overall Model Schematic



Subcatchment ID's

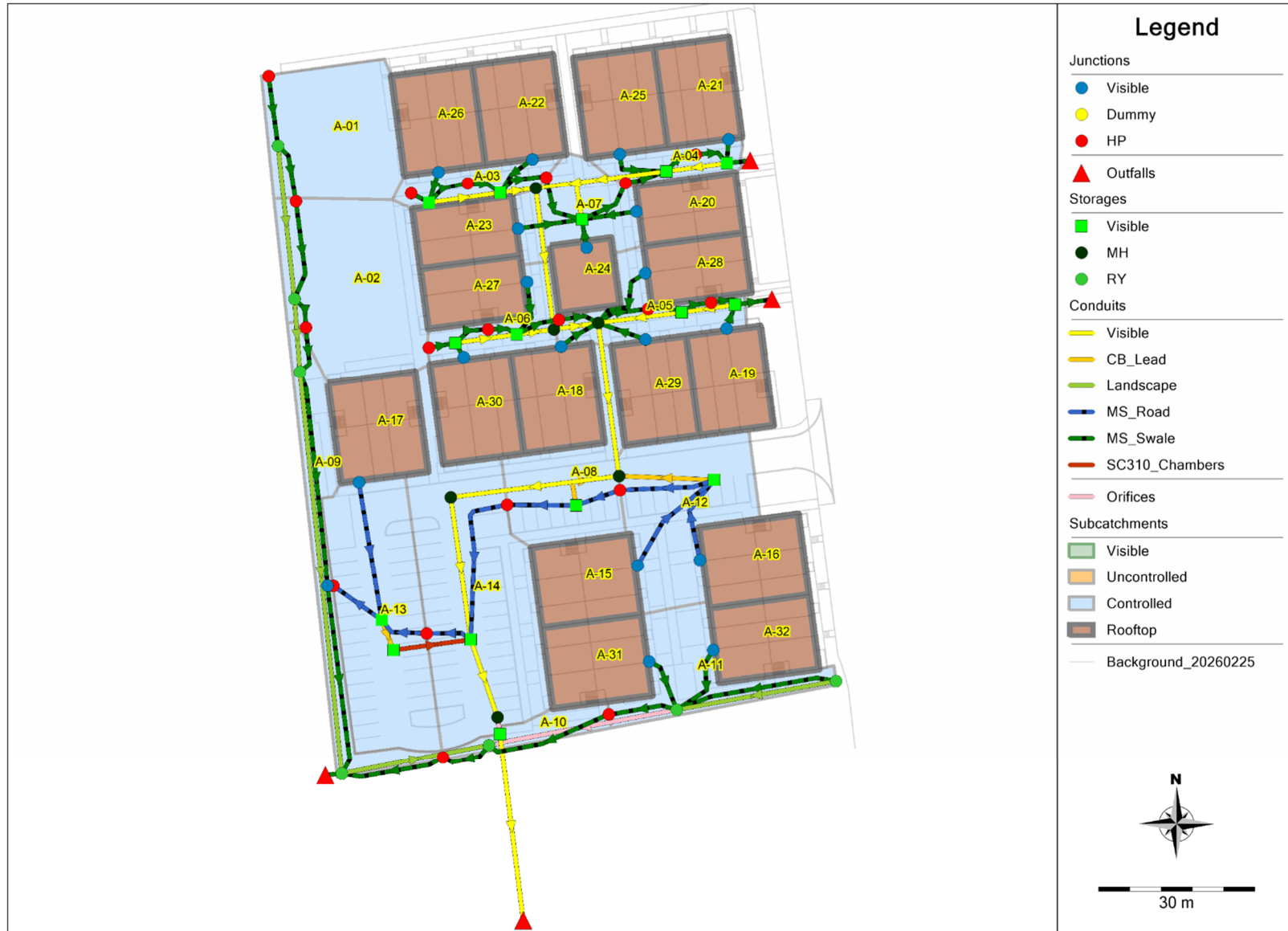

Node ID's

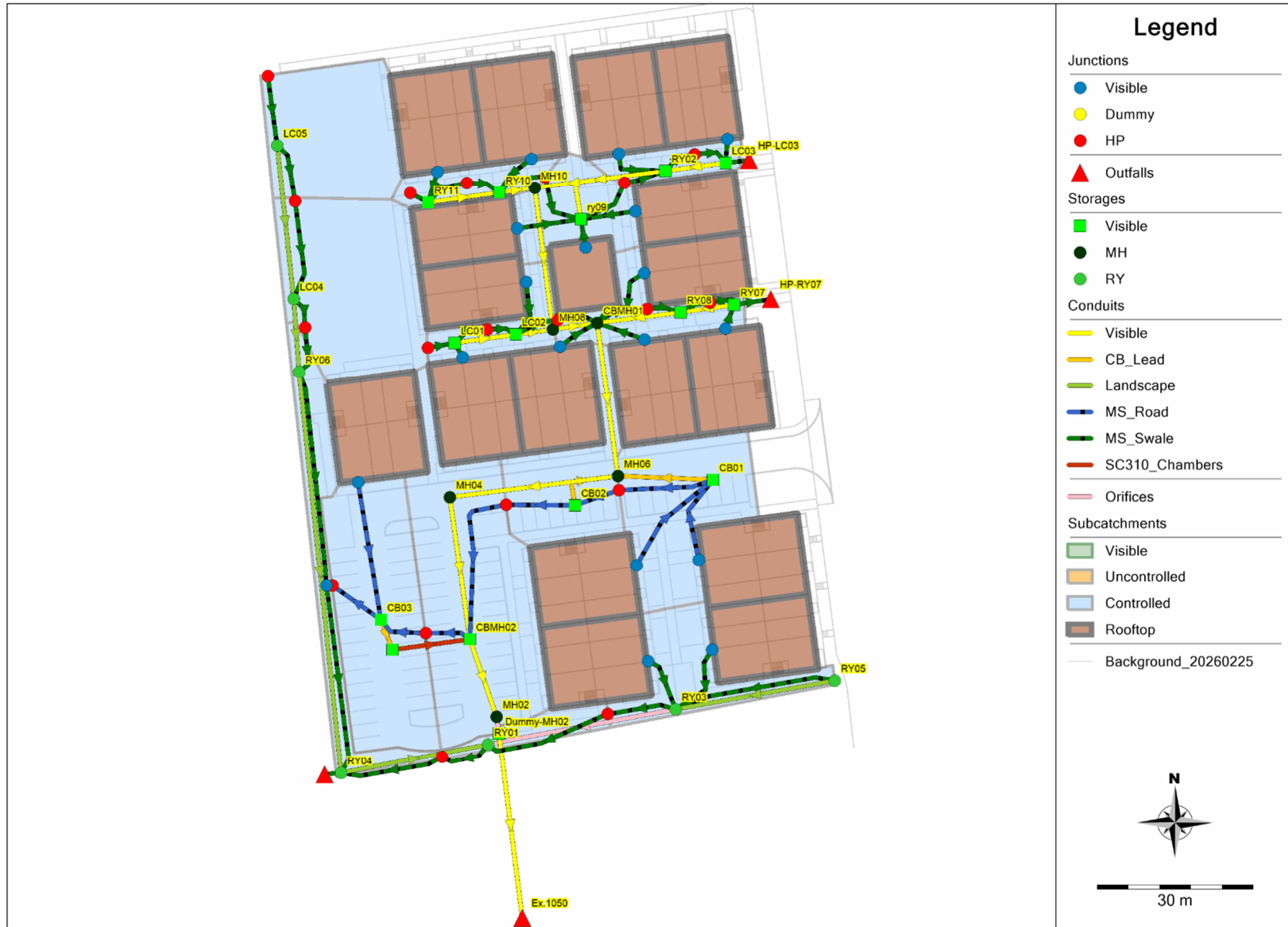

SC-310 CHAMBER

Designed to meet the most stringent industry performance standards for superior structural integrity while providing designers with a cost-effective method to save valuable land and protect water resources. The StormTech system is designed primarily to be used under parking lots, thus maximizing land usage for private (commercial) and public applications. StormTech chambers can also be used in conjunction with Green Infrastructure, thus enhancing the performance and extending the service life of these practices.

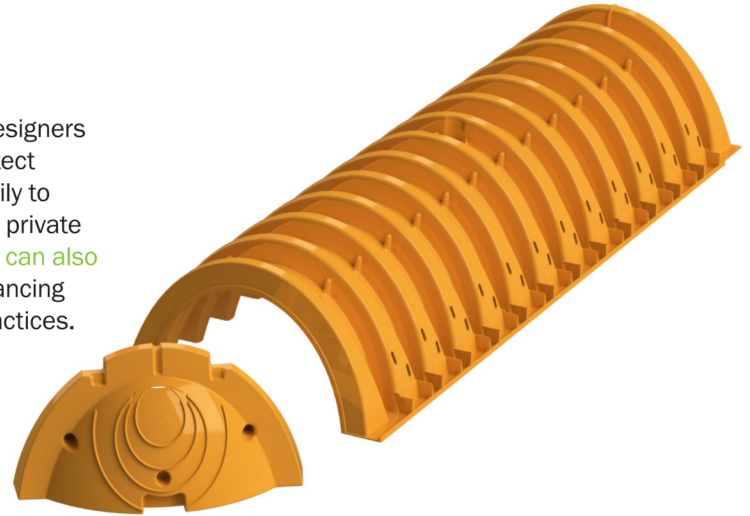

STORMTECH SC-310 CHAMBER (not to scale)

Nominal Chamber Specifications

Size (L x W x H)
85.4" x 34.0" x 16.0"
2,170 mm x 864 mm x 406 mm

Chamber Storage
14.7 ft³ (0.42 m³)

Min. Installed Storage*
31.0 ft³ (0.88 m³)

Weight
37.0 lbs (16.8 kg)

Shipping
41 chambers/pallet
108 end caps/pallet
18 pallets/truck

*Assumes 6" (150 mm) stone above and below chambers and 40% stone porosity.

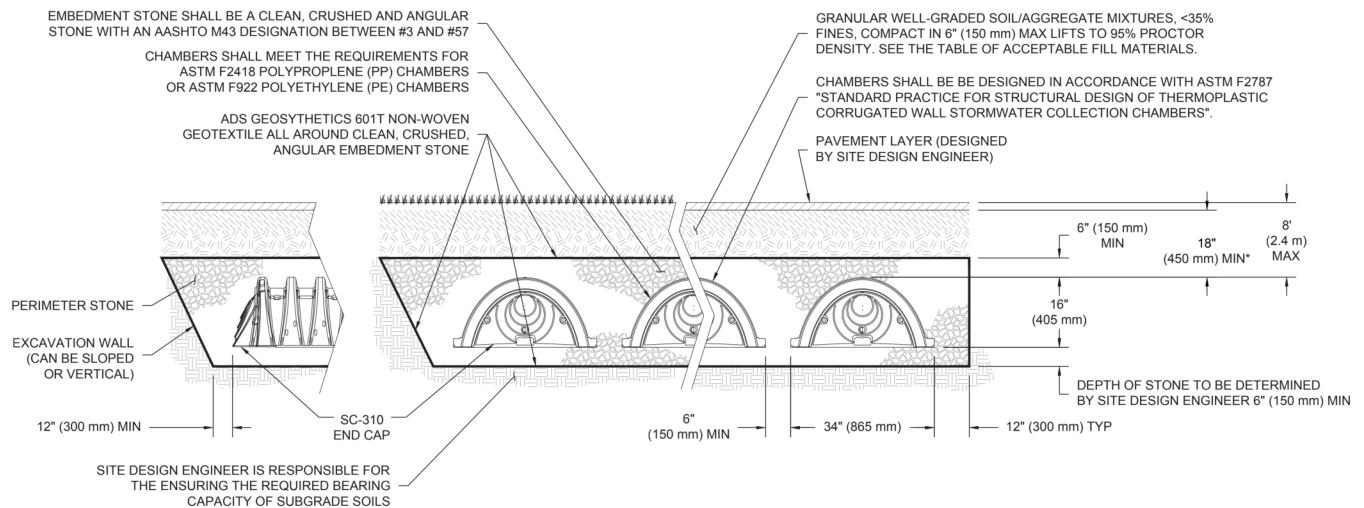
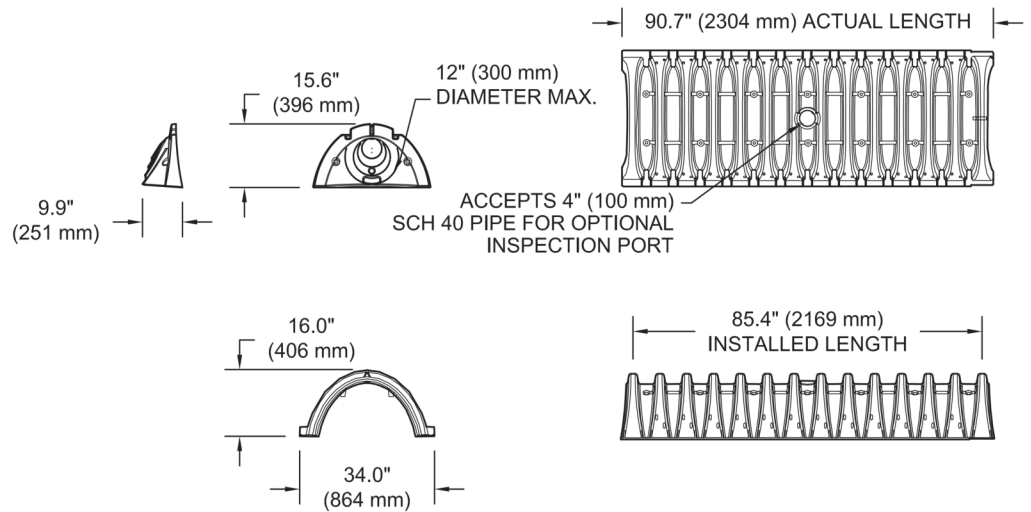

*MINIMUM COVER TO BOTTOM OF FLEXIBLE PAVEMENT. FOR UNPAVED INSTALLATIONS WHERE RUTTING FROM VEHICLES MAY OCCUR, INCREASE COVER TO 24" (600 mm).

SC-310 CUMULATIVE STORAGE VOLUMES PER CHAMBER

Assumes 40% Stone Porosity. Calculations are Based Upon a 6" (150 mm) Stone Base Under Chambers.

Depth of Water in System Inches (mm)	Cumulative Chamber Storage ft ³ (m ³)	Total System Cumulative Storage ft ³ (m ³)
28 (711)	↑ 14.70 (0.416)	31.00 (0.878)
27 (686)	↑ 14.70 (0.416)	30.21 (0.855)
26 (680)	Stone 14.70 (0.416)	29.42 (0.833)
25 (610)	Cover 14.70 (0.416)	28.63 (0.811)
24 (609)	↓ 14.70 (0.416)	27.84 (0.788)
23 (584)	↓ 14.70 (0.416)	27.05 (0.766)
22 (559)	14.70 (0.416)	26.26 (0.748)
21 (533)	14.64 (0.415)	25.43 (0.720)
20 (508)	14.49 (0.410)	24.54 (0.695)
19 (483)	14.22 (0.403)	23.58 (0.668)
18 (457)	13.68 (0.387)	22.47 (0.636)
17 (432)	12.99 (0.368)	21.25 (0.602)
16 (406)	12.17 (0.345)	19.97 (0.566)
15 (381)	11.25 (0.319)	18.62 (0.528)
14 (356)	10.23 (0.290)	17.22 (0.488)
13 (330)	9.15 (0.260)	15.78 (0.447)
12 (305)	7.99 (0.227)	14.29 (0.425)
11 (279)	6.78 (0.192)	12.77 (0.362)
10 (254)	5.51 (0.156)	11.22 (0.318)
9 (229)	4.19 (0.119)	9.64 (0.278)
8 (203)	2.83 (0.081)	8.03 (0.227)
7 (178)	1.43 (0.041)	6.40 (0.181)
6 (152)	↑ 0	4.74 (0.134)
5 (127)	0	3.95 (0.112)
4 (102)	Stone Foundation 0	3.16 (0.090)
3 (76)	0	2.37 (0.067)
2 (51)	0	1.58 (0.046)
1 (25)	↓ 0	0.79 (0.022)

Note: Add 0.79 ft³ (0.022 m³) of storage for each additional inch. (25 mm) of stone foundation.

STORAGE VOLUME PER CHAMBER FT³ (M³)

	Bare Chamber Storage ft ³ (m ³)	Chamber and Stone Foundation Depth in. (mm)		
		6 (150)	12 (300)	18 (450)
StormTech SC-310	14.7 (0.4)	31.0 (0.9)	35.7 (1.0)	40.4 (1.1)

Note: Assumes 6" (150 mm) of stone above chambers, 6" (150 mm) row spacing and 40% stone porosity.

AMOUNT OF STONE PER CHAMBER

ENGLISH TONS (yds ³)	Stone Foundation Depth		
	6"	12"	18"
StormTech SC-310	2.1 (1.5 yd ³)	2.7 (1.9 yd ³)	3.4 (2.4 yd ³)
METRIC KILOGRAMS (m ³)	150 mm	300 mm	450 mm
StormTech SC-310	1830 (1.1 m ³)	2490 (1.5 m ³)	2990 (1.8 m ³)

Note: Assumes 6" (150 mm) of stone above, and between chambers.

VOLUME EXCAVATION PER CHAMBER YD³ (M³)

	Stone Foundation Depth		
	6" (150 mm)	12" (300 mm)	18" (450 mm)
StormTech SC-310	2.9 (2.2)	3.4 (2.6)	3.8 (2.9)

Note: Assumes 6" (150 mm) of row separation and 18" (450 mm) of cover. The volume of excavation will vary as the depth of the cover increases.

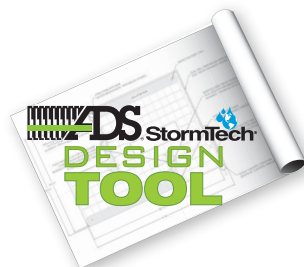

Working on a project?
Visit us at www.stormtech.com
and utilize the StormTech Design Tool

For more information on the StormTech SC-310 Chamber and other ADS products, please contact our Customer Service Representatives at 1-800-821-6710

THE MOST **ADVANCED** NAME IN WATER MANAGEMENT SOLUTIONS™

Advanced Drainage Systems, Inc.
4640 Trueman Blvd., Hilliard, OH 43026
1-800-821-6710 www.ads-pipe.com

ACCEPTABLE FILL MATERIALS: STORMTECH SC-310 CHAMBER SYSTEMS

MATERIAL LOCATION		DESCRIPTION	AASHTO MATERIAL CLASSIFICATIONS	COMPACTION / DENSITY REQUIREMENT
D	FINAL FILL: FILL MATERIAL FOR LAYER 'D' STARTS FROM THE TOP OF THE 'C' LAYER TO THE BOTTOM OF FLEXIBLE PAVEMENT OR UNPAVED FINISHED GRADE ABOVE. NOTE THAT PAVEMENT SUBBASE MAY BE PART OF THE 'D' LAYER.	ANY SOIL/ROCK MATERIALS, NATIVE SOILS, OR PER ENGINEER'S PLANS. CHECK PLANS FOR PAVEMENT SUBGRADE REQUIREMENTS.	N/A	PREPARE PER SITE DESIGN ENGINEER'S PLANS. PAVED INSTALLATIONS MAY HAVE STRINGENT MATERIAL AND PREPARATION REQUIREMENTS.
C	INITIAL FILL: FILL MATERIAL FOR LAYER 'C' STARTS FROM THE TOP OF THE EMBEDMENT STONE ('B' LAYER) TO 18" (450 mm) ABOVE THE TOP OF THE CHAMBER. NOTE THAT PAVEMENT SUBBASE MAY BE A PART OF THE 'C' LAYER.	GRANULAR WELL-GRADED SOIL/AGGREGATE MIXTURES, <35% FINES OR PROCESSED AGGREGATE. MOST PAVEMENT SUBBASE MATERIALS CAN BE USED IN LIEU OF THIS LAYER.	AASHTO M145 ¹ A-1, A-2-4, A-3 OR AASHTO M43 ¹ 3, 357, 4, 467, 5, 56, 57, 6, 67, 68, 7, 78, 8, 89, 9, 10	BEGIN COMPACTIONS AFTER 12" (300 mm) OF MATERIAL OVER THE CHAMBERS IS REACHED. COMPACT ADDITIONAL LAYERS IN 6" (150 mm) MAX LIFTS TO A MIN. 95% PROCTOR DENSITY FOR WELL GRADED MATERIAL AND 95% RELATIVE DENSITY FOR PROCESSED AGGREGATE MATERIALS. ROLLER GROSS VEHICLE WEIGHT NOT TO EXCEED 12,000 lbs (53 kN). DYNAMIC FORCE NOT TO EXCEED 20,000 lbs (89 kN).
B	EMBEDMENT STONE: FILL SURROUNDING THE CHAMBERS FROM THE FOUNDATION STONE ('A' LAYER) TO THE 'C' LAYER ABOVE.	CLEAN, CRUSHED, ANGULAR STONE OR RECYCLED CONCRETE ⁵	AASHTO M43 ¹ 3, 357, 4, 467, 5, 56, 57	NO COMPACTION REQUIRED.
A	FOUNDATION STONE: FILL BELOW CHAMBERS FROM THE SUBGRADE UP TO THE FOOT (BOTTOM) OF THE CHAMBER.	CLEAN, CRUSHED, ANGULAR STONE OR RECYCLED CONCRETE ⁵	AASHTO M43 ¹ 3, 357, 4, 467, 5, 56, 57	PLATE COMPACT OR ROLL TO ACHIEVE A FLAT SURFACE. ^{2,3}

PLEASE NOTE:

- THE LISTED AASHTO DESIGNATIONS ARE FOR GRADATIONS ONLY. THE STONE MUST ALSO BE CLEAN, CRUSHED, ANGULAR. FOR EXAMPLE, A SPECIFICATION FOR #4 STONE WOULD STATE: "CLEAN, CRUSHED, ANGULAR NO. 4 (AASHTO M43) STONE".
- STORMTECH COMPACTION REQUIREMENTS ARE MET FOR 'A' LOCATION MATERIALS WHEN PLACED AND COMPACTED IN 6" (150 mm) (MAX) LIFTS USING TWO FULL COVERAGES WITH A VIBRATORY COMPACTOR.
- WHERE INFILTRATION SURFACES MAY BE COMPROMISED BY COMPACTION, FOR STANDARD DESIGN LOAD CONDITIONS, A FLAT SURFACE MAY BE ACHIEVED BY RAKING OR DRAGGING WITHOUT COMPACTION EQUIPMENT. FOR SPECIAL LOAD DESIGNS, CONTACT STORMTECH FOR COMPACTION REQUIREMENTS.
- ONCE LAYER 'C' IS PLACED, ANY SOIL/MATERIAL CAN BE PLACED IN LAYER 'D' UP TO THE FINISHED GRADE. MOST PAVEMENT SUBBASE SOILS CAN BE USED TO REPLACE THE MATERIAL REQUIREMENTS OF LAYER 'C' OR 'D' AT THE SITE DESIGN ENGINEER'S DISCRETION.
- WHERE RECYCLED CONCRETE AGGREGATE IS USED IN LAYERS 'A' OR 'B' THE MATERIAL SHOULD ALSO MEET THE ACCEPTABILITY CRITERIA OUTLINED IN TECHNICAL NOTE 6.20 "RECYCLED CONCRETE STRUCTURAL BACKFILL".

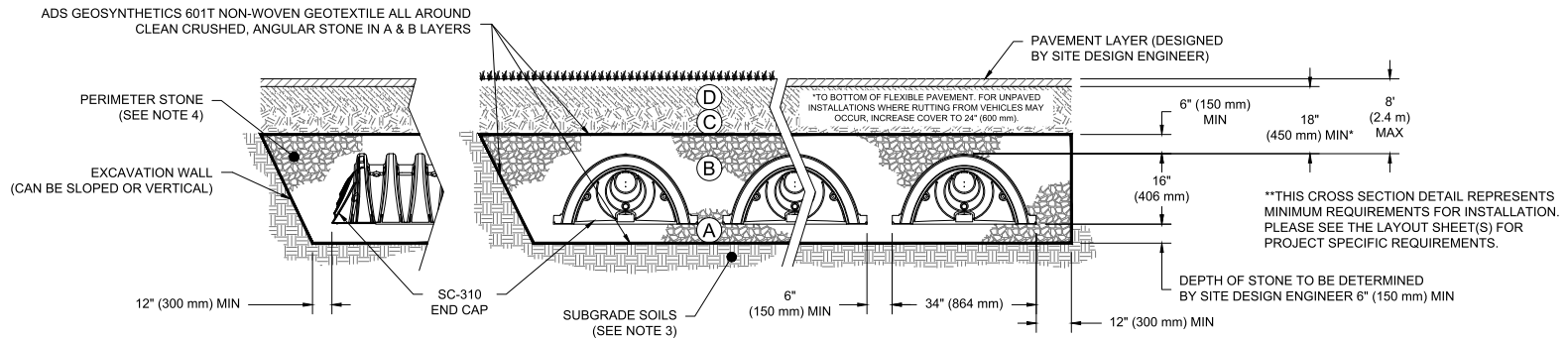

NOTES:

- CHAMBERS SHALL MEET THE REQUIREMENTS OF ASTM F2922 (POLETHYLENE) OR ASTM F2418 (POLYPROPYLENE), "STANDARD SPECIFICATION FOR CORRUGATED WALL STORMWATER COLLECTION CHAMBERS".
- SC-310 CHAMBERS SHALL BE DESIGNED IN ACCORDANCE WITH ASTM F2787 "STANDARD PRACTICE FOR STRUCTURAL DESIGN OF THERMOPLASTIC CORRUGATED WALL STORMWATER COLLECTION CHAMBERS".
- THE SITE DESIGN ENGINEER IS RESPONSIBLE FOR ASSESSING THE BEARING RESISTANCE (ALLOWABLE BEARING CAPACITY) OF THE SUBGRADE SOILS AND THE DEPTH OF FOUNDATION STONE WITH CONSIDERATION FOR THE RANGE OF EXPECTED SOIL MOISTURE CONDITIONS.
- PERIMETER STONE MUST BE EXTENDED HORIZONTALLY TO THE EXCAVATION WALL FOR BOTH VERTICAL AND SLOPED EXCAVATION WALLS.
- REQUIREMENTS FOR HANDLING AND INSTALLATION:
 - TO MAINTAIN THE WIDTH OF CHAMBERS DURING SHIPPING AND HANDLING, CHAMBERS SHALL HAVE INTEGRAL, INTERLOCKING STACKING LUGS.
 - TO ENSURE A SECURE JOINT DURING INSTALLATION AND BACKFILL, THE HEIGHT OF THE CHAMBER JOINT SHALL NOT BE LESS THAN 2".
 - TO ENSURE THE INTEGRITY OF THE ARCH SHAPE DURING INSTALLATION, a) THE ARCH STIFFNESS CONSTANT AS DEFINED IN SECTION 6.2.8 OF ASTM F2922 SHALL BE GREATER THAN OR EQUAL TO 400 LBS/FT²%. AND b) TO RESIST CHAMBER DEFORMATION DURING INSTALLATION AT ELEVATED TEMPERATURES (ABOVE 73° F / 23° C), CHAMBERS SHALL BE PRODUCED FROM REFLECTIVE GOLD OR YELLOW COLORS.

SC-310	STANDARD CROSS SECTION	DRAWN: SLS	CHECKED: SLS
	DATE: 12/21/23	PROJECT #:	
	DESCRIPTION	DATE	DRAWN
THIS DRAWING HAS BEEN PREPARED BASED ON INFORMATION PROVIDED TO ADS UNDER THE DIRECTION OF THE SITE DESIGN ENGINEER OR OTHER PROJECT REPRESENTATIVE. THE SITE DESIGN ENGINEER SHALL REVIEW THIS DRAWING PRIOR TO CONSTRUCTION. IT IS THE ULTIMATE RESPONSIBILITY OF THE SITE DESIGN ENGINEER TO ENSURE THAT THE PRODUCT(S) DEPICTED AND ALL ASSOCIATED DETAILS MEET ALL APPLICABLE LAWS, REGULATIONS, AND PROJECT REQUIREMENTS.			
		888-892-2654 WWW.STORMTECH.COM	
4640 TRUEMAN BLVD HILLIARD, OH 43026		1 SHEET OF 1	

User Inputs

Chamber Model:	SC-310
Outlet Control Structure:	Yes
Project Name:	200 Baribeau - 20 Chambers
Engineer:	undefined undefined
Project Location:	
Measurement Type:	Metric
Required Storage Volume:	38.00 cubic meters.
Stone Porosity:	40%
Stone Foundation Depth:	153 mm.
Stone Above Chambers:	200 mm.
Design Constraint Dimensions:	(9.01 m. x 20.01 m.)

Results

System Volume and Bed Size

Installed Storage Volume:	40.52 cubic meters.
Storage Volume Per Chamber:	0.42 cubic meters.
Number Of Chambers Required:	35
Number Of End Caps Required:	10
Chamber Rows:	5
Maximum Length:	17.67 m.
Maximum Width:	5.93 m.
Approx. Bed Size Required:	104.70 square meters.
Average Cover Over Chambers:	N/A .

System Components

Amount Of Stone Required:	65 cubic meters
Volume Of Excavation (Not Including Fill):	80 cubic meters
Total Non-woven Geotextile Required:	295 square meters
Woven Geotextile Required (excluding Isolator Row):	27 square meters
Woven Geotextile Required (Isolator Row):	23 square meters
Total Woven Geotextile Required:	49 square meters
Impervious Liner Required:	0 square meters

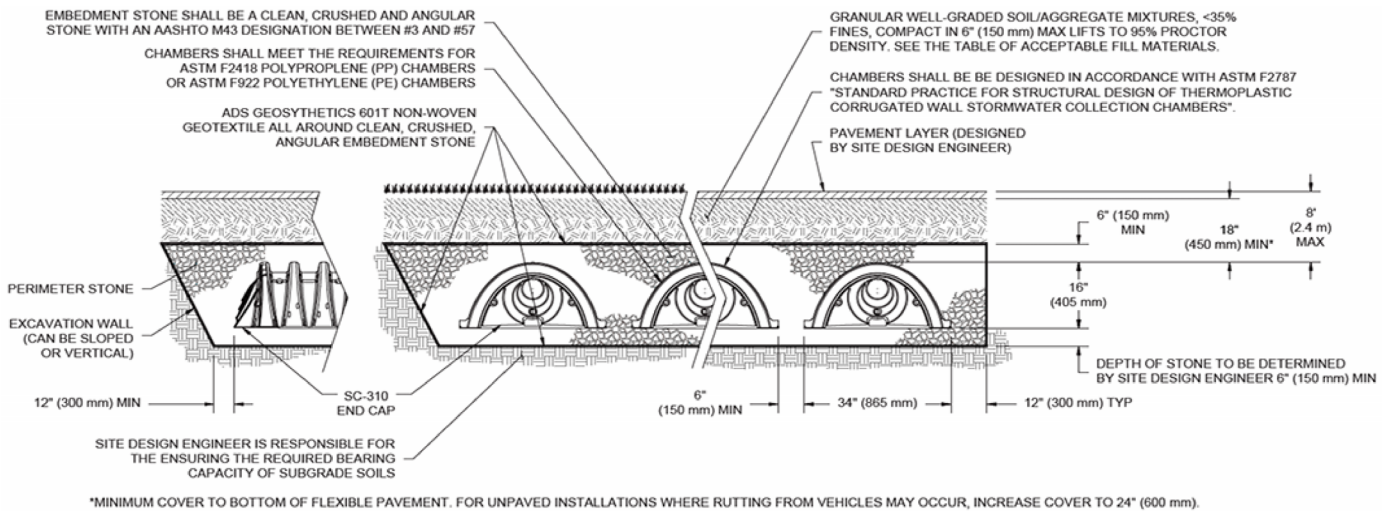

FRP_Ottawa East_2yr_v2_FF FRP_Ottawa East_100yr_v2 FRP_Ottawa East_50yr_v2 FRP_Ottawa East_25yr_v2 FRP_Ottawa East_10yr_v2 FRP_Ottawa East_5yr_v2 FRP_Ottawa East_2yr_v2

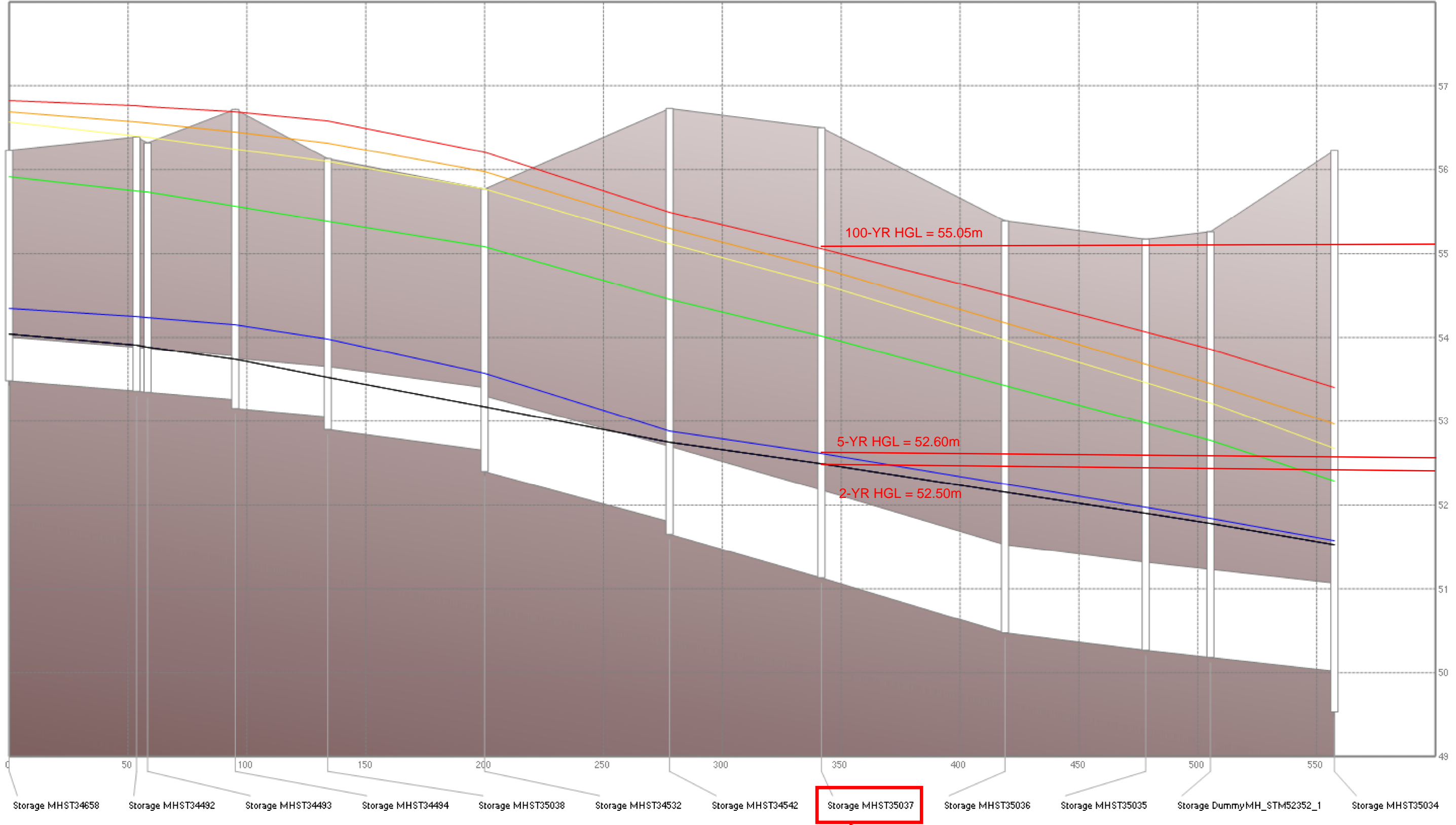

Storage MHST35037

MANHOLE LOCATED AT
127 CARILLON STREET

APPENDIX C: Drawings

119068-GP
119068-GR
119068-STM
119068-ESC

ICD TABLE				
STRUCTURE ID	ICD TYPE	INVERT (m)	100-YR HEAD (m)	100-YR PEAK FLOW (L/s)
RY3	90mm	E=55.30 W=55.30	0.71	14.0
RY1	TEMPEST LMF	E=54.45 W=54.45	1.14	6.1
2	152mm	N=53.11 S=52.51	3.70	92.1

SANITARY MANHOLE TABLE				
MANHOLE ID	SIZE (mm)	T/G ELEV (m)	INVERT (m)	PIPE DIAMETER (mm)
3	1200	56.67	E=54.07 W=54.13	E=200 W=200
5	1200	56.69	N=54.36 E=54.28 W=54.30	N=200 E=200 W=200
7	1200	55.64	W=53.78 N=53.69 S=53.69	W=200 N=250 S=250
9	1200	56.48	N=54.18 E=54.12	N=200 E=200
11	1200	56.28	E=54.34 W=54.28	E=150 S=200
13	1200	56.74	S=54.08 W=54.14	S=200 W=150
15	1200	56.52	W=53.92 E=53.91 N=53.97	W=200 E=200 N=200
17	1200	56.69	S=54.47 W=54.52	S=200 W=150
19	1200	56.75	S=54.51 E=54.45	S=150 E=200

STORM MANHOLE TABLE				
MANHOLE ID	SIZE (mm)	T/G ELEV (m)	INVERT (m)	PIPE DIAMETER (mm)
2	1200	56.29	N=53.11 S=53.51	N=450 S=450
4	1200	56.44	S=53.55 E=53.58	S=450 E=450
6	1200	56.49	N=54.31 W=53.89 S=54.67	N=375 W=450 E=200
8	1200	56.66	N=55.10 E=55.09 W=55.17	N=375 E=375 W=300
10	1200	56.70	E=55.32 S=55.24 W=55.32	E=300 S=375 W=300
CBMH1	1200	56.57	W=55.05 S=54.62 E=55.12	W=375 S=375 E=300
CBMH2	1200	56.06	N=53.29 S=53.28 W=55.05	N=450 S=450 W=450

CATCHBASIN TABLE		
CB ID	T/G ELEVATION	INVERT
CB1	56.25	54.85
CB2	56.25	54.85
CB3	56.06	55.28

REAR YARD CATCHBASIN TABLE				
RYCB No.	T/G ELEVATION	INVERT	I.C.D.	
LC1	56.58	55.27	-	-
LC2	56.57	55.20	-	-
LC3	56.55	55.49	-	-
LC4	55.69	55.09	-	-
LC5	55.80	55.24	-	-
RY1	55.50	54.45	90mm	TEMPEST LMF
RY2	56.55	55.43	-	-
RY3	55.84	55.30	90mm	
RY4	55.25	54.60	-	-
RY5	56.01	55.45	-	-
RY6	55.72	55.02	-	-
RY7	56.56	55.26	-	-
RY8	56.55	55.20	-	-
RY9	56.55	55.55	-	-
RY10	56.60	55.35	-	-
RY11	56.60	55.43	-	-

SEWER CROSSING TABLE		
LOCATION	ELEVATIONS	CLEARANCE
C1	SAN INV=53.96 WM OBV=53.46	0.50m
C2	WM INV=53.97 STM OBV=53.67	0.30m
C3	SAN INV=54.03 STM OBV=53.66	0.37m
C4	STM INV=55.48 SAN OBV=54.52	0.97m
C5	STM INV=55.24 SAN OBV=54.57	0.67m
C6	STM INV=54.32 SAN OBV=54.13	0.20m
C7	SAN INV=54.49 STM OBV=54.26	0.23m
C8	SAN INV=53.76 STM OBV=53.45	0.31m
C9	WM INV=53.75 STM OBV=53.45	0.30m
C10	SAN INV=53.69 WM OBV=53.19	0.50m
C11	WM INV=53.90 STM OBV=52.16	1.74m
C12	SAN INV=52.63 STM OBV=52.11	0.52m
C13	STM INV=55.36 SAN OBV=54.57	0.79m

WATERMAIN TABLE			
Station	PROPOSED GROUND ELEVATION	TOP OF WATERMAIN	DESCRIPTION
1+000.00	56.04	53.64	200 x 200 TEE
1+019.33	56.70	54.30	R3-1
1+026.16	56.75	54.36	WTR SERVICE
1+044.81	56.77	54.49	WTR SERVICE
1+049.60	56.76	54.36	WTR SERVICE
1+071.02	56.78	54.38	WTR SERVICE
1+079.75	56.72	54.32	H. BEND
1+084.33	56.75	54.35	H. BEND
1+111.03	56.74	54.34	VB2
1+124.70	56.73	54.33	WTR SERVICE
1+125.70	56.72	54.34	WTR SERVICE
1+138.39	56.65	54.25	H. BEND
1+139.03	56.71	54.31	HYD1 TEE
1+141.67	56.51	54.11	H. BEND
1+162.35	56.52	54.22	WTR SERVICE
1+172.43	56.56	54.21	WTR SERVICE
1+181.58	56.53	54.13	HYD2 TEE
1+195.43	56.56	54.16	WTR SERVICE
1+201.39	56.65	54.25	R3-2
1+221.32	55.70	53.30	200 x 200 TEE

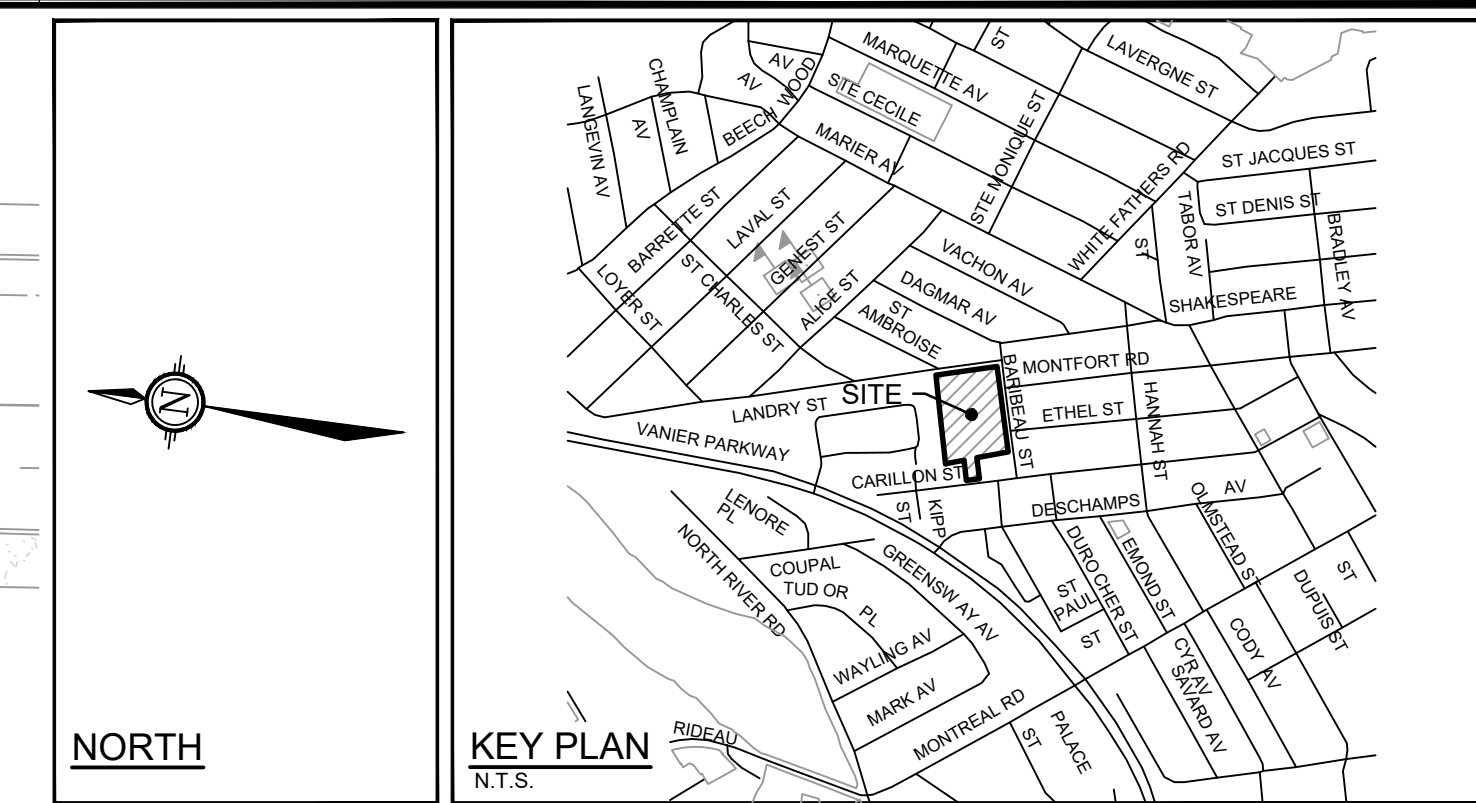
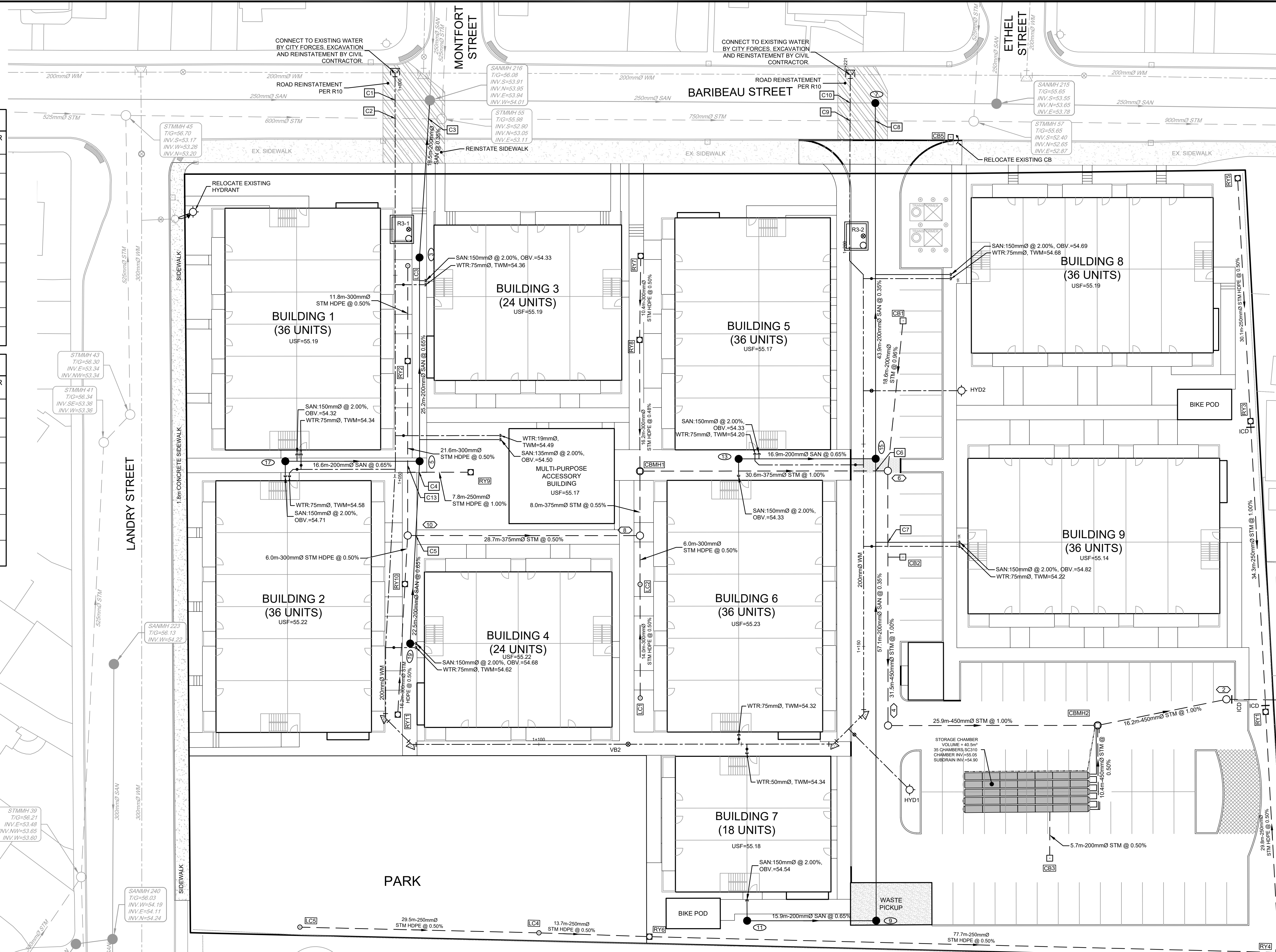

- GENERAL NOTES:**
- DIMENSIONS AND LAYOUT INFORMATION SHALL BE CONFIRMED PRIOR TO COMMENCEMENT OF CONSTRUCTION.
 - THE ORIGINAL TOPOGRAPHY AND GROUND ELEVATIONS, SERVICING AND SURVEY INFORMATION SHOWN ON THIS PLAN ARE SUPPLIED FOR INFORMATION PURPOSES ONLY. IT SHALL BE THE RESPONSIBILITY OF THE CONTRACTOR TO VERIFY THE ACCURACY OF ALL INFORMATION OBTAINED FROM THIS PLAN.
 - CO-ORDINATE AND SCHEDULE ALL WORK WITH OTHER TRADES AND CONTRACTORS.
 - BEFORE COMMENCING CONSTRUCTION, PROVIDE PROOF OF COMPREHENSIVE ALL RISK AND OPERATIONAL LIABILITY INSURANCE INCLUDING BLASTING. INSURANCE POLICY TO NAME THE OWNER, ENGINEER AND THE CITY AS CO-INSURED.
 - CONNECT TO EXISTING SYSTEMS AS DETAILED, INCLUDING ALL RESTORATION WORK NECESSARY TO REINSTATE SURFACES TO EXISTING CONDITIONS OR BETTER.
 - DETERMINE THE EXACT LOCATION, SIZE, MATERIAL AND ELEVATION OF ALL EXISTING UTILITIES PRIOR TO COMMENCING CONSTRUCTION. PROTECT AND ASSUME RESPONSIBILITY FOR ALL EXISTING UTILITIES WHETHER OR NOT SHOWN ON THESE DRAWINGS.
 - OBTAIN AND PAY FOR ALL NECESSARY PERMITS AND APPROVALS BEFORE COMMENCING CONSTRUCTION.
 - RESTORE ALL TRENCHES AND SURFACE FEATURES TO EXISTING CONDITIONS OR BETTER AND TO THE SATISFACTION OF MUNICIPAL AUTHORITIES.
 - REMOVE FROM SITE ALL DEBRIS AND EXCESS EXCAVATED MATERIAL UNLESS OTHERWISE INSTRUCTED BY THE ENGINEER.
 - ALL ELEVATIONS ARE GEODETIC AND UTILIZE METRIC UNITS.
 - REFER TO GEOTECHNICAL INVESTIGATION PA#278-1 (DATED JULY 15, 2019, PREPARED BY PATERSON GROUP INC. FOR SUBSURFACE CONDITIONS AND CONSTRUCTION RECOMMENDATIONS).
 - PERFORATED PIPE SUB-DRAINS TO BE PROVIDED AT SUBGRADE LEVEL EXTENDING FROM THE ROADSIDE CATCHBASIN FOR A DISTANCE OF 3.0m, PARALLEL TO THE CURB IN TWO DIRECTIONS.

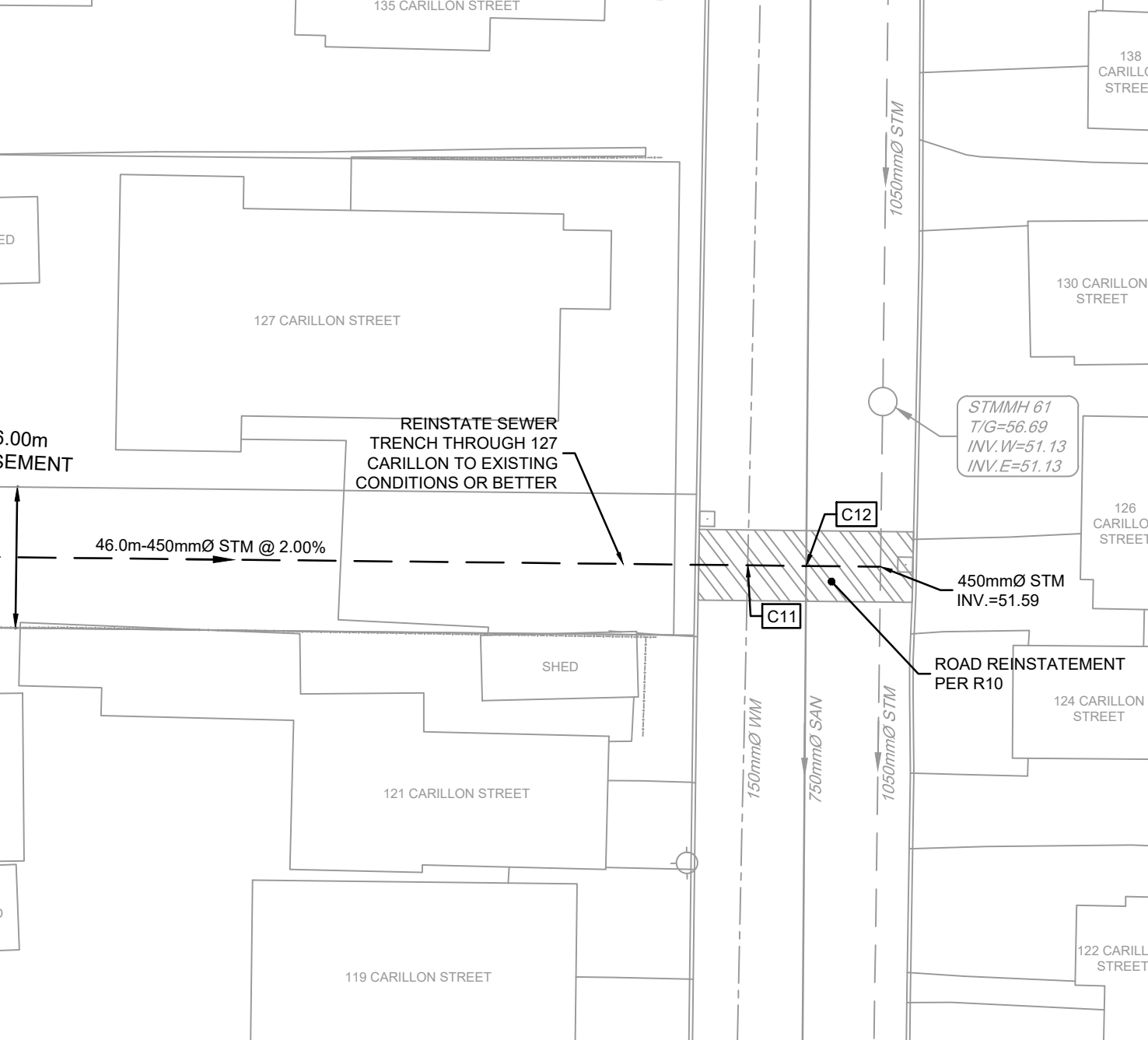

- SEWER NOTES:**
- SPECIFICATIONS:

ITEM	SPEC. No.	REFERENCE
CATCHBASIN (600x600mm)	705.010	OPSD
CATCHBASIN MANHOLE (1200)	701.010	OPSD
STORM / SANITARY MANHOLE (1200)	701.010	OPSD
ROADSIDE CB. FRAME & COVER	S2 & S19	CITY OF OTTAWA
CBMH FRAME & COVER	S25 & S28	CITY OF OTTAWA
STORM / SANITARY MH FRAME & COVER	S24 / S24 & S25	CITY OF OTTAWA
STORM SEWER	PVC DR 35 OR CONC.	(CLASS SPECIFIED ON PROFILE DRAWINGS)
SANITARY SEWER	PVC DR 35	
CATCHBASIN LEAD	PVC DR 35	
 - INSULATE ALL PIPES (SAN/STM) THAT HAVE LESS THAN 1.5m COVER WITH 50mmx1200mm HI-40 INSULATION. PROVIDE 150mm CLEARANCE BETWEEN PIPE AND INSULATION.
 - SERVICES ARE TO BE CONSTRUCTED TO PROPERTY LINE AT MINIMUM SLOPE OF 1.0% (2.0% IS PREFERRED).
 - PIPE BEDDING, COVER AND BACKFILL ARE TO BE COMPACTED TO AT LEAST 95% OF THE STANDARD PROCTOR MAXIMUM DRY DENSITY. THE USE OF CLEAR CRUSHED STONE AS A BEDDING LAYER SHALL NOT BE PERMITTED.
 - SEWER SERVICE CONNECTIONS PER CITY OF OTTAWA DETAILS S11 AND S11.1.
 - THE SITE SERVICING CONTRACTOR SHALL PERFORM FIELD TESTS FOR QUALITY CONTROL OF ALL SANITARY SEWERS. LEAKAGE TESTING SHALL BE COMPLETED IN ACCORDANCE WITH OPSQ 410.07.16 AND 407.07.24. DYE TESTING IS TO BE COMPLETED ON ALL SANITARY SERVICES TO CONFIRM PROPER CONNECTION TO THE SANITARY SEWER MAIN. THE FIELD TESTS SHALL BE PERFORMED IN THE PRESENCE OF THE ENGINEER.
 - STORM MANHOLES AND CBMHs SHALL HAVE 300mm SUMPS UNLESS OTHERWISE INDICATED.
 - CONTRACTOR TO TELEVIEW (CCTV) ALL PROPOSED SEWERS, 200mm OR GREATER PRIOR TO BASE COURSE ASPHALT. UPON COMPLETION OF CONTRACT, THE CONTRACTOR IS RESPONSIBLE TO FLUSH AND CLEAN ALL SEWERS & APPURTENANCES.

- WATERMAIN NOTES:**
- GENERAL:

ITEM	DETAIL No.	REFERENCE
WATERMAIN TRENCHING	W17	CITY OF OTTAWA
THERMAL INSULATION IN SHALLOW TRENCHES	W22	CITY OF OTTAWA
WATERMAIN CROSSING BELOW SEWER / OVER SEWER	W25 / W25.2	CITY OF OTTAWA
 - THE WATERMAIN SHALL BE PVC DR 18 IN ACCORDANCE WITH MATERIAL SPECIFICATION MW-18.1, UNLESS OTHERWISE INDICATED.
 - SUPPLY AND CONSTRUCT ALL WATERMANS AND APPURTENANCES IN ACCORDANCE WITH THE CITY OF OTTAWA STANDARDS AND SPECIFICATIONS. EXCAVATION, INSTALLATION, BACKFILL AND RESTORATION OF ALL WATERMANS BY THE CONTRACTOR. CONNECTIONS AND SHUT-OFFS AT THE MAIN AND CHLORINATION OF THE WATER SYSTEM SHALL BE PERFORMED BY CITY OFFICIALS.
 - WATERMAIN SHALL BE MINIMUM 2.4m DEPTH BELOW GRADE UNLESS OTHERWISE INDICATED.
 - PROVIDE MINIMUM 0.50m CLEARANCE BETWEEN OUTSIDE OF PIPES AT ALL CROSSINGS.

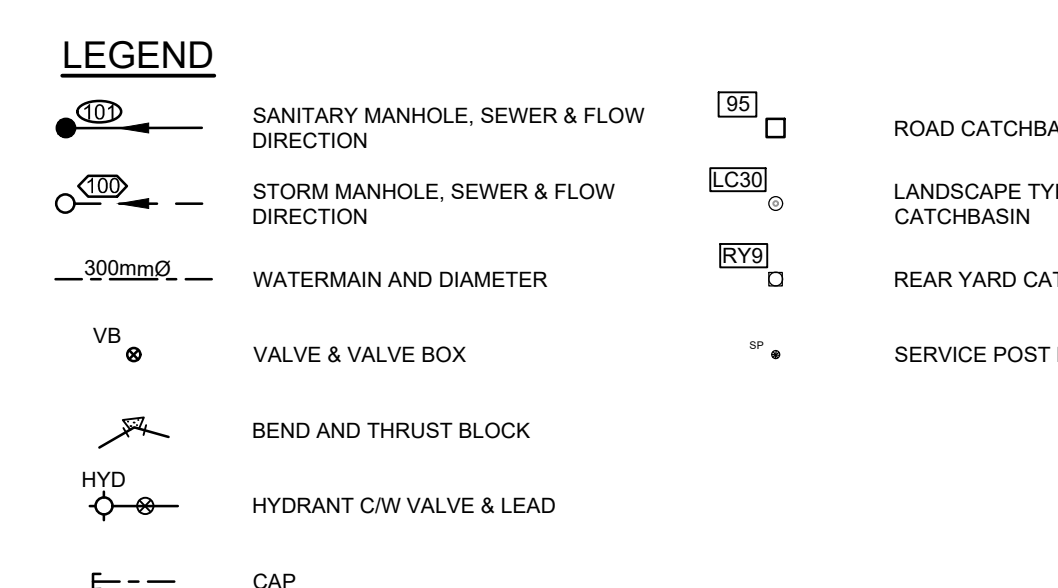

NOTES:
 RIDEAU RIVER REGULATORY FLOOD LEVEL (REDUCED FLOOD RISK) = 56.44
 ALL BUILDINGS ARE SLAB-ON-GRADE

NOTE:
 THE POSITION OF ALL POLE LINES, CONDUITS, WATERMANS, SEWERS AND OTHER UNDERGROUND AND OVERGROUND UTILITIES AND STRUCTURES IS NOT NECESSARILY SHOWN ON THE CONTRACT DRAWINGS, AND WHERE SHOWN, THE ACCURACY OF THE POSITION OF SUCH UTILITIES AND STRUCTURES IS NOT GUARANTEED. BEFORE STARTING WORK, DETERMINE THE EXACT LOCATION OF ALL SUCH UTILITIES AND STRUCTURES AND ASSUME ALL LIABILITY FOR DAMAGE TO THEM.

No.	REVISION	DATE	BY	No.	REVISION	DATE	BY
16.	SITE PLAN UPDATE	OCT 9/24	MAB	8.	CITY SUBMISSION	OCT 21/21	MAB
15.	CONCEPT UPDATE	JUN 27/24	MAB	7.	CITY SUBMISSION	AUG 3/21	MAB
14.	MINOR UPDATES TO BLOCKS 1-4, 9	NOV 16/22	MAB	6.	CITY SUBMISSION	JUN 8/21	MAB
13.	USF LOWERED BLOCKS 1, 2, 3, 4 & 9	JUL 20/22	MAB	5.	CITY SUBMISSION	FEB 5/21	MAB
12.	SITE PLAN UPDATE	JUL 15/22	MAB	4.	STORM OUTLET VIA 127 CARILLION	OCT 23/20	MAB
11.	ISSUED FOR ECA	MAR 24/22	MAB	3.	SITE PLAN APPLICATION	AUG 24/20	MAB
10.	ISSUED FOR BUILDING PERMIT	MAR 2/22	MAB	2.	RVCA APPROVAL IN PRINCIPAL APPLICATION	MAY 28/20	MAB
9.	CITY SUBMISSION - PARK UPDATE	FEB 15/22	MAB	1.	ISSUED FOR RVCA REVIEW	MAR 26/20	MAB

SCALE
1:250

FOR REVIEW ONLY

DATE: DTD
 CHECKED: LRW
 DRAWN: DTD
 APPROVED: LRW
 MAB

PROFESSIONAL ENGINEER
 L.R. WILSON
 10160055
 PROVINCE OF ONTARIO

PROFESSIONAL ENGINEER
 M.A. BISSETT
 2026.03.10
 PROVINCE OF ONTARIO

NOVATECH
 Engineers, Planners & Landscape Architects
 Suite 200, 240 Michael Copland Drive
 Ottawa, Ontario, Canada K2M 1P6
 Telephone: (613) 254-9643
 Facsimile: (613) 254-5867
 Website: www.novatech-eng.com

CITY OF OTTAWA
 DOMINION VILLAGE - 200 BARBEAU STREET

SERVICING PLAN

PROJECT No.: 119068
 REV: REV #18
 DRAWING No.: 119068-GP

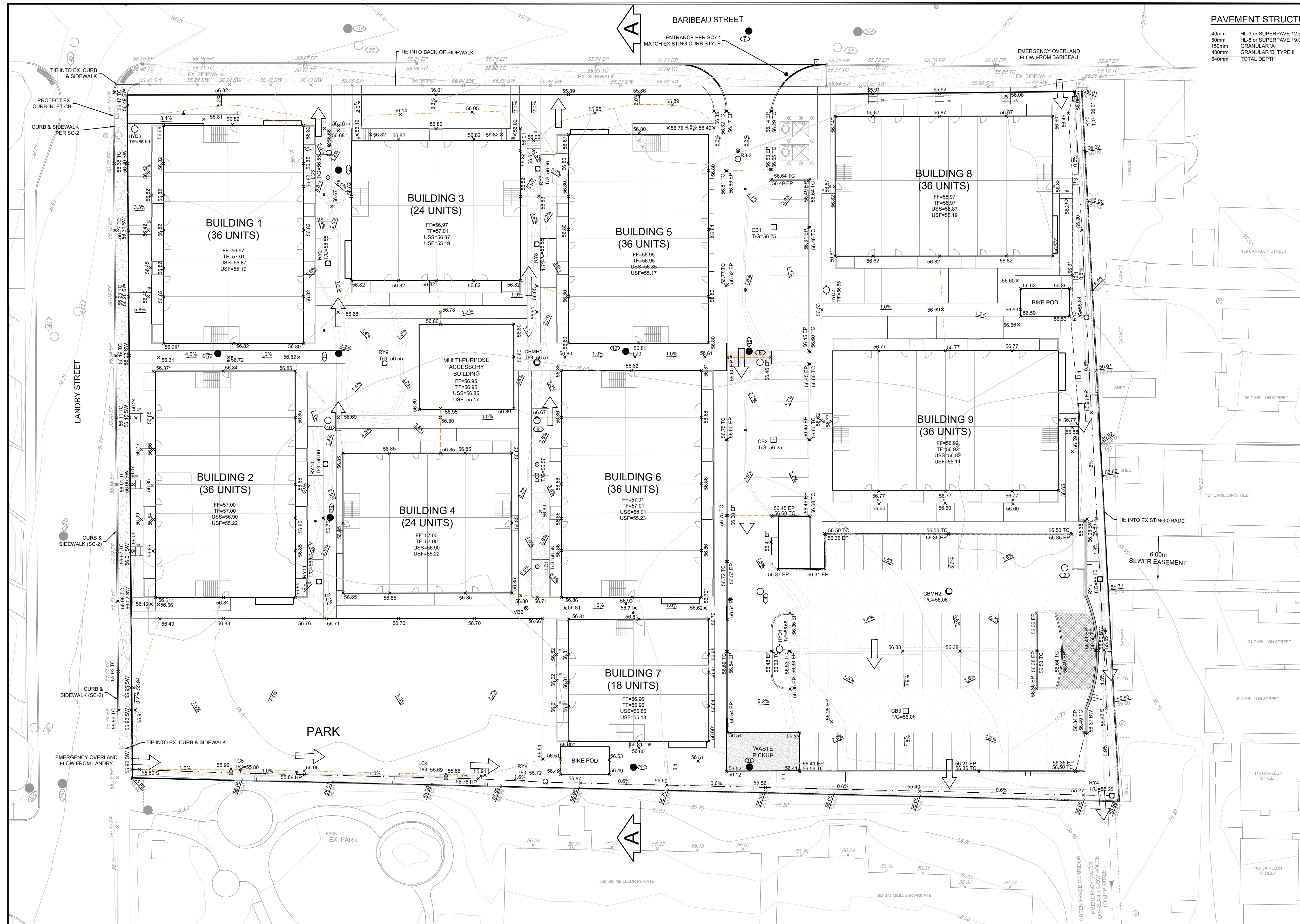

PAVEMENT STRUCTURE:

40mm	HL-3 or SUPERPAVE 12.5 PG 58-34
50mm	HL-4 or SUPERPAVE 15.0 PG 58-34
150mm	GRANULAR 'A'
400mm	GRANULAR 'B' TYPE II
640mm	TOTAL DEPTH

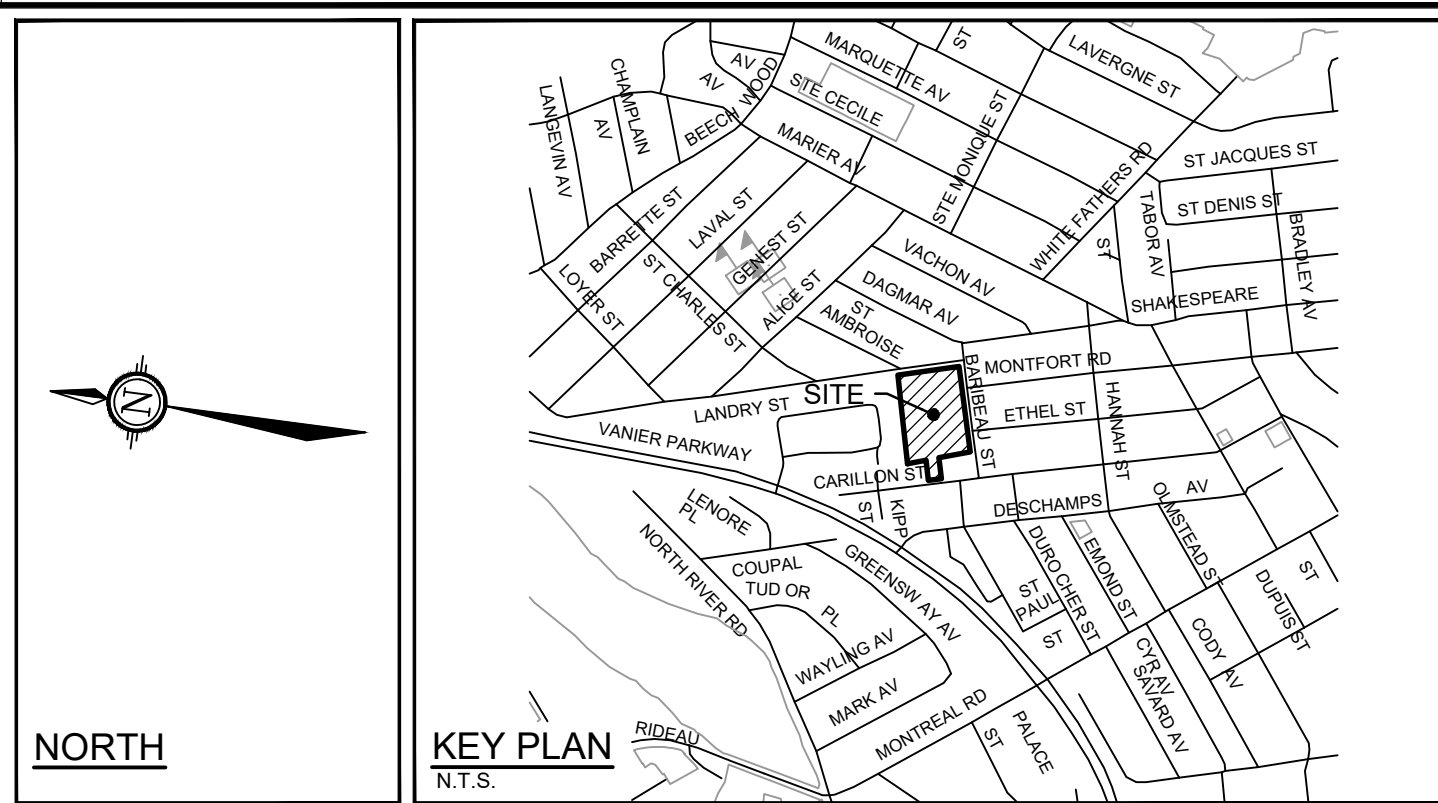

LEGEND

PROPOSED ELEVATION	HYDRANT WITH TOP OF FLANGE ELEVATION
PROPOSED ELEVATION AT BUILDING LESS THAN 1.5m COVER	STORM MANHOLE
PROPOSED GRADE AND DIRECTION OF FLOW	CATCHBASIN WITH TOP OF GRATE ELEVATION
PROPOSED ELEVATION AT HIGH POINT	LANDSCAPE TYPE CATCHBASIN WITH TOP OF GRATE ELEVATION
PROPOSED ELEVATION EXISTING ELEVATION	VALVE & VALVE BOX LOCATION
EXISTING SPOT ELEVATION	FINISHED FLOOR
EXISTING ELEVATION AT BACK OF SIDEWALK	TOP OF FOUNDATION
EXISTING CONTOUR ELEVATION	UNDERSIDE OF SLAB
EXISTING UTILITY POLE AND GUY WIRE	UNDERSIDE OF FOOTING
MAJOR OVERLAND FLOW DIRECTION	EDGE OF PAVEMENT
TERRACE GRADE (3:1 MAX)	TOP OF CURB
SWALE AND TERRACE	SIDEWALK
MAX STATIC PONDING LIMITS	GARDEN WALL
100-YR PONDING LIMITS	EXISTING PRIVACY FENCE
100-YR +20% PONDING LIMITS	RIDEAU RIVER REGULATORY FLOOD LEVEL (REDUCED FLOOD RISK) = 56.44

GENERAL NOTES:

- DIMENSIONS AND LAYOUT INFORMATION SHALL BE CONFIRMED PRIOR TO COMMENCEMENT OF CONSTRUCTION.
- THE ORIGINAL TOPOGRAPHY AND GROUND ELEVATIONS, SURVEYING AND SURVEY INFORMATION SHOWN ON THIS PLAN ARE SUPPLIED FOR INFORMATION PURPOSES ONLY. IT SHALL BE THE RESPONSIBILITY OF THE CONTRACTOR TO VERIFY THE ACCURACY OF ALL INFORMATION OBTAINED FROM THIS PLAN.
- COORDINATE AND SCHEDULE ALL WORK WITH OTHER TRADES AND CONTRACTORS.
- BEFORE COMMENCING CONSTRUCTION, PROVIDE PROOF OF COMPREHENSIVE ALL RISK AND OPERATIONAL LIABILITY INSURANCE INCLUDING BLASTING, INSURANCE POLICY TO NAME THE OWNER, ENGINEER AND THE CITY AS CO-INSURED. AMOUNT OF INSURANCE TO BE SPECIFIED BY OWNERS AGENT.
- CONNECT TO EXISTING SYSTEMS AS DETAILED, INCLUDING ALL RESTORATION WORK NECESSARY TO REINSTATE SURFACES TO EXISTING CONDITIONS OR BETTER.
- DETERMINE THE EXACT LOCATION, SIZE, MATERIAL AND ELEVATION OF ALL EXISTING UTILITIES PRIOR TO COMMENCING CONSTRUCTION. PROTECT AND ASSUME ALL RESPONSIBILITY FOR ALL EXISTING UTILITIES WHETHER OR NOT SHOWN ON THESE DRAWINGS.
- OBTAIN AND PAY FOR ALL NECESSARY PERMITS AND APPROVALS BEFORE COMMENCING CONSTRUCTION.
- RESTORE ALL TRENCHES AND SURFACE FEATURES TO EXISTING CONDITIONS OR BETTER AND TO THE SATISFACTION OF CITY OF OTTAWA AUTHORITIES.
 - ASPHALT RESTORATION SHALL BE IN ACCORDANCE WITH CITY OF OTTAWA DETAIL R-10.
 - THICKNESS OF GRANULAR MATERIAL AND ASPHALT LAYERS TO MATCH EXISTING.
 - BOULEVARDS SHALL BE REINSTATED WITH 100mm OF TOPSOIL AND SOD.
- REMOVE FROM SITE ALL EXCESS EXCAVATED MATERIAL UNLESS OTHERWISE INSTRUCTED BY ENGINEER.
- ALL ELEVATIONS ARE GEODETIC AND UTILIZE METRIC UNITS.
- REFER TO GEOTECHNICAL INVESTIGATION PG4951-1 (DATED JULY 15, 2019), PREPARED BY PATERSON GROUP FOR SUBSURFACE CONDITIONS AND CONSTRUCTION RECOMMENDATIONS.
- PERFORATED PIPE SUB-DRAINS TO BE PROVIDED AT SUBGRADE LEVEL EXTENDING FROM THE ROADSIDE CATCHBASIN FOR A DISTANCE OF 3.0m, PARALLEL TO THE CURB IN TWO DIRECTIONS.

GRADING AND PAVEMENT NOTES:

- ALL TOPSOIL, ORGANIC OR DELETERIOUS MATERIAL MUST BE ENTIRELY REMOVED FROM BENEATH THE PROPOSED HARD SURFACE (i.e. PAVEMENT, CURB, SIDEWALK, ETC.) AREAS AS DIRECTED BY THE SITE ENGINEER OR GEOTECHNICAL ENGINEER.
- EXPOSED SUBGRADES IN PROPOSED PAVED AREAS SHOULD BE HEAVILY PROOF ROLLED WITH A LARGE (10 TON) VIBRATORY STEEL DRUM ROLLER UNDER DRY CONDITIONS AND INSPECTED BY THE GEOTECHNICAL ENGINEER PRIOR TO THE PLACEMENT OF GRANULARS.
- ANY SOFT AREAS EVIDENT FROM THE PROOF ROLLING SHOULD BE SUB-EXCAVATED AND REPLACED WITH SUITABLE MATERIAL THAT IS FROST COMPATIBLE WITH THE EXISTING SOILS AS RECOMMENDED BY THE GEOTECHNICAL ENGINEER.
- THE GRANULAR BASE SHOULD BE PLACED IN MAXIMUM 300mm LIFTS AND COMPACTED TO AT LEAST 100% OF THE STANDARD PROCTOR MAXIMUM DRY DENSITY VALUE. ANY ADDITIONAL GRANULAR FILL USED BELOW THE PROPOSED PAVEMENT SHOULD BE PLACED IN MAXIMUM 300mm LIFTS AND COMPACTED TO AT LEAST 95% OF THE STANDARD PROCTOR MAXIMUM DRY DENSITY VALUE.
- ROADWAY SUBGRADE TO BE INSPECTED BY THE GEOTECHNICAL ENGINEER AT THE TIME OF CONSTRUCTION TO REVIEW IF A WOVEN GEOTEXTILE IS REQUIRED BELOW THE GRANULAR MATERIALS, AND TO CONFIRM THE DEPTH AND COMPACTION OF GRANULAR 'B'.
- MINIMUM OF 2% GRADE FOR ALL GRASS AREAS UNLESS OTHERWISE NOTED.
- MAXIMUM TERRACING GRADE TO BE 3:1 UNLESS OTHERWISE NOTED.
- ALL GRADES BY CURBS ARE EDGE OF PAVEMENT GRADES UNLESS OTHERWISE INDICATED.
- ALL CURBS SHALL BE MOUNTABLE CURB UNLESS OTHERWISE NOTED AND CONSTRUCTED PER CITY OF OTTAWA STANDARD (SC1.3).
- REFER TO LANDSCAPE PLAN FOR PLANTING AND OTHER LANDSCAPE FEATURE DETAILS.

STRUCTURE	100 YEAR PONDING ELEVATION	100 YEAR +20% PONDING DEPTH (m)	100 YEAR +20% PONDING ELEVATION	100 YEAR +20% PONDING DEPTH (m)	MAX STATIC PONDING ELEVATION	MAX STATIC PONDING DEPTH (m)
CB01	56.47	0.22	56.48	0.23	56.46	0.21
CB02	56.44	0.19	56.45	0.21	56.45	0.20
CB03	56.36	0.30	56.38	0.32	56.36	0.30
CBM01	56.58	0.01	56.63	0.06	56.65	0.08
CBM02	56.36	0.30	56.39	0.33	56.38	0.32
LC01	56.62	0.04	56.67	0.09	56.69	0.11
LC02	56.62	0.05	56.66	0.09	56.67	0.10
LC03	56.66	0.11	56.69	0.14	56.66	0.11
LC04	56.82	0.13	56.89	0.20	56.76	0.07
LC05	56.84	0.09	56.92	0.13	56.89	0.10
RY01	56.60	0.19	56.64	0.14	56.65	0.09
RY02	56.66	0.11	56.69	0.14	56.67	0.12
RY03	56.01	0.17	56.04	0.20	56.01	0.07
RY04	56.59	0.34	56.63	0.38	56.50	0.25
RY05	56.51	0.01	56.54	0.04	56.50	0.00
RY06	56.77	0.05	56.83	0.11	56.72	0.00
RY07	56.59	0.03	56.63	0.07	56.61	0.05
RY08	56.59	0.04	56.63	0.08	56.63	0.08
RY09	56.66	0.11	56.70	0.15	56.68	0.13
RY10	56.66	0.06	56.70	0.10	56.69	0.10
RY11	56.66	0.06	56.70	0.10	56.70	0.09

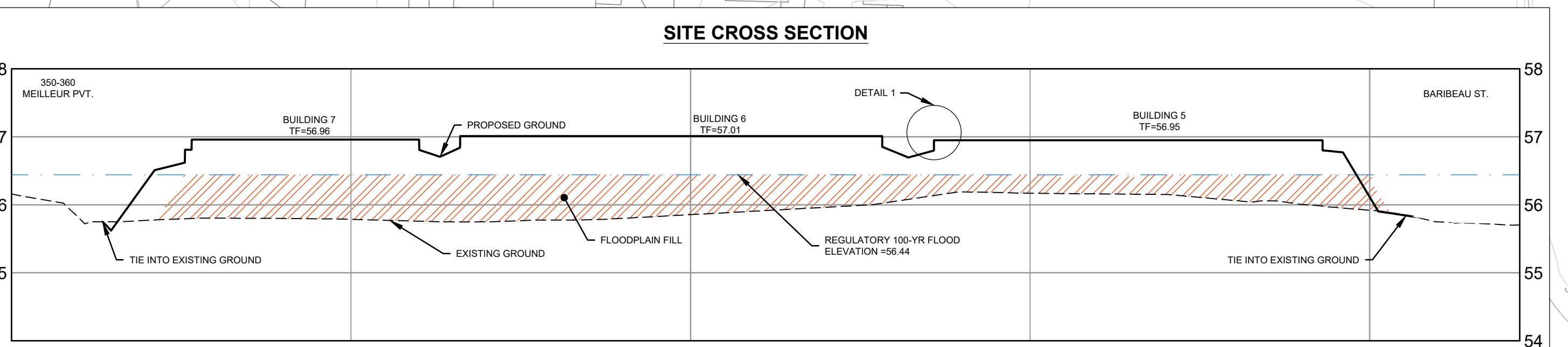
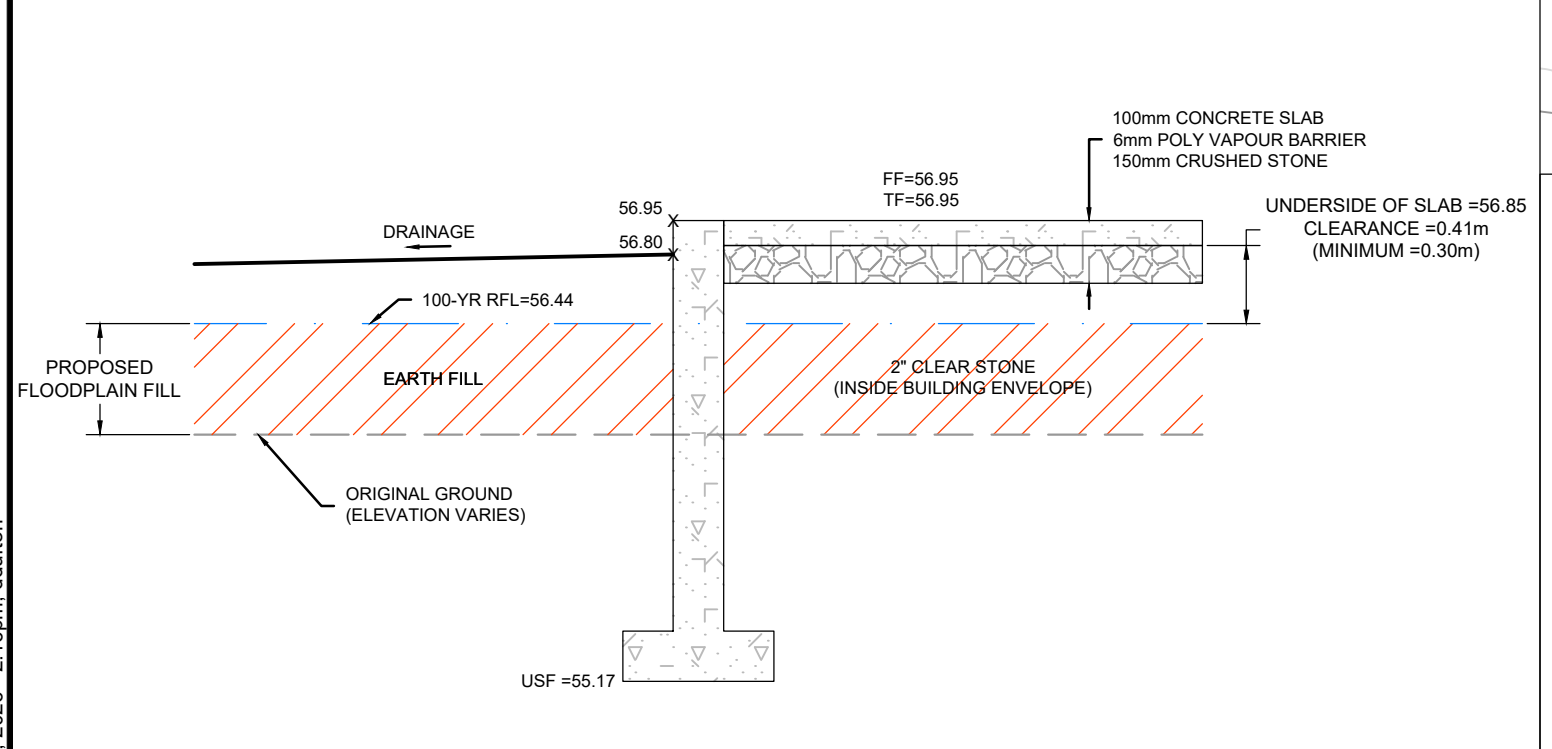

DETAIL 1 - BUILDING 5: FLOOD PROOFING
N.T.S.

SECTION A-A
HORIZONTAL SCALE 1:300
VERTICAL SCALE 1:60

NOTE:
THE POSITION OF ALL POLE LINES, CONDUITS, WATERMANS, SEWERS AND OTHER UNDERGROUND AND OVERGROUND UTILITIES AND STRUCTURES IS NOT NECESSARILY SHOWN ON THE CONTRACT DRAWINGS, AND WHERE SHOWN, THE ACCURACY OF THE POSITION OF SUCH UTILITIES AND STRUCTURES IS NOT GUARANTEED. BEFORE STARTING WORK, DETERMINE THE EXACT LOCATION OF ALL SUCH UTILITIES AND STRUCTURES AND ASSUME ALL LIABILITY FOR DAMAGE TO THEM.

No.	REVISION	DATE	BY	No.	REVISION	DATE	BY
16.	MEILLEUR PVT REAR LOT GRADES ADDED	NOV 30/22	MAB	8.	FILL ADJUSTMENT PER RVCA	SEPT 27/21	MAB
15.	MINOR UPDATES TO BLOCKS 1-4, 9	NOV 16/22	MAB	7.	CITY SUBMISSION	AUG 3/21	MAB
14.	USF LOWERED BLOCK 1, 2, 3, 4 & 9	JUL 20/22	MAB	6.	CITY SUBMISSION	JUN 8/21	MAB
13.	SITE PLAN UPDATE	JUL 15/22	MAB	5.	CITY SUBMISSION	FEB 5/21	MAB
12.	ISSUED FOR ECA	MAR 24/22	MAB	4.	STORM OUTLET VIA 127 CARILLON	OCT 23/20	MAB
11.	ISSUED FOR BUILDING PERMIT	MAR 2/22	MAB	3.	SITE PLAN APPLICATION	AUG 24/20	MAB
10.	CITY SUBMISSION - PARK UPDATE	FEB 15/22	MAB	2.	RVCA APPROVAL IN PRINCIPAL APPLICATION	MAY 29/20	MAB
9.	CITY SUBMISSION	OCT 21/21	MAB	1.	ISSUED FOR RVCA REVIEW	MAR 26/20	MAB

FOR REVIEW ONLY

SCALE: 1:250

DTD [Signature]

LRW [Signature]

DTD [Signature]

LRW [Signature]

MAB [Signature]

NOVATECH
Engineers, Planners & Landscape Architects
Suite 200, 240 Michael Copland Drive
Ottawa, Ontario, Canada K2M 1P6
Telephone: (613) 254-9643
Facsimile: (613) 254-5867
Website: www.novatech-emp.com

CITY OF OTTAWA
DOMINION HALL - 200 BARBEAU STREET

GRADING PLAN

PROJECT No. 119068
REV # 20
DRAWING No. 119068-GR

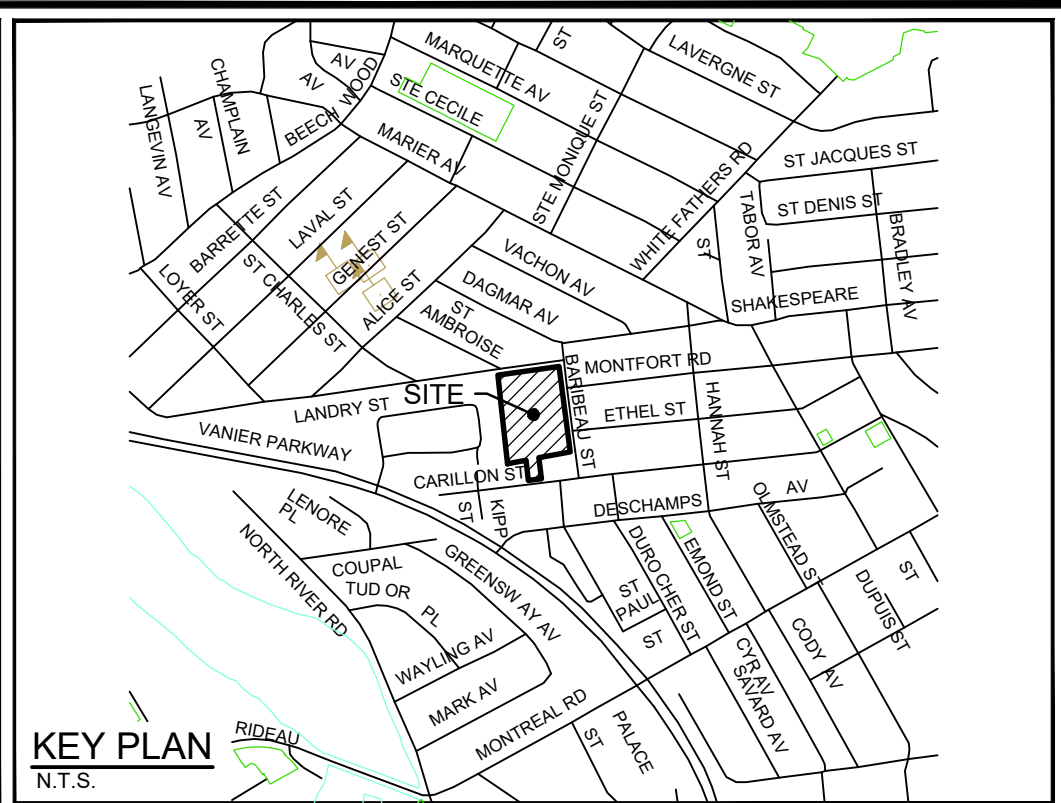
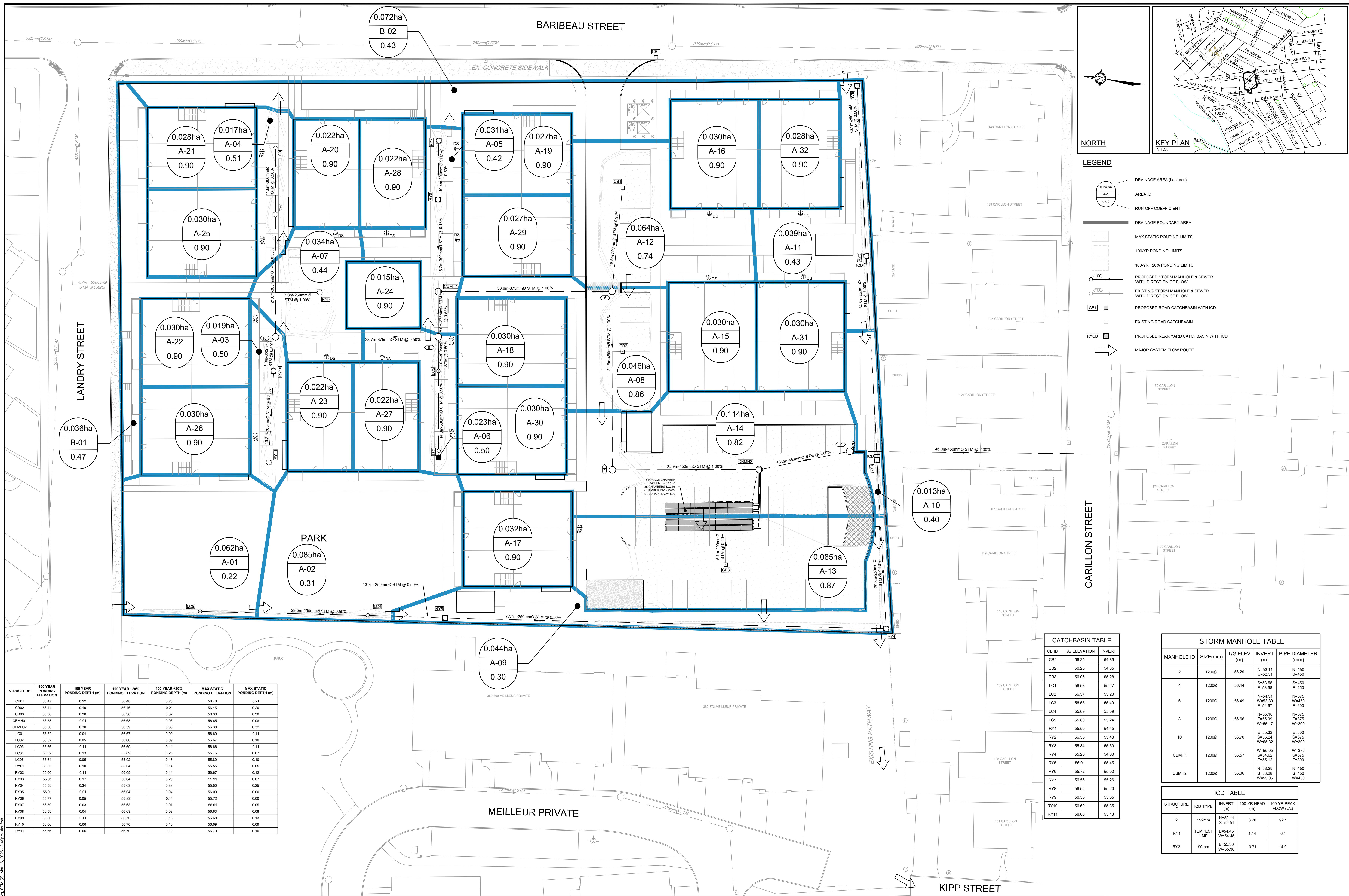

NORTH

LEGEND

- 0.24 ha
0.65 AREA ID
- DRAINAGE AREA (hectares)
- AREA ID
- RUN-OFF COEFFICIENT
- DRAINAGE BOUNDARY AREA
- MAX STATIC PONDING LIMITS
- 100-YR PONDING LIMITS
- 100-YR +20% PONDING LIMITS
- PROPOSED STORM MANHOLE & SEWER WITH DIRECTION OF FLOW
- EXISTING STORM MANHOLE & SEWER WITH DIRECTION OF FLOW
- PROPOSED ROAD CATCHBASIN WITH ICD
- EXISTING ROAD CATCHBASIN
- PROPOSED REAR YARD CATCHBASIN WITH ICD
- MAJOR SYSTEM FLOW ROUTE

CB ID	T/G ELEVATION	INVERT
CB1	56.25	54.85
CB2	56.25	54.85
CB3	56.06	55.28
LC1	56.58	55.27
LC2	56.57	55.20
LC3	56.55	55.49
LC4	56.69	55.09
LC5	56.80	55.24
RY1	55.50	54.45
RY2	56.55	55.43
RY3	55.84	55.30
RY4	55.25	54.60
RY5	56.01	55.45
RY6	55.72	55.02
RY7	56.56	55.26
RY8	56.55	55.20
RY9	56.55	55.55
RY10	56.60	55.35
RY11	56.60	55.43

MANHOLE ID	SIZE(mm)	T/G ELEV (m)	INVERT (m)	PIPE DIAMETER (mm)
2	1200	56.29	N=53.11 S=52.51	N=450 S=450
4	1200	56.44	S=53.55 E=53.58	S=450 E=450
6	1200	56.49	N=54.31 W=53.89 E=54.67	N=375 W=450 E=200
8	1200	56.66	N=55.10 E=55.09 W=55.17	N=375 E=375 W=300
10	1200	56.70	E=55.32 S=55.24 W=55.32	N=375 S=375 W=300
CBMH1	1200	56.57	W=55.05 S=54.62 E=55.12	W=375 S=375 E=300
CBMH2	1200	56.06	N=53.29 S=53.28 W=55.05	N=450 S=450 W=450

STRUCTURE ID	ICD TYPE	INVERT (m)	100-YR HEAD (m)	100-YR PEAK FLOW (L/s)
2	152mm	N=53.11 S=52.51	3.70	92.1
RY1	TEMPEST LMF	E=54.45 W=54.45	1.14	6.1
RY3	90mm	E=55.30 W=55.30	0.71	14.0

STRUCTURE	100 YEAR PONDING ELEVATION	100 YEAR PONDING DEPTH (m)	100 YEAR +20% PONDING ELEVATION	100 YEAR +20% PONDING DEPTH (m)	MAX STATIC PONDING ELEVATION	MAX STATIC PONDING DEPTH (m)
CB01	56.47	0.22	56.48	0.23	56.46	0.21
CB02	56.44	0.19	56.46	0.21	56.45	0.20
CB03	56.36	0.30	56.38	0.32	56.36	0.30
CBMH01	56.58	0.01	56.63	0.06	56.65	0.08
CBMH02	56.36	0.30	56.39	0.33	56.38	0.32
LC01	56.82	0.04	56.87	0.09	56.89	0.11
LC02	56.82	0.05	56.86	0.09	56.87	0.10
LC03	56.66	0.11	56.69	0.14	56.66	0.11
LC04	55.82	0.13	55.89	0.20	55.76	0.07
LC05	55.84	0.05	55.92	0.13	55.89	0.10
RY01	55.60	0.10	55.64	0.14	55.55	0.05
RY02	56.66	0.11	56.69	0.14	56.67	0.12
RY03	56.61	0.17	56.04	0.20	55.91	0.07
RY04	55.59	0.34	55.63	0.38	55.50	0.25
RY05	56.01	0.01	56.04	0.04	56.00	0.00
RY06	55.77	0.05	55.83	0.11	55.72	0.00
RY07	56.59	0.03	56.63	0.07	56.61	0.05
RY08	56.59	0.04	56.63	0.08	56.63	0.08
RY09	56.66	0.11	56.70	0.15	56.68	0.13
RY10	56.66	0.06	56.70	0.10	56.69	0.09
RY11	56.66	0.06	56.70	0.10	56.70	0.10

NOTE: THE POSITION OF ALL POLE LINES, CONDUITS, WATERMANS, SEWERS AND OTHER UNDERGROUND AND OVERGROUND UTILITIES AND STRUCTURES IS NOT NECESSARILY SHOWN ON THE CONTRACT DRAWINGS, AND WHERE SHOWN, THE ACCURACY OF THE POSITION OF SUCH UTILITIES AND STRUCTURES IS NOT GUARANTEED. BEFORE STARTING WORK, DETERMINE THE EXACT LOCATION OF ALL SUCH UTILITIES AND STRUCTURES AND ASSUME ALL LIABILITY FOR DAMAGE TO THEM.

No.	REVISION	DATE	BY	No.	REVISION	DATE	BY
8.	ISSUED FOR ECA	MAR 24/22	MAB	8.	ISSUED FOR ECA	MAR 24/22	MAB
7.	CITY SUBMISSION - PARK UPDATE	FEB 15/22	MAB	7.	CITY SUBMISSION - PARK UPDATE	FEB 15/22	MAB
6.	CITY SUBMISSION	JUN 8/21	MAB	6.	CITY SUBMISSION	JUN 8/21	MAB
5.	CITY SUBMISSION	FEB 5/21	MAB	5.	CITY SUBMISSION	FEB 5/21	MAB
4.	STORM OUTLET VIA 127 CARILLON	OCT 23/20	MAB	4.	STORM OUTLET VIA 127 CARILLON	OCT 23/20	MAB
3.	SITE PLAN APPLICATION	AUG 24/20	MAB	3.	SITE PLAN APPLICATION	AUG 24/20	MAB
2.	RVCA APPROVAL IN PRINCIPAL APPLICATION	MAY 29/20	MAB	2.	RVCA APPROVAL IN PRINCIPAL APPLICATION	MAY 29/20	MAB
1.	ISSUED FOR RVCA REVIEW	MAR 26/20	MAB	1.	ISSUED FOR RVCA REVIEW	MAR 26/20	MAB

SCALE: 1:250

FOR REVIEW ONLY

DESIGN: LRW
CHECKED: MAB
DRAWN: BRP
CHECKED: LRW
APPROVED: MAB

PROFESSIONAL ENGINEER
L.R. WILSON
10180055
PROVINCE OF ONTARIO

PROFESSIONAL ENGINEER
M.A. BISSETT
2026.03.13
PROVINCE OF ONTARIO

NOVATECH
Engineers, Planners & Landscape Architects
Suite 200, 240 Michael Cowpland Drive
Ottawa, Ontario, Canada K2M 1P6
Telephone: (613) 254-9643
Facsimile: (613) 254-5867
Website: www.novatech-eng.com

CITY OF OTTAWA
200 BARIBEAU STREET

DRAWING NAME: STORM DRAINAGE AREA PLAN

PROJECT No.: 119068

REV #12

DRAWING No.: 119068-STM

Appendix D:

DSS Checklist

Emergency Overland Flow Route Documentation

**200 BARIBEAU STREET, OTTAWA
DEVELOPMENT SERVICING STUDY CHECKLIST**

4.1 General Content	Addressed (Y/N/NA)	Comments
Executive Summary (for larger reports only).	N/A	
Date and revision number of the report.	Y	
Location map and plan showing municipal address, boundary, and layout of proposed development.	Y	Refer to Report Figures
Plan showing the site and location of all existing services.	Y	Refer to Grading and Servicing Plans
Development statistics, land use, density, adherence to zoning and official plan, and reference to applicable subwatershed and watershed plans that provide context to which individual developments must adhere.	Y	Refer to Site Plan
Summary of Pre-consultation Meetings with City and other approval agencies.	Y	
Reference and confirm conformance to higher level studies and reports (Master Servicing Studies, Environmental Assessments, Community Design Plans), or in the case where it is not in conformance, the proponent must provide justification and develop a defensible design criteria.	Y	
Statement of objectives and servicing criteria.	Y	Refer to Sections: 5.0 Sanitary Sewers, 6.0 Stormwater Management, 7.0 Water
Identification of existing and proposed infrastructure available in the immediate area.	Y	
Identification of Environmentally Significant Areas, watercourses and Municipal Drains potentially impacted by the proposed development (Reference can be made to the Natural Heritage Studies, if available).	N/A	
Concept level master grading plan to confirm existing and proposed grades in the development. This is required to confirm the feasibility of proposed stormwater management and drainage, soil removal and fill constraints, and potential impacts to neighboring properties. This is also required to confirm that the proposed grading will not impede existing major system flow paths.	Y	Refer to Grading Plan and Stormwater Management Plan

**200 BARIBEAU STREET, OTTAWA
DEVELOPMENT SERVICING STUDY CHECKLIST**

4.1 General Content	Addressed (Y/N/NA)	Comments
Identification of potential impacts of proposed piped services on private services (such as wells and septic fields on adjacent lands) and mitigation required to address potential impacts.	N/A	
Proposed phasing of the development, if applicable.	N/A	
Reference to geotechnical studies and recommendations concerning servicing.	Y	Refer to Section 3.0 Grading
All preliminary and formal site plan submissions should have the following information:		
Metric scale	Y	
North arrow (including construction North)	Y	
Key plan	Y	
Name and contact information of applicant and property owner	Y	
Property limits including bearings and dimensions	Y	
Existing and proposed structures and parking areas	Y	
Easements, road widening and rights-of-way	Y	
Adjacent street names	Y	

**200 BARIBEAU STREET, OTTAWA
DEVELOPMENT SERVICING STUDY CHECKLIST**

4.2 Water	Addressed (Y/N/NA)	Comments
Confirm consistency with Master Servicing Study, if available.	Y	
Availability of public infrastructure to service proposed development.	Y	Refer to Sections: 5.0 Sanitary Sewers, 6.0 Stormwater Management, 7.0 Water
Identification of system constraints.	N/A	
Identify boundary conditions.	Y	Provided by City of Ottawa
Confirmation of adequate domestic supply and pressure.	Y	Refer to Appendix A
Confirmation of adequate fire flow protection and confirmation that fire flow is calculated as per the Fire Underwriter's Survey. Output should show available fire flow at locations throughout the development.	Y	Refer to Appendix A
Provide a check of high pressures. If pressure is found to be high, an assessment is required to confirm the application of pressure reducing valves.	Y	Refer to Appendix A
Definition of phasing constraints. Hydraulic modeling is required to confirm servicing for all defined phases of the project including the ultimate design.	N/A	
Address reliability requirements such as appropriate location of shut-off valves.	Y	
Check on the necessity of a pressure zone boundary modification.	N/A	
Reference to water supply analysis to show that major infrastructure is capable of delivering sufficient water for the proposed land use. This includes data that shows that the expected demands under average day, peak hour and fire flow conditions provide water within the required pressure range.	Y	Refer to Section 7.0 Water
Description of the proposed water distribution network, including locations of proposed connections to the existing system, provisions for necessary looping, and appurtenances (valves, pressure reducing valves, valve chambers, and fire hydrants) including special metering provisions.	Y	Refer to Section 7.0 Water
Description of off-site required feeder mains, booster pumping stations, and other water infrastructure that will be ultimately required to service proposed development, including financing, interim facilities, and timing of implementation.	N/A	
Confirmation that water demands are calculated based on the City of Ottawa Design Guidelines.	Y	Refer to Section 7.0 Water
Provision of a model schematic showing the boundary conditions locations, streets, parcels, and building locations for reference.	N/A	

**200 BARIBEAU STREET, OTTAWA
DEVELOPMENT SERVICING STUDY CHECKLIST**

4.3 Wastewater	Addressed (Y/N/NA)	Comments
Summary of proposed design criteria (Note: Wet-weather flow criteria should not deviate from the City of Ottawa Sewer Design Guidelines. Monitored flow data from relatively new infrastructure cannot be used to justify capacity requirements for proposed infrastructure).	Y	Refer to Section 5.0 Sanitary Sewers
Confirm consistency with Master Servicing Study and/or justifications for deviations.	N/A	
Consideration of local conditions that may contribute to extraneous flows that are higher than the recommended flows in the guidelines. This includes groundwater and soil conditions, and age and condition of sewers.	N/A	
Description of existing sanitary sewer available for discharge of wastewater from proposed development.	Y	Refer to Section 5.0 Sanitary Sewers
Verify available capacity in downstream sanitary sewer and/or identification of upgrades necessary to service the proposed development. (Reference can be made to previously completed Master Servicing Study if applicable)	y	Refer to Appendix A
Calculations related to dry-weather and wet-weather flow rates from the development in standard MOE sanitary sewer design table (Appendix 'C') format.	N/A	
Description of proposed sewer network including sewers, pumping stations, and forcemains.	Y	Refer to Section 5.0 Sanitary Sewers
Discussion of previously identified environmental constraints and impact on servicing (environmental constraints are related to limitations imposed on the development in order to preserve the physical condition of watercourses, vegetation, soil cover, as well as protecting against water quantity and quality).	N/A	
Pumping stations: impacts of proposed development on existing pumping stations or requirements for new pumping station to service development.	N/A	
Forcemain capacity in terms of operational redundancy, surge pressure and maximum flow velocity.	N/A	
Identification and implementation of the emergency overflow from sanitary pumping stations in relation to the hydraulic grade line to protect against basement flooding.	N/A	
Special considerations such as contamination, corrosive environment etc.	N/A	

**200 BARIBEAU STREET, OTTAWA
DEVELOPMENT SERVICING STUDY CHECKLIST**

4.4 Stormwater	Addressed (Y/N/NA)	Comments
Description of drainage outlets and downstream constraints including legality of outlet (i.e. municipal drain, right-of-way, watercourse, or private property).	Y	Refer to Section 6.0 Stormwater Management
Analysis of the available capacity in existing public infrastructure.	Y	Refer to Appendix A
A drawing showing the subject lands, its surroundings, the receiving watercourse, existing drainage patterns and proposed drainage patterns.	Y	Refer to Storm Drainage Area Plan (119068-STM)
Water quantity control objective (e.g. controlling post-development peak flows to pre-development level for storm events ranging from the 2 or 5 year event (dependent on the receiving sewer design) to 100 year return period); if other objectives are being applied, a rationale must be included with reference to hydrologic analyses of the potentially affected subwatersheds, taking into account long-term cumulative effects.	Y	Refer to Section 6.0 Stormwater Management
Water Quality control objective (basic, normal or enhanced level of protection based on the sensitivities of the receiving watercourse) and storage requirements.	Y	Refer to Section 6.0 Stormwater Management
Description of stormwater management concept with facility locations and descriptions with references and supporting information.	Y	Refer to Section 6.0 Stormwater Management
Set-back from private sewage disposal systems.	N/A	
Watercourse and hazard lands setbacks.	N/A	
Record of pre-consultation with the Ontario Ministry of Environment and the Conservation Authority that has jurisdiction on the affected watershed.	N/A	
Confirm consistency with sub-watershed and Master Servicing Study, if applicable study exists.	N/A	
Storage requirements (complete with calcs) and conveyance capacity for 5 yr and 100 yr events.	Y	Refer to Appendix B
Identification of watercourse within the proposed development and how watercourses will be protected, or, if necessary, altered by the proposed development with applicable approvals.	N/A	
Calculate pre and post development peak flow rates including a description of existing site conditions and proposed impervious areas and drainage catchments in comparison to existing conditions.	Y	Refer to Appendix B
Any proposed diversion of drainage catchment areas from one outlet to another.	N/A	
Proposed minor and major systems including locations and sizes of stormwater trunk sewers, and SWM facilities.	N/A	
If quantity control is not proposed, demonstration that downstream system has adequate capacity for the post-development flows up to and including the 100-year return period storm event.	N/A	

**200 BARIBEAU STREET, OTTAWA
DEVELOPMENT SERVICING STUDY CHECKLIST**

4.4 Stormwater	Addressed (Y/N/NA)	Comments
Identification of potential impacts to receiving watercourses.	N/A	
Identification of municipal drains and related approval requirements.	N/A	
Description of how the conveyance and storage capacity will be achieved for the development.	Y	Refer to Section 6.0 Stormwater Management
100 year flood levels and major flow routing to protect proposed development from flooding for establishing minimum building elevations (MBE) and overall grading.	Y	Refer to Grading Plan and Storm Drainage Area Plan
Inclusion of hydraulic analysis including HGL elevations.	N/A	
Description of approach to erosion and sediment control during construction for the protection of receiving watercourse or drainage corridors.	Y	Refer to Section 4.0 Erosion Sediment Control
Identification of floodplains – proponent to obtain relevant floodplain information from the appropriate Conservation Authority. The proponent may be required to delineate floodplain elevations to the satisfaction of the Conservation Authority if such information is not available or if information does not match current conditions.	N/A	
Identification of fill constrains related to floodplain and geotechnical investigation.	N/A	

4.5 Approval and Permit Requirements	Addressed (Y/N/NA)	Comments
Conservation Authority as the designated approval agency for modification of floodplain, potential impact on fish habitat, proposed works in or adjacent to a watercourse, cut/fill permits and Approval under Lakes and Rivers Improvement Act. The Conservation Authority is not the approval authority for the Lakes and Rivers Improvement Act. Where there are Conservation Authority regulations in place, approval under the Lakes and Rivers Improvement Act is not required, except in cases of dams as defined in the Act.	N/A	
Application for Certificate of Approval (CofA) under the Ontario Water Resources Act.	N/A	
Changes to Municipal Drains.	N/A	
Other permits (National Capital Commission, Parks Canada, Public Works and Government Services Canada, Ministry of Transportation etc.)	N/A	

4.6 Conclusion	Addressed (Y/N/NA)	Comments
Clearly stated conclusions and recommendations.	Y	Refer to Section 8.0 Conclusions and Recommendations
Comments received from review agencies including the City of Ottawa and information on how the comments were addressed. Final sign-off from the responsible reviewing agency.	Y	
All draft and final reports shall be signed and stamped by a professional Engineer registered in Ontario.	Y	

MEMORANDUM

DATE: MAY 4, 2020 **PROJECT:** 119068

TO: ERIC TOUSIGNANT, HIRAN SANDANAYAKE

FROM: MARK BISSETT, LUCAS WILSON, CONRAD STANG

RE: 200 BARIBEAU STREET – SWM MODELLING

CC: KEVIN MCMAHON, PIERRE BOULET, JOHN RIDDELL

Novatech has updated our drainage model to quantify major overland flow routed through the planned development at 200 Baribeau Street. Before we finalize the Concept Plan and expend significant design effort, we request a staff review of the model so we might find consensus on the overland flow accommodation. The magnitude of conveyance informs how we design the site.

Using City 1:1000 topographic mapping we have delineated the drainage boundaries (shown on Figures DSK-2A and 2B) with excellent correlation to the DRAPE 2014 Lidar mapping. There are two overland flow parcels that need consideration and are described below:

Area 1: East of Baribeau Street

There is a large 616ha drainage catchment to the east. Our analysis shows the majority of this parcel is located in a bowl and does not produce overland flow towards 200 Baribeau under any reasonable design storm (we assessed up to the 100-year+20% rainfall event). As such, the effective drainage area contributing overland flow from the east is 29.0ha.

Using the City-suggested criteria a minor system capture rate of 85L/s/ha and surface storage of 100m³/ha we calculate overland flow of $Q_{100}=1,650\text{L/s}$ at Baribeau Street. Interestingly, only minor adjustments to either parameter lower the overland flow at Baribeau Street to $Q_{100}=0\text{L/s}$. We tested model sensitivity by adjusting the inlet capture rate to 100L/s/ha and the surface storage to 125m³/ha. In our opinion, these values are more representative of actual conditions as we understand there is no ICD control, and the topographic modelling supports the increased surface storage.

In all likelihood, we think there will be no overland flow from this upstream area during a 100-year rainfall event due to the probable inlet capture rate and available surface storage. Regardless, we see value in an emergency overland flow route as protection against extreme weather events and/or inlet capture obstruction.

Area 2: Northwest of Landry Street

There is a 6.6ha drainage catchment northwest of the development site with overland flow routed to a parkette on Landry Street (part of a recent development by Claridge Homes). Using a minor system capture rate of 85L/s/ha and surface storage of 100m³/ha we calculate overland flow of $Q_{100}=190\text{L/s}$. Civil design plans indicate the major system flow from Landry Street is routed through the parkette and residential rear yards toward Kipp Street. Novatech will obtain

the as-built design plans and servicing report to confirm the intended conveyance along this corridor.

Similar to Area 1, the modelled overland flow drops to $Q_{100}=0\text{L/s}$ if either of the SWM parameters are modified to reflect the anticipated real-world conditions (i.e. inlet capture of 100L/s/ha , or surface storage of $125\text{m}^3/\text{ha}$). Our conclusion is that Area 2 will not likely experience overland flow from the upstream drainage area during a 100-year design storm. Regardless, a prudent design will provide an emergency overland flow route as protection against extreme events.

Next Steps

In closing, we respectfully ask staff to review our SWM model so we might find a mutually acceptable overland conveyance rate through the development for both Area 1 and Area 2. This value is required to finalize the development concept, design the flow route, and make our submission to the City and RVCA.

Hoping the above is agreeable. Please call with any question or concerns.
Respectfully submitted.

Lucas Wilson

From: Tousignant, Eric <Eric.Tousignant@ottawa.ca>
Sent: Tuesday, June 2, 2020 1:47 PM
To: Mark Bissett
Cc: Sandanayake, Hiran; Lucas Wilson; Conrad Stang
Subject: RE: 200 Baribeau - Community Model

Hi Mark

Given that this is an emergency route and not part of the 100 year design, and not even part of the 20% stress test, I would not be concerned about including it in your final report if you fear it could be an issue. This was more as a check on our part to make sure that should any flow spill onto the property that it could be conveyed to the channel at the rear. This was important because the only way flow will get to the channel is through the property as it cannot spill around it. You have shown that the property can convey 900 L/s should there be some kind of major system spill (i.e. blockage or even less than anticipated storage in the upstream sewershed). It is not our intent to designate this property as an overland flow route, but it is good to know that should it be required, flow can safely make it to the channel.

In short, I am fine with the approach you have taken.

Eric

Eric Tousignant, P.Eng.

Senior Water Resources Engineer
Infrastructure Services
613-580-2424 ext 25129

From: Mark Bissett <m.bissett@novatech-eng.com>
Sent: May 29, 2020 2:28 PM
To: Tousignant, Eric <Eric.Tousignant@ottawa.ca>
Cc: Sandanayake, Hiran <Hiran.Sandanayake@ottawa.ca>; Lucas Wilson <l.wilson@novatech-eng.com>; Conrad Stang <c.stang@novatech-eng.com>
Subject: 200 Baribeau - Community Model

CAUTION: This email originated from an External Sender. Please do not click links or open attachments unless you recognize the source.

ATTENTION : Ce courriel provient d'un expéditeur externe. Ne cliquez sur aucun lien et n'ouvrez pas de pièce jointe, excepté si vous connaissez l'expéditeur.

Eric- I think we've developed a reasonable solution, but want to bounce this off your team one last time. Here's our approach:

- 1) **Existing Conditions:** overland flow from Baribeau Street is routed through the existing school site. We suspect this does not occur during any design storm up to the 100-year+20% event (based on previous modelling), but

agree allowance should be made for safety. The spill point is an access road at elevation 56.00m between the school and garage at 143 Carillon Street. Using the broad-crested weir equation, we calculated flow for various water levels (see PDF-Existing). The trick of course is choosing an appropriate max. spill elevation. We think 56.15m is a reasonable peak water level, as higher elevations suggest extensive community flooding...to our knowledge this is not occurring. At 56.15m there is an emergency overland flow of $Q=908\text{L/s}$ through the existing school block and pathway to Kipp Street (same discharge point as the 100 Landry development).

- 2) **Proposed Conditions:** provide an equivalent emergency overland flow ($Q>908\text{L/s}$) through the proposed development with a maximum water level of 56.15m on Baribeau. It appears this can be achieved...we would prepare a detailed model as part of the submission, but for now using a broad-crested weir at the Baribeau spill point and Manning's open channel through the rear yards suggest about $1,000\text{L/s}$ can be conveyed (see PDF-Proposed).

Hoping your team can advise if you generally agree with this approach. My risk here is that we complete a detail design, submit to RVCA for a Fill Permit (has to go to Executive Committee), and then it all blows up because of the off-site overland flow conveyance. Totally respect that your not giving approval...just guidance. Thanking you in advance, have a great weekend, and my apologies for the long email. Best,

Mark Bissett, P.Eng., Senior Project Manager | Land Development & Municipal

NOVATECH Engineers, Planners & Landscape Architects

240 Michael Cowpland Drive, Suite 200, Ottawa, ON, K2M 1P6 | Tel: 613.254.9643 Ext: 237 | Cell: 613.261.4792

The information contained in this email message is confidential and is for exclusive use of the addressee.

From: Tousignant, Eric <Eric.Tousignant@ottawa.ca>

Sent: Tuesday, May 5, 2020 10:59 AM

To: Mark Bissett <m.bissett@novatech-eng.com>

Cc: Sandanayake, Hiran <Hiran.Sandanayake@ottawa.ca>; Conrad Stang <c.stang@novatech-eng.com>; Lucas Wilson <l.wilson@novatech-eng.com>; Pierre Boulet (Boulet) <pierreb@bouletconstruction.com>; Kevin McMahon <kevin@ulra.ca>; John Riddell <J.Riddell@novatech-eng.com>

Subject: RE: 200 Baribeau - Community Model

Hi Mark

Your analysis appears to be reasonable and in line with previous assessments done in this area. What I would require though, is for you to show that should there be excess external major system flow (i.e due to CB blockages for example), that this flow could be routed through the property to the ditch that was create for the 100 Landry street Development (i.e. emergency overflow route).

Eric

Eric Tousignant, P.Eng.

Senior Water Resources Engineer

Infrastructure Services

613-580-2424 ext 25129

From: Mark Bissett <m.bissett@novatech-eng.com>

Sent: May 04, 2020 12:52 PM

To: Tousignant, Eric <Eric.Tousignant@ottawa.ca>

Cc: Sandanayake, Hiran <Hiran.Sandanayake@ottawa.ca>; Conrad Stang <c.stang@novatech-eng.com>; Lucas Wilson <l.wilson@novatech-eng.com>; Pierre Boulet (Boulet) <pierreb@bouletconstruction.com>; Kevin McMahon <kevin@ulra.ca>; John Riddell <J.Riddell@novatech-eng.com>

Subject: 200 Baribeau - Community Model

CAUTION: This email originated from an External Sender. Please do not click links or open attachments unless you recognize the source.

ATTENTION : Ce courriel provient d'un expéditeur externe. Ne cliquez sur aucun lien et n'ouvrez pas de pièce jointe, excepté si vous connaissez l'expéditeur.

Eric- kindly refer to the attached memo and SWM model for the 200 Baribeau development site.

We're hoping to establish consensus on a reasonable overland conveyance from two upstream parcels that are routed through this site.

We appreciate staff input and assistance with this matter. Sincerely,

Mark Bissett, P.Eng., Senior Project Manager | Land Development & Municipal

NOVATECH Engineers, Planners & Landscape Architects

240 Michael Cowpland Drive, Suite 200, Ottawa, ON, K2M 1P6 | Tel: 613.254.9643 Ext: 237 | Cell: 613.261.4792

The information contained in this email message is confidential and is for exclusive use of the addressee.

From: Tousignant, Eric <Eric.Tousignant@ottawa.ca>

Sent: Monday, April 6, 2020 10:48 AM

To: Mark Bissett <m.bissett@novatech-eng.com>

Subject: FW: 200 Baribeau - Community Model

Hi Mark

Below is a rough idea of the entire overland drainage system that goes through the Property. As you can see, it is very large. Back in 2006-2007, I did a high level estimate of the flow reaching the property just to the west (100 Landry). I have attached some old emails about this. The 100 year estimate was quite high but IBI created a ditch on the property to take the upstream flow. I'm sure that if a more detailed model was created that we would have a lower peak flow, but that would be a huge undertaking at this time.

Now if you only want to account for the 2.2 ha area area, I would do a lumped rational method computation for the 100 year and subtract the 2 year. This should give you a good idea of the overland flow from the 2.2 ha area.

Eric

Eric Tousignant, P.Eng.

Senior Water Resources Engineer

Infrastructure Services

613-580-2424 ext 25129

From: Cooke, Ryan <ryan.cooke@ottawa.ca>
Sent: April 03, 2020 5:48 PM
To: Tousignant, Eric <Eric.Tousignant@ottawa.ca>
Cc: Sandanayake, Hiran <Hiran.Sandanayake@ottawa.ca>
Subject: RE: 200 Baribeau - Community Model

Hi Eric,

Our DEM/streams show that the upstream area is very large, as shown below ('major' upstream drainage area shown, drainage area to low point would be larger).

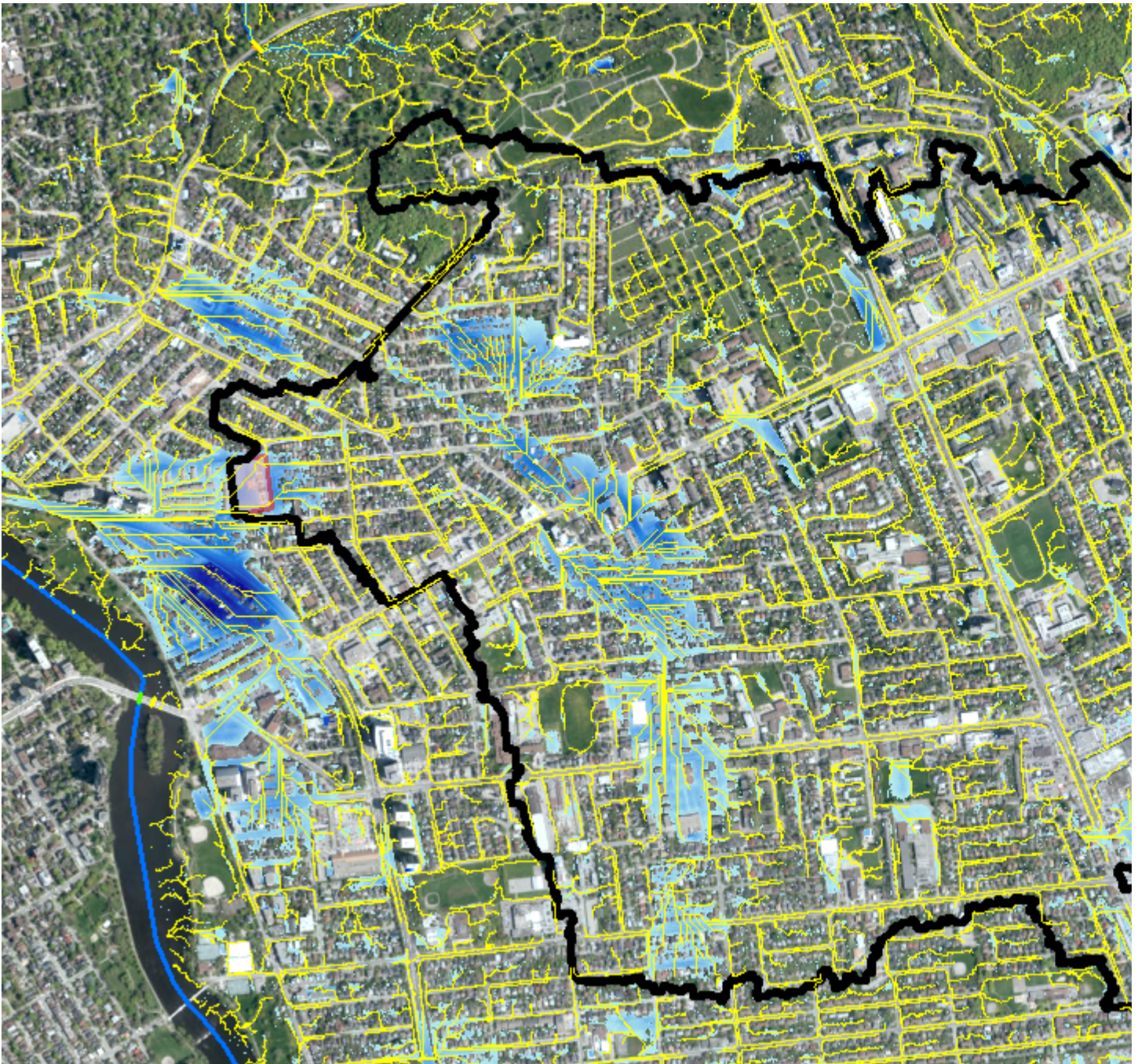

Although not all this drainage area would make its way to the site, the stream lines are also not accurate in this location because it's in a low point.



Unfortunately we don't have a major system model that can provide hydrographs.

Maybe we can discuss further next week?

Thanks,

Ryan

From: Tousignant, Eric <Eric.Tousignant@ottawa.ca>

Sent: April 02, 2020 1:27 PM

To: Sandanayake, Hiran <Hiran.Sandanayake@ottawa.ca>; Cooke, Ryan <ryan.cooke@ottawa.ca>

Subject: FW: 200 Baribeau - Community Model

Gentlemen

Mark Bisette at Novatech is looking at a redevelopment project at 200 Baribeau in Vanier. The attached figure shows a drainage area of approximately 2.2 ha that goes through the site, but I wonder if this was not determined with a high Level DEM. What does our more detailed DEM show? Does it go through the site or does it follow Baribeau Street. If it does go through the site, do we have major system flow/hydrograph and this location from the Major system model?

Thanks

Eric

From: Mark Bissett <m.bissett@novatech-eng.com>

Sent: March 30, 2020 10:39 AM

To: Tousignant, Eric <Eric.Tousignant@ottawa.ca>

Cc: Conrad Stang <c.stang@novatech-eng.com>

Subject: 200 Baribeau - Community Model

CAUTION: This email originated from an External Sender. Please do not click links or open attachments unless you recognize the source.

ATTENTION : Ce courriel provient d'un expéditeur externe. Ne cliquez sur aucun lien et n'ouvrez pas de pièce jointe, excepté si vous connaissez l'expéditeur.

Eric- I'm working on a preliminary design for a site at 200 Baribeau Street in Vanier. The site is currently a private school, which the developer intends to convert to residential units. As part of our preliminary design, it appears that external major system roadway flow is routed through the private site from both the north (10ha parcel near Landry Street & St. Ambroise Avenue) and from the east (25ha parcel near Baribeau Street & Ethel Street). The drainage areas are depicted on the attached Figure DSK-2, generated using the DRAPE 2014 elevation model.

Does the City have modelling information that can be shared to help quantify overland flow conveyed via each upstream parcel? We'd need the catchbasin info and ICD controls (if any), and roadway depression storage. Not sure if this is available...we'd really appreciate any modelling staff might be able to share, or guidance on your experience in this community.

Hope you are keeping well. Stay safe, all the best.

Mark Bissett, P.Eng., Senior Project Manager | Land Development & Municipal

NOVATECH Engineers, Planners & Landscape Architects

240 Michael Cowpland Drive, Suite 200, Ottawa, ON, K2M 1P6 | Tel: 613.254.9643 Ext: 237 | Cell: 613.261.4792

The information contained in this email message is confidential and is for exclusive use of the addressee.

This e-mail originates from the City of Ottawa e-mail system. Any distribution, use or copying of this e-mail or the information it contains by other than the intended recipient(s) is unauthorized. Thank you.

Le présent courriel a été expédié par le système de courriels de la Ville d'Ottawa. Toute distribution, utilisation ou reproduction du courriel ou des renseignements qui s'y trouvent par une personne autre que son destinataire prévu est interdite. Je vous remercie de votre collaboration.

This e-mail originates from the City of Ottawa e-mail system. Any distribution, use or copying of this e-mail or the information it contains by other than the intended recipient(s) is unauthorized. Thank you.

Le présent courriel a été expédié par le système de courriels de la Ville d'Ottawa. Toute distribution, utilisation ou reproduction du courriel ou des renseignements qui s'y trouvent par une personne autre que son destinataire prévu est interdite. Je vous remercie de votre collaboration.

This e-mail originates from the City of Ottawa e-mail system. Any distribution, use or copying of this e-mail or the information it contains by other than the intended recipient(s) is unauthorized. Thank you.

Le présent courriel a été expédié par le système de courriels de la Ville d'Ottawa. Toute distribution, utilisation ou reproduction du courriel ou des renseignements qui s'y trouvent par une personne autre que son destinataire prévu est interdite. Je vous remercie de votre collaboration.