

# Memorandum

To: Josiane Gervais, P.Eng. Date: February 28, 2025  
From: Basel Ansari, P.Eng. Parsons No.: 479008-01000  
Cc: Austin Shih P.Eng; Pamela Whyte, MCIP, RPP  
Subject: **The Ottawa Hospital Riverside Campus – Transportation Review Memo**

---

## 1.0 Project Background

The Ottawa Hospital (TOH) is proposing two new surface parking lots at its Riverside Campus to replace the existing surface parking that will be lost due to a new private long-term care facility at the north end of the site. Approximately 398 surface parking spaces have been removed and an internal road connection leading to Smyth Road has been severed as part of early construction of the long-term care and retirement home buildings called Schlegel Villages. This is illustrated by **Figure 1**, which shows the original parking layout of the hospital and original connections to both Riverside Drive and Smyth Road, as well as **Figure 2**, which shows the current layout and ongoing changes to the site with Schlegel Villages under construction. As a temporary condition, the hospital currently provides 20 contractor parking spaces for construction purposes in the future Lot C location and 80 spaces for hospital staff to use in the previous Lot B location.

The construction of Schlegel Villages not only results in a loss of existing hospital parking supply, but hospital users (whether staff or visitors) can no longer access the campus via Smyth Road – the internal road connection between Schlegel Village and the campus has been severed. Therefore, general vehicle access (passenger cars and trucks) to the Riverside campus is only provided off Riverside Drive.

As discussed with City staff, a full Transportation Impact Assessment (TIA) process was not required to support this application, due to the net decrease in campus parking spaces and corresponding traffic volumes as a result. However, a short transportation review memo was requested by City staff to address potential site access implications of the two new parking lots and provide an evaluation of future intersection operations at the Riverside Drive intersections related to redirection of campus traffic away from Smyth Road to the Riverside Drive access. It is important to note that the approved TIA Report for Schlegel Villages has already assessed the impacts of redirecting hospital traffic to the Riverside Drive connection. This memo will serve to confirm that no major deviations to the conclusions and recommendations of the Schlegel Villages study are expected.

## 2.0 Proposed New Parking Lots

TOH plans to replenish some of the lost supply in two locations, as shown in **Figure 3** – a new Lot C located at the southeast corner of the site is expected to provide approximately 44 parking spaces, and a new Lot D located on the east side of Riverside Drive at the northwest corner of the site is expected to provide approximately 126 parking spaces. In addition to Lots C and D, the existing hospital medical building has recently gained an approximate 28 spaces as part of the construction of Schlegel Villages. Therefore, a total number of 198 campus parking spaces will be replenished.

Lot C, which is illustrated in **Figure 4**, will be accessed via the Hospital Road, with the access located at the 90-degree bend of the road. Lot D, which is illustrated in **Figure 5**, will be accessed via a right-in/right-out access along Riverside Drive, approximately 50m north of the Transitway intersection.

Figure 1: Original Hospital Layout

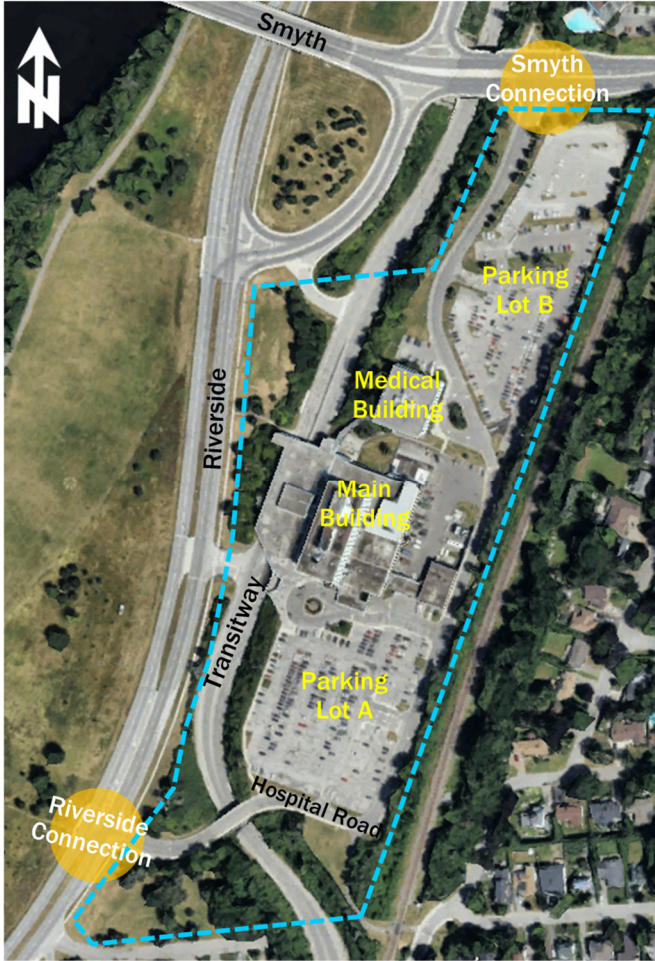

Figure 2: Existing/Interim Hospital Layout

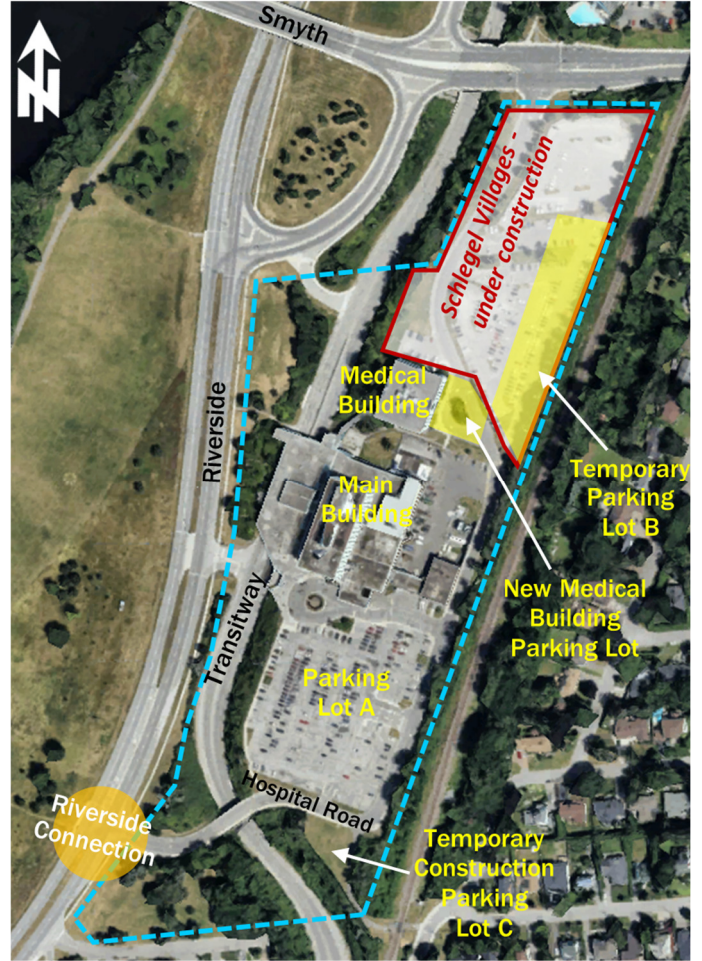

Figure 3: Future Hospital Layout

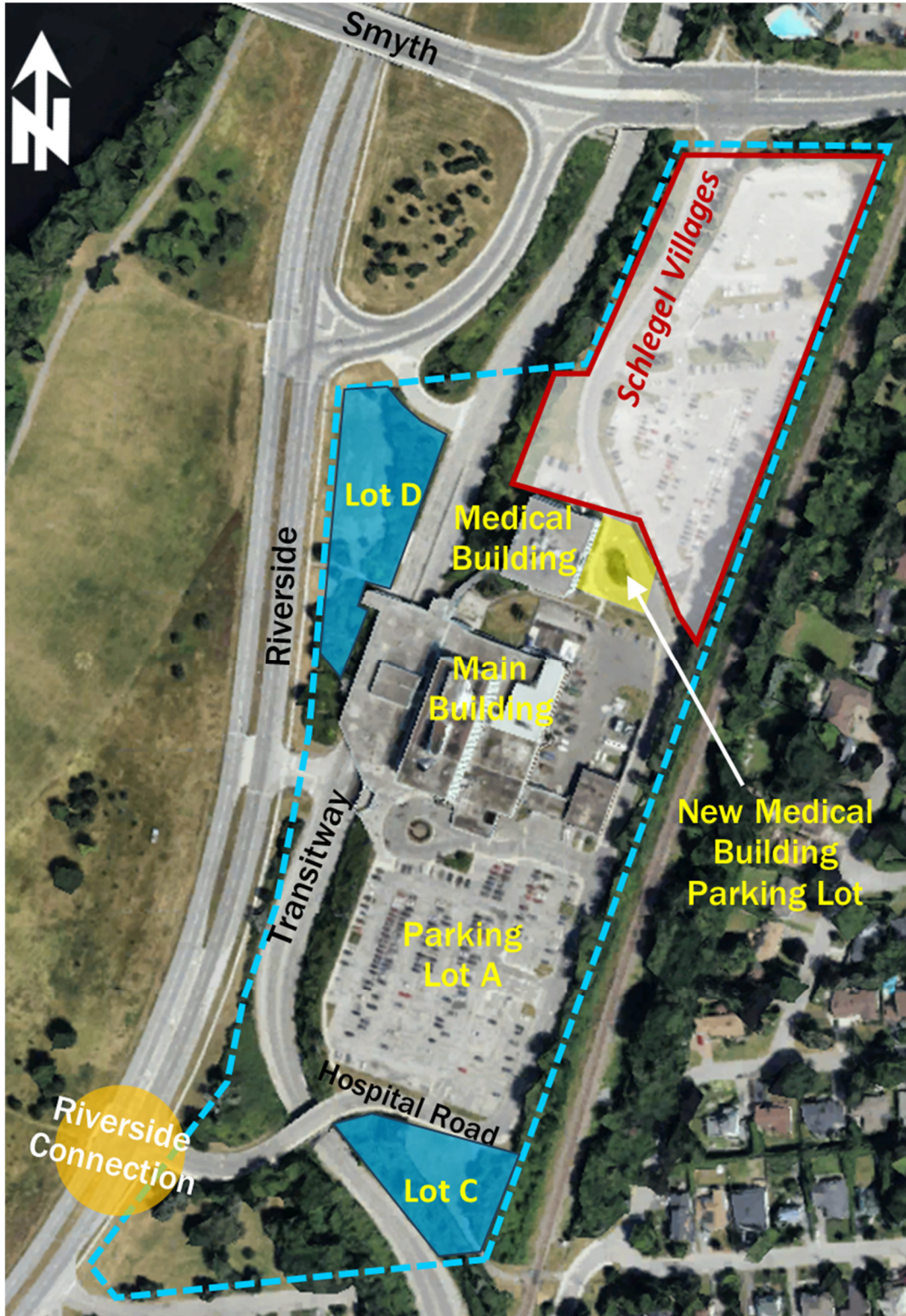
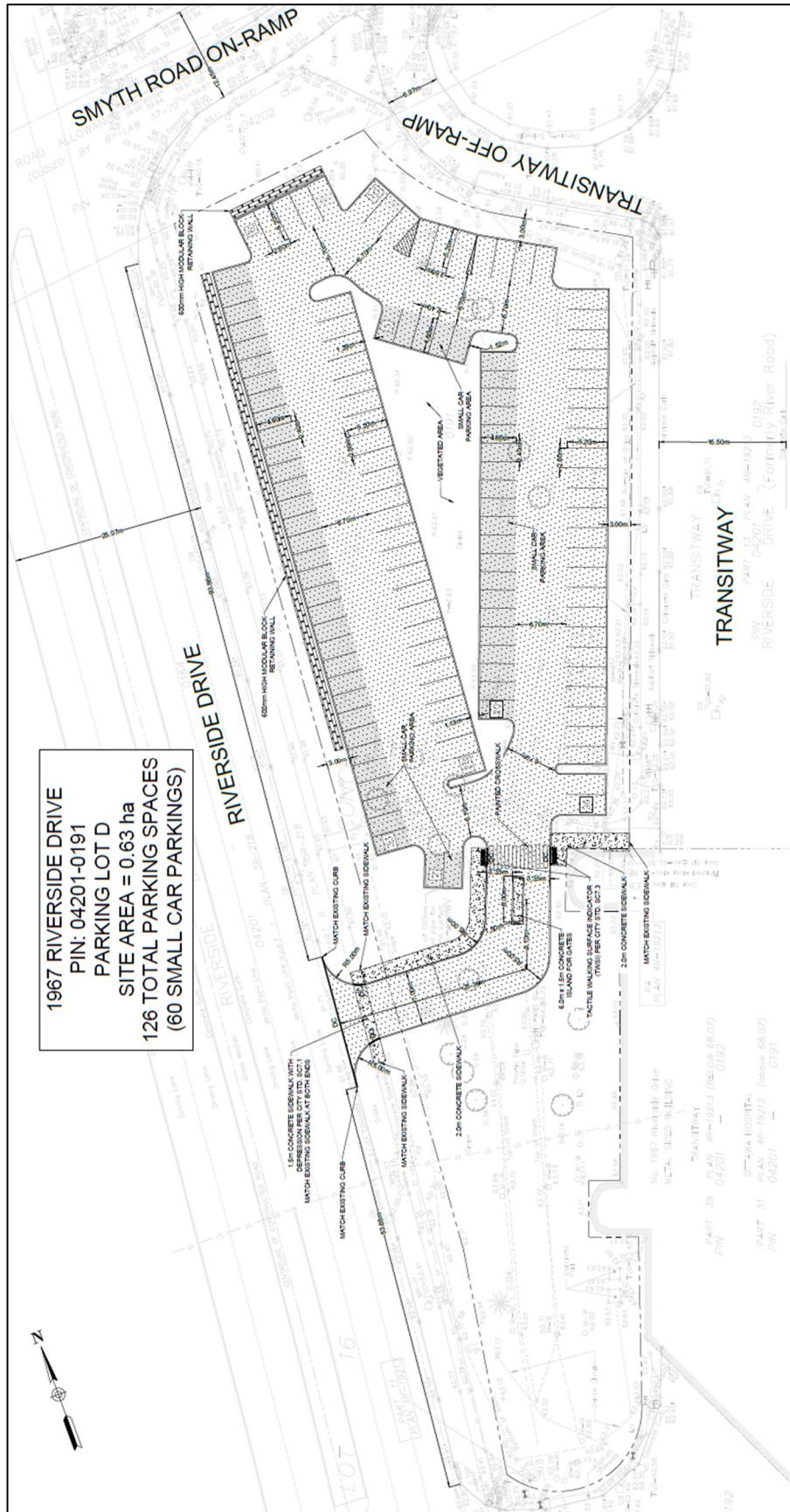



Figure 5: Lot D Parking Layout Plan



### 3.0 Existing Conditions

#### 3.1 Hospital Parking Supply

The original Riverside Campus parking supply was approximately 761 spaces (Figure 1). Of the total supply, approximately 398 were provided in Lot B and at the existing medical building, both of which are currently being replaced by Schlegel Villages, while the existing approximately 363 spaces provided in the main parking lot (Lot A) and other areas will remain.

Figure 2 illustrated the current supply of parking at the hospital, which is assumed to be the existing condition in this memo. The medical building’s parking supply, which previously consisted of approximately 11 parking spaces, has recently gained an additional 28 spaces from the Schlegel Villages development for a total of 39 spaces. Furthermore, as a temporary condition to replace some of the parking loss, the hospital added approximately 100 spaces to the campus, which consists of 20 spaces at the future Lot C location currently being used for construction contractor parking for the Schlegel Villages development and 80 spaces used by hospital staff at the south end of the previous Lot B location (to be removed in the future and relocated to future Lot D). With Lot A, the hospital currently provides approximately 502 parking spaces in total.

#### 3.2 Active Transportation

Sidewalks are provided on the east side of Riverside Drive, and to the west is the Rideau River Eastern Pathway that runs parallel of Riverside Drive. Within the hospital site, sidewalks are provided along buildings’ frontages and around the north and west perimeters of the main parking lot (Lot A). A sidewalk is also situated on the south side of the Hospital Road, connecting Riverside Drive to the existing Multi-Use Pathway (MUP) at the future Lot C site.

The existing active transportation facilities surrounding the Lot C site are illustrated in Figure 6. The MUP provides a connection to residential communities on the other side of the rail corridor. An existing pedestrian crossover (PXO) connects the sidewalk on the south side of the Hospital Road to the sidewalk on the west side of the main parking lot (Lot A).

The existing active transportation facilities surrounding the future Lot D site are illustrated in Figure 7. An asphalt sidewalk is provided on the west side of the Transitway. A pedestrian pathway connects the sidewalk on the east side of Riverside Drive to the sidewalk on the west side of the Transitway, providing access to both the hospital building and Riverside Station. The lot is also located at the southeast corner of the Riverside/Smyth South Ramp intersection.

Figure 6: Lot C Existing Active Transport Facilities

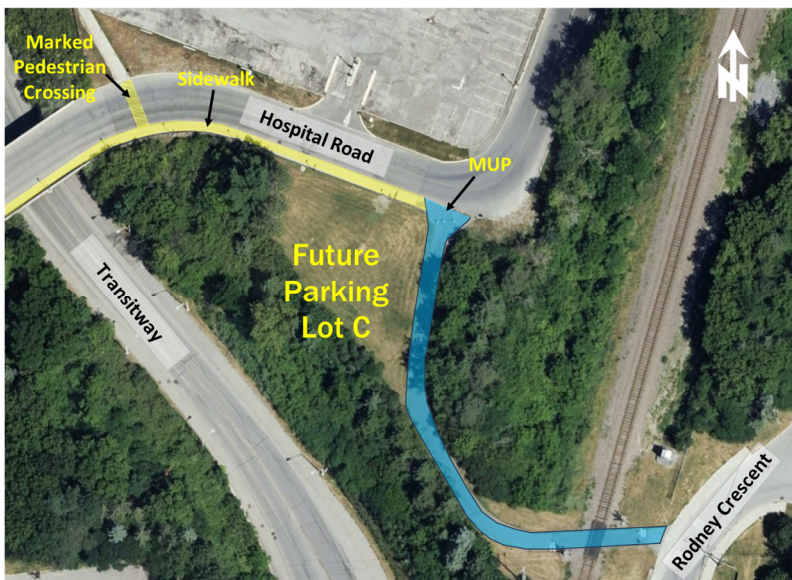
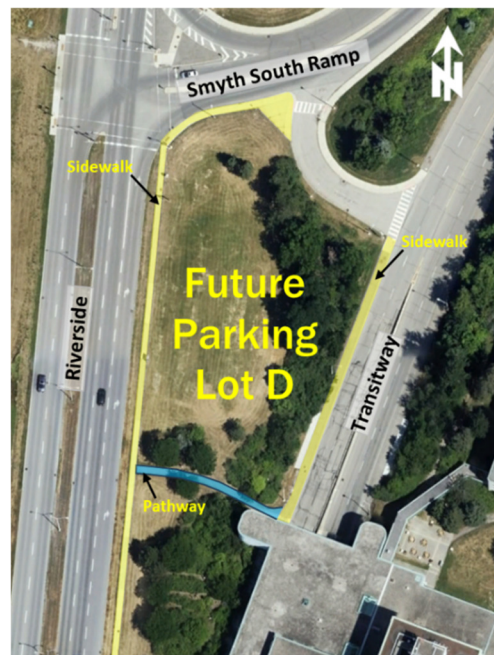

Figure 7: Lot D Existing Active Transport Facilities



### 3.3 Transit

The city Transitway, or Bus Rapid Transit (BRT), currently connects to the site at Riverside Station. The BRT begins at South Keys Station to the south, connecting to LRT Line 2 at different stations, and ends at Hurdman Station in the north, where it connects to LRT Line 1. Riverside Station currently serves a large number of bus routes, including Route #10, #48, #49, #88, #90, #92, #93, #96, #97, #98, #99, #190, #199, #290, #291, #294, and #299.

The bus station layout obtained from OC Transpo website is illustrated in **Figure 8** below, with a green outline added for the future Lot D location.

Figure 8: Riverside Station Layout

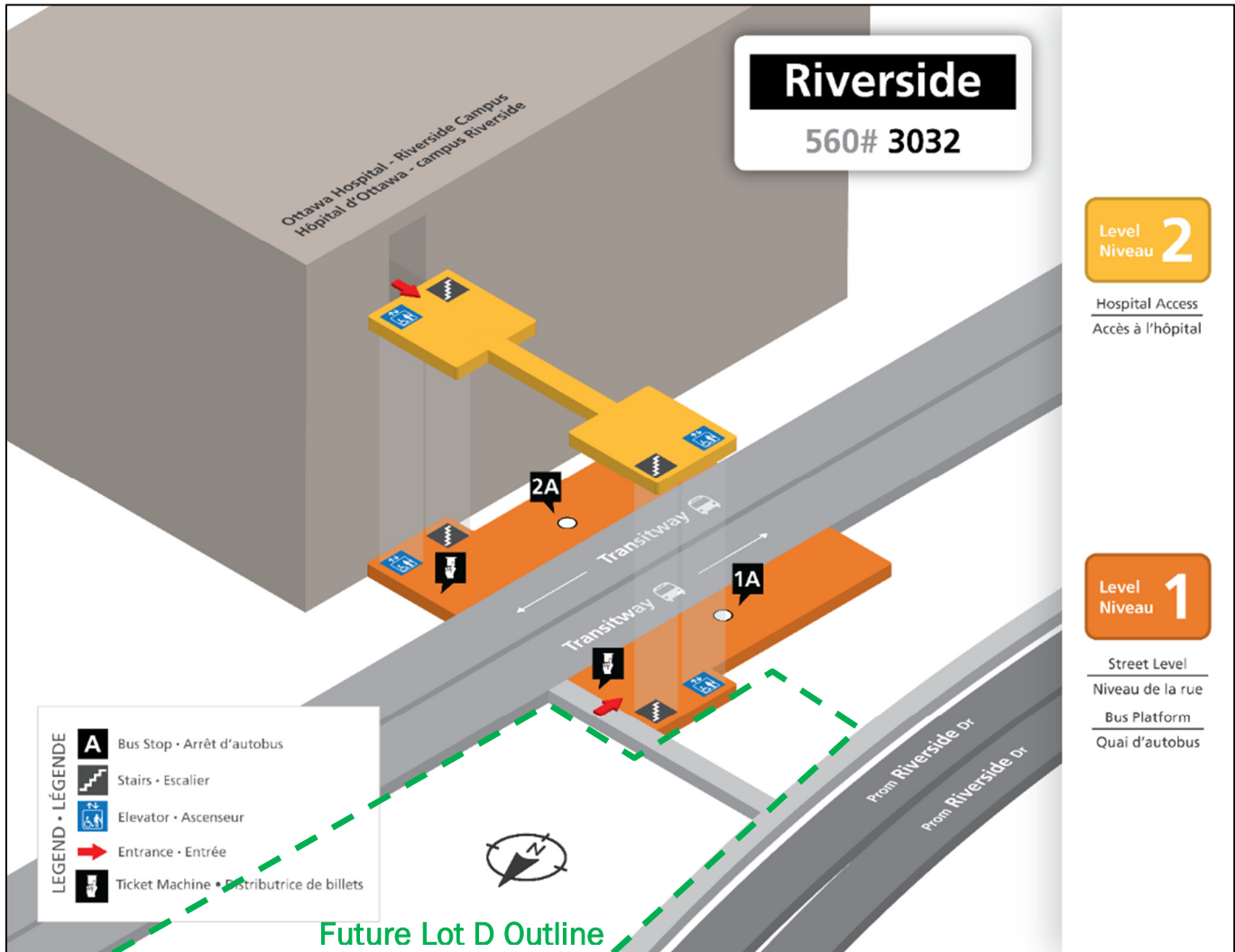

The Transitway can also be accessed by buses via a traffic signal intersection along Riverside Drive. Although **Figure 9** below illustrates bus route #49 currently utilizing the intersection with a NBR turn into the Transitway or a WBL turn out of the Transitway, recent OC Transpo bus route updates in the “New Ways to Bus” network removes the Transitway from Route 49. Therefore, no active bus routes currently use the transitway. Accordingly, no traffic volumes are assumed to turn in or out of the Transitway at its Riverside Dr intersection at this time.

Figure 9: OC Transpo Bus Network Map

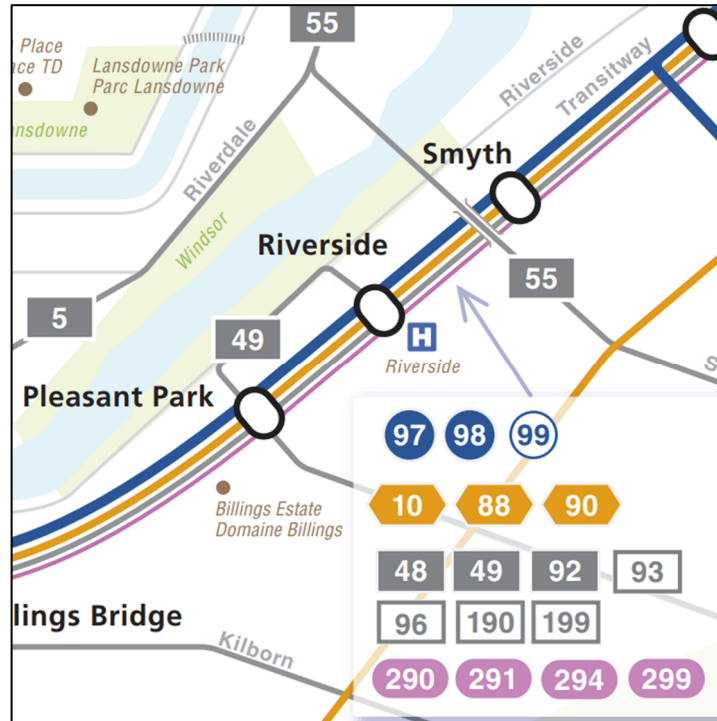

### 3.4 Traffic Volumes

Morning and afternoon peak hour traffic volumes, representing conditions in Spring, Summer and Fall of 2024, are shown in **Figure 10**, with raw data provided in **Appendix A**. These traffic volumes represent the current hospital conditions that were indicated in **Figure 2**. The traffic counts including pedestrians and cyclists were collected at the following two intersections along Riverside Drive:

- Riverside/Hospital Road – two recent counts were conducted at this intersection. One count was conducted on March 27, 2024, which reflected conditions prior to the closure of the Smyth Road access and removal of Lot B parking spaces. A second count was conducted on October 1, 2024, where inbound and outbound traffic volumes along the hospital road were collected to reflect the current conditions in which the Smyth Road access has been removed and parking conditions reflect the ones described in **Section 3.1**.

The October volumes reflected a notable increase of 50% to 100% in the inbound and outbound hospital traffic compared to the March count, which is expected due to traffic rerouting from the closed Smyth Road access. Therefore, the October inbound and outbound volumes were used to calibrate the March volumes by applying the traffic increase to the WBR and SBL movements to reflect the rerouted traffic coming from and returning to Smyth Road.

- Riverside/Smyth South Ramp – count conducted on August 13, 2024

The counts mostly record minimal pedestrian and cyclist activity, with less than 5 pedestrians and less than 5 cyclists observed at any location. Traffic volumes between the two intersections were balanced conservatively to the higher volume.



Figure 10: Existing Peak Hour Traffic Volumes

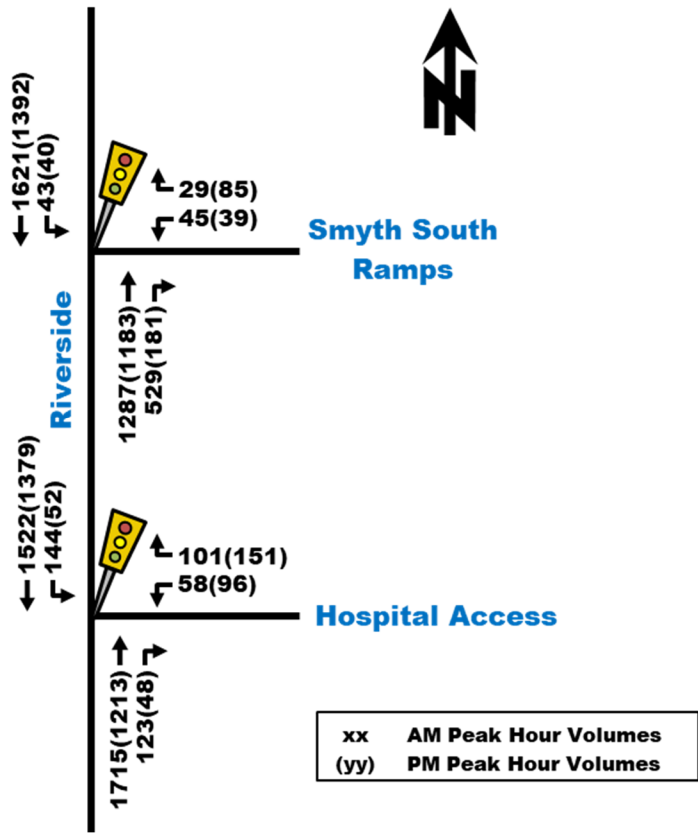

### 3.5 Intersection Capacity Analysis

Synchro 11 was used to analyze intersection performance of intersections within the study area. Critical movements at each of the intersections were assessed based on the movement with the highest volume-to-capacity ratio. Summary results of the existing conditions analysis is provided in **Table 1**, with Synchro reports provided in **Appendix B**. As per the requirements of the TIA Guidelines, a PHF of 0.9 was used.

Table 1: Existing Peak Hour Intersection Capacity Analysis

Intersection	Weekday AM Peak (PM Peak)					
	Critical Movement			Intersection		
	LOS	max. v/c	Movement	Delay (s)	LOS	v/c
Riverside/Hospital Road (S)	F(C)	1.39(0.75)	SBL(SBT)	17.2(9.2)	C(C)	0.75(0.74)
Riverside/Smyth South Ramp (S)	B(C)	0.67(0.73)	SBT(SBT)	7.1(10.4)	B(C)	0.66(0.72)

Note: Analysis of signalized intersections assumes a PHF of 0.9 and a saturation flow rate of 1800 veh/h/lane.  
 (S) – Signalized intersection, movement with highest v/c ratio identified as critical movement.

Based on the results in **Table 1**, the two signalized intersections currently operate acceptably with LOS ‘C’ or better for the overall intersections during peak hours. However, critical movements indicate that the SBL at the Riverside/Hospital Road intersection operates at capacity during the morning peak hour. All other critical movements operate acceptably with LOS ‘C’ or better during peak hours.

It is important to note that the Synchro analysis indicates that no movements exceed available storage length for any of the auxiliary turn lanes, including the SBL lane, where the 95<sup>th</sup> percentile queue length is 68m in Synchro and does not exceed the existing 80m storage length. This is further supported by field observations of the traffic at the Riverside/Hospital Road intersection during the October traffic count, where traffic queues of the auxiliary turn lanes did not exceed storage length.

### 4.0 Future Conditions

The hospital currently provides a total of approximately 502 parking spaces. As previously shown in **Figure 3**, the proposed future parking plan will result in a total of 572 hospital parking spaces in the future. Based on total future spaces, it is expected that the hospital will maintain at least 14 accessible parking spaces for the entire campus, as per calculated requirements of the AODA. At this time, all hospital traffic has been redirected to the Riverside Drive connection post closure of the Smyth Road access. The following sections provide a review of future trip generation and anticipated traffic impacts.

#### 4.1 Schlegel Villages Development

Schlegel Villages will consist of an 8-storey long-term care home with 256 beds (Phase 1) and a 15-storey retirement home building with 270 dwellings (Phase 2). The development will provide both underground and surface parking lots, where access to the parking areas is separated between an east and west parking lot. The west parking areas can only access Smyth Road, while the east parking areas consisting of 115 total spaces can only access the Hospital Road. Therefore, the Schlegel Villages east parking lot will result in some additional impact to the Riverside/Hospital Road intersection. The site-generated traffic volumes of the Schlegel Villages development are shown in **Figure 11**, which indicate east parking lot generates 34 morning and 48 afternoon two-way peak hour traffic volumes at the Riverside Drive access.

Figure 11: Schlegel Villages Site-Generated Traffic Volumes

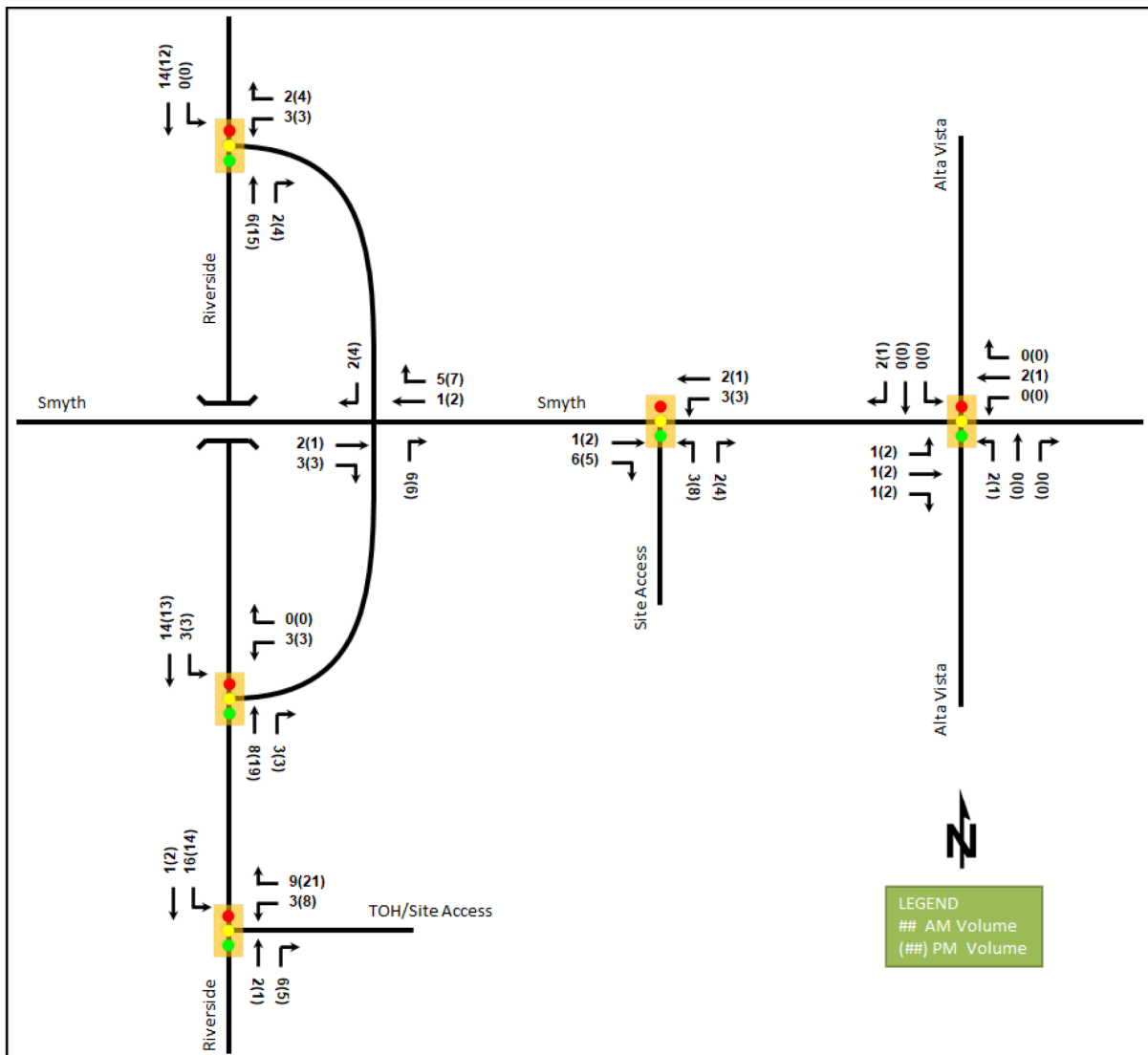

## 4.2 Trip Generation and Distribution

### Trip Generation

The existing hospital access traffic volumes in **Figure 10** already account for the medical building’s new supply of 39 spaces, a temporary construction parking Lot C (20 spaces) and a temporary hospital staff Lot B (80 spaces), resulting in a total current supply of 502 spaces. Trips generated by the two temporary lots were counted manually using pictures taken at the two lots during peak hours of the October count, where trips were generated as shown in **Table 2**. Inbound trips were calculated as being the number of new vehicles at the end of each peak hour time period and outbound trips were calculated as being the number of vehicles that were no longer parked in each parking lot also at the end of each peak hour time period.

Considering that the trips generated by the temporary previous Lot B are equivalent to or more than the trips anticipated to be generated by Schlegel Villages, it is assumed that both the future Lot C (44 spaces) and Schlegel Villages are already accounted for in the existing peak hour traffic volumes. For the purpose of being conservative, an additional 10 trips will be added to the future traffic volumes of Lot C for the PM peak hour only.

Table 2: Peak Hour Trips Generated by the Temporary Parking Lots

Temporary Parking Lot	AM Peak Hour Vehicle Trips			PM Peak Hour Vehicle Trips		
	IN	OUT	TOTAL	IN	OUT	TOTAL
Lot C (20 spaces)	5	0	5	0	8	8
Previous Lot B (80 spaces)	44	2	46	0	48	48

A different approach will be taken to determine the trips generated by the future Lot D, where a first-principles method will be used to estimate the trips. The method assumes that the total number of two-way vehicle trips generated by Lot D during peak hours is equivalent to 80% of the number of spaces provided. This is a conservative assumption, considering that the temporary hospital parking lots were observed to generate trips equivalent to 40-60% of the number of spaces in their respective lots during the peak hours.

Following this method, the number of potential trips generated by the proposed Lot D during the morning and afternoon peak hours is summarized in **Table 3** below. In total, Lot D may generate up to 101 two-way vehicular trips during peak hours. The inbound and outbound percentages were determined using the existing travel patterns at the Hospital Road site access, calculated using existing traffic volumes in **Figure 10**.

Table 3: Method 1 Trips Generated by Proposed Lot D

Parking Lot	Number of Spaces	Equivalent Number of Total Two-Way Trips (factor of 0.8)	AM (vehicle trips/hour)		PM (vehicle trips/hour)	
			In (60%)	Out (40%)	In (30%)	Out (70%)
Lot D	126	101	61	40	30	71

### Trip Distribution and Assignment

Based on the existing inbound/outbound trip distribution at the hospital access, the future Lot D and the additional Lot C trips (10 PM peak hour outbound trips) have been assigned to the study area as shown in **Figure 12**, which includes SB U-turns generated by inbound movements to Lot D at the Riverside/Hospital Road intersection for trips arriving from the north on Riverside Drive. For trips exiting the site and destined to the south, vehicles would have to travel an approximate 1.5km downstream on Riverside Drive for the nearest permissible opportunity for vehicles to conduct a U-turn. Therefore, most outbound vehicles have been assumed to use either Smyth Road or continue on Riverside Drive to Highway 417 instead to find an alternative route to their destination. The vehicle trip distribution assumptions are provided below.

- Inbound Vehicle Trips
  - 40% from north via Riverside Drive or Smyth Road
  - 10% from east via Riverside Drive or Smyth Road
  - 30% from south via Riverside Drive
  - 20% from west via Riverside Drive

- Outbound Vehicle Trips
  - 60% to north/south/east/west via Smyth Road
  - 40% to north/west via Riverside Drive

Figure 12: Peak Hour Site-Generated Vehicle Trips

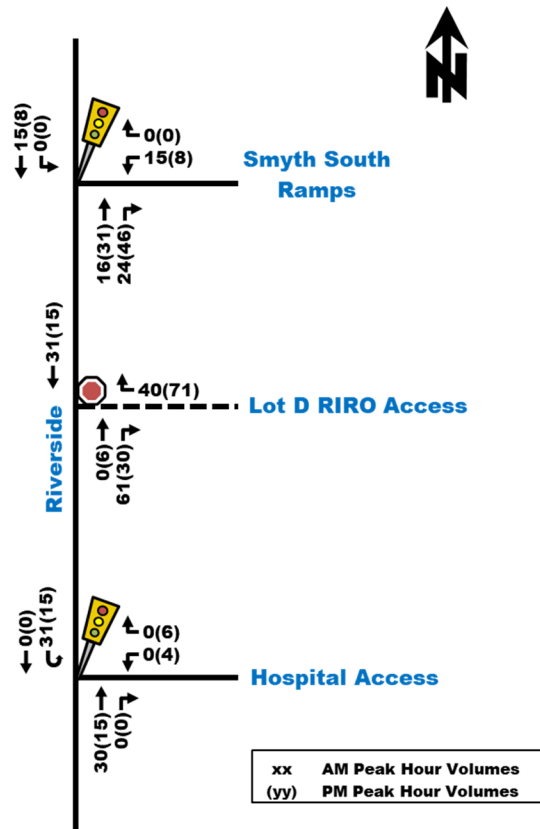

### 4.3 Projected Traffic Volumes

The total projected future study area peak hour traffic volumes can be calculated by layering the future trip generation of the new lots (Figure 12) onto the existing study area traffic volumes (Figure 10). The resulting total projected peak hour traffic volumes are illustrated in Figure 13. The SB U-turn volumes at the Riverside/Hospital Road intersection have been combined with the SBL volumes as both will use the left-turn lane, however, it will be modeled appropriately as a U-turn movement in the projected Synchro analysis.

Figure 13: Projected Total Peak Hour Traffic Volumes

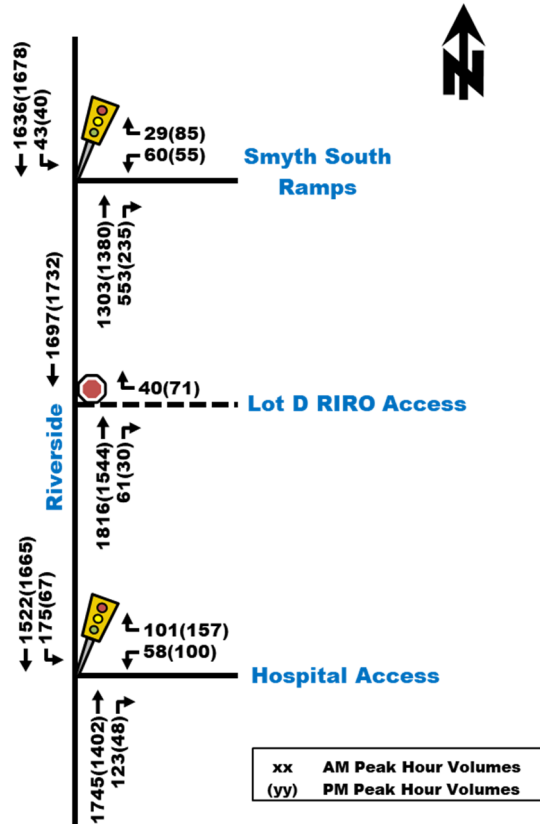

#### 4.4 Intersection Capacity Analysis

Analysis of future projected total traffic operations at study area intersections was completed using Synchro 11 based on traffic volumes shown in **Figure 13**. Critical movements at each of the intersections were assessed based on either the movement with the highest volume-to-capacity ratio (for signalized intersections), or the movement experiencing the highest average delay (for unsignalized intersections). As per the requirements of TIA Guidelines, the PHF was increased to 1.0. Summary results of the projected total conditions analysis is provided in **Table 4**, with Synchro reports provided in **Appendix C**. Existing cycle lengths at the signalized intersections have been maintained.

Table 4: Projected Total Peak Hour Intersection Capacity Analysis

Intersection	Weekday AM Peak (PM Peak)					
	Critical Movement			Intersection		
	LOS	max. v/c or avg. delay (s)	Movement	Delay (s)	LOS	v/c
Riverside/Hospital Road (S)	D(B)	0.84(0.65)	NBT(SBT)	14.7(10.9)	D(B)	0.82(0.64)
Riverside/Smyth South Ramp (S)	B(B)	0.61(0.66)	SBT(SBT)	4.7(8.4)	A(B)	0.60(0.65)
Riverside/Lot D Access (U)	B(A)	11.6(10.0)	WBR(WBR)	0.1(0.2)	A(A)	-

Note: Analysis of signalized intersections assumes a PHF of 1.0 and a saturation flow rate of 1800 veh/h/lane.  
 (S) – Signalized intersection, movement with highest v/c ratio identified as critical movement.  
 (U) – Unsignalized intersection, movement with highest average delay identified as critical movement.  
 \*a protected-permissive phase has been added to the SBL turn movement

Based on the results in **Table 4**, the study area intersections show some improvements compared to existing conditions due to both increasing the PHF and optimizing the phase times in Synchro. Additionally, a protected-permissive SBL turn phase was added to the Riverside/Hospital Road intersection to improve operations experienced based on analysis of existing conditions. Given the increase in SBL turn traffic volumes as a result of the closure of the Smyth Rd hospital access, the protected-permissive phase would be beneficial to improve traffic operations at the intersection and may help reduce safety concerns related to the anticipated U-turn traffic (up to 30 vehicles in peak hours). The new Lot D access along

Riverside Drive is expected to operate acceptably with LOS 'B' or better for the outbound WBR movement during peak hours.

### Queue Lengths

A review of queue lengths at the intersection of Riverside/Hospital Road indicates that the available storage lengths of the NBR, WBR and SBL auxiliary lanes is sufficient, and no design modifications are needed. Should the decision be made to implement a protected-permissive southbound left-turn movement (currently a permitted phase), a 95<sup>th</sup> percentile queue length of 35m is anticipated and the existing storage lane length of approximately 80m for this movement is considered adequate. It should also be noted that the 95<sup>th</sup> percentile queue length of the NBR lane at the Riverside/Smyth South Ramps intersection is minimal with up to 8m queue length anticipated during peak hours. Therefore, the queue length is not expected to extend to the Lot D access.

It should be noted that the protected-permissive SBL phase would slightly reduce the green time of the NBT movement. Based on the Synchro analysis, this results in an increase to the 95<sup>th</sup> percentile queue length of the NBT movement up to approximately 205m during peak hours, compared to the 123m in existing conditions. However, the queue length is still not anticipated to exceed the available storage space of approximately 235m between the Hospital Road and Pleasant Park Road intersections. Therefore, no concerns are expected from queueing.

## 4.5 TDM Considerations

---

A Transportation Demand Management Strategy for The Ottawa Hospital was prepared in March 2023 by Steer/Parsons in support of the New Civic Campus Development. Many of the strategies identified in the report would have applicability to the Riverside Campus, and TOH is encouraged to begin their implementation.

The Transitway passing through the Riverside Campus site and the Riverside Station connection to the main hospital building offer a convenient transit service that should alleviate reliance on private auto usage. Transit usage is particularly useful to hospital staff, many of whom are required to travel to the site regularly. Transit usage can be further incentivized by the hospital through transit fare subsidization for staff. The reduction in total hospital parking supply will likely result in a natural shift in travel mode in favor of more transit usage and walking/cycling for those living in the area.

## 5.0 Design Review

### 5.1 Lot C Review

---

The parking layout plan for Lot C is illustrated in **Figure 4**. The lot would be located in a vacant area (currently being used as temporary construction contractor parking with 20 spaces) on the south side of the Hospital Road, between the Transitway overhead bridge and the internal 90-degree road bend.

### Traffic

Lot C is expected to provide approximately 44 parking spaces, generating up to an estimated two-way traffic volume of approximately 20 vehicles during peak hours. This volume would be minimally impactful to study area intersections based on intersection operations.

### Pedestrian/Cyclist Connectivity

As shown, the parking lot access will be located at the 90-degree bend of the Hospital Road. As a result, the existing MUP will be realigned to the east by approximately 10m and the existing 1.8m concrete sidewalk on the south side of the Hospital Road will be extended across the access to connect to the new MUP location. Bike sharrows are proposed to be added as pavement lane markings where pavement is proposed to be widened along the Hospital Road and the new MUP connects to the road. As per City standard City drawing SC19.3, the MUP provides a yellow centreline, with bollard and armour stone to prevent vehicle intrusion.

At the parking lot access, the sidewalk will be depressed and continuous as per the standard City drawing SC7.1. A new short 1.8m wide concrete sidewalk would also be constructed on the west end of the parking lot for additional connection to the existing sidewalk on the south side of the Hospital Road. Additional modifications as part of Lot C include upgrading the existing pedestrian crossing on the Hospital Road, just west of the Lot C location, to a formalized Level 2 Type D Pedestrian Crossover, as per recommendation of the Ontario Traffic Manual Book 15.

Figure 14: Level 2 Type D Pedestrian Crossover

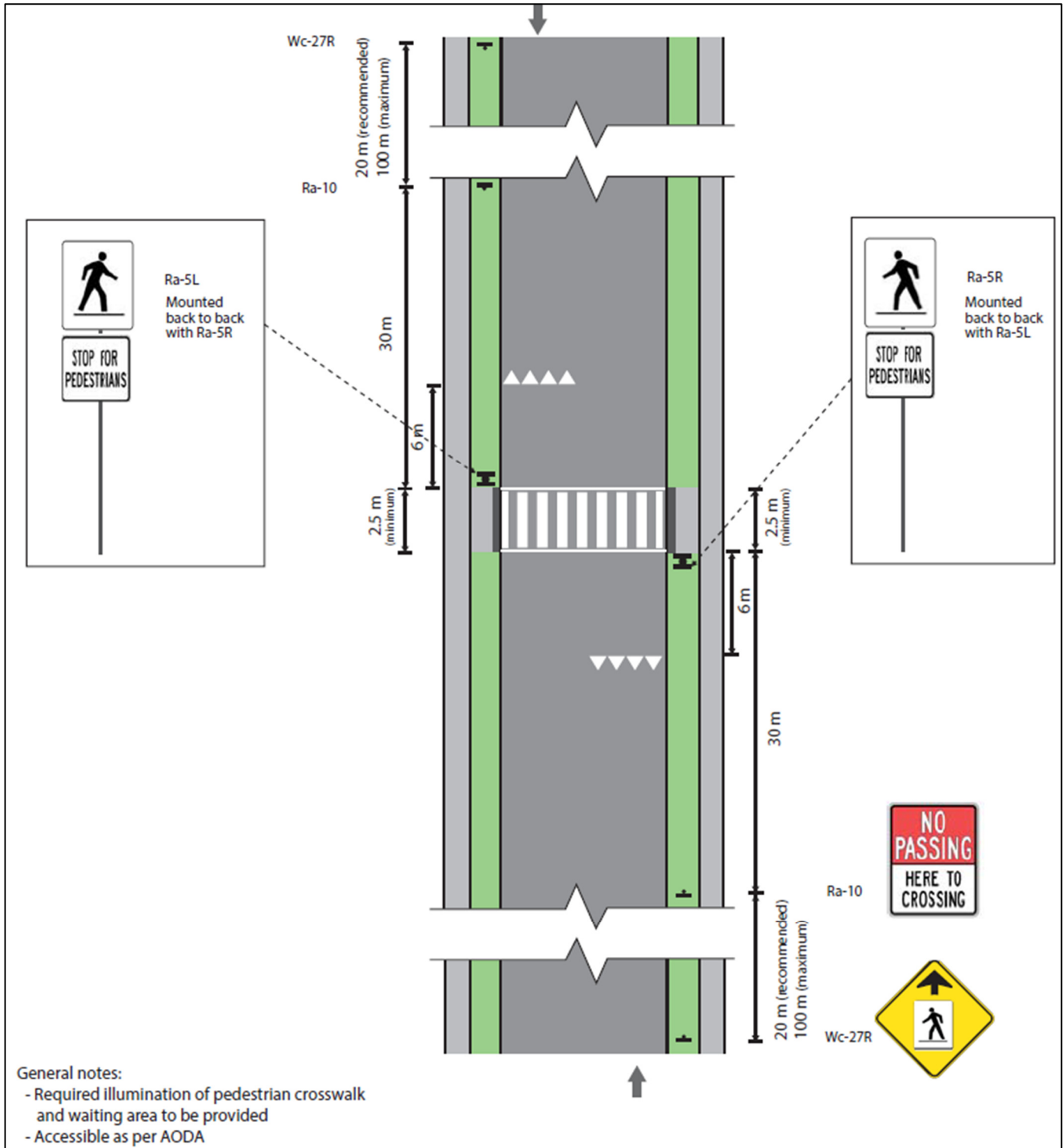

## Parking Lot Design

In accordance with the requirements of the Zoning By-law (Section 106 and 107), parking stalls provided are 2.6m wide and 5.2m long, with a parking lot aisle at least 6.7m wide. The City of Ottawa does not provide minimum access throat length requirements for this context and the suggested throat lengths in the TAC Guidelines apply to collector and arterial roads, which would not apply to the context of the private Hospital Road. A throat length of approximately 8m (2m sidewalk + 6m curb length) was provided for the access, which is considered sufficient given the low number of parking spaces. Within the access throat length, a 1.5m wide and 6m long island is provided after the sidewalk to accommodate parking lot gates.

## Hospital Road Truck Turns

Starting at the 90-degree road bend and for an approximately 40m section along the east side of the Hospital Road, the pavement is proposed to be widened by relocating the curb to match the existing curb where the auxiliary northbound left-turn lane begins at the main Lot A access. This pavement widening will provide extra space to allow large WB-20 trucks to complete their turns more easily without major concerns. However, it should be noted that hospital staff have indicated through on-site knowledge that trucks are currently able to navigate other areas of the site without any major concerns.

To ensure large trucks are able to complete their turns at the road bend, truck turning templates have been prepared using a WB-20 truck profile. The templates have been provided in **Appendix D**, which indicates no concerns for trucks to maneuver the turn. In regard to the parking lot, only passenger vehicles will be entering and exiting Lot C and no concerns are identified for the provided access width and curb radii.

## 5.2 Lot D Review

The parking layout plan for Lot D is illustrated in **Figure 5**. The lot would be located on the east side of Riverside Drive, in a vacant area between the Transitway intersection and the Smyth Road South Ramp.

## Traffic

Lot D is expected to provide approximately 126 parking spaces (including 60 small car spaces), generating up to an estimated two-way traffic volume of 101 vehicles during peak hours. Based on intersection operations analysis, this volume is not anticipated to result in major impacts to intersection operations, provided a protected-permissive phase is provided at the SBL movement to mitigate existing operational concerns.

## Pedestrian/Cyclist Connectivity

The existing pathway connecting Riverside Drive to Riverside Station will be removed and a new 2.0m wide sidewalk will connect from the existing Riverside Drive sidewalk to an internal painted parking lot crosswalk and to the Transitway (at the same approximate location of the previous pathway). At the site access, the existing 1.5m sidewalk along Riverside Drive will be depressed and continuous as per standard City drawing SC7.1.

## Parking Lot Design

In accordance with the requirements of the Zoning By-law (Section 106 and 107), parking stalls provided are 2.6m wide and 5.2m long, with less than 50% (60 spaces) of the spaces reduced to 4.6m long and 2.4m wide and identified as small car spaces. The parking aisles are at least 6.7m wide and the driveway width is approximately 7.0m wide. A throat length of approximately 35m is provided to the parking gates. TAC Guidelines do not provide a suggested minimum clear throat length for this specific land use; however, it provides a range for a variety of land uses along arterial roads, with 15m in small developments to 75m in very large developments. The throat length provided for Lot D is considered appropriate as the parking lot considered to reflect a small sized development. Similar to Lot C, a 1.5m wide and 6m long island is provided after to accommodate parking lot gates.



## Access Location and Design

The access would permit right-in/right-out movements only and will be located approximately 54m north of the Riverside/Transitway intersection and 94m south of the Riverside/Smyth South Ramp intersection. The City of Ottawa's Private Approach By-Law does not indicate a minimum separation distance between an intersection and the proposed access for this specific land use (private parking lot). However, for a public parking lot, which represents a similar land use, the recommended minimum separation distance is indicated to be 45m based on the number of spaces provided, which the site access exceeds on both sides. Only passenger vehicles are expected to enter and exit the parking lot and access width and curb radii are expected to have no concerns accommodating the turns.

It is noted that the Lot D access will allow traffic to enter and exit the lot via an existing right-turn lane along Riverside Drive. The right-turn lane extends along the full length of the Riverside Drive segment between its intersections with the Transitway and the Smyth Road South Ramps. Traffic operations indicate that the 95<sup>th</sup> percentile queue length of the NBR at Riverside/Smyth South Ramps intersection is minimal in the future (up to 8m) and would not extend to the Lot D access. Nonetheless, a significant separation distance of 94m is provided between the access and the signal. Additionally, as discussed in **Section 3.3**, no bus routes currently turn right from the Transitway onto Riverside Drive, which eliminates concerns of potential conflict with traffic coming from the intersection. Therefore, modifying the existing right-turn lane is not considered needed to mitigate any major safety concerns. With regards to U-turns being conducted in the SBL lane at the Riverside/Hospital Road intersection, a protected-permissive phase is recommended to mitigate safety and operational concerns and accommodate the increase in traffic volume as a result of losing the Smyth Road access.

## 6.0 Summary and Conclusion

The purpose of this transportation memo is to document future parking plans of the Ottawa Hospital's Riverside Campus, through a review of potential safety concerns and intersection operations impacts. A full Transportation Impact Assessment report was considered unwarranted as the overall supply of parking spaces will have a net decrease in the future.

### Proposed Parking Plan

- The hospital's previous Lot B and medical building's parking lots, consisting of approximately 398 spaces in total, are being replaced by a long-term care and retirement home development (Schlegel Villages). This results in a reduction to the previous overall parking supply from 761 spaces to 363 spaces.
- As a temporary existing measure until new parking lots are constructed, the hospital has provided 100 temporary parking spaces accessed via the hospital road and constructed the medical building's parking lot to its final condition, resulting in a total current supply of approximately 502 spaces, which have been captured as part of recent traffic data collection at the Riverside Drive access.
- To replace some of the parking loss, the hospital is adding two new lots in the future:
  - Lot C will be located on the south side along the Hospital Road, at the 90-degree road bend, providing 44 parking spaces.
  - Lot D will be located along the east side of Riverside Drive, between the Transitway and Smyth Road South Ramps, providing 126 parking spaces (including 60 small spaces).
  - In total, the future hospital parking supply will be approximately 572 parking spaces.

### Anticipated Traffic Operational Impacts

- As the Smyth Road access to the Hospital Road has been closed off recently for the Schlegel Villages construction, all traffic has been rerouted to use only the Riverside Drive hospital access. Based on a Synchro analysis of existing conditions, this has resulted in the SBL movement operating at capacity.
- In future conditions, Lot D is expected to generate an approximate 101 two-way vehicle trips during peak hours. Traffic volumes from Lot C, the medical building and the future Schlegel Villages development are all assumed to be accounted for as part of the recent data collection at Riverside Drive access. However, to be conservative with

regard to future outbound trips from Lot C, 10 outbound trips from the hospital were added in the afternoon peak hour.

- Due to the location of Lot D and its access permitting right-in/right-out movements only, inbound traffic volumes from the north of Riverside Drive would need to conduct a U-turn at the Riverside/Hospital Road intersection using the SBL turn lane. In order to improve operations of the SBL movement to accommodate the increase in traffic due to closure of the Smyth Road access, a protected-permissive phase is recommended. No other intersection capacity constraints are anticipated from the new parking lots.
- Traffic queues at all study area intersections are expected to be acceptable and not exceeding available storage lengths in both existing and future conditions.

### Safety Review

- Due to the closure of Smyth Road access, trucks must now divert to use the Riverside Drive access. A pavement widening of the Hospital Road is proposed to take place near the Lot C location at the 90-degree road bend. This would provide extra space to allow large WB-20 trucks to maneuver the corner more easily. Hospital staff indicated that trucks currently have no major concerns navigating other areas of the site.
- With the proposed Lot C location, the existing MUP will be realigned approximately 10m to the east and bike sharrows will be added as pavement markings on the widened pavement area of the Hospital Road where the new MUP would connect. Also, the existing pedestrian crossing on the Hospital Road, just west of Lot C, will be upgraded to a Level 2 Type D Pedestrian Crossover, as per the suggestion of the Ontario Traffic Manual Book 15.
- No concerns are anticipated with the Lot D access design due to the following:
  - The access will be located a safe distance of 94m from the Riverside/Smyth South Ramps intersection and a distance of 54m from the Riverside/Transitway intersection, both of which meet the minimum requirements of the City of Ottawa Private Approach By-Law. No conflicts or concerns are expected with traffic exiting the Transitway as no active bus routes currently use the intersection.
  - The access will connect to an existing right-turn lane along Riverside Drive. Future 95<sup>th</sup> percentile traffic queues based on Synchro analysis indicate minimal queue length of up to 8m on the NBR lane at the Riverside/Smyth South Ramps intersection.
  - A throat length of approximately 35m will be provided, which is considered sufficient based on the suggested clear throat length of TAC Guidelines.
  - Traffic expected to conduct a U-turn at the intersection of Riverside/Hospital Road to access Lot D is relatively small (approximately 15 to 30 vehicles during peak hours) and not anticipated to cause safety concerns. The provision of a protected-permissive phase for the SBL movement at the intersection of Riverside/Hospital Road may also help to further reduce safety concerns.

# Document Control Page

<b>CLIENT:</b>	The Ottawa Hospital				
<b>PROJECT NAME:</b>	The Ottawa Hospital Riverside Campus				
<b>REPORT TITLE:</b>	Transportation Review Memorandum				
<b>PARSONS PROJECT NO:</b>	479008 - 01000				
<b>DIGITAL MASTER:</b>	<a href="https://parsons365can.sharepoint.com/sites/OttawaHub/Projects/Projects/479008 - Riverside Campus Parking Lot (The Ottawa Hospital)/4.01000 - PLANNING/Documents/Transportation Memos/Documents/4-Transportation Review Memo (TIA) w City Comments 2/TOH Riverside Transportation Memo.docx">https://parsons365can.sharepoint.com/sites/OttawaHub/Projects/Projects/479008 - Riverside Campus Parking Lot (The Ottawa Hospital)/4.01000 - PLANNING/Documents/Transportation Memos/Documents/4-Transportation Review Memo (TIA) w City Comments 2/TOH Riverside Transportation Memo.docx</a>				
<b>HISTORY:</b>	<b>Version</b>	<b>Originator</b>	<b>Reviewer</b>	<b>Back Checker</b>	
	Original	October 09, 2024	Basel Ansari, P.Eng.	Austin Shih, P.Eng.	Basel Ansari, P.Eng.
	Update	November 01, 2024	Basel Ansari, P.Eng.	Austin Shih, P.Eng.	Basel Ansari, P.Eng.
	Update	January 17, 2025	Basel Ansari, P.Eng.	Austin Shih, P.Eng.	Basel Ansari, P.Eng.
	Final	February 28, 2025	Basel Ansari, P.Eng.	Austin Shih, P.Eng.	Basel Ansari, P.Eng.



## **TIA Plan Reports**

On 14 June 2017, the Council of the City of Ottawa adopted new Transportation Impact Assessment (TIA) Guidelines. In adopting the guidelines, Council established a requirement for those preparing and delivering transportation impact assessments and reports to sign a letter of certification.

Individuals submitting TIA reports will be responsible for all aspects of development-related transportation assessment and reporting, and undertaking such work, in accordance and compliance with the City of Ottawa's Official Plan, the Transportation Master Plan and the Transportation Impact Assessment (2017) Guidelines.

By submitting the attached TIA report (and any associated documents) and signing this document, the individual acknowledges that s/he meets the four criteria listed below.

### **CERTIFICATION**

1. I have reviewed and have a sound understanding of the objectives, needs and requirements of the City of Ottawa's Official Plan, Transportation Master Plan and the Transportation Impact Assessment (2017) Guidelines;
2. I have a sound knowledge of industry standard practice with respect to the preparation of transportation impact assessment reports, including multi modal level of service review;
3. I have substantial experience (more than 5 years) in undertaking and delivering transportation impact studies (analysis, reporting and geometric design) with strong background knowledge in transportation planning, engineering or traffic operations; and
4. I am either a licensed<sup>1</sup> or registered<sup>2</sup> professional in good standing, whose field of expertise [check  appropriate field(s)] is either transportation engineering  or transportation planning .

**1,2 License of registration body that oversees the profession is required to have a code of conduct and ethics guidelines that will ensure appropriate conduct and representation for transportation planning and/or transportation engineering works.**

City Of Ottawa  
Infrastructure Services and Community  
Sustainability  
Planning and Growth Management  
110 Laurier Avenue West, 4th fl.  
Ottawa, ON K1P 1J1  
Tel. : 613-580-2424  
Fax: 613-560-6006

Ville d'Ottawa  
Services d'infrastructure et Viabilité des  
collectivités  
Urbanisme et Gestion de la croissance  
110, avenue Laurier Ouest  
Ottawa (Ontario) K1P 1J1  
Tél. : 613-580-2424  
Télécopieur: 613-560-6006



# Appendix A

Traffic Counts



# Turning Movement Count Summary, AM and PM Peak Hour Flow Diagrams All Vehicles Except Bicycles



## Riverside Drive & Ottawa Hospital Riverside Campus

Ottawa, ON

**All Vehicles**  
(Except Bicycles & Electric Scooters)

Total vehicle volume,  
all approaches.  
(B + C + D)

Wednesday, March 27, 2024

0700-0900 & 1600-1800

4 Hour Survey

City of Ottawa Ward 18

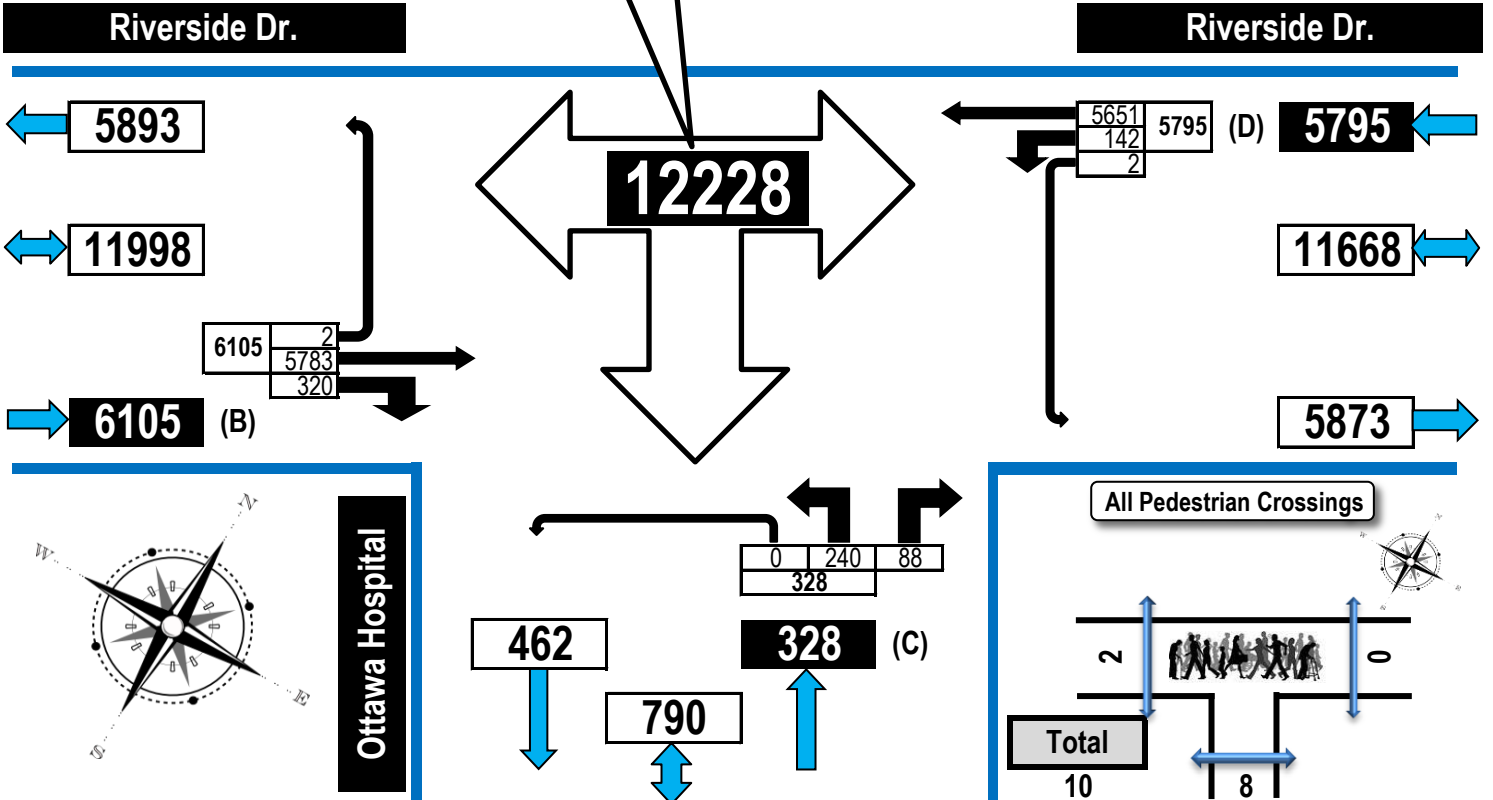

### AM Peak Hour Flow Diagram      PM Peak Hour Flow Diagram

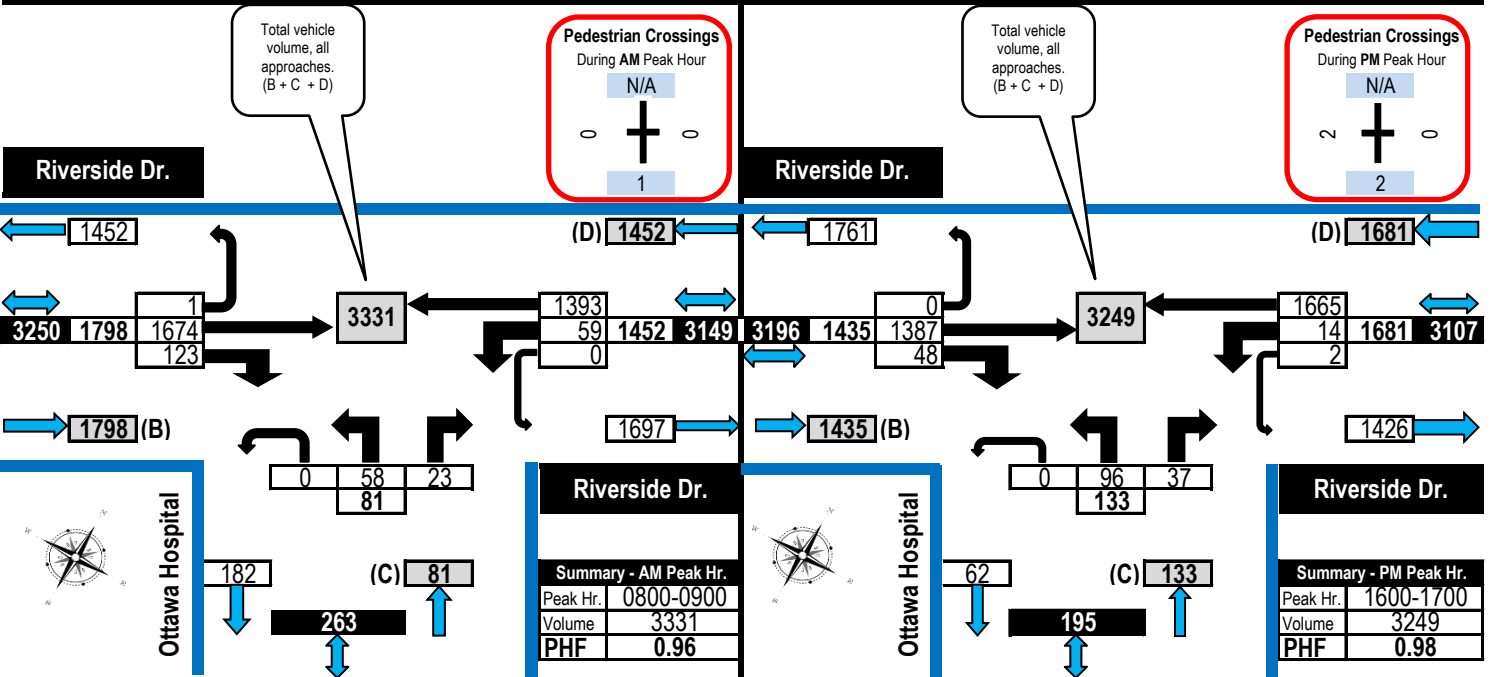



# Turning Movement Count

## Heavy Vehicle Summary (FHWA Class 4 to 13)

### Flow Diagram



## Riverside Drive & Ottawa Hospital Riverside Campus Ottawa, ON

**Heavy Vehicles**  
 (Construction Vehicles, Heavy Trucks, Buses & School Buses).  
 Heavy vehicle totals ARE included in the all vehicles summary and flow diagrams.

Total heavy vehicle volume, all approaches.  
 (B + C + D)

Wednesday, March 27, 2024  
 0700-0900 & 1600-1800  
 4 Hour Survey  
 City of Ottawa Ward ► 18

Heavy Vehicles  
 Comprise  
**2.35%**  
 of Total Traffic

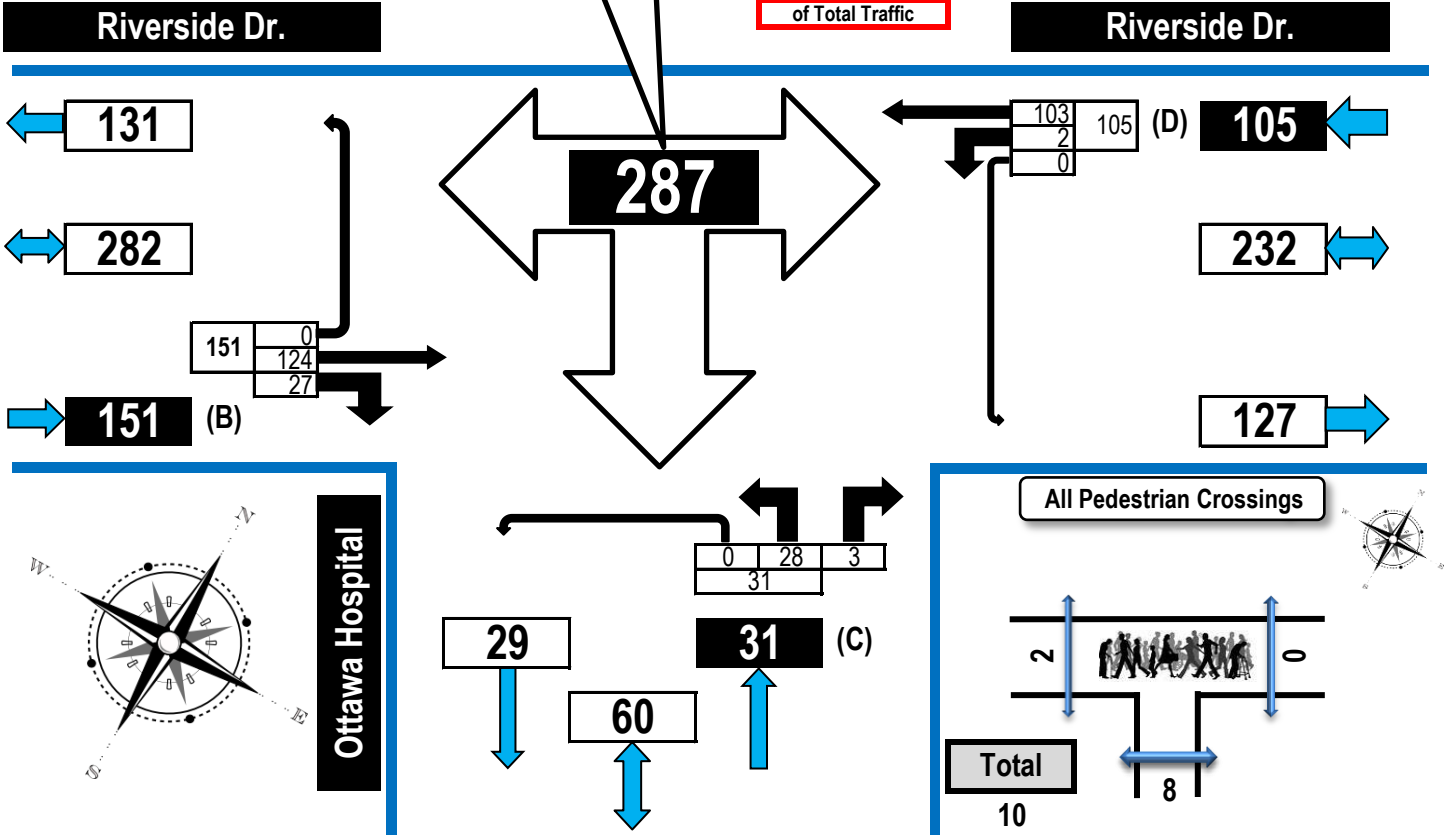

Riverside Dr.	Riverside Dr.	Ottawa Hospital	N/A
Eastbound	Westbound	Northbound	Southbound

Time Period	Riverside Dr. Eastbound					Riverside Dr. Westbound					Ottawa Hospital Northbound					N/A Southbound					SB Tot	GR Tot	
	LT	ST	RT	UT	EB Tot	LT	ST	RT	UT	WB Tot	LT	ST	RT	UT	NB Tot	LT	ST	RT	UT				
0700-0800		26	7	0	33	1	27		0	28	8		1	0	9								70
0800-0900		43	7	0	50	0	42		0	42	7		1	0	8								100
1600-1700		35	7	0	42	1	19		0	20	7		1	0	8								70
1700-1800		20	6	0	26	0	15		0	15	6		0	0	6								47
<b>Totals</b>		124	27	0	151	2	103		0	105	28		3	0	31								287

Comments:  
 OC Transpo and Para Transpo buses, Ottawa Hospital shuttle buses and school buses comprise 40.42% of the heavy vehicle traffic. Westbound traffic occasionally backs up from Pleasant Park Road after 1600H.





# Turning Movement Count All Buses Summary (FHWA Class 4 ONLY) Flow Diagram



## Riverside Drive & Ottawa Hospital Riverside Campus Ottawa, ON

**Buses ONLY**  
(Transit, Intercity, School Buses & Other Buses).  
Bus totals **ARE** included in the all vehicles summary, heavy vehicle summary & flow diagrams.

Total bus volume, all approaches.  
(B + C + D)

All Buses Comprise  
**0.95%**  
of Total Traffic  
and  
**40.42%**  
of the Heavy Vehicle Traffic

Wednesday, March 27, 2024  
0700-0900 & 1600-1800  
4 Hour Survey  
City of Ottawa Ward ► 18

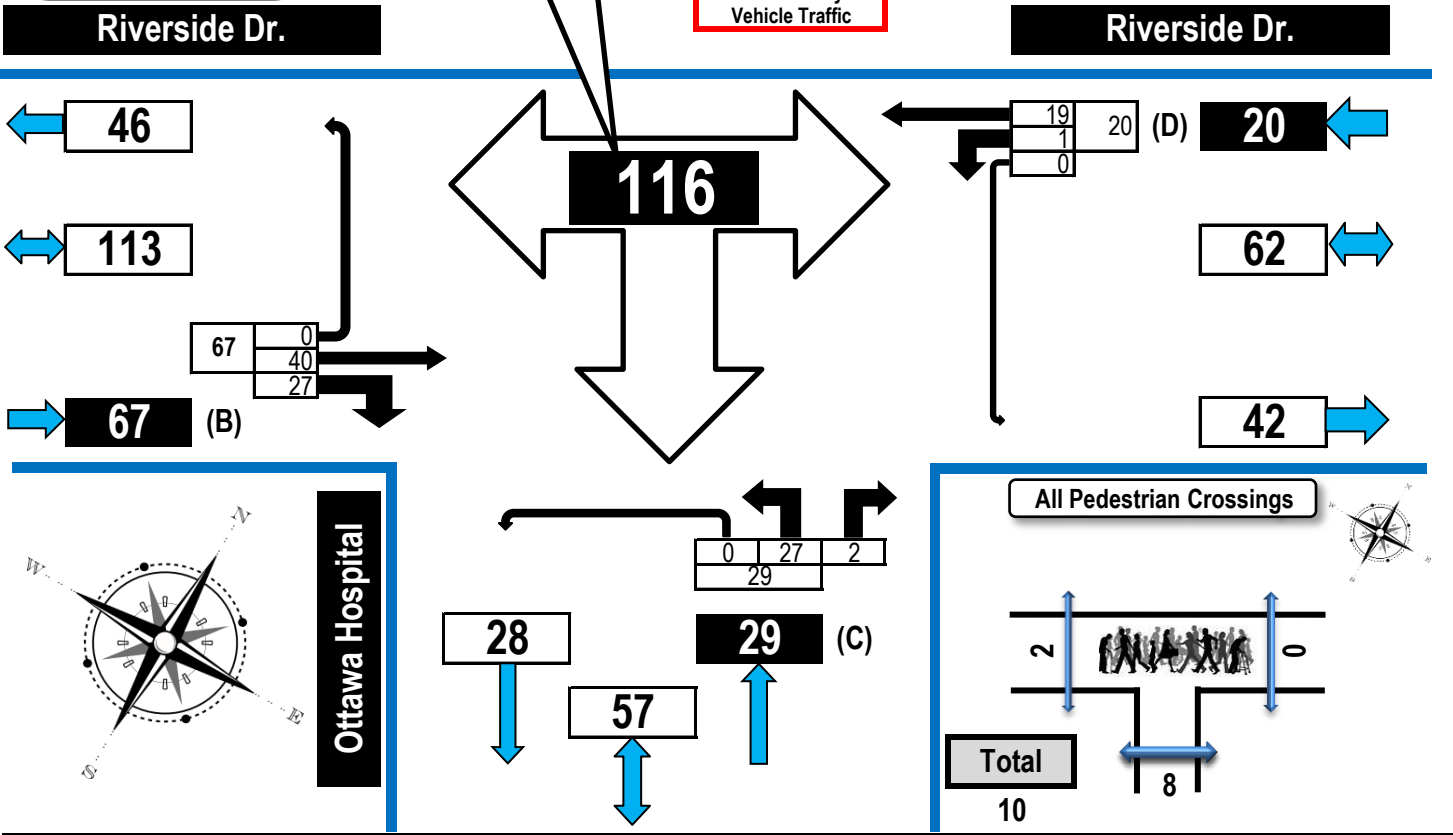

Riverside Dr.	Riverside Dr.	Ottawa Hospital	N/A
Eastbound	Westbound	Northbound	Southbound

Time Period	LT	ST	RT	UT	EB Tot	LT	ST	RT	UT	WB Tot	LT	ST	RT	UT	NB Tot	LT	ST	RT	UT	SB Tot	GR Tot	
0700-0800		7	7	0	14	0	5		0	5	7		1	0	8							27
0800-0900		14	7	0	21	0	7		0	7	7		0	0	7							35
1600-1700		13	7	0	20	1	3		0	4	7		1	0	8							32
1700-1800		6	6	0	12	0	4		0	4	6		0	0	6							22
<b>Totals</b>		<b>40</b>	<b>27</b>	<b>0</b>	<b>67</b>	<b>1</b>	<b>19</b>		<b>0</b>	<b>20</b>	<b>27</b>		<b>2</b>	<b>0</b>	<b>29</b>							<b>116</b>

Comments:  
OC Transpo and Para Transpo buses, Ottawa Hospital shuttle buses and school buses comprise 40.42% of the heavy vehicle traffic. Westbound traffic occasionally backs up from Pleasant Park Road after 1600H.



# Turning Movement Count Bicycle Summary Flow Diagram



## Riverside Drive & Ottawa Hospital Riverside Campus Ottawa, ON

**Bicycles**  
(Including electric bicycles and electric scooters)  
**Note:**  
Bicycle volumes are **NOT** included in vehicle totals.

Total bicycle volume, all approaches.  
(B + C + D)

Bicycles comprise  
**0.03%**  
of total traffic

**Wednesday, March 27, 2024**  
**0700-0900 & 1600-1800**  
**4 Hour Survey**  
City of Ottawa Ward ► 18

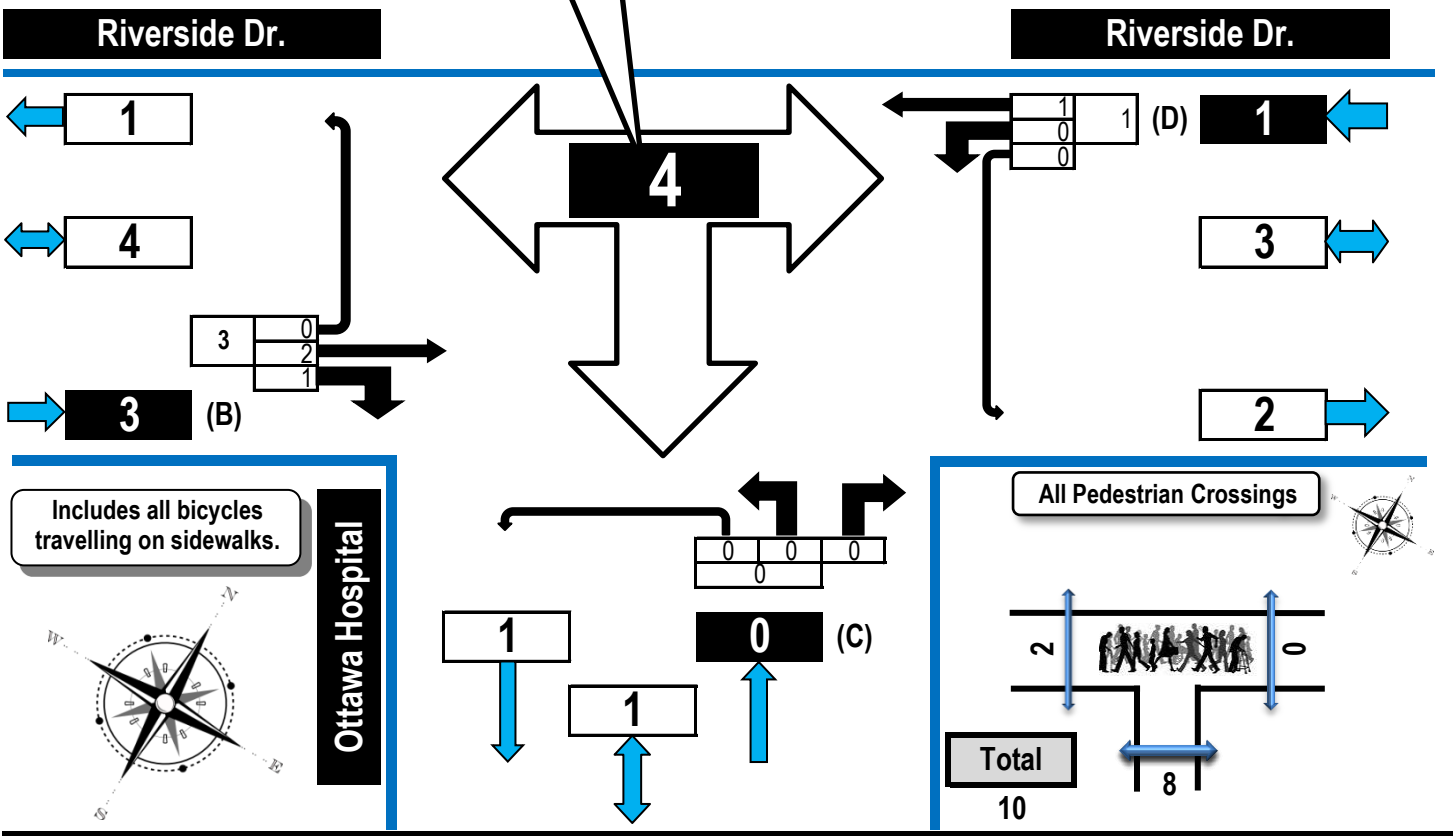

Riverside Dr. Eastbound	Riverside Dr. Westbound	Ottawa Hospital Northbound	N/A Southbound
----------------------------	----------------------------	-------------------------------	-------------------

Time Period	Riverside Dr. Eastbound					Riverside Dr. Westbound					Ottawa Hospital Northbound					N/A Southbound					
	LT	ST	RT	UT	EB Tot	LT	ST	RT	UT	WB Tot	LT	ST	RT	UT	NB Tot	LT	ST	RT	UT	SB Tot	GR Tot
0700-0800		1	0	0	1	0	0	0	0	0	0	0	0	0	0						
0800-0900		0	0	0	0	0	0	0	0	0	0	0	0	0	0						
1600-1700		0	1	0	1	0	0	0	0	0	0	0	0	0	0						
1700-1800		1	0	0	1	0	1	0	0	1	0	0	0	0	0						
<b>Totals</b>		<b>2</b>	<b>1</b>	<b>0</b>	<b>3</b>	<b>0</b>	<b>1</b>	<b>0</b>	<b>0</b>	<b>1</b>	<b>0</b>	<b>0</b>	<b>0</b>	<b>0</b>	<b>0</b>						<b>4</b>

Comments:  
 OC Transpo and Para Transpo buses, Ottawa Hospital shuttle buses and school buses comprise 40.42% of the heavy vehicle traffic. Westbound traffic occasionally backs up from Pleasant Park Road after 1600H.



# Turning Movement Count Pedestrian Crossings Summary and Flow Diagram



## Riverside Drive & Ottawa Hospital Riverside Campus Ottawa, ON

### Pedestrian Crossings

Wednesday, March 27, 2024

0700-0900 & 1600-1800

4 Hour Survey

City of Ottawa Ward ► 18

Total number of all pedestrian crossings

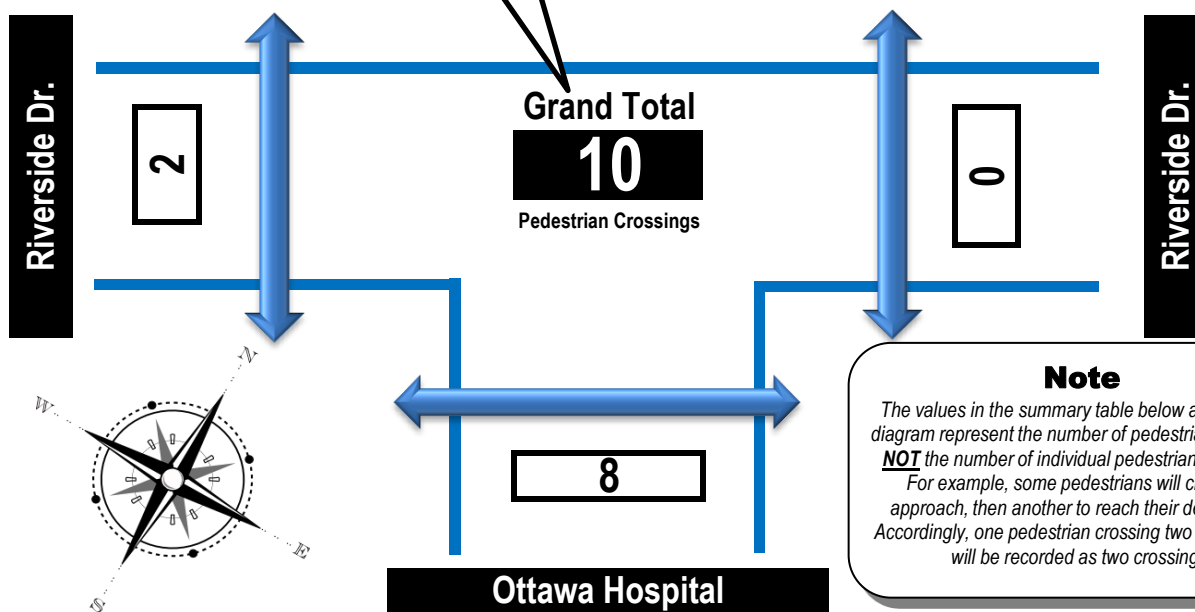

**Note**

The values in the summary table below and the flow diagram represent the number of pedestrian crossings NOT the number of individual pedestrians crossing. For example, some pedestrians will cross one approach, then another to reach their destination. Accordingly, one pedestrian crossing two approaches will be recorded as two crossings.

Time Period	West Side Crossing Riverside Dr.	East Side Crossing Riverside Dr.	Street Total	South Side Crossing Ottawa Hospital	North Side Crossing N/A	Street Total	Grand Total
0700-0800	0	0	0	1		1	1
0800-0900	0	0	0	1		1	1
1600-1700	2	0	2	2		2	4
1700-1800	0	0	0	4		4	4
<b>Totals</b>	<b>2</b>	<b>0</b>	<b>2</b>	<b>8</b>		<b>8</b>	<b>10</b>

**Comments:**

OC Transpo and Para Transpo buses, Ottawa Hospital shuttle buses and school buses comprise 40.42% of the heavy vehicle traffic. Westbound traffic occasionally backs up from Pleasant Park Road after 1600H.



# Turning Movement Count

## Summary Report

### Including AM and PM Peak Hours

All Vehicles Except Bicycles



## Riverside Drive & Ottawa Hospital Riverside Campus Ottawa, ON

**Survey Date:** Wednesday, March 27, 2024      **Start Time:** 0700      **AADT Factor:** 1.0  
**Weather AM:** Mostly Cloudy +6° C      **Survey Duration:** 4 Hrs.      **Survey Hours:** 0700-0900 & 1600-1800  
**Weather PM:** Mostly Cloudy +15° C      **Surveyor(s):** J. Mousseau

Time Period	Riverside Dr. Eastbound					Riverside Dr. Westbound					Ottawa Hospital Northbound					N/A Southbound					Street Total	Grand Total	
	LT	ST	RT	UT	E/B Tot	LT	ST	RT	UT	W/B Tot	LT	ST	RT	UT	N/B Tot	LT	ST	RT	UT	S/B Tot			
	0700-0800	0	1422	123	1	1546	58	1044	0	0	1102	2648	38	0	11	0	49						
0800-0900	0	1674	123	1	1798	59	1393	0	0	1452	3250	58	0	23	0	81						81	3331
1600-1700	0	1387	48	0	1435	14	1665	0	2	1681	3116	96	0	37	0	133						133	3249
1700-1800	0	1300	26	0	1326	11	1549	0	0	1560	2886	48	0	17	0	65						65	2951
<b>Totals</b>	<b>0</b>	<b>5783</b>	<b>320</b>	<b>2</b>	<b>6105</b>	<b>142</b>	<b>5651</b>	<b>0</b>	<b>2</b>	<b>5795</b>	<b>11900</b>	<b>240</b>	<b>0</b>	<b>88</b>	<b>0</b>	<b>328</b>						<b>328</b>	<b>12228</b>

**Equivalent 12 & 24-hour Vehicle Volumes Including the Annual Average Daily Traffic (AADT) Factor**  
**Applicable to the Day and Month of the Turning Movement Count**

**Expansion factors are applied exclusively to standard weekday 8-hour turning movement counts conducted during the hours of 0700h - 1000h, 1130h - 1330h and 1500h - 1800h**

Equivalent 12-hour vehicle volumes. These volumes are calculated by multiplying the 8-hour totals by the 8 → 12 expansion factor of 1.39																					
Equ. 12 Hr	n/a	n/a	n/a	n/a	n/a	n/a	n/a	n/a	n/a	n/a	n/a	n/a	n/a	n/a	n/a	n/a	n/a	n/a	n/a	n/a	n/a
Average daily 12-hour vehicle volumes. These volumes are calculated by multiplying the equivalent 12-hour totals by the AADT factor of: 1.0																					
AADT 12-hr	n/a	n/a	n/a	n/a	n/a	n/a	n/a	n/a	n/a	n/a	n/a	n/a	n/a	n/a	n/a	n/a	n/a	n/a	n/a	n/a	n/a
24-Hour AADT. These volumes are calculated by multiplying the average daily 12-hour vehicle volumes by the 12 → 24 expansion factor of 1.31																					
AADT 24 Hr	n/a	n/a	n/a	n/a	n/a	n/a	n/a	n/a	n/a	n/a	n/a	n/a	n/a	n/a	n/a	n/a	n/a	n/a	n/a	n/a	n/a

**AADT and expansion factors provided by the City of Ottawa**

<b>AM Peak Hour Factor → 0.96</b>												<b>Highest Hourly Vehicle Volume Between 0700h &amp; 0900h</b>											
AM Peak Hr	LT	ST	RT	UT	Total	LT	ST	RT	UT	Total	Str. Tot.	LT	ST	RT	UT	Total	LT	ST	RT	UT	Total	Str. Tot.	Gr. Tot.
0800-0900	0	1674	123	1	1798	59	1393	0	0	1452	3250	58	0	23	0	81	0	0	0	0	0	81	3331
<b>PM Peak Hour Factor → 0.98</b>												<b>Highest Hourly Vehicle Volume Between 1600h &amp; 1800h</b>											
PM Peak Hr	LT	ST	RT	UT	Total	LT	ST	RT	UT	Total	Str. Tot.	LT	ST	RT	UT	Total	LT	ST	RT	UT	Total	Str. Tot.	Gr. Tot.
1600-1700	0	1387	48	0	1435	14	1665	0	2	1681	3116	96	0	37	0	133	0	0	0	0	0	133	3249

**Comments:**

OC Transpo and Para Transpo buses, Ottawa Hospital shuttle buses and school buses comprise 40.42% of the heavy vehicle traffic. Westbound traffic occasionally backs up from Pleasant Park Road after 1600H.

**Notes:**

1. Includes all vehicle types except bicycles, electric bicycles, and electric scooters.
2. When expansion and AADT factors are applied, the results will differ slightly due to rounding.

**Intersection** Riverside Dr at Hospital Rd

**Date** 10/1/2024 Tuesday

**Observer** Jordan Terada

	AM	MID	PM
<b>Weather</b>	Sunny & Clear		Mix of Clouds
<b>Time Period</b>	7:30 - 9:30		3:30 - 5:30

From Time	To Time	Auto Vehicles		Pedestrians		Cyclists		Hourly	Peak Hour	From	To	Ins	Outs
		Ins	Outs	Ins	Outs	Ins	Outs						
7:30	7:45	75	17		1								
7:45	8:00	62	26										
8:00	8:15	81	30		1								
8:15	8:30	66	29			1		386					
8:30	8:45	60	33	2	2			387	AM	8:30:00 AM	9:30:00 AM	267	159
8:45	9:00	64	40	2				403					
9:00	9:15	79	39		2			410					
9:15	9:30	64	47	1				426					
9:30	9:45							333					
9:45	10:00							229					
15:00	15:15												
15:15	15:30												
15:30	15:45	27	81										
15:45	16:00	30	63				1						
16:00	16:15	24	66		3				PM	3:30:00 PM	4:30:00 PM	100	247
16:15	16:30	19	37	2	1			347					
16:30	16:45	22	45					306					
16:45	17:00	14	26					253					
17:00	17:15	18	34	1	4			215					
17:15	17:30	8	25		1			192					



# Turning Movement Count Summary, AM and PM Peak Hour Flow Diagrams All Vehicles Except Bicycles



## Riverside Drive & Smyth Road South Ramps Ottawa, ON

**All Vehicles**  
(Except Bicycles & Electric Scooters)

Tuesday, August 13, 2024  
0700-0900 & 1600-1800  
4 Hour Survey  
City of Ottawa Ward ► 18

### Smyth Rd. S Ramps

Total vehicle volume,  
all approaches.  
(A + C + D)

12282

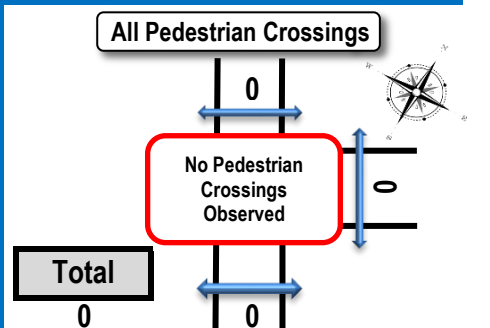
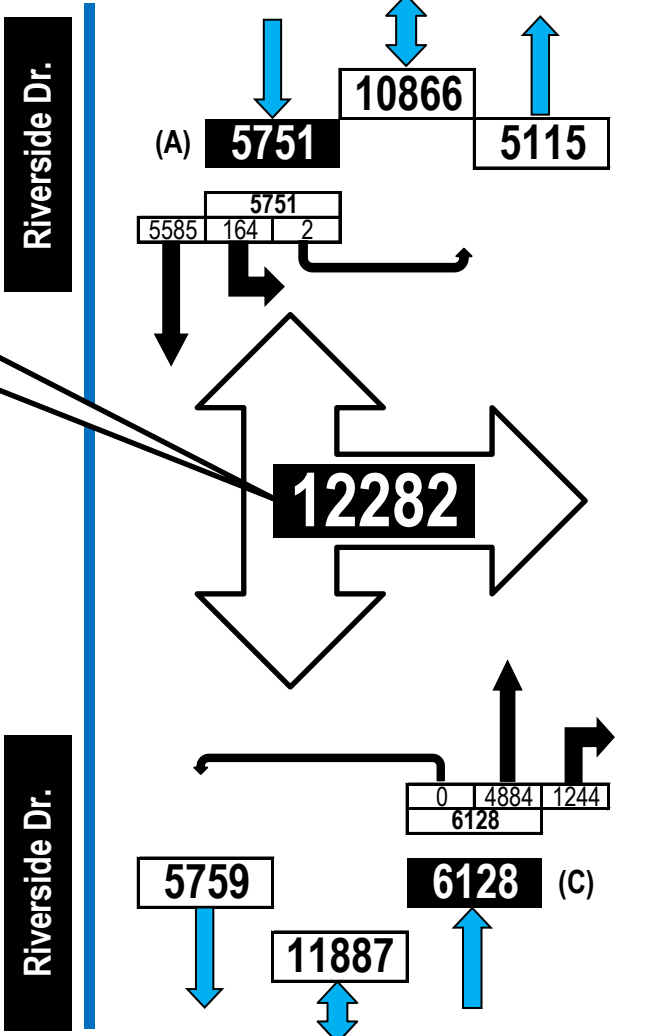
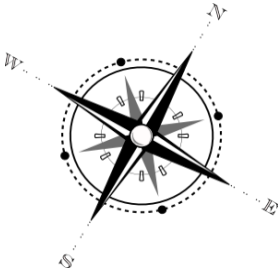
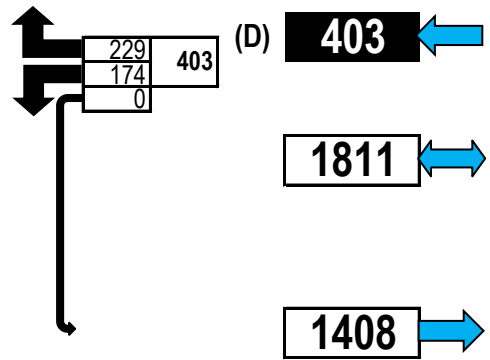

### AM Peak Hour Flow Diagram PM Peak Hour Flow Diagram

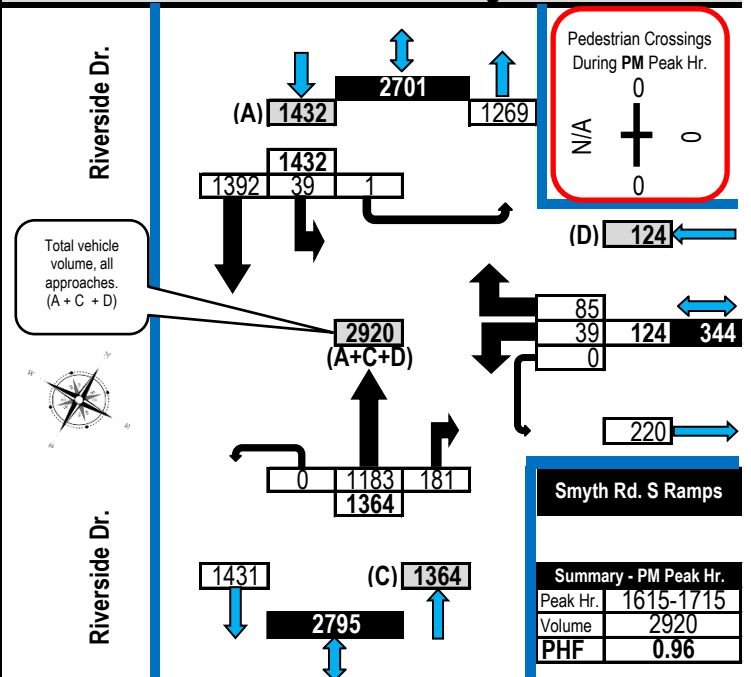
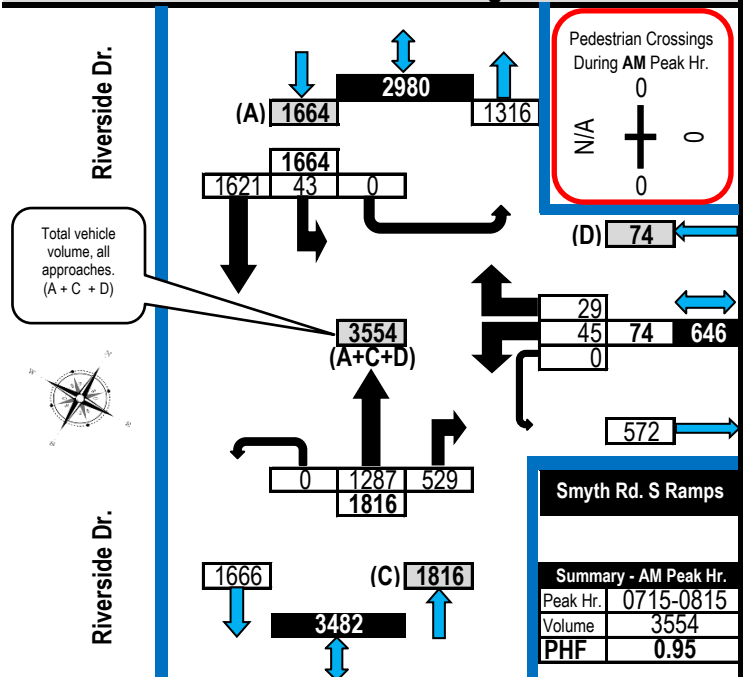



# Turning Movement Count

## Heavy Vehicle Summary (FHWA Class 4 to 13)

### Flow Diagram



## Riverside Drive & Smyth Road South Ramps Ottawa, ON

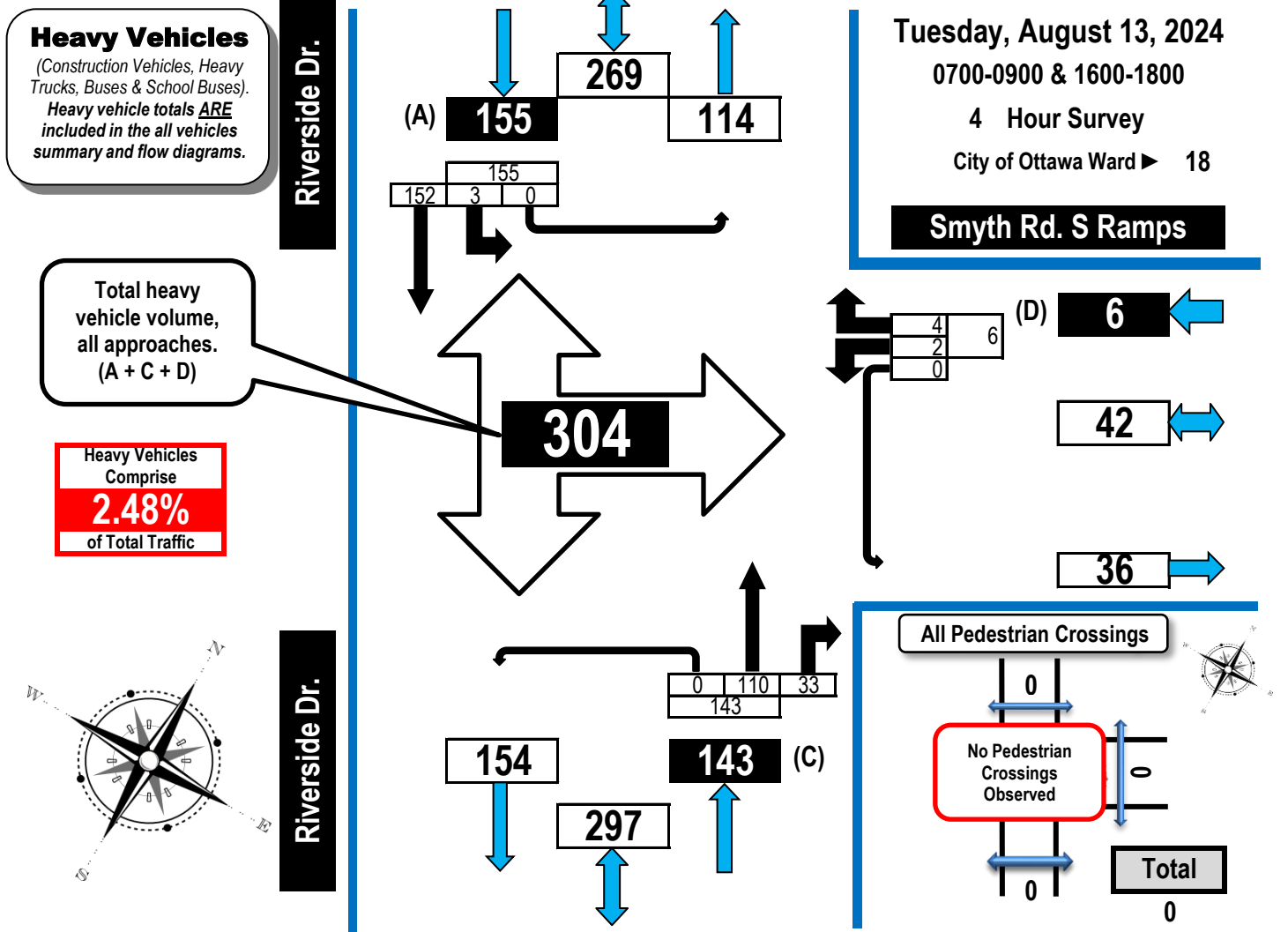

Time Period	N/A					Smyth Rd. S Ramps					Riverside Dr.					Riverside Dr.					GR Tot
	Eastbound					Westbound					Northbound					Southbound					
	LT	ST	RT	UT	EB Tot	LT	ST	RT	UT	WB Tot	LT	ST	RT	UT	NB Tot	LT	ST	RT	UT	SB Tot	
0700-0800						0		1	0	1		29	11	0	40	1	53		0	54	95
0800-0900						0		0	0	0		46	7	0	53	1	56		0	57	110
1600-1700						1		2	0	3		23	7	0	30	1	26		0	27	60
1700-1800						1		1	0	2		12	8	0	20	0	17		0	17	39
<b>Totals</b>						<b>2</b>		<b>4</b>	<b>0</b>	<b>6</b>		<b>110</b>	<b>33</b>	<b>0</b>	<b>143</b>	<b>3</b>	<b>152</b>		<b>0</b>	<b>155</b>	<b>304</b>



# Turning Movement Count

## All Buses Summary (FHWA Class 4 ONLY)

### Flow Diagram



## Riverside Drive & Smyth Road South Ramps Ottawa, ON

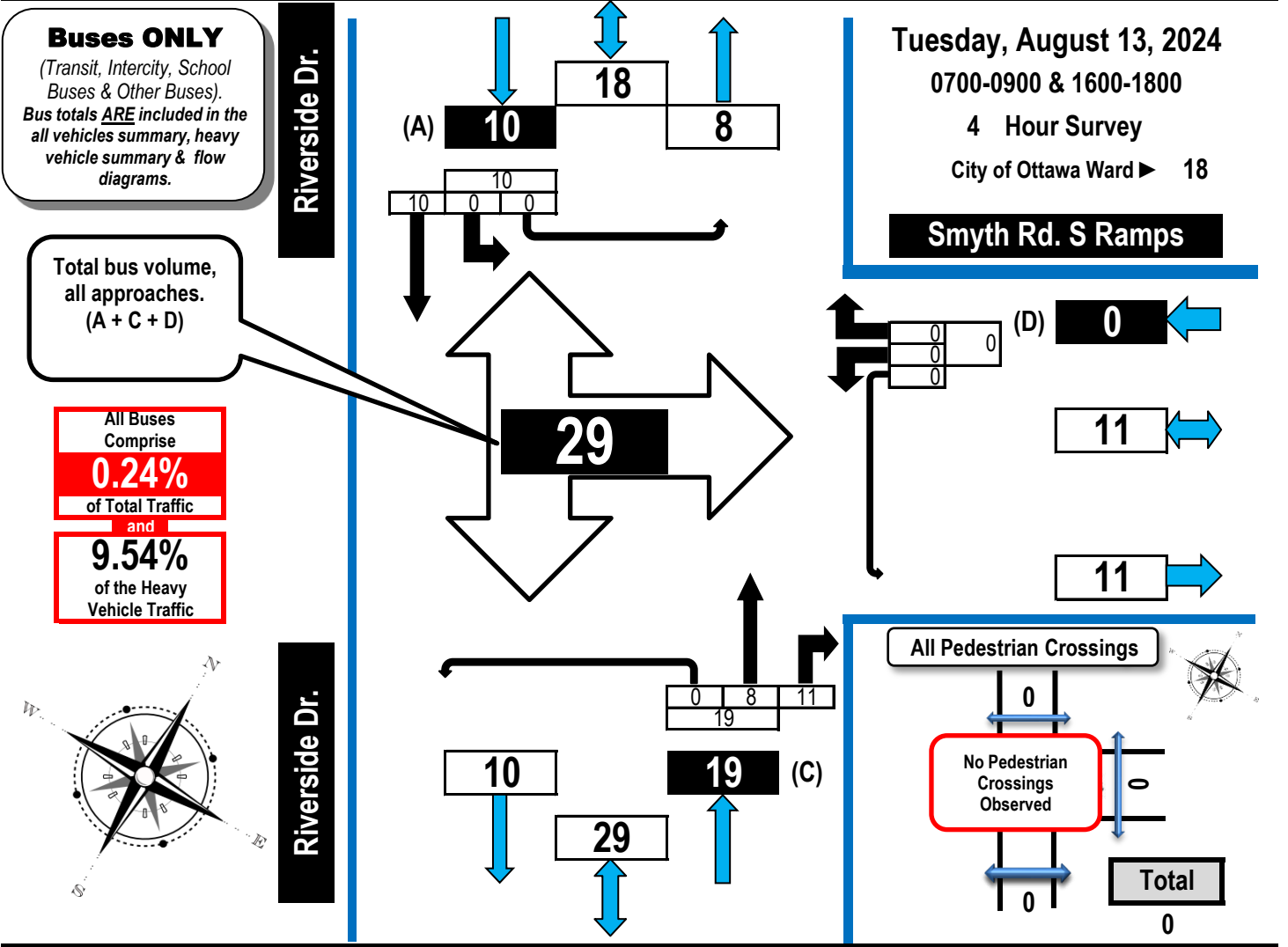

Time Period	N/A					Smyth Rd. S Ramps					Riverside Dr.					Riverside Dr.					
	Eastbound					Westbound					Northbound					Southbound					
	LT	ST	RT	UT	EB Tot	LT	ST	RT	UT	WB Tot	LT	ST	RT	UT	NB Tot	LT	ST	RT	UT	SB Tot	GR Tot
0700-0800						0		0	0	0		2	2	0	4	0	3		0	3	7
0800-0900						0		0	0	0		2	5	0	7	0	1		0	1	8
1600-1700						0		0	0	0		3	2	0	5	0	3		0	3	8
1700-1800						0		0	0	0		1	2	0	3	0	3		0	3	6
<b>Totals</b>						<b>0</b>		<b>0</b>	<b>0</b>	<b>0</b>		<b>8</b>	<b>11</b>	<b>0</b>	<b>19</b>	<b>0</b>	<b>10</b>		<b>0</b>	<b>10</b>	<b>29</b>





# Turning Movement Count

## Pedestrian Crossings Summary and Flow Diagram



### Riverside Drive & Smyth Road South Ramps Ottawa, ON

#### Pedestrian Crossings

Tuesday, August 13, 2024

0700-0900 & 1600-1800

4 Hour Survey

City of Ottawa Ward ► 18

Total number of all pedestrian crossings

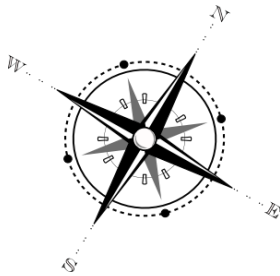
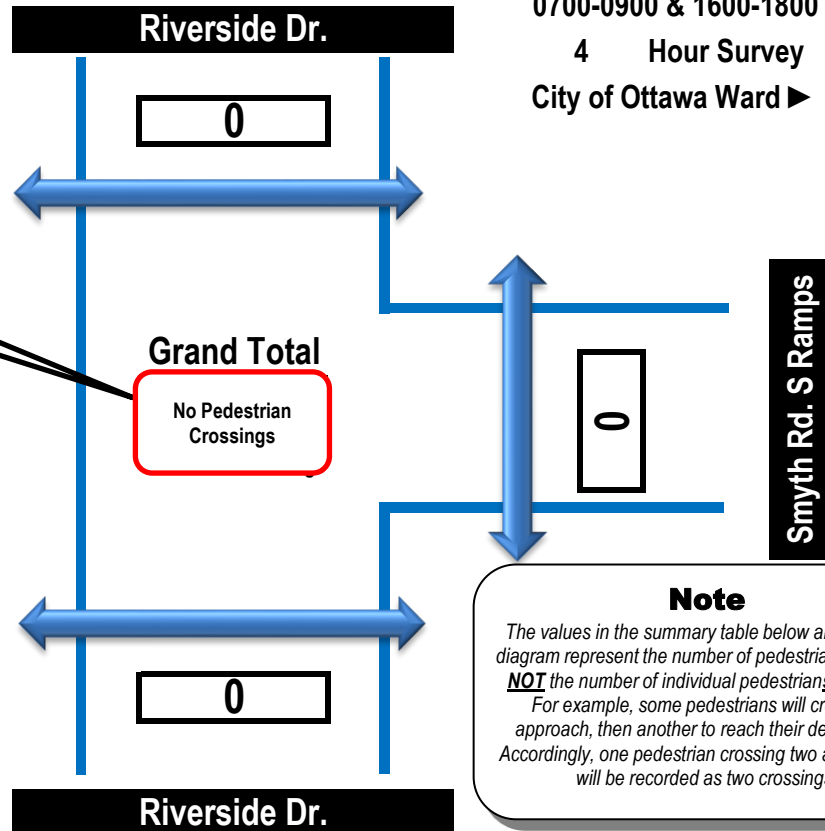

#### Note

The values in the summary table below and the flow diagram represent the number of pedestrian crossings **NOT** the number of individual pedestrians crossing. For example, some pedestrians will cross one approach, then another to reach their destination. Accordingly, one pedestrian crossing two approaches will be recorded as two crossings.

Time Period	West Side Crossing N/A	East Side Crossing Smyth Rd. S Ramps	Street Total	South Side Crossing Riverside Dr.	North Side Crossing Riverside Dr.	Street Total	Grand Total
0700-0800		0	0	0	0	0	0
0800-0900		0	No Pedestrian Crossings	0	0	0	0
1600-1700		0		0	0	0	0
1700-1800		0		0	0	0	0
<b>Totals</b>		0	0	0	0	0	0

#### Comments:

OC Transpo buses and school buses comprise 9.54% of the heavy vehicle traffic. Three cyclists travelled to and from a path located on the west side of Riverside Drive.



# Turning Movement Count

## Summary Report

### Including AM and PM Peak Hours

All Vehicles Except Bicycles



## Riverside Drive & Smyth Road South Ramps Ottawa, ON

**Survey Date:** Tuesday, August 13, 2024      **Start Time:** 0700      **AADT Factor:** 0.9  
**Weather AM:** Mostly Sunny      **Survey Duration:** 4 Hrs.      **Survey Hours:** 0700-0900 & 1600-1800  
**Weather PM:** Mostly Sunny 26° C      **Surveyor(s):** J. Mousseau & S. Merrett

N/A					Smyth Rd. S Ramps					Riverside Dr.					Riverside Dr.								
Eastbound					Westbound					Northbound					Southbound								
Time Period	LT	ST	RT	UT	E/B Tot	LT	ST	RT	UT	W/B Tot	Street Total	LT	ST	RT	UT	N/B Tot	LT	ST	RT	UT	S/B Tot	Street Total	Grand Total
0700-0800						44		23	0	67	67		1250	512	0	1762	36	1461		0	1497	3259	3326
0800-0900						46		40	0	86	86		1314	399	0	1713	40	1469		1	1510	3223	3309
1600-1700						46		82	0	128	128		1219	191	0	1410	35	1331		0	1366	2776	2904
1700-1800						38		84	0	122	122		1101	142	0	1243	53	1324		1	1378	2621	2743
<b>Totals</b>						<b>174</b>		<b>229</b>	<b>0</b>	<b>403</b>	<b>403</b>		<b>4884</b>	<b>1244</b>	<b>0</b>	<b>6128</b>	<b>164</b>	<b>5585</b>		<b>2</b>	<b>5751</b>	<b>11879</b>	<b>12282</b>

**Equivalent 12 & 24-hour Vehicle Volumes Including the Annual Average Daily Traffic (AADT) Factor**  
**Applicable to the Day and Month of the Turning Movement Count**

**Expansion factors are applied exclusively to standard weekday 8-hour turning movement counts conducted during the hours of 0700h - 1000h, 1130h - 1330h and 1500h - 1800h**

Equivalent 12-hour vehicle volumes. These volumes are calculated by multiplying the 8-hour totals by the 8 → 12 expansion factor of 1.39

Equ. 12 Hr	n/a	n/a	n/a	n/a	n/a	n/a	n/a	n/a	n/a	n/a	n/a	n/a	n/a	n/a	n/a	n/a	n/a	n/a	n/a	n/a	n/a	n/a	n/a	n/a	n/a
------------	-----	-----	-----	-----	-----	-----	-----	-----	-----	-----	-----	-----	-----	-----	-----	-----	-----	-----	-----	-----	-----	-----	-----	-----	-----

Average daily 12-hour vehicle volumes. These volumes are calculated by multiplying the equivalent 12-hour totals by the AADT factor of: 0.9

AADT 12-hr	n/a	n/a	n/a	n/a	n/a	n/a	n/a	n/a	n/a	n/a	n/a	n/a	n/a	n/a	n/a	n/a	n/a	n/a	n/a	n/a	n/a	n/a	n/a	n/a	n/a
------------	-----	-----	-----	-----	-----	-----	-----	-----	-----	-----	-----	-----	-----	-----	-----	-----	-----	-----	-----	-----	-----	-----	-----	-----	-----

24-Hour AADT. These volumes are calculated by multiplying the average daily 12-hour vehicle volumes by the 12 → 24 expansion factor of 1.31

AADT 24 Hr	n/a	n/a	n/a	n/a	n/a	n/a	n/a	n/a	n/a	n/a	n/a	n/a	n/a	n/a	n/a	n/a	n/a	n/a	n/a	n/a	n/a	n/a	n/a	n/a	n/a
------------	-----	-----	-----	-----	-----	-----	-----	-----	-----	-----	-----	-----	-----	-----	-----	-----	-----	-----	-----	-----	-----	-----	-----	-----	-----

**AADT and expansion factors provided by the City of Ottawa**

<b>AM Peak Hour Factor → 0.95</b>											<b>Highest Hourly Vehicle Volume Between 0700h &amp; 0900h</b>													
<b>AM Peak Hr</b>	<b>LT</b>	<b>ST</b>	<b>RT</b>	<b>UT</b>	<b>Total</b>	<b>LT</b>	<b>ST</b>	<b>RT</b>	<b>UT</b>	<b>Total</b>	<b>Str. Tot.</b>	<b>LT</b>	<b>ST</b>	<b>RT</b>	<b>UT</b>	<b>Total</b>	<b>LT</b>	<b>ST</b>	<b>RT</b>	<b>UT</b>	<b>Total</b>	<b>Str. Tot.</b>	<b>Gr. Tot.</b>	
0715-0815						45	0	29	0	74	74		0	1287	529	0	1816	43	1621	0	0	1664	3480	3554

<b>PM Peak Hour Factor → 0.96</b>											<b>Highest Hourly Vehicle Volume Between 1600h &amp; 1800h</b>													
<b>PM Peak Hr</b>	<b>LT</b>	<b>ST</b>	<b>RT</b>	<b>UT</b>	<b>Total</b>	<b>LT</b>	<b>ST</b>	<b>RT</b>	<b>UT</b>	<b>Total</b>	<b>Str. Tot.</b>	<b>LT</b>	<b>ST</b>	<b>RT</b>	<b>UT</b>	<b>Total</b>	<b>LT</b>	<b>ST</b>	<b>RT</b>	<b>UT</b>	<b>Total</b>	<b>Str. Tot.</b>	<b>Gr. Tot.</b>	
1615-1715						39	0	85	0	124	124		0	1183	181	0	1364	39	1392	0	1	1432	2796	2920

**Comments:**

OC Transpo buses and school buses comprise 9.54% of the heavy vehicle traffic. Three cyclists travelled to and from a path located on the west side of Riverside Drive.

**Notes:**

- Includes all vehicle types except bicycles, electric bicycles, and electric scooters.
- When expansion and AADT factors are applied, the results will differ slightly due to rounding.



# Turning Movement Count Bicycle Summary Flow Diagram



## Riverside Drive & Smyth Road South Ramps Ottawa, ON

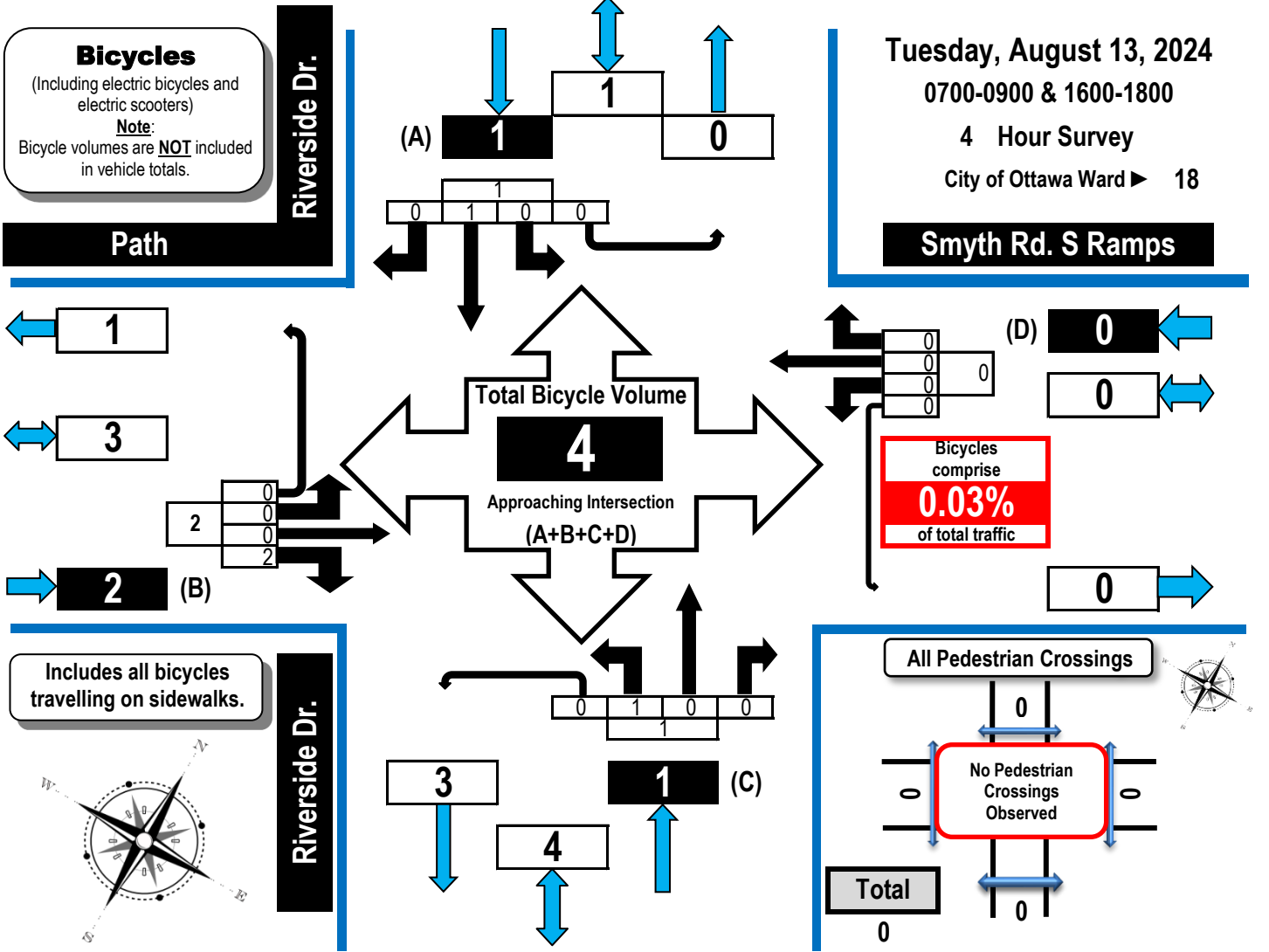

Time Period	N/A					Smyth Rd. S Ramps					Riverside Dr.					Riverside Dr.					GR Tot	
	Eastbound					Westbound					Northbound					Southbound						
	LT	ST	RT	UT	EB Tot	LT	ST	RT	UT	WB Tot	LT	ST	RT	UT	NB Tot	LT	ST	RT	UT	SB Tot		
0700-0800	0	0	1	0	1	0	0	0	0	0	1	0	0	0	1	0	1	0	0	1	0	3
0800-0900	0	0	1	0	1	0	0	0	0	0	0	0	0	0	0	0	0	0	0	0	0	1
1600-1700	0	0	0	0	0	0	0	0	0	0	0	0	0	0	0	0	0	0	0	0	0	0
1700-1800	0	0	0	0	0	0	0	0	0	0	0	0	0	0	0	0	0	0	0	0	0	0
<b>Totals</b>	<b>0</b>	<b>0</b>	<b>2</b>	<b>0</b>	<b>2</b>	<b>0</b>	<b>0</b>	<b>0</b>	<b>0</b>	<b>0</b>	<b>1</b>	<b>0</b>	<b>0</b>	<b>0</b>	<b>1</b>	<b>0</b>	<b>1</b>	<b>0</b>	<b>0</b>	<b>1</b>	<b>4</b>	

**Comments:**  
OC Transpo buses and school buses comprise 9.54% of the heavy vehicle traffic. Three cyclists travelled to and from a path located on the west side of Riverside Drive.

# **Appendix B**

Existing Conditions Synchro Analysis

Lanes, Volumes, Timings  
1: Riverside Rd & Hospital Access

10/02/2024



Lane Group	WBL	WBR	NBT	NBR	SBL	SBT
Lane Configurations						
Traffic Volume (vph)	58	101	1715	123	144	1522
Future Volume (vph)	58	101	1715	123	144	1522
Lane Group Flow (vph)	64	112	1906	137	160	1691
Turn Type	Perm	Perm	NA	Perm	Perm	NA
Protected Phases			2			6
Permitted Phases	8	8		2	6	
Detector Phase	8	8	2	2	6	6
Switch Phase						
Minimum Initial (s)	10.0	10.0	10.0	10.0	10.0	10.0
Minimum Split (s)	30.3	30.3	29.3	29.3	23.3	23.3
Total Split (s)	30.0	30.0	60.0	60.0	60.0	60.0
Total Split (%)	33.3%	33.3%	66.7%	66.7%	66.7%	66.7%
Yellow Time (s)	3.3	3.3	3.7	3.7	3.7	3.7
All-Red Time (s)	2.0	2.0	1.6	1.6	1.6	1.6
Lost Time Adjust (s)	0.0	0.0	0.0	0.0	0.0	0.0
Total Lost Time (s)	5.3	5.3	5.3	5.3	5.3	5.3
Lead/Lag						
Lead-Lag Optimize?						
Recall Mode	None	None	C-Max	C-Max	C-Max	C-Max
Act Effct Green (s)	12.2	12.2	71.3	71.3	71.3	71.3
Actuated g/C Ratio	0.14	0.14	0.79	0.79	0.79	0.79
v/c Ratio	0.31	0.52	0.71	0.12	1.39	0.64
Control Delay	38.1	39.7	8.4	2.6	230.9	5.8
Queue Delay	0.0	0.0	0.0	0.0	0.0	0.0
Total Delay	38.1	39.7	8.4	2.6	230.9	5.8
LOS	D	D	A	A	F	A
Approach Delay	39.1		8.0			25.3
Approach LOS	D		A			C
Queue Length 50th (m)	10.3	15.9	77.0	3.1	~36.2	55.1
Queue Length 95th (m)	20.6	30.3	132.7	9.3	m#67.9	71.7
Internal Link Dist (m)	162.8		460.5			360.9
Turn Bay Length (m)		30.0		20.0	80.0	
Base Capacity (vph)	423	419	2686	1140	115	2659
Starvation Cap Reductn	0	0	0	0	0	0
Spillback Cap Reductn	0	0	0	0	0	0
Storage Cap Reductn	0	0	0	0	0	0
Reduced v/c Ratio	0.15	0.27	0.71	0.12	1.39	0.64

Intersection Summary

Cycle Length: 90  
 Actuated Cycle Length: 90  
 Offset: 49 (54%), Referenced to phase 2:NBT and 6:SBTL, Start of Green  
 Natural Cycle: 130  
 Control Type: Actuated-Coordinated  
 Maximum v/c Ratio: 1.39  
 Intersection Signal Delay: 17.2  
 Intersection LOS: B  
 Intersection Capacity Utilization 80.0%  
 ICU Level of Service D  
 Analysis Period (min) 15  
 ~ Volume exceeds capacity, queue is theoretically infinite.  
 Queue shown is maximum after two cycles.  
 # 95th percentile volume exceeds capacity, queue may be longer.  
 Queue shown is maximum after two cycles.  
 m Volume for 95th percentile queue is metered by upstream signal.

Splits and Phases: 1: Riverside Rd & Hospital Access

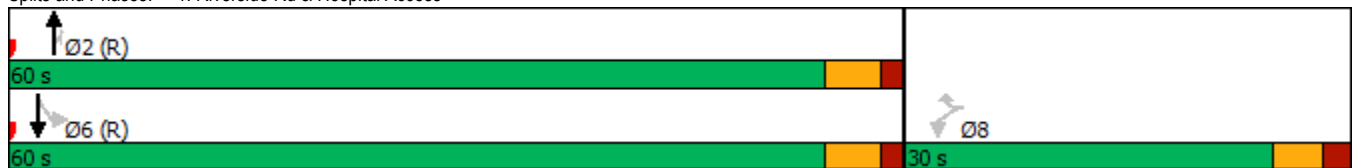

Lanes, Volumes, Timings  
 2: Riverside Rd & Smyth Rd South Ramp

10/02/2024

	↙	↑	↘	↙	↓
Lane Group	WBL	NBT	NBR	SBL	SBT
Lane Configurations	↘↘	↑↑	↘	↘	↑↑
Traffic Volume (vph)	45	1287	529	43	1621
Future Volume (vph)	45	1287	529	43	1621
Lane Group Flow (vph)	82	1430	588	48	1801
Turn Type	Perm	NA	Perm	Prot	NA
Protected Phases		2		1	6
Permitted Phases	8		2		
Detector Phase	8	2	2	1	6
Switch Phase					
Minimum Initial (s)	10.0	10.0	10.0	5.0	10.0
Minimum Split (s)	34.1	26.6	26.6	10.6	15.6
Total Split (s)	35.0	40.0	40.0	15.0	55.0
Total Split (%)	38.9%	44.4%	44.4%	16.7%	61.1%
Yellow Time (s)	3.3	3.7	3.7	3.7	3.7
All-Red Time (s)	2.8	1.9	1.9	1.9	1.9
Lost Time Adjust (s)	0.0	0.0	0.0	0.0	0.0
Total Lost Time (s)	6.1	5.6	5.6	5.6	5.6
Lead/Lag		Lag	Lag	Lead	
Lead-Lag Optimize?		Yes	Yes	Yes	
Recall Mode	None	C-Max	C-Max	None	C-Max
Act Effct Green (s)	10.4	63.3	63.3	8.0	72.2
Actuated g/C Ratio	0.12	0.70	0.70	0.09	0.80
v/c Ratio	0.37	0.60	0.47	0.32	0.67
Control Delay	29.3	7.2	1.3	43.3	6.8
Queue Delay	0.0	0.0	0.0	0.0	0.0
Total Delay	29.3	7.2	1.3	43.3	6.8
LOS	C	A	A	D	A
Approach Delay	29.3	5.5			7.8
Approach LOS	C	A			A
Queue Length 50th (m)	8.1	31.9	0.0	7.9	68.1
Queue Length 95th (m)	20.7	64.0	9.2	17.8	101.0
Internal Link Dist (m)	155.6	360.9			107.9
Turn Bay Length (m)			170.0	45.0	
Base Capacity (vph)	549	2383	1241	182	2693
Starvation Cap Reductn	0	0	0	0	0
Spillback Cap Reductn	0	0	0	0	0
Storage Cap Reductn	0	0	0	0	0
Reduced v/c Ratio	0.15	0.60	0.47	0.26	0.67

Intersection Summary

Cycle Length: 90  
 Actuated Cycle Length: 90  
 Offset: 76 (84%), Referenced to phase 2:NBT and 6:SBT, Start of Green  
 Natural Cycle: 90  
 Control Type: Actuated-Coordinated  
 Maximum v/c Ratio: 0.67  
 Intersection Signal Delay: 7.1  
 Intersection LOS: A  
 Intersection Capacity Utilization 65.4%  
 ICU Level of Service C  
 Analysis Period (min) 15

Splits and Phases: 2: Riverside Rd & Smyth Rd South Ramp

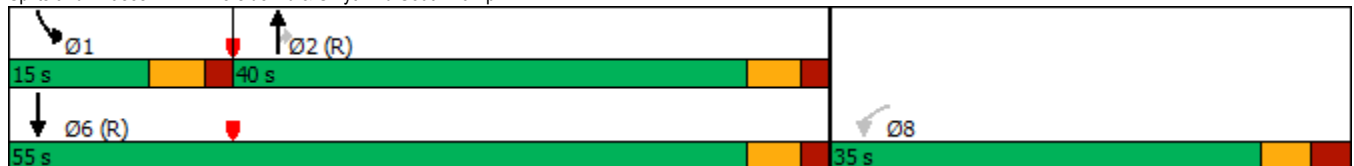

Lanes, Volumes, Timings  
1: Riverside Rd & Hospital Access

10/02/2024



Lane Group	WBL	WBR	NBT	NBR	SBL	SBT
Lane Configurations						
Traffic Volume (vph)	96	151	1387	48	52	1665
Future Volume (vph)	96	151	1387	48	52	1665
Lane Group Flow (vph)	107	168	1541	53	58	1850
Turn Type	Perm	Perm	NA	Perm	Perm	NA
Protected Phases			2			6
Permitted Phases	8	8		2	6	
Detector Phase	8	8	2	2	6	6
Switch Phase						
Minimum Initial (s)	10.0	10.0	10.0	10.0	10.0	10.0
Minimum Split (s)	30.3	30.3	29.3	29.3	23.3	23.3
Total Split (s)	30.0	30.0	60.0	60.0	60.0	60.0
Total Split (%)	33.3%	33.3%	66.7%	66.7%	66.7%	66.7%
Yellow Time (s)	3.3	3.3	3.7	3.7	3.7	3.7
All-Red Time (s)	2.0	2.0	1.6	1.6	1.6	1.6
Lost Time Adjust (s)	0.0	0.0	0.0	0.0	0.0	0.0
Total Lost Time (s)	5.3	5.3	5.3	5.3	5.3	5.3
Lead/Lag						
Lead-Lag Optimize?						
Recall Mode	None	None	C-Max	C-Max	C-Max	C-Max
Act Effct Green (s)	14.0	14.0	65.4	65.4	65.4	65.4
Actuated g/C Ratio	0.16	0.16	0.73	0.73	0.73	0.73
v/c Ratio	0.43	0.64	0.63	0.05	0.36	0.75
Control Delay	38.5	38.5	8.2	3.1	8.9	5.9
Queue Delay	0.0	0.0	0.0	0.0	0.0	0.0
Total Delay	38.5	38.5	8.2	3.1	8.9	5.9
LOS	D	D	A	A	A	A
Approach Delay	38.5		8.0			6.0
Approach LOS	D		A			A
Queue Length 50th (m)	17.1	21.8	56.9	1.1	2.2	38.3
Queue Length 95th (m)	29.9	38.9	98.5	5.1	m3.4	46.6
Internal Link Dist (m)	162.8		460.5			360.9
Turn Bay Length (m)		30.0		20.0	80.0	
Base Capacity (vph)	442	437	2461	966	159	2461
Starvation Cap Reductn	0	0	0	0	0	0
Spillback Cap Reductn	0	0	0	0	0	0
Storage Cap Reductn	0	0	0	0	0	0
Reduced v/c Ratio	0.24	0.38	0.63	0.05	0.36	0.75

Intersection Summary

Cycle Length: 90  
 Actuated Cycle Length: 90  
 Offset: 83 (92%), Referenced to phase 2:NBT and 6:SBTL, Start of Green  
 Natural Cycle: 80  
 Control Type: Actuated-Coordinated  
 Maximum v/c Ratio: 0.75  
 Intersection Signal Delay: 9.2  
 Intersection LOS: A  
 Intersection Capacity Utilization 65.7%  
 ICU Level of Service C  
 Analysis Period (min) 15  
 m Volume for 95th percentile queue is metered by upstream signal.

Splits and Phases: 1: Riverside Rd & Hospital Access

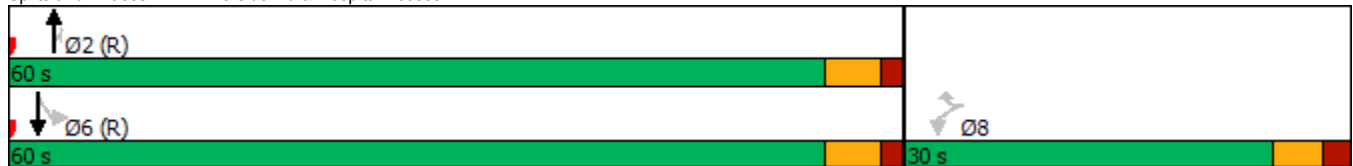

Lanes, Volumes, Timings  
 2: Riverside Rd & Smyth Rd South Ramp

10/02/2024

	↙	↑	↘	↙	↓
Lane Group	WBL	NBT	NBR	SBL	SBT
Lane Configurations	↘↘	↑↑	↘	↘	↑↑
Traffic Volume (vph)	47	1349	189	40	1670
Future Volume (vph)	47	1349	189	40	1670
Lane Group Flow (vph)	146	1499	210	44	1856
Turn Type	Perm	NA	Perm	Prot	NA
Protected Phases		2		1	6
Permitted Phases	8		2		
Detector Phase	8	2	2	1	6
Switch Phase					
Minimum Initial (s)	10.0	10.0	10.0	5.0	10.0
Minimum Split (s)	34.1	26.6	26.6	10.6	15.6
Total Split (s)	35.0	40.0	40.0	15.0	55.0
Total Split (%)	38.9%	44.4%	44.4%	16.7%	61.1%
Yellow Time (s)	3.3	3.7	3.7	3.7	3.7
All-Red Time (s)	2.8	1.9	1.9	1.9	1.9
Lost Time Adjust (s)	0.0	0.0	0.0	0.0	0.0
Total Lost Time (s)	6.1	5.6	5.6	5.6	5.6
Lead/Lag		Lag	Lag	Lead	
Lead-Lag Optimize?		Yes	Yes	Yes	
Recall Mode	None	C-Max	C-Max	None	C-Max
Act Effct Green (s)	11.0	58.5	58.5	7.8	67.3
Actuated g/C Ratio	0.12	0.65	0.65	0.09	0.75
v/c Ratio	0.53	0.68	0.20	0.30	0.73
Control Delay	22.1	11.5	2.4	43.1	8.8
Queue Delay	0.0	0.0	0.0	0.0	0.0
Total Delay	22.1	11.5	2.4	43.1	8.8
LOS	C	B	A	D	A
Approach Delay	22.1	10.4			9.6
Approach LOS	C	B			A
Queue Length 50th (m)	8.4	61.3	0.0	7.3	71.6
Queue Length 95th (m)	24.8	91.1	11.7	16.8	118.7
Internal Link Dist (m)	155.6	360.9			107.9
Turn Bay Length (m)			170.0	45.0	
Base Capacity (vph)	577	2204	1041	181	2534
Starvation Cap Reductn	0	0	0	0	0
Spillback Cap Reductn	0	0	0	0	0
Storage Cap Reductn	0	0	0	0	0
Reduced v/c Ratio	0.25	0.68	0.20	0.24	0.73

Intersection Summary

Cycle Length: 90  
 Actuated Cycle Length: 90  
 Offset: 8 (9%), Referenced to phase 2:NBT and 6:SBT, Start of Green  
 Natural Cycle: 90  
 Control Type: Actuated-Coordinated  
 Maximum v/c Ratio: 0.73  
 Intersection Signal Delay: 10.4  
 Intersection LOS: B  
 Intersection Capacity Utilization 66.8%  
 ICU Level of Service C  
 Analysis Period (min) 15

Splits and Phases: 2: Riverside Rd & Smyth Rd South Ramp

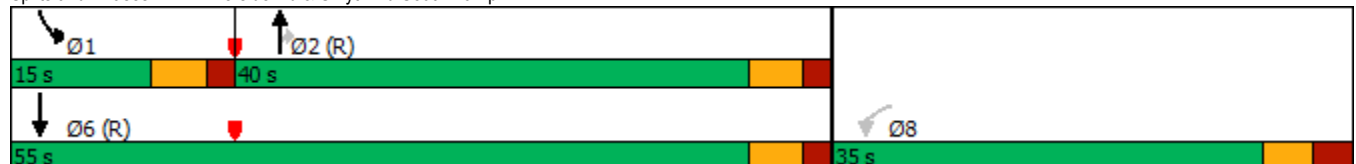



# **Appendix C**

Projected Total Conditions Synchro Analysis

Lanes, Volumes, Timings  
1: Riverside Rd & Hospital Access

10/03/2024



Lane Group	WBL	WBR	NBT	NBR	SBU	SBL	SBT
Lane Configurations							
Traffic Volume (vph)	58	101	1744	123	30	144	1522
Future Volume (vph)	58	101	1744	123	30	144	1522
Lane Group Flow (vph)	58	101	1744	123	0	174	1522
Turn Type	Perm	Perm	NA	Perm	custom	pm+pt	NA
Protected Phases			2			1	6
Permitted Phases	8	8		2	1	6	
Detector Phase	8	8	2	2	1	1	6
Switch Phase							
Minimum Initial (s)	10.0	10.0	10.0	10.0	5.0	5.0	10.0
Minimum Split (s)	30.3	30.3	29.3	29.3	10.3	10.3	23.3
Total Split (s)	30.3	30.3	48.9	48.9	10.8	10.8	59.7
Total Split (%)	33.7%	33.7%	54.3%	54.3%	12.0%	12.0%	66.3%
Yellow Time (s)	3.3	3.3	3.7	3.7	3.7	3.7	3.7
All-Red Time (s)	2.0	2.0	1.6	1.6	1.6	1.6	1.6
Lost Time Adjust (s)	0.0	0.0	0.0	0.0		0.0	0.0
Total Lost Time (s)	5.3	5.3	5.3	5.3		5.3	5.3
Lead/Lag			Lag	Lag	Lead	Lead	
Lead-Lag Optimize?			Yes	Yes	Yes	Yes	
Recall Mode	None	None	C-Max	C-Max	None	None	C-Max
Act Effct Green (s)	10.5	10.5	55.0	55.0		72.0	73.0
Actuated g/C Ratio	0.12	0.12	0.61	0.61		0.80	0.81
v/c Ratio	0.32	0.41	0.84	0.14		0.57	0.56
Control Delay	41.5	16.3	21.3	7.2		19.9	6.1
Queue Delay	0.0	0.0	0.0	0.0		0.0	0.0
Total Delay	41.5	16.3	21.3	7.2		19.9	6.1
LOS	D	B	C	A		B	A
Approach Delay	25.5		20.4				7.5
Approach LOS	C		C				A
Queue Length 50th (m)	9.4	2.4	126.2	6.0		16.8	43.3
Queue Length 95th (m)	20.2	16.1	#205.1	15.7		35.3	104.6
Internal Link Dist (m)	162.8		460.5				230.3
Turn Bay Length (m)		30.0		20.0		80.0	
Base Capacity (vph)	428	475	2070	886		306	2724
Starvation Cap Reductn	0	0	0	0		0	0
Spillback Cap Reductn	0	0	0	0		0	0
Storage Cap Reductn	0	0	0	0		0	0
Reduced v/c Ratio	0.14	0.21	0.84	0.14		0.57	0.56

Intersection Summary

Cycle Length: 90  
 Actuated Cycle Length: 90  
 Offset: 49 (54%), Referenced to phase 2:NBT and 6:SBTL, Start of Green  
 Natural Cycle: 100  
 Control Type: Actuated-Coordinated  
 Maximum v/c Ratio: 0.84  
 Intersection Signal Delay: 14.7  
 Intersection LOS: B  
 Intersection Capacity Utilization 82.6%  
 ICU Level of Service E  
 Analysis Period (min) 15  
 # 95th percentile volume exceeds capacity, queue may be longer.  
 Queue shown is maximum after two cycles.

Splits and Phases: 1: Riverside Rd & Hospital Access



Lanes, Volumes, Timings  
 2: Riverside Rd & Smyth Rd South Ramp

10/03/2024



Lane Group	WBL	NBT	NBR	SBL	SBT
Lane Configurations	W	A	A	P	A
Traffic Volume (vph)	60	1303	552	43	1636
Future Volume (vph)	60	1303	552	43	1636
Lane Group Flow (vph)	89	1303	552	43	1636
Turn Type	Perm	NA	Perm	Prot	NA
Protected Phases		2		1	6
Permitted Phases	8		2		
Detector Phase	8	2	2	1	6
Switch Phase					
Minimum Initial (s)	10.0	10.0	10.0	5.0	10.0
Minimum Split (s)	34.1	26.6	26.6	10.6	15.6
Total Split (s)	34.1	45.3	45.3	10.6	55.9
Total Split (%)	37.9%	50.3%	50.3%	11.8%	62.1%
Yellow Time (s)	3.3	3.7	3.7	3.7	3.7
All-Red Time (s)	2.8	1.9	1.9	1.9	1.9
Lost Time Adjust (s)	0.0	0.0	0.0	0.0	0.0
Total Lost Time (s)	6.1	5.6	5.6	5.6	5.6
Lead/Lag		Lag	Lag	Lead	
Lead-Lag Optimize?		Yes	Yes	Yes	
Recall Mode	None	C-Max	C-Max	None	C-Max
Act Effct Green (s)	10.7	63.2	63.2	7.8	72.0
Actuated g/C Ratio	0.12	0.70	0.70	0.09	0.80
v/c Ratio	0.40	0.55	0.45	0.29	0.61
Control Delay	31.7	1.4	0.7	43.0	6.1
Queue Delay	0.0	0.0	0.0	0.0	0.0
Total Delay	31.7	1.4	0.7	43.0	6.1
LOS	C	A	A	D	A
Approach Delay	31.7	1.2			7.1
Approach LOS	C	A			A
Queue Length 50th (m)	9.9	5.3	0.0	7.1	55.7
Queue Length 95th (m)	23.0	9.1	m0.0	16.5	85.4
Internal Link Dist (m)	155.6	107.7			107.9
Turn Bay Length (m)			170.0	45.0	
Base Capacity (vph)	535	2382	1230	146	2684
Starvation Cap Reductn	0	0	0	0	0
Spillback Cap Reductn	0	0	0	0	0
Storage Cap Reductn	0	0	0	0	0
Reduced v/c Ratio	0.17	0.55	0.45	0.29	0.61

Intersection Summary

Cycle Length: 90  
 Actuated Cycle Length: 90  
 Offset: 76 (84%), Referenced to phase 2:NBT and 6:SBT, Start of Green  
 Natural Cycle: 80  
 Control Type: Actuated-Coordinated  
 Maximum v/c Ratio: 0.61  
 Intersection Signal Delay: 4.7  
 Intersection LOS: A  
 Intersection Capacity Utilization 65.8%  
 ICU Level of Service C  
 Analysis Period (min) 15  
 m Volume for 95th percentile queue is metered by upstream signal.

Splits and Phases: 2: Riverside Rd & Smyth Rd South Ramp

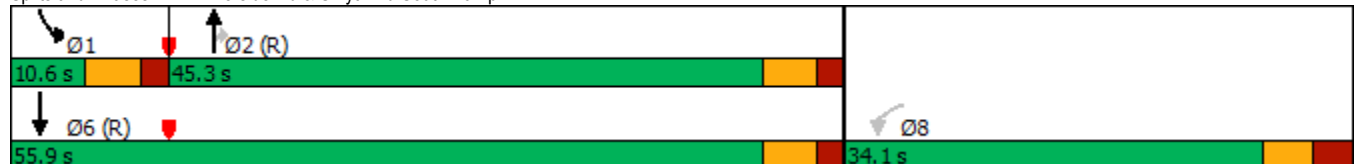

Lanes, Volumes, Timings  
 5: Riverside Rd & Lot D Access

10/03/2024



Lane Group	WBR	NBT	NBR	SBT
Lane Configurations				
Traffic Volume (vph)	39	1816	59	1696
Future Volume (vph)	39	1816	59	1696
Lane Group Flow (vph)	39	1816	59	1696
Sign Control		Free		Free

Intersection Summary	
Control Type: Unsignalized	
Intersection Capacity Utilization 63.0%	ICU Level of Service B
Analysis Period (min) 15	

HCM Unsignalized Intersection Capacity Analysis  
 5: Riverside Rd & Lot D Access

10/03/2024



Movement	WBL	WBR	NBT	NBR	SBL	SBT
Lane Configurations						
Traffic Volume (veh/h)	0	39	1816	59	0	1696
Future Volume (Veh/h)	0	39	1816	59	0	1696
Sign Control	Stop		Free			Free
Grade	0%		0%			0%
Peak Hour Factor	1.00	1.00	1.00	1.00	1.00	1.00
Hourly flow rate (vph)	0	39	1816	59	0	1696
Pedestrians						
Lane Width (m)						
Walking Speed (m/s)						
Percent Blockage						
Right turn flare (veh)						
Median type			None			None
Median storage (veh)						
Upstream signal (m)			254			132
pX, platoon unblocked	0.66	0.54			0.54	
vC, conflicting volume	2664	908			1875	
vC1, stage 1 conf vol						
vC2, stage 2 conf vol						
vCu, unblocked vol	890	0			919	
tC, single (s)	6.8	6.9			4.1	
tC, 2 stage (s)						
tF (s)	3.5	3.3			2.2	
p0 queue free %	100	93			100	
cM capacity (veh/h)	185	586			399	
Direction, Lane #	WB 1	NB 1	NB 2	NB 3	SB 1	SB 2
Volume Total	39	908	908	59	848	848
Volume Left	0	0	0	0	0	0
Volume Right	39	0	0	59	0	0
cSH	586	1700	1700	1700	1700	1700
Volume to Capacity	0.07	0.53	0.53	0.03	0.50	0.50
Queue Length 95th (m)	1.6	0.0	0.0	0.0	0.0	0.0
Control Delay (s)	11.6	0.0	0.0	0.0	0.0	0.0
Lane LOS	B					
Approach Delay (s)	11.6	0.0			0.0	
Approach LOS	B					
Intersection Summary						
Average Delay			0.1			
Intersection Capacity Utilization			63.0%		ICU Level of Service	B
Analysis Period (min)			15			

Lanes, Volumes, Timings  
1: Riverside Rd & Hospital Access

10/03/2024

Lane Group	WBL	WBR	NBT	NBR	SBU	SBL	SBT
Lane Configurations							
Traffic Volume (vph)	100	157	1402	48	14	52	1665
Future Volume (vph)	100	157	1402	48	14	52	1665
Lane Group Flow (vph)	100	157	1402	48	0	66	1665
Turn Type	Perm	Perm	NA	Perm	Perm	pm+pt	NA
Protected Phases			2			1	6
Permitted Phases	8	8		2	6	6	
Detector Phase	8	8	2	2	6	1	6
Switch Phase							
Minimum Initial (s)	10.0	10.0	10.0	10.0	10.0	5.0	10.0
Minimum Split (s)	30.3	30.3	29.3	29.3	23.3	10.3	23.3
Total Split (s)	30.3	30.3	49.4	49.4	59.7	10.3	59.7
Total Split (%)	33.7%	33.7%	54.9%	54.9%	66.3%	11.4%	66.3%
Yellow Time (s)	3.3	3.3	3.7	3.7	3.7	3.7	3.7
All-Red Time (s)	2.0	2.0	1.6	1.6	1.6	1.6	1.6
Lost Time Adjust (s)	0.0	0.0	0.0	0.0		0.0	0.0
Total Lost Time (s)	5.3	5.3	5.3	5.3		5.3	5.3
Lead/Lag			Lag	Lag		Lead	
Lead-Lag Optimize?			Yes	Yes		Yes	
Recall Mode	None	None	C-Max	C-Max	C-Max	None	C-Max
Act Effct Green (s)	11.8	11.8	58.0	58.0		67.6	67.6
Actuated g/C Ratio	0.13	0.13	0.64	0.64		0.75	0.75
v/c Ratio	0.47	0.53	0.64	0.06		0.25	0.65
Control Delay	43.4	18.6	12.7	5.6		6.1	7.1
Queue Delay	0.0	0.0	0.0	0.0		0.0	0.0
Total Delay	43.4	18.6	12.7	5.6		6.1	7.1
LOS	D	B	B	A		A	A
Approach Delay	28.3		12.4				7.1
Approach LOS	C		B				A
Queue Length 50th (m)	16.5	6.7	72.0	1.7		2.2	55.3
Queue Length 95th (m)	30.1	23.3	113.2	6.7		m5.9	87.2
Internal Link Dist (m)	162.8		460.5				230.3
Turn Bay Length (m)		30.0		20.0		80.0	
Base Capacity (vph)	447	500	2184	858		260	2546
Starvation Cap Reductn	0	0	0	0		0	0
Spillback Cap Reductn	0	0	0	0		0	0
Storage Cap Reductn	0	0	0	0		0	0
Reduced v/c Ratio	0.22	0.31	0.64	0.06		0.25	0.65

**Intersection Summary**

Cycle Length: 90  
 Actuated Cycle Length: 90  
 Offset: 83 (92%), Referenced to phase 2:NBT and 6:SBTL, Start of Green  
 Natural Cycle: 80  
 Control Type: Actuated-Coordinated  
 Maximum v/c Ratio: 0.65  
 Intersection Signal Delay: 10.9  
 Intersection LOS: B  
 Intersection Capacity Utilization 68.6%  
 ICU Level of Service C  
 Analysis Period (min) 15  
 m Volume for 95th percentile queue is metered by upstream signal.



Lanes, Volumes, Timings  
 2: Riverside Rd & Smyth Rd South Ramp

10/03/2024



Lane Group	WBL	NBT	NBR	SBL	SBT
Lane Configurations	W	T	T	T	T
Traffic Volume (vph)	54	1380	233	40	1677
Future Volume (vph)	54	1380	233	40	1677
Lane Group Flow (vph)	139	1380	233	40	1677
Turn Type	Perm	NA	Perm	Prot	NA
Protected Phases		2		1	6
Permitted Phases	8		2		
Detector Phase	8	2	2	1	6
Switch Phase					
Minimum Initial (s)	10.0	10.0	10.0	5.0	10.0
Minimum Split (s)	34.1	26.6	26.6	10.6	15.6
Total Split (s)	34.1	45.3	45.3	10.6	55.9
Total Split (%)	37.9%	50.3%	50.3%	11.8%	62.1%
Yellow Time (s)	3.3	3.7	3.7	3.7	3.7
All-Red Time (s)	2.8	1.9	1.9	1.9	1.9
Lost Time Adjust (s)	0.0	0.0	0.0	0.0	0.0
Total Lost Time (s)	6.1	5.6	5.6	5.6	5.6
Lead/Lag		Lag	Lag	Lead	
Lead-Lag Optimize?		Yes	Yes	Yes	
Recall Mode	None	C-Max	C-Max	None	C-Max
Act Effct Green (s)	11.0	58.7	58.7	7.6	67.3
Actuated g/C Ratio	0.12	0.65	0.65	0.08	0.75
v/c Ratio	0.51	0.62	0.22	0.28	0.66
Control Delay	23.1	8.2	1.6	42.9	7.5
Queue Delay	0.0	0.0	0.0	0.0	0.0
Total Delay	23.1	8.2	1.6	42.9	7.5
LOS	C	A	A	D	A
Approach Delay	23.1	7.2			8.3
Approach LOS	C	A			A
Queue Length 50th (m)	8.7	34.6	0.0	6.6	58.0
Queue Length 95th (m)	24.9	55.1	7.6	15.7	94.9
Internal Link Dist (m)	155.6	107.7			107.9
Turn Bay Length (m)			170.0	45.0	
Base Capacity (vph)	557	2211	1051	143	2534
Starvation Cap Reductn	0	0	0	0	0
Spillback Cap Reductn	0	0	0	0	0
Storage Cap Reductn	0	0	0	0	0
Reduced v/c Ratio	0.25	0.62	0.22	0.28	0.66

Intersection Summary

Cycle Length: 90  
 Actuated Cycle Length: 90  
 Offset: 8 (9%), Referenced to phase 2:NBT and 6:SBT, Start of Green  
 Natural Cycle: 90  
 Control Type: Actuated-Coordinated  
 Maximum v/c Ratio: 0.66  
 Intersection Signal Delay: 8.4  
 Intersection LOS: A  
 Intersection Capacity Utilization 67.4%  
 ICU Level of Service C  
 Analysis Period (min) 15

Splits and Phases: 2: Riverside Rd & Smyth Rd South Ramp



Lanes, Volumes, Timings  
 5: Riverside Rd & Lot D Access

10/03/2024



Lane Group	WBR	NBT	NBR	SBT
Lane Configurations				
Traffic Volume (vph)	69	1544	29	1731
Future Volume (vph)	69	1544	29	1731
Lane Group Flow (vph)	69	1544	29	1731
Sign Control		Free		Free

Intersection Summary	
Control Type: Unsignalized	
Intersection Capacity Utilization 56.2%	ICU Level of Service B
Analysis Period (min) 15	



HCM Unsignalized Intersection Capacity Analysis  
 5: Riverside Rd & Lot D Access

10/03/2024



Movement	WBL	WBR	NBT	NBR	SBL	SBT
Lane Configurations						
Traffic Volume (veh/h)	0	69	1544	29	0	1731
Future Volume (Veh/h)	0	69	1544	29	0	1731
Sign Control	Stop		Free			Free
Grade	0%		0%			0%
Peak Hour Factor	1.00	1.00	1.00	1.00	1.00	1.00
Hourly flow rate (vph)	0	69	1544	29	0	1731
<b>Pedestrians</b>						
Lane Width (m)						
Walking Speed (m/s)						
Percent Blockage						
Right turn flare (veh)						
Median type			None			None
Median storage (veh)						
Upstream signal (m)			254			132
pX, platoon unblocked	0.86	0.73			0.73	
vC, conflicting volume	2410	772			1573	
vC1, stage 1 conf vol						
vC2, stage 2 conf vol						
vCu, unblocked vol	900	0			1042	
tC, single (s)	6.8	6.9			4.1	
tC, 2 stage (s)						
tF (s)	3.5	3.3			2.2	
p0 queue free %	100	91			100	
cM capacity (veh/h)	240	790			483	
<b>Direction, Lane #</b>	<b>WB 1</b>	<b>NB 1</b>	<b>NB 2</b>	<b>NB 3</b>	<b>SB 1</b>	<b>SB 2</b>
Volume Total	69	772	772	29	866	866
Volume Left	0	0	0	0	0	0
Volume Right	69	0	0	29	0	0
cSH	790	1700	1700	1700	1700	1700
Volume to Capacity	0.09	0.45	0.45	0.02	0.51	0.51
Queue Length 95th (m)	2.2	0.0	0.0	0.0	0.0	0.0
Control Delay (s)	10.0	0.0	0.0	0.0	0.0	0.0
Lane LOS	A					
Approach Delay (s)	10.0	0.0			0.0	
Approach LOS	A					
<b>Intersection Summary</b>						
Average Delay			0.2			
Intersection Capacity Utilization			56.2%		ICU Level of Service	B
Analysis Period (min)			15			

# Appendix D

Truck Turn Templates

Consultants C:\Users\p091\2\2\0\m\drive - Parsons Corp\179008 - Riverside Campus Parking Lot (The Ottawa Hospital)\4-01000 - PLANNING\Documents\Truck\WB-20\WB-20-Truck.dwg  
 Plot Date: Thursday, October 03, 2024 17:02:49

NOTE: The location of utilities is approximate only, the exact location should be determined by consulting the municipal authorities and utility companies concerned. The contractor shall prove the location of utilities and shall be responsible for adequate protection from damage.

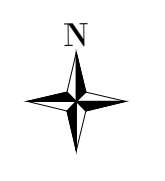

Legend

	WB-20
	300mm
	400mm
	500mm
	600mm
	750mm
	900mm
	1200mm

Not to Scale

Drawing Description <b>Ottawa Hospital Riverside Campus Parking Lot</b>			
Client	TOH	Date	Oct. 03, 2024
Project Number	479008-01000	Figure Number	001
Project Description		WB-20 Truck Inbound	



**PARSONS**

NOTE: The location of utilities is approximate only, the exact location should be determined by consulting the municipal authorities and utility companies concerned. The contractor shall prove the location of utilities and shall be responsible for adequate protection from damage.

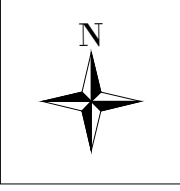

**Legend**

WB-20  
Tactplate  
Job Benchmark

Scale: 1:100

Not to Scale

<b>Drawing Description</b>			
<b>Ottawa Hospital Riverside Campus Parking Lot</b>			
<b>Client</b>	TOH	<b>Date</b>	Oct. 03, 2024
<b>Project Number</b>	479008-01000	<b>Figure Number</b>	002
<b>Project Description</b>		WB-20 Truck Outbound	