



**2760-2770 SHEFFIELD ROAD
INDUSTRIAL SITE
TECHNICAL MEMORANDUM**

Presented to:

Mr. Mike Giampa
Transportation Services Department
City of Ottawa
110 Laurier Avenue
Ottawa, Ontario K1P 1J1

July 10th, 2023

Project No. 7326



CASTLEGLENN CONSULTANTS LTD.

THIRD PARTY DISCLAIMER

This study has been prepared by Castleglenn Consultants Inc. (“CGI”) for the benefit of the Client to whom it is addressed. The information and data contained herein represents CGI’s best professional judgment considering the knowledge and information available to CGI at the time of preparation. Except as required by law, this study and the information and data contained herein are to be treated as confidential and may be used and relied upon only by the Client, its officers, and employees. CGI denies any liability whatsoever to other parties who may obtain access to this study for any injury, loss or damage suffered by such parties arising from their use of, or reliance upon, this study or any of its contents without the express written consent of CGI and the Client.

The following Technical Memorandum report has been produced, reviewed, and is respectfully submitted for consideration to whom it has been addressed.



Mr. Arthur Gordon B.A., P.Eng
Principal Engineer
Castleglenn Consultants Inc.



Mr. Konstantin Joulanov B. Eng. M. Sc.
Transportation Planner
Castleglenn Consultants Inc.

TABLE OF CONTENTS

1.0	INTRODUCTION	1-1
2.0	EXISTING CONDITIONS	2-1
2.1	STUDY AREA AND SITE LOCATION	2-1
2.2	STUDY AREA ROADWAYS	2-2
2.3	STUDY AREA INTERSECTIONS	2-2
2.4	EXISTING TRAFFIC VOLUMES (2023)	2-4
2.5	EXISTING TRAFFIC ANALYSIS	2-5
3.0	TRAFFIC FORECASTS	3-1
3.1	ADJACENT DEVELOPMENT AND BACKGROUND TRAFFIC GROWTH	3-1
3.2	SITE TRAFFIC GENERATION	3-1
4.0	TRAFFIC FORECAST (2024 & 2029)	4-1
4.1	OPERATIONAL (2024) TRAFFIC ANALYSIS	4-1
4.2	5-YEAR HORIZON (2029) TRAFFIC ANALYSIS	4-3
5.0	SUPPLEMENTAL ANALYSIS	5-4
5.1	HEAVY VEHICLE TURNING MOVEMENTS	5-4
5.2	LEFT TURN LANE WARRANTS	5-4
6.0	FINDINGS AND RECOMMENDATIONS	6-1
6.1	SUMMARY OF FINDINGS	6-1
6.1.1	<i>Access Impacts Associated with Forecast Traffic</i>	<i>6-1</i>
6.1.2	<i>Heavy Vehicle Traffic</i>	<i>6-1</i>
6.2	SUMMARY OF RECOMMENDATIONS	6-1

APPENDICES

APPENDIX A: EXISTING TRAFFIC, BALANCED TRAFFIC, BACKGROUND TRAFFIC GROWTH COUNTS AND SITE TRAFFIC BY TURNING MOVEMENT	"A"
APPENDIX B: EXISTING AND FORECAST TRAFFIC VOLUMES	"B"
APPENDIX C: SYNCHRO ANALYSIS SHEETS	"C"
APPENDIX D: AUTOTURN™ TURNING MOVEMENTS	"D"
APPENDIX E: LEFT TURN LANE WARRANT ANALYSES	"E"

LIST OF TABLES

Table 2-1: Existing 2023 Intersection Capacity Analysis Result.....	2-5
Table 3-1: Distribution of Required Parking Stalls by Type	3-2
Table 3-2: Peak Hour Site Generated Traffic: (Vehicles-per-Hour).....	3-2
Table 4-1: Operational (2024) Intersection Capacity Analysis.....	4-1
Table 4-2: Operational (2029) Intersection Capacity Analysis.....	4-3

LIST OF EXHIBITS

Exhibit 2-1: Study Area Context	2-1
Exhibit 2-2: Sheffield Road / Commercial Access “B”	2-2
Exhibit 2-3: Sheffield Road / Commercial Access “A”	2-3
Exhibit 2-4: Sheffield Road / Commercial Access “C”	2-3
Exhibit 2-5: Lancaster Road / Commercial Access “A”	2-4

1.0 INTRODUCTION

This technical memorandum is intended to address the proposed re-development of a parcel of lands within the City of Ottawa Industrial Park located between 2760-70 Sheffield Road and 2713 Lancaster Road. The concept would provide for a new industrial building that would, for the most part, be located on a former CN rail corridor (60m in width) that had separated Lancaster Road from Sheffield Road but has since been consolidated within the 2760 Sheffield Road parcel.

The realization of the concept would result in a 6th industrial building being developed on the site which presently provides for existing industrial buildings that have access to Sheffield Road and a single existing office building that has access on Lancaster Road.

On September 21, 2022, a pre-consultation meeting was held with City of Ottawa staff and the development proponents (Richcraft) to discuss the above initiative. The City's direction at that time in relation to traffic and transportation indicated that a full traffic impact assessment (TIA), a noise study and right-of-way (ROW) protection would not be required. Rather, a technical memorandum would be required that would:

- Provide “*the additional forecasted trips and their impacts to the Sheffield and Lancaster accesses*”, and
- “*Ensure on-site truck movements are acceptable using AutoTurn™.*”

Further clarification was received from City staff (Mr. Mike Giampa) on June 12, 2023 that indicated that the technical memorandum was to:

- concentrate on the Sheffield Road and Lancaster Road accesses to the proposed site;
- provide forecasts for the 2024 (assumed time of occupancy) and 2029 (five-years after occupancy) horizon years.
- include the impact of the development of adjacent sites; and
- ensure that the turning movements using the Autoturn software of the on-road accesses to the site and internal circulation through the site would be “*confirmed to work*”.

This technical memorandum has been structured to address the above City traffic and transportation requirements and provides:

- a review of the study area, the site location, the entrance roadways, and intersection configuration;
- a review of existing (2023) background traffic operational conditions within the study area;
- a description of the proposed site development and its anticipated impact on future (2024 and 2029) traffic operations;
- a traffic forecast for the proposed development site that reflected typical weekday morning and afternoon peak hour operations.

- Intersection capacity analyses assuming both existing and forecast morning and afternoon peak hours of travel demand within the study area;
- analysis of the site access intersections for left turn auxiliary lane warrants; and
- analysis of heavy vehicle turning movements at accesses and internal to the site.

The following sections of this technical memorandum serve to:

- describe the existing conditions;
- provide traffic forecasts and the resulting traffic operations associated with the proposed re-development initiative
- presents resulting performance measures (levels, of service, (v/c) volume-to-capacity ratios, queue length and delay estimates) for the anticipated time of operation (2024) and a 5-year horizon (2029) at the redeveloped site; and
- provide supplemental evaluation results associated with vehicle turning movements and access requirements.

2.0 EXISTING CONDITIONS

2.1 STUDY AREA AND SITE LOCATION

Exhibit 2-1: Study Area Context illustrates the general location of the lands owned by the proponent between Sheffield Road and Lancaster Road, located north of the Walkley Road corridor. The entire site would be accessible by way of the three accesses to the 2760-70 Sheffield Road and the single accesses that provides access to 2713 Lancaster Road. The concept would also involve the reduction of one of the existing Sheffield Road industrial buildings. Access to the new building would see passenger vehicles access the new site by way of the existing Lancaster Road access and heavy vehicle traffic and passenger vehicle traffic access the site by way of the existing Sheffield Road accesses.

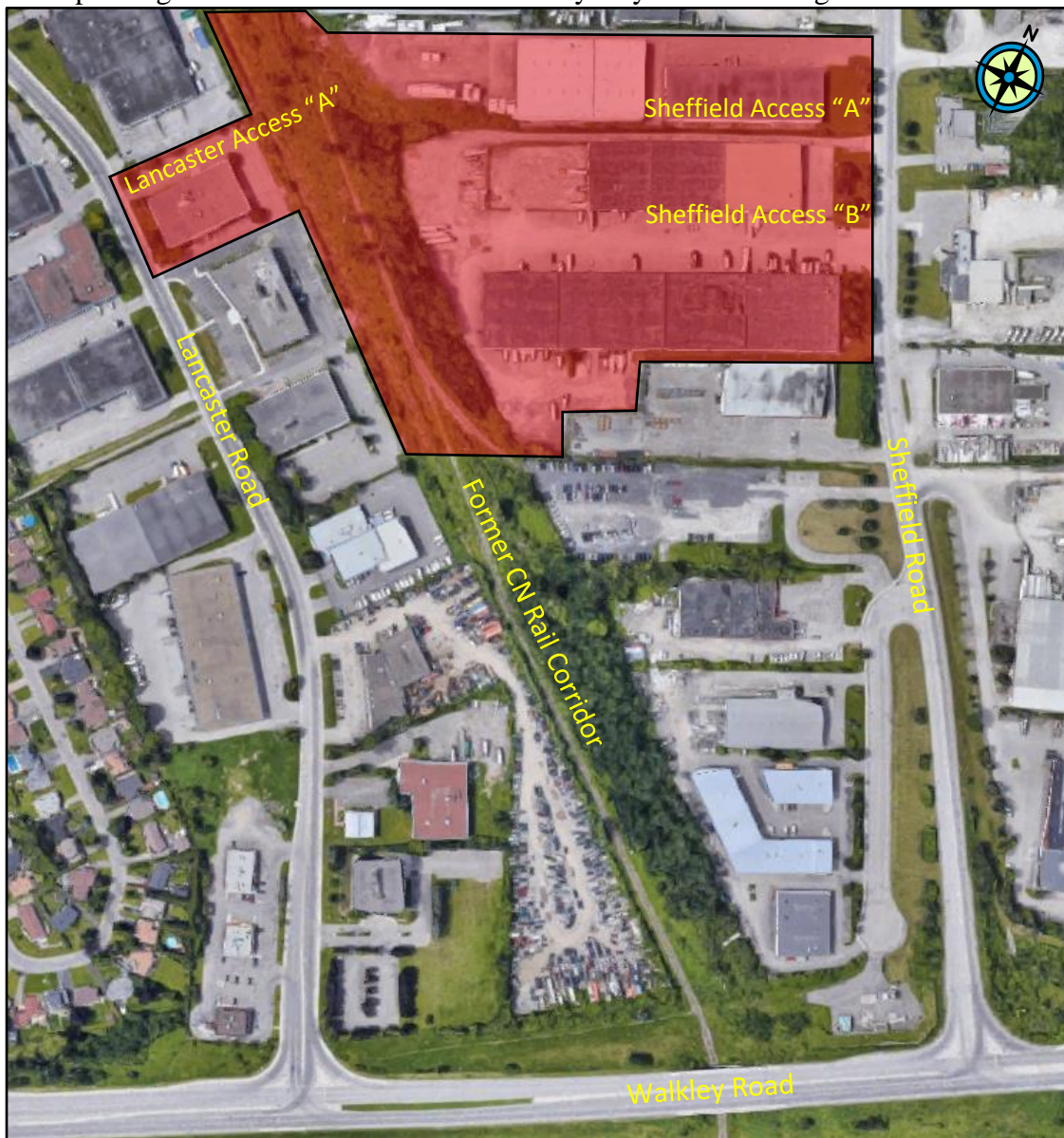

Exhibit 2-1: Study Area Context

2.2 STUDY AREA ROADWAYS

The following sub-sections serve to characterize the primary roadways within the vicinity of the proposed extraction site.

Exhibit 2-1 illustrates the location of the following study area roadways:

- **LANCASTER ROAD:** is an urban collector road that generally runs in a north-south alignment with a posted speed limit of 50 km/h. It has one traffic lane in each direction. Street parking is prohibited on both sides of the roadway except for a short section nearest the 2571 Lancaster Road at the Enbridge Ottawa Operation Centre where a parking restriction is only in effect during December 1-to-March 21.
- **SHEFFIELD ROAD:** is a north-south two-lane collector roadway that extends from Walkley Road in the south to Old Innes Road in the north. It has a posted speed limit of 50 km/h and sidewalks on the west side of the roadway.

2.3 STUDY AREA INTERSECTIONS

The following section summarizes the study area intersections having access to the site presented from the south of the proposed site to the north.

1. SHEFFIELD ROAD / COMMERCIAL ACCESS 'B'

Exhibit 2-2 illustrates the "T" access to the 2760-2770 Sheffield Road site;



Exhibit 2-2: Sheffield Road / Commercial Access "B"

- The curb-to-curb access is 20m in width and provides for the turning movements of heavy vehicle access into, and out of, the site;
- The northbound and southbound approaches to this access provides for a single shared through-turn movement lane with no auxiliary lanes;
- There is a sidewalk along the west side of the Sheffield Road corridor; and
- the Sheffield Road paved width in the vicinity of this access (between curb and edge of outside edge of shoulders) is 12.5m in width.

2. SHEFFIELD ROAD / COMMERCIAL ACCESS 'A'

Exhibit 2-3 illustrates a “T” configured access between the 2750 and 2760-2770 Sheffield Road buildings;

- The curb-to-curb access is 8.5m in width and provides for the turning movements of predominantly passenger vehicles into, and out of, the site;
- The northbound and southbound approaches to this access provides for a single shared through-turn movement lane with no auxiliary lanes;
- There is a sidewalk along the west side of the Sheffield Road corridor; and
- the Sheffield Road paved width in the vicinity of this access (between curb and edge of outside edge of shoulders) is 11.0m in width.



Exhibit 2-3: Sheffield Road / Commercial Access “A”

3. SHEFFIELD ROAD / COMMERCIAL ACCESS 'C'

Exhibit 2-4 illustrates the “T” configured access located just north of the 2750 Sheffield Road building;

- The curb-to-curb access is 12.5m in width and provides for turning movements of a mix of heavy vehicles and passenger vehicles into 2750 Sheffield Road site;
- The northbound and southbound approaches to this access provides for a single shared through-turn movement lane with no auxiliary lanes;
- There is a sidewalk along the west side of the Sheffield Road corridor; and
- the Sheffield Road paved width in the vicinity of this access (between curb and edge of outside edge of shoulders) is 11.0m in width.



Exhibit 2-4: Sheffield Road / Commercial Access “C”

4. LANCASTER ROAD / COMMERCIAL ACCESS 'A'

Exhibit 2-5 illustrates the “T” configured access to the 2713 Lancaster Road building;



Exhibit 2-5: Lancaster Road / Commercial Access “A”
(Looking to the South)

- The curb-to-curb access is 6.5m in width and provides access for passenger vehicles into the parking lot located immediately to the north of the building;
- The northbound and southbound approaches to this access provides for a single shared through-turn movement lane with no auxiliary lanes;
- There is a sidewalk along both the east and west sides of the Lancaster Road corridor; and
- the paved width of Lancaster Road in the vicinity of this access (between curbs) is 11.0m in width and provides for 1.6m wide paved shoulders on both sides of the roadway.

5. LANCASTER ROAD / COMMERCIAL ACCESS 'B'

- There is an existing access between the 2713 and 2723 Lancaster Road buildings that provides for convenient limited (9 parking stalls) access to the 2713 building. This access to the south is within the 2723 (Urbandale) building/property.

2.4 EXISTING TRAFFIC VOLUMES (2023)

Manual traffic counts were conducted on Thursday, June 22nd and Thursday, June 29th, 2023 at the above accesses during the morning (7:00-to-9:00 AM) and afternoon (3:30-to-6:00 PM) peak periods of travel demand. The counts recorded the number of passenger vehicles and heavy vehicles (3-or-more axles). [Appendix “A” provides the collected traffic count information.] and the peak hour of traffic demand of each access was determined.

Appendix “B” (Page B-1) illustrates the existing (2023) balanced morning and afternoon “peak hour” traffic volumes within the study area at each access.

2.5 EXISTING TRAFFIC ANALYSIS

Intersection capacity analysis for the intersections was undertaken utilizing Synchro™ 10 analysis software. The software incorporates Highway Capacity Manual (HCM) 6th edition methodologies to determine level-of-service (delay-based) and volume-to-capacity (v/c) performance metrics. The analyses assumed a peak hour factor of 0.90 which simulates the busiest 15-minute-period of the overall peak hour.

Appendix “C” documents the resulting Synchro output sheet indicating the existing traffic operational performance.

Table 2-1: Existing 2023 Intersection Capacity Analysis Result

Intersection	Control Type	Critical Approach/ Movement	Weekday			
			Morning Peak Hour		Afternoon Peak Hour	
			Average Delay per Vehicle (seconds)	Level of Service	95 th Percentile Queue (m)	Volume-to-Capacity Ratio (v/c)
1. Sheffield Road / Access 'A'	Minor leg- STOP	EB	11 (0)	B (A)	0 (-)	0.00 (-)
		NB-LT	0 (8.0)	A (A)	0.0 (0.0)	- (0.00)
2. Sheffield Road / Access 'B'	Minor leg- STOP	EB	13.0 (14.8)	B (B)	1.50 (2.25)	0.07 (0.08)
		NB-LT	8.3 (8.4)	A (A)	0.75 (0.75)	0.03 (0.02)
3. Sheffield Road / Access 'C'	Minor leg- STOP	EB	15.2 (13.6)	C (B)	0.75 (0.75)	0.02 (0.02)
		NB-LT	8.3 (8.0)	A (A)	0.0 (0.0)	0.01 (0.00)
4. Lancaster Road / Access 'A'	Minor leg- STOP	WB	13.1 (11.9)	B (B)	0.0 (0.0)	0.00 (0.01)
		SB-LT	8.3 (0.0)	A (A)	0.75 (0.0)	0.03 (-)
5. Lancaster Road / Access 'B'	Minor leg- STOP	WB	11.3 (12.1)	B (B)	0.0 (0.75)	0.01 (0.04)
		SB-LT	8.3 (7.5)	A (A)	0.00 (0.0)	0.00 (0.00)

Values outside of brackets represent morning peak hour results.

Values inside of brackets represent afternoon peak hour results.

Table 2-1 summarizes the results of the intersection capacity analyses assuming the existing traffic conditions as illustrated within Appendix “B” (Page B-1) and the existing intersection configurations. The table indicates that all intersections presently operate at LOS “C” or higher. Queue lengths are all minimal (less than 3 meters) and delay is below 15 seconds for all critical movements.

3.0 TRAFFIC FORECASTS

3.1 ADJACENT DEVELOPMENT AND BACKGROUND TRAFFIC GROWTH

The City of Ottawa’s “Development Application Search” tool was used to identify adjacent developments that would result in additional traffic growth along the Sheffield Road and Lancaster Road corridors. The following developments were identified:

- *2555 Sheffield Road*: [Status: Inactive]: This site proposes demolition of an existing building and the construction of a 5,676m² GFA building along the Sheffield Road frontage, with a second, building of 624m² GFA at the rear of the property. The facility would be used for metal and material recovery/recycling, producing bricks and bales of various sizes for transfer. These metal / materials are temporarily stored both indoors and outdoors while awaiting transfer by truck to the major metal processing facility in Montreal.
- *2920 Sheffield Road*: [Status: Inactive]: This site involves a proposed 945 m² industrial warehouse building located adjacent to an existing 1,244m² industrial building fronting on the Sheffield Road cul-de-sac street north of Walkley Road.
- *2625 Sheffield Road*: [Status: Inactive]: This site involves the development of a facility which includes a 24,484m² warehouse/distribution centre, an 11,214m² warehouse, 1,186m² of office and a 12,084m² interior queueing/loading area.
- *2571 /2595 Lancaster Road*: [Status: Inactive]: This site involves the development of an Enbridge Ottawa Operations facility which replaces the former Minto Skating Centre located on the east side of Lancaster Road. The development is currently under construction and includes a 2-storey 3,829m² office component, a 723m² warehouse component and a 557m² shop.
- *2784 /2786 Lancaster Road*: [Status: Inactive]: This site is located just north of Walkley Road on the west side of Lancaster and just north of the existing Tim Hortons’s development. A Minor Zoning By-Law amendment application was requested that would permit a change of use to “retail store” in the existing units of the 1-storey 2786 building. There are no physical changes to the building envelope, the site or parking that are proposed.

When the above proposed developments were considered, it was determined that a 2% average annual growth factor applied to thru-traffic volumes would be sufficient to accommodate the future traffic growth associated with anticipated adjacent developments. A 2% growth factor was applied to the 2024 horizon year and 12% growth factor was applied to the 2029 horizon year traffic forecasts.

3.2 SITE TRAFFIC GENERATION

The proposed site plan indicates the following inventory of parking stalls:

- 126 passenger vehicle parking stalls (of which 12 were designated for accessible parking stalls.) [Note: City of Ottawa zoning provisions only require 63 parking stalls, or half of the provided parking stalls.];
- 42 docking areas were available at the rear of the building; and
- 24 parking stalls reserved for storage of truck trailers.

The split of heavy vehicle traffic to passenger vehicle traffic was based on the “required” parking rates associated with the proposed 113,715 SF warehouse development. Hence, 63 passenger vehicles are “required”, and the 24 stalls reserved for the storage of trailers was also included in the overall total in that these trailer stalls would represent an additional pick-up and drop-off trip.

Table 3-1 summarizes the distribution of stalls and indicates that roughly half of the peak hour trips are anticipated be by passenger vehicles and the remaining half by heavy vehicles.

Table 3-1: Distribution of Required Parking Stalls by Type

Vehicle Type	Required Stalls	Percentage
Passenger Vehicles	63	49%
Docking Areas	42	33%
Trailer Storage	24	18%
Total	129 Required Stalls	100%

Hence, 49% of the required on-site vehicle parking is reserved for passenger vehicles and 51% for heavy vehicles.

ITE¹ traffic generation rates (Land Use 150) were referenced to determine the traffic volumes associated with the proposed land use. The ITE definition of “warehousing” development includes the constituent office component within the building.

Table 3-2 summarizes the anticipated “net” site generated traffic volumes associated with the proposed new warehouse development and includes a reduction to account for the planned demolished portion of Building No. 4. The net impact of the development is anticipated to result in 28 (75% inbound/25% outbound) morning peak hour and 21 (33% inbound/66% outbound) afternoon peak hour trips.

**Table 3-2: Peak Hour Site Generated Traffic: (Vehicles-per-Hour)
(ITE Trip Generation Manual, 11th Edition)**

ITE Land Use	Variable	Morning Peak Hour		Afternoon Peak Hour	
		Entry	Exit	Entry	Exit
150 – Warehousing (with supporting office)	113,715 Sq. Ft. GFA	30	10	10	25
Reduction: Demolished Portion of Building “4”	20,2430 Sq. Ft. GFA	9	3	4	11
Net Effect of Proposed Development		21	7	6	14
Total Trips Generated by New Development		28		21	
(49%) Forecast Passenger Vehicle Demand		10	3	3	7
(51%) Forecast Heavy Vehicle Demand		11	4	3	7

Appendix “B” (Page B-2) illustrates the resulting site generated traffic.

1. Institute of Transportation Engineers (ITE) Trip Generation Web Based App 11th Edition

4.0 TRAFFIC FORECAST (2024 & 2029)

Appendix B (Page B-3 and B-4) illustrate the resulting forecast first year of operation (2024) and 5-Year (2029) total morning and afternoon peak hour traffic volumes. The following sections highlight the traffic operational analysis that was undertaken utilizing Synchro™ 10 analysis software to simulate the busiest 15-minute-period of the overall morning and afternoon peak hours of travel demand for each of the two horizon years.

4.1 OPERATIONAL (2024) TRAFFIC ANALYSIS

Table 4-1 presents the forecast traffic operations for the 2024 year of operation both, with, and without, the proposed development in place for comparison purposes.

[The Synchro output sheets for forecast 2024 operational traffic analysis are provided within Appendix “C”.]

Table 4-1: Operational (2024) Intersection Capacity Analysis

Intersection	Control Type	Critical Approach/ Movement	Weekday			
			Morning Peak Hour (Afternoon Peak Hour)		95 th Percentile Queue (m)	Volume-to-Capacity Ratio (v/c)
Without Redevelopment of Site						
1. Sheffield Road / Access 'A'	Minor leg-STOP	EB	10.7 (0.0)	B (A)	0.0 (-)	0.00 (-)
		NB-LT	0.0 (7.9)	A (A)	0.0 (0.0)	- (0.00)
2. Sheffield Road / Access 'B'	Minor leg-STOP	EB	12.4 (12.7)	B (B)	1.50 (1.50)	0.05 (0.06)
		NB-LT	8.2 (8.0)	A (A)	0.75 (0.75)	0.02 (0.02)
3. Sheffield Road / Access 'C'	Minor leg-STOP	EB	14.3 (12.9)	B (B)	0.75 (0.75)	0.02 (0.02)
		NB-LT	8.2 (7.9)	A (A)	0.0 (0.0)	0.01 (0.00)
4. Lancaster Road / Access 'A'	Minor leg-STOP	WB	12.5 (11.6)	B (B)	0.0 (0.0)	0.00 (0.01)
		SB-LT	8.2 (0.0)	A (A)	0.75 (0.0)	0.02 (-)
5. Lancaster Road / Access 'B'	Minor leg-STOP	WB	11.0 (11.7)	B (B)	0.0 (0.75)	0.01 (0.04)
		SB-LT	8.2 (7.5)	A (A)	0.0 (0.0)	0.00 (0.00)
Assuming Redevelopment of Site is in Place						
1. Sheffield Road / Access 'A'	Minor leg-STOP	EB	10.7 (0.0)	B (A)	0.0 (-)	0.00 (-)
		NB-LT	0.0 (7.9)	A (A)	0.0 (0.0)	- (0.00)
2. Sheffield Road / Access 'B'	Minor leg-STOP	EB	12.7 (14.4)	B (B)	1.50 (2.25)	0.07 (0.08)
		NB-LT	8.3 (8.2)	A (A)	0.75 (0.75)	0.03 (0.02)
3. Sheffield Road / Access 'C'	Minor leg-STOP	EB	14.4 (12.9)	B (B)	0.75 (0.75)	0.02 (0.02)
		NB-LT	8.2 (7.9)	A (A)	0.0 (0.0)	0.01 (0.00)
4. Lancaster Road / Access 'A'	Minor leg-STOP	WB	12.2 (11.5)	B (B)	0.0 (0.0)	0.01 (0.02)
		SB-LT	8.2 (7.5)	A (A)	0.75 (0.0)	0.03 (0.00)
5. Lancaster Road / Access 'B'	Minor leg-STOP	WB	11.0 (11.7)	B (B)	0.0 (0.75)	0.01 (0.04)
		SB-LT	8.2 (7.5)	A (A)	0.0 (0.0)	0.00 (0.00)

The north-south traffic flow along both Sheffield Road and Lancaster Road are unimpeded and free-flow. Left turn vehicle traffic either headed into, or out of, the proposed site must yield the right-of-way to oncoming east-west traffic. The operational analyses present the delays associated with the southbound left turn into the Lancaster Access “A” and the northbound left turn into the Sheffield accesses which represent the forecast delays to north-south thru-traffic on the two corridors that would be associated with the development of the proposed site.

Table 4-1 indicates that for the forecast 2024 year of operation:

- The “worst-case” average delay of the five accesses analyzed occurs at the Sheffield Road/Commercial Access “B” and “C” locations and was determined to be under 15 seconds with a queue length of a single vehicle. [Note, this Access ‘B’ is the heavy-vehicle access that would be used by the proposed development.];
- All the study area intersections were determined to operate under LOS ‘B’-or-better which is satisfactory; and
- A comparison of the results with, or without, the development in place indicates that the site generated traffic associated with the proposed new development would have minimal impact on traffic operations upon the Lancaster Road and Sheffield Road corridors.

4.2 5-YEAR HORIZON (2029) TRAFFIC ANALYSIS

Table 4-2 summarizes the intersection capacity analyses results derived from the intersection capacity analyses assuming the 2029 horizon year.

[The Synchro output sheets for forecast 2029 operational traffic analysis are provided within Appendix “C”.]

Table 4-2: Operational (2029) Intersection Capacity Analysis

Intersection	Control Type	Critical Approach/ Movement	Weekday				
			Morning Peak Hour		Afternoon Peak Hour		
			Average Delay per Vehicle (seconds)	Level of Service	95 th Percentile Queue (m)	Volume-to-Capacity Ratio (v/c)	
Without Redevelopment of Site							
1.	Sheffield Road / Access ‘A’	Minor leg- STOP	EB	11.0 (0.0)	B (A)	0.0 (0.0)	0.00 (-)
			NB-LT	0.0 (8.0)	A (A)	0.0 (0.0)	- (0.00)
2.	Sheffield Road / Access ‘B’	Minor leg- STOP	EB	13.1 (13.5)	B (B)	1.50 (1.50)	0.07 (0.07)
			NB-LT	8.4 (8.1)	A (A)	0.75 (0.75)	0.03 (0.02)
3.	Sheffield Road / Access ‘C’	Minor leg- STOP	EB	15.3 (13.7)	C (B)	0.75 (0.75)	0.03 (0.02)
			NB-LT	8.3 (8.0)	A (A)	0.0 (0.0)	0.01 (0.00)
4.	Lancaster Road / Access ‘A’	Minor leg- STOP	WB	13.1 (12.0)	B (B)	0.0 (0.0)	0.00 (0.01)
			SB-LT	8.3 (0.0)	A (A)	0.75 (0.0)	0.03 (-)
5.	Lancaster Road / Access ‘B’	Minor leg- STOP	WB	11.3 (12.2)	B (B)	0.0 (0.75)	0.01 (0.04)
			SB-LT	8.3 (7.6)	A (A)	0.0 (0.0)	0.01 (0.00)
Assuming Redevelopment of Site is in Place							
1.	Sheffield Road / Access ‘A’	Minor leg- STOP	EB	11.0 (0.0)	B (A)	0.0 (0.0)	0.00 (-)
			NB-LT	0.0 (8.0)	A (A)	0.0 (0.0)	- (0.00)
2.	Sheffield Road / Access ‘B’	Minor leg- STOP	EB	13.5 (14.0)	B (B)	1.50 (2.25)	0.08 (0.09)
			NB-LT	8.4 (8.1)	A (A)	0.75 (0.75)	0.03 (0.02)
3.	Sheffield Road / Access ‘C’	Minor leg- STOP	EB	15.4 (13.7)	C (B)	0.75 (0.75)	0.03 (0.02)
			NB-LT	8.3 (8.0)	A (A)	0.0 (0.0)	0.01 (0.00)
4.	Lancaster Road / Access ‘A’	Minor leg- STOP	WB	12.8 (11.9)	B (B)	0.0 (0.0)	0.01 (0.02)
			SB-LT	8.4 (7.6)	A (A)	0.75 (0.0)	0.03 (0.00)
5.	Lancaster Road / Access ‘B’	Minor leg- STOP	WB	11.4 (12.2)	B (B)	0.0 (0.75)	0.01 (0.04)
			SB-LT	8.3 (7.6)	A (A)	0.0 (0.0)	0.01 (0.00)

Table 4-2 indicates that for the forecast 2029 horizon year, five-years after operation commenced...:

- The “worst-case” average delay of the five accesses analyzed continues to occur at the Sheffield Road/Commercial Access “B” and “C” locations and were determined to be under 16 seconds with a queue length of a single vehicle;
- All the study area intersection continues to operate under acceptable LOS ‘C’-or-better in the 2029 horizon year which is acceptable; and
- A comparison of the results, with and without, the development in place, indicates that of the site generated traffic has minimal impact on traffic operations.

5.0 SUPPLEMENTAL ANALYSIS

5.1 HEAVY VEHICLE TURNING MOVEMENTS

All heavy vehicle must enter, and leave, the proposed development by way of the Sheffield Road / Commercial Vehicle “B” access. This access is 20m wide which provides sufficient turning radii and width to accommodate a WB-20 heavy vehicle.

Appendix “D” (Page D-1 and D-2) illustrates the resulting turning movements at this access assuming a WB-20 heavy vehicle. It was concluded that the turning movements of such a heavy vehicle can easily be accommodated at this access.

Internal to the site is a storage area intended to accommodate pick-up and drop-off of heavy vehicle trailers. Appendix “D” (Page D-3 and D-4) illustrates this entry to this storage area and presents the AutoTurn™ simulation associated with:

- a WB-20 vehicle (cab and trailer) entering the storage area and then backing the trailer into the storage bay located near the entrance to the lot; and
- a WB-20 vehicle (cab and trailer) exiting the storage area with trailer attached.

It was concluded that, although backing the trailer into the storage area lot may require several turns, depending on the stall that was selected, it was determined that this turning maneuver could be accomplished. Backing the heavy vehicle cab to pick up the trailer and depart the storage area can be done with ease.

5.2 LEFT TURN LANE WARRANTS

An auxiliary left turn lane warrant analysis was undertaken for all study area intersections the were analyzed following MTO geometric design standards² for Ontario roadways. The analysis assumed the 5-Year Horizon 2029 traffic volumes. The percentage of left turn vehicles was determined and only those intersections with forecast peak hour travel demands with sufficient left-turn percentages needed to satisfy the MTO criteria were selected for further analysis. Only the Lancaster Road/Access “A” and Sheffield Road/Access “B” was forecast to have high enough to continue with the MTO analyses. Appendix “E” illustrates the results of the MTO left-turn warrant analysis the remaining analysis charts.

It was determined that none of the accesses evaluated triggered the need for an auxiliary left-turn lane assuming the forecast 2029 horizon year traffic volumes.

2. “Geometric Design Guide for Canadian Roads, Chapter 9: Intersections” TAC, June 2017, MTO Design Supplement”, Appendix 9

6.0 FINDINGS AND RECOMMENDATIONS

6.1 SUMMARY OF FINDINGS

The following findings were determined within this technical memorandum.

6.1.1 Access Impacts Associated with Forecast Traffic

- Each of the critical turning movements associated with forecast 2024 and 2029 traffic levels with the proposed site in place were analyzed and evaluated. It was determined that:
 - the existing roadway configurations at each access to the site were found to provide satisfactory traffic operations in terms of the forecast level-of-service, delay and volume-to-capacity (v/c) ratios;
 - The available on-site storage lengths were found to accommodate the forecast 95th percentile queue lengths;
 - the delays associated with the on-road left turns into the site from Lancaster Road and Sheffield Road were found to result in acceptable delays to the on-road thru traffic; and
 - the need for left turn auxiliary lanes at all the accesses to the site were found to be unwarranted.

6.1.2 Heavy Vehicle Traffic

The Sheffield Road / Commercial Vehicle “B” access (which is 20m wide) was found to satisfactorily provide for the turning maneuvers associated with heavy vehicle (WB-20) traffic into, and out of, the proposed site.

The proposed site plan and the planned trailer storage area were found to satisfactorily accommodate the turning maneuvers associated with heavy vehicle traffic.

6.2 SUMMARY OF RECOMMENDATIONS

It is recommended that the City of Ottawa receive this technical memorandum that indicates:

- from a transportation/traffic perspective, the traffic impacts associated with the proposed development site will have negligible impact to traffic operations along Sheffield Road and Lancaster Road; and
- that the existing Sheffield and Lancaster Road accesses to/from the proposed site and the internal driveways/aisles as illustrated within the proposed site plan are acceptable in that the turning movements associated with heavy vehicle traffic are accommodated without the need for additional roadway modifications or changes to the site plan.

APPENDIX A: EXISTING TRAFFIC, BALANCED TRAFFIC COUNTS, BACKGROUND GROWTH AND SITE TRAFFIC BY TURNING MOVEMENT

1. Lancaster Rd / Commercial Access 'A'													1. Lancaster Rd / Commercial Access 'A'								
Time Period	Westbound			Northbound			Eastbound			Southbound			Westbound	Southbound	Northbound	Westbound	Southbound	Northbound			
	RT	TH	LT	RT	TH	LT	RT	TH	LT	RT	TH	LT	Approach	Egress	Approach	Egress	Approach	Egress	Approach	Egress	
Raw Existing Traffic Volumes	AM	0	0	1	3	399	0	0	0	0	0	0	1	29	402	95	0	0	120	399	
Balance Adjustment	AM	2	0	0	0	147	0	0	0	0	0	0	6	0	147	437	0	0	433	149	
Balanced Existing Traffic Volumes	AM	0	0	1	3	399	0	0	0	0	0	0	7	0	147	437	0	0	0	0	
2024 Background Traffic	AM	2	0	4	0	147	0	0	0	0	0	0	6	0	147	437	0	0	433	149	
2029 Background Traffic	AM	0	0	1	3	407	0	0	0	0	0	0	6	0	150	446	0	0	122	407	
Site Trip Generation	AM	2	0	4	0	150	0	0	0	0	0	0	6	0	150	446	0	0	442	152	
2024 Background Forecast	AM	0	0	1	3	447	0	0	0	0	0	0	6	0	150	446	0	0	122	407	
2029 Background Forecast	AM	1	0	3	8	447	0	0	0	0	0	0	6	0	150	446	0	0	442	152	
Design Traffic Volume - 2024	AM	1	0	3	8	407	0	0	0	0	0	0	7	0	165	489	0	0	485	167	
Design Traffic Volume - 2029	AM	1	0	3	8	447	0	0	0	0	0	0	4	0	415	99	0	0	127	408	
Site Trip Assignment	AM	0%	0%	0%	0%	0%	0%	0%	0%	0%	0%	0%	0	0	0	0	0	0	0	0	
0	AM	0	0	0	0	0	0	0	0	0	0	0	0	0	0	0	0	0	0	0	
Exhibit	AM	1	0	3	8	447	0	0	0	0	0	0	4	0	42	455	108	3	0	139	448
	PM	1	0	3	8	165	0	0	0	0	0	0	4	0	42	455	108	3	0	139	448
	PM	1	0	3	8	165	0	0	0	0	0	0	14	3	167	493	0	0	485	170	

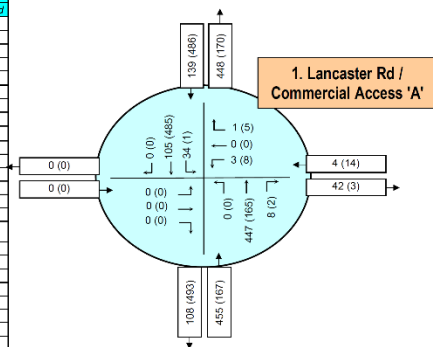

2. Lancaster Rd / Commercial Access 'B'													2. Lancaster Rd / Commercial Access 'B'							
Time Period	Westbound			Northbound			Eastbound			Southbound			Westbound	Southbound	Northbound	Westbound	Southbound	Northbound		
	RT	TH	LT	RT	TH	LT	RT	TH	LT	RT	TH	LT	Approach	Egress	Approach	Egress	Approach	Egress	Approach	Egress
Raw Existing Traffic Volumes	AM	3	0	1	12	399	0	0	0	0	0	0	4	15	411	93	0	0	95	402
Balance Adjustment	AM	0	0	0	0	140	0	0	0	0	0	0	20	9	146	447	0	0	437	147
Balanced Existing Traffic Volumes	AM	0	0	0	0	0	0	0	0	0	0	0	0	0	0	0	0	0	0	0
2024 Background Traffic	AM	3	0	1	12	399	0	0	0	0	0	0	4	15	411	93	0	0	95	402
2029 Background Traffic	AM	7	0	13	6	140	0	0	0	0	0	0	4	15	419	95	0	0	97	410
Site Trip Generation	AM	3	0	1	12	407	0	0	0	0	0	0	4	15	419	95	0	0	97	410
2024 Background Forecast	AM	7	0	13	6	143	0	0	0	0	0	0	20	9	149	456	0	0	446	150
2029 Background Forecast	AM	3	0	1	13	447	0	0	0	0	0	0	4	17	460	104	0	0	106	450
Design Traffic Volume - 2024	AM	3	0	1	12	412	0	0	0	0	0	0	22	10	164	501	0	0	489	165
Design Traffic Volume - 2029	AM	3	0	1	13	447	0	0	0	0	0	0	4	15	424	97	0	0	99	415
Site Trip Assignment	AM	0%	0%	0%	0%	0%	0%	0%	0%	0%	0%	0%	0	0	0	0	0	0	0	0
0	AM	0	0	0	0	0	0	0	0	0	0	0	0	0	0	0	0	0	0	0
Exhibit	AM	3	0	1	13	452	0	0	0	0	0	0	4	17	465	106	0	0	108	455
	PM	3	0	1	13	157	0	0	0	0	0	0	22	10	164	501	0	0	489	165
	PM	3	0	1	12	412	0	0	0	0	0	0	4	15	424	97	0	0	99	415

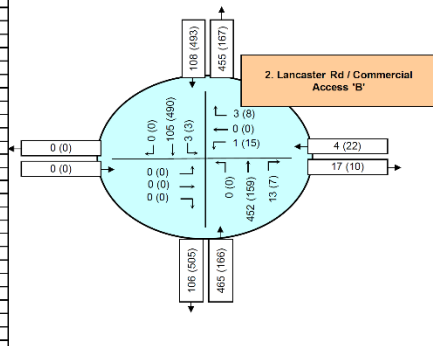

3. Sheffield Rd / Commercial Access 'A'													3. Sheffield Rd / Commercial Access 'A'							
Time Period	Westbound			Northbound			Eastbound			Southbound			Westbound	Southbound	Northbound	Westbound	Southbound	Northbound		
	RT	TH	LT	RT	TH	LT	RT	TH	LT	RT	TH	LT	Approach	Egress	Approach	Egress	Approach	Egress	Approach	Egress
Raw Existing Traffic Volumes	AM	0	0	0	0	324	0	1	0	0	0	0	0	0	324	410	1	0	409	324
Balance Adjustment	AM	0	0	0	0	489	1	0	0	0	0	0	0	0	490	319	0	1	319	489
Balanced Existing Traffic Volumes	AM	0	0	0	0	0	0	0	0	0	0	0	0	0	0	0	0	0	0	0
2024 Background Traffic	AM	0	0	0	0	324	0	1	0	0	0	0	0	0	324	410	1	0	409	324
2029 Background Traffic	AM	0	0	0	0	489	1	0	0	0	0	0	0	0	490	319	0	1	319	489
Site Trip Generation	AM	0	0	0	0	330	0	1	0	0	0	0	0	0	330	416	1	0	417	330
2024 Background Forecast	AM	0	0	0	0	499	1	0	0	0	0	0	0	0	500	325	0	1	325	499
2029 Background Forecast	AM	0	0	0	0	363	0	1	0	0	0	0	0	0	363	459	1	0	458	363
Design Traffic Volume - 2024	AM	0	0	0	0	548	1	0	0	0	0	0	0	0	549	357	0	1	357	548
Design Traffic Volume - 2029	AM	0	0	0	0	2	0	0	0	0	0	0	0	0	2	5	0	0	5	2
Site Trip Assignment	AM	0%	0%	0%	0%	0%	0%	0%	0%	0%	0%	0%	0	0	0	0	0	0	0	0
0	AM	0	0	0	0	330	1	0	0	0	0	0	0	0	330	416	1	0	417	330
Exhibit	AM	0	0	0	0	499	1	0	0	0	0	0	0	0	325	325	0	1	325	499
	PM	0	0	0	0	548	1	0	0	0	0	0	0	0	363	459	1	0	458	363
	PM	0	0	0	0	2	0	0	0	0	0	0	0	0	549	357	0	1	357	548

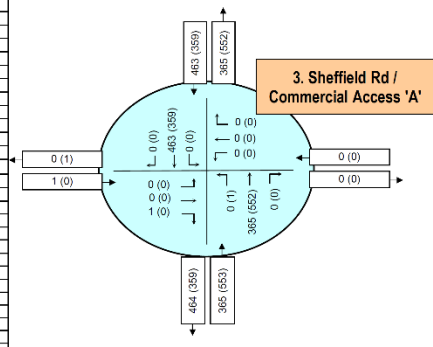

APPENDIX B: EXISTING AND FORECAST TRAFFIC VOLUMES

- Existing (2023)
- Site Traffic Generation
- Forecast Operations: Occupancy Year (2024)
- Forecast Operations: 5-Year Horizon (2029)

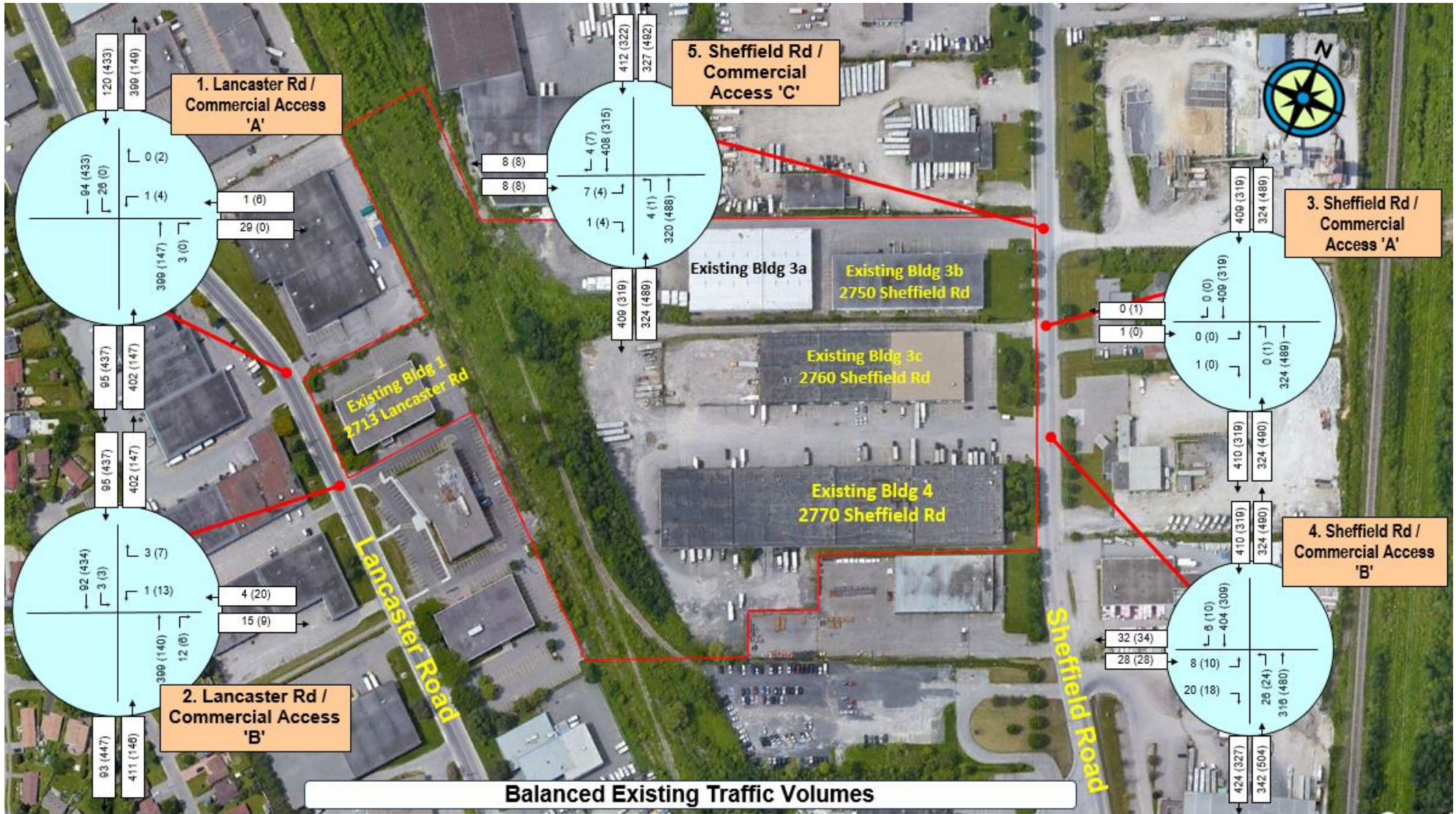

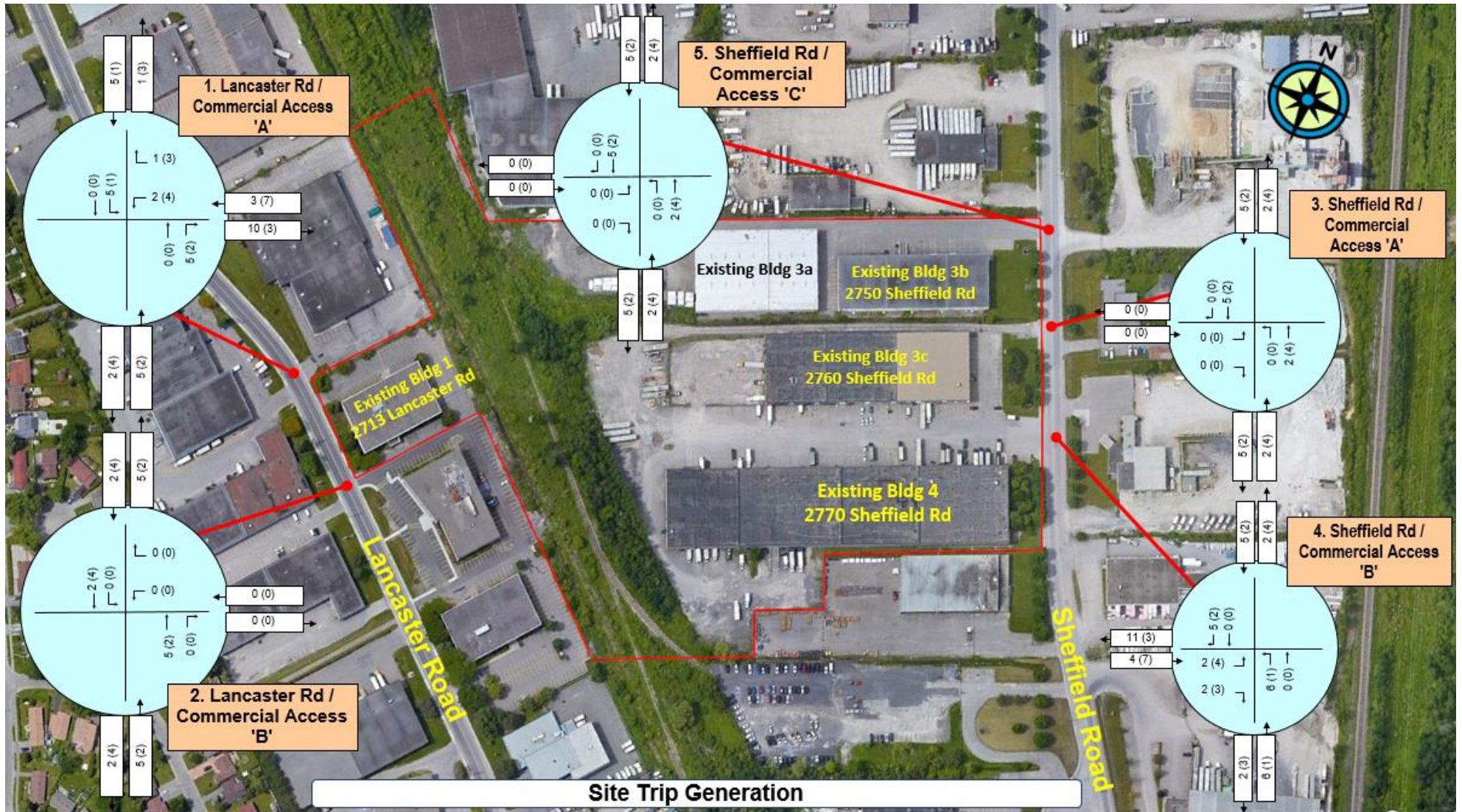

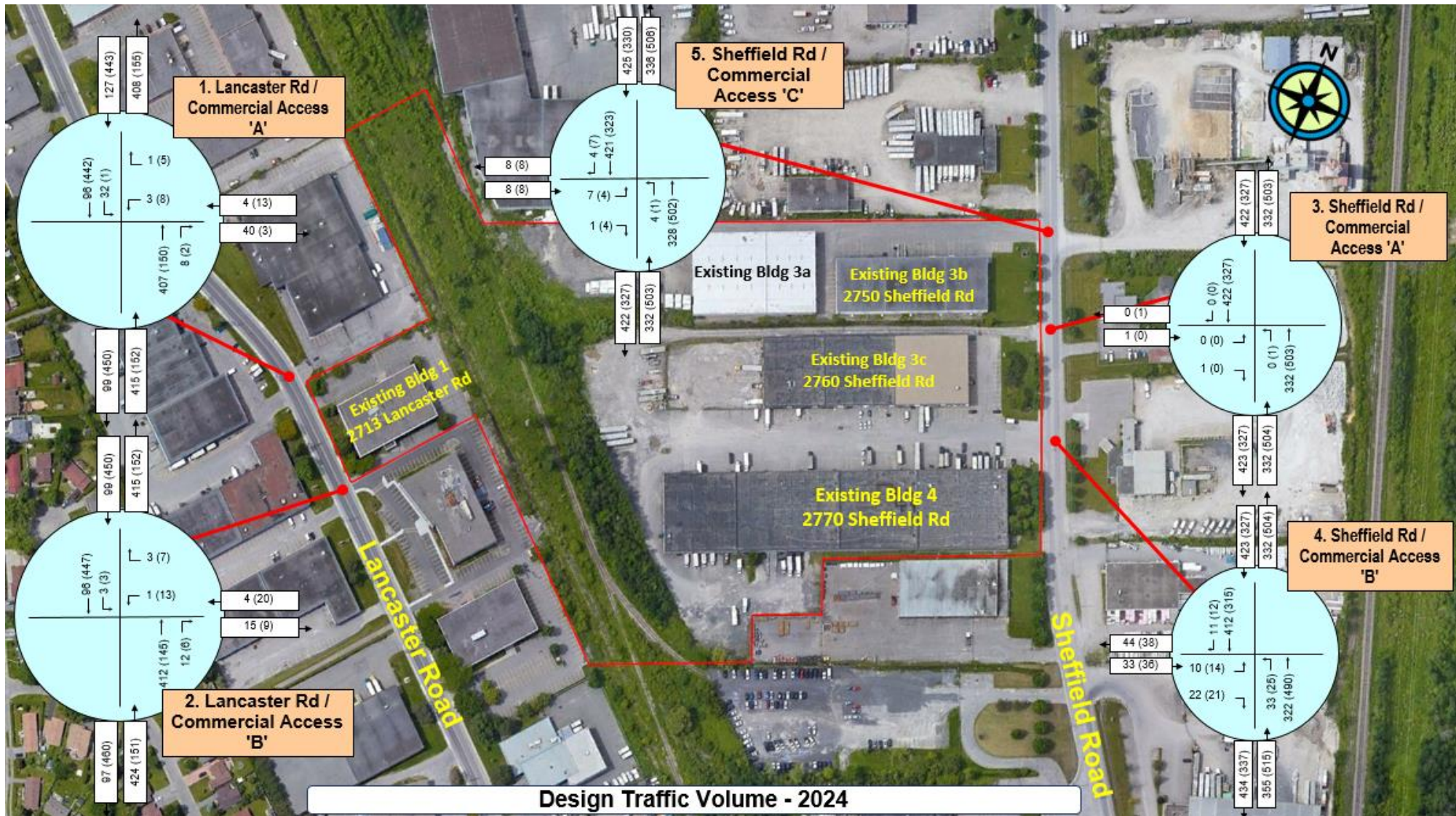

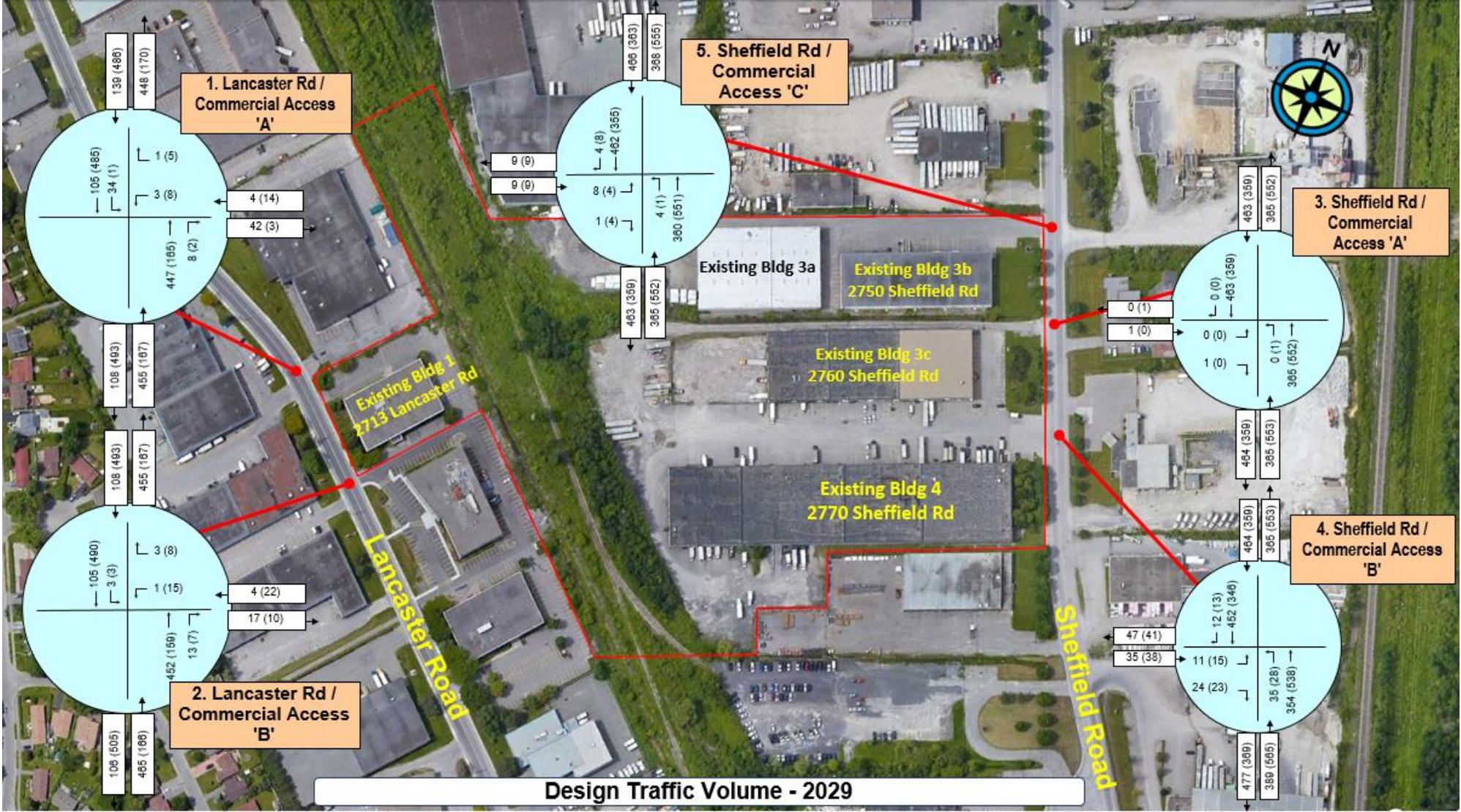



**Castleglenn
Consultants**

Engineers, Project Managers & Planners

APPENDIX C: SYNCHRO ANALYSIS SHEETS

Intersection						
Int Delay, s/veh	0.4					
Movement	WBL	WBR	NBT	NBR	SBL	SBT
Lane Configurations	W		T			T
Traffic Vol, veh/h	1	0	399	3	26	94
Future Vol, veh/h	1	0	399	3	26	94
Conflicting Peds, #/hr	0	0	0	0	0	0
Sign Control	Stop	Stop	Free	Free	Free	Free
RT Channelized	-	None	-	None	-	None
Storage Length	0	-	-	-	-	-
Veh in Median Storage, #	0	-	0	-	-	0
Grade, %	0	-	0	-	-	0
Peak Hour Factor	90	90	90	90	90	90
Heavy Vehicles, %	2	2	2	2	2	2
Mvmt Flow	1	0	443	3	29	104

Major/Minor	Minor1	Major1	Major2			
Conflicting Flow All	607	445	0	0	446	0
Stage 1	445	-	-	-	-	-
Stage 2	162	-	-	-	-	-
Critical Hdwy	6.42	6.22	-	-	4.12	-
Critical Hdwy Stg 1	5.42	-	-	-	-	-
Critical Hdwy Stg 2	5.42	-	-	-	-	-
Follow-up Hdwy	3.518	3.318	-	-	2.218	-
Pot Cap-1 Maneuver	460	613	-	-	1114	-
Stage 1	646	-	-	-	-	-
Stage 2	867	-	-	-	-	-
Platoon blocked, %			-	-		-
Mov Cap-1 Maneuver	447	613	-	-	1114	-
Mov Cap-2 Maneuver	447	-	-	-	-	-
Stage 1	646	-	-	-	-	-
Stage 2	843	-	-	-	-	-

Approach	WB	NB	SB
HCM Control Delay, s	13.1	0	1.8
HCM LOS	B		

Minor Lane/Major Mvmt	NBT	NBRWBLn1	SBL	SBT
Capacity (veh/h)	-	-	447	1114
HCM Lane V/C Ratio	-	-	0.002	0.026
HCM Control Delay (s)	-	-	13.1	8.3
HCM Lane LOS	-	-	B	A
HCM 95th %tile Q(veh)	-	-	0	0.1

Intersection						
Int Delay, s/veh	0.1					
Movement	WBL	WBR	NBT	NBR	SBL	SBT
Lane Configurations	W	R	T	R	L	T
Traffic Vol, veh/h	1	3	399	12	3	92
Future Vol, veh/h	1	3	399	12	3	92
Conflicting Peds, #/hr	0	0	0	0	0	0
Sign Control	Stop	Stop	Free	Free	Free	Free
RT Channelized	-	None	-	None	-	None
Storage Length	0	-	-	-	-	-
Veh in Median Storage, #	0	-	0	-	-	0
Grade, %	0	-	0	-	-	0
Peak Hour Factor	90	90	90	90	90	90
Heavy Vehicles, %	2	2	2	2	2	2
Mvmt Flow	1	3	443	13	3	102

Major/Minor	Minor1	Major1	Major2		
Conflicting Flow All	558	450	0	0	456
Stage 1	450	-	-	-	-
Stage 2	108	-	-	-	-
Critical Hdwy	6.42	6.22	-	-	4.12
Critical Hdwy Stg 1	5.42	-	-	-	-
Critical Hdwy Stg 2	5.42	-	-	-	-
Follow-up Hdwy	3.518	3.318	-	-	2.218
Pot Cap-1 Maneuver	491	609	-	-	1105
Stage 1	642	-	-	-	-
Stage 2	916	-	-	-	-
Platoon blocked, %					
Mov Cap-1 Maneuver	490	609	-	-	1105
Mov Cap-2 Maneuver	490	-	-	-	-
Stage 1	642	-	-	-	-
Stage 2	913	-	-	-	-

Approach	WB	NB	SB
HCM Control Delay, s	11.3	0	0.3
HCM LOS	B		

Minor Lane/Major Mvmt	NBT	NBRWBLn1	SBL	SBT
Capacity (veh/h)	-	-	574	1105
HCM Lane V/C Ratio	-	-	0.008	0.003
HCM Control Delay (s)	-	-	11.3	8.3
HCM Lane LOS	-	-	B	A
HCM 95th %tile Q(veh)	-	-	0	0

Intersection						
Int Delay, s/veh	0.7					
Movement	EBL	EBR	NBL	NBT	SBT	SBR
Lane Configurations	T			T		T
Traffic Vol, veh/h	8	20	26	316	404	6
Future Vol, veh/h	8	20	26	316	404	6
Conflicting Peds, #/hr	0	0	0	0	0	0
Sign Control	Stop	Stop	Free	Free	Free	Free
RT Channelized	-	None	-	None	-	None
Storage Length	0	-	-	-	-	-
Veh in Median Storage, #	0	-	-	0	0	-
Grade, %	0	-	-	0	0	-
Peak Hour Factor	90	90	90	90	90	90
Heavy Vehicles, %	2	2	2	2	2	2
Mvmt Flow	9	22	29	351	449	7

Major/Minor	Minor2	Major1	Major2			
Conflicting Flow All	862	453	456	0	-	0
Stage 1	453	-	-	-	-	-
Stage 2	409	-	-	-	-	-
Critical Hdwy	6.42	6.22	4.12	-	-	-
Critical Hdwy Stg 1	5.42	-	-	-	-	-
Critical Hdwy Stg 2	5.42	-	-	-	-	-
Follow-up Hdwy	3.518	3.318	2.218	-	-	-
Pot Cap-1 Maneuver	325	607	1105	-	-	-
Stage 1	640	-	-	-	-	-
Stage 2	671	-	-	-	-	-
Platoon blocked, %				-	-	-
Mov Cap-1 Maneuver	314	607	1105	-	-	-
Mov Cap-2 Maneuver	314	-	-	-	-	-
Stage 1	619	-	-	-	-	-
Stage 2	671	-	-	-	-	-

Approach	EB	NB	SB
HCM Control Delay, s	13	0.6	0
HCM LOS	B		

Minor Lane/Major Mvmt	NBL	NBT	EBLn1	SBT	SBR
Capacity (veh/h)	1105	-	479	-	-
HCM Lane V/C Ratio	0.026	-	0.065	-	-
HCM Control Delay (s)	8.3	0	13	-	-
HCM Lane LOS	A	A	B	-	-
HCM 95th %tile Q(veh)	0.1	-	0.2	-	-

Intersection						
Int Delay, s/veh	0					
Movement	EBL	EBR	NBL	NBT	SBT	SBR
Lane Configurations	W			W	W	
Traffic Vol, veh/h	0	1	0	324	409	0
Future Vol, veh/h	0	1	0	324	409	0
Conflicting Peds, #/hr	0	0	0	0	0	0
Sign Control	Stop	Stop	Free	Free	Free	Free
RT Channelized	-	None	-	None	-	None
Storage Length	0	-	-	-	-	-
Veh in Median Storage, #	0	-	-	0	0	-
Grade, %	0	-	-	0	0	-
Peak Hour Factor	90	90	90	90	90	90
Heavy Vehicles, %	2	2	2	2	2	2
Mvmt Flow	0	1	0	360	454	0

Major/Minor	Minor2	Major1	Major2			
Conflicting Flow All	814	454	454	0	-	0
Stage 1	454	-	-	-	-	-
Stage 2	360	-	-	-	-	-
Critical Hdwy	6.42	6.22	4.12	-	-	-
Critical Hdwy Stg 1	5.42	-	-	-	-	-
Critical Hdwy Stg 2	5.42	-	-	-	-	-
Follow-up Hdwy	3.518	3.318	2.218	-	-	-
Pot Cap-1 Maneuver	347	606	1107	-	-	-
Stage 1	640	-	-	-	-	-
Stage 2	706	-	-	-	-	-
Platoon blocked, %				-	-	-
Mov Cap-1 Maneuver	347	606	1107	-	-	-
Mov Cap-2 Maneuver	347	-	-	-	-	-
Stage 1	640	-	-	-	-	-
Stage 2	706	-	-	-	-	-

Approach	EB	NB	SB
HCM Control Delay, s	11	0	0
HCM LOS	B		

Minor Lane/Major Mvmt	NBL	NBT	EBLn1	SBT	SBR
Capacity (veh/h)	1107	-	606	-	-
HCM Lane V/C Ratio	-	-	0.002	-	-
HCM Control Delay (s)	0	-	11	-	-
HCM Lane LOS	A	-	B	-	-
HCM 95th %tile Q(veh)	0	-	0	-	-

Intersection						
Int Delay, s/veh	0.2					
Movement	EBL	EBR	NBL	NBT	SBT	SBR
Lane Configurations						
Traffic Vol, veh/h	7	1	4	320	408	4
Future Vol, veh/h	7	1	4	320	408	4
Conflicting Peds, #/hr	0	0	0	0	0	0
Sign Control	Stop	Stop	Free	Free	Free	Free
RT Channelized	-	None	-	None	-	None
Storage Length	0	-	-	-	-	-
Veh in Median Storage, #	0	-	-	0	0	-
Grade, %	0	-	-	0	0	-
Peak Hour Factor	90	90	90	90	90	90
Heavy Vehicles, %	2	2	2	2	2	2
Mvmt Flow	8	1	4	356	453	4

Major/Minor	Minor2	Major1	Major2			
Conflicting Flow All	819	455	457	0	-	0
Stage 1	455	-	-	-	-	-
Stage 2	364	-	-	-	-	-
Critical Hdwy	6.42	6.22	4.12	-	-	-
Critical Hdwy Stg 1	5.42	-	-	-	-	-
Critical Hdwy Stg 2	5.42	-	-	-	-	-
Follow-up Hdwy	3.518	3.318	2.218	-	-	-
Pot Cap-1 Maneuver	345	605	1104	-	-	-
Stage 1	639	-	-	-	-	-
Stage 2	703	-	-	-	-	-
Platoon blocked, %				-	-	-
Mov Cap-1 Maneuver	343	605	1104	-	-	-
Mov Cap-2 Maneuver	343	-	-	-	-	-
Stage 1	636	-	-	-	-	-
Stage 2	703	-	-	-	-	-

Approach	EB	NB	SB
HCM Control Delay, s	15.2	0.1	0
HCM LOS	C		

Minor Lane/Major Mvmt	NBL	NBT	EBLn1	SBT	SBR
Capacity (veh/h)	1104	-	363	-	-
HCM Lane V/C Ratio	0.004	-	0.024	-	-
HCM Control Delay (s)	8.3	0	15.2	-	-
HCM Lane LOS	A	A	C	-	-
HCM 95th %tile Q(veh)	0	-	0.1	-	-

Intersection						
Int Delay, s/veh	0.1					
Movement	WBL	WBR	NBT	NBR	SBL	SBT
Lane Configurations	W		T			T
Traffic Vol, veh/h	4	2	147	0	0	433
Future Vol, veh/h	4	2	147	0	0	433
Conflicting Peds, #/hr	0	0	0	0	0	0
Sign Control	Stop	Stop	Free	Free	Free	Free
RT Channelized	-	None	-	None	-	None
Storage Length	0	-	-	-	-	-
Veh in Median Storage, #	0	-	0	-	-	0
Grade, %	0	-	0	-	-	0
Peak Hour Factor	90	90	90	90	90	90
Heavy Vehicles, %	2	2	2	2	2	2
Mvmt Flow	4	2	163	0	0	481

Major/Minor	Minor1	Major1	Major2			
Conflicting Flow All	644	163	0	0	163	0
Stage 1	163	-	-	-	-	-
Stage 2	481	-	-	-	-	-
Critical Hdwy	6.42	6.22	-	-	4.12	-
Critical Hdwy Stg 1	5.42	-	-	-	-	-
Critical Hdwy Stg 2	5.42	-	-	-	-	-
Follow-up Hdwy	3.518	3.318	-	-	2.218	-
Pot Cap-1 Maneuver	437	882	-	-	1416	-
Stage 1	866	-	-	-	-	-
Stage 2	622	-	-	-	-	-
Platoon blocked, %			-	-		-
Mov Cap-1 Maneuver	437	882	-	-	1416	-
Mov Cap-2 Maneuver	437	-	-	-	-	-
Stage 1	866	-	-	-	-	-
Stage 2	622	-	-	-	-	-

Approach	WB	NB	SB
HCM Control Delay, s	11.9	0	0
HCM LOS	B		

Minor Lane/Major Mvmt	NBT	NBRWBLn1	SBL	SBT
Capacity (veh/h)	-	-	525	1416
HCM Lane V/C Ratio	-	-	0.013	-
HCM Control Delay (s)	-	-	11.9	0
HCM Lane LOS	-	-	B	A
HCM 95th %tile Q(veh)	-	-	0	0

Intersection						
Int Delay, s/veh	0.5					
Movement	WBL	WBR	NBT	NBR	SBL	SBT
Lane Configurations	W		T			T
Traffic Vol, veh/h	13	7	140	6	3	434
Future Vol, veh/h	13	7	140	6	3	434
Conflicting Peds, #/hr	0	0	0	0	0	0
Sign Control	Stop	Stop	Free	Free	Free	Free
RT Channelized	-	None	-	None	-	None
Storage Length	0	-	-	-	-	-
Veh in Median Storage, #	0	-	0	-	-	0
Grade, %	0	-	0	-	-	0
Peak Hour Factor	90	90	90	90	90	90
Heavy Vehicles, %	2	2	2	2	2	2
Mvmt Flow	14	8	156	7	3	482

Major/Minor	Minor1	Major1	Major2			
Conflicting Flow All	648	160	0	0	163	0
Stage 1	160	-	-	-	-	-
Stage 2	488	-	-	-	-	-
Critical Hdwy	6.42	6.22	-	-	4.12	-
Critical Hdwy Stg 1	5.42	-	-	-	-	-
Critical Hdwy Stg 2	5.42	-	-	-	-	-
Follow-up Hdwy	3.518	3.318	-	-	2.218	-
Pot Cap-1 Maneuver	435	885	-	-	1416	-
Stage 1	869	-	-	-	-	-
Stage 2	617	-	-	-	-	-
Platoon blocked, %			-	-		-
Mov Cap-1 Maneuver	434	885	-	-	1416	-
Mov Cap-2 Maneuver	434	-	-	-	-	-
Stage 1	869	-	-	-	-	-
Stage 2	615	-	-	-	-	-

Approach	WB	NB	SB
HCM Control Delay, s	12.1	0	0.1
HCM LOS	B		

Minor Lane/Major Mvmt	NBT	NBRWBLn1	SBL	SBT
Capacity (veh/h)	-	-	528	1416
HCM Lane V/C Ratio	-	-	0.042	0.002
HCM Control Delay (s)	-	-	12.1	7.5
HCM Lane LOS	-	-	B	A
HCM 95th %tile Q(veh)	-	-	0.1	0

Intersection						
Int Delay, s/veh	0.7					
Movement	EBL	EBR	NBL	NBT	SBT	SBR
Lane Configurations						
Traffic Vol, veh/h	10	18	24	480	404	10
Future Vol, veh/h	10	18	24	480	404	10
Conflicting Peds, #/hr	0	0	0	0	0	0
Sign Control	Stop	Stop	Free	Free	Free	Free
RT Channelized	-	None	-	None	-	None
Storage Length	0	-	-	-	-	-
Veh in Median Storage, #	0	-	-	0	0	-
Grade, %	0	-	-	0	0	-
Peak Hour Factor	90	90	90	90	90	90
Heavy Vehicles, %	2	2	2	2	2	2
Mvmt Flow	11	20	27	533	449	11

Major/Minor	Minor2	Major1	Major2			
Conflicting Flow All	1042	455	460	0	-	0
Stage 1	455	-	-	-	-	-
Stage 2	587	-	-	-	-	-
Critical Hdwy	6.42	6.22	4.12	-	-	-
Critical Hdwy Stg 1	5.42	-	-	-	-	-
Critical Hdwy Stg 2	5.42	-	-	-	-	-
Follow-up Hdwy	3.518	3.318	2.218	-	-	-
Pot Cap-1 Maneuver	254	605	1101	-	-	-
Stage 1	639	-	-	-	-	-
Stage 2	556	-	-	-	-	-
Platoon blocked, %				-	-	-
Mov Cap-1 Maneuver	245	605	1101	-	-	-
Mov Cap-2 Maneuver	245	-	-	-	-	-
Stage 1	617	-	-	-	-	-
Stage 2	556	-	-	-	-	-

Approach	EB	NB	SB
HCM Control Delay, s	14.8	0.4	0
HCM LOS	B		

Minor Lane/Major Mvmt	NBL	NBT	EBLn1	SBT	SBR
Capacity (veh/h)	1101	-	397	-	-
HCM Lane V/C Ratio	0.024	-	0.078	-	-
HCM Control Delay (s)	8.4	0	14.8	-	-
HCM Lane LOS	A	A	B	-	-
HCM 95th %tile Q(veh)	0.1	-	0.3	-	-

Intersection						
Int Delay, s/veh	0					
Movement	EBL	EBR	NBL	NBT	SBT	SBR
Lane Configurations	FF			FF	FF	
Traffic Vol, veh/h	0	0	1	489	319	0
Future Vol, veh/h	0	0	1	489	319	0
Conflicting Peds, #/hr	0	0	0	0	0	0
Sign Control	Stop	Stop	Free	Free	Free	Free
RT Channelized	-	None	-	None	-	None
Storage Length	0	-	-	-	-	-
Veh in Median Storage, #	0	-	-	0	0	-
Grade, %	0	-	-	0	0	-
Peak Hour Factor	90	90	90	90	90	90
Heavy Vehicles, %	2	2	2	2	2	2
Mvmt Flow	0	0	1	543	354	0

Major/Minor	Minor2	Major1	Major2			
Conflicting Flow All	899	354	354	0	-	0
Stage 1	354	-	-	-	-	-
Stage 2	545	-	-	-	-	-
Critical Hdwy	6.42	6.22	4.12	-	-	-
Critical Hdwy Stg 1	5.42	-	-	-	-	-
Critical Hdwy Stg 2	5.42	-	-	-	-	-
Follow-up Hdwy	3.518	3.318	2.218	-	-	-
Pot Cap-1 Maneuver	309	690	1205	-	-	-
Stage 1	710	-	-	-	-	-
Stage 2	581	-	-	-	-	-
Platoon blocked, %				-	-	-
Mov Cap-1 Maneuver	309	690	1205	-	-	-
Mov Cap-2 Maneuver	309	-	-	-	-	-
Stage 1	709	-	-	-	-	-
Stage 2	581	-	-	-	-	-

Approach	EB	NB	SB
HCM Control Delay, s	0	0	0
HCM LOS	A		

Minor Lane/Major Mvmt	NBL	NBT	EBLn1	SBT	SBR
Capacity (veh/h)	1205	-	-	-	-
HCM Lane V/C Ratio	0.001	-	-	-	-
HCM Control Delay (s)	8	0	0	-	-
HCM Lane LOS	A	A	A	-	-
HCM 95th %tile Q(veh)	0	-	-	-	-

Intersection						
Int Delay, s/veh	0.1					
Movement	EBL	EBR	NBL	NBT	SBT	SBR
Lane Configurations	T			T		
Traffic Vol, veh/h	4	4	1	488	315	7
Future Vol, veh/h	4	4	1	488	315	7
Conflicting Peds, #/hr	0	0	0	0	0	0
Sign Control	Stop	Stop	Free	Free	Free	Free
RT Channelized	-	None	-	None	-	None
Storage Length	0	-	-	-	-	-
Veh in Median Storage, #	0	-	-	0	0	-
Grade, %	0	-	-	0	0	-
Peak Hour Factor	90	90	90	90	90	90
Heavy Vehicles, %	2	2	2	2	2	2
Mvmt Flow	4	4	1	542	350	8

Major/Minor	Minor2	Major1	Major2			
Conflicting Flow All	898	354	358	0	-	0
Stage 1	354	-	-	-	-	-
Stage 2	544	-	-	-	-	-
Critical Hdwy	6.42	6.22	4.12	-	-	-
Critical Hdwy Stg 1	5.42	-	-	-	-	-
Critical Hdwy Stg 2	5.42	-	-	-	-	-
Follow-up Hdwy	3.518	3.318	2.218	-	-	-
Pot Cap-1 Maneuver	310	690	1201	-	-	-
Stage 1	710	-	-	-	-	-
Stage 2	582	-	-	-	-	-
Platoon blocked, %				-	-	-
Mov Cap-1 Maneuver	310	690	1201	-	-	-
Mov Cap-2 Maneuver	310	-	-	-	-	-
Stage 1	709	-	-	-	-	-
Stage 2	582	-	-	-	-	-

Approach	EB	NB	SB
HCM Control Delay, s	13.6	0	0
HCM LOS	B		

Minor Lane/Major Mvmt	NBL	NBT	EBLn1	SBT	SBR
Capacity (veh/h)	1201	-	428	-	-
HCM Lane V/C Ratio	0.001	-	0.021	-	-
HCM Control Delay (s)	8	0	13.6	-	-
HCM Lane LOS	A	A	B	-	-
HCM 95th %tile Q(veh)	0	-	0.1	-	-

Intersection						
Int Delay, s/veh	0.4					
Movement	WBL	WBR	NBT	NBR	SBL	SBT
Lane Configurations	W		T			T
Traffic Vol, veh/h	1	0	399	3	27	96
Future Vol, veh/h	1	0	399	3	27	96
Conflicting Peds, #/hr	0	0	0	0	0	0
Sign Control	Stop	Stop	Free	Free	Free	Free
RT Channelized	-	None	-	None	-	None
Storage Length	0	-	-	-	-	-
Veh in Median Storage, #	0	-	0	-	-	0
Grade, %	0	-	0	-	-	0
Peak Hour Factor	100	100	100	100	100	100
Heavy Vehicles, %	2	2	2	2	2	2
Mvmt Flow	1	0	399	3	27	96

Major/Minor	Minor1	Major1	Major2			
Conflicting Flow All	551	401	0	0	402	0
Stage 1	401	-	-	-	-	-
Stage 2	150	-	-	-	-	-
Critical Hdwy	6.42	6.22	-	-	4.12	-
Critical Hdwy Stg 1	5.42	-	-	-	-	-
Critical Hdwy Stg 2	5.42	-	-	-	-	-
Follow-up Hdwy	3.518	3.318	-	-	2.218	-
Pot Cap-1 Maneuver	495	649	-	-	1157	-
Stage 1	676	-	-	-	-	-
Stage 2	878	-	-	-	-	-
Platoon blocked, %			-	-		-
Mov Cap-1 Maneuver	483	649	-	-	1157	-
Mov Cap-2 Maneuver	483	-	-	-	-	-
Stage 1	676	-	-	-	-	-
Stage 2	856	-	-	-	-	-

Approach	WB	NB	SB
HCM Control Delay, s	12.5	0	1.8
HCM LOS	B		

Minor Lane/Major Mvmt	NBT	NBRWBLn1	SBL	SBT
Capacity (veh/h)	-	-	483	1157
HCM Lane V/C Ratio	-	-	0.002	0.023
HCM Control Delay (s)	-	-	12.5	8.2
HCM Lane LOS	-	-	B	A
HCM 95th %tile Q(veh)	-	-	0	0.1

Intersection						
Int Delay, s/veh	0.1					
Movement	WBL	WBR	NBT	NBR	SBL	SBT
Lane Configurations	W		T			T
Traffic Vol, veh/h	1	3	407	12	3	94
Future Vol, veh/h	1	3	407	12	3	94
Conflicting Peds, #/hr	0	0	0	0	0	0
Sign Control	Stop	Stop	Free	Free	Free	Free
RT Channelized	-	None	-	None	-	None
Storage Length	0	-	-	-	-	-
Veh in Median Storage, #	0	-	0	-	-	0
Grade, %	0	-	0	-	-	0
Peak Hour Factor	100	100	100	100	100	100
Heavy Vehicles, %	2	2	2	2	2	2
Mvmt Flow	1	3	407	12	3	94

Major/Minor	Minor1	Major1	Major2			
Conflicting Flow All	513	413	0	0	419	0
Stage 1	413	-	-	-	-	-
Stage 2	100	-	-	-	-	-
Critical Hdwy	6.42	6.22	-	-	4.12	-
Critical Hdwy Stg 1	5.42	-	-	-	-	-
Critical Hdwy Stg 2	5.42	-	-	-	-	-
Follow-up Hdwy	3.518	3.318	-	-	2.218	-
Pot Cap-1 Maneuver	521	639	-	-	1140	-
Stage 1	668	-	-	-	-	-
Stage 2	924	-	-	-	-	-
Platoon blocked, %			-	-		-
Mov Cap-1 Maneuver	519	639	-	-	1140	-
Mov Cap-2 Maneuver	519	-	-	-	-	-
Stage 1	668	-	-	-	-	-
Stage 2	921	-	-	-	-	-

Approach	WB	NB	SB
HCM Control Delay, s	11	0	0.3
HCM LOS	B		

Minor Lane/Major Mvmt	NBT	NBRWBLn1	SBL	SBT
Capacity (veh/h)	-	-	604	1140
HCM Lane V/C Ratio	-	-	0.007	0.003
HCM Control Delay (s)	-	-	11	8.2
HCM Lane LOS	-	-	B	A
HCM 95th %tile Q(veh)	-	-	0	0

Intersection						
Int Delay, s/veh	0.7					
Movement	EBL	EBR	NBL	NBT	SBT	SBR
Lane Configurations						
Traffic Vol, veh/h	8	20	27	322	412	6
Future Vol, veh/h	8	20	27	322	412	6
Conflicting Peds, #/hr	0	0	0	0	0	0
Sign Control	Stop	Stop	Free	Free	Free	Free
RT Channelized	-	None	-	None	-	None
Storage Length	0	-	-	-	-	-
Veh in Median Storage, #	0	-	-	0	0	-
Grade, %	0	-	-	0	0	-
Peak Hour Factor	100	100	100	100	100	100
Heavy Vehicles, %	2	2	2	2	2	2
Mvmt Flow	8	20	27	322	412	6

Major/Minor	Minor2	Major1		Major2	
Conflicting Flow All	791	415	418	0	0
Stage 1	415	-	-	-	-
Stage 2	376	-	-	-	-
Critical Hdwy	6.42	6.22	4.12	-	-
Critical Hdwy Stg 1	5.42	-	-	-	-
Critical Hdwy Stg 2	5.42	-	-	-	-
Follow-up Hdwy	3.518	3.318	2.218	-	-
Pot Cap-1 Maneuver	358	637	1141	-	-
Stage 1	666	-	-	-	-
Stage 2	694	-	-	-	-
Platoon blocked, %				-	-
Mov Cap-1 Maneuver	348	637	1141	-	-
Mov Cap-2 Maneuver	348	-	-	-	-
Stage 1	647	-	-	-	-
Stage 2	694	-	-	-	-

Approach	EB	NB	SB
HCM Control Delay, s	12.4	0.6	0
HCM LOS	B		

Minor Lane/Major Mvmt	NBL	NBT	EBLn1	SBT	SBR
Capacity (veh/h)	1141	-	515	-	-
HCM Lane V/C Ratio	0.024	-	0.054	-	-
HCM Control Delay (s)	8.2	0	12.4	-	-
HCM Lane LOS	A	A	B	-	-
HCM 95th %tile Q(veh)	0.1	-	0.2	-	-

Intersection						
Int Delay, s/veh	0					
Movement	EBL	EBR	NBL	NBT	SBT	SBR
Lane Configurations	W			W	W	
Traffic Vol, veh/h	0	1	0	330	417	0
Future Vol, veh/h	0	1	0	330	417	0
Conflicting Peds, #/hr	0	0	0	0	0	0
Sign Control	Stop	Stop	Free	Free	Free	Free
RT Channelized	-	None	-	None	-	None
Storage Length	0	-	-	-	-	-
Veh in Median Storage, #	0	-	-	0	0	-
Grade, %	0	-	-	0	0	-
Peak Hour Factor	100	100	100	100	100	100
Heavy Vehicles, %	2	2	2	2	2	2
Mvmt Flow	0	1	0	330	417	0

Major/Minor	Minor2	Major1	Major2			
Conflicting Flow All	747	417	417	0	-	0
Stage 1	417	-	-	-	-	-
Stage 2	330	-	-	-	-	-
Critical Hdwy	6.42	6.22	4.12	-	-	-
Critical Hdwy Stg 1	5.42	-	-	-	-	-
Critical Hdwy Stg 2	5.42	-	-	-	-	-
Follow-up Hdwy	3.518	3.318	2.218	-	-	-
Pot Cap-1 Maneuver	381	636	1142	-	-	-
Stage 1	665	-	-	-	-	-
Stage 2	728	-	-	-	-	-
Platoon blocked, %				-	-	-
Mov Cap-1 Maneuver	381	636	1142	-	-	-
Mov Cap-2 Maneuver	381	-	-	-	-	-
Stage 1	665	-	-	-	-	-
Stage 2	728	-	-	-	-	-

Approach	EB	NB	SB
HCM Control Delay, s	10.7	0	0
HCM LOS	B		

Minor Lane/Major Mvmt	NBL	NBT	EBLn1	SBT	SBR
Capacity (veh/h)	1142	-	636	-	-
HCM Lane V/C Ratio	-	-	0.002	-	-
HCM Control Delay (s)	0	-	10.7	-	-
HCM Lane LOS	A	-	B	-	-
HCM 95th %tile Q(veh)	0	-	0	-	-

Intersection						
Int Delay, s/veh	0.2					
Movement	EBL	EBR	NBL	NBT	SBT	SBR
Lane Configurations						
Traffic Vol, veh/h	7	1	4	326	416	4
Future Vol, veh/h	7	1	4	326	416	4
Conflicting Peds, #/hr	0	0	0	0	0	0
Sign Control	Stop	Stop	Free	Free	Free	Free
RT Channelized	-	None	-	None	-	None
Storage Length	0	-	-	-	-	-
Veh in Median Storage, #	0	-	-	0	0	-
Grade, %	0	-	-	0	0	-
Peak Hour Factor	100	100	100	100	100	100
Heavy Vehicles, %	2	2	2	2	2	2
Mvmt Flow	7	1	4	326	416	4

Major/Minor	Minor2	Major1	Major2			
Conflicting Flow All	752	418	420	0	-	0
Stage 1	418	-	-	-	-	-
Stage 2	334	-	-	-	-	-
Critical Hdwy	6.42	6.22	4.12	-	-	-
Critical Hdwy Stg 1	5.42	-	-	-	-	-
Critical Hdwy Stg 2	5.42	-	-	-	-	-
Follow-up Hdwy	3.518	3.318	2.218	-	-	-
Pot Cap-1 Maneuver	378	635	1139	-	-	-
Stage 1	664	-	-	-	-	-
Stage 2	725	-	-	-	-	-
Platoon blocked, %				-	-	-
Mov Cap-1 Maneuver	376	635	1139	-	-	-
Mov Cap-2 Maneuver	376	-	-	-	-	-
Stage 1	661	-	-	-	-	-
Stage 2	725	-	-	-	-	-

Approach	EB	NB	SB
HCM Control Delay, s	14.3	0.1	0
HCM LOS	B		

Minor Lane/Major Mvmt	NBL	NBT	EBLn1	SBT	SBR
Capacity (veh/h)	1139	-	396	-	-
HCM Lane V/C Ratio	0.004	-	0.02	-	-
HCM Control Delay (s)	8.2	0	14.3	-	-
HCM Lane LOS	A	A	B	-	-
HCM 95th %tile Q(veh)	0	-	0.1	-	-

Intersection						
Int Delay, s/veh	0.1					
Movement	WBL	WBR	NBT	NBR	SBL	SBT
Lane Configurations	W		T			T
Traffic Vol, veh/h	4	2	160	0	0	442
Future Vol, veh/h	4	2	160	0	0	442
Conflicting Peds, #/hr	0	0	0	0	0	0
Sign Control	Stop	Stop	Free	Free	Free	Free
RT Channelized	-	None	-	None	-	None
Storage Length	0	-	-	-	-	-
Veh in Median Storage, #	0	-	0	-	-	0
Grade, %	0	-	0	-	-	0
Peak Hour Factor	100	100	100	100	100	100
Heavy Vehicles, %	2	2	2	2	2	2
Mvmt Flow	4	2	160	0	0	442

Major/Minor	Minor1	Major1	Major2			
Conflicting Flow All	602	160	0	0	160	0
Stage 1	160	-	-	-	-	-
Stage 2	442	-	-	-	-	-
Critical Hdwy	6.42	6.22	-	-	4.12	-
Critical Hdwy Stg 1	5.42	-	-	-	-	-
Critical Hdwy Stg 2	5.42	-	-	-	-	-
Follow-up Hdwy	3.518	3.318	-	-	2.218	-
Pot Cap-1 Maneuver	463	885	-	-	1419	-
Stage 1	869	-	-	-	-	-
Stage 2	648	-	-	-	-	-
Platoon blocked, %			-	-	-	-
Mov Cap-1 Maneuver	463	885	-	-	1419	-
Mov Cap-2 Maneuver	463	-	-	-	-	-
Stage 1	869	-	-	-	-	-
Stage 2	648	-	-	-	-	-

Approach	WB	NB	SB
HCM Control Delay, s	11.6	0	0
HCM LOS	B		

Minor Lane/Major Mvmt	NBT	NBRWBLn1	SBL	SBT
Capacity (veh/h)	-	-	550	1419
HCM Lane V/C Ratio	-	-	0.011	-
HCM Control Delay (s)	-	-	11.6	0
HCM Lane LOS	-	-	B	A
HCM 95th %tile Q(veh)	-	-	0	0

Intersection						
Int Delay, s/veh	0.5					
Movement	WBL	WBR	NBT	NBR	SBL	SBT
Lane Configurations	W		T			T
Traffic Vol, veh/h	13	7	143	6	3	443
Future Vol, veh/h	13	7	143	6	3	443
Conflicting Peds, #/hr	0	0	0	0	0	0
Sign Control	Stop	Stop	Free	Free	Free	Free
RT Channelized	-	None	-	None	-	None
Storage Length	0	-	-	-	-	-
Veh in Median Storage, #	0	-	0	-	-	0
Grade, %	0	-	0	-	-	0
Peak Hour Factor	100	100	100	100	100	100
Heavy Vehicles, %	2	2	2	2	2	2
Mvmt Flow	13	7	143	6	3	443

Major/Minor	Minor1	Major1	Major2		
Conflicting Flow All	595	146	0	0	149
Stage 1	146	-	-	-	-
Stage 2	449	-	-	-	-
Critical Hdwy	6.42	6.22	-	-	4.12
Critical Hdwy Stg 1	5.42	-	-	-	-
Critical Hdwy Stg 2	5.42	-	-	-	-
Follow-up Hdwy	3.518	3.318	-	-	2.218
Pot Cap-1 Maneuver	467	901	-	-	1432
Stage 1	881	-	-	-	-
Stage 2	643	-	-	-	-
Platoon blocked, %			-	-	-
Mov Cap-1 Maneuver	466	901	-	-	1432
Mov Cap-2 Maneuver	466	-	-	-	-
Stage 1	881	-	-	-	-
Stage 2	641	-	-	-	-

Approach	WB	NB	SB
HCM Control Delay, s	11.7	0	0.1
HCM LOS	B		

Minor Lane/Major Mvmt	NBT	NBRWBLn1	SBL	SBT
Capacity (veh/h)	-	-	561	1432
HCM Lane V/C Ratio	-	-	0.036	0.002
HCM Control Delay (s)	-	-	11.7	7.5
HCM Lane LOS	-	-	B	A
HCM 95th %tile Q(veh)	-	-	0.1	0

Intersection						
Int Delay, s/veh	0.6					
Movement	EBL	EBR	NBL	NBT	SBT	SBR
Lane Configurations	T			T		T
Traffic Vol, veh/h	10	18	24	490	315	10
Future Vol, veh/h	10	18	24	490	315	10
Conflicting Peds, #/hr	0	0	0	0	0	0
Sign Control	Stop	Stop	Free	Free	Free	Free
RT Channelized	-	None	-	None	-	None
Storage Length	0	-	-	-	-	-
Veh in Median Storage, #	0	-	-	0	0	-
Grade, %	0	-	-	0	0	-
Peak Hour Factor	100	100	100	100	100	100
Heavy Vehicles, %	2	2	2	2	2	2
Mvmt Flow	10	18	24	490	315	10

Major/Minor	Minor2	Major1	Major2			
Conflicting Flow All	858	320	325	0	-	0
Stage 1	320	-	-	-	-	-
Stage 2	538	-	-	-	-	-
Critical Hdwy	6.42	6.22	4.12	-	-	-
Critical Hdwy Stg 1	5.42	-	-	-	-	-
Critical Hdwy Stg 2	5.42	-	-	-	-	-
Follow-up Hdwy	3.518	3.318	2.218	-	-	-
Pot Cap-1 Maneuver	327	721	1235	-	-	-
Stage 1	736	-	-	-	-	-
Stage 2	585	-	-	-	-	-
Platoon blocked, %				-	-	-
Mov Cap-1 Maneuver	318	721	1235	-	-	-
Mov Cap-2 Maneuver	318	-	-	-	-	-
Stage 1	716	-	-	-	-	-
Stage 2	585	-	-	-	-	-

Approach	EB	NB	SB
HCM Control Delay, s	12.7	0.4	0
HCM LOS	B		

Minor Lane/Major Mvmt	NBL	NBT	EBLn1	SBT	SBR
Capacity (veh/h)	1235	-	496	-	-
HCM Lane V/C Ratio	0.019	-	0.056	-	-
HCM Control Delay (s)	8	0	12.7	-	-
HCM Lane LOS	A	A	B	-	-
HCM 95th %tile Q(veh)	0.1	-	0.2	-	-

Intersection						
Int Delay, s/veh	0					
Movement	EBL	EBR	NBL	NBT	SBT	SBR
Lane Configurations	W			W	W	
Traffic Vol, veh/h	0	0	1	499	325	0
Future Vol, veh/h	0	0	1	499	325	0
Conflicting Peds, #/hr	0	0	0	0	0	0
Sign Control	Stop	Stop	Free	Free	Free	Free
RT Channelized	-	None	-	None	-	None
Storage Length	0	-	-	-	-	-
Veh in Median Storage, #	0	-	-	0	0	-
Grade, %	0	-	-	0	0	-
Peak Hour Factor	100	100	100	100	100	100
Heavy Vehicles, %	2	2	2	2	2	2
Mvmt Flow	0	0	1	499	325	0

Major/Minor	Minor2	Major1	Major2			
Conflicting Flow All	826	325	325	0	-	0
Stage 1	325	-	-	-	-	-
Stage 2	501	-	-	-	-	-
Critical Hdwy	6.42	6.22	4.12	-	-	-
Critical Hdwy Stg 1	5.42	-	-	-	-	-
Critical Hdwy Stg 2	5.42	-	-	-	-	-
Follow-up Hdwy	3.518	3.318	2.218	-	-	-
Pot Cap-1 Maneuver	342	716	1235	-	-	-
Stage 1	732	-	-	-	-	-
Stage 2	609	-	-	-	-	-
Platoon blocked, %				-	-	-
Mov Cap-1 Maneuver	342	716	1235	-	-	-
Mov Cap-2 Maneuver	342	-	-	-	-	-
Stage 1	731	-	-	-	-	-
Stage 2	609	-	-	-	-	-

Approach	EB	NB	SB
HCM Control Delay, s	0	0	0
HCM LOS	A		

Minor Lane/Major Mvmt	NBL	NBT	EBLn1	SBT	SBR
Capacity (veh/h)	1235	-	-	-	-
HCM Lane V/C Ratio	0.001	-	-	-	-
HCM Control Delay (s)	7.9	0	0	-	-
HCM Lane LOS	A	A	A	-	-
HCM 95th %tile Q(veh)	0	-	-	-	-

Intersection						
Int Delay, s/veh	0.1					
Movement	EBL	EBR	NBL	NBT	SBT	SBR
Lane Configurations	T			T		T
Traffic Vol, veh/h	4	4	1	498	321	7
Future Vol, veh/h	4	4	1	498	321	7
Conflicting Peds, #/hr	0	0	0	0	0	0
Sign Control	Stop	Stop	Free	Free	Free	Free
RT Channelized	-	None	-	None	-	None
Storage Length	0	-	-	-	-	-
Veh in Median Storage, #	0	-	-	0	0	-
Grade, %	0	-	-	0	0	-
Peak Hour Factor	100	100	100	100	100	100
Heavy Vehicles, %	2	2	2	2	2	2
Mvmt Flow	4	4	1	498	321	7

Major/Minor	Minor2	Major1	Major2			
Conflicting Flow All	825	325	328	0	-	0
Stage 1	325	-	-	-	-	-
Stage 2	500	-	-	-	-	-
Critical Hdwy	6.42	6.22	4.12	-	-	-
Critical Hdwy Stg 1	5.42	-	-	-	-	-
Critical Hdwy Stg 2	5.42	-	-	-	-	-
Follow-up Hdwy	3.518	3.318	2.218	-	-	-
Pot Cap-1 Maneuver	342	716	1232	-	-	-
Stage 1	732	-	-	-	-	-
Stage 2	609	-	-	-	-	-
Platoon blocked, %				-	-	-
Mov Cap-1 Maneuver	342	716	1232	-	-	-
Mov Cap-2 Maneuver	342	-	-	-	-	-
Stage 1	731	-	-	-	-	-
Stage 2	609	-	-	-	-	-

Approach	EB	NB	SB
HCM Control Delay, s	12.9	0	0
HCM LOS	B		

Minor Lane/Major Mvmt	NBL	NBT	EBLn1	SBT	SBR
Capacity (veh/h)	1232	-	463	-	-
HCM Lane V/C Ratio	0.001	-	0.017	-	-
HCM Control Delay (s)	7.9	0	12.9	-	-
HCM Lane LOS	A	A	B	-	-
HCM 95th %tile Q(veh)	0	-	0.1	-	-

Intersection						
Int Delay, s/veh	0.4					
Movement	WBL	WBR	NBT	NBR	SBL	SBT
Lane Configurations	W		T			T
Traffic Vol, veh/h	1	0	447	3	29	105
Future Vol, veh/h	1	0	447	3	29	105
Conflicting Peds, #/hr	0	0	0	0	0	0
Sign Control	Stop	Stop	Free	Free	Free	Free
RT Channelized	-	None	-	None	-	None
Storage Length	0	-	-	-	-	-
Veh in Median Storage, #	0	-	0	-	-	0
Grade, %	0	-	0	-	-	0
Peak Hour Factor	100	100	100	100	100	100
Heavy Vehicles, %	2	2	2	2	2	2
Mvmt Flow	1	0	447	3	29	105

Major/Minor	Minor1	Major1	Major2		
Conflicting Flow All	612	449	0	0	450
Stage 1	449	-	-	-	-
Stage 2	163	-	-	-	-
Critical Hdwy	6.42	6.22	-	-	4.12
Critical Hdwy Stg 1	5.42	-	-	-	-
Critical Hdwy Stg 2	5.42	-	-	-	-
Follow-up Hdwy	3.518	3.318	-	-	2.218
Pot Cap-1 Maneuver	456	610	-	-	1110
Stage 1	643	-	-	-	-
Stage 2	866	-	-	-	-
Platoon blocked, %			-	-	-
Mov Cap-1 Maneuver	443	610	-	-	1110
Mov Cap-2 Maneuver	443	-	-	-	-
Stage 1	643	-	-	-	-
Stage 2	842	-	-	-	-

Approach	WB	NB	SB
HCM Control Delay, s	13.1	0	1.8
HCM LOS	B		

Minor Lane/Major Mvmt	NBT	NBRWBLn1	SBL	SBT
Capacity (veh/h)	-	-	443	1110
HCM Lane V/C Ratio	-	-	0.002	0.026
HCM Control Delay (s)	-	-	13.1	8.3
HCM Lane LOS	-	-	B	A
HCM 95th %tile Q(veh)	-	-	0	0.1

Intersection						
Int Delay, s/veh	0.1					
Movement	WBL	WBR	NBT	NBR	SBL	SBT
Lane Configurations	W	R	T	R	L	T
Traffic Vol, veh/h	1	3	447	13	3	103
Future Vol, veh/h	1	3	447	13	3	103
Conflicting Peds, #/hr	0	0	0	0	0	0
Sign Control	Stop	Stop	Free	Free	Free	Free
RT Channelized	-	None	-	None	-	None
Storage Length	0	-	-	-	-	-
Veh in Median Storage, #	0	-	0	-	-	0
Grade, %	0	-	0	-	-	0
Peak Hour Factor	100	100	100	100	100	100
Heavy Vehicles, %	2	2	2	2	2	2
Mvmt Flow	1	3	447	13	3	103

Major/Minor	Minor1	Major1	Major2		
Conflicting Flow All	563	454	0	0	460
Stage 1	454	-	-	-	-
Stage 2	109	-	-	-	-
Critical Hdwy	6.42	6.22	-	-	4.12
Critical Hdwy Stg 1	5.42	-	-	-	-
Critical Hdwy Stg 2	5.42	-	-	-	-
Follow-up Hdwy	3.518	3.318	-	-	2.218
Pot Cap-1 Maneuver	487	606	-	-	1101
Stage 1	640	-	-	-	-
Stage 2	916	-	-	-	-
Platoon blocked, %			-	-	-
Mov Cap-1 Maneuver	486	606	-	-	1101
Mov Cap-2 Maneuver	486	-	-	-	-
Stage 1	640	-	-	-	-
Stage 2	913	-	-	-	-

Approach	WB	NB	SB
HCM Control Delay, s	11.3	0	0.2
HCM LOS	B		

Minor Lane/Major Mvmt	NBT	NBRWBLn1	SBL	SBT
Capacity (veh/h)	-	-	571	1101
HCM Lane V/C Ratio	-	-	0.007	0.003
HCM Control Delay (s)	-	-	11.3	8.3
HCM Lane LOS	-	-	B	A
HCM 95th %tile Q(veh)	-	-	0	0

Intersection						
Int Delay, s/veh	0.7					
Movement	EBL	EBR	NBL	NBT	SBT	SBR
Lane Configurations	T			T		
Traffic Vol, veh/h	9	22	29	354	452	7
Future Vol, veh/h	9	22	29	354	452	7
Conflicting Peds, #/hr	0	0	0	0	0	0
Sign Control	Stop	Stop	Free	Free	Free	Free
RT Channelized	-	None	-	None	-	None
Storage Length	0	-	-	-	-	-
Veh in Median Storage, #	0	-	-	0	0	-
Grade, %	0	-	-	0	0	-
Peak Hour Factor	100	100	100	100	100	100
Heavy Vehicles, %	2	2	2	2	2	2
Mvmt Flow	9	22	29	354	452	7

Major/Minor	Minor2	Major1	Major2			
Conflicting Flow All	868	456	459	0	-	0
Stage 1	456	-	-	-	-	-
Stage 2	412	-	-	-	-	-
Critical Hdwy	6.42	6.22	4.12	-	-	-
Critical Hdwy Stg 1	5.42	-	-	-	-	-
Critical Hdwy Stg 2	5.42	-	-	-	-	-
Follow-up Hdwy	3.518	3.318	2.218	-	-	-
Pot Cap-1 Maneuver	323	604	1102	-	-	-
Stage 1	638	-	-	-	-	-
Stage 2	669	-	-	-	-	-
Platoon blocked, %				-	-	-
Mov Cap-1 Maneuver	312	604	1102	-	-	-
Mov Cap-2 Maneuver	312	-	-	-	-	-
Stage 1	617	-	-	-	-	-
Stage 2	669	-	-	-	-	-

Approach	EB	NB	SB
HCM Control Delay, s	13.1	0.6	0
HCM LOS	B		

Minor Lane/Major Mvmt	NBL	NBT	EBLn1	SBT	SBR
Capacity (veh/h)	1102	-	475	-	-
HCM Lane V/C Ratio	0.026	-	0.065	-	-
HCM Control Delay (s)	8.4	0	13.1	-	-
HCM Lane LOS	A	A	B	-	-
HCM 95th %tile Q(veh)	0.1	-	0.2	-	-

Intersection						
Int Delay, s/veh	0					
Movement	EBL	EBR	NBL	NBT	SBT	SBR
Lane Configurations						
Traffic Vol, veh/h	0	1	0	363	458	0
Future Vol, veh/h	0	1	0	363	458	0
Conflicting Peds, #/hr	0	0	0	0	0	0
Sign Control	Stop	Stop	Free	Free	Free	Free
RT Channelized	-	None	-	None	-	None
Storage Length	0	-	-	-	-	-
Veh in Median Storage, #	0	-	-	0	0	-
Grade, %	0	-	-	0	0	-
Peak Hour Factor	100	100	100	100	100	100
Heavy Vehicles, %	2	2	2	2	2	2
Mvmt Flow	0	1	0	363	458	0

Major/Minor	Minor2	Major1	Major2			
Conflicting Flow All	821	458	458	0	-	0
Stage 1	458	-	-	-	-	-
Stage 2	363	-	-	-	-	-
Critical Hdwy	6.42	6.22	4.12	-	-	-
Critical Hdwy Stg 1	5.42	-	-	-	-	-
Critical Hdwy Stg 2	5.42	-	-	-	-	-
Follow-up Hdwy	3.518	3.318	2.218	-	-	-
Pot Cap-1 Maneuver	344	603	1103	-	-	-
Stage 1	637	-	-	-	-	-
Stage 2	704	-	-	-	-	-
Platoon blocked, %				-	-	-
Mov Cap-1 Maneuver	344	603	1103	-	-	-
Mov Cap-2 Maneuver	344	-	-	-	-	-
Stage 1	637	-	-	-	-	-
Stage 2	704	-	-	-	-	-

Approach	EB	NB	SB
HCM Control Delay, s	11	0	0
HCM LOS	B		

Minor Lane/Major Mvmt	NBL	NBT	EBLn1	SBT	SBR
Capacity (veh/h)	1103	-	603	-	-
HCM Lane V/C Ratio	-	-	0.002	-	-
HCM Control Delay (s)	0	-	11	-	-
HCM Lane LOS	A	-	B	-	-
HCM 95th %tile Q(veh)	0	-	0	-	-

Intersection						
Int Delay, s/veh	0.2					
Movement	EBL	EBR	NBL	NBT	SBT	SBR
Lane Configurations						
Traffic Vol, veh/h	8	1	4	358	457	4
Future Vol, veh/h	8	1	4	358	457	4
Conflicting Peds, #/hr	0	0	0	0	0	0
Sign Control	Stop	Stop	Free	Free	Free	Free
RT Channelized	-	None	-	None	-	None
Storage Length	0	-	-	-	-	-
Veh in Median Storage, #	0	-	-	0	0	-
Grade, %	0	-	-	0	0	-
Peak Hour Factor	100	100	100	100	100	100
Heavy Vehicles, %	2	2	2	2	2	2
Mvmt Flow	8	1	4	358	457	4

Major/Minor	Minor2	Major1	Major2			
Conflicting Flow All	825	459	461	0	-	0
Stage 1	459	-	-	-	-	-
Stage 2	366	-	-	-	-	-
Critical Hdwy	6.42	6.22	4.12	-	-	-
Critical Hdwy Stg 1	5.42	-	-	-	-	-
Critical Hdwy Stg 2	5.42	-	-	-	-	-
Follow-up Hdwy	3.518	3.318	2.218	-	-	-
Pot Cap-1 Maneuver	342	602	1100	-	-	-
Stage 1	636	-	-	-	-	-
Stage 2	702	-	-	-	-	-
Platoon blocked, %				-	-	-
Mov Cap-1 Maneuver	340	602	1100	-	-	-
Mov Cap-2 Maneuver	340	-	-	-	-	-
Stage 1	633	-	-	-	-	-
Stage 2	702	-	-	-	-	-

Approach	EB	NB	SB
HCM Control Delay, s	15.3	0.1	0
HCM LOS	C		

Minor Lane/Major Mvmt	NBL	NBT	EBLn1	SBT	SBR
Capacity (veh/h)	1100	-	357	-	-
HCM Lane V/C Ratio	0.004	-	0.025	-	-
HCM Control Delay (s)	8.3	0	15.3	-	-
HCM Lane LOS	A	A	C	-	-
HCM 95th %tile Q(veh)	0	-	0.1	-	-

Intersection						
Int Delay, s/veh	0.1					
Movement	WBL	WBR	NBT	NBR	SBL	SBT
Lane Configurations	TT		TT			TT
Traffic Vol, veh/h	4	2	166	0	0	485
Future Vol, veh/h	4	2	166	0	0	485
Conflicting Peds, #/hr	0	0	0	0	0	0
Sign Control	Stop	Stop	Free	Free	Free	Free
RT Channelized	-	None	-	None	-	None
Storage Length	0	-	-	-	-	-
Veh in Median Storage, #	0	-	0	-	-	0
Grade, %	0	-	0	-	-	0
Peak Hour Factor	100	100	100	100	100	100
Heavy Vehicles, %	2	2	2	2	2	2
Mvmt Flow	4	2	166	0	0	485

Major/Minor	Minor1	Major1	Major2			
Conflicting Flow All	651	166	0	0	166	0
Stage 1	166	-	-	-	-	-
Stage 2	485	-	-	-	-	-
Critical Hdwy	6.42	6.22	-	-	4.12	-
Critical Hdwy Stg 1	5.42	-	-	-	-	-
Critical Hdwy Stg 2	5.42	-	-	-	-	-
Follow-up Hdwy	3.518	3.318	-	-	2.218	-
Pot Cap-1 Maneuver	433	878	-	-	1412	-
Stage 1	863	-	-	-	-	-
Stage 2	619	-	-	-	-	-
Platoon blocked, %			-	-		-
Mov Cap-1 Maneuver	433	878	-	-	1412	-
Mov Cap-2 Maneuver	433	-	-	-	-	-
Stage 1	863	-	-	-	-	-
Stage 2	619	-	-	-	-	-

Approach	WB	NB	SB
HCM Control Delay, s	12	0	0
HCM LOS	B		

Minor Lane/Major Mvmt	NBT	NBRWBLn1	SBL	SBT
Capacity (veh/h)	-	-	521	1412
HCM Lane V/C Ratio	-	-	0.012	-
HCM Control Delay (s)	-	-	12	0
HCM Lane LOS	-	-	B	A
HCM 95th %tile Q(veh)	-	-	0	0

Intersection						
Int Delay, s/veh	0.4					
Movement	WBL	WBR	NBT	NBR	SBL	SBT
Lane Configurations	W		T			T
Traffic Vol, veh/h	15	8	157	7	3	486
Future Vol, veh/h	15	8	157	7	3	486
Conflicting Peds, #/hr	0	0	0	0	0	0
Sign Control	Stop	Stop	Free	Free	Free	Free
RT Channelized	-	None	-	None	-	None
Storage Length	0	-	-	-	-	-
Veh in Median Storage, #	0	-	0	-	-	0
Grade, %	0	-	0	-	-	0
Peak Hour Factor	100	100	100	100	100	100
Heavy Vehicles, %	2	2	2	2	2	2
Mvmt Flow	15	8	157	7	3	486

Major/Minor	Minor1	Major1	Major2			
Conflicting Flow All	653	161	0	0	164	0
Stage 1	161	-	-	-	-	-
Stage 2	492	-	-	-	-	-
Critical Hdwy	6.42	6.22	-	-	4.12	-
Critical Hdwy Stg 1	5.42	-	-	-	-	-
Critical Hdwy Stg 2	5.42	-	-	-	-	-
Follow-up Hdwy	3.518	3.318	-	-	2.218	-
Pot Cap-1 Maneuver	432	884	-	-	1414	-
Stage 1	868	-	-	-	-	-
Stage 2	615	-	-	-	-	-
Platoon blocked, %			-	-		-
Mov Cap-1 Maneuver	431	884	-	-	1414	-
Mov Cap-2 Maneuver	431	-	-	-	-	-
Stage 1	868	-	-	-	-	-
Stage 2	613	-	-	-	-	-

Approach	WB	NB	SB
HCM Control Delay, s	12.2	0	0
HCM LOS	B		

Minor Lane/Major Mvmt	NBT	NBRWBLn1	SBL	SBT
Capacity (veh/h)	-	-	524	1414
HCM Lane V/C Ratio	-	-	0.044	0.002
HCM Control Delay (s)	-	-	12.2	7.6
HCM Lane LOS	-	-	B	A
HCM 95th %tile Q(veh)	-	-	0.1	0

Intersection						
Int Delay, s/veh	0.7					
Movement	EBL	EBR	NBL	NBT	SBT	SBR
Lane Configurations	W			W	W	
Traffic Vol, veh/h	11	20	27	538	348	11
Future Vol, veh/h	11	20	27	538	348	11
Conflicting Peds, #/hr	0	0	0	0	0	0
Sign Control	Stop	Stop	Free	Free	Free	Free
RT Channelized	-	None	-	None	-	None
Storage Length	0	-	-	-	-	-
Veh in Median Storage, #	0	-	-	0	0	-
Grade, %	0	-	-	0	0	-
Peak Hour Factor	100	100	100	100	100	100
Heavy Vehicles, %	2	2	2	2	2	2
Mvmt Flow	11	20	27	538	348	11

Major/Minor	Minor2	Major1	Major2			
Conflicting Flow All	946	354	359	0	-	0
Stage 1	354	-	-	-	-	-
Stage 2	592	-	-	-	-	-
Critical Hdwy	6.42	6.22	4.12	-	-	-
Critical Hdwy Stg 1	5.42	-	-	-	-	-
Critical Hdwy Stg 2	5.42	-	-	-	-	-
Follow-up Hdwy	3.518	3.318	2.218	-	-	-
Pot Cap-1 Maneuver	290	690	1200	-	-	-
Stage 1	710	-	-	-	-	-
Stage 2	553	-	-	-	-	-
Platoon blocked, %				-	-	-
Mov Cap-1 Maneuver	281	690	1200	-	-	-
Mov Cap-2 Maneuver	281	-	-	-	-	-
Stage 1	687	-	-	-	-	-
Stage 2	553	-	-	-	-	-

Approach	EB	NB	SB
HCM Control Delay, s	13.5	0.4	0
HCM LOS	B		

Minor Lane/Major Mvmt	NBL	NBT	EBLn1	SBT	SBR
Capacity (veh/h)	1200	-	455	-	-
HCM Lane V/C Ratio	0.023	-	0.068	-	-
HCM Control Delay (s)	8.1	0	13.5	-	-
HCM Lane LOS	A	A	B	-	-
HCM 95th %tile Q(veh)	0.1	-	0.2	-	-

Intersection						
Int Delay, s/veh	0					
Movement	EBL	EBR	NBL	NBT	SBT	SBR
Lane Configurations	W			W	W	
Traffic Vol, veh/h	0	0	1	548	357	0
Future Vol, veh/h	0	0	1	548	357	0
Conflicting Peds, #/hr	0	0	0	0	0	0
Sign Control	Stop	Stop	Free	Free	Free	Free
RT Channelized	-	None	-	None	-	None
Storage Length	0	-	-	-	-	-
Veh in Median Storage, #	0	-	-	0	0	-
Grade, %	0	-	-	0	0	-
Peak Hour Factor	100	100	100	100	100	100
Heavy Vehicles, %	2	2	2	2	2	2
Mvmt Flow	0	0	1	548	357	0

Major/Minor	Minor2	Major1	Major2			
Conflicting Flow All	907	357	357	0	-	0
Stage 1	357	-	-	-	-	-
Stage 2	550	-	-	-	-	-
Critical Hdwy	6.42	6.22	4.12	-	-	-
Critical Hdwy Stg 1	5.42	-	-	-	-	-
Critical Hdwy Stg 2	5.42	-	-	-	-	-
Follow-up Hdwy	3.518	3.318	2.218	-	-	-
Pot Cap-1 Maneuver	306	687	1202	-	-	-
Stage 1	708	-	-	-	-	-
Stage 2	578	-	-	-	-	-
Platoon blocked, %				-	-	-
Mov Cap-1 Maneuver	306	687	1202	-	-	-
Mov Cap-2 Maneuver	306	-	-	-	-	-
Stage 1	707	-	-	-	-	-
Stage 2	578	-	-	-	-	-

Approach	EB	NB	SB
HCM Control Delay, s	0	0	0
HCM LOS	A		

Minor Lane/Major Mvmt	NBL	NBT	EBLn1	SBT	SBR
Capacity (veh/h)	1202	-	-	-	-
HCM Lane V/C Ratio	0.001	-	-	-	-
HCM Control Delay (s)	8	0	0	-	-
HCM Lane LOS	A	A	A	-	-
HCM 95th %tile Q(veh)	0	-	-	-	-

Intersection						
Int Delay, s/veh	0.1					
Movement	EBL	EBR	NBL	NBT	SBT	SBR
Lane Configurations	W			W	W	
Traffic Vol, veh/h	4	4	1	547	353	8
Future Vol, veh/h	4	4	1	547	353	8
Conflicting Peds, #/hr	0	0	0	0	0	0
Sign Control	Stop	Stop	Free	Free	Free	Free
RT Channelized	-	None	-	None	-	None
Storage Length	0	-	-	-	-	-
Veh in Median Storage, #	0	-	-	0	0	-
Grade, %	0	-	-	0	0	-
Peak Hour Factor	100	100	100	100	100	100
Heavy Vehicles, %	2	2	2	2	2	2
Mvmt Flow	4	4	1	547	353	8

Major/Minor	Minor2	Major1	Major2			
Conflicting Flow All	906	357	361	0	-	0
Stage 1	357	-	-	-	-	-
Stage 2	549	-	-	-	-	-
Critical Hdwy	6.42	6.22	4.12	-	-	-
Critical Hdwy Stg 1	5.42	-	-	-	-	-
Critical Hdwy Stg 2	5.42	-	-	-	-	-
Follow-up Hdwy	3.518	3.318	2.218	-	-	-
Pot Cap-1 Maneuver	307	687	1198	-	-	-
Stage 1	708	-	-	-	-	-
Stage 2	579	-	-	-	-	-
Platoon blocked, %				-	-	-
Mov Cap-1 Maneuver	307	687	1198	-	-	-
Mov Cap-2 Maneuver	307	-	-	-	-	-
Stage 1	707	-	-	-	-	-
Stage 2	579	-	-	-	-	-

Approach	EB	NB	SB
HCM Control Delay, s	13.7	0	0
HCM LOS	B		

Minor Lane/Major Mvmt	NBL	NBT	EBLn1	SBT	SBR
Capacity (veh/h)	1198	-	424	-	-
HCM Lane V/C Ratio	0.001	-	0.019	-	-
HCM Control Delay (s)	8	0	13.7	-	-
HCM Lane LOS	A	A	B	-	-
HCM 95th %tile Q(veh)	0	-	0.1	-	-

Intersection						
Int Delay, s/veh	0.6					
Movement	WBL	WBR	NBT	NBR	SBL	SBT
Lane Configurations						
Traffic Vol, veh/h	3	1	407	8	32	96
Future Vol, veh/h	3	1	407	8	32	96
Conflicting Peds, #/hr	0	0	0	0	0	0
Sign Control	Stop	Stop	Free	Free	Free	Free
RT Channelized	-	None	-	None	-	None
Storage Length	0	-	-	-	-	-
Veh in Median Storage, #	0	-	0	-	-	0
Grade, %	0	-	0	-	-	0
Peak Hour Factor	100	100	100	100	100	100
Heavy Vehicles, %	2	2	2	2	2	2
Mvmt Flow	3	1	407	8	32	96

Major/Minor	Minor1	Major1	Major2		
Conflicting Flow All	571	411	0	0	415
Stage 1	411	-	-	-	-
Stage 2	160	-	-	-	-
Critical Hdwy	6.42	6.22	-	-	4.12
Critical Hdwy Stg 1	5.42	-	-	-	-
Critical Hdwy Stg 2	5.42	-	-	-	-
Follow-up Hdwy	3.518	3.318	-	-	2.218
Pot Cap-1 Maneuver	482	641	-	-	1144
Stage 1	669	-	-	-	-
Stage 2	869	-	-	-	-
Platoon blocked, %			-	-	-
Mov Cap-1 Maneuver	468	641	-	-	1144
Mov Cap-2 Maneuver	468	-	-	-	-
Stage 1	669	-	-	-	-
Stage 2	843	-	-	-	-

Approach	WB	NB	SB
HCM Control Delay, s	12.2	0	2.1
HCM LOS	B		

Minor Lane/Major Mvmt	NBT	NBRWBLn1	SBL	SBT
Capacity (veh/h)	-	-	502	1144
HCM Lane V/C Ratio	-	-	0.008	0.028
HCM Control Delay (s)	-	-	12.2	8.2
HCM Lane LOS	-	-	B	A
HCM 95th %tile Q(veh)	-	-	0	0.1

Intersection						
Int Delay, s/veh	0.1					
Movement	WBL	WBR	NBT	NBR	SBL	SBT
Lane Configurations	W		T			T
Traffic Vol, veh/h	1	3	412	12	3	96
Future Vol, veh/h	1	3	412	12	3	96
Conflicting Peds, #/hr	0	0	0	0	0	0
Sign Control	Stop	Stop	Free	Free	Free	Free
RT Channelized	-	None	-	None	-	None
Storage Length	0	-	-	-	-	-
Veh in Median Storage, #	0	-	0	-	-	0
Grade, %	0	-	0	-	-	0
Peak Hour Factor	100	100	100	100	100	100
Heavy Vehicles, %	2	2	2	2	2	2
Mvmt Flow	1	3	412	12	3	96

Major/Minor	Minor1	Major1	Major2		
Conflicting Flow All	520	418	0	0	424
Stage 1	418	-	-	-	-
Stage 2	102	-	-	-	-
Critical Hdwy	6.42	6.22	-	-	4.12
Critical Hdwy Stg 1	5.42	-	-	-	-
Critical Hdwy Stg 2	5.42	-	-	-	-
Follow-up Hdwy	3.518	3.318	-	-	2.218
Pot Cap-1 Maneuver	516	635	-	-	1135
Stage 1	664	-	-	-	-
Stage 2	922	-	-	-	-
Platoon blocked, %			-	-	-
Mov Cap-1 Maneuver	514	635	-	-	1135
Mov Cap-2 Maneuver	514	-	-	-	-
Stage 1	664	-	-	-	-
Stage 2	919	-	-	-	-

Approach	WB	NB	SB
HCM Control Delay, s	11	0	0.2
HCM LOS	B		

Minor Lane/Major Mvmt	NBT	NBRWBLn1	SBL	SBT
Capacity (veh/h)	-	-	600	1135
HCM Lane V/C Ratio	-	-	0.007	0.003
HCM Control Delay (s)	-	-	11	8.2
HCM Lane LOS	-	-	B	A
HCM 95th %tile Q(veh)	-	-	0	0

Intersection						
Int Delay, s/veh	0.9					
Movement	EBL	EBR	NBL	NBT	SBT	SBR
Lane Configurations	T			T		T
Traffic Vol, veh/h	10	22	33	322	412	11
Future Vol, veh/h	10	22	33	322	412	11
Conflicting Peds, #/hr	0	0	0	0	0	0
Sign Control	Stop	Stop	Free	Free	Free	Free
RT Channelized	-	None	-	None	-	None
Storage Length	0	-	-	-	-	-
Veh in Median Storage, #	0	-	-	0	0	-
Grade, %	0	-	-	0	0	-
Peak Hour Factor	100	100	100	100	100	100
Heavy Vehicles, %	2	2	2	2	2	2
Mvmt Flow	10	22	33	322	412	11

Major/Minor	Minor2	Major1		Major2	
Conflicting Flow All	806	418	423	0	0
Stage 1	418	-	-	-	-
Stage 2	388	-	-	-	-
Critical Hdwy	6.42	6.22	4.12	-	-
Critical Hdwy Stg 1	5.42	-	-	-	-
Critical Hdwy Stg 2	5.42	-	-	-	-
Follow-up Hdwy	3.518	3.318	2.218	-	-
Pot Cap-1 Maneuver	351	635	1136	-	-
Stage 1	664	-	-	-	-
Stage 2	686	-	-	-	-
Platoon blocked, %				-	-
Mov Cap-1 Maneuver	339	635	1136	-	-
Mov Cap-2 Maneuver	339	-	-	-	-
Stage 1	641	-	-	-	-
Stage 2	686	-	-	-	-

Approach	EB	NB	SB
HCM Control Delay, s	12.7	0.8	0
HCM LOS	B		

Minor Lane/Major Mvmt	NBL	NBT	EBLn1	SBT	SBR
Capacity (veh/h)	1136	-	499	-	-
HCM Lane V/C Ratio	0.029	-	0.064	-	-
HCM Control Delay (s)	8.3	0	12.7	-	-
HCM Lane LOS	A	A	B	-	-
HCM 95th %tile Q(veh)	0.1	-	0.2	-	-

Intersection						
Int Delay, s/veh	0					
Movement	EBL	EBR	NBL	NBT	SBT	SBR
Lane Configurations						
Traffic Vol, veh/h	0	1	0	332	422	0
Future Vol, veh/h	0	1	0	332	422	0
Conflicting Peds, #/hr	0	0	0	0	0	0
Sign Control	Stop	Stop	Free	Free	Free	Free
RT Channelized	-	None	-	None	-	None
Storage Length	0	-	-	-	-	-
Veh in Median Storage, #	0	-	-	0	0	-
Grade, %	0	-	-	0	0	-
Peak Hour Factor	100	100	100	100	100	100
Heavy Vehicles, %	2	2	2	2	2	2
Mvmt Flow	0	1	0	332	422	0

Major/Minor	Minor2	Major1	Major2			
Conflicting Flow All	754	422	422	0	-	0
Stage 1	422	-	-	-	-	-
Stage 2	332	-	-	-	-	-
Critical Hdwy	6.42	6.22	4.12	-	-	-
Critical Hdwy Stg 1	5.42	-	-	-	-	-
Critical Hdwy Stg 2	5.42	-	-	-	-	-
Follow-up Hdwy	3.518	3.318	2.218	-	-	-
Pot Cap-1 Maneuver	377	632	1137	-	-	-
Stage 1	662	-	-	-	-	-
Stage 2	727	-	-	-	-	-
Platoon blocked, %				-	-	-
Mov Cap-1 Maneuver	377	632	1137	-	-	-
Mov Cap-2 Maneuver	377	-	-	-	-	-
Stage 1	662	-	-	-	-	-
Stage 2	727	-	-	-	-	-

Approach	EB	NB	SB
HCM Control Delay, s	10.7	0	0
HCM LOS	B		

Minor Lane/Major Mvmt	NBL	NBT	EBLn1	SBT	SBR
Capacity (veh/h)	1137	-	632	-	-
HCM Lane V/C Ratio	-	-	0.002	-	-
HCM Control Delay (s)	0	-	10.7	-	-
HCM Lane LOS	A	-	B	-	-
HCM 95th %tile Q(veh)	0	-	0	-	-

Intersection						
Int Delay, s/veh	0.2					
Movement	EBL	EBR	NBL	NBT	SBT	SBR
Lane Configurations	T		T		T	
Traffic Vol, veh/h	7	1	4	328	421	4
Future Vol, veh/h	7	1	4	328	421	4
Conflicting Peds, #/hr	0	0	0	0	0	0
Sign Control	Stop	Stop	Free	Free	Free	Free
RT Channelized	-	None	-	None	-	None
Storage Length	0	-	-	-	-	-
Veh in Median Storage, #	0	-	-	0	0	-
Grade, %	0	-	-	0	0	-
Peak Hour Factor	100	100	100	100	100	100
Heavy Vehicles, %	2	2	2	2	2	2
Mvmt Flow	7	1	4	328	421	4

Major/Minor	Minor2	Major1	Major2			
Conflicting Flow All	759	423	425	0	-	0
Stage 1	423	-	-	-	-	-
Stage 2	336	-	-	-	-	-
Critical Hdwy	6.42	6.22	4.12	-	-	-
Critical Hdwy Stg 1	5.42	-	-	-	-	-
Critical Hdwy Stg 2	5.42	-	-	-	-	-
Follow-up Hdwy	3.518	3.318	2.218	-	-	-
Pot Cap-1 Maneuver	374	631	1134	-	-	-
Stage 1	661	-	-	-	-	-
Stage 2	724	-	-	-	-	-
Platoon blocked, %				-	-	-
Mov Cap-1 Maneuver	373	631	1134	-	-	-
Mov Cap-2 Maneuver	373	-	-	-	-	-
Stage 1	658	-	-	-	-	-
Stage 2	724	-	-	-	-	-

Approach	EB	NB	SB
HCM Control Delay, s	14.4	0.1	0
HCM LOS	B		

Minor Lane/Major Mvmt	NBL	NBT	EBLn1	SBT	SBR
Capacity (veh/h)	1134	-	393	-	-
HCM Lane V/C Ratio	0.004	-	0.02	-	-
HCM Control Delay (s)	8.2	0	14.4	-	-
HCM Lane LOS	A	A	B	-	-
HCM 95th %tile Q(veh)	0	-	0.1	-	-

Intersection						
Int Delay, s/veh	0.2					
Movement	WBL	WBR	NBT	NBR	SBL	SBT
Lane Configurations						
Traffic Vol, veh/h	8	5	160	2	1	442
Future Vol, veh/h	8	5	160	2	1	442
Conflicting Peds, #/hr	0	0	0	0	0	0
Sign Control	Stop	Stop	Free	Free	Free	Free
RT Channelized	-	None	-	None	-	None
Storage Length	0	-	-	-	-	-
Veh in Median Storage, #	0	-	0	-	-	0
Grade, %	0	-	0	-	-	0
Peak Hour Factor	100	100	100	100	100	100
Heavy Vehicles, %	2	2	2	2	2	2
Mvmt Flow	8	5	160	2	1	442

Major/Minor	Minor1	Major1	Major2			
Conflicting Flow All	605	161	0	0	162	0
Stage 1	161	-	-	-	-	-
Stage 2	444	-	-	-	-	-
Critical Hdwy	6.42	6.22	-	-	4.12	-
Critical Hdwy Stg 1	5.42	-	-	-	-	-
Critical Hdwy Stg 2	5.42	-	-	-	-	-
Follow-up Hdwy	3.518	3.318	-	-	2.218	-
Pot Cap-1 Maneuver	461	884	-	-	1417	-
Stage 1	868	-	-	-	-	-
Stage 2	646	-	-	-	-	-
Platoon blocked, %			-	-		-
Mov Cap-1 Maneuver	461	884	-	-	1417	-
Mov Cap-2 Maneuver	461	-	-	-	-	-
Stage 1	868	-	-	-	-	-
Stage 2	645	-	-	-	-	-

Approach	WB	NB	SB
HCM Control Delay, s	11.5	0	0
HCM LOS	B		

Minor Lane/Major Mvmt	NBT	NBRWBLn1	SBL	SBT
Capacity (veh/h)	-	-	565	1417
HCM Lane V/C Ratio	-	-	0.023	0.001
HCM Control Delay (s)	-	-	11.5	7.5
HCM Lane LOS	-	-	B	A
HCM 95th %tile Q(veh)	-	-	0.1	0

Intersection						
Int Delay, s/veh	0.4					
Movement	WBL	WBR	NBT	NBR	SBL	SBT
Lane Configurations	W		T			T
Traffic Vol, veh/h	13	7	145	6	3	447
Future Vol, veh/h	13	7	145	6	3	447
Conflicting Peds, #/hr	0	0	0	0	0	0
Sign Control	Stop	Stop	Free	Free	Free	Free
RT Channelized	-	None	-	None	-	None
Storage Length	0	-	-	-	-	-
Veh in Median Storage, #	0	-	0	-	-	0
Grade, %	0	-	0	-	-	0
Peak Hour Factor	100	100	100	100	100	100
Heavy Vehicles, %	2	2	2	2	2	2
Mvmt Flow	13	7	145	6	3	447

Major/Minor	Minor1	Major1	Major2			
Conflicting Flow All	601	148	0	0	151	0
Stage 1	148	-	-	-	-	-
Stage 2	453	-	-	-	-	-
Critical Hdwy	6.42	6.22	-	-	4.12	-
Critical Hdwy Stg 1	5.42	-	-	-	-	-
Critical Hdwy Stg 2	5.42	-	-	-	-	-
Follow-up Hdwy	3.518	3.318	-	-	2.218	-
Pot Cap-1 Maneuver	463	899	-	-	1430	-
Stage 1	880	-	-	-	-	-
Stage 2	640	-	-	-	-	-
Platoon blocked, %			-	-		-
Mov Cap-1 Maneuver	462	899	-	-	1430	-
Mov Cap-2 Maneuver	462	-	-	-	-	-
Stage 1	880	-	-	-	-	-
Stage 2	638	-	-	-	-	-

Approach	WB	NB	SB
HCM Control Delay, s	11.7	0	0.1
HCM LOS	B		

Minor Lane/Major Mvmt	NBT	NBRWBLn1	SBL	SBT
Capacity (veh/h)	-	-	557	1430
HCM Lane V/C Ratio	-	-	0.036	0.002
HCM Control Delay (s)	-	-	11.7	7.5
HCM Lane LOS	-	-	B	A
HCM 95th %tile Q(veh)	-	-	0.1	0

Intersection						
Int Delay, s/veh	0.7					
Movement	EBL	EBR	NBL	NBT	SBT	SBR
Lane Configurations	T			T		T
Traffic Vol, veh/h	14	21	25	490	412	11
Future Vol, veh/h	14	21	25	490	412	11
Conflicting Peds, #/hr	0	0	0	0	0	0
Sign Control	Stop	Stop	Free	Free	Free	Free
RT Channelized	-	None	-	None	-	None
Storage Length	0	-	-	-	-	-
Veh in Median Storage, #	0	-	-	0	0	-
Grade, %	0	-	-	0	0	-
Peak Hour Factor	100	100	100	100	100	100
Heavy Vehicles, %	2	2	2	2	2	2
Mvmt Flow	14	21	25	490	412	11

Major/Minor	Minor2	Major1	Major2			
Conflicting Flow All	958	418	423	0	-	0
Stage 1	418	-	-	-	-	-
Stage 2	540	-	-	-	-	-
Critical Hdwy	6.42	6.22	4.12	-	-	-
Critical Hdwy Stg 1	5.42	-	-	-	-	-
Critical Hdwy Stg 2	5.42	-	-	-	-	-
Follow-up Hdwy	3.518	3.318	2.218	-	-	-
Pot Cap-1 Maneuver	285	635	1136	-	-	-
Stage 1	664	-	-	-	-	-
Stage 2	584	-	-	-	-	-
Platoon blocked, %				-	-	-
Mov Cap-1 Maneuver	276	635	1136	-	-	-
Mov Cap-2 Maneuver	276	-	-	-	-	-
Stage 1	644	-	-	-	-	-
Stage 2	584	-	-	-	-	-

Approach	EB	NB	SB
HCM Control Delay, s	14.4	0.4	0
HCM LOS	B		

Minor Lane/Major Mvmt	NBL	NBT	EBLn1	SBT	SBR
Capacity (veh/h)	1136	-	418	-	-
HCM Lane V/C Ratio	0.022	-	0.084	-	-
HCM Control Delay (s)	8.2	0	14.4	-	-
HCM Lane LOS	A	A	B	-	-
HCM 95th %tile Q(veh)	0.1	-	0.3	-	-

Intersection						
Int Delay, s/veh	0					
Movement	EBL	EBR	NBL	NBT	SBT	SBR
Lane Configurations	W			W	W	
Traffic Vol, veh/h	0	0	1	503	327	0
Future Vol, veh/h	0	0	1	503	327	0
Conflicting Peds, #/hr	0	0	0	0	0	0
Sign Control	Stop	Stop	Free	Free	Free	Free
RT Channelized	-	None	-	None	-	None
Storage Length	0	-	-	-	-	-
Veh in Median Storage, #	0	-	-	0	0	-
Grade, %	0	-	-	0	0	-
Peak Hour Factor	100	100	100	100	100	100
Heavy Vehicles, %	2	2	2	2	2	2
Mvmt Flow	0	0	1	503	327	0

Major/Minor	Minor2	Major1	Major2			
Conflicting Flow All	832	327	327	0	-	0
Stage 1	327	-	-	-	-	-
Stage 2	505	-	-	-	-	-
Critical Hdwy	6.42	6.22	4.12	-	-	-
Critical Hdwy Stg 1	5.42	-	-	-	-	-
Critical Hdwy Stg 2	5.42	-	-	-	-	-
Follow-up Hdwy	3.518	3.318	2.218	-	-	-
Pot Cap-1 Maneuver	339	714	1233	-	-	-
Stage 1	731	-	-	-	-	-
Stage 2	606	-	-	-	-	-
Platoon blocked, %				-	-	-
Mov Cap-1 Maneuver	339	714	1233	-	-	-
Mov Cap-2 Maneuver	339	-	-	-	-	-
Stage 1	730	-	-	-	-	-
Stage 2	606	-	-	-	-	-

Approach	EB	NB	SB
HCM Control Delay, s	0	0	0
HCM LOS	A		

Minor Lane/Major Mvmt	NBL	NBT	EBLn1	SBT	SBR
Capacity (veh/h)	1233	-	-	-	-
HCM Lane V/C Ratio	0.001	-	-	-	-
HCM Control Delay (s)	7.9	0	0	-	-
HCM Lane LOS	A	A	A	-	-
HCM 95th %tile Q(veh)	0	-	-	-	-

Intersection						
Int Delay, s/veh	0.1					
Movement	EBL	EBR	NBL	NBT	SBT	SBR
Lane Configurations	T			T		T
Traffic Vol, veh/h	4	4	1	502	323	7
Future Vol, veh/h	4	4	1	502	323	7
Conflicting Peds, #/hr	0	0	0	0	0	0
Sign Control	Stop	Stop	Free	Free	Free	Free
RT Channelized	-	None	-	None	-	None
Storage Length	0	-	-	-	-	-
Veh in Median Storage, #	0	-	-	0	0	-
Grade, %	0	-	-	0	0	-
Peak Hour Factor	100	100	100	100	100	100
Heavy Vehicles, %	2	2	2	2	2	2
Mvmt Flow	4	4	1	502	323	7

Major/Minor	Minor2	Major1	Major2			
Conflicting Flow All	831	327	330	0	-	0
Stage 1	327	-	-	-	-	-
Stage 2	504	-	-	-	-	-
Critical Hdwy	6.42	6.22	4.12	-	-	-
Critical Hdwy Stg 1	5.42	-	-	-	-	-
Critical Hdwy Stg 2	5.42	-	-	-	-	-
Follow-up Hdwy	3.518	3.318	2.218	-	-	-
Pot Cap-1 Maneuver	340	714	1229	-	-	-
Stage 1	731	-	-	-	-	-
Stage 2	607	-	-	-	-	-
Platoon blocked, %				-	-	-
Mov Cap-1 Maneuver	340	714	1229	-	-	-
Mov Cap-2 Maneuver	340	-	-	-	-	-
Stage 1	730	-	-	-	-	-
Stage 2	607	-	-	-	-	-

Approach	EB	NB	SB
HCM Control Delay, s	12.9	0	0
HCM LOS	B		

Minor Lane/Major Mvmt	NBL	NBT	EBLn1	SBT	SBR
Capacity (veh/h)	1229	-	461	-	-
HCM Lane V/C Ratio	0.001	-	0.017	-	-
HCM Control Delay (s)	7.9	0	12.9	-	-
HCM Lane LOS	A	A	B	-	-
HCM 95th %tile Q(veh)	0	-	0.1	-	-

Intersection						
Int Delay, s/veh	0.6					
Movement	WBL	WBR	NBT	NBR	SBL	SBT
Lane Configurations	W		T			T
Traffic Vol, veh/h	3	1	447	8	34	105
Future Vol, veh/h	3	1	447	8	34	105
Conflicting Peds, #/hr	0	0	0	0	0	0
Sign Control	Stop	Stop	Free	Free	Free	Free
RT Channelized	-	None	-	None	-	None
Storage Length	0	-	-	-	-	-
Veh in Median Storage, #	0	-	0	-	-	0
Grade, %	0	-	0	-	-	0
Peak Hour Factor	100	100	100	100	100	100
Heavy Vehicles, %	2	2	2	2	2	2
Mvmt Flow	3	1	447	8	34	105

Major/Minor	Minor1	Major1	Major2		
Conflicting Flow All	624	451	0	0	455
Stage 1	451	-	-	-	-
Stage 2	173	-	-	-	-
Critical Hdwy	6.42	6.22	-	-	4.12
Critical Hdwy Stg 1	5.42	-	-	-	-
Critical Hdwy Stg 2	5.42	-	-	-	-
Follow-up Hdwy	3.518	3.318	-	-	2.218
Pot Cap-1 Maneuver	449	608	-	-	1106
Stage 1	642	-	-	-	-
Stage 2	857	-	-	-	-
Platoon blocked, %			-	-	-
Mov Cap-1 Maneuver	434	608	-	-	1106
Mov Cap-2 Maneuver	434	-	-	-	-
Stage 1	642	-	-	-	-
Stage 2	829	-	-	-	-

Approach	WB	NB	SB
HCM Control Delay, s	12.8	0	2
HCM LOS	B		

Minor Lane/Major Mvmt	NBT	NBRWBLn1	SBL	SBT
Capacity (veh/h)	-	-	467	1106
HCM Lane V/C Ratio	-	-	0.009	0.031
HCM Control Delay (s)	-	-	12.8	8.4
HCM Lane LOS	-	-	B	A
HCM 95th %tile Q(veh)	-	-	0	0.1

Intersection						
Int Delay, s/veh	0.1					
Movement	WBL	WBR	NBT	NBR	SBL	SBT
Lane Configurations	W		T			T
Traffic Vol, veh/h	1	3	452	13	3	105
Future Vol, veh/h	1	3	452	13	3	105
Conflicting Peds, #/hr	0	0	0	0	0	0
Sign Control	Stop	Stop	Free	Free	Free	Free
RT Channelized	-	None	-	None	-	None
Storage Length	0	-	-	-	-	-
Veh in Median Storage, #	0	-	0	-	-	0
Grade, %	0	-	0	-	-	0
Peak Hour Factor	100	100	100	100	100	100
Heavy Vehicles, %	2	2	2	2	2	2
Mvmt Flow	1	3	452	13	3	105

Major/Minor	Minor1	Major1	Major2		
Conflicting Flow All	570	459	0	0	465
Stage 1	459	-	-	-	-
Stage 2	111	-	-	-	-
Critical Hdwy	6.42	6.22	-	-	4.12
Critical Hdwy Stg 1	5.42	-	-	-	-
Critical Hdwy Stg 2	5.42	-	-	-	-
Follow-up Hdwy	3.518	3.318	-	-	2.218
Pot Cap-1 Maneuver	483	602	-	-	1096
Stage 1	636	-	-	-	-
Stage 2	914	-	-	-	-
Platoon blocked, %			-	-	-
Mov Cap-1 Maneuver	482	602	-	-	1096
Mov Cap-2 Maneuver	482	-	-	-	-
Stage 1	636	-	-	-	-
Stage 2	911	-	-	-	-

Approach	WB	NB	SB
HCM Control Delay, s	11.4	0	0.2
HCM LOS	B		

Minor Lane/Major Mvmt	NBT	NBRWBLn1	SBL	SBT
Capacity (veh/h)	-	-	567	1096
HCM Lane V/C Ratio	-	-	0.007	0.003
HCM Control Delay (s)	-	-	11.4	8.3
HCM Lane LOS	-	-	B	A
HCM 95th %tile Q(veh)	-	-	0	0

Intersection						
Int Delay, s/veh	0.9					
Movement	EBL	EBR	NBL	NBT	SBT	SBR
Lane Configurations	T			T		T
Traffic Vol, veh/h	11	24	35	354	452	12
Future Vol, veh/h	11	24	35	354	452	12
Conflicting Peds, #/hr	0	0	0	0	0	0
Sign Control	Stop	Stop	Free	Free	Free	Free
RT Channelized	-	None	-	None	-	None
Storage Length	0	-	-	-	-	-
Veh in Median Storage, #	0	-	-	0	0	-
Grade, %	0	-	-	0	0	-
Peak Hour Factor	100	100	100	100	100	100
Heavy Vehicles, %	2	2	2	2	2	2
Mvmt Flow	11	24	35	354	452	12

Major/Minor	Minor2	Major1	Major2			
Conflicting Flow All	882	458	464	0	-	0
Stage 1	458	-	-	-	-	-
Stage 2	424	-	-	-	-	-
Critical Hdwy	6.42	6.22	4.12	-	-	-
Critical Hdwy Stg 1	5.42	-	-	-	-	-
Critical Hdwy Stg 2	5.42	-	-	-	-	-
Follow-up Hdwy	3.518	3.318	2.218	-	-	-
Pot Cap-1 Maneuver	317	603	1097	-	-	-
Stage 1	637	-	-	-	-	-
Stage 2	660	-	-	-	-	-
Platoon blocked, %				-	-	-
Mov Cap-1 Maneuver	304	603	1097	-	-	-
Mov Cap-2 Maneuver	304	-	-	-	-	-
Stage 1	612	-	-	-	-	-
Stage 2	660	-	-	-	-	-

Approach	EB	NB	SB
HCM Control Delay, s	13.5	0.8	0
HCM LOS	B		

Minor Lane/Major Mvmt	NBL	NBT	EBLn1	SBT	SBR
Capacity (veh/h)	1097	-	461	-	-
HCM Lane V/C Ratio	0.032	-	0.076	-	-
HCM Control Delay (s)	8.4	0	13.5	-	-
HCM Lane LOS	A	A	B	-	-
HCM 95th %tile Q(veh)	0.1	-	0.2	-	-

Intersection						
Int Delay, s/veh	0					
Movement	EBL	EBR	NBL	NBT	SBT	SBR
Lane Configurations						
Traffic Vol, veh/h	0	1	0	365	463	0
Future Vol, veh/h	0	1	0	365	463	0
Conflicting Peds, #/hr	0	0	0	0	0	0
Sign Control	Stop	Stop	Free	Free	Free	Free
RT Channelized	-	None	-	None	-	None
Storage Length	0	-	-	-	-	-
Veh in Median Storage, #	0	-	-	0	0	-
Grade, %	0	-	-	0	0	-
Peak Hour Factor	100	100	100	100	100	100
Heavy Vehicles, %	2	2	2	2	2	2
Mvmt Flow	0	1	0	365	463	0

Major/Minor	Minor2	Major1	Major2			
Conflicting Flow All	828	463	463	0	-	0
Stage 1	463	-	-	-	-	-
Stage 2	365	-	-	-	-	-
Critical Hdwy	6.42	6.22	4.12	-	-	-
Critical Hdwy Stg 1	5.42	-	-	-	-	-
Critical Hdwy Stg 2	5.42	-	-	-	-	-
Follow-up Hdwy	3.518	3.318	2.218	-	-	-
Pot Cap-1 Maneuver	341	599	1098	-	-	-
Stage 1	634	-	-	-	-	-
Stage 2	702	-	-	-	-	-
Platoon blocked, %				-	-	-
Mov Cap-1 Maneuver	341	599	1098	-	-	-
Mov Cap-2 Maneuver	341	-	-	-	-	-
Stage 1	634	-	-	-	-	-
Stage 2	702	-	-	-	-	-

Approach	EB	NB	SB
HCM Control Delay, s	11	0	0
HCM LOS	B		

Minor Lane/Major Mvmt	NBL	NBT	EBLn1	SBT	SBR
Capacity (veh/h)	1098	-	599	-	-
HCM Lane V/C Ratio	-	-	0.002	-	-
HCM Control Delay (s)	0	-	11	-	-
HCM Lane LOS	A	-	B	-	-
HCM 95th %tile Q(veh)	0	-	0	-	-

Intersection						
Int Delay, s/veh	0.2					
Movement	EBL	EBR	NBL	NBT	SBT	SBR
Lane Configurations						
Traffic Vol, veh/h	8	1	4	360	462	4
Future Vol, veh/h	8	1	4	360	462	4
Conflicting Peds, #/hr	0	0	0	0	0	0
Sign Control	Stop	Stop	Free	Free	Free	Free
RT Channelized	-	None	-	None	-	None
Storage Length	0	-	-	-	-	-
Veh in Median Storage, #	0	-	-	0	0	-
Grade, %	0	-	-	0	0	-
Peak Hour Factor	100	100	100	100	100	100
Heavy Vehicles, %	2	2	2	2	2	2
Mvmt Flow	8	1	4	360	462	4

Major/Minor	Minor2	Major1	Major2			
Conflicting Flow All	832	464	466	0	-	0
Stage 1	464	-	-	-	-	-
Stage 2	368	-	-	-	-	-
Critical Hdwy	6.42	6.22	4.12	-	-	-
Critical Hdwy Stg 1	5.42	-	-	-	-	-
Critical Hdwy Stg 2	5.42	-	-	-	-	-
Follow-up Hdwy	3.518	3.318	2.218	-	-	-
Pot Cap-1 Maneuver	339	598	1095	-	-	-
Stage 1	633	-	-	-	-	-
Stage 2	700	-	-	-	-	-
Platoon blocked, %				-	-	-
Mov Cap-1 Maneuver	337	598	1095	-	-	-
Mov Cap-2 Maneuver	337	-	-	-	-	-
Stage 1	630	-	-	-	-	-
Stage 2	700	-	-	-	-	-

Approach	EB	NB	SB
HCM Control Delay, s	15.4	0.1	0
HCM LOS	C		

Minor Lane/Major Mvmt	NBL	NBT	EBLn1	SBT	SBR
Capacity (veh/h)	1095	-	354	-	-
HCM Lane V/C Ratio	0.004	-	0.025	-	-
HCM Control Delay (s)	8.3	0	15.4	-	-
HCM Lane LOS	A	A	C	-	-
HCM 95th %tile Q(veh)	0	-	0.1	-	-

Intersection						
Int Delay, s/veh	0.2					
Movement	WBL	WBR	NBT	NBR	SBL	SBT
Lane Configurations						
Traffic Vol, veh/h	8	5	166	2	1	485
Future Vol, veh/h	8	5	166	2	1	485
Conflicting Peds, #/hr	0	0	0	0	0	0
Sign Control	Stop	Stop	Free	Free	Free	Free
RT Channelized	-	None	-	None	-	None
Storage Length	0	-	-	-	-	-
Veh in Median Storage, #	0	-	0	-	-	0
Grade, %	0	-	0	-	-	0
Peak Hour Factor	100	100	100	100	100	100
Heavy Vehicles, %	2	2	2	2	2	2
Mvmt Flow	8	5	166	2	1	485

Major/Minor	Minor1	Major1	Major2			
Conflicting Flow All	654	167	0	0	168	0
Stage 1	167	-	-	-	-	-
Stage 2	487	-	-	-	-	-
Critical Hdwy	6.42	6.22	-	-	4.12	-
Critical Hdwy Stg 1	5.42	-	-	-	-	-
Critical Hdwy Stg 2	5.42	-	-	-	-	-
Follow-up Hdwy	3.518	3.318	-	-	2.218	-
Pot Cap-1 Maneuver	431	877	-	-	1410	-
Stage 1	863	-	-	-	-	-
Stage 2	618	-	-	-	-	-
Platoon blocked, %			-	-		-
Mov Cap-1 Maneuver	431	877	-	-	1410	-
Mov Cap-2 Maneuver	431	-	-	-	-	-
Stage 1	863	-	-	-	-	-
Stage 2	617	-	-	-	-	-

Approach	WB	NB	SB
HCM Control Delay, s	11.9	0	0
HCM LOS	B		

Minor Lane/Major Mvmt	NBT	NBRWBLn1	SBL	SBT
Capacity (veh/h)	-	-	536	1410
HCM Lane V/C Ratio	-	-	0.024	0.001
HCM Control Delay (s)	-	-	11.9	7.6
HCM Lane LOS	-	-	B	A
HCM 95th %tile Q(veh)	-	-	0.1	0

Intersection						
Int Delay, s/veh	0.4					
Movement	WBL	WBR	NBT	NBR	SBL	SBT
Lane Configurations	TT		TT			TT
Traffic Vol, veh/h	15	8	159	7	3	490
Future Vol, veh/h	15	8	159	7	3	490
Conflicting Peds, #/hr	0	0	0	0	0	0
Sign Control	Stop	Stop	Free	Free	Free	Free
RT Channelized	-	None	-	None	-	None
Storage Length	0	-	-	-	-	-
Veh in Median Storage, #	0	-	0	-	-	0
Grade, %	0	-	0	-	-	0
Peak Hour Factor	100	100	100	100	100	100
Heavy Vehicles, %	2	2	2	2	2	2
Mvmt Flow	15	8	159	7	3	490

Major/Minor	Minor1	Major1	Major2			
Conflicting Flow All	659	163	0	0	166	0
Stage 1	163	-	-	-	-	-
Stage 2	496	-	-	-	-	-
Critical Hdwy	6.42	6.22	-	-	4.12	-
Critical Hdwy Stg 1	5.42	-	-	-	-	-
Critical Hdwy Stg 2	5.42	-	-	-	-	-
Follow-up Hdwy	3.518	3.318	-	-	2.218	-
Pot Cap-1 Maneuver	429	882	-	-	1412	-
Stage 1	866	-	-	-	-	-
Stage 2	612	-	-	-	-	-
Platoon blocked, %			-	-		-
Mov Cap-1 Maneuver	428	882	-	-	1412	-
Mov Cap-2 Maneuver	428	-	-	-	-	-
Stage 1	866	-	-	-	-	-
Stage 2	610	-	-	-	-	-

Approach	WB	NB	SB
HCM Control Delay, s	12.2	0	0
HCM LOS	B		

Minor Lane/Major Mvmt	NBT	NBRWBLn1	SBL	SBT
Capacity (veh/h)	-	-	521	1412
HCM Lane V/C Ratio	-	-	0.044	0.002
HCM Control Delay (s)	-	-	12.2	7.6
HCM Lane LOS	-	-	B	A
HCM 95th %tile Q(veh)	-	-	0.1	0

Intersection						
Int Delay, s/veh	0.8					
Movement	EBL	EBR	NBL	NBT	SBT	SBR
Lane Configurations	T			T		T
Traffic Vol, veh/h	15	23	28	538	348	13
Future Vol, veh/h	15	23	28	538	348	13
Conflicting Peds, #/hr	0	0	0	0	0	0
Sign Control	Stop	Stop	Free	Free	Free	Free
RT Channelized	-	None	-	None	-	None
Storage Length	0	-	-	-	-	-
Veh in Median Storage, #	0	-	-	0	0	-
Grade, %	0	-	-	0	0	-
Peak Hour Factor	100	100	100	100	100	100
Heavy Vehicles, %	2	2	2	2	2	2
Mvmt Flow	15	23	28	538	348	13

Major/Minor	Minor2	Major1	Major2			
Conflicting Flow All	949	355	361	0	-	0
Stage 1	355	-	-	-	-	-
Stage 2	594	-	-	-	-	-
Critical Hdwy	6.42	6.22	4.12	-	-	-
Critical Hdwy Stg 1	5.42	-	-	-	-	-
Critical Hdwy Stg 2	5.42	-	-	-	-	-
Follow-up Hdwy	3.518	3.318	2.218	-	-	-
Pot Cap-1 Maneuver	289	689	1198	-	-	-
Stage 1	710	-	-	-	-	-
Stage 2	552	-	-	-	-	-
Platoon blocked, %				-	-	-
Mov Cap-1 Maneuver	279	689	1198	-	-	-
Mov Cap-2 Maneuver	279	-	-	-	-	-
Stage 1	687	-	-	-	-	-
Stage 2	552	-	-	-	-	-

Approach	EB	NB	SB
HCM Control Delay, s	14	0.4	0
HCM LOS	B		

Minor Lane/Major Mvmt	NBL	NBT	EBLn1	SBT	SBR
Capacity (veh/h)	1198	-	436	-	-
HCM Lane V/C Ratio	0.023	-	0.087	-	-
HCM Control Delay (s)	8.1	0	14	-	-
HCM Lane LOS	A	A	B	-	-
HCM 95th %tile Q(veh)	0.1	-	0.3	-	-

Intersection						
Int Delay, s/veh	0					
Movement	EBL	EBR	NBL	NBT	SBT	SBR
Lane Configurations						
Traffic Vol, veh/h	0	0	1	552	359	0
Future Vol, veh/h	0	0	1	552	359	0
Conflicting Peds, #/hr	0	0	0	0	0	0
Sign Control	Stop	Stop	Free	Free	Free	Free
RT Channelized	-	None	-	None	-	None
Storage Length	0	-	-	-	-	-
Veh in Median Storage, #	0	-	-	0	0	-
Grade, %	0	-	-	0	0	-
Peak Hour Factor	100	100	100	100	100	100
Heavy Vehicles, %	2	2	2	2	2	2
Mvmt Flow	0	0	1	552	359	0

Major/Minor	Minor2	Major1	Major2			
Conflicting Flow All	913	359	359	0	-	0
Stage 1	359	-	-	-	-	-
Stage 2	554	-	-	-	-	-
Critical Hdwy	6.42	6.22	4.12	-	-	-
Critical Hdwy Stg 1	5.42	-	-	-	-	-
Critical Hdwy Stg 2	5.42	-	-	-	-	-
Follow-up Hdwy	3.518	3.318	2.218	-	-	-
Pot Cap-1 Maneuver	304	685	1200	-	-	-
Stage 1	707	-	-	-	-	-
Stage 2	575	-	-	-	-	-
Platoon blocked, %				-	-	-
Mov Cap-1 Maneuver	304	685	1200	-	-	-
Mov Cap-2 Maneuver	304	-	-	-	-	-
Stage 1	706	-	-	-	-	-
Stage 2	575	-	-	-	-	-

Approach	EB	NB	SB
HCM Control Delay, s	0	0	0
HCM LOS	A		

Minor Lane/Major Mvmt	NBL	NBT	EBLn1	SBT	SBR
Capacity (veh/h)	1200	-	-	-	-
HCM Lane V/C Ratio	0.001	-	-	-	-
HCM Control Delay (s)	8	0	0	-	-
HCM Lane LOS	A	A	A	-	-
HCM 95th %tile Q(veh)	0	-	-	-	-

Intersection						
Int Delay, s/veh	0.1					
Movement	EBL	EBR	NBL	NBT	SBT	SBR
Lane Configurations	T			T		T
Traffic Vol, veh/h	4	4	1	551	355	8
Future Vol, veh/h	4	4	1	551	355	8
Conflicting Peds, #/hr	0	0	0	0	0	0
Sign Control	Stop	Stop	Free	Free	Free	Free
RT Channelized	-	None	-	None	-	None
Storage Length	0	-	-	-	-	-
Veh in Median Storage, #	0	-	-	0	0	-
Grade, %	0	-	-	0	0	-
Peak Hour Factor	100	100	100	100	100	100
Heavy Vehicles, %	2	2	2	2	2	2
Mvmt Flow	4	4	1	551	355	8

Major/Minor	Minor2	Major1	Major2			
Conflicting Flow All	912	359	363	0	-	0
Stage 1	359	-	-	-	-	-
Stage 2	553	-	-	-	-	-
Critical Hdwy	6.42	6.22	4.12	-	-	-
Critical Hdwy Stg 1	5.42	-	-	-	-	-
Critical Hdwy Stg 2	5.42	-	-	-	-	-
Follow-up Hdwy	3.518	3.318	2.218	-	-	-
Pot Cap-1 Maneuver	304	685	1196	-	-	-
Stage 1	707	-	-	-	-	-
Stage 2	576	-	-	-	-	-
Platoon blocked, %				-	-	-
Mov Cap-1 Maneuver	304	685	1196	-	-	-
Mov Cap-2 Maneuver	304	-	-	-	-	-
Stage 1	706	-	-	-	-	-
Stage 2	576	-	-	-	-	-

Approach	EB	NB	SB
HCM Control Delay, s	13.7	0	0
HCM LOS	B		

Minor Lane/Major Mvmt	NBL	NBT	EBLn1	SBT	SBR
Capacity (veh/h)	1196	-	421	-	-
HCM Lane V/C Ratio	0.001	-	0.019	-	-
HCM Control Delay (s)	8	0	13.7	-	-
HCM Lane LOS	A	A	B	-	-
HCM 95th %tile Q(veh)	0	-	0.1	-	-



**Castleglenn
Consultants**

Engineers, Project Managers & Planners

APPENDIX D: AUTOTURN™ TURNING MOVEMENTS

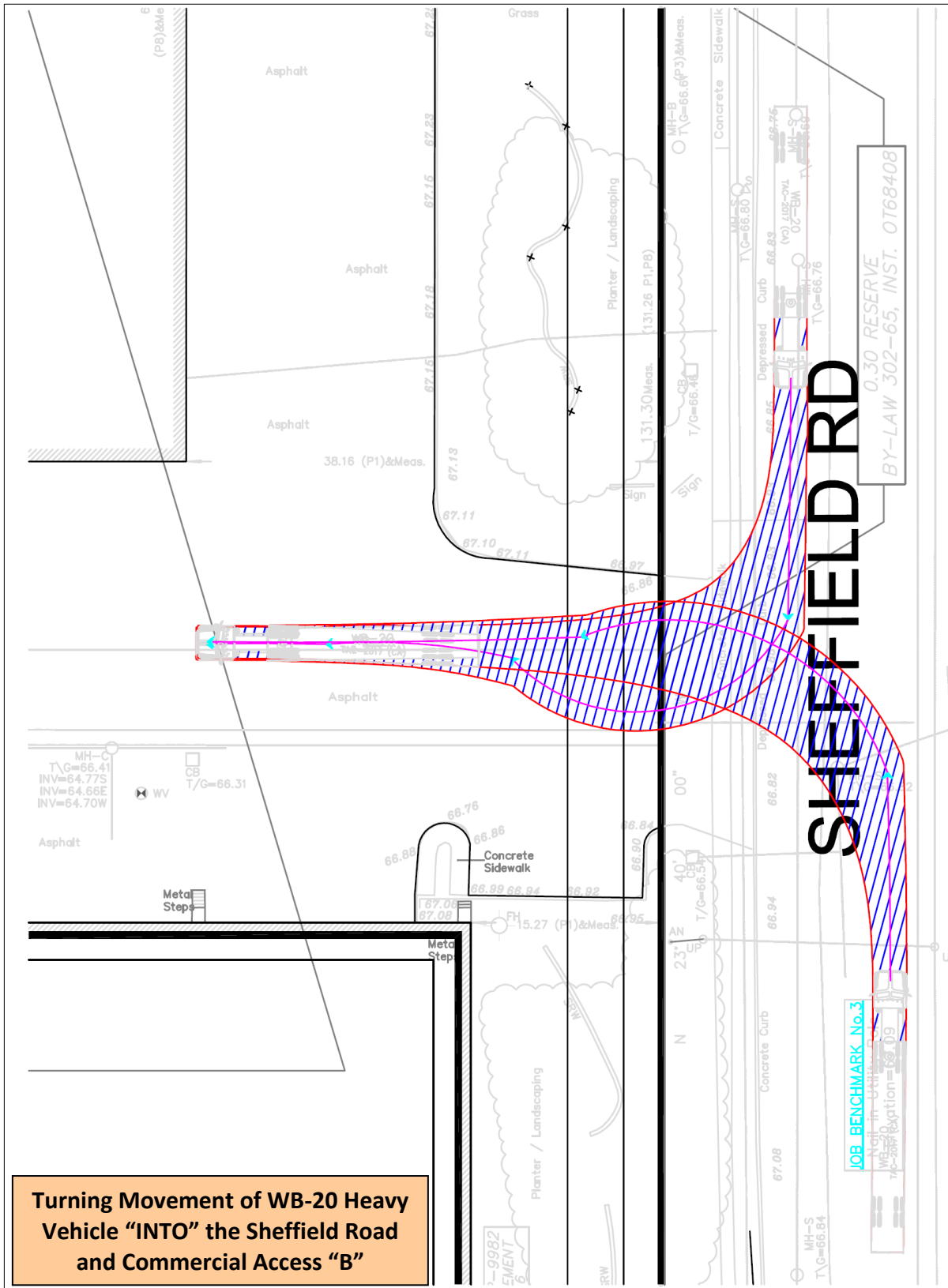

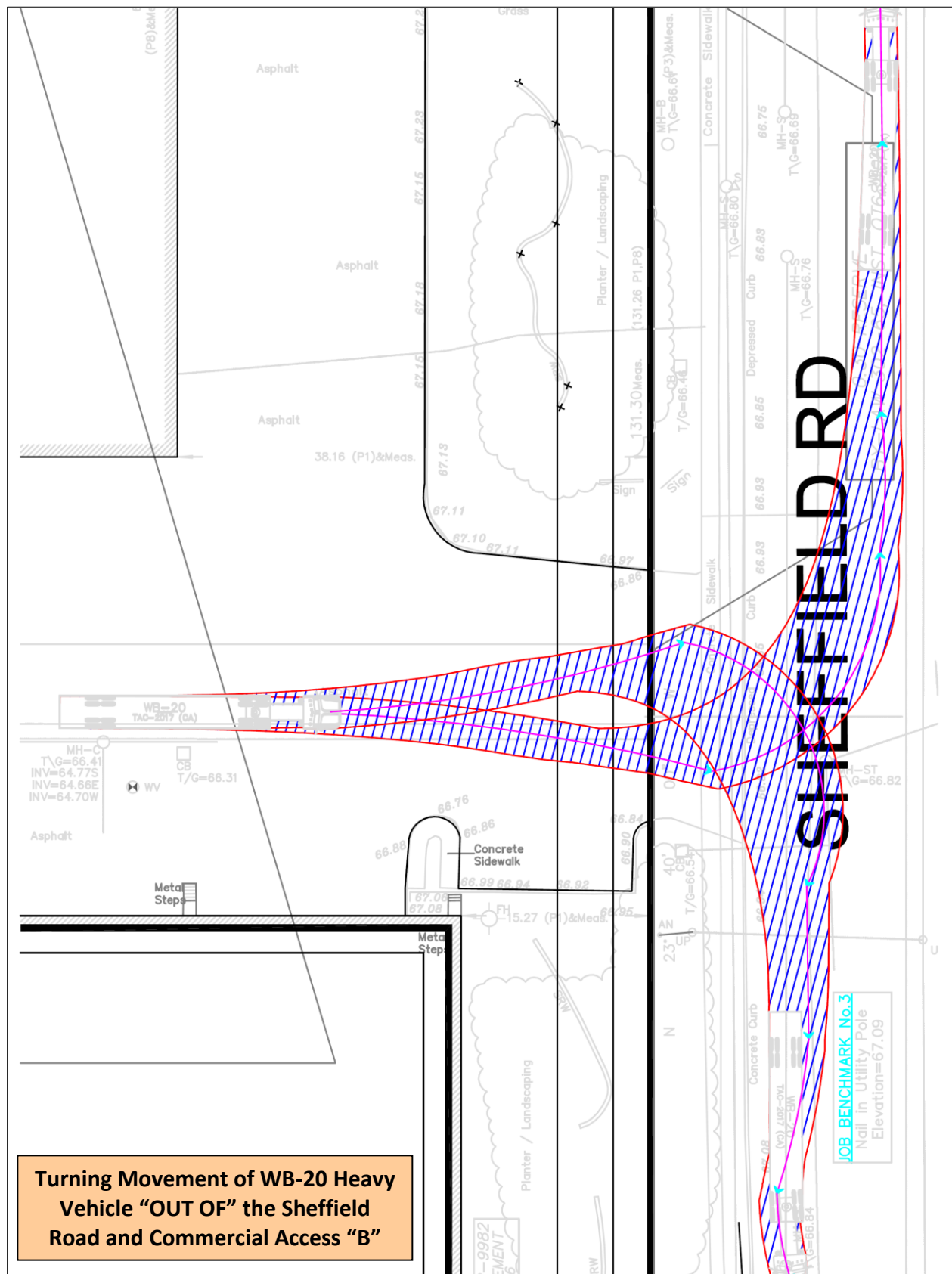

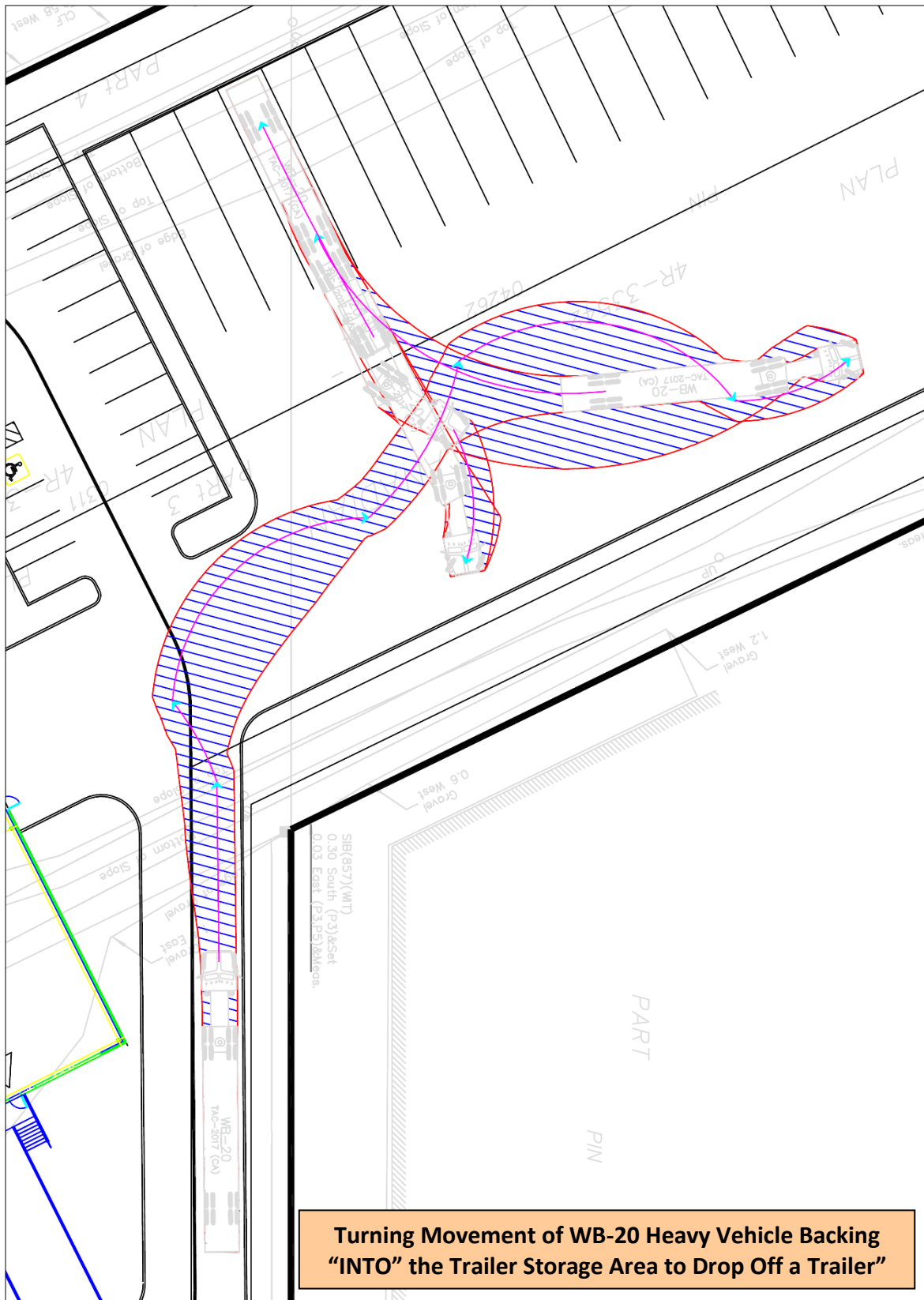

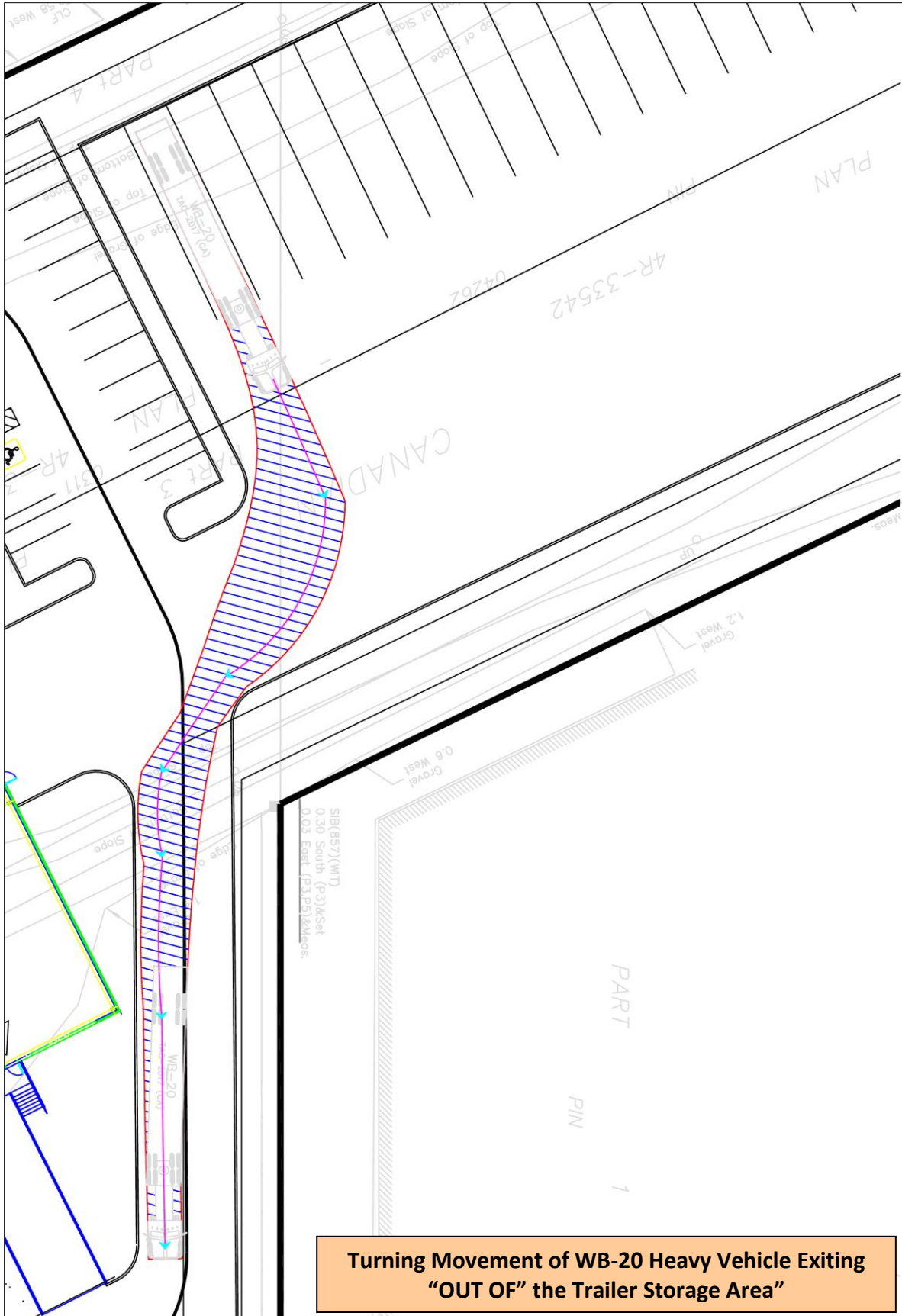



**Castleglenn
Consultants**

Engineers, Project Managers & Planners

APPENDIX E: LEFT TURN LANE WARRANT ANALYSES

Left Turn Lane Warrant Analysis Parameters (2029 Design Traffic Volumes)

Parameter	Symbol	Intersection 1: Lancaster Road / Commercial Access 'A'	Intersection 2: Lancaster Road / Commercial Access 'B'	Intersection 3: Sheffield Road / Commercial Access 'A'	Intersection 4: Sheffield Road / Commercial Access 'B'	Intersection 5: Sheffield Road / Commercial Access 'C'
Left-Turn Traffic Volume	LT_{vol} (vph)	34(1)	3(3)	0(1)	35(28)	4(1)
Number of vehicles approaching	V_a (vph)	139(486)	108(493)	365(553)	369(566)	365(552)
Number of opposing vehicles	V_o (vph)	455(167)	465(166)	463(359)	464(359)	466(363)
Percentage of left-turning vehicles	$LT_{Percent}$ (%)	24(0)	3(0)	0(0)	9(5)	1(0)

vph – Vehicles-per-hour
Morning (Afternoon) Peak Hour

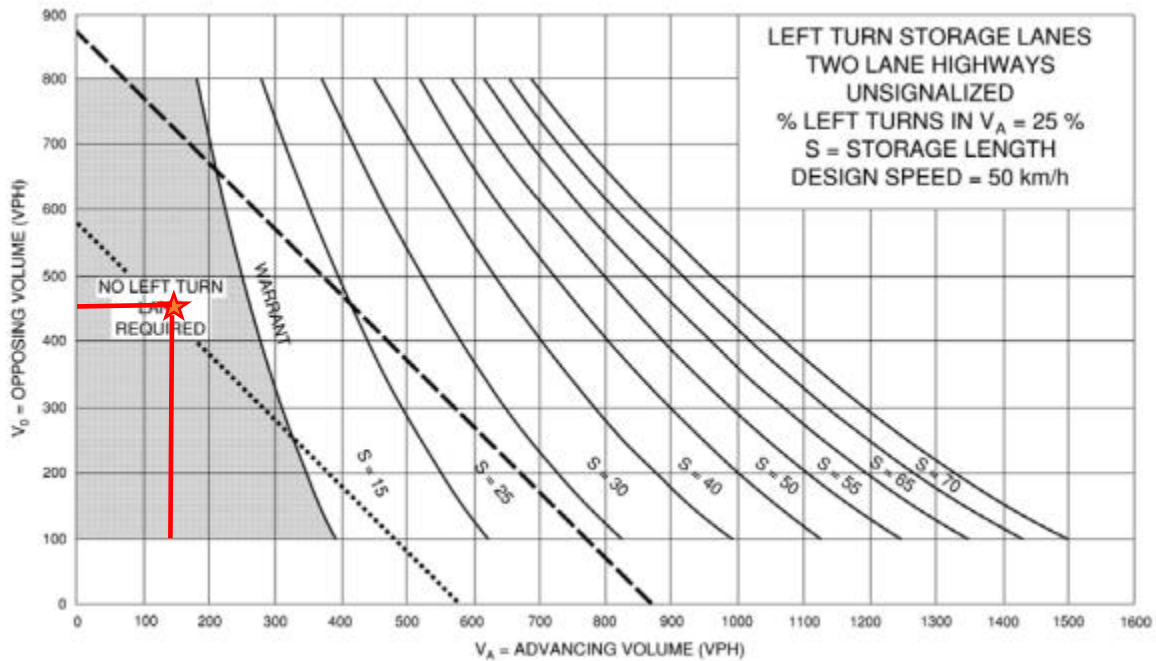

Intersection 1: Lancaster Road / Commercial Access 'A' (Morning Peak Hour)

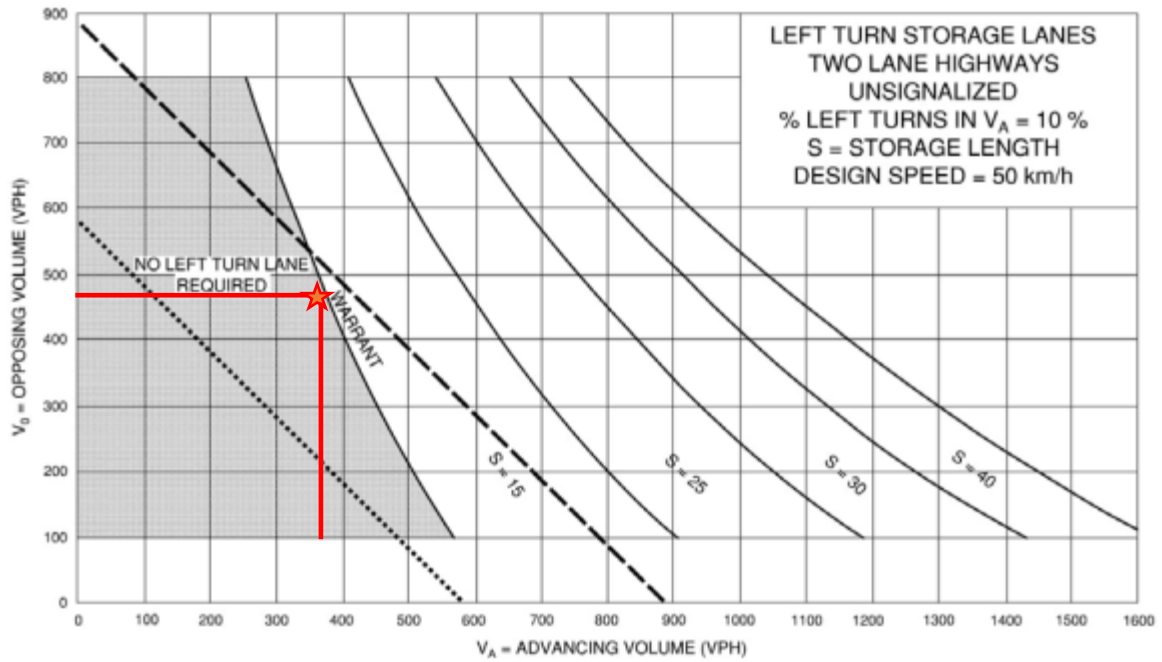

Intersection 4: Sheffield Road / Commercial Access 'B' (Morning Peak Hour)

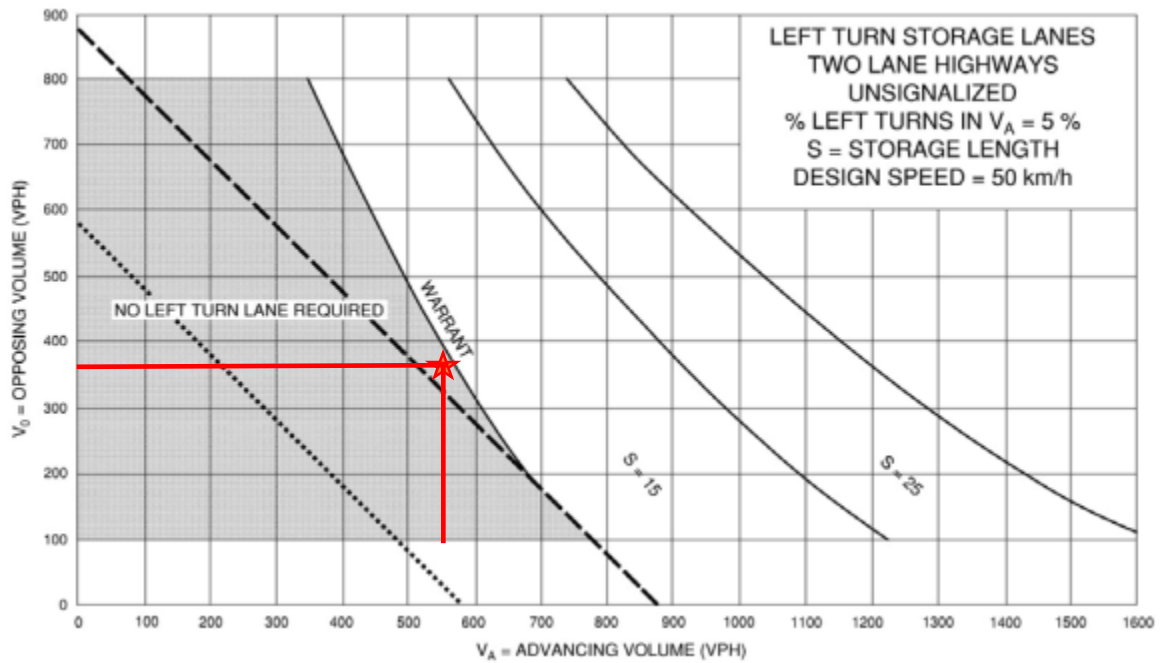

Intersection 4: Sheffield Road / Commercial Access 'B' (Afternoon Peak Hour)