

JLR No.: 29899-003
Revision: 2

January 31, 2025

Prepared for:

12714001 CANADA INC.
100-768 Boulevard St-Joseph
Gatineau, QC
J8Y 4B8

Prepared by:

J.L. RICHARDS & ASSOCIATES LIMITED
343 Preston Street, Suite 900 and 1000
Ottawa, ON
K1S 1N4

Site Servicing Report

2983 Navan Road – Block 16 Gas Station, Commercial Building, Drive-Thru Restaurant & Car Wash



Site Servicing Report
2983 Navan Road – Block 16
Gas Station, Commercial Building, Drive-Thru Restaurant & Car Wash

Table of Contents

1.0	INTRODUCTION.....	1
1.1	General.....	1
1.2	Site Description.....	1
1.3	Proposed Development.....	1
1.4	Proposed Connections to Existing Infrastructure.....	1
1.5	Consultation and Permits.....	2
2.0	WATER SERVICING.....	2
2.1	Water Supply Design Criteria.....	2
2.2	Domestic Water Demands.....	3
2.3	Fire Flow Requirements.....	3
2.4	Proposed Water Servicing, Boundary Conditions and Water Model.....	3
	2.4.1 Proposed Water Servicing.....	3
	2.4.2 Boundary Conditions.....	4
	2.4.3 Water Model.....	4
2.5	Simulation Results.....	4
	2.5.1 Peak Hour.....	5
	2.5.2 Maximum Day Plus Fire Flow.....	5
	2.5.3 Maximum Pressure.....	5
2.6	Summary and Conclusions.....	5
3.0	WASTEWATER SERVICING.....	5
3.1	Design Criteria.....	5
3.2	Proposed Sanitary Servicing and Design Flows.....	6
3.3	Summary and Conclusions.....	7
4.0	STORM SERVICING AND STORMWATER MANAGEMENT.....	7
4.1	Design Criteria.....	7
4.2	Proposed Stormwater Management Approach.....	8
4.3	Proposed Minor System Servicing.....	8
4.4	Stormwater Management Modelling Approach.....	8
	4.4.1 Dual Drainage Model.....	8
	4.4.2 Boundary Conditions.....	9
	4.4.3 Ditch Drainage.....	9
4.5	Modelling Parameters.....	9
	4.5.1 Hydrological Modelling Parameters.....	9
	4.5.2 Simulation of Storm Distributions.....	10
4.6	Simulation Results.....	10
	4.6.1 Low Point Ponding Analysis.....	10
	4.6.2 Site Release Rate.....	11
4.7	Water Quality.....	11
4.8	Summary and Conclusions.....	11
5.0	Erosion and Sediment Control.....	12
6.0	CONCLUSIONS.....	13

Site Servicing Report
2983 Navan Road – Block 16
Gas Station, Commercial Building, Drive-Thru Restaurant & Car Wash

List of Tables

Table 1: Water Demands	3
Table 2: Hydraulic Boundary Conditions	4
Table 3: Watermain Internal Diameters and C-Factors.....	4
Table 4: Wastewater Key Design Parameters	6
Table 5: Sanitary Design Flow Summary	6
Table 6: Catchbasin Ponding Depths	10
Table 7: Release Rates.....	11

List of Appendices

Appendix A	Concept Plan, Draft Plan of Subdivision and Topographical Survey
Appendix B	Pre-consultation Meeting Notes and Site Servicing Report Checklist
Appendix C	Water Servicing
Appendix D	Sanitary Design Sheet
Appendix E	Storm Design Sheet
Appendix F	Stormwater Management

Site Servicing Report

2983 Navan Road – Block 16

Gas Station, Commercial Building, Drive-Thru Restaurant & Car Wash

1.0 INTRODUCTION

1.1 General

In 2023, J.L. Richards & Associates Limited (JLR) was retained by 12714001 Canada Inc. (the Owner) to prepare the detailed design of municipal infrastructure for Site Plan Approval (SPA) of their parcel located at 2983 Navan Road. The mixed-use site known as “Block 16 - Gas Station, Commercial Building, Drive-Thru Restaurant and Car Wash” will be referred to herein as Block 16. This Site Servicing Report (SSR) presents the servicing constraints and strategies for water, wastewater, stormwater servicing, and stormwater management in accordance with the City of Ottawa Design Guidelines, the associated technical bulletins and relevant design excerpts. This SSR also includes strategies for implementing erosion and sedimentation control measures throughout the construction phase of the project.

1.2 Site Description

The Block 16 is located within the City of Ottawa’s Official Plan boundary and consists of a 0.77 ha parcel bounded by Navan Road to the south and existing residential properties to the east, the proposed East Ridge Orleans Subdivision and Future Mixed-Use Block 15 to the north, and Brian Coburn Boulevard to the west. The legal description of the subject property can be found in the Draft Plan of Subdivision attached to Appendix A.

A topographical survey was completed by Stantec Inc. in August 2023 (Appendix A). The survey indicates that the existing ground surface generally slopes downwards in a southeasterly direction towards Navan Road.

1.3 Proposed Development

The proposed commercial development will consist of a gas station including a car wash, a commercial retail space along with a Drive-Thru Restaurant. The Concept Plan for the Block 16 is attached to Appendix A.

1.4 Proposed Connections to Existing Infrastructure

The proposed site plan will be serviced via the future East Ridge Orleans Subdivision and via existing infrastructure on Navan Road as follows and as shown on the servicing drawings:

Watermain

- Connection to the proposed existing 204 mm diameter watermain along Navan Road

Sanitary

- Connection to the future East Ridge Orleans Subdivision. A 200mm sanitary sewer stub will be dropped to service Block 16 as part of this future subdivision.

Site Servicing Report

2983 Navan Road – Block 16

Gas Station, Commercial Building, Drive-Thru Restaurant & Car Wash

Storm

- Connection to the future East Ridge Orleans Subdivision. A 525 mm storm sewer stub will be dropped to service Block 16 as part of this future subdivision.

1.5 Consultation and Permits

An initial pre-consultation meeting was held on July 6, 2022, followed by a Phase 2 Pre-consultation help on September 13, 2023, each to discuss the proposed site plan, the planning approval process requirements, provide clarifications on design criteria, and high level discussion on servicing constraints. A copy of the pre-consultation meeting notes and the site servicing checklist has been provided in Appendix B.

2.0 WATER SERVICING

2.1 Water Supply Design Criteria

A Hydraulic Network Analysis (HNA) was completed as part of the detailed design for the East Ridge Orleans subdivision to confirm that the proposed watermains could provide adequate supply while complying with both the Ottawa Design Guidelines for Water Distribution (July 2010) and Technical Bulletins ISDTB-2014-02, ISTB-2018-02 and ISTB-2021-03. These documents are herein referred to as the Design Guidelines and TB-2014-02, TB-2018-02, and TB-2021-03, respectively.

The HNA completed as part of the East Ridge Orleans Subdivision design included water demands for the Commercial Site Plan (Block 16). The HNA has since been updated to reflect the proposed water service lateral for Block 16 but is based on the same demands and the boundary conditions used in the original East Ridge Orleans Subdivision HNA (refer to Appendix C for a copy of City correspondence for boundary conditions).

Section 4.2.2 of the Design Guidelines states the following criteria for development additions to the public water distribution system:

- Under maximum hourly demand conditions (peak hour), the residual pressures shall not be less than 276 kPa (40 psi);
- During periods of maximum day and fire flow demand, the residual pressure at any point in the distribution system shall not be less than 140 kPa (20 psi);
- In accordance with the Ontario Building Code (OBC) in areas that may be occupied, the static pressure at any fixture shall not exceed 552 kPa (80 psi);
- The maximum pressure at any point in the distribution system in unoccupied areas shall not exceed 689 kPa (100 psi); and
- Feeder mains, which have been provided primarily for the purpose of redundancy, shall meet, at a minimum, the basic day plus fire flow demand.

Site Servicing Report

2983 Navan Road – Block 16

Gas Station, Commercial Building, Drive-Thru Restaurant & Car Wash

2.2 Domestic Water Demands

The estimated commercial water demands presented in this section are based on the site layout proposed in the Site Plan (Appendix A). A plug flow of 3.60 L/s was added to each demand scenario to consider the demands required for the car wash (refer to Appendix D for a confirmation letter from the mechanical engineer). Table 1 summarizes the water demands projected for this site.

Table 1: Water Demands

Demand Scenario	Commercial Water Consumption or Peaking Factor	Commercial Water Demands (L/s)	Car Wash Demands (L/s)	Total Demands (L/s)
Average Day Demand	28,000 L/ha/d	0.25	3.60 L/s	3.85
Maximum Day Demand	1.5 x Avg Day	0.37	3.60 L/s	3.97
Peak Hour Demand	1.8 x Max Day	0.67	3.60 L/s	4.27

2.3 Fire Flow Requirements

The City has specified that the Fire Underwriters Survey (FUS) method shall be used for any public or private site where new fire hydrants are being designed. Specifically, the required fire flow (RFF) for each structure was calculated in accordance with TB-2018-02.

The required fire flow for the Commercial Site Plan (Block 16) was calculated to be 83 L/s. Refer to Appendix C for the detailed RFF calculations for the critical fire area.

2.4 Proposed Water Servicing, Boundary Conditions and Water Model

2.4.1 Proposed Water Servicing

Water will be supplied to the Commercial Site Plan (Block 16) by a 150 mm diameter water service that will connect to the existing 305 mm watermain on Navan Road, located east of the intersection between Navan Road and Brian Coburn Blvd. Fire protection will be provided by a new proposed hydrant within the site. As shown in the servicing plan, the car wash is serviced directly by the gas station. Design of the service will be verified by Owner's mechanical engineer however, as noted in Section 2.2, the demand from the car wash has been included in this HNA.

Watermain roughness coefficients were determined using friction factors presented in Section 4.2.12 of the Design Guidelines and the internal pipe diameters were modelled based on Section 4.3.5 of the design Guidelines.

Site Servicing Report
2983 Navan Road – Block 16
Gas Station, Commercial Building, Drive-Thru Restaurant & Car Wash

2.4.2 Boundary Conditions

Hydraulic boundary conditions were provided by the City at the proposed connection location listed in Section 2.4.1 above. Table 2 summarizes the hydraulic boundary conditions received by the City (refer to Appendix C for a copy of the City correspondence). The boundary condition for maximum day plus fire flow corresponds to a required fire flow of 100 L/s. It is noted that the fire flow demand for the City boundary condition is more conservative than the calculated fire flow requirement of 5000 L/min (83 L/s).

Table 2: Hydraulic Boundary Conditions

Demand Scenarios	Connection 3 Head (m)
Maximum HGL	130.7
Peak Hour	126.8
Max Day plus Fire Flow 6,000 L/min (100.00 L/s)	127.3

2.4.3 Water Model

A hydraulic water model within the WaterCAD® software platform was used to carry out the HNA (refer to the overall schematics presented in Appendix C). The water demands from Table 1 and the boundary conditions from Table 2 were input into the model for each demand scenario. Table 3 summarizes the watermain diameters and roughness coefficients used in the model, based on Sections 4.2.12 and 4.3.5 of the Design Guidelines.

Table 3: Watermain Internal Diameters and C-Factors

Nominal Diameter	Inside Diameter	C-Factor
150 mm	155 mm	100
200 mm	204 mm	110
300 mm	297 mm	120

2.5 Simulation Results

The HNA was carried out under steady-state peak hour, maximum day plus fire flow, and maximum pressure conditions to confirm that the proposed water servicing can meet the design criteria outlined in Section 2.1.

Site Servicing Report

2983 Navan Road – Block 16

Gas Station, Commercial Building, Drive-Thru Restaurant & Car Wash

2.5.1 Peak Hour

The simulation results found the minimum pressure at the site during the peak hour condition to be 399 kPa (57.9psi) (refer to Appendix C), which exceeds the minimum pressure criterion of 276 kPa (40 psi) per the Design Guidelines.

2.5.2 Maximum Day Plus Fire Flow

Fire water supply will be provided by a proposed hydrant off the 150 mm diameter water service for Block 16. Hydrant spacing was carried out in accordance with the Design Guidelines.

To ensure adequate fire protection, the maximum day demand shown in Table 1 was analyzed simultaneously with the fire flow requirements. The fire flow simulation was carried out by allowing WaterCAD® to calculate the maximum fire flow that can be drawn from the hydrant without allowing any part of the system to experience pressures less than 140 kPa (20 psi). Using the 6,000 L/min (100 L/s) boundary condition provided by the City (refer to Table 2), the system is expected to deliver a minimum of 6,000 L/min (100 L/s) within the site. Per Appendix I of TB-2018-02, adequate water supply can be provided by the hydrant to the proposed site.

2.5.3 Maximum Pressure

Based on a zero (0 L/s) demand condition, the simulation results found the maximum pressure at the site to be 437 kPa (63.4). This value is below the maximum pressure constraint of 552 kPa (80 psi), therefore pressure reducing valves (PRVs) are not anticipated to be required.

2.6 Summary and Conclusions

Based on the water simulation results, the proposed development can be serviced by the proposed 150 mm water service lateral connected to the 305 mm diameter watermain on Navan Road. Furthermore, adequate fire water supply can be achieved with the proposed hydrant off the 150 mm water lateral servicing Block 16.

3.0 WASTEWATER SERVICING

3.1 Design Criteria

The sanitary sewer system within the Block 16 is designed in accordance with the Ottawa Sewer Design Guidelines and subsequent technical bulletins. The design parameters are applied under two scenarios as per ISTB Technical Bulletin 2018-01. The key design parameters have been summarized in Table 4.

Site Servicing Report
2983 Navan Road – Block 16
Gas Station, Commercial Building, Drive-Thru Restaurant & Car Wash

Table 4: Wastewater Key Design Parameters

Design Parameter	Design Value
Commercial Average Flow	28,000 L/gross ha/Day
Residential Average Flow	280 L/Cap/Day
Residential Peaking Factor	Harmon's Formula
Commercial Peaking Factor	1.5
Harmon's Correction Factor (K)	0.8
Infiltration Allowance	0.33 L/s/ha
Manning's Roughness Coefficient (n)	0.013
Allowable Slopes	Varies (Refer to Section 6.1.2.2 of ODSG)
Allowable Velocities	0.6 m/s – 3.0 m/s
Allowable Freeboard	-

3.2 Proposed Sanitary Servicing and Design Flows

Wastewater generated from the Block 16 will be conveyed via a proposed 200 mm diameter sanitary sewer system. Wastewater will then discharge into the East Ridge Orleans Subdivision via a 200mm sanitary sewer stub proposed as part of the subdivision as shown on the Servicing Plan.

Wastewater flows from the proposed development are presented in the Block 16 Sanitary Design Sheet (refer to Appendix D). Based on the design criteria presented in Table 3-1 the total design peak flow of 4.23 L/s is calculated for the development which is based on the site area of 0.77ha. Table 5 summarizes the results from the sanitary design sheet.

Table 5: Sanitary Design Flow Summary

Commercial Type	Site Area	Average Flow	Com. Peak Flow	Infilt. Flow	Total Flow
Commercial Flows	0.77 ha	28,000 L/gross ha/Day	0.374 L/s	0.254 L/s	0.628 L/s
Car Wash Flows	-	-	-	-	3.6 L/s
Total Wastewater Flows – Block 16					4.23 L/s

Site Servicing Report

2983 Navan Road – Block 16

Gas Station, Commercial Building, Drive-Thru Restaurant & Car Wash

The flows from Block 16 (4.23 L/s) were incorporated in the detailed design of the sanitary sewer within the future East Ridge Orleans Subdivision thus there is sufficient downstream capacity. It is proposed to adopt the sanitary servicing strategy described in this section.

3.3 Summary and Conclusions

Wastewater servicing for Block 16 will be designed in accordance with the City of Ottawa Sewer Design Guidelines, the associated technical bulletins, and various background documents as highlighted throughout this section. Wastewater generated from the Block 16 will be conveyed via a proposed 200 mm diameter sanitary sewer outletting to the East Ridge Orleans Subdivision to the north of the site. It is recommended that this wastewater servicing plan be implemented to provide adequate sanitary servicing for the proposed development.

4.0 STORM SERVICING AND STORMWATER MANAGEMENT

4.1 Design Criteria

Storm and stormwater management servicing for the Gas Bar Site Plan (Block 16) was developed in accordance with the City of Ottawa 2012 Sewer Design Guidelines (OSDG) and the more recent Technical Bulletin PIEDTB-2016-01 (September 6, 2016). These two documents are herein referred to as the Design Guidelines in this section. A summary of the key storm and stormwater management criteria follows:

- Control minor system flows to the allowable release rates of 68 L/s as identified in Table 5-4 Site Servicing Report 2983, 3053 and 3079 Navan Road & 2690 Pagé Road, Ottawa, Ontario (JLR 2024);
- The runoff coefficients (C-factors) to be calculated based on the ratio of pervious and impervious surfaces depicted on proposed site plans;
- Minimum roadway slope of 0.1% from crest-to-crest for overland flow route;
- Maximum parking ponding depth of 350 mm (static and dynamic) as per the Design Guidelines and maximum depth of surface flow to be 300 mm;
- Minimum vertical clearance of 0.15 m between the spill elevation on the street and the finished grade;
- Major system flows, up to and including the 1:100-year design storm event, are contained within the site.
- Quality control will be accommodated by Pond #3 to meet an MECP Enhanced Level of Protection (80% TSS removal) as identified in Site Servicing Report 2983, 3053 and 3079 Navan Road & 2690 Pagé Road, Ottawa, Ontario (JLR 2023).
- Ponding in landscaped areas to enhance groundwater recharge in accordance with the City of Ottawa Urban Design Guidelines for Gas Stations, Guideline 30.
- Provide measures to ensure that site preparation and construction is in accordance with the current Best Management Practices for Erosion and Sediment Control.

Site Servicing Report

2983 Navan Road – Block 16

Gas Station, Commercial Building, Drive-Thru Restaurant & Car Wash

4.2 Proposed Stormwater Management Approach

In order to achieve the allowable release rates, the stormwater management of the site will include:

- Surface storage within the site in greater than a 1:2-year event with captured flows conveyed to the minor system;
- Controlled release of the flows captured in the minor system for the entire site using Inlet Control Devices (ICDs).
- Flows stored in oversized storage pipes underground. Flows will accumulate in the storage pipes and be released from the site via an OGS and orifice control into the minor system on Paleo Drive.

4.3 Proposed Minor System Servicing

Internal to the gas station site, two minor system sewer runs will be provided on either side of the main building structure. Both of these sewer runs will be oversized and will connect into a single manhole upstream of the connection upstream of the easement stub, upstream of Paleo Drive. The connection manhole will have a 127mm diameter orifice plate on the downstream outlet sewer to control to the allowable release rate, 68 L/s, as defined in the Site Servicing Report 2983, 3053 and 3079 Navan Road & 2690 Pagé Road, Ottawa, Ontario (JLR 2023). The upsized storm sewers will be 525mm diameter.

Downstream of the orifice an Stormceptor EFO4 model, or equivalent, will provide 80% TSS removal as well as capture of oils and spills.

The runoff coefficient is based on the ratio of impervious surfaces and areas. A design sheet for sizing of the sewers to confirm capacity for the 1:2-year rational method flow is provided in Appendix E.

The gas station roof structure is uncontrolled and drains directly to the minor system.

There are no basements and therefore no HGL constraints in the system.

4.4 Stormwater Management Modelling Approach

4.4.1 Dual Drainage Model

The analysis of both major and minor drainage systems was carried out to demonstrate their compliance with respect to the design criteria described in Section 4.6. The performance of the major overland system and minor storm sewer system was analyzed with PCSWMM. This software is a dynamic model which allows both hydrologic and hydraulic components to be simulated in the same platform and also allows the simulation of the interaction between the major and minor systems. The PCSWMM software platform was used to:

Site Servicing Report

2983 Navan Road – Block 16

Gas Station, Commercial Building, Drive-Thru Restaurant & Car Wash

- Generate the surface runoff hydrograph for each sub-area under various recurrences.
- Subdivide each inflow hydrograph into its minor and major system components based on the proposed inlet capture rates and roadway sag storage.
- Assess cascading, if any, and carry out dynamic routing of storm flows to determine flow depths along the roadways. As previously stated, the maximum major overland flow depths within the parking lot areas are to be limited to 350 mm or less, as per Technical Bulletin PIEDTB-2016-01.

PCSWMM was set-up to evaluate the proposed servicing as detailed on Drawing C01 and C02. Subcatchments were delineated for the structure roof areas, parking lot low points and landscaped low points. Model schematics are prepared in Appendix F.

4.4.2 Boundary Conditions

Boundary conditions are taken from the downstream subdivision model issued as part of the Site Servicing Report 2983, 3053 and 3079 Navan Road & 2690 Pagé Road, Ottawa, Ontario (JLR 2023).

The downstream 1:100-year HGL at the connection to the Subdivision at MH518A is identified as 81.28 m. The boundary condition in the model was set at this elevation as a constant during the storm simulations.

4.4.3 Ditch Drainage

The ditch drainage system surrounding the site currently contains a single 375mm diameter culvert at the proposed site access on Navan Road. Due to access requirements the culvert will have to be extended. Since the culvert is not to current Ottawa City design standards for the minimum driveway culvert, it is proposed to replace the undersized culvert with a new 600mm diameter culvert.

The outlet of the proposed access culvert will be such that a 1% grade on the existing ditch will be maintained to the downstream conveyance culvert under Navan Road. The Navan Road culvert inlet is lower than the proposed culvert outlet to facilitate conveyance of the stormwater and mitigate potential ponding in this ditch section.

4.5 Modelling Parameters

4.5.1 Hydrological Modelling Parameters

The following parameters were used in the hydrologic component of PCSWMM:

- **Areas and Imperviousness:** Catchment ID and drainage areas used by PCSWMM match those shown on either Drawing DST or Figure E-1 (Appendix

Site Servicing Report
2983 Navan Road – Block 16
Gas Station, Commercial Building, Drive-Thru Restaurant & Car Wash

E1). Sealed and roof areas are set at 100% impervious and other grassed or landscaped areas are pervious.

- **Catchment Width:** The catchment width is estimated at the width of overland sheet flow based on the grading of the catchment and slope direction.
- **Manning's Roughness Coefficient:** Manning's Roughness Coefficients of 0.013 and 0.25 were used for the impervious and pervious surfaces, respectively.
- **Horton Infiltration parameters:** City of Ottawa OSDG Horton Infiltration Parameters have been used in the modelling.
- **Initial Abstraction:** Initial abstraction of 4.67 mm and 1.57 mm was used for the pervious and impervious surfaces respectively, consistent with the OSDG.

4.5.2 Simulation of Storm Distributions

To assess peak flow rates and peak volume storage requirements the 3-hour Chicago storm has been simulated for the site for the 1:2-year event and 1:100-year event and the 24-hour SCS storms for the 1:100-year event.

4.6 Simulation Results

4.6.1 Low Point Ponding Analysis

Ponding depths in the low points in the parking area and landscaped areas are shown in Table 6.

Table 6: Catchbasin Ponding Depths

Low Point ID	Top of Grate (m)	Maximum Static Depth (mm)	3-hour Chicago 1:2 year Depth (mm)	3-hour Chicago 1:100 year Depth (mm)	24-hour SCS 1:100 year Depth (mm)
1	85.25	190/300	-	250	230
2A	85.35	250	-	-	-
2B	85.40	220	-	-	-
3	85.35	300	-	60	30
4	84.75	150	-	100	-
5	85.35	150	-	100	70
6	85.37	80	-	100	90

Site Servicing Report
2983 Navan Road – Block 16
Gas Station, Commercial Building, Drive-Thru Restaurant & Car Wash

Low Point ID	Top of Grate (m)	Maximum Static Depth (mm)	3-hour Chicago 1:2 year Depth (mm)	3-hour Chicago 1:100 year Depth (mm)	24-hour SCS 1:100 year Depth (mm)
7	84.55	300	-	300	160
8	85.04	270	-	290	250
9	84.80	300	-	190	130
10	85.18	240	-	150	90
11	85.12	300	-	210	170
12	85.45	150	-	90	70
13	85.50	150	-	160	150

The simulation results compiled in Table 6 shows that:

- No ponding nor dynamic flow will occur in the 1:2-year event;
- Maximum ponding depth of 300 mm during the 1:100-year event; and,
- There is no spill from the site in the 1:100-year event.

4.6.2 Site Release Rate

Table 8 below shows the release rates from the site via the 127mm diameter orifice plate. All release rates are below the 68 L/s allowable release rate.

Table 7: Release Rates

	3-hour Chicago 1:2 year Release Rate (L/s)	3-hour Chicago 1:100 year Release Rate (L/s)	24-hour SCS 1:100 year Release Rate (L/s)
Flow at MH 514	46	66	65

4.7 Water Quality

An OGS unit is proposed for the site to provide site specific water quality to 80% TSS removal and capture of oils and spills. The sizing details for the unit are contained in Appendix F. The unit sized for the site is an Stormceptor EFO4, or equivalent.

4.8 Summary and Conclusions

The stormwater servicing achieves a release rate from the site to the minor system limited to the allowable release rate and contains up to the 1:100 year on site.

Site Servicing Report

2983 Navan Road – Block 16

Gas Station, Commercial Building, Drive-Thru Restaurant & Car Wash

5.0 Erosion and Sediment Control

Erosion and sediment control measures, as outlined in the Ontario Ministry of Natural Resources (MNR) Guidelines on Erosion and Sediment Control for Urban Construction Sites, will be implemented to trap sediment on site. The following erosion and sediment control measures can be implemented during construction as shown on the Erosion and Sediment Control Plan (Drawing ESC):

- Supply and installation of a silt fence barrier, as per OPSD 219.110.
- Supply and installation of siltsack or sentinel CB inserts between the frame and cover of catch basins and maintenance holes adjacent to the project area during construction, to prevent sediment from entering the sewer system.
- Stockpiling of material during construction is to be located along flat areas away from drainage paths. For material placed on sloped areas, stockpiles are to be enclosed with a silt fence to protect watercourses.
- All catch basins are to be equipped with sumps, inspected frequently, and cleaned as required.
- Temporary ICDs are to be placed blocking part of the sewer pipe in the connecting storm maintenance holes to eliminate construction debris from entering the existing storm sewer system. The ICDs are to be removed after the proposed storm sewers have been fully cleaned.
- A mud mat is to be built at each of the site entranceways to prevent the transport of sediment onto paved surfaces. The mud mat shall be:
 - Minimum of 20 m in length for the full width of the entrance way (10 m wide minimum).
 - Minimum of 400 mm thick underlain with a geotextile (or graded aggregate filter); and
 - Constructed with 50 mm diameter clear stone for the first 10 m (extending from the paved street) and the remainder of the length with 150 mm diameter clear stone.

The proposed removal and reinstatement measures as well as the erosion control measures shall conform to the following documents:

- “Guidelines on Erosion and Sediment Control for Urban Construction Sites” published by Ontario Ministries of Natural Resources, Environment, Municipal Affairs, and Transportation & Communication, Association of Construction Authorities of Ontario and Urban Development Institute, Ontario, May 1987.
- “MTO Drainage Manual”, Chapter F: “Erosion of Materials and Sediment Control”, Ministry of Transportation & Communications, 1985.
- “Erosion and Sediment Control” Training Manual by Ministry of Environment, Spring 1998.
- Applicable Regulations and Guidelines of the Ministry of Natural Resources.

Site Servicing Report
2983 Navan Road – Block 16
Gas Station, Commercial Building, Drive-Thru Restaurant & Car Wash

6.0 CONCLUSIONS

Block 16 will be serviced as follows:

- Water servicing will be provided by connection to the proposed watermain along the Navan Road.
- Wastewater servicing will be provided by a connection to the future East Ridge Orleans Subdivision
- Storm servicing will be provided by a connection to the future East Ridge Orleans Subdivision
- Flows exceeding the allowable peak flow for Block 16, will be held on-site, using a combination of both, above ground and underground storage.

Site Servicing Report
2983 Navan Road – Block 16
Gas Station, Commercial Building, Drive-Thru Restaurant & Car Wash

This report has been prepared by J.L. Richards & Associates Limited for 12714001 CANADA INC.'s exclusive use. Its discussions and conclusions are summary in nature and cannot properly be used, interpreted or extended to other purposes without a detailed understanding and discussions with the client as to its mandated purpose, scope and limitations. This report is based on information, drawings, data, or reports provided by the named client, its agents, and certain other suppliers or third parties, as applicable, and relies upon the accuracy and completeness of such information. Any inaccuracy or omissions in information provided, or changes to applications, designs, or materials may have a significant impact on the accuracy, reliability, findings, or conclusions of this report.

This report was prepared for the sole benefit and use of the named client and may not be used or relied on by any other party without the express written consent of J.L. Richards & Associates Limited, and anyone intending to rely upon this report is advised to contact J.L. Richards & Associates Limited in order to obtain permission and to ensure that the report is suitable for their purpose.

J.L. RICHARDS & ASSOCIATES LIMITED

Prepared by:

Prepared by:

William Rugamba,
Civil Engineering Graduate

Bobby Pettigrew, P. Eng.
Senior Water Resource Engineer

Reviewed by:

Karla Ferrey, P. Eng.
Senior Associate, Manager,
Ottawa, Civil Development

Site Servicing Report
2983 Navan Road – Block 16
Gas Station, Commercial Building, Drive-Thru Restaurant & Car Wash

Appendix A

Concept Plan, Draft Plan of
Subdivision and Topographical
Survey

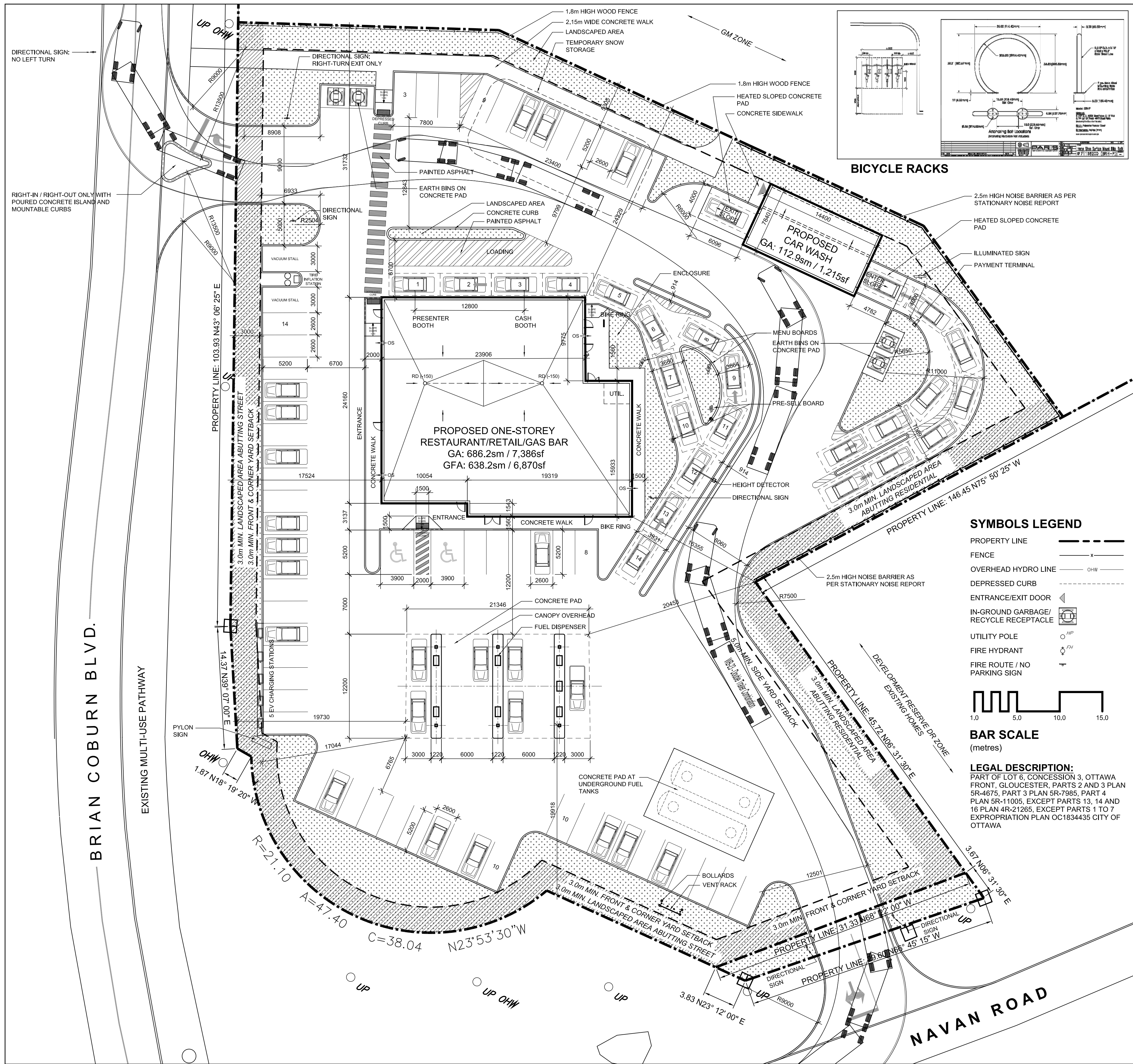

SITE INFORMATION

SITE AREA: 7,717sm / 1.93 acres

NOTE THAT PROPERTY BOUNDARY INFORMATION HAS BEEN TAKEN FROM SURVEY PREPARED BY STANTEC, DATED 12 OCTOBER 2023.

BUILDING DATA:

AREA CALCULATIONS:

Gross Area (by Ontario Building Code definition):
The total area of all floors above grade measured between the outside surfaces of exterior walls is:

Retail Building: 686.2sm / 7,386sf
Carwash Building: 112.9sm / 1,215sf
Total Gross Area: 799.1sm / 8,600sf

Gross Floor Area (City of Ottawa Zoning Bylaw definition for the purpose of determining maximum building area and parking requirements): The total floor area measured from the interior of outside walls excluding mechanical/electrical service rooms, stairwells, elevator shafts, parking/loading facilities, washrooms and storage areas:

GFA (Restaurant/Retail Bldg): 602sm / 6,480sf

ZONING

DESIGNATION: GM[2546] H(14.5)
General Mixed use, Exception 2546

PERMITTED NON RESIDENTIAL USES:

- Section 187: Convenience Store, Drive-through Facility, Restaurant, Retail Store, Car Wash, Gas Bar
- Exception 2546:

MINIMUM SETBACKS:

- Table 187(c): Front & Corner Yard: 3.0m
- Table 187(d): Interior Side Yard: 5.0m (abutting res. zone)
- Table 187(e.iii): Rear Side Yard: 7.5m (abutting res. bldg)

BUILDING HEIGHT:

- Exception 2546: 14.5m maximum permitted, 5.5m proposed

FSI:

- Table 187(g): 2.0 times coverage (15,000sm) maximum permitted, 0.1 times coverage (799.1sm) proposed

MINIMUM WIDTH OF LANDSCAPED AREA:

- Table 187(h.i): Abutting a Street: 3.0m
- Table 187(h.ii): Abutting a Res.Zone: 3.0m

PARKING:

- Table 101: Convenience Store: 3.4 cars per 100sm of GFA, Fast-Food Restaurant: 10 cars per 100sm of GFA, 9 for Convenience Store (266sm/100x3.4), 34 for Restaurant (336sm/100x10)
- Required: 61 cars (not incl. fuel dispensers & drive-through)
- Provided:

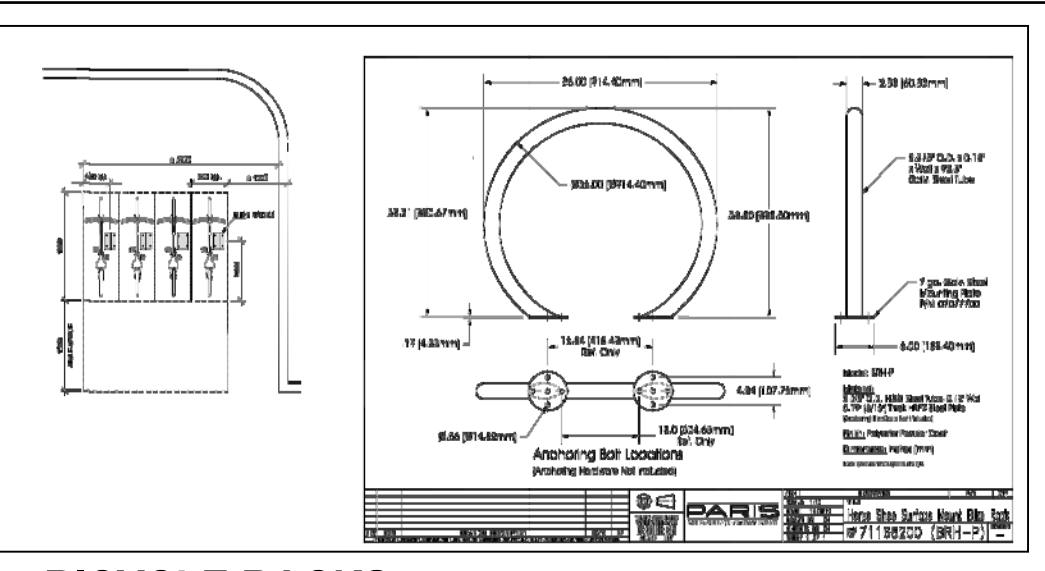

BICYCLE RACKS

SYMBOLS LEGEND

- PROPERTY LINE
- FENCE
- OVERHEAD HYDRO LINE
- DEPRESSED CURB
- ENTRANCE/EXIT DOOR
- IN-GROUND GARBAGE/RECYCLE RECEPTACLE
- UTILITY POLE
- FIRE HYDRANT
- FIRE ROUTE / NO PARKING SIGN



BAR SCALE (metres)

LEGAL DESCRIPTION:

PART OF LOT 6, CONCESSION 3, OTTAWA FRONT, GLOUCESTER, PARTS 2 AND 3 PLAN 5R-4675, PART 3 PLAN 5R-7985, PART 4 PLAN 5R-11005, EXCEPT PARTS 13, 14 AND 16 PLAN 4R-21265, EXCEPT PARTS 1 TO 7 EXPROPRIATION PLAN OC1834435 CITY OF OTTAWA

02 SITE & BUILDING DATA and ZONING REVIEW



01 LOCATION PLAN

SCALE: NTS

03 SITE PLAN

SCALE: 1:250

OWNER:
1274001 CANADA INC.
100-768 Boulevard St Joseph
Gatineau, QC J8Y 4B8

PLANNING, CIVIL & TRAFFIC CONSULTANT:
J.L.RICHARDS & ASSOCIATES LTD.
1000-343 Preston Street
Ottawa, ON K1J 1N4

LANDSCAPE ARCHITECT:
JAMES B. LENNOX & ASSOCIATES INC.
3332 Carling Avenue
Ottawa, ON K2H 5A8

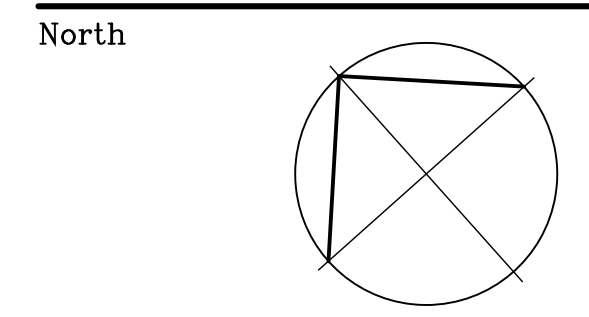

Revisions

No.	By	Description	Date
08	IW	SITE PLAN APPLICATION	08 DEC 2023
09	IW	REVISED FOR SPA	01 MAR 2024
10	IW	REVISED FOR SPA	14 AUG 2024

NEW RESTAURANT, CONVENIENCE STORE & GAS BAR

2130 BRIAN COBURN BLVD.

SITE PLAN

Scale AS SHOWN

Drawn AK / KE

Checked



Project No. 22-127

Date 12 MAY 2022

SP-A01

PLAN NO.

44-20-2033

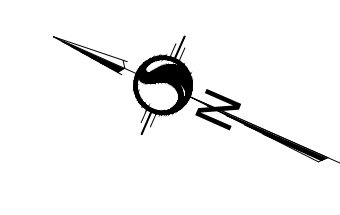

PAGE ROAD
ROAD ALLOWANCE BETWEEN LOTS 5 & 6 (AS WIDENED)
PIN 04404-0409

APPROVED UNDER SECTION 51 OF THE PLANNING ACT BY THE
CITY OF OTTAWA THIS ____ DAY OF _____ 20____

DON HERWEYER, M.C.P., R.P.P., ACTING GENERAL
MANAGER PLANNING, REAL ESTATE AND
ECONOMIC DEVELOPMENT DEPARTMENT,
CITY OF OTTAWA

PLAN 4M-

I HEREBY CERTIFY THAT THIS PLAN 4M-_____ IS REGISTERED IN THE
LAND REGISTRY OFFICE FOR THE LAND TITLES DIVISION OF
OTTAWA-CARLETON (No.4) AT _____ O'CLOCK ON THE _____ DAY OF
_____ 2023 AND ENTERED IN THE REGISTER FOR P.L.N.'s
04756-0303, 04756-0315, 04756-0316 & 04756-1337, AND THE REQUIRED
CONSENTS ARE REGISTERED AS PLAN DOCUMENT NUMBER
OC-_____
REPRESENTATIVE FOR LAND REGISTRAR

THIS PLAN COMPRISES OF ALL OF PINS 04756-0303, 04756-0315, 04756-0316 & 04756-1337.

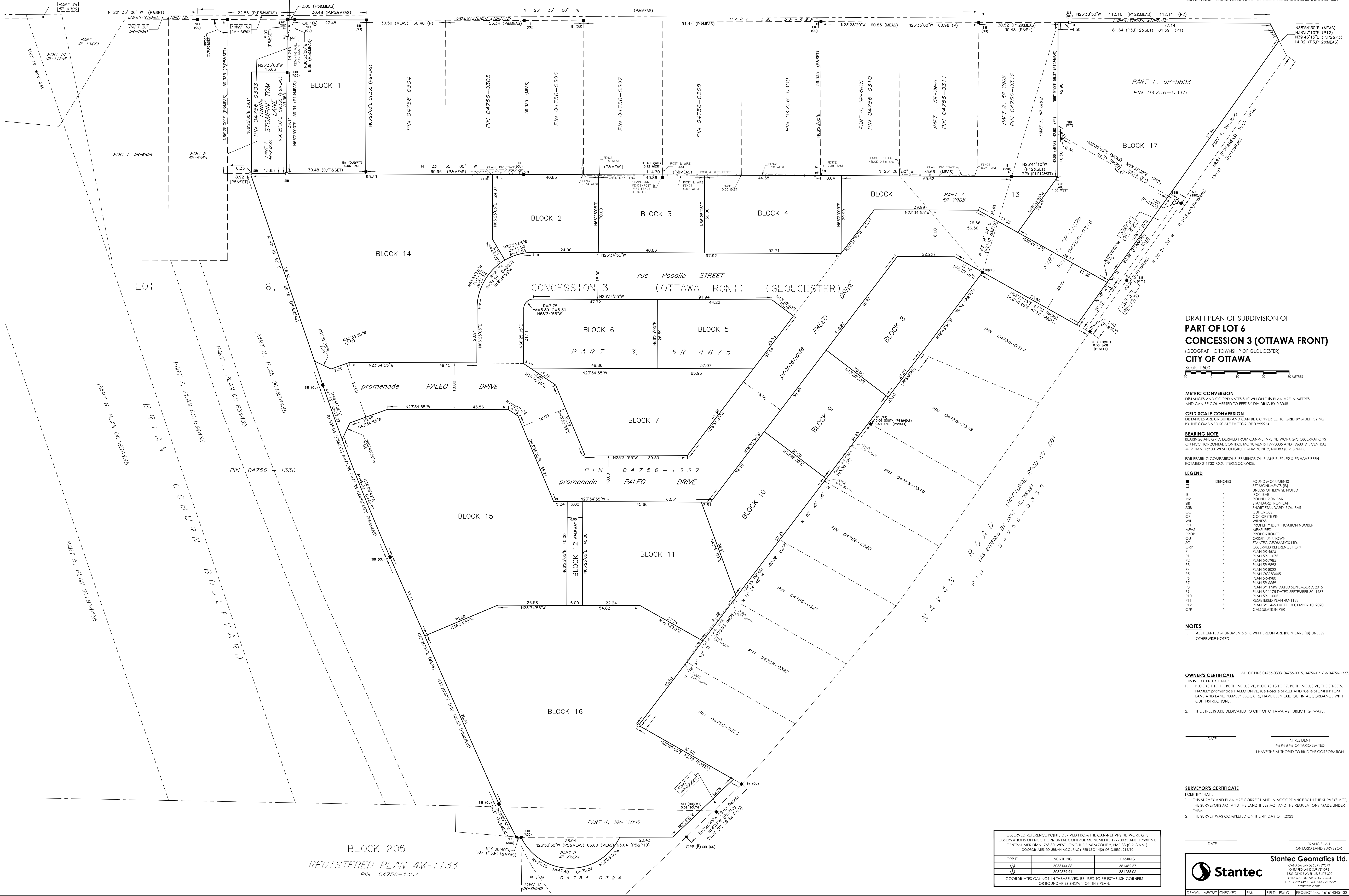

DRAFT PLAN OF SUBDIVISION OF
**PART OF LOT 6
CONCESSION 3 (OTTAWA FRONT)**
(GEOGRAPHIC TOWNSHIP OF GLOUCESTER)
CITY OF OTTAWA

Scale 1:500
0 5 10 15 20 30 METRES

METRIC CONVERSION
DISTANCES AND COORDINATES SHOWN ON THIS PLAN ARE IN METRES
AND CAN BE CONVERTED TO FEET BY DIVIDING BY 0.3048

GRID SCALE CONVERSION
DISTANCES ARE GROUND AND CAN BE CONVERTED TO GRID BY MULTIPLYING
BY THE COMBINED SCALE FACTOR OF 0.999964

BEARING NOTE
BEARINGS ARE GRID, DERIVED FROM CAN-NET VRS NETWORK GPS OBSERVATIONS
ON NCC HORIZONTAL CONTROL MONUMENTS 1977035 AND 1980191, CENTRAL
MERIDIAN, 76° 30' WEST LONGITUDE MAM ZONE 9, NAD83 (ORIGINAL).

FOR BEARING COMPARISONS, BEARINGS ON PLANS P. 1, P. 2 & P. 3 HAVE BEEN
ROTATED 0°41'30" COUNTERCLOCKWISE.

LEGEND

SYMBOL	DENOTES	FOUND MONUMENTS
□	SET MONUMENTS (B)	SET MONUMENTS (B)
○	UNLESS OTHERWISE NOTED	UNLESS OTHERWISE NOTED
IB	IRON BAR	IRON BAR
IBD	ROUND IRON BAR	ROUND IRON BAR
SB	STANDARD IRON BAR	STANDARD IRON BAR
SIB	SHORT STANDARD IRON BAR	SHORT STANDARD IRON BAR
CC	CUT CROSS	CUT CROSS
CF	CONCRETE PIN	CONCRETE PIN
WIT	WITNESS	WITNESS
FIN	PROPERTY IDENTIFICATION NUMBER	PROPERTY IDENTIFICATION NUMBER
MEAS	MEASURED	MEASURED
PROP	PROPORTIONED	PROPORTIONED
CU	ORDER UNDEROWN	ORDER UNDEROWN
SG	STANTEC GEOMATICS LTD.	STANTEC GEOMATICS LTD.
CRP	OBSERVED REFERENCE POINT	OBSERVED REFERENCE POINT
P1	PLAN SR-4475	PLAN SR-4475
P2	PLAN SR-7995	PLAN SR-7995
P3	PLAN SR-8893	PLAN SR-8893
P4	PLAN SR-8822	PLAN SR-8822
P5	PLAN OC18345	PLAN OC18345
P6	PLAN SR-4990	PLAN SR-4990
P7	PLAN SR-6659	PLAN SR-6659
P8	PLAN BY FIRM DATED SEPTEMBER 9, 2015	PLAN BY FIRM DATED SEPTEMBER 9, 2015
P9	PLAN BY 1175 DATED SEPTEMBER 30, 1987	PLAN BY 1175 DATED SEPTEMBER 30, 1987
P10	PLAN SR-11025	PLAN SR-11025
P11	REGISTERED PLAN 4M-1133	REGISTERED PLAN 4M-1133
P12	PLAN BY 1465 DATED DECEMBER 10, 2020	PLAN BY 1465 DATED DECEMBER 10, 2020
CIP	CALCULATION PIN	CALCULATION PIN

NOTES

1. ALL PLANTED MONUMENTS SHOWN HEREON ARE IRON BARS (B) UNLESS OTHERWISE NOTED.

OWNER'S CERTIFICATE

ALL OF PINS 04756-0303, 04756-0315, 04756-0316 & 04756-1337.

- BLOCKS 1 TO 11, BOTH INCLUSIVE, BLOCKS 13 TO 17, BOTH INCLUSIVE, THE STREETS, NAMELY PROMENADE PALEO DRIVE, rue Rosalie STREET and rue STONPIN TOM LANE AND LANE, NAMELY BLOCK 12, HAVE BEEN Laid OUT IN ACCORDANCE WITH OUR INSTRUCTIONS.
- THE STREETS ARE DEDICATED TO CITY OF OTTAWA AS PUBLIC HIGHWAYS.

DATE _____ PRESIDENT
ONTARIO LIMITED
I HAVE THE AUTHORITY TO BIND THE CORPORATION

SURVEYOR'S CERTIFICATE

- THIS SURVEY AND PLAN ARE CORRECT AND IN ACCORDANCE WITH THE SURVEYS ACT, THE SURVEYS ACT AND THE LAND TITLES ACT AND THE REGULATIONS MADE UNDER THEM.
- THE SURVEY WAS COMPLETED ON THE ____-DAY OF ____ 2023.

DATE _____ FRANCIS LAU
ONTARIO LAND SURVEYOR

Stantec Stantec Geomatics Ltd.
CANADA LAND SURVEYORS
ONTARIO LAND SURVEYORS
1331 CYCLE AVENUE, SUITE 300
OTTAWA, ONTARIO, CANADA K1G 3Z4
TEL: 416-752-4400 FAX: 416-752-2799
dgn@stn.com

OBSERVED REFERENCE POINTS DERIVED FROM THE CAN-NET VRS NETWORK GPS OBSERVATIONS ON NCC HORIZONTAL CONTROL MONUMENTS 1977035 AND 1980191, CENTRAL MERIDIAN, 76° 30' WEST LONGITUDE MAM ZONE 9, NAD83 (ORIGINAL). COORDINATES TO UTM ACCURACY PER SEC 1463.05 REG. 314115

CRP ID	NORTHING	EASTING
①	9233144.68	381482.57
②	9232879.91	381255.06

COORDINATES CANNOT, IN THEMSELVES, BE USED TO RE-ESTABLISH CORNERS OR BOUNDARIES SHOWN ON THIS PLAN.

BLOCK 205
REGISTERED PLAN 4M-1133
PIN 04756-1307

PART 4, 5R-11005
PIN 04756-0324

Site Servicing Report
2983 Navan Road – Block 16
Gas Station, Commercial Building, Drive-Thru Restaurant & Car Wash

Appendix B

Pre Consultation Meeting Notes
and Site Servicing Report
Checklist

Carmine Zayoun
12714001 Canada Inc (Zayoun Group)
Via email: carmine@zayoungroup.com

**Subject: Pre-Consultation: Meeting Feedback
Proposed Site Plan Application – 2983 Navan Road ‘
Gas Station and Commercial Building – PC2023-0227**

Please find below information regarding next steps as well as consolidated comments from the above-noted pre-consultation meeting held on September 13, 2023.

Pre-Consultation Preliminary Assessment

1 <input type="checkbox"/>	2 <input type="checkbox"/>	3 <input type="checkbox"/>	4 <input checked="" type="checkbox"/>	5 <input type="checkbox"/>
----------------------------	----------------------------	----------------------------	---------------------------------------	----------------------------

One (1) indicates that considerable major revisions are required while five (5) suggests that the proposal appears to meet the City’s key land use policies and guidelines. This assessment is purely advisory and does not consider technical aspects of the proposal or in any way guarantee application approval.

Next Steps

1. A review of the proposal and materials submitted for the above-noted pre-consultation has been undertaken. Please proceed to complete a Phase 2 / Phase 3 Pre-consultation Application Form and submit it together with the necessary studies and/or plans to planningcirculations@ottawa.ca.
2. In your subsequent pre-consultation submission, please ensure that all comments or issues detailed herein are addressed. A detailed cover letter stating how each issue has been addressed must be included with the submission materials. Please coordinate the numbering of your responses within the cover letter with the comment number(s) herein.
3. Please note, if your development proposal changes significantly in scope, design, or density before the Phase 3 pre-consultation, you may be required to complete or repeat the Phase 2 pre-consultation process.

Supporting Information and Material Requirements

1. The attached **Study and Plan Identification List** outlines the information and material that has been identified, during this phase of pre-consultation, as either required (R) or advised (A) as part of a future complete application submission.
 - a. The required plans and studies must meet the City’s Terms of Reference (ToR) and/or Guidelines, as available on Ottawa.ca. These ToR and Guidelines outline

the specific requirements that must be met for each plan or study to be deemed adequate.

Consultation with Technical Agencies

1. You are encouraged to consult with technical agencies early in the development process and throughout the development of your project concept. A list of technical agencies and their contact information is enclosed.

Planning

Comments:

1. In the Official Plan the subject site is designated as Neighbourhood is modified with the Evolving Neighbourhood overlay. Brian Coburn Boulevard is also designated as a Minor Corridor. The property is further identified as Low-density residential in the EUC – Phases 1 Community Design Plans (CDP). The subject lands are currently zoned GM[2546]H(14.5) General Mixed-Use, Exception.

2. Committee of Adjustment

No variances have been identified at this point. Staff will set up a meeting with a Committee of Adjustment Plan if any required.

3. Design guidelines

Urban Design Guidelines for Drive-Through Facilities

Urban Design Guidelines for Gas Stations

4. Landscape requirements

Landscape buffers will need to comply with Section 110 of the Zoning By-law and are consistent with the design guidelines.

The turning radius encroached into the landscape buffers on the demonstration plan. Ensure all landscaping is protected by barrier curbs

5. Parking requirements

Parking should comply with Sections 100, 101, 106, 109 and 111

Vehicle and bicycle parking should be situated with easily access while minimizing pavement. There seems to be a lot of pavement in front of this building.

6. Easements

Are there service easements required over the pedestrian walkway connecting this property with the subdivision?

7. Confirm that the location of the Car Wash will not become a noise problem for future residents of the townhouses behind it. Noise study will need to identify any issues and provide remediation measures.
8. Provide locations of signage and ensure that space is made available for tree planting

Urban Design

9. Relevant guidelines – The City’s Urban Design Guidelines for Gas Stations and Urban Design Guidelines for Drive-Through Facilities are both applicable to this site. The applicant should ensure their submission meets the direction of these guidelines.
10. Design Brief - A Design Brief is required. Please refer to the attached Terms of Reference for details.
11. Public realm – Please refer to the attached PDF for Urban Design comments related to the location of sidewalks, walkways and pedestrian movements on the site
12. Landscaping - Extensive tree and shrub planting is need on this site, in particular to soften the interface with the existing and future residential and to enhance the ROW.

Feel free to contact the Urban Design Planner, Christopher Moise, at Christopher.Moise@ottawa.ca , for follow-up questions

Engineering

Comments:

13. General Comments:

- a. Review of the Phase 3 submission for this application will not occur until the detailed design of the subdivision that it is within (D07-16-21-0027) is approved.
- b. At the stage of site plan approval, a condition will be imposed detailing that a commence work notification will not be issued until the subdivision’s infrastructure is in-service.

14. Engineering Studies:

- a. All engineering studies (detailed in the Study and Plan Identification List form) are to follow the to be approved draft plan of subdivision D07-16-21-0027.

- b. An interceptor pit is required with the provision of the car wash.
15. An MECP Environmental Compliance Approval **Industrial Sewage Works** will be required for the proposed development. Please contact the Ministry of the Environment, Conservation and Parks, Ottawa District Office to arrange a pre-submission consultation:

b. Emily Diamond at (613) 521-3450, ext. 238 or
Emily.Diamond@ontario.ca

Note: this site does not meet the City's requirements for ToR. To have the ECA application reviewed under ToR, a request will need to be sent to Charles Warnock (charles.warnock@ottawa.ca).

Feel free to contact Reed Adams (reed.adams@ottawa.ca), Infrastructure Project Manager, for follow-up questions.

Noise

Comments:

16. A stationary noise report for the car wash is required because of the adjacent residential.

Feel free to contact the Senior Transportation Engineer, Mike Giampa, at Mike.Giampa@ottawa.ca , for follow-up questions.

Transportation

Comments:

17. A full TIA is not required as this site is covered under the recent subdivision TIA.
18. A memo including the pertinent subdivision trips is sufficient.
19. The right of way protection on Brian Coburn and Navan Roads is 40m and 37.5m, respectively

Feel free to contact the Senior Transportation Engineer, Mike Giampa, at Mike.Giampa@ottawa.ca , for follow-up questions

Planning Forestry

Comments:

20. A Tree Conservation Report and Landscape Plan must be submitted with both SPC applications

21. A permit is required prior to any tree removal on site. The tree permit will be released upon site plan approval. Please contact the File Lead or the Planning Forester, Hayley Murray (hayley.murray@ottawa.ca) for information on obtaining the tree permit.
22. If marine clay soils are present, setbacks on City properties must adhere to the 2017 SMC guidelines (attached). The Geotechnical report must address the implications of these soils, if present, on tree planting in relation to private land.
23. If underground parking is planned, a design must be provided for the site to support tree planting
24. We expect a very strong landscape plan to re-establish canopy cover across the properties. Tree planting and protecting existing urban forest canopy is imperative to reach the City's target of 40% canopy cover.

Feel free to contact Hayley Murray, Planning Forester, for follow-up questions.

Parkland

Comments:

25. Parkland contributions were made through the Subdivision process.

Feel free to contact Jessica Button, Parks Planner, for follow-up questions.

Conservation Authority

Comments:

26. The Rideau Valley Conservation authority will be commenting on this application

Feel free to contact RVCA, for follow-up questions.

Other

27. The High Performance Development Standard (HPDS) is a collection of voluntary and required standards that raise the performance of new building projects to achieve sustainable and resilient design. The HPDS was passed by Council on April 13, 2022.
 - a. At this time, the HPDS is not in effect and Council has referred the 2023 HPDS Update Report back to staff with direction to bring forward an updated report to Committee with recommendations for revised phasing timelines, resource requirements and associated amendments to the Site Plan Control By-law by no later than Q1 2024.



- b. Please refer to the HPDS information attached and ottawa.ca/HPDS for more information.

Submission Requirements and Fees

1. Outlines the application type/subtype required and the associated fees
 - a. Additional information regarding fees related to planning applications can be found [here](#).
2. The attached **Study and Plan Identification List** outlines the information and material that has been identified as either required (R) or advised (A) as part of a future complete application submission.
 - a. The required plans and studies must meet the City's Terms of Reference (ToR) and/or Guidelines, as available on Ottawa.ca. These ToR and Guidelines outline the specific requirements that must be met for each plan or study to be deemed adequate.
3. All of the above comments or issues should be addressed to ensure the effectiveness of the application submission review.

Should there be any questions, please do not hesitate to contact myself or the contact identified for the above areas / disciplines.

Yours Truly,
Steve Belan

cc.

Tim Chadder
Raad Akrawi
Madelen Fellows
Karla Ferrey
Tatyana Roumie
Christopher Moise
Adam Reed
Mike Giampa
Haley Murray
Jessica Button

12714001 Canada Inc – Block 16 – Gas Bar, Commercial Building/Drive-Through Restaurant and Car Wash

2983 Navan Road

SITE SERVICING REPORT CHECKLIST

REFERENCED STUDIES AND REPORTS	REFERENCE
Site Servicing Report for 12714001 Canada Inc, Block 16 – Gas Bar, Commercial Building/Drive-Through Restaurant and Car Wash, 2983 Navan Road Road (J.L. Richards & Associates Limited, December 8, 2023)	Site Servicing Report

4.1	GENERAL CONTENT	REFERENCE
<input type="checkbox"/>	Executive Summary (for larger reports only).	N/A
<input checked="" type="checkbox"/>	Date and revision number of the report.	Site Servicing Report
<input checked="" type="checkbox"/>	Location map and plan showing municipal address, boundary, and layout of proposed development.	Site Servicing Report (Appendix A) All Drawings
<input checked="" type="checkbox"/>	Plan showing the site and location of all existing services.	Servicing Plan
<input checked="" type="checkbox"/>	Development statistics, land use, density, adherence to zoning and official plan, and reference to applicable subwatershed and watershed plans that provide context to which individual developments must adhere.	Site Servicing Report
<input checked="" type="checkbox"/>	Summary of Pre-consultation Meetings with City and other approval agencies.	Site Servicing Report (Appendix 'A')
<input checked="" type="checkbox"/>	Reference and confirm conformance to higher level studies and reports (Master Servicing Studies, Environmental Assessments, Community Design Plans), or in the case where it is not in conformance, the proponent must provide justification and develop a defensible design criteria.	Reference made to Stantec 2005 EUC ISSU
<input checked="" type="checkbox"/>	Statement of objectives and servicing criteria.	Site Servicing Report
<input checked="" type="checkbox"/>	Identification of existing and proposed infrastructure available in the immediate area.	Site Servicing Report Servicing Plan
<input type="checkbox"/>	Identification of Environmentally Significant Areas, watercourses and Municipal Drains potentially impacted by the proposed development (Reference can be made to the Natural Heritage Studies, if available).	N/A

<input checked="" type="checkbox"/>	Concept level master grading plan to confirm existing and proposed grades in the development. This is required to confirm the feasibility of proposed stormwater management and drainage, soil removal and fill constraints, and potential impacts to neighbouring properties. This is also required to confirm that the proposed grading will not impede existing major system flow paths.	Grading Plan
<input type="checkbox"/>	Identification of potential impacts of proposed piped services on private services (such as wells and septic fields on adjacent lands) and mitigation required to address potential impacts.	N/A
<input type="checkbox"/>	Proposed phasing of the development, if applicable.	N/A
<input checked="" type="checkbox"/>	Reference to geotechnical studies and recommendations concerning servicing.	Site Servicing Report and Drawings
<input checked="" type="checkbox"/>	All preliminary and formal site plan submissions should have the following information: <ul style="list-style-type: none"> ▪ Metric scale ▪ North arrow (including construction North) ▪ Key plan ▪ Name and contact information of applicant and property owner ▪ Property limits, including bearings and dimensions ▪ Existing and proposed structures and parking areas ▪ Easements, road widening and rights-of-way ▪ Adjacent street names 	All Drawings

4.2	SITE SERVICING REPORT: WATER	REFERENCE
<input type="checkbox"/>	Confirm consistency with Master Servicing Study, if available.	N/A
<input checked="" type="checkbox"/>	Availability of public infrastructure to service proposed development.	Site Servicing Report (Section 2.0) Servicing Plan
<input checked="" type="checkbox"/>	Identification of system constraints.	Site Servicing Report (Section 2.0) Servicing Plan
<input checked="" type="checkbox"/>	Identify boundary conditions.	Site Servicing Report (Section 2.0)
<input checked="" type="checkbox"/>	Confirmation of adequate domestic supply and pressure.	Site Servicing Report (Section 2.0)
<input checked="" type="checkbox"/>	Confirmation of adequate fire flow protection and confirmation that fire flow is calculated as per the Fire Underwriter's Survey. Output should show available fire flow at locations throughout the development.	Site Servicing Report (Section 2.0)
<input checked="" type="checkbox"/>	Provide a check of high pressures. If pressure is found to be high, an assessment is required to confirm the application of pressure reducing valves.	Site Servicing Report (Section 2.0)

<input type="checkbox"/>	Definition of phasing constraints. Hydraulic modelling is required to confirm servicing for all defined phases of the project, including the ultimate design.	N/A
<input checked="" type="checkbox"/>	Address reliability requirements, such as appropriate location of shutoff valves.	Site Servicing Report (Section 2.0)
<input type="checkbox"/>	Check on the necessity of a pressure zone boundary modification.	N/A
<input checked="" type="checkbox"/>	Reference to water supply analysis to show that major infrastructure can deliver sufficient water for the proposed land use. This includes data that shows that the expected demands under average day, peak hour and fire flow conditions provide water within the required pressure range.	Site Servicing Report (Section 2.0)
<input checked="" type="checkbox"/>	Description of the proposed water distribution network, including locations of proposed connections to the existing system, provisions for necessary looping, and appurtenances (valves, pressure reducing valves, valve chambers, and fire hydrants), including special metering provisions.	Site Servicing Report (Section 2.0) Servicing Plan
<input type="checkbox"/>	Description of off-site required feeder mains, booster pumping stations, and other water infrastructure that will be ultimately required to service proposed development, including financing, interim facilities, and timing of implementation.	N/A
<input checked="" type="checkbox"/>	Confirmation that water demands are calculated based on the City of Ottawa Design Guidelines.	Site Servicing Report (Section 2.0)
<input checked="" type="checkbox"/>	Provision of a model schematic showing the boundary conditions locations, streets, parcels, and building locations for reference.	Site Servicing Report (Section 2.0)

4.3	SITE SERVICING REPORT: WASTEWATER	REFERENCE
<input checked="" type="checkbox"/>	Summary of proposed design criteria (Note: Wet weather flow criteria should not deviate from the City of Ottawa Sewer Design Guidelines. Monitored flow data from relatively new infrastructure cannot be used to justify capacity requirements for proposed infrastructure).	Site Servicing Report (Section 3.0,
<input type="checkbox"/>	Confirm consistency with Master Servicing Study and/or justifications for deviations.	Stantec 2005 EUC ISSU
<input type="checkbox"/>	Consideration of local conditions that may contribute to extraneous flows that are higher than the recommended flows in the Guidelines. This includes groundwater and soil conditions, and age and condition of sewers.	N/A
<input checked="" type="checkbox"/>	Description of existing sanitary sewer available for discharge of wastewater from proposed development.	Site Servicing Report (Section 3.0) Servicing Plan

<input checked="" type="checkbox"/>	Verify available capacity in downstream sanitary sewer and/or identification of upgrades necessary to service the proposed development. (Reference can be made to previously completed Master Servicing Study if applicable.)	Site Servicing Report (Section 3.0)
<input checked="" type="checkbox"/>	Calculations related to dry weather and wet weather flow rates from the development in standard MOE sanitary sewer design table (Appendix 'C') format.	Site Servicing Report (Section 3.0)
<input checked="" type="checkbox"/>	Description of proposed sewer network, including sewers, pumping stations and forcemains.	Site Servicing Report (Section 3.0) Servicing Plan
<input type="checkbox"/>	Discussion of previously identified environmental constraints and impact on servicing (environmental constraints are related to limitations imposed on the development in order to preserve the physical condition of watercourses, vegetation, soil cover, as well as protecting against water quantity and quality).	N/A
<input type="checkbox"/>	Pumping stations: impacts of proposed development on existing pumping stations or requirements for new pumping station to service development.	N/A
<input type="checkbox"/>	Forcemain capacity in terms of operational redundancy, surge pressure and maximum flow velocity.	N/A
<input type="checkbox"/>	Identification and implementation of the emergency overflow from sanitary pumping stations in relation to the hydraulic grade line to protect against basement flooding.	N/A
<input type="checkbox"/>	Special considerations, such as contamination, corrosive environment, etc.	N/A

4.4	SITE SERVICING REPORT: STORMWATER	REFERENCE
<input checked="" type="checkbox"/>	Description of drainage outlets and downstream constraints, including legality of outlets (i.e., municipal drain, right-of-way, watercourse, or private property).	Site Servicing Report (Section 4.0)
<input checked="" type="checkbox"/>	Analysis of available capacity in existing public infrastructure.	Site Servicing Report (Section 4.0)
<input checked="" type="checkbox"/>	A drawing showing the subject lands, its surroundings, the receiving watercourse, existing drainage patterns, and proposed drainage pattern.	Servicing, Grading and Drainage Plans
<input checked="" type="checkbox"/>	Water quantity control objective (e.g. controlling post-development peak flows to pre-development level for storm events ranging from the 2 or 5 year event (dependent on the receiving sewer design) to 100 year return period); if other objectives are being applied, a rationale must be included with reference to hydrologic analyses of the potentially affected subwatersheds, taking into account long-term cumulative effects.	Site Servicing Report (Section 4.0)

<input checked="" type="checkbox"/>	Water Quality control objective (basic, normal or enhanced level of protection based on the sensitivities of the receiving watercourse) and storage requirements.	Site Servicing Report (Section 4.0)
<input checked="" type="checkbox"/>	Description of the stormwater management concept with facility locations and descriptions with references and supporting information.	Site Servicing Report (Section 4.0) Servicing, Grading and Drainage Plans
<input type="checkbox"/>	Setback from private sewage disposal systems.	N/A
<input type="checkbox"/>	Watercourse and hazard lands setbacks.	N/A
<input checked="" type="checkbox"/>	Record of pre-consultation with the Ontario Ministry of Environment and the Conservation Authority that has jurisdiction on the affected watershed.	Site Servicing Report (Appendix 'A')
<input type="checkbox"/>	Confirm consistency with subwatershed and Master Servicing Study, if applicable study exists.	Stantec 2005 EUC ISSU
<input checked="" type="checkbox"/>	Storage requirements (complete with calculations) and conveyance capacity for minor events (1:2 year return period) and major events (1:100 year return period).	Site Servicing Report (Section 4.0)
<input type="checkbox"/>	Identification of watercourses within the proposed development and how watercourses will be protected, or, if necessary, altered by the proposed development with applicable approvals.	N/A
<input checked="" type="checkbox"/>	Calculate pre- and post-development peak flow rates, including a description of existing site conditions and proposed impervious areas and drainage catchments in comparison to existing conditions.	Site Servicing Report (Section 4.0)
<input checked="" type="checkbox"/>	Any proposed diversion of drainage catchment areas from one outlet to another.	Site Servicing Report (Section 4.0)
<input checked="" type="checkbox"/>	Proposed minor and major systems, including locations and sizes of stormwater trunk sewers, and stormwater management facilities.	Servicing, Grading and Drainage Plans
<input type="checkbox"/>	If quantity control is not proposed, demonstration that downstream system has adequate capacity for the post-development flows up to and including the 100-year return period storm event.	Quantity control proposed per Site Servicing Report (Section 4.0)
<input type="checkbox"/>	Identification of potential impacts to receiving watercourses.	N/A
<input type="checkbox"/>	Identification of municipal drains and related approval requirements.	N/A
<input checked="" type="checkbox"/>	Description of how the conveyance and storage capacity will be achieved for the development.	Site Servicing Report (Section 4.0)

<input checked="" type="checkbox"/>	100 year flood levels and major flow routing to protect proposed development from flooding for establishing minimum building elevations (MBE) and overall grading.	Site Servicing Report (Section 4.0) Servicing, Grading and Drainage Plans
<input checked="" type="checkbox"/>	Inclusion of hydraulic analysis, including hydraulic grade line elevations.	Site Servicing Report (Section 4.0)
<input checked="" type="checkbox"/>	Description of approach to erosion and sediment control during construction for the protection of receiving watercourse or drainage corridors.	Site Servicing Report (Section 5.0) Servicing Plan
<input type="checkbox"/>	Identification of floodplains – proponent to obtain relevant floodplain information from the appropriate Conservation Authority. The proponent may be required to delineate floodplain elevations to the satisfaction of the Conservation Authority if such information is not available or if information does not match current conditions.	N/A
<input type="checkbox"/>	Identification of fill constraints related to floodplain and geotechnical investigation.	N/A

4.5	APPROVAL AND PERMIT REQUIREMENTS	REFERENCE
The Site Servicing Report shall provide a list of applicable permits and regulatory approvals necessary for the proposed development, as well as the relevant issues affecting such approval. The approval and permitting shall include but not be limited to the following:		
<input type="checkbox"/>	Conservation Authority as the designated approval agency for modification of floodplain, potential impact on fish habitat, proposed works in or adjacent to a watercourse, cut/fill permits and Approval under Lakes and Rivers Improvement Act. The Conservation Authority is not the approval authority for the Lakes and Rivers Improvement Act. Where there are Conservation Authority regulations in place, approval under the Lakes and Rivers Improvement Act is not required, except in cases of dams, as defined in the Act.	N/A
<input type="checkbox"/>	Application for Environmental Compliance Approval (ECA) under the Ontario Water Resources Act.	As part of future submission
<input type="checkbox"/>	Changes to Municipal Drains.	N/A
<input type="checkbox"/>	Other permits (National Capital Commission, Parks Canada, Public Works and Government Services Canada, Ministry of Transportation, etc.).	N/A

4.6	CONCLUSION CHECKLIST	REFERENCE
<input checked="" type="checkbox"/>	Clearly stated conclusions and recommendations.	Site Servicing Report
<input checked="" type="checkbox"/>	Comments received from review agencies, including the City of Ottawa and information on how the comments were addressed. Final sign-off from the responsible reviewing agency.	Not yet applicable

<input checked="" type="checkbox"/>	All draft and final reports shall be signed and stamped by a Professional Engineer registered in Ontario.	Site Servicing Report All Drawings

Site Servicing Report
2983 Navan Road – Block 16
Gas Station, Commercial Building, Drive-Thru Restaurant & Car Wash

Appendix C

Water Servicing

WATERMAIN DEMAND CALCULATION SHEET

PROJECT : NAVAN ROAD DEVELOPMENT PROJECT - GAS BAR
LOCATION : CITY OF OTTAWA
DEVELOPER : 12714001 Canada Inc.

NODE	RESIDENTIAL			NON-RESIDENTIAL	AVERAGE DAILY DEMAND (l/s)				MAXIMUM DAILY DEMAND (l/s)				PEAK HOUR DEMAND (l/s)			
	UNITS		POP'N	COMM (ha.)	Res.	Non-res.	Plug flow	Total	Res.	Non-res.	Plug flow	Total	Res.	Non-res.	Plug flow	Total
	Townhouses (TH)	Condo Units (CU)														
J-14	0	0	0	0.77	0.00	0.25	3.60	3.85	0.00	0.37	3.60	3.97	0.00	0.67	3.60	4.27
TOTALS	0	0	0	0.77	0.00	0.25	3.60	3.85	0.00	0.37	3.60	3.97	0.00	0.67	3.60	4.27

ASSUMPTIONS			
RESIDENTIAL DENSITIES			AVG. DAILY DEMAND
- Townhouse (TH)	2.7	p / p / u	- Residential 280 l / cap / day
			- Institutional 28,000 l / ha / day
- Condo Units (CU)	1.8	p / p / u	- Commercial 28,000 l / ha / day
			MAX. DAILY DEMAND
			- Residential 700 l / cap / day
			- Institutional 42,000 l / ha / day
			- Commercial 42,000 l / ha / day
			MAX. HOURLY DEMAND
			- Residential 1,540 l / cap / day
			- Institutional 75,600 l / ha / day
			- Commercial 75,600 l / ha / day

FUS Fire Flow Calculations

NAVAN ROAD DEVELOPMENT PROJECT - Commercial Building
(JLR 29899-002)

Step	Parameter	Value	Note
A	Type of Construction	Non-combustible	
	Coefficient (C)	0.8	
B	Ground Floor Area	686 m ²	Commercial area consisting of a Gas Retail and Drive Thru
C	Height in storeys	1 storeys	Basements are excluded.
	Total Floor Area	686 m ²	
D	Fire Flow Formula	F=220C√A	
	Fire Flow	4610 L/min	
	Rounded Fire Flow	5000 L/min	Flow rounded to nearest 1000 L/min.
E	Occupancy Class	Combustible	
	Occupancy Charge	0%	
	Occupancy Increase or Decrease	0	
	Fire Flow	5000 L/min	No rounding applied.
F	Sprinkler Protection	None	
	Sprinkler Credit	0%	
	Decrease for Sprinkler	0 L/min	
G	<i>North Side Exposure</i>		
	Exposing Wall:	Non-combustible	Gas Retail/Drive Thru
	Exposed Wall:	Wood Frame	4 Storey Condo Unit
	Length of Exposed Wall:	32.2 m	
	Height of Exposed Wall:	4 storeys	
	Length-Height Factor	128.6 m-storeys	
	Separation Distance	38.96 m	
	North Side Exposure Charge	5%	
	<i>East Side Exposure</i>		
	Exposing Wall:	Non-combustible	Gas Retail/Drive Thru
	Exposed Wall:	Wood Frame	
	Length of Exposed Wall:	0.0 m	
	Height of Exposed Wall:	0 storeys	
	Length-Height Factor	0.0 m-storeys	
	Separation Distance	46 m	
East Side Exposure Charge	0%		
<i>South Side Exposure</i>			
Exposing Wall:	Non-combustible		
Exposed Wall:	Wood Frame		
Length of Exposed Wall:	0.0 m		
Height of Exposed Wall:	0 storeys		
Length-Height Factor	0.0 m-storeys		
Separation Distance	46 m	Over 45 m to next structure	
South Side Exposure Charge	0%		
<i>West Side Exposure</i>			
Exposing Wall:	Non-combustible	Gas Retail/Drive Thru	
Exposed Wall:	Wood Frame		
Length of Exposed Wall:	0.0 m		
Height of Exposed Wall:	0 storeys		
Length-Height Factor	0.0 m-storeys		
Separation Distance	46 m	Over 200 m to next structure	
West Side Exposure Charge	0%		
Total Exposure Charge	5%	The total exposure charge is below the maximum value of 75%.	
Increase for Exposures	250 L/min		
H	Fire Flow	5250 L/min	
	Rounded Fire Flow	5000 L/min	Flow rounded to nearest 1000 L/min.
City Cap (RFF)	Required Fire Flow	5000 L/min	
		83 L/s	

Fire Underwriters Survey (FUS) Fire Flow Calculations
In accordance with City of Ottawa Technical Bulletin ISTB-2018-02 dated March 21, 2018

FUS Fire Flow Calculations

NAVAN ROAD DEVELOPMENT PROJECT - Commercial Building
(JLR 29899-002)

Step	Parameter	Value	Note
A	Type of Construction	Non-combustible	
	Coefficient (C)	0.8	
B	Ground Floor Area	107 m ²	Commercial Buildign - Car Wash
C	Height in storeys	1 storeys	Basements are excluded.
	Total Floor Area	107 m ²	
D	Fire Flow Formula	F=220C√A	
	Fire Flow	1821 L/min	
	Rounded Fire Flow	2000 L/min	Flow rounded to nearest 1000 L/min.
E	Occupancy Class	Combustible	
	Occupancy Charge	0%	
	Occupancy Increase or Decrease	0	
	Fire Flow	2000 L/min	No rounding applied.
F	Sprinkler Protection	None	
	Sprinkler Credit	0%	
	Decrease for Sprinkler	0 L/min	
G	<i>North Side Exposure</i>		
	Exposing Wall:	Non-combustible	Car Wash
	Exposed Wall:	Wood Frame	Townhomes
	Length of Exposed Wall:	14.4 m	
	Height of Exposed Wall:	2 storeys	
	Length-Height Factor	28.9 m-storeys	
	Separation Distance	18.81 m	
	North Side Exposure Charge	12%	
	<i>East Side Exposure</i>		
	Exposing Wall:	Non-combustible	Car Wash
	Exposed Wall:	Wood Frame	
	Length of Exposed Wall:	0.0 m	
	Height of Exposed Wall:	0 storeys	
	Length-Height Factor	0.0 m-storeys	
	Separation Distance	46 m	
	East Side Exposure Charge	0%	
	<i>South Side Exposure</i>		
	Exposing Wall:	Non-combustible	Car Wash
	Exposed Wall:	Non-combustible	Gas Retail/Drive Thru
	Length of Exposed Wall:	5.4 m	
	Height of Exposed Wall:	0 storeys	
	Length-Height Factor	0.0 m-storeys	
	Separation Distance	32.22 m	Over 45 m to next structure
	South Side Exposure Charge	5%	
	<i>West Side Exposure</i>		
	Exposing Wall:	Non-combustible	Gas Retail/Drive Thru
	Exposed Wall:	Wood Frame	
Length of Exposed Wall:	0.0 m		
Height of Exposed Wall:	0 storeys		
Length-Height Factor	0.0 m-storeys		
Separation Distance	46 m	Over 200 m to next structure	
West Side Exposure Charge	0%		
Total Exposure Charge	17%	The total exposure charge is below the maximum value of 75%.	
Increase for Exposures	340 L/min		
H	Fire Flow	2340 L/min	
	Rounded Fire Flow	2000 L/min	Flow rounded to nearest 1000 L/min.
City Cap (RFF)	Required Fire Flow (RFF)	2000 L/min	
		33 L/s	

Fire Underwriters Survey (FUS) Fire Flow Calculations
In accordance with City of Ottawa Technical Bulletin ISTB-2018-02 dated March 21, 2018

William Rugamba

From: William Rugamba
Sent: July 15, 2024 4:00 PM
To: William Rugamba
Subject: FW: Navan Subdivision - Boundary Condition Request
Attachments: NavanSubdivision_Boundary Condition(4july2024).docx

William Rugamba, M.Eng., B.A.Sc., EIT
Civil Engineering Graduate
Ottawa, ON
Work: [343-804-4374](tel:343-804-4374)

From: Polyak, Alex <alex.polyak@ottawa.ca>
Sent: Monday, July 15, 2024 10:12 AM
To: Mahad Musse <mmusse@jlrichards.ca>
Cc: Karla Ferrey <kferrey@jlrichards.ca>; Raad Akrawi <rakrawi@groupeheafey.com>; Carmine Zayoun <carmine@zayoungroup.com>; Armstrong, Justin <justin.armstrong@ottawa.ca>; Tatyana Roumie <troumie@jlrichards.ca>
Subject: RE: Navan Subdivision - Boundary Condition Request

[CAUTION] This email originated from outside JLR. Do not click links or open attachments unless you recognize the sender and know the content is safe. Do not forward suspicious emails, if you are unsure, please send a separate message to Helpdesk.

Good morning Mahad,

Please find the boundary conditions attached.

Regards,

Oleksandr (Alex) Polyak, B.Eng., C.E.T., P.Eng. 

Project Manager, Infrastructure Approvals, Development Review East Branch | Gestionnaire de projet, Direction de l'examen des projets d'aménagement – Est.
Planning, Development and Building Services Department (PDBS) | Direction générale des services de la planification, de l'aménagement et du bâtiment (DGSPAB)

City of Ottawa | Ville d'Ottawa
110 Laurier Ave., 4th Fl East, Ottawa ON K1P 1J1
Email: alex.polyak@ottawa.ca
Cell : 613-857-4380
www.Ottawa.ca



From: Mahad Musse <mmusse@jlrichards.ca>

Sent: July 12, 2024 1:31 PM

To: Polyak, Alex <alex.polyak@ottawa.ca>

Cc: Karla Ferrey <kferrey@jlrichards.ca>; Raad Akrawi <rakrawi@groupeheafey.com>; Carmine Zayoun <carmine@zayoungroup.com>; Armstrong, Justin <justin.armstrong@ottawa.ca>; Tatyana Roumie <troumie@jlrichards.ca>

Subject: RE: Navan Subdivision - Boundary Condition Request

CAUTION: This email originated from an External Sender. Please do not click links or open attachments unless you recognize the source.

ATTENTION : Ce courriel provient d'un expéditeur externe. Ne cliquez sur aucun lien et n'ouvrez pas de pièce jointe, excepté si vous connaissez l'expéditeur.

Hi Alex,

Just wondering if you have a status update for the boundary conditions for Navan.

Thanks
Mahad



Mahad Musse, B.Eng., EIT
Civil Engineering Graduate

1000-343 Preston Street
Ottawa, ON, K1S 1N4

Work: [343-633-1501](tel:343-633-1501)
mmusse@jlrichards.ca

From: Mahad Musse <mmusse@jlrichards.ca>

Sent: Wednesday, July 3, 2024 11:02 AM

To: Polyak, Alex <alex.polyak@ottawa.ca>

Cc: Karla Ferrey <kferrey@jlrichards.ca>; Raad Akrawi <rakrawi@groupeheafey.com>; Carmine Zayoun <carmine@zayoungroup.com>; Armstrong, Justin <justin.armstrong@ottawa.ca>; Tatyana Roumie <troumie@jlrichards.ca>

Subject: RE: Navan Subdivision - Boundary Condition Request

Good morning Alex,

As we discussed last week our Client is looking into the option of converting the row townhouse units into duplex units (townhouse units with apartments in the basement). As a result, this will increase the total demand on the site and we will therefore require new water boundary conditions. We'd like to note that the footprint of the blocks will not change and neither will their layout or any of the offsets.

As a summary:

- Domestic demands were calculated based on a daily consumption rate of 280 L/cap/day with peaking factors consistent with City of Ottawa Guidelines
- Required Fire Flow (RFF) was calculated in accordance to the Fire Underwriters Survey (FUS) Water Supply for Public Fire Protection and the City of Ottawa FUS protocol (Bulletin ISDTB-2014-02 & Bulletin ISDTB-2018-02), which considers material, expose distance & height. We have attached the calculation spreadsheet and the figure.

We request boundary conditions under high pressure, peak hour, and maximum day + fire flow conditions (for each of the below fire flows). Domestic demand and fire flow calculations are attached. Please provide the boundary conditions at the proposed connection locations as shown in the attached figure.

Average Day Demand: 6.74 L/s

Maximum Day Demand: 10.53 L/s

Peak Hour Demand: 18.17 L/s

Required Fire Flow (per FUS): 6,000 L/min (100 L/s)

Required Fire Flow (per FUS): 10,000 L/min (167 L/s)

Required Fire Flow (per FUS): 14,000 L/min (233 L/s)

Required Fire Flow (per FUS): 15,000 L/min (250 L/s)

For your reference, the previous boundary condition received from the City is attached and below is the email chain.

If you have any questions or comments please let us know.

Thanks
Mahad



Mahad Musse, B.Eng., EIT
Civil Engineering Graduate

1000-343 Preston Street
Ottawa, ON, K1S 1N4

Work: [343-633-1501](tel:343-633-1501)
mmusse@jlrichards.ca

From: Polyak, Alex <alex.polyak@ottawa.ca>

Sent: Thursday, August 17, 2023 3:01 PM

To: William Rugamba <wrugamba@jlrichards.ca>

Cc: Karla Ferrey <kferrey@jlrichards.ca>; Raad Akrawi <rakrawi@groupeheafey.com>; Carmine Zayoun <carmine@zayoungroup.com>; Shahira Jalal <sjalal@jlrichards.ca>

Subject: RE: Navan Subdivision - Boundary Condition Request

[CAUTION] This email originated from outside JLR. Do not click links or open attachments unless you recognize the sender and know the content is safe. Do not forward suspicious emails, if you are unsure, please send a separate message to Helpdesk.

Hello William,

Sorry that I missed your call, I was in a meeting. The boundary conditions are attached.

Regards,

Oleksandr (Alex) Polyak, B.Eng., P.Eng

Project Manager, Infrastructure Approvals, Development Review East Branch | Gestionnaire de projet, Direction de l'examen des projets d'aménagement – Est. Planning, Real Estate and Economic Development Department | Direction générale de la planification, des biens immobiliers et du développement économique

City of Ottawa | Ville d'Ottawa
110 Laurier Ave., 4th Fl East, Ottawa ON K1P 1J1
Email: alex.polyak@ottawa.ca
Cell : 613-857-4380
www.Ottawa.ca



From: William Rugamba <wrugamba@jlrichards.ca>
Sent: August 15, 2023 9:26 AM
To: Polyak, Alex <alex.polyak@ottawa.ca>
Cc: Karla Ferrey <kferrey@jlrichards.ca>; Raad Akrawi <rakrawi@groupeheafey.com>; Carmine Zayoun <carmine@zayoungroup.com>; Shahira Jalal <sjalal@jlrichards.ca>
Subject: RE: Navan Subdivision - Boundary Condition Request

CAUTION: This email originated from an External Sender. Please do not click links or open attachments unless you recognize the source.

ATTENTION : Ce courriel provient d'un expéditeur externe. Ne cliquez sur aucun lien et n'ouvrez pas de pièce jointe, excepté si vous connaissez l'expéditeur.

Good morning Alex,

Just wanted to follow up on the status of this boundary request. Please let me know if you need anything else from us.

Thanks,
William

William Rugamba, M.Eng.
Civil Engineering Intern

J.L. Richards & Associates Limited
1000-343 Preston Street, Ottawa, ON K1S 1N4
Direct: 343-804-4374



From: Tatyana Roumie
Sent: Tuesday, July 25, 2023 3:53 PM
To: 'alex.polyak@ottawa.ca' <alex.polyak@ottawa.ca>
Cc: Karla Ferrey <kferrey@jlrichards.ca>; Raad Akrawi <rakrawi@groupeheafey.com>; carmine@zayoungroup.com; Shahira Jalal <sjalal@jlrichards.ca>
Subject: Navan Subdivision - Boundary Condition Request

Hello Alex.

To support our upcoming detailed design for the site, we are requesting updated boundary conditions for the 3079 Navan Road Development.

As a brief history, we received boundary conditions from the City in July 2021 (attached, but with incorrect connection locations) and again in April 2022 (also attached) in support of the functional servicing design. We understand from the April 2022 boundary conditions that the maximum available fire flow for the site is 250 L/s.

We are currently requesting updated boundary conditions for this site as we are commencing the detailed servicing design and this request will accommodate the recent site plan changes and proposed connection points. This request is also applicable to the upcoming site plan designs which will be submitted as separate applications.

We request boundary conditions under high pressure, peak hour, and maximum day + fire flow conditions (for each of the below fire flows). Domestic demand and fire flow calculations are attached. Please provide the boundary conditions at the proposed connection locations as shown in the attached figure.

Average Day Demand: 6.44 L/s
Maximum Day Demand: 9.77 L/s
Peak Hour Demand: 16.50 L/s
Required Fire Flow (per FUS): 6,000 L/min (100 L/s)
Required Fire Flow (per FUS): 10,000 L/min (167 L/s)
Required Fire Flow (per FUS): 14,000 L/min (233 L/s)
Required Fire Flow (per FUS): 15,000 L/min (250 L/s)

Thanks,
Tatyana

This e-mail originates from the City of Ottawa e-mail system. Any distribution, use or copying of this e-mail or the information it contains by other than the intended recipient(s) is unauthorized. Thank you.

Le présent courriel a été expédié par le système de courriels de la Ville d'Ottawa. Toute distribution, utilisation ou reproduction du courriel ou des renseignements qui s'y trouvent par une personne autre que son destinataire prévu est interdite. Je vous remercie de votre collaboration.

'
'
This e-mail originates from the City of Ottawa e-mail system. Any distribution, use or copying of this e-mail or the information it contains by other than the intended recipient(s) is unauthorized. Thank you.

Le présent courriel a été expédié par le système de courriels de la Ville d'Ottawa. Toute distribution, utilisation ou reproduction du courriel ou des renseignements qui s'y trouvent par une personne autre que son destinataire prévu est interdite. Je vous remercie de votre collaboration.

Boundary Conditions Navan Subdivision

Provided Information

Scenario	Demand	
	L/min	L/s
Average Daily Demand	404	6.74
Maximum Daily Demand	632	10.53
Peak Hour	1,090	18.17
Fire Flow Demand #1	6,000	100.00
Fire Flow Demand #2	10,000	166.67
Fire Flow Demand #3	14,000	233.33
Fire Flow Demand #4	15,000	250.00

Location



Results

Connection 1 - Page Road

Demand Scenario	Head (m)	Pressure¹ (psi)
Maximum HGL	130.7	64.0
Peak Hour	127.0	58.6
Max Day plus Fire Flow #1	128.2	60.4
Max Day plus Fire Flow #2	126.8	58.3
Max Day plus Fire Flow #3	124.9	55.7
Max Day plus Fire Flow #4	124.4	55.0

¹ Ground Elevation = 85.7 m

Connection 2 - Navan Road East

Demand Scenario	Head (m)	Pressure¹ (psi)
Maximum HGL	130.7	71.4
Peak Hour	126.8	65.9
Max Day plus Fire Flow #1	127.7	67.1
Max Day plus Fire Flow #2	125.5	64.1
Max Day plus Fire Flow #3	122.7	60.1
Max Day plus Fire Flow #4	121.9	58.9

¹ Ground Elevation = 80.5 m

Connection 3 - Navan Road West

Demand Scenario	Head (m)	Pressure¹ (psi)
Maximum HGL	130.7	69.3
Peak Hour	126.8	63.8
Max Day plus Fire Flow #1	127.3	64.5
Max Day plus Fire Flow #2	124.6	60.6
Max Day plus Fire Flow #3	120.9	55.3
Max Day plus Fire Flow #4	119.8	53.8

¹ Ground Elevation = 81.9 m

Disclaimer

The boundary condition information is based on current operation of the city water distribution system. The computer model simulation is based on the best information available at the time. The operation of the water distribution system can change on a regular basis, resulting in a variation in boundary conditions. The physical properties of watermains deteriorate over time, as such must be assumed in the absence of actual field test data. The variation in physical watermain properties can therefore alter the results of the computer model simulation. Fire Flow analysis is a reflection of available flow in the watermain; there may be additional restrictions that occur between the watermain and the hydrant that the model cannot take into account.

Gas Bar, Commercial Building, and Car Wash (Block 16) Model Schematic

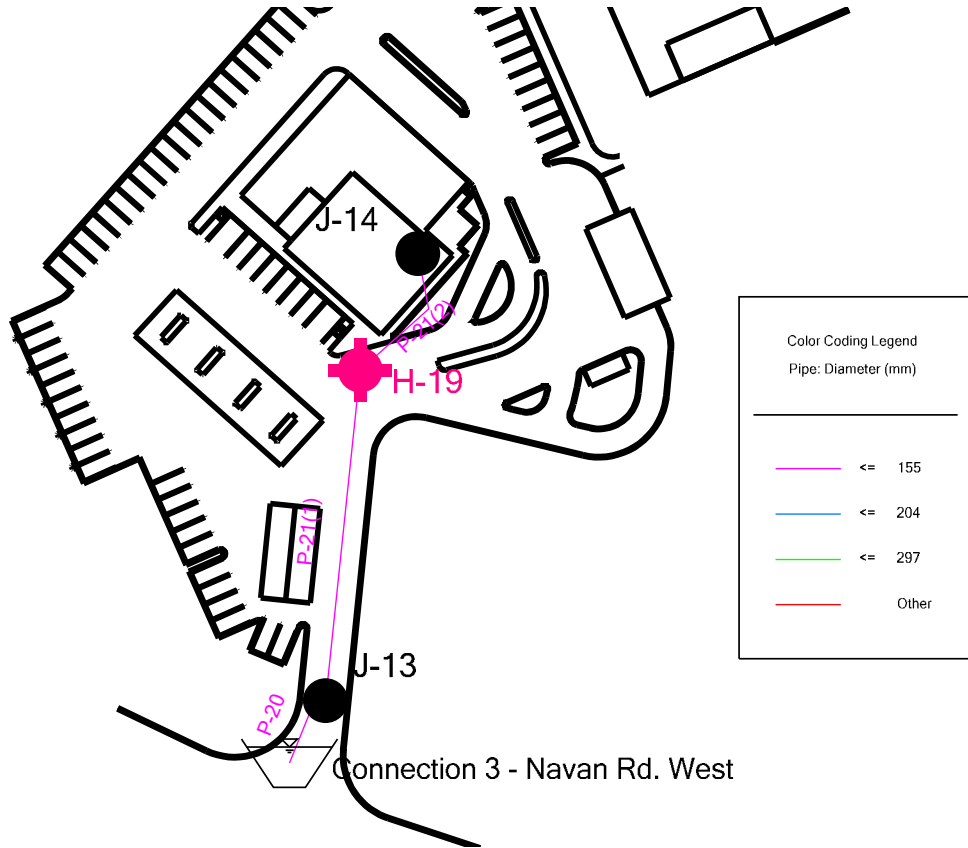

Gas Bar, Commercial Building, and Car Wash (Block 16)

Model Schematic

Elevation Model

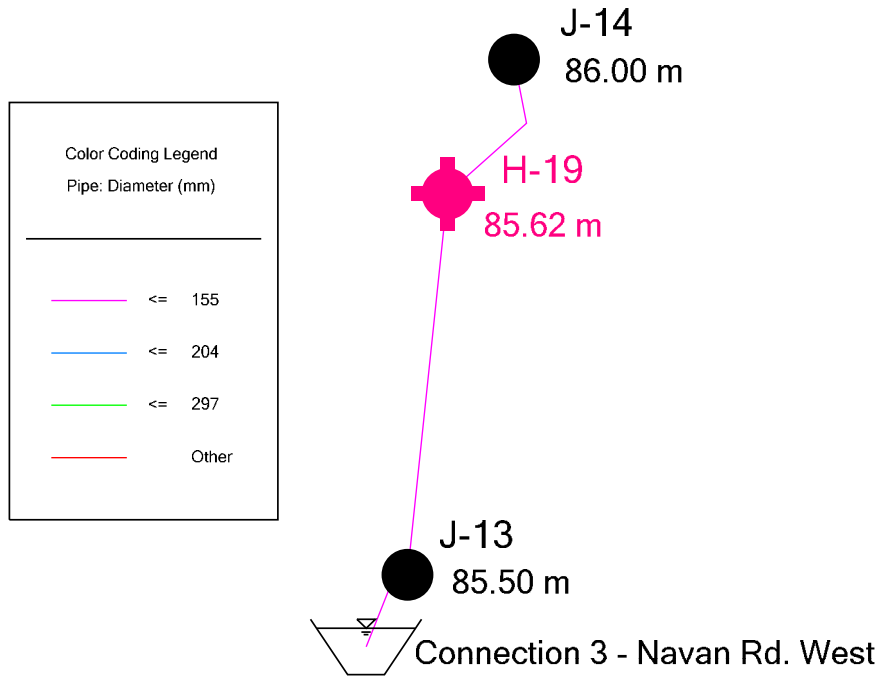

Gas Bar, Commercial Building, and Car Wash (Block 16) Peak Hour Demand

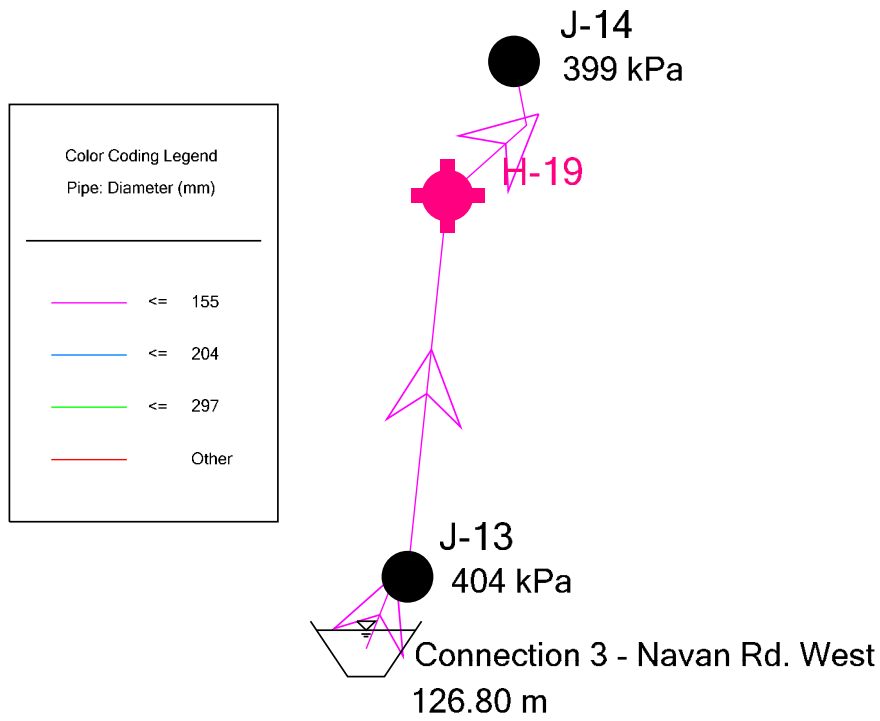

Gas Bar, Commercial Building, and Car Wash (Block 16)
Peak Hour Demand
Junction Table

Label	Elevation (m)	Demand (L/s)	Hydraulic Grade (m)	Pressure (kPa)
J-14	86.00	4.27	126.74	399
J-13	85.50	0.00	126.79	404

Gas Bar, Commercial Building, and Car Wash (Block 16)
Peak Hour Demand
Pipe Table

ID	Label	Length (Scaled) (m)	Diameter (mm)	Material	Hazen-Williams C	Flow (L/s)	Velocity (m/s)
61	P-20	11	155	PVC	100.0	4.27	0.23
175	P-21(1)	49	155	PVC	100.0	4.27	0.23
176	P-21(2)	22	155	PVC	100.0	4.27	0.23

Gas Bar, Commercial Building, and Car Wash (Block 16)

Max Day + Fire Flow Requirement

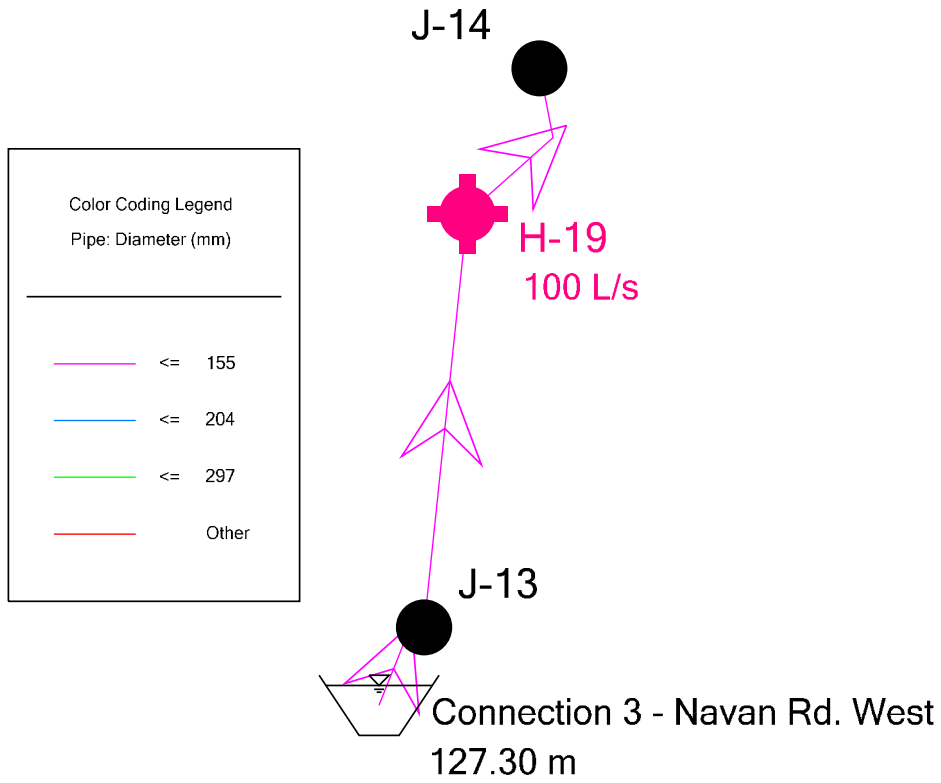

Gas Bar, Commercial Building, and Car Wash (Block 16)
Max Day + Fire Flow Requirement

Label	Satisfies Fire Flow Constraints?	Fire Flow (Available) (L/s)	Flow (Total Available) (L/s)	Pressure (Residual Lower Limit) (kPa)	Pressure (Calculated Residual) (kPa)	Pressure (Calculated System Lower Limit) (kPa)	Junction w/ Minimum Pressure (System)
H-19	True	100	100	140	224	238	J-14

Gas Bar, Commercial Building, and Car Wash (Block 16) Maximum Pressure Analysis

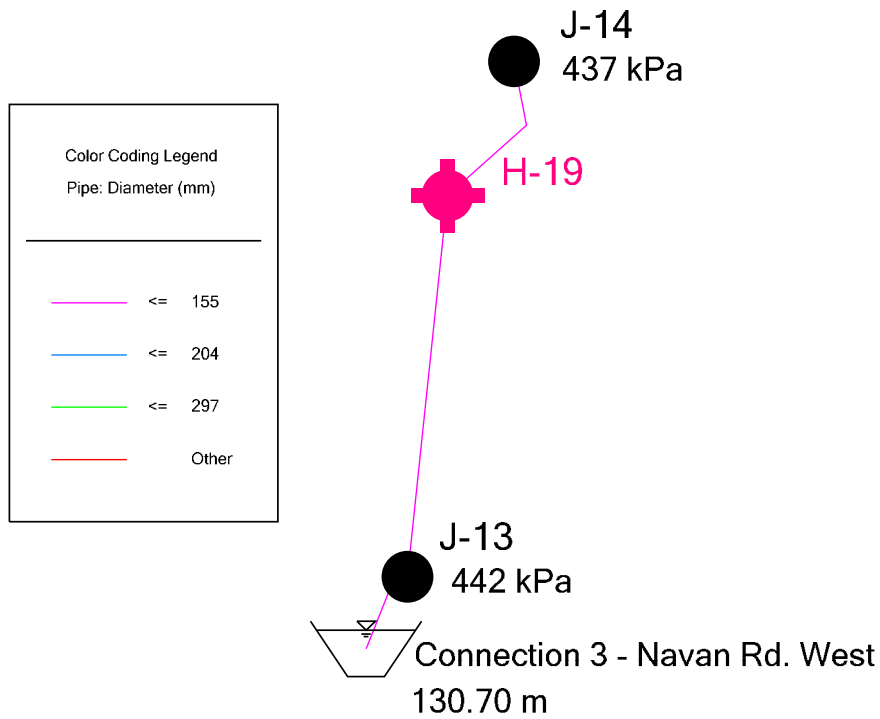

Gas Bar, Commercial Building, and Car Wash (Block 16)

Maximum Pressure Analysis

Junction Table

Label	Elevation (m)	Demand (L/s)	Hydraulic Grade (m)	Pressure (kPa)
J-14	86.00	0	130.70	437
J-13	85.50	0	130.70	442

Gas Bar, Commercial Building, and Car Wash (Block 16)

Maximum Pressure Analysis

Pipe Table

ID	Label	Length (Scaled) (m)	Diameter (mm)	Material	Hazen-Williams C	Flow (L/s)	Velocity (m/s)
61	P-20	11	155	PVC	100.0	0	0.00
175	P-21(1)	49	155	PVC	100.0	0	0.00
176	P-21(2)	22	155	PVC	100.0	0	0.00

Site Servicing Report
2983 Navan Road – Block 16
Gas Station, Commercial Building, Drive-Thru Restaurant & Car Wash

Appendix D
Sanitary Design Sheet

Street Name	MH No.		Residential								Commercial/Institutional				Infiltration			Peak Design Flow L/s	Pipe Data							Upstream Geometry				Downstream Geometry							
	From	To	Multiples	Apartments	Area (ha)	Pop.	Cum. Pop.	Cum. Area (ha)	Peaking Factor	Residential Flow (L/s)	Area (ha)	Cum. Area (ha)	Peaking Factor	Inst. Flow (L/s)	Plug Flow (L/s)	Area (ha)	Cum. Area (ha)		Peak Extr. Flow L/s	Dia	Type	Actual Diameter	Slope	Q Full (L/s)	V Full	Length	Residual Capacity	% Full	TG From	Obvert	Invert	Cover	TG TO	Drop	Obvert	Invert	Cover
GAS STATION	GAS BAR	22			0.00	0	0	0.00	3.80	0.00	0.77	0.77	1.50	0.37		0.77	0.77	0.25	0.63	200	Circular	203.20	1.00%	34.22	1.06	27.26	33.59	2%	86.000	83.369	83.165	2.631	85.590	0.510	83.096	82.893	2.494
GAS STATION	CAR WASH	22			0.00	0	0	0.00	3.80	0.00		0.00	1.50	0.00	3.60	0.00	0.00	3.60	200	Circular	203.20	1.00%	34.22	1.06	5.91	30.62	11%	85.770	82.705	82.502	3.065	85.590	0.060	82.646	82.443	2.944	
GAS STATION TO EXISTING STUB	22	STUB 16			0.00	0	0	0.00	3.80	0.00		0.77	1.50	0.37	3.60	0.00	0.77	0.25	4.23	200	Circular	203.20	0.65%	27.59	0.85	2.02	23.36	15%	85.590	82.586	82.383	3.004	85.350		82.573	82.370	2.777
EXISTING STUB TO PALEO DRIVE	STUB 16	21	0	0	0.04	0	0	0.04	3.80	0.00		0.77	1.50	0.37	3.60	0.04	0.81	0.27	4.24	200	Circular	203.20	0.65%	27.59	0.85	38.75	23.34	15%	85.350	82.573	82.370	2.777	85.041		82.321	82.118	2.720

Design Parameters	
Single Family Population	3.4 Cap/Unit
Semi-Detached/Townhouse Population	2.7 Cap/Unit
Apartments Population	1.8 Cap/Unit
Residential Flows	280 L/Cap/Day
Infiltration Flows	0.33 L/s/ha
Correction Factor	0.8
Commercial Peak Factor	1.5
Institutional/Commercial Average Flow	28000 L/gross ha/d
Manning Coefficient	0.013



Friday, August 16, 2024

J. L. Richards
1000-343 Preston St.
Ottawa, Ontario, K1S 1N4

Attn: W. Rugamba

Re: 2983 Navan Road, Ontario - Gas Bar-Commercial-QM&E Project # 23-047
Confirmations

Dear William,

This letter serves as confirmation of items you sent by e-mail August 12, 2024.

1. Maximum domestic water flow rate is 57 gpm (3.60 L/s).
2. That quantity was arrived at by referring to data provided by the client's car wash specialist.
3. The design of the oil interceptor has been completed, it will be located entirely within the walls of the car wash building.

Please do not hesitate to contact us should you have any questions or comments.

Yours truly,

A handwritten signature in black ink, appearing to read 'C. W. Clark', with a stylized flourish at the end.

C. W. Clark, P.Eng
QM&E Engineering
CC: by you to whom it may concern

Site Servicing Report
2983 Navan Road – Block 16
Gas Station, Commercial Building, Drive-Thru Restaurant & Car Wash

Appendix E

Storm Design Sheet

PIPE REACH			Peak Flow Estimation										Sewer Data								Upstream Geometry					Downstream Geometry					Self Cleansing Velocities						
LOCATION	From MH	To MH	C-Factor (1:2)		Total Area (ha)	Cum. Total Area (ha)	Inlet Time (min.)	In Pipe Flow Time (min)	Total Time	1:2 Year Storm (RATIONAL METHOD)				Plug Flows Orifice Flow ⁽¹⁾ MH518 (L/s)	Total Peak Flow ⁽⁵⁾ (L/s)	Type	Nominal Dia. (mm)	Actual Dia. (mm)	Slope	Length (m)	Q Full (L/s)	V Full (m/s)	Residual Capacity ⁽⁶⁾ (L/s)	% Full	TG From	Obvert	Invert	Cover	TG To	Drop	Obvert	Invert	Cover	Q/Qf Ratio	Flow Depth (mm)	Actual Velocity ⁽⁷⁾ (m/s)	Flow Depth to Dia. Ratio (d/D)
			0.20	0.90						2.78AR	Cum. 2.78AR	1:2 Year Intensity (mm/hr)	1:2 Year Peak Flow (L/s)																								
GAS STATION	MH520	MH519	0.055	0.265	0.32	0.32	10.00	0.75	10.75	0.69	0.69	76.81	53.33	53.33	CONCRETE	625	533.40	0.40%	57.15	284.46	1.27	231.14	19%	85.374	83.320	82.787	2.05	85.709	0.060	83.090	82.557	2.62	0.19	156.29	0.98	0.29	
GAS STATION	MH519	MH518			0.00	0.32	10.75	0.38	11.12	0.00	0.69	74.05	51.41	51.41	CONCRETE	625	533.40	0.50%	31.97	317.25	1.42	265.64	16%	85.709	83.030	82.497	2.68	85.468	1.062	82.871	82.337	2.69	0.16	145.08	1.04	0.27	
GAS STATION	MH522	MH521	0.066	0.168	0.23	0.23	10.00	0.53	10.53	0.46	0.46	76.81	35.15	35.15	CONCRETE	525	533.40	0.50%	45.09	317.25	1.42	282.10	11%	85.505	83.016	82.482	2.49	85.630		82.790	82.257	2.84	0.11	119.48	0.93	0.22	
GAS STATION	MH521	MH518	0.030	0.149	0.18	0.41	10.53	0.38	10.91	0.39	0.85	74.83	63.33	63.33	CONCRETE	625	533.40	0.35%	27.21	265.81	1.19	202.48	24%	85.630	82.790	82.257	2.84	85.468	0.876	82.695	82.161	2.77	0.24	177.09	0.98	0.33	
GAS STATION	MH518	MH518A	0.021	0.016	0.04	0.77	11.12	0.29	11.41	0.05	1.59	72.74	115.83	66.14	66.14	CONCRETE	450	457.20	0.25%	15.62	148.72	0.91	32.89	78%	85.468	81.819	81.361	3.65	85.591	0.300	81.780	81.322	3.81	0.44	213.51	0.88	0.47
EAST ORLEANS RIDGE SUBDIVISION	EXST MH518A	EXST MH514 ⁽⁸⁾	Refer to Note 8		1.07		11.41	0.83	12.24	2.29	2.29	71.78	164.59	Refer to Note 5	CONCRETE	625	533.40	0.25%	50.21	224.33	1.00	99.74	73%	85.400	81.480	80.946	3.92	84.620		81.354	80.821	3.27				Refer to Note 8	

Design Parameters (Per OSDG)	
Manning's Coefficient =	0.013
1:2 Year Intensity =	732.951 / (Tc + 6.199) ^{0.810}
Note: Tc is the time of concentration in minutes	

Drainage Areas Breakdown	
Total Site Area:	0.77 ha
Controlled Area Within Site Property Line:	0.77 ha -->
Existing Navan Rd Rear-Yard Area Captured Within Site:	0.05 ha
Block 15 Rear-Yard area captured in 518A-514:	0.07 ha
Subdivision Block 11 Rear-Yard Area in 518A-514:	0.14
Existing Navan Rd Rear-Yard Area Captured in 518A-514:	0.04
Total Captured Areas:	1.07
Uncontrolled Area - Outlet to Subdivision:	0.00 ha -->

Notes on Plug Flows	
(1) Orifice Flow Rate from Block 16	

Notes on Peak Flow and Pipe Sizing	
(5) Peak flows are lower than the allowable release rate for Block 16 (68 L/s)	
(6) Pipes are conservatively sized for 1:2 Year Peak Flow Rate	
(7) Actual Velocities based on actual peak flows from Note 5	
(8) Details from Existing Sewers Downstream of EXST MH518A (referred to as STUB 16) can be found within East Orleans Ridge Subdivision Design Sheet. This line is only used to carry over the downstream values for time of concentration and 1:2 year peak flow	

Site Servicing Report
2983 Navan Road – Block 16
Gas Station, Commercial Building, Drive-Thru Restaurant & Car Wash

Appendix F

Stormwater Management

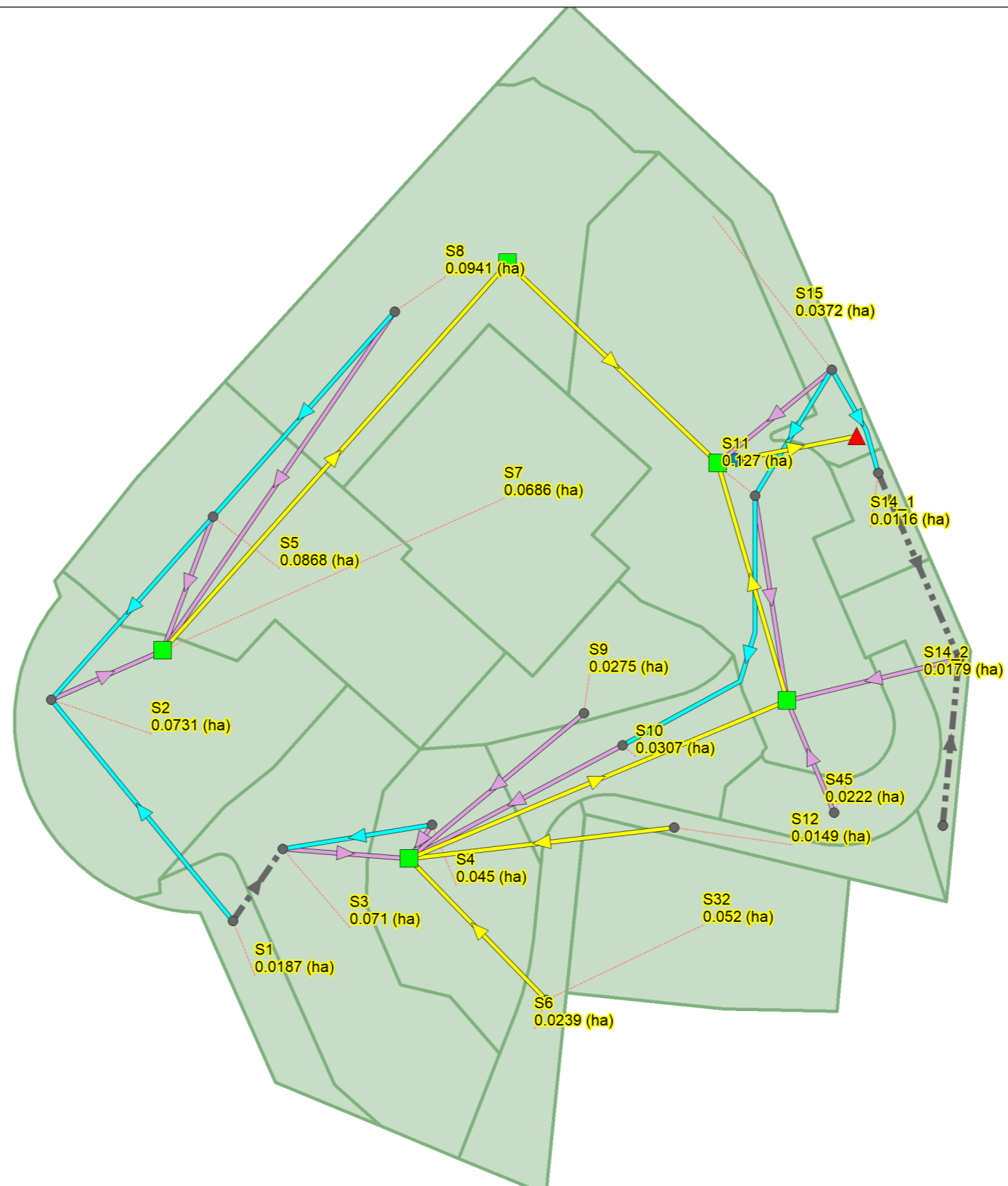

Legend

- Junctions
- ▲ Outfalls
- Manholes
- Catchbasins
- Storm Sewers
- Weirs
- Outlets
- Subcatchments



35 m

PROJECT:

**2983 Navan Road - Block 16
Ottawa ON**

DRAWING:

Overall System Model Schematic



This drawing is copyright protected and may not be reproduced or use for purposes other than execution of the described work without the express written consent of J.L. Richards & Associates Limited.

DESIGN:	ML	JLR NO.:	29899-002
DRAWN:	ML	DRAWING NO.:	Figure 3
CHECKED:	BP		

File Location: P:\29000\298899-002 - Navan Subdivision\05-Production\01-Civil\298899-002 C PRE-DST.dwg

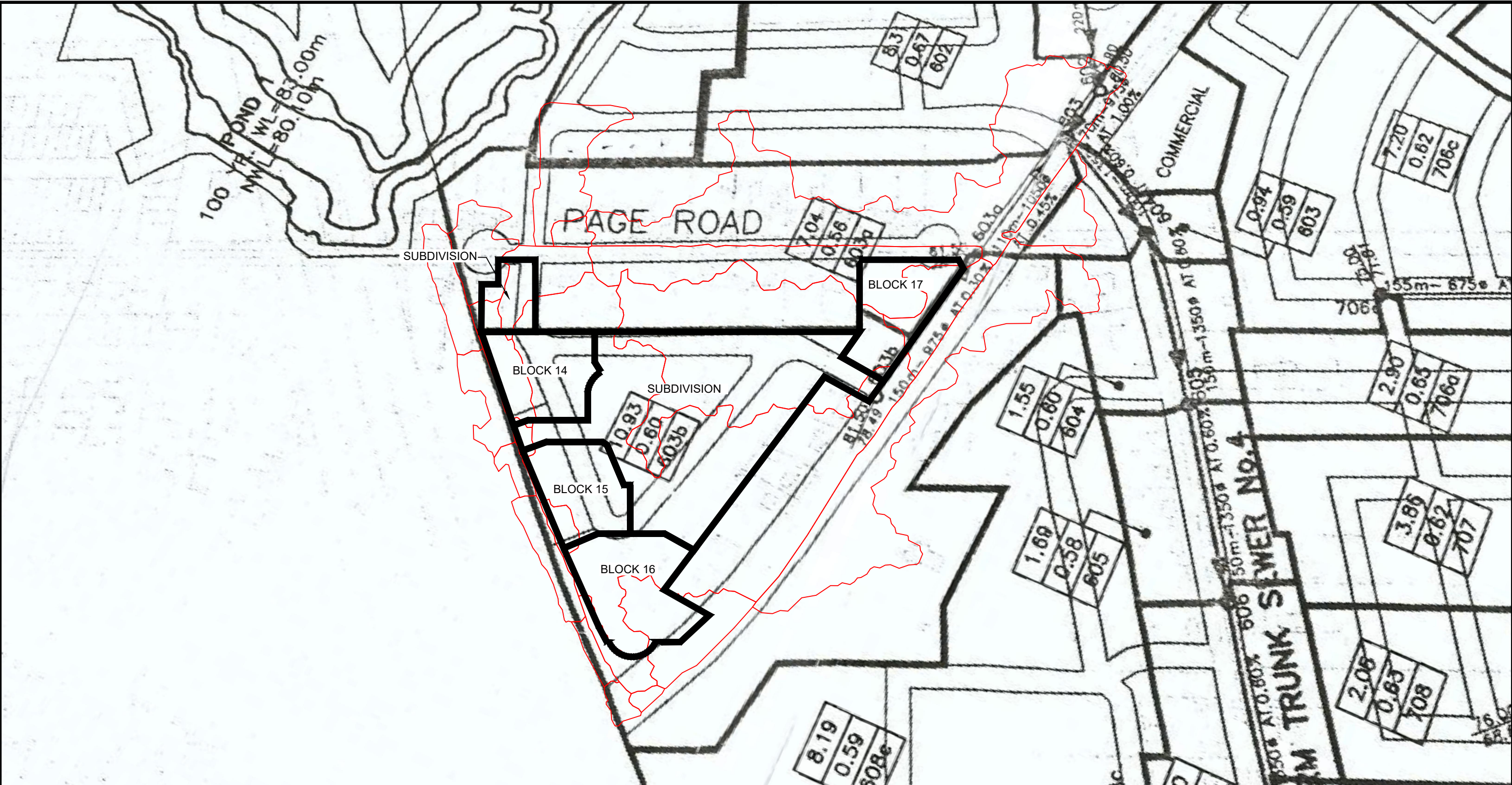

LEGEND:

- PRE-DEVELOPMENT DRAINAGE AREAS
- NAVAN SITE PLAN AND SUBDIVISION BOUNDARY

NOTE:
 UNDERLYING CATCHMENT DELINEATION FROM GLOUCESTER EUC INFRASTRUCTURE SERVICING UPDATE 2005 WHICH INFORMED THE ALLOWABLE RELEASE RATES FROM THE SITE AND NO PRE-DEVELOPMENT MODELLING WAS REQUIRED

PROJECT:	2983, 3053 AND 3079 NAVAN RD & 2690 PAGE RD		
DRAWING:	PRE-DEVELOPMENT DRAINAGE PLAN		
 <small>www.jrichards.ca</small> J.L. Richards <small>ENGINEERS-ARCHITECTS-PLANNERS</small>	DESIGN:	BP	FIGURE
	DRAWN:	KC	
CHECKED:	BP		
JLR #:	298899-002		
		DRAWING #:	

This drawing is copyright protected and may not be reproduced or used for purposes other than execution of the described work without the express written consent of J.L. Richards & Associates Limited.

PLOT DATE: July 26, 2024 2:27:18 PM

Post-Development 3-hour Chicago 1:2 year Event

[TITLE]												521_(P-Stm)	81.957	3.673	0	FUNCTIONAL	0	0	1.13	0	
;Project Title/Notes												;Cylindrical Structure Slab Top Circular Frame SI									
[OPTIONS]												522_(P-Stm)	82.182	3.323	0	FUNCTIONAL	0	0	1.13	0	
;Option Value												;85.1800000001676									
FLOW UNITS LFS												CB200	83.18	2.32	0	TABULAR	CB200	0	0	0	0
INFILTRATION HORTON												;85.5000000001435									
FLOW ROUTING DYNWAVE												CB201	83.09	2.66	0	TABULAR	CB201	0	0	0	0
LINK OFFSETS ELEVATION												;85.36									
MIN SLOPE 0												CB202	82.76	2.89	0	TABULAR	CB202	0	0	0	0
ALLOW PONDING NO												;85.3500000000931									
SKIP STEADY_STATE NO												CB203	82.75	2.9	0	TABULAR	CB203	0	0	0	0
START_DATE 01/01/2000												;85.3500080822731									
START_TIME 01:00:00												CB204	82.75	2.75	0	TABULAR	CB204	0	0	0	0
REPORT_START_DATE 01/01/2000												;85.4500080823662									
REPORT_START_TIME 00:00:00												CB205	82.85	2.75	0	TABULAR	CB205	0	0	0	0
END_DATE 01/01/2000												;85.48									
END_TIME 06:00:00												CB206	82.77	2.73	0	TABULAR	CB206	0	0	0	0
SWEEP_START 01/01												;85.05									
SWEEP_END 12/31												CB207	83.15	2.3	0	TABULAR	CB207	0	0	0	0
DRY_DAYS 0												;84.9000080821652									
REPORT_STEP 00:01:00												CB208	83.3	2.04	0	TABULAR	CB208	0	0	0	0
WET_STEP 00:01:00												;84.8									
DRY_STEP 00:01:00												CB209	83.2	1.9	0	TABULAR	CB209	0	0	0	0
ROUTING_STEP 1												;85.25									
RULE_STEP 00:00:00												CB210B	82.65	3	0	TABULAR	CB210B	0	0	0	0
INERTIAL DAMPING PARTIAL												;85.35									
NORMAL FLOW LIMITED BOTH												CB211	83.7	1.9	0	TABULAR	CB211	0	0	0	0
FORCE MAIN EQUATION H-W												;85.4									
VARIABLE_STEP 0.75												CB212	83.2	2.42	0	TABULAR	CB212	0	0	0	0
LENGTHENING_STEP 0												;85.5000000000554									
MIN SURFACE 8												CB212A	83.62	2	0	TABULAR	CB212A	0	0	0	0
MAX TRIALS 8												;84.75									
HEAD TOLERANCE 0.0015												CB213	83.15	1.75	0	TABULAR	CB213	0	0	0	0
SYS_FLOW_TOL 5												;84.55									
LAT_FLOW_TOL 5												CB214	82.95	1.9	0	TABULAR	CB214	0	0	0	0
MINIMUM_STEP 0.5												;85.4									
THREADS 12												CB212	83.2	2.42	0	TABULAR	CB212	0	0	0	0
[EVAPORATION]												;85.5000000000554									
;Data Source Parameters												CB212A	83.62	2	0	TABULAR	CB212A	0	0	0	0
;CONSTANT 0.0												;84.75									
;DRY_ONLY NO												CB213	83.15	1.75	0	TABULAR	CB213	0	0	0	0
[RAINGAGES]												;84.55									
;Name Format Interval SCF Source												CB214	82.95	1.9	0	TABULAR	CB214	0	0	0	0
3CHI002 INTENSITY 0:10 1.0 TIMESERIES 3CHI002												;85.4									
3CHI100 INTENSITY 0:10 1.0 TIMESERIES 3CHI100												CB212	83.2	2.42	0	TABULAR	CB212	0	0	0	0
[SUBCATCHMENTS]												;85.5000000000554									
;Name Rain Gage Outlet Area %Imperv Width %Slope CurbLen												CB212A	83.62	2	0	TABULAR	CB212A	0	0	0	0
;Subcatchment												;84.75									
S10 3CHI002 CB208 0.0187 0.061 23.61 2.2 0												CB213	83.15	1.75	0	TABULAR	CB213	0	0	0	0
S11 3CHI002 CB204 0.0307 99.617 55.32 2.2 0												;84.55									
S12 3CHI002 CB202 0.127 86.66 65.66 2.2 0												CB214	82.95	1.9	0	TABULAR	CB214	0	0	0	0
S14_1 3CHI002 CB213 0.0149 0.253 6.44 2.2 0												;85.4									
S14_2 3CHI002 CB211 0.0116 52.747 22.78 2.2 0												CB212	83.2	2.42	0	TABULAR	CB212	0	0	0	0
S15 3CHI002 CB212 0.0179 31.754 58.12 2.2 0												;85.5000000000554									
S2 3CHI002 CB210B 0.0372 25.766 108.74 2.2 0												CB213	83.15	1.75	0	TABULAR	CB213	0	0	0	0
S3 3CHI002 CB209 0.0731 63.05 33.61 2.2 0												;84.75									
S32 3CHI002 CB207 0.071 96.627 45.79 2.2 0												CB214	82.95	1.9	0	TABULAR	CB214	0	0	0	0
S4 3CHI002 CB214 0.052 14.286 29.7 2.2 0												;85.4									
S45 3CHI002 CB206 0.045 99.974 24.67 2.2 0												CB212	83.2	2.42	0	TABULAR	CB212	0	0	0	0
S5 3CHI002 CB203 0.0222 99.961 14.32 2.2 0												;85.5000000000554									
S6 3CHI002 CB200 0.0868 89.897 82.96 2.2 0												CB213	83.15	1.75	0	TABULAR	CB213	0	0	0	0
S7 3CHI002 520_(P-Stm) 0.0239 0.002 40.3 2.2 0												;84.75									
S8 3CHI002 CB201 0.0686 100 25.95 2.2 0												CB214	82.95	1.9	0	TABULAR	CB214	0	0	0	0
S9 3CHI002 CB205 0.0941 80.117 35.06 2.2 0												;85.4									
												CB212	83.2	2.42	0	TABULAR	CB212	0	0	0	0
												;85.5000000000554									
[SUBAREAS]												;84.75									
;Subcatchment N-Imperv N-Periv S-Imperv S-Periv PctZero RouteTo PctRouted												CB213	83.15	1.75	0	TABULAR	CB213	0	0	0	0
S10 0.013 0.25 1.57 4.67 0 OUTLET												;84.55									
S11 0.013 0.25 1.57 4.67 0 OUTLET												;85.4									
S12 0.013 0.25 1.57 4.67 0 OUTLET												CB214	82.95	1.9	0	TABULAR	CB214	0	0	0	0
S14_1 0.013 0.25 1.57 4.67 0 PERVIOUS 100												;85.4									
S14_2 0.013 0.25 1.57 4.67 0 PERVIOUS 100												CB212	83.2	2.42	0	TABULAR	CB212	0	0	0	0
S15 0.013 0.25 1.57 4.67 0 PERVIOUS 100												;85.5000000000554									
S2 0.013 0.25 1.57 4.67 0 OUTLET												;84.75									
S3 0.013 0.25 1.57 4.67 0 OUTLET												CB214	82.95	1.9	0	TABULAR	CB214	0	0	0	0
S32 0.013 0.25 1.57 4.67 0 PERVIOUS 80												;85.4									
S4 0.013 0.25 1.57 4.67 0 OUTLET												;85.5000000000554									
S45 0.013 0.25 1.57 4.67 0 IMPERVIOUS 100												CB213	83.15	1.75	0	TABULAR	CB213	0	0	0	0
S5 0.013 0.25 1.57 4.67 0 IMPERVIOUS 100												;84.75									
S6 0.013 0.25 1.57 4.67 0 OUTLET												;85.4									
S7 0.013 0.25 1.57 4.67 0 OUTLET												CB214	82.95	1.9	0	TABULAR	CB214	0	0	0	0
S8 0.013 0.25 1.57 4.67 0 IMPERVIOUS 100												;85.4									
S9 0.013 0.25 1.57 4.67 0 OUTLET												;85.5000000000554									
[INFILTRATION]												;84.75									
;Subcatchment Param1 Param2 Param3 Param4 Param5												CB212	83.2	2.42	0	TABULAR	CB212	0	0	0	0
S10 76.2 13.2 4.14 7 0												;85.4									
S11 76.2 13.2 4.14 7 0												CB213	83.15	1.75	0	TABULAR	CB213	0	0	0	0
S12 76.2 13.2 4.14 7 0												;85.5000000000554									
S14_1 76.2 13.2 4.14 7 0												CB214	82.95	1.9	0	TABULAR	CB214	0	0	0	0
S14_2 76.2 13.2 4.14 7 0												;84.75									
S15 76.2 13.2 4.14 7 0												CB212	83.2	2.42	0	TABULAR	CB212	0	0	0	0
S2 76.2 13.2 4.14 7 0												;85.4									
S3 76.2 13.2 4.14 7 0												CB213	83.15	1.75	0	TABULAR	CB213	0	0	0	0
S32 76.2 13.2 4.14 7 0												;85.5000000000554									
S4 76.2 13.2 4.14 7 0												CB214	82.95	1.9	0	TABULAR	CB214	0	0	0	0
S45 76.2 13.2 4.14 7 0												;84.75									
S5 76.2 13.2 4.14 7 0												CB212	83.2	2.42	0	TABULAR	CB212	0	0	0	0
S6 76.2 13.2 4.14 7 0												;85.4									
S7 76.2 13.2 4.14 7 0												CB213	83.15	1.75	0	TABULAR	CB213	0	0	0	0
S8 76.2 13.2 4.14 7 0												;85.5000000000554									
S9 76.2 13.2 4.14 7 0												CB214	82.95	1.9	0	TABULAR	CB214	0	0	0	0
[JUNCTIONS]												;84.75									
;Name Elevation MaxDepth InitDepth SurDepth Aponded												CB212	83.2	2.42	0	TABULAR	CB212	0	0	0	0
518_Orifice 81.361 4.106 0 0 0												;85.4									
[OUTFALLS]												;85.5000000000554									
;Name Elevation Type Stage Data Gated Route To												CB213	83.15	1.75	0	TABULAR	CB213	0	0	0	0
;Cylindrical Structure Slab Top Circular Frame SI												;84.75									
518A_(P-Stm) 80.646 FIXED 81.2 NO												CB214	82.95	1.9	0	TABULAR	CB214	0	0	0	0
[STORAGE]												;85.4									
;Name Elev. MaxDepth InitDepth Shape Curve Name/Params												CB212	83.2	2.42	0	TABULAR	CB212	0	0	0	0
SurDepth Evap Psi Ksat IMD												;85.5000000000554									
;Cylindrical Structure Slab Top Circular Frame SI												CB213	83.15	1.75	0	TABULAR	CB213	0	0	0	0
518_(P-Stm) 81.061 4.406 0.139 FUNCTIONAL 0 0 1.13 0												;84.75									
;Cylindrical Structure Slab Top Circular Frame SI												CB214	82.95	1.9	0	TABULAR	CB214	0	0	0	0
519_(P-Stm) 82.197 3.512 0 FUNCTIONAL 0 0 1.13 0												;85.4									
;Cylindrical Structure Slab Top Circular Frame SI												CB212	83.2	2.42	0	TABULAR	CB212	0	0	0	0
520_(P-Stm) 82.487 2.888 0 FUNCTIONAL 0 0 1.13 0												;85.5000000000554									
;Cylindrical Structure Slab Top Circular Frame SI												CB213	83.15	1.75	0	TABULAR	CB213	0	0	0	0
												;84.75									
												CB214	82.95	1.9	0	TABULAR	CB214	0	0	0	0
												;85.4									
												CB212	83.2	2.42	0	TABULAR	CB212	0	0	0	0
												;85.5000000000554									
												CB213	83.15	1.75	0	TABULAR	CB213	0	0	0	0
												;84.75									
												CB214	82.95	1.9	0	TABULAR	CB214	0	0	0	0
												;85.4									
												CB212	83.2	2.42	0	TABULAR	CB212	0	0	0	0
												;85.5000000000554									
												CB213	83.15	1.75	0	TABULAR	CB213	0	0	0	0
												;84.75									
												CB214	82.95	1.9	0	TABULAR	CB214	0	0	0	0
												;85.4									
												CB212	83.2	2.42	0	TABULAR	CB212	0	0	0	0
												;85.5000000000554									
												CB213	83.15	1.75	0	TABULAR	CB213	0	0	0	0

Link Culvert	Shape	Geom1	Geom2	Geom3	Geom4	Barrels	Vortex ICD 100	1	8.9

C2	CIRCULAR	0.25	0	0	0	1	Vortex ICD 100	1.2	9.8
C4	CIRCULAR	0.25	0	0	0	1	Vortex ICD 100	1.4	10.6
C5	CIRCULAR	0.25	0	0	0	1	Vortex ICD 100	1.6	11.3
CB213	CIRCULAR	0.25	0	0	0	1	Vortex ICD 100	1.8	12
CB214	CIRCULAR	0.25	0	0	0	1	Vortex ICD 100	2	12.6
Pipe -- (104) (P-Stm) 2	CIRCULAR	0.45	0	0	0	1	Vortex ICD 100	2.5	14.1
Pipe -- (110) (P-Stm)	CIRCULAR	0.525	0	0	0	1	Vortex ICD 100	3	15.5
Pipe -- (111) (P-Stm)	CIRCULAR	0.525	0	0	0	1	;Tempest Rating Curve for Vortex ICD 105, No grate allowance		
Pipe -- (71) (P-Stm)	CIRCULAR	0.525	0	0	0	1	Vortex ICD 105	Rating	0
Pipe -- (72) (P-Stm)	CIRCULAR	0.525	0	0	0	1	Vortex ICD 105	0.1	3.1
OR1	CIRCULAR	0.127	0	0	0	0	Vortex ICD 105	0.2	4.4
W1	RECT_OPEN	0.03	1.5	0	0	0	Vortex ICD 105	0.3	5.4
W2	RECT_OPEN	0.05	2.59	0	0	0	Vortex ICD 105	0.4	6.2
W3	RECT_OPEN	0.2	1.34	0	0	0	Vortex ICD 105	0.6	6.9
W4	RECT_OPEN	0.1	4.9	0	0	0	Vortex ICD 105	0.7	7.6
W5	RECT_OPEN	0.05	4.725	0	0	0	Vortex ICD 105	0.8	8.2
W6	RECT_OPEN	0.1	6	0	0	0	Vortex ICD 105	0.9	8.8
W7	RECT_OPEN	0.08	10.5	0	0	0	Vortex ICD 105	1.2	9.3
							Vortex ICD 105	1.2	10.7
							Vortex ICD 105	1.4	11.6
							Vortex ICD 105	1.6	12.4
							Vortex ICD 105	1.8	13.1
							Vortex ICD 105	2	13.9
							Vortex ICD 105	2.5	15.5
							Vortex ICD 105	3	17

[LOSSES]									
	Kentry	Kexit	Kavg	Flap Gate	Seepage				

[CURVES]									
	Type	X-Value	Y-Value						

CB210-OUT85.5	Rating	0	0				Vortex ICD 40	Rating	0
CB210-OUT85.5		85.5	0.04				Vortex ICD 40	0.1	0.4
CB210-OUT85.5		100	0.04				Vortex ICD 40	0.2	0.6
							Vortex ICD 40	0.3	0.7
							Vortex ICD 40	0.4	0.9
							Vortex ICD 40	0.5	1
							Vortex ICD 40	0.6	1.1
							Vortex ICD 40	0.7	1.1
							Vortex ICD 40	0.8	1.2
							Vortex ICD 40	0.9	1.3
							Vortex ICD 40	1	1.4
							Vortex ICD 40	1.2	1.5
							Vortex ICD 40	1.4	1.6
							Vortex ICD 40	1.6	1.7
							Vortex ICD 40	1.8	1.8
							Vortex ICD 40	2	1.9
							Vortex ICD 40	2.5	2.2
							Vortex ICD 40	3	2.4
							;Tempest Rating Curve for Vortex ICD 45, No grate allowance		
							Vortex ICD 45	Rating	0
							Vortex ICD 45	0.1	0.6
							Vortex ICD 45	0.2	0.8
							Vortex ICD 45	0.3	1
							Vortex ICD 45	0.4	1.1
							Vortex ICD 45	0.5	1.3
							Vortex ICD 45	0.6	1.4
							Vortex ICD 45	0.7	1.5
							Vortex ICD 45	0.8	1.6
							Vortex ICD 45	0.9	1.7
							Vortex ICD 45	1	1.8
							Vortex ICD 45	1.2	2
							Vortex ICD 45	1.4	2.1
							Vortex ICD 45	1.6	2.3
							Vortex ICD 45	1.8	2.4
							Vortex ICD 45	2	2.6
							Vortex ICD 45	2.5	2.9
							Vortex ICD 45	3	3.1
							;Tempest Rating Curve for Vortex ICD 50, No grate allowance		
							Vortex ICD 50	Rating	0
							Vortex ICD 50	0.1	0.7
							Vortex ICD 50	0.2	1
							Vortex ICD 50	0.3	1.2
							Vortex ICD 50	0.4	1.4
							Vortex ICD 50	0.5	1.6
							Vortex ICD 50	0.6	1.8
							Vortex ICD 50	0.7	1.9
							Vortex ICD 50	0.8	2
							Vortex ICD 50	0.9	2.1
							Vortex ICD 50	1	2.3
							Vortex ICD 50	1.2	2.5
							Vortex ICD 50	1.4	2.7
							Vortex ICD 50	1.6	2.9
							Vortex ICD 50	1.8	3
							Vortex ICD 50	2	3.2
							Vortex ICD 50	2.5	3.6
							Vortex ICD 50	3	3.9
							;Tempest Rating Curve for Vortex ICD 55, No grate allowance		
							Vortex ICD 55	Rating	0
							Vortex ICD 55	0.1	0.9
							Vortex ICD 55	0.2	1.2
							Vortex ICD 55	0.3	1.5
							Vortex ICD 55	0.4	1.7
							Vortex ICD 55	0.5	1.9
							Vortex ICD 55	0.6	2.1
							Vortex ICD 55	0.7	2.3
							Vortex ICD 55	0.8	2.4
							Vortex ICD 55	0.9	2.6
							Vortex ICD 55	1	2.7
							Vortex ICD 55	1.2	3
							Vortex ICD 55	1.4	3.2
							Vortex ICD 55	1.6	3.4
							Vortex ICD 55	1.8	3.6
							Vortex ICD 55	2	3.8
							Vortex ICD 55	2.5	4.3
							Vortex ICD 55	3	4.7
							;Tempest Rating Curve for Vortex ICD 60, No grate allowance		
							Vortex ICD 60	Rating	0
							Vortex ICD 60	0.1	1.1
							Vortex ICD 60	0.2	1.5
							Vortex ICD 60	0.3	1.8
							Vortex ICD 60	0.4	2.1
							Vortex ICD 60	0.5	2.3
							Vortex ICD 60	0.6	2.5
							Vortex ICD 60	0.7	2.7
							Vortex ICD 60	0.8	2.9
							Vortex ICD 60	0.9	3.1
							Vortex ICD 60	1	3.2
							Vortex ICD 60	1.2	3.6
							Vortex ICD 60	1.4	3.8
							Vortex ICD 60	1.6	4.1
							Vortex ICD 60	1.8	4.3
							Vortex ICD 60	2	4.6
							Vortex ICD 60	2.5	5.1
							Vortex ICD 60	3	5.6
							;Tempest Rating Curve for Vortex ICD 65, No grate allowance		
							Vortex ICD 65	Rating	0
							Vortex ICD 65	0.1	1.2
							Vortex ICD 65	0.2	1.6
							Vortex ICD 65	0.3	2
							Vortex ICD 65	0.4	2.3
							Vortex ICD 65	0.5	2.5
							Vortex ICD 65	0.6	2.8
							Vortex ICD 65	0.7	3
							Vortex ICD 65	0.8	3.2
							Vortex ICD 65	0.9	3.4
							Vortex ICD 65	1	3.6
							Vortex ICD 65	1.2	4
							Vortex ICD 65	1.4	4.3
							Vortex ICD 65	1.6	4.6
							Vortex ICD 65	1.8	4.9
							Vortex ICD 65	2	5.1
							Vortex ICD 65	2.5	5.7
							Vortex ICD 65	3	6.3
							;Tempest Rating Curve for Vortex ICD 100, No grate allowance		
							Vortex ICD 100	Rating	0
							Vortex ICD 100	0.1	2.8
							Vortex ICD 100	0.2	4
							Vortex ICD 100	0.3	4.9
							Vortex ICD 100	0.4	5.6
							Vortex ICD 100	0.5	6.3
							Vortex ICD 100	0.6	6.9
							Vortex ICD 100	0.7	7.5
							Vortex ICD 100	0.8	8
							Vortex ICD 100	0.9	8.5

```

;Tempest Rating Curve for Vortex ICD 70, No grate allowance
Vortex_ICD_70 Rating 0 0
Vortex_ICD_70 0.1 1.3
Vortex_ICD_70 0.2 1.9
Vortex_ICD_70 0.3 2.3
Vortex_ICD_70 0.4 2.7
Vortex_ICD_70 0.5 3.3
Vortex_ICD_70 0.6 3.3
Vortex_ICD_70 0.7 3.6
Vortex_ICD_70 0.8 3.8
Vortex_ICD_70 0.9 4.1
Vortex_ICD_70 1 4.7
Vortex_ICD_70 1.2 4.7
Vortex_ICD_70 1.4 5.1
Vortex_ICD_70 1.6 5.5
Vortex_ICD_70 1.8 5.8
Vortex_ICD_70 2 6.1
Vortex_ICD_70 2.5 6.8
Vortex_ICD_70 3 7.5

```

```

;Tempest Rating Curve for Vortex ICD 75, No grate allowance
Vortex_ICD_75 Rating 0 0
Vortex_ICD_75 0.1 1.6
Vortex_ICD_75 0.2 2.2
Vortex_ICD_75 0.3 2.7
Vortex_ICD_75 0.4 3.2
Vortex_ICD_75 0.5 3.5
Vortex_ICD_75 0.6 3.9
Vortex_ICD_75 0.7 4.2
Vortex_ICD_75 0.8 4.5
Vortex_ICD_75 0.9 4.8
Vortex_ICD_75 1 5.7
Vortex_ICD_75 1.2 5.5
Vortex_ICD_75 1.4 5.9
Vortex_ICD_75 1.6 6.3
Vortex_ICD_75 1.8 6.7
Vortex_ICD_75 2 7.1
Vortex_ICD_75 2.5 7.9
Vortex_ICD_75 3 8.7

```

```

;Tempest Rating Curve for Vortex ICD 80, No grate allowance
Vortex_ICD_80 Rating 0 0
Vortex_ICD_80 0.1 1.8
Vortex_ICD_80 0.2 2.6
Vortex_ICD_80 0.3 3.1
Vortex_ICD_80 0.4 3.6
Vortex_ICD_80 0.5 4
Vortex_ICD_80 0.6 4.4
Vortex_ICD_80 0.7 4.8
Vortex_ICD_80 0.8 5.1
Vortex_ICD_80 0.9 5.4
Vortex_ICD_80 1 5.7
Vortex_ICD_80 1.2 6.3
Vortex_ICD_80 1.4 6.8
Vortex_ICD_80 1.6 7.2
Vortex_ICD_80 1.8 7.7
Vortex_ICD_80 2 8.1
Vortex_ICD_80 2.5 9
Vortex_ICD_80 3 9.9

```

```

;Tempest Rating Curve for Vortex ICD 85, No grate allowance
Vortex_ICD_85 Rating 0 0
Vortex_ICD_85 0.1 2
Vortex_ICD_85 0.2 2.9
Vortex_ICD_85 0.3 3.5
Vortex_ICD_85 0.4 4.1
Vortex_ICD_85 0.5 4.5
Vortex_ICD_85 0.6 5
Vortex_ICD_85 0.7 5.4
Vortex_ICD_85 0.8 5.7
Vortex_ICD_85 0.9 6.1
Vortex_ICD_85 1 6.4
Vortex_ICD_85 1.2 7
Vortex_ICD_85 1.4 7.6
Vortex_ICD_85 1.6 8.1
Vortex_ICD_85 1.8 8.6
Vortex_ICD_85 2 9.1
Vortex_ICD_85 2.5 10.1
Vortex_ICD_85 3 11.1

```

```

;Tempest Rating Curve for Vortex ICD 90, No grate allowance
Vortex_ICD_90 Rating 0 0
Vortex_ICD_90 0.1 2.2
Vortex_ICD_90 0.2 3.2
Vortex_ICD_90 0.3 3.9
Vortex_ICD_90 0.4 4.5
Vortex_ICD_90 0.5 5.1
Vortex_ICD_90 0.6 5.5
Vortex_ICD_90 0.7 6
Vortex_ICD_90 0.8 6.4
Vortex_ICD_90 0.9 6.8
Vortex_ICD_90 1 7.2
Vortex_ICD_90 1.2 7.9
Vortex_ICD_90 1.4 8.5
Vortex_ICD_90 1.6 9.1
Vortex_ICD_90 1.8 9.6
Vortex_ICD_90 2 10.2
Vortex_ICD_90 2.5 11.4
Vortex_ICD_90 3 12.5

```

```

;Tempest Rating Curve for Vortex ICD 95, No grate allowance
Vortex_ICD_95 Rating 0 0
Vortex_ICD_95 0.1 2.6
Vortex_ICD_95 0.2 3.6
Vortex_ICD_95 0.3 4.4
Vortex_ICD_95 0.4 5.1
Vortex_ICD_95 0.5 5.7
Vortex_ICD_95 0.6 6.2
Vortex_ICD_95 0.7 7.1
Vortex_ICD_95 0.8 7.6
Vortex_ICD_95 0.9 8
Vortex_ICD_95 1 8.7
Vortex_ICD_95 1.2 9.4
Vortex_ICD_95 1.4 10.1
Vortex_ICD_95 1.6 10.7
Vortex_ICD_95 1.8 11.3
Vortex_ICD_95 2 12.6
Vortex_ICD_95 2.5 13.8

```

```

CB200 Storage 0 0.36
CB200 2.24 217.87
CB200 2.32 217.87
CB201 Storage 0 0.36
CB201 2.41 169.64
CB201 2.56 169.64
CB201 2.66 169.64
CB202 Storage 0 0.36
CB202 2.6 273.92
CB202 2.79 273.92
CB202 2.89 273.92
CB203 Storage 0 0.36
CB203 2.6 178.09
CB203 2.9 178.09
CB204 Storage 0 0.36
CB204 2.6 146.08
CB204 2.75 146.08
CB205 Storage 0 0.36
CB205 2.6 86.52
CB205 2.75 86.52
CB206 Storage 0 0.36
CB206 2.6 0.36

```

```

CB206 2.68 57.95
CB206 2.73 57.95
CB207 Storage 0 0.36
CB207 1.97 0.36
CB207 2.3 178.5
CB208 Storage 0 0.073
CB208 1.74 0.073
CB208 2.01 67.88
CB208 2.04 67.88
CB209 Storage 0 0.073
CB209 1.6 0.073
CB209 1.9 84.87
CB210B Storage 0 0.073
CB210B 2.6 0.073
CB210B 2.9 70.98
CB210B 3 70.98
CB211 Storage 0 0.073
CB211 1.65 0.073
CB211 1.9 21.99
CB212 Storage 0 0.36
CB212 2.2 0.36
CB212 2.42 55.12
CB212A Storage 0 0.073
CB212A 2 0.073
CB213 Storage 0 0.073
CB213 1.6 0.073
CB213 1.75 9.05
CB214 Storage 0 0.073
CB214 1.6 0.073
CB214 1.9 34.75

```

```

[TIMESERIES]
;Name Date Time Value
;Rainfall (mm/hr)
3CHI002 01/01/2000 00:00:00 2.491
3CHI002 01/01/2000 00:10:00 2.366
3CHI002 01/01/2000 00:20:00 3.696
3CHI002 01/01/2000 00:30:00 4.976
3CHI002 01/01/2000 00:40:00 7.828
3CHI002 01/01/2000 00:50:00 19.966
3CHI002 01/01/2000 01:00:00 76.805
3CHI002 01/01/2000 01:10:00 22.777
3CHI002 01/01/2000 01:20:00 11.852
3CHI002 01/01/2000 01:30:00 8.222
3CHI002 01/01/2000 01:40:00 6.096
3CHI002 01/01/2000 01:50:00 4.938
3CHI002 01/01/2000 02:00:00 4.165
3CHI002 01/01/2000 02:10:00 3.613
3CHI002 01/01/2000 02:20:00 3.197
3CHI002 01/01/2000 02:30:00 2.873
3CHI002 01/01/2000 02:40:00 2.613
3CHI002 01/01/2000 02:50:00 2.4
3CHI002 01/01/2000 03:00:00 0

```

```

;Rainfall (mm/hr)
3CHI100 01/01/2000 00:00:00 5.339
3CHI100 01/01/2000 00:10:00 6.376
3CHI100 01/01/2000 00:20:00 7.977
3CHI100 01/01/2000 00:30:00 10.797
3CHI100 01/01/2000 00:40:00 17.136
3CHI100 01/01/2000 00:50:00 45.128
3CHI100 01/01/2000 01:00:00 178.107
3CHI100 01/01/2000 01:10:00 51.056
3CHI100 01/01/2000 01:20:00 26.163
3CHI100 01/01/2000 01:30:00 17.571
3CHI100 01/01/2000 01:40:00 13.277
3CHI100 01/01/2000 01:50:00 10.712
3CHI100 01/01/2000 02:00:00 9.008
3CHI100 01/01/2000 02:10:00 7.793
3CHI100 01/01/2000 02:20:00 6.883
3CHI100 01/01/2000 02:30:00 6.174
3CHI100 01/01/2000 02:40:00 5.607
3CHI100 01/01/2000 02:50:00 5.142
3CHI100 01/01/2000 03:00:00 0

```

```

[REPORT]
;Reporting Options
INPUT YES
CONTROLS NO
SUBCATCHMENTS ALL
NODES ALL
LINKS ALL

```

```

[TAGS]
Node 518 Orifice RY Manhole
Node CB200 RY Manhole
Node CB201 RY Manhole
Node CB202 RY Manhole
Node CB203 RY Manhole
Node CB204 RY Manhole
Node CB205 RY Manhole
Node CB206 RY Manhole
Node CB207 RY Manhole
Node CB208 RY Manhole
Node CB209 RY Manhole
Node CB210B RY Manhole
Node CB211 RY Manhole
Node CB212 RY Manhole
Node CB212A RY Manhole
Node CB213 RY Manhole
Node CB214 RY Manhole
Link C2 RY Sewer
Link C4 RY Sewer
Link C5 RY Sewer

```

```

[MAP]
DIMENSIONS 381219.0294 5032865.6782 381334.8286 5033009.9278
UNITS Meters

```

```

[COORDINATES]
;Node X-Coord Y-Coord
518 Orifice 381303.7 5032953.188
518A (P-Stm) 381317.029 5032955.797
518 (P-Stm) 381301.695 5032952.807
519 (P-Stm) 381278.958 5032974.866
520 (P-Stm) 381240.562 5032926.182
521 (P-Stm) 381309.324 5032926.69
522 (P-Stm) 381267.739 5032909.252
CB200 381246.119 5032946.933
CB201 381266.142 5032969.504
CB202 381305.816 5032949.229
CB203 381314.519 5032914.342
CB204 381291.187 5032921.779
CB205 381286.939 5032925.282
CB206 381270.233 5032913.017
CB207 381253.811 5032910.356
CB208 381248.314 5032902.406
CB209 381228.288 5032926.78
CB210B 381314.246 5032963.095
CB211 381319.351 5032951.771
CB212 381328.283 5032931.288
CB212A 381326.507 5032912.9
CB213 381296.875 5032912.718
CB214 381282.831 5032893.727

```

```

[VERTICES]
;Link X-Coord Y-Coord

```

```

W2      381318.013    5032956.452
W4      381305.808    5032934.267
W4      381304.151    5032928.843

[POLYGONS]
;;Subcatchment X-Coord Y-Coord
-----
S1      381237.464    5032904.825
S1      381240.329    5032905.467
...
S9      381290.74     5032939.886

;;Storage Node X-Coord Y-Coord
-----
[SYMBOLS]
;;Gage X-Coord Y-Coord
-----

```

EPA STORM WATER MANAGEMENT MODEL - VERSION 5.2 (Build 5.2.4)

```

*****
Element Count
*****
Number of rain gages ..... 2
Number of subcatchments ... 17
Number of nodes ..... 23
Number of links ..... 29
Number of pollutants ..... 0
Number of land uses ..... 0

```

```

*****
Raingage Summary
*****

```

Name	Data Source	Data Type	Recording Interval
3CHI002	3CHI002	INTENSITY	10 min.
3CHI100	3CHI100	INTENSITY	10 min.

```

*****
Subcatchment Summary
*****

```

Name	Area	Width	%Imperv	%Slope	Rain Gage	Outlet
S1	0.02	29.61	0.06	2.2000	3CHI002	CB208
S10	0.03	55.32	99.62	2.2000	3CHI002	CB204
S11	0.13	65.66	86.66	2.2000	3CHI002	CB202
S12	0.01	6.44	0.25	2.2000	3CHI002	CB213
S14_1	0.01	22.78	52.75	2.2000	3CHI002	CB211
S14_2	0.02	58.12	31.75	2.2000	3CHI002	CB212
S15	0.04	108.74	25.77	2.2000	3CHI002	CB210B
S2	0.07	33.61	63.05	2.2000	3CHI002	CB209
S3	0.07	45.79	96.63	2.2000	3CHI002	CB207
S32	0.05	29.70	14.29	2.2000	3CHI002	CB214
S4	0.04	24.67	99.97	2.2000	3CHI002	CB206
S45	0.02	14.32	99.96	2.2000	3CHI002	CB203
S5	0.09	82.96	89.99	2.2000	3CHI002	CB200
S6	0.02	40.30	0.00	2.2000	3CHI002	CB214
S7	0.07	25.95	100.00	2.2000	3CHI002	520_(P-Stm)
S8	0.09	35.06	80.12	2.2000	3CHI002	CB201
S9	0.03	19.08	76.83	2.2000	3CHI002	CB205

```

*****
Node Summary
*****

```

Name	Type	Invert Elev.	Max. Depth	Ponded Area	External Inflow
518 Orifice	JUNCTION	81.36	4.11	0.0	
518A_(P-Stm)	OUTFALL	80.65	1.13	0.0	
518_(P-Stm)	STORAGE	81.06	4.41	0.0	
519_(P-Stm)	STORAGE	82.20	3.51	0.0	
520_(P-Stm)	STORAGE	82.49	2.89	0.0	
521_(P-Stm)	STORAGE	81.96	3.67	0.0	
522_(P-Stm)	STORAGE	82.18	3.32	0.0	
CB200	STORAGE	83.18	2.32	0.0	
CB201	STORAGE	83.09	2.66	0.0	
CB202	STORAGE	82.76	2.89	0.0	
CB203	STORAGE	82.75	2.90	0.0	
CB204	STORAGE	82.75	2.75	0.0	
CB205	STORAGE	82.85	2.75	0.0	
CB206	STORAGE	82.77	2.73	0.0	
CB207	STORAGE	83.15	2.30	0.0	
CB208	STORAGE	83.30	2.04	0.0	
CB209	STORAGE	83.20	1.90	0.0	
CB210B	STORAGE	82.65	3.00	0.0	
CB211	STORAGE	83.70	1.90	0.0	
CB212	STORAGE	83.20	2.42	0.0	
CB212A	STORAGE	83.62	2.00	0.0	
CB213	STORAGE	83.15	1.75	0.0	
CB214	STORAGE	82.95	1.90	0.0	

```

*****
Link Summary
*****

```

Name	From Node	To Node	Type	Length	%Slope
C2	CB208	CB207	CONDUIT	9.7	1.0346
C4	CB212A	CB212	CONDUIT	18.5	2.0031
C5	CB211	CB212	CONDUIT	22.3	2.0142
CB213	CB213	522_(P-Stm)	CONDUIT	29.3	1.3396
CB214	CB214	522_(P-Stm)	CONDUIT	21.6	0.8915
Pipe_-(104)_(P-Stm)_2	518_Orifice	518A_(P-Stm)	CONDUIT	15.6	0.2496
Pipe_-(110)_(P-Stm)	521_(P-Stm)	518_(P-Stm)	CONDUIT	27.2	0.3528
Pipe_-(111)_(P-Stm)	522_(P-Stm)	521_(P-Stm)	CONDUIT	45.1	0.4990
Pipe_-(71)_(P-Stm)	520_(P-Stm)	519_(P-Stm)	CONDUIT	57.1	0.4025
Pipe_-(72)_(P-Stm)	519_(P-Stm)	518_(P-Stm)	CONDUIT	32.0	0.5005
OR1	518_(P-Stm)	518 Orifice	ORIFICE		
W1	CB208	CB209	WEIR		
W2	CB210B	CB211	WEIR		
W3	CB210B	CB202	WEIR		
W4	CB202	CB204	WEIR		
W5	CB206	CB207	WEIR		
W6	CB201	CB200	WEIR		
W7	CB200	CB209	WEIR		
CB200	CB200	520_(P-Stm)	OUTLET		
CB201	CB201	520_(P-Stm)	OUTLET		
CB202	CB202	521_(P-Stm)	OUTLET		
CB203	CB203	521_(P-Stm)	OUTLET		
CB204	CB204	522_(P-Stm)	OUTLET		
CB205	CB205	522_(P-Stm)	OUTLET		
CB206	CB206	522_(P-Stm)	OUTLET		
CB207	CB207	522_(P-Stm)	OUTLET		
CB209	CB209	520_(P-Stm)	OUTLET		
CB210B	CB210B	518_(P-Stm)	OUTLET		
CB212	CB212	521_(P-Stm)	OUTLET		

```

*****
Cross Section Summary
*****

```

Conduit	Shape	Full Depth	Full Area	Hyd. Rad.	Max. Width	No. of Barrels	Full Flow
C2	CIRCULAR	0.25	0.05	0.06	0.25	1	60.49
C4	CIRCULAR	0.25	0.05	0.06	0.25	1	84.17
C5	CIRCULAR	0.25	0.05	0.06	0.25	1	84.40
CB213	CIRCULAR	0.25	0.05	0.06	0.25	1	68.83
CB214	CIRCULAR	0.25	0.05	0.06	0.25	1	56.15
Pipe_-(104)_(P-Stm)_2	CIRCULAR	0.45	0.16	0.11	0.45	1	142.46
Pipe_-(110)_(P-Stm)	CIRCULAR	0.53	0.22	0.13	0.53	1	255.47
Pipe_-(111)_(P-Stm)	CIRCULAR	0.53	0.22	0.13	0.53	1	303.80
Pipe_-(71)_(P-Stm)	CIRCULAR	0.53	0.22	0.13	0.53	1	272.85
Pipe_-(72)_(P-Stm)	CIRCULAR	0.53	0.22	0.13	0.53	1	304.28

```

*****
Analysis Options
*****
Flow Units ..... LPS
Process Models:
  Rainfall/Runoff ..... YES
  RDII ..... NO
  Snowmelt ..... NO
  Groundwater ..... NO
  Flow Routing ..... YES
  Ponding Allowed ..... NO
  Water Quality ..... NO
Infiltration Method ..... HORTON
Flow Routing Method ..... DYNWAVE
Surcharge Method ..... EXTRAN
Starting Date ..... 01/01/2000 00:00:00
Ending Date ..... 01/01/2000 06:00:00
Antecedent Dry Days ..... 0.0
Report Time Step ..... 00:01:00
Wet Time Step ..... 00:01:00
Dry Time Step ..... 00:01:00
Routing Time Step ..... 1.00 sec
Variable Time Step ..... YES
Maximum Trials ..... 8
Number of Threads ..... 1
Head Tolerance ..... 0.001500 m
  
```

```

*****
Volume      Depth
Runoff Quantity Continuity  hectare-m      mm
*****
Total Precipitation ..... 0.026      31.880
Evaporation Loss ..... 0.000      0.000
Infiltration Loss ..... 0.008      9.225
Surface Runoff ..... 0.018      21.549
Final Storage ..... 0.001      1.137
Continuity Error (%) ..... -0.099
  
```

```

*****
Volume      Volume
Flow Routing Continuity  hectare-m      10^6 ltr
*****
Dry Weather Inflow ..... 0.000      0.000
Wet Weather Inflow ..... 0.018      0.177
Groundwater Inflow ..... 0.000      0.000
RDII Inflow ..... 0.000      0.000
External Inflow ..... 0.000      0.000
External Outflow ..... 0.018      0.176
Flooding Loss ..... 0.000      0.000
Evaporation Loss ..... 0.000      0.000
Exfiltration Loss ..... 0.000      0.000
Initial Stored Volume ..... 0.000      0.000
Final Stored Volume ..... 0.000      0.002
Continuity Error (%) ..... 0.000
  
```

```

*****
Highest Continuity Errors
*****
Node 520 (P-Stm) (1.34%)
  
```

```

*****
Time-Step Critical Elements
*****
None
  
```

```

*****
Highest Flow Instability Indexes
*****
All links are stable.
  
```

```

*****
Most Frequent Nonconverging Nodes
*****
Convergence obtained at all time steps.
  
```

```

*****
Routing Time Step Summary
*****
Minimum Time Step : 0.50 sec
Average Time Step : 1.00 sec
Maximum Time Step : 1.00 sec
% of Time in Steady State : 0.00
Average Iterations per Step : 2.00
% of Steps Not Converging : 0.00
Time Step Frequencies
  1.000 - 0.871 sec : 100.00 %
  0.871 - 0.758 sec : 0.00 %
  0.758 - 0.660 sec : 0.00 %
  0.660 - 0.574 sec : 0.00 %
  0.574 - 0.500 sec : 0.00 %
  
```

```

*****
Subcatchment Runoff Summary
*****
  
```

Total Runoff	Total Runoff	Peak Runoff	Total Runoff	Total Runoff	Total Runoff	Total Runoff	Imperv Runoff	Perv Runoff
Subcatchment	Subcatchment	Subcatchment	Subcatchment	Subcatchment	Subcatchment	Subcatchment	Subcatchment	Subcatchment
mm	10^6 ltr	LPS	mm	mm	mm	mm	mm	mm
S1			31.88	0.00	0.00	31.67	0.02	0.20
0.22	0.00	0.20	0.007					
S10			31.88	0.00	0.00	0.12	30.24	0.01
30.25	0.01	6.54	0.949					
S11			31.88	0.00	0.00	4.21	26.29	0.05
26.34	0.03	23.88	0.826					
S4			31.88	0.00	0.00	31.73	0.08	0.07
0.15	0.00	0.05	0.005					
S14_1			31.88	0.00	0.00	20.07	16.01	11.05
11.05	0.00	2.04	0.347					
S14_2			31.88	0.00	0.00	25.36	9.63	6.08
6.08	0.00	2.56	0.191					
S15			31.88	0.00	0.00	26.75	7.82	4.77
4.77	0.00	4.58	0.150					
S2			31.88	0.00	0.00	11.72	19.13	0.06
19.20	0.01	10.06	0.602					
S3			31.88	0.00	0.00	1.05	29.32	0.02
29.34	0.02	14.82	0.920					
S2			31.88	0.00	0.00	29.66	4.34	1.14
2.01	0.00	1.28	0.063					
S4			31.88	0.00	0.00	0.01	30.33	0.00
30.33	0.01	9.60	0.951					
S5			31.88	0.00	0.00	0.01	30.33	0.00
30.33	0.01	4.74	0.951					
S5			31.88	0.00	0.00	3.17	27.34	0.06
27.34	0.02	16.72	0.858					
S1			31.88	0.00	0.00	31.68	0.00	0.21
0.21	0.00	0.27	0.007					
S7			31.88	0.00	0.00	0.00	30.33	0.00
30.33	0.02	14.63	0.951					
S8			31.88	0.00	0.00	6.30	24.35	0.05
24.35	0.02	16.11	0.764					
S9			31.88	0.00	0.00	7.32	23.32	0.07
23.39	0.01	4.63	0.734					

Node Depth Summary

Node	Type	Average Depth Meters	Maximum Depth Meters	Maximum HGL Meters	Time of Max Occurrence days hr:min	Reported Max Depth Meters
518 Orifice	JUNCTION	0.05	0.17	81.53	0 01:18	0.17
518A (P-Stm)	OUTFALL	0.55	0.55	81.20	0 00:00	0.55
518 (P-Stm)	STORAGE	0.54	2.08	83.15	0 01:18	2.08
519 (P-Stm)	STORAGE	0.33	0.95	83.15	0 01:20	0.95
520 (P-Stm)	STORAGE	0.31	0.66	83.15	0 01:17	0.66
521 (P-Stm)	STORAGE	0.37	1.19	83.15	0 01:18	1.19
522 (P-Stm)	STORAGE	0.33	0.97	83.15	0 01:19	0.97
CB200	STORAGE	0.03	0.84	84.02	0 01:10	0.84
CB201	STORAGE	0.10	2.41	85.50	0 01:10	2.40
CB202	STORAGE	0.08	1.70	84.46	0 01:10	1.69
CB203	STORAGE	0.06	0.87	83.62	0 01:10	0.87
CB204	STORAGE	0.10	1.66	84.41	0 01:10	1.65
CB205	STORAGE	0.06	0.96	83.81	0 01:10	0.95
CB206	STORAGE	0.14	2.39	85.16	0 01:10	2.39
CB207	STORAGE	0.08	1.56	84.71	0 01:10	1.55
CB208	STORAGE	0.05	1.41	84.71	0 01:10	1.40
CB209	STORAGE	0.01	0.30	83.50	0 01:10	0.30
CB210B	STORAGE	0.04	0.65	83.30	0 01:12	0.65
CB211	STORAGE	0.00	0.03	83.73	0 01:10	0.03
CB212	STORAGE	0.00	0.15	83.35	0 01:11	0.15
CB212A	STORAGE	0.00	0.00	83.62	0 00:00	0.00
CB213	STORAGE	0.00	0.00	83.15	0 01:12	0.00
CB214	STORAGE	0.01	0.21	83.16	0 01:16	0.21

Node Inflow Summary

Flow	Maximum Lateral	Maximum Total	Time of Max Occurrence	Lateral Inflow Volume	Total Inflow Volume	
Balance	Lateral	Total	Time of Max Occurrence	Volume	Volume	
Error	Inflow	Inflow	Occurrence	Volume	Volume	
Node Percent	Type	LPS	LPS	days hr:min	10^6 ltr	
518 Orifice	JUNCTION	0.00	46.41	0 01:18	0	0.176
0.000						
518A (P-Stm)	OUTFALL	0.00	46.39	0 01:19	0	0.176
0.000						
518 (P-Stm)	STORAGE	0.00	87.25	0 01:07	0	0.176
0.338						
519 (P-Stm)	STORAGE	0.00	54.76	0 01:10	0	0.0801
0.779						
520 (P-Stm)	STORAGE	14.63	54.95	0 01:10	0.0208	0.0815
1.361						
521 (P-Stm)	STORAGE	0.00	54.86	0 01:11	0	0.0948
0.168						
522 (P-Stm)	STORAGE	0.00	37.72	0 01:08	0	0.0524
0.048						
CB200	STORAGE	16.72	16.72	0 01:10	0.0237	0.0237
0.001						
CB201	STORAGE	16.11	16.11	0 01:10	0.0229	0.0229
0.001						
CB202	STORAGE	23.88	23.88	0 01:10	0.0335	0.0335
0.000						
CB203	STORAGE	4.74	4.74	0 01:10	0.00673	0.00673
0.000						
CB204	STORAGE	6.54	6.54	0 01:10	0.00929	0.00929
0.000						
CB205	STORAGE	4.63	4.63	0 01:10	0.00643	0.00643
0.000						
CB206	STORAGE	9.60	9.60	0 01:10	0.0136	0.0136
0.000						
CB207	STORAGE	14.82	14.82	0 01:10	0.0208	0.0225
0.009						
CB208	STORAGE	0.20	3.97	0 01:02	4.12e-05	0.00168
0.106						
CB209	STORAGE	10.06	10.06	0 01:10	0.014	0.014
0.002						
CB210B	STORAGE	4.58	4.58	0 01:10	0.00177	0.00177
0.001						
CB211	STORAGE	2.04	2.04	0 01:10	0.00128	0.00128
0.858						
CB212	STORAGE	2.56	4.60	0 01:10	0.00109	0.00236
0.620						
CB212A	STORAGE	0.00	0.00	0 00:00	0	0
0.000 ltr						
CB213	STORAGE	0.05	0.05	0 01:10	2.19e-05	2.19e-05
0.732 ltr						
CB214	STORAGE	1.55	8.18	0 01:11	0.00109	0.00167
0.079						

Node Surcharge Summary

No nodes were surcharged.

Node Flooding Summary

No nodes were flooded.

Storage Volume Summary

Maximum Outflow	Average Volume	Avg Pcnt	Evap Pcnt	Exfil Pcnt	Maximum Volume	Max Pcnt	Time of Max Occurrence
Storage Unit	1000 m^3	Full	Loss	Loss	1000 m^3	Full	days hr:min
LPS	LPS				LPS		
518 (P-Stm)	0.001	12.3	0.0	0.0	0.002	47.3	0 01:18
59.33							
519 (P-Stm)	0.000	9.5	0.0	0.0	0.001	27.0	0 01:20
51.62							
520 (P-Stm)	0.000	10.7	0.0	0.0	0.001	23.0	0 01:17
54.76							
521 (P-Stm)	0.000	10.0	0.0	0.0	0.001	32.4	0 01:18
55.22							
522 (P-Stm)	0.000	10.0	0.0	0.0	0.001	29.2	0 01:19
51.53							
CB200	0.000	0.0	0.0	0.0	0.000	0.7	0 01:10
16.60							
CB201	0.000	0.1	0.0	0.0	0.001	2.9	0 01:10
13.84							
CB202	0.000	0.1	0.0	0.0	0.001	1.1	0 01:10
22.58							
CB203	0.000	0.1	0.0	0.0	0.000	1.1	0 01:10
3.65							
CB204	0.000	0.3	0.0	0.0	0.001	5.0	0 01:10
4.39							
CB205	0.000	0.3	0.0	0.0	0.000	4.6	0 01:10
3.34							
CB206	0.000	0.8	0.0	0.0	0.001	14.0	0 01:10
6.37							

CB207	0.000	0.1	0.0	0.0	0.001	1.9	0	01:10
12.84								
CB208	0.000	0.0	0.0	0.0	0.000	0.9	0	01:10
2.78								
CB209	0.000	0.0	0.0	0.0	0.000	0.2	0	01:10
9.92								
CB210B	0.000	0.0	0.0	0.0	0.000	0.3	0	01:12
1.86								
CB211	0.000	0.0	0.0	0.0	0.000	0.1	0	01:10
2.03								
CB212	0.000	0.0	0.0	0.0	0.000	0.8	0	01:11
3.35								
CB212A	0.000	0.0	0.0	0.0	0.000	0.0	0	00:00
0.00								
CB213	0.000	0.0	0.0	0.0	0.000	0.0	0	01:12
0.03								
CB214	0.000	0.0	0.0	0.0	0.000	0.3	0	01:16
8.59								

Outfall Loading Summary

Outfall Node	Flow Freq Pcnt	Avg Flow LPS	Max Flow LPS	Total Volume 10 ⁶ ltr
518A (P-Stm)	62.49	13.01	46.39	0.176
System	62.49	13.01	46.39	0.176

Link Flow Summary

Link	Type	Maximum Flow LPS	Time of Max Occurrence days hr:min	Maximum Veloc m/sec	Max/ Full Flow	Max/ Full Depth
C2	CONDUIT	3.97	0 01:02	0.10	0.07	1.00
C4	CONDUIT	0.00	0 00:00	0.00	0.00	0.19
C5	CONDUIT	2.03	0 01:10	0.67	0.02	0.24
CB213	CONDUIT	0.03	0 01:12	0.08	0.00	0.51
CB214	CONDUIT	8.59	0 01:12	0.33	0.15	0.92
Pipe_-(104)-(P-Stm)	2 CONDUIT	46.39	0 01:19	0.94	0.33	0.35
Pipe_-(110)-(P-Stm)	CONDUIT	55.22	0 01:07	0.71	0.22	1.00
Pipe_-(111)-(P-Stm)	CONDUIT	30.05	0 01:11	0.51	0.10	1.00
Pipe_-(71)-(P-Stm)	CONDUIT	54.76	0 01:10	1.00	0.20	0.85
Pipe_-(72)-(P-Stm)	CONDUIT	51.62	0 01:06	0.97	0.17	1.00
OR1	ORIFICE	46.41	0 01:18			1.00
W1	WEIR	0.00	0 00:00			0.00
W2	WEIR	0.00	0 00:00			0.00
W3	WEIR	0.00	0 00:00			0.00
W4	WEIR	0.00	0 00:00			0.00
W5	WEIR	0.00	0 00:00			0.00
W6	WEIR	0.00	0 00:00			0.00
W7	WEIR	0.00	0 00:00			0.00
CB200	DUMMY	16.60	0 01:10			
CB201	DUMMY	13.84	0 01:10			
CB202	DUMMY	22.58	0 01:08			
CB203	DUMMY	3.65	0 01:08			
CB204	DUMMY	4.39	0 01:10			
CB205	DUMMY	3.34	0 01:09			
CB206	DUMMY	6.37	0 01:10			
CB207	DUMMY	11.17	0 01:10			
CB209	DUMMY	9.92	0 01:10			
CB210B	DUMMY	1.86	0 01:11			
CB212	DUMMY	3.35	0 01:11			

Flow Classification Summary

Conduit	Adjusted /Actual Length	Fraction of Time in Flow Class								
		Dry	Up Dry	Down Dry	Sub Crit	Sup Crit	Up Crit	Down Crit	Norm Ltd	Inlet Ctrl
C2	1.00	0.10	0.00	0.00	0.16	0.00	0.00	0.75	0.07	0.00
C4	1.00	0.97	0.03	0.00	0.00	0.00	0.00	0.00	0.00	0.00
C5	1.00	0.17	0.00	0.00	0.02	0.00	0.00	0.80	0.03	0.00
CB213	1.00	0.09	0.00	0.00	0.09	0.00	0.00	0.82	0.09	0.00
CB214	1.00	0.09	0.00	0.00	0.09	0.00	0.00	0.83	0.03	0.00
Pipe_-(104)-(P-Stm)	2	1.00	0.11	0.00	0.00	0.00	0.00	0.89	0.00	0.00
Pipe_-(110)-(P-Stm)		1.00	0.11	0.00	0.00	0.14	0.00	0.75	0.00	0.00
Pipe_-(111)-(P-Stm)		1.00	0.10	0.00	0.00	0.89	0.00	0.00	0.77	0.00
Pipe_-(71)-(P-Stm)		1.00	0.10	0.00	0.00	0.11	0.00	0.00	0.79	0.04
Pipe_-(72)-(P-Stm)		1.00	0.11	0.00	0.00	0.13	0.00	0.00	0.76	0.01

Conduit Surcharge Summary

Conduit	Hours Full			Hours Above Full Normal Flow	Hours Capacity Limited
	Both Ends	Upstream	Dnstream		
C2	0.34	0.34	0.38	0.01	0.01
CB213	0.01	0.01	0.30	0.01	0.01
CB214	0.01	0.01	0.30	0.01	0.01
Pipe_-(110)-(P-Stm)	0.51	0.51	0.60	0.01	0.01
Pipe_-(111)-(P-Stm)	0.30	0.30	0.51	0.01	0.01
Pipe_-(71)-(P-Stm)	0.01	0.01	0.19	0.01	0.01
Pipe_-(72)-(P-Stm)	0.27	0.27	0.44	0.01	0.01

Analysis begun on: Tue Jan 28 12:44:04 2025
Analysis ended on: Tue Jan 28 12:44:05 2025
Total elapsed time: 00:00:01

Post-Development 3-hour Chicago 1:100 year Event

```

[TITLE]
;;Project Title/Notes
520_(P-Stm) 82.487 2.888 0 FUNCTIONAL 0 0 1.13 0
0
;Cylindrical Structure Slab Top Circular Frame SI
521_(P-Stm) 81.957 3.673 0 FUNCTIONAL 0 0 1.13 0
0
;Cylindrical Structure Slab Top Circular Frame SI
522_(P-Stm) 82.182 3.323 0 FUNCTIONAL 0 0 1.13 0
0
;85.1800000001676
CB200 83.18 2.32 0 TABULAR CB200 0
;85.5000000001435
CB201 83.09 2.66 0 TABULAR CB201 0
;85.36
CB202 82.76 2.89 0 TABULAR CB202 0
;85.3500000000931
CB203 82.75 2.9 0 TABULAR CB203 0
;85.3500080822731
CB204 82.75 2.75 0 TABULAR CB204 0
;85.4500080823662
CB205 82.85 2.75 0 TABULAR CB205 0
;85.48
CB206 82.77 2.73 0 TABULAR CB206 0
;85.05
CB207 83.15 2.3 0 TABULAR CB207 0
;84.9000080821652
CB208 83.3 2.04 0 TABULAR CB208 0
;84.8
CB209 83.2 1.9 0 TABULAR CB209 0
;85.25
CB210B 82.65 3 0 TABULAR CB210B 0
;85.35
CB211 83.7 1.9 0 TABULAR CB211 0
;85.4
CB212 83.2 2.42 0 TABULAR CB212 0
;85.5000000000554
CB212A 83.62 2 0 TABULAR CB212A 0
;84.75
CB213 83.15 1.75 0 TABULAR CB213 0
;84.55
CB214 82.95 1.9 0 TABULAR CB214 0
0

[EVAPORATION]
;;Data Source Parameters
;-----
CONSTANT 0.0
DRY_ONLY NO

[RAINGAGES]
;;Name Format Interval SCF Source
;-----
3CHI100 INTENSITY 0:10 1.0 TIMESERIES 3CHI100

[SUBCATCHMENTS]
Rain Gage Outlet Area %Imperv Width %Slope CurbLen
;;Name
SnowPack
;-----
S1 3CHI100 CB208 0.0187 0.061 29.61 2.2 0
S10 CB204 0.0307 99.617 55.32 2.2 0
S11 3CHI100 CB202 0.127 86.66 65.66 2.2 0
S12 3CHI100 CB213 0.0149 0.253 6.44 2.2 0
S14_1 3CHI100 CB211 0.0116 52.747 22.78 2.2 0
S14_2 3CHI100 CB212 0.0179 31.754 58.12 2.2 0
S15 3CHI100 CB210B 0.0372 25.766 108.74 2.2 0
S2 3CHI100 CB209 0.0731 63.05 33.61 2.2 0
S3 3CHI100 CB207 0.071 96.627 45.79 2.2 0
S32 3CHI100 CB214 0.052 14.286 29.7 2.2 0
S4 3CHI100 CB206 0.045 99.974 24.67 2.2 0
S45 3CHI100 CB203 0.0222 99.961 14.32 2.2 0
S5 3CHI100 CB200 0.0668 89.897 82.96 2.2 0
S6 3CHI100 CB214 0.0239 0.002 40.3 2.2 0
S7 3CHI100 520_(P-Stm) 0.0686 100 25.95 2.2 0
S8 3CHI100 CB211 0.0941 80.117 35.06 2.2 0
S9 3CHI100 CB205 0.0275 76.829 19.08 2.2 0

[CONDUITS]
;;Name From Node To Node Length Roughness InOffset OutOffset
InitFlow MaxFlow
;-----
C2 0 CB208 CB207 9.666 0.013 83.3 83.2
C4 0 CB212A CB212 18.475 0.013 83.62 83.25
C5 0 CB211 CB212 22.346 0.013 83.7 83.25
CB213 0 CB213 522_(P-Stm) 29.34 0.013 83.15 82.757
CB214 0 CB214 522_(P-Stm) 21.65 0.013 82.95 82.757
;FVC Pipes
Pipe_(104)_(P-Stm)_2 518_Orifice 518A_(P-Stm) 15.623 0.013 81.361 81.322
;FVC Pipes
Pipe_(110)_(P-Stm) 521_(P-Stm) 518_(P-Stm) 27.209 0.013 82.257 82.161
;PVC Pipes
Pipe_(111)_(P-Stm) 522_(P-Stm) 521_(P-Stm) 45.094 0.013 82.482 82.257
;Concrete Pipes 100-D
Pipe_(71)_(P-Stm) 520_(P-Stm) 519_(P-Stm) 57.146 0.013 82.787 82.557
;Concrete Pipes 100-D
Pipe_(72)_(P-Stm) 519_(P-Stm) 518_(P-Stm) 31.967 0.013 82.497 82.337

[ORIFICES]
;;Name From Node To Node Type Offset Qcoeff Gated
CloseTime
;-----
OR1 518_(P-Stm) 518_Orifice SIDE 81.361 0.65 NO

[WEIRS]
;;Name From Node To Node Type CrestHt Qcoeff Gated
EndCon EndCoeff SurchARGE RoadWidth RoadSurf Coeff. Curve
;-----
W1 0 CB208 CB209 TRANSVERSE 85.31 1.84 NO
W2 0 CB210B CB211 TRANSVERSE 85.6 1.84 NO
W3 0 CB210B CB202 TRANSVERSE 85.45 1.84 NO
W4 0 CB202 CB204 TRANSVERSE 85.55 1.84 NO
W5 0 CB206 CB207 TRANSVERSE 85.45 1.84 NO
W6 0 CB201 CB200 TRANSVERSE 85.65 1.84 NO
W7 0 CB200 CB209 TRANSVERSE 85.42 1.84 NO

[OUTLETS]
;;Name Gated From Node To Node Offset Type QTable/Qcoeff
;-----
CB200 CB200 520_(P-Stm) 83.18 TABULAR/HEAD IPEX_Type_A
NO
;Critical
CB201 CB201 520_(P-Stm) 83.09 TABULAR/HEAD Vortex_ICD_100
NO
;Critical
CB202 CB202 521_(P-Stm) 82.76 TABULAR/HEAD IPEX_Type_A
NO
CB203 CB203 521_(P-Stm) 82.75 TABULAR/HEAD Vortex_ICD_70
NO
CB204 CB204 522_(P-Stm) 82.75 TABULAR/HEAD Vortex_ICD_65
NO
CB205 CB205 522_(P-Stm) 82.85 TABULAR/HEAD Vortex_ICD_65
NO
CB206 CB206 522_(P-Stm) 82.77 TABULAR/HEAD Vortex_ICD_70
NO
CB207 CB207 522_(P-Stm) 83.15 TABULAR/HEAD Vortex_ICD_100
NO
CB209 CB209 520_(P-Stm) 83.2 TABULAR/HEAD IPEX_Type_A
NO

```

Vortex_ICD_65	1.6	4.6
Vortex_ICD_65	1.8	4.9
Vortex_ICD_65	2	5.1
Vortex_ICD_65	2.5	5.7
Vortex_ICD_65	3	6.3
;Tempest Rating Curve for Vortex ICD 70, No grate allowance		
Vortex_ICD_70	0	1.3
Vortex_ICD_70	0.1	1.3
Vortex_ICD_70	0.2	1.9
Vortex_ICD_70	0.3	2.3
Vortex_ICD_70	0.4	2.7
Vortex_ICD_70	0.5	3
Vortex_ICD_70	0.6	3.3
Vortex_ICD_70	0.7	3.6
Vortex_ICD_70	0.8	3.8
Vortex_ICD_70	0.9	4.1
Vortex_ICD_70	1	4.3
Vortex_ICD_70	1.2	4.7
Vortex_ICD_70	1.4	5.1
Vortex_ICD_70	1.6	5.5
Vortex_ICD_70	1.8	5.8
Vortex_ICD_70	2	6.1
Vortex_ICD_70	2.5	6.8
Vortex_ICD_70	3	7.5

;Tempest Rating Curve for Vortex ICD 75, No grate allowance		
Vortex_ICD_75	0	1.6
Vortex_ICD_75	0.1	1.6
Vortex_ICD_75	0.2	2.2
Vortex_ICD_75	0.3	2.7
Vortex_ICD_75	0.4	3.2
Vortex_ICD_75	0.5	3.5
Vortex_ICD_75	0.6	3.9
Vortex_ICD_75	0.7	4.2
Vortex_ICD_75	0.8	4.5
Vortex_ICD_75	0.9	4.8
Vortex_ICD_75	1	5
Vortex_ICD_75	1.2	5.5
Vortex_ICD_75	1.4	5.9
Vortex_ICD_75	1.6	6.3
Vortex_ICD_75	1.8	6.7
Vortex_ICD_75	2	7.1
Vortex_ICD_75	2.5	7.9
Vortex_ICD_75	3	8.7

;Tempest Rating Curve for Vortex ICD 80, No grate allowance		
Vortex_ICD_80	0	1.8
Vortex_ICD_80	0.1	1.8
Vortex_ICD_80	0.2	2.6
Vortex_ICD_80	0.3	3.1
Vortex_ICD_80	0.4	3.6
Vortex_ICD_80	0.5	4
Vortex_ICD_80	0.6	4.4
Vortex_ICD_80	0.7	4.8
Vortex_ICD_80	0.8	5.1
Vortex_ICD_80	0.9	5.4
Vortex_ICD_80	1	5.7
Vortex_ICD_80	1.2	6.3
Vortex_ICD_80	1.4	6.8
Vortex_ICD_80	1.6	7.2
Vortex_ICD_80	1.8	7.7
Vortex_ICD_80	2	8.1
Vortex_ICD_80	2.5	9
Vortex_ICD_80	3	9.9

;Tempest Rating Curve for Vortex ICD 85, No grate allowance		
Vortex_ICD_85	0	2.9
Vortex_ICD_85	0.1	2.9
Vortex_ICD_85	0.2	3.5
Vortex_ICD_85	0.3	3.5
Vortex_ICD_85	0.4	4.1
Vortex_ICD_85	0.5	4.5
Vortex_ICD_85	0.6	5
Vortex_ICD_85	0.7	5.4
Vortex_ICD_85	0.8	5.7
Vortex_ICD_85	0.9	6.1
Vortex_ICD_85	1	6.4
Vortex_ICD_85	1.2	7
Vortex_ICD_85	1.4	7.6
Vortex_ICD_85	1.6	8.1
Vortex_ICD_85	1.8	8.6
Vortex_ICD_85	2	9.1
Vortex_ICD_85	2.5	10.1
Vortex_ICD_85	3	11.1

;Tempest Rating Curve for Vortex ICD 90, No grate allowance		
Vortex_ICD_90	0	3.9
Vortex_ICD_90	0.1	3.2
Vortex_ICD_90	0.2	3.2
Vortex_ICD_90	0.3	3.9
Vortex_ICD_90	0.4	4.5
Vortex_ICD_90	0.5	5.1
Vortex_ICD_90	0.6	5.5
Vortex_ICD_90	0.7	6
Vortex_ICD_90	0.8	6.4
Vortex_ICD_90	0.9	6.8
Vortex_ICD_90	1	7.2
Vortex_ICD_90	1.2	7.9
Vortex_ICD_90	1.4	8.5
Vortex_ICD_90	1.6	9.1
Vortex_ICD_90	1.8	9.6
Vortex_ICD_90	2	10.2
Vortex_ICD_90	2.5	11.4
Vortex_ICD_90	3	12.5

;Tempest Rating Curve for Vortex ICD 95, No grate allowance		
Vortex_ICD_95	0	4.4
Vortex_ICD_95	0.1	2.6
Vortex_ICD_95	0.2	3.6
Vortex_ICD_95	0.3	4.4
Vortex_ICD_95	0.4	5.1
Vortex_ICD_95	0.5	5.7
Vortex_ICD_95	0.6	6.2
Vortex_ICD_95	0.7	6.7
Vortex_ICD_95	0.8	7.1
Vortex_ICD_95	0.9	7.6
Vortex_ICD_95	1	8
Vortex_ICD_95	1.2	8.7
Vortex_ICD_95	1.4	9.4
Vortex_ICD_95	1.6	10.1
Vortex_ICD_95	1.8	10.7
Vortex_ICD_95	2	11.3
Vortex_ICD_95	2.5	12.6
Vortex_ICD_95	3	13.8

CB200	Storage	0	0.36
CB200		2.24	217.87
CB200		2.32	217.87

CB201	Storage	0	0.36
CB201		2.41	169.64
CB201		2.56	169.64
CB201		2.66	169.64

CB202	Storage	0	0.36
CB202		2.6	273.92
CB202		2.79	273.92
CB202		2.89	273.92

CB203	Storage	0	0.36
CB203		2.6	178.09
CB203		2.9	178.09

CB204	Storage	0	0.36
CB204		2.6	146.08
CB204		2.75	146.08

CB205	Storage	0	0.36
CB205		2.6	0.36
CB205		2.75	86.52
CB206	Storage	0	0.36
CB206		2.6	0.36
CB206		2.68	57.95
CB206		2.73	57.95
CB207	Storage	0	0.36
CB207		1.97	0.36
CB207		2.3	178.5
CB208	Storage	0	0.073
CB208		1.74	0.073
CB208		2.01	67.88
CB208		2.04	67.88
CB209	Storage	0	0.073
CB209		1.6	0.073
CB209		1.9	84.87
CB210B	Storage	0	0.073
CB210B		2.6	0.073
CB210B		2.9	70.98
CB210B		3	70.98
CB211	Storage	0	0.073
CB211		1.65	0.073
CB211		1.9	21.99
CB212	Storage	0	0.36
CB212		2.2	0.36
CB212		2.42	55.12
CB212A	Storage	0	0.073
CB212A		2	0.073
CB213	Storage	0	0.073
CB213		1.6	0.073
CB213		1.75	9.05
CB214	Storage	0	0.073
CB214		1.6	0.073
CB214		1.9	34.75

```

[TIMESERIES]
;Name Date Time Value
;Rainfall (mm/hr)
3CHI100 01/01/2000 00:00:00 5.339
3CHI100 01/01/2000 00:10:00 6.376
3CHI100 01/01/2000 00:20:00 7.977
3CHI100 01/01/2000 00:30:00 10.797
3CHI100 01/01/2000 00:40:00 17.136
3CHI100 01/01/2000 00:50:00 45.128
3CHI100 01/01/2000 01:00:00 178.107
3CHI100 01/01/2000 01:10:00 51.056
3CHI100 01/01/2000 01:20:00 26.163
3CHI100 01/01/2000 01:30:00 17.571
3CHI100 01/01/2000 01:40:00 13.277
3CHI100 01/01/2000 01:50:00 10.712
3CHI100 01/01/2000 02:00:00 9.008
3CHI100 01/01/2000 02:10:00 7.793
3CHI100 01/01/2000 02:20:00 6.883
3CHI100 01/01/2000 02:30:00 6.174
3CHI100 01/01/2000 02:40:00 5.607
3CHI100 01/01/2000 02:50:00 5.142
3CHI100 01/01/2000 03:00:00 0
    
```

```

[REPORT]
;Reporting Options
INPUF YES
CONTROLS NO
SUBCATCHMENTS ALL
NODES ALL
LINKS ALL
    
```

```

[TAGS]
Node 518 Orifice RY_Manhole
Node CB200 RY_Manhole
Node CB201 RY_Manhole
Node CB202 RY_Manhole
Node CB203 RY_Manhole
Node CB204 RY_Manhole
Node CB205 RY_Manhole
Node CB206 RY_Manhole
Node CB207 RY_Manhole
Node CB208 RY_Manhole
Node CB209 RY_Manhole
Node CB210B RY_Manhole
Node CB211 RY_Manhole
Node CB212 RY_Manhole
Node CB212A RY_Manhole
Node CB213 RY_Manhole
Node CB214 RY_Manhole
Link C2 RY_Sewer
Link C4 RY_Sewer
Link C5 RY_Sewer
    
```

```

[MAP]
DIMENSIONS 381219.0294 5032865.6782 381334.8286 5033009.9278
UNITS Meters
    
```

```

[COORDINATES]
;Node X-Coord Y-Coord
518 Orifice 381303.7 5032953.188
518A (P-Stm) 381317.029 5032955.797
518 (P-Stm) 381301.695 5032952.807
519 (P-Stm) 381278.558 5032974.866
520 (P-Stm) 381240.562 5032932.182
521 (P-Stm) 381309.324 5032926.69
522 (P-Stm) 381267.739 5032909.252
CB200 381246.119 5032946.933
CB201 381266.142 5032969.504
CB202 381305.816 5032949.229
CB203 381314.519 5032914.342
CB204 381291.187 5032921.779
CB205 381286.939 5032925.282
CB206 381270.233 5032913.017
CB207 381253.811 5032910.356
CB208 381248.314 5032902.406
CB209 381228.288 5032926.78
CB210B 381314.246 5032963.095
CB211 381319.351 5032991.771
CB212 381328.283 5032931.288
CB212A 381326.507 5032912.9
CB213 381296.875 5032912.718
CB214 381282.831 5032893.727
    
```

```

[VERTICES]
;Link X-Coord Y-Coord
W2 381318.013 5032956.452
W4 381305.808 5032934.267
W4 381304.151 5032928.843
    
```

```

[POLYGONS]
;Subcatchment X-Coord Y-Coord
S1 381237.464 5032904.425
S1 381240.329 5032905.867
S9 381273.896 5032926.903
S9 381277.469 5032930.913
S9 381278.399 5032931.986
S9 381281.347 5032922.355
S9 381290.74 5032939.886
    
```

```
;;Storage Node X-Coord Y-Coord
;;-----
[SYMBOLS]
;;Gage X-Coord Y-Coord
;;-----
```

EPA STORM WATER MANAGEMENT MODEL - VERSION 5.2 (Build 5.2.4)

```
*****
Element Count
*****
Number of rain gages ..... 1
Number of subcatchments ... 17
Number of nodes ..... 23
Number of links ..... 29
Number of pollutants ..... 0
Number of land uses ..... 0
```

```
*****
Raingage Summary
*****
Name Data Source Data Type Recording Interval
-----
3CHI100 3CHI100 INTENSITY 10 min.
```

```
*****
Subcatchment Summary
*****
Name Area Width %Imperv %Slope Rain Gage Outlet
-----
S1 0.02 29.61 0.06 2.2000 3CHI100 CB208
S10 0.03 55.32 99.62 2.2000 3CHI100 CB204
S11 0.13 65.66 86.66 2.2000 3CHI100 CB202
S12 0.01 6.44 0.25 2.2000 3CHI100 CB213
S14_1 0.01 22.78 52.75 2.2000 3CHI100 CB211
S14_2 0.02 58.12 31.75 2.2000 3CHI100 CB212
S15_2 0.04 108.74 25.77 2.2000 3CHI100 CB210B
S2 0.07 33.61 63.05 2.2000 3CHI100 CB209
S3 0.07 45.79 96.63 2.2000 3CHI100 CB207
S32 0.05 29.70 14.29 2.2000 3CHI100 CB214
S4 0.04 24.67 99.97 2.2000 3CHI100 CB206
S45 0.02 14.32 99.96 2.2000 3CHI100 CB203
S5 0.09 82.96 89.90 2.2000 3CHI100 CB200
S6 0.02 40.30 0.05 2.2000 3CHI100 CB214
S7 0.07 25.95 100.00 2.2000 3CHI100 520_(P-
Stm)
S8 0.09 35.06 80.12 2.2000 3CHI100 CB201
S9 0.03 19.08 76.83 2.2000 3CHI100 CB205
```

```
*****
Node Summary
*****
Name Type Invert Elev. Max. Depth Ponded Area External Inflow
-----
518 Orifice JUNCTION 81.36 4.11 0.0
518A (P-Stm) OUTFALL 80.65 1.13 0.0
518 (P-Stm) STORAGE 81.06 4.41 0.0
519 (P-Stm) STORAGE 82.20 3.51 0.0
520 (P-Stm) STORAGE 82.49 2.89 0.0
521 (P-Stm) STORAGE 81.96 3.67 0.0
522 (P-Stm) STORAGE 82.18 3.32 0.0
CB207 STORAGE 83.18 2.32 0.0
CB201 STORAGE 83.09 2.66 0.0
CB202 STORAGE 82.76 2.89 0.0
CB203 STORAGE 82.75 2.90 0.0
CB204 STORAGE 82.75 2.75 0.0
CB205 STORAGE 82.85 2.75 0.0
CB206 STORAGE 82.77 2.73 0.0
CB207 STORAGE 83.15 2.30 0.0
CB208 STORAGE 83.30 2.04 0.0
CB209 STORAGE 83.20 1.90 0.0
CB210B STORAGE 82.65 3.00 0.0
CB211 STORAGE 83.70 1.90 0.0
CB212 STORAGE 83.20 2.42 0.0
CB212A STORAGE 83.62 2.00 0.0
CB213 STORAGE 83.15 1.75 0.0
CB214 STORAGE 82.95 1.90 0.0
```

```
*****
Link Summary
*****
Name From Node To Node Type Length %Slope
-----
C2 CB208 CB207 CONDUIT 9.7 1.0346
C4 CB212A CB212 CONDUIT 18.5 2.0031
C5 CB211 CB212 CONDUIT 22.3 2.0142
CB213 CB213 522_(P-Stm) CONDUIT 29.3 1.3396
CB214 CB214 522_(P-Stm) CONDUIT 21.6 0.8915
Pipe_ (104)_ (P-Stm)_2 518_Orifice 518A (P-Stm) CONDUIT 15.6 0.2496
Pipe_ (110)_ (P-Stm) 521_ (P-Stm) 518_ (P-Stm) CONDUIT 27.2 0.3528
Pipe_ (111)_ (P-Stm) 522_ (P-Stm) 521_ (P-Stm) CONDUIT 45.1 0.4990
Pipe_ (71)_ (P-Stm) 520_ (P-Stm) 519_ (P-Stm) CONDUIT 57.1 0.4025
Pipe_ (72)_ (P-Stm) 519_ (P-Stm) 518_ (P-Stm) CONDUIT 32.0 0.5005
OR1 518 (P-Stm) 518 Orifice ORIFICE
W1 CB208 CB209 WEIR
W2 CB210B CB211 WEIR
W3 CB210B CB202 WEIR
W4 CB202 CB204 WEIR
W5 CB206 CB207 WEIR
W6 CB201 CB200 WEIR
W7 CB200 CB209 WEIR
CB200 CB200 520 (P-Stm) OUTLET
CB201 CB201 520 (P-Stm) OUTLET
CB202 CB202 521 (P-Stm) OUTLET
CB203 CB203 521 (P-Stm) OUTLET
CB204 CB204 522 (P-Stm) OUTLET
CB205 CB205 522 (P-Stm) OUTLET
CB206 CB206 522 (P-Stm) OUTLET
CB207 CB207 522 (P-Stm) OUTLET
CB209 CB209 520 (P-Stm) OUTLET
CB210B CB210B 518 (P-Stm) OUTLET
CB212 CB212 521 (P-Stm) OUTLET
```

```
*****
Cross Section Summary
*****
Conduit Shape Full Depth Full Area Hyd. Rad. Max. Width No. of Barrels Full Flow
-----
C2 CIRCULAR 0.25 0.05 0.06 0.25 1 60.49
C4 CIRCULAR 0.25 0.05 0.06 0.25 1 84.17
C5 CIRCULAR 0.25 0.05 0.06 0.25 1 84.40
CB213 CIRCULAR 0.25 0.05 0.06 0.25 1 68.83
CB214 CIRCULAR 0.25 0.05 0.06 0.25 1 56.15
Pipe_ (104)_ (P-Stm)_2 CIRCULAR 0.45 0.16 0.11 0.45 1 142.46
Pipe_ (110)_ (P-Stm) CIRCULAR 0.53 0.22 0.13 0.53 1 255.47
Pipe_ (111)_ (P-Stm) CIRCULAR 0.53 0.22 0.13 0.53 1 303.80
Pipe_ (71)_ (P-Stm) CIRCULAR 0.53 0.22 0.13 0.53 1 272.85
Pipe_ (72)_ (P-Stm) CIRCULAR 0.53 0.22 0.13 0.53 1 304.28
```

```
*****
Analysis Options
*****
Flow Units ..... LPS
Process Models:
Rainfall/Runoff ..... YES
RDII ..... NO
Snowmelt ..... NO
Groundwater ..... NO
Flow Routing ..... YES
Ponding Allowed ..... NO
Water Quality ..... NO
Infiltration Method ..... HORTON
Flow Routing Method ..... DYNWAVE
Surcharge Method ..... EXTRAN
Starting Date ..... 01/01/2000 00:00:00
Ending Date ..... 01/01/2000 06:00:00
Antecedent Dry Days ..... 0.0
Report Time Step ..... 00:01:00
Wet Time Step ..... 00:01:00
Dry Time Step ..... 00:01:00
Routing Time Step ..... 1.00 sec
Variable Time Step ..... YES
Maximum Trials ..... 8
Number of Threads ..... 1
Head Tolerance ..... 0.001500 m
```

```
*****
Volume      Depth
Runoff Quantity Continuity  hectare-m      mm
*****
Total Precipitation ..... 0.059      71.708
Evaporation Loss ..... 0.000      0.000
Infiltration Loss ..... 0.010      12.469
Surface Runoff ..... 0.048      58.202
Final Storage ..... 0.001      1.137
Continuity Error (%) ..... -0.141
```

```
*****
Volume      Volume
Flow Routing Continuity  hectare-m      10^6 ltr
*****
Dry Weather Inflow ..... 0.000      0.000
Wet Weather Inflow ..... 0.048      0.479
Groundwater Inflow ..... 0.000      0.000
RDII Inflow ..... 0.000      0.000
External Inflow ..... 0.000      0.000
External Outflow ..... 0.048      0.477
Flooding Loss ..... 0.000      0.000
Evaporation Loss ..... 0.000      0.000
Exfiltration Loss ..... 0.000      0.000
Initial Stored Volume ..... 0.000      0.000
Final Stored Volume ..... 0.000      0.002
Continuity Error (%) ..... -0.030
```

```
*****
Time-Step Critical Elements
*****
None
```

```
*****
Highest Flow Instability Indexes
*****
Link W3 (1)
```

```
*****
Most Frequent Nonconverging Nodes
*****
Convergence obtained at all time steps.
```

```
*****
Routing Time Step Summary
*****
Minimum Time Step : 0.50 sec
Average Time Step : 1.00 sec
Maximum Time Step : 1.00 sec
% of Time in Steady State : 0.00
Average Iterations per Step : 2.00
% of Steps Not Converging : 0.00
Time Step Frequencies :
1.000 - 0.871 sec : 100.00 %
0.871 - 0.758 sec : 0.00 %
0.758 - 0.660 sec : 0.00 %
0.660 - 0.574 sec : 0.00 %
0.574 - 0.500 sec : 0.00 %
```

```
*****
Subcatchment Runoff Summary
*****
```

Total Runoff mm	Total Runoff Subcatchment mm	Peak Runoff mm	Total Runoff Precip mm	Total Runoff mm	Total Evap mm	Total Infil mm	Imperv Runoff mm	Perv Runoff mm
28.09	0.01	7.47	71.71	0.00	0.00	43.70	0.04	28.05
70.09	0.02	15.18	71.71	0.00	0.00	0.16	69.98	0.12
64.67	0.08	61.68	71.71	0.00	0.00	5.78	60.87	3.80
26.64	0.00	3.78	71.71	0.00	0.00	24.62	37.03	46.38
46.38	0.01	5.46	71.71	0.00	0.00	32.72	22.28	38.63
38.63	0.01	8.14	71.71	0.00	0.00	34.87	18.08	36.59
30.59	0.01	16.73	71.71	0.00	0.00	16.22	44.29	10.30
54.59	0.04	33.11	71.71	0.00	0.00	1.46	67.87	0.98
68.85	0.05	34.97	71.71	0.00	0.00	39.41	10.03	30.12
32.13	0.02	18.19	71.71	0.00	0.00	0.01	70.21	0.01
70.22	0.03	22.26	71.71	0.00	0.00	0.02	70.22	0.01
70.22	0.02	10.98	71.71	0.00	0.00	4.36	66.05	2.90
60.05	0.06	42.36	71.71	0.00	0.00	43.69	0.00	28.10
28.10	0.01	9.63	71.71	0.00	0.00	0.00	70.22	0.00
70.22	0.05	33.94	71.71	0.00	0.00	8.68	61.86	5.60
61.86	0.06	44.54	71.71	0.00	0.00	10.06	53.97	6.58
60.55	0.02	13.15	71.71	0.844				

```
*****
Node Depth Summary
*****
```

Node	Type	Average Depth Meters	Maximum Depth Meters	Maximum HGL Meters	Time of Max Occurrence days hr:min	Reported Max Depth Meters
------	------	-------------------------	-------------------------	-----------------------	---------------------------------------	------------------------------

Node	Type	Inflow LPS	Inflow LPS	Time of Max Occurrence days hr:min	Lateral Inflow 10^6 ltr	Total Inflow 10^6 ltr
518 Orifice	JUNCTION	0.08	0.20	0 01:37	0	0.20
518A (P-Stm)	OUTFALL	0.63	0.63	0 00:00	0	0.63
519 (P-Stm)	STORAGE	1.27	3.78	0 01:37	0	3.78
519 (P-Stm)	STORAGE	0.81	2.65	0 01:37	0	2.65
520 (P-Stm)	STORAGE	0.72	2.36	0 01:37	0	2.36
521 (P-Stm)	STORAGE	0.90	2.89	0 01:37	0	2.89
522 (P-Stm)	STORAGE	0.81	2.66	0 01:37	0	2.66
CB200	STORAGE	0.43	2.15	0 01:20	0	2.15
CB201	STORAGE	0.58	2.57	0 01:11	0	2.57
CB202	STORAGE	0.60	2.74	0 01:20	0	2.74
CB203	STORAGE	0.54	2.66	0 01:11	0	2.66
CB204	STORAGE	0.65	2.70	0 01:20	0	2.70
CB205	STORAGE	0.56	2.69	0 01:20	0	2.69
CB206	STORAGE	0.63	2.70	0 01:10	0	2.70
CB207	STORAGE	0.58	2.18	0 01:20	0	2.17
CB208	STORAGE	0.52	2.03	0 01:21	0	2.03
CB209	STORAGE	0.37	1.79	0 01:25	0	1.79
CB210B	STORAGE	0.64	2.85	0 01:20	0	2.85
CB211	STORAGE	0.19	1.18	0 01:36	0	1.18
CB212	STORAGE	0.32	1.67	0 01:35	0	1.67
CB212A	STORAGE	0.21	1.26	0 01:35	0	1.25
CB213	STORAGE	0.32	1.70	0 01:38	0	1.70
CB214	STORAGE	0.37	1.90	0 01:36	0	1.90

```
*****
Node Inflow Summary
*****
```

Flow	Maximum Lateral Inflow	Maximum Total Inflow	Time of Max Occurrence	Lateral Inflow 10^6 ltr	Total Inflow 10^6 ltr
518 Orifice	0.00	66.10	0 01:37	0	0.477
518A (P-Stm)	0.00	66.10	0 01:37	0	0.477
519 (P-Stm)	0.00	84.12	0 01:07	0	0.477
519 (P-Stm)	0.00	92.47	0 01:03	0	0.206
520 (P-Stm)	33.94	96.71	0 01:05	0.0482	0.207
521 (P-Stm)	0.00	78.54	0 01:05	0	0.256
522 (P-Stm)	0.00	60.78	0 01:06	0	0.15
CB200	42.36	43.45	0 01:10	0.0573	0.0621
CB201	44.54	44.54	0 01:10	0.0582	0.0582
CB202	61.68	61.68	0 01:10	0.0821	0.0834
CB203	10.98	10.98	0 01:10	0.0156	0.0156
CB204	15.18	15.18	0 01:10	0.0215	0.0215
CB205	13.15	13.15	0 01:10	0.0167	0.0167
CB206	22.26	22.26	0 01:10	0.0316	0.0316
CB207	34.97	51.81	0 01:10	0.0489	0.068
CB208	7.47	26.09	0 01:03	0.00525	0.0156
CB209	33.11	33.11	0 01:10	0.0399	0.0434
CB210B	16.73	37.44	0 01:09	0.0136	0.0176
CB211	5.46	7.13	0 01:08	0.00538	0.00544
CB212	8.14	13.45	0 01:06	0.00691	0.0143
CB212A	0.00	5.30	0 01:09	0	0.00175
CB213	3.78	20.64	0 01:06	0.00397	0.00517
CB214	27.81	27.81	0 01:10	0.0234	0.0235

```
*****
Node Surcharge Summary
*****
```

No nodes were surcharged.

```
*****
Node Flooding Summary
*****
```

No nodes were flooded.

```
*****
Storage Volume Summary
*****
```

Node	Type	Average Volume 1000 m^3	Avg Full	Evap Loss	Exfil Loss	Maximum Volume 1000 m^3	Max Full	Time of Max Occurrence days hr:min
518 (P-Stm)	STORAGE	0.001	28.9	0.0	0.0	0.004	85.8	0 01:37
519 (P-Stm)	STORAGE	0.001	23.0	0.0	0.0	0.003	75.4	0 01:37
520 (P-Stm)	STORAGE	0.001	24.9	0.0	0.0	0.003	81.7	0 01:37
521 (P-Stm)	STORAGE	0.001	24.5	0.0	0.0	0.003	78.6	0 01:37
522 (P-Stm)	STORAGE	0.001	24.5	0.0	0.0	0.003	80.1	0 01:37
CB200	STORAGE	0.001	2.0	0.0	0.0	0.011	25.0	0 01:20
CB201	STORAGE	0.002	6.1	0.0	0.0	0.015	49.8	0 01:11
CB202	STORAGE	0.001	2.7	0.0	0.0	0.015	28.0	0 01:20
CB203	STORAGE	0.000	0.8	0.0	0.0	0.002	6.7	0 01:11
CB204	STORAGE	0.001	6.4	0.0	0.0	0.006	46.3	0 01:20
CB205	STORAGE	0.000	4.7	0.0	0.0	0.003	42.4	0 01:20
CB206	STORAGE	0.001	8.4	0.0	0.0	0.004	67.6	0 01:10
CB207	STORAGE	0.002	6.2	0.0	0.0	0.012	40.2	0 01:20
CB208	STORAGE	0.002	15.2	0.0	0.0	0.010	91.1	0 01:21
CB209	STORAGE	0.000	3.6	0.0	0.0	0.005	39.9	0 01:25
CB210B	STORAGE	0.000	3.6	0.0	0.0	0.005	39.9	0 01:25

Post-Development 3-hour Chicago 1:100-year Event

January 2025

CB210B	0.001	4.8	0.0	0.0	0.008	42.5	0	01:20
7.22								
CB211	0.000	0.5	0.0	0.0	0.000	3.0	0	01:36
5.42								
CB212	0.000	1.7	0.0	0.0	0.001	8.7	0	01:35
10.15								
CB212A	0.000	10.6	0.0	0.0	0.000	62.8	0	01:35
1.32								
CB213	0.000	4.6	0.0	0.0	0.000	49.4	0	01:38
7.52								
CB214	0.000	8.1	0.0	0.0	0.005	97.2	0	01:36
25.87								

Outfall Loading Summary

Outfall Node	Flow Pcnt	Avg Flow LPS	Max Flow LPS	Total Volume 10 ⁶ ltr
518A (P-Stm)	67.75	32.60	66.10	0.477
System	67.75	32.60	66.10	0.477

Link Flow Summary

Link	Type	Maximum Flow LPS	Time of Max Occurrence days hr:min	Maximum Veloc m/sec	Max/ Full Flow	Max/ Full Depth
C2	CONDUIT	24.70	0 01:03	0.50	0.41	1.00
C4	CONDUIT	5.30	0 01:09	0.15	0.06	1.00
C5	CONDUIT	5.42	0 01:06	0.66	0.06	1.00
CB213	CONDUIT	18.57	0 01:06	0.38	0.27	1.00
CB214	CONDUIT	25.87	0 01:09	0.53	0.46	1.00
Pipe _ (104) (P-Stm)	2 CONDUIT	66.10	0 01:37	1.05	0.46	0.42
Pipe _ (110) (P-Stm)	CONDUIT	64.79	0 01:05	0.72	0.25	1.00
Pipe _ (111) (P-Stm)	CONDUIT	40.32	0 01:05	0.49	0.13	1.00
Pipe _ (71) (P-Stm)	CONDUIT	92.47	0 01:03	1.04	0.34	1.00
Pipe _ (72) (P-Stm)	CONDUIT	65.69	0 01:06	0.89	0.22	1.00
OR1	ORIFICE	66.10	0 01:37			1.00
W1	WEIR	5.11	0 01:21			0.50
W2	WEIR	0.00	0 00:00			0.00
W3	WEIR	20.72	0 01:09			0.25
W4	WEIR	0.00	0 00:00			0.00
W5	WEIR	16.85	0 01:10			0.31
W6	WEIR	10.31	0 01:11			0.10
W7	WEIR	0.00	0 00:00			0.00
CB200	DUMMY	26.02	0 01:05			
CB201	DUMMY	14.08	0 01:04			
CB202	DUMMY	29.09	0 01:02			
CB203	DUMMY	5.70	0 01:07			
CB204	DUMMY	5.52	0 01:03			
CB205	DUMMY	2.18	0 01:06			
CB206	DUMMY	6.86	0 01:02			
CB207	DUMMY	12.67	0 01:04			
CB209	DUMMY	23.04	0 01:05			
CB210B	DUMMY	5.01	0 01:06			
CB212	DUMMY	5.95	0 01:05			

Flow Classification Summary

Conduit	Adjusted /Actual Length	Fraction of Time in Flow Class								
		Up Dry	Down Dry	Sub Dry	Sup Crit	Up Crit	Down Crit	Norm Ltd	Inlet Ctrl	
C2	1.00	0.05	0.00	0.00	0.39	0.00	0.00	0.56	0.07	0.00
C4	1.00	0.17	0.01	0.00	0.27	0.00	0.00	0.55	0.03	0.00
C5	1.00	0.15	0.00	0.00	0.28	0.00	0.00	0.56	0.05	0.00
CB213	1.00	0.05	0.00	0.00	0.32	0.00	0.00	0.63	0.05	0.00
CB214	1.00	0.05	0.00	0.00	0.32	0.00	0.00	0.63	0.03	0.00
Pipe _ (104) (P-Stm)	2 1.00	0.07	0.00	0.00	0.00	0.00	0.00	0.93	0.00	0.00
Pipe _ (110) (P-Stm)	1.00	0.06	0.00	0.00	0.38	0.00	0.00	0.56	0.00	0.00
Pipe _ (111) (P-Stm)	1.00	0.06	0.00	0.00	0.94	0.00	0.00	0.00	0.58	0.00
Pipe _ (71) (P-Stm)	1.00	0.06	0.00	0.00	0.34	0.00	0.00	0.60	0.03	0.00
Pipe _ (72) (P-Stm)	1.00	0.07	0.00	0.00	0.37	0.00	0.00	0.57	0.02	0.00

Conduit Surcharge Summary

Conduit	Hours Full			Hours Above Normal Flow	Hours Capacity Limited
	Both Ends	Upstream	Dnstream		
C2	1.76	1.76	1.80	0.01	0.01
C4	1.29	1.29	1.54	0.01	0.01
C5	1.23	1.23	1.55	0.01	0.01
CB213	1.50	1.50	1.74	0.01	0.01
CB214	1.63	1.63	1.74	0.01	0.01
Pipe _ (110) (P-Stm)	1.90	1.90	1.98	0.01	0.01
Pipe _ (111) (P-Stm)	1.74	1.74	1.90	0.01	0.01
Pipe _ (71) (P-Stm)	1.56	1.56	1.69	0.01	0.01
Pipe _ (72) (P-Stm)	1.73	1.73	1.85	0.01	0.01

Analysis begun on: Tue Jan 28 12:44:03 2025
Analysis ended on: Tue Jan 28 12:44:04 2025
Total elapsed time: 00:00:01

Post-Development 24-hour SCS 1:100-year Event

```

[ TITLE ]
;;Project Title/Notes

[ OPTIONS ]
;;Option Value
FLOW UNITS LPS
INFILTRATION HORTON
FLOW ROUTING DYNWAVE
LINK OFFSETS ELEVATION
MIN_SLOPE 0
ALLOW_PONDING NO
SKIP_STEADY_STATE NO

START_DATE 01/01/2000
START_TIME 00:00:00
REPORT_START_DATE 01/01/2000
REPORT_START_TIME 00:00:00
END_DATE 01/01/2000
END_TIME 06:00:00
SWEEP_START 01/01
SWEEP_END 12/31
DRY_DAYS 0
REPORT_STEP 00:01:00
WET_STEP 00:01:00
DRY_STEP 00:01:00
ROUTING_STEP 1
RULE_STEP 00:00:00

INERTIAL_DAMPING PARTIAL
NORMAL_FLOW_LIMITED BOTH
FORCE_MAIN_EQUATION H-W
VARIABLE_STEP 0.75
LENGTHENING_STEP 0
MIN_SURFAREA 0
MAX_TRIALS 8
HEAD_TOLERANCE 0.0015
SYS_FLOW_TOL 5
LAT_FLOW_TOL 5
MINIMUM_STEP 0.5
THREADS 12

[ EVAPORATION ]
;;Data Source Parameters
CONSTANT 0.0
DRY_ONLY NO

[ RAINGAGES ]
;;Name Format Interval SCF Source
3CHI100 INTENSITY 0:10 1.0 TIMESERIES 3CHI100

[ SUBCATCHMENTS ]
;;Name Rain Gage Outlet Area %Imperv Width %Slope CurbLen
SnowPack
S1 3CHI100 CB208 0.0187 0.061 29.61 2.2 0
S10 3CHI100 CB204 0.0307 99.617 55.32 2.2 0
S11 3CHI100 CB202 0.127 86.66 65.66 2.2 0
S12 3CHI100 CB213 0.0149 0.253 6.44 2.2 0
S14_1 3CHI100 CB211 0.0116 52.747 22.78 2.2 0
S14_2 3CHI100 CB212 0.0179 31.754 58.12 2.2 0
S15 3CHI100 CB210B 0.0372 25.766 108.74 2.2 0
S2 3CHI100 CB209 0.0731 63.05 33.61 2.2 0
S3 3CHI100 CB207 0.071 96.627 45.79 2.2 0
S32 3CHI100 CB214 0.052 14.286 29.7 2.2 0
S4 3CHI100 CB206 0.045 99.974 24.67 2.2 0
S45 3CHI100 CB203 0.0222 99.961 14.32 2.2 0
S5 3CHI100 CB200 0.0868 89.897 82.96 2.2 0
S6 3CHI100 CB214 0.0239 0.002 40.3 2.2 0
S7 3CHI100 520 (P-Stm) 0.0686 100 25.95 2.2 0
S8 3CHI100 CB211 0.0941 80.117 35.06 2.2 0
S9 3CHI100 CB205 0.0275 76.829 19.08 2.2 0

[ SUBAREAS ]
;;Subcatchment N-Imperv N-Periv S-Imperv S-Periv PctZero RouteTo PctRouted
S1 0.013 0.25 1.57 4.67 0 OUTLET 0
S10 0.013 0.25 1.57 4.67 0 OUTLET 0
S11 0.013 0.25 1.57 4.67 0 OUTLET 0
S12 0.013 0.25 1.57 4.67 0 OUTLET 0
S14_1 0.013 0.25 1.57 4.67 0 PERVIOUS 100
S14_2 0.013 0.25 1.57 4.67 0 PERVIOUS 100
S15 0.013 0.25 1.57 4.67 0 PERVIOUS 100
S2 0.013 0.25 1.57 4.67 0 OUTLET 0
S3 0.013 0.25 1.57 4.67 0 OUTLET 0
S32 0.013 0.25 1.57 4.67 0 PERVIOUS 80
S4 0.013 0.25 1.57 4.67 0 OUTLET 0
S45 0.013 0.25 1.57 4.67 0 IMPERVIOUS 100
S5 0.013 0.25 1.57 4.67 0 IMPERVIOUS 100
S6 0.013 0.25 1.57 4.67 0 OUTLET 0
S7 0.013 0.25 1.57 4.67 0 OUTLET 0
S8 0.013 0.25 1.57 4.67 0 IMPERVIOUS 100
S9 0.013 0.25 1.57 4.67 0 OUTLET 0

[ INFILTRATION ]
;;Subcatchment Param1 Param2 Param3 Param4 Param5
S1 76.2 13.2 4.14 7 0
S10 76.2 13.2 4.14 7 0
S11 76.2 13.2 4.14 7 0
S12 76.2 13.2 4.14 7 0
S14_1 76.2 13.2 4.14 7 0
S14_2 76.2 13.2 4.14 7 0
S15 76.2 13.2 4.14 7 0
S2 76.2 13.2 4.14 7 0
S3 76.2 13.2 4.14 7 0
S32 76.2 13.2 4.14 7 0
S4 76.2 13.2 4.14 7 0
S45 76.2 13.2 4.14 7 0
S5 76.2 13.2 4.14 7 0
S6 76.2 13.2 4.14 7 0
S7 76.2 13.2 4.14 7 0
S8 76.2 13.2 4.14 7 0
S9 76.2 13.2 4.14 7 0

[ JUNCTIONS ]
;;Name Elevation MaxDepth InitDepth SurDepth Aponded
518_Orifice 81.361 4.106 0 0 0

[ OUTFALLS ]
;;Name Elevation Type Stage Data Gated Route To
;Cylindrical Structure Slab Top Circular Frame SI
518A (P-Stm) 80.646 FIXED 81.28 NO

[ STORAGE ]
;;Name Elev. MaxDepth InitDepth Shape Curve Name/Params
SDepth Fevap Psi Keat IMD
;Cylindrical Structure Slab Top Circular Frame SI
518 (P-Stm) 81.061 4.405 0.219 FUNCTIONAL 0 0 1.13 0
;Cylindrical Structure Slab Top Circular Frame SI
519 (P-Stm) 82.197 3.512 0 FUNCTIONAL 0 0 1.13 0

520 (P-Stm) 82.487 2.888 0 FUNCTIONAL 0 0 1.13 0
;Cylindrical Structure Slab Top Circular Frame SI
521 (P-Stm) 81.957 3.673 0 FUNCTIONAL 0 0 1.13 0
;Cylindrical Structure Slab Top Circular Frame SI
522 (P-Stm) 82.182 3.323 0 FUNCTIONAL 0 0 1.13 0
;85.1800000001676
CB200 83.18 2.32 0 TABULAR CB200 0
;85.5000000001435
CB201 83.09 2.66 0 TABULAR CB201 0
;85.36
CB202 82.76 2.89 0 TABULAR CB202 0
;85.3500000000931
CB203 82.75 2.9 0 TABULAR CB203 0
;85.3500080822731
CB204 82.75 2.75 0 TABULAR CB204 0
;85.4500080823662
CB205 82.85 2.75 0 TABULAR CB205 0
;85.48
CB206 82.77 2.73 0 TABULAR CB206 0
;85.05
CB207 83.15 2.3 0 TABULAR CB207 0
;84.9000080821652
CB208 83.3 2.04 0 TABULAR CB208 0
;84.8
CB209 83.2 1.9 0 TABULAR CB209 0
;85.25
CB210B 82.65 3 0 TABULAR CB210B 0
;85.35
CB211 83.7 1.9 0 TABULAR CB211 0
;85.4
CB212 83.2 2.42 0 TABULAR CB212 0
;85.5000000000554
CB212A 83.62 2 0 TABULAR CB212A 0
;84.75
CB213 83.15 1.75 0 TABULAR CB213 0
;84.55
CB214 82.95 1.9 0 TABULAR CB214 0

[ CONDUITS ]
;;Name From Node To Node Length Roughness InOffset OutOffset
InitFlow MaxFlow
C2 0 CB208 CB207 9.666 0.013 83.3 83.2
C4 0 CB212A CB212 18.475 0.013 83.62 83.25
C5 0 CB211 CB212 22.346 0.013 83.7 83.25
CB213 0 CB213 522 (P-Stm) 29.34 0.013 83.15 82.757
CB214 0 CB214 522 (P-Stm) 21.65 0.013 82.95 82.757
;PVC Pipes
Pipe_ (104) (P-Stm)_2 518_Orifice 518A (P-Stm) 15.623 0.013 81.361 81.322
;PVC Pipes
Pipe_ (110) (P-Stm) 521 (P-Stm) 518 (P-Stm) 27.209 0.013 82.257 82.161
;PVC Pipes
Pipe_ (111) (P-Stm) 522 (P-Stm) 521 (P-Stm) 45.094 0.013 82.482 82.257
;Concrete Pipes 100-D
Pipe_ (71) (P-Stm) 520 (P-Stm) 519 (P-Stm) 57.146 0.013 82.787 82.557
;Concrete Pipes 100-D
Pipe_ (72) (P-Stm) 519 (P-Stm) 518 (P-Stm) 31.967 0.013 82.497 82.337

[ ORIFICES ]
;;Name From Node To Node Type Offset Qcoeff Gated
CloseTime
OR1 518 (P-Stm) 518_Orifice SIDE 81.361 0.65 NO

[ WEIRS ]
;;Name EndCoeff From Node To Node Type CrestHt Qcoeff Gated
EndCon EndCoeff SurchARGE RoadWidth RoadSurf Coeff. Curve
W1 0 CB208 CB209 TRANSVERSE 85.31 1.84 NO
W2 0 CB210B CB211 TRANSVERSE 85.6 1.84 NO
W3 0 CB210B CB202 TRANSVERSE 85.45 1.84 NO
W4 0 CB202 CB204 TRANSVERSE 85.55 1.84 NO
W5 0 CB206 CB207 TRANSVERSE 85.45 1.84 NO
W6 0 CB201 CB200 TRANSVERSE 85.65 1.84 NO
W7 0 CB200 CB209 TRANSVERSE 85.42 1.84 NO

[ OUTLETS ]
;;Name Gated From Node To Node Offset Type QTable/Qcoeff
CB200 CB200 520 (P-Stm) 83.18 TABULAR/HEAD IPEX_Type_A
NO
;Critical
CB201 CB201 520 (P-Stm) 83.09 TABULAR/HEAD Vortex_ICD_100
NO
;Critical
CB202 CB202 521 (P-Stm) 82.76 TABULAR/HEAD IPEX_Type_A
NO
CB203 CB203 521 (P-Stm) 82.75 TABULAR/HEAD Vortex_ICD_70
NO
CB204 CB204 522 (P-Stm) 82.75 TABULAR/HEAD Vortex_ICD_65
NO
CB205 CB205 522 (P-Stm) 82.85 TABULAR/HEAD Vortex_ICD_65
NO
CB206 CB206 522 (P-Stm) 82.77 TABULAR/HEAD Vortex_ICD_70
NO
CB207 CB207 522 (P-Stm) 83.15 TABULAR/HEAD Vortex_ICD_100
NO
CB209 CB209 520 (P-Stm) 83.2 TABULAR/HEAD IPEX_Type_A
NO
CB210B CB210B 518 (P-Stm) 82.65 TABULAR/HEAD Vortex_ICD_65
NO
CB212 CB212 521 (P-Stm) 83.2 TABULAR/HEAD Vortex_ICD_100
NO

[ SECTIONS ]
;;link Shape Geom1 Geom2 Geom3 Geom4 Barrels
Culvert
    
```



```

-----
C2          CIRCULAR      0.25      0      0      0      1
C4          CIRCULAR      0.25      0      0      0      1
C5          CIRCULAR      0.25      0      0      0      1
CB213      CIRCULAR      0.25      0      0      0      1
CB214      CIRCULAR      0.25      0      0      0      1
Pipe -- (104) (P-Stm) 2 CIRCULAR 0.45      0      0      0      1
Pipe -- (110) (P-Stm) CIRCULAR 0.525     0      0      0      1
Pipe -- (111) (P-Stm) CIRCULAR 0.525     0      0      0      1
Pipe -- (71) (P-Stm) CIRCULAR 0.525     0      0      0      1
Pipe -- (72) (P-Stm) CIRCULAR 0.525     0      0      0      1
OR1        CIRCULAR      0.127     0      0      0      0
W1         RECT_OPEN      0.03      1.5     0      0      0
W2         RECT_OPEN      0.05      2.59    0      0      0
W3         RECT_OPEN      0.2       1.34    0      0      0
W4         RECT_OPEN      0.1       4.9     0      0      0
W5         RECT_OPEN      0.05      4.725   0      0      0
W6         RECT_OPEN      0.1       6       0      0      0
W7         RECT_OPEN      0.08      10.5    0      0      0

[LOSSES]
;;Link      Kentry      Kexit      Kavg      Flap Gate      Seepage
-----
[CURVES]
;;Name      Type      X-Value      Y-Value
-----
CB210-OUT85.5      Rating      0      0
CB210-OUT85.5      Rating      85.5     0.04
CB210-OUT85.5      Rating      100     0.04

CB210-OUT-85.6      Rating      0      0
CB210-OUT-85.6      Rating      85.6     0.08
CB210-OUT-85.6      Rating      100     0.08

;IPEX Type A ICD Rating Curve
IPEX_Type_A      Rating      0      0
IPEX_Type_A      Rating      0.1     5.7
IPEX_Type_A      Rating      0.2     8.1
IPEX_Type_A      Rating      0.3     9.9
IPEX_Type_A      Rating      0.4     11.4
IPEX_Type_A      Rating      0.5     12.8
IPEX_Type_A      Rating      0.6     14.2
IPEX_Type_A      Rating      0.7     15.1
IPEX_Type_A      Rating      0.8     16.2
IPEX_Type_A      Rating      0.9     17.2
IPEX_Type_A      Rating      1       18.1
IPEX_Type_A      Rating      1.2     19.8
IPEX_Type_A      Rating      1.4     21.4
IPEX_Type_A      Rating      1.6     22.9
IPEX_Type_A      Rating      1.8     24.3
IPEX_Type_A      Rating      2       25.6
IPEX_Type_A      Rating      2.5     28.6
IPEX_Type_A      Rating      3       31.3

;IPEX Type B ICD Rating Curve
IPEX_Type_B      Rating      0      0
IPEX_Type_B      Rating      0.1     8.1
IPEX_Type_B      Rating      0.2     11.5
IPEX_Type_B      Rating      0.3     14.1
IPEX_Type_B      Rating      0.4     16.2
IPEX_Type_B      Rating      0.5     18.2
IPEX_Type_B      Rating      0.6     19.9
IPEX_Type_B      Rating      0.7     21.5
IPEX_Type_B      Rating      0.8     23.4
IPEX_Type_B      Rating      0.9     24.4
IPEX_Type_B      Rating      1       25.7
IPEX_Type_B      Rating      1.2     28.1
IPEX_Type_B      Rating      1.4     30.4
IPEX_Type_B      Rating      1.6     32.5
IPEX_Type_B      Rating      1.8     34.4
IPEX_Type_B      Rating      2       36.3
IPEX_Type_B      Rating      2.5     40.6
IPEX_Type_B      Rating      3       44.5

;IPEX Type C ICD Rating Curve
IPEX_Type_C      Rating      0      0
IPEX_Type_C      Rating      0.1     10.6
IPEX_Type_C      Rating      0.2     15
IPEX_Type_C      Rating      0.3     18.3
IPEX_Type_C      Rating      0.4     21.2
IPEX_Type_C      Rating      0.5     23.7
IPEX_Type_C      Rating      0.6     25.9
IPEX_Type_C      Rating      0.7     28
IPEX_Type_C      Rating      0.8     29.9
IPEX_Type_C      Rating      0.9     31.7
IPEX_Type_C      Rating      1       33.5
IPEX_Type_C      Rating      1.2     36.6
IPEX_Type_C      Rating      1.4     39.6
IPEX_Type_C      Rating      1.6     42.3
IPEX_Type_C      Rating      1.8     44.9
IPEX_Type_C      Rating      2       47.3
IPEX_Type_C      Rating      2.5     52.9
IPEX_Type_C      Rating      3       57.9

;IPEX Type AA ICD Rating Curve
IPEX_Type_D      Rating      0      0
IPEX_Type_D      Rating      0.1     15.4
IPEX_Type_D      Rating      0.2     21.7
IPEX_Type_D      Rating      0.3     26.6
IPEX_Type_D      Rating      0.4     30.7
IPEX_Type_D      Rating      0.5     34.3
IPEX_Type_D      Rating      0.6     37.6
IPEX_Type_D      Rating      0.7     40.6
IPEX_Type_D      Rating      0.8     43.4
IPEX_Type_D      Rating      0.9     46.1
IPEX_Type_D      Rating      1       48.5
IPEX_Type_D      Rating      1.2     53.2
IPEX_Type_D      Rating      1.4     57.4
IPEX_Type_D      Rating      1.6     61.4
IPEX_Type_D      Rating      1.8     65.1
IPEX_Type_D      Rating      2       68.7
IPEX_Type_D      Rating      2.5     76.8
IPEX_Type_D      Rating      3       84.1

;IPEX Type E ICD Rating Curve
IPEX_Type_E      Rating      0      0
IPEX_Type_E      Rating      0.1     20.5
IPEX_Type_E      Rating      0.2     28.9
IPEX_Type_E      Rating      0.3     35.5
IPEX_Type_E      Rating      0.4     40.9
IPEX_Type_E      Rating      0.5     45.8
IPEX_Type_E      Rating      0.6     50.1
IPEX_Type_E      Rating      0.7     54.2
IPEX_Type_E      Rating      0.8     57.9
IPEX_Type_E      Rating      0.9     61.4
IPEX_Type_E      Rating      1       64.7
IPEX_Type_E      Rating      1.2     70.9
IPEX_Type_E      Rating      1.4     76.6
IPEX_Type_E      Rating      1.6     81.9
IPEX_Type_E      Rating      1.8     86.8
IPEX_Type_E      Rating      2       91.5
IPEX_Type_E      Rating      2.5     102.3
IPEX_Type_E      Rating      3       112.1

;Tempest Rating Curve for Vortex ICD 100, No grate allowance
Vortex_ICD_100      Rating      0      0
Vortex_ICD_100      Rating      0.1     2.8
Vortex_ICD_100      Rating      0.2     4
Vortex_ICD_100      Rating      0.3     4.9
Vortex_ICD_100      Rating      0.4     5.6
Vortex_ICD_100      Rating      0.5     6.3
Vortex_ICD_100      Rating      0.6     6.9
Vortex_ICD_100      Rating      0.7     7.5
Vortex_ICD_100      Rating      0.8     8
Vortex_ICD_100      Rating      0.9     8.5
Vortex_ICD_100      Rating      1       8.9
Vortex_ICD_100      Rating      1.2     9.8

Vortex_ICD_100      1.4     10.6
Vortex_ICD_100      1.6     11.3
Vortex_ICD_100      1.8     12
Vortex_ICD_100      2       12.6
Vortex_ICD_100      2.5     14.1
Vortex_ICD_100      3       15.5

;Tempest Rating Curve for Vortex ICD 105, No grate allowance
Vortex_ICD_105      Rating      0      0
Vortex_ICD_105      Rating      0.1     3.1
Vortex_ICD_105      Rating      0.2     4.4
Vortex_ICD_105      Rating      0.3     5.4
Vortex_ICD_105      Rating      0.4     6.2
Vortex_ICD_105      Rating      0.5     6.9
Vortex_ICD_105      Rating      0.6     7.6
Vortex_ICD_105      Rating      0.7     8.2
Vortex_ICD_105      Rating      0.8     8.8
Vortex_ICD_105      Rating      0.9     9.3
Vortex_ICD_105      Rating      1       9.8
Vortex_ICD_105      Rating      1.2     10.7
Vortex_ICD_105      Rating      1.4     11.6
Vortex_ICD_105      Rating      1.6     12.4
Vortex_ICD_105      Rating      1.8     13.1
Vortex_ICD_105      Rating      2       13.9
Vortex_ICD_105      Rating      2.5     15.5
Vortex_ICD_105      Rating      3       17

;Tempest Rating Curve for Vortex ICD 40, No grate allowance
Vortex_ICD_40      Rating      0      0
Vortex_ICD_40      Rating      0.1     0.4
Vortex_ICD_40      Rating      0.2     0.6
Vortex_ICD_40      Rating      0.3     0.7
Vortex_ICD_40      Rating      0.4     0.9
Vortex_ICD_40      Rating      0.5     1
Vortex_ICD_40      Rating      0.6     1
Vortex_ICD_40      Rating      0.7     1.1
Vortex_ICD_40      Rating      0.8     1.2
Vortex_ICD_40      Rating      0.9     1.3
Vortex_ICD_40      Rating      1       1.4
Vortex_ICD_40      Rating      1.2     1.5
Vortex_ICD_40      Rating      1.4     1.6
Vortex_ICD_40      Rating      1.6     1.7
Vortex_ICD_40      Rating      1.8     1.8
Vortex_ICD_40      Rating      2       1.9
Vortex_ICD_40      Rating      2.5     2.2
Vortex_ICD_40      Rating      3       2.4

;Tempest Rating Curve for Vortex ICD 45, No grate allowance
Vortex_ICD_45      Rating      0      0
Vortex_ICD_45      Rating      0.1     0.6
Vortex_ICD_45      Rating      0.2     0.8
Vortex_ICD_45      Rating      0.3     1
Vortex_ICD_45      Rating      0.4     1.1
Vortex_ICD_45      Rating      0.5     1.3
Vortex_ICD_45      Rating      0.6     1.4
Vortex_ICD_45      Rating      0.7     1.5
Vortex_ICD_45      Rating      0.8     1.6
Vortex_ICD_45      Rating      0.9     1.7
Vortex_ICD_45      Rating      1       1.8
Vortex_ICD_45      Rating      1.2     2
Vortex_ICD_45      Rating      1.4     2.1
Vortex_ICD_45      Rating      1.6     2.3
Vortex_ICD_45      Rating      1.8     2.4
Vortex_ICD_45      Rating      2       2.6
Vortex_ICD_45      Rating      2.5     2.9
Vortex_ICD_45      Rating      3       3.1

;Tempest Rating Curve for Vortex ICD 50, No grate allowance
Vortex_ICD_50      Rating      0      0
Vortex_ICD_50      Rating      0.1     0.7
Vortex_ICD_50      Rating      0.2     1
Vortex_ICD_50      Rating      0.3     1.2
Vortex_ICD_50      Rating      0.4     1.4
Vortex_ICD_50      Rating      0.5     1.6
Vortex_ICD_50      Rating      0.6     1.8
Vortex_ICD_50      Rating      0.7     1.9
Vortex_ICD_50      Rating      0.8     2
Vortex_ICD_50      Rating      0.9     2.1
Vortex_ICD_50      Rating      1       2.3
Vortex_ICD_50      Rating      1.2     2.5
Vortex_ICD_50      Rating      1.4     2.7
Vortex_ICD_50      Rating      1.6     2.9
Vortex_ICD_50      Rating      1.8     3
Vortex_ICD_50      Rating      2       3.2
Vortex_ICD_50      Rating      2.5     3.6
Vortex_ICD_50      Rating      3       3.9

;Tempest Rating Curve for Vortex ICD 55, No grate allowance
Vortex_ICD_55      Rating      0      0
Vortex_ICD_55      Rating      0.1     0.9
Vortex_ICD_55      Rating      0.2     1.2
Vortex_ICD_55      Rating      0.3     1.5
Vortex_ICD_55      Rating      0.4     1.7
Vortex_ICD_55      Rating      0.5     1.9
Vortex_ICD_55      Rating      0.6     2.1
Vortex_ICD_55      Rating      0.7     2.3
Vortex_ICD_55      Rating      0.8     2.4
Vortex_ICD_55      Rating      0.9     2.6
Vortex_ICD_55      Rating      1       2.7
Vortex_ICD_55      Rating      1.2     3
Vortex_ICD_55      Rating      1.4     3.2
Vortex_ICD_55      Rating      1.6     3.4
Vortex_ICD_55      Rating      1.8     3.6
Vortex_ICD_55      Rating      2       3.8
Vortex_ICD_55      Rating      2.5     4.3
Vortex_ICD_55      Rating      3       4.7

;Tempest Rating Curve for Vortex ICD 60, No grate allowance
Vortex_ICD_60      Rating      0      0
Vortex_ICD_60      Rating      0.1     1.1
Vortex_ICD_60      Rating      0.2     1.5
Vortex_ICD_60      Rating      0.3     1.8
Vortex_ICD_60      Rating      0.4     2.1
Vortex_ICD_60      Rating      0.5     2.3
Vortex_ICD_60      Rating      0.6     2.5
Vortex_ICD_60      Rating      0.7     2.7
Vortex_ICD_60      Rating      0.8     2.9
Vortex_ICD_60      Rating      0.9     3.1
Vortex_ICD_60      Rating      1       3.2
Vortex_ICD_60      Rating      1.2     3.6
Vortex_ICD_60      Rating      1.4     4
Vortex_ICD_60      Rating      1.6     4.1
Vortex_ICD_60      Rating      1.8     4.3
Vortex_ICD_60      Rating      2       4.6
Vortex_ICD_60      Rating      2.5     5.1
Vortex_ICD_60      Rating      3       5.6

;Tempest Rating Curve for Vortex ICD 65, No grate allowance
Vortex_ICD_65      Rating      0      0
Vortex_ICD_65      Rating      0.1     1.2
Vortex_ICD_65      Rating      0.2     1.6
Vortex_ICD_65      Rating      0.3     2
Vortex_ICD_65      Rating      0.4     2.3
Vortex_ICD_65      Rating      0.5     2.5
Vortex_ICD_65      Rating      0.6     2.8
Vortex_ICD_65      Rating      0.7     3
Vortex_ICD_65      Rating      0.8     3.2
Vortex_ICD_65      Rating      0.9     3.4
Vortex_ICD_65      Rating      1       3.6
Vortex_ICD_65      Rating      1.2     4
Vortex_ICD_65      Rating      1.4     4.3
Vortex_ICD_65      Rating      1.6     4.6
Vortex_ICD_65      Rating      1.8     4.9
Vortex_ICD_65      Rating      2       5.1
Vortex_ICD_65      Rating      2.5     5.7
Vortex_ICD_65      Rating      3       6.3

;Tempest Rating Curve for Vortex ICD 70, No grate allowance
Vortex_ICD_70      Rating      0      0

```

Vortex_ICD_70	0.1	1.3
Vortex_ICD_70	0.2	1.9
Vortex_ICD_70	0.3	2.3
Vortex_ICD_70	0.4	2.7
Vortex_ICD_70	0.5	3.1
Vortex_ICD_70	0.6	3.3
Vortex_ICD_70	0.7	3.6
Vortex_ICD_70	0.8	3.8
Vortex_ICD_70	0.9	4.1
Vortex_ICD_70	1	4.3
Vortex_ICD_70	1.2	4.7
Vortex_ICD_70	1.4	5.1
Vortex_ICD_70	1.6	5.5
Vortex_ICD_70	1.8	5.8
Vortex_ICD_70	2	6.1
Vortex_ICD_70	2.5	6.8
Vortex_ICD_70	3	7.5

;Tempest Rating Curve for Vortex ICD 75, No grate allowance		
Vortex_ICD_75	Rating	0
Vortex_ICD_75	0.1	1.6
Vortex_ICD_75	0.2	2.2
Vortex_ICD_75	0.3	2.7
Vortex_ICD_75	0.4	3.2
Vortex_ICD_75	0.5	3.6
Vortex_ICD_75	0.6	3.9
Vortex_ICD_75	0.7	4.2
Vortex_ICD_75	0.8	4.5
Vortex_ICD_75	0.9	4.8
Vortex_ICD_75	1	5
Vortex_ICD_75	1.2	5.5
Vortex_ICD_75	1.4	5.9
Vortex_ICD_75	1.6	6.3
Vortex_ICD_75	1.8	6.7
Vortex_ICD_75	2	7.1
Vortex_ICD_75	2.5	7.9
Vortex_ICD_75	3	8.7

;Tempest Rating Curve for Vortex ICD 80, No grate allowance		
Vortex_ICD_80	Rating	0
Vortex_ICD_80	0.1	1.8
Vortex_ICD_80	0.2	2.6
Vortex_ICD_80	0.3	3.1
Vortex_ICD_80	0.4	3.6
Vortex_ICD_80	0.5	4.1
Vortex_ICD_80	0.6	4.4
Vortex_ICD_80	0.7	4.8
Vortex_ICD_80	0.8	5.1
Vortex_ICD_80	0.9	5.4
Vortex_ICD_80	1	5.7
Vortex_ICD_80	1.2	6.3
Vortex_ICD_80	1.4	6.8
Vortex_ICD_80	1.6	7.2
Vortex_ICD_80	1.8	7.7
Vortex_ICD_80	2	8.1
Vortex_ICD_80	2.5	9.9
Vortex_ICD_80	3	9.9

;Tempest Rating Curve for Vortex ICD 85, No grate allowance		
Vortex_ICD_85	Rating	0
Vortex_ICD_85	0.1	2
Vortex_ICD_85	0.2	2.9
Vortex_ICD_85	0.3	3.5
Vortex_ICD_85	0.4	4.1
Vortex_ICD_85	0.5	4.5
Vortex_ICD_85	0.6	5
Vortex_ICD_85	0.7	5.4
Vortex_ICD_85	0.8	5.7
Vortex_ICD_85	0.9	6.1
Vortex_ICD_85	1	6.4
Vortex_ICD_85	1.2	7
Vortex_ICD_85	1.4	7.6
Vortex_ICD_85	1.6	8.1
Vortex_ICD_85	1.8	8.6
Vortex_ICD_85	2	9.1
Vortex_ICD_85	2.5	10.1
Vortex_ICD_85	3	11.1

;Tempest Rating Curve for Vortex ICD 90, No grate allowance		
Vortex_ICD_90	Rating	0
Vortex_ICD_90	0.1	2.2
Vortex_ICD_90	0.2	3.2
Vortex_ICD_90	0.3	3.9
Vortex_ICD_90	0.4	4.5
Vortex_ICD_90	0.5	5.1
Vortex_ICD_90	0.6	5.5
Vortex_ICD_90	0.7	6
Vortex_ICD_90	0.8	6.4
Vortex_ICD_90	0.9	6.8
Vortex_ICD_90	1	7.2
Vortex_ICD_90	1.2	7.9
Vortex_ICD_90	1.4	8.5
Vortex_ICD_90	1.6	9.1
Vortex_ICD_90	1.8	9.6
Vortex_ICD_90	2	10.2
Vortex_ICD_90	2.5	11.4
Vortex_ICD_90	3	12.5

;Tempest Rating Curve for Vortex ICD 95, No grate allowance		
Vortex_ICD_95	Rating	0
Vortex_ICD_95	0.1	2.6
Vortex_ICD_95	0.2	3.6
Vortex_ICD_95	0.3	4.4
Vortex_ICD_95	0.4	5.1
Vortex_ICD_95	0.5	5.7
Vortex_ICD_95	0.6	6.2
Vortex_ICD_95	0.7	6.7
Vortex_ICD_95	0.8	7.1
Vortex_ICD_95	0.9	7.6
Vortex_ICD_95	1	8
Vortex_ICD_95	1.2	8.7
Vortex_ICD_95	1.4	9.4
Vortex_ICD_95	1.6	10.1
Vortex_ICD_95	1.8	10.7
Vortex_ICD_95	2	11.3
Vortex_ICD_95	2.5	12.6
Vortex_ICD_95	3	13.8

CB200	Storage	0	0.36
CB200		2	0.36
CB200		2.24	217.87
CB200		2.32	217.87
CB201	Storage	0	0.36
CB201		2.41	0.36
CB201		2.56	169.64
CB201		2.66	169.64
CB202	Storage	0	0.36
CB202		2.6	0.36
CB202		2.79	273.92
CB202		2.89	273.92
CB203	Storage	0	0.36
CB203		2.6	0.36
CB203		2.9	178.09
CB204	Storage	0	0.36
CB204		2.6	0.36
CB204		2.75	146.08
CB205	Storage	0	0.36
CB205		2.6	0.36
CB205		2.75	86.52
CB206	Storage	0	0.36
CB206		2.6	0.36
CB206		2.68	57.95
CB206		2.73	57.95

CB207	Storage	0	0.36
CB207		1.97	0.36
CB207		2.3	178.5
CB208	Storage	0	0.073
CB208		1.74	0.073
CB208		2.01	67.88
CB208		2.04	67.88
CB209	Storage	0	0.073
CB209		1.6	0.073
CB209		1.9	84.87
CB210B	Storage	0	0.073
CB210B		2.6	0.073
CB210B		2.9	70.98
CB210B		3	70.98
CB211	Storage	0	0.073
CB211		1.65	0.073
CB211		1.9	21.99
CB212	Storage	0	0.36
CB212		2.2	0.36
CB212		2.42	55.12
CB212A	Storage	0	0.073
CB212A		2	0.073
CB213	Storage	0	0.073
CB213		1.6	0.073
CB213		1.75	9.05
CB214	Storage	0	0.073
CB214		1.6	0.073
CB214		1.9	34.75

[TIMESERIES]			
;;Name	Date	Time	Value
;Rainfall (mm/hr)			
3CHI100	01/01/2000	00:00:00	5.339
3CHI100	01/01/2000	00:10:00	6.376
3CHI100	01/01/2000	00:20:00	7.977
3CHI100	01/01/2000	00:30:00	10.797
3CHI100	01/01/2000	00:40:00	17.136
3CHI100	01/01/2000	00:50:00	45.128
3CHI100	01/01/2000	01:00:00	178.107
3CHI100	01/01/2000	01:10:00	51.056
3CHI100	01/01/2000	01:20:00	26.163
3CHI100	01/01/2000	01:30:00	17.571
3CHI100	01/01/2000	01:40:00	13.277
3CHI100	01/01/2000	01:50:00	10.712
3CHI100	01/01/2000	02:00:00	9.008
3CHI100	01/01/2000	02:10:00	7.793
3CHI100	01/01/2000	02:20:00	6.883
3CHI100	01/01/2000	02:30:00	6.174
3CHI100	01/01/2000	02:40:00	5.607
3CHI100	01/01/2000	02:50:00	5.142
3CHI100	01/01/2000	03:00:00	0

[REPORT]	
;;Reporting Options	
INFUT	YES
CONTROLS	NO
SUBCATCHMENTS	ALL
NODES	ALL
LINKS	ALL

[TAGS]		
Node	518 Orifice	RY Manhole
Node	CB200	RY Manhole
Node	CB201	RY Manhole
Node	CB202	RY Manhole
Node	CB203	RY Manhole
Node	CB204	RY Manhole
Node	CB205	RY Manhole
Node	CB206	RY Manhole
Node	CB207	RY Manhole
Node	CB208	RY Manhole
Node	CB209	RY Manhole
Node	CB210B	RY Manhole
Node	CB211	RY Manhole
Node	CB212	RY Manhole
Node	CB212A	RY Manhole
Node	CB213	RY Manhole
Node	CB214	RY Manhole
Link	C2	RY Sewer
Link	C4	RY Sewer
Link	C5	RY Sewer

[MAP]				
DIMENSIONS	381219.0294	5032865.6782	381334.8286	5033009.9278
UNITS	Meters			

[COORDINATES]		
;;Node	X-Coord	Y-Coord
518 Orifice	381303.7	5032953.188
518A (P-Stm)	381317.029	5032955.797
518 (P-Stm)	381301.695	5032952.807
519 (P-Stm)	381276.558	5032974.866
520 (P-Stm)	381240.562	5032932.182
521 (P-Stm)	381309.324	5032926.69
522 (P-Stm)	381267.739	5032909.252
CB200	381246.119	5032946.933
CB201	381266.142	5032969.504
CB202	381305.816	5032949.229
CB203	381314.519	5032914.342
CB204	381291.887	5032921.779
CB205	381286.939	5032925.282
CB206	381270.233	5032913.017
CB207	381253.811	5032910.356
CB208	381248.314	5032902.406
CB209	381228.288	5032926.78
CB210B	381314.246	5032963.095
CB211	381319.351	5032951.771
CB212	381328.283	5032931.288
CB212A	381326.507	5032912.9
CB213	381296.875	5032912.718
CB214	381282.831	5032893.727

[VERTICES]		
;;Link	X-Coord	Y-Coord
W2	381318.013	5032956.452
W4	381305.808	5032934.267
W4	381304.151	5032928.843

[POLYGONS]		
;;Subcatchment	X-Coord	Y-Coord
S1	381237.464	5032904.825
S1	381240.329	5032905.467
S1	381240.224	5032906.884
S9	381278.399	5032931.986
S9	381281.347	5032929.355
S9	381290.74	5032939.886

[SYMBOLS]		
;;Gage	X-Coord	Y-Coord

EPA STORM WATER MANAGEMENT MODEL - VERSION 5.2 (Build 5.2.4)

Element Count

Number of rain gages 1
Number of subcatchments ... 17
Number of nodes 23
Number of links 29
Number of pollutants 0
Number of land uses 0

Raiingage Summary

Name	Data Source	Data Type	Recording Interval
3CH1100	3CH1100	INTENSITY	10 min.

Subcatchment Summary

Name	Area	Width	%Imperv	%Slope	Rain Gage	Outlet
S1	0.02	29.61	0.06	2.2000	3CH1100	CB208
S10	0.03	55.32	99.62	2.2000	3CH1100	CB204
S18	0.13	65.66	86.66	2.2000	3CH1100	CB202
S12	0.01	6.44	0.25	2.2000	3CH1100	CB213
S14_1	0.01	22.78	52.75	2.2000	3CH1100	CB211
S14_2	0.02	58.12	31.75	2.2000	3CH1100	CB212
S15	0.04	108.74	25.77	2.2000	3CH1100	CB210B
S2	0.07	33.61	63.05	2.2000	3CH1100	CB209
S3	0.07	45.79	96.63	2.2000	3CH1100	CB207
S32	0.05	29.70	14.29	2.2000	3CH1100	CB214
S4	0.04	24.67	99.97	2.2000	3CH1100	CB206
S45	0.02	14.32	99.96	2.2000	3CH1100	CB203
S5	0.09	82.96	89.90	2.2000	3CH1100	CB200
S6	0.02	40.30	0.00	2.2000	3CH1100	CB214
S7	0.07	25.95	100.00	2.2000	3CH1100	520 (P- Stm)
S8	0.09	35.06	80.12	2.2000	3CH1100	CB201
S9	0.03	19.08	76.83	2.2000	3CH1100	CB205

Node Summary

Name	Type	Invert Elev.	Max. Depth	Ponded Area	External Inflow
518 Orifice	JUNCTION	81.36	4.11	0.0	0.0
518A (P-Stm)	OUTFALL	80.65	1.13	0.0	0.0
518 (P-Stm)	STORAGE	81.06	4.41	0.0	0.0
519 (P-Stm)	STORAGE	82.20	3.51	0.0	0.0
520 (P-Stm)	STORAGE	82.49	2.93	0.0	0.0
521 (P-Stm)	STORAGE	81.96	3.67	0.0	0.0
522 (P-Stm)	STORAGE	82.18	3.32	0.0	0.0
CB200	STORAGE	83.18	2.32	0.0	0.0
CB201	STORAGE	83.09	2.66	0.0	0.0
CB202	STORAGE	82.76	2.89	0.0	0.0
CB203	STORAGE	82.75	2.90	0.0	0.0
CB204	STORAGE	82.75	2.75	0.0	0.0
CB205	STORAGE	82.85	2.75	0.0	0.0
CB206	STORAGE	82.77	2.73	0.0	0.0
CB207	STORAGE	83.15	2.30	0.0	0.0
CB208	STORAGE	83.30	2.04	0.0	0.0
CB209	STORAGE	83.20	1.90	0.0	0.0
CB210B	STORAGE	82.65	3.00	0.0	0.0
CB211	STORAGE	83.70	1.90	0.0	0.0
CB212	STORAGE	83.20	2.42	0.0	0.0
CB212A	STORAGE	83.62	2.00	0.0	0.0
CB213	STORAGE	83.15	1.75	0.0	0.0
CB214	STORAGE	82.95	1.90	0.0	0.0

Link Summary

Name	From Node	To Node	Type	Length	%Slope	
C2	CB208	CB207	CONDUIT	9.7	1.0346	
C4	CB212A	CB212	CONDUIT	18.5	2.0031	
C5	CB211	CB212	CONDUIT	22.3	2.0142	
CB213	CB213	522_ (P-Stm)	CONDUIT	29.3	1.3396	
CB214	CB214	522_ (P-Stm)	CONDUIT	21.6	0.8915	
Pipe_ (104) (P-Stm)	518 Orifice	518A (P-Stm)	CONDUIT	0.0	15.6	0.2496
Pipe_ (110) (P-Stm)	521_ (P-Stm)	518_ (P-Stm)	CONDUIT	27.2	0.3528	
Pipe_ (111) (P-Stm)	522_ (P-Stm)	521_ (P-Stm)	CONDUIT	45.1	0.4990	
Pipe_ (71) (P-Stm)	520_ (P-Stm)	519_ (P-Stm)	CONDUIT	57.1	0.4025	
Pipe_ (72) (P-Stm)	519_ (P-Stm)	518_ (P-Stm)	CONDUIT	32.0	0.5005	
OR1	518 (P-Stm)	518 Orifice	ORIFICE			
W1	CB208	CB209	WEIR			
W2	CB210B	CB211	WEIR			
W3	CB210B	CB202	WEIR			
W4	CB204	CB204	WEIR			
W5	CB206	CB207	WEIR			
W6	CB201	CB200	WEIR			
W7	CB200	CB209	WEIR			
CB200	CB200	520 (P-Stm)	OUTLET			
CB201	CB201	520 (P-Stm)	OUTLET			
CB202	CB202	521 (P-Stm)	OUTLET			
CB203	CB203	521 (P-Stm)	OUTLET			
CB204	CB204	522 (P-Stm)	OUTLET			
CB205	CB205	522 (P-Stm)	OUTLET			
CB206	CB206	522 (P-Stm)	OUTLET			
CB207	CB207	522 (P-Stm)	OUTLET			
CB209	CB209	520 (P-Stm)	OUTLET			
CB210B	CB210B	518 (P-Stm)	OUTLET			
CB212	CB212	521 (P-Stm)	OUTLET			

Cross Section Summary

Conduit	Shape	Full Depth	Full Area	Hyd. Rad.	Max. Width	No. of Barrels	Full Flow
C2	CIRCULAR	0.25	0.05	0.06	0.25	1	60.49
C4	CIRCULAR	0.25	0.05	0.06	0.25	1	84.17
C5	CIRCULAR	0.25	0.05	0.06	0.25	1	84.40
CB213	CIRCULAR	0.25	0.05	0.06	0.25	1	68.83
CB214	CIRCULAR	0.25	0.05	0.06	0.25	1	56.15
Pipe_ (104) (P-Stm)	2 CIRCULAR	0.45	0.16	0.11	0.45	1	142.46
Pipe_ (110) (P-Stm)	CIRCULAR	0.53	0.22	0.13	0.53	1	255.47
Pipe_ (111) (P-Stm)	CIRCULAR	0.53	0.22	0.13	0.53	1	303.80
Pipe_ (71) (P-Stm)	CIRCULAR	0.53	0.22	0.13	0.53	1	272.85
Pipe_ (72) (P-Stm)	CIRCULAR	0.53	0.22	0.13	0.53	1	304.28

Analysis Options

Flow Units LPS
Process Models
Rainfall/Runoff YES
RDII NO
Snowmelt NO
Groundwater NO
Flow Routing YES
Ponding Allowed NO
Water Quality NO
Infiltration Method HORTON
Flow Routing Method DYNWAVE
Surcharge Method EXTRAN
Starting Date 01/01/2000 00:00:00
Ending Date 01/01/2000 06:00:00
Antecedent Dry Days 0.0
Report Time Step 00:01:00
Wet Time Step 00:01:00
Dry Time Step 00:01:00
Routing Time Step 1.00 sec
Variable Time Step YES
Maximum Trials 8
Number of Threads 1
Head Tolerance 0.001500 m

Runoff Quantity Continuity	Volume hectare-m	Depth mm
Total Precipitation	0.059	71.708
Evaporation Loss	0.000	0.000
Infiltration Loss	0.010	12.469
Surface Runoff	0.048	58.202
Final Storage	0.001	1.137
Continuity Error (%)	-0.141	

Flow Routing Continuity	Volume hectare-m	Volume 10^6 ltr
Dry Weather Inflow	0.000	0.000
Wet Weather Inflow	0.048	0.479
Groundwater Inflow	0.000	0.000
RDII Inflow	0.000	0.000
External Inflow	0.000	0.000
External Outflow	0.048	0.477
Flooding Loss	0.000	0.000
Evaporation Loss	0.000	0.000
Exfiltration Loss	0.000	0.000
Initial Stored Volume	0.000	0.000
Final Stored Volume	0.000	0.002
Continuity Error (%)	-0.030	

Time-Step Critical Elements

None

Highest Flow Instability Indexes

Link W3 (1)

Most Frequent Nonconverging Nodes

Convergence obtained at all time steps.

Routing Time Step Summary

Minimum Time Step	: 0.50 sec
Average Time Step	: 1.00 sec
Maximum Time Step	: 1.00 sec
% of Time in Steady State	: 0.00
Average Iterations per Step	: 2.00
% of Steps Not Converging	: 0.00
Time Step Frequencies	:
1.000 - 0.871 sec	: 100.00 %
0.871 - 0.758 sec	: 0.00 %
0.758 - 0.660 sec	: 0.00 %
0.660 - 0.574 sec	: 0.00 %
0.574 - 0.500 sec	: 0.00 %

Subcatchment Runoff Summary

Total Runoff	Total Runoff	Peak Runoff	Total Precip	Total Runon	Total Evap	Total Infil	Total Imperv	Total Perv	
mm	mm	mm	mm	mm	mm	mm	mm	mm	
S1	28.09	0.01	7.47	71.71	0.00	0.00	43.70	0.04	28.05
S10	70.09	0.02	15.18	0.392	0.00	0.00	0.16	69.98	0.12
S12	64.67	0.08	61.68	71.71	0.00	0.00	5.78	60.87	3.80
S14_1	26.64	0.00	3.78	71.71	0.00	0.00	45.10	0.18	26.46
S14_2	46.38	0.01	5.46	71.71	0.00	0.00	24.62	37.03	46.38
S15	38.63	0.01	8.14	0.647	0.00	0.00	32.72	22.28	38.63
S2	36.59	0.01	16.73	71.71	0.00	0.00	34.87	18.08	36.59
S3	54.59	0.04	33.11	0.510	0.00	0.00	16.22	44.29	10.30
S32	68.85	0.05	34.97	71.71	0.00	0.00	1.46	67.87	0.98
S4	32.13	0.02	18.19	0.960	0.00	0.00	39.41	10.03	30.12
S45	70.22	0.03	22.26	71.71	0.00	0.00	0.01	70.21	0.01
S5	70.22	0.02	10.98	0.979	0.00	0.00	0.02	70.22	0.01
S6	66.05	0.06	42.36	71.71	0.00	0.00	4.36	66.05	2.90
S7	28.10	0.01	9.63	0.921	0.00	0.00	43.69	0.00	28.10
S8	70.22	0.05	33.94	71.71	0.00	0.00	0.00	70.22	0.00
S9	61.86	0.06	44.54	0.979	0.00	0.00	8.68	61.86	5.60
S9	60.55	0.02	13.15	71.71	0.00	0.00	10.06	53.97	6.58

Node Depth Summary

Node	Type	Average Depth Meters	Maximum Depth Meters	Maximum HGL Meters	Time of Max Occurrence days hr:min	Reported Max Depth Meters
------	------	----------------------	----------------------	--------------------	------------------------------------	---------------------------

Node	Type	0.08	0.20	81.56	0	01:37	0.20
518_Orifice	JUNCTION	0.08	0.20	81.56	0	01:37	0.20
518A (P-Stm)	OUTFALL	0.63	0.63	81.28	0	00:00	0.63
518 (P-Stm)	STORAGE	1.27	3.78	84.84	0	01:37	3.78
519 (P-Stm)	STORAGE	0.81	2.65	84.84	0	01:37	2.65
520 (P-Stm)	STORAGE	0.72	2.36	84.85	0	01:37	2.36
521 (P-Stm)	STORAGE	0.90	2.89	84.84	0	01:37	2.89
522 (P-Stm)	STORAGE	0.81	2.66	84.85	0	01:37	2.66
CB200	STORAGE	0.43	2.15	85.33	0	01:20	2.15
CB201	STORAGE	0.58	2.57	85.66	0	01:11	2.57
CB202	STORAGE	0.60	2.74	85.50	0	01:20	2.74
CB203	STORAGE	0.54	2.66	85.41	0	01:11	2.65
CB204	STORAGE	0.62	2.70	85.45	0	01:20	2.70
CB205	STORAGE	0.56	2.69	85.54	0	01:20	2.69
CB206	STORAGE	0.63	2.70	85.47	0	01:10	2.70
CB207	STORAGE	0.58	2.18	85.33	0	01:20	2.17
CB208	STORAGE	0.52	2.03	85.33	0	01:21	2.03
CB209	STORAGE	0.37	1.79	84.99	0	01:25	1.79
CB210B	STORAGE	0.64	2.85	85.50	0	01:20	2.85
CB211	STORAGE	0.19	1.18	84.88	0	01:36	1.18
CB212	STORAGE	0.32	1.67	84.87	0	01:35	1.67
CB212A	STORAGE	0.21	1.26	84.88	0	01:35	1.25
CB213	STORAGE	0.32	1.70	84.85	0	01:38	1.70
CB214	STORAGE	0.37	1.90	84.85	0	01:36	1.90

Node Inflow Summary

Flow Balance	Maximum Lateral Inflow	Maximum Total Inflow	Time of Max Occurrence	Lateral Inflow Volume	Total Inflow Volume
518_Orifice	0.00	66.10	0 01:37	0	0.477
518A (P-Stm)	0.00	66.10	0 01:37	0	0.477
518 (P-Stm)	0.00	84.12	0 01:07	0	0.477
519 (P-Stm)	0.00	92.47	0 01:03	0	0.206
520 (P-Stm)	33.94	96.71	0 01:05	0.0482	0.207
521 (P-Stm)	0.00	78.54	0 01:05	0	0.256
522 (P-Stm)	0.00	60.78	0 01:06	0	0.15
CB200	42.36	43.45	0 01:10	0.0573	0.0621
CB201	44.54	44.54	0 01:10	0.0582	0.0582
CB202	61.68	61.68	0 01:10	0.0821	0.0834
CB203	10.98	10.98	0 01:10	0.0156	0.0156
CB204	15.18	15.18	0 01:10	0.0215	0.0215
CB205	13.15	13.15	0 01:10	0.0167	0.0167
CB206	22.26	22.26	0 01:10	0.0316	0.0316
CB207	34.97	51.81	0 01:10	0.0489	0.068
CB208	7.47	26.09	0 01:03	0.00525	0.0156
CB209	33.11	33.11	0 01:10	0.0399	0.0434
CB210B	16.73	37.44	0 01:09	0.0136	0.0176
CB211	5.46	7.13	0 01:08	0.00538	0.00544
CB212	8.14	13.45	0 01:06	0.00691	0.0143
CB212A	0.00	5.30	0 01:09	0	0.00175
CB213	3.78	20.64	0 01:06	0.00397	0.00517
CB214	27.81	27.81	0 01:10	0.0234	0.0235

Node Surchage Summary

No nodes were surcharged.

Node Flooding Summary

No nodes were flooded.

Storage Volume Summary

Maximum Outflow Storage Unit	Average Volume	Avg Pcnt	Evap Pcnt	Exfil Pcnt	Maximum Volume	Max Pcnt	Time of Max Occurrence
518 (P-Stm)	0.001	28.9	0.0	0.0	0.004	85.8	0 01:37
519 (P-Stm)	0.001	23.0	0.0	0.0	0.003	75.4	0 01:37
65.69 (P-Stm)	0.001	24.9	0.0	0.0	0.003	81.7	0 01:37
92.47 (P-Stm)	0.001	24.5	0.0	0.0	0.003	78.6	0 01:37
64.79 (P-Stm)	0.001	24.5	0.0	0.0	0.003	80.1	0 01:37
43.77 (P-Stm)	0.001	2.0	0.0	0.0	0.011	25.0	0 01:20
26.02 (P-Stm)	0.002	6.1	0.0	0.0	0.015	49.8	0 01:11
21.05 (P-Stm)	0.001	2.7	0.0	0.0	0.015	28.0	0 01:20
43.18 (P-Stm)	0.000	0.8	0.0	0.0	0.002	6.7	0 01:11
5.70 (P-Stm)	0.001	6.4	0.0	0.0	0.006	46.3	0 01:20
5.52 (P-Stm)	0.000	4.7	0.0	0.0	0.003	42.4	0 01:20
5.18 (P-Stm)	0.001	8.4	0.0	0.0	0.004	67.6	0 01:10
22.10 (P-Stm)	0.002	6.2	0.0	0.0	0.012	40.2	0 01:20
37.16 (P-Stm)	0.002	15.2	0.0	0.0	0.010	91.1	0 01:21
9.56 (P-Stm)	0.000	3.6	0.0	0.0	0.005	39.9	0 01:25
23.04 (P-Stm)	0.001	4.8	0.0	0.0	0.008	42.5	0 01:20
7.22 (P-Stm)							

Node	0.000	0.5	0.0	0.0	0.000	3.0	0 01:36
CB211	0.000	0.5	0.0	0.0	0.000	3.0	0 01:36
CB212	0.000	1.7	0.0	0.0	0.001	8.7	0 01:35
CB212A	0.000	10.6	0.0	0.0	0.000	62.8	0 01:35
CB213	0.000	4.6	0.0	0.0	0.000	49.4	0 01:38
CB214	0.000	8.1	0.0	0.0	0.005	97.2	0 01:36

Outfall Loading Summary

Outfall Node	Flow Freq Pcnt	Avg Flow LPS	Max Flow LPS	Total Volume 10 ⁶ ltr
518A (P-Stm)	67.75	32.60	66.10	0.477
System	67.75	32.60	66.10	0.477

Link Flow Summary

Link	Type	Maximum Flow LPS	Time of Max Occurrence days hr:min	Maximum Veloc m/sec	Max/Full Flow	Max/Full Depth
C2	CONDUIT	24.70	0 01:03	0.50	0.41	1.00
C4	CONDUIT	5.30	0 01:09	0.15	0.06	1.00
C5	CONDUIT	5.42	0 01:06	0.66	0.06	1.00
CB213	CONDUIT	18.57	0 01:06	0.38	0.27	1.00
CB214	CONDUIT	25.87	0 01:09	0.53	0.46	1.00
Pipe_ (104) (P-Stm)	2 CONDUIT	66.10	0 01:37	1.05	0.46	0.42
Pipe_ (110) (P-Stm)	CONDUIT	64.79	0 01:05	0.72	0.25	1.00
Pipe_ (111) (P-Stm)	CONDUIT	40.32	0 01:05	0.49	0.13	1.00
Pipe_ (71) (P-Stm)	CONDUIT	92.47	0 01:03	1.04	0.34	1.00
Pipe_ (72) (P-Stm)	CONDUIT	65.69	0 01:06	0.89	0.22	1.00
OR_ (72) (P-Stm)	ORIFICE	66.10	0 01:37			1.00
W1	WEIR	5.11	0 01:21			0.50
W2	WEIR	0.00	0 00:00			0.00
W3	WEIR	20.72	0 01:09			0.25
W4	WEIR	0.00	0 00:00			0.00
W5	WEIR	16.85	0 01:10			0.31
W6	WEIR	10.31	0 01:11			0.10
W7	WEIR	0.00	0 00:00			0.00
CB200	DUMMY	26.02	0 01:05			
CB201	DUMMY	14.08	0 01:04			
CB202	DUMMY	29.09	0 01:02			
CB203	DUMMY	5.70	0 01:07			
CB204	DUMMY	5.52	0 01:03			
CB205	DUMMY	5.18	0 01:06			
CB206	DUMMY	6.86	0 01:02			
CB207	DUMMY	12.67	0 01:04			
CB209	DUMMY	23.04	0 01:05			
CB210B	DUMMY	5.01	0 01:06			
CB212	DUMMY	5.95	0 01:05			

Flow Classification Summary

Conduit	Adjusted /Actual Length	Up Dry	Down Dry	Fraction of Sub Crit	Time in Flow Class	Sup Crit	Up Crit	Down Crit	Norm Crit	Inlet Ctrl
C2	1.00	0.05	0.00	0.00	0.39	0.00	0.00	0.56	0.07	0.00
C4	1.00	0.17	0.01	0.00	0.27	0.00	0.00	0.55	0.03	0.00
C5	1.00	0.15	0.00	0.00	0.28	0.00	0.00	0.56	0.05	0.00
CB213	1.00	0.05	0.00	0.00	0.32	0.00	0.00	0.63	0.05	0.00
CB214	1.00	0.05	0.00	0.00	0.32	0.00	0.00	0.63	0.03	0.00
Pipe_ (104) (P-Stm) 2	1.00	0.07	0.00	0.00	0.00	0.00	0.00	0.93	0.00	0.00
Pipe_ (110) (P-Stm)	1.00	0.06	0.00	0.00	0.38	0.00	0.00	0.56	0.00	0.00
Pipe_ (111) (P-Stm)	1.00	0.06	0.00	0.00	0.94	0.00	0.00	0.00	0.58	0.00
Pipe_ (71) (P-Stm)	1.00	0.06	0.00	0.00	0.34	0.00	0.00	0.60	0.03	0.00
Pipe_ (72) (P-Stm)	1.00	0.07	0.00	0.00	0.37	0.00	0.00	0.57	0.02	0.00

Conduit Surchage Summary

Conduit	Hours Full Both Ends	Hours Full Upstream	Hours Full Dnstream	Hours Above Full Normal Flow	Hours Capacity Limited
C2	1.76	1.76	1.80	0.01	0.01
C4	1.29	1.29	1.54	0.01	0.01
C5	1.23	1.23	1.55	0.01	0.01
CB213	1.50	1.50	1.74	0.01	0.01
CB214	1.63	1.63	1.74	0.01	0.01
Pipe_ (110) (P-Stm)	1.90	1.90	1.98	0.01	0.01
Pipe_ (111) (P-Stm)	1.74	1.74	1.90	0.01	0.01
Pipe_ (71) (P-Stm)	1.56	1.56	1.69	0.01	0.01
Pipe_ (72) (P-Stm)	1.73	1.73	1.85	0.01	0.01

Analysis begun on: Tue Jan 28 12:44:03 2025
Analysis ended on: Tue Jan 28 12:44:04 2025
Total elapsed time: 00:00:01

Stormceptor® EF Sizing Report

Imbrium® Systems

ESTIMATED NET ANNUAL SEDIMENT (TSS) LOAD REDUCTION

08/28/2024

Province:	Ontario
City:	Ottawa
Nearest Rainfall Station:	OTTAWA CDA RCS
Climate Station Id:	6105978
Years of Rainfall Data:	20

Project Name:	Navan Gas Bar
Project Number:	29899-002
Designer Name:	Bobby Pettigrew
Designer Company:	J.L. Richards & Associates Ltd
Designer Email:	bpettigrew@jlrichards.ca
Designer Phone:	343-804-5381
EOR Name:	
EOR Company:	
EOR Email:	
EOR Phone:	

Site Name:

Drainage Area (ha): 0.82

% Imperviousness: 73.64

Runoff Coefficient 'c': 0.74

Particle Size Distribution: Fine

Target TSS Removal (%): 80.0

Required Water Quality Runoff Volume Capture (%):	90.00
Estimated Water Quality Flow Rate (L/s):	19.63
Oil / Fuel Spill Risk Site?	Yes
Upstream Flow Control?	Yes
Upstream Orifice Control Flow Rate to Stormceptor (L/s):	66.00
Peak Conveyance (maximum) Flow Rate (L/s):	66.00
Influent TSS Concentration (mg/L):	200
Estimated Average Annual Sediment Load (kg/yr):	657
Estimated Average Annual Sediment Volume (L/yr):	534

Net Annual Sediment (TSS) Load Reduction Sizing Summary	
Stormceptor Model	TSS Removal Provided (%)
EFO4	80
EFO6	90
EFO8	95
EFO10	97
EFO12	99

Recommended Stormceptor EFO Model: **EFO4**

Estimated Net Annual Sediment (TSS) Load Reduction (%): **80**

Water Quality Runoff Volume Capture (%): **> 90**



Stormceptor® EF Sizing Report

THIRD-PARTY TESTING AND VERIFICATION

► Stormceptor® EF and Stormceptor® EFO are the latest evolutions in the Stormceptor® oil-grit separator (OGS) technology series, and are designed to remove a wide variety of pollutants from stormwater and snowmelt runoff. These technologies have been third-party tested in accordance with the Canadian ETV **Procedure for Laboratory Testing of Oil-Grit Separators** and performance has been third-party verified in accordance with the **ISO 14034 Environmental Technology Verification (ETV)** protocol.

PERFORMANCE

► Stormceptor® EF and EFO remove stormwater pollutants through gravity separation and floatation, and feature a patent-pending design that generates positive removal of total suspended solids (TSS) throughout each storm event, including high-intensity storms. Captured pollutants include sediment, free oils, and sediment-bound pollutants such as nutrients, heavy metals, and petroleum hydrocarbons. Stormceptor is sized to remove a high level of TSS from the frequent rainfall events that contribute the vast majority of annual runoff volume and pollutant load. The technology incorporates an internal bypass to convey excessive stormwater flows from high-intensity storms through the device without resuspension and washout (scour) of previously captured pollutants. Proper routine maintenance ensures high pollutant removal performance and protection of downstream waterways.

PARTICLE SIZE DISTRIBUTION (PSD)

► The Canadian ETV PSD shown in the table below was used, or in part, for this sizing. This is the identical PSD that is referenced in the Canadian ETV **Procedure for Laboratory Testing of Oil-Grit Separators** for both sediment removal testing and scour testing. The Canadian ETV PSD contains a wide range of particle sizes in the sand and silt fractions, and is considered reasonably representative of the particle size fractions found in typical urban stormwater runoff.

Particle Size (µm)	Percent Less Than	Particle Size Fraction (µm)	Percent
1000	100	500-1000	5
500	95	250-500	5
250	90	150-250	15
150	75	100-150	15
100	60	75-100	10
75	50	50-75	5
50	45	20-50	10
20	35	8-20	15
8	20	5-8	10
5	10	2-5	5
2	5	<2	5

Stormceptor® EF Sizing Report

Upstream Flow Controlled Results

Rainfall Intensity (mm / hr)	Percent Rainfall Volume (%)	Cumulative Rainfall Volume (%)	Flow Rate (L/s)	Flow Rate (L/min)	Surface Loading Rate (L/min/m²)	Removal Efficiency (%)	Incremental Removal (%)	Cumulative Removal (%)
0.50	8.6	8.6	0.85	51.0	42.0	100	8.6	8.6
1.00	20.3	29.0	1.69	101.0	85.0	98	20.0	28.6
2.00	16.2	45.2	3.38	203.0	169.0	87	14.1	42.7
3.00	12.0	57.2	5.07	304.0	254.0	81	9.7	52.4
4.00	8.4	65.6	6.76	406.0	338.0	77	6.5	58.9
5.00	5.9	71.6	8.46	507.0	423.0	73	4.3	63.3
6.00	4.6	76.2	10.15	609.0	507.0	69	3.2	66.5
7.00	3.1	79.3	11.84	710.0	592.0	65	2.0	68.5
8.00	2.7	82.0	13.53	812.0	676.0	64	1.8	70.2
9.00	3.3	85.3	15.22	913.0	761.0	63	2.1	72.3
10.00	2.3	87.6	16.91	1015.0	846.0	63	1.4	73.8
11.00	1.6	89.2	18.60	1116.0	930.0	62	1.0	74.8
12.00	1.3	90.5	20.29	1218.0	1015.0	61	0.8	75.6
13.00	1.7	92.2	21.98	1319.0	1099.0	59	1.0	76.6
14.00	1.2	93.5	23.68	1421.0	1184.0	57	0.7	77.3
15.00	1.2	94.6	25.37	1522.0	1268.0	56	0.6	77.9
16.00	0.7	95.3	27.06	1623.0	1353.0	53	0.4	78.3
17.00	0.7	96.1	28.75	1725.0	1437.0	51	0.4	78.7
18.00	0.4	96.5	30.44	1826.0	1522.0	48	0.2	78.9
19.00	0.4	96.9	32.13	1928.0	1607.0	46	0.2	79.1
20.00	0.2	97.1	33.82	2029.0	1691.0	43	0.1	79.2
21.00	0.5	97.5	35.51	2131.0	1776.0	41	0.2	79.4
22.00	0.2	97.8	37.20	2232.0	1860.0	39	0.1	79.4
23.00	1.0	98.8	38.90	2334.0	1945.0	38	0.4	79.8
24.00	0.3	99.1	40.59	2435.0	2029.0	36	0.1	79.9
25.00	0.9	100.0	42.28	2537.0	2114.0	35	0.3	80.3
30.00	0.9	100.9	50.73	3044.0	2537.0	29	0.3	80.5
35.00	-0.9	100.0	59.19	3551.0	2959.0	25	N/A	80.3
40.00	0.0	100.0	66.00	3960.0	3300.0	22	0.0	80.3
45.00	0.0	100.0	66.00	3960.0	3300.0	22	0.0	80.3
Estimated Net Annual Sediment (TSS) Load Reduction =								80 %

Climate Station ID: 6105978 Years of Rainfall Data: 20



Stormceptor® EF Sizing Report

RAINFALL DATA FROM OTTAWA CDA RCS RAINFALL STATION

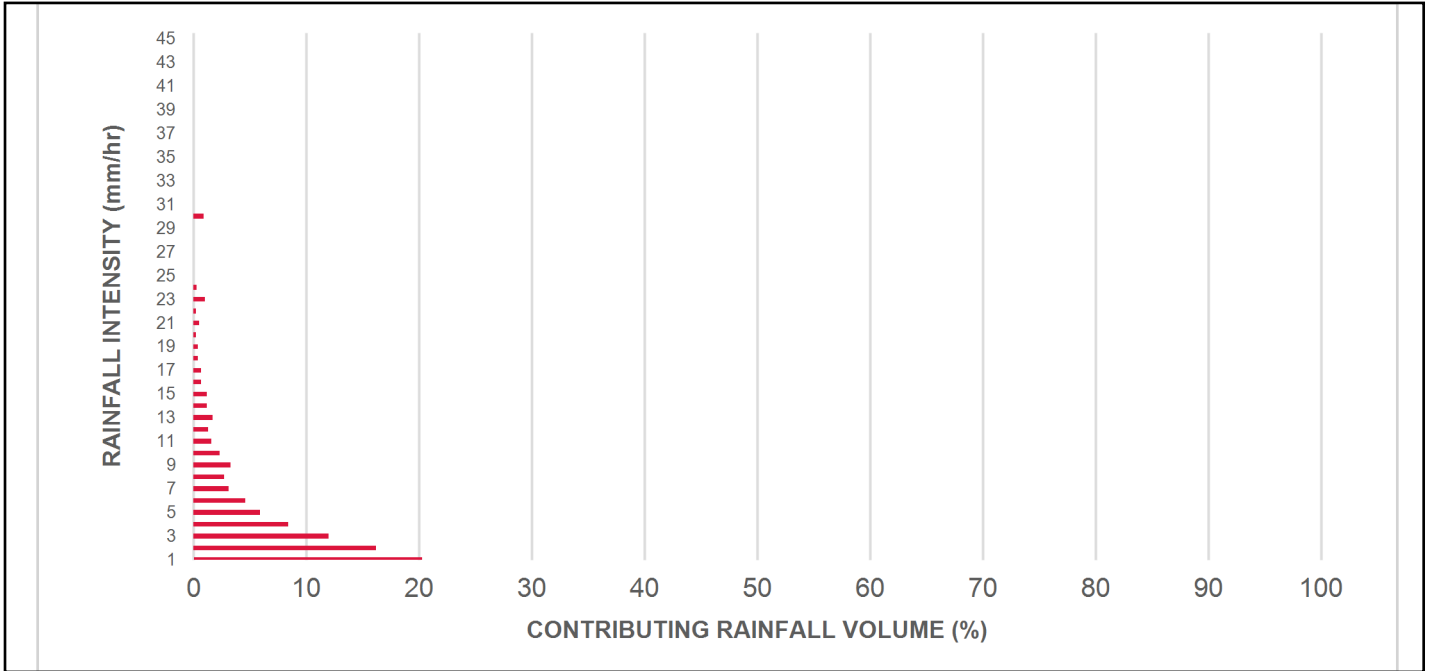

INCREMENTAL AND CUMULATIVE TSS REMOVAL FOR THE RECOMMENDED STORMCEPTOR® MODEL

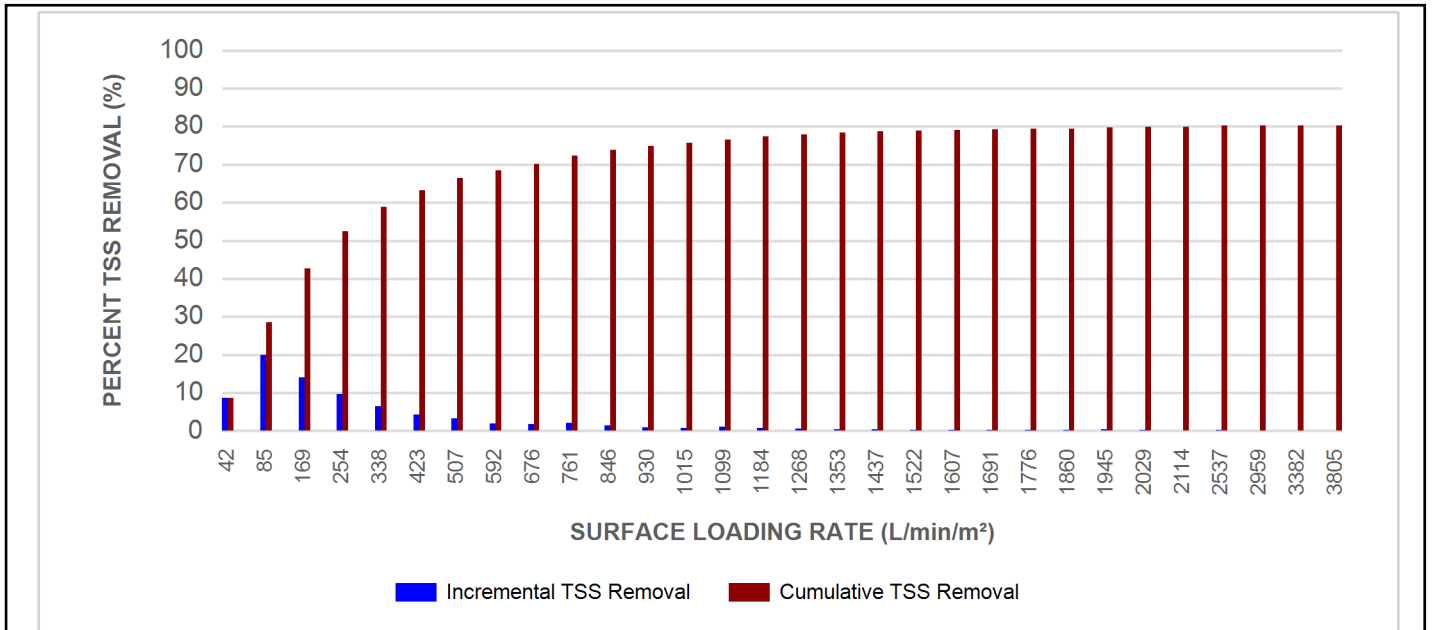

Stormceptor® EF Sizing Report

Maximum Pipe Diameter / Peak Conveyance

Stormceptor EF / EFO	Model Diameter		Min Angle Inlet / Outlet Pipes	Max Inlet Pipe Diameter		Max Outlet Pipe Diameter		Peak Conveyance Flow Rate	
	(m)	(ft)		(mm)	(in)	(mm)	(in)	(L/s)	(cfs)
EF4 / EFO4	1.2	4	90	609	24	609	24	425	15
EF6 / EFO6	1.8	6	90	914	36	914	36	990	35
EF8 / EFO8	2.4	8	90	1219	48	1219	48	1700	60
EF10 / EFO10	3.0	10	90	1828	72	1828	72	2830	100
EF12 / EFO12	3.6	12	90	1828	72	1828	72	2830	100

SCOUR PREVENTION AND ONLINE CONFIGURATION

► Stormceptor® EF and EFO feature an internal bypass and superior scour prevention technology that have been demonstrated in third-party testing according to the scour testing provisions of the Canadian ETV Procedure for Laboratory Testing of Oil-Grit Separators, and the exceptional scour test performance has been third-party verified in accordance with the ISO 14034 ETV protocol. As a result, Stormceptor EF and EFO are approved for online installation, eliminating the need for costly additional bypass structures, piping, and installation expense.

DESIGN FLEXIBILITY

► Stormceptor® EF and EFO offers design flexibility in one simplified platform, accepting stormwater flow from a single inlet pipe or multiple inlet pipes, and/or surface runoff through an inlet grate. The device can also serve as a junction structure, accommodate a 90-degree inlet-to-outlet bend angle, and can be modified to ensure performance in submerged conditions.

OIL CAPTURE AND RETENTION

► While Stormceptor® EF will capture and retain oil from dry weather spills and low intensity runoff, Stormceptor® EFO has demonstrated superior oil capture and greater than 99% oil retention in third-party testing according to the light liquid re-entrainment testing provisions of the Canadian ETV Procedure for Laboratory Testing of Oil-Grit Separators. Stormceptor EFO is recommended for sites where oil capture and retention is a requirement.

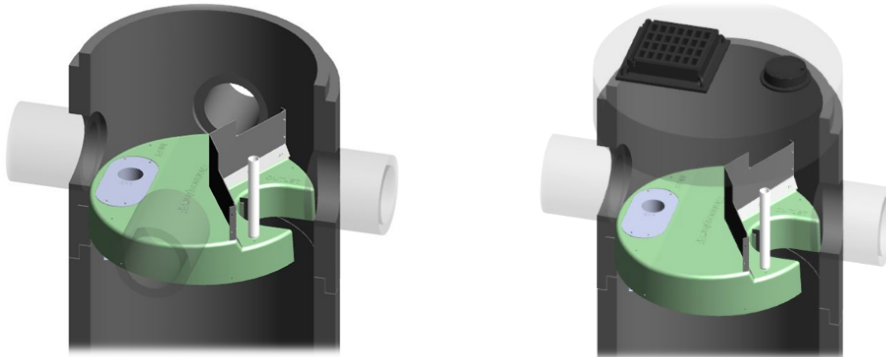

Stormceptor® EF Sizing Report

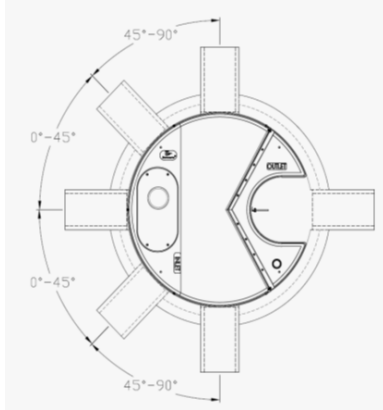

INLET-TO-OUTLET DROP

Elevation differential between inlet and outlet pipe inverts is dictated by the angle at which the inlet pipe(s) enters the unit.

0° - 45° : The inlet pipe is 1-inch (25mm) higher than the outlet pipe.

45° - 90° : The inlet pipe is 2-inches (50mm) higher than the outlet pipe.

HEAD LOSS

The head loss through Stormceptor EF is similar to that of a 60-degree bend structure.

The applicable K value for calculating minor losses through the unit is 1.1.

For submerged conditions the applicable K value is 3.0.

Pollutant Capacity

Stormceptor EF / EFO	Model Diameter		Depth (Outlet Pipe Invert to Sump Floor)		Oil Volume		Recommended Sediment Maintenance Depth *		Maximum Sediment Volume *		Maximum Sediment Mass **	
	(m)	(ft)	(m)	(ft)	(L)	(Gal)	(mm)	(in)	(L)	(ft³)	(kg)	(lb)
EF4 / EFO4	1.2	4	1.52	5.0	265	70	203	8	1190	42	1904	5250
EF6 / EFO6	1.8	6	1.93	6.3	610	160	305	12	3470	123	5552	15375
EF8 / EFO8	2.4	8	2.59	8.5	1070	280	610	24	8780	310	14048	38750
EF10 / EFO10	3.0	10	3.25	10.7	1670	440	610	24	17790	628	28464	78500
EF12 / EFO12	3.6	12	3.89	12.8	2475	655	610	24	31220	1103	49952	137875

*Increased sump depth may be added to increase sediment storage capacity

** Average density of wet packed sediment in sump = 1.6 kg/L (100 lb/ft³)

Feature	Benefit	Feature Appeals To
Patent-pending enhanced flow treatment and scour prevention technology	Superior, verified third-party performance	Regulator, Specifying & Design Engineer
Third-party verified light liquid capture and retention for EFO version	Proven performance for fuel/oil hotspot locations	Regulator, Specifying & Design Engineer, Site Owner
Functions as bend, junction or inlet structure	Design flexibility	Specifying & Design Engineer
Minimal drop between inlet and outlet	Site installation ease	Contractor
Large diameter outlet riser for inspection and maintenance	Easy maintenance access from grade	Maintenance Contractor & Site Owner

STANDARD STORMCEPTOR EF/EFO DRAWINGS

For standard details, please visit <http://www.imbriumsystems.com/stormwater-treatment-solutions/stormceptor-ef>

STANDARD STORMCEPTOR EF/EFO SPECIFICATION

For specifications, please visit <http://www.imbriumsystems.com/stormwater-treatment-solutions/stormceptor-ef>

STANDARD PERFORMANCE SPECIFICATION FOR “OIL GRIT SEPARATOR” (OGS) STORMWATER QUALITY TREATMENT DEVICE

PART 1 – GENERAL

1.1 WORK INCLUDED

This section specifies requirements for selecting, sizing, and designing an underground Oil Grit Separator (OGS) device for stormwater quality treatment, with third-party testing results and a Statement of Verification in accordance with ISO 14034 Environmental Management – Environmental Technology Verification (ETV).

1.2 REFERENCE STANDARDS & PROCEDURES

ISO 14034:2016 Environmental management – Environmental technology verification (ETV)

Canadian Environmental Technology Verification (ETV) Program's **Procedure for Laboratory Testing of Oil-Grit Separators**

1.3 SUBMITTALS

1.3.1 All submittals, including sizing reports & shop drawings, shall be submitted upon request with each order to the contractor then forwarded to the Engineer of Record for review and acceptance. Shop drawings shall detail all OGS components, elevations, and sequence of construction.

1.3.2 Alternative devices shall have features identical to or greater than the specified device, including: treatment chamber diameter, treatment chamber wet volume, sediment storage volume, and oil storage volume.

1.3.3 Unless directed otherwise by the Engineer of Record, OGS stormwater quality treatment product substitutions or alternatives submitted within ten days prior to project bid shall not be accepted. All alternatives or substitutions submitted shall be signed and sealed by a local registered Professional Engineer, based on the exact same criteria detailed in Section 3, in entirety, subject to review and approval by the Engineer of Record.

PART 2 – PRODUCTS

2.1 OGS POLLUTANT STORAGE

The OGS device shall include a sump for sediment storage, and a protected volume for the capture and storage of petroleum hydrocarbons and buoyant gross pollutants. The minimum sediment & petroleum hydrocarbon storage capacity shall be as follows:

2.1.1	4 ft (1219 mm) Diameter OGS Units:	1.19 m ³ sediment / 265 L oil
	6 ft (1829 mm) Diameter OGS Units:	3.48 m ³ sediment / 609 L oil
	8 ft (2438 mm) Diameter OGS Units:	8.78 m ³ sediment / 1,071 L oil
	10 ft (3048 mm) Diameter OGS Units:	17.78 m ³ sediment / 1,673 L oil
	12 ft (3657 mm) Diameter OGS Units:	31.23 m ³ sediment / 2,476 L oil

PART 3 – PERFORMANCE & DESIGN

3.1 GENERAL

The OGS stormwater quality treatment device shall be verified in accordance with ISO 14034:2016 Environmental management – Environmental technology verification (ETV). The OGS stormwater quality treatment device shall

Stormceptor® EF Sizing Report

remove oil, sediment and gross pollutants from stormwater runoff during frequent wet weather events, and retain these pollutants during less frequent high flow wet weather events below the insert within the OGS for later removal during maintenance. The Manufacturer shall have at least ten (10) years of local experience, history and success in engineering design, manufacturing and production and supply of OGS stormwater quality treatment device systems, acceptable to the Engineer of Record.

3.2 SIZING METHODOLOGY

The OGS device shall be engineered, designed and sized to provide stormwater quality treatment based on treating a minimum of 90 percent of the average annual runoff volume and a minimum removal of an annual average 60% of the sediment (TSS) load based on the Particle Size Distribution (PSD) specified in the sizing report for the specified device. Sizing of the OGS shall be determined by use of a minimum ten (10) years of local historical rainfall data provided by Environment Canada. Sizing shall also be determined by use of the sediment removal performance data derived from the ISO 14034 ETV third-party verified laboratory testing data from testing conducted in accordance with the Canadian ETV protocol Procedure for Laboratory Testing of Oil-Grit Separators, as follows:

3.2.1 Sediment removal efficiency for a given surface loading rate and its associated flow rate shall be based on sediment removal efficiency demonstrated at the seven (7) tested surface loading rates specified in the protocol, ranging 40 L/min/m² to 1400 L/min/m², and as stated in the ISO 14034 ETV Verification Statement for the OGS device.

3.2.2 Sediment removal efficiency for surface loading rates between 40 L/min/m² and 1400 L/min/m² shall be based on linear interpolation of data between consecutive tested surface loading rates.

3.2.3 Sediment removal efficiency for surface loading rates less than the lowest tested surface loading rate of 40 L/min/m² shall be assumed to be identical to the sediment removal efficiency at 40 L/min/m². No extrapolation shall be allowed that results in a sediment removal efficiency that is greater than that demonstrated at 40 L/min/m².

3.2.4 Sediment removal efficiency for surface loading rates greater than the highest tested surface loading rate of 1400 L/min/m² shall assume zero sediment removal for the portion of flow that exceeds 1400 L/min/m², and shall be calculated using a simple proportioning formula, with 1400 L/min/m² in the numerator and the higher surface loading rate in the denominator, and multiplying the resulting fraction times the sediment removal efficiency at 1400 L/min/m².

The OGS device shall also have sufficient annual sediment storage capacity as specified and calculated in Section 2.1.

3.3 CANADIAN ETV or ISO 14034 ETV VERIFICATION OF SCOUR TESTING

The OGS device shall have Canadian ETV or ISO 14034 ETV Verification of third-party scour testing conducted in accordance with the Canadian ETV Program's **Procedure for Laboratory Testing of Oil-Grit Separators**.

3.3.1 To be acceptable for on-line installation, the OGS device must demonstrate an average scour test effluent concentration less than 10 mg/L at each surface loading rate tested, up to and including 2600 L/min/m².

3.4 LIGHT LIQUID RE-ENTRAINMENT SIMULATION TESTING

The OGS device shall have Canadian ETV or ISO 14034 ETV Verification of completed third-party Light Liquid Re-entrainment Simulation Testing in accordance with the Canadian ETV **Program's Procedure for Laboratory Testing of Oil-Grit Separators**, with results reported within the Canadian ETV or ISO 14034 ETV verification. This re-entrainment testing is conducted with the device pre-loaded with low density polyethylene (LDPE) plastic beads as a surrogate for light liquids such as oil and fuel. Testing is conducted on the same OGS unit tested for sediment removal to

Stormceptor® **EF** Sizing Report

assess whether light liquids captured after a spill are effectively retained at high flow rates.

3.4.1 For an OGS device to be an acceptable stormwater treatment device on a site where vehicular traffic occurs and the potential for an oil or fuel spill exists, the OGS device must have reported verified performance results of greater than 99% cumulative retention of LDPE plastic beads for the five specified surface loading rates (ranging 200 L/min/m² to 2600 L/min/m²) in accordance with the Light Liquid Re-entrainment Simulation Testing within the Canadian ETV Program's **Procedure for Laboratory Testing of Oil-Grit Separators**. However, an OGS device shall not be allowed if the Light Liquid Re-entrainment Simulation Testing was performed with screening components within the OGS device that are effective at retaining the LDPE plastic beads, but would not be expected to retain light liquids such as oil and fuel.



Platinum
member

www.jlrichards.ca

Ottawa

343 Preston Street
Tower II, Suite 1000
Ottawa ON Canada
K1S 1N4
Tel: 613 728-3571
ottawa@jlrichards.ca

Kingston

203-863 Princess Street
Kingston ON Canada
K7L 5N4
Tel: 613 544-1424
kingston@jlrichards.ca

Sudbury

314 Countryside Drive
Sudbury ON Canada
P3E 6G2
Tel: 705 522-8174
sudbury@jlrichards.ca

Timmins

834 Mountjoy Street S
Timmins ON Canada
P4N 7C5
Tel: 705 360-1899
timmins@jlrichards.ca

North Bay

501-555 Oak Street E
North Bay ON Canada
P1B 8E3
Tel: 705 495-7597

northbay@jlrichards.ca

Hawkesbury

326 Bertha Street
Hawkesbury ON Canada
K6A 2A8
Tel: 613 632-0287

hawkesbury@jlrichards.ca

Guelph

107-450 Speedvale Ave. West
Guelph ON Canada
N1H 7Y6
Tel: 519 763-0713

guelph@jlrichards.ca

