

# SERVICING & STORMWATER MANAGEMENT REPORT

## BOONE PLUMBING – 1560 STAR TOP ROAD

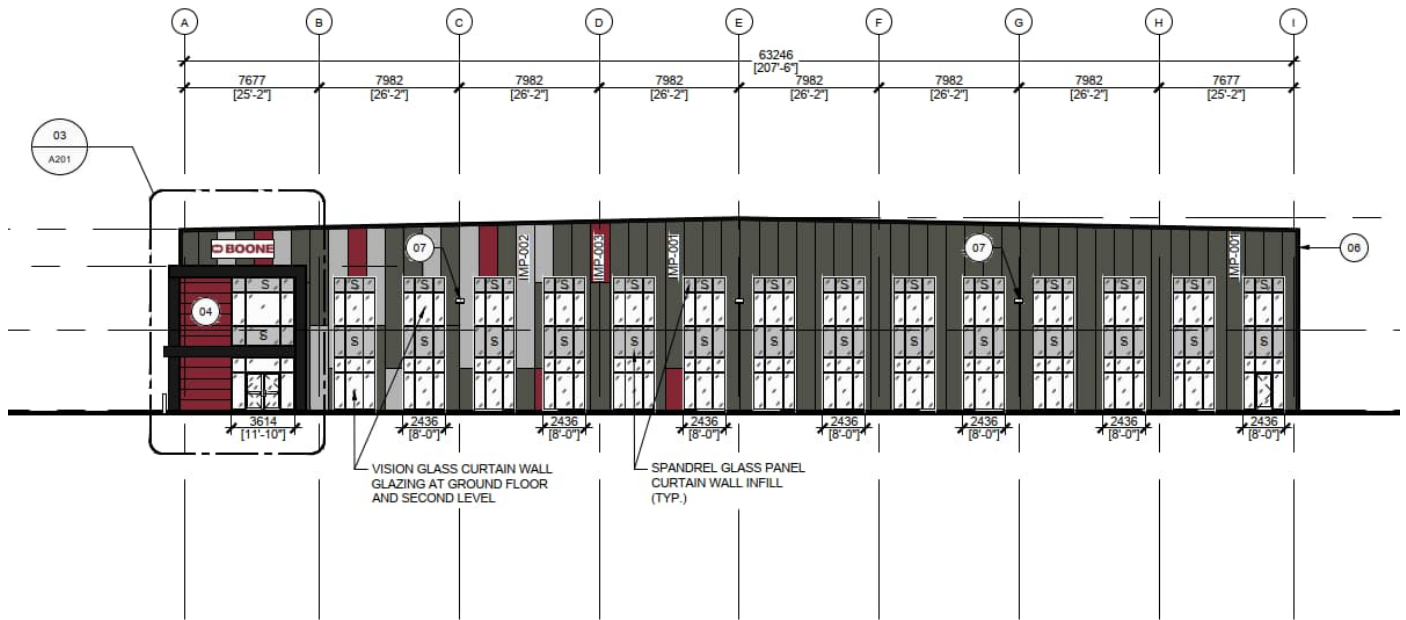

Project No.: CCO-23-3725

City File No.: D07-12-23-0107

Prepared for:

Pete Van Grootheest  
 BBS Construction LTD.  
 1805 Woodward Drive  
 Ottawa, ON K2C 0P91

Prepared by:

McIntosh Perry Consulting Engineers Ltd.  
 115 Walgreen Road  
 Carp, ON K0A 1L0

October 7, 2024

Original Submission: August 8, 2023

## TABLE OF CONTENTS

1.0	PROJECT DESCRIPTION .....	1
1.1	<i>Purpose</i> .....	1
1.2	<i>Site Description</i> .....	1
1.3	<i>Existing Conditions and Infrastructure</i> .....	2
1.4	<i>Proposed Development and Statistics</i> .....	3
1.5	<i>Approvals</i> .....	3
2.0	BACKGROUND STUDIES .....	3
3.0	PRE-CONSULTATION SUMMARY .....	4
4.0	WATERMAIN .....	4
4.1	<i>Existing Watermain</i> .....	4
4.2	<i>Proposed Watermain</i> .....	5
5.0	SANITARY DESIGN .....	6
5.1	<i>Existing Sanitary Sewer</i> .....	6
5.2	<i>Proposed Sanitary Sewer</i> .....	7
6.0	STORM SEWER DESIGN .....	8
6.1	<i>Existing Storm Sewers</i> .....	8
6.2	<i>Proposed Storm Sewers</i> .....	8
7.0	PROPOSED STORMWATER MANAGEMENT .....	9
7.1	<i>Design Criteria and Methodology</i> .....	9
7.2	<i>Runoff Calculations</i> .....	9
7.3	<i>Pre-Development Drainage</i> .....	10
7.4	<i>Post-Development Drainage</i> .....	10
7.5	<i>Quantity Control</i> .....	11
7.6	<i>Quality Control</i> .....	13
8.0	SITE SERVICING.....	14
9.0	EROSION AND SEDIMENT CONTROL.....	14
9.1	<i>Temporary Measures</i> .....	14
9.2	<i>Permanent Measures</i> .....	15

---

10.0	SUMMARY .....	15
11.0	RECOMMENDATION .....	16
12.0	STATEMENT OF LIMITATIONS .....	17

## LIST OF TABLES

Table 1: Water Demands .....	6
Table 2: Sanitary Design Criteria .....	7
Table 3: Summary of Estimated Sanitary Flow .....	7
Table 4: Pre-Development Runoff Summary .....	10
Table 5: Post-Development Runoff Summary .....	11
Table 6: Post-Development Restricted Runoff Summary .....	12

## APPENDICES

Appendix A: Site Location Plan

Appendix B: City of Ottawa Pre-Consultation Notes

Appendix C: Watermain Calculations

Appendix D: Sanitary Calculations

Appendix E: Pre-Development Drainage Plan

Appendix F: Post-Development Drainage Plan

Appendix G: Stormwater Management Calculations

Appendix H: City of Ottawa Design Checklist

## 1.0 PROJECT DESCRIPTION

### 1.1 Purpose

McIntosh Perry (MP) has been retained by BBS Construction LTD. to prepare this Servicing and Stormwater Management Report in support of the Site Plan Control process for the proposed Boone Plumbing Warehouse, located at 1560 Star Top Road within the City of Ottawa.

The main purpose of this report is to present a servicing design for the development in accordance with the recommendations and guidelines provided by the City of Ottawa (the City), the Rideau Valley Conservation Authority (RVCA), and the Ministry of the Environment, Conservation and Parks (MECP). This report will address the water, sanitary and storm sewer servicing for the development, ensuring that existing and available services will adequately service the proposed development.

This report should be read in conjunction with the following drawings:

- CCO-23-3725, C101 – Site Grading and Drainage Plan,
- CCO-23-3725, C102 – Site Servicing Plan,
- CCO-23-3725, PRE – Pre-Development Drainage Area Plan (*Appendix 'E'*), and
- CCO-23-3725, POST – Post-Development Drainage Area Plan (*Appendix 'F'*).

### 1.2 Site Description

The property is located at 1560 Star Top Road and is described as Part of Lot 25, Concession 2 (Ottawa Front), Geographic Township of Gloucester, City of Ottawa. The land in question covers approximately 3.0 ha and is bounded by Star Top Road and other industrial sites.

The subject property is a large industrial site currently occupied by four small buildings and a large outdoor storage area serving several tenants. The property is accessed via two driveways on Star Top Road and two bridges over a drainage channel that connect to 1282 Algoma Street.

The subject property is zoned Light Industrial (IL). See Site Location Plan in *Appendix 'A'* for more details.





Figure 1: Site Map

### 1.3 Existing Conditions and Infrastructure

The existing site is currently partially developed with existing water and sanitary services. Stormwater runoff currently flows overland from the southwest of the site towards the east at Star Top Road and towards the north to the South Cyrville Municipal Drain. There is an existing ditch adjacent to the west property line that has an outlet to the Municipal Drain. There is also an existing ditch at the east of the site, adjacent to Star Top Road, which collects runoff from the existing site and Star Top Road.

Sewer and watermain mapping collected from the City of Ottawa indicate that the following services exist across the property frontages within the adjacent municipal rights-of-way(s):

- 305mm diameter water main within Star Top Road
- 300mm diameter sanitary sewer within Star Top Road

There is an existing 675mm diameter sanitary sewer north of the property but is not permitted to be connected to. There is no storm sewer for this property.

## 1.4 Proposed Development and Statistics

The proposed development consists of an  $8,368m^2$  storage building to consolidate the Boone Plumbing storage into one contiguous site that will allow for future expansion. On the subject property, the two existing buildings in the area proposed for the new building are to be demolished, as well as the existing building closest to Star Top Road. The one additional existing building is to remain. Parking will be provided along the northern boundaries of the site, and additional parking will be added adjacent to the existing fenced storage yard. Further details are available in the site plan provided by Deimling Architecture and Interior Design in *Appendix 'B'*.

## 1.5 Approvals

The proposed development is subject to the City of Ottawa site plan control process. Site plan control requires the City to review, provide concurrence and approve the engineering design package. Permits to construct can be requested once the City has issued a site plan agreement.

An Environmental Compliance Approval (ECA) through the Ministry of Environment, Conservation and Parks (MECP) is not anticipated to be required for the development since the development proposes no manufacturing element to its property usage.

## 2.0 BACKGROUND STUDIES

Background studies that have been completed for the proposed site include City of Ottawa as-built drawings, a Geotechnical Investigation, an Environmental Impact Study, a Phase II Environmental Site Assessment, and a topographical survey.

As-built drawings of existing services within the vicinity of the proposed site were reviewed in order to determine accurate servicing and stormwater management schemes for the site.

A topographic survey of the site was completed by McIntosh Perry Surveying Inc., dated June 15, 2023.

A Phase II Environmental Site Assessment (ESA) was completed by Paterson Group, dated June 8, 2023.

A Geotechnical Investigation for the proposed warehouse development was completed by Paterson Group, dated June 22, 2023.

An Environmental Impact Study (EIS) was completed by Muncaster Environmental Planning Inc., on July 14, 2023.

### 3.0 PRE-CONSULTATION SUMMARY

A pre-consultation meeting was conducted on May 12, 2023, regarding the proposed site. Specific design parameters to be incorporated within this design include the following:

- The pre-development discharge rate for the site will need to be calculated based on the pre-development runoff coefficient or a maximum equivalent value of 0.5, whichever is less.
- The post-development discharge rates for the site shall match the pre-development discharge rates for all storm events.
- Ensure no overland flow for all storm events up to and including the 100-year event. Provide adequate emergency overflow conveyance off-site.
- Provide Enhanced level of protection (80%) for suspended solids removal.
- Provide a water balance analysis as per the conservation authority guidelines for development applications. Control the recharge to meet Pre-development conditions on property.

The notes from the City of Ottawa can be found in *Appendix 'B'*.

### 4.0 WATERMAIN

#### 4.1 Existing Watermain

There is an existing 305mm diameter watermain within Star Top Road. The watermain services the existing property and adjacent properties as well as the fire hydrants along Star Top Road.

As there are existing buildings on the subject property, it is assumed that there are existing water services. These services have not been identified on the plans or in the as-builts, but can be seen on the GeoOttawa database, along with existing hydrants and valves, as shown in Figure 2 below.

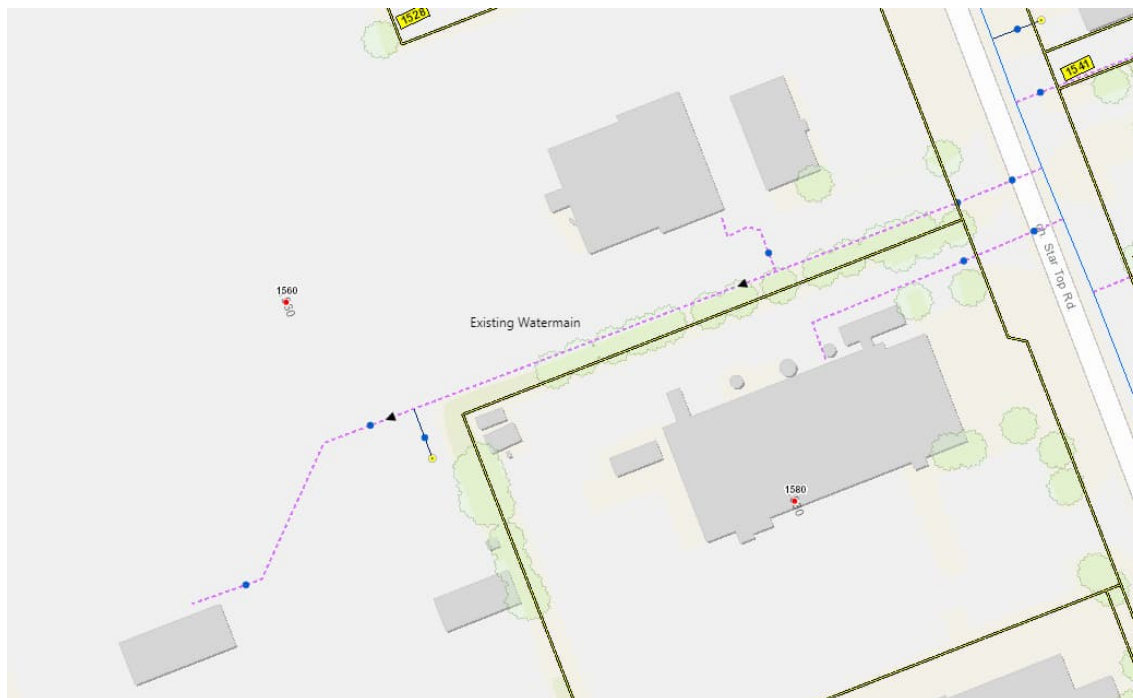

Figure 2: GeoOttawa Existing Water Services

## 4.2 Proposed Watermain

A new 150mm diameter PVC water service is proposed to service the site. The connection is to be made to the existing 150mm diameter watermain located within the subject property. The water service is designed to have a minimum of 2.4m cover and will be insulated where required per City standards.

The Fire Underwriters Survey 2020 (FUS) method and Ontario Building Code was utilized to determine the required fire flow for the site. The 'C' factor (type of construction) for the FUS calculation was determined to be 0.8 (noncombustible type construction). The total floor area ('A' value) for the FUS calculation was determined to be 8,853 m<sup>2</sup>. The results of the calculations yielded a required fire flow of 17,000 L/min. Due to the occupancy, sprinklers, and exposures, the adjusted required fire flow is 6,000 L/min. A fire flow of 9,000 L/min was calculated using the Ontario Building Code (OBC) requirements. The detailed calculations for the FUS and OBC can be found in *Appendix 'C'*.

The water demands for the proposed building have been calculated to adhere to the Ottawa Design Guidelines – Water Distribution manual and can be found in *Appendix 'C'*. The results have been summarized in *Table 1*, below.

Table 1: Water Demands

Site Area	3.0 ha
Industrial - Light	35,000 L/ha/day
Average Day Demand (L/s)	1.22
Maximum Daily Demand (L/s)	1.82
Peak Hourly Demand (L/s)	3.28
FUS Fire Flow Requirement (L/s)	100
OBC Fire Flow Requirement (L/s)	150

Boundary conditions for the site were provided by the City of Ottawa for the average day scenario, peak hour scenario and the maximum day plus fire flow scenario using the demands indicated above, and the results are summarized in below.

	Total HGL (m)	Head Pressure* (m)	Head Pressure* (psi)
Peak Hourly (Minimum HGL)	110.1	43.84	62.34
Average Day (Maximum HGL)	117.8	51.54	73.29
Max Day + Fire Flow (150 L/sec)	110.2	43.94	62.48

*\*Adjusted for an estimated ground elevation of 66.26m above the connection point.*

The boundary conditions were used to ensure the normal operating pressures are not less than 275kPa (40psi) or more than 552kPa (80psi), as well as to confirm that there is at least 140kPa (20psi) of pressure during a fire flow scenario. The resultant hydraulic grade line (HGL) shows that the pressures are within the recommended limits during the average day and peak hour scenarios. The 20psi minimum pressure is also satisfied during the fire flow scenario.

## 5.0 SANITARY DESIGN

### 5.1 Existing Sanitary Sewer

There is an existing 300 mm diameter sanitary sewer within Star Top Road. There is also an existing 675mm diameter sanitary sewer north of the property which is not permitted to be connected to.

As there are existing buildings on the subject property, it is assumed that there is an existing sanitary service. Although, this service has not been identified on the plans or in the as-builts.

## 5.2 Proposed Sanitary Sewer

A new 200 mm diameter gravity sanitary lateral is proposed be connected to the existing 300 mm diameter sanitary sewer within Star Top Road. Monitoring for site sanitary flows will occur at the proposed maintenance hole just inside the property line. Refer to drawing *C102* for a detailed servicing layout.

The peak design flows for the proposed building were calculated using criteria from the *Ottawa Sewer Guidelines* and are summarized in Table 2, below. Based on the unit occupancy statistics provided by the architect, the proposed site development will generate a flow of 7.55 L/s. See *Appendix 'D'* of this report for more details.

Table 2: Sanitary Design Criteria

Design Parameter	Value
Site Area	3.0 ha
Industrial - Light	35,000 L/ha/day
Light Industrial Peaking Factor	5.4
Extraneous Flow Allowance	0.33 L/s/ha

Table 3 below, summarizes the estimated wastewater flow from the proposed development. Refer to *Appendix D* for detailed calculations.

Table 3: Summary of Estimated Sanitary Flow

Design Parameter	Total Flow (L/s)
Total Estimated Average Dry Weather Flow	1.37
Total Estimated Peak Dry Weather Flow	6.71
Total Estimated Peak Wet Weather Flow	7.55



## 6.0 STORM SEWER DESIGN

### 6.1 Existing Storm Sewers

There are no existing storm sewers on the subject property. Water runoff from the site is currently split, as a portion is draining towards an existing ditch adjacent to the west property line which outlets to the Cyrville Municipal Drain, and the remainder is draining to the existing ditch on Star Top Road. Runoff from the property northeast of the site at 1528 Star Top Road is currently collected by private catch basins and conveyed to an existing ditch draining north of the subject property. Star Top Road. Refer to *Appendix 'E'*.

### 6.2 Proposed Storm Sewers

Most of the runoff from the proposed site will be collected in proposed catch basins. The catch basins are proposed throughout the subject property, which will connect to the proposed storm sewer system. The new system will collect storm flows and restrict runoff leaving the site. The storm sewer will outlet to the existing ditch adjacent to Star Top Road.

A storm sewer design sheet was created using the rational method and City of Ottawa 5-year storm event. The storm design sheet calculates the proper sizing of the storm pipes within the development. Drainage area information, along with respective pipe slopes and other necessary information was utilized to evaluate the performance of the storm sewer network. The time of concentration calculated for the storm sewer system is based on a 10-minute inlet time at the uppermost sewer run. Within the design sheet, pipe capacities and associated full flow velocities have been calculated. Storm runoff will be controlled by various inlet control device (ICDs) or orifice plates to limit flows to the specified allowable release rates. The storm sewers will range from 200 to 525mm in diameter throughout the subject property.

Half of the runoff from the proposed building will be conveyed to the rear-yard dry retention area along the western boundary of the site. This retention area will be controlled by an ICD or orifice plate and will outlet to an existing ditch onsite that ultimately outlets to the Cyrville Municipal Drain. The use of the ICD's will result in ponding in the retention areas. These controls allow for adequate storage within the site.

See CCO-23-3725 – *POST* and *Storm Sewer Design Sheet* in Appendix 'F' of this report for more details. The Stormwater Management design for the subject property will be outlined in Section 7.0.

## 7.0 PROPOSED STORMWATER MANAGEMENT

### 7.1 Design Criteria and Methodology

Stormwater management for the proposed site will be maintained through positive drainage away from the proposed building, onsite storage, a new underground storm sewer system. Half of the runoff from the proposed building will be captured by a dry retention area and outlet to the existing ditch onsite prior to outletting to the Cyrville Municipal Drain. The storm system will capture the other half of building runoff, parking lot runoff and store water in proposed surface ponding areas. The restricted flow in the storm sewer system will then release into the existing ditch adjacent to Star Top Road.

The quantitative and qualitative properties of the storm runoff for both the pre- and post-development flows are further detailed below. Stormwater Best Management Practices (SWM BMP's) will be implemented at the "Lot level", "Conveyance" and "End of Pipe" locations. These concepts will be explained further in Section 7.6.

In summary, the following design criteria have been employed in developing the stormwater management design for the site as directed by the RVCA and City:

#### Quality Control

- The site has been designed to achieve an 80% total suspended solids removal (*enhanced level*) using a proposed oil/grit separator.

#### Quantity Control

- Post-development flow 5/100-year is be restricted to match the 5/100-year pre-development flow with a maximum C value of 0.50.

### 7.2 Runoff Calculations

Runoff calculations presented in this report are derived using the Rational Method, given as:

$$Q = 2.78 CIA \text{ (L/s)}$$

Where	C	= Runoff coefficient
	I	= Rainfall intensity in mm/hr (City of Ottawa IDF curves)
	A	= Drainage area in hectares

It is recognized that the Rational Method tends to overestimate runoff rates. As a result, the conservative calculation of runoff ensures that any SWM facility sized using this method is expected to function as intended.

The following coefficients were used to develop an average C for each area:



Roofs/Concrete/Asphalt	0.90
Gravel	0.60
Undeveloped and Grass	0.20

As per the *City of Ottawa - Sewer Design Guidelines*, the 5-year balanced 'C' value must be increased by 25% for a 100-year storm event to a maximum of 1.0.

### 7.3 Pre-Development Drainage

In existing conditions, stormwater runoff currently flows overland from the southwest of the site towards the east at Star Top Road and towards the north to the South Cyrville Municipal Drain. There is an existing ditch adjacent to the west property line that has an outlet to the Municipal Drain. There is also an existing ditch at the east of the site, adjacent to Star Top Road, which collects runoff from the existing site and Star Top Road.

The existing site drainage limits are demonstrated on the Pre-Development Drainage Area Plan. A summary of the Pre-Development Runoff Calculations can be found below. Refer to Appendix 'G' for detailed calculations.

Area A1 drains towards the Cyrville Municipal Drain directly, while Area A2 drains towards Star Top Road. As the site is developed and largely impervious, times of concentration (Tc) were calculated for both drainage areas. Tc calculations can be found in Appendix 'G'.

Table 4: Pre-Development Runoff Summary

Drainage Area	Area (ha)	C 5-Year	C 100-Year	Tc (min)	I (mm/hr)		Q (L/s)	
					5-Year	100-Year	5-Year	100-Year
A1	1.12	0.46	0.50	10	104.2	178.6	149.91	277.83
A2	1.88	0.48	0.50	16	80.5	137.5	201.23	359.45
Total	3.00						351.13	637.28

### 7.4 Post-Development Drainage

Stormwater management for the proposed site will be maintained through positive drainage away from the proposed building and into a new underground storm sewer system.

Half of the runoff from the proposed building will be conveyed to the rear-yard dry retention area at the western boundary of the site. This retention area will be controlled by an ICD that will then outlet to an existing ditch on site and ultimately outlet to the Cyrville Municipal Drain.

There is an uncontrolled area on the north side of the site that will drain towards the Cyrville Municipal Drain as per existing conditions.

The storm system will capture half of the building runoff, parking lot runoff and store water in proposed surface ponding areas within the parking structure. The emergency overland flow route for the proposed site will be directed east towards the existing ditch adjacent to Star Top Road.

The proposed site drainage limits are demonstrated on the Post-Development Drainage Area Plan. See CCO-23-3725 – POST in Appendix ‘F’ of this report for more details. A summary of the Post-Development Runoff Calculations can be found below.

Table 5: Post-Development Runoff Summary

Drainage Area	Area (ha)	C 5-Year	C 100-Year	Tc (min)	I (mm/hr)		Q (L/s)	
					5-Year	100-Year	5-Year	100-Year
B1	0.44	0.78	0.87	10	104.2	178.6	98.25	188.12
B2	0.54	0.75	0.84	10	104.2	178.6	115.92	222.36
B3	0.29	0.90	1.00	10	104.2	178.6	75.27	143.33
B4	0.72	0.90	1.00	10	104.2	178.6	187.73	357.46
B5	0.24	0.71	0.80	10	104.2	178.6	50.04	96.18
B6	0.54	0.84	0.93	10	104.2	178.6	129.88	247.97
B7	0.24	0.64	0.72	10	104.2	178.6	44.24	85.44
Total	3.00						657.10	1,340.87

Post-development drainage conveyed to Star Top Road will be restricted to a maximum release rate of 351.13 and 637.28 L/s for 5-year and 100-year storm events respectively.

To meet the stormwater objectives, the development includes site storage through surface ponds restricted by ICDs.

Runoff for areas B1, B3, B4 and B5 will be restricted, and the required storage will be provided within the parking area. Runoff for Area B2 will be restricted and stored within the proposed dry retention area west of the proposed building. The flow will be controlled by various inlet control devices. A 266mm diameter orifice plate is to be located in STMH 1, which will pond areas B3 and B4 to an elevation of 66.35m in the event of a 100-year storm. An ICD vortex 99 will be located at the outlet of CB 3 to control area B5. An additional 87mm diameter orifice plate is to be placed within CB 4 controlling area B1. Finally, a 101mm diameter orifice plate will be placed at the outlet of LSCB 1 to control drainage area B2. The restriction devices will account for the unrestricted flow (Areas B6 and B7) leaving the site uncontrolled. This quantity and quality control will be further detailed in Sections 7.5 and 7.6.

## 7.5 Quantity Control

The 5 and 100-year post-development runoff for this site has been restricted to match the 5 and 100-year pre-development flow rate with a combined C value of 0.50 or less. (See Appendix ‘B’ for

pre-consultation notes). These values create the following allowable release rate and storage volumes for the development site. See *Appendix 'G'* for calculations.

Reducing site flows will be achieved using flow restrictions and will create the need for onsite storage. Runoff from areas B1 to B5 will be restricted as shown in the table below.

Table 6: Post-Development Restricted Runoff Summary

Drainage Area	Unrestricted Flow (L/s)		Restricted Flow (L/s)		Storage Required (m <sup>3</sup> )		Storage Provided (m <sup>3</sup> )	
	5-Year	100-Year	5-Year	100-Year	5-Year	100-Year	5-Year	100-Year
B1	98.25	188.12	7.76	15.00	83.89	157.99	85.92	167.97
B2	115.92	222.36	12.91	25.00	87.18	164.67	90.03	166.95
B3	75.27	143.33	91.07	175.00	107.86	203.19	109.70	211.00
B4	187.73	357.46						
B5	50.04	96.18	5.67	11.00	37.38	70.74	38.26	74.88
B6	129.88	247.97	129.88	247.97	x	x	x	x
B7	44.24	85.44	44.24	85.44	x	x	x	x
Total	657.10	1255.42	291.53	559.41	316.31	596.60	323.91	620.80

Runoff from Areas B1, B2, B3, B4, and B5 will be restricted at the various structures mentioned in the text above. ICDs and Orifice plates sizing can be found in *Appendix 'G'*. The orifice plug at STMH 1 will restrict areas B3 & B4 to 91.07 L/s for 5-year storm events and 175.00 L/s for 100-year storm events. The restriction creates a water surface elevation (WSEL) of 66.29m for the 5-year storm event and 66.35m for the 100-year storm event. The storage for this area will be provided above the parking lot structures CB 1 and CB 2.

The orifice plug at CB 3 will restrict area B5 to 5.67 L/s for 5-year storm events and 11.00 L/s for 100-year storm events. The restriction creates a water surface elevation (WSEL) of 67.04m for the 5-year storm event and 67.12m for the 100-year storm event. The storage for this area will be provided above the parking lot structure CB 3. This area will capture the runoff from the south side of the building (conveyed through a landscaped swale complete with a 250mm perforated HDPE subdrain), as well as the south east parking lot section.

The orifice plug at CB 4 will restrict area B1 to 7.76 L/s for 5-year storm events and 15.00 L/s for 100-year storm events. The restriction creates a water surface elevation (WSEL) of 65.73m for the 5-year storm event and 65.79m for the 100-year storm event. The storage for this area will be provided above the parking lot structure CB 4.

Finally, the orifice plug at LSCB 1 will restrict area B2 to 12.91L/s for 5-year events and 25.00L/s for 100-year storm events. The restriction creates a water surface elevation (WSEL) of 66.87m for the 5-year storm event and 67.08m for the 100-year storm event. The storage for this area will be

provided in the retention area above structure LSCB 1 within the retention area. The controlled flows will ultimately outlet through a 450mm HDPE pipe.

See Appendix 'G' for details of the required and provided storage volumes.

In the event that there is a rainfall above the 100-year storm event, or a blockage within the storm sewer system, an emergency overland flow route has been provided so that the storm water runoff will be conveyed towards the east entrance at Star Top Road. The proposed Grading Plan has been designed to ensure no water backs up towards the existing building, nor the proposed. Overland flow arrows can be found on the grading plan illustrating the spill points of each catchment area and the flow route to the ultimate outlet. Stress test flows (100-year + 20%) will be conveyed through the overland flow route as storage areas are designed to spill to overland flow in the event of any storm more intense than a 100-year event.

Area B6 is uncontrolled and will drain directly to the Cyrville Municipal Drain. This catchment area as well as area B2 will be the only areas which drain to the Cyrville Drain in any storm equal or lesser than a 100-year event. The post development flows directed to the Drain are lesser than pre-development for both 5 and 100-year storm events as can be seen in Appendix 'G'.

Area B7 drains uncontrolled towards Star Top Road and the runoff will be directed towards the existing ditch within the frontage of Star Top Road.

## 7.6 Quality Control

The following methods will be utilized to provide quality controls for the site:

Area B2 will collect rooftop drainage and therefore drainage is considered clean. Roof drainage will sheet drain to the dry retention area to the west of the building, and outlet to the existing ditch onsite.

The development of this lot will employ Best Management Practices (BMP's) wherever possible. The intent of implementing stormwater BMP's is to ensure that water quality and quantity concerns are addressed at all stages of development. Lot level BMP's typically include temporary retention of the parking lot runoff, minimizing ground slopes and maximizing landscaped areas. Some of these BMP's cannot be provided for this site due to site constraints and development requirements.

A quality treatment unit has been proposed to provide a TSS removal rate of 80% as per Rideau Valley Conservation Authority requirements. The OGS (Oil & Grit Separator) unit will provide a water quality of at least 80% TSS. The OGS Unit shall be placed downstream of the parking area storm structures and sewers to provide the required water quality treatment for the site runoff before discharging to the ditch adjacent to Star Top Road.

As the proposal of manufactured water quality treatment systems became prevalent in Ontario, scrutiny of such systems was deemed necessary, and a standardized third-party testing protocol

called Canadian Environmental Technology Verification (CA-ETV-ISO 14034) was established in Ontario. Irrespective of the manufacturer and model, oil and grit separator units achieve a maximum of 60% TSS removals under the CA ETV testing. Some other acceptable testing protocols include Fine particle size distribution (PSD) and distribution based on the varying particle sizes are commonly accepted testing protocols. Under the Fine PSD, OGS units can achieve > 90 percent TSS removals. Irrespective of the testing protocol selected, the actual TSS removal efficacy of the OGS units heavily relies on the actual site conditions, nature of the runoff and on-going OGS maintenance.

Detailed OGS sizing is provided within *Appendix 'G'*. The OGS was sized to achieve a TSS removal of 80% or greater under the Fine PSD criteria, as well as TSS removal of 60% or greater under the CA-ETV standards. The result of the sizing generated a Stormceptor EFO10, providing 61% under CA-ETV as well as 91% under fine PSD. An approved equivalent will be acceptable for the site as well.

## 8.0 SITE SERVICING

Due to the high groundwater table and shallow bedrock at this site, the geotechnical engineer was consulted to ensure that the proposed sewer and watermain lengths/slopes are feasible for this development. Paterson Group confirmed that the proposed site servicing works are considered feasible from a geotechnical perspective. It is expected that some bedrock removal will be required to undertake the proposed site servicing works. Groundwater infiltration into the site servicing trench excavations is expected to be low to moderate and controllable using open sumps.

It was determined that the majority of the invert elevations for service pipes entering the stormwater and sanitary manhole structures throughout the site were observed to be in the frost zone. Soil cover over the landscape storm sewer and some segments of the storm service pipe within the parking areas and access lanes have insufficient frost protection. However, it is expected that significant frost heave issues will not occur for the storm service alignments within the landscaping area. Insulation was recommended on storm pipes from CB1, CB2, CB4, and STMH3 & OGS1, and has been reflected in the drawings.

In areas where the service subgrade transitions from soil to bedrock, it is recommended that the founding medium be inspected in the field to determine how steeply the bedrock surface drops off. It is recommended that this be reviewed in the field by Paterson personnel.

## 9.0 EROSION AND SEDIMENT CONTROL

### 9.1 Temporary Measures

Before construction begins, temporary silt fence, straw bale or rock flow check dams will be installed at all natural runoff outlets from the property. It is crucial that these controls be maintained throughout construction and inspection of sediment and erosion control will be facilitated by the Contractor or Contract Administration staff throughout the construction period.

Silt fences will be installed where shown on the final engineering plans, specifically along the downstream property limits. The Contractor, at their discretion or at the instruction of the City, Conservation Authority or the Contract Administrator shall increase the quantity of sediment and erosion controls on-site to ensure that the site is operating as intended and no additional sediment finds its way off site. The rock flow, straw bale & silt fence check dams and barriers shall be inspected weekly and after rainfall events. Care shall be taken to properly remove sediment from the fences and check dams as required. Fibre roll barriers are to be installed at all existing curb inlet catchbasins and filter fabric is to be placed under the grates of all existing catchbasins and manholes along the frontage of the site and any new structures immediately upon installation. The measures for the existing/proposed structures are to be removed only after all areas have been paved. Care shall be taken at the removal stage to ensure that any silt that has accumulated is properly handled and disposed of. Removal of silt fences without prior removal of the sediments shall not be permitted.

Although not anticipated, work through winter months shall be closely monitored for erosion along sloped areas. Should erosion be noted, the Contractor shall be alerted and shall take all necessary steps to rectify the situation. Should the Contractor's efforts fail at remediating the eroded areas, the Contractor shall contact the City and/or Conservation Authority to review the site conditions and determine the appropriate course of action. As the ground begins to thaw, the Contractor shall place silt fencing at all required locations as soon as ground conditions warrant. Please see the *Site Grading, Drainage and Sediment & Erosion Control Plan* for additional details regarding the temporary measures to be installed and their appropriate OPSD references.

## 9.2 Permanent Measures

Rip-rap will be placed at all locations that have the potential for concentrated flow. It is crucial that the Contractor ensure that the geotextile is keyed in properly to ensure runoff does not undermine the rip rapped area. Additional rip rap is to be placed at erosion prone locations as identified by the Contractor / Contract Administrator / City or Conservation Authority.

It is expected that the Contractor will promptly ensure that all disturbed areas receive topsoil and seed/sod and that grass be established as soon as possible. Any areas of excess fill shall be removed or levelled as soon as possible and must be located a sufficient distance from any watercourse to ensure that no sediment is washed out into the watercourse. As the vegetation growth within the site provides a key component to the control of sediment for the site, it must be properly maintained once established. Once the construction is complete, it will be up to the landowner to maintain the vegetation and ensure that the vegetation is not overgrown or impeded by foreign objects.

## 10.0 SUMMARY

- A new 8,368m<sup>2</sup> warehouse building is proposed along the west property line at 1560 Star Top Road.

- A new 150mm diameter water service is proposed to service the site, extending from the existing 150mm watermain within the subject property.
- A new 200mm sanitary service is proposed to service the site. The service will extend from a proposed spring line connection to the existing 300mm sanitary sewer within Star Top Road.
- The proposed storm sewer, ranging in diameter from 200 mm to 525 mm, will be installed throughout the site and drain to the existing ditch adjacent to Star Top Road.
- Storage for the 5- through 100-year storm events will be provided within the parking lot areas above the proposed storm structures, and within the dry retention area.
- An OGS downstream of the site restrictions will provide quality control for the proposed storm network.

## 11.0 RECOMMENDATION

Based on the information presented in this report, we recommend that City of Ottawa approve this Servicing and Stormwater Management Report in support of the proposed warehouse development at 1560 Star Top Road.

This report is respectfully being submitted for approval.

Regards,

McIntosh Perry Consulting Engineers Ltd.



Mitch Raper, B.Eng.  
Engineering Intern  
T: 343.764.2090  
E: [m.raper@mcintoshperry.com](mailto:m.raper@mcintoshperry.com)



Charissa Hampel, P.Eng.  
Project Engineer  
T: 613.714.4625  
E: [c.hampel@mcintoshperry.com](mailto:c.hampel@mcintoshperry.com)

u:\infrastructure\2023\cco-23-3725 bbs\_boone warehouse\_1540 startop road\03 - servicing\report\cco-23-3725\_servicing report - rev3 - 11.15.docx

## 12.0 STATEMENT OF LIMITATIONS

This report was produced for the exclusive use of BBS Construction. The purpose of the report is to assess the existing stormwater management system and provide recommendations and designs for the post-construction scenario that are in compliance with the guidelines and standards from the Ministry of the Environment, Conservation and Parks, City of Ottawa and local approval agencies. McIntosh Perry reviewed the site information and background documents listed in Section 2.0 of this report. While the previous data was reviewed by McIntosh Perry and site visits were performed, no field verification/measures of any information were conducted.

Any use of this review by a third party, or any reliance on decisions made based on it, without a reliance report is the responsibility of such third parties. McIntosh Perry accepts no responsibility for damages, if any, suffered by any third party as a result of decisions or actions made based on this review.

The findings, conclusions and/or recommendations of this report are only valid as of the date of this report. No assurance is made regarding any changes in conditions subsequent to this date. If additional information is discovered or becomes available at a future date, McIntosh Perry should be requested to re-evaluate the conclusions presented in this report, and provide amendments, if required.



APPENDIX A  
KEY PLAN



ch. Algoma Rd.

ch. Comstock Rd.

ch. Star Top Rd.

HWY 417

APPENDIX B  
BACKGROUND DOCUMENTS

## City Surveyor

Bill Harper, City's Surveyor | [Bill.Harper@ottawa.ca](mailto:Bill.Harper@ottawa.ca)

The determination of property boundaries, minimum setbacks and other regulatory constraints are a critical component of development. An Ontario Land Surveyor (O.L.S.) needs to be consulted at the outset of a project to ensure properties are properly defined and can be used as the geospatial framework for the development.

Topographic details may also be required for a project and should be either carried out by the O.L.S. that has provided the Legal Survey or done in consultation with the O.L.S. to ensure that the project is integrated to the appropriate control network.

The survey being prepared for the application will indicate whether easements over the City-owned right of way over the South Cyrville Drain at the northern boundary of the lot are existing or required.

## Engineering

Kelsey Charie, Project Manager Infrastructure Approvals | [kelsey.charie@ottawa.ca](mailto:kelsey.charie@ottawa.ca)

### List of Reports and Plans (Site Plan Control):

1. Site Servicing Plan
2. Site Grading and Ponding Plan
3. Erosion and Sediment Control Plan
4. Existing Condition Storm Drainage Plan
5. Post Development Storm Drainage Plan
6. Stormwater Management and Site Servicing Report
7. Geotechnical Investigation Report

Please note the following information regarding the engineering design submissions for the above noted site:

1. The Servicing Study Guidelines for Development Applications are available at the following address:

<https://ottawa.ca/en/city-hall/planning-and-development/how-develop-property/development-application-review-process-2/guide-preparing-studies-and-plans>

2. Servicing and site works shall be in accordance with the following documents:

- Ottawa Sewer Design Guidelines, Second Edition, (October 2012), including Technical Bulletins, ISDTB-2014-01, PIEDTB-2016-01, ISTB 2018-01, ISTB-2018-04, and ISTB-2019-02
  - Ottawa Design Guidelines – Water Distribution, First Edition, (July 2010), including Technical Bulletins ISD-2010-2, ISDTB-2014-02, ISTB-2018-02, and ISTB-2021-03
  - Geotechnical Investigation and Reporting Guidelines for Development Applications in the City of Ottawa (Revised 2008)
  - City of Ottawa Slope Stability Guidelines for Development Applications (Revised 2012)
  - City of Ottawa Environmental Noise Control Guidelines (January 2016)
  - City of Ottawa Hydrogeological and Terrain Analysis Guidelines (March 2021)
  - City of Ottawa Park and Pathway Development Manual (2012)
  - City of Ottawa Accessibility Design Standards (2012)
  - Ottawa Standard Tender Documents (latest version)
  - Ontario Provincial Standards for Roads & Public Works (2013)
3. Record drawings and utility plans are also available for purchase from the City (Contact the City's Information Centre by email at [InformationCentre@ottawa.ca](mailto:InformationCentre@ottawa.ca) or by phone at (613) 580-2424 x 44455
4. Stormwater Management Criteria
- i. Quantity
    - The storm water quantity control requirements for this site shall be based on the existing/pre-development conditions.
    - The pre-development discharge rate for the site will need to be calculated based on the pre-development runoff coefficient or a maximum equivalent value of 0.5, whichever is less.
    - The post development discharge rates for the site shall match the pre-development discharge rates for all storm events. i.e.: the 2-year post development rate shall match the 2-year pre-development rate and so on for the 5-year and 100-year events
    - Ensure no overland flow for all storm events up to and including the 100-year event. Provide adequate emergency overflow conveyance off-site
  - ii. Quality
    - Characterize the water quality to be protected and Stormwater Contaminants (e.g., suspended solids, nutrients, bacteria, water

temperature) for potential impact on the Natural Environment, and control as necessary, OR

- As per the watershed/subwatershed plan, similar area-wide Stormwater study, or Stormwater management plan to minimize, or where possible, prevent increases in contaminant loads and impacts to receiving waters.
- Provide Enhanced level of protection (80%) for suspended solids removal.
- Provide a water balance analysis as per the conservation authority guidelines for development applications. Control the recharge to meet Pre-development conditions on property.



5. Deep Services:

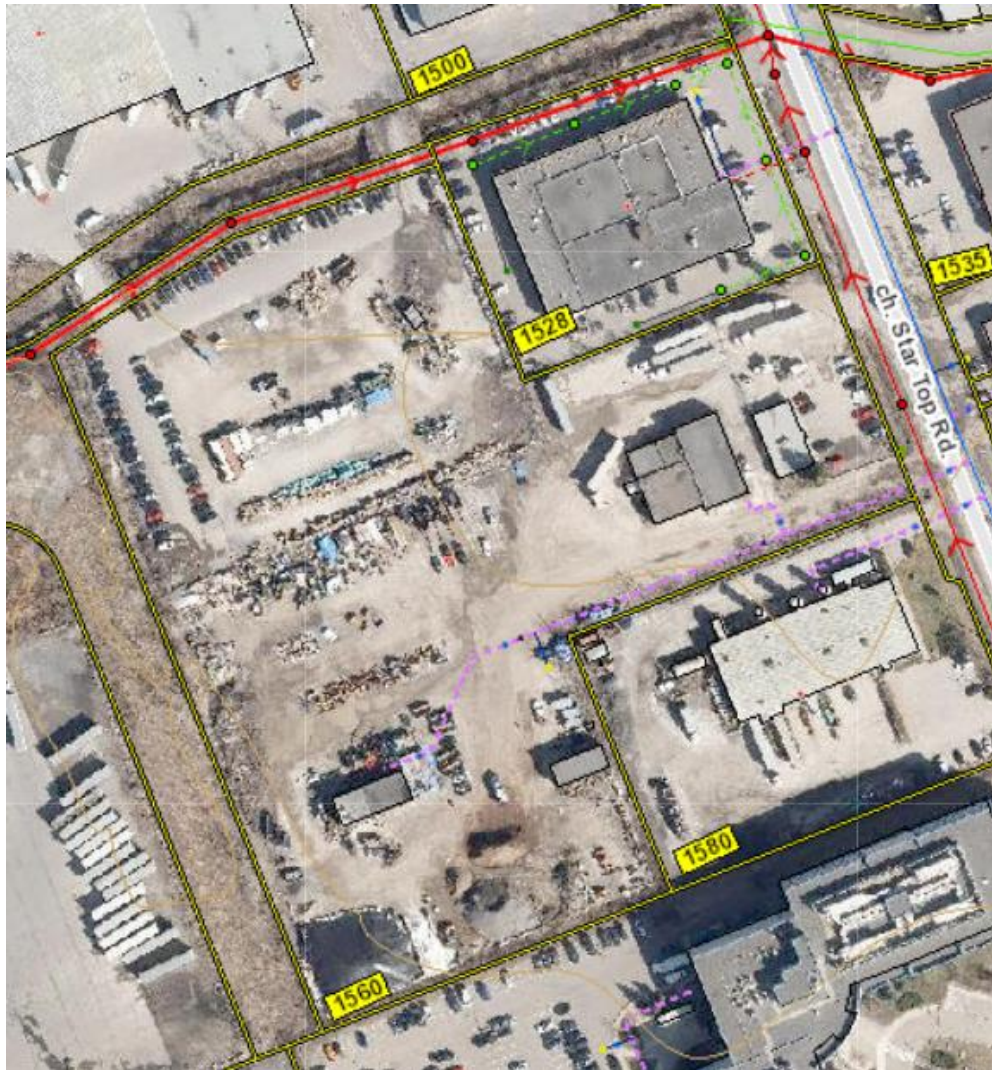

- i. *A plan view of the approximate existing public services may be seen above. The sizing of available services are:*

Connections:

- i. 305 mm dia. water main within Star Top Road
- ii. 300 mm dia. sanitary sewer within Star Top Road
- iii. Note: the 675 mm dia. sanitary sewer north of the property is not permitted to be connected to
- iv. Note: There is also no storm sewer for this property. The South Cyrville Drain may be a possibility to drain to but will likely require additional measures prior to approval

- ii. *Provide existing servicing information and the recommended location for the proposed connections. Services should ideally be grouped in a common trench to minimize the number of road cuts.*
- iii. *Provide information on the monitoring manhole requirements – should be located in an accessible location on private property near the property line (i.e. Not in a parking area).*
- iv. *Provide information on the type of connection permitted*

Sewer connections to be made above the springline of the sewermain as per:

- a. *Std Dwg S11.1 for flexible main sewers – connections made using approved tee or wye fittings.*
  - b. *Std Dwg S11 (For rigid main sewers) – lateral must be less than 50% the diameter of the sewermain,*
  - c. *Std Dwg S11.2 (for rigid main sewers using bell end insert method) – for larger diameter laterals where manufactured inserts are not available; lateral must be less than 50% the diameter of the sewermain,*
  - d. *Connections to manholes permitted when the connection is to rigid main sewers where the lateral exceeds 50% the diameter of the sewermain. – Connect obvert to obvert with the outlet pipe unless pipes are a similar size.*
  - e. *No submerged outlet connections.*
  - v. *Please provide estimated sanitary flows with the first submission (or beforehand if possible), to allow the City to confirm whether there are any downstream capacity constraints.*
6. Civil consultant must request boundary conditions from the City's assigned Project Manager prior to first submission. Water Boundary condition requests must include the location of the service and the expected loads required by the proposed development. Please provide the following information:
- i. Location of service(s)
  - ii. Type of development and the amount of fire flow required (as per FUS, 2020).
  - iii. Average daily demand: \_\_\_ l/s.



- iv. Maximum daily demand: \_\_\_ l/s.
  - v. Maximum hourly daily demand: \_\_\_ l/s.
  - vi. Hydrant location and spacing to meet City's Water Design guidelines.
  - vii. Water supply redundancy will be required for more than 50 m<sup>3</sup>/day water demand.
7. Phase 1 ESAs and Phase 2 ESAs must conform to clause 4.8.4 of the Official Plan that requires that development applications conform to Ontario Regulation 153/04.
8. All development applications should be considered for an Environmental Compliance Approval (ECA) by the Ministry of the Environment, Conservation, and Parks (MECP):
- a. The consultants determine if an approval for sewage works under Section 53 of OWRA is required and determines what type of application. The City's project manager may help confirm and coordinate with the MECP as required.
  - b. The project will be either transfer of review (standard), transfer of review (additional), direct submission, or exempt as per O. Reg. 525/98.
  - c. Pre-consultation is not required if applying for standard or additional works (Schedule A of the Agreement) under Transfer Review.
  - d. Pre-consultation with local District office of MECP is recommended for direct submission.
  - e. Consultant completes an MECP request form for a pre-consultation. Send request to [moeccottawasewage@ontario.ca](mailto:moeccottawasewage@ontario.ca)
  - f. ECA applications are required to be submitted online through the MECP portal. A business account required to submit ECA application. For more information visit <https://www.ontario.ca/page/environmental-compliance-approval>

NOTE: Site Plan Approval, or Draft Approval, is required before an application is sent to the MECP.

9. General Engineering Submission requirements:

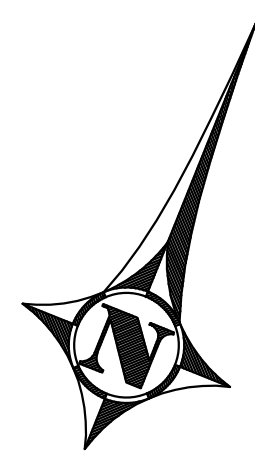

**ELEVATIONS:**

ELEVATIONS ARE GEODETIC (CGVD 28/78) BY GNSS OBSERVATIONS REFERENCED TO THE CANADA HT\_2 GEOD MODEL AND ARE ILLUSTRATED VIA CONTOUR SURFACE MODELLING AT 0.25m INTERVALS.

**BENCHMARKS:**

TOPOGRAPHIC INFORMATION DERIVED FROM FIELD SURVEY BY MCINTOSH PERRY SURVEYING INC. (MPSI). THIS FIELD WORK WAS COMPLETED ON THE 26TH DAY OF APRIL, 2023.

TEMPORARY SITE BENCHMARK #1 - CUT CROSS SET ON BASE OF LS, HAVING AN ELEVATION OF 66.38m.

TEMPORARY SITE BENCHMARK #2 - TOP OF SPINDLE ON FIRE HYDRANT, HAVING AN ELEVATION OF 67.24m.

TEMPORARY SITE BENCHMARK #2 - TOP OF SPINDLE ON FIRE HYDRANT, HAVING AN ELEVATION OF 67.03m.

**BEARINGS & DISTANCES:**

BEARINGS SHOWN HEREON ARE MTM GRID BEARINGS, DERIVED FROM REAL-TIME NETWORK (RTN) GPS OBSERVATIONS ON OBSERVED REFERENCE POINTS 'A' AND 'B', SHOWN HEREON, AND ARE RELATED TO NAD83 (ORIGINAL) MTM ZONE 9 (CENTRAL MERIDIAN 75° 30' W).

DISTANCES SHOWN ON THIS PLAN ARE GROUND DISTANCES AND CAN BE CONVERTED TO GRID DISTANCES BY MULTIPLYING BY A COMBINED SCALE FACTOR OF 0.999951.

**BEARING ROTATION:**

FOR THE PURPOSE OF COMPARISON, ASTRONOMIC BEARINGS HAVE BEEN ROTATED AS FOLLOWS:

PLAN	ROTATION	DIRECTION
(p1), (p5), (p6)	00°43'40"	COUNTER CLOCKWISE

**INTEGRATION DATA:**

OBSERVED REFERENCE POINTS (ORPs) DERIVED FROM GNSS OBSERVATIONS USING THE CANNET REAL TIME NETWORK (RTN) SERVICE. COORDINATES ARE CONFIRMED BY THE NRCAN RTK COMPLIANCE AGREEMENT.

COORDINATE SYSTEM : NAD83 (ORIGINAL), MTM ZONE 9.  
COORDINATES TO URBAN ACCURACY PER SEC. 14 (2) OF O.REG. 216/10

POINT ID	NORTHING	EASTING
ORP 'A'	5030725.83	373685.29
ORP 'B'	5031195.48	373921.66

COORDINATES CANNOT, IN THEMSELVES, BE USED TO RE-ESTABLISH CORNERS OR BOUNDARIES SHOWN ON THIS PLAN.

**PLAN OF SURVEY SHOWING TOPOGRAPHIC DETAIL OF PART OF LOT 25 CONCESSION 2 (OTTAWA FRONT) GEOGRAPHIC TOWNSHIP OF GLOUCESTER CITY OF OTTAWA**

McINTOSH PERRY SURVEYING INC

SCALE 1 : 500

0 10 20 30 40 50 Metres

THE INTENDED PLOT SIZE OF THIS PLAN IS 914mm IN WIDTH BY 660mm IN HEIGHT WHEN PLOTTED AT A SCALE OF 1 : 500.

**METRIC:**

DISTANCES AND COORDINATES SHOWN ON THIS PLAN ARE IN METRES AND CAN BE CONVERTED TO FEET BY DIVIDING BY 0.3048.

**SURVEYOR'S CERTIFICATE**

I CERTIFY THAT:

- THIS SURVEY AND PLAN ARE CORRECT AND IN ACCORDANCE WITH THE SURVEYS ACT, THE SURVEYORS ACT, AND THE REGULATIONS MADE UNDER THEM.
- THE SURVEY WAS COMPLETED ON THE 15TH DAY OF JUNE, 2023.

JUNE 15, 2023

DATE

THIS PLAN OF SURVEY RELATES TO AOLS PLAN SUBMISSION FORM NUMBER V-50077.

John Gauthier  
ONTARIO LAND SURVEYOR

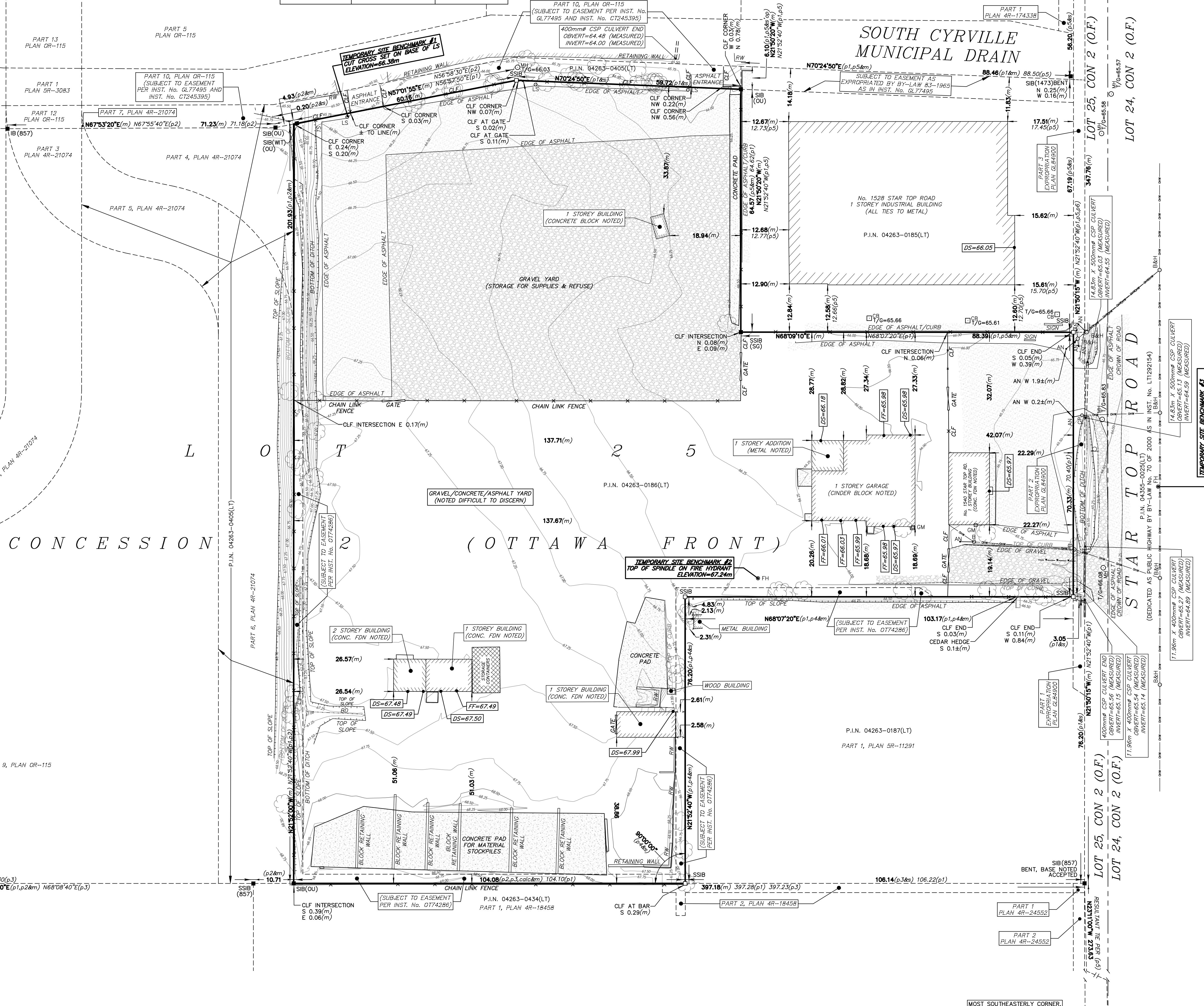

**LEGEND:**

- D DENOTES MONUMENT PLANTED
- DENOTES MONUMENT FOUND
- SIB DENOTES STANDARD IRON BAR
- IB DENOTES SHORT STANDARD IRON BAR
- IB(S) DENOTES IRON BAR
- N.S.E.W DENOTES NORTH, SOUTH, EAST, WEST
- NW DENOTES NORTHWEST
- SE DENOTES SOUTHWEST
- SW DENOTES SOUTHWEST
- N.T.S. DENOTES NOT TO SCALE
- CON 2 DENOTES CONCESSION 2
- (O.F.) DENOTES OTTAWA FRONT
- (WT) DENOTES WITNESS
- (S) DENOTES SET
- (F) DENOTES MEASURED
- (FOP) DENOTES SET ON PRODUCTION
- FDN DENOTES FOUNDATION
- S/T DENOTES SUBJECT TO
- INST. No. DENOTES INSTRUMENT NUMBER
- (p1) DENOTES PLAN OR-115
- (p2) DENOTES PLAN 4R-21074
- (p3) DENOTES PLAN 4R-18458
- (p4) DENOTES PLAN 5R-11291
- (p5) DENOTES SURVEYOR'S REAL PROPERTY REPORT BY STANTEC GEOMATICS LTD, DATED OCTOBER 3, 2007, PLAN 4R-17338
- (p6) DENOTES FAIRHALL, MOFFATT & WOODLAND LTD, O.L.S.
- (857) DENOTES JOHN E. KIH, O.L.S.
- (1475) DENOTES DOUGLAS A. SIMMONDS, O.L.S.
- (SC) DENOTES STANTEC GEOMATICS, O.L.S.
- ELEV DENOTES ELEVATION
- BMH DENOTES BELL & HYDRO UTILITY POLE
- BP DENOTES BELL UTILITY POLE
- GP DENOTES GUY POLE
- ANOR DENOTES ANCHOR
- OHW DENOTES OVERHEAD UTILITY WIRES
- GM DENOTES GAS METER
- FI DENOTES FIRE HYDRANT
- CONC. DENOTES CONCRETE
- MH DENOTES MAINTENANCE HOLE
- CB DENOTES CATCH BASIN
- T/G DENOTES TOP OF GRATE/AID
- DS DENOTES DOOR SILL ELEVATION
- FF DENOTES FINISHED FLOOR ELEVATION
- LS DENOTES LIGHT STANDARD
- BD DENOTES BOTTOM OF DITCH
- TS DENOTES TOP OF SLOPE
- W- DENOTES UNDERGROUND WATER SERVICE
- CLF DENOTES CHAIN LINK FENCE
- DENOTES TREE(S)
- DENOTES SIGN

**UTILITIES:**

THE LOCATION AND CONFIGURATION OF UNDERGROUND SERVICES AND UTILITIES WERE NOT INCLUDED IN THIS SURVEY. IT IS THE RESPONSIBILITY OF THE CONTRACTOR TO VERIFY THE CONFIGURATION AND LOCATION OF UNDERGROUND SERVICES AT THE SITE PRIOR TO CONSTRUCTION.

© COPYRIGHT IN THIS PLAN REMAINS THE PROPERTY OF MCINTOSH PERRY SURVEYING INC. REPRODUCTION OF THIS PLAN BY ANY MEANS IS PROHIBITED.

JOB: CSI 23-3729 DWG: CSI 23-3729 - 1540 STAR TOP ROAD TOPO (RF)

THIS PLAN WAS PREPARED FOR: MCINTOSH PERRY CONSULTING ENGINEERS

**McINTOSH PERRY SURVEYING INC.**

3240 Drummond Con. 5A, R.R. #7, Perth, ON K7H 3C9  
Tel: 613-267-6524 Fax: 613-267-7992  
www.mcintoshperry.com

EXAMINED BY: J.G.

DRAFTED BY: R.F., S.R.



THIS SITE PLAN HAS BEEN BASED ON THE SURVEYOR'S PLAN OF SURVEY PREPARED BY MINTOSH PERRY SURVEYING INC., DATED JUNE 15th, 2023.

# SOUTH CYRVILLE MUNICIPAL DRAIN

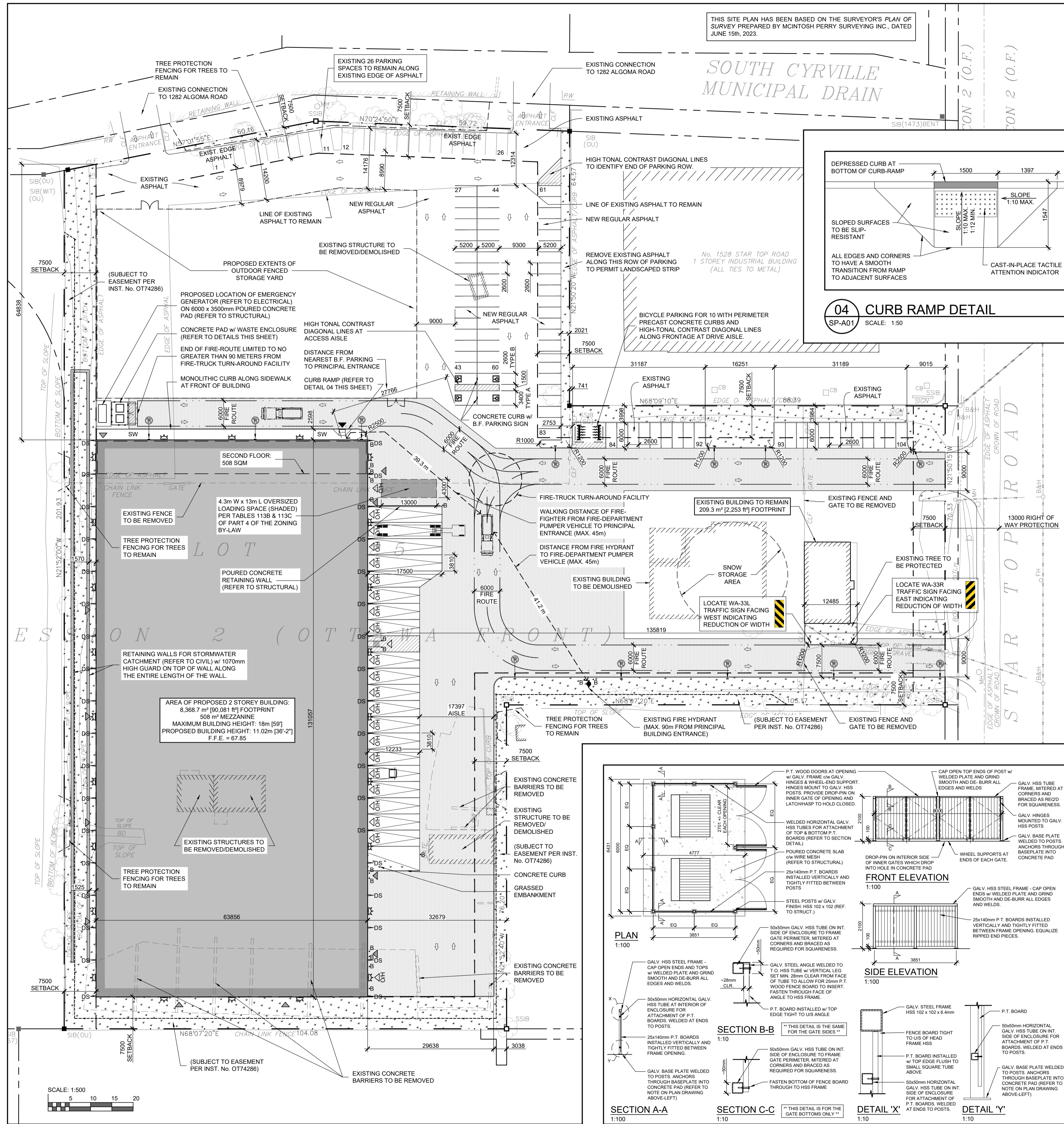

## 02 WASTE ENCLOSURE DETAILS

SCALE: AS NOTED

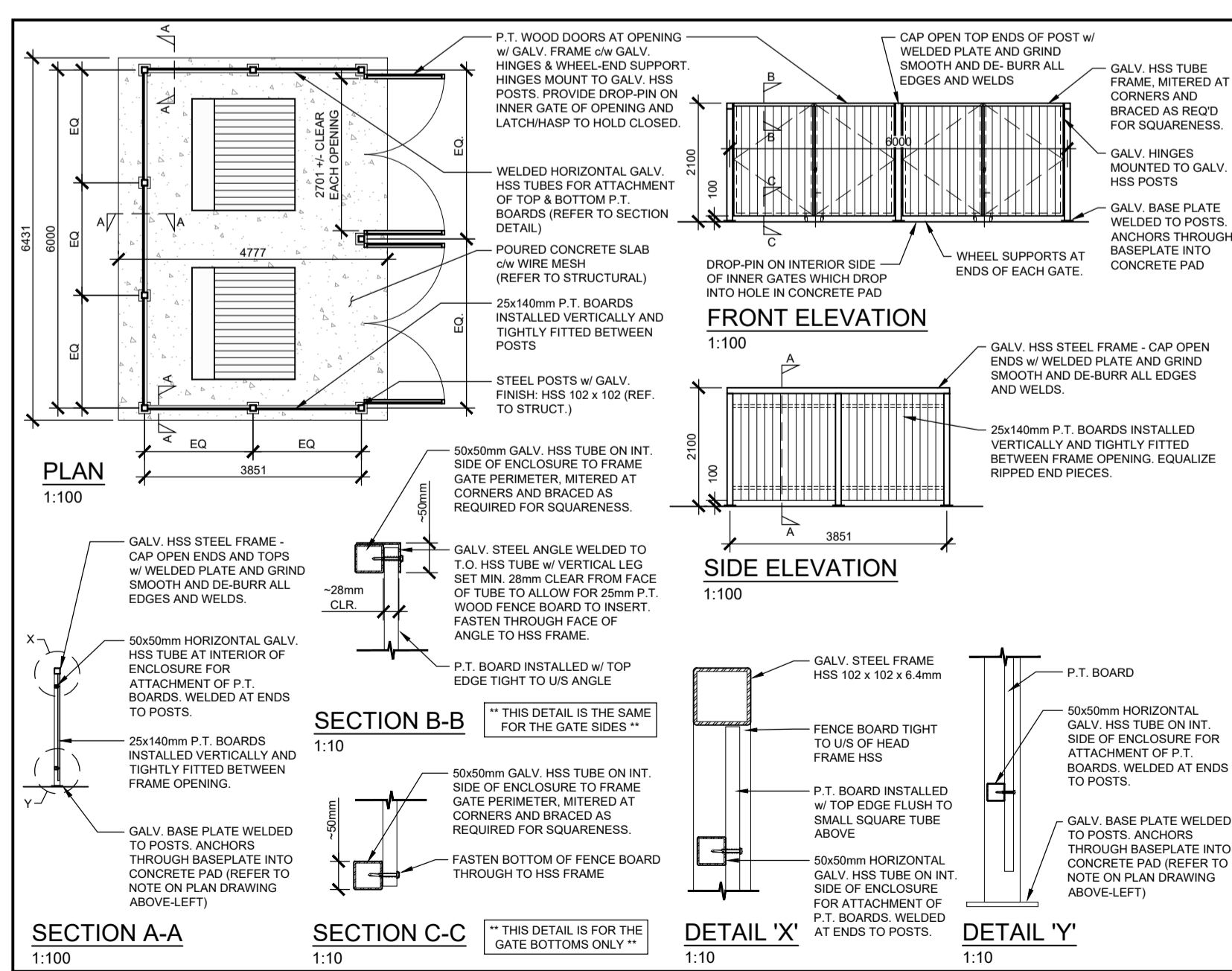

## LOCATION KEY

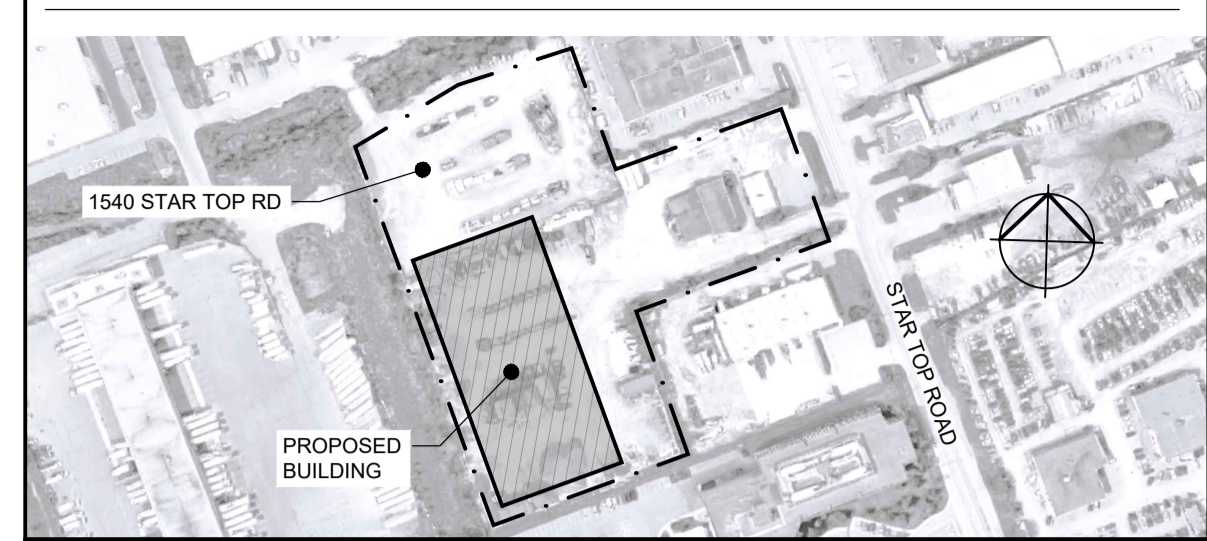

## ZONING INFORMATION

PER THE CITY OF OTTAWA ZONING BY-LAW 2008-250 CONSOLIDATION

**LEGAL DESCRIPTION:**  
PART OF LOT 25, CONCESSION 2 (OTTAWA FRONT) GEOGRAPHIC TOWNSHIP OF GLOUCESTER CITY OF OTTAWA

**PROPOSAL:**  
NEW 8,369 m<sup>2</sup> [90,081 ft<sup>2</sup>] SINGLE STOREY BUILDING.

**ZONING:**  
DESIGNATION: (IL) LIGHT INDUSTRIAL

**ZONING PROVISIONS (PER TABLE 203):**

- LOT AREA (MIN.) = 2,000 m<sup>2</sup>
- ACTUAL LOT AREA = 30,051 m<sup>2</sup>
- LOT WIDTH (MIN.) = NO MINIMUM
- ACTUAL FRONTAGE = 73 m
- SETBACKS (MIN.):
  - FRONT = 7.5 m
  - INT. SIDE = 7.5 m
  - REAR = 7.5 m
- FLOOR SPACE INDEX (MAX.) = 2
- ACTUAL INDEX = 0.3
- LANDSCAPED MIN. WIDTHS = 3m ABUTTING STREETS
- LOT COVERAGE = 65% MAX
- ACTUAL LOT COVERAGE = 29.9 % (8,993 m<sup>2</sup>)
- MAX. BUILDING HEIGHT = 18 m
- ACTUAL HEIGHT = 11.4 m

**LOADING REQUIREMENTS:**  
(PER TABLE 113A UNDER PART 4)

LOADING SPACES ARE REQUIRED TO BE PROVIDED FOR EACH USE AS FOLLOWS:

WAREHOUSE: 1  
OFFICE: 1

**OVERSIZE LOADING REQUIREMENTS:**  
(PER TABLES 113B & 113C)

OVERSIZE SPACES IS REQUIRED: 1  
DIMENSIONS: 4.3m W x 13m L

**GROSS FLOOR AREAS BY USE (for the purpose of parking calcs)**

GROUND FLOOR WAREHOUSE	7,861 m <sup>2</sup>
OFFICE AREA	508 m <sup>2</sup>
MEZZANINE OFFICE	508 m <sup>2</sup>
TOTAL	8,877 m <sup>2</sup>

**LOADING REQUIREMENTS:**  
(PER TABLE 113A UNDER PART 4)

REQUIRED: 52 SPACES  
PROVIDED: 56 SPACES

**ROW N89 - WAREHOUSE** REQUIRES 0.8 PARKING SPACES PER 100m<sup>2</sup> OF GROSS FLOOR AREA FOR THE FIRST 5,000 m<sup>2</sup>, AFTER WHICH 0.4 PARKING SPACES ARE REQUIRED PER 100m<sup>2</sup> BEYOND 5,000m<sup>2</sup> OF GROSS FLOOR AREA. PARKING SPACES UNDER THIS SECTION RECOGNIZE ONLY THOSE WHICH ARE WITHIN THE PROPERTY BOUNDARY.

**ROW N89 - OFFICE USE** REQUIRES 2.4 PARKING SPACES PER 100m<sup>2</sup> OF GROSS FLOOR AREA. PARKING SPACES UNDER THIS SECTION RECOGNIZE ONLY THOSE WHICH ARE WITHIN THE PROPERTY BOUNDARY.

**LOADING REQUIREMENTS:**  
(PER SECTION 111 UNDER PART C OF BY-LAW NO. 2017-301):

RESERVED BARRIER-FREE PARKING SPACES:  
REQUIRED: 2 SPACES (TYPE 'A')

THE HIGHWAY TRAFFIC ACT OF ONTARIO REQUIRES AN ADDITIONAL 2 BARRIER-FREE PARKING SPACES, DESIGNATED AS TYPE 'B' SPACES.  
\* TYPE 'A' WIDTH: 3.6m MIN.  
\*\* TYPE 'B' WIDTH: 2.4m MIN.  
SIGNAGE FOR BARRIER-FREE PARKING SHALL COMPLY WITH SECTION 113 UNDER PART C OF BY-LAW No. 2017-301.

**BICYCLE PARKING:**  
(PER SECTION 111 UNDER PART C OF BY-LAW No. 2017-301):

OFFICE: 1 PER 250m<sup>2</sup> GFA = 5 SPACES  
WAREHOUSE: 1 PER 200m<sup>2</sup> GFA = 4 SPACES

## VERTICAL PARKING LOT SIGNAGE

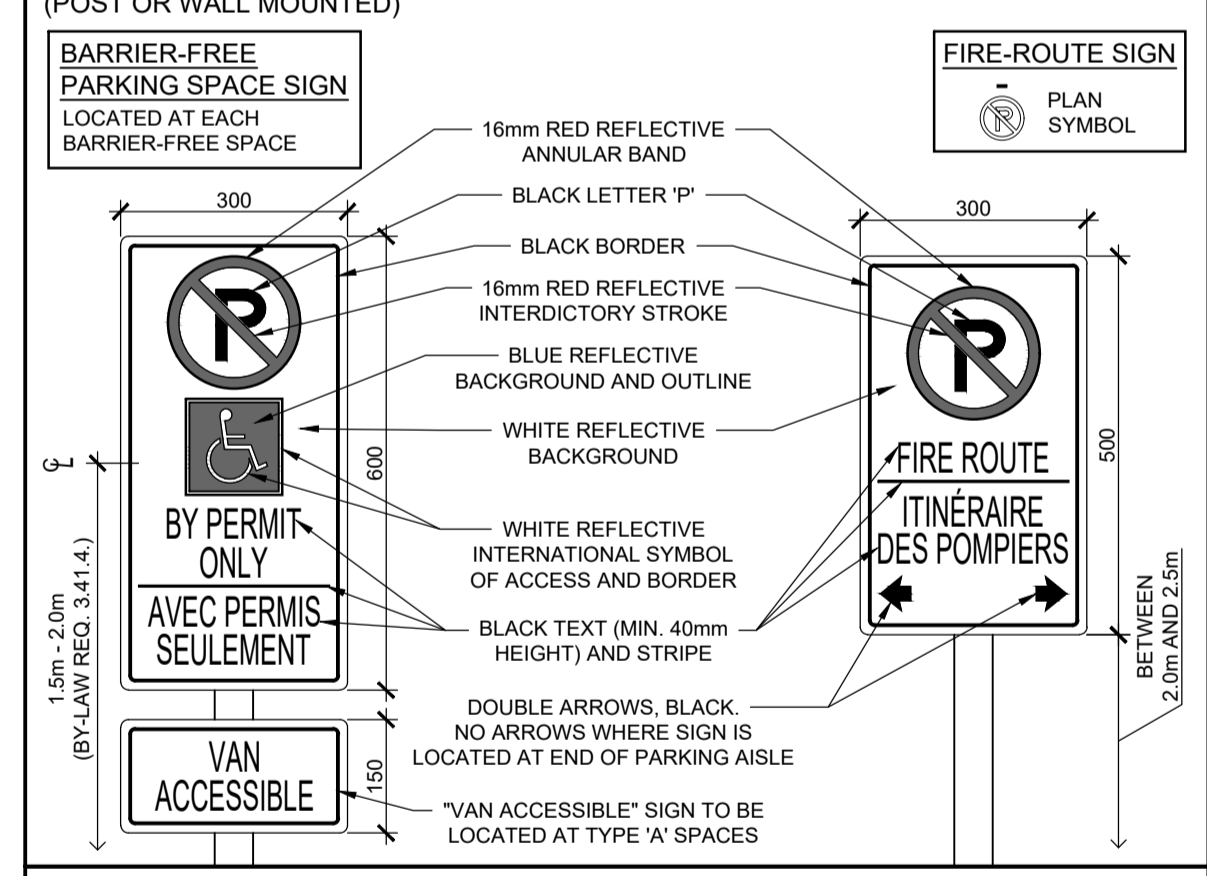

## SITE PLAN LEGEND

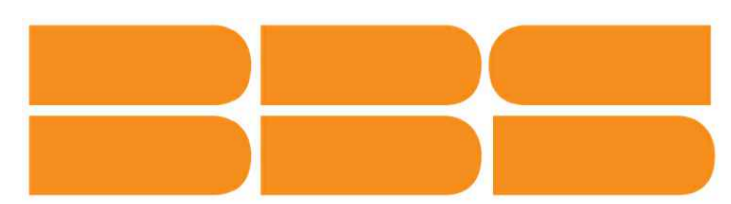
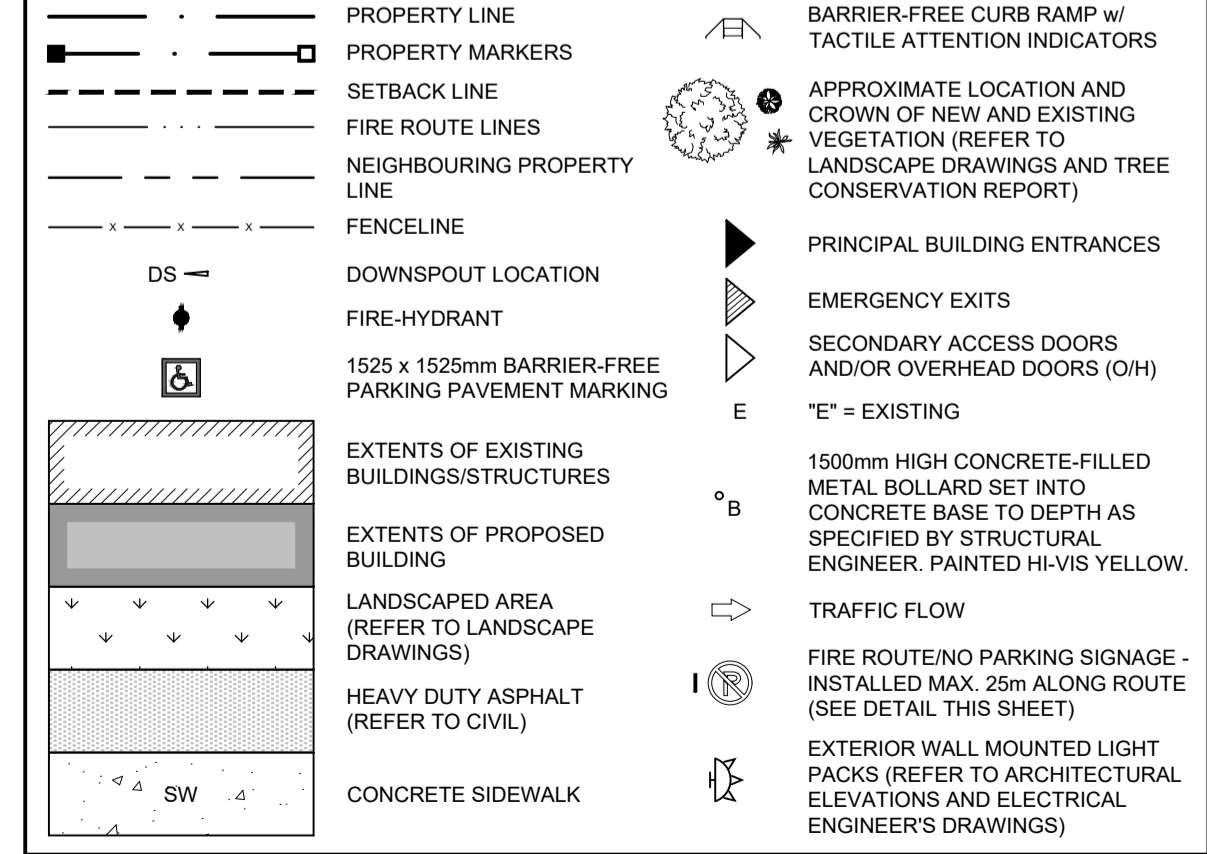

**BBS CONSTRUCTION (Ontario) LTD.**

**CONSULTANT TEAM:**  
DESIGN BUILDER: BBS CONSTRUCTION INC. (613) 228-8830  
ARCHITECT: DEIMLING ARCHITECTURE & INTERIOR DESIGN (613) 697-6113  
TRANSPORTATION, PLANNING AND CIVIL: MINTOSH PERRY CONSULTING ENGINEERS (613) 836-2184  
LANDSCAPE ARCHITECT: GJA INC. (613) 286-5130  
GEOTECHNICAL AND ENVIRONMENTAL: PATERSON GROUP INC. (613) 228-7381  
SURVEYOR: MINTOSH PERRY SURVEYING INC. (613) 267-6524  
ENVIRONMENTAL PLANNING: MUNCASTER ENVIRONMENTAL PLANNING INC. (613) 748-3753



North

## Revisions

No.	By	Description	Date
11	JF	ISSUED FOR FORMAL SITE PLAN CONTROL COMMENTS RESPONSE	30 SEPT 2024
10	JF	ISSUED FOR FORMAL SITE PLAN CONTROL COMMENTS RESPONSE	09 AUG 2024
09	JM	ISSUED FOR FORMAL SITE PLAN CONTROL	26 MAR 2024
08	JF	PHASE 3 FEEDBACK RESPONSE SUBMISSION No. 2	12 JAN 2024
07	JF	ISSUED FOR COORDINATION	21 DEC 2023
06	JF	ISSUED FOR COORDINATION	20 DEC 2023
05	JF	ISSUED FOR SITE PLAN CONTROL RESPONSE 01	08 NOV 2023
04	JF	ISSUED FOR COORDINATION	02 NOV 2023
03	JF	ISSUED FOR SITE PLAN CONTROL	01 AUG 2023
02	JF	ISSUED FOR REVIEW AND COORDINATION	25 JUL 2023
01	JF	ISSUED FOR REVIEW AND COORDINATION	29 JUN 2023

Project

## BOONE PLUMBING NEW WAREHOUSE

1540 STAR TOP ROAD, OTTAWA, ONTARIO

## Drawing PROPOSED SITE PLAN

Scale AS NOTED  
Drawn J.F.  
Checked J.F. / C.D.  
Project No. 23-128  
Date JUNE 2023

Stamp  
ONTARIO ASSOCIATION OF ARCHITECTS  
CHRISTOPHER LEE DEIMLING LICENCE 6238

Drawing No. SP-A01



APPENDIX C  
WATERMAIN CALCULATIONS

## WATER DEMAND CALCULATIONS

**PROJECT:** New Warehouse Building  
**LOCATION:** 1560 Startop Rd, Gloucester, ON  
**CLIENT:** BBS Construction Ltd.

McINTOSH PERRY

LOCATION	RESIDENTIAL UNITS							RESIDENTIAL DEMANDS								INDUSTRIAL/AMENITY DEMANDS						TOTAL DEMANDS						
	1	2	3	4	5	6	7	8	9	10	11	12	13	14	15	16	17	18	19	20	21	22	23	24	25	26	27	28
	UNIT TYPES							AREA (ha)	POPULATION	PEAKING FACTORS		AVERAGE DAY FLOW		MAX DAY FLOW		PEAK HOURLY FLOW Q(h)		AREA (ha)	PEAKING FACTORS		AVERAGE DAY FLOW		MAX DAY FLOW		PEAK HOURLY FLOW Q(h)		Average Day	Max Day
1540 Star Top Road	SF	SD	TH	1BR	2BR	3BR	STU.				MAX DAY	PEAK HOUR	Q(a) (L/s)	Q(a) (L/min)	Q(max) (L/s)	Q(max) (L/min)	Q(h) (L/s)		Q(h) (L/min)		MAX DAY	PEAK HOUR	Q(a) (L/s)	Q(a) (L/min)	Q(max) (L/s)	Q(max) (L/min)		
Proposed Industrial Building																	3.00	1.5	2.7	1.215	0.073	1.823	0.11	3.281	0.20	1.22	1.82	3.28
<b>TOTALS</b>																	<b>3.0</b>			<b>1.2</b>	<b>0.073</b>	<b>1.8</b>	<b>0.11</b>	<b>3.3</b>	<b>0.20</b>	<b>1.22</b>	<b>1.82</b>	<b>3.28</b>

**Design Parameters:**

Single Family	3.4	p/p/u
TH/SD	2.7	p/p/u
1 Bed/Studio	1.4	p/p/u
2 Bedroom	2.1	p/p/u
3 Bedroom	3.1	p/p/u
Studio (Avg.)	1.8	p/p/u
Commercial	28000	L/ha/d
Industrial - Light	35000	

**Notes:**

- Domestic Flow: 280 L/(cap-day)
  - Peaking factors based on 501-3000 population
- Q (a) = Average Daily Flow  
 Q (max) = Maximum Daily Flow  
 Q (h) = Peak Hour Flow  
 Q (min) = Night Minimum Hour Flow

Q (max) = Q(a) \* Peaking Factor  
 Q (h) = Q(a) \* Peaking Factor  
 Q (min) = Q(a) \* Peaking Factor

**Designed:**

M. Raper

**Checked:**

C. Melanson

**Project No.:**

CCO-23-3725

REF: CITY OF OTTAWA - WATER DISTRIBUTION GUIDELINES, JULY 2010

## Ontario Building Code 2006 - Fire Flow Calculations

**Building No. / Type:** 1560 Star Top Road , 3-Storey Warehouse

1 of 2

Ontario 2006 Building Code Compendium (Div. B - Part 3)

Water Supply for Fire-Fighting

### A. Determine the Major Occupancy Classification of the Building

Refer to OBC Table 3.1.2.1:

**Input:** F3 *Low hazard industrial occupancies*

### B. Determine the Construction Type & Water Supply Coefficient

Choose the building construction type:

**Input:** 1 *Building is of noncombustible construction with fire separations and fire-resistance ratings provided in accordance with subsections 3.2.2., including loadbearing walls, columns and arches*

Resulting Water Supply Coefficient (From Table 1):

**K = 12**

### C. Determine Building Volume

Floor No.	Area (m <sup>2</sup> )	Floor Height (m)	Floor Volume (m <sup>3</sup> )	Total Building Volume (m <sup>3</sup> )
1	8368.7	11.0	92056	92056

*Note: The area and height values are marked as 'Input:' in the original image.*

### D. Determine Spatial Coefficient Due to Exposures

From Div. B A-3.2.5.7. of the Ontario Building Code - 3. Building On-Site Water Supply:

Exposure Side	Exposure Distance (m)	Spatial Coefficient	Total Spatial Coefficient
S <sub>north</sub>	126.0	0	S <sub>tot</sub> = 1.0 + [S <sub>north</sub> + S <sub>south</sub> + S <sub>east</sub> + S <sub>west</sub> ] <b>1</b>
S <sub>east</sub>	66.0	0	
S <sub>south</sub>	39.5	0	
S <sub>west</sub>	152.0	0	

*Note: The exposure distance values are marked as 'Input:' in the original image.*

## Ontario Building Code 2006 - Fire Flow Calculations

---

2 of 2

### E. Determine Required On-Site Water Volume

---

From Div. B A-3.2.5.7. of the Ontario Building Code - 3. Building On-Site Water Supply:

$$Q = K \times V \times S_{\text{tot}}$$

*where:*

Q = minimum supply of water in litres

K = water supply coefficient from Table 1

V = total building volume in cubic metres

S<sub>tot</sub> = total of spatial coefficient values from the property line exposures on all sides

Q = 1,104,672 L

### F. Determine Required On-Site Water Flow Rate

---

Is the building one-storey with building area not exceeding 600m<sup>2</sup>?

Input: No

Minimum Flow Rate (from Table 2) = 9000 L/min (Q > 270,000 L)

# McINTOSH PERRY

## Fire Flow Requirements Based on Fire Underwriters Survey (FUS) 2020

**Building No. / Type:** 1560 Star Top Road, 3-Storey Warehouse

An estimate of the Fire Flow required for a given fire area may be estimated by:

1 of 2

**RFF = 220 x C x √A Where:**

- F = Required fire flow in liters per minute
- C = Coefficient related to the type of construction.
- A = The total floor area in square meters (including all storey's, but excluding basements at least 50 percent below grade) in the building being considered.

### A. Determine the Construction Coefficient (C)

Choose the construction type and coefficient to be used in the required fire flow formula:

- C = 1.5 **Type V** Wood Frame Construction
- = 0.8 **Type IV-A** Mass Timber Construction
- = 0.9 **Type IV-B** Mass Timber Construction
- = 1.0 **Type IV-C** Mass Timber Construction
- = 1.5 **Type IV-D** Mass Timber Construction
- = 1.0 **Type III** Ordinary Construction
- = 0.8 **Type II** Noncombustible Construction
- = 0.6 **Type I** Fire Resistive Construction

**Input:** C = **Type II Noncombustible Construction** = 0.8

### B. Determine Total Effective Floor Area (A)

Input building floor areas:

Floor No.	Area (m <sup>2</sup> )	% Used	Area Used (m <sup>2</sup> )	Total (m <sup>2</sup> )
1	<b>8853.7</b> Input:	100%	8853.7	<b>8853.7</b>

### C. Determine Required Fire Flow

$$\text{RFF} = 220 \times C \times \sqrt{A} = 16561 \text{ L/min} = \mathbf{17000 \text{ L/min}} \text{ (Rounded to nearest 1,000 L/min)}$$

### D. Determine Increase or Decrease Based on Occupancy Contents Adjustment Factor

Choose the combustibility of building contents:

Option	Factor	Fire Flow Change	Adjusted RFF
<b>Non-Combustible</b>			
Limited Combustible			
Combustible			
Free Burning			
Rapid Burning			
	<b>Non-Combustible</b>	<b>-25%</b>	<b>-4250 L/min</b>
			<b>12750 L/min</b>



# McINTOSH PERRY

## Fire Flow Requirements Based on Fire Underwriters Survey (FUS) 2020

2 of 2

### E. Determine the Decrease for Automatic Sprinkler Protection, if Applicable

Choose the sprinkler options that apply:

Option		Applicable?	Factor	Fire Flow Change	Adjusted RFF
Automatic sprinkler conforms to NFPA 13	-30%	Yes	-30%	-3825 L/min	8925 L/min
Standard water supply for system and Fire Department hose line	-10%	Yes	-10%	-1275 L/min	7650 L/min
Fully supervised system	-10%	Yes	-10%	-1275 L/min	6375 L/min

### F. Determine the Total Increase for Exposures

Choose separation distance and wall lengths:

Subject Side	Separation Distance (m)	Exposed Wall Type	Wall Length (m)	No. of Storeys	Length-Height Factor	Charge (%) (See FUS-Table 6)	Total Charge (%)	Fire Flow Change (L/min)	Adjusted RFF (L/min)
North	126	Type II	66.86	3	200.58	0%	0%	0	6375
South	39.45	Type II	63.86	3	191.58	0%			
East	66	Type II	130.135	3	390.405	0%			
West	152	Type II	130.135	3	390.405	0%			
Input:									

### G. Determine the Total Required Fire Flow

Total Required Fire Flow, Rounded to the Nearest 1,000 L/min = 6000 L/min  
 Total Required Fire Flow (L/sec) = 100 L/sec  
 Does the 10,000 L/min (167 L/sec) RFF limit apply, based on "TECHNICAL BULLITEN ISTB-2018-02"? = No

Resultant Total Required Fire Flow (L/sec) = 100 L/sec

APPENDIX D  
SANITARY CALCULATIONS

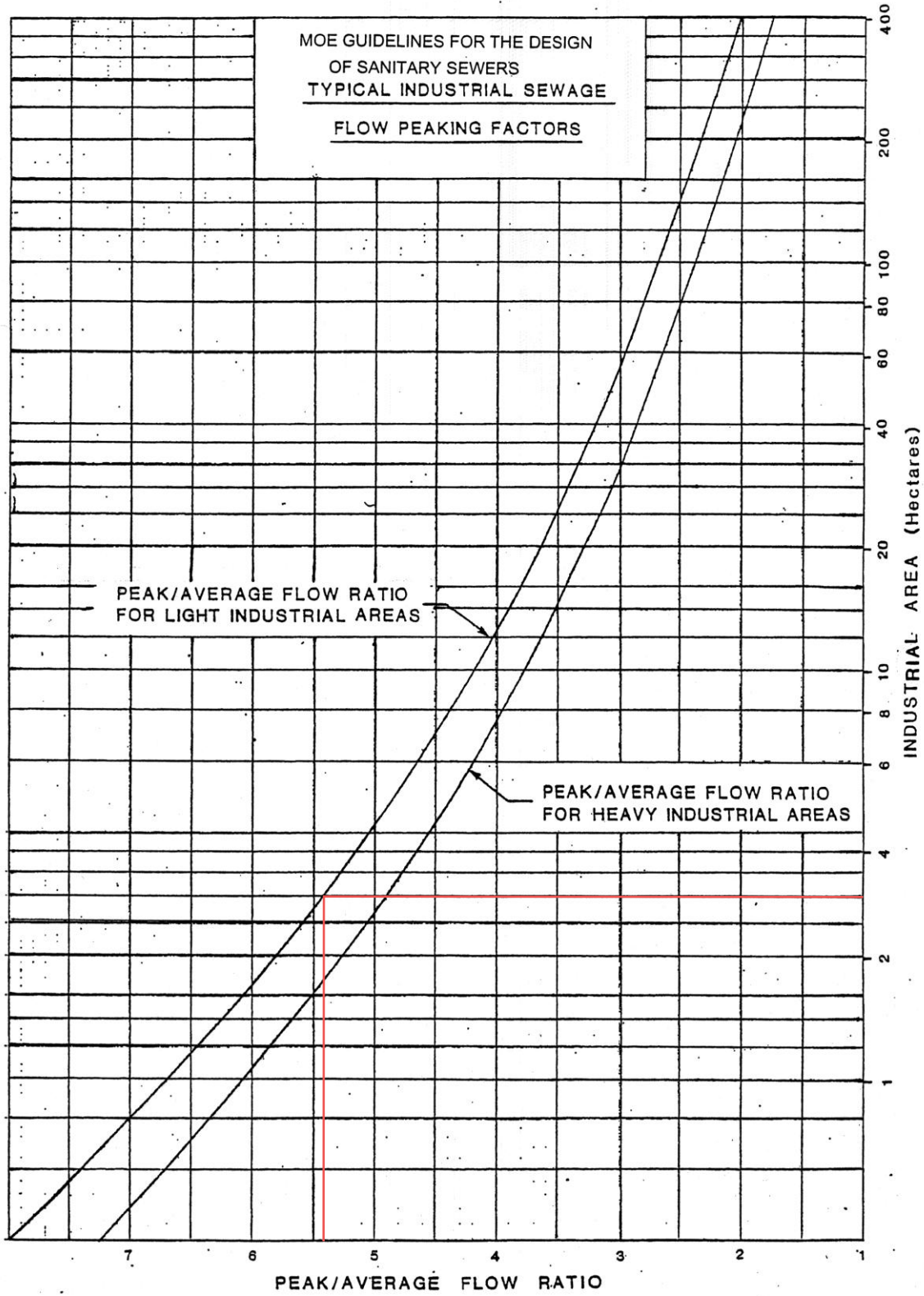

# McINTOSH PERRY

## CCO-23-3725 - 1560 Star Top Road - Sanitary Demands

Project:	1560 Star Top Road
Project No.:	CCO-23-3725
Designed By:	R.R.R.
Checked By:	C.J.M.
Date:	August 4, 2023

Site Area	3.00	Gross ha		
Duplex	0		0.00	Persons per unit
Apartment	0		0.00	Persons per unit
Total Population	0	Persons		
Commercial Area	0.00	m <sup>2</sup>		
Amenity Space	0.00	m <sup>2</sup>		

### DESIGN PARAMETERS

Light Industrial Peaking Factor	5.4	*Check Ottawa Sewer Design Guidelines Appendix 4B
Institutional/Commercial Peaking Factor	1.5	*Check technical bulleting (Either use 1.0 or 1.5)
Residential Peaking Factor	3.80	* Using Harmon Formula = $1+(14/(4+P^{0.5}))^{*0.8}$ where P = population in thousands, Harmon's Correction Factor = 0.8
Mannings coefficient (n)	0.013	
Demand (per capita)	280	L/day
Infiltration allowance	0.33	L/s/Ha

### EXTRANEIOUS FLOW ALLOWANCES

Infiltration / Inflow	Flow (L/s)
Dry	0.15
Wet	0.84
<b>Total</b>	<b>0.99</b>

### AVERAGE DAILY DEMAND

DEMAND TYPE	AMOUNT	UNITS	POPULATION / AREA	Flow (L/s)
Residential	280	L/c/d		0.00
Industrial - Light**	35,000	L/gross ha/d	3.00	1.22
Industrial - Heavy**	55,000	L/gross ha/d		0
Commercial / Amenity	2,800	L/(1000m <sup>2</sup> /d )		0.00
Hospital	900	L/(bed/day)		0
Schools	70	L/(Student/d)		0
Trailer Parks no Hook-Ups	340	L/(space/d)		0
Trailer Park with Hook-Ups	800	L/(space/d)		0
Campgrounds	225	L/(campsite/d)		0
Mobile Home Parks	1,000	L/(Space/d)		0
Motels	150	L/(bed-space/d)		0
Hotels	225	L/(bed-space/d)		0
Office	75	L/7.0m <sup>2</sup> /d		0
Tourist Commercial	28,000	L/gross ha/d		0
Other Commercial	28,000	L/gross ha/d		0

# McINTOSH PERRY

AVERAGE RESIDENTIAL FLOW	0.00	L/s
PEAK RESIDENTIAL FLOW	0.00	L/s
AVERAGE ICI FLOW	0.00	L/s
PEAK INSTITUTIONAL/COMMERCIAL FLOW	0.00	L/s
PEAK INDUSTRIAL FLOW	6.56	L/s
TOTAL PEAK ICI FLOW	6.56	L/s

## TOTAL SANITARY DEMAND

TOTAL ESTIMATED AVERAGE DRY WEATHER FLOW	1.37	L/s
TOTAL ESTIMATED PEAK DRY WEATHER FLOW	6.71	L/s
TOTAL ESTIMATED PEAK WET WEATHER FLOW	7.55	L/s

\*\* PEAK INDUSTRIAL FLOW PER CITY OF OTTAWA SEWER DESIGN GUIDELINES APPENDIX 4B

APPENDIX E  
PRE-DEVELOPMENT DRAINAGE PLAN







APPENDIX F  
POST-DEVELOPMENT DRAINAGE PLAN

FILENAME: I:\Projects\2023\CCO-23-3725-886\_Boone Warehouse\_1560 Star Top Road\11 - Drawings\CCO-23-3725 - PRESENTATION.dwg  
 LAST SAVED: Tuesday, January 16, 2024, 1:52:54 PM  
 LAST PLOTTED: Tuesday, January 16, 2024, 1:52:54 PM  
 CREDITS: ---

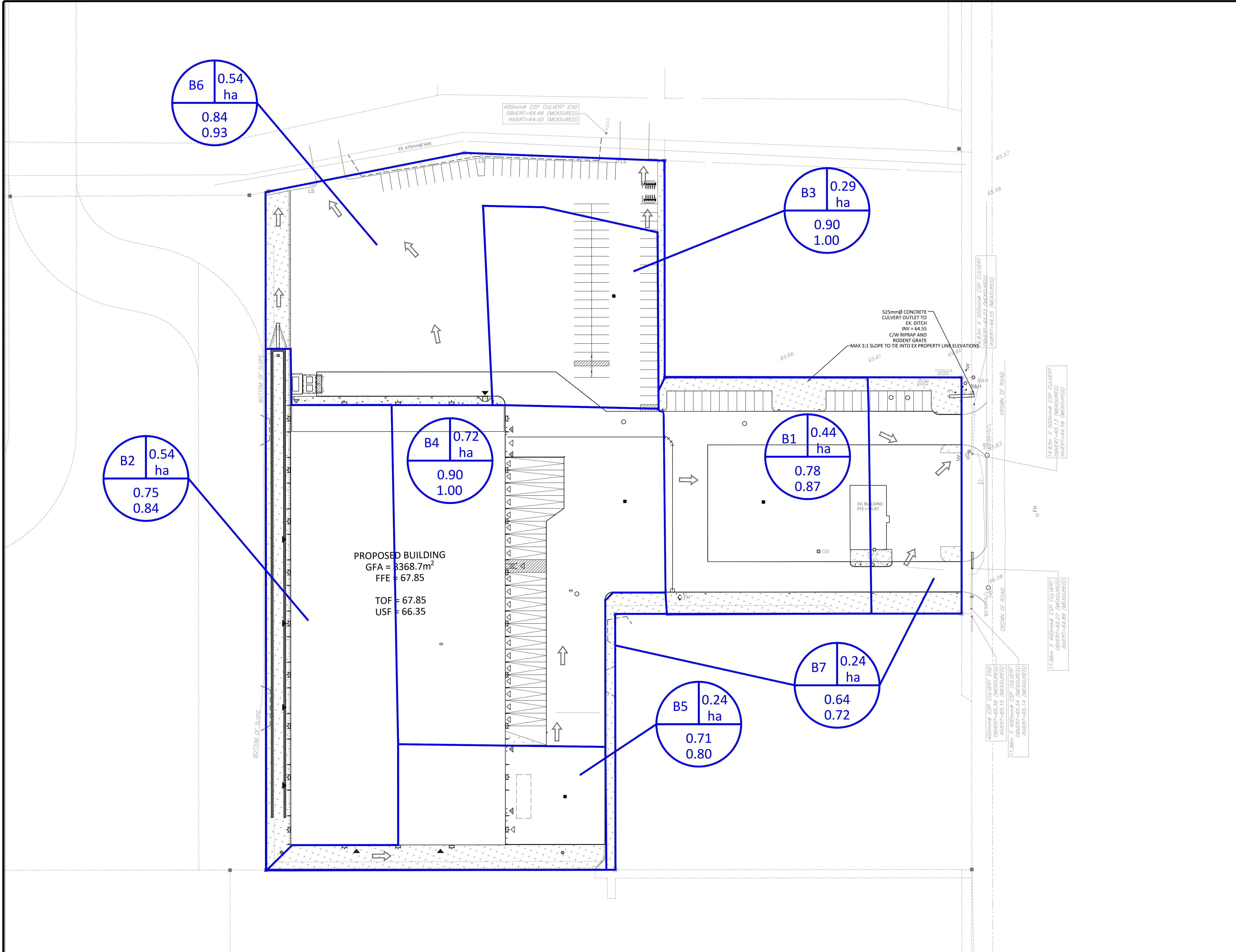

**LOCATION PLAN**

**LEGEND**

DRAINAGE AREA

AREA

100-YEAR RUNOFF COEFFICIENT  
5-YEAR RUNOFF COEFFICIENT

FOR REVIEW ONLY  
 NOT FOR CONSTRUCTION

No.	Revisions	Date
3	ISSUED FOR SITE PLAN CONTROL	2023.01.17
2	ISSUED FOR SITE PLAN APPLICATION	2023.11.14
1	ISSUED FOR SITE PLAN APPLICATION	2023.08.04

Check and verify all dimensions before proceeding with the work. Do not scale drawings.

SCALE 1 : 500

McINTOSH PERRY

115 Walgreen Road, RR3, Carp, ON K0A 1L0  
 Tel: 613-836-2184 Fax: 613-836-3742  
 www.mcintoshperry.com

Client:

**BBS CONSTRUCTION**  
1805 WOODWARD DRIVE  
OTTAWA, ON K2C 0P9

Project:

**BOONE PLUMBING WAREHOUSE**  
1560 STAR TOP ROAD

Drawing Title:

**POST DEVELOPMENT DRAINAGE PLAN**

Scale: 1:500	Project Number: CCO-23-3725
Drawn By: M.R.	POST
Checked By: A.B.	
Designed By: M.R.	

D07-12-XX-XXXX

#XXXX

APPENDIX G  
STORMWATER MANAGEMENT CALCULATIONS

# McINTOSH PERRY

Pre-Development Runoff Coefficient

Drainage Area	Area (ha)	Impervious	C	Gravel	C	Pervious	C	C <sub>AVG</sub> 5-Year	C <sub>AVG</sub> 100-Year
		Area (m <sup>2</sup> )		Area (m <sup>2</sup> )		Area (m <sup>2</sup> )			
A1	1.12	0.00	0.90	9,788.47	0.50	1,405.37	0.20	0.46	0.58
A2	1.88	0.00	0.90	17,454.24	0.50	1,345.94	0.20	0.48	0.60

Pre-Development Runoff Calculations

Drainage Area	Area (ha)	C 5-Year	C 100-Year	Tc (min)	I (mm/hr)		Q (L/s)	
					5-Year	100-Year	5-Year	100-Year
					A1	1.12	0.46	0.50
A2	1.88	0.48	0.50	16	80.5	137.5	201.23	359.45
Total	3.00						351.13	637.28

Post-Development Runoff Coefficient

Drainage Area	Area (ha)	Impervious	C	Gravel	C	Pervious	C	C <sub>AVG</sub> 5-Year	C <sub>AVG</sub> 100-Year
		Area (m <sup>2</sup> )		Area (m <sup>2</sup> )		Area (m <sup>2</sup> )			
B1	0.44	3,602.28	0.90	0.00	0.60	749.72	0.20	0.78	0.87
B2	0.54	4,184.58	0.90	0.00	0.60	1,180.03	0.20	0.75	0.84
B3	0.29	2,887.49	0.90	0.00	0.60	0.00	0.20	0.90	1.00
B4	0.72	7,201.13	0.90	0.00	0.60	0.00	0.20	0.90	1.00
B5	0.24	1,777.21	0.90	0.00	0.60	641.19	0.20	0.71	0.80
B6	0.54	4,876.15	0.90	0.00	0.60	477.02	0.20	0.84	0.93
B7	0.24	1,502.23	0.90	0.00	0.60	876.25	0.20	0.64	0.72

Restricted  
 Restricted  
 Restricted  
 Restricted  
 Restricted  
 Unrestricted to Drain  
 Unrestricted to Row

Post-Development Runoff Calculations

Drainage Area	Area (ha)	C 5-Year	C 100-Year	Tc (min)	I (mm/hr)		Q (L/s)	
					5-Year	100-Year	5-Year	100-Year
					B1	0.44	0.78	0.87
B2	0.54	0.75	0.84	10	104.2	178.6	115.92	222.36
B3	0.29	0.90	1.00	10	104.2	178.6	75.27	143.33
B4	0.72	0.90	1.00	10	104.2	178.6	187.73	357.46
B5	0.24	0.71	0.80	10	104.2	178.6	50.04	96.18
B6	0.54	0.84	0.93	10	104.2	178.6	129.88	247.97
B7	0.24	0.64	0.72	10	104.2	178.6	44.24	85.44
Total	3.00						657.10	1,340.87

EAST LOT  
 ROOF/POND  
 N POND  
 M POND  
 S POND

Required Restricted Flow

Drainage Area	Area (ha)	C 5-Year	C 100-Year	Tc (min)	I		Q	
					5-Year	100-Year	5-Year	100-Year
A1	1.12	0.46	0.50	10	104.2	178.6	149.91	277.83
A2	1.88	0.48	0.50	16	80.5	137.5	201.23	359.45
Total	3.00						351.13	637.28

Drainage Area	Unrestricted Flow (L/s)		Restricted Flow (L/s)		Storage Required (m <sup>3</sup> )		Storage Provided (m <sup>3</sup> )	
	5-Year	100-Year	5-Year	100-Year	5-Year	100-Year	5-Year	100-Year
B1	98.25	188.12	7.76	15.00	83.89	157.99	85.92	167.97
B2	115.92	222.36	12.91	25.00	87.18	164.67	90.03	166.95
B3	75.27	143.33	91.07	175.00	107.86	203.19	109.70	211.00
B4	187.73	357.46						
B5	50.04	96.18	5.67	11.00	37.38	70.74	38.26	74.88
B6	129.88	247.97	129.88	247.97	x	x	x	x
B7	44.24	85.44	44.24	85.44	x	x	x	x
Total	657.10	1255.42	291.53	559.41	316.31	596.60	323.91	620.80

RESTRICTED  
 RESTRICTED  
 RESTRICTED  
 RESTRICTED  
 RESTRICTED  
 Unrestricted  
 Unrestricted

# McINTOSH PERRY

Storage Requirements for Area B1

5-Year Storm Event

Tc (min)	I (mm/hr)	B1 Runoff (L/s)	Allowable Outflow (L/s)	Runoff to be Stored (L/s)	Storage Required (m <sup>3</sup> )
0	230.5	217.34	7.76	209.58	0.00
5	141.2	133.13	7.76	125.36	37.61
10	104.2	98.25	7.76	90.49	54.29
15	83.6	78.79	7.76	71.03	63.93
20	70.3	66.25	7.76	58.48	70.18
25	60.9	57.42	7.76	49.66	74.49
30	53.9	50.85	7.76	43.09	77.56
35	48.5	45.75	7.76	37.99	79.77
40	44.2	41.66	7.76	33.90	81.36
45	40.6	38.31	7.76	30.55	82.48
50	37.7	35.51	7.76	27.74	83.23
55	35.1	33.12	7.76	25.36	83.68
60	32.9	31.06	7.76	23.30	83.89
65	31.0	29.27	7.76	21.51	83.89
70	29.4	27.70	7.76	19.93	83.72
75	27.9	26.30	7.76	18.54	83.41
80	26.6	25.05	7.76	17.28	82.97
Maximum Storage Required 100-Year (m <sup>3</sup> ) =					83.89

100-Year Storm Event

Tc (min)	I (mm/hr)	B1 Runoff (L/s)	Allowable Outflow (L/s)	Runoff to be Stored (L/s)	Storage Required (m <sup>3</sup> )
0	398.6	419.96	15.00	404.96	0.00
5	242.7	255.70	15.00	240.70	72.21
10	178.6	188.12	15.00	173.12	103.87
15	142.9	150.54	15.00	135.54	121.99
20	120.0	126.37	15.00	111.37	133.65
25	103.8	109.41	15.00	94.41	141.61
30	91.9	96.79	15.00	81.79	147.22
35	82.6	87.00	15.00	72.00	151.20
40	75.1	79.17	15.00	64.17	154.00
45	69.1	72.75	15.00	57.75	155.92
50	64.0	67.38	15.00	52.38	157.13
55	59.6	62.82	15.00	47.82	157.79
60	55.9	58.89	15.00	43.89	157.99
35	82.6	87.00	15.00	72.00	151.20
40	75.1	79.17	15.00	64.17	154.00
45	69.1	72.75	15.00	57.75	155.92
50	64.0	67.38	15.00	52.38	157.13
55	59.6	62.82	15.00	47.82	157.79
60	55.9	58.89	15.00	43.89	157.99
65	52.6	55.47	15.00	40.47	157.81
70	49.8	52.46	15.00	37.46	157.31
75	47.3	49.79	15.00	34.79	156.53
80	45.0	47.40	15.00	32.40	155.52
85	43.0	45.25	15.00	30.25	154.29
90	41.1	43.31	15.00	28.31	152.88
Maximum Storage Required 100-Year (m <sup>3</sup> ) =					157.99

OS

# McINTOSH PERRY

CCO-23-3725 - Boone Plumbing - Runoff Calculations

3 of 11

## Storage Occupied In Area B1

### 5-Year Storm Event

Pond Storage			
Location	Area*	Depth	Volume (m <sup>3</sup> )
CB 4	1081.29	0.230	85.92
Total			85.92

Storage Available (m <sup>3</sup> ) =	85.92
Storage Required (m <sup>3</sup> ) =	83.89

\*Pond volumes derived in CAD

### 100-Year Storm Event

Pond Storage			
Location	Area*	Depth	Volume (m <sup>3</sup> )
CB 4	1672.20	0.290	167.97
Total			167.97

Storage Available (m <sup>3</sup> ) =	167.97
Storage Required (m <sup>3</sup> ) =	157.99

\*Pond volumes derived in CAD

### 100-Year Storm Event

Pond Storage			
Location	Area*	Depth	Volume (m <sup>3</sup> )
CB 4	1672.20	0.290	167.97
Total			167.97

Storage Available (m <sup>3</sup> ) =	167.97
Storage Required (m <sup>3</sup> ) =	201.37

\*Pond volumes derived in CAD

# McINTOSH PERRY

Storage Requirements for Area B2

5-Year Storm Event

Tc (min)	I (mm/hr)	B2 Runoff (L/s)	Allowable Outflow (L/s)	Runoff to be Stored (L/s)	Storage Required (m <sup>3</sup> )
0	230.5	256.43	12.91	243.52	0.00
5	141.2	157.07	12.91	144.16	43.25
10	104.2	115.92	12.91	103.01	61.81
15	83.6	92.96	12.91	80.05	72.05
20	70.3	78.16	12.91	65.25	78.30
25	60.9	67.75	12.91	54.84	82.26
30	53.9	60.00	12.91	47.08	84.75
35	48.5	53.98	12.91	41.07	86.24
40	44.2	49.16	12.91	36.24	86.99
45	40.6	45.20	12.91	32.29	87.18
50	37.7	41.89	12.91	28.98	86.93
55	35.1	39.08	12.91	26.16	86.34
60	32.9	36.65	12.91	23.74	85.46
65	31.0	34.54	12.91	21.62	84.34
70	29.4	32.68	12.91	19.76	83.01
75	27.9	31.03	12.91	18.11	81.51
Maximum Storage Required 100-Year (m <sup>3</sup> ) =					87.18

100-Year Storm Event

Tc (min)	I (mm/hr)	B2 Runoff (L/s)	Allowable Outflow (L/s)	Runoff to be Stored (L/s)	Storage Required (m <sup>3</sup> )
0	398.6	496.41	25.00	471.41	0.00
5	242.7	302.24	25.00	277.24	83.17
10	178.6	222.36	25.00	197.36	118.42
15	142.9	177.95	25.00	152.95	137.65
20	120.0	149.38	25.00	124.38	149.25
25	103.8	129.32	25.00	104.32	156.48
30	91.9	114.41	25.00	89.41	160.93
35	82.6	102.84	25.00	77.84	163.46
40	75.1	93.58	25.00	68.58	164.59
45	69.1	85.99	25.00	60.99	164.67
50	64.0	79.64	25.00	54.64	163.93
55	59.6	74.25	25.00	49.25	162.53
60	55.9	69.61	25.00	44.61	160.58
35	82.6	102.84	25.00	77.84	163.46
40	75.1	93.58	25.00	68.58	164.59
45	69.1	85.99	25.00	60.99	164.67
50	64.0	79.64	25.00	54.64	163.93
55	59.6	74.25	25.00	49.25	162.53
Maximum Storage Required 100-Year (m <sup>3</sup> ) =					164.67



# McINTOSH PERRY

CCO-23-3725 - Boone Plumbing - Runoff Calculations

5 of 11

Storage Occupied In Area B2  
5-Year Storm Event

Pond Storage			
Location	Area*	Depth	Volume (m <sup>3</sup> )
LSCB 1	313.91	0.570	90.03
Total			90.03

Storage Available (m <sup>3</sup> ) =	90.03
Storage Required (m <sup>3</sup> ) =	87.18

\*Pond volumes derived in CAD

100-Year Storm Event

Pond Storage			
Location	Area*	Depth	Volume (m <sup>3</sup> )
LSCB 1	418.88	0.780	166.95
Total			166.95

Storage Available (m <sup>3</sup> ) =	166.95
Storage Required (m <sup>3</sup> ) =	164.67

\*Pond volumes derived in CAD

# McINTOSH PERRY

Storage Requirements for Area B3 & B4

5-Year Storm Event

Tc (min)	I (mm/hr)	B3 & B4 Runoff (L/s)	Allowable Outflow (L/s)	Runoff to be Stored (L/s)	Storage Required (m <sup>3</sup> )
0	230.5	581.78	91.07	490.71	0.00
5	141.2	356.36	91.07	265.29	79.59
10	104.2	263.00	91.07	171.93	103.16
15	83.6	210.91	91.07	119.85	107.86
20	70.3	177.33	91.07	86.26	103.51
25	60.9	153.71	91.07	62.65	93.97
Maximum Storage Required 100-Year (m <sup>3</sup> ) =					107.86

100-Year Storm Event

Tc (min)	I (mm/hr)	B3 & B4 Runoff (L/s)	Allowable Outflow (L/s)	Runoff to be Stored (L/s)	Storage Required (m <sup>3</sup> )
0	398.6	1,117.98	175.00	942.98	0.00
5	242.7	680.70	175.00	505.70	151.71
10	178.6	500.79	175.00	325.79	195.48
15	142.9	400.77	175.00	225.77	203.19
20	120.0	336.42	175.00	161.42	193.70
25	103.8	291.25	175.00	116.25	174.38
30	91.9	257.66	175.00	82.66	148.78
Maximum Storage Required 100-Year (m <sup>3</sup> ) =					203.19

Storage Occupied In Area B3 & B4

5-Year Storm Event

Pond Storage			
Location	Area*	Depth	Volume (m <sup>3</sup> )
CB 1	583.17	0.240	47.19
CB 2	753.39	0.240	62.51
Total			109.70

Storage Available (m <sup>3</sup> ) =	109.70
Storage Required (m <sup>3</sup> ) =	107.86

\*Pond volumes derived in CAD

100-Year Storm Event

Pond Storage			
Location	Area*	Depth	Volume (m <sup>3</sup> )
CB 1	906.92	0.300	91.54
CB 2	1159.53	0.300	119.46
Total			211.00

Storage Available (m <sup>3</sup> ) =	211.00
Storage Required (m <sup>3</sup> ) =	203.19

\*Pond volumes derived in CAD

# McINTOSH PERRY

CCO-23-3725 - Boone Plumbing - Runoff Calculations

8 of 11

Storage Requirements for Area B5

5-Year Storm Event

Tc (min)	I (mm/hr)	B5 Runoff (L/s)	Allowable Outflow (L/s)	Runoff to be Stored (L/s)	Storage Required (m <sup>3</sup> )
0	230.5	110.70	5.67	105.03	0.00
5	141.2	67.81	5.67	62.14	18.64
10	104.2	50.04	5.67	44.37	26.62
15	83.6	40.13	5.67	34.46	31.02
20	70.3	33.74	5.67	28.07	33.68
25	60.9	29.25	5.67	23.58	35.37
30	53.9	25.90	5.67	20.23	36.41
35	48.5	23.30	5.67	17.63	37.03
40	44.2	21.22	5.67	15.55	37.32
45	40.6	19.51	5.67	13.84	37.38
50	37.7	18.09	5.67	12.41	37.24
55	35.1	16.87	5.67	11.20	36.95
60	32.9	15.82	5.67	10.15	36.55
Maximum Storage Required 100-Year (m <sup>3</sup> ) =					37.38

100-Year Storm Event

Tc (min)	I (mm/hr)	B5 Runoff (L/s)	Allowable Outflow (L/s)	Runoff to be Stored (L/s)	Storage Required (m <sup>3</sup> )
0	398.6	214.71	11.00	203.71	0.00
5	242.7	130.73	11.00	119.73	35.92
10	178.6	96.18	11.00	85.18	51.11
15	142.9	76.97	11.00	65.97	59.37
20	120.0	64.61	11.00	53.61	64.33
25	103.8	55.93	11.00	44.93	67.40
30	91.9	49.48	11.00	38.48	69.27
35	82.6	44.48	11.00	33.48	70.31
40	75.1	40.48	11.00	29.48	70.74
45	69.1	37.19	11.00	26.19	70.72
50	64.0	34.45	11.00	23.45	70.34
55	59.6	32.11	11.00	21.11	69.68
60	55.9	30.11	11.00	19.11	68.78
35	82.6	44.48	11.00	33.48	70.31
40	75.1	40.48	11.00	29.48	70.74
45	69.1	37.19	11.00	26.19	70.72
50	64.0	34.45	11.00	23.45	70.34
55	59.6	32.11	11.00	21.11	69.68
Maximum Storage Required 100-Year (m <sup>3</sup> ) =					70.74

CCO-23-3725 - Boone Plumbing - Runoff Calculations

9 of 11

Storage Occupied In Area B5

5-Year Storm Event

Pond Storage			
Location	Area*	Depth	Volume (m <sup>3</sup> )
CB 3	399.53	0.190	38.26
Total			38.26

Storage Available (m <sup>3</sup> ) =	38.26
Storage Required (m <sup>3</sup> ) =	37.38

\*Pond volumes derived in CAD

100-Year Storm Event

Pond Storage			
Location	Area*	Depth	Volume (m <sup>3</sup> )
CB 3	517.73	0.270	74.88
Total			74.88

Storage Available (m <sup>3</sup> ) =	74.88
Storage Required (m <sup>3</sup> ) =	70.74

\*Pond volumes derived in CAD

# McINTOSH PERRY

CCO-23-3725 - Boone Plumbing - Runoff Calculations

10 of 11

## Time of Concentration Pre-Development

Drainage Area ID	Sheet Flow Distance (m)	Slope of Land (%)	Tc (min) (5-Year)	Tc (min) (100-Year)
A1	67	2.17	8	7

Therefore, a Tc of 10 can be used

$$T_c = (3.26(1.1-c)L^{0.5}/S^{0.33})$$

c= Balanced Runoff Coefficient

L= Length of drainage area

S= Average slope of watershed

# McINTOSH PERRY

Time of Concentration Pre-Development

Drainage Area ID	Sheet Flow Distance (m)	Slope of Land (%)	Tc (min) (5-Year)	Tc (min) (100-Year)
A2	155	1.10	16	14

Therefore, a Tc of 16 can be used

$T_c = (3.26(1.1-c)L^{0.5}/S^{0.33})$   
c= Balanced Runoff Coefficient  
L= Length of drainage area  
S= Average slope of watershed

**STORM SEWER DESIGN SHEET**

PROJECT: CCO-23-3725  
 LOCATION: 1560 Star Top Road  
 CLIENT: BBS Construction



LOCATION				CONTRIBUTING AREA (ha)				RATIONAL DESIGN FLOW										SEWER DATA													
1	2	3	4	5	6	7	8	9	10	11	12	13	14	15	16	17	18	19	20	21	22			23	24	25	26	27	28		
STREET	AREA ID	FROM MH	TO MH	C-VALUE	AREA	INDIV AC	CUMUL AC	INLET (min)	TIME IN PIPE	TOTAL (min)	i (5) (mm/hr)	i (10) (mm/hr)	i (100) (mm/hr)	5yr PEAK FLOW (L/s)	10yr PEAK FLOW (L/s)	100yr PEAK FLOW (L/s)	FIXED FLOW (L/s)	DESIGN FLOW (L/s)	CAPACITY (L/s)	LENGTH (m)	PIPE SIZE (mm)			SLOPE (%)	VELOCITY (m/s)	AVAIL CAP (5yr)					
																						DIA	W	H							
N Pond	B3	CB 1	STMH 1	0.90	0.29	0.26	0.26	10.00	0.78	10.78	104.19	122.14	178.56	75.60	88.62	129.56		75.60	91.46	37.57	375			0.25	0.802	15.86	17.34%				
M Pond	B4	CB 2	STMH 1	0.90	0.72	0.65	0.65	10.00	0.32	10.32	104.19	122.14	178.56	187.70	220.03	321.66		187.70	199.52	23.69	450			0.45	1.215	11.83	5.93%				
Combined Flow	B3/B4	STMH 1	STMH 3	0.90	1.01	0.00	0.91	10.78	0.68	11.46	100.24	117.49	171.72	253.32	296.90	433.95	91.07	253.32	145.71	36.05	450			0.24	0.888	145.71	37.50%				
S Pond	B5	CB 3	STMH 2	0.71	0.24	0.17	0.17	10.00	1.18	11.18	104.19	122.14	178.56	49.36	57.86	84.59	5.67	49.36	27.59	60.45	200			0.65	0.851	21.92	79.45%				
SPond	B5	STMH 2	STMH 3	0.71	0.00	0.00	0.17	11.18	1.46	12.65	98.33	115.23	168.41	46.47	54.46	79.59	14.44	46.47	41.15	71.19	250			0.44	0.812	26.71	64.91%				
Flows (B3/B4/B5)	B3/B4/B5/B1	STMH 3	STMH 4	0.90	0.10	0.00	1.08	12.65	0.89	13.53	92.03	107.82	157.52	276.05	323.41	472.50	112.31	276.05	136.30	44.29	450			0.21	0.830	23.99	17.60%				
E Pond	B1	CB 4	STMH3	0.84	0.55	0.46	0.46	10.00	0.50	10.50	104.19	122.14	178.56	133.82	156.87	229.33	15.57	133.82	40.68	24.020	250			0.43	0.803	25.11	61.73%				
Flows ( B1/B3/B4/B5)	Parking Area Total	STMH 4	OGS1	0.00	0.00	0.00	1.54	13.53	0.10	13.64	88.61	103.80	151.62	379.61	444.67	649.54	112.31	379.61	179.46	4.950	525			0.16	0.803	67.15	37.42%				
	Parking Area Total	OGS 1	Ex. East Ditch	0.00	0.00		1.54	13.64	0.41	14.05	88.24	103.35	150.97	378.00	442.77	646.76	112.31	378.00	179.46	19.780	525			0.16	0.803	67.15	37.42%				
W Pond	B2	LSCB 1	Ex. West Ditch	0.75	0.54	0.41	0.41	10.00	0.13	10.13	104.19	122.14	178.56	118.76	139.22	203.52	12.91	118.76	210.32	9.65	450			0.50	1.281	197.41	93.86%				
<b>Definitions:</b> Q = 2.78CIA, where: Q = Peak Flow in Litres per Second (L/s) A = Area in Hectares (ha) i = Rainfall intensity in millimeters per hour (mm/hr) [i = 998.071 / (TC+6.053)^0.814] 5 YEAR [i = 1174.184 / (TC+6.014)^0.816] 10 YEAR [i = 1735.688 / (TC+6.014)^0.820] 100 YEAR				<b>Notes:</b> 1. Mannings coefficient (n) = 0.013				<b>Designed:</b> M.R.				<b>Checked:</b> C.H.				<b>Project No.:</b> CCO-23-3725				<b>No.</b> 1. 2. 3. 4.				<b>Revision</b> Issued for Site Plan Application Issued for Site Plan Application Issued for Site Plan Application Issued for Site Plan Application				<b>Date</b> 2023.08.03 2023.11.14 2024.01.17 2024.08.15			
																		<b>Date:</b> 2023.08.03				<b>Sheet No:</b> 1 of 1									

# TEMPEST Product Submittal Package R1



Date: November 14, 2023

Customer: McIntosh Perry

Contact: Mitch Raper

Location: - -

Project Name: Boone Plumbing CCO-23-3725





# Tempest LMF ICD Sq Shop Drawing

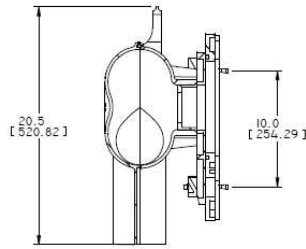
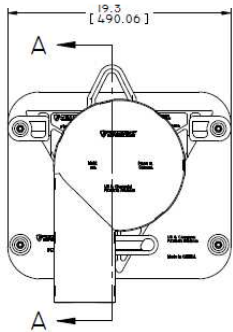
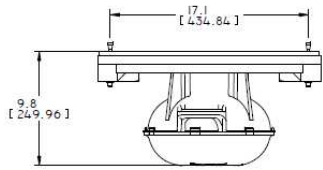

SECTION A-A

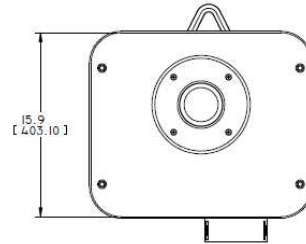

*Handwritten signature and date: H. M. MARTIN 2011-07-27*

<b>TOLERANCES</b> UNLESS OTHERWISE SPECIFIED: FRACTIONS DECIMALS .X ±0.005 (0.0005) .XX ±0.002 (0.0002) .XXX ±0.001 (0.0001) .XXXX ±0.0005 (0.00005) HOLE POSITION ±0.010 HOLE DIA ±0.005		<b>IPEX TECHNOLOGIES INC.</b> PRODUCT DEVELOPMENT DEPARTMENT 27 PARKER ROAD, WASHINGTON, DC 20007 PHONE: 703-746-2222 WWW.IPEX.COM	
PROJECTION: FIRST ANGLE UNIT: in (mm)		TITLE: LMF SQUARE CB ASSEMBLY	
DRAWN BY: H. M. MARTIN CHECKED BY:	DATE: 2011-07-27	SIZE: 8 1/8	SHEET: 1 OF 1
CERTIFIED BY:	DATE: 2011-07-27	DRAWING NUMBER: 55174_A4001R03	REV: 3



# Tempest MHF ICD Sq Shop Drawing

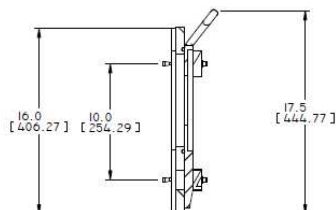
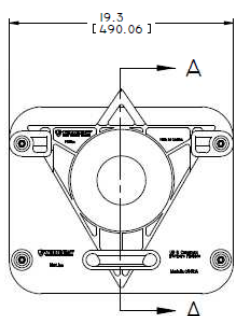
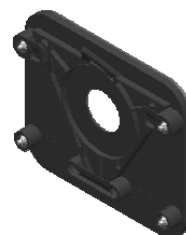
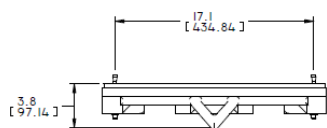

SECTION A-A



<b>TOLERANCES:</b> UNLESS OTHERWISE SPECIFIED: FRACTIONS DECIMALS .X .45 .0007 (1/16) .005 .X.X .45 .001 (1/32) .005 .X.X.X .45 .002 (1/16) .005 .X.X.X.X .45 .005 (1/32) .005		<b>PROJECT INFORMATION</b> PROJECT NAME: MHF SQUARE CB ASSEMBLY DRAWING NUMBER: 2011-7-AD07R01	
<b>UNIT:</b> IN (MM)		<b>SCALE:</b> B 1/8	
<b>DESIGNER:</b> H. M-MARTIN		<b>DATE:</b> 2011-07-25	
<b>VERIFIED BY:</b> [Signature]		<b>REV:</b> 1 OF 1	



## Plate ICD Rd Shop Drawing

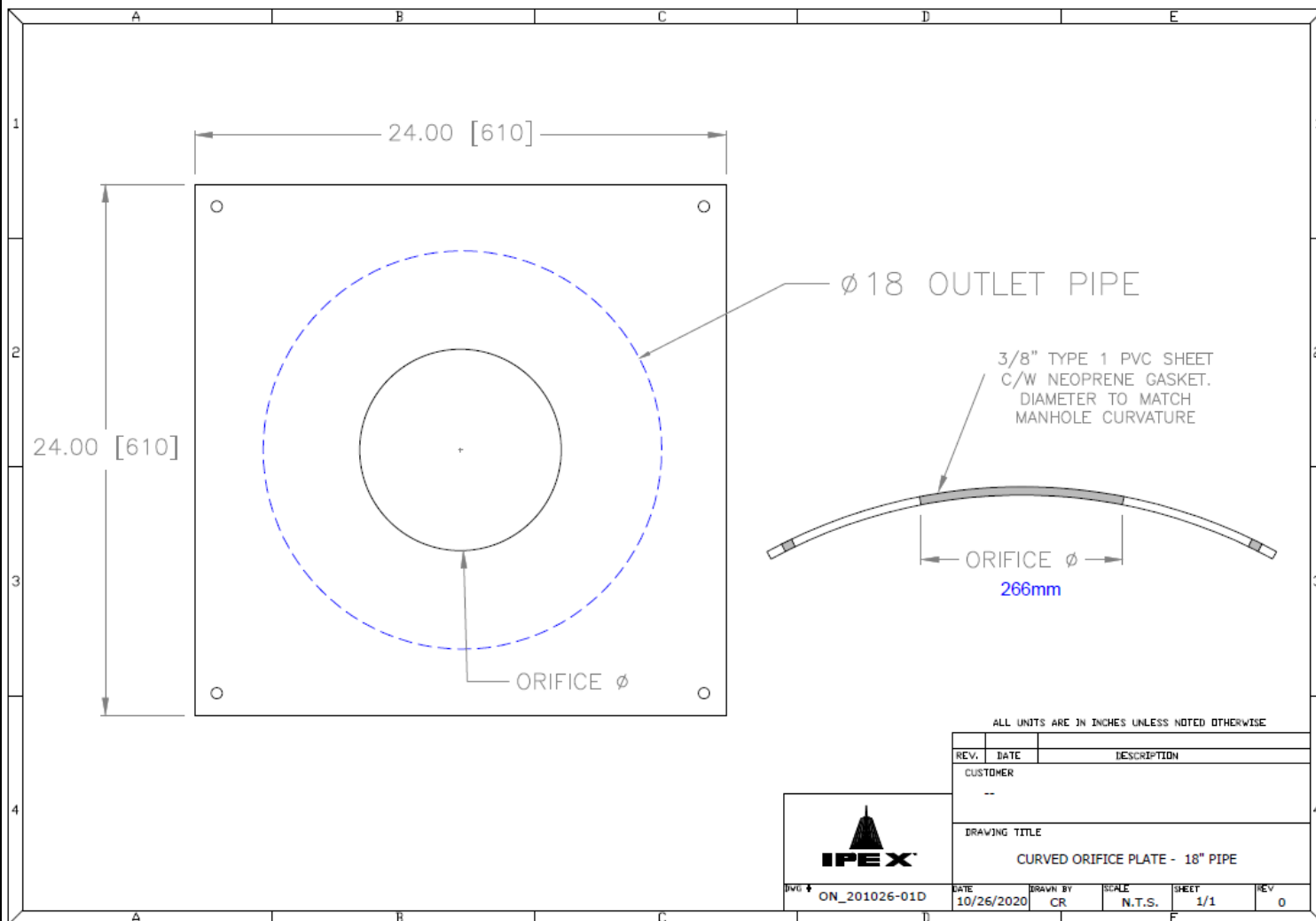

ALL UNITS ARE IN INCHES UNLESS NOTED OTHERWISE

REV.	DATE	DESCRIPTION
CUSTOMER		
---		



DRAWING TITLE				
CURVED ORIFICE PLATE - 18" PIPE				

DWG #	DATE	DRAWN BY	SCALE	SHEET	REV
ON_201026-01D	10/26/2020	CR	N.T.S.	1/1	0

## Plate ICD Flow Curve

Flow: 175 L/s  
Head: 1.53 m  
STMH 1

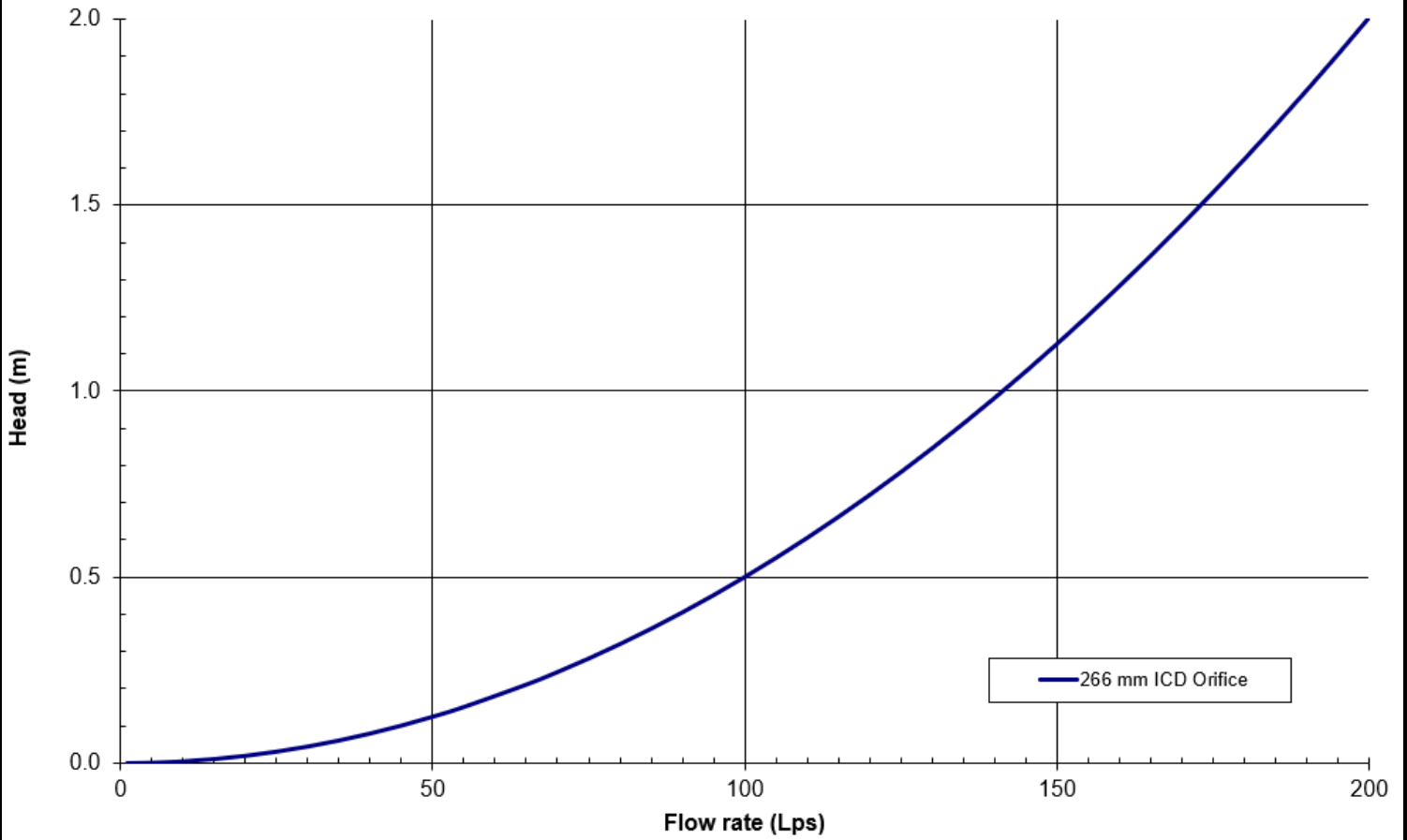

## Tempest LMF ICD Flow Curve

Flow: 11 L/s  
Head: 1.65 m  
CB 3

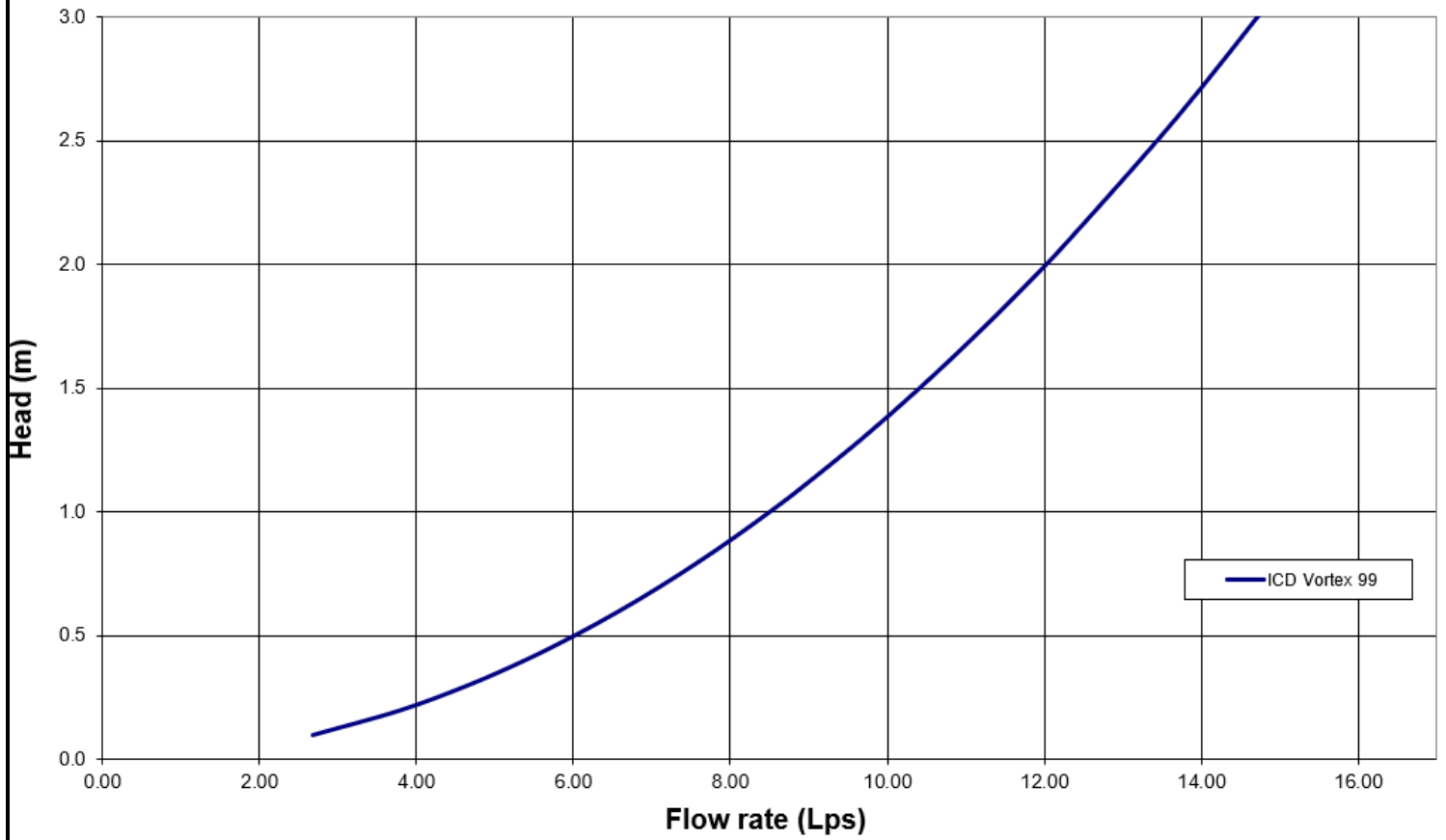

## Tempest MHF ICD Flow Curve

Flow: 25 L/s  
Head: 1.53 m  
LSCB 1

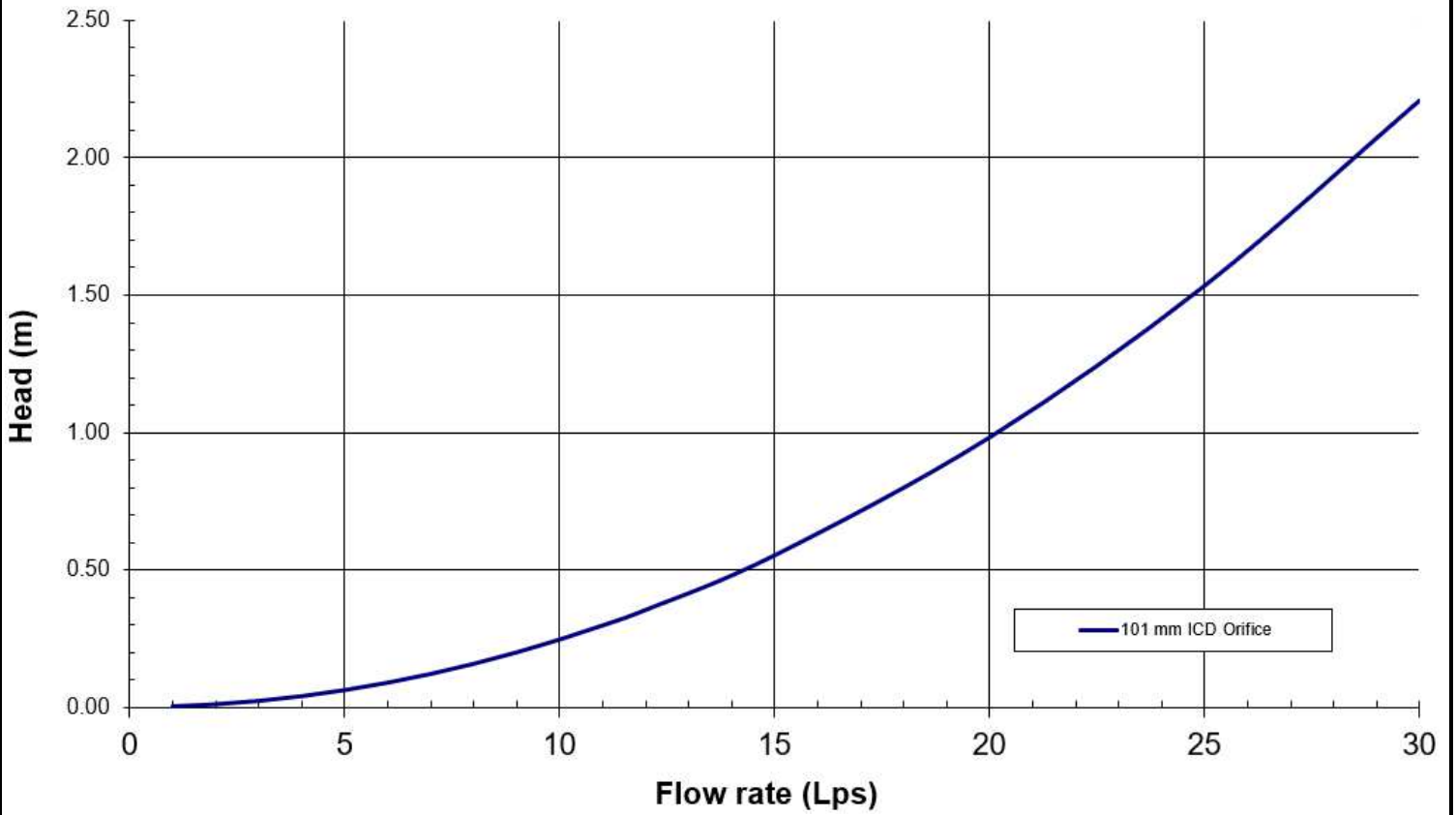

## Tempest MHF ICD Flow Curve

Flow: 15 L/s  
Head: 1.01 m  
CB 4

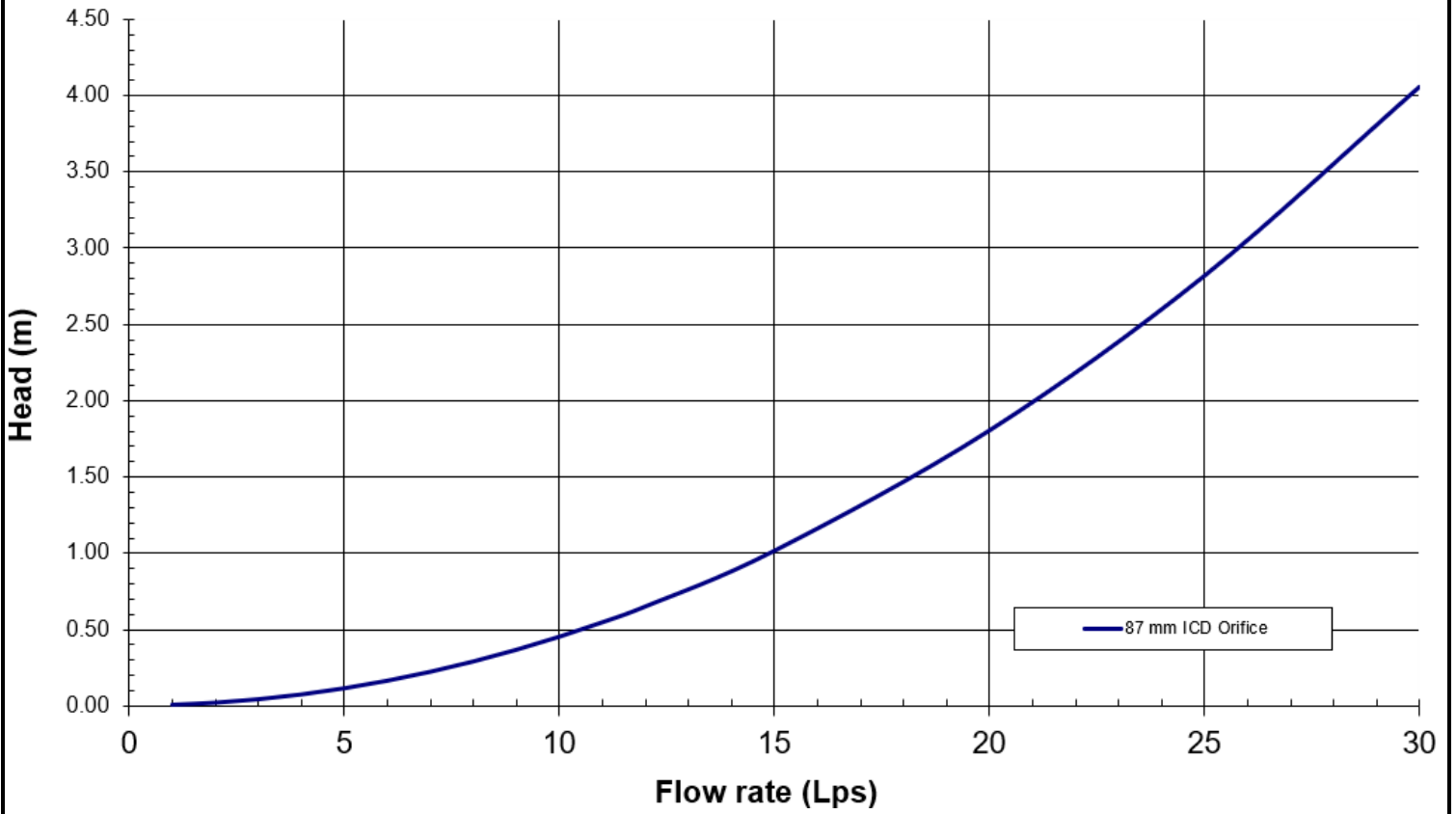

### **Square CB Installation Notes:**

1. Materials and tooling verification:
  - Tooling: impact drill, 3/8'' concrete bit, torque wrench for 9/16'' nut, hand hammer, level, and marker.
  - Material: (4) concrete anchor 3/8x3-1/2, (4) washers, (4) nuts
2. Use the mounting wall plate to locate and mark the hole (4) pattern on the catch basin wall. You should use a level to ensure that the plate is at the horizontal.
3. Use an impact drill with a 3/8'' concrete bit to make the four holes at a minimum of 1-1/2'' depth up to 2-1/2''. Clean the concrete dust from the holes.
4. Install the anchors (4) in the holes by using a hammer. Put the nuts on the top of the anchors to protect the threads when you will hit the anchors with the hammer. Remove the nuts on the ends of the anchors
5. Install the wall mounting plate on the anchors and screw the nut in place with a maximum torque of 40 N.m (30 lbf-ft). There should be no gap between the wall mounting plate and the catch basin wall.
6. From ground above using a reach bar, lower the device by hooking the end of the reach bar to the handle of the LMF device. Align the triangular plate portion into the mounting wall plate. Push down the device to be sure it has centered in to the wall mounting plate and has created a seal.





**Round CB Installation Notes:** (Refer to square install notes above for steps 1 , 3, & 4)

2. Use spigot catch basin wall plate to locate and mark the hole (4) pattern on the catch basin wall. You should use a level to ensure that the plate is at the horizontal.
5. Install the CB spigot wall plate on the anchors and screw the 4 nuts in place with a maximum torque of 40 N.m (30 lb-ft). There should be no gap between the CB spigot wall plate and the catch basin wall.
6. Apply solvent cement on the hub of the universal mounting plate and the spigot of the spigot CB wall plate. Slide the hub over the spigot. Make sure the universal mounting plate is at the horizontal and its hub is completely inserted onto the spigot. Normally, the corners of the universal mounting plate hub adapter should touch the catch basin wall.
7. From ground above using a reach bar, lower the ICD device by hooking the end of the reach bar to the handle of the ICD device. Align the triangular plate portion into the mounting wall plate. Push down the device to be sure it has centered into the mounting plate and has created a seal.

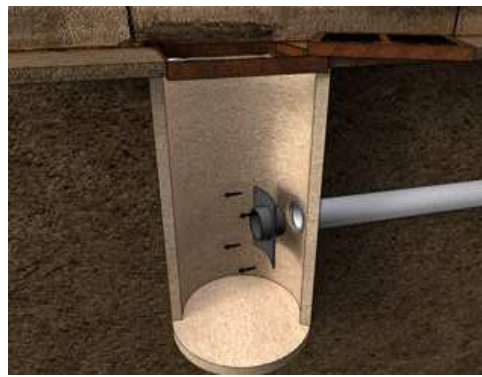

**CAUTION/WARNING/DISCLAIM:**

- Verify that the inlet(s) pipe(s) is not protruding into the catch basin. If it is, cut it back so that the inlet pipe is flush with the catch basin wall.
- Any required cement in the installation must be approved for PVC.
- The solvent cement should not be used below 0°C (32°F) or in a high humidity environment. Please refer to the IPEX solvent cement guide to confirm required curing times or attend the IPEX [Online Solvent Cement Training Course](#).
- Call your IPEX representative for more information or if you have any questions about our products.

## **IPEX TEMPEST Inlet Control Devices Technical Specification**

### **General**

Inlet control devices (ICD's) are designed to provide flow control at a specified rate for a given water head level and also provide odour and floatable control where specified. All ICD's will be IPEX Tempest or approved equal.

All devices shall be removable from a universal mounting plate. An operator from street level using only a T-bar with a hook will be able to retrieve the device while leaving the universal mounting plate secured to the catch basin wall face. The removal of the TEMPEST devices listed above must not require any unbolting or special manipulation or any special tools.

High Flow (HF) Sump devices will consist of a removable threaded cap which can be accessible from street level with out entry into the catchbasin (CB). The removal of the threaded cap shall not require any special tools other than the operator's hand.

ICD's must have no moving parts.

### **Materials**

ICD's are to be manufactured from Polyvinyl Chloride (PVC) or Polyurethane material, designed to be durable enough to withstand multiple freeze-thaw cycles and exposure to harsh elements.

The inner ring seal will be manufactured using a Buna or Nitrile material with hardness between Duro 50 and Duro 70.

The wall seal is to be comprised of a 3/8" thick Neoprene Closed Cell Sponge gasket which is attached to the back of the wall plate.

All hardware will be made from 304 stainless steel.

### **Dimensioning**

The Low Medium Flow (LMF), High Flow (HF) and the High Flow (HF) Sump shall allow for a minimum outlet pipe diameter of 200mm with a 600mm deep Catch Basin sump.

### **Installation**

Contractor shall be responsible for securing, supporting and connecting the ICD's to the existing influent pipe and catchbasin/manhole structure as specified and designed by the Engineer.



Stormceptor® EF Sizing Report

Imbrium® Systems

ESTIMATED NET ANNUAL SEDIMENT (TSS) LOAD REDUCTION

01/16/2024

Province:	Ontario
City:	Ottawa
Nearest Rainfall Station:	OTTAWA CDA RCS
Climate Station Id:	6105978
Years of Rainfall Data:	20

Project Name:	Boone Plumbing
Project Number:	62819
Designer Name:	Mitch Raper
Designer Company:	Mcintosh Perry
Designer Email:	m.raper@mcintoshperry.com
Designer Phone:	613-315-9801
EOR Name:	
EOR Company:	
EOR Email:	
EOR Phone:	

Site Name:	1540 Star Top CA ETV
------------	----------------------

Drainage Area (ha):	1.8
% Imperviousness:	94.00

Runoff Coefficient 'c': 0.86

Particle Size Distribution:	CA ETV
-----------------------------	--------

Target TSS Removal (%):	60.0
-------------------------	------

Required Water Quality Runoff Volume Capture (%):	90.00
Estimated Water Quality Flow Rate (L/s):	50.19
Oil / Fuel Spill Risk Site?	Yes
Upstream Flow Control?	Yes
Upstream Orifice Control Flow Rate to Stormceptor (L/s):	175.00
Peak Conveyance (maximum) Flow Rate (L/s):	
Influent TSS Concentration (mg/L):	200
Estimated Average Annual Sediment Load (kg/yr):	1404
Estimated Average Annual Sediment Volume (L/yr):	1142

Net Annual Sediment (TSS) Load Reduction Sizing Summary	
Stormceptor Model	TSS Removal Provided (%)
EFO4	41
EFO6	51
EFO8	57
<b>EFO10</b>	<b>61</b>
EFO12	65

Recommended Stormceptor EFO Model: **EFO10**

Estimated Net Annual Sediment (TSS) Load Reduction (%): **61**

Water Quality Runoff Volume Capture (%): **> 90**



Stormceptor® **EF** Sizing Report

**THIRD-PARTY TESTING AND VERIFICATION**

► Stormceptor® EF and Stormceptor® EFO are the latest evolutions in the Stormceptor® oil-grit separator (OGS) technology series, and are designed to remove a wide variety of pollutants from stormwater and snowmelt runoff. These technologies have been third-party tested in accordance with the Canadian ETV **Procedure for Laboratory Testing of Oil-Grit Separators** and performance has been third-party verified in accordance with the **ISO 14034 Environmental Technology Verification (ETV)** protocol.

**PERFORMANCE**

► Stormceptor® EF and EFO remove stormwater pollutants through gravity separation and floatation, and feature a patent-pending design that generates positive removal of total suspended solids (TSS) throughout each storm event, including high-intensity storms. Captured pollutants include sediment, free oils, and sediment-bound pollutants such as nutrients, heavy metals, and petroleum hydrocarbons. Stormceptor is sized to remove a high level of TSS from the frequent rainfall events that contribute the vast majority of annual runoff volume and pollutant load. The technology incorporates an internal bypass to convey excessive stormwater flows from high-intensity storms through the device without resuspension and washout (scour) of previously captured pollutants. Proper routine maintenance ensures high pollutant removal performance and protection of downstream waterways.

**PARTICLE SIZE DISTRIBUTION (PSD)**

► The Canadian ETV PSD shown in the table below was used, or in part, for this sizing. This is the identical PSD that is referenced in the Canadian ETV **Procedure for Laboratory Testing of Oil-Grit Separators** for both sediment removal testing and scour testing. The Canadian ETV PSD contains a wide range of particle sizes in the sand and silt fractions, and is considered reasonably representative of the particle size fractions found in typical urban stormwater runoff.

Particle Size (µm)	Percent Less Than	Particle Size Fraction (µm)	Percent
1000	100	500-1000	5
500	95	250-500	5
250	90	150-250	15
150	75	100-150	15
100	60	75-100	10
75	50	50-75	5
50	45	20-50	10
20	35	8-20	15
8	20	5-8	10
5	10	2-5	5
2	5	<2	5



Stormceptor®EF Sizing Report

Upstream Flow Controlled Results

Rainfall Intensity (mm / hr)	Percent Rainfall Volume (%)	Cumulative Rainfall Volume (%)	Flow Rate (L/s)	Flow Rate (L/min)	Surface Loading Rate (L/min/m²)	Removal Efficiency (%)	Incremental Removal (%)	Cumulative Removal (%)
0.50	8.6	8.6	2.16	130.0	18.0	70	6.1	6.1
1.00	20.3	29.0	4.32	259.0	36.0	70	14.3	20.4
2.00	16.2	45.2	8.65	519.0	71.0	66	10.6	31.0
3.00	12.0	57.2	12.97	778.0	107.0	62	7.5	38.5
4.00	8.4	65.6	17.29	1038.0	142.0	59	5.0	43.5
5.00	5.9	71.6	21.62	1297.0	178.0	57	3.4	46.8
6.00	4.6	76.2	25.94	1556.0	213.0	54	2.5	49.3
7.00	3.1	79.3	30.26	1816.0	249.0	53	1.6	51.0
8.00	2.7	82.0	34.59	2075.0	284.0	52	1.4	52.4
9.00	3.3	85.3	38.91	2335.0	320.0	50	1.7	54.0
10.00	2.3	87.6	43.23	2594.0	355.0	50	1.1	55.2
11.00	1.6	89.2	47.56	2853.0	391.0	48	0.8	55.9
12.00	1.3	90.5	51.88	3113.0	426.0	47	0.6	56.6
13.00	1.7	92.2	56.20	3372.0	462.0	46	0.8	57.4
14.00	1.2	93.5	60.53	3632.0	497.0	45	0.6	57.9
15.00	1.2	94.6	64.85	3891.0	533.0	44	0.5	58.4
16.00	0.7	95.3	69.18	4151.0	569.0	43	0.3	58.7
17.00	0.7	96.1	73.50	4410.0	604.0	42	0.3	59.0
18.00	0.4	96.5	77.82	4669.0	640.0	42	0.2	59.2
19.00	0.4	96.9	82.15	4929.0	675.0	42	0.2	59.4
20.00	0.2	97.1	86.47	5188.0	711.0	41	0.1	59.5
21.00	0.5	97.5	90.79	5448.0	746.0	41	0.2	59.7
22.00	0.2	97.8	95.12	5707.0	782.0	41	0.1	59.8
23.00	1.0	98.8	99.44	5966.0	817.0	41	0.4	60.2
24.00	0.3	99.1	103.76	6226.0	853.0	41	0.1	60.3
25.00	0.9	100.0	108.09	6485.0	888.0	41	0.4	60.7
30.00	0.9	100.9	129.70	7782.0	1066.0	39	0.4	61.0
35.00	-0.9	100.0	151.32	9079.0	1244.0	36	N/A	60.7
40.00	0.0	100.0	172.94	10376.0	1421.0	34	0.0	60.7
45.00	0.0	100.0	175.00	10500.0	1438.0	33	0.0	60.7
<b>Estimated Net Annual Sediment (TSS) Load Reduction =</b>								<b>61 %</b>

Climate Station ID: 6105978 Years of Rainfall Data: 20



Stormceptor® EF Sizing Report

RAINFALL DATA FROM OTTAWA CDA RCS RAINFALL STATION

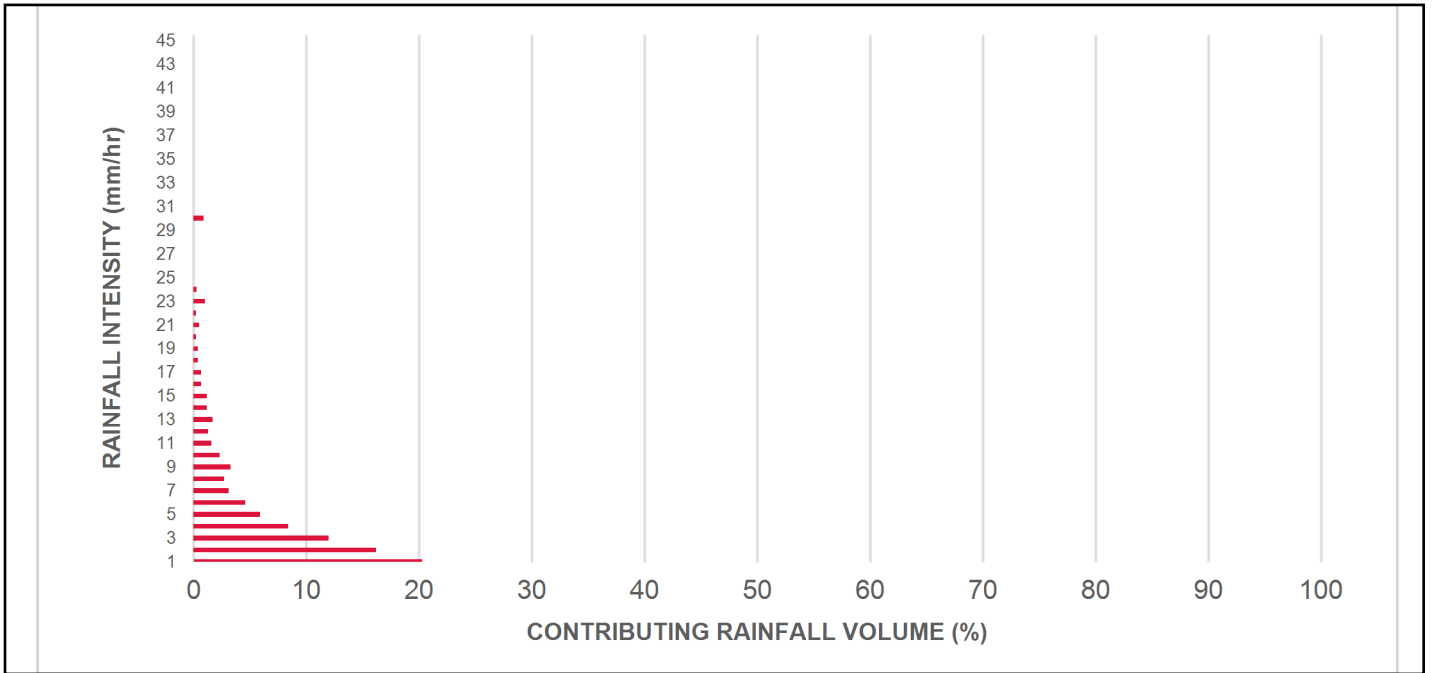

INCREMENTAL AND CUMULATIVE TSS REMOVAL FOR THE RECOMMENDED STORMCEPTOR® MODEL

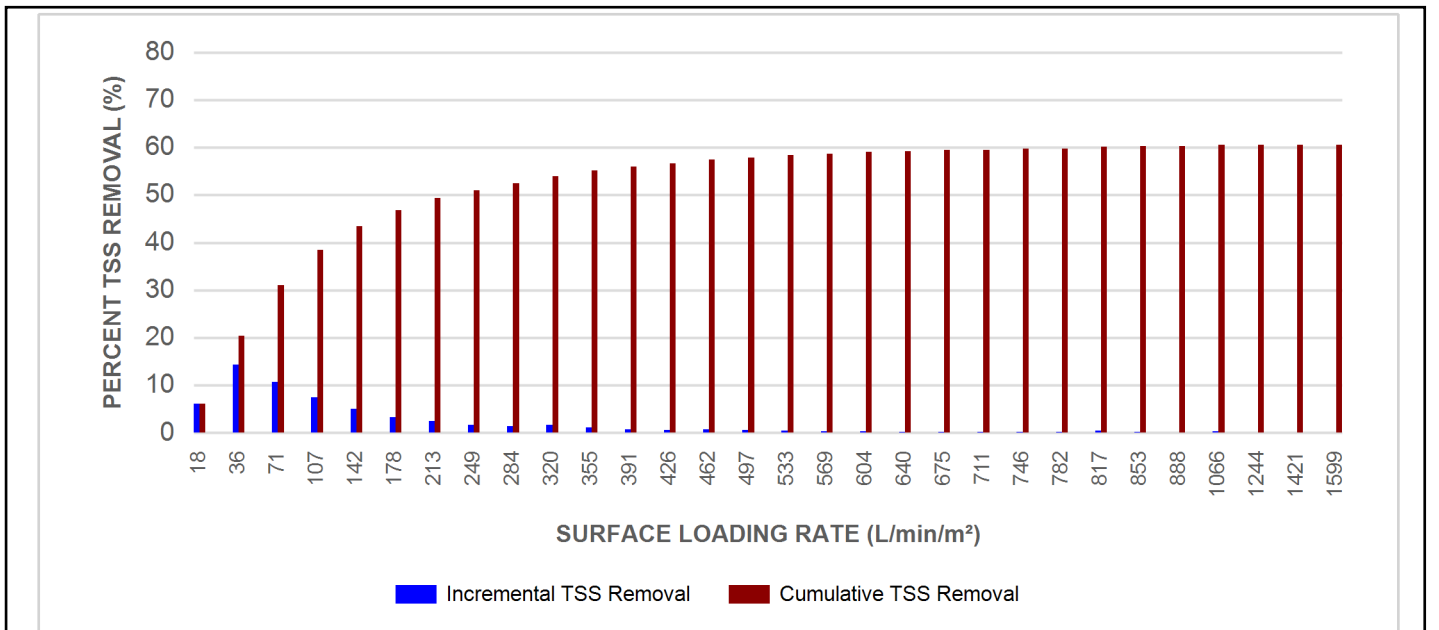



Stormceptor® EF Sizing Report

Maximum Pipe Diameter / Peak Conveyance

Stormceptor EF / EFO	Model Diameter		Min Angle Inlet / Outlet Pipes	Max Inlet Pipe Diameter		Max Outlet Pipe Diameter		Peak Conveyance Flow Rate	
	(m)	(ft)		(mm)	(in)	(mm)	(in)	(L/s)	(cfs)
EF4 / EFO4	1.2	4	90	609	24	609	24	425	15
EF6 / EFO6	1.8	6	90	914	36	914	36	990	35
EF8 / EFO8	2.4	8	90	1219	48	1219	48	1700	60
EF10 / EFO10	3.0	10	90	1828	72	1828	72	2830	100
EF12 / EFO12	3.6	12	90	1828	72	1828	72	2830	100

SCOUR PREVENTION AND ONLINE CONFIGURATION

► Stormceptor® EF and EFO feature an internal bypass and superior scour prevention technology that have been demonstrated in third-party testing according to the scour testing provisions of the Canadian ETV Procedure for Laboratory Testing of Oil-Grit Separators, and the exceptional scour test performance has been third-party verified in accordance with the ISO 14034 ETV protocol. As a result, Stormceptor EF and EFO are approved for online installation, eliminating the need for costly additional bypass structures, piping, and installation expense.

DESIGN FLEXIBILITY

► Stormceptor® EF and EFO offers design flexibility in one simplified platform, accepting stormwater flow from a single inlet pipe or multiple inlet pipes, and/or surface runoff through an inlet grate. The device can also serve as a junction structure, accommodate a 90-degree inlet-to-outlet bend angle, and can be modified to ensure performance in submerged conditions.

OIL CAPTURE AND RETENTION

► While Stormceptor® EF will capture and retain oil from dry weather spills and low intensity runoff, Stormceptor® EFO has demonstrated superior oil capture and greater than 99% oil retention in third-party testing according to the light liquid re-entrainment testing provisions of the Canadian ETV Procedure for Laboratory Testing of Oil-Grit Separators. Stormceptor EFO is recommended for sites where oil capture and retention is a requirement.

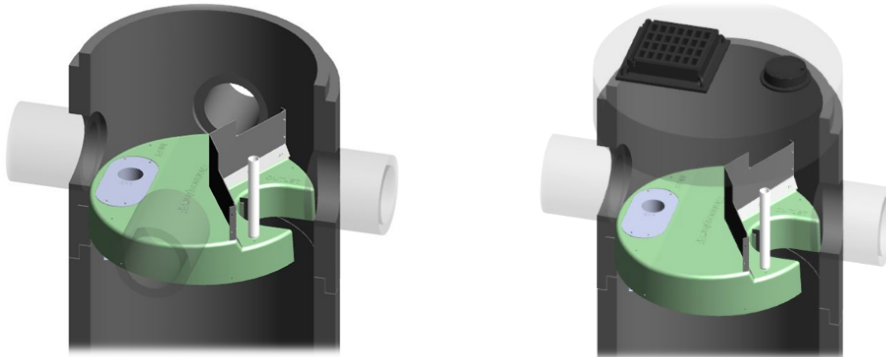

Stormceptor® EF Sizing Report

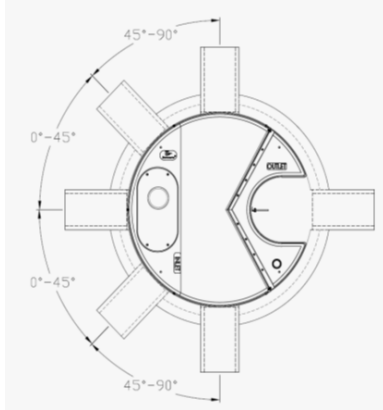

**INLET-TO-OUTLET DROP**

Elevation differential between inlet and outlet pipe inverts is dictated by the angle at which the inlet pipe(s) enters the unit.

0° - 45° : The inlet pipe is 1-inch (25mm) higher than the outlet pipe.

45° - 90° : The inlet pipe is 2-inches (50mm) higher than the outlet pipe.

**HEAD LOSS**

The head loss through Stormceptor EF is similar to that of a 60-degree bend structure. The applicable K value for calculating minor losses through the unit is 1.1. For submerged conditions the applicable K value is 3.0.

**Pollutant Capacity**

Stormceptor EF / EFO	Model Diameter		Depth (Outlet Pipe Invert to Sump Floor)		Oil Volume		Recommended Sediment Maintenance Depth *		Maximum Sediment Volume *		Maximum Sediment Mass **	
	(m)	(ft)	(m)	(ft)	(L)	(Gal)	(mm)	(in)	(L)	(ft³)	(kg)	(lb)
EF4 / EFO4	1.2	4	1.52	5.0	265	70	203	8	1190	42	1904	5250
EF6 / EFO6	1.8	6	1.93	6.3	610	160	305	12	3470	123	5552	15375
EF8 / EFO8	2.4	8	2.59	8.5	1070	280	610	24	8780	310	14048	38750
EF10 / EFO10	3.0	10	3.25	10.7	1670	440	610	24	17790	628	28464	78500
EF12 / EFO12	3.6	12	3.89	12.8	2475	655	610	24	31220	1103	49952	137875

\*Increased sump depth may be added to increase sediment storage capacity

\*\* Average density of wet packed sediment in sump = 1.6 kg/L (100 lb/ft³ )

Feature	Benefit	Feature Appeals To
Patent-pending enhanced flow treatment and scour prevention technology	Superior, verified third-party performance	Regulator, Specifying & Design Engineer
Third-party verified light liquid capture and retention for EFO version	Proven performance for fuel/oil hotspot locations	Regulator, Specifying & Design Engineer, Site Owner
Functions as bend, junction or inlet structure	Design flexibility	Specifying & Design Engineer
Minimal drop between inlet and outlet	Site installation ease	Contractor
Large diameter outlet riser for inspection and maintenance	Easy maintenance access from grade	Maintenance Contractor & Site Owner

**STANDARD STORMCEPTOR EF/EFO DRAWINGS**

For standard details, please visit <http://www.imbriumsystems.com/stormwater-treatment-solutions/stormceptor-ef>

**STANDARD STORMCEPTOR EF/EFO SPECIFICATION**

For specifications, please visit <http://www.imbriumsystems.com/stormwater-treatment-solutions/stormceptor-ef>

Stormceptor® EF Sizing Report

Table of TSS Removal vs Surface Loading Rate Based on Third-Party Test Results  
Stormceptor® EFO

SLR (L/min/m <sup>2</sup> )	TSS % REMOVAL	SLR (L/min/m <sup>2</sup> )	TSS % REMOVAL	SLR (L/min/m <sup>2</sup> )	TSS % REMOVAL	SLR (L/min/m <sup>2</sup> )	TSS % REMOVAL
1	70	660	42	1320	35	1980	24
30	70	690	42	1350	35	2010	24
60	67	720	41	1380	34	2040	23
90	63	750	41	1410	34	2070	23
120	61	780	41	1440	33	2100	23
150	58	810	41	1470	32	2130	22
180	56	840	41	1500	32	2160	22
210	54	870	41	1530	31	2190	22
240	53	900	41	1560	31	2220	21
270	52	930	40	1590	30	2250	21
300	51	960	40	1620	29	2280	21
330	50	990	40	1650	29	2310	21
360	49	1020	40	1680	28	2340	20
390	48	1050	39	1710	28	2370	20
420	47	1080	39	1740	27	2400	20
450	47	1110	38	1770	27	2430	20
480	46	1140	38	1800	26	2460	19
510	45	1170	37	1830	26	2490	19
540	44	1200	37	1860	26	2520	19
570	43	1230	37	1890	25	2550	19
600	42	1260	36	1920	25	2580	18
630	42	1290	36	1950	24	2600	26

**STANDARD PERFORMANCE SPECIFICATION FOR  
“OIL GRIT SEPARATOR” (OGS) STORMWATER QUALITY TREATMENT DEVICE**

**PART 1 – GENERAL**

1.1 WORK INCLUDED

This section specifies requirements for selecting, sizing, and designing an underground Oil Grit Separator (OGS) device for stormwater quality treatment, with third-party testing results and a Statement of Verification in accordance with ISO 14034 Environmental Management – Environmental Technology Verification (ETV).

1.2 REFERENCE STANDARDS & PROCEDURES

ISO 14034:2016 Environmental management – Environmental technology verification (ETV)

Canadian Environmental Technology Verification (ETV) Program’s **Procedure for Laboratory Testing of Oil-Grit Separators**

1.3 SUBMITTALS

1.3.1 All submittals, including sizing reports & shop drawings, shall be submitted upon request with each order to the contractor then forwarded to the Engineer of Record for review and acceptance. Shop drawings shall detail all OGS components, elevations, and sequence of construction.

1.3.2 Alternative devices shall have features identical to or greater than the specified device, including: treatment chamber diameter, treatment chamber wet volume, sediment storage volume, and oil storage volume.

1.3.3 Unless directed otherwise by the Engineer of Record, OGS stormwater quality treatment product substitutions or alternatives submitted within ten days prior to project bid shall not be accepted. All alternatives or substitutions submitted shall be signed and sealed by a local registered Professional Engineer, based on the exact same criteria detailed in Section 3, in entirety, subject to review and approval by the Engineer of Record.

**PART 2 – PRODUCTS**

2.1 OGS POLLUTANT STORAGE

The OGS device shall include a sump for sediment storage, and a protected volume for the capture and storage of petroleum hydrocarbons and buoyant gross pollutants. The minimum sediment & petroleum hydrocarbon storage capacity shall be as follows:

2.1.1	4 ft (1219 mm) Diameter OGS Units:	1.19 m <sup>3</sup> sediment / 265 L oil
	6 ft (1829 mm) Diameter OGS Units:	3.48 m <sup>3</sup> sediment / 609 L oil
	8 ft (2438 mm) Diameter OGS Units:	8.78 m <sup>3</sup> sediment / 1,071 L oil
	10 ft (3048 mm) Diameter OGS Units:	17.78 m <sup>3</sup> sediment / 1,673 L oil
	12 ft (3657 mm) Diameter OGS Units:	31.23 m <sup>3</sup> sediment / 2,476 L oil

**PART 3 – PERFORMANCE & DESIGN**

3.1 GENERAL

The OGS stormwater quality treatment device shall be verified in accordance with ISO 14034:2016 Environmental management – Environmental technology verification (ETV). The OGS stormwater quality treatment device shall



## Stormceptor® EF Sizing Report

remove oil, sediment and gross pollutants from stormwater runoff during frequent wet weather events, and retain these pollutants during less frequent high flow wet weather events below the insert within the OGS for later removal during maintenance. The Manufacturer shall have at least ten (10) years of local experience, history and success in engineering design, manufacturing and production and supply of OGS stormwater quality treatment device systems, acceptable to the Engineer of Record.

### 3.2 SIZING METHODOLOGY

The OGS device shall be engineered, designed and sized to provide stormwater quality treatment based on treating a minimum of 90 percent of the average annual runoff volume and a minimum removal of an annual average 60% of the sediment (TSS) load based on the Particle Size Distribution (PSD) specified in the sizing report for the specified device. Sizing of the OGS shall be determined by use of a minimum ten (10) years of local historical rainfall data provided by Environment Canada. Sizing shall also be determined by use of the sediment removal performance data derived from the ISO 14034 ETV third-party verified laboratory testing data from testing conducted in accordance with the Canadian ETV protocol Procedure for Laboratory Testing of Oil-Grit Separators, as follows:

3.2.1 Sediment removal efficiency for a given surface loading rate and its associated flow rate shall be based on sediment removal efficiency demonstrated at the seven (7) tested surface loading rates specified in the protocol, ranging 40 L/min/m<sup>2</sup> to 1400 L/min/m<sup>2</sup>, and as stated in the ISO 14034 ETV Verification Statement for the OGS device.

3.2.2 Sediment removal efficiency for surface loading rates between 40 L/min/m<sup>2</sup> and 1400 L/min/m<sup>2</sup> shall be based on linear interpolation of data between consecutive tested surface loading rates.

3.2.3 Sediment removal efficiency for surface loading rates less than the lowest tested surface loading rate of 40 L/min/m<sup>2</sup> shall be assumed to be identical to the sediment removal efficiency at 40 L/min/m<sup>2</sup>. No extrapolation shall be allowed that results in a sediment removal efficiency that is greater than that demonstrated at 40 L/min/m<sup>2</sup>.

3.2.4 Sediment removal efficiency for surface loading rates greater than the highest tested surface loading rate of 1400 L/min/m<sup>2</sup> shall assume zero sediment removal for the portion of flow that exceeds 1400 L/min/m<sup>2</sup>, and shall be calculated using a simple proportioning formula, with 1400 L/min/m<sup>2</sup> in the numerator and the higher surface loading rate in the denominator, and multiplying the resulting fraction times the sediment removal efficiency at 1400 L/min/m<sup>2</sup>.

The OGS device shall also have sufficient annual sediment storage capacity as specified and calculated in Section 2.1.

### 3.3 CANADIAN ETV or ISO 14034 ETV VERIFICATION OF SCOUR TESTING

The OGS device shall have Canadian ETV or ISO 14034 ETV Verification of third-party scour testing conducted in accordance with the Canadian ETV Program's **Procedure for Laboratory Testing of Oil-Grit Separators**.

3.3.1 To be acceptable for on-line installation, the OGS device must demonstrate an average scour test effluent concentration less than 10 mg/L at each surface loading rate tested, up to and including 2600 L/min/m<sup>2</sup>.

### 3.4 LIGHT LIQUID RE-ENTRAINMENT SIMULATION TESTING

The OGS device shall have Canadian ETV or ISO 14034 ETV Verification of completed third-party Light Liquid Re-entrainment Simulation Testing in accordance with the Canadian ETV **Program's Procedure for Laboratory Testing of Oil-Grit Separators**, with results reported within the Canadian ETV or ISO 14034 ETV verification. This re-entrainment testing is conducted with the device pre-loaded with low density polyethylene (LDPE) plastic beads as a surrogate for light liquids such as oil and fuel. Testing is conducted on the same OGS unit tested for sediment removal to

Stormceptor® **EF** Sizing Report

assess whether light liquids captured after a spill are effectively retained at high flow rates.

3.4.1 For an OGS device to be an acceptable stormwater treatment device on a site where vehicular traffic occurs and the potential for an oil or fuel spill exists, the OGS device must have reported verified performance results of greater than 99% cumulative retention of LDPE plastic beads for the five specified surface loading rates (ranging 200 L/min/m<sup>2</sup> to 2600 L/min/m<sup>2</sup>) in accordance with the Light Liquid Re-entrainment Simulation Testing within the Canadian ETV Program's **Procedure for Laboratory Testing of Oil-Grit Separators**. However, an OGS device shall not be allowed if the Light Liquid Re-entrainment Simulation Testing was performed with screening components within the OGS device that are effective at retaining the LDPE plastic beads, but would not be expected to retain light liquids such as oil and fuel.



Stormceptor® EF Sizing Report

Imbrium® Systems

ESTIMATED NET ANNUAL SEDIMENT (TSS) LOAD REDUCTION

01/16/2024

Province:	Ontario
City:	Ottawa
Nearest Rainfall Station:	OTTAWA CDA RCS
Climate Station Id:	6105978
Years of Rainfall Data:	20

Project Name:	Boone Plumbing
Project Number:	62819
Designer Name:	Mitch Raper
Designer Company:	Mcintosh Perry
Designer Email:	m.raper@mcintoshperry.com
Designer Phone:	613-315-9801
EOR Name:	
EOR Company:	
EOR Email:	
EOR Phone:	

Site Name:	1540 Star Top Fine
------------	--------------------

Drainage Area (ha):	1.8
% Imperviousness:	94.00

Runoff Coefficient 'c': 0.86

Particle Size Distribution:	Fine
-----------------------------	------

Target TSS Removal (%):	80.0
-------------------------	------

Required Water Quality Runoff Volume Capture (%):	90.00
Estimated Water Quality Flow Rate (L/s):	50.19
Oil / Fuel Spill Risk Site?	Yes
Upstream Flow Control?	Yes
Upstream Orifice Control Flow Rate to Stormceptor (L/s):	175.00
Peak Conveyance (maximum) Flow Rate (L/s):	
Influent TSS Concentration (mg/L):	200
Estimated Average Annual Sediment Load (kg/yr):	1980
Estimated Average Annual Sediment Volume (L/yr):	1610

Net Annual Sediment (TSS) Load Reduction Sizing Summary	
Stormceptor Model	TSS Removal Provided (%)
EFO4	63
EFO6	78
<b>EFO8</b>	<b>86</b>
EFO10	91
EFO12	95

Recommended Stormceptor EFO Model: **EFO8**

Estimated Net Annual Sediment (TSS) Load Reduction (%): **86**

Water Quality Runoff Volume Capture (%): **> 90**



Stormceptor® **EF** Sizing Report

**THIRD-PARTY TESTING AND VERIFICATION**

► Stormceptor® EF and Stormceptor® EFO are the latest evolutions in the Stormceptor® oil-grit separator (OGS) technology series, and are designed to remove a wide variety of pollutants from stormwater and snowmelt runoff. These technologies have been third-party tested in accordance with the Canadian ETV **Procedure for Laboratory Testing of Oil-Grit Separators** and performance has been third-party verified in accordance with the **ISO 14034 Environmental Technology Verification (ETV)** protocol.

**PERFORMANCE**

► Stormceptor® EF and EFO remove stormwater pollutants through gravity separation and floatation, and feature a patent-pending design that generates positive removal of total suspended solids (TSS) throughout each storm event, including high-intensity storms. Captured pollutants include sediment, free oils, and sediment-bound pollutants such as nutrients, heavy metals, and petroleum hydrocarbons. Stormceptor is sized to remove a high level of TSS from the frequent rainfall events that contribute the vast majority of annual runoff volume and pollutant load. The technology incorporates an internal bypass to convey excessive stormwater flows from high-intensity storms through the device without resuspension and washout (scour) of previously captured pollutants. Proper routine maintenance ensures high pollutant removal performance and protection of downstream waterways.

**PARTICLE SIZE DISTRIBUTION (PSD)**

► The Canadian ETV PSD shown in the table below was used, or in part, for this sizing. This is the identical PSD that is referenced in the Canadian ETV **Procedure for Laboratory Testing of Oil-Grit Separators** for both sediment removal testing and scour testing. The Canadian ETV PSD contains a wide range of particle sizes in the sand and silt fractions, and is considered reasonably representative of the particle size fractions found in typical urban stormwater runoff.

Particle Size (µm)	Percent Less Than	Particle Size Fraction (µm)	Percent
1000	100	500-1000	5
500	95	250-500	5
250	90	150-250	15
150	75	100-150	15
100	60	75-100	10
75	50	50-75	5
50	45	20-50	10
20	35	8-20	15
8	20	5-8	10
5	10	2-5	5
2	5	<2	5



Stormceptor® EF Sizing Report

Upstream Flow Controlled Results

Rainfall Intensity (mm / hr)	Percent Rainfall Volume (%)	Cumulative Rainfall Volume (%)	Flow Rate (L/s)	Flow Rate (L/min)	Surface Loading Rate (L/min/m²)	Removal Efficiency (%)	Incremental Removal (%)	Cumulative Removal (%)
0.50	8.6	8.6	2.16	130.0	28.0	100	8.6	8.6
1.00	20.3	29.0	4.32	259.0	55.0	100	20.3	29.0
2.00	16.2	45.2	8.65	519.0	110.0	95	15.3	44.3
3.00	12.0	57.2	12.97	778.0	166.0	88	10.6	54.9
4.00	8.4	65.6	17.29	1038.0	221.0	82	6.9	61.8
5.00	5.9	71.6	21.62	1297.0	276.0	80	4.7	66.6
6.00	4.6	76.2	25.94	1556.0	331.0	77	3.6	70.1
7.00	3.1	79.3	30.26	1816.0	386.0	75	2.3	72.4
8.00	2.7	82.0	34.59	2075.0	442.0	72	2.0	74.4
9.00	3.3	85.3	38.91	2335.0	497.0	70	2.3	76.7
10.00	2.3	87.6	43.23	2594.0	552.0	67	1.5	78.3
11.00	1.6	89.2	47.56	2853.0	607.0	65	1.0	79.3
12.00	1.3	90.5	51.88	3113.0	662.0	64	0.8	80.1
13.00	1.7	92.2	56.20	3372.0	718.0	64	1.1	81.2
14.00	1.2	93.5	60.53	3632.0	773.0	63	0.8	82.0
15.00	1.2	94.6	64.85	3891.0	828.0	63	0.7	82.7
16.00	0.7	95.3	69.18	4151.0	883.0	62	0.4	83.2
17.00	0.7	96.1	73.50	4410.0	938.0	62	0.5	83.6
18.00	0.4	96.5	77.82	4669.0	993.0	62	0.2	83.9
19.00	0.4	96.9	82.15	4929.0	1049.0	61	0.2	84.1
20.00	0.2	97.1	86.47	5188.0	1104.0	59	0.1	84.2
21.00	0.5	97.5	90.79	5448.0	1159.0	58	0.3	84.5
22.00	0.2	97.8	95.12	5707.0	1214.0	57	0.1	84.6
23.00	1.0	98.8	99.44	5966.0	1269.0	55	0.6	85.2
24.00	0.3	99.1	103.76	6226.0	1325.0	54	0.1	85.4
25.00	0.9	100.0	108.09	6485.0	1380.0	53	0.5	85.8
30.00	0.9	100.9	129.70	7782.0	1656.0	44	0.4	86.3
35.00	-0.9	100.0	151.32	9079.0	1932.0	38	N/A	85.9
40.00	0.0	100.0	172.94	10376.0	2208.0	33	0.0	85.9
45.00	0.0	100.0	175.00	10500.0	2234.0	33	0.0	85.9
<b>Estimated Net Annual Sediment (TSS) Load Reduction =</b>								<b>86 %</b>

Climate Station ID: 6105978 Years of Rainfall Data: 20



Stormceptor® EF Sizing Report

RAINFALL DATA FROM OTTAWA CDA RCS RAINFALL STATION

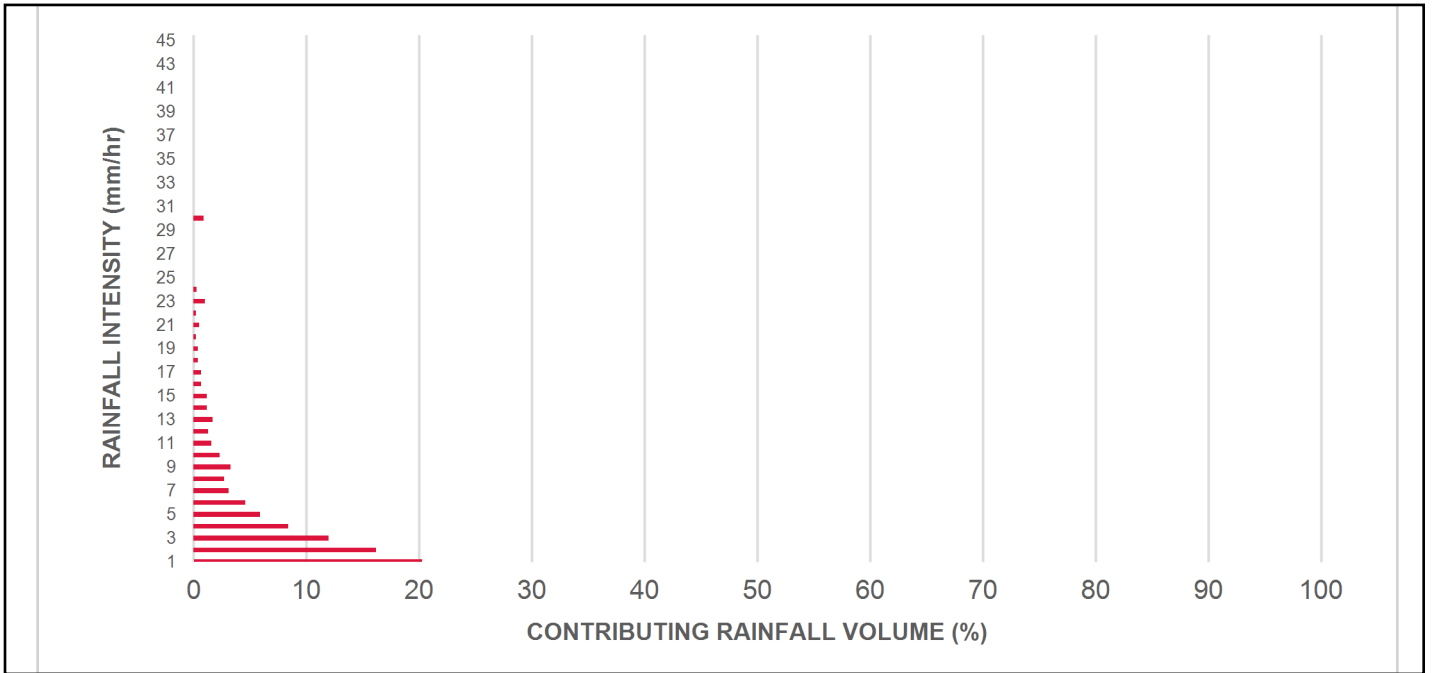

INCREMENTAL AND CUMULATIVE TSS REMOVAL FOR THE RECOMMENDED STORMCEPTOR® MODEL

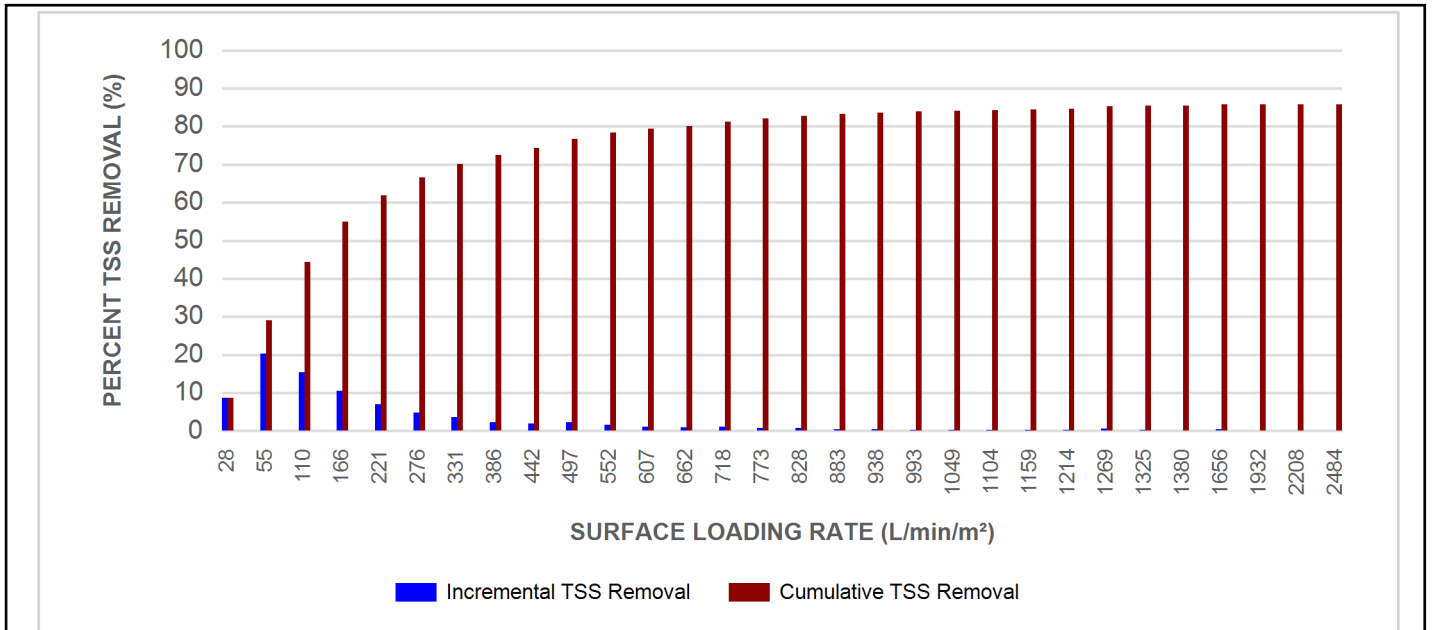

Stormceptor® EF Sizing Report

Maximum Pipe Diameter / Peak Conveyance

Stormceptor EF / EFO	Model Diameter		Min Angle Inlet / Outlet Pipes	Max Inlet Pipe Diameter		Max Outlet Pipe Diameter		Peak Conveyance Flow Rate	
	(m)	(ft)		(mm)	(in)	(mm)	(in)	(L/s)	(cfs)
EF4 / EFO4	1.2	4	90	609	24	609	24	425	15
EF6 / EFO6	1.8	6	90	914	36	914	36	990	35
EF8 / EFO8	2.4	8	90	1219	48	1219	48	1700	60
EF10 / EFO10	3.0	10	90	1828	72	1828	72	2830	100
EF12 / EFO12	3.6	12	90	1828	72	1828	72	2830	100

SCOUR PREVENTION AND ONLINE CONFIGURATION

► Stormceptor® EF and EFO feature an internal bypass and superior scour prevention technology that have been demonstrated in third-party testing according to the scour testing provisions of the Canadian ETV Procedure for Laboratory Testing of Oil-Grit Separators, and the exceptional scour test performance has been third-party verified in accordance with the ISO 14034 ETV protocol. As a result, Stormceptor EF and EFO are approved for online installation, eliminating the need for costly additional bypass structures, piping, and installation expense.

DESIGN FLEXIBILITY

► Stormceptor® EF and EFO offers design flexibility in one simplified platform, accepting stormwater flow from a single inlet pipe or multiple inlet pipes, and/or surface runoff through an inlet grate. The device can also serve as a junction structure, accommodate a 90-degree inlet-to-outlet bend angle, and can be modified to ensure performance in submerged conditions.

OIL CAPTURE AND RETENTION

► While Stormceptor® EF will capture and retain oil from dry weather spills and low intensity runoff, Stormceptor® EFO has demonstrated superior oil capture and greater than 99% oil retention in third-party testing according to the light liquid re-entrainment testing provisions of the Canadian ETV Procedure for Laboratory Testing of Oil-Grit Separators. Stormceptor EFO is recommended for sites where oil capture and retention is a requirement.

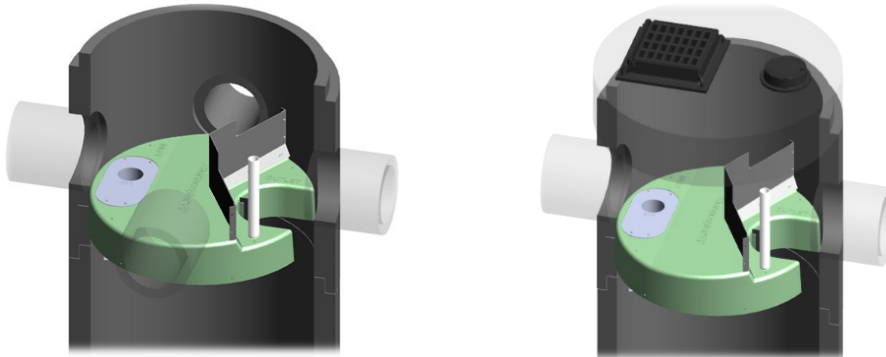

Stormceptor® EF Sizing Report

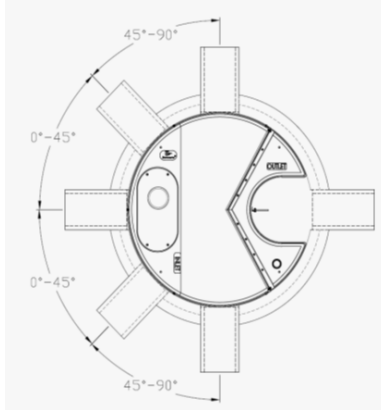

**INLET-TO-OUTLET DROP**

Elevation differential between inlet and outlet pipe inverts is dictated by the angle at which the inlet pipe(s) enters the unit.

0° - 45° : The inlet pipe is 1-inch (25mm) higher than the outlet pipe.

45° - 90° : The inlet pipe is 2-inches (50mm) higher than the outlet pipe.

**HEAD LOSS**

The head loss through Stormceptor EF is similar to that of a 60-degree bend structure. The applicable K value for calculating minor losses through the unit is 1.1. For submerged conditions the applicable K value is 3.0.

**Pollutant Capacity**

Stormceptor EF / EFO	Model Diameter		Depth (Outlet Pipe Invert to Sump Floor)		Oil Volume		Recommended Sediment Maintenance Depth *		Maximum Sediment Volume *		Maximum Sediment Mass **	
	(m)	(ft)	(m)	(ft)	(L)	(Gal)	(mm)	(in)	(L)	(ft³)	(kg)	(lb)
EF4 / EFO4	1.2	4	1.52	5.0	265	70	203	8	1190	42	1904	5250
EF6 / EFO6	1.8	6	1.93	6.3	610	160	305	12	3470	123	5552	15375
EF8 / EFO8	2.4	8	2.59	8.5	1070	280	610	24	8780	310	14048	38750
EF10 / EFO10	3.0	10	3.25	10.7	1670	440	610	24	17790	628	28464	78500
EF12 / EFO12	3.6	12	3.89	12.8	2475	655	610	24	31220	1103	49952	137875

\*Increased sump depth may be added to increase sediment storage capacity

\*\* Average density of wet packed sediment in sump = 1.6 kg/L (100 lb/ft³ )

Feature	Benefit	Feature Appeals To
Patent-pending enhanced flow treatment and scour prevention technology	Superior, verified third-party performance	Regulator, Specifying & Design Engineer
Third-party verified light liquid capture and retention for EFO version	Proven performance for fuel/oil hotspot locations	Regulator, Specifying & Design Engineer, Site Owner
Functions as bend, junction or inlet structure	Design flexibility	Specifying & Design Engineer
Minimal drop between inlet and outlet	Site installation ease	Contractor
Large diameter outlet riser for inspection and maintenance	Easy maintenance access from grade	Maintenance Contractor & Site Owner

**STANDARD STORMCEPTOR EF/EFO DRAWINGS**

For standard details, please visit <http://www.imbriumsystems.com/stormwater-treatment-solutions/stormceptor-ef>

**STANDARD STORMCEPTOR EF/EFO SPECIFICATION**

For specifications, please visit <http://www.imbriumsystems.com/stormwater-treatment-solutions/stormceptor-ef>



**STANDARD PERFORMANCE SPECIFICATION FOR  
“OIL GRIT SEPARATOR” (OGS) STORMWATER QUALITY TREATMENT DEVICE**

**PART 1 – GENERAL**

1.1 WORK INCLUDED

This section specifies requirements for selecting, sizing, and designing an underground Oil Grit Separator (OGS) device for stormwater quality treatment, with third-party testing results and a Statement of Verification in accordance with ISO 14034 Environmental Management – Environmental Technology Verification (ETV).

1.2 REFERENCE STANDARDS & PROCEDURES

ISO 14034:2016 Environmental management – Environmental technology verification (ETV)

Canadian Environmental Technology Verification (ETV) Program’s **Procedure for Laboratory Testing of Oil-Grit Separators**

1.3 SUBMITTALS

1.3.1 All submittals, including sizing reports & shop drawings, shall be submitted upon request with each order to the contractor then forwarded to the Engineer of Record for review and acceptance. Shop drawings shall detail all OGS components, elevations, and sequence of construction.

1.3.2 Alternative devices shall have features identical to or greater than the specified device, including: treatment chamber diameter, treatment chamber wet volume, sediment storage volume, and oil storage volume.

1.3.3 Unless directed otherwise by the Engineer of Record, OGS stormwater quality treatment product substitutions or alternatives submitted within ten days prior to project bid shall not be accepted. All alternatives or substitutions submitted shall be signed and sealed by a local registered Professional Engineer, based on the exact same criteria detailed in Section 3, in entirety, subject to review and approval by the Engineer of Record.

**PART 2 – PRODUCTS**

2.1 OGS POLLUTANT STORAGE

The OGS device shall include a sump for sediment storage, and a protected volume for the capture and storage of petroleum hydrocarbons and buoyant gross pollutants. The minimum sediment & petroleum hydrocarbon storage capacity shall be as follows:

2.1.1	4 ft (1219 mm) Diameter OGS Units:	1.19 m <sup>3</sup> sediment / 265 L oil
	6 ft (1829 mm) Diameter OGS Units:	3.48 m <sup>3</sup> sediment / 609 L oil
	8 ft (2438 mm) Diameter OGS Units:	8.78 m <sup>3</sup> sediment / 1,071 L oil
	10 ft (3048 mm) Diameter OGS Units:	17.78 m <sup>3</sup> sediment / 1,673 L oil
	12 ft (3657 mm) Diameter OGS Units:	31.23 m <sup>3</sup> sediment / 2,476 L oil

**PART 3 – PERFORMANCE & DESIGN**

3.1 GENERAL

The OGS stormwater quality treatment device shall be verified in accordance with ISO 14034:2016 Environmental management – Environmental technology verification (ETV). The OGS stormwater quality treatment device shall



## Stormceptor® EF Sizing Report

remove oil, sediment and gross pollutants from stormwater runoff during frequent wet weather events, and retain these pollutants during less frequent high flow wet weather events below the insert within the OGS for later removal during maintenance. The Manufacturer shall have at least ten (10) years of local experience, history and success in engineering design, manufacturing and production and supply of OGS stormwater quality treatment device systems, acceptable to the Engineer of Record.

### 3.2 SIZING METHODOLOGY

The OGS device shall be engineered, designed and sized to provide stormwater quality treatment based on treating a minimum of 90 percent of the average annual runoff volume and a minimum removal of an annual average 60% of the sediment (TSS) load based on the Particle Size Distribution (PSD) specified in the sizing report for the specified device. Sizing of the OGS shall be determined by use of a minimum ten (10) years of local historical rainfall data provided by Environment Canada. Sizing shall also be determined by use of the sediment removal performance data derived from the ISO 14034 ETV third-party verified laboratory testing data from testing conducted in accordance with the Canadian ETV protocol Procedure for Laboratory Testing of Oil-Grit Separators, as follows:

3.2.1 Sediment removal efficiency for a given surface loading rate and its associated flow rate shall be based on sediment removal efficiency demonstrated at the seven (7) tested surface loading rates specified in the protocol, ranging 40 L/min/m<sup>2</sup> to 1400 L/min/m<sup>2</sup>, and as stated in the ISO 14034 ETV Verification Statement for the OGS device.

3.2.2 Sediment removal efficiency for surface loading rates between 40 L/min/m<sup>2</sup> and 1400 L/min/m<sup>2</sup> shall be based on linear interpolation of data between consecutive tested surface loading rates.

3.2.3 Sediment removal efficiency for surface loading rates less than the lowest tested surface loading rate of 40 L/min/m<sup>2</sup> shall be assumed to be identical to the sediment removal efficiency at 40 L/min/m<sup>2</sup>. No extrapolation shall be allowed that results in a sediment removal efficiency that is greater than that demonstrated at 40 L/min/m<sup>2</sup>.

3.2.4 Sediment removal efficiency for surface loading rates greater than the highest tested surface loading rate of 1400 L/min/m<sup>2</sup> shall assume zero sediment removal for the portion of flow that exceeds 1400 L/min/m<sup>2</sup>, and shall be calculated using a simple proportioning formula, with 1400 L/min/m<sup>2</sup> in the numerator and the higher surface loading rate in the denominator, and multiplying the resulting fraction times the sediment removal efficiency at 1400 L/min/m<sup>2</sup>.

The OGS device shall also have sufficient annual sediment storage capacity as specified and calculated in Section 2.1.

### 3.3 CANADIAN ETV or ISO 14034 ETV VERIFICATION OF SCOUR TESTING

The OGS device shall have Canadian ETV or ISO 14034 ETV Verification of third-party scour testing conducted in accordance with the Canadian ETV Program's **Procedure for Laboratory Testing of Oil-Grit Separators**.

3.3.1 To be acceptable for on-line installation, the OGS device must demonstrate an average scour test effluent concentration less than 10 mg/L at each surface loading rate tested, up to and including 2600 L/min/m<sup>2</sup>.

### 3.4 LIGHT LIQUID RE-ENTRAINMENT SIMULATION TESTING

The OGS device shall have Canadian ETV or ISO 14034 ETV Verification of completed third-party Light Liquid Re-entrainment Simulation Testing in accordance with the Canadian ETV **Program's Procedure for Laboratory Testing of Oil-Grit Separators**, with results reported within the Canadian ETV or ISO 14034 ETV verification. This re-entrainment testing is conducted with the device pre-loaded with low density polyethylene (LDPE) plastic beads as a surrogate for light liquids such as oil and fuel. Testing is conducted on the same OGS unit tested for sediment removal to

## Stormceptor® EF Sizing Report

assess whether light liquids captured after a spill are effectively retained at high flow rates.

3.4.1 For an OGS device to be an acceptable stormwater treatment device on a site where vehicular traffic occurs and the potential for an oil or fuel spill exists, the OGS device must have reported verified performance results of greater than 99% cumulative retention of LDPE plastic beads for the five specified surface loading rates (ranging 200 L/min/m<sup>2</sup> to 2600 L/min/m<sup>2</sup>) in accordance with the Light Liquid Re-entrainment Simulation Testing within the Canadian ETV Program's **Procedure for Laboratory Testing of Oil-Grit Separators**. However, an OGS device shall not be allowed if the Light Liquid Re-entrainment Simulation Testing was performed with screening components within the OGS device that are effective at retaining the LDPE plastic beads, but would not be expected to retain light liquids such as oil and fuel.

APPENDIX H  
CITY OF OTTAWA DESIGN CHECKLIST

# City of Ottawa

## 4. Development Servicing Study Checklist

The following section describes the checklist of the required content of servicing studies. It is expected that the proponent will address each one of the following items for the study to be deemed complete and ready for review by City of Ottawa Infrastructure Approvals staff.

The level of required detail in the Servicing Study will increase depending on the type of application. For example, for Official Plan amendments and re-zoning applications, the main issues will be to determine the capacity requirements for the proposed change in land use and confirm this against the existing capacity constraint, and to define the solutions, phasing of works and the financing of works to address the capacity constraint. For subdivisions and site plans, the above will be required with additional detailed information supporting the servicing within the development boundary.

### 4.1 General Content

Criteria	Location (if applicable)
<input type="checkbox"/> Executive Summary (for larger reports only).	N/A
<input type="checkbox"/> Date and revision number of the report.	On Cover
<input type="checkbox"/> Location map and plan showing municipal address, boundary, and layout of proposed development.	Appendix A
<input type="checkbox"/> Plan showing the site and location of all existing services.	Site Servicing Plan (C102)
<input type="checkbox"/> Development statistics, land use, density, adherence to zoning and official plan, and reference to applicable subwatershed and watershed plans that provide context to which individual developments must adhere.	1.1 Purpose 1.2 Site Description 6.0 Stormwater Management
<input type="checkbox"/> Summary of pre-consultation meetings with City and other approval agencies.	Appendix B
<input type="checkbox"/> Reference and confirm conformance to higher level studies and reports (Master Servicing Studies, Environmental Assessments, Community Design Plans), or in the case where it is not in conformance, the proponent must provide justification and develop a defensible design criteria.	1.1 Purpose 1.2 Site Description 6.0 Stormwater Management
<input type="checkbox"/> Statement of objectives and servicing criteria.	3.0 Pre-Consultation Summary

<input type="checkbox"/> Identification of existing and proposed infrastructure available in the immediate area.	N/A
<input type="checkbox"/> Identification of Environmentally Significant Areas, watercourses and Municipal Drains potentially impacted by the proposed development (Reference can be made to the Natural Heritage Studies, if available).	Site Grading Plan (C101)
<input type="checkbox"/> Concept level master grading plan to confirm existing and proposed grades in the development. This is required to confirm the feasibility of proposed stormwater management and drainage, soil removal and fill constraints, and potential impacts to neighbouring properties. This is also required to confirm that the proposed grading will not impede existing major system flow paths.	Site Grading Plan (C101)
<input type="checkbox"/> Identification of potential impacts of proposed piped services on private services (such as wells and septic fields on adjacent lands) and mitigation required to address potential impacts.	N/A
<input type="checkbox"/> Proposed phasing of the development, if applicable.	N/A
<input type="checkbox"/> Reference to geotechnical studies and recommendations concerning servicing.	Section 2.0 Background Studies, Standards and References
<input type="checkbox"/> All preliminary and formal site plan submissions should have the following information: <ul style="list-style-type: none"> <li>○ Metric scale</li> <li>○ North arrow (including construction North)</li> <li>○ Key plan</li> <li>○ Name and contact information of applicant and property owner</li> <li>○ Property limits including bearings and dimensions</li> <li>○ Existing and proposed structures and parking areas</li> <li>○ Easements, road widening and rights-of-way</li> <li>○ Adjacent street names</li> </ul>	Site Grading Plan (C101)



## 4.2 Development Servicing Report: Water

Criteria	Location (if applicable)
<input type="checkbox"/> Confirm consistency with Master Servicing Study, if available	N/A
<input type="checkbox"/> Availability of public infrastructure to service proposed development	N/A
<input type="checkbox"/> Identification of system constraints	N/A
<input type="checkbox"/> Identify boundary conditions	Appendix C
<input type="checkbox"/> Confirmation of adequate domestic supply and pressure	N/A
<input type="checkbox"/> Confirmation of adequate fire flow protection and confirmation that fire flow is calculated as per the Fire Underwriter's Survey. Output should show available fire flow at locations throughout the development.	Appendix C
<input type="checkbox"/> Provide a check of high pressures. If pressure is found to be high, an assessment is required to confirm the application of pressure reducing valves.	N/A
<input type="checkbox"/> Definition of phasing constraints. Hydraulic modeling is required to confirm servicing for all defined phases of the project including the ultimate design	N/A
<input type="checkbox"/> Address reliability requirements such as appropriate location of shut-off valves	N/A
<input type="checkbox"/> Check on the necessity of a pressure zone boundary modification.	N/A
<input type="checkbox"/> Reference to water supply analysis to show that major infrastructure is capable of delivering sufficient water for the proposed land use. This includes data that shows that the expected demands under average day, peak hour and fire flow conditions provide water within the required pressure range	Appendix C, Section 4.2

<input type="checkbox"/> Description of the proposed water distribution network, including locations of proposed connections to the existing system, provisions for necessary looping, and appurtenances (valves, pressure reducing valves, valve chambers, and fire hydrants) including special metering provisions.	Site Servicing Plan (C101)
<input type="checkbox"/> Description of off-site required feeder mains, booster pumping stations, and other water infrastructure that will be ultimately required to service proposed development, including financing, interim facilities, and timing of implementation.	N/A
<input type="checkbox"/> Confirmation that water demands are calculated based on the City of Ottawa Design Guidelines.	Appendix C
<input type="checkbox"/> Provision of a model schematic showing the boundary conditions locations, streets, parcels, and building locations for reference.	N/A

#### 4.3 Development Servicing Report: Wastewater

Criteria	Location (if applicable)
<input type="checkbox"/> Summary of proposed design criteria (Note: Wet-weather flow criteria should not deviate from the City of Ottawa Sewer Design Guidelines. Monitored flow data from relatively new infrastructure cannot be used to justify capacity requirements for proposed infrastructure).	N/A
<input type="checkbox"/> Confirm consistency with Master Servicing Study and/or justifications for deviations.	N/A
<input type="checkbox"/> Consideration of local conditions that may contribute to extraneous flows that are higher than the recommended flows in the guidelines. This includes groundwater and soil conditions, and age and condition of sewers.	N/A
<input type="checkbox"/> Description of existing sanitary sewer available for discharge of wastewater from proposed development.	Section 5.2 Proposed Sanitary Sewer

<input type="checkbox"/> Verify available capacity in downstream sanitary sewer and/or identification of upgrades necessary to service the proposed development. (Reference can be made to previously completed Master Servicing Study if applicable)	Section 5.3 Proposed Sanitary Design
<input type="checkbox"/> Calculations related to dry-weather and wet-weather flow rates from the development in standard MOE sanitary sewer design table (Appendix 'C') format.	N/A
<input type="checkbox"/> Description of proposed sewer network including sewers, pumping stations, and forcemains.	Section 5.2 Proposed Sanitary Sewer
<input type="checkbox"/> Discussion of previously identified environmental constraints and impact on servicing (environmental constraints are related to limitations imposed on the development in order to preserve the physical condition of watercourses, vegetation, soil cover, as well as protecting against water quantity and quality).	N/A
<input type="checkbox"/> Pumping stations: impacts of proposed development on existing pumping stations or requirements for new pumping station to service development.	N/A
<input type="checkbox"/> Forcemain capacity in terms of operational redundancy, surge pressure and maximum flow velocity.	N/A
<input type="checkbox"/> Identification and implementation of the emergency overflow from sanitary pumping stations in relation to the hydraulic grade line to protect against basement flooding.	N/A
<input type="checkbox"/> Special considerations such as contamination, corrosive environment etc.	N/A

#### 4.4 Development Servicing Report: Stormwater Checklist

Criteria	Location (if applicable)
<input type="checkbox"/> Description of drainage outlets and downstream constraints including legality of outlets (i.e. municipal drain, right-of-way, watercourse, or private property)	Section 6.0 Stormwater Sewer Design & Section 7.0 Proposed Stormwater Management
<input type="checkbox"/> Analysis of available capacity in existing public infrastructure.	N/A
<input type="checkbox"/> A drawing showing the subject lands, its surroundings, the receiving watercourse, existing drainage patterns, and proposed drainage pattern.	Pre & Post-Development Plans
<input type="checkbox"/> Water quantity control objective (e.g. controlling post-development peak flows to pre-development level for storm events ranging from the 2 or 5-year event (dependent on the receiving sewer design) to 100-year return period); if other objectives are being applied, a rationale must be included with reference to hydrologic analyses of the potentially affected subwatersheds, taking into account long-term cumulative effects.	Section 6.0 Stormwater Sewer Design & Section 7.0 Proposed Stormwater Management
<input type="checkbox"/> Water Quality control objective (basic, normal or enhanced level of protection based on the sensitivities of the receiving watercourse) and storage requirements.	Section 6.0 Stormwater Sewer Design & Section 7.0 Proposed Stormwater Management
<input type="checkbox"/> Description of the stormwater management concept with facility locations and descriptions with references and supporting information.	Section 6.0 Stormwater Sewer Design & Section 7.0 Proposed Stormwater Management
<input type="checkbox"/> Set-back from private sewage disposal systems.	N/A
<input type="checkbox"/> Watercourse and hazard lands setbacks.	N/A
<input type="checkbox"/> Record of pre-consultation with the Ontario Ministry of Environment and the Conservation Authority that has jurisdiction on the affected watershed.	N/A
<input type="checkbox"/> Confirm consistency with sub-watershed and Master Servicing Study, if applicable study exists.	N/A
<input type="checkbox"/> Storage requirements (complete with calculations) and conveyance capacity for minor events (1:5-year return period) and major events (1:100-year return period).	Appendix G

<input type="checkbox"/> Identification of watercourses within the proposed development and how watercourses will be protected, or, if necessary, altered by the proposed development with applicable approvals.	Site Grading Plan
<input type="checkbox"/> Calculate pre-and post development peak flow rates including a description of existing site conditions and proposed impervious areas and drainage catchments in comparison to existing conditions.	Section 7.0 Proposed Stormwater Management Appendix G
<input type="checkbox"/> Any proposed diversion of drainage catchment areas from one outlet to another.	Section 6.0 Stormwater Sewer Design & Section 7.0 Proposed Stormwater Management
<input type="checkbox"/> Proposed minor and major systems including locations and sizes of stormwater trunk sewers, and stormwater management facilities.	Section 6.0 Stormwater Sewer Design & Section 7.0 Proposed Stormwater Management
<input type="checkbox"/> If quantity control is not proposed, demonstration that downstream system has adequate capacity for the post-development flows up to and including the 100-year return period storm event.	N/A
<input type="checkbox"/> Identification of potential impacts to receiving watercourses	N/A
<input type="checkbox"/> Identification of municipal drains and related approval requirements.	N/A
<input type="checkbox"/> Descriptions of how the conveyance and storage capacity will be achieved for the development.	Section 6.0 Stormwater Sewer Design & Section 7.0 Proposed Stormwater Management
<input type="checkbox"/> 100-year flood levels and major flow routing to protect proposed development from flooding for establishing minimum building elevations (MBE) and overall grading.	Site Grading Plan (C101)
<input type="checkbox"/> Inclusion of hydraulic analysis including hydraulic grade line elevations.	N/A

<input type="checkbox"/> Description of approach to erosion and sediment control during construction for the protection of receiving watercourse or drainage corridors.	Section 8.0 Sediment & Erosion Control
<input type="checkbox"/> Identification of floodplains – proponent to obtain relevant floodplain information from the appropriate Conservation Authority. The proponent may be required to delineate floodplain elevations to the satisfaction of the Conservation Authority if such information is not available or if information does not match current conditions.	N/A
<input type="checkbox"/> Identification of fill constraints related to floodplain and geotechnical investigation.	N/A

#### 4.5 Approval and Permit Requirements: Checklist

The Servicing Study shall provide a list of applicable permits and regulatory approvals necessary for the proposed development as well as the relevant issues affecting each approval. The approval and permitting shall include but not be limited to the following:

Criteria	Location (if applicable)
<input type="checkbox"/> Conservation Authority as the designated approval agency for modification of floodplain, potential impact on fish habitat, proposed works in or adjacent to a watercourse, cut/fill permits and Approval under Lakes and Rivers Improvement Act. The Conservation Authority is not the approval authority for the Lakes and Rivers Improvement Act. Where there are Conservation Authority regulations in place, approval under the Lakes and Rivers Improvement Act is not required, except in cases of dams as defined in the Act.	N/A
<input type="checkbox"/> Application for Certificate of Approval (CofA) under the Ontario Water Resources Act.	N/A
<input type="checkbox"/> Changes to Municipal Drains.	N/A
<input type="checkbox"/> Other permits (National Capital Commission, Parks Canada, Public Works and Government Services Canada, Ministry of Transportation etc.)	N/A



#### 4.6 Conclusion Checklist

Criteria	Location (if applicable)
<input type="checkbox"/> Clearly stated conclusions and recommendations	Section 9.0 Summary  Section 10.0 Recommendations
<input type="checkbox"/> Comments received from review agencies including the City of Ottawa and information on how the comments were addressed. Final sign-off from the responsible reviewing agency.	All are stamped
<input type="checkbox"/> All draft and final reports shall be signed and stamped by a professional Engineer registered in Ontario	All are stamped