

1305 MARITIME WAY - GEOTECHNICAL REPORT

Project No.: CP-18-0534

Prepared for:

Silver Hotel Group
Suite 100
5830 Campus Road, Mississauga
ON K2G 6J8

Prepared by:

McIntosh Perry
104-215 Menten Place
Ottawa, ON K2H 9C1

April 2021

TABLE OF CONTENTS

1.0	INTRODUCTION	1
2.0	SITE DESCRIPTION	1
3.0	PROJECT UNDERSTANDING	1
4.0	FIELD PROCEDURES	2
5.0	IDENTIFICATION AND TEST PROCEDURES	2
6.0	SITE GEOLOGY AND SUBSURFACE CONDITIONS	3
6.1	<i>Site Geology.....</i>	3
6.2	<i>Subsurface Conditions.....</i>	3
6.2.1	Topsoil	4
6.2.2	Clayey Silt and Sand	4
6.2.3	Silty Sand	4
6.2.4	Gravelly Silty Sand	5
6.2.5	Bedrock.....	6
6.3	<i>Groundwater</i>	6
6.4	<i>Chemical Analysis</i>	7
7.0	DISCUSSIONS AND RECOMMENDATIONS	7
7.1	<i>General.....</i>	7
7.2	<i>Overview</i>	7
7.3	<i>Site Preparation.....</i>	8
7.4	<i>Foundation Excavation</i>	9
7.5	<i>Foundations.....</i>	9
7.5.1	Shallow Foundations	10
7.5.2	Pile Foundations	12
7.5.3	Rock-Socketed Cast-in-Place Concrete Caissons	15
7.5.4	Frost Protection	19
7.6	<i>Seismic Site Classification.....</i>	19
7.6.1	Liquefaction Potential	19
7.7	<i>Engineered Fill</i>	20
7.8	<i>Slabs-on-Grade.....</i>	20

7.9 Lateral Earth Pressure.....21

7.10 Pavement Structure21

7.11 Sidewalks and Hard Surfacing.....22

7.12 Cement Type and Corrosion Potential23

8.0 CONSTRUCTION CONSIDERATIONS 23

9.0 GROUNDWATER SEEPAGE..... 24

10.0 SITE SERVICES 24

11.0 CLOSURE..... 25

APPENDICES

- Appendix A – Limitations of Report
- Appendix B – Figures
- Appendix C – Borehole Records
- Appendix D – Laboratory Test Results
- Appendix E – Seismic Hazard Calculation
- Appendix F – Deep Foundation Analysis
- Appendix G – Relevant Standards

**GEOTECHNICAL INVESTIGATION and
FOUNDATION DESIGN RECOMMENDATION REPORT
1305 Maritime Way, Kanata, Ontario**

1.0 INTRODUCTION

This report presents the factual findings obtained from a geotechnical investigation performed at the above-mentioned site for the proposed six-storey hotel. The fieldwork was carried out on April 8, 2020, to April 15, 2020, and comprised of seven boreholes to a maximum depth of 19.1 m.

The purpose of the investigation was to explore the subsurface conditions at this site and to provide borehole location plans, a record of borehole logs, and laboratory test results. This report provides anticipated geotechnical conditions influencing the design and construction of the proposed six-storey hotel, as well as recommendations for foundation design. Recommendations are offered based on the authors' interpretation of the subsurface investigation and test results. The readers are referred to Appendix A, Limitations of Report, which has an integral part of this document.

The investigation was performed at the request of the Silver Hotel Group.

2.0 SITE DESCRIPTION

The site in general, and the proposed building footprint in particular, are located on a hill that slopes down from west to east, with the northwestern end of the building footprint situated on the upper elevation of the hill, while the southeastern end is situated on the toe of the hill, as per the latest site plan provided, and as shown on figure 2, in Appendix B. The site was vegetated with trees at the time of the investigation, except for the area in proximity of the boreholes, which had been cleared for the drilling operation.

The property limits are shown in figure 2, in Appendix B. To the northwest direction of the site, trees were observed to have been cleared for the construction of the proposed roadway connecting Maritime Way and Canadian Shield Ave. To the south was a 7-storey retirement home, recently constructed, and to the east, was a 5-storey Marriott Town Place Suites hotel building.

3.0 PROJECT UNDERSTANDING

It is understood that the proposed building is a 6-storey hotel, with its height at approximately 20.3 m, with no basement. The proposed building is to be constructed on an uneven landscape, the elevation at the northwestern end of the building is at about 103.0 MSAL, and the southeastern end at about 95.0 MASL, a total elevation difference of approximately 8 m. It is also understood that to the east of the building, within the property limits, a parking lot serving the hotel will be constructed with an entrance canopy leading into the hotel.

4.0 FIELD PROCEDURES

The staff of McIntosh Perry Consulting Engineers (McIntosh Perry) visited the site before the drilling investigation to mark out the proposed borehole locations for tree clearing, and to obtain utility clearance to identify the location of underground infrastructures. Utility clearance was carried out by Underground Service Locators (USL-1) on behalf of McIntosh Perry. Public and private utility authorities were informed, and all utility clearance documents were obtained before the commencement of drilling work.

The equipment used for drilling was owned and operated by CCC Geotechnical & Environmental Drilling Ltd. of Ottawa, Ontario. Boreholes were advanced using hollow stem augers aided by track-mounted CME 850 drill rig. Boreholes were advanced to a maximum depth of 19.1 m (El. 77.1 m) below the ground level. Soil samples were obtained at 0.75 m intervals in boreholes using a 50 mm outside diameter split spoon sampler following the Standard Penetration Test (SPT) procedure. Boreholes were backfilled with auger cuttings and restored to the original surface. Borehole locations are shown in Figure 2, included in Appendix B.

5.0 IDENTIFICATION AND TEST PROCEDURES

All samples were logged as retrieved, and visual description and soil type identification were added to the logs. Subsequently, soil descriptions were confirmed by additional tactile examination of the soils in the laboratory. Laboratory testing on representative SPT samples was performed at McIntosh Perry geotechnical lab and included moisture content, grain-size distribution, and Atterberg Limit tests. The laboratory tests to determine index properties were performed in accordance with the American Society for Testing Materials (ASTM) test procedures.

Paracel Laboratories Ltd., in Ottawa, carried out chemical tests on one representative soil sample to determine the soil corrosivity characteristics. In addition, LRL Associates Ltd., in Ottawa, carried out rock core unconfined compressive strength tests.

Test procedures are listed below;

ASTM C117 – Materials Finer than 75 µm (No. 200) Sieve by Washing (LS-601)

ASTM C136 – Sieve Analysis of Fine and Coarse Aggregates (LS-602)

LS-702 – Determination of Particle Size Analysis of Soils

ASTM D2216 – Laboratory Determination of Water Content of Soil and Rock by Mass

ASTM D4318 – Liquid Limit, Plastic Limit, and Plasticity Index of Soils (LS-703/704)

ASTM D1586 – Standard Penetration Test (SPT) and Split-Barrel Sampling of Soils

ASTM D2573 – Field Vane Shear Test in Saturated Fine-Grained Soils

The rest of the soil samples recovered will be stored in McIntosh Perry storage facility for a period of one month after submission of the final report. Samples will be disposed of after this time unless otherwise requested in writing by the Client.

6.0 SITE GEOLOGY AND SUBSURFACE CONDITIONS

6.1 Site Geology

Based on published physiography maps of the area (Ontario Geological Survey), the site is located within the Ottawa Valley Clay Plains. Surficial geology maps of southern Ontario indicate the site is underlain by Precambrian Bedrock, with expected shallow elevation of bedrock, surrounded by fine-textured glaciomarine deposits and organic deposits. Glaciomarine deposits in this region are predominantly quiet water silt and clay deposited in post glaciation lakes.

The Ottawa Valley between Pembroke and Hawkesbury, Ontario, consists of clay plains interrupted by ridges of rock or sand. It is naturally divided into two parts, above and below Ottawa, Ontario. Within the valley, the bedrock is further faulted so that some of the uplifted blocks appear above the clay beds. The sediments themselves in the valley are deep silty clay. Although the clay deposits are grey in color like the limestones that underlie them in part, they are only mildly calcareous and likely derived from the more acidic rock of the Canadian Shield.

Bedrock geology maps show Clastic metasedimentary rocks, Conglomerate, wacke, quartz arenite, arkose, limestone, siltstone, chert, minor iron formation, minor metavolcanic rocks of Grenville Supergroup and Flinton Group.

6.2 Subsurface Conditions

In general, the site stratigraphy consists of various layers of topsoil, clayey silt and sand, silty sand, and gravelly sand, followed by bedrock, which extends to the maximum depth of investigation in borehole 20-1. For classification purposes, the soils encountered at this site can be divided into five major zones.

- a) Topsoil
- b) Clayey Silt and Sand
- c) Silty Sand
- d) Gravelly Silty Sand
- e) Bedrock

The soils encountered during the investigation, together with the field and laboratory test results, are shown on the Record of Borehole sheets included in Appendix C. Laboratory test results are included in Appendix D. Description of the strata encountered are given below.

6.2.1 Topsoil

The topsoil layer's thickness varies between borehole 20-1 through 20-5. Between borehole 20-1, 20-2, and 20-3, the topsoil layer was observed to be dark brown to reddish-brown silty sand to sand, with traces of gravel and a presence of organic deposits, peat, and tree roots. The topsoil layers in these boreholes were observed to have a thickness ranging from 0.1 m to 2.3 m. For borehole 20-4 and 20-5, the topsoil layers were observed to be dark brown to black silty clay, with the presence of organic deposits, ranging from a thickness of 0.1 m to 0.2 m.

6.2.2 Clayey Silt and Sand

Underlying the topsoil in borehole 20-1, was a layer of clayey silt and sand with traces of gravel, observed to be grey, dry to wet, and compact to soft. The SPT 'N' value ranges from 1 to 19 blows/300mm. Two samples underwent the Atterberg Limit test, and results showed the liquid limit to be on average 26.6% and the plastic limit to be 14.2%. In addition, two representative samples underwent grain size analysis testing, and the layer was observed to contain, on average, 4.0% gravel, 35.5% sand, 35% silt, and 25.5% clay. A summary of the grain size distribution for this layer is shown in table 1. Test results are shown in Figure 3 to 5, included in Appendix B.

Table 6-1 Grain Size Distribution of the Clayey Silt and Sand Layer

Grain Size	Range (%)
Gravel	2 – 6
Sand	34 – 37
Silt	32 – 38
Clay	23 – 28

6.2.3 Silty Sand

Below the clayey silt and sand layer in borehole 20-1, and below the topsoil layer in 20-2, was a layer of silty sand. In borehole 20-1, this layer was observed to be grey in color with some gravel and traces of clay, wet, and loose. The SPT 'N' values range from 3 to 10 blows/300mm. One representative sample underwent grain size analysis testing, and the layer was observed to contain 14% gravel, 47% sand, 30% silt, and 9% clay. A summary of the grain size distribution for this layer in BH20-1 is shown in table 2.

Table 6-2 Grain Size Distribution of the Silty Sand Layer in BH20-1

Grain Size	(%)
Gravel	14
Sand	47
Silt	30
Clay	9

In borehole 20-2, this silt sand layer was observed to be between the depth of 1.1 m and 3.8 m, as well as from 7.2 m to 9.1 m. The upper layer was observed to be relatively more compact, with SPT 'N' values from 42 to 56 blows/300mm, whereas the SPT 'N' values for the deeper layer were observed to range from 0 to 20 blows/300mm. Two representative samples underwent grain size analysis testing and were found to contain, on average, 15% gravel, 45% sand, 31.5% silt, and 8.5% clay. A summary of the grain size distribution for this layer is shown in table 3. Test results are shown in Figure 3 to 5, included in Appendix B

Table 6-3 Grain Size Distribution of the Silty Sand Layer in BH20-2

Grain Size	Range (%)
Gravel	11 – 19
Sand	40 – 50
Silt	31 – 32
Clay	8 – 9

6.2.4 Gravelly Silty Sand

A layer of gravelly silty sand was observed above the bedrock in borehole 20-1. This layer was found to be grey, moist to wet, and compact to dense, with SPT 'N' values ranging from 25 to 102 blows/300mm, with spoon refusal in the lower end of this layer. In borehole 20-1, one representative sample underwent grain size analysis testing, and this layer was found to contain, on average, 18.5% gravel, 32.5% sand, and 49% fines. A summary of the grain size distribution for this layer is shown in table 4. Test results are shown in Figure 3 to 5, included in Appendix B

Table 6-4 Grain size Distribution of the Gravelly Silt and Sand Layer

Grain Size	Range (%)
Gravel	15 – 22
Sand	19 – 46
Fines	32 – 66

6.2.5 Bedrock

Bedrock was cored at three boreholes, BH20-1 through BH20-3, once refusal to auger drilling was encountered. The rock is sedimentary and metasedimentary bedrock. Rock varied in composition through the depth and between boreholes. The rock is mostly carbonate and composed of conglomerates to some extent. Rock core photo logs are shown in Appendix C. Details of rock coring are shown in Table 6-5. Selected rock core samples were tested for unconfined compressive strength, and results are shown in Table 6-6.

Table 6-5 Rock Coring Depths and Quantities

Borehole	Borehole Surface El. (m)	Rock Surface Depth (m)	Rock Surface El. (m)	Total Length of Cored Rock (m)	Notes
BH20-1	96.2	16.4	79.9	2.7	
BH20-2	98.5	12.7	85.7	3.1	
BH-20-3	103.1	4.0	99.1	3.5	
BH20-7	100.0	3.5	96.5	0	Inferred rock at refusal

Table 6-6 Rock Cores Unconfined Compressive Strengths

Borehole	Rock core	Sample Depth (m)	Sample El. (m)	Unconfined Compressive Strength (MPa)
BH20-1	RC-21	18.0	78.2	57.3
BH20-2	RC-19	14.6	83.9	44.3
BH20-3	RC-7	5.3	97.8	107.6

6.3 Groundwater

A monitoring well was installed in borehole BH20-7, and its assembly is shown on the borehole log. The groundwater table was monitored on the following dates.

Borehole	Monitoring Date	Surface El. (m)	Groundwater Depth (m)	Water Table El. (m)
BH20-7	2020-05-27	100.0	1.64	98.3

6.4 Chemical Analysis

The chemical test results conducted by Paracel Laboratories in Ottawa, Ontario, to determine the resistivity, pH, sulphate and chloride content of representative soil samples are shown in Table 6-5 below. Chemical test results are included in Appendix D.

Table 6-7: Soil Chemical Analysis Results

Borehole	Sample	Depth / El. (m)	pH	Sulphate (%)	Chloride (%)	Resistivity (Ohm-m)
BH20-1	SS-04	2.3 – 2.9	7.71	0.0023	0.0263	23.1
BH20-1	SS-09	6.1 – 6.7	7.86	0.0100	0.0016	62.6
BH20-1	SS-16	11.4 – 11.8	7.86	0.0065	0.0026	58.5
BH20-2	SS-04	2.3 – 2.9	7.93	0.0005	0.0013	111
BH20-2	SS-09	6.1 – 6.7	8.07	0.0082	0.0022	67.9
BH20-2	SS-15	10.7 – 11.3	8.94	0.0070	0.0011	88.8
BH20-3	SS-04	2.3 – 2.7	7.77	<0.0005	0.0015	94.0

7.0 DISCUSSIONS AND RECOMMENDATIONS

7.1 General

This section of the report provides engineering recommendations on the geotechnical design aspect of the project based on the project requirements and our interpretation of the subsurface soil and bedrock information. The recommendations presented herein are subject to the limitations noted in Appendix A “Limitations of Report” which forms an integral part of this document.

The foundation engineering recommendations presented in this section have been developed following Part 4 of the 2012 Ontario Building Code (OBC) extending the Limit State Design approach.

7.2 Overview

It is understood that the proposed hotel is a six (6) storey structure with no basement. It is also understood that the finished floor elevation for the proposed development will be at 98.15 m.

For the current project, the following list summarizes some key geotechnical facts that were considered in the suggested geotechnical recommendations:

- The expected foundation loads for the six (6) storey hotel are significant and will need to be supported on the underlying bedrock by means of a combination of the following foundation options:

- Spread footing founded on or within the bedrock;
 - Spread footing founded on mass concrete that extends to the bedrock surface;
 - Drilled cast-in-place concrete caisson socketed into the bedrock; and/or,
 - Steel piles driven to the bedrock surface.
- The proposed structure can be designed using a seismic Site Class C provided that the boundary zones of the shear walls and all column loads are extended to and supported on the bedrock surface, using either spread footings or caissons. Otherwise, Site Class E would be required.
 - The bedrock was observed to slope down from northwest to southeast, at a variant gradient ranging from approximately 1V:1.4H between BH20-2 and BH20-3, and to 1V:5.2H between BH20-1 and BH20-2. The drop in bedrock elevation of between Bh20-2 and BH20-3 is approximately 13.4 m, and between Bh20-1 and BH20-2 is approximately 5.8m.
 - A large portion of the site, including the footprint of the proposed hotel, is underlain by incompetent topsoil and peat deposits of various thickness ranging. The topsoil and peat are not considered acceptable for the support of the foundation, slab-on-grade, or any site grading fill. Consideration should be given to sub-excavating the topsoil and peat, and replacing with compacted engineered fill, especially within the building footprint.
 - Should topsoil and peat removal be required, it should be possible to handle the groundwater inflow to the excavation by pumping from well-filtered sumps established on the floor of the excavation. The actual inflow into the excavation will depend on many factors including: the contractor's schedule and the rate of excavation, the size of the excavation, and the time of the year at which the excavation is to occur. Based on the encountered stratigraphy, the amount of groundwater intake is expected to stay below the PTTW limit. If more precise information on potential groundwater seepage is needed, a separate permeability test can be carried in the existing monitoring well as part of a separate scope of work.

7.3 Site Preparation

As previously noted, a large portion of the site is underlain by a thick deposit of topsoil, peat clayey silt and sand, and silty sand/sandy silt.

The topsoil and peat are not considered acceptable for the support of the slab-on-grade and other elements of the design sensitive to excessive settlement. Anywhere on the site, the loads from the site grading will overstress the topsoil and peat and potentially lead to excessive settlements. It is also recommended that the existing topsoil and peat or organic and loose soil materials be excavated from the parking lot and access road area. If a decision is made to keep the existing topsoil and peat or organic and loose soil materials beneath the

parking lot and access road, the pavement structure might experience excessive uneven settlement that will result in damaging the pavement surface.

7.4 Foundation Excavation

It is understood that no basement is provisioned. The expected foundation level will be at about an elevation of 96.2 m. Excavation for the construction of the foundation will proceed through the topsoil, peat, native soil, and bedrock. Excavating of overburden soil shall be performed using conventional hydraulic excavating equipment; Large-size of rock fill, cobbles, and boulders may be encountered. The Occupational Health and Safety Act (OHSA) of Ontario indicated that side slopes in the rock fill above the water table could be classified as Type 3 soil and sloped no steeper than 1H:1V. In accordance with OHSA of Ontario, topsoil, peat, and native soil below the water table are classified as Type 4 soil, and excavation side slopes must be sloped at a minimum of 3H:1V or be shored.

Boulders larger than 0.3 meters in diameter should be removed from the excavation side slopes for worker safety.

Depending on space restrictions, shoring may be required to carry out the excavations. Further guidelines on shoring systems can be provided when needed.

At the time of the investigation, the groundwater level in the proximity of the area of the proposed hotel was measured in a monitoring well installed in BH20-7. The reading was taken a week after installation to allow the groundwater table to come to equilibrium and stabilize in the well. The water table was found to be at elevation 98.3 m, which is above the expected depth of excavation.

Under the new regulations (O.Reg 63/16 and O.Reg 387/04), a PTTW is required from the Ministry of the Environment and Climate Change (MOEC) if a volume of water greater than 400,000 liters per day is pumped from the excavation under normal operation. However, for more than 50,000 liters per day, the water taking will not require a PTTW, but will need to be registered in the EASR as a prescribed activity.

7.5 Foundations

In general, the subsurface conditions in the area of the proposed hotel consist of a layer of topsoil and peat overlying discontinuous deposit of silty clay, silty sand, and/or gravelly silty sand (glacial till), over sedimentary and metasedimentary bedrock. The elevation of the bedrock is quite variable across the building footprint, ranging from about elevation 79.9 m at the southeastern corner to about elevation 99.1 m at the northwestern corner of the building.

It is understood that the finished floor elevation for the new building is proposed to be at 98.15 m, and the underside of the foundations will likely be at an elevation of 96.2 m. Based on these elevations, it appears that the bedrock surface would be above the foundations level on the northwestern portion of the building, and bedrock surface depth increases as moving towards the southeastern portion of the building to a maximum

depth of 17 m. The bedrock surface is sloped down from northwest to southeast at a variant gradient ranging from 1V:1.4H to 1V:5.2H between BH20-2 and BH20-3, and between BH20-1 and BH20-2, respectively.

The topsoil and peat that underlies the building are not considered suitable to support the loads from the structure; these loads would lead to substantial and unacceptable settlements. Therefore, a deep foundation system should be used to transfer the foundation loads through the topsoil and peat, which has to be cleared from the building footprint to a more competent bearing stratum at depth or to the bedrock.

Two foundation options that can be considered where the bedrock is deep:

- Rock-socketed cast-in-place concrete caissons; or,
- Driven steel pile foundations.

As previously noted, the underside of the foundations' level of the proposed structure would be deeper than the bedrock surface on the northern portion of the building. A foundation alternative that can be considered where the bedrock is shallower would be:

- Spread footings founded on or within the bedrock; or,
- Spread footings founded on mass concrete that extends to the bedrock surface.

Spread footings on silty sand or glacial till are not recommended. The silty sand and glacial till are wet and, therefore, likely quite sensitive to disturbance. In addition, differential settlement may occur in the area where footings are founded on both bedrock and silty sand and/or glacial till due to the difference in material stiffness and settlement properties. It is therefore proposed that the entire structure be supported on the underlying bedrock using deep foundations and/or shallow spread footing foundations.

7.5.1 *Shallow Foundations*

For shallow spread footings, the overburden soil and rock below the columns and foundation walls can be excavated to the level of founding down to the bedrock surface and then either:

- Spread footings constructed directly on the deeper bedrock; or,
- The excavation filled back up to a higher founding level using mass lean concrete.

7.5.1.1 *Bearing Resistance*

Provided there are no continuous soil-filled seams or mud seams present at shallow depth in the bedrock below the founding level, footings on the bedrock surface, or a platform of lean concrete of compressive strength of greater than 15 MPa extending down to the bedrock surface, may be designed using an Ultimate Limit State (ULS) factored bearing resistance of 2,000 kPa.

The ULS factored bearing resistance was estimated using the Rock Mass Rating (RMR) method by Bieniawski (1989). RMR method was utilized to determine the required parameters for bearing capacity resistance at ULS conditions for the bedrock.

Based on the bedrock cores quality and uniaxial compressive strength tests, the following ratings are estimated:

- Average compressive strength of intact rock rating: The average uniaxial compressive strength of three rock core samples was approximately 75 MPa, which results in rating = 7,
- RQD rating: The RQD of the rock core ranges 74 to 100, which results in rating = 17,
- Joint spacing rating: The joint spacing for the rock core samples ranges from 50 -300mm, which gives an estimated rating = 10,
- Joint condition: The joint condition was observed to be slightly rough, and the rating is estimated to be = 20,
- Ground water rating: groundwater elevation was measured in a monitoring well installed in BH20-7 and was at level 98.3 m. Therefore, the estimated rating for water condition = 4; and
- Orientation rating: The fractures were observed to be oriented at approximately 80° to 90° with respect to load direction; therefore, fair rating was estimated = -7.

The RMR for the rock approximately equals (51) which can be classified to have fair rock quality.

Assuming the above-noted conditions are provided, the following bearing capacity can be used for structural design.

Table 7-1: Rock Bearing Capacities

Footing Type	ULS (kPa)	SLS (kPa)
square footings	2,000	1,000

The provided factored bearing resistance at ULS is based on the uniaxial compressive strength of rock. The size of the selected footing shall be determined by structural engineer. The selected size of the footing shall have adequate compressive strength to provide resistance to the structural loads from the building and to avoid failure in concrete material under the applied pressure. Shallow footings shall not be smaller than 0.75 m in their smaller dimension.

Provided the bedrock surface is properly cleaned of soil and weathered material at the time of construction, the settlement of footings sized using the above factored bearing resistance should be negligible. However, since the bedrock is sloped down at approximately 35°, the allowable bearing capacity should be reduced to

account for the reduced lateral resistance provided by the smaller mass of rock on the downslope side of the footing. Given that the spread footing will be socketed or bearing at a minimum depth equals its width in the rock, the allowable bearing capacity shall not exceed 1,000 kPa with a factor of safety of 2.5, and should govern the foundation design.

Highly weathered or fractured bedrock, which includes bedrock that can be excavated using hydraulic excavating equipment with only moderate effort, would need to be removed and replaced with concrete.

The rock bearing surface should be inspected by qualified geotechnical personnel to confirm that the surface has been acceptably cleaned of soil, and that weathered or excessively fractured bedrock has been removed.

7.5.1.2 Resistance to Lateral Loads

The factored ultimate resistance of the footings to lateral loading 'shear resistance for sliding' across the interface between the footing, and the bedrock may be calculated using Mohr-Coulomb criterion with load and resistance factored given in Table 7-2.

Table 7-2: f Values of Minimum Partial Factors after Meyerhof (1984) (Wyllie 2009)

Category	Item	Load Factor	Resistance factor
Loads	Dead Loads	1.25	--
	Live Loads, Wind, earthquake	1.5	--
	Water Pressure	1.25	--
Shear strength	Cohesion "c" - stability, earth pressure	--	0.65
	Cohesion "c" - Foundation	--	0.5
	Friction angle " ϕ "	--	0.8

7.5.1.3 Frost Protection

Based on the freezing index for the Southern Ontario Region provided for this site, the frost penetration depth is expected at 1.8 m below the ground surface. All perimeter and exterior foundation elements or interior foundation elements in unheated areas should be provided with a minimum of 1.8 meters of earth cover for frost protection purposes. Frost protection depth can be reduced to 1.5 m for those buildings constantly heated during the cold season.

7.5.2 Pile Foundations

It is considered that where the bedrock surface starts to deepen, and placing mass concrete is no longer feasible, the new structure can be supported on driven steel pipe piles.

However, the rock fill and/or glacial till that overlies the bedrock at this site contains numerous cobbles and boulders. It is expected that some of the piles will have difficulty penetrating to the bedrock at depth and may encounter refusal at a shallower depth in the rock fill or glacial till. Pre-drilling of the overburden will likely be required for most of the piles, and a provision for pre-drilling should be included in the budget.

For short piles that are less than about 3 m in length, the shallow depth of the overburden soil may not provide adequate resistance to lateral movement, and the pile may not be stable. In order to improve the stability of the pile, considerations can be given to providing structural fixity between the pile and the pile cap as well as between the pile and the bedrock surface, the structural fixity at the pile cap would be designed by structural engineer. However, it would likely involve increasing the embedment length of the pile into the pile cap. At the bedrock surface, the piles can be socketed into the bedrock so that rotation will be prevented. With this arrangement, there should be no technical restriction on the minimum pile length.

7.5.2.1 Axial Resistance

As one possible design example, the ULS factored structural resistance of a 245 mm diameter steel pipe pile with a wall thickness of at least 9 millimeters may be taken as 1,000 kN. The provided resistance assumes that steel with a yield stress (f_y) of 350 MPa and concrete with a compressive strength (f_c') of 35 MPa are used. Assuming the ULS factored structural load from the building per column equals 3,000 kN, a group of 3 piles connected by a pile cap will be required to support each column.

The ULS factored geotechnical resistance of the pile, if founded on bedrock, should equal to or exceed the structural resistance if the piles are installed using an appropriate set criterion and using a hammer of sufficient energy.

Pipe piles must be equipped with a driving shoe having a thickness of at least 20 mm to limit damage to the pile tip during driving.

For piles end-bearing on or within bedrock, SLS generally do not govern the design since the stresses required to induce 25 mm of settlement, as per SLS criteria, exceed those at ULS. Accordingly, the post-construction settlement of structural elements which derive their support from piles bearing on bedrock may be neglected.

The pile termination or set criteria for driven piles will be highly dependent on the pile driving hammer type, helmet, selected pile, and length of the pile. All of these factors must be taken into account while establishing the driving criteria to ensure that the piles will have adequate capacity yet are not overdriven and damaged. In this regard, it is generally accepted practice to reduce the hammer energy after abrupt peaking is met on the bedrock surface, and to gradually increase the energy over a series of blows to seat the pile.

As previously noted, the depth to the bedrock surface varies across the site. Some pile bending or breakage should be expected. The piles should, therefore, be equipped with rock points, such as Titus SK-6140 rock injector points, to assist in seating the piles on the sloping bedrock surface. Further, the deriving energy should be reduced by about 75 percent, and only 25 percent of the nominal driving energy should be used when

contact with the bedrock is made. The lower energy should be maintained to chip the rock injector point into the bedrock, after which the energy may be gradually increased to the design set.

Relaxation of the piles following the initial set can result from several processes, including:

- Softening of the bedrock into which the piles are driven;
- Dissipation of negative excess pore water pressure in the dense silty or glacial till deposit above the bedrock surface; and,
- Driving of adjacent piles.

Provision should be made for restriking all the piles at least once to confirm the design set and/or the permanence of the set and to check for upward displacement due to driving adjacent piles. Piles that do not meet the design set criteria on the first restrike should receive additional restriking until the design set is met. All restriking should be performed no sooner than 24 hours after the previous set.

It is recommended that the contractor performs dynamic monitoring and capacity testing at an early stage in the piling operation to verify both the transferred energy from the pile driving equipment and the load-carrying capacity of the piles. Further guidelines can be provided on the testing frequency to be included in the specification once the foundation design has been finalized. However, as a preliminary guideline, the specification should require that at least 10 percent of the piles be included in the dynamic testing program. Case method estimates of the capacities should be provided for all piles tested. These estimates should be provided in a field report on the day of testing. In addition, Case Pile Wave Analysis Program (CAPWAP) should be carried out for at least one-third of the piles tested, with results provided no later than one week following testing. The final report should be stamped by a professional engineer.

The purpose of the Pile Driving Analyzer (PDA) testing will be to confirm that the contractor's proposed set criterion is appropriate and that the provided pile geotechnical capacity is being achieved. It will, therefore, be necessary for the piles to have sufficient structural capacity to survive that testing, which can require a stronger pile section than would otherwise be required by the design loading.

For example, for the PDA testing to be able to record/confirm a factored geotechnical resistance of 1,000 kN, it will be necessary to successfully proof load the tested piles to 2,000 kN during PDA testing considering a resistance factor of 0.5 to be applied to PDA test results. However, that proof load may exceed the actual structural capacity of the piles. If the piles structurally fail at a lower load, then the full geotechnical capacity cannot be confirmed. In other words, piles will have been damaged and will need to be wasted.

The following options can, therefore, be considered:

- Piles with a structural capacity higher than the geotechnical capacity may be specified, so that the piles can be successfully tested with PDA testing to the required loading. In other words, piles with a ULS

factored structural resistance higher than the factored geotechnical resistance, and higher than required by the design loading may be specified. However, this option can increase the cost of the piled foundation significantly.

- A reduced ULS factored geotechnical resistance can be used for the design; for example, 750 kN instead of 1,000 kN, such that the piles would have sufficient structural capacity to be loaded to twice the design geotechnical resistance. This option would again increase the cost for the piled foundations, by increasing the number of piles that would be required.

7.5.2.2 *Resistance to Lateral Loading*

It is understood that all of the lateral loadings will be resisted by the rock-socketed caisson foundation as it is the preferred option. If pile foundation is selected, soil and structure interaction curves can be calculated based on the structural design. However, this level of detail for the pile analysis shall be done in collaboration with the structural engineer, and it depends on the group pile arrangement for each pile cap.

7.5.3 *Rock-Socketed Cast-in-Place Concrete Caissons*

The use of liner or casing will be required to advance the caisson with minimal loss of ground since the overburden materials would not stand unsupported. It is also recommended that the casings be left-in-place as a permanent component of the caissons. Otherwise, if the casings are withdrawn during the pouring of concrete, there is a risk of creating defects due to movement of soil into the concrete. Additionally, it will be difficult to clean the bedrock socket/surface, even with the use of casings, unless the casings are socketed into the bedrock.

The axial resistance of caisson foundation is primarily based on sidewall or shaft shear resistance rather than the end bearing. The caisson can, therefore, be socketed into the bedrock and designed based on sidewall shear resistance.

To provide suitable fixity, the caisson should be provided with a minimum socket length equal to two (2) times the socketed diameter. A minimum caisson diameter of 0.9 m or greater is recommended to facilitate inspection.

Since it may not be feasible to dewater the sockets, it should be planned to use tremie technique to construct the caissons under wet condition.

It should be noted that casing installation through the boulder rockfill or glacial till will be difficult. The foundation installation contractor should be made aware that significant amounts of chiseling/churn drilling or other methods will be required to advance the caissons through the rockfill and glacial till.

The sedimentary limestone bedrock is strong to very strong with uniaxial compressive strength ranges from 44 MPa to 107 MPa. The caisson rock sockets will have to be advanced by rock coring, chisel/churn drilling, and/or a down-the-hole hammer technique.

7.5.3.1 Axial Resistance

Rock-socketed caissons should be designed based on the sidewall or shaft resistance of the rock socket and a factored geotechnical resistance of 3,000 kPa. The factored geotechnical resistance was estimated following recommendations available in Canadian Foundation Engineering Manual (CFEM) (2006). The geotechnical resistance factor of 0.4 is used to estimate the factored geotechnical resistance as per CFEM. The shaft resistance at ULS was estimated using the following formula:

$$Q_s = q_s \cdot A_s$$

Where:

- Q_s = socket shaft resistance (kN);
- A_s = area of the socket sidewall;
- q_s = unit shear resistance along the socket.

Many formulas are available to estimate q_s based on uniaxial compressive strength of intact rock. The following formula is recommended by CFEM.

$$\frac{q_s}{P_a} = b \left(\frac{\sigma_{ci}}{P_a} \right)^{0.5}$$

Where:

- σ_{ci} = uniaxial compressive strength, average value was taken as 75 MPa,
- P_a = atmospheric pressure (101.3 kPa)
- b = an empirical factor = 0.63 (Carte and Kulhawy, 1988).

However, if the concrete compressive strength (f'_c) is less than σ_{ci} , the allowable bearing pressure shall not exceed $0.05 f'_c$.

The SLS resistances do not apply to caissons socketed in the bedrock since the SLS resistance for 25 mm of settlement is greater than the factored axial geotechnical resistance at ULS.

7.5.3.2 Uplift Resistance

Socketed foundations uplift capacity is developed from both sides and tip resistance. However, due to associated construction difficulties related to cleaning of the bottom of a socket hole, it is prudent to ignore the tensile resistance developed at the tip, and only side resistance should be considered.

Given that the shaft is relatively rigid, the factored uplift resistance can be taken as 70 % of the factored axial resistance based on socket shaft resistance.

Alternatively, CFEM suggests that uplift resistance can be estimated based on average uniaxial compressive strength of intact rock using the following formula:

$$q_a = \sigma_c K_{sp} d$$

where

- q_a = allowable bearing pressure;
- σ_c = average unconfined compressive strength of rock;
- $K_{sp} = 0.1$, an empirical factor including a factor of safety of 3;
- d = depth factor = $1 + 0.4\left(\frac{L_s}{B_s}\right) \leq 3$
- L_s = depth or length of socket
- B_s = diameter of socket.

The ultimate axial capacity can be calculated as multiplying the allowable bearing capacity by three. The factored geotechnical resistance at ULS condition for uplift can be obtained by multiplying the ultimate capacity by a geotechnical resistance factor of 0.3.

It is noteworthy, that the first approach provided a more conservative factored geotechnical uplift resistance, and is recommended to consider.

7.5.3.3 Resistance to Lateral Loads

It is understood that all of the lateral loads will be transferred to the underlying soil and bedrock. Lateral load analysis was performed using LPile program. Since the bedrock sloped down from northwest to southeast, the caisson foundation will have different lengths at different locations within the building footprint. Three rock-socketed concrete caissons of different lengths under an axial load of 3,000 kN were modelled: short length caisson of 4.6 m long, medium length caisson of 11.8 m long, and long caisson of 18.1 m long.

All the caissons were modelled with a round concrete section of 0.9 m diameter. Rebar reinforcement of yield stress (f_y) of 400 MPa, circular single bar arrangement with steel ratio of 1.87% was used. The concrete annulus to edge of bar was set at 75 mm with concrete compressive strength (f'_c) of 35 MPa.

Soil and rock were modelled using built-in models within the LPILE software. Soil and bedrock mechanical properties were estimated based on field and laboratory tests. The lateral soil subgrade reaction may be estimated using the following formula given by (Terzaghi 1955) and (NAFAC design Manual DM7.2 1982). Due to subgrade disturbance associated with drilling, the coefficient of horizontal subgrade reaction for the first three (3) m was set to zero.

$$k_h = \frac{f \cdot Z}{D}$$

where:

- k_h = coefficient of horizontal subgrade reaction;
- f = a soil type and condition-related factor given in the following table (kN/m^3);
- Z = depth (m);
- D = caisson diameter (m); and

Since the estimated k_h value using the above formula increases significantly at greater depths, Bowles (1996) recommended using $(Z/D)^n$

n = is a fitting parameter ranged between 0.4 to 0.7

Table 7-3: f Values for Coefficient of Horizontal Subgrade Reaction below the foundation level

Values for f				
Soil layer	Depth (m)	Estimated Relative Density, D_r (%)	f (kN/m^3)	Average k_h (kN/m^3)
Clayey silt and sand	0 - 3	--	--	0
	4.6	30	800	4,000
Silty Sand / Sandy silt	3 – 16.3	30 - 65	800 – 3,000	6,000 – 22,000
Till	8.2 – 9.1	40 - 70	1,400 – 3,400	6,500 – 17,000

The coefficient of horizontal subgrade reaction may need to be reduced, based on the caisson spacing, to account for pile group effects, if the structural design places caissons at close spacing. The reduction factors to be used for a pile group-oriented in the direction of loading are provided in Table 7-4. Intermediate values may be obtained by linear interpolation.

Push-over analysis was performed to determine the lateral load with respect to pile head horizontal displacement which is presented in Appendix F. In addition, p-y curves were obtained by changing the pile head boundary conditions, specifically, displacement and slope and several load cases were generated (Load Case 1 through Load Case 15). Since preliminary design considers fixed pile head condition, the slope of the pile head was set to zero for all load cases. The pile head displacement boundary conditions were increased by constant increments to a maximum lateral displacement of 25.4 mm (1") to generate the soil-pile interaction curves.

The number of increments was 15, including an initial increment of very small displacement of (approximately zero) to develop the full lateral load-pile head displacement curve. p-y curves data for every meter of depth are presented in Appendix F in a table format along with a few soil and pile interaction curves, including bending moment, shear force, soil reaction, lateral displacement with depth.

**Table 7-4: Coefficient of Horizontal Subgrade Reaction Reduction Factors for Pile Spacing
(Prakash and Sharma 1990)**

Pile Spacing Centre-to-Centre	Horizontal Subgrade Reaction Reduction Factor
3D	0.25
4D	0.40
6D	0.70
8D	1.00

7.5.4 Frost Protection

Based on the subsurface investigation results, the encountered native silty sand/silt and sand are classified as low to moderate susceptibility material. Frost susceptibility is categorized in the MTO Pavement Design and Rehabilitation Manual which is considered for the design of pavement structures. Frost penetration depth is 1.8 m below the surface for the subject site. Frost penetration depth is estimated based on the OPSD 3090.101, Foundation Frost Penetration Depths for Southern Ontario.

All perimeter and exterior foundation elements, or interior foundation elements in unheated areas should be provided with a minimum of 1.8 m of earth cover for frost protection purposes.

7.6 Seismic Site Classification

Seismic site classification is completed based on OBC 2012 Section 4.1.8.4 and Table 4.1.8.4.A. This classification system is based on the average soil properties in the upper 30 m and accounts for site-specific shear wave velocity, standard penetration resistance, and plasticity parameters of cohesive soils.

Based on the subsurface condition and field and SPT values, the site can be classified as Seismic Site Class (C) provided that the boundary zones of the shear walls and all column loads are extended to and supported on the bedrock, using either spread footings or caissons. Otherwise, Site Class E would be required.

7.6.1 Liquefaction Potential

Soil stratigraphy for the hotel site consists of a relatively thick layer of silt sand/sandy silt layer that extends to approximately 16.0 m below the proposed level of the hotel in BH20-1 and approximately 11.0 m in BH20-2. The native silty sand/sandy silt layer is underlain by dense glacial till followed by bedrock.

Herein liquefaction susceptibility of the native clayey silt and sand, and silty sand/sandy silt layers was evaluated. The native clayey silt and sand, silty sand/sandy silt, and glacial till were found non-susceptible to liquefaction. The results of the analysis are presented in Appendix E.

7.7 Engineered Fill

For shallow foundation, lean concrete is recommended for any grade adjustment on the bedrock due to over excavation within footing influence zone (1H:1V) slope. Lean concrete with compressive strength of a minimum of 15 MPa is adequate.

The proposed engineered fill, beyond footings influence zone, can be any material conforming to granular criteria as outlined in OPSS.MUNI 1010. Material conforming to 'Granular' criteria are considered free draining and compactable and can be utilized as the engineered fill. This can apply to the backfill beyond foundation walls and engineered fill in between the footings. The engineered fill shall be compacted to a minimum of 98% SPMDD.

The native soil shall not be used for any portion of the design with a specified compaction target. It is noteworthy that among all material noted in OPSS 1010, Select Subgrade Material (SSM) tolerates the highest percentage of fine component, which is 25%. Ten grain size analysis was carried out for this site and resulted in approximately 30 to 66 % fines, which makes the material unsuitable for compaction when anticipated load bearing and controlled deformation is expected.

All fill should be placed in horizontal lifts of uniform thickness of no more than 300 mm before compaction at appropriate moisture content determined by the Proctor test. The requirement for fill material and compaction may be addressed with a note on the structural drawing for foundation or grading drawing, and with a Non-Standard Special Provision (NSSP). Any topsoil, organics, or loose sand should be removed before placing engineered fill material.

7.8 Slabs-on-Grade

Slab-on-grades are considered free-floating (not attached to the foundation walls) and should be supported on a minimum of 200 mm of Granular A bedding compacted to 100% SPMDD. The requirements of the fill underneath slab-on-grade is noted in section 7.7 Engineered Fill.

If the slab on grade is proposed to support concentrated linear or point loads, the design loading shall be indicated in the structural specifications.

It is recommended that subgrade preparation and compaction efforts are approved under the supervision of a geotechnical representative.

It is understood that the modulus of subgrade reaction (k) is needed for the design of the slab on grade. Modulus of subgrade reaction is a multi-function complex correlation that varies with the subgrade material,

grade-raise fill material, and the flexural stiffness of the structural slab. However, simplified assumptions were made to estimate the spring modulus for slab-on-grade on compacted Granular A. To estimate the modulus of subgrade reaction, it was assumed that a 2 m square section of the concrete slab-on-grade under the applied loads. Since the modulus of subgrade reaction is needed for the ultimate failure design of the slab, it is assumed the failure can occur at a 25 mm deformation. Considering these assumptions, a subgrade reaction modulus of 20,000 kN/m²/m can be used for the design of the interior slab-on-grade. This k-value is only valid for the construction of slab-on-grade on compacted Granular A bedding. This value shall not be used for the native subgrade.

7.9 Lateral Earth Pressure

Free draining material should be used as backfill material for foundation walls. If proper drainage is provided, “at rest” condition may be assumed for calculation of earth pressure on foundation walls. The following parameters are recommended for the granular backfill.

Table 7-5: Lateral Pressure parameters for Granular A and B and Horizontal Backfill

Pressure Parameter		Expected Value		
		Granular A	Granular B	Other OPSS1010 'Granular'
Unit Weight (γ) kN/m ³	Above groundwater	22.5	21.7	21.7
	Below groundwater	12.7	11.9	11.9
Angle of Internal Friction (ϕ)		35°	32°	31°
Coefficient of Active Earth Pressure (k_a)		0.27	0.31	0.32
Coefficient of Passive Earth Pressure (k_p)		3.69	3.23	3.12
Coefficient of Earth Pressure at Rest (k_o)		0.43	0.47	0.48

7.10 Pavement Structure

It is understood that the parking lot, access roadway, and the rest of the paved areas of the proposed hotel are to be used by clients and staff members with lightweight passenger vehicle to medium-size delivery trucks on a daily basis. Pavement structure is most likely to be placed on engineered fill material overlaying native subgrade or bedrock. If topsoil or peat is encountered during construction, it is recommended to be replaced with compacted Granular B Type II or Granular A and compacted to 98% SPMDD. In addition, should grade raise be required, compacted Granular B Type II or Granular A should be placed as needed and compacted to 98% SPMDD prior to construction of pavement structure.

If the bedrock is encountered close or at the ground surface, a minimum of 300 mm of Granular A material compacted to 100% SPMDD should be placed on the bedrock prior to placing the asphalt layer. This is to reduce the risk of differential behaviors between adjacent portions of the flexible pavement structure if alternatively placed on the fill or the rigid surface of the rock. The asphalt layer thickness, including the surface, shall be as noted in Table 7-6.

The proposed pavement structure for the parking area and the access road is included in Table 7-6:

Table 7-6: “Medium Duty” Pavement Structure

Material		Thickness (mm)	
		Parking lot	Access roadway and truck traffic area
Surface	Superpave 12.5 mm, PG 58-34	40	40
Upper Binder	Superpave 19 mm, PG 58-34	50	50
Base	OPSS Granular A	150	150
Sub-base	OPSS Granular B Type II	450	600

The base and sub-base materials, i.e., Granular A for base and Granular B Type II for sub-base, shall be in accordance with OPSS.MUNI 1010. Both base and sub-base should be compacted to 100% SPMDD. Asphalt layers should be compacted to comply with OPSS 310. Where the pavement structure is to be placed on engineered fill, the upper 600 mm of the fill should be compacted to 98% SPMDD to act as subbase.

7.11 Sidewalks and Hard Surfacing

Even with the ground improvement program, some ground settlement should still be expected. Those settlements would be entirely differential relative to pile supported structure. This should be taken into consideration for the design of sidewalks and hard surfacing adjacent to the structure. Further guidelines can be provided as the design progresses.

The width and extent of the sidewalks will be defined as per the architectural drawings. The designer shall provision adequate slope, based on applicable codes, to provide appropriate runoff discharge. Expansion, construction, and dummy joints shall be spaced as required by the applicable standards. Sidewalks can be categorized under commercial use, and therefore, the concrete sidewalks should have a thickness of 150 to 200 mm. Requirements of OPSD 310.010 ‘Concrete Sidewalk’, OPSD 310.020 ‘Concrete Sidewalks Adjacent to Curb and Gutter’ and OPSD 310.030 ‘Concrete Sidewalk Ramps at intersection’ are recommended for the construction of the concrete sidewalk. A minimum of 150 mm bedding of OPSS Granular A compacted to 100% Standard Proctor Maximum Dry Density (SPMDD) is required for the concrete sidewalk panels.

All proposed new curbs shall be constructed as per applicable standards. It is recommended to follow City of Ottawa detail provided in SC3, Concrete Curb, and Sidewalk as a minimum requirement. All curbs shall receive a minimum of 150 mm Granular A bedding on approved subgrade free from soft, loose, and organic material.

7.12 Cement Type and Corrosion Potential

Seven soil samples were submitted to Parcel laboratories for testing of chemical properties relevant to exposure of concrete elements to sulphate attacks as well as potential soil corrosivity effects on buried metallic structural elements. Test results are presented in Table 6-7.

The potential for sulphate attack on concrete structures is moderate to low. Therefore, Type GU Portland cement may be adequate to protect buried concrete elements in the subsurface conditions encountered.

Based on electrical resistivity results and chloride content, the corrosion potential for buried steel elements is within the nonaggressive range.

8.0 CONSTRUCTION CONSIDERATIONS

Any organic material and loose sand of any kind should be removed from the footprint of the footings and all structurally load-bearing elements. Site preparation and requirements of engineered fill placement are noted in through previous sections. Refer to relevant sections for material and compaction requirements.

As noted in the previous section, all grade adjustments due to over-excavation, within the shallow footings influence zone, shall be done using lean concrete. This is to reduce the risk of differential settlements. Moreover, lean concrete can reduce the risk of movement in rock fractures. All loose pieces of rock shall be removed from the foundation subgrade.

All backfilling shall comply with the City of Ottawa Special Provision General No. D-029 for compaction requirements, unless the design recommendations included in this report exceed provisions of D-029.

Foundation walls should be backfilled with free-draining material with granular material conforming to OPSS 1010 Granular criteria. The native soil is not a suitable material for compaction. However, the native soil can provide drainage if it is proposed to be used for any portion of the design with no compaction requirement.

A geotechnical engineer or technician should attend the site to confirm the bedrock, type of fill material, and level of compaction. All bearing surfaces should be inspected by experienced geotechnical personnel prior to pouring the concrete to ensure that strata having adequate bearing capacity have been reached, and the bearing surfaces have been properly prepared.

Piling operations should be inspected on a full-time basis by geotechnical personnel to monitor the pile locations and plumbness, initial sets, penetrations on restrike, and to check the integrity of the piles following installation. The caisson sockets will also need to be inspected to document that they have been adequately cleaned, have been drilled to the required depth, and the rock quality is consistent with the design.

Vibration monitoring should be carried out during pile installation to ensure that the vibration levels at the existing surrounding structures and utilities are maintained below tolerable levels. A maximum peak particle

velocity of 50 mm/sec is recommended. The piles further from the existing structure and utilities should be driven first, in order to check the vibration level at the existing structures and, if necessary, alter the pile driving method or criteria for the remaining piles.

9.0 GROUNDWATER SEEPAGE

Depending on the construction season, groundwater may present above the depth of excavation. Hydraulic conductivity values of the native clayey silt and sand and silty sand are expected approximately 5×10^{-5} and 1×10^{-4} cm/s, respectively. This hydraulic conductivity values are estimated based on soil gradation analysis. In-situ percolation tests were not performed as part of this investigation. The provided hydraulic conductivity values can be used for the selection of the pump capacity for dewatering. The excavated subgrade must be kept dry at all times to minimize the disturbance of the subgrade. The water level shall be lowered to a minimum of 1 m below the proposed bottom of excavation before excavation and compaction. Groundwater elevation is expected to fluctuate seasonally. Any surface water infiltrating into the open excavation can be removed through conventional sump and pump methods. The subgrade shall be kept dry at all times, especially before compaction and proof rolling.

Under the new regulations (O.Reg 63/16 and O.Reg 387/04), a Permit to Take Water (PTTW) is required from the Ministry of the Environment and Climate Change (MOEC) if a volume of water greater than 400,000 liters per day is pumped from the excavation under normal operation, but more than 50,000 liters per day, the water taking will not require a PTTW, but will need to be registered in the EASR as a prescribed activity. Since the excavations will likely be above the groundwater level, it is considered unlikely that a PTTW would be required. The site designer shall decide on the permit application based on the expected excavation volume.

The design of the dewatering system should be the responsibility of the contractor. An outlet(s) should be identified, which the contractor can use to dispose of the pumped groundwater and incident precipitation. In order for pumped groundwater to be discharged to a City sewer, the groundwater quality needs to meet the City of Ottawa Sewer Use By-law limits, and a separate sewer discharge permit or City approval is required.

10.0 SITE SERVICES

At the subject site, the burial depth of water-bearing utility lines is typically 2.4 m below the ground surface. If this depth is not achievable due to the bedrock level, equivalent thermal insulation should be provided. The contractor should retain a professional engineer to provide detailed drawings for excavation and temporary support of the excavation walls during construction.

Excavation will proceed through the topsoil, peat, native soil, and bedrock. Excavating of overburden soil shall be performed using conventional hydraulic excavating equipment. Cobbles or boulders larger than 300 mm in diameter should be removed from the side slopes for worker safety.

The Occupational Health and Safety Act (OHSA) of Ontario indicated that side slopes in the rock fill above the water table could be classified as Type 3 soil and sloped no steeper than 1H:1V. In accordance with OHSA of Ontario, topsoil, peat, and native soil below the water table are classified as Type 4 soil, and excavation side slopes must be sloped at a minimum of 3H:1V or be shored. If space restrictions exist, the excavations can be carried out within closed sheeting, which is fully braced to resist lateral earth pressure.

Due to the potential for long term settlement of topsoil and organic materials and the effects of this settlement on service lines sensitive to level change, the existing topsoil, and organic materials are not considered suitable for the support of site services. Utilities should be supported on a minimum of 150 mm bedding of Granular A compacted to a minimum of 98% of SPMDD. Utility cover can be Granular A or Granular B type II compacted to 96% SPMDD. All covers are to be compacted to 100% SPMDD if they are intersecting structural elements. The engineer designing utilities shall ensure the proposed utility pipes can tolerate compaction loads.

To extend the life of buried utilities, it is recommended utility bedding and backfill to be separated from the native soil by filter geotextile.

11.0 CLOSURE

We trust this geotechnical investigation report meets the requirements of your project. The “Limitations of Report” presented in Appendix A are an integral part of this report. Please contact the undersigned should you have any questions or concerns.

McIntosh Perry Consulting Engineers Ltd.



M.A. Al-Khazaali

Mohammed Al-Khazaali, Ph.D., P.Eng.
Geotechnical Engineer

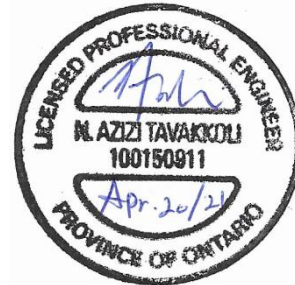

N. Azizi Tavakkoli

N'eem Tavakkoli, M.Eng., P.Eng.
Senior Geotechnical Engineer

REFERENCES

- 1) Canadian Geotechnical Society, "Canadian Foundation Engineering Manual", 4th Edition, 2006.
- 2) Ontario Ministry of Natural Resources (OMNR), Ontario Geological Survey, Special Volume 2, "The Physiography of Southern Ontario", 3rd Edition, 1984.
- 3) Google Earth, Google, 2015.
- 4) Government of Canada, National Building Code of Canada (NBCC), "Seismic Hazard Calculation" (online), 2010.
- 5) Canadian Standards Association (CSA), "Concrete Materials and Methods of Concrete Construction", A23.1, 2009
- 6) Government of Ontario, "Ontario Building Code (OBC)," (online), 2012.
- 7) MTO – Pavement Design and Rehabilitation Manual
- 8) Natural Resources Canada – Seismic Hazard Calculator

1305 MARITIME WAY

APPENDIX A
LIMITATIONS OF REPORT

LIMITATIONS OF REPORT

McIntosh Perry Consulting Engineers Ltd. (McIntosh Perry) carried out the field work and prepared the report. This document is an integral part of the Foundation Investigation and Design report presented.

The conclusions and recommendations provided in this report are based on the information obtained at the borehole locations where the tests were conducted. Subsurface and groundwater conditions between and beyond the boreholes may differ from those encountered at the specific locations where tests were conducted and conditions may become apparent during construction, which were not detected and could not be anticipated at the time of the site investigation. The benchmark level used and borehole elevations presented in this report are primarily to establish relative differences in elevations between the borehole locations and should not be used for other purposes such as to establish elevations for grading, depth of excavations or for planning construction.

The recommendations presented in this report for design are applicable only to the intended structure and the project described in the scope of the work, and if constructed in accordance with the details outlined in the report. Unless otherwise noted, the information contained in this report does not reflect on any environmental aspects of either the site or the subsurface conditions.

The comments or recommendation provided in this report on potential construction problems and possible construction methods are intended only to guide the designer. The number of boreholes advanced at this site may not be sufficient or adequate to reveal all the subsurface information or factors that may affect the method and cost of construction. The contractors who are undertaking the construction shall make their own interpretation of the factual data presented in this report and make their conclusions, as to how the subsurface conditions of the site may affect their construction work.

The boundaries between soil strata presented in the report are based on information obtained at the borehole locations. The boundaries of the soil strata between borehole locations are assumed from geological evidences. If differing site conditions are encountered, or if the Client becomes aware of any additional information that differs from or is relevant to the McIntosh Perry findings, the Client agrees to immediately advise McIntosh Perry so that the conclusions presented in this report may be re-evaluated.

Under no circumstances shall the liability of McIntosh Perry for any claim in contract or in tort, related to the services provided and/or the content and recommendations in this report, exceed the extent that such liability is covered by such professional liability insurance from time to time in effect including the deductible therein, and which is available to indemnify McIntosh Perry. Such errors and omissions policies are available for inspection by the Client at all times upon request, and if the Client desires to obtain further insurance to protect it against any risks beyond the coverage provided by such policies, McIntosh Perry will co-operate with the Client to obtain such insurance.





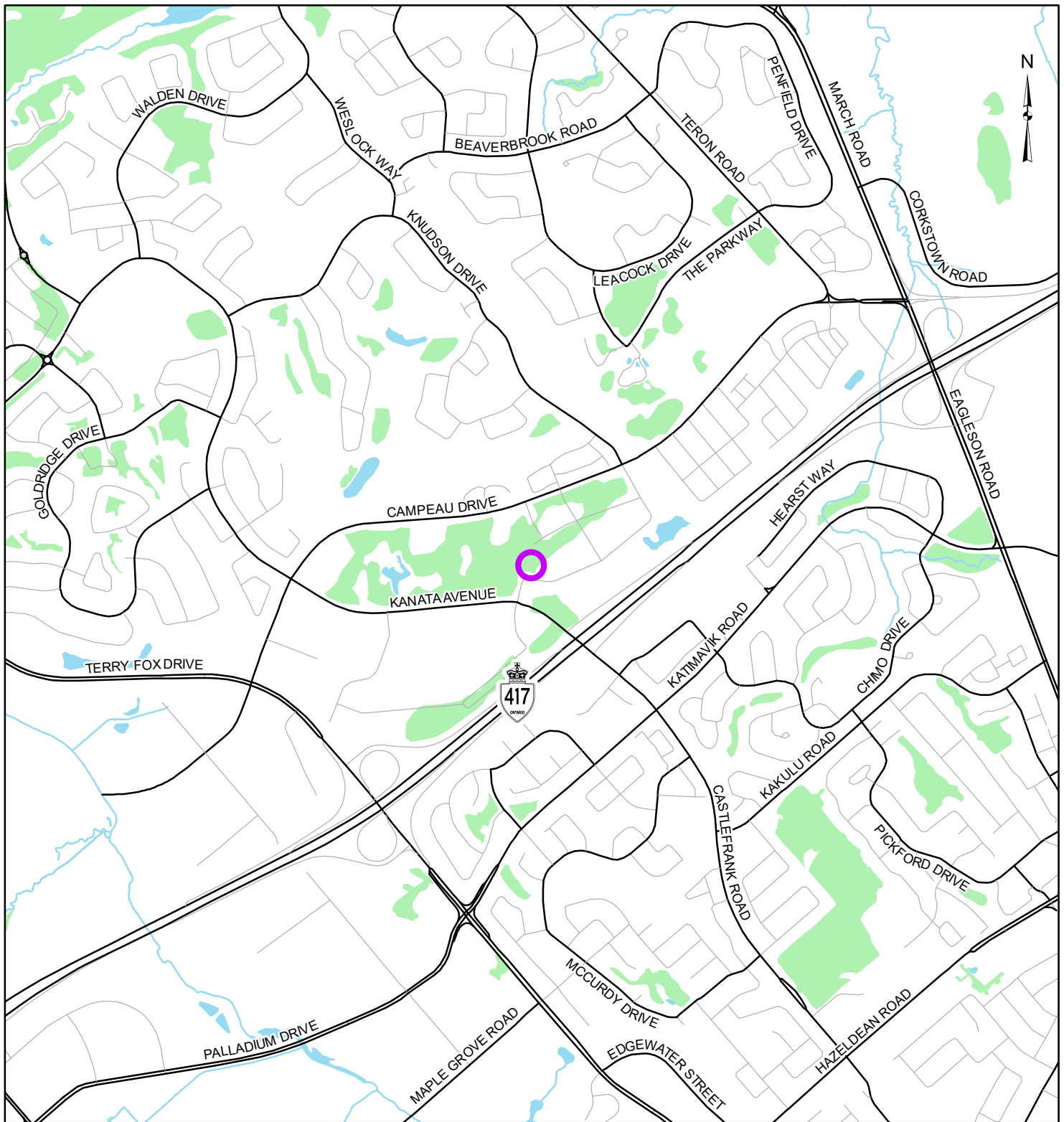

McIntosh Perry prepared this report for the exclusive use of the Client. Any use which a third party makes of this report, or any reliance on or decision to be made based on it, are the responsibility of such third parties. McIntosh Perry accepts no responsibility and will not be liable for damages, if any, suffered by any third party as a result of decisions made or actions taken based on this report.

1305 MARITIME WAY

APPENDIX B
FIGURES



LEGEND

-  Site Location
-  Watercourse
-  Local Road
-  Waterbody
-  Major Road
-  Wooded Area

REFERENCE

GIS data provided by the Ontario Ministry of Natural Resources and Forestry, 2020.





CLIENT:		SILVER HOTEL GROUP	
PROJECT:		GEOTECHNICAL INVESTIGATION 1305 MARITIME WAY	
TITLE:		SITE LOCATION	
PROJECT NO: CP-18-0534		FIGURE:	
Date	May. 13, 2020	1	
GIS	EU		
Checked By	AL		

McINTOSH PERRY
 115 Walgreen Road, RR3, Carp, ON K0A1L0
 Tel: 613-836-2184 Fax: 613-836-3742
 www.mcintoshperry.com

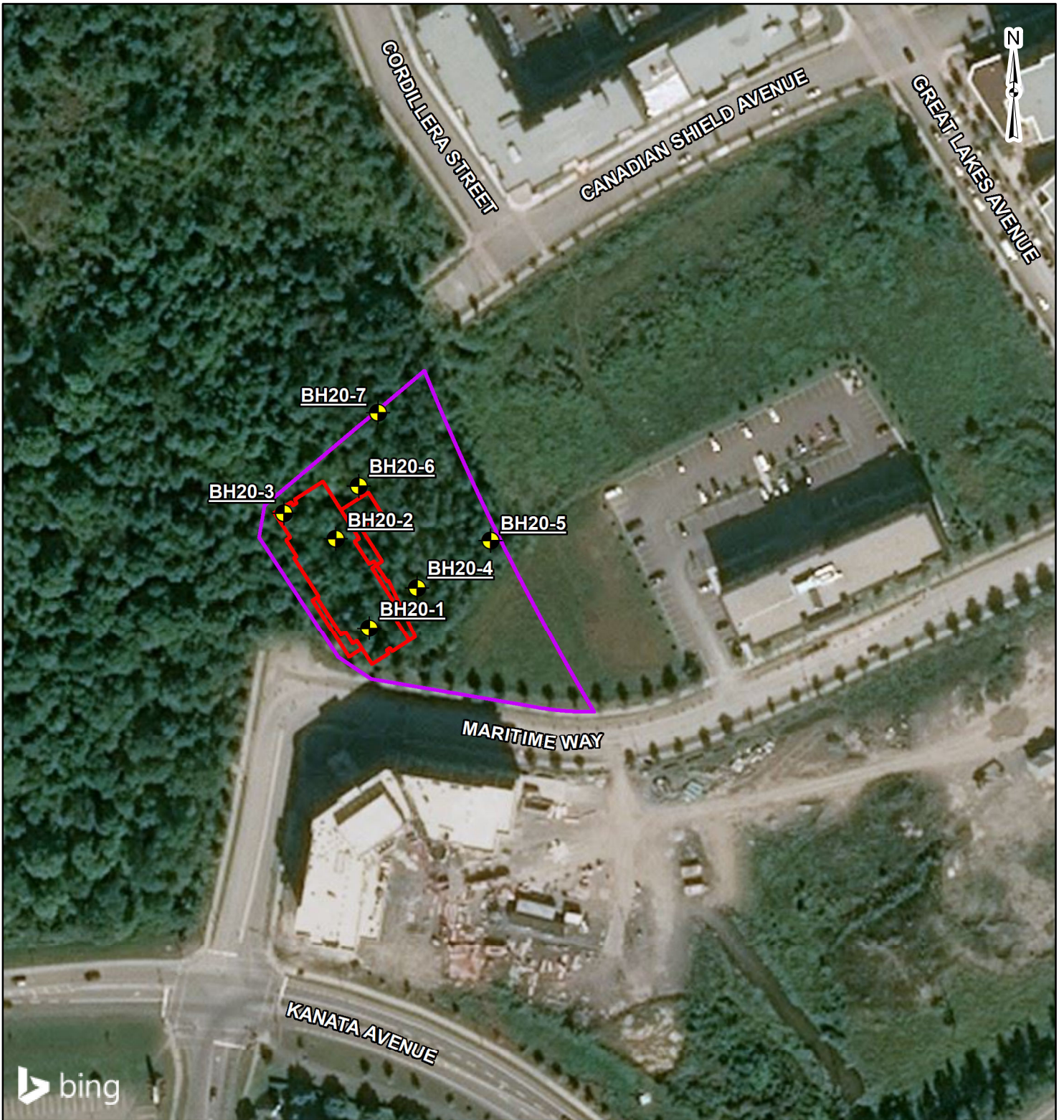
U:\Ottawa\01 Project - Proposals\2018 Jobs\CP-18-0534 Chamberlain Hampton Inn_1305 Maritime Way\GIS\mxd\CP-18-0534_01_SiteLocation_NEW2.mxd



LEGEND

-  BoreholeLocation
-  Approximate Proposed Building Footprint
-  Approximate Site Boundary

REFERENCE

GIS data provided by the Ontario Ministry of Natural Resources and Forestry, 2020.

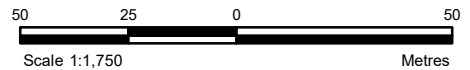

CLIENT:		SILVER HOTEL GROUP	
PROJECT:		GEOTECHNICAL INVESTIGATION 1305 MARITIME WAY	
TITLE:		BOREHOLE LOCATION	
PROJECT NO: CP-18-0534		FIGURE:	
Date	May., 29, 2020	2	
GIS	EU		
Checked By	AL		

McINTOSH PERRY
 115 Walgreen Road, RR3, Carp, ON K0A1L0
 Tel: 613-836-2184 Fax: 613-836-3742
 www.mcintoshperry.com

Particle Size Distribution Report

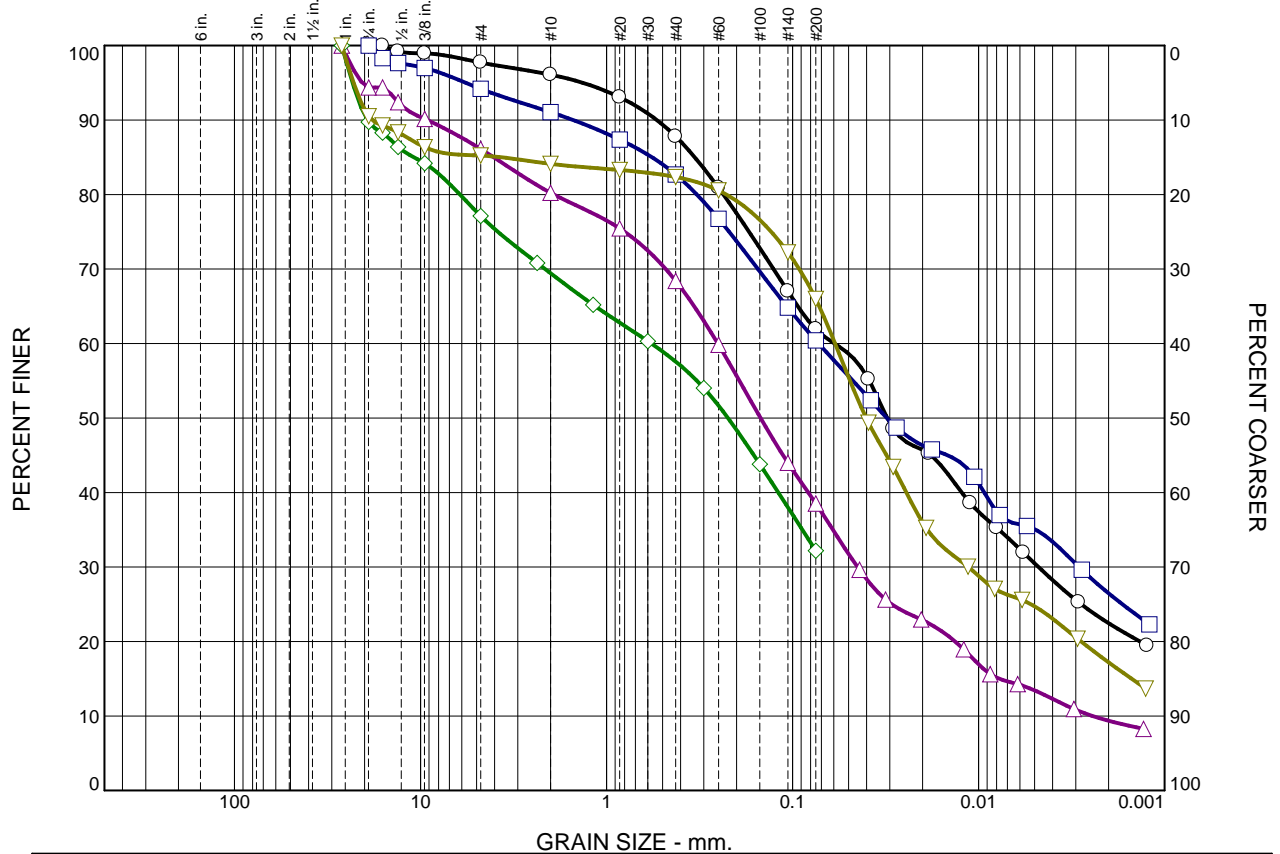

	% +75mm	% Gravel		% Sand			% Fines	
		Coarse	Fine	Coarse	Medium	Fine	Silt	Clay
○	0.0	0.0	2.3	1.6	8.3	25.9	39.4	22.5
□	0.0	0.0	5.8	3.1	8.4	22.3	33.9	26.5
△	0.0	5.6	8.3	5.9	11.8	29.9	29.1	9.4
◇	0.0	10.2	12.7	7.7	11.8	25.4	32.2	
▽	0.0	9.5	5.3	1.1	1.7	16.4	48.8	17.2

SOIL DATA					
SYMBOL	SOURCE	SAMPLE NO.	DEPTH (ft.)	Material Description	USCS
○	Maritime Way	BH2002SS03	5.0-7.0'	Clayey Silt and Sand trace Gravel	CL
□	Maritime Way	BH2002SS05	10.0-12.0'	Clayey Silt and Sand trace Gravel	CL
△	Maritime Way	BH2002SS08	12.5-19.5'	Silty Sand some Gravel trace Clay	
◇	Maritime Way	BH2002SS15	35.0-37.0'	Gravelly Silty Sand	
▽	Maritime Way	BH2002SS18	42.0-44.5'	Silt some Sand some Clay some Gravel	

McINTOSH PERRY

Client: Silver Hotel Group
Project: Geotech Investigation - 1305 Maritime Way Kanata
Project No.: CP18-0534

Figure 3

These results are for the exclusive use of the client for whom they were obtained.

Checked By: H.Smith

Particle Size Distribution Report

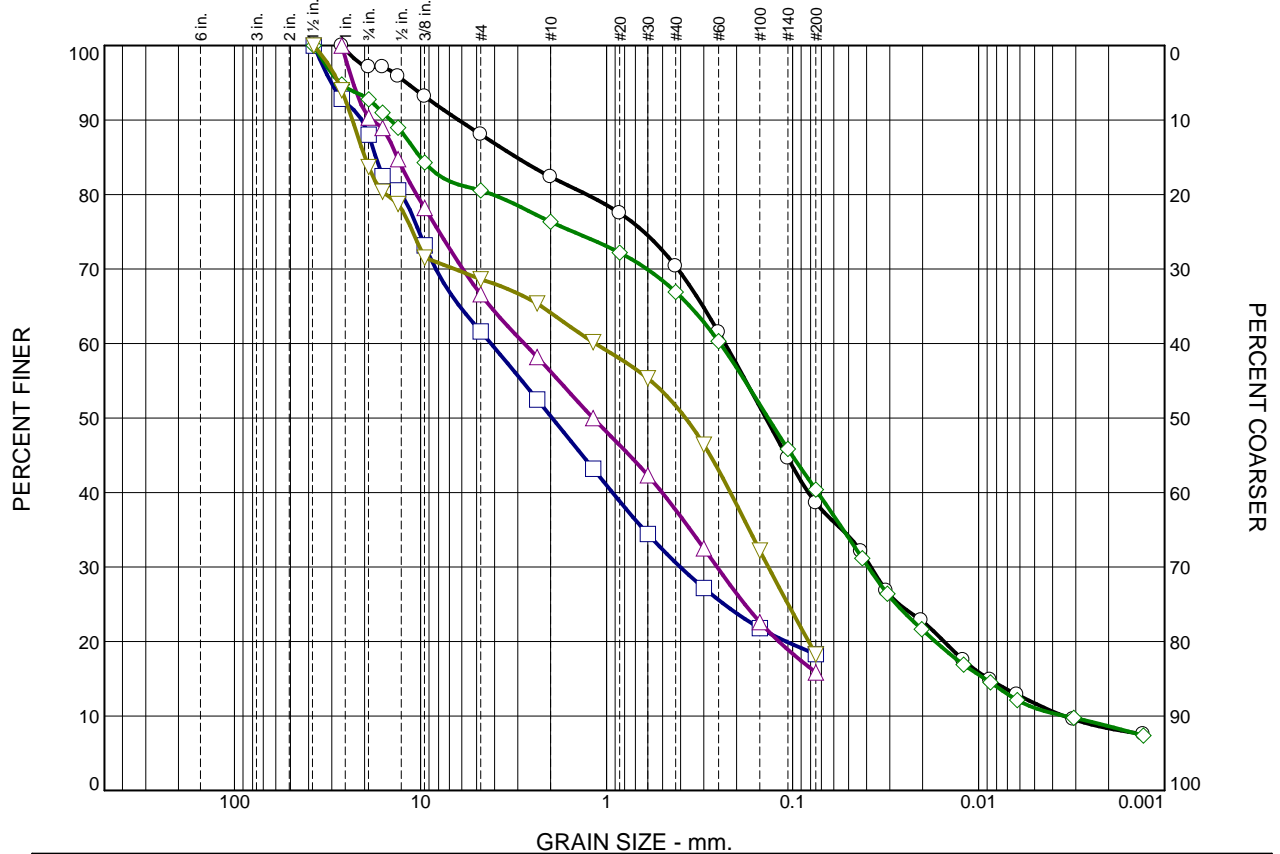

	% +75mm	% Gravel		% Sand			% Fines	
		Coarse	Fine	Coarse	Medium	Fine	Silt	Clay
○	0.0	2.9	9.0	5.7	12.0	31.8	30.3	8.3
□	0.0	11.9	26.5	11.3	19.7	12.3	18.3	
△	0.0	9.6	23.8	10.4	18.5	21.9	15.8	
◇	0.0	7.2	12.2	4.3	9.4	26.5	31.8	8.6
▽	0.0	16.2	15.2	4.5	12.5	33.3	18.3	

SOIL DATA					
SYMBOL	SOURCE	SAMPLE NO.	DEPTH (ft.)	Material Description	USCS
○	Maritime Way	BH20003SS03	5.0-7.0'	Silt Sand some Gravel trace Clay	
□	Maritime Way	BH2003SS06	12.5-14.5'	Sand and Gravel some Silt	
△	Maritime Way	BH2003SS08	17.5-19.5'	Gravelly Sand some Silt	
◇	Maritime Way	BH2003SS12	27.5-29.5'	Silty Sand some Gravel trace Clay	
▽	Maritime Way	BH2003SS14	32.5-34.5'	Gravelly Sand some Silt	

McINTOSH PERRY

Client: Silver Hotel Group
Project: Geotech Investigation - 1305 Maritime Way Kanata
Project No.: CP18-0534

Figure 4

These results are for the exclusive use of the client for whom they were obtained.

Checked By: H.Smith

LIQUID AND PLASTIC LIMITS TEST REPORT

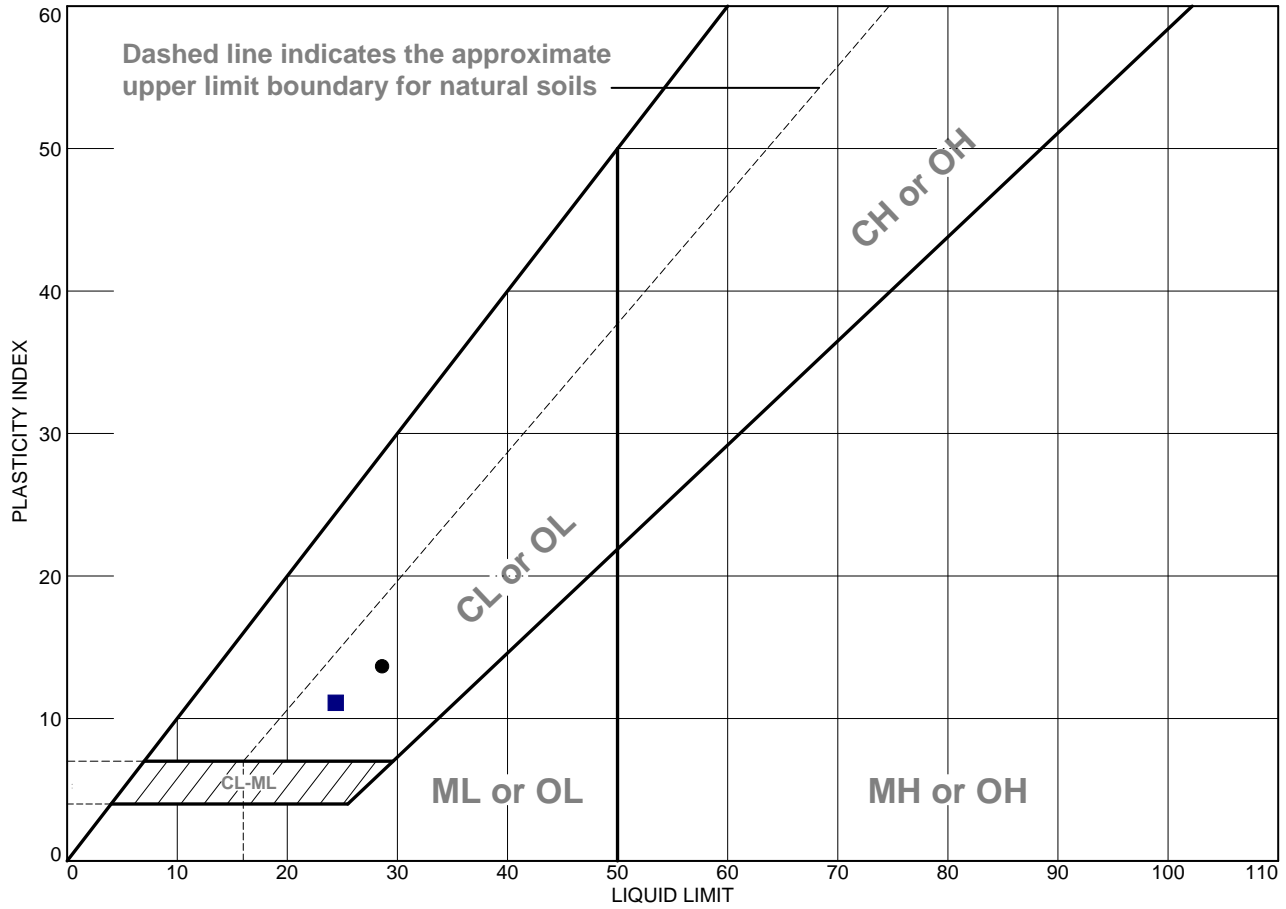

MATERIAL DESCRIPTION	LL	PL	PI	%<#40	%<#200	USCS
● Clayey Silt and Sand trace Gravel	28.7	15.1	13.6	87.8	61.9	CL
■ Clayey Silt and Sand trace Gravel	24.4	13.3	11.1	82.7	60.4	CL

Project No. CP18-0534 **Client:** Silver Hotel Group
Project: Geotech Investigation - 1305 Maritime Way Kanata
● Location: BH20-02 SS03 **Depth:** 5.0-7.0' **Sample Number:** BH2002SS03
■ Location: BH20-02 SS05 **Depth:** 10.0-12.0' **Sample Number:** BH2002SS05

Remarks:

McINTOSH PERRY

Figure 5

These results are for the exclusive use of the client for whom they were obtained.

Checked By: H.Smith

1305 MARITIME WAY

APPENDIX C
BOREHOLE LOGS

EXPLANATION OF TERMS USED IN REPORT

N-VALUE: THE STANDARD PENETRATION TEST (SPT) N-VALUE IS THE NUMBER OF BLOWS REQUIRED TO CAUSE A STANDARD 51mm O.D SPLIT BARREL SAMPLER TO PENETRATE 0.3m INTO UNDISTURBED GROUND IN A BOREHOLE WHEN DRIVEN BY A HAMMER WITH A MASS OF 63.5 kg, FALLING FREELY A DISTANCE OF 0.76m. FOR PENETRATIONS OF LESS THAN 0.3m N-VALUES ARE INDICATED AS THE NUMBER OF BLOWS FOR THE PENETRATION ACHIEVED. AVERAGE N-VALUE IS DENOTED THUS \bar{N} .

DYNAMIC CONE PENETRATION TEST: CONTINUOUS PENETRATION OF A CONICAL STEEL POINT (51mm O.D. 60° CONE ANGLE) DRIVEN BY 475J IMPACT ENERGY ON 'A' SIZE DRILL RODS. THE RESISTANCE TO CONE PENETRATION IS MEASURED AS THE NUMBER OF BLOWS FOR EACH 0.3m ADVANCE OF THE CONICAL POINT INTO THE UNDISTURBED GROUND.

SOILS ARE DESCRIBED BY THEIR COMPOSITION AND CONSISTENCY OR DENSENESS.

CONSISTENCY: COHESIVE SOILS ARE DESCRIBED ON THE BASIS OF THEIR UNDRAINED SHEAR STRENGTH (c_u) AS FOLLOWS:

C_u (kPa)	0 – 12	12 – 25	25 – 50	50 – 100	100 – 200	>200
	VERY SOFT	SOFT	FIRM	STIFF	VERY STIFF	HARD

DENSENESS: COHESIONLESS SOILS ARE DESCRIBED ON THE BASIS OF DENSENESS AS INDICATED BY SPT N VALUES AS FOLLOWS:

N (BLOWS/0.3m)	0 – 5	5 – 10	10 – 30	30 – 50	>50
	VERY LOOSE	LOOSE	COMPACT	DENSE	VERY DENSE

ROCKS ARE DESCRIBED BY THEIR COMPOSITION AND STRUCTURAL FEATURES AND/OR STRENGTH.

RECOVERY: SUM OF ALL RECOVERED ROCK CORE PIECES FROM A CORING RUN EXPRESSED AS A PERCENT OF THE TOTAL LENGTH OF THE CORING RUN.

MODIFIED RECOVERY: SUM OF THOSE INTACT CORE PIECES, 100mm+ IN LENGTH EXPRESSED AS A PERCENT OF THE LENGTH OF THE CORING RUN. THE ROCK QUALITY DESIGNATION (RQD), FOR MODIFIED RECOVERY IS:

RQD (%)	0 – 25	25 – 50	50 – 75	75 – 90	90 – 100
	VERY POOR	POOR	FAIR	GOOD	EXCELLENT

JOINT AND BEDDING:

SPACING	50mm	50 – 300mm	0.3m – 1m	1m – 3m	>3m
JOINTING	VERY CLOSE	CLOSE	MOD. CLOSE	WIDE	VERY WIDE
BEDDING	VERY THIN	THIN	MEDIUM	THICK	VERY THICK

ABBREVIATIONS AND SYMBOLS

FIELD SAMPLING

SS	SPLIT SPOON	TP	THINWALL PISTON
WS	WASH SAMPLE	OS	OSTERBERG SAMPLE
ST	SLOTTED TUBE SAMPLE	RC	ROCK CORE
BS	BLOCK SAMPLE	PH	TW ADVANCED HYDRAULICALLY
CS	CHUNK SAMPLE	PM	TW ADVANCED MANUALLY
TW	THINWALL OPEN	FS	FOIL SAMPLE

STRESS AND STRAIN

u_w	kPa	PORE WATER PRESSURE
r_u	1	PORE PRESSURE RATIO
σ	kPa	TOTAL NORMAL STRESS
σ'	kPa	EFFECTIVE NORMAL STRESS
τ	kPa	SHEAR STRESS
$\sigma_1, \sigma_2, \sigma_3$	kPa	PRINCIPAL STRESSES
ϵ	%	LINEAR STRAIN
$\epsilon_1, \epsilon_2, \epsilon_3$	%	PRINCIPAL STRAINS
E	kPa	MODULUS OF LINEAR DEFORMATION
G	kPa	MODULUS OF SHEAR DEFORMATION
μ	1	COEFFICIENT OF FRICTION

MECHANICAL PROPERTIES OF SOIL

m_v	kPa^{-1}	COEFFICIENT OF VOLUME CHANGE
c_c	1	COMPRESSION INDEX
c_s	1	SWELLING INDEX
c_a	1	RATE OF SECONDARY CONSOLIDATION
c_v	m^2/s	COEFFICIENT OF CONSOLIDATION
H	m	DRAINAGE PATH
T_v	1	TIME FACTOR
U	%	DEGREE OF CONSOLIDATION
σ'_{v0}	kPa	EFFECTIVE OVERBURDEN PRESSURE
σ'_p	kPa	PRECONSOLIDATION PRESSURE
τ_f	kPa	SHEAR STRENGTH
c'	kPa	EFFECTIVE COHESION INTERCEPT
Φ_i	-°	EFFECTIVE ANGLE OF INTERNAL FRICTION
c_u	kPa	APPARENT COHESION INTERCEPT
Φ_u	-°	APPARENT ANGLE OF INTERNAL FRICTION
τ_R	kPa	RESIDUAL SHEAR STRENGTH
τ_r	kPa	REMOULDED SHEAR STRENGTH
S_t	1	SENSITIVITY = c_u / τ_r

PHYSICAL PROPERTIES OF SOIL

ρ_s	kg/m^3	DENSITY OF SOLID PARTICLES	e	1, %	VOID RATIO	e_{min}	1, %	VOID RATIO IN DENSEST STATE
γ_s	kN/m^3	UNIT WEIGHT OF SOLID PARTICLES	n	1, %	POROSITY	I_D	1	DENSITY INDEX = $\frac{e_{max} - e}{e_{max} - e_{min}}$
ρ_w	kg/m^3	DENSITY OF WATER	w	1, %	WATER CONTENT	D	mm	GRAIN DIAMETER
γ_w	kN/m^3	UNIT WEIGHT OF WATER	s_r	%	DEGREE OF SATURATION	D_n	mm	N PERCENT – DIAMETER
ρ	kg/m^3	DENSITY OF SOIL	w_L	%	LIQUID LIMIT	C_u	1	UNIFORMITY COEFFICIENT
γ	kN/m^3	UNIT WEIGHT OF SOIL	w_p	%	PLASTIC LIMIT	h	m	HYDRAULIC HEAD OR POTENTIAL
ρ_d	kg/m^3	DENSITY OF DRY SOIL	w_s	%	SHRINKAGE LIMIT	q	m^3/s	RATE OF DISCHARGE
γ_d	kN/m^3	UNIT WEIGHT OF DRY SOIL	I_p	%	PLASTICITY INDEX = $(W_L - W_L)$	v	m/s	DISCHARGE VELOCITY
ρ_{sat}	kg/m^3	DENSITY OF SATURATED SOIL	I_L	1	LIQUIDITY INDEX = $(W - W_p) / I_p$	i	1	HYDAULIC GRADIENT
γ_{sat}	kN/m^3	UNIT WEIGHT OF SATURATED SOIL	I_c	1	CONSISTENCY INDEX = $(W_L - W) / I_p$	k	m/s	HYDRAULIC CONDUCTIVITY
ρ'	kg/m^3	DENSITY OF SUBMERGED SOIL	e_{max}	1, %	VOID RATIO IN LOOSEST STATE	j	kN/m^3	SEEPAGE FORCE
γ'	kN/m^3	UNIT WEIGHT OF SUBMERGED SOIL						

DATE: 14/04/2020 - 15/04/2020
 PROJECT: OCP-18-0534_MARITIME
 CLIENT: Silver Hotel Group
 ELEVATION: 96.22 m

LOCATION: 1305 Maritime Way, Kanata, Ottawa
 COORDINATES: Lat: 45.313448356 , Lon: -75.904709828
 DATUM: Geodetic
 REMARK:

ORIGINATED BY: A.L.
 COMPILED BY: A.L.
 CHECKED BY: N.T.
 REPORT DATE: 29/05/2020

DEPTH - feet	DEPTH - meters	SOIL PROFILE		SYMBOL	SAMPLES				GROUNDWATER CONDITIONS	DYNAMIC CONE PEN. RESISTANCE PLOT				WATER CONTENT and LIMITS (%)			REMARKS & GRAIN SIZE DISTRIBUTION (%)				
		ELEVATION - m	DEPTH - m		DESCRIPTION	TYPE AND NUMBER	STATE	RECOVERY		"N" or RQD	20	40	60	80	W _p	W	W _L	G	S	M	C
		96.2	0.0	Natural ground surface																	
		96.1	0.1	Sand, dark brown. Presence of organic matter.	SS-01	X	50	3													
	1			Clayey silt and sand, traces of gravel, grey, dry to wet, compact.	SS-02	X	100	14													
	5				SS-03	X	100	5										2	37	38	23
	2				SS-04	X	100	5													
	10	93.2	3.0	Clayey silt and sand, traces of gravel, grey, dry to wet, soft.	SS-05	X	100	1										6	34	32	28
	4				SS-06	X	42	19													
	15	91.6	4.6	Silty sand, some gravel, traces of clay, grey, wet, loose.	SS-07	X	21	3													
	5				SS-08	X	54	10										14	47	30	9
	20				SS-09	X	29	9													
	7	89.4	6.9	Sand, brown, wet, loose.	SS-10	X	92	17													
	25	89.2	7.0	Sandy silt, traces of gravel, grey, wet, loose.	SS-11	X	100	16													
	8	88.6	7.6	Sand, brown, wet, loose.																	
		88.1	8.1	Sandy silt, traces of gravel, grey, wet, loose.																	
		88.0	8.2	Cobbles and Boulders	RC-12	█	64	55													
	9	87.1	9.1	Gravelly silty sand, traces of clay, grey, moist to wet, compact to dense.	SS-13	X	50	25													

I:\LICENSES7\Sobek\Geotec80\Style\Lcg_Borehole_v5.sty

DATE: 14/04/2020 - 15/04/2020
 PROJECT: OCP-18-0534_MARITIME
 CLIENT: Silver Hotel Group
 ELEVATION: 96.22 m

LOCATION: 1305 Maritime Way, Kanata, Ottawa
 COORDINATES: Lat: 45.313448356 , Lon: -75.904709828
 DATUM: Geodetic
 REMARK:

ORIGINATED BY: A.L.
 COMPILED BY: A.L.
 CHECKED BY: N.T.
 REPORT DATE: 29/05/2020

DEPTH - feet	DEPTH - meters	SOIL PROFILE		SYMBOL	SAMPLES				GROUNDWATER CONDITIONS	DYNAMIC CONE PEN. RESISTANCE PLOT		WATER CONTENT and LIMITS (%)			REMARKS & GRAIN SIZE DISTRIBUTION (%)					
		ELEVATION - m	DEPTH - m		DESCRIPTION	TYPE AND NUMBER	STATE	RECOVERY		"N" or RQD	20	40	60	80	W _P	W	W _L	G	S	M
10					SS-13	⊗	50	25												
35					SS-14	⊗	46	31												
11					SS-15	⊗	62	71									22	46	32	
12					SS-16	⊗	100	REF												
40					SS-17	⊗	79	102												
13					SS-18	⊗	61	REF									15	19	49	17
45																				
15		81.2 15.0		Presence of cobbles.																
50					RC-19	█	21	15												
16																				
55		79.9 16.4		Sedimentary and Metasedimentary bedrock, conglomerate. Limestone																
17					RC-20	+	100	90												
18																				
60					RC-21	+	98	85												
																				Unconfined compressive strength = 57.3MPa

I:\LICENSES7\Sobek\Geotec801\Style\Log_Borehole_v5.sty

DATE: 14/04/2020 - 15/04/2020 LOCATION: 1305 Maritime Way, Kanata, Ottawa ORIGINATED BY: A.L.
 PROJECT: OCP-18-0534_MARITIME COORDINATES: Lat: 45.313448356 , Lon: -75.904709828 COMPILED BY: A.L.
 CLIENT: Silver Hotel Group DATUM: Geodetic CHECKED BY: N.T.
 ELEVATION: 96.22 m REMARK: REPORT DATE: 29/05/2020

DEPTH - feet	DEPTH - meters	SOIL PROFILE		SYMBOL	SAMPLES				GROUNDWATER CONDITIONS	DYNAMIC CONE PEN. RESISTANCE PLOT		WATER CONTENT and LIMITS (%)			REMARKS & GRAIN SIZE DISTRIBUTION (%)
		ELEVATION - m	DEPTH - m		DESCRIPTION	TYPE AND NUMBER	STATE	RECOVERY		"N" or RQD	SHEAR STRENGTH (kPa)		W _p	W	
		19.1		+											
			END OF BOREHOLE												
65	20		Water level could not be measured in open borehole due to coring water.												
		21													
70															
		22													
		23													
		24													
80															
		25													
		26													
		27													
90															
		28													

DATE: 08/04/2020 - 14/04/2020
 PROJECT: OCP-18-0534_MARITIME
 CLIENT: Silver Hotel Group
 ELEVATION: 98.45 m

LOCATION: 1305 Maritime Way, Kanata, Ottawa
 COORDINATES: Lat: 45.313708574 , Lon: -75.904845183
 DATUM: Geodetic
 REMARK:

ORIGINATED BY: A.L.
 COMPILED BY: A.L.
 CHECKED BY: N.T.
 REPORT DATE: 29/05/2020

DEPTH - feet	DEPTH - meters	SOIL PROFILE		SYMBOL	SAMPLES				GROUNDWATER CONDITIONS	DYNAMIC CONE PEN. RESISTANCE PLOT				WATER CONTENT and LIMITS (%)			REMARKS & GRAIN SIZE DISTRIBUTION (%)			
		ELEVATION - m	DEPTH - m		DESCRIPTION	TYPE AND NUMBER	STATE	RECOVERY		"N" or RQD	20	40	60	80	W _P	W	W _L	G	S	M
		98.5	0.0	Natural ground surface																
	1	97.4	1.1	Silty sand, some gravel, traces of clay, brown to grey, dry to moist, compact.	SS-01	X	21	5												
	5				SS-02	X	100	12												
	2				SS-03	X	75	42									11	50	31	8
					SS-04	X	54	48												
	3				SS-05	X	67	56												
		94.6	3.8	Sand and gravel, some silt, light brown, compact.	SS-06	X	58	23									39	42	19	
	5				SS-07	X	54	51												
					SS-08	X	54	126									32	53	15	
	6				SS-09	X	12	55												
	7				SS-10	X	100	7												
		91.3	7.2	Silty sand, some gravel, traces of clay, grey, wet, very loose.	SS-11	X	37	WOH												
	8				SS-12	X	87	20												
					SS-13	X	100	56												
	9																			
	30	89.3	9.1	Gravelly sand, some silt, brown, wet, compact.																

I:\LICENSES7\Sobek\Geotec80\Style\L Log_Borehole_v5.sty

DATE: 08/04/2020 - 14/04/2020
PROJECT: OCP-18-0534_MARITIME
CLIENT: Silver Hotel Group
ELEVATION: 98.45 m

LOCATION: 1305 Maritime Way, Kanata, Ottawa
COORDINATES: Lat: 45.313708574, Lon: -75.904845183
DATUM: Geodetic
REMARK:

ORIGINATED BY: A.L.
COMPILED BY: A.L.
CHECKED BY: N.T.
REPORT DATE: 29/05/2020

Table with columns: DEPTH - feet, DEPTH - meters, ELEVATION - m, SOIL PROFILE DESCRIPTION, SYMBOL, SAMPLES (TYPE AND NUMBER, STATE, RECOVERY, "N" or RQD), GROUNDWATER CONDITIONS, DYNAMIC CONE PEN. RESISTANCE PLOT, SHEAR STRENGTH (kPa), WATER CONTENT and LIMITS (%), REMARKS & GRAIN SIZE DISTRIBUTION (%).

\\LICENSES7\Sobek\Geotec801\Style\L.Log_Borehole_v5.sty

DATE: 14/04/2020 - 14/04/2020
 PROJECT: OCP-18-0534_MARITIME
 CLIENT: Silver Hotel Group
 ELEVATION: 103.08 m

LOCATION: 1305 Maritime Way, Kanata, Ottawa
 COORDINATES: Lat: 45.313784686 , Lon: -75.905057126
 DATUM: Geodetic
 REMARK:

ORIGINATED BY: A.L.
 COMPILED BY: A.L.
 CHECKED BY: N.T.
 REPORT DATE: 29/05/2020

DEPTH - feet	DEPTH - meters	SOIL PROFILE		SYMBOL	SAMPLES				GROUNDWATER CONDITIONS	DYNAMIC CONE PEN. RESISTANCE PLOT				WATER CONTENT and LIMITS (%)			REMARKS & GRAIN SIZE DISTRIBUTION (%)		
		ELEVATION - m	DEPTH - m		DESCRIPTION	TYPE AND NUMBER	STATE	RECOVERY		"N" or RQD	20	40	60	80	W _p	W		W _L	G
		103.1	0.0	Natural ground surface															
	1			Silty sand, traces of gravel, reddish brown. Presence of organic matter.	SS-01	X	25	3											
	5				SS-02	X	62	35											
	2				SS-03	X	50	REF											
		100.8	2.3	Sandy and gravelly silt, reddish grey, dry, compact.	SS-04	X	72	REF											
	3				SS-05	X	33	REF											
	4	99.1	4.0	Sedimentary and metasedimentary bedrock: Limestone	RC-06	█	93	93											
	5				RC-07	█	100	100											
	6				RC-08	█	98	74											
	7																		
	8	95.5	7.5	END OF BOREHOLE															
	9			Water level was not measured in open borehole due to coring water.															
	30																		

Unconfined compressive strength = 107.6MPa

DATE: 15/04/2020 - 15/04/2020
 PROJECT: OCP-18-0534_MARITIME
 CLIENT: Silver Hotel Group
 ELEVATION: 95.71 m

LOCATION: 1305 Maritime Way, Kanata, Ottawa
 COORDINATES: Lat: 45.313565179 , Lon: -75.90451095
 DATUM: Geodetic
 REMARK:

ORIGINATED BY: A.L.
 COMPILED BY: A.L.
 CHECKED BY: N.T.
 REPORT DATE: 29/05/2020

DEPTH - feet	DEPTH - meters	SOIL PROFILE		SYMBOL	SAMPLES				GROUNDWATER CONDITIONS	DYNAMIC CONE PEN. RESISTANCE PLOT		WATER CONTENT and LIMITS (%)			REMARKS & GRAIN SIZE DISTRIBUTION (%)			
		ELEVATION - m	DEPTH - m		DESCRIPTION	TYPE AND NUMBER	STATE	RECOVERY		"N" or RQD	20	40	60	80		W _P	W	W _L
		95.7		Natural ground surface														
		0.0		Fill : Silty clay, dark brown. Presence of organic matter.														
		95.6																
		0.2		Clayey silt, traces of sand, light brown to grey, moist, soft to firm.	SS-01	X	67	2										
1																		
		94.3			SS-02	X	100	8										
5		1.4		END OF BOREHOLE														
2				No water was observed in open borehole.														
3																		
4																		
5																		
6																		
7																		
8																		
9																		

I:\LICENSES7\Sobek\Geotec801\Style\Log_Borehole_v5.sty

DATE: 15/04/2020 - 15/04/2020
 PROJECT: OCP-18-0534_MARITIME
 CLIENT: Silver Hotel Group
 ELEVATION: 95.70 m

LOCATION: 1305 Maritime Way, Kanata, Ottawa
 COORDINATES: Lat: 45.313700698 , Lon: -75.904207743
 DATUM: Geodetic
 REMARK:

ORIGINATED BY: A.L.
 COMPILED BY: A.L.
 CHECKED BY: N.T.
 REPORT DATE: 29/05/2020

DEPTH - feet	DEPTH - meters	SOIL PROFILE		SYMBOL	SAMPLES				GROUNDWATER CONDITIONS	DYNAMIC CONE PEN. RESISTANCE PLOT		WATER CONTENT and LIMITS (%)			REMARKS & GRAIN SIZE DISTRIBUTION (%)		
		ELEVATION - m	DEPTH - m		DESCRIPTION	TYPE AND NUMBER	STATE	RECOVERY		"N" or RQD	20	40	60	80		W _P	W
		95.7		Natural ground surface													
		0.0		Fill : Silty clay, black to brown. Presence of organic matter.													
		95.6		Clayey silt, traces of sand, grey, moist, soft to stiff.	SS-01	X	67	1									
	1	0.1															
					SS-02	X	100	7									
	5	94.3		END OF BOREHOLE													
		1.4		No water level was observed in open borehole.													
	2																
	3																
	4																
	5																
	6																
	7																
	8																
	9																
	30																

I:\LICENSES7\Sozbek\Geotec801\Style\Log_Borehole_v5.sty

DATE: 15/04/2020 - 15/04/2020
 PROJECT: OCP-18-0534_MARITIME
 CLIENT: Silver Hotel Group
 ELEVATION: 99.31 m

LOCATION: 1305 Maritime Way, Kanata, Ottawa
 COORDINATES: Lat: 45.313861281, Lon: -75.904749501
 DATUM: Geodetic
 REMARK:

ORIGINATED BY: A.L.
 COMPILED BY: A.L.
 CHECKED BY: N.T.
 REPORT DATE: 29/05/2020

DEPTH - feet	DEPTH - meters	SOIL PROFILE		SYMBOL	SAMPLES				GROUNDWATER CONDITIONS	DYNAMIC CONE PEN. RESISTANCE PLOT		WATER CONTENT and LIMITS (%)			REMARKS & GRAIN SIZE DISTRIBUTION (%)			
		ELEVATION - m	DEPTH - m		DESCRIPTION	TYPE AND NUMBER	STATE	RECOVERY		"N" or RQD	20	40	60	80		W _p	W	W _L
		99.3	0.0	Natural ground surface														
	1			Silty and gravelly sand, light brown, dry, dense.	SS-01	X	71	4										
	5				SS-02	X	100	REF										
	97.6				SS-03	X	33	REF										
	1.8			END OF BOREHOLE														
	2			No water was observed in open borehole.														
	3																	
	4																	
	15																	
	5																	
	20																	
	6																	
	7																	
	25																	
	8																	
	9																	
	30																	

I:\LICENSES7\Sobek\Geotec801\Style\Log_Borehole_v5.sty

DATE: 22/05/2020 - 22/05/2020
 PROJECT: OCP-18-0534 MARITIME
 CLIENT: Silver Hotel Group
 ELEVATION: 99.96 m

LOCATION: 1305 Maritime Way, Kanata, Ottawa
 COORDINATES: Lat: 45.31407594 , Lon: -75.90466701
 DATUM: Geodetic
 REMARK:

ORIGINATED BY: A.L.
 COMPILED BY: A.L.
 CHECKED BY: N.T.
 REPORT DATE: 05/06/2020

DEPTH - feet	DEPTH - meters	SOIL PROFILE		SYMBOL	SAMPLES				GROUNDWATER CONDITIONS	DYNAMIC CONE PEN. RESISTANCE PLOT		WATER CONTENT and LIMITS (%)			REMARKS & GRAIN SIZE DISTRIBUTION (%)			
		ELEVATION - m	DEPTH - m		DESCRIPTION	TYPE AND NUMBER	STATE	RECOVERY		"N" or RQD	20	40	60	80		W _P	W	W _L
		100.0		Natural ground surface														
	1	0.0	0.9	Peat with tree roots, loose, dark brown, dry	SS-01	X	33	6										
		99.0	0.9	Clay and silt, traces of sand, grey to brown, dry to wet.	SS-02	X	71	8										0 8 51 41
	2	97.8	2.1	Silt and sand, traces of clay and gravel, light brown, wet, loose.	SS-03	X	29	4										
		96.5	3.5	END OF BOREHOLE	SS-04	X	79	1										
					SS-05	X	36	13										
	4																	Auger refusal at 3.5 m on probable bedrock.
	5																	
	6																	
	7																	
	8																	
	9																	

BH20-1

BOREHOLE NO.
FROM 53'8" TO 58'4"
LOCATION 1305 Maritime Way

* Boulders / Cobbles included
(RC-12)
(RC-19)

CCC
Geotechnical & Environmental
Drilling Ltd.



McINTOSH PERRY

Client: Silver Hotel Group

Project: 1305 Maritime Way

Borehole #: 20-1 Sample #: RC-20 Depth: 53'8" to 58'4"

Project No.: OCP-18-0534

BH20-1

BOREHOLE NO. _____
FROM 58'4" TO 62'9"
LOCATION 1305 Maritime

CCC
Geotechnical & Environmental
Drilling Ltd.



McINTOSH PERRY

Client: Silver Hotel Group

Project: 1305 Maritime Way

Borehole #: 20-1 Sample #: RC-21

Depth: 58'4" to 62'9"

Project No.: OCP-18-0534

BH20-2

BOREHOLE NO. _____
FROM 41'8" TO 48'4"
LOCATION 1305 Maritime Way

CCC
Geotechnical & Environmental
Drilling Ltd.



McINTOSH PERRY

Client: Silver Hotel Group

Project: 1305 Maritime Way

Borehole #: 20-2 Sample #: RC-18/19 Depth: 41'8" to 48'4"

Project No.: OCP-18-0534

BH20-2

BOREHOLE NO.
FROM 48' 0" TO 51' 9"
LOCATION 1305 Maritime Way

CCC
Geotechnical & Environmental
Drilling Ltd.



McINTOSH PERRY

Client: Silver Hotel Group
Project: 1305 Maritime Way
Borehole #: 20-2 Sample #: RC-19/20 Depth: 48'4" to 51'9"
Project No.: OCP-18-0534

BH20-3

BOREHOLE NO.
FROM 13'0" TO 19'9"
LOCATION 1305 Maritime Way

CCC
Geotechnical & Environmental
Drilling Ltd.



McINTOSH PERRY

Client: Silver Hotel Group

Project: 1305 Maritime Way

Borehole #: 20-3 Sample #: RC-6/7 Depth: 13'0" to 19'9"

Project No.: OCP-18-0534

BH20-3

BOREHOLE NO.
FROM 19'9" TO 24'9"
LOCATION 1305 Maritime Way

CCC
Geotechnical & Environmental
Drilling Ltd.



McINTOSH PERRY

Client: Silver Hotel Group

Project: 1305 Maritime Way

Borehole #: 20-3 Sample #: RC-8

Depth: 19'9" to 24'9"

Project No.: OCP-18-0534

1305 MARITIME WAY

APPENDIX D
LAB RESULTS

Certificate of Analysis

McIntosh Perry Consulting Eng. (Nepean)

215 Menten Place, Unit 104
Nepean, ON K2H 9C1
Attn: Harrison Smith

Client PO:
Project: OCP-18-0534
Custody: 124212

Report Date: 19-May-2020
Order Date: 14-May-2020

Order #: 2020328

This Certificate of Analysis contains analytical data applicable to the following samples as submitted:

Parcel ID	Client ID
2020328-01	BH20-2/SS-4
2020328-02	BH20-2/SS-9
2020328-03	BH20-2/SS-16
2020328-04	BH20-3/SS-4
2020328-05	BH20-3/SS-9
2020328-06	BH20-3/SS-15
2020328-07	BH20-4/SS-4

Approved By:



Dale Robertson, BSc
Laboratory Director

Certificate of Analysis

Report Date: 19-May-2020

Client: McIntosh Perry Consulting Eng. (Nepean)

Order Date: 14-May-2020

Client PO:

Project Description: OCP-18-0534

Analysis Summary Table

Analysis	Method Reference/Description	Extraction Date	Analysis Date
Anions	EPA 300.1 - IC, water extraction	15-May-20	15-May-20
pH, soil	EPA 150.1 - pH probe @ 25 °C, CaCl buffered ext.	16-May-20	16-May-20
Resistivity	EPA 120.1 - probe, water extraction	15-May-20	15-May-20
Solids, %	Gravimetric, calculation	15-May-20	15-May-20

Certificate of Analysis

Report Date: 19-May-2020

Client: McIntosh Perry Consulting Eng. (Nepean)

Order Date: 14-May-2020

Client PO:

Project Description: OCP-18-0534

Client ID:	BH20-1 /SS-4	BH20-1 /SS-9	BH20-1 /SS-16	BH20-2 /SS-4
Sample Date:	15-Apr-20 09:00	15-Apr-20 09:00	15-Apr-20 09:00	08-Apr-20 09:00
Sample ID:	2020328-01	2020328-02	2020328-03	2020328-04
MDL/Units	Soil	Soil	Soil	Soil

Physical Characteristics

% Solids	0.1 % by Wt.	69.7	90.6	86.7	92.2
----------	--------------	------	------	------	------

General Inorganics

pH	0.05 pH Units	7.71 [1]	7.86 [1]	7.86 [1]	7.93 [1]
Resistivity	0.10 Ohm.m	23.1	62.6	58.5	111

Anions

Chloride	5 ug/g dry	263 [1]	16 [1]	26 [1]	13 [1]
Sulphate	5 ug/g dry	23 [1]	100 [1]	65 [1]	5 [1]

Client ID:	BH20-2 /SS-9	BH20-2 /SS-15	BH20-3 /SS-4	-
Sample Date:	08-Apr-20 09:00	08-Apr-20 09:00	14-Apr-20 09:00	-
Sample ID:	2020328-05	2020328-06	2020328-07	-
MDL/Units	Soil	Soil	Soil	-

Physical Characteristics

% Solids	0.1 % by Wt.	93.2	85.7	91.7	-
----------	--------------	------	------	------	---

General Inorganics

pH	0.05 pH Units	8.07 [1]	8.94 [1]	7.77 [1]	-
Resistivity	0.10 Ohm.m	67.9	88.8	94.0	-

Anions

Chloride	5 ug/g dry	22 [1]	11 [1]	15 [1]	-
Sulphate	5 ug/g dry	82 [1]	70 [1]	<5 [1]	-

Unconfined Compressive Strength of Intact Rock Core

ASTM D 7012: Method C



Client: McIntosh Perry Consulting Engineers
 Project: Materials Testing
 Location: Maritime Way, Ottawa, ON.

Reference No.: OCP-18-0534
 File No.: 170496-43
 Report No.: 1

Drill Core Information

Date(s) Sampled: April 15, 2020
 Sampled By: McIntosh Perry Consulting Engineers
 Date Received: May 20, 2020

Laboratory Identification	Core No.	Field Identification	Borehole	Run	Depth, m	Location / Description
C01106	1		BH20-2 BH20-1	RC-21	~ 18.0	Maritime Way
C01107	2		BH20-3 BH20-2	RC-19	~ 14.6	Maritime Way
C01108	3		BH20-4 BH20-3	RC-7	~ 5.3	Maritime Way

Rock Core Unconfined Compressive Strength Test Data

Laboratory Identification	Core No.	Conditioning	Length, mm	Diameter, mm	Density, kg/m ³	MPa	Description of Failure
C01106	1	As received	92.0	44.9	2560	57.3	Columnar, relatively well formed cone on one end
C01107	2	As received	92.0	44.9	2686	44.3	Vertical fractures through both ends with a well formed cone on one end
C01108	3	As received	91.0	44.9	2753	107.6	Columnar, relatively well formed cone on one end

Comments: _____

Date Issued: May 21, 2020

Reviewed By: W.A. McLaughlin

W.A.M^cLaughlin, Geo.Tech., C.Tech.

1305 MARITIME WAY

APPENDIX E SEISMIC HAZARD CALCULATION

2010 National Building Code Seismic Hazard Calculation

INFORMATION: Eastern Canada English (613) 995-5548 français (613) 995-0600 Facsimile (613) 992-8836
Western Canada English (250) 363-6500 Facsimile (250) 363-6565

Site: 45.314N 75.905W

User File Reference: 1305 Maritime Way

2020-05-13 18:11 UT

Probability of exceedance per annum	0.000404	0.001	0.0021	0.01
Probability of exceedance in 50 years	2 %	5 %	10 %	40 %
Sa (0.2)	0.621	0.377	0.241	0.085
Sa (0.5)	0.300	0.181	0.119	0.042
Sa (1.0)	0.134	0.085	0.054	0.017
Sa (2.0)	0.045	0.027	0.017	0.006
PGA (g)	0.317	0.195	0.119	0.036

Notes: Spectral ($S_a(T)$, where T is the period in seconds) and peak ground acceleration (PGA) values are given in units of g (9.81 m/s^2). Peak ground velocity is given in m/s . Values are for "firm ground" (NBCC2015 Site Class C, average shear wave velocity 450 m/s). NBCC2015 and CSAS6-14 values are highlighted in yellow. Three additional periods are provided - their use is discussed in the NBCC2015 Commentary. Only 2 significant figures are to be used. **These values have been interpolated from a 10-km-spaced grid of points. Depending on the gradient of the nearby points, values at this location calculated directly from the hazard program may vary. More than 95 percent of interpolated values are within 2 percent of the directly calculated values.**

References

National Building Code of Canada 2015 NRCC no. 56190; Appendix C: Table C-3, Seismic Design Data for Selected Locations in Canada

Structural Commentaries (User's Guide - NBC 2015: Part 4 of Division B)
Commentary J: Design for Seismic Effects

Geological Survey of Canada Open File 7893 Fifth Generation Seismic Hazard Model for Canada: Grid values of mean hazard to be used with the 2015 National Building Code of Canada

See the websites www.EarthquakesCanada.ca and www.nationalcodes.ca for more information

1305 Maritime Way Hotel - Liquefaction Analysis

OCP-18-0534

Soil stratigraphy for the hotel site consists of a relatively thick layer of silt sand/sandy silt layer that extends to approximately 16.0 m below the proposed level of the hotel in BH20-1 and approximately 11.0 m in BH20-2. The native silty sand/sandy silt layer is underlain by dense glacial till followed by a bedrock.

Herein liquefaction susceptibility of the native clayey silt and sand, and silty sand/sandy silt layers was evaluated. The native clayey silt and sand, silty sand/sandy silt, and glacial till were found non-susceptible to liquefaction.

For coarse-grained soils with different fines content, the corrected SPT resistance can be used to determine the susceptibility of the coarse-grained soil to liquefaction according to Canadian Foundation Engineering Manual CFEM (2006). Ten representative samples from the native soil layers underwent grain size analysis. The percentage of gravel, sand, silt and clay are presented in Table 1 and Table 2.

Table 1: Grain Size Distribution of Native Clayey Silt and Sand

Borehole No.	Sample No.	Corrected SPT	CRS	Depth (m)	Gravel (%)	Sand (%)	Silt (%)	Clay (%)
BH20-1	SS-03	9	0.040746	1.52 – 2.13	2	37	38	23
BH20-1	SS-05	2	0.042276	3.05 – 3.66	6	34	32	28

Table 2: Grain Size Distribution of Native Silty Sand/Sandy Silt and Glacial Till

Borehole No.	Sample No.	Corrected SPT	CRS	Depth (m)	Gravel (%)	Sand (%)	Silt (%)	Clay (%)
BH20-1	SS-08	10	0.043509	5.3 - 5.9	14	47	30	9
BH20-1	SS-15	35	0.04224	10.6 – 11.3	22	46	32	
BH20-1	SS-18	33	0.040907	13 – 13.4	15	19	49	17
BH20-2	SS-03	77	0.05094	1.52 – 2.13	11	50	31	8
BH20-2	SS-06	27	0.052034	3.8 – 4.4	39	42	19	
BH20-2	SS-08	49	0.053397	5.3 – 5.9	32	53	15	
BH20-2	SS-12	16	0.054006	8.4 – 9.0	19	40	32	9
BH20-2	SS-14	36	0.054377	9.9 – 10.5	31	50	19	

To evaluate the liquefaction susceptibility of the native soil layers layer using SPT test results, Cyclic Stress Ratio (CSR) has to be estimated based on site seismicity characteristics that were obtained from seismic calculator available on Natural Resources Canada website. CSR can be calculated using the following formula:

$$CSR = 0.65 \times \frac{a_{max} \cdot \sigma_v}{g \cdot \sigma'_{v0}} \times r_d$$

where a_{max} is the peak ground surface acceleration for the design earthquake, g is gravity acceleration (9.81 m/s^2), σ_v is total vertical overburden pressure, σ'_{v0} is the initial effective overburden pressure and r_d is stress reduction factor at the depth of interest.

Based on the calculated CSR and corrected SPT values (presented in Table 1 and 2), Figure 1 from CFEM can be used to evaluate the native sand/silty sand layer susceptibility to liquefaction. Accordingly, All the CRS-(N1)60 data results are within the red box and therefore the native soil was found to be non-susceptible to liquefaction.

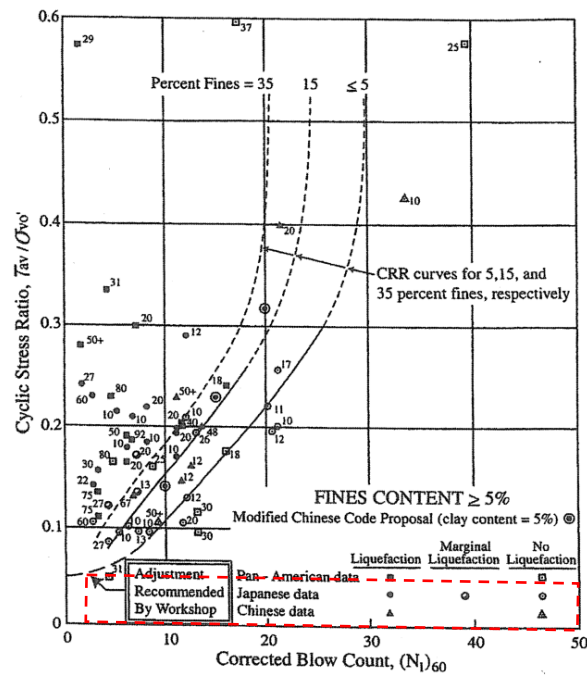

Figure 1: CRS vs Corrected SPT N value, $(N_1)_{60}$ (modified from CFEM 2006)

1305 MARITIME WAY

APPENDIX F
CONCRETE CAISSON AND SOIL INTERACTION
CURVES

p-y Curve Data for Short Caissons (L ≈ 4.6 m)

Depth = 1.0 m		Depth = 2.0 m		Depth = 3.0 m		Depth = 4.0 m	
Y (m)	P (kN/m)	Y (m)	P (kN/m)	Y (m)	P (kN/m)	Y (m)	P (kN/m)
0.000	0.000	0.000	0.000	0.000	0.000	0.000	0.000
0.005	46.959	0.004	80.912	0.000	735.540	0.000	749.028
0.006	49.355	0.005	86.593	0.000	1471.081	0.000	1498.055
0.007	51.505	0.006	91.616	0.000	2206.621	0.000	2247.083
0.008	53.462	0.007	96.142	0.000	2942.162	0.000	2996.111
0.009	55.264	0.008	100.280	0.001	3677.702	0.001	3745.138
0.010	56.938	0.009	104.103	0.001	4413.243	0.001	4494.166
0.010	58.503	0.010	107.665	0.002	5148.783	0.002	5243.194
0.011	59.976	0.011	111.006	0.003	5884.323	0.003	5992.221
0.012	61.368	0.012	114.159	0.004	6252.094	0.004	6366.735
0.013	62.690	0.013	117.147	0.006	6619.864	0.006	6741.249
0.014	63.950	0.014	119.990	0.007	6730.195	0.007	6853.603
0.015	65.153	0.015	122.705	0.009	6840.526	0.009	6965.957
0.024	77.308	0.024	148.333	0.011	6914.080	0.011	7040.860
0.034	89.464	0.034	173.961	0.013	6987.634	0.013	7115.763
0.041	89.464	0.041	173.961	0.016	7061.188	0.017	7190.665
0.047	89.464	0.047	173.961	0.020	7108.579	0.020	7238.925

Lateral Load Analysis

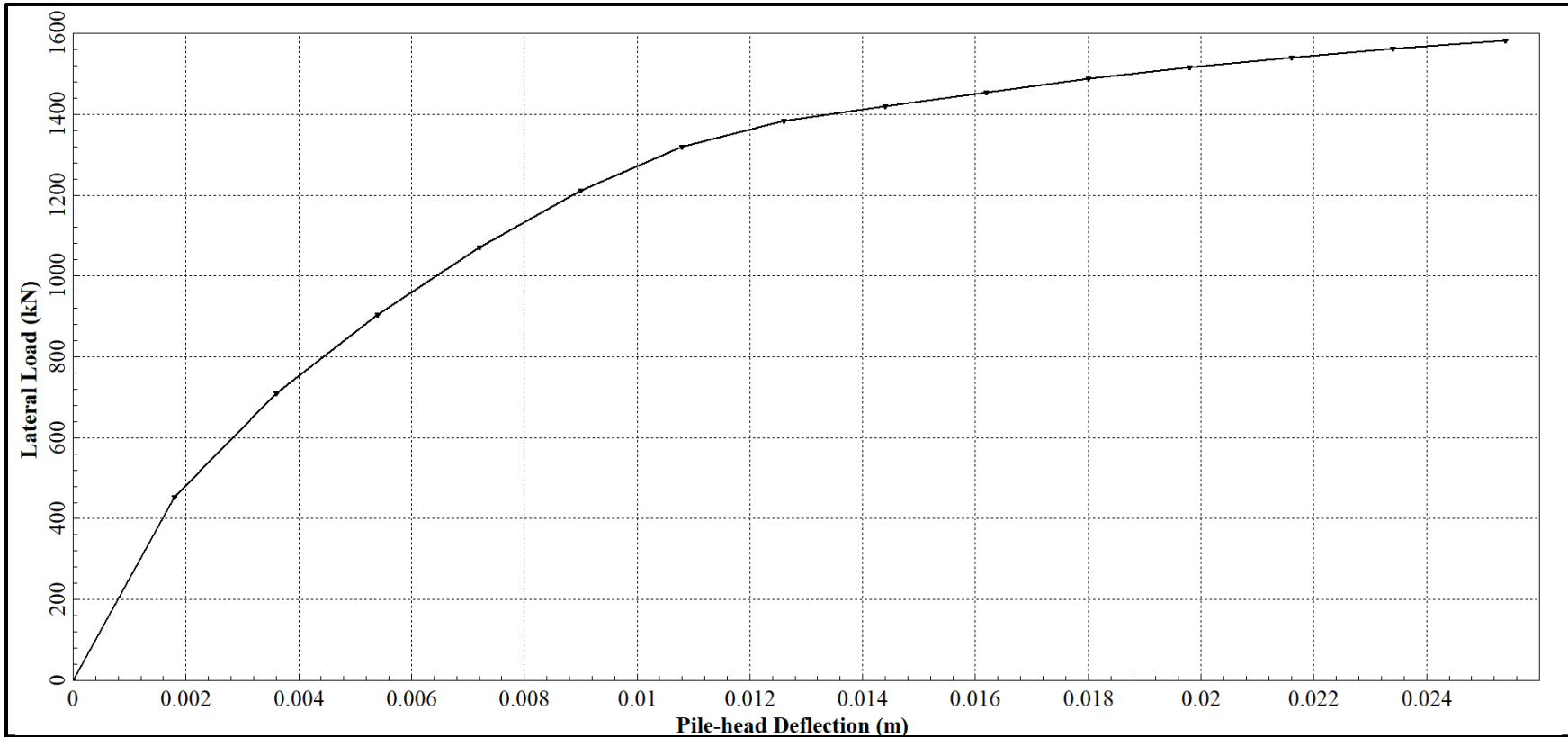

Lateral Load vs. Pile Head Displacement*

* Assumed ULS axial load = 3000 kN

McINTOSH PERRY

Short Length Pile Analysis (L ~ 4.6 m)

Client: Silver Hotel Group

Project: Geotech. Investigation – 1305 Maritime Way, Kanata, ON.

Project No.: CM-19-0534

Lateral Load Analysis

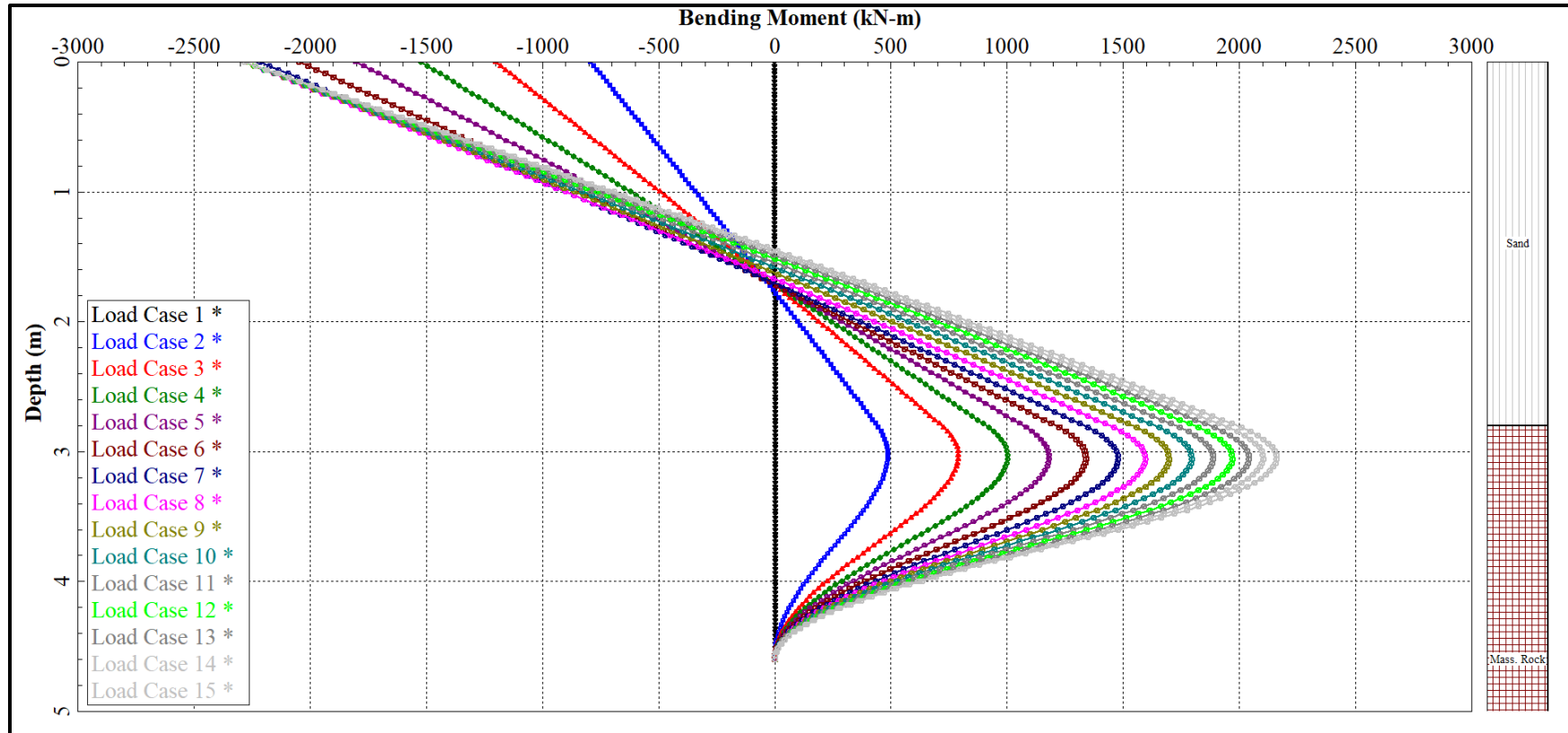

Bending Moment vs. Depth*

* Assumed ULS axial load = 3000 kN

McINTOSH PERRY

Short Length Pile Analysis (L ~ 4.6 m)

Client: Silver Hotel Group

Project: Geotech. Investigation – 1305 Maritime Way, Kanata, ON.

Project No.: CM-19-0534

Lateral Load Analysis

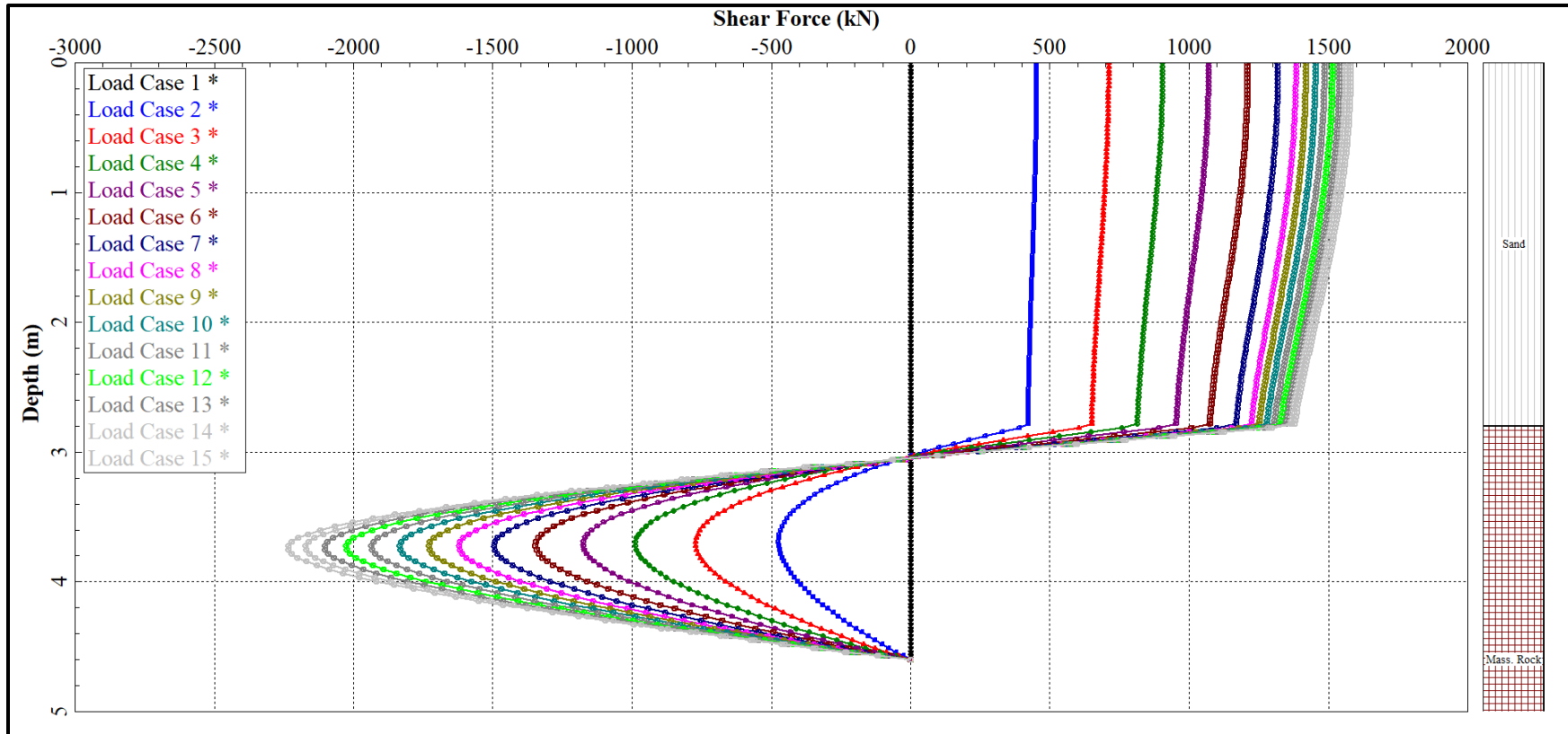

Shear Force vs. Depth*

* Assumed ULS axial load = 3000 kN

McINTOSH PERRY

Short Length Pile Analysis (L ~ 4.6 m)

Client: Silver Hotel Group

Project: Geotech. Investigation – 1305 Maritime Way, Kanata, ON.

Project No.: CM-19-0534

Lateral Load Analysis

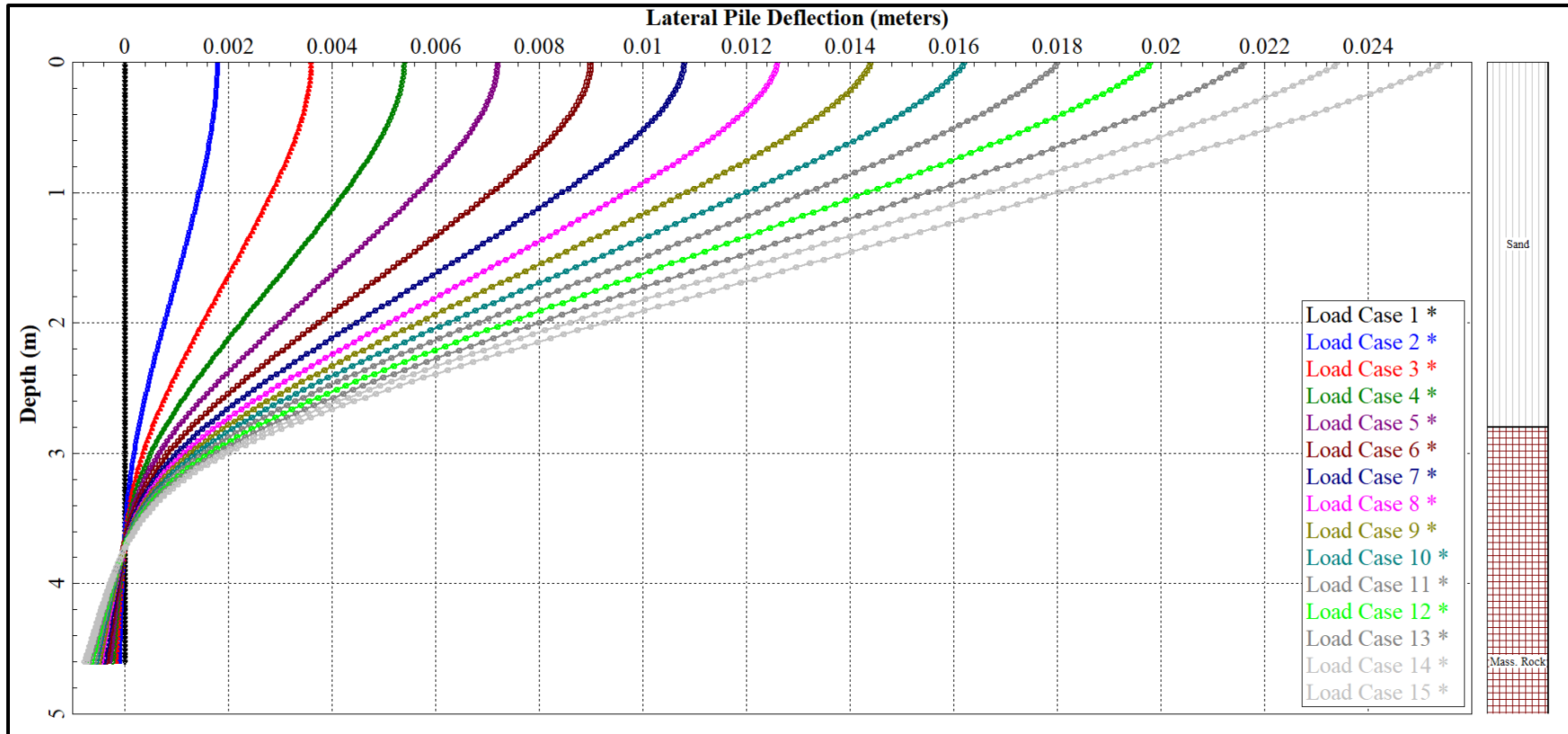

Lateral Deflection vs. Depth*

* Assumed ULS axial load = 3000 kN

McINTOSH PERRY

Short Length Pile Analysis (L ~ 4.6 m)

Client: Silver Hotel Group

Project: Geotech. Investigation – 1305 Maritime Way, Kanata, ON.

Project No.: CM-19-0534

Lateral Load Analysis

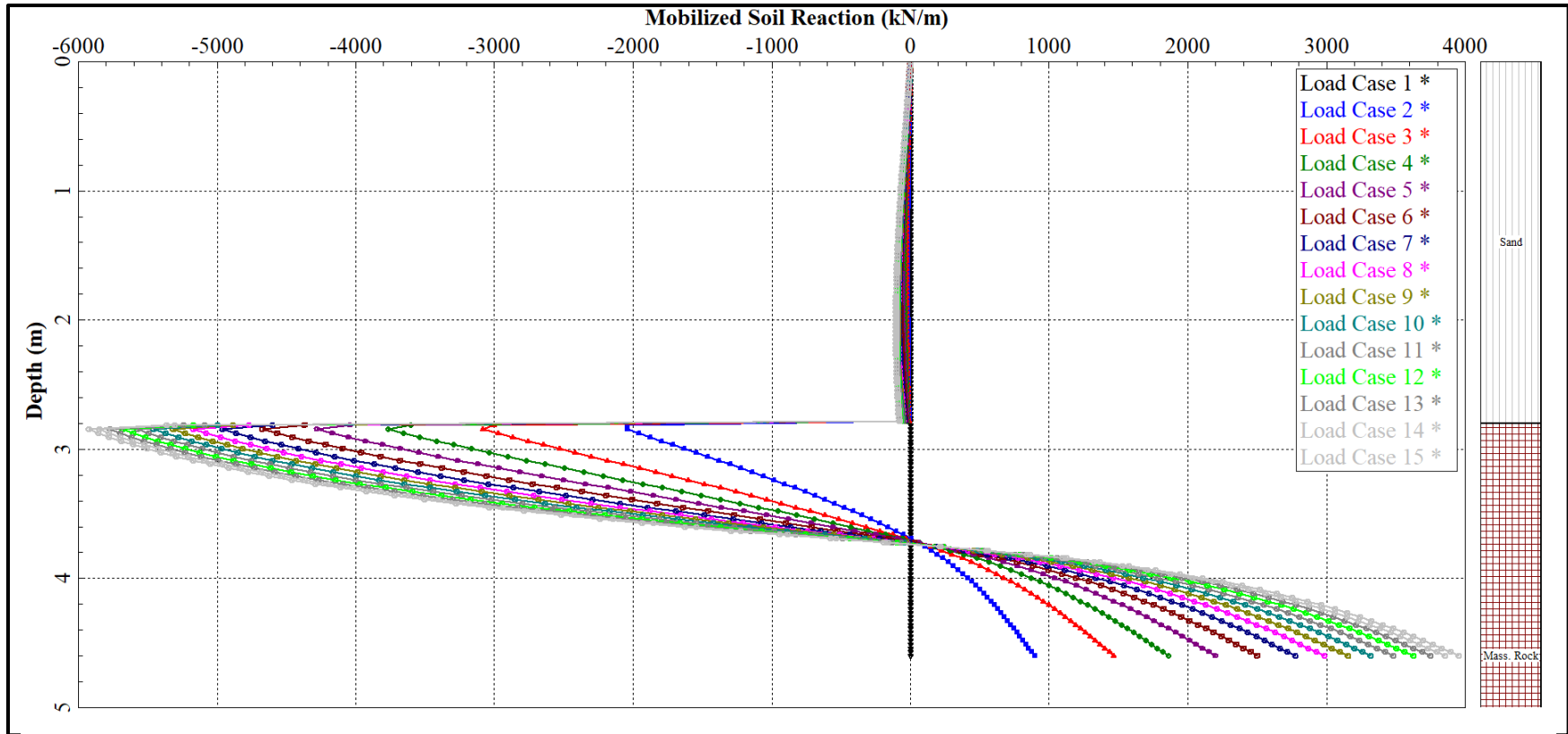

Soil Reaction vs. Depth*

* Assumed ULS axial load = 3000 kN

McINTOSH PERRY

Short Length Pile Analysis (L ~ 4.6 m)

Client: Silver Hotel Group

Project: Geotech. Investigation – 1305 Maritime Way, Kanata, ON.

Project No.: CM-19-0534

p-y Curve Data for Medium Caissons (L ≈ 11.8 m)

Depth = 1.0 m		Depth = 2.0 m		Depth = 3.0 m		Depth = 4.0 m		Depth = 5.0 m		Depth = 6.0 m	
Y (m)	P (kN/m)	Y (m)	P (kN/m)	Y (m)	P (kN/m)	Y (m)	P (kN/m)	Y (m)	P (kN/m)	Y (m)	P (kN/m)
0.000	0.000	0.000	0.000	0.000	0.000	0.000	0.000	0.000	0.000	0.000	0.000
0.005	46.959	0.004	80.912	0.003	76.566	0.001	55.139	0.000	36.331	0.001	85.678
0.006	49.355	0.005	86.593	0.004	89.034	0.003	78.442	0.002	83.390	0.002	137.406
0.007	51.505	0.006	91.616	0.005	99.592	0.004	97.514	0.003	116.984	0.004	178.668
0.008	53.462	0.007	96.142	0.006	108.883	0.005	114.190	0.004	145.212	0.005	214.502
0.009	55.264	0.008	100.280	0.007	117.258	0.006	129.260	0.006	170.262	0.006	246.822
0.010	56.938	0.009	104.103	0.008	124.930	0.008	143.149	0.007	193.127	0.007	276.612
0.010	58.503	0.010	107.665	0.009	132.042	0.009	156.124	0.008	214.364	0.009	304.461
0.011	59.976	0.011	111.006	0.011	138.696	0.010	168.359	0.010	234.321	0.010	330.755
0.012	61.368	0.012	114.159	0.012	144.965	0.011	179.981	0.011	253.237	0.011	355.764
0.013	62.690	0.013	117.147	0.013	150.905	0.013	191.083	0.012	271.282	0.012	379.687
0.014	63.950	0.014	119.990	0.014	156.560	0.014	201.735	0.014	288.584	0.014	402.675
0.015	65.153	0.015	122.705	0.015	161.966	0.015	211.995	0.015	305.242	0.015	424.846
0.024	77.308	0.024	148.333	0.024	206.403	0.024	288.814	0.024	421.234	0.024	586.287
0.034	89.464	0.034	173.961	0.034	250.840	0.034	365.634	0.034	537.226	0.034	747.729
0.041	89.464	0.041	173.961	0.041	250.840	0.041	365.634	0.041	537.226	0.041	747.729
0.047	89.464	0.047	173.961	0.047	250.840	0.047	365.634	0.047	537.226	0.047	747.729

p-y Curve Data for Medium Caissons (L ≈ 11.8 m) “Continue”

Depth = 7.0 m		Depth = 8.0 m		Depth = 9.0 m		Depth = 10.0 m		Depth = 11.0 m	
Y (m)	P (kN/m)	Y (m)	P (kN/m)	Y (m)	P (kN/m)	Y (m)	P (kN/m)	Y (m)	P (kN/m)
0.000	0.000	0.000	0.000	0.000	0.000	0.000	0.000	0.000	0.000
0.002	188.054	0.002	229.503	0.002	275.377	0.000	339.773	0.000	456.353
0.004	236.947	0.003	294.558	0.003	358.808	0.000	679.546	0.000	912.705
0.005	280.029	0.005	351.392	0.004	431.196	0.000	1019.320	0.000	1369.058
0.006	319.196	0.006	402.816	0.006	496.453	0.000	1359.093	0.000	1825.411
0.007	355.477	0.007	450.309	0.007	556.585	0.000	1698.866	0.001	2281.763
0.008	389.510	0.008	494.768	0.008	612.787	0.001	2038.639	0.001	2738.116
0.009	421.725	0.009	536.785	0.009	665.842	0.001	2378.413	0.001	3194.469
0.010	452.424	0.010	576.780	0.010	716.299	0.002	2718.186	0.002	3650.822
0.012	481.834	0.012	615.061	0.011	764.561	0.002	2888.073	0.003	3878.998
0.013	510.130	0.013	651.863	0.013	810.933	0.004	3057.959	0.005	4107.174
0.014	537.447	0.014	687.371	0.014	855.654	0.005	3108.925	0.006	4175.627
0.015	563.897	0.015	721.733	0.015	898.916	0.006	3159.891	0.007	4244.080
0.024	778.178	0.024	995.992	0.024	1240.504	0.007	3193.868	0.009	4289.715
0.034	992.459	0.034	1270.250	0.034	1582.091	0.008	3227.846	0.011	4335.351
0.041	992.459	0.041	1270.250	0.041	1582.091	0.010	3261.823	0.014	4380.986
0.047	992.459	0.047	1270.250	0.047	1582.091	0.012	3283.715	0.016	4410.388

Lateral Load Analysis

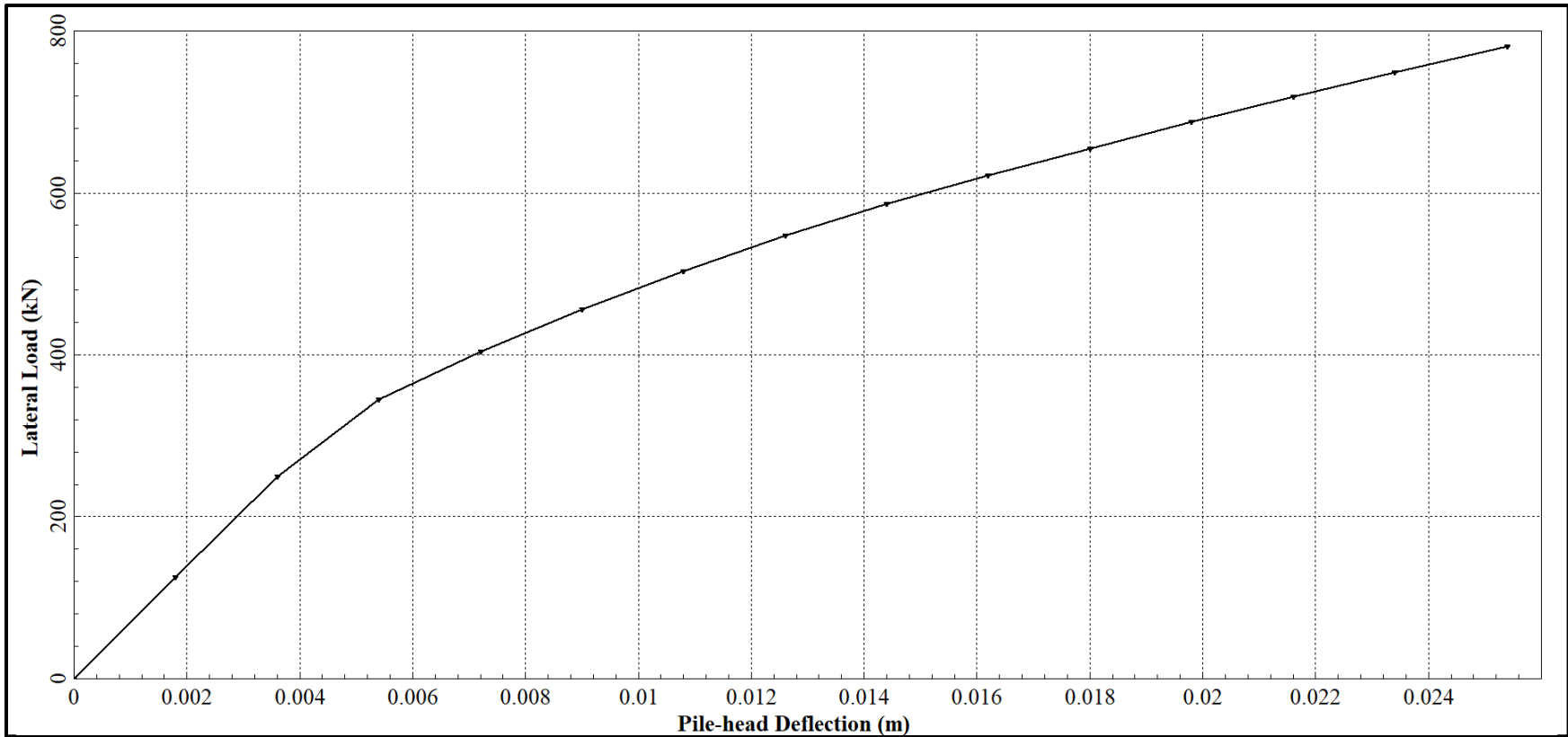

Lateral Load vs. Pile Head Displacement*

* Assumed ULS axial load = 3000 kN

McINTOSH PERRY

Medium Length Pile Analysis (L ~ 11.8 m)

Client: Silver Hotel Group

Project: Geotech. Investigation – 1305 Maritime Way, Kanata, ON.

Project No.: CM-19-0534

Lateral Load Analysis

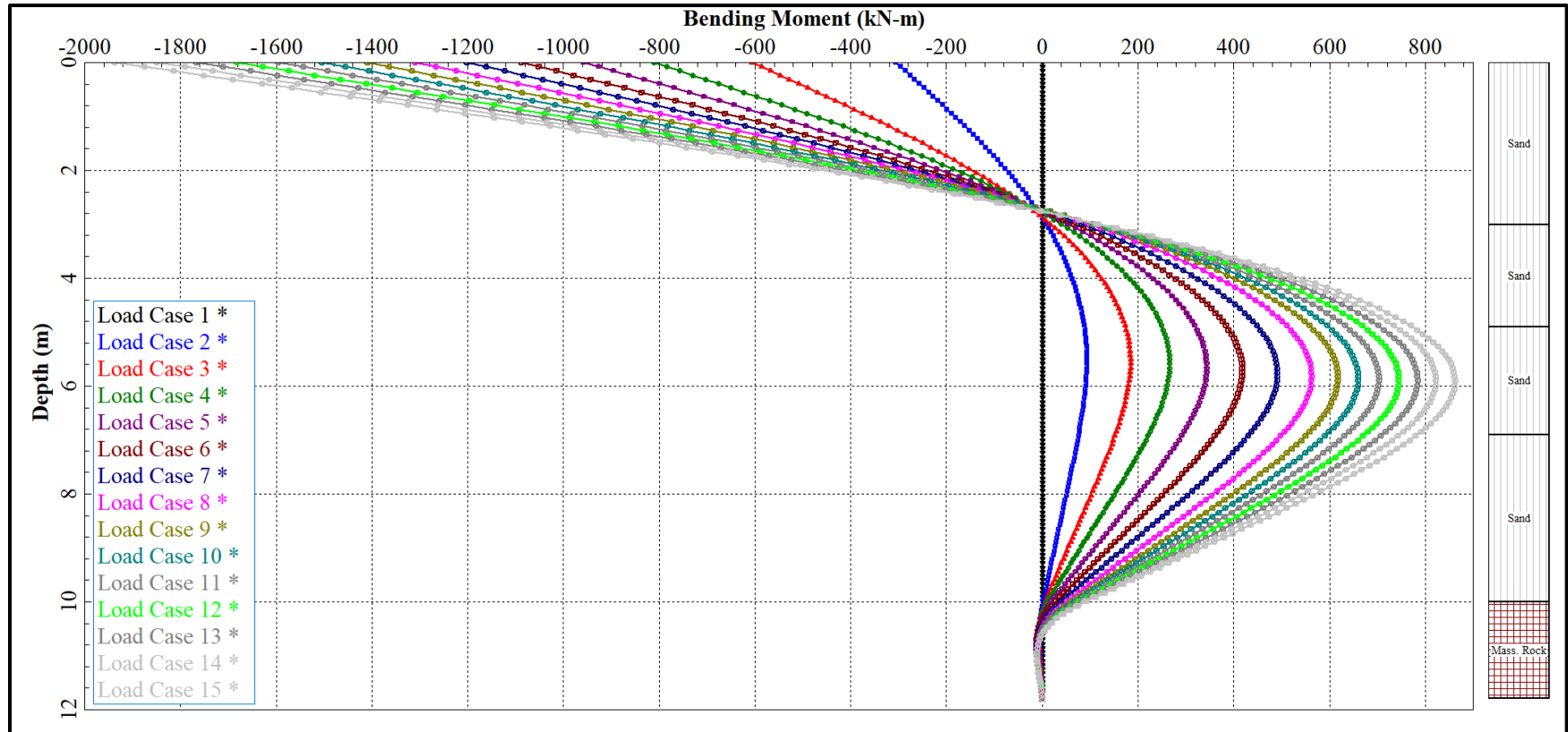

Bending Moment vs. Depth*

* Assumed ULS axial load = 3000 kN

McINTOSH PERRY

Medium Length Pile Analysis (L ~ 11.8 m)

Client: Silver Hotel Group

Project: Geotech. Investigation – 1305 Maritime Way, Kanata, ON.

Project No.: CM-19-0534

Lateral Load Analysis

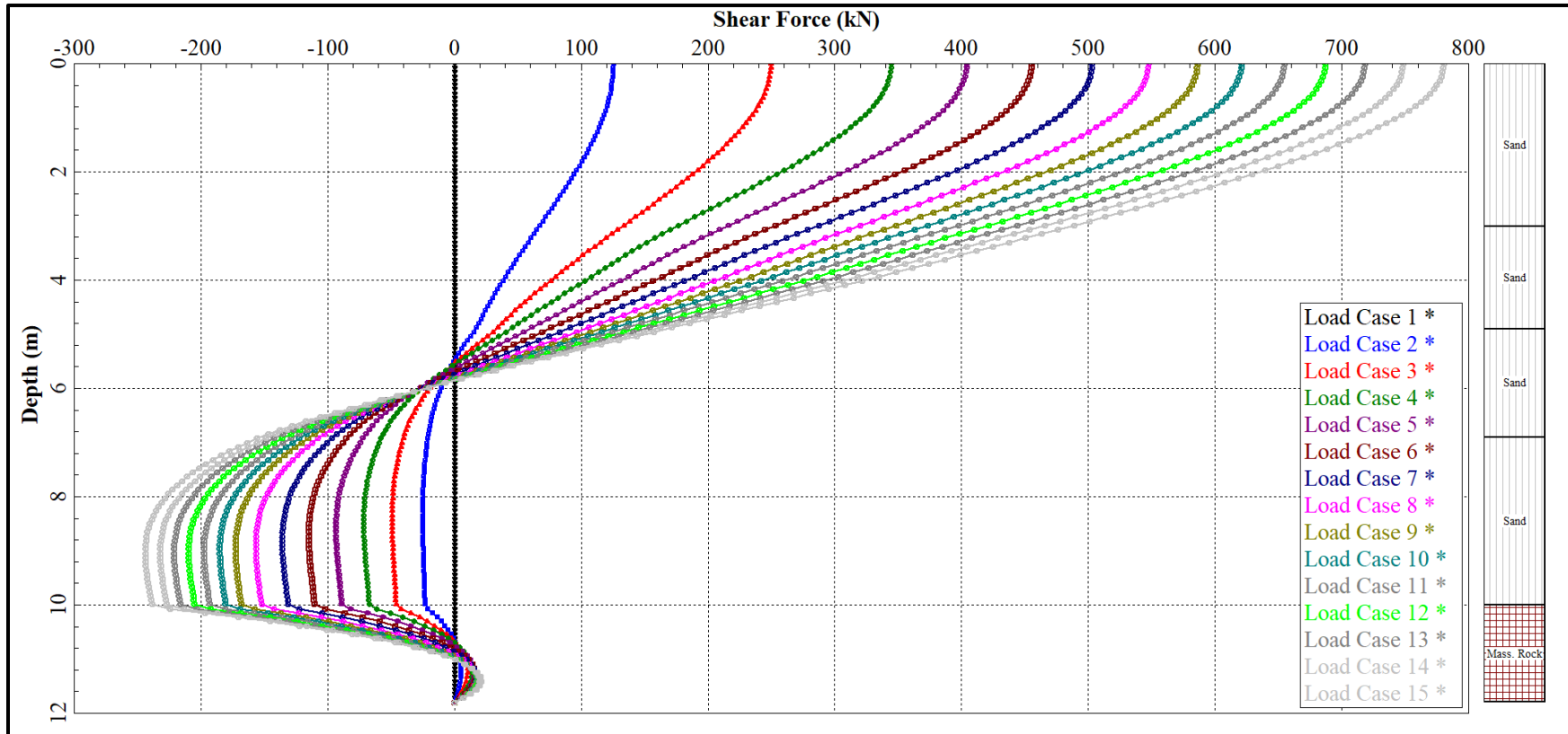

Shear Force vs. Depth*

* Assumed ULS axial load = 3000 kN

McINTOSH PERRY

Medium Length Pile Analysis (L ~ 11.8 m)

Client: Silver Hotel Group

Project: Geotech. Investigation – 1305 Maritime Way, Kanata, ON.

Project No.: CM-19-0534

Lateral Load Analysis

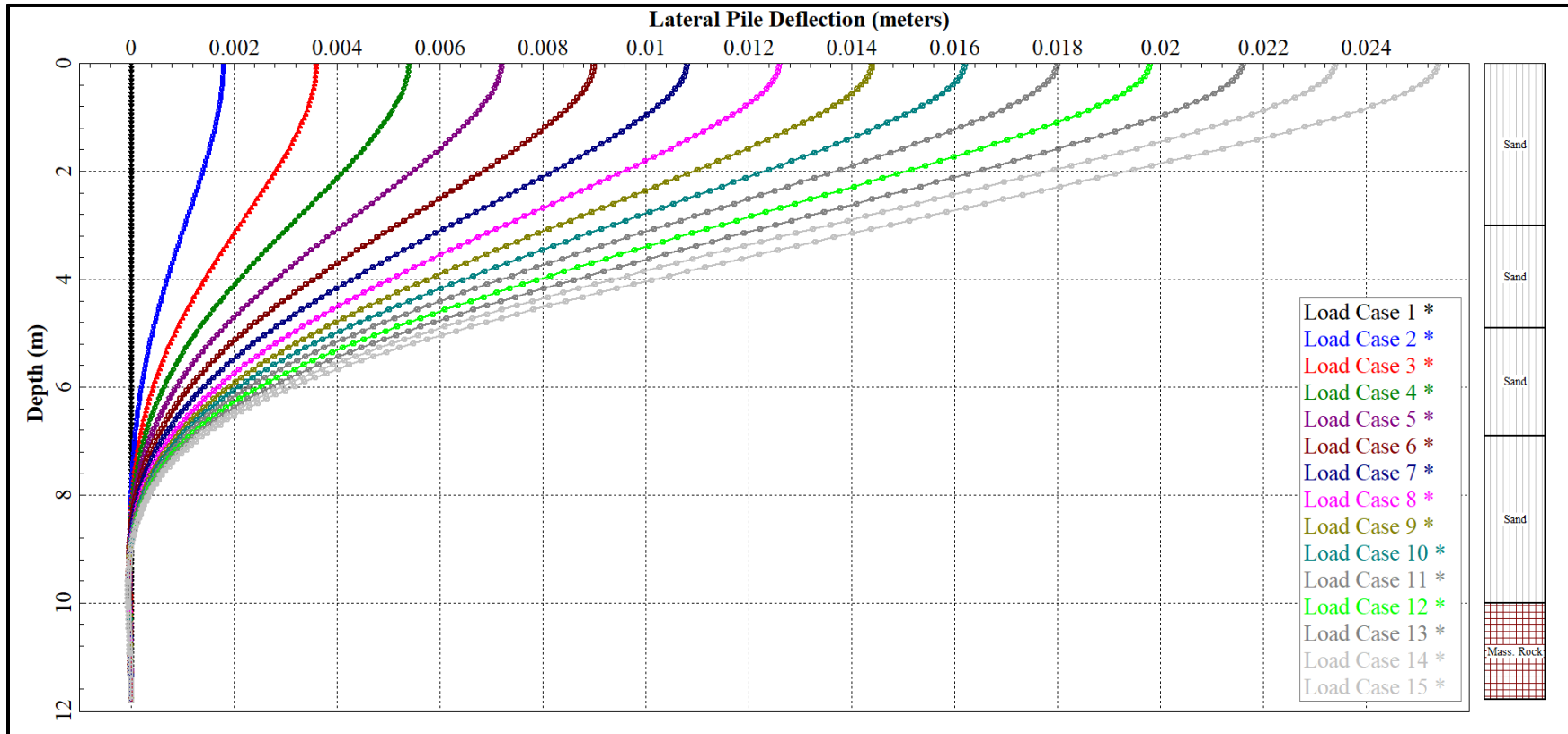

Lateral Deflection vs. Depth*

* Assumed ULS axial load = 3000 kN

McINTOSH PERRY

Medium length Pile Analysis (L ~ 11.8 m)

Client: Silver Hotel Group

Project: Geotech. Investigation – 1305 Maritime Way, Kanata, ON.

Project No.: CM-19-0534

Lateral Load Analysis

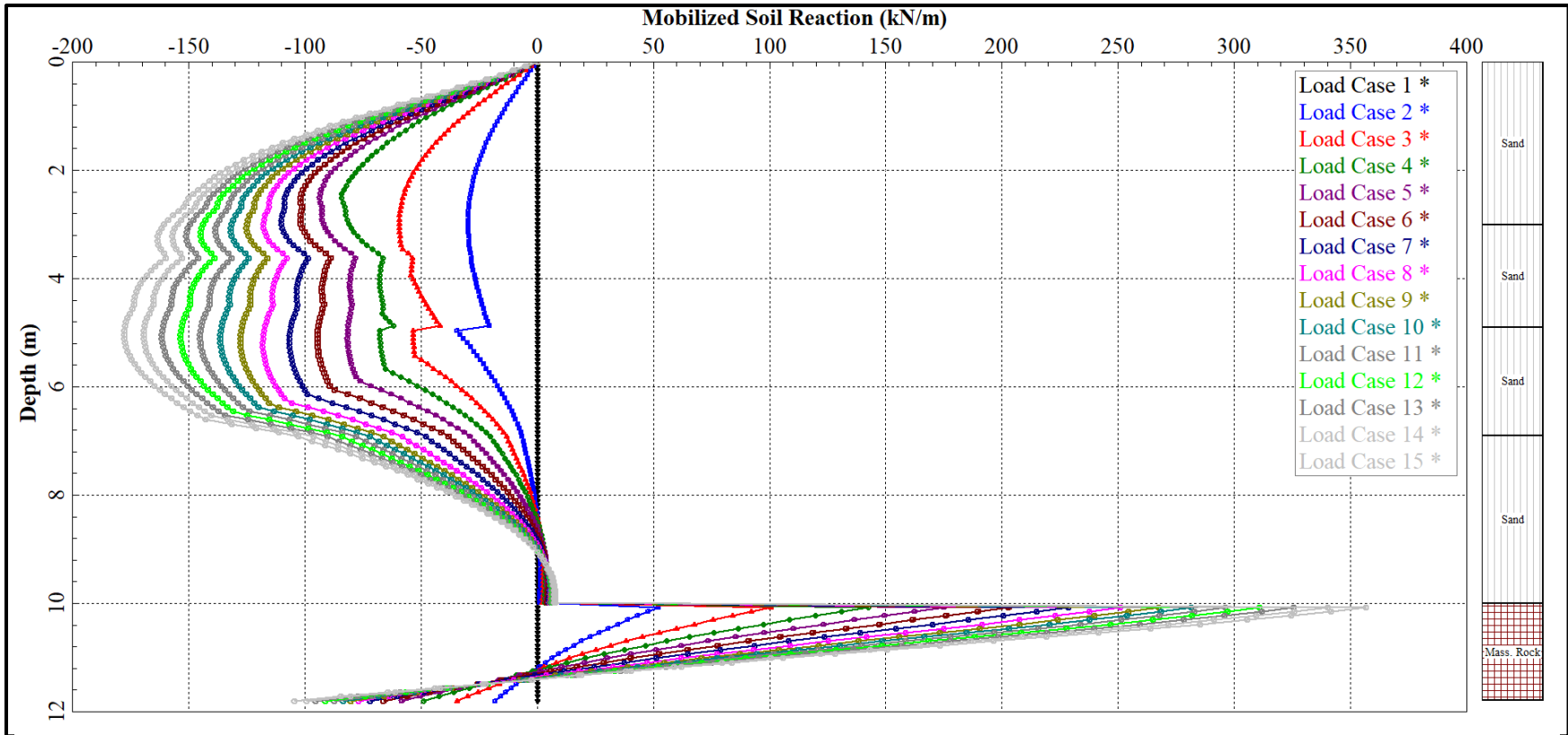

Soil Reaction vs. Depth*

* Assumed ULS axial load = 3000 kN

McINTOSH PERRY

Medium Length Pile Analysis (L ~ 11.8 m)

Client: Silver Hotel Group

Project: Geotech. Investigation – 1305 Maritime Way, Kanata, ON.

Project No.: CM-19-0534

p-y Curve Data for Long Caissons (L ≈ 18.1 m)

Depth = 1.0 m		Depth = 2.0 m		Depth = 3.0 m		Depth = 4.0 m		Depth = 5.0 m		Depth = 6.0 m	
Y (m)	P (kN/m)	Y (m)	P (kN/m)	Y (m)	P (kN/m)	Y (m)	P (kN/m)	Y (m)	P (kN/m)	Y (m)	P (kN/m)
0.000	0.000	0.000	0.000	0.000	0.000	0.000	0.000	0.000	0.000	0.000	0.000
0.005	46.959	0.004	80.912	0.003	76.566	0.001	55.139	0.012	266.351	0.011	351.626
0.006	49.355	0.005	86.593	0.004	89.034	0.003	78.442	0.012	270.034	0.011	358.673
0.007	51.505	0.006	91.616	0.005	99.592	0.004	97.514	0.013	273.684	0.012	365.632
0.008	53.462	0.007	96.142	0.006	108.883	0.005	114.190	0.013	277.304	0.012	372.507
0.009	55.264	0.008	100.280	0.007	117.258	0.006	129.260	0.013	280.893	0.012	379.300
0.010	56.938	0.009	104.103	0.008	124.930	0.008	143.149	0.013	284.453	0.013	386.017
0.010	58.503	0.010	107.665	0.009	132.042	0.009	156.124	0.014	287.984	0.013	392.658
0.011	59.976	0.011	111.006	0.011	138.696	0.010	168.359	0.014	291.487	0.014	399.228
0.012	61.368	0.012	114.159	0.012	144.965	0.011	179.981	0.014	294.964	0.014	405.729
0.013	62.690	0.013	117.147	0.013	150.905	0.013	191.083	0.014	298.414	0.014	412.164
0.014	63.950	0.014	119.990	0.014	156.560	0.014	201.735	0.015	301.839	0.015	418.534
0.015	65.153	0.015	122.705	0.015	161.966	0.015	211.995	0.015	305.239	0.015	424.843
0.024	77.308	0.024	148.333	0.024	206.403	0.024	288.814	0.024	421.230	0.024	586.283
0.034	89.464	0.034	173.961	0.034	250.840	0.034	365.634	0.034	537.221	0.034	747.723
0.041	89.464	0.041	173.961	0.041	250.840	0.041	365.634	0.041	537.221	0.041	747.723
0.047	89.464	0.047	173.961	0.047	250.840	0.047	365.634	0.047	537.221	0.047	747.723

p-y Curve Data for Long Caissons (L ≈ 18.1 m) “Continue”

Depth = 7.0 m		Depth = 8.0 m		Depth = 9.0 m		Depth = 10.0 m		Depth = 11.0 m		Depth = 12.0 m	
Y (m)	P (kN/m)	Y (m)	P (kN/m)	Y (m)	P (kN/m)	Y (m)	P (kN/m)	Y (m)	P (kN/m)	Y (m)	P (kN/m)
0.000	0.000	0.000	0.000	0.000	0.000	0.000	0.000	0.000	0.000	0.000	0.000
0.010	448.961	0.010	558.333	0.002	232.116	0.002	324.211	0.003	500.285	0.005	760.460
0.011	460.165	0.010	574.488	0.003	326.731	0.003	429.077	0.004	601.783	0.006	850.934
0.011	471.196	0.011	590.355	0.004	406.123	0.004	519.429	0.005	693.241	0.007	935.583
0.012	482.063	0.011	605.952	0.005	476.529	0.006	600.588	0.006	777.491	0.007	1015.553
0.012	492.774	0.012	621.294	0.006	540.770	0.007	675.205	0.007	856.219	0.008	1091.652
0.012	503.338	0.012	636.396	0.008	600.421	0.008	744.841	0.008	930.528	0.009	1164.472
0.013	513.760	0.013	651.270	0.009	656.469	0.009	810.506	0.010	1001.192	0.010	1234.467
0.013	524.047	0.013	665.929	0.010	709.587	0.010	872.905	0.011	1068.774	0.011	1301.990
0.014	534.206	0.014	680.382	0.011	760.254	0.011	932.549	0.012	1133.706	0.012	1367.327
0.014	544.242	0.014	694.640	0.013	808.830	0.013	989.829	0.013	1196.322	0.013	1430.709
0.015	554.160	0.015	708.711	0.014	855.594	0.014	1045.045	0.014	1256.893	0.014	1492.330
0.015	563.965	0.015	722.605	0.015	900.764	0.015	1098.441	0.015	1315.637	0.015	1552.352
0.024	778.271	0.024	997.195	0.024	1243.054	0.024	1515.849	0.024	1815.579	0.024	2142.245
0.034	992.578	0.034	1271.785	0.034	1585.345	0.034	1933.257	0.034	2315.522	0.034	2732.139
0.041	992.578	0.041	1271.785	0.041	1585.345	0.041	1933.257	0.041	2315.522	0.041	2732.139
0.047	992.578	0.047	1271.785	0.047	1585.345	0.047	1933.257	0.047	2315.522	0.047	2732.139

p-y Curve Data for Long Caissons (L ≈ 18.1 m) “Continue”

Depth = 13.0 m		Depth = 14.0 m		Depth = 15.0 m		Depth = 16.0 m		Depth = 17.0 m		Depth = 18.0 m	
Y (m)	P (kN/m)	Y (m)	P (kN/m)	Y (m)	P (kN/m)	Y (m)	P (kN/m)	Y (m)	P (kN/m)	Y (m)	P (kN/m)
0.000	0.000	0.000	0.000	0.000	0.000	0.000	0.000	0.000	0.000	0.000	0.000
0.006	1002.896	0.008	1265.631	0.011	1618.034	0.002	599.213	0.000	577.495	0.000	586.551
0.007	1079.793	0.009	1325.266	0.011	1653.118	0.003	806.955	0.000	1154.989	0.000	1173.102
0.008	1153.308	0.009	1383.218	0.012	1687.728	0.004	984.581	0.000	1732.484	0.000	1759.653
0.009	1223.918	0.010	1439.646	0.012	1721.887	0.005	1143.520	0.001	2309.979	0.001	2346.204
0.009	1291.992	0.011	1494.682	0.012	1755.614	0.007	1289.309	0.001	2887.474	0.001	2932.755
0.010	1357.828	0.011	1548.441	0.013	1788.928	0.008	1425.152	0.001	3464.968	0.001	3519.306
0.011	1421.666	0.012	1601.023	0.013	1821.847	0.009	1553.106	0.002	4042.463	0.002	4105.856
0.012	1483.707	0.012	1652.513	0.013	1854.387	0.010	1674.593	0.003	4619.958	0.003	4692.407
0.013	1544.119	0.013	1702.990	0.014	1886.563	0.011	1790.641	0.004	4908.705	0.004	4985.683
0.013	1603.043	0.014	1752.519	0.014	1918.389	0.013	1902.029	0.007	5197.452	0.007	5278.958
0.014	1660.603	0.014	1801.163	0.015	1949.878	0.014	2009.359	0.008	5284.076	0.008	5366.941
0.015	1716.903	0.015	1848.973	0.015	1981.042	0.015	2113.112	0.010	5370.701	0.010	5454.924
0.024	2369.327	0.024	2551.583	0.024	2733.838	0.024	2916.094	0.012	5428.450	0.012	5513.579
0.034	3021.750	0.034	3254.192	0.034	3486.635	0.034	3719.077	0.014	5486.200	0.015	5572.234
0.041	3021.750	0.041	3254.192	0.041	3486.635	0.041	3719.077	0.018	5543.949	0.018	5630.889
0.047	3021.750	0.047	3254.192	0.047	3486.635	0.047	3719.077	0.022	5581.157	0.022	5668.680

Lateral Load Analysis

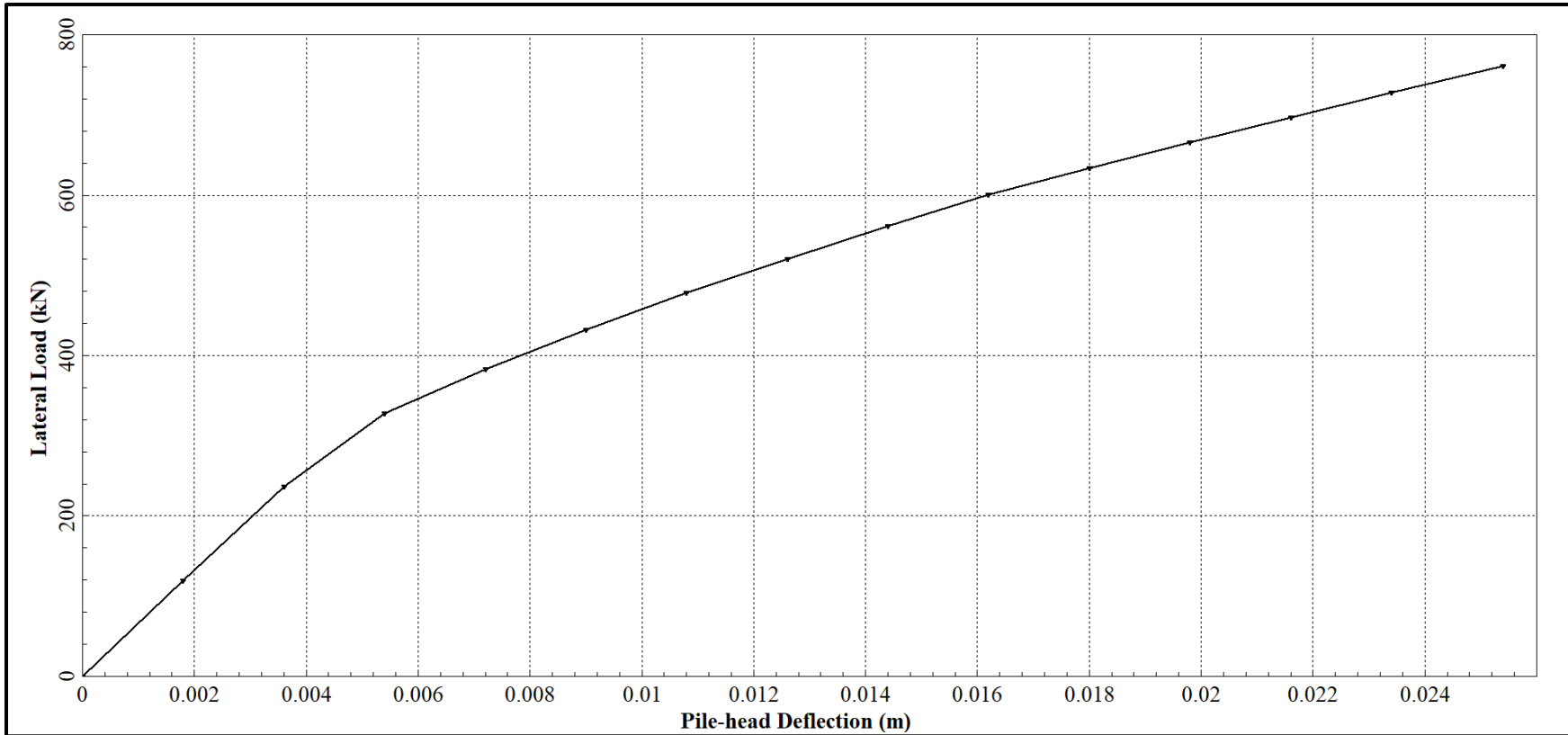

Lateral Load vs. Pile Head Displacement*

* Assumed ULS axial load = 3000 kN

McINTOSH PERRY

Long Pile Analysis (L ~ 18.1 m)

Client: Silver Hotel Group

Project: Geotech. Investigation – 1305 Maritime Way, Kanata, ON.

Project No.: CM-19-0534

Lateral Load Analysis

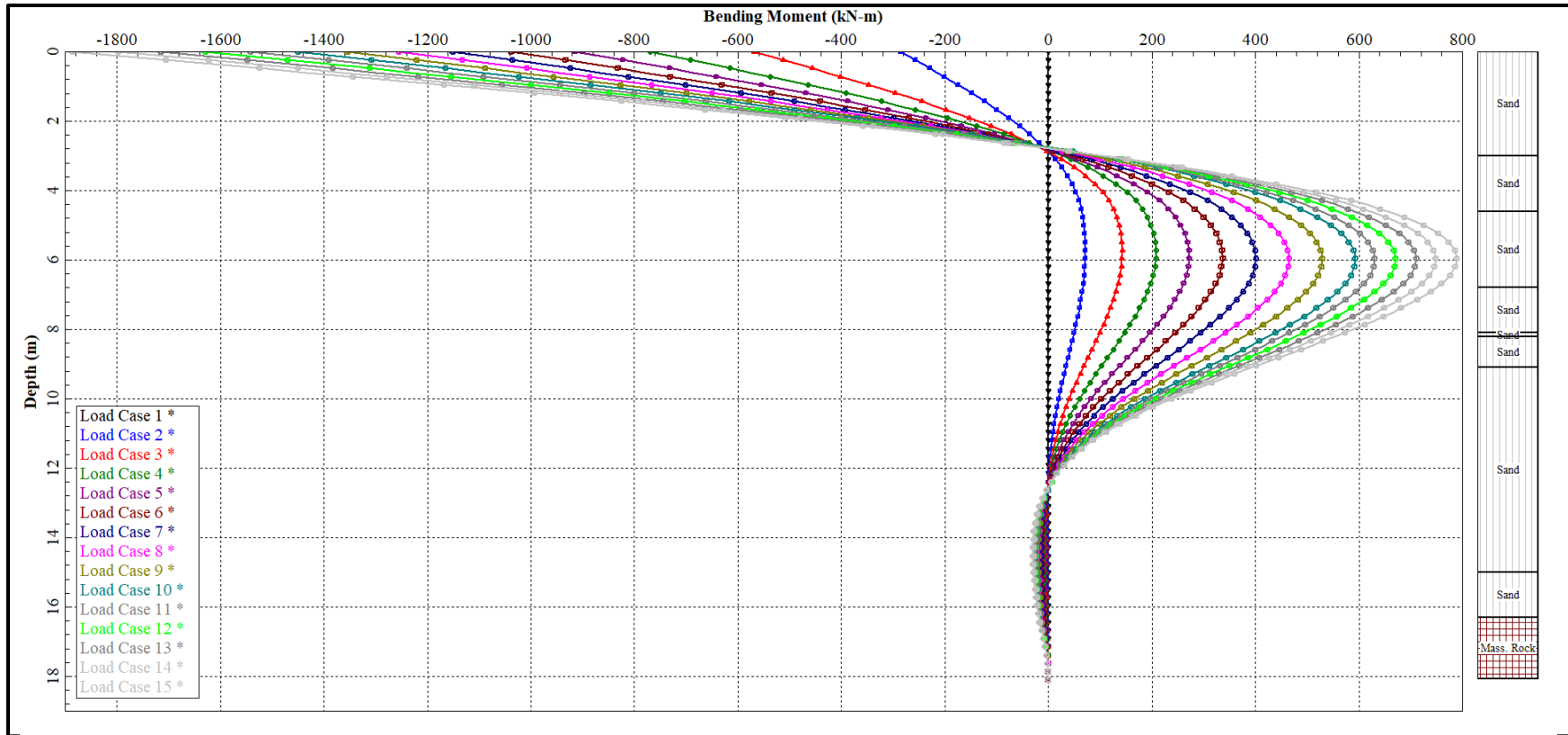

Bending Moment vs. Depth*

* Assumed ULS axial load = 3000 kN

McINTOSH PERRY

Long Pile Analysis (L ~ 18.1 m)

Client: Silver Hotel Group

Project: Geotech. Investigation – 1305 Maritime Way, Kanata, ON.

Project No.: CM-19-0534

Lateral Load Analysis

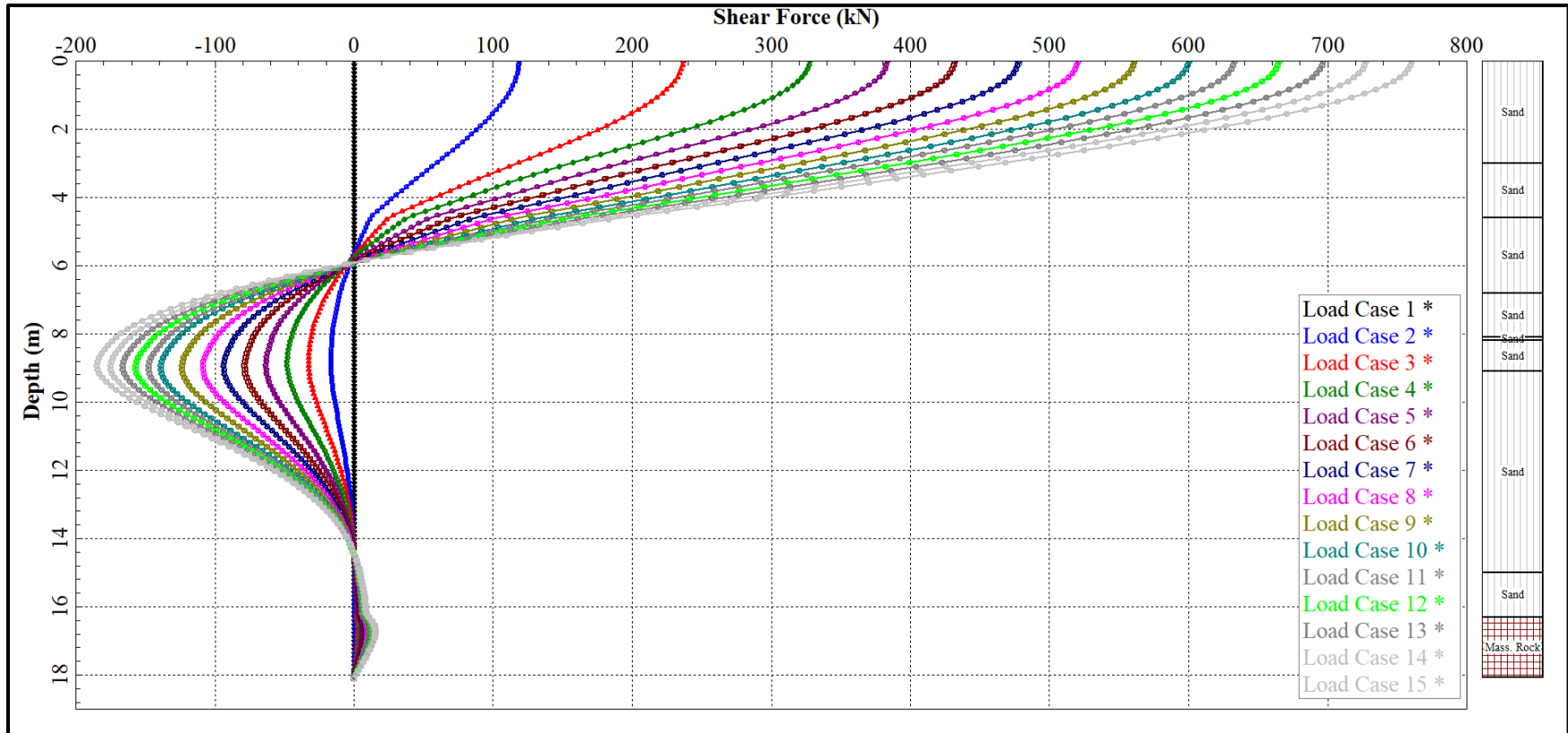

Shear Force vs. Depth*

* Assumed ULS axial load = 3000 kN

McINTOSH PERRY

Long Pile Analysis (L ~ 18.1 m)

Client: Silver Hotel Group

Project: Geotech. Investigation – 1305 Maritime Way, Kanata, ON.

Project No.: CM-19-0534

Lateral Load Analysis

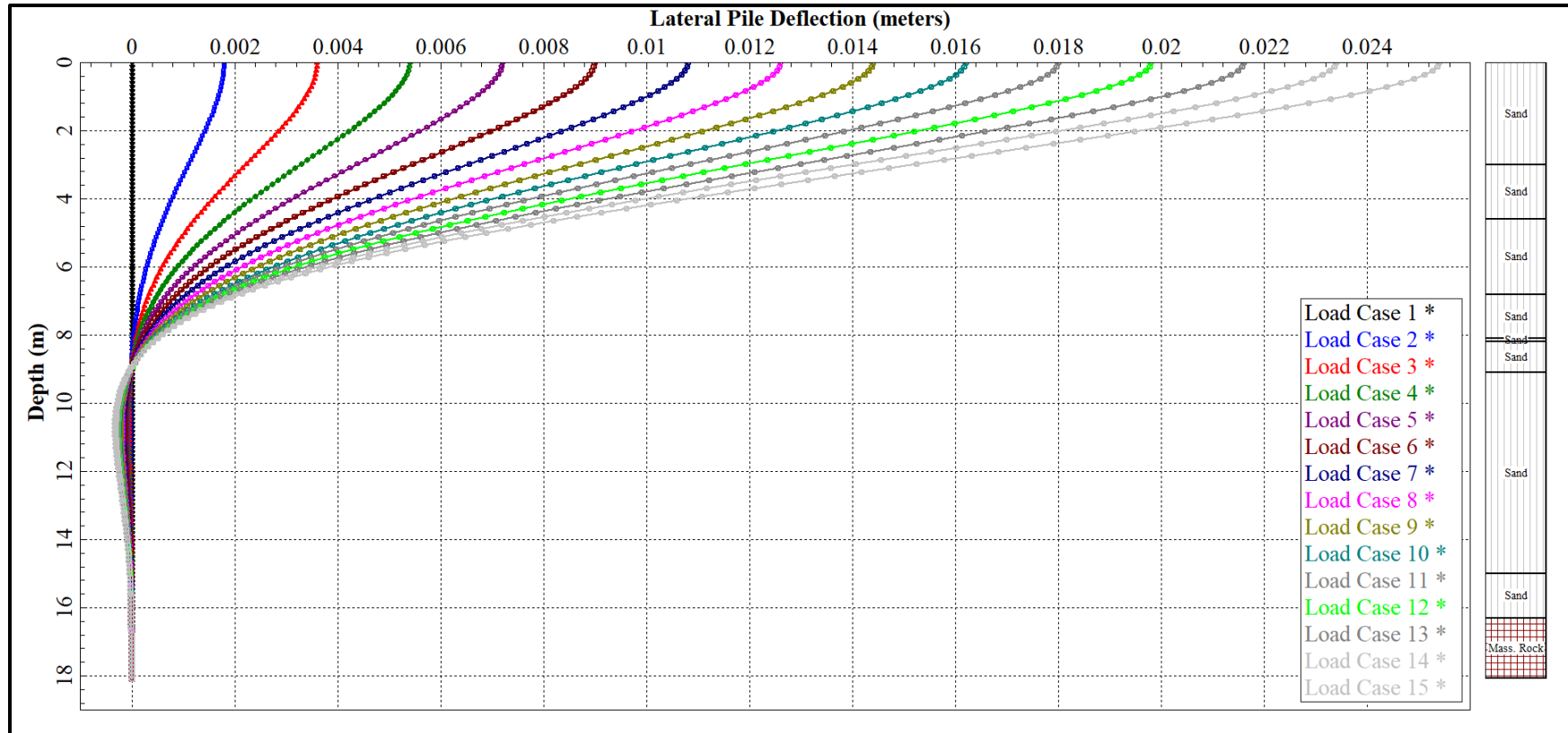

Lateral Deflection vs. Depth*

* Assumed ULS axial load = 3000 kN

McINTOSH PERRY

Long Pile Analysis (L ~ 18.1 m)

Client: Silver Hotel Group

Project: Geotech. Investigation – 1305 Maritime Way, Kanata, ON.

Project No.: CM-19-0534

Lateral Load Analysis

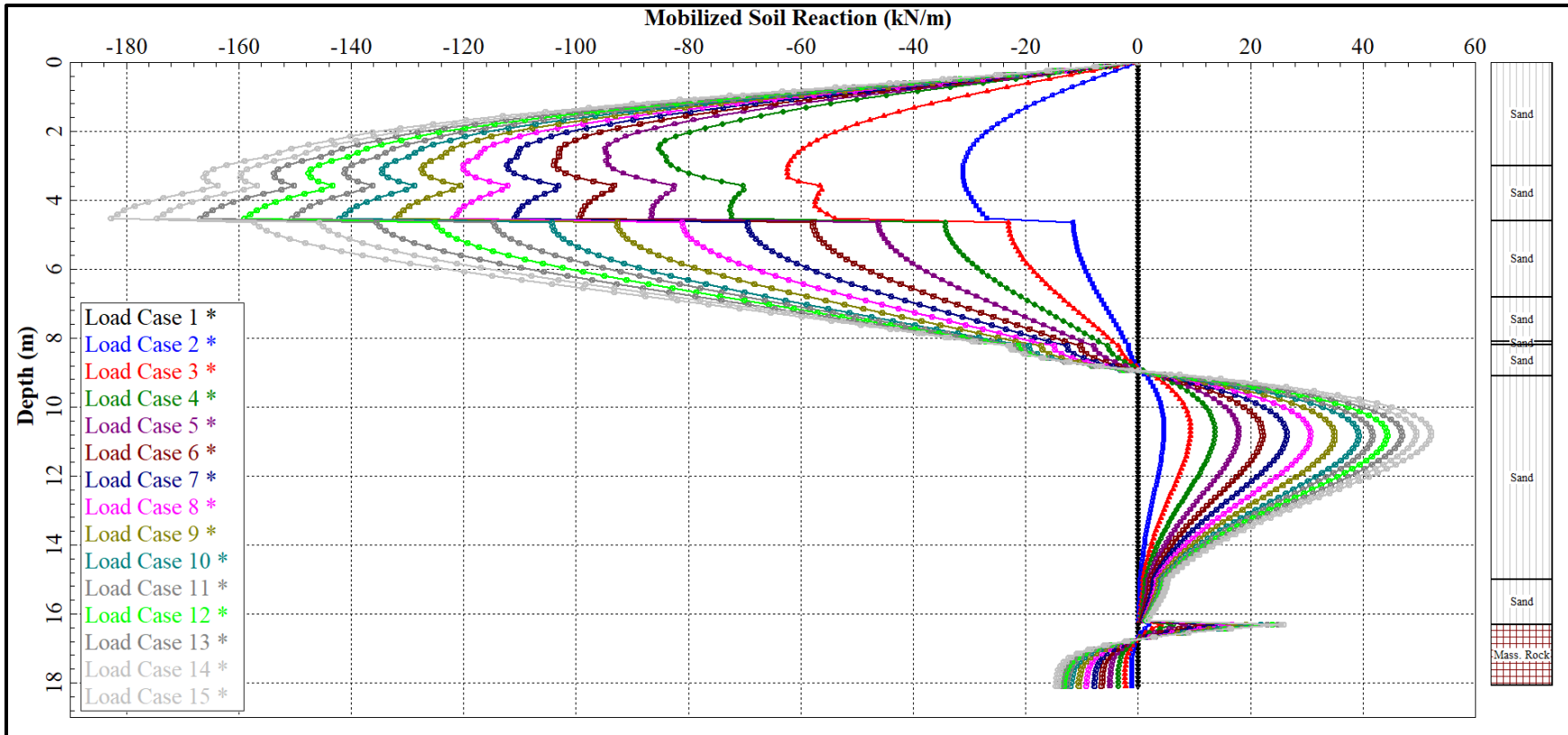

Soil Reaction vs. Depth*

* Assumed ULS axial load = 3000 kN

McINTOSH PERRY

Long Pile Analysis (L ~ 18.1 m)

Client: Silver Hotel Group

Project: Geotech. Investigation – 1305 Maritime Way, Kanata, ON.

Project No.: CM-19-0534

1305 MARITIME WAY

**APPENDIX G
RELEVANT STANDARDS**

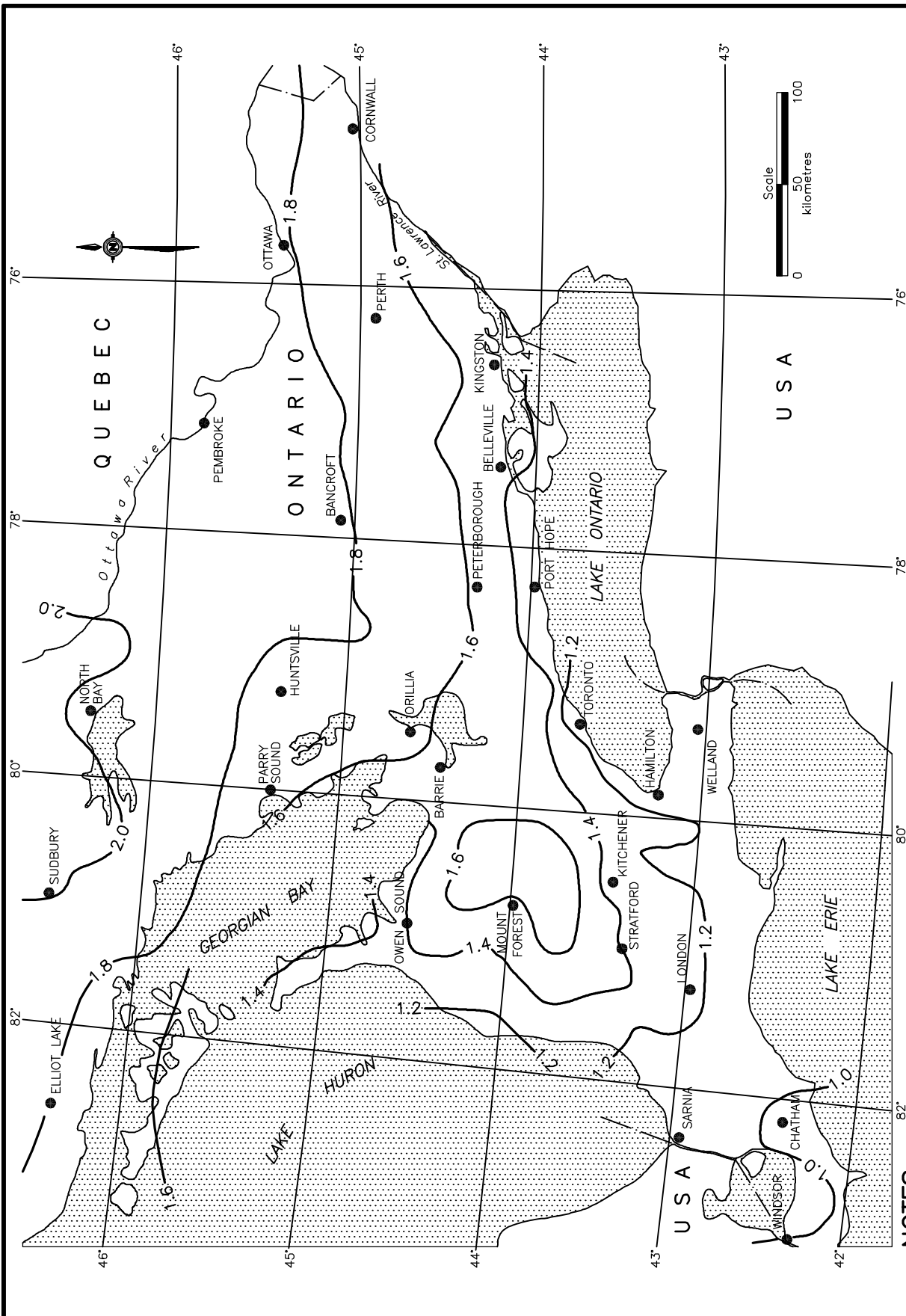

NOTES:

- A These values are approximate and should only be used where the recommendations of a geotechnical engineer are not available.
- B This information is based on the Ministry of Transportation and Communications Research Publication RR225 "Aspects of Prolonged Exposure of Pavements to Sub-Zero Temperatures" dated December 1981.
- C Values between contours should be interpolated. If interpolation is not possible, use the adjacent contour with the greater depth.
- D Frost penetration depths are in metres.

ONTARIO PROVINCIAL STANDARD DRAWING

Nov 2010 Rev 1

**FOUNDATION
FROST PENETRATION DEPTHS
FOR SOUTHERN ONTARIO**



OPSD 3090.101

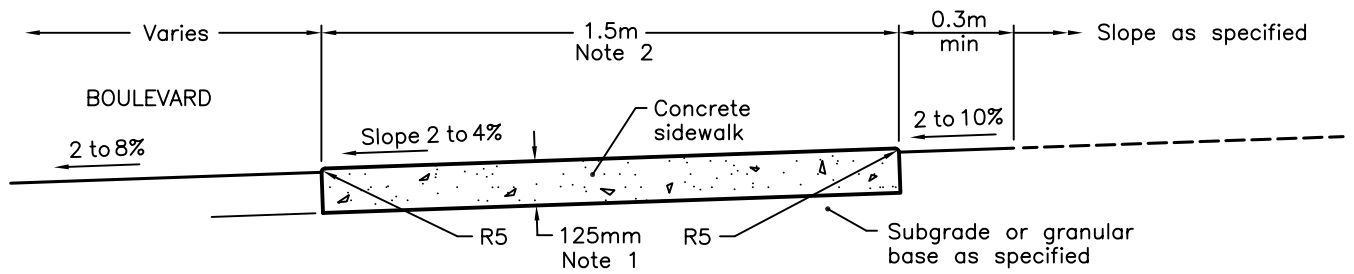

TYPICAL SECTION

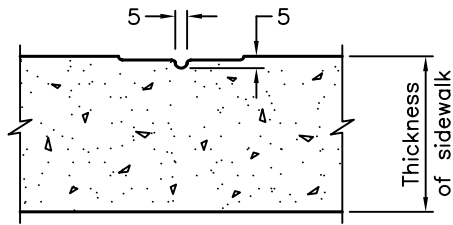

DUMMY JOINT

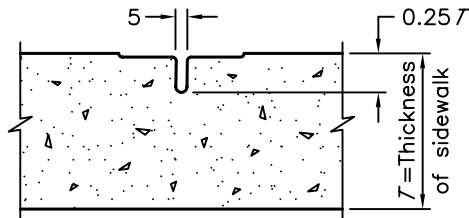

CONTRACTION JOINT

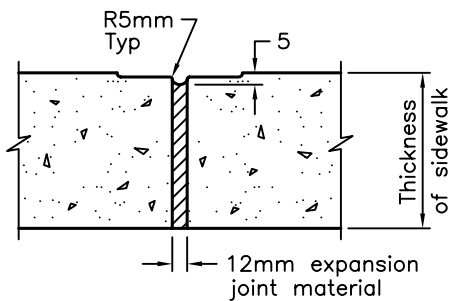

EXPANSION JOINT

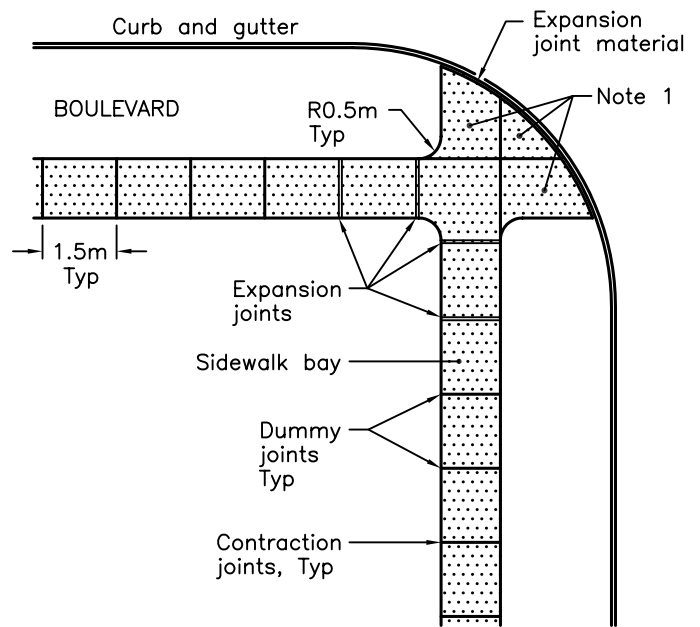

JOINT LAYOUT

NOTES:

- 1 Sidewalk thickness at residential driveways and adjacent to curb shall be 150mm. At commercial and industrial driveways, the thickness shall be 200mm.
- 2 Sidewalk width shall be increased to 2.4m at schools, bus stops, and other high pedestrian areas.

- A This OPSD to be read in conjunction with OPSD-310.030.
- B All dimensions are in millimetres unless otherwise shown.

ONTARIO PROVINCIAL STANDARD DRAWING

Nov 2005 Rev 1

CONCRETE SIDEWALK

OPSD - 310.010



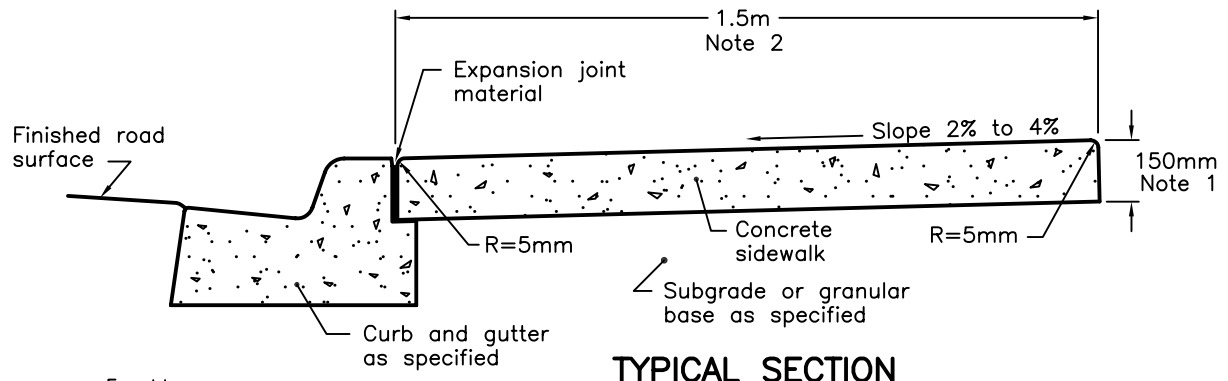

TYPICAL SECTION

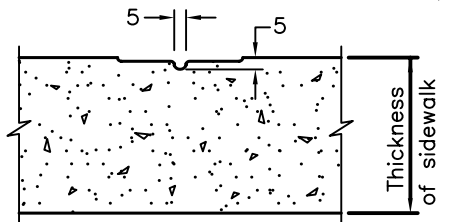

DUMMY JOINT

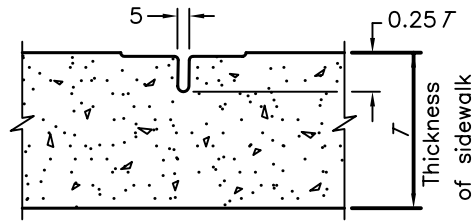

CONTRACTION JOINT

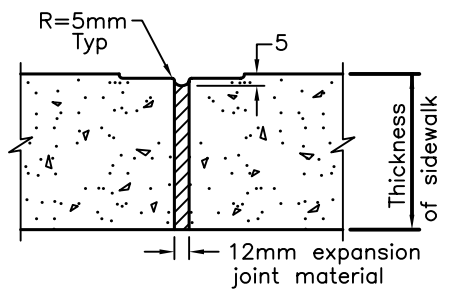

EXPANSION JOINT

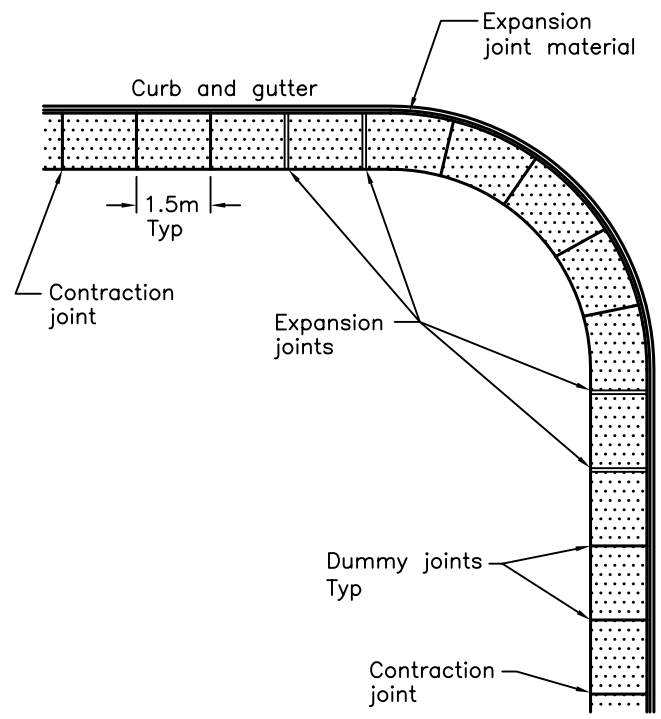

JOINT LAYOUT

NOTES:

- 1 Sidewalk thickness at residential driveways and adjacent to curb shall be 150mm. At commercial and industrial driveways, the thickness shall be 200mm.
- 2 Sidewalk width shall be increased to:
 - 1.8m when adjacent to curb on major roadways
 - 2.4m at schools, bus stops and other high pedestrian areas.

A All dimensions are in millimetres or metres unless otherwise shown.

ONTARIO PROVINCIAL STANDARD DRAWING

1993 10 01 Rev

CONCRETE SIDEWALK
ADJACENT TO
CURB AND GUTTER

Date



OPSD - 310.020

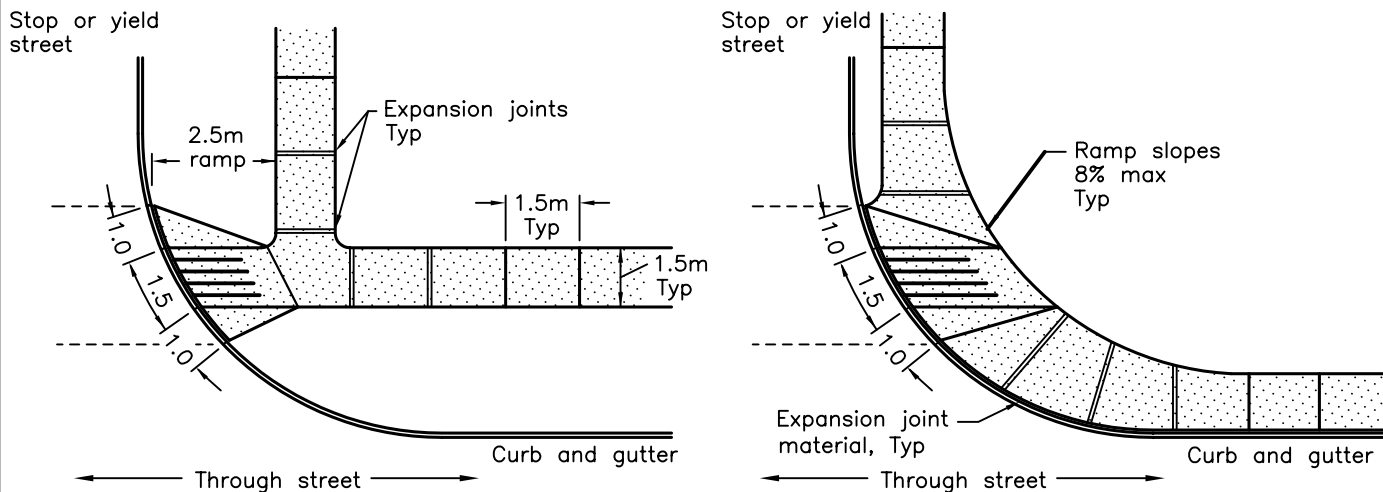

UNSIGNALIZED INTERSECTIONS

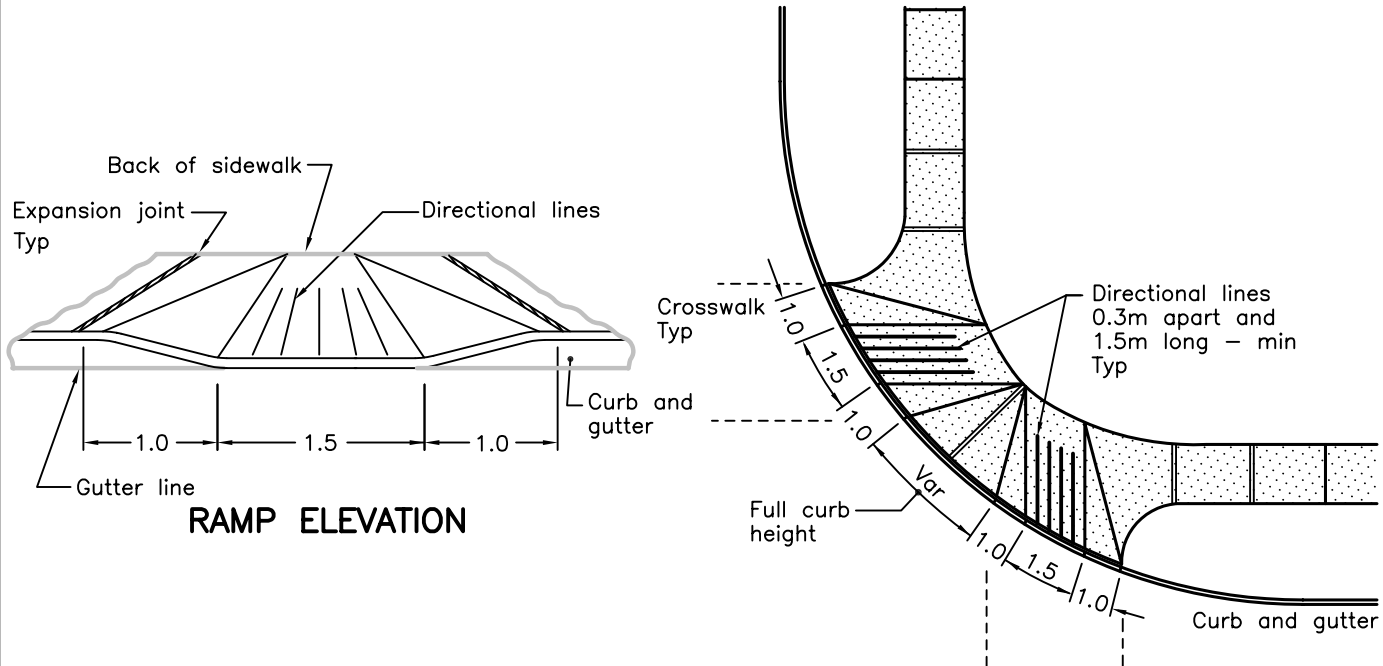

SIGNALIZED INTERSECTIONS

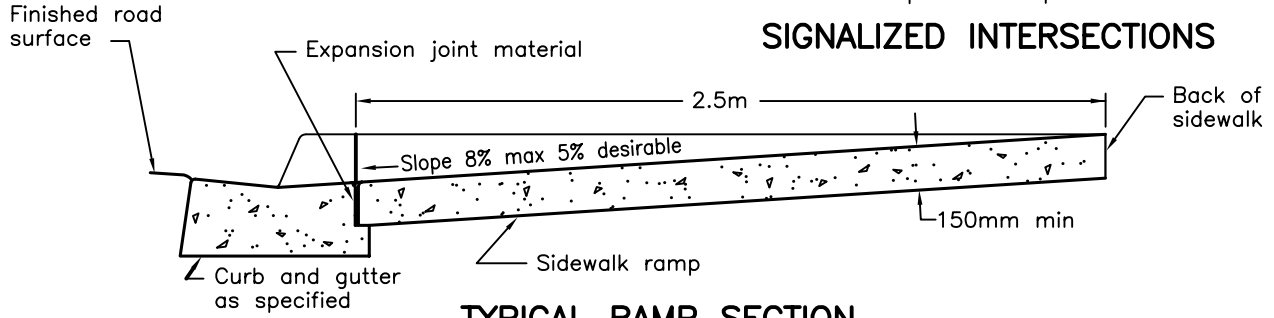

NOTES:

A Directional lines shall be 10x10mm made with grooving tool having a 15mm radius.

B All dimensions are in millimetres or metres unless otherwise shown.

ONTARIO PROVINCIAL STANDARD DRAWING		1993 10 01	Rev	
<p>CONCRETE SIDEWALK RAMPS AT INTERSECTIONS</p>		Date		
		OPSD - 310.030		