

384 ARLINGTON AVE

Location

OTTAWA, ON

ISSUED FOR SPA 2

Key Plan

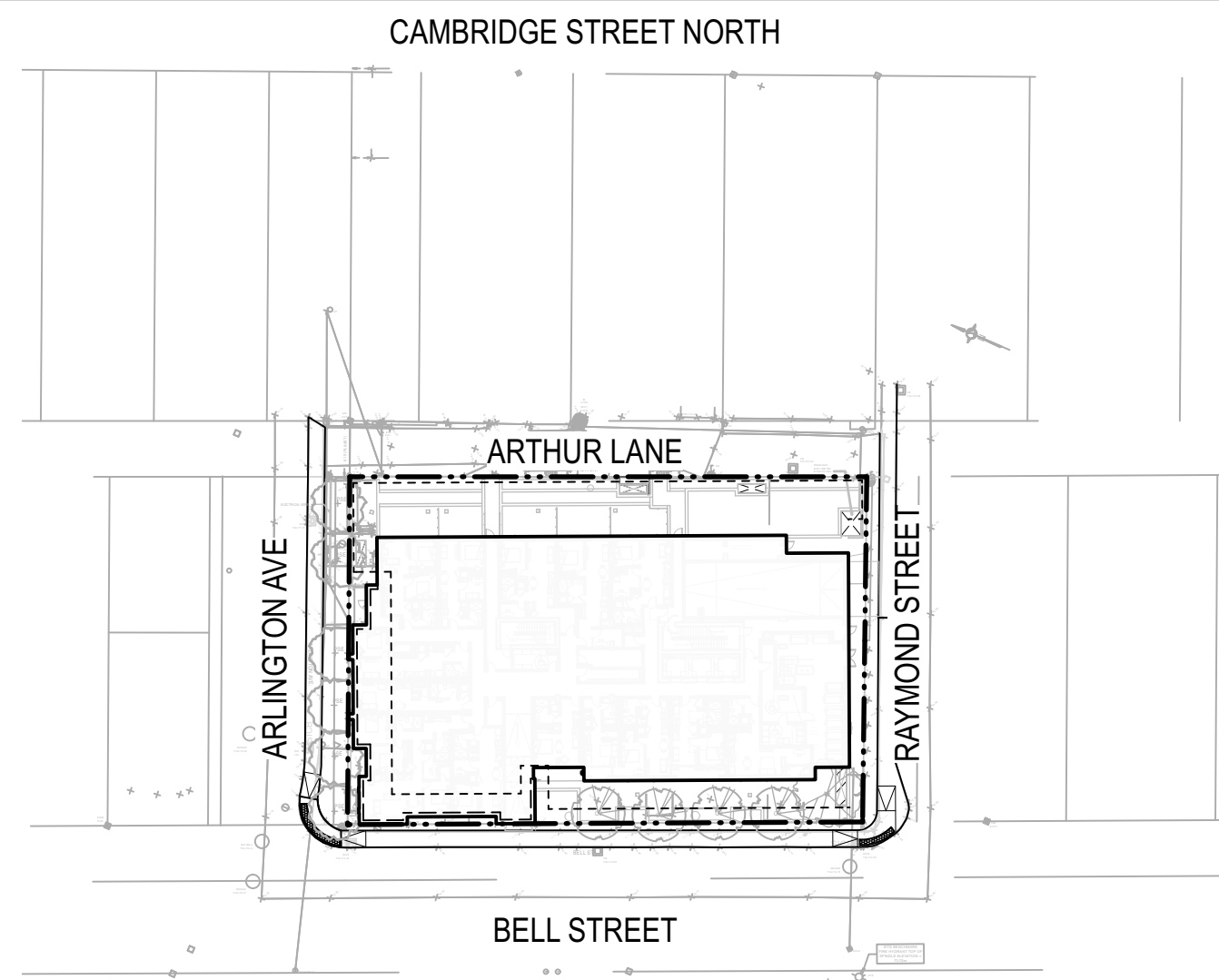

Project Team

CONSULTANT TEAM

ARCHITECTS NEUF
 PLANNER FOTENN
 CIVIL ENGINEER CIMA+

General Notes

1. EXISTING CONDITIONS ARE FROM TOPOGRAPHIC SURVEY BY (STANTEC, JUNE 16, 2022).
2. REFER TO ARCHITECTURAL DRAWINGS FOR BUILDING INFORMATION, AND TO ENGINEERING DRAWINGS FOR SERVICES, GRADING, STRUCTURAL, AND MECHANICAL INFORMATION.
3. CONTRACTOR SHALL REVIEW ALL DRAWINGS AND SPECIFICATIONS TO DETERMINE THE REQUIRED SCOPE OF WORK AND ALL REQUIRED COORDINATION.
4. CONTRACTOR IS RESPONSIBLE FOR A THOROUGH SITE EXAMINATION TO CONFIRM THE ACTUAL SITE CONDITIONS PRIOR TO SUBMISSION OF BIDS OR COMMENCING WORK.
5. CONTRACTOR SHALL VERIFY ALL EXISTING UTILITY LOCATIONS PRIOR TO EXCAVATION AND COMMENCING WORK.
6. ALL PROPOSED WORK LINES ARE PARALLEL OR PERPENDICULAR TO THE LINES FROM WHICH THEY ARE MEASURED, UNLESS OTHERWISE NOTED.
7. CONTRACTOR SHALL BE RESPONSIBLE FOR DOCUMENTING THE LOCATIONS OF ALL SITE ELEMENTS TO BE RESET IN THEIR SAME LOCATION.
8. ANY AREA OUTSIDE OF THE LIMIT OF WORK THAT IS DISTURBED SHALL BE RESTORED TO ITS ORIGINAL CONDITION BY THE CONTRACTOR, AT NO COST TO THE OWNER.
9. REQUIRED SHOP DRAWINGS SHALL BE BASED ON FIELD MEASUREMENT AND LAYOUT VERIFICATION BY THE CONTRACTOR.
10. WHERE APPLICABLE, THE LIMIT OF WORK LINE IS THE FACE OF THE BUILDING AND THE PROPERTY LINE, OR AS OTHERWISE NOTED ON THE DRAWINGS.
11. ALL LINE AND GRADE WORK PER DRAWINGS AND SPECIFICATIONS SHALL BE LAID OUT BY A REGISTERED CIVIL ENGINEER OR SURVEYOR ENGAGED BY THE GENERAL CONTRACTOR.
12. STORAGE AREAS FOR CONTRACTOR'S EQUIPMENT AND MATERIALS SHALL BE WITHIN THE LIMIT OF WORK AS SHOWN ON THE PLAN.
13. CONTRACTOR TO PROTECT ALL TREES FROM DAMAGE (THE CANOPY, TRUNK, AND ROOT ZONE AREAS) AS REQUIRED BY LOCAL GOVERNMENT REGULATIONS, AND TO THE SATISFACTION OF THE LANDSCAPE ARCHITECT.
14. ALL LAYOUTS FOR WALKS AND PATHS SHALL BE ADEQUATELY STAKED BY THE CONTRACTOR AND APPROVED BY THE LANDSCAPE ARCHITECT PRIOR TO CONSTRUCTION.
15. WHERE NEW PAVING OR EARTHWORK MEETS EXISTING PAVING OR EARTHWORK, CONTRACTOR IS TO SMOOTHLY BLEND THE LINE AND GRADE OF EXISTING WITH NEW.
16. DIMENSIONS ON ROADS AND SIDEWALKS ARE FROM FACE OF CURB UNLESS OTHERWISE NOTED ON DRAWINGS. DIMENSIONS TO SITE FROM BUILDING ARE FROM THE OUTSIDE (EXPOSED) FACE OF WALL, UNLESS OTHERWISE NOTED.
17. EXPANSION JOINT FILLER SHALL BE PLACED WHERE PAVEMENT MEETS STRUCTURES, INCLUDING WALLS, LIGHT POLES, HYDRANTS, BUILDINGS, AND BUILDING COLUMNS, STAIRS, AND AT OTHER LOCATIONS SHOWN ON THE DRAWINGS. CONTRACTOR SHALL REQUEST THE PRESENCE OF THE LANDSCAPE ARCHITECT TO REVIEW THE LAYOUT OF EXPANSION JOINTS AND CONTROL JOINTS PRIOR TO PLACING FINISHED WORK.
18. EXCAVATION REQUIRED WITHIN PROXIMITY OF UTILITY LINES AND WITHIN DRIFLINE OF TREES DESIGNATED TO REMAIN SHALL BE DONE BY HAND. CONTRACTOR SHALL REPAIR ANY DAMAGE TO EXISTING UTILITY LINES OR STRUCTURES INCURRED DURING CONSTRUCTION OPERATIONS, AT NO COST TO THE UTILITY COMPANIES OR THE OWNER.
19. ALL POINTS OF CONSTRUCTION EGRESS OR INGRESS SHALL BE MAINTAINED TO PREVENT TRACKING OR FLOWING OF SEDIMENT ONTO PUBLIC ROADS OR ADJUTING PROPERTY.

Sheet

Sheet Title

L0.1	SOIL VOLUME PLAN
L1.1	LANDSCAPE PLAN - GROUND FLOOR
L1.2	LANDSCAPE PLAN - 4TH FLOOR
L1.3	LANDSCAPE PLAN - 7TH FLOOR
L2	LANDSCAPE DETAILS
L3	LANDSCAPE DETAILS
L4	PLANTING DETAILS

10		
9		
8		
7		
6		
5		
4		
3	ISSUED FOR SPC FORMAL SUBMISSION	2024-10-04
2	ISSUED FOR SPA 2	2024-06-06
1	ISSUED FOR SPA	2024-02-09

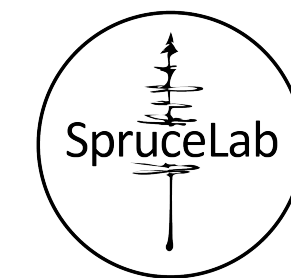
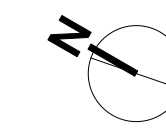

SpruceLab Inc.
 Address: 550 Bayview Ave, Suite 300
 Toronto, ON, M4W 3X8
 Telephone: (647) 899-5891
 www.sprucelab.ca

Disclaimer:
 All drawing information in this set shall be checked and verified and any discrepancies reported in writing to the Landscape Architect before commencing any affected work. This drawing set shall be used only for the project named and for reference purposes only. The drawings in this set shall not be scaled. This drawing set is not for construction unless signed by the Landscape Architect. This drawing set and all aspects of its content are the copyright property of SpruceLab. Reproduction in whole or in part, by any means whatsoever, without the express written permission of SpruceLab, is prohibited.

Client

Windmill Developments
 Toronto, ON

Project

384 ARLINGTON AVE
 OTTAWA, ON

Drawing Title

COVER PAGE

Scale:	NTS	Project #	
Designed By:	SB		0.001
Drawn By:	KG/NS		Drawing #
Approved By:	SB		
Date:	10/13/21		

L0

NOT FOR CONSTRUCTION

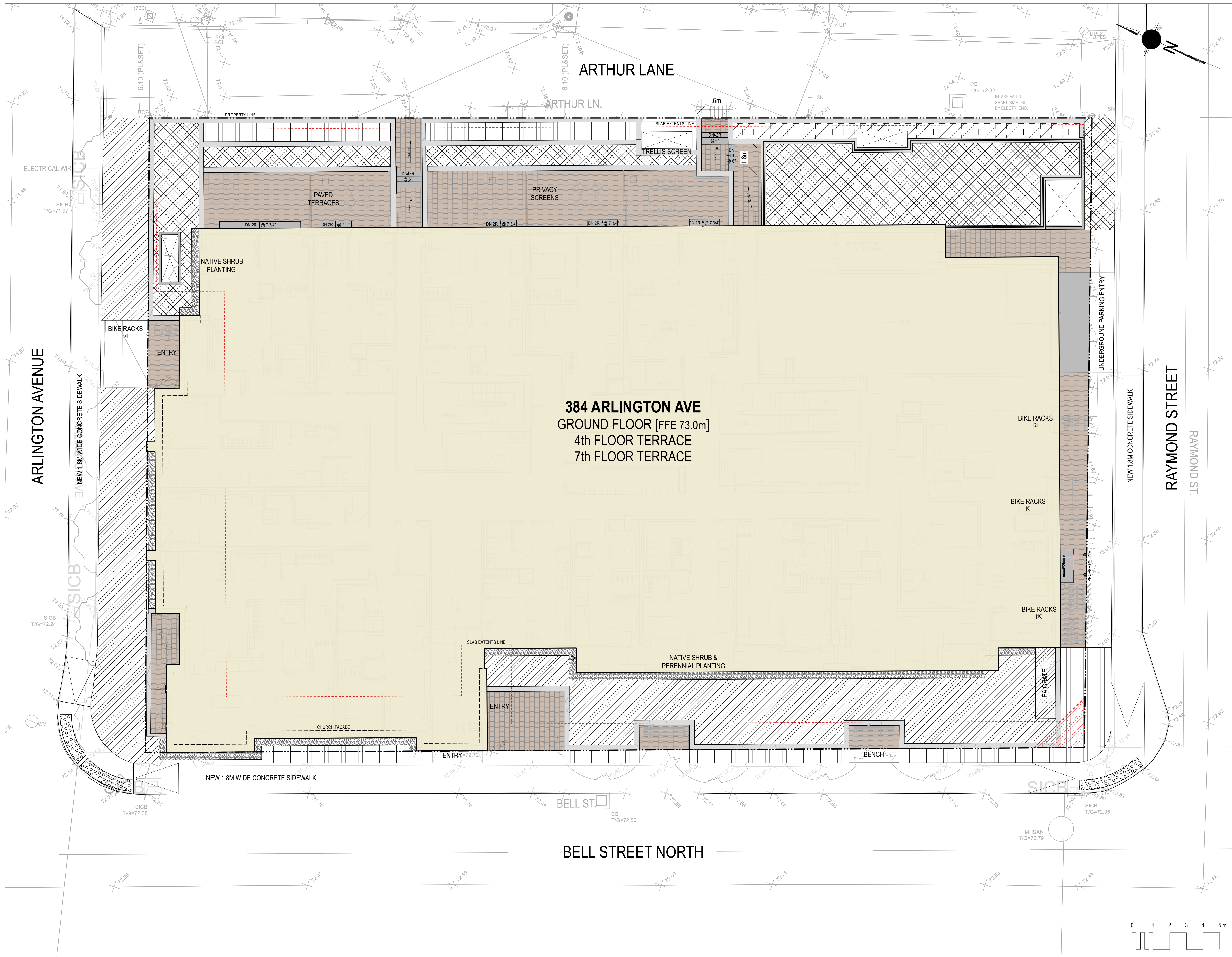

384 ARLINGTON AVE
 GROUND FLOOR [FFE 73.0m]
 4th FLOOR TERRACE
 7th FLOOR TERRACE

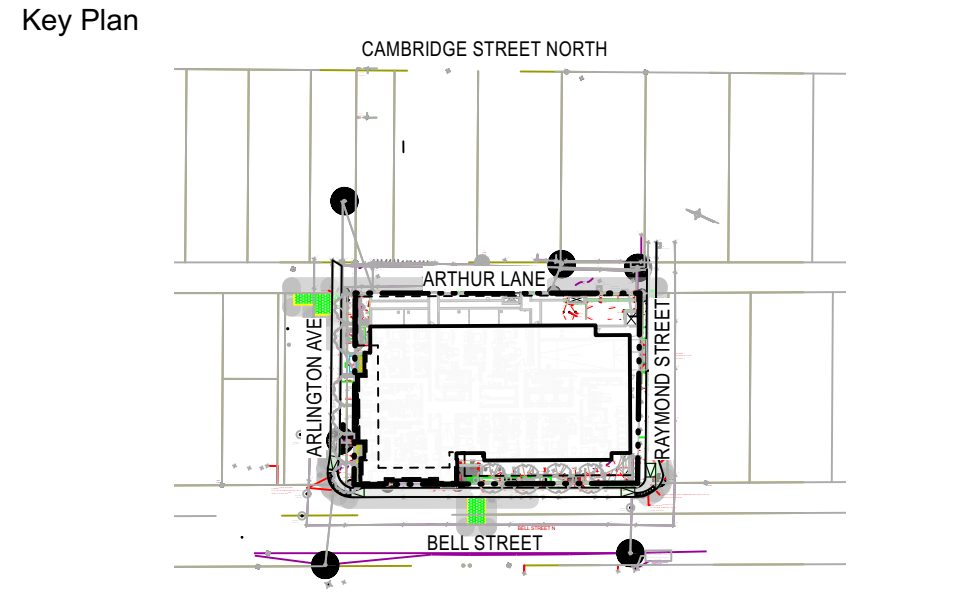

SOIL VOLUME LEGEND:

	1m (3') DEPTH
	600mm (2') DEPTH
	450mm (1.5') DEPTH
	200mm (8") DEPTH

10		
9		
8		
7		
6		
5		
4		
3	ISSUED FOR SPC FORMAL SUBMISSION	2024-10-04
2	ISSUED FOR SPA 2	2024-06-06
1	ISSUED FOR SPA	2024-02-09

Stamp

SpruceLab Inc.
 Address: 550 Bayview Ave, Suite 300
 Toronto, ON, M4W 3X8
 Telephone: (647) 899-5891
 www.sprucelab.ca

Disclaimer:
 All drawing information shall be checked and verified and any discrepancies reported in writing to the Landscape Architect before commencing any affected work. This drawing shall be used only for the project named on this drawing and for reference purposes only. This drawing shall not be scaled. This drawing is not for construction unless signed by the Landscape Architect. This drawing and all aspects of its content are the copyright property of SpruceLab. Reproduction in whole or in part, by any means whatsoever, without the express written permission of SpruceLab, is prohibited.

Client
Windmill Developments
 Toronto, ON

Project
384 ARLINGTON AVE
 OTTAWA, ON

Drawing Title
Soil Depth Plan

Scale: 1:100	Project # 0.001
Designed By: SB	Drawing # L0.1
Drawn By: KG/NS	
Approved By: SB	
Date: 10/13/21	

NOT FOR CONSTRUCTION

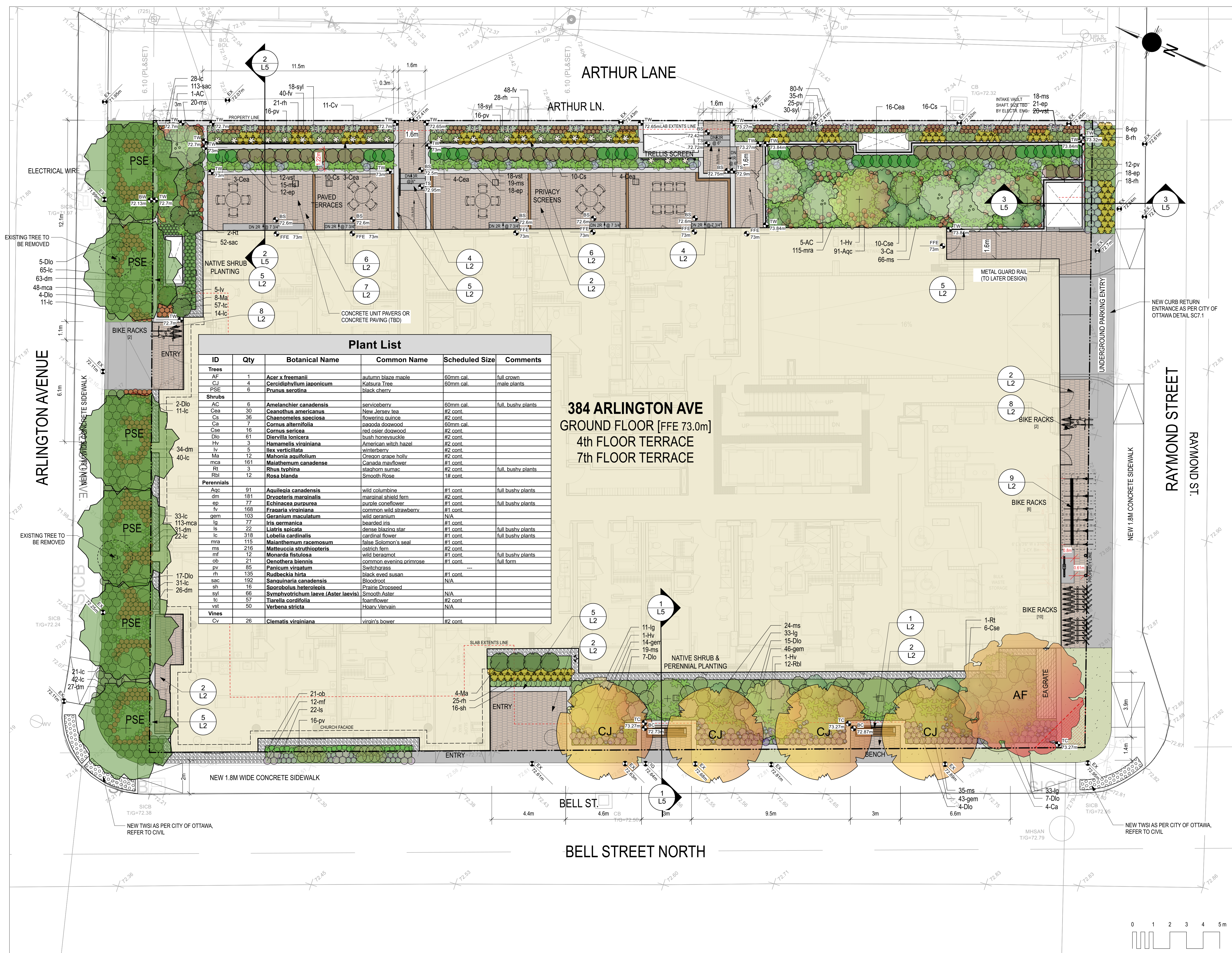

ID	Qty	Botanical Name	Common Name	Scheduled Size	Comments
Trees					
AF	1	<i>Acer x freemanii</i>	autumn blaze maple	60mm cal.	full crown
CJ	4	<i>Cercidiphyllum japonicum</i>	Katsura Tree	60mm cal.	male plants
PSE	6	<i>Prunus serotina</i>	black cherry		
Shrubs					
AC	6	<i>Amelanchier canadensis</i>	serviceberry	60mm cal.	full, bushy plants
Cea	30	<i>Ceanothus americanus</i>	New Jersey tea	#2 cont.	
Ca	36	<i>Chaenomeles speciosa</i>	flowering quince	#2 cont.	
Ca	7	<i>Cornus alternifolia</i>	paocoda dogwood	60mm cal.	
Cse	16	<i>Cornus sericea</i>	red osier dogwood	#2 cont.	
Dlo	61	<i>Diervilla lonicera</i>	bush honeysuckle	#2 cont.	
Hv	3	<i>Hamamelis virginiana</i>	American witch hazel	#2 cont.	
lv	5	<i>Ilex verticillata</i>	winterberry	#2 cont.	
Ma	12	<i>Mahonia aquifolium</i>	Oregon grape holly	#2 cont.	
mca	161	<i>Maianthemum canadense</i>	Canada mayflower	#1 cont.	
Rt	3	<i>Rhus typhina</i>	staghorn sumac	#2 cont.	full, bushy plants
Rbl	12	<i>Rosa blanda</i>	Smooth Rose	1# cont.	
Perennials					
Aqc	91	<i>Aquilegia canadensis</i>	wild columbine	#1 cont.	full bushy plants
dm	181	<i>Dryopteris marginalis</i>	marginal shield fern	#2 cont.	
ep	77	<i>Echinacea purpurea</i>	purple coneflower	#1 cont.	full bushy plants
fv	168	<i>Fragaria virginiana</i>	common wild strawberry	#1 cont.	
gem	103	<i>Geranium maculatum</i>	wild geranium	N/A	
lg	77	<i>Iris germanica</i>	bearded iris	#1 cont.	
ls	22	<i>Liatris spicata</i>	dense blazing star	#1 cont.	full bushy plants
lc	318	<i>Lobelia cardinalis</i>	cardinal flower	#1 cont.	full bushy plants
mra	115	<i>Maianthemum racemosum</i>	false Solomon's seal	#1 cont.	
ms	216	<i>Matteuccia struthiopteris</i>	ostrich fern	#2 cont.	
mf	12	<i>Monarda fistulosa</i>	wild bergamot	#1 cont.	full bushy plants
ob	21	<i>Oenothera biennis</i>	common evening primrose	#1 cont.	full form
pv	85	<i>Panicum virgatum</i>	Switchgrass	#1 cont.	
rh	135	<i>Rudbeckia hirta</i>	black eyed susan	#1 cont.	
sac	192	<i>Sanguinaria canadensis</i>	Bloodroot	N/A	
sh	16	<i>Sporobolus heterolepis</i>	Prairie Dropseed	N/A	
svl	66	<i>Symphoricarpon laeve (Aster laevis)</i>	Smooth Aster	N/A	
tc	57	<i>Tiarella cordifolia</i>	foamflower	#2 cont.	
vst	50	<i>Verbena stricta</i>	Hoary Vervain	N/A	
Vines					
Cv	26	<i>Clematis virginiana</i>	virgin's bower	#2 cont.	

384 ARLINGTON AVE
GROUND FLOOR [FFE 73.0m]
4th FLOOR TERRACE
7th FLOOR TERRACE

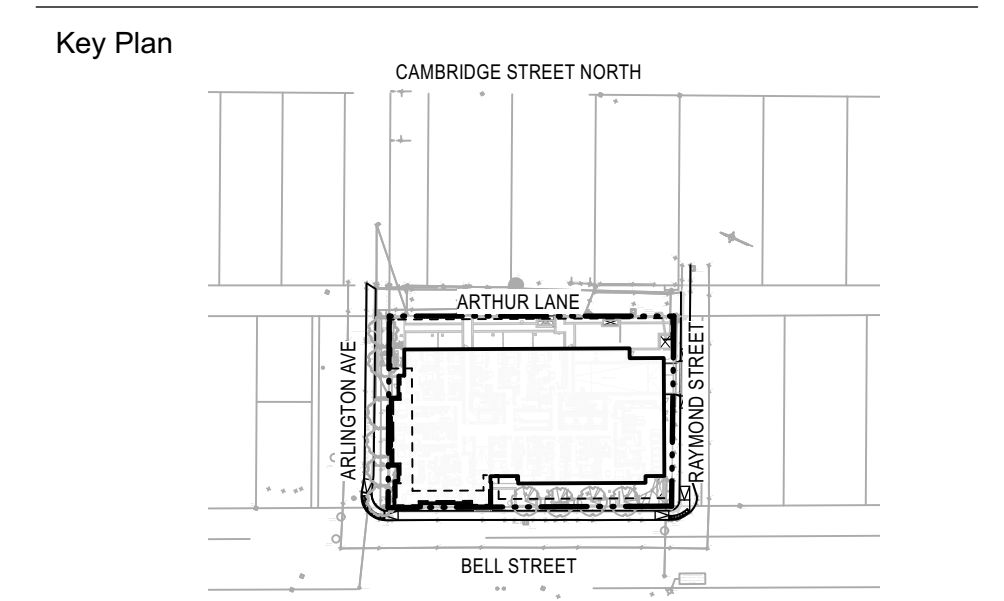

- LEGEND:**
- Property Line
 - Sod
 - Concrete Pavers (4th, 7th floors)
 - Conc. Unit Pavers or Conc. Paving
 - Bench
 - Stone Planter Curb
 - 450mm Drip Strip
 - Stone Steps
 - Metal Planters
- GRADING LEGEND:**
- Existing Survey Grade
 - Existing Grade
 - Proposed Grade
 - TW Top of Wall
 - BW Bottom of Wall
 - TC Top of Curb
 - BR Bottom of Ramp
 - TS Top of Step
 - BS Bottom of Step

10		
9		
8		
7		
6		
5		
4		
3	ISSUED FOR SPC FORMAL SUBMISSION	2024-10-04
2	ISSUED FOR SPA 2	2024-06-06
1	ISSUED FOR SPA	2024-02-09

Stamp

SpruceLab Inc.
 Address: 550 Bayview Ave, Suite 300
 Toronto, ON, M4W 3X8
 Telephone: (647) 899-5891
 www.spruceclab.ca

Disclaimer:
 All drawing information shall be checked and verified and any discrepancies reported in writing to the Landscape Architect before commencing any affected work. This drawing shall be used only for the project named on this drawing and for reference purposes only. This drawing shall not be scaled. This drawing is not for construction unless signed by the Landscape Architect. This drawing and all aspects of its content are the copyright property of SpruceLab. Reproduction in whole or in part, by any means whatsoever, without the express written permission of SpruceLab, is prohibited.

Client
Windmill Developments
 Toronto, ON

Project
384 ARLINGTON AVE
 OTTAWA, ON

Drawing Title
Landscape Plan - Gound Floor

Scale: 1:100
 Project #: 0.001
 Designed By: SB
 Drawing #: L1.1
 Drawn By: KG/NS
 Approved By: SB
 Date: 10/13/21

NOT FOR CONSTRUCTION

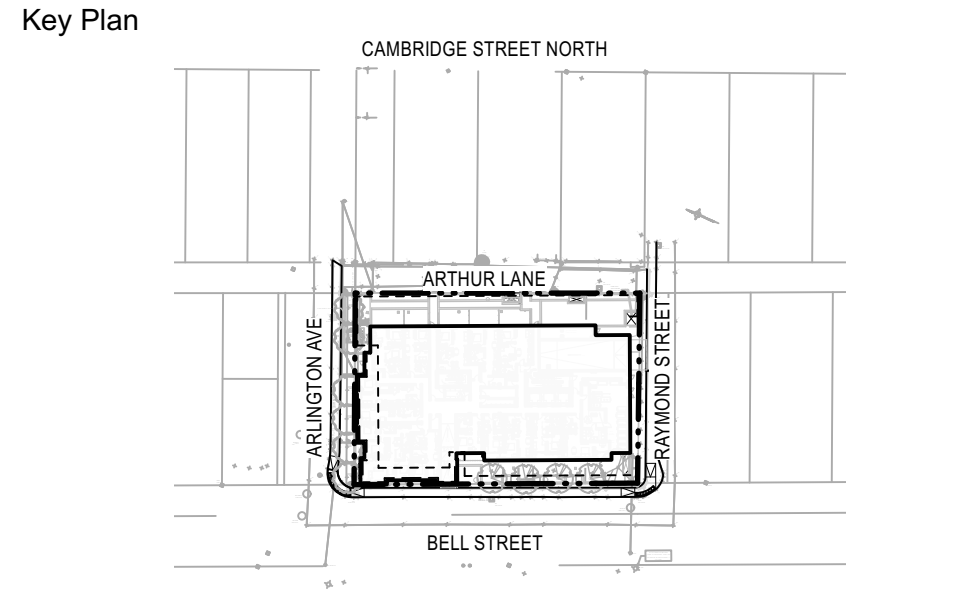
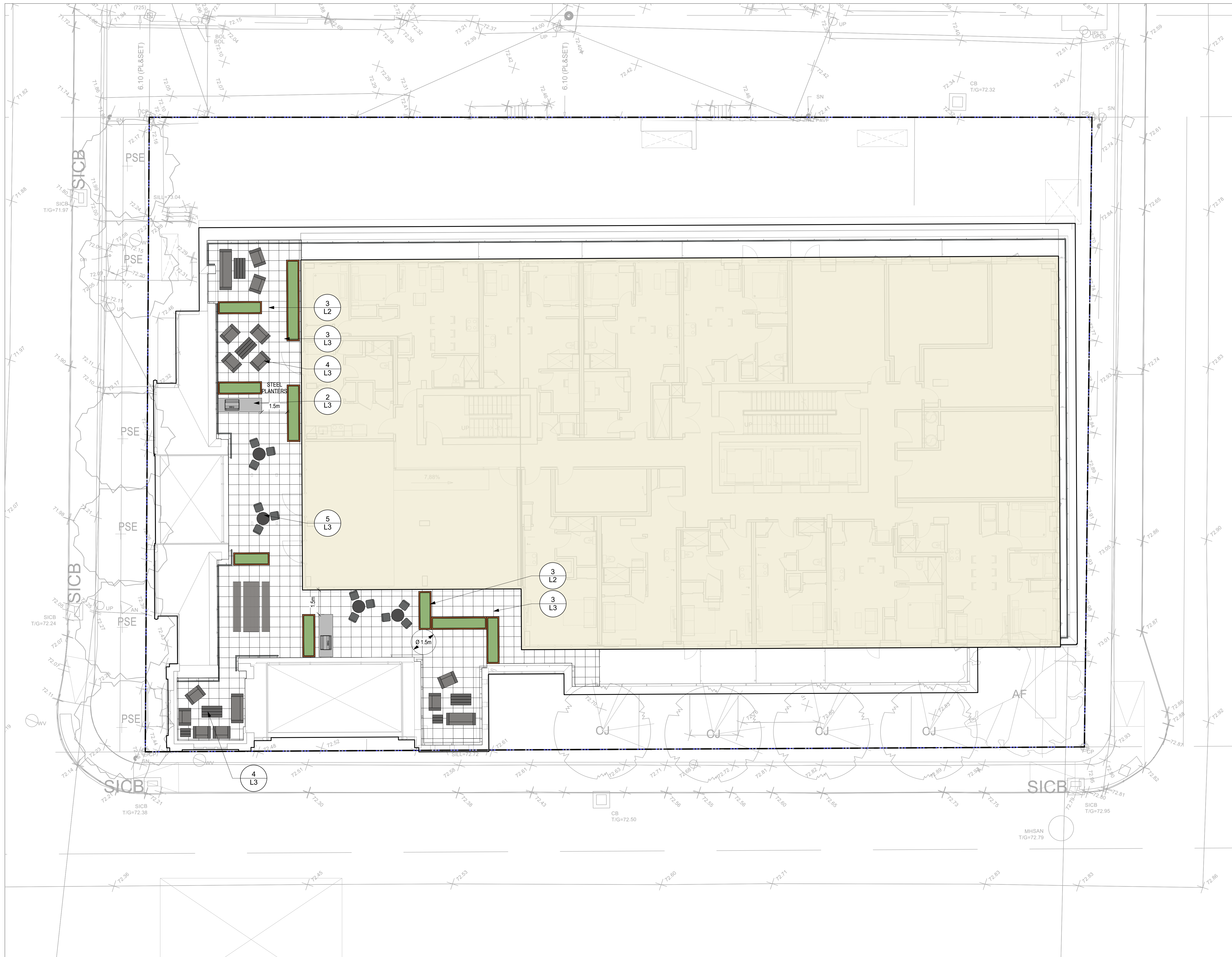

Legend

10		
9		
8		
7		
6		
5		
4		
3	ISSUED FOR SPC FORMAL SUBMISSION	2024-10-04
2	ISSUED FOR SPA 2	2024-06-06
1	ISSUED FOR SPA	2024-02-09

Stamp

SpruceLab Inc.
 Address: 550 Bayview Ave, Suite 300
 Toronto, ON, M4W 3X8
 Telephone: (647) 899-5891
 www.sprucelab.ca

Disclaimer:
 All drawing information shall be checked and verified and any discrepancies reported in writing to the Landscape Architect before commencing any affected work. This drawing shall be used only for the project named on this drawing and for reference purposes only. This drawing shall not be scaled. This drawing is not for construction unless signed by the Landscape Architect. This drawing and all aspects of its content are the copyright property of SpruceLab. Reproduction in whole or in part, by any means whatsoever, without the express written permission of SpruceLab, is prohibited.

Client
Windmill Developments
 Toronto, ON

Project
384 ARLINGTON AVE
 OTTAWA, ON

Drawing Title
Landscape Plan - 4th Floor

Scale:	Project #
Designed By: SB	0.001
Drawn By: KG/NS	Drawing #
Approved By: SB	L1.2
Date: 10/13/21	

NOT FOR CONSTRUCTION

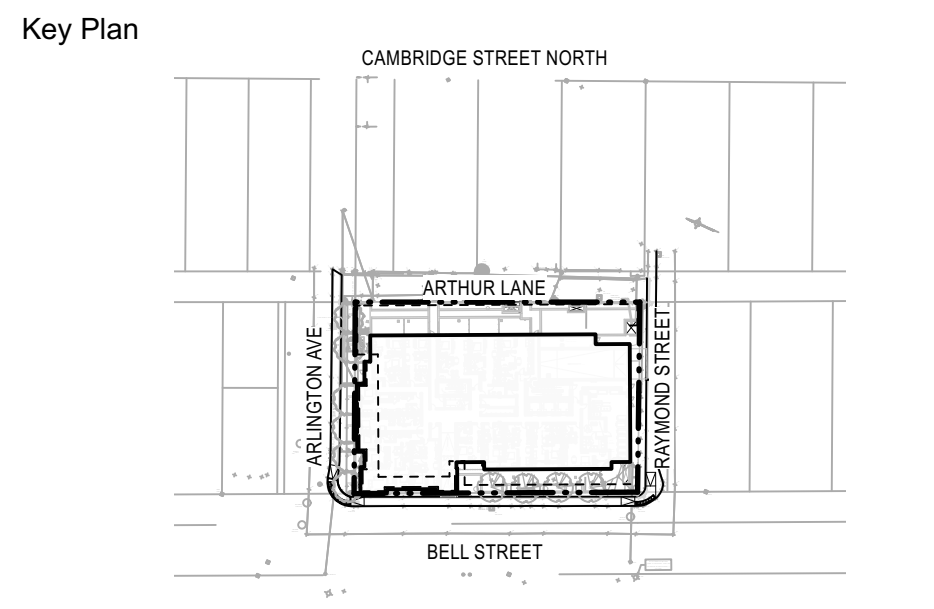
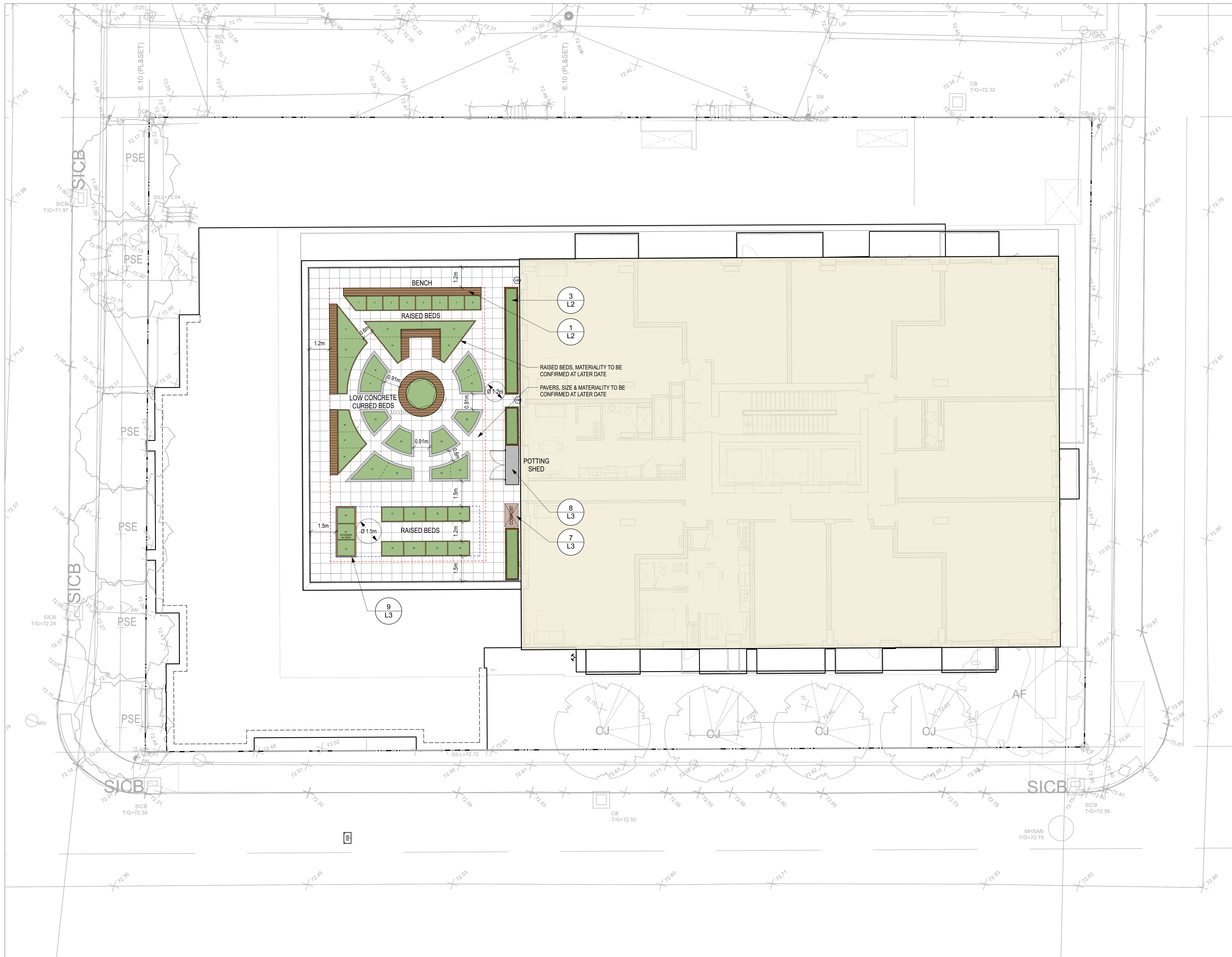

Legend

10		
9		
8		
7		
6		
5		
4		
3	ISSUED FOR SPC FORMAL SUBMISSION	2024-10-04
2	ISSUED FOR SPA 2	2024-06-06
1	ISSUED FOR SPA	2024-02-09

Stamp

SpruceLab Inc.
 Address: 550 Bayview Ave, Suite 300
 Toronto, ON, M4W 3X8
 Telephone: (647) 899-5891
 www.sprucelab.ca

Disclaimer:
 All drawing information shall be checked and verified and any discrepancies reported in writing to the Landscape Architect before commencing any affected work. This drawing shall be used only for the project named on this drawing and for reference purposes only. This drawing shall not be scaled. This drawing is for construction unless signed by the Landscape Architect. This drawing and all aspects of its content are the copyright property of SpruceLab. Reproduction in whole or in part, by any means whatsoever, without the express written permission of SpruceLab, is prohibited.

Client
Windmill Developments
 Toronto, ON

Project
384 ARLINGTON AVE
 OTTAWA, ON

Drawing Title
Landscape Plan - 7th Floor

Scale:	Project #
Designed By: SB	0.001
Drawn By: KG/NS	Drawing #
Approved By: SB	L1.3
Date: 10/13/21	

NOT FOR CONSTRUCTION



ROUGHREADY BENCH BY STREETLIFE WITH BACK & ARM RESTS
CUT SHEET PENDING



INDUSTRIA 300 SERIES

DESCRIPTION: Paver TEXTURE: HD¹ Polished

PALLET OVERVIEW - 300x100

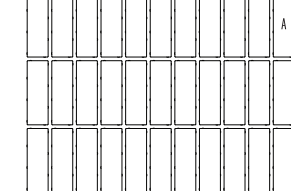

PALLET OVERVIEW - 300x150

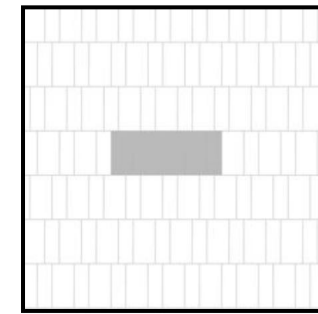
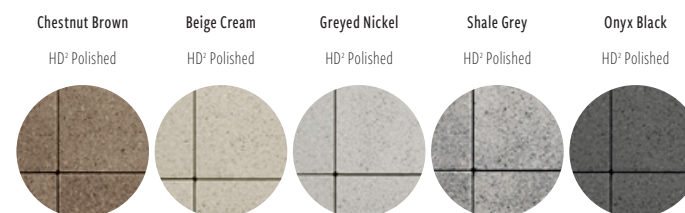

Linear laying pattern 04 for Industria 300 Series pavers

Specifications per pallet	Imperial	Metric
Cubing	71.20 Ft ³	6.62 m ³
Approx. Weight	3 288 lbs	1 491 kg
Number of rows	7	
Coverage per row	10.17 Ft ²	0.95 m ²
Linear coverage per row	Depth 20.67 lin. ft	6.30 lin. m
	Length 10.33 lin. ft	3.15 lin. m



NOTES

See page 62 to 64 for more technical information.

See page 30 for more information about applications.

300 Series HD¹ Polished and HD¹ Granite are made-to-order, minimum order of 500 sq. ft. Deposit required. HD¹ Smooth is in stock with shorter lead times.

Unit dimensions	in	mm	Units/pallet
Height	3 3/4	98	147 units
Width	11 13/16	300	
Length	5 3/4	150	

2 DETAIL: PAVERS
Scale: N.T.S.

1 DETAIL: BENCH
Scale: N.T.S.



Product Sheet Shrubtubs Square

Steel tree planter including 7cm high supports rails at the bottom and a 6 cm wide lip at the top

Product Code **STUB-PL-90-180-90-CT / STUB-PL-90-180-90-PC**

Dimensions ca. 90x180x90 cm | 35x71x35" (l=w×h), vol. 1,35 m³ | 48 ft³

Weight Empty ca. 220 kg | 485 lbs
Filled with soil approx. 2515kg | 5545 lbs (based on 1700 kg / m³)

Material Planter (-CT) version: Corten Steel (weathering steel) 4mm thick, delivered unweathered
Planter (-PC) version: Corten Steel (weathering steel), finished with a double powder coating in RAL colour

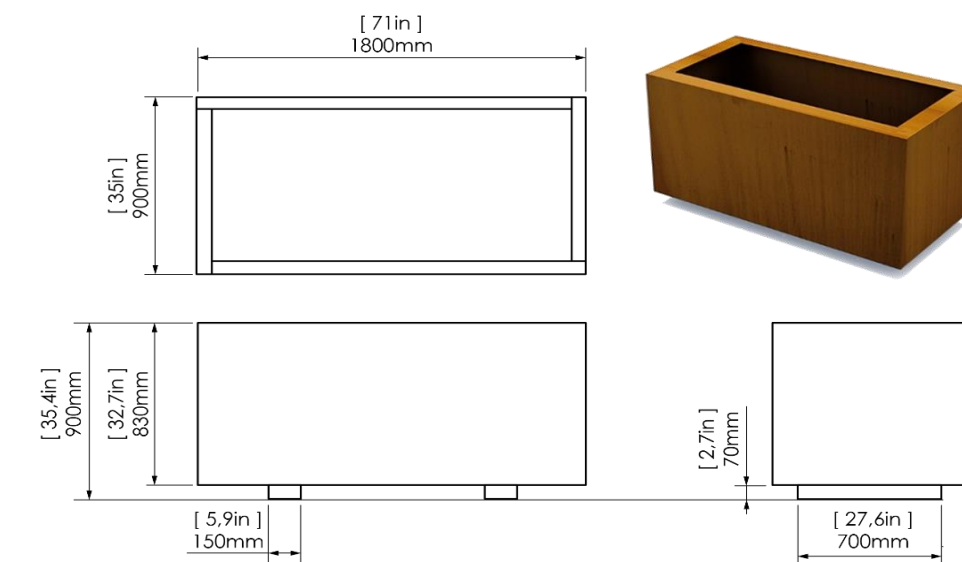

*Metric units are leading
Design: Streetlife
Protected by int. Modeldepots & Patents



NOTE: TO BE CUSTOM DESIGNED TO THE FOLLOWING DIMENSIONS (HEIGHT)

3 DETAIL: CORTEN STEEL RAISED PLANTERS
Scale: N.T.S.

ERAMOSA-FLAGSTONE™ COLLECTION
Product Specifications

ROCKFACE STEPS

48" x 16" x 6"
(1207mm x 406mm x 152mm)

72" x 16" x 6"
(1810mm x 432mm x 150mm)

APPLICATIONS

steps, retaining walls, seat walls, raised landings

FEATURES

- flamed top finish with low relief texture
- flamed ends for tighter joints
- rockface front with natural undercuts

AVAILABLE COLOURS

sand buff, charcoal grey, terra brown

4 MATERIAL: ROCK FACE STEPS
Scale: N.T.S.

ORILLIA GUILLOTINE WALL-STONE™ COLLECTION
Product Specifications

WALL STONE

18"L x 12"W x 4"H
(444mm x 300mm x 102mm)

18"L x 12"W x 4"H - Wall Ends
(444mm x 300mm x 102mm)

APPLICATIONS

retaining walls, planters, steps, pool copings, water features, garden beds, raised landings

FEATURES

- sawn bed and ends
- authentic sawn texture
- natural guillotine finish on two sides
- tight joints for seamless appearance
- wall ends - guillotine finish on three sides

AVAILABLE COLOURS

sand buff, charcoal grey, terra brown

5 MATERIAL: RETAINING WALL STONE
Scale: N.T.S.

POTENTIAL FOR INDIGENOUS CUSTOM ART DESIGN

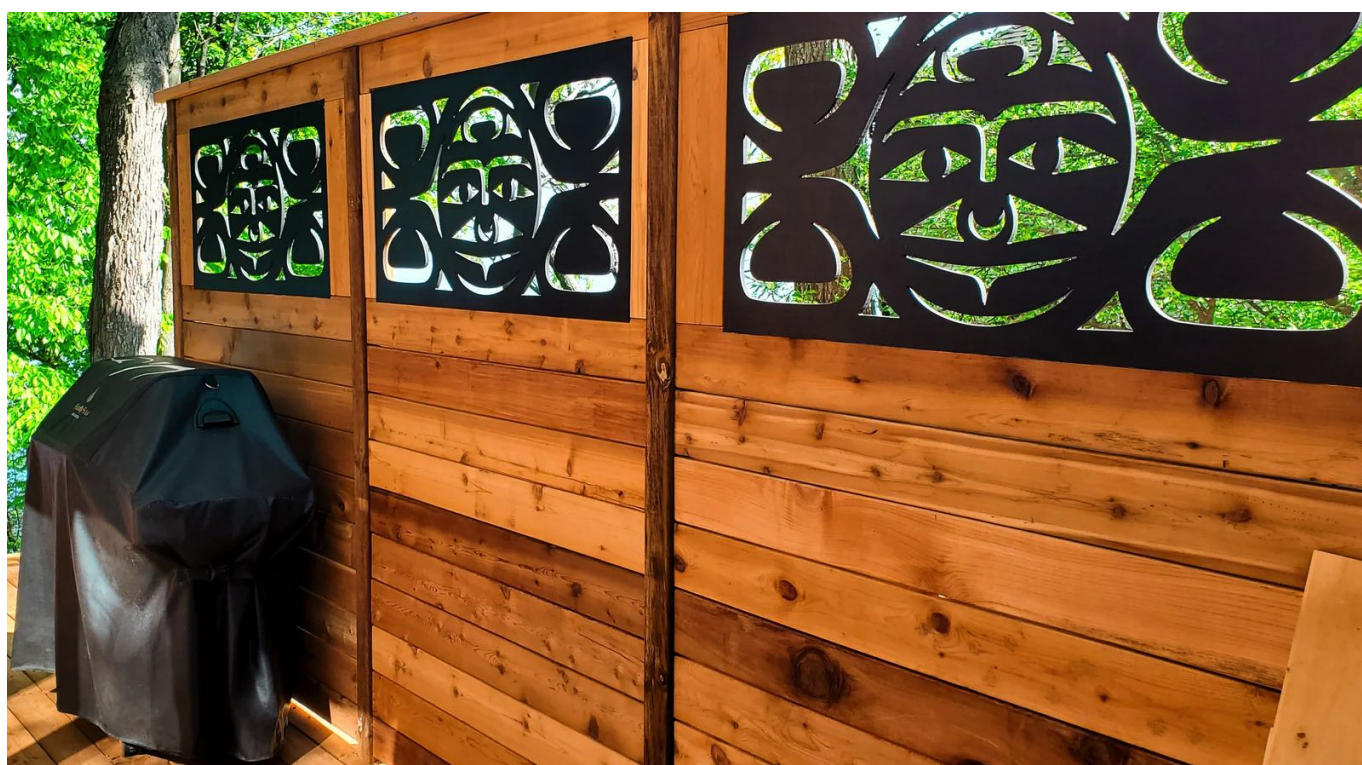

7 DETAIL: 6" WOOD PRIVACY SCREEN W/ POTENTIAL ART
Scale: N.T.S.



Multiple Series



STANDARD SPECIFICATIONS

Boa model, as manufactured by Dobra Design, Vancouver BC. (604-733-9486) info@dobradesign.com
Material to be Hollow Structural Steel Tubing, 1.900 x 0.100" (48mm x 2.24mm) ASTM A500C
Preparation to be by Mechanical and Chemical cleaning and Iron Phosphate treatment
Finish to be electrostatic polyester powdercoating in triple-thick MaxiCoat™ with oven curing
Installation to be by flush, drop-in anchors and button-head capscrews 1/2" UNC (12.7mm), 2 per rack
All fasteners to be concealed inside rack tubes for safety and vandal resistance and access holes capped
Stainless Steel Boa series to be 1 1/2" SCH 10 x 0.109 304 stainless steel pipe with #4 Architectural finish

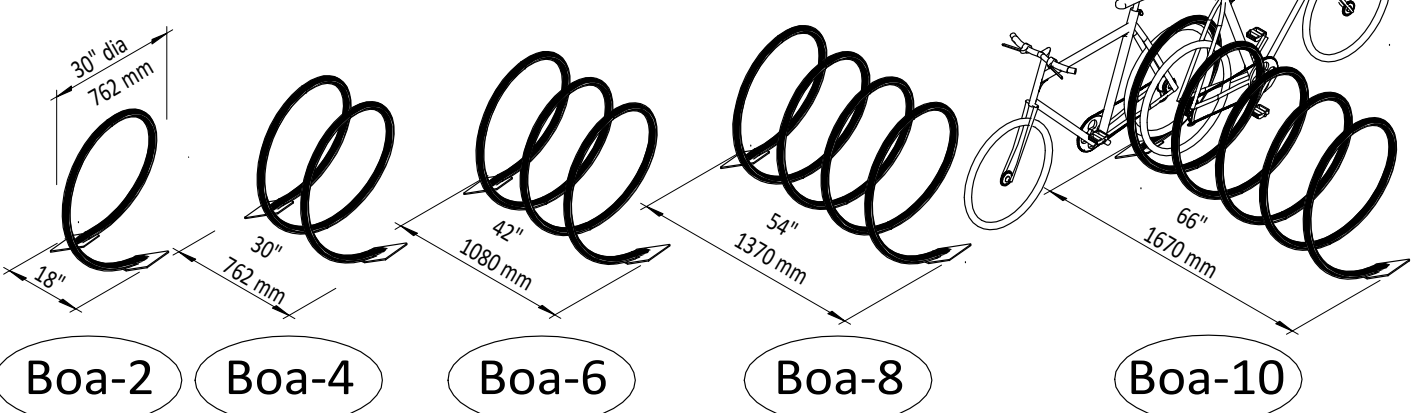

8 DETAIL: Bike Rack
Scale: N.T.S.

6 DETAIL: GREENSCREEN
Scale: N.T.S.

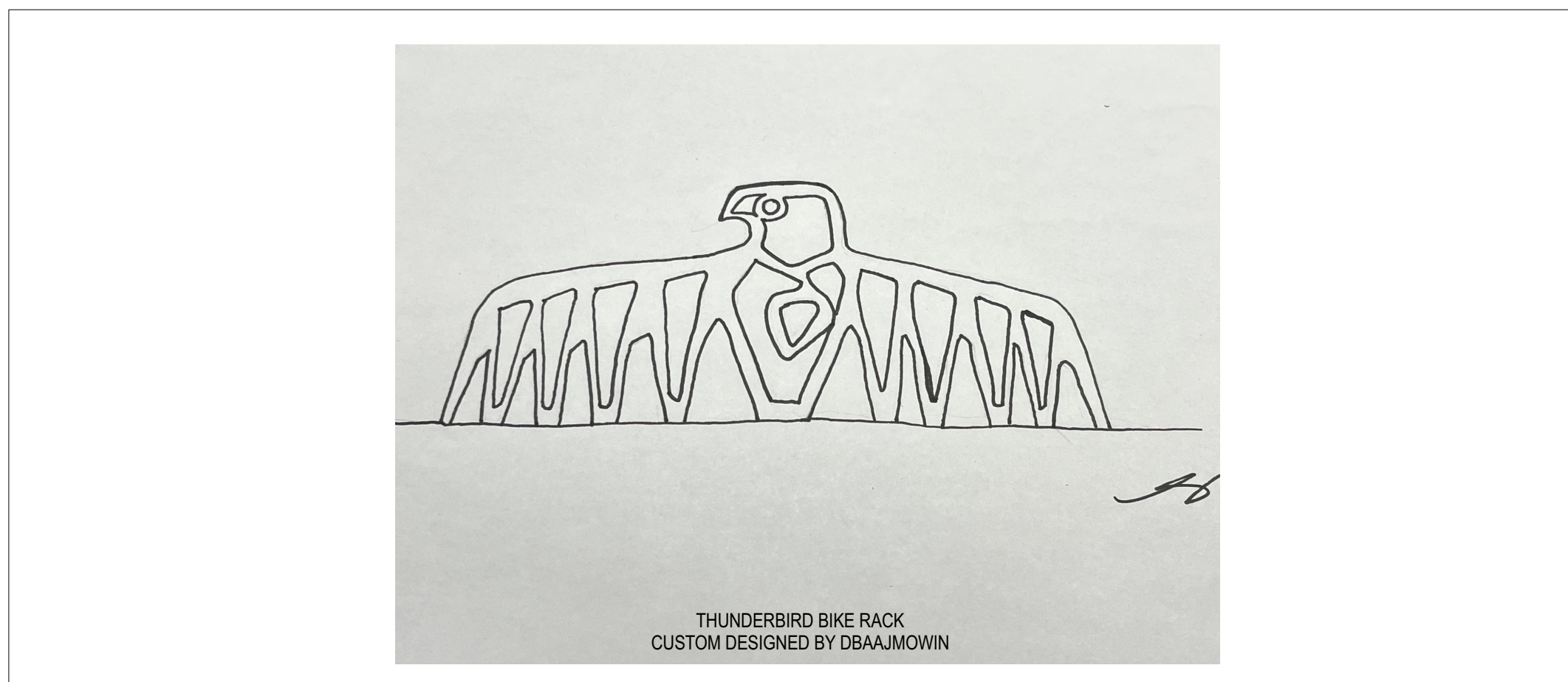
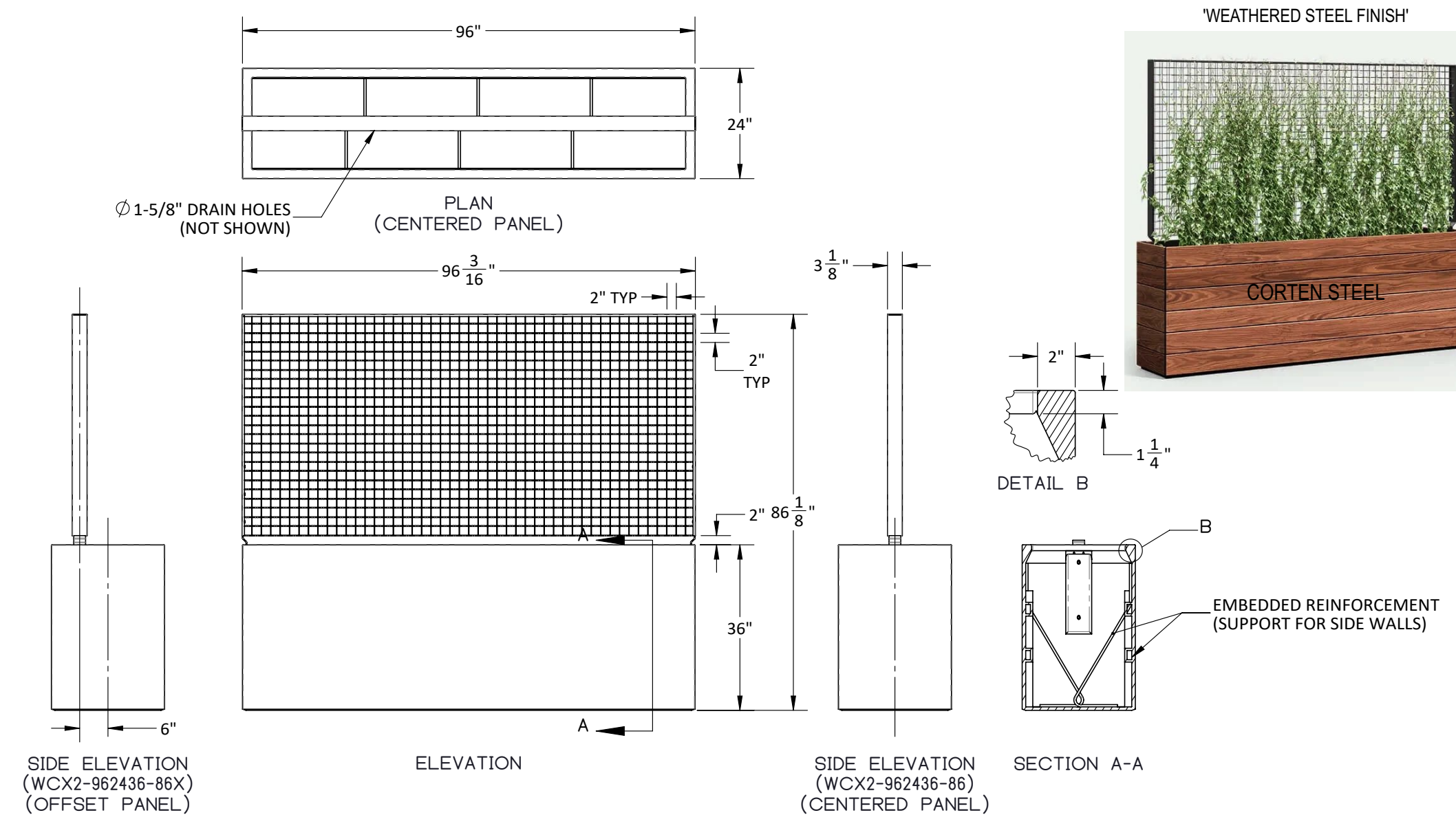

9 DETAIL: Custom Bike Rack
Scale: N.T.S.

Key Plan

Legend

10		
9		
8		
7		
6		
5		
4		
3	ISSUE FOR SPC FORMAL SUBMISSION	2024-10-04
2	ISSUED FOR SPA 2	2024-06-06
1	ISSUED FOR SPA	2024-02-09

Stamp

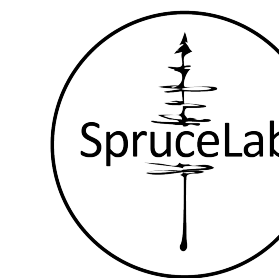

SpruceLab Inc.
Address: 550 Bayview Ave, Suite 300
Toronto, ON, M4W 3X8
Telephone: (647) 899-5891
www.sprucelab.ca

Disclaimer:
All drawing information shall be checked and verified and any discrepancies reported in writing to the Landscape Architect before commencing any affected work. This drawing shall be used only for the project named on this drawing and for reference purposes only. This drawing shall not be scaled. This drawing is not for construction unless signed by the Landscape Architect. This drawing and all aspects of its content are the copyright property of SpruceLab. Reproduction in whole or in part, by any means whatsoever, without the express written permission of SpruceLab, is prohibited.

Client

Windmill Developments
Toronto, ON

Project

384 ARLINGTON AVE
OTTAWA, ON

Drawing Title

Landscape Details - Ground Floor

Scale: _____ Project # _____

Designed By: SB _____ 0.001

Drawn By: KG/NS _____ Drawing # _____

Approved By: SB _____

Date: 10/13/21 _____

L2

NOT FOR CONSTRUCTION



HARVEST TABLE BY STREETLIFE
CUT SHEET PENDING

1 DETAIL: Harvest Table
Scale: N.T.S.

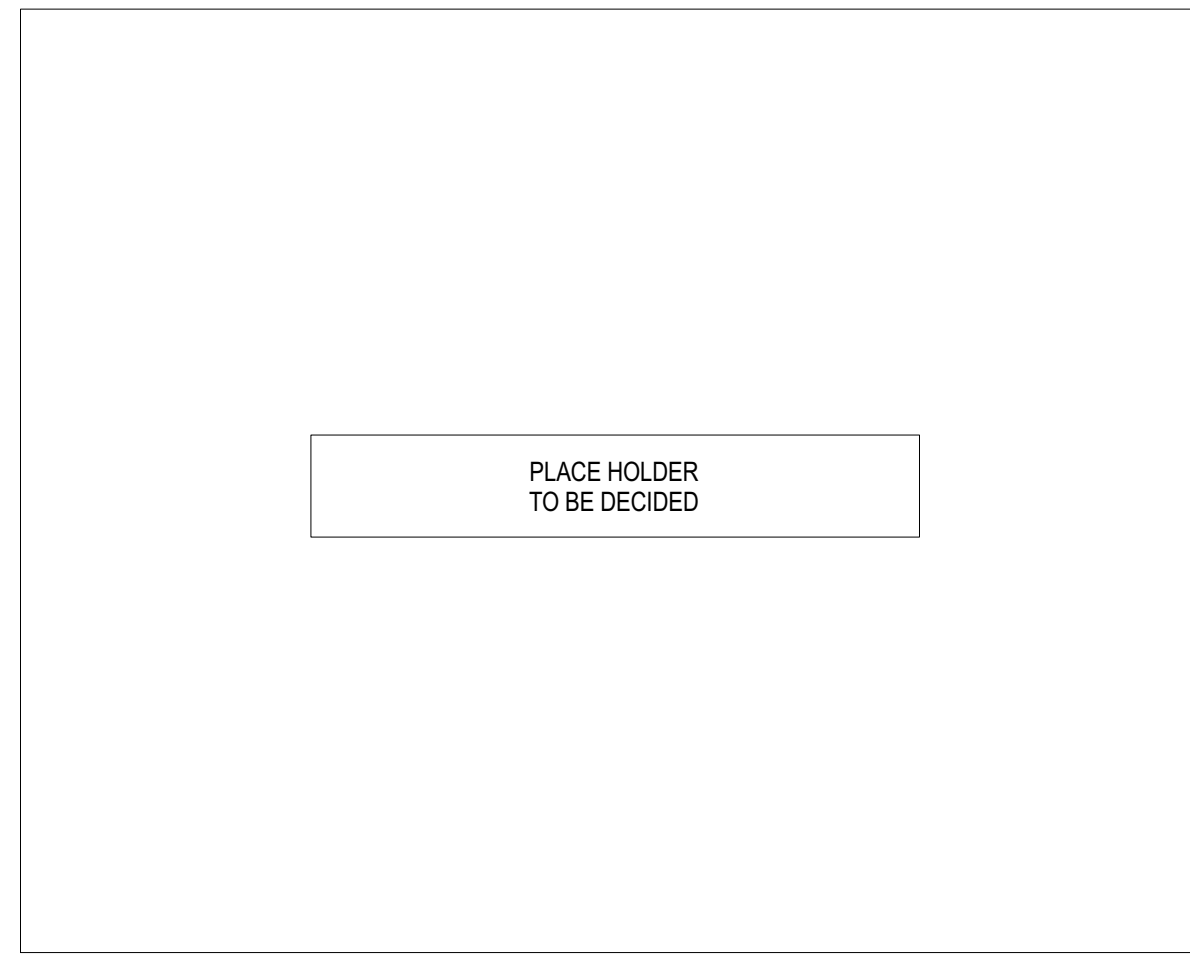

2 DETAIL: Outdoor Kitchen - BBQ & Counter
Scale: N.T.S.

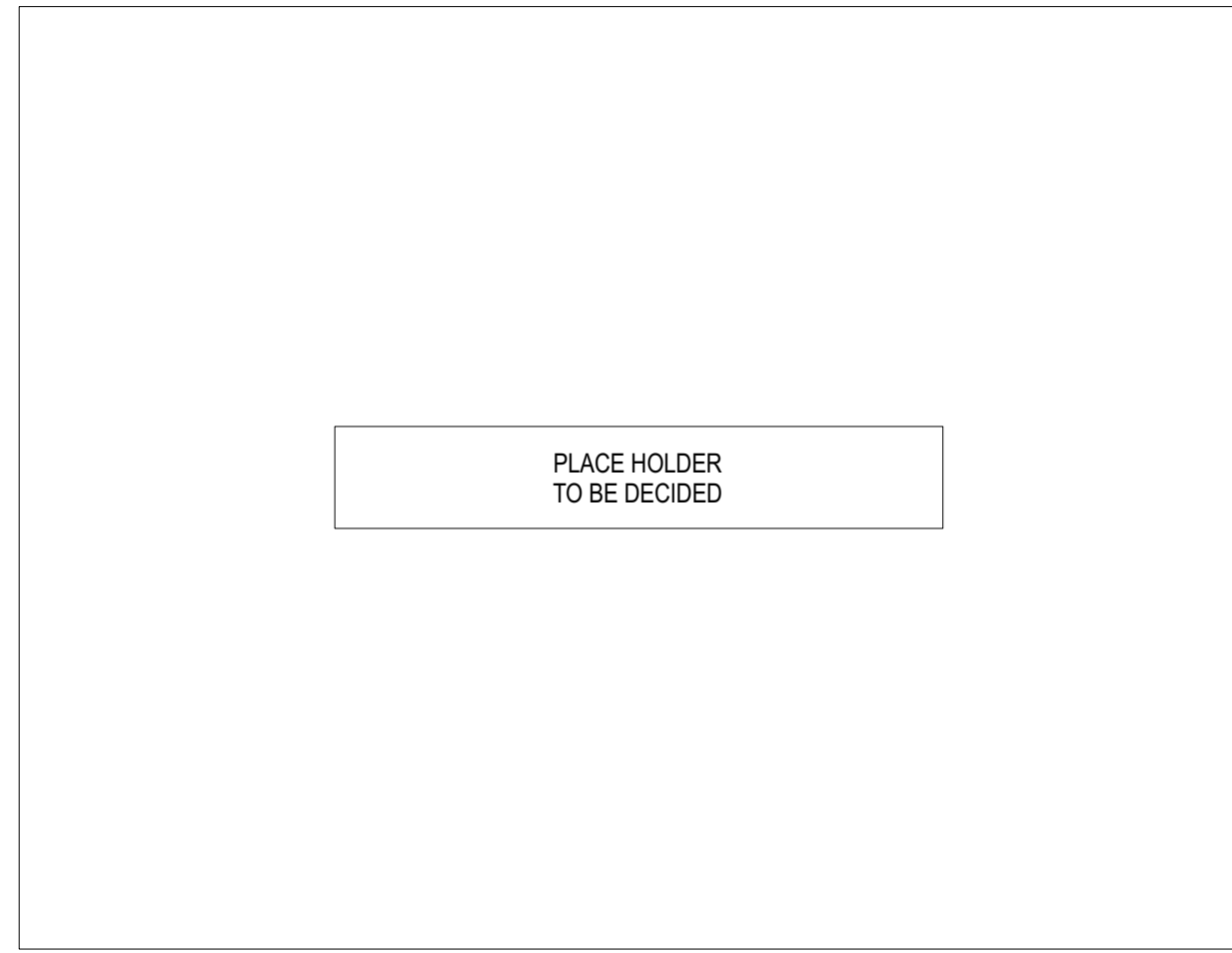

3 DETAIL: Pavers
Scale: N.T.S.



LARNACA OUTDOOR SLATE GREY METAL x ALL-WEATHER WEAVE LINE

4 DETAIL: Lounge Furniture
Scale: N.T.S.



RIVERVIEW OUTDOOR BISTRO SET - WEST ELM CANADA

5 DETAIL: Bistro Set
Scale: N.T.S.

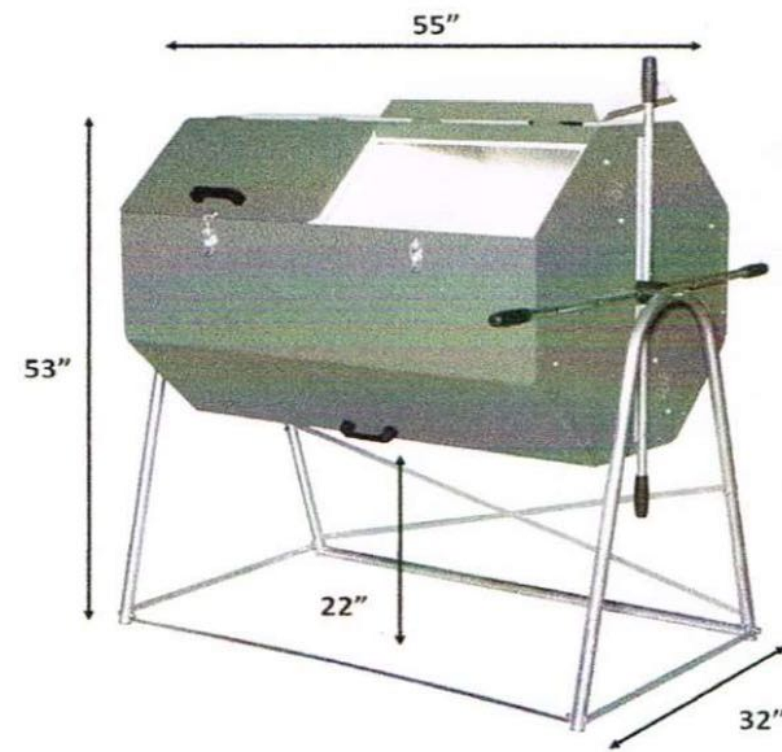

ALL JORA COMPOSTERS

JK 400
UPC 13964468601

14.2 Cubic Feet
106-Gallon Capacity

167 pounds
Each JK400 Ships in **3 Boxes**

- Galvanized Steel
- Powder Coated I Green
- Low and High Density Polyethylene Insulation

7 DETAIL: Composter
Scale: N.T.S.

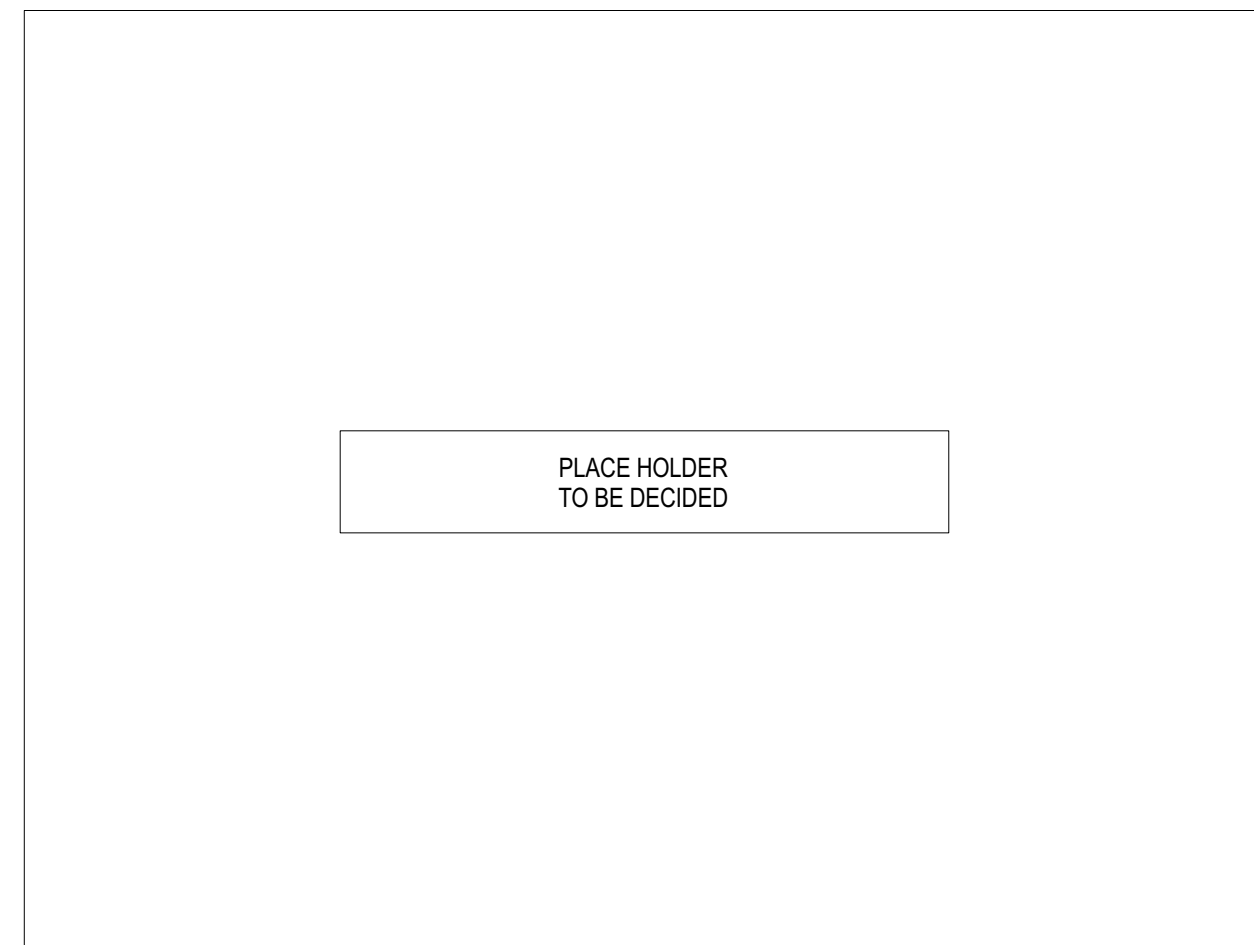

8 DETAIL: Garden Shed
Scale: N.T.S.

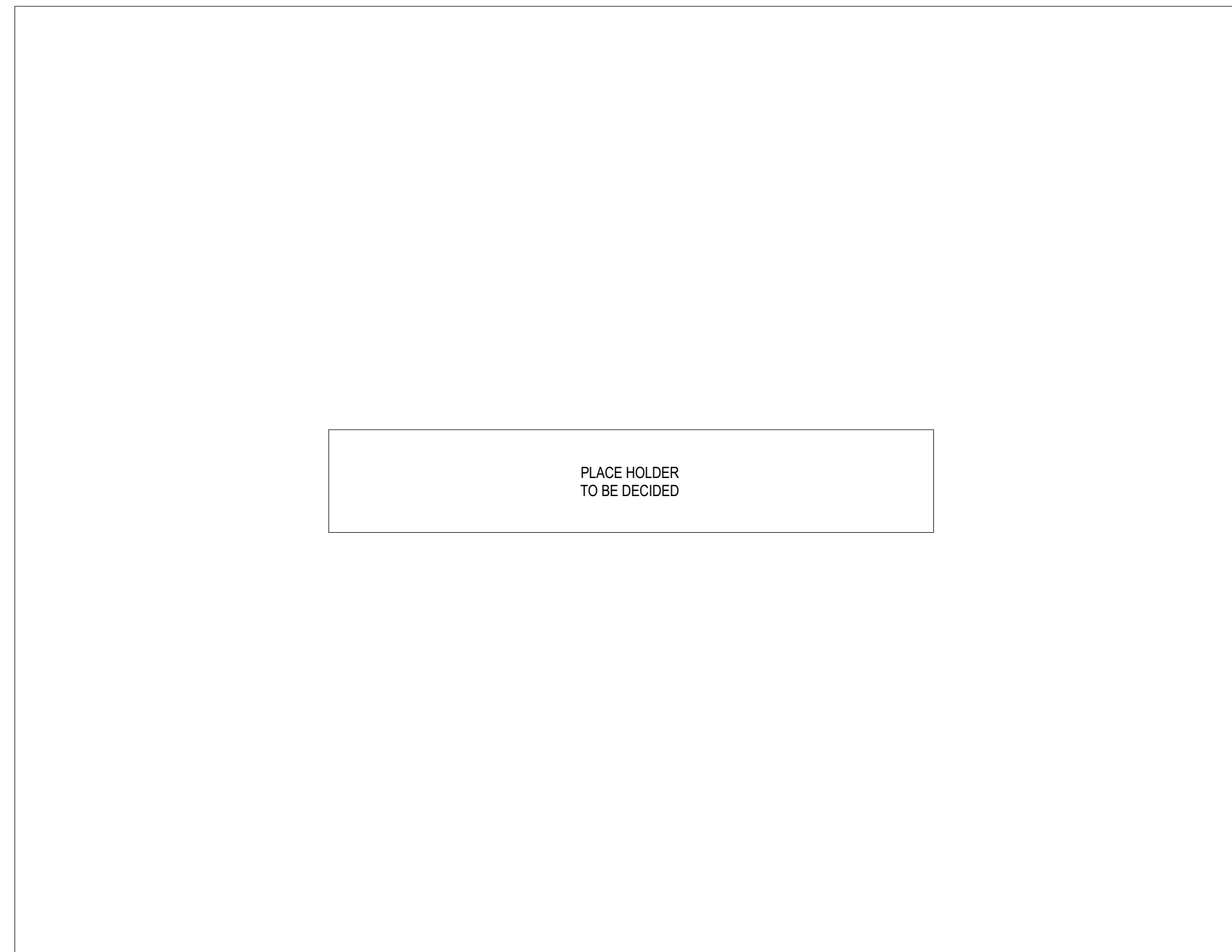

9 DETAIL: Wheelchair Accessible Raised Beds
Scale: N.T.S.

Key Plan

Legend

10		
9		
8		
7		
6		
5		
4		
3	ISSUE FOR SPC FORMAL SUBMISSION	2024-10-04
2	ISSUED FOR SPA 2	2024-06-06
1	ISSUED FOR SPA	2024-02-09

Stamp

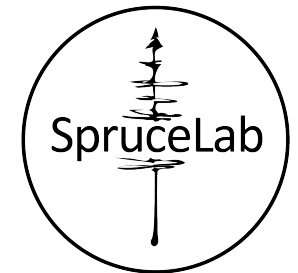

SpruceLab Inc.
Address: 550 Bayview Ave, Suite 300
Toronto, ON, M4W 3X8
Telephone: (647) 899-5891
www.sprucelab.ca

Disclaimer:
All drawing information shall be checked and verified and any discrepancies reported in writing to the Landscape Architect before commencing any affected work. This drawing shall be used only for the project named on this drawing and for reference purposes only. This drawing shall not be scaled. This drawing is not for construction unless signed by the Landscape Architect. This drawing and all aspects of its content are the copyright property of SpruceLab. Reproduction in whole or in part, by any means whatsoever, without the express written permission of SpruceLab, is prohibited.

Client

Windmill Developments
Toronto, ON

Project

384 ARLINGTON AVE
OTTAWA, ON

Drawing Title

Landscape Details - Terraces

Scale: _____ Project # _____
Designed By: SB _____ 0.001
Drawn By: KG/NS _____ Drawing # _____
Approved By: SB _____
Date: 10/13/21

L3

NOT FOR CONSTRUCTION

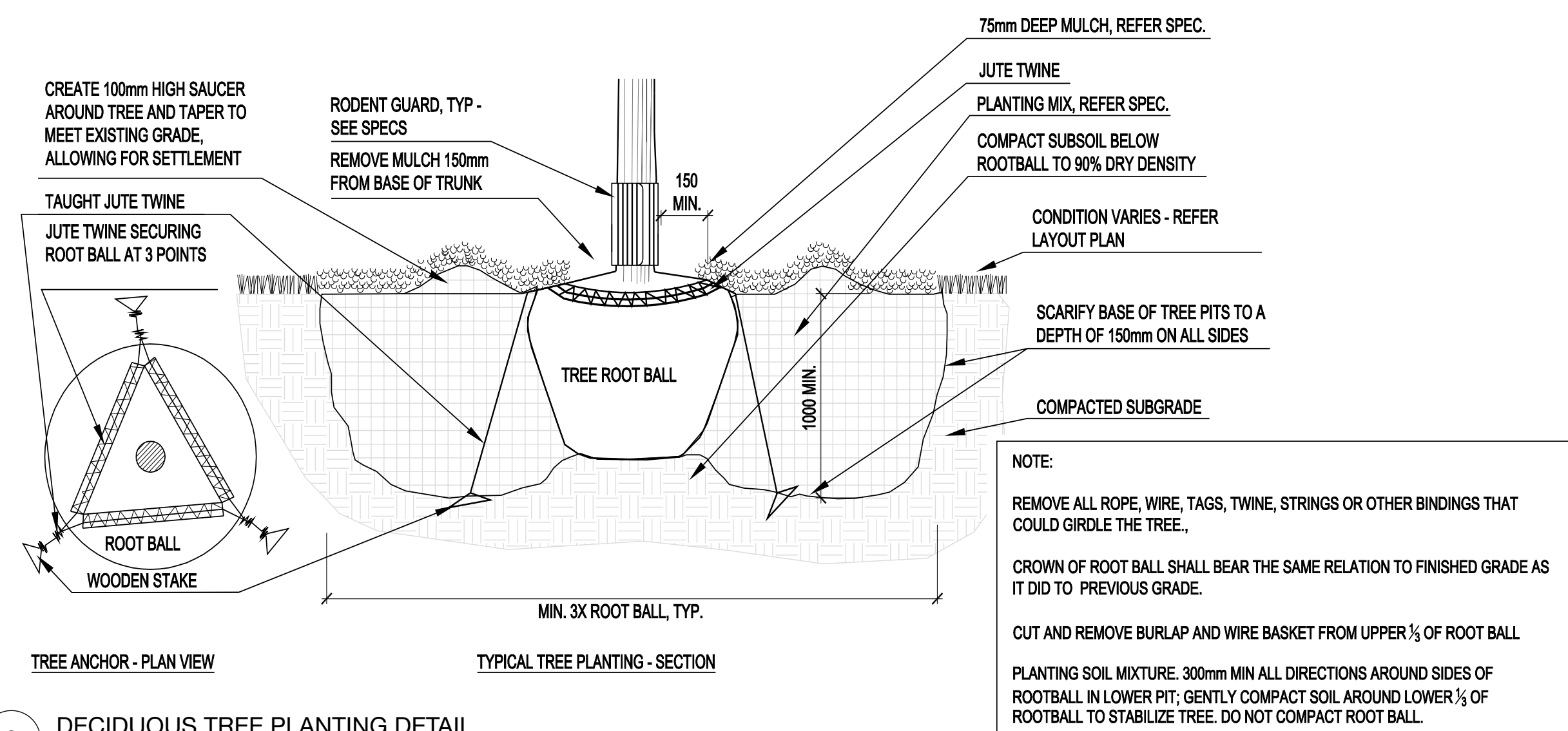

8 DECIDUOUS TREE PLANTING DETAIL
Scale: N.T.S.

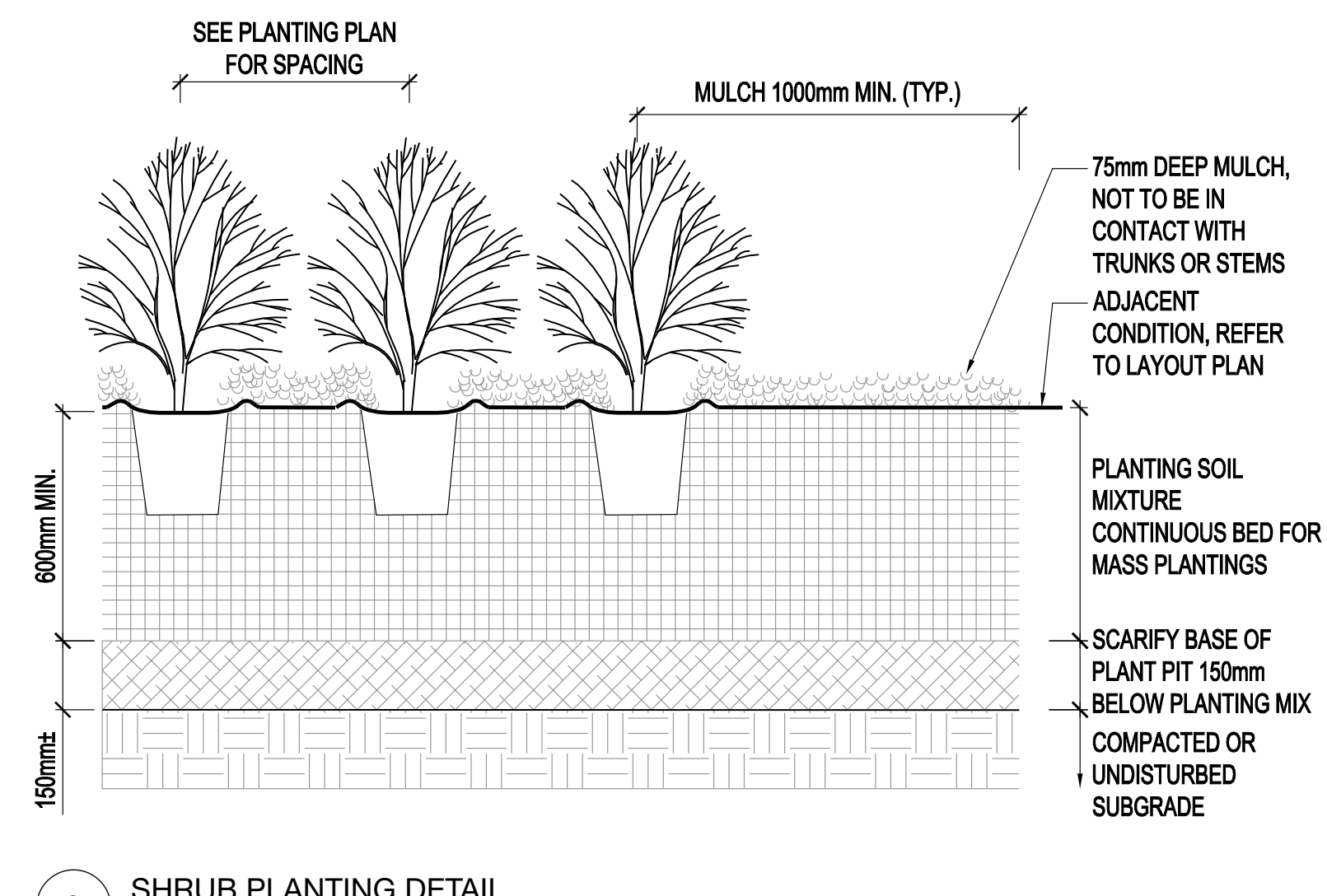

9 SHRUB PLANTING DETAIL
Scale: N.T.S.

Legend

10		
9		
8		
7		
6		
5		
4		
3	ISSUE FOR SPC FORMAL SUBMISSION	2024-10-04
2	ISSUED FOR SPA 2	2024-06-06
1	ISSUED FOR SPA	2024-02-09

Stamp

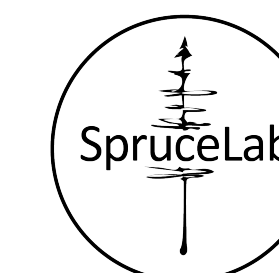

SpruceLab Inc.
Address: 550 Bayview Ave, Suite 300
Toronto, ON, M4W 3X8
Telephone: (647) 899-5891
www.sprucelab.ca

Disclaimer:
All drawing information shall be checked and verified and any discrepancies reported in writing to the Landscape Architect before commencing any affected work. This drawing shall be used only for the project named on this drawing and for reference purposes only. This drawing shall not be scaled. This drawing is not for construction unless signed by the Landscape Architect. This drawing and all aspects of its content are the copyright property of SpruceLab. Reproduction in whole or in part, by any means whatsoever, without the express written permission of SpruceLab, is prohibited.

Client

Windmill Developments
Toronto, ON

Project

384 ARLINGTON AVE
OTTAWA, ON

Drawing Title

Planting Details

Scale:	Project #
Designed By: SB	0.001
Drawn By: KG/NS	Drawing #
Approved By: SB	
Date: 10/13/21	

L4

NOT FOR CONSTRUCTION