



265 Catherine Street

Transportation Impact Assessment (TIA) Report

FINAL

September 2024



TIA Plan Reports

On 14 June 2017, the Council of the City of Ottawa adopted new Transportation Impact Assessment (TIA) Guidelines. In adopting the guidelines, Council established a requirement for those preparing and delivering transportation impact assessments and reports to sign a letter of certification.

Individuals submitting TIA reports will be responsible for all aspects of development-related transportation assessment and reporting, and undertaking such work, in accordance and compliance with the City of Ottawa's Official Plan, the Transportation Master Plan and the Transportation Impact Assessment (2017) Guidelines.

By submitting the attached TIA report (and any associated documents) and signing this document, the individual acknowledges that s/he meets the four criteria listed below.

CERTIFICATION

1. I have reviewed and have a sound understanding of the objectives, needs and requirements of the City of Ottawa's Official Plan, Transportation Master Plan and the Transportation Impact Assessment (2017) Guidelines;
2. I have a sound knowledge of industry standard practice with respect to the preparation of transportation impact assessment reports, including multi modal level of service review;
3. I have substantial experience (more than 5 years) in undertaking and delivering transportation impact studies (analysis, reporting and geometric design) with strong background knowledge in transportation planning, engineering or traffic operations; and
4. I am either a licensed¹ or registered² professional in good standing, whose field of expertise [check appropriate field(s)] is either transportation engineering or transportation planning .

1,2 License of registration body that oversees the profession is required to have a code of conduct and ethics guidelines that will ensure appropriate conduct and representation for transportation planning and/or transportation engineering works.

City Of Ottawa
Infrastructure Services and Community
Sustainability
Planning and Growth Management
110 Laurier Avenue West, 4th fl.
Ottawa, ON K1P 1J1
Tel. : 613-580-2424
Fax: 613-560-6006

Ville d'Ottawa
Services d'infrastructure et Viabilité des
collectivités
Urbanisme et Gestion de la croissance
110, avenue Laurier Ouest
Ottawa (Ontario) K1P 1J1
Tél. : 613-580-2424
Télécopieur: 613-560-6006

Dated at Ottawa this 22 day of May, 2024
(City)

Name: Austin Shih, P.Eng.
(Please Print)

Professional Title: Senior Project Manager



Signature of Individual certifier that s/he meets the above four criteria

Office Contact Information (Please Print)
Address: 1223 Michael Street North, Suite 100
City / Postal Code: Ottawa, Ontario, K1J 7T2
Telephone / Extension: 613-738-4160
E-Mail Address: austin.shih@parsons.com

265 Catherine Street

Transportation Impact Assessment (TIA) Report

prepared for:
Brigil Construction Inc.
98 Lois Street
Gatineau, QC
J8Y 3R7

prepared by:
 **PARSONS**
1223 Michael Street North
Suite 100
Ottawa, ON K1J 7T2

September 10, 2024

478038-01000

DOCUMENT CONTROL PAGE

CLIENT:	Brigil Construction
PROJECT NAME:	265 Catherine Street
REPORT TITLE:	Transportation Impact Assessment (TIA) Report
PARSONS PROJECT NO:	478038 - 01000
APPLICATION TYPE:	Site Plan Control (SPC) Application
VERSION:	Final
DIGITAL MASTER:	\\xcca57fs01\data\ISO\478038\1000\DOCS\STEP5-TIA Submission SPC\265 Catherine St SPC - TIA Report Sept 2024.docx
ORIGINATOR	Basel Ansari P.Eng.
REVIEWER:	Austin Shih, M.A.Sc., P.Eng.
AUTHORIZATION:	
CIRCULATION LIST:	Wally Dubyk, C.E.T.
HISTORY:	<ul style="list-style-type: none"> - TIA Step 1 Screening Form – June 14, 2022 - TIA Step 2 Scoping Report – June 14, 2022 - TIA Step 3 Forecasting Report – March 13, 2023 - TIA Step 4 Strategy Report – May 19, 2023 - TIA Report – March 08, 2024 - TIA Report Submission #2 – May 23, 2024 - TIA Report SPC Submission – September 10, 2024

TABLE OF CONTENTS

- 1.0 SCREENING FORM 1
- 2.0 SCOPING REPORT 1
 - 2.1. EXISTING AND PLANNED CONDITIONS 1
 - 2.1.1. PROPOSED DEVELOPMENT 1
 - 2.1.2. EXISTING CONDITIONS..... 4
 - 2.1.3. PLANNED CONDITIONS 14
 - 2.1.3.2 Future Transportation Network Changes 14
 - 2.1.3.3 Other Area Developments 17
 - 2.2. STUDY AREA AND TIME PERIODS 17
 - 2.3. EXEMPTION REVIEW 18
- 3.0 FORECASTING 18
 - 3.1. DEVELOPMENT GENERATED TRAVEL DEMAND 18
 - 3.1.1. TRIP GENERATION AND MODE SHARES 18
 - 3.1.2. TRIP DISTRIBUTION AND ASSIGNMENT 25
 - 3.2. BACKGROUND NETWORK TRAFFIC 26
 - 3.2.1. TRANSPORTATION NETWORK PLANS 26
 - 3.2.2. BACKGROUND GROWTH..... 26
 - 3.2.3. OTHER DEVELOPMENTS 28
 - 3.3. DEMAND RATIONALIZATION..... 28
- 4.0 ANALYSIS 31
 - 4.1. DEVELOPMENT DESIGN 31
 - 4.1.1. DESIGN FOR SUSTAINABLE MODES 31
 - 4.1.2. CIRCULATION AND ACCESS 32
 - 4.1.3. NEW STREET NETWORK 33
 - 4.2. PARKING 33
 - 4.2.1. PARKING SUPPLY 33
 - 4.2.2. PARKING VARIANCE IMPLICATIONS 35
 - 4.3. BOUNDARY STREET DESIGN..... 35
 - 4.4. ACCESS INTERSECTION DESIGN 37
 - 4.5. TRANSPORTATION DEMAND MANAGEMENT 38
 - 4.5.1. CONTEXT FOR TDM 38
 - 4.5.2. NEED AND OPPORTUNITY 38
 - 4.5.3. TDM PROGRAM 39
 - 4.6. NEIGHBOURHOOD TRAFFIC MANAGEMENT..... 40
 - 4.7. TRANSIT..... 41
 - 4.8. REVIEW OF NETWORK CONCEPT..... 42
 - 4.9. INTERSECTION DESIGN..... 42
 - 4.9.1. INTERSECTION CONTROL 42
 - 4.9.2. INTERSECTION DESIGN 42
- 5.0 FINDINGS, CONCLUSIONS AND RECOMMENDATIONS 48

LIST OF FIGURES

FIGURE 1: LOCAL CONTEXT.....	1
FIGURE 2: EXISTING SITE ACCESSES AND CIRCULATION	2
FIGURE 3: PROPOSED FULL SITE CONCEPT PLAN.....	3
FIGURE 4: ADJACENT DRIVEWAYS WITHIN 200M OF SITE ACCESS.....	9
FIGURE 5: STUDY AREA ACTIVE TRANSPORTATION FACILITIES	10
FIGURE 6: AREA TRANSIT NETWORK.....	11
FIGURE 7: BUS STOP LOCATIONS	11
FIGURE 8: EXISTING PEAK HOUR TRAFFIC VOLUMES	12
FIGURE 9: EXISTING PEDESTRIAN AND CYCLISTS PEAK HOUR VOLUMES	13
FIGURE 10: CENTRETOWN CDP STUDY AREA.....	16
FIGURE 11: STUDY AREA.....	18
FIGURE 12: PHASE 1 SITE-GENERATED TRAFFIC	25
FIGURE 13: FULL BUILDOUT PHASE 1 + PHASE 2 SITE-GENERATED TRAFFIC.....	26
FIGURE 14: FUTURE BACKGROUND 2026 TRAFFIC VOLUMES	27
FIGURE 15: FUTURE BACKGROUND 2031 TRAFFIC VOLUMES	27
FIGURE 16: FUTURE BACKGROUND 2036 TRAFFIC VOLUMES	28
FIGURE 17: TOTAL PROJECTED 2026 TRAFFIC VOLUMES.....	29
FIGURE 18: TOTAL PROJECTED 2031 TRAFFIC VOLUMES.....	30
FIGURE 19: TOTAL PROJECTED 2036 TRAFFIC VOLUMES.....	30
FIGURE 20: PROPOSED BUS STOP REALIGNMENT AND ENHANCEMENT	31
FIGURE 21: TRANSIT RIDERSHIP DATA BUS STOP LOCATIONS	41

LIST OF TABLES

TABLE 1: PROPOSED DEVELOPMENT SITE STATISTICS	2
TABLE 2: EXEMPTIONS REVIEW SUMMARY	18
TABLE 3: PROPOSED DEVELOPMENT TRIP RATES	18
TABLE 4: RESIDENTIAL UNITS PEAK PERIOD PERSON TRIP GENERATION	19
TABLE 5: HIGH-RISE APARTMENTS PEAK PERIOD TRIPS MODE SHARES BREAKDOWN	19
TABLE 6: TOWNHOMES PEAK PERIOD TRIPS MODE SHARES BREAKDOWN.....	19
TABLE 7: PEAK PERIOD TO PEAK HOUR CONVERSION FACTORS (2020 TRANS MANUAL)	20
TABLE 8: HIGH-RISE APARTMENTS PEAK HOUR TRIPS MODE SHARE BREAKDOWN	20
TABLE 9: TOWNHOMES PEAK HOUR TRIPS MODE SHARE BREAKDOWN.....	20
TABLE 10: HIGH-RISE APARTMENTS PEAK HOUR TRIPS MODE SHARE BREAKDOWN	21
TABLE 11: TOWNHOMES PEAK HOUR TRIPS MODE SHARE BREAKDOWN.....	21
TABLE 12: HIGH-RISE APARTMENTS MODE SHARES BREAKDOWN (2020 TRANS REPORT).....	21
TABLE 13: TOWNHOMES MODE SHARES BREAKDOWN (2020 TRANS REPORT)	21
TABLE 14: TOTAL RESIDENTIAL TRIP GENERATION	22
TABLE 15: RETAIL UNITS PEAK HOUR PERSON TRIPS	22
TABLE 16: TRANS 2020 MODE SHARES FOR COMMERCIAL USE AND PROPOSED MODE SHARES	23
TABLE 17: RETAIL PEAK HOUR TRIPS MODE SHARE BREAKDOWN	23
TABLE 18: TOTAL NONRESIDENTIAL TRIP GENERATION.....	24
TABLE 19: RESIDENTIAL PEAK HOUR TRIPS WITH INTERNAL REDUCTIONS	24
TABLE 20: TOTAL TRIPS GENERATED.....	24
TABLE 21: REQUIRED AND PROPOSED VEHICLE PARKING SPACES.....	34
TABLE 22: REQUIRED AND PROPOSED BICYCLE PARKING SPACES	34
TABLE 23: MMLOS ANALYSIS, BOUNDARY ROAD SEGMENTS	37
TABLE 24: ARLINGTON AVE EXISTING AND FUTURE TWO-WAY VOLUMES.....	40

TABLE 25: TRANSIT RIDERSHIP DATA (JAN 5, 2020 - MAR 16, 2020)	41
TABLE 26: EXISTING CONDITIONS INTERSECTION PERFORMANCE	43
TABLE 27: FUTURE BACKGROUND 2036 CONDITIONS INTERSECTION PERFORMANCE	44
TABLE 28: TOTAL PROJECTED 2026 CONDITIONS INTERSECTION PERFORMANCE – PHASE 1	44
TABLE 29: FUTURE PROJECTED 2031 INTERSECTION PERFORMANCE – PHASE 1 & 2	45
TABLE 30: FUTURE PROJECTED 2036 INTERSECTION PERFORMANCE – PHASE 1 & 2	46
TABLE 31: QUEUEING ANALYSIS FOR SENSITIVE INTERSECTION MOVEMENTS (2036 PROJECTED).....	46
TABLE 32: MMLOS ANALYSIS, SIGNALIZED INTERSECTION	47

LIST OF APPENDICES

APPENDIX A: SCREENING FORM & CITY COMMENT REPOSES
APPENDIX B: TRANSIT ROUTE MAPS
APPENDIX C: TRAFFIC DATA
APPENDIX D: COLLISION DATA
APPENDIX E: INTERNAL REDUCTION CALCULATIONS
APPENDIX F: TDM CHECKLIST
APPENDIX G: PASSENGER CAR AND TRUCK TURNING TEMPLATES
APPENDIX H: MMLOS ANALYSIS: ROAD SEGMENTS
APPENDIX I: SYNCHRO ANALYSIS SUMMARY REPORTS
APPENDIX J: SIMTRAFFIC SUMMARY REPORTS
APPENDIX K: MMLOS ANALYSIS: INTERSECTIONS

TRANSPORTATION IMPACT ASSESSMENT REPORT

Parsons has been retained by Brigil Construction to prepare a TIA Report in support of a Site Plan Control (SPC) Application for a three-tower residential development. This document follows the TIA process as outlined in the City Transportation Impact Assessment (TIA) Guidelines (2017). The following report represents Step 5 – TIA Report. The Screening Form and responses to City Comments have been provided in **Appendix A**.

1.0 SCREENING FORM

The Screening Form confirmed the need for a TIA Report based on the Trip Generation and Safety triggers. The Trip Generation trigger was met as the development is anticipated to generate more than 60 person trips during peak hours. The Safety trigger was met following a review of collisions history in the study area.

2.0 SCOPING REPORT

2.1. Existing and Planned Conditions

2.1.1. Proposed Development

The proposed development will be located at the municipal address of 265 Catherine St, replacing the previous Greyhound Bus Station that is no longer active. The local context of the site is illustrated in **Figure 1**.

Figure 1: Local Context

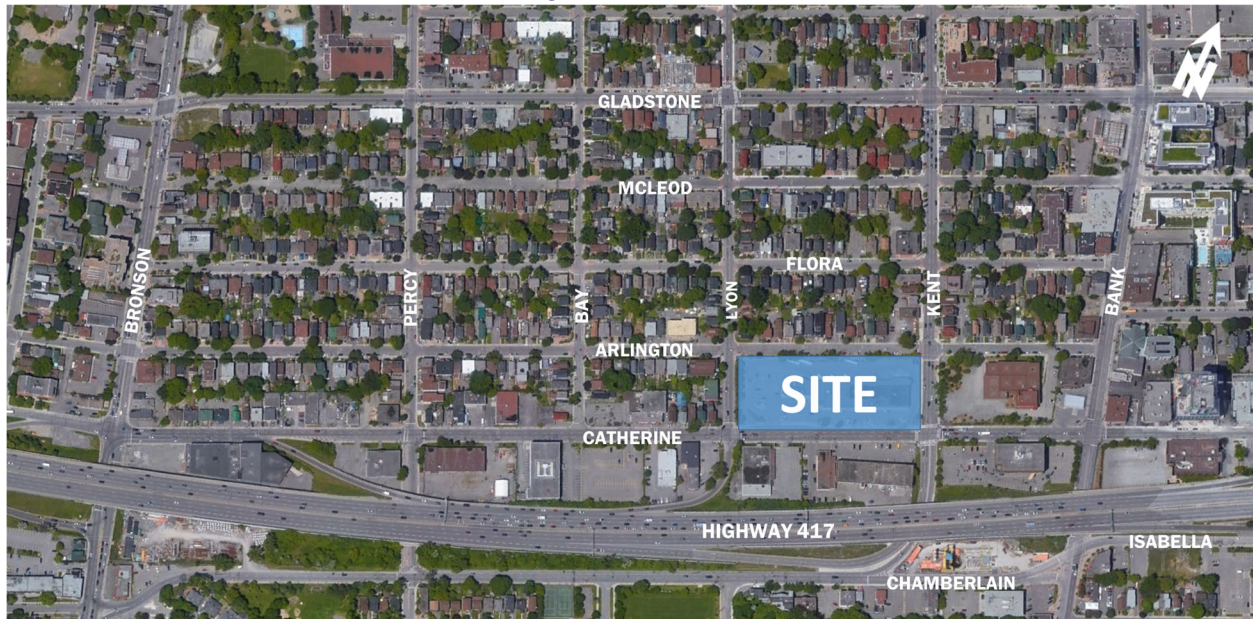

The subject site currently provides accesses onto Catherine St only as shown in **Figure 2**. The site is currently zoned as a General Mixed-Use Zone and is located within the Ontario Ministry of Transportation (MTO) permit control zone.

Figure 2: Existing Site Accesses and Circulation

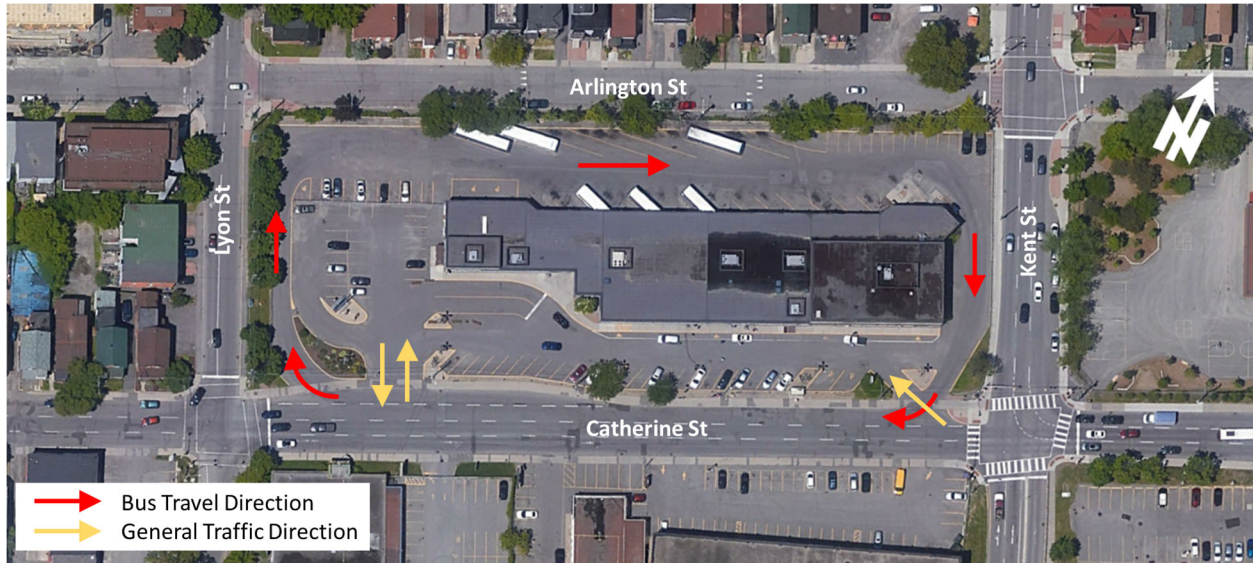

The proposed development will consist of residential and commercial uses constructed as a two phased development. The site statistics have been summarized in **Table 1**. The full buildout concept plan is illustrated in **Figure 3** (high quality plan provided in **Appendix A**).

Table 1: Proposed Development Site Statistics

Land Use	Storeys	Residential (Units)	Commercial (m ²)	Vehicle Parking	Bike Parking
Phase 1					
Building A (Tower 1)	32	423	1,430	187	423
Phase 1 Total		423	1,430	187	423
Phase 2					
Building B (Towers 2, 3)	34 to 36	734	1,123	358	743
Building C (Townhomes)	3	7	0	-	-
Phase 2 Total		739	1,123	358	743
Full Buildout Total		1,164	2,653	545	1,166

All vehicle parking will be provided in a three-level underground parking garage accessed by new two-way ramps on Catherine St and Arlington Ave. Almost all bicycle parking spaces will be provided on the first level of the underground parking garage and can be accessed through main elevator cores or through the parking ramps. A one-way southbound woonerf connecting Arlington Ave to Catherine St is proposed which will primarily serve as an extension of the expansive pedestrian realm onsite but has been designed to also accommodate loading operations, garbage truck operations and short-term deliveries. Phase 1, including the woonerf is assumed to be completed by 2026 and Phase 2 is assumed to be completed by 2031.

Further detail for onsite circulation can be found in **Section 4.1**, for vehicle and bike parking in **Section 4.2**, and for site access/driveways in **Section 4.4**.

Figure 3: Proposed Full Site Concept Plan

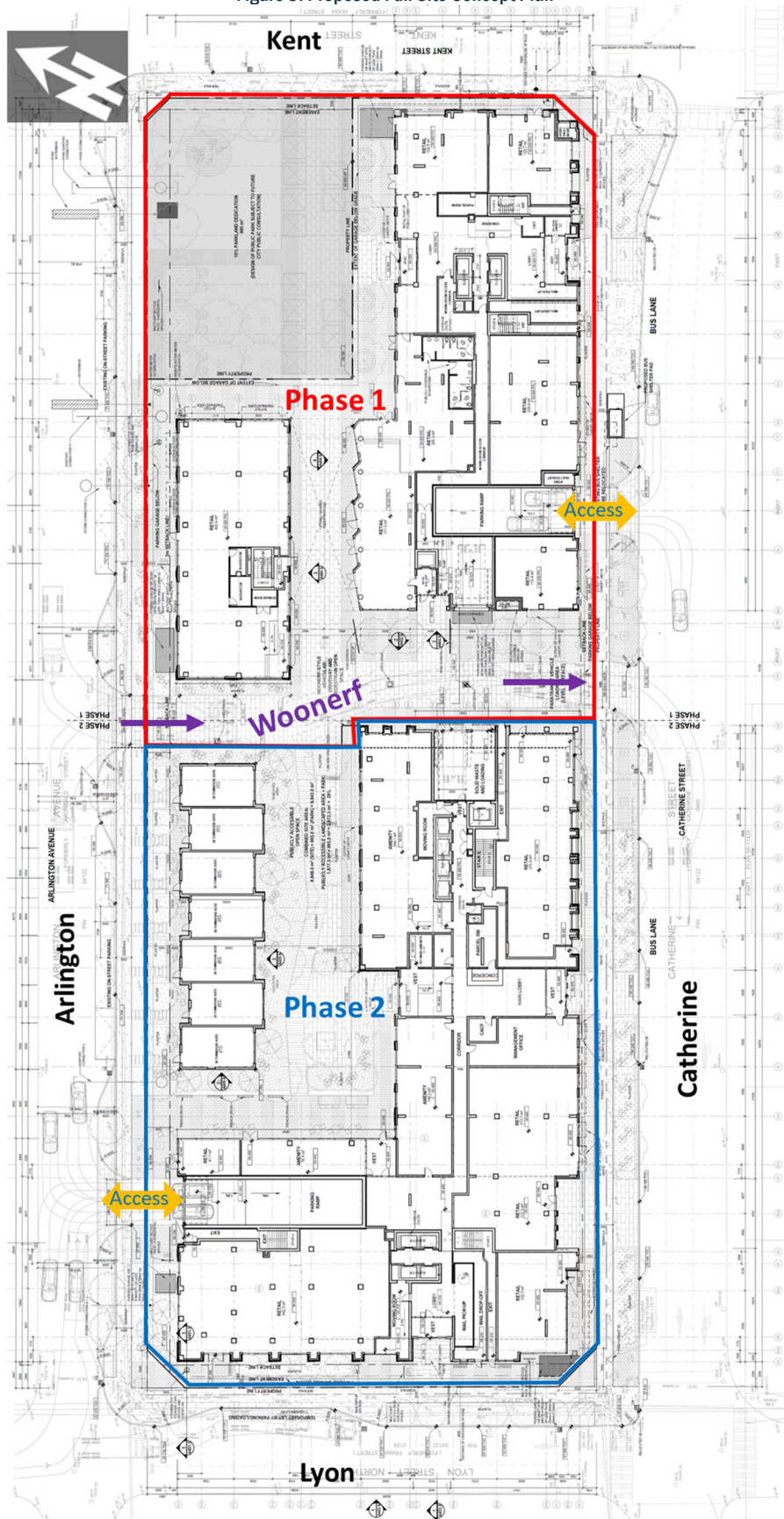

2.1.2. Existing Conditions

Area Road Network

The following roads were included in the TIA. Description for each road within the study area has been provided below.

Kent Street is a north-south municipal arterial road that extends from Wellington St in the north to Chamberlain Ave in the south forming the east boundary road to the site. The roadway operates as a one-way northbound road with a three-lane cross-section and on-street parking. The posted speed limit is 50km/h.

Lyon Street N is a north-south municipal arterial road that extends from Wellington St in the north to Catherine St in the south that forms the western site boundary. The roadway operates as a one-way southbound road with a two-lane cross-section. The speed limit is assumed to be 50km/h.

Catherine Street is an east-west municipal arterial road bordering the site to the south that extends from Queen Elizabeth Dr in the east to Bronson Ave in the west, where it continues as Raymond St. The roadway currently operates as a one-way westbound road with a three-lane cross-section and an assumed speed limit of 50km/h.

Arlington Avenue is an east-west municipal local road that extends from Bank St in the east to Booth St in the west, forming the northern site boundary. The roadway consists of a two-way two-lane cross-section, with a posted speed limit of 30km/h.

Bank Street is a north-south municipal arterial road that extends from Wellington St in the north to past the City of Ottawa's limits in the south. Within the study area, the roadway consists of a two-way two-lane cross-section with a posted speed limit of 50km/h north of Catherine St and 40km/h south of thereof. Additionally, Bank St is designated as a traditional mainstreet in the City of Ottawa Official Plan.

Percy Street is a north-south municipal local road that extends from Laurier Ave W in the north to Fifth Ave in the south. Notably, the southbound through movement is not permitted on Percy St at the Chamberlain Ave intersection. Within the study area, the road consists of a two-way two-lane cross-section with on-street parking, a posted speed limit of 30km/h north of Catherine St and an assumed speed limit of 40km/h south of thereof.

Gladstone Avenue is an east-west municipal major collector road that extends from Parkdale Ave in the west to Cartier St in the east. The roadway consists of a two-lane cross-section along the majority of its length, with a four-lane cross-section between Bank St and Kent St. The speed limit is assumed to be 50km/h in the study area.

Bronson Avenue is a north-south municipal arterial road that extends from Sparks St in the north to Heron St on/off ramps in the south, where it continues as the Airport Parkway. The road consists of a four-lane cross-section, with posted speed limits of 50km/h.

Chamberlain Avenue/Isabella Street are east-west municipal arterial roads that extend from Bronson Ave in the west as Chamberlain Ave to Bank St, where it continues east as Isabella St to Queen Elizabeth Dr in the east. The roadway is one-way eastbound only with a two-lane cross-section and a 50km/h speed limit within the study area.

Existing Study Area Intersections

Lyon/Catherine

The Lyon/Catherine intersection is a four-legged signalized intersection of southbound and westbound one-way streets. The westbound approach consists of two through lanes and a shared through/left-turn lane. The southbound approach consists of a through lane and a right-turn lane. Only westbound and southbound operations are permitted at this intersection. The southbound egress serves the Hwy 417 westbound on-ramp



Kent/Catherine

The Kent/Catherine intersection is a four-legged signalized intersection of northbound and westbound one-way streets. The westbound approach consists of one through lane, one through/right-turn lane and one right-turn lane. The northbound approach consists of two through lanes and a through/left-turn lane. One northbound through lane is separated by a median on the approach. Only westbound and northbound operations are permitted at this intersection and westbound right-turns are not permitted on a red light.



Bank/Catherine

The Bank/Catherine intersection is a signalized four-legged intersection, where Catherine St is westbound only. The northbound approach consists of a through lane and a through/left-turn lane. The southbound approach consists of a through lane and a through/right-turn lane. The westbound approach consists of two through lanes and a through/right-turn lane. There are no eastbound operations at this intersection.

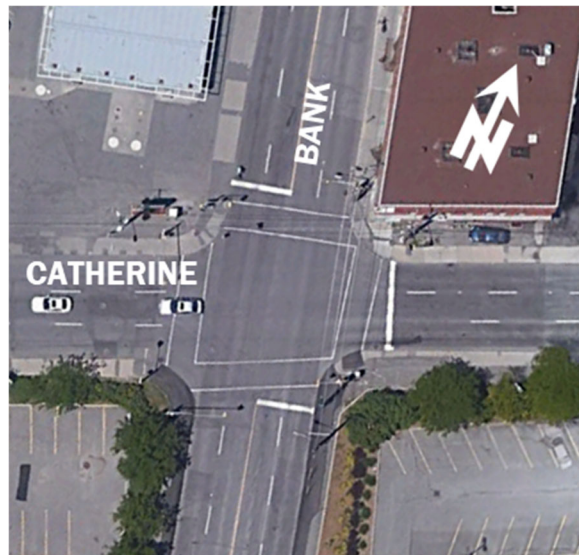

Percy/Catherine

The Percy/Catherine intersection is a four-legged signalized intersection of southbound and westbound one-way streets. The westbound approach consists of two through lanes and a shared through/left-turn lane. The southbound approach consists of a through lane and a right-turn lane. A north-south bidirectional bike crossing with a bike signal is provided on the west leg of the intersection. Only westbound and southbound operations are permitted at this intersection for vehicles. The southbound right-turn on red is prohibited.



Lyon/Arlington

The Lyon/Arlington intersection is an unsignalized four-legged intersection, with Stop control on Arlington Ave. Lyon St operates as one-way southbound. The westbound approach consists of a through/left-turn lane and the eastbound approach consists of a through/right-turn lane. Lyon St consists of a through/left-turn and through/right-turn lanes. There are no northbound operations at this intersection.



Kent/Arlington

The Kent/Arlington intersection is a signalized four-legged intersection, where Kent St is northbound only. The northbound approach consists of a through lane, a through/left-turn lane and a through/right-turn lane. The eastbound approach consists of a through/left-turn lane and the westbound approach consists of a through/right-turn lane. There are no southbound operations at this intersection.



Bank/Arlington

The Bank/Arlington intersection is an unsignalized three-legged “T” intersection, with Stop control on Arlington Ave. The northbound approach consists of a through lane and a shared through/left-turn lane. The southbound approach consists of a through lane and a shared through/right-turn lane. Arlington Ave consists of a single all-movement lane. There are no restricted movements at this intersection.



Kent/Gladstone

The Kent/Gladstone intersection is a signalized four-legged intersection, where Kent St is northbound only. The northbound approach consists two through lanes, a shared through/right-turn lane and a left-turn lane. The eastbound approach consists of a through lane and a left-turn lane, while the westbound approach consists of a shared through/right-turn lane. There are no southbound operations at the intersection.



Lyon/Gladstone

The Lyon/Gladstone intersection is a signalized four-legged intersection, where Lyon St is southbound only. The southbound approach consists of a shared through/right-turn lane and a shared through-left-turn lane. The eastbound approach consists of a through lane and an unmarked short right-turn lane. The westbound approach consists of a through lane and an unmarked short left-turn lane. There are no northbound operations at this intersection.



Bank/Chamberlain/Isabella

The Bank/Chamberlain/Isabella intersection is a signalized four-legged intersection, where Chamberlain Ave/Isabella St is eastbound only. The northbound approach consists of a through lane and a shared through/right-turn lane. The southbound approach consists of a through lane and a shared through/left-turn lane. The eastbound approach consist of a through lane, a shared through/left-turn lane and a stop-controlled right-turn lane. There are no westbound operations at this intersection.

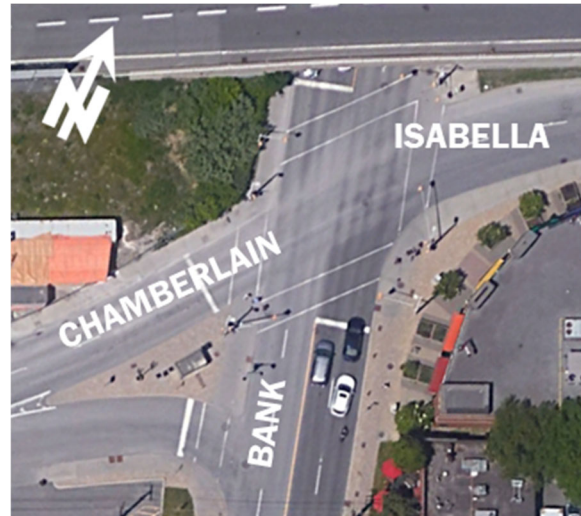

Bronson/Catherine

The Bronson/Catherine intersection is a signalized four-legged intersection, where Catherine St is westbound only. The northbound approach consists of two through lanes and a left-turn lane. The southbound approach consists of a through lane and a shared through/right-turn lane. The westbound approach consists of a through lane, a shared through/left-turn lane, a left-turn lane and a right-turn lane. There are no eastbound operations at this intersection.

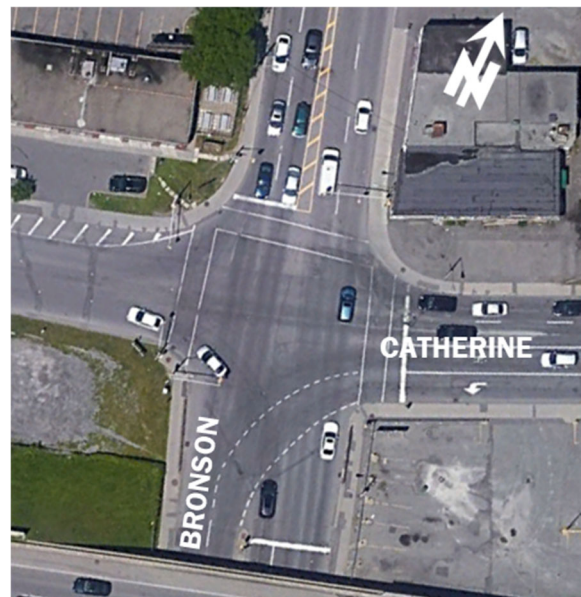

Existing Driveways to Adjacent Developments

Within 200m of the proposed site accesses along Catherine St and Arlington Ave, there is a total of 37 adjacent driveways as shown in **Figure 4**. Along Arlington Ave, there are 24 adjacent accesses (21 north side, 3 south side). Nearly all Arlington Ave accesses are used by individual residential units, with the exception of the access nearest to the northwest corner of the Kent/Arlington intersection, which is used to give access to the parking lot of a small restaurant.

Along Catherine St, there are 13 adjacent accesses (5 north side, 8 south side). On the north side of Catherine St, the four accesses west of Lyon St are for individual residential units, some of which are being used as office/business, while the accesses east of Kent St is for a gas station. All south side accesses are used for office buildings, business, and commercial units of different sizes.

Figure 4: Adjacent Driveways within 200m of Site Access



Existing Area Traffic Management Measures

Various area traffic management measures are currently provided within the study area, including the following:

- Advance pedestrian walk phases at the intersections of Kent/Catherine and Bank/Catherine,
- Bike signal and crossing phase at the intersection of Percy/Catherine,
- Zebra crosswalks on all legs at the intersection of Kent/Catherine, Lyon/Gladstone, Bank/Catherine, and Bronson/Catherine,
- Textured brick crosswalks on the east leg of the intersection of Lyon/Arlington, west leg of Kent/Arlington and west leg of Bank/Arlington,
- Curb extensions on the south side of Arlington Ave at the intersections of Lyon St and Kent St, as well as north side at the intersection of Kent St,
- Curb extension on the east side of Kent St at the intersection of Arlington Ave,
- On-street parking permitted along sections of Arlington Ave (including south side site frontage), Kent St (including east side site frontage), Lyon St, Percy St, Catherine St, and Gladstone Ave,
- Speed humps at different locations along Percy St, Lyon St, and Arlington Ave (including two at site frontage),
- Reduced 30km/h speeds along Percy St north of Catherine St and Arlington Ave,
- Southbound through restriction along Percy St at Chamberlain Ave intersection, where only bikes are permitted, and
- Modal filter along Bay St, 20m north of Catherine St, which prevent vehicles from passing and permits pedestrians and cyclists.
- Eastbound traffic restriction on Arlington Ave, approximately 50m east of Bronson Ave.

In addition to the above, the City of Ottawa has provided a list of Temporary Traffic Calming (TTC) measures within or near the study area, which includes:

- A “SLOW” pavement marking on Arlington Ave, west of Kent St.
- A speed display board on Kent St, north of Arlington Ave.
- Delineators on Lyon St, north of Gladstone Ave.
- Delineators, painted bulb-out, “SLOW” pavement marking and speed display boards on different locations of Percy St, north of Catherine St.

Pedestrian/Cycling Network

The active transportation network facilities for pedestrians and cyclists are illustrated in **Figure 5** (map obtained from GeoOttawa). As shown, sidewalk facilities are provided throughout the study area, including both sides of all roadways. Southbound bike lanes are provided on Lyon St, north of Arlington Ave, and a bi-directional cycle track is provided along Percy St. Northbound bike lanes are also provided along Bay St, 30m north of Catherine St. Although not identified in the map shown, it is noted that a contraflow (eastbound) bike lane is provided on McLeod St, between Percy St and Lyon St.

Additionally, the City of Ottawa Transportation Master Plan (TMP) designates Chamberlain Ave/Isabella St as part of a Crosstown Bikeway route. Bank St and Gladstone Ave are suggested cycling routes, along with a small portion of Arlington Ave, between Percy St and Lyon St.

Figure 5: Study Area Active Transportation Facilities

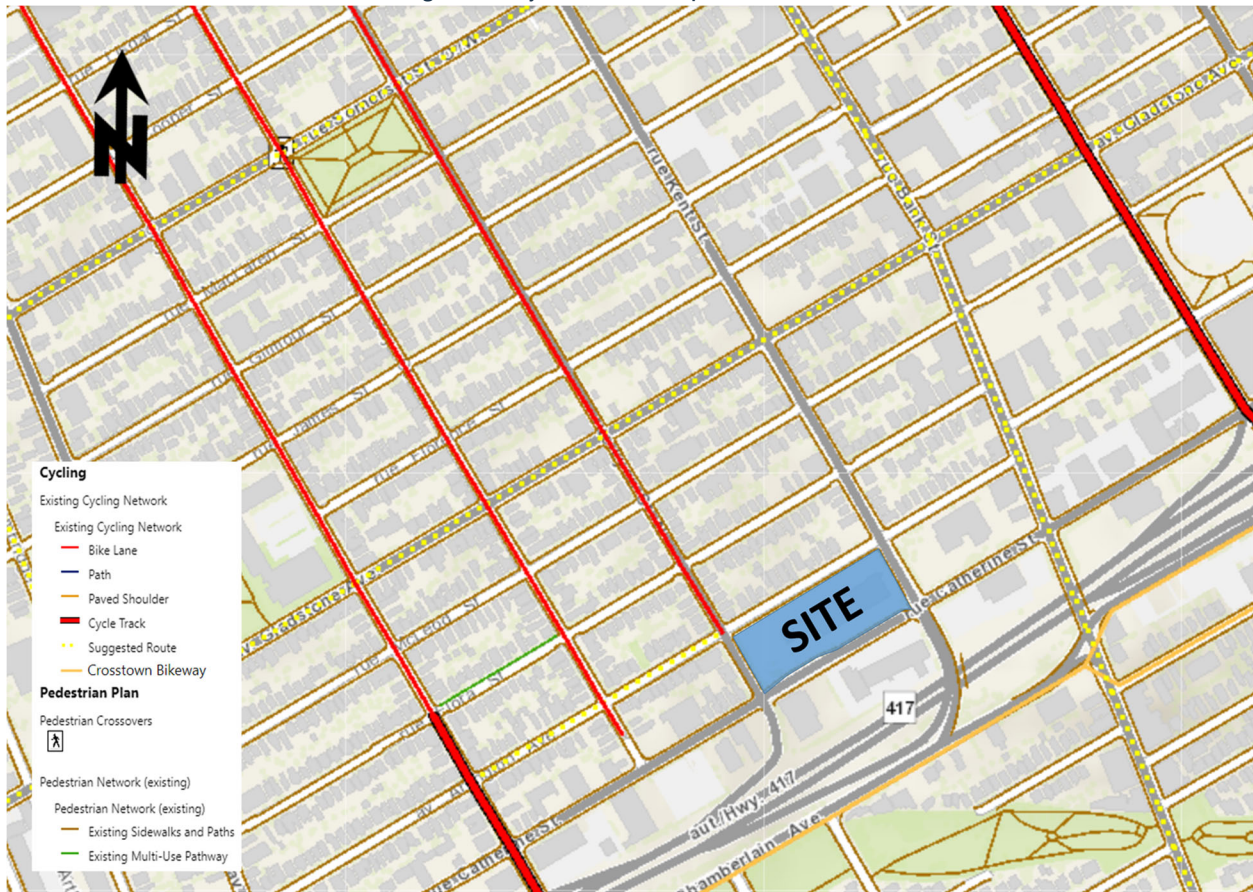

Transit Network

The following description of OC Transpo routes within the study area reflect the current bus operations:

- **Route #6 (Greenboro <-> Rockcliffe):** identified by OC Transpo as a “Frequent Route”, this route operates all day, 7 days a week and at an average rate of every 15 minutes or less from 6am to 6pm. The nearest bus stops to the site are at the intersections of Bank/Arlington and Bank/Catherine.
- **Route #7 (Carleton <-> St. Laurent):** identified by OC Transpo as a “Frequent Route”, this route operates all day, 7 days a week and at an average rate of every 15 minutes or less from 6am to 6pm. The nearest bus stops to the site are at the intersections of Bank/Arlington and Bank/Catherine.

- **Route #14 (St-Laurent <-> Tunney's Pasture):** identified by OC Transpo as a "Frequent Route", this route operates all day, 7 days a week and at an average rate of every 15 minutes or less from 6am to 6pm. The nearest bus stops to the site are at the intersections of Lyon/Gladstone and Kent/Gladstone.
- **Route #55 (Westgate <-> Elmvale):** identified by OC Transpo as a "Local Route", this route operates throughout the day during the week. The nearest bus stop to the site is along Catherine St, at the frontage of the site.
- **Route #114 (Rideau <-> Carlington):** identified by OC Transpo as a "Local Route", this route operates from Monday to Friday on a selected trip only basis. The nearest bus stops to the site are at the intersections of Lyon/Gladstone and Kent/Gladstone.

The transit network for the study area is illustrated in **Figure 6** and the transit route maps are provided in **Appendix B**. **Figure 7** illustrates the bus stop locations.

Figure 6: Area Transit Network



Figure 7: Bus Stop Locations



Peak Hour Travel Demands

The existing peak hour traffic volumes at the signalized intersections within the study area were obtained from the City of Ottawa for the following intersections:

- Kent/Catherine – Conducted Wednesday, April 18, 2018
- Lyon/Catherine – Conducted Wednesday, April 18, 2018
- Bank/Catherine – Conducted Thursday, April 19, 2018
- Percy/Catherine – Conducted Thursday, April 19, 2018
- Lyon/Gladstone – Conducted Wednesday, August 24, 2022
- Kent/Gladstone – Conducted Tuesday, April 25, 2017
- Bank/Isabella/Chamberlain – Conducted Wednesday, April 18, 2018
- Catherine/Bronson - Conducted Thursday, April 19, 2018

In addition to the City of Ottawa counts, new traffic counts were obtained separately for the following intersection:

- Kent/Arlington – Conducted Tuesday, April 11, 2023
- Lyon/Arlington – Conducted Tuesday, April 11, 2023
- Bank/Arlington (mainly in/out volumes on Arlington Ave were collected) – Conducted Tuesday, April 18, 2023

The traffic volumes at study area intersections are illustrated in **Figure 8**, While existing active transportations (pedestrian and cyclist) volumes at study area intersections has been provided in **Figure 9**. Raw traffic count data provided in **Appendix C**.

It is important to note that Greyhound shut down their operations in Canada during the COVID-19 pandemic. While some of the traffic counts collected predate the closure, there is no way to verify peak hour traffic activity when the station was still active. The expectation is the weekday morning and afternoon activity was not significant. Therefore, existing traffic counts were not adjusted to remove the bus station traffic from pre-COVID-19 traffic data.

Traffic volumes at study area intersections were balanced conservatively to account for notable differences between adjacent intersections. No additional traffic growth adjustment was applied to the traffic volumes up to the existing horizon year (2023).

However, two developments that have been constructed in recent years, which includes 203 Catherine St and 488-500 Bank St, have been accounted for by adding their estimated vehicle trips to the existing traffic volumes. Note that the transportation memo for 488-500 Bank St was obtained from the City, but City staff have indicated that the TIA brief for 203 Catherine St is outdated (2011) and unavailable. Using the number of units for the 203 Catherine St development (200 units based on developer website), the number of site-generated trips were calculated. Travel mode and trip distribution assumptions followed the same assumptions of 265 Catherine St, as provided in **Section 3.0**.

Figure 8: Existing Peak Hour Traffic Volumes

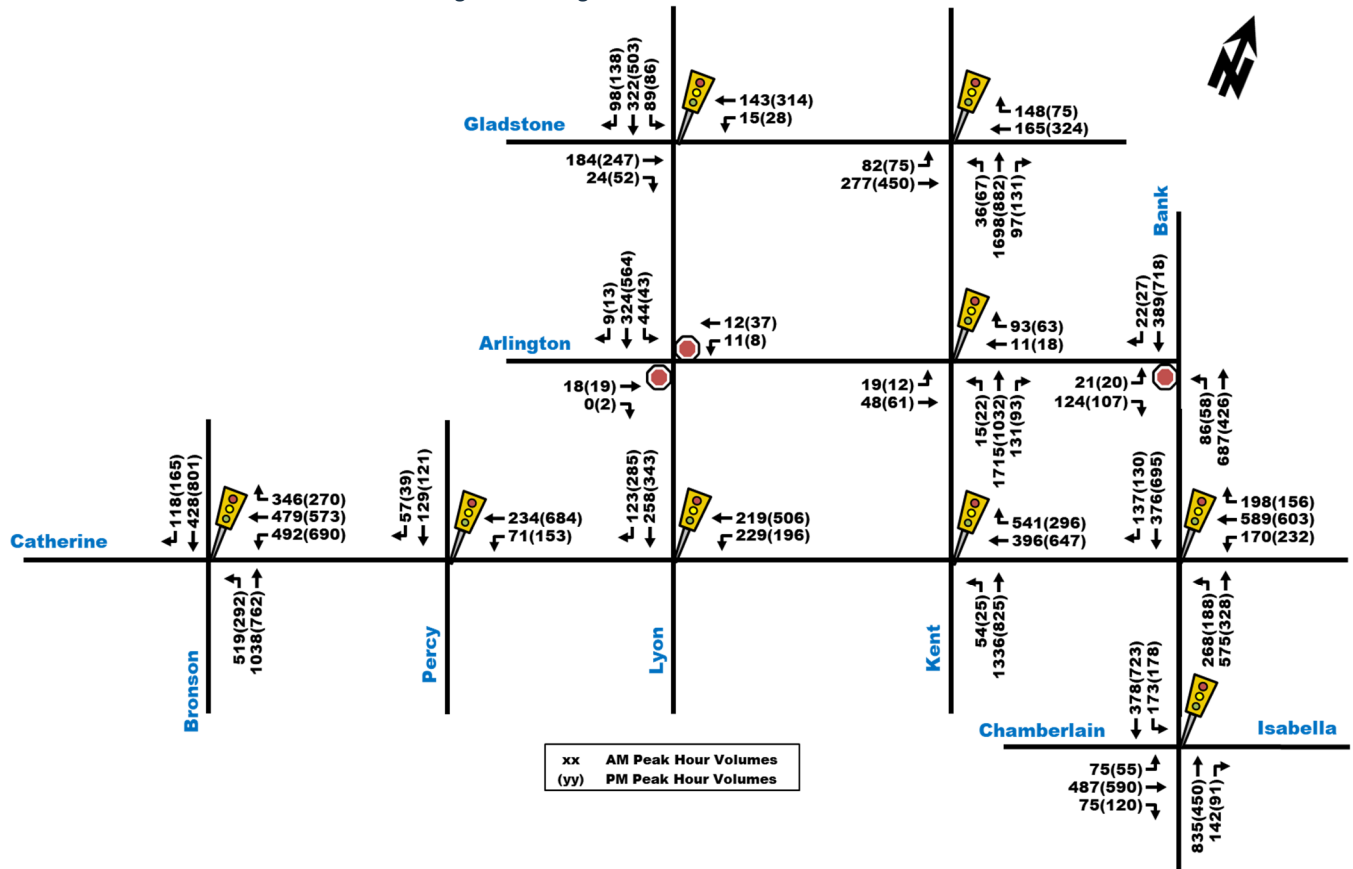
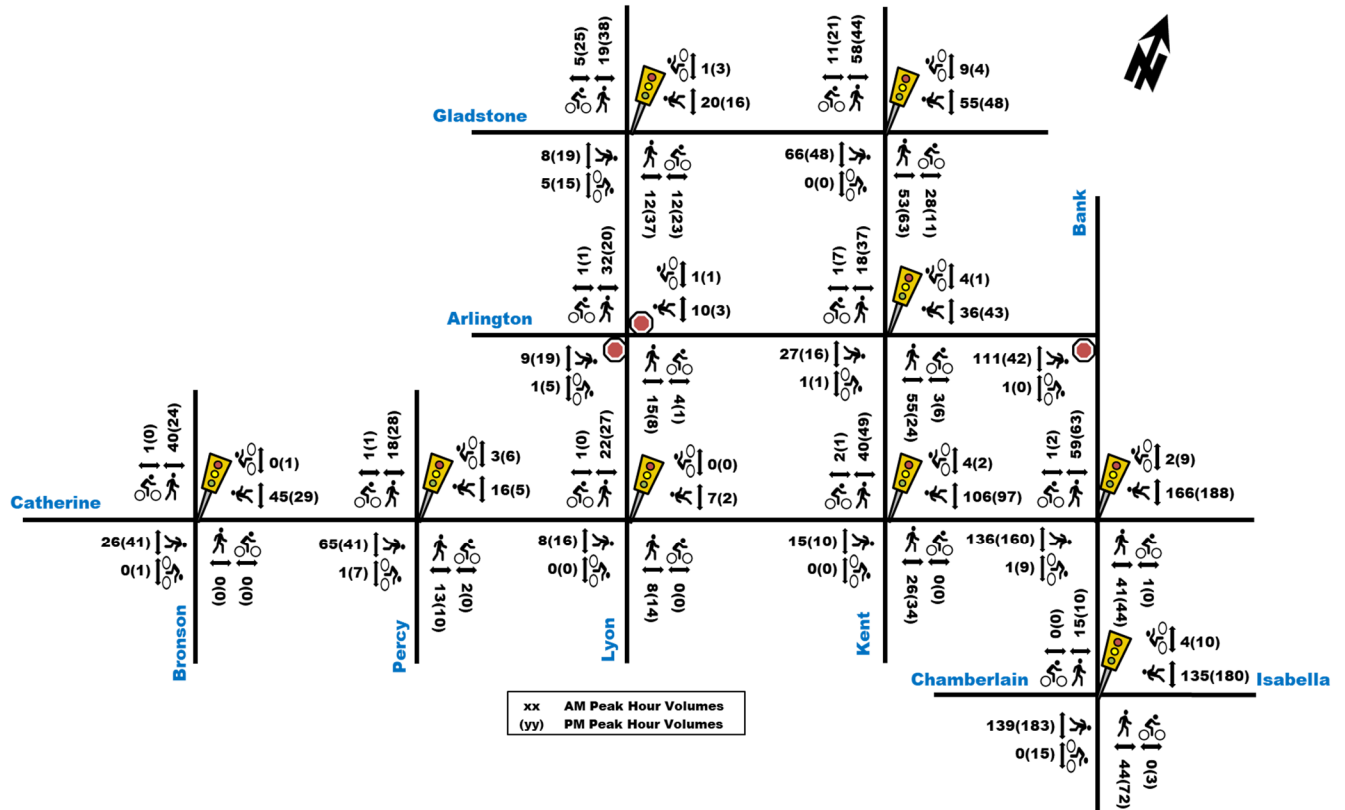

Figure 9: Existing Pedestrian and Cyclists Peak Hour Volumes



Existing Road Safety Conditions

A five-year collision history data (2017-2021, inclusive) was obtained from the City of Ottawa open data source for the 11 study area intersections and segments between intersections. Upon analyzing the collision data, the total number of collisions observed within the broader study area was 427 collisions within the past five-years. The majority of the collisions 359 (84%) resulted in property damage only, and 68 (16%) resulted in non-fatal injury. There were no fatal collisions recorded. Overall, the collisions type frequencies were mainly split in three distinct groups, 117 (27%) were sideswipe, 110 (26%) angle, 98 (23%) turning movement. Rear end collisions accounted for 62 (15%) and the rest less than 25 (<5%) collisions each type.

Within the study area, the quantity of collisions and collisions per million entering vehicles (MEV) at each location has occurred at a rate of:

- Bronson/Catherine: 91, MEV 1.27
- Percy/Catherine: 6, MEV 0.42
- Lyon/Catherine: 17, MEV 0.80
- Kent/Catherine: 96, MEV 2.64
- Bank/Catherine: 61, MEV 1.44
- Gladstone/Lyon: 8, MEV 0.42
- Arlington/Lyon: 2, MEV 0.12
- Gladstone/Kent: 25, MEV 0.59
- Arlington/Kent: 23, MEV 0.82
- Arlington/Bank: 10, MEV 0.41
- Bank/Chamberlain: 41, MEV 0.93
- Mid-block on Catherine (Bronson to Bank): 16 (915m)
- Mid-block on Arlington (Lyon to Bank): 8 (350m)
- Mid-block on Gladstone (Lyon to Kent): 8 (190m)
- Mid-block on Lyon (Gladstone to Catherine): 4 (315m)
- Mid-block on Kent (Gladstone to Catherine): 7 (315m)
- Mid-block on Bank (Arlington to Chamberlain): 4 (185m)
- Collisions with Pedestrians: 13 (3%)
- Collisions with Cyclists: 10 (2%)

Kent/Catherine showed to have a higher-than-average MEV or likeliness of collision than other intersections. The leading types of collisions at this intersection involved turning movements 46 (48%), sideswipe 23 (24%) and angle 20 (21%), accounting for up to 93% of all collision types. All these types of collisions involve a vehicle

changing directions, switching lanes, or turning. The City has implemented no right or left turns for the heavier northbound movement and have added a no-right-on-red for the westbound movement, effectively eliminating potential turning conflicts with opposing movements. Still, turning movements account for the highest collision type, a possible side effect of non-compliance. A red-light camera has been added to the westbound movement as of 2020, which can help mitigate some collisions from the westbound approach. The shared westbound through/right-turn lane may be resulting in unpredictable movements or lane changes by drivers which causes confusion and leads to increased conflict potential. Although there are many collisions at this location, it is believed that they occur at low speeds given that only 7% of all collisions caused non-fatal injuries.

Other intersections with MEV greater than one was all intersections where two arterials meet. The higher quantity of collisions at these intersections are indicative of the high volumes of vehicles, congestion and increased decision-making tasks required by drivers.

The intersection of Bank/Catherine experienced collisions with 6 cyclists and 8 pedestrians, accounting for 61% of all study area active transportation collisions. Bank Street, an arterial mainstreet with plenty of commercial opportunities attracts large crowds of pedestrians, cyclists, and vehicles alike. It is highly recommended that this intersection be redesigned to comply with the recent introduction of the Protected Intersection Design measures to priority the safety of the more vulnerable active transportation users. However, this task of retrofitting this intersection should not be a responsibility of the developer.

It is important to note that there are long-term plans to redesign a section of the Catherine St corridor that includes some of the intersections noted above, with the intention of enhancing safety and transit priority that benefits all road users. Further discussion on this design is provided in **Section 2.1.3**.

No other major trends were identified. The source collision data as provided by the City of Ottawa and related analysis is provided as **Appendix D**.

2.1.3. Planned Conditions

2.1.3.2 Future Transportation Network Changes

Transportation Master Plan (TMP)

The City of Ottawa's TMP (2031 affordable Rapid Transit and Transit Priority Network) illustrates Bank St as a transit priority corridor with isolated measures between Albert St in the north and Riverside Dr in the south, along with Gladstone Ave between Elgin St in the east and Preston St in the west.

Catherine St Functional Design Study

A functional design study was completed by the City for Chamberlain Ave, Catherine St, and Isabella St. Within the study area frontage, modifications include:

- A proposed transit priority lane on Catherine St, west of Kent St, which converts the north general-purpose lane to a dedicated transit lane. Based on input from City staff, the western half of the bus lane would permit 1 hour parking during off-peak hours from 9am to 3:30pm. The development proposed modifications along Catherine St are not expected to impact the proposed design of the transit lane.
- A double westbound right-turn lane at the intersection of Catherine/Kent, which allows for separate pedestrian and right-turn traffic signal phases and significantly reduces collision potential at the westbound approach of the intersection.
- No right-turn-on-red for the westbound movement at the intersection of Catherine/Kent.
- A two-way 3.0m wide multi-use pathways on the south side of Chamberlain Ave and Isabella St.

These plans have received formal approval based on traffic study and public consultation. However, the detailed design and subsequent construction are not anticipated to begin until the ongoing MTO bridge rehabilitation

work on Highway 417 is completed. City staff confirmed it would be reasonable to assume implementation of the Catherine St design by 2031.

Centretown Community Design Plan (CDP) and Secondary Plan

The CDP and Secondary Plan were completed in 2013 with the purpose of creating a comprehensive design plan to guide and manage future growth in the Centretown area of Ottawa. The purpose of the Secondary Plan is to translate many key aspects of the CDP into statutory policy. Note that the secondary plan was consolidated into the Central and East Downtown Core Secondary Plan as part of the new city Official Plan. As illustrated in **Figure 10**, the CDP spans a wide area from Rideau Canal to Bronson Ave and from the Queensway to Gloucester St. However, the core study area of the CDP is an area bounded by Elgin St to the east, Kent St to the west, Highway 417 to the south and Gloucester St to the north. Nonetheless, recommendations were made in the CDP for the Centretown area as a whole.

Based on the CDP, the Centretown area is divided into four different character areas, which include the Northern Character Area, the Central Character Area, the Southern Character Area, and the Residential Character Area. The proposed 265 Catherine St development is located in the Southern Character Area, which acts as a “buffer” between the busy Highway 417 and the Central and Residential zones. The Southern Area currently consists of mostly low to mid-rise buildings, with few high-rise buildings and primarily retail and employment land uses. The vision for the Southern area anticipates high-rise buildings with at-grade commercial uses in addition to residential uses and “gateway buildings and architecture” on corner sites fronting arterials (such as Catherine St), along with improved streetscape and public park opportunities along all routes, including Catherine St.



The relevant recommendations below were provided in the CDP.

- **Pedestrian Network:** Catherine St intersections at Lyon St, Kent St and Bank St have been identified as potential locations for improved pedestrian crossing. It should be noted that some measures were already in place or may have already taken effect since the CDP and Secondary Plans were introduced in 2013. Some of the measures included providing curb extensions and removing on-street parking, providing zebra crosswalks, prohibiting right-turns on red, and providing pedestrian push buttons and countdown signals.
- **Transit Network:** general suggested strategies include provision of transit priority measures during future roadway reconstruction such as transit lanes, bulbouts and additional shelters, as well as providing enhanced waiting facilities at bus stops. The City has completed a functional design study for Chamberlain, Catherine, and Isabella, which includes the conversion of a general-purpose lane to a new transit priority lane.
- **Cycling Network:** a suggested general strategy included provision of cycling infrastructure as part of new proposed developments, expanding the cycling network and implementing other cycling improvements guided by the Ottawa Cycling Plan and Centretown CDP. The City functional design study also includes new cycling infrastructure and treatments.
- **Transportation Demand Management:** suggested TDM Measures which could be incorporated as part of new developments include the provision of enhanced bicycle and pedestrian access (weather-protected facilities, safe and secure bicycle parking, streetscape improvements), improvements to transit access (provision of shelters and other amenities, service planning changes), and provision of car-sharing facilities. TDM measures were incorporated into the development proposal.

- **Right of Way (ROW) Protection:** the City identifies target widths for ROW protection to be 23m for Catherine St and 20m for Kent St and Lyon St (with a perspective to address the needs of pedestrians and increase streetscape opportunities). For Kent St and Lyon St, the maximum land requirement from property abutting the existing ROW is 0.90m. Additionally, the two roads are subject to a widening/easement policy (discussed in more detail in **Section 4.3**). These ROW protection limits were accounted for in the development proposal.
- **Parking Supply:** the CDP suggests encouraging the provision of off-street public parking in new development where appropriate. The amount of available on-street parking is expected to decrease overtime due to providing additional space for pedestrians, cyclists, and public transit.
- **Two-Way Conversion of Roads:** one major recommendation of the CDP involves converting each of Kent St and Lyon St to two-way roads. This would improve the street environment for all users, slow down traffic, create a greater choice of routes and improve wayfinding. The timeline for this modification is unknown and no studies assessing the effects of this modification have been produced yet. It has been assumed this recommendation will not be implemented within the established future horizons for this TIA.
- **Streetscapes:** the Catherine St and Kent St corridors are both illustrated as locations for priority streetscape improvements in the CDP and Secondary Plan, with Catherine St and Lyon St both enlisted in the Secondary Plan as key streets to undertake streetscape improvements as part of the capital budget for any road and infrastructure renewal program. For Catherine St, streetscape design strategies include a vision for a tree-lined street, and a generous sidewalk and landscape setbacks between the development and the sidewalk. For Kent St and Lyon St, streetscape design strategies include streetscape environment improvement through conversion of both roads to two-way, planting trees where space permits and rebuilding the asphalt sidewalk along Lyon St to City standards.

Figure 10: Centretown CDP Study Area

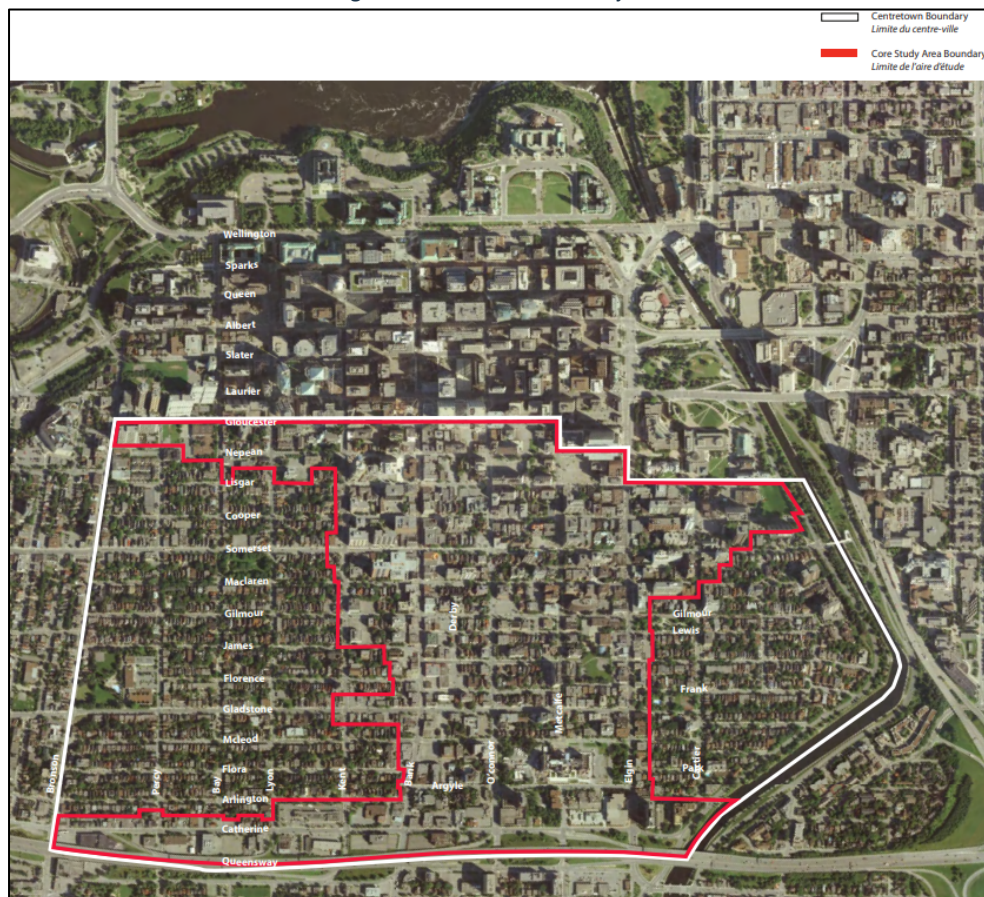

2.1.3.3 Other Area Developments

This section outlines adjacent developments within the study area. Based on the City of Ottawa's Development Applications search tool, several applications have been initiated near the proposed development site. However, the majority of these applications are either for low-rise apartment buildings with minimal traffic generation or for renovating/adding new units to existing low-rise units. Any traffic generated by the minor adjacent future developments will be captured in the background growth rate in traffic forecasting. Only one development has been identified given its relatively larger size:

- **30-48 Chamberlain Avenue:** a TIA report was prepared by CGH in October 2020 in support of a 16-storey apartment building containing 150 apartment units. The development is anticipated to be constructed in a single phase by 2024 and is expected to generate a minimal number of vehicles in the study area with up to 42 total two-way traffic volumes during peak hours. Given the low number of traffic volumes, this development has been captured in the background growth rate in traffic forecasting.

2.2. Study Area and Time Periods

For the purposes of this report, Phase 1 of the proposed development is assumed to be constructed by 2026, while the full buildout is assumed to be completed by 2031. As such, horizon years 2026 and 2031 will be analyzed using the weekday morning and afternoon peak hour time period traffic volumes. Analysis of horizon year 2036 (five-years after full buildout) will also be included as per the requirements of the TIA Guidelines. However, it should be noted that the City of Ottawa TMP, including the affordable networks only provide plans for future City transportation infrastructure up to year 2031.

A meeting was held with City staff on Tuesday, April 25, 2023, to discuss the TIA Step 3 comments received on March 30, 2023. City staff confirmed in a meeting they do not have major concerns with excluding three select intersections: Chamberlain/Percy, Gladston/Bank and Flora/Bank.

We have discounted the Chamberlain/Percy intersection because Percy St is a one-way street section, it only permits the southbound left-turn at Chamberlain, and it is signalized with no opposing traffic. We do not anticipate any concerns with operations at this location with the low amount of site generated traffic anticipated.

The two Bank St intersections were also excluded because we do not anticipate significant site generated traffic at either of the Gladstone/Bank or Flora/Bank intersections; they will be few in comparison to existing traffic volumes on Bank St. Kent St is expected to be the primary outbound route northbound. Inbound traffic from the north will be split between Lyon St and Bank Street, and the likely access street from Bank St will be either Arlington Ave (which we have added) or Catherine St (that was already captured). We expect site generated traffic will have negligible long-term impacts on these intersections.

Proposed study area intersections, agreed to by City staff, are listed below and illustrated in **Figure 11**.

- Lyon/Catherine
- Kent/Catherine
- Bank/Catherine
- Bronson/Catherine
- Percy/Catherine
- Kent/Gladstone
- Lyon/Gladstone
- Lyon/Arlington
- Kent/Arlington
- Bank/Arlington
- Bank/Chamberlain/Isabella

Figure 11: Study Area

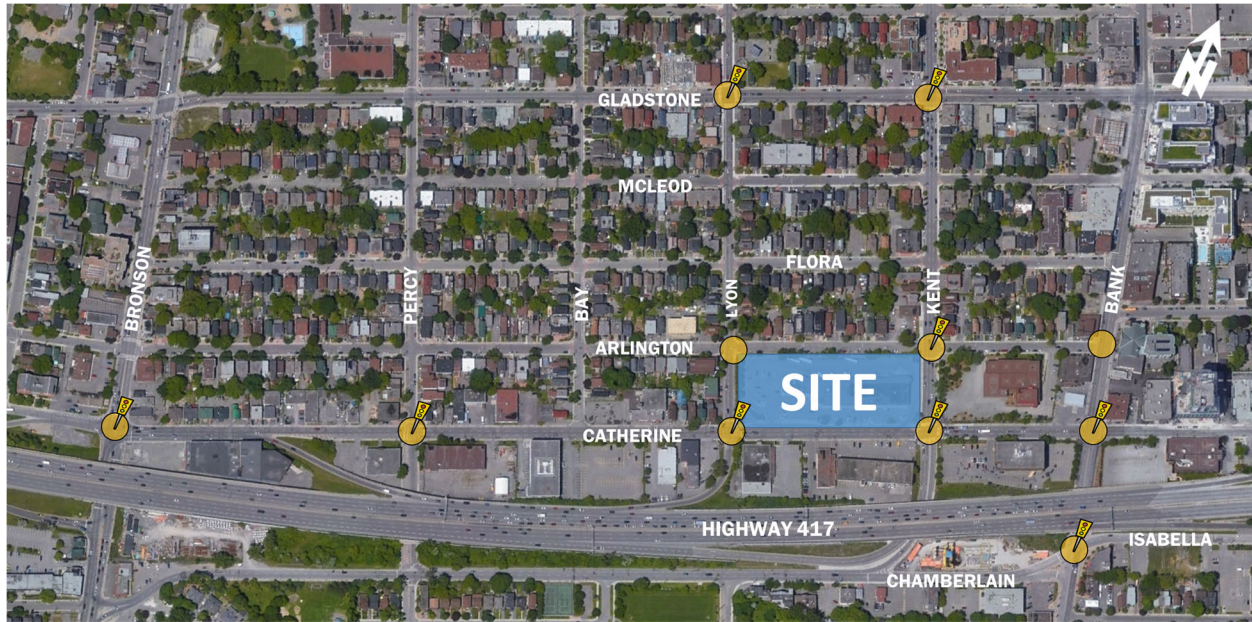

2.3. Exemption Review

The modules/elements of the TIA process in **Table 2** are recommended to be exempt based on the City’s TIA guidelines, the current ZBLA/SPC process and the current site plan arrangement.

Table 2: Exemptions Review Summary

Module	Element	Exemption Consideration
4.1 Development Design	4.1.3 New Street Networks	Only required for plans of subdivision.

3.0 FORECASTING

3.1. Development Generated Travel Demand

3.1.1. Trip Generation and Mode Shares

Trip Generation Rates

The proposed development will consist of 7 townhome units, 1,157 apartment units and 2,653m² (28,557ft²) of ground floor retail space. The trip rates for the land uses are summarized in **Table 3** below.

The appropriate trip generation rates for townhomes and high-rise apartment units were obtained from the 2020 TRANS Trip Generation Manual. The Manual provides person-trip rates during the peak AM and PM periods (i.e. 7am-9:30am and 3:30pm-6pm). The peak hour trip generation rates for the non-residential land uses were obtained from the ITE Trip Generation Manual (11th edition), assuming the “Retail Strip Plaza (less than 40,000 ft² GFA)” land use for the total retail area.

Table 3: Proposed Development Trip Rates

Land Use	ITE/TRANS Designation	Data Source	Trip Rates	
			AM Peak	PM Peak
Residential	“High-Rise Apartments”	TRANS	T = 0.8(du);	T = 0.9(du);
	“Townhomes (Low-Rise Units)”	TRANS	T = 1.35(du);	T = 1.58(du);
Commercial	“Retail Strip Plaza”	ITE 822	T = 0.66Ln(x) + 1.84	T = 0.71Ln(x) + 2.72

Notes:
 T = Average Vehicle Trip Ends
 du = Dwelling unit
 x = Gross Floor Area (1,000 ft²)

Residential Trip Generation

Using the respective residential trip rates in **Table 3**, the total number of vehicles per hour generated by the proposed residential land uses of the development are calculated for the morning and afternoon peak periods, as shown in **Table 4**.

Table 4: Residential Units Peak Period Person Trip Generation

Phase	Land Use	Dwelling Units	AM Peak Period Person Trips	PM Peak Period Person Trips
Phase 1	High-Rise Apartments	423	338	381
Phase 2	High-Rise Apartments	734	586	659
	Townhomes (Low-Rise Units)	7	9	11
Total		1,164	933	1,051

The proposed development's residential land use is anticipated to generate a total of approximately 933 and 1,051 person trips during the morning and afternoon peak periods, respectively. The total peak period person trips in **Table 4** for each land use are then divided into different travel modes using mode share percentages obtained from the 2020 TRANS Manual for the "Ottawa Inner Area" district. **Table 5** and **Table 6** provide the travel mode breakdown for the proposed high-rise apartments and townhomes, respectively.

Table 5: High-Rise Apartments Peak Period Trips Mode Shares Breakdown

Travel Mode	Mode Share	AM Peak Period Person Trip	Mode Share	PM Peak Period Person Trips
Phase 1				
Auto Driver	26%	89	25%	97
Auto Passenger	6%	21	8%	31
Transit	28%	94	21%	81
Cycling	5%	19	6%	22
Walking	34%	116	39%	150
Total Person Trips	100%	338	100%	381
Phase 2				
Auto Driver	26%	153	25%	167
Auto Passenger	6%	36	8%	54
Transit	28%	163	21%	141
Cycling	5%	32	6%	38
Walking	34%	201	39%	259
Total Person Trips	100%	586	100%	659

Table 6: Townhomes Peak Period Trips Mode Shares Breakdown

Travel Mode	Mode Share	AM Peak Period Person Trip	Mode Share	PM Peak Period Person Trips
Phase 2				
Auto Driver	27%	3	31%	3
Auto Passenger	8%	1	9%	1
Transit	26%	2	20%	2
Cycling	9%	1	9%	1
Walking	30%	3	31%	3
Total Person Trips	100%	9	100%	11

Standard traffic analysis is usually conducted using the morning and afternoon peak hour trips as they represent a worst-case scenario. The 2020 TRANS Manual provides conversions rates from peak period to peak hours for different mode shares, as shown in **Table 7** below.

Table 7: Peak Period to Peak Hour Conversion Factors (2020 TRANS Manual)

Travel Mode	Peak Period to Peak Hour Conversion Factors	
	AM	PM
Auto Driver and Passenger	0.48	0.44
Transit	0.55	0.47
Bike	0.58	0.48
Walk	0.58	0.52

Using the conversion rates in **Table 7** and the peak period person trips for different travel modes in **Table 5** and **Table 6**, the peak hour trips for different travel modes can be calculated as shown in **Table 8** and **Table 9**.

Table 8: High-Rise Apartments Peak Hour Trips Mode Share Breakdown

Travel Mode	AM Peak Hour Trips	PM Peak Hour Trips
Phase 1		
Auto Driver	43	43
Auto Passenger	10	14
Transit	52	38
Cycling	11	11
Walking	67	78
Total Person Trips	183	183
Phase 2		
Auto Driver	74	74
Auto Passenger	17	24
Transit	90	66
Cycling	19	18
Walking	117	135
Total Person Trips	316	316

Table 9: Townhomes Peak Hour Trips Mode Share Breakdown

Travel Mode	AM Peak Hour Trips	PM Peak Hour Trips
Phase 2		
Auto Driver	1	2
Auto Passenger	0	0
Transit	1	1
Cycling	1	0
Walking	2	2
Total Person Trips	5	5

As shown above, the residential land use of the proposed development is anticipated to generate a total of up to 504 total person trips, which includes up to 119 vehicle trips, 27 to 38 passenger trips, 105 to 143 transit trips and 217 to 244 active transportation (walking and cycling) trips during peak hours.

Considering the location and context surrounding the proposed development, such as proximity to the Highway 417, and the notable distance from LRT or a rapid transit corridor, it was assumed that a higher auto driver mode share would be more appropriate relative to the district average, which accounts for the Confederation line and several LRT stations. The increase in auto-driver mode share comes at the expense of transit, walking and cycling. The adjusted mode share percentages are shown in **Table 10** and **Table 11** for the high-rise apartments and townhomes, respectively. Note that the same mode share percentages are applied to both the AM and PM peak hours.

Table 10: High-Rise Apartments Peak Hour Trips Mode Share Breakdown

Travel Mode	Mode Share	AM Peak Hour Trips	PM Peak Hour Trips
Phase 1			
Auto Driver	40%	73	73
Auto Passenger	10%	18	18
Transit	20%	37	37
Cycling	5%	9	9
Walking	25%	46	46
Total Person Trips	100%	183	183
Phase 2			
Auto Driver	40%	126	127
Auto Passenger	10%	32	32
Transit	20%	63	63
Cycling	5%	16	16
Walking	25%	79	79
Total Person Trips	100%	316	316

Table 11: Townhomes Peak Hour Trips Mode Share Breakdown

Travel Mode	Mode Share	AM Peak Hour Trips	PM Peak Hour Trips
Phase 2			
Auto Driver	40%	2	2
Auto Passenger	10%	1	1
Transit	20%	1	1
Cycling	5%	0	0
Walking	25%	1	1
Total Person Trips	100%	5	5

Using the modified mode shares above, the breakdown of inbound and outbound trips for the high-rise apartments and townhomes are provided in **Table 12** and **Table 13** respectively. The inbound and outbound percentages were obtained from the 2020 TRANS Manual.

Table 12: High-Rise Apartments Mode Shares Breakdown (2020 TRANS Report)

Travel Mode	AM Peak (Person Trips/h)			PM Peak (Person Trips/h)		
	In (31%)	Out (69%)	Total	In (58%)	Out (42%)	Total
Phase 1						
Auto Driver	23	50	73	42	31	73
Auto Passenger	6	12	18	10	8	18
Transit	11	26	37	21	16	37
Cycling	3	6	9	5	4	9
Walking	14	32	46	27	19	46
Total Person Trips	57	126	183	106	77	183
Phase 2						
Auto Driver	39	87	126	74	53	127
Auto Passenger	10	22	32	19	13	32
Transit	20	43	63	37	26	63
Cycling	5	11	16	9	7	16
Walking	24	55	79	46	33	79
Total Person Trips	98	218	316	183	133	316

Table 13: Townhomes Mode Shares Breakdown (2020 TRANS Report)

Travel Mode	AM Peak (Person Trips/h)			PM Peak (Person Trips/h)		
	In (30%)	Out (70%)	Total	In (56%)	Out (44%)	Total
Phase 2						
Auto Driver	1	1	2	1	1	2
Auto Passenger	0	1	1	1	0	1
Transit	0	1	1	1	0	1
Cycling	0	0	0	0	0	0
Walking	0	1	1	1	0	1
Total Person Trips	2	4	5	3	2	5

Using the tables above, the projected number of trips anticipated to be generated by the residential land uses of the proposed development are provided in **Table 14**.

Table 14: Total Residential Trip Generation

Travel Mode	AM Peak (Person Trips/h)			PM Peak (Person Trips/h)		
	In	Out	Total	In	Out	Total
Phase 1						
Auto Driver	23	50	73	42	31	73
Auto Passenger	6	12	18	10	8	18
Transit	11	26	37	21	16	37
Cycling	3	6	9	5	4	9
Walking	14	32	46	27	19	46
Total Person Trips	57	126	183	106	77	183
Phase 2						
Auto Driver	40	88	128	75	54	129
Auto Passenger	10	23	33	20	13	33
Transit	20	44	64	38	26	64
Cycling	5	11	16	9	7	16
Walking	24	56	80	47	33	80
Total Person Trips	100	222	321	186	135	321
Total						
Auto Driver	63	138	201	117	85	202
Auto Passenger	16	35	51	30	21	51
Transit	31	70	101	59	42	101
Cycling	8	17	25	14	11	25
Walking	38	88	126	74	52	126
Total Person Trips	157	348	504	292	212	504

As shown in **Table 14**, the total number of vehicle trips anticipated to be generated by the residential land uses are 202 vehicles per hour during both the morning and afternoon peak hours.

Retail Units Trip Generation

The proposed non-residential land uses of the site consist of retail units, where the exact occupants of the retail units have not been confirmed as of yet. It is important to note that the development is not located in any retail node and the Catherine St corridor is not utilized for any many retail uses, as opposed to a traditional mainstreet such as Bank St. Therefore, the majority of patrons using the retail units are expected to be either internal site residents or local walking trips from adjacent developments, which would generate a very minimal number of new vehicle trips.

Using the trip rates provided in **Table 3**, the total number of person trips per hour generated by the proposed retail units are multiplied by a factor of 1.28, as per TIA standards, to account for typical North American auto occupancy values of approximately 1.15 and combined transit and non-motorized modal shares of less than 10%. The resulting total person trips per hour are summarized in **Table 15**.

Table 15: Retail Units Peak Hour Person Trips

Land Use	GFA (ft²)	AM Peak (Person Trips/h)			PM Peak (Person Trips/h)		
		In (60%)	Out (40%)	Total	In (50%)	Out (50%)	Total
Phase 1							
Strip Retail Plaza	15,392	29	20	49	67	68	135
Phase 2							
Strip Retail Plaza	12,089	25	17	42	57	57	114
Total		54	37	91	124	125	249

The commercial elements of the proposed development are intended primarily to serve local residents and nearby communities (the population will increase as future developments and intensification plans continue to progress in the downtown).

Given the mixture of land uses proposed onsite, an internal reduction rate was applied based on mixed-use parameters described in Section 6.5 of the ITE Trip Generation Manual 3rd Edition, to account for multi-purpose peak hour trips such as a local resident shopping, getting a haircut, stopping at a drycleaner, or any other minor

retail tenant that may occupy a retail space. These trips may be reduced to reflect double counted trips, which has been incorporated in the trip generation tables that follow. The base calculation for determining the quantity of internal reductions has been provided in **Appendix E**.

Pass-by trips were also considered for commercial uses. Pass-by trips are intermediate trips along the original route between the primary origin and destination, such as a trip to a retail use while travelling between home and another destination. These are not considered ‘new’ trips, but existing trips already on the network. Appendix E of the ITE Trip Generation Manual 3rd edition was used to determine pass-by rates. Pass-by trips were calculated after the internal reduction factor was applied.

The proposed mode shares for commercial uses have been summarized in **Table 16**.

Table 16: TRANS 2020 Mode Shares for Commercial Use and Proposed Mode Shares

Travel Mode	TRANS Mode Shares		Proposed Mode Share (AM & PM)	Proposed Modal Share Rationale
	AM	PM		
Auto Driver	39%	22%	15%	A reduction in driver mode share from TRANS is justifiable given the small scale of commercial uses proposed. Nearby high-density residential, commercial and office settings promote walking and cycling to access the commercial uses on site. Transit anticipated to be similar to existing mode shares. The majority of trips are anticipated to be generated locally and will most likely attract nearby pedestrians, cyclists, and residents of the same development.
Auto Passenger	2%	4%	5%	
Transit	16%	12%	15%	
Cycling	3%	4%	5%	
Walking	40%	58%	60%	

The trip generation rates for commercial land uses from **Table 15** were used along with the proposed sizes for each phase of development and the proposed mode shares from **Table 16** to provide the retail peak hour trips breakdown shown in **Table 17**. Residential and commercial vehicle trips are both inputted into the internal reductions sheets in **Appendix E** to determine the internal trips. Note that the internal reductions for Phase 2 use combined vehicle trips of both Phases 1 and 2 to internal trips at full buildout.

Table 17: Retail Peak Hour Trips Mode Share Breakdown

Travel Mode	Mode Share	AM Peak (Person Trips/h)			PM Peak (Person Trips/h)		
		In (60%)	Out (40%)	Total	In (50%)	Out (50%)	Total
Phase 1							
Auto Driver	15%	4	3	7	10	8	18
<i>Pre-Internal Reduction</i>		5	3	8	11	11	22
<i>Vehicles Reduced</i>		-1	0	-1	-1	-3	-4
Auto Passenger	5%	2	1	3	3	3	6
Transit	15%	4	3	7	10	10	20
Cycling	5%	1	1	2	3	3	7
Walking	60%	17	12	29	40	41	80
Total Person Trips	100%	28	20	48	66	65	131
Pass-By	0%(35%)	0	0	0	-4	-4	-8
Total 'New' Vehicle Trips	-	4	3	7	6	4	10
Phase 2							
Auto Driver	15%	3	3	6	8	7	15
<i>Pre-Internal Reduction</i>		4	3	7	9	9	18
<i>Vehicles Reduced</i>		-1	0	-1	-1	-2	-3
Auto Passenger	5%	2	1	3	3	3	6
Transit	15%	3	2	5	8	8	16
Cycling	5%	1	1	2	3	3	6
Walking	60%	15	10	25	34	34	68
Total Person Trips	100%	24	17	41	56	55	111
Pass-By	0%(35%)	0	0	0	-3	-3	-6
Total 'New' Vehicle Trips	-	3	3	6	5	4	9

As shown in **Table 17**, the retail land uses are expected to generate 48 to 131 person trips during peak hours of Phase 1, as well as 41 to 111 persons trips during the peak hours of Phase 2. In total, the nonresidential land uses are expected to generate trips as shown in **Table 18** below.

Table 18: Total Nonresidential Trip Generation

Travel Mode	AM Peak (Person Trips/h)			PM Peak (Person Trips/h)		
	In	Out	Total	In	Out	Total
Auto Driver	7	6	13	18	15	33
<i>Pre-Internal Reduction</i>	9	6	15	20	20	40
<i>Vehicles Reduced</i>	-2	0	-2	-2	-5	-7
Auto Passenger	4	2	6	6	6	12
Transit	7	5	12	18	18	36
Cycling	2	2	4	6	6	13
Walking	32	22	54	74	75	148
Total Person Trips	52	37	89	122	120	242
Pass-By	0	0	0	-7	-7	-14
Total 'New' Vehicle Trips	7	6	13	11	8	19

Total Trips Generated

Similar to commercial, an internal reduction to residential trips is applicable, as shown in Table 19.

Table 19: Residential Peak Hour Trips with Internal Reductions

Travel Mode	Mode Share	AM Peak (Person Trips/h)			PM Peak (Person Trips/h)		
		In	Out	Total	In	Out	Total
Phase 1							
Auto Driver		23	49	72	39	30	69
<i>Pre-Internal Reduction</i>		23	50	73	42	31	73
<i>Vehicles Reduced</i>		0	-1	-1	-3	-1	-4
Total 'New' Vehicle Trips		23	49	72	39	30	69
Phase 1 & 2 Combined							
Auto Driver		63	136	199	112	83	195
<i>Pre-Internal Reduction</i>		63	138	201	117	85	202
<i>Vehicles Reduced</i>		0	-2	-2	-5	-2	-7
Total 'New' Vehicle Trips		63	136	199	112	83	195

The total person trips anticipated to be generated by the residential and non-residential land uses of the proposed future development are provided in Table 20, which includes all travel mode shares of the residential units plus the auto driver mode of the nonresidential uses.

Table 20: Total Trips Generated

Travel Mode	AM Peak (Person Trips/h)			PM Peak (Person Trips/h)		
	In	Out	Total	In	Out	Total
Phase 1						
Auto Driver	27	52	79	49	38	87
<i>Pre-Internal Reduction</i>	28	53	81	53	42	95
<i>Vehicles Reduced</i>	-1	-1	-2	-4	-4	-8
Auto Passenger	8	13	21	13	11	24
Transit	15	29	44	31	26	57
Cycling	4	7	11	8	7	16
Walking	31	44	75	67	60	126
Total Person Trips	85	145	230	168	142	310
Pass-By	0	0	0	-4	-4	-8
Total 'New' Vehicle Trips	27	52	79	45	34	79
Phase 1 & 2 Combined						
Auto Driver	70	142	212	130	98	228
<i>Pre-Internal Reduction</i>	72	144	216	137	105	242
<i>Vehicles Reduced</i>	-2	-2	-4	-7	-7	-14
Auto Passenger	20	37	57	36	27	63
Transit	38	75	113	77	60	137
Cycling	10	19	29	20	17	38
Walking	70	110	180	148	127	274
Total Person Trips	208	383	591	411	329	740
Pass-By	0	0	0	-7	-7	-14
Total 'New' Vehicle Trips	70	142	212	123	91	214

Based on the results provided in **Table 20**, the proposed future development is anticipated to generate a total of approximately 591 and 740 person trips during the morning and afternoon peak hours respectively, including roughly 215 'new' vehicle trips in both peak hour periods.

3.1.2. Trip Distribution and Assignment

Based on the 2011 OD Survey (Ottawa Inner Area district) and the location of adjacent arterial roadways and neighbourhoods, the distribution of site-generated traffic volumes was estimated as follows:

- 20% to/from the east via HWY-417;
- 30% to/from the west HWY-417;
- 25% to/from the north via Bronson Ave/Bank St/Lyon St/Kent St; and,
- 25% to/from the south via Bronson Ave/Bank St.

The anticipated 'new' auto trips for the proposed development from **Table 20** were then assigned to the road network as shown in **Figure 12** for Phase 1 and **Figure 13** for total site-generated traffic at full buildout. At Phase 1, the Catherine St garage access and the woonerf are expected to be constructed. The Arlington Ave access is expected to be constructed at Phase 2. Note that no vehicles were modelled using the woonerf as truck traffic using this access will be infrequent and generally occur during off-peak hours.

Figure 12: Phase 1 Site-Generated Traffic

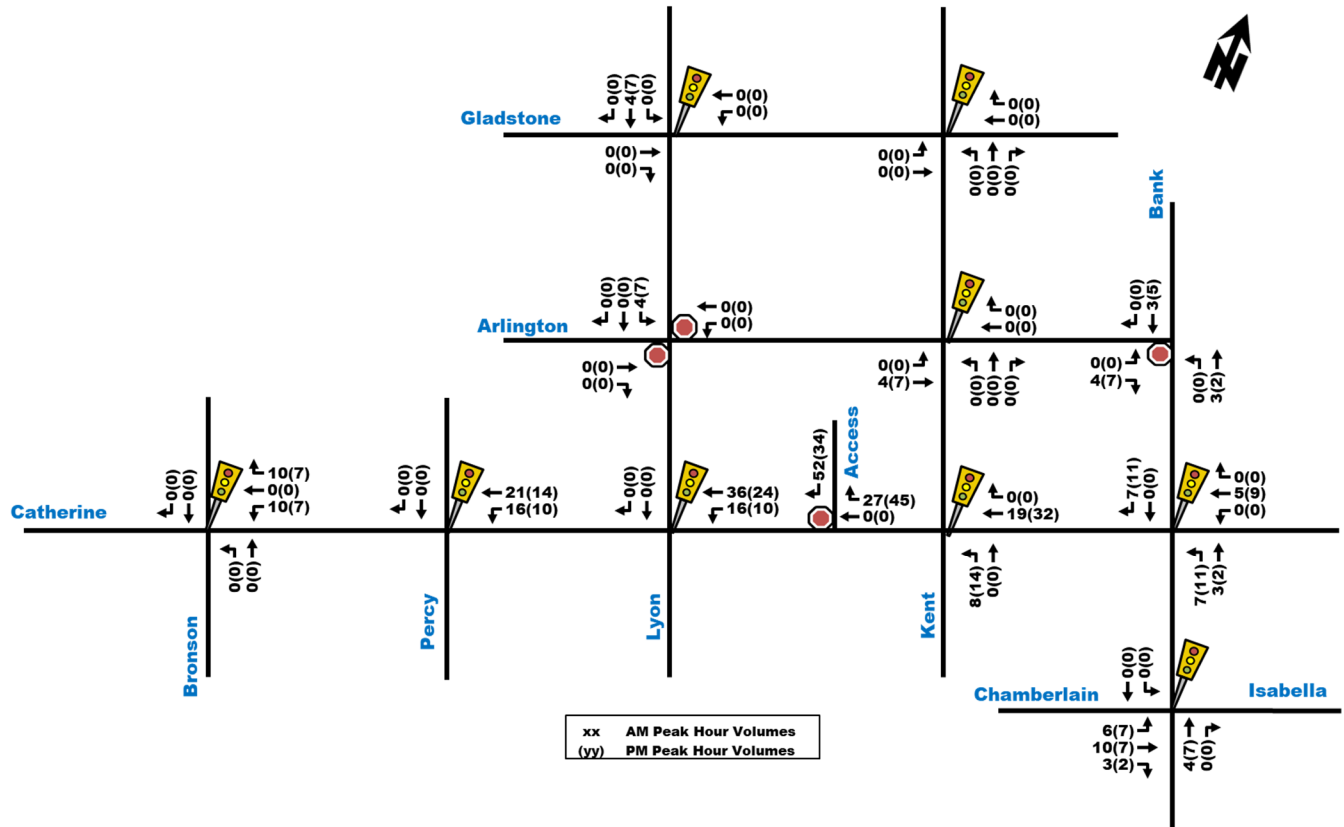
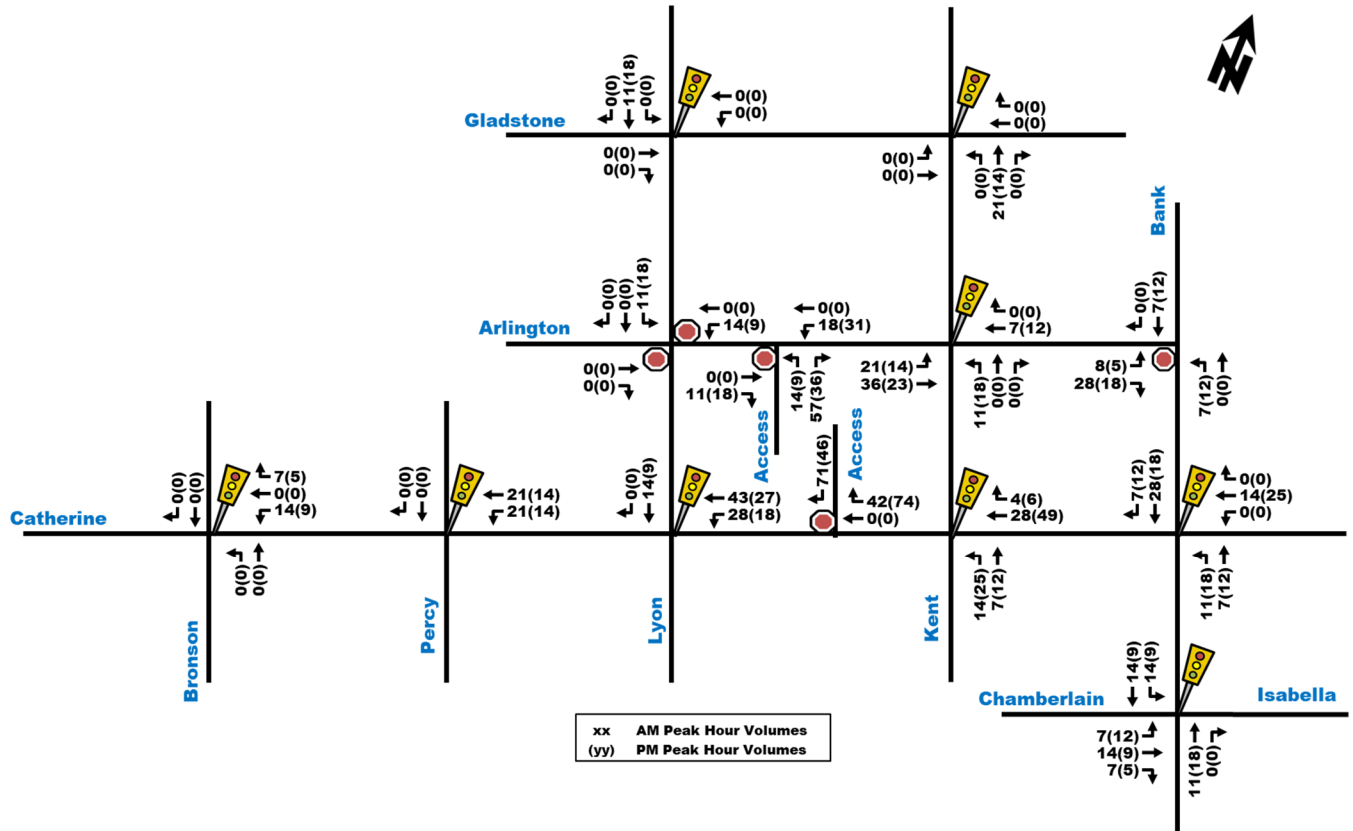

Figure 13: Full Buildout Phase 1 + Phase 2 Site-Generated Traffic



3.2. Background Network Traffic

3.2.1. Transportation network plans

Refer to Section 2.1.3: Planned Conditions.

3.2.2. Background Growth

The development is located in the Downtown Core Transect (as designated within the Official Plan), where policies are aimed towards augmenting and prioritizing the movement of pedestrians, cyclists, and transit users. Traffic flow and parking requirements are secondary priorities, which suggest traffic volumes along study area roadways may not increase as rapidly in the future and may even experience a decline. However, based on the vision of the Centretown CDP and Secondary Plan, more development intensification is planned along Catherine St, which will increase population within the study area. As such, a conservative 0.5% background growth rate was applied to arterial roads within the study area that provide connectivity to and from Highway 417, including Catherine St, Kent St, Lyon St, and Chamberlain Ave. The future background 2026, 2031 and 2036 traffic volumes are illustrated in Figure 14, Figure 15 and Figure 16, respectively.

Figure 14: Future Background 2026 Traffic Volumes

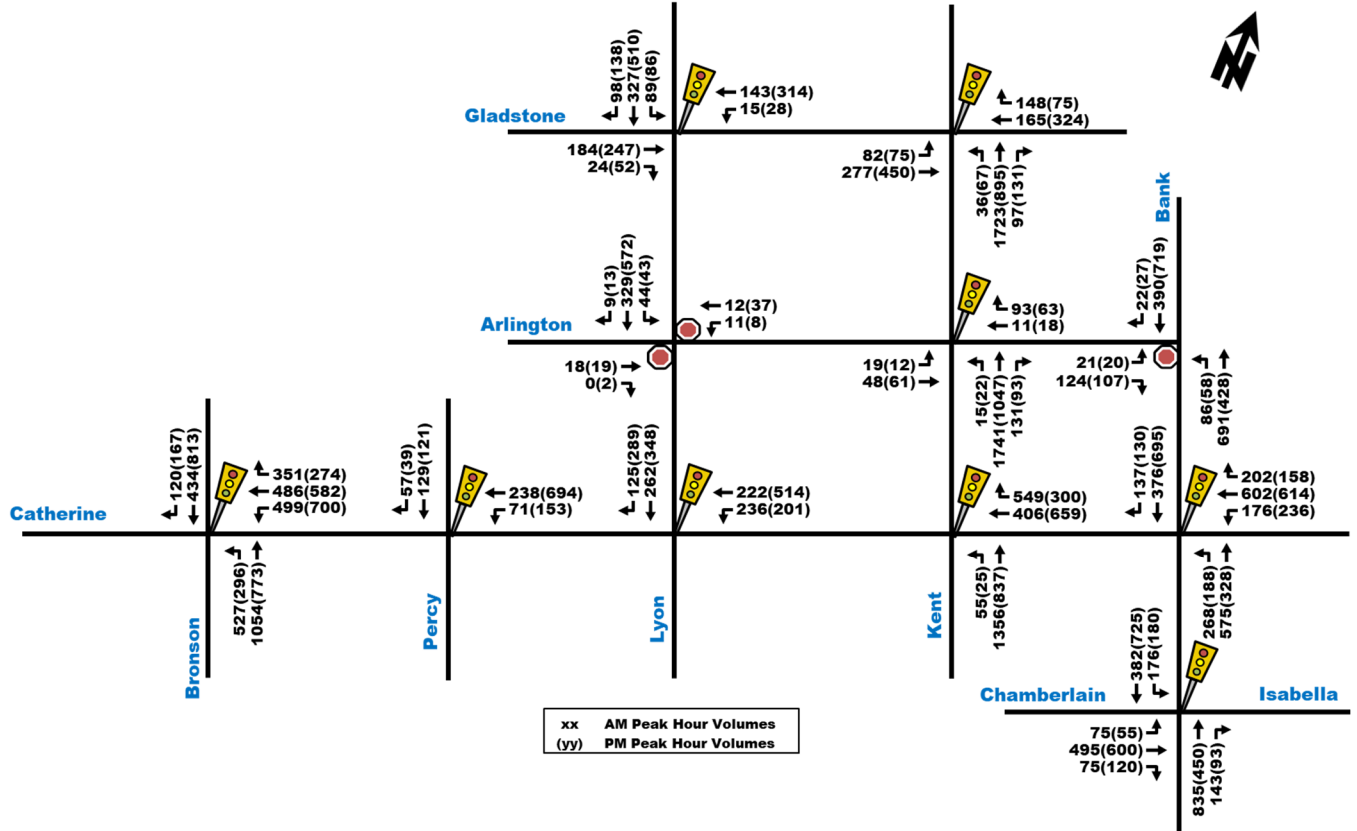

Figure 15: Future Background 2031 Traffic Volumes

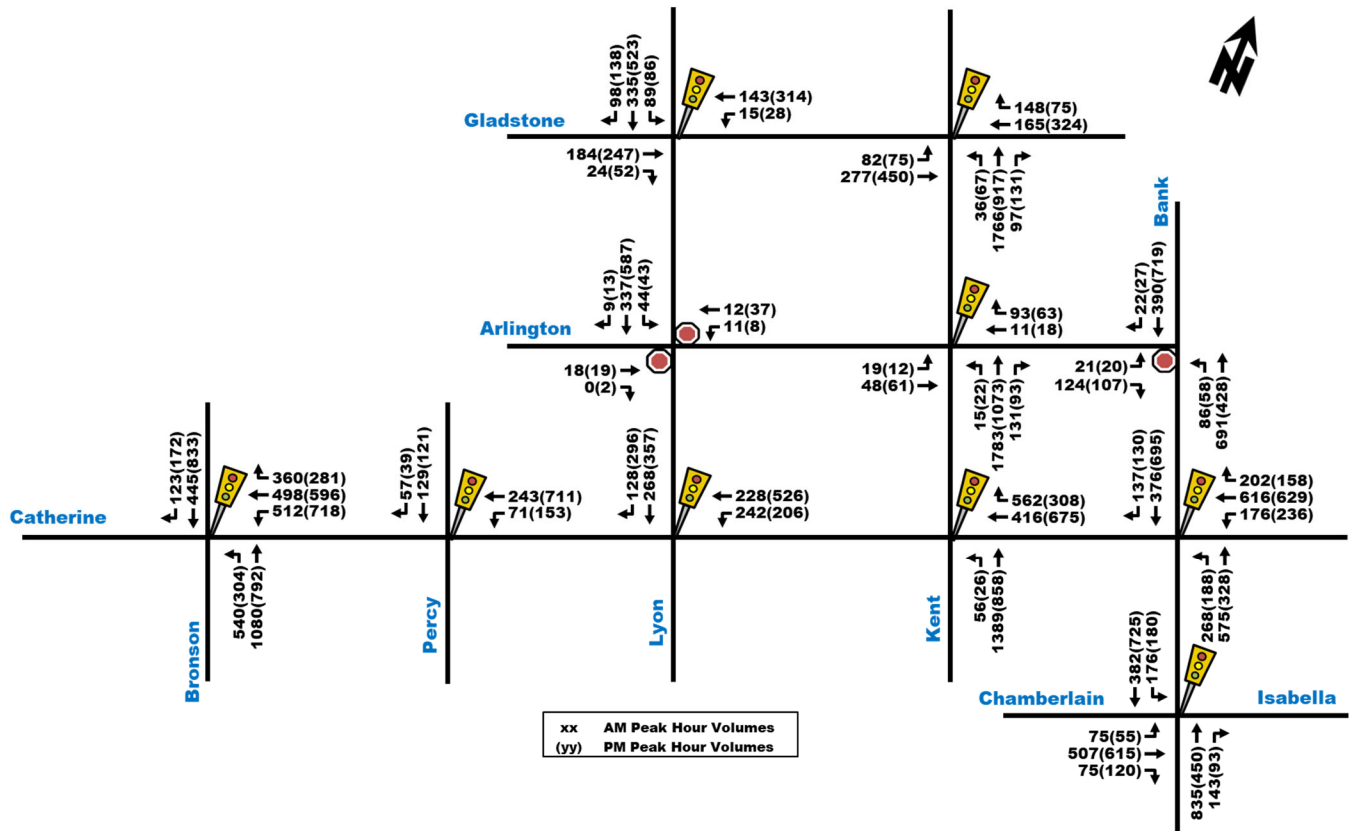
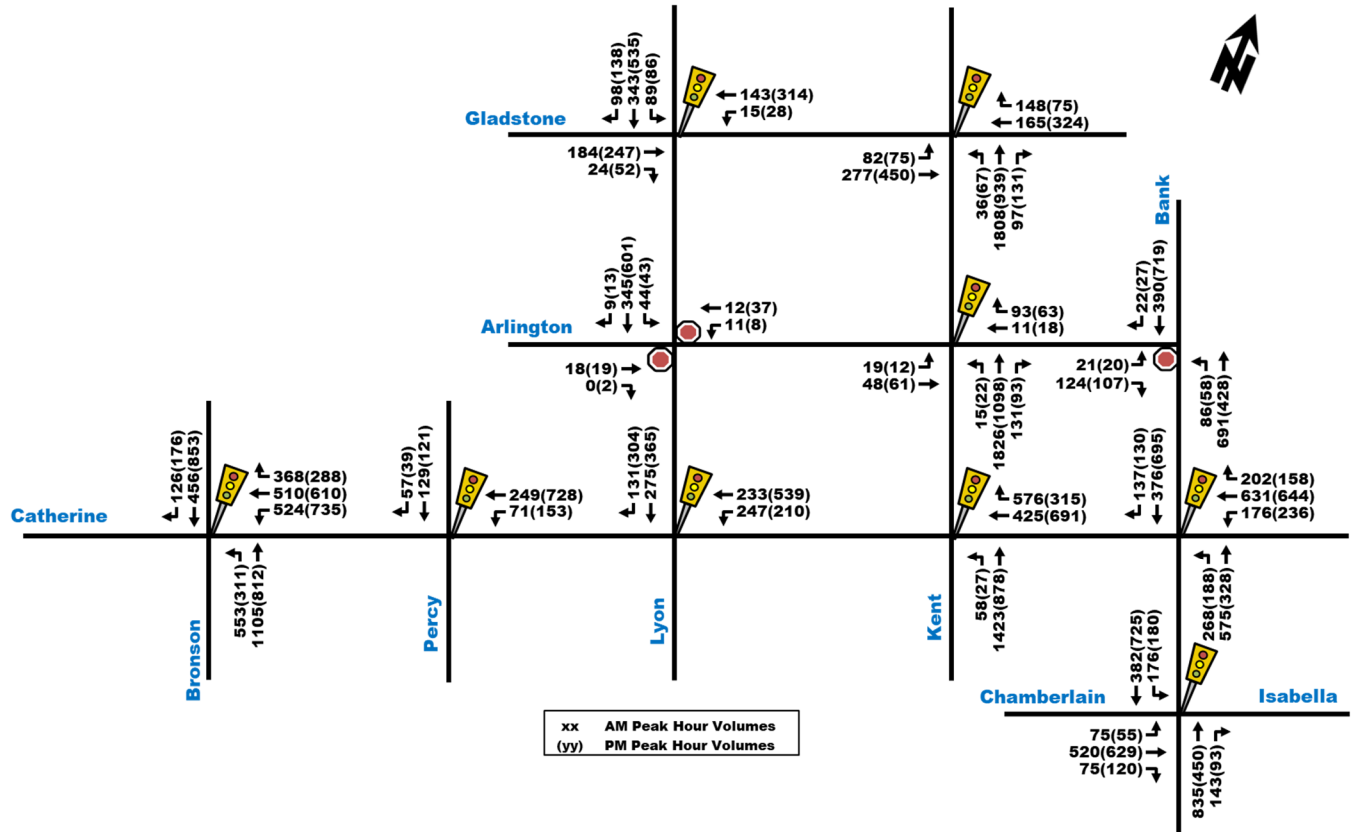

Figure 16: Future Background 2036 Traffic Volumes



3.2.3. Other Developments

Refer to **Section 2.1.3.3 - Other Area Developments**, no other area development included in future conditions.

3.3. Demand Rationalization

The following section indicates factors that may be used to rationalize the future travel demands in the study area and determine if there are potential capacity limitations and how they may be addressed.

The total projected 2026, 2031 and 2036 traffic volumes can be calculated by superimposing the site-generated traffic in **Figure 12** and **Figure 13**, onto the future background traffic in **Figure 14**, **Figure 15** and **Figure 16**. The total projected 2026, 2031 and 2036 traffic volumes are illustrated in **Figure 17**, **Figure 18** and **Figure 19**, respectively.

It is important to note that the ongoing evolution of travel behaviour post-COVID-19, combined with long-term transportation network changes of the Centretown area and broader City of Ottawa investments in transit and active transportation (as discussed in **Section 2.1.3**), are expected to gradually discourage auto use in the Downtown Transect (as designated in the City Official Plan). Further discussion on elements is provided below.

TDM Measures

The Centretown CDP suggests implementing aggressive TDM Measure as part of new developments in the Southern Area of the Centretown district, where the proposed development is located. These measures include providing enhanced pedestrian, cycling, and transit facilities where possible, as part of new developments. The purpose of such measures is to reduce reliance on vehicle travel modes and encourage alternative travel behaviors. Depending on the size and density of future developments, implementing appropriate TDM measures may help reduce future traffic volumes in the Centretown area. For the future development at 265 Catherine St,

aggressive measures may be implemented to incentivize residents to rely on transit and active transportation modes such as walking and cycling. These measures are identified in **Section 4.5**.

LRT

The City of Ottawa LRT construction is underway, where Stage 1 has already been constructed and in use as of 2019, while Stage 2 is under construction and includes further expansions of the LRT corridor in different directions. Lyon Station and Parliament Station are located along Queen St in the Centretown area, where the Lyon Station is located approximately 1.4km north of the proposed development site.

The LRT is expected to have resulted in significant reductions in background traffic volumes, influencing the Centretown area as a whole. Most traffic volumes used for the purpose of this TIA Report were mostly conducted in 2018, prior to the opening of the LRT Stage 1. As such, they may not reflect any changes in travel patterns as a result of the LRT. As the LRT continues to expand and the travel behaviors of background trips adjust, it is expected that transit usage would increase, while background traffic decreases.

COVID-19 Changes to Travel Behavior

The COVID-19 pandemic resulted in significant implications to travel behaviors across the country. A considerable percentage of the workforce have shifted to a work-from-home only or hybrid home/office work schedule, with such effects expected to have long lasting impacts. This change resulted in a noticeable reduction of traffic volumes during peak hours – anecdotally, interprovincial bridge crossings are currently 75% below pre-covid levels (based on ongoing work for the Wellington Street Closure Assessment by the City of Ottawa).

As businesses continue to adjust to new and more widely desirable work schedules, it is uncertain how persistent the reduction in traffic volumes will remain. Therefore, it is important to acknowledge that any growth applied to background traffic volumes from pre-COVID levels should be considered a conservative assumption.

In this TIA, a 0.5% background traffic growth rate was assumed from pre-COVID traffic volumes (discussed in **Section 3.2.2**) without applying any further reductions to the study area traffic volumes, representing as a worst-case scenario. The impact of the proposed development’s site-generated traffic volumes on the study area intersections and roadways will be determined in the subsequent sections of the TIA report.

Figure 17: Total Projected 2026 Traffic Volumes

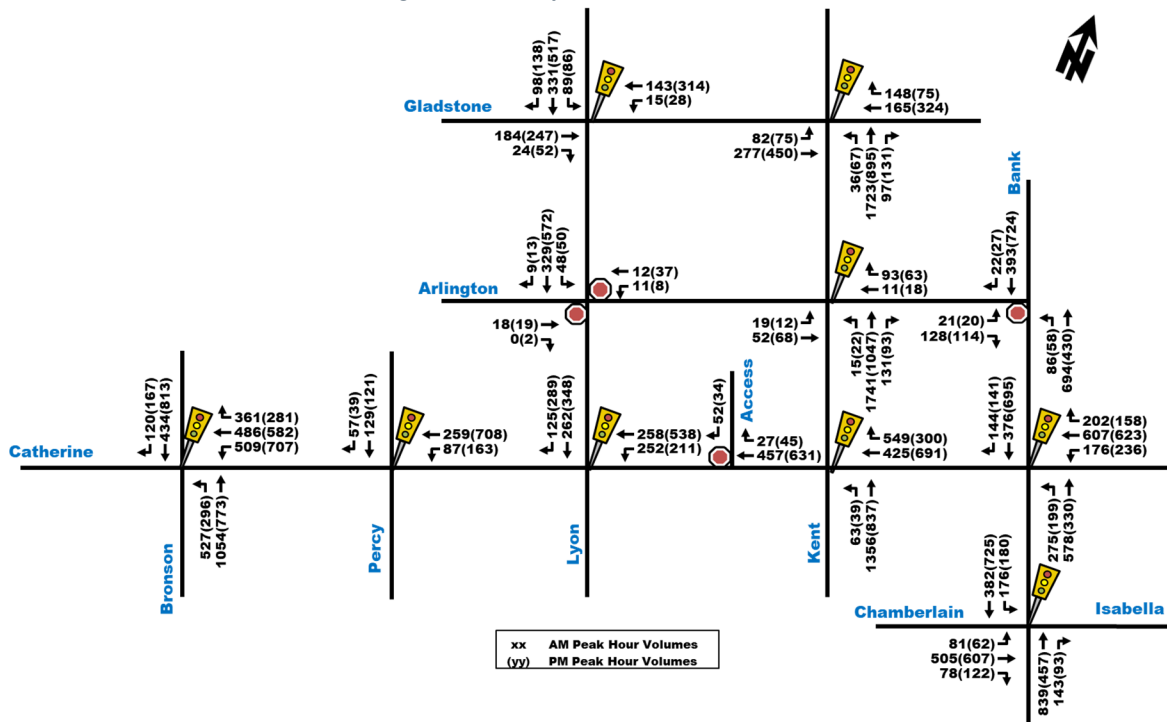

Figure 18: Total Projected 2031 Traffic Volumes

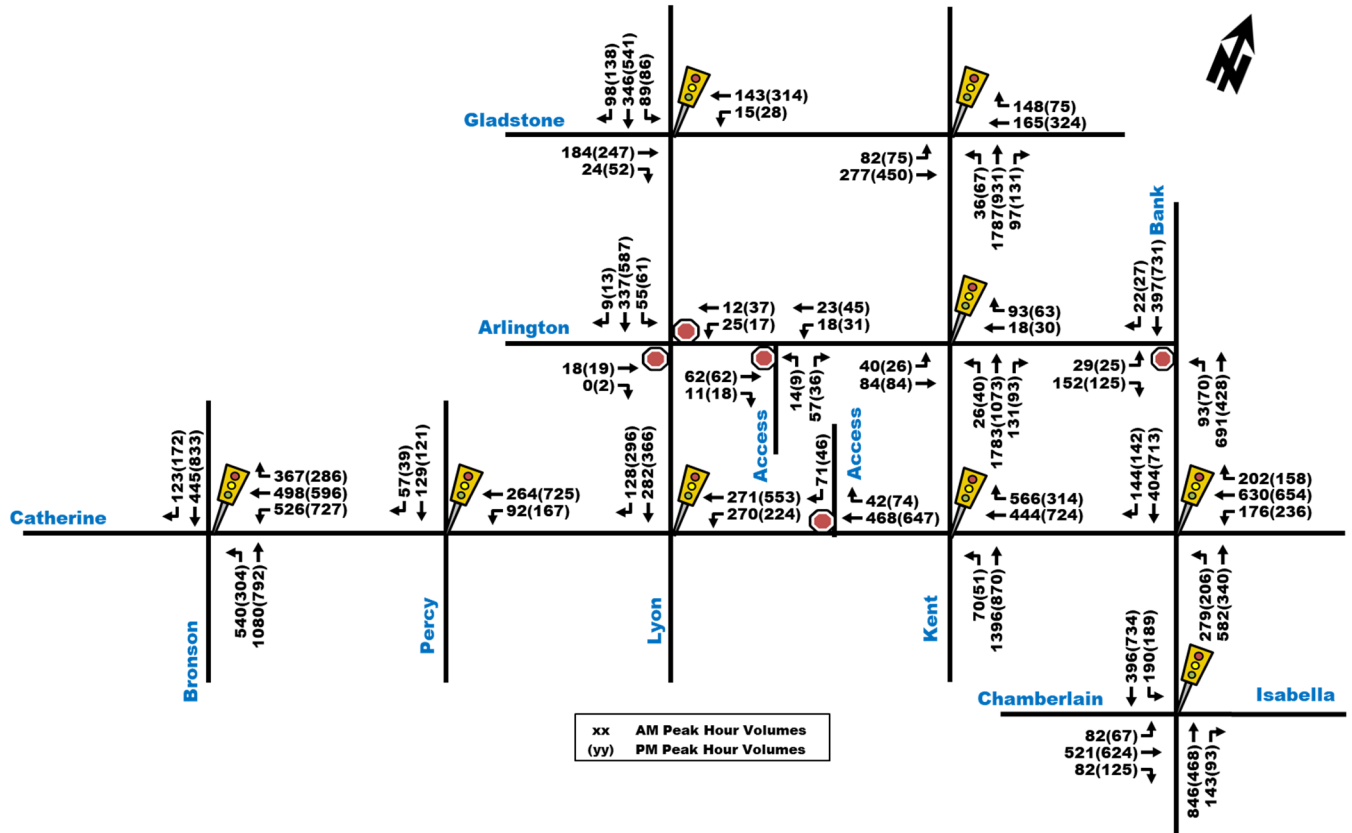
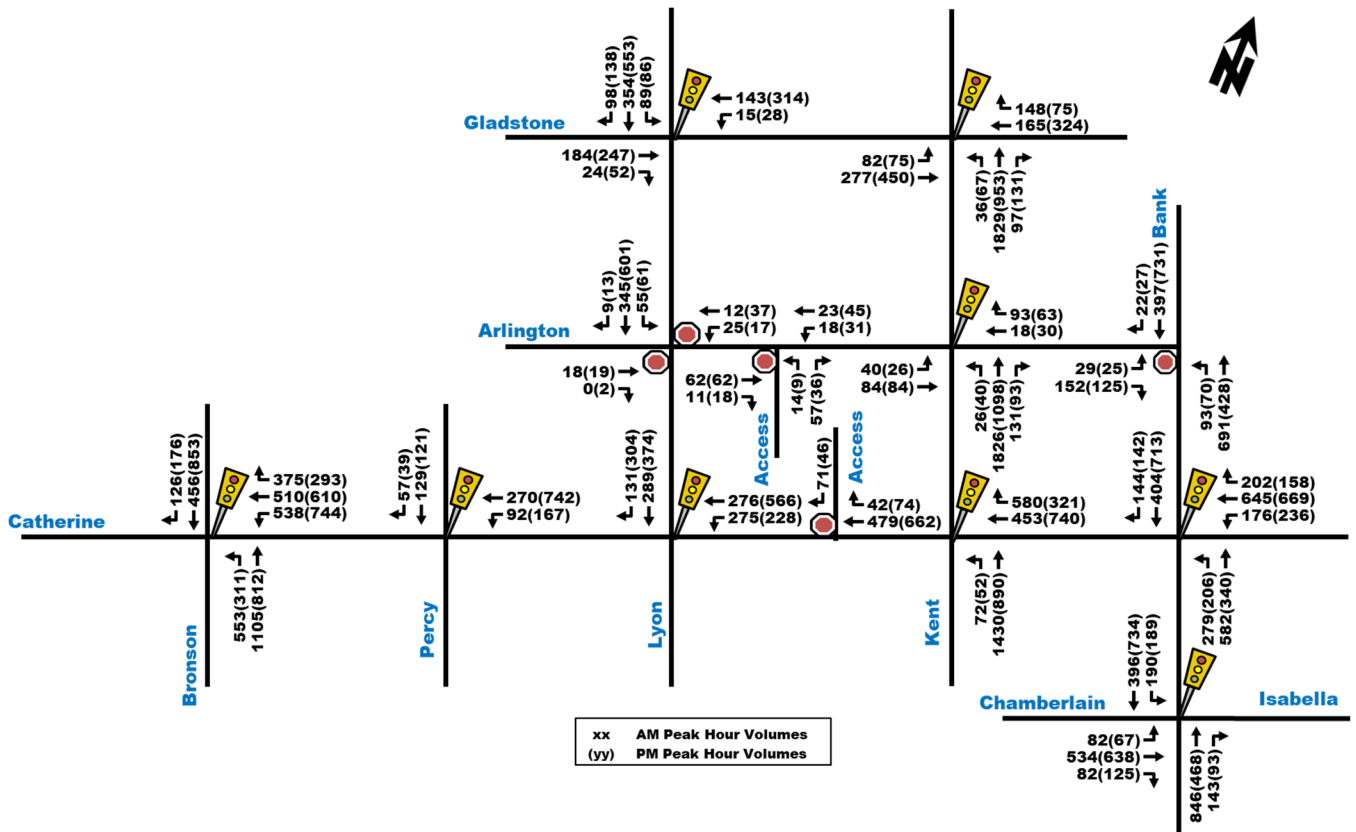

Figure 19: Total Projected 2036 Traffic Volumes



4.0 ANALYSIS

4.1. Development Design

A description of the available and proposed transportation network elements for different travel modes is provided in the sections below.

4.1.1. Design for Sustainable Modes

A woonerf is proposed that bisects the site north-south connecting Catherine St and Arlington Ave. It has been carefully designed as an enhanced pedestrian amenity area that also permits infrequent vehicle access for trucks/loading vehicles (see **Section 4.1.2** for further discussion on vehicle access). The woonerf ties into the publicly accessible open spaces within the site, and feature unique pavers, an offset alignment and various landscaping accents that provides strong visual cues to any drivers that this is a calm pedestrian environment. The woonerf provides excellent pedestrian and cycling permeability through the block that ties into the existing municipal active transportation network.

Sidewalk facilities will be provided on all site frontages and will be at least 2.0m wide at all locations. Given the location of the development, pedestrian facilities within the Centretown area are well established and help to provide optimal access to transit stop locations.

Along Catherine St, the existing bus stop at the site frontage (approximately 45m west of Kent St) will be maintained at the same approximate location but realigned slightly to the new proposed curb location. **Figure 20** illustrates the proposed future bus facilities. The bus stop provided will be in accordance with City specification SC12, which includes a bus shelter and a 15m bus landing pad. The design of the bus stop prevents the bus shelter from interrupting the pedestrian realm, providing a better experience for active users.

The city intends to convert the north curbside general purpose travel lane on Catherine St to a transit priority lane between the Kent St and Bronson Ave, as per the Catherine Street Functional Design Study. The proposed bus lane design will not be impacted by the proposed development at 265 Catherine St.

In order to reduce potential weaving conflicts between the site parking garage access and the bus lane, the west curb radius was reduced to 3m, which helps direct traffic exiting the site onto the general traffic lane. Additionally, to prevent right turns from Catherine St onto the woonerf, a slight bumpout was added to the east curb of the woonerf access, which reinforces the one-way southbound only operations of the woonerf.

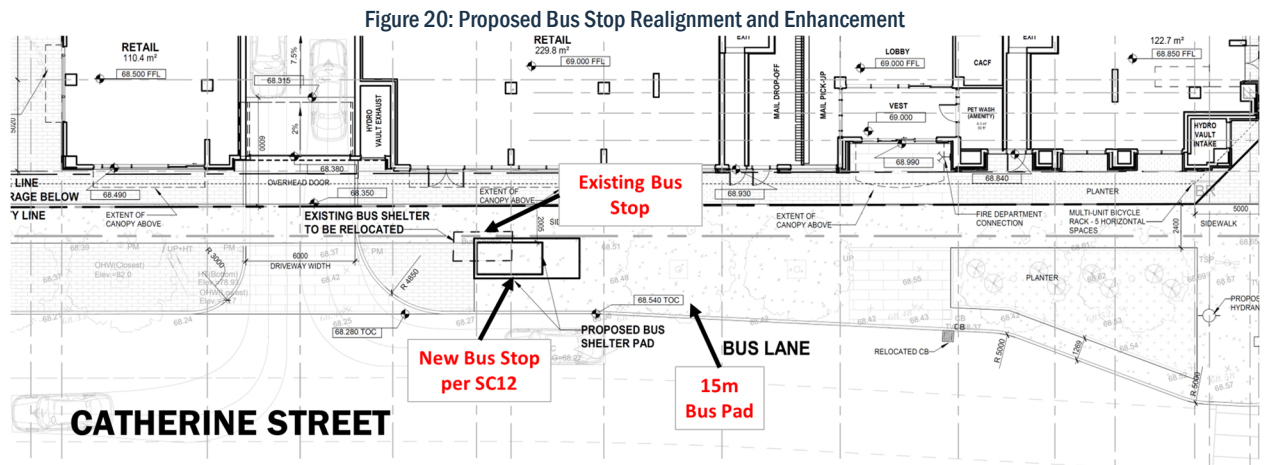

Other bus stops in the study area include existing bus stops on Gladstone Ave at both Lyon St and Kent St that are approximately 250m walking distance from the site. While outside of typical walking distance, it is noted that the LRT operates north of the site at approximately 1.4km walking distance.

Note that the City of Ottawa's TDM-Supportive Development Design and Infrastructure has been provided in **Appendix F** and discussed in more detail in **Section 4.5**.

4.1.2. Circulation and Access

Truck and passenger vehicle turning maneuvers at all site accesses and laybys have been reviewed in significant detail and several iterations and adjustments were made to ensure their ability to accommodate the expected design vehicles. All vehicle turning templates have been provided in **Appendix G**.

Circulation and Access

The proposed development will provide two accesses to the underground parking garage:

1. Catherine St, approximately 50m west of Kent St, and
2. Arlington Ave, approximately 25m east of Lyon St.

There will be 3-levels of underground parking, where visitor and retail parking spaces will be provided on the first level and will be separated from resident parking spaces through the use of restricted gate access that only residents can enter.

The proposed woonerf, connecting Arlington Ave to Catherine St, was developed after early discussions with City staff. Current City policies (in the New Official Plan and Centretown CDP) encourage loading activities in the downtown districts to be off-street/internalized rather than on-street. Although the primary function of the woonerf is to provide an enhanced pedestrian environment and meeting place for the local community, its secondary function is to enable garbage pickup for all buildings, and moving/loading operations for Buildings A and B. The woonerf will also permit other infrequent activities such as deliveries and provide an accessible passenger loading zone for paratransit and other accessible vehicles.

General traffic is not permitted within the woonerf, only designated truck traffic (garbage, emergency and moving trucks). This restriction will be reinforced with signage, but is also supported by its various unique design elements, such as:

- One-way southbound – vehicle travel on Arlington Ave is far less intense than Catherine St, which reduces the risk of short-cutting or infiltration of general traffic on the woonerf. Furthermore, the one-way restrictions on the main fronting streets (Catherine St, Kent St, and Lyon St) make shortcutting less prominent or attractive for drivers.
- Materials and landscaping – the aesthetic provides strong visual cues to drivers that the woonerf is not a road. To reinforce this messaging, the vehicular unit paving on the woonerf is also provided between the sidewalk and the curb at each of Catherine St and Arlington Ave.
- Furniture and fixtures – the placement of street furniture and fixtures also offer visual cues as well as added friction to further reinforce the woonerf is not a road.
- A slight bulbout at the east curb of the woonerf access along Catherine St to prevent traffic from turning right into the woonerf.

If the proposed design is shown to be insufficient to maintain compliance, property management may always consider a physical gate in the future.

Given the proposed curb extensions along Arlington Ave and at the Lyon/Arlington intersection resulting in a narrower road for Arlington Ave, City staff requested a truck turn check be completed for southbound left-turns from Lyon St to Arlington Ave. The truck turn templates are provided in **Appendix G**, which show that HSU trucks would be able to complete their turns from the left lane on Lyon St, without conflict with curbs or any vehicles in the oncoming lane of Arlington Ave. Given the one-way travel direction of Lyon St, completing a truck turn from the right turn without any conflicts would be difficult for both existing and proposed conditions. Trucks completing the turn from the left lane are expected to take reasonable precautions to ensure the right lane is clear of vehicles before completing the turn.

Lyon St Layby

The layby on Lyon Street serves as a drop-off space for move-ins and is located near a secured service corridor that leads to the elevator core in Tower 3. Due to the configuration of Building B with the two towers, it is not possible to provide internal access to both tower cores from the loading bay located under Tower 2 adjacent to the internal lane. Since the City will not permit loading vehicles to reverse onto a public street, the internal lane (or woonerf) functions to allow loading vehicles to access the site and leave in a forward motion during scheduled times. Since the core of Tower 3 is not near the internal lane, vehicles are not be able to access this tower from the internal part of the site without either reversing onto Arlington Avenue from an exterior loading space located between Buildings B and C (townhouse), or an internal loading bay located adjacent to the parking garage ramp along Arlington Avenue, or driving through the entire site to reach the internal lane to be able to leave in a forward motion.

The Central and East Downtown Core Secondary Plan indicates in Section 3.3.2.17 that loading and other vehicle access infrastructure should be located where it would not compromise sustainable modes and prohibits its provision on Corridors where possible. It is noted that the landscaped open space throughout the site has been designed to minimize vehicles and to favor pedestrians. Additionally, the buildings have been designed to minimize blank façades or 'back-of-house' type functions such as loading bays, garbage rooms etc., and instead have been designed to favor the pedestrian realm by providing as much animation and visibility around the entire site. From a transportation perspective, the layby proposal is considered acceptable for the following reasons as well:

- Lyon St is one-way southbound, which eliminates vehicle conflicts from on-coming vehicles.
- Lyon St is a traffic calmed road, there is a speed hump and on-street parking on the east side of the road just north of Arlington Ave.
- The layby is located as far north as possible along the frontage, ensuring there is as much separation from the Catherine St intersection as possible.
- Lyon St has a wide pavement width (nearly 9m for two travel lanes), which provides ample space for vehicles in the adjacent lane to pass comfortably if a truck is in the layby.
- The proposed design includes a 2.0m continuous sidewalk along the frontage, thus the layby does not impinge on the pedestrian realm.
- Loading operations with large trucks are expected to be infrequent (coinciding with move-ins), and rarely occur during the weekday morning/afternoon peak hour periods.

The Lyon St layby should be signed as a loading zone with time restrictions, which limits use to 15-minutes or less for loading/ unloading operations.

4.1.3. New Street Network

Exempt, refer to **Table 2**.

4.2. Parking

4.2.1. Parking Supply

Based on City of Ottawa Parking Provisions, Schedule 1A, the proposed development is located in "Area X". As such, the required number of parking spaces will be calculated based on the rates set out for this area. The proposed development will locate all vehicle and most bicycle parking spaces in the three-level underground parking garage. **Table 21** provides a summary of the required and the proposed parking rates for vehicles and **Table 22** for bicycles.

Table 21: Required and Proposed Vehicle Parking Spaces

Land Use	Size	Zoning By-Law Parking Rates		Required Spaces			Proposed Spaces		
		Base	Visitor/Retail	Base	Visitor/Retail	Total	Base	Visitor/Retail	Total
Phase 1									
High-Rise Residential	423 Units	0.5 per unit, excluding first 12 units	0.1 per unit, excluding first 12 units, 30 spaces max per building	206	30	236	145	42 Shared with retail	187
Retail*	695 m ²	-	1.25 per 100 m ²	-	9	9	Shared with Residential visitor parking		-
Phase 1 Total				206	39	245	145	42	187
Phase 2									
High-Rise Residential	734 Units	0.5 per unit, excluding first 12 units per building	0.1 per unit, excluding first 12 units, 30 spaces max per building	361	60	421	283	75 Shared with retail	358
Townhomes	7 units	0.75 per unit	0.1 per unit, excluding first 12 units, 30 spaces max per building	6	1	7			
Retail*	932 m ²	-	1.25 per 100 m ²	-	12	12	Shared with Residential visitor parking		-
Phase 2 Total				367	73	440	283	75	358
Full Buildout Total				573	112	685	428	117	545

*Retail units with an area less than 200 m² do not require off-street vehicle parking to be provided, as per the Parking Provisions.

As shown in **Table 21**, the development intends to provide fewer vehicle parking spaces than the minimum requirements by approximately 140 residential parking spaces. As such, a parking variance is needed as part of the development application.

The potential implications for residential vehicle parking demand are provided in the following section. However, it is noted that the minimum requirements for both visitors and retail use are being maintained. Additionally, it is worth noting that 1 carshare space will be provided as part of Phase 1, and 2 carshare spaces will be provided as part of Phase 2, for a total of 3 carshare spaces.

Although visitor and retail parking requirements are being met, additional opportunities for parking are provided at on-street locations around the site, which can help enable quick drop-off/pick-up activities as needed. On-street parking will continue to be permitted on the east side of Kent St and the south side of Arlington Ave in the future. Additionally, off-peak 1-hour parking will be permitted along the transit lane on the west half of the block.

Table 22: Required and Proposed Bicycle Parking Spaces

Land Use	Size	Zoning By-Law Parking Rates	Required Spaces	Proposed Spaces
		Bicycle	Bicycle	Bicycle
Phase 1				
High-Rise Residential	423 Units	0.5 per unit	200	423
Retail	1,430 m ²	1.0 per 250 m ²	6	15
Phase 1 Total			206	438
Phase 2				
High-Rise Residential	734 Units	0.5 per unit	367	743
Townhomes	7 units	-	-	-
Retail	1,123 m ²	1.0 per 250 m ²	5	20
Phase 2 Total			372	763
Full Buildout Total			578	1,201

The proposed number of bicycle parking spaces exceed the required minimum, providing at least a 1:1 ratio for the number of units to promote cycling use. The majority of bicycle parking is proposed to be provided on the first level of the underground parking garage, with easy access through building elevators and the garage ramps. Some bike parking is also proposed outdoor near amenity and retail areas. At least 50% of bicycle spaces are horizontal as per City requirements.

4.2.2. Parking Variance Implications

The development proposal provides approximately 140 fewer vehicle parking spaces than the By-Law requirement. To offset the reliance on vehicles and vehicle parking requirements, the site is providing excess bike parking spaces (at least a 1:1 ratio with units) that is supported by high quality pedestrian and cycling facilities in the vicinity, and a mix of different land uses that promotes a walkable neighbourhood. The City's long-term plan for Catherine St includes a new transit priority lane with a bus stop along the development frontage, as well as augmented pedestrian and cycling accommodations at study area intersections. A strong TDM program is proposed to encourage alternate modes of transportation that will leverage the existing and planned infrastructure provided by the city (further details provided in Section 4.5), which reduces the need for excess vehicle parking. During the public consultation with the local community, the reduction in parking supply was supported. Lastly, the reduction in parking is supported by policies in the New Official Plan to maximize the priority of movement for sustainable modes in the Downtown Core Transect and limiting on-site parking where possible.¹

In the unlikely event that parking spillover is observed, the Centretown Local Area Parking Study (LAPS) from 2016 suggests there is available on-street parking supply within the Centretown neighbourhood to accommodate potential demand. The LAPS table 22 documented between 50-57% on-street parking utilization during all time periods, meaning that there is almost half of remaining on-street parking unoccupied and available. During paid periods, an increase in public off-street parking up to a maximum of 80% occupancy was documented. During weekends, the off-street parking utilization is normally less than 10%, providing a large availability of parking². City By-Law is also equipped to respond with greater enforcement if there is an observed increase in parking infractions.

4.3. Boundary Street Design

Rights-of-Way and Corner Triangles

The City of Ottawa Official Plan Schedule C16 identifies Right-of-Way (ROW) protection requirements, including widening/easement needs and corner triangles at intersections. For the boundary streets surrounding the development site, the ROW requirements at the site frontage are as follows:

- Catherine St: the Official Plan indicates the ROW protection requirement to be 23m. The existing ROW is approximately 18m. The development meets the ROW protection needs along Catherine St.
- Kent St and Lyon St: the Official Plan indicates the ROW protection requirement to be 20m, with a stipulation that the maximum land requirements needed from the property abutting the existing ROW being 0.9m. Additionally, both frontages are subject to a widening/easement policy, whereby a 1.5m wide and 4.5m high unobstructed surface easement for the use of pedestrians along the street frontage is required. The development meets both the ROW protection needs and widening/easement policy needs along Kent St and Lyon St.

In addition to the ROW protection at frontages, corner triangles at intersections are required as dedications of land for road ROW. As shown in the Site Plan, a 5mx5m corner triangle, as per minimum requirement, is provided on all corners of the property, with the exception of the Arlington/Kent intersection, where a 3mx3m sight triangle was proposed. This corner of the property will be city owned for the future public park. City staff confirmed in a meeting held on April 25, 2023, that there are no concerns with the reduced sight triangle at the Arlington/Kent intersection corner.

MMLOS Analysis for Boundary Streets

Using discrete quantitative methods, the Multi-Modal Level of Service (MMLOS) analysis describes the level of convenience and comfort experienced by pedestrians, cyclists, transit, and trucks. MMLOS analysis was

¹ City of Ottawa Official Plan (2021), City of Ottawa, Section 5.1, Pg 133-137.

² <https://pub-ottawa.escribemeetings.com/filestream.ashx?documentid=41676>

conducted at the boundary roads of the proposed development, which includes Catherine St, Kent St, Lyon St, and Arlington Ave. The geometry and features along the of boundary streets are anticipated to differ between the existing and future horizon year conditions as a result of both the future Catherine St Functional Design Plan and the proposed development's Site Plan. Below is a description of the proposed development's existing boundary streets and future modifications at the site's frontage:

Catherine St (arterial road classification)

- *Existing*
 - 2.0m wide sidewalk and no boulevard,
 - 3 lanes total (WB only),
 - 3.7m or wider lanes,
 - Operating speed of 50 to 60km/h,
 - Less than 3000 average daily curbside lane traffic volume,
 - No on-street parking, cycling facilities or transit facilities, and
 - A designated truck route.
- *Future*
 - New curbside bus lane
 - Greater than 2.0m wide boulevard, and
 - 3.5m wide lanes.

Kent St (arterial road classification)

- *Existing*
 - 1.8m wide sidewalk and no boulevard,
 - 3 lanes total (NB only),
 - 3.7m or wider lanes,
 - Operating speed of 50 to 60km/h,
 - More than 3000 average daily curbside lane traffic volume,
 - No on-street parking on the west side (only on east side), cycling facilities or bus routes, and
 - A designated truck route.
- *Future*
 - 2.0m wide sidewalks and no boulevard.

Lyon St (arterial road classification)

- *Existing*
 - 1.5m wide sidewalk and no boulevard,
 - 2 lanes total (SB only),
 - 3.7m or wider lanes,
 - Operating speed of 50 to 60km/h,
 - More than 3000 average daily curbside lane traffic volume,
 - No on-street parking, cycling facilities or bus routes, and
 - Not a designated truck route.
- *Future*
 - A greater than 2.0m wide sidewalk and no boulevard with loading layby (assumed as on-street parking in analysis) on the north half of the block.
 - A 2.0m wide sidewalk and 3m wide boulevard on the south half of the block.
 - *Note that the north half design will be used for analysis to assess a more "critical" condition.*

Arlington Ave (local road classification)

- *Existing*
 - 1.5m wide sidewalk and no boulevard,

- 2 lanes total (1 WB and 1 EB),
- Operating speed of 30 to 50km/h,
- Less than 3000 average daily curb lane traffic volume,
- Permitted on-street parking,
- No cycling facilities or bus routes, and
- Not a designated truck route.
- *Future*
 - 2.0m wide sidewalks and greater than 2.0m wide boulevard where curb extensions are located.

Detailed analysis sheets have been provided in **Appendix H. Table 23** below provides a summary of the results, along with the minimum desirable targets obtained from the MMLoS Guidelines, for each respective travel mode. The targets are based on the proposed development site’s location in a “within 300m of a school” (i.e. Glashan Elementary School) Policy Area for both existing and future conditions.

Table 23: MMLoS Analysis, Boundary Road Segments

Road Segment	Level of Service							
	Pedestrian (PLOS)		Bicycle (BLOS)		Transit (TLOS)		Truck (TkLOS)	
	PLOS	Target	BLOS	Target	TLOS	Target	TkLOS	Target
Catherine St	C, B*	A	E	D	D, B*	C	A, A*	D
Kent St	F, E*	A	E	D	N/A	N/A	A, A*	D
Lyon St	F, D*	A	D	D	N/A	N/A	A, A*	E
Arlington Ave	E, B*	A	A	B	N/A	N/A	N/A	No Target

*Result based on future street design at site frontage.

Red font in the table above indicates that the respective desirable target has not been met. As shown in **Table 23**, the minimum desirable pedestrian LOS targets are not met at any of the road segments in both existing and future conditions. This is due to a combination of factors, which includes high curbside lane traffic volumes, high operating speeds given the arterial designation of three of the boundary roads and limited opportunity for boulevard width. It should be noted that in future conditions, a boulevard wider than 2.0m will be provided along both Catherine St and Arlington Ave, which reflects significant improvements in the PLOS results.

The minimum desirable bicycle LOS targets are not met on Catherine St and Kent St primarily due to the number of travel lanes (three on-way lanes), which reduces cyclist comfort. The minimum desirable transit LOS target is not met on Catherine St in existing conditions but is expected to be met in the future as a result of the proposed transit lane.

It should be noted that there are no applicable TLOS results or targets for Kent St, Lyon St, or Arlington Ave as there are no active transit routes along these roads. Similarly, there are no minimum desirable truck LOS target along Arlington Ave given its local road designation with limited truck usage.

4.4. Access Intersection Design

As was described in **Section 4.1.2**, access to the underground parking garage will be provided via two accesses, one along Catherine St that will be constructed as part of Phase 1, and the other access along Arlington Ave to be constructed as part of Phase 2. Both accesses will provide 6m wide ramps. The Catherine St access will be located approximately 50m west of Kent St, while the Arlington Ave access will be located approximately 25m east of Lyon St. The Arlington Ave access design includes bulb-outs on both sides according to City specifications, which also act as a traffic calming measures along the frontage street (by reducing the effective pavement width). At the Catherine St access, the west curb radius was reduced to 3m rather than the typical 5m to help direct exiting traffic more onto the general traffic lane and less onto the future transit lane. Continuous depressed sidewalks are provided across all site accesses.

The two garage access points ensure a balanced spread of traffic (thereby reducing traffic loading to any one access point) and provides more direct access for residents. One of the drawbacks of one-way streets on three

frontages is it forces inefficient vehicle routing if access points to the site are limited. A single access off Catherine St would encourage traffic infiltration on surrounding streets (particularly vehicles coming from the northwest), increasing the number of turns and creating more pedestrian and cyclist conflicts on the adjacent road network than having a secondary access of Arlington Ave.

The proposed access design would also reduce traffic loading on any one street. Both Arlington Ave and Catherine St are sensitive corridors for different reasons. Catherine St is a future transit priority corridor and a “feeder” street to Highway 417, which would benefit from fewer vehicle trips turning in and out of the site during peak hour periods. Arlington Ave is a traffic calmed local street with direct residential frontage, which requires more consideration of traffic implications to local residents. Splitting the traffic distribution at two different access points reduces long-term operational risks.

The design considerations for the proposed woonerf were previously described in **Section 4.1.2**. It will be constructed as part of Phase 1. The south access point will be located approximately 15m west of the proposed garage access off Catherine St, which does not adhere to the Private Approach By-law (PABL). However, Catherine St is a one-way only street with westbound travel and the woonerf is one-way only southbound. At Catherine St, the woonerf would only permit outbound vehicles from the site and reinforces it with a slight bulbout at the east curb, resulting in very low conflict potential between the woonerf access and the underground parking garage access. Therefore, the proposed separation distance was considered acceptable. The north woonerf access will be located approximately 50m east of the Arlington Ave access, which adheres to the PABL and is similarly designed based on City specifications.

Providing additional access points from the woonerf was a strategic choice to prioritize off-street loading operations within the woonerf, as well as separate residential traffic from truck traffic, which ultimately balances onsite and adjacent corridor operations.

In order to not impede sightlines for vehicles and pedestrians at the different access points of the site, trees proposed to be planted near accesses are expected to be large canopy trees where sightlines will be protected below the canopies. Landscaping choices were made to avoid any potential impediment of sightlines.

4.5. Transportation Demand Management

4.5.1. Context for TDM

Based on the 2021 City of Ottawa Official Plan, the proposed development’s boundary roads Catherine St, Kent St and Lyon St are all designated as minor corridors within Design Priority Areas, along with Gladstone Ave. Bank St and Bronson Ave are both designated as mainstreet corridors within Design Priority Areas.

Given the proposed land-use of the development as a residential building, it is assumed that most trips generated will be from residents leaving the site in the AM peak to go to work and returning to the site in the PM peak. **Sections 3.1.1** and **3.1.2** describe how many trips are anticipated per travel mode and anticipates the likely locations that they will travel to and from based on the OD-Survey 2011 for Ottawa.

The development is proposing to provide 1,164 apartment units within 3 towers up to 36-storeys high, along with 7 townhome units and approximately 2,653m² of retail space. A breakdown of the unit types on the Site Plan indicates that the apartment units provided will consist of 191 bachelor units, 263 one-bedroom units, 278 one-bedroom and den units, 350 two-bedroom units, 33 two-bedroom and den units and 49 three-bedroom units. The property is owned and will be managed by the property developer, Brigil.

4.5.2. Need and Opportunity

The proposed development is located in a well-developed core area of the City of Ottawa, where transit and active transportation facilities are well-maintained and developed, which naturally results in an increased transit and active transportation usage and decreased auto trips. However, given the development’s location relative

to Highway 417, as well as near the southern limit of the Centretown area, it is reasonable to expect that auto driver mode shares will be higher relative to the typical Centretown mode share splits.

In order to ensure that personal vehicle use remains reasonable given the size of the proposed development, aggressive Transportation Demand Management (TDM) measures will need to be utilized. The proposed development TDM measures are described in detail in **Section 4.5.3** below. Additionally, **Section 4.2** details the rationale for providing a reduced number of parking spaces compared to minimum zoning bylaw requirements.

4.5.3. TDM Program

The TDM Infrastructure and TDM Measures Checklists have been provided in **Appendix F**. The proposed measures in each respective checklists are identified below.

Proposed measures identified in the TDM-supportive Development Design and Infrastructure Checklist are:

- Ten (10) out of the ten (10) “Required” measures have been satisfied.
- Twelve (12) out of fourteen (14) “Basic” measures related to Walking and Cycling and Parking have been satisfied, namely:
 - Locating building close to the street.
 - Locating building entrances to minimize walk distance to sidewalks and transit.
 - Locating building doors and windows to ensure visibility of pedestrians.
 - Providing safe, direct and attractive walking routes to transit.
 - Ensuring walking routes are secure, visible, and lighted.
 - Designing roads for cyclist circulation.
 - Providing lighting, landscaping and benches along walking and cycling routes.
 - Providing wayfinding signage for site access.
 - Providing bicycle parking equivalent to expected number of resident-owned and visitor cyclists.
 - Providing off-site transit shelter at a new location with shelter.
 - Providing a designated area to drop off or pick up passengers.
 - Providing shared parking for different uses (i.e. visitors, commercial, etc.)
- Four (4) out of seven (7) “Better” measures related to Walking and Cycling and Carsharing have been satisfied, namely:
 - Providing secure bike parking spaces equivalent to at least the number of units.
 - Providing a permanent bike repair station adjacent to bicycle parking area.
 - Providing up to three carshare parking spaces.
 - Providing separate areas for short-term and long-term parking with access controls.

Proposed measures identified in the TDM Measures Checklist are:

- Five (5) out of seven (7) “Basic” measures related to Walking and Cycling, Transit, Parking and TDM Marketing have been satisfied. Three (3) of those, which have been designated by an asterisk (*), are considered by the TDM Measures to be some of the most dependably effective tools to encourage sustainable travel modes. This includes:
 - Display walking and cycling information at major entrances.
 - Display transit information at major entrances.
 - *Offer preloaded PRESTO card to residents one monthly transit pass.
 - * Unbundle parking costs from monthly rent.
 - * Provide multi-modal travel information package to new residents.
- Three (3) out of eleven (11) “Better” measures related to Walking and Cycling, Transit, Carsharing, Parking and TDM Marketing have been satisfied. One (1) of those, which has been designated by an asterisk (*), is considered by the TDM Measures to be some of the most dependably effective tools to encourage sustainable travel modes. This includes:
 - Offer on-site cycling courses for residents or subsidize off-site courses.
 - Provide on-site carshare vehicles for residents.

- *Offer personalized trip planning to new residents.

4.6. Neighbourhood Traffic Management

This module compares the maximum one-way traffic of a local road during morning and afternoon peak hours, to the respective threshold provided by the City of Ottawa TIA Guidelines.

Site-generated traffic of the proposed development is expected to use local road Arlington Ave as part of their access route to/from the proposed development. The thresholds provided in the TIA Guidelines indicate a maximum ideal one-way traffic of 120 veh/h for local roads during peak hours. Using the total projected 2036 traffic volumes in **Figure 19**, future traffic volumes along Arlington Ave were compared to existing volumes and the ideal local road threshold as shown in **Table 24**. Arlington Ave was divided into three sections to gain full understanding of traffic activity.

Table 24: Arlington Ave Existing and Future Two-Way Volumes

Roadway	Classification	Ideal Daily Threshold (veh/day)	Ideal Peak Hour Threshold (veh/h)	Section	Peak Hour Two-Way Volumes AM (PM)	
					Existing	Projected
Arlington Ave	Local	1,000	120	West of Lyon St	39 (71)	39 (71)
				Between Lyon St and Kent St	93 (113)	165 (186)
				Between Kent St and Bank St	283 (235)	326 (270)

As shown in **Table 24**, note the following:

- West of Lyon St: traffic volumes along this section of Arlington Ave are well below the ideal threshold of a local road in both existing and future conditions. This indicates the majority of this traffic is local traffic and there is very limited cut-through traffic activity occurring on Arlington Ave between Bronson Ave and Lyon St. The low volumes are also attributed to the eastbound traffic restriction on Arlington Ave, approximately 50m east of Bronson Ave.
- Between Lyon St and Kent St: traffic volumes along this section of Arlington Ave are near the ideal threshold of a local road in existing conditions but are expected to exceed the threshold by up to approximately 73 veh/h in future projected conditions.
 - It should be noted that some traffic increase along Arlington Ave would have occurred regardless of whether an access is provided along Arlington Ave. This is due to the one-way nature of the surrounding roads that would have forced southbound traffic on Lyon St to take a circuitous route along Arlington Ave and Bank St to use the access along Catherine St.
 - Traffic volumes exceeding the ideal threshold of a local road is not an automatic indication of traffic operational problems on Arlington Ave. Traffic analysis will identify if there will be any intersection operational concerns at adjacent intersections and any safety concerns can be mitigated through the use of traffic calming measures and speed reduction. It is noted that this section of Arlington Ave has a reduced posted speed of 30km/h, along with intersection curb extensions and two speed humps. The future development is expected to add additional mid-block curb extensions at site accesses that will further narrow the road and help further calm the street.
- Between Kent St and Bank St: traffic volumes along this section of Arlington Ave are well above the ideal threshold of a local road in both existing and projected conditions and are approaching the 300veh/h threshold of a collector road. The high traffic volumes are like caused by a combination of the following:
 - The drop-off/pick-up activity that would occur during peak hours (especially in the AM) at Glashan Elementary School on the south side of Bank St. Since the school acts as a traffic generator during peak hours, there would be limited opportunity to mitigate these traffic volumes.

- Cut-through traffic may be using Arlington Ave as a quicker route to travel between Kent St and Bank St – more specifically, eastbound traffic exiting Highway 417 at Kent St are likely using Arlington Ave in order to access Bank St. Similarly, traffic travelling northbound on Bank St can use Arlington Ave instead of Catherine St to travel northbound on Kent St. There are few opportunities to limit this traffic infiltration besides road closures, which requires further study by the City and Council approval.

While site generated traffic is expected to contribute to this section, it will be to a much smaller proportion compared to existing/background traffic. The city Neighbourhood Traffic Calming Branch may consider investigating this section of Arlington Ave if future concerns are raised and validated through the established city process.

It is important to reiterate that the Arlington Ave corridor is already traffic calmed, including speed humps. That said, the development proposal introduces four new bulb-outs at the two proposed access points (ramp and woonerf) that will narrow the road from existing 10m to a minimum of 7m, which reinforces the traffic calmed environment.

4.7. Transit

As shown in **Table 20**, the proposed development is anticipated to generate up to 137 transit trips during peak hour periods. These trips will have access to existing bus routes within the study area, which includes OC Transpo bus routes #6, #7, #14, #55 and #114.

Existing transit ridership data (pre-COVID to reflect ‘typical’ ridership before pandemic impacts) was obtained from OC Transpo for six bus stops near the proposed development site, as shown in **Figure 21**. The data, as provided in **Table 25**, is a summary of average bus boarding, alighting and occupancy information for bus routes at each of the respective stop numbers, during morning and afternoon peak hours.

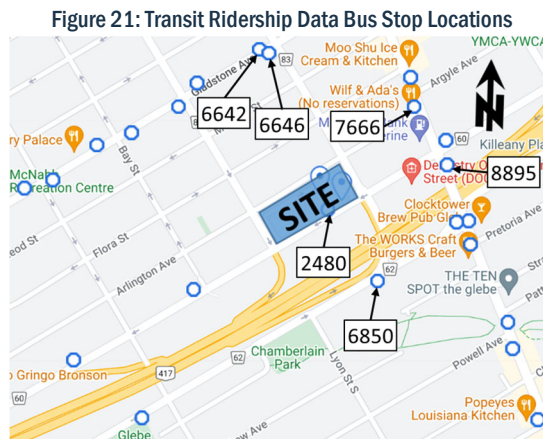

Table 25: Transit Ridership Data (Jan 5, 2020 - Mar 16, 2020)

Stop No.	Location	Route	Direction	AM			PM		
				Boarding	Alighting	Avg. Load at Depart.	Boarding	Alighting	Avg. Load at Depart.
2480	Catherine/ Kent	55	WB	11	5	21	11	8	16
6642	Gladstone/ Kent	14	WB	5	6	20	7	12	28
		114	WB	-	-	-	-	-	-
6646	Gladstone/ Kent	14	EB	6	13	19	12	17	16
		114	EB	-	-	-	-	-	-
6850	Chamberlain/ Kent	55	EB	16	8	17	15	17	15
7666	Bank/ Arlington	6	SB	22	34	23	58	54	38
		7	WB	24	26	24	20	38	28
8895	Bank/ Catherine	6	NB	14	28	33	12	16	30
		7	EB	11	5	23	20	19	31

As shown in **Table 25**, the average load of each bus route at its respective bus stop ranges from about 15 to 38 persons during the peak hours. It should be noted that these bus routes serve their respective stops several times during peak hours. Bus route #6, #7 and #14 in particular are “frequent routes” that arrive every 15 minutes or less during peak hours.

Based on information obtained from the OC Transpo website, the person capacity of OC Transpo vehicles, which includes the number of seats on the bus plus the standing capacity, ranges from approximately 57 occupants in its smallest vehicles to approximately 110 occupants in its largest vehicles. Some of these routes connect to the Confederation Line LRT approximately 1.4km north of the development site, which has a significantly higher frequency and ample capacity of 336 occupants.

Therefore, based on the current average bus loads and the future implementation of the Catherine St transit priority lane, the estimated 137 site generated transit trips during the peak hour periods are expected to be adequately accommodated by transit service at full buildout.

The existing bus stop located along Catherine St at the site frontage will be redesigned as a bus shelter at the new curb location that will adhere to the City bus stop specification SC12. No modifications are anticipated to the proposed future transit lane design as a result of the development. At the south end of the woonerf, an accessible passenger loading zone will be provided, which can accommodate paratransit vehicles.

4.8. Review of Network Concept

There are no identifiable planning screenlines within or in close proximity of the study area. A strong TDM program in combination with planned City sustainable infrastructure limits the anticipated number of vehicle and transit trips. Therefore, no major modifications are needed for the network to continue to perform acceptably. Transit trips were discussed in **Section 4.7** and is expected to be accommodated by the existing bus operations in the study area. Vehicle trips are also expected to be accommodated along study area roads, where any intersection operational concerns will be confirmed as part of **Section 4.9.2**.

4.9. Intersection Design

4.9.1. Intersection Control

Stop or Yield control may be considered for traffic exiting the underground parking garage ramps and the woonerf, to be confirmed during the detailed design. All other off-site intersection controls in the study area will continue to operate as per existing conditions, with the exceptions of recommended signal timing adjustments at the intersections of Catherine/Kent and Bank/Chamberlain/Isabella, as part of the future Catherine St Functional Design Plan Modifications, which is assumed to be completed in the 2031 and 2036 horizon years.

Additionally, the WBR movement at Catherine/Kent, will be fully protected with no-right-turn-on-red restriction and time separated pedestrian phase. At Bank/Chamberlain/Isabella, the NBR will not permit right-turn-on-red due to the proposed bidirectional crossing on the south leg of the intersection.

4.9.2. Intersection Design

Synchro 11 Trafficware was used to analyze intersection performance of intersections within the study area. Critical movements at each of the intersections were assessed based on either the movement with the highest volume-to-capacity ratio (for signalized intersections), or the movement experiencing the highest average delay (for unsignalized intersections). It should be noted that, as per the TIA Guidelines, the Peak Hour Factor (PHF) used for analysis was 0.90 in existing conditions and 1.0 in all future scenario conditions. All Synchro report outputs for existing and future conditions have been provided in **Appendix I**.

Existing Conditions Intersection Performance

Table 26 below summarizes the intersection performance of study area intersections, based on existing conditions traffic volumes illustrated in **Figure 8**.

Table 26: Existing Conditions Intersection Performance

Intersection	Weekday AM Peak (PM Peak)					
	Critical Movement			Intersection 'As a Whole'		
	LOS	max. v/c or avg. delay (s)	Movement	Delay (s)	LOS	v/c
Catherine/Lyon (S)	A(A)	0.41(0.51)	SBT(WBT)	11.4(16.5)	A(A)	0.29(0.47)
Catherine/Kent (S)	C(A)	0.72(0.56)	NBT(WBR)	24.7(17.4)	C(A)	0.72(0.55)
Bank/Catherine (S)	D(E)	0.89(0.99)	WBT(SBT)	29.1(50.8)	D(D)	0.89(0.88)
Catherine/Percy (S)	A(A)	0.28(0.52)	SBT(WBT)	7.5(10.6)	A(A)	0.26(0.48)
Arlington/Kent (S)	C(A)	0.77(0.47)	NBT(NBT)	16.1(8.1)	C(A)	0.72(0.43)
Gladstone/Lyon (S)	A(A)	0.41(0.60)	SBT(SBT)	16.3(15.5)	A(A)	0.37(0.55)
Gladstone/Kent (S)	C(B)	0.79(0.61)	NBT(EBT)	9.7(13.5)	C(B)	0.76(0.61)
Bank/Isabella/Chamberlain (S)	E(C)	0.91(0.79)	SBT(SBT)	16.7(17.7)	D(C)	0.82(0.76)
Catherine/Bronson (S)	F(F)	1.03(1.11)	WBL(WBL)	45.2(55.8)	E(E)	0.91(0.98)
Arlington/Lyon (U)	B(C)	13(18)	EB(WB)	2(2)	A(A)	-
Arlington/Bank (U)	C(C)	20(20)	EB(EB)	3(3)	A(A)	-

Note: Analysis of signalized intersections assumes a PHF of 0.9 and a saturation flow rate of 1800 veh/h/lane.
 (S) - Signalized intersection, movement with highest v/c ratio identified as critical movement.
 (U) - Unsignalized intersection, movement with highest average delay identified as critical movement.

As shown in **Table 26**, the signalized intersections ‘as a whole’ operate at a LOS ‘E’ or better during the morning and afternoon peak hours.

The Catherine/Bronson intersection had a critical westbound left-turn above capacity for both the AM and PM peak hour. Bronson Ave is a major north-south arterial road in the city, which moves large volumes of commuters from the downtown and from the east end who exit Highway 417 and proceed southbound on Bronson Ave. The resulting performance for the WBL movement was expected. That said, the WB approach queue was shown to be acceptable (further detail provided in **Section 4.9.3**). Considering the Catherine/Bronson intersection was only recently modified as part of the MTO bridge rehabilitation project, only signal timing optimizations should be completed - no further mitigation is recommended at this location.

Future Background 2036 Intersection Performance

The most critical of all background conditions between background 2026, 2031 and 2036 was chosen for analysis. The 2036 background accounts for a 0.5% annual growth rate and includes all adjacent developments plus the transit priority lane conversion along Catherine Street resulting in a reduction from three general travel lanes to two general travel lanes as part of the Catherine St Functional Design Plan.

The results from this scenario were compared with intersection performance results within the study area after the proposed development is added, in order to quantify the adjacent road network implications of the proposed development. **Table 27** below summarizes the intersection operational performance at study area intersections using Synchro analysis software for this scenario.

Table 27: Future Background 2036 Conditions Intersection Performance

Intersection	Weekday AM Peak (PM Peak)					
	Critical Movement			Intersection 'As a Whole'		
	LOS	max. v/c or avg. delay (s)	Movement	Delay (s)	LOS	v/c
Catherine/Lyon (S)	A(A)	0.34(0.50)	SBT(WBT)	14.6(17.9)	A(A)	0.33(0.49)
Catherine/Kent (S)	D(B)	0.83(0.61)	NBT(NBT)	55.9(25.4)	C(A)	0.75(0.55)
Bank/Catherine (S)	D(D)	0.89(0.89)	WBT(WBT)	26.6(29.1)	D(C)	0.85(0.78)
Catherine/Percy (S)	A(B)	0.42(0.69)	WBT(WBT)	9.7(14.6)	A(B)	0.34(0.62)
Arlington/Kent (S)	C(A)	0.73(0.49)	NBT(NBT)	60.7(55.5)	B(A)	0.69(0.45)
Gladstone/Lyon (S)	A(A)	0.36(0.53)	SBT(SBT)	12.5(14.9)	A(A)	0.33(0.50)
Gladstone/Kent (S)	C(B)	0.79(0.64)	NBT(NBT)	13.4(13.3)	C(A)	0.74(0.60)
Bank/Isabella/Chamberlain (S)	C(C)	0.76(0.79)	EBT(EBT)	17.3(18.2)	B(C)	0.65(0.72)
Catherine/Bronson (S)	E(E)	0.91(0.92)	SBT(WBL)	38.1(39.4)	D(E)	0.90(0.92)
Arlington/Lyon (U)	B(C)	13(17)	EB(WB)	2(2)	A(A)	-
Arlington/Bank (U)	C(C)	18(17)	EB(EB)	3(2)	A(A)	-

Note: Analysis of signalized intersections assumes a PHF of 1.0 and a saturation flow rate of 1800 veh/h/lane.
 (S) - Signalized intersection, movement with highest v/c ratio identified as critical movement.
 (U) - Unsignalized intersection, movement with highest average delay identified as critical movement.

As shown in **Table 27** intersections are projected to operate similarly to existing conditions. In general, intersections with roads connecting to Highway 417 and which received a 0.5% annual growth rate experienced a slight worsening in intersection performance, while other intersections a slight improvement due to increasing the PHF to 1.00 compared to existing PHF of 0.90 as per TIA Guidelines.

Total Projected 2026 Intersection Performance

Within this scenario, a new right-in-right-out (RIRO) access to the site has been added to Catherine Street approximately 50m west of Kent St. The Woonerf was not modelled as traffic volumes are expected to be very minimal and generally off-peak hours.

Table 28 below summarizes the intersection operational performance at study area intersections using Synchro analysis software for this scenario, based on total projected 2026 volumes in **Figure 17**.

Table 28: Total Projected 2026 Conditions Intersection Performance - Phase 1

Intersection	Weekday AM Peak (PM Peak)					
	Critical Movement			Intersection 'As a Whole'		
	LOS	max. v/c or avg. delay (s)	Movement	Delay (s)	LOS	v/c
Catherine/Lyon (S)	A(A)	0.32(0.42)	SBT(SBT)	8.7(14.1)	A(A)	0.28(0.39)
Catherine/Kent (S)	C(A)	0.75(0.59)	NBT(NBT)	22.9(15.2)	B(A)	0.70(0.54)
Bank/Catherine (S)	D(D)	0.84(0.86)	WBT(WBT)	25.6(28.5)	D(C)	0.84(0.78)
Catherine/Percy (S)	A(A)	0.25(0.52)	WBT(WBT)	7.4(10.5)	A(A)	0.25(0.47)
Arlington/Kent (S)	C(A)	0.71(0.46)	NBT(NBT)	15.6(7.3)	B(A)	0.67(0.42)
Gladstone/Lyon (S)	A(A)	0.35(0.52)	SBT(SBT)	12.4(14.6)	A(A)	0.32(0.49)
Gladstone/Kent (S)	C(B)	0.77(0.62)	NBT(NBT)	13.1(11.2)	C(A)	0.72(0.59)
Bank/Isabella/Chamberlain (S)	C(C)	0.75(0.73)	EBT(EBT)	17.0(16.9)	B(B)	0.64(0.70)
Catherine/Bronson (S)	D(D)	0.87(0.89)	WBL(WBL)	34.4(36.4)	D(D)	0.85(0.88)
Arlington/Lyon (U)	B(C)	13(16)	EB(WB)	2(2)	A(A)	-
Catherine/Site Access (U)	A(A)	10(10)	SB(SB)	1(0)	A(A)	-
Arlington/Bank (U)	C(C)	15(17)	EB(EB)	2(2)	A(A)	-

Note: Analysis of signalized intersections assumes a PHF of 1.0 and a saturation flow rate of 1800 veh/h/lane. Catherine/Bronson was optimized while keeping the same cycle length.
 (S) - Signalized intersection, movement with highest v/c ratio identified as critical movement.
 (U) - Unsignalized intersection, movement with highest average delay identified as critical movement.

As shown in **Table 28**, the intersections will continue to operate similar to, or in some instances better than, existing conditions. The site access intersection to Catherine St operates well.

Total Projected 2031 Intersection Performance

Within this scenario, a new full movement site access to Arlington Ave approximately 25m east of Lyon St has been added. Additionally, a general-purpose travel lane on Catherine St has been removed to a total of two general travel lanes to account for the Catherine St Functional Design Plan. As requested by city staff, a time separated east-west pedestrian phase was modelled. The crossing distance was measured at approximately 13m, and as such, a 13s pedestrian phase was modelled assuming 1m/s approach.

Table 29 below summarizes the intersection operational performance at study area intersections using Synchro analysis software for this scenario, based on total projected 2031 traffic volumes in **Figure 18**.

Table 29: Future Projected 2031 Intersection Performance - Phase 1 & 2

Intersection	Weekday AM Peak (PM Peak)					
	Critical Movement			Intersection 'As a Whole'		
	LOS	max. v/c or avg. delay (s)	Movement	Delay (s)	LOS	v/c
Catherine/Lyon (S)	A(A)	0.37(0.52)	WBT(WBT)	13.6(17.5)	A(A)	0.36(0.51)
Catherine/Kent (S)	D(B)	0.83(0.65)	NBT(NBT)	55.5(25.8)	C(A)	0.75(0.57)
Bank/Catherine (S)	E(E)	0.94(0.92)	WBT(WBT)	29.2(30.6)	D(D)	0.88(0.81)
Catherine/Percy (S)	A(B)	0.35(0.64)	WBT(WBT)	8.0(12.0)	A(A)	0.32(0.58)
Arlington/Kent (S)	C(A)	0.73(0.48)	NBT(NBT)	59.6(53.7)	B(A)	0.70(0.46)
Gladstone/Lyon (S)	A(A)	0.36(0.54)	SBT(SBT)	12.5(14.9)	A(A)	0.33(0.51)
Gladstone/Kent (S)	C(B)	0.78(0.64)	NBT(NBT)	13.3(13.5)	C(A)	0.73(0.60)
Bank/Isabella/Chamberlain (S)	C(C)	0.76(0.76)	EBT(EBT)	17.3(17.8)	B(C)	0.66(0.73)
Catherine/Bronson (S)	D(E)	0.88(0.91)	WBL(WBL)	35.9(37.9)	D(D)	0.87(0.90)
Arlington/Lyon (U)	B(C)	13(16)	EB(WB)	2(2)	A(A)	-
Catherine/Site Access (U)	A(A)	9(9)	SB(SB)	1(0)	A(A)	-
Arlington/Site Access (U)	A(A)	9(9)	NB(NB)	4(3)	A(A)	-
Arlington/Bank (U)	C(C)	17(19)	EB(EB)	3(3)	A(A)	-
Note: Analysis of signalized intersections assumes a PHF of 1.0 and a saturation flow rate of 1800 veh/h/lane. Catherine/Bronson was optimized while keeping the same cycle length. (S) - Signalized intersection, movement with highest v/c ratio identified as critical movement. (U) - Unsignalized intersection, movement with highest average delay identified as critical movement.						

As shown in **Table 29**, the study area intersections will continue to operate similar to, or in some instances better than, existing conditions. All the site accesses operate well.

Total Projected 2036 Intersection Performance

Total projected 2036 model assumes the same road geometries as total projected 2031 scenario. The main difference in this scenario is that a 0.5% annual growth rate has been applied to background traffic volumes for an additional 5 years, which represents a conservative scenario (as previously discussed in **Section 3.3**).

Table 30 below summarizes the intersection operational performance at study area intersections using Synchro analysis software for this scenario, based on total projected 2036 traffic volumes in **Figure 19**.

Table 30: Future Projected 2036 Intersection Performance - Phase 1 & 2

Intersection	Weekday AM Peak (PM Peak)					
	Critical Movement			Intersection 'As a Whole'		
	LOS	max. v/c or avg. delay (s)	Movement	Delay (s)	LOS	v/c
Catherine/Lyon (S)	A(A)	0.38(0.53)	WBT(WBT)	19.4(17.8)	A(A)	0.37(0.52)
Catherine/Kent (S)	C(B)	0.80(0.66)	NBT(NBT)	22.0(27.2)	C(A)	0.74(0.58)
Bank/Catherine (S)	D(E)	0.90(0.93)	WBT(WBT)	28.1(31.2)	D(D)	0.87(0.81)
Catherine/Percy (S)	A(B)	0.36(0.65)	WBT(WBT)	8.0(12.1)	A(A)	0.32(0.59)
Arlington/Kent (S)	C(A)	0.73(0.49)	NBT(NBT)	25.3(53.9)	B(A)	0.70(0.47)
Gladstone/Lyon (S)	A(A)	0.37(0.54)	SBT(SBT)	12.5(15.1)	A(A)	0.34(0.51)
Gladstone/Kent (S)	C(B)	0.79(0.63)	NBT(NBT)	17.2(13.8)	C(A)	0.74(0.60)
Bank/Isabella/Chamberlain (S)	C(C)	0.78(0.75)	EBT(EBT)	17.7(17.6)	B(C)	0.68(0.73)
Catherine/Bronson (S)	D(E)	0.82(0.93)	SBT(WBL)	31.8(39.8)	C(E)	0.80(0.92)
Arlington/Lyon (U)	B(C)	13(16)	EB(WB)	2(2)	A(A)	-
Catherine/Site Access (U)	A(A)	9(9)	SB(SB)	1(0)	A(A)	-
Arlington/Site Access (U)	A(A)	9(9)	NB(NB)	4(3)	A(A)	-
Arlington/Bank (U)	C(C)	16(19)	EB(EB)	3(3)	A(A)	-

Note: Analysis of signalized intersections assumes a PHF of 1.0 and a saturation flow rate of 1800 veh/h/lane. Catherine/Bronson was optimized while keeping the same cycle length.
(S) - Signalized intersection, movement with highest v/c ratio identified as critical movement.
(U) - Unsignalized intersection, movement with highest average delay identified as critical movement.

Even with 5 years of additional background growth, the full buildout volumes plus 2036 background volumes continue to operate well. All intersections as a whole and associated critical movements operate within City of Ottawa standards with a v/c below 1.00.

Queueing Implications on Catherine Street

SimTraffic and Synchro softwares were used to determine queueing and the risk of spillback on study area intersections. Within the simulation parameters, the westbound right-turn at the Bank/Catherine intersection was treated as a defacto turn-lane to model a more realistic flow in the SimTraffic model. **Table 31** summarizes sensitive locations for queueing, predominantly on Catherine St which is proposed to have future exclusive transit lanes. Detailed SimTraffic output results have been provided in **Appendix J**.

Table 31: Queueing Analysis for Sensitive Intersection Movements (2036 Projected)

Intersection - Movement	Available Storage (m)	Synchro Forecasted Queues AM (PM) (m)		SimTraffic Forecasted Queues AM (PM) (m)	
		50th Percentile	95th Percentile	50th Percentile	95th Percentile
Bank/Catherine - WB ¹	210m	48(52)	#72(#77)	91(104)	141(185)
Kent/Catherine - WBR	130m	44(24)	m54(m28)	42(24)	62(39)
Kent/Catherine - WBT		32(55)	m39(m64)	32(43)	47(58)
Lyon/Catherine - WBL	160m	30(55)	m43(73)	48(35)	70(63)
Lyon/Catherine - WBT				30(24)	49(45)
Percy/Catherine - WB ¹	275m	6(25)	12(39)	19(41)	35(66)
Bronson/Catherine - WB ¹	120, 250m*	75(91)	#125(#157)	72(73)	110(100)

- 95th percentile volume exceeds capacity; queue may be longer; m - volume for 95th percentile queue is metered by upstream signal. * - 120m to terminus of 417 off-ramp and 250m to Percy St. 1. The longest westbound movement queue was used.

As shown in **Table 31**, all forecasted vehicle queues within the Catherine St corridor are contained to their respective road segments without spilling back to the upstream signalized intersection.

The Catherine St Functional Design Study proposes converting a general-purpose travel lane to a transit priority lane along Catherine St between Kent St and Bronson St. The proposed development is not anticipated to impact the design of the future transit lane.

As shown in **Table 31**, vehicle queues on Lyon/Catherine westbound do not exceed 70m in the WBL lane and 50m in the WBT lane, which suggests the risk of buses being blocked from entering the transit priority lane in the future is low. Furthermore, the signal timing plans between Kent St and Lyon St may be optimized to ensure the vehicle queue is “flushed” out prior to the arrival of oncoming vehicles if needed.

The corridor performance along Catherine St in the 2036 horizon (provided in **Table 30**) does not suggest there will be any notable operational implications to transit operations and travel times with the development proposal. The transit priority lane is expected to ensure buses can move efficiently through the corridor unencumbered.

MMLOS Analysis for Signalized Intersections

As per requirements of the TIA Guidelines, MMLOS analysis was conducted for signalized intersections within the study area. Since the Catherine St Functional Design Plan will result in future modifications at study area intersections, analysis was conducted for each of existing and future conditions.

Similar to boundary street MMLOS analysis, the signalized intersection MMLOS analysis is conducted for four different travel modes, including pedestrian, cyclist, transit, and trucks. For each travel mode, the minimum desirable LOS target is obtained from the City of Ottawa TIA Guidelines. A summary of the analysis results and respective minimum desirable LOS targets are provided in **Table 32**, with the detailed analysis provided in **Appendix K**.

Table 32: MMLOS Analysis, Signalized Intersection

Intersection	Level of Service							
	Pedestrian (PLOS)		Bicycle (BLOS)		Transit (TLOS)		Truck (TkLOS)	
	PLOS	Target	BLOS	Target	TLOS ₁	Target	TkLOS	Target
Catherine/Kent	C, C*	A	F	D	D	- (D)	D	D
Catherine/Lyon	C, C*	A	F	C	C	- (D)	D	D
Arlington/Kent	D	A	E	D, (C)	-	-	-	-
Bank/Catherine	C, C*	A	E	D, (B)	F	D	B	D
Gladstone/Lyon	C	C	A	C	C	D	F	-
Gladstone/Kent	C	A	F	D, (C)	D	D	D	D
Catherine/Percy	D, D*	C	E, F*	C	C	- (D)	D	D
Catherine/Bronson	E, E*	C	E	D	F	- (D)	D	D
Bank/Isabella/Chamberlain	D, D*	A	E, D*	D, (B)	E	D	D, B*	D

*Result based on Catherine St Functional Design Plan; (xx) = future target when it differs from existing target 1. TLOS was evaluated based on 2036 full buildout operations only.

Red font in the table above indicates that the desirable target LOS is not achieved.

- With regards to pedestrian LOS, the results are largely based on the number of lanes that pedestrians have to cross, followed by the degree of comfort and safety that pedestrians feel while crossing. This includes factors such as the amount of interference with crossing pedestrians due to permissible vehicle left-turns and right-turns.
- With regards to bicycle LOS, the target LOS was only met at Gladstone/Lyon and future Bank/Isabella intersections. Other intersections failed to meet the bicycle LOS target due to the lack of cycling facilities at the intersection or turning movement facilities at the approaches such as two-stage left-turn boxes.
- With regards to transit LOS, the target LOS is achieved at most intersections with the exception of Bank/Catherine, Bank/Isabella, and Catherine/Bronson due to the bus movement approaches exceeding 30 second delays. Buses operate in mixed traffic at various locations, so they experience the same level of delay as general traffic at the intersection. Adjusting the signal timing and phasing of the intersections to provide more dedicated green time to the approaches used by busses may help reduce the traffic delays.
- With regards to truck LOS, all locations with a target goal were met.

5.0 FINDINGS, CONCLUSIONS AND RECOMMENDATIONS

Based on the results summarized herein, the following transportation related conclusions are offered:

Existing Conditions

- The site is located at the former Greyhound Bus Station (currently not in operation).
- Nearby Bank St and Gladstone Ave are designated transit priority corridors with isolated measures within the 2031 Affordable Network in the TMP.
- Overall, there were 427 collisions recorded in five years within the study area. Kent/Catherine showed to have higher than average likeliness of collisions, but most resulted in property damage only. Bank/Catherine intersection broadcasted a disproportionate number of collisions with pedestrians and cyclists compared to other study intersections. Bank St being an arterial mainstreet which attracts active users is recommended to be retrofitted to include Protected Intersection Design Guide measures to priority the safety of vulnerable users.
- The site is currently accessed by three right-in right-out driveways to/from Catherine St.
- Existing intersections operate at acceptable overall LoS 'E' or better. The intersection of Catherine/Bronson has critical movements at capacity during the weekday peak hours for the westbound left-turn.

Proposed Development

- A two phased development is proposed, with the first phase of development occurring on the east half of the site.
- The proposed development will comprise of approximately 1,157 residential apartment units and 28,557 ft² of ground floor commercial/retail within three towers and podiums ranging from 32 to 36-storeys high, along with 7 townhome units.
- The proposed development is projected to generate approximately 113 to 137 'new' transit trips during the AM and PM peak hour periods, which can be accommodated by various routes operating near to the site. Local route 50 operates on Catherine St adjacent to the site. Frequent routes 6 and 7 operate on Bank St and frequent route 14 operates on Gladstone Ave. An ongoing study is determining the feasibility of adding exclusive transit lanes on Catherine St.
- A total of 545 parking spaces are proposed which is lower than the city's minimum parking requirements for this location, triggering a parking variance. The development has proposed strong TDM measures and excess bike parking spaces to promote alternate modes of transportation and reduce the reliance on vehicles for this site. In the event of spillover, on-street parking is available, which would help promote slower driving speeds as a traffic calming measure. The minimum requirements for visitor and commercial parking were met.
- The developer proposes 1,201 bike parking spaces, with the majority located on the first level in the underground parking garage. A few bike parking spaces are proposed outdoor near the commercial uses. The proposed number of bike parking are provided at a ratio of at least 1:1 per residential unit.
- An extensive list of TDM measures have been proposed for this development to support a parking variance to provide fewer spaces than the By-Law requirement, as well as support the Official Plan policies to encourage sustainable modes of transportation in the Downtown Transect. Refer to **Section 4.5** or **Appendix F** for further details.
- The proposed development is projected to generate 'new' vehicle volumes up to approximately 228 veh/h two-way total during the weekday morning and afternoon peak hours.

- Access to the underground parking lot will be provided via two accesses, where one access will be located along Catherine St and will be constructed as part of Phase 1, and the other access will be located along Arlington Ave and constructed at full buildout. Two access points to the parking garage ensure efficient access for residents and spread of vehicle traffic to the site. This prevents excess traffic infiltration on adjacent streets (increasing pedestrian and cycling conflicts at intersections) with only one access point, due to the one-way operation of the three frontage streets to the subject site.
- A one-way southbound woonerf is proposed connecting Arlington Ave and Catherine St. This woonerf was added to allow garbage pick-up and delivery drop off internal to the site as dictated in various policies for the City of Ottawa. The risk of short-cutting by general traffic is expected to be very low due to lower traffic volumes on Arlington Ave and limited route options with Catherine St being one-way westbound. Materials, landscaping, furniture and fixtures were carefully chosen to dissuade drivers as well as promote an enhanced environment for pedestrians. The woonerf will allow delivery activities such as mail drop off and other short-term stay activities, as well as provide an accessible passenger loading zone for paratransit vehicles near the south end.
- The separation distance between the woonerf access and the adjacent parking garage access off Catherine St does not adhere to the Private Approach By-law. However, considering the very low anticipated volume, predominantly off-peak, combined with the one-way operations of Catherine St, the proposed separation distance was deemed appropriate given the context.
- Due to difficulties in providing an internal loading bay for Tower 3, a loading layby has been proposed on Lyon St for any commercial uses relating to Phase 2. Given that Lyon St is a one-way traffic calmed street with wide pavement width and loading operations expected to be infrequent and during off-peak hours, the layby was considered acceptable.
- On-street parking availability around the site provide opportunity for pick-up and drop-off activities to the site. Parking is available along the east side of Kent St and will be provided along the south side of Arlington Ave as part of the proposed development. The future transit lane along Catherine St will also permit short-term parking on the west half of the site during off-peak hours.

Future Conditions

- Other nearby developments applied a 0.5% annual growth rate to existing volumes on arterials connecting to Highway 417 to estimate future background conditions. The furthest horizon, 2036 background conditions showed overall intersection performance of all study area intersections was LoS 'E' or better and with critical movement of 'E' or better which is similar to existing.
- The MMLOS road segment analysis shows that existing and future conditions on boundary streets do not meet MMLOS area targets for pedestrians due the pedestrian infrastructure and high vehicular volumes, coupled with aggressive targets due to the proximity to a school. However, there are notable improvements proposed to the pedestrian realm as part of the development, such as wide boulevards and sidewalks. The bike targets were only met at Lyon St and Arlington Ave due to the number of travel lanes. There is only a transit route on Catherine St. Transit goals are not met for existing conditions due to mixed traffic but meet the target in future conditions if a segregated bus lane is built. Truck targets were all met.
- The MMLOS intersection analysis shows that truck target goals are met at all intersections. Given the higher-operating speeds and number of travel lanes, or high target rate due to proximity to a school, it is not possible to meet pedestrian target goals with the exception of Gladstone/Lyon. The bicycle target goals were also not met at most locations given the lack of cycling facilities on all approaches, the quantity of lanes required to be crossed and the higher operating speeds. Only Gladstone/Lyon met the bike targets and future Bank/Isabella. The transit TLoS was met at most intersections with the exception of Bank/Catherine, Bank/Isabella, and Catherine/Bronson due to delays greater than 30 seconds.

- Future Phase 1 conditions with the addition of pedestrians, cyclists, transit users and site vehicle traffic performed at acceptable levels of service with respect to v/c and delay resulting in overall LoS 'D' or better and with critical movement of 'D' or better.
- Future full buildout conditions with the addition of pedestrians, cyclists, transit users and site vehicle traffic performed at acceptable levels of service with respect to v/c and delay resulting in overall LoS 'D' or better and with critical movement of 'E' or better.
- The section of Arlington Ave between Kent St and Bank St experiences higher levels of vehicle traffic than the city local road threshold, which is likely triggered by short-cut traffic to/from Kent St (predominantly the Hwy 417 off-ramp) and Bank St. While site generated traffic is expected to contribute to this section, it will be to a much smaller proportion compared to existing/background traffic. It is also important to reiterate that the Arlington Ave corridor is already traffic calmed, including speed humps. That said, the development proposal introduces four new bulb-outs at the two proposed access points that will narrow the road from existing 10m to 7m minimum, which reinforces the traffic calmed environment. The city Neighbourhood Traffic Calming Branch may consider investigating this section of Arlington Ave if future concerns are raised and validated through the established city process.
- The City of Ottawa has completed a study to convert a general-purpose travel lane to a peak hour transit priority lane on Catherine St, starting at Kent St and extending west to Bronson Ave. The proposed development is not anticipated to impact the design of the future transit lane. Synchro and SimTraffic simulation determined that WB queue lengths on Catherine St would not block buses from entering the bus lane. If needed, the city can also consider optimizing signal timing plans of the Lyon St and Kent St intersections on Catherine St to ensure vehicles are "flushed" out prior to the arrival of oncoming vehicles.
- The corridor performance along Catherine St in the 2036 horizon does not suggest there will be any notable operational implications to transit operations and travel times with the development proposal. The transit priority lane is expected to ensure buses can move efficiently through the corridor unencumbered.

Based on the foregoing findings, the proposed development located at 265 Catherine St is recommended from a transportation perspective.

Prepared By:



Basel Ansari, P. Eng.
Transportation Engineers

Reviewed By:



Austin Shih, M.A.Sc., P.Eng.
Senior Transportation Engineer

Appendix A:

Screening Form & City Comment Responses

City of Ottawa 2017 TIA Guidelines

Date

03-Sep-24

TIA Screening Form

Project

265 Catherine TIA

Project Number

478038-01000

Results of Screening	Yes/No
Development Satisfies the Trip Generation Trigger	Yes
Development Satisfies the Location Trigger	No
Development Satisfies the Safety Trigger	Yes

Module 1.1 - Description of Proposed Development	
Municipal Address	265 Catherine St
Description of location	At Greyhound Station, borders Kent, Catherine, Lyon, Arlington
Land Use	Residential apartment building
Development Size	1164 units, two towers, townhomes
Number of Accesses and Locations	Two on Catherine, two on Arlington
Development Phasing	Two phases
Buildout Year	Assumed 2031
Sketch Plan / Site Plan	See attached

Module 1.2 - Trip Generation Trigger		
Land Use Type	Townhomes or Apartments	
Development Size	1164	Units
Trip Generation Trigger Met?	Yes	

Module 1.3 - Location Triggers	
Development Proposes a new driveway to a boundary street that is designated as part of the City's Transit Priority, Rapid Transit, or Spine Bicycle Networks (See Sheet 3)	No
Development is in a Design Priority Area (DPA) or Transit-oriented Development (TOD) zone. (See Sheet 3)	No
Location Trigger Met?	No

Module 1.4 - Safety Triggers		
Posted Speed Limit on any boundary road	<80	km/h
Horizontal / Vertical Curvature on a boundary street limits sight lines at a proposed driveway	No	
A proposed driveway is within the area of influence of an adjacent traffic signal or roundabout (i.e. within 300 m of intersection in rural conditions, or within 150 m of intersection in urban/ suburban conditions) or within auxiliary lanes of an intersection;	Yes	
A proposed driveway makes use of an existing median break that serves an existing site	No	
There is a documented history of traffic operations or safety concerns on the boundary streets within 500 m of the development	Yes	
The development includes a drive-thru facility	No	
Safety Trigger Met?	Yes	



Date	No.	Description
2024-03-15	Zoning By-Law Amendment & Site Plan Approval (Resubmission)	
2023-05-15	Zoning By-Law Amendment & Site Plan Approval	

ISSUE RECORD

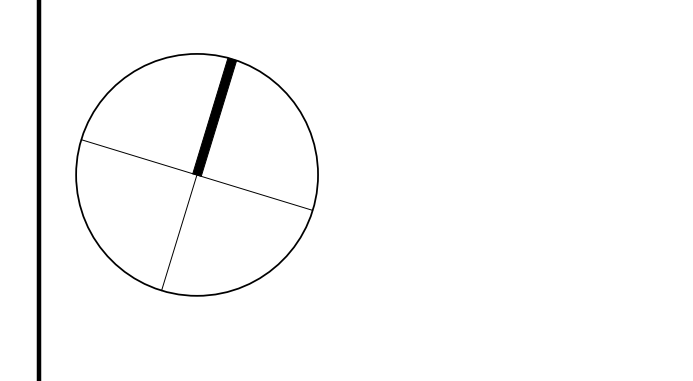

BDP. Quadrangle

Quadrangle Architects Limited
 1415 Spadina Avenue, Suite 2100, Toronto, ON M5S 2E8
 416-598-1200 www.quadrangle.com

265 Catherine Street, Ottawa
 265 Catherine Street, Ottawa

for
 Brilg
 DWG198911 - 001-13-23-0017-SPC / 002-02-23-0042-28A / 201-01-23-0008-DMA

21007 1:150 GZ R/L
 PROJECT SCALE DRAWN REVIEWED

Ground Floor Plan

A200.S

1 Ground Floor Plan

2024-03-15 10:00 AM

10 September 2024

City of Ottawa
Development Review Services
110 Laurier Avenue West
Ottawa, ON K1P 1J1

Attention: Wally Dubyk

Dear Wally:

Re: 265 Catherine Street TIA
Step 5 SPC Submission – Response to City Comments

The following response has been prepared in response to City of Ottawa TIA Report comments received on July 29, 2024. City comments are presented in black with the corresponding responses from Parsons in **Green**.

General Comments

1. Catherine Street is designated as an Arterial Road within the City's Official Plan with a ROW protection limit of 23.0 metres. The ROW protection limit and the offset distance (11.5 metres) are to be dimensioned from the existing centerline of pavement and shown on the drawings. The Certified Ontario Land Surveyor is to confirm the ROW protected limits and any portion that may fall within the private property to be conveyed to the City.

Site Plan illustrates the ROW protection measurements as indicated.

2. ROW interpretation – Land for a road widening will be taken equally from both sides of a road, measured from the centreline in existence at the time of the widening if required by the city. The centreline is a line running down the middle of a road surface, equidistant from both edges of the pavement. In determining the centreline, paved shoulders, bus lay-bys, auxiliary lanes, turning lanes and other special circumstances are not included in the road surface.

Site Plan illustrates the ROW protection measurements as indicated.

3. Kent Street is designated as an Arterial Road within the City's Official Plan with a ROW protection limit of 20.0 metres. Maximum land requirement from property abutting existing ROW (0.90 m). Subject to widening/easement policy. The ROW protection limit is to be dimensioned on the drawings. The Certified Ontario Land Surveyor is to confirm the ROW protected limits and any portion that may fall within the private property to be conveyed to the City. Ensure that the development proposal complies with the Right-of-Way protection requirements of the Official Plan's Schedule C16.

Site Plan illustrates the ROW protection measurements as indicated. Development proposal complies with the ROW protection requirements of the Official Plan's Schedule C16.

4. Lyon Street is designated as an Arterial Road within the City's Official Plan with a ROW protection limit of 20.0 metres. Maximum land requirement from property abutting existing ROW (0.90 m). Subject to widening/easement policy. The ROW protection limit is to be dimensioned on the drawings. The Certified Ontario Land Surveyor is to confirm the ROW protected limits and any portion that may fall within the private property to be conveyed to the City. Ensure that the development proposal complies with the Right-of-Way protection requirements of the Official Plan's Schedule C16.

Site Plan illustrates the ROW protection measurements as indicated. Development proposal complies with the ROW protection requirements of the Official Plan's Schedule C16.

5. A 5.0 metres x 5.0 metres sight triangle would be required at the intersection of Kent Street Arlington Avenue. The sight triangle area is to be conveyed to the city and is to be shown on all drawings. The sight triangle dimensions are to be measured from the ROW protected limits.

As indicated in previous responses and discussions with City staff, a 3x3m sight triangle was provided considered acceptable by City staff considering the provision of a public park at this corner.

6. A 5.0 metres x 5.0 metres sight triangle would be required at the intersection of Lyon Street and Catherine Street. The sight triangle area is to be conveyed to the city and is to be shown on all drawings. The sight triangle dimensions are to be measured from the ROW protected limits.

The 5m x 5m sight triangle has been provided.

Transportation Engineering

Prior Comments:

7. Note that the comment numbers below refer to the numbering in the 'Parsons Step 5 Submission #2 – Response to Comments' memo dated 2024-05-23.

Noted.

8. Comment 10: The previous comment on the catch basin in the northeast corner of the Catherine Street / Lyon Street does not appear to be resolved in the latest site plan, as the inlet catch basin is located within the taper from the required depressed curb at the east crosswalk. Catch basin type and location should continue to be examined for feasibility. This comment may be resolved as part of roadway modification approval and detail design.

Noted, to be addressed as part of RMA.

Additional Road Modification Comments (to be resolved as part of RMA submissions):

General:

9. As noted in previous circulations, the proposed road modifications on Catherine Street, Lyon Street, and Arlington Avenue will require Roadway Modification Approval (RMA). The proponent must provide RMA report figures, functional design drawings, and a cost estimate for the proposed works. Refer to Step 5 and Appendix D of the 2017 TIA Guidelines.

Noted. RMA package to be provided to the City as part of the SPC application.

10. Confirm if utilities will be buried. If maintained overhead, maintain a 2m min. clear zone within sidewalks between poles and edge of sidewalks.

Utilities to be buried along Catherine Street only. A 2m min. clear zone to be maintained in RMA.

11. Show opposing side of all streets and resulting road width dimensions.

To be addressed as part of RMA.

Catherine Street:

12. Label 2m minimum clear width within sidewalk, on City ROW, between bus shelter and property line on Catherine Street.

To be addressed as part of RMA.

13. At the start of the bus lane:
 - a. Recommend a more gradual taper to mimic the movement of a bus entering the lane to service the stop.
 - b. Consider expanding the proposed planter to mirror the curb's taper, while maintaining 1.8m of space between the planter and the curb for pedestrians to circulate between the bus stop and the west crosswalk of the Catherine Street / Kent Street intersection (refer to markup below).
 - c. Reconsider the 'Unit Paver Type 2' surface in the boulevard in front of the main residential entrance of Building A. The proposed unit paver material choice may visually encourage illegal stopping for pick-up and drop-off activities at this location. Consider concrete as a visual extension of the bus stop.

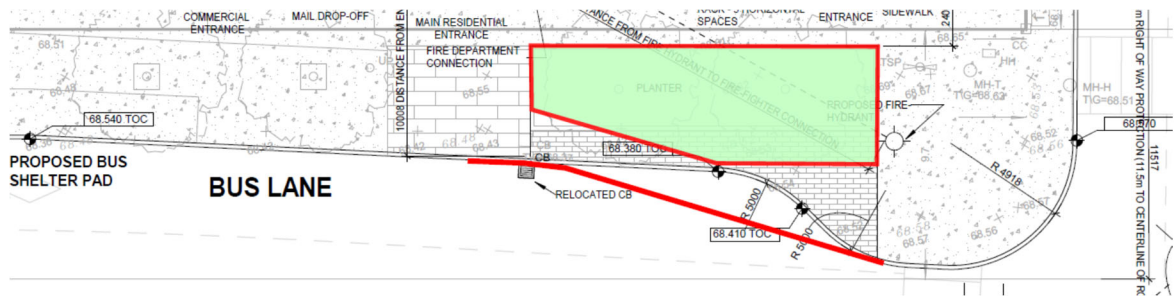

Gradual taper implemented in latest Site Plan.

Arlington Avenue:

14. Confirm/label size of curb extensions and resulting road width on Arlington Avenue as the north side is not shown.

To be addressed as part of RMA.

15. Preserve space for future sidewalk widening on north side of Arlington to 2.0m, widened away from property line, and an 8.5m road width, measured from the existing southern curb line.

To be addressed as part of RMA.

16. To achieve the future road design as described in #6, ensure that the parking bays are not sized too large, and that turning movements will work with a future road width of 8.5m, measured from the existing southern curb line. A 3.0m parking bay is currently shown, which is too wide for future two-way traffic operation if/when north curb line is moved south, and the road is standardized to an 8.5m road width. Recommend:
 - a. Maintaining the existing southern curb line at the parking bays.
 - b. Sizing the road narrowings to provide 2.5-metre-wide parking bays.

To be addressed as part of RMA.

17. Mid-block curb extensions must maintain 6m min. throat width and wider at intersections as needed to accommodate HSUs, assuming this future narrower road.

To be addressed as part of RMA.

18. Show reinstatement or maintenance of existing traffic calming measures (speed humps). If existing speed humps are within the proposed accesses, they will need to be relocated.

To be addressed as part of RMA.

Kent Street

19. Label proposed sidewalk and road widths on Kent Street.

To be addressed as part of RMA.

20. Confirm intent to slightly modify curb location on Kent Street. Clarify rationale for maintaining a wider road width on Kent near Catherine Street than near Arlington Avenue.

Curbs shown on Site Plan match the City's proposed functional design of Catherine Street.

21. Recommend sharing the design of Catherine Street / Kent Street with the MTO for review.

Noted.

Lyon Street:

22. Confirm/label proposed sidewalk, curb extension and road widths.

To be addressed as part of RMA.

23. Share design of Catherine Street / Lyon Street with the MTO for review.

Noted.

24. Confirm width of Lyon Street preserves space for future sidewalk widening on west side of Lyon Street to 2.0m, widened away from property line.

To be addressed as part of RMA.

Streetlighting

25. City of Ottawa street light asset located within the bounds of the construction site on Hydro poles. Light calculations will be required and possible lighting design will be required for geometry changes on Lyon St for the Temp Lay/By Parking/Loading. Currently the street lights are located on Hydro poles, if any of the Hydro poles are being relocated or removed, street light calcs and design will be required for those sections of the roadway. If conflict arises please contact Ryan Zaichkowsky (ryan.zaichkowsky@ottawa.ca) The applicant is 100% responsible for all costs of any required street light plant alterations and/or repairs. Repairs or alterations to the exiting street light plant must be performed by the city's street light maintenance contractor.

Noted. Proponent notified and comment to be addressed as part of RMA.

Road Safety

26. Ensure sightlines are sufficient at the site accesses.

Noted. Trees or landscape planted near site accesses will be either minor shrubs or large canopy trees where sightlines will be protected below the canopies, as confirmed by the site's Landscape Architect.

Appendix B:

Transit Route Maps



6

ROCKCLIFFE GREENBORO

Fréquent

7 days a week / 7 jours par semaine

All day service

Service toute la journée

ROCKCLIFFE

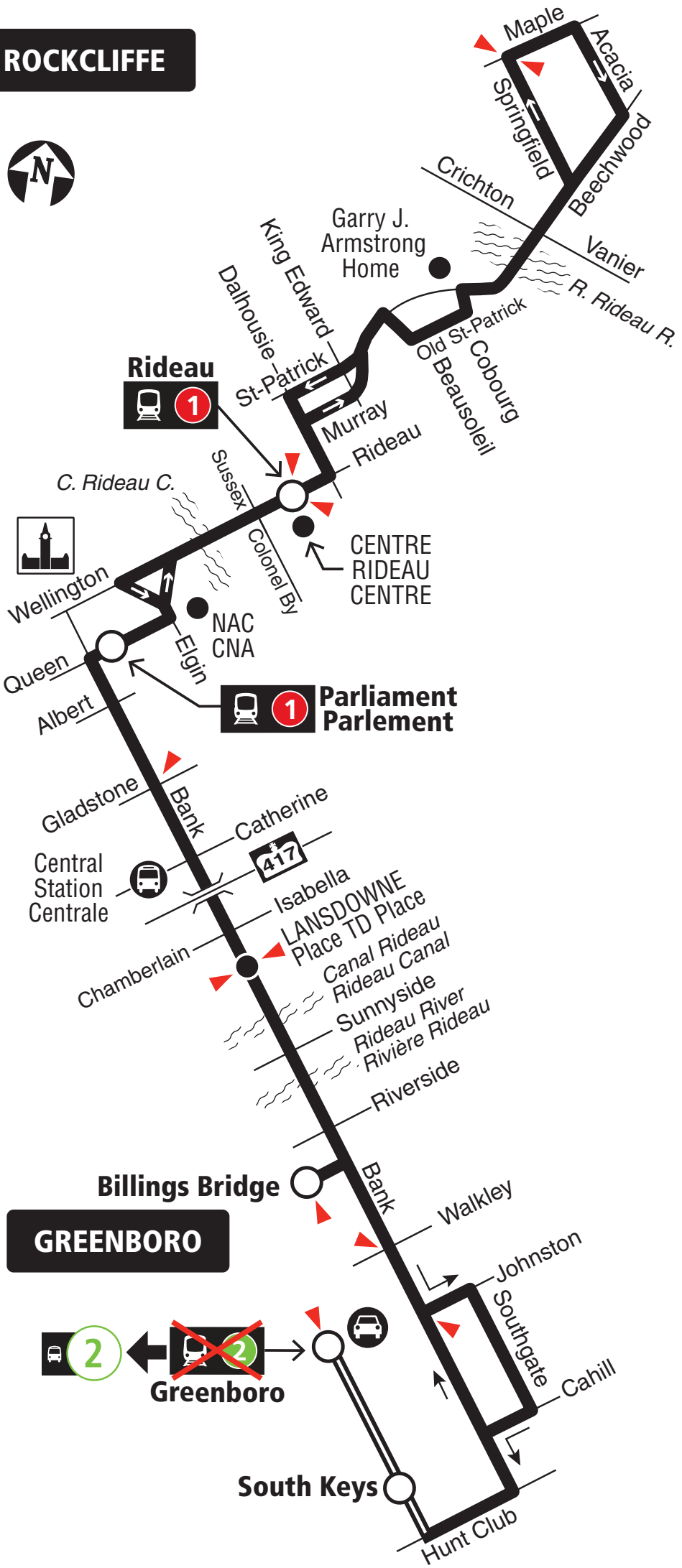

Transitway & Station



Park & Ride / Parc-o-Bus



Timepoint / Heures de passage

2023/09

2023.09



Schedule / Horaire 613-560-1000

Text / Texto* 560560

plus your four digit bus stop number / plus votre numéro d'arrêt à quatre chiffres

*Standard message rates may apply / Les tarifs réguliers de messagerie texte peuvent s'appliquer

Customer Service

Service à la clientèle **613-560-5000**

Lost and Found / Objets perdus **613-563-4011**

Security / Sécurité **613-741-2478**

Effective Fall 2020

En vigueur automne 2020



INFO 613-560-5000
octranspo.com



7

CARLETON ST-LAURENT

Fréquent

7 days a week / 7 jours par semaine

All day service

Service toute la journée

BRITTANY

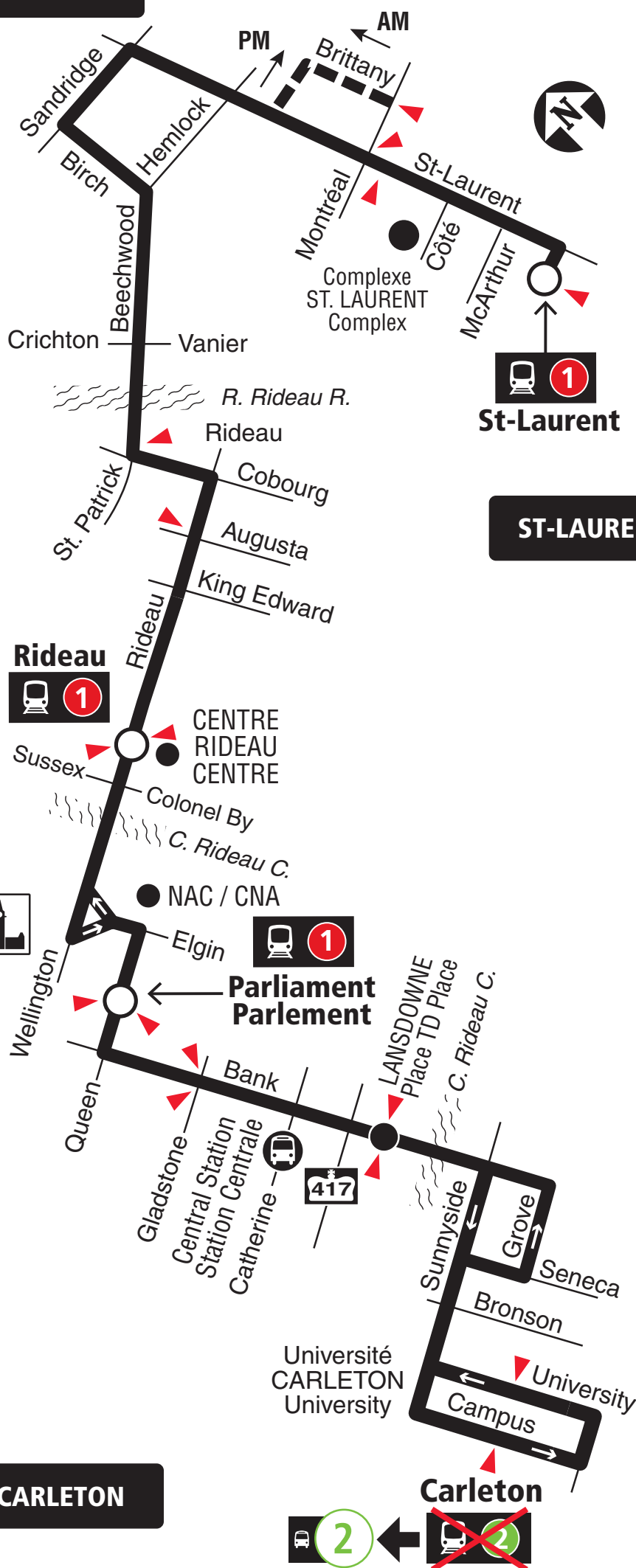

ST-LAURENT

CARLETON

- Station
- Peak periods only / Périodes de pointe seulement
- Timepoint / Heures de passage

2020.08



Schedule / Horaire 613-560-1000

Text / Texto* 560560

plus your four digit bus stop number / plus votre numéro d'arrêt à quatre chiffres

*Standard message rates may apply / Les tarifs réguliers de messagerie texte peuvent s'appliquer

Customer Service / Service à la clientèle **613-560-5000**

Lost and Found / Objets perdus **613-563-4011**

Security / Sécurité **613-741-2478**

Effective Fall 2020

En vigueur automne 2020



INFO 613-560-5000
octranspo.com



14

ST-LAURENT TUNNEY'S PASTURE

Fréquent

7 days a week / 7 jours par semaine

All day service

Service toute la journée

ST-LAURENT

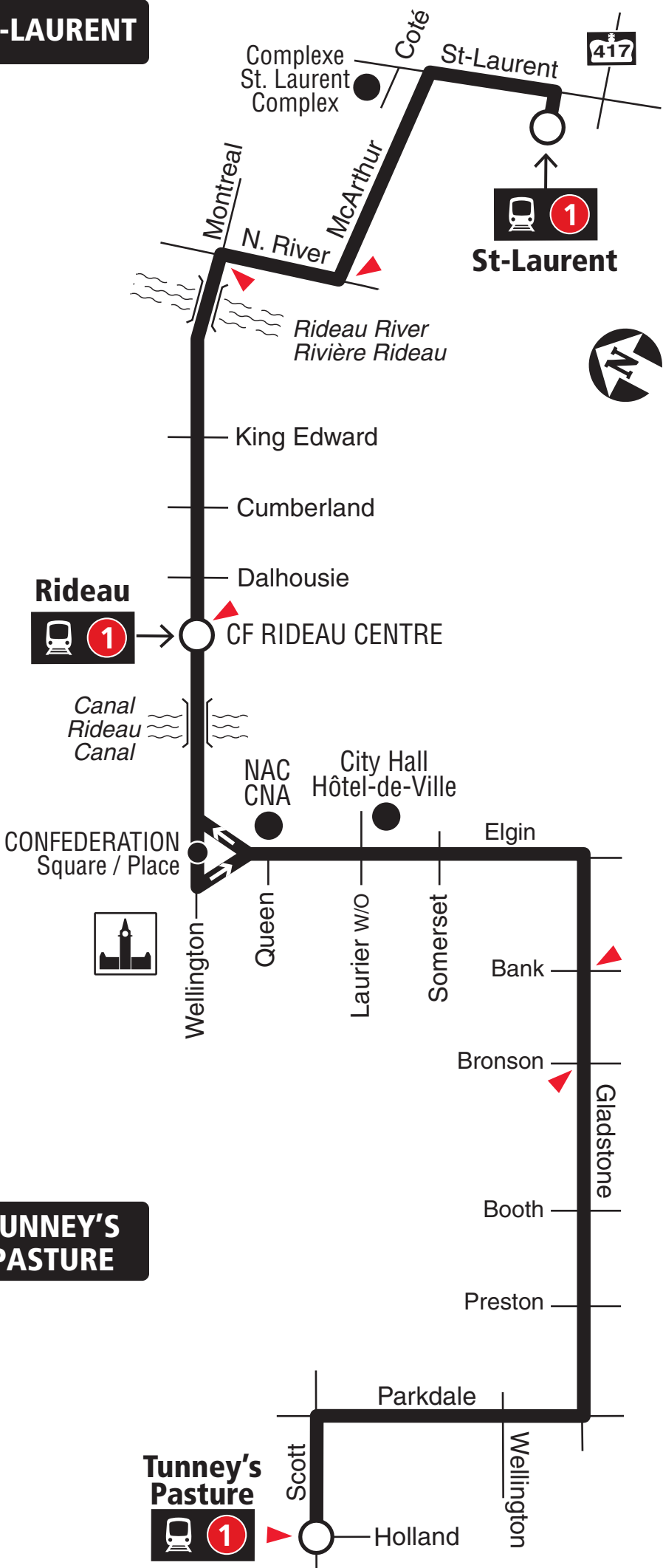

TUNNEY'S PASTURE



Station



Timepoint / Heures de passage

2020.09



Schedule / Horaire.....613-560-1000

Text / Texto560560

plus your four digit bus stop number / plus votre numéro d'arrêt à quatre chiffres

Customer Service

Service à la clientèle **613-741-4390**

Lost and Found / Objets perdus..... **613-563-4011**

Security / Sécurité **613-741-2478**

Fall 2020

Automne 2020



INFO 613-741-4390
octranspo.com



55

ELMVALE WESTGATE

Local

7 days a week / 7 jours par semaine

ELMVALE

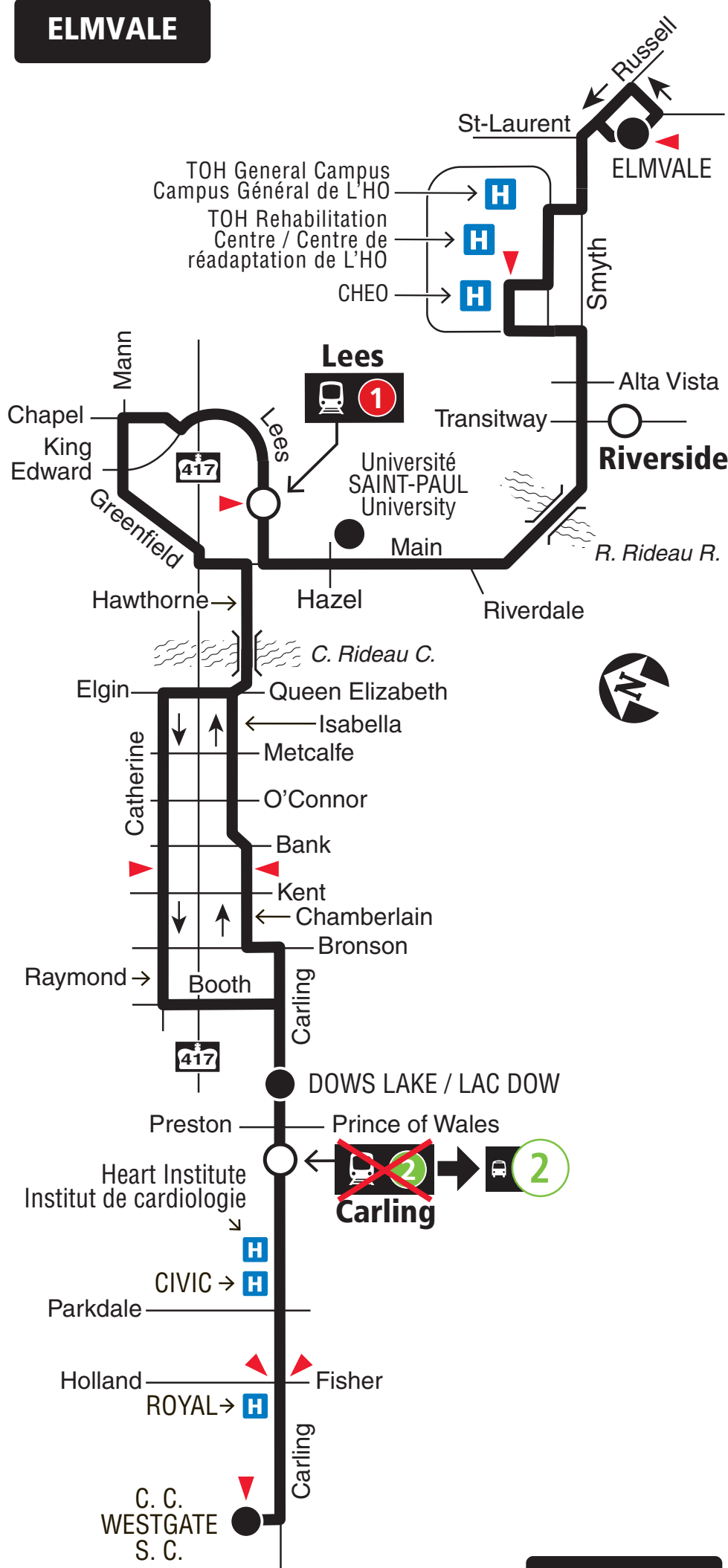

WESTGATE



Stations



Timepoint / Heures de passage

2021.06



Schedule / Horaire 613-560-1000

Text / Texto* 560560

plus your four digit bus stop number / plus votre numéro d'arrêt à quatre chiffres

*Standard message rates may apply / Les tarifs réguliers de messagerie texte peuvent s'appliquer

Customer Service

Service à la clientèle **613-741-4390**

Lost and Found / Objets perdus..... **613-563-4011**

Security / Sécurité **613-741-2478**

Effective June 20, 2021

En vigueur 20 juin 2021



INFO 613-741-4390
octranspo.com



114

CARLINGTON RIDEAU

Local

Monday to Friday / Lundi au vendredi

Selected trips only

Trajets sélectionnés seulement

RIDEAU

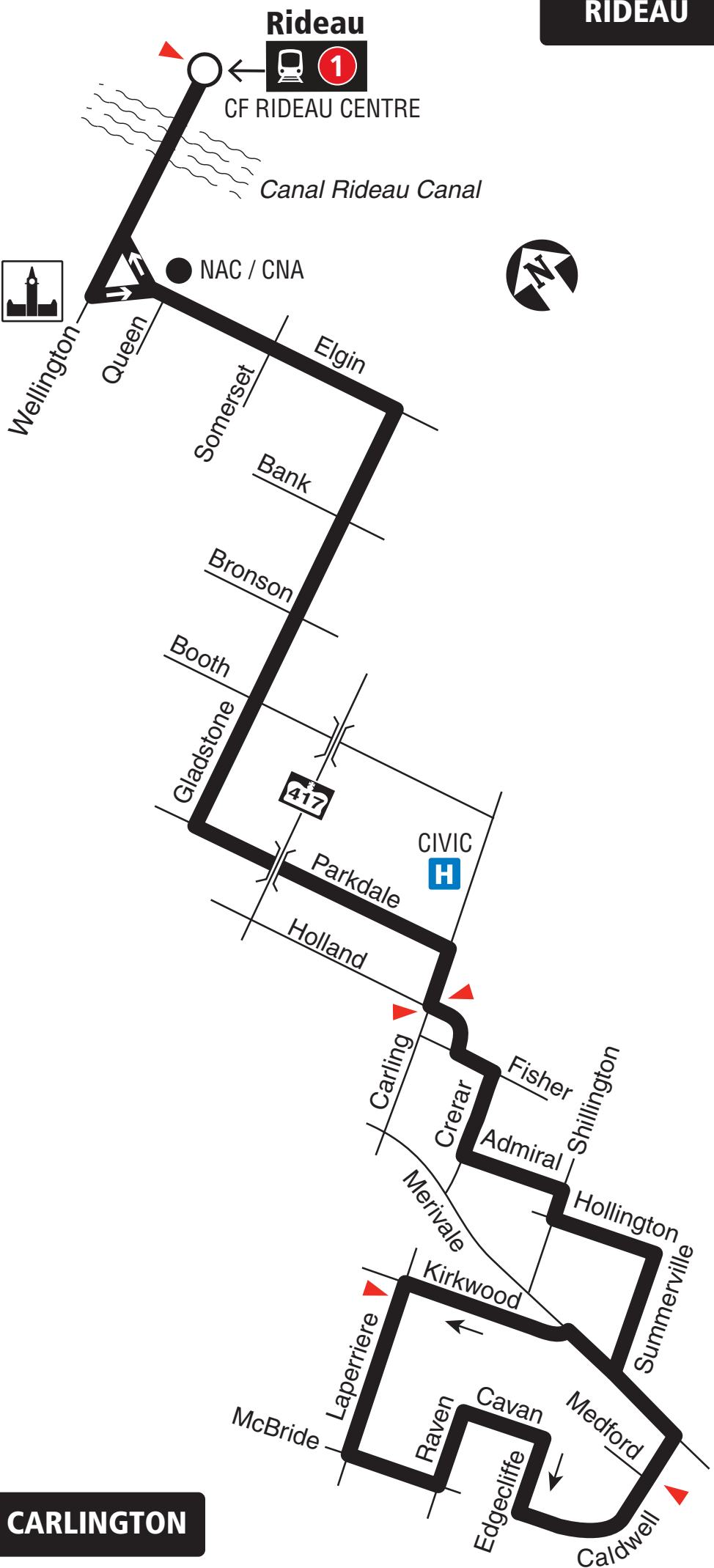

CARLINGTON



Station



Timepoint / Heures de passage

2020.08



Schedule / Horaire.....613-560-1000

Text / Texto560560

plus your four digit bus stop number / plus votre numéro d'arrêt à quatre chiffres

Customer Service

Service à la clientèle **613-560-5000**

Lost and Found / Objets perdus..... **613-563-4011**

Security / Sécurité **613-741-2478**

Effective Fall 2020

En vigueur automne 2020



INFO 613-560-5000
octranspo.com

Appendix C:

Traffic Data



Turning Movement Count

Summary Report Including Peak Hours, AADT and Expansion Factors

All Vehicles Except Bicycles



Arlington Street & Kent Street Ottawa, ON

Survey Date: Tuesday, April 11, 2023 **Start Time:** 0700 **AADT Factor:** 0.7
Weather AM: Cloudy 7° C **Survey Duration:** 8 Hrs. **Survey Hours:** 0700-1000, 1130-1330 & 1500-1800
Weather PM: Mostly Sunny 17° C **Surveyor(s):** T. Carmody

Time Period	Arlington St. Eastbound					Arlington St. Westbound					Kent St. Northbound					Kent St. Southbound					Street Total	Grand Total	
	LT	ST	RT	UT	E/B Tot	LT	ST	RT	UT	W/B Tot	LT	ST	RT	UT	N/B Tot	LT	ST	RT	UT	S/B Tot			
0700-0800	4	27	0	0	31	0	7	53	0	60	91	9	1524	60	0	1593	0	0	0	0	0	1593	1684
0800-0900	19	48	0	0	67	0	11	93	0	104	171	15	1618	121	0	1754	0	0	0	0	0	1754	1925
0900-1000	7	41	0	0	48	0	9	49	0	58	106	18	1225	103	0	1346	0	0	0	0	0	1346	1452
1130-1230	5	32	0	0	37	0	3	52	0	55	92	19	775	117	0	911	0	0	0	0	0	911	1003
1230-1330	7	31	0	0	38	0	14	40	0	54	92	17	711	114	0	842	0	0	0	0	0	842	934
1500-1600	18	51	0	0	69	0	21	53	0	74	143	17	914	84	0	1015	0	0	0	0	0	1015	1158
1600-1700	7	53	0	0	60	0	14	44	0	58	118	25	923	74	0	1022	0	0	0	0	0	1022	1140
1700-1800	12	61	0	0	73	0	18	63	1	82	155	22	1021	93	0	1136	0	0	0	0	0	1136	1291
Totals	79	344	0	0	423	0	97	447	1	545	968	142	8711	766	0	9619	0	0	0	0	0	9619	10587

Equivalent 12 & 24-hour Vehicle Volumes Including the Annual Average Daily Traffic (AADT) Factor
Applicable to the Day and Month of the Turning Movement Count

Expansion factors are applied exclusively to standard weekday 8-hour turning movement counts conducted during the hours of 0700h - 1000h, 1130h - 1330h and 1500h - 1800h

Equivalent 12-hour vehicle volumes. These volumes are calculated by multiplying the 8-hour totals by the 8 → 12 expansion factor of 1.39

Equ. 12 Hr	110	478	0	0	588	0	135	621	1	758	1346	197	12108	1065	0	13370	0	0	0	0	0	13370	14716
------------	-----	-----	---	---	-----	---	-----	-----	---	-----	------	-----	-------	------	---	-------	---	---	---	---	---	-------	-------

Average daily 12-hour vehicle volumes. These volumes are calculated by multiplying the equivalent 12-hour totals by the AADT factor of: 0.7

AADT 12-hr	77	335	0	0	412	0	94	435	1	530	942	138	8476	745	0	9359	0	0	0	0	0	9359	10301
------------	----	-----	---	---	-----	---	----	-----	---	-----	-----	-----	------	-----	---	------	---	---	---	---	---	------	-------

24-Hour AADT. These volumes are calculated by multiplying the average daily 12-hour vehicle volumes by the 12 → 24 expansion factor of 1.31

AADT 24 Hr	101	438	0	0	539	0	124	570	1	695	1234	181	11103	976	0	12261	0	0	0	0	0	12261	13495
------------	-----	-----	---	---	-----	---	-----	-----	---	-----	------	-----	-------	-----	---	-------	---	---	---	---	---	-------	-------

AADT and expansion factors provided by the City of Ottawa

AM Peak Hour Factor → 0.95											Highest Hourly Vehicle Volume Between 0700h & 1000h												
AM Peak Hr	LT	ST	RT	UT	Total	LT	ST	RT	UT	Total	Str. Tot.	LT	ST	RT	UT	Total	LT	ST	RT	UT	Total	Str. Tot.	Gr. Tot.
0800-0900	19	48	0	0	67	0	11	93	0	104	171	15	1618	121	0	1754	0	0	0	0	0	1754	1925
OFF Peak Hour Factor → 0.90											Highest Hourly Vehicle Volume Between 1130h & 1330h												
OFF Peak Hr	LT	ST	RT	UT	Total	LT	ST	RT	UT	Total	Str. Tot.	LT	ST	RT	UT	Total	LT	ST	RT	UT	Total	Str. Tot.	Gr. Tot.
1130-1230	5	32	0	0	37	0	3	52	0	55	92	19	775	117	0	911	0	0	0	0	0	911	1003
PM Peak Hour Factor → 0.89											Highest Hourly Vehicle Volume Between 1500h & 1800h												
PM Peak Hr	LT	ST	RT	UT	Total	LT	ST	RT	UT	Total	Str. Tot.	LT	ST	RT	UT	Total	LT	ST	RT	UT	Total	Str. Tot.	Gr. Tot.
1700-1800	12	61	0	0	73	0	18	63	1	82	155	22	1021	93	0	1136	0	0	0	0	0	1136	1291

Comments:

OC Transpo and Para Transpo buses, private buses and school buses comprise 20.00% of the heavy vehicle traffic. The bicycle totals include 7 varieties of electric personal transportation types. Many vehicles on Kent Street turn left or right to Arlington Street from the centre lane.

Notes:

1. Includes all vehicle types except bicycles, electric bicycles, and electric scooters.
2. When expansion and AADT factors are applied, the results will differ slightly due to rounding.



Turning Movement Count

Summary, AM and PM Peak Hour

Flow Diagrams

All Vehicles Except Bicycles



Arlington Street & Kent Street Ottawa, ON

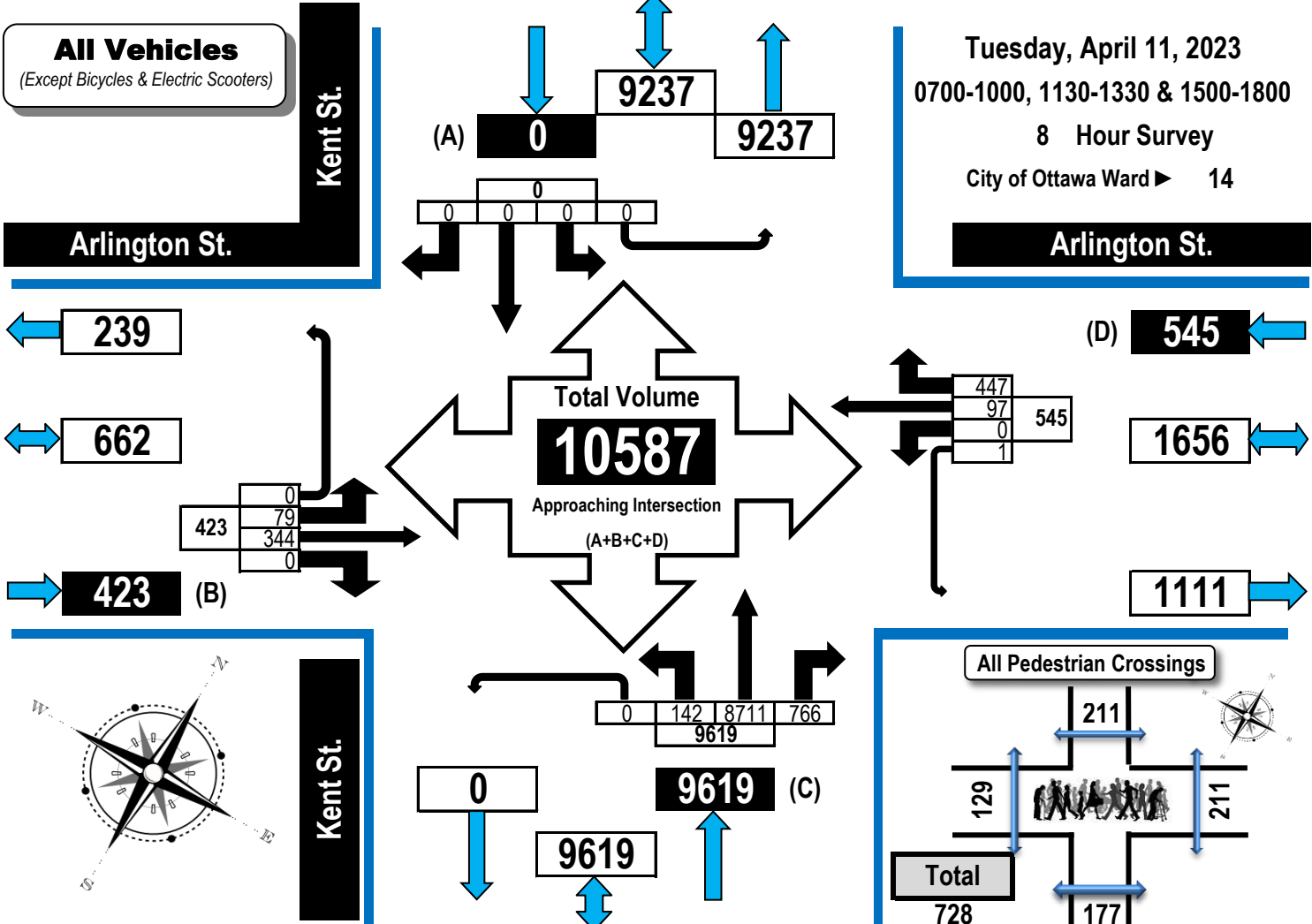

AM Peak Hour Flow Diagram PM Peak Hour Flow Diagram

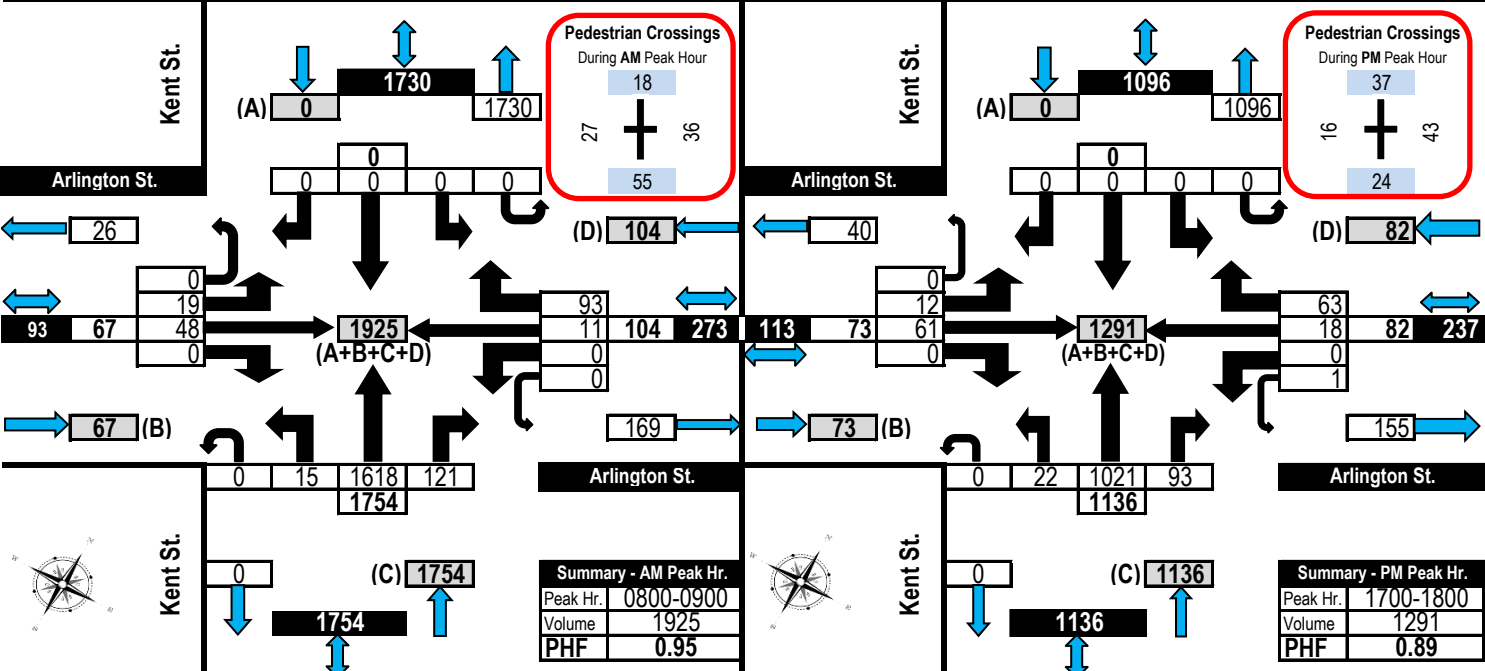



Turning Movement Count

Summary, OFF and EVENING Peak Hour

Flow Diagrams

All Vehicles Except Bicycles



Arlington Street & Kent Street Ottawa, ON

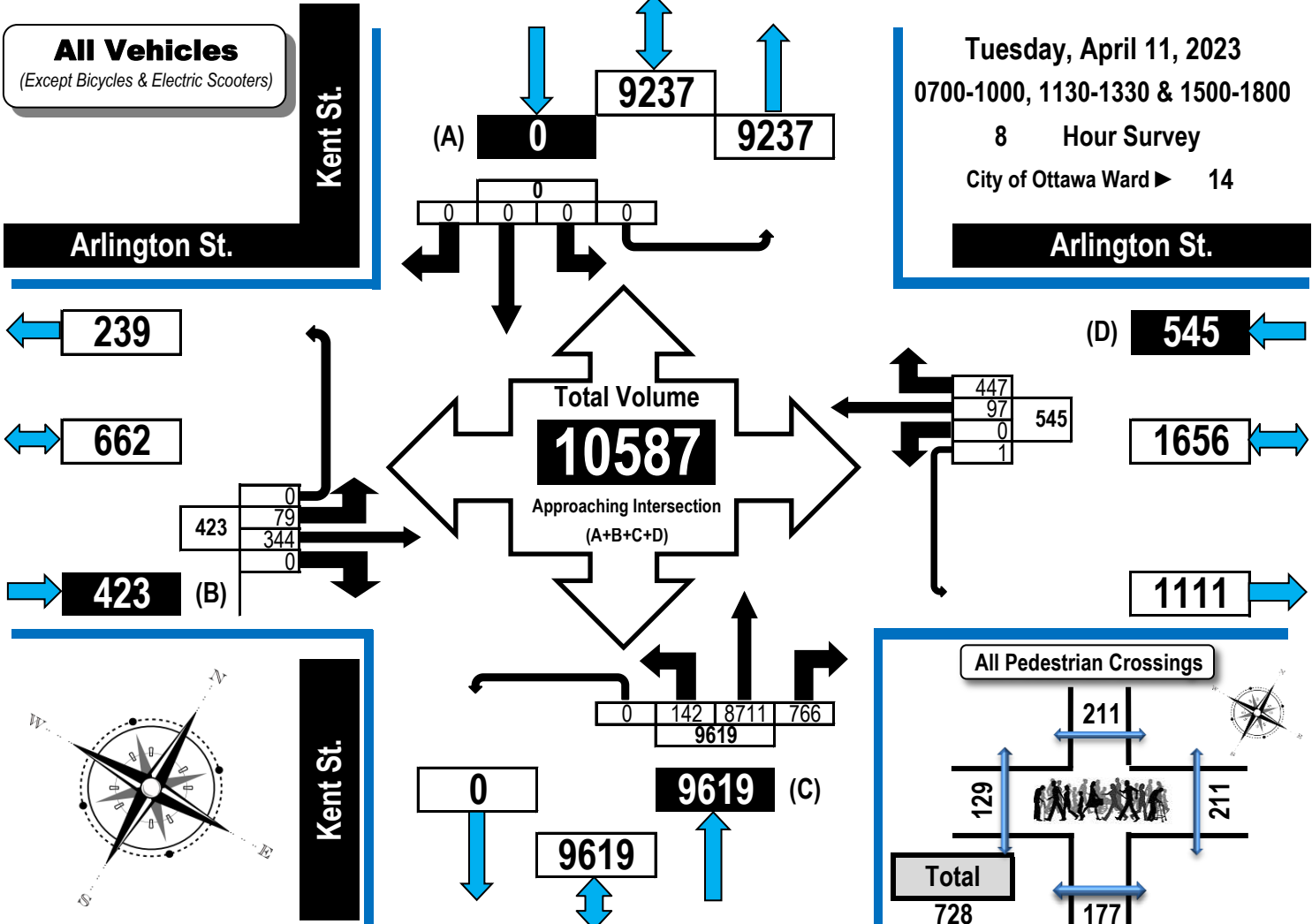

Off Peak Hour Flow Diagram Evening Peak Hour Flow Diagram

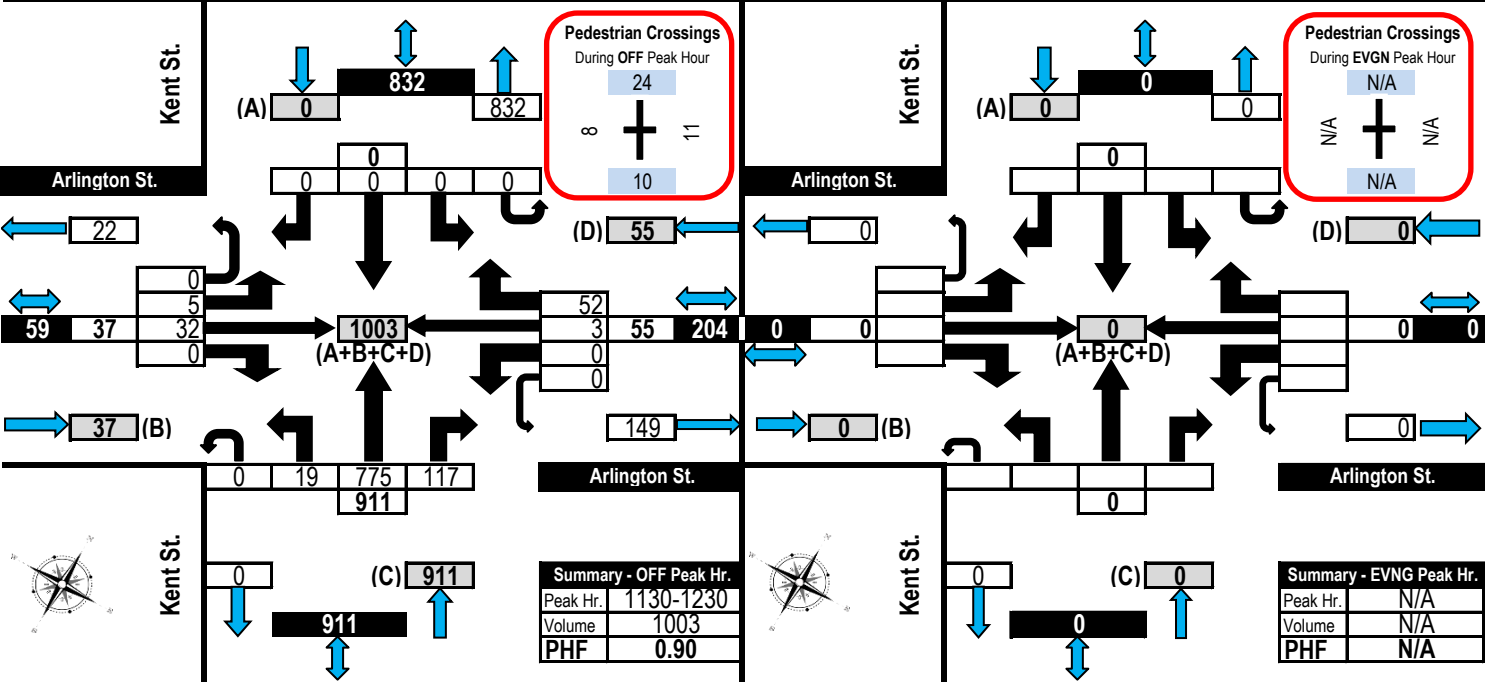



Turning Movement Count Heavy Vehicle Summary (FHWA Class 4-13) Flow Diagram



Arlington Street & Kent Street

Ottawa, ON

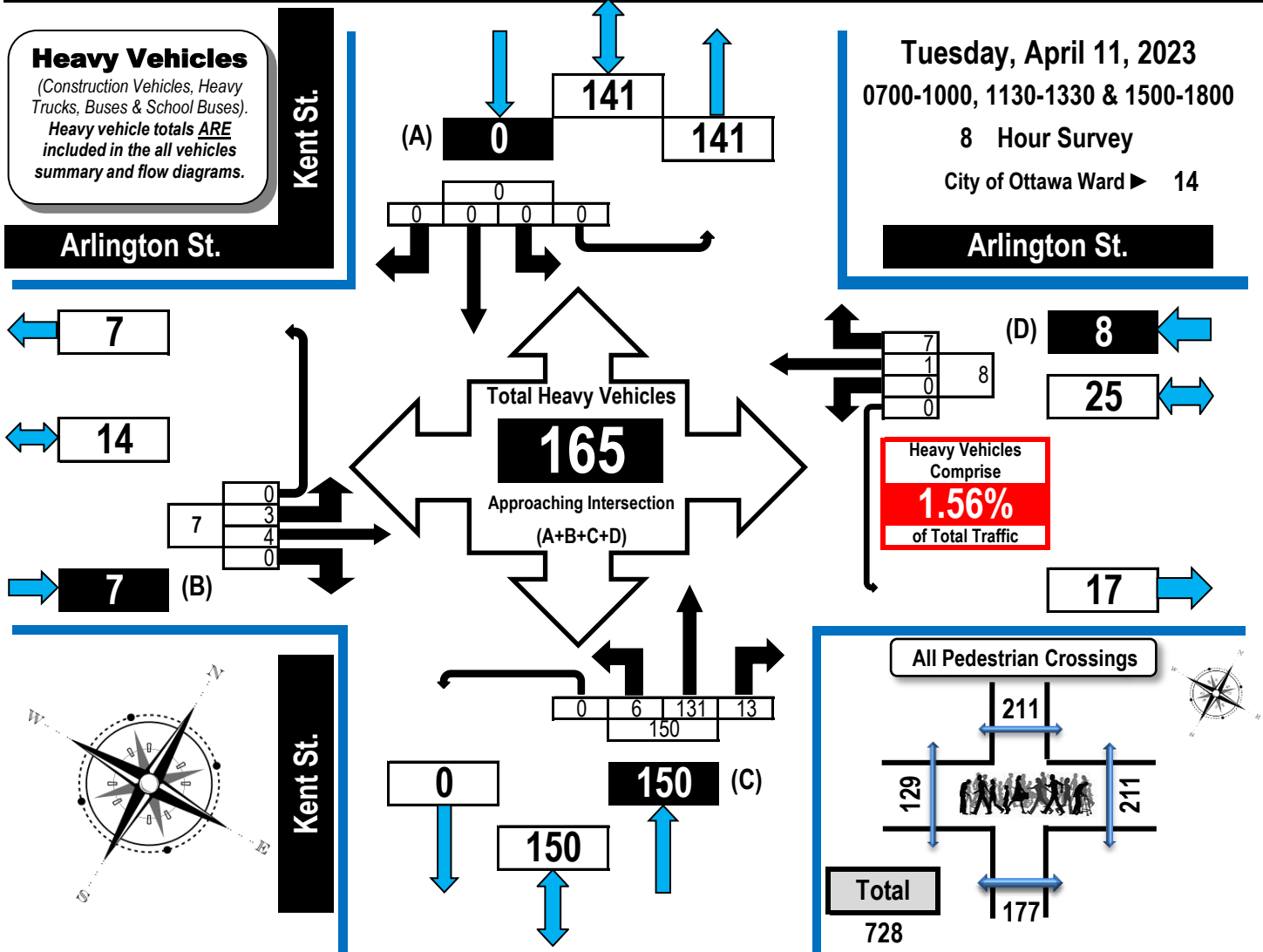

Arlington St. Eastbound					Arlington St. Westbound					Kent St. Northbound					Kent St. Southbound				
-------------------------	--	--	--	--	-------------------------	--	--	--	--	---------------------	--	--	--	--	---------------------	--	--	--	--

Time Period	LT	ST	RT	UT	EB Tot	LT	ST	RT	UT	WB Tot	LT	ST	RT	UT	NB Tot	LT	ST	RT	UT	SB Tot	GR Tot
0700-0800	0	0	0	0	0	0	1	2	0	3	1	17	1	0	19	0	0	0	0	0	22
0800-0900	0	2	0	0	2	0	0	1	0	1	1	27	3	0	31	0	0	0	0	0	34
0900-1000	3	1	0	0	4	0	0	2	0	2	2	29	2	0	33	0	0	0	0	0	39
1130-1230	0	0	0	0	0	0	0	2	0	2	0	12	4	0	16	0	0	0	0	0	18
1230-1330	0	0	0	0	0	0	0	0	0	0	0	20	0	0	20	0	0	0	0	0	20
1500-1600	0	0	0	0	0	0	0	0	0	0	0	9	0	0	9	0	0	0	0	0	9
1600-1700	0	1	0	0	1	0	0	0	0	0	2	10	2	0	14	0	0	0	0	0	15
1700-1800	0	0	0	0	0	0	0	0	0	0	0	7	1	0	8	0	0	0	0	0	8
Totals	3	4	0	0	7	0	1	7	0	8	6	131	13	0	150	0	0	0	0	0	165

Comments:

OC Transpo and Para Transpo buses, private buses and school buses comprise 20.00% of the heavy vehicle traffic. The bicycle totals include 7 varieties of electric personal transportation types. Many vehicles on Kent Street turn left or right to Arlington Street from the centre lane.



Turning Movement Count

All Buses Summary (FHWA Class 4 ONLY)

Flow Diagram



Arlington Street & Kent Street Ottawa, ON

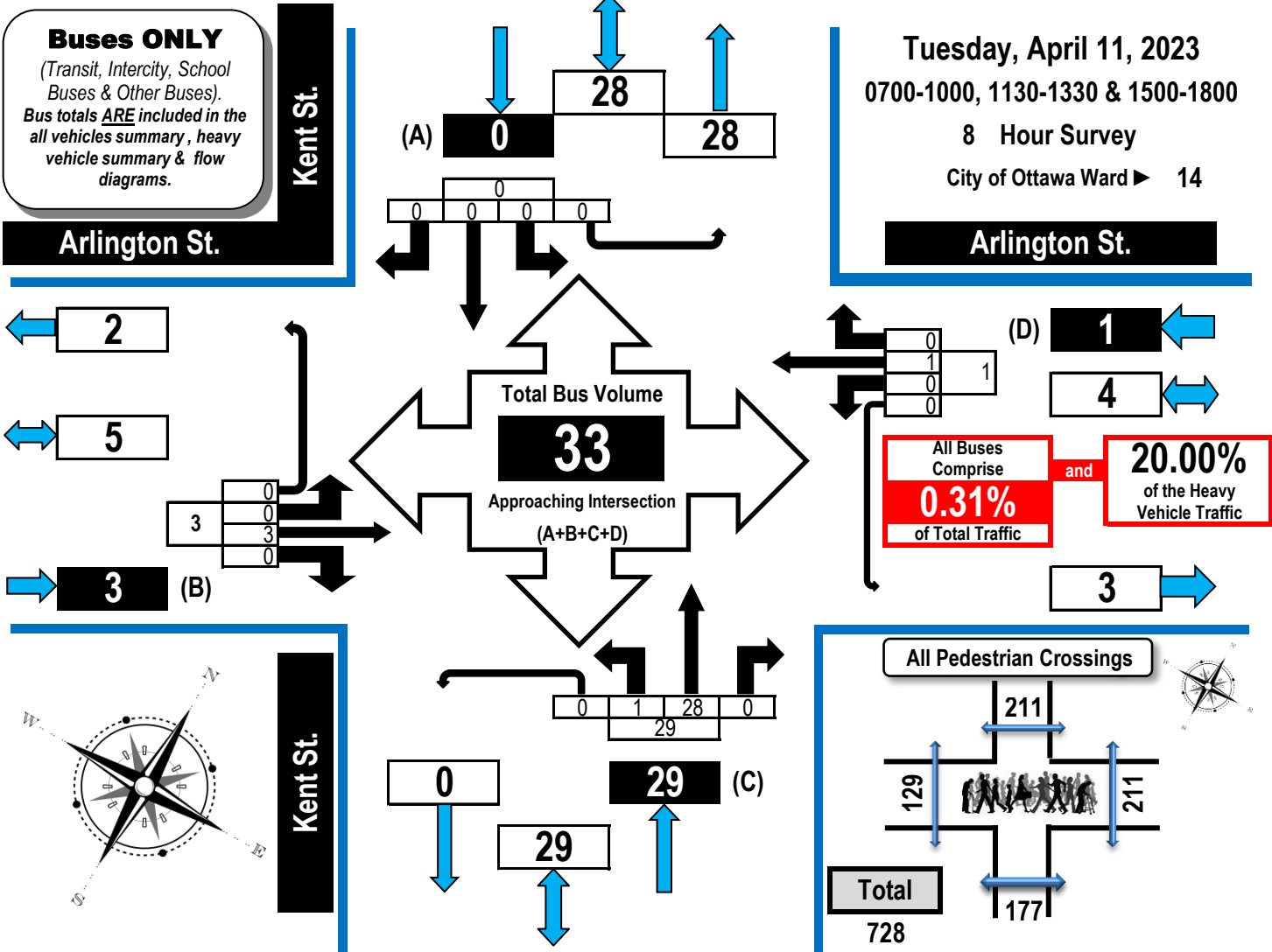

Time Period	Arlington St. Eastbound					Arlington St. Westbound					Kent St. Northbound					Kent St. Southbound					GR Tot
	LT	ST	RT	UT	EB Tot	LT	ST	RT	UT	WB Tot	LT	ST	RT	UT	NB Tot	LT	ST	RT	UT	SB Tot	
0700-0800	0	0	0	0	0	0	1	0	0	1	0	2	0	0	2	0	0	0	0	0	3
0800-0900	0	1	0	0	1	0	0	0	0	0	0	2	0	0	2	0	0	0	0	0	3
0900-1000	0	1	0	0	1	0	0	0	0	0	0	4	0	0	4	0	0	0	0	0	5
1130-1230	0	0	0	0	0	0	0	0	0	0	0	2	0	0	2	0	0	0	0	0	2
1230-1330	0	0	0	0	0	0	0	0	0	0	0	2	0	0	2	0	0	0	0	0	2
1500-1600	0	0	0	0	0	0	0	0	0	0	0	3	0	0	3	0	0	0	0	0	3
1600-1700	0	1	0	0	1	0	0	0	0	0	1	8	0	0	9	0	0	0	0	0	10
1700-1800	0	0	0	0	0	0	0	0	0	0	0	5	0	0	5	0	0	0	0	0	5
Totals	0	3	0	0	3	0	1	0	0	1	1	28	0	0	29	0	0	0	0	0	33

Comments:
 OC Transpo and Para Transpo buses, private buses and school buses comprise 20.00% of the heavy vehicle traffic. The bicycle totals include 7 varieties of electric personal transportation types. Many vehicles on Kent Street turn left or right to Arlington Street from the centre lane.



Turning Movement Count Bicycle Summary Flow Diagram



Arlington Street & Kent Street Ottawa, ON

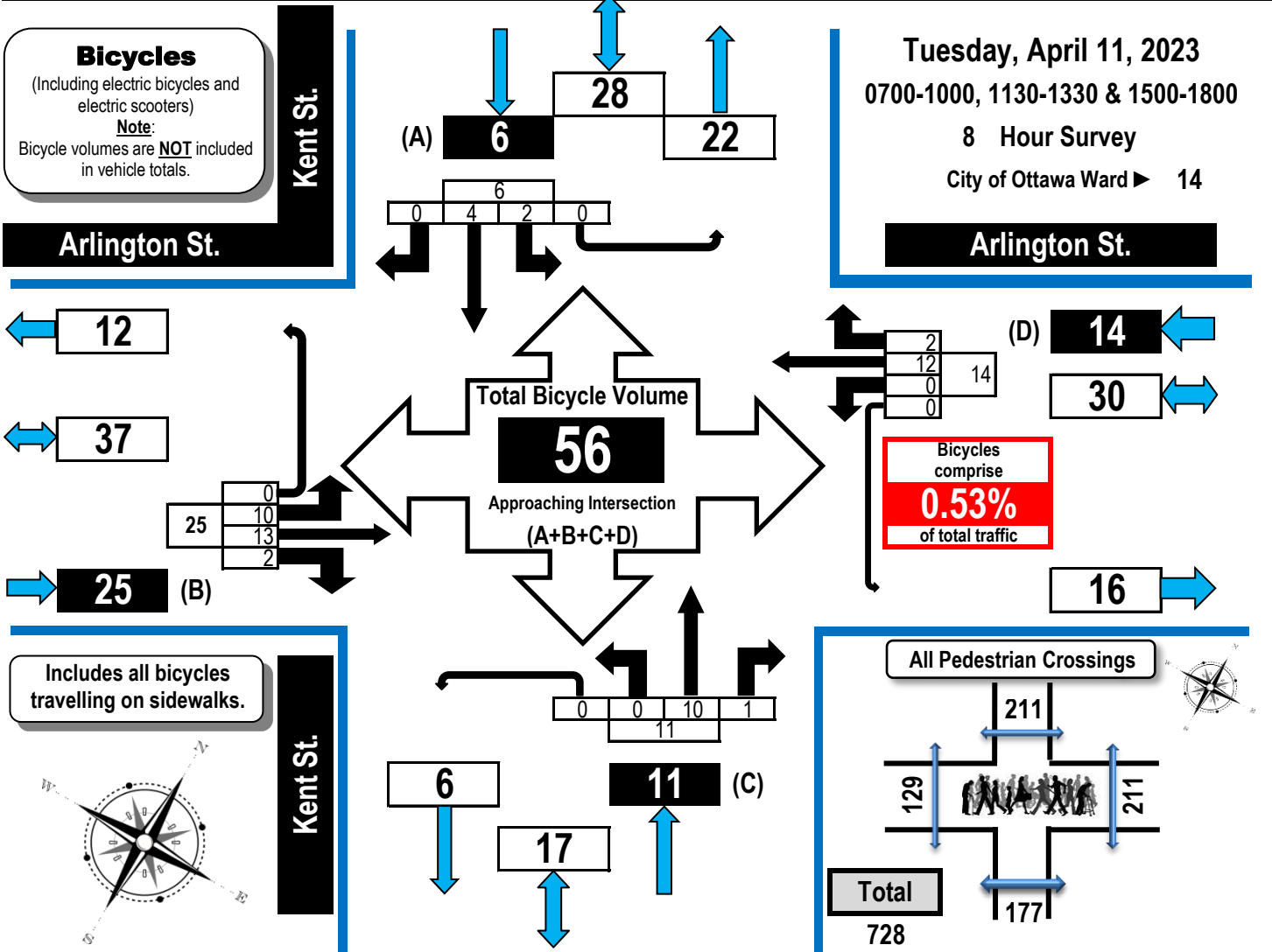

Time Period	Arlington St. Eastbound					Arlington St. Westbound					Kent St. Northbound					Kent St. Southbound					GR Tot	
	LT	ST	RT	UT	EB Tot	LT	ST	RT	UT	WB Tot	LT	ST	RT	UT	NB Tot	LT	ST	RT	UT	SB Tot		
0700-0800	1	1	0	0	2	0	0	0	0	0	0	1	0	0	1	0	0	0	0	0	0	3
0800-0900	3	0	0	0	3	0	1	0	0	1	0	1	0	0	1	0	4	0	0	4	0	9
0900-1000	1	2	0	0	3	0	0	1	0	1	0	0	1	0	1	0	0	0	0	0	0	5
1130-1230	1	4	0	0	5	0	0	0	0	0	0	0	0	0	0	0	0	0	0	0	0	5
1230-1330	1	2	0	0	3	0	1	1	0	2	0	1	0	0	1	1	0	0	0	1	1	7
1500-1600	0	1	0	0	1	0	1	0	0	1	0	3	0	0	3	0	0	0	0	0	0	5
1600-1700	1	0	1	0	2	0	2	0	0	2	0	3	0	0	3	0	0	0	0	0	0	7
1700-1800	2	3	1	0	6	0	7	0	0	7	0	1	0	0	1	1	0	0	0	1	1	15
Totals	10	13	2	0	25	0	12	2	0	14	0	10	1	0	11	2	4	0	0	6	56	

Comments:
 OC Transpo and Para Transpo buses, private buses and school buses comprise 20.00% of the heavy vehicle traffic. The bicycle totals include 7 varieties of electric personal transportation types. Many vehicles on Kent Street turn left or right to Arlington Street from the centre lane.



Turning Movement Count Pedestrian Crossings Summary and Flow Diagram



Arlington Street & Kent Street **Ottawa, ON**

**Pedestrian
Crossings**

Tuesday, April 11, 2023
0700-1000, 1130-1330 & 1500-1800
8 Hour Survey
City of Ottawa Ward ► **14**

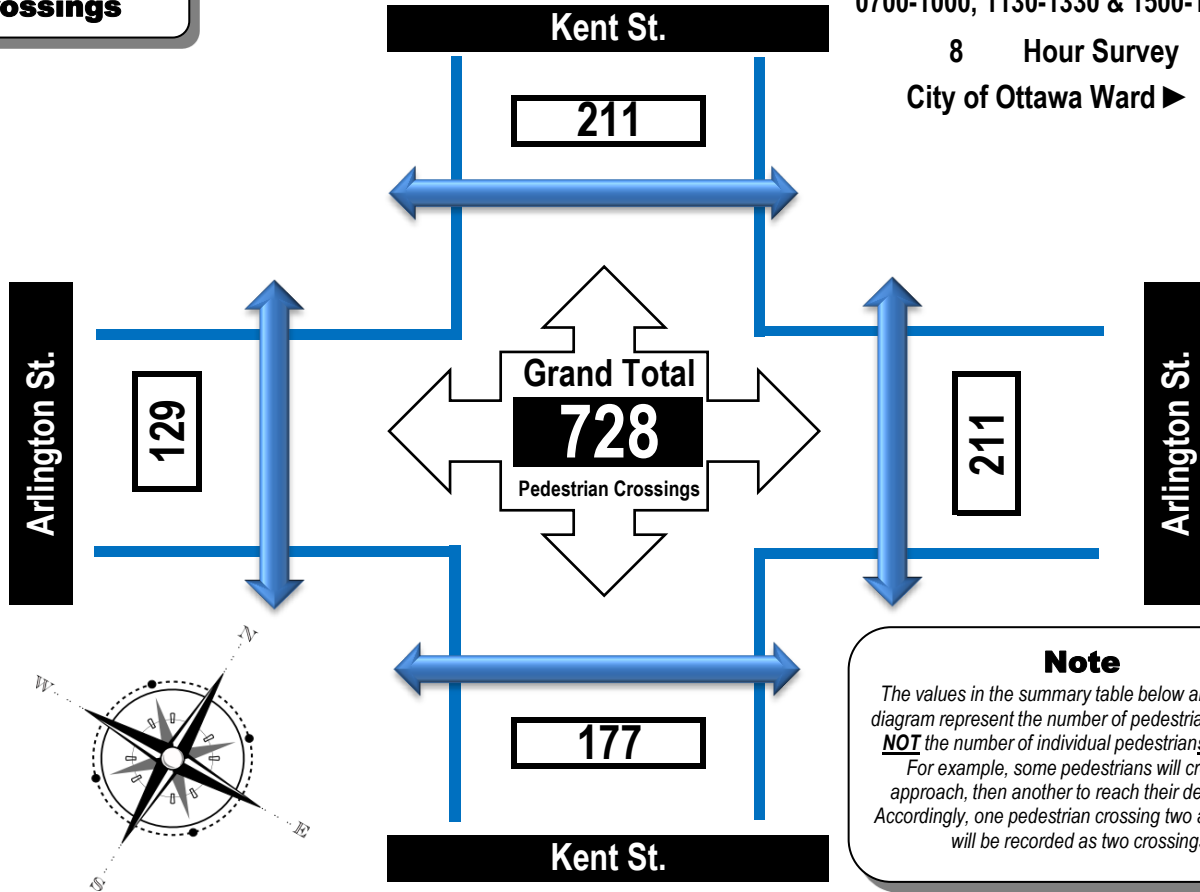

Note

*The values in the summary table below and the flow diagram represent the number of pedestrian crossings **NOT** the number of individual pedestrians crossing. For example, some pedestrians will cross one approach, then another to reach their destination. Accordingly, one pedestrian crossing two approaches will be recorded as two crossings.*

Time Period	West Side Crossing Arlington St.	East Side Crossing Arlington St.	Street Total	South Side Crossing Kent St.	North Side Crossing Kent St.	Street Total	Grand Total
0700-0800	10	16	26	4	21	25	51
0800-0900	27	36	63	55	18	73	136
0900-1000	15	18	33	12	20	32	65
1130-1230	8	11	19	10	24	34	53
1230-1330	9	18	27	3	23	26	53
1500-1600	17	42	59	46	44	90	149
1600-1700	27	27	54	23	24	47	101
1700-1800	16	43	59	24	37	61	120
Totals	129	211	340	177	211	388	728

Comments:

OC Transpo and Para Transpo buses, private buses and school buses comprise 20.00% of the heavy vehicle traffic. The bicycle totals include 7 varieties of electric personal transportation types. Many vehicles on Kent Street turn left or right to Arlington Street from the centre lane.

Diagrams, Maps and Photographs

Arlington Street & Lyon Street

Tuesday, April 11, 2023

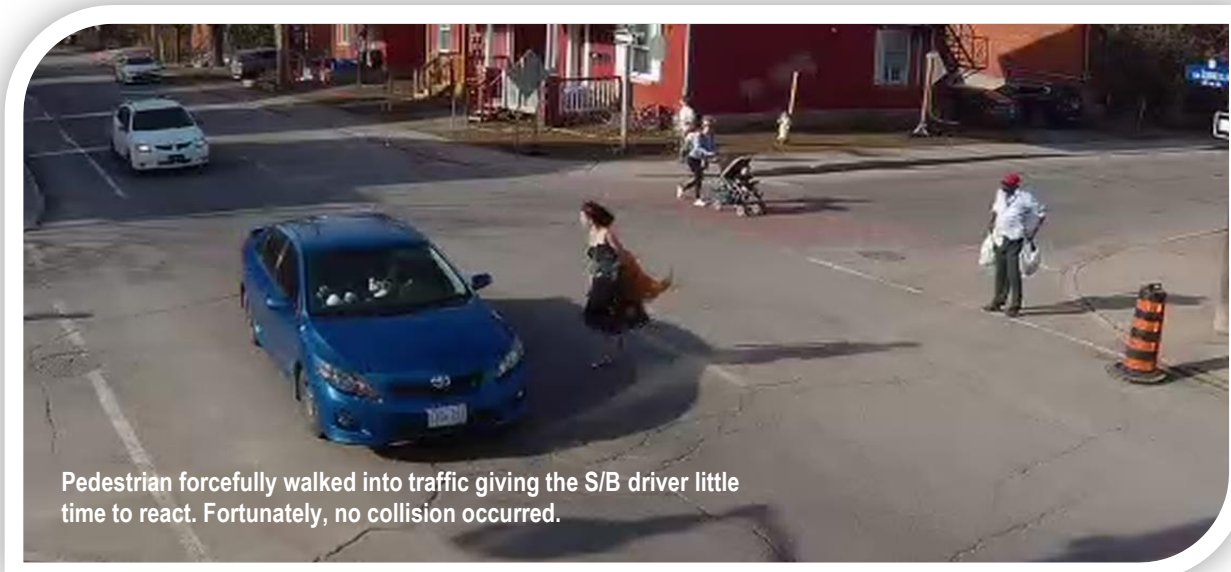



Turning Movement Count

Summary Report Including Peak Hours, AADT and Expansion Factors

All Vehicles Except Bicycles



Arlington Street & Lyon StreetOttawa, ON

Survey Date: Tuesday, April 11, 2023 **Start Time:** 0700 **AADT Factor:** 0.7
Weather AM: Cloudy 7° C **Survey Duration:** 8 Hrs. **Survey Hours:** 0700-1000, 1130-1330 & 1500-1800
Weather PM: Mostly Sunny 17° C **Surveyor(s):** J. Mousseau

Arlington St.					Arlington St.					Kent St.					Kent St.				
Eastbound					Westbound					Northbound					Southbound				

Time Period	LT	ST	RT	UT	E/B Tot	LT	ST	RT	UT	W/B Tot	Street Total	LT	ST	RT	UT	N/B Tot	LT	ST	RT	UT	S/B Tot	Street Total	Grand Total
0700-0800	0	10	0	1	11	5	7	0	0	12	23	0	0	0	0	0	19	113	2	0	134	134	157
0800-0900	0	19	0	0	19	11	13	0	0	24	43	0	0	0	0	0	44	166	7	0	217	217	260
0900-1000	0	11	4	0	15	7	16	0	0	23	38	0	0	0	0	0	39	161	9	0	209	209	247
1130-1230	0	10	3	0	13	7	13	0	0	20	33	0	0	0	0	0	27	150	13	0	190	190	223
1230-1330	0	5	2	0	7	8	20	0	0	28	35	0	0	0	0	0	35	160	9	0	204	204	239
1500-1600	0	21	4	0	25	12	25	0	1	38	63	0	0	0	0	0	39	344	6	0	389	389	452
1600-1700	0	19	1	0	20	7	33	0	0	40	60	0	0	0	0	0	46	336	12	0	394	394	454
1700-1800	0	17	2	0	19	13	23	0	2	38	57	0	0	0	0	0	42	278	18	0	338	338	395
Totals	0	112	16	1	129	70	150	0	3	223	352	0	0	0	0	0	291	1708	76	0	2075	2075	2427

Equivalent 12 & 24-hour Vehicle Volumes Including the Annual Average Daily Traffic (AADT) Factor
Applicable to the Day and Month of the Turning Movement Count

Expansion factors are applied exclusively to standard weekday 8-hour turning movement counts conducted during the hours of 0700h - 1000h, 1130h - 1330h and 1500h - 1800h

Equivalent 12-hour vehicle volumes. These volumes are calculated by multiplying the 8-hour totals by the 8 → 12 expansion factor of 1.39																							
Equ. 12 Hr	0	156	22	1	179	97	209	0	4	310	489	0	0	0	0	0	404	2374	106	0	2884	2884	3374

Average daily 12-hour vehicle volumes. These volumes are calculated by multiplying the equivalent 12-hour totals by the AADT factor of: 0.7																							
AADT 12-hr	0	109	16	1	126	68	146	0	3	217	342	0	0	0	0	0	283	1662	74	0	2019	2019	2361

24-Hour AADT. These volumes are calculated by multiplying the average daily 12-hour vehicle volumes by the 12 → 24 expansion factor of 1.31																							
AADT 24 Hr	0	143	20	1	164	89	191	0	4	284	449	0	0	0	0	0	371	2177	97	0	2645	2645	3094

AADT and expansion factors provided by the City of Ottawa

AM Peak Hour Factor → 0.89											Highest Hourly Vehicle Volume Between 0700h & 1000h												
AM Peak Hr	LT	ST	RT	UT	Total	LT	ST	RT	UT	Total	Str. Tot.	LT	ST	RT	UT	Total	LT	ST	RT	UT	Total	Str. Tot.	Gr. Tot.
0815-0915	0	18	0	0	18	11	12	0	0	23	41	0	0	0	0	0	44	174	9	0	227	227	268
OFF Peak Hour Factor → 0.95											Highest Hourly Vehicle Volume Between 1130h & 1330h												
OFF Peak Hr	LT	ST	RT	UT	Total	LT	ST	RT	UT	Total	Str. Tot.	LT	ST	RT	UT	Total	LT	ST	RT	UT	Total	Str. Tot.	Gr. Tot.
1230-1330	0	5	2	0	7	8	20	0	0	28	35	0	0	0	0	0	35	160	9	0	204	204	239
PM Peak Hour Factor → 0.93											Highest Hourly Vehicle Volume Between 1500h & 1800h												
PM Peak Hr	LT	ST	RT	UT	Total	LT	ST	RT	UT	Total	Str. Tot.	LT	ST	RT	UT	Total	LT	ST	RT	UT	Total	Str. Tot.	Gr. Tot.
1545-1645	0	19	2	0	21	8	37	0	0	45	66	0	0	0	0	0	43	364	13	0	420	420	486

Comments:

Transit buses and school buses comprise 30.23% of the heavy vehicle traffic. Lyon Street ramp to Highway 417 westbound closed due to construction. Southbound traffic south of Arlington Street is open to right turns to Catherine Street. Many S/B left turning vehicles to Arlington Street E/B do so from the west through lane.

Notes:

1. Includes all vehicle types except bicycles, electric bicycles, and electric scooters.
2. When expansion and AADT factors are applied, the results will differ slightly due to rounding.



Turning Movement Count

Summary, AM and PM Peak Hour

Flow Diagrams

All Vehicles Except Bicycles



Arlington Street & Lyon Street

Ottawa, ON

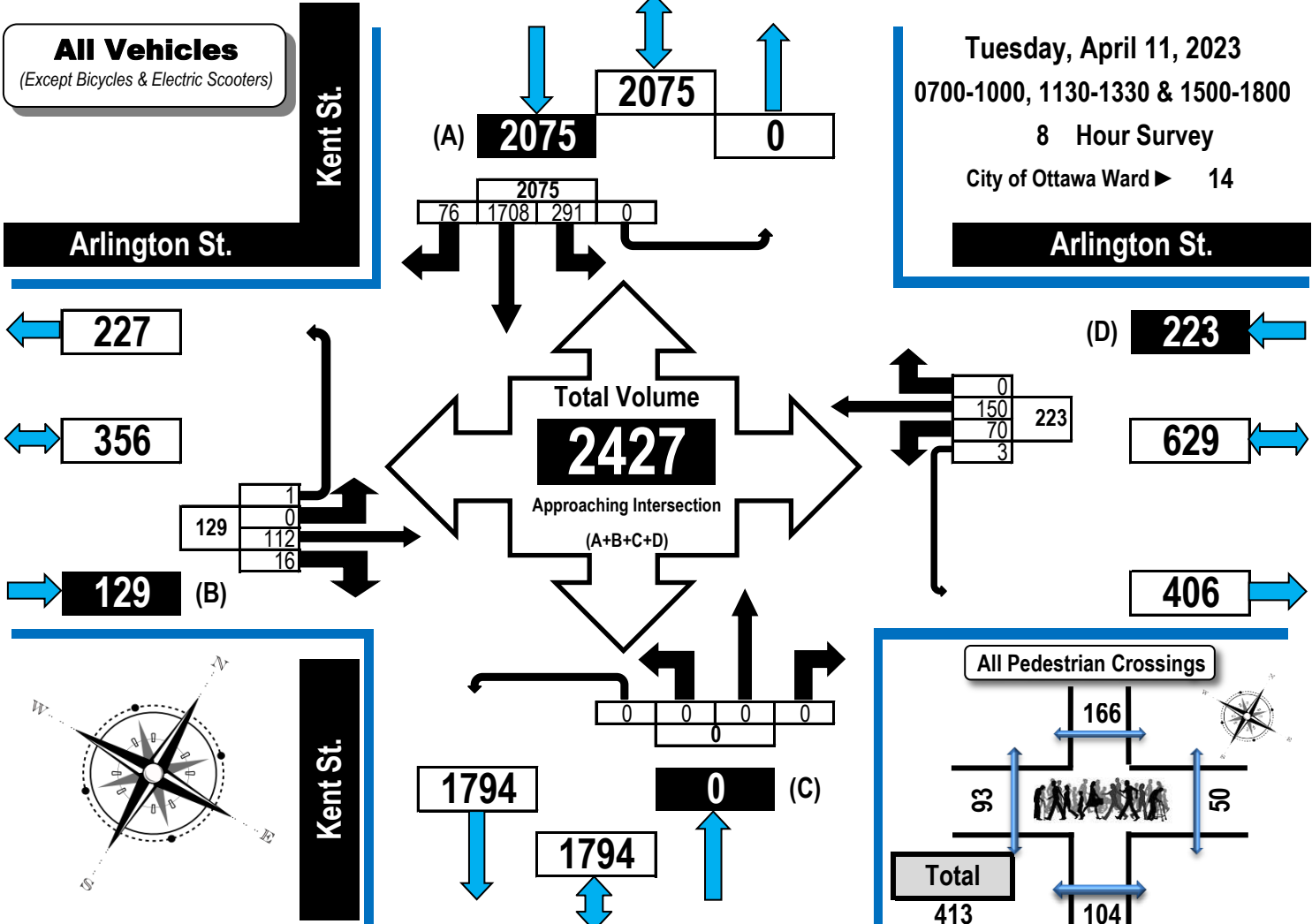

AM Peak Hour Flow Diagram

PM Peak Hour Flow Diagram

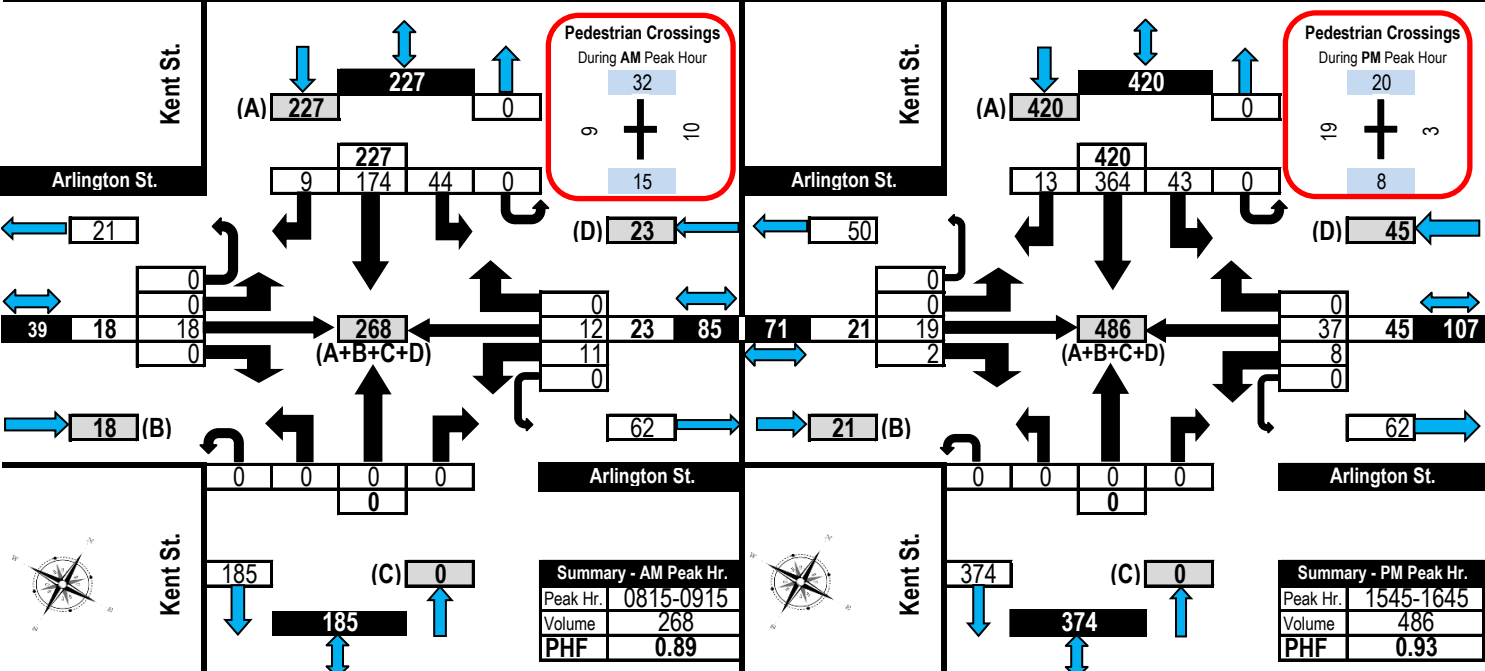



Turning Movement Count

Summary, OFF and EVENING Peak Hour

Flow Diagrams

All Vehicles Except Bicycles



Arlington Street & Lyon Street

Ottawa, ON

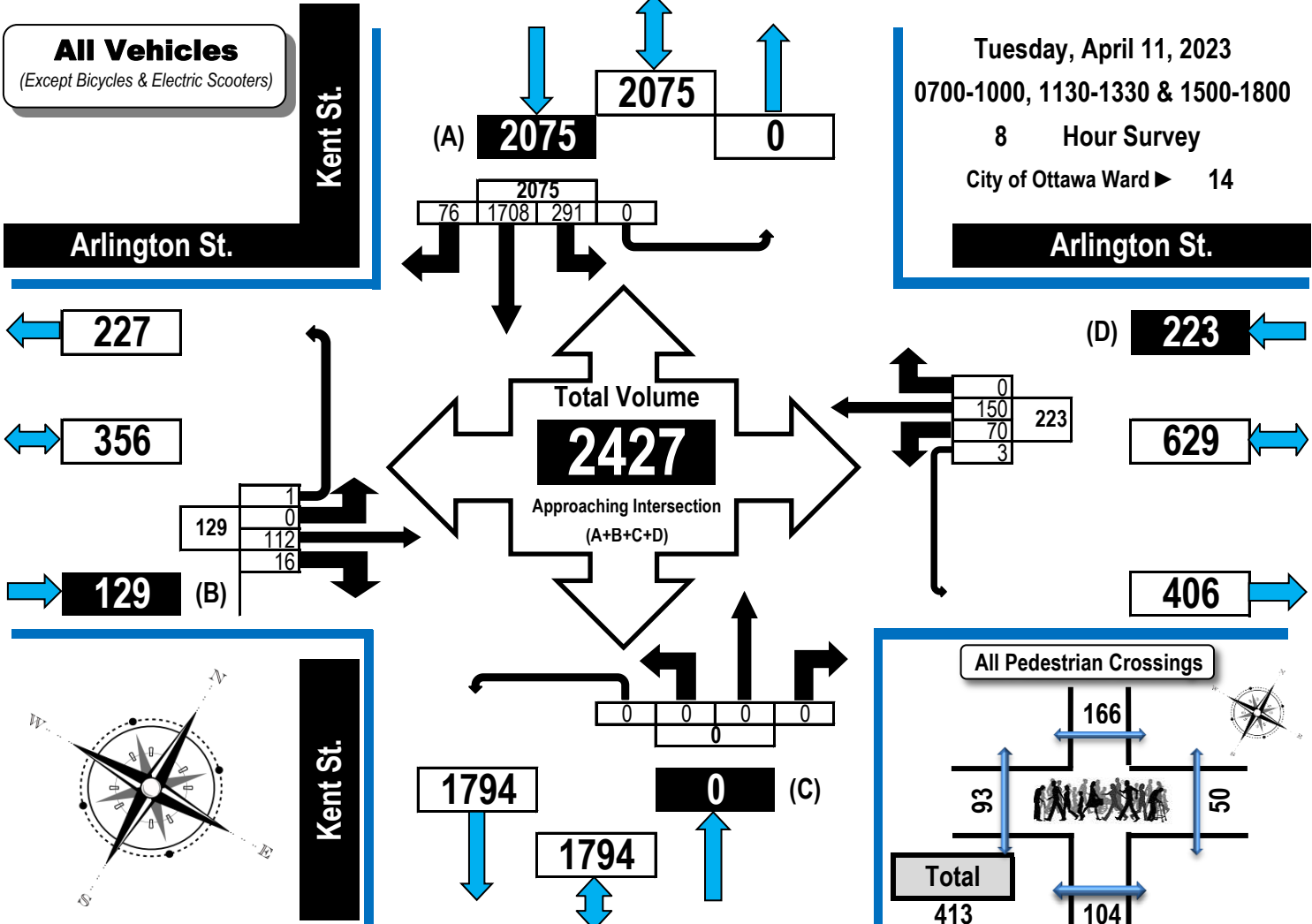

Off Peak Hour Flow Diagram

Evening Peak Hour Flow Diagram

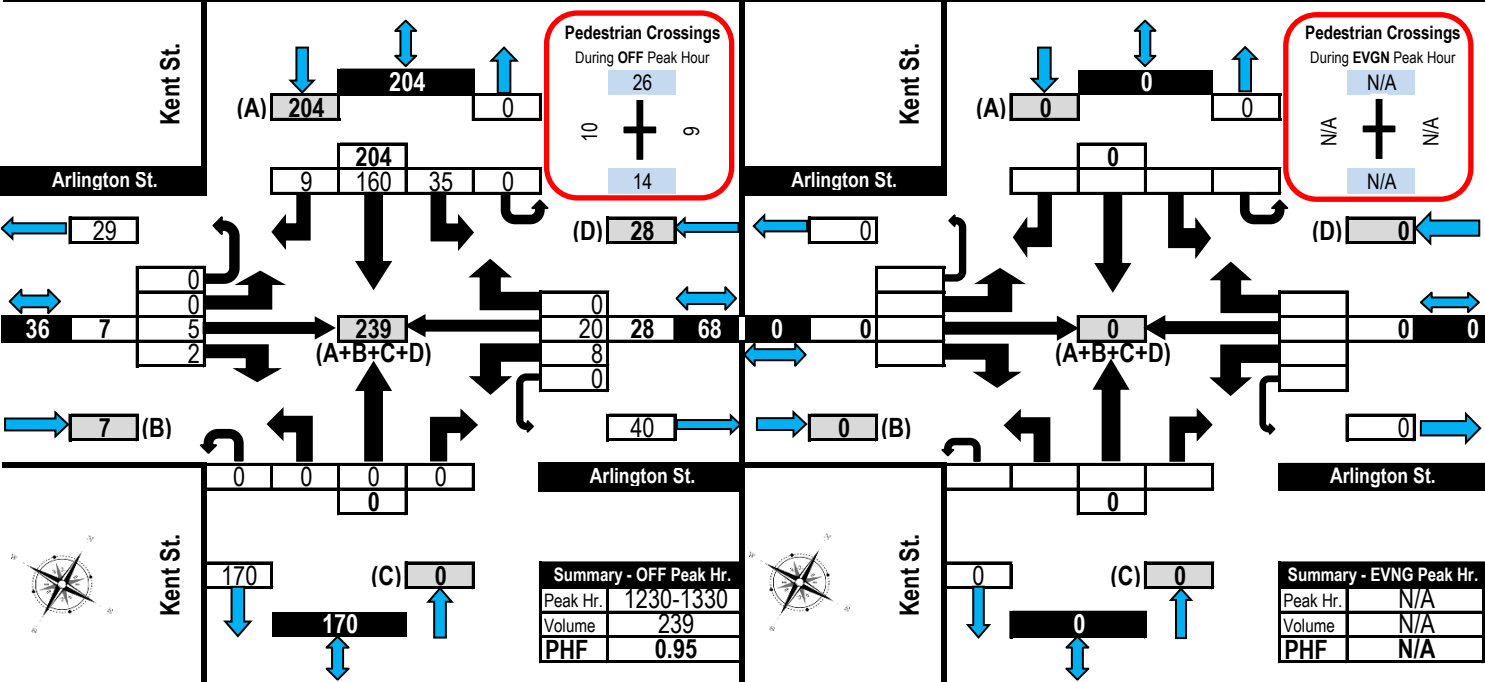



Turning Movement Count

Heavy Vehicle Summary (FHWA Class 4-13)

Flow Diagram



Arlington Street & Lyon Street

Ottawa, ON

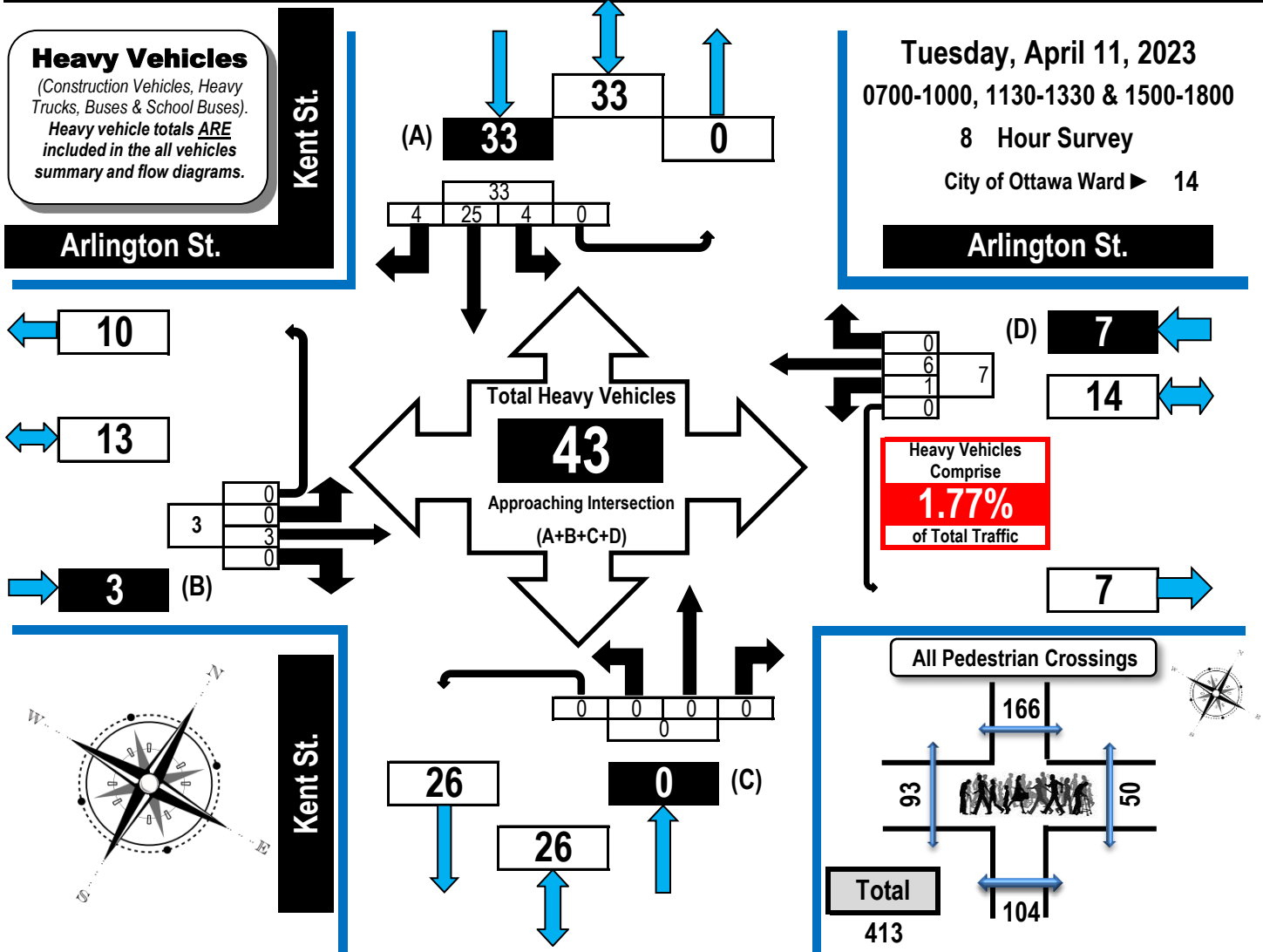

Arlington St.	Arlington St.	Kent St.	Kent St.
Eastbound	Westbound	Northbound	Southbound

Time Period	LT	ST	RT	UT	EB Tot	LT	ST	RT	UT	WB Tot	LT	ST	RT	UT	NB Tot	LT	ST	RT	UT	SB Tot	GR Tot
0700-0800	0	0	0	0	0	0	2	0	0	2	0	0	0	0	0	0	1	0	0	1	3
0800-0900	0	1	0	0	1	1	0	0	0	1	0	0	0	0	0	2	2	1	0	5	7
0900-1000	0	1	0	0	1	0	2	0	0	2	0	0	0	0	0	2	6	2	0	10	13
1130-1230	0	0	0	0	0	0	0	0	0	0	0	0	0	0	0	0	7	1	0	8	8
1230-1330	0	0	0	0	0	0	0	0	0	0	0	0	0	0	0	0	2	0	0	2	2
1500-1600	0	0	0	0	0	0	0	0	0	0	0	0	0	0	0	0	3	0	0	3	3
1600-1700	0	1	0	0	1	0	2	0	0	2	0	0	0	0	0	0	1	0	0	1	4
1700-1800	0	0	0	0	0	0	0	0	0	0	0	0	0	0	0	0	3	0	0	3	3
Totals	0	3	0	0	3	1	6	0	0	7	0	0	0	0	0	4	25	4	0	33	43

Comments:

Transit buses and school buses comprise 30.23% of the heavy vehicle traffic. Lyon Street ramp to Highway 417 westbound closed due to construction. Southbound traffic south of Arlington Street is open to right turns to Catherine Street. Many S/B left turning vehicles to Arlington Street E/B do so from the west through lane.



Turning Movement Count All Buses Summary (FHWA Class 4 ONLY) Flow Diagram



Arlington Street & Lyon Street Ottawa, ON

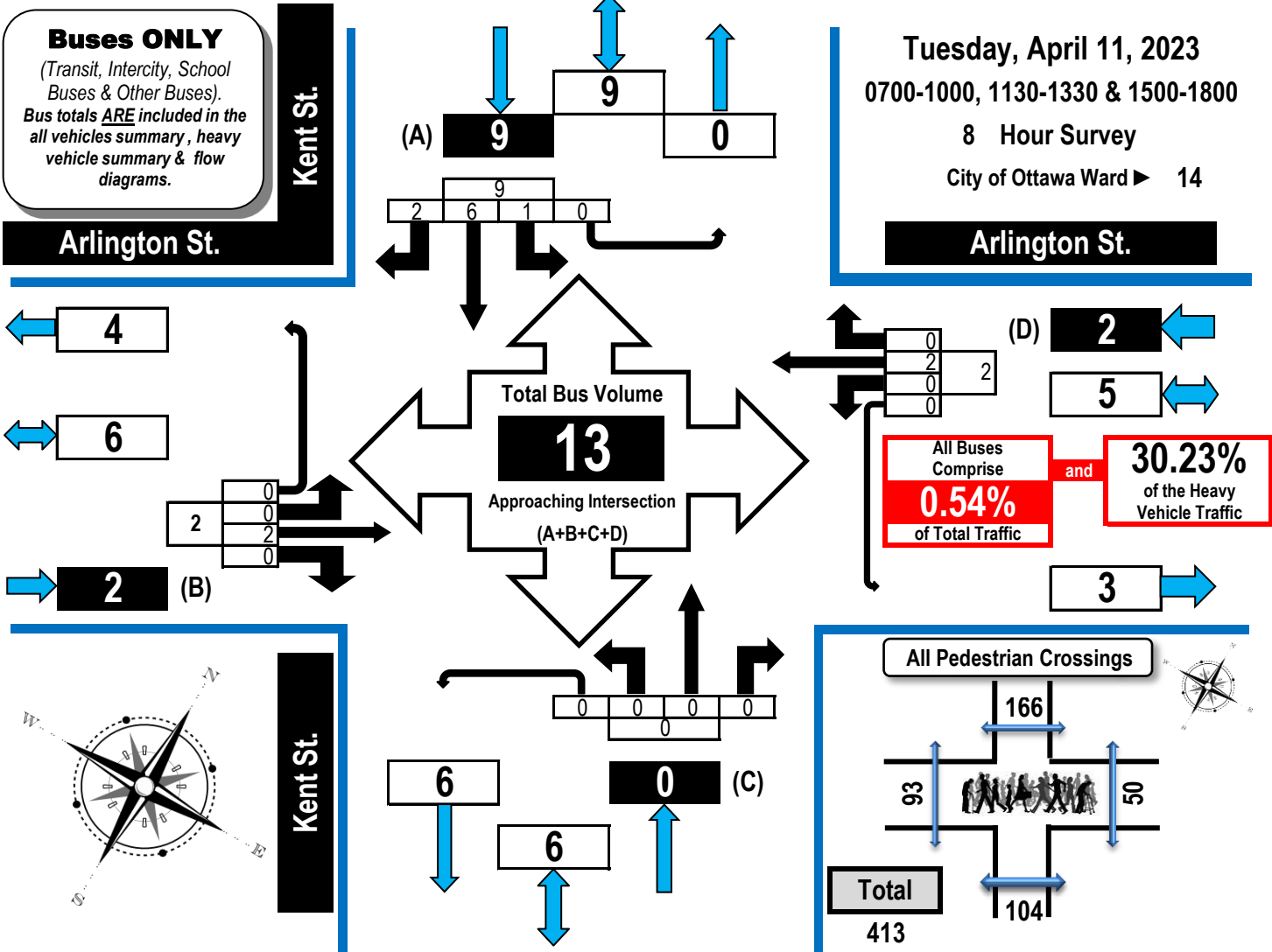

Time Period	Arlington St. Eastbound					Arlington St. Westbound					Kent St. Northbound					Kent St. Southbound					GR Tot	
	LT	ST	RT	UT	EB Tot	LT	ST	RT	UT	WB Tot	LT	ST	RT	UT	NB Tot	LT	ST	RT	UT	SB Tot		
0700-0800	0	0	0	0	0	0	1	0	0	1	0	0	0	0	0	0	1	0	0	1	2	
0800-0900	0	1	0	0	1	0	0	0	0	0	0	0	0	0	0	0	1	0	0	0	1	2
0900-1000	0	0	0	0	0	0	0	0	0	0	0	0	0	0	0	0	0	2	1	0	3	3
1130-1230	0	0	0	0	0	0	0	0	0	0	0	0	0	0	0	0	0	0	1	0	1	1
1230-1330	0	0	0	0	0	0	0	0	0	0	0	0	0	0	0	0	0	1	0	0	1	1
1500-1600	0	0	0	0	0	0	0	0	0	0	0	0	0	0	0	0	0	2	0	0	2	2
1600-1700	0	1	0	0	1	0	1	0	0	1	0	0	0	0	0	0	0	0	0	0	0	2
1700-1800	0	0	0	0	0	0	0	0	0	0	0	0	0	0	0	0	0	0	0	0	0	0
Totals	0	2	0	0	2	0	2	0	0	2	0	0	0	0	0	0	1	6	2	0	9	13

Comments:
Transit buses and school buses comprise 30.23% of the heavy vehicle traffic. Lyon Street ramp to Highway 417 westbound closed due to construction. Southbound traffic south of Arlington Street is open to right turns to Catherine Street. Many S/B left turning vehicles to Arlington Street E/B do so from the west through lane.



Turning Movement Count Bicycle Summary Flow Diagram



Arlington Street & Lyon Street Ottawa, ON

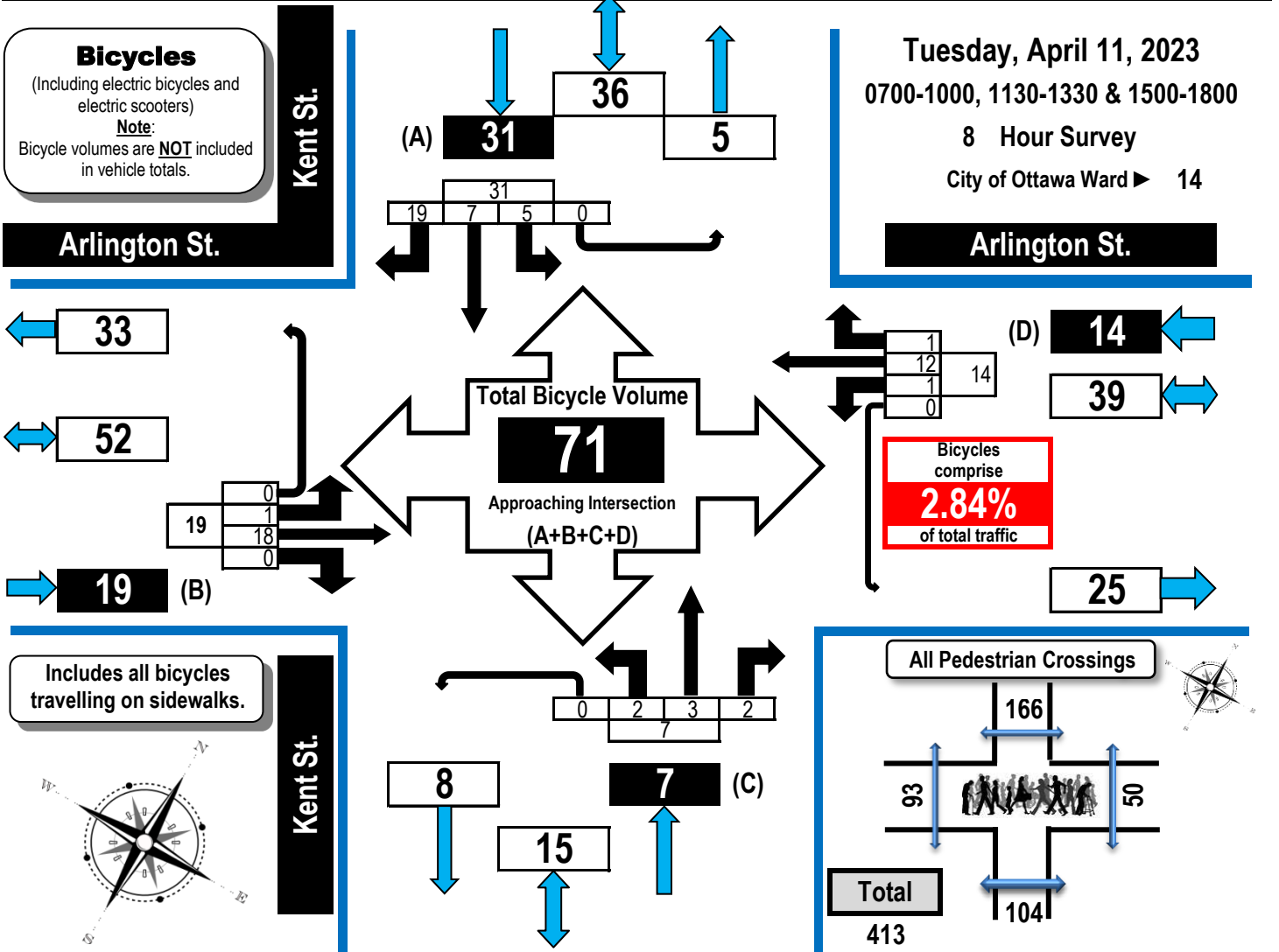

Arlington St. Eastbound	Arlington St. Westbound	Kent St. Northbound	Kent St. Southbound
----------------------------	----------------------------	------------------------	------------------------

Time Period	Arlington St. Eastbound					Arlington St. Westbound					Kent St. Northbound					Kent St. Southbound					GR Tot
	LT	ST	RT	UT	EB Tot	LT	ST	RT	UT	WB Tot	LT	ST	RT	UT	NB Tot	LT	ST	RT	UT	SB Tot	
0700-0800	0	1	0	0	1	0	0	0	0	0	2	0	0	0	2	0	2	0	0	2	5
0800-0900	0	4	0	0	4	0	1	0	0	1	0	1	0	0	1	0	1	0	0	1	7
0900-1000	0	1	0	0	1	0	2	0	0	2	0	1	0	0	1	1	0	1	0	2	6
1130-1230	0	3	0	0	3	0	0	0	0	0	0	0	1	0	1	1	2	1	0	4	8
1230-1330	0	1	0	0	1	0	1	0	0	1	0	1	0	0	1	1	0	0	0	1	4
1500-1600	0	1	0	0	1	0	1	0	0	1	0	0	0	0	0	0	0	5	0	5	7
1600-1700	1	0	0	0	1	0	1	0	0	1	0	0	1	0	1	1	0	4	0	5	8
1700-1800	0	7	0	0	7	1	6	1	0	8	0	0	0	0	0	1	2	8	0	11	26
Totals	1	18	0	0	19	1	12	1	0	14	2	3	2	0	7	5	7	19	0	31	71

Comments:

Transit buses and school buses comprise 30.23% of the heavy vehicle traffic. Lyon Street ramp to Highway 417 westbound closed due to construction. Southbound traffic south of Arlington Street is open to right turns to Catherine Street. Many S/B left turning vehicles to Arlington Street E/B do so from the west through lane.



Turning Movement Count Pedestrian Crossings Summary and Flow Diagram



Arlington Street & Lyon Street

Ottawa, ON

Pedestrian Crossings

Tuesday, April 11, 2023
0700-1000, 1130-1330 & 1500-1800
8 Hour Survey
City of Ottawa Ward ► **14**

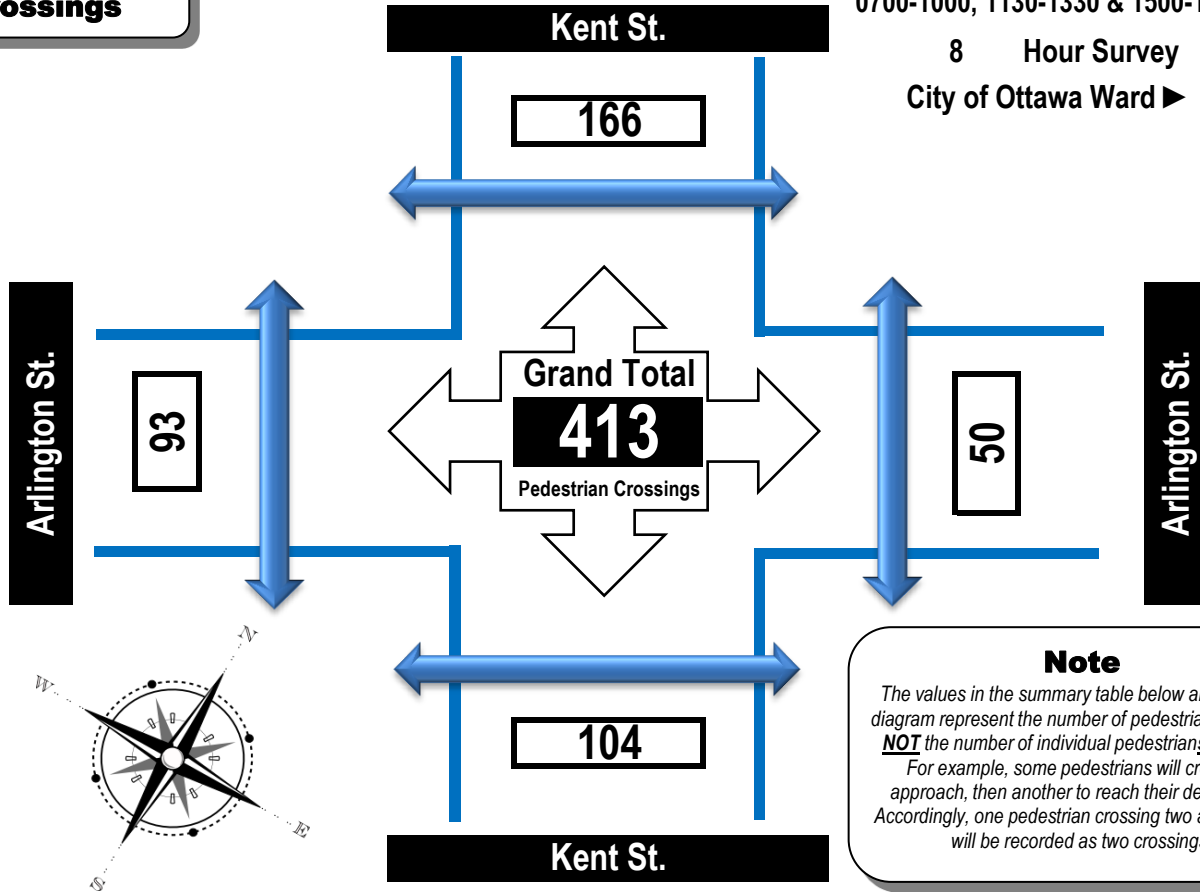

Note
The values in the summary table below and the flow diagram represent the number of pedestrian crossings **NOT** the number of individual pedestrians crossing. For example, some pedestrians will cross one approach, then another to reach their destination. Accordingly, one pedestrian crossing two approaches will be recorded as two crossings.

Time Period	West Side Crossing Arlington St.	East Side Crossing Arlington St.	Street Total	South Side Crossing Kent St.	North Side Crossing Kent St.	Street Total	Grand Total
0700-0800	7	4	11	5	15	20	31
0800-0900	11	11	22	16	31	47	69
0900-1000	3	5	8	4	7	11	19
1130-1230	12	6	18	21	10	31	49
1230-1330	10	9	19	14	26	40	59
1500-1600	16	5	21	23	35	58	79
1600-1700	18	4	22	11	17	28	50
1700-1800	16	6	22	10	25	35	57
Totals	93	50	143	104	166	270	413

Comments:

Transit buses and school buses comprise 30.23% of the heavy vehicle traffic. Lyon Street ramp to Highway 417 westbound closed due to construction. Southbound traffic south of Arlington Street is open to right turns to Catherine Street. Many S/B left turning vehicles to Arlington Street E/B do so from the west through lane.

DIRECTIONAL TRAFFIC FLOW

Intersection: Arlington Avenue at Bank Street

DATE: Day: 18 Month: Apr. Year: 2023 Day of Week: Tuesday

Observer: Jordan Terada Weather: Overcast

Chkd by: _____ Date: _____

TIME PERIOD: From: 7 : 35 To: 8 : 35

N

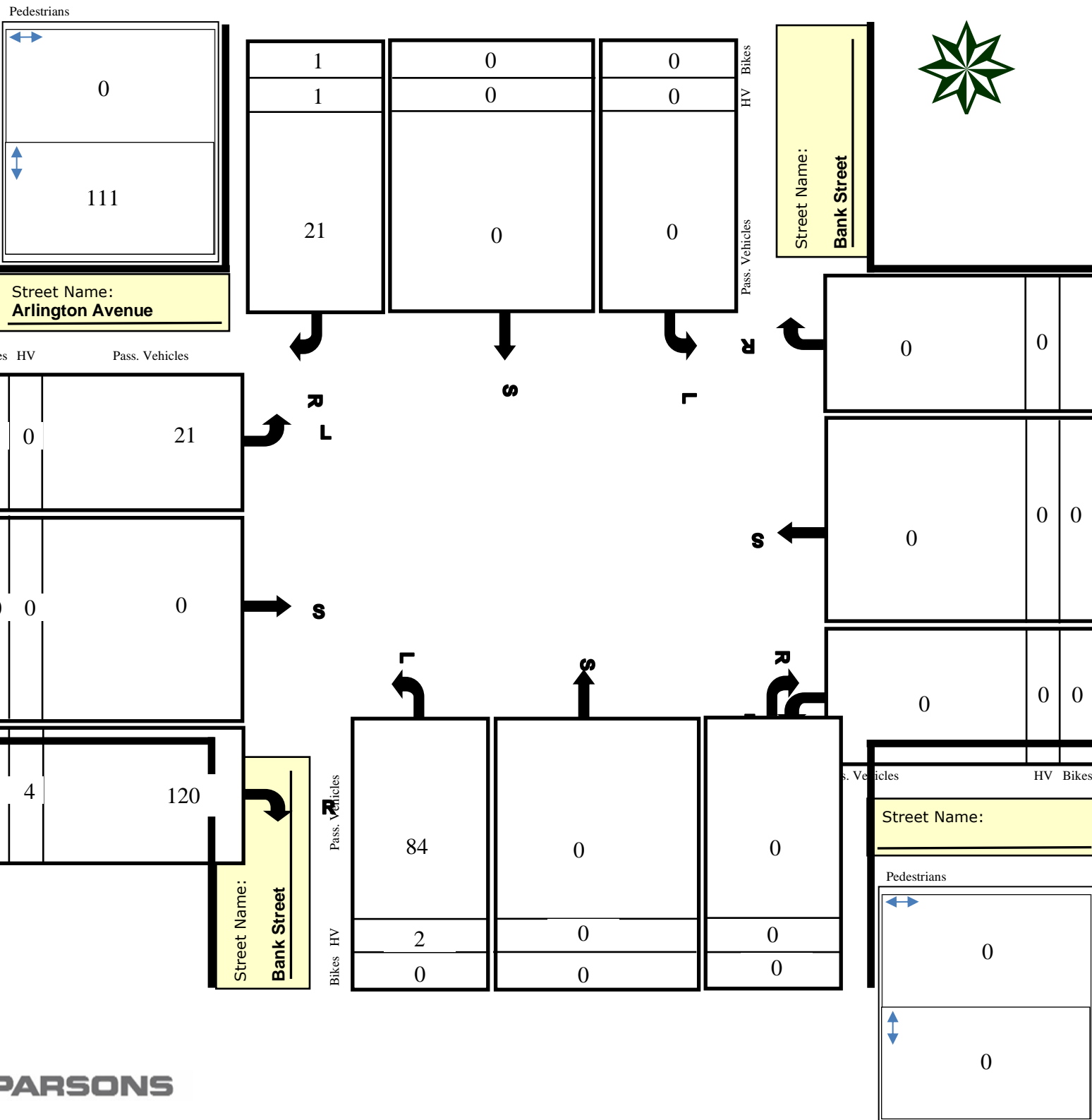

DIRECTIONAL TRAFFIC FLOW

Intersection: Arlington Avenue at Bank Street

DATE: Day: 18 Month: Apr. Year: 2023 Day of Week: Tuesday

Observer: Jordan Terada Weather: Rain

Chkd by: _____ Date: _____

TIME PERIOD: From: 4 : 15 To: 5 : 15

N



Pedestrians

0
42

Street Name:
Arlington Avenue

0	0	0
0	0	0
27		

HV Bikes
Pass. Vehicles

Street Name:
Bank Street

Bikes HV Pass. Vehicles

0	0	20
---	---	----

R
L

0	0	0
---	---	---

S

1	1	106
---	---	-----

Street Name:
Bank Street

Pass. Vehicles
Bikes HV

58	0	0
0	0	0
3	0	0

L
R

	0	
--	---	--

	0	0
--	---	---

S

	0	0
--	---	---

Pass. Vehicles

HV Bikes

Street Name:

Pedestrians

0
0

Turning Movement Count - Study Results

BANK ST @ CATHERINE ST

Survey Date: Thursday, April 19, 2018

WO No: 39991

Start Time: 07:00

Device: Miovision

Full Study Peak Hour Diagram

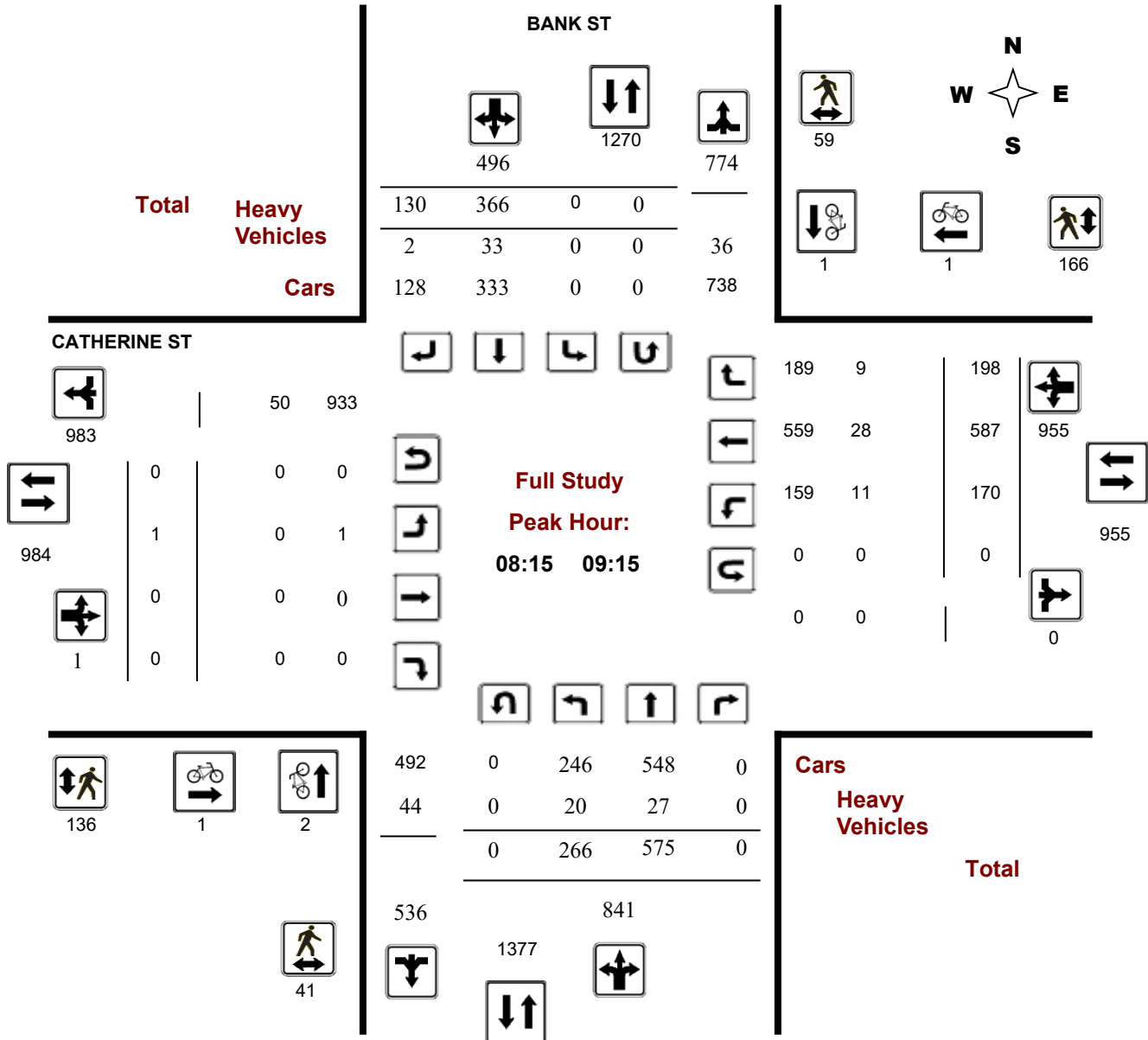

Turning Movement Count - Peak Hour Diagram

BANK ST @ CATHERINE ST

Survey Date: Thursday, April 19, 2018

Start Time: 07:00

WO No: 39991

Device: Miovision

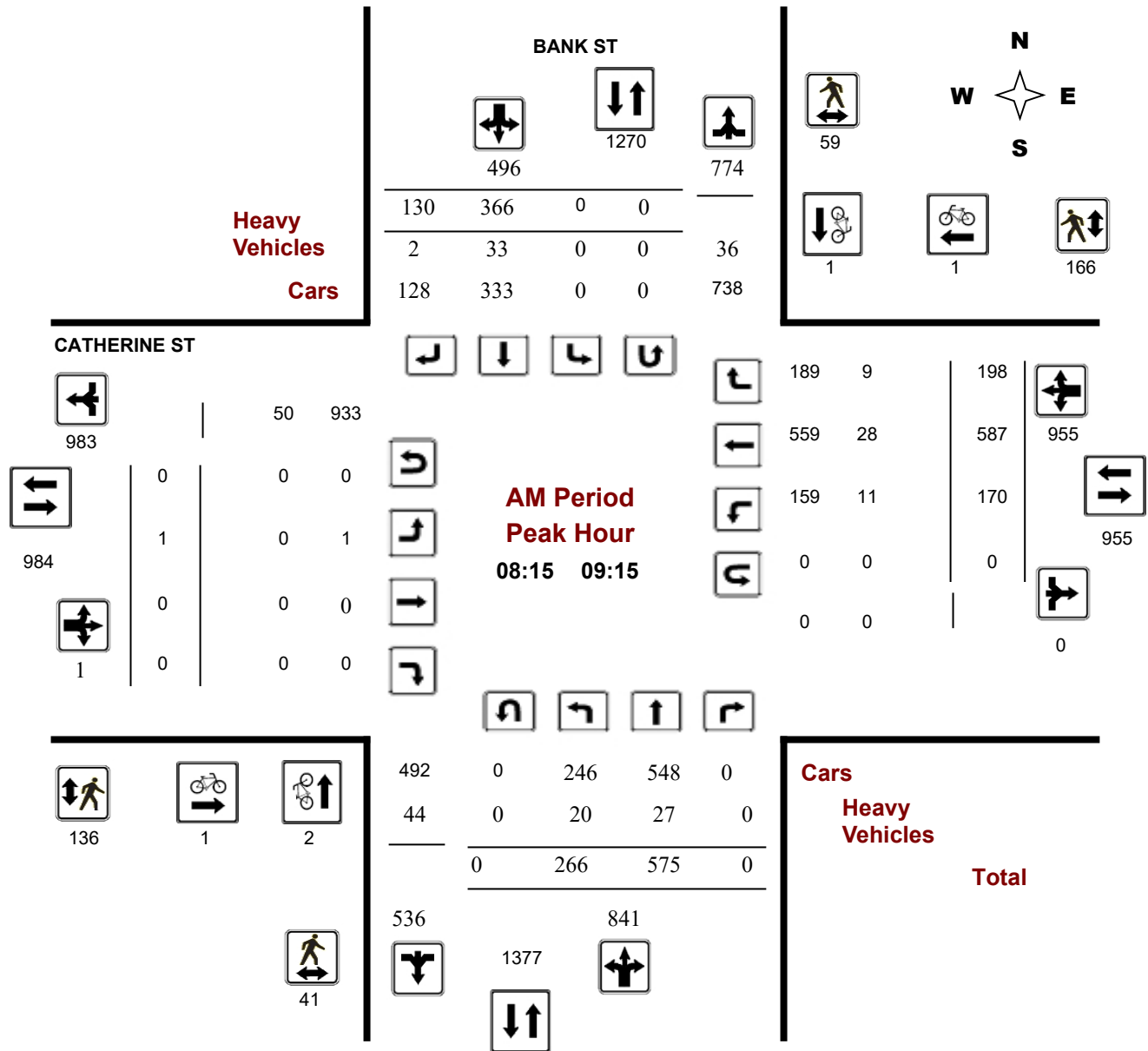

Turning Movement Count - Peak Hour Diagram

BANK ST @ CATHERINE ST

Survey Date: Thursday, April 19, 2018

Start Time: 07:00

WO No: 39991

Device: Miovision

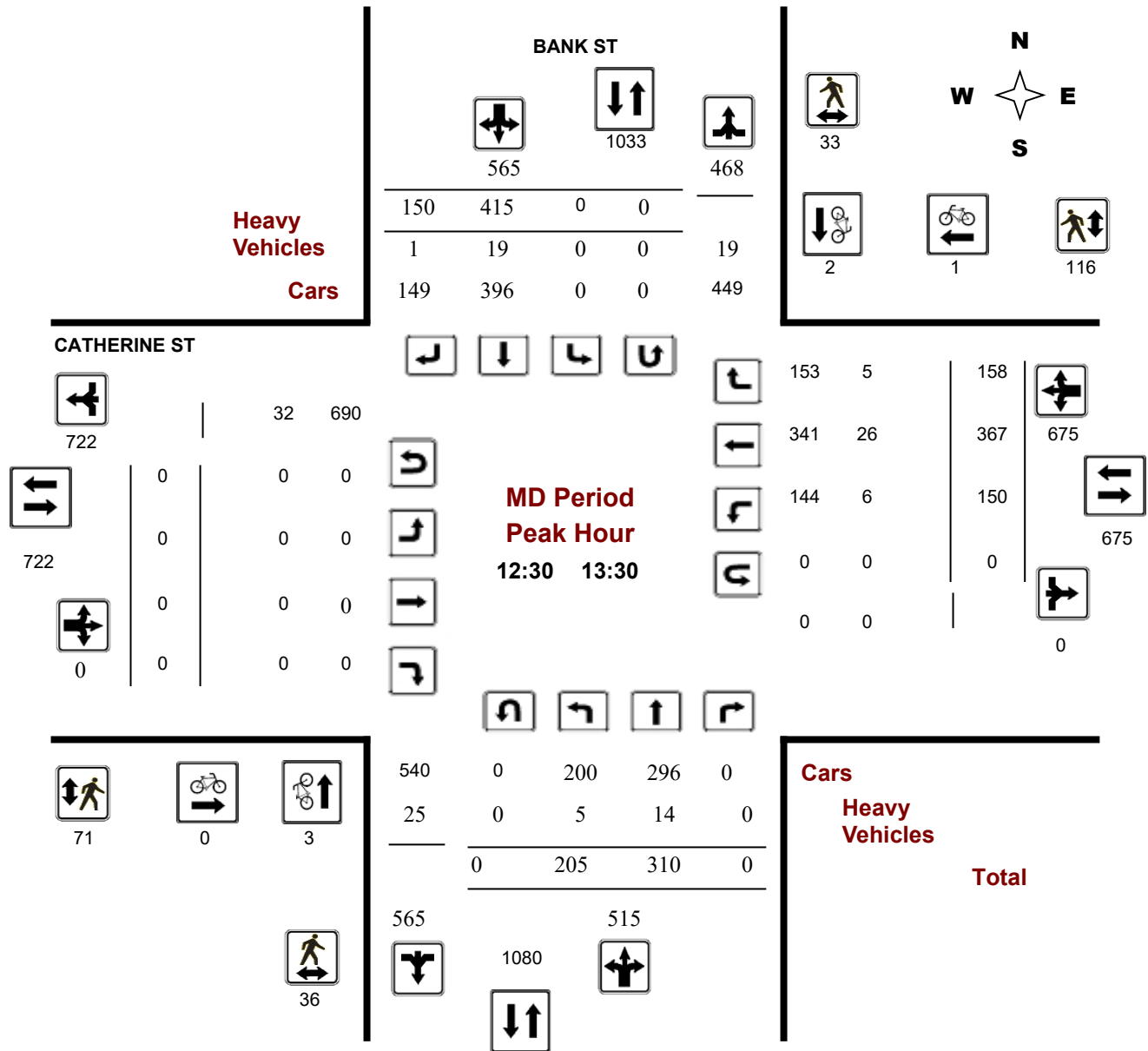

Comments

Turning Movement Count - Peak Hour Diagram

BANK ST @ CATHERINE ST

Survey Date: Thursday, April 19, 2018

Start Time: 07:00

WO No: 39991

Device: Miovision

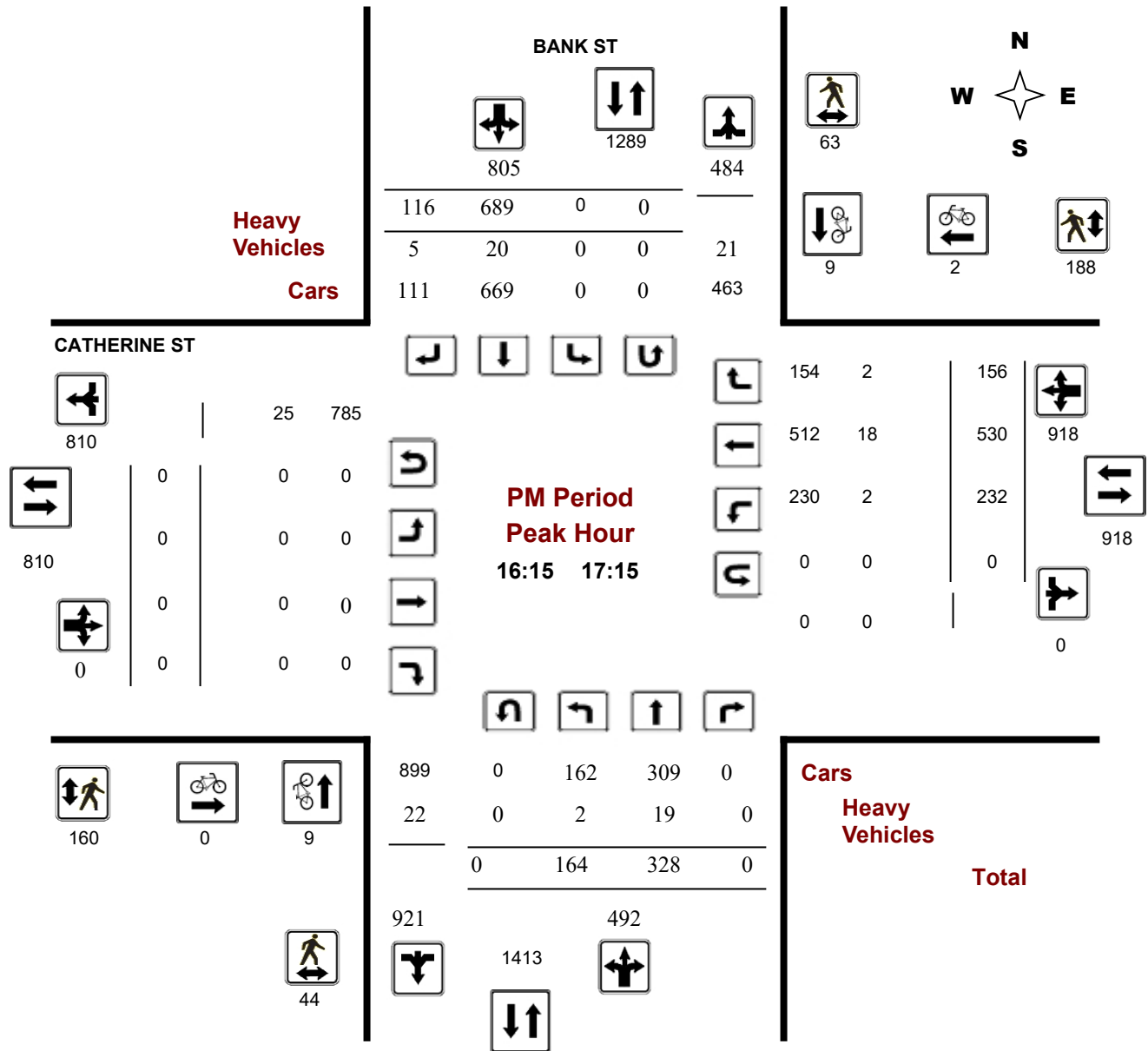



Transportation Services - Traffic Services

Turning Movement Count - Study Results

BANK ST @ CATHERINE ST

Survey Date: Thursday, April 19, 2018

WO No: 39991

Start Time: 07:00

Device: Miovision

Full Study Summary (8 HR Standard)

Survey Date: Thursday, April 19, 2018

Total Observed U-Turns

AADT Factor

Northbound: 0 Southbound: 0
 Eastbound: 0 Westbound: 1
 .90

Period	BANK ST										CATHERINE ST										Grand Total
	Northbound					Southbound					Eastbound					Westbound					
	LT	ST	RT	NB TOT	STR TOT	LT	ST	RT	SB TOT	STR TOT	LT	ST	RT	EB TOT	STR TOT	LT	ST	RT	WB TOT	STR TOT	
07:00 08:00	212	493	0	705	1065	0	268	92	360	1065	0	0	0	0	0	100	566	165	831	831	1896
08:00 09:00	271	602	0	873	1342	0	356	113	469	1342	0	0	0	0	0	167	580	196	943	943	2285
09:00 10:00	211	392	0	603	1088	0	350	135	485	1088	1	0	0	1	1	153	436	172	761	762	1850
11:30 12:30	195	288	0	483	1005	0	380	142	522	1005	0	0	0	0	0	154	349	132	635	635	1640
12:30 13:30	205	310	0	515	1080	0	415	150	565	1080	0	0	0	0	0	150	367	158	675	675	1755
15:00 16:00	194	268	0	462	1176	0	566	148	714	1176	0	0	0	0	0	177	538	161	876	876	2052
16:00 17:00	164	325	0	489	1274	0	663	122	785	1274	0	0	0	0	0	219	559	153	931	931	2205
17:00 18:00	176	352	0	528	1285	0	644	113	757	1285	0	0	0	0	0	218	371	150	739	739	2024
Sub Total	1628	3030	0	4658	9315	0	3642	1015	4657	9315	1	0	0	1	1	1338	3766	1287	6391	6392	15707
U Turns				0	0				0	0				0	0				1	1	1
Total	1628	3030	0	4658	9315	0	3642	1015	4657	9315	1	0	0	1	1	1338	3766	1287	6392	6393	15708
EQ 12Hr	2263	4212	0	6475	12948	0	5062	1411	6473	12948	1	0	0	1	1	1860	5235	1789	8885	8886	21834
Note: These values are calculated by multiplying the totals by the appropriate expansion factor.														1.39							
AVG 12Hr	2037	3791	0	5828	11653	0	5969	1663	5826	11653	1	0	0	1	1	1674	4712	1610	7996	7997	19651
Note: These volumes are calculated by multiplying the Equivalent 12 hr. totals by the AADT factor.														.90							
AVG 24Hr	2668	4966	0	7635	15265	0	7819	2179	7632	15265	1	0	0	1	1	2193	6173	2109	10475	10476	25743
Note: These volumes are calculated by multiplying the Average Daily 12 hr. totals by 12 to 24 expansion factor.														1.31							
Note: U-Turns provided for approach totals. Refer to 'U-Turn' Report for specific breakdown.																					



Transportation Services - Traffic Services

Turning Movement Count - Study Results

BANK ST @ CATHERINE ST

Survey Date: Thursday, April 19, 2018

WO No: 39991

Start Time: 07:00

Device: Miovision

Full Study 15 Minute Increments

BANK ST

CATHERINE ST

Northbound

Southbound

Eastbound

Westbound

Time Period	LT	ST	RT	N TOT	LT	ST	RT	S TOT	STR TOT	LT	ST	RT	E TOT	LT	ST	RT	W TOT	STR TOT	Grand Total
07:00 07:15	37	86	0	123	0	50	26	76	199	0	0	0	0	19	128	44	191	191	390
07:15 07:30	49	111	0	160	0	66	21	87	247	0	0	0	0	24	128	47	199	199	446
07:30 07:45	58	136	0	194	0	71	22	93	287	0	0	0	0	17	160	37	214	214	501
07:45 08:00	68	160	0	228	0	81	23	104	332	0	0	0	0	40	150	37	227	227	559
08:00 08:15	68	143	0	211	0	82	18	100	311	0	0	0	0	36	141	51	228	228	539
08:15 08:30	65	154	0	219	0	99	36	135	354	0	0	0	0	46	150	46	242	242	596
08:30 08:45	70	159	0	229	0	104	33	137	366	0	0	0	0	37	142	52	231	231	597
08:45 09:00	68	146	0	214	0	71	26	97	311	0	0	0	0	48	147	47	242	242	553
09:00 09:15	63	116	0	179	0	92	35	127	306	1	0	0	1	39	148	53	240	241	547
09:15 09:30	60	73	0	133	0	81	28	109	242	0	0	0	0	45	109	53	207	207	449
09:30 09:45	56	101	0	157	0	90	27	117	274	0	0	0	0	42	91	35	168	168	442
09:45 10:00	32	102	0	134	0	87	45	132	266	0	0	0	0	27	88	31	147	147	413
11:30 11:45	45	67	0	112	0	96	33	129	241	0	0	0	0	43	83	37	163	163	404
11:45 12:00	54	76	0	130	0	93	32	125	255	0	0	0	0	46	94	42	182	182	437
12:00 12:15	54	79	0	133	0	88	38	126	259	0	0	0	0	37	98	25	160	160	419
12:15 12:30	42	66	0	108	0	103	39	142	250	0	0	0	0	28	74	28	130	130	380
12:30 12:45	46	79	0	125	0	96	44	140	265	0	0	0	0	45	90	38	173	173	438
12:45 13:00	42	76	0	118	0	110	39	149	267	0	0	0	0	32	91	41	164	164	431
13:00 13:15	66	79	0	145	0	100	29	129	274	0	0	0	0	30	88	31	149	149	423
13:15 13:30	51	76	0	127	0	109	38	147	274	0	0	0	0	43	98	48	189	189	463
15:00 15:15	54	66	0	120	0	134	48	182	302	0	0	0	0	41	93	40	174	174	476
15:15 15:30	50	70	0	120	0	144	36	180	300	0	0	0	0	35	130	52	217	217	517
15:30 15:45	51	63	0	114	0	144	38	182	296	0	0	0	0	51	139	33	223	223	519
15:45 16:00	39	69	0	108	0	144	26	170	278	0	0	0	0	50	176	36	262	262	540
16:00 16:15	45	86	0	131	0	160	38	198	329	0	0	0	0	45	140	36	221	221	550
17:15 17:30	48	85	0	133	0	161	28	189	322	0	0	0	0	57	101	43	201	201	523
17:30 17:45	39	80	0	119	0	154	20	174	293	0	0	0	0	53	83	33	169	169	462
17:45 18:00	44	98	0	142	0	143	33	176	318	0	0	0	0	50	76	35	161	161	479
16:15 16:30	42	70	0	112	0	169	29	198	310	0	0	0	0	64	184	34	282	282	592
16:30 16:45	41	86	0	127	0	151	29	180	307	0	0	0	0	57	123	43	223	223	530
16:45 17:00	36	83	0	119	0	183	26	209	328	0	0	0	0	53	112	40	205	205	533
17:00 17:15	45	89	0	134	0	186	32	218	352	0	0	0	0	58	111	39	208	208	560
Total:	1628	3030	0	4658	0	3642	1015	4657	9315	1	0	0	1	1338	3766	1287	6392	6393	15,708

Note: U-Turns are included in Totals.



Transportation Services - Traffic Services

Turning Movement Count - Study Results

BANK ST @ CATHERINE ST

Survey Date: Thursday, April 19, 2018

WO No: 39991

Start Time: 07:00

Device: Miovision

Full Study Cyclist Volume

Time Period	BANK ST			CATHERINE ST			Grand Total
	Northbound	Southbound	Street Total	Eastbound	Westbound	Street Total	
07:00 07:15	1	1	2	0	0	0	2
07:15 07:30	1	0	1	0	0	0	1
07:30 07:45	1	0	1	0	0	0	1
07:45 08:00	3	0	3	0	0	0	3
08:00 08:15	3	0	3	0	0	0	3
08:15 08:30	1	1	2	0	1	1	3
08:30 08:45	1	0	1	0	0	0	1
08:45 09:00	0	0	0	0	0	0	0
09:00 09:15	0	0	0	1	0	1	1
09:15 09:30	1	1	2	0	0	0	2
09:30 09:45	2	0	2	0	0	0	2
09:45 10:00	2	0	2	0	0	0	2
11:30 11:45	0	1	1	0	1	1	2
11:45 12:00	1	2	3	0	0	0	3
12:00 12:15	1	1	2	0	0	0	2
12:15 12:30	0	4	4	0	0	0	4
12:30 12:45	2	1	3	0	0	0	3
12:45 13:00	0	0	0	0	1	1	1
13:00 13:15	0	0	0	0	0	0	0
13:15 13:30	1	1	2	0	0	0	2
15:00 15:15	1	2	3	0	2	2	5
15:15 15:30	2	2	4	1	0	1	5
15:30 15:45	3	2	5	0	0	0	5
15:45 16:00	4	1	5	0	1	1	6
16:00 16:15	0	1	1	0	1	1	2
17:15 17:30	1	2	3	0	0	0	3
17:30 17:45	0	1	1	0	0	0	1
17:45 18:00	4	3	7	0	0	0	7
16:15 16:30	2	2	4	0	1	1	5
16:30 16:45	4	2	6	0	1	1	7
16:45 17:00	3	1	4	0	0	0	4
17:00 17:15	0	4	4	0	0	0	4
Total	45	36	81	2	9	11	92



Transportation Services - Traffic Services

Turning Movement Count - Study Results

BANK ST @ CATHERINE ST

Survey Date: Thursday, April 19, 2018

WO No: 39991

Start Time: 07:00

Device: Miovision

Full Study Pedestrian Volume

BANK ST

CATHERINE ST

Time Period	NB Approach (E or W Crossing)	SB Approach (E or W Crossing)	Total	EB Approach (N or S Crossing)	WB Approach (N or S Crossing)	Total	Grand Total
07:00 07:15	2	5	7	8	9	17	24
07:15 07:30	4	5	9	18	10	28	37
07:30 07:45	2	5	7	18	18	36	43
07:45 08:00	2	6	8	12	16	28	36
08:00 08:15	10	5	15	18	42	60	75
08:15 08:30	13	17	30	28	46	74	104
08:30 08:45	11	19	30	74	50	124	154
08:45 09:00	9	15	24	19	34	53	77
09:00 09:15	8	8	16	15	36	51	67
09:15 09:30	4	14	18	9	25	34	52
09:30 09:45	4	19	23	2	23	25	48
09:45 10:00	5	3	8	4	23	27	35
11:30 11:45	7	11	18	15	25	40	58
11:45 12:00	5	11	16	21	28	49	65
12:00 12:15	7	24	31	18	28	46	77
12:15 12:30	6	14	20	21	37	58	78
12:30 12:45	4	12	16	28	14	42	58
12:45 13:00	15	10	25	16	42	58	83
13:00 13:15	8	6	14	12	30	42	56
13:15 13:30	9	5	14	15	30	45	59
15:00 15:15	9	14	23	22	23	45	68
15:15 15:30	10	22	32	69	42	111	143
15:30 15:45	9	13	22	25	34	59	81
15:45 16:00	11	4	15	37	33	70	85
16:00 16:15	6	9	15	32	27	59	74
17:15 17:30	8	8	16	43	61	104	120
17:30 17:45	10	6	16	38	41	79	95
17:45 18:00	7	15	22	31	50	81	103
16:15 16:30	13	15	28	48	41	89	117
16:30 16:45	6	11	17	33	49	82	99
16:45 17:00	12	22	34	43	45	88	122
17:00 17:15	13	15	28	36	53	89	117
Total	249	368	617	828	1065	1893	2510



Transportation Services - Traffic Services

Turning Movement Count - Study Results

BANK ST @ CATHERINE ST

Survey Date: Thursday, April 19, 2018

WO No: 39991

Start Time: 07:00

Device: Miovision

Full Study Heavy Vehicles

BANK ST

CATHERINE ST

Northbound

Southbound

Eastbound

Westbound

Time Period	Northbound			N TOT	Southbound			S TOT	STR TOT	Eastbound			E TOT	Westbound			W TOT	STR TOT	Grand Total
	LT	ST	RT		LT	ST	RT			LT	ST	RT		LT	ST	RT			
07:00 07:15	2	4	0	13	0	5	1	11	24	0	0	0	9	2	6	1	9	18	21
07:15 07:30	0	3	0	10	0	5	2	17	27	0	0	0	5	2	3	7	12	17	22
07:30 07:45	2	4	0	12	0	3	1	9	21	0	0	0	10	3	7	1	11	21	21
07:45 08:00	1	6	0	16	0	8	0	16	32	0	0	0	7	1	6	2	9	16	24
08:00 08:15	0	5	0	11	0	2	1	11	22	0	0	0	9	4	8	3	15	24	23
08:15 08:30	2	7	0	22	0	10	0	18	40	0	0	0	10	3	8	1	12	22	31
08:30 08:45	3	3	0	18	0	8	1	12	30	0	0	0	13	4	9	0	13	26	28
08:45 09:00	3	11	0	23	0	7	1	24	47	0	0	0	10	2	6	5	13	23	35
09:00 09:15	12	6	0	28	0	8	0	17	45	0	0	0	17	2	5	3	10	27	36
09:15 09:30	0	4	0	17	0	11	0	17	34	0	0	0	5	2	5	2	9	14	24
09:30 09:45	4	4	0	18	0	7	0	14	32	0	0	0	6	3	2	3	8	14	23
09:45 10:00	1	2	0	15	0	10	1	16	31	0	0	0	14	2	12	3	17	31	31
11:30 11:45	3	3	0	17	0	8	0	14	31	0	0	0	6	3	3	3	9	15	23
11:45 12:00	0	10	0	14	0	2	0	13	27	0	0	0	3	2	3	1	6	9	18
12:00 12:15	1	6	0	16	0	4	0	10	26	0	0	0	11	5	10	0	15	26	26
12:15 12:30	2	6	0	11	0	3	2	12	23	0	0	0	6	0	2	1	3	9	16
12:30 12:45	2	0	0	7	0	4	0	5	12	0	0	0	8	1	6	1	8	16	14
12:45 13:00	1	7	0	17	0	6	1	15	32	0	0	0	8	3	6	1	10	18	25
13:00 13:15	1	3	0	8	0	4	0	7	15	0	0	0	6	0	5	0	5	11	13
13:15 13:30	1	4	0	12	0	5	0	12	24	0	0	0	10	2	9	3	14	24	24
15:00 15:15	0	5	0	15	0	7	3	15	30	0	0	0	13	3	10	0	13	26	28
15:15 15:30	0	3	0	13	0	8	1	12	25	0	0	0	13	2	12	0	14	27	26
15:30 15:45	0	7	0	12	0	4	0	12	24	0	0	0	13	1	13	1	15	28	26
15:45 16:00	0	6	0	8	0	2	0	8	16	0	0	0	8	0	8	0	8	16	16
16:00 16:15	0	5	0	8	0	3	1	9	17	0	0	0	10	0	9	0	9	19	18
17:15 17:30	0	1	0	12	0	10	0	11	23	0	0	0	2	1	2	0	3	5	14
17:30 17:45	0	6	0	10	0	3	0	9	19	0	0	0	4	1	4	0	5	9	14
17:45 18:00	0	7	0	13	0	6	0	14	27	0	0	0	2	0	2	1	3	5	16
16:15 16:30	0	3	0	6	0	2	2	7	13	0	0	0	10	1	8	0	9	19	16
16:30 16:45	0	5	0	11	0	6	1	12	23	0	0	0	5	0	4	0	4	9	16
16:45 17:00	1	7	0	16	0	7	1	17	33	0	0	0	3	1	1	2	4	7	20
17:00 17:15	1	4	0	10	0	5	1	10	20	0	0	0	7	0	5	0	5	12	16
Total: None	43	157	0	439	0	183	21	406	845	0	0	0	263	56	199	45	300	563	704



Transportation Services - Traffic Services

Turning Movement Count - Study Results

BANK ST @ CATHERINE ST

Survey Date: Thursday, April 19, 2018

WO No: 39991

Start Time: 07:00

Device: Miovision

Full Study 15 Minute U-Turn Total

BANK ST

CATHERINE ST

Time Period		Northbound U-Turn Total	Southbound U-Turn Total	Eastbound U-Turn Total	Westbound U-Turn Total	Total
07:00	07:15	0	0	0	0	0
07:15	07:30	0	0	0	0	0
07:30	07:45	0	0	0	0	0
07:45	08:00	0	0	0	0	0
08:00	08:15	0	0	0	0	0
08:15	08:30	0	0	0	0	0
08:30	08:45	0	0	0	0	0
08:45	09:00	0	0	0	0	0
09:00	09:15	0	0	0	0	0
09:15	09:30	0	0	0	0	0
09:30	09:45	0	0	0	0	0
09:45	10:00	0	0	0	1	1
11:30	11:45	0	0	0	0	0
11:45	12:00	0	0	0	0	0
12:00	12:15	0	0	0	0	0
12:15	12:30	0	0	0	0	0
12:30	12:45	0	0	0	0	0
12:45	13:00	0	0	0	0	0
13:00	13:15	0	0	0	0	0
13:15	13:30	0	0	0	0	0
15:00	15:15	0	0	0	0	0
15:15	15:30	0	0	0	0	0
15:30	15:45	0	0	0	0	0
15:45	16:00	0	0	0	0	0
16:00	16:15	0	0	0	0	0
17:15	17:30	0	0	0	0	0
17:30	17:45	0	0	0	0	0
17:45	18:00	0	0	0	0	0
16:15	16:30	0	0	0	0	0
16:30	16:45	0	0	0	0	0
16:45	17:00	0	0	0	0	0
17:00	17:15	0	0	0	0	0
Total		0	0	0	1	1

Survey Date: Wednesday, April 18, 2018

WO No: 39632

Start Time: 07:00

Device: Miovision

Full Study Diagram

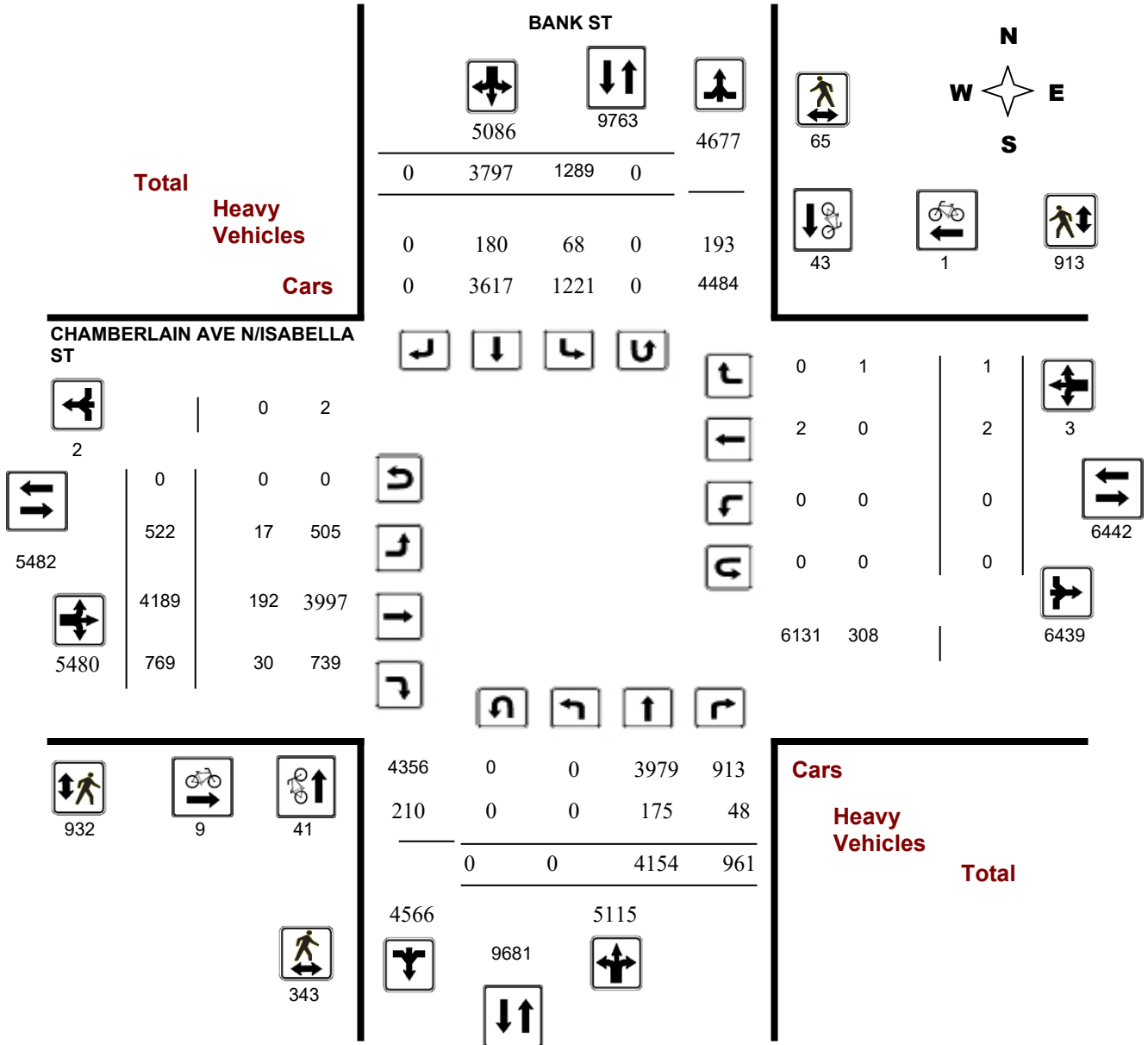

W.O. 5365004 - WED APR 18TH - CONSULTANT - (8HR REIMPORT)

Turning Movement Count - Study Results

BANK ST @ CHAMBERLAIN AVE N/ISABELLA ST

Survey Date: Wednesday, April 18, 2018

WO No: 39632

Start Time: 07:00

Device: Miovision

Full Study Peak Hour Diagram

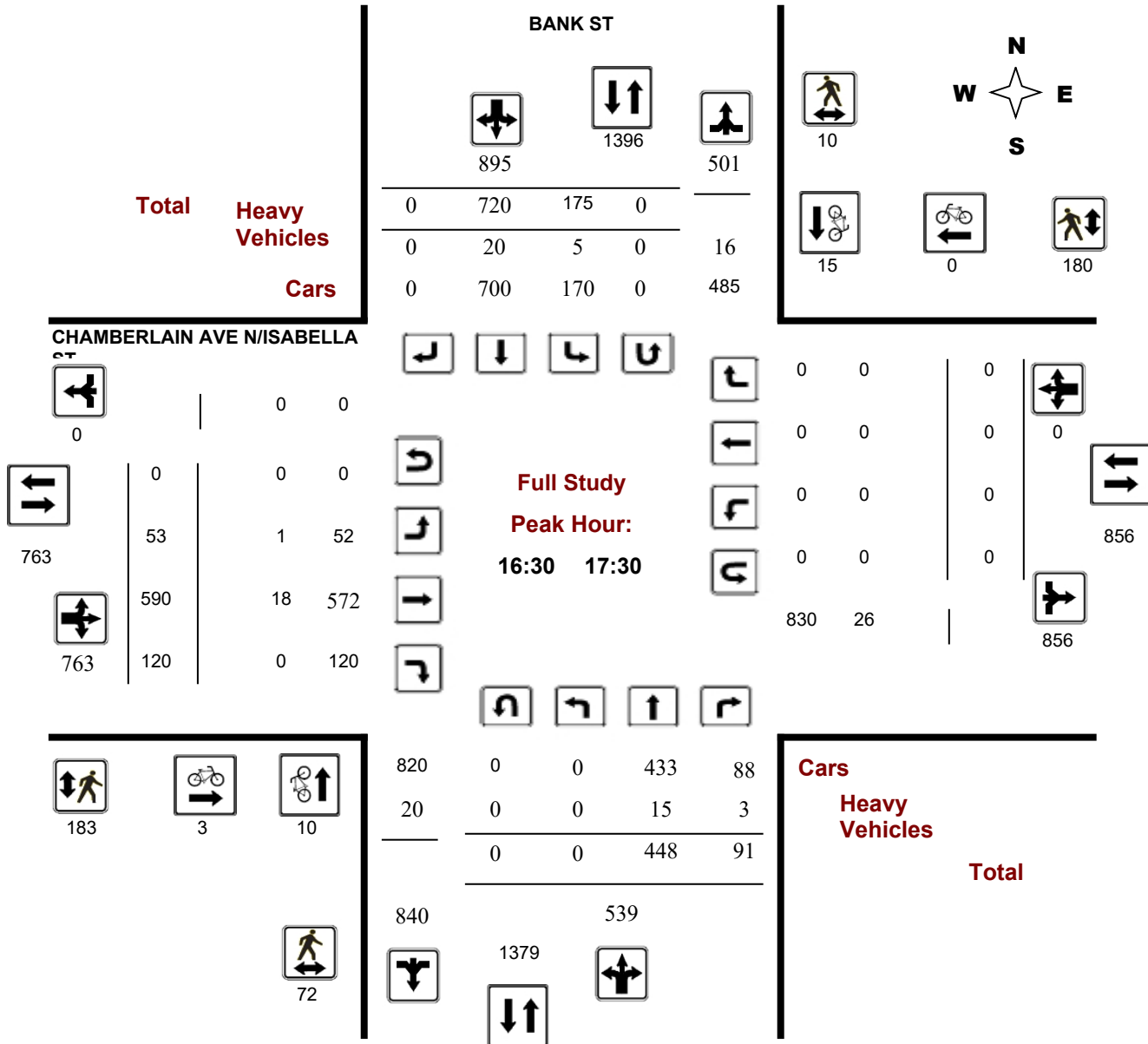

W.O. 5365004 - WED APR 18TH - CONSULTANT - (8HR REIMPORT)

Turning Movement Count - Peak Hour Diagram

BANK ST @ CHAMBERLAIN AVE N/ISABELLA ST

Survey Date: Wednesday, April 18, 2018

Start Time: 07:00

WO No: 39632

Device: Miovision

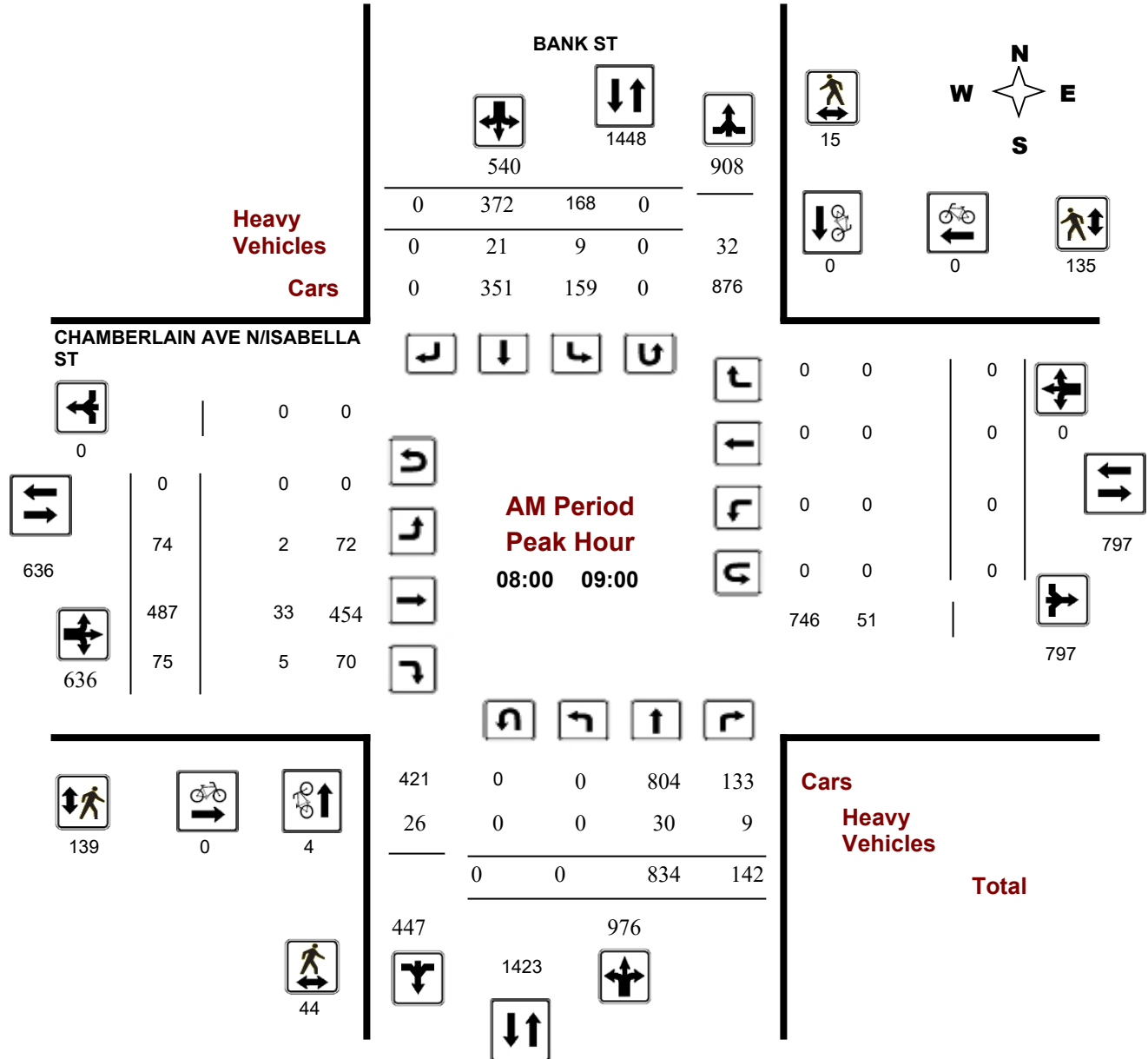

Comments W.O. 5365004 - WED APR 18TH - CONSULTANT - (8HR REIMPORT)



Transportation Services - Traffic Services

Turning Movement Count - Peak Hour Diagram

BANK ST @ CHAMBERLAIN AVE N/ISABELLA ST

Survey Date: Wednesday, April 18, 2018

Start Time: 07:00

WO No: 39632

Device: Miovision

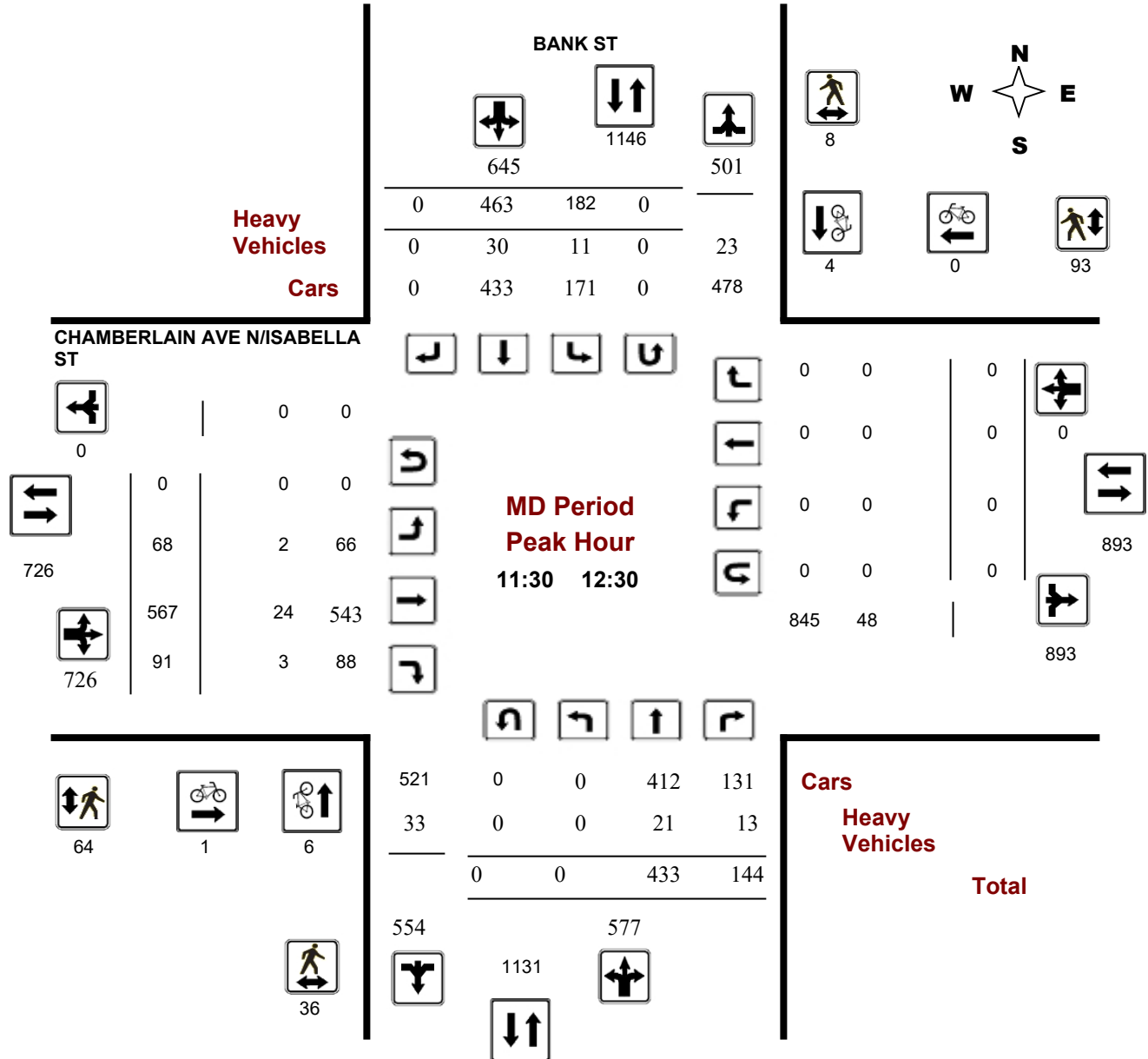

Comments W.O. 5365004 - WED APR 18TH - CONSULTANT - (8HR REIMPORT)

Turning Movement Count - Peak Hour Diagram

BANK ST @ CHAMBERLAIN AVE N/ISABELLA ST

Survey Date: Wednesday, April 18, 2018

Start Time: 07:00

WO No: 39632

Device: Miovision

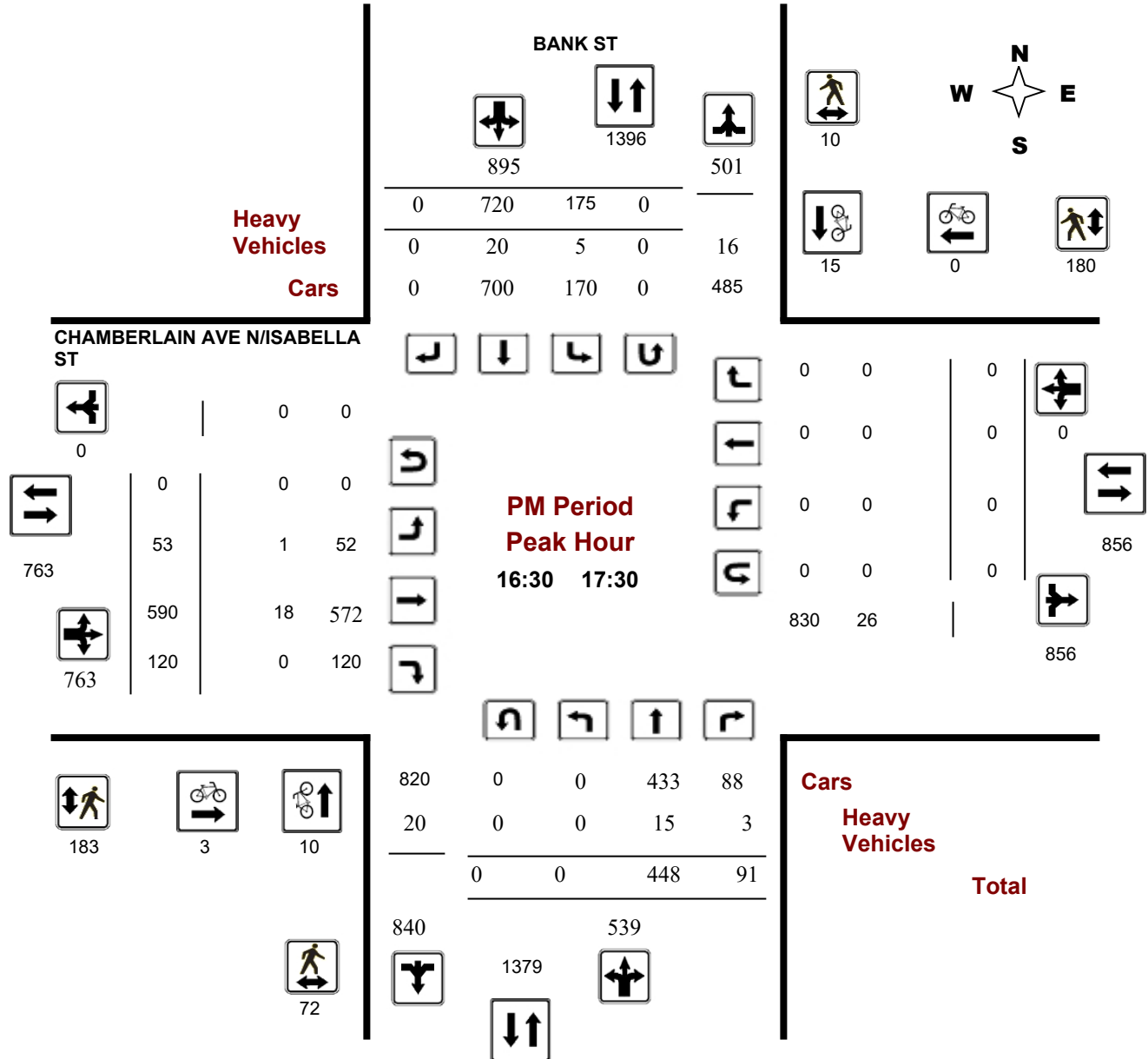

Comments W.O. 5365004 - WED APR 18TH - CONSULTANT - (8HR REIMPORT)



Transportation Services - Traffic Services

Turning Movement Count - Study Results

BANK ST @ CHAMBERLAIN AVE N/ISABELLA ST

Survey Date: Wednesday, April 18, 2018

WO No: 39632

Start Time: 07:00

Device: Miovision

Full Study Summary (8 HR Standard)

Survey Date: Wednesday, April 18, 2018

Total Observed U-Turns

AADT Factor

Northbound: 0 Southbound: 0
 Eastbound: 0 Westbound: 0

.90

Period	BANK ST									CHAMBERLAIN AVE N/ISABELLA ST									Grand Total
	Northbound			NB TOT	Southbound			SB TOT	STR TOT	Eastbound			EB TOT	Westbound			WB TOT	STR TOT	
	LT	ST	RT		LT	ST	RT			LT	ST	RT		LT	ST	RT			
07:00 08:00	0	655	83	738	105	264	0	369	1107	58	391	56	505	0	2	0	2	507	1614
08:00 09:00	0	834	142	976	168	372	0	540	1516	74	487	75	636	0	0	0	0	636	2152
09:00 10:00	0	471	111	582	158	380	0	538	1120	84	499	68	651	0	0	1	1	652	1772
11:30 12:30	0	433	144	577	182	463	0	645	1222	68	567	91	726	0	0	0	0	726	1948
12:30 13:30	0	429	139	568	135	432	0	567	1135	67	518	115	700	0	0	0	0	700	1835
15:00 16:00	0	441	139	580	185	523	0	708	1288	63	582	126	771	0	0	0	0	771	2059
16:00 17:00	0	442	102	544	174	686	0	860	1404	54	565	99	718	0	0	0	0	718	2122
17:00 18:00	0	449	101	550	182	677	0	859	1409	54	580	139	773	0	0	0	0	773	2182
Sub Total	0	4154	961	5115	1289	3797	0	5086	10201	522	4189	769	5480	0	2	1	3	5483	15684
U Turns				0				0	0				0				0	0	0
Total	0	4154	961	5115	1289	3797	0	5086	10201	522	4189	769	5480	0	2	1	3	5483	15684
EQ 12Hr	0	5774	1336	7110	1792	5278	0	7070	14179	726	5823	1069	7617	0	3	1	4	7621	21801
Note: These values are calculated by multiplying the totals by the appropriate expansion factor.																	1.39		
AVG 12Hr	0	4898	1133	6031	1520	4477	0	5996	12761	615	4939	907	6461	0	2	1	4	6859	19621
Note: These volumes are calculated by multiplying the Equivalent 12 hr. totals by the AADT factor.																	0.9		
AVG 24Hr	0	6416	1484	7900	1991	5864	0	7855	15755	806	6470	1188	8464	0	3	2	5	8469	24224
Note: These volumes are calculated by multiplying the Average Daily 12 hr. totals by 12 to 24 expansion factor.																	1.31		

Note: U-Turns provided for approach totals. Refer to 'U-Turn' Report for specific breakdown.



Transportation Services - Traffic Services

Turning Movement Count - Study Results

BANK ST @ CHAMBERLAIN AVE N/ISABELLA ST

Survey Date: Wednesday, April 18, 2018

WO No: 39632

Start Time: 07:00

Device: Miovision

Full Study 15 Minute Increments

BANK ST

CHAMBERLAIN AVE N/ISABELLA S

Northbound

Southbound

Eastbound

Westbound

Time Period	LT	ST	RT	N TOT	LT	ST	RT	S TOT	STR TOT	LT	ST	RT	E TOT	LT	ST	RT	W TOT	STR TOT	Grand Total
07:00 07:15	0	118	15	133	24	54	0	78	16	10	74	16	100	0	2	0	2	16	313
07:15 07:30	0	128	15	143	26	54	0	80	18	15	94	22	131	0	0	0	0	18	354
07:30 07:45	0	196	21	217	25	78	0	103	11	20	102	10	132	0	0	0	0	11	452
07:45 08:00	0	213	32	245	30	78	0	108	15	13	121	8	142	0	0	0	0	15	495
08:00 08:15	0	215	37	252	43	81	0	124	18	21	102	20	143	0	0	0	0	18	519
08:15 08:30	0	210	31	241	41	83	0	124	16	23	121	15	159	0	0	0	0	16	524
08:30 08:45	0	214	37	251	41	95	0	136	15	13	118	18	149	0	0	0	0	15	536
08:45 09:00	0	195	37	232	43	113	0	156	20	17	146	22	185	0	0	0	0	20	573
09:00 09:15	0	143	45	188	34	87	0	121	22	21	142	16	179	0	0	0	0	22	488
09:15 09:30	0	113	27	140	37	98	0	135	20	23	141	11	175	0	0	1	1	20	451
09:30 09:45	0	109	14	123	59	94	0	153	22	15	109	19	143	0	0	0	0	22	419
09:45 10:00	0	106	25	131	28	101	0	129	20	25	107	22	154	0	0	0	0	20	414
11:30 11:45	0	110	30	140	36	124	0	160	19	21	137	18	176	0	0	0	0	19	476
11:45 12:00	0	117	27	144	50	106	0	156	16	12	144	28	184	0	0	0	0	16	484
12:00 12:15	0	111	38	149	50	104	0	154	19	20	151	21	192	0	0	0	0	19	495
12:15 12:30	0	95	49	144	46	129	0	175	21	15	135	24	174	0	0	0	0	21	493
12:30 12:45	0	100	31	131	39	109	0	148	12	18	139	20	177	0	0	0	0	12	456
12:45 13:00	0	117	37	154	28	105	0	133	14	17	120	30	167	0	0	0	0	14	454
13:00 13:15	0	98	40	138	34	112	0	146	12	21	141	22	184	0	0	0	0	12	468
13:15 13:30	0	114	31	145	34	106	0	140	15	11	118	43	172	0	0	0	0	15	457
15:00 15:15	0	120	38	158	45	114	0	159	12	16	148	28	192	0	0	0	0	12	509
15:15 15:30	0	114	33	147	51	120	0	171	14	17	141	32	190	0	0	0	0	14	508
15:30 15:45	0	98	38	136	40	131	0	171	6	13	137	41	191	0	0	0	0	6	498
15:45 16:00	0	109	30	139	49	158	0	207	13	17	156	25	198	0	0	0	0	13	544
16:00 16:15	0	132	27	159	35	163	0	198	10	13	133	34	180	0	0	0	0	10	537
16:15 16:30	0	102	28	130	50	165	0	215	12	14	137	22	173	0	0	0	0	12	518
16:30 16:45	0	98	25	123	46	179	0	225	15	17	153	26	196	0	0	0	0	15	544
16:45 17:00	0	110	22	132	43	179	0	222	9	10	142	17	169	0	0	0	0	9	523
17:00 17:15	0	117	24	141	43	174	0	217	10	12	156	35	203	0	0	0	0	10	561
17:15 17:30	0	123	20	143	43	188	0	231	9	14	139	42	195	0	0	0	0	9	569
17:30 17:45	0	100	24	124	50	148	0	198	12	18	141	40	199	0	0	0	0	12	521
17:45 18:00	0	109	33	142	46	167	0	213	8	10	144	22	176	0	0	0	0	8	531
Total:	0	4154	961	5115	1289	3797	0	5086	471	522	4189	769	5480	0	2	1	3	471	15,684

Note: U-Turns are included in Totals.



Transportation Services - Traffic Services

Turning Movement Count - Study Results

BANK ST @ CHAMBERLAIN AVE N/ISABELLA ST

Survey Date: Wednesday, April 18, 2018

WO No: 39632

Start Time: 07:00

Device: Miovision

Full Study Cyclist Volume

Time Period	BANK ST			CHAMBERLAIN AVE N/ISABELLA ST			Grand Total
	Northbound	Southbound	Street Total	Eastbound	Westbound	Street Total	
07:00 07:15	0	1	1	0	0	0	1
07:15 07:30	0	0	0	0	0	0	0
07:30 07:45	2	0	2	0	0	0	2
07:45 08:00	0	1	1	0	0	0	1
08:00 08:15	1	0	1	0	0	0	1
08:15 08:30	0	0	0	0	0	0	0
08:30 08:45	0	0	0	0	0	0	0
08:45 09:00	3	0	3	0	0	0	3
09:00 09:15	1	0	1	0	0	0	1
09:15 09:30	0	2	2	1	0	1	3
09:30 09:45	1	0	1	0	1	1	2
09:45 10:00	0	0	0	0	0	0	0
11:30 11:45	2	1	3	0	0	0	3
11:45 12:00	1	1	2	1	0	1	3
12:00 12:15	2	0	2	0	0	0	2
12:15 12:30	1	2	3	0	0	0	3
12:30 12:45	0	1	1	0	0	0	1
12:45 13:00	2	0	2	0	0	0	2
13:00 13:15	0	0	0	0	0	0	0
13:15 13:30	1	1	2	0	0	0	2
15:00 15:15	2	2	4	2	0	2	6
15:15 15:30	2	3	5	0	0	0	5
15:30 15:45	3	1	4	0	0	0	4
15:45 16:00	0	2	2	0	0	0	2
16:00 16:15	3	5	8	0	0	0	8
16:15 16:30	0	1	1	0	0	0	1
16:30 16:45	3	4	7	2	0	2	9
16:45 17:00	4	4	8	0	0	0	8
17:00 17:15	1	2	3	1	0	1	4
17:15 17:30	2	5	7	0	0	0	7
17:30 17:45	2	1	3	1	0	1	4
17:45 18:00	2	3	5	1	0	1	6
Total	41	43	84	9	1	10	94



Transportation Services - Traffic Services

Turning Movement Count - Study Results

BANK ST @ CHAMBERLAIN AVE N/ISABELLA ST

Survey Date: Wednesday, April 18, 2018

WO No: 39632

Start Time: 07:00

Device: Miovision

Full Study Pedestrian Volume

BANK ST

CHAMBERLAIN AVE N/ISABELLA S

Time Period	NB Approach (E or W Crossing)	SB Approach (E or W Crossing)	Total	EB Approach (N or S Crossing)	WB Approach (N or S Crossing)	Total	Grand Total
07:00 07:15	6	1	7	11	7	18	25
07:15 07:30	5	2	7	8	14	22	29
07:30 07:45	5	0	5	18	15	33	38
07:45 08:00	4	2	6	19	17	36	42
08:00 08:15	5	2	7	17	32	49	56
08:15 08:30	18	3	21	29	28	57	78
08:30 08:45	12	5	17	60	43	103	120
08:45 09:00	9	5	14	33	32	65	79
09:00 09:15	7	1	8	19	23	42	50
09:15 09:30	7	5	12	13	24	37	49
09:30 09:45	0	1	1	16	12	28	29
09:45 10:00	23	0	23	31	16	47	70
11:30 11:45	8	1	9	13	19	32	41
11:45 12:00	5	2	7	15	25	40	47
12:00 12:15	17	2	19	15	30	45	64
12:15 12:30	6	3	9	21	19	40	49
12:30 12:45	8	2	10	16	29	45	55
12:45 13:00	9	1	10	18	20	38	48
13:00 13:15	3	1	4	22	21	43	47
13:15 13:30	6	0	6	20	31	51	57
15:00 15:15	12	1	13	24	24	48	61
15:15 15:30	21	0	21	95	28	123	144
15:30 15:45	7	1	8	26	31	57	65
15:45 16:00	10	2	12	27	32	59	71
16:00 16:15	15	1	16	23	29	52	68
16:15 16:30	13	5	18	49	41	90	108
16:30 16:45	16	2	18	39	49	88	106
16:45 17:00	19	2	21	46	34	80	101
17:00 17:15	21	3	24	43	43	86	110
17:15 17:30	16	3	19	55	54	109	128
17:30 17:45	19	5	24	50	50	100	124
17:45 18:00	11	1	12	41	41	82	94
Total	343	65	408	932	913	1845	2253

W.O. 5365004 - WED APR 18TH - CONSULTANT - (8HR REIMPORT)



Transportation Services - Traffic Services

Turning Movement Count - Study Results

BANK ST @ CHAMBERLAIN AVE N/ISABELLA ST

Survey Date: Wednesday, April 18, 2018

WO No: 39632

Start Time: 07:00

Device: Miovision

Full Study Heavy Vehicles

BANK ST

CHAMBERLAIN AVE N/ISABELLA S

Northbound

Southbound

Eastbound

Westbound

Time Period	Northbound			N TOT	Southbound			S TOT	STR TOT	Eastbound			E TOT	Westbound			W TOT	STR TOT	Grand Total
	LT	ST	RT		LT	ST	RT			LT	ST	RT		LT	ST	RT			
07:00 07:15	0	7	0	7	0	9	0	9	16	0	5	1	6	0	0	0	0	6	22
07:15 07:30	0	9	1	10	1	7	0	8	18	0	6	1	7	0	0	0	0	7	25
07:30 07:45	0	6	0	6	1	4	0	5	11	1	4	1	6	0	0	0	0	6	17
07:45 08:00	0	6	3	9	3	3	0	6	15	0	2	0	2	0	0	0	0	2	17
08:00 08:15	0	8	1	9	4	5	0	9	18	0	8	1	9	0	0	0	0	9	27
08:15 08:30	0	6	3	9	0	7	0	7	16	0	4	0	4	0	0	0	0	4	20
08:30 08:45	0	6	1	7	4	4	0	8	15	1	8	3	12	0	0	0	0	12	27
08:45 09:00	0	10	4	14	1	5	0	6	20	1	13	1	15	0	0	0	0	15	35
09:00 09:15	0	5	6	11	5	6	0	11	22	2	7	1	10	0	0	0	0	10	32
09:15 09:30	0	8	3	11	1	8	0	9	20	3	11	0	14	0	0	1	1	15	35
09:30 09:45	0	6	1	7	6	9	0	15	22	1	7	3	11	0	0	0	0	11	33
09:45 10:00	0	4	1	5	5	10	0	15	20	0	3	3	6	0	0	0	0	6	26
11:30 11:45	0	2	6	8	1	10	0	11	19	1	7	1	9	0	0	0	0	9	28
11:45 12:00	0	6	2	8	1	7	0	8	16	0	5	0	5	0	0	0	0	5	21
12:00 12:15	0	9	1	10	4	5	0	9	19	0	4	0	4	0	0	0	0	4	23
12:15 12:30	0	4	4	8	5	8	0	13	21	1	8	2	11	0	0	0	0	11	32
12:30 12:45	0	3	2	5	1	6	0	7	12	0	4	1	5	0	0	0	0	5	17
12:45 13:00	0	6	1	7	2	5	0	7	14	0	5	3	8	0	0	0	0	8	22
13:00 13:15	0	4	1	5	3	4	0	7	12	1	9	0	10	0	0	0	0	10	22
13:15 13:30	0	7	1	8	2	5	0	7	15	0	7	2	9	0	0	0	0	9	24
15:00 15:15	0	6	0	6	0	6	0	6	12	0	8	0	8	0	0	0	0	8	20
15:15 15:30	0	3	1	4	1	9	0	10	14	1	4	1	6	0	0	0	0	6	20
15:30 15:45	0	3	0	3	2	1	0	3	6	0	4	1	5	0	0	0	0	5	11
15:45 16:00	0	6	0	6	3	4	0	7	13	1	4	1	6	0	0	0	0	6	19
16:00 16:15	0	5	1	6	0	4	0	4	10	1	8	2	11	0	0	0	0	11	21
16:15 16:30	0	5	0	5	5	2	0	7	12	1	6	0	7	0	0	0	0	7	19
16:30 16:45	0	6	1	7	2	6	0	8	15	1	1	0	2	0	0	0	0	2	17
16:45 17:00	0	4	1	5	2	2	0	4	9	0	5	0	5	0	0	0	0	5	14
17:00 17:15	0	4	0	4	0	6	0	6	10	0	6	0	6	0	0	0	0	6	16
17:15 17:30	0	1	1	2	1	6	0	7	9	0	6	0	6	0	0	0	0	6	15
17:30 17:45	0	5	1	6	1	5	0	6	12	0	6	1	7	0	0	0	0	7	19
17:45 18:00	0	5	0	5	1	2	0	3	8	0	7	0	7	0	0	0	0	7	15
Total: None	0	175	48	223	68	180	0	248	471	17	192	30	239	0	0	1	1	240	711



Transportation Services - Traffic Services

Turning Movement Count - Study Results

BANK ST @ CHAMBERLAIN AVE N/ISABELLA ST

Survey Date: Wednesday, April 18, 2018

WO No: 39632

Start Time: 07:00

Device: Miovision

Full Study 15 Minute U-Turn Total

BANK ST

CHAMBERLAIN AVE N/ISABELLA S

Time Period		Northbound U-Turn Total	Southbound U-Turn Total	Eastbound U-Turn Total	Westbound U-Turn Total	Total
07:00	07:15	0	0	0	0	0
07:15	07:30	0	0	0	0	0
07:30	07:45	0	0	0	0	0
07:45	08:00	0	0	0	0	0
08:00	08:15	0	0	0	0	0
08:15	08:30	0	0	0	0	0
08:30	08:45	0	0	0	0	0
08:45	09:00	0	0	0	0	0
09:00	09:15	0	0	0	0	0
09:15	09:30	0	0	0	0	0
09:30	09:45	0	0	0	0	0
09:45	10:00	0	0	0	0	0
11:30	11:45	0	0	0	0	0
11:45	12:00	0	0	0	0	0
12:00	12:15	0	0	0	0	0
12:15	12:30	0	0	0	0	0
12:30	12:45	0	0	0	0	0
12:45	13:00	0	0	0	0	0
13:00	13:15	0	0	0	0	0
13:15	13:30	0	0	0	0	0
15:00	15:15	0	0	0	0	0
15:15	15:30	0	0	0	0	0
15:30	15:45	0	0	0	0	0
15:45	16:00	0	0	0	0	0
16:00	16:15	0	0	0	0	0
16:15	16:30	0	0	0	0	0
16:30	16:45	0	0	0	0	0
16:45	17:00	0	0	0	0	0
17:00	17:15	0	0	0	0	0
17:15	17:30	0	0	0	0	0
17:30	17:45	0	0	0	0	0
17:45	18:00	0	0	0	0	0
Total		0	0	0	0	0

Turning Movement Count - Study Results

BRONSON AVE @ CATHERINE ST/RAYMOND ST

Survey Date: Thursday, April 19, 2018

WO No: 39598

Start Time: 07:00

Device: Miovision

Full Study Diagram

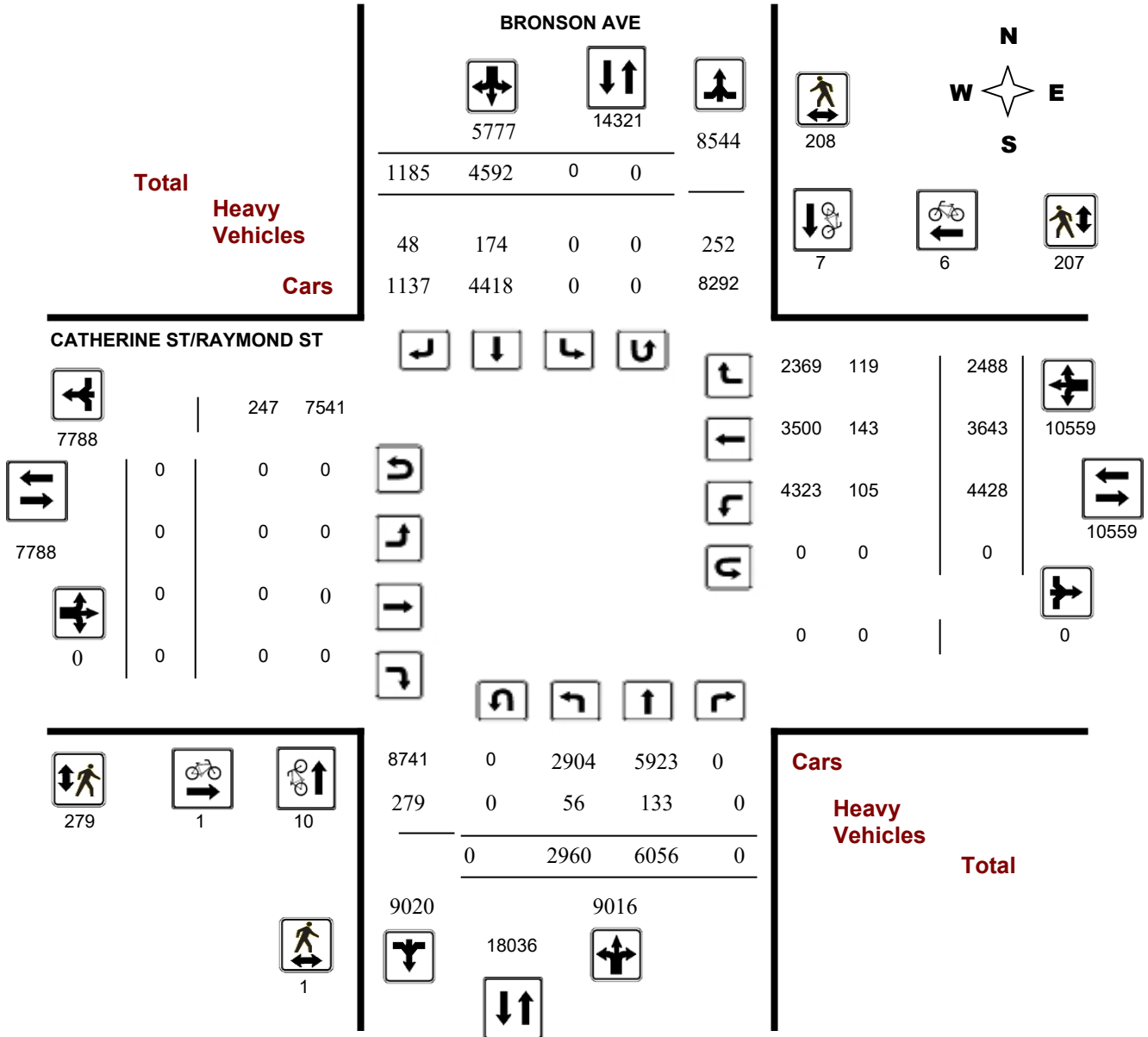

W.O. 5365004 - THURS APR 19TH - CONSULTANT - 48 HRS (REIMPORT - 8HR STANDARD)

Survey Date: Thursday, April 19, 2018

WO No: 39598

Start Time: 07:00

Device: Miovision

Full Study Peak Hour Diagram

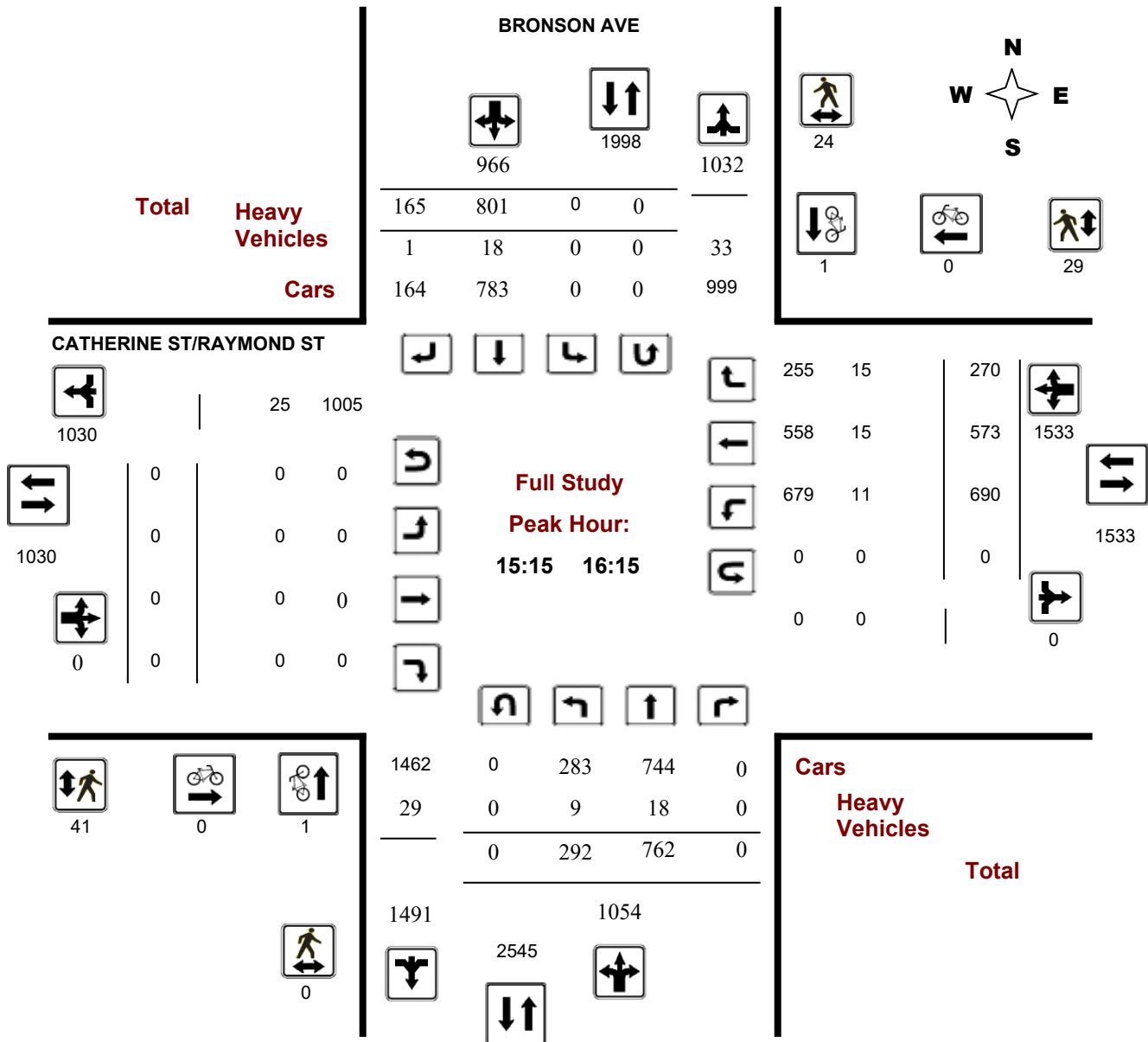

W.O. 5365004 - THURS APR 19TH - CONSULTANT - 48 HRS (REIMPORT - 8HR STANDARD)

Turning Movement Count - Peak Hour Diagram

BRONSON AVE @ CATHERINE ST/RAYMOND ST

Survey Date: Thursday, April 19, 2018

Start Time: 07:00

WO No: 39598

Device: Miovision

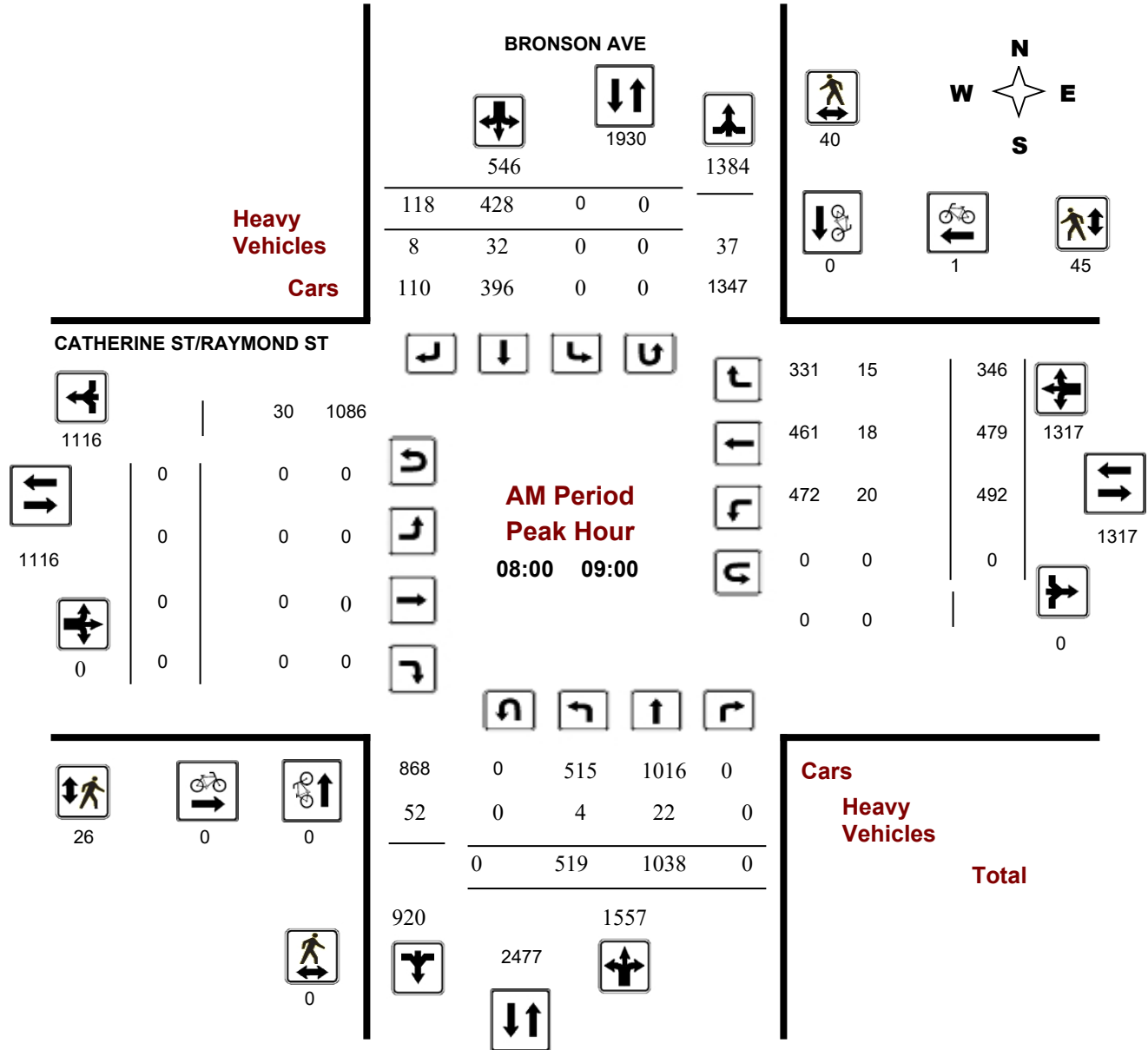

Comments W.O. 5365004 - THURS APR 19TH - CONSULTANT - 48 HRS (REIMPORT - 8HR STANDAR

Turning Movement Count - Peak Hour Diagram

BRONSON AVE @ CATHERINE ST/RAYMOND ST

Survey Date: Thursday, April 19, 2018

Start Time: 07:00

WO No: 39598

Device: Miovision

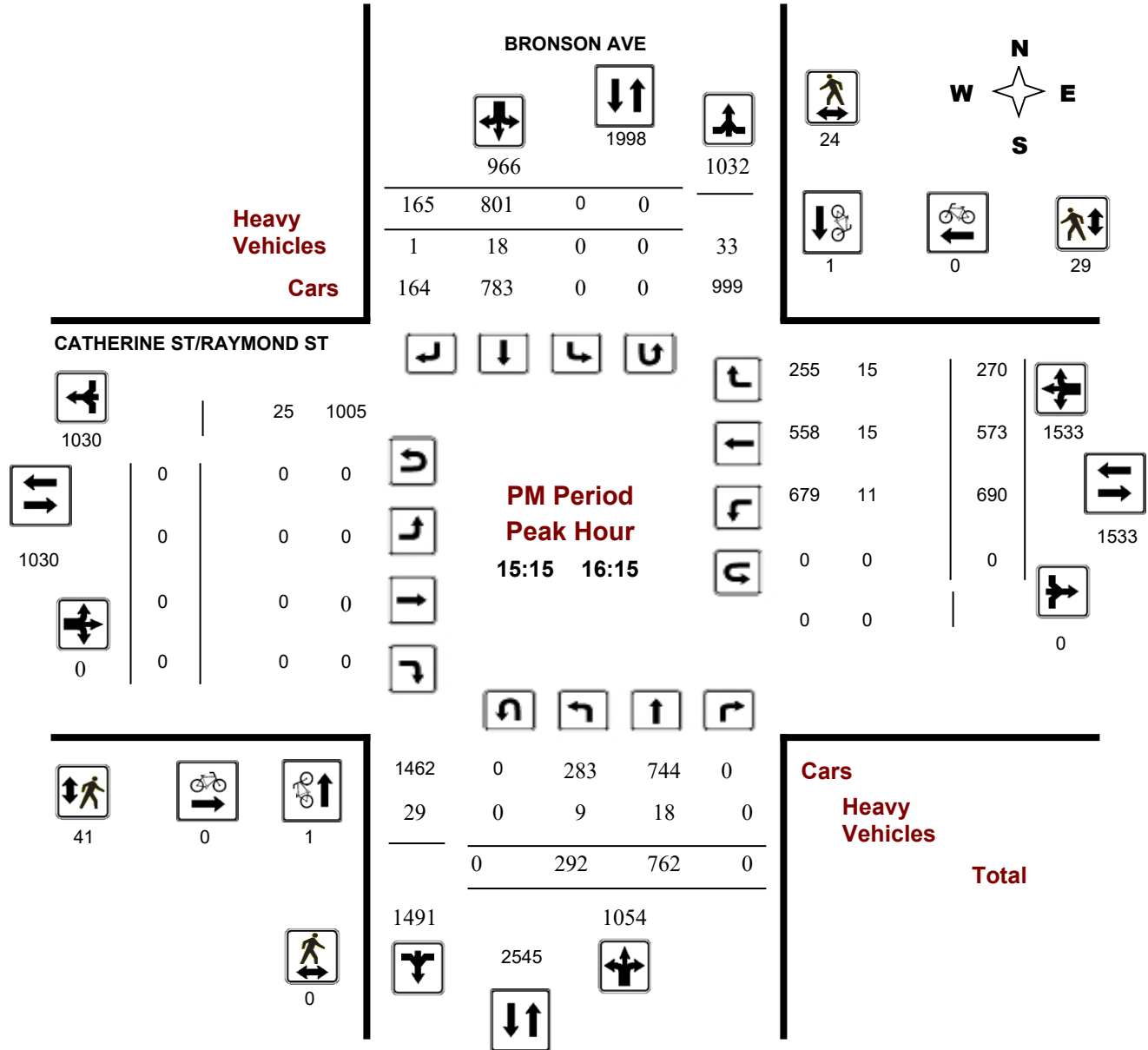

Comments W.O. 5365004 - THURS APR 19TH - CONSULTANT - 48 HRS (REIMPORT - 8HR STANDAR



Transportation Services - Traffic Services

Turning Movement Count - Study Results

BRONSON AVE @ CATHERINE ST/RAYMOND ST

Survey Date: Thursday, April 19, 2018

WO No: 39598

Start Time: 07:00

Device: Miovision

Full Study Summary (8 HR Standard)

Survey Date: Thursday, April 19, 2018

Total Observed U-Turns

AADT Factor

Northbound: 0 Southbound: 0

.90

Eastbound: 0 Westbound: 0

BRONSON AVE

CATHERINE ST/RAYMOND ST

Period	Northbound					Southbound					Eastbound					Westbound					Grand Total
	LT	ST	RT	NB TOT	STR TOT	LT	ST	RT	SB TOT	STR TOT	LT	ST	RT	EB TOT	WB TOT	STR TOT	WB TOT	STR TOT			
07:00 08:00	478	846	0	1324	1892	0	428	140	568	1892	0	0	0	0	465	446	345	1256	1256	3148	
08:00 09:00	519	1038	0	1557	2103	0	428	118	546	2103	0	0	0	0	492	479	346	1317	1317	3420	
09:00 10:00	387	699	0	1086	1625	0	406	133	539	1625	0	0	0	0	480	403	329	1212	1212	2837	
11:30 12:30	382	620	0	1002	1702	0	527	173	700	1702	0	0	0	0	471	401	301	1173	1173	2875	
12:30 13:30	349	568	0	917	1644	0	560	167	727	1644	0	0	0	0	484	321	310	1115	1115	2759	
15:00 16:00	299	747	0	1046	2006	0	783	177	960	2006	0	0	0	0	697	517	299	1513	1513	3519	
16:00 17:00	265	813	0	1078	1941	0	733	130	863	1941	0	0	0	0	677	638	248	1563	1563	3504	
17:00 18:00	281	725	0	1006	1880	0	727	147	874	1880	0	0	0	0	662	438	310	1410	1410	3290	
Sub Total	2960	6056	0	9016	14793	0	4592	1185	5777	14793	0	0	0	0	4428	3643	2488	10559	10559	25352	
U Turns				0	0				0	0				0				0	0	0	
Total	2960	6056	0	9016	14793	0	4592	1185	5777	14793	0	0	0	0	4428	3643	2488	10559	10559	25352	
EQ 12Hr	4114	8418	0	12532	20562	0	6383	1647	8030	20562	0	0	0	0	6155	5064	3458	14677	14677	35239	
Note: These values are calculated by multiplying the totals by the appropriate expansion factor.														1.39							
AVG 12Hr	3490	7140	0	10630	18506	0	5414	1397	6811	18506	0	0	0	0	5221	4295	2933	12449	13209	31715	
Note: These volumes are calculated by multiplying the Equivalent 12 hr. totals by the AADT factor.														0.9							
AVG 24Hr	4572	9353	0	13925	22848	0	7092	1830	8923	22848	0	0	0	0	6839	5627	3843	16308	16308	39156	

Note: These volumes are calculated by multiplying the Average Daily 12 hr. totals by 12 to 24 expansion factor. **1.31**

Note: U-Turns provided for approach totals. Refer to 'U-Turn' Report for specific breakdown.



Transportation Services - Traffic Services

Turning Movement Count - Study Results

BRONSON AVE @ CATHERINE ST/RAYMOND ST

Survey Date: Thursday, April 19, 2018

WO No: 39598

Start Time: 07:00

Device: Miovision

Full Study 15 Minute Increments

BRONSON AVE

CATHERINE ST/RAYMOND ST

Northbound

Southbound

Eastbound

Westbound

Time Period	LT	ST	RT	N TOT	LT	ST	RT	S TOT	STR TOT	LT	ST	RT	E TOT	LT	ST	RT	W TOT	STR TOT	Grand Total
07:00 07:15	92	184	0	276	0	99	31	130	883	0	0	0	0	103	112	91	306	883	712
07:15 07:30	120	223	0	343	0	115	38	153	1036	0	0	0	0	113	99	89	301	1036	797
07:30 07:45	143	228	0	371	0	107	41	148	1061	0	0	0	0	118	115	89	322	1061	841
07:45 08:00	123	211	0	334	0	107	30	137	996	0	0	0	0	131	120	76	327	996	798
08:00 08:15	129	244	0	373	0	106	31	137	1064	0	0	0	0	131	122	73	326	1064	836
08:15 08:30	124	267	0	391	0	104	31	135	1119	0	0	0	0	132	125	90	347	1119	873
08:30 08:45	125	262	0	387	0	109	23	132	1118	0	0	0	0	136	128	92	356	1118	875
08:45 09:00	141	265	0	406	0	109	33	142	1106	0	0	0	0	93	104	91	288	1106	836
09:00 09:15	129	207	0	336	0	87	25	112	967	0	0	0	0	120	128	105	353	967	801
09:15 09:30	88	179	0	267	0	124	37	161	942	0	0	0	0	132	107	79	318	942	746
09:30 09:45	81	164	0	245	0	107	39	146	838	0	0	0	0	106	90	70	266	838	657
09:45 10:00	89	149	0	238	0	88	32	120	792	0	0	0	0	122	78	75	275	792	633
11:30 11:45	97	165	0	262	0	104	40	144	874	0	0	0	0	117	107	82	306	874	712
11:45 12:00	93	134	0	227	0	109	48	157	829	0	0	0	0	117	108	85	310	829	694
12:00 12:15	99	143	0	242	0	167	42	209	934	0	0	0	0	104	98	69	271	934	722
12:15 12:30	93	178	0	271	0	147	43	190	984	0	0	0	0	133	88	65	286	984	747
12:30 12:45	90	140	0	230	0	139	33	172	895	0	0	0	0	124	87	90	301	895	703
12:45 13:00	84	139	0	223	0	103	45	148	806	0	0	0	0	126	78	67	271	806	642
13:00 13:15	84	148	0	232	0	168	46	214	957	0	0	0	0	118	71	77	266	957	712
13:15 13:30	91	141	0	232	0	150	43	193	908	0	0	0	0	116	85	76	277	908	702
15:00 15:15	73	192	0	265	0	174	47	221	1117	0	0	0	0	184	104	81	369	1117	855
15:15 15:30	77	183	0	260	0	195	41	236	1124	0	0	0	0	169	136	81	386	1124	882
15:30 15:45	69	175	0	244	0	214	48	262	1156	0	0	0	0	191	139	70	400	1156	906
15:45 16:00	80	197	0	277	0	200	41	241	1135	0	0	0	0	153	138	67	358	1135	876
16:00 16:15	66	207	0	273	0	192	35	227	1128	0	0	0	0	177	160	52	389	1128	889
16:15 16:30	78	190	0	268	0	184	28	212	1084	0	0	0	0	183	170	47	400	1084	880
16:30 16:45	63	203	0	266	0	191	40	231	1122	0	0	0	0	157	162	74	393	1122	890
16:45 17:00	58	213	0	271	0	166	27	193	1078	0	0	0	0	160	146	75	381	1078	845
17:00 17:15	51	179	0	230	0	185	30	215	1066	0	0	0	0	174	138	83	395	1066	840
17:15 17:30	73	199	0	272	0	178	36	214	1121	0	0	0	0	173	119	85	377	1121	863
17:30 17:45	76	174	0	250	0	208	39	247	1103	0	0	0	0	150	89	74	313	1103	810
17:45 18:00	81	173	0	254	0	156	42	198	1014	0	0	0	0	165	92	68	325	1014	777
Total:	2960	6056	0	9016	0	4592	1185	5777	32357	0	0	0	0	4428	3643	2488	10559	32357	25,352

Note: U-Turns are included in Totals.



Transportation Services - Traffic Services

Turning Movement Count - Study Results

BRONSON AVE @ CATHERINE ST/RAYMOND ST

Survey Date: Thursday, April 19, 2018

WO No: 39598

Start Time: 07:00

Device: Miovision

Full Study Cyclist Volume

Time Period	BRONSON AVE			CATHERINE ST/RAYMOND ST			Grand Total
	Northbound	Southbound	Street Total	Eastbound	Westbound	Street Total	
07:00 07:15	1	0	1	0	0	0	1
07:15 07:30	1	0	1	0	0	0	1
07:30 07:45	0	0	0	0	0	0	0
07:45 08:00	0	0	0	0	1	1	1
08:00 08:15	0	0	0	0	1	1	1
08:15 08:30	0	0	0	0	0	0	0
08:30 08:45	0	0	0	0	0	0	0
08:45 09:00	0	0	0	0	0	0	0
09:00 09:15	1	0	1	0	0	0	1
09:15 09:30	0	0	0	0	0	0	0
09:30 09:45	0	0	0	0	0	0	0
09:45 10:00	0	0	0	0	0	0	0
11:30 11:45	0	0	0	1	0	1	1
11:45 12:00	0	0	0	0	0	0	0
12:00 12:15	1	1	2	0	0	0	2
12:15 12:30	0	0	0	0	0	0	0
12:30 12:45	2	1	3	0	0	0	3
12:45 13:00	0	0	0	0	2	2	2
13:00 13:15	0	0	0	0	0	0	0
13:15 13:30	0	0	0	0	0	0	0
15:00 15:15	0	0	0	0	0	0	0
15:15 15:30	0	0	0	0	0	0	0
15:30 15:45	0	0	0	0	0	0	0
15:45 16:00	0	0	0	0	0	0	0
16:00 16:15	1	1	2	0	0	0	2
16:15 16:30	1	1	2	0	0	0	2
16:30 16:45	1	0	1	0	0	0	1
16:45 17:00	0	2	2	0	0	0	2
17:00 17:15	0	0	0	0	0	0	0
17:15 17:30	1	1	2	0	1	1	3
17:30 17:45	0	0	0	0	0	0	0
17:45 18:00	0	0	0	0	1	1	1
Total	10	7	17	1	6	7	24



Transportation Services - Traffic Services

Turning Movement Count - Study Results

BRONSON AVE @ CATHERINE ST/RAYMOND ST

Survey Date: Thursday, April 19, 2018

WO No: 39598

Start Time: 07:00

Device: Miovision

Full Study Pedestrian Volume

BRONSON AVE

CATHERINE ST/RAYMOND ST

Time Period	NB Approach (E or W Crossing)	SB Approach (E or W Crossing)	Total	EB Approach (N or S Crossing)	WB Approach (N or S Crossing)	Total	Grand Total
07:00 07:15	0	2	2	3	6	9	11
07:15 07:30	0	6	6	5	6	11	17
07:30 07:45	0	6	6	4	5	9	15
07:45 08:00	0	2	2	4	9	13	15
08:00 08:15	0	6	6	7	7	14	20
08:15 08:30	0	11	11	8	15	23	34
08:30 08:45	0	12	12	4	8	12	24
08:45 09:00	0	11	11	7	15	22	33
09:00 09:15	0	8	8	9	11	20	28
09:15 09:30	0	4	4	4	1	5	9
09:30 09:45	0	6	6	8	1	9	15
09:45 10:00	0	4	4	10	2	12	16
11:30 11:45	0	5	5	9	6	15	20
11:45 12:00	0	11	11	7	3	10	21
12:00 12:15	0	12	12	6	5	11	23
12:15 12:30	0	1	1	10	2	12	13
12:30 12:45	0	9	9	13	8	21	30
12:45 13:00	0	5	5	10	2	12	17
13:00 13:15	0	7	7	8	8	16	23
13:15 13:30	0	2	2	5	4	9	11
15:00 15:15	0	8	8	20	12	32	40
15:15 15:30	0	14	14	11	18	29	43
15:30 15:45	0	4	4	12	3	15	19
15:45 16:00	0	1	1	8	3	11	12
16:00 16:15	0	5	5	10	5	15	20
16:15 16:30	0	7	7	7	10	17	24
16:30 16:45	0	7	7	6	4	10	17
16:45 17:00	0	4	4	8	8	16	20
17:00 17:15	0	12	12	14	8	22	34
17:15 17:30	0	5	5	11	3	14	19
17:30 17:45	1	5	6	18	5	23	29
17:45 18:00	0	6	6	13	4	17	23
Total	1	208	209	279	207	486	695

W.O. 5365004 - THURS APR 19TH - CONSULTANT - 48 HRS (REIMPORT - 8HR STANDARD)



Transportation Services - Traffic Services

Turning Movement Count - Study Results

BRONSON AVE @ CATHERINE ST/RAYMOND ST

Survey Date: Thursday, April 19, 2018

WO No: 39598

Start Time: 07:00

Device: Miovision

Full Study Heavy Vehicles

BRONSON AVE

CATHERINE ST/RAYMOND ST

Northbound

Southbound

Eastbound

Westbound

Time Period	Northbound			N TOT	Southbound			S TOT	STR TOT	Eastbound			E TOT	Westbound			W TOT	STR TOT	Grand Total
	LT	ST	RT		LT	ST	RT			LT	ST	RT		LT	ST	RT			
07:00 07:15	1	1	0	10	0	6	8	18	28	0	0	0	17	2	8	3	13	30	29
07:15 07:30	2	3	0	14	0	7	4	18	32	0	0	0	11	2	5	4	11	22	27
07:30 07:45	2	5	0	13	0	4	5	16	29	0	0	0	11	2	4	2	8	19	24
07:45 08:00	4	2	0	15	0	6	6	18	33	0	0	0	15	3	5	4	12	27	30
08:00 08:15	2	2	0	13	0	5	2	13	26	0	0	0	12	4	8	4	16	28	27
08:15 08:30	1	9	0	21	0	7	1	18	39	0	0	0	4	4	2	1	7	11	25
08:30 08:45	1	8	0	23	0	9	2	23	46	0	0	0	7	5	4	4	13	20	33
08:45 09:00	0	3	0	21	0	11	3	23	44	0	0	0	7	7	4	6	17	24	34
09:00 09:15	8	6	0	25	0	7	2	26	51	0	0	0	17	4	7	11	22	39	45
09:15 09:30	1	7	0	23	0	10	1	26	49	0	0	0	11	5	9	8	22	33	41
09:30 09:45	2	5	0	15	0	4	2	14	29	0	0	0	9	4	5	3	12	21	25
09:45 10:00	3	5	0	22	0	5	0	21	43	0	0	0	9	9	6	11	26	35	39
11:30 11:45	2	3	0	13	0	2	0	10	23	0	0	0	8	6	6	5	17	25	24
11:45 12:00	3	4	0	17	0	6	4	20	37	0	0	0	14	4	7	6	17	31	34
12:00 12:15	2	3	0	12	0	6	0	13	25	0	0	0	7	1	5	4	10	17	21
12:15 12:30	1	3	0	12	0	3	0	8	20	0	0	0	6	5	5	2	12	18	19
12:30 12:45	2	6	0	15	0	6	1	18	33	0	0	0	9	1	6	5	12	21	27
12:45 13:00	0	3	0	10	0	3	1	10	20	0	0	0	3	4	2	3	9	12	16
13:00 13:15	1	5	0	15	0	6	0	15	30	0	0	0	8	3	7	4	14	22	26
13:15 13:30	4	4	0	15	0	4	0	11	26	0	0	0	10	3	6	3	12	22	24
15:00 15:15	0	6	0	18	0	9	2	21	39	0	0	0	4	3	2	4	9	13	26
15:15 15:30	2	8	0	15	0	2	0	13	28	0	0	0	5	3	3	3	9	14	21
15:30 15:45	2	4	0	13	0	5	1	16	29	0	0	0	6	2	3	6	11	17	23
15:45 16:00	4	3	0	14	0	5	0	10	24	0	0	0	7	2	3	2	7	14	19
16:00 16:15	1	3	0	14	0	6	0	13	27	0	0	0	7	4	6	4	14	21	24
16:15 16:30	1	4	0	14	0	7	1	13	27	0	0	0	3	2	1	1	4	7	17
16:30 16:45	1	1	0	9	0	6	0	11	20	0	0	0	4	1	3	4	8	12	16
16:45 17:00	0	4	0	11	0	4	0	9	20	0	0	0	4	3	4	1	8	12	16
17:00 17:15	0	3	0	11	0	5	0	9	20	0	0	0	2	3	2	1	6	8	14
17:15 17:30	0	2	0	6	0	2	0	4	10	0	0	0	1	2	1	0	3	4	7
17:30 17:45	2	5	0	10	0	2	2	9	19	0	0	0	6	1	2	0	3	9	14
17:45 18:00	1	3	0	9	0	4	0	7	16	0	0	0	3	1	2	0	3	6	11
Total: None	56	133	0	468	0	174	48	474	942	0	0	0	247	105	143	119	367	614	778



Transportation Services - Traffic Services

Turning Movement Count - Study Results

BRONSON AVE @ CATHERINE ST/RAYMOND ST

Survey Date: Thursday, April 19, 2018

WO No: 39598

Start Time: 07:00

Device: Miovision

Full Study 15 Minute U-Turn Total

BRONSON AVE

CATHERINE ST/RAYMOND ST

Time Period		Northbound U-Turn Total	Southbound U-Turn Total	Eastbound U-Turn Total	Westbound U-Turn Total	Total
07:00	07:15	0	0	0	0	0
07:15	07:30	0	0	0	0	0
07:30	07:45	0	0	0	0	0
07:45	08:00	0	0	0	0	0
08:00	08:15	0	0	0	0	0
08:15	08:30	0	0	0	0	0
08:30	08:45	0	0	0	0	0
08:45	09:00	0	0	0	0	0
09:00	09:15	0	0	0	0	0
09:15	09:30	0	0	0	0	0
09:30	09:45	0	0	0	0	0
09:45	10:00	0	0	0	0	0
11:30	11:45	0	0	0	0	0
11:45	12:00	0	0	0	0	0
12:00	12:15	0	0	0	0	0
12:15	12:30	0	0	0	0	0
12:30	12:45	0	0	0	0	0
12:45	13:00	0	0	0	0	0
13:00	13:15	0	0	0	0	0
13:15	13:30	0	0	0	0	0
15:00	15:15	0	0	0	0	0
15:15	15:30	0	0	0	0	0
15:30	15:45	0	0	0	0	0
15:45	16:00	0	0	0	0	0
16:00	16:15	0	0	0	0	0
16:15	16:30	0	0	0	0	0
16:30	16:45	0	0	0	0	0
16:45	17:00	0	0	0	0	0
17:00	17:15	0	0	0	0	0
17:15	17:30	0	0	0	0	0
17:30	17:45	0	0	0	0	0
17:45	18:00	0	0	0	0	0
Total		0	0	0	0	0

Survey Date: Wednesday, April 18, 2018

WO No: 40741

Start Time: 07:00

Device: Miovision

Full Study Diagram

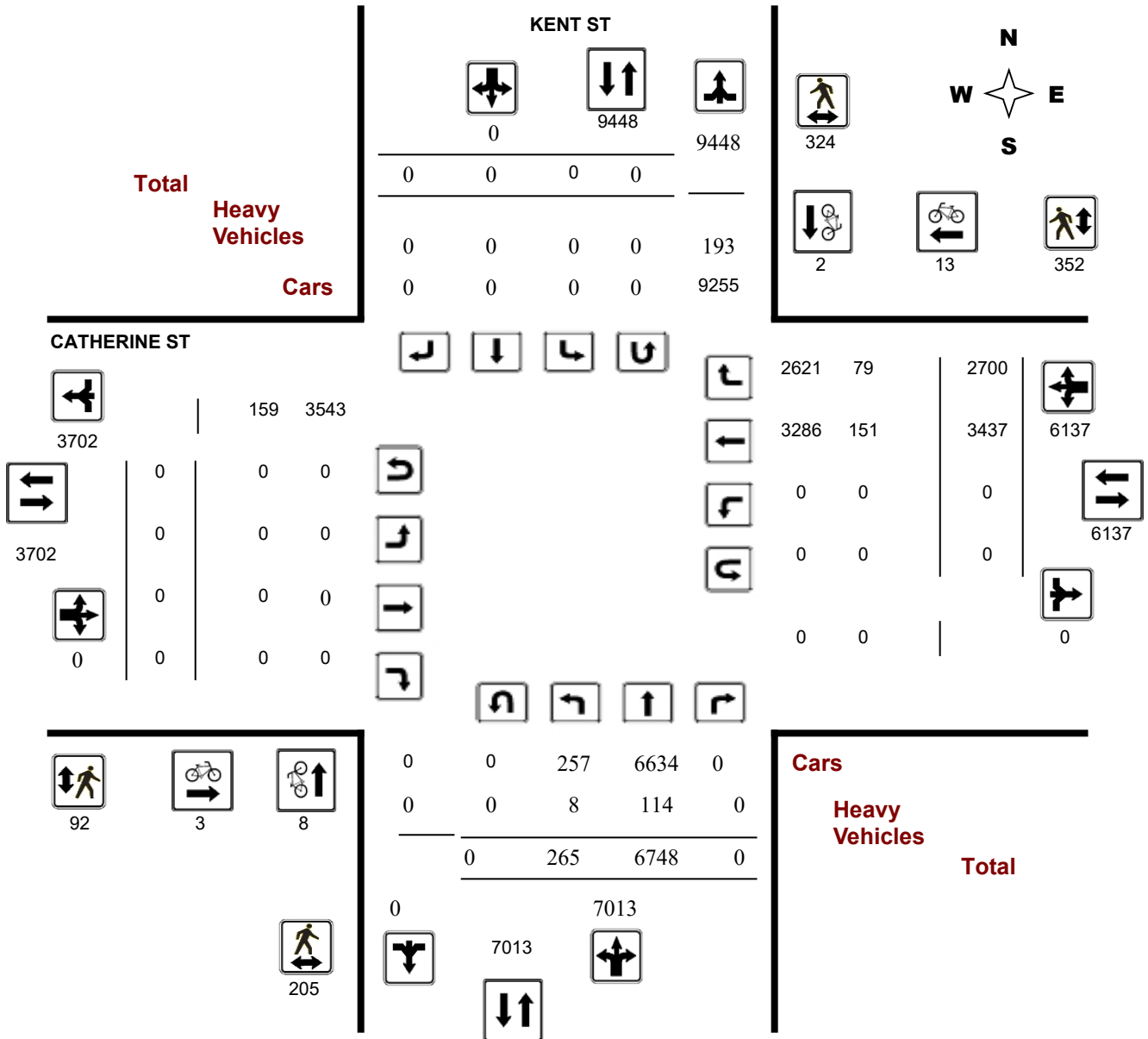

Turning Movement Count - Peak Hour Diagram

CATHERINE ST @ KENT ST

Survey Date: Wednesday, April 18, 2018

Start Time: 07:00

WO No: 40741

Device: Miovision

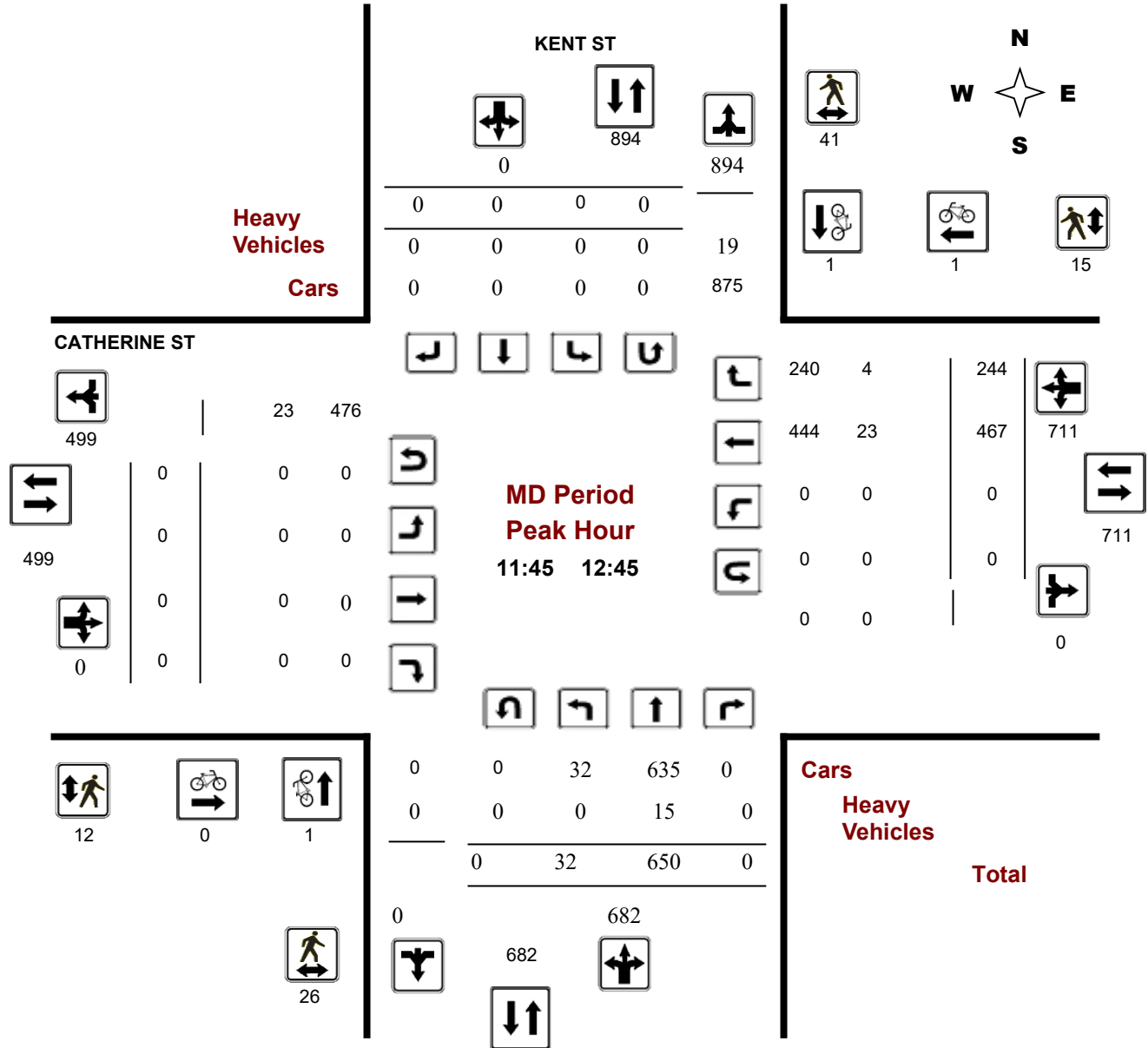

Comments

Turning Movement Count - Peak Hour Diagram

CATHERINE ST @ KENT ST

Survey Date: Wednesday, April 18, 2018

Start Time: 07:00

WO No: 40741

Device: Miovision

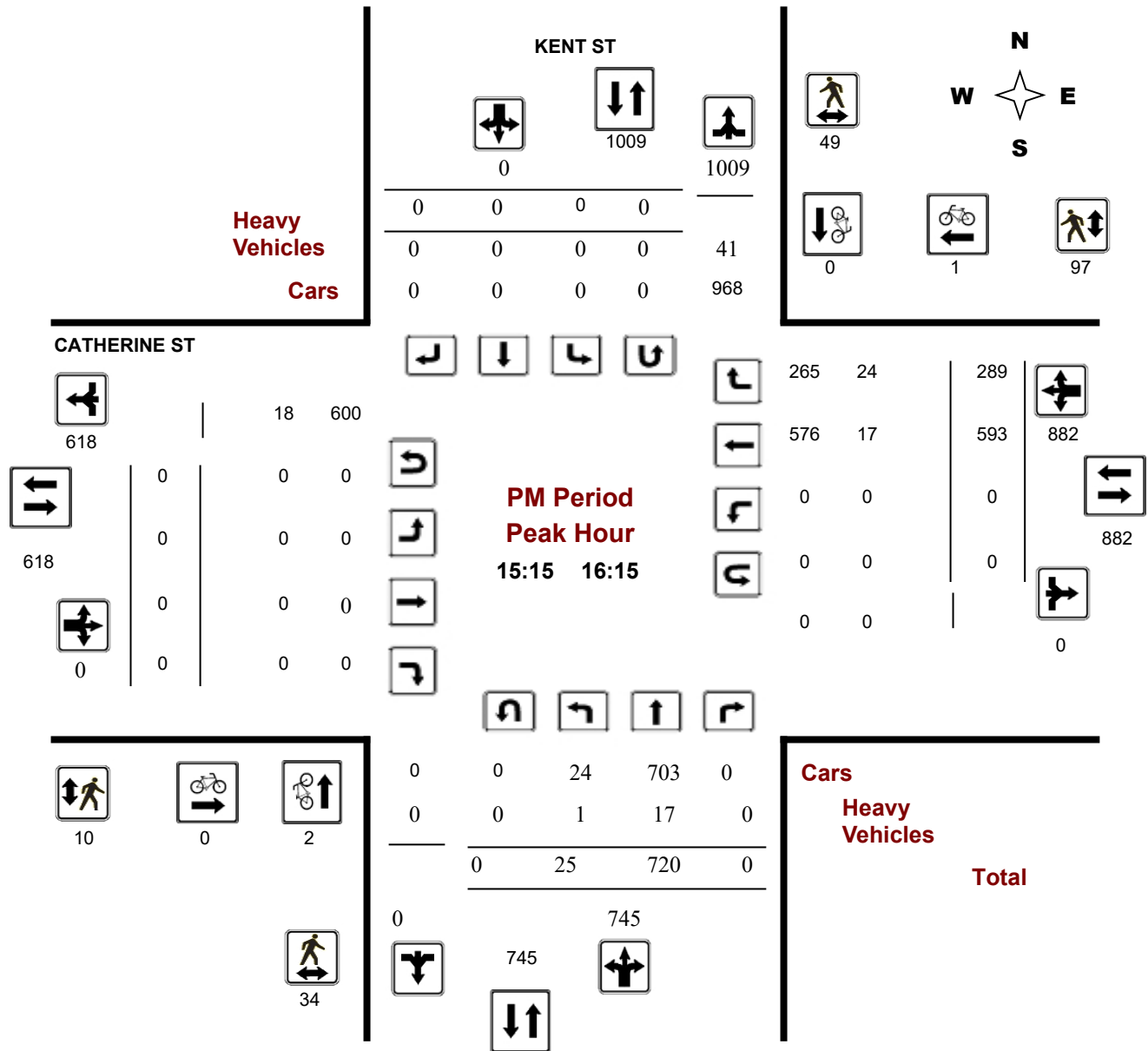



Transportation Services - Traffic Services

Turning Movement Count - Study Results

CATHERINE ST @ KENT ST

Survey Date: Wednesday, April 18, 2018

WO No: 40741

Start Time: 07:00

Device: Miovision

Full Study Summary (8 HR Standard)

Survey Date: Wednesday, April 18, 2018

Total Observed U-Turns

AADT Factor

Northbound: 0 Southbound: 0

.90

Eastbound: 0 Westbound: 0

Period	KENT ST									CATHERINE ST									Grand Total
	Northbound			NB TOT	Southbound			SB TOT	STR TOT	Eastbound			EB TOT	Westbound			WB TOT	STR TOT	
	LT	ST	RT		LT	ST	RT			LT	ST	RT		LT	ST	RT			
07:00 08:00	36	1225	0	1261	0	0	0	0	1261	0	0	0	0	0	304	504	808	808	2069
08:00 09:00	54	1326	0	1380	0	0	0	0	1380	0	0	0	0	0	392	530	922	922	2302
09:00 10:00	41	968	0	1009	0	0	0	0	1009	0	0	0	0	0	411	342	753	753	1762
11:30 12:30	36	626	0	662	0	0	0	0	662	0	0	0	0	0	452	231	683	683	1345
12:30 13:30	40	631	0	671	0	0	0	0	671	0	0	0	0	0	477	174	651	651	1322
15:00 16:00	29	652	0	681	0	0	0	0	681	0	0	0	0	0	556	302	858	858	1539
16:00 17:00	18	590	0	608	0	0	0	0	608	0	0	0	0	0	479	311	790	790	1398
17:00 18:00	11	730	0	741	0	0	0	0	741	0	0	0	0	0	366	306	672	672	1413
Sub Total	265	6748	0	7013	0	0	0	0	7013	0	0	0	0	0	3437	2700	6137	6137	13150
U Turns				0					0	0							0	0	0
Total	265	6748	0	7013	0	0	0	0	7013	0	0	0	0	0	3437	2700	6137	6137	13150

EQ 12Hr 368 9380 0 9748 0 0 0 0 9748 0 0 0 0 0 4777 3753 8530 8530 18278

Note: These values are calculated by multiplying the totals by the appropriate expansion factor.

1.39

AVG 12Hr 331 8442 0 8773 0 0 0 0 8773 0 0 0 0 0 4299 3378 7677 7677 16450

Note: These volumes are calculated by multiplying the Equivalent 12 hr. totals by the AADT factor.

.90

AVG 24Hr 434 11059 0 11493 0 0 0 0 11493 0 0 0 0 0 5632 4425 10057 10057 21550

Note: These volumes are calculated by multiplying the Average Daily 12 hr. totals by 12 to 24 expansion factor.

1.31

Note: U-Turns provided for approach totals. Refer to 'U-Turn' Report for specific breakdown.



Transportation Services - Traffic Services

Turning Movement Count - Study Results

CATHERINE ST @ KENT ST

Survey Date: Wednesday, April 18, 2018

WO No: 40741

Start Time: 07:00

Device: Miovision

Full Study 15 Minute Increments

KENT ST

CATHERINE ST

Northbound

Southbound

Eastbound

Westbound

Time Period	LT	ST	RT	N TOT	LT	ST	RT	S TOT	STR TOT	LT	ST	RT	E TOT	LT	ST	RT	W TOT	STR TOT	Grand Total
07:00 07:15	7	277	0	284	0	0	0	0	284	0	0	0	0	0	72	116	188	188	472
07:15 07:30	8	293	0	301	0	0	0	0	301	0	0	0	0	0	58	123	181	181	482
07:30 07:45	9	312	0	321	0	0	0	0	321	0	0	0	0	0	90	117	207	207	528
07:45 08:00	12	343	0	355	0	0	0	0	355	0	0	0	0	0	84	148	232	232	587
08:00 08:15	12	314	0	326	0	0	0	0	326	0	0	0	0	0	100	134	234	234	560
08:15 08:30	13	347	0	360	0	0	0	0	360	0	0	0	0	0	98	127	225	225	585
08:30 08:45	17	329	0	346	0	0	0	0	346	0	0	0	0	0	107	128	235	235	581
08:45 09:00	12	336	0	348	0	0	0	0	348	0	0	0	0	0	87	141	228	228	576
09:00 09:15	8	293	0	301	0	0	0	0	301	0	0	0	0	0	95	97	192	192	493
09:15 09:30	12	229	0	241	0	0	0	0	241	0	0	0	0	0	104	91	195	195	436
09:30 09:45	8	225	0	233	0	0	0	0	233	0	0	0	0	0	112	76	188	188	421
09:45 10:00	13	221	0	234	0	0	0	0	234	0	0	0	0	0	100	78	178	178	412
11:30 11:45	13	169	0	182	0	0	0	0	182	0	0	0	0	0	105	52	157	157	339
11:45 12:00	7	150	0	157	0	0	0	0	157	0	0	0	0	0	105	68	173	173	330
12:00 12:15	6	133	0	139	0	0	0	0	139	0	0	0	0	0	125	50	175	175	314
12:15 12:30	10	174	0	184	0	0	0	0	184	0	0	0	0	0	117	61	178	178	362
12:30 12:45	9	193	0	202	0	0	0	0	202	0	0	0	0	0	120	65	185	185	387
12:45 13:00	9	160	0	169	0	0	0	0	169	0	0	0	0	0	125	31	156	156	325
13:00 13:15	8	134	0	142	0	0	0	0	142	0	0	0	0	0	108	34	142	142	284
13:15 13:30	14	144	0	158	0	0	0	0	158	0	0	0	0	0	124	44	168	168	326
15:00 15:15	8	151	0	159	0	0	0	0	159	0	0	0	0	0	120	90	210	210	369
15:15 15:30	10	148	0	158	0	0	0	0	158	0	0	0	0	0	154	67	221	221	379
15:30 15:45	3	180	0	183	0	0	0	0	183	0	0	0	0	0	156	69	225	225	408
15:45 16:00	8	173	0	181	0	0	0	0	181	0	0	0	0	0	126	76	202	202	383
16:00 16:15	4	219	0	223	0	0	0	0	223	0	0	0	0	0	157	77	234	234	457
16:15 16:30	0	102	0	102	0	0	0	0	102	0	0	0	0	0	144	92	236	236	338
16:30 16:45	5	113	0	118	0	0	0	0	118	0	0	0	0	0	100	79	179	179	297
16:45 17:00	9	156	0	165	0	0	0	0	165	0	0	0	0	0	78	63	141	141	306
17:00 17:15	4	193	0	197	0	0	0	0	197	0	0	0	0	0	100	70	170	170	367
17:15 17:30	1	193	0	194	0	0	0	0	194	0	0	0	0	0	95	88	183	183	377
17:30 17:45	4	158	0	162	0	0	0	0	162	0	0	0	0	0	86	90	176	176	338
17:45 18:00	2	186	0	188	0	0	0	0	188	0	0	0	0	0	85	58	143	143	331
Total:	265	6748	0	7013	0	0	0	0	7013	0	0	0	0	0	3437	2700	6137	6137	13,150

Note: U-Turns are included in Totals.



Transportation Services - Traffic Services

Turning Movement Count - Study Results

CATHERINE ST @ KENT ST

Survey Date: Wednesday, April 18, 2018

WO No: 40741

Start Time: 07:00

Device: Miovision

Full Study Cyclist Volume

Time Period	KENT ST			CATHERINE ST			Grand Total
	Northbound	Southbound	Street Total	Eastbound	Westbound	Street Total	
07:00 07:15	0	0	0	0	0	0	0
07:15 07:30	0	0	0	0	0	0	0
07:30 07:45	0	0	0	0	0	0	0
07:45 08:00	1	0	1	0	0	0	1
08:00 08:15	1	0	1	0	0	0	1
08:15 08:30	1	0	1	0	2	2	3
08:30 08:45	1	0	1	0	0	0	1
08:45 09:00	0	0	0	0	0	0	0
09:00 09:15	0	0	0	0	2	2	2
09:15 09:30	0	0	0	0	0	0	0
09:30 09:45	0	0	0	0	0	0	0
09:45 10:00	0	0	0	0	0	0	0
11:30 11:45	0	0	0	0	0	0	0
11:45 12:00	0	0	0	0	0	0	0
12:00 12:15	0	0	0	0	1	1	1
12:15 12:30	0	1	1	0	0	0	1
12:30 12:45	1	0	1	0	0	0	1
12:45 13:00	0	0	0	0	0	0	0
13:00 13:15	0	0	0	0	0	0	0
13:15 13:30	0	0	0	1	0	1	1
15:00 15:15	0	0	0	0	1	1	1
15:15 15:30	0	0	0	0	0	0	0
15:30 15:45	0	0	0	0	0	0	0
15:45 16:00	0	0	0	0	1	1	1
16:00 16:15	2	0	2	0	0	0	2
16:15 16:30	0	0	0	0	3	3	3
16:30 16:45	0	0	0	0	1	1	1
16:45 17:00	0	1	1	1	0	1	2
17:00 17:15	0	0	0	0	1	1	1
17:15 17:30	0	0	0	1	0	1	1
17:30 17:45	0	0	0	0	0	0	0
17:45 18:00	1	0	1	0	1	1	2
Total	8	2	10	3	13	16	26



Transportation Services - Traffic Services

Turning Movement Count - Study Results

CATHERINE ST @ KENT ST

Survey Date: Wednesday, April 18, 2018

WO No: 40741

Start Time: 07:00

Device: Miovision

Full Study Pedestrian Volume

KENT ST

CATHERINE ST

Time Period	NB Approach (E or W Crossing)	SB Approach (E or W Crossing)	Total	EB Approach (N or S Crossing)	WB Approach (N or S Crossing)	Total	Grand Total
07:00 07:15	2	9	11	3	0	3	14
07:15 07:30	0	4	4	0	3	3	7
07:30 07:45	4	9	13	5	9	14	27
07:45 08:00	7	8	15	4	6	10	25
08:00 08:15	8	12	20	5	8	13	33
08:15 08:30	8	9	17	6	20	26	43
08:30 08:45	3	11	14	0	72	72	86
08:45 09:00	10	10	20	3	15	18	38
09:00 09:15	8	6	14	2	5	7	21
09:15 09:30	4	7	11	4	5	9	20
09:30 09:45	8	15	23	2	2	4	27
09:45 10:00	6	8	14	8	2	10	24
11:30 11:45	8	10	18	2	6	8	26
11:45 12:00	4	12	16	2	6	8	24
12:00 12:15	12	12	24	5	3	8	32
12:15 12:30	5	11	16	3	6	9	25
12:30 12:45	5	6	11	2	0	2	13
12:45 13:00	9	15	24	9	2	11	35
13:00 13:15	7	8	15	0	3	3	18
13:15 13:30	6	11	17	0	7	7	24
15:00 15:15	5	13	18	3	9	12	30
15:15 15:30	8	15	23	4	77	81	104
15:30 15:45	10	12	22	2	2	4	26
15:45 16:00	8	8	16	3	9	12	28
16:00 16:15	8	14	22	1	9	10	32
16:15 16:30	10	12	22	5	11	16	38
16:30 16:45	8	4	12	1	2	3	15
16:45 17:00	4	15	19	0	12	12	31
17:00 17:15	8	10	18	3	13	16	34
17:15 17:30	7	9	16	3	12	15	31
17:30 17:45	4	14	18	2	8	10	28
17:45 18:00	1	5	6	0	8	8	14
Total	205	324	529	92	352	444	973



Transportation Services - Traffic Services

Turning Movement Count - Study Results

CATHERINE ST @ KENT ST

Survey Date: Wednesday, April 18, 2018

WO No: 40741

Start Time: 07:00

Device: Miovision

Full Study Heavy Vehicles

KENT ST

CATHERINE ST

Northbound

Southbound

Eastbound

Westbound

Time Period	KENT ST Northbound			KENT ST Southbound			CATHERINE ST Eastbound			CATHERINE ST Westbound			Grand Total							
	LT	ST	RT	N TOT	LT	ST	RT	S TOT	STR TOT	LT	ST	RT		E TOT	LT	ST	RT	W TOT	STR TOT	
07:00-07:15	0	1	0	1	0	0	0	2	3	0	0	0	11	0	11	1	12	23	13	
07:15-07:30	0	2	0	2	0	0	0	4	6	0	0	0	5	0	5	2	7	12	9	
07:30-07:45	1	1	0	2	0	0	0	6	8	0	0	0	6	0	5	5	10	16	12	
07:45-08:00	0	4	0	4	0	0	0	7	11	0	0	0	4	0	4	3	7	11	11	
08:00-08:15	0	3	0	3	0	0	0	5	8	0	0	0	10	0	10	2	12	22	15	
08:15-08:30	0	3	0	3	0	0	0	4	7	0	0	0	4	0	4	1	5	9	8	
08:30-08:45	0	7	0	7	0	0	0	7	14	0	0	0	7	0	7	0	7	14	14	
08:45-09:00	0	5	0	5	0	0	0	7	12	0	0	0	4	0	4	2	6	10	11	
09:00-09:15	0	6	0	6	0	0	0	8	14	0	0	0	4	0	4	2	6	10	12	
09:15-09:30	0	4	0	4	0	0	0	6	10	0	0	0	10	0	10	2	12	22	16	
09:30-09:45	0	4	0	4	0	0	0	5	9	0	0	0	7	0	7	1	8	15	12	
09:45-10:00	0	7	0	7	0	0	0	12	19	0	0	0	4	0	4	5	9	13	16	
11:30-11:45	1	4	0	5	0	0	0	6	11	0	0	0	2	0	1	2	3	5	8	
11:45-12:00	0	2	0	2	0	0	0	2	4	0	0	0	5	0	5	0	5	10	7	
12:00-12:15	0	3	0	3	0	0	0	3	6	0	0	0	3	0	3	0	3	6	6	
12:15-12:30	0	6	0	6	0	0	0	10	16	0	0	0	8	0	8	4	12	20	18	
12:30-12:45	0	4	0	4	0	0	0	4	8	0	0	0	7	0	7	0	7	14	11	
12:45-13:00	0	4	0	4	0	0	0	5	9	0	0	0	2	0	2	1	3	5	7	
13:00-13:15	0	4	0	4	0	0	0	6	10	0	0	0	5	0	5	2	7	12	11	
13:15-13:30	2	1	0	3	0	0	0	3	6	0	0	0	5	0	3	2	5	10	8	
15:00-15:15	1	1	0	2	0	0	0	10	12	0	0	0	8	0	7	9	16	24	18	
15:15-15:30	0	2	0	2	0	0	0	10	12	0	0	0	4	0	4	8	12	16	14	
15:30-15:45	0	4	0	4	0	0	0	12	16	0	0	0	7	0	7	8	15	22	19	
15:45-16:00	0	5	0	5	0	0	0	6	11	0	0	0	5	0	5	1	6	11	11	
16:00-16:15	1	6	0	7	0	0	0	13	20	0	0	0	2	0	1	7	8	10	15	
16:15-16:30	0	2	0	2	0	0	0	3	5	0	0	0	7	0	7	1	8	15	10	
16:30-16:45	0	2	0	2	0	0	0	5	7	0	0	0	3	0	3	3	6	9	8	
16:45-17:00	2	3	0	5	0	0	0	3	8	0	0	0	4	0	2	0	2	6	7	
17:00-17:15	0	4	0	4	0	0	0	7	11	0	0	0	1	0	1	3	4	5	8	
17:15-17:30	0	4	0	4	0	0	0	4	8	0	0	0	2	0	2	0	2	4	6	
17:30-17:45	0	3	0	3	0	0	0	4	7	0	0	0	2	0	2	1	3	5	6	
17:45-18:00	0	3	0	3	0	0	0	4	7	0	0	0	1	0	1	1	2	3	5	
Total:	None	8	114	0	122	0	0	0	193	315	0	0	0	159	0	151	79	230	389	352



Transportation Services - Traffic Services

Turning Movement Count - Study Results

CATHERINE ST @ KENT ST

Survey Date: Wednesday, April 18, 2018

WO No: 40741

Start Time: 07:00

Device: Miovision

Full Study 15 Minute U-Turn Total

KENT ST

CATHERINE ST

Time Period		Northbound U-Turn Total	Southbound U-Turn Total	Eastbound U-Turn Total	Westbound U-Turn Total	Total
07:00	07:15	0	0	0	0	0
07:15	07:30	0	0	0	0	0
07:30	07:45	0	0	0	0	0
07:45	08:00	0	0	0	0	0
08:00	08:15	0	0	0	0	0
08:15	08:30	0	0	0	0	0
08:30	08:45	0	0	0	0	0
08:45	09:00	0	0	0	0	0
09:00	09:15	0	0	0	0	0
09:15	09:30	0	0	0	0	0
09:30	09:45	0	0	0	0	0
09:45	10:00	0	0	0	0	0
11:30	11:45	0	0	0	0	0
11:45	12:00	0	0	0	0	0
12:00	12:15	0	0	0	0	0
12:15	12:30	0	0	0	0	0
12:30	12:45	0	0	0	0	0
12:45	13:00	0	0	0	0	0
13:00	13:15	0	0	0	0	0
13:15	13:30	0	0	0	0	0
15:00	15:15	0	0	0	0	0
15:15	15:30	0	0	0	0	0
15:30	15:45	0	0	0	0	0
15:45	16:00	0	0	0	0	0
16:00	16:15	0	0	0	0	0
16:15	16:30	0	0	0	0	0
16:30	16:45	0	0	0	0	0
16:45	17:00	0	0	0	0	0
17:00	17:15	0	0	0	0	0
17:15	17:30	0	0	0	0	0
17:30	17:45	0	0	0	0	0
17:45	18:00	0	0	0	0	0
Total		0	0	0	0	0

Survey Date: Wednesday, April 18, 2018

WO No: 40740

Start Time: 07:00

Device: Miovision

Full Study Diagram

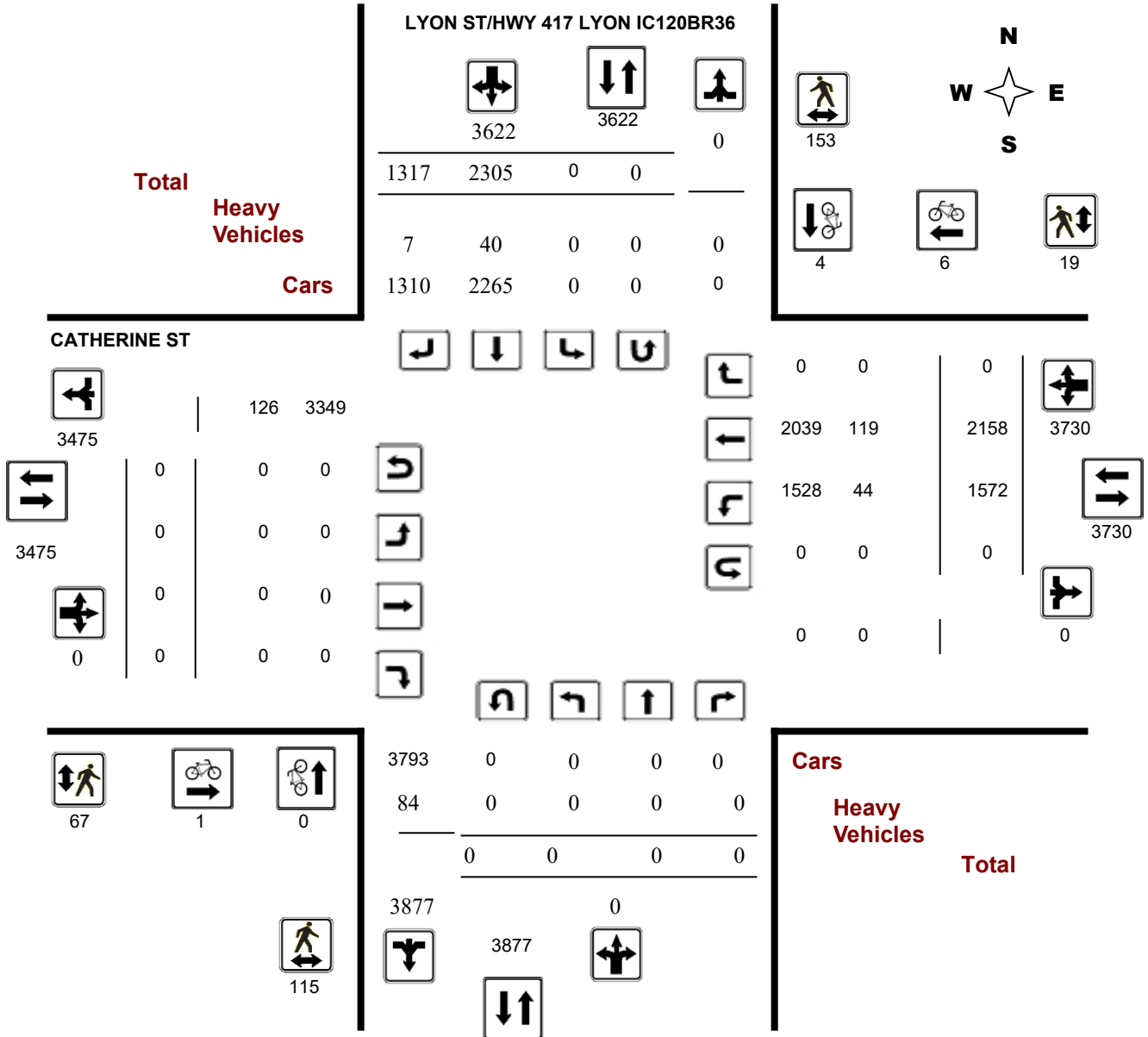

Turning Movement Count - Study Results

CATHERINE ST @ LYON ST/HWY 417 LYON IC120BR36

Survey Date: Wednesday, April 18, 2018

WO No: 40740

Start Time: 07:00

Device: Miovision

Full Study Peak Hour Diagram

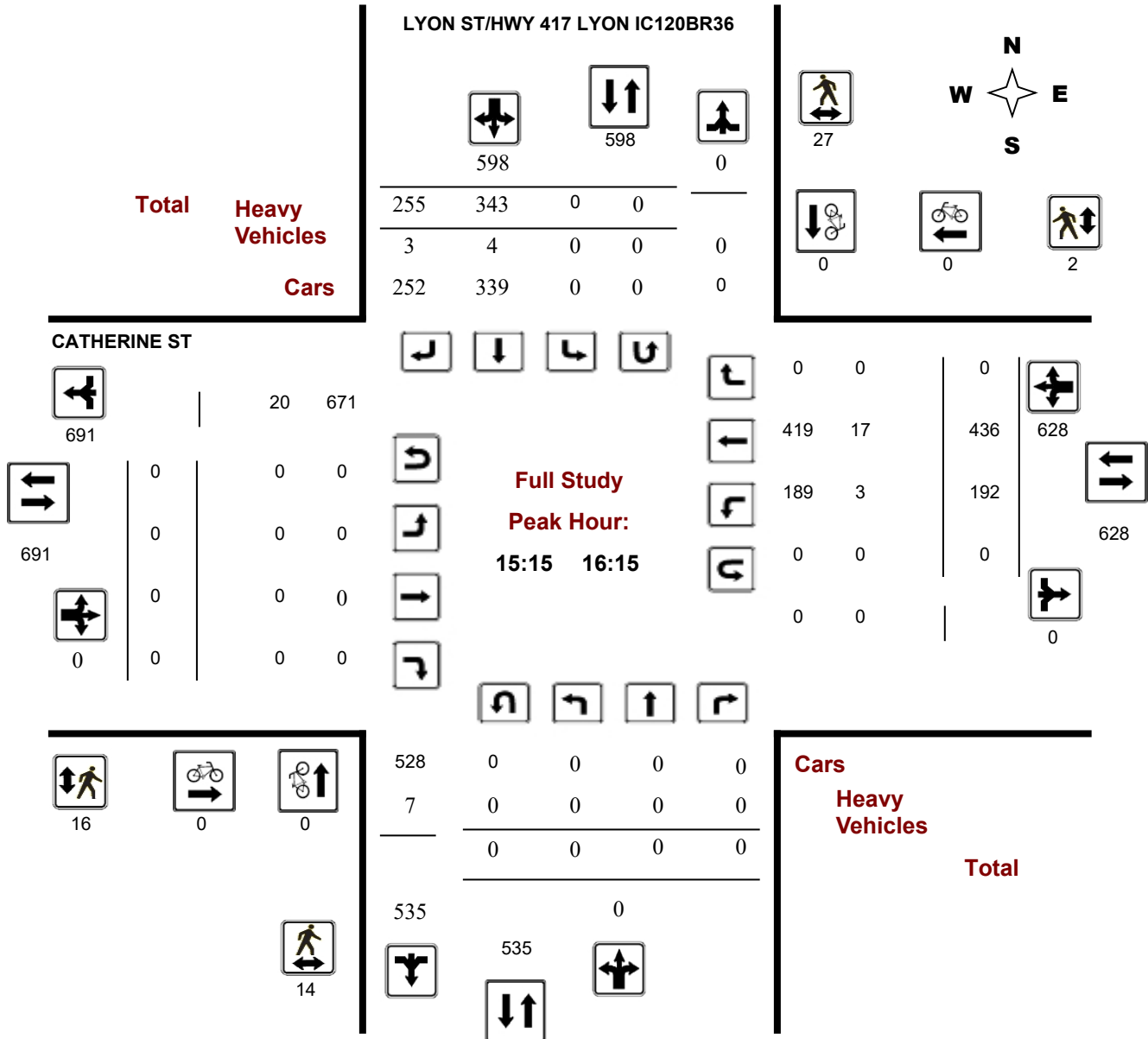

Turning Movement Count - Peak Hour Diagram

CATHERINE ST @ LYON ST/HWY 417 LYON IC120BR36

Survey Date: Wednesday, April 18, 2018

Start Time: 07:00

WO No: 40740

Device: Miovision

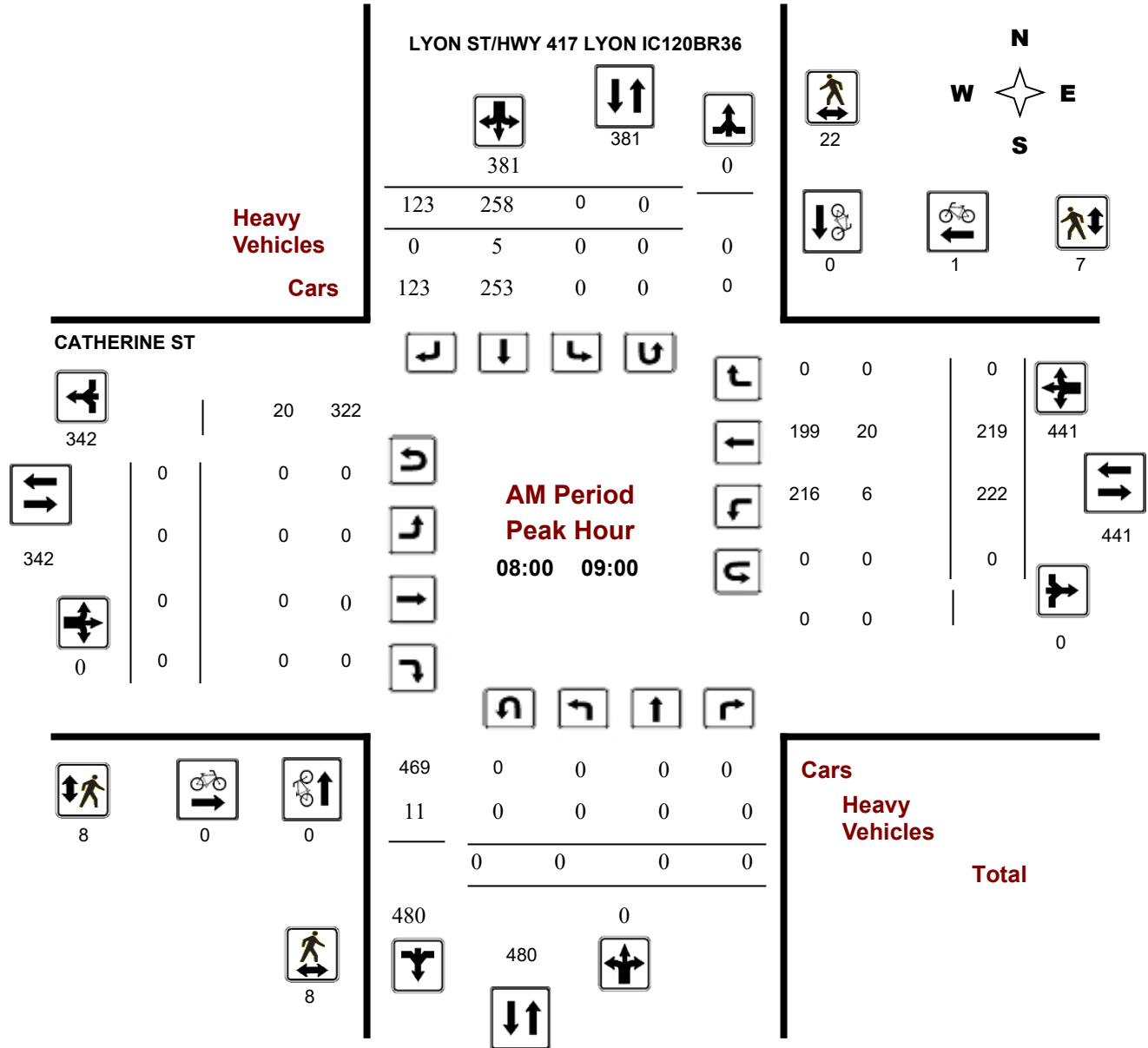

Comments

Turning Movement Count - Peak Hour Diagram

CATHERINE ST @ LYON ST/HWY 417 LYON IC120BR36

Survey Date: Wednesday, April 18, 2018

Start Time: 07:00

WO No: 40740

Device: Miovision

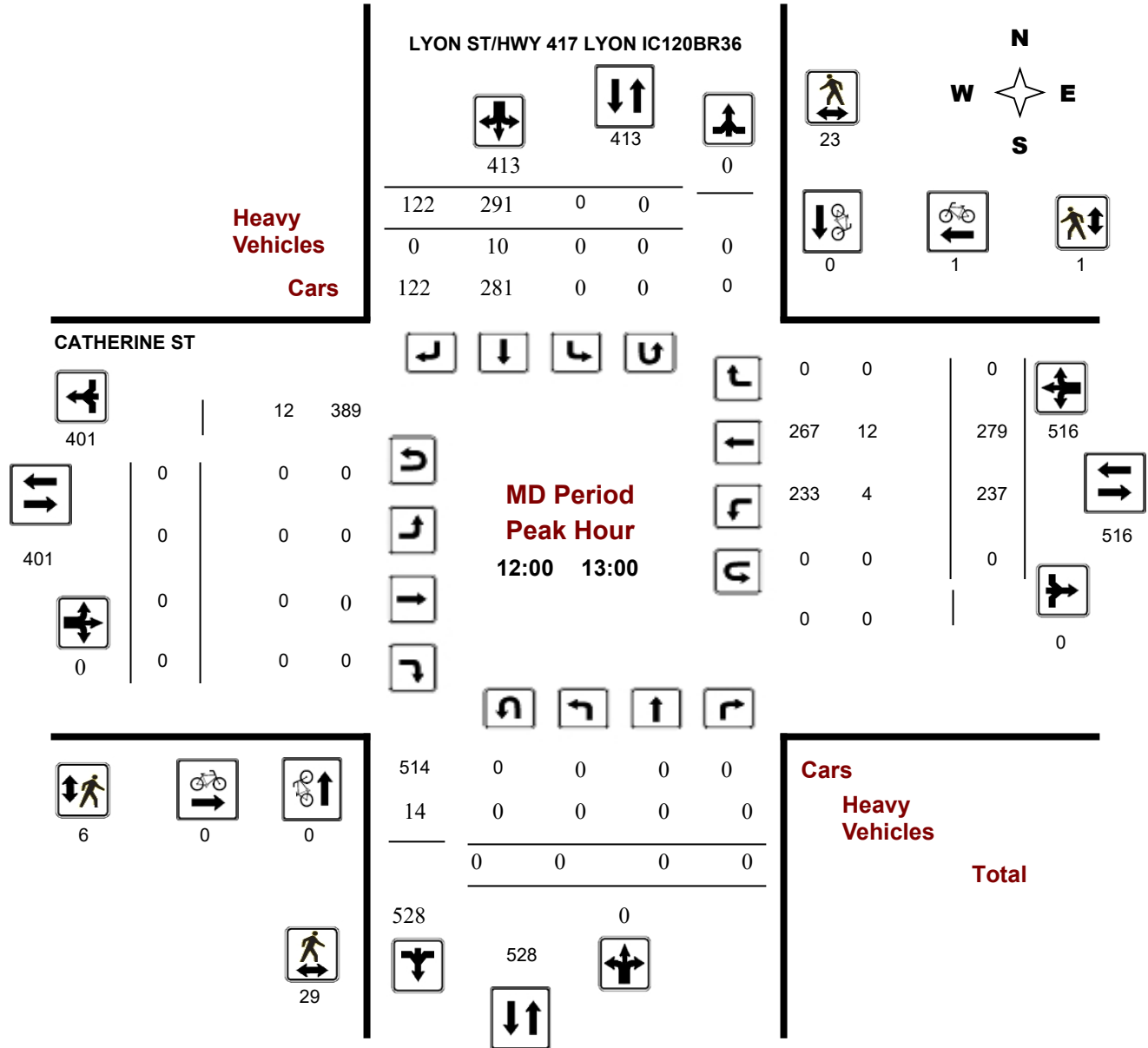

Comments

Turning Movement Count - Peak Hour Diagram

CATHERINE ST @ LYON ST/HWY 417 LYON IC120BR36

Survey Date: Wednesday, April 18, 2018

Start Time: 07:00

WO No: 40740

Device: Miovision

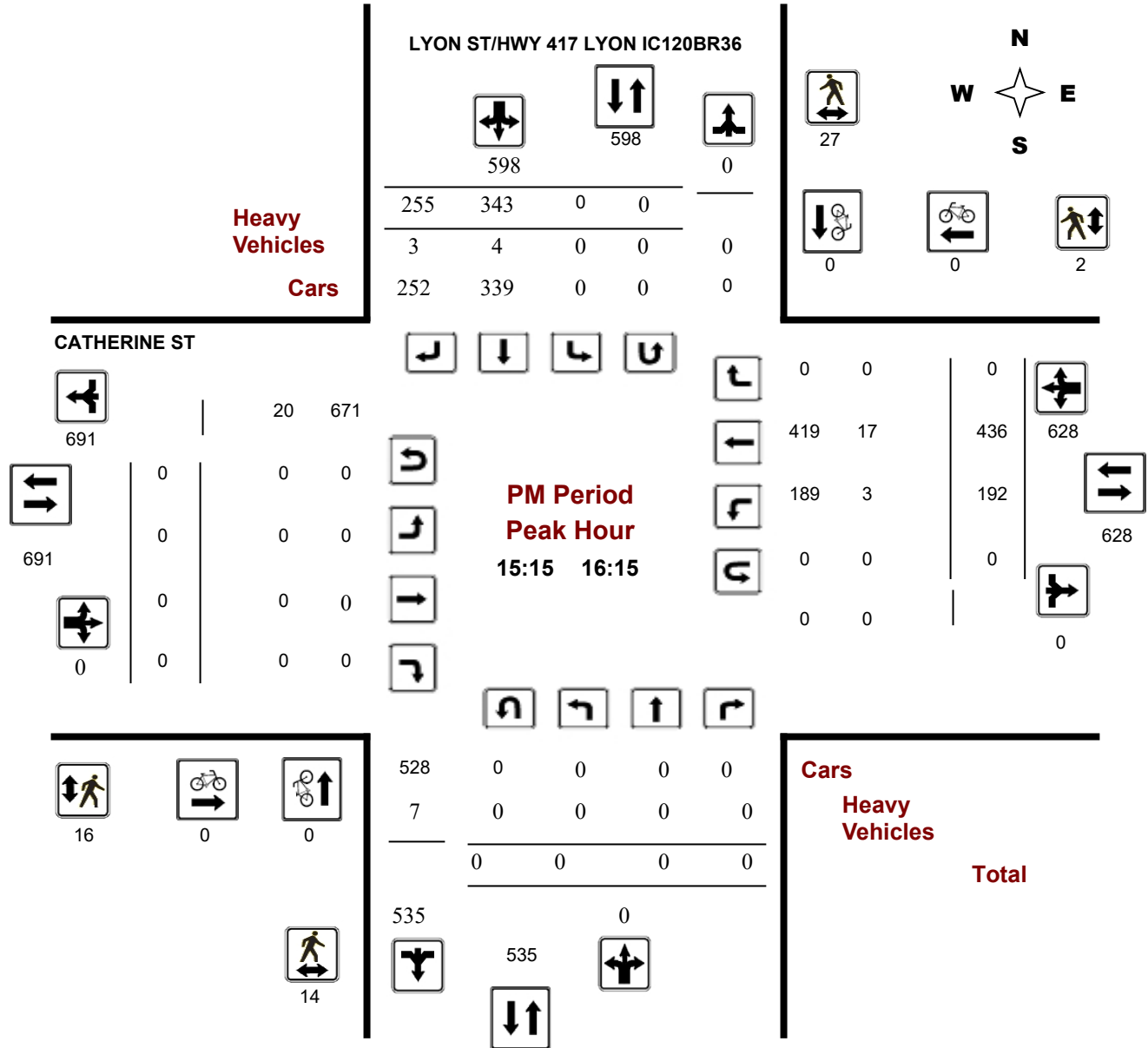

Comments



Transportation Services - Traffic Services

Turning Movement Count - Study Results

CATHERINE ST @ LYON ST/HWY 417 LYON IC120BR36

Survey Date: Wednesday, April 18, 2018

WO No: 40740

Start Time: 07:00

Device: Miovision

Full Study Summary (8 HR Standard)

Survey Date: Wednesday, April 18, 2018

Total Observed U-Turns

AADT Factor

Northbound: 0 Southbound: 0

.90

Eastbound: 0 Westbound: 0

LYON ST/HWY 417 LYON IC120BR36

CATHERINE ST

Period	Northbound				Southbound				STR TOT	Eastbound				Westbound			WB TOT	STR TOT	Grand Total
	LT	ST	RT	NB TOT	LT	ST	RT	SB TOT		LT	ST	RT	EB TOT	LT	ST	RT			
07:00 08:00	0	0	0	0	0	223	94	317	317	0	0	0	0	150	192	0	342	342	659
08:00 09:00	0	0	0	0	0	258	123	381	381	0	0	0	0	222	219	0	441	441	822
09:00 10:00	0	0	0	0	0	213	108	321	321	0	0	0	0	183	244	0	427	427	748
11:30 12:30	0	0	0	0	0	279	122	401	401	0	0	0	0	236	265	0	501	501	902
12:30 13:30	0	0	0	0	0	267	110	377	377	0	0	0	0	241	269	0	510	510	887
15:00 16:00	0	0	0	0	0	402	213	615	615	0	0	0	0	200	407	0	607	607	1222
16:00 17:00	0	0	0	0	0	297	301	598	598	0	0	0	0	169	344	0	513	513	1111
17:00 18:00	0	0	0	0	0	366	246	612	612	0	0	0	0	171	218	0	389	389	1001
Sub Total	0	0	0	0	0	2305	1317	3622	3622	0	0	0	0	1572	2158	0	3730	3730	7352
U Turns				0				0	0				0				0	0	0
Total	0	0	0	0	0	2305	1317	3622	3622	0	0	0	0	1572	2158	0	3730	3730	7352

EQ 12Hr 0 0 0 0 0 3204 1831 5035 5035 0 0 0 0 2185 3000 0 5185 5185 10219

Note: These values are calculated by multiplying the totals by the appropriate expansion factor.

1.39

AVG 12Hr 0 0 0 0 0 3777 2158 4532 4532 0 0 0 0 1966 2700 0 4666 4666 9197

Note: These volumes are calculated by multiplying the Equivalent 12 hr. totals by the AADT factor.

.90

AVG 24Hr 0 0 0 0 0 4948 2827 5937 5937 0 0 0 0 2575 3537 0 6112 6112 12048

Note: These volumes are calculated by multiplying the Average Daily 12 hr. totals by 12 to 24 expansion factor.

1.31

Note: U-Turns provided for approach totals. Refer to 'U-Turn' Report for specific breakdown.



Transportation Services - Traffic Services

Turning Movement Count - Study Results

CATHERINE ST @ LYON ST/HWY 417 LYON IC120BR36

Survey Date: Wednesday, April 18, 2018

WO No: 40740

Start Time: 07:00

Device: Miovision

Full Study 15 Minute Increments

LYON ST/HWY 417 LYON
IC120BR36

CATHERINE ST

Northbound

Southbound

Eastbound

Westbound

Time Period	Northbound				Southbound				Eastbound				Westbound				Grand Total		
	LT	ST	RT	N TOT	LT	ST	RT	S TOT	STR TOT	LT	ST	RT	E TOT	LT	ST	RT		W TOT	STR TOT
07:00 07:15	0	0	0	0	0	44	20	64	64	0	0	0	0	37	51	0	88	88	152
07:15 07:30	0	0	0	0	0	58	19	77	77	0	0	0	0	24	38	0	62	62	139
07:30 07:45	0	0	0	0	0	64	30	94	94	0	0	0	0	45	50	0	95	95	189
07:45 08:00	0	0	0	0	0	57	25	82	82	0	0	0	0	44	53	0	97	97	179
08:00 08:15	0	0	0	0	0	62	27	89	89	0	0	0	0	57	57	0	114	114	203
08:15 08:30	0	0	0	0	0	66	29	95	95	0	0	0	0	59	53	0	112	112	207
08:30 08:45	0	0	0	0	0	74	38	112	112	0	0	0	0	56	57	0	113	113	225
08:45 09:00	0	0	0	0	0	56	29	85	85	0	0	0	0	50	52	0	102	102	187
09:00 09:15	0	0	0	0	0	57	34	91	91	0	0	0	0	46	56	0	102	102	193
09:15 09:30	0	0	0	0	0	61	28	89	89	0	0	0	0	53	56	0	109	109	198
09:30 09:45	0	0	0	0	0	64	26	90	90	0	0	0	0	50	61	0	111	111	201
09:45 10:00	0	0	0	0	0	31	20	51	51	0	0	0	0	34	71	0	105	105	156
11:30 11:45	0	0	0	0	0	56	31	87	87	0	0	0	0	62	74	0	136	136	223
11:45 12:00	0	0	0	0	0	68	28	96	96	0	0	0	0	53	58	0	111	111	207
12:00 12:15	0	0	0	0	0	73	31	104	104	0	0	0	0	53	72	0	125	125	229
12:15 12:30	0	0	0	0	0	82	32	114	114	0	0	0	0	68	61	0	129	129	243
12:30 12:45	0	0	0	0	0	65	29	94	94	0	0	0	0	54	72	0	126	126	220
12:45 13:00	0	0	0	0	0	71	30	101	101	0	0	0	0	62	74	0	136	136	237
13:00 13:15	0	0	0	0	0	80	25	105	105	0	0	0	0	62	51	0	113	113	218
13:15 13:30	0	0	0	0	0	51	26	77	77	0	0	0	0	63	72	0	135	135	212
15:00 15:15	0	0	0	0	0	132	47	179	179	0	0	0	0	61	72	0	133	133	312
15:15 15:30	0	0	0	0	0	100	62	162	162	0	0	0	0	50	114	0	164	164	326
15:30 15:45	0	0	0	0	0	92	52	144	144	0	0	0	0	43	131	0	174	174	318
15:45 16:00	0	0	0	0	0	78	52	130	130	0	0	0	0	46	90	0	136	136	266
16:00 16:15	0	0	0	0	0	73	89	162	162	0	0	0	0	53	101	0	154	154	316
16:15 16:30	0	0	0	0	0	88	76	164	164	0	0	0	0	46	115	0	161	161	325
16:30 16:45	0	0	0	0	0	69	62	131	131	0	0	0	0	36	63	0	99	99	230
16:45 17:00	0	0	0	0	0	67	74	141	141	0	0	0	0	34	65	0	99	99	240
17:00 17:15	0	0	0	0	0	93	77	170	170	0	0	0	0	48	57	0	105	105	275
17:15 17:30	0	0	0	0	0	110	60	170	170	0	0	0	0	50	61	0	111	111	281
17:30 17:45	0	0	0	0	0	84	68	152	152	0	0	0	0	35	52	0	87	87	239
17:45 18:00	0	0	0	0	0	79	41	120	120	0	0	0	0	38	48	0	86	86	206
Total:	0	0	0	0	0	2305	1317	3622	3622	0	0	0	0	1572	2158	0	3730	3730	7,352

Note: U-Turns are included in Totals.



Transportation Services - Traffic Services

Turning Movement Count - Study Results

CATHERINE ST @ LYON ST/HWY 417 LYON IC120BR36

Survey Date: Wednesday, April 18, 2018

WO No: 40740

Start Time: 07:00

Device: Miovision

Full Study Cyclist Volume

LYON ST/HWY 417 LYON IC120BR36

CATHERINE ST

Time Period	Northbound	Southbound	Street Total	Eastbound	Westbound	Street Total	Grand Total
07:00 07:15	0	0	0	0	0	0	0
07:15 07:30	0	0	0	0	0	0	0
07:30 07:45	0	0	0	0	0	0	0
07:45 08:00	0	0	0	0	0	0	0
08:00 08:15	0	0	0	0	0	0	0
08:15 08:30	0	0	0	0	1	1	1
08:30 08:45	0	0	0	0	0	0	0
08:45 09:00	0	0	0	0	0	0	0
09:00 09:15	0	0	0	0	0	0	0
09:15 09:30	0	0	0	0	1	1	1
09:30 09:45	0	0	0	0	0	0	0
09:45 10:00	0	0	0	0	0	0	0
11:30 11:45	0	1	1	0	0	0	1
11:45 12:00	0	1	1	0	0	0	1
12:00 12:15	0	0	0	0	0	0	0
12:15 12:30	0	0	0	0	1	1	1
12:30 12:45	0	0	0	0	0	0	0
12:45 13:00	0	0	0	0	0	0	0
13:00 13:15	0	0	0	0	0	0	0
13:15 13:30	0	0	0	0	0	0	0
15:00 15:15	0	0	0	0	0	0	0
15:15 15:30	0	0	0	0	0	0	0
15:30 15:45	0	0	0	0	0	0	0
15:45 16:00	0	0	0	0	0	0	0
16:00 16:15	0	0	0	0	0	0	0
16:15 16:30	0	0	0	0	2	2	2
16:30 16:45	0	0	0	0	1	1	1
16:45 17:00	0	0	0	1	0	1	1
17:00 17:15	0	0	0	0	0	0	0
17:15 17:30	0	0	0	0	0	0	0
17:30 17:45	0	1	1	0	0	0	1
17:45 18:00	0	1	1	0	0	0	1
Total	0	4	4	1	6	7	11



Transportation Services - Traffic Services

Turning Movement Count - Study Results

CATHERINE ST @ LYON ST/HWY 417 LYON IC120BR36

Survey Date: Wednesday, April 18, 2018

WO No: 40740

Start Time: 07:00

Device: Miovision

Full Study Pedestrian Volume

LYON ST/HWY 417 LYON
IC120BR36

CATHERINE ST

Time Period	NB Approach (E or W Crossing)	SB Approach (E or W Crossing)	Total	EB Approach (N or S Crossing)	WB Approach (N or S Crossing)	Total	Grand Total
07:00 07:15	1	4	5	0	0	0	5
07:15 07:30	0	0	0	1	0	1	1
07:30 07:45	1	3	4	0	0	0	4
07:45 08:00	1	3	4	0	0	0	4
08:00 08:15	1	8	9	0	3	3	12
08:15 08:30	2	5	7	3	1	4	11
08:30 08:45	4	2	6	4	1	5	11
08:45 09:00	1	7	8	1	2	3	11
09:00 09:15	3	6	9	1	1	2	11
09:15 09:30	1	1	2	0	0	0	2
09:30 09:45	7	2	9	5	0	5	14
09:45 10:00	8	2	10	2	0	2	12
11:30 11:45	6	2	8	0	2	2	10
11:45 12:00	5	7	12	0	1	1	13
12:00 12:15	14	7	21	3	0	3	24
12:15 12:30	5	6	11	1	1	2	13
12:30 12:45	7	5	12	1	0	1	13
12:45 13:00	3	5	8	1	0	1	9
13:00 13:15	1	4	5	4	1	5	10
13:15 13:30	7	7	14	3	2	5	19
15:00 15:15	9	11	20	6	0	6	26
15:15 15:30	4	6	10	5	1	6	16
15:30 15:45	0	11	11	6	1	7	18
15:45 16:00	7	5	12	3	0	3	15
16:00 16:15	3	5	8	2	0	2	10
16:15 16:30	4	6	10	5	2	7	17
16:30 16:45	1	1	2	1	0	1	3
16:45 17:00	3	3	6	3	0	3	9
17:00 17:15	3	9	12	4	0	4	16
17:15 17:30	1	7	8	2	0	2	10
17:30 17:45	1	2	3	0	0	0	3
17:45 18:00	1	1	2	0	0	0	2
Total	115	153	268	67	19	86	354



Transportation Services - Traffic Services

Turning Movement Count - Study Results

CATHERINE ST @ LYON ST/HWY 417 LYON IC120BR36

Survey Date: Wednesday, April 18, 2018

WO No: 40740

Start Time: 07:00

Device: Miovision

Full Study Heavy Vehicles

LYON ST/HWY 417 LYON
IC120BR36

CATHERINE ST

Northbound Southbound Eastbound Westbound

Time Period	Northbound			N TOT	Southbound			S TOT	STR TOT	Eastbound			E TOT	Westbound			W TOT	STR TOT	Grand Total
	LT	ST	RT		LT	ST	RT			LT	ST	RT		LT	ST	RT			
07:00 07:15	0	0	0	8	0	4	0	4	12	0	0	0	9	4	9	0	13	22	17
07:15 07:30	0	0	0	7	0	5	0	5	12	0	0	0	3	2	3	0	5	8	10
07:30 07:45	0	0	0	3	0	2	0	2	5	0	0	0	3	1	3	0	4	7	6
07:45 08:00	0	0	0	0	0	0	0	0	0	0	0	0	5	0	5	0	5	10	5
08:00 08:15	0	0	0	4	0	0	0	0	4	0	0	0	7	4	7	0	11	18	11
08:15 08:30	0	0	0	2	0	1	0	1	3	0	0	0	5	1	5	0	6	11	7
08:30 08:45	0	0	0	3	0	2	0	2	5	0	0	0	4	1	4	0	5	9	7
08:45 09:00	0	0	0	2	0	2	0	2	4	0	0	0	4	0	4	0	4	8	6
09:00 09:15	0	0	0	1	0	0	0	0	1	0	0	0	3	1	3	0	4	7	4
09:15 09:30	0	0	0	5	0	0	0	0	5	0	0	0	4	5	4	0	9	13	9
09:30 09:45	0	0	0	5	0	3	0	3	8	0	0	0	2	2	2	0	4	6	7
09:45 10:00	0	0	0	1	0	1	0	1	2	0	0	0	6	0	6	0	6	12	7
11:30 11:45	0	0	0	1	0	0	2	2	3	0	0	0	4	1	2	0	3	7	5
11:45 12:00	0	0	0	6	0	3	1	4	10	0	0	0	6	3	5	0	8	14	12
12:00 12:15	0	0	0	2	0	2	0	2	4	0	0	0	4	0	4	0	4	8	6
12:15 12:30	0	0	0	5	0	4	0	4	9	0	0	0	4	1	4	0	5	9	9
12:30 12:45	0	0	0	3	0	1	0	1	4	0	0	0	4	2	4	0	6	10	7
12:45 13:00	0	0	0	4	0	3	0	3	7	0	0	0	0	1	0	0	1	1	4
13:00 13:15	0	0	0	3	0	1	0	1	4	0	0	0	3	2	3	0	5	8	6
13:15 13:30	0	0	0	1	0	0	1	1	2	0	0	0	3	1	2	0	3	6	4
15:00 15:15	0	0	0	5	0	1	0	1	6	0	0	0	6	4	6	0	10	16	11
15:15 15:30	0	0	0	2	0	1	0	1	3	0	0	0	2	1	2	0	3	5	4
15:30 15:45	0	0	0	3	0	1	1	2	5	0	0	0	6	2	5	0	7	13	9
15:45 16:00	0	0	0	0	0	0	0	0	0	0	0	0	4	0	4	0	4	8	4
16:00 16:15	0	0	0	2	0	2	2	4	6	0	0	0	8	0	6	0	6	14	10
16:15 16:30	0	0	0	2	0	0	0	0	2	0	0	0	6	2	6	0	8	14	8
16:30 16:45	0	0	0	1	0	0	0	0	1	0	0	0	2	1	2	0	3	5	3
16:45 17:00	0	0	0	1	0	1	0	1	2	0	0	0	4	0	4	0	4	8	5
17:00 17:15	0	0	0	0	0	0	0	0	0	0	0	0	2	0	2	0	2	4	2
17:15 17:30	0	0	0	0	0	0	0	0	0	0	0	0	1	0	1	0	1	2	1
17:30 17:45	0	0	0	2	0	0	0	0	2	0	0	0	2	2	2	0	4	6	4
17:45 18:00	0	0	0	0	0	0	0	0	0	0	0	0	0	0	0	0	0	0	0
Total: None	0	0	0	84	0	40	7	47	131	0	0	0	126	44	119	0	163	289	210



Transportation Services - Traffic Services

Turning Movement Count - Study Results

CATHERINE ST @ LYON ST/HWY 417 LYON IC120BR36

Survey Date: Wednesday, April 18, 2018

WO No: 40740

Start Time: 07:00

Device: Miovision

Full Study 15 Minute U-Turn Total

LYON ST/HWY 417 LYON CATHERINE ST

IC120BR36

Time Period		Northbound U-Turn Total	Southbound U-Turn Total	Eastbound U-Turn Total	Westbound U-Turn Total	Total
07:00	07:15	0	0	0	0	0
07:15	07:30	0	0	0	0	0
07:30	07:45	0	0	0	0	0
07:45	08:00	0	0	0	0	0
08:00	08:15	0	0	0	0	0
08:15	08:30	0	0	0	0	0
08:30	08:45	0	0	0	0	0
08:45	09:00	0	0	0	0	0
09:00	09:15	0	0	0	0	0
09:15	09:30	0	0	0	0	0
09:30	09:45	0	0	0	0	0
09:45	10:00	0	0	0	0	0
11:30	11:45	0	0	0	0	0
11:45	12:00	0	0	0	0	0
12:00	12:15	0	0	0	0	0
12:15	12:30	0	0	0	0	0
12:30	12:45	0	0	0	0	0
12:45	13:00	0	0	0	0	0
13:00	13:15	0	0	0	0	0
13:15	13:30	0	0	0	0	0
15:00	15:15	0	0	0	0	0
15:15	15:30	0	0	0	0	0
15:30	15:45	0	0	0	0	0
15:45	16:00	0	0	0	0	0
16:00	16:15	0	0	0	0	0
16:15	16:30	0	0	0	0	0
16:30	16:45	0	0	0	0	0
16:45	17:00	0	0	0	0	0
17:00	17:15	0	0	0	0	0
17:15	17:30	0	0	0	0	0
17:30	17:45	0	0	0	0	0
17:45	18:00	0	0	0	0	0
Total		0	0	0	0	0

Turning Movement Count - Study Results

CATHERINE ST @ PERCY ST

Survey Date: Thursday, April 19, 2018

WO No: 40917

Start Time: 07:00

Device: Miovision

Full Study Diagram

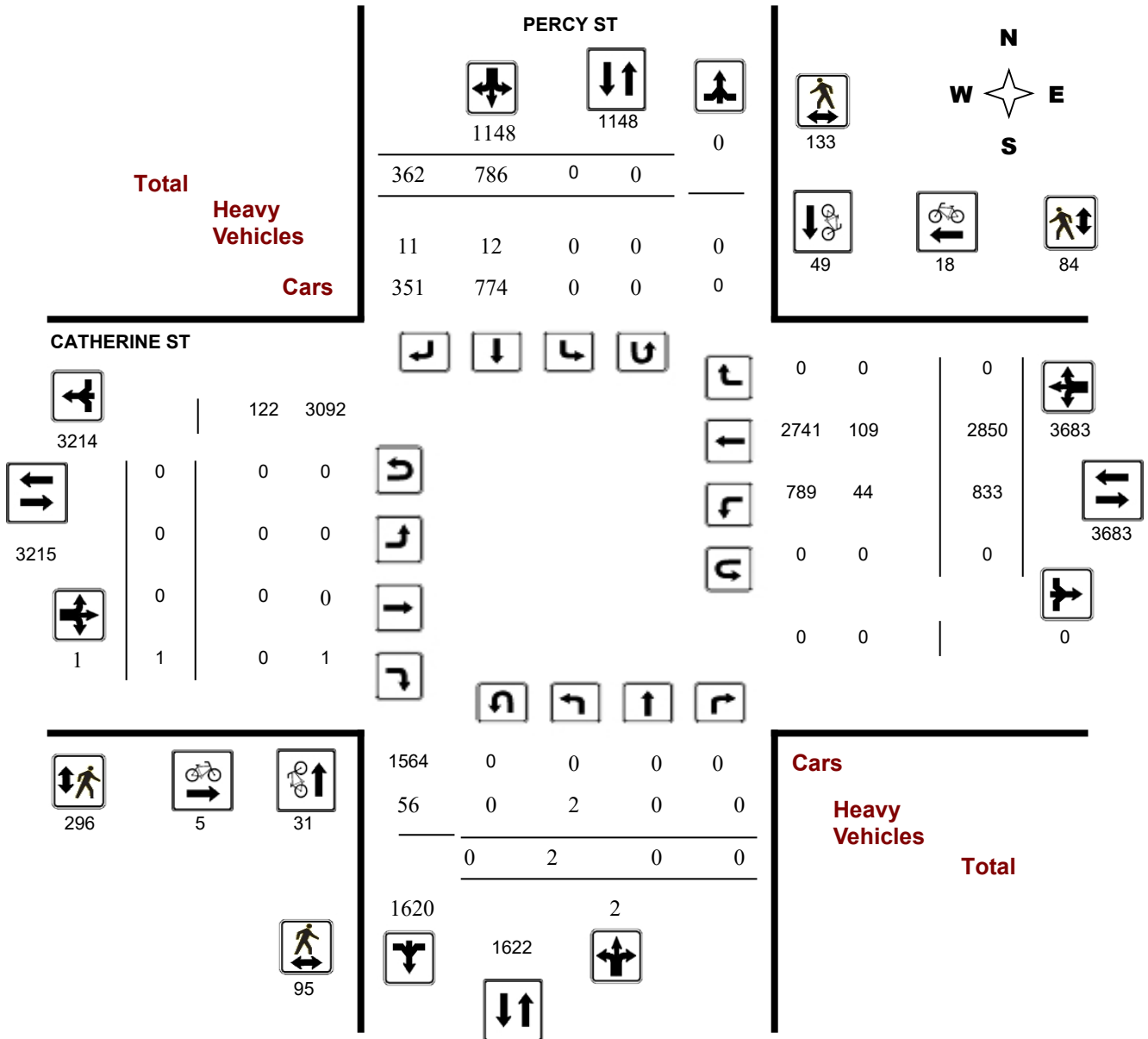

Turning Movement Count - Study Results

CATHERINE ST @ PERCY ST

Survey Date: Thursday, April 19, 2018

WO No: 40917

Start Time: 07:00

Device: Miovision

Full Study Peak Hour Diagram

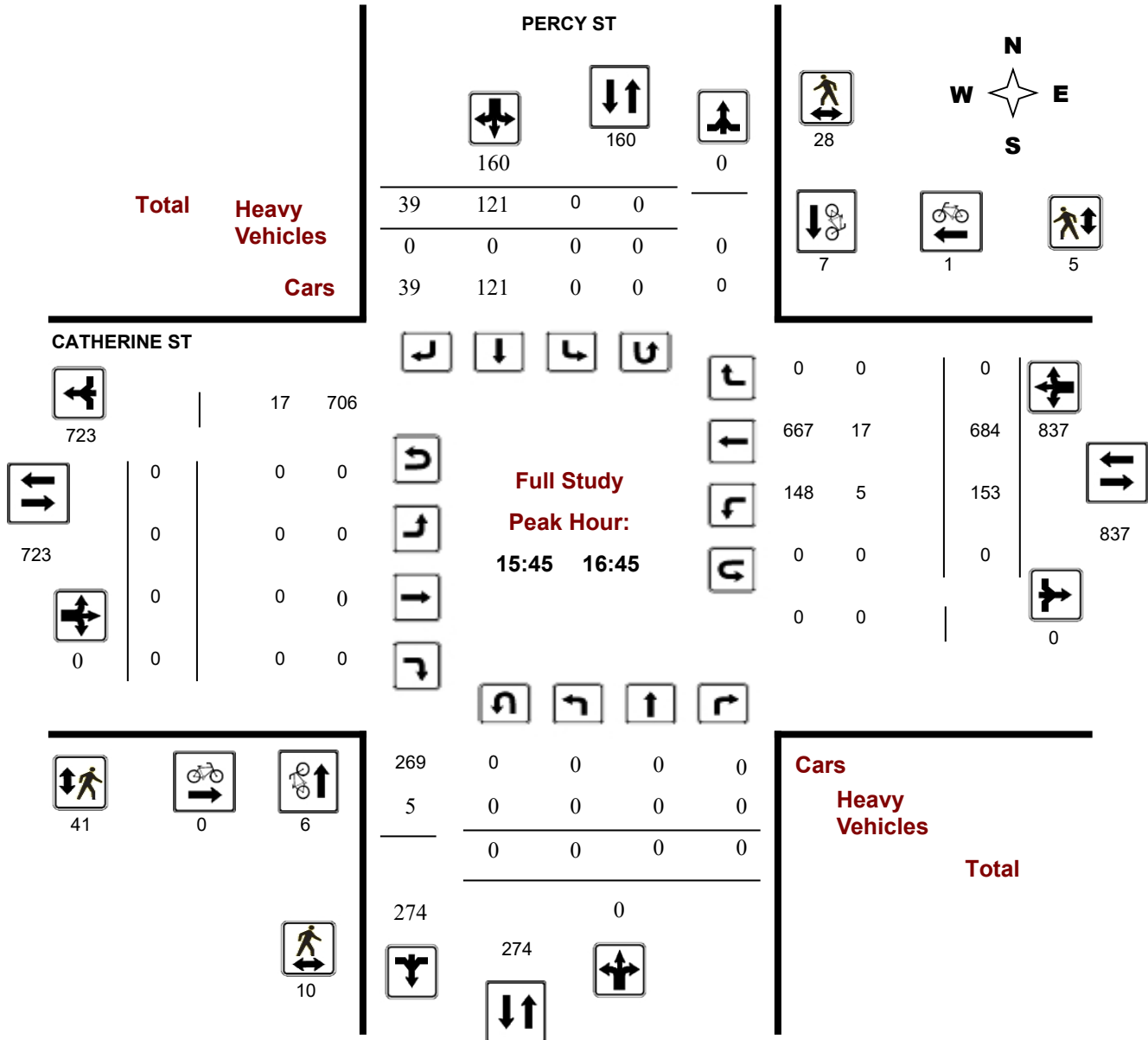

Turning Movement Count - Peak Hour Diagram

CATHERINE ST @ PERCY ST

Survey Date: Thursday, April 19, 2018

Start Time: 07:00

WO No: 40917

Device: Miovision

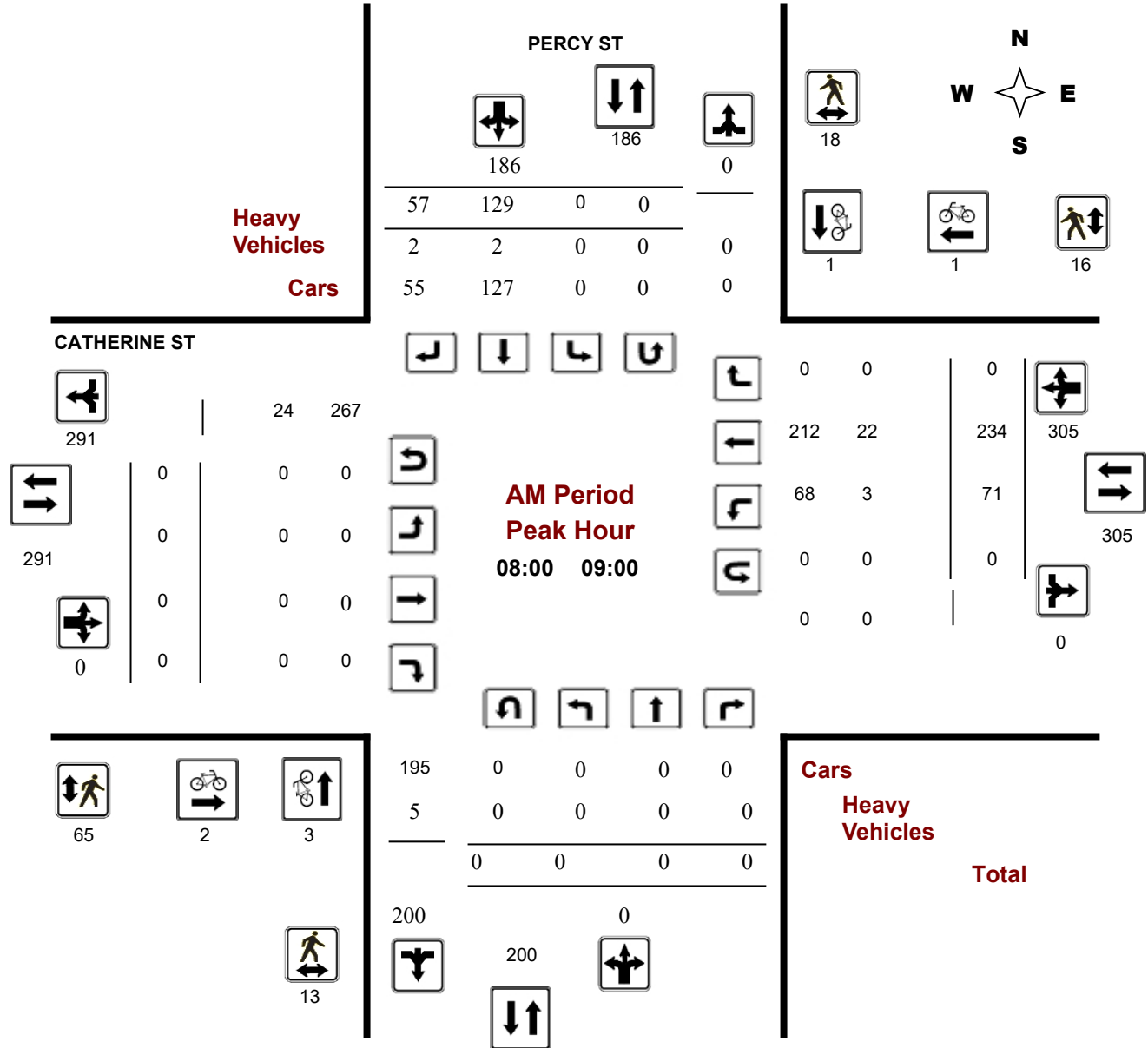

Turning Movement Count - Peak Hour Diagram

CATHERINE ST @ PERCY ST

Survey Date: Thursday, April 19, 2018

Start Time: 07:00

WO No: 40917

Device: Miovision

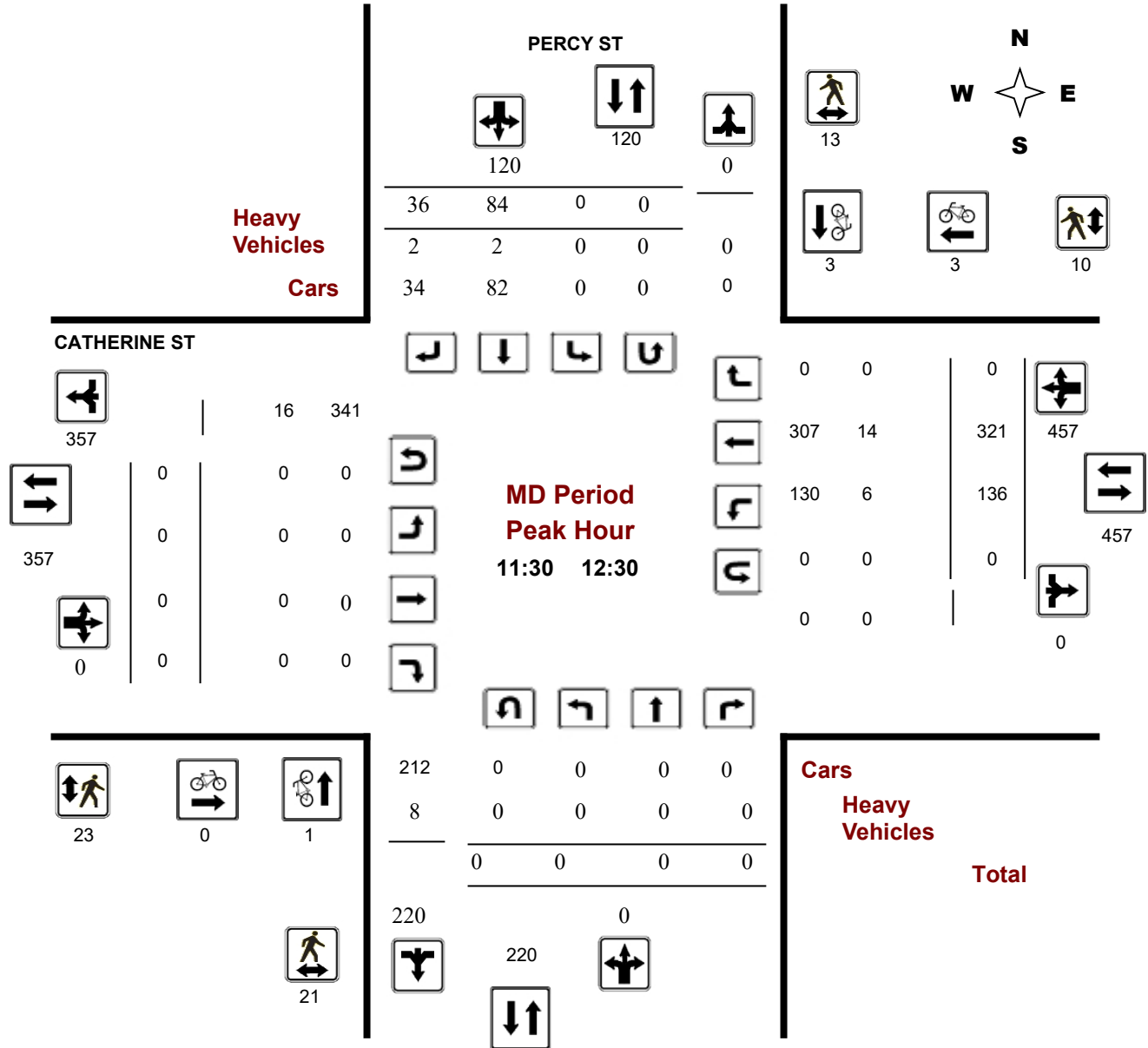

Comments

Turning Movement Count - Peak Hour Diagram

CATHERINE ST @ PERCY ST

Survey Date: Thursday, April 19, 2018

Start Time: 07:00

WO No: 40917

Device: Miovision

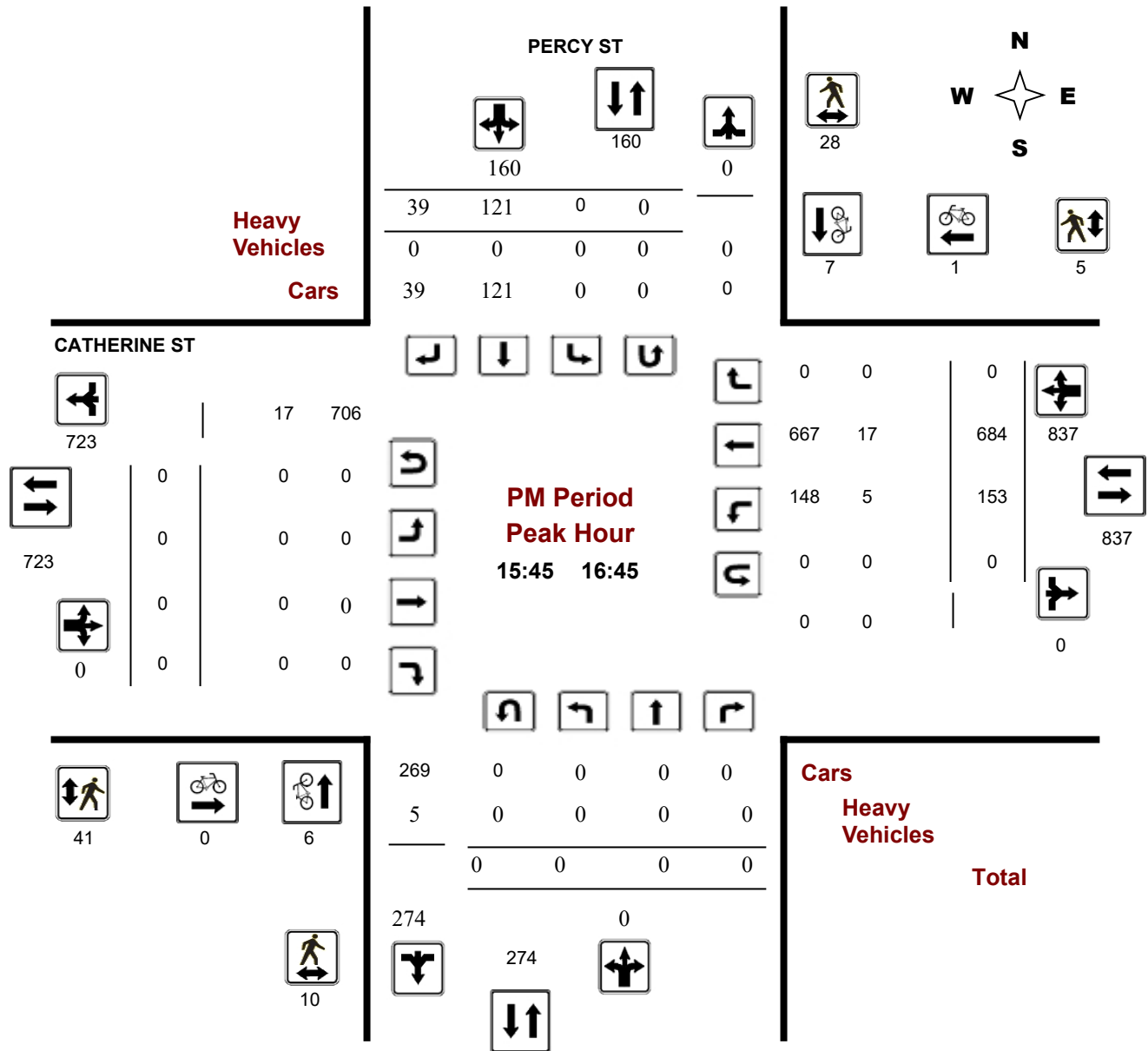



Transportation Services - Traffic Services

Turning Movement Count - Study Results

CATHERINE ST @ PERCY ST

Survey Date: Thursday, April 19, 2018

WO No: 40917

Start Time: 07:00

Device: Miovision

Full Study Summary (8 HR Standard)

Survey Date: Thursday, April 19, 2018

Total Observed U-Turns

AADT Factor

Northbound: 0 Southbound: 0

.90

Eastbound: 0 Westbound: 0

Period	PERCY ST										CATHERINE ST										Grand Total
	Northbound					Southbound					Eastbound					Westbound					
	LT	ST	RT	NB TOT	LT	ST	RT	SB TOT	STR TOT	LT	ST	RT	EB TOT	LT	ST	RT	WB TOT	STR TOT			
07:00 08:00	0	0	0	0	0	83	39	122	122	0	0	0	0	45	161	0	206	206	328		
08:00 09:00	0	0	0	0	0	129	57	186	186	0	0	0	0	71	234	0	305	305	491		
09:00 10:00	0	0	0	0	0	79	33	112	112	0	0	0	0	84	216	0	300	300	412		
11:30 12:30	0	0	0	0	0	84	36	120	120	0	0	0	0	136	321	0	457	457	577		
12:30 13:30	2	0	0	2	0	64	33	97	99	0	0	0	0	89	279	0	368	368	467		
15:00 16:00	0	0	0	0	0	103	58	161	161	0	0	0	0	126	553	0	679	679	840		
16:00 17:00	0	0	0	0	0	119	43	162	162	0	0	0	0	162	644	0	806	806	968		
17:00 18:00	0	0	0	0	0	125	63	188	188	0	0	1	1	120	442	0	562	563	751		
Sub Total	2	0	0	2	0	786	362	1148	1150	0	0	1	1	833	2850	0	3683	3684	4834		
U Turns				0				0	0				0				0	0	0		
Total	2	0	0	2	0	786	362	1148	1150	0	0	1	1	833	2850	0	3683	3684	4834		
EQ 12Hr	3	0	0	3	0	1093	503	1596	1598	0	0	1	1	1158	3961	0	5119	5121	6719		
Note: These values are calculated by multiplying the totals by the appropriate expansion factor.													1.39								
AVG 12Hr	3	0	0	3	0	1288	593	1436	1438	0	0	1	1	1042	3565	0	4607	4609	6047		
Note: These volumes are calculated by multiplying the Equivalent 12 hr. totals by the AADT factor.													.90								
AVG 24Hr	4	0	0	4	0	1687	777	1881	1884	0	0	1	1	1365	4670	0	6035	6038	7922		
Note: These volumes are calculated by multiplying the Average Daily 12 hr. totals by 12 to 24 expansion factor.													1.31								
Note: U-Turns provided for approach totals. Refer to 'U-Turn' Report for specific breakdown.																					



Transportation Services - Traffic Services

Turning Movement Count - Study Results

CATHERINE ST @ PERCY ST

Survey Date: Thursday, April 19, 2018

WO No: 40917

Start Time: 07:00

Device: Miovision

Full Study 15 Minute Increments

PERCY ST

CATHERINE ST

Northbound

Southbound

Eastbound

Westbound

Time Period	LT	ST	RT	N TOT	LT	ST	RT	S TOT	STR TOT	LT	ST	RT	E TOT	LT	ST	RT	W TOT	STR TOT	Grand Total
07:00 07:15	0	0	0	0	0	9	9	18	18	0	0	0	0	9	36	0	45	45	63
07:15 07:30	0	0	0	0	0	20	7	27	27	0	0	0	0	9	36	0	45	45	72
07:30 07:45	0	0	0	0	0	23	5	28	28	0	0	0	0	14	48	0	62	62	90
07:45 08:00	0	0	0	0	0	31	18	49	49	0	0	0	0	13	41	0	54	54	103
08:00 08:15	0	0	0	0	0	32	16	48	48	0	0	0	0	14	54	0	68	68	116
08:15 08:30	0	0	0	0	0	32	14	46	46	0	0	0	0	17	59	0	76	76	122
08:30 08:45	0	0	0	0	0	30	18	48	48	0	0	0	0	17	67	0	84	84	132
08:45 09:00	0	0	0	0	0	35	9	44	44	0	0	0	0	23	54	0	77	77	121
09:00 09:15	0	0	0	0	0	19	4	23	23	0	0	0	0	27	63	0	90	90	113
09:15 09:30	0	0	0	0	0	26	12	38	38	0	0	0	0	19	52	0	71	71	109
09:30 09:45	0	0	0	0	0	12	13	25	25	0	0	0	0	17	50	0	67	67	92
09:45 10:00	0	0	0	0	0	22	4	26	26	0	0	0	0	21	51	0	72	72	98
11:30 11:45	0	0	0	0	0	22	8	30	30	0	0	0	0	29	77	0	106	106	136
11:45 12:00	0	0	0	0	0	20	13	33	33	0	0	0	0	29	78	0	107	107	140
12:00 12:15	0	0	0	0	0	21	8	29	29	0	0	0	0	37	76	0	113	113	142
12:15 12:30	0	0	0	0	0	21	7	28	28	0	0	0	0	41	90	0	131	131	159
12:30 12:45	2	0	0	2	0	19	9	28	30	0	0	0	0	23	67	0	90	90	120
12:45 13:00	0	0	0	0	0	19	8	27	27	0	0	0	0	23	59	0	82	82	109
13:00 13:15	0	0	0	0	0	12	6	18	18	0	0	0	0	21	79	0	100	100	118
13:15 13:30	0	0	0	0	0	14	10	24	24	0	0	0	0	22	74	0	96	96	120
15:00 15:15	0	0	0	0	0	21	15	36	36	0	0	0	0	25	83	0	108	108	144
15:15 15:30	0	0	0	0	0	24	16	40	40	0	0	0	0	42	147	0	189	189	229
15:30 15:45	0	0	0	0	0	34	18	52	52	0	0	0	0	25	172	0	197	197	249
15:45 16:00	0	0	0	0	0	24	9	33	33	0	0	0	0	34	151	0	185	185	218
16:00 16:15	0	0	0	0	0	30	11	41	41	0	0	0	0	26	165	0	191	191	232
16:15 16:30	0	0	0	0	0	31	11	42	42	0	0	0	0	34	202	0	236	236	278
16:30 16:45	0	0	0	0	0	36	8	44	44	0	0	0	0	59	166	0	225	225	269
16:45 17:00	0	0	0	0	0	22	13	35	35	0	0	0	0	43	111	0	154	154	189
17:00 17:15	0	0	0	0	0	43	15	58	58	0	0	0	0	43	120	0	163	163	221
17:15 17:30	0	0	0	0	0	26	11	37	37	0	0	1	1	30	131	0	161	162	199
17:30 17:45	0	0	0	0	0	36	21	57	57	0	0	0	0	21	85	0	106	106	163
17:45 18:00	0	0	0	0	0	20	16	36	36	0	0	0	0	26	106	0	132	132	168
Total:	2	0	0	2	0	786	362	1148	1150	0	0	1	1	833	2850	0	3683	3684	4,834

Note: U-Turns are included in Totals.



Transportation Services - Traffic Services

Turning Movement Count - Study Results

CATHERINE ST @ PERCY ST

Survey Date: Thursday, April 19, 2018

WO No: 40917

Start Time: 07:00

Device: Miovision

Full Study Cyclist Volume

Time Period	PERCY ST			CATHERINE ST			Grand Total
	Northbound	Southbound	Street Total	Eastbound	Westbound	Street Total	
07:00 07:15	1	0	1	0	0	0	1
07:15 07:30	0	1	1	0	0	0	1
07:30 07:45	0	0	0	0	0	0	0
07:45 08:00	0	0	0	0	0	0	0
08:00 08:15	2	1	3	0	0	0	3
08:15 08:30	0	0	0	0	0	0	0
08:30 08:45	0	0	0	0	1	1	1
08:45 09:00	1	0	1	2	0	2	3
09:00 09:15	2	0	2	0	0	0	2
09:15 09:30	4	0	4	0	0	0	4
09:30 09:45	2	0	2	1	0	1	3
09:45 10:00	4	0	4	0	0	0	4
11:30 11:45	1	1	2	0	3	3	5
11:45 12:00	0	1	1	0	0	0	1
12:00 12:15	0	0	0	0	0	0	0
12:15 12:30	0	1	1	0	0	0	1
12:30 12:45	0	3	3	0	0	0	3
12:45 13:00	0	1	1	0	2	2	3
13:00 13:15	0	0	0	0	0	0	0
13:15 13:30	3	2	5	1	1	2	7
15:00 15:15	1	1	2	0	1	1	3
15:15 15:30	2	0	2	0	3	3	5
15:30 15:45	1	3	4	1	1	2	6
15:45 16:00	0	1	1	0	0	0	1
16:00 16:15	2	1	3	0	1	1	4
16:15 16:30	1	4	5	0	0	0	5
16:30 16:45	3	1	4	0	0	0	4
16:45 17:00	0	3	3	0	1	1	4
17:00 17:15	1	4	5	0	0	0	5
17:15 17:30	0	10	10	0	1	1	11
17:30 17:45	0	4	4	0	2	2	6
17:45 18:00	0	6	6	0	1	1	7
Total	31	49	80	5	18	23	103



Transportation Services - Traffic Services

Turning Movement Count - Study Results

CATHERINE ST @ PERCY ST

Survey Date: Thursday, April 19, 2018

WO No: 40917

Start Time: 07:00

Device: Miovision

Full Study Pedestrian Volume

PERCY ST

CATHERINE ST

Time Period	NB Approach (E or W Crossing)	SB Approach (E or W Crossing)	Total	EB Approach (N or S Crossing)	WB Approach (N or S Crossing)	Total	Grand Total
07:00 07:15	1	1	2	3	3	6	8
07:15 07:30	1	3	4	8	3	11	15
07:30 07:45	2	0	2	12	1	13	15
07:45 08:00	2	1	3	10	2	12	15
08:00 08:15	2	2	4	15	3	18	22
08:15 08:30	2	7	9	13	4	17	26
08:30 08:45	6	5	11	23	5	28	39
08:45 09:00	3	4	7	14	4	18	25
09:00 09:15	3	2	5	9	5	14	19
09:15 09:30	0	1	1	1	2	3	4
09:30 09:45	0	2	2	4	1	5	7
09:45 10:00	0	3	3	6	0	6	9
11:30 11:45	2	0	2	3	3	6	8
11:45 12:00	7	2	9	10	1	11	20
12:00 12:15	9	4	13	6	4	10	23
12:15 12:30	3	7	10	4	2	6	16
12:30 12:45	3	3	6	4	0	4	10
12:45 13:00	4	5	9	3	0	3	12
13:00 13:15	4	3	7	4	7	11	18
13:15 13:30	3	2	5	2	1	3	8
15:00 15:15	8	2	10	17	6	23	33
15:15 15:30	2	12	14	7	5	12	26
15:30 15:45	5	5	10	8	1	9	19
15:45 16:00	0	5	5	5	1	6	11
16:00 16:15	8	5	13	13	1	14	27
16:15 16:30	2	6	8	9	0	9	17
16:30 16:45	0	12	12	14	3	17	29
16:45 17:00	6	10	16	14	6	20	36
17:00 17:15	0	9	9	16	2	18	27
17:15 17:30	5	4	9	17	2	19	28
17:30 17:45	1	4	5	13	3	16	21
17:45 18:00	1	2	3	9	3	12	15
Total	95	133	228	296	84	380	608



Transportation Services - Traffic Services

Turning Movement Count - Study Results

CATHERINE ST @ PERCY ST

Survey Date: Thursday, April 19, 2018

WO No: 40917

Start Time: 07:00

Device: Miovision

Full Study Heavy Vehicles

PERCY ST

CATHERINE ST

Northbound

Southbound

Eastbound

Westbound

Time Period	PERCY ST Northbound			N TOT	PERCY ST Southbound			S TOT	STR TOT	CATHERINE ST Eastbound			E TOT	CATHERINE ST Westbound			W TOT	STR TOT	Grand Total
	LT	ST	RT		LT	ST	RT			LT	ST	RT		LT	ST	RT			
07:00 07:15	0	0	0	2	0	0	1	1	3	0	0	0	5	2	4	0	6	11	7
07:15 07:30	0	0	0	1	0	0	1	1	2	0	0	0	4	1	3	0	4	8	5
07:30 07:45	0	0	0	0	0	0	0	0	0	0	0	0	2	0	2	0	2	4	2
07:45 08:00	0	0	0	2	0	0	1	1	3	0	0	0	5	2	4	0	6	11	7
08:00 08:15	0	0	0	1	0	0	0	0	1	0	0	0	10	1	10	0	11	21	11
08:15 08:30	0	0	0	1	0	1	1	2	3	0	0	0	3	0	2	0	2	5	4
08:30 08:45	0	0	0	2	0	1	1	2	4	0	0	0	8	1	7	0	8	16	10
08:45 09:00	0	0	0	1	0	0	0	0	1	0	0	0	3	1	3	0	4	7	4
09:00 09:15	0	0	0	7	0	1	0	1	8	0	0	0	7	6	7	0	13	20	14
09:15 09:30	0	0	0	1	0	0	0	0	1	0	0	0	3	1	3	0	4	7	4
09:30 09:45	0	0	0	0	0	0	0	0	0	0	0	0	1	0	1	0	1	2	1
09:45 10:00	0	0	0	6	0	2	1	3	9	0	0	0	4	4	3	0	7	11	10
11:30 11:45	0	0	0	2	0	1	0	1	3	0	0	0	6	1	6	0	7	13	8
11:45 12:00	0	0	0	2	0	1	2	3	5	0	0	0	2	1	0	0	1	3	4
12:00 12:15	0	0	0	1	0	0	0	0	1	0	0	0	4	1	4	0	5	9	5
12:15 12:30	0	0	0	3	0	0	0	0	3	0	0	0	4	3	4	0	7	11	7
12:30 12:45	2	0	0	4	0	0	0	0	4	0	0	0	4	2	2	0	4	8	6
12:45 13:00	0	0	0	1	0	0	0	0	1	0	0	0	1	1	1	0	2	3	2
13:00 13:15	0	0	0	2	0	0	0	0	2	0	0	0	4	2	4	0	6	10	6
13:15 13:30	0	0	0	2	0	0	0	0	2	0	0	0	3	2	3	0	5	8	5
15:00 15:15	0	0	0	3	0	1	1	2	5	0	0	0	3	2	2	0	4	7	6
15:15 15:30	0	0	0	2	0	0	1	1	3	0	0	0	4	2	3	0	5	9	6
15:30 15:45	0	0	0	1	0	0	1	1	2	0	0	0	4	1	3	0	4	8	5
15:45 16:00	0	0	0	1	0	0	0	0	1	0	0	0	3	1	3	0	4	7	4
16:00 16:15	0	0	0	3	0	0	0	0	3	0	0	0	8	3	8	0	11	19	11
16:15 16:30	0	0	0	1	0	0	0	0	1	0	0	0	5	1	5	0	6	11	6
16:30 16:45	0	0	0	0	0	0	0	0	0	0	0	0	1	0	1	0	1	2	1
16:45 17:00	0	0	0	1	0	1	0	1	2	0	0	0	4	0	4	0	4	8	5
17:00 17:15	0	0	0	4	0	2	0	2	6	0	0	0	1	2	1	0	3	4	5
17:15 17:30	0	0	0	0	0	0	0	0	0	0	0	0	3	0	3	0	3	6	3
17:30 17:45	0	0	0	1	0	1	0	1	2	0	0	0	1	0	1	0	1	2	2
17:45 18:00	0	0	0	0	0	0	0	0	0	0	0	0	2	0	2	0	2	4	2
Total: None	2	0	0	58	0	12	11	23	81	0	0	0	122	44	109	0	153	275	178



Transportation Services - Traffic Services

Turning Movement Count - Study Results

CATHERINE ST @ PERCY ST

Survey Date: Thursday, April 19, 2018

WO No: 40917

Start Time: 07:00

Device: Miovision

Full Study 15 Minute U-Turn Total

PERCY ST

CATHERINE ST

Time Period		Northbound U-Turn Total	Southbound U-Turn Total	Eastbound U-Turn Total	Westbound U-Turn Total	Total
07:00	07:15	0	0	0	0	0
07:15	07:30	0	0	0	0	0
07:30	07:45	0	0	0	0	0
07:45	08:00	0	0	0	0	0
08:00	08:15	0	0	0	0	0
08:15	08:30	0	0	0	0	0
08:30	08:45	0	0	0	0	0
08:45	09:00	0	0	0	0	0
09:00	09:15	0	0	0	0	0
09:15	09:30	0	0	0	0	0
09:30	09:45	0	0	0	0	0
09:45	10:00	0	0	0	0	0
11:30	11:45	0	0	0	0	0
11:45	12:00	0	0	0	0	0
12:00	12:15	0	0	0	0	0
12:15	12:30	0	0	0	0	0
12:30	12:45	0	0	0	0	0
12:45	13:00	0	0	0	0	0
13:00	13:15	0	0	0	0	0
13:15	13:30	0	0	0	0	0
15:00	15:15	0	0	0	0	0
15:15	15:30	0	0	0	0	0
15:30	15:45	0	0	0	0	0
15:45	16:00	0	0	0	0	0
16:00	16:15	0	0	0	0	0
16:15	16:30	0	0	0	0	0
16:30	16:45	0	0	0	0	0
16:45	17:00	0	0	0	0	0
17:00	17:15	0	0	0	0	0
17:15	17:30	0	0	0	0	0
17:30	17:45	0	0	0	0	0
17:45	18:00	0	0	0	0	0
Total		0	0	0	0	0

Survey Date: Tuesday, April 25, 2017

WO No: 36848

Start Time: 07:00

Device: Miovision

Full Study Diagram

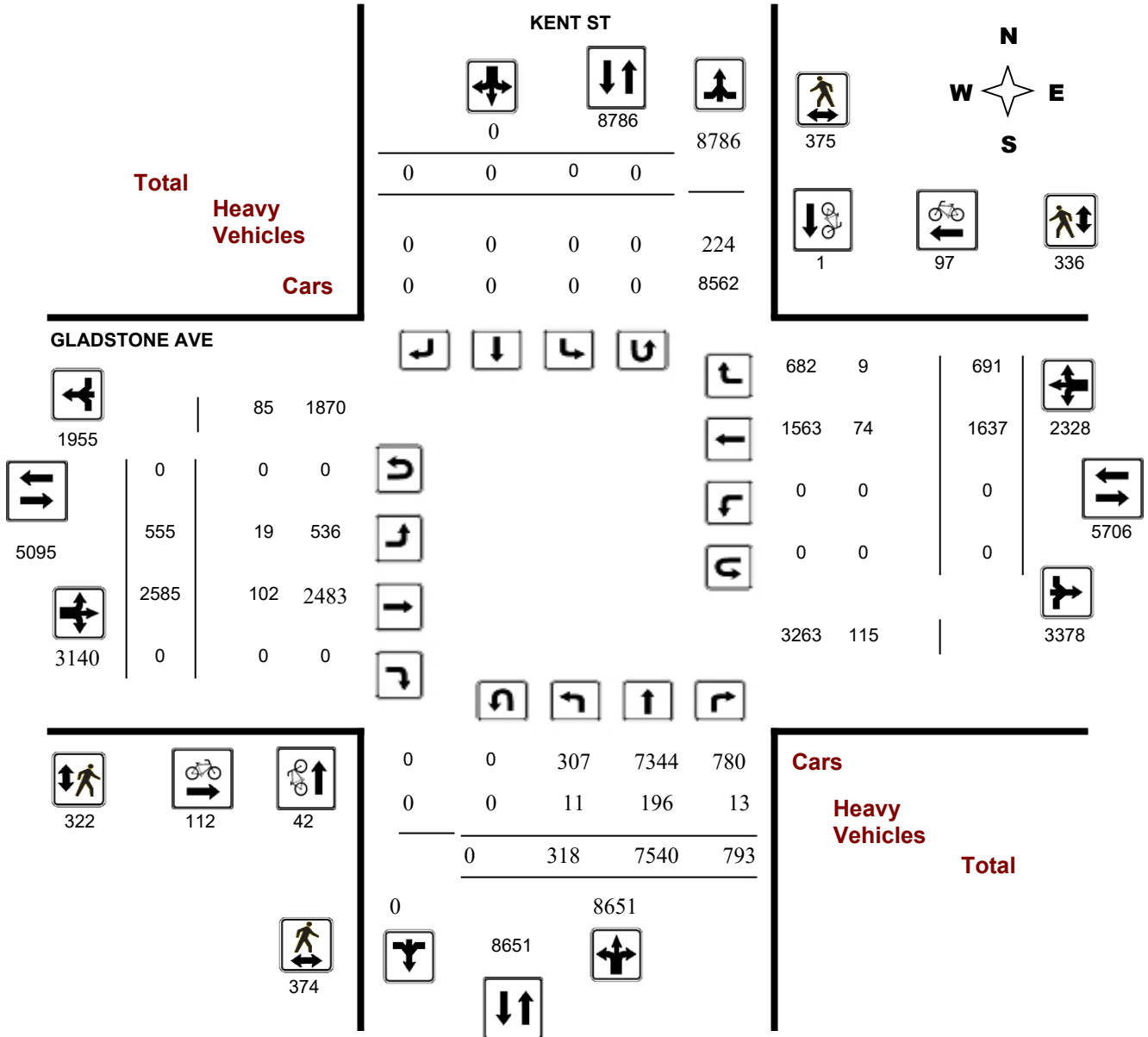

Turning Movement Count - Study Results

GLADSTONE AVE @ KENT ST

Survey Date: Tuesday, April 25, 2017

WO No: 36848

Start Time: 07:00

Device: Miovision

Full Study Peak Hour Diagram

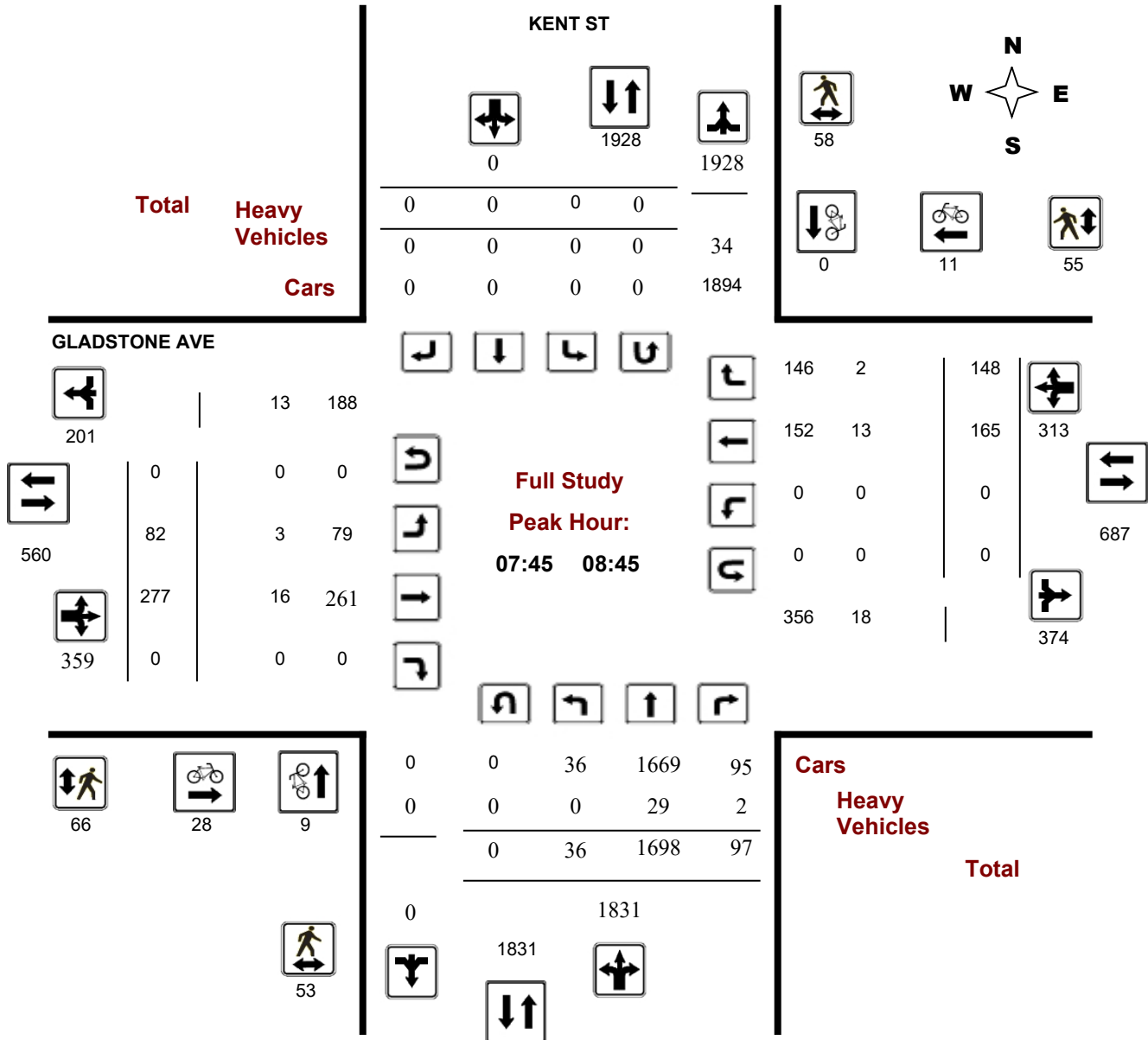

Turning Movement Count - Peak Hour Diagram

GLADSTONE AVE @ KENT ST

Survey Date: Tuesday, April 25, 2017

Start Time: 07:00

WO No: 36848

Device: Miovision

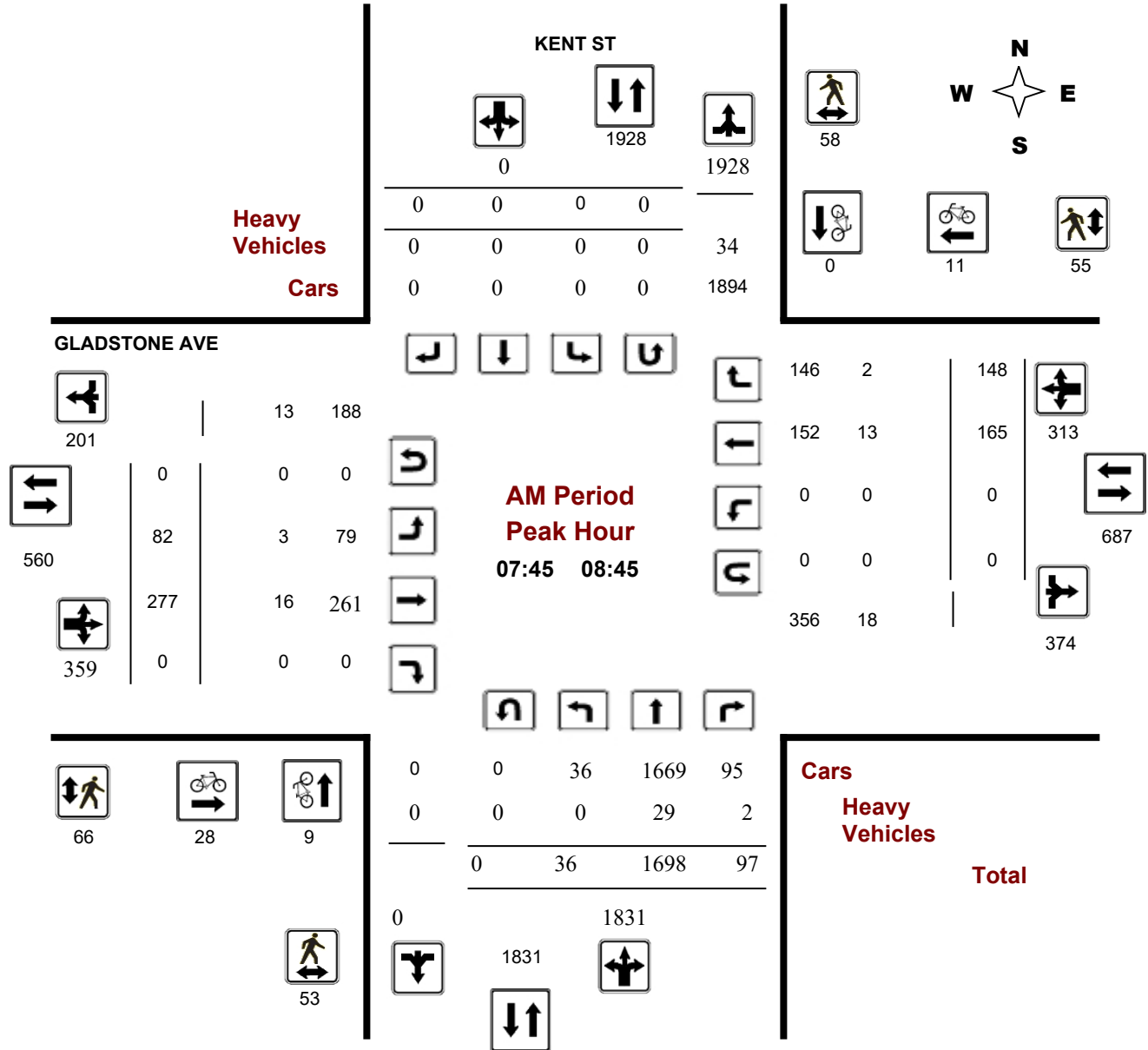

Turning Movement Count - Peak Hour Diagram

GLADSTONE AVE @ KENT ST

Survey Date: Tuesday, April 25, 2017

Start Time: 07:00

WO No: 36848

Device: Miovision

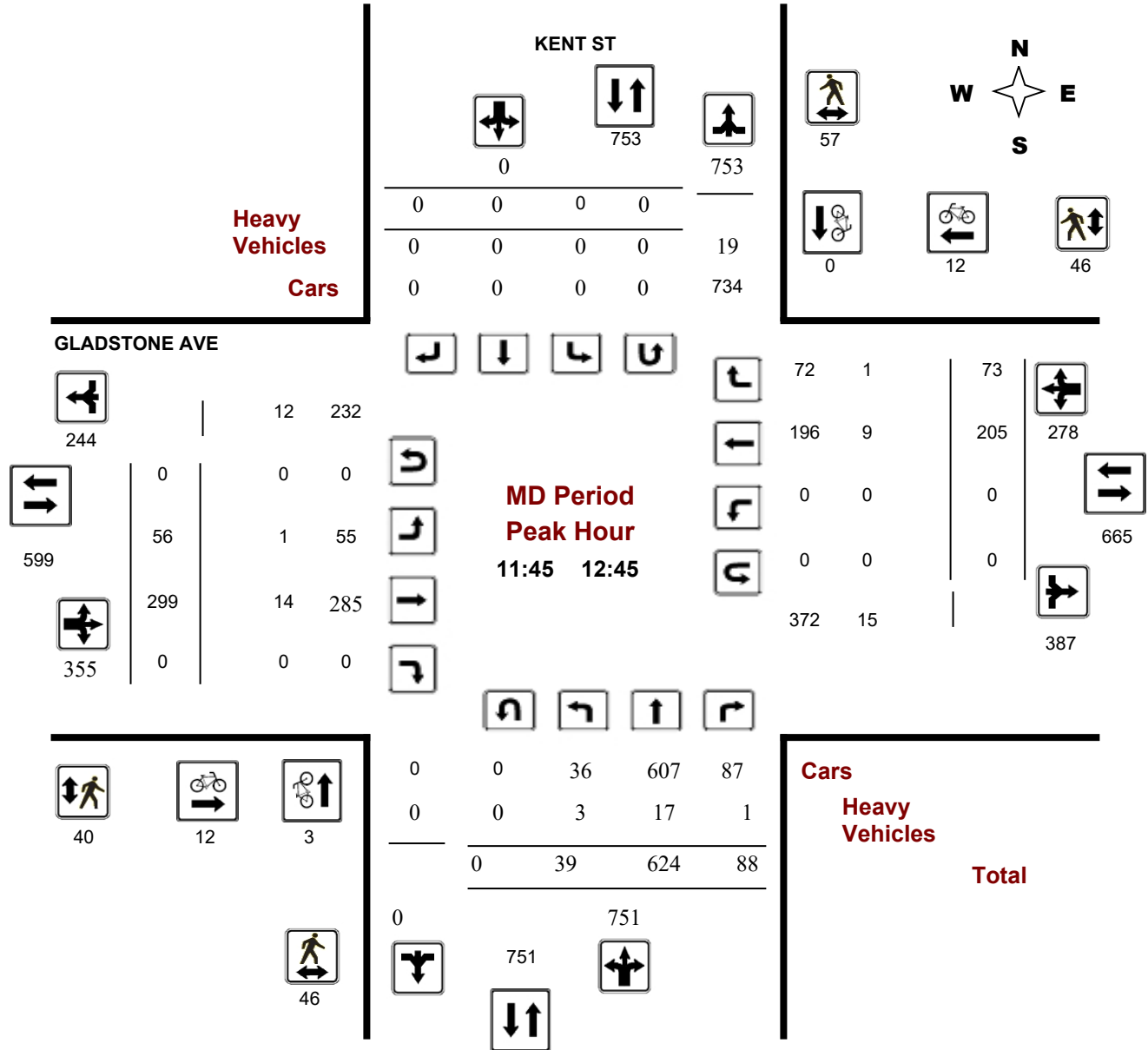

Comments

Turning Movement Count - Peak Hour Diagram

GLADSTONE AVE @ KENT ST

Survey Date: Tuesday, April 25, 2017

Start Time: 07:00

WO No: 36848

Device: Miovision

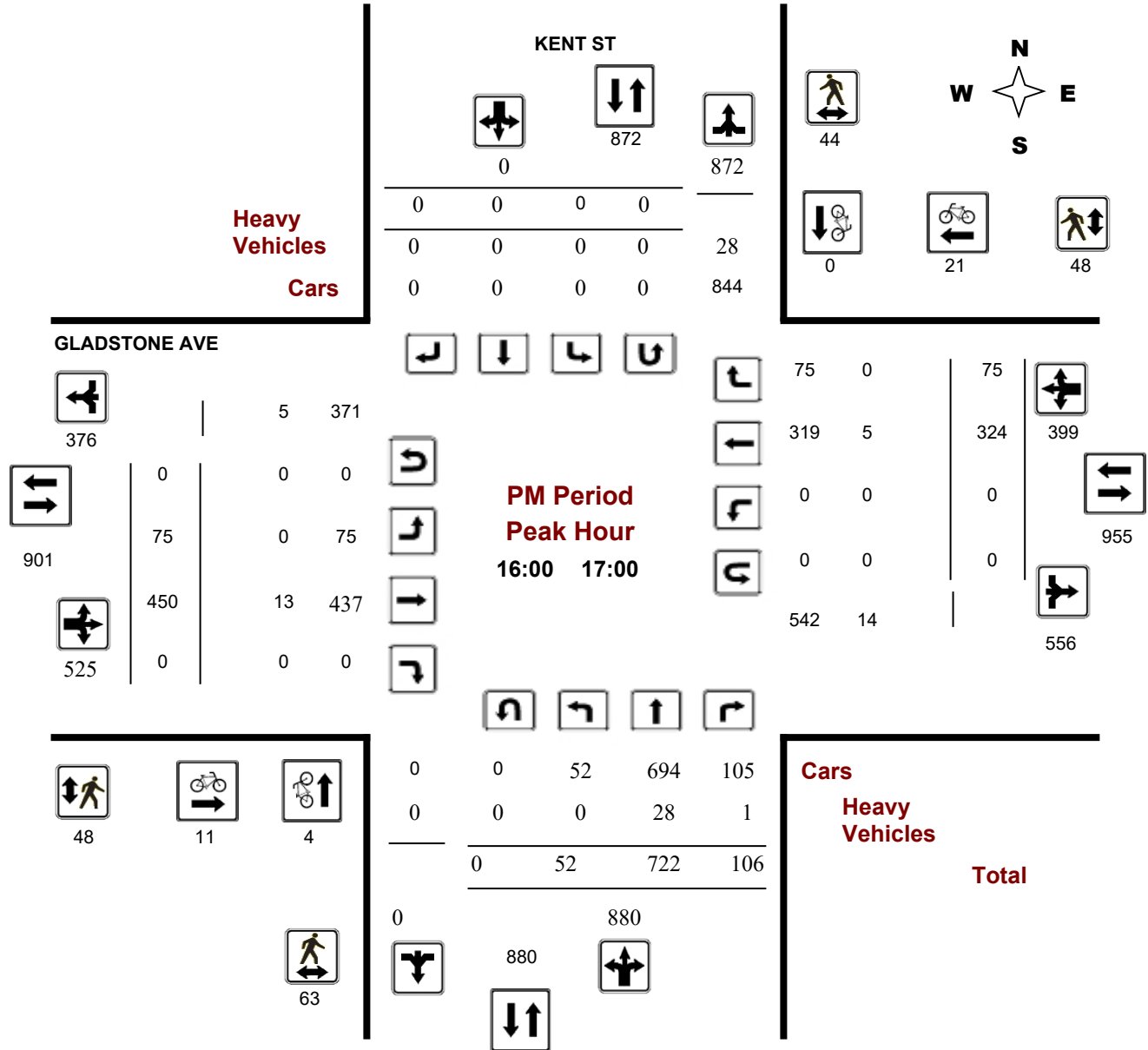



Transportation Services - Traffic Services

Turning Movement Count - Study Results

GLADSTONE AVE @ KENT ST

Survey Date: Tuesday, April 25, 2017

WO No: 36848

Start Time: 07:00

Device: Miovision

Full Study Summary (8 HR Standard)

Survey Date: Tuesday, April 25, 2017

Total Observed U-Turns
 Northbound: 0 Southbound: 0
 Eastbound: 0 Westbound: 0

AADT Factor
 .90

Period	KENT ST									GLADSTONE AVE									Grand Total
	Northbound				Southbound					Eastbound			Westbound						
	LT	ST	RT	NB TOT	LT	ST	RT	SB TOT	STR TOT	LT	ST	RT	EB TOT	LT	ST	RT	WB TOT	STR TOT	
07:00 08:00	14	1536	96	1646	0	0	0	0	1646	61	214	0	275	0	100	104	204	479	2125
08:00 09:00	42	1679	98	1819	0	0	0	0	1819	82	291	0	373	0	172	130	302	675	2494
09:00 10:00	34	943	107	1084	0	0	0	0	1084	76	256	0	332	0	173	76	249	581	1665
11:30 12:30	36	633	80	749	0	0	0	0	749	55	288	0	343	0	182	77	259	602	1351
12:30 13:30	33	569	97	699	0	0	0	0	699	54	321	0	375	0	201	74	275	650	1349
15:00 16:00	47	667	108	822	0	0	0	0	822	66	394	0	460	0	237	72	309	769	1591
16:00 17:00	52	722	106	880	0	0	0	0	880	75	450	0	525	0	324	75	399	924	1804
17:00 18:00	60	791	101	952	0	0	0	0	952	86	371	0	457	0	248	83	331	788	1740
Sub Total	318	7540	793	8651	0	0	0	0	8651	555	2585	0	3140	0	1637	691	2328	5468	14119
U Turns	0			0	0			0	0	0			0	0			0	0	0
Total	318	7540	793	8651	0	0	0	0	8651	555	2585	0	3140	0	1637	691	2328	5468	14119
EQ 12Hr	442	10481	1102	12025	0	0	0	0	12025	771	3593	0	4364	0	2275	960	3235	7599	19624
Note: These values are calculated by multiplying the totals by the appropriate expansion factor.																	1.39		
AVG 12Hr	398	9433	992	10823	0	0	0	0	10823	694	3234	0	3928	0	2048	864	2912	6840	17663
Note: These volumes are calculated by multiplying the Equivalent 12 hr. totals by the AADT factor.																	.90		
AVG 24Hr	521	12357	1300	14178	0	0	0	0	14178	909	4237	0	5146	0	2683	1132	3815	8961	23139
Note: These volumes are calculated by multiplying the Average Daily 12 hr. totals by 12 to 24 expansion factor.																	1.31		

Note: U-Turns provided for approach totals. Refer to 'U-Turn' Report for specific breakdown.



Transportation Services - Traffic Services

Turning Movement Count - Study Results

GLADSTONE AVE @ KENT ST

Survey Date: Tuesday, April 25, 2017

WO No: 36848

Start Time: 07:00

Device: Miovision

Full Study 15 Minute Increments

KENT ST

GLADSTONE AVE

Northbound

Southbound

Eastbound

Westbound

Time Period	LT	ST	RT	N TOT	LT	ST	RT	S TOT	STR TOT	LT	ST	RT	E TOT	LT	ST	RT	W TOT	STR TOT	Grand Total
07:00 07:15	1	319	24	344	0	0	0	0	344	17	51	0	68	0	20	10	30	98	442
07:15 07:30	2	382	24	408	0	0	0	0	408	13	40	0	53	0	18	21	39	92	500
07:30 07:45	6	402	25	433	0	0	0	0	433	15	64	0	79	0	22	31	53	132	565
07:45 08:00	5	433	23	461	0	0	0	0	461	16	59	0	75	0	40	42	82	157	618
08:00 08:15	8	428	33	469	0	0	0	0	469	22	79	0	101	0	31	42	73	174	643
08:15 08:30	7	435	19	461	0	0	0	0	461	22	70	0	92	0	50	28	78	170	631
08:30 08:45	16	402	22	440	0	0	0	0	440	22	69	0	91	0	44	36	80	171	611
08:45 09:00	11	414	24	449	0	0	0	0	449	16	73	0	89	0	47	24	71	160	609
09:00 09:15	6	319	28	353	0	0	0	0	353	17	66	0	83	0	51	31	82	165	518
09:15 09:30	14	243	26	283	0	0	0	0	283	27	66	0	93	0	33	17	50	143	426
09:30 09:45	4	177	29	210	0	0	0	0	210	15	61	0	76	0	41	15	56	132	342
09:45 10:00	10	204	24	238	0	0	0	0	238	17	63	0	80	0	48	13	61	141	379
11:30 11:45	6	158	12	176	0	0	0	0	176	14	67	0	81	0	33	18	51	132	308
11:45 12:00	8	167	28	203	0	0	0	0	203	17	82	0	99	0	55	25	80	179	382
12:00 12:15	14	153	25	192	0	0	0	0	192	13	65	0	78	0	44	19	63	141	333
12:15 12:30	8	155	15	178	0	0	0	0	178	11	74	0	85	0	50	15	65	150	328
12:30 12:45	9	149	20	178	0	0	0	0	178	15	78	0	93	0	56	14	70	163	341
12:45 13:00	6	153	19	178	0	0	0	0	178	12	66	0	78	0	47	22	69	147	325
13:00 13:15	15	141	32	188	0	0	0	0	188	16	96	0	112	0	48	19	67	179	367
13:15 13:30	3	126	26	155	0	0	0	0	155	11	81	0	92	0	50	19	69	161	316
15:00 15:15	11	154	15	180	0	0	0	0	180	20	85	0	105	0	59	19	78	183	363
15:15 15:30	14	157	28	199	0	0	0	0	199	18	102	0	120	0	56	21	77	197	396
15:30 15:45	9	167	21	197	0	0	0	0	197	16	107	0	123	0	65	14	79	202	399
15:45 16:00	13	189	44	246	0	0	0	0	246	12	100	0	112	0	57	18	75	187	433
16:00 16:15	14	172	23	209	0	0	0	0	209	14	118	0	132	0	86	25	111	243	452
16:15 16:30	9	195	28	232	0	0	0	0	232	24	111	0	135	0	71	19	90	225	457
16:30 16:45	16	167	18	201	0	0	0	0	201	19	116	0	135	0	89	18	107	242	443
16:45 17:00	13	188	37	238	0	0	0	0	238	18	105	0	123	0	78	13	91	214	452
17:00 17:15	19	176	29	224	0	0	0	0	224	20	99	0	119	0	69	17	86	205	429
17:15 17:30	14	201	27	242	0	0	0	0	242	26	109	0	135	0	53	25	78	213	455
17:30 17:45	15	215	26	256	0	0	0	0	256	25	93	0	118	0	69	21	90	208	464
17:45 18:00	12	199	19	230	0	0	0	0	230	15	70	0	85	0	57	20	77	162	392
Total:	318	7540	793	8651	0	0	0	0	8651	555	2585	0	3140	0	1637	691	2328	8651	14,119

Note: U-Turns are included in Totals.



Transportation Services - Traffic Services

Turning Movement Count - Study Results

GLADSTONE AVE @ KENT ST

Survey Date: Tuesday, April 25, 2017

WO No: 36848

Start Time: 07:00

Device: Miovision

Full Study Cyclist Volume

Time Period	KENT ST			GLADSTONE AVE			Grand Total
	Northbound	Southbound	Street Total	Eastbound	Westbound	Street Total	
07:00 07:15	1	0	1	2	3	5	6
07:15 07:30	1	0	1	3	2	5	6
07:30 07:45	0	0	0	4	5	9	9
07:45 08:00	3	0	3	6	2	8	11
08:00 08:15	2	0	2	9	3	12	14
08:15 08:30	4	0	4	6	1	7	11
08:30 08:45	0	0	0	7	5	12	12
08:45 09:00	7	0	7	7	4	11	18
09:00 09:15	0	0	0	7	1	8	8
09:15 09:30	7	0	7	1	2	3	10
09:30 09:45	1	0	1	2	1	3	4
09:45 10:00	0	0	0	3	2	5	5
11:30 11:45	0	0	0	3	3	6	6
11:45 12:00	1	0	1	1	4	5	6
12:00 12:15	0	0	0	6	2	8	8
12:15 12:30	1	0	1	2	2	4	5
12:30 12:45	1	0	1	3	4	7	8
12:45 13:00	3	0	3	2	7	9	12
13:00 13:15	1	0	1	3	1	4	5
13:15 13:30	3	0	3	0	1	1	4
15:00 15:15	0	0	0	4	1	5	5
15:15 15:30	0	1	1	1	0	1	2
15:30 15:45	0	0	0	3	2	5	5
15:45 16:00	0	0	0	0	2	2	2
16:00 16:15	0	0	0	4	2	6	6
16:15 16:30	3	0	3	1	7	8	11
16:30 16:45	0	0	0	2	7	9	9
16:45 17:00	1	0	1	4	5	9	10
17:00 17:15	0	0	0	6	5	11	11
17:15 17:30	1	0	1	4	7	11	12
17:30 17:45	0	0	0	3	3	6	6
17:45 18:00	1	0	1	3	1	4	5
Total	42	1	43	112	97	209	252



Transportation Services - Traffic Services

Turning Movement Count - Study Results

GLADSTONE AVE @ KENT ST

Survey Date: Tuesday, April 25, 2017

WO No: 36848

Start Time: 07:00

Device: Miovision

Full Study Pedestrian Volume

KENT ST

GLADSTONE AVE

Time Period	NB Approach (E or W Crossing)	SB Approach (E or W Crossing)	Total	EB Approach (N or S Crossing)	WB Approach (N or S Crossing)	Total	Grand Total
07:00 07:15	2	4	6	3	4	7	13
07:15 07:30	3	9	12	9	5	14	26
07:30 07:45	8	5	13	16	5	21	34
07:45 08:00	9	8	17	13	8	21	38
08:00 08:15	10	11	21	18	12	30	51
08:15 08:30	17	24	41	21	17	38	79
08:30 08:45	17	15	32	14	18	32	64
08:45 09:00	12	10	22	13	10	23	45
09:00 09:15	6	11	17	7	14	21	38
09:15 09:30	6	6	12	8	6	14	26
09:30 09:45	6	13	19	4	4	8	27
09:45 10:00	6	15	21	8	7	15	36
11:30 11:45	9	6	15	11	5	16	31
11:45 12:00	5	13	18	4	8	12	30
12:00 12:15	13	16	29	8	12	20	49
12:15 12:30	12	13	25	14	17	31	56
12:30 12:45	16	15	31	14	9	23	54
12:45 13:00	14	10	24	3	9	12	36
13:00 13:15	15	16	31	4	13	17	48
13:15 13:30	12	16	28	6	8	14	42
15:00 15:15	10	14	24	5	12	17	41
15:15 15:30	12	6	18	17	15	32	50
15:30 15:45	13	11	24	2	16	18	42
15:45 16:00	12	9	21	5	11	16	37
16:00 16:15	12	11	23	9	10	19	42
16:15 16:30	17	12	29	17	14	31	60
16:30 16:45	18	10	28	9	12	21	49
16:45 17:00	16	11	27	13	12	25	52
17:00 17:15	23	13	36	13	13	26	62
17:15 17:30	8	17	25	13	14	27	52
17:30 17:45	20	12	32	9	10	19	51
17:45 18:00	15	13	28	12	6	18	46
Total	374	375	749	322	336	658	1407



Transportation Services - Traffic Services

Turning Movement Count - Study Results

GLADSTONE AVE @ KENT ST

Survey Date: Tuesday, April 25, 2017

WO No: 36848

Start Time: 07:00

Device: Miovision

Full Study Heavy Vehicles

KENT ST					GLADSTONE AVE															Grand Total
Time Period	Northbound			N TOT	Southbound			S TOT	STR TOT	Eastbound			E TOT	Westbound			W TOT	STR TOT		
	LT	ST	RT		LT	ST	RT			LT	ST	RT		LT	ST	RT			LT	
07:00	07:15	0	5	0	5	0	0	0	0	5	3	2	0	5	0	2	0	2	7	12
07:15	07:30	1	3	1	5	0	0	0	0	5	1	2	0	3	0	1	1	2	5	10
07:30	07:45	1	4	0	5	0	0	0	0	5	1	5	0	6	0	5	0	5	11	16
07:45	08:00	0	5	1	6	0	0	0	0	6	0	3	0	3	0	3	0	3	6	12
08:00	08:15	0	7	1	8	0	0	0	0	8	3	4	0	7	0	2	2	4	11	19
08:15	08:30	0	10	0	10	0	0	0	0	10	0	3	0	3	0	4	0	4	7	17
08:30	08:45	0	7	0	7	0	0	0	0	7	0	6	0	6	0	4	0	4	10	17
08:45	09:00	2	7	0	9	0	0	0	0	9	2	3	0	5	0	0	0	0	5	14
09:00	09:15	2	5	3	10	0	0	0	0	10	0	5	0	5	0	3	2	5	10	20
09:15	09:30	0	4	1	5	0	0	0	0	5	0	2	0	2	0	3	0	3	5	10
09:30	09:45	0	9	1	10	0	0	0	0	10	1	2	0	3	0	2	0	2	5	15
09:45	10:00	0	6	0	6	0	0	0	0	6	1	3	0	4	0	7	0	7	11	17
11:30	11:45	0	5	0	5	0	0	0	0	5	1	2	0	3	0	2	0	2	5	10
11:45	12:00	1	7	1	9	0	0	0	0	9	0	2	0	2	0	3	0	3	5	14
12:00	12:15	0	4	0	4	0	0	0	0	4	0	4	0	4	0	2	1	3	7	11
12:15	12:30	1	4	0	5	0	0	0	0	5	1	4	0	5	0	1	0	1	6	11
12:30	12:45	1	2	0	3	0	0	0	0	3	0	4	0	4	0	3	0	3	7	10
12:45	13:00	0	3	0	3	0	0	0	0	3	1	3	0	4	0	0	0	0	4	7
13:00	13:15	0	3	0	3	0	0	0	0	3	0	2	0	2	0	3	0	3	5	8
13:15	13:30	1	4	0	5	0	0	0	0	5	1	7	0	8	0	2	0	2	10	15
15:00	15:15	0	13	1	14	0	0	0	0	14	1	4	0	5	0	5	1	6	11	25
15:15	15:30	0	11	2	13	0	0	0	0	13	0	1	0	1	0	1	1	2	3	16
15:30	15:45	0	12	0	12	0	0	0	0	12	0	6	0	6	0	3	0	3	9	21
15:45	16:00	0	9	0	9	0	0	0	0	9	1	2	0	3	0	3	1	4	7	16
16:00	16:15	0	8	0	8	0	0	0	0	8	0	4	0	4	0	2	0	2	6	14
16:15	16:30	0	9	0	9	0	0	0	0	9	0	5	0	5	0	1	0	1	6	15
16:30	16:45	0	7	1	8	0	0	0	0	8	0	1	0	1	0	1	0	1	2	10
16:45	17:00	0	4	0	4	0	0	0	0	4	0	3	0	3	0	1	0	1	4	8
17:00	17:15	1	6	0	7	0	0	0	0	7	1	4	0	5	0	1	0	1	6	13
17:15	17:30	0	7	0	7	0	0	0	0	7	0	0	0	0	0	0	0	0	0	7
17:30	17:45	0	4	0	4	0	0	0	0	4	0	4	0	4	0	1	0	1	5	9
17:45	18:00	0	2	0	2	0	0	0	0	2	0	0	0	0	0	3	0	3	3	5
Total:	None	11	196	13	220	0	0	0	0	220	19	102	0	121	0	74	9	83	204	424



Transportation Services - Traffic Services

Turning Movement Count - Study Results

GLADSTONE AVE @ KENT ST

Survey Date: Tuesday, April 25, 2017

WO No: 36848

Start Time: 07:00

Device: Miovision

Full Study 15 Minute U-Turn Total

KENT ST

GLADSTONE AVE

Time Period	Northbound U-Turn Total	Southbound U-Turn Total	Eastbound U-Turn Total	Westbound U-Turn Total	Total
07:00	07:15	0	0	0	0
07:15	07:30	0	0	0	0
07:30	07:45	0	0	0	0
07:45	08:00	0	0	0	0
08:00	08:15	0	0	0	0
08:15	08:30	0	0	0	0
08:30	08:45	0	0	0	0
08:45	09:00	0	0	0	0
09:00	09:15	0	0	0	0
09:15	09:30	0	0	0	0
09:30	09:45	0	0	0	0
09:45	10:00	0	0	0	0
11:30	11:45	0	0	0	0
11:45	12:00	0	0	0	0
12:00	12:15	0	0	0	0
12:15	12:30	0	0	0	0
12:30	12:45	0	0	0	0
12:45	13:00	0	0	0	0
13:00	13:15	0	0	0	0
13:15	13:30	0	0	0	0
15:00	15:15	0	0	0	0
15:15	15:30	0	0	0	0
15:30	15:45	0	0	0	0
15:45	16:00	0	0	0	0
16:00	16:15	0	0	0	0
16:15	16:30	0	0	0	0
16:30	16:45	0	0	0	0
16:45	17:00	0	0	0	0
17:00	17:15	0	0	0	0
17:15	17:30	0	0	0	0
17:30	17:45	0	0	0	0
17:45	18:00	0	0	0	0
Total		0	0	0	0

Turning Movement Count - Study Results

GLADSTONE AVE @ LYON ST

Survey Date: Wednesday, August 24, 2022

WO No: 40574

Start Time: 07:00

Device: Miovision

Full Study Diagram

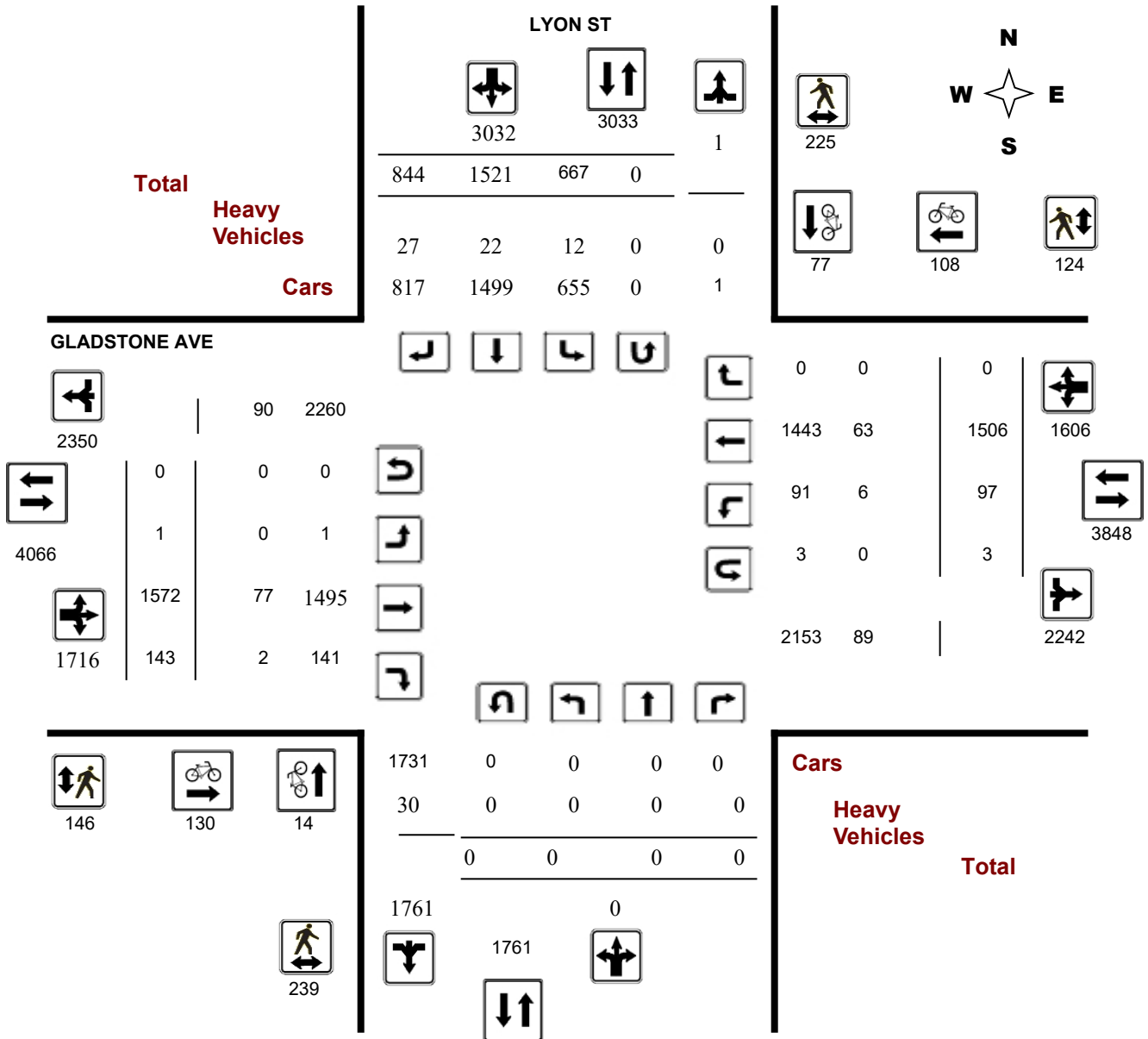

Turning Movement Count - Study Results

GLADSTONE AVE @ LYON ST

Survey Date: Wednesday, August 24, 2022

WO No: 40574

Start Time: 07:00

Device: Miovision

Full Study Peak Hour Diagram

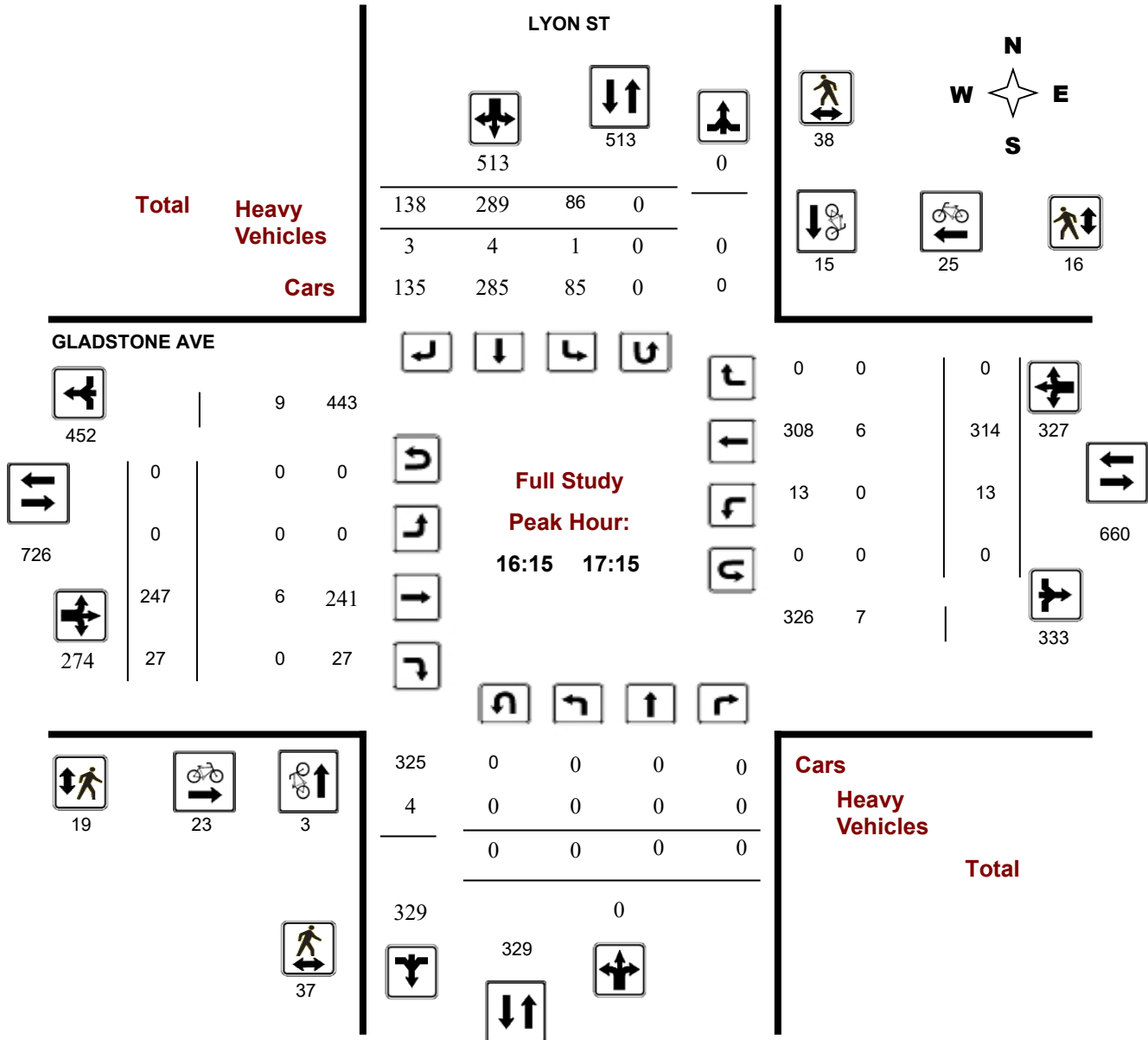

Turning Movement Count - Peak Hour Diagram

GLADSTONE AVE @ LYON ST

Survey Date: Wednesday, August 24, 2022

Start Time: 07:00

WO No: 40574

Device: Miovision

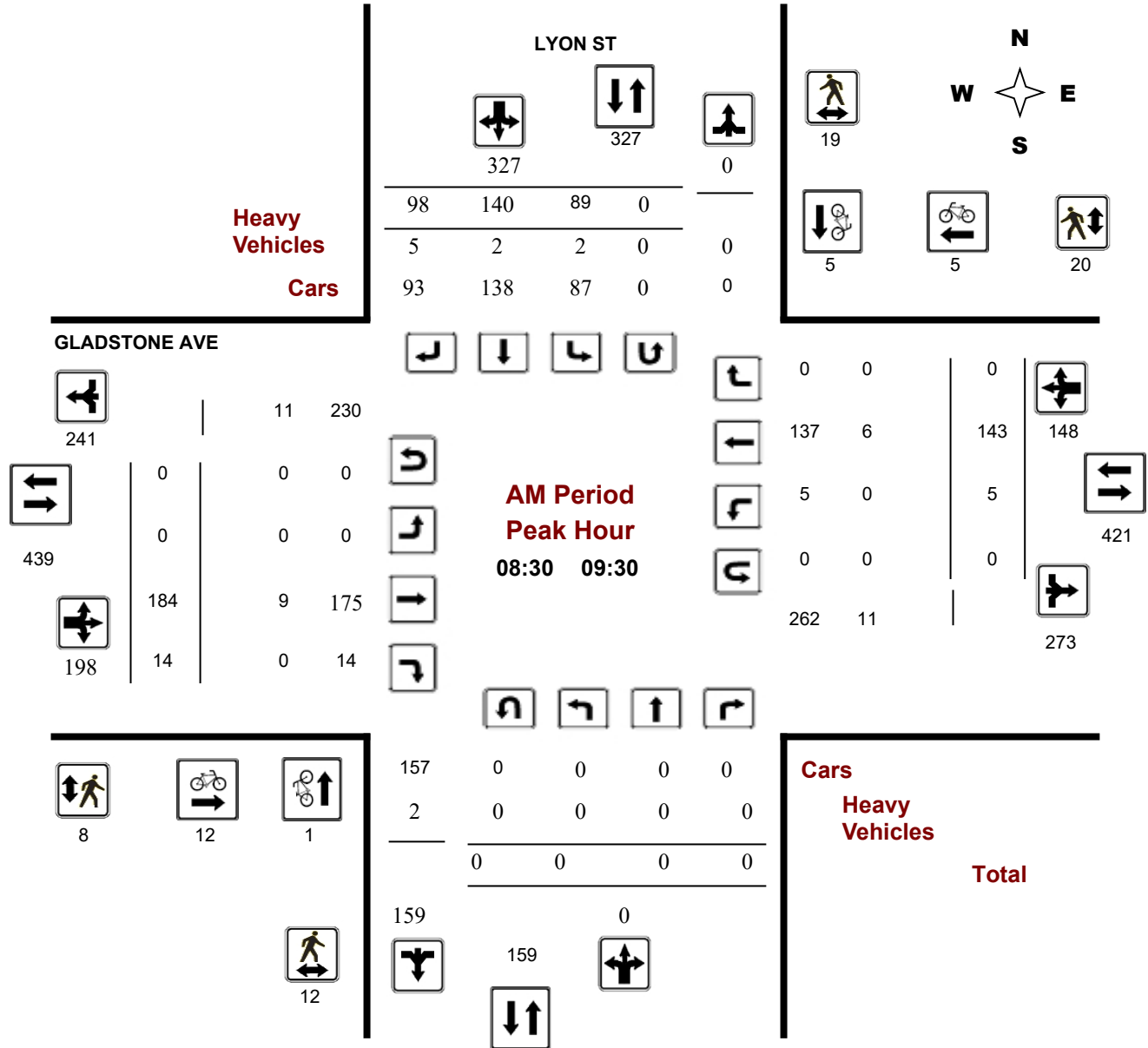

Turning Movement Count - Peak Hour Diagram

GLADSTONE AVE @ LYON ST

Survey Date: Wednesday, August 24, 2022

Start Time: 07:00

WO No: 40574

Device: Miovision

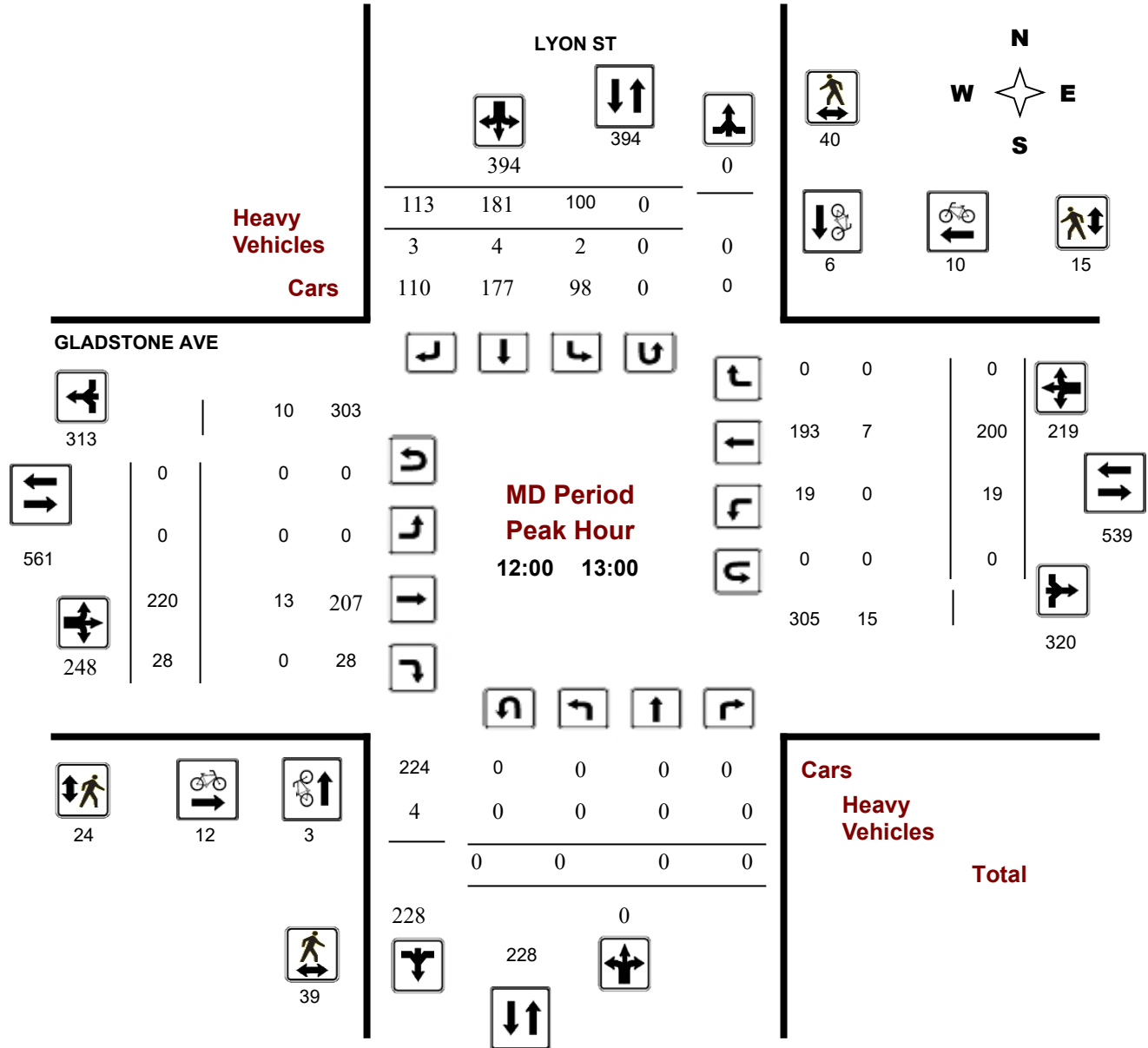

Comments

Turning Movement Count - Peak Hour Diagram

GLADSTONE AVE @ LYON ST

Survey Date: Wednesday, August 24, 2022

Start Time: 07:00

WO No: 40574

Device: Miovision

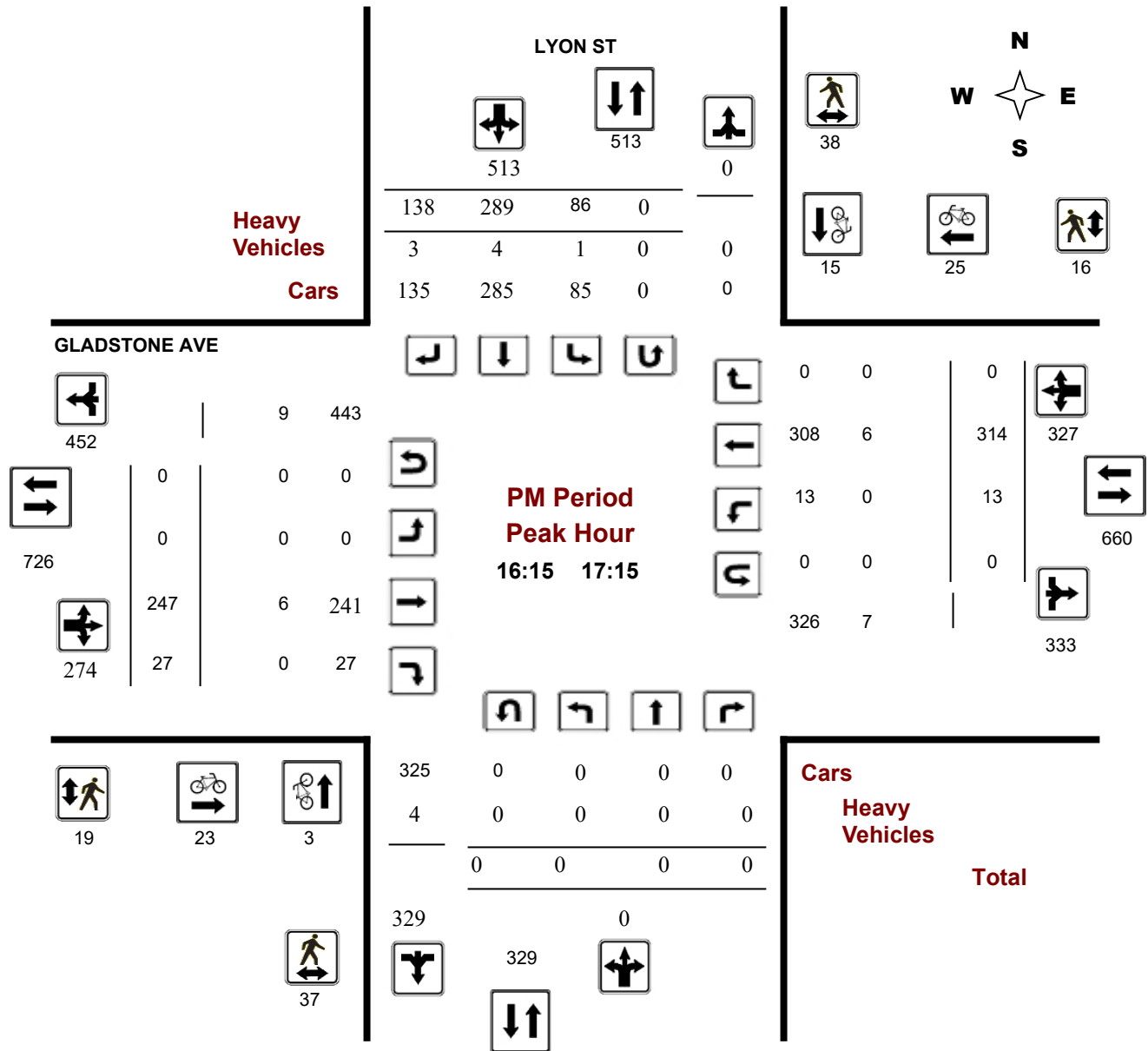



Transportation Services - Traffic Services

Turning Movement Count - Study Results

GLADSTONE AVE @ LYON ST

Survey Date: Wednesday, August 24, 2022

WO No: 40574

Start Time: 07:00

Device: Miovision

Full Study Summary (8 HR Standard)

Survey Date: Wednesday, August 24, 2022

Total Observed U-Turns

AADT Factor

Northbound: 0 Southbound: 0

.90

Eastbound: 0 Westbound: 3

Period	LYON ST										GLADSTONE AVE										Grand Total
	Northbound					Southbound					Eastbound					Westbound					
	LT	ST	RT	NB TOT	STR TOT	LT	ST	RT	SB TOT	STR TOT	LT	ST	RT	EB TOT	STR TOT	LT	ST	RT	WB TOT	STR TOT	
07:00 08:00	0	0	0	0	259	60	133	66	259	259	0	125	6	131	226	7	88	0	95	226	485
08:00 09:00	0	0	0	0	339	92	149	98	339	339	0	155	9	164	277	9	104	0	113	277	616
09:00 10:00	0	0	0	0	285	60	143	82	285	285	0	184	18	202	341	2	137	0	139	341	626
11:30 12:30	0	0	0	0	378	89	176	113	378	378	0	217	22	239	456	20	197	0	217	456	834
12:30 13:30	0	0	0	0	366	91	172	103	366	366	1	227	20	248	469	17	204	0	221	469	835
15:00 16:00	0	0	0	0	430	96	212	122	430	430	0	198	18	216	446	14	216	0	230	446	876
16:00 17:00	0	0	0	0	501	85	273	143	501	501	0	229	25	254	581	12	315	0	327	581	1082
17:00 18:00	0	0	0	0	474	94	263	117	474	474	0	237	25	262	523	16	245	0	261	523	997
Sub Total	0	0	0	0	3032	667	1521	844	3032	3032	1	1572	143	1716	3319	97	1506	0	1603	3319	6351
U Turns				0	0				0	0				0	3				3	3	3
Total	0	0	0	0	3032	667	1521	844	3032	3032	1	1572	143	1716	3322	97	1506	0	1606	3322	6354
EQ 12Hr	0	0	0	0	4214	927	2114	1173	4214	4214	1	2185	199	2385	4618	135	2093	0	2232	4618	8832
Note: These values are calculated by multiplying the totals by the appropriate expansion factor.														1.39							
AVG 12Hr	0	0	0	0	3793	834	2493	1383	3793	3793	1	1966	179	2146	4156	122	1884	0	2009	4156	7949
Note: These volumes are calculated by multiplying the Equivalent 12 hr. totals by the AADT factor.														.90							
AVG 24Hr	0	0	0	0	4969	1093	3266	1812	4969	4969	1	2575	234	2811	5444	160	2468	0	2632	5444	10413
Note: These volumes are calculated by multiplying the Average Daily 12 hr. totals by 12 to 24 expansion factor.														1.31							
Note: U-Turns provided for approach totals. Refer to 'U-Turn' Report for specific breakdown.																					



Transportation Services - Traffic Services

Turning Movement Count - Study Results

GLADSTONE AVE @ LYON ST

Survey Date: Wednesday, August 24, 2022

WO No: 40574

Start Time: 07:00

Device: Miovision

Full Study 15 Minute Increments

LYON ST

GLADSTONE AVE

Northbound

Southbound

Eastbound

Westbound

Time Period	LT	ST	RT	N TOT	LT	ST	RT	S TOT	STR TOT	LT	ST	RT	E TOT	LT	ST	RT	W TOT	STR TOT	Grand Total
07:00 07:15	0	0	0	0	10	23	13	46	46	0	20	3	23	0	12	0	12	35	81
07:15 07:30	0	0	0	0	17	29	14	60	60	0	29	0	29	1	23	0	24	53	113
07:30 07:45	0	0	0	0	18	31	15	64	64	0	43	2	45	3	28	0	31	76	140
07:45 08:00	0	0	0	0	15	50	24	89	89	0	33	1	34	3	25	0	28	62	151
08:00 08:15	0	0	0	0	20	37	20	77	77	0	36	3	39	1	23	0	25	64	141
08:15 08:30	0	0	0	0	21	40	22	83	83	0	31	1	32	3	17	0	20	52	135
08:30 08:45	0	0	0	0	31	34	24	89	89	0	44	3	47	5	30	0	35	82	171
08:45 09:00	0	0	0	0	20	38	32	90	90	0	44	2	46	0	34	0	34	80	170
09:00 09:15	0	0	0	0	16	34	17	67	67	0	54	4	58	0	47	0	47	105	172
09:15 09:30	0	0	0	0	22	34	25	81	81	0	42	5	47	0	32	0	32	79	160
09:30 09:45	0	0	0	0	10	47	19	76	76	0	39	5	44	1	26	0	27	71	147
09:45 10:00	0	0	0	0	12	28	21	61	61	0	49	4	53	1	32	0	33	86	147
11:30 11:45	0	0	0	0	11	51	31	93	93	0	56	7	63	5	48	0	54	117	210
11:45 12:00	0	0	0	0	30	36	23	89	89	0	58	2	60	4	52	0	56	116	205
12:00 12:15	0	0	0	0	29	52	27	108	108	0	56	3	59	6	43	0	49	108	216
12:15 12:30	0	0	0	0	19	37	32	88	88	0	47	10	57	5	54	0	59	116	204
12:30 12:45	0	0	0	0	27	43	27	97	97	0	66	4	70	4	47	0	51	121	218
12:45 13:00	0	0	0	0	25	49	27	101	101	0	51	11	62	4	56	0	60	122	223
13:00 13:15	0	0	0	0	23	48	22	93	93	1	54	4	59	4	52	0	56	115	208
13:15 13:30	0	0	0	0	16	32	27	75	75	0	56	1	57	5	49	0	54	111	186
15:00 15:15	0	0	0	0	19	48	29	96	96	0	56	5	61	2	56	0	58	119	215
15:15 15:30	0	0	0	0	26	57	36	119	119	0	50	3	53	4	50	0	55	108	227
15:30 15:45	0	0	0	0	29	52	27	108	108	0	40	4	44	5	54	0	59	103	211
15:45 16:00	0	0	0	0	22	55	30	107	107	0	52	6	58	3	56	0	59	117	224
16:00 16:15	0	0	0	0	21	55	27	103	103	0	50	5	55	2	67	0	69	124	227
16:15 16:30	0	0	0	0	27	79	39	145	145	0	64	8	72	4	79	0	83	155	300
16:30 16:45	0	0	0	0	18	76	44	138	138	0	49	6	55	1	85	0	86	141	279
16:45 17:00	0	0	0	0	19	63	33	115	115	0	66	6	72	5	84	0	89	161	276
17:00 17:15	0	0	0	0	22	71	22	115	115	0	68	7	75	3	66	0	69	144	259
17:15 17:30	0	0	0	0	31	77	27	135	135	0	66	11	77	6	58	0	64	141	276
17:30 17:45	0	0	0	0	21	60	31	112	112	0	59	3	62	4	69	0	73	135	247
17:45 18:00	0	0	0	0	20	55	37	112	112	0	44	4	48	3	52	0	55	103	215
Total:	0	0	0	0	667	1521	844	3032	3032	1	1572	143	1716	97	1506	0	1606	3322	6,354

Note: U-Turns are included in Totals.



Transportation Services - Traffic Services

Turning Movement Count - Study Results

GLADSTONE AVE @ LYON ST

Survey Date: Wednesday, August 24, 2022

WO No: 40574

Start Time: 07:00

Device: Miovision

Full Study Cyclist Volume

Time Period	LYON ST			GLADSTONE AVE			Grand Total
	Northbound	Southbound	Street Total	Eastbound	Westbound	Street Total	
07:00 07:15	0	2	2	3	4	7	9
07:15 07:30	0	0	0	2	1	3	3
07:30 07:45	0	0	0	4	2	6	6
07:45 08:00	1	1	2	7	1	8	10
08:00 08:15	0	4	4	4	3	7	11
08:15 08:30	1	0	1	3	0	3	4
08:30 08:45	1	0	1	2	1	3	4
08:45 09:00	0	3	3	3	1	4	7
09:00 09:15	0	2	2	2	1	3	5
09:15 09:30	0	0	0	5	2	7	7
09:30 09:45	0	1	1	2	2	4	5
09:45 10:00	0	1	1	2	1	3	4
11:30 11:45	0	3	3	2	2	4	7
11:45 12:00	0	3	3	6	4	10	13
12:00 12:15	0	2	2	4	1	5	7
12:15 12:30	2	1	3	4	3	7	10
12:30 12:45	0	0	0	2	3	5	5
12:45 13:00	1	3	4	2	3	5	9
13:00 13:15	0	3	3	5	1	6	9
13:15 13:30	0	7	7	2	1	3	10
15:00 15:15	0	2	2	7	4	11	13
15:15 15:30	0	0	0	9	7	16	16
15:30 15:45	0	2	2	2	2	4	6
15:45 16:00	1	1	2	1	4	5	7
16:00 16:15	4	3	7	10	8	18	25
16:15 16:30	1	4	5	8	5	13	18
16:30 16:45	1	2	3	5	5	10	13
16:45 17:00	1	5	6	4	10	14	20
17:00 17:15	0	4	4	6	5	11	15
17:15 17:30	0	10	10	3	7	10	20
17:30 17:45	0	6	6	2	7	9	15
17:45 18:00	0	2	2	7	7	14	16
Total	14	77	91	130	108	238	329



Transportation Services - Traffic Services

Turning Movement Count - Study Results

GLADSTONE AVE @ LYON ST

Survey Date: Wednesday, August 24, 2022

WO No: 40574

Start Time: 07:00

Device: Miovision

Full Study Pedestrian Volume

LYON ST

GLADSTONE AVE

Time Period	NB Approach (E or W Crossing)	SB Approach (E or W Crossing)	Total	EB Approach (N or S Crossing)	WB Approach (N or S Crossing)	Total	Grand Total
07:00 07:15	1	0	1	0	0	0	1
07:15 07:30	1	0	1	1	2	3	4
07:30 07:45	1	3	4	1	0	1	5
07:45 08:00	11	6	17	1	9	10	27
08:00 08:15	5	2	7	2	3	5	12
08:15 08:30	2	3	5	4	4	8	13
08:30 08:45	3	5	8	0	4	4	12
08:45 09:00	6	5	11	4	8	12	23
09:00 09:15	1	1	2	3	3	6	8
09:15 09:30	2	8	10	1	5	6	16
09:30 09:45	5	6	11	6	3	9	20
09:45 10:00	11	3	14	3	3	6	20
11:30 11:45	4	7	11	5	2	7	18
11:45 12:00	16	5	21	0	4	4	25
12:00 12:15	6	9	15	5	3	8	23
12:15 12:30	15	12	27	8	3	11	38
12:30 12:45	10	8	18	5	3	8	26
12:45 13:00	8	11	19	6	6	12	31
13:00 13:15	13	5	18	8	4	12	30
13:15 13:30	8	2	10	7	6	13	23
15:00 15:15	4	10	14	5	1	6	20
15:15 15:30	12	15	27	6	2	8	35
15:30 15:45	11	5	16	5	7	12	28
15:45 16:00	5	12	17	6	4	10	27
16:00 16:15	7	5	12	11	1	12	24
16:15 16:30	11	8	19	5	4	9	28
16:30 16:45	9	9	18	4	8	12	30
16:45 17:00	5	10	15	5	3	8	23
17:00 17:15	12	11	23	5	1	6	29
17:15 17:30	19	18	37	17	3	20	57
17:30 17:45	6	10	16	3	7	10	26
17:45 18:00	9	11	20	4	8	12	32
Total	239	225	464	146	124	270	734



Transportation Services - Traffic Services

Turning Movement Count - Study Results

GLADSTONE AVE @ LYON ST

Survey Date: Wednesday, August 24, 2022

WO No: 40574

Start Time: 07:00

Device: Miovision

Full Study Heavy Vehicles

LYON ST

GLADSTONE AVE

Northbound

Southbound

Eastbound

Westbound

Time Period	Northbound			N TOT	Southbound			S TOT	STR TOT	Eastbound			E TOT	Westbound			W TOT	STR TOT	Grand Total
	LT	ST	RT		LT	ST	RT			LT	ST	RT		LT	ST	RT			
07:00 07:15	0	0	0	1	0	1	1	2	3	0	2	0	5	0	2	0	4	9	6
07:15 07:30	0	0	0	1	1	0	1	2	3	0	0	0	2	1	1	0	3	5	4
07:30 07:45	0	0	0	2	0	0	0	0	2	0	5	0	10	2	5	0	12	22	12
07:45 08:00	0	0	0	0	0	0	2	2	2	0	2	0	6	0	2	0	4	10	6
08:00 08:15	0	0	0	1	1	1	1	3	4	0	2	0	6	0	3	0	6	12	8
08:15 08:30	0	0	0	1	0	1	1	2	3	0	2	0	5	0	2	0	4	9	6
08:30 08:45	0	0	0	1	1	1	1	3	4	0	1	0	3	0	1	0	3	6	5
08:45 09:00	0	0	0	0	0	0	1	1	1	0	1	0	4	0	2	0	3	7	4
09:00 09:15	0	0	0	0	1	0	2	3	3	0	4	0	8	0	2	0	7	15	9
09:15 09:30	0	0	0	1	0	1	1	2	3	0	3	0	5	0	1	0	4	9	6
09:30 09:45	0	0	0	3	0	2	0	2	5	0	1	1	2	0	0	0	1	3	4
09:45 10:00	0	0	0	1	1	0	0	1	2	0	3	1	7	0	3	0	7	14	8
11:30 11:45	0	0	0	1	0	0	3	3	4	0	4	0	9	1	2	0	7	16	10
11:45 12:00	0	0	0	2	0	2	1	3	5	0	2	0	5	0	2	0	4	9	7
12:00 12:15	0	0	0	1	0	1	1	2	3	0	2	0	5	0	2	0	4	9	6
12:15 12:30	0	0	0	0	0	0	0	0	0	0	4	0	6	0	2	0	6	12	6
12:30 12:45	0	0	0	2	1	2	2	5	7	0	2	0	6	0	2	0	5	11	9
12:45 13:00	0	0	0	1	1	1	0	2	3	0	5	0	6	0	1	0	7	13	8
13:00 13:15	0	0	0	0	1	0	2	3	3	0	3	0	9	0	4	0	8	17	10
13:15 13:30	0	0	0	2	0	1	2	3	5	0	1	0	6	1	3	0	5	11	8
15:00 15:15	0	0	0	2	0	2	0	2	4	0	4	0	7	0	3	0	7	14	9
15:15 15:30	0	0	0	0	1	0	1	2	2	0	1	0	3	0	1	0	3	6	4
15:30 15:45	0	0	0	0	2	0	0	2	2	0	6	0	10	0	4	0	12	22	12
15:45 16:00	0	0	0	1	0	1	0	1	2	0	2	0	4	0	2	0	4	8	5
16:00 16:15	0	0	0	1	0	1	1	2	3	0	4	0	7	0	2	0	6	13	8
16:15 16:30	0	0	0	0	1	0	0	1	1	0	1	0	3	0	2	0	4	7	4
16:30 16:45	0	0	0	2	0	2	2	4	6	0	2	0	5	0	1	0	3	8	7
16:45 17:00	0	0	0	0	0	0	0	0	0	0	1	0	3	0	2	0	3	6	3
17:00 17:15	0	0	0	2	0	2	1	3	5	0	2	0	4	0	1	0	3	7	6
17:15 17:30	0	0	0	1	0	0	0	0	1	0	2	0	4	1	2	0	5	9	5
17:30 17:45	0	0	0	0	0	0	0	0	0	0	0	0	1	0	1	0	1	2	1
17:45 18:00	0	0	0	0	0	0	0	0	0	0	3	0	3	0	0	0	3	6	3
Total: None	0	0	0	30	12	22	27	61	91	0	77	2	169	6	63	0	158	327	209



Transportation Services - Traffic Services

Turning Movement Count - Study Results

GLADSTONE AVE @ LYON ST

Survey Date: Wednesday, August 24, 2022

WO No: 40574

Start Time: 07:00

Device: Miovision

Full Study 15 Minute U-Turn Total

LYON ST

GLADSTONE AVE

Time Period		Northbound U-Turn Total	Southbound U-Turn Total	Eastbound U-Turn Total	Westbound U-Turn Total	Total
07:00	07:15	0	0	0	0	0
07:15	07:30	0	0	0	0	0
07:30	07:45	0	0	0	0	0
07:45	08:00	0	0	0	0	0
08:00	08:15	0	0	0	1	1
08:15	08:30	0	0	0	0	0
08:30	08:45	0	0	0	0	0
08:45	09:00	0	0	0	0	0
09:00	09:15	0	0	0	0	0
09:15	09:30	0	0	0	0	0
09:30	09:45	0	0	0	0	0
09:45	10:00	0	0	0	0	0
11:30	11:45	0	0	0	1	1
11:45	12:00	0	0	0	0	0
12:00	12:15	0	0	0	0	0
12:15	12:30	0	0	0	0	0
12:30	12:45	0	0	0	0	0
12:45	13:00	0	0	0	0	0
13:00	13:15	0	0	0	0	0
13:15	13:30	0	0	0	0	0
15:00	15:15	0	0	0	0	0
15:15	15:30	0	0	0	1	1
15:30	15:45	0	0	0	0	0
15:45	16:00	0	0	0	0	0
16:00	16:15	0	0	0	0	0
16:15	16:30	0	0	0	0	0
16:30	16:45	0	0	0	0	0
16:45	17:00	0	0	0	0	0
17:00	17:15	0	0	0	0	0
17:15	17:30	0	0	0	0	0
17:30	17:45	0	0	0	0	0
17:45	18:00	0	0	0	0	0
Total		0	0	0	3	3

Appendix D:

Collision Data

Total Area

Classification of Accident	Rear End	Turning Movement	Sideswipe	Angle	Approaching	SMV other	SMV unattended vehicle	Other	Total
P.D. only	55	85	112	81	1	8	12	5	359
Non-fatal injury	7	13	5	29	0	13	1	0	68
Non-reportable	0	0	0	0	0	0	0	0	0
Total	62	98	117	110	1	21	13	5	427
	#4 or 15%	#3 or 23%	#1 or 27%	#2 or 26%	#8 or 0%	#5 or 5%	#6 or 3%	#7 or 1%	

84%
16%
0%
100%

BRN SON AVE/CATHERINE ST/RAYMOND ST

Years	Total # Collisions	24 Hr AADT Veh Volume	Days	Collisions/MEV
2017-2021	91	39,156	1825	1.27

Peds	Cyclists
2	1

Classification of Accident	Rear End	Turning Movement	Sideswipe	Angle	Approaching	SMV other	SMV unattended vehicle	Other	Total
P.D. only	16	14	25	16	0	1	0	1	73
Non-fatal injury	1	5	1	9	0	2	0	0	18
Non-reportable	0	0	0	0	0	0	0	0	0
Total	17	19	26	25	0	3	0	1	91
	19%	21%	29%	27%	0%	3%	0%	1%	

80%
20%
0%
100%

CATHERINE ST/PERCY ST

Years	Total # Collisions	24 Hr AADT Veh Volume	Days	Collisions/MEV
2017-2021	6	7,922	1825	0.42

Peds	Cyclists
0	0

Classification of Accident	Rear End	Turning Movement	Sideswipe	Angle	Approaching	SMV other	SMV unattended vehicle	Other	Total
P.D. only	1	2	0	1	0	0	0	1	5
Non-fatal injury	0	0	0	1	0	0	0	0	1
Non-reportable	0	0	0	0	0	0	0	0	0
Total	1	2	0	2	0	0	0	1	6
	17%	33%	0%	33%	0%	0%	0%	17%	

83%
17%
0%
100%

CATHERINE ST/LYON ST/HWY 417 LYON IC120BR36

Years	Total # Collisions	24 Hr AADT Veh Volume	Days	Collisions/MEV
2017-2021	17	11,711	1825	0.80

Peds	Cyclists
0	0

Classification of Accident	Rear End	Turning Movement	Sideswipe	Angle	Approaching	SMV other	SMV unattended vehicle	Other	Total
P.D. only	2	0	1	10	0	1	0	0	14
Non-fatal injury	1	0	0	2	0	0	0	0	3
Non-reportable	0	0	0	0	0	0	0	0	0
Total	3	0	1	12	0	1	0	0	17
	18%	0%	6%	71%	0%	6%	0%	0%	

82%
18%
0%
100%

CATHERINE ST/KENT ST

Years	Total # Collisions	24 Hr AADT Veh Volume	Days	Collisions/MEV
2017-2021	96	19,918	1825	2.64

Peds	Cyclists
0	0

Classification of Accident	Rear End	Turning Movement	Sideswipe	Angle	Approaching	SMV other	SMV unattended vehicle	Other	Total
P.D. only	5	42	22	18	0	0	0	2	89
Non-fatal injury	0	4	1	2	0	0	0	0	7
Non-reportable	0	0	0	0	0	0	0	0	0
Total	5	46	23	20	0	0	0	2	96
	5%	48%	24%	21%	0%	0%	0%	2%	

93%
7%
0%
100%

BANK ST/CATHERINE ST

Years	Total # Collisions	24 Hr AADT Veh Volume	Days	Collisions/MEV
2017-2021	61	23,164	1825	1.44

Peds	Cyclists
8	6

Classification of Accident	Rear End	Turning Movement	Sideswipe	Angle	Approaching	SMV other	SMV unattended vehicle	Other	Total
P.D. only	11	3	15	7	1	2	0	0	39
Non-fatal injury	3	3	1	7	0	8	0	0	22
Non-reportable	0	0	0	0	0	0	0	0	0
Total	14	6	16	14	1	10	0	0	61
	23%	10%	26%	23%	2%	16%	0%	0%	

64%
36%
0%
100%

GLADSTONE AVE/LYON ST

Years	Total # Collisions	24 Hr AADT Veh Volume	Days	Collisions/MEV
2017-2021	8	10,413	1825	0.42

Peds	Cyclists
1	1

Classification of Accident	Rear End	Turning Movement	Sideswipe	Angle	Approaching	SMV other	SMV unattended vehicle	Other	Total
P.D. only	2	1	0	3	0	0	0	0	6
Non-fatal injury	0	0	0	1	0	1	0	0	2
Non-reportable	0	0	0	0	0	0	0	0	0
Total	2	1	0	4	0	1	0	0	8
	25%	13%	0%	50%	0%	13%	0%	0%	

75%
25%
0%
100%

ARLINGTON AVE/LYON ST

Years	Total # Collisions	24 Hr AADT Veh Volume	Days	Collisions/MEV
2017-2021	2	8,854	1825	0.12

Peds	Cyclists
0	0

Classification of Accident	Rear End	Turning Movement	Sideswipe	Angle	Approaching	SMV other	SMV unattended vehicle	Other	Total
P.D. only	0	0	1	1	0	0	0	0	2
Non-fatal injury	0	0	0	0	0	0	0	0	0
Non-reportable	0	0	0	0	0	0	0	0	0
Total	0	0	1	1	0	0	0	0	2
	0%	0%	50%	50%	0%	0%	0%	0%	

100%
0%
0%
100%

GLADSTONE AVE/KENT ST

Years	Total # Collisions	24 Hr AADT Veh Volume	Days	Collisions/MEV
2017-2021	25	23,139	1825	0.59

Peds	Cyclists
1	0

Classification of Accident	Rear End	Turning Movement	Sideswipe	Angle	Approaching	SMV other	SMV unattended vehicle	Other	Total
P.D. only	5	4	5	10	0	0	0	0	24
Non-fatal injury	0	0	0	0	0	1	0	0	1
Non-reportable	0	0	0	0	0	0	0	0	0
Total	5	4	5	10	0	1	0	0	25
	20%	16%	20%	40%	0%	4%	0%	0%	

96%
4%
0%
100%

ARLINGTON AVE/KENT ST

Years	Total # Collisions	24 Hr AADT Veh Volume	Days	Collisions/MEV
2017-2021	23	15,280	1825	0.82

Peds	Cyclists
0	0

Classification of Accident	Rear End	Turning Movement	Sideswipe	Angle	Approaching	SMV other	SMV unattended vehicle	Other	Total
P.D. only	1	6	12	3	0	0	0	0	22
Non-fatal injury	0	0	0	1	0	0	0	0	1
Non-reportable	0	0	0	0	0	0	0	0	0
Total	1	6	12	4	0	0	0	0	23
	4%	26%	52%	17%	0%	0%	0%	0%	

96%
4%
0%
100%

ARLINGTON AVE/BANK ST

Years	Total # Collisions	24 Hr AADT Veh Volume	Days	Collisions/MEV
2017-2021	10	13,240	1825	0.41

Peds	Cyclists
1	1

Classification of Accident	Rear End	Turning Movement	Sideswipe	Angle	Approaching	SMV other	SMV unattended vehicle	Other	Total
----------------------------	----------	------------------	-----------	-------	-------------	-----------	------------------------	-------	-------

P.D. only	1	2	1	3	0	0	0	1	8	80%
Non-fatal injury	0	0	0	1	0	1	0	0	2	20%
Non-reportable	0	0	0	0	0	0	0	0	0	0%
Total	1	2	1	4	0	1	0	1	10	100%
	10%	20%	10%	40%	0%	10%	0%	10%		

BANK ST/CHAMBERLAIN AVE N/ISABELLA ST

Years	Total # Collisions	24 Hr AADT Veh Volume	Days	Collisions/MEV
2017-2021	41	24,224	1825	0.93

Peds	Cyclists
0	0

Classification of Accident	Rear End	Turning Movement	Sideswipe	Angle	Approaching	SMV other	SMV unattended vehicle	Other	Total	
P.D. only	8	8	11	5	0	2	0	0	34	83%
Non-fatal injury	2	0	0	5	0	0	0	0	7	17%
Non-reportable	0	0	0	0	0	0	0	0	0	0%
Total	10	8	11	10	0	2	0	0	41	100%
	24%	20%	27%	24%	0%	5%	0%	0%		

ROAD SEGMENTS

CATHERINE ST, BRONSON AVE to PERCY ST

Years	Total # Collisions	24 Hr AADT Veh Volume	Days	Collisions/MEV
2017-2021	5	n/a	1825	n/a

Peds	Cyclists
0	0

Classification of Accident	Rear End	Turning Movement	Sideswipe	Angle	Approaching	SMV other	SMV unattended vehicle	Other	Total	
P.D. only	1	0	3	1	0	0	0	0	5	100%
Non-fatal injury	0	0	0	0	0	0	0	0	0	0%
Non-reportable	0	0	0	0	0	0	0	0	0	0%
Total	1	0	3	1	0	0	0	0	5	100%
	20%	0%	60%	20%	0%	0%	0%	0%		

CATHERINE ST, BAY ST to PERCY ST

Years	Total # Collisions	24 Hr AADT Veh Volume	Days	Collisions/MEV
2017-2021	2	n/a	1825	n/a

Peds	Cyclists
0	0

Classification of Accident	Rear End	Turning Movement	Sideswipe	Angle	Approaching	SMV other	SMV unattended vehicle	Other	Total	
P.D. only	0	1	0	1	0	0	0	0	2	100%
Non-fatal injury	0	0	0	0	0	0	0	0	0	0%
Non-reportable	0	0	0	0	0	0	0	0	0	0%
Total	0	1	0	1	0	0	0	0	2	100%
	0%	50%	0%	50%	0%	0%	0%	0%		

CATHERINE ST, LYON to KENT ST

Years	Total # Collisions	24 Hr AADT Veh Volume	Days	Collisions/MEV
2017-2021	5	n/a	1825	n/a

Peds	Cyclists
0	0

Classification of Accident	Rear End	Turning Movement	Sideswipe	Angle	Approaching	SMV other	SMV unattended vehicle	Other	Total	
P.D. only	0	1	3	0	0	1	0	0	5	100%
Non-fatal injury	0	0	0	0	0	0	0	0	0	0%
Non-reportable	0	0	0	0	0	0	0	0	0	0%
Total	0	1	3	0	0	1	0	0	5	100%
	0%	20%	60%	0%	0%	20%	0%	0%		

CATHERINE ST, BANK ST to KENT ST

Years	Total # Collisions	24 Hr AADT Veh Volume	Days	Collisions/MEV
2017-2021	4	n/a	1825	n/a

Peds	Cyclists
0	0

Classification of Accident	Rear End	Turning Movement	Sideswipe	Angle	Approaching	SMV other	SMV unattended vehicle	Other	Total
P.D. only	0	0	2	2	0	0	0	0	4
Non-fatal injury	0	0	0	0	0	0	0	0	0
Non-reportable	0	0	0	0	0	0	0	0	0
Total	0	0	2	2	0	0	0	0	4
	0%	0%	50%	50%	0%	0%	0%	0%	

100%
0%
0%
100%

LYON ST N, GLADSTONE AVE to CATHERINE ST

Years	Total # Collisions	24 Hr AADT Veh Volume	Days	Collisions/MEV
2017-2021	4	n/a	1825	n/a

Peds	Cyclists
0	0

Classification of Accident	Rear End	Turning Movement	Sideswipe	Angle	Approaching	SMV other	SMV unattended vehicle	Other	Total
P.D. only	0	0	1	0	0	1	2	0	4
Non-fatal injury	0	0	0	0	0	0	0	0	0
Non-reportable	0	0	0	0	0	0	0	0	0
Total	0	0	1	0	0	1	2	0	4
	0%	0%	25%	0%	0%	25%	50%	0%	

100%
0%
0%
100%

GLADSTONE AVE, KENT ST to LYON ST N

Years	Total # Collisions	24 Hr AADT Veh Volume	Days	Collisions/MEV
2017-2021	8	n/a	1825	n/a

Peds	Cyclists
0	0

Classification of Accident	Rear End	Turning Movement	Sideswipe	Angle	Approaching	SMV other	SMV unattended vehicle	Other	Total
P.D. only	1	0	1	0	0	0	4	0	6
Non-fatal injury	0	0	1	0	0	0	1	0	2
Non-reportable	0	0	0	0	0	0	0	0	0
Total	1	0	2	0	0	0	5	0	8
	13%	0%	25%	0%	0%	0%	63%	0%	

75%
25%
0%
100%

KENT ST, FLORA ST to MCLEOD ST

Years	Total # Collisions	24 Hr AADT Veh Volume	Days	Collisions/MEV
2017-2021	2	n/a	1825	n/a

Peds	Cyclists
0	0

Classification of Accident	Rear End	Turning Movement	Sideswipe	Angle	Approaching	SMV other	SMV unattended vehicle	Other	Total
P.D. only	0	0	2	0	0	0	0	0	2
Non-fatal injury	0	0	0	0	0	0	0	0	0
Non-reportable	0	0	0	0	0	0	0	0	0
Total	0	0	2	0	0	0	0	0	2
	0%	0%	100%	0%	0%	0%	0%	0%	

100%
0%
0%
100%

KENT ST, ARLINGTON AVE to CATHERINE ST

Years	Total # Collisions	24 Hr AADT Veh Volume	Days	Collisions/MEV
2017-2021	5	n/a	1825	n/a

Peds	Cyclists
0	0

Classification of Accident	Rear End	Turning Movement	Sideswipe	Angle	Approaching	SMV other	SMV unattended vehicle	Other	Total
P.D. only	0	0	4	0	0	0	0	0	4
Non-fatal injury	0	0	1	0	0	0	0	0	1
Non-reportable	0	0	0	0	0	0	0	0	0
Total	0	0	5	0	0	0	0	0	5
	0%	0%	100%	0%	0%	0%	0%	0%	

80%
20%
0%
100%

ARLINGTON AVE, KENT ST to LYON ST N

Years	Total # Collisions	24 Hr AADT Veh Volume	Days	Collisions/MEV
2017-2021	2	n/a	1825	n/a

Peds	Cyclists
0	0

Classification of Accident	Rear End	Turning Movement	Sideswipe	Angle	Approaching	SMV other	SMV unattended vehicle	Other	Total
----------------------------	----------	------------------	-----------	-------	-------------	-----------	------------------------	-------	-------

P.D. only	0	0	0	0	0	0	2	0	2	100%
Non-fatal injury	0	0	0	0	0	0	0	0	0	0%
Non-reportable	0	0	0	0	0	0	0	0	0	0%
Total	0	0	0	0	0	0	2	0	2	100%
	0%	0%	0%	0%	0%	0%	100%	0%		

ARLINGTON AVE, BANK ST to KENT ST

Years	Total # Collisions	24 Hr AADT Veh Volume	Days	Collisions/MEV
2017-2021	6	n/a	1825	n/a

Peds	Cyclists
0	0

Classification of Accident	Rear End	Turning Movement	Sideswipe	Angle	Approaching	SMV other	SMV unattended vehicle	Other	Total	
P.D. only	0	1	1	0	0	0	4	0	6	100%
Non-fatal injury	0	0	0	0	0	0	0	0	0	0%
Non-reportable	0	0	0	0	0	0	0	0	0	0%
Total	0	1	1	0	0	0	4	0	6	100%
	0%	17%	17%	0%	0%	0%	67%	0%		

BANK ST, ARLINGTON AVE to CATHERINE ST

Years	Total # Collisions	24 Hr AADT Veh Volume	Days	Collisions/MEV
2017-2021	4	n/a	1825	n/a

Peds	Cyclists
0	1

Classification of Accident	Rear End	Turning Movement	Sideswipe	Angle	Approaching	SMV other	SMV unattended vehicle	Other	Total	
P.D. only	1	0	2	0	0	0	0	0	3	75%
Non-fatal injury	0	1	0	0	0	0	0	0	1	25%
Non-reportable	0	0	0	0	0	0	0	0	0	0%
Total	1	1	2	0	0	0	0	0	4	100%
	25%	25%	50%	0%	0%	0%	0%	0%		

Appendix E:

Internal Reduction Calculations

NCHRP 684 Internal Trip Capture Estimation Tool					
Project Name:	265 Catherine Phase 1			Organization:	Parsons
Project Location:				Performed By:	
Scenario Description:	AM Internal Reduction			Date:	9/3/2024
Analysis Year:				Checked By:	
Analysis Period:	AM Street Peak Hour			Date:	

Table 1-A: Base Vehicle-Trip Generation Estimates (Single-Use Site Estimate)						
Land Use	Development Data (For Information Only)			Estimated Vehicle-Trips ³		
	ITE LUCs ¹	Quantity	Units	Total	Entering	Exiting
Office				0		
Retail				8	5	3
Restaurant				0		
Cinema/Entertainment				0		
Residential				73	23	50
Hotel				0		
All Other Land Uses ²				0		
				81	28	53

Table 2-A: Mode Split and Vehicle Occupancy Estimates						
Land Use	Entering Trips			Exiting Trips		
	Veh. Occ. ⁴	% Transit	% Non-Motorized	Veh. Occ. ⁴	% Transit	% Non-Motorized
Office						
Retail						
Restaurant						
Cinema/Entertainment						
Residential						
Hotel						
All Other Land Uses ²						

Table 3-A: Average Land Use Interchange Distances (Feet Walking Distance)						
Origin (From)	Destination (To)					
	Office	Retail	Restaurant	Cinema/Entertainment	Residential	Hotel
Office						
Retail						
Restaurant						
Cinema/Entertainment						
Residential						
Hotel						

Table 4-A: Internal Person-Trip Origin-Destination Matrix*						
Origin (From)	Destination (To)					
	Office	Retail	Restaurant	Cinema/Entertainment	Residential	Hotel
Office						
Retail	0					
Restaurant	0	0				
Cinema/Entertainment	0	0	0			
Residential	0	1	0	0		
Hotel	0	0	0	0	0	

Table 5-A: Computations Summary			
	Total	Entering	Exiting
All Person-Trips	81	28	53
Internal Capture Percentage	2%	4%	2%
External Vehicle-Trips ⁵	79	27	52
External Transit-Trips ⁶	0	0	0
External Non-Motorized Trips ⁶	0	0	0

Table 6-A: Internal Trip Capture Percentages by Land Use		
Land Use	Entering Trips	Exiting Trips
Office	N/A	N/A
Retail	20%	0%
Restaurant	N/A	N/A
Cinema/Entertainment	N/A	N/A
Residential	0%	2%
Hotel	N/A	N/A

¹Land Use Codes (LUCs) from *Trip Generation Manual*, published by the Institute of Transportation Engineers.

²Total estimate for all other land uses at mixed-use development site is not subject to internal trip capture computations in this estimator.

³Enter trips assuming no transit or non-motorized trips (as assumed in ITE *Trip Generation Manual*).

⁴Enter vehicle occupancy assumed in Table 1-A vehicle trips. If vehicle occupancy changes for proposed mixed-use project, manual adjustments must be made to Tables 5-A, 9-A (O and D). Enter transit, non-motorized percentages that will result with proposed mixed-use project complete.

⁵Vehicle-trips computed using the mode split and vehicle occupancy values provided in Table 2-A.

⁶Person-Trips

*Indicates computation that has been rounded to the nearest whole number.

Estimation Tool Developed by the Texas A&M Transportation Institute - Version 2013.1

Project Name:	265 Catherine Phase 1
Analysis Period:	AM Street Peak Hour

Table 7-A: Conversion of Vehicle-Trip Ends to Person-Trip Ends						
Land Use	Table 7-A (D): Entering Trips			Table 7-A (O): Exiting Trips		
	Veh. Occ.	Vehicle-Trips	Person-Trips*	Veh. Occ.	Vehicle-Trips	Person-Trips*
Office	1.00	0	0	1.00	0	0
Retail	1.00	5	5	1.00	3	3
Restaurant	1.00	0	0	1.00	0	0
Cinema/Entertainment	1.00	0	0	1.00	0	0
Residential	1.00	23	23	1.00	50	50
Hotel	1.00	0	0	1.00	0	0

Table 8-A (O): Internal Person-Trip Origin-Destination Matrix (Computed at Origin)						
Origin (From)	Destination (To)					
	Office	Retail	Restaurant	Cinema/Entertainment	Residential	Hotel
Office		0	0	0	0	0
Retail	1		0	0	0	0
Restaurant	0	0		0	0	0
Cinema/Entertainment	0	0	0		0	0
Residential	1	1	10	0		0
Hotel	0	0	0	0	0	

Table 8-A (D): Internal Person-Trip Origin-Destination Matrix (Computed at Destination)						
Origin (From)	Destination (To)					
	Office	Retail	Restaurant	Cinema/Entertainment	Residential	Hotel
Office		2	0	0	0	0
Retail	0		0	0	0	0
Restaurant	0	0		0	1	0
Cinema/Entertainment	0	0	0		0	0
Residential	0	1	0	0		0
Hotel	0	0	0	0	0	

Table 9-A (D): Internal and External Trips Summary (Entering Trips)						
Destination Land Use	Person-Trip Estimates			External Trips by Mode*		
	Internal	External	Total	Vehicles ¹	Transit ²	Non-Motorized ²
Office	0	0	0	0	0	0
Retail	1	4	5	4	0	0
Restaurant	0	0	0	0	0	0
Cinema/Entertainment	0	0	0	0	0	0
Residential	0	23	23	23	0	0
Hotel	0	0	0	0	0	0
All Other Land Uses ³	0	0	0	0	0	0

Table 9-A (O): Internal and External Trips Summary (Exiting Trips)						
Origin Land Use	Person-Trip Estimates			External Trips by Mode*		
	Internal	External	Total	Vehicles ¹	Transit ²	Non-Motorized ²
Office	0	0	0	0	0	0
Retail	0	3	3	3	0	0
Restaurant	0	0	0	0	0	0
Cinema/Entertainment	0	0	0	0	0	0
Residential	1	49	50	49	0	0
Hotel	0	0	0	0	0	0
All Other Land Uses ³	0	0	0	0	0	0

¹Vehicle-trips computed using the mode split and vehicle occupancy values provided in Table 2-A
²Person-Trips
³Total estimate for all other land uses at mixed-use development site is not subject to internal trip capture computations in this estimator
*Indicates computation that has been rounded to the nearest whole number.

NCHRP 684 Internal Trip Capture Estimation Tool					
Project Name:	265 Catherine Phase 1			Organization:	Parsons
Project Location:				Performed By:	
Scenario Description:	PM Internal Reduction			Date:	9/3/2024
Analysis Year:				Checked By:	
Analysis Period:	PM Street Peak Hour			Date:	

Table 1-P: Base Vehicle-Trip Generation Estimates (Single-Use Site Estimate)						
Land Use	Development Data (For Information Only)			Estimated Vehicle-Trips ³		
	ITE LUCs ¹	Quantity	Units	Total	Entering	Exiting
Office				0		
Retail				22	11	11
Restaurant				0		
Cinema/Entertainment				0		
Residential				73	42	31
Hotel				0		
All Other Land Uses ²				0		
				95	53	42

Table 2-P: Mode Split and Vehicle Occupancy Estimates						
Land Use	Entering Trips			Exiting Trips		
	Veh. Occ. ⁴	% Transit	% Non-Motorized	Veh. Occ. ⁴	% Transit	% Non-Motorized
Office						
Retail						
Restaurant						
Cinema/Entertainment						
Residential						
Hotel						
All Other Land Uses ²						

Table 3-P: Average Land Use Interchange Distances (Feet Walking Distance)						
Origin (From)	Destination (To)					
	Office	Retail	Restaurant	Cinema/Entertainment	Residential	Hotel
Office						
Retail					150	
Restaurant						
Cinema/Entertainment						
Residential		150				
Hotel						

Table 4-P: Internal Person-Trip Origin-Destination Matrix*						
Origin (From)	Destination (To)					
	Office	Retail	Restaurant	Cinema/Entertainment	Residential	Hotel
Office		0	0	0	0	0
Retail	0		0	0	3	0
Restaurant	0	0		0	0	0
Cinema/Entertainment	0	0	0		0	0
Residential	0	1	0	0		0
Hotel	0	0	0	0	0	

Table 5-P: Computations Summary			
	Total	Entering	Exiting
All Person-Trips	95	53	42
Internal Capture Percentage	8%	8%	10%
External Vehicle-Trips ⁵	87	49	38
External Transit-Trips ⁶	0	0	0
External Non-Motorized Trips ⁶	0	0	0

Table 6-P: Internal Trip Capture Percentages by Land Use		
Land Use	Entering Trips	Exiting Trips
Office	N/A	N/A
Retail	9%	27%
Restaurant	N/A	N/A
Cinema/Entertainment	N/A	N/A
Residential	7%	3%
Hotel	N/A	N/A

¹Land Use Codes (LUCs) from *Trip Generation Manual*, published by the Institute of Transportation Engineers.

²Total estimate for all other land uses at mixed-use development site is not subject to internal trip capture computations in this estimator.

³Enter trips assuming no transit or non-motorized trips (as assumed in ITE *Trip Generation Manual*).

⁴Enter vehicle occupancy assumed in Table 1-P vehicle trips. If vehicle occupancy changes for proposed mixed-use project, manual adjustments must be made.

⁵Vehicle-trips computed using the mode split and vehicle occupancy values provided in Table 2-P.

⁶Person-Trips

*Indicates computation that has been rounded to the nearest whole number.

Estimation Tool Developed by the Texas A&M Transportation Institute - Version 2013.1

Project Name:	265 Catherine Phase 1
Analysis Period:	PM Street Peak Hour

Table 7-P: Conversion of Vehicle-Trip Ends to Person-Trip Ends						
Land Use	Table 7-P (D): Entering Trips			Table 7-P (O): Exiting Trips		
	Veh. Occ.	Vehicle-Trips	Person-Trips*	Veh. Occ.	Vehicle-Trips	Person-Trips*
Office	1.00	0	0	1.00	0	0
Retail	1.00	11	11	1.00	11	11
Restaurant	1.00	0	0	1.00	0	0
Cinema/Entertainment	1.00	0	0	1.00	0	0
Residential	1.00	42	42	1.00	31	31
Hotel	1.00	0	0	1.00	0	0

Table 8-P (O): Internal Person-Trip Origin-Destination Matrix (Computed at Origin)						
Origin (From)	Destination (To)					
	Office	Retail	Restaurant	Cinema/Entertainment	Residential	Hotel
Office		0	0	0	0	0
Retail	0		3	0	3	1
Restaurant	0	0		0	0	0
Cinema/Entertainment	0	0	0		0	0
Residential	1	13	7	0		1
Hotel	0	0	0	0	0	

Table 8-P (D): Internal Person-Trip Origin-Destination Matrix (Computed at Destination)						
Origin (From)	Destination (To)					
	Office	Retail	Restaurant	Cinema/Entertainment	Residential	Hotel
Office		1	0	0	2	0
Retail	0		0	0	19	0
Restaurant	0	6		0	7	0
Cinema/Entertainment	0	0	0		2	0
Residential	0	1	0	0		0
Hotel	0	0	0	0	0	

Table 9-P (D): Internal and External Trips Summary (Entering Trips)						
Destination Land Use	Person-Trip Estimates			External Trips by Mode*		
	Internal	External	Total	Vehicles ¹	Transit ²	Non-Motorized ²
Office	0	0	0	0	0	0
Retail	1	10	11	10	0	0
Restaurant	0	0	0	0	0	0
Cinema/Entertainment	0	0	0	0	0	0
Residential	3	39	42	39	0	0
Hotel	0	0	0	0	0	0
All Other Land Uses ³	0	0	0	0	0	0

Table 9-P (O): Internal and External Trips Summary (Exiting Trips)						
Origin Land Use	Person-Trip Estimates			External Trips by Mode*		
	Internal	External	Total	Vehicles ¹	Transit ²	Non-Motorized ²
Office	0	0	0	0	0	0
Retail	3	8	11	8	0	0
Restaurant	0	0	0	0	0	0
Cinema/Entertainment	0	0	0	0	0	0
Residential	1	30	31	30	0	0
Hotel	0	0	0	0	0	0
All Other Land Uses ³	0	0	0	0	0	0

¹Vehicle-trips computed using the mode split and vehicle occupancy values provided in Table 2-P

²Person-Trips

³Total estimate for all other land uses at mixed-use development site is not subject to internal trip capture computations in this estimator

*Indicates computation that has been rounded to the nearest whole number.

NCHRP 684 Internal Trip Capture Estimation Tool						
Project Name:	Full Buildout 265 Catherine			Organization:	Parsons	
Project Location:				Performed By:		
Scenario Description:	AM Internal Reduction			Date:	9/3/2024	
Analysis Year:				Checked By:		
Analysis Period:	AM Street Peak Hour			Date:		

Table 1-A: Base Vehicle-Trip Generation Estimates (Single-Use Site Estimate)						
Land Use	Development Data (For Information Only)			Estimated Vehicle-Trips ³		
	ITE LUCs ¹	Quantity	Units	Total	Entering	Exiting
Office				0		
Retail				15	9	6
Restaurant				0		
Cinema/Entertainment				0		
Residential				201	63	138
Hotel				0		
All Other Land Uses ²				0		
				216	72	144

Table 2-A: Mode Split and Vehicle Occupancy Estimates						
Land Use	Entering Trips			Exiting Trips		
	Veh. Occ. ⁴	% Transit	% Non-Motorized	Veh. Occ. ⁴	% Transit	% Non-Motorized
Office						
Retail						
Restaurant						
Cinema/Entertainment						
Residential						
Hotel						
All Other Land Uses ²						

Table 3-A: Average Land Use Interchange Distances (Feet Walking Distance)						
Origin (From)	Destination (To)					
	Office	Retail	Restaurant	Cinema/Entertainment	Residential	Hotel
Office						
Retail						
Restaurant						
Cinema/Entertainment						
Residential						
Hotel						

Table 4-A: Internal Person-Trip Origin-Destination Matrix*						
Origin (From)	Destination (To)					
	Office	Retail	Restaurant	Cinema/Entertainment	Residential	Hotel
Office						
Retail	0		0	0	1	0
Restaurant	0	0		0	0	0
Cinema/Entertainment	0	0	0		0	0
Residential	0	1	0	0		0
Hotel	0	0	0	0	0	

Table 5-A: Computations Summary			
	Total	Entering	Exiting
All Person-Trips	216	72	144
Internal Capture Percentage	2%	3%	1%
External Vehicle-Trips ⁵	212	70	142
External Transit-Trips ⁶	0	0	0
External Non-Motorized Trips ⁶	0	0	0

Table 6-A: Internal Trip Capture Percentages by Land Use		
Land Use	Entering Trips	Exiting Trips
Office	N/A	N/A
Retail	11%	17%
Restaurant	N/A	N/A
Cinema/Entertainment	N/A	N/A
Residential	2%	1%
Hotel	N/A	N/A

¹Land Use Codes (LUCs) from *Trip Generation Manual*, published by the Institute of Transportation Engineers.

²Total estimate for all other land uses at mixed-use development site is not subject to internal trip capture computations in this estimator.

³Enter trips assuming no transit or non-motorized trips (as assumed in ITE *Trip Generation Manual*).

⁴Enter vehicle occupancy assumed in Table 1-A vehicle trips. If vehicle occupancy changes for proposed mixed-use project, manual adjustments must be made to Tables 5-A, 9-A (O and D). Enter transit, non-motorized percentages that will result with proposed mixed-use project complete.

⁵Vehicle-trips computed using the mode split and vehicle occupancy values provided in Table 2-A.

⁶Person-Trips

*Indicates computation that has been rounded to the nearest whole number.

Estimation Tool Developed by the Texas A&M Transportation Institute - Version 2013.1

Project Name:	Full Buildout 265 Catherine
Analysis Period:	AM Street Peak Hour

Table 7-A: Conversion of Vehicle-Trip Ends to Person-Trip Ends						
Land Use	Table 7-A (D): Entering Trips			Table 7-A (O): Exiting Trips		
	Veh. Occ.	Vehicle-Trips	Person-Trips*	Veh. Occ.	Vehicle-Trips	Person-Trips*
Office	1.00	0	0	1.00	0	0
Retail	1.00	9	9	1.00	6	6
Restaurant	1.00	0	0	1.00	0	0
Cinema/Entertainment	1.00	0	0	1.00	0	0
Residential	1.00	63	63	1.00	138	138
Hotel	1.00	0	0	1.00	0	0

Table 8-A (O): Internal Person-Trip Origin-Destination Matrix (Computed at Origin)						
Origin (From)	Destination (To)					
	Office	Retail	Restaurant	Cinema/Entertainment	Residential	Hotel
Office		0	0	0	0	0
Retail	2		1	0	1	0
Restaurant	0	0		0	0	0
Cinema/Entertainment	0	0	0		0	0
Residential	3	1	28	0		0
Hotel	0	0	0	0	0	

Table 8-A (D): Internal Person-Trip Origin-Destination Matrix (Computed at Destination)						
Origin (From)	Destination (To)					
	Office	Retail	Restaurant	Cinema/Entertainment	Residential	Hotel
Office		3	0	0	0	0
Retail	0		0	0	1	0
Restaurant	0	1		0	3	0
Cinema/Entertainment	0	0	0		0	0
Residential	0	2	0	0		0
Hotel	0	0	0	0	0	

Table 9-A (D): Internal and External Trips Summary (Entering Trips)						
Destination Land Use	Person-Trip Estimates			External Trips by Mode*		
	Internal	External	Total	Vehicles ¹	Transit ²	Non-Motorized ²
Office	0	0	0	0	0	0
Retail	1	8	9	8	0	0
Restaurant	0	0	0	0	0	0
Cinema/Entertainment	0	0	0	0	0	0
Residential	1	62	63	62	0	0
Hotel	0	0	0	0	0	0
All Other Land Uses ³	0	0	0	0	0	0

Table 9-A (O): Internal and External Trips Summary (Exiting Trips)						
Origin Land Use	Person-Trip Estimates			External Trips by Mode*		
	Internal	External	Total	Vehicles ¹	Transit ²	Non-Motorized ²
Office	0	0	0	0	0	0
Retail	1	5	6	5	0	0
Restaurant	0	0	0	0	0	0
Cinema/Entertainment	0	0	0	0	0	0
Residential	1	137	138	137	0	0
Hotel	0	0	0	0	0	0
All Other Land Uses ³	0	0	0	0	0	0

¹Vehicle-trips computed using the mode split and vehicle occupancy values provided in Table 2-A
²Person-Trips
³Total estimate for all other land uses at mixed-use development site is not subject to internal trip capture computations in this estimator
*Indicates computation that has been rounded to the nearest whole number.

NCHRP 684 Internal Trip Capture Estimation Tool			
Project Name:	Full Buildout 265 Catherine	Organization:	Parsons
Project Location:		Performed By:	
Scenario Description:	PM Internal Reduction	Date:	9/3/2024
Analysis Year:		Checked By:	
Analysis Period:	PM Street Peak Hour	Date:	

Table 1-P: Base Vehicle-Trip Generation Estimates (Single-Use Site Estimate)						
Land Use	Development Data (For Information Only)			Estimated Vehicle-Trips ³		
	ITE LUCs ¹	Quantity	Units	Total	Entering	Exiting
Office				0		
Retail				40	20	20
Restaurant				0		
Cinema/Entertainment				0		
Residential				202	117	85
Hotel				0		
All Other Land Uses ²				0		
				242	137	105

Table 2-P: Mode Split and Vehicle Occupancy Estimates						
Land Use	Entering Trips			Exiting Trips		
	Veh. Occ. ⁴	% Transit	% Non-Motorized	Veh. Occ. ⁴	% Transit	% Non-Motorized
Office						
Retail						
Restaurant						
Cinema/Entertainment						
Residential						
Hotel						
All Other Land Uses ²						

Table 3-P: Average Land Use Interchange Distances (Feet Walking Distance)						
Origin (From)	Destination (To)					
	Office	Retail	Restaurant	Cinema/Entertainment	Residential	Hotel
Office						
Retail					150	
Restaurant						
Cinema/Entertainment						
Residential		150				
Hotel						

Table 4-P: Internal Person-Trip Origin-Destination Matrix*						
Origin (From)	Destination (To)					
	Office	Retail	Restaurant	Cinema/Entertainment	Residential	Hotel
Office						
Retail	0				5	0
Restaurant	0	0			0	0
Cinema/Entertainment	0	0	0		0	0
Residential	0	2	0	0		0
Hotel	0	0	0	0	0	

Table 5-P: Computations Summary			
	Total	Entering	Exiting
All Person-Trips	242	137	105
Internal Capture Percentage	6%	5%	7%
External Vehicle-Trips ⁵	228	130	98
External Transit-Trips ⁶	0	0	0
External Non-Motorized Trips ⁶	0	0	0

Table 6-P: Internal Trip Capture Percentages by Land Use		
Land Use	Entering Trips	Exiting Trips
Office	N/A	N/A
Retail	10%	25%
Restaurant	N/A	N/A
Cinema/Entertainment	N/A	N/A
Residential	4%	2%
Hotel	N/A	N/A

¹Land Use Codes (LUCs) from *Trip Generation Manual*, published by the Institute of Transportation Engineers.

²Total estimate for all other land uses at mixed-use development site is not subject to internal trip capture computations in this estimator.

³Enter trips assuming no transit or non-motorized trips (as assumed in ITE *Trip Generation Manual*).

⁴Enter vehicle occupancy assumed in Table 1-P vehicle trips. If vehicle occupancy changes for proposed mixed-use project, manual adjustments must be made.

⁵Vehicle-trips computed using the mode split and vehicle occupancy values provided in Table 2-P.

⁶Person-Trips

*Indicates computation that has been rounded to the nearest whole number.

Estimation Tool Developed by the Texas A&M Transportation Institute - Version 2013.1

Project Name:	Full Buildout 265 Catherine
Analysis Period:	PM Street Peak Hour

Table 7-P: Conversion of Vehicle-Trip Ends to Person-Trip Ends						
Land Use	Table 7-P (D): Entering Trips			Table 7-P (O): Exiting Trips		
	Veh. Occ.	Vehicle-Trips	Person-Trips*	Veh. Occ.	Vehicle-Trips	Person-Trips*
Office	1.00	0	0	1.00	0	0
Retail	1.00	20	20	1.00	20	20
Restaurant	1.00	0	0	1.00	0	0
Cinema/Entertainment	1.00	0	0	1.00	0	0
Residential	1.00	117	117	1.00	85	85
Hotel	1.00	0	0	1.00	0	0

Table 8-P (O): Internal Person-Trip Origin-Destination Matrix (Computed at Origin)						
Origin (From)	Destination (To)					
	Office	Retail	Restaurant	Cinema/Entertainment	Residential	Hotel
Office		0	0	0	0	0
Retail	0		6	1	5	1
Restaurant	0	0		0	0	0
Cinema/Entertainment	0	0	0		0	0
Residential	3	36	18	0		3
Hotel	0	0	0	0	0	

Table 8-P (D): Internal Person-Trip Origin-Destination Matrix (Computed at Destination)						
Origin (From)	Destination (To)					
	Office	Retail	Restaurant	Cinema/Entertainment	Residential	Hotel
Office		2	0	0	5	0
Retail	0		0	0	54	0
Restaurant	0	10		0	19	0
Cinema/Entertainment	0	1	0		5	0
Residential	0	2	0	0		0
Hotel	0	0	0	0	0	

Table 9-P (D): Internal and External Trips Summary (Entering Trips)						
Destination Land Use	Person-Trip Estimates			External Trips by Mode*		
	Internal	External	Total	Vehicles ¹	Transit ²	Non-Motorized ²
Office	0	0	0	0	0	0
Retail	2	18	20	18	0	0
Restaurant	0	0	0	0	0	0
Cinema/Entertainment	0	0	0	0	0	0
Residential	5	112	117	112	0	0
Hotel	0	0	0	0	0	0
All Other Land Uses ³	0	0	0	0	0	0

Table 9-P (O): Internal and External Trips Summary (Exiting Trips)						
Origin Land Use	Person-Trip Estimates			External Trips by Mode*		
	Internal	External	Total	Vehicles ¹	Transit ²	Non-Motorized ²
Office	0	0	0	0	0	0
Retail	5	15	20	15	0	0
Restaurant	0	0	0	0	0	0
Cinema/Entertainment	0	0	0	0	0	0
Residential	2	83	85	83	0	0
Hotel	0	0	0	0	0	0
All Other Land Uses ³	0	0	0	0	0	0

¹Vehicle-trips computed using the mode split and vehicle occupancy values provided in Table 2-P

²Person-Trips

³Total estimate for all other land uses at mixed-use development site is not subject to internal trip capture computations in this estimator

*Indicates computation that has been rounded to the nearest whole number.

Appendix F:

TDM Checklist

TDM-Supportive Development Design and Infrastructure Checklist:
Residential Developments (multi-family or condominium)

Legend	
REQUIRED	The Official Plan or Zoning By-law provides related guidance that must be followed
BASIC	The measure is generally feasible and effective, and in most cases would benefit the development and its users
BETTER	The measure could maximize support for users of sustainable modes, and optimize development performance

TDM-supportive design & infrastructure measures: <i>Residential developments</i>		Check if completed & add descriptions, explanations or plan/drawing references
1. WALKING & CYCLING: ROUTES		
1.1 Building location & access points		
BASIC	1.1.1 Locate building close to the street, and do not locate parking areas between the street and building entrances	<input checked="" type="checkbox"/>
BASIC	1.1.2 Locate building entrances in order to minimize walking distances to sidewalks and transit stops/stations	<input checked="" type="checkbox"/>
BASIC	1.1.3 Locate building doors and windows to ensure visibility of pedestrians from the building, for their security and comfort	<input checked="" type="checkbox"/>
1.2 Facilities for walking & cycling		
REQUIRED	1.2.1 Provide convenient, direct access to stations or major stops along rapid transit routes within 600 metres; minimize walking distances from buildings to rapid transit; provide pedestrian-friendly, weather-protected (where possible) environment between rapid transit accesses and building entrances; ensure quality linkages from sidewalks through building entrances to integrated stops/stations (<i>see Official Plan policy 4.3.3</i>)	<input checked="" type="checkbox"/>
REQUIRED	1.2.2 Provide safe, direct and attractive pedestrian access from public sidewalks to building entrances through such measures as: reducing distances between public sidewalks and major building entrances; providing walkways from public streets to major building entrances; within a site, providing walkways along the front of adjoining buildings, between adjacent buildings, and connecting areas where people may congregate, such as courtyards and transit stops; and providing weather protection through canopies, colonnades, and other design elements wherever possible (<i>see Official Plan policy 4.3.12</i>)	<input checked="" type="checkbox"/>

TDM-supportive design & infrastructure measures: <i>Residential developments</i>		Check if completed & add descriptions, explanations or plan/drawing references
REQUIRED	1.2.3 Provide sidewalks of smooth, well-drained walking surfaces of contrasting materials or treatments to differentiate pedestrian areas from vehicle areas, and provide marked pedestrian crosswalks at intersection sidewalks (<i>see Official Plan policy 4.3.10</i>)	<input checked="" type="checkbox"/>
REQUIRED	1.2.4 Make sidewalks and open space areas easily accessible through features such as gradual grade transition, depressed curbs at street corners and convenient access to extra-wide parking spaces and ramps (<i>see Official Plan policy 4.3.10</i>)	<input checked="" type="checkbox"/>
REQUIRED	1.2.5 Include adequately spaced inter-block/street cycling and pedestrian connections to facilitate travel by active transportation. Provide links to the existing or planned network of public sidewalks, multi-use pathways and on-road cycle routes. Where public sidewalks and multi-use pathways intersect with roads, consider providing traffic control devices to give priority to cyclists and pedestrians (<i>see Official Plan policy 4.3.11</i>)	<input checked="" type="checkbox"/>
BASIC	1.2.6 Provide safe, direct and attractive walking routes from building entrances to nearby transit stops	<input checked="" type="checkbox"/>
BASIC	1.2.7 Ensure that walking routes to transit stops are secure, visible, lighted, shaded and wind-protected wherever possible	<input checked="" type="checkbox"/>
BASIC	1.2.8 Design roads used for access or circulation by cyclists using a target operating speed of no more than 30 km/h, or provide a separated cycling facility	<input checked="" type="checkbox"/>
1.3 Amenities for walking & cycling		
BASIC	1.3.1 Provide lighting, landscaping and benches along walking and cycling routes between building entrances and streets, sidewalks and trails	<input checked="" type="checkbox"/>
BASIC	1.3.2 Provide wayfinding signage for site access (where required, e.g. when multiple buildings or entrances exist) and egress (where warranted, such as when directions to reach transit stops/stations, trails or other common destinations are not obvious)	<input checked="" type="checkbox"/>

TDM-supportive design & infrastructure measures: <i>Residential developments</i>		Check if completed & add descriptions, explanations or plan/drawing references
2. WALKING & CYCLING: END-OF-TRIP FACILITIES		
2.1 Bicycle parking		
REQUIRED	2.1.1 Provide bicycle parking in highly visible and lighted areas, sheltered from the weather wherever possible (see <i>Official Plan policy 4.3.6</i>)	<input checked="" type="checkbox"/>
REQUIRED	2.1.2 Provide the number of bicycle parking spaces specified for various land uses in different parts of Ottawa; provide convenient access to main entrances or well-used areas (see <i>Zoning By-law Section 111</i>)	<input checked="" type="checkbox"/>
REQUIRED	2.1.3 Ensure that bicycle parking spaces and access aisles meet minimum dimensions; that no more than 50% of spaces are vertical spaces; and that parking racks are securely anchored (see <i>Zoning By-law Section 111</i>)	<input checked="" type="checkbox"/>
BASIC	2.1.4 Provide bicycle parking spaces equivalent to the expected number of resident-owned bicycles, plus the expected peak number of visitor cyclists	<input checked="" type="checkbox"/>
2.2 Secure bicycle parking		
REQUIRED	2.2.1 Where more than 50 bicycle parking spaces are provided for a single residential building, locate at least 25% of spaces within a building/structure, a secure area (e.g. supervised parking lot or enclosure) or bicycle lockers (see <i>Zoning By-law Section 111</i>)	<input checked="" type="checkbox"/>
BETTER	2.2.2 Provide secure bicycle parking spaces equivalent to at least the number of units at condominiums or multi-family residential developments	<input checked="" type="checkbox"/>
2.3 Bicycle repair station		
BETTER	2.3.1 Provide a permanent bike repair station, with commonly used tools and an air pump, adjacent to the main bicycle parking area (or secure bicycle parking area, if provided)	<input checked="" type="checkbox"/>
3. TRANSIT		
3.1 Customer amenities		
BASIC	3.1.1 Provide shelters, lighting and benches at any on-site transit stops	<input type="checkbox"/>
BASIC	3.1.2 Where the site abuts an off-site transit stop and insufficient space exists for a transit shelter in the public right-of-way, protect land for a shelter and/or install a shelter	<input checked="" type="checkbox"/>
BETTER	3.1.3 Provide a secure and comfortable interior waiting area by integrating any on-site transit stops into the building	<input type="checkbox"/>

TDM-supportive design & infrastructure measures: <i>Residential developments</i>		Check if completed & add descriptions, explanations or plan/drawing references
4. RIDESHARING		
4.1 Pick-up & drop-off facilities		
BASIC	4.1.1 Provide a designated area for carpool drivers (plus taxis and ride-hailing services) to drop off or pick up passengers without using fire lanes or other no-stopping zones	<input checked="" type="checkbox"/>
5. CARSHARING & BIKESHARING		
5.1 Carshare parking spaces		
BETTER	5.1.1 Provide up to three carshare parking spaces in an R3, R4 or R5 Zone for specified residential uses (see <i>Zoning By-law Section 94</i>)	<input checked="" type="checkbox"/>
5.2 Bikeshare station location		
BETTER	5.2.1 Provide a designated bikeshare station area near a major building entrance, preferably lighted and sheltered with a direct walkway connection	<input type="checkbox"/>
6. PARKING		
6.1 Number of parking spaces		
REQUIRED	6.1.1 Do not provide more parking than permitted by zoning, nor less than required by zoning, unless a variance is being applied for	<input checked="" type="checkbox"/>
BASIC	6.1.2 Provide parking for long-term and short-term users that is consistent with mode share targets, considering the potential for visitors to use off-site public parking	<input type="checkbox"/>
BASIC	6.1.3 Where a site features more than one use, provide shared parking and reduce the cumulative number of parking spaces accordingly (see <i>Zoning By-law Section 104</i>)	<input checked="" type="checkbox"/>
BETTER	6.1.4 Reduce the minimum number of parking spaces required by zoning by one space for each 13 square metres of gross floor area provided as shower rooms, change rooms, locker rooms and other facilities for cyclists in conjunction with bicycle parking (see <i>Zoning By-law Section 111</i>)	<input type="checkbox"/>
6.2 Separate long-term & short-term parking areas		
BETTER	6.2.1 Provide separate areas for short-term and long-term parking (using signage or physical barriers) to permit access controls and simplify enforcement (i.e. to discourage residents from parking in visitor spaces, and vice versa)	<input checked="" type="checkbox"/>

TDM Measures Checklist:
Residential Developments (multi-family, condominium or subdivision)

Legend	
BASIC	The measure is generally feasible and effective, and in most cases would benefit the development and its users
BETTER	The measure could maximize support for users of sustainable modes, and optimize development performance
★	The measure is one of the most dependably effective tools to encourage the use of sustainable modes

TDM measures: <i>Residential developments</i>		Check if proposed & add descriptions
1. TDM PROGRAM MANAGEMENT		
1.1 Program coordinator		
BASIC	★ 1.1.1 Designate an internal coordinator, or contract with an external coordinator	<input type="checkbox"/>
1.2 Travel surveys		
BETTER	1.2.1 Conduct periodic surveys to identify travel-related behaviours, attitudes, challenges and solutions, and to track progress	<input type="checkbox"/>
2. WALKING AND CYCLING		
2.1 Information on walking/cycling routes & destinations		
BASIC	2.1.1 Display local area maps with walking/cycling access routes and key destinations at major entrances (<i>multi-family, condominium</i>)	<input checked="" type="checkbox"/>
2.2 Bicycle skills training		
BETTER	2.2.1 Offer on-site cycling courses for residents, or subsidize off-site courses	<input checked="" type="checkbox"/>

TDM measures: <i>Residential developments</i>		Check if proposed & add descriptions
3. TRANSIT		
3.1 Transit information		
BASIC	3.1.1 Display relevant transit schedules and route maps at entrances (<i>multi-family, condominium</i>)	<input checked="" type="checkbox"/>
BETTER	3.1.2 Provide real-time arrival information display at entrances (<i>multi-family, condominium</i>)	<input type="checkbox"/>
3.2 Transit fare incentives		
BASIC ★	3.2.1 Offer PRESTO cards preloaded with one monthly transit pass on residence purchase/move-in, to encourage residents to use transit	<input checked="" type="checkbox"/>
BETTER	3.2.2 Offer at least one year of free monthly transit passes on residence purchase/move-in	<input type="checkbox"/>
3.3 Enhanced public transit service		
BETTER ★	3.3.1 Contract with OC Transpo to provide early transit services until regular services are warranted by occupancy levels (<i>subdivision</i>)	<input type="checkbox"/>
3.4 Private transit service		
BETTER	3.4.1 Provide shuttle service for seniors homes or lifestyle communities (e.g. scheduled mall or supermarket runs)	<input type="checkbox"/>
4. CARSHARING & BIKESHARING		
4.1 Bikeshare stations & memberships		
BETTER	4.1.1 Contract with provider to install on-site bikeshare station (<i>multi-family</i>)	<input type="checkbox"/>
BETTER	4.1.2 Provide residents with bikeshare memberships, either free or subsidized (<i>multi-family</i>)	<input type="checkbox"/>
4.2 Carshare vehicles & memberships		
BETTER	4.2.1 Contract with provider to install on-site carshare vehicles and promote their use by residents	<input checked="" type="checkbox"/>
BETTER	4.2.2 Provide residents with carshare memberships, either free or subsidized	<input type="checkbox"/>
5. PARKING		
5.1 Priced parking		
BASIC ★	5.1.1 Unbundle parking cost from purchase price (<i>condominium</i>)	<input type="checkbox"/>
BASIC ★	5.1.2 Unbundle parking cost from monthly rent (<i>multi-family</i>)	<input checked="" type="checkbox"/>

TDM measures: <i>Residential developments</i>		Check if proposed & add descriptions
6. TDM MARKETING & COMMUNICATIONS		
6.1 Multimodal travel information		
BASIC	★ 6.1.1 Provide a multimodal travel option information package to new residents	<input checked="" type="checkbox"/>
6.2 Personalized trip planning		
BETTER	★ 6.2.1 Offer personalized trip planning to new residents	<input checked="" type="checkbox"/>

Appendix G:

Passenger Car and Truck Turning Templates



Legend

	P	width : 2.00 track : 2.00 lock to lock time : 4.0 steering angle : 35.9
	MSU	width : 2.60 track : 2.60 lock to lock time : 6.0 steering angle : 42.2
	HSU	width : 2.80 track : 2.80 lock to lock time : 6.0 steering angle : 41.0

Not to Scale

Drawing Description		Arlington Ave	
Client	Date	September 10, 2024	Figure Number
Project Number	Project Description	478038	265 Catherine St
			002

NOTE: The location of utilities is approximate only, the exact location should be determined by consulting the municipal authorities and utility companies concerned. The contractor shall prove the location of utilities and shall be responsible for adequate protection from damage.

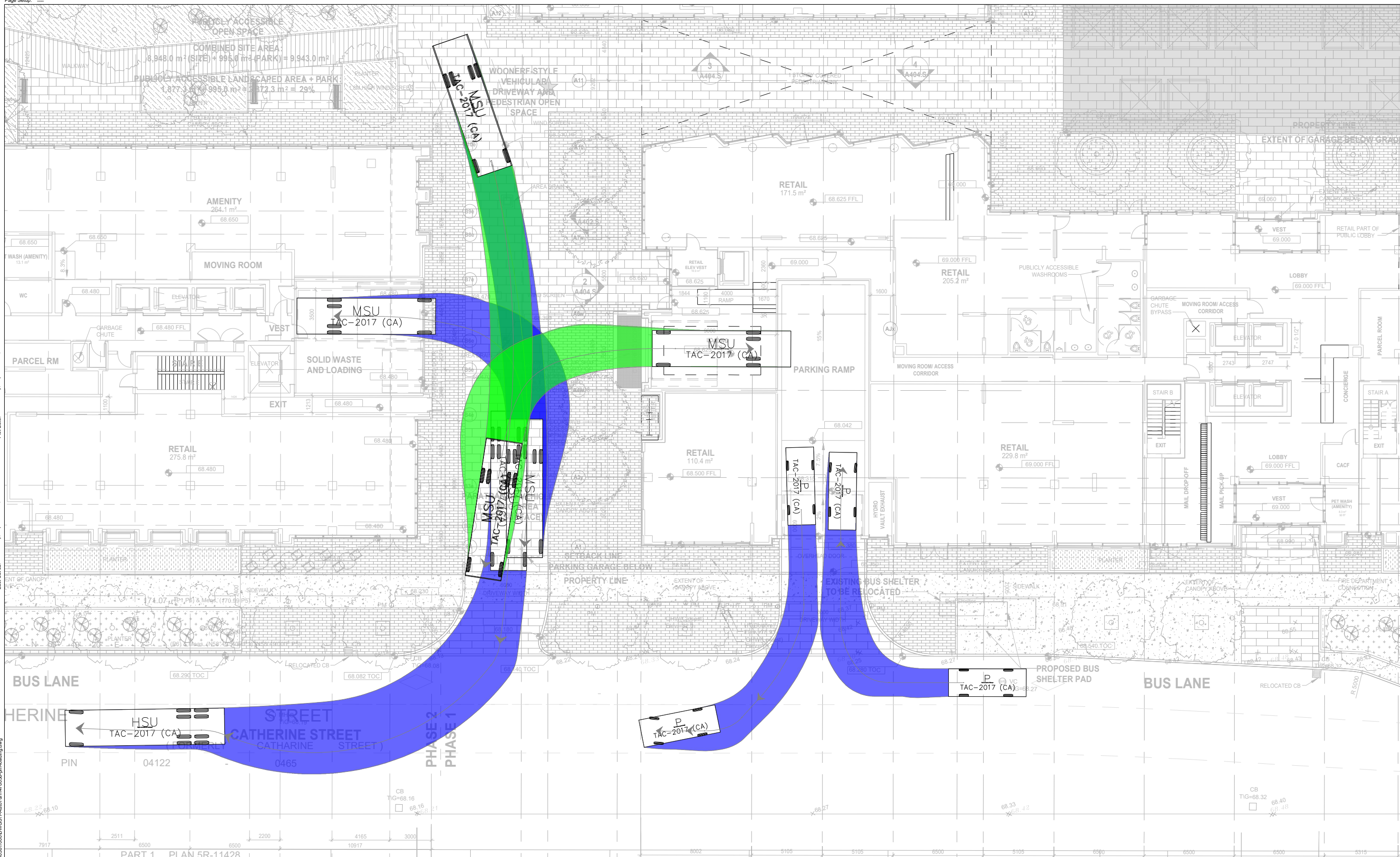

PARSONS

NOTE: The location of utilities is approximate only, the exact location should be determined by consulting the municipal authorities and utility companies concerned. The contractor shall prove the location of utilities and shall be responsible for adequate protection from damage.



Legend	
<p>P Width : 2.00 Track : 2.00 Lock to Lock Time : 6.0 Steering Angle : 35.9</p>	<p>MSU Width : 2.60 Track : 2.60 Lock to Lock Time : 6.0 Steering Angle : 42.2</p>
<p>HSU Width : 2.80 Track : 2.80 Lock to Lock Time : 6.0 Steering Angle : 40.0</p>	

Not to Scale

Drawing Description		Catherine St	
Client		Date	September 10, 2024
Project Number	478038	Figure Number	001
Project Description		265 Catherine St	

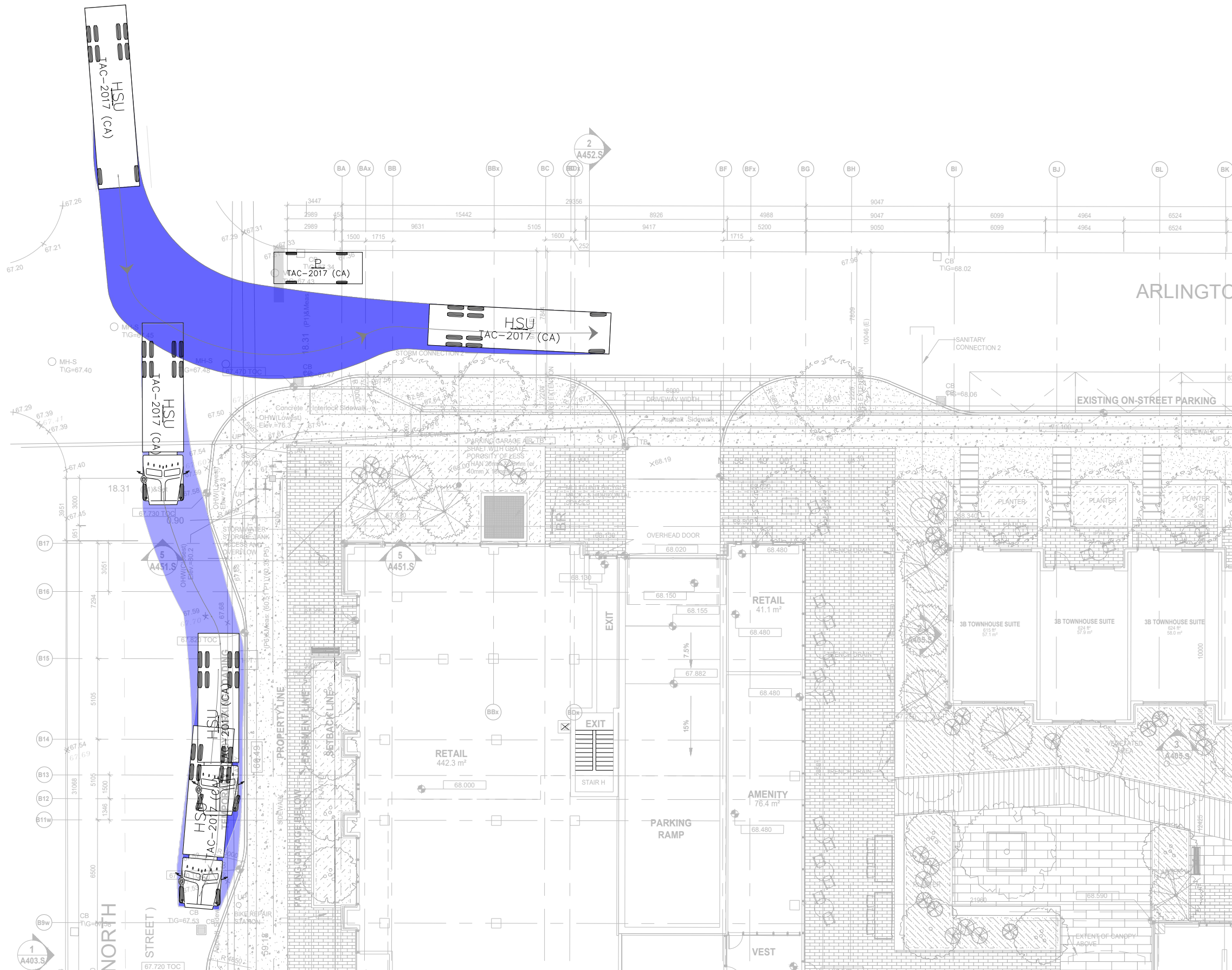

Legend	

Vehicle	Width (meters)	Track (meters)	Lock to Lock Time (seconds)	Steering Angle (degrees)
P	1.10	2.80	2.00	35.9
MSU	0.80	2.60	6.0	42.2
HSU	0.80	2.80	6.0	40.0

Not to Scale

Drawing Description		Lyon St	
Client		Date	September 10, 2024
Project Number	478038	Figure Number	003
Project Description		265 Catherine St	

NOTE: The location of utilities is approximate only, the exact location should be determined by consulting the municipal authorities and utility companies concerned. The contractor shall prove the location of utilities and shall be responsible for adequate protection from damage.

Appendix H:

MMLOS Analysis: Road Segments

Multi-Modal Level of Service - Segments Form

Consultant	Parsons
Scenario	Existing and Future
Comments	

Project	478038-01000
Date	14-May-24

SEGMENTS		Street A	Catherine St 1	Kent St 2	Lyon St 3	Arlington Ave 4	Catherine (future) 5	Kent (future) 6	Lyon (future) 7	Arlington (future) 8	
Pedestrian	Sidewalk Width	F	≥ 2 m	1.8 m	1.5 m	1.5 m	≥ 2 m	≥ 2 m	≥ 2 m	≥ 2 m	
	Boulevard Width		< 0.5	< 0.5 m	< 0.5 m	< 0.5 m	> 2 m	< 0.5	< 0.5	< 0.5	
	Avg Daily Curb Lane Traffic Volume		≤ 3000	> 3000	> 3000	≤ 3000	≤ 3000	> 3000	> 3000	≤ 3000	
	Operating Speed		> 50 to 60 km/h	> 50 to 60 km/h	> 50 to 60 km/h	> 30 to 50 km/h	> 50 to 60 km/h	> 50 to 60 km/h	> 50 to 60 km/h	> 50 to 60 km/h	> 30 to 50 km/h
	On-Street Parking		no	no	no	yes	no	no	yes	yes	
	Exposure to Traffic PLoS		C	F	F	E	A	E	D	B	
	Effective Sidewalk Width		2.0 m	1.5 m	1.5 m	1.5 m	2.5 m	2.0 m	2.0 m	2.0 m	
	Pedestrian Volume		250 ped/hr	250 ped/hr	250 ped/hr	250 ped/hr	250 ped/hr	250 ped/hr	250 ped/hr	250 ped/hr	
Crowding PLoS	B	B	B	B	B	B	B	B			
Level of Service	C	F	F	E	B	E	D	B			
Bicycle	Type of Cycling Facility	E	Mixed Traffic	Mixed Traffic	Mixed Traffic	Mixed Traffic					
	Number of Travel Lanes		2-3 lanes total	2-3 lanes total	≤ 2 (no centreline)	≤ 2 (no centreline)					
	Operating Speed		≥ 50 to 60 km/h	≥ 50 to 60 km/h	≥ 50 to 60 km/h	≤ 40 km/h					
	# of Lanes & Operating Speed LoS		E	E	D	A	-	-	-	-	
	Bike Lane (+ Parking Lane) Width										
	Bike Lane Width LoS		-	-	-	-	-	-	-	-	
	Bike Lane Blockages										
	Blockage LoS		-	-	-	-	-	-	-	-	
	Median Refuge Width (no median = < 1.8 m)		< 1.8 m refuge	< 1.8 m refuge	< 1.8 m refuge	< 1.8 m refuge					
	No. of Lanes at Unsignalized Crossing		≤ 3 lanes	≤ 3 lanes	≤ 3 lanes	≤ 3 lanes					
Sidestreet Operating Speed	≤ 40 km/h	≤ 40 km/h	≤ 40 km/h	≤ 40 km/h							
Unsignalized Crossing - Lowest LoS	A	A	A	A	-	-	-	-			
Level of Service	E	E	D	A	-	-	-	-			
Transit	Facility Type	D	Mixed Traffic				Bus lane				
	Friction or Ratio Transit:Posted Speed		Vt/Vp ≥ 0.8				Cf ≤ 60				
Level of Service	D	-	-	-	B	-	-	-			
Truck	Truck Lane Width	A	> 3.7 m	> 3.7 m	> 3.7 m		≤ 3.5 m				
	Travel Lanes per Direction		> 1	> 1	> 1		> 1				
	Level of Service		A	A	A	-	A	-	-		

Appendix I:

Synchro Analysis Summary Reports

Existing Conditions

Lanes, Volumes, Timings

1: Hwy 417 WB On Ramp/Lyon St N & Catherine St

05/04/2023



Lane Group	EBL	EBT	EBR	WBL	WBT	WBR	NBL	NBT	NBR	SBL	SBT	SBR
Lane Configurations					↕↕↕						↕	↕
Traffic Volume (vph)	0	0	0	222	219	0	0	0	0	0	258	123
Future Volume (vph)	0	0	0	222	219	0	0	0	0	0	258	123
Satd. Flow (prot)	0	0	0	0	4571	0	0	0	0	0	1784	1547
Fit Permitted					0.975							
Satd. Flow (perm)	0	0	0	0	4538	0	0	0	0	0	1784	1517
Satd. Flow (RTOR)					247							137
Lane Group Flow (vph)	0	0	0	0	490	0	0	0	0	0	287	137
Turn Type				Perm	NA						NA	Perm
Protected Phases					8						6	
Permitted Phases				8								6
Minimum Split (s)				26.2	26.2						28.3	28.3
Total Split (s)				40.0	40.0						35.0	35.0
Total Split (%)				53.3%	53.3%						46.7%	46.7%
Yellow Time (s)				3.3	3.3						3.3	3.3
All-Red Time (s)				1.9	1.9						2.0	2.0
Lost Time Adjust (s)					0.0						0.0	0.0
Total Lost Time (s)					5.2						5.3	5.3
Lead/Lag												
Lead-Lag Optimize?												
Act Effct Green (s)					34.8						29.7	29.7
Actuated g/C Ratio					0.46						0.40	0.40
v/c Ratio					0.22						0.41	0.20
Control Delay					9.9						16.3	6.2
Queue Delay					0.0						0.0	0.0
Total Delay					9.9						16.3	6.2
LOS					A						B	A
Approach Delay					9.9						13.1	
Approach LOS					A						B	
Queue Length 50th (m)					19.9						34.8	3.5
Queue Length 95th (m)					25.4						57.2	18.3
Internal Link Dist (m)		271.6			163.9			117.8			52.8	
Turn Bay Length (m)												
Base Capacity (vph)					2238						706	683
Starvation Cap Reductn					0						0	0
Spillback Cap Reductn					0						0	0
Storage Cap Reductn					0						0	0
Reduced v/c Ratio					0.22						0.41	0.20

Intersection Summary

Cycle Length: 75	
Actuated Cycle Length: 75	
Offset: 48 (64%), Referenced to phase 8:WBTL, Start of Green	
Natural Cycle: 55	
Control Type: Pretimed	
Maximum v/c Ratio: 0.41	
Intersection Signal Delay: 11.4	Intersection LOS: B
Intersection Capacity Utilization 47.6%	ICU Level of Service A
Analysis Period (min) 15	

Splits and Phases: 1: Hwy 417 WB On Ramp/Lyon St N & Catherine St

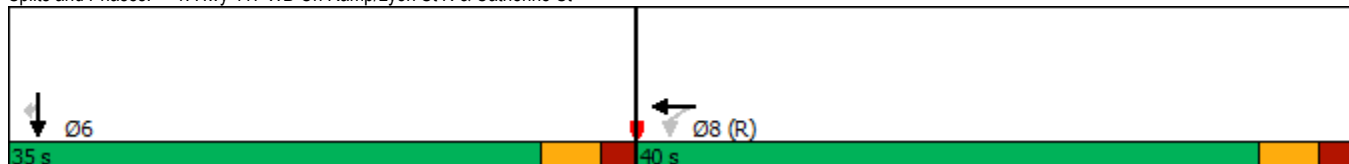

Lanes, Volumes, Timings

2: Hwy 417 EB Off Ramp/Chamberlain Ave/Kent St & Catherine St

05/04/2023



Lane Group	EBL	EBT	EBR	WBL	WBT	WBR	NBL	NBT	NBR	SBL	SBT	SBR
Lane Configurations					↕↕	↗		↕↕↕				
Traffic Volume (vph)	0	0	0	0	389	537	54	1333	0	0	0	0
Future Volume (vph)	0	0	0	0	389	537	54	1333	0	0	0	0
Satd. Flow (prot)	0	0	0	0	2923	1394	0	4911	0	0	0	0
Fit Permitted								0.998				
Satd. Flow (perm)	0	0	0	0	2923	1303	0	4906	0	0	0	0
Satd. Flow (RTOR)								70				
Lane Group Flow (vph)	0	0	0	0	707	322	0	1541	0	0	0	0
Turn Type					NA	Perm	Perm	NA				
Protected Phases					8			2				
Permitted Phases						8		2				
Minimum Split (s)					22.8	22.8		22.5				
Total Split (s)					32.0	32.0		38.0				
Total Split (%)					42.7%	42.7%		50.7%				
Yellow Time (s)					3.3	3.3		3.3				
All-Red Time (s)					2.5	2.5		2.5				
Lost Time Adjust (s)					0.0	0.0		0.0				
Total Lost Time (s)					5.8	5.8		5.8				
Lead/Lag												
Lead-Lag Optimize?												
Act Effct Green (s)					26.2	26.2		32.2				
Actuated g/C Ratio					0.35	0.35		0.43				
v/c Ratio					0.69	0.71		0.72				
Control Delay					26.7	30.2		19.1				
Queue Delay					0.0	0.0		3.4				
Total Delay					26.7	30.2		22.6				
LOS					C	C		C				
Approach Delay					27.8			22.6				
Approach LOS					C			C				
Queue Length 50th (m)					52.0	47.5		60.6				
Queue Length 95th (m)					m60.6	m56.4		76.6				
Internal Link Dist (m)		163.9			131.7			67.4			53.0	
Turn Bay Length (m)												
Base Capacity (vph)					1021	455		2146				
Starvation Cap Reductn					0	0		0				
Spillback Cap Reductn					0	0		496				
Storage Cap Reductn					0	0		0				
Reduced v/c Ratio					0.69	0.71		0.93				

Intersection Summary

Cycle Length: 75
 Actuated Cycle Length: 75
 Offset: 15 (20%), Referenced to phase 8:WBT, Start of Green
 Natural Cycle: 55
 Control Type: Pretimed
 Maximum v/c Ratio: 0.72
 Intersection Signal Delay: 24.7
 Intersection Capacity Utilization 64.8%
 Analysis Period (min) 15
 m Volume for 95th percentile queue is metered by upstream signal.

Splits and Phases: 2: Hwy 417 EB Off Ramp/Chamberlain Ave/Kent St & Catherine St

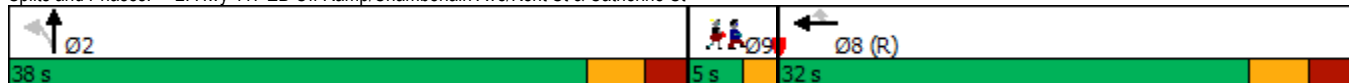

Lanes, Volumes, Timings

2: Hwy 417 EB Off Ramp/Chamberlain Ave/Kent St & Catherine St

05/04/2023

Lane Group	Ø9
Lane Configurations	
Traffic Volume (vph)	
Future Volume (vph)	
Satd. Flow (prot)	
Fit Permitted	
Satd. Flow (perm)	
Satd. Flow (RTOR)	
Lane Group Flow (vph)	
Turn Type	
Protected Phases	9
Permitted Phases	
Minimum Split (s)	5.0
Total Split (s)	5.0
Total Split (%)	7%
Yellow Time (s)	2.0
All-Red Time (s)	0.0
Lost Time Adjust (s)	
Total Lost Time (s)	
Lead/Lag	
Lead-Lag Optimize?	
Act Effct Green (s)	
Actuated g/C Ratio	
v/c Ratio	
Control Delay	
Queue Delay	
Total Delay	
LOS	
Approach Delay	
Approach LOS	
Queue Length 50th (m)	
Queue Length 95th (m)	
Internal Link Dist (m)	
Turn Bay Length (m)	
Base Capacity (vph)	
Starvation Cap Reductn	
Spillback Cap Reductn	
Storage Cap Reductn	
Reduced v/c Ratio	
Intersection Summary	

Lanes, Volumes, Timings
3: Bank St & Catherine St

05/04/2023



Lane Group	EBL	EBT	EBR	WBL	WBT	WBR	NBL	NBT	NBR	SBL	SBT	SBR
Lane Configurations					↕↕↕			↕↕			↕↕	
Traffic Volume (vph)	0	0	0	170	587	198	266	575	0	0	366	130
Future Volume (vph)	0	0	0	170	587	198	266	575	0	0	366	130
Satd. Flow (prot)	0	0	0	0	4430	0	0	3212	0	0	2870	0
Fit Permitted					0.991			0.617				
Satd. Flow (perm)	0	0	0	0	4374	0	0	1951	0	0	2870	0
Satd. Flow (RTOR)					84						64	
Lane Group Flow (vph)	0	0	0	0	1061	0	0	935	0	0	551	0
Turn Type				Perm	NA		pm+pt	NA			NA	
Protected Phases					8		9	2			6	
Permitted Phases				8			2					
Minimum Split (s)				18.6	18.6		10.4	16.4			16.4	
Total Split (s)				25.0	25.0		15.0	40.0			25.0	
Total Split (%)				33.3%	33.3%		20.0%	53.3%			33.3%	
Yellow Time (s)				3.3	3.3		3.3	3.3			3.3	
All-Red Time (s)				2.3	2.3		2.1	2.1			2.1	
Lost Time Adjust (s)					0.0			0.0			0.0	
Total Lost Time (s)					5.6			5.4			5.4	
Lead/Lag				Lag	Lag		Lag	Lag			Lag	
Lead-Lag Optimize?				Yes	Yes		Yes	Yes			Yes	
Act Effct Green (s)					19.4			34.6			19.6	
Actuated g/C Ratio					0.26			0.46			0.26	
v/c Ratio					0.89			0.88			0.69	
Control Delay					35.6			22.7			27.2	
Queue Delay					0.0			0.0			0.0	
Total Delay					35.6			22.7			27.2	
LOS					D			C			C	
Approach Delay					35.6			22.7			27.2	
Approach LOS					D			C			C	
Queue Length 50th (m)					48.9			25.0			32.5	
Queue Length 95th (m)					#72.7			#48.9			49.1	
Internal Link Dist (m)		131.7			201.7			90.2			52.9	
Turn Bay Length (m)												
Base Capacity (vph)					1193			1061			797	
Starvation Cap Reductn					0			0			0	
Spillback Cap Reductn					0			0			0	
Storage Cap Reductn					0			0			0	
Reduced v/c Ratio					0.89			0.88			0.69	

Intersection Summary

Cycle Length: 75
 Actuated Cycle Length: 75
 Offset: 70 (93%), Referenced to phase 2:NBT and 6:SBT, Start of Green
 Natural Cycle: 90
 Control Type: Pretimed
 Maximum v/c Ratio: 0.89
 Intersection Signal Delay: 29.1 Intersection LOS: C
 Intersection Capacity Utilization 78.9% ICU Level of Service D
 Analysis Period (min) 15
 # 95th percentile volume exceeds capacity, queue may be longer.
 Queue shown is maximum after two cycles.

Splits and Phases: 3: Bank St & Catherine St

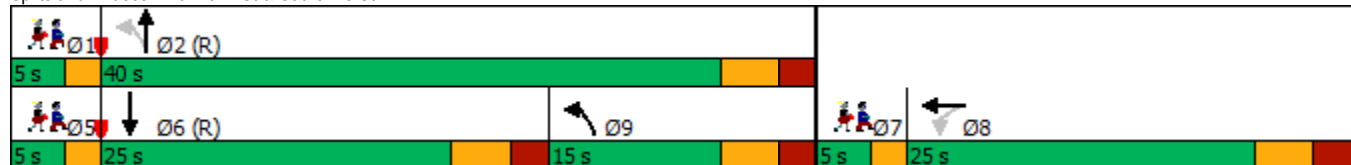

Lanes, Volumes, Timings
 3: Bank St & Catherine St

05/04/2023

Lane Group	Ø1	Ø5	Ø7
Lane Configurations			
Traffic Volume (vph)			
Future Volume (vph)			
Satd. Flow (prot)			
Fit Permitted			
Satd. Flow (perm)			
Satd. Flow (RTOR)			
Lane Group Flow (vph)			
Turn Type			
Protected Phases	1	5	7
Permitted Phases			
Minimum Split (s)	5.0	5.0	5.0
Total Split (s)	5.0	5.0	5.0
Total Split (%)	7%	7%	7%
Yellow Time (s)	2.0	2.0	2.0
All-Red Time (s)	0.0	0.0	0.0
Lost Time Adjust (s)			
Total Lost Time (s)			
Lead/Lag	Lead	Lead	Lead
Lead-Lag Optimize?	Yes	Yes	Yes
Act Effct Green (s)			
Actuated g/C Ratio			
v/c Ratio			
Control Delay			
Queue Delay			
Total Delay			
LOS			
Approach Delay			
Approach LOS			
Queue Length 50th (m)			
Queue Length 95th (m)			
Internal Link Dist (m)			
Turn Bay Length (m)			
Base Capacity (vph)			
Starvation Cap Reductn			
Spillback Cap Reductn			
Storage Cap Reductn			
Reduced v/c Ratio			
Intersection Summary			

Lanes, Volumes, Timings
4: Percy St & Catherine St

05/04/2023



Lane Group	EBL	EBT	EBR	WBL	WBT	WBR	NBL	NBT	NBR	SBL	SBT	SBR
Lane Configurations					↑↑↑						↓	
Traffic Volume (vph)	0	0	0	71	234	0	0	0	0	0	129	57
Future Volume (vph)	0	0	0	71	234	0	0	0	0	0	129	57
Satd. Flow (prot)	0	0	0	0	4552	0	0	0	0	0	1645	0
Fit Permitted					0.988							
Satd. Flow (perm)	0	0	0	0	4523	0	0	0	0	0	1645	0
Satd. Flow (RTOR)					160							
Lane Group Flow (vph)	0	0	0	0	339	0	0	0	0	0	206	0
Turn Type				Perm	NA							NA
Protected Phases					8							6
Permitted Phases				8								
Detector Phase				8	8							6
Switch Phase												
Minimum Initial (s)				10.0	10.0							10.0
Minimum Split (s)				26.5	26.5							23.4
Total Split (s)				34.0	34.0							24.0
Total Split (%)				37.8%	37.8%							26.7%
Yellow Time (s)				3.3	3.3							3.3
All-Red Time (s)				2.2	2.2							2.1
Lost Time Adjust (s)					0.0							0.0
Total Lost Time (s)					5.5							5.4
Lead/Lag				Lag	Lag							
Lead-Lag Optimize?				Yes	Yes							
Recall Mode				None	None							Max
Act Effct Green (s)					11.9							18.8
Actuated g/C Ratio					0.29							0.45
v/c Ratio					0.24							0.28
Control Delay					6.3							9.6
Queue Delay					0.0							0.0
Total Delay					6.3							9.6
LOS					A							A
Approach Delay					6.3							9.6
Approach LOS					A							A
Queue Length 50th (m)					3.4							7.4
Queue Length 95th (m)					7.4							25.6
Internal Link Dist (m)		71.6			271.6			106.7				288.0
Turn Bay Length (m)												
Base Capacity (vph)					3170							740
Starvation Cap Reductn					0							0
Spillback Cap Reductn					0							0
Storage Cap Reductn					0							0
Reduced v/c Ratio					0.11							0.28

Intersection Summary

Cycle Length: 90
 Actuated Cycle Length: 41.7
 Natural Cycle: 65
 Control Type: Semi Act-Uncoord
 Maximum v/c Ratio: 0.28
 Intersection Signal Delay: 7.5
 Intersection Capacity Utilization 37.9%
 Analysis Period (min) 15

Intersection LOS: A
 ICU Level of Service A

Splits and Phases: 4: Percy St & Catherine St

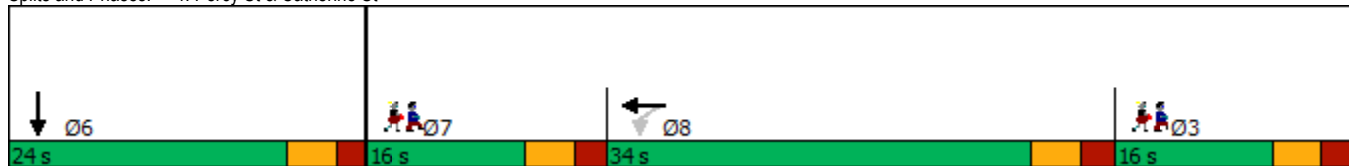

Lanes, Volumes, Timings
 4: Percy St & Catherine St

05/04/2023

Lane Group	Ø3	Ø7
Lane Configurations		
Traffic Volume (vph)		
Future Volume (vph)		
Satd. Flow (prot)		
Fit Permitted		
Satd. Flow (perm)		
Satd. Flow (RTOR)		
Lane Group Flow (vph)		
Turn Type		
Protected Phases	3	7
Permitted Phases		
Detector Phase		
Switch Phase		
Minimum Initial (s)	1.0	1.0
Minimum Split (s)	6.4	6.4
Total Split (s)	16.0	16.0
Total Split (%)	18%	18%
Yellow Time (s)	3.3	3.3
All-Red Time (s)	2.1	2.1
Lost Time Adjust (s)		
Total Lost Time (s)		
Lead/Lag		Lead
Lead-Lag Optimize?		Yes
Recall Mode	None	None
Act Effct Green (s)		
Actuated g/C Ratio		
v/c Ratio		
Control Delay		
Queue Delay		
Total Delay		
LOS		
Approach Delay		
Approach LOS		
Queue Length 50th (m)		
Queue Length 95th (m)		
Internal Link Dist (m)		
Turn Bay Length (m)		
Base Capacity (vph)		
Starvation Cap Reductn		
Spillback Cap Reductn		
Storage Cap Reductn		
Reduced v/c Ratio		
Intersection Summary		

Lanes, Volumes, Timings
6: Kent St & Arlington Ave

05/04/2023



Lane Group	EBL	EBT	EBR	WBL	WBT	WBR	NBL	NBT	NBR	SBL	SBT	SBR
Lane Configurations		↕			↕			↕↕↕				
Traffic Volume (vph)	19	48	0	0	11	93	15	1708	131	0	0	0
Future Volume (vph)	19	48	0	0	11	93	15	1708	131	0	0	0
Satd. Flow (prot)	0	1745	0	0	1542	0	0	4790	0	0	0	0
Fit Permitted		0.914										
Satd. Flow (perm)	0	1610	0	0	1542	0	0	4788	0	0	0	0
Satd. Flow (RTOR)					8			26				
Lane Group Flow (vph)	0	74	0	0	115	0	0	2061	0	0	0	0
Turn Type	Perm	NA			NA		Perm	NA				
Protected Phases		4			8			2				
Permitted Phases	4						2					
Minimum Split (s)	27.3	27.3			27.3		32.3	32.3				
Total Split (s)	28.0	28.0			28.0		47.0	47.0				
Total Split (%)	37.3%	37.3%			37.3%		62.7%	62.7%				
Yellow Time (s)	3.3	3.3			3.3		3.3	3.3				
All-Red Time (s)	2.0	2.0			2.0		2.0	2.0				
Lost Time Adjust (s)		0.0			0.0			0.0				
Total Lost Time (s)		5.3			5.3			5.3				
Lead/Lag												
Lead-Lag Optimize?												
Act Effct Green (s)		22.7			22.7			41.7				
Actuated g/C Ratio		0.30			0.30			0.56				
v/c Ratio		0.15			0.24			0.77				
Control Delay		13.3			19.4			13.2				
Queue Delay		0.0			0.0			2.8				
Total Delay		13.3			19.4			16.0				
LOS		B			B			B				
Approach Delay		13.3			19.4			16.0				
Approach LOS		B			B			B				
Queue Length 50th (m)		6.3			9.0			104.4				
Queue Length 95th (m)		13.4			m12.7			113.9				
Internal Link Dist (m)		164.0			143.1			53.0			216.0	
Turn Bay Length (m)												
Base Capacity (vph)		487			472			2673				
Starvation Cap Reductn		0			0			483				
Spillback Cap Reductn		0			0			0				
Storage Cap Reductn		0			0			0				
Reduced v/c Ratio		0.15			0.24			0.94				

Intersection Summary
 Cycle Length: 75
 Actuated Cycle Length: 75
 Offset: 50 (67%), Referenced to phase 2:NBT, Start of Green
 Natural Cycle: 60
 Control Type: Pretimed
 Maximum v/c Ratio: 0.77
 Intersection Signal Delay: 16.1
 Intersection Capacity Utilization 67.8%
 Analysis Period (min) 15
 m Volume for 95th percentile queue is metered by upstream signal.

Splits and Phases: 6: Kent St & Arlington Ave



Lanes, Volumes, Timings
7: Lyon St N & Gladstone Ave

05/04/2023



Lane Group	EBL	EBT	EBR	WBL	WBT	WBR	NBL	NBT	NBR	SBL	SBT	SBR
Lane Configurations		↑	↗	↖	↑						↕	
Traffic Volume (vph)	0	184	24	15	143	0	0	0	0	89	320	98
Future Volume (vph)	0	184	24	15	143	0	0	0	0	89	320	98
Satd. Flow (prot)	0	1733	1547	1729	1750	0	0	0	0	0	3240	0
Fit Permitted				0.626							0.991	
Satd. Flow (perm)	0	1733	1485	1120	1750	0	0	0	0	0	3215	0
Satd. Flow (RTOR)			38								48	
Lane Group Flow (vph)	0	204	27	17	159	0	0	0	0	0	564	0
Turn Type		NA	Perm	Perm	NA					Perm	NA	
Protected Phases		4			8							6
Permitted Phases			4	8						6		
Minimum Split (s)		17.2	17.2	17.2	17.2					22.6	22.6	
Total Split (s)		38.0	38.0	38.0	38.0					37.0	37.0	
Total Split (%)		50.7%	50.7%	50.7%	50.7%					49.3%	49.3%	
Yellow Time (s)		3.3	3.3	3.3	3.3					3.3	3.3	
All-Red Time (s)		1.9	1.9	1.9	1.9					2.3	2.3	
Lost Time Adjust (s)		0.0	0.0	0.0	0.0						0.0	
Total Lost Time (s)		5.2	5.2	5.2	5.2						5.6	
Lead/Lag												
Lead-Lag Optimize?												
Act Effct Green (s)		32.8	32.8	32.8	32.8						31.4	
Actuated g/C Ratio		0.44	0.44	0.44	0.44						0.42	
v/c Ratio		0.27	0.04	0.03	0.21						0.41	
Control Delay		14.7	3.5	21.7	24.7						15.0	
Queue Delay		0.0	0.0	0.0	0.0						0.0	
Total Delay		14.7	3.5	21.7	24.7						15.0	
LOS		B	A	C	C						B	
Approach Delay		13.4			24.4						15.0	
Approach LOS		B			C						B	
Queue Length 50th (m)		17.7	0.0	2.2	21.3						25.7	
Queue Length 95th (m)		31.2	3.1	m4.1	m33.2						38.0	
Internal Link Dist (m)		254.8			165.0			215.6			214.3	
Turn Bay Length (m)				25.0								
Base Capacity (vph)		757	670	489	765						1373	
Starvation Cap Reductn		0	0	0	0						0	
Spillback Cap Reductn		0	0	0	0						0	
Storage Cap Reductn		0	0	0	0						0	
Reduced v/c Ratio		0.27	0.04	0.03	0.21						0.41	

Intersection Summary
 Cycle Length: 75
 Actuated Cycle Length: 75
 Offset: 10 (13%), Referenced to phase 4:EBT and 8:WBTL, Start of Green
 Natural Cycle: 40
 Control Type: Pretimed
 Maximum v/c Ratio: 0.41
 Intersection Signal Delay: 16.3
 Intersection Capacity Utilization 79.8%
 Analysis Period (min) 15
 Intersection LOS: B
 ICU Level of Service D
 m Volume for 95th percentile queue is metered by upstream signal.

Splits and Phases: 7: Lyon St N & Gladstone Ave

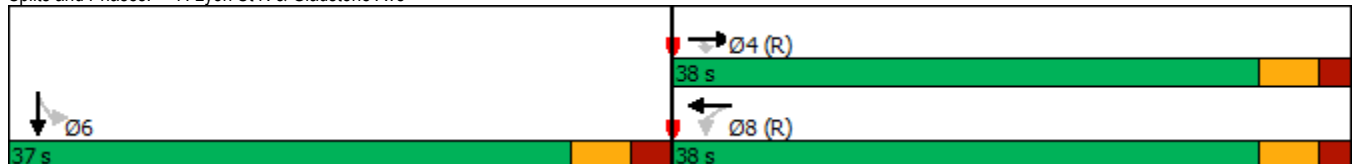

Lanes, Volumes, Timings
8: Kent St & Gladstone Ave

05/04/2023



Lane Group	EBL	EBT	EBR	WBL	WBT	WBR	NBL	NBT	NBR	SBL	SBT	SBR
Lane Configurations												
Traffic Volume (vph)	82	277	0	0	165	148	36	1698	97	0	0	0
Future Volume (vph)	82	277	0	0	165	148	36	1698	97	0	0	0
Satd. Flow (prot)	1662	1717	0	0	1552	0	1729	4790	0	0	0	0
Fit Permitted	0.404						0.950					
Satd. Flow (perm)	679	1717	0	0	1552	0	1444	4790	0	0	0	0
Satd. Flow (RTOR)					6			18				
Lane Group Flow (vph)	91	308	0	0	347	0	40	1995	0	0	0	0
Turn Type	Perm	NA			NA		Perm	NA				
Protected Phases		4			8			2				
Permitted Phases	4						2					
Minimum Split (s)	21.4	21.4			21.4		20.4	20.4				
Total Split (s)	30.0	30.0			30.0		45.0	45.0				
Total Split (%)	40.0%	40.0%			40.0%		60.0%	60.0%				
Yellow Time (s)	3.3	3.3			3.3		3.3	3.3				
All-Red Time (s)	2.1	2.1			2.1		2.1	2.1				
Lost Time Adjust (s)	0.0	0.0			0.0		0.0	0.0				
Total Lost Time (s)	5.4	5.4			5.4		5.4	5.4				
Lead/Lag												
Lead-Lag Optimize?												
Act Effct Green (s)	24.6	24.6			24.6		39.6	39.6				
Actuated g/C Ratio	0.33	0.33			0.33		0.53	0.53				
v/c Ratio	0.41	0.55			0.68		0.05	0.79				
Control Delay	27.1	25.9			29.2		1.5	3.1				
Queue Delay	0.0	0.0			0.0		0.0	0.0				
Total Delay	27.1	25.9			29.2		1.5	3.1				
LOS	C	C			C		A	A				
Approach Delay		26.1			29.2			3.1				
Approach LOS		C			C			A				
Queue Length 50th (m)	11.5	40.4			41.1		0.4	7.3				
Queue Length 95th (m)	25.7	65.2			68.8		m0.6	8.3				
Internal Link Dist (m)		165.0			168.8			216.0			203.6	
Turn Bay Length (m)	30.0						40.0					
Base Capacity (vph)	222	563			513		762	2537				
Starvation Cap Reductn	0	0			0		0	0				
Spillback Cap Reductn	0	0			0		0	0				
Storage Cap Reductn	0	0			0		0	0				
Reduced v/c Ratio	0.41	0.55			0.68		0.05	0.79				

Intersection Summary

Cycle Length: 75
 Actuated Cycle Length: 75
 Offset: 36 (48%), Referenced to phase 4:EBTL and 8:WBT, Start of Green
 Natural Cycle: 55
 Control Type: Pretimed
 Maximum v/c Ratio: 0.79
 Intersection Signal Delay: 9.7
 Intersection Capacity Utilization 79.8%
 Analysis Period (min) 15
 m Volume for 95th percentile queue is metered by upstream signal.

Intersection LOS: A
 ICU Level of Service D

Splits and Phases: 8: Kent St & Gladstone Ave

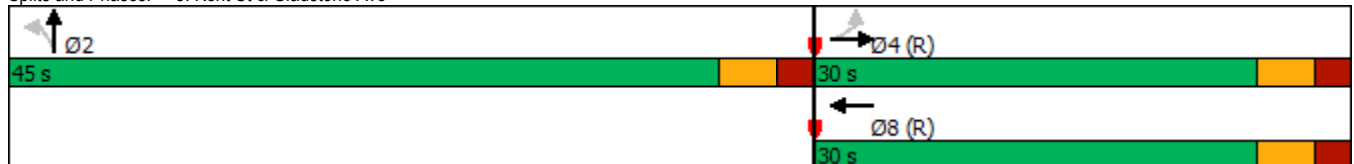

Lanes, Volumes, Timings
 9: Bank St & Chamberlain Ave/Isabella St

05/04/2023



Lane Group	EBL	EBT	EBR	WBL	WBT	WBR	NBL	NBT	NBR	SBL	SBT	SBR
Lane Configurations		↕↕	↗					↕↕			↕↕	
Traffic Volume (vph)	74	487	75	0	0	0	0	834	142	168	372	0
Future Volume (vph)	74	487	75	0	0	0	0	834	142	168	372	0
Satd. Flow (prot)	0	3225	1446	0	0	0	0	3154	0	0	3223	0
Fit Permitted		0.993									0.526	
Satd. Flow (perm)	0	3218	1358	0	0	0	0	3154	0	0	1721	0
Satd. Flow (RTOR)			134					27				
Lane Group Flow (vph)	0	623	83	0	0	0	0	1085	0	0	600	0
Turn Type	Perm	NA	Perm					NA		pm+pt	NA	
Protected Phases		4						2		5	6	
Permitted Phases	4		4							6		
Detector Phase	4	4	4					2		5	6	
Switch Phase												
Minimum Initial (s)	10.0	10.0	10.0					10.0		5.0	10.0	
Minimum Split (s)	26.2	26.2	26.2					23.1		11.1	23.1	
Total Split (s)	29.0	29.0	29.0					31.0		15.0	46.0	
Total Split (%)	38.7%	38.7%	38.7%					41.3%		20.0%	61.3%	
Yellow Time (s)	3.3	3.3	3.3					3.0		3.0	3.0	
All-Red Time (s)	2.9	2.9	2.9					3.1		3.1	3.1	
Lost Time Adjust (s)		0.0	0.0					0.0			0.0	
Total Lost Time (s)		6.2	6.2					6.1			6.1	
Lead/Lag												
Lead-Lag Optimize?												
Recall Mode	None	None	None					C-Max		None	C-Max	
Act Effct Green (s)		19.9	19.9					42.8			42.8	
Actuated g/C Ratio		0.27	0.27					0.57			0.57	
v/c Ratio		0.73	0.18					0.60			0.91dl	
Control Delay		30.2	2.2					12.6			12.2	
Queue Delay		0.0	0.0					0.0			0.0	
Total Delay		30.2	2.2					12.6			12.2	
LOS		C	A					B			B	
Approach Delay		26.9						12.6			12.2	
Approach LOS		C						B			B	
Queue Length 50th (m)		41.1	0.0					48.8			17.2	
Queue Length 95th (m)		56.1	3.4					71.1			m62.0	
Internal Link Dist (m)		296.0			233.4			215.6			90.2	
Turn Bay Length (m)			40.0									
Base Capacity (vph)		978	506					1809			981	
Starvation Cap Reductn		0	0					0			0	
Spillback Cap Reductn		0	0					0			0	
Storage Cap Reductn		0	0					0			0	
Reduced v/c Ratio		0.64	0.16					0.60			0.61	

Intersection Summary

Cycle Length: 75
 Actuated Cycle Length: 75
 Offset: 1 (1%), Referenced to phase 2:NBT and 6:SBTL, Start of Green
 Natural Cycle: 70
 Control Type: Actuated-Coordinated
 Maximum v/c Ratio: 0.73
 Intersection Signal Delay: 16.7
 Intersection Capacity Utilization 81.2%
 Analysis Period (min) 15
 m Volume for 95th percentile queue is metered by upstream signal.
 dl Defacto Left Lane. Recode with 1 though lane as a left lane.

Splits and Phases: 9: Bank St & Chamberlain Ave/Isabella St

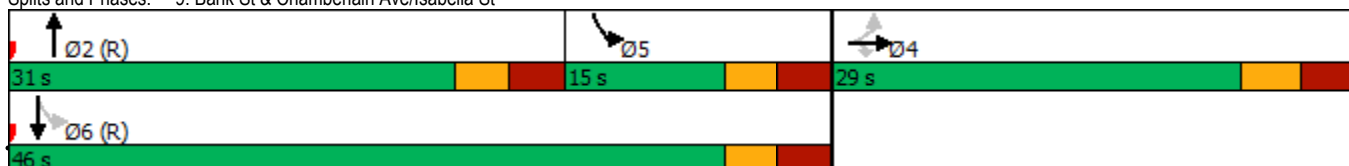

Existing AM

Lanes, Volumes, Timings
13: Bronson Ave & Catherine St

05/04/2023



Lane Group	EBL	EBT	EBR	WBL	WBT	WBR	NBL	NBT	NBR	SBL	SBT	SBR
Lane Configurations				↔↔↔	↔↔↔		↔↔	↔↔			↔↔	
Traffic Volume (vph)	0	0	0	492	479	346	519	1038	0	0	428	118
Future Volume (vph)	0	0	0	492	479	346	519	1038	0	0	428	118
Satd. Flow (prot)	0	0	0	1430	4136	0	1712	3390	0	0	3087	0
Fit Permitted				0.950	0.992		0.234					
Satd. Flow (perm)	0	0	0	1430	4136	0	422	3390	0	0	3087	0
Satd. Flow (RTOR)					78						30	
Lane Group Flow (vph)	0	0	0	372	1091	0	577	1153	0	0	607	0
Turn Type				Perm	NA		pm+pt	NA			NA	
Protected Phases					8		5	7			2	6
Permitted Phases				8			2					
Minimum Split (s)				28.3	28.3			23.8			23.8	
Total Split (s)				34.0	34.0			76.0			33.0	
Total Split (%)				30.9%	30.9%			69.1%			30.0%	
Yellow Time (s)				3.3	3.3			3.3			3.3	
All-Red Time (s)				3.0	3.0			3.5			3.5	
Lost Time Adjust (s)				0.0	0.0			0.0			0.0	
Total Lost Time (s)				6.3	6.3			6.8			6.8	
Lead/Lag												Lag
Lead-Lag Optimize?												Yes
Act Effct Green (s)				27.7	27.7		69.8	69.2			26.2	
Actuated g/C Ratio				0.25	0.25		0.63	0.63			0.24	
v/c Ratio				1.03	0.99		0.92	0.54			0.80	
Control Delay				97.6	64.1		39.1	12.6			46.6	
Queue Delay				0.0	0.0		0.0	0.0			0.0	
Total Delay				97.6	64.1		39.1	12.6			46.6	
LOS				F	E		D	B			D	
Approach Delay					72.6			21.5			46.6	
Approach LOS					E			C			D	
Queue Length 50th (m)				~100.0	85.3		62.9	67.5			61.7	
Queue Length 95th (m)				#166.0	#118.8		#123.4	84.3			82.7	
Internal Link Dist (m)		141.5			120.8			240.1			287.4	
Turn Bay Length (m)				80.0			45.0					
Base Capacity (vph)				360	1099		626	2132			758	
Starvation Cap Reductn				0	0		0	0			0	
Spillback Cap Reductn				0	0		0	0			0	
Storage Cap Reductn				0	0		0	0			0	
Reduced v/c Ratio				1.03	0.99		0.92	0.54			0.80	

Intersection Summary

Cycle Length: 110
 Actuated Cycle Length: 110
 Offset: 38 (35%), Referenced to phase 2:NBT and 6:SBT, Start of Green
 Natural Cycle: 100
 Control Type: Pretimed
 Maximum v/c Ratio: 1.03
 Intersection Signal Delay: 45.2
 Intersection LOS: D
 Intersection Capacity Utilization 85.7%
 ICU Level of Service E
 Analysis Period (min) 15
 ~ Volume exceeds capacity, queue is theoretically infinite.
 Queue shown is maximum after two cycles.
 # 95th percentile volume exceeds capacity, queue may be longer.
 Queue shown is maximum after two cycles.

Splits and Phases: 13: Bronson Ave & Catherine St

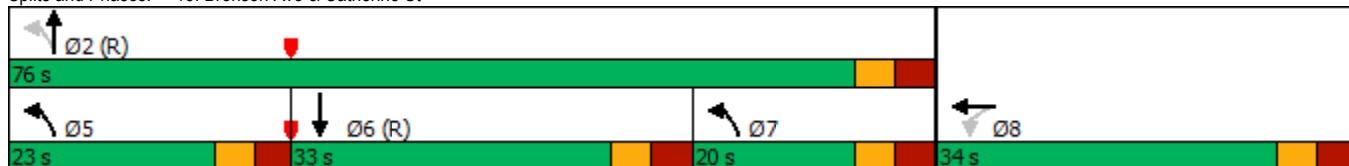

Lanes, Volumes, Timings
 13: Bronson Ave & Catherine St

05/04/2023

Lane Group	Ø5	Ø7
Lane Configurations		
Traffic Volume (vph)		
Future Volume (vph)		
Satd. Flow (prot)		
Fit Permitted		
Satd. Flow (perm)		
Satd. Flow (RTOR)		
Lane Group Flow (vph)		
Turn Type		
Protected Phases	5	7
Permitted Phases		
Minimum Split (s)	11.2	11.8
Total Split (s)	23.0	20.0
Total Split (%)	21%	18%
Yellow Time (s)	3.3	3.3
All-Red Time (s)	2.9	3.5
Lost Time Adjust (s)		
Total Lost Time (s)		
Lead/Lag	Lead	
Lead-Lag Optimize?	Yes	
Act Effct Green (s)		
Actuated g/C Ratio		
v/c Ratio		
Control Delay		
Queue Delay		
Total Delay		
LOS		
Approach Delay		
Approach LOS		
Queue Length 50th (m)		
Queue Length 95th (m)		
Internal Link Dist (m)		
Turn Bay Length (m)		
Base Capacity (vph)		
Starvation Cap Reductn		
Spillback Cap Reductn		
Storage Cap Reductn		
Reduced v/c Ratio		
Intersection Summary		

Lanes, Volumes, Timings

1: Hwy 417 WB On Ramp/Lyon St N & Catherine St

05/04/2023



Lane Group	EBL	EBT	EBR	WBL	WBT	WBR	NBL	NBT	NBR	SBL	SBT	SBR
Lane Configurations					↕↕↕						↕	↕
Traffic Volume (vph)	0	0	0	192	506	0	0	0	0	0	343	285
Future Volume (vph)	0	0	0	192	506	0	0	0	0	0	343	285
Satd. Flow (prot)	0	0	0	0	4736	0	0	0	0	0	1802	1532
Fit Permitted					0.986							
Satd. Flow (perm)	0	0	0	0	4703	0	0	0	0	0	1802	1490
Satd. Flow (RTOR)					131							73
Lane Group Flow (vph)	0	0	0	0	775	0	0	0	0	0	381	317
Turn Type				Perm	NA						NA	Perm
Protected Phases					8						6	
Permitted Phases				8								6
Minimum Split (s)				26.2	26.2						28.3	28.3
Total Split (s)				28.0	28.0						47.0	47.0
Total Split (%)				37.3%	37.3%						62.7%	62.7%
Yellow Time (s)				3.3	3.3						3.3	3.3
All-Red Time (s)				1.9	1.9						2.0	2.0
Lost Time Adjust (s)					0.0						0.0	0.0
Total Lost Time (s)					5.2						5.3	5.3
Lead/Lag												
Lead-Lag Optimize?												
Act Effct Green (s)					22.8						41.7	41.7
Actuated g/C Ratio					0.30						0.56	0.56
v/c Ratio					0.51						0.38	0.37
Control Delay					18.6						15.5	12.8
Queue Delay					0.0						0.0	0.0
Total Delay					18.6						15.5	12.8
LOS					B						B	B
Approach Delay					18.6						14.3	
Approach LOS					B						B	
Queue Length 50th (m)					11.4						48.3	33.7
Queue Length 95th (m)					17.8						72.0	56.8
Internal Link Dist (m)		271.6			163.9			117.8			52.8	
Turn Bay Length (m)												
Base Capacity (vph)					1520						1001	860
Starvation Cap Reductn					0						0	0
Spillback Cap Reductn					0						0	0
Storage Cap Reductn					0						0	0
Reduced v/c Ratio					0.51						0.38	0.37

Intersection Summary

Cycle Length: 75	
Actuated Cycle Length: 75	
Offset: 24 (32%), Referenced to phase 8:WBTL, Start of Green	
Natural Cycle: 55	
Control Type: Pretimed	
Maximum v/c Ratio: 0.51	
Intersection Signal Delay: 16.5	Intersection LOS: B
Intersection Capacity Utilization 46.5%	ICU Level of Service A
Analysis Period (min) 15	

Splits and Phases: 1: Hwy 417 WB On Ramp/Lyon St N & Catherine St



Lanes, Volumes, Timings

2: Hwy 417 EB Off Ramp/Chamberlain Ave/Kent St & Catherine St

05/04/2023



Lane Group	EBL	EBT	EBR	WBL	WBT	WBR	NBL	NBT	NBR	SBL	SBT	SBR
Lane Configurations					↕↕	↗		↕↕↕				
Traffic Volume (vph)	0	0	0	0	643	289	25	820	0	0	0	0
Future Volume (vph)	0	0	0	0	643	289	25	820	0	0	0	0
Satd. Flow (prot)	0	0	0	0	3180	1303	0	4863	0	0	0	0
Fit Permitted								0.999				
Satd. Flow (perm)	0	0	0	0	3180	1204	0	4861	0	0	0	0
Satd. Flow (RTOR)								70				
Lane Group Flow (vph)	0	0	0	0	746	289	0	939	0	0	0	0
Turn Type					NA	Perm	Perm	NA				
Protected Phases					8			2				
Permitted Phases						8		2				
Minimum Split (s)					22.8	22.8	22.5	22.5				
Total Split (s)					38.0	38.0	32.0	32.0				
Total Split (%)					50.7%	50.7%	42.7%	42.7%				
Yellow Time (s)					3.3	3.3	3.3	3.3				
All-Red Time (s)					2.5	2.5	2.5	2.5				
Lost Time Adjust (s)					0.0	0.0		0.0				
Total Lost Time (s)					5.8	5.8		5.8				
Lead/Lag												
Lead-Lag Optimize?												
Act Effct Green (s)					32.2	32.2		26.2				
Actuated g/C Ratio					0.43	0.43		0.35				
v/c Ratio					0.55	0.56		0.54				
Control Delay					15.1	17.1		19.4				
Queue Delay					0.0	0.0		0.0				
Total Delay					15.1	17.1		19.4				
LOS					B	B		B				
Approach Delay					15.7			19.4				
Approach LOS					B			B				
Queue Length 50th (m)					35.2	27.3		35.3				
Queue Length 95th (m)					m38.3	m31.7		46.9				
Internal Link Dist (m)		163.9			131.7			67.4			53.0	
Turn Bay Length (m)												
Base Capacity (vph)					1365	516		1743				
Starvation Cap Reductn					0	0		0				
Spillback Cap Reductn					0	0		21				
Storage Cap Reductn					0	0		0				
Reduced v/c Ratio					0.55	0.56		0.55				

Intersection Summary

Cycle Length: 75
 Actuated Cycle Length: 75
 Offset: 12 (16%), Referenced to phase 8:WBT, Start of Green
 Natural Cycle: 55
 Control Type: Pretimed
 Maximum v/c Ratio: 0.56
 Intersection Signal Delay: 17.4 Intersection LOS: B
 Intersection Capacity Utilization 51.7% ICU Level of Service A
 Analysis Period (min) 15
 m Volume for 95th percentile queue is metered by upstream signal.

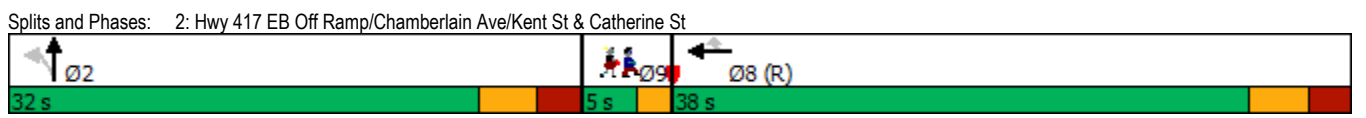

Lanes, Volumes, Timings

2: Hwy 417 EB Off Ramp/Chamberlain Ave/Kent St & Catherine St

05/04/2023

Lane Group	Ø9
Lane Configurations	
Traffic Volume (vph)	
Future Volume (vph)	
Satd. Flow (prot)	
Fit Permitted	
Satd. Flow (perm)	
Satd. Flow (RTOR)	
Lane Group Flow (vph)	
Turn Type	
Protected Phases	9
Permitted Phases	
Minimum Split (s)	5.0
Total Split (s)	5.0
Total Split (%)	7%
Yellow Time (s)	2.0
All-Red Time (s)	0.0
Lost Time Adjust (s)	
Total Lost Time (s)	
Lead/Lag	
Lead-Lag Optimize?	
Act Effct Green (s)	
Actuated g/C Ratio	
v/c Ratio	
Control Delay	
Queue Delay	
Total Delay	
LOS	
Approach Delay	
Approach LOS	
Queue Length 50th (m)	
Queue Length 95th (m)	
Internal Link Dist (m)	
Turn Bay Length (m)	
Base Capacity (vph)	
Starvation Cap Reductn	
Spillback Cap Reductn	
Storage Cap Reductn	
Reduced v/c Ratio	
Intersection Summary	

Lanes, Volumes, Timings
3: Bank St & Catherine St

05/04/2023



Lane Group	EBL	EBT	EBR	WBL	WBT	WBR	NBL	NBT	NBR	SBL	SBT	SBR
Lane Configurations					↕↕↕			↕↕			↕↕	
Traffic Volume (vph)	0	0	0	232	600	156	184	328	0	0	689	126
Future Volume (vph)	0	0	0	232	600	156	184	328	0	0	689	126
Satd. Flow (prot)	0	0	0	0	4598	0	0	3259	0	0	3116	0
Fit Permitted					0.988			0.551				
Satd. Flow (perm)	0	0	0	0	4516	0	0	1828	0	0	3116	0
Satd. Flow (RTOR)					48			28			28	
Lane Group Flow (vph)	0	0	0	0	1098	0	0	568	0	0	906	0
Turn Type				Perm	NA		pm+pt	NA			NA	
Protected Phases					8		9	2			6	
Permitted Phases				8			2					
Minimum Split (s)				18.6	18.6		10.4	16.4			16.4	
Total Split (s)				24.0	24.0		14.0	41.0			27.0	
Total Split (%)				32.0%	32.0%		18.7%	54.7%			36.0%	
Yellow Time (s)				3.3	3.3		3.3	3.3			3.3	
All-Red Time (s)				2.3	2.3		2.1	2.1			2.1	
Lost Time Adjust (s)					0.0			0.0			0.0	
Total Lost Time (s)					5.6			5.4			5.4	
Lead/Lag				Lag	Lag		Lag	Lag			Lag	
Lead-Lag Optimize?				Yes	Yes		Yes	Yes			Yes	
Act Effct Green (s)					18.4			35.6			21.6	
Actuated g/C Ratio					0.25			0.47			0.29	
v/c Ratio					0.96			0.55			0.99	
Control Delay					46.8			12.3			54.8	
Queue Delay					0.1			0.0			25.0	
Total Delay					46.9			12.3			79.7	
LOS					D			B			E	
Approach Delay					46.9			12.3			79.7	
Approach LOS					D			B			E	
Queue Length 50th (m)					53.9			15.8			65.0	
Queue Length 95th (m)					#81.5			20.1			#104.3	
Internal Link Dist (m)		131.7			201.7			90.2			52.9	
Turn Bay Length (m)												
Base Capacity (vph)					1144			1031			917	
Starvation Cap Reductn					0			0			0	
Spillback Cap Reductn					1			0			69	
Storage Cap Reductn					0			0			0	
Reduced v/c Ratio					0.96			0.55			1.07	

Intersection Summary
 Cycle Length: 75
 Actuated Cycle Length: 75
 Offset: 50 (67%), Referenced to phase 2:NBT and 6:SBT, Start of Green
 Natural Cycle: 80
 Control Type: Pretimed
 Maximum v/c Ratio: 0.99
 Intersection Signal Delay: 50.8
 Intersection Capacity Utilization 78.2%
 Analysis Period (min) 15
 # 95th percentile volume exceeds capacity, queue may be longer.
 Queue shown is maximum after two cycles.

Splits and Phases: 3: Bank St & Catherine St

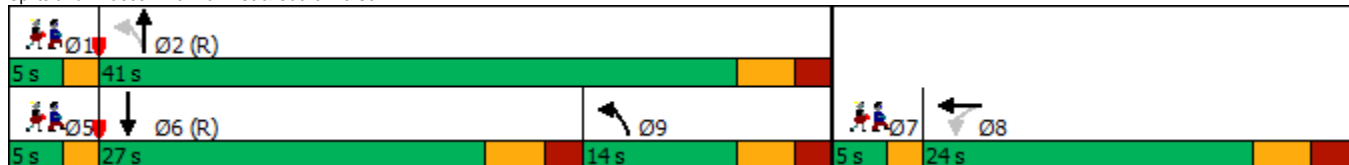

Lanes, Volumes, Timings
 3: Bank St & Catherine St

05/04/2023

Lane Group	Ø1	Ø5	Ø7
Lane Configurations			
Traffic Volume (vph)			
Future Volume (vph)			
Satd. Flow (prot)			
Fit Permitted			
Satd. Flow (perm)			
Satd. Flow (RTOR)			
Lane Group Flow (vph)			
Turn Type			
Protected Phases	1	5	7
Permitted Phases			
Minimum Split (s)	5.0	5.0	5.0
Total Split (s)	5.0	5.0	5.0
Total Split (%)	7%	7%	7%
Yellow Time (s)	2.0	2.0	2.0
All-Red Time (s)	0.0	0.0	0.0
Lost Time Adjust (s)			
Total Lost Time (s)			
Lead/Lag	Lead	Lead	Lead
Lead-Lag Optimize?	Yes	Yes	Yes
Act Effct Green (s)			
Actuated g/C Ratio			
v/c Ratio			
Control Delay			
Queue Delay			
Total Delay			
LOS			
Approach Delay			
Approach LOS			
Queue Length 50th (m)			
Queue Length 95th (m)			
Internal Link Dist (m)			
Turn Bay Length (m)			
Base Capacity (vph)			
Starvation Cap Reductn			
Spillback Cap Reductn			
Storage Cap Reductn			
Reduced v/c Ratio			
Intersection Summary			

Lanes, Volumes, Timings
4: Percy St & Catherine St

05/04/2023



Lane Group	EBL	EBT	EBR	WBL	WBT	WBR	NBL	NBT	NBR	SBL	SBT	SBR
Lane Configurations					↑↑↑						↓	
Traffic Volume (vph)	0	0	0	153	684	0	0	0	0	0	121	39
Future Volume (vph)	0	0	0	153	684	0	0	0	0	0	121	39
Satd. Flow (prot)	0	0	0	0	4819	0	0	0	0	0	1726	0
Fit Permitted					0.991							
Satd. Flow (perm)	0	0	0	0	4800	0	0	0	0	0	1726	0
Satd. Flow (RTOR)					160							
Lane Group Flow (vph)	0	0	0	0	930	0	0	0	0	0	177	0
Turn Type				Perm	NA							NA
Protected Phases					8							6
Permitted Phases					8							
Detector Phase					8	8						6
Switch Phase												
Minimum Initial (s)				10.0	10.0							10.0
Minimum Split (s)				26.5	26.5							23.4
Total Split (s)				34.0	34.0							24.0
Total Split (%)				37.8%	37.8%							26.7%
Yellow Time (s)				3.3	3.3							3.3
All-Red Time (s)				2.2	2.2							2.1
Lost Time Adjust (s)					0.0							0.0
Total Lost Time (s)					5.5							5.4
Lead/Lag				Lag	Lag							
Lead-Lag Optimize?				Yes	Yes							
Recall Mode				None	None							Max
Act Effct Green (s)					15.8							18.7
Actuated g/C Ratio					0.35							0.41
v/c Ratio					0.52							0.25
Control Delay					10.6							11.1
Queue Delay					0.0							0.0
Total Delay					10.6							11.1
LOS					B							B
Approach Delay					10.6							11.1
Approach LOS					B							B
Queue Length 50th (m)					16.6							8.6
Queue Length 95th (m)					24.8							22.0
Internal Link Dist (m)		71.6			271.6			106.7				288.0
Turn Bay Length (m)												
Base Capacity (vph)					3082							709
Starvation Cap Reductn					0							0
Spillback Cap Reductn					0							0
Storage Cap Reductn					0							0
Reduced v/c Ratio					0.30							0.25

Intersection Summary
 Cycle Length: 90
 Actuated Cycle Length: 45.5
 Natural Cycle: 65
 Control Type: Semi Act-Uncoord
 Maximum v/c Ratio: 0.52
 Intersection Signal Delay: 10.6
 Intersection Capacity Utilization 43.5%
 Analysis Period (min) 15
 Intersection LOS: B
 ICU Level of Service A

Splits and Phases: 4: Percy St & Catherine St

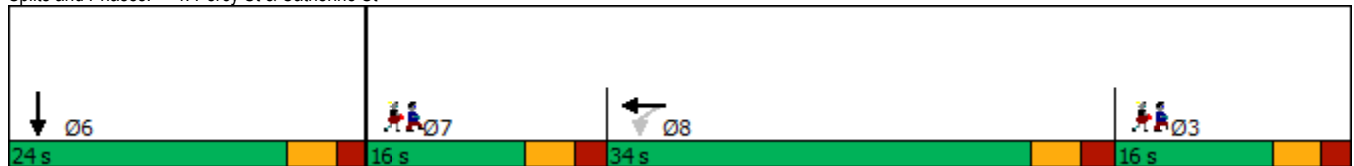

Lanes, Volumes, Timings
 4: Percy St & Catherine St

05/04/2023

Lane Group	Ø3	Ø7
Lane Configurations		
Traffic Volume (vph)		
Future Volume (vph)		
Satd. Flow (prot)		
Fit Permitted		
Satd. Flow (perm)		
Satd. Flow (RTOR)		
Lane Group Flow (vph)		
Turn Type		
Protected Phases	3	7
Permitted Phases		
Detector Phase		
Switch Phase		
Minimum Initial (s)	1.0	1.0
Minimum Split (s)	6.4	6.4
Total Split (s)	16.0	16.0
Total Split (%)	18%	18%
Yellow Time (s)	3.3	3.3
All-Red Time (s)	2.1	2.1
Lost Time Adjust (s)		
Total Lost Time (s)		
Lead/Lag		Lead
Lead-Lag Optimize?		Yes
Recall Mode	None	None
Act Effct Green (s)		
Actuated g/C Ratio		
v/c Ratio		
Control Delay		
Queue Delay		
Total Delay		
LOS		
Approach Delay		
Approach LOS		
Queue Length 50th (m)		
Queue Length 95th (m)		
Internal Link Dist (m)		
Turn Bay Length (m)		
Base Capacity (vph)		
Starvation Cap Reductn		
Spillback Cap Reductn		
Storage Cap Reductn		
Reduced v/c Ratio		
Intersection Summary		

Lanes, Volumes, Timings
6: Kent St & Arlington Ave

05/04/2023



Lane Group	EBL	EBT	EBR	WBL	WBT	WBR	NBL	NBT	NBR	SBL	SBT	SBR
Lane Configurations		↕			↕			↕↕↕				
Traffic Volume (vph)	12	61	0	0	18	63	22	1021	93	0	0	0
Future Volume (vph)	12	61	0	0	18	63	22	1021	93	0	0	0
Satd. Flow (prot)	0	1805	0	0	1561	0	0	4823	0	0	0	0
Fit Permitted		0.958						0.999				
Satd. Flow (perm)	0	1734	0	0	1561	0	0	4821	0	0	0	0
Satd. Flow (RTOR)					58			31				
Lane Group Flow (vph)	0	81	0	0	90	0	0	1261	0	0	0	0
Turn Type	Perm	NA			NA		Perm	NA				
Protected Phases		4			8			2				
Permitted Phases	4						2					
Minimum Split (s)	27.3	27.3			27.3		32.3	32.3				
Total Split (s)	28.0	28.0			28.0		47.0	47.0				
Total Split (%)	37.3%	37.3%			37.3%		62.7%	62.7%				
Yellow Time (s)	3.3	3.3			3.3		3.3	3.3				
All-Red Time (s)	2.0	2.0			2.0		2.0	2.0				
Lost Time Adjust (s)		0.0			0.0			0.0				
Total Lost Time (s)		5.3			5.3			5.3				
Lead/Lag												
Lead-Lag Optimize?												
Act Effct Green (s)		22.7			22.7			41.7				
Actuated g/C Ratio		0.30			0.30			0.56				
v/c Ratio		0.15			0.18			0.47				
Control Delay		28.8			9.8			6.4				
Queue Delay		0.0			0.0			0.3				
Total Delay		28.8			9.8			6.6				
LOS		C			A			A				
Approach Delay		28.8			9.8			6.6				
Approach LOS		C			A			A				
Queue Length 50th (m)		10.4			1.3			20.1				
Queue Length 95th (m)		m19.9			m5.6			23.9				
Internal Link Dist (m)		164.0			143.1			53.0			216.0	
Turn Bay Length (m)												
Base Capacity (vph)		524			512			2694				
Starvation Cap Reductn		0			0			659				
Spillback Cap Reductn		0			0			0				
Storage Cap Reductn		0			0			0				
Reduced v/c Ratio		0.15			0.18			0.62				

Intersection Summary
 Cycle Length: 75
 Actuated Cycle Length: 75
 Offset: 50 (67%), Referenced to phase 2:NBT, Start of Green
 Natural Cycle: 60
 Control Type: Pretimed
 Maximum v/c Ratio: 0.47
 Intersection Signal Delay: 8.1
 Intersection Capacity Utilization 53.2%
 Analysis Period (min) 15
 m Volume for 95th percentile queue is metered by upstream signal.

Splits and Phases: 6: Kent St & Arlington Ave



Lanes, Volumes, Timings
7: Lyon St N & Gladstone Ave

05/04/2023



Lane Group	EBL	EBT	EBR	WBL	WBT	WBR	NBL	NBT	NBR	SBL	SBT	SBR
Lane Configurations		↑	↗	↖	↑						↕	↘
Traffic Volume (vph)	0	247	52	28	314	0	0	0	0	86	499	138
Future Volume (vph)	0	247	52	28	314	0	0	0	0	86	499	138
Satd. Flow (prot)	0	1784	1547	1729	1784	0	0	0	0	0	3252	0
Fit Permitted				0.552							0.994	
Satd. Flow (perm)	0	1784	1408	961	1784	0	0	0	0	0	3238	0
Satd. Flow (RTOR)			58								46	
Lane Group Flow (vph)	0	274	58	31	349	0	0	0	0	0	803	0
Turn Type		NA	Perm	Perm	NA					Perm	NA	
Protected Phases		4			8							6
Permitted Phases			4	8						6		
Minimum Split (s)		17.2	17.2	17.2	17.2					22.6	22.6	
Total Split (s)		39.0	39.0	39.0	39.0					36.0	36.0	
Total Split (%)		52.0%	52.0%	52.0%	52.0%					48.0%	48.0%	
Yellow Time (s)		3.3	3.3	3.3	3.3					3.3	3.3	
All-Red Time (s)		1.9	1.9	1.9	1.9					2.3	2.3	
Lost Time Adjust (s)		0.0	0.0	0.0	0.0						0.0	
Total Lost Time (s)		5.2	5.2	5.2	5.2						5.6	
Lead/Lag												
Lead-Lag Optimize?												
Act Effct Green (s)		33.8	33.8	33.8	33.8						30.4	
Actuated g/C Ratio		0.45	0.45	0.45	0.45						0.41	
v/c Ratio		0.34	0.09	0.07	0.43						0.60	
Control Delay		14.9	4.0	6.7	11.3						18.7	
Queue Delay		0.0	0.0	0.0	0.0						0.0	
Total Delay		14.9	4.0	6.7	11.3						18.7	
LOS		B	A	A	B						B	
Approach Delay		13.0			10.9						18.7	
Approach LOS		B			B						B	
Queue Length 50th (m)		24.0	0.0	1.4	39.4						42.7	
Queue Length 95th (m)		40.5	5.7	m2.7	52.4						59.8	
Internal Link Dist (m)		254.8			165.0			215.6			214.3	
Turn Bay Length (m)				25.0								
Base Capacity (vph)		803	666	433	803						1339	
Starvation Cap Reductn		0	0	0	0						0	
Spillback Cap Reductn		0	0	0	0						0	
Storage Cap Reductn		0	0	0	0						0	
Reduced v/c Ratio		0.34	0.09	0.07	0.43						0.60	

Intersection Summary
 Cycle Length: 75
 Actuated Cycle Length: 75
 Offset: 45 (60%), Referenced to phase 4:EBT and 8:WBTL, Start of Green
 Natural Cycle: 40
 Control Type: Pretimed
 Maximum v/c Ratio: 0.60
 Intersection Signal Delay: 15.5
 Intersection LOS: B
 Intersection Capacity Utilization 66.9%
 ICU Level of Service C
 Analysis Period (min) 15
 m Volume for 95th percentile queue is metered by upstream signal.

Splits and Phases: 7: Lyon St N & Gladstone Ave

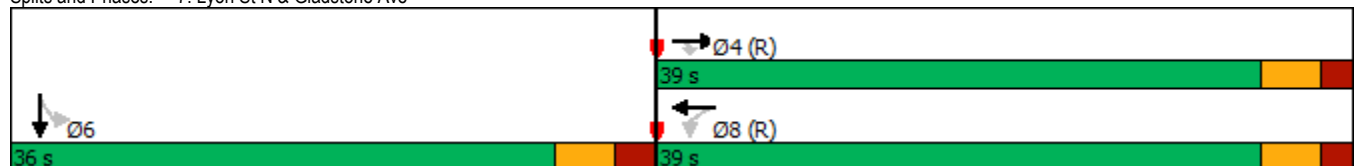

Lanes, Volumes, Timings
8: Kent St & Gladstone Ave

05/04/2023



Lane Group	EBL	EBT	EBR	WBL	WBT	WBR	NBL	NBT	NBR	SBL	SBT	SBR
Lane Configurations												
Traffic Volume (vph)	75	450	0	0	324	75	67	882	131	0	0	0
Future Volume (vph)	75	450	0	0	324	75	67	882	131	0	0	0
Satd. Flow (prot)	1729	1767	0	0	1719	0	1729	4618	0	0	0	0
Fit Permitted	0.392						0.950					
Satd. Flow (perm)	695	1767	0	0	1719	0	1522	4618	0	0	0	0
Satd. Flow (RTOR)					21			44				
Lane Group Flow (vph)	83	500	0	0	443	0	74	1126	0	0	0	0
Turn Type	Perm	NA			NA		Perm	NA				
Protected Phases		4			8			2				
Permitted Phases	4						2					
Minimum Split (s)	21.4	21.4			21.4		20.4	20.4				
Total Split (s)	40.0	40.0			40.0		35.0	35.0				
Total Split (%)	53.3%	53.3%			53.3%		46.7%	46.7%				
Yellow Time (s)	3.3	3.3			3.3		3.3	3.3				
All-Red Time (s)	2.1	2.1			2.1		2.1	2.1				
Lost Time Adjust (s)	0.0	0.0			0.0		0.0	0.0				
Total Lost Time (s)	5.4	5.4			5.4		5.4	5.4				
Lead/Lag												
Lead-Lag Optimize?												
Act Effct Green (s)	34.6	34.6			34.6		29.6	29.6				
Actuated g/C Ratio	0.46	0.46			0.46		0.39	0.39				
v/c Ratio	0.26	0.61			0.55		0.12	0.61				
Control Delay	23.4	28.7			17.1		4.6	5.2				
Queue Delay	0.0	0.0			0.0		0.0	0.0				
Total Delay	23.4	28.7			17.1		4.6	5.2				
LOS	C	C			B		A	A				
Approach Delay		27.9			17.1			5.1				
Approach LOS		C			B			A				
Queue Length 50th (m)	8.9	66.5			40.9		1.5	7.0				
Queue Length 95th (m)	m19.7	97.8			66.8		3.3	9.0				
Internal Link Dist (m)		165.0			168.8			216.0			203.6	
Turn Bay Length (m)	30.0						40.0					
Base Capacity (vph)	320	815			804		600	1849				
Starvation Cap Reductn	0	0			0		0	0				
Spillback Cap Reductn	0	0			0		0	0				
Storage Cap Reductn	0	0			0		0	0				
Reduced v/c Ratio	0.26	0.61			0.55		0.12	0.61				

Intersection Summary

Cycle Length: 75
 Actuated Cycle Length: 75
 Offset: 23 (31%), Referenced to phase 4:EBTL and 8:WBT, Start of Green
 Natural Cycle: 45
 Control Type: Pretimed
 Maximum v/c Ratio: 0.61
 Intersection Signal Delay: 13.5
 Intersection Capacity Utilization 66.9%
 Analysis Period (min) 15
 m Volume for 95th percentile queue is metered by upstream signal.

Intersection LOS: B
 ICU Level of Service C

Splits and Phases: 8: Kent St & Gladstone Ave

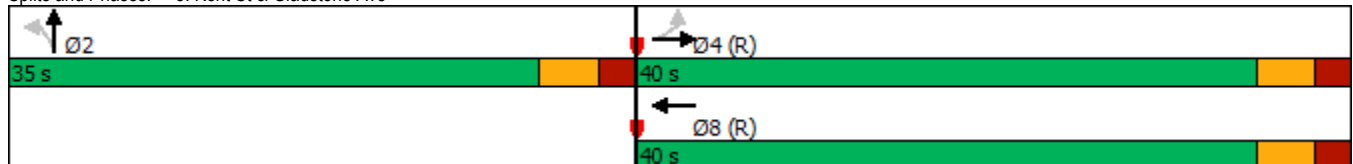

Lanes, Volumes, Timings
 9: Bank St & Chamberlain Ave/Isabella St

05/04/2023



Lane Group	EBL	EBT	EBR	WBL	WBT	WBR	NBL	NBT	NBR	SBL	SBT	SBR
Lane Configurations		↕↕	↗					↕↕			↕↕	
Traffic Volume (vph)	53	590	120	0	0	0	0	448	91	175	720	0
Future Volume (vph)	53	590	120	0	0	0	0	448	91	175	720	0
Satd. Flow (prot)	0	3347	1547	0	0	0	0	3136	0	0	3324	0
Fit Permitted		0.996									0.700	
Satd. Flow (perm)	0	3343	1403	0	0	0	0	3136	0	0	2309	0
Satd. Flow (RTOR)			134					33				
Lane Group Flow (vph)	0	715	133	0	0	0	0	599	0	0	994	0
Turn Type	Perm	NA	Perm					NA		pm+pt	NA	
Protected Phases		4						2		5	6	
Permitted Phases	4		4							6		
Detector Phase	4	4	4					2		5	6	
Switch Phase												
Minimum Initial (s)	10.0	10.0	10.0					10.0		5.0	10.0	
Minimum Split (s)	26.2	26.2	26.2					23.1		11.1	23.1	
Total Split (s)	31.0	31.0	31.0					30.0		14.0	44.0	
Total Split (%)	41.3%	41.3%	41.3%					40.0%		18.7%	58.7%	
Yellow Time (s)	3.3	3.3	3.3					3.0		3.0	3.0	
All-Red Time (s)	2.9	2.9	2.9					3.1		3.1	3.1	
Lost Time Adjust (s)		0.0	0.0					0.0			0.0	
Total Lost Time (s)		6.2	6.2					6.1			6.1	
Lead/Lag												
Lead-Lag Optimize?												
Recall Mode	None	None	None					C-Max		None	C-Max	
Act Effct Green (s)		22.1	22.1					40.6			40.6	
Actuated g/C Ratio		0.29	0.29					0.54			0.54	
v/c Ratio		0.73	0.26					0.35			0.79	
Control Delay		28.2	5.1					10.4			14.1	
Queue Delay		0.0	0.0					0.0			2.1	
Total Delay		28.2	5.1					10.4			16.3	
LOS		C	A					B			B	
Approach Delay		24.6						10.4			16.3	
Approach LOS		C						B			B	
Queue Length 50th (m)		46.2	0.0					22.7			82.3	
Queue Length 95th (m)		62.2	10.5					34.6			m84.1	
Internal Link Dist (m)		296.0			233.4			215.6			90.2	
Turn Bay Length (m)			40.0									
Base Capacity (vph)		1105	553					1714			1251	
Starvation Cap Reductn		0	0					0			139	
Spillback Cap Reductn		0	0					0			0	
Storage Cap Reductn		0	0					0			0	
Reduced v/c Ratio		0.65	0.24					0.35			0.89	

Intersection Summary

Cycle Length: 75
 Actuated Cycle Length: 75
 Offset: 60 (80%), Referenced to phase 2:NBT and 6:SBTL, Start of Green
 Natural Cycle: 65
 Control Type: Actuated-Coordinated
 Maximum v/c Ratio: 0.79
 Intersection Signal Delay: 17.7
 Intersection Capacity Utilization 81.3%
 Analysis Period (min) 15
 Intersection LOS: B
 ICU Level of Service D
 m Volume for 95th percentile queue is metered by upstream signal.

Splits and Phases: 9: Bank St & Chamberlain Ave/Isabella St

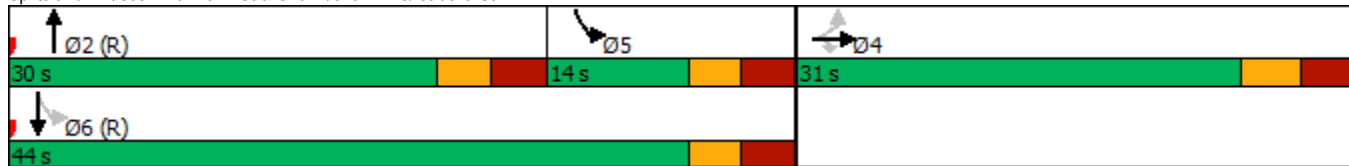

Lanes, Volumes, Timings
13: Bronson Ave & Catherine St

05/04/2023



Lane Group	EBL	EBT	EBR	WBL	WBT	WBR	NBL	NBT	NBR	SBL	SBT	SBR
Lane Configurations				↔↔↔	↔↔↔		↔↔	↔↔			↔↔	
Traffic Volume (vph)	0	0	0	690	573	270	292	762	0	0	801	165
Future Volume (vph)	0	0	0	690	573	270	292	762	0	0	801	165
Satd. Flow (prot)	0	0	0	1458	4279	0	1679	3390	0	0	3261	0
Fit Permitted				0.950	0.987		0.097					
Satd. Flow (perm)	0	0	0	1458	4279	0	171	3390	0	0	3261	0
Satd. Flow (RTOR)					76						27	
Lane Group Flow (vph)	0	0	0	430	1274	0	324	847	0	0	1073	0
Turn Type				Perm	NA		pm+pt	NA			NA	
Protected Phases					8		5	2				6
Permitted Phases				8			2					
Minimum Split (s)				28.3	28.3		11.2	23.8			23.8	
Total Split (s)				33.0	33.0		25.0	67.0			42.0	
Total Split (%)				33.0%	33.0%		25.0%	67.0%			42.0%	
Yellow Time (s)				3.3	3.3		3.3	3.3			3.3	
All-Red Time (s)				3.0	3.0		2.9	3.5			3.5	
Lost Time Adjust (s)				0.0	0.0		0.0	0.0			0.0	
Total Lost Time (s)				6.3	6.3		6.2	6.8			6.8	
Lead/Lag							Lead				Lag	
Lead-Lag Optimize?							Yes				Yes	
Act Effct Green (s)				26.7	26.7		60.8	60.2			35.2	
Actuated g/C Ratio				0.27	0.27		0.61	0.60			0.35	
v/c Ratio				1.11	1.06		0.84	0.42			0.92	
Control Delay				113.2	78.8		44.0	11.3			44.2	
Queue Delay				0.0	0.0		0.0	0.0			0.0	
Total Delay				113.2	78.8		44.0	11.3			44.2	
LOS				F	E		D	B			D	
Approach Delay					87.5			20.4			44.2	
Approach LOS					F			C			D	
Queue Length 50th (m)				~111.0	~101.7		45.0	42.4			101.6	
Queue Length 95th (m)				#177.9	#132.0		#90.1	54.9			#142.1	
Internal Link Dist (m)		141.5			120.8			240.1			287.4	
Turn Bay Length (m)				80.0			45.0					
Base Capacity (vph)				389	1198		387	2040			1165	
Starvation Cap Reductn				0	0		0	0			0	
Spillback Cap Reductn				0	0		0	0			0	
Storage Cap Reductn				0	0		0	0			0	
Reduced v/c Ratio				1.11	1.06		0.84	0.42			0.92	

Intersection Summary

Cycle Length: 100
 Actuated Cycle Length: 100
 Offset: 60 (60%), Referenced to phase 2:NBT and 6:SBT, Start of Green
 Natural Cycle: 90
 Control Type: Pretimed
 Maximum v/c Ratio: 1.11
 Intersection Signal Delay: 55.8 Intersection LOS: E
 Intersection Capacity Utilization 87.7% ICU Level of Service E
 Analysis Period (min) 15
 ~ Volume exceeds capacity, queue is theoretically infinite.
 Queue shown is maximum after two cycles.
 # 95th percentile volume exceeds capacity, queue may be longer.
 Queue shown is maximum after two cycles.

Splits and Phases: 13: Bronson Ave & Catherine St

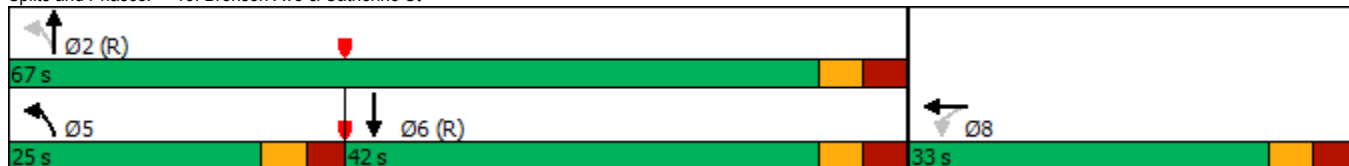

Intersection												
Int Delay, s/veh	2.1											
Movement	EBL	EBT	EBR	WBL	WBT	WBR	NBL	NBT	NBR	SBL	SBT	SBR
Lane Configurations		↕			↕						↕↔	
Traffic Vol, veh/h	0	18	0	11	12	0	0	0	0	44	324	9
Future Vol, veh/h	0	18	0	11	12	0	0	0	0	44	324	9
Conflicting Peds, #/hr	32	0	15	15	0	32	9	0	10	10	0	9
Sign Control	Stop	Stop	Stop	Stop	Stop	Stop	Free	Free	Free	Free	Free	Free
RT Channelized	-	-	None	-	-	None	-	-	None	-	-	None
Storage Length	-	-	-	-	-	-	-	-	-	-	-	-
Veh in Median Storage, #	-	0	-	-	0	-	-	-	-	-	0	-
Grade, %	-	0	-	-	0	-	-	0	-	-	0	-
Peak Hour Factor	90	90	90	90	90	90	90	90	90	90	90	90
Heavy Vehicles, %	0	6	0	9	0	0	0	0	0	5	1	11
Mvmt Flow	0	20	0	12	13	0	0	0	0	49	360	10
Major/Minor	Minor2		Minor1			Major2						
Conflicting Flow All	-	482	209	313	487	-	-	10	0	0	-	-
Stage 1	-	472	-	10	10	-	-	-	-	-	-	-
Stage 2	-	10	-	303	477	-	-	-	-	-	-	-
Critical Hdwy	-	6.62	6.9	7.68	6.5	-	-	4.2	-	-	-	-
Critical Hdwy Stg 1	-	5.62	-	-	-	-	-	-	-	-	-	-
Critical Hdwy Stg 2	-	-	-	6.68	5.5	-	-	-	-	-	-	-
Follow-up Hdwy	-	4.06	3.3	3.59	4	-	-	2.25	-	-	-	-
Pot Cap-1 Maneuver	0	474	803	599	484	0	-	1586	-	-	-	-
Stage 1	0	547	-	-	-	0	-	-	-	-	-	-
Stage 2	0	-	-	662	559	0	-	-	-	-	-	-
Platoon blocked, %	-	-	-	-	-	-	-	-	-	-	-	-
Mov Cap-1 Maneuver	-	448	796	556	457	-	-	1571	-	-	-	-
Mov Cap-2 Maneuver	-	448	-	556	457	-	-	-	-	-	-	-
Stage 1	-	521	-	-	-	-	-	-	-	-	-	-
Stage 2	-	-	-	612	533	-	-	-	-	-	-	-
Approach	EB		WB			SB						
HCM Control Delay, s	13.4		12.6			0.9						
HCM LOS	B		B									
Minor Lane/Major Mvmt	EBLn1	WBLn1	SBL	SBT	SBR							
Capacity (veh/h)	448	500	1571	-	-							
HCM Lane V/C Ratio	0.045	0.051	0.031	-	-							
HCM Control Delay (s)	13.4	12.6	7.4	0.1	-							
HCM Lane LOS	B	B	A	A	-							
HCM 95th %tile Q(veh)	0.1	0.2	0.1	-	-							

Intersection						
Int Delay, s/veh	3.2					
Movement	EBL	EBR	NBL	NBT	SBT	SBR
Lane Configurations	↔			↕↕	↕↕	
Traffic Vol, veh/h	21	124	86	687	372	22
Future Vol, veh/h	21	124	86	687	372	22
Conflicting Peds, #/hr	0	0	111	0	0	111
Sign Control	Stop	Stop	Free	Free	Free	Free
RT Channelized	-	None	-	None	-	None
Storage Length	0	-	-	-	-	-
Veh in Median Storage, #	0	-	-	0	0	-
Grade, %	0	-	-	0	0	-
Peak Hour Factor	90	90	90	90	90	90
Heavy Vehicles, %	0	3	2	5	8	5
Mvmt Flow	23	138	96	763	413	24
Major/Minor	Minor2	Major1		Major2		
Conflicting Flow All	1110	330	548	0	-	0
Stage 1	536	-	-	-	-	-
Stage 2	574	-	-	-	-	-
Critical Hdwy	6.8	6.96	4.14	-	-	-
Critical Hdwy Stg 1	5.8	-	-	-	-	-
Critical Hdwy Stg 2	5.8	-	-	-	-	-
Follow-up Hdwy	3.5	3.33	2.22	-	-	-
Pot Cap-1 Maneuver	207	663	1018	-	-	-
Stage 1	556	-	-	-	-	-
Stage 2	532	-	-	-	-	-
Platoon blocked, %				-	-	-
Mov Cap-1 Maneuver	136	595	914	-	-	-
Mov Cap-2 Maneuver	136	-	-	-	-	-
Stage 1	408	-	-	-	-	-
Stage 2	477	-	-	-	-	-
Approach	EB	NB		SB		
HCM Control Delay, s	19.9	1.7		0		
HCM LOS	C					
Minor Lane/Major Mvmt	NBL	NBT	EBLn1	SBT	SBR	
Capacity (veh/h)	914	-	400	-	-	
HCM Lane V/C Ratio	0.105	-	0.403	-	-	
HCM Control Delay (s)	9.4	0.7	19.9	-	-	
HCM Lane LOS	A	A	C	-	-	
HCM 95th %tile Q(veh)	0.3	-	1.9	-	-	

Intersection												
Int Delay, s/veh	2.2											
Movement	EBL	EBT	EBR	WBL	WBT	WBR	NBL	NBT	NBR	SBL	SBT	SBR
Lane Configurations		↔			↔						↔↔	
Traffic Vol, veh/h	0	19	2	8	37	0	0	0	0	43	564	13
Future Vol, veh/h	0	19	2	8	37	0	0	0	0	43	564	13
Conflicting Peds, #/hr	20	0	8	8	0	20	19	0	3	3	0	19
Sign Control	Stop	Stop	Stop	Stop	Stop	Stop	Free	Free	Free	Free	Free	Free
RT Channelized	-	-	None	-	-	None	-	-	None	-	-	None
Storage Length	-	-	-	-	-	-	-	-	-	-	-	-
Veh in Median Storage, #	-	0	-	-	0	-	-	-	-	-	0	-
Grade, %	-	0	-	-	0	-	-	0	-	-	0	-
Peak Hour Factor	90	90	90	90	90	90	90	90	90	90	90	90
Heavy Vehicles, %	0	5	0	0	5	0	0	0	0	0	0	0
Mvmt Flow	0	21	2	9	41	0	0	0	0	48	627	14
Major/Minor	Minor2		Minor1				Major2					
Conflicting Flow All	-	752	348	431	759	-	-	-	3	0	0	
Stage 1	-	749	-	3	3	-	-	-	-	-	-	
Stage 2	-	3	-	428	756	-	-	-	-	-	-	
Critical Hdwy	-	6.6	6.9	7.5	6.6	-	-	-	4.1	-	-	
Critical Hdwy Stg 1	-	5.6	-	-	-	-	-	-	-	-	-	
Critical Hdwy Stg 2	-	-	-	6.5	5.6	-	-	-	-	-	-	
Follow-up Hdwy	-	4.05	3.3	3.5	4.05	-	-	-	2.2	-	-	
Pot Cap-1 Maneuver	0	332	654	513	329	0	-	-	1632	-	-	
Stage 1	0	410	-	-	-	0	-	-	-	-	-	
Stage 2	0	-	-	581	407	0	-	-	-	-	-	
Platoon blocked, %	-	-	-	-	-	-	-	-	-	-	-	
Mov Cap-1 Maneuver	-	310	643	466	307	-	-	-	1627	-	-	
Mov Cap-2 Maneuver	-	310	-	466	307	-	-	-	-	-	-	
Stage 1	-	384	-	-	-	-	-	-	-	-	-	
Stage 2	-	-	-	522	381	-	-	-	-	-	-	
Approach	EB		WB				SB					
HCM Control Delay, s	16.9		18				0.6					
HCM LOS	C		C									
Minor Lane/Major Mvmt	EBLn1	WBLn1	SBL	SBT	SBR							
Capacity (veh/h)	326	327	1627	-	-							
HCM Lane V/C Ratio	0.072	0.153	0.029	-	-							
HCM Control Delay (s)	16.9	18	7.3	0.1	-							
HCM Lane LOS	C	C	A	A	-							
HCM 95th %tile Q(veh)	0.2	0.5	0.1	-	-							

Intersection						
Int Delay, s/veh	2.5					
Movement	EBL	EBR	NBL	NBT	SBT	SBR
Lane Configurations	↔			↕↕	↕↕	
Traffic Vol, veh/h	20	107	58	426	708	27
Future Vol, veh/h	20	107	58	426	708	27
Conflicting Peds, #/hr	0	0	42	0	0	42
Sign Control	Stop	Stop	Free	Free	Free	Free
RT Channelized	-	None	-	None	-	None
Storage Length	0	-	-	-	-	-
Veh in Median Storage, #	0	-	-	0	0	-
Grade, %	0	-	-	0	0	-
Peak Hour Factor	90	90	90	90	90	90
Heavy Vehicles, %	0	1	0	5	3	0
Mvmt Flow	22	119	64	473	787	30
Major/Minor	Minor2	Major1		Major2		
Conflicting Flow All	1209	451	859	0	-	0
Stage 1	844	-	-	-	-	-
Stage 2	365	-	-	-	-	-
Critical Hdwy	6.8	6.92	4.1	-	-	-
Critical Hdwy Stg 1	5.8	-	-	-	-	-
Critical Hdwy Stg 2	5.8	-	-	-	-	-
Follow-up Hdwy	3.5	3.31	2.2	-	-	-
Pot Cap-1 Maneuver	178	558	791	-	-	-
Stage 1	387	-	-	-	-	-
Stage 2	679	-	-	-	-	-
Platoon blocked, %				-	-	-
Mov Cap-1 Maneuver	146	536	760	-	-	-
Mov Cap-2 Maneuver	146	-	-	-	-	-
Stage 1	329	-	-	-	-	-
Stage 2	653	-	-	-	-	-
Approach	EB	NB		SB		
HCM Control Delay, s	20.2	1.7		0		
HCM LOS	C					
Minor Lane/Major Mvmt	NBL	NBT	EBLn1	SBT	SBR	
Capacity (veh/h)	760	-	377	-	-	
HCM Lane V/C Ratio	0.085	-	0.374	-	-	
HCM Control Delay (s)	10.2	0.5	20.2	-	-	
HCM Lane LOS	B	A	C	-	-	
HCM 95th %tile Q(veh)	0.3	-	1.7	-	-	

Future Background 2036

Lanes, Volumes, Timings

1: Hwy 417 WB On Ramp/Lyon St N & Catherine St

05/18/2023



Lane Group	EBL	EBT	EBR	WBL	WBT	WBR	NBL	NBT	NBR	SBL	SBT	SBR
Lane Configurations					↕↕						↕	↕
Traffic Volume (vph)	0	0	0	247	233	0	0	0	0	0	275	131
Future Volume (vph)	0	0	0	247	233	0	0	0	0	0	275	131
Satd. Flow (prot)	0	0	0	0	3183	0	0	0	0	0	1784	1547
Fit Permitted					0.975							
Satd. Flow (perm)	0	0	0	0	3160	0	0	0	0	0	1784	1517
Satd. Flow (RTOR)					247							131
Lane Group Flow (vph)	0	0	0	0	480	0	0	0	0	0	275	131
Turn Type				Perm	NA						NA	Perm
Protected Phases					8						6	
Permitted Phases				8								6
Minimum Split (s)				26.2	26.2						28.3	28.3
Total Split (s)				36.0	36.0						39.0	39.0
Total Split (%)				48.0%	48.0%						52.0%	52.0%
Yellow Time (s)				3.3	3.3						3.3	3.3
All-Red Time (s)				1.9	1.9						2.0	2.0
Lost Time Adjust (s)					0.0						0.0	0.0
Total Lost Time (s)					5.2						5.3	5.3
Lead/Lag												
Lead-Lag Optimize?												
Act Effct Green (s)					30.8						33.7	33.7
Actuated g/C Ratio					0.41						0.45	0.45
v/c Ratio					0.33						0.34	0.17
Control Delay					10.2						23.8	11.9
Queue Delay					0.0						0.0	0.0
Total Delay					10.2						23.8	11.9
LOS					B						C	B
Approach Delay					10.2						19.9	
Approach LOS					B						B	
Queue Length 50th (m)					29.0						36.9	2.1
Queue Length 95th (m)					m41.7						59.0	20.4
Internal Link Dist (m)		271.6			163.9			117.8			52.8	
Turn Bay Length (m)												
Base Capacity (vph)					1443						801	753
Starvation Cap Reductn					0						0	0
Spillback Cap Reductn					0						0	0
Storage Cap Reductn					0						0	0
Reduced v/c Ratio					0.33						0.34	0.17

Intersection Summary

Cycle Length: 75
 Actuated Cycle Length: 75
 Offset: 24 (32%), Referenced to phase 8:WBTL, Start of Green
 Natural Cycle: 55
 Control Type: Pretimed
 Maximum v/c Ratio: 0.34
 Intersection Signal Delay: 14.6 Intersection LOS: B
 Intersection Capacity Utilization 49.0% ICU Level of Service A
 Analysis Period (min) 15
 m Volume for 95th percentile queue is metered by upstream signal.

Splits and Phases: 1: Hwy 417 WB On Ramp/Lyon St N & Catherine St

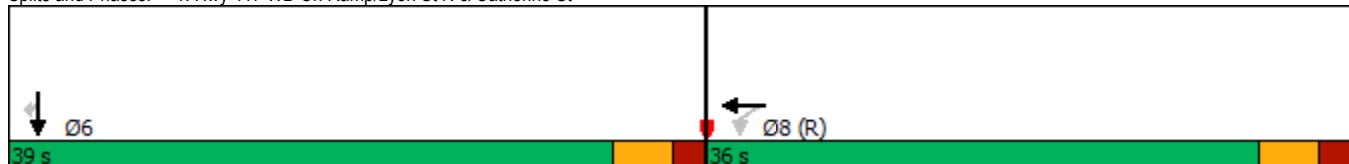

Lanes, Volumes, Timings

2: Hwy 417 EB Off Ramp/Chamberlain Ave/Kent St & Catherine St

05/18/2023



Lane Group	EBL	EBT	EBR	WBL	WBT	WBR	NBL	NBT	NBR	SBL	SBT	SBR
Lane Configurations					↑↑	↑↑		↑↑↑				
Traffic Volume (vph)	0	0	0	0	425	576	58	1423	0	0	0	0
Future Volume (vph)	0	0	0	0	425	576	58	1423	0	0	0	0
Satd. Flow (prot)	0	0	0	0	3262	2696	0	4911	0	0	0	0
Fit Permitted								0.998				
Satd. Flow (perm)	0	0	0	0	3262	2696	0	4906	0	0	0	0
Satd. Flow (RTOR)								70				
Lane Group Flow (vph)	0	0	0	0	425	576	0	1481	0	0	0	0
Turn Type					NA	Prot	Perm	NA				
Protected Phases					8	8		2				
Permitted Phases							2					
Detector Phase					8	8	2	2				
Switch Phase												
Minimum Initial (s)					10.0	10.0	10.0	10.0				
Minimum Split (s)					15.8	15.8	22.5	22.5				
Total Split (s)					29.6	29.6	32.4	32.4				
Total Split (%)					39.5%	39.5%	43.2%	43.2%				
Yellow Time (s)					3.3	3.3	3.3	3.3				
All-Red Time (s)					2.5	2.5	2.5	2.5				
Lost Time Adjust (s)					0.0	0.0		0.0				
Total Lost Time (s)					5.8	5.8		5.8				
Lead/Lag												
Lead-Lag Optimize?												
Recall Mode					C-Max	C-Max	Max	Max				
Act Effct Green (s)					29.0	29.0		26.6				
Actuated g/C Ratio					0.39	0.39		0.35				
v/c Ratio					0.34	0.55		0.83				
Control Delay					23.3	26.5		26.1				
Queue Delay					0.0	0.0		50.5				
Total Delay					23.3	26.5		76.6				
LOS					C	C		E				
Approach Delay					25.2			76.6				
Approach LOS					C			E				
Queue Length 50th (m)					28.7	44.2		65.8				
Queue Length 95th (m)					m35.2	m55.1		83.5				
Internal Link Dist (m)		163.9			131.7			67.4			53.0	
Turn Bay Length (m)						60.0						
Base Capacity (vph)					1261	1042		1785				
Starvation Cap Reductn					0	0		0				
Spillback Cap Reductn					0	0		1050				
Storage Cap Reductn					0	0		0				
Reduced v/c Ratio					0.34	0.55		2.01				

Intersection Summary

Cycle Length: 75
 Actuated Cycle Length: 75
 Offset: 0 (0%), Referenced to phase 8:WBT, Start of Green
 Natural Cycle: 60
 Control Type: Actuated-Coordinated
 Maximum v/c Ratio: 0.83
 Intersection Signal Delay: 55.9
 Intersection LOS: E
 Intersection Capacity Utilization 64.6%
 ICU Level of Service C
 Analysis Period (min) 15
 m Volume for 95th percentile queue is metered by upstream signal.

Splits and Phases: 2: Hwy 417 EB Off Ramp/Chamberlain Ave/Kent St & Catherine St

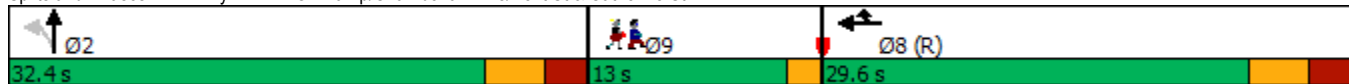

Lanes, Volumes, Timings

2: Hwy 417 EB Off Ramp/Chamberlain Ave/Kent St & Catherine St

05/18/2023

Lane Group	Ø9
Lane Configurations	
Traffic Volume (vph)	
Future Volume (vph)	
Satd. Flow (prot)	
Fit Permitted	
Satd. Flow (perm)	
Satd. Flow (RTOR)	
Lane Group Flow (vph)	
Turn Type	
Protected Phases	9
Permitted Phases	
Detector Phase	
Switch Phase	
Minimum Initial (s)	3.0
Minimum Split (s)	13.0
Total Split (s)	13.0
Total Split (%)	17%
Yellow Time (s)	2.0
All-Red Time (s)	0.0
Lost Time Adjust (s)	
Total Lost Time (s)	
Lead/Lag	
Lead-Lag Optimize?	
Recall Mode	None
Act Effct Green (s)	
Actuated g/C Ratio	
v/c Ratio	
Control Delay	
Queue Delay	
Total Delay	
LOS	
Approach Delay	
Approach LOS	
Queue Length 50th (m)	
Queue Length 95th (m)	
Internal Link Dist (m)	
Turn Bay Length (m)	
Base Capacity (vph)	
Starvation Cap Reductn	
Spillback Cap Reductn	
Storage Cap Reductn	
Reduced v/c Ratio	
Intersection Summary	

Lanes, Volumes, Timings
3: Bank St & Catherine St

05/18/2023



Lane Group	EBL	EBT	EBR	WBL	WBT	WBR	NBL	NBT	NBR	SBL	SBT	SBR
Lane Configurations					↕↕↕			↕↕			↕↕	
Traffic Volume (vph)	0	0	0	176	631	202	268	575	0	0	376	137
Future Volume (vph)	0	0	0	176	631	202	268	575	0	0	376	137
Satd. Flow (prot)	0	0	0	0	4439	0	0	3211	0	0	2863	0
Fit Permitted					0.991			0.648				
Satd. Flow (perm)	0	0	0	0	4384	0	0	2049	0	0	2863	0
Satd. Flow (RTOR)					76						74	
Lane Group Flow (vph)	0	0	0	0	1009	0	0	843	0	0	513	0
Turn Type				Perm	NA		pm+pt	NA			NA	
Protected Phases					8		9	2			6	
Permitted Phases					8		2					
Minimum Split (s)				18.6	18.6		10.4	16.4			16.4	
Total Split (s)				24.0	24.0		10.4	41.0			30.6	
Total Split (%)				32.0%	32.0%		13.9%	54.7%			40.8%	
Yellow Time (s)				3.3	3.3		3.3	3.3			3.3	
All-Red Time (s)				2.3	2.3		2.1	2.1			2.1	
Lost Time Adjust (s)					0.0			0.0			0.0	
Total Lost Time (s)					5.6			5.4			5.4	
Lead/Lag				Lag	Lag			Lag			Lag	
Lead-Lag Optimize?				Yes	Yes			Yes			Yes	
Act Effct Green (s)					18.4			35.6			25.2	
Actuated g/C Ratio					0.25			0.47			0.34	
v/c Ratio					0.89			0.80			0.51	
Control Delay					36.9			19.0			19.0	
Queue Delay					0.0			0.0			0.0	
Total Delay					36.9			19.0			19.0	
LOS					D			B			B	
Approach Delay					36.9			19.0			19.0	
Approach LOS					D			B			B	
Queue Length 50th (m)					46.9			25.6			25.4	
Queue Length 95th (m)					#70.3			#39.3			39.2	
Internal Link Dist (m)		131.7			201.7			90.2			52.9	
Turn Bay Length (m)												
Base Capacity (vph)					1132			1050			1011	
Starvation Cap Reductn					0			0			0	
Spillback Cap Reductn					0			0			0	
Storage Cap Reductn					0			0			0	
Reduced v/c Ratio					0.89			0.80			0.51	

Intersection Summary
 Cycle Length: 75
 Actuated Cycle Length: 75
 Offset: 50 (67%), Referenced to phase 2:NBT and 6:SBT, Start of Green
 Natural Cycle: 65
 Control Type: Pretimed
 Maximum v/c Ratio: 0.89
 Intersection Signal Delay: 26.6
 Intersection LOS: C
 Intersection Capacity Utilization 80.6%
 ICU Level of Service D
 Analysis Period (min) 15
 # 95th percentile volume exceeds capacity, queue may be longer.
 Queue shown is maximum after two cycles.

Splits and Phases: 3: Bank St & Catherine St

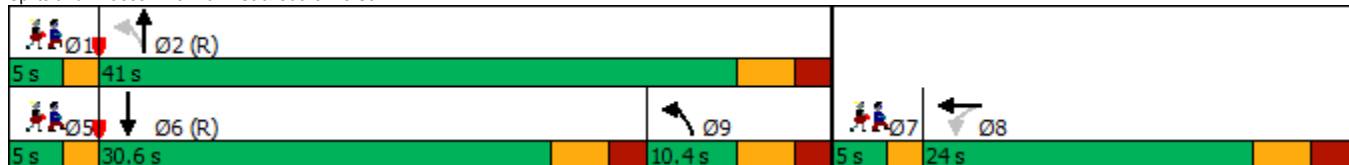

Lanes, Volumes, Timings
 3: Bank St & Catherine St

05/18/2023

Lane Group	Ø1	Ø5	Ø7
Lane Configurations			
Traffic Volume (vph)			
Future Volume (vph)			
Satd. Flow (prot)			
Fit Permitted			
Satd. Flow (perm)			
Satd. Flow (RTOR)			
Lane Group Flow (vph)			
Turn Type			
Protected Phases	1	5	7
Permitted Phases			
Minimum Split (s)	5.0	5.0	5.0
Total Split (s)	5.0	5.0	5.0
Total Split (%)	7%	7%	7%
Yellow Time (s)	2.0	2.0	2.0
All-Red Time (s)	0.0	0.0	0.0
Lost Time Adjust (s)			
Total Lost Time (s)			
Lead/Lag	Lead	Lead	Lead
Lead-Lag Optimize?	Yes	Yes	Yes
Act Effct Green (s)			
Actuated g/C Ratio			
v/c Ratio			
Control Delay			
Queue Delay			
Total Delay			
LOS			
Approach Delay			
Approach LOS			
Queue Length 50th (m)			
Queue Length 95th (m)			
Internal Link Dist (m)			
Turn Bay Length (m)			
Base Capacity (vph)			
Starvation Cap Reductn			
Spillback Cap Reductn			
Storage Cap Reductn			
Reduced v/c Ratio			
Intersection Summary			

Lanes, Volumes, Timings
4: Percy St & Catherine St

05/18/2023



Lane Group	EBL	EBT	EBR	WBL	WBT	WBR	NBL	NBT	NBR	SBL	SBT	SBR
Lane Configurations					↕↕						↕	
Traffic Volume (vph)	0	0	0	71	249	0	0	0	0	0	129	57
Future Volume (vph)	0	0	0	71	249	0	0	0	0	0	129	57
Satd. Flow (prot)	0	0	0	0	3170	0	0	0	0	0	1645	0
Fit Permitted					0.989							
Satd. Flow (perm)	0	0	0	0	3150	0	0	0	0	0	1645	0
Satd. Flow (RTOR)					160							
Lane Group Flow (vph)	0	0	0	0	320	0	0	0	0	0	186	0
Turn Type				Perm	NA						NA	
Protected Phases					8						6	
Permitted Phases				8								
Detector Phase				8	8						6	
Switch Phase												
Minimum Initial (s)				10.0	10.0						10.0	
Minimum Split (s)				26.5	26.5						23.4	
Total Split (s)				36.0	36.0						41.2	
Total Split (%)				40.0%	40.0%						45.8%	
Yellow Time (s)				3.3	3.3						3.3	
All-Red Time (s)				2.2	2.2						2.1	
Lost Time Adjust (s)					0.0						0.0	
Total Lost Time (s)					5.5						5.4	
Lead/Lag				Lag	Lag							
Lead-Lag Optimize?				Yes	Yes							
Recall Mode				None	None						Max	
Act Effct Green (s)					12.0						36.0	
Actuated g/C Ratio					0.20						0.61	
v/c Ratio					0.42						0.19	
Control Delay					11.6						6.4	
Queue Delay					0.0						0.0	
Total Delay					11.6						6.4	
LOS					B						A	
Approach Delay					11.6						6.4	
Approach LOS					B						A	
Queue Length 50th (m)					7.6						6.6	
Queue Length 95th (m)					16.2						21.3	
Internal Link Dist (m)		106.8			271.6			106.7			288.0	
Turn Bay Length (m)												
Base Capacity (vph)					1716						1004	
Starvation Cap Reductn					0						0	
Spillback Cap Reductn					0						0	
Storage Cap Reductn					0						0	
Reduced v/c Ratio					0.19						0.19	

Intersection Summary
 Cycle Length: 90
 Actuated Cycle Length: 58.9
 Natural Cycle: 65
 Control Type: Semi Act-Uncoord
 Maximum v/c Ratio: 0.42
 Intersection Signal Delay: 9.7
 Intersection Capacity Utilization 39.0%
 Analysis Period (min) 15
 Intersection LOS: A
 ICU Level of Service A

Splits and Phases: 4: Percy St & Catherine St

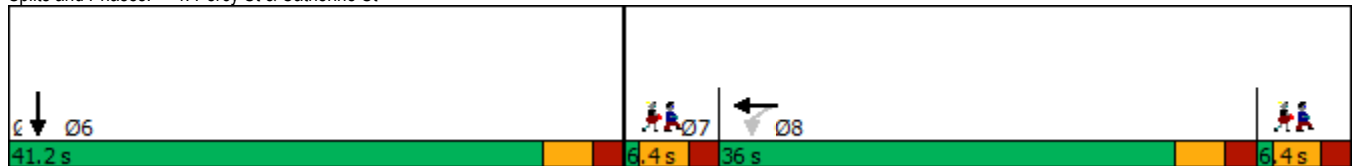

Lanes, Volumes, Timings
 4: Percy St & Catherine St

05/18/2023

Lane Group	Ø3	Ø7
Lane Configurations		
Traffic Volume (vph)		
Future Volume (vph)		
Satd. Flow (prot)		
Fit Permitted		
Satd. Flow (perm)		
Satd. Flow (RTOR)		
Lane Group Flow (vph)		
Turn Type		
Protected Phases	3	7
Permitted Phases		
Detector Phase		
Switch Phase		
Minimum Initial (s)	1.0	1.0
Minimum Split (s)	6.4	6.4
Total Split (s)	6.4	6.4
Total Split (%)	7%	7%
Yellow Time (s)	3.3	3.3
All-Red Time (s)	2.1	2.1
Lost Time Adjust (s)		
Total Lost Time (s)		
Lead/Lag		Lead
Lead-Lag Optimize?		Yes
Recall Mode	None	None
Act Effct Green (s)		
Actuated g/C Ratio		
v/c Ratio		
Control Delay		
Queue Delay		
Total Delay		
LOS		
Approach Delay		
Approach LOS		
Queue Length 50th (m)		
Queue Length 95th (m)		
Internal Link Dist (m)		
Turn Bay Length (m)		
Base Capacity (vph)		
Starvation Cap Reductn		
Spillback Cap Reductn		
Storage Cap Reductn		
Reduced v/c Ratio		
Intersection Summary		

Lanes, Volumes, Timings
6: Kent St & Arlington Ave

05/18/2023



Lane Group	EBL	EBT	EBR	WBL	WBT	WBR	NBL	NBT	NBR	SBL	SBT	SBR
Lane Configurations		↕			↕			↕↕↕				
Traffic Volume (vph)	19	48	0	0	11	93	15	1826	131	0	0	0
Future Volume (vph)	19	48	0	0	11	93	15	1826	131	0	0	0
Satd. Flow (prot)	0	1745	0	0	1542	0	0	4797	0	0	0	0
Fit Permitted		0.918										
Satd. Flow (perm)	0	1617	0	0	1542	0	0	4795	0	0	0	0
Satd. Flow (RTOR)					11			24				
Lane Group Flow (vph)	0	67	0	0	104	0	0	1972	0	0	0	0
Turn Type	Perm	NA			NA		Perm	NA				
Protected Phases		4			8			2				
Permitted Phases	4						2					
Minimum Split (s)	27.3	27.3			27.3		32.3	32.3				
Total Split (s)	27.4	27.4			27.4		47.6	47.6				
Total Split (%)	36.5%	36.5%			36.5%		63.5%	63.5%				
Yellow Time (s)	3.3	3.3			3.3		3.3	3.3				
All-Red Time (s)	2.0	2.0			2.0		2.0	2.0				
Lost Time Adjust (s)		0.0			0.0			0.0				
Total Lost Time (s)		5.3			5.3			5.3				
Lead/Lag												
Lead-Lag Optimize?												
Act Effct Green (s)		22.1			22.1			42.3				
Actuated g/C Ratio		0.29			0.29			0.56				
v/c Ratio		0.14			0.23			0.73				
Control Delay		33.0			16.6			15.3				
Queue Delay		0.0			0.0			48.7				
Total Delay		33.0			16.6			64.0				
LOS		C			B			E				
Approach Delay		33.0			16.6			64.0				
Approach LOS		C			B			E				
Queue Length 50th (m)		9.0			8.3			88.2				
Queue Length 95th (m)		19.9			m13.3			107.7				
Internal Link Dist (m)		164.0			143.1			53.0			216.0	
Turn Bay Length (m)												
Base Capacity (vph)		476			462			2714				
Starvation Cap Reductn		0			0			1414				
Spillback Cap Reductn		0			0			0				
Storage Cap Reductn		0			0			0				
Reduced v/c Ratio		0.14			0.23			1.52				

Intersection Summary
 Cycle Length: 75
 Actuated Cycle Length: 75
 Offset: 50 (67%), Referenced to phase 2:NBT, Start of Green
 Natural Cycle: 60
 Control Type: Pretimed
 Maximum v/c Ratio: 0.73
 Intersection Signal Delay: 60.7
 Intersection Capacity Utilization 70.2%
 Analysis Period (min) 15
 m Volume for 95th percentile queue is metered by upstream signal.

Splits and Phases: 6: Kent St & Arlington Ave

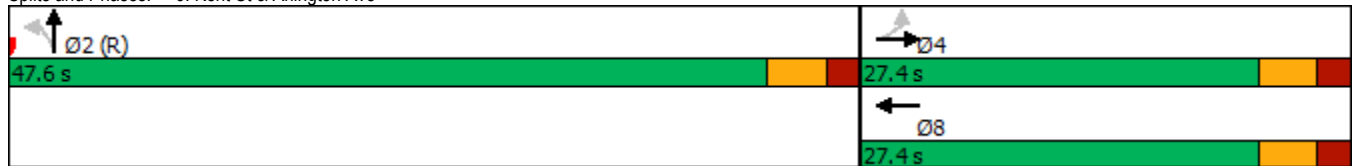

Lanes, Volumes, Timings
7: Lyon St N & Gladstone Ave

05/18/2023



Lane Group	EBL	EBT	EBR	WBL	WBT	WBR	NBL	NBT	NBR	SBL	SBT	SBR
Lane Configurations		↑	↗	↖	↑						↕	↕
Traffic Volume (vph)	0	184	24	15	143	0	0	0	0	89	343	98
Future Volume (vph)	0	184	24	15	143	0	0	0	0	89	343	98
Satd. Flow (prot)	0	1733	1547	1729	1750	0	0	0	0	0	3249	0
Fit Permitted				0.641							0.992	
Satd. Flow (perm)	0	1733	1485	1146	1750	0	0	0	0	0	3225	0
Satd. Flow (RTOR)			38								47	
Lane Group Flow (vph)	0	184	24	15	143	0	0	0	0	0	530	0
Turn Type		NA	Perm	Perm	NA					Perm	NA	
Protected Phases		4			8							6
Permitted Phases			4	8						6		
Minimum Split (s)		17.2	17.2	17.2	17.2					22.6	22.6	
Total Split (s)		36.0	36.0	36.0	36.0					39.0	39.0	
Total Split (%)		48.0%	48.0%	48.0%	48.0%					52.0%	52.0%	
Yellow Time (s)		3.3	3.3	3.3	3.3					3.3	3.3	
All-Red Time (s)		1.9	1.9	1.9	1.9					2.3	2.3	
Lost Time Adjust (s)		0.0	0.0	0.0	0.0						0.0	
Total Lost Time (s)		5.2	5.2	5.2	5.2						5.6	
Lead/Lag												
Lead-Lag Optimize?												
Act Effct Green (s)		30.8	30.8	30.8	30.8						33.4	
Actuated g/C Ratio		0.41	0.41	0.41	0.41						0.45	
v/c Ratio		0.26	0.04	0.03	0.20						0.36	
Control Delay		15.8	3.3	5.4	7.4						13.3	
Queue Delay		0.0	0.0	0.0	0.0						0.0	
Total Delay		15.8	3.3	5.4	7.4						13.3	
LOS		B	A	A	A						B	
Approach Delay		14.4			7.3						13.3	
Approach LOS		B			A						B	
Queue Length 50th (m)		16.6	0.0	0.7	9.4						22.4	
Queue Length 95th (m)		29.8	2.8	m1.1	13.7						33.4	
Internal Link Dist (m)		254.8			165.0			215.6			214.3	
Turn Bay Length (m)				25.0								
Base Capacity (vph)		711	632	470	718						1462	
Starvation Cap Reductn		0	0	0	0						0	
Spillback Cap Reductn		0	0	0	0						0	
Storage Cap Reductn		0	0	0	0						0	
Reduced v/c Ratio		0.26	0.04	0.03	0.20						0.36	

Intersection Summary

Cycle Length: 75
 Actuated Cycle Length: 75
 Offset: 45 (60%), Referenced to phase 4:EBT and 8:WBTL, Start of Green
 Natural Cycle: 40
 Control Type: Pretimed
 Maximum v/c Ratio: 0.36
 Intersection Signal Delay: 12.5
 Intersection Capacity Utilization 82.0%
 Analysis Period (min) 15
 Intersection LOS: B
 ICU Level of Service D
 m Volume for 95th percentile queue is metered by upstream signal.

Splits and Phases: 7: Lyon St N & Gladstone Ave

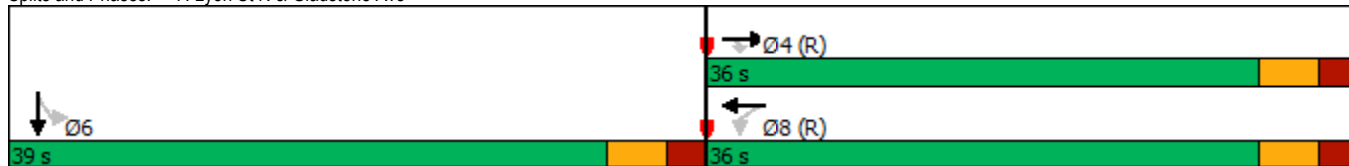

Lanes, Volumes, Timings
8: Kent St & Gladstone Ave

05/18/2023



Lane Group	EBL	EBT	EBR	WBL	WBT	WBR	NBL	NBT	NBR	SBL	SBT	SBR
Lane Configurations												
Traffic Volume (vph)	82	277	0	0	165	148	36	1808	97	0	0	0
Future Volume (vph)	82	277	0	0	165	148	36	1808	97	0	0	0
Satd. Flow (prot)	1662	1717	0	0	1552	0	1729	4793	0	0	0	0
Fit Permitted	0.468						0.950					
Satd. Flow (perm)	786	1717	0	0	1552	0	1444	4793	0	0	0	0
Satd. Flow (RTOR)					5			16				
Lane Group Flow (vph)	82	277	0	0	313	0	36	1905	0	0	0	0
Turn Type	Perm	NA			NA		Perm	NA				
Protected Phases		4			8			2				
Permitted Phases	4						2					
Minimum Split (s)	21.4	21.4			21.4		20.4	20.4				
Total Split (s)	32.0	32.0			32.0		43.0	43.0				
Total Split (%)	42.7%	42.7%			42.7%		57.3%	57.3%				
Yellow Time (s)	3.3	3.3			3.3		3.3	3.3				
All-Red Time (s)	2.1	2.1			2.1		2.1	2.1				
Lost Time Adjust (s)	0.0	0.0			0.0		0.0	0.0				
Total Lost Time (s)	5.4	5.4			5.4		5.4	5.4				
Lead/Lag												
Lead-Lag Optimize?												
Act Effct Green (s)	26.6	26.6			26.6		37.6	37.6				
Actuated g/C Ratio	0.35	0.35			0.35		0.50	0.50				
v/c Ratio	0.29	0.46			0.57		0.05	0.79				
Control Delay	27.3	28.1			24.1		8.1	9.1				
Queue Delay	0.0	0.0			0.0		0.0	0.0				
Total Delay	27.3	28.1			24.1		8.1	9.1				
LOS	C	C			C		A	A				
Approach Delay		27.9			24.1			9.0				
Approach LOS		C			C			A				
Queue Length 50th (m)	9.9	37.6			34.5		1.4	28.4				
Queue Length 95th (m)	23.4	59.7			58.6		m2.9	43.3				
Internal Link Dist (m)		165.0			168.8			216.0			203.6	
Turn Bay Length (m)	30.0						40.0					
Base Capacity (vph)	278	608			553		723	2410				
Starvation Cap Reductn	0	0			0		0	0				
Spillback Cap Reductn	0	0			0		0	0				
Storage Cap Reductn	0	0			0		0	0				
Reduced v/c Ratio	0.29	0.46			0.57		0.05	0.79				

Intersection Summary
 Cycle Length: 75
 Actuated Cycle Length: 75
 Offset: 23 (31%), Referenced to phase 4:EBTL and 8:WBT, Start of Green
 Natural Cycle: 55
 Control Type: Pretimed
 Maximum v/c Ratio: 0.79
 Intersection Signal Delay: 13.4
 Intersection LOS: B
 Intersection Capacity Utilization 82.0%
 ICU Level of Service D
 Analysis Period (min) 15
 m Volume for 95th percentile queue is metered by upstream signal.

Splits and Phases: 8: Kent St & Gladstone Ave

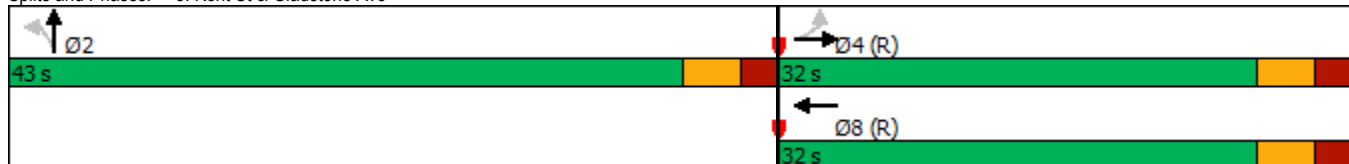

Lanes, Volumes, Timings
 9: Bank St & Chamberlain Ave/Isabella St

05/18/2023



Lane Group	EBL	EBT	EBR	WBL	WBT	WBR	NBL	NBT	NBR	SBL	SBT	SBR
Lane Configurations		↕↕	↗					↕↕			↕↕	
Traffic Volume (vph)	75	520	75	0	0	0	0	835	143	176	382	0
Future Volume (vph)	75	520	75	0	0	0	0	835	143	176	382	0
Satd. Flow (prot)	0	3228	1446	0	0	0	0	3153	0	0	3220	0
Fit Permitted		0.994									0.547	
Satd. Flow (perm)	0	3221	1358	0	0	0	0	3153	0	0	1772	0
Satd. Flow (RTOR)			134									
Lane Group Flow (vph)	0	595	75	0	0	0	0	978	0	0	558	0
Turn Type	Perm	NA	Perm					NA		pm+pt	NA	
Protected Phases		4						2		5	6	
Permitted Phases	4		4							6		
Detector Phase	4	4	4					2		5	6	
Switch Phase												
Minimum Initial (s)	10.0	10.0	10.0					10.0		5.0	10.0	
Minimum Split (s)	26.2	26.2	26.2					23.1		11.1	23.1	
Total Split (s)	26.2	26.2	26.2					37.7		11.1	48.8	
Total Split (%)	34.9%	34.9%	34.9%					50.3%		14.8%	65.1%	
Yellow Time (s)	3.3	3.3	3.3					3.0		3.0	3.0	
All-Red Time (s)	2.9	2.9	2.9					3.1		3.1	3.1	
Lost Time Adjust (s)		0.0	0.0					0.0			0.0	
Total Lost Time (s)		6.2	6.2					6.1			6.1	
Lead/Lag												
Lead-Lag Optimize?												
Recall Mode	None	None	None					C-Max		None	C-Max	
Act Effct Green (s)		18.3	18.3					44.4			44.4	
Actuated g/C Ratio		0.24	0.24					0.59			0.59	
v/c Ratio		0.76	0.17					0.52			0.53	
Control Delay		32.8	1.8					10.7			14.3	
Queue Delay		0.0	0.0					0.0			0.0	
Total Delay		32.8	1.8					10.7			14.3	
LOS		C	A					B			B	
Approach Delay		29.4						10.7			14.3	
Approach LOS		C						B			B	
Queue Length 50th (m)		39.7	0.0					41.4			40.2	
Queue Length 95th (m)		56.6	2.4					56.7			m55.8	
Internal Link Dist (m)		296.0			233.4			215.6			90.2	
Turn Bay Length (m)			40.0									
Base Capacity (vph)		858	460					1865			1047	
Starvation Cap Reductn		0	0					0			0	
Spillback Cap Reductn		0	0					0			0	
Storage Cap Reductn		0	0					0			0	
Reduced v/c Ratio		0.69	0.16					0.52			0.53	

Intersection Summary
 Cycle Length: 75
 Actuated Cycle Length: 75
 Offset: 60 (80%), Referenced to phase 2:NBT and 6:SBTL, Start of Green
 Natural Cycle: 65
 Control Type: Actuated-Coordinated
 Maximum v/c Ratio: 0.76
 Intersection Signal Delay: 17.3
 Intersection Capacity Utilization 82.8%
 Analysis Period (min) 15
 Intersection LOS: B
 ICU Level of Service E
 m Volume for 95th percentile queue is metered by upstream signal.

Splits and Phases: 9: Bank St & Chamberlain Ave/Isabella St

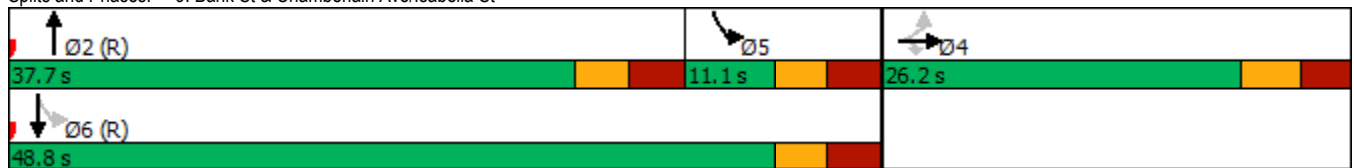

Lanes, Volumes, Timings
13: Bronson Ave & Catherine St

05/18/2023



Lane Group	EBL	EBT	EBR	WBL	WBT	WBR	NBL	NBT	NBR	SBL	SBT	SBR
Lane Configurations				↖ ↗	↖ ↗		↖ ↗	↖ ↗			↖ ↗	
Traffic Volume (vph)	0	0	0	524	510	368	553	1105	0	0	456	126
Future Volume (vph)	0	0	0	524	510	368	553	1105	0	0	456	126
Satd. Flow (prot)	0	0	0	1430	4136	0	1712	3390	0	0	3087	0
Fit Permitted				0.950	0.992		0.218					
Satd. Flow (perm)	0	0	0	1430	4136	0	393	3390	0	0	3087	0
Satd. Flow (RTOR)					78						29	
Lane Group Flow (vph)	0	0	0	356	1046	0	553	1105	0	0	582	0
Turn Type				Perm	NA		pm+pt	NA			NA	
Protected Phases					8		5	7			2	6
Permitted Phases				8			2					
Minimum Split (s)				28.3	28.3			23.8			23.8	
Total Split (s)				36.8	36.8			73.2			28.9	
Total Split (%)				33.5%	33.5%			66.5%			26.3%	
Yellow Time (s)				3.3	3.3			3.3			3.3	
All-Red Time (s)				3.0	3.0			3.5			3.5	
Lost Time Adjust (s)				0.0	0.0			0.0			0.0	
Total Lost Time (s)				6.3	6.3			6.8			6.8	
Lead/Lag												Lag
Lead-Lag Optimize?												Yes
Act Effct Green (s)				30.5	30.5		67.0	66.4			22.1	
Actuated g/C Ratio				0.28	0.28		0.61	0.60			0.20	
v/c Ratio				0.90	0.87		0.89	0.54			0.91	
Control Delay				65.2	44.0		34.2	14.0			60.0	
Queue Delay				0.0	0.0		0.0	0.0			0.0	
Total Delay				65.2	44.0		34.2	14.0			60.0	
LOS				E	D		C	B			E	
Approach Delay					49.4			20.8			60.0	
Approach LOS					D			C			E	
Queue Length 50th (m)				85.4	77.4		63.9	68.4			61.7	
Queue Length 95th (m)				#147.2	#97.8		#122.6	85.5			#93.3	
Internal Link Dist (m)		141.5			120.8			240.1			287.4	
Turn Bay Length (m)				80.0			45.0					
Base Capacity (vph)				396	1203		621	2046			643	
Starvation Cap Reductn				0	0		0	0			0	
Spillback Cap Reductn				0	0		0	0			0	
Storage Cap Reductn				0	0		0	0			0	
Reduced v/c Ratio				0.90	0.87		0.89	0.54			0.91	

Intersection Summary
 Cycle Length: 110
 Actuated Cycle Length: 110
 Offset: 60 (55%), Referenced to phase 2:NBT and 6:SBT, Start of Green
 Natural Cycle: 90
 Control Type: Pretimed
 Maximum v/c Ratio: 0.91
 Intersection Signal Delay: 38.1 Intersection LOS: D
 Intersection Capacity Utilization 90.1% ICU Level of Service E
 Analysis Period (min) 15
 # 95th percentile volume exceeds capacity, queue may be longer.
 Queue shown is maximum after two cycles.

Splits and Phases: 13: Bronson Ave & Catherine St

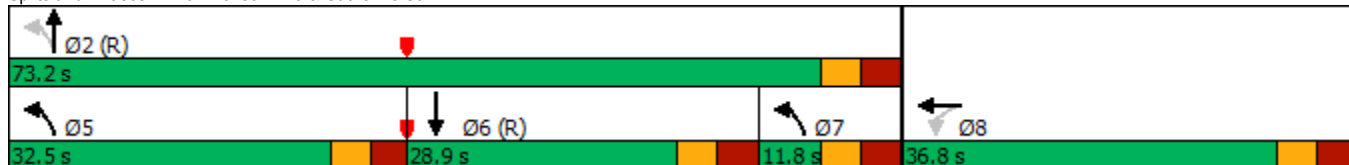

Lanes, Volumes, Timings
 13: Bronson Ave & Catherine St

05/18/2023

Lane Group	Ø5	Ø7
Lane Configurations		
Traffic Volume (vph)		
Future Volume (vph)		
Satd. Flow (prot)		
Fit Permitted		
Satd. Flow (perm)		
Satd. Flow (RTOR)		
Lane Group Flow (vph)		
Turn Type		
Protected Phases	5	7
Permitted Phases		
Minimum Split (s)	11.2	11.8
Total Split (s)	32.5	11.8
Total Split (%)	30%	11%
Yellow Time (s)	3.3	3.3
All-Red Time (s)	2.9	3.5
Lost Time Adjust (s)		
Total Lost Time (s)		
Lead/Lag	Lead	
Lead-Lag Optimize?	Yes	
Act Effct Green (s)		
Actuated g/C Ratio		
v/c Ratio		
Control Delay		
Queue Delay		
Total Delay		
LOS		
Approach Delay		
Approach LOS		
Queue Length 50th (m)		
Queue Length 95th (m)		
Internal Link Dist (m)		
Turn Bay Length (m)		
Base Capacity (vph)		
Starvation Cap Reductn		
Spillback Cap Reductn		
Storage Cap Reductn		
Reduced v/c Ratio		
Intersection Summary		

Lanes, Volumes, Timings

1: Hwy 417 WB On Ramp/Lyon St N & Catherine St

05/18/2023



Lane Group	EBL	EBT	EBR	WBL	WBT	WBR	NBL	NBT	NBR	SBL	SBT	SBR
Lane Configurations					↕↕						↕	↗
Traffic Volume (vph)	0	0	0	210	539	0	0	0	0	0	365	304
Future Volume (vph)	0	0	0	210	539	0	0	0	0	0	365	304
Satd. Flow (prot)	0	0	0	0	3296	0	0	0	0	0	1802	1532
Fit Permitted					0.986							
Satd. Flow (perm)	0	0	0	0	3273	0	0	0	0	0	1802	1490
Satd. Flow (RTOR)					97							184
Lane Group Flow (vph)	0	0	0	0	749	0	0	0	0	0	365	304
Turn Type				Perm	NA						NA	Perm
Protected Phases					8						6	
Permitted Phases				8								6
Minimum Split (s)				26.2	26.2						28.3	28.3
Total Split (s)				38.0	38.0						37.0	37.0
Total Split (%)				50.7%	50.7%						49.3%	49.3%
Yellow Time (s)				3.3	3.3						3.3	3.3
All-Red Time (s)				1.9	1.9						2.0	2.0
Lost Time Adjust (s)					0.0						0.0	0.0
Total Lost Time (s)					5.2						5.3	5.3
Lead/Lag												
Lead-Lag Optimize?												
Act Effct Green (s)					32.8						31.7	31.7
Actuated g/C Ratio					0.44						0.42	0.42
v/c Ratio					0.50						0.48	0.41
Control Delay					13.8						26.7	17.1
Queue Delay					0.0						0.0	0.0
Total Delay					13.8						26.7	17.1
LOS					B						C	B
Approach Delay					13.8						22.3	
Approach LOS					B						C	
Queue Length 50th (m)					56.5						52.2	26.8
Queue Length 95th (m)					73.2						77.5	50.0
Internal Link Dist (m)		271.6			163.9			117.8			52.8	
Turn Bay Length (m)												
Base Capacity (vph)					1485						761	736
Starvation Cap Reductn					0						0	0
Spillback Cap Reductn					0						0	0
Storage Cap Reductn					0						0	0
Reduced v/c Ratio					0.50						0.48	0.41

Intersection Summary

Cycle Length: 75	
Actuated Cycle Length: 75	
Offset: 24 (32%), Referenced to phase 8:WBTL, Start of Green	
Natural Cycle: 55	
Control Type: Pretimed	
Maximum v/c Ratio: 0.50	
Intersection Signal Delay: 17.9	Intersection LOS: B
Intersection Capacity Utilization 54.5%	ICU Level of Service A
Analysis Period (min) 15	

Splits and Phases: 1: Hwy 417 WB On Ramp/Lyon St N & Catherine St

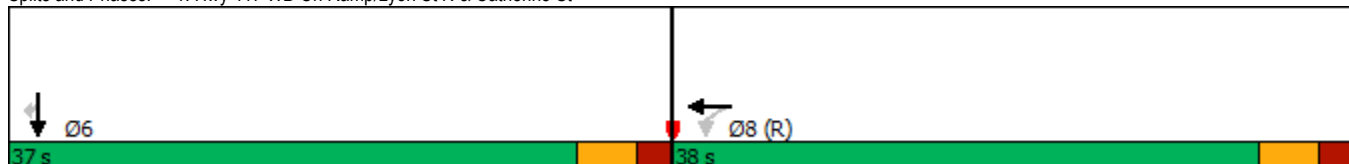

Lanes, Volumes, Timings

2: Hwy 417 EB Off Ramp/Chamberlain Ave/Kent St & Catherine St

05/18/2023



Lane Group	EBL	EBT	EBR	WBL	WBT	WBR	NBL	NBT	NBR	SBL	SBT	SBR
Lane Configurations					↑↑	↑↑		↑↑↑				
Traffic Volume (vph)	0	0	0	0	691	315	27	878	0	0	0	0
Future Volume (vph)	0	0	0	0	691	315	27	878	0	0	0	0
Satd. Flow (prot)	0	0	0	0	3357	2521	0	4863	0	0	0	0
Fit Permitted								0.999				
Satd. Flow (perm)	0	0	0	0	3357	2521	0	4861	0	0	0	0
Satd. Flow (RTOR)								70				
Lane Group Flow (vph)	0	0	0	0	691	315	0	905	0	0	0	0
Turn Type					NA	Prot	Perm	NA				
Protected Phases					8	8		2				
Permitted Phases							2					
Detector Phase					8	8	2	2				
Switch Phase												
Minimum Initial (s)					10.0	10.0	10.0	10.0				
Minimum Split (s)					15.8	15.8	22.5	22.5				
Total Split (s)					34.0	34.0	28.0	28.0				
Total Split (%)					45.3%	45.3%	37.3%	37.3%				
Yellow Time (s)					3.3	3.3	3.3	3.3				
All-Red Time (s)					2.5	2.5	2.5	2.5				
Lost Time Adjust (s)					0.0	0.0		0.0				
Total Lost Time (s)					5.8	5.8		5.8				
Lead/Lag												
Lead-Lag Optimize?												
Recall Mode					C-Max	C-Max	Max	Max				
Act Effct Green (s)					33.4	33.4		22.2				
Actuated g/C Ratio					0.45	0.45		0.30				
v/c Ratio					0.46	0.28		0.61				
Control Delay					27.3	25.1		22.9				
Queue Delay					0.0	0.0		1.2				
Total Delay					27.3	25.1		24.1				
LOS					C	C		C				
Approach Delay					26.6			24.1				
Approach LOS					C			C				
Queue Length 50th (m)					51.4	23.8		36.7				
Queue Length 95th (m)					m62.2	m28.8		49.1				
Internal Link Dist (m)		163.9			131.7			67.4			53.0	
Turn Bay Length (m)						60.0						
Base Capacity (vph)					1495	1122		1488				
Starvation Cap Reductn					0	0		0				
Spillback Cap Reductn					0	0		345				
Storage Cap Reductn					0	0		0				
Reduced v/c Ratio					0.46	0.28		0.79				

Intersection Summary

Cycle Length: 75
 Actuated Cycle Length: 75
 Offset: 0 (0%), Referenced to phase 8:WBT, Start of Green
 Natural Cycle: 60
 Control Type: Actuated-Coordinated
 Maximum v/c Ratio: 0.61
 Intersection Signal Delay: 25.4
 Intersection Capacity Utilization 50.5%
 Analysis Period (min) 15
 Intersection LOS: C
 ICU Level of Service A
 m Volume for 95th percentile queue is metered by upstream signal.

Splits and Phases: 2: Hwy 417 EB Off Ramp/Chamberlain Ave/Kent St & Catherine St

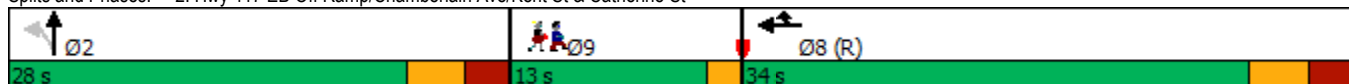

Lanes, Volumes, Timings

2: Hwy 417 EB Off Ramp/Chamberlain Ave/Kent St & Catherine St

05/18/2023

Lane Group	Ø9
Lane Configurations	
Traffic Volume (vph)	
Future Volume (vph)	
Satd. Flow (prot)	
Fit Permitted	
Satd. Flow (perm)	
Satd. Flow (RTOR)	
Lane Group Flow (vph)	
Turn Type	
Protected Phases	9
Permitted Phases	
Detector Phase	
Switch Phase	
Minimum Initial (s)	1.0
Minimum Split (s)	13.0
Total Split (s)	13.0
Total Split (%)	17%
Yellow Time (s)	2.0
All-Red Time (s)	0.0
Lost Time Adjust (s)	
Total Lost Time (s)	
Lead/Lag	
Lead-Lag Optimize?	
Recall Mode	None
Act Effct Green (s)	
Actuated g/C Ratio	
v/c Ratio	
Control Delay	
Queue Delay	
Total Delay	
LOS	
Approach Delay	
Approach LOS	
Queue Length 50th (m)	
Queue Length 95th (m)	
Internal Link Dist (m)	
Turn Bay Length (m)	
Base Capacity (vph)	
Starvation Cap Reductn	
Spillback Cap Reductn	
Storage Cap Reductn	
Reduced v/c Ratio	
Intersection Summary	

Lanes, Volumes, Timings
3: Bank St & Catherine St

05/18/2023



Lane Group	EBL	EBT	EBR	WBL	WBT	WBR	NBL	NBT	NBR	SBL	SBT	SBR
Lane Configurations					↕↕↕			↕↕			↕↕	
Traffic Volume (vph)	0	0	0	236	644	158	188	328	0	0	695	130
Future Volume (vph)	0	0	0	236	644	158	188	328	0	0	695	130
Satd. Flow (prot)	0	0	0	0	4610	0	0	3260	0	0	3110	0
Fit Permitted					0.989			0.536				
Satd. Flow (perm)	0	0	0	0	4530	0	0	1746	0	0	3110	0
Satd. Flow (RTOR)					46			31				
Lane Group Flow (vph)	0	0	0	0	1038	0	0	516	0	0	825	0
Turn Type				Perm	NA		pm+pt	NA			NA	
Protected Phases					8		9	2			6	
Permitted Phases					8		2					
Minimum Split (s)				18.6	18.6		10.4	16.4			16.4	
Total Split (s)				24.4	24.4		10.4	40.6			30.2	
Total Split (%)				32.5%	32.5%		13.9%	54.1%			40.3%	
Yellow Time (s)				3.3	3.3		3.3	3.3			3.3	
All-Red Time (s)				2.3	2.3		2.1	2.1			2.1	
Lost Time Adjust (s)					0.0			0.0			0.0	
Total Lost Time (s)					5.6			5.4			5.4	
Lead/Lag				Lag	Lag			Lag			Lag	
Lead-Lag Optimize?				Yes	Yes			Yes			Yes	
Act Effct Green (s)					18.8			35.2			24.8	
Actuated g/C Ratio					0.25			0.47			0.33	
v/c Ratio					0.89			0.56			0.79	
Control Delay					37.0			13.5			28.4	
Queue Delay					0.0			0.0			0.5	
Total Delay					37.0			13.5			28.9	
LOS					D			B			C	
Approach Delay					37.0			13.5			28.9	
Approach LOS					D			B			C	
Queue Length 50th (m)					49.6			15.0			52.8	
Queue Length 95th (m)					#73.0			20.0			73.7	
Internal Link Dist (m)		131.7			201.7			90.2			52.9	
Turn Bay Length (m)												
Base Capacity (vph)					1169			920			1049	
Starvation Cap Reductn					0			0			0	
Spillback Cap Reductn					0			0			45	
Storage Cap Reductn					0			0			0	
Reduced v/c Ratio					0.89			0.56			0.82	

Intersection Summary
 Cycle Length: 75
 Actuated Cycle Length: 75
 Offset: 50 (67%), Referenced to phase 2:NBT and 6:SBT, Start of Green
 Natural Cycle: 70
 Control Type: Pretimed
 Maximum v/c Ratio: 0.89
 Intersection Signal Delay: 29.1
 Intersection Capacity Utilization 79.6%
 Analysis Period (min) 15
 # 95th percentile volume exceeds capacity, queue may be longer.
 Queue shown is maximum after two cycles.

Splits and Phases: 3: Bank St & Catherine St

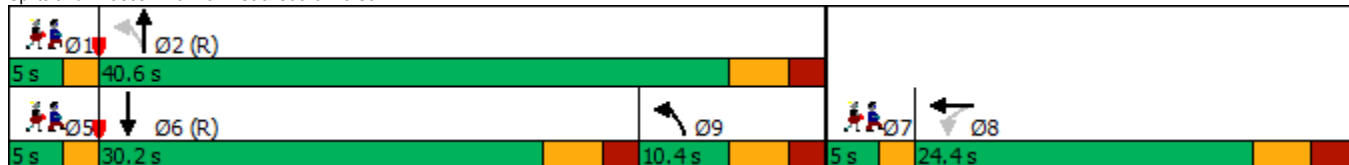

Lanes, Volumes, Timings
 3: Bank St & Catherine St

05/18/2023

Lane Group	Ø1	Ø5	Ø7
Lane Configurations			
Traffic Volume (vph)			
Future Volume (vph)			
Satd. Flow (prot)			
Fit Permitted			
Satd. Flow (perm)			
Satd. Flow (RTOR)			
Lane Group Flow (vph)			
Turn Type			
Protected Phases	1	5	7
Permitted Phases			
Minimum Split (s)	5.0	5.0	5.0
Total Split (s)	5.0	5.0	5.0
Total Split (%)	7%	7%	7%
Yellow Time (s)	2.0	2.0	2.0
All-Red Time (s)	0.0	0.0	0.0
Lost Time Adjust (s)			
Total Lost Time (s)			
Lead/Lag	Lead	Lead	Lead
Lead-Lag Optimize?	Yes	Yes	Yes
Act Effct Green (s)			
Actuated g/C Ratio			
v/c Ratio			
Control Delay			
Queue Delay			
Total Delay			
LOS			
Approach Delay			
Approach LOS			
Queue Length 50th (m)			
Queue Length 95th (m)			
Internal Link Dist (m)			
Turn Bay Length (m)			
Base Capacity (vph)			
Starvation Cap Reductn			
Spillback Cap Reductn			
Storage Cap Reductn			
Reduced v/c Ratio			
Intersection Summary			

Lanes, Volumes, Timings
4: Percy St & Catherine St

05/18/2023



Lane Group	EBL	EBT	EBR	WBL	WBT	WBR	NBL	NBT	NBR	SBL	SBT	SBR
Lane Configurations					↕↕						↕	
Traffic Volume (vph)	0	0	0	153	728	0	0	0	0	0	121	39
Future Volume (vph)	0	0	0	153	728	0	0	0	0	0	121	39
Satd. Flow (prot)	0	0	0	0	3354	0	0	0	0	0	1727	0
Fit Permitted					0.991							
Satd. Flow (perm)	0	0	0	0	3341	0	0	0	0	0	1727	0
Satd. Flow (RTOR)					160							
Lane Group Flow (vph)	0	0	0	0	881	0	0	0	0	0	160	0
Turn Type				Perm	NA						NA	
Protected Phases					8						6	
Permitted Phases				8								
Detector Phase				8	8						6	
Switch Phase												
Minimum Initial (s)				10.0	10.0						10.0	
Minimum Split (s)				26.5	26.5						23.4	
Total Split (s)				47.0	47.0						30.2	
Total Split (%)				52.2%	52.2%						33.6%	
Yellow Time (s)				3.3	3.3						3.3	
All-Red Time (s)				2.2	2.2						2.1	
Lost Time Adjust (s)					0.0						0.0	
Total Lost Time (s)					5.5						5.4	
Lead/Lag				Lag	Lag							
Lead-Lag Optimize?				Yes	Yes							
Recall Mode				None	None						Max	
Act Effct Green (s)					19.7						25.0	
Actuated g/C Ratio					0.35						0.45	
v/c Ratio					0.69						0.21	
Control Delay					15.1						11.8	
Queue Delay					0.0						0.0	
Total Delay					15.1						11.8	
LOS					B						B	
Approach Delay					15.1						11.8	
Approach LOS					B						B	
Queue Length 50th (m)					30.8						9.2	
Queue Length 95th (m)					46.3						23.6	
Internal Link Dist (m)		106.8			271.6			106.7			288.0	
Turn Bay Length (m)												
Base Capacity (vph)					2547						774	
Starvation Cap Reductn					0						0	
Spillback Cap Reductn					0						0	
Storage Cap Reductn					0						0	
Reduced v/c Ratio					0.35						0.21	

Intersection Summary
 Cycle Length: 90
 Actuated Cycle Length: 55.7
 Natural Cycle: 65
 Control Type: Semi Act-Uncoord
 Maximum v/c Ratio: 0.69
 Intersection Signal Delay: 14.6
 Intersection Capacity Utilization 53.3%
 Analysis Period (min) 15
 Intersection LOS: B
 ICU Level of Service A

Splits and Phases: 4: Percy St & Catherine St

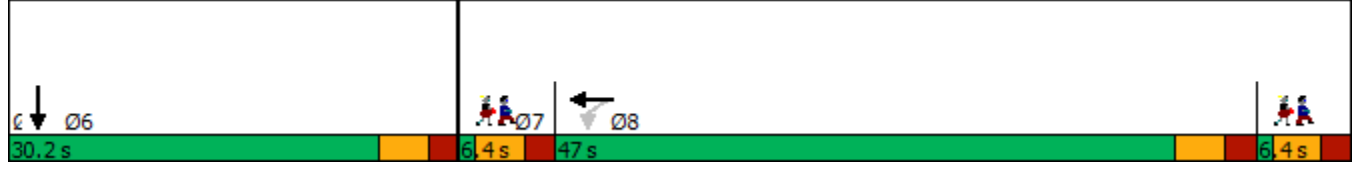

Lanes, Volumes, Timings
 4: Percy St & Catherine St

05/18/2023

Lane Group	Ø3	Ø7
Lane Configurations		
Traffic Volume (vph)		
Future Volume (vph)		
Satd. Flow (prot)		
Fit Permitted		
Satd. Flow (perm)		
Satd. Flow (RTOR)		
Lane Group Flow (vph)		
Turn Type		
Protected Phases	3	7
Permitted Phases		
Detector Phase		
Switch Phase		
Minimum Initial (s)	1.0	1.0
Minimum Split (s)	6.4	6.4
Total Split (s)	6.4	6.4
Total Split (%)	7%	7%
Yellow Time (s)	3.3	3.3
All-Red Time (s)	2.1	2.1
Lost Time Adjust (s)		
Total Lost Time (s)		
Lead/Lag		Lead
Lead-Lag Optimize?		Yes
Recall Mode	None	None
Act Effct Green (s)		
Actuated g/C Ratio		
v/c Ratio		
Control Delay		
Queue Delay		
Total Delay		
LOS		
Approach Delay		
Approach LOS		
Queue Length 50th (m)		
Queue Length 95th (m)		
Internal Link Dist (m)		
Turn Bay Length (m)		
Base Capacity (vph)		
Starvation Cap Reductn		
Spillback Cap Reductn		
Storage Cap Reductn		
Reduced v/c Ratio		
Intersection Summary		

Lanes, Volumes, Timings
6: Kent St & Arlington Ave

05/18/2023



Lane Group	EBL	EBT	EBR	WBL	WBT	WBR	NBL	NBT	NBR	SBL	SBT	SBR
Lane Configurations		↕			↕			↕↕↕				
Traffic Volume (vph)	12	61	0	0	18	63	22	1098	93	0	0	0
Future Volume (vph)	12	61	0	0	18	63	22	1098	93	0	0	0
Satd. Flow (prot)	0	1805	0	0	1561	0	0	4825	0	0	0	0
Fit Permitted		0.961						0.999				
Satd. Flow (perm)	0	1739	0	0	1561	0	0	4823	0	0	0	0
Satd. Flow (RTOR)					50			26				
Lane Group Flow (vph)	0	73	0	0	81	0	0	1213	0	0	0	0
Turn Type	Perm	NA			NA		Perm	NA				
Protected Phases		4			8			2				
Permitted Phases	4						2					
Minimum Split (s)	27.3	27.3			27.3		32.3	32.3				
Total Split (s)	31.0	31.0			31.0		44.0	44.0				
Total Split (%)	41.3%	41.3%			41.3%		58.7%	58.7%				
Yellow Time (s)	3.3	3.3			3.3		3.3	3.3				
All-Red Time (s)	2.0	2.0			2.0		2.0	2.0				
Lost Time Adjust (s)		0.0			0.0			0.0				
Total Lost Time (s)		5.3			5.3			5.3				
Lead/Lag												
Lead-Lag Optimize?												
Act Effct Green (s)		25.7			25.7			38.7				
Actuated g/C Ratio		0.34			0.34			0.52				
v/c Ratio		0.12			0.14			0.49				
Control Delay		26.9			9.3			10.5				
Queue Delay		0.0			0.0			49.8				
Total Delay		26.9			9.3			60.3				
LOS		C			A			E				
Approach Delay		26.9			9.3			60.3				
Approach LOS		C			A			E				
Queue Length 50th (m)		9.1			1.3			48.5				
Queue Length 95th (m)		m18.8			m5.6			68.8				
Internal Link Dist (m)		164.0			143.1			53.0			216.0	
Turn Bay Length (m)												
Base Capacity (vph)		595			567			2501				
Starvation Cap Reductn		0			0			1423				
Spillback Cap Reductn		0			0			0				
Storage Cap Reductn		0			0			0				
Reduced v/c Ratio		0.12			0.14			1.13				

Intersection Summary
 Cycle Length: 75
 Actuated Cycle Length: 75
 Offset: 50 (67%), Referenced to phase 2:NBT, Start of Green
 Natural Cycle: 60
 Control Type: Pretimed
 Maximum v/c Ratio: 0.49
 Intersection Signal Delay: 55.5
 Intersection LOS: E
 Intersection Capacity Utilization 54.7%
 ICU Level of Service A
 Analysis Period (min) 15
 m Volume for 95th percentile queue is metered by upstream signal.

Splits and Phases: 6: Kent St & Arlington Ave



Lanes, Volumes, Timings
7: Lyon St N & Gladstone Ave

05/18/2023



Lane Group	EBL	EBT	EBR	WBL	WBT	WBR	NBL	NBT	NBR	SBL	SBT	SBR
Lane Configurations		↑	↗	↖	↑						↕	↘
Traffic Volume (vph)	0	247	52	28	314	0	0	0	0	86	535	138
Future Volume (vph)	0	247	52	28	314	0	0	0	0	86	535	138
Satd. Flow (prot)	0	1784	1547	1729	1784	0	0	0	0	0	3261	0
Fit Permitted				0.574							0.994	
Satd. Flow (perm)	0	1784	1407	997	1784	0	0	0	0	0	3248	0
Satd. Flow (RTOR)			52								45	
Lane Group Flow (vph)	0	247	52	28	314	0	0	0	0	0	759	0
Turn Type		NA	Perm	Perm	NA					Perm	NA	
Protected Phases		4			8							6
Permitted Phases			4	8						6		
Minimum Split (s)		17.2	17.2	17.2	17.2					22.6	22.6	
Total Split (s)		37.0	37.0	37.0	37.0					38.0	38.0	
Total Split (%)		49.3%	49.3%	49.3%	49.3%					50.7%	50.7%	
Yellow Time (s)		3.3	3.3	3.3	3.3					3.3	3.3	
All-Red Time (s)		1.9	1.9	1.9	1.9					2.3	2.3	
Lost Time Adjust (s)		0.0	0.0	0.0	0.0						0.0	
Total Lost Time (s)		5.2	5.2	5.2	5.2						5.6	
Lead/Lag												
Lead-Lag Optimize?												
Act Effct Green (s)		31.8	31.8	31.8	31.8						32.4	
Actuated g/C Ratio		0.42	0.42	0.42	0.42						0.43	
v/c Ratio		0.33	0.08	0.07	0.42						0.53	
Control Delay		16.0	4.5	8.4	12.7						16.4	
Queue Delay		0.0	0.0	0.0	0.0						0.0	
Total Delay		16.0	4.5	8.4	12.7						16.4	
LOS		B	A	A	B						B	
Approach Delay		14.0			12.3						16.4	
Approach LOS		B			B						B	
Queue Length 50th (m)		22.6	0.0	1.5	35.6						37.5	
Queue Length 95th (m)		38.4	5.7	m3.3	55.1						52.8	
Internal Link Dist (m)		254.8			165.0			215.6			214.3	
Turn Bay Length (m)				25.0								
Base Capacity (vph)		756	626	422	756						1428	
Starvation Cap Reductn		0	0	0	0						0	
Spillback Cap Reductn		0	0	0	0						0	
Storage Cap Reductn		0	0	0	0						0	
Reduced v/c Ratio		0.33	0.08	0.07	0.42						0.53	

Intersection Summary
 Cycle Length: 75
 Actuated Cycle Length: 75
 Offset: 45 (60%), Referenced to phase 4:EBT and 8:WBTL, Start of Green
 Natural Cycle: 40
 Control Type: Pretimed
 Maximum v/c Ratio: 0.53
 Intersection Signal Delay: 14.9
 Intersection LOS: B
 Intersection Capacity Utilization 68.0%
 ICU Level of Service C
 Analysis Period (min) 15
 m Volume for 95th percentile queue is metered by upstream signal.

Splits and Phases: 7: Lyon St N & Gladstone Ave

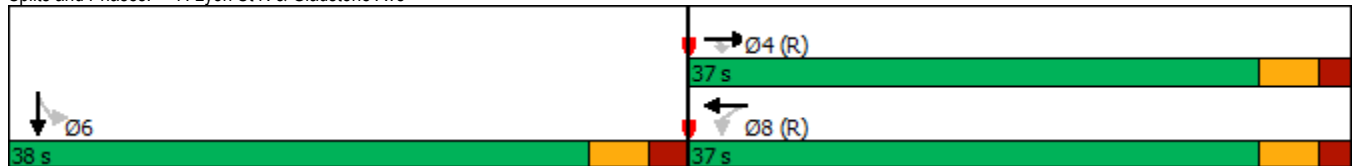

Lanes, Volumes, Timings
8: Kent St & Gladstone Ave

05/18/2023



Lane Group	EBL	EBT	EBR	WBL	WBT	WBR	NBL	NBT	NBR	SBL	SBT	SBR
Lane Configurations												
Traffic Volume (vph)	75	450	0	0	324	75	67	939	131	0	0	0
Future Volume (vph)	75	450	0	0	324	75	67	939	131	0	0	0
Satd. Flow (prot)	1729	1767	0	0	1720	0	1729	4627	0	0	0	0
Fit Permitted	0.453						0.950					
Satd. Flow (perm)	800	1767	0	0	1720	0	1522	4627	0	0	0	0
Satd. Flow (RTOR)					21			37				
Lane Group Flow (vph)	75	450	0	0	399	0	67	1070	0	0	0	0
Turn Type	Perm	NA			NA		Perm	NA				
Protected Phases		4			8			2				
Permitted Phases	4						2					
Minimum Split (s)	21.4	21.4			21.4		20.4	20.4				
Total Split (s)	43.0	43.0			43.0		32.0	32.0				
Total Split (%)	57.3%	57.3%			57.3%		42.7%	42.7%				
Yellow Time (s)	3.3	3.3			3.3		3.3	3.3				
All-Red Time (s)	2.1	2.1			2.1		2.1	2.1				
Lost Time Adjust (s)	0.0	0.0			0.0		0.0	0.0				
Total Lost Time (s)	5.4	5.4			5.4		5.4	5.4				
Lead/Lag												
Lead-Lag Optimize?												
Act Effct Green (s)	37.6	37.6			37.6		26.6	26.6				
Actuated g/C Ratio	0.50	0.50			0.50		0.35	0.35				
v/c Ratio	0.19	0.51			0.46		0.12	0.64				
Control Delay	18.1	21.5			13.5		8.6	9.7				
Queue Delay	0.0	0.0			0.0		0.0	0.0				
Total Delay	18.1	21.5			13.5		8.6	9.7				
LOS	B	C			B		A	A				
Approach Delay		21.0			13.5			9.6				
Approach LOS		C			B			A				
Queue Length 50th (m)	6.6	49.4			32.3		3.0	16.4				
Queue Length 95th (m)	m16.0	78.6			53.2		m4.7	15.0				
Internal Link Dist (m)		165.0			168.8			216.0			203.6	
Turn Bay Length (m)	30.0						40.0					
Base Capacity (vph)	401	885			872		539	1664				
Starvation Cap Reductn	0	0			0		0	0				
Spillback Cap Reductn	0	0			0		0	0				
Storage Cap Reductn	0	0			0		0	0				
Reduced v/c Ratio	0.19	0.51			0.46		0.12	0.64				

Intersection Summary

Cycle Length: 75
 Actuated Cycle Length: 75
 Offset: 23 (31%), Referenced to phase 4:EBTL and 8:WBT, Start of Green
 Natural Cycle: 45
 Control Type: Pretimed
 Maximum v/c Ratio: 0.64
 Intersection Signal Delay: 13.3
 Intersection Capacity Utilization 68.0%
 Analysis Period (min) 15
 Intersection LOS: B
 ICU Level of Service C
 m Volume for 95th percentile queue is metered by upstream signal.

Splits and Phases: 8: Kent St & Gladstone Ave

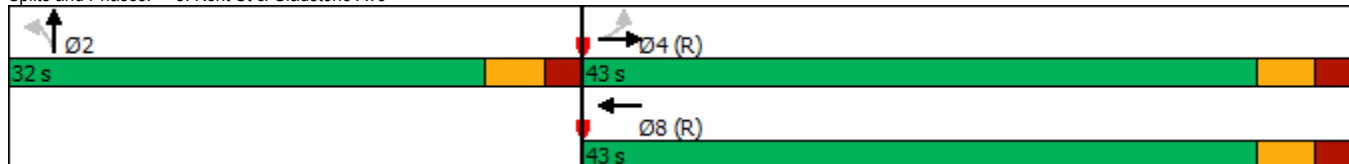

Lanes, Volumes, Timings
 9: Bank St & Chamberlain Ave/Isabella St

05/18/2023

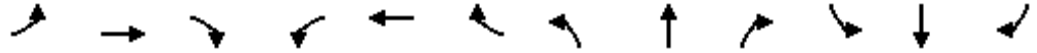

Lane Group	EBL	EBT	EBR	WBL	WBT	WBR	NBL	NBT	NBR	SBL	SBT	SBR
Lane Configurations		↕↕	↗					↕↕			↕↕	
Traffic Volume (vph)	55	629	120	0	0	0	0	450	93	180	725	0
Future Volume (vph)	55	629	120	0	0	0	0	450	93	180	725	0
Satd. Flow (prot)	0	3346	1547	0	0	0	0	3131	0	0	3324	0
Fit Permitted		0.996									0.722	
Satd. Flow (perm)	0	3343	1402	0	0	0	0	3131	0	0	2373	0
Satd. Flow (RTOR)			134									
Lane Group Flow (vph)	0	684	120	0	0	0	0	543	0	0	905	0
Turn Type	Perm	NA	Perm					NA		pm+pt	NA	
Protected Phases		4						2		5	6	
Permitted Phases	4		4							6		
Detector Phase	4	4	4					2		5	6	
Switch Phase												
Minimum Initial (s)	10.0	10.0	10.0					10.0		5.0	10.0	
Minimum Split (s)	26.2	26.2	26.2					23.1		11.1	23.1	
Total Split (s)	27.0	27.0	27.0					36.9		11.1	48.0	
Total Split (%)	36.0%	36.0%	36.0%					49.2%		14.8%	64.0%	
Yellow Time (s)	3.3	3.3	3.3					3.0		3.0	3.0	
All-Red Time (s)	2.9	2.9	2.9					3.1		3.1	3.1	
Lost Time Adjust (s)		0.0	0.0					0.0			0.0	
Total Lost Time (s)		6.2	6.2					6.1			6.1	
Lead/Lag												
Lead-Lag Optimize?												
Recall Mode	None	None	None					C-Max		None	C-Max	
Act Effct Green (s)		19.5	19.5					43.2			43.2	
Actuated g/C Ratio		0.26	0.26					0.58			0.58	
v/c Ratio		0.79	0.26					0.30			0.66	
Control Delay		32.9	5.1					9.0			12.8	
Queue Delay		0.0	0.0					0.0			1.4	
Total Delay		32.9	5.1					9.0			14.3	
LOS		C	A					A			B	
Approach Delay		28.7						9.0			14.3	
Approach LOS		C						A			B	
Queue Length 50th (m)		46.1	0.0					19.8			71.9	
Queue Length 95th (m)		64.3	9.4					28.5			m90.9	
Internal Link Dist (m)		296.0			233.4			215.6			90.2	
Turn Bay Length (m)			40.0									
Base Capacity (vph)		927	485					1801			1365	
Starvation Cap Reductn		0	0					0			265	
Spillback Cap Reductn		0	0					0			0	
Storage Cap Reductn		0	0					0			0	
Reduced v/c Ratio		0.74	0.25					0.30			0.82	

Intersection Summary

Cycle Length: 75
 Actuated Cycle Length: 75
 Offset: 60 (80%), Referenced to phase 2:NBT and 6:SBTL, Start of Green
 Natural Cycle: 65
 Control Type: Actuated-Coordinated
 Maximum v/c Ratio: 0.79
 Intersection Signal Delay: 18.2
 Intersection Capacity Utilization 82.9%
 Analysis Period (min) 15
 Intersection LOS: B
 ICU Level of Service E
 m Volume for 95th percentile queue is metered by upstream signal.

Splits and Phases: 9: Bank St & Chamberlain Ave/Isabella St

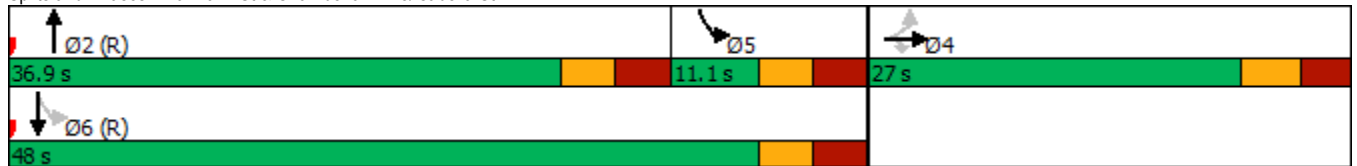

Lanes, Volumes, Timings
13: Bronson Ave & Catherine St

05/18/2023



Lane Group	EBL	EBT	EBR	WBL	WBT	WBR	NBL	NBT	NBR	SBL	SBT	SBR
Lane Configurations				↖ ↗	↖ ↗		↖ ↗	↖ ↗			↖ ↗	
Traffic Volume (vph)	0	0	0	735	610	288	311	812	0	0	853	176
Future Volume (vph)	0	0	0	735	610	288	311	812	0	0	853	176
Satd. Flow (prot)	0	0	0	1458	4279	0	1679	3390	0	0	3260	0
Fit Permitted				0.950	0.987		0.099					
Satd. Flow (perm)	0	0	0	1458	4279	0	175	3390	0	0	3260	0
Satd. Flow (RTOR)					80						26	
Lane Group Flow (vph)	0	0	0	412	1221	0	311	812	0	0	1029	0
Turn Type				Perm	NA		pm+pt	NA			NA	
Protected Phases					8		5	2				6
Permitted Phases				8			2					
Minimum Split (s)				28.3	28.3		11.2	23.8			23.8	
Total Split (s)				37.0	37.0		22.0	63.0			41.0	
Total Split (%)				37.0%	37.0%		22.0%	63.0%			41.0%	
Yellow Time (s)				3.3	3.3		3.3	3.3			3.3	
All-Red Time (s)				3.0	3.0		2.9	3.5			3.5	
Lost Time Adjust (s)				0.0	0.0		0.0	0.0			0.0	
Total Lost Time (s)				6.3	6.3		6.2	6.8			6.8	
Lead/Lag							Lead				Lag	
Lead-Lag Optimize?							Yes				Yes	
Act Effct Green (s)				30.7	30.7		56.8	56.2			34.2	
Actuated g/C Ratio				0.31	0.31		0.57	0.56			0.34	
v/c Ratio				0.92	0.89		0.92	0.43			0.91	
Control Delay				61.9	40.5		59.4	13.5			43.5	
Queue Delay				0.0	0.0		0.0	0.0			0.0	
Total Delay				61.9	40.5		59.4	13.5			43.5	
LOS				E	D		E	B			D	
Approach Delay					45.9			26.2			43.5	
Approach LOS					D			C			D	
Queue Length 50th (m)				89.3	82.1		44.4	44.8			97.0	
Queue Length 95th (m)				#154.3	#109.4		#94.6	58.3			#136.1	
Internal Link Dist (m)		141.5			120.8			240.1			287.4	
Turn Bay Length (m)				80.0			45.0					
Base Capacity (vph)				447	1369		337	1905			1132	
Starvation Cap Reductn				0	0		0	0			0	
Spillback Cap Reductn				0	0		0	0			0	
Storage Cap Reductn				0	0		0	0			0	
Reduced v/c Ratio				0.92	0.89		0.92	0.43			0.91	

Intersection Summary
 Cycle Length: 100
 Actuated Cycle Length: 100
 Offset: 60 (60%), Referenced to phase 2:NBT and 6:SBT, Start of Green
 Natural Cycle: 90
 Control Type: Pretimed
 Maximum v/c Ratio: 0.92
 Intersection Signal Delay: 39.4 Intersection LOS: D
 Intersection Capacity Utilization 92.3% ICU Level of Service F
 Analysis Period (min) 15
 # 95th percentile volume exceeds capacity, queue may be longer.
 Queue shown is maximum after two cycles.

Splits and Phases: 13: Bronson Ave & Catherine St

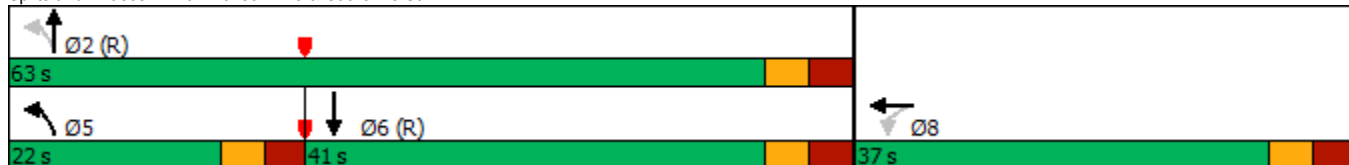

Intersection												
Int Delay, s/veh	2											
Movement	EBL	EBT	EBR	WBL	WBT	WBR	NBL	NBT	NBR	SBL	SBT	SBR
Lane Configurations		↕			↕						↕↕	
Traffic Vol, veh/h	0	18	0	11	12	0	0	0	0	44	345	9
Future Vol, veh/h	0	18	0	11	12	0	0	0	0	44	345	9
Conflicting Peds, #/hr	32	0	15	15	0	32	9	0	10	10	0	9
Sign Control	Stop	Stop	Stop	Stop	Stop	Stop	Free	Free	Free	Free	Free	Free
RT Channelized	-	-	None	-	-	None	-	-	None	-	-	None
Storage Length	-	-	-	-	-	-	-	-	-	-	-	-
Veh in Median Storage, #	-	0	-	-	0	-	-	-	-	-	0	-
Grade, %	-	0	-	-	0	-	-	0	-	-	0	-
Peak Hour Factor	100	100	100	100	100	100	100	100	100	100	100	100
Heavy Vehicles, %	0	6	0	9	0	0	0	0	0	5	1	11
Mvmt Flow	0	18	0	11	12	0	0	0	0	44	345	9
Major/Minor	Minor2			Minor1			Major2					
Conflicting Flow All	-	457	201	295	461	-	-	-	-	10	0	0
Stage 1	-	447	-	10	10	-	-	-	-	-	-	-
Stage 2	-	10	-	285	451	-	-	-	-	-	-	-
Critical Hdwy	-	6.62	6.9	7.68	6.5	-	-	-	-	4.2	-	-
Critical Hdwy Stg 1	-	5.62	-	-	-	-	-	-	-	-	-	-
Critical Hdwy Stg 2	-	-	-	6.68	5.5	-	-	-	-	-	-	-
Follow-up Hdwy	-	4.06	3.3	3.59	4	-	-	-	-	2.25	-	-
Pot Cap-1 Maneuver	0	490	813	617	500	0	-	-	-	1586	-	-
Stage 1	0	562	-	-	-	0	-	-	-	-	-	-
Stage 2	0	-	-	679	574	0	-	-	-	-	-	-
Platoon blocked, %	-	-	-	-	-	-	-	-	-	-	-	-
Mov Cap-1 Maneuver	-	465	806	578	475	-	-	-	-	1571	-	-
Mov Cap-2 Maneuver	-	465	-	578	475	-	-	-	-	-	-	-
Stage 1	-	538	-	-	-	-	-	-	-	-	-	-
Stage 2	-	-	-	633	549	-	-	-	-	-	-	-
Approach	EB			WB			SB					
HCM Control Delay, s	13.1			12.3			0.9					
HCM LOS	B			B								
Minor Lane/Major Mvmt	EBLn1	WBLn1	SBL	SBT	SBR							
Capacity (veh/h)	465	519	1571	-	-							
HCM Lane V/C Ratio	0.039	0.044	0.028	-	-							
HCM Control Delay (s)	13.1	12.3	7.4	0.1	-							
HCM Lane LOS	B	B	A	A	-							
HCM 95th %tile Q(veh)	0.1	0.1	0.1	-	-							

Intersection						
Int Delay, s/veh	2.8					
Movement	EBL	EBR	NBL	NBT	SBT	SBR
Lane Configurations	↔			↕	↕	
Traffic Vol, veh/h	21	124	86	691	390	22
Future Vol, veh/h	21	124	86	691	390	22
Conflicting Peds, #/hr	0	0	111	0	0	111
Sign Control	Stop	Stop	Free	Free	Free	Free
RT Channelized	-	None	-	None	-	None
Storage Length	0	-	-	-	-	-
Veh in Median Storage, #	0	-	-	0	0	-
Grade, %	0	-	-	0	0	-
Peak Hour Factor	100	100	100	100	100	100
Heavy Vehicles, %	0	3	2	5	8	5
Mvmt Flow	21	124	86	691	390	22

Major/Minor	Minor2	Major1	Major2			
Conflicting Flow All	1030	317	523	0	-	0
Stage 1	512	-	-	-	-	-
Stage 2	518	-	-	-	-	-
Critical Hdwy	6.8	6.96	4.14	-	-	-
Critical Hdwy Stg 1	5.8	-	-	-	-	-
Critical Hdwy Stg 2	5.8	-	-	-	-	-
Follow-up Hdwy	3.5	3.33	2.22	-	-	-
Pot Cap-1 Maneuver	233	676	1040	-	-	-
Stage 1	572	-	-	-	-	-
Stage 2	568	-	-	-	-	-
Platoon blocked, %				-	-	-
Mov Cap-1 Maneuver	159	607	933	-	-	-
Mov Cap-2 Maneuver	159	-	-	-	-	-
Stage 1	436	-	-	-	-	-
Stage 2	509	-	-	-	-	-

Approach	EB	NB	SB
HCM Control Delay, s	17.5	1.6	0
HCM LOS	C		

Minor Lane/Major Mvmt	NBL	NBT	EBLn1	SBT	SBR
Capacity (veh/h)	933	-	431	-	-
HCM Lane V/C Ratio	0.092	-	0.336	-	-
HCM Control Delay (s)	9.2	0.6	17.5	-	-
HCM Lane LOS	A	A	C	-	-
HCM 95th %tile Q(veh)	0.3	-	1.5	-	-

Intersection												
Int Delay, s/veh	2.1											
Movement	EBL	EBT	EBR	WBL	WBT	WBR	NBL	NBT	NBR	SBL	SBT	SBR
Lane Configurations		↕			↕						↕↔	
Traffic Vol, veh/h	0	19	2	8	37	0	0	0	0	43	601	13
Future Vol, veh/h	0	19	2	8	37	0	0	0	0	43	601	13
Conflicting Peds, #/hr	20	0	8	8	0	20	19	0	3	3	0	19
Sign Control	Stop	Stop	Stop	Stop	Stop	Stop	Free	Free	Free	Free	Free	Free
RT Channelized	-	-	None	-	-	None	-	-	None	-	-	None
Storage Length	-	-	-	-	-	-	-	-	-	-	-	-
Veh in Median Storage, #	-	0	-	-	0	-	-	-	-	-	0	-
Grade, %	-	0	-	-	0	-	-	0	-	-	0	-
Peak Hour Factor	100	100	100	100	100	100	100	100	100	100	100	100
Heavy Vehicles, %	0	5	0	0	5	0	0	0	0	0	0	0
Mvmt Flow	0	19	2	8	37	0	0	0	0	43	601	13
Major/Minor	Minor2			Minor1			Major2					
Conflicting Flow All	-	716	334	407	722	-	-	-	3	0	0	-
Stage 1	-	713	-	3	3	-	-	-	-	-	-	-
Stage 2	-	3	-	404	719	-	-	-	-	-	-	-
Critical Hdwy	-	6.6	6.9	7.5	6.6	-	-	-	4.1	-	-	-
Critical Hdwy Stg 1	-	5.6	-	-	-	-	-	-	-	-	-	-
Critical Hdwy Stg 2	-	-	-	6.5	5.6	-	-	-	-	-	-	-
Follow-up Hdwy	-	4.05	3.3	3.5	4.05	-	-	-	2.2	-	-	-
Pot Cap-1 Maneuver	0	348	668	533	346	0	-	-	1632	-	-	-
Stage 1	0	426	-	-	-	0	-	-	-	-	-	-
Stage 2	0	-	-	600	424	0	-	-	-	-	-	-
Platoon blocked, %	-	-	-	-	-	-	-	-	-	-	-	-
Mov Cap-1 Maneuver	-	327	656	491	325	-	-	-	1627	-	-	-
Mov Cap-2 Maneuver	-	327	-	491	325	-	-	-	-	-	-	-
Stage 1	-	402	-	-	-	-	-	-	-	-	-	-
Stage 2	-	-	-	547	400	-	-	-	-	-	-	-
Approach	EB			WB			SB					
HCM Control Delay, s	16.2			17			0.6					
HCM LOS	C			C								
Minor Lane/Major Mvmt	EBLn1	WBLn1	SBL	SBT	SBR							
Capacity (veh/h)	343	346	1627	-	-							
HCM Lane V/C Ratio	0.061	0.13	0.026	-	-							
HCM Control Delay (s)	16.2	17	7.3	0.1	-							
HCM Lane LOS	C	C	A	A	-							
HCM 95th %tile Q(veh)	0.2	0.4	0.1	-	-							

Intersection						
Int Delay, s/veh	2.2					
Movement	EBL	EBR	NBL	NBT	SBT	SBR
Lane Configurations	↔			↕↕	↕↕	
Traffic Vol, veh/h	20	107	58	428	719	27
Future Vol, veh/h	20	107	58	428	719	27
Conflicting Peds, #/hr	0	0	42	0	0	42
Sign Control	Stop	Stop	Free	Free	Free	Free
RT Channelized	-	None	-	None	-	None
Storage Length	0	-	-	-	-	-
Veh in Median Storage, #	0	-	-	0	0	-
Grade, %	0	-	-	0	0	-
Peak Hour Factor	100	100	100	100	100	100
Heavy Vehicles, %	0	1	0	5	3	0
Mvmt Flow	20	107	58	428	719	27

Major/Minor	Minor2	Major1	Major2			
Conflicting Flow All	1105	415	788	0	-	0
Stage 1	775	-	-	-	-	-
Stage 2	330	-	-	-	-	-
Critical Hdwy	6.8	6.92	4.1	-	-	-
Critical Hdwy Stg 1	5.8	-	-	-	-	-
Critical Hdwy Stg 2	5.8	-	-	-	-	-
Follow-up Hdwy	3.5	3.31	2.2	-	-	-
Pot Cap-1 Maneuver	208	589	840	-	-	-
Stage 1	420	-	-	-	-	-
Stage 2	707	-	-	-	-	-
Platoon blocked, %				-	-	-
Mov Cap-1 Maneuver	174	566	807	-	-	-
Mov Cap-2 Maneuver	174	-	-	-	-	-
Stage 1	366	-	-	-	-	-
Stage 2	679	-	-	-	-	-

Approach	EB	NB	SB
HCM Control Delay, s	17.3	1.5	0
HCM LOS	C		

Minor Lane/Major Mvmt	NBL	NBT	EBLn1	SBT	SBR
Capacity (veh/h)	807	-	418	-	-
HCM Lane V/C Ratio	0.072	-	0.304	-	-
HCM Control Delay (s)	9.8	0.4	17.3	-	-
HCM Lane LOS	A	A	C	-	-
HCM 95th %tile Q(veh)	0.2	-	1.3	-	-

Total Projected 2026

Lanes, Volumes, Timings

1: Hwy 417 WB On Ramp/Lyon St N & Catherine St

02/28/2024



Lane Group	WBT	SBT	SBR
Lane Configurations	↕↕↕	↕	↗
Traffic Volume (vph)	260	262	125
Future Volume (vph)	260	262	125
Lane Group Flow (vph)	512	262	125
Turn Type	NA	NA	Perm
Protected Phases	8	6	
Permitted Phases			6
Minimum Split (s)	26.2	28.3	28.3
Total Split (s)	35.0	40.0	40.0
Total Split (%)	46.7%	53.3%	53.3%
Yellow Time (s)	3.3	3.3	3.3
All-Red Time (s)	1.9	2.0	2.0
Lost Time Adjust (s)	0.0	0.0	0.0
Total Lost Time (s)	5.2	5.3	5.3
Lead/Lag			
Lead-Lag Optimize?			
Act Effct Green (s)	29.8	34.7	34.7
Actuated g/C Ratio	0.40	0.46	0.46
v/c Ratio	0.26	0.32	0.16
Control Delay	1.0	22.5	11.4
Queue Delay	0.0	0.0	0.0
Total Delay	1.0	22.5	11.4
LOS	A	C	B
Approach Delay	1.0	18.9	
Approach LOS	A	B	
Queue Length 50th (m)	0.3	34.8	1.9
Queue Length 95th (m)	m1.2	54.1	19.3
Internal Link Dist (m)	109.2	52.8	
Turn Bay Length (m)			
Base Capacity (vph)	1956	825	769
Starvation Cap Reductn	0	0	0
Spillback Cap Reductn	0	0	0
Storage Cap Reductn	0	0	0
Reduced v/c Ratio	0.26	0.32	0.16

Intersection Summary

Cycle Length: 75
 Actuated Cycle Length: 75
 Offset: 24 (32%), Referenced to phase 8:WBTL, Start of Green
 Natural Cycle: 55
 Control Type: Pretimed
 Maximum v/c Ratio: 0.32
 Intersection Signal Delay: 8.7
 Intersection LOS: A
 Intersection Capacity Utilization 49.3%
 ICU Level of Service A
 Analysis Period (min) 15
 m Volume for 95th percentile queue is metered by upstream signal.

Splits and Phases: 1: Hwy 417 WB On Ramp/Lyon St N & Catherine St

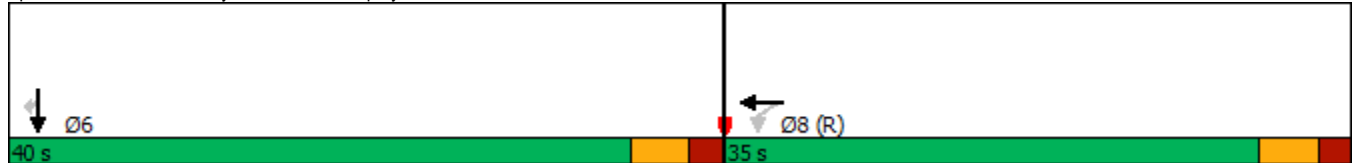

Lanes, Volumes, Timings

2: Hwy 417 EB Off Ramp/Chamberlain Ave/Kent St & Catherine St

02/28/2024



Lane Group	WBT	WBR	NBT	Ø9
Lane Configurations	↕↕	↗	↕↕↕	
Traffic Volume (vph)	426	549	1356	
Future Volume (vph)	426	549	1356	
Lane Group Flow (vph)	673	302	1420	
Turn Type	NA	Perm	NA	
Protected Phases	8		2	9
Permitted Phases		8		
Minimum Split (s)	22.8	22.8	22.5	5.0
Total Split (s)	36.0	36.0	34.0	5.0
Total Split (%)	48.0%	48.0%	45.3%	7%
Yellow Time (s)	3.3	3.3	3.3	2.0
All-Red Time (s)	2.5	2.5	2.5	0.0
Lost Time Adjust (s)	0.0	0.0	0.0	
Total Lost Time (s)	5.8	5.8	5.8	
Lead/Lag				
Lead-Lag Optimize?				
Act Effct Green (s)	30.2	30.2	28.2	
Actuated g/C Ratio	0.40	0.40	0.38	
v/c Ratio	0.57	0.58	0.75	
Control Delay	17.4	19.5	22.4	
Queue Delay	0.0	0.0	3.9	
Total Delay	17.4	19.5	26.2	
LOS	B	B	C	
Approach Delay	18.0		26.3	
Approach LOS	B		C	
Queue Length 50th (m)	31.8	28.5	59.5	
Queue Length 95th (m)	m46.4	m43.0	75.6	
Internal Link Dist (m)	131.7		67.4	
Turn Bay Length (m)				
Base Capacity (vph)	1181	524	1888	
Starvation Cap Reductn	0	0	0	
Spillback Cap Reductn	0	0	377	
Storage Cap Reductn	0	0	0	
Reduced v/c Ratio	0.57	0.58	0.94	

Intersection Summary

Cycle Length: 75
 Actuated Cycle Length: 75
 Offset: 12 (16%), Referenced to phase 8:WBT, Start of Green
 Natural Cycle: 55
 Control Type: Pretimed
 Maximum v/c Ratio: 0.75
 Intersection Signal Delay: 22.9
 Intersection LOS: C
 Intersection Capacity Utilization 66.0%
 ICU Level of Service C
 Analysis Period (min) 15
 m Volume for 95th percentile queue is metered by upstream signal.

Splits and Phases: 2: Hwy 417 EB Off Ramp/Chamberlain Ave/Kent St & Catherine St

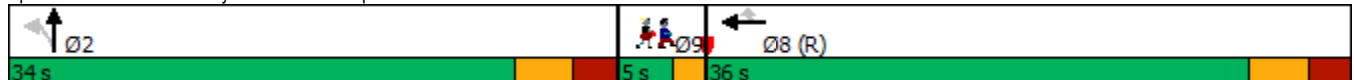

Lanes, Volumes, Timings
3: Bank St & Catherine St

02/28/2024



Lane Group	WBT	NBL	NBT	SBT	Ø1	Ø5	Ø7
Lane Configurations	↕↕↕		↕↕	↕↕			
Traffic Volume (vph)	608	275	578	376			
Future Volume (vph)	608	275	578	376			
Lane Group Flow (vph)	986	0	853	520			
Turn Type	NA	pm+pt	NA	NA			
Protected Phases	8	9	2	6	1	5	7
Permitted Phases		2					
Minimum Split (s)	18.6	10.4	16.4	16.4	5.0	5.0	5.0
Total Split (s)	24.7	10.4	40.3	29.9	5.0	5.0	5.0
Total Split (%)	32.9%	13.9%	53.7%	39.9%	7%	7%	7%
Yellow Time (s)	3.3	3.3	3.3	3.3	2.0	2.0	2.0
All-Red Time (s)	2.3	2.1	2.1	2.1	0.0	0.0	0.0
Lost Time Adjust (s)	0.0		0.0	0.0			
Total Lost Time (s)	5.6		5.4	5.4			
Lead/Lag	Lag		Lag	Lag	Lead	Lead	Lead
Lead-Lag Optimize?	Yes		Yes	Yes	Yes	Yes	Yes
Act Effct Green (s)	19.1		34.9	24.5			
Actuated g/C Ratio	0.25		0.47	0.33			
v/c Ratio	0.84		0.84	0.53			
Control Delay	32.2		21.6	19.5			
Queue Delay	0.0		0.0	0.0			
Total Delay	32.2		21.6	19.5			
LOS	C		C	B			
Approach Delay	32.2		21.6	19.5			
Approach LOS	C		C	B			
Queue Length 50th (m)	44.6		27.3	26.0			
Queue Length 95th (m)	#64.9		#45.9	40.2			
Internal Link Dist (m)	201.7		90.2	52.9			
Turn Bay Length (m)							
Base Capacity (vph)	1175		1018	984			
Starvation Cap Reductn	0		0	0			
Spillback Cap Reductn	0		0	0			
Storage Cap Reductn	0		0	0			
Reduced v/c Ratio	0.84		0.84	0.53			

Intersection Summary

Cycle Length: 75
 Actuated Cycle Length: 75
 Offset: 50 (67%), Referenced to phase 2:NBT and 6:SBT, Start of Green
 Natural Cycle: 70
 Control Type: Pretimed
 Maximum v/c Ratio: 0.84
 Intersection Signal Delay: 25.6
 Intersection LOS: C
 Intersection Capacity Utilization 80.7%
 ICU Level of Service D
 Analysis Period (min) 15
 # 95th percentile volume exceeds capacity, queue may be longer.
 Queue shown is maximum after two cycles.

Splits and Phases: 3: Bank St & Catherine St

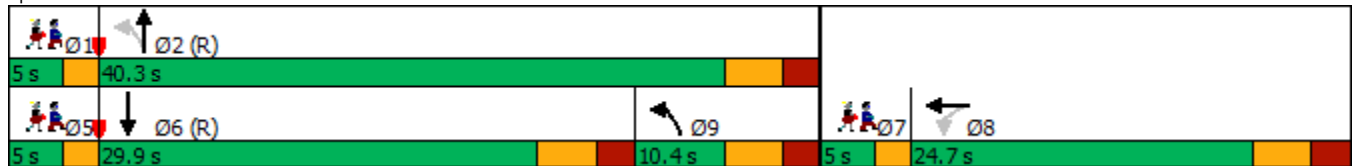

Lanes, Volumes, Timings
4: Percy St & Catherine St

02/28/2024

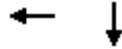

Lane Group	WBT	SBT	Ø3	Ø7
Lane Configurations				
Traffic Volume (vph)	260	129		
Future Volume (vph)	260	129		
Lane Group Flow (vph)	347	186		
Turn Type	NA	NA		
Protected Phases	8	6	3	7
Permitted Phases				
Detector Phase	8	6		
Switch Phase				
Minimum Initial (s)	10.0	10.0	1.0	1.0
Minimum Split (s)	26.5	23.4	6.4	6.4
Total Split (s)	34.0	24.0	16.0	16.0
Total Split (%)	37.8%	26.7%	18%	18%
Yellow Time (s)	3.3	3.3	3.3	3.3
All-Red Time (s)	2.2	2.1	2.1	2.1
Lost Time Adjust (s)	0.0	0.0		
Total Lost Time (s)	5.5	5.4		
Lead/Lag	Lag			Lead
Lead-Lag Optimize?	Yes			Yes
Recall Mode	None	Max	None	None
Act Effct Green (s)	11.9	18.8		
Actuated g/C Ratio	0.29	0.45		
v/c Ratio	0.25	0.25		
Control Delay	6.4	9.4		
Queue Delay	0.0	0.0		
Total Delay	6.4	9.4		
LOS	A	A		
Approach Delay	6.4	9.4		
Approach LOS	A	A		
Queue Length 50th (m)	3.5	6.6		
Queue Length 95th (m)	7.6	23.3		
Internal Link Dist (m)	271.6	288.0		
Turn Bay Length (m)				
Base Capacity (vph)	3171	740		
Starvation Cap Reductn	0	0		
Spillback Cap Reductn	0	0		
Storage Cap Reductn	0	0		
Reduced v/c Ratio	0.11	0.25		

Intersection Summary

Cycle Length: 90	
Actuated Cycle Length: 41.7	
Natural Cycle: 65	
Control Type: Semi Act-Uncoord	
Maximum v/c Ratio: 0.25	
Intersection Signal Delay: 7.4	Intersection LOS: A
Intersection Capacity Utilization 38.4%	ICU Level of Service A
Analysis Period (min) 15	

Splits and Phases: 4: Percy St & Catherine St

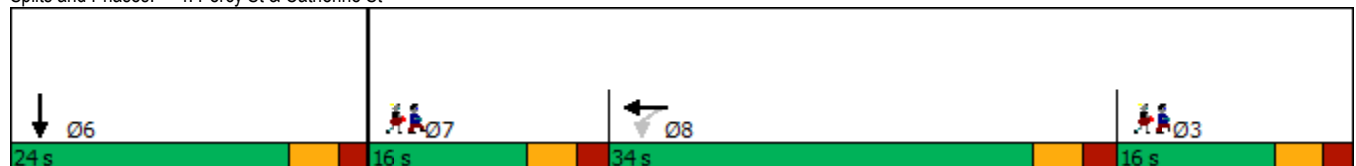

Lanes, Volumes, Timings
 5: Lyon St N & Arlington Ave

02/28/2024

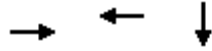

Lane Group	EBT	WBT	SBT
Lane Configurations			
Traffic Volume (vph)	18	12	329
Future Volume (vph)	18	12	329
Lane Group Flow (vph)	18	23	386
Sign Control	Stop	Stop	Free
Intersection Summary			
Control Type: Unsignalized			
Intersection Capacity Utilization 32.9%		ICU Level of Service A	
Analysis Period (min) 15			

Intersection												
Int Delay, s/veh	2.1											
Movement	EBL	EBT	EBR	WBL	WBT	WBR	NBL	NBT	NBR	SBL	SBT	SBR
Lane Configurations		↕			↕						↕↕	
Traffic Vol, veh/h	0	18	0	11	12	0	0	0	0	48	329	9
Future Vol, veh/h	0	18	0	11	12	0	0	0	0	48	329	9
Conflicting Peds, #/hr	32	0	15	15	0	32	9	0	10	10	0	9
Sign Control	Stop	Stop	Stop	Stop	Stop	Stop	Free	Free	Free	Free	Free	Free
RT Channelized	-	-	None	-	-	None	-	-	None	-	-	None
Storage Length	-	-	-	-	-	-	-	-	-	-	-	-
Veh in Median Storage, #	-	0	-	-	0	-	-	-	-	-	0	-
Grade, %	-	0	-	-	0	-	-	0	-	-	0	-
Peak Hour Factor	100	100	100	100	100	100	100	100	100	100	100	100
Heavy Vehicles, %	0	6	0	9	0	0	0	0	0	5	1	11
Mvmt Flow	0	18	0	11	12	0	0	0	0	48	329	9

Major/Minor	Minor2		Minor1			Major2			
Conflicting Flow All	-	449	193	295	453	-	10	0	0
Stage 1	-	439	-	10	10	-	-	-	-
Stage 2	-	10	-	285	443	-	-	-	-
Critical Hdwy	-	6.62	6.9	7.68	6.5	-	4.2	-	-
Critical Hdwy Stg 1	-	5.62	-	-	-	-	-	-	-
Critical Hdwy Stg 2	-	-	-	6.68	5.5	-	-	-	-
Follow-up Hdwy	-	4.06	3.3	3.59	4	-	2.25	-	-
Pot Cap-1 Maneuver	0	495	822	617	506	0	1586	-	-
Stage 1	0	567	-	-	0	-	-	-	-
Stage 2	0	-	-	679	579	0	-	-	-
Platoon blocked, %	-	-	-	-	-	-	-	-	-
Mov Cap-1 Maneuver	-	468	815	576	479	-	1571	-	-
Mov Cap-2 Maneuver	-	468	-	576	479	-	-	-	-
Stage 1	-	541	-	-	-	-	-	-	-
Stage 2	-	-	-	631	552	-	-	-	-

Approach	EB		WB			SB		
HCM Control Delay, s	13		12.2			1		
HCM LOS	B		B					

Minor Lane/Major Mvmt	EBLn1	WBLn1	SBL	SBT	SBR
Capacity (veh/h)	468	521	1571	-	-
HCM Lane V/C Ratio	0.038	0.044	0.031	-	-
HCM Control Delay (s)	13	12.2	7.4	0.1	-
HCM Lane LOS	B	B	A	A	-
HCM 95th %tile Q(veh)	0.1	0.1	0.1	-	-

Lanes, Volumes, Timings
6: Kent St & Arlington Ave

02/28/2024



Lane Group	EBL	EBT	WBT	NBT
Lane Configurations		↕	↕	↕↕↕
Traffic Volume (vph)	19	52	11	1741
Future Volume (vph)	19	52	11	1741
Lane Group Flow (vph)	0	71	104	1887
Turn Type	Perm	NA	NA	NA
Protected Phases		4	8	2
Permitted Phases	4			
Minimum Split (s)	27.3	27.3	27.3	32.3
Total Split (s)	28.0	28.0	28.0	47.0
Total Split (%)	37.3%	37.3%	37.3%	62.7%
Yellow Time (s)	3.3	3.3	3.3	3.3
All-Red Time (s)	2.0	2.0	2.0	2.0
Lost Time Adjust (s)		0.0	0.0	0.0
Total Lost Time (s)		5.3	5.3	5.3
Lead/Lag				
Lead-Lag Optimize?				
Act Effct Green (s)		22.7	22.7	41.7
Actuated g/C Ratio		0.30	0.30	0.56
v/c Ratio		0.14	0.22	0.71
Control Delay		32.6	16.1	11.5
Queue Delay		0.0	0.0	3.4
Total Delay		32.6	16.1	15.0
LOS		C	B	B
Approach Delay		32.6	16.1	15.0
Approach LOS		C	B	B
Queue Length 50th (m)		9.5	8.3	32.8
Queue Length 95th (m)		20.6	m12.8	52.3
Internal Link Dist (m)		164.0	143.1	53.0
Turn Bay Length (m)				
Base Capacity (vph)		491	475	2676
Starvation Cap Reductn		0	0	676
Spillback Cap Reductn		0	0	0
Storage Cap Reductn		0	0	0
Reduced v/c Ratio		0.14	0.22	0.94

Intersection Summary

Cycle Length: 75
 Actuated Cycle Length: 75
 Offset: 50 (67%), Referenced to phase 2:NBTL, Start of Green
 Natural Cycle: 60
 Control Type: Pretimed
 Maximum v/c Ratio: 0.71
 Intersection Signal Delay: 15.6
 Intersection LOS: B
 Intersection Capacity Utilization 68.5%
 ICU Level of Service C
 Analysis Period (min) 15
 m Volume for 95th percentile queue is metered by upstream signal.

Splits and Phases: 6: Kent St & Arlington Ave



Lanes, Volumes, Timings
7: Lyon St N & Gladstone Ave

02/28/2024



Lane Group	EBT	EBR	WBL	WBT	SBT
Lane Configurations	↑	↑	↑	↑	↑↓
Traffic Volume (vph)	184	24	15	143	331
Future Volume (vph)	184	24	15	143	331
Lane Group Flow (vph)	184	24	15	143	518
Turn Type	NA	Perm	Perm	NA	NA
Protected Phases	4			8	6
Permitted Phases		4	8		
Minimum Split (s)	17.2	17.2	17.2	17.2	22.6
Total Split (s)	36.0	36.0	36.0	36.0	39.0
Total Split (%)	48.0%	48.0%	48.0%	48.0%	52.0%
Yellow Time (s)	3.3	3.3	3.3	3.3	3.3
All-Red Time (s)	1.9	1.9	1.9	1.9	2.3
Lost Time Adjust (s)	0.0	0.0	0.0	0.0	0.0
Total Lost Time (s)	5.2	5.2	5.2	5.2	5.6
Lead/Lag					
Lead-Lag Optimize?					
Act Effct Green (s)	30.8	30.8	30.8	30.8	33.4
Actuated g/C Ratio	0.41	0.41	0.41	0.41	0.45
v/c Ratio	0.26	0.04	0.03	0.20	0.35
Control Delay	15.8	3.3	5.7	7.7	13.2
Queue Delay	0.0	0.0	0.0	0.0	0.0
Total Delay	15.8	3.3	5.7	7.7	13.2
LOS	B	A	A	A	B
Approach Delay	14.4			7.5	13.2
Approach LOS	B			A	B
Queue Length 50th (m)	16.6	0.0	0.7	10.0	21.7
Queue Length 95th (m)	29.8	2.8	m1.1	14.1	32.5
Internal Link Dist (m)	254.8			165.0	214.3
Turn Bay Length (m)			25.0		
Base Capacity (vph)	711	632	470	718	1460
Starvation Cap Reductn	0	0	0	0	0
Spillback Cap Reductn	0	0	0	0	0
Storage Cap Reductn	0	0	0	0	0
Reduced v/c Ratio	0.26	0.04	0.03	0.20	0.35

Intersection Summary

Cycle Length: 75
 Actuated Cycle Length: 75
 Offset: 45 (60%), Referenced to phase 4:EBT and 8:WBTL, Start of Green
 Natural Cycle: 40
 Control Type: Pretimed
 Maximum v/c Ratio: 0.35
 Intersection Signal Delay: 12.4
 Intersection LOS: B
 Intersection Capacity Utilization 80.3%
 ICU Level of Service D
 Analysis Period (min) 15
 m Volume for 95th percentile queue is metered by upstream signal.

Splits and Phases: 7: Lyon St N & Gladstone Ave

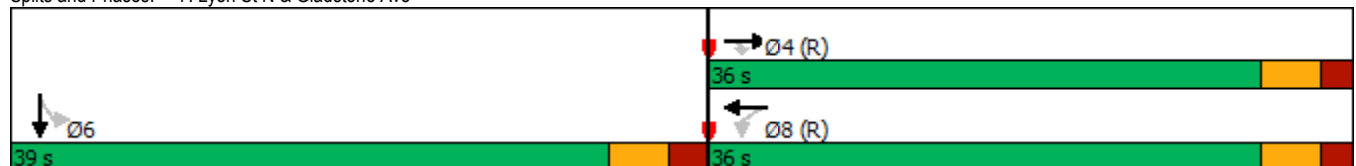

Lanes, Volumes, Timings
8: Kent St & Gladstone Ave

02/28/2024

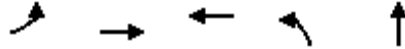

Lane Group	EBL	EBT	WBT	NBL	NBT
Lane Configurations					
Traffic Volume (vph)	82	277	165	36	1723
Future Volume (vph)	82	277	165	36	1723
Lane Group Flow (vph)	82	277	313	36	1820
Turn Type	Perm	NA	NA	Perm	NA
Protected Phases		4	8		2
Permitted Phases	4			2	
Minimum Split (s)	21.4	21.4	21.4	20.4	20.4
Total Split (s)	32.9	32.9	32.9	42.1	42.1
Total Split (%)	43.9%	43.9%	43.9%	56.1%	56.1%
Yellow Time (s)	3.3	3.3	3.3	3.3	3.3
All-Red Time (s)	2.1	2.1	2.1	2.1	2.1
Lost Time Adjust (s)	0.0	0.0	0.0	0.0	0.0
Total Lost Time (s)	5.4	5.4	5.4	5.4	5.4
Lead/Lag					
Lead-Lag Optimize?					
Act Effct Green (s)	27.5	27.5	27.5	36.7	36.7
Actuated g/C Ratio	0.37	0.37	0.37	0.49	0.49
v/c Ratio	0.28	0.44	0.55	0.05	0.77
Control Delay	26.7	27.6	22.8	8.1	8.6
Queue Delay	0.0	0.0	0.0	0.0	0.0
Total Delay	26.7	27.6	22.8	8.1	8.6
LOS	C	C	C	A	A
Approach Delay		27.4	22.8		8.6
Approach LOS		C	C		A
Queue Length 50th (m)	9.8	37.3	33.6	1.0	19.4
Queue Length 95th (m)	23.1	59.2	57.1	m2.8	39.1
Internal Link Dist (m)		165.0	168.8		216.0
Turn Bay Length (m)	30.0			40.0	
Base Capacity (vph)	291	629	572	706	2352
Starvation Cap Reductn	0	0	0	0	0
Spillback Cap Reductn	0	0	0	0	0
Storage Cap Reductn	0	0	0	0	0
Reduced v/c Ratio	0.28	0.44	0.55	0.05	0.77

Intersection Summary

Cycle Length: 75
 Actuated Cycle Length: 75
 Offset: 23 (31%), Referenced to phase 4:EBTL and 8:WBT, Start of Green
 Natural Cycle: 50
 Control Type: Pretimed
 Maximum v/c Ratio: 0.77
 Intersection Signal Delay: 13.1
 Intersection LOS: B
 Intersection Capacity Utilization 80.3%
 ICU Level of Service D
 Analysis Period (min) 15
 m Volume for 95th percentile queue is metered by upstream signal.

Splits and Phases: 8: Kent St & Gladstone Ave

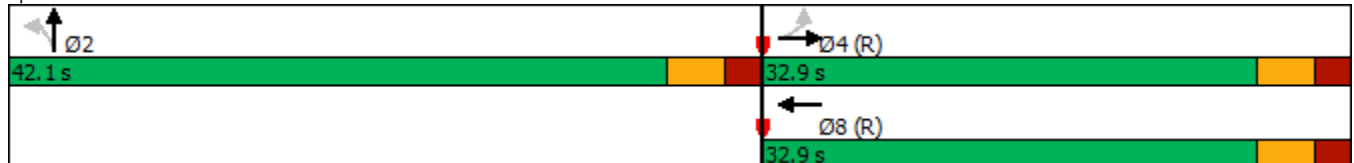

Lanes, Volumes, Timings
 9: Bank St & Chamberlain Ave/Isabella St

02/28/2024



Lane Group	EBT	EBR	NBT	SBL	SBT
Lane Configurations	↕↕	↗	↕↕		↕↕
Traffic Volume (vph)	506	78	839	176	382
Future Volume (vph)	506	78	839	176	382
Lane Group Flow (vph)	587	78	982	0	558
Turn Type	NA	Perm	NA	pm+pt	NA
Protected Phases	4		2	5	6
Permitted Phases		4		6	
Detector Phase	4	4	2	5	6
Switch Phase					
Minimum Initial (s)	10.0	10.0	10.0	5.0	10.0
Minimum Split (s)	26.2	26.2	23.1	11.1	23.1
Total Split (s)	26.2	26.2	37.7	11.1	48.8
Total Split (%)	34.9%	34.9%	50.3%	14.8%	65.1%
Yellow Time (s)	3.3	3.3	3.0	3.0	3.0
All-Red Time (s)	2.9	2.9	3.1	3.1	3.1
Lost Time Adjust (s)	0.0	0.0	0.0		0.0
Total Lost Time (s)	6.2	6.2	6.1		6.1
Lead/Lag					
Lead-Lag Optimize?					
Recall Mode	None	None	C-Max	None	C-Max
Act Effct Green (s)	18.3	18.3	44.4		44.4
Actuated g/C Ratio	0.24	0.24	0.59		0.59
v/c Ratio	0.75	0.18	0.52		0.53
Control Delay	32.5	2.1	10.3		14.5
Queue Delay	0.0	0.0	0.0		0.0
Total Delay	32.5	2.1	10.3		14.5
LOS	C	A	B		B
Approach Delay	29.0		10.3		14.5
Approach LOS	C		B		B
Queue Length 50th (m)	39.1	0.0	40.0		40.4
Queue Length 95th (m)	55.8	2.9	55.1		m57.5
Internal Link Dist (m)	296.0		215.6		90.2
Turn Bay Length (m)		40.0			
Base Capacity (vph)	858	460	1880		1047
Starvation Cap Reductn	0	0	0		0
Spillback Cap Reductn	0	0	0		0
Storage Cap Reductn	0	0	0		0
Reduced v/c Ratio	0.68	0.17	0.52		0.53

Intersection Summary

Cycle Length: 75
 Actuated Cycle Length: 75
 Offset: 60 (80%), Referenced to phase 2:NBT and 6:SBTL, Start of Green
 Natural Cycle: 65
 Control Type: Actuated-Coordinated
 Maximum v/c Ratio: 0.75
 Intersection Signal Delay: 17.0
 Intersection LOS: B
 Intersection Capacity Utilization 82.7%
 ICU Level of Service E
 Analysis Period (min) 15
 m Volume for 95th percentile queue is metered by upstream signal.

Splits and Phases: 9: Bank St & Chamberlain Ave/Isabella St

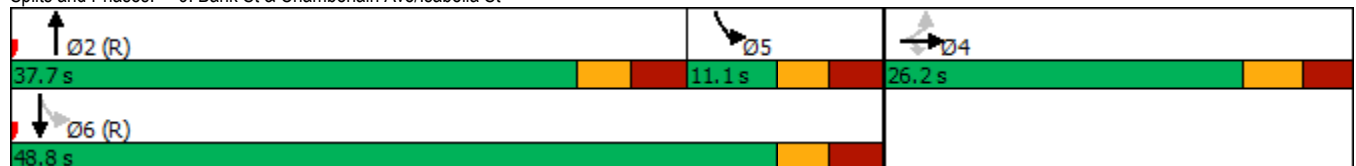

Lanes, Volumes, Timings
10: Catherine St & Access

02/28/2024

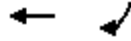

Lane Group	WBT	SBR
Lane Configurations	↑↑↓	↑
Traffic Volume (vph)	457	54
Future Volume (vph)	457	54
Lane Group Flow (vph)	486	54
Sign Control	Free	

Intersection Summary	
Control Type: Unsignalized	
Intersection Capacity Utilization 20.2%	ICU Level of Service A
Analysis Period (min) 15	

Intersection						
Int Delay, s/veh	1.1					
Movement	EBL	EBT	WBT	WBR	SBL	SBR
Lane Configurations			↑↑↑			↑
Traffic Vol, veh/h	0	0	457	29	0	54
Future Vol, veh/h	0	0	457	29	0	54
Conflicting Peds, #/hr	0	0	0	0	0	0
Sign Control	Free	Free	Free	Free	Stop	Stop
RT Channelized	-	None	-	None	-	None
Storage Length	-	-	-	-	-	0
Veh in Median Storage, #	-3538944		0	-	0	-
Grade, %	-	0	0	-	0	-
Peak Hour Factor	100	100	100	100	100	100
Heavy Vehicles, %	2	2	2	2	2	2
Mvmt Flow	0	0	457	29	0	54
Major/Minor	Major2		Minor2			
Conflicting Flow All			-	0	-	243
Stage 1			-	-	-	-
Stage 2			-	-	-	-
Critical Hdwy			-	-	-	7.14
Critical Hdwy Stg 1			-	-	-	-
Critical Hdwy Stg 2			-	-	-	-
Follow-up Hdwy			-	-	-	3.92
Pot Cap-1 Maneuver			-	-	0	646
Stage 1			-	-	0	-
Stage 2			-	-	0	-
Platoon blocked, %			-	-	-	-
Mov Cap-1 Maneuver			-	-	-	646
Mov Cap-2 Maneuver			-	-	-	-
Stage 1			-	-	-	-
Stage 2			-	-	-	-
Approach	WB		SB			
HCM Control Delay, s			0			11.1
HCM LOS						B
Minor Lane/Major Mvmt	WBT	WBR	SBLn1			
Capacity (veh/h)	-	-	646			
HCM Lane V/C Ratio	-	-	0.084			
HCM Control Delay (s)	-	-	11.1			
HCM Lane LOS	-	-	B			
HCM 95th %tile Q(veh)	-	-	0.3			

Lanes, Volumes, Timings
 12: Bank St & Arlington Ave

02/28/2024



Lane Group	EBL	NBT	SBT
Lane Configurations			
Traffic Volume (vph)	21	694	393
Future Volume (vph)	21	694	393
Lane Group Flow (vph)	149	780	415
Sign Control	Stop	Free	Free

Intersection Summary	
Control Type: Unsignalized	
Intersection Capacity Utilization 55.8%	ICU Level of Service B
Analysis Period (min) 15	

Intersection						
Int Delay, s/veh	2.9					
Movement	EBL	EBR	NBL	NBT	SBT	SBR
Lane Configurations	↔			↕	↕	
Traffic Vol, veh/h	21	128	86	694	393	22
Future Vol, veh/h	21	128	86	694	393	22
Conflicting Peds, #/hr	0	0	111	0	0	111
Sign Control	Stop	Stop	Free	Free	Free	Free
RT Channelized	-	None	-	None	-	None
Storage Length	0	-	-	-	-	-
Veh in Median Storage, #	0	-	-	0	0	-
Grade, %	0	-	-	0	0	-
Peak Hour Factor	100	100	100	100	100	100
Heavy Vehicles, %	0	3	2	5	8	5
Mvmt Flow	21	128	86	694	393	22

Major/Minor	Minor2	Major1	Major2			
Conflicting Flow All	1034	319	526	0	-	0
Stage 1	515	-	-	-	-	-
Stage 2	519	-	-	-	-	-
Critical Hdwy	6.8	6.96	4.14	-	-	-
Critical Hdwy Stg 1	5.8	-	-	-	-	-
Critical Hdwy Stg 2	5.8	-	-	-	-	-
Follow-up Hdwy	3.5	3.33	2.22	-	-	-
Pot Cap-1 Maneuver	231	674	1037	-	-	-
Stage 1	570	-	-	-	-	-
Stage 2	568	-	-	-	-	-
Platoon blocked, %				-	-	-
Mov Cap-1 Maneuver	158	605	931	-	-	-
Mov Cap-2 Maneuver	158	-	-	-	-	-
Stage 1	434	-	-	-	-	-
Stage 2	509	-	-	-	-	-

Approach	EB	NB	SB
HCM Control Delay, s	17.6	1.6	0
HCM LOS	C		

Minor Lane/Major Mvmt	NBL	NBT	EBLn1	SBT	SBR
Capacity (veh/h)	931	-	433	-	-
HCM Lane V/C Ratio	0.092	-	0.344	-	-
HCM Control Delay (s)	9.3	0.6	17.6	-	-
HCM Lane LOS	A	A	C	-	-
HCM 95th %tile Q(veh)	0.3	-	1.5	-	-

Lanes, Volumes, Timings
13: Bronson Ave & Catherine St

02/28/2024



Lane Group	WBL	WBT	NBL	NBT	SBT	Ø5	Ø7
Lane Configurations							
Traffic Volume (vph)	510	486	527	1054	434		
Future Volume (vph)	510	486	527	1054	434		
Lane Group Flow (vph)	347	1011	527	1054	554		
Turn Type	Perm	NA	pm+pt	NA	NA		
Protected Phases		8	5 7	2	6	5	7
Permitted Phases	8		2				
Minimum Split (s)	28.3	28.3		23.8	23.8	11.2	11.8
Total Split (s)	37.0	37.0		73.0	30.2	31.0	11.8
Total Split (%)	33.6%	33.6%		66.4%	27.5%	28%	11%
Yellow Time (s)	3.3	3.3		3.3	3.3	3.3	3.3
All-Red Time (s)	3.0	3.0		3.5	3.5	2.9	3.5
Lost Time Adjust (s)	0.0	0.0		0.0	0.0		
Total Lost Time (s)	6.3	6.3		6.8	6.8		
Lead/Lag					Lag	Lead	
Lead-Lag Optimize?					Yes	Yes	
Act Effct Green (s)	30.7	30.7	66.8	66.2	23.4		
Actuated g/C Ratio	0.28	0.28	0.61	0.60	0.21		
v/c Ratio	0.87	0.83	0.85	0.52	0.82		
Control Delay	60.8	41.0	28.9	13.8	50.0		
Queue Delay	0.0	0.0	0.0	0.0	0.0		
Total Delay	60.8	41.0	28.9	13.8	50.0		
LOS	E	D	C	B	D		
Approach Delay		46.1		18.8	50.0		
Approach LOS		D		B	D		
Queue Length 50th (m)	82.5	72.8	59.8	64.2	57.0		
Queue Length 95th (m)	#140.8	91.0	#106.4	80.4	#81.7		
Internal Link Dist (m)		120.8		240.1	287.4		
Turn Bay Length (m)	80.0		45.0				
Base Capacity (vph)	399	1215	618	2040	679		
Starvation Cap Reductn	0	0	0	0	0		
Spillback Cap Reductn	0	0	0	0	0		
Storage Cap Reductn	0	0	0	0	0		
Reduced v/c Ratio	0.87	0.83	0.85	0.52	0.82		

Intersection Summary

Cycle Length: 110
 Actuated Cycle Length: 110
 Offset: 60 (55%), Referenced to phase 2:NBT and 6:SBT, Start of Green
 Natural Cycle: 90
 Control Type: Pretimed
 Maximum v/c Ratio: 0.87
 Intersection Signal Delay: 34.4
 Intersection LOS: C
 Intersection Capacity Utilization 87.1%
 ICU Level of Service E
 Analysis Period (min) 15
 # 95th percentile volume exceeds capacity, queue may be longer.
 Queue shown is maximum after two cycles.

Splits and Phases: 13: Bronson Ave & Catherine St



Lanes, Volumes, Timings

1: Hwy 417 WB On Ramp/Lyon St N & Catherine St

02/28/2024



Lane Group	WBT	SBT	SBR
Lane Configurations	↕↕↕	↕	↗
Traffic Volume (vph)	540	348	289
Future Volume (vph)	540	348	289
Lane Group Flow (vph)	752	348	289
Turn Type	NA	NA	Perm
Protected Phases	8	6	
Permitted Phases			6
Minimum Split (s)	26.2	28.3	28.3
Total Split (s)	35.0	40.0	40.0
Total Split (%)	46.7%	53.3%	53.3%
Yellow Time (s)	3.3	3.3	3.3
All-Red Time (s)	1.9	2.0	2.0
Lost Time Adjust (s)	0.0	0.0	0.0
Total Lost Time (s)	5.2	5.3	5.3
Lead/Lag			
Lead-Lag Optimize?			
Act Effct Green (s)	29.8	34.7	34.7
Actuated g/C Ratio	0.40	0.46	0.46
v/c Ratio	0.38	0.42	0.37
Control Delay	9.3	23.1	15.8
Queue Delay	0.0	0.0	0.0
Total Delay	9.3	23.1	15.8
LOS	A	C	B
Approach Delay	9.3	19.8	
Approach LOS	A	B	
Queue Length 50th (m)	6.0	47.4	27.1
Queue Length 95th (m)	13.7	72.9	46.4
Internal Link Dist (m)	109.2	52.8	
Turn Bay Length (m)			
Base Capacity (vph)	1962	833	771
Starvation Cap Reductn	0	0	0
Spillback Cap Reductn	0	0	0
Storage Cap Reductn	0	0	0
Reduced v/c Ratio	0.38	0.42	0.37

Intersection Summary

Cycle Length: 75
 Actuated Cycle Length: 75
 Offset: 24 (32%), Referenced to phase 8:WBTL, Start of Green
 Natural Cycle: 55
 Control Type: Pretimed
 Maximum v/c Ratio: 0.42
 Intersection Signal Delay: 14.1
 Intersection LOS: B
 Intersection Capacity Utilization 47.1%
 ICU Level of Service A
 Analysis Period (min) 15

Splits and Phases: 1: Hwy 417 WB On Ramp/Lyon St N & Catherine St

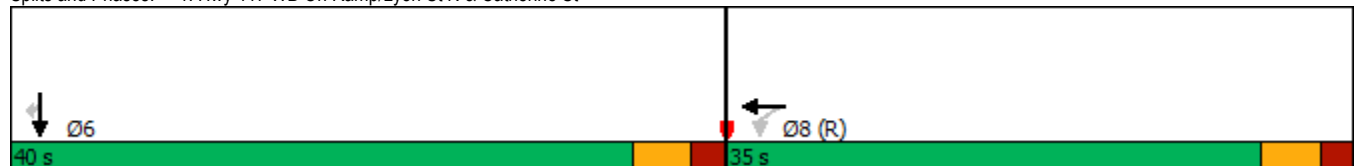

Lanes, Volumes, Timings

2: Hwy 417 EB Off Ramp/Chamberlain Ave/Kent St & Catherine St

02/28/2024



Lane Group	WBT	WBR	NBT	Ø9
Lane Configurations				
Traffic Volume (vph)	693	300	837	
Future Volume (vph)	693	300	837	
Lane Group Flow (vph)	723	270	876	
Turn Type	NA	Perm	NA	
Protected Phases	8		2	9
Permitted Phases		8		
Minimum Split (s)	22.8	22.8	22.5	5.0
Total Split (s)	42.0	42.0	28.0	5.0
Total Split (%)	56.0%	56.0%	37.3%	7%
Yellow Time (s)	3.3	3.3	3.3	2.0
All-Red Time (s)	2.5	2.5	2.5	0.0
Lost Time Adjust (s)	0.0	0.0	0.0	
Total Lost Time (s)	5.8	5.8	5.8	
Lead/Lag				
Lead-Lag Optimize?				
Act Effct Green (s)	36.2	36.2	22.2	
Actuated g/C Ratio	0.48	0.48	0.30	
v/c Ratio	0.47	0.46	0.59	
Control Delay	8.5	9.7	22.5	
Queue Delay	0.0	0.0	0.0	
Total Delay	8.5	9.7	22.5	
LOS	A	A	C	
Approach Delay	8.8		22.5	
Approach LOS	A		C	
Queue Length 50th (m)	21.7	16.1	35.2	
Queue Length 95th (m)	m29.6	m23.2	47.3	
Internal Link Dist (m)	131.7		67.4	
Turn Bay Length (m)				
Base Capacity (vph)	1534	581	1485	
Starvation Cap Reductn	0	0	0	
Spillback Cap Reductn	0	0	0	
Storage Cap Reductn	0	0	0	
Reduced v/c Ratio	0.47	0.46	0.59	

Intersection Summary

Cycle Length: 75
 Actuated Cycle Length: 75
 Offset: 12 (16%), Referenced to phase 8:WBT, Start of Green
 Natural Cycle: 55
 Control Type: Pretimed
 Maximum v/c Ratio: 0.59
 Intersection Signal Delay: 15.2
 Intersection LOS: B
 Intersection Capacity Utilization 53.9%
 ICU Level of Service A
 Analysis Period (min) 15
 m Volume for 95th percentile queue is metered by upstream signal.

Splits and Phases: 2: Hwy 417 EB Off Ramp/Chamberlain Ave/Kent St & Catherine St

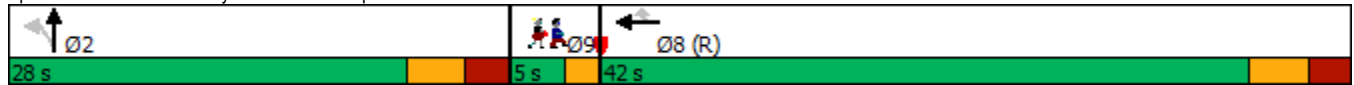

Lanes, Volumes, Timings
3: Bank St & Catherine St

02/28/2024



Lane Group	WBT	NBL	NBT	SBT	Ø1	Ø5	Ø7
Lane Configurations	↕↕↕		↕↕	↕↕			
Traffic Volume (vph)	624	200	330	695			
Future Volume (vph)	624	200	330	695			
Lane Group Flow (vph)	1018	0	530	837			
Turn Type	NA	pm+pt	NA	NA			
Protected Phases	8	9	2	6	1	5	7
Permitted Phases		2					
Minimum Split (s)	18.6	10.4	16.4	16.4	5.0	5.0	5.0
Total Split (s)	24.6	10.4	40.4	30.0	5.0	5.0	5.0
Total Split (%)	32.8%	13.9%	53.9%	40.0%	7%	7%	7%
Yellow Time (s)	3.3	3.3	3.3	3.3	2.0	2.0	2.0
All-Red Time (s)	2.3	2.1	2.1	2.1	0.0	0.0	0.0
Lost Time Adjust (s)	0.0		0.0	0.0			
Total Lost Time (s)	5.6		5.4	5.4			
Lead/Lag	Lag		Lag	Lag	Lead	Lead	Lead
Lead-Lag Optimize?	Yes		Yes	Yes	Yes	Yes	Yes
Act Effct Green (s)	19.0		35.0	24.6			
Actuated g/C Ratio	0.25		0.47	0.33			
v/c Ratio	0.86		0.58	0.81			
Control Delay	34.7		13.7	29.6			
Queue Delay	0.0		0.0	0.7			
Total Delay	34.7		13.7	30.2			
LOS	C		B	C			
Approach Delay	34.7		13.7	30.2			
Approach LOS	C		B	C			
Queue Length 50th (m)	48.1		16.0	54.0			
Queue Length 95th (m)	#69.9		20.7	#77.2			
Internal Link Dist (m)	201.7		90.2	52.9			
Turn Bay Length (m)							
Base Capacity (vph)	1181		920	1037			
Starvation Cap Reductn	0		0	0			
Spillback Cap Reductn	0		0	43			
Storage Cap Reductn	0		0	0			
Reduced v/c Ratio	0.86		0.58	0.84			

Intersection Summary

Cycle Length: 75
 Actuated Cycle Length: 75
 Offset: 50 (67%), Referenced to phase 2:NBT and 6:SBT, Start of Green
 Natural Cycle: 70
 Control Type: Pretimed
 Maximum v/c Ratio: 0.86
 Intersection Signal Delay: 28.5
 Intersection LOS: C
 Intersection Capacity Utilization 80.1%
 ICU Level of Service D
 Analysis Period (min) 15
 # 95th percentile volume exceeds capacity, queue may be longer.
 Queue shown is maximum after two cycles.

Splits and Phases: 3: Bank St & Catherine St

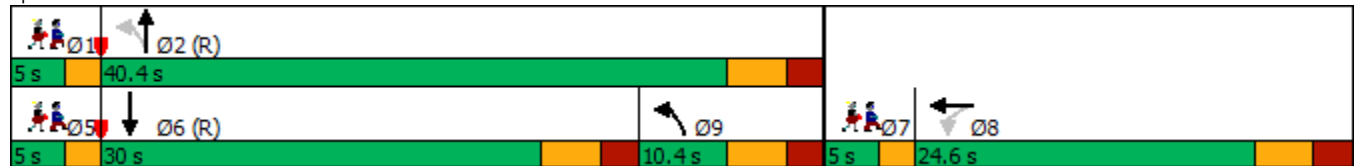

Lanes, Volumes, Timings
4: Percy St & Catherine St

02/28/2024

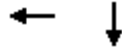

Lane Group	WBT	SBT	Ø3	Ø7
Lane Configurations				
Traffic Volume (vph)	709	121		
Future Volume (vph)	709	121		
Lane Group Flow (vph)	873	160		
Turn Type	NA	NA		
Protected Phases	8	6	3	7
Permitted Phases				
Detector Phase	8	6		
Switch Phase				
Minimum Initial (s)	10.0	10.0	1.0	1.0
Minimum Split (s)	26.5	23.4	6.4	6.4
Total Split (s)	34.0	24.0	16.0	16.0
Total Split (%)	37.8%	26.7%	18%	18%
Yellow Time (s)	3.3	3.3	3.3	3.3
All-Red Time (s)	2.2	2.1	2.1	2.1
Lost Time Adjust (s)	0.0	0.0		
Total Lost Time (s)	5.5	5.4		
Lead/Lag	Lag			Lead
Lead-Lag Optimize?	Yes			Yes
Recall Mode	None	Max	None	None
Act Effct Green (s)	14.6	18.7		
Actuated g/C Ratio	0.33	0.42		
v/c Ratio	0.52	0.22		
Control Delay	10.5	10.4		
Queue Delay	0.0	0.0		
Total Delay	10.5	10.4		
LOS	B	B		
Approach Delay	10.5	10.4		
Approach LOS	B	B		
Queue Length 50th (m)	15.2	7.2		
Queue Length 95th (m)	22.8	20.1		
Internal Link Dist (m)	271.6	288.0		
Turn Bay Length (m)				
Base Capacity (vph)	3166	729		
Starvation Cap Reductn	0	0		
Spillback Cap Reductn	0	0		
Storage Cap Reductn	0	0		
Reduced v/c Ratio	0.28	0.22		

Intersection Summary

Cycle Length: 90	
Actuated Cycle Length: 44.3	
Natural Cycle: 65	
Control Type: Semi Act-Uncoord	
Maximum v/c Ratio: 0.52	
Intersection Signal Delay: 10.5	Intersection LOS: B
Intersection Capacity Utilization 44.2%	ICU Level of Service A
Analysis Period (min) 15	

Splits and Phases: 4: Percy St & Catherine St

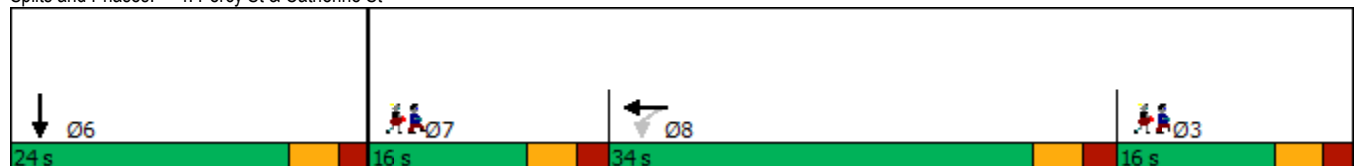

Lanes, Volumes, Timings
 5: Lyon St N & Arlington Ave

02/28/2024

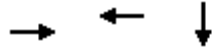

Lane Group	EBT	WBT	SBT
Lane Configurations			
Traffic Volume (vph)	19	37	572
Future Volume (vph)	19	37	572
Lane Group Flow (vph)	21	45	635
Sign Control	Stop	Stop	Free
Intersection Summary			
Control Type: Unsignalized			
Intersection Capacity Utilization 39.9%		ICU Level of Service A	
Analysis Period (min) 15			

Intersection												
Int Delay, s/veh	2.2											
Movement	EBL	EBT	EBR	WBL	WBT	WBR	NBL	NBT	NBR	SBL	SBT	SBR
Lane Configurations		↕			↕						↕↔	
Traffic Vol, veh/h	0	19	2	8	37	0	0	0	0	50	572	13
Future Vol, veh/h	0	19	2	8	37	0	0	0	0	50	572	13
Conflicting Peds, #/hr	20	0	8	8	0	20	19	0	3	3	0	19
Sign Control	Stop	Stop	Stop	Stop	Stop	Stop	Free	Free	Free	Free	Free	Free
RT Channelized	-	-	None	-	-	None	-	-	None	-	-	None
Storage Length	-	-	-	-	-	-	-	-	-	-	-	-
Veh in Median Storage, #	-	0	-	-	0	-	-	-	-	-	0	-
Grade, %	-	0	-	-	0	-	-	0	-	-	0	-
Peak Hour Factor	100	100	100	100	100	100	100	100	100	100	100	100
Heavy Vehicles, %	0	5	0	0	5	0	0	0	0	0	0	0
Mvmt Flow	0	19	2	8	37	0	0	0	0	50	572	13

Major/Minor	Minor2		Minor1			Major2			
Conflicting Flow All	-	701	320	407	707	-	3	0	0
Stage 1	-	698	-	3	3	-	-	-	-
Stage 2	-	3	-	404	704	-	-	-	-
Critical Hdwy	-	6.6	6.9	7.5	6.6	-	4.1	-	-
Critical Hdwy Stg 1	-	5.6	-	-	-	-	-	-	-
Critical Hdwy Stg 2	-	-	-	6.5	5.6	-	-	-	-
Follow-up Hdwy	-	4.05	3.3	3.5	4.05	-	2.2	-	-
Pot Cap-1 Maneuver	0	355	682	533	353	0	1632	-	-
Stage 1	0	433	-	-	-	0	-	-	-
Stage 2	0	-	-	600	430	0	-	-	-
Platoon blocked, %	-	-	-	-	-	-	-	-	-
Mov Cap-1 Maneuver	-	332	670	489	330	-	1627	-	-
Mov Cap-2 Maneuver	-	332	-	489	330	-	-	-	-
Stage 1	-	406	-	-	-	-	-	-	-
Stage 2	-	-	-	544	403	-	-	-	-

Approach	EB		WB			SB		
HCM Control Delay, s	16		16.8			0.7		
HCM LOS	C		C					

Minor Lane/Major Mvmt	EBLn1	WBLn1	SBL	SBT	SBR
Capacity (veh/h)	349	350	1627	-	-
HCM Lane V/C Ratio	0.06	0.129	0.031	-	-
HCM Control Delay (s)	16	16.8	7.3	0.1	-
HCM Lane LOS	C	C	A	A	-
HCM 95th %tile Q(veh)	0.2	0.4	0.1	-	-

Lanes, Volumes, Timings
6: Kent St & Arlington Ave

02/28/2024



Lane Group	EBL	EBT	WBT	NBT
Lane Configurations		↕	↕	↕↕↕
Traffic Volume (vph)	12	68	18	1047
Future Volume (vph)	12	68	18	1047
Lane Group Flow (vph)	0	80	81	1162
Turn Type	Perm	NA	NA	NA
Protected Phases		4	8	2
Permitted Phases	4			
Minimum Split (s)	27.3	27.3	27.3	32.3
Total Split (s)	31.0	31.0	31.0	44.0
Total Split (%)	41.3%	41.3%	41.3%	58.7%
Yellow Time (s)	3.3	3.3	3.3	3.3
All-Red Time (s)	2.0	2.0	2.0	2.0
Lost Time Adjust (s)		0.0	0.0	0.0
Total Lost Time (s)		5.3	5.3	5.3
Lead/Lag				
Lead-Lag Optimize?				
Act Effct Green (s)		25.7	25.7	38.7
Actuated g/C Ratio		0.34	0.34	0.52
v/c Ratio		0.13	0.14	0.46
Control Delay		27.6	8.2	5.7
Queue Delay		0.0	0.0	0.2
Total Delay		27.6	8.2	5.9
LOS		C	A	A
Approach Delay		27.6	8.2	5.9
Approach LOS		C	A	A
Queue Length 50th (m)		10.2	1.1	16.1
Queue Length 95th (m)		m20.8	m5.1	19.7
Internal Link Dist (m)		164.0	143.1	53.0
Turn Bay Length (m)				
Base Capacity (vph)		598	573	2501
Starvation Cap Reductn		0	0	491
Spillback Cap Reductn		0	0	0
Storage Cap Reductn		0	0	0
Reduced v/c Ratio		0.13	0.14	0.58

Intersection Summary

Cycle Length: 75
 Actuated Cycle Length: 75
 Offset: 50 (67%), Referenced to phase 2:NBTL, Start of Green
 Natural Cycle: 60
 Control Type: Pretimed
 Maximum v/c Ratio: 0.46
 Intersection Signal Delay: 7.3
 Intersection LOS: A
 Intersection Capacity Utilization 53.7%
 ICU Level of Service A
 Analysis Period (min) 15
 m Volume for 95th percentile queue is metered by upstream signal.

Splits and Phases: 6: Kent St & Arlington Ave



Lanes, Volumes, Timings
7: Lyon St N & Gladstone Ave

02/28/2024



Lane Group	EBT	EBR	WBL	WBT	SBT
Lane Configurations	↑	↑	↑	↑	↑↓
Traffic Volume (vph)	247	52	28	314	517
Future Volume (vph)	247	52	28	314	517
Lane Group Flow (vph)	247	52	28	314	741
Turn Type	NA	Perm	Perm	NA	NA
Protected Phases	4			8	6
Permitted Phases		4	8		
Minimum Split (s)	17.2	17.2	17.2	17.2	22.6
Total Split (s)	37.0	37.0	37.0	37.0	38.0
Total Split (%)	49.3%	49.3%	49.3%	49.3%	50.7%
Yellow Time (s)	3.3	3.3	3.3	3.3	3.3
All-Red Time (s)	1.9	1.9	1.9	1.9	2.3
Lost Time Adjust (s)	0.0	0.0	0.0	0.0	0.0
Total Lost Time (s)	5.2	5.2	5.2	5.2	5.6
Lead/Lag					
Lead-Lag Optimize?					
Act Effct Green (s)	31.8	31.8	31.8	31.8	32.4
Actuated g/C Ratio	0.42	0.42	0.42	0.42	0.43
v/c Ratio	0.33	0.08	0.07	0.42	0.52
Control Delay	16.0	4.5	7.8	12.1	16.1
Queue Delay	0.0	0.0	0.0	0.0	0.0
Total Delay	16.0	4.5	7.8	12.1	16.1
LOS	B	A	A	B	B
Approach Delay	14.0			11.8	16.1
Approach LOS	B			B	B
Queue Length 50th (m)	22.6	0.0	1.5	35.5	36.2
Queue Length 95th (m)	38.4	5.7	m3.3	55.1	51.2
Internal Link Dist (m)	254.8			165.0	214.3
Turn Bay Length (m)			25.0		
Base Capacity (vph)	756	626	422	756	1427
Starvation Cap Reductn	0	0	0	0	0
Spillback Cap Reductn	0	0	0	0	0
Storage Cap Reductn	0	0	0	0	0
Reduced v/c Ratio	0.33	0.08	0.07	0.42	0.52

Intersection Summary

Cycle Length: 75
 Actuated Cycle Length: 75
 Offset: 45 (60%), Referenced to phase 4:EBT and 8:WBTL, Start of Green
 Natural Cycle: 40
 Control Type: Pretimed
 Maximum v/c Ratio: 0.52
 Intersection Signal Delay: 14.6
 Intersection LOS: B
 Intersection Capacity Utilization 67.2%
 ICU Level of Service C
 Analysis Period (min) 15
 m Volume for 95th percentile queue is metered by upstream signal.

Splits and Phases: 7: Lyon St N & Gladstone Ave

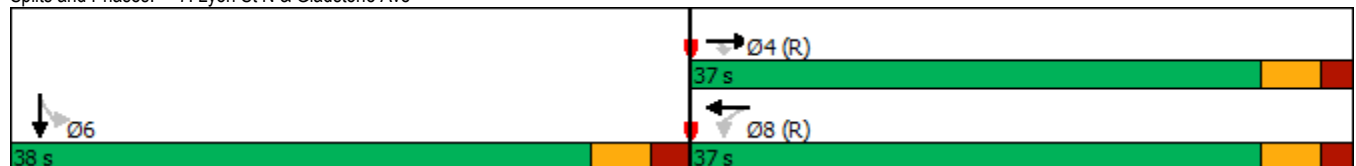

Lanes, Volumes, Timings
8: Kent St & Gladstone Ave

02/28/2024

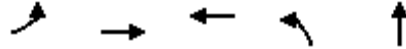

Lane Group	EBL	EBT	WBT	NBL	NBT
Lane Configurations					
Traffic Volume (vph)	75	450	324	67	895
Future Volume (vph)	75	450	324	67	895
Lane Group Flow (vph)	75	450	399	67	1026
Turn Type	Perm	NA	NA	Perm	NA
Protected Phases		4	8		2
Permitted Phases	4			2	
Minimum Split (s)	21.4	21.4	21.4	20.4	20.4
Total Split (s)	43.0	43.0	43.0	32.0	32.0
Total Split (%)	57.3%	57.3%	57.3%	42.7%	42.7%
Yellow Time (s)	3.3	3.3	3.3	3.3	3.3
All-Red Time (s)	2.1	2.1	2.1	2.1	2.1
Lost Time Adjust (s)	0.0	0.0	0.0	0.0	0.0
Total Lost Time (s)	5.4	5.4	5.4	5.4	5.4
Lead/Lag					
Lead-Lag Optimize?					
Act Effct Green (s)	37.6	37.6	37.6	26.6	26.6
Actuated g/C Ratio	0.50	0.50	0.50	0.35	0.35
v/c Ratio	0.19	0.51	0.46	0.12	0.62
Control Delay	18.0	21.5	13.5	5.1	5.7
Queue Delay	0.0	0.0	0.0	0.0	0.0
Total Delay	18.0	21.5	13.5	5.1	5.7
LOS	B	C	B	A	A
Approach Delay		21.0	13.5		5.6
Approach LOS		C	B		A
Queue Length 50th (m)	6.6	49.6	32.2	1.4	6.1
Queue Length 95th (m)	m16.2	78.9	53.1	3.0	8.1
Internal Link Dist (m)		165.0	168.8		216.0
Turn Bay Length (m)	30.0			40.0	
Base Capacity (vph)	401	885	873	539	1664
Starvation Cap Reductn	0	0	0	0	0
Spillback Cap Reductn	0	0	0	0	0
Storage Cap Reductn	0	0	0	0	0
Reduced v/c Ratio	0.19	0.51	0.46	0.12	0.62

Intersection Summary

Cycle Length: 75
 Actuated Cycle Length: 75
 Offset: 23 (31%), Referenced to phase 4:EBTL and 8:WBT, Start of Green
 Natural Cycle: 45
 Control Type: Pretimed
 Maximum v/c Ratio: 0.62
 Intersection Signal Delay: 11.2
 Intersection LOS: B
 Intersection Capacity Utilization 67.2%
 ICU Level of Service C
 Analysis Period (min) 15
 m Volume for 95th percentile queue is metered by upstream signal.

Splits and Phases: 8: Kent St & Gladstone Ave

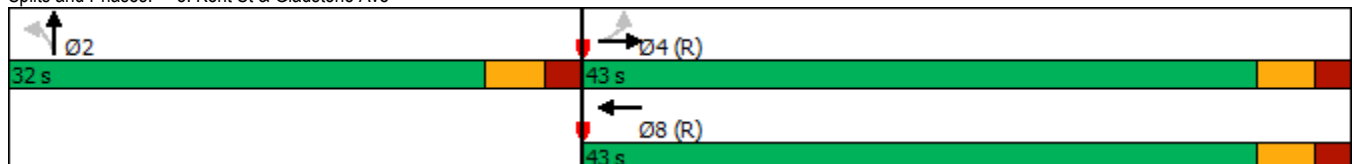

Lanes, Volumes, Timings
 9: Bank St & Chamberlain Ave/Isabella St

02/28/2024



Lane Group	EBT	EBR	NBT	SBL	SBT
Lane Configurations	↕↕	↗	↕↕		↕↕
Traffic Volume (vph)	607	122	457	180	725
Future Volume (vph)	607	122	457	180	725
Lane Group Flow (vph)	669	122	550	0	905
Turn Type	NA	Perm	NA	pm+pt	NA
Protected Phases	4		2	5	6
Permitted Phases		4		6	
Detector Phase	4	4	2	5	6
Switch Phase					
Minimum Initial (s)	10.0	10.0	10.0	5.0	10.0
Minimum Split (s)	26.2	26.2	23.1	11.1	23.1
Total Split (s)	28.8	28.8	35.1	11.1	46.2
Total Split (%)	38.4%	38.4%	46.8%	14.8%	61.6%
Yellow Time (s)	3.3	3.3	3.0	3.0	3.0
All-Red Time (s)	2.9	2.9	3.1	3.1	3.1
Lost Time Adjust (s)	0.0	0.0	0.0		0.0
Total Lost Time (s)	6.2	6.2	6.1		6.1
Lead/Lag					
Lead-Lag Optimize?					
Recall Mode	None	None	C-Max	None	C-Max
Act Effct Green (s)	20.5	20.5	42.2		42.2
Actuated g/C Ratio	0.27	0.27	0.56		0.56
v/c Ratio	0.73	0.25	0.31		0.68
Control Delay	29.7	4.9	9.1		12.6
Queue Delay	0.0	0.0	0.0		1.1
Total Delay	29.7	4.9	9.1		13.8
LOS	C	A	A		B
Approach Delay	25.9		9.1		13.8
Approach LOS	C		A		B
Queue Length 50th (m)	43.3	0.0	19.5		71.8
Queue Length 95th (m)	60.4	9.3	29.0		m91.5
Internal Link Dist (m)	296.0		215.6		90.2
Turn Bay Length (m)		40.0			
Base Capacity (vph)	1006	516	1779		1329
Starvation Cap Reductn	0	0	0		211
Spillback Cap Reductn	0	0	0		0
Storage Cap Reductn	0	0	0		0
Reduced v/c Ratio	0.67	0.24	0.31		0.81

Intersection Summary

Cycle Length: 75
 Actuated Cycle Length: 75
 Offset: 60 (80%), Referenced to phase 2:NBT and 6:SBTL, Start of Green
 Natural Cycle: 65
 Control Type: Actuated-Coordinated
 Maximum v/c Ratio: 0.73
 Intersection Signal Delay: 16.9
 Intersection LOS: B
 Intersection Capacity Utilization 82.7%
 ICU Level of Service E
 Analysis Period (min) 15
 m Volume for 95th percentile queue is metered by upstream signal.

Splits and Phases: 9: Bank St & Chamberlain Ave/Isabella St

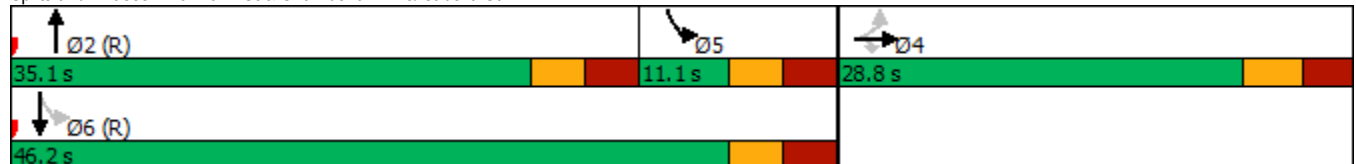

Lanes, Volumes, Timings
10: Catherine St & Access

02/28/2024

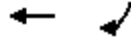

Lane Group	WBT	SBR
Lane Configurations	↑↑↓	↗
Traffic Volume (vph)	631	37
Future Volume (vph)	631	37
Lane Group Flow (vph)	679	37
Sign Control	Free	
Intersection Summary		
Control Type: Unsignalized		
Intersection Capacity Utilization 24.0%		ICU Level of Service A
Analysis Period (min) 15		

Intersection						
Int Delay, s/veh	0.6					
Movement	EBL	EBT	WBT	WBR	SBL	SBR
Lane Configurations			↑↑↑			↑
Traffic Vol, veh/h	0	0	631	48	0	37
Future Vol, veh/h	0	0	631	48	0	37
Conflicting Peds, #/hr	0	0	0	0	0	0
Sign Control	Free	Free	Free	Free	Stop	Stop
RT Channelized	-	None	-	None	-	None
Storage Length	-	-	-	-	-	0
Veh in Median Storage, #	-2424832		0	-	0	-
Grade, %	-	0	0	-	0	-
Peak Hour Factor	100	100	100	100	100	100
Heavy Vehicles, %	2	2	2	2	2	2
Mvmt Flow	0	0	631	48	0	37

Major/Minor	Major2	Minor2		
Conflicting Flow All	-	0	-	340
Stage 1	-	-	-	-
Stage 2	-	-	-	-
Critical Hdwy	-	-	-	7.14
Critical Hdwy Stg 1	-	-	-	-
Critical Hdwy Stg 2	-	-	-	-
Follow-up Hdwy	-	-	-	3.92
Pot Cap-1 Maneuver	-	-	0	560
Stage 1	-	-	0	-
Stage 2	-	-	0	-
Platoon blocked, %	-	-	-	-
Mov Cap-1 Maneuver	-	-	-	560
Mov Cap-2 Maneuver	-	-	-	-
Stage 1	-	-	-	-
Stage 2	-	-	-	-

Approach	WB	SB
HCM Control Delay, s	0	11.9
HCM LOS		B

Minor Lane/Major Mvmt	WBT	WBR	SBLn1
Capacity (veh/h)	-	-	560
HCM Lane V/C Ratio	-	-	0.066
HCM Control Delay (s)	-	-	11.9
HCM Lane LOS	-	-	B
HCM 95th %tile Q(veh)	-	-	0.2

Lanes, Volumes, Timings
 12: Bank St & Arlington Ave

02/28/2024



Lane Group	EBL	NBT	SBT
Lane Configurations			
Traffic Volume (vph)	20	430	724
Future Volume (vph)	20	430	724
Lane Group Flow (vph)	134	488	751
Sign Control	Stop	Free	Free

Intersection Summary	
Control Type: Unsignalized	
Intersection Capacity Utilization 55.1%	ICU Level of Service B
Analysis Period (min) 15	

Intersection						
Int Delay, s/veh	2.2					
Movement	EBL	EBR	NBL	NBT	SBT	SBR
Lane Configurations	↔↔			↕↕	↕↕	
Traffic Vol, veh/h	20	114	58	430	724	27
Future Vol, veh/h	20	114	58	430	724	27
Conflicting Peds, #/hr	0	0	42	0	0	42
Sign Control	Stop	Stop	Free	Free	Free	Free
RT Channelized	-	None	-	None	-	None
Storage Length	0	-	-	-	-	-
Veh in Median Storage, #	0	-	-	0	0	-
Grade, %	0	-	-	0	0	-
Peak Hour Factor	100	100	100	100	100	100
Heavy Vehicles, %	0	1	0	5	3	0
Mvmt Flow	20	114	58	430	724	27

Major/Minor	Minor2	Major1		Major2	
Conflicting Flow All	1111	418	793	0	0
Stage 1	780	-	-	-	-
Stage 2	331	-	-	-	-
Critical Hdwy	6.8	6.92	4.1	-	-
Critical Hdwy Stg 1	5.8	-	-	-	-
Critical Hdwy Stg 2	5.8	-	-	-	-
Follow-up Hdwy	3.5	3.31	2.2	-	-
Pot Cap-1 Maneuver	206	587	837	-	-
Stage 1	418	-	-	-	-
Stage 2	706	-	-	-	-
Platoon blocked, %				-	-
Mov Cap-1 Maneuver	172	564	805	-	-
Mov Cap-2 Maneuver	172	-	-	-	-
Stage 1	364	-	-	-	-
Stage 2	678	-	-	-	-

Approach	EB	NB	SB
HCM Control Delay, s	17.5	1.5	0
HCM LOS	C		

Minor Lane/Major Mvmt	NBL	NBT	EBLn1	SBT	SBR
Capacity (veh/h)	805	-	421	-	-
HCM Lane V/C Ratio	0.072	-	0.318	-	-
HCM Control Delay (s)	9.8	0.4	17.5	-	-
HCM Lane LOS	A	A	C	-	-
HCM 95th %tile Q(veh)	0.2	-	1.4	-	-

Lanes, Volumes, Timings
13: Bronson Ave & Catherine St

02/28/2024



Lane Group	WBL	WBT	NBL	NBT	SBT
Lane Configurations					
Traffic Volume (vph)	707	582	296	773	813
Future Volume (vph)	707	582	296	773	813
Lane Group Flow (vph)	396	1174	296	773	980
Turn Type	Perm	NA	pm+pt	NA	NA
Protected Phases		8	5	2	6
Permitted Phases	8		2		
Minimum Split (s)	28.3	28.3	11.2	23.8	23.8
Total Split (s)	37.0	37.0	23.0	63.0	40.0
Total Split (%)	37.0%	37.0%	23.0%	63.0%	40.0%
Yellow Time (s)	3.3	3.3	3.3	3.3	3.3
All-Red Time (s)	3.0	3.0	2.9	3.5	3.5
Lost Time Adjust (s)	0.0	0.0	0.0	0.0	0.0
Total Lost Time (s)	6.3	6.3	6.2	6.8	6.8
Lead/Lag			Lead		Lag
Lead-Lag Optimize?			Yes		Yes
Act Effct Green (s)	30.7	30.7	56.8	56.2	33.2
Actuated g/C Ratio	0.31	0.31	0.57	0.56	0.33
v/c Ratio	0.89	0.86	0.84	0.41	0.89
Control Delay	56.4	37.9	44.8	13.2	42.4
Queue Delay	0.0	0.0	0.0	0.0	0.0
Total Delay	56.4	37.9	44.8	13.2	42.4
LOS	E	D	D	B	D
Approach Delay		42.5		22.0	42.4
Approach LOS		D		C	D
Queue Length 50th (m)	84.5	77.5	40.1	42.0	92.0
Queue Length 95th (m)	#145.8	96.6	#83.5	54.7	#128.5
Internal Link Dist (m)		120.8		240.1	287.4
Turn Bay Length (m)	80.0		45.0		
Base Capacity (vph)	447	1368	354	1905	1100
Starvation Cap Reductn	0	0	0	0	0
Spillback Cap Reductn	0	0	0	0	0
Storage Cap Reductn	0	0	0	0	0
Reduced v/c Ratio	0.89	0.86	0.84	0.41	0.89

Intersection Summary

Cycle Length: 100
 Actuated Cycle Length: 100
 Offset: 60 (60%), Referenced to phase 2:NBT and 6:SBT, Start of Green
 Natural Cycle: 75
 Control Type: Pretimed
 Maximum v/c Ratio: 0.89
 Intersection Signal Delay: 36.4
 Intersection LOS: D
 Intersection Capacity Utilization 89.0%
 ICU Level of Service E
 Analysis Period (min) 15
 # 95th percentile volume exceeds capacity, queue may be longer.
 Queue shown is maximum after two cycles.

Splits and Phases: 13: Bronson Ave & Catherine St



Total Projected 2031

Lanes, Volumes, Timings

1: Hwy 417 WB On Ramp/Lyon St N & Catherine St

02/28/2024



Lane Group	WBT	SBT	SBR
Lane Configurations	↕↕	↕	↗
Traffic Volume (vph)	270	282	128
Future Volume (vph)	270	282	128
Lane Group Flow (vph)	540	282	128
Turn Type	NA	NA	Perm
Protected Phases	8	6	
Permitted Phases			6
Minimum Split (s)	26.2	28.3	28.3
Total Split (s)	36.0	39.0	39.0
Total Split (%)	48.0%	52.0%	52.0%
Yellow Time (s)	3.3	3.3	3.3
All-Red Time (s)	1.9	2.0	2.0
Lost Time Adjust (s)	0.0	0.0	0.0
Total Lost Time (s)	5.2	5.3	5.3
Lead/Lag			
Lead-Lag Optimize?			
Act Effct Green (s)	30.8	33.7	33.7
Actuated g/C Ratio	0.41	0.45	0.45
v/c Ratio	0.37	0.35	0.17
Control Delay	8.9	23.7	11.5
Queue Delay	0.0	0.0	0.0
Total Delay	8.9	23.7	11.5
LOS	A	C	B
Approach Delay	8.9	19.9	
Approach LOS	A	B	
Queue Length 50th (m)	28.0	37.6	2.0
Queue Length 95th (m)	m40.1	60.0	19.5
Internal Link Dist (m)	107.6	52.8	
Turn Bay Length (m)			
Base Capacity (vph)	1457	801	752
Starvation Cap Reductn	0	0	0
Spillback Cap Reductn	0	0	0
Storage Cap Reductn	0	0	0
Reduced v/c Ratio	0.37	0.35	0.17

Intersection Summary

Cycle Length: 75
 Actuated Cycle Length: 75
 Offset: 24 (32%), Referenced to phase 8:WBTL, Start of Green
 Natural Cycle: 55
 Control Type: Pretimed
 Maximum v/c Ratio: 0.37
 Intersection Signal Delay: 13.6
 Intersection LOS: B
 Intersection Capacity Utilization 50.4%
 ICU Level of Service A
 Analysis Period (min) 15
 m Volume for 95th percentile queue is metered by upstream signal.

Splits and Phases: 1: Hwy 417 WB On Ramp/Lyon St N & Catherine St

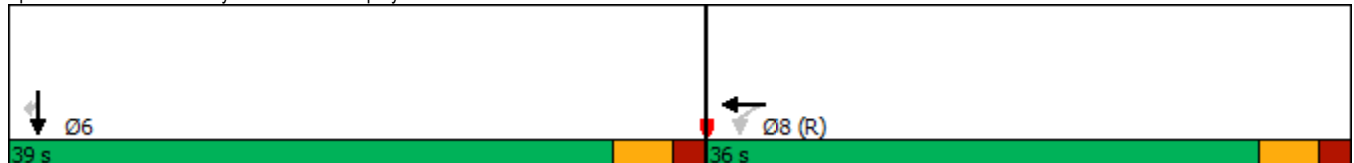

Lanes, Volumes, Timings

2: Hwy 417 EB Off Ramp/Chamberlain Ave/Kent St & Catherine St

02/28/2024



Lane Group	WBT	WBR	NBT	Ø9
Lane Configurations	↑↑	↑↑	↑↑↑	
Traffic Volume (vph)	443	565	1396	
Future Volume (vph)	443	565	1396	
Lane Group Flow (vph)	443	565	1466	
Turn Type	NA	Prot	NA	
Protected Phases	8	8	2	9
Permitted Phases				
Detector Phase	8	8	2	
Switch Phase				
Minimum Initial (s)	10.0	10.0	10.0	1.0
Minimum Split (s)	15.8	15.8	22.5	13.0
Total Split (s)	30.0	30.0	32.0	13.0
Total Split (%)	40.0%	40.0%	42.7%	17%
Yellow Time (s)	3.3	3.3	3.3	2.0
All-Red Time (s)	2.5	2.5	2.5	0.0
Lost Time Adjust (s)	0.0	0.0	0.0	
Total Lost Time (s)	5.8	5.8	5.8	
Lead/Lag				
Lead-Lag Optimize?				
Recall Mode	C-Max	C-Max	Max	None
Act Effct Green (s)	29.4	29.4	26.2	
Actuated g/C Ratio	0.39	0.39	0.35	
v/c Ratio	0.35	0.54	0.83	
Control Delay	22.6	25.3	26.5	
Queue Delay	0.0	0.0	50.6	
Total Delay	22.6	25.3	77.1	
LOS	C	C	E	
Approach Delay	24.1		77.1	
Approach LOS	C		E	
Queue Length 50th (m)	29.6	42.6	65.5	
Queue Length 95th (m)	m35.0	m51.1	82.9	
Internal Link Dist (m)	131.7		67.4	
Turn Bay Length (m)		60.0		
Base Capacity (vph)	1278	1056	1759	
Starvation Cap Reductn	0	0	0	
Spillback Cap Reductn	0	0	1033	
Storage Cap Reductn	0	0	0	
Reduced v/c Ratio	0.35	0.54	2.02	

Intersection Summary

Cycle Length: 75
 Actuated Cycle Length: 75
 Offset: 0 (0%), Referenced to phase 8:WBT, Start of Green
 Natural Cycle: 60
 Control Type: Actuated-Coordinated
 Maximum v/c Ratio: 0.83
 Intersection Signal Delay: 55.5
 Intersection LOS: E
 Intersection Capacity Utilization 63.9%
 ICU Level of Service B
 Analysis Period (min) 15
 m Volume for 95th percentile queue is metered by upstream signal.

Splits and Phases: 2: Hwy 417 EB Off Ramp/Chamberlain Ave/Kent St & Catherine St

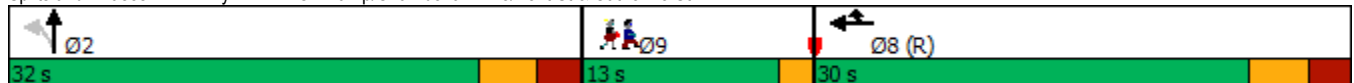

Lanes, Volumes, Timings
3: Bank St & Catherine St

02/28/2024



Lane Group	WBT	NBL	NBT	SBT	Ø1	Ø5	Ø7
Lane Configurations							
Traffic Volume (vph)	630	278	582	404			
Future Volume (vph)	630	278	582	404			
Lane Group Flow (vph)	1008	0	860	548			
Turn Type	NA	pm+pt	NA	NA			
Protected Phases	8	9	2	6	1	5	7
Permitted Phases		2					
Minimum Split (s)	18.6	10.4	16.4	16.4	5.0	5.0	5.0
Total Split (s)	23.0	10.4	42.0	31.6	5.0	5.0	5.0
Total Split (%)	30.7%	13.9%	56.0%	42.1%	7%	7%	7%
Yellow Time (s)	3.3	3.3	3.3	3.3	2.0	2.0	2.0
All-Red Time (s)	2.3	2.1	2.1	2.1	0.0	0.0	0.0
Lost Time Adjust (s)	0.0		0.0	0.0			
Total Lost Time (s)	5.6		5.4	5.4			
Lead/Lag	Lag		Lag	Lag	Lead	Lead	Lead
Lead-Lag Optimize?	Yes		Yes	Yes	Yes	Yes	Yes
Act Effct Green (s)	17.4		36.6	26.2			
Actuated g/C Ratio	0.23		0.49	0.35			
v/c Ratio	0.94		0.82	0.52			
Control Delay	43.6		19.1	18.7			
Queue Delay	0.0		0.0	0.0			
Total Delay	43.6		19.1	18.7			
LOS	D		B	B			
Approach Delay	43.6		19.1	18.7			
Approach LOS	D		B	B			
Queue Length 50th (m)	47.8		25.3	27.2			
Queue Length 95th (m)	#73.5		#38.8	41.5			
Internal Link Dist (m)	201.7		90.2	52.9			
Turn Bay Length (m)							
Base Capacity (vph)	1075		1054	1050			
Starvation Cap Reductn	0		0	0			
Spillback Cap Reductn	0		0	0			
Storage Cap Reductn	0		0	0			
Reduced v/c Ratio	0.94		0.82	0.52			

Intersection Summary

Cycle Length: 75
 Actuated Cycle Length: 75
 Offset: 50 (67%), Referenced to phase 2:NBT and 6:SBT, Start of Green
 Natural Cycle: 70
 Control Type: Pretimed
 Maximum v/c Ratio: 0.94
 Intersection Signal Delay: 29.2
 Intersection LOS: C
 Intersection Capacity Utilization 82.1%
 ICU Level of Service E
 Analysis Period (min) 15
 # 95th percentile volume exceeds capacity, queue may be longer.
 Queue shown is maximum after two cycles.

Splits and Phases: 3: Bank St & Catherine St

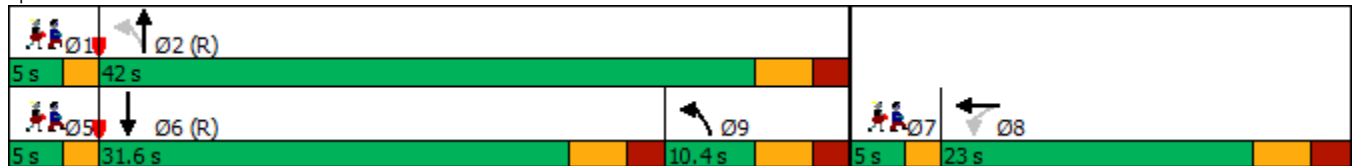

Lanes, Volumes, Timings
4: Percy St & Catherine St

02/28/2024

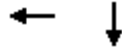

Lane Group	WBT	SBT	Ø3	Ø7
Lane Configurations				
Traffic Volume (vph)	264	129		
Future Volume (vph)	264	129		
Lane Group Flow (vph)	356	186		
Turn Type	NA	NA		
Protected Phases	8	6	3	7
Permitted Phases				
Detector Phase	8	6		
Switch Phase				
Minimum Initial (s)	10.0	10.0	1.0	1.0
Minimum Split (s)	26.5	23.4	6.4	6.4
Total Split (s)	34.0	24.0	16.0	16.0
Total Split (%)	37.8%	26.7%	18%	18%
Yellow Time (s)	3.3	3.3	3.3	3.3
All-Red Time (s)	2.2	2.1	2.1	2.1
Lost Time Adjust (s)	0.0	0.0		
Total Lost Time (s)	5.5	5.4		
Lead/Lag	Lag			Lead
Lead-Lag Optimize?	Yes			Yes
Recall Mode	None	Max	None	None
Act Effct Green (s)	11.9	18.8		
Actuated g/C Ratio	0.29	0.45		
v/c Ratio	0.35	0.25		
Control Delay	7.2	9.4		
Queue Delay	0.0	0.0		
Total Delay	7.2	9.4		
LOS	A	A		
Approach Delay	7.2	9.4		
Approach LOS	A	A		
Queue Length 50th (m)	5.4	6.6		
Queue Length 95th (m)	11.8	23.3		
Internal Link Dist (m)	271.6	288.0		
Turn Bay Length (m)				
Base Capacity (vph)	2220	740		
Starvation Cap Reductn	0	0		
Spillback Cap Reductn	0	0		
Storage Cap Reductn	0	0		
Reduced v/c Ratio	0.16	0.25		

Intersection Summary

Cycle Length: 90	
Actuated Cycle Length: 41.7	
Natural Cycle: 65	
Control Type: Semi Act-Uncoord	
Maximum v/c Ratio: 0.35	
Intersection Signal Delay: 8.0	Intersection LOS: A
Intersection Capacity Utilization 39.6%	ICU Level of Service A
Analysis Period (min) 15	

Splits and Phases: 4: Percy St & Catherine St

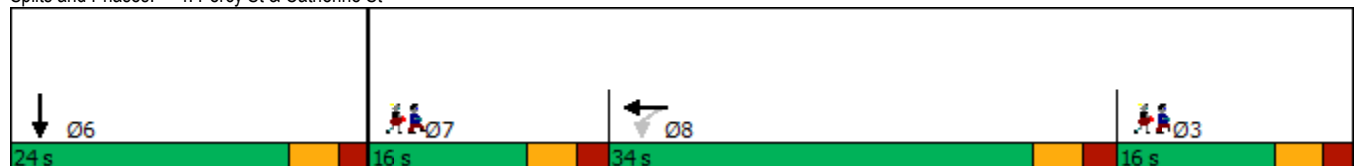

Lanes, Volumes, Timings
 5: Lyon St N & Arlington Ave

02/28/2024

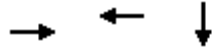

Lane Group	EBT	WBT	SBT
Lane Configurations			
Traffic Volume (vph)	18	12	337
Future Volume (vph)	18	12	337
Lane Group Flow (vph)	18	37	400
Sign Control	Stop	Stop	Free
Intersection Summary			
Control Type: Unsignalized			
Intersection Capacity Utilization 33.6%		ICU Level of Service A	
Analysis Period (min) 15			

Intersection												
Int Delay, s/veh	2.5											
Movement	EBL	EBT	EBR	WBL	WBT	WBR	NBL	NBT	NBR	SBL	SBT	SBR
Lane Configurations		↕			↕						↕↕	
Traffic Vol, veh/h	0	18	0	25	12	0	0	0	0	54	337	9
Future Vol, veh/h	0	18	0	25	12	0	0	0	0	54	337	9
Conflicting Peds, #/hr	32	0	15	15	0	32	9	0	10	10	0	9
Sign Control	Stop	Stop	Stop	Stop	Stop	Stop	Free	Free	Free	Free	Free	Free
RT Channelized	-	-	None	-	-	None	-	-	None	-	-	None
Storage Length	-	-	-	-	-	-	-	-	-	-	-	-
Veh in Median Storage, #	-	0	-	-	0	-	-	-	-	-	0	-
Grade, %	-	0	-	-	0	-	-	0	-	-	0	-
Peak Hour Factor	100	100	100	100	100	100	100	100	100	100	100	100
Heavy Vehicles, %	0	6	0	9	0	0	0	0	0	5	1	11
Mvmt Flow	0	18	0	25	12	0	0	0	0	54	337	9

Major/Minor	Minor2		Minor1			Major2			
Conflicting Flow All	-	469	197	311	473	-	10	0	0
Stage 1	-	459	-	10	10	-	-	-	-
Stage 2	-	10	-	301	463	-	-	-	-
Critical Hdwy	-	6.62	6.9	7.68	6.5	-	4.2	-	-
Critical Hdwy Stg 1	-	5.62	-	-	-	-	-	-	-
Critical Hdwy Stg 2	-	-	-	6.68	5.5	-	-	-	-
Follow-up Hdwy	-	4.06	3.3	3.59	4	-	2.25	-	-
Pot Cap-1 Maneuver	0	482	817	601	493	0	1586	-	-
Stage 1	0	555	-	-	0	-	-	-	-
Stage 2	0	-	-	664	568	0	-	-	-
Platoon blocked, %	-	-	-	-	-	-	-	-	-
Mov Cap-1 Maneuver	-	454	810	558	464	-	1571	-	-
Mov Cap-2 Maneuver	-	454	-	558	464	-	-	-	-
Stage 1	-	527	-	-	-	-	-	-	-
Stage 2	-	-	-	614	539	-	-	-	-

Approach	EB		WB			SB		
HCM Control Delay, s	13.3		12.4			1.1		
HCM LOS	B		B					

Minor Lane/Major Mvmt	EBLn1	WBLn1	SBL	SBT	SBR
Capacity (veh/h)	454	524	1571	-	-
HCM Lane V/C Ratio	0.04	0.071	0.034	-	-
HCM Control Delay (s)	13.3	12.4	7.4	0.1	-
HCM Lane LOS	B	B	A	A	-
HCM 95th %tile Q(veh)	0.1	0.2	0.1	-	-

Lanes, Volumes, Timings
6: Kent St & Arlington Ave

02/28/2024



Lane Group	EBL	EBT	WBT	NBT
Lane Configurations		↕	↕	↕↕↕
Traffic Volume (vph)	40	83	18	1783
Future Volume (vph)	40	83	18	1783
Lane Group Flow (vph)	0	123	111	1940
Turn Type	Perm	NA	NA	NA
Protected Phases		4	8	2
Permitted Phases	4			
Minimum Split (s)	27.3	27.3	27.3	32.3
Total Split (s)	28.0	28.0	28.0	47.0
Total Split (%)	37.3%	37.3%	37.3%	62.7%
Yellow Time (s)	3.3	3.3	3.3	3.3
All-Red Time (s)	2.0	2.0	2.0	2.0
Lost Time Adjust (s)		0.0	0.0	0.0
Total Lost Time (s)		5.3	5.3	5.3
Lead/Lag				
Lead-Lag Optimize?				
Act Effct Green (s)		22.7	22.7	41.7
Actuated g/C Ratio		0.30	0.30	0.56
v/c Ratio		0.26	0.23	0.73
Control Delay		29.1	15.9	15.4
Queue Delay		0.0	0.0	48.7
Total Delay		29.1	15.9	64.1
LOS		C	B	E
Approach Delay		29.1	15.9	64.1
Approach LOS		C	B	E
Queue Length 50th (m)		15.1	8.7	87.6
Queue Length 95th (m)		29.2	m13.3	106.9
Internal Link Dist (m)		138.7	143.1	53.0
Turn Bay Length (m)				
Base Capacity (vph)		471	479	2672
Starvation Cap Reductn		0	0	1393
Spillback Cap Reductn		0	0	0
Storage Cap Reductn		0	0	0
Reduced v/c Ratio		0.26	0.23	1.52

Intersection Summary

Cycle Length: 75
 Actuated Cycle Length: 75
 Offset: 50 (67%), Referenced to phase 2:NBT, Start of Green
 Natural Cycle: 60
 Control Type: Pretimed
 Maximum v/c Ratio: 0.73
 Intersection Signal Delay: 59.6
 Intersection LOS: E
 Intersection Capacity Utilization 69.6%
 ICU Level of Service C
 Analysis Period (min) 15
 m Volume for 95th percentile queue is metered by upstream signal.

Splits and Phases: 6: Kent St & Arlington Ave



Lanes, Volumes, Timings
7: Lyon St N & Gladstone Ave

02/28/2024



Lane Group	EBT	EBR	WBL	WBT	SBT
Lane Configurations	↑	↑	↑	↑	↑↓
Traffic Volume (vph)	184	24	15	143	345
Future Volume (vph)	184	24	15	143	345
Lane Group Flow (vph)	184	24	15	143	532
Turn Type	NA	Perm	Perm	NA	NA
Protected Phases	4			8	6
Permitted Phases		4	8		
Minimum Split (s)	17.2	17.2	17.2	17.2	22.6
Total Split (s)	36.0	36.0	36.0	36.0	39.0
Total Split (%)	48.0%	48.0%	48.0%	48.0%	52.0%
Yellow Time (s)	3.3	3.3	3.3	3.3	3.3
All-Red Time (s)	1.9	1.9	1.9	1.9	2.3
Lost Time Adjust (s)	0.0	0.0	0.0	0.0	0.0
Total Lost Time (s)	5.2	5.2	5.2	5.2	5.6
Lead/Lag					
Lead-Lag Optimize?					
Act Effct Green (s)	30.8	30.8	30.8	30.8	33.4
Actuated g/C Ratio	0.41	0.41	0.41	0.41	0.45
v/c Ratio	0.26	0.04	0.03	0.20	0.36
Control Delay	15.8	3.3	5.5	7.5	13.3
Queue Delay	0.0	0.0	0.0	0.0	0.0
Total Delay	15.8	3.3	5.5	7.5	13.3
LOS	B	A	A	A	B
Approach Delay	14.4			7.3	13.3
Approach LOS	B			A	B
Queue Length 50th (m)	16.6	0.0	0.7	9.4	22.5
Queue Length 95th (m)	29.8	2.8	m1.1	13.8	33.5
Internal Link Dist (m)	254.8			165.0	214.3
Turn Bay Length (m)			25.0		
Base Capacity (vph)	711	632	470	718	1462
Starvation Cap Reductn	0	0	0	0	0
Spillback Cap Reductn	0	0	0	0	0
Storage Cap Reductn	0	0	0	0	0
Reduced v/c Ratio	0.26	0.04	0.03	0.20	0.36

Intersection Summary

Cycle Length: 75
 Actuated Cycle Length: 75
 Offset: 45 (60%), Referenced to phase 4:EBT and 8:WBTL, Start of Green
 Natural Cycle: 40
 Control Type: Pretimed
 Maximum v/c Ratio: 0.36
 Intersection Signal Delay: 12.5
 Intersection LOS: B
 Intersection Capacity Utilization 81.6%
 ICU Level of Service D
 Analysis Period (min) 15
 m Volume for 95th percentile queue is metered by upstream signal.

Splits and Phases: 7: Lyon St N & Gladstone Ave

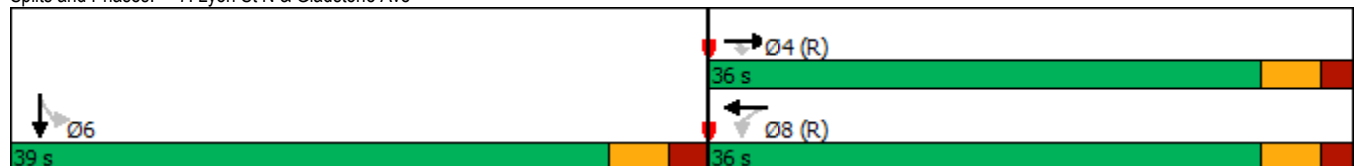

Lanes, Volumes, Timings
8: Kent St & Gladstone Ave

02/28/2024

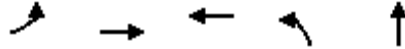

Lane Group	EBL	EBT	WBT	NBL	NBT
Lane Configurations					
Traffic Volume (vph)	82	277	165	36	1787
Future Volume (vph)	82	277	165	36	1787
Lane Group Flow (vph)	82	277	313	36	1884
Turn Type	Perm	NA	NA	Perm	NA
Protected Phases		4	8		2
Permitted Phases	4			2	
Minimum Split (s)	21.4	21.4	21.4	20.4	20.4
Total Split (s)	31.9	31.9	31.9	43.1	43.1
Total Split (%)	42.5%	42.5%	42.5%	57.5%	57.5%
Yellow Time (s)	3.3	3.3	3.3	3.3	3.3
All-Red Time (s)	2.1	2.1	2.1	2.1	2.1
Lost Time Adjust (s)	0.0	0.0	0.0	0.0	0.0
Total Lost Time (s)	5.4	5.4	5.4	5.4	5.4
Lead/Lag					
Lead-Lag Optimize?					
Act Effct Green (s)	26.5	26.5	26.5	37.7	37.7
Actuated g/C Ratio	0.35	0.35	0.35	0.50	0.50
v/c Ratio	0.30	0.46	0.57	0.05	0.78
Control Delay	27.4	28.2	24.1	7.9	8.9
Queue Delay	0.0	0.0	0.0	0.0	0.0
Total Delay	27.4	28.2	24.1	7.9	8.9
LOS	C	C	C	A	A
Approach Delay		28.0	24.1		8.8
Approach LOS		C	C		A
Queue Length 50th (m)	9.9	37.6	34.4	1.5	28.8
Queue Length 95th (m)	23.4	59.7	58.6	m2.9	43.3
Internal Link Dist (m)		165.0	168.8		216.0
Turn Bay Length (m)	30.0			40.0	
Base Capacity (vph)	275	606	552	725	2416
Starvation Cap Reductn	0	0	0	0	0
Spillback Cap Reductn	0	0	0	0	0
Storage Cap Reductn	0	0	0	0	0
Reduced v/c Ratio	0.30	0.46	0.57	0.05	0.78

Intersection Summary

Cycle Length: 75
 Actuated Cycle Length: 75
 Offset: 23 (31%), Referenced to phase 4:EBTL and 8:WBT, Start of Green
 Natural Cycle: 55
 Control Type: Pretimed
 Maximum v/c Ratio: 0.78
 Intersection Signal Delay: 13.3
 Intersection LOS: B
 Intersection Capacity Utilization 81.6%
 ICU Level of Service D
 Analysis Period (min) 15
 m Volume for 95th percentile queue is metered by upstream signal.

Splits and Phases: 8: Kent St & Gladstone Ave



Lanes, Volumes, Timings
 9: Bank St & Chamberlain Ave/Isabella St

02/28/2024



Lane Group	EBT	EBR	NBT	SBL	SBT
Lane Configurations	↕↕	↗	↕↕		↕↕
Traffic Volume (vph)	521	82	845	190	396
Future Volume (vph)	521	82	845	190	396
Lane Group Flow (vph)	603	82	988	0	586
Turn Type	NA	Perm	NA	pm+pt	NA
Protected Phases	4		2	5	6
Permitted Phases		4		6	
Detector Phase	4	4	2	5	6
Switch Phase					
Minimum Initial (s)	10.0	10.0	10.0	5.0	10.0
Minimum Split (s)	26.2	26.2	23.1	11.1	23.1
Total Split (s)	26.2	26.2	37.7	11.1	48.8
Total Split (%)	34.9%	34.9%	50.3%	14.8%	65.1%
Yellow Time (s)	3.3	3.3	3.0	3.0	3.0
All-Red Time (s)	2.9	2.9	3.1	3.1	3.1
Lost Time Adjust (s)	0.0	0.0	0.0		0.0
Total Lost Time (s)	6.2	6.2	6.1		6.1
Lead/Lag					
Lead-Lag Optimize?					
Recall Mode	None	None	C-Max	None	C-Max
Act Effct Green (s)	18.4	18.4	44.3		44.3
Actuated g/C Ratio	0.25	0.25	0.59		0.59
v/c Ratio	0.76	0.19	0.53		0.56
Control Delay	33.1	2.4	10.8		14.2
Queue Delay	0.0	0.0	0.0		0.0
Total Delay	33.1	2.4	10.8		14.2
LOS	C	A	B		B
Approach Delay	29.4		10.8		14.2
Approach LOS	C		B		B
Queue Length 50th (m)	40.3	0.0	42.1		42.4
Queue Length 95th (m)	57.5	3.5	57.5		m58.0
Internal Link Dist (m)	296.0		215.6		90.2
Turn Bay Length (m)		40.0			
Base Capacity (vph)	858	460	1861		1039
Starvation Cap Reductn	0	0	0		0
Spillback Cap Reductn	0	0	0		0
Storage Cap Reductn	0	0	0		0
Reduced v/c Ratio	0.70	0.18	0.53		0.56

Intersection Summary

Cycle Length: 75
 Actuated Cycle Length: 75
 Offset: 60 (80%), Referenced to phase 2:NBT and 6:SBTL, Start of Green
 Natural Cycle: 65
 Control Type: Actuated-Coordinated
 Maximum v/c Ratio: 0.76
 Intersection Signal Delay: 17.3
 Intersection LOS: B
 Intersection Capacity Utilization 84.2%
 ICU Level of Service E
 Analysis Period (min) 15
 m Volume for 95th percentile queue is metered by upstream signal.

Splits and Phases: 9: Bank St & Chamberlain Ave/Isabella St

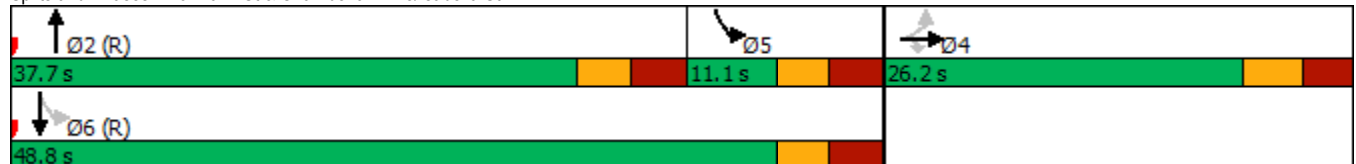

Lanes, Volumes, Timings
10: Catherine St & Access

02/28/2024

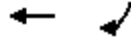

Lane Group	WBT	SBR
Lane Configurations		
Traffic Volume (vph)	468	69
Future Volume (vph)	468	69
Lane Group Flow (vph)	509	69
Sign Control	Free	

Intersection Summary

Control Type: Unsignalized
Intersection Capacity Utilization 26.2% ICU Level of Service A
Analysis Period (min) 15

Intersection						
Int Delay, s/veh	1.2					
Movement	EBL	EBT	WBT	WBR	SBL	SBR
Lane Configurations			↑↑			↑
Traffic Vol, veh/h	0	0	468	41	0	69
Future Vol, veh/h	0	0	468	41	0	69
Conflicting Peds, #/hr	0	0	0	0	0	0
Sign Control	Free	Free	Free	Free	Stop	Stop
RT Channelized	-	None	-	None	-	None
Storage Length	-	-	-	-	-	0
Veh in Median Storage, #	-4521984		0	-	0	-
Grade, %	-	0	0	-	0	-
Peak Hour Factor	100	100	100	100	100	100
Heavy Vehicles, %	2	2	2	2	2	2
Mvmt Flow	0	0	468	41	0	69
Major/Minor	Major2		Minor2			
Conflicting Flow All			-	0	-	255
Stage 1			-	-	-	-
Stage 2			-	-	-	-
Critical Hdwy			-	-	-	6.94
Critical Hdwy Stg 1			-	-	-	-
Critical Hdwy Stg 2			-	-	-	-
Follow-up Hdwy			-	-	-	3.32
Pot Cap-1 Maneuver			-	-	0	744
Stage 1			-	-	0	-
Stage 2			-	-	0	-
Platoon blocked, %			-	-	-	-
Mov Cap-1 Maneuver			-	-	-	744
Mov Cap-2 Maneuver			-	-	-	-
Stage 1			-	-	-	-
Stage 2			-	-	-	-
Approach	WB		SB			
HCM Control Delay, s			0		10.3	
HCM LOS					B	
Minor Lane/Major Mvmt	WBT	WBR	SBLn1			
Capacity (veh/h)	-	-	744			
HCM Lane V/C Ratio	-	-	0.093			
HCM Control Delay (s)	-	-	10.3			
HCM Lane LOS	-	-	B			
HCM 95th %tile Q(veh)	-	-	0.3			

Lanes, Volumes, Timings
 11: Access & Arlington Ave

02/28/2024



Lane Group	EBT	WBT	NBL
Lane Configurations			
Traffic Volume (vph)	62	23	14
Future Volume (vph)	62	23	14
Lane Group Flow (vph)	72	40	70
Sign Control	Free	Free	Stop

Intersection Summary	
Control Type: Unsignalized	
Intersection Capacity Utilization 20.1%	ICU Level of Service A
Analysis Period (min) 15	

Intersection						
Int Delay, s/veh	4.1					
Movement	EBT	EBR	WBL	WBT	NBL	NBR
Lane Configurations	↔			↔	↔	
Traffic Vol, veh/h	62	10	17	23	14	56
Future Vol, veh/h	62	10	17	23	14	56
Conflicting Peds, #/hr	0	0	0	0	0	0
Sign Control	Free	Free	Free	Free	Stop	Stop
RT Channelized	-	None	-	None	-	None
Storage Length	-	-	-	-	0	-
Veh in Median Storage, #	0	-	-	0	0	-
Grade, %	0	-	-	0	0	-
Peak Hour Factor	100	100	100	100	100	100
Heavy Vehicles, %	2	2	2	2	2	2
Mvmt Flow	62	10	17	23	14	56

Major/Minor	Major1	Major2	Minor1			
Conflicting Flow All	0	0	72	0	124	67
Stage 1	-	-	-	-	67	-
Stage 2	-	-	-	-	57	-
Critical Hdwy	-	-	4.12	-	6.42	6.22
Critical Hdwy Stg 1	-	-	-	-	5.42	-
Critical Hdwy Stg 2	-	-	-	-	5.42	-
Follow-up Hdwy	-	-	2.218	-	3.518	3.318
Pot Cap-1 Maneuver	-	-	1528	-	871	997
Stage 1	-	-	-	-	956	-
Stage 2	-	-	-	-	966	-
Platoon blocked, %	-	-	-	-	-	-
Mov Cap-1 Maneuver	-	-	1528	-	861	997
Mov Cap-2 Maneuver	-	-	-	-	861	-
Stage 1	-	-	-	-	956	-
Stage 2	-	-	-	-	955	-

Approach	EB	WB	NB
HCM Control Delay, s	0	3.1	9
HCM LOS			A

Minor Lane/Major Mvmt	NBLn1	EBT	EBR	WBL	WBT
Capacity (veh/h)	966	-	-	1528	-
HCM Lane V/C Ratio	0.072	-	-	0.011	-
HCM Control Delay (s)	9	-	-	7.4	0
HCM Lane LOS	A	-	-	A	A
HCM 95th %tile Q(veh)	0.2	-	-	0	-

Lanes, Volumes, Timings
 12: Bank St & Arlington Ave

02/28/2024



Lane Group	EBL	NBT	SBT
Lane Configurations			
Traffic Volume (vph)	28	691	397
Future Volume (vph)	28	691	397
Lane Group Flow (vph)	180	784	419
Sign Control	Stop	Free	Free

Intersection Summary	
Control Type: Unsignalized	
Intersection Capacity Utilization 57.9%	ICU Level of Service B
Analysis Period (min) 15	

Intersection						
Int Delay, s/veh	3.5					
Movement	EBL	EBR	NBL	NBT	SBT	SBR
Lane Configurations	↔			↕	↕	
Traffic Vol, veh/h	28	152	93	691	397	22
Future Vol, veh/h	28	152	93	691	397	22
Conflicting Peds, #/hr	0	0	111	0	0	111
Sign Control	Stop	Stop	Free	Free	Free	Free
RT Channelized	-	None	-	None	-	None
Storage Length	0	-	-	-	-	-
Veh in Median Storage, #	0	-	-	0	0	-
Grade, %	0	-	-	0	0	-
Peak Hour Factor	100	100	100	100	100	100
Heavy Vehicles, %	0	3	2	5	8	5
Mvmt Flow	28	152	93	691	397	22

Major/Minor	Minor2	Major1	Major2			
Conflicting Flow All	1051	321	530	0	-	0
Stage 1	519	-	-	-	-	-
Stage 2	532	-	-	-	-	-
Critical Hdwy	6.8	6.96	4.14	-	-	-
Critical Hdwy Stg 1	5.8	-	-	-	-	-
Critical Hdwy Stg 2	5.8	-	-	-	-	-
Follow-up Hdwy	3.5	3.33	2.22	-	-	-
Pot Cap-1 Maneuver	226	672	1033	-	-	-
Stage 1	568	-	-	-	-	-
Stage 2	559	-	-	-	-	-
Platoon blocked, %				-	-	-
Mov Cap-1 Maneuver	152	603	927	-	-	-
Mov Cap-2 Maneuver	152	-	-	-	-	-
Stage 1	427	-	-	-	-	-
Stage 2	501	-	-	-	-	-

Approach	EB	NB	SB
HCM Control Delay, s	20.3	1.6	0
HCM LOS	C		

Minor Lane/Major Mvmt	NBL	NBT	EBLn1	SBT	SBR
Capacity (veh/h)	927	-	413	-	-
HCM Lane V/C Ratio	0.1	-	0.436	-	-
HCM Control Delay (s)	9.3	0.6	20.3	-	-
HCM Lane LOS	A	A	C	-	-
HCM 95th %tile Q(veh)	0.3	-	2.2	-	-

Lanes, Volumes, Timings
13: Bronson Ave & Catherine St

02/28/2024



Lane Group	WBL	WBT	NBL	NBT	SBT	Ø5	Ø7
Lane Configurations							
Traffic Volume (vph)	526	498	540	1080	445		
Future Volume (vph)	526	498	540	1080	445		
Lane Group Flow (vph)	352	1039	540	1080	568		
Turn Type	Perm	NA	pm+pt	NA	NA		
Protected Phases		8	5 7	2	6	5	7
Permitted Phases	8		2				
Minimum Split (s)	28.3	28.3		23.8	23.8	11.2	11.8
Total Split (s)	37.0	37.0		73.0	30.2	31.0	11.8
Total Split (%)	33.6%	33.6%		66.4%	27.5%	28%	11%
Yellow Time (s)	3.3	3.3		3.3	3.3	3.3	3.3
All-Red Time (s)	3.0	3.0		3.5	3.5	2.9	3.5
Lost Time Adjust (s)	0.0	0.0		0.0	0.0		
Total Lost Time (s)	6.3	6.3		6.8	6.8		
Lead/Lag					Lag	Lead	
Lead-Lag Optimize?					Yes	Yes	
Act Effct Green (s)	30.7	30.7	66.8	66.2	23.4		
Actuated g/C Ratio	0.28	0.28	0.61	0.60	0.21		
v/c Ratio	0.88	0.86	0.88	0.53	0.84		
Control Delay	62.5	42.8	32.4	14.0	51.5		
Queue Delay	0.0	0.0	0.0	0.0	0.0		
Total Delay	62.5	42.8	32.4	14.0	51.5		
LOS	E	D	C	B	D		
Approach Delay		47.8		20.1	51.5		
Approach LOS		D		C	D		
Queue Length 50th (m)	84.0	76.1	62.1	66.5	58.9		
Queue Length 95th (m)	#143.9	94.8	#114.9	83.1	#85.3		
Internal Link Dist (m)		120.8		240.1	287.4		
Turn Bay Length (m)	80.0		45.0				
Base Capacity (vph)	399	1213	613	2040	679		
Starvation Cap Reductn	0	0	0	0	0		
Spillback Cap Reductn	0	0	0	0	0		
Storage Cap Reductn	0	0	0	0	0		
Reduced v/c Ratio	0.88	0.86	0.88	0.53	0.84		

Intersection Summary

Cycle Length: 110
 Actuated Cycle Length: 110
 Offset: 60 (55%), Referenced to phase 2:NBT and 6:SBT, Start of Green
 Natural Cycle: 90
 Control Type: Pretimed
 Maximum v/c Ratio: 0.88
 Intersection Signal Delay: 35.9
 Intersection LOS: D
 Intersection Capacity Utilization 88.8%
 ICU Level of Service E
 Analysis Period (min) 15
 # 95th percentile volume exceeds capacity, queue may be longer.
 Queue shown is maximum after two cycles.

Splits and Phases: 13: Bronson Ave & Catherine St



Lanes, Volumes, Timings

1: Hwy 417 WB On Ramp/Lyon St N & Catherine St

02/28/2024



Lane Group	WBT	SBT	SBR
Lane Configurations	↕↕	↕	↗
Traffic Volume (vph)	553	366	296
Future Volume (vph)	553	366	296
Lane Group Flow (vph)	777	366	296
Turn Type	NA	NA	Perm
Protected Phases	8	6	
Permitted Phases			6
Minimum Split (s)	26.2	28.3	28.3
Total Split (s)	38.0	37.0	37.0
Total Split (%)	50.7%	49.3%	49.3%
Yellow Time (s)	3.3	3.3	3.3
All-Red Time (s)	1.9	2.0	2.0
Lost Time Adjust (s)	0.0	0.0	0.0
Total Lost Time (s)	5.2	5.3	5.3
Lead/Lag			
Lead-Lag Optimize?			
Act Effct Green (s)	32.8	31.7	31.7
Actuated g/C Ratio	0.44	0.42	0.42
v/c Ratio	0.52	0.48	0.40
Control Delay	13.3	26.7	17.0
Queue Delay	0.0	0.0	0.0
Total Delay	13.3	26.7	17.0
LOS	B	C	B
Approach Delay	13.3	22.3	
Approach LOS	B	C	
Queue Length 50th (m)	53.6	52.3	26.1
Queue Length 95th (m)	71.5	77.8	49.0
Internal Link Dist (m)	107.6	52.8	
Turn Bay Length (m)			
Base Capacity (vph)	1489	761	731
Starvation Cap Reductn	0	0	0
Spillback Cap Reductn	0	0	0
Storage Cap Reductn	0	0	0
Reduced v/c Ratio	0.52	0.48	0.40

Intersection Summary

Cycle Length: 75	
Actuated Cycle Length: 75	
Offset: 24 (32%), Referenced to phase 8:WBTL, Start of Green	
Natural Cycle: 55	
Control Type: Pretimed	
Maximum v/c Ratio: 0.52	
Intersection Signal Delay: 17.5	Intersection LOS: B
Intersection Capacity Utilization 55.4%	ICU Level of Service B
Analysis Period (min) 15	

Splits and Phases: 1: Hwy 417 WB On Ramp/Lyon St N & Catherine St

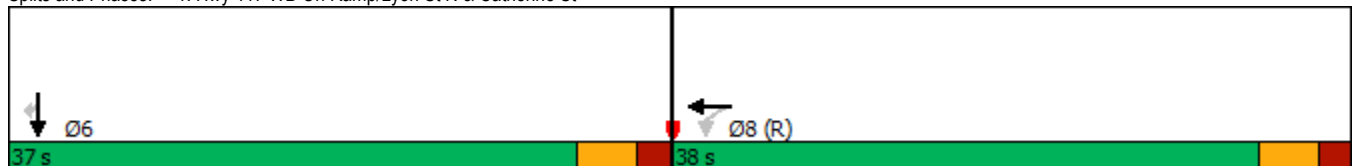

Lanes, Volumes, Timings

2: Hwy 417 EB Off Ramp/Chamberlain Ave/Kent St & Catherine St

02/28/2024



Lane Group	WBT	WBR	NBT	Ø9
Lane Configurations	↑↑	↑↑	↑↑↑	
Traffic Volume (vph)	723	314	870	
Future Volume (vph)	723	314	870	
Lane Group Flow (vph)	723	314	920	
Turn Type	NA	Prot	NA	
Protected Phases	8	8	2	9
Permitted Phases				
Detector Phase	8	8	2	
Switch Phase				
Minimum Initial (s)	10.0	10.0	10.0	1.0
Minimum Split (s)	15.8	15.8	22.5	13.0
Total Split (s)	35.0	35.0	27.0	13.0
Total Split (%)	46.7%	46.7%	36.0%	17%
Yellow Time (s)	3.3	3.3	3.3	2.0
All-Red Time (s)	2.5	2.5	2.5	0.0
Lost Time Adjust (s)	0.0	0.0	0.0	
Total Lost Time (s)	5.8	5.8	5.8	
Lead/Lag				
Lead-Lag Optimize?				
Recall Mode	C-Max	C-Max	Max	None
Act Effct Green (s)	34.4	34.4	21.2	
Actuated g/C Ratio	0.46	0.46	0.28	
v/c Ratio	0.47	0.27	0.65	
Control Delay	26.8	24.3	24.2	
Queue Delay	0.0	0.0	1.3	
Total Delay	26.8	24.3	25.6	
LOS	C	C	C	
Approach Delay	26.1		25.6	
Approach LOS	C		C	
Queue Length 50th (m)	53.8	23.4	38.3	
Queue Length 95th (m)	m63.2	m27.7	51.3	
Internal Link Dist (m)	131.7		67.4	
Turn Bay Length (m)		60.0		
Base Capacity (vph)	1539	1156	1420	
Starvation Cap Reductn	0	0	0	
Spillback Cap Reductn	0	0	289	
Storage Cap Reductn	0	0	0	
Reduced v/c Ratio	0.47	0.27	0.81	

Intersection Summary

Cycle Length: 75
 Actuated Cycle Length: 75
 Offset: 0 (0%), Referenced to phase 8:WBT, Start of Green
 Natural Cycle: 60
 Control Type: Actuated-Coordinated
 Maximum v/c Ratio: 0.65
 Intersection Signal Delay: 25.8
 Intersection LOS: C
 Intersection Capacity Utilization 51.8%
 ICU Level of Service A
 Analysis Period (min) 15
 m Volume for 95th percentile queue is metered by upstream signal.

Splits and Phases: 2: Hwy 417 EB Off Ramp/Chamberlain Ave/Kent St & Catherine St



Lanes, Volumes, Timings
3: Bank St & Catherine St

02/28/2024



Lane Group	WBT	NBL	NBT	SBT	Ø1	Ø5	Ø7
Lane Configurations	↕↕↕		↕↕	↕↕			
Traffic Volume (vph)	653	206	340	713			
Future Volume (vph)	653	206	340	713			
Lane Group Flow (vph)	1047	0	546	855			
Turn Type	NA	pm+pt	NA	NA			
Protected Phases	8	9	2	6	1	5	7
Permitted Phases		2					
Minimum Split (s)	18.6	10.4	16.4	16.4	5.0	5.0	5.0
Total Split (s)	24.0	10.4	41.0	30.6	5.0	5.0	5.0
Total Split (%)	32.0%	13.9%	54.7%	40.8%	7%	7%	7%
Yellow Time (s)	3.3	3.3	3.3	3.3	2.0	2.0	2.0
All-Red Time (s)	2.3	2.1	2.1	2.1	0.0	0.0	0.0
Lost Time Adjust (s)	0.0		0.0	0.0			
Total Lost Time (s)	5.6		5.4	5.4			
Lead/Lag	Lag		Lag	Lag	Lead	Lead	Lead
Lead-Lag Optimize?	Yes		Yes	Yes	Yes	Yes	Yes
Act Effct Green (s)	18.4		35.6	25.2			
Actuated g/C Ratio	0.25		0.47	0.34			
v/c Ratio	0.92		0.58	0.81			
Control Delay	40.3		13.2	29.0			
Queue Delay	0.0		0.0	0.8			
Total Delay	40.3		13.2	29.8			
LOS	D		B	C			
Approach Delay	40.3		13.2	29.8			
Approach LOS	D		B	C			
Queue Length 50th (m)	50.7		15.6	54.9			
Queue Length 95th (m)	#75.5		20.4	#77.5			
Internal Link Dist (m)	201.7		90.2	52.9			
Turn Bay Length (m)							
Base Capacity (vph)	1144		946	1062			
Starvation Cap Reductn	0		0	0			
Spillback Cap Reductn	0		0	52			
Storage Cap Reductn	0		0	0			
Reduced v/c Ratio	0.92		0.58	0.85			

Intersection Summary

Cycle Length: 75
 Actuated Cycle Length: 75
 Offset: 50 (67%), Referenced to phase 2:NBT and 6:SBT, Start of Green
 Natural Cycle: 75
 Control Type: Pretimed
 Maximum v/c Ratio: 0.92
 Intersection Signal Delay: 30.6
 Intersection LOS: C
 Intersection Capacity Utilization 81.7%
 ICU Level of Service D
 Analysis Period (min) 15
 # 95th percentile volume exceeds capacity, queue may be longer.
 Queue shown is maximum after two cycles.

Splits and Phases: 3: Bank St & Catherine St

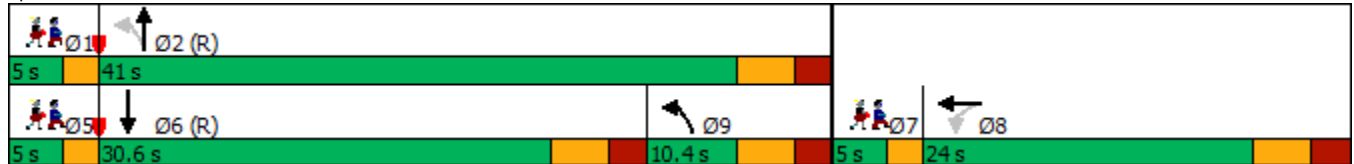

Lanes, Volumes, Timings
4: Percy St & Catherine St

02/28/2024

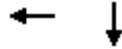

Lane Group	WBT	SBT	Ø3	Ø7
Lane Configurations				
Traffic Volume (vph)	724	121		
Future Volume (vph)	724	121		
Lane Group Flow (vph)	890	160		
Turn Type	NA	NA		
Protected Phases	8	6	3	7
Permitted Phases				
Detector Phase	8	6		
Switch Phase				
Minimum Initial (s)	10.0	10.0	1.0	1.0
Minimum Split (s)	26.5	23.4	6.4	6.4
Total Split (s)	34.0	24.0	16.0	16.0
Total Split (%)	37.8%	26.7%	18%	18%
Yellow Time (s)	3.3	3.3	3.3	3.3
All-Red Time (s)	2.2	2.1	2.1	2.1
Lost Time Adjust (s)	0.0	0.0		
Total Lost Time (s)	5.5	5.4		
Lead/Lag	Lag			Lead
Lead-Lag Optimize?	Yes			Yes
Recall Mode	None	Max	None	None
Act Effct Green (s)	18.6	18.7		
Actuated g/C Ratio	0.39	0.39		
v/c Ratio	0.64	0.24		
Control Delay	11.9	12.6		
Queue Delay	0.0	0.0		
Total Delay	11.9	12.6		
LOS	B	B		
Approach Delay	11.9	12.6		
Approach LOS	B	B		
Queue Length 50th (m)	24.5	8.5		
Queue Length 95th (m)	38.3	22.9		
Internal Link Dist (m)	271.6	288.0		
Turn Bay Length (m)				
Base Capacity (vph)	2050	669		
Starvation Cap Reductn	0	0		
Spillback Cap Reductn	0	0		
Storage Cap Reductn	0	0		
Reduced v/c Ratio	0.43	0.24		

Intersection Summary

Cycle Length: 90	
Actuated Cycle Length: 48.3	
Natural Cycle: 65	
Control Type: Semi Act-Uncoord	
Maximum v/c Ratio: 0.64	
Intersection Signal Delay: 12.0	Intersection LOS: B
Intersection Capacity Utilization 53.6%	ICU Level of Service A
Analysis Period (min) 15	

Splits and Phases: 4: Percy St & Catherine St

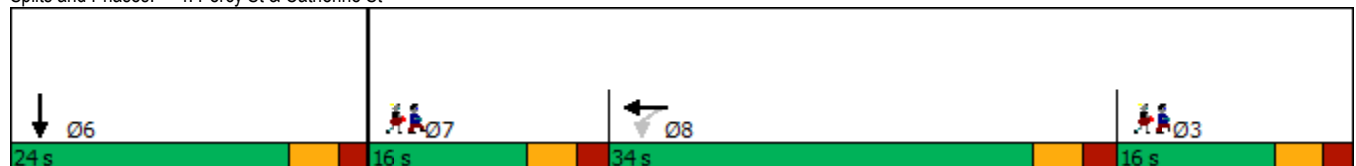

Lanes, Volumes, Timings
 5: Lyon St N & Arlington Ave

02/28/2024

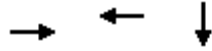

Lane Group	EBT	WBT	SBT
Lane Configurations			
Traffic Volume (vph)	19	37	587
Future Volume (vph)	19	37	587
Lane Group Flow (vph)	21	54	661
Sign Control	Stop	Stop	Free
Intersection Summary			
Control Type: Unsignalized			
Intersection Capacity Utilization 40.9%		ICU Level of Service A	
Analysis Period (min) 15			

HCM 2010 TWSC
5: Lyon St N & Arlington Ave

02/28/2024

Intersection												
Int Delay, s/veh	2.6											
Movement	EBL	EBT	EBR	WBL	WBT	WBR	NBL	NBT	NBR	SBL	SBT	SBR
Lane Configurations		↕			↕						↕↔	
Traffic Vol, veh/h	0	19	2	17	37	0	0	0	0	61	587	13
Future Vol, veh/h	0	19	2	17	37	0	0	0	0	61	587	13
Conflicting Peds, #/hr	20	0	8	8	0	20	19	0	3	3	0	19
Sign Control	Stop	Stop	Stop	Stop	Stop	Stop	Free	Free	Free	Free	Free	Free
RT Channelized	-	-	None	-	-	None	-	-	None	-	-	None
Storage Length	-	-	-	-	-	-	-	-	-	-	-	-
Veh in Median Storage, #	-	0	-	-	0	-	-	-	-	-	0	-
Grade, %	-	0	-	-	0	-	-	0	-	-	0	-
Peak Hour Factor	100	100	100	100	100	100	100	100	100	100	100	100
Heavy Vehicles, %	0	5	0	0	5	0	0	0	0	0	0	0
Mvmt Flow	0	19	2	17	37	0	0	0	0	61	587	13

Major/Minor	Minor2		Minor1			Major2			
Conflicting Flow All	-	738	327	436	744	-	3	0	0
Stage 1	-	735	-	3	3	-	-	-	-
Stage 2	-	3	-	433	741	-	-	-	-
Critical Hdwy	-	6.6	6.9	7.5	6.6	-	4.1	-	-
Critical Hdwy Stg 1	-	5.6	-	-	-	-	-	-	-
Critical Hdwy Stg 2	-	-	-	6.5	5.6	-	-	-	-
Follow-up Hdwy	-	4.05	3.3	3.5	4.05	-	2.2	-	-
Pot Cap-1 Maneuver	0	338	675	509	335	0	1632	-	-
Stage 1	0	416	-	-	-	0	-	-	-
Stage 2	0	-	-	577	414	0	-	-	-
Platoon blocked, %	-	-	-	-	-	-	-	-	-
Mov Cap-1 Maneuver	-	312	663	462	310	-	1627	-	-
Mov Cap-2 Maneuver	-	312	-	462	310	-	-	-	-
Stage 1	-	386	-	-	-	-	-	-	-
Stage 2	-	-	-	516	384	-	-	-	-

Approach	EB		WB			SB		
HCM Control Delay, s	16.7		17.3			0.9		
HCM LOS	C		C					

Minor Lane/Major Mvmt	EBLn1	WBLn1	SBL	SBT	SBR
Capacity (veh/h)	329	346	1627	-	-
HCM Lane V/C Ratio	0.064	0.156	0.037	-	-
HCM Control Delay (s)	16.7	17.3	7.3	0.2	-
HCM Lane LOS	C	C	A	A	-
HCM 95th %tile Q(veh)	0.2	0.5	0.1	-	-

Lanes, Volumes, Timings
6: Kent St & Arlington Ave

02/28/2024



Lane Group	EBL	EBT	WBT	NBT
Lane Configurations		↕	↕	↕↕↕
Traffic Volume (vph)	25	83	30	1073
Future Volume (vph)	25	83	30	1073
Lane Group Flow (vph)	0	108	93	1206
Turn Type	Perm	NA	NA	NA
Protected Phases		4	8	2
Permitted Phases	4			
Minimum Split (s)	27.3	27.3	27.3	32.3
Total Split (s)	31.0	31.0	31.0	44.0
Total Split (%)	41.3%	41.3%	41.3%	58.7%
Yellow Time (s)	3.3	3.3	3.3	3.3
All-Red Time (s)	2.0	2.0	2.0	2.0
Lost Time Adjust (s)		0.0	0.0	0.0
Total Lost Time (s)		5.3	5.3	5.3
Lead/Lag				
Lead-Lag Optimize?				
Act Effct Green (s)		25.7	25.7	38.7
Actuated g/C Ratio		0.34	0.34	0.52
v/c Ratio		0.19	0.16	0.48
Control Delay		26.0	9.3	9.8
Queue Delay		0.0	0.0	49.8
Total Delay		26.0	9.3	59.6
LOS		C	A	E
Approach Delay		26.0	9.3	59.6
Approach LOS		C	A	E
Queue Length 50th (m)		13.0	1.6	48.0
Queue Length 95th (m)		m25.4	m6.3	68.3
Internal Link Dist (m)		138.7	143.1	53.0
Turn Bay Length (m)				
Base Capacity (vph)		576	582	2498
Starvation Cap Reductn		0	0	1422
Spillback Cap Reductn		0	0	0
Storage Cap Reductn		0	0	0
Reduced v/c Ratio		0.19	0.16	1.12

Intersection Summary

Cycle Length: 75
 Actuated Cycle Length: 75
 Offset: 50 (67%), Referenced to phase 2:NBTL, Start of Green
 Natural Cycle: 60
 Control Type: Pretimed
 Maximum v/c Ratio: 0.48
 Intersection Signal Delay: 53.7
 Intersection LOS: D
 Intersection Capacity Utilization 54.6%
 ICU Level of Service A
 Analysis Period (min) 15
 m Volume for 95th percentile queue is metered by upstream signal.

Splits and Phases: 6: Kent St & Arlington Ave



Lanes, Volumes, Timings
7: Lyon St N & Gladstone Ave

02/28/2024



Lane Group	EBT	EBR	WBL	WBT	SBT
Lane Configurations	↑	↑	↑	↑	↑↓
Traffic Volume (vph)	247	52	28	314	541
Future Volume (vph)	247	52	28	314	541
Lane Group Flow (vph)	247	52	28	314	765
Turn Type	NA	Perm	Perm	NA	NA
Protected Phases	4			8	6
Permitted Phases		4	8		
Minimum Split (s)	17.2	17.2	17.2	17.2	22.6
Total Split (s)	37.0	37.0	37.0	37.0	38.0
Total Split (%)	49.3%	49.3%	49.3%	49.3%	50.7%
Yellow Time (s)	3.3	3.3	3.3	3.3	3.3
All-Red Time (s)	1.9	1.9	1.9	1.9	2.3
Lost Time Adjust (s)	0.0	0.0	0.0	0.0	0.0
Total Lost Time (s)	5.2	5.2	5.2	5.2	5.6
Lead/Lag					
Lead-Lag Optimize?					
Act Effct Green (s)	31.8	31.8	31.8	31.8	32.4
Actuated g/C Ratio	0.42	0.42	0.42	0.42	0.43
v/c Ratio	0.33	0.08	0.07	0.42	0.54
Control Delay	16.0	4.5	8.4	12.7	16.4
Queue Delay	0.0	0.0	0.0	0.0	0.0
Total Delay	16.0	4.5	8.4	12.7	16.4
LOS	B	A	A	B	B
Approach Delay	14.0			12.3	16.4
Approach LOS	B			B	B
Queue Length 50th (m)	22.6	0.0	1.5	35.6	38.0
Queue Length 95th (m)	38.4	5.7	m3.3	55.1	53.4
Internal Link Dist (m)	254.8			165.0	214.3
Turn Bay Length (m)			25.0		
Base Capacity (vph)	756	626	422	756	1428
Starvation Cap Reductn	0	0	0	0	0
Spillback Cap Reductn	0	0	0	0	0
Storage Cap Reductn	0	0	0	0	0
Reduced v/c Ratio	0.33	0.08	0.07	0.42	0.54

Intersection Summary

Cycle Length: 75
 Actuated Cycle Length: 75
 Offset: 45 (60%), Referenced to phase 4:EBT and 8:WBTL, Start of Green
 Natural Cycle: 40
 Control Type: Pretimed
 Maximum v/c Ratio: 0.54
 Intersection Signal Delay: 14.9
 Intersection LOS: B
 Intersection Capacity Utilization 67.8%
 ICU Level of Service C
 Analysis Period (min) 15
 m Volume for 95th percentile queue is metered by upstream signal.

Splits and Phases: 7: Lyon St N & Gladstone Ave

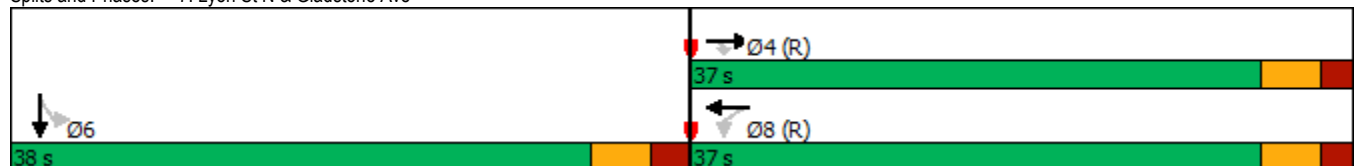

Lanes, Volumes, Timings
8: Kent St & Gladstone Ave

02/28/2024

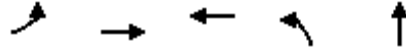

Lane Group	EBL	EBT	WBT	NBL	NBT
Lane Configurations					
Traffic Volume (vph)	75	450	324	67	930
Future Volume (vph)	75	450	324	67	930
Lane Group Flow (vph)	75	450	399	67	1061
Turn Type	Perm	NA	NA	Perm	NA
Protected Phases		4	8		2
Permitted Phases	4			2	
Minimum Split (s)	21.4	21.4	21.4	20.4	20.4
Total Split (s)	43.0	43.0	43.0	32.0	32.0
Total Split (%)	57.3%	57.3%	57.3%	42.7%	42.7%
Yellow Time (s)	3.3	3.3	3.3	3.3	3.3
All-Red Time (s)	2.1	2.1	2.1	2.1	2.1
Lost Time Adjust (s)	0.0	0.0	0.0	0.0	0.0
Total Lost Time (s)	5.4	5.4	5.4	5.4	5.4
Lead/Lag					
Lead-Lag Optimize?					
Act Effct Green (s)	37.6	37.6	37.6	26.6	26.6
Actuated g/C Ratio	0.50	0.50	0.50	0.35	0.35
v/c Ratio	0.19	0.51	0.46	0.12	0.64
Control Delay	18.0	21.5	13.5	9.0	10.1
Queue Delay	0.0	0.0	0.0	0.0	0.0
Total Delay	18.0	21.5	13.5	9.0	10.1
LOS	B	C	B	A	B
Approach Delay		21.0	13.5		10.0
Approach LOS		C	B		A
Queue Length 50th (m)	6.6	49.2	32.3	3.1	16.9
Queue Length 95th (m)	m16.0	78.4	53.2	m5.0	15.6
Internal Link Dist (m)		165.0	168.8		216.0
Turn Bay Length (m)	30.0			40.0	
Base Capacity (vph)	401	885	872	539	1663
Starvation Cap Reductn	0	0	0	0	0
Spillback Cap Reductn	0	0	0	0	0
Storage Cap Reductn	0	0	0	0	0
Reduced v/c Ratio	0.19	0.51	0.46	0.12	0.64

Intersection Summary

Cycle Length: 75
 Actuated Cycle Length: 75
 Offset: 23 (31%), Referenced to phase 4:EBTL and 8:WBT, Start of Green
 Natural Cycle: 45
 Control Type: Pretimed
 Maximum v/c Ratio: 0.64
 Intersection Signal Delay: 13.5
 Intersection LOS: B
 Intersection Capacity Utilization 67.8%
 ICU Level of Service C
 Analysis Period (min) 15
 m Volume for 95th percentile queue is metered by upstream signal.

Splits and Phases: 8: Kent St & Gladstone Ave

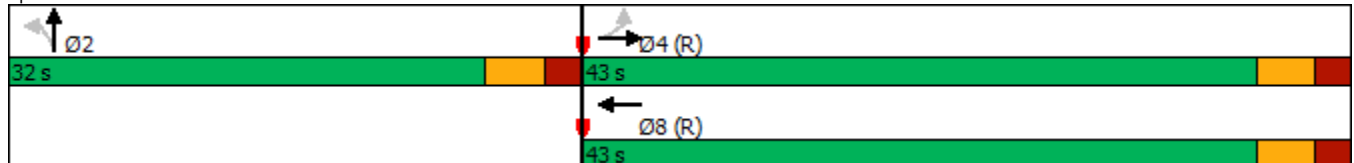

Lanes, Volumes, Timings
 9: Bank St & Chamberlain Ave/Isabella St

02/28/2024



Lane Group	EBT	EBR	NBT	SBL	SBT
Lane Configurations					
Traffic Volume (vph)	624	124	468	189	734
Future Volume (vph)	624	124	468	189	734
Lane Group Flow (vph)	691	124	561	0	923
Turn Type	NA	Perm	NA	pm+pt	NA
Protected Phases	4		2	5	6
Permitted Phases		4		6	
Detector Phase	4	4	2	5	6
Switch Phase					
Minimum Initial (s)	10.0	10.0	10.0	5.0	10.0
Minimum Split (s)	26.2	26.2	23.1	11.1	23.1
Total Split (s)	28.0	28.0	35.9	11.1	47.0
Total Split (%)	37.3%	37.3%	47.9%	14.8%	62.7%
Yellow Time (s)	3.3	3.3	3.0	3.0	3.0
All-Red Time (s)	2.9	2.9	3.1	3.1	3.1
Lost Time Adjust (s)	0.0	0.0	0.0		0.0
Total Lost Time (s)	6.2	6.2	6.1		6.1
Lead/Lag					
Lead-Lag Optimize?					
Recall Mode	None	None	C-Max	None	C-Max
Act Effct Green (s)	20.3	20.3	42.4		42.4
Actuated g/C Ratio	0.27	0.27	0.57		0.57
v/c Ratio	0.76	0.26	0.32		0.70
Control Delay	31.2	5.2	9.6		13.0
Queue Delay	0.0	0.0	0.0		1.5
Total Delay	31.2	5.2	9.6		14.4
LOS	C	A	A		B
Approach Delay	27.2		9.6		14.4
Approach LOS	C		A		B
Queue Length 50th (m)	45.6	0.0	21.3		74.0
Queue Length 95th (m)	63.8	9.8	30.7		m92.0
Internal Link Dist (m)	296.0		215.6		90.2
Turn Bay Length (m)		40.0			
Base Capacity (vph)	970	502	1772		1320
Starvation Cap Reductn	0	0	0		215
Spillback Cap Reductn	0	0	0		0
Storage Cap Reductn	0	0	0		0
Reduced v/c Ratio	0.71	0.25	0.32		0.84

Intersection Summary

Cycle Length: 75
 Actuated Cycle Length: 75
 Offset: 60 (80%), Referenced to phase 2:NBT and 6:SBTL, Start of Green
 Natural Cycle: 65
 Control Type: Actuated-Coordinated
 Maximum v/c Ratio: 0.76
 Intersection Signal Delay: 17.8
 Intersection LOS: B
 Intersection Capacity Utilization 84.2%
 ICU Level of Service E
 Analysis Period (min) 15
 m Volume for 95th percentile queue is metered by upstream signal.

Splits and Phases: 9: Bank St & Chamberlain Ave/Isabella St

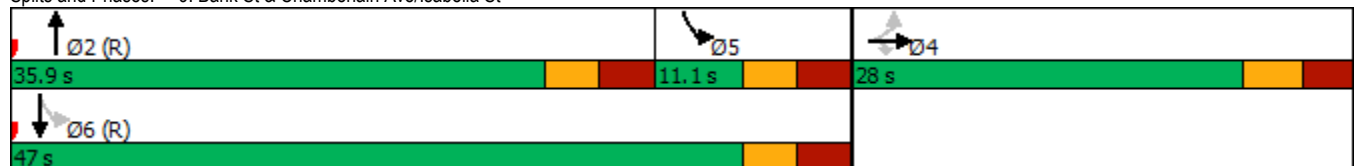

Lanes, Volumes, Timings
10: Catherine St & Access

02/28/2024

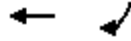

Lane Group	WBT	SBR
Lane Configurations		
Traffic Volume (vph)	647	45
Future Volume (vph)	647	45
Lane Group Flow (vph)	719	45
Sign Control	Free	

Intersection Summary

Control Type: Unsignalized	
Intersection Capacity Utilization 31.3%	ICU Level of Service A
Analysis Period (min) 15	

Intersection						
Int Delay, s/veh	0.7					
Movement	EBL	EBT	WBT	WBR	SBL	SBR
Lane Configurations			↑↑			↑
Traffic Vol, veh/h	0	0	647	72	0	45
Future Vol, veh/h	0	0	647	72	0	45
Conflicting Peds, #/hr	0	0	0	0	0	0
Sign Control	Free	Free	Free	Free	Stop	Stop
RT Channelized	-	None	-	None	-	None
Storage Length	-	-	-	-	-	0
Veh in Median Storage, #	-2949	120	0	-	0	-
Grade, %	-	0	0	-	0	-
Peak Hour Factor	100	100	100	100	100	100
Heavy Vehicles, %	2	2	2	2	2	2
Mvmt Flow	0	0	647	72	0	45

Major/Minor	Major2	Minor2
Conflicting Flow All	-	0
Stage 1	-	-
Stage 2	-	-
Critical Hdwy	-	-
Critical Hdwy Stg 1	-	-
Critical Hdwy Stg 2	-	-
Follow-up Hdwy	-	-
Pot Cap-1 Maneuver	-	-
Stage 1	-	-
Stage 2	-	-
Platoon blocked, %	-	-
Mov Cap-1 Maneuver	-	-
Mov Cap-2 Maneuver	-	-
Stage 1	-	-
Stage 2	-	-

Approach	WB	SB
HCM Control Delay, s	0	11.1
HCM LOS		B

Minor Lane/Major Mvmt	WBT	WBR	SBLn1
Capacity (veh/h)	-	-	637
HCM Lane V/C Ratio	-	-	0.071
HCM Control Delay (s)	-	-	11.1
HCM Lane LOS	-	-	B
HCM 95th %tile Q(veh)	-	-	0.2

Lanes, Volumes, Timings
 11: Access & Arlington Ave

02/28/2024

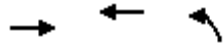

Lane Group	EBT	WBT	NBL
Lane Configurations			
Traffic Volume (vph)	62	45	9
Future Volume (vph)	62	45	9
Lane Group Flow (vph)	80	75	45
Sign Control	Free	Free	Stop

Intersection Summary	
Control Type: Unsignalized	
Intersection Capacity Utilization 20.9%	ICU Level of Service A
Analysis Period (min) 15	

Intersection						
Int Delay, s/veh	3.2					
Movement	EBT	EBR	WBL	WBT	NBL	NBR
Lane Configurations	↔			↕	↔	
Traffic Vol, veh/h	62	18	30	45	9	36
Future Vol, veh/h	62	18	30	45	9	36
Conflicting Peds, #/hr	0	0	0	0	0	0
Sign Control	Free	Free	Free	Free	Stop	Stop
RT Channelized	-	None	-	None	-	None
Storage Length	-	-	-	-	0	-
Veh in Median Storage, #	0	-	-	0	0	-
Grade, %	0	-	-	0	0	-
Peak Hour Factor	100	100	100	100	100	100
Heavy Vehicles, %	2	2	2	2	2	2
Mvmt Flow	62	18	30	45	9	36

Major/Minor	Major1	Major2	Minor1	Minor2	Minor3
Conflicting Flow All	0	0	80	0	176
Stage 1	-	-	-	-	71
Stage 2	-	-	-	-	105
Critical Hdwy	-	-	4.12	-	6.42
Critical Hdwy Stg 1	-	-	-	-	5.42
Critical Hdwy Stg 2	-	-	-	-	5.42
Follow-up Hdwy	-	-	2.218	-	3.518
Pot Cap-1 Maneuver	-	-	1518	-	814
Stage 1	-	-	-	-	952
Stage 2	-	-	-	-	919
Platoon blocked, %	-	-	-	-	-
Mov Cap-1 Maneuver	-	-	1518	-	798
Mov Cap-2 Maneuver	-	-	-	-	798
Stage 1	-	-	-	-	952
Stage 2	-	-	-	-	901

Approach	EB	WB	NB
HCM Control Delay, s	0	3	9
HCM LOS			A

Minor Lane/Major Mvmt	NBLn1	EBT	EBR	WBL	WBT
Capacity (veh/h)	945	-	-	1518	-
HCM Lane V/C Ratio	0.048	-	-	0.02	-
HCM Control Delay (s)	9	-	-	7.4	0
HCM Lane LOS	A	-	-	A	A
HCM 95th %tile Q(veh)	0.1	-	-	0.1	-

Lanes, Volumes, Timings
 12: Bank St & Arlington Ave

02/28/2024



Lane Group	EBL	NBT	SBT
Lane Configurations			
Traffic Volume (vph)	24	428	731
Future Volume (vph)	24	428	731
Lane Group Flow (vph)	149	498	758
Sign Control	Stop	Free	Free

Intersection Summary	
Control Type: Unsignalized	
Intersection Capacity Utilization 56.5%	ICU Level of Service B
Analysis Period (min) 15	

Intersection						
Int Delay, s/veh	2.6					
Movement	EBL	EBR	NBL	NBT	SBT	SBR
Lane Configurations	↔			↕	↕	
Traffic Vol, veh/h	24	125	70	428	731	27
Future Vol, veh/h	24	125	70	428	731	27
Conflicting Peds, #/hr	0	0	42	0	0	42
Sign Control	Stop	Stop	Free	Free	Free	Free
RT Channelized	-	None	-	None	-	None
Storage Length	0	-	-	-	-	-
Veh in Median Storage, #	0	-	-	0	0	-
Grade, %	0	-	-	0	0	-
Peak Hour Factor	100	100	100	100	100	100
Heavy Vehicles, %	0	1	0	5	3	0
Mvmt Flow	24	125	70	428	731	27

Major/Minor	Minor2	Major1	Major2			
Conflicting Flow All	1141	421	800	0	-	0
Stage 1	787	-	-	-	-	-
Stage 2	354	-	-	-	-	-
Critical Hdwy	6.8	6.92	4.1	-	-	-
Critical Hdwy Stg 1	5.8	-	-	-	-	-
Critical Hdwy Stg 2	5.8	-	-	-	-	-
Follow-up Hdwy	3.5	3.31	2.2	-	-	-
Pot Cap-1 Maneuver	197	584	832	-	-	-
Stage 1	414	-	-	-	-	-
Stage 2	687	-	-	-	-	-
Platoon blocked, %				-	-	-
Mov Cap-1 Maneuver	161	561	800	-	-	-
Mov Cap-2 Maneuver	161	-	-	-	-	-
Stage 1	352	-	-	-	-	-
Stage 2	660	-	-	-	-	-

Approach	EB	NB	SB
HCM Control Delay, s	19.2	1.7	0
HCM LOS	C		

Minor Lane/Major Mvmt	NBL	NBT	EBLn1	SBT	SBR
Capacity (veh/h)	800	-	401	-	-
HCM Lane V/C Ratio	0.088	-	0.372	-	-
HCM Control Delay (s)	9.9	0.4	19.2	-	-
HCM Lane LOS	A	A	C	-	-
HCM 95th %tile Q(veh)	0.3	-	1.7	-	-

Lanes, Volumes, Timings
13: Bronson Ave & Catherine St

02/28/2024



Lane Group	WBL	WBT	NBL	NBT	SBT
Lane Configurations					
Traffic Volume (vph)	727	596	304	792	833
Future Volume (vph)	727	596	304	792	833
Lane Group Flow (vph)	407	1201	304	792	1005
Turn Type	Perm	NA	pm+pt	NA	NA
Protected Phases		8	5	2	6
Permitted Phases	8		2		
Minimum Split (s)	28.3	28.3	11.2	23.8	23.8
Total Split (s)	37.0	37.0	22.0	63.0	41.0
Total Split (%)	37.0%	37.0%	22.0%	63.0%	41.0%
Yellow Time (s)	3.3	3.3	3.3	3.3	3.3
All-Red Time (s)	3.0	3.0	2.9	3.5	3.5
Lost Time Adjust (s)	0.0	0.0	0.0	0.0	0.0
Total Lost Time (s)	6.3	6.3	6.2	6.8	6.8
Lead/Lag			Lead		Lag
Lead-Lag Optimize?			Yes		Yes
Act Effct Green (s)	30.7	30.7	56.8	56.2	34.2
Actuated g/C Ratio	0.31	0.31	0.57	0.56	0.34
v/c Ratio	0.91	0.88	0.90	0.42	0.89
Control Delay	60.0	39.3	55.5	13.3	41.4
Queue Delay	0.0	0.0	0.0	0.0	0.0
Total Delay	60.0	39.3	55.5	13.3	41.4
LOS	E	D	E	B	D
Approach Delay		44.6		25.0	41.4
Approach LOS		D		C	D
Queue Length 50th (m)	87.7	80.1	42.8	43.4	93.8
Queue Length 95th (m)	#151.5	#102.4	#90.8	56.4	#130.6
Internal Link Dist (m)		120.8		240.1	287.4
Turn Bay Length (m)	80.0		45.0		
Base Capacity (vph)	447	1368	337	1905	1132
Starvation Cap Reductn	0	0	0	0	0
Spillback Cap Reductn	0	0	0	0	0
Storage Cap Reductn	0	0	0	0	0
Reduced v/c Ratio	0.91	0.88	0.90	0.42	0.89

Intersection Summary

Cycle Length: 100
 Actuated Cycle Length: 100
 Offset: 60 (60%), Referenced to phase 2:NBT and 6:SBT, Start of Green
 Natural Cycle: 75
 Control Type: Pretimed
 Maximum v/c Ratio: 0.91
 Intersection Signal Delay: 37.9
 Intersection LOS: D
 Intersection Capacity Utilization 90.8%
 ICU Level of Service E
 Analysis Period (min) 15
 # 95th percentile volume exceeds capacity, queue may be longer.
 Queue shown is maximum after two cycles.

Splits and Phases: 13: Bronson Ave & Catherine St



Total Projected 2036

Lanes, Volumes, Timings

1: Hwy 417 WB On Ramp/Lyon St N & Catherine St

02/28/2024



Lane Group	WBT	SBT	SBR
Lane Configurations	↕↕	↕	↗
Traffic Volume (vph)	275	289	131
Future Volume (vph)	275	289	131
Lane Group Flow (vph)	550	289	131
Turn Type	NA	NA	Perm
Protected Phases	8	6	
Permitted Phases			6
Minimum Split (s)	26.2	28.3	28.3
Total Split (s)	36.0	39.0	39.0
Total Split (%)	48.0%	52.0%	52.0%
Yellow Time (s)	3.3	3.3	3.3
All-Red Time (s)	1.9	2.0	2.0
Lost Time Adjust (s)	0.0	0.0	0.0
Total Lost Time (s)	5.2	5.3	5.3
Lead/Lag			
Lead-Lag Optimize?			
Act Effct Green (s)	30.8	33.7	33.7
Actuated g/C Ratio	0.41	0.45	0.45
v/c Ratio	0.38	0.36	0.17
Control Delay	18.9	23.9	11.6
Queue Delay	0.0	0.0	0.0
Total Delay	18.9	23.9	11.6
LOS	B	C	B
Approach Delay	18.9	20.1	
Approach LOS	B	C	
Queue Length 50th (m)	29.6	38.7	2.3
Queue Length 95th (m)	43.0	61.4	19.9
Internal Link Dist (m)	107.6	52.8	
Turn Bay Length (m)			
Base Capacity (vph)	1460	801	753
Starvation Cap Reductn	0	0	0
Spillback Cap Reductn	0	0	0
Storage Cap Reductn	0	0	0
Reduced v/c Ratio	0.38	0.36	0.17

Intersection Summary

Cycle Length: 75
 Actuated Cycle Length: 75
 Offset: 24 (32%), Referenced to phase 8:WBTL, Start of Green
 Natural Cycle: 55
 Control Type: Pretimed
 Maximum v/c Ratio: 0.38
 Intersection Signal Delay: 19.4
 Intersection LOS: B
 Intersection Capacity Utilization 50.7%
 ICU Level of Service A
 Analysis Period (min) 15
 m Volume for 95th percentile queue is metered by upstream signal.

Splits and Phases: 1: Hwy 417 WB On Ramp/Lyon St N & Catherine St

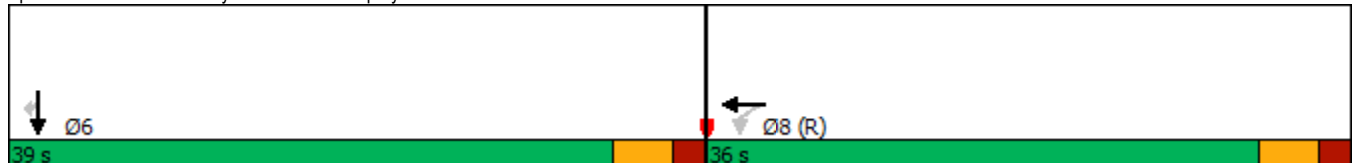

Lanes, Volumes, Timings

2: Hwy 417 EB Off Ramp/Chamberlain Ave/Kent St & Catherine St

02/28/2024



Lane Group	WBT	WBR	NBT	Ø9
Lane Configurations	↑↑	↑↑	↑↑↑	
Traffic Volume (vph)	452	579	1430	
Future Volume (vph)	452	579	1430	
Lane Group Flow (vph)	452	579	1502	
Turn Type	NA	Prot	NA	
Protected Phases	8	8	2	9
Permitted Phases				
Detector Phase	8	8	2	
Switch Phase				
Minimum Initial (s)	10.0	10.0	10.0	1.0
Minimum Split (s)	15.8	15.8	22.5	13.0
Total Split (s)	28.0	28.0	34.0	13.0
Total Split (%)	37.3%	37.3%	45.3%	17%
Yellow Time (s)	3.3	3.3	3.3	2.0
All-Red Time (s)	2.5	2.5	2.5	0.0
Lost Time Adjust (s)	0.0	0.0	0.0	
Total Lost Time (s)	5.8	5.8	5.8	
Lead/Lag				
Lead-Lag Optimize?				
Recall Mode	Max	Max	C-Max	None
Act Effct Green (s)	27.4	27.4	28.2	
Actuated g/C Ratio	0.37	0.37	0.38	
v/c Ratio	0.38	0.59	0.80	
Control Delay	16.4	19.1	23.7	
Queue Delay	0.0	2.2	0.2	
Total Delay	16.4	21.3	23.9	
LOS	B	C	C	
Approach Delay	19.1		23.9	
Approach LOS	B		C	
Queue Length 50th (m)	31.6	44.2	64.6	
Queue Length 95th (m)	m38.6	m53.5	81.9	
Internal Link Dist (m)	131.7		689.6	
Turn Bay Length (m)		60.0		
Base Capacity (vph)	1191	985	1887	
Starvation Cap Reductn	0	0	0	
Spillback Cap Reductn	0	263	56	
Storage Cap Reductn	0	0	0	
Reduced v/c Ratio	0.38	0.80	0.82	

Intersection Summary

Cycle Length: 75
 Actuated Cycle Length: 75
 Offset: 0 (0%), Referenced to phase 2:NBT, Start of Green
 Natural Cycle: 60
 Control Type: Actuated-Coordinated
 Maximum v/c Ratio: 0.80
 Intersection Signal Delay: 22.0
 Intersection LOS: C
 Intersection Capacity Utilization 65.1%
 ICU Level of Service C
 Analysis Period (min) 15
 m Volume for 95th percentile queue is metered by upstream signal.

Splits and Phases: 2: Hwy 417 EB Off Ramp/Chamberlain Ave/Kent St & Catherine St

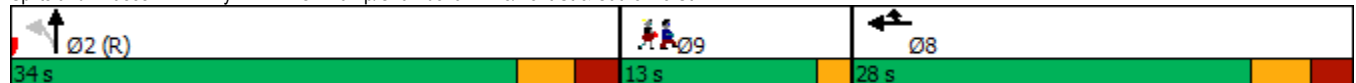

Lanes, Volumes, Timings
3: Bank St & Catherine St

02/28/2024



Lane Group	WBT	NBL	NBT	SBT	Ø1	Ø5	Ø7
Lane Configurations	↕↕↕		↕↕	↕↕			
Traffic Volume (vph)	645	278	582	404			
Future Volume (vph)	645	278	582	404			
Lane Group Flow (vph)	1023	0	860	548			
Turn Type	NA	pm+pt	NA	NA			
Protected Phases	8	9	2	6	1	5	7
Permitted Phases		2					
Minimum Split (s)	18.6	10.4	16.4	16.4	5.0	5.0	5.0
Total Split (s)	24.0	10.4	41.0	30.6	5.0	5.0	5.0
Total Split (%)	32.0%	13.9%	54.7%	40.8%	7%	7%	7%
Yellow Time (s)	3.3	3.3	3.3	3.3	2.0	2.0	2.0
All-Red Time (s)	2.3	2.1	2.1	2.1	0.0	0.0	0.0
Lost Time Adjust (s)	0.0		0.0	0.0			
Total Lost Time (s)	5.6		5.4	5.4			
Lead/Lag	Lag		Lag	Lag	Lead	Lead	Lead
Lead-Lag Optimize?	Yes		Yes	Yes	Yes	Yes	Yes
Act Effct Green (s)	18.4		35.6	25.2			
Actuated g/C Ratio	0.25		0.47	0.34			
v/c Ratio	0.90		0.84	0.54			
Control Delay	38.3		21.2	19.8			
Queue Delay	0.0		0.0	0.0			
Total Delay	38.3		21.2	19.8			
LOS	D		C	B			
Approach Delay	38.3		21.2	19.8			
Approach LOS	D		C	B			
Queue Length 50th (m)	47.9		26.2	28.1			
Queue Length 95th (m)	#72.1		#44.5	42.7			
Internal Link Dist (m)	702.3		90.2	52.9			
Turn Bay Length (m)							
Base Capacity (vph)	1131		1025	1011			
Starvation Cap Reductn	0		0	0			
Spillback Cap Reductn	0		0	0			
Storage Cap Reductn	0		0	0			
Reduced v/c Ratio	0.90		0.84	0.54			

Intersection Summary

Cycle Length: 75
 Actuated Cycle Length: 75
 Offset: 50 (67%), Referenced to phase 2:NBT and 6:SBT, Start of Green
 Natural Cycle: 75
 Control Type: Pretimed
 Maximum v/c Ratio: 0.90
 Intersection Signal Delay: 28.1
 Intersection LOS: C
 Intersection Capacity Utilization 82.4%
 ICU Level of Service E
 Analysis Period (min) 15
 # 95th percentile volume exceeds capacity, queue may be longer.
 Queue shown is maximum after two cycles.

Splits and Phases: 3: Bank St & Catherine St

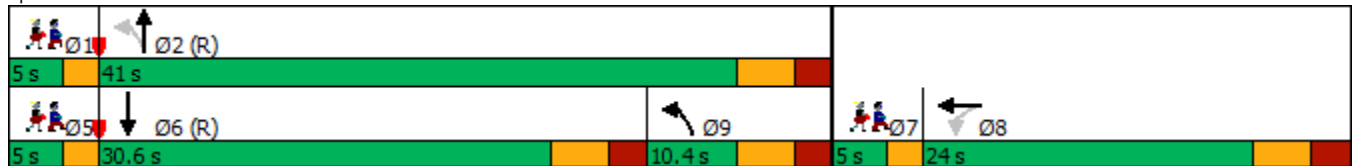

Lanes, Volumes, Timings
4: Percy St & Catherine St

02/28/2024

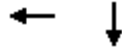

Lane Group	WBT	SBT	Ø3	Ø7
Lane Configurations				
Traffic Volume (vph)	270	129		
Future Volume (vph)	270	129		
Lane Group Flow (vph)	362	186		
Turn Type	NA	NA		
Protected Phases	8	6	3	7
Permitted Phases				
Detector Phase	8	6		
Switch Phase				
Minimum Initial (s)	10.0	10.0	1.0	1.0
Minimum Split (s)	26.5	23.4	6.4	6.4
Total Split (s)	34.0	24.0	16.0	16.0
Total Split (%)	37.8%	26.7%	18%	18%
Yellow Time (s)	3.3	3.3	3.3	3.3
All-Red Time (s)	2.2	2.1	2.1	2.1
Lost Time Adjust (s)	0.0	0.0		
Total Lost Time (s)	5.5	5.4		
Lead/Lag	Lag			Lead
Lead-Lag Optimize?	Yes			Yes
Recall Mode	None	Max	None	None
Act Effct Green (s)	11.9	18.8		
Actuated g/C Ratio	0.29	0.45		
v/c Ratio	0.36	0.25		
Control Delay	7.3	9.4		
Queue Delay	0.0	0.0		
Total Delay	7.3	9.4		
LOS	A	A		
Approach Delay	7.3	9.4		
Approach LOS	A	A		
Queue Length 50th (m)	5.6	6.6		
Queue Length 95th (m)	12.1	23.3		
Internal Link Dist (m)	271.6	288.0		
Turn Bay Length (m)				
Base Capacity (vph)	2220	740		
Starvation Cap Reductn	0	0		
Spillback Cap Reductn	0	0		
Storage Cap Reductn	0	0		
Reduced v/c Ratio	0.16	0.25		

Intersection Summary

Cycle Length: 90	
Actuated Cycle Length: 41.7	
Natural Cycle: 65	
Control Type: Semi Act-Uncoord	
Maximum v/c Ratio: 0.36	
Intersection Signal Delay: 8.0	Intersection LOS: A
Intersection Capacity Utilization 39.7%	ICU Level of Service A
Analysis Period (min) 15	

Splits and Phases: 4: Percy St & Catherine St

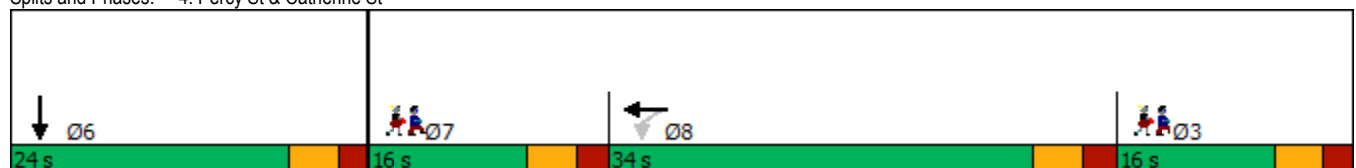

Lanes, Volumes, Timings
 5: Lyon St N & Arlington Ave

02/28/2024

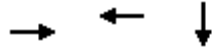

Lane Group	EBT	WBT	SBT
Lane Configurations			
Traffic Volume (vph)	18	12	345
Future Volume (vph)	18	12	345
Lane Group Flow (vph)	18	37	408
Sign Control	Stop	Stop	Free
Intersection Summary			
Control Type: Unsignalized			
Intersection Capacity Utilization 33.8%		ICU Level of Service A	
Analysis Period (min) 15			

Intersection												
Int Delay, s/veh	2.5											
Movement	EBL	EBT	EBR	WBL	WBT	WBR	NBL	NBT	NBR	SBL	SBT	SBR
Lane Configurations		↕			↕						↕↕	
Traffic Vol, veh/h	0	18	0	25	12	0	0	0	0	54	345	9
Future Vol, veh/h	0	18	0	25	12	0	0	0	0	54	345	9
Conflicting Peds, #/hr	32	0	15	15	0	32	9	0	10	10	0	9
Sign Control	Stop	Stop	Stop	Stop	Stop	Stop	Free	Free	Free	Free	Free	Free
RT Channelized	-	-	None	-	-	None	-	-	None	-	-	None
Storage Length	-	-	-	-	-	-	-	-	-	-	-	-
Veh in Median Storage, #	-	0	-	-	0	-	-	-	-	-	0	-
Grade, %	-	0	-	-	0	-	-	0	-	-	0	-
Peak Hour Factor	100	100	100	100	100	100	100	100	100	100	100	100
Heavy Vehicles, %	0	0	0	9	0	0	0	0	0	5	1	11
Mvmt Flow	0	18	0	25	12	0	0	0	0	54	345	9

Major/Minor	Minor2		Minor1			Major2			
Conflicting Flow All	-	477	201	315	481	-	10	0	0
Stage 1	-	467	-	10	10	-	-	-	-
Stage 2	-	10	-	305	471	-	-	-	-
Critical Hdwy	-	6.5	6.9	7.68	6.5	-	4.2	-	-
Critical Hdwy Stg 1	-	5.5	-	-	-	-	-	-	-
Critical Hdwy Stg 2	-	-	-	6.68	5.5	-	-	-	-
Follow-up Hdwy	-	4	3.3	3.59	4	-	2.25	-	-
Pot Cap-1 Maneuver	0	490	813	597	487	0	1586	-	-
Stage 1	0	565	-	-	0	-	-	-	-
Stage 2	0	-	-	660	563	0	-	-	-
Platoon blocked, %	-	-	-	-	-	-	-	-	-
Mov Cap-1 Maneuver	-	461	806	555	458	-	1571	-	-
Mov Cap-2 Maneuver	-	461	-	555	458	-	-	-	-
Stage 1	-	536	-	-	-	-	-	-	-
Stage 2	-	-	-	610	534	-	-	-	-

Approach	EB		WB			SB		
HCM Control Delay, s	13.1		12.5			1.1		
HCM LOS	B		B					

Minor Lane/Major Mvmt	EBLn1	WBLn1	SBL	SBT	SBR
Capacity (veh/h)	461	519	1571	-	-
HCM Lane V/C Ratio	0.039	0.071	0.034	-	-
HCM Control Delay (s)	13.1	12.5	7.4	0.1	-
HCM Lane LOS	B	B	A	A	-
HCM 95th %tile Q(veh)	0.1	0.2	0.1	-	-

Lanes, Volumes, Timings
6: Kent St & Arlington Ave

02/28/2024



Lane Group	EBL	EBT	WBT	NBT
Lane Configurations		↕	↕	↕↕↕
Traffic Volume (vph)	40	83	18	1826
Future Volume (vph)	40	83	18	1826
Lane Group Flow (vph)	0	123	111	1983
Turn Type	Perm	NA	NA	NA
Protected Phases		4	8	2
Permitted Phases	4			
Minimum Split (s)	27.3	27.3	27.3	32.3
Total Split (s)	27.6	27.6	27.6	47.4
Total Split (%)	36.8%	36.8%	36.8%	63.2%
Yellow Time (s)	3.3	3.3	3.3	3.3
All-Red Time (s)	2.0	2.0	2.0	2.0
Lost Time Adjust (s)		0.0	0.0	0.0
Total Lost Time (s)		5.3	5.3	5.3
Lead/Lag				
Lead-Lag Optimize?				
Act Effct Green (s)		22.3	22.3	42.1
Actuated g/C Ratio		0.30	0.30	0.56
v/c Ratio		0.26	0.23	0.73
Control Delay		29.3	16.6	14.1
Queue Delay		0.0	0.0	11.5
Total Delay		29.3	16.6	25.6
LOS		C	B	C
Approach Delay		29.3	16.6	25.6
Approach LOS		C	B	C
Queue Length 50th (m)		15.2	9.1	47.8
Queue Length 95th (m)		29.2	m13.7	71.5
Internal Link Dist (m)		138.7	143.1	53.0
Turn Bay Length (m)				
Base Capacity (vph)		475	474	2698
Starvation Cap Reductn		0	0	723
Spillback Cap Reductn		0	0	0
Storage Cap Reductn		0	0	0
Reduced v/c Ratio		0.26	0.23	1.00

Intersection Summary

Cycle Length: 75
 Actuated Cycle Length: 75
 Offset: 50 (67%), Referenced to phase 2:NBTL, Start of Green
 Natural Cycle: 60
 Control Type: Pretimed
 Maximum v/c Ratio: 0.73
 Intersection Signal Delay: 25.3
 Intersection LOS: C
 Intersection Capacity Utilization 70.5%
 ICU Level of Service C
 Analysis Period (min) 15
 m Volume for 95th percentile queue is metered by upstream signal.

Splits and Phases: 6: Kent St & Arlington Ave

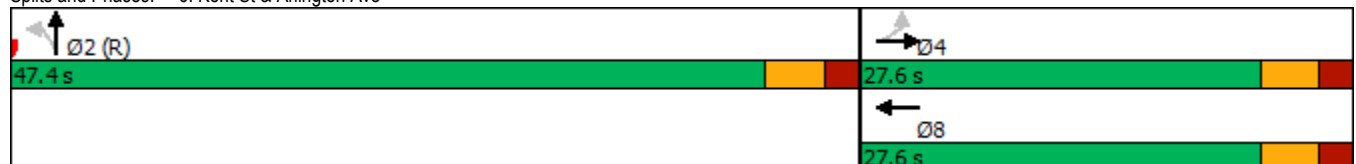

Lanes, Volumes, Timings
7: Lyon St N & Gladstone Ave

02/28/2024



Lane Group	EBT	EBR	WBL	WBT	SBT
Lane Configurations	↑	↑	↑	↑	↑↓
Traffic Volume (vph)	184	24	15	143	353
Future Volume (vph)	184	24	15	143	353
Lane Group Flow (vph)	184	24	15	143	540
Turn Type	NA	Perm	Perm	NA	NA
Protected Phases	4			8	6
Permitted Phases		4	8		
Minimum Split (s)	17.2	17.2	17.2	17.2	22.6
Total Split (s)	36.0	36.0	36.0	36.0	39.0
Total Split (%)	48.0%	48.0%	48.0%	48.0%	52.0%
Yellow Time (s)	3.3	3.3	3.3	3.3	3.3
All-Red Time (s)	1.9	1.9	1.9	1.9	2.3
Lost Time Adjust (s)	0.0	0.0	0.0	0.0	0.0
Total Lost Time (s)	5.2	5.2	5.2	5.2	5.6
Lead/Lag					
Lead-Lag Optimize?					
Act Effct Green (s)	30.8	30.8	30.8	30.8	33.4
Actuated g/C Ratio	0.41	0.41	0.41	0.41	0.45
v/c Ratio	0.26	0.04	0.03	0.20	0.37
Control Delay	15.8	3.3	5.1	7.0	13.4
Queue Delay	0.0	0.0	0.0	0.0	0.0
Total Delay	15.8	3.3	5.1	7.0	13.4
LOS	B	A	A	A	B
Approach Delay	14.4			6.8	13.4
Approach LOS	B			A	B
Queue Length 50th (m)	16.6	0.0	0.6	8.5	23.1
Queue Length 95th (m)	29.8	2.8	m1.0	m13.4	34.2
Internal Link Dist (m)	254.8			165.0	214.3
Turn Bay Length (m)			25.0		
Base Capacity (vph)	711	632	470	718	1463
Starvation Cap Reductn	0	0	0	0	0
Spillback Cap Reductn	0	0	0	0	0
Storage Cap Reductn	0	0	0	0	0
Reduced v/c Ratio	0.26	0.04	0.03	0.20	0.37

Intersection Summary

Cycle Length: 75
 Actuated Cycle Length: 75
 Offset: 45 (60%), Referenced to phase 4:EBT and 8:WBTL, Start of Green
 Natural Cycle: 40
 Control Type: Pretimed
 Maximum v/c Ratio: 0.37
 Intersection Signal Delay: 12.5
 Intersection LOS: B
 Intersection Capacity Utilization 82.4%
 ICU Level of Service E
 Analysis Period (min) 15
 m Volume for 95th percentile queue is metered by upstream signal.

Splits and Phases: 7: Lyon St N & Gladstone Ave

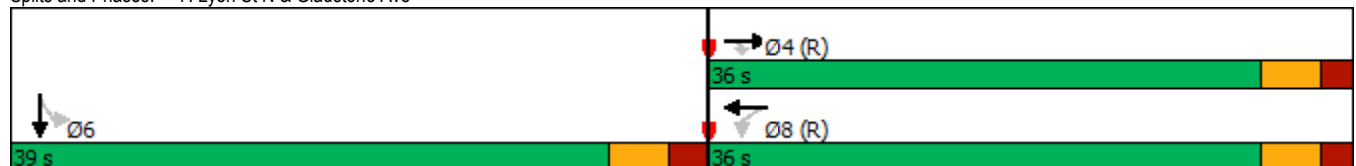

Lanes, Volumes, Timings
8: Kent St & Gladstone Ave

02/28/2024



Lane Group	EBL	EBT	WBT	NBL	NBT
Lane Configurations					
Traffic Volume (vph)	82	277	165	36	1829
Future Volume (vph)	82	277	165	36	1829
Lane Group Flow (vph)	82	277	313	36	1926
Turn Type	Perm	NA	NA	Perm	NA
Protected Phases		4	8		2
Permitted Phases	4			2	
Minimum Split (s)	21.4	21.4	21.4	20.4	20.4
Total Split (s)	31.5	31.5	31.5	43.5	43.5
Total Split (%)	42.0%	42.0%	42.0%	58.0%	58.0%
Yellow Time (s)	3.3	3.3	3.3	3.3	3.3
All-Red Time (s)	2.1	2.1	2.1	2.1	2.1
Lost Time Adjust (s)	0.0	0.0	0.0	0.0	0.0
Total Lost Time (s)	5.4	5.4	5.4	5.4	5.4
Lead/Lag					
Lead-Lag Optimize?					
Act Effct Green (s)	26.1	26.1	26.1	38.1	38.1
Actuated g/C Ratio	0.35	0.35	0.35	0.51	0.51
v/c Ratio	0.30	0.46	0.58	0.05	0.79
Control Delay	27.7	28.4	24.7	9.3	14.1
Queue Delay	0.0	0.0	0.0	0.0	0.0
Total Delay	27.7	28.4	24.7	9.3	14.1
LOS	C	C	C	A	B
Approach Delay		28.3	24.7		14.0
Approach LOS		C	C		B
Queue Length 50th (m)	10.0	37.8	34.9	2.3	45.2
Queue Length 95th (m)	23.5	59.9	59.3	m2.9	45.7
Internal Link Dist (m)		165.0	168.8		216.0
Turn Bay Length (m)	30.0			40.0	
Base Capacity (vph)	269	597	543	733	2442
Starvation Cap Reductn	0	0	0	0	0
Spillback Cap Reductn	0	0	0	0	0
Storage Cap Reductn	0	0	0	0	0
Reduced v/c Ratio	0.30	0.46	0.58	0.05	0.79

Intersection Summary

Cycle Length: 75
 Actuated Cycle Length: 75
 Offset: 23 (31%), Referenced to phase 4:EBTL and 8:WBT, Start of Green
 Natural Cycle: 55
 Control Type: Pretimed
 Maximum v/c Ratio: 0.79
 Intersection Signal Delay: 17.2
 Intersection LOS: B
 Intersection Capacity Utilization 82.4%
 ICU Level of Service E
 Analysis Period (min) 15
 m Volume for 95th percentile queue is metered by upstream signal.

Splits and Phases: 8: Kent St & Gladstone Ave



Lanes, Volumes, Timings
 9: Bank St & Chamberlain Ave/Isabella St

02/28/2024



Lane Group	EBT	EBR	NBT	SBL	SBT
Lane Configurations	↕↕	↗	↕↕		↕↕
Traffic Volume (vph)	534	82	845	190	396
Future Volume (vph)	534	82	845	190	396
Lane Group Flow (vph)	616	82	988	0	586
Turn Type	NA	Perm	NA	pm+pt	NA
Protected Phases	4		2	5	6
Permitted Phases		4		6	
Detector Phase	4	4	2	5	6
Switch Phase					
Minimum Initial (s)	10.0	10.0	10.0	5.0	10.0
Minimum Split (s)	26.2	26.2	23.1	11.1	23.1
Total Split (s)	26.2	26.2	37.7	11.1	48.8
Total Split (%)	34.9%	34.9%	50.3%	14.8%	65.1%
Yellow Time (s)	3.3	3.3	3.0	3.0	3.0
All-Red Time (s)	2.9	2.9	3.1	3.1	3.1
Lost Time Adjust (s)	0.0	0.0	0.0		0.0
Total Lost Time (s)	6.2	6.2	6.1		6.1
Lead/Lag					
Lead-Lag Optimize?					
Recall Mode	None	None	C-Max	None	C-Max
Act Effct Green (s)	18.5	18.5	44.2		44.2
Actuated g/C Ratio	0.25	0.25	0.59		0.59
v/c Ratio	0.78	0.19	0.53		0.57
Control Delay	33.6	2.4	10.9		14.6
Queue Delay	0.0	0.0	0.0		0.0
Total Delay	33.6	2.4	10.9		14.6
LOS	C	A	B		B
Approach Delay	30.0		10.9		14.6
Approach LOS	C		B		B
Queue Length 50th (m)	41.5	0.0	42.1		43.0
Queue Length 95th (m)	58.8	3.5	57.5		m59.6
Internal Link Dist (m)	677.2		578.7		90.2
Turn Bay Length (m)		40.0			
Base Capacity (vph)	858	460	1858		1037
Starvation Cap Reductn	0	0	0		0
Spillback Cap Reductn	0	0	0		0
Storage Cap Reductn	0	0	0		0
Reduced v/c Ratio	0.72	0.18	0.53		0.57

Intersection Summary

Cycle Length: 75
 Actuated Cycle Length: 75
 Offset: 60 (80%), Referenced to phase 2:NBT and 6:SBTL, Start of Green
 Natural Cycle: 65
 Control Type: Actuated-Coordinated
 Maximum v/c Ratio: 0.78
 Intersection Signal Delay: 17.7
 Intersection LOS: B
 Intersection Capacity Utilization 84.6%
 ICU Level of Service E
 Analysis Period (min) 15
 m Volume for 95th percentile queue is metered by upstream signal.

Splits and Phases: 9: Bank St & Chamberlain Ave/Isabella St

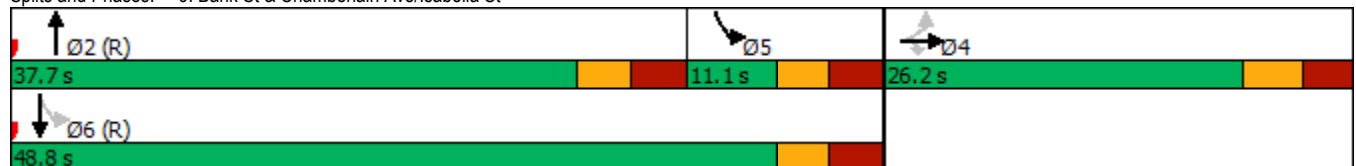

Lanes, Volumes, Timings
10: Catherine St & Access

02/28/2024

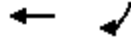

Lane Group	WBT	SBR
Lane Configurations		
Traffic Volume (vph)	479	69
Future Volume (vph)	479	69
Lane Group Flow (vph)	520	69
Sign Control	Free	

Intersection Summary

Control Type: Unsignalized
Intersection Capacity Utilization 26.5% ICU Level of Service A
Analysis Period (min) 15

Intersection						
Int Delay, s/veh	1.2					
Movement	EBL	EBT	WBT	WBR	SBL	SBR
Lane Configurations			↑↓			↑
Traffic Vol, veh/h	0	0	479	41	0	69
Future Vol, veh/h	0	0	479	41	0	69
Conflicting Peds, #/hr	0	0	0	0	0	0
Sign Control	Free	Free	Free	Free	Stop	Stop
RT Channelized	-	None	-	None	-	None
Storage Length	-	-	-	-	-	0
Veh in Median Storage, #	-4521984		0	-	0	-
Grade, %	-	0	0	-	0	-
Peak Hour Factor	100	100	100	100	100	100
Heavy Vehicles, %	2	2	2	2	2	2
Mvmt Flow	0	0	479	41	0	69
Major/Minor	Major2		Minor2			
Conflicting Flow All			-	0	-	260
Stage 1			-	-	-	-
Stage 2			-	-	-	-
Critical Hdwy			-	-	-	6.94
Critical Hdwy Stg 1			-	-	-	-
Critical Hdwy Stg 2			-	-	-	-
Follow-up Hdwy			-	-	-	3.32
Pot Cap-1 Maneuver			-	-	0	739
Stage 1			-	-	0	-
Stage 2			-	-	0	-
Platoon blocked, %			-	-	-	-
Mov Cap-1 Maneuver			-	-	-	739
Mov Cap-2 Maneuver			-	-	-	-
Stage 1			-	-	-	-
Stage 2			-	-	-	-
Approach	WB		SB			
HCM Control Delay, s			0			10.4
HCM LOS						B
Minor Lane/Major Mvmt	WBT	WBR	SBLn1			
Capacity (veh/h)	-	-	739			
HCM Lane V/C Ratio	-	-	0.093			
HCM Control Delay (s)	-	-	10.4			
HCM Lane LOS	-	-	B			
HCM 95th %tile Q(veh)	-	-	0.3			

Lanes, Volumes, Timings
 11: Access & Arlington Ave

02/28/2024



Lane Group	EBT	WBT	NBL
Lane Configurations			
Traffic Volume (vph)	62	23	14
Future Volume (vph)	62	23	14
Lane Group Flow (vph)	72	40	70
Sign Control	Free	Free	Stop

Intersection Summary	
Control Type: Unsignalized	
Intersection Capacity Utilization 20.1%	ICU Level of Service A
Analysis Period (min) 15	

Intersection						
Int Delay, s/veh	4.1					
Movement	EBT	EBR	WBL	WBT	NBL	NBR
Lane Configurations	↔			↕	↔	
Traffic Vol, veh/h	62	10	17	23	14	56
Future Vol, veh/h	62	10	17	23	14	56
Conflicting Peds, #/hr	0	0	0	0	0	0
Sign Control	Free	Free	Free	Free	Stop	Stop
RT Channelized	-	None	-	None	-	None
Storage Length	-	-	-	-	0	-
Veh in Median Storage, #	0	-	-	0	0	-
Grade, %	0	-	-	0	0	-
Peak Hour Factor	100	100	100	100	100	100
Heavy Vehicles, %	2	2	0	0	2	2
Mvmt Flow	62	10	17	23	14	56

Major/Minor	Major1	Major2	Minor1			
Conflicting Flow All	0	0	72	0	124	67
Stage 1	-	-	-	-	67	-
Stage 2	-	-	-	-	57	-
Critical Hdwy	-	-	4.1	-	6.42	6.22
Critical Hdwy Stg 1	-	-	-	-	5.42	-
Critical Hdwy Stg 2	-	-	-	-	5.42	-
Follow-up Hdwy	-	-	2.2	-	3.518	3.318
Pot Cap-1 Maneuver	-	-	1541	-	871	997
Stage 1	-	-	-	-	956	-
Stage 2	-	-	-	-	966	-
Platoon blocked, %	-	-	-	-	-	-
Mov Cap-1 Maneuver	-	-	1541	-	861	997
Mov Cap-2 Maneuver	-	-	-	-	861	-
Stage 1	-	-	-	-	956	-
Stage 2	-	-	-	-	955	-

Approach	EB	WB	NB
HCM Control Delay, s	0	3.1	9
HCM LOS			A

Minor Lane/Major Mvmt	NBLn1	EBT	EBR	WBL	WBT
Capacity (veh/h)	966	-	-	1541	-
HCM Lane V/C Ratio	0.072	-	-	0.011	-
HCM Control Delay (s)	9	-	-	7.4	0
HCM Lane LOS	A	-	-	A	A
HCM 95th %tile Q(veh)	0.2	-	-	0	-

Lanes, Volumes, Timings
 12: Bank St & Arlington Ave

02/28/2024



Lane Group	EBL	NBT	SBT
Lane Configurations			
Traffic Volume (vph)	28	691	397
Future Volume (vph)	28	691	397
Lane Group Flow (vph)	180	784	419
Sign Control	Stop	Free	Free

Intersection Summary	
Control Type: Unsignalized	
Intersection Capacity Utilization 57.9%	ICU Level of Service B
Analysis Period (min) 15	

Intersection						
Int Delay, s/veh	3.5					
Movement	EBL	EBR	NBL	NBT	SBT	SBR
Lane Configurations	↔			↕	↕	
Traffic Vol, veh/h	28	152	93	691	397	22
Future Vol, veh/h	28	152	93	691	397	22
Conflicting Peds, #/hr	0	0	111	0	0	111
Sign Control	Stop	Stop	Free	Free	Free	Free
RT Channelized	-	None	-	None	-	None
Storage Length	0	-	-	-	-	-
Veh in Median Storage, #	0	-	-	0	0	-
Grade, %	0	-	-	0	0	-
Peak Hour Factor	100	100	100	100	100	100
Heavy Vehicles, %	0	0	2	5	8	5
Mvmt Flow	28	152	93	691	397	22

Major/Minor	Minor2	Major1	Major2			
Conflicting Flow All	1051	321	530	0	-	0
Stage 1	519	-	-	-	-	-
Stage 2	532	-	-	-	-	-
Critical Hdwy	6.8	6.9	4.14	-	-	-
Critical Hdwy Stg 1	5.8	-	-	-	-	-
Critical Hdwy Stg 2	5.8	-	-	-	-	-
Follow-up Hdwy	3.5	3.3	2.22	-	-	-
Pot Cap-1 Maneuver	226	681	1033	-	-	-
Stage 1	568	-	-	-	-	-
Stage 2	559	-	-	-	-	-
Platoon blocked, %				-	-	-
Mov Cap-1 Maneuver	152	611	927	-	-	-
Mov Cap-2 Maneuver	152	-	-	-	-	-
Stage 1	427	-	-	-	-	-
Stage 2	501	-	-	-	-	-

Approach	EB	NB	SB
HCM Control Delay, s	20.1	1.6	0
HCM LOS	C		

Minor Lane/Major Mvmt	NBL	NBT	EBLn1	SBT	SBR
Capacity (veh/h)	927	-	416	-	-
HCM Lane V/C Ratio	0.1	-	0.433	-	-
HCM Control Delay (s)	9.3	0.6	20.1	-	-
HCM Lane LOS	A	A	C	-	-
HCM 95th %tile Q(veh)	0.3	-	2.1	-	-

Lanes, Volumes, Timings
13: Bronson Ave & Catherine St

02/28/2024



Lane Group	WBL	WBT	NBL	NBT	SBT	Ø5	Ø7
Lane Configurations							
Traffic Volume (vph)	538	510	553	1105	456		
Future Volume (vph)	538	510	553	1105	456		
Lane Group Flow (vph)	324	957	498	995	523		
Turn Type	Perm	NA	pm+pt	NA	NA		
Protected Phases		8	5 7	2	6	5	7
Permitted Phases	8		2				
Minimum Split (s)	28.3	28.3		23.8	23.8	11.2	11.8
Total Split (s)	37.6	37.6		72.4	28.8	31.8	11.8
Total Split (%)	34.2%	34.2%		65.8%	26.2%	29%	11%
Yellow Time (s)	3.3	3.3		3.3	3.3	3.3	3.3
All-Red Time (s)	3.0	3.0		3.5	3.5	2.9	3.5
Lost Time Adjust (s)	0.0	0.0		0.0	0.0		
Total Lost Time (s)	6.3	6.3		6.8	6.8		
Lead/Lag					Lag	Lead	
Lead-Lag Optimize?					Yes	Yes	
Act Effct Green (s)	31.3	31.3	66.2	65.6	22.0		
Actuated g/C Ratio	0.28	0.28	0.60	0.60	0.20		
v/c Ratio	0.80	0.77	0.79	0.49	0.82		
Control Delay	52.6	37.0	23.6	13.7	51.3		
Queue Delay	0.0	0.0	0.0	0.0	0.0		
Total Delay	52.6	37.0	23.6	13.7	51.3		
LOS	D	D	C	B	D		
Approach Delay		41.0		17.0	51.3		
Approach LOS		D		B	D		
Queue Length 50th (m)	74.7	65.8	56.1	60.1	54.0		
Queue Length 95th (m)	#125.2	83.0	#83.4	75.5	#78.2		
Internal Link Dist (m)		120.8		240.1	287.4		
Turn Bay Length (m)	80.0		45.0				
Base Capacity (vph)	406	1246	631	2021	640		
Starvation Cap Reductn	0	0	0	0	0		
Spillback Cap Reductn	0	0	0	0	0		
Storage Cap Reductn	0	0	0	0	0		
Reduced v/c Ratio	0.80	0.77	0.79	0.49	0.82		

Intersection Summary

Cycle Length: 110
 Actuated Cycle Length: 110
 Offset: 60 (55%), Referenced to phase 2:NBT and 6:SBT, Start of Green
 Natural Cycle: 90
 Control Type: Pretimed
 Maximum v/c Ratio: 0.82
 Intersection Signal Delay: 31.8
 Intersection LOS: C
 Intersection Capacity Utilization 83.2%
 ICU Level of Service E
 Analysis Period (min) 15
 # 95th percentile volume exceeds capacity, queue may be longer.
 Queue shown is maximum after two cycles.

Splits and Phases: 13: Bronson Ave & Catherine St

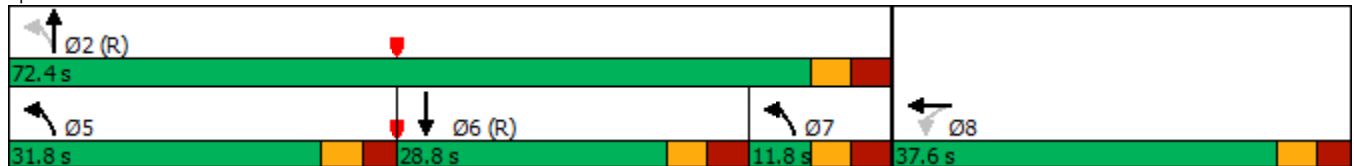

Lanes, Volumes, Timings

1: Hwy 417 WB On Ramp/Lyon St N & Catherine St

02/28/2024



Lane Group	WBT	SBT	SBR
Lane Configurations			
Traffic Volume (vph)	566	374	304
Future Volume (vph)	566	374	304
Lane Group Flow (vph)	794	374	304
Turn Type	NA	NA	Perm
Protected Phases	8	6	
Permitted Phases			6
Minimum Split (s)	26.2	28.3	28.3
Total Split (s)	38.0	37.0	37.0
Total Split (%)	50.7%	49.3%	49.3%
Yellow Time (s)	3.3	3.3	3.3
All-Red Time (s)	1.9	2.0	2.0
Lost Time Adjust (s)	0.0	0.0	0.0
Total Lost Time (s)	5.2	5.3	5.3
Lead/Lag			
Lead-Lag Optimize?			
Act Effct Green (s)	32.8	31.7	31.7
Actuated g/C Ratio	0.44	0.42	0.42
v/c Ratio	0.53	0.49	0.42
Control Delay	13.6	26.9	17.6
Queue Delay	0.0	0.0	0.0
Total Delay	13.6	26.9	17.6
LOS	B	C	B
Approach Delay	13.6	22.7	
Approach LOS	B	C	
Queue Length 50th (m)	55.1	53.5	27.8
Queue Length 95th (m)	73.1	79.2	51.1
Internal Link Dist (m)	107.6	52.8	
Turn Bay Length (m)			
Base Capacity (vph)	1488	761	727
Starvation Cap Reductn	0	0	0
Spillback Cap Reductn	0	0	0
Storage Cap Reductn	0	0	0
Reduced v/c Ratio	0.53	0.49	0.42

Intersection Summary

Cycle Length: 75	
Actuated Cycle Length: 75	
Offset: 24 (32%), Referenced to phase 8:WBTL, Start of Green	
Natural Cycle: 55	
Control Type: Pretimed	
Maximum v/c Ratio: 0.53	
Intersection Signal Delay: 17.8	Intersection LOS: B
Intersection Capacity Utilization 56.3%	ICU Level of Service B
Analysis Period (min) 15	

Splits and Phases: 1: Hwy 417 WB On Ramp/Lyon St N & Catherine St

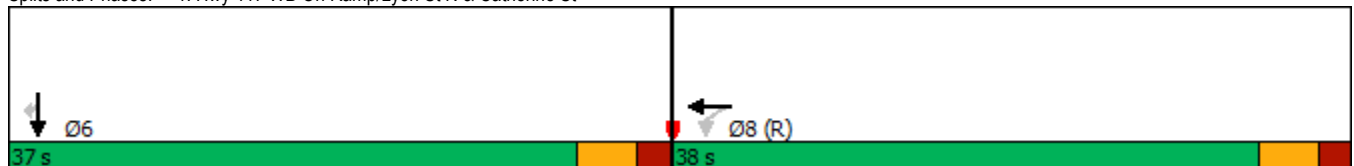

Lanes, Volumes, Timings

2: Hwy 417 EB Off Ramp/Chamberlain Ave/Kent St & Catherine St

02/28/2024



Lane Group	WBT	WBR	NBT	Ø9
Lane Configurations	↑↑	↑↑	↑↑↑	
Traffic Volume (vph)	739	321	890	
Future Volume (vph)	739	321	890	
Lane Group Flow (vph)	739	321	941	
Turn Type	NA	Prot	NA	
Protected Phases	8	8	2	9
Permitted Phases				
Detector Phase	8	8	2	
Switch Phase				
Minimum Initial (s)	10.0	10.0	10.0	1.0
Minimum Split (s)	15.8	15.8	22.5	13.0
Total Split (s)	35.0	35.0	27.0	13.0
Total Split (%)	46.7%	46.7%	36.0%	17%
Yellow Time (s)	3.3	3.3	3.3	2.0
All-Red Time (s)	2.5	2.5	2.5	0.0
Lost Time Adjust (s)	0.0	0.0	0.0	
Total Lost Time (s)	5.8	5.8	5.8	
Lead/Lag				
Lead-Lag Optimize?				
Recall Mode	C-Max	C-Max	Max	None
Act Effct Green (s)	34.4	34.4	21.2	
Actuated g/C Ratio	0.46	0.46	0.28	
v/c Ratio	0.48	0.28	0.66	
Control Delay	27.0	24.4	24.6	
Queue Delay	0.0	0.0	3.8	
Total Delay	27.0	24.4	28.4	
LOS	C	C	C	
Approach Delay	26.2		28.4	
Approach LOS	C		C	
Queue Length 50th (m)	55.2	23.9	39.5	
Queue Length 95th (m)	m64.0	m28.1	52.6	
Internal Link Dist (m)	131.7		689.6	
Turn Bay Length (m)		60.0		
Base Capacity (vph)	1539	1156	1420	
Starvation Cap Reductn	0	0	0	
Spillback Cap Reductn	0	0	382	
Storage Cap Reductn	0	0	0	
Reduced v/c Ratio	0.48	0.28	0.91	

Intersection Summary

Cycle Length: 75
 Actuated Cycle Length: 75
 Offset: 0 (0%), Referenced to phase 8:WBT, Start of Green
 Natural Cycle: 60
 Control Type: Actuated-Coordinated
 Maximum v/c Ratio: 0.66
 Intersection Signal Delay: 27.2
 Intersection LOS: C
 Intersection Capacity Utilization 52.7%
 ICU Level of Service A
 Analysis Period (min) 15
 m Volume for 95th percentile queue is metered by upstream signal.

Splits and Phases: 2: Hwy 417 EB Off Ramp/Chamberlain Ave/Kent St & Catherine St



Lanes, Volumes, Timings
3: Bank St & Catherine St

02/28/2024



Lane Group	WBT	NBL	NBT	SBT	Ø1	Ø5	Ø7
Lane Configurations							
Traffic Volume (vph)	668	206	340	713			
Future Volume (vph)	668	206	340	713			
Lane Group Flow (vph)	1062	0	546	855			
Turn Type	NA	pm+pt	NA	NA			
Protected Phases	8	9	2	6	1	5	7
Permitted Phases		2					
Minimum Split (s)	18.6	10.4	16.4	16.4	5.0	5.0	5.0
Total Split (s)	24.0	10.4	41.0	30.6	5.0	5.0	5.0
Total Split (%)	32.0%	13.9%	54.7%	40.8%	7%	7%	7%
Yellow Time (s)	3.3	3.3	3.3	3.3	2.0	2.0	2.0
All-Red Time (s)	2.3	2.1	2.1	2.1	0.0	0.0	0.0
Lost Time Adjust (s)	0.0		0.0	0.0			
Total Lost Time (s)	5.6		5.4	5.4			
Lead/Lag	Lag		Lag	Lag	Lead	Lead	Lead
Lead-Lag Optimize?	Yes		Yes	Yes	Yes	Yes	Yes
Act Effct Green (s)	18.4		35.6	25.2			
Actuated g/C Ratio	0.25		0.47	0.34			
v/c Ratio	0.93		0.58	0.81			
Control Delay	41.7		13.1	29.0			
Queue Delay	0.0		0.0	0.8			
Total Delay	41.7		13.1	29.8			
LOS	D		B	C			
Approach Delay	41.7		13.1	29.8			
Approach LOS	D		B	C			
Queue Length 50th (m)	51.7		15.4	54.9			
Queue Length 95th (m)	#77.2		20.0	#77.5			
Internal Link Dist (m)	702.3		90.2	52.9			
Turn Bay Length (m)							
Base Capacity (vph)	1146		946	1062			
Starvation Cap Reductn	0		0	0			
Spillback Cap Reductn	0		0	52			
Storage Cap Reductn	0		0	0			
Reduced v/c Ratio	0.93		0.58	0.85			

Intersection Summary

Cycle Length: 75
 Actuated Cycle Length: 75
 Offset: 50 (67%), Referenced to phase 2:NBT and 6:SBT, Start of Green
 Natural Cycle: 75
 Control Type: Pretimed
 Maximum v/c Ratio: 0.93
 Intersection Signal Delay: 31.2
 Intersection LOS: C
 Intersection Capacity Utilization 82.0%
 ICU Level of Service D
 Analysis Period (min) 15
 # 95th percentile volume exceeds capacity, queue may be longer.
 Queue shown is maximum after two cycles.

Splits and Phases: 3: Bank St & Catherine St

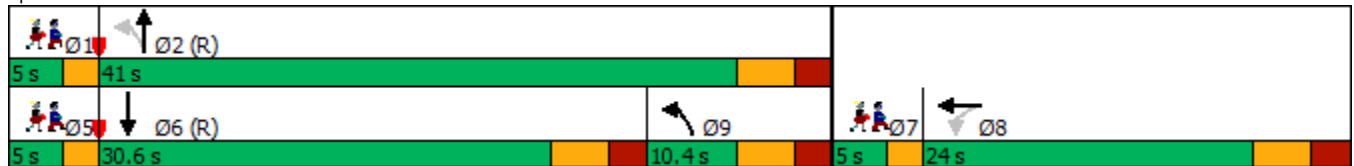

Lanes, Volumes, Timings
4: Percy St & Catherine St

02/28/2024

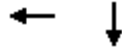

Lane Group	WBT	SBT	Ø3	Ø7
Lane Configurations				
Traffic Volume (vph)	741	121		
Future Volume (vph)	741	121		
Lane Group Flow (vph)	907	160		
Turn Type	NA	NA		
Protected Phases	8	6	3	7
Permitted Phases				
Detector Phase	8	6		
Switch Phase				
Minimum Initial (s)	10.0	10.0	1.0	1.0
Minimum Split (s)	26.5	23.4	6.4	6.4
Total Split (s)	34.0	24.0	16.0	16.0
Total Split (%)	37.8%	26.7%	18%	18%
Yellow Time (s)	3.3	3.3	3.3	3.3
All-Red Time (s)	2.2	2.1	2.1	2.1
Lost Time Adjust (s)	0.0	0.0		
Total Lost Time (s)	5.5	5.4		
Lead/Lag	Lag			Lead
Lead-Lag Optimize?	Yes			Yes
Recall Mode	None	Max	None	None
Act Effct Green (s)	18.9	18.7		
Actuated g/C Ratio	0.39	0.38		
v/c Ratio	0.65	0.24		
Control Delay	12.0	12.8		
Queue Delay	0.0	0.0		
Total Delay	12.0	12.8		
LOS	B	B		
Approach Delay	12.0	12.8		
Approach LOS	B	B		
Queue Length 50th (m)	25.3	8.6		
Queue Length 95th (m)	39.3	23.2		
Internal Link Dist (m)	271.6	288.0		
Turn Bay Length (m)				
Base Capacity (vph)	2039	665		
Starvation Cap Reductn	0	0		
Spillback Cap Reductn	0	0		
Storage Cap Reductn	0	0		
Reduced v/c Ratio	0.44	0.24		

Intersection Summary

Cycle Length: 90	
Actuated Cycle Length: 48.6	
Natural Cycle: 65	
Control Type: Semi Act-Uncoord	
Maximum v/c Ratio: 0.65	
Intersection Signal Delay: 12.1	Intersection LOS: B
Intersection Capacity Utilization 54.1%	ICU Level of Service A
Analysis Period (min) 15	

Splits and Phases: 4: Percy St & Catherine St

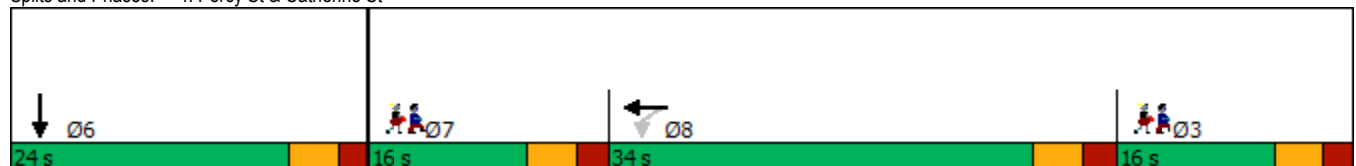

Lanes, Volumes, Timings
 5: Lyon St N & Arlington Ave

02/28/2024

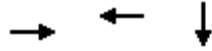

Lane Group	EBT	WBT	SBT
Lane Configurations			
Traffic Volume (vph)	19	37	601
Future Volume (vph)	19	37	601
Lane Group Flow (vph)	21	54	675
Sign Control	Stop	Stop	Free
Intersection Summary			
Control Type: Unsignalized			
Intersection Capacity Utilization 41.3%		ICU Level of Service A	
Analysis Period (min) 15			

HCM 2010 TWSC
5: Lyon St N & Arlington Ave

02/28/2024

Intersection												
Int Delay, s/veh	2.5											
Movement	EBL	EBT	EBR	WBL	WBT	WBR	NBL	NBT	NBR	SBL	SBT	SBR
Lane Configurations		↕			↕						↕↔	
Traffic Vol, veh/h	0	19	2	17	37	0	0	0	0	61	601	13
Future Vol, veh/h	0	19	2	17	37	0	0	0	0	61	601	13
Conflicting Peds, #/hr	20	0	8	8	0	20	19	0	3	3	0	19
Sign Control	Stop	Stop	Stop	Stop	Stop	Stop	Free	Free	Free	Free	Free	Free
RT Channelized	-	-	None	-	-	None	-	-	None	-	-	None
Storage Length	-	-	-	-	-	-	-	-	-	-	-	-
Veh in Median Storage, #	-	0	-	-	0	-	-	-	-	-	0	-
Grade, %	-	0	-	-	0	-	-	0	-	-	0	-
Peak Hour Factor	100	100	100	100	100	100	100	100	100	100	100	100
Heavy Vehicles, %	0	5	0	0	5	0	0	0	0	0	0	0
Mvmt Flow	0	19	2	17	37	0	0	0	0	61	601	13

Major/Minor	Minor2		Minor1				Major2			
Conflicting Flow All	-	752	334	443	758	-	-	3	0	0
Stage 1	-	749	-	3	3	-	-	-	-	-
Stage 2	-	3	-	440	755	-	-	-	-	-
Critical Hdwy	-	6.6	6.9	7.5	6.6	-	-	4.1	-	-
Critical Hdwy Stg 1	-	5.6	-	-	-	-	-	-	-	-
Critical Hdwy Stg 2	-	-	-	6.5	5.6	-	-	-	-	-
Follow-up Hdwy	-	4.05	3.3	3.5	4.05	-	-	2.2	-	-
Pot Cap-1 Maneuver	0	332	668	503	329	0	-	1632	-	-
Stage 1	0	410	-	-	-	0	-	-	-	-
Stage 2	0	-	-	571	408	0	-	-	-	-
Platoon blocked, %	-	-	-	-	-	-	-	-	-	-
Mov Cap-1 Maneuver	-	306	656	456	304	-	-	1627	-	-
Mov Cap-2 Maneuver	-	306	-	456	304	-	-	-	-	-
Stage 1	-	380	-	-	-	-	-	-	-	-
Stage 2	-	-	-	510	378	-	-	-	-	-

Approach	EB		WB				SB		
HCM Control Delay, s	17		17.6				0.8		
HCM LOS	C		C						

Minor Lane/Major Mvmt	EBLn1	WBLn1	SBL	SBT	SBR
Capacity (veh/h)	322	340	1627	-	-
HCM Lane V/C Ratio	0.065	0.159	0.037	-	-
HCM Control Delay (s)	17	17.6	7.3	0.2	-
HCM Lane LOS	C	C	A	A	-
HCM 95th %tile Q(veh)	0.2	0.6	0.1	-	-

Lanes, Volumes, Timings
6: Kent St & Arlington Ave

02/28/2024



Lane Group	EBL	EBT	WBT	NBT
Lane Configurations		↕	↕	↕↕↕
Traffic Volume (vph)	25	83	30	1098
Future Volume (vph)	25	83	30	1098
Lane Group Flow (vph)	0	108	93	1231
Turn Type	Perm	NA	NA	NA
Protected Phases		4	8	2
Permitted Phases	4			
Minimum Split (s)	27.3	27.3	27.3	32.3
Total Split (s)	31.0	31.0	31.0	44.0
Total Split (%)	41.3%	41.3%	41.3%	58.7%
Yellow Time (s)	3.3	3.3	3.3	3.3
All-Red Time (s)	2.0	2.0	2.0	2.0
Lost Time Adjust (s)		0.0	0.0	0.0
Total Lost Time (s)		5.3	5.3	5.3
Lead/Lag				
Lead-Lag Optimize?				
Act Effct Green (s)		25.7	25.7	38.7
Actuated g/C Ratio		0.34	0.34	0.52
v/c Ratio		0.19	0.16	0.49
Control Delay		25.9	9.8	10.0
Queue Delay		0.0	0.0	49.8
Total Delay		25.9	9.8	59.7
LOS		C	A	E
Approach Delay		25.9	9.8	59.7
Approach LOS		C	A	E
Queue Length 50th (m)		13.0	1.6	49.7
Queue Length 95th (m)		m25.2	m6.4	69.9
Internal Link Dist (m)		138.7	143.1	53.0
Turn Bay Length (m)				
Base Capacity (vph)		576	579	2501
Starvation Cap Reductn		0	0	1427
Spillback Cap Reductn		0	0	0
Storage Cap Reductn		0	0	0
Reduced v/c Ratio		0.19	0.16	1.15

Intersection Summary

Cycle Length: 75
 Actuated Cycle Length: 75
 Offset: 50 (67%), Referenced to phase 2:NBTL, Start of Green
 Natural Cycle: 60
 Control Type: Pretimed
 Maximum v/c Ratio: 0.49
 Intersection Signal Delay: 53.9
 Intersection LOS: D
 Intersection Capacity Utilization 55.1%
 ICU Level of Service B
 Analysis Period (min) 15
 m Volume for 95th percentile queue is metered by upstream signal.

Splits and Phases: 6: Kent St & Arlington Ave



Lanes, Volumes, Timings
7: Lyon St N & Gladstone Ave

02/28/2024



Lane Group	EBT	EBR	WBL	WBT	SBT
Lane Configurations	↑	↑	↑	↑	↑↓
Traffic Volume (vph)	247	52	28	314	553
Future Volume (vph)	247	52	28	314	553
Lane Group Flow (vph)	247	52	28	314	777
Turn Type	NA	Perm	Perm	NA	NA
Protected Phases	4			8	6
Permitted Phases		4	8		
Minimum Split (s)	17.2	17.2	17.2	17.2	22.6
Total Split (s)	37.0	37.0	37.0	37.0	38.0
Total Split (%)	49.3%	49.3%	49.3%	49.3%	50.7%
Yellow Time (s)	3.3	3.3	3.3	3.3	3.3
All-Red Time (s)	1.9	1.9	1.9	1.9	2.3
Lost Time Adjust (s)	0.0	0.0	0.0	0.0	0.0
Total Lost Time (s)	5.2	5.2	5.2	5.2	5.6
Lead/Lag					
Lead-Lag Optimize?					
Act Effct Green (s)	31.8	31.8	31.8	31.8	32.4
Actuated g/C Ratio	0.42	0.42	0.42	0.42	0.43
v/c Ratio	0.33	0.08	0.07	0.42	0.54
Control Delay	16.0	4.5	8.5	12.8	16.6
Queue Delay	0.0	0.0	0.0	0.0	0.0
Total Delay	16.0	4.5	8.5	12.8	16.6
LOS	B	A	A	B	B
Approach Delay	14.0			12.4	16.6
Approach LOS	B			B	B
Queue Length 50th (m)	22.6	0.0	1.5	36.2	38.8
Queue Length 95th (m)	38.4	5.7	m3.2	55.1	54.6
Internal Link Dist (m)	254.8			165.0	214.3
Turn Bay Length (m)			25.0		
Base Capacity (vph)	756	626	422	756	1428
Starvation Cap Reductn	0	0	0	0	0
Spillback Cap Reductn	0	0	0	0	0
Storage Cap Reductn	0	0	0	0	0
Reduced v/c Ratio	0.33	0.08	0.07	0.42	0.54

Intersection Summary

Cycle Length: 75
 Actuated Cycle Length: 75
 Offset: 45 (60%), Referenced to phase 4:EBT and 8:WBTL, Start of Green
 Natural Cycle: 40
 Control Type: Pretimed
 Maximum v/c Ratio: 0.54
 Intersection Signal Delay: 15.1
 Intersection LOS: B
 Intersection Capacity Utilization 68.3%
 ICU Level of Service C
 Analysis Period (min) 15
 m Volume for 95th percentile queue is metered by upstream signal.

Splits and Phases: 7: Lyon St N & Gladstone Ave

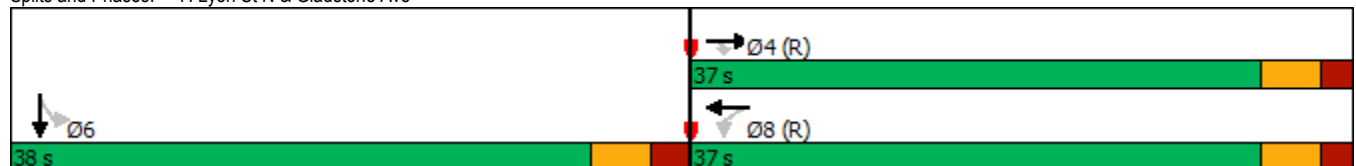

Lanes, Volumes, Timings
8: Kent St & Gladstone Ave

02/28/2024

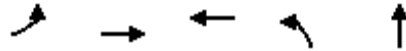

Lane Group	EBL	EBT	WBT	NBL	NBT
Lane Configurations					
Traffic Volume (vph)	75	450	324	67	952
Future Volume (vph)	75	450	324	67	952
Lane Group Flow (vph)	75	450	399	67	1083
Turn Type	Perm	NA	NA	Perm	NA
Protected Phases		4	8		2
Permitted Phases	4			2	
Minimum Split (s)	21.4	21.4	21.4	20.4	20.4
Total Split (s)	42.0	42.0	42.0	33.0	33.0
Total Split (%)	56.0%	56.0%	56.0%	44.0%	44.0%
Yellow Time (s)	3.3	3.3	3.3	3.3	3.3
All-Red Time (s)	2.1	2.1	2.1	2.1	2.1
Lost Time Adjust (s)	0.0	0.0	0.0	0.0	0.0
Total Lost Time (s)	5.4	5.4	5.4	5.4	5.4
Lead/Lag					
Lead-Lag Optimize?					
Act Effct Green (s)	36.6	36.6	36.6	27.6	27.6
Actuated g/C Ratio	0.49	0.49	0.49	0.37	0.37
v/c Ratio	0.19	0.52	0.47	0.12	0.63
Control Delay	20.1	24.3	14.2	8.5	9.1
Queue Delay	0.0	0.0	0.0	0.0	0.0
Total Delay	20.1	24.3	14.2	8.5	9.1
LOS	C	C	B	A	A
Approach Delay		23.7	14.2		9.1
Approach LOS		C	B		A
Queue Length 50th (m)	7.3	54.0	33.2	3.1	16.9
Queue Length 95th (m)	m17.0	83.0	54.8	m4.8	15.7
Internal Link Dist (m)		165.0	168.8		216.0
Turn Bay Length (m)	30.0			40.0	
Base Capacity (vph)	385	862	850	560	1726
Starvation Cap Reductn	0	0	0	0	0
Spillback Cap Reductn	0	0	0	0	0
Storage Cap Reductn	0	0	0	0	0
Reduced v/c Ratio	0.19	0.52	0.47	0.12	0.63

Intersection Summary

Cycle Length: 75
 Actuated Cycle Length: 75
 Offset: 23 (31%), Referenced to phase 4:EBTL and 8:WBT, Start of Green
 Natural Cycle: 45
 Control Type: Pretimed
 Maximum v/c Ratio: 0.63
 Intersection Signal Delay: 13.8
 Intersection LOS: B
 Intersection Capacity Utilization 68.3%
 ICU Level of Service C
 Analysis Period (min) 15
 m Volume for 95th percentile queue is metered by upstream signal.

Splits and Phases: 8: Kent St & Gladstone Ave

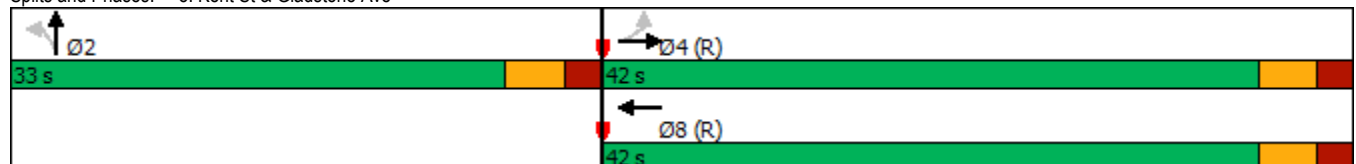

Lanes, Volumes, Timings
 9: Bank St & Chamberlain Ave/Isabella St

02/28/2024



Lane Group	EBT	EBR	NBT	SBL	SBT
Lane Configurations	↕↕	↗	↕↕		↕↕
Traffic Volume (vph)	638	124	468	189	734
Future Volume (vph)	638	124	468	189	734
Lane Group Flow (vph)	705	124	561	0	923
Turn Type	NA	Perm	NA	pm+pt	NA
Protected Phases	4		2	5	6
Permitted Phases		4		6	
Detector Phase	4	4	2	5	6
Switch Phase					
Minimum Initial (s)	10.0	10.0	10.0	5.0	10.0
Minimum Split (s)	26.2	26.2	23.1	11.1	23.1
Total Split (s)	29.0	29.0	34.9	11.1	46.0
Total Split (%)	38.7%	38.7%	46.5%	14.8%	61.3%
Yellow Time (s)	3.3	3.3	3.0	3.0	3.0
All-Red Time (s)	2.9	2.9	3.1	3.1	3.1
Lost Time Adjust (s)	0.0	0.0	0.0		0.0
Total Lost Time (s)	6.2	6.2	6.1		6.1
Lead/Lag					
Lead-Lag Optimize?					
Recall Mode	None	None	C-Max	None	C-Max
Act Effct Green (s)	21.1	21.1	41.6		41.6
Actuated g/C Ratio	0.28	0.28	0.55		0.55
v/c Ratio	0.75	0.25	0.32		0.71
Control Delay	30.0	5.0	10.1		13.0
Queue Delay	0.0	0.0	0.0		1.3
Total Delay	30.0	5.0	10.1		14.3
LOS	C	A	B		B
Approach Delay	26.3		10.1		14.3
Approach LOS	C		B		B
Queue Length 50th (m)	45.8	0.0	22.1		74.1
Queue Length 95th (m)	63.9	9.6	31.7		m91.8
Internal Link Dist (m)	677.2		578.7		90.2
Turn Bay Length (m)		40.0			
Base Capacity (vph)	1015	519	1742		1296
Starvation Cap Reductn	0	0	0		184
Spillback Cap Reductn	0	0	0		0
Storage Cap Reductn	0	0	0		0
Reduced v/c Ratio	0.69	0.24	0.32		0.83

Intersection Summary

Cycle Length: 75
 Actuated Cycle Length: 75
 Offset: 60 (80%), Referenced to phase 2:NBT and 6:SBTL, Start of Green
 Natural Cycle: 65
 Control Type: Actuated-Coordinated
 Maximum v/c Ratio: 0.75
 Intersection Signal Delay: 17.6
 Intersection LOS: B
 Intersection Capacity Utilization 84.6%
 ICU Level of Service E
 Analysis Period (min) 15
 m Volume for 95th percentile queue is metered by upstream signal.

Splits and Phases: 9: Bank St & Chamberlain Ave/Isabella St

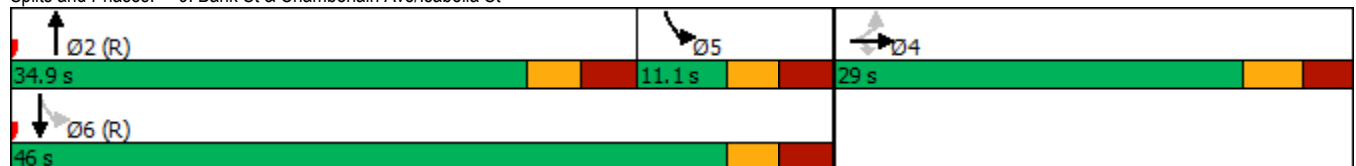

Lanes, Volumes, Timings
10: Catherine St & Access

02/28/2024

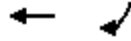

Lane Group	WBT	SBR
Lane Configurations		
Traffic Volume (vph)	662	45
Future Volume (vph)	662	45
Lane Group Flow (vph)	734	45
Sign Control	Free	

Intersection Summary

Control Type: Unsignalized
Intersection Capacity Utilization 31.7% ICU Level of Service A
Analysis Period (min) 15

Intersection							
Int Delay, s/veh	0.6						
Movement	EBL	EBT	WBT	WBR	SBL	SBR	
Lane Configurations			↑↑			↑	
Traffic Vol, veh/h	0	0	662	72	0	45	
Future Vol, veh/h	0	0	662	72	0	45	
Conflicting Peds, #/hr	0	0	0	0	0	0	
Sign Control	Free	Free	Free	Free	Stop	Stop	
RT Channelized	-	None	-	None	-	None	
Storage Length	-	-	-	-	-	0	
Veh in Median Storage, #	-2949	120	0	-	0	-	
Grade, %	-	0	0	-	0	-	
Peak Hour Factor	100	100	100	100	100	100	
Heavy Vehicles, %	2	2	2	2	2	2	
Mvmt Flow	0	0	662	72	0	45	
Major/Minor	Major2		Minor2				
Conflicting Flow All			-	0	-	367	
Stage 1			-	-	-	-	
Stage 2			-	-	-	-	
Critical Hdwy			-	-	-	6.94	
Critical Hdwy Stg 1			-	-	-	-	
Critical Hdwy Stg 2			-	-	-	-	
Follow-up Hdwy			-	-	-	3.32	
Pot Cap-1 Maneuver			-	-	0	630	
Stage 1			-	-	0	-	
Stage 2			-	-	0	-	
Platoon blocked, %			-	-	-	-	
Mov Cap-1 Maneuver			-	-	-	630	
Mov Cap-2 Maneuver			-	-	-	-	
Stage 1			-	-	-	-	
Stage 2			-	-	-	-	
Approach	WB		SB				
HCM Control Delay, s			0	11.2			
HCM LOS			B				
Minor Lane/Major Mvmt	WBT	WBR	SBLn1				
Capacity (veh/h)	-	-	630				
HCM Lane V/C Ratio	-	-	0.071				
HCM Control Delay (s)	-	-	11.2				
HCM Lane LOS	-	-	B				
HCM 95th %tile Q(veh)	-	-	0.2				

Lanes, Volumes, Timings
 11: Access & Arlington Ave

02/28/2024



Lane Group	EBT	WBT	NBL
Lane Configurations			
Traffic Volume (vph)	62	45	9
Future Volume (vph)	62	45	9
Lane Group Flow (vph)	80	75	45
Sign Control	Free	Free	Stop

Intersection Summary	
Control Type: Unsignalized	
Intersection Capacity Utilization 20.9%	ICU Level of Service A
Analysis Period (min) 15	

Intersection						
Int Delay, s/veh	3.2					
Movement	EBT	EBR	WBL	WBT	NBL	NBR
Lane Configurations						
Traffic Vol, veh/h	62	18	30	45	9	36
Future Vol, veh/h	62	18	30	45	9	36
Conflicting Peds, #/hr	0	0	0	0	0	0
Sign Control	Free	Free	Free	Free	Stop	Stop
RT Channelized	-	None	-	None	-	None
Storage Length	-	-	-	-	0	-
Veh in Median Storage, #	0	-	-	0	0	-
Grade, %	0	-	-	0	0	-
Peak Hour Factor	100	100	100	100	100	100
Heavy Vehicles, %	2	2	2	2	2	2
Mvmt Flow	62	18	30	45	9	36

Major/Minor	Major1	Major2	Minor1	Minor2	Minor3
Conflicting Flow All	0	0	80	0	176
Stage 1	-	-	-	-	71
Stage 2	-	-	-	-	105
Critical Hdwy	-	-	4.12	-	6.42
Critical Hdwy Stg 1	-	-	-	-	5.42
Critical Hdwy Stg 2	-	-	-	-	5.42
Follow-up Hdwy	-	-	2.218	-	3.518
Pot Cap-1 Maneuver	-	-	1518	-	814
Stage 1	-	-	-	-	952
Stage 2	-	-	-	-	919
Platoon blocked, %	-	-	-	-	-
Mov Cap-1 Maneuver	-	-	1518	-	798
Mov Cap-2 Maneuver	-	-	-	-	798
Stage 1	-	-	-	-	952
Stage 2	-	-	-	-	901

Approach	EB	WB	NB
HCM Control Delay, s	0	3	9
HCM LOS			A

Minor Lane/Major Mvmt	NBLn1	EBT	EBR	WBL	WBT
Capacity (veh/h)	945	-	-	1518	-
HCM Lane V/C Ratio	0.048	-	-	0.02	-
HCM Control Delay (s)	9	-	-	7.4	0
HCM Lane LOS	A	-	-	A	A
HCM 95th %tile Q(veh)	0.1	-	-	0.1	-

Lanes, Volumes, Timings
 12: Bank St & Arlington Ave

02/28/2024



Lane Group	EBL	NBT	SBT
Lane Configurations			
Traffic Volume (vph)	24	428	731
Future Volume (vph)	24	428	731
Lane Group Flow (vph)	149	498	758
Sign Control	Stop	Free	Free

Intersection Summary	
Control Type: Unsignalized	
Intersection Capacity Utilization 56.5%	ICU Level of Service B
Analysis Period (min) 15	

Intersection						
Int Delay, s/veh	2.6					
Movement	EBL	EBR	NBL	NBT	SBT	SBR
Lane Configurations	↔			↕	↕	
Traffic Vol, veh/h	24	125	70	428	731	27
Future Vol, veh/h	24	125	70	428	731	27
Conflicting Peds, #/hr	0	0	42	0	0	42
Sign Control	Stop	Stop	Free	Free	Free	Free
RT Channelized	-	None	-	None	-	None
Storage Length	0	-	-	-	-	-
Veh in Median Storage, #	0	-	-	0	0	-
Grade, %	0	-	-	0	0	-
Peak Hour Factor	100	100	100	100	100	100
Heavy Vehicles, %	0	1	0	5	3	0
Mvmt Flow	24	125	70	428	731	27

Major/Minor	Minor2	Major1	Major2			
Conflicting Flow All	1141	421	800	0	-	0
Stage 1	787	-	-	-	-	-
Stage 2	354	-	-	-	-	-
Critical Hdwy	6.8	6.92	4.1	-	-	-
Critical Hdwy Stg 1	5.8	-	-	-	-	-
Critical Hdwy Stg 2	5.8	-	-	-	-	-
Follow-up Hdwy	3.5	3.31	2.2	-	-	-
Pot Cap-1 Maneuver	197	584	832	-	-	-
Stage 1	414	-	-	-	-	-
Stage 2	687	-	-	-	-	-
Platoon blocked, %				-	-	-
Mov Cap-1 Maneuver	161	561	800	-	-	-
Mov Cap-2 Maneuver	161	-	-	-	-	-
Stage 1	352	-	-	-	-	-
Stage 2	660	-	-	-	-	-

Approach	EB	NB	SB
HCM Control Delay, s	19.2	1.7	0
HCM LOS	C		

Minor Lane/Major Mvmt	NBL	NBT	EBLn1	SBT	SBR
Capacity (veh/h)	800	-	401	-	-
HCM Lane V/C Ratio	0.088	-	0.372	-	-
HCM Control Delay (s)	9.9	0.4	19.2	-	-
HCM Lane LOS	A	A	C	-	-
HCM 95th %tile Q(veh)	0.3	-	1.7	-	-

Lanes, Volumes, Timings
13: Bronson Ave & Catherine St

02/28/2024



Lane Group	WBL	WBT	NBL	NBT	SBT
Lane Configurations					
Traffic Volume (vph)	744	610	311	812	853
Future Volume (vph)	744	610	311	812	853
Lane Group Flow (vph)	417	1229	311	812	1029
Turn Type	Perm	NA	pm+pt	NA	NA
Protected Phases		8	5	2	6
Permitted Phases	8		2		
Minimum Split (s)	28.3	28.3	11.2	23.8	23.8
Total Split (s)	37.0	37.0	22.0	63.0	41.0
Total Split (%)	37.0%	37.0%	22.0%	63.0%	41.0%
Yellow Time (s)	3.3	3.3	3.3	3.3	3.3
All-Red Time (s)	3.0	3.0	2.9	3.5	3.5
Lost Time Adjust (s)	0.0	0.0	0.0	0.0	0.0
Total Lost Time (s)	6.3	6.3	6.2	6.8	6.8
Lead/Lag			Lead		Lag
Lead-Lag Optimize?			Yes		Yes
Act Effct Green (s)	30.7	30.7	56.8	56.2	34.2
Actuated g/C Ratio	0.31	0.31	0.57	0.56	0.34
v/c Ratio	0.93	0.90	0.92	0.43	0.91
Control Delay	63.9	41.1	59.4	13.5	43.5
Queue Delay	0.0	0.0	0.0	0.0	0.0
Total Delay	63.9	41.1	59.4	13.5	43.5
LOS	E	D	E	B	D
Approach Delay		46.8		26.2	43.5
Approach LOS		D		C	D
Queue Length 50th (m)	90.6	82.9	44.4	44.8	97.0
Queue Length 95th (m)	#157.0	#110.9	#94.6	58.3	#136.1
Internal Link Dist (m)		120.8		240.1	287.4
Turn Bay Length (m)	80.0		45.0		
Base Capacity (vph)	447	1368	337	1905	1132
Starvation Cap Reductn	0	0	0	0	0
Spillback Cap Reductn	0	0	0	0	0
Storage Cap Reductn	0	0	0	0	0
Reduced v/c Ratio	0.93	0.90	0.92	0.43	0.91

Intersection Summary

Cycle Length: 100
 Actuated Cycle Length: 100
 Offset: 60 (60%), Referenced to phase 2:NBT and 6:SBT, Start of Green
 Natural Cycle: 90
 Control Type: Pretimed
 Maximum v/c Ratio: 0.93
 Intersection Signal Delay: 39.8
 Intersection LOS: D
 Intersection Capacity Utilization 92.5%
 ICU Level of Service F
 Analysis Period (min) 15
 # 95th percentile volume exceeds capacity, queue may be longer.
 Queue shown is maximum after two cycles.

Splits and Phases: 13: Bronson Ave & Catherine St

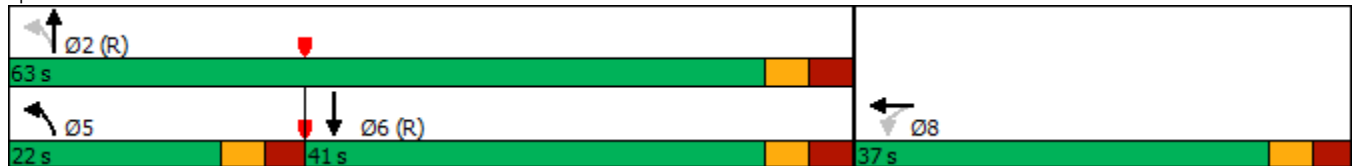

Appendix J:

SimTraffic Summary Reports

Intersection: 1: Hwy 417 WB On Ramp/Lyon St N & Catherine St

Movement	WB	WB	SB	SB
Directions Served	LT	T	T	R
Maximum Queue (m)	77.3	52.1	65.5	27.6
Average Queue (m)	47.5	29.7	40.5	13.1
95th Queue (m)	70.3	48.8	61.1	22.2
Link Distance (m)	123.9	123.9	62.4	62.4
Upstream Blk Time (%)			1	
Queuing Penalty (veh)			1	
Storage Bay Dist (m)				
Storage Blk Time (%)				
Queuing Penalty (veh)				

Intersection: 2: Hwy 417 EB Off Ramp/Chamberlain Ave/Kent St & Catherine St

Movement	WB	WB	WB	WB	NB	NB	NB
Directions Served	T	T	R	R	LT	T	T
Maximum Queue (m)	53.1	48.9	56.4	64.9	78.7	87.6	86.5
Average Queue (m)	32.1	26.3	33.0	42.5	54.1	56.6	56.0
95th Queue (m)	47.4	43.6	50.8	62.0	72.5	78.0	79.6
Link Distance (m)	132.5	132.5	132.5		711.8	711.8	711.8
Upstream Blk Time (%)							
Queuing Penalty (veh)							
Storage Bay Dist (m)				60.0			
Storage Blk Time (%)			0	1			
Queuing Penalty (veh)			0	2			

Intersection: 3: Bank St & Catherine St

Movement	WB	WB	WB	NB	NB	SB	SB
Directions Served	LT	T	R	LT	T	T	TR
Maximum Queue (m)	142.3	145.8	48.7	107.1	102.2	59.9	59.7
Average Queue (m)	78.2	91.4	20.5	61.0	43.6	37.2	30.5
95th Queue (m)	123.5	141.2	37.1	100.8	83.9	58.4	52.6
Link Distance (m)	714.6	714.6	714.6	107.4	107.4	56.5	56.5
Upstream Blk Time (%)				1	0	1	1
Queuing Penalty (veh)				3	0	3	2
Storage Bay Dist (m)							
Storage Blk Time (%)							
Queuing Penalty (veh)							

Intersection: 4: Percy St & Catherine St

Movement	WB	WB	SB
Directions Served	LT	T	TR
Maximum Queue (m)	48.1	44.6	39.2
Average Queue (m)	18.7	16.9	17.1
95th Queue (m)	35.0	33.1	33.1
Link Distance (m)	284.8	284.8	302.5
Upstream Blk Time (%)			
Queuing Penalty (veh)			
Storage Bay Dist (m)			
Storage Blk Time (%)			
Queuing Penalty (veh)			

Intersection: 6: Kent St & Arlington Ave

Movement	EB	WB	NB	NB	NB
Directions Served	LT	TR	LT	T	TR
Maximum Queue (m)	41.2	22.1	61.1	69.4	64.4
Average Queue (m)	20.0	10.2	47.0	53.1	57.0
95th Queue (m)	35.0	19.9	62.7	69.5	68.4
Link Distance (m)	157.2	142.2	54.3	54.3	54.3
Upstream Blk Time (%)			3	7	12
Queuing Penalty (veh)			17	45	79
Storage Bay Dist (m)					
Storage Blk Time (%)					
Queuing Penalty (veh)					

Intersection: 7: Lyon St N & Gladstone Ave

Movement	EB	EB	WB	WB	SB	SB
Directions Served	T	R	L	T	LT	TR
Maximum Queue (m)	50.2	11.6	12.3	25.3	56.6	49.9
Average Queue (m)	21.7	2.8	2.1	10.9	32.3	21.1
95th Queue (m)	39.8	9.8	8.5	21.4	51.6	40.0
Link Distance (m)	269.8	269.8		183.7	231.1	231.1
Upstream Blk Time (%)						
Queuing Penalty (veh)						
Storage Bay Dist (m)			25.0			
Storage Blk Time (%)				0		
Queuing Penalty (veh)				0		

Intersection: 8: Kent St & Gladstone Ave

Movement	EB	EB	WB	NB	NB	NB	NB
Directions Served	L	T	TR	L	T	T	TR
Maximum Queue (m)	46.4	79.0	81.6	21.2	90.7	63.5	68.7
Average Queue (m)	14.6	38.8	39.9	4.6	40.6	45.7	48.7
95th Queue (m)	33.0	65.4	69.4	15.0	68.8	59.1	64.4
Link Distance (m)		183.7	178.3		227.2	227.2	227.2
Upstream Blk Time (%)					0		
Queuing Penalty (veh)					0		
Storage Bay Dist (m)	30.0			40.0			
Storage Blk Time (%)	1	17			7		
Queuing Penalty (veh)	1	14			2		

Intersection: 9: Bank St & Chamberlain Ave/Isabella St

Movement	EB	EB	EB	NB	NB	SB	SB
Directions Served	LT	T	R	T	TR	LT	T
Maximum Queue (m)	62.3	65.8	38.2	83.5	74.3	97.8	85.4
Average Queue (m)	39.3	41.4	1.3	41.8	42.7	45.4	31.1
95th Queue (m)	57.8	61.0	16.0	68.8	67.6	81.7	65.8
Link Distance (m)	690.7	690.7		591.2	591.2	107.4	107.4
Upstream Blk Time (%)						0	0
Queuing Penalty (veh)						1	0
Storage Bay Dist (m)			40.0				
Storage Blk Time (%)		9					
Queuing Penalty (veh)		7					

Intersection: 13: Bronson Ave & Catherine St

Movement	WB	WB	WB	WB	NB	NB	NB	SB	SB
Directions Served	L	LT	T	TR	L	T	T	T	TR
Maximum Queue (m)	85.3	89.0	82.8	120.9	47.4	139.2	112.8	90.8	81.0
Average Queue (m)	51.8	59.5	50.5	71.7	44.2	75.5	57.4	54.5	47.7
95th Queue (m)	76.5	82.1	73.8	109.5	54.0	127.3	97.0	81.2	74.4
Link Distance (m)		126.8	126.8	126.8		261.7	261.7	295.2	295.2
Upstream Blk Time (%)				0					
Queuing Penalty (veh)				1					
Storage Bay Dist (m)	80.0				45.0				
Storage Blk Time (%)	0	2			13	7			
Queuing Penalty (veh)	1	4			63	37			

Zone Summary

Zone wide Queuing Penalty: 285

Intersection: 1: Hwy 417 WB On Ramp/Lyon St N & Catherine St

Movement	WB	WB	SB	SB
Directions Served	LT	T	T	R
Maximum Queue (m)	78.7	58.9	67.5	53.8
Average Queue (m)	34.9	23.7	48.9	29.2
95th Queue (m)	62.7	45.2	68.8	47.1
Link Distance (m)	123.9	123.9	62.4	62.4
Upstream Blk Time (%)			2	0
Queuing Penalty (veh)			5	0
Storage Bay Dist (m)				
Storage Blk Time (%)				
Queuing Penalty (veh)				

Intersection: 2: Hwy 417 EB Off Ramp/Chamberlain Ave/Kent St & Catherine St

Movement	WB	WB	WB	WB	NB	NB	NB
Directions Served	T	T	R	R	LT	T	T
Maximum Queue (m)	62.6	61.4	39.7	43.3	60.8	64.3	63.0
Average Queue (m)	42.9	41.4	19.5	24.5	40.5	40.6	36.6
95th Queue (m)	58.1	55.0	33.0	38.9	57.2	57.9	57.5
Link Distance (m)	132.5	132.5	132.5		711.8	711.8	711.8
Upstream Blk Time (%)							
Queuing Penalty (veh)							
Storage Bay Dist (m)				60.0			
Storage Blk Time (%)							
Queuing Penalty (veh)							

Intersection: 3: Bank St & Catherine St

Movement	WB	WB	WB	NB	NB	SB	SB
Directions Served	LT	T	R	LT	T	T	TR
Maximum Queue (m)	183.6	179.8	58.9	111.7	112.5	68.9	62.4
Average Queue (m)	103.2	104.2	16.2	80.7	52.1	49.2	46.3
95th Queue (m)	185.3	185.0	37.3	132.5	116.2	66.7	66.6
Link Distance (m)	714.6	714.6	714.6	107.4	107.4	56.5	56.5
Upstream Blk Time (%)				14	1	5	5
Queuing Penalty (veh)				37	4	21	22
Storage Bay Dist (m)							
Storage Blk Time (%)							
Queuing Penalty (veh)							

Intersection: 4: Percy St & Catherine St

Movement	WB	WB	SB
Directions Served	LT	T	TR
Maximum Queue (m)	74.7	61.7	35.5
Average Queue (m)	40.8	30.8	16.3
95th Queue (m)	65.5	52.5	29.4
Link Distance (m)	284.8	284.8	302.5
Upstream Blk Time (%)			
Queuing Penalty (veh)			
Storage Bay Dist (m)			
Storage Blk Time (%)			
Queuing Penalty (veh)			

Intersection: 6: Kent St & Arlington Ave

Movement	EB	WB	NB	NB	NB
Directions Served	LT	TR	LT	T	TR
Maximum Queue (m)	37.2	22.4	56.8	60.6	58.9
Average Queue (m)	18.1	9.8	33.5	38.8	41.3
95th Queue (m)	31.4	19.6	52.0	58.1	58.6
Link Distance (m)	157.2	142.2	54.3	54.3	54.3
Upstream Blk Time (%)			0	1	1
Queuing Penalty (veh)			1	2	3
Storage Bay Dist (m)					
Storage Blk Time (%)					
Queuing Penalty (veh)					

Intersection: 7: Lyon St N & Gladstone Ave

Movement	EB	EB	WB	WB	SB	SB
Directions Served	T	R	L	T	LT	TR
Maximum Queue (m)	55.5	15.7	21.4	48.2	73.7	68.4
Average Queue (m)	25.7	5.6	4.7	20.6	38.1	37.3
95th Queue (m)	44.7	13.7	14.8	37.5	61.4	58.6
Link Distance (m)	269.8	269.8		183.7	231.1	231.1
Upstream Blk Time (%)						
Queuing Penalty (veh)						
Storage Bay Dist (m)			25.0			
Storage Blk Time (%)			0	2		
Queuing Penalty (veh)			0	1		

Intersection: 8: Kent St & Gladstone Ave

Movement	EB	EB	WB	NB	NB	NB	NB
Directions Served	L	T	TR	L	T	T	TR
Maximum Queue (m)	54.8	99.7	74.8	19.6	33.7	33.3	47.1
Average Queue (m)	14.5	51.9	36.2	5.4	14.8	16.9	22.9
95th Queue (m)	37.8	86.7	59.9	15.0	29.4	29.1	37.4
Link Distance (m)		183.7	178.3		227.2	227.2	227.2
Upstream Blk Time (%)							
Queuing Penalty (veh)							
Storage Bay Dist (m)	30.0			40.0			
Storage Blk Time (%)	0	24			0		
Queuing Penalty (veh)	0	18			0		

Intersection: 9: Bank St & Chamberlain Ave/Isabella St

Movement	EB	EB	EB	NB	NB	SB	SB
Directions Served	LT	T	R	T	TR	LT	T
Maximum Queue (m)	70.2	70.4	39.5	74.7	78.1	79.6	75.8
Average Queue (m)	41.9	43.7	1.9	34.9	30.6	33.6	27.9
95th Queue (m)	61.2	64.6	18.5	70.0	63.3	60.9	56.5
Link Distance (m)	690.7	690.7		591.2	591.2	107.4	107.4
Upstream Blk Time (%)						0	0
Queuing Penalty (veh)						0	0
Storage Bay Dist (m)			40.0				
Storage Blk Time (%)		11	0				
Queuing Penalty (veh)		13	0				

Intersection: 13: Bronson Ave & Catherine St

Movement	WB	WB	WB	WB	NB	NB	NB	SB	SB
Directions Served	L	LT	T	TR	L	T	T	T	TR
Maximum Queue (m)	102.2	110.2	88.2	99.5	47.4	119.2	100.3	173.6	171.0
Average Queue (m)	66.4	73.3	56.8	64.7	41.0	56.9	41.8	101.5	95.8
95th Queue (m)	93.3	99.8	82.3	93.5	55.6	102.1	80.3	162.8	157.3
Link Distance (m)		126.8	126.8	126.8		261.7	261.7	295.2	295.2
Upstream Blk Time (%)		0							
Queuing Penalty (veh)		1							
Storage Bay Dist (m)	80.0				45.0				
Storage Blk Time (%)	3	5			11	4			
Queuing Penalty (veh)	17	20			45	14			

Zone Summary

Zone wide Queuing Penalty: 224

Appendix K:

MMLOS Analysis: Intersections

Multi-Modal Level of Service - Intersections Form

Consultant
Scenario
Comments

Parsons
Existing and Future

Project	478038-01000
Date	29-Feb-24

INTERSECTIONS											
Crossing Side		Catherine/Kent				Catherine/Lyon				Arlington	
Crossing Side		NORTH	SOUTH	EAST	WEST	NORTH	SOUTH	EAST	WEST	NORTH	SOUTH
Pedestrian	Lanes	5	5	4	3	3	4	4	4	4	4
	Median	No Median - 2.4 m	No Median - 2.4 m	No Median - 2.4 m	No Median - 2.4 m	No Median - 2.4 m	No Median - 2.4 m	No Median - 2.4 m	No Median - 2.4 m	No Median - 2.4 m	No Median - 2.4 m
	Conflicting Left Turns	No left turn / Prohib.	No left turn / Prohib.	No left turn / Prohib.	Permissive	No left turn / Prohib.	Permissive	No left turn / Prohib.	No left turn / Prohib.	Permissive	Permissive
	Conflicting Right Turns	Permissive or yield control	No right turn	No right turn	No right turn	No right turn	No right turn	No right turn	Permissive or yield control	Permissive or yield control	Permissive or yield control
	Right Turns on Red (RTor) ?	RTOR prohibited	RTOR prohibited	RTOR prohibited	RTOR prohibited	RTOR prohibited	RTOR prohibited	RTOR prohibited	RTOR allowed	RTOR prohibited	RTOR allowed
	Ped Signal Leading Interval?	Yes	Yes	No	No	No	No	No	No	No	No
	Right Turn Channel	No Right Turn	No Right Turn	No Channel	No Right Turn	No Channel	No Right Turn	No Right Turn	No Right Turn	No Right Turn	No Channel
	Corner Radius	No Right Turn	No Right Turn	3-5m	No Right Turn	5-10m	No Right Turn	No Right Turn	No Right Turn	No Right Turn	10-15m
	Crosswalk Type	Zebra stripe hi-vis markings	Zebra stripe hi-vis markings	Zebra stripe hi-vis markings	Zebra stripe hi-vis markings	Std transverse markings	Std transverse markings	Std transverse markings	Std transverse markings	Std transverse markings	Std transverse markings
	PETSI Score	63	68	74	91	87	71	79	71	66	53
	Ped. Exposure to Traffic LoS	C	C	C	A	B	C	B	C	C	D
	Cycle Length	75	75	75	75	75	75	75	75	75	75
	Effective Walk Time	16	16	27	27	15	15	32	32	11	11
	Average Pedestrian Delay	23	23	15	15	24	24	12	12	27	27
Pedestrian Delay LoS	C	C	B	B	C	C	B	B	C	C	
Level of Service	C	C	C	B	C	C	B	C	C	D	
Approach From		NORTH	SOUTH	EAST	WEST	NORTH	SOUTH	EAST	WEST	NORTH	SOUTH
Bicycle	Bicycle Lane Arrangement on Approach	Mixed Traffic				Mixed Traffic				Mixed Traffic	
	Right Turn Lane Configuration	> 50 m				> 50 m				≤ 50 m	
	Right Turning Speed	≤ 25 km/h				≤ 25 km/h				≤ 25 km/h	
	Cyclist relative to RT motorists	-	-	F	-	F	-	-	-	-	D
	Separated or Mixed Traffic	-	-	Mixed Traffic	-	Mixed Traffic	-	-	-	-	Mixed Traffic
	Left Turn Approach									One lane crossed	
	Operating Speed									> 50 to < 60 km/h	
Left Turning Cyclist	-	-	-	-	-	-	-	-	-	E	
Level of Service	-	-	-	-	-	-	-	-	-	E	
Transit	Average Signal Delay										
	Level of Service	-	-	-	-	-	-	-	-	-	-
Truck	Effective Corner Radius	< 10 m				< 10 m					
	Number of Receiving Lanes on Departure from Intersection	≥ 2				≥ 2					
Level of Service	-	-	D	-	D	-	-	-	-	-	
Level of Service		D				D				D	

Don/Kent		Bank/Catherine				Gladstone/Lyon				Gladstone/Kent		
EAST	WEST	NORTH	SOUTH	EAST	WEST	NORTH	SOUTH	EAST	WEST	NORTH	SOUTH	EAST
3	3	4	5	3	4	3	3	4	4	4	4	4
No Median - 2.4 m	No Median - 2.4 m	No Median - 2.4 m	No Median - 2.4 m	No Median - 2.4 m	No Median - 2.4 m	No Median - 2.4 m	No Median - 2.4 m	No Median - 2.4 m	No Median - 2.4 m	No Median - 2.4 m	No Median - 2.4 m	No Median - 2.4 m
No left turn / Prohib.	Permissive	No left turn / Prohib.	Permissive	No left turn / Prohib.	Protected/ Permissive	No left turn / Prohib.	Permissive	Permissive	No left turn / Prohib.	Permissive	No left turn / Prohib.	No left turn / Prohib.
Permissive or yield control	No right turn	Permissive or yield control	No right turn	No right turn	Permissive or yield control	No right turn	Permissive or yield control	No right turn	Permissive or yield control	Permissive or yield control	No right turn	Permissive or yield control
RTOR allowed	RTOR prohibited	RTOR allowed	RTOR prohibited	RTOR allowed	RTOR prohibited	RTOR allowed	RTOR prohibited	RTOR prohibited	RTOR allowed	RTOR prohibited	RTOR allowed	RTOR allowed
No	No	Yes	Yes	Yes	Yes	No	No	No	No	No	No	No
No Channel	No Right Turn	No Channel	No Right Turn	No Channel	No Right Turn	No Channel	No Right Turn	No Right Turn	No Channel	No Right Turn	No Channel	No Channel
5-10m	No Right Turn	5-10m	No Right Turn	5-10m	No Right Turn	5-10m	No Right Turn	No Right Turn	5-10m	No Right Turn	3-5m	3-5m
Std transverse markings	Textured/coloured pavement	Zebra stripe hi-vis markings	Zebra stripe hi-vis markings	Zebra stripe hi-vis markings	Zebra stripe hi-vis markings	Zebra stripe hi-vis markings	Zebra stripe hi-vis markings	Zebra stripe hi-vis markings	Zebra stripe hi-vis markings	Std transverse markings	Std transverse markings	Textured/coloured pavement
79	91	67	60	89	71	87	86	74	65	66	68	66
B	A	C	C	B	C	B	B	C	C	C	C	C
75	75	75	75	75	75	75	75	75	75	75	75	75
33	33	13	13	31	16	28	28	21	21	16	16	32
12	12	26	26	13	23	15	15	19	19	23	23	12
B	B	C	C	B	C	B	B	B	B	C	C	B
B	B	C	C	B	C	B	B	C	C	C	C	C
		C				C				C		
EAST	WEST	NORTH	SOUTH	EAST	WEST	NORTH	SOUTH	EAST	WEST	NORTH	SOUTH	EAST
Mixed Traffic		Mixed Traffic		Mixed Traffic		Curb Bike Lane, Cycletrack or MUP				Mixed Traffic		Mixed Traffic
≤ 50 m		≤ 50 m		≤ 50 m		Not Applicable				≤ 50 m		≤ 50 m
≤ 25 km/h		≤ 25 km/h		≤ 25 km/h		Not Applicable				≤ 25 km/h		≤ 25 km/h
D	-	D	-	D	-	Not Applicable	-	-	-	D	-	-
Mixed Traffic	-	Mixed Traffic	-	Mixed Traffic	-	Separated	-	-	-	Mixed Traffic	-	Mixed Traffic
	No lane crossed		One lane crossed	One lane crossed		2-stage, LT box		No lane crossed			≥ 2 lanes crossed	No lane crossed
	≤ 40 km/h		> 50 to < 60 km/h	> 50 to < 60 km/h		> 50 to < 60 km/h		> 50 to < 60 km/h			> 50 to < 60 km/h	> 50 to < 60 km/h
-	B	-	E	E	-	A	-	C	-	-	F	C
-	-	-	-	E	-	A	-	-	-	-	F	-
		E				A				F		
						≤ 20 sec				≤ 20 sec		
-	-	-	-	-	-	-	-	C	C	-	-	D
						C				D		
		10 - 15 m		10 - 15 m		< 10 m		< 10 m		< 10 m		< 10 m
		≥ 2		≥ 2		1		≥ 2		≥ 2		≥ 2
-	-	B	-	B	-	F	-	-	D	-	D	D
		B				F				D		

Catherine/Percy					Catherine/Bronson					Bank/Isabella/Chamberlain			
WEST	NORTH	SOUTH	EAST	WEST	NORTH	SOUTH	EAST	WEST	NORTH	SOUTH	EAST	WEST	
4	4	5	4	3	6		4	4	5	5	4	3	
No Median - 2.4 m	No Median - 2.4 m	No Median - 2.4 m	No Median - 2.4 m	No Median - 2.4 m	No Median - 2.4 m		No Median - 2.4 m	No Median - 2.4 m	No Median - 2.4 m	No Median - 2.4 m	No Median - 2.4 m	No Median - 2.4 m	
Permissive	No left turn / Prohib.	Permissive	No left turn / Prohib.	No left turn / Prohib.	No left turn / Prohib.		No left turn / Prohib.	Protected/ Permissive	Permissive	No left turn / Prohib.	Protected/ Permissive	No left turn / Prohib.	
No right turn	No right turn	No right turn	No right turn	Protected	Permissive or yield control		No right turn	Permissive or yield control	No right turn	Protected/ Permissive	Permissive or yield control	No right turn	
RTOR prohibited	RTOR prohibited	RTOR prohibited	RTOR prohibited	RTOR prohibited	RTOR allowed		RTOR allowed	RTOR prohibited	RTOR prohibited	RTOR allowed	RTOR prohibited	RTOR allowed	
No	No	No	No	Yes	No		No	No	No	No	No	No	
No Right Turn	No Channel	No Right Turn	No Right Turn	No Right Turn	No Channel		No Channel	No Right Turn	No Right Turn	No Channel	No Right Turn	Smart Channel	
No Right Turn	5-10m	No Right Turn	No Right Turn	No Right Turn	10-15m		5-10m	No Right Turn	No Right Turn	10-15m	No Right Turn	5-10m	
Textured/coloured pavement	Std transverse markings	Std transverse markings	Std transverse markings	Std transverse markings	Zebra stripe hi-vis markings		Zebra stripe hi-vis markings	Zebra stripe hi-vis markings	Std transverse markings	Std transverse markings	Std transverse markings	Std transverse markings	
74	70	55	79	98	31		70	69	55	45	66	90	
C	C	D	B	A	E	-	C	C	D	D	C	A	
75	90	90	90	90	100		100	100	75	75	75	75	
32	8	8	22	22	12		50	16	12	12	14	28	
12	37	37	26	26	39		13	35	26	26	25	15	
B	D	D	C	C	D	-	B	D	C	C	C	B	
C	D	D	C	C	E	-	C	D	D	D	C	B	
D					E					D			
WEST	NORTH	SOUTH	EAST	WEST	NORTH	SOUTH	EAST	WEST	NORTH	SOUTH	EAST	WEST	
Mixed Traffic	Curb Bike Lane, Cycletrack or MUP	Curb Bike Lane, Cycletrack or MUP	Mixed Traffic		Mixed Traffic		Mixed Traffic			Mixed Traffic		Mixed Traffic	
≤ 50 m	Not Applicable	Not Applicable	≤ 50 m		≤ 50 m		≤ 50 m			≤ 50 m		≤ 50 m	
≤ 25 km/h	Not Applicable	Not Applicable	≤ 25 km/h		≤ 25 km/h		≤ 25 km/h			≤ 25 km/h		≤ 25 km/h	
D	Not Applicable	Not Applicable	D	-	D	-	D	-	-	D	-	D	
Mixed Traffic	Separated	Separated	Mixed Traffic	-	Mixed Traffic	-	Mixed Traffic	-	-	Mixed Traffic	-	Mixed Traffic	
		No lane crossed	One lane crossed			One lane crossed	One lane crossed			One lane crossed		One lane crossed	
		≤ 40 km/h	> 50 to < 60 km/h			> 50 to < 60 km/h	> 50 to < 60 km/h			> 40 to ≤ 50 km/h		> 50 to < 60 km/h	
-	-	B	E	-	-	E	E	-	-	D	-	E	
-	-	B	E	-	-	-	E	-	-	-	-	E	
E					E					E			
≤ 30 sec													
D	-	-	-	-	-	-	-	-	-	-	-	-	
	< 10 m				> 15 m		< 10 m			10 - 15 m		< 10 m	
	≥ 2				≥ 2		≥ 2			≥ 2		≥ 2	
-	D	-	-	-	A	-	D	-	-	B	-	D	
D					D					D			

Catherine/Percy (Future)			Catherine/Bronson (Future)				Bank/Isabella/Chamberlain (Future)			
SOUTH	EAST	WEST	NORTH	SOUTH	EAST	WEST	NORTH	SOUTH	EAST	WEST
3	3	3	6		4	4	4	5	3	3
No Median - 2.4 m	No Median - 2.4 m	No Median - 2.4 m	No Median - 2.4 m		No Median - 2.4 m	No Median - 2.4 m	No Median - 2.4 m	No Median - 2.4 m	No Median - 2.4 m	No Median - 2.4 m
Permissive	No left turn / Prohib.	No left turn / Prohib.	No left turn / Prohib.		No left turn / Prohib.	Protected/ Permissive	Permissive	No left turn / Prohib.	Protected/ Permissive	No left turn / Prohib.
No right turn	No right turn	Protected	Permissive or yield control		No right turn	Permissive or yield control	No right turn	Protected	Permissive or yield control	No right turn
RTOR prohibited	RTOR prohibited	RTOR prohibited	RTOR allowed		RTOR allowed	RTOR prohibited	RTOR prohibited	RTOR prohibited	RTOR prohibited	RTOR allowed
No	No	Yes	No		No	No	No	No	No	No
No Right Turn	No Right Turn	No Right Turn	No Channel		No Channel	No Right Turn	No Right Turn	No Channel	No Right Turn	Smart Channel
No Right Turn	No Right Turn	No Right Turn	10-15m		5-10m	No Right Turn	No Right Turn	10-15m	No Right Turn	10-15m
Std transverse markings	Std transverse markings	Zebra stripe hi-vis markings	Zebra stripe hi-vis markings		Zebra stripe hi-vis markings	Zebra stripe hi-vis markings	Zebra stripe hi-vis markings	Zebra stripe hi-vis markings	Zebra stripe hi-vis markings	Zebra stripe hi-vis markings
88	96	101	31		70	69	74	56	86	92
B	A	A	E	-	C	C	C	D	B	A
90	90	90	100		100	100	75	75	75	75
8	22	22	12		50	16	12	12	14	28
37	26	26	39		13	35	26	26	25	15
D	C	C	D	-	B	D	C	C	C	B
D	C	C	E	-	C	D	C	D	C	B
D			E				D			
SOUTH	EAST	WEST	NORTH	SOUTH	EAST	WEST	NORTH	SOUTH	EAST	WEST
Curb Bike Lane, Cycletrack or MUP	Mixed Traffic							Curb Bike Lane, Cycletrack or MUP	Curb Bike Lane, Cycletrack or MUP	Curb Bike Lane, Cycletrack or MUP
Not Applicable	> 50 m							Not Applicable	Not Applicable	Not Applicable
Not Applicable	≤ 25 km/h							Not Applicable	Not Applicable	Not Applicable
Not Applicable	F	-	-	-	-	-	-	Not Applicable	Not Applicable	Not Applicable
Separated	Mixed Traffic	-	-	-	-	-	-	Separated	Separated	Separated
No lane crossed	One lane crossed						One lane crossed	2-stage, LT box		1 lane crossed
≤ 40 km/h	> 50 to < 60 km/h						> 40 to ≤ 50 km/h	> 40 to ≤ 50 km/h		> 50 to < 60 km/h
B	E	-	-	-	-	-	D	A	-	D
B	F	-	-	-	-	-	-	A	-	D
F			-				D			
	≤ 20 sec		> 40 sec	≤ 20 sec	> 40 sec		≤ 20 sec	≤ 20 sec		≤ 40 sec
-	C	-	F	C	F	-	C	C	-	E
C			F				E			
								10 - 15 m		10 - 15 m
								≥ 2		≥ 2
-	-	-	-	-	-	-	-	B	-	B
-			-				B			