

UNIVERSITY OF OTTAWA / PCL CONSTRUCTION

ADVANCED MEDICAL RESEARCH CENTRE (AMRC) TRANSPORTATION IMPACT ASSESSMENT FINAL REPORT

APRIL 18, 2024





ADVANCED MEDICAL
RESEARCH CENTRE
(AMRC)
TRANSPORTATION
IMPACT ASSESSMENT
FINAL REPORT

UNIVERSITY OF OTTAWA / PCL
CONSTRUCTION

PROJECT NO.: CA0009956.0165
DATE: APRIL 18, 2024

WSP
SUITE 300
2611 QUEENSVIEW DRIVE
OTTAWA, ON, CANADA K2B 8K2

T: +1 613 829-2800
F: +1 613 829-8299
WSP.COM



Certification Form for Transportation Impact Assessment (TIA) Study

TIA Reports

Individuals submitting TIA reports will be responsible for all aspects of development-related transportation assessment and reporting, and undertaking such work, in accordance and compliance with the City of Ottawa’s Official Plan, the Transportation Master Plan and the Transportation Impact Assessment (2017) Guidelines and 2023 amendments.

Please note that the Certification is only required for the submission of a TIA. The Screening can be undertaken by a non-certified individual for the purpose of identifying if a TIA is needed or not.

By submitting the attached TIA report (and any associated documents) and signing this document, the individual acknowledges that they meet the four criteria listed below.

CERTIFICATION



I have reviewed and have a sound understanding of the objectives, needs and requirements of the City of Ottawa’s Official Plan, Transportation Master Plan and the Transportation Impact Assessment (2017) Guidelines; (Update effective July 2023)



I have a sound knowledge of industry standard practice with respect to the preparation of transportation impact assessment reports, including multi modal level of service review;



I have substantial experience (more than 5 years) in undertaking and delivering transportation impact studies (analysis, reporting and geometric design) with strong background knowledge in transportation planning, engineering or traffic operations; and



I am either a licensed or registered¹ professional in good standing, whose field of expertise



is either transportation engineering



or transportation planning.

¹ License of registration body that oversees the profession is required to have a code of conduct and ethics guidelines that will ensure appropriate conduct and representation for transportation planning and/or transportation engineering works.

Dated at London, ON this 19 day of April, 20 24.
(City)

Name : Kari Fellows, P.Eng., PTOE, RSP1

Professional title: Principal Transportation Engineer

Signature of individual certifier that they meet the above four criteria

Office Contact Information (Please Print)
Address: <u>201 King Street, 4th Floor</u>
City / Postal Code: <u>London, ON N6A 1C9</u>
Telephone / Extension: <u>1-519-476-8507</u>
Email Address: <u>kari.fellows@wsp.com</u>

Stamp

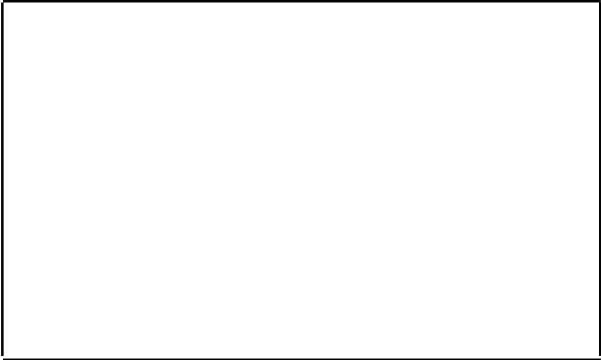



TABLE OF CONTENTS

1	SCREENING	1
2	SCOPING	2
2.1	Description of Proposed Development.....	2
2.2	Existing Conditions	3
2.2.1	Roadways	3
2.2.2	Intersections	4
2.2.3	Driveways.....	11
2.2.4	Pedestrian and Cycling Facilities	11
2.2.5	Transit Facilities.....	12
2.2.6	Area Traffic Management Measures	14
2.2.7	Peak Hour Travel Demands	15
2.2.8	Collision History.....	20
2.3	Planned Conditions	23
2.3.1	Changes to the Study Area Transportation Network.....	23
2.3.2	Other Study Area Developments.....	24
2.4	Study Area and Time Period	25
2.5	Horizon Years	25
2.6	Exemptions Review	25
2.7	Development-Generated Traffic	27
2.7.1	Trip Generation.....	27
2.7.2	Trip Distribution	31
2.7.3	Trip Assignment.....	32
3	STRATEGY	34
3.1	Background Network Traffic	34
3.1.1	Changes to the Background Transportation Network	34
3.1.2	General Background Growth Rates.....	34
3.1.3	Other Area Developments	34
3.2	Demand Rationalization	37
3.2.1	Description of Capacity Issues.....	37
3.2.2	Adjustment to Development Generated demands.....	37
3.2.3	Adjustments to Background Network Demands	37



3.3	Development Design	40
3.3.1	Design for Sustainable Modes	40
3.3.2	Circulation and Site Access	40
3.4	Parking	42
3.4.1	Parking Supply	42
3.5	Boundary Streets	46
3.5.1	Mobility	46
3.5.2	Road Safety	47
3.6	Transportation Demand Management	48
3.6.1	Context for TDM	48
3.6.2	Need and Opportunity	48
3.6.3	TDM Program	48
3.7	Transit	49
3.7.1	Transit Priority	49
3.8	Intersection Design	49
3.8.1	Design of Access	49
3.8.2	Intersection Control	50
3.8.3	Intersection Design	51
3.9	Summary of Improvements Indicated and Modification Options	62

TABLES

TABLE 1-1: TRANSPORTATION IMPACT ASSESSMENT (TIA) SCREENING TRIGGERS.....	1
TABLE 2-1: DESCRIPTION OF STUDY AREA INTERSECTIONS.....	4
TABLE 2-2: PEAK HOUR TRIPS BY TRAVEL MODE – ALTA VISTA DISTRICT	15
TABLE 2-3: OTTAWA HOSPITAL GENERAL CAMPUS EXISTING MODE SHARES.....	16
TABLE 2-4: TRAFFIC COUNT DATA	17
TABLE 2-5: HISTORICAL COLLISIONS FROM CITY OF OTTAWA DETAILED RECORDS 2017-2021 BY LOCATION.....	20
TABLE 2-6: EXEMPTIONS SUMMARY.....	25
TABLE 2-7: PROPOSED DEVELOPMENT- GENERATED VEHICLE TRIPS	28
TABLE 2-8: PROPOSED DEVELOPMENT- GENERATED PERSON TRIPS	28
TABLE 2-9: EXISTING MODE SHARE.....	29
TABLE 2-10: FUTURE MODE SHARE TARGETS FOR THE PROPOSED DEVELOPMENT.	30
TABLE 2-11: DEVELOPMENT TRIPS BY MODE AND PHASE	31
TABLE 2-12: INBOUND AND OUTBOUND TRIP DISTRIBUTION	31
TABLE 2-13: INBOUND AND OUTBOUND TRIP ASSIGNMENT	32
TABLE 3-1: SWEEP PATH ASSESSMENT	41
TABLE 3-2: MINIMUM ZONING BY-LAW REQUIREMENTS FOR VEHICLE PARKING AND PROPOSED DEVELOPMENT PARKING SUPPLY	44
TABLE 3-3: MINIMUM ZONING BY-LAW REQUIREMENTS FOR BICYCLE PARKING AND PROPOSED DEVELOPMENT PARKING SUPPLY	45
TABLE 3-4: SEGMENT MMLOS ALONG HOSPITAL LINK ROAD / RING ROAD BETWEEN ALTA VISTA DRIVE AND UOTTAWA/REHAB E ACCESS.....	47
TABLE 3-5: MODE SHARE COMPARISON	48
TABLE 3-6: ACCESS INTERSECTION DESIGN ELEMENTS.....	50

TABLE 3-7: OTM BOOK 12 SIGNAL WARRANT JUSTIFICATION 7 - PROPOSED DEVELOPMENT ACCESS	51
TABLE 3-8: SUMMARY OF INTERSECTION MULTI- MODAL LEVEL OF SERVICE (MMLOS) ANALYSIS – SIGNALIZED INTERSECTIONS.....	52
TABLE 3-9: CITY OF OTTAWA MMLOS GUIDELINES, LOS CRITERIA – SIGNALIZED INTERSECTIONS.....	54
TABLE 3-10: HIGHWAY CAPACITY MANUAL 2010, LOS CRITERIA – ALL-WAY STOP CONTROL OR TWO-WAY STOP CONTROL INTERSECTIONS.....	54
TABLE 3-11: SUMMARY OF TRAFFIC OPERATIONS ANALYSIS – 2023 EXISTING CONDITIONS.....	55
TABLE 3-12: SUMMARY OF TRAFFIC OPERATIONS ANALYSIS – 2026 / 2031 FUTURE BACKGROUND.....	57
TABLE 3-13: SUMMARY OF TRAFFIC OPERATIONS ANALYSIS – 2026 / 2031 FUTURE TOTAL.....	59

FIGURES

FIGURE 2-1: STUDY AREA CONTEXT	2
FIGURE 2-2: STUDY AREA EXISTING PEDESTRIAN AND CYCLING INFRASTRUCTURE (SOURCE: GEOOTTAWA).....	12
FIGURE 2-3: STUDY AREA OC TRANSPOR BUS ROUTES (SOURCE: OC TRANSPOR NETWORK MAP)	13
FIGURE 2-4: STUDY AREA OC TRANSPOR BUS STOPS (SOURCE: OC TRANSPOR). ..	14
FIGURE 2-5: EXISTING (2023) PEAK HOUR VEHICULAR VOLUMES.....	18
FIGURE 2-6: EXISTING (2023) PEAK HOUR PEDESTRIAN AND CYCLIST VOLUMES.....	19
FIGURE 2-7: ALTA VISTA TRANSPORTATION CORRIDOR (EXCERPT FROM CITY OF OTTAWA OFFICIAL PLAN SCHEDULE C-4)	23
FIGURE 2-8: DEVELOPMENT-GENERATED AUTO TRIPS	33

FIGURE 3-1: 2026 BACKGROUND TRAFFIC VOLUMES.....	35
FIGURE 3-2: 2031 BACKGROUND TRAFFIC VOLUMES.....	36
FIGURE 3-3: 2026 TOTAL TRAFFIC VOLUMES.....	38
FIGURE 3-4: 2031 TOTAL TRAFFIC VOLUMES.....	39

APPENDICES

- A** SCREENING FORM
- B** SITE PLAN
- C** TRANS O-D SURVEY
- D** TRAFFIC COUNTS
- E** COLLISION RECORDS
- F** RELATED TIA EXCERPTS
- G** TDM CHECKLISTS
- H** AUTOTURN SWEPT PATHS
- I** MMLOS SHEETS
- J** SYNCHRO RESULTS

1 SCREENING

This Transportation Impact Assessment (TIA) has been prepared to support the Site Plan Control and Minor Zoning Bylaw Amendment application for the development to be located in the existing parking lot of the uOttawa Roger Guindon Hall immediately south of Ring Road in The Ottawa Hospital General Campus at 451 Smyth Road. The TIA follows the City of Ottawa (the City) TIA Guidelines (2017). Revisions to the TIA Guidelines (May 2023) have been made to comply with Bill 109 and the update has been effective as of June 14, 2023. The updated TIA process includes four steps:

- 1 Screening
- 2 Scoping
- 3 Analysis
- 4 TIA Submission

The Screening Step determines the need to continue with a Transportation Impact Assessment (TIA) Study. The development is assessed against three triggers: trip generation, location, and safety to identify the next step of the study. If one or more of the triggers is satisfied, the Scoping Step must be completed. If none of the triggers are satisfied, the TIA is deemed complete. If one or more triggers are satisfied, specific TIA components are required to be carried out depending on the combination of triggers (**Table 1-1**) that have been satisfied.

The proposed development at 451 Smyth Road **satisfies the Trip Generation and Location triggers** indicating that, as part of Steps Two through Four of the TIA process, the Design Review and Network Impact components should be completed. For reference, the completed Screening Form is provided in **Appendix A**.

Table 1-1: Transportation Impact Assessment (TIA) Screening Triggers

Next Step of the TIA Process	TIA TRIGGERS SATISFIED		
	Trip Generation	Location	Safety
<i>Design Review and Network Impact</i>	Yes	Yes	No

2 SCOPING

2.1 DESCRIPTION OF PROPOSED DEVELOPMENT

The University of Ottawa is proposing to develop the Advanced Medical Research Centre (AMRC), a six-storey medical research facility within the Ottawa Health Science Complex (OHSC) at 451 Smyth Road (referred to herein as ‘site’ or ‘proposed development’). The proposed building will have a gross floor area (GFA) of approximately 13,726.17 m² (147,747.26 ft²) and a proposed building envelope of approximately 5,839.45 m² (62,855.32 ft²).

The proposed AMRC building has been designed to be LEED Gold certified and will be equipped with the building systems necessary to support intensive wet lab requirements. The 6-storey building is proposed as follows:

- First storey (i.e., ground floor) will contain Animal Care and Veterinary Services (ACVS); and
- The second to sixth storeys will contain space for the Innovation Hub and Labs, including open collaboration spaces, and mechanical penthouse.

The proposed AMRC has been designed to have holistic integration with the surrounding OHSC Campus. The new AMRC building will have several connections to the existing Roger Guindon Hall (RGN), which is located southeast of the proposed building. These include: a service connection on the ground floor, a pedestrian link on the second storey.

The site is currently zoned as Major Institutional Zone, Urban Exception 402, Floor Space Index 1.5, Schedule 144 (I2[402] F(1.5) S144) based on the City of Ottawa’s Zoning By-law No. 2008-250 (Consolidation September 8, 2021). A Minor Zoning By-law Amendment application will be submitted to request relief from various zoning requirements. A Site Plan Control application will also be permitted to facilitate the proposed development.

As a result of the proposed building construction, the existing surface parking lot containing 361 parking spaces (OHSC Parking Lot 13) would be demolished. The site property will include the provision of 126 new parking spaces, including 120 visitor/staff spaces and 6 accessible spaces. There will be one new vehicle access point on Ring Road and the existing access to the OHSC from Smyth Road and Ring Road will be maintained.

The proposed development is anticipated to be completed in a single phase, with the expected build-out year of 2026. The proposed site plan (dated April 18th, 2024) by Parkin Architects Limited is provided in **Appendix B** and **Figure 2-1** illustrates the study area context, including road network and roadway classifications near the proposed development.

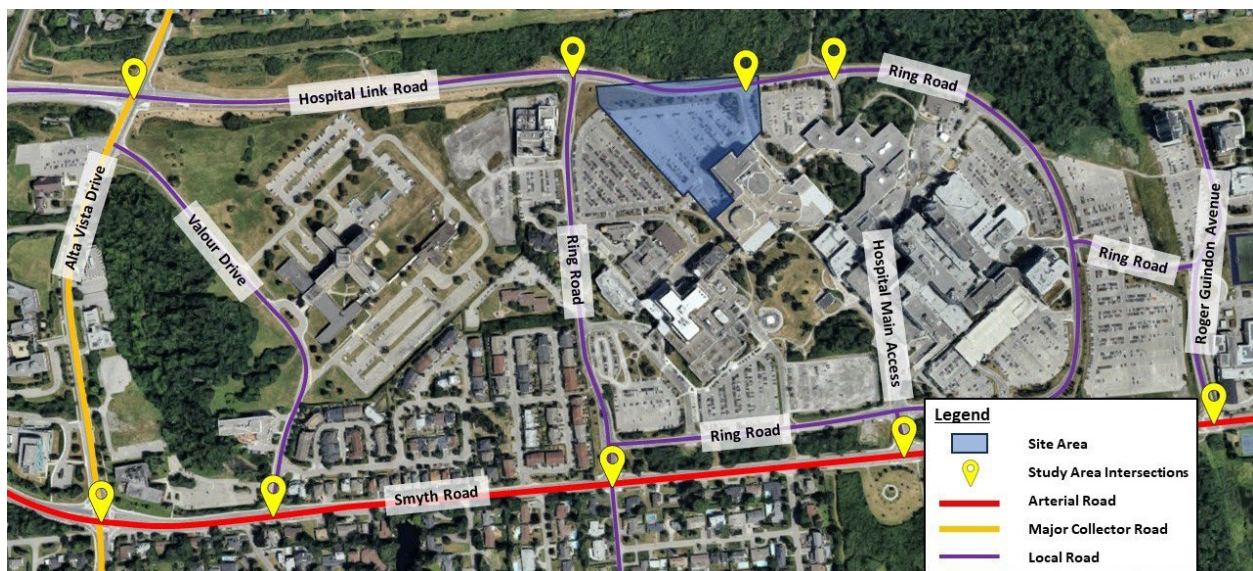

Figure 2-1: Study Area Context

2.2 EXISTING CONDITIONS

2.2.1 ROADWAYS

This TIA will consider the impacts on five (5) existing roadways: Smyth Road, Alta Vista Drive, Hospital Link Road, Ring Road, and Roger Guindon Avenue. Descriptions of the existing road classification, geometry, and operational constraints are noted below.

Smyth Road is a City of Ottawa Arterial Road that runs on a generally east-west alignment. Smyth Road in the vicinity of the proposed development has a posted speed limit of 50 km/h and is configured with two travel lanes in each direction. Per the previous Official Plan, Smyth Road has historically had a protected right of way of 30 m. On-street parking is prohibited along both sides of Smyth Road and the corridor is designated as a full load truck route. Smyth Road includes continuous sidewalks along both sides of the road and no existing cycling facilities east of Alta Vista Drive.

Alta Vista Drive is a City of Ottawa Major Collector Road that runs on a generally north-south alignment. Alta Vista Drive in the vicinity of the proposed development has a posted speed limit of 50 km/h and is configured with one travel lane in each direction. The right-of-way within the study area is 30 m. Alta Vista Drive is not included in the City of Ottawa truck route network; north-south access for trucks is provided on Riverside Drive to the west. Alta Vista Drive includes sidewalks on both sides of the road and painted bike lanes in each direction. On-street parking is prohibited on Alta Vista Drive through the study area.

Hospital Link Road is a City of Ottawa Local Road that begins at Riverside Drive opposite Hincks Lane, travelling south a short distance before diverting to the east, crossing over Riverside Drive, OC Transpo's southeast Transitway and the O-Train corridor, crossing Alta Vista Drive at an at-grade signalized intersection and continuing east to Ring Road. Hospital Link Road is the first constructed segment of the planned Alta Vista Transportation Corridor (AVTC) which is proposed to eventually connect south to Walkley Road and Conroy Avenue. In the future, Hospital Link Road will be classified as an Arterial roadway. Hospital Link Road is configured with a single lane in each direction and a posted speed limit of 50 km/h. Through the study area, Hospital Link Road includes a multi-use pathway (MUP) along the south side from the Transitway to Ring Road. On-street parking is not permitted on Hospital Link Road.

Ring Road is a Private Local Road that travels along the perimeter of The Ottawa Hospital General Campus. It is configured with a single lane of traffic in each direction and a posted speed limit of 40 km/h. Ring Road includes a number of two-way and all-way stop controlled intersections at parking garage accesses serving facilities on the General Hospital Campus. Pedestrians and cyclists are accommodated on a MUP running parallel to Ring Road on the north and east side of the campus and a sidewalk provides pedestrian accommodation on the west side of the campus. Isolated sidewalk segments are provided on the portion of Ring Road on the south side of the campus, generally to facilitate connections to and from the sidewalk along Smyth Road. Ring Road acts as the fire route for The Ottawa Hospital General Campus, and thus on-street parking on Ring Road is not permitted.

Roger Guindon Avenue is a City of Ottawa Local Road that runs on a north-south alignment. Roger Guindon Avenue has no posted speed limit and is configured with one travel lane in each direction. On-street parking is prohibited on the east side of Roger Guindon Avenue and 2-hour parking is available on the west side of Roger Guindon Avenue from 7 a.m. to 7 p.m. on weekdays. Roger Guindon Avenue includes continuous sidewalks on the east side of the road and a MUP on the west side of the road between Smyth Road and Ring Road.

Road classifications for City of Ottawa roadways are defined in Schedule C16 – Road Classification and Rights-of-Way Protection as part of the City of Ottawa's New Official Plan.

2.2.2 INTERSECTIONS



In accordance with the City of Ottawa TIA Guidelines (2017) and based on correspondence with the City of Ottawa, this TIA will consider nine (9) intersections within 600m of the proposed development that are on walking and cycling access routes, and arterial intersections impacted by auto demands from the proposed development (typically within 400m in urban conditions), as identified and described in **Table 2-1**.

Table 2-1: Description of Study Area Intersections

INTERSECTION DESCRIPTION	LANE CONFIGURATION
<p>Alta Vista Drive / Hospital Link Road is a signalized intersection.</p> <ul style="list-style-type: none"> — North Approach: One shared through/right turn lane and one left turn lane for authorized vehicles only. — East Approach: One left turn lane, one through lane, and one shared through/right turn lane. The through/right turn lane is a dedicated bus lane and right turns are only permitted for authorized vehicles. — West Approach: One shared left turn/through lane and one channelized right turn lane. Left turns are only permitted for authorized vehicles. — South Approach: One left turn lane and one shared through/right turn lane. — Pedestrian/Bicycle: <ul style="list-style-type: none"> - Bike lanes are provided on both sides of the road for the north and south approaches and a bi-directional multi-use pathway is provided on the south side of the roadway for the east and west approaches. The multi-use pathway is separated from the roadway with a grass boulevard east of Alta Vista Drive. - Curbside concrete sidewalks are provided on both sides of the road for the north and south approaches, as well as the north side of the road for the west approach. - Crosswalks are provided at all approaches and there is a crossride across the south approach. 	

INTERSECTION DESCRIPTION	LANE CONFIGURATION
<p>Smyth Road / Alta Vista Drive is a signalized intersection.</p> <ul style="list-style-type: none"> — North Approach: One left turn lane, one through lane, and one channelized right turn lane. — East Approach: One left turn lane, two through lanes, and one channelized right turn lane. — West Approach: One left turn lane, two through lanes, and one channelized right turn lane. — South Approach: One left turn lane, one through lane, and one channelized right turn lane. — Pedestrian/Bicycle: <ul style="list-style-type: none"> - Bike lanes are provided on both sides of the road for the north and south approaches. - Curbside concrete sidewalks are provided on both sides of the road for the west and south approaches. The east approach has a curbside concrete sidewalk on the north side of the road and a curbside asphalt sidewalk on the south side of the road. The north approach has a curbside concrete sidewalk on the west side of the road and a concrete sidewalk separated by a grass boulevard on the east side of the road. - Zebra-striped crosswalks are provided at all approaches. 	

INTERSECTION DESCRIPTION	LANE CONFIGURATION
<p>Smyth Road / Valour Drive is a signalized T-intersection.</p> <ul style="list-style-type: none"> — North Approach: One left turn lane and one right turn lane. — East Approach: One through lane and one shared through/right turn lane. — West Approach: One left turn lane and two through lanes. — Pedestrian/Bicycle: <ul style="list-style-type: none"> - Curbside concrete sidewalks are provided on both sides of the road for the north approach. The east and west approaches have a curbside concrete sidewalk on the north side of the road and a curbside asphalt sidewalk on the south side of the road. - Crosswalks are provided at all approaches. 	

INTERSECTION DESCRIPTION	LANE CONFIGURATION
<p>Smyth Road / Ring Road-South Haven Place is a signalized intersection.</p> <ul style="list-style-type: none"> — North Approach: One left turn lane and one right turn lane. Through movements are only permitted for bicycles. — East Approach: One shared left turn/through lane and one shared through/right turn lane. — West Approach: One shared left turn/through lane and one shared through/right turn lane. — South Approach: One shared left/right turn lane. Through movements are only permitted for bicycles. — Pedestrian/Bicycle: <ul style="list-style-type: none"> - The north approach has a curbside asphalt sidewalk on the east side of the road. The east approach has a curbside asphalt sidewalk on the north side of the road and an asphalt sidewalk separated by a grass boulevard on the south side of the road. The west approach has an asphalt sidewalk separated by a grass boulevard on the south side of the road and a curbside asphalt sidewalk on the south side of the road. - Crosswalks are provided at all approaches. 	
<p>Smyth Road / Hospital Main Access is a signalized T-intersection.</p> <ul style="list-style-type: none"> — North Approach: Two left turn lanes and one right turn lane. — East Approach: Two through lanes and one right turn lane. — West Approach: One left turn lane and two through lanes. — Pedestrian/Bicycle: <ul style="list-style-type: none"> - All approaches have a curbside asphalt sidewalk on both sides of the road. - Crosswalks are provided at all approaches. 	

INTERSECTION DESCRIPTION	LANE CONFIGURATION
<p>Smyth Road / Roger Guindon Avenue is a signalized T-intersection.</p> <ul style="list-style-type: none"> — North Approach: One left turn lane and one right turn lane. — East Approach: One through lane and one shared through/right turn lane. — West Approach: One left turn lane and two through lanes. — Pedestrian/Bicycle: <ul style="list-style-type: none"> - A bi-directional multi-use pathway is provided on the west side of the roadway for the north approach and is separated from the roadway by a concrete boulevard. - The north approach has a curbside concrete sidewalk on the east side of the road. The east approach has an asphalt sidewalk separated by a grass boulevard on both sides of the road. The west approach has a curbside concrete sidewalk on the north side of the road and an asphalt sidewalk separated by a grass boulevard on the south side of the road. - Zebra-striped crosswalks are provided at all approaches. 	

INTERSECTION DESCRIPTION	LANE CONFIGURATION
<p>Ring Road / Hospital Link Road is an unsignalized T-intersection with all-way stop control. Note that Ring Road is a private road.</p> <ul style="list-style-type: none"> — East Approach: One shared left turn/through lane. — West Approach: One shared through/right turn lane. — South Approach: One shared left/right turn lane. — Pedestrian/Bicycle: <ul style="list-style-type: none"> - A curbside bi-directional multi-use pathway is provided on the north side of the roadway for the east approach and on the south side of the roadway for the west approach, which is separated from the roadway by a grass boulevard. - The east approach has an asphalt sidewalk separated by a grass boulevard on the south side of the road. The south approach has a curbside asphalt sidewalk on the east side of the road. - Crosswalks are provided at all approaches and a crossride is provided at the west approach. 	

INTERSECTION DESCRIPTION

Ring Road / uOttawa-Rehab W Access is an unsignalized T-intersection with free-flow conditions for the east and west approaches, except in the presence of crossing pedestrians, and stop-control for the south approach. Note that these roadways are private roads.

- **East Approach:** One shared left turn/through lane.
- **West Approach:** One shared through/right turn lane.
- **South Approach:** One shared left/right turn lane.
- **Pedestrian/Bicycle:**
 - A bi-directional multi-use pathway is provided on the north side of the roadway for the east and west approaches and is separated from the roadway by a grass boulevard.
 - The west approach has a curbside asphalt sidewalk on the south side of the road. The south approach has a curbside asphalt sidewalk on the west side of the road.
 - A new Level 2, Type D PXO was installed at the west approach in mid 2023 to early 2024 based on July 2023 Google Street View and a site visit on March 30th, 2024.

LANE CONFIGURATION



INTERSECTION DESCRIPTION	LANE CONFIGURATION
<p>Ring Road / uOttawa-Rehab E Access is an unsignalized T-intersection with all-way stop control. Note that these roadways are private roads.</p> <ul style="list-style-type: none"> — East Approach: One through lane. Left turn movements are not permitted. — West Approach: One through lane. Right turn movements are not permitted. — South Approach: One shared left/right turn lane. Northbound traffic only (one-way). — Pedestrian/Bicycle: <ul style="list-style-type: none"> - A bi-directional multi-use pathway is provided on the north side of the roadway for the east and west approaches and is separated from the roadway by a grass boulevard. - The south approach has a curbside asphalt sidewalk on the east side of the road. - A zebra-striped crosswalk is provided at the east approach. 	

2.2.3 DRIVEWAYS

There is only one existing driveway or access point within a 200m radius of the proposed development site on the roads bordering the site (i.e., Ring Road and the uOttawa-Rehab west access). This access is the entrance and exit to The Ottawa Hospital General Campus' Lot 14, which is a gated parking lot for the Rehabilitation Centre. It is located on the east side of the uOttawa-Rehab west access roadway. The south end of the future lay-by / drop-off area by the main entrance of the proposed development will be situated directly across from the Lot 14 entrance and exit.

2.2.4 PEDESTRIAN AND CYCLING FACILITIES

The study area has a built-up and connected network of pedestrian and cycling infrastructure including on- and off-road cycling facilities, pedestrian sidewalks, and multi-use pathways. Adjacent to the proposed development, there is a bi-directional multi-use pathway on the south side of Hospital Link Road and on the north side of Ring Road that borders the north and east sides of the General Campus; this pathway is designated as part of the City of Ottawa's cross-town bikeway network. The multi-use pathway connects to other pathways that lead to residential areas north and south of the General Campus. Every study area roadway and intersection provide some level of pedestrian and cycling infrastructure and there are no gaps in facilities leading to the proposed development, which includes the provision of pedestrian crosswalks at most intersections and accesses. Smyth Road and Alta Vista Drive have sidewalks on both sides of the road, whereas Hospital Link Road and Ring Road mainly have pedestrian and cycling facilities on one side of the road only.

The existing pedestrian and cycling facilities providing connections to the proposed development are shown in **Figure 2-2**.



Figure 2-2: Study Area Existing Pedestrian and Cycling Infrastructure (Source: geoOttawa)

2.2.5 TRANSIT FACILITIES

OC Transpo Routes 44, 45, and 55 provide transit service within the study area as follows:

- **Route 44** is a Frequent route which provides service every 15 minutes or less on weekdays and operates seven days per week during all time periods. Route 44 travels in a predominantly north-south direction between Hurdman Station on the Confederation Line and Billings Bridge Shopping Centre, specifically along Alta Vista Drive in the study area.
- **Route 45** is a Rapid route which provides station-to-station bus service and operates seven days per week during all time periods. Service is provided every 15 minutes for most of the day on weekdays and every 30 minutes on weekends. Route 45 travels in a predominantly east-west direction between The Ottawa Hospital Rehabilitation Centre and Hurdman Station on the Confederation Line, specifically along Hospital Link Road and Ring Road in the study area. The route diverges from the Transitway to serve The Ottawa Hospital General Campus and provides direct access to the Smyth, Lycée Claudel, and Hurdman Transit Stations. Additionally, Route 45 provides limited overnight service such that its route will be extended to Rideau Station in Downtown Ottawa when the O-Train Line 1 is not running.
- **Route 55** is a Local route which provides custom routing to local destinations. Route 55 travels in a predominantly east-west direction between Elmvale Acres Shopping Centre and Westgate Shopping Centre, specifically along Smyth Road and Ring Road at the southwest corner of the General Campus in the study area. All-day service is provided every 15 minutes for most of the day on weekdays and every 30 minutes on weekends. Route 55 operates seven days per week.

Figure 2-3 highlights all OC Transpo bus routes on roadways near the proposed development. The proposed development is within 1 km of the southeast Transitway located to the west of the study area. In addition, OC Transpo provides service to high schools and middle schools on 600s series routes in which Routes 609 and 645 travel along Smyth Road within the study area. Route 45 provides access between The Ottawa Hospital General Campus and the Transitway, eliminating the need to walk between these locations.

The closest transit stops to the proposed development are OC Transpo Stops #1591 (Ring Road / Rehab (TOH)) and #7231 (Ring Road / Ronald McDonald House), as illustrated in **Figure 2-4**, which are located within 200m of the proposed building entrances. These stops are served by Route 45.



Figure 2-3: Study Area OC Transpo Bus Routes (Source: OC Transpo Network Map)



Figure 2-4: Study Area OC Transpo Bus Stops (Source: OC Transpo)

2.2.6 AREA TRAFFIC MANAGEMENT MEASURES

The proposed development is within a developed Outer Urban area with traffic management measures implemented. The existing area traffic management measures identified within the study area include:

- Smyth Road is designated as a community safety zone between 183m west of Roger Guindon Avenue and 43m east of Haig Drive; this community safety zone is in support of Vincent Massey Public School, Hillcrest High School and École Secondaire Catholique Franco-Cité, all located off Smyth Road to the east of the study area.
- Ring Road has a posted 40 km/h speed limit; this is communicated through pavement markings as well as signage.
- Ring Road includes a Level 2, Type D PXO at the intersection of Ring Road / uOttawa-Rehab W Access. This crossing provides a connection between the MUP on the north side of the road and the terminus of the asphalt sidewalk on the south side of the road.
- Hospital Link Road includes a Level 2, Type C PXO approximately 300m west of the intersection with Ring Road. This crossing provides a connection between the Hospital Link Road MUP and a path connecting northerly to Knox Crescent.

There are no additional traffic calming measures implemented or proposed on the boundary streets near the proposed AMRC.

2.2.7 PEAK HOUR TRAVEL DEMANDS

The TRANS Committee was established to co-ordinate transportation planning efforts among various planning agencies located within the National Capital Region. The proposed development is located in Alta Vista, corresponding to TRANS District 140. The most recent Origin-Destination (O-D) survey was completed by TRANS in the Fall of 2011 and provides a mode share for travel from, to, and within each district. The complete TRANS O-D results, including a map of the district area, is provided in **Appendix C** and the TRANS mode share for the Alta Vista District is summarized in **Table 2-2**. For this analysis, the mode share for trips to and from the Alta Vista District was taken as the existing mode share (i.e., from district during the AM peak period and to district during the PM peak period).

Table 2-2: Peak Hour Trips by Travel Mode – Alta Vista District

TRAVEL MODE	AM PEAK PERIOD (6:30 A.M. – 9:00 A.M.)			PM PEAK PERIOD (3:30 P.M. – 6:00 P.M.)		
	From District	To District	Within District	From District	To District	Within District
Auto-Driver	50%	62%	39%	64%	57%	49%
Auto-Passenger	12%	12%	15%	13%	15%	18%
Transit	30%	17%	10%	17%	23%	8%
Bicycle	3%	2%	2%	1%	2%	2%
Walk	1%	1%	20%	1%	1%	17%
Other	4%	7%	13%	4%	1%	6%

Source: 2011 TRANS O-D Survey Report, Alta Vista

Based on the district mode share, most trips during the AM and PM peak periods are auto driver trips. Walking and cycling trips represent a low proportion of trips to and from Alta Vista District, but it is noted that within the district walking trips have a mode share of 20% during the AM peak period and 17% during the PM peak period.

The Ottawa Hospital, in coordination with Steer and Parsons, undertook an employee commuter survey for employees at all Ottawa Hospital Campuses in 2022. The survey included the question of each employees' typical mode to travel to work, which was used to report mode shares at each of the hospital campuses. Survey results are summarized in the March 2023 Transportation Demand Management Strategy for The Ottawa Hospital – New Campus Development Report¹. Mode share results for the Ottawa Hospital General Campus from this report are summarized in **Table 2-3**.

¹ Accessed November 9, 2023 from

http://webcast.ottawa.ca/plan/All_Image%20Referencing_Site%20Plan%20Application_Image%20Reference_2023-04-17%20-%20Transportation%20Demand%20Management%20Strategy%20-%20D07-12-22-0168.PDF

Table 2-3: Ottawa Hospital General Campus Existing Mode Shares

MODE	MODE SHARE	MODE	MODE SHARE
Auto Driver	59%	Motorcycle	0%
Carpool (Drive or ride)	6%	Bicycle	9%
Taxi / Uber / Lyft	2%	Walk	5%
Transit	9%	Dropped off / picked up	4%
Care Share	0%	Work from home	6%

Excerpt from “Transportation Demand Management Strategy for The Ottawa Hospital-New Campus Development” Table 3.6. Parsons and Steer, March 2023.
http://webcast.ottawa.ca/plan/All_Image%20Referencing_Site%20Plan%20Application_Image%20Reference_2023-04-17%20-%20Transportation%20Demand%20Management%20Strategy%20-%20D07-12-22-0168.PDF

Overall, the survey results show an auto mode share of approximately 70% for staff considering auto driver, passenger, carpool and taxi / Uber / Lyft combined. Transit share for The Ottawa Hospital General Campus staff is 9%, which is lower than the Alta Vista District transit shares reported in the TRANS mode share surveys; this may be a result of the Hospital Campus’ further distance from the Transitway and O-Train service compared to other destinations in the Alta Vista District that are closer to these higher order transit facilities. The bicycle mode share is higher for staff than the district results at 9%, but the walk mode share is lower at 5%; this may reflect the availability of connecting cycling infrastructure.

The existing peak hour turning movement counts at the study area intersections are listed in **Table 2-4** and illustrated in **Figure 2-5**. The existing peak hour pedestrian and cyclist volumes are illustrated in **Figure 2-6**. It is noted that the traffic counts were captured during the Fall and Winter months such that pedestrian and cyclist volumes may be less than what is expected during warmer months. The full raw traffic counts are provided in **Appendix D**.

Table 2-4: Traffic Count Data

INTERSECTION	SOURCE	COUNT DATE
Alta Vista Drive / Hospital Link Road	City of Ottawa	Tuesday, January 8, 2019
Smyth Road / Alta Vista Drive	City of Ottawa	Wednesday, February 14, 2018
Smyth Road / Valour Drive	City of Ottawa	Tuesday, November 20, 2018
Smyth Road / Ring Road-South Haven Place ¹	City of Ottawa	Tuesday, October 4, 2022
Smyth Road / Hospital Main Access ¹	City of Ottawa	Wednesday, December 11, 2019
Smyth Road / Roger Guindon Avenue	City of Ottawa	Tuesday, January 8, 2019
Ring Road / Hospital Link Road	City of Ottawa	Thursday, February 20, 2020
Ring Road / uOttawa-Rehab W Access ²	WSP	Friday, November 3, 2023
Ring Road / uOttawa-Rehab E Access ²	WSP	Friday, November 3, 2023
¹ Traffic counts are from the Children’s Hospital of Eastern Ontario (CHEO) 1Door4Care Phase 1A – Parking Garage Traffic Impact Assessment (August 2023). ² Traffic counts captured and processed using Miovision Cameras.		

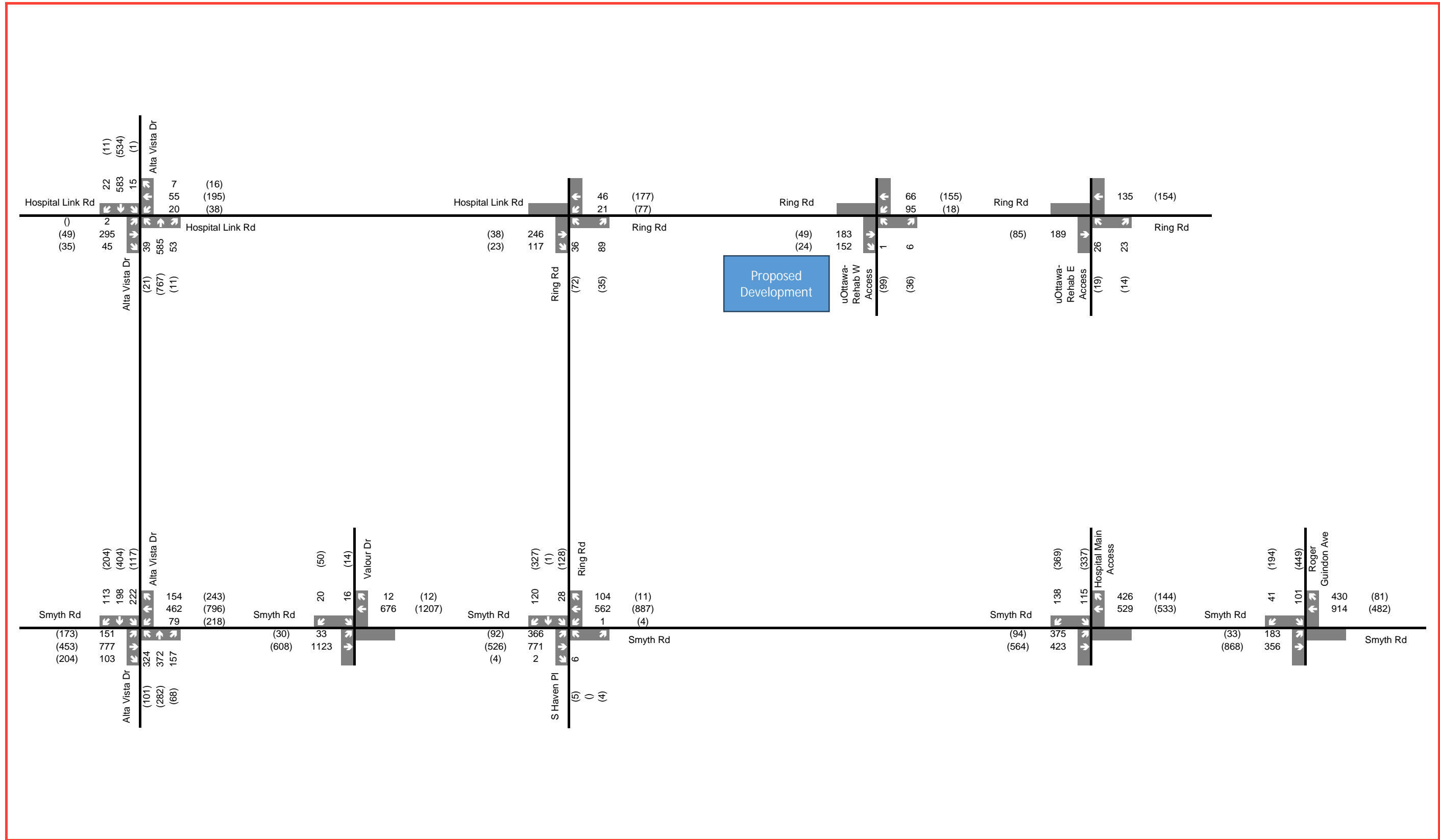

xx A.M. Peak Hour Traffic Volumes (xx) P.M. Peak Hour Traffic Volumes

Figure 2-5 Existing (2023) Peak Hour Vehicular Volumes

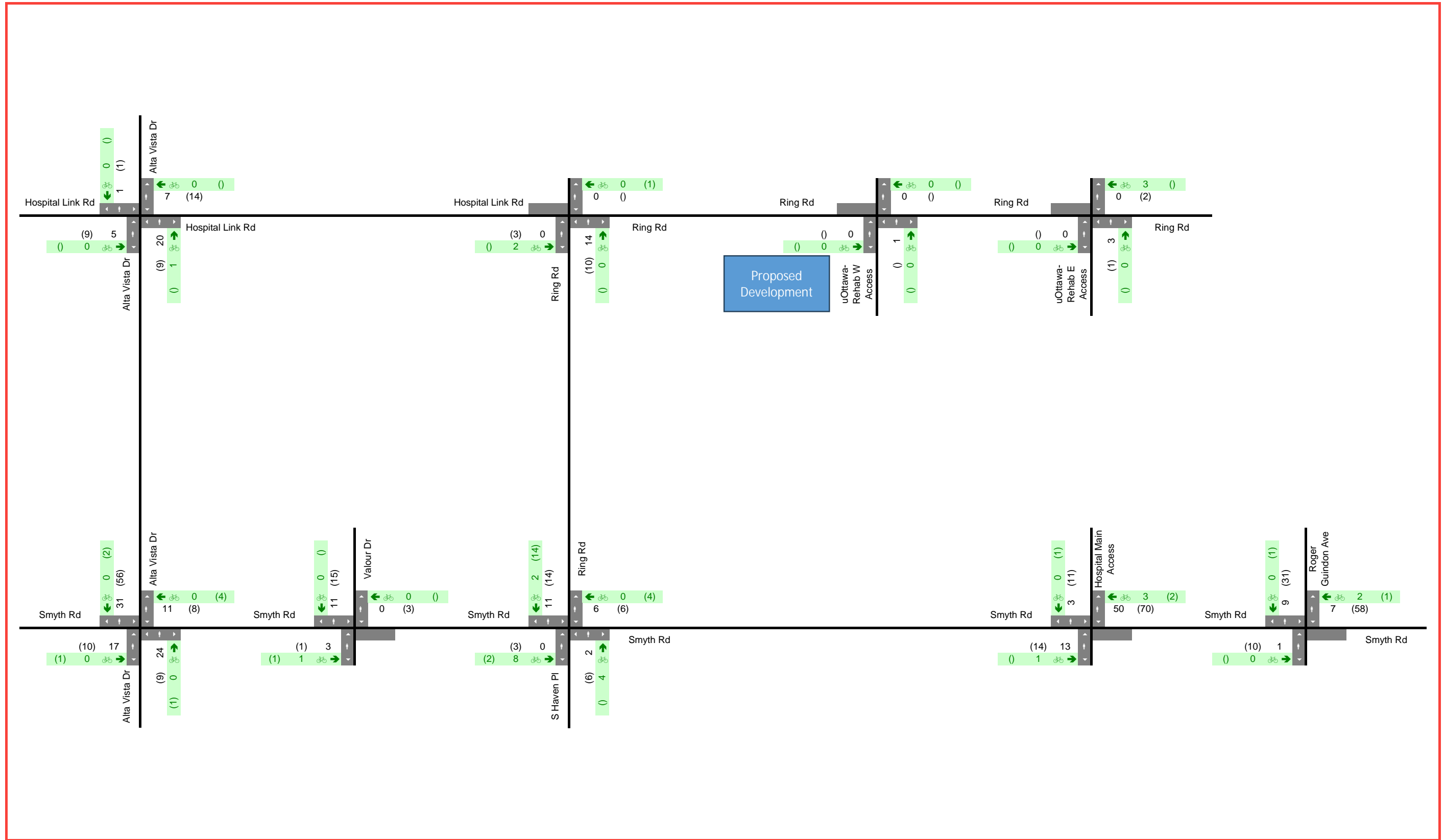

xx A.M. Peak Hour Volumes (xx) P.M. Peak Hour Volumes

Figure 2-6 Existing (2023) Peak Hour Pedestrian and Cyclist Volumes

2.2.8 COLLISION HISTORY

Two sources of collision data were considered in this study: collision summaries available through City of Ottawa Open Data for January 1, 2013 to December 31, 2020, as provided in **Appendix E-1**, and detailed collision records for January 1, 2017 to December 31, 2021 provided by City of Ottawa Staff and further described below.

It is noted that there are differences in total numbers of collisions between the information from Open Data and the detailed records provided by the City. Different periods for the data would contribute to this issue. It is assumed that the detailed records represent cleaned data and provide the complete data set.

2.2.8.1 CITY OF OTTAWA DETAILED COLLISION RECORDS – 2017 TO 2021

As requested by the City in comments on the Scoping Report, detailed collision records were obtained from the City for the most recent five year period available, 2017 to 2021, for Alta Vista Drive between Hospital Link Road and Smyth Road and Smyth Road between Alta Vista Drive and Roger Guindon Avenue.

Detailed collision records are provided in **Appendix E-2**.

These data were analysed to consider the following:

- Patterns for the high number of turning movement collisions at Alta Vista Drive and Smyth Road
- Patterns for the relatively high volume of angle collisions at the intersection of Lynda Lane and Smyth Road
- Number of collisions involving pedestrians and cyclists

-The City provided a detailed database including 79 collisions along Alta Vista Drive and 74 collisions along Smyth Road during this 5 year period. The locations and number of collisions during the five years are tabulated in **Table 2-5**.

Table 2-5: Historical Collisions from City of Ottawa Detailed Records 2017-2021 by Location

LOCATION	TOTAL NUMBER OF COLLISIONS	NUMBER OF COLLISIONS INVOLVING PEDESTRIANS	NUMBER OF COLLISIONS INVOLVING CYCLISTS
ALTA VISTA DR @ HOSPITAL LINK RD	2	0	0
ALTA VISTA DR @ SMYTH RD	66	1	0
ALTA VISTA DR @ VALOUR DR	5	0	0
ALTA VISTA DR btwn SMYTH RD & VALOUR RD	4	0	0
ALTA VISTA DR btwn VALOUR DR & BALFOUR AVE	2	0	0
BROADMOOR AVE @ SMYTH RD	1	0	0
FAIRBANKS AVE @ SMYTH RD	1	0	0
HIGHLAND TER @ SMYTH RD	2	0	0
LYNDA LANE @ SMYTH RD	15	0	0

LOCATION	TOTAL NUMBER OF COLLISIONS	NUMBER OF COLLISIONS INVOLVING PEDESTRIANS	NUMBER OF COLLISIONS INVOLVING CYCLISTS
ROGER GUIDON AVE @ SMYTH RD	8	0	0
SMYTH RD @ BARNHART PL	1	0	0
SMYTH RD @ GENERAL HOSPITAL E	17	0	0
SMYTH RD @ SOUTH HAVEN PL/GENERAL HOSPITAL ENTRANCE W	13	0	0
SMYTH RD btwn BARNHART PL & FREEDON PRIV	1	0	0
SMYTH RD btwn BROODMOOR AVE & SOUTH HAVEN PL	1	0	0
SMYTH RD btwn HIGHLAND TERR & RING RD/GENERAL HOSPITAL	3	0	0
SMYTH RD btwn LINDA LANE & ROGER GUIDON AVE	3	0	0
SMYTH RD btwn RING RD/GENERAL HOSPITAL & LYNDA LANE	1	0	0
SMYTH RD btwn VALOUR DR & BARNHART PL	3	0	0
VALOUR DR @ SMYTH RD	4	0	0

As the table indicates, there was 1 collision involving a pedestrian at the intersection of Alta Vista Drive and Smyth Road. The collision occurred at 7:56AM on a Thursday in November, in daylight and clear conditions and involved a southbound vehicle turning left. The collision resulted in personal injury.

To further evaluate collision patterns at the two identified intersections and other locations with more than six collisions during the five-year period, collision diagrams were prepared for the following five (5) intersections:

- Alta Vista Drive and Smyth Road
- Smyth Road and South Haven Place/General Hospital Entrance West Entrance
- Smyth Road and General Hospital East Entrance
- Lynda Lane and Smyth Road (unsignalized)
- Roger Guindon Avenue and Smyth Road

These collision diagrams are provided in **Appendix E-3**. Discussion of the findings from these diagrams follows.

Alta Vista Drive and Smyth Road had one pedestrian collision on the east leg, when a pedestrian was struck by a driver making a southbound left turn. There were recurrent left turn cross path collisions for all left turning movements at the intersection. The westbound left turn versus eastbound through pattern had the highest frequency, with 14 collisions over the 5 years. The eastbound left turn versus the westbound through had 10. There were six collisions between southbound left turns and northbound through movements and three collisions between northbound left turning and southbound through movements. Other collision patterns with more than one per year were eastbound rear end collisions, with eight in the 5 years and northbound rear end collisions.

There are actuated protected-permitted left turn phases for each approach which operate at all times except overnight. It is noted that all of the collisions in the data set for this intersection occurred during times when the left turn phases were callable.

Advance walk signals for pedestrians crossing Smyth Road could provide the benefit of pedestrians entering the crosswalk and moving to a more visible position before vehicle drivers get their green signal. This measure is particularly effective in reducing drivers turning right and striking pedestrians, but also has potential to reduce collisions between drivers turning left and pedestrians crossing with the right of way.

Potential countermeasures to address the left turn cross path and rear end collisions include modifications to traffic signal heads to make them more conspicuous to approaching drivers by upgrading from “Highway” heads to “Oversized Highway” heads that have 300 mm lenses for all displays, modifications to the intersection design to shift the alignment of the left turn lanes using features such as channelization islands between the through and left turn lanes to allow an unobstructed sight line to opposing through movements for drivers turning left, and changing the left turn phasing to protected only phasing. Traffic signal lens upgrades would preferably be applied to a whole corridor. Each of these countermeasures have impacts on City practices and programs or other movements at the intersection, therefore a more detailed examination of these alternatives and benefit-cost analysis would be beneficial.

Smyth Road and South Haven Place/General Hospital Entrance West had no collision patterns of more than one collision per year. The highest collision occurrence was the westbound left turn versus the eastbound through, which had 3 occurrences during the five-year period. There were also three eastbound rear end collisions. At this intersection, eastbound and westbound left turns are made from a shared lane and there is a fixed time eastbound protected-permitted left turn phase which is omitted overnight. All collisions considered in this analysis occurred during times when the left turn phase was operating.

Upgrading signal heads from “Highway” to “Oversized Highway” heads with 300 mm lenses for all displays would improve visibility of the displays and has potential to improve recognition of the displays and prevent these types of collisions. Construction of eastbound and westbound left turn lanes could provide improved sight distance between drivers turning left and the opposing vehicles they must judge gaps between and allow for the addition of a westbound left turn phase. Each of these countermeasures have impacts on City practices and programs or other movements at the intersection, therefore a more detailed examination of these alternatives and benefit-cost analysis would be beneficial.

Smyth Road and General Hospital Entrance East had 17 collisions during the five-year period. The most frequently occurring patterns were eastbound left turn versus westbound through movements and westbound rear end collisions, each with three collisions. There is a callable protected-permitted eastbound left-turn phase that operates between 6:15AM and 10:30PM. All but one of the collisions, a single motor vehicle collision, occurred during operation of the left turn phase.

Like the other intersections along Smyth Road in the study area, this intersection has “Highway” traffic signal heads with 300 mm red and left turn green arrow lenses and 200 mm lenses for yellow and all-red. Upgrading signal heads to “Oversized Highway” heads with 300 mm lenses for all displays would improve conspicuity of all displays and reduce the chance of a driver not seeing or interpreting the display correctly. Application of this upgrade for the full corridor would be preferable. Provision of an eastbound protected-only left turn phase would reduce or eliminate the left turn cross path collisions. Each of these countermeasures have impacts on City practices and programs or other movements at the intersection, therefore a more detailed examination of these alternatives and benefit-cost analysis would be beneficial.

Linda Lane and Smyth Road is an unsignalized T-intersection where there were 15 collisions during the five year period reviewed. Most occurred during weekday morning or afternoon peak periods. There were six right angle crashes, four of which involved an eastbound driver and a northbound driver, and two involving a westbound driver and a northbound driver. Of these six collisions, in five cases the northbound driver was turning left.

This intersection is close to the signalized intersection of Smyth Road and the Hospital East Entrance, with approximately 90 meters measured center line to center line between the intersections. Since the westbound right turn lane on Smyth Road at the Hospital East Entrance is approximately 175 meters long and extends well past Lynda Lane, this unsignalized intersection is effectively within the functional area of the intersection of Smyth Road and the Hospital East Entrance. All-movements are permitted at Smyth Road and Lynda Lane, and during peak periods,

queuing traffic, higher traffic volumes and buses stopping at the eastbound near side bus stop probably obstruct the sight distance available for northbound drivers turning from Lynda Lane onto Smyth Road. In addition, drivers making a northbound left turn movement may be weaving over this short distance to make a westbound right turn into the hospital entrance. There is on-street parking along Lynda Lane between Billings Avenue and Smyth Road, which is a significant generator of the traffic on this road.

The distance between the existing signalized intersection of Smyth Road and the Hospital East Entrance precludes installing a traffic signal at this intersection. The historical collision experience is below the level where the collision experience justification for installing a traffic signal (based on Ontario Traffic Manual (OTM) Book 12 for Traffic Signals) is met; the level to 100% satisfy the justification is 15 correctible collisions over three years, or five per year, and the historical data indicates less than two per year. Modification of this intersection to prevent northbound left turns from Lynda Lane onto Smyth Road by extending the median island on the east leg of Smyth Road at the Hospital East Entrance would significantly reduce this pattern. Extending the median further past Lynda Lane to the east to also block westbound left turns from Smyth Road onto Lynda Lane would reduce or eliminate collisions involving westbound left turning drivers. These measures would necessitate diversion of trips to other roads in the area, therefore evaluation of the impacts of these measures would be beneficial.

Roger Guidon Avenue and Smyth Road had nine collisions during the five-year period reviewed. There was sufficient information in the dataset to plot eight of these onto the collision diagram. There were three eastbound left turn versus westbound through collisions and two eastbound rear end collisions.

This intersection is signalized with an eastbound left turn lane and a callable eastbound protected-permitted left turn phase. The eastbound left turn phase is only operational during the following time periods: 6:30AM to 9:30AM and 3:45PM to 6:30PM. Two of the eastbound left turn versus westbound through movement collisions occurred during the time that the eastbound protected-permitted left turn phase is not operating. Expanding the time during which this phase is callable could prevent this collision pattern, provided the impact on other movements is acceptable. Similarly, to the other intersections discussed in the preceding text, upgrading the traffic signal heads to “Oversized Highway” heads with 300 mm lenses for all displays would improve the conspicuity of the displays and may reduce collision occurrence. Each of these countermeasures have impacts on City practices and programs or other movements at the intersection, therefore a more detailed examination of these alternatives and benefit-cost analysis would be beneficial.

2.3 PLANNED CONDITIONS

2.3.1 CHANGES TO THE STUDY AREA TRANSPORTATION NETWORK

The City of Ottawa Official Plan and Transportation Master Plan (TMP) (2013), were reviewed to identify potential future roadway upgrades in the vicinity of the proposed development site within the study horizon years, as listed below:

- The Alta Vista Transportation Corridor (AVTC), illustrated in **Figure 2-7**, is a proposed arterial roadway that is proposed to connect from Highway 417 at the Lees Avenue / Nicholas Street interchange south to Walkley Road opposite Conroy Road. The Environmental Assessment for the AVTC was prepared by Delcan (now Parsons) in 2005 and has been adopted into the Ottawa Official Plan and Transportation Master Plan future road network concepts since this point. Hospital Link Road from Riverside Drive to Ring Road represents the first completed segment of the AVTC which opened in 2019. The remainder of the AVTC was included in the City of Ottawa’s future network concept in the last Transportation Master Plan (2013) but was not included in the affordable network for

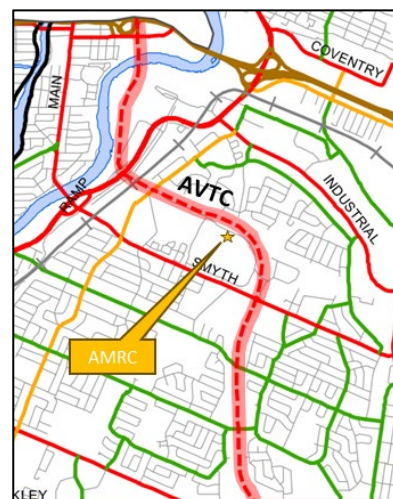

Figure 2-7: Alta Vista Transportation Corridor (Excerpt from City of Ottawa Official Plan Schedule C-4)

construction to 2031. As a result, there is currently no set timeline for the implementation of the rest of the AVTC. The Alta Vista Transportation Corridor includes the following Transit Priority and Road Projects:

- New four-lane road between Nicholas Street / Highway 417 interchange and Riverside Drive
 - Bus / high occupancy vehicle lanes and transit signal priority between Riverside Drive and the Ottawa Health Sciences Centre
 - Road widening between Riverside Drive and the Ottawa Health Sciences Centre (adjacent to the development)
 - Transit signal priority and queue jump lanes between the Ottawa Health Sciences Centre and Walkley Road
 - New four-lane road (including two peak-period bus lanes) between the Ottawa Health Sciences Centre and Walkley Road
- A Ten-Year Road Rehabilitation Plan for The Ottawa Hospital General Campus was prepared by Morrison Hershfield in 2022. This plan provides a review of current road, pavement and sidewalk conditions on The Ottawa Hospital General Campus and outlines a rehabilitation plan where improvements are required. Improvements in the vicinity of the AMRC includes roadway and sidewalk improvements along the Ottawa Rehabilitation Centre access road; sidewalk improvements have been designated as Priority A (2023-2026) and roadway improvements have been designated as Priority B (2023-2032). The plan includes only rehabilitation of existing roads and sidewalks and does not propose any new or modified facilities.

In addition, the parking garage for CHEO's 1Door4Care development further described in **Section 2.3.2** below, proposes an upgrade to the existing asphalt sidewalk on the north side of Ring Road fronting the site to a multi-use pathway (i.e., 3.0m+ width, painted centreline, etc.). This includes the provision of pedestrian crossings at vehicle accesses.

2.3.2 OTHER STUDY AREA DEVELOPMENTS

Two developments are noted in the City of Ottawa's Development Application Search tool that are likely to occur within the proposed horizon years of the subject development and could have direct influences on the study area are noted below:

- 401 Smyth Road (Application # D07-12-22-0170) includes the construction of a parking garage on The Ottawa Hospital General Campus in support of the proposed 1Door4Care facility to be constructed in the southwest corner of the General Campus. The parking garage will accommodate 1,083 spaces, replacing the existing lot E. The TIA prepared for the development indicates that no new trips will be generated by the parking facility alone, but instead new trips generated by the parking facility will consist of the current Ottawa Hospital staff on a waitlist for parking. Trip generation based on this assumption will result in approximately 100 new trips in the study area during the weekday AM and PM peak hours by the built-out horizon year of 2027. The supporting TIA (August 2023) was prepared by EXP Services Inc.
- Vincent Massey Public School at 745 Smyth Road (Application # D07-12-23-0091) has prepared a development application to support the applications to transportation circulation on the site, including the construction of a new bus loop accessed from Smyth Road and replacement of the existing Smyth Road accesses with a full movement access at Edgecombe Street. This development is not anticipated to generate any new person trips and impacts to vehicle movements will be isolated to the school site.

In addition, The Ottawa Hospital Parking Study was conducted by WSP at the time of this report to address the parking demand across all three campuses (Civic, Riverside, and General) for patients/visitors and staff through operational planning for short-term and long-term needs. For the General Campus, construction activities at CHEO and the significant portion of leased parking lots are subject to change the existing parking inventory, such that parking alternatives and Transportation Demand Management (TDM) measures will need to be reviewed to address parking demand for The Ottawa Hospital in the future.

2.4 STUDY AREA AND TIME PERIOD

The time periods identified for the traffic analysis are:

- Weekday AM Peak Hour: 7:30 a.m. to 8:30 a.m.
- Weekday PM Peak Hour: 3:30 p.m. to 4:30 p.m.

These are consistent with the peak hours identified in the turning movement counts that were collected at the study area intersections.

2.5 HORIZON YEARS

The proposed development is expected to be completed in a single phase with a target build-out year of 2026. In accordance with the City of Ottawa TIA Guidelines (2017), the following horizon years will be considered for analysis:

- 2026, which represents the anticipated opening year.
- 2031, which represents the build-out year plus five years.

2.6 EXEMPTIONS REVIEW

Table 2-6 provides a summary of the TIA modules that will be included and exempted in this TIA Report.

Table 2-6: Exemptions Summary

SITE DESIGN AND			
TDM MODULES	ELEMENT	EXEMPTION CONSIDERATIONS	REQUIRED
DESIGN REVIEW COMPONENT			
4.1 Development Design	4.1.1 Design for Sustainable Modes	Required for all TIAs	Yes
	4.1.2 Circulation and Access	Required for all site plan and zoning by-law applications	Yes
	4.1.3 New Street Networks	Required for all plans of subdivision	No
4.2 Parking	4.2.1 Parking Supply ¹	Required for all site plan and zoning by-law applications	Yes
4.3 Boundary Street Design		Required for all TIAs	Yes
NETWORK IMPACT COMPONENT			
4.5 TDM	4.5.1 Context for TDM	Required for all TIAs	Yes
	4.5.2 Need and Opportunity	Required for all TIAs	Yes
	4.5.3 TDM Program	Required for all TIAs	Yes

SITE DESIGN AND

TDM MODULES	ELEMENT	EXEMPTION CONSIDERATIONS	REQUIRED
	4.6 Neighborhood Traffic Calming	<p>If the development meets all of the following criteria along the route(s) site generated traffic is expected to utilize between and arterial road and the site’s access:</p> <ol style="list-style-type: none"> 1. <input type="checkbox"/> Access to Collector or Local (OP Urban, Downtown, Rural, Village Road Networks); 2. <input type="checkbox"/> “Significant sensitive land use presence” exists, where there is at least two of the following adjacent to the subject street segment: <ol style="list-style-type: none"> a. <input type="checkbox"/> School (within 250m walking distance); b. <input type="checkbox"/> Park; c. <input type="checkbox"/> Retirement / Older Adult Facility (i.e., long-term care and retirement homes); d. <input type="checkbox"/> License Child Care Centre; e. <input type="checkbox"/> Community Centre; or f. <input type="checkbox"/> 50%, or greater, of adjacent property along the route(s) is occupied by residential lands and a minimum of 10 occupied residential units are present on the route. 3. <input checked="" type="checkbox"/> Application is for Zoning By-Law Amendment or Draft Plan of Subdivision; 4. <input checked="" type="checkbox"/> At least 75 site-generated auto trips; 5. <input type="checkbox"/> Site Trip Infiltration is expected. Site traffic will increase peak hour vehicle volumes along the route by 50% or more. 	No
4.7 Transit	4.7.1 Transit Route Capacity	> 75 site transit trips	No
	4.7.2 Transit Priority Requirements	> 75 site auto trips	Yes
4.8 Network Concept		When proposed development generates > 200 person-trips during the peak hour in excess of the equivalent volume permitted by established zoning.	No
4.9 Intersection Design ²	4.9.1 Intersection Controls (including site accesses)	> 75 site auto trips	Yes
	4.9.2 Intersection Design	> 75 site auto trips	Yes
<p>¹ Include language that asks for justification of change to Zoning By-law parking requirements.</p> <p>² Module 4.4: Access Intersections Design has been consolidated in Module 4.9 per the revisions to the TIA Guidelines (May 2023).</p>			

Based on the above, the TIA Report will include the following modules:

- Module 4.1: Development Design
- Module 4.2: Parking
- Module 4.3: Boundary Street Design
- Module 4.5: TDM
- Module 4.7: Transit
- Module 4.9: Intersection Design

The following modules are proposed to be exempted:

- Module 4.1.3 New Street Networks
- Module 4.6: Neighbourhood Traffic Calming
- Module 4.7.1: Transit Route Capacity
- Module 4.8: Network Concept

2.7 DEVELOPMENT-GENERATED TRAFFIC

2.7.1 TRIP GENERATION

TRIP GENERATION RATES

1. Base Trip Generation Rate Selection

The ITE Trip Generation Manual (11th Edition) was used to determine the base trip generation rate for the proposed development during the AM and PM weekday peak hours of adjacent street traffic according to *Research and Development Center* (Land Use Code 760). A Research and Development Center has been defined in the ITE Trip Generation Manual as a facility or group of facilities devoted almost exclusively to research and development activities where the facility may include offices and light fabrication areas. The weekday AM and PM Peak Hour base trip generation rates are as follows:

- AM Base Rate: 1.03 trips per 1,000 square feet GFA
- PM Base Rate: 0.98 trip per 1,000 square feet GFA

The development site plan indicates a GFA for the proposed building of 13,726 m² or 147,747 square feet. It is noted that this GFA calculation is based on the City of Ottawa Zoning By-law definition which includes floor area within the exterior walls that excludes common internal spaces including hallways, corridors, stairwells, washrooms, and storage areas. The Ontario Building Code calculates GFA that includes the space within the exterior building faces but excludes basement levels below grade and mechanical areas; under this calculation, the proposed building would have a GFA of 24,830.3 m², or 267,271 square feet.

ITE Trip Generation provides the following definition for Gross Floor Area as it is applied as a basis for the calculation of trips:

Gross Floor Area (GFA)—the sum of the area of each floor level of a building (expressed in square feet), including cellars, basements, mezzanines, penthouses, corridors, lobbies, stores, and offices, that are within the principal outside faces of exterior walls, not including architectural setbacks or projections. Included are all areas that have floor surfaces with clear standing head room (6 ft. 6 in. minimum) regardless of their use. With the exception of buildings containing enclosed malls or atriums, GFA is equal to gross leasable area and gross rentable area. If a ground-level area, or part thereof, within the principal outside faces of the exterior walls is not enclosed, this floor area is considered part of the overall GFA of the building. However, unroofed areas and unenclosed roofed-over

spaces, except those contained within the principal outside faces of exterior walls, should be excluded from the area calculations. For the purpose of trip generation calculation, the floor area of all parking garages within the building should not be included in the GFA of the entire building. The majority of land uses in Trip Generation Manual use GFA as an independent variable. (ITE Trip Generation 11th Edition Desk Reference (2021). p.14).

As it includes the full extent of the building space within the exterior walls, the ITE definition of GFA aligns more closely with the Ontario Building Code definition of GFA than the Ottawa Zoning By-Law definition that excludes some of the interior space. As a result, the OBC GFA calculation of 24,830.3 m², or 267,271 square feet has been used for the trip estimation using ITE rates. The total new vehicle trips generated by the proposed development according to the ITE rates that are summarized in **Table 2-7**.

Table 2-7: Proposed Development-Generated Vehicle Trips

AM PEAK HOUR									
Land Use	ITE Code	Size	Unit	Avg. Rate	% In	% Out	Total Trips	Trips In	Trips Out
Research and Development Center	760	267.27	1000sqft GFA	1.03	82%	18%	275	226	50
Total New Trips							275	226	50
PM PEAK HOUR									
Land Use	ITE Code	Size	Unit	Avg. Rate	% In	% Out	Total Trips	Trips In	Trips Out
Research and Development Center	760	267.27	1000sqft GFA	0.98	16%	84%	262	42	220
Total New Trips							262	42	220

Based on the ITE trip rates, the proposed AMRC is projected to generate 275 and 262 vehicle trips during the weekday AM and PM peak hours, respectively.

2. Total Development-Generated Person-Trips Estimate

In accordance with the City of Ottawa Transportation Impact Assessment Guidelines (2017), the ITE vehicle-trip rates have been multiplied by a factor 1.28 to convert to person-trip rates. The resulting person trip calculations are summarized in **Table 2-8**.

Table 2-8: Proposed Development-Generated Person Trips

AM PEAK HOUR									
Land Use	ITE Code	Size	Unit	Avg. Rate	% In	% Out	Total Trips	Trips In	Trips Out
Research and Development Center	760	267.27	1000sqft GFA	1.32	82%	18%	352	289	63
Total New Trips							352	289	63
PM PEAK HOUR									
Land Use	ITE Code	Size	Unit	Avg. Rate	% In	% Out	Total Trips	Trips In	Trips Out
Research and Development Center	760	267.27	1000sqft GFA	1.25	16%	84%	335	54	282
Total New Trips							335	54	282

Based on the ITE trip rates and Ottawa conversion factor, the proposed AMRC is projected to generate 352 and 335 person trips during the weekday AM and PM peak hours, respectively.

MODE SHARES

3. Existing Mode Shares for Traffic Assessment Zones

The existing peak hour travel demand was adopted from The Ottawa Hospital employee commuter survey for employees at all Ottawa Hospital Campuses in 2022, referenced previously in **Section 2.2.7** of this report. As the trip generation is originally based on ITE rates, it is assumed the trip generation accounts only for staff arriving to the site and would already exclude staff working from home. As a result, the 6% work from home proportion of the mode share from the survey results was removed and the mode share percentages recalculated based on the remaining 94% total, in order to avoid double counting the staff who would be working from home under the mode share reported in the survey. Additionally, the revised mode share combines the carpool mode share as part of auto driver and the Uber/Lyft/Taxi mode into auto passenger trips.

The revised existing mode share is based on the mode share for trips to and from the General Campus and shown in **Table 2-9**.

Table 2-9: Existing Mode Share

PEAK PERIOD	AUTO DRIVER	AUTO PASSENGER	TRANSIT	BICYCLE	WALK	OTHER
AM / PM	69%	6%	10%	10%	5%	0%

4. Future Mode Share Targets for the Proposed Development

Mode shares applied to the anticipated site trip generation from the AMRC facility are based on the modified mode shares identified from The Ottawa Hospital Commuter survey as identified above. This assumes that traffic generated by the AMRC will follow a similar mode share pattern as staff at The Ottawa Hospital General Campus as a whole. It is noted that the Travel Survey undertaken was limited to Ottawa Hospital Staff and not patients, and as such trip generation for staff only will be comparable to the research and education focus of the AMRC without patient care. The future modes shares applied for the trip generation for the proposed AMRC development are summarized in **Table 2-10**.

Table 2-10: Future Mode Share Targets for the Proposed Development

TRAVEL MODE	MODE SHARE TARGET	RATIONALE
Transit	10%	Walking distance to Transitway service at Smyth or Lycée Claudel Station is approximately 1.5km or 20 minutes, and thus connections between the AMRC and rapid transit service will depend on transfers from local bus Route 45. Transit service will also account for uOttawa shuttles, the effectiveness of which will depend on frequency and the distribution of students and staff between uOttawa Campuses. Given the distance from rapid transit and reliance on connector services, no increase in transit mode share from existing has conservatively been anticipated, but this may be possible through service increases or additional TDM measures.
Walking	5%	Given the distance to the Transitway and LRT, last mile walking access may occur but is more likely to be accommodate by local transit and shuttle service to the AMRC. This would leave the surrounding neighbourhood as the key contributor of walking trips; as no significant additional developments are planned, no increase in the walking mode share has been assumed.
Cycling	10%	Ottawa’s Crosstown Bikeway currently runs parallel to Ring Road on the north side of The Ottawa Hospital Campus and contributes to the existing 10% bicycle mode share to the hospital campus which is significantly higher than the Alta Vista District cycling mode share. As a conservative approach no increase from the existing TOH mode share has been assumed, but it is anticipated that minor increases may be possible through additional TDM measures.
Auto Passenger	6%	Access to The Ottawa Hospital General Campus is generally auto focused and this is reflected in the results of the employee commuter survey. The construction of the Hospital Link and any future work to extend the Alta Vista Transportation Corridor will service to further promote vehicle access to the General Campus. The increase in prevalence of carpool modes or the use of rideshare services may shift some of the current auto demand between auto driver and auto passenger, but both would continue to generate private vehicle trips to and from the campus.
Auto Driver	69%	As a conservative approach to the evaluation of traffic operational impacts for this TIA, no reduction of the auto mode share has been assumed below the existing share. As previously noted however, some reduction may be possible through improved transit and shuttle service, as well as TDM measures.

Based on the above, the TIA mode share for the projected AMRC trip generation maintains the mode shared adopted from The Ottawa Hospital Employee commuter survey for The Ottawa Hospital General Campus. This will be a conservative representation of traffic operational impacts at intersections within the TIA study area because the future mode share beyond 2031 is expected to shift to higher transit/rideshare use.

5. Projected Proposed Development Trips by Mode and Phase

The proposed development will be constructed in one phase and the development trips by mode and phase are shown in **Table 2-11**.

Table 2-11: Development Trips by Mode and Phase

PEAK HOUR	DIRECTION	AUTO DRIVER	AUTO PASSENGER	TRANSIT	BICYCLE	WALK	TOTAL
AM	Inbound	199	17	29	29	14	289
	Outbound	44	4	6	6	3	63
	TOTAL	243	21	35	35	18	352
PM	Inbound	37	3	5	5	3	54
	Outbound	194	17	28	28	14	282
	TOTAL	231	20	34	34	17	335

6. Trip Reduction Factors

A Research and Development Center land use is not anticipated to generate a high percentage of pass-by trips or diverted linked trips as part of the trip composition; therefore, adjustments for these trip types have not been applied to the development-generated trips. All inbound and outbound trips are new/primary trips added to the surrounding transportation network. In addition, the proposed development is not a mixed-use development where the internal capture of trips (i.e., trips between uses of the same development) would occur.

2.7.2 TRIP DISTRIBUTION

The overall trip distribution of the site generated trips has been adopted from existing traffic patterns and the current transportation network using the traffic volumes from the intersections of Alta Vista Drive / Hospital Link Road, Smyth Road / Alta Vista Drive, and Smyth Road / Roger Guindon Avenue (see **Appendix D**). The trip distribution for the proposed development is presented in **Table 2-12**.

Table 2-12: Inbound and Outbound Trip Distribution

DIRECTION	AM PEAK HOUR		PM PEAK HOUR	
	% In	% Out	% In	% Out
North (via Alta Vista Dr)	14%	23%	20%	18%
South (via Alta Vista Dr)	20%	15%	17%	19%
East (via Smyth Rd)	31%	18%	23%	31%
West (via Smyth Rd)	27%	40%	36%	27%
West (via Hospital Link Rd)	7%	5%	3%	5%
Total	100%	100%	100%	100%

2.7.3 TRIP ASSIGNMENT

The AMRC will be located on the existing OHSC Parking Lot 13; the construction of the AMRC will displace 361 spaces from the original uOttawa Parking lot but will include a reconfigured parking lot with 126 new spaces to the west of the building. The existing access to Parking Lot 13 from the Ottawa Rehab access road opposite Parking Lot 14 will be removed, and a new access will be provided to the reconfigured parking area from Ring Road approximately 60m east of the intersection with Hospital Link. This new lot will be fully separated from the adjacent CHEO Parking Lot D. A passenger pickup and drop-off area will be provided on the east side of the building on the Ottawa Rehab access road opposite the Parking Lot 14 access.

Distribution of the auto trips for trip assignment is generally based on auto driver trips being assigned to and from the parking lot, and auto passenger trips being assigned to the pick-up and drop-off area on the Ottawa Rehab access road on the east side of the building. However, it is noted that per the assumed modes shares above, the inbound AM and outbound PM trips both exceed the 126-vehicle parking capacity of the reconfigured AMRC uOttawa parking lot. As a result, the assignment of all auto driver trips to and from the AMRC parking lot will not be feasible.

It is noted that The Ottawa Hospital was undertaking a parking study at the time of this report to assess the current and future parking demand at the General Campus and noted that as part of the CHEO 1Door4Care development, The Ottawa Hospital will be replacing surface parking lots B (286 stalls) and E (270 stalls) with a new parking structure accommodating 1,050 new stalls. Between these two initiatives, it is assumed that there will be capacity elsewhere on the campus for the remaining 73 AM peak hour inbound auto trips and 68 PM peak hour outbound auto trips that exceed the capacity of the AMRC parking lot.

As a conservative approach, the trip assignment limits the AM inbound and PM outbound auto driver trips to and from the AMRC parking lot to the 126 available spaces; the remaining vehicles are assumed to enter The Ottawa Hospital General Campus but park in one of the other lots accessible from Ring Road. This approach will provide a conservative examination of traffic operational impacts by maintaining all the projected auto driver trips at The Ottawa Hospital General Campus boundary intersections rather than assuming they will switch to other modes. **Table 2-13** shows the breakdown of auto driver trips and auto passenger trips.

Table 2-13: Inbound and Outbound Trip Assignment

PEAK HOUR	DIRECTION	AUTO DRIVER (TO AMRC LOT)	AUTO DRIVER (TO OTHER PARKING)	AUTO PASSENGER	TOTAL
AM	Inbound	126	73	17	217
	Outbound	44	0	4	48
PM	Inbound	37	0	3	40
	Outbound	126	68	17	211

It is assumed that the inbound auto passenger trips will equal the outbound passenger trips due to the short stay duration at the lay-by / drop-off area. Therefore, the inbound and outbound auto passenger trips in **Table 2-13** have been added together for each peak hour. In other words, there are 21 inbound and outbound trips during the AM Peak Hour and 20 inbound and outbound trips during the PM Peak Hour.

Based on the trip generation, mode share and distribution assumptions, **Figure 2-8** shows the distribution of development-generated vehicle trips assigned to the study area intersections for the purpose of analysis.

	AM	PM
Trips In	221	(57)
Trips Out	65	(214)
Total Trips	285	(272)

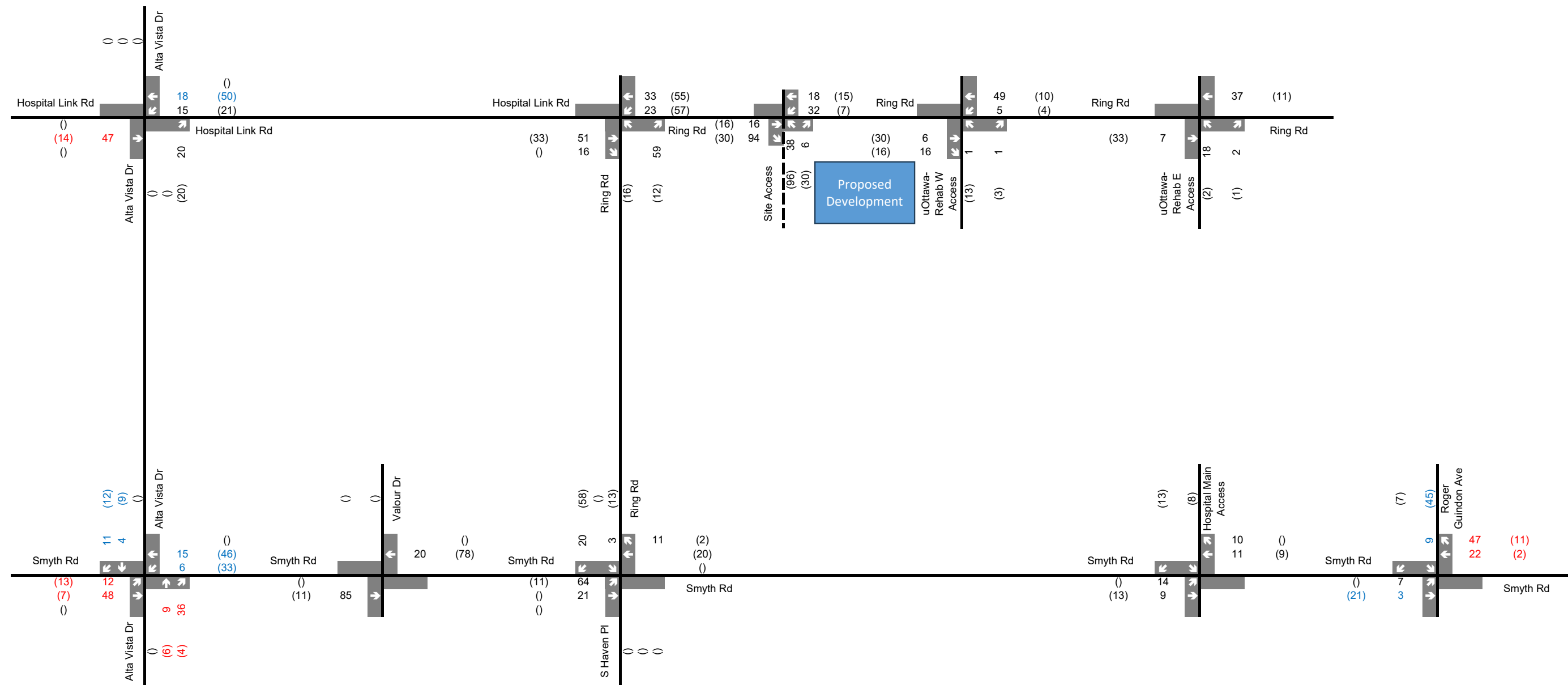

xx A.M. Peak Hour Traffic Volumes (xx) P.M. Peak Hour Traffic Volumes

Figure 2-8 Development-Generated Auto Trips

3 STRATEGY

3.1 BACKGROUND NETWORK TRAFFIC

3.1.1 CHANGES TO THE BACKGROUND TRANSPORTATION NETWORK

Planned changes to the study area transportation network such as modifications to the existing lane configurations and transit route networks were described in **Section 2.3.1**. The construction of the Alta Vista Transportation Corridor is not anticipated to occur within the study horizon years (2026 and 2031), therefore, no adjustments to traffic volumes and the road network were made for analysis purposes. The assignment of future background traffic is expected to be similar to existing traffic patterns and vehicle trips to and from the south will utilize Alta Vista Drive. The construction of the Alta Vista Transportation Corridor will be beneficial for future vehicle demands as there will be an additional north-south connection and capacity provided to accommodate future background traffic.

3.1.2 GENERAL BACKGROUND GROWTH RATES

A 1.0% annual growth rate was used in this study to account for background traffic growth other than what has been captured in the City's development application process. This annual increase in traffic volumes is consistent with the growth assumption used in the approved 1Door4Care Phase 1A – Parking Garage TIA, which was based on Exhibit 2.11 of the City of Ottawa's TMP (2013) that illustrates projected growth in travel demand between key areas of Ottawa from 2011 to 2031.

3.1.3 OTHER AREA DEVELOPMENTS

Other study area developments that would have an influence on the study area transportation network were summarized in **Section 2.3.2**. Of the two other study area developments identified, only the 1Door4Care facility to be located 401 Smyth Road has development-generated traffic and the trip assignment for these traffic volumes were included in the TIA report.

The anticipated build-out year for the 1Door4Care facility is 2027, which is one year after the opening year for the AMRC development. As such, the estimated trips for the 1Door4Care facility were only added to the 2031 background traffic volumes. The three study area intersections that are shared between the 1Door4Care Phase 1A – Parking Garage TIA and this study include Smyth Road / Ring Road-South Haven Place, Smyth Road / Hospital Main Access, and Ring Road / Hospital Link Road. The 1Door4Care development-generated traffic volumes were added to those three intersections and then carried through the remainder of the study area transportation network using existing traffic patterns.

The 2026 and 2031 background traffic volumes are provided in **Figure 3-1** and **Figure 3-2**, respectively. The relevant excerpts from the approved TIA are included in **Appendix F**.

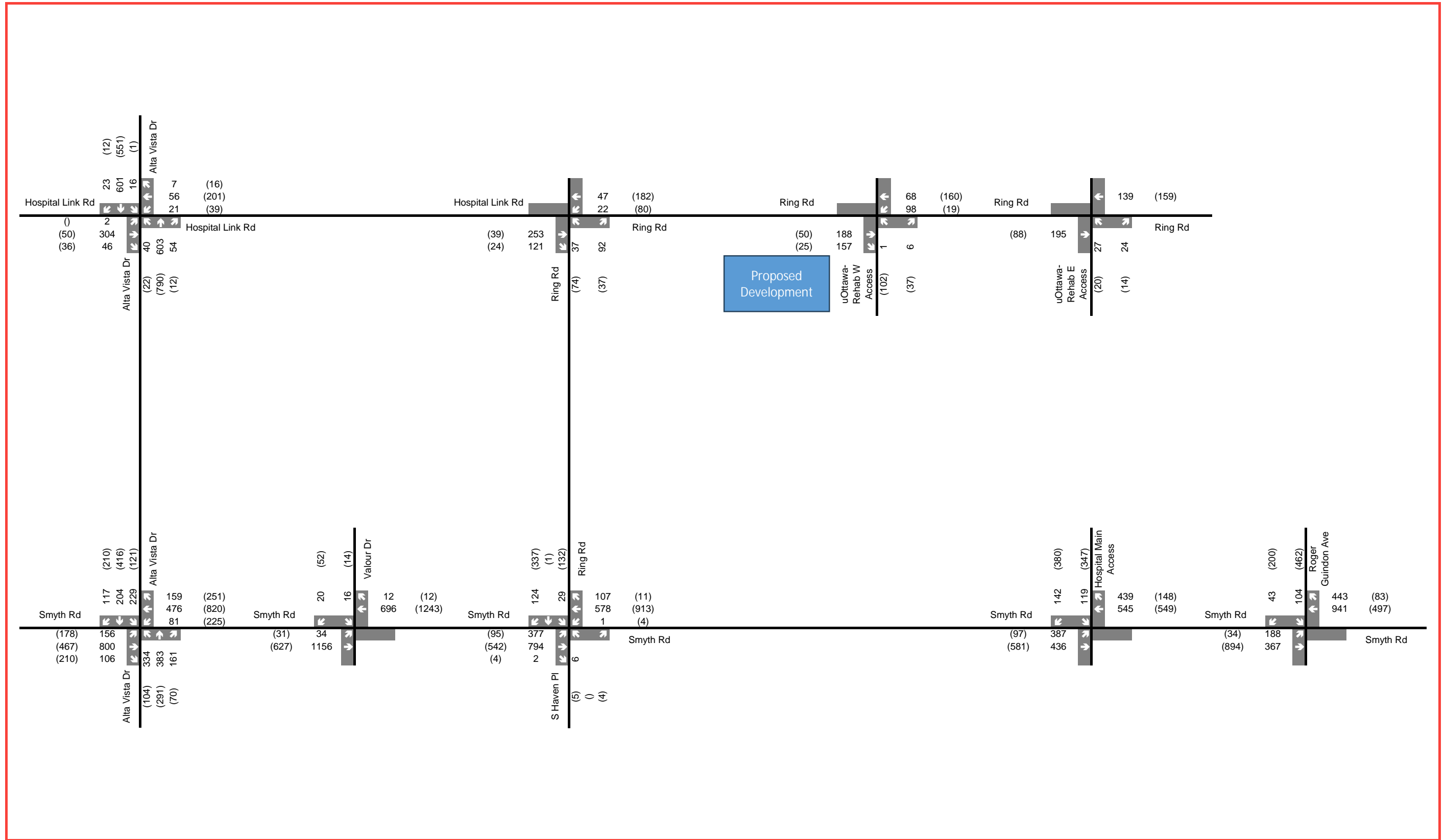

xx A.M. Peak Hour Traffic Volumes (xx) P.M. Peak Hour Traffic Volumes

Figure 3-1
2026 Background Traffic Volumes

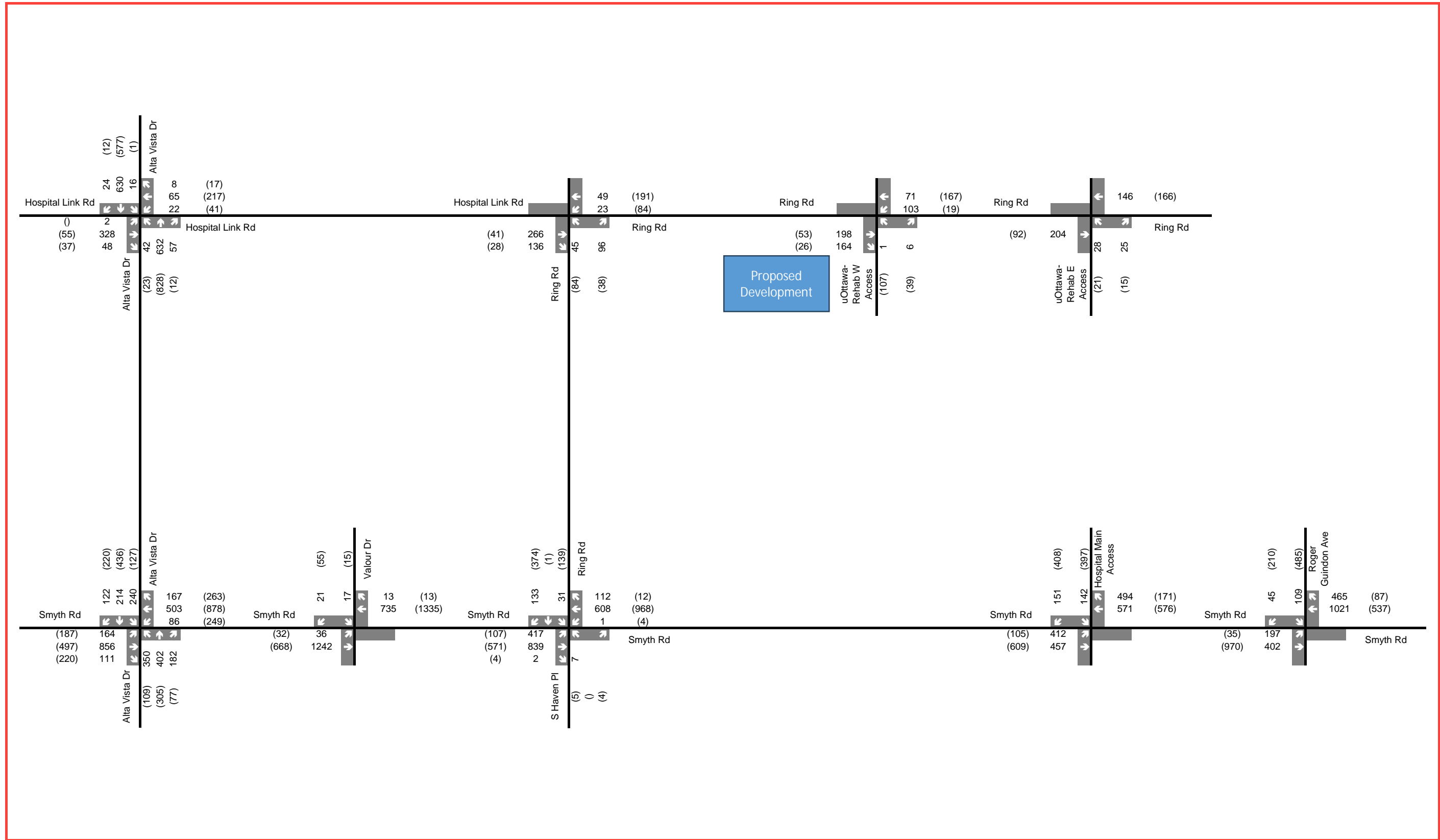

xx A.M. Peak Hour Traffic Volumes (xx) P.M. Peak Hour Traffic Volumes

Legend

Figure 3-2
2031 Background Traffic Volumes

3.2 DEMAND RATIONALIZATION

3.2.1 DESCRIPTION OF CAPACITY ISSUES

The total traffic volumes for the 2026 and 2031 planning horizons were estimated by:

1. Applying a 1% background growth rate to the existing traffic volumes, which were grown to the existing (2023) base year where applicable using a 1% growth rate.
2. Adding the vehicle trips generated by other study area developments.
3. Adding the vehicle trips generated by the proposed development.

The uOttawa-Rehab W Access currently serves uOttawa Lot 13 and The Ottawa Hospital Lot 14. There is a higher proportion of parking spaces at Lot 13 compared to Lot 14 (approximately a 70:30 ratio). With the development in place, the access to Lot 13 will be removed and the future use of the intersection of Ring Road / uOttawa-Rehab W Access will include access to the proposed lay-by / drop-off area, continued access to Lot 14, and continued circulation of OC Transpo Route 45. As a result, the inbound and outbound volumes at the intersection of Ring Road / uOttawa-Rehab W Access have been reduced based on the proportion of parking spaces and are assumed to reroute to other parking lots. Similar to **Section 2.7.3**, the displaced vehicles are assumed to enter The Ottawa Hospital General Campus but park in one of the other lots accessible from Ring Road.

The estimated 2026 and 2031 total traffic volumes are shown in **Figure 3-3** and **Figure 3-4**, respectively.

3.2.2 ADJUSTMENT TO DEVELOPMENT GENERATED DEMANDS

Adjustments to development-generated demands have not been proposed since the trips generated by the proposed development are not expected to adversely impact the study area transportation network. A detailed assessment of intersection operations using Synchro (version 11) for the 2026 and 2031 future total horizons is carried out in **Section 3.8.3.2**.

3.2.3 ADJUSTMENTS TO BACKGROUND NETWORK DEMANDS

Adjustments to background network demands have not been proposed since the traffic forecasting analysis and the expanded arterial road network through the provision of the Alta Vista Transportation Corridor suggest that the future study area transportation network will have capacity to accommodate future traffic demand. A detailed assessment of intersection operations using Synchro (version 11) for the 2026 and 2031 future background horizons is carried out in **Section 3.8.3.2**.

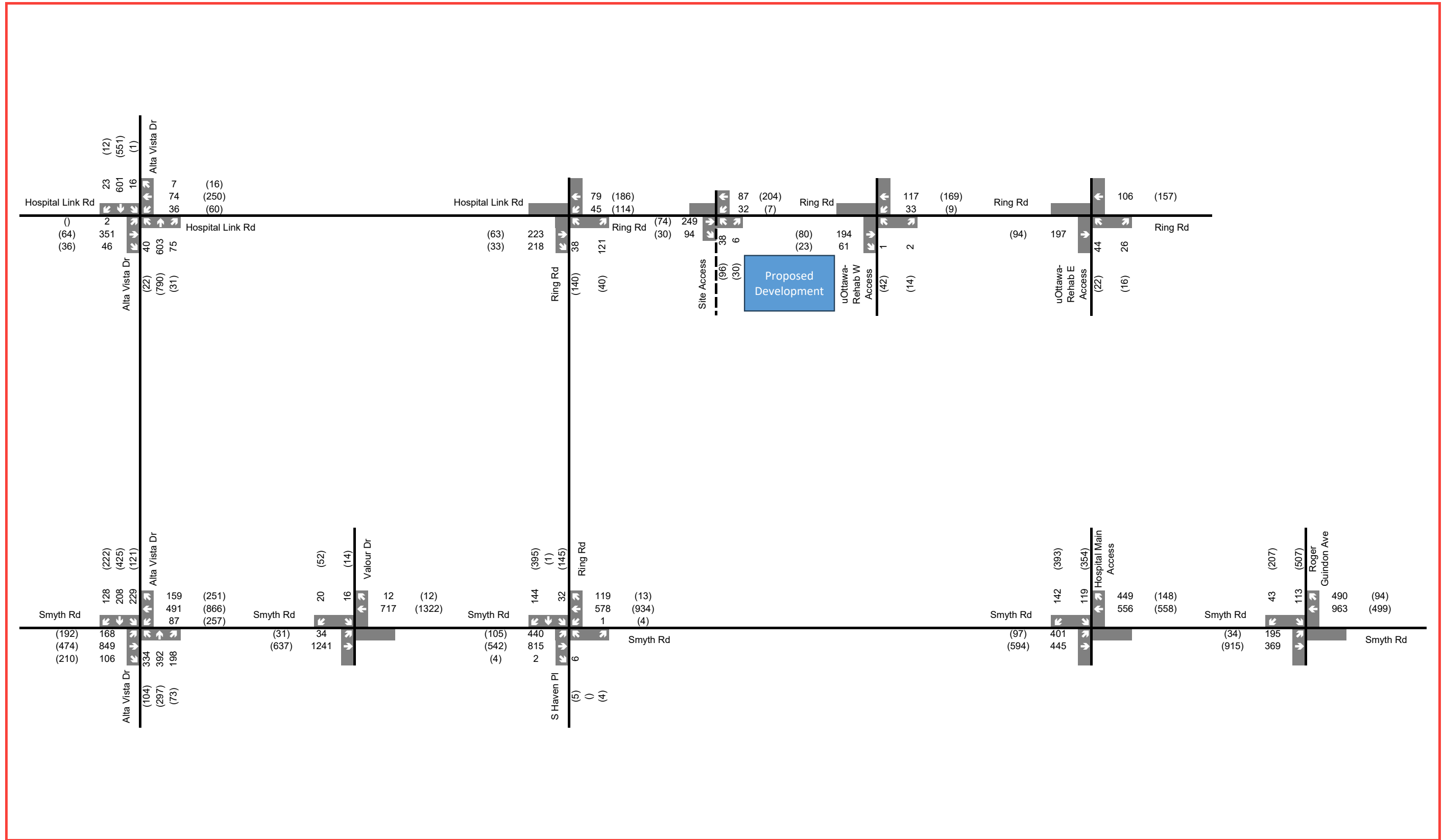

xx A.M. Peak Hour Traffic Volumes (xx) P.M. Peak Hour Traffic Volumes

Figure 3-3
2026 Total Traffic Volumes

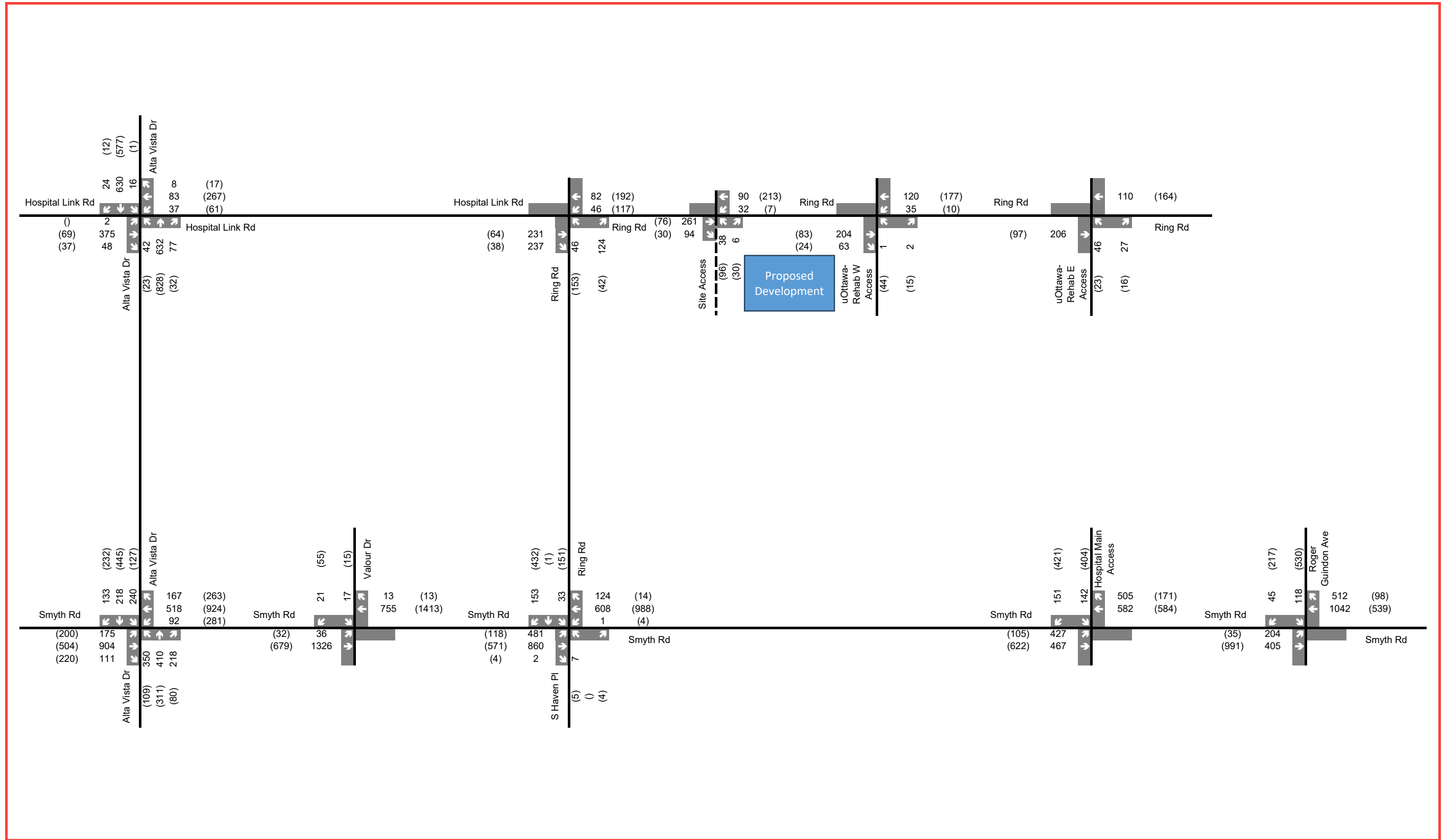

xx A.M. Peak Hour Traffic Volumes (xx) P.M. Peak Hour Traffic Volumes

Legend

Figure 3-4
2031 Total Traffic Volumes

3.3 DEVELOPMENT DESIGN

3.3.1 DESIGN FOR SUSTAINABLE MODES

The City of Ottawa's TDM-Supportive Development Design and Infrastructure Checklist for Non-Residential Developments was completed to assess the opportunity to implement facilities that are supportive of sustainable modes, including cycling, walking and transit. The completed checklist is attached as **Appendix G**.

As indicated in the TDM Checklist and shown on the site plan (**Appendix B**), the proposed site accommodates sustainable modes in the following ways:

- 222 dedicated bicycle parking spaces through the provision of outdoor bicycle racks. 186 of those dedicated bicycle parking spaces are covered by building canopies. Bicycle parking is proposed in three locations throughout the AMRC site and will include bicycle spaces by the main AMRC building entrance and below the canopy by the AMRC parking entrance.
- Walking distance between the site and the nearest transit stop is within 200m. The walking route between the AMRC main entrance and the OC Transpo bus stop just northeast of the RGN main entrance will include the provision of sidewalks.
- There is an existing asphalt sidewalk on the south side of Ring Road and west side of the uOttawa-Rehab W Access adjacent to the site. The development will incorporate and expand the existing pedestrian infrastructure fronting the building to provide connections to building entrances.
- Depressed curb ramps to facilitate pedestrian movement and accessibility (ex. lay-by / drop-off area, between internal roadways and on-site pedestrian infrastructure).
- Provision of pedestrian walkways / crosswalks connecting the parking lot to building entrances, as well as at the proposed vehicle access on Ring Road.

In addition, it is assumed that upon completion, the site access intersection on Ring Road will be stop controlled for the side street for pedestrian safety.

3.3.2 CIRCULATION AND SITE ACCESS

Site circulation at the proposed access and lay-by / drop-off area was assessed using AutoTURN 11 to confirm the suitability of the layout for a variety of design vehicles. The results are provided in **Table 3-1** and the AutoTURN swept paths are provided in **Appendix H**.

The proposed lay-by / drop-off area located on the east side of the building is designed to operate with traffic circulation in a counter-clockwise direction. It is noted that the design of the lay-by / drop-off area shown in the site plan (**Appendix B**) includes an accessible passenger loading zone per the City of Ottawa Accessibility Design Standards, which involves the provision of an access aisle and curb ramp. In addition, the proposed lay-by / drop-off area does not interfere with the uOttawa shuttle bus stop, which is located south of the proposed lay-by / drop-off area. The uOttawa shuttle bus stop is separate from the OC Transpo bus stop.

It is noted that there is a painted crosswalk on the Rehabilitation Centre access road connecting The Ottawa Hospital General Campus' Lot 14 and the northeast corner of the RGN building, which is outside of the site property line. When an OC Transpo bus (standard or articulated) is stopped at Stop #1591 just west of the curb bulb-out, the bus extends across the crosswalk due to the short distance between the bus stop and the crosswalk. This is an existing issue and potential future relocation of the crosswalk or alternative improvements are under consideration by uOttawa.

Table 3-1: Swept Path Assessment

DESIGN VEHICLE	VEHICLE REPRESENTING	FINDINGS
<p>HSU (TAC 2017)</p>	<p>Municipal Services / Waste Removal / Delivery Vehicle</p>	<p>Access: The HSU may access the waste collection location from the existing Ring Road entrance to the west of the site or the proposed access to the north. The proposed access can accommodate the movements of an HSU without conflicting with any curbs or built features.</p> <p>Circulation: An HSU design vehicle will be able to maneuver to and from the waste containers located to the south of the proposed building. HSU trucks are the only type of delivery trucks that can access the corner loading dock due to space limitations. The maneuver into and out of the corner loading dock can only be safely completed when there is no waste truck in the AMRC waste collection area or vehicles parked in the new uOttawa service parking spaces. The University of Ottawa will implement operating practices to ensure that the schedules for use of the affected docks is staggered to ensure safe operation.</p>
<p>WB-20 (TAC 2017)</p>	<p>Delivery Vehicle</p>	<p>Access: The WB-20 may access the loading docks by the existing access to the west or the proposed access to the north. The proposed access can accommodate the movements of a WB-20 without impacting any built features. However, the WB-20 is required to encroach on the opposing vehicle lane for inbound movements.</p> <p>Circulation: The WB-20 design vehicle will be able to maneuver to and from the loading docks located at the south side of the proposed building without conflicting with any curbs or other built features. The loading area is sufficiently large enough to allow the WB-20 from the north access to turn around and reverse into the loading dock. The reverse maneuver into the “clean” dock (middle dock) is only possible if there is no WB-20 truck parked in the adjacent “dirty” dock (outermost dock). The corner loading dock cannot accommodate a WB-20 truck, only HSU trucks, because of limited space. The University of Ottawa will implement operating practices to ensure that the schedules for use of the affected docks is staggered to ensure safe operation.</p>
<p>Fire Truck (Toronto Aerial)</p>	<p>Fire Truck</p>	<p>Access: The modified access to the northeast of the proposed building can accommodate the inbound and outbound movements of an aerial fire truck without impacting any built features or encroachments into the opposing vehicle lane.</p> <p>Circulation: The aerial fire truck will be able to maneuver to the principal entrance and fire department connection of the proposed building without any conflicts. The length of the fire route to the entrance and fire department connection is approximately 54 metres.</p>

DESIGN VEHICLE	VEHICLE REPRESENTING	FINDINGS
B-12 (TAC 2017)	Transit (OC Transpo Standard Bus)	<p>Access: The modified access to the northeast of the proposed building can accommodate the inbound movements of a B-12 bus (OC Transpo bus) without impacting any built features or encroachments into the opposing vehicle lane.</p> <p>Circulation: The B-12 bus will be able to maneuver to the existing Roger Guindon Hall bus stop and Rehabilitation Centre driveway. The outbound access from the Rehabilitation Centre has no proposed modifications.</p>
A-BUS (TAC 2017)	Transit (OC Transpo Articulated Bus)	<p>Access: The modified access to the northeast of the proposed building can accommodate the inbound movements of an A-BUS (OC Transpo articulated bus) without impacting any built features or encroachments into the opposing vehicle lane.</p> <p>Circulation: The A-BUS will be able to maneuver to the existing Roger Guindon Hall bus stop and Rehabilitation Centre driveway. The outbound access from the Rehabilitation Centre has no proposed modifications.</p>
AllStar Chevrolet 4500 (2016) Type 4 (City – Transit Shuttles)	Transit (Para Transpo Bus)	<p>Access: The modified access to the northeast of the proposed building can accommodate the inbound movements of a Para Transpo bus without impacting any built features or encroachments into the opposing vehicle lane.</p> <p>Circulation: The Para Transpo bus will be able to maneuver to the proposed layby and passenger loading zone. The Para Transpo bus may either complete a three-point turn to exit through the access to the northeast of the building or use the outbound access from the Rehabilitation Centre, which has no proposed modifications.</p>
2020 Blue Bird Vision (City – Transit Shuttles)	Transit (uOttawa Shuttle)	<p>Access: The modified access to the northeast of the proposed building can accommodate the inbound movements of a uOttawa shuttle bus (school bus) without impacting any built features or encroachments into the opposing vehicle lane.</p> <p>Circulation: The uOttawa shuttle bus will be able to maneuver to the existing Roger Guindon Hall shuttle stop and Rehabilitation Centre driveway. The outbound access from the Rehabilitation Centre has no proposed modifications.</p>

3.4 PARKING

3.4.1 PARKING SUPPLY

Parking requirements and the proposed parking supply are described in detail in the Planning Rationale document dated April 18th, 2024 prepared by WSP, with details summarized in this table also. The site is designated as Area B

“Inner Urban” in Schedule 1A of the City of Ottawa Zoning By-law No. 2008-250. The subject site is not within 300 metres of a rapid transit station in Schedule 2A or Schedule 2B of this By-law.

The minimum parking supply requirements for this development compared with the proposed parking supply are highlighted in **Table 3-2** below for the vehicle parking supply and **Table 3-2** for the bicycle parking supply.

As the tables indicate, a sufficient supply of parking for vehicles and bikes is proposed on the overall site, including:

- 1863 vehicle parking spaces (1720 required)
- 699 bike parking spaces (267 required)

As also indicated in the table, for the AMRC building on its own, a sufficient parking supply is proposed, including:

- 126 vehicle parking spaces (103 required)
- 222 bike parking spaces (55 required)

The site plans also includes 6 accessible parking spaces for the proposed AMRC building, exceeding the required 2 spaces.

Three loading dock spaces are required and the plan includes 3 new loading dock spaces and retains 2 existing loading docks.

Bike parking spaces are proposed to be located near building entrances, and less than 50% of spaces (16%) are located in landscaped areas.

Table 3-2: Minimum Zoning By-Law Requirements for Vehicle Parking and Proposed Development Parking Supply

ZONING PROVISION	REQUIREMENT	CALCULATION	COMPLIANCE (YES/NO)
Minimum Parking Space Rates – Sec. 101, Table 101	<p>Area B (Schedule 1A):</p> <p>Proposed Use (AMRC):</p> <p>Post Secondary Educational Institution:</p> <p>0.75 per 100 m² of gross floor area</p> <p>Other existing uses on-site (451 Smyth Road):</p> <p>Hospital:</p> <p>1.4 per 100 m² of gross floor area</p> <p>Daycare:</p> <p>2 per 100 m² of gross floor area</p>	<p>451 Smyth Road (All uses – proposed AMRC and existing):</p> <p>GFA:</p> <p>Proposed AMRC = 13,726.17 m²</p> <p>Existing RGN = 27,387 m²</p> <p>Existing TOH = 124,985 m²</p> <p>Existing Oasis = 809.9 m²</p> <p>Required Parking:</p> <p>Proposed AMRC only:</p> <p>= 0.75 * (13,726.17/100)</p> <p>= 0.75 * 137.26</p> <p>= 102.94</p> <p>= 103 (rounded)</p> <p>Proposed AMRC + Existing RGN:</p> <p>= 0.75 * ((13,726.17 + 27,387)/100)</p> <p>= 0.75 * (411.1317)</p> <p>= 308</p> <p>Existing TOH:</p> <p>= 1.4 * (99,988/100)</p> <p>= 1,399</p> <p>Existing Oasis:</p> <p>= 2 * (648/100)</p> <p>= 13</p> <p>Total Required Parking (451 Smyth Road):</p> <p>= 308 + 1,399 + 13</p> <p>= 1,720</p> <p>= 1,720</p> <p>Additional notes:</p> <p>Existing Parking at 451 Smyth Road:</p> <p>= 1,737 spaces</p> <p>Parking spaces to be removed from the existing RGN Parking Lot H (361 existing parking spaces):</p> <p>= 361 spaces</p>	<p>Yes – The existing parking lot with 361 parking spaces will be demolished. As part of the AMRC redevelopment, 126 additional new spaces will be provided.</p> <p>See below:</p> <p>Proposed Parking (Proposed AMRC building only):</p> <p>= 120 (new parking spaces) + 6 (new service spaces)</p> <p>= 126 spaces</p> <p>Total Proposed Parking (451 Smyth Road):</p> <p>= 126 + (2,098 (existing) – 361 (removed from RGN Parking Lot H))</p> <p>= 126 + 1,737</p> <p>= 1,863 parking spaces</p>

Table 3-3: Minimum Zoning By-Law Requirements for Bicycle Parking and Proposed Development Parking Supply

ZONING PROVISION	REQUIREMENT	CALCULATION	COMPLIANCE (YES/NO)
Minimum number of bicycle parking spaces – Sec. 111(2), Table 111A	<p>Proposed Use (AMRC): (e) post secondary educational institution</p> <p>1 per 250 m² of gross floor area</p> <p>Other existing uses on-site (451 Smyth Road): (e) daycare: 1 per 250 m² of gross floor area (g) hospital: 1 per 1,000 m² of gross floor area</p>	<p>451 Smyth Road (All uses – proposed AMRC and existing): GFA: Proposed AMRC: = 13,726.17 m²</p> <p>Required Bicycle Parking: GFA: Proposed AMRC = 13,726.17 m² Existing RGN = 27,387 m² Existing TOH = 124,985 m² Existing Oasis = 809.9 m²</p> <p>Proposed AMRC only: = 1 * (13,726.17/250) = 54.90 = 55 (rounded)</p> <p>Proposed AMRC + Existing RGN: = 1 * ((13,726.17 + 27,387)/250) = 164.45 = 164 (rounded)</p> <p>Existing TOH: = 1 * (99,988/1000) = 99.98 spots = 100 (rounded)</p> <p>Existing Oasis: = 1 * (648/250) = 2.59 = 3 (rounded)</p> <p>Total Required Bicycle Parking (451 Smyth Road): = 164 + 100 + 3 = 267 bicycle parking spaces</p> <p>Additional Notes: Existing Bicycle Parking serving the existing RGN, TOH and Oasis buildings = 497</p>	<p>Yes – 222 bicycle parking spaces are proposed for the AMRC building.</p> <p>497 existing bicycle parking spaces serve the existing RGN, TOH and Oasis buildings. 20 spaces will be removed as result of construction works.</p> <p>A total of 699 bicycle spaces will be included across the entire 451 Smyth Road site.</p>

3.5 BOUNDARY STREETS

3.5.1 MOBILITY

The City of Ottawa's Multi-Modal Level of Service (MMLOS) targets consider road classification, adjacent land-use designation, and special policy areas and are intended to evaluate how users of the proposed development will be accommodated by the boundary streets bordering the site to the north and east. MMLOS is typically documented for the worst-case scenario and for a segment analysis, this includes an evaluation of both sides of the roadway.

It is acknowledged that Road Segments, as defined in City of Ottawa's MMLOS Guidelines (2015), are referred to as a roadway link between signalized intersections. However, in the absence of signalized intersections in proximity to the east of the development, segment analyses have been adapted for Ring Road between unsignalized intersections. The level of service has only been evaluated for Ring Road as it is the only boundary street that connects the development to the rest of the study area transportation network.

It is to be noted that the City of Ottawa's New Official Plan was approved in November 2022 and the City of Ottawa's MMLOS Guidelines are being updated at the time of this report. The City's MMLOS Guidelines (2015) provide targets for land-use designations that are based on Schedule B – Urban Plan Policy of the City of Ottawa's previous Official Plan. Schedule B has been updated in the New Official Plan to form a series (Schedule B1 to B9) of transect policy areas. The proposed development is located within the Outer Urban Transect. For consistency, the MMLOS analysis has been based on the previous Official Plan's land-use designations as the updated MMLOS Guidelines have not been released, which will likely reflect changes in the New Official Plan.

3.5.1.1 RING ROAD

The segment under evaluation is Hospital Link Road between Alta Vista Drive and Ring Road (N-S) and Ring Road between Ring Road (N-S) and uOttawa-Rehab E Access. Ring Road borders the development to the north and is designated as a Private Local Road. Therefore, the study segment of Ring Road was evaluated as a Local Road within a General Urban Area with the corresponding LOS targets taken from Exhibit 22 of the MMLOS Guidelines. Per the 2013 Ottawa Cycling Plan, Ring Road is considered a bicycle Spine Route. Ring Road is not a designated truck route such that no target has been assigned, and Vehicle Level of Service (VLOS) is not reported for segments. Only Pedestrian Level of Service (PLOS), Bicycle Level of Service (BLOS), and Transit Level of Service (TLOS) have been evaluated for the segment analysis.

The segment MMLOS results are summarized in **Table 3-4** below and the detailed MMLOS spreadsheets are provided in **Appendix I**. The results in **Table 3-4** are representative of the existing 2023, future background (2026 and 2031), and future total (2026 and 2031) conditions as there are no anticipated road infrastructure upgrades along Ring Road throughout the horizon years.

Table 3-4: Segment MMLOS along Hospital Link Road / Ring Road between Alta Vista Drive and uOttawa/Rehab E Access

	PLOS	BLOS	TLOS
Target	C	C	D
Hospital Link Road between Alta Vista Drive and Ring Road	A	E ¹	D
Ring Road between Ring Road (N-S) and uOttawa/Rehab W Access	B	D ²	D
Ring Road between uOttawa/Rehab W Access and uOttawa/Rehab E Access	A	D ²	D
<p>Notes:</p> <p>1. The south side MUP between Alta Vista Drive and Ring Road (N-S) will meet the BLOS target of ‘C’ since it operates at a LOS of ‘A’. The lack of cycling facilities on the north side of Hospital Link Road in this area governs the reported BLOS.</p> <p>2. The north side MUP between Ring Road (N-S) and uOttawa/Rehab E Access will meet the BLOS target of ‘C’ since it operates at a LOS of ‘A’. The lack of cycling facilities on the south side of Ring Road in this area governs the reported BLOS.</p>			

The results of the segment analysis indicate that the PLOS and TLOS targets are met, whereas BLOS does not meet the target.

The MUP along the analysis segment is located on the south side of Hospital Link Road between Alta Vista Drive and Ring Road (N-S). At the intersection of Ring Road / Hospital Link Road, the MUP transitions to the north side of the road via the crossride provided at the west leg. The MUP is a bi-directional facility that serves both pedestrians and cyclists travelling in both the eastbound and westbound directions. In addition, there are no key destinations on the north side of Hospital Link Road and Ring Road in the study area aside from the pathways leading to the residential area north of the development. One pathway that intersects with the MUP is located at the midblock between Alta Vista Drive and Ring Road (N-S) and the other intersecting pathway is across from the existing TOH parking Lot 14.

It would be preferable to have a MUP on the south side of Ring Road fronting the site. Aside from potentially upgrading the existing asphalt sidewalk (approximately 3m wide) fronting the site to a MUP, the existing pedestrian and cycling infrastructure is sufficient to meet the MMLOS targets based on the location of accesses to surrounding land uses.

3.5.2 ROAD SAFETY

3.5.2.1 RING ROAD

Collision data was not available for Ring Road. The 40 km/h posted speed limit, road design features such as curves and short, consistent distances between intersections and parking accesses, and good design and adequate sight distance at intersections contribute to safe operation. Therefore, no collision reduction measures have been identified for this section of roadway.

3.6 TRANSPORTATION DEMAND MANAGEMENT

3.6.1 CONTEXT FOR TDM

The proposed development is considered as a post secondary educational institution and the operating hours and shift schedules are unknown at the time of this report. The building will contain office and laboratory facilities for student and staff use.

The future mode share targets were described in **Section 2.7.1** and adopted from The Ottawa Hospital Employee commuter survey for the General Campus. **Table 3-5** shows a comparison between the proposed mode share targets and the Employment Generator Mode Share for the Alta Vista District (AM Peak Period) provided in the 2020 TRANS Trip Generation Manual.

Table 3-5: Mode Share Comparison

MODE SHARE	AUTO DRIVER	AUTO PASSENGER	TRANSIT	BICYCLE	WALK
Proposed Mode Share Targets	69%	6%	10%	10%	5%
2020 TRANS Trip Generation Manual (Alta Vista District)	69%	7%	18%	3%	3%

The mode shares for employment trips to The Ottawa Hospital General Campus are similar to employment trips to the overall Alta Vista District. The development is in proximity to Ottawa's cross-town bikeway network and located approximately 1.5km from Transitway service at Smyth or Lycée Claudel Station, which suggests the increase in the bicycle mode share and decrease in transit mode share, despite Route 45 servicing the site, compared to the mode shares provided in the 2020 TRANS Trip Generation Manual. Additionally, the development is not located within a Design Priority Area (DPA) or Transit-oriented Development (TOD) zone.

3.6.2 NEED AND OPPORTUNITY

The existing road network has available capacity should the mode share targets not be met, as indicated in **Section 3.8.3.2**.

3.6.3 TDM PROGRAM

The TDM Measures Checklist for Non-Residential Developments was completed to allow and encourage travel by sustainable modes to and from the proposed development at the time of occupancy. The completed checklist is provided in **Appendix G**.

The following TDM measures are recommended for the proposed development:

- Display local area maps with walking/cycling access routes and key destinations at major entrances.
- Display relevant transit schedules and route maps at entrances.
- Provide shuttle service when OC Transpo cannot offer sufficient quality or capacity to serve demand (e.g., for shift changes, weekends, etc.).
- Charge for long-term parking (daily, weekly, monthly).
- Charge for short-term parking (hourly).
- Provide a multimodal travel option information package to new/relocating employees and students.

3.7 TRANSIT

3.7.1 TRANSIT PRIORITY

Based on **Section 2.7.1**, the proposed development is anticipated to generate approximately 35 transit trips during both the AM and PM Peak Hours and only OC Transpo Route 45 coincides with the boundary street segments bordering the site, which operates with a 15-minute service frequency on weekdays. The detailed performance analysis provided in **Section 3.8.3.2** below indicates that the study area intersections along Ring Road operate well below capacity with minimal delay. Therefore, transit service along Ring Road in terms of travel times will not be impacted with the addition of the development access and development-generated demand.

In addition, the planned Alta Vista Transportation Corridor already considers the following transit priority measures beyond 2031 that will improve service to The Ottawa Hospital General Campus:

- Bus / high occupancy vehicle lanes and transit signal priority between Riverside Drive and the Ottawa Health Sciences Centre
- Transit signal priority and queue jump lanes between the Ottawa Health Sciences Centre and Walkley Road

3.8 INTERSECTION DESIGN

3.8.1 DESIGN OF ACCESS

There is one vehicle access proposed for this development and is indicated in the site plan (**Appendix B**). It is located off Ring Road at the north-west corner of the site, approximately 50 m east of the intersection of Ring Road / Hospital Link Road. The three-legged access is proposed as a two-way, full movement access with stop-control on the side approach and free-flow conditions for the east and west approaches along Ring Road.

A design compliance check was carried out for the development's proposed access on Ring Road for a variety of interrelated design elements for driveways following the Transportation Association of Canada's Geometric Design Guidelines for Canadian Roads (2017). The design compliance check is summarized in **Table 3-6**.

Table 3-6: Access Intersection Design Elements

DESIGN ELEMENTS	MINIMUM REQUIRED	RING ROAD ACCESS
Access Type	-	Full Movement
One-way vs. Two-way Operation	Two-way Operation*	Two-way Operation
Entrance Width* (Two-way)	Not exceeding 9m	9m
Right Turn Radius*	Should accommodate design vehicle*	Can accommodate passenger vehicles
Corner Clearance	6m	42m
Sight Distance (Intersections with Stop Control on Minor Road)	Left Turn from Stop = 65m* Right Turn from Stop = 55m*	Left Turn from Stop > 65m Right Turn from Stop > 55m
Throat Length	Dependent on site specific traffic study*	67m
Angle of Intersection	70°	81°
Proximity to Adjacent Driveways	9m	148m
Pedestrian + Cycling Crossing Considerations	Continuous sidewalk through entrance, depressed curb across sidewalk	Continuous asphalt sidewalk, depressed curb across asphalt sidewalk, painted crosswalk
<p>Note: Asterisk (*) - indicates TAC requirements for design elements absent in City of Ottawa requirements.</p>		

Overall, the design elements for the site access on Ring Road meet the minimum requirements of TAC 2017 to be considered as good design practice.

3.8.2 INTERSECTION CONTROL

3.8.2.1 ACCESS INTERSECTION

Ontario Traffic Manual (OTM) Book 12 (2012) Justification 7 includes two warrants (1 and 2) for signalization with two evaluation criteria (A and B) for each as follows:

- 1A – total volume entering the intersection from all approaches.
- 1B – total volume entering the intersection from the minor approaches only.
- 2A – total volume entering the intersection from the main road only.
- 2B – total volume crossing major road, calculated as the sum of the following:
 - Total left turns from the minor approaches
 - Pedestrian crossings
 - Highest through volume from one of the minor approaches
 - 50% of the heavier left turn from the main road if it exceeds 120 vehicles per hour and the heavier left turn volume plus the opposing traffic exceeds 720 vehicle per hour.

Signalization can be warranted based on Warrant 1 or 2, but only if both criteria (A and B) are 100% met.

Based on **Section 2.7.1**, the site is estimated to generate 126 and 44 auto vehicle trips in and out of the access during the AM Peak Hour, respectively. During the PM Peak Hour, the site is estimated to generate 37 and 126 auto vehicle trips in and out of the access, respectively. In addition, the 2026 and 2031 total traffic volumes were shown in **Figure 3-3** and **Figure 3-4**.

Provided that the development access is considered as a T-intersection with one vehicle travel lane in both directions and that it is a future intersection, thresholds are raised for the consideration of traffic signals due to using average hourly volumes instead of eight-hour volumes as they are unavailable.

In accordance with OTM Book 12, the site generated volumes at the Ring Road access listed above are below the minimum requirements for a traffic signal based on Justification 7 – Projected Volumes, as shown in **Table 3-7**. Therefore, the projected site generated volumes indicate that signalization at the access intersection is not warranted since the volumes fall below the minimum requirements when considering the adjusted volume thresholds for all evaluation criteria.

Table 3-7: OTM Book 12 Signal Warrant Justification 7 - Proposed Development Access

JUSTIFICATION 7	MINIMUM REQUIREMENT	
	FLOW ¹	ADJ. FLOW ²
1A - All Approaches	480	1080
1B - Minor Road	120	270
2A - Major Road	480	1080
2B - Crossing Major Road	50	115
Notes ¹ Base Volume Thresholds are based on a 1-lane major road with free flow conditions. ² Adjusted Volume Thresholds are based on the following requirements in the OTM Warrant Methodology: <ul style="list-style-type: none"> • x1.5 for Justification 7, based on a new intersection • x1.5 for a T-intersection 		

The proposed development access will be located on a low-volume local road such that stop-control on the minor road (site access) is sufficient.

3.8.2.2 NETWORK INTERSECTIONS

Of the nine (9) study area intersections analyzed, all intersections are signalized except for Ring Road / Hospital Link Road, Ring Road / uOttawa-Rehab W Access, and Ring Road / uOttawa-Rehab E Access. The detailed performance analysis provided in **Section 3.8.3.2** below indicates that all the intersections and their associated vehicle movements, except for the NBTR movement at Alta Vista Drive / Hospital Link Road during the AM and PM Peak Hours and the SBT movement at Smyth Road / Alta Vista Drive during the PM Peak Hour, operate at a LOS of D or better for both the AM and PM Peak Hours of all scenarios (i.e., existing conditions, future background, and future total). Due to the traffic operations at each intersection performing below the capacity with the current intersection control, this suggests that there is no need to modify the intersection control to serve the future background and future total traffic demands.

3.8.3 INTERSECTION DESIGN

3.8.3.1 MULTI-MODAL LEVEL OF SERVICE ANALYSIS

ACCESS INTERSECTION

According to the City of Ottawa’s MMLOS Guidelines (2015), only signalized intersections are evaluated against the LOS measures for intersections. As such, no formal evaluation has been applied to the proposed site access due to its unsignalized traffic control.

NETWORK INTERSECTIONS

A MMLOS intersection analysis was carried out in accordance with the methodology outlined in the City of Ottawa’s MMLOS Guidelines (2015). Within the study area, all intersections except for Ring Road / Hospital Link Road, Ring Road / uOttawa-Rehab W Access, and Ring Road / uOttawa-Rehab E Access, are signalized. The MMLOS analysis evaluates the 2023 existing conditions, 2031 future background, and 2031 future total time horizons to provide a comparison between the baseline and future conditions. MMLOS is typically documented for the worst-case scenario and for an intersection analysis, this includes an evaluation of both the AM and PM Peak Hours. Since there are no anticipated road infrastructure upgrades within the study area throughout the horizon years, PLOS and BLOS are expected to remain the same, whereas TLOS and VLOS are expected to change since they are based on average signal delay and volume to capacity ratio, respectively.

As indicated in **Section 3.5.1**, the study area can be classified as a General Urban Area with the corresponding LOS targets taken from Exhibit 22 of the MMLOS Guidelines. Within a General Urban Area, the MMLOS targets for all modes, except for trucks, are the same regardless of road classification. It is noted that the intersection of Smyth Road / Roger Guindon Avenue is located within 300m of a school (Franco-Cité Catholic High School) such that the MMLOS targets are governed by the policy area instead of the land use designation. Smyth Road is an arterial road and designated truck route such that Truck Level of Service (TkLOS) will need to be evaluated. However, TkLOS was only evaluated for the intersections of Smyth Road / Alta Vista Drive and Smyth Road / Ring Road-South Haven Place as they are anticipated to be key delivery access routes to service the proposed development.

The intersection MMLOS results are summarized in **Table 3-8** below and the detailed MMLOS spreadsheets are provided in **Appendix I**.

Table 3-8: Summary of Intersection Multi-Modal Level of Service (MMLOS) Analysis – Signalized Intersections

SCENARIO	PLOS	BLOS	TLOS	TKLOS	VLOS
Land-Use Designation Target – General Urban Area	C	C	D	D	D
Policy Area Target – Within 300m of a School*	A	A	D	-	E
Alta Vista Drive / Hospital Link Road					
Existing Conditions (2023)	E	D	F	-	C
Future Background (2031)	E	D	F	-	C
Future Total (2031)	E	D	F	-	D
Smyth Road / Alta Vista Drive					
Existing Conditions (2023)	F	F	F	C	C
Future Background (2031)	F	F	F	C	C
Future Total (2031)	F	F	F	C	D
Smyth Road / Valour Drive					

SCENARIO	PLOS	BLOS	TLOS	TKLOS	VLOS
Existing Conditions (2023)	E	F	C	-	A
Future Background (2031)	E	F	C	-	A
Future Total (2031)	E	F	C	-	A
Smyth Road / Ring Road-South Haven Place					
Existing Conditions (2023)	E	E	E	D	C
Future Background (2031)	E	E	C	D	C
Future Total (2031)	E	E	F	D	D
Smyth Road / Hospital Main Access					
Existing Conditions (2023)	F	F	F	-	B
Future Background (2031)	F	F	F	-	B
Future Total (2031)	F	F	F	-	B
Smyth Road / Roger Guindon Avenue					
Existing Conditions (2023)	D	F	C	-	C
Future Background (2031)	D	F	C	-	C
Future Total (2031)	D	F	D	-	C
Notes:					
*Only applicable to the intersection of Smyth Road / Roger Guindon Avenue.					

The MMLOS targets that were not met (highlighted in red in **Table 3-8**) are explained below:

The **PLOS** targets of ‘C’ for a General Urban Area and ‘A’ for being located within 300m of a school were not met for any of the intersections. PLOS for signalized intersections is based on the consideration of individual level of service related to the exposure to traffic and average pedestrian delay at the intersection. Pedestrian Exposure to Traffic at Signalized Intersections (PETSIT) LOS considers number of lanes crossed, left and right turning conflicts, Right Turn on Red (RTOR) restrictions, corner radius and type, and crosswalk treatment type. Pedestrian Delay LOS considers the cycle length at the intersection and the effective walk time on the crossing side. In certain cases, the target can be met or close to being met if the effective walk time is increased to more than 30s. Otherwise, the current number of travel lanes crossed and turn conflicts increases the pedestrian exposure to traffic and ultimately decreases the LOS.

The **BLOS** targets of ‘C’ for a General Urban Area and ‘A’ for being located within 300m of a school were not met for any of the intersections. The lack of cycling facilities on Smyth Road and facilitation of left turn cyclist movements decreases the BLOS.

The **TLOS** target of ‘D’ was not met for the intersections of Alta Vista Drive / Hospital Link Road, Smyth Road / Alta Vista Drive, Smyth Road / Ring Road-South Haven Place, and Smyth Road / Hospital Main Access. TLOS for signalized intersections is based on individual transit delay on intersection approaches that include transit routes. With no dedicated transit priority measures at the intersections, OC Transpo buses experience the same delays as general vehicles. The TLOS target of ‘D’ is not met when the average signal delay is greater than 30s.

3.8.3.2 DETAILED PERFORMANCE ANALYSIS

The existing and future conditions were analyzed based upon the weekday peak hour traffic volumes presented in **Sections 2.2.7** and **3.2.3**. The City of Ottawa’s MMLOS Guidelines assigns the vehicle level of service (VLOS) based on ranges of volume to capacity ratio, as indicated in **Table 3-9**. The VLOS for the signalized intersections were evaluated using the volume to capacity ratio.

Table 3-9: City of Ottawa MMLOS Guidelines, LOS Criteria – Signalized Intersections

VLOS	VOLUME TO CAPACITY RATIO
A	0 – 0.60
B	0.61 – 0.70
C	0.71 – 0.80
D	0.81 – 0.90
E	0.91 – 1.00
F	> 1.00

For unsignalized intersections, VLOS is based on control delay, as indicated in **Table 3-10**. Unsignalized intersections include stop-controlled intersections. The VLOS for the three unsignalized intersections were evaluated using the control delay.

Table 3-10: Highway Capacity Manual 2010, LOS Criteria – All-Way Stop Control or Two-Way Stop Control Intersections

VLOS	CONTROL DELAY (S)
A	0 – 10
B	> 10 – 15
C	> 15 – 25
D	> 25 – 35
E	> 35 – 50
F	> 50

Typically, a LOS between A and D represents acceptable operations, E represents operations approaching capacity with noticeable congestion, and F represents operations exceeding capacity that will generate extensive congestion.

The following tables present the results of the intersection capacity analysis. All intersections were analyzed using Synchro 11 following the analysis parameters in the TIA Guidelines. **Appendix J** contains the detailed Synchro analysis sheets.

EXISTING CONDITIONS

The existing traffic conditions were evaluated using the balanced existing (2023) traffic volumes and the existing traffic signal timing and intersection control. The existing conditions (2023) intersection operations analysis results are summarized in **Table 3-11**.

Table 3-11: Summary of Traffic Operations Analysis – 2023 Existing Conditions

Movement	AM Peak Hour				PM Peak Hour			
	LOS	V/C	Delay (s)	95 th %ile Queue (m)	LOS	V/C	Delay (s)	95 th %ile Queue (m)
Alta Vista Drive / Hospital Link Road								
EBL	A	0.01	31.0	2.4	-	-	-	-
EBTR	D	0.86	56.7	#140.8	A	0.30	27.4	26.0
WBL	A	0.12	24.2	8.6	A	0.15	24.8	13.7
WBT	A	0.13	24.4	18.2	A	0.46	31.0	53.4
WBR	A	0.02	0.0	0.1	A	0.05	4.1	2.9
NBL	A	0.17	14.8	12.4	A	0.06	12.4	7.1
NBTR	C	0.74	23.7	181.1	C	0.77	23.0	#255.8
SBL	A	0.08	13.4	5.9	A	0.01	13.0	1.1
SBTR	B	0.69	21.4	161.8	A	0.54	15.9	132.4
Intersection LOS	C				C			
Smyth Road / Alta Vista Drive								
EBL	A	0.47	23.5	38.2	B	0.62	24.2	37.0
EBT	C	0.74	38.8	#129.0	A	0.41	29.6	64.8
EBR	A	0.20	3.8	8.9	A	0.35	10.0	29.8
WBL	A	0.39	29.4	33.1	A	0.51	20.0	62.2
WBT	A	0.51	30.5	67.3	B	0.68	30.4	98.6
WBR	A	0.34	13.7	33.1	A	0.48	16.1	52.4
NBL	D	0.81	40.5	#98.3	A	0.51	33.3	30.9
NBT	D	0.88	61.5	#151.8	C	0.74	53.5	#112.7
NBR	A	0.35	11.3	25.2	A	0.17	1.0	0.6
SBL	D	0.83	46.9	#74.6	A	0.46	30.2	35.5
SBT	A	0.47	39.3	68.4	F	1.04	98.9	#187.7
SBR	A	0.25	5.9	12.6	A	0.49	19.6	43.2
Intersection LOS	C				C			
Smyth Road / Valour Drive								
EBL	A	0.07	1.2	m0.9	A	0.10	1.5	1.4
EBT	A	0.42	1.2	12.8	A	0.23	0.9	8.8
WBTR	A	0.27	8.6	86.0	A	0.50	14.1	167.7
SBL	A	0.14	47.8	10.2	A	0.12	46.9	9.6
SBR	A	0.16	18.9	7.4	A	0.31	16.1	11.4
Intersection LOS	A				A			
Smyth Road / Ring Road-South Haven Place								
EBLTR	C	0.79	15.6	#80.9	A	0.41	4.2	18.0
WBLTR	A	0.30	2.5	16.7	A	0.40	6.2	59.1
NBLR	A	0.05	43.2	5.5	A	0.03	0.2	0.0
SBTL	A	0.22	48.3	15.0	B	0.65	57.5	48.5

Movement	AM Peak Hour				PM Peak Hour			
	LOS	V/C	Delay (s)	95 th %ile Queue (m)	LOS	V/C	Delay (s)	95 th %ile Queue (m)
SBR	A	0.49	13.4	16.6	D	0.82	31.3	61.3
Intersection LOS	C				A			
Smyth Road / Hospital Main Access								
EBL	B	0.66	17.0	m90.2	A	0.18	5.9	14.1
EBT	A	0.20	9.9	m37.8	A	0.25	6.6	40.5
WBT	A	0.35	20.3	70.0	A	0.28	12.4	54.8
WBR	A	0.44	5.4	46.7	A	0.13	0.8	4.9
SBL	A	0.23	40.6	22.0	A	0.58	46.5	57.0
SBR	A	0.27	10.0	19.7	C	0.80	37.8	88.0
Intersection LOS	B				A			
Smyth Road / Roger Guindon Avenue								
EBL	C	0.72	31.8	45.8	A	0.10	10.9	7.7
EBT	A	0.16	4.8	23.8	A	0.52	15.1	74.5
WBTR	C	0.80	22.2	#218.6	A	0.41	18.6	59.1
SBL	A	0.49	41.8	31.9	E	0.97	64.9	#154.3
SBR	A	0.19	11.1	8.6	A	0.36	5.4	16.1
Intersection LOS	C				C			
Ring Road / Hospital Link Road								
EBTR	B	0.47	10.8	-	A	0.08	7.8	-
WBLT	A	0.10	8.3	-	A	0.34	9.6	-
NBLR	A	0.18	8.7	-	A	0.16	8.6	-
Intersection LOS	B				A			
Ring Road / uOttawa-Rehab W Access								
EBTR	A	0.22	0.0	-	A	0.05	0.0	-
WBLT	A	0.09	5.3	2.4	A	0.01	0.9	0.3
NBLR	B	0.01	10.3	0.3	B	0.20	10.8	5.8
Intersection LOS	A				A			
Ring Road / uOttawa-Rehab E Access								
EBT	A	0.25	8.6	-	A	0.11	7.8	-
WBT	A	0.18	8.3	-	A	0.19	8.1	-
NBLR	A	0.07	8.1	-	A	0.05	7.8	-
Intersection LOS	A				A			

Notes:

1. Movement and overall intersection LOS for signalized intersections is based on the City of Ottawa's Multi-Modal Level of Service (MMLOS) Guidelines for signalized intersections.
2. Movement and overall intersection LOS for unsignalized intersections is based on control delay.
3. # - volume for the 95th percentile exceeds capacity, queue may be longer.
4. m – volume for 95th percentile queue is metered by upstream signal.

As shown in **Table 3-11**, all the study intersections and the respective intersections' turning movements are operating at acceptable VLOS of 'D' or better, except for the southbound-thru movement at the intersection of Alta Vista Drive and Smyth Road, which is operating at VLOS of 'F' with a v/c ratio of 1.04 during the PM Peak Hour and the southbound left movement at the intersection of Roger Guindon Avenue and Smyth Road, which is operating at VLOS of 'E' with a v/c ratio of 0.97 during the PM Peak Hour.

It is to be noted that as per the analysis, the 95th percentile queue for the northbound thru and right movement at Alta Vista Drive and Hospital Link Road, exceeds 250 m during the PM peak hour, which will spill back to the south beyond the intersection of Valour Drive. This condition is consistently observed for the future conditions as well. Also, the 95th percentile queue for the southbound left turn movement at Alta Vista Drive and Smyth Road exceeds the available storage length of 44 m during the AM Peak Hour. This is also the case for the westbound left and right movements, where the 95th percentile queue exceeds the available storage lengths of 61 m and 10 m, respectively, during the PM Peak Hour. Since there is reserve capacity for other movements at these intersections during these times of day, improved operation may result from optimized green splits.

FUTURE BACKGROUND

The future background conditions were evaluated for the 2026 and 2031 horizon years using the future background volumes, existing lane configuration, existing traffic signal timing, and intersection control. The 2026 and 2031 future background intersection operations analysis results are summarized in **Table 3-12**.

Table 3-12: Summary of Traffic Operations Analysis – 2026 / 2031 Future Background

Movement	AM Peak Hour				PM Peak Hour			
	LOS	V/C	Delay (s)	95 th %ile Queue (m)	LOS	V/C	Delay (s)	95 th %ile Queue (m)
Alta Vista Drive / Hospital Link Road								
EBL	A / A	0.01 / 0.01	31 / 31	2.4 / 2.4	- / -	- / -	- / -	- / -
EBTR	D / D	0.83 / 0.86	53.2 / 56.1	#125.6 / #139.7	A / A	0.28 / 0.3	26.5 / 27.8	23.8 / 25.9
WBL	A / A	0.11 / 0.12	24.1 / 24.3	8.4 / 8.6	A / A	0.14 / 0.14	24.7 / 24.8	12.9 / 13.4
WBT	A / A	0.12 / 0.13	24.3 / 24.5	16.9 / 19.1	A / A	0.43 / 0.46	30.6 / 31	49.6 / 53.4
WBR	A / A	0.02 / 0.02	0 / 0.1	0 / 0.1	A / A	0.04 / 0.04	3.8 / 3.9	2.5 / 2.7
NBL	A / A	0.14 / 0.16	13.8 / 14.4	11.2 / 12.1	A / A	0.05 / 0.06	12.2 / 12.4	6.8 / 7.1
NBTR	B / C	0.68 / 0.72	20.9 / 22.8	158.5 / 172.3	C / C	0.71 / 0.74	20.4 / 22	#211.6 / #243.1
SBL	A / A	0.06 / 0.07	12.9 / 13.2	5.6 / 5.7	A / A	0 / 0	12 / 13	1.1 / 1.1
SBTR	B / B	0.63 / 0.67	19.4 / 20.8	143.5 / 155	A / A	0.5 / 0.53	15 / 15.6	118.6 / 126.9
Intersection LOS	C / C				B / C			
Smyth Road / Alta Vista Drive								
EBL	A / A	0.42 / 0.45	22.5 / 23.2	35.8 / 37.5	A / A	0.55 / 0.6	21.6 / 23.5	34.4 / 36.1
EBT	B / C	0.68 / 0.73	36.6 / 38.5	115.1 / 126.0	A / A	0.38 / 0.41	28.7 / 29.7	60 / 64.1
EBR	A / A	0.19 / 0.2	3 / 3.5	7.1 / 8.2	A / A	0.32 / 0.34	8.6 / 9.9	25.6 / 28.9
WBL	A / A	0.34 / 0.38	24.3 / 28.2	29.1 / 32.3	A / A	0.46 / 0.52	15.1 / 20.4	55.7 / 64
WBT	A / A	0.47 / 0.5	29.9 / 30.4	61.7 / 65.7	B / B	0.62 / 0.67	23.7 / 30.3	89.3 / 97.6
WBR	A / A	0.32 / 0.33	12.9 / 13.4	28.6 / 31.9	A / A	0.44 / 0.47	9.5 / 15.7	47 / 50.5
NBL	C / C	0.72 / 0.77	34.4 / 37.7	79.4 / #90.1	A / A	0.49 / 0.5	32.5 / 32.9	29.1 / 30.4
NBT	D / D	0.81 / 0.85	53.7 / 58.1	#135.5 / #145.8	B / C	0.68 / 0.72	50.2 / 52.2	#97.5 / #108.2
NBR	A / A	0.32 / 0.37	9.9 / 12.3	21.5 / 27.3	A / A	0.15 / 0.17	0.7 / 1.1	0 / 0.9

Movement	AM Peak Hour				PM Peak Hour			
	LOS	V/C	Delay (s)	95 th %ile Queue (m)	LOS	V/C	Delay (s)	95 th %ile Queue (m)
SBL	C / C	0.73 / 0.79	35.9 / 42	#55.0 / #66.4	A / A	0.4 / 0.44	28.8 / 29.7	33.1 / 34.7
SBT	A / A	0.44 / 0.46	38.5 / 39	63.5 / 66.6	E / F	0.96 / 1.01	78.6 / 90.7	#169.9 / #180.3
SBR	A / A	0.24 / 0.25	4.9 / 5.4	10.5 / 11.8	A / A	0.45 / 0.47	17.5 / 18.7	37.8 / 41.1
Intersection LOS	C / C				B / C			
Smyth Road / Valour Drive								
EBL	A / A	0.06 / 0.07	1.2 / 1.2	m1.0 / m1.0	A / A	0.09 / 0.1	1.4 / 1.5	1.4 / 1.4
EBT	A / A	0.39 / 0.42	1.1 / 1.1	13.1 / 13.2	A / A	0.22 / 0.23	0.9 / 0.9	8.1 / 8.7
WBTR	A / A	0.25 / 0.26	8.3 / 8.6	78.7 / 84.2	A / A	0.46 / 0.49	13.3 / 14.1	158.3 / 165.3
SBL	A / A	0.13 / 0.13	47.4 / 47.5	9.6 / 10	A / A	0.1 / 0.11	46.6 / 46.7	8.5 / 9.1
SBR	A / A	0.15 / 0.15	19.1 / 18.8	6.9 / 7.1	A / A	0.3 / 0.31	16.3 / 16.1	10.8 / 11.2
Intersection LOS	A / A				A / A			
Smyth Road / Ring Road-South Haven Place								
EBLTR	C / C	0.71 / 0.78	11.5 / 15.1	62.5 / 73.3	A / A	0.36 / 0.41	3.4 / 4.6	13.5 / 18.7
WBLTR	A / A	0.28 / 0.29	2.3 / 2.5	15.3 / 16.4	A / A	0.37 / 0.4	5.5 / 6.4	50.4 / 59.5
NBLR	A / A	0.04 / 0.05	42.8 / 43.1	5.1 / 5.5	A / A	0.03 / 0.03	0.2 / 0.1	0 / 0
SBTL	A / A	0.2 / 0.22	47.9 / 48.3	14.4 / 15	B / B	0.66 / 0.63	60.6 / 55.4	47.1 / 46.9
SBR	A / A	0.47 / 0.49	13.5 / 13.5	16 / 16.6	C / D	0.77 / 0.83	25.4 / 32.4	51 / 63.8
Intersection LOS	B / C				A / A			
Smyth Road / Hospital Main Access								
EBL	B / B	0.61 / 0.65	16.4 / 16.6	82.5 / m88.5	A / A	0.16 / 0.18	4.9 / 6.1	11.8 / 14.8
EBT	A / A	0.18 / 0.19	10.6 / 9.9	36.4 / m36.8	A / A	0.23 / 0.25	5.6 / 6.8	34.8 / 39.5
WBT	A / A	0.31 / 0.34	17.6 / 19.5	57.9 / 65.5	A / A	0.25 / 0.27	11.2 / 12.2	45.4 / 52.2
WBR	A / A	0.39 / 0.46	3.4 / 5.2	27 / 46.2	A / A	0.12 / 0.14	0.6 / 0.7	3.7 / 4.7
SBL	A / A	0.21 / 0.25	40.3 / 41	20.6 / 24	A / B	0.55 / 0.61	45.7 / 47	52.9 / 59.9
SBR	A / A	0.26 / 0.27	8.1 / 9.4	17.4 / 19.2	C / C	0.76 / 0.8	33.5 / 36.9	81.6 / 87.8
Intersection LOS	A / B				A / A			
Smyth Road / Roger Guindon Avenue								
EBL	B / B	0.62 / 0.7	19.9 / 29.6	37 / 43.6	A / A	0.08 / 0.09	10.8 / 10.9	7.4 / 7.4
EBT	A / A	0.15 / 0.16	4.7 / 4.8	22.1 / 24.2	A / A	0.47 / 0.51	14 / 14.8	67.6 / 75.1
WBTR	C / C	0.73 / 0.79	19.4 / 21.6	#195.6 / #217.6	A / A	0.37 / 0.4	17.7 / 18.3	54.1 / 58.9
SBL	A / A	0.47 / 0.48	41.4 / 41.7	29.9 / 31.2	E / E	0.93 / 0.96	59.7 / 64.3	#138.6 / #148.6
SBR	A / A	0.18 / 0.18	11.3 / 11.1	8.3 / 8.6	A / A	0.35 / 0.36	5.6 / 5.5	15.5 / 15.9
Intersection LOS	B / C				B / B			
Ring Road / Hospital Link Road								
EBTR	B / B	0.43 / 0.47	10.2 / 10.7	- / -	A / A	0.08 / 0.08	7.7 / 7.8	- / -
WBLT	A / A	0.09 / 0.10	8.2 / 8.3	- / -	A / A	0.31 / 0.33	9.3 / 9.5	- / -

Movement	AM Peak Hour				PM Peak Hour			
	LOS	V/C	Delay (s)	95 th %ile Queue (m)	LOS	V/C	Delay (s)	95 th %ile Queue (m)
NBLR	A / A	0.16 / 0.18	8.5 / 8.8	- / -	A / A	0.14 / 0.16	8.4 / 8.6	- / -
Intersection LOS	A / B				A / A			
Ring Road / uOttawa-Rehab W Access								
EBTR	A / A	0.2 / 0.21	0 / 0	0 / 0	A / A	0.04 / 0.05	0 / 0	0 / 0
WBLT	A / A	0.08 / 0.09	5.1 / 5.2	2.1 / 2.3	A / A	0.01 / 0.01	0.9 / 0.9	0.3 / 0.3
NBLR	B / B	0.01 / 0.01	10.1 / 10.2	0.2 / 0.2	B / B	0.18 / 0.19	10.6 / 10.7	5.1 / 5.5
Intersection LOS	A / A				A / A			
Ring Road / uOttawa-Rehab E Access								
EBT	A / A	0.23 / 0.24	8.5 / 8.6	- / -	A / A	0.10 / 0.11	7.7 / 7.7	- / -
WBT	A / A	0.17 / 0.18	8.2 / 8.2	- / -	A / A	0.18 / 0.19	8 / 8.1	- / -
NBLR	A / A	0.07 / 0.07	8 / 8.1	- / -	A / A	0.04 / 0.05	7.8 / 7.8	- / -
Intersection LOS	A / A				A / A			
Notes:								
1. Movement and overall intersection LOS for signalized intersections is based on the City of Ottawa's Multi-Modal Level of Service (MMLOS) Guidelines for signalized intersections.								
2. Movement and overall intersection LOS for unsignalized intersections is based on control delay.								
3. # - volume for the 95th percentile exceeds capacity, queue may be longer.								
4. m – volume for 95th percentile queue is metered by upstream signal.								

As shown in **Table 3-12**, all the study intersections are operating similar to the existing conditions with not much deterioration of performance in the 2026 and 2031 future background conditions. It is to be noted that although signal timing optimization may improve the performance of the intersections in the future horizon years, existing signal timings were used to evaluate the future conditions, since there is not much change in the traffic volumes and estimated VLOS.

Similar to the existing conditions, the southbound thru movement at Smyth Road and Alta Vista Drive intersection is projected to operate at LOS 'E' and 'F' during the PM Peak Hour for the 2026 and 2031 horizon years, respectively. Since there is reserve capacity for other movements at this intersection during these times of day, improved operation may result from optimized green splits.

FUTURE TOTAL

The future total conditions were evaluated using the 2026 and 2031 future total volumes, existing lane configuration, existing traffic signal timing, and the new intersection at the development access driveway on Ring Road. The 2026 and 2031 future total intersection operations analysis results are summarized in **Table 3-13**.

Table 3-13: Summary of Traffic Operations Analysis – 2026 / 2031 Future Total

Movement	AM Peak Hour				PM Peak Hour			
	LOS	V/C	Delay (s)	95 th %ile Queue (m)	LOS	V/C	Delay (s)	95 th %ile Queue (m)
Alta Vista Drive / Hospital Link Road								
EBL	A / A	0.01 / 0.01	32 / 32	2.4 / 2.4	- / -	- / -	- / -	- / -
EBTR	E / F	0.93 / 1	69.2 / 82.8	#152.6 / #166.5	A / A	0.34 / 0.36	31.4 / 32.4	29.5 / 31.2
WBL	A / A	0.2 / 0.22	25.1 / 25.6	12.2 / 12.5	A / A	0.19 / 0.19	25 / 25	17.7 / 18.1
WBT	A / A	0.14 / 0.16	23.9 / 24.2	21.1 / 23.1	A / A	0.48 / 0.51	30.6 / 31.3	61.5 / 65.7

Movement	AM Peak Hour				PM Peak Hour			
	LOS	V/C	Delay (s)	95 th %ile Queue (m)	LOS	V/C	Delay (s)	95 th %ile Queue (m)
WBR	A / A	0.01 / 0.02	0 / 0	0 / 0.1	A / A	0.04 / 0.04	3.6 / 3.7	2.5 / 2.7
NBL	A / A	0.15 / 0.17	15.4 / 16	11.6 / 12.3	A / A	0.06 / 0.06	12.8 / 13	6.9 / 7.2
NBTR	C / C	0.74 / 0.77	24.9 / 26.6	171.7 / #189.1	C / C	0.76 / 0.8	23.8 / 25.7	#239.8 / #259.3
SBL	A / A	0.07 / 0.08	14.4 / 14.7	5.8 / 5.9	A / A	0.01 / 0.01	13 / 13	1 / 1
SBTR	B / B	0.66 / 0.69	22 / 23.1	146.9 / 158.2	A / A	0.52 / 0.55	16.6 / 17.1	122.2 / 130.2
Intersection LOS	C / D				C / C			
Smyth Road / Alta Vista Drive								
EBL	A / A	0.46 / 0.48	23.2 / 23.9	38.2 / 39.7	B / B	0.61 / 0.66	23.6 / 27.6	37 / 42.1
EBT	C / D	0.73 / 0.83	38.3 / 43.9	124.6 / #145.4	A / A	0.39 / 0.42	29.5 / 30.3	61 / 65.1
EBR	A / A	0.19 / 0.21	3 / 3.6	7.2 / 8.2	A / A	0.32 / 0.34	9 / 10.1	26.1 / 29.1
WBL	A / A	0.38 / 0.45	27.5 / 36.2	32.7 / 35.3	A / A	0.52 / 0.58	20.5 / 23.3	65.7 / 74.3
WBT	A / A	0.49 / 0.52	30.6 / 30.8	64 / 67.9	B / C	0.66 / 0.72	30.2 / 31.7	96 / 104.3
WBR	A / A	0.32 / 0.34	13.1 / 13.4	30 / 32.1	A / A	0.45 / 0.47	15 / 15.9	47.3 / 51.2
NBL	C / C	0.73 / 0.78	34.8 / 38.2	79.4 / #91.2	A / A	0.49 / 0.5	32.5 / 32.9	29.1 / 30.4
NBT	D / D	0.83 / 0.87	55.5 / 60.2	#140.4 / #149.8	B / C	0.7 / 0.73	50.9 / 53.1	#103.8 / #111.7
NBR	A / A	0.4 / 0.44	14.1 / 16.4	32.1 / 38.2	A / A	0.16 / 0.18	0.7 / 1.4	0 / 1.7
SBL	C / D	0.74 / 0.81	37.2 / 43.8	#55.1 / #69.1	A / A	0.41 / 0.45	29 / 29.9	33.1 / 34.7
SBT	A / A	0.45 / 0.47	38.6 / 39.2	64.8 / 67.9	E / F	0.98 / 1.03	83.2 / 95.6	#174.9 / #185.2
SBR	A / A	0.26 / 0.27	6.1 / 6.6	13.1 / 14.3	A / A	0.47 / 0.5	18.9 / 20.1	41.7 / 44.9
Intersection LOS	C / D				C / C			
Smyth Road / Valour Drive								
EBL	A / A	0.06 / 0.07	1.2 / 1.3	m1.0 / m0.9	A / A	0.1 / 0.11	1.5 / 1.8	1.4 / 1.5
EBT	A / A	0.42 / 0.45	1.1 / 1.6	13.6 / 15	A / A	0.22 / 0.23	0.9 / 0.9	8.2 / 9.2
WBTR	A / A	0.25 / 0.27	8.5 / 8.5	81.8 / 85.1	A / A	0.49 / 0.52	14.2 / 15.3	160.9 / 168.1
SBL	A / A	0.13 / 0.13	47.4 / 47.5	9.6 / 10	A / A	0.1 / 0.11	46.6 / 46.7	8.5 / 9.1
SBR	A / A	0.15 / 0.15	19.1 / 18.8	6.9 / 7.1	A / A	0.3 / 0.31	16.3 / 16.1	10.8 / 11.2
Intersection LOS	A / A				A / A			
Smyth Road / Ring Road-South Haven Place								
EBLTR	C / E	0.78 / 0.92	14.9 / 19.6	71.6 / #205.4	A / A	0.39 / 0.46	4.2 / 5.6	74.3 / 82.8
WBLTR	A / A	0.29 / 0.3	2.4 / 2.5	15.2 / 16.1	A / A	0.39 / 0.42	6.7 / 7.7	58.4 / 61.5
NBLR	A / A	0.04 / 0.05	42.8 / 43.1	5.1 / 5.5	A / A	0.03 / 0.02	0.1 / 0.1	0 / 0
SBTL	A / A	0.22 / 0.23	48.5 / 48.7	15.4 / 15.6	B / A	0.62 / 0.58	54.2 / 49.4	48 / 50.1
SBR	A / A	0.51 / 0.52	13.5 / 13.5	17.3 / 17.7	D / D	0.85 / 0.89	34.3 / 41.1	68.5 / 85.1
Intersection LOS	C / D				A / A			
Smyth Road / Hospital Main Access								
EBL	B / B	0.63 / 0.67	15.7 / 15.9	m83.6 / m83.3	A / A	0.17 / 0.18	5.6 / 6.9	12.8 / 16.7

Movement	AM Peak Hour				PM Peak Hour			
	LOS	V/C	Delay (s)	95 th %ile Queue (m)	LOS	V/C	Delay (s)	95 th %ile Queue (m)
EBT	A / A	0.18 / 0.19	9.8 / 9.3	m35.7 / m34.1	A / A	0.24 / 0.25	6.2 / 7.6	37.1 / 43.3
WBT	A / A	0.32 / 0.36	18.6 / 20.8	61.5 / 70.1	A / A	0.26 / 0.28	11.5 / 12.7	48 / 55
WBR	A / A	0.41 / 0.48	4.1 / 6.2	33.5 / 55.9	A / A	0.12 / 0.14	0.7 / 0.8	4 / 5
SBL	A / A	0.21 / 0.25	40.3 / 41	20.6 / 24	A / B	0.56 / 0.62	45.9 / 47.1	54 / 60.8
SBR	A / A	0.26 / 0.26	8.3 / 9	17.4 / 18.8	C / D	0.78 / 0.81	35.2 / 37.9	84.4 / 89.7
Intersection LOS	B / B				A / A			
Smyth Road / Roger Guindon Avenue								
EBL	B / C	0.68 / 0.71	26.7 / 31.2	41.9 / 45.9	A / A	0.09 / 0.1	10.9 / 10.9	7.4 / 7.4
EBT	A / A	0.15 / 0.17	4.8 / 5.1	22.2 / 24.4	A / A	0.5 / 0.54	14.9 / 15.6	69.7 / 77.4
WBTR	C / D	0.77 / 0.88	20.8 / 26.6	#208.7 / #230.6	A / A	0.39 / 0.42	18.2 / 18.8	55.1 / 60
SBL	A / A	0.5 / 0.51	41.9 / 42.3	32.3 / 33.3	E / F	0.97 / 1	64.9 / 73.9	#157.7 / #167.7
SBR	A / A	0.17 / 0.18	11.2 / 11	8.3 / 8.6	A / A	0.34 / 0.36	5.4 / 5.4	15.8 / 16.1
Intersection LOS	C / C				B / C			
Ring Road / Hospital Link Road								
EBTR	B / B	0.51 / 0.55	11.5 / 12.3	- / -	A / A	0.12 / 0.13	8.3 / 8.4	- / -
WBLT	A / A	0.17 / 0.18	8.9 / 9.1	- / -	B / B	0.38 / 0.40	10.4 / 10.7	- / -
NBLR	A / A	0.21 / 0.23	9.1 / 9.4	- / -	A / A	0.25 / 0.27	9.6 / 9.9	- / -
Intersection LOS	B / B				A / B			
Ring Road / uOttawa-Rehab W Access								
EBTR	A / A	0.15 / 0.16	0 / 0	0 / 0	A / A	0.06 / 0.06	0 / 0	0 / 0
WBLT	A / A	0.03 / 0.03	1.9 / 2	0.6 / 0.7	A / A	0.01 / 0.01	0.4 / 0.5	0.2 / 0.2
NBLR	A / B	0 / 0	10 / 10.1	0.1 / 0.1	B / B	0.07 / 0.08	10.1 / 10.2	1.9 / 2
Intersection LOS	A / A				A / A			
Ring Road / uOttawa-Rehab E Access								
EBT	A / A	0.23 / 0.24	8.5 / 8.6	- / -	A / A	0.11 / 0.11	7.8 / 7.8	- / -
WBT	A / A	0.13 / 0.13	8 / 8.1	- / -	A / A	0.18 / 0.19	8 / 8.1	- / -
NBLR	A / A	0.09 / 0.09	8.1 / 8.2	- / -	A / A	0.05 / 0.05	7.8 / 7.8	- / -
Intersection LOS	A / A				A / A			
Ring Road / Site Access								
EBTR	A / A	0.20 / 0.21	0 / 0	0 / 0	A / A	0.06 / 0.06	0 / 0	0 / 0
WBTL	A / A	0.03 / 0.03	2.3 / 2.3	2.3 / 0.7	A / A	0 / 0	0.3 / 0.3	0.1 / 0.1
NBLR	B / B	0.08 / 0.08	11.8 / 11.9	11.8 / 2	B / B	0.17 / 0.17	10.9 / 11	4.9 / 5
Intersection LOS	A / A				A / A			
Notes:								
1. Movement and overall intersection LOS for signalized intersections is based on the City of Ottawa's Multi-Modal Level of Service (MMLoS) Guidelines for signalized intersections.								
2. Movement and overall intersection LOS for unsignalized intersections is based on control delay.								

Movement	AM Peak Hour				PM Peak Hour			
	LOS	V/C	Delay (s)	95 th %ile Queue (m)	LOS	V/C	Delay (s)	95 th %ile Queue (m)
3. # - volume for the 95th percentile exceeds capacity, queue may be longer.								
4. m – volume for 95th percentile queue is metered by upstream signal.								

As shown in **Table 3-13**, all the study intersections are operating similar to the future background conditions with not much deterioration of performance in the 2026 and 2031 future total conditions. It is to be noted that although signal timing optimization may improve the performance of the intersections in the future horizon years, existing signal timings were used to evaluate the future conditions, since there is not much change in the traffic volumes and estimated VLOS.

Similar to the future background and existing conditions, the southbound thru movement at Smyth Road and Alta Vista Drive intersection is projected to operate at LOS ‘E’ and ‘F’ during the PM Peak Hour in the 2026 and 2031 horizon years, respectively. Compared to future background conditions, the eastbound thru-right movement at the intersection of Alta Vista Drive and Hospital Link Road will decrease from a LOS of ‘D’ to a LOS of ‘E’ and ‘F’ during the AM Peak Hour of the 2026 and 2031 horizon years, respectively. Since there is reserve capacity for other movements at these intersections during these times of day, improved operation may result from optimized green splits. The new intersection at the development access driveway on Ring Road is projected to operate at LOS of ‘A’ during both the peak hours and horizon years. The vehicle queues at the new intersection will not extend to the intersection of Ring Road / Hospital Link Road nor the new PXO at the intersection of Ring Road / uOttawa-Rehab W Access.

3.9 SUMMARY OF IMPROVEMENTS INDICATED AND MODIFICATION OPTIONS

A summary of transportation improvements proposed as part of this Transportation Impact Assessment and the proposed modifications are presented as follows:

1. Development Design

- Sustainable modes have been accounted for on-site through the provision of internal sidewalks, bicycle parking, crosswalks, and direct connections and access to an existing adjacent transit stop.
- The site plan was assessed using AutoTurn 11 for various design vehicles (i.e., municipal services / waste removal, delivery vehicle, fire truck, and transit) circulating around the site. The AutoTurn swept paths indicate that the site access on Ring Road can accommodate the movements of these design vehicles entering and exiting the site without conflicting with built features. However, the WB-20 is required to encroach on the opposing vehicle lane for inbound movements. The lay-by / drop-off area can accommodate the turning maneuvers of a fire truck and Para Transpo bus.
- Operating practices will need to be put in place to ensure that the schedules for use of the loading docks are staggered for safe operation. This is due to space limitations for HSU and WB-20 vehicles.

2. Parking

- The 120 regular auto parking, six accessible auto parking, 222 bicycle parking and six service vehicle spaces provided in the site plan for the proposed AMRC building meet the minimum requirements of the City of Ottawa’s Zoning By-Law.

3. Boundary Streets

- The existing pedestrian and cycling infrastructure on Ring Road (i.e., bi-directional MUP on one side of the road) is sufficient to meet the MMLoS targets based on the location of accesses to surrounding land uses.

4. Transportation Demand Management

- The existing road network has available capacity should the mode share targets not be met.

- The TDM measures recommended for the proposed development include displaying local area maps with walking/cycling access routes and transit schedules with route maps, continually providing shuttle service when OC Transpo cannot offer sufficient quality or capacity to serve demand, charging for long- and short-term parking, and providing a multimodal travel option information package to new/relocating employees and students.

5. Transit

- Transit service (OC Transpo Route 45) along Ring Road will not be impacted according to the low development-generated demand estimated and minimal delay.

6. Intersection Design

- A few alternative traffic safety countermeasures to address historical collisions at the study area intersections have been included for the City of Ottawa's consideration, such as upgraded signal heads, reconstructing left turn lane alignment for better sight distance, and changes to time of day protected-permitted left turns and protected-only left turns. Each of these countermeasures have impacts on City practices and programs or other movements at the intersection, therefore, a more detailed examination of these alternatives and benefit-cost analysis would be beneficial.
- The site access on Ring Road meets the requirements set out for driveways in TAC 2017 to be considered as part of good design practice.
- In accordance with OTM Book 12, the addition of the site generated volumes results in total volumes below the minimum requirements for a traffic signal to be warranted at the access on Ring Road at the site access based on Justification 7 – Projected Volumes.
- Stop-control on the minor road (site access) is sufficient for the intersection of Ring Road and the site access.
- Based on the City of Ottawa's MMLOS Guidelines (2015), the PLOS and BLOS targets were not met for all study area intersections for both the existing and future conditions. The TLOS target was not met for the intersections of Alta Vista Drive / Hospital Link Road, Smyth Road / Alta Vista Drive, Smyth Road / Ring Road-South Haven Place, and Smyth Road / Hospital Main Access for both the existing and future conditions.
 - The current number of travel lanes crossed and turn conflicts increases the pedestrian exposure to traffic and ultimately decreases the LOS.
 - The lack of cycling facilities on Smyth Road and facilitation of left turn cyclist movements decreases the BLOS.
 - With no dedicated transit priority measures at the intersections, OC Transpo buses currently experience the same delays as general vehicles.
- The MMLOS analysis should be revisited when the updated MMLOS Guidelines are released, which will likely reflect changes in the New Official Plan.
- Control type and capacity are sufficient for all study area intersections.

Based on the results of this Transportation Impact Assessment, the transportation network surrounding the proposed Advanced Medical Research Centre for uOttawa located at 451 Smyth Road can accommodate the development without adverse impacts to future traffic operations during the 2026 built-out year and 2031 planning horizon.

Appendix A

SCREENING FORM





CITY OF OTTAWA TIA SCREENING FORM

Based on July 2023 Traffic Impact Guidelines Revisions

1. Description of Proposed Development	
Municipal Address	451 Smyth Road, Ottawa ON
Description of Location	Existing Parking Lot 13 adjacent to OU Roger Guindon Hall, Overflow Parking on Peter Morand Crescent east of Ring Road.
Land Use Classification	Existing I2[402] (development), IP11 (Overflow Parking Site)
Development Size (units)	N/A
Development Size (m ²)	20,325 m ²
Number of Accesses and Locations	One new access from Ring Road
Phase of Development	1
Buildout Year	2024

2. Trip Generation Trigger (60 Trips)			
Land Use Type	Minimum Development Size	Proposed Development Size	Trigger Met
Single-Detached ¹	60 units	-	<input type="checkbox"/>
Multi-Use Family (Low-Rise) ¹	90 units	-	<input type="checkbox"/>
Multi-Use Family (High-Rise) ¹	150 units	-	<input type="checkbox"/>
Office ²	1,400 m ²	-	<input type="checkbox"/>
Industrial ²	7,000 m ²	-	<input type="checkbox"/>
Fast-food restaurant or coffee shop ²	110 m ²	-	<input type="checkbox"/>
Destination retail ²	1800 m ²	-	<input type="checkbox"/>
Gas station or convenience market ²	90 m ²	-	<input type="checkbox"/>
Other	60 trips generated *Convert ITE vehicle trips to person trips using factor of 1.28	ITE Category 760 – Research and Development Centre 1.03 AM / 0.98 PM trips per 1000sq.ft GFA 225 (215) AM (PM) vehicle trips 288 (275) AM (PM) vehicle trips	<input checked="" type="checkbox"/>

¹Table 2, Table 3 & Table 4 TRANS Trip Generation Manual

²ITE Trip Generation Manual 11.1 Ed.



3. Location Triggers	YES	NO
Does the development propose a new driveway to a boundary street that is designated as:	<input checked="" type="checkbox"/>	<input type="checkbox"/>
– <input checked="" type="checkbox"/> Part of the City’s Rapid Transit or Transit Priority Networks (<u>OP Schedule C2</u>)		
– <input checked="" type="checkbox"/> A Cross-Town Bikeway (<u>Ottawa TMP</u>)		
Is the development in a:	<input type="checkbox"/>	<input checked="" type="checkbox"/>
– <input type="checkbox"/> Hub Area (<u>OP Schedule B Series</u>)		
– <input type="checkbox"/> Design Priority Area (DPA) (OP Schedules <u>C7A-Urban</u> and <u>C7B-Villages</u>)		
– <input type="checkbox"/> Protected Major Transit Station Area (<u>OP Schedule C1</u>)		

4. Safety Triggers	YES	NO
Are posted speed limits on a boundary street are 80 km/hr or greater?	<input type="checkbox"/>	<input checked="" type="checkbox"/>
Are there any horizontal/vertical curvatures on a boundary street limits sight lines at a proposed driveway?	<input type="checkbox"/>	<input checked="" type="checkbox"/>
Is the proposed driveway within the area of influence of an adjacent traffic signal or roundabout (i.e. within 300 m of intersection in rural conditions, or within 150 m of intersection in urban/ suburban conditions)?	<input type="checkbox"/>	<input checked="" type="checkbox"/>
Is the proposed driveway within auxiliary lanes of an intersection?	<input type="checkbox"/>	<input checked="" type="checkbox"/>
Does the proposed driveway make use of an existing median break that serves an existing site?	<input type="checkbox"/>	<input checked="" type="checkbox"/>
Is there is a documented history of traffic operations or safety concerns on the boundary streets within 500 m of the development?	<input type="checkbox"/>	<input checked="" type="checkbox"/>
Does the development include a drive-thru facility?	<input type="checkbox"/>	<input checked="" type="checkbox"/>

5. Summary	YES	NO
Does the Development Satisfy the Trip Generation Trigger?	<input checked="" type="checkbox"/>	<input type="checkbox"/>
Does the Development Satisfy the Location Trigger?	<input checked="" type="checkbox"/>	<input type="checkbox"/>
Does the Development Satisfy the Safety Trigger?	<input type="checkbox"/>	<input checked="" type="checkbox"/>
Is a TIA Report Required for the Proposed Development?	<input checked="" type="checkbox"/>	<input type="checkbox"/>



CITY OF OTTAWA TIA SCOPING CHECKLIST

Based on July 2023 Traffic Impact Guidelines Revisions

Site Design and TDM Modules	Requirements	Required
4.1 Development Design		
4.1.1 Design for Sustainable Modes	Required for all TIAs	<input checked="" type="checkbox"/>
4.1.2 Circulation and Access	All site plan and zoning by-law applications	<input checked="" type="checkbox"/>
4.1.3 New Street Networks	All plans of subdivision	<input type="checkbox"/>
4.2 Parking		
4.2.1 Parking Supply	All site plan and zoning by-law applications Include language that asks for justification of change to Zoning By-law parking requirements	<input checked="" type="checkbox"/>
4.3 Boundary Street Design	Required for all TIAs	<input checked="" type="checkbox"/>
4.4 Access Intersections Design	Not Required - consolidated into 4.9	
4.5 TDM		
4.5.1 Context for TDM	Required for all TIAs	<input checked="" type="checkbox"/>
4.5.2 Need and Opportunity	Required for all TIAs	<input checked="" type="checkbox"/>
4.5.3 TDM Program	Required for all TIAs	<input checked="" type="checkbox"/>
4.6 Neighbourhood Traffic Calming	<p>If the development meets all of the following criteria along the route(s) site generated traffic is expected to utilize between an arterial road and the site's access:</p> <ol style="list-style-type: none"> 1 <input type="checkbox"/> Access to Collector or Local (OP <u>Urban</u>, <u>Downtown</u>, <u>Rural</u>, <u>Village</u> Road Networks); 2 <input type="checkbox"/> "Significant sensitive land use presence" exists, where there is at least two of the following adjacent to the subject street segment: <ol style="list-style-type: none"> a <input type="checkbox"/> School (within 250m walking distance); b <input type="checkbox"/> Park; c <input type="checkbox"/> Retirement / Older Adult Facility (i.e. long-term care and retirement homes); d <input type="checkbox"/> Licenced Child Care Centre; e <input type="checkbox"/> Community Centre; or f <input type="checkbox"/> 50%, or greater, of adjacent property along the route(s) is occupied by residential lands and a minimum of 10 occupied residential units are present on the route. 3 <input checked="" type="checkbox"/> Application is for Zoning By-Law Amendment or Draft Plan of Subdivision; 4 <input checked="" type="checkbox"/> At least 75 site-generated auto trips; 5 <input type="checkbox"/> Site Trip Infiltration is expected. Site traffic will increase peak hour vehicle volumes along the route by 50% or more. 	<input type="checkbox"/>
4.7 Transit		
4.7.1 Transit Route Capacity	> 75 site transit trips	<input checked="" type="checkbox"/>



Site Design and TDM Modules		Requirements	Required
4.7.2	Transit Priority Requirements	> 75 site auto trips	<input checked="" type="checkbox"/>
4.8	Network Concept	When proposed development generates > 200 person-trips during the peak hour in excess of the equivalent volume permitted by established zoning.	<input type="checkbox"/>
4.9	Intersection Design		
4.9.1	Intersection Controls (including site accesses)	> 75 site auto trips	<input checked="" type="checkbox"/>
4.9.2	Intersection Design (including site accesses)	> 75 site auto trips	<input checked="" type="checkbox"/>

Appendix B

SITE PLAN



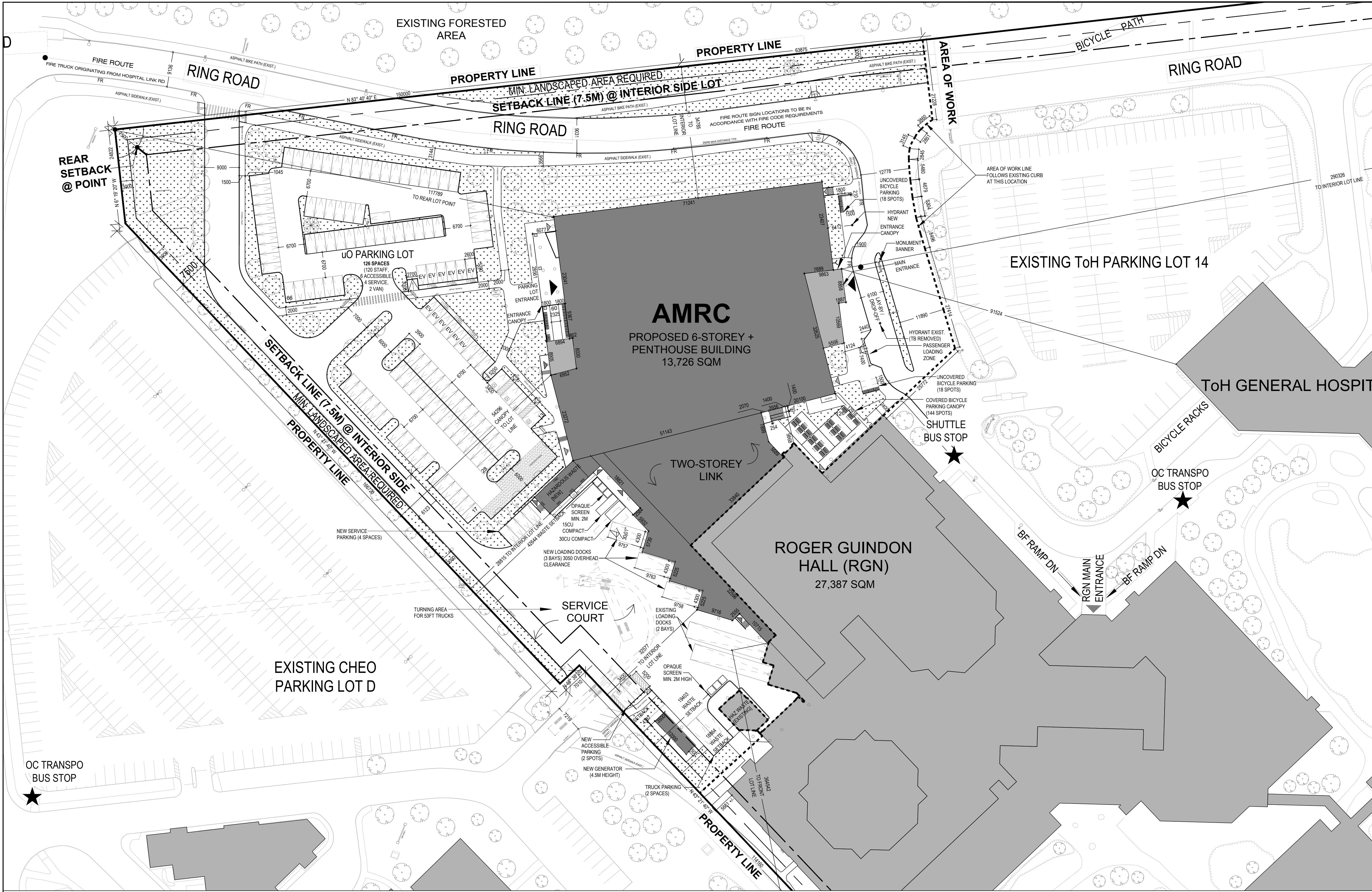

KEY PLAN

REFERENCE SURVEY: 1) 2023-11-25 REF. NO. 105 - 15 (JIG) GR*
2) 2022-11-22 FILE NO. 623-22**

MUNICIPAL ADDRESS: 451 SMYTH ROAD, OTTAWA, ON K1H 8M5, CANADA
PIN: 04258-0412

ZONE: 12 (H2) F1 (S) S144
AREA B - INNER URBAN
AREA B

SCHEDULE 1A:
SCHEDULE 1B:

AREA OF WORK: 24,076.02 M2
COMPLETE SITE AREA: 204,834.211 M2
GFA** OF PROPOSED AMRC: 13,726.17 M2
GFA** OF EXISTING BUILDINGS ON SITE: 128,023 M2
GFA** OF PROPOSED EXIST. BUILDINGS ON SITE: 141,749.17 M2
BUILDING HEIGHT: 40.3M (6 STOREYS + MECH. PENTHOUSE AND ATRIUM ROOF)

ZONING PROVISION	REQUIRED	PROVIDED
MIN. LOT WIDTH	NO MINIMUM	257.13 M
MIN. LOT AREA	NO MINIMUM	204834.211 M
MIN. FRONT YARD SETBACK	4.6M	YES - 364.54M
MIN. REAR YARD SETBACK***	7.5M	YES - 117.79M
MIN. INTERIOR YARD SETBACK	7.5M	YES - 34.79M
MAX. HEIGHT	NO MAXIMUM	39.1 M
LANDSCAPED AREA (AREA OF WORK)	15%	22.8% (5902.69 M2)
LANDSCAPED AREA (SITE)	15%	29% (59721.75 M2)

PARKING QUEUING + LOADING	REQUIRED	PROVIDED
EXISTING PARKING SPACES	1617	2079
EXISTING SPACES TO BE ELIMINATED	N/A	361
PROPOSED PARKING SPACES	N/A	120
PROPOSED SERVICE SPACES	N/A	6
PROPOSED ACCESSIBLE SPACES	3	6
PROPOSED TOTAL SPACES	103	126
TOTAL PARKING (EXIST + PROPOSED)	1720	1863
BY USE: AMRC (POST-SEC. FACTOR)	103	126
BY USE: RGN (POST-SEC. FACTOR)	206	191
BY USE: TOTAL POST-SEC. FACTOR	308	317
BY USE: DAYCARE FACTOR	13	11
BY USE: HOSPITAL FACTOR	1399	1535
EXISTING BICYCLE PARKING	212	477
PROPOSED BICYCLE PARKING (AMRC)	55	222
TOTAL BICYCLE PARKING (PRO + EXIST)	267	699
BY USE: AMRC (POST-SEC. FACTOR)	55	222
BY USE: RGN (POST-SEC. FACTOR)	109	190
BY USE: TOTAL POST-SEC. FACTOR	164	412
BY USE: DAYCARE FACTOR	3	0
BY USE: HOSPITAL FACTOR	100	287
EXISTING LOADING DOCKS	2	2
NEW LOADING DOCKS	2	3
TOTAL LOADING DOCKS	2	5

SITE PLAN GENERAL NOTES:

- ALL SITE INFORMATION GATHERED FROM SURVEYS 2022-11-22 FILE NO. 623-22 AND 2023-11-25 REF. NO. 101 - 15 (JIG) GR
- NO EXISTING TREES TO BE RETAINED - ALL TREES IN PLAN WILL BE PLANTED.
- SNOW STORAGE WILL OCCUR OFF SITE. AN INTERIM SNOW STORAGE LOCATION HAS BEEN OUTLINED AS PER THE RELEVANT HATCH (SEE LEGEND).

* A PORTION OF THE LANDS OWNED BY THE OTTAWA HEALTH SERVICES BOARD, INC. AND CHILDREN'S HOSPITAL FOR THE QUEEN CITY OF OTTAWA HEALTH SERVICES BOARD, INC. IS SHOWN HEREIN.

** GFA OF 2023-11-25 REF. NO. 101 - 15 (JIG) GR IS A 3% PART OF FORMING ROAD GRADING BY AMRC'S DESIGN CONSULTANTS REGISTERED PROFESSIONAL ENGINEERS (RPE) AND ARCHITECTS (RA) OF OTTAWA, ONTARIO, K1H 8M5 TEL: 613-592-3200

*** MEASURED TO REAR LOT FRONT BEAM LET IS A POINT, NOT A LINE

PARKING CALCULATIONS:

VEHICLE:

GFA OF BUILDINGS ON SITE (PER CITY OF OTTAWA DEFINITION):

AMRC = 13,726.17 m²
RGN = 27,387 m²
TOH = 99,988 m²
OASIS = 648 m²

POST-SECONDARY FACTOR (AMRC + RGN) = 0.75 * ((13,726.17 + 27,387)/100) = 0.75 * (411,137) = 308 SPOTS

HOSPITAL FACTOR (TOH) = 1.4 * (99,988/100) = 1,399.83 SPOTS

DAYCARE FACTOR (OASIS) = 2 * (648/100) = 12.96 SPOTS

TOTAL = (308 + 1,399.83 + 12.96) = 1720.79 SPOTS REQ. = 1720 SPOTS (ROUNDED)

* BUILDING AREAS AS PER PLANNING RATIONALE

BICYCLE:

GFA OF BUILDINGS ON SITE (PER CITY OF OTTAWA DEFINITION):

AMRC = 13,726.17 m²
RGN = 27,387 m²
TOH = 99,988 m²
OASIS = 648 m²

POST-SECONDARY FACTOR (AMRC + RGN) = 1 * ((13,726.17 + 27,387)/250) = 164.45 SPOTS

HOSPITAL FACTOR (TOH) = 1 * (99,988/100) = 99.99 SPOTS

DAYCARE FACTOR (OASIS) = 1 * (648/250) = 2.59 SPOTS

TOTAL = (164.45 + 99.99 + 2.59) = 267.03 SPOTS REQ. = 267 SPOTS TOTAL

LEGEND

- EXISTING ELEMENT
- NEW ELEMENT
- NEW ELEMENT - CANOPY
- SNOW STORAGE AREA
- LANDSCAPED AREA
- BUILDING ENTRANCE
- SERVICE ENTRANCE
- EMERGENCY EXIT
- PROPERTY LINE
- SETBACK LINE
- LANDSCAPE BUFFER LINE
- AREA OF WORK LINE
- TREE
- ACCESSIBLE PARKING SPOT
- ELECTRIC VEHICLE PARKING SPOT
- FIRE ACCESS ROUTE SIGN
- CR CURB RAMP
- STANDARD EXT. LIGHT FIXTURE
- STANDARD EXT. POST LIGHT

SCALE BAR 1:500

0 5 10 25 50

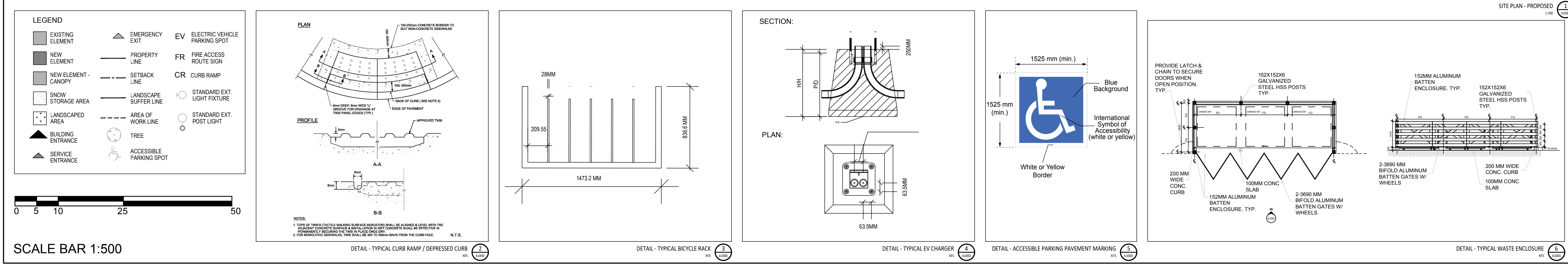

ISSUED FOR ZBLA AND SPC SUBMISSION 04/18/24

ISSUED FOR SPA PHASE 3 RESUBMISSION 04/10/24

ISSUED FOR SPA PHASE 3 RESUBMISSION 02/28/24

ISSUED FOR REVISED SITE PLAN APPL. 01/22/24

Revisions:

ONARIO ASSOCIATION OF ARCHITECTS

Richard Wilson Huot
LICENCE 7932

All measurements are to be checked and verified on site by the contractor before proceeding with the work. Do not scale the drawings.

PARKIN

Owner: uOttawa

UNIVERSITY OF OTTAWA
451 SMYTH ROAD
OTTAWA, ONTARIO, K1H 8M5
TEL: 613-229-7004

Applicant:

PCL

PCL CONSTRUCTORS CANADA INC.
49 AVIGNA DRIVE
NEPEAN, ONTARIO, K2E 8A1
TEL: 613-229-7004

Consultants:

wsp

5511 QUEENSWAY DRIVE, SUITE 300
OTTAWA, ONTARIO, K2B 9K2
TEL: 613-569-3300

Fairhall Moffatt & Woodland
FARRHALL MOFFATT & WOODLAND LTD.
600 TERRY FOX DRIVE, SUITE 100
OTTAWA, ONTARIO, K2L 4B9
TEL: 613-591-1495

CLELAND JARDINE

CLELAND JARDINE ENGINEERING LTD.
590 TERRY FOX DRIVE
KANATA, ONTARIO, K2L 4B9
TEL: 613-591-1495

MERRICK CANADA

MERRICK
590 TERRY FOX DRIVE
KANATA, ONTARIO, K2L 4B9
TEL: 613-592-5289

Project: ADVANCED MEDICAL RESEARCH CENTRE

Address: 451 SMYTH ROAD OTTAWA, ON K1H 8M5

Drawn By: Date: 04/18/2024

Checked By: Scale: 1:500

Sheet Title: SITE PLAN - PROPOSED

Sheet Number: A100D

Appendix C

TRANS O-D SURVEY



Demographic Characteristics

Population	74,770	Actively Travelled	59,190
Employed Population	32,910	Number of Vehicles	37,270
Households	32,590	Area (km ²)	38.5

Occupation Status (age 5+)	Male	Female	Total
Full Time Employed	15,840	12,940	28,780
Part Time Employed	1,660	2,470	4,130
Student	8,130	8,750	16,870
Retiree	6,200	8,840	15,030
Unemployed	1,200	950	2,150
Homemaker	50	2,150	2,200
Other	630	900	1,530
Total:	33,700	36,990	70,700

Traveller Characteristics	Male	Female	Total
Transit Pass Holders	7,620	9,140	16,760
Licensed Drivers	25,060	24,810	49,870
Telecommuters	140	60	200
Trips made by residents	92,440	98,770	191,210

Selected Indicators	
Daily Trips per Person (age 5+)	2.70
Vehicles per Person	0.50
Number of Persons per Household	2.29
Daily Trips per Household	5.87
Vehicles per Household	1.14
Workers per Household	1.01
Population Density (Pop/km ²)	1940

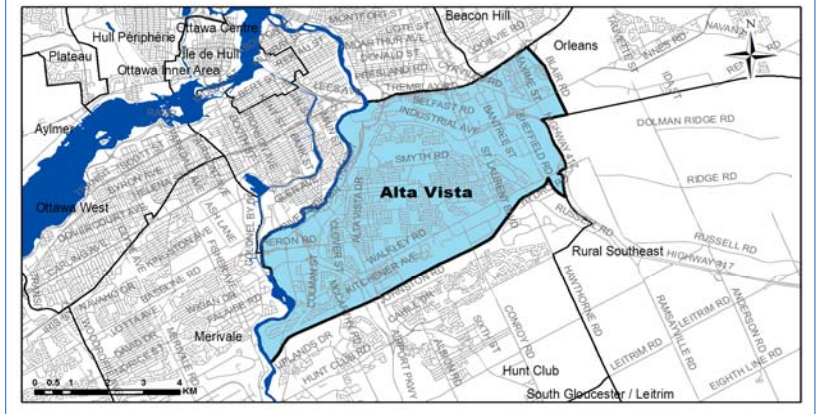

Household Size		
1 person	10,780	33%
2 persons	11,010	34%
3 persons	4,790	15%
4 persons	3,880	12%
5+ persons	2,130	7%
Total:	32,590	100%

Households by Vehicle Availability		
0 vehicles	6,320	19%
1 vehicle	16,930	52%
2 vehicles	8,030	25%
3 vehicles	1,030	3%
4+ vehicles	290	1%
Total:	32,590	100%

Households by Dwelling Type		
Single-detached	12,320	38%
Semi-detached	1,790	5%
Townhouse	4,700	14%
Apartment/Condo	13,780	42%
Total:	32,590	100%

Population

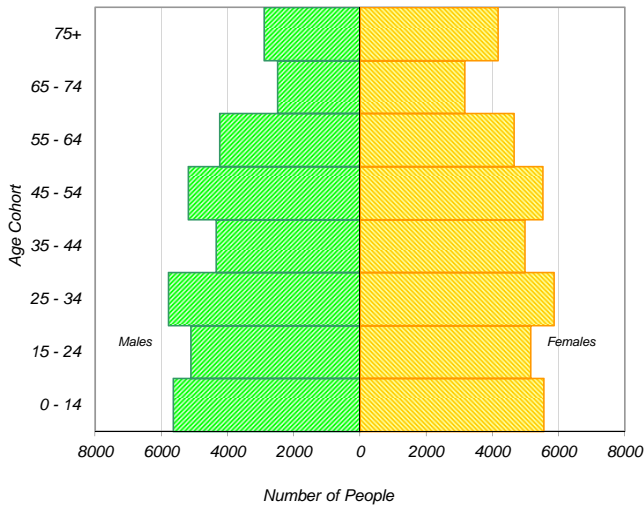

Employed Population

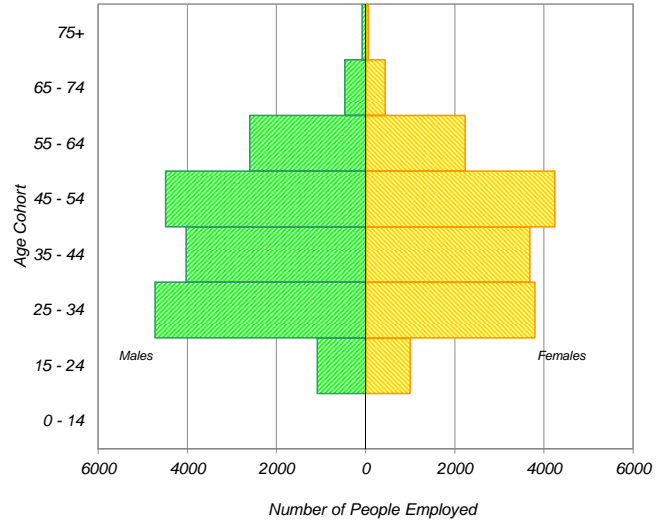

* In 2005 data was only collected for household members aged 11+ therefore these results cannot be compared to the 2011 data.

Travel Patterns

Top Five Origins of Trips to Alta Vista

AM Peak Period

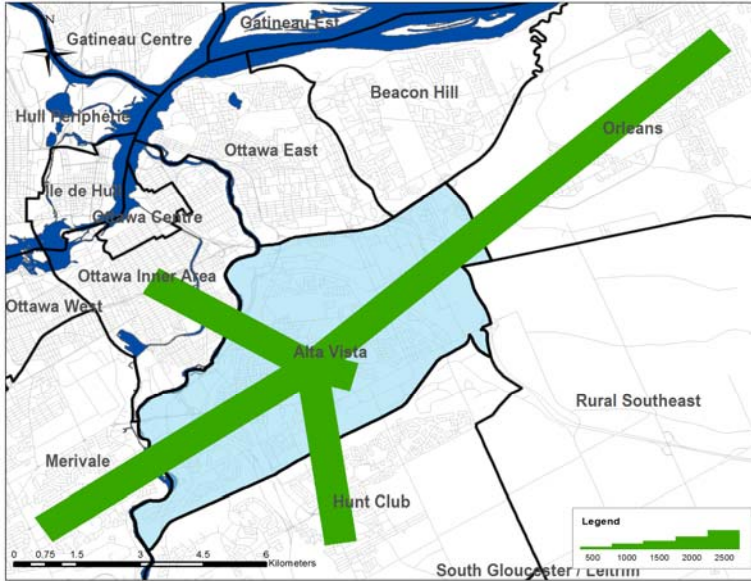

Summary of Trips to and from Alta Vista

AM Peak Period (6:30 - 8:59)

Districts	Destinations of Trips From		Origins of Trips To	
	District	% Total	District	% Total
Ottawa Centre	4,180	10%	680	1%
Ottawa Inner Area	4,970	12%	4,270	7%
Ottawa East	1,940	5%	2,370	4%
Beacon Hill	2,690	7%	1,850	3%
Alta Vista	16,220	39%	16,220	27%
Hunt Club	1,980	5%	7,990	13%
Merivale	3,010	7%	3,690	6%
Ottawa West	1,160	3%	1,550	3%
Bayshore / Cedarview	830	2%	2,330	4%
Orléans	1,050	3%	5,890	10%
Rural East	110	0%	430	1%
Rural Southeast	140	0%	1,550	3%
South Gloucester / Leirtrim	160	0%	1,970	3%
South Nepean	460	1%	2,360	4%
Rural Southwest	160	0%	690	1%
Kanata / Stittsville	660	2%	1,810	3%
Rural West	20	0%	180	0%
Île de Hull	710	2%	190	0%
Hull Périphérie	360	1%	420	1%
Plateau	0	0%	680	1%
Aylmer	40	0%	480	1%
Rural Northwest	40	0%	300	1%
Pointe Gatineau	20	0%	740	1%
Gatineau Est	220	1%	270	0%
Rural Northeast	10	0%	320	1%
Buckingham / Masson-Angers	10	0%	70	0%
Ontario Sub-Total:	39,740	97%	55,830	94%
Québec Sub-Total:	1,410	3%	3,470	6%
Total:	41,150	100%	59,300	100%

Trips by Trip Purpose

24 Hours	From District		To District		Within District	
Work or related	22,370	15%	46,540	31%	10,770	13%
School	8,550	6%	8,090	5%	6,440	8%
Shopping	16,500	11%	16,600	11%	14,550	17%
Leisure	11,940	8%	13,340	9%	7,720	9%
Medical	2,990	2%	7,860	5%	2,380	3%
Pick-up / drive passenger	9,390	6%	9,900	6%	6,990	8%
Return Home	75,570	50%	44,070	29%	33,060	39%
Other	4,870	3%	6,050	4%	3,240	4%
Total:	152,180	100%	152,450	100%	85,150	100%

AM Peak (06:30 - 08:59)	From District		To District		Within District	
Work or related	13,920	56%	28,300	66%	5,390	33%
School	5,340	21%	7,330	17%	5,600	35%
Shopping	510	2%	530	1%	320	2%
Leisure	570	2%	990	2%	480	3%
Medical	500	2%	1,760	4%	460	3%
Pick-up / drive passenger	1,790	7%	2,490	6%	2,110	13%
Return Home	1,380	6%	730	2%	910	6%
Other	910	4%	940	2%	930	6%
Total:	24,920	100%	43,070	100%	16,200	100%

PM Peak (15:30 - 17:59)	From District		To District		Within District	
Work or related	820	2%	1,340	5%	740	4%
School	550	1%	90	0%	70	0%
Shopping	3,920	9%	3,630	13%	2,830	14%
Leisure	2,550	6%	2,440	9%	1,580	8%
Medical	260	1%	670	2%	300	2%
Pick-up / drive passenger	3,310	7%	2,550	9%	2,390	12%
Return Home	31,900	72%	15,950	57%	11,310	58%
Other	1,270	3%	1,230	4%	440	2%
Total:	44,580	100%	27,900	100%	19,660	100%

Peak Period (%)	Total:	% of 24 Hours	Within District (%)
24 Hours	389,780		22%
AM Peak Period	84,190	22%	19%
PM Peak Period	92,140	24%	21%

Trips by Primary Travel Mode

24 Hours	From District		To District		Within District	
Auto Driver	92,240	61%	92,670	61%	43,390	51%
Auto Passenger	24,030	16%	24,040	16%	13,430	16%
Transit	27,890	18%	27,220	18%	6,520	8%
Bicycle	2,180	1%	2,110	1%	1,390	2%
Walk	1,440	1%	1,510	1%	15,170	18%
Other	4,420	3%	4,890	3%	5,260	6%
Total:	152,200	100%	152,440	100%	85,160	100%

AM Peak (06:30 - 08:59)	From District		To District		Within District	
Auto Driver	12,430	50%	26,810	62%	6,330	39%
Auto Passenger	3,040	12%	5,100	12%	2,500	15%
Transit	7,540	30%	7,300	17%	1,700	10%
Bicycle	750	3%	750	2%	340	2%
Walk	280	1%	280	1%	3,210	20%
Other	880	4%	2,850	7%	2,140	13%
Total:	24,920	100%	43,090	100%	16,220	100%

PM Peak (15:30 - 17:59)	From District		To District		Within District	
Auto Driver	28,570	64%	15,990	57%	9,640	49%
Auto Passenger	5,930	13%	4,230	15%	3,570	18%
Transit	7,460	17%	6,420	23%	1,500	8%
Bicycle	630	1%	610	2%	470	2%
Walk	340	1%	310	1%	3,280	17%
Other	1,660	4%	340	1%	1,210	6%
Total:	44,590	100%	27,900	100%	19,670	100%

Avg Vehicle Occupancy	From District		To District		Within District	
24 Hours	1.26		1.26		1.31	
AM Peak Period	1.24		1.19		1.39	
PM Peak Period	1.21		1.26		1.37	

Transit Modal Split	From District		To District		Within District	
24 Hours	19%		19%		10%	
AM Peak Period	33%		19%		16%	
PM Peak Period	18%		24%		10%	

Appendix D

TRAFFIC COUNTS



Turning Movement Count - Study Results

ALTA VISTA DR @ HOSPITAL LINK RD

Survey Date: Tuesday, January 08, 2019

WO No: 38225

Start Time: 07:00

Device: Miovision

Full Study Diagram

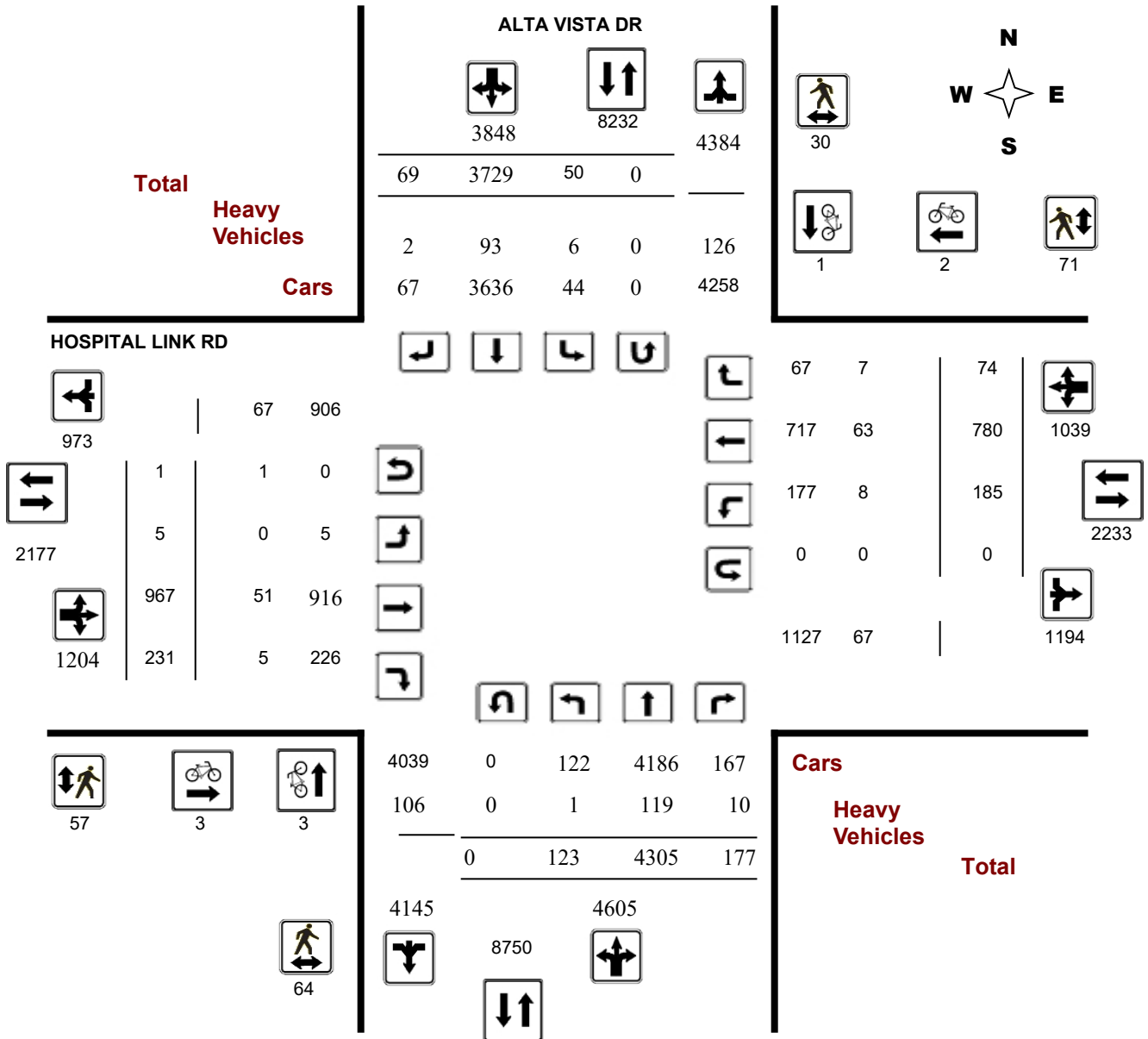

Turning Movement Count - Study Results

ALTA VISTA DR @ HOSPITAL LINK RD

Survey Date: Tuesday, January 08, 2019

WO No: 38225

Start Time: 07:00

Device: Miovision

Full Study Peak Hour Diagram

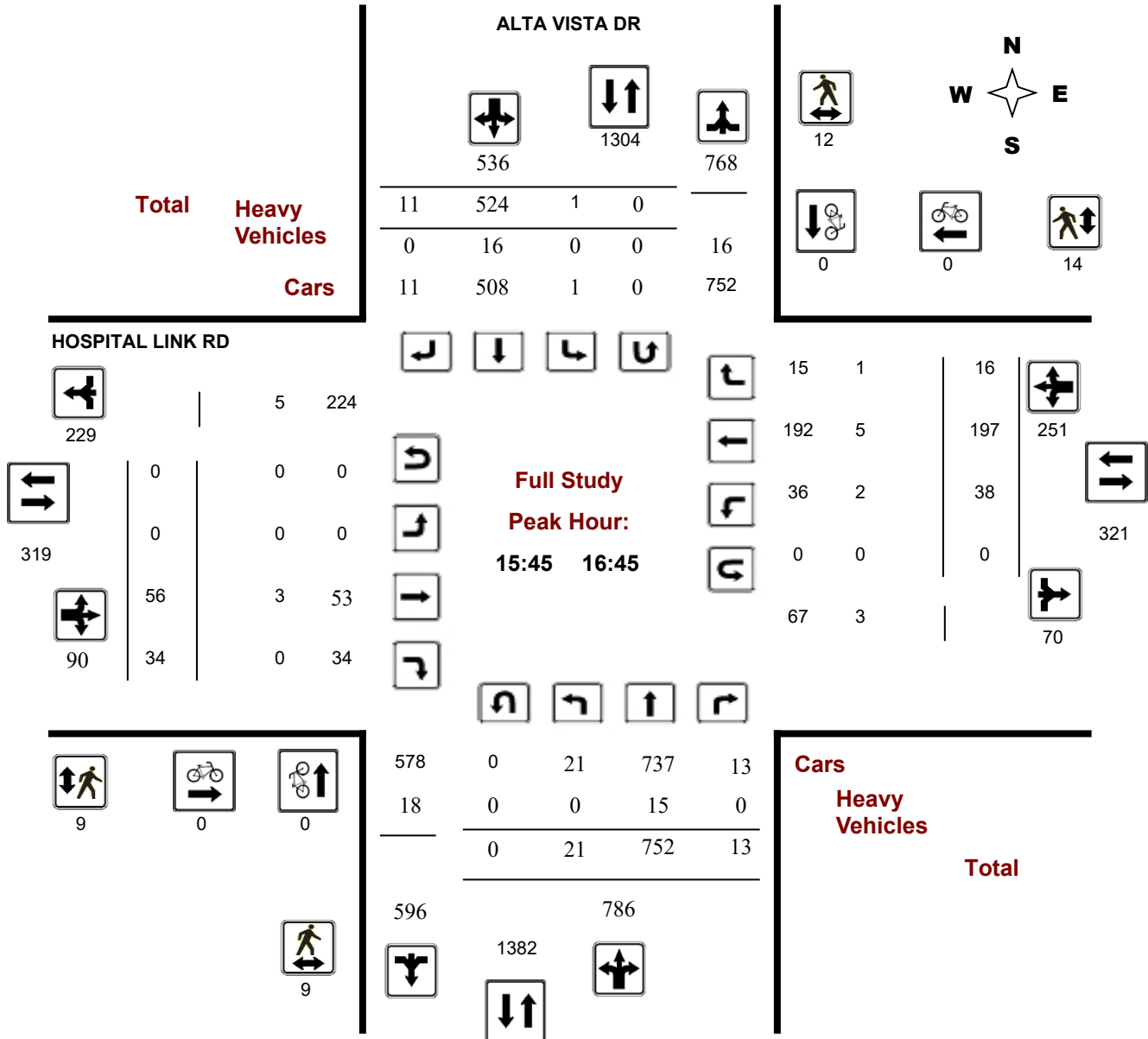

Turning Movement Count - Peak Hour Diagram

ALTA VISTA DR @ HOSPITAL LINK RD

Survey Date: Tuesday, January 08, 2019

Start Time: 07:00

WO No: 38225

Device: Miovision

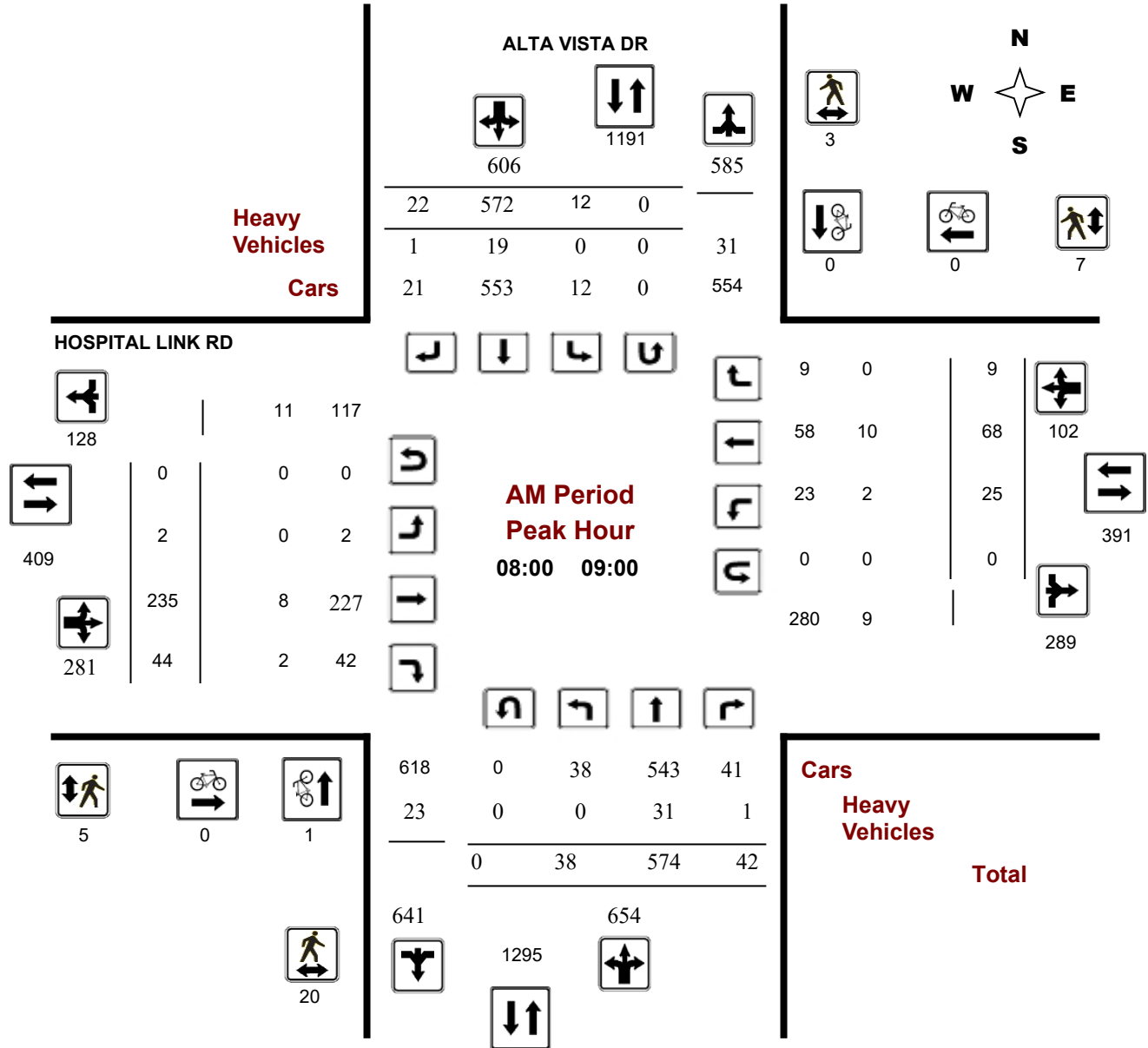

Turning Movement Count - Peak Hour Diagram

ALTA VISTA DR @ HOSPITAL LINK RD

Survey Date: Tuesday, January 08, 2019

Start Time: 07:00

WO No: 38225

Device: Miovision

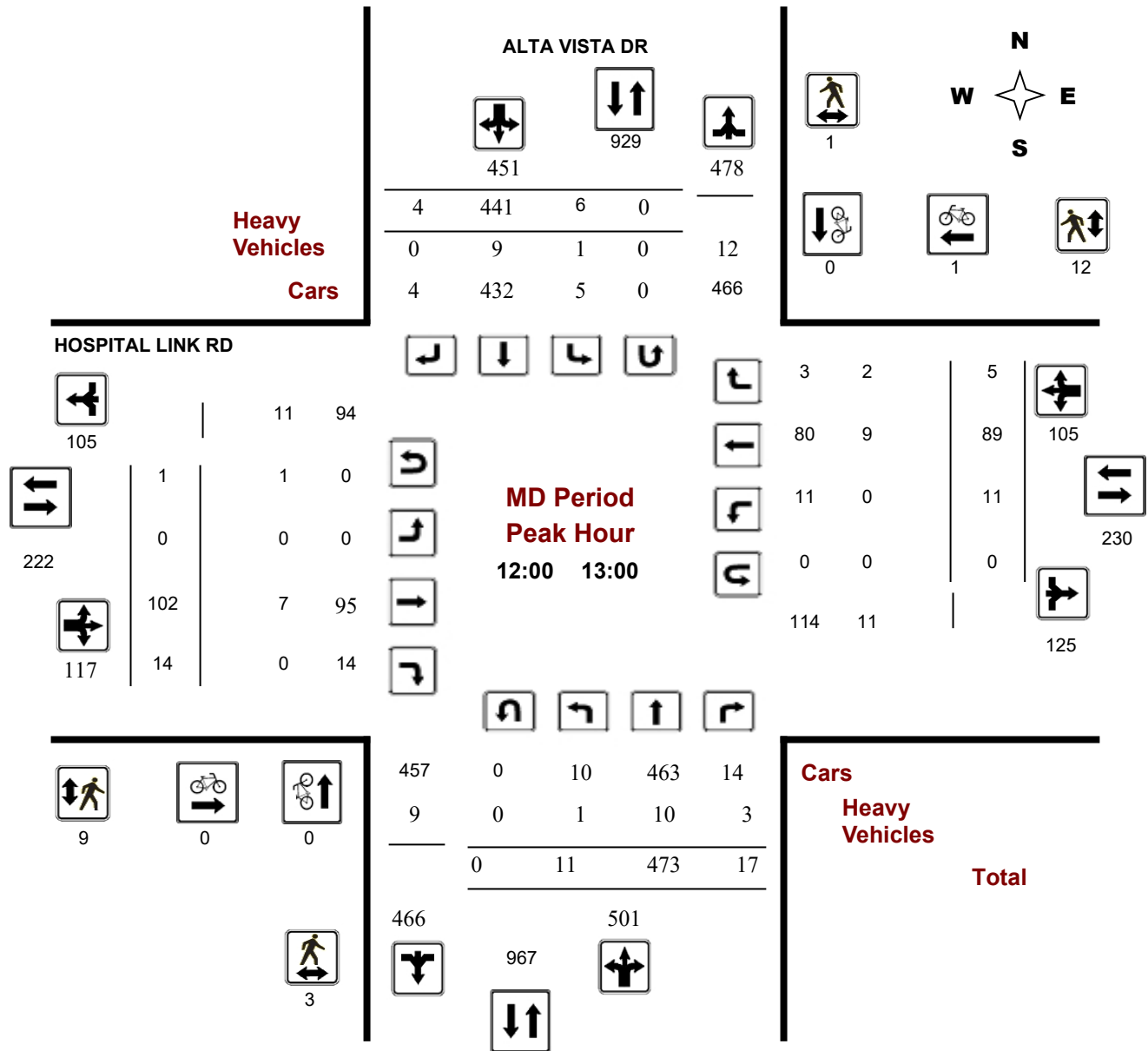

Turning Movement Count - Peak Hour Diagram

ALTA VISTA DR @ HOSPITAL LINK RD

Survey Date: Tuesday, January 08, 2019

Start Time: 07:00

WO No: 38225

Device: Miovision

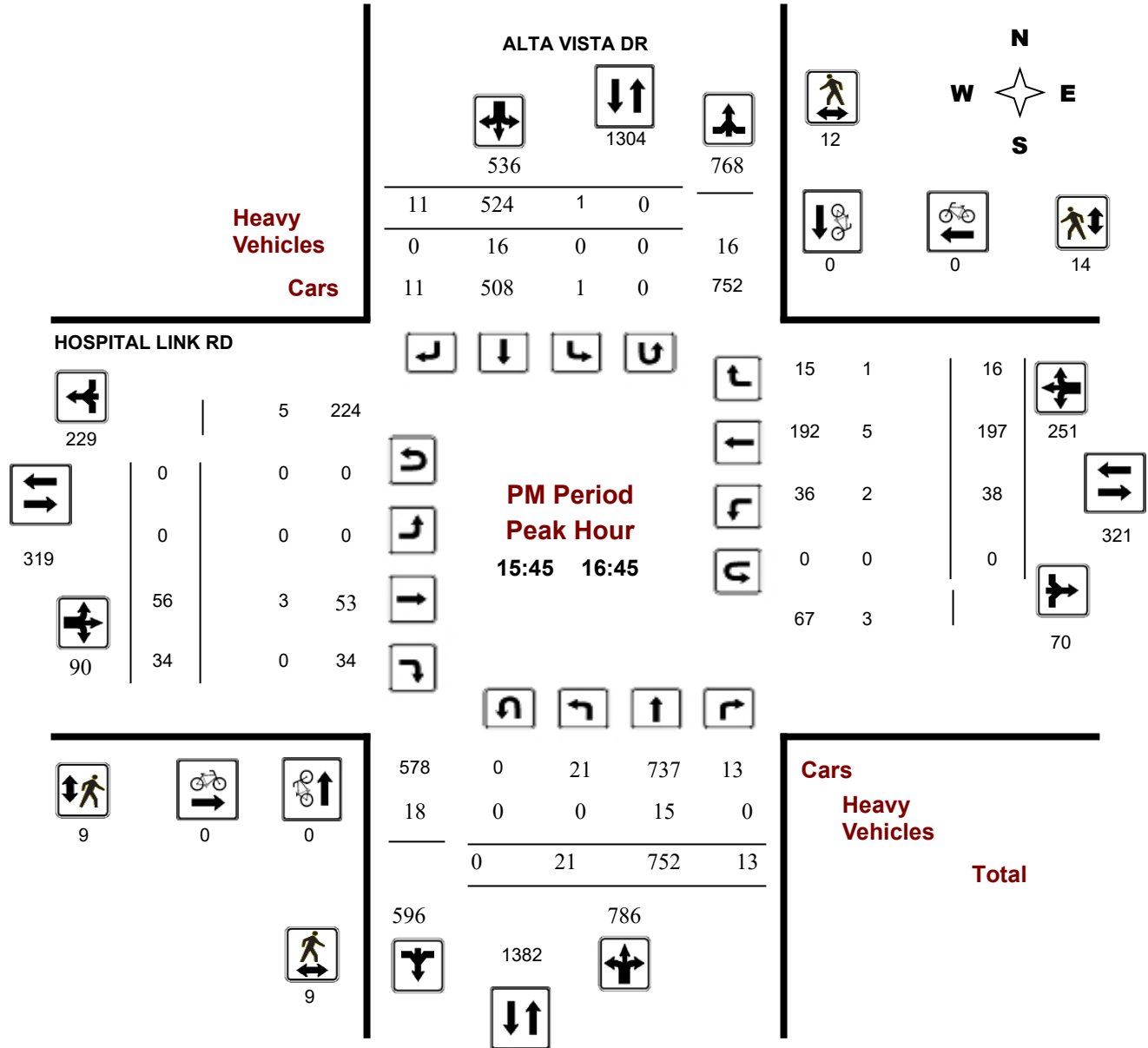



Transportation Services - Traffic Services

Turning Movement Count - Study Results

ALTA VISTA DR @ HOSPITAL LINK RD

Survey Date: Tuesday, January 08, 2019

WO No: 38225

Start Time: 07:00

Device: Miovision

Full Study Summary (8 HR Standard)

Survey Date: Tuesday, January 08, 2019

Total Observed U-Turns

AADT Factor

Northbound: 0 Southbound: 0
 Eastbound: 1 Westbound: 0

1.10

ALTA VISTA DR

HOSPITAL LINK RD

Period	Northbound					Southbound					Eastbound				Westbound			STR TOT	Grand Total	
	LT	ST	RT	NB TOT	STR TOT	LT	ST	RT	SB TOT	STR TOT	LT	ST	RT	EB TOT	LT	ST	RT			WB TOT
07:00 08:00	5	407	41	453	6	408	4	418	871	0	239	20	259	14	48	0	62	321	1192	
08:00 09:00	38	574	42	654	12	572	22	606	1260	2	235	44	281	25	68	9	102	383	1643	
09:00 10:00	6	474	24	504	13	464	9	486	990	1	143	35	179	10	46	13	69	248	1238	
11:30 12:30	14	463	12	489	8	381	5	394	883	0	77	17	94	16	81	8	105	199	1082	
12:30 13:30	7	476	19	502	3	450	2	455	957	0	101	10	111	10	76	6	92	203	1160	
15:00 16:00	24	677	15	716	3	504	9	516	1232	1	75	38	114	43	160	9	212	326	1558	
16:00 17:00	17	705	12	734	1	497	11	509	1243	0	45	31	76	37	191	15	243	319	1562	
17:00 18:00	12	529	12	553	4	453	7	464	1017	1	52	36	89	30	110	14	154	243	1260	
Sub Total	123	4305	177	4605	50	3729	69	3848	8453	5	967	231	1203	185	780	74	1039	2242	10695	
U Turns	0				0				0				1			0		1	1	
Total	123	4305	177	4605	50	3729	69	3848	8453	5	967	231	1204	185	780	74	1039	2243	10696	

EQ 12Hr 171 5984 246 6401 70 5183 96 5349 11750 7 1344 321 1674 257 1084 103 1444 3118 14867
 Note: These values are calculated by multiplying the totals by the appropriate expansion factor. **1.39**

AVG 12Hr 188 6582 271 7041 77 7469 138 5884 12925 8 1478 353 1841 283 1192 113 1588 3430 16354
 Note: These volumes are calculated by multiplying the Equivalent 12 hr. totals by the AADT factor. **1.10**

AVG 24Hr 246 8622 355 9224 101 9784 181 7708 16932 10 1936 462 2412 371 1562 148 2080 4493 21424
 Note: These volumes are calculated by multiplying the Average Daily 12 hr. totals by 12 to 24 expansion factor. **1.31**

Note: U-Turns provided for approach totals. Refer to 'U-Turn' Report for specific breakdown.



Transportation Services - Traffic Services

Turning Movement Count - Study Results

ALTA VISTA DR @ HOSPITAL LINK RD

Survey Date: Tuesday, January 08, 2019

WO No: 38225

Start Time: 07:00

Device: Miovision

Full Study 15 Minute Increments

ALTA VISTA DR

HOSPITAL LINK RD

Northbound

Southbound

Eastbound

Westbound

Time Period	LT	ST	RT	N TOT	LT	ST	RT	S TOT	STR TOT	LT	ST	RT	E TOT	LT	ST	RT	W TOT	STR TOT	Grand Total
07:00 07:15	2	61	6	69	1	93	0	94	163	0	41	3	44	3	10	0	13	57	220
07:15 07:30	0	96	11	107	1	91	3	95	202	0	56	2	58	3	12	0	15	73	275
07:30 07:45	0	118	12	130	0	102	0	102	232	0	58	5	63	6	14	0	20	83	315
07:45 08:00	3	132	12	147	4	122	1	127	274	0	84	10	94	2	12	0	14	108	382
08:00 08:15	12	129	9	150	3	158	7	168	318	0	64	9	73	6	17	2	25	98	416
08:15 08:30	18	125	13	156	4	146	7	157	313	2	60	7	69	12	14	0	26	95	408
08:30 08:45	7	160	13	180	3	133	6	142	322	0	54	18	72	2	18	6	26	98	420
08:45 09:00	1	160	7	168	2	135	2	139	307	0	57	10	67	5	19	1	25	92	399
09:00 09:15	2	144	10	156	4	119	2	125	281	0	49	12	61	5	12	4	21	82	363
09:15 09:30	3	128	6	137	4	133	3	140	277	1	38	7	46	4	13	6	23	69	346
09:30 09:45	1	100	5	106	2	98	3	103	209	0	22	8	30	1	11	1	13	43	252
09:45 10:00	0	102	3	105	3	114	1	118	223	0	34	8	42	0	10	2	12	54	277
11:30 11:45	1	116	2	119	1	86	0	87	206	0	16	2	18	4	17	3	24	42	248
11:45 12:00	3	104	1	108	4	89	2	95	203	0	18	9	27	4	14	1	19	46	249
12:00 12:15	5	122	3	130	2	97	1	100	230	0	20	4	24	4	32	4	40	64	294
12:15 12:30	5	121	6	132	1	109	2	112	244	0	23	2	25	4	18	0	22	47	291
12:30 12:45	0	120	4	124	1	125	1	127	251	0	22	6	28	3	24	1	28	56	307
12:45 13:00	1	110	4	115	2	110	0	112	227	0	37	2	40	0	15	0	15	55	282
13:00 13:15	1	134	8	143	0	89	1	90	233	0	20	1	21	3	18	3	24	45	278
13:15 13:30	5	112	3	120	0	126	0	126	246	0	22	1	23	4	19	2	25	48	294
15:00 15:15	4	162	3	169	0	124	0	124	293	0	15	7	22	9	43	1	53	75	368
15:15 15:30	9	149	5	163	1	128	4	133	296	1	22	9	32	11	36	4	51	83	379
15:30 15:45	4	163	2	169	1	105	2	108	277	0	17	10	27	14	44	1	59	86	363
15:45 16:00	7	203	5	215	1	147	3	151	366	0	21	12	33	9	37	3	49	82	448
16:00 16:15	3	185	3	191	0	126	4	130	321	0	16	7	23	17	58	7	82	105	426
16:15 16:30	7	200	4	211	0	122	2	124	335	0	10	4	14	6	60	5	71	85	420
16:30 16:45	4	164	1	169	0	129	2	131	300	0	9	11	20	6	42	1	49	69	369
16:45 17:00	3	156	4	163	1	120	3	124	287	0	10	9	19	8	31	2	41	60	347
17:00 17:15	4	138	2	144	0	104	1	105	249	0	12	9	21	11	37	4	52	73	322
17:15 17:30	5	169	3	177	1	121	2	124	301	0	17	11	28	9	28	8	45	73	374
17:30 17:45	2	116	4	122	1	116	2	119	241	0	13	8	21	4	24	1	29	50	291
17:45 18:00	1	106	3	110	2	112	2	116	226	1	10	8	19	6	21	1	28	47	273
Total:	123	4305	177	4605	50	3729	69	3848	8453	5	967	231	1204	185	780	74	1039	2243	10,696

Note: U-Turns are included in Totals.



Transportation Services - Traffic Services

Turning Movement Count - Study Results

ALTA VISTA DR @ HOSPITAL LINK RD

Survey Date: Tuesday, January 08, 2019

WO No: 38225

Start Time: 07:00

Device: Miovision

Full Study Cyclist Volume

ALTA VISTA DR

HOSPITAL LINK RD

Time Period	Northbound	Southbound	Street Total	Eastbound	Westbound	Street Total	Grand Total
07:00 07:15	0	0	0	0	0	0	0
07:15 07:30	0	0	0	0	0	0	0
07:30 07:45	0	0	0	0	0	0	0
07:45 08:00	0	0	0	0	0	0	0
08:00 08:15	1	0	1	0	0	0	1
08:15 08:30	0	0	0	0	0	0	0
08:30 08:45	0	0	0	0	0	0	0
08:45 09:00	0	0	0	0	0	0	0
09:00 09:15	0	0	0	1	0	1	1
09:15 09:30	0	0	0	0	0	0	0
09:30 09:45	0	0	0	0	0	0	0
09:45 10:00	0	0	0	0	0	0	0
11:30 11:45	0	0	0	0	0	0	0
11:45 12:00	0	0	0	0	0	0	0
12:00 12:15	0	0	0	0	0	0	0
12:15 12:30	0	0	0	0	1	1	1
12:30 12:45	0	0	0	0	0	0	0
12:45 13:00	0	0	0	0	0	0	0
13:00 13:15	0	0	0	0	0	0	0
13:15 13:30	0	0	0	0	0	0	0
15:00 15:15	1	0	1	0	0	0	1
15:15 15:30	1	0	1	1	0	1	2
15:30 15:45	0	0	0	0	0	0	0
15:45 16:00	0	0	0	0	0	0	0
16:00 16:15	0	0	0	0	0	0	0
16:15 16:30	0	0	0	0	0	0	0
16:30 16:45	0	0	0	0	0	0	0
16:45 17:00	0	0	0	0	0	0	0
17:00 17:15	0	1	1	1	1	2	3
17:15 17:30	0	0	0	0	0	0	0
17:30 17:45	0	0	0	0	0	0	0
17:45 18:00	0	0	0	0	0	0	0
Total	3	1	4	3	2	5	9



Transportation Services - Traffic Services

Turning Movement Count - Study Results

ALTA VISTA DR @ HOSPITAL LINK RD

Survey Date: Tuesday, January 08, 2019

WO No: 38225

Start Time: 07:00

Device: Miovision

Full Study Pedestrian Volume

ALTA VISTA DR

HOSPITAL LINK RD

Time Period	NB Approach (E or W Crossing)	SB Approach (E or W Crossing)	Total	EB Approach (N or S Crossing)	WB Approach (N or S Crossing)	Total	Grand Total
07:00 07:15	1	0	1	2	1	3	4
07:15 07:30	0	0	0	0	1	1	1
07:30 07:45	2	0	2	1	0	1	3
07:45 08:00	6	0	6	2	3	5	11
08:00 08:15	7	2	9	1	2	3	12
08:15 08:30	10	0	10	2	2	4	14
08:30 08:45	2	0	2	2	0	2	4
08:45 09:00	1	1	2	0	3	3	5
09:00 09:15	4	0	4	1	1	2	6
09:15 09:30	4	0	4	1	0	1	5
09:30 09:45	0	1	1	0	3	3	4
09:45 10:00	0	0	0	0	1	1	1
11:30 11:45	2	0	2	1	3	4	6
11:45 12:00	0	0	0	1	2	3	3
12:00 12:15	2	0	2	3	3	6	8
12:15 12:30	1	1	2	4	3	7	9
12:30 12:45	0	0	0	2	5	7	7
12:45 13:00	0	0	0	0	1	1	1
13:00 13:15	2	0	2	0	3	3	5
13:15 13:30	1	0	1	1	0	1	2
15:00 15:15	0	3	3	2	4	6	9
15:15 15:30	1	1	2	3	0	3	5
15:30 15:45	2	3	5	5	4	9	14
15:45 16:00	5	3	8	3	5	8	16
16:00 16:15	2	5	7	2	3	5	12
16:15 16:30	2	2	4	2	3	5	9
16:30 16:45	0	2	2	2	3	5	7
16:45 17:00	1	0	1	2	3	5	6
17:00 17:15	0	0	0	5	0	5	5
17:15 17:30	4	2	6	5	2	7	13
17:30 17:45	1	4	5	0	5	5	10
17:45 18:00	1	0	1	2	2	4	5
Total	64	30	94	57	71	128	222



Transportation Services - Traffic Services

Turning Movement Count - Study Results

ALTA VISTA DR @ HOSPITAL LINK RD

Survey Date: Tuesday, January 08, 2019

WO No: 38225

Start Time: 07:00

Device: Miovision

Full Study Heavy Vehicles

ALTA VISTA DR

HOSPITAL LINK RD

Northbound

Southbound

Eastbound

Westbound

Time Period	Northbound				Southbound				Eastbound				Westbound				Grand Total		
	LT	ST	RT	N TOT	LT	ST	RT	S TOT	STR TOT	LT	ST	RT	E TOT	LT	ST	RT		W TOT	STR TOT
07:00 07:15	0	4	0	6	0	1	0	5	11	0	2	0	5	1	3	0	6	11	11
07:15 07:30	0	5	1	9	0	3	0	8	17	0	2	0	5	0	3	0	6	11	14
07:30 07:45	0	4	0	5	0	0	0	4	9	0	2	0	2	1	0	0	3	5	7
07:45 08:00	0	2	0	4	0	2	0	4	8	0	2	0	4	0	2	0	4	8	8
08:00 08:15	0	11	0	19	0	7	0	18	37	0	1	0	4	1	3	0	5	9	23
08:15 08:30	0	8	1	14	0	5	0	13	27	0	1	0	3	0	2	0	4	7	17
08:30 08:45	0	7	0	10	0	3	1	11	21	0	1	0	3	0	1	0	2	5	13
08:45 09:00	0	5	0	12	0	4	0	9	21	0	5	2	11	1	4	0	10	21	21
09:00 09:15	0	9	0	13	0	3	0	12	25	0	3	0	4	1	1	0	5	9	17
09:15 09:30	0	3	3	9	0	2	0	8	17	0	2	1	6	0	3	3	11	17	17
09:30 09:45	0	4	1	8	0	3	1	8	16	0	1	0	5	0	3	0	5	10	13
09:45 10:00	0	2	0	3	1	1	0	4	7	0	2	0	3	0	1	0	4	7	7
11:30 11:45	0	2	0	6	0	2	0	4	10	0	2	1	5	1	2	0	5	10	10
11:45 12:00	0	4	0	8	2	3	0	10	18	0	2	1	4	0	1	1	6	10	14
12:00 12:15	0	1	2	5	0	2	0	5	10	0	1	0	4	0	3	2	8	12	11
12:15 12:30	1	2	0	4	0	1	0	3	7	0	1	0	3	0	1	0	2	5	6
12:30 12:45	0	3	1	7	1	3	0	7	14	0	4	0	7	0	3	0	9	16	15
12:45 13:00	0	4	0	7	0	3	0	7	14	0	1	0	5	0	2	0	3	8	11
13:00 13:15	0	1	0	3	0	2	0	3	6	0	1	0	4	0	3	0	4	8	7
13:15 13:30	0	3	0	4	0	1	0	4	8	0	1	0	4	0	3	0	4	8	8
15:00 15:15	0	6	0	10	0	4	0	10	20	0	1	0	4	0	3	0	4	8	14
15:15 15:30	0	4	0	11	0	7	0	11	22	0	2	0	5	0	3	0	5	10	16
15:30 15:45	0	1	1	3	0	1	0	2	5	0	2	0	3	0	1	0	4	7	6
15:45 16:00	0	5	0	13	0	6	0	12	25	0	1	0	3	2	2	1	6	9	17
16:00 16:15	0	6	0	10	0	4	0	10	20	0	1	0	2	0	1	0	2	4	12
16:15 16:30	0	4	0	7	0	3	0	7	14	0	1	0	3	0	2	0	3	6	10
16:30 16:45	0	0	0	3	0	3	0	3	6	0	0	0	0	0	0	0	0	0	3
16:45 17:00	0	2	0	4	0	2	0	4	8	0	1	0	2	0	1	0	2	4	6
17:00 17:15	0	2	0	4	0	2	0	4	8	0	1	0	2	0	1	0	2	4	6
17:15 17:30	0	2	0	5	0	3	0	5	10	0	2	0	3	0	1	0	3	6	8
17:30 17:45	0	1	0	4	0	3	0	4	8	0	1	0	4	0	3	0	4	8	8
17:45 18:00	0	2	0	6	2	4	0	8	14	0	1	0	2	0	1	0	4	6	10
Total: None	1	119	10	236	6	93	2	227	463	0	51	5	124	8	63	7	145	269	366



Transportation Services - Traffic Services

Turning Movement Count - Study Results

ALTA VISTA DR @ HOSPITAL LINK RD

Survey Date: Tuesday, January 08, 2019

WO No: 38225

Start Time: 07:00

Device: Miovision

Full Study 15 Minute U-Turn Total

ALTA VISTA DR

HOSPITAL LINK RD

Time Period		Northbound U-Turn Total	Southbound U-Turn Total	Eastbound U-Turn Total	Westbound U-Turn Total	Total
07:00	07:15	0	0	0	0	0
07:15	07:30	0	0	0	0	0
07:30	07:45	0	0	0	0	0
07:45	08:00	0	0	0	0	0
08:00	08:15	0	0	0	0	0
08:15	08:30	0	0	0	0	0
08:30	08:45	0	0	0	0	0
08:45	09:00	0	0	0	0	0
09:00	09:15	0	0	0	0	0
09:15	09:30	0	0	0	0	0
09:30	09:45	0	0	0	0	0
09:45	10:00	0	0	0	0	0
11:30	11:45	0	0	0	0	0
11:45	12:00	0	0	0	0	0
12:00	12:15	0	0	0	0	0
12:15	12:30	0	0	0	0	0
12:30	12:45	0	0	0	0	0
12:45	13:00	0	0	1	0	1
13:00	13:15	0	0	0	0	0
13:15	13:30	0	0	0	0	0
15:00	15:15	0	0	0	0	0
15:15	15:30	0	0	0	0	0
15:30	15:45	0	0	0	0	0
15:45	16:00	0	0	0	0	0
16:00	16:15	0	0	0	0	0
16:15	16:30	0	0	0	0	0
16:30	16:45	0	0	0	0	0
16:45	17:00	0	0	0	0	0
17:00	17:15	0	0	0	0	0
17:15	17:30	0	0	0	0	0
17:30	17:45	0	0	0	0	0
17:45	18:00	0	0	0	0	0
Total		0	0	1	0	1

Turning Movement Count - Study Results

ALTA VISTA DR @ SMYTH RD

Survey Date: Wednesday, February 14, 2018

WO No: 37527

Start Time: 07:00

Device: Miovision

Full Study Diagram

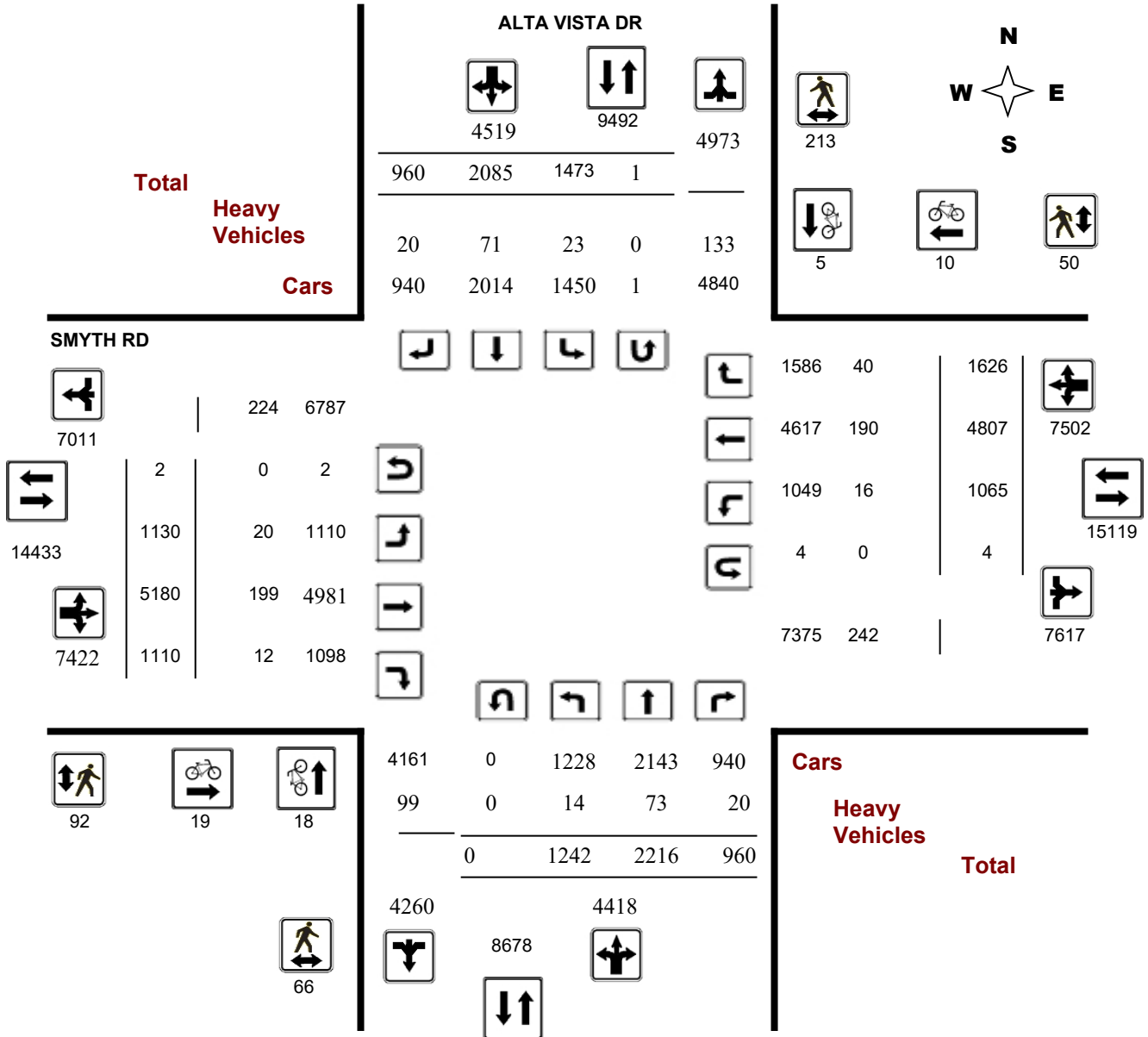

Turning Movement Count - Study Results

ALTA VISTA DR @ SMYTH RD

Survey Date: Wednesday, February 14, 2018

WO No: 37527

Start Time: 07:00

Device: Miovision

Full Study Peak Hour Diagram

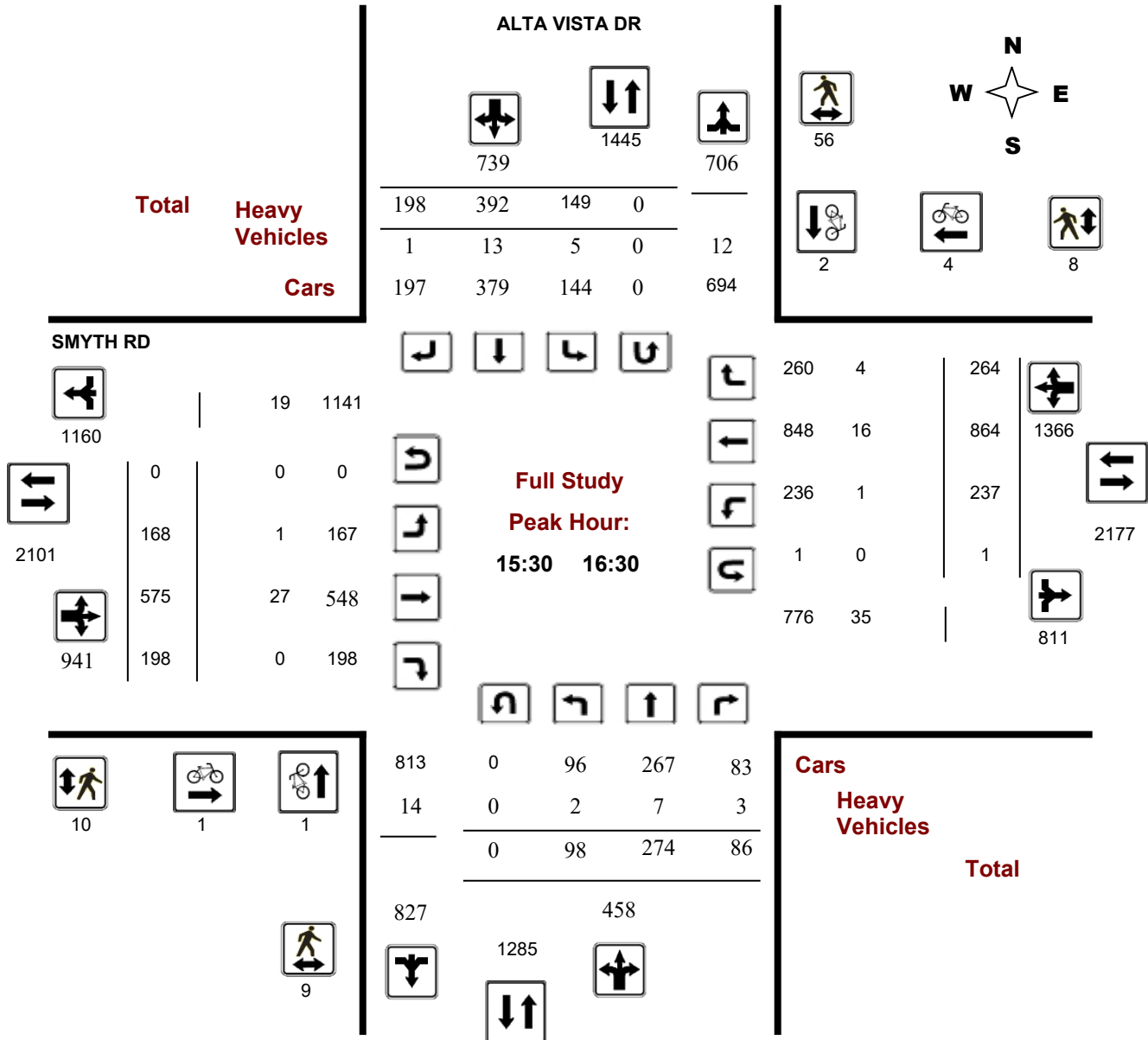

Turning Movement Count - Peak Hour Diagram

ALTA VISTA DR @ SMYTH RD

Survey Date: Wednesday, February 14, 2018

Start Time: 07:00

WO No: 37527

Device: Miovision

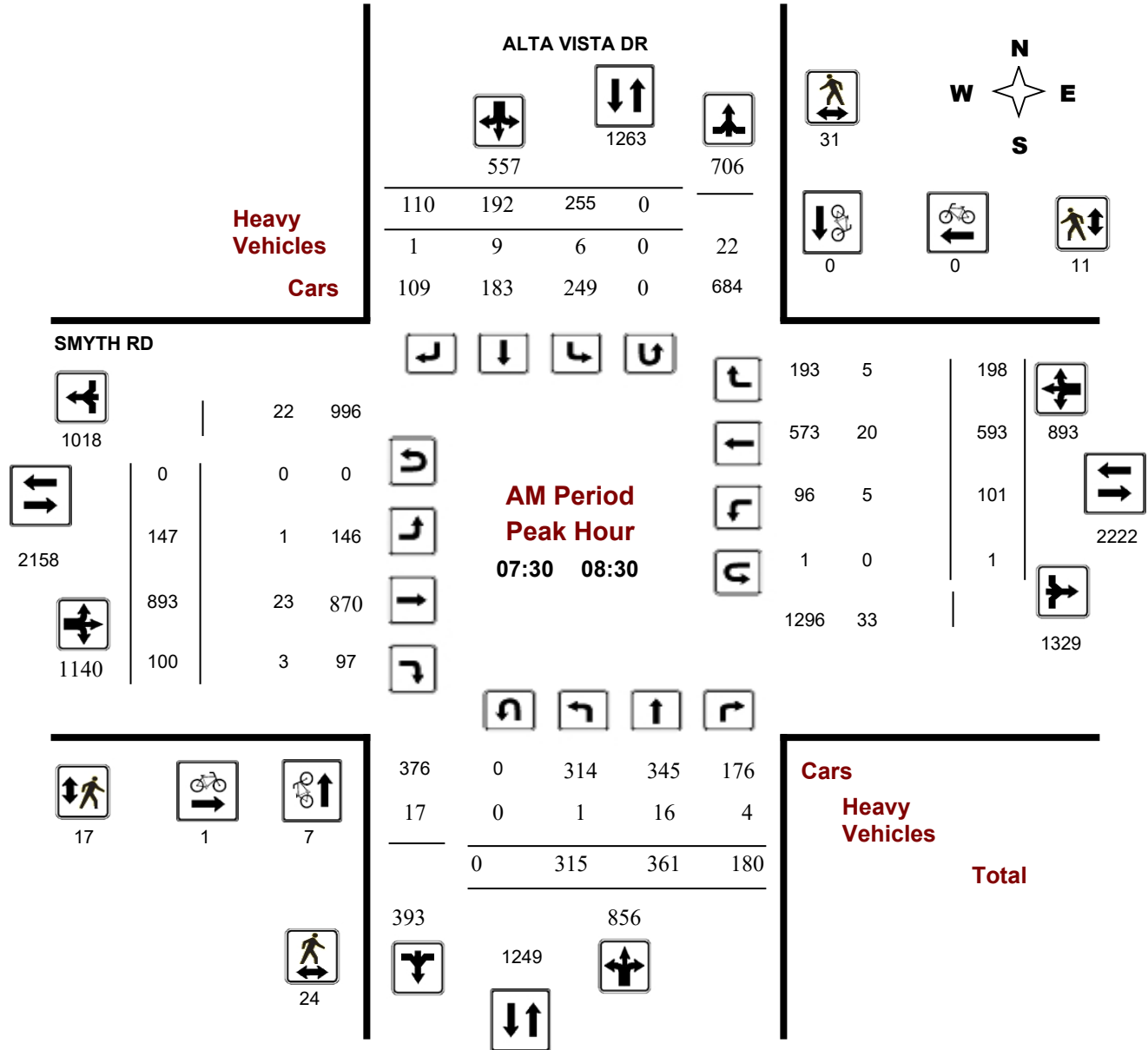

Turning Movement Count - Peak Hour Diagram

ALTA VISTA DR @ SMYTH RD

Survey Date: Wednesday, February 14, 2018

Start Time: 07:00

WO No: 37527

Device: Miovision

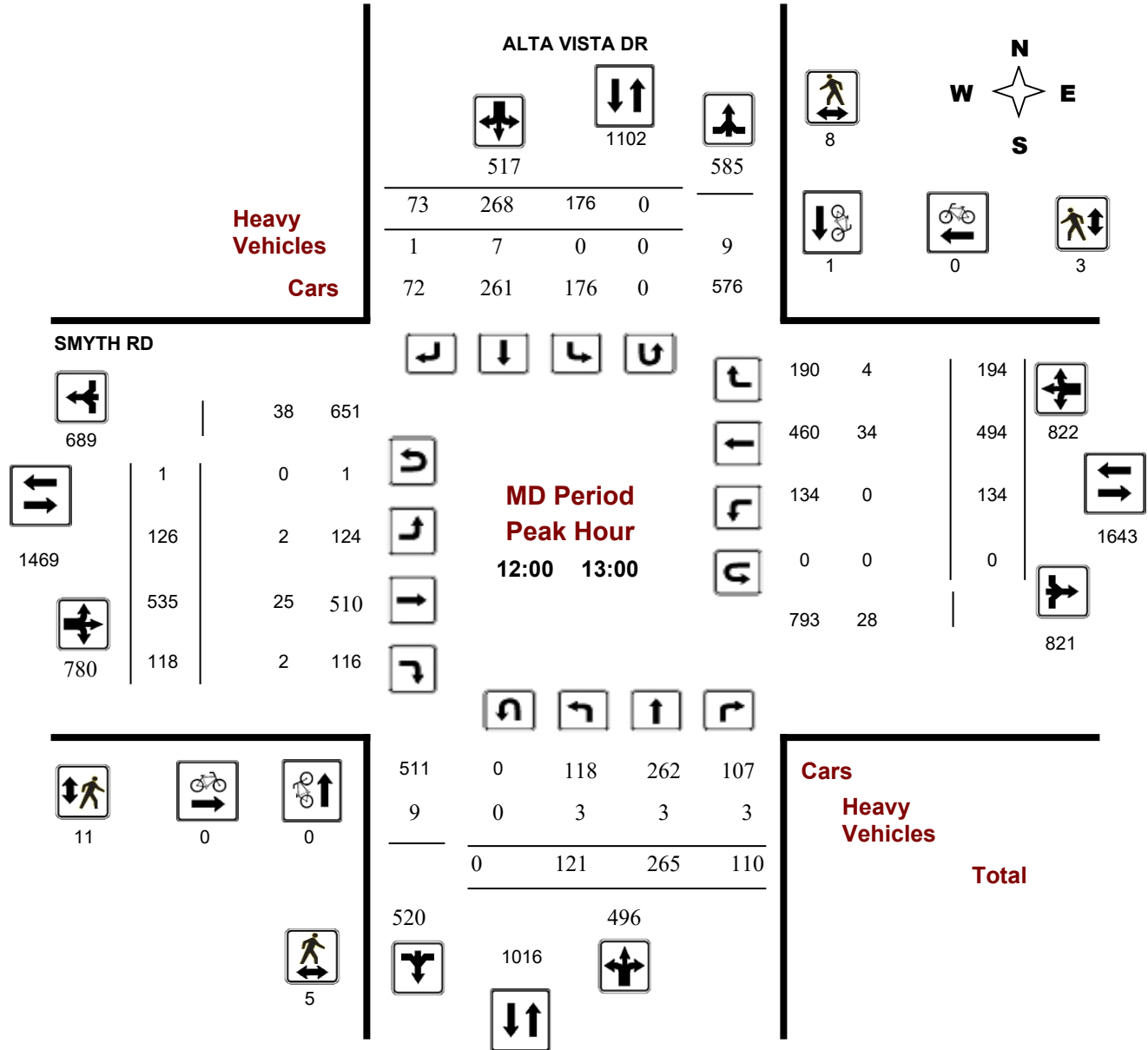

Turning Movement Count - Peak Hour Diagram

ALTA VISTA DR @ SMYTH RD

Survey Date: Wednesday, February 14, 2018

Start Time: 07:00

WO No: 37527

Device: Miovision

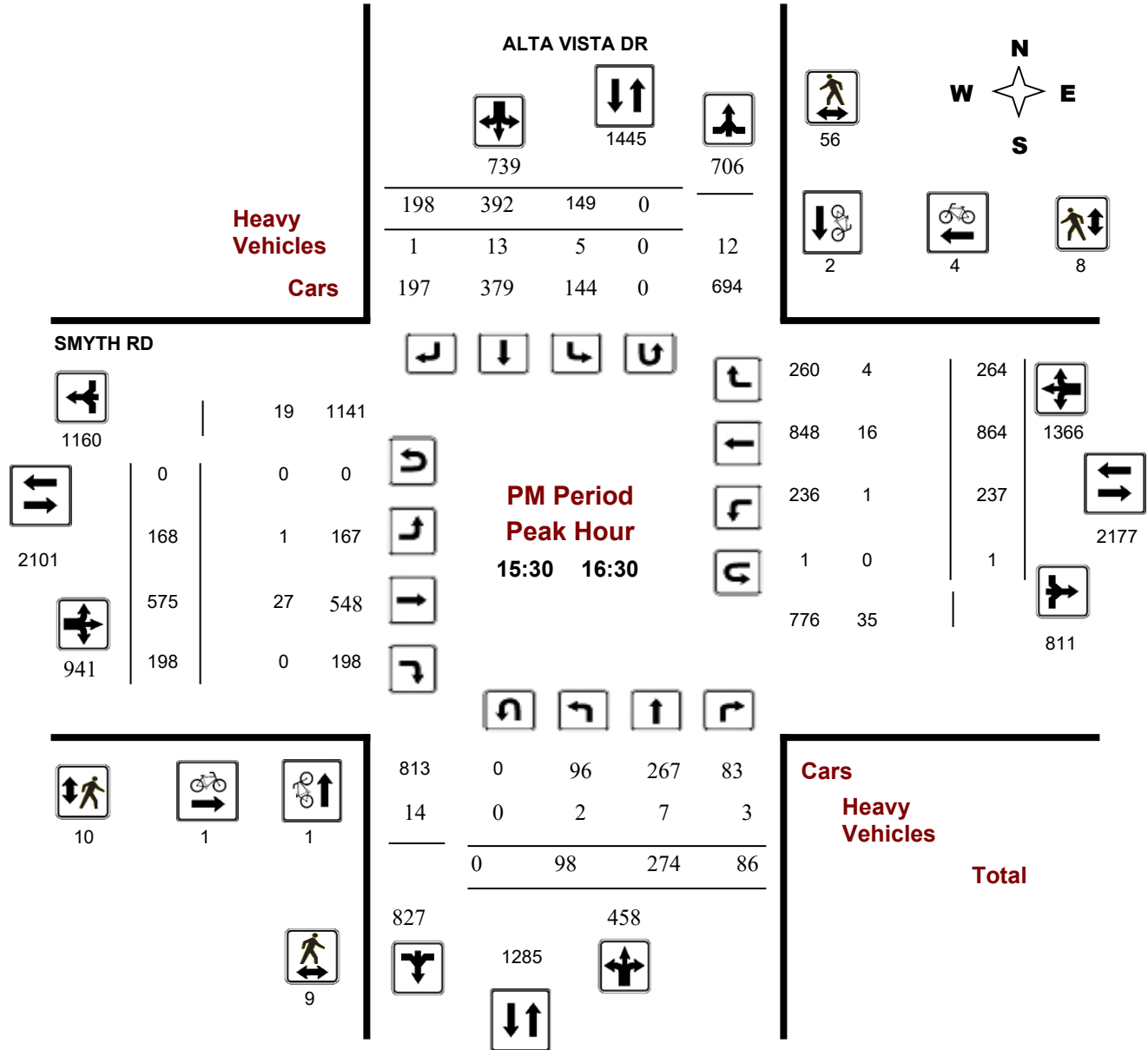



Transportation Services - Traffic Services

Turning Movement Count - Study Results

ALTA VISTA DR @ SMYTH RD

Survey Date: Wednesday, February 14, 2018

WO No: 37527

Start Time: 07:00

Device: Miovision

Full Study Summary (8 HR Standard)

Survey Date: Wednesday, February 14, 2018

Total Observed U-Turns
 Northbound: 0 Southbound: 1
 Eastbound: 2 Westbound: 4

AADT Factor
 1.00

ALTA VISTA DR

SMYTH RD

Period	ALTA VISTA DR					SMYTH RD					WB TOT	STR TOT	Grand Total						
	Northbound			Southbound		Eastbound			Westbound										
	LT	ST	RT	NB TOT	LT	ST	RT	SB TOT	STR TOT	LT	ST	RT	EB TOT	LT	ST	RT			
07:00 08:00	235	263	178	676	211	160	104	475	1151	125	933	90	1148	95	560	197	852	2000	3151
08:00 09:00	264	397	197	858	273	205	117	595	1453	177	849	108	1134	98	563	184	845	1979	3432
09:00 10:00	151	245	126	522	227	168	95	490	1012	132	643	104	879	96	416	162	674	1553	2565
11:30 12:30	103	271	103	477	147	250	66	463	940	110	498	109	717	138	474	220	832	1549	2489
12:30 13:30	119	256	94	469	188	256	88	532	1001	119	511	123	753	98	470	180	748	1501	2502
15:00 16:00	122	257	93	472	167	355	174	696	1168	151	541	181	873	219	917	260	1396	2269	3437
16:00 17:00	121	290	86	497	133	378	184	695	1192	184	624	194	1002	185	740	239	1164	2166	3358
17:00 18:00	127	237	83	447	127	313	132	572	1019	132	581	201	914	136	667	184	987	1901	2920
Sub Total	1242	2216	960	4418	1473	2085	960	4518	8936	1130	5180	1110	7420	1065	4807	1626	7498	14918	23854
U Turns	0			0	1			1	1	2			2	4			4	6	7
Total	1242	2216	960	4418	1474	2085	960	4519	8937	1132	5180	1110	7422	1069	4807	1626	7502	14924	23861
EQ 12Hr	1726	3080	1334	6140	2049	2898	1334	6281	12421	1573	7200	1543	10316	1486	6682	2260	10428	20744	33165
Note: These values are calculated by multiplying the totals by the appropriate expansion factor.																	1.39		
AVG 12Hr	1726	3080	1334	6140	2049	2898	1334	6281	12421	1573	7200	1543	10316	1486	6682	2260	10428	20744	33165
Note: These volumes are calculated by multiplying the Equivalent 12 hr. totals by the AADT factor.																	1.00		
AVG 24Hr	2261	4035	1748	8044	2684	3796	1748	8228	16272	2061	9432	2021	13514	1947	8753	2961	13661	27175	43447
Note: These volumes are calculated by multiplying the Average Daily 12 hr. totals by 12 to 24 expansion factor.																	1.31		

Note: U-Turns provided for approach totals. Refer to 'U-Turn' Report for specific breakdown.



Transportation Services - Traffic Services

Turning Movement Count - Study Results

ALTA VISTA DR @ SMYTH RD

Survey Date: Wednesday, February 14, 2018

WO No: 37527

Start Time: 07:00

Device: Miovision

Full Study 15 Minute Increments

ALTA VISTA DR

SMYTH RD

Northbound

Southbound

Eastbound

Westbound

Time Period	LT	ST	RT	N TOT	LT	ST	RT	S TOT	STR TOT	LT	ST	RT	E TOT	LT	ST	RT	W TOT	STR TOT	Grand Total	
07:00	07:15	35	36	49	120	45	40	21	106	226	26	227	31	284	20	100	35	155	439	665
07:15	07:30	48	57	44	149	46	36	31	113	262	25	224	16	265	20	145	50	215	480	742
07:30	07:45	62	77	44	183	64	49	29	142	325	33	249	21	303	27	159	51	237	540	865
07:45	08:00	90	93	41	224	56	35	23	114	338	41	233	22	296	28	156	61	245	541	879
08:00	08:15	90	81	56	227	64	45	31	140	367	32	199	24	255	20	147	42	209	464	831
08:15	08:30	73	110	39	222	71	63	27	161	383	41	212	33	286	27	131	44	202	488	871
08:30	08:45	56	99	56	211	65	48	33	146	357	48	225	20	293	22	140	50	212	505	862
08:45	09:00	45	107	46	198	73	49	26	148	346	56	213	31	300	30	145	48	223	523	869
09:00	09:15	55	84	44	183	72	56	32	160	343	41	206	24	271	26	133	60	219	490	833
09:15	09:30	35	59	26	120	58	38	28	124	244	38	139	25	202	29	96	22	147	349	593
09:30	09:45	35	45	32	112	51	37	19	107	219	20	167	26	213	17	109	37	163	376	595
09:45	10:00	26	57	24	107	46	37	16	99	206	33	131	29	193	24	78	43	145	338	544
11:30	11:45	26	58	21	105	27	56	15	98	203	20	108	18	146	30	119	43	192	338	541
11:45	12:00	25	79	33	137	39	64	22	125	262	30	112	26	168	30	104	67	201	369	631
12:00	12:15	24	62	20	106	29	77	10	116	222	32	130	31	193	43	121	61	225	418	640
12:15	12:30	28	72	29	129	52	53	19	124	253	28	148	34	210	35	130	49	214	424	677
12:30	12:45	40	75	33	148	47	61	18	126	274	35	115	28	178	29	121	54	204	382	656
12:45	13:00	29	56	28	113	48	77	26	151	264	32	142	25	199	27	122	30	179	378	642
13:00	13:15	21	70	15	106	49	55	20	124	230	31	130	37	198	21	126	49	196	394	624
13:15	13:30	29	55	18	102	44	63	24	131	233	22	124	33	179	22	101	47	170	349	582
15:00	15:15	38	66	24	128	47	69	40	156	284	36	127	41	204	56	250	60	366	570	854
15:15	15:30	38	66	25	129	43	83	39	165	294	34	129	45	208	43	232	73	348	556	850
15:30	15:45	28	63	18	109	49	102	49	200	309	39	139	50	228	58	225	58	341	569	878
15:45	16:00	18	62	26	106	28	101	46	175	281	42	146	45	233	63	210	69	342	575	856
16:00	16:15	26	69	23	118	40	97	54	191	309	43	148	41	232	66	214	71	351	583	892
16:15	16:30	26	80	19	125	32	92	49	173	298	44	142	62	248	51	215	66	332	580	878
16:30	16:45	30	81	23	134	27	86	35	148	282	45	153	44	242	31	156	61	248	490	772
16:45	17:00	39	60	21	120	35	103	46	184	304	52	181	47	280	38	155	41	234	514	818
17:00	17:15	27	52	15	94	37	84	30	151	245	41	132	56	229	46	191	64	301	530	775
17:15	17:30	31	61	22	114	23	88	46	157	271	38	149	46	233	33	178	45	256	489	760
17:30	17:45	38	66	25	129	28	67	26	121	250	21	140	47	208	33	169	36	238	446	696
17:45	18:00	31	58	21	110	39	74	30	143	253	33	160	52	245	24	129	39	192	437	690
Total:		1242	2216	960	4418	1474	2085	960	4519	8937	1132	5180	1110	7422	1069	4807	1626	7502	8937	23,861

Note: U-Turns are included in Totals.



Transportation Services - Traffic Services

Turning Movement Count - Study Results

ALTA VISTA DR @ SMYTH RD

Survey Date: Wednesday, February 14, 2018

WO No: 37527

Start Time: 07:00

Device: Miovision

Full Study Cyclist Volume

Time Period	ALTA VISTA DR			SMYTH RD			Grand Total
	Northbound	Southbound	Street Total	Eastbound	Westbound	Street Total	
07:00 07:15	2	0	2	1	0	1	3
07:15 07:30	3	1	4	0	0	0	4
07:30 07:45	2	0	2	0	0	0	2
07:45 08:00	1	0	1	0	0	0	1
08:00 08:15	3	0	3	1	0	1	4
08:15 08:30	1	0	1	0	0	0	1
08:30 08:45	1	0	1	1	0	1	2
08:45 09:00	0	0	0	2	1	3	3
09:00 09:15	1	0	1	0	1	1	2
09:15 09:30	1	0	1	0	0	0	1
09:30 09:45	0	0	0	1	0	1	1
09:45 10:00	0	0	0	0	0	0	0
11:30 11:45	0	0	0	0	0	0	0
11:45 12:00	0	0	0	0	0	0	0
12:00 12:15	0	1	1	0	0	0	1
12:15 12:30	0	0	0	0	0	0	0
12:30 12:45	0	0	0	0	0	0	0
12:45 13:00	0	0	0	0	0	0	0
13:00 13:15	0	0	0	0	0	0	0
13:15 13:30	0	0	0	2	0	2	2
15:00 15:15	0	0	0	0	0	0	0
15:15 15:30	2	0	2	0	1	1	3
15:30 15:45	0	1	1	0	1	1	2
15:45 16:00	0	0	0	1	1	2	2
16:00 16:15	0	0	0	0	1	1	1
16:15 16:30	1	1	2	0	1	1	3
16:30 16:45	0	1	1	2	0	2	3
16:45 17:00	0	0	0	2	0	2	2
17:00 17:15	0	0	0	3	1	4	4
17:15 17:30	0	0	0	1	1	2	2
17:30 17:45	0	0	0	1	1	2	2
17:45 18:00	0	0	0	1	0	1	1
Total	18	5	23	19	10	29	52



Transportation Services - Traffic Services

Turning Movement Count - Study Results

ALTA VISTA DR @ SMYTH RD

Survey Date: Wednesday, February 14, 2018

WO No: 37527

Start Time: 07:00

Device: Miovision

Full Study Pedestrian Volume

ALTA VISTA DR

SMYTH RD

Time Period	NB Approach (E or W Crossing)	SB Approach (E or W Crossing)	Total	EB Approach (N or S Crossing)	WB Approach (N or S Crossing)	Total	Grand Total
07:00 07:15	0	3	3	1	0	1	4
07:15 07:30	1	3	4	3	1	4	8
07:30 07:45	1	6	7	2	1	3	10
07:45 08:00	5	10	15	4	2	6	21
08:00 08:15	8	7	15	3	3	6	21
08:15 08:30	10	8	18	8	5	13	31
08:30 08:45	3	7	10	2	0	2	12
08:45 09:00	4	12	16	8	3	11	27
09:00 09:15	0	13	13	4	2	6	19
09:15 09:30	1	3	4	1	1	2	6
09:30 09:45	0	4	4	3	1	4	8
09:45 10:00	0	6	6	1	0	1	7
11:30 11:45	0	1	1	0	0	0	1
11:45 12:00	2	3	5	2	2	4	9
12:00 12:15	0	2	2	0	1	1	3
12:15 12:30	1	1	2	4	1	5	7
12:30 12:45	2	2	4	3	0	3	7
12:45 13:00	2	3	5	4	1	5	10
13:00 13:15	1	1	2	3	0	3	5
13:15 13:30	0	1	1	1	0	1	2
15:00 15:15	1	9	10	1	3	4	14
15:15 15:30	0	4	4	4	1	5	9
15:30 15:45	0	19	19	5	0	5	24
15:45 16:00	0	12	12	0	0	0	12
16:00 16:15	2	13	15	1	4	5	20
16:15 16:30	7	12	19	4	4	8	27
16:30 16:45	2	16	18	4	2	6	24
16:45 17:00	2	6	8	3	2	5	13
17:00 17:15	3	11	14	4	3	7	21
17:15 17:30	2	8	10	6	5	11	21
17:30 17:45	4	4	8	1	2	3	11
17:45 18:00	2	3	5	2	0	2	7
Total	66	213	279	92	50	142	421



Transportation Services - Traffic Services

Turning Movement Count - Study Results

ALTA VISTA DR @ SMYTH RD

Survey Date: Wednesday, February 14, 2018

WO No: 37527

Start Time: 07:00

Device: Miovision

Full Study Heavy Vehicles

ALTA VISTA DR

SMYTH RD

Northbound

Southbound

Eastbound

Westbound

Time Period	Northbound			N TOT	Southbound			S TOT	STR TOT	Eastbound			E TOT	Westbound			W TOT	STR TOT	Grand Total	
	LT	ST	RT		LT	ST	RT			LT	ST	RT		LT	ST	RT				
07:00 07:15	0	2	0	2	0	3	1	4	6	0	6	1	7	0	3	2	5	12	18	
07:15 07:30	2	3	0	5	0	2	3	5	10	0	7	0	7	2	10	0	12	19	29	
07:30 07:45	0	1	0	1	0	2	0	2	3	0	6	0	6	0	5	0	5	11	14	
07:45 08:00	1	6	2	9	1	2	0	3	12	0	3	2	5	0	5	1	6	11	23	
08:00 08:15	0	5	2	7	2	1	0	3	10	0	8	1	9	1	3	1	5	14	24	
08:15 08:30	0	4	0	4	3	4	1	8	12	1	6	0	7	4	7	3	14	21	33	
08:30 08:45	0	5	1	6	0	1	0	1	7	1	8	1	10	1	15	1	17	27	34	
08:45 09:00	1	4	2	7	0	1	1	2	9	1	11	0	12	0	8	2	10	22	31	
09:00 09:15	1	5	3	9	2	4	2	8	17	1	12	1	14	0	8	4	12	26	43	
09:15 09:30	0	2	0	2	1	3	4	8	10	1	3	0	4	1	5	2	8	12	22	
09:30 09:45	0	2	0	2	2	1	1	4	6	0	5	1	6	1	8	0	9	15	21	
09:45 10:00	0	2	0	2	1	1	1	3	5	0	7	0	7	0	7	2	9	16	21	
11:30 11:45	1	1	0	2	0	1	0	1	3	0	8	0	8	1	6	0	7	15	18	
11:45 12:00	0	3	0	3	1	1	1	3	6	1	8	1	10	0	6	1	7	17	23	
12:00 12:15	1	0	1	2	0	2	1	3	5	1	4	2	7	0	5	1	6	13	18	
12:15 12:30	1	2	1	4	0	1	0	1	5	0	5	0	5	0	10	2	12	17	22	
12:30 12:45	0	1	1	2	0	1	0	1	3	1	6	0	7	0	9	1	10	17	20	
12:45 13:00	1	0	0	1	0	3	0	3	4	0	10	0	10	0	10	0	10	20	24	
13:00 13:15	0	2	0	2	0	3	0	3	5	1	5	0	6	0	8	1	9	15	20	
13:15 13:30	1	1	0	2	1	2	1	4	6	1	6	1	8	0	7	4	11	19	25	
15:00 15:15	1	3	1	5	2	1	0	3	8	1	7	0	8	1	8	2	11	19	27	
15:15 15:30	0	1	0	1	1	3	0	4	5	0	6	1	7	0	4	5	9	16	21	
15:30 15:45	1	1	0	2	3	3	0	6	8	0	9	0	9	1	5	0	6	15	23	
15:45 16:00	0	1	0	1	1	4	1	6	7	0	6	0	6	0	4	2	6	12	19	
16:00 16:15	1	3	1	5	0	3	0	3	8	1	6	0	7	0	2	1	3	10	18	
16:15 16:30	0	2	2	4	1	3	0	4	8	0	6	0	6	0	5	1	6	12	20	
16:30 16:45	0	2	0	2	0	4	0	4	6	1	4	0	5	0	3	1	4	9	15	
16:45 17:00	0	3	2	5	0	2	1	3	8	1	4	0	5	0	4	0	4	9	17	
17:00 17:15	0	2	0	2	1	3	0	4	6	2	4	0	6	1	3	0	4	10	16	
17:15 17:30	0	0	0	0	0	3	0	3	3	2	4	0	6	1	1	0	2	8	11	
17:30 17:45	0	1	0	1	0	0	1	1	2	1	5	0	6	1	3	0	4	10	12	
17:45 18:00	1	3	1	5	0	3	0	3	8	1	4	0	5	0	3	0	3	8	16	
Total:	None	14	73	20	107	23	71	20	114	221	20	199	12	231	16	190	40	246	477	698



Transportation Services - Traffic Services

Turning Movement Count - Study Results

ALTA VISTA DR @ SMYTH RD

Survey Date: Wednesday, February 14, 2018

WO No: 37527

Start Time: 07:00

Device: Miovision

Full Study 15 Minute U-Turn Total

ALTA VISTA DR

SMYTH RD

Time Period		Northbound U-Turn Total	Southbound U-Turn Total	Eastbound U-Turn Total	Westbound U-Turn Total	Total
07:00	07:15	0	0	0	0	0
07:15	07:30	0	0	0	0	0
07:30	07:45	0	0	0	0	0
07:45	08:00	0	0	0	0	0
08:00	08:15	0	0	0	0	0
08:15	08:30	0	0	0	1	1
08:30	08:45	0	0	0	0	0
08:45	09:00	0	0	0	0	0
09:00	09:15	0	0	0	0	0
09:15	09:30	0	0	0	0	0
09:30	09:45	0	0	0	0	0
09:45	10:00	0	0	0	0	0
11:30	11:45	0	0	0	0	0
11:45	12:00	0	0	0	0	0
12:00	12:15	0	0	0	0	0
12:15	12:30	0	0	0	0	0
12:30	12:45	0	0	1	0	1
12:45	13:00	0	0	0	0	0
13:00	13:15	0	0	0	1	1
13:15	13:30	0	0	0	0	0
15:00	15:15	0	0	0	0	0
15:15	15:30	0	0	0	1	1
15:30	15:45	0	0	0	0	0
15:45	16:00	0	0	0	0	0
16:00	16:15	0	0	0	1	1
16:15	16:30	0	0	0	0	0
16:30	16:45	0	1	0	0	1
16:45	17:00	0	0	0	0	0
17:00	17:15	0	0	0	0	0
17:15	17:30	0	0	0	0	0
17:30	17:45	0	0	0	0	0
17:45	18:00	0	0	1	0	1
Total		0	1	2	4	7

Survey Date: Tuesday, November 20, 2018

WO No: 38132

Start Time: 07:00

Device: Miovision

Full Study Diagram

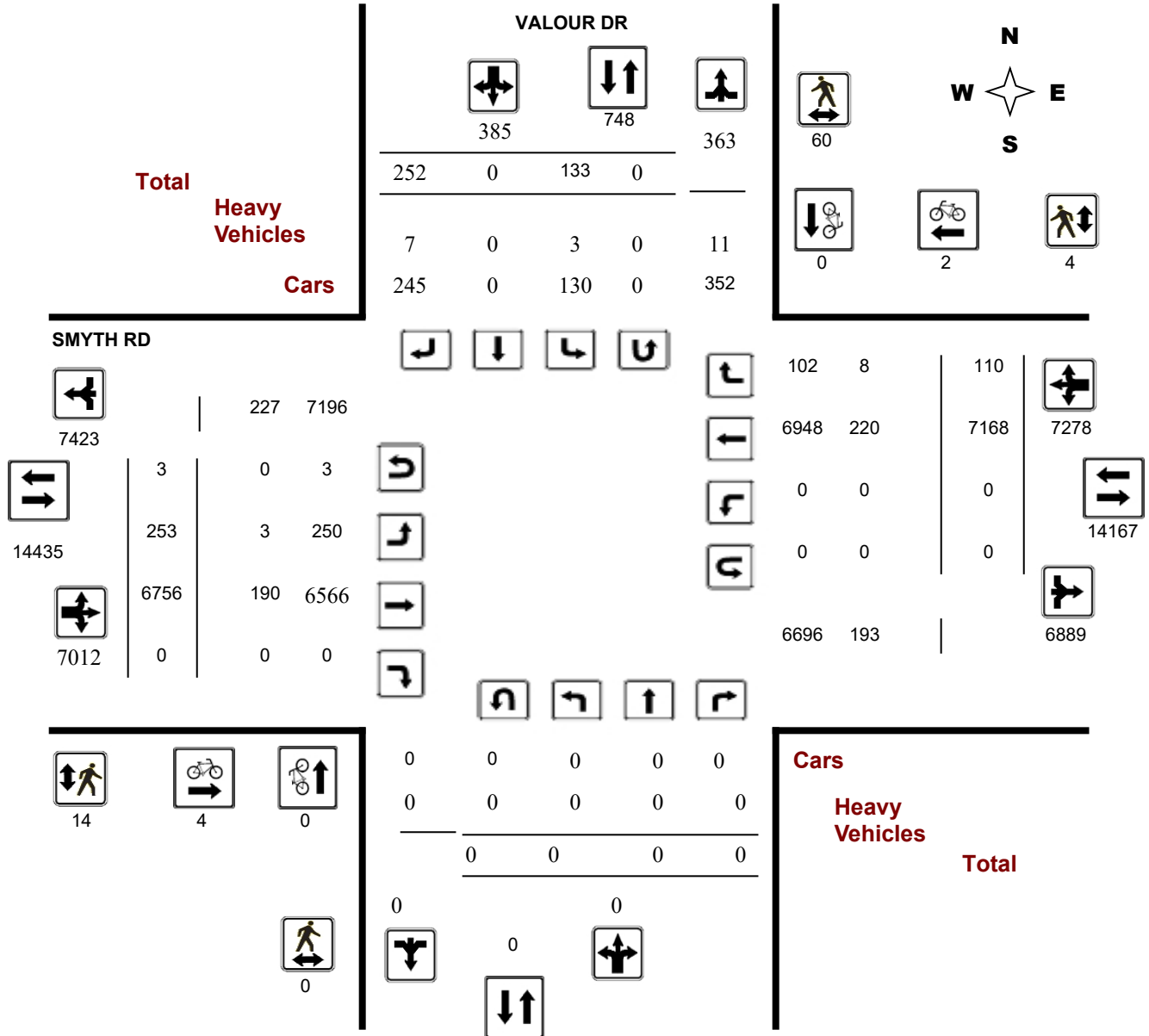

Turning Movement Count - Study Results

VALOUR DR @ SMYTH RD

Survey Date: Tuesday, November 20, 2018

WO No: 38132

Start Time: 07:00

Device: Miovision

Full Study Peak Hour Diagram

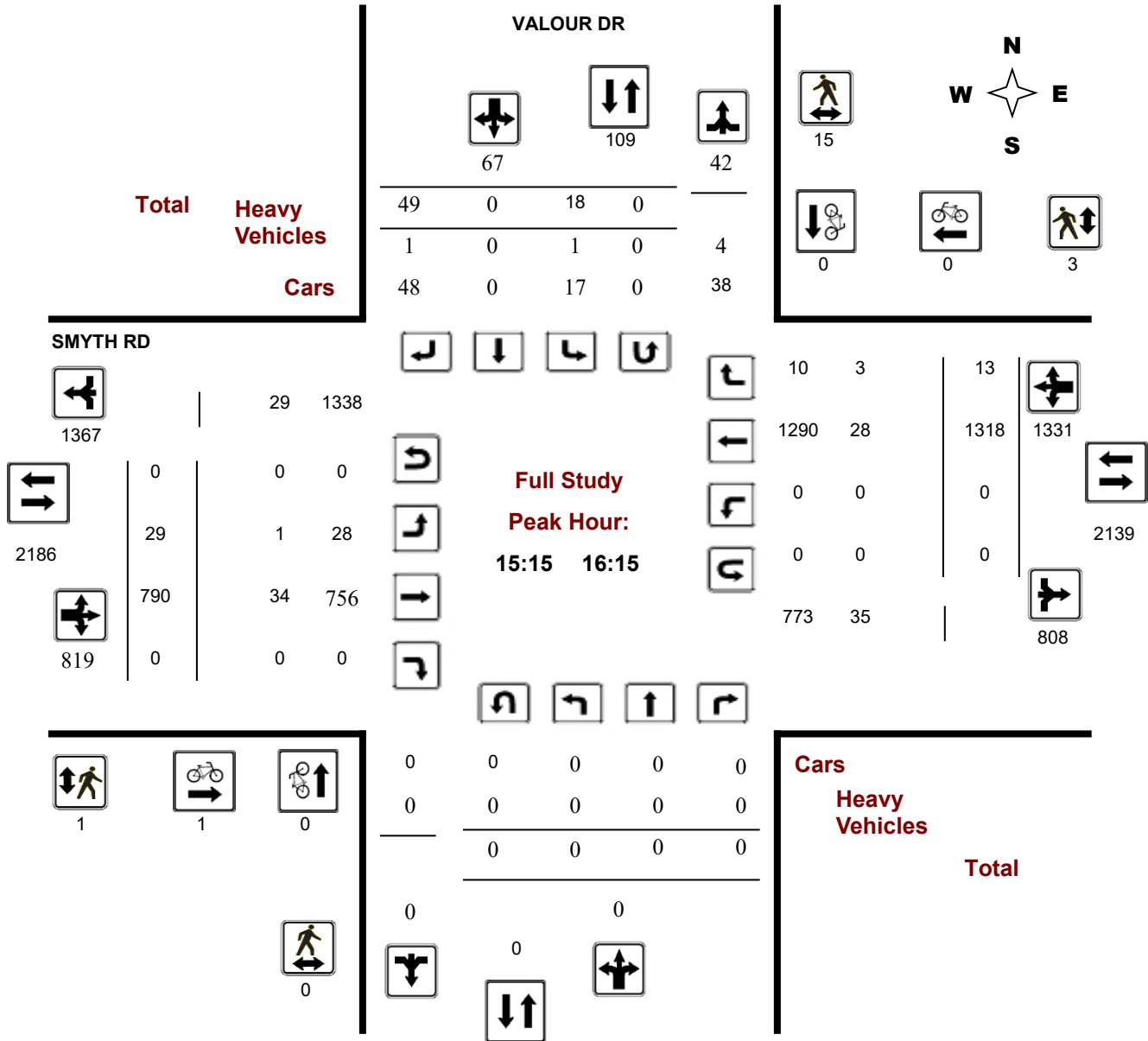

Turning Movement Count - Peak Hour Diagram

VALOUR DR @ SMYTH RD

Survey Date: Tuesday, November 20, 2018

Start Time: 07:00

WO No: 38132

Device: Miovision

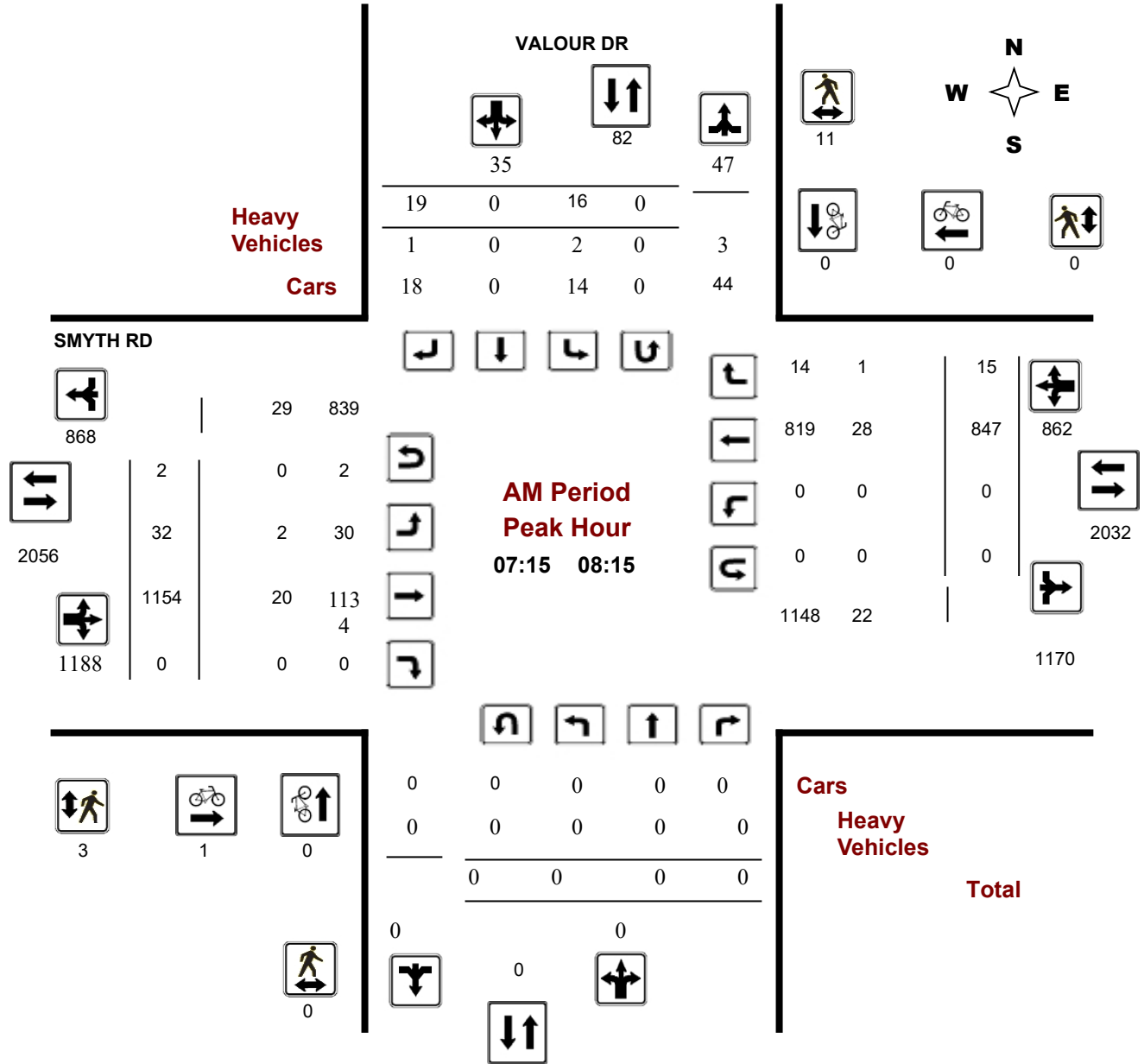

Turning Movement Count - Peak Hour Diagram

VALOUR DR @ SMYTH RD

Survey Date: Tuesday, November 20, 2018

Start Time: 07:00

WO No: 38132

Device: Miovision

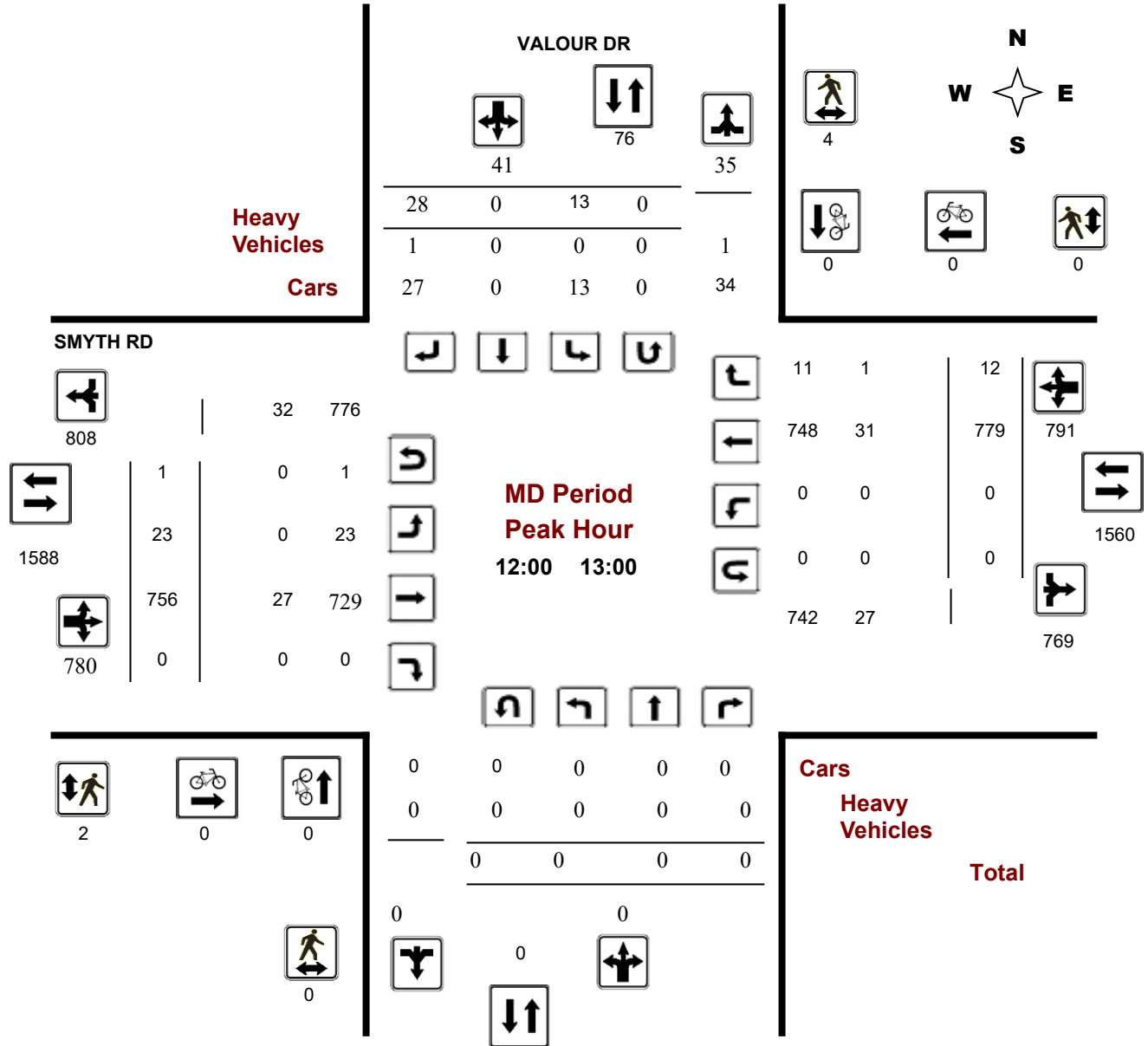

Comments

Survey Date: Tuesday, November 20, 2018

Start Time: 07:00

WO No: 38132

Device: Miovision

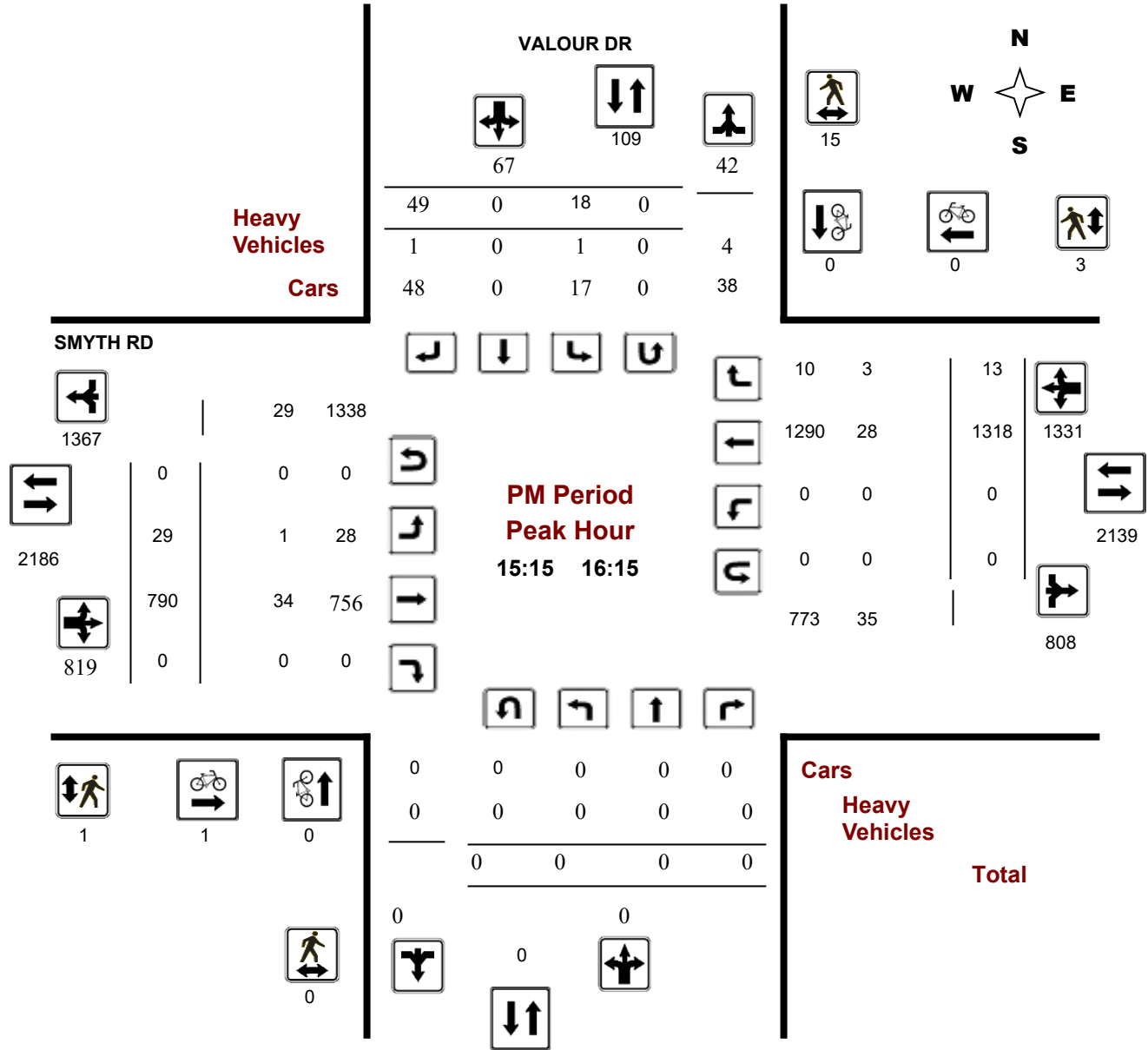

Comments



Transportation Services - Traffic Services

Turning Movement Count - Study Results

VALOUR DR @ SMYTH RD

Survey Date: Tuesday, November 20, 2018

WO No: 38132

Start Time: 07:00

Device: Miovision

Full Study Summary (8 HR Standard)

Survey Date: Tuesday, November 20, 2018

Total Observed U-Turns

AADT Factor

Northbound: 0 Southbound: 0

1.00

Eastbound: 3 Westbound: 0

VALOUR DR

SMYTH RD

Period	Northbound					Southbound					Eastbound					Westbound			STR TOT	Grand Total
	LT	ST	RT	NB TOT	LT	ST	RT	SB TOT	STR TOT	LT	ST	RT	EB TOT	LT	ST	RT	WB TOT			
07:00 08:00	0	0	0	0	12	0	21	33	33	29	1150	0	1179	0	757	18	775	1954	1987	
08:00 09:00	0	0	0	0	20	0	19	39	39	35	1003	0	1038	0	821	20	841	1879	1918	
09:00 10:00	0	0	0	0	11	0	18	29	29	44	977	0	1021	0	734	21	755	1776	1805	
11:30 12:30	0	0	0	0	18	0	28	46	46	21	701	0	722	0	755	12	767	1489	1535	
12:30 13:30	0	0	0	0	14	0	26	40	40	29	699	0	728	0	713	11	724	1452	1492	
15:00 16:00	0	0	0	0	15	0	48	63	63	31	791	0	822	0	1292	12	1304	2126	2189	
16:00 17:00	0	0	0	0	31	0	44	75	75	26	769	0	795	0	1134	11	1145	1940	2015	
17:00 18:00	0	0	0	0	12	0	48	60	60	38	666	0	704	0	962	5	967	1671	1731	
Sub Total	0	0	0	0	133	0	252	385	385	253	6756	0	7009	0	7168	110	7278	14287	14672	
U Turns				0				0	0				3				0	3	3	
Total	0	0	0	0	133	0	252	385	385	253	6756	0	7012	0	7168	110	7278	14290	14675	

EQ 12Hr 0 0 0 0 185 0 350 535 535 352 9391 0 9747 0 9964 153 10116 19863 20398

Note: These values are calculated by multiplying the totals by the appropriate expansion factor.

1.39

AVG 12Hr 0 0 0 0 185 0 459 535 535 352 9391 0 9747 0 9964 153 10116 19863 20398

Note: These volumes are calculated by multiplying the Equivalent 12 hr. totals by the AADT factor.

1.00

AVG 24Hr 0 0 0 0 242 0 601 701 701 461 12302 0 12769 0 13053 200 13252 26021 26721

Note: These volumes are calculated by multiplying the Average Daily 12 hr. totals by 12 to 24 expansion factor.

1.31

Note: U-Turns provided for approach totals. Refer to 'U-Turn' Report for specific breakdown.



Transportation Services - Traffic Services

Turning Movement Count - Study Results

VALOUR DR @ SMYTH RD

Survey Date: Tuesday, November 20, 2018

WO No: 38132

Start Time: 07:00

Device: Miovision

Full Study 15 Minute Increments

VALOUR DR

SMYTH RD

Northbound

Southbound

Eastbound

Westbound

Time Period	LT	ST	RT	N TOT	LT	ST	RT	S TOT	STR TOT	LT	ST	RT	E TOT	LT	ST	RT	W TOT	STR TOT	Grand Total
07:00 07:15	0	0	0	0	3	0	6	9	9	5	249	0	254	0	129	4	133	387	396
07:15 07:30	0	0	0	0	4	0	6	10	10	4	305	0	309	0	175	5	180	489	499
07:30 07:45	0	0	0	0	3	0	8	11	11	12	279	0	291	0	233	1	234	525	536
07:45 08:00	0	0	0	0	2	0	1	3	3	8	317	0	325	0	220	8	228	553	556
08:00 08:15	0	0	0	0	7	0	4	11	11	8	253	0	263	0	219	1	220	483	494
08:15 08:30	0	0	0	0	7	0	7	14	14	7	225	0	232	0	199	6	205	437	451
08:30 08:45	0	0	0	0	1	0	5	6	6	12	252	0	264	0	220	6	226	490	496
08:45 09:00	0	0	0	0	5	0	3	8	8	8	273	0	281	0	183	7	190	471	479
09:00 09:15	0	0	0	0	3	0	1	4	4	12	243	0	255	0	194	4	198	453	457
09:15 09:30	0	0	0	0	5	0	4	9	9	11	270	0	281	0	189	7	196	477	486
09:30 09:45	0	0	0	0	0	0	8	8	8	9	238	0	247	0	179	7	186	433	441
09:45 10:00	0	0	0	0	3	0	5	8	8	12	226	0	238	0	172	3	175	413	421
11:30 11:45	0	0	0	0	6	0	8	14	14	7	161	0	168	0	158	3	161	329	343
11:45 12:00	0	0	0	0	2	0	4	6	6	4	166	0	170	0	189	1	190	360	366
12:00 12:15	0	0	0	0	7	0	8	15	15	5	171	0	176	0	216	3	219	395	410
12:15 12:30	0	0	0	0	3	0	8	11	11	5	203	0	208	0	192	5	197	405	416
12:30 12:45	0	0	0	0	0	0	7	7	7	4	206	0	210	0	195	1	196	406	413
12:45 13:00	0	0	0	0	3	0	5	8	8	9	176	0	186	0	176	3	179	365	373
13:00 13:15	0	0	0	0	10	0	6	16	16	7	174	0	181	0	161	3	164	345	361
13:15 13:30	0	0	0	0	1	0	8	9	9	9	143	0	152	0	181	4	185	337	346
15:00 15:15	0	0	0	0	4	0	11	15	15	7	194	0	201	0	308	2	310	511	526
15:15 15:30	0	0	0	0	3	0	19	22	22	4	188	0	192	0	330	2	332	524	546
15:30 15:45	0	0	0	0	3	0	8	11	11	11	189	0	200	0	344	5	349	549	560
15:45 16:00	0	0	0	0	5	0	10	15	15	9	220	0	229	0	310	3	313	542	557
16:00 16:15	0	0	0	0	7	0	12	19	19	5	193	0	198	0	334	3	337	535	554
16:15 16:30	0	0	0	0	9	0	6	15	15	6	199	0	205	0	287	0	287	492	507
16:30 16:45	0	0	0	0	7	0	10	17	17	6	190	0	196	0	269	4	273	469	486
16:45 17:00	0	0	0	0	8	0	16	24	24	9	187	0	196	0	244	4	248	444	468
17:00 17:15	0	0	0	0	7	0	16	23	23	10	195	0	205	0	306	2	308	513	536
17:15 17:30	0	0	0	0	2	0	13	15	15	8	155	0	163	0	251	2	253	416	431
17:30 17:45	0	0	0	0	3	0	13	16	16	6	154	0	160	0	220	0	220	380	396
17:45 18:00	0	0	0	0	0	0	6	6	6	14	162	0	176	0	185	1	186	362	368
Total:	0	0	0	0	133	0	252	385	385	253	6756	0	7012	0	7168	110	7278	14290	14,675

Note: U-Turns are included in Totals.



Transportation Services - Traffic Services

Turning Movement Count - Study Results

VALOUR DR @ SMYTH RD

Survey Date: Tuesday, November 20, 2018

WO No: 38132

Start Time: 07:00

Device: Miovision

Full Study Cyclist Volume

Time Period	VALOUR DR			SMYTH RD			Grand Total
	Northbound	Southbound	Street Total	Eastbound	Westbound	Street Total	
07:00 07:15	0	0	0	0	0	0	0
07:15 07:30	0	0	0	0	0	0	0
07:30 07:45	0	0	0	0	0	0	0
07:45 08:00	0	0	0	0	0	0	0
08:00 08:15	0	0	0	1	0	1	1
08:15 08:30	0	0	0	1	0	1	1
08:30 08:45	0	0	0	0	0	0	0
08:45 09:00	0	0	0	0	0	0	0
09:00 09:15	0	0	0	0	0	0	0
09:15 09:30	0	0	0	0	0	0	0
09:30 09:45	0	0	0	0	0	0	0
09:45 10:00	0	0	0	0	0	0	0
11:30 11:45	0	0	0	0	0	0	0
11:45 12:00	0	0	0	0	0	0	0
12:00 12:15	0	0	0	0	0	0	0
12:15 12:30	0	0	0	0	0	0	0
12:30 12:45	0	0	0	0	0	0	0
12:45 13:00	0	0	0	0	0	0	0
13:00 13:15	0	0	0	0	0	0	0
13:15 13:30	0	0	0	0	0	0	0
15:00 15:15	0	0	0	0	0	0	0
15:15 15:30	0	0	0	0	0	0	0
15:30 15:45	0	0	0	0	0	0	0
15:45 16:00	0	0	0	0	0	0	0
16:00 16:15	0	0	0	1	0	1	1
16:15 16:30	0	0	0	0	1	1	1
16:30 16:45	0	0	0	1	0	1	1
16:45 17:00	0	0	0	0	1	1	1
17:00 17:15	0	0	0	0	0	0	0
17:15 17:30	0	0	0	0	0	0	0
17:30 17:45	0	0	0	0	0	0	0
17:45 18:00	0	0	0	0	0	0	0
Total	0	0	0	4	2	6	6



Transportation Services - Traffic Services

Turning Movement Count - Study Results

VALOUR DR @ SMYTH RD

Survey Date: Tuesday, November 20, 2018

WO No: 38132

Start Time: 07:00

Device: Miovision

Full Study Pedestrian Volume

VALOUR DR

SMYTH RD

Time Period	NB Approach (E or W Crossing)	SB Approach (E or W Crossing)	Total	EB Approach (N or S Crossing)	WB Approach (N or S Crossing)	Total	Grand Total
07:00 07:15	0	2	2	0	0	0	2
07:15 07:30	0	0	0	1	0	1	1
07:30 07:45	0	2	2	0	0	0	2
07:45 08:00	0	6	6	2	0	2	8
08:00 08:15	0	3	3	0	0	0	3
08:15 08:30	0	5	5	0	0	0	5
08:30 08:45	0	1	1	0	0	0	1
08:45 09:00	0	2	2	0	0	0	2
09:00 09:15	0	0	0	1	0	1	1
09:15 09:30	0	0	0	0	0	0	0
09:30 09:45	0	0	0	0	0	0	0
09:45 10:00	0	1	1	1	1	2	3
11:30 11:45	0	0	0	0	0	0	0
11:45 12:00	0	1	1	0	0	0	1
12:00 12:15	0	1	1	1	0	1	2
12:15 12:30	0	2	2	1	0	1	3
12:30 12:45	0	1	1	0	0	0	1
12:45 13:00	0	0	0	0	0	0	0
13:00 13:15	0	3	3	1	0	1	4
13:15 13:30	0	1	1	1	0	1	2
15:00 15:15	0	1	1	1	0	1	2
15:15 15:30	0	3	3	0	0	0	3
15:30 15:45	0	3	3	0	2	2	5
15:45 16:00	0	4	4	0	1	1	5
16:00 16:15	0	5	5	1	0	1	6
16:15 16:30	0	2	2	2	0	2	4
16:30 16:45	0	2	2	0	0	0	2
16:45 17:00	0	3	3	1	0	1	4
17:00 17:15	0	4	4	0	0	0	4
17:15 17:30	0	1	1	0	0	0	1
17:30 17:45	0	1	1	0	0	0	1
17:45 18:00	0	0	0	0	0	0	0
Total	0	60	60	14	4	18	78



Transportation Services - Traffic Services

Turning Movement Count - Study Results

VALOUR DR @ SMYTH RD

Survey Date: Tuesday, November 20, 2018

WO No: 38132

Start Time: 07:00

Device: Miovision

Full Study Heavy Vehicles

VALOUR DR

SMYTH RD

Northbound

Southbound

Eastbound

Westbound

Time Period	Northbound			N TOT	Southbound			S TOT	STR TOT	Eastbound			E TOT	Westbound			W TOT	STR TOT	Grand Total
	LT	ST	RT		LT	ST	RT			LT	ST	RT		LT	ST	RT			
07:00 07:15	0	0	0	0	0	0	0	1	1	0	7	0	12	0	5	1	13	25	13
07:15 07:30	0	0	0	0	1	0	1	3	3	0	4	0	14	0	9	1	15	29	16
07:30 07:45	0	0	0	0	0	0	0	0	0	0	6	0	10	0	4	0	10	20	10
07:45 08:00	0	0	0	0	0	0	0	1	1	1	3	0	10	0	6	0	9	19	10
08:00 08:15	0	0	0	0	1	0	0	2	2	1	7	0	17	0	9	0	17	34	18
08:15 08:30	0	0	0	0	0	0	0	0	0	0	3	0	9	0	6	0	9	18	9
08:30 08:45	0	0	0	0	0	0	0	0	0	0	2	0	7	0	5	0	7	14	7
08:45 09:00	0	0	0	0	0	0	0	0	0	0	8	0	16	0	8	0	16	32	16
09:00 09:15	0	0	0	0	0	0	0	0	0	0	9	0	19	0	10	0	19	38	19
09:15 09:30	0	0	0	0	0	0	0	0	0	0	8	0	18	0	10	0	18	36	18
09:30 09:45	0	0	0	0	0	0	0	0	0	0	3	0	12	0	9	0	12	24	12
09:45 10:00	0	0	0	0	0	0	0	0	0	0	5	0	15	0	10	0	15	30	15
11:30 11:45	0	0	0	0	0	0	1	1	1	0	2	0	8	0	5	0	7	15	8
11:45 12:00	0	0	0	0	0	0	0	0	0	0	3	0	10	0	7	0	10	20	10
12:00 12:15	0	0	0	0	0	0	0	1	1	0	4	0	9	0	5	1	10	19	10
12:15 12:30	0	0	0	0	0	0	1	1	1	0	7	0	22	0	14	0	21	43	22
12:30 12:45	0	0	0	0	0	0	0	0	0	0	6	0	10	0	4	0	10	20	10
12:45 13:00	0	0	0	0	0	0	0	0	0	0	10	0	18	0	8	0	18	36	18
13:00 13:15	0	0	0	0	0	0	0	0	0	0	17	0	24	0	7	0	24	48	24
13:15 13:30	0	0	0	0	0	0	0	1	1	0	4	0	19	0	15	1	20	39	20
15:00 15:15	0	0	0	0	0	0	1	2	2	0	4	0	15	0	10	1	15	30	16
15:15 15:30	0	0	0	0	0	0	0	0	0	0	8	0	15	0	7	0	15	30	15
15:30 15:45	0	0	0	0	1	0	0	2	2	1	10	0	18	0	7	0	18	36	19
15:45 16:00	0	0	0	0	0	0	0	0	0	0	10	0	16	0	6	0	16	32	16
16:00 16:15	0	0	0	0	0	0	1	4	4	0	6	0	15	0	8	3	17	32	18
16:15 16:30	0	0	0	0	0	0	1	1	1	0	10	0	16	0	5	0	15	31	16
16:30 16:45	0	0	0	0	0	0	1	1	1	0	7	0	11	0	3	0	10	21	11
16:45 17:00	0	0	0	0	0	0	0	0	0	0	3	0	7	0	4	0	7	14	7
17:00 17:15	0	0	0	0	0	0	0	0	0	0	5	0	8	0	3	0	8	16	8
17:15 17:30	0	0	0	0	0	0	0	0	0	0	6	0	10	0	4	0	10	20	10
17:30 17:45	0	0	0	0	0	0	0	0	0	0	1	0	3	0	2	0	3	6	3
17:45 18:00	0	0	0	0	0	0	0	0	0	0	2	0	7	0	5	0	7	14	7
Total: None	0	0	0	0	3	0	7	21	21	3	190	0	420	0	220	8	421	841	431



Transportation Services - Traffic Services

Turning Movement Count - Study Results

VALOUR DR @ SMYTH RD

Survey Date: Tuesday, November 20, 2018

WO No: 38132

Start Time: 07:00

Device: Miovision

Full Study 15 Minute U-Turn Total

VALOUR DR

SMYTH RD

Time Period		Northbound U-Turn Total	Southbound U-Turn Total	Eastbound U-Turn Total	Westbound U-Turn Total	Total
07:00	07:15	0	0	0	0	0
07:15	07:30	0	0	0	0	0
07:30	07:45	0	0	0	0	0
07:45	08:00	0	0	0	0	0
08:00	08:15	0	0	2	0	2
08:15	08:30	0	0	0	0	0
08:30	08:45	0	0	0	0	0
08:45	09:00	0	0	0	0	0
09:00	09:15	0	0	0	0	0
09:15	09:30	0	0	0	0	0
09:30	09:45	0	0	0	0	0
09:45	10:00	0	0	0	0	0
11:30	11:45	0	0	0	0	0
11:45	12:00	0	0	0	0	0
12:00	12:15	0	0	0	0	0
12:15	12:30	0	0	0	0	0
12:30	12:45	0	0	0	0	0
12:45	13:00	0	0	1	0	1
13:00	13:15	0	0	0	0	0
13:15	13:30	0	0	0	0	0
15:00	15:15	0	0	0	0	0
15:15	15:30	0	0	0	0	0
15:30	15:45	0	0	0	0	0
15:45	16:00	0	0	0	0	0
16:00	16:15	0	0	0	0	0
16:15	16:30	0	0	0	0	0
16:30	16:45	0	0	0	0	0
16:45	17:00	0	0	0	0	0
17:00	17:15	0	0	0	0	0
17:15	17:30	0	0	0	0	0
17:30	17:45	0	0	0	0	0
17:45	18:00	0	0	0	0	0
Total		0	0	3	0	3

Turning Movement Count - Study Results

SMYTH RD @ SOUTH HAVEN PL/GENERAL HOSPITAL ENTRANCE W

Survey Date: Tuesday, October 04, 2022

WO No: 40590

Start Time: 07:00

Device: Miovision

Full Study Diagram

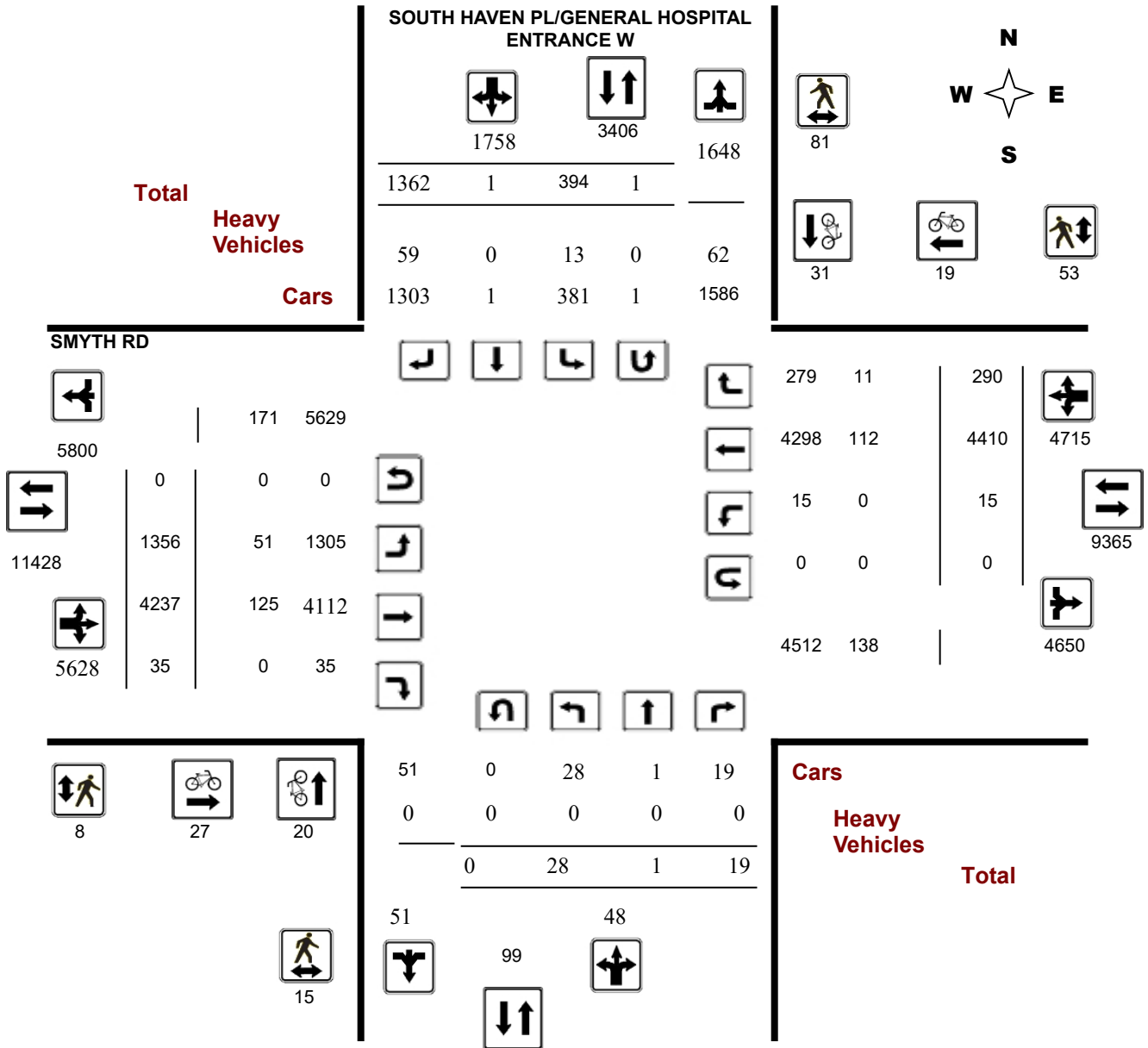

Turning Movement Count - Study Results

SMYTH RD @ SOUTH HAVEN PL/GENERAL HOSPITAL ENTRANCE W

Survey Date: Tuesday, October 04, 2022

WO No: 40590

Start Time: 07:00

Device: Miovision

Full Study Peak Hour Diagram

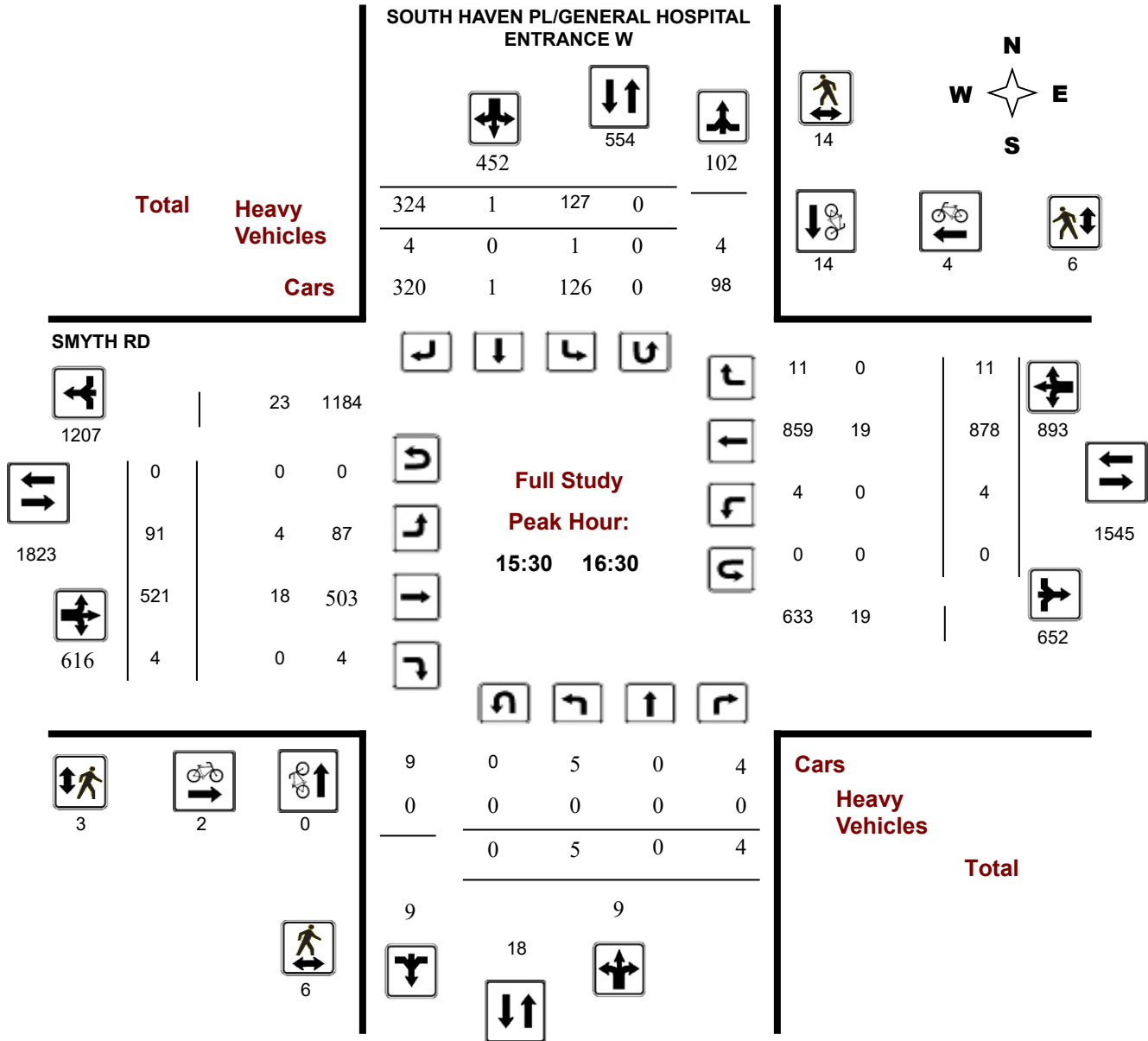

Turning Movement Count - Peak Hour Diagram

SMYTH RD @ SOUTH HAVEN PL/GENERAL HOSPITAL ENTRANCE W

Survey Date: Tuesday, October 04, 2022

Start Time: 07:00

WO No: 40590

Device: Miovision

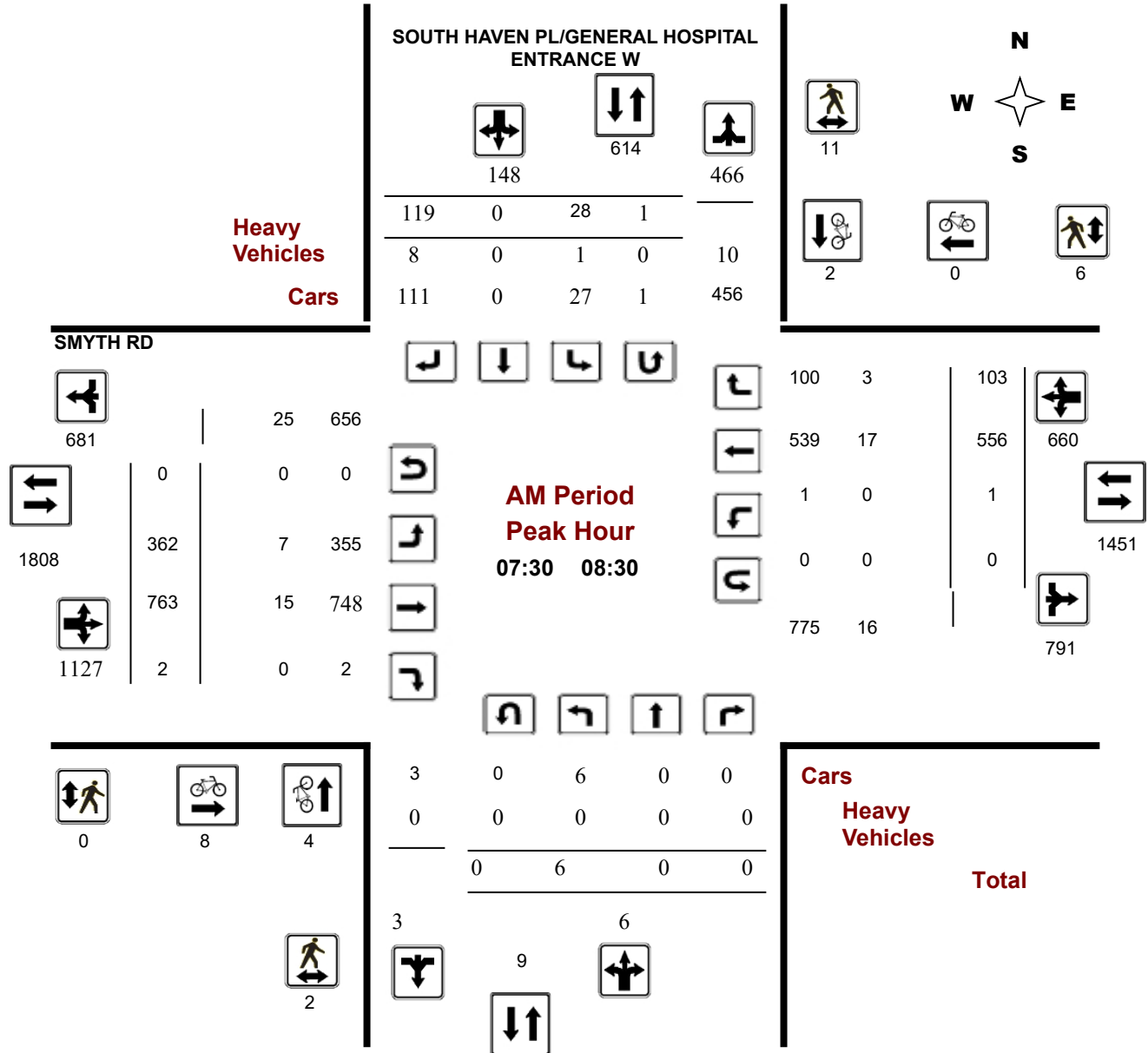

Comments

Turning Movement Count - Peak Hour Diagram

SMYTH RD @ SOUTH HAVEN PL/GENERAL HOSPITAL ENTRANCE W

Survey Date: Tuesday, October 04, 2022

Start Time: 07:00

WO No: 40590

Device: Miovision

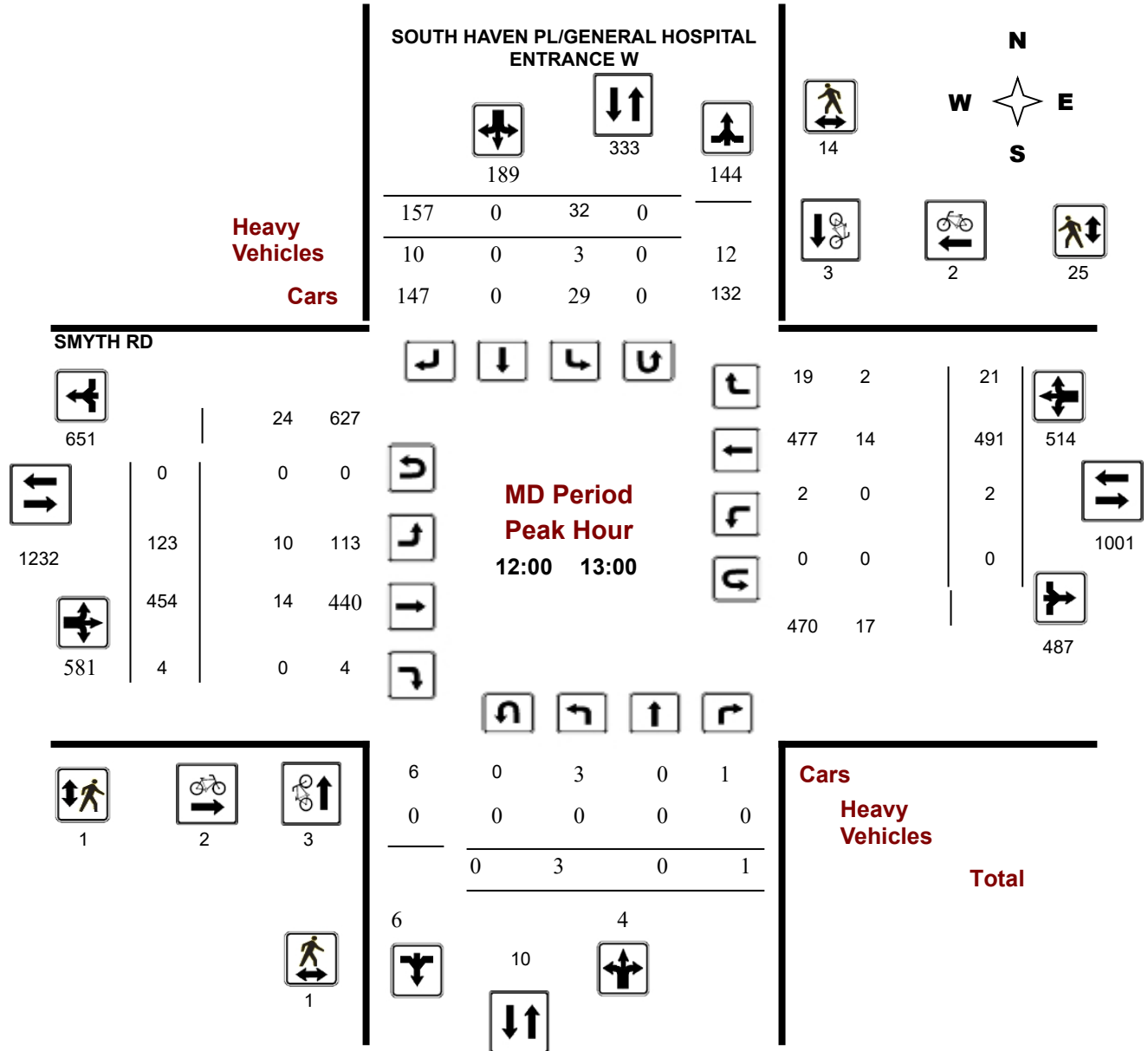

Comments

Turning Movement Count - Peak Hour Diagram

SMYTH RD @ SOUTH HAVEN PL/GENERAL HOSPITAL ENTRANCE W

Survey Date: Tuesday, October 04, 2022

Start Time: 07:00

WO No: 40590

Device: Miovision

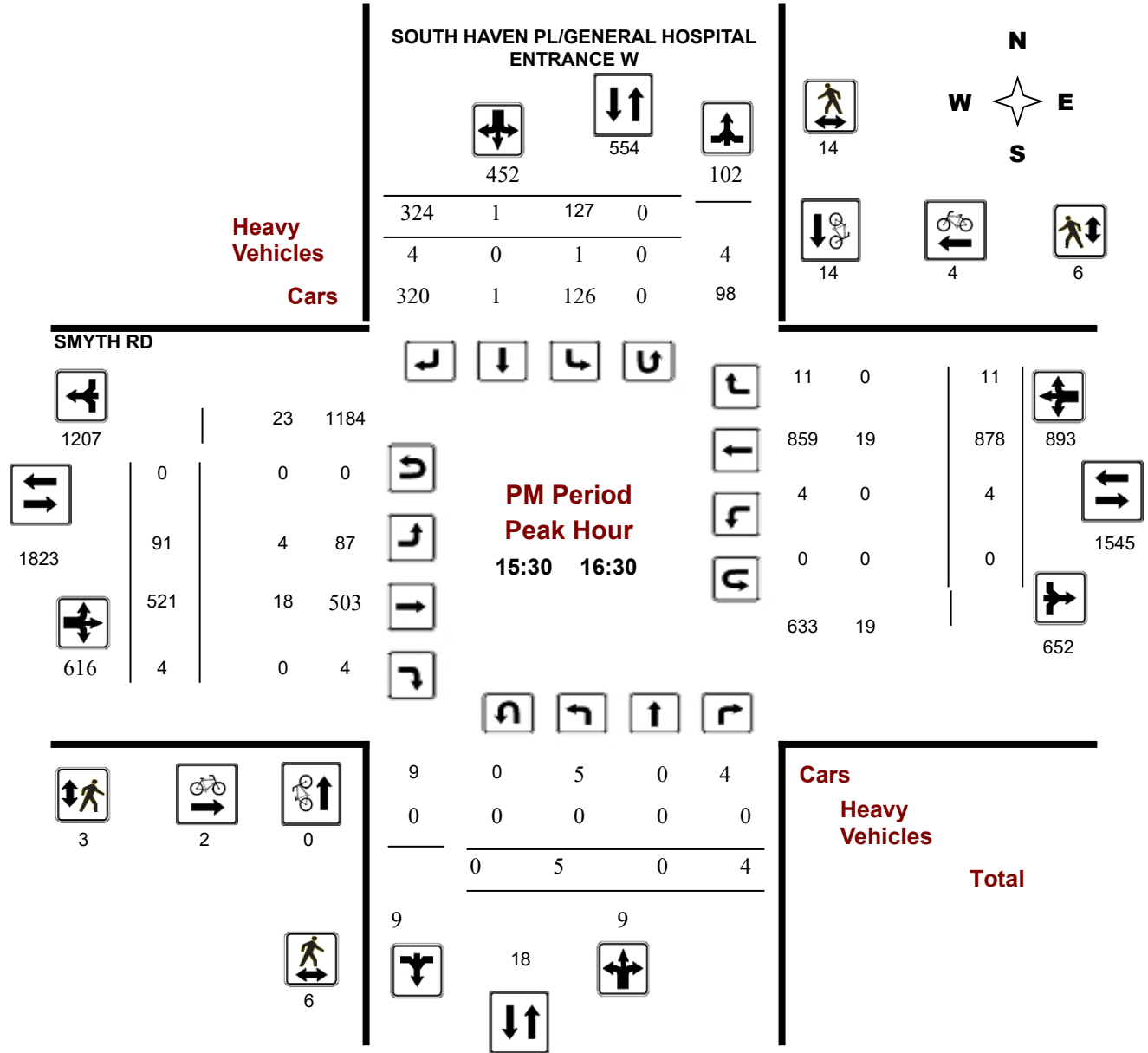

Comments



Transportation Services - Traffic Services

Turning Movement Count - Study Results

SMYTH RD @ SOUTH HAVEN PL/GENERAL HOSPITAL ENTRANCE W

Survey Date: Tuesday, October 04, 2022

WO No: 40590

Start Time: 07:00

Device: Miovision

Full Study Summary (8 HR Standard)

Survey Date: Tuesday, October 04, 2022

Total Observed U-Turns

AADT Factor

Northbound: 0 Southbound: 1
 Eastbound: 0 Westbound: 0

.90

SOUTH HAVEN PL/GENERAL HOSPITAL ENTRANCE W

SMYTH RD

Period	Northbound				Southbound				STR TOT	Eastbound			Westbound			WB TOT	STR TOT	Grand Total	
	LT	ST	RT	NB TOT	LT	ST	RT	SB TOT		LT	ST	RT	EB TOT	LT	ST				RT
07:00 08:00	4	0	1	5	28	0	99	127	132	337	713	1	1051	2	442	102	546	1597	1729
08:00 09:00	3	1	3	7	26	0	107	133	140	324	694	5	1023	2	564	77	643	1666	1806
09:00 10:00	3	0	1	4	22	0	129	151	155	201	511	3	715	3	401	34	438	1153	1308
11:30 12:30	3	0	3	6	28	0	152	180	186	111	428	4	543	2	465	15	482	1025	1211
12:30 13:30	3	0	3	6	31	0	150	181	187	147	407	4	558	1	441	23	465	1023	1210
15:00 16:00	5	0	5	10	119	0	296	415	425	113	551	6	670	3	822	23	848	1518	1943
16:00 17:00	4	0	1	5	102	1	258	361	366	67	469	2	538	2	697	3	702	1240	1606
17:00 18:00	3	0	2	5	38	0	171	209	214	56	464	10	530	0	578	13	591	1121	1335
Sub Total	28	1	19	48	394	1	1362	1757	1805	1356	4237	35	5628	15	4410	290	4715	10343	12148
U Turns				0				1	1				0				0	0	1
Total	28	1	19	48	394	1	1362	1758	1806	1356	4237	35	5628	15	4410	290	4715	10343	12149

EQ 12Hr 39 1 26 67 548 1 1893 2444 2510 1885 5889 49 7823 21 6130 403 6554 14377 16887

Note: These values are calculated by multiplying the totals by the appropriate expansion factor. **1.39**

AVG 12Hr 35 1 23 60 493 2 2232 2200 2259 1696 5300 44 7041 19 5517 363 5899 12939 15198

Note: These volumes are calculated by multiplying the Equivalent 12 hr. totals by the AADT factor. **.90**

AVG 24Hr 46 1 30 79 646 3 2924 2882 2959 2222 6943 58 9224 25 7227 476 7728 16950 19909

Note: These volumes are calculated by multiplying the Average Daily 12 hr. totals by 12 to 24 expansion factor. **1.31**

Note: U-Turns provided for approach totals. Refer to 'U-Turn' Report for specific breakdown.



Transportation Services - Traffic Services

Turning Movement Count - Study Results

SMYTH RD @ SOUTH HAVEN PL/GENERAL HOSPITAL ENTRANCE W

Survey Date: Tuesday, October 04, 2022

WO No: 40590

Start Time: 07:00

Device: Miovision

Full Study Cyclist Volume

SOUTH HAVEN PL/GENERAL HOSPITAL
ENTRANCE W

SMYTH RD

Time Period	Northbound	Southbound	Street Total	Eastbound	Westbound	Street Total	Grand Total
07:00 07:15	1	0	1	4	2	6	7
07:15 07:30	0	0	0	0	0	0	0
07:30 07:45	0	1	1	2	0	2	3
07:45 08:00	2	0	2	4	0	4	6
08:00 08:15	1	1	2	0	0	0	2
08:15 08:30	1	0	1	2	0	2	3
08:30 08:45	2	0	2	1	1	2	4
08:45 09:00	1	0	1	4	0	4	5
09:00 09:15	0	1	1	0	1	1	2
09:15 09:30	0	0	0	0	0	0	0
09:30 09:45	1	0	1	1	1	2	3
09:45 10:00	0	0	0	0	0	0	0
11:30 11:45	0	1	1	0	0	0	1
11:45 12:00	0	0	0	1	1	2	2
12:00 12:15	0	2	2	0	0	0	2
12:15 12:30	1	0	1	0	1	1	2
12:30 12:45	0	1	1	1	1	2	3
12:45 13:00	2	0	2	1	0	1	3
13:00 13:15	1	0	1	0	1	1	2
13:15 13:30	0	0	0	0	0	0	0
15:00 15:15	2	0	2	0	0	0	2
15:15 15:30	1	2	3	1	1	2	5
15:30 15:45	0	2	2	0	1	1	3
15:45 16:00	0	2	2	0	3	3	5
16:00 16:15	0	3	3	0	0	0	3
16:15 16:30	0	7	7	2	0	2	9
16:30 16:45	1	2	3	0	0	0	3
16:45 17:00	0	1	1	2	1	3	4
17:00 17:15	1	1	2	0	0	0	2
17:15 17:30	0	3	3	1	1	2	5
17:30 17:45	0	0	0	0	2	2	2
17:45 18:00	2	1	3	0	1	1	4
Total	20	31	51	27	19	46	97



Transportation Services - Traffic Services

Turning Movement Count - Study Results

SMYTH RD @ SOUTH HAVEN PL/GENERAL HOSPITAL ENTRANCE W

Survey Date: Tuesday, October 04, 2022

WO No: 40590

Start Time: 07:00

Device: Miovision

Full Study Pedestrian Volume

SOUTH HAVEN PL/GENERAL HOSPITAL ENTRANCE W

SMYTH RD

Time Period	NB Approach (E or W Crossing)	SB Approach (E or W Crossing)	Total	EB Approach (N or S Crossing)	WB Approach (N or S Crossing)	Total	Grand Total
07:00 07:15	0	0	0	0	0	0	0
07:15 07:30	1	1	2	1	0	1	3
07:30 07:45	1	2	3	0	1	1	4
07:45 08:00	0	7	7	0	2	2	9
08:00 08:15	1	1	2	0	0	0	2
08:15 08:30	0	1	1	0	3	3	4
08:30 08:45	0	3	3	0	2	2	5
08:45 09:00	0	2	2	0	1	1	3
09:00 09:15	0	1	1	0	0	0	1
09:15 09:30	0	2	2	1	2	3	5
09:30 09:45	0	0	0	0	0	0	0
09:45 10:00	0	0	0	0	0	0	0
11:30 11:45	1	2	3	0	0	0	3
11:45 12:00	0	2	2	0	1	1	3
12:00 12:15	0	3	3	0	10	10	13
12:15 12:30	0	5	5	1	9	10	15
12:30 12:45	1	5	6	0	1	1	7
12:45 13:00	0	1	1	0	5	5	6
13:00 13:15	2	3	5	0	2	2	7
13:15 13:30	0	5	5	0	1	1	6
15:00 15:15	0	4	4	0	0	0	4
15:15 15:30	0	1	1	0	0	0	1
15:30 15:45	0	1	1	0	0	0	1
15:45 16:00	2	5	7	1	4	5	12
16:00 16:15	2	3	5	2	2	4	9
16:15 16:30	2	5	7	0	0	0	7
16:30 16:45	0	1	1	0	3	3	4
16:45 17:00	2	2	4	1	1	2	6
17:00 17:15	0	3	3	0	0	0	3
17:15 17:30	0	7	7	1	0	1	8
17:30 17:45	0	1	1	0	3	3	4
17:45 18:00	0	2	2	0	0	0	2
Total	15	81	96	8	53	61	157



Transportation Services - Traffic Services

Turning Movement Count - Study Results

SMYTH RD @ SOUTH HAVEN PL/GENERAL HOSPITAL ENTRANCE W

Survey Date: Tuesday, October 04, 2022

WO No: 40590

Start Time: 07:00

Device: Miovision

Full Study Heavy Vehicles

**SOUTH HAVEN PL/GENERAL
HOSPITAL ENTRANCE W**

SMYTH RD

Northbound

Southbound

Eastbound

Westbound

Time Period	Northbound			N TOT	Southbound			S TOT	STR TOT	Eastbound			E TOT	Westbound			W TOT	STR TOT	Grand Total
	LT	ST	RT		LT	ST	RT			LT	ST	RT		LT	ST	RT			
07:00 07:15	0	0	0	0	0	0	1	3	3	1	2	0	6	0	2	1	5	11	7
07:15 07:30	0	0	0	0	0	0	1	3	3	1	2	0	6	0	2	1	5	11	7
07:30 07:45	0	0	0	0	1	0	2	6	6	1	3	0	8	0	2	2	8	16	11
07:45 08:00	0	0	0	0	0	0	3	4	4	1	4	0	9	0	1	0	5	14	9
08:00 08:15	0	0	0	0	0	0	0	0	0	0	3	0	8	0	5	0	8	16	8
08:15 08:30	0	0	0	0	0	0	3	9	9	5	5	0	22	0	9	1	15	37	23
08:30 08:45	0	0	0	0	1	0	2	8	8	4	4	0	15	0	5	1	11	26	17
08:45 09:00	0	0	0	0	1	0	4	6	6	0	7	0	18	0	7	1	16	34	20
09:00 09:15	0	0	0	0	1	0	2	5	5	2	5	0	14	0	5	0	11	25	15
09:15 09:30	0	0	0	0	0	0	1	4	4	2	3	0	10	0	4	1	8	18	11
09:30 09:45	0	0	0	0	0	0	1	2	2	1	2	0	6	0	2	0	4	10	6
09:45 10:00	0	0	0	0	1	0	2	6	6	2	6	0	13	0	3	1	11	24	15
11:30 11:45	0	0	0	0	0	0	3	6	6	3	1	0	13	0	6	0	7	20	13
11:45 12:00	0	0	0	0	1	0	2	4	4	1	5	0	12	0	4	0	10	22	13
12:00 12:15	0	0	0	0	1	0	2	6	6	2	2	0	12	0	6	1	10	22	14
12:15 12:30	0	0	0	0	0	0	3	6	6	2	3	0	9	0	1	1	5	14	10
12:30 12:45	0	0	0	0	1	0	1	3	3	1	6	0	14	0	6	0	13	27	15
12:45 13:00	0	0	0	0	1	0	4	10	10	5	3	0	13	0	1	0	5	18	14
13:00 13:15	0	0	0	0	0	0	3	4	4	1	7	0	15	0	4	0	11	26	15
13:15 13:30	0	0	0	0	0	0	2	4	4	2	1	0	5	0	0	0	1	6	5
15:00 15:15	0	0	0	0	0	0	2	4	4	2	4	0	12	0	4	0	8	20	12
15:15 15:30	0	0	0	0	3	0	1	4	4	0	7	0	11	0	3	0	13	24	14
15:30 15:45	0	0	0	0	0	0	1	2	2	1	3	0	8	0	3	0	6	14	8
15:45 16:00	0	0	0	0	0	0	0	1	1	1	5	0	13	0	7	0	12	25	13
16:00 16:15	0	0	0	0	0	0	1	2	2	1	5	0	9	0	2	0	7	16	9
16:15 16:30	0	0	0	0	1	0	2	4	4	1	5	0	15	0	7	0	13	28	16
16:30 16:45	0	0	0	0	0	0	2	3	3	1	3	0	10	0	4	0	7	17	10
16:45 17:00	0	0	0	0	0	0	0	2	2	2	6	0	9	0	1	0	7	16	9
17:00 17:15	0	0	0	0	0	0	3	4	4	1	1	0	5	0	0	0	1	6	5
17:15 17:30	0	0	0	0	0	0	1	1	1	0	3	0	5	0	1	0	4	9	5
17:30 17:45	0	0	0	0	0	0	1	2	2	1	4	0	9	0	3	0	7	16	9
17:45 18:00	0	0	0	0	0	0	3	6	6	3	5	0	13	0	2	0	7	20	13
Total: None	0	0	0	0	13	0	59	134	134	51	125	0	347	0	112	11	261	608	371



Transportation Services - Traffic Services

Turning Movement Count - Study Results

SMYTH RD @ SOUTH HAVEN PL/GENERAL HOSPITAL ENTRANCE W

Survey Date: Tuesday, October 04, 2022

WO No: 40590

Start Time: 07:00

Device: Miovision

Full Study 15 Minute U-Turn Total

Time Period	SOUTH HAVEN PL/GENERAL HOSPITAL ENTRANCE W		SMYTH RD		Total	
	Northbound U-Turn Total	Southbound U-Turn Total	Eastbound U-Turn Total	Westbound U-Turn Total		
07:00	07:15	0	0	0	0	
07:15	07:30	0	0	0	0	
07:30	07:45	0	1	0	1	
07:45	08:00	0	0	0	0	
08:00	08:15	0	0	0	0	
08:15	08:30	0	0	0	0	
08:30	08:45	0	0	0	0	
08:45	09:00	0	0	0	0	
09:00	09:15	0	0	0	0	
09:15	09:30	0	0	0	0	
09:30	09:45	0	0	0	0	
09:45	10:00	0	0	0	0	
11:30	11:45	0	0	0	0	
11:45	12:00	0	0	0	0	
12:00	12:15	0	0	0	0	
12:15	12:30	0	0	0	0	
12:30	12:45	0	0	0	0	
12:45	13:00	0	0	0	0	
13:00	13:15	0	0	0	0	
13:15	13:30	0	0	0	0	
15:00	15:15	0	0	0	0	
15:15	15:30	0	0	0	0	
15:30	15:45	0	0	0	0	
15:45	16:00	0	0	0	0	
16:00	16:15	0	0	0	0	
16:15	16:30	0	0	0	0	
16:30	16:45	0	0	0	0	
16:45	17:00	0	0	0	0	
17:00	17:15	0	0	0	0	
17:15	17:30	0	0	0	0	
17:30	17:45	0	0	0	0	
17:45	18:00	0	0	0	0	
Total		0	1	0	0	1



Transportation Services - Traffic Services

Turning Movement Count - Study Results SMYTH RD @ GENERAL HOSPITAL E

Survey Date: Wednesday, December 11, 2019
Start Time: 07:00

WO No: 39229
Device: Miovision

Full Study Peak Hour Diagram

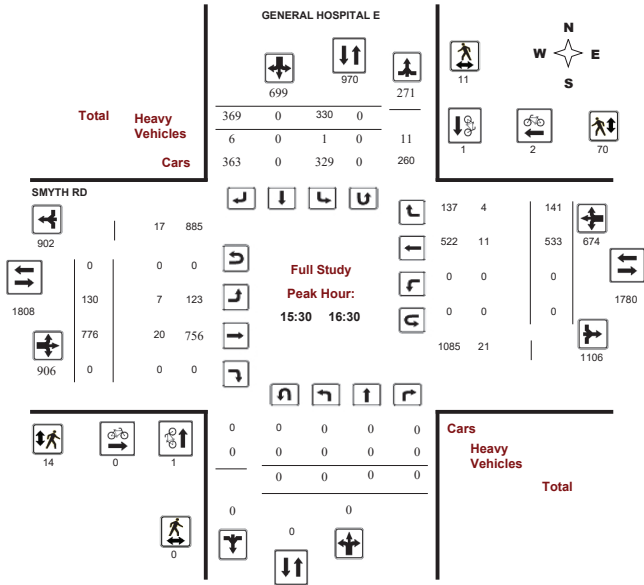

Transportation Services - Traffic Services

Turning Movement Count - Peak Hour Diagram SMYTH RD @ GENERAL HOSPITAL E

Survey Date: Wednesday, December 11, 2019
Start Time: 07:00

WO No: 39229
Device: Miovision

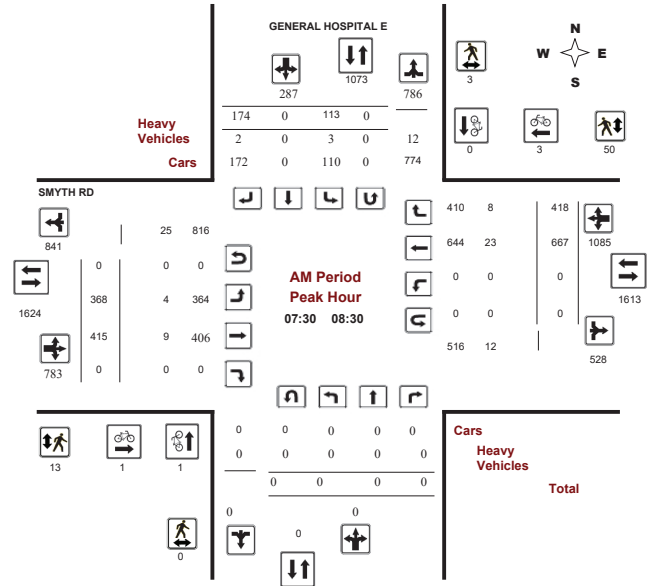

Comments



Transportation Services - Traffic Services

Turning Movement Count - Study Results

SMYTH RD @ GENERAL HOSPITAL E

Survey Date: Wednesday, December 11, 2019

WO No: 39229

Start Time: 07:00

Device: Miovision

Full Study Summary (8 HR Standard)

Survey Date: Wednesday, December 11, 2019

Total Observed U-Turns

AADT Factor

Northbound: 0
Southbound: 0
Eastbound: 0
Westbound: 1

1.39

Period	GENERAL HOSPITAL E						SMYTH RD						Grand Total						
	Northbound			Southbound			Eastbound			Westbound									
	LT	ST	RT	SB TOT	STR TOT	LT	ST	RT	EB TOT	LT	ST	RT		WB TOT	STR TOT				
07:00 08:00	0	0	0	0	122	0	173	295	295	396	399	0	795	0	579	394	973	1768	2063
08:00 09:00	0	0	0	0	93	0	155	248	248	354	440	0	794	0	680	381	1061	1655	2103
09:00 10:00	0	0	0	0	143	0	156	299	299	294	378	0	672	0	400	240	640	1312	1611
11:30 12:30	0	0	0	0	162	0	256	418	418	183	391	0	574	0	369	197	566	1140	1558
12:30 13:30	0	0	0	0	163	0	201	364	364	239	353	0	592	0	358	238	596	1188	1552
15:00 16:00	0	0	0	0	286	0	371	657	657	162	641	0	803	0	582	149	731	1534	2191
16:00 17:00	0	0	0	0	307	0	303	610	610	117	756	0	873	0	458	126	584	1457	2067
17:00 18:00	0	0	0	0	148	0	238	386	386	87	582	0	669	0	370	90	460	1129	1515
Sub Total	0	0	0	0	1424	0	1853	3277	3277	1832	3940	0	5772	0	3796	1815	5611	11383	14660
U Turns	0	0	0	0	0	0	0	0	0	0	0	0	0	0	1	1	1	1	1

Total 0 0 0 0 1424 0 1853 3277 3277 1832 3940 0 5772 0 3796 1815 5611 11384 14661

EQ 12hr 0 0 0 0 1979 0 2576 4555 4555 2546 5477 0 8023 0 5276 2523 7801 15824 20379

Note: These values are calculated by multiplying the totals by the appropriate expansion factor. 1.39

AVG 12hr 0 0 0 0 1979 0 2576 4555 4555 2546 5477 0 8023 0 5276 2523 7801 15824 20379

Note: These volumes are calculated by multiplying the Equivalent 12 hr. totals by the AADT factor. 1

AVG 24hr 0 0 0 0 2593 0 3374 5967 5967 3336 7174 0 10510 0 6912 3305 10219 20729 26696

Note: These volumes are calculated by multiplying the Average Daily 12 hr. totals by 12 to 24 expansion factor. 1.31

Note: U-Turns provided for approach totals. Refer to 'U-Turn' Report for specific breakdown.



Transportation Services - Traffic Services

Turning Movement Count - Study Results

SMYTH RD @ GENERAL HOSPITAL E

Survey Date: Wednesday, December 11, 2019

WO No: 39229

Start Time: 07:00

Device: Miovision

Full Study 15 Minute Increments

GENERAL HOSPITAL E

SMYTH RD

Time Period	Northbound				Southbound				Eastbound				Westbound				Grand Total		
	LT	ST	RT	N TOT	LT	ST	RT	S TOT	LT	ST	RT	E TOT	LT	ST	RT	W TOT		STR TOT	
07:00 07:15	0	0	0	0	23	0	33	56	241	111	68	0	179	0	121	74	195	241	430
07:15 07:30	0	0	0	0	31	0	41	72	257	91	109	0	200	0	147	94	241	257	513
07:30 07:45	0	0	0	0	36	0	58	94	284	92	108	0	200	0	165	98	263	284	557
07:45 08:00	0	0	0	0	32	0	41	73	303	102	114	0	216	0	146	128	274	303	583
08:00 08:15	0	0	0	0	24	0	38	62	263	87	91	0	178	0	167	114	281	263	521
08:15 08:30	0	0	0	0	21	0	37	58	223	87	102	0	189	0	189	78	267	223	514
08:30 08:45	0	0	0	0	23	0	40	63	255	90	107	0	187	0	170	112	282	255	532
08:45 09:00	0	0	0	0	25	0	40	65	242	100	140	0	240	0	154	77	231	242	536
09:00 09:15	0	0	0	0	22	0	38	60	194	75	122	0	197	0	127	59	186	194	443
09:15 09:30	0	0	0	0	38	0	39	77	212	74	78	0	152	0	96	61	157	212	386
09:30 09:45	0	0	0	0	38	0	28	66	202	73	83	0	156	0	86	63	149	202	371
09:45 10:00	0	0	0	0	45	0	51	96	225	72	95	0	167	0	91	57	149	225	412
11:30 11:45	0	0	0	0	41	0	56	97	168	28	98	0	126	0	102	43	145	168	368
11:45 12:00	0	0	0	0	41	0	70	111	210	46	93	0	139	0	84	53	137	210	387
12:00 12:15	0	0	0	0	47	0	64	111	213	57	98	0	155	0	98	45	143	213	409
12:15 12:30	0	0	0	0	33	0	66	99	207	52	102	0	154	0	85	56	141	207	394
12:30 12:45	0	0	0	0	49	0	50	99	235	67	92	0	159	0	81	69	150	235	408
12:45 13:00	0	0	0	0	40	0	51	91	204	54	91	0	145	0	96	59	155	204	391
13:00 13:15	0	0	0	0	39	0	40	79	191	53	87	0	140	0	86	59	145	191	364
13:15 13:30	0	0	0	0	35	0	60	95	211	65	83	0	148	0	95	51	146	211	389
15:00 15:15	0	0	0	0	63	0	99	162	251	54	137	0	191	0	149	35	184	251	537
15:15 15:30	0	0	0	0	72	0	79	151	228	35	142	0	177	0	150	42	192	228	520
15:30 15:45	0	0	0	0	70	0	93	163	235	39	198	0	237	0	127	33	160	235	560
15:45 16:00	0	0	0	0	81	0	100	181	254	34	164	0	198	0	156	39	195	254	574
16:00 16:15	0	0	0	0	83	0	98	181	242	21	192	0	213	0	142	40	182	242	576
16:15 16:30	0	0	0	0	96	0	78	174	239	36	222	0	258	0	108	29	137	239	569
16:30 16:45	0	0	0	0	60	0	65	125	182	30	167	0	197	0	105	27	132	182	454
16:45 17:00	0	0	0	0	68	0	62	130	190	30	175	0	205	0	103	30	133	190	468
17:00 17:15	0	0	0	0	42	0	64	106	153	20	150	0	170	0	104	27	131	153	407
17:15 17:30	0	0	0	0	38	0	61	99	142	23	138	0	161	0	88	20	108	142	368
17:30 17:45	0	0	0	0	33	0	55	88	128	27	130	0	157	0	93	13	106	128	351
17:45 18:00	0	0	0	0	35	0	58	93	140	17	164	0	181	0	85	30	115	140	389
Total	0	0	0	0	1424	0	1853	3277	3277	1832	3940	0	5772	0	3796	1815	5612	6924	14661

Note: U-Turns are included in Totals.



Transportation Services - Traffic Services

Turning Movement Count - Study Results
SMYTH RD @ GENERAL HOSPITAL E

Survey Date: Wednesday, December 11, 2019
Start Time: 07:00

WO No: 39229
Device: Miovision

Full Study Heavy Vehicles

GENERAL HOSPITAL E SMYTH RD

Table with columns: Time Period, Northbound (LT, ST, RT, N TOT), Southbound (LT, ST, RT, S TOT), Eastbound (LT, ST, RT, E TOT), Westbound (LT, ST, RT, W TOT), STR TOT, Grand Total. Rows show 15-minute intervals from 07:00 to 18:00.



Transportation Services - Traffic Services

Turning Movement Count - Study Results
SMYTH RD @ GENERAL HOSPITAL E

Survey Date: Wednesday, December 11, 2019
Start Time: 07:00

WO No: 39229
Device: Miovision

Full Study 15 Minute U-Turn Total

GENERAL HOSPITAL E SMYTH RD

Table with columns: Time Period, Northbound U-Turn Total, Southbound U-Turn Total, Eastbound U-Turn Total, Westbound U-Turn Total, Total. Rows show 15-minute intervals from 07:00 to 18:00.

Turning Movement Count - Study Results

ROGER GUINDON AVE @ SMYTH RD

Survey Date: Tuesday, January 08, 2019

WO No: 38227

Start Time: 07:00

Device: Miovision

Full Study Diagram

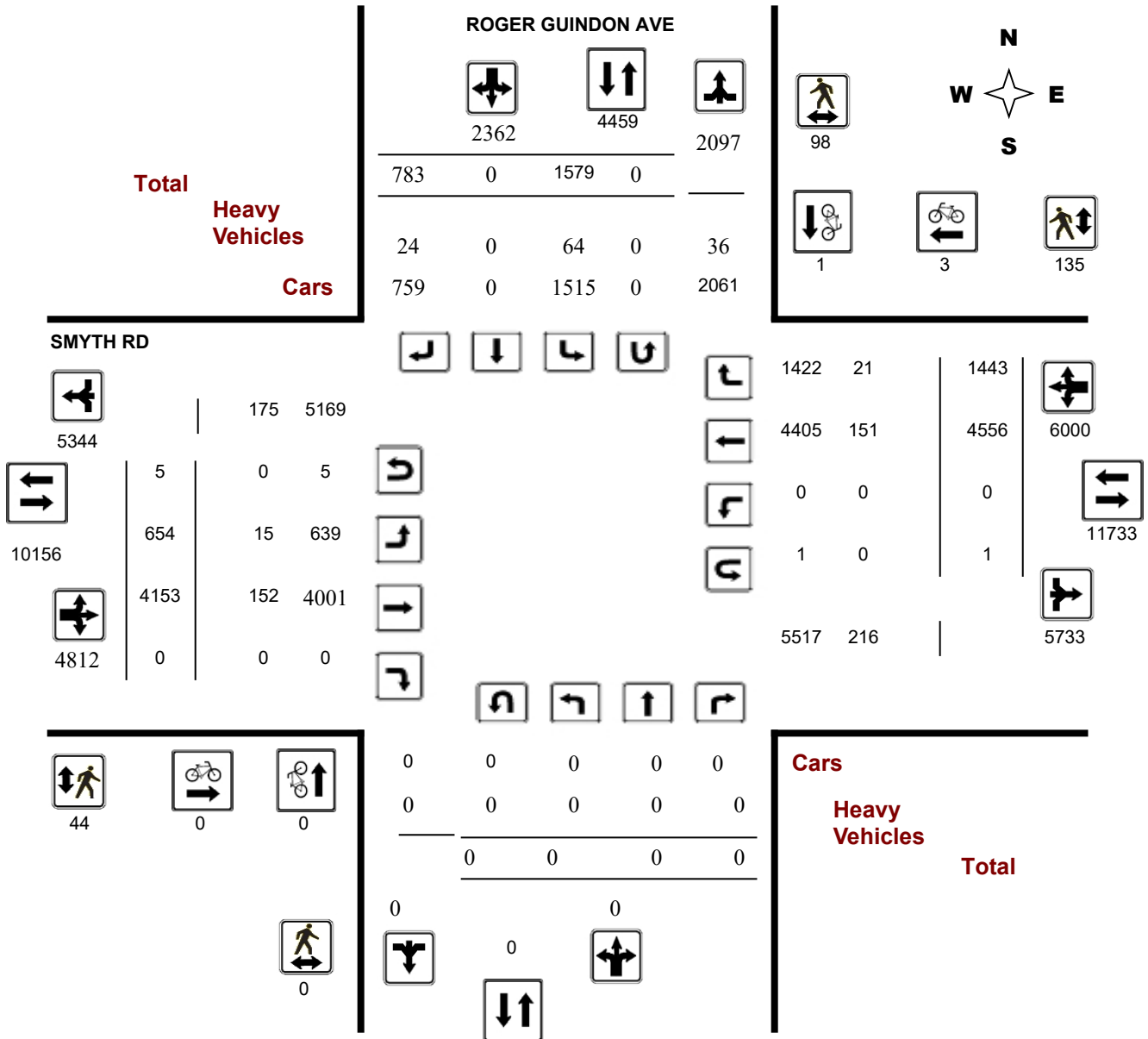

Turning Movement Count - Study Results

ROGER GUINDON AVE @ SMYTH RD

Survey Date: Tuesday, January 08, 2019

WO No:

38227

Start Time: 07:00

Device:

Miovision

Full Study Peak Hour Diagram

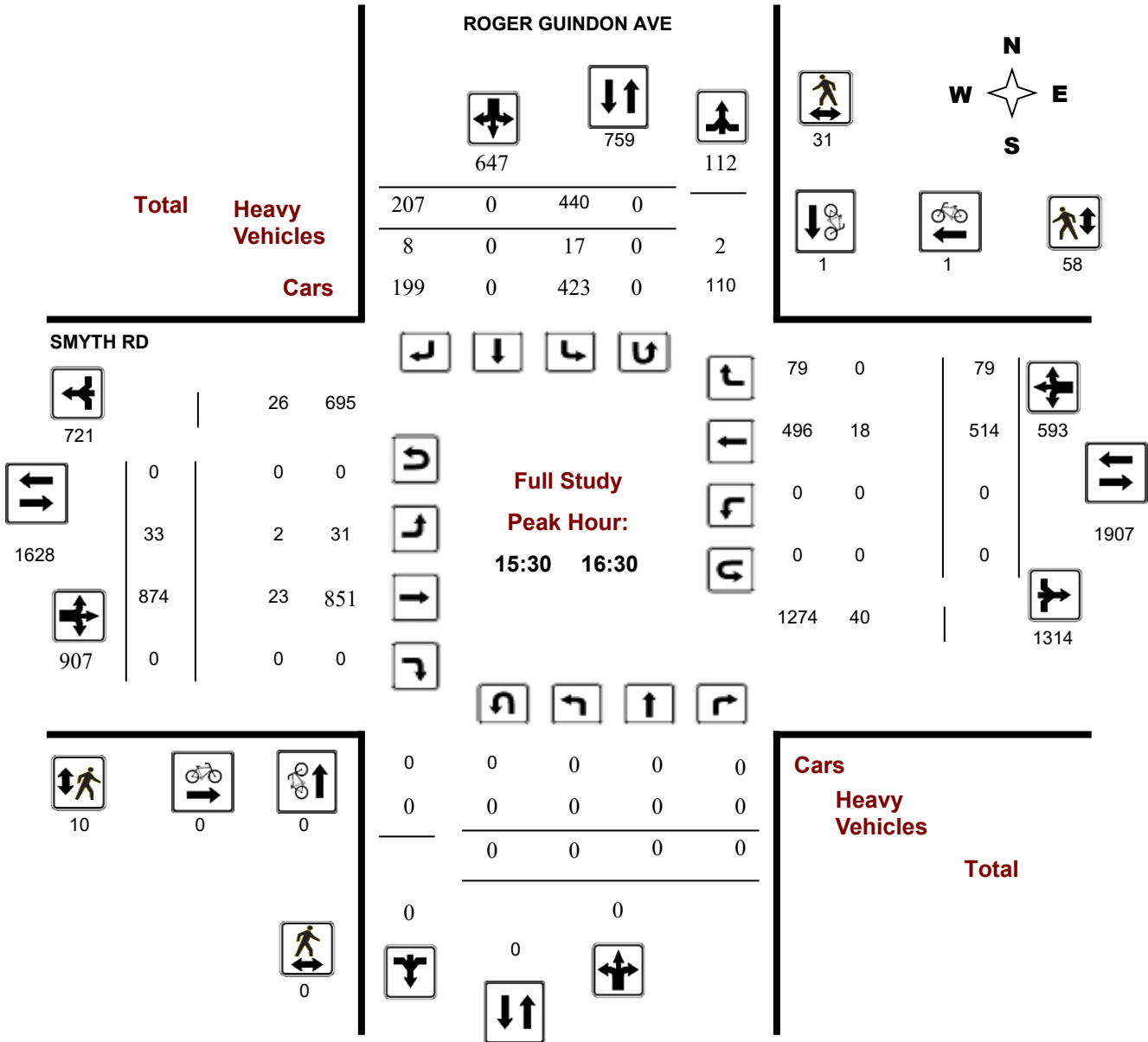

Turning Movement Count - Peak Hour Diagram

ROGER GUINDON AVE @ SMYTH RD

Survey Date: Tuesday, January 08, 2019

Start Time: 07:00

WO No: 38227

Device: Miovision

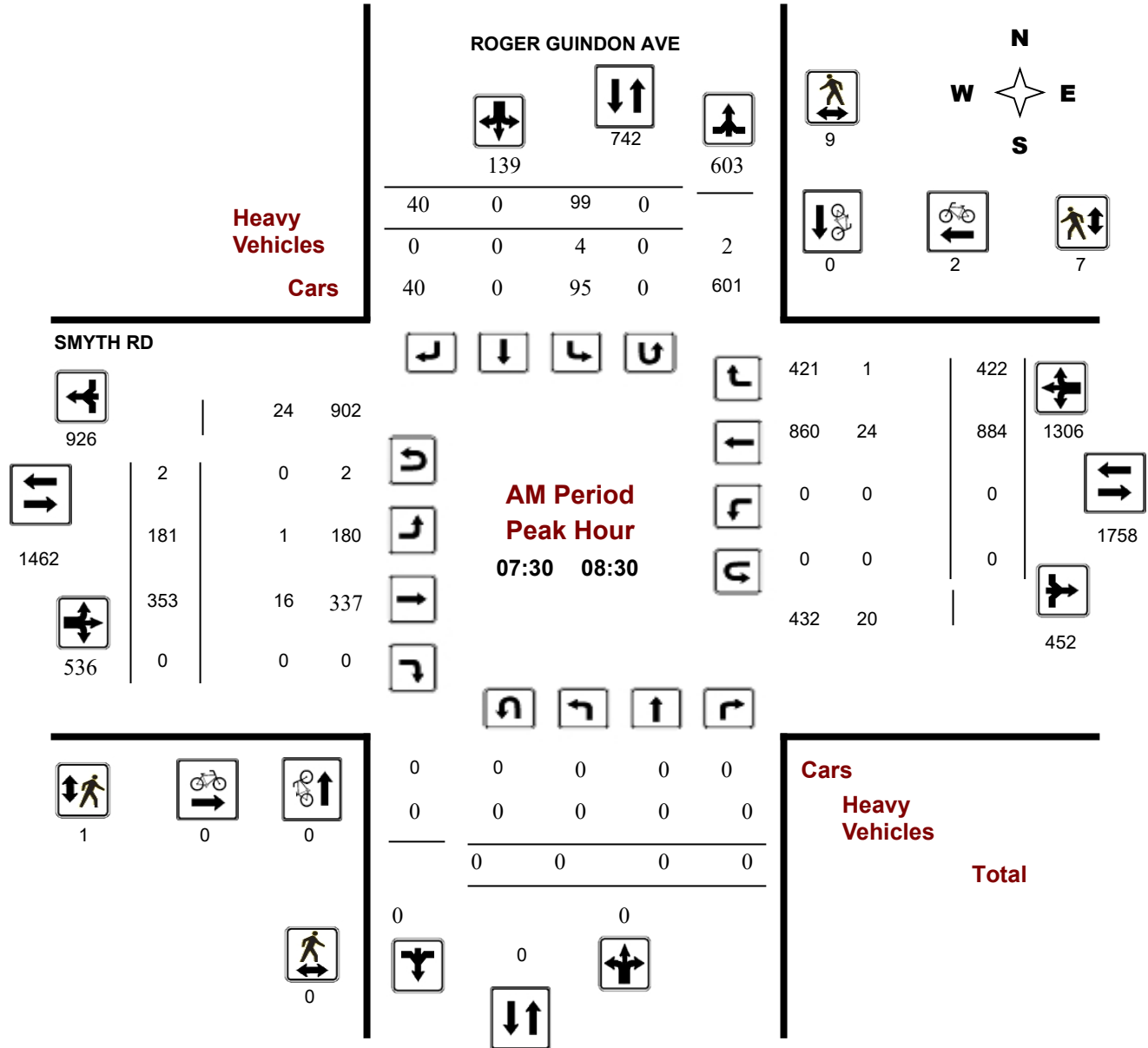

Comments



Transportation Services - Traffic Services

Turning Movement Count - Peak Hour Diagram

ROGER GUINDON AVE @ SMYTH RD

Survey Date: Tuesday, January 08, 2019

Start Time: 07:00

WO No: 38227

Device: Miovision

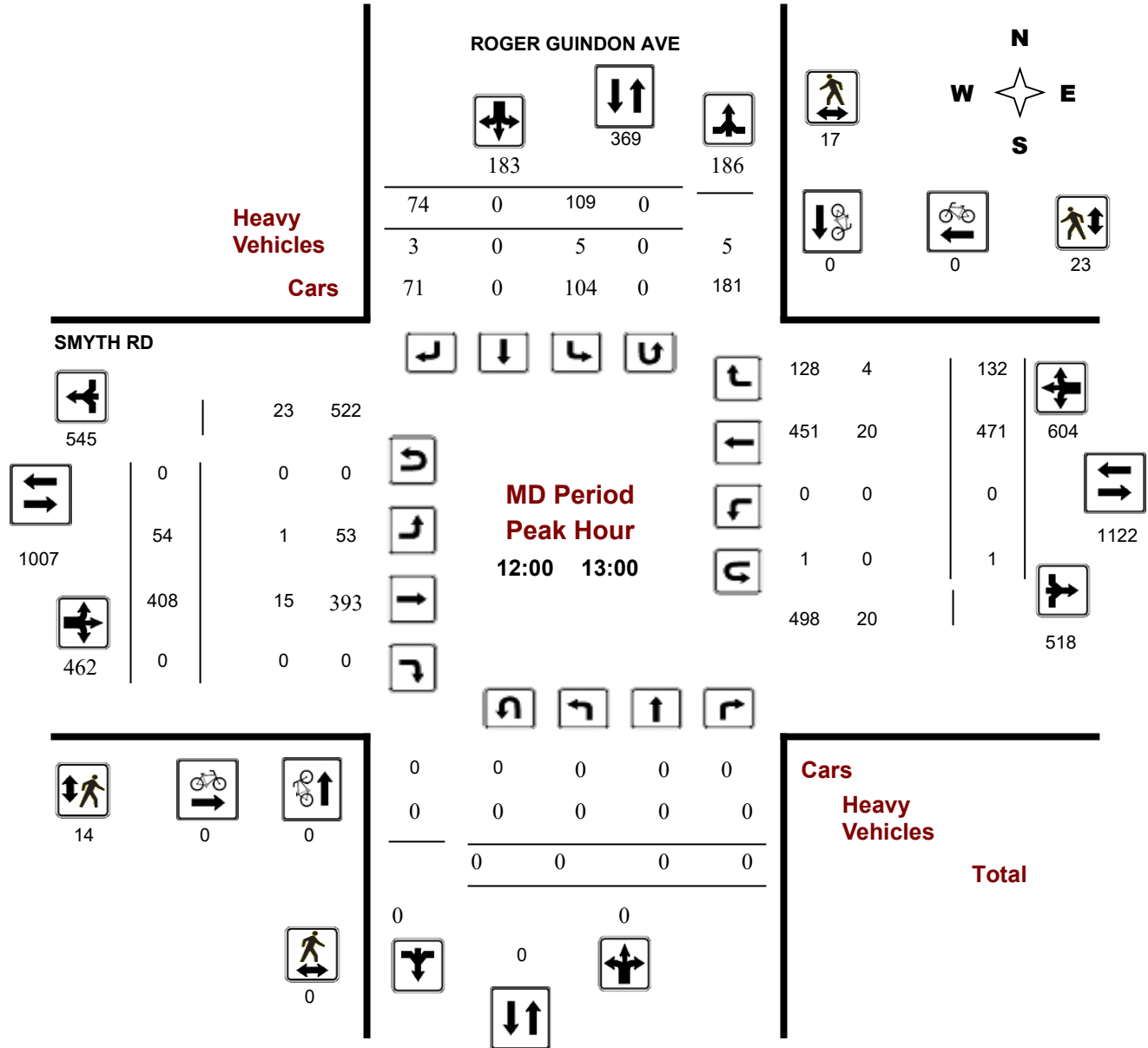

Turning Movement Count - Peak Hour Diagram

ROGER GUINDON AVE @ SMYTH RD

Survey Date: Tuesday, January 08, 2019

Start Time: 07:00

WO No: 38227

Device: Miovision

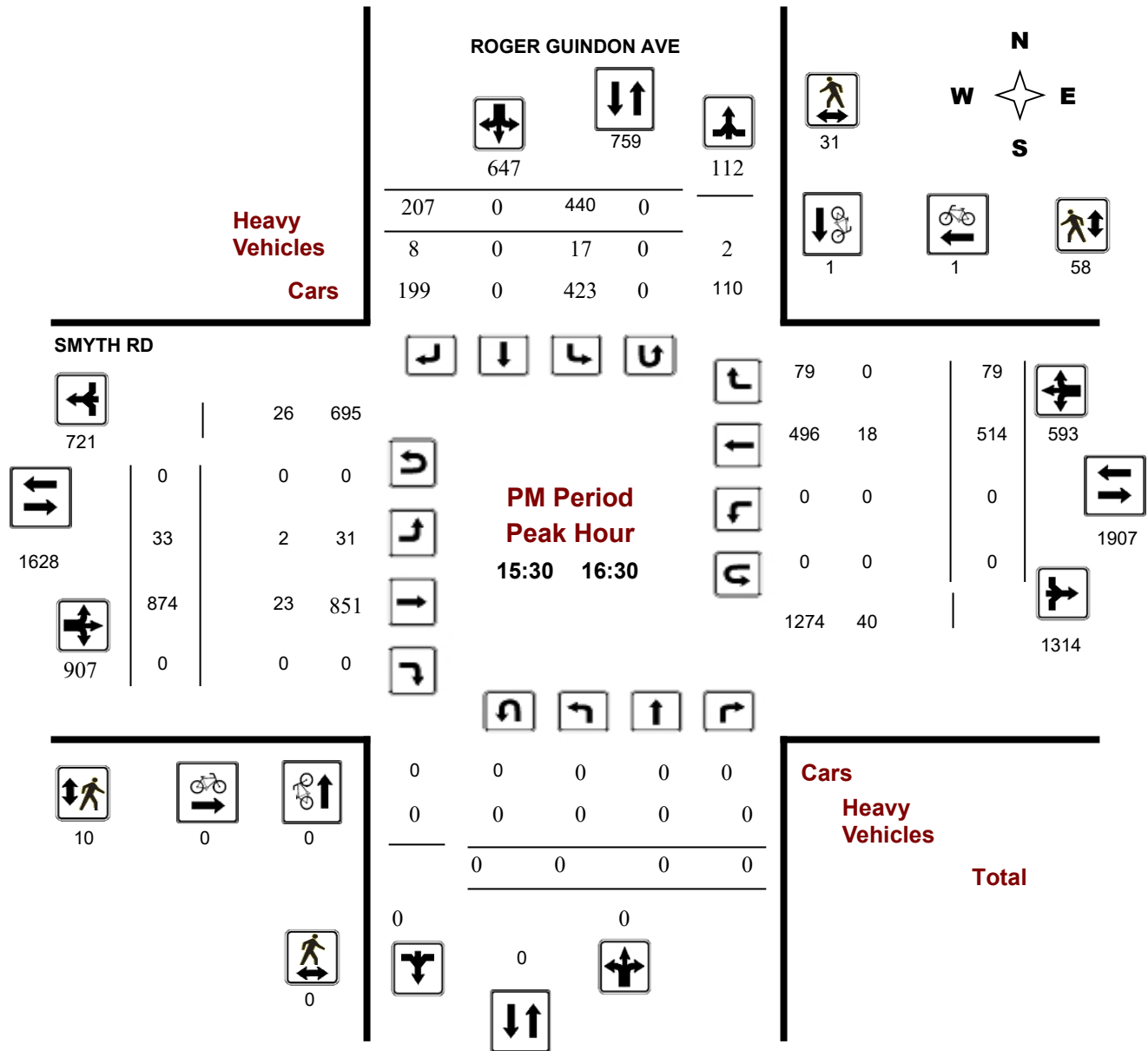



Transportation Services - Traffic Services

Turning Movement Count - Study Results

ROGER GUINDON AVE @ SMYTH RD

Survey Date: Tuesday, January 08, 2019

WO No: 38227

Start Time: 07:00

Device: Miovision

Full Study Summary (8 HR Standard)

Survey Date: Tuesday, January 08, 2019

Total Observed U-Turns

AADT Factor

Northbound: 0 Southbound: 0
 Eastbound: 5 Westbound: 1

1.10

Period	ROGER GUINDON AVE										SMYTH RD										Grand Total
	Northbound					Southbound					Eastbound					Westbound					
	LT	ST	RT	NB TOT	STR TOT	LT	ST	RT	SB TOT	STR TOT	LT	ST	RT	EB TOT	STR TOT	LT	ST	RT	WB TOT	STR TOT	
07:00 08:00	0	0	0	0	108	68	0	40	108	108	195	318	0	513	1740	0	825	402	1227	1740	1848
08:00 09:00	0	0	0	0	167	116	0	51	167	167	151	403	0	554	1938	0	830	387	1217	1771	1938
09:00 10:00	0	0	0	0	191	136	0	55	191	191	115	373	0	488	1518	0	626	213	839	1327	1518
11:30 12:30	0	0	0	0	183	123	0	60	183	183	50	420	0	470	1160	0	391	116	507	977	1160
12:30 13:30	0	0	0	0	181	103	0	78	181	181	54	389	0	443	1226	0	495	107	602	1045	1226
15:00 16:00	0	0	0	0	646	406	0	240	646	646	39	782	0	821	2122	0	563	92	655	1476	2122
16:00 17:00	0	0	0	0	552	398	0	154	552	552	29	866	0	895	1939	0	423	69	492	1387	1939
17:00 18:00	0	0	0	0	334	229	0	105	334	334	21	602	0	623	1417	0	403	57	460	1083	1417
Sub Total	0	0	0	0	2362	1579	0	783	2362	2362	654	4153	0	4807	13168	0	4556	1443	5999	10806	13168
U Turns				0	0				0	0				5					1	6	6
Total	0	0	0	0	2362	1579	0	783	2362	2362	654	4153	0	4812	13174	0	4556	1443	6000	10812	13174
EQ 12Hr	0	0	0	0	3283	2195	0	1088	3283	3283	909	5773	0	6689	18312	0	6333	2006	8340	15029	18312
Note: These values are calculated by multiplying the totals by the appropriate expansion factor.														1.39							
AVG 12Hr	0	0	0	0	3611	2414	0	1568	3611	3611	1000	6350	0	7358	20143	0	6966	2207	9174	16532	20143
Note: These volumes are calculated by multiplying the Equivalent 12 hr. totals by the AADT factor.														1.10							
AVG 24Hr	0	0	0	0	4730	3162	0	2054	4730	4730	1310	8318	0	9639	26387	0	9125	2891	12018	21657	26387
Note: These volumes are calculated by multiplying the Average Daily 12 hr. totals by 12 to 24 expansion factor.														1.31							
Note: U-Turns provided for approach totals. Refer to 'U-Turn' Report for specific breakdown.																					



Transportation Services - Traffic Services

Turning Movement Count - Study Results

ROGER GUINDON AVE @ SMYTH RD

Survey Date: Tuesday, January 08, 2019

WO No: 38227

Start Time: 07:00

Device: Miovision

Full Study 15 Minute Increments

ROGER GUINDON AVE

SMYTH RD

Northbound

Southbound

Eastbound

Westbound

Time Period	LT	ST	RT	N TOT	LT	ST	RT	S TOT	STR TOT	LT	ST	RT	E TOT	LT	ST	RT	W TOT	STR TOT	Grand Total
07:00 07:15	0	0	0	0	13	0	9	22	22	37	67	0	104	0	150	86	236	340	362
07:15 07:30	0	0	0	0	15	0	11	26	26	57	80	0	139	0	203	97	300	439	465
07:30 07:45	0	0	0	0	19	0	10	29	29	47	84	0	131	0	241	104	345	476	505
07:45 08:00	0	0	0	0	21	0	10	31	31	54	87	0	142	0	231	115	346	488	519
08:00 08:15	0	0	0	0	29	0	11	40	40	48	79	0	128	0	195	103	298	426	466
08:15 08:30	0	0	0	0	30	0	9	39	39	32	103	0	135	0	217	100	317	452	491
08:30 08:45	0	0	0	0	26	0	16	42	42	30	96	0	126	0	195	97	292	418	460
08:45 09:00	0	0	0	0	31	0	15	46	46	41	125	0	166	0	223	87	310	476	522
09:00 09:15	0	0	0	0	49	0	17	66	66	35	122	0	157	0	193	61	254	411	477
09:15 09:30	0	0	0	0	35	0	14	49	49	24	89	0	113	0	181	63	244	357	406
09:30 09:45	0	0	0	0	26	0	7	33	33	28	75	0	103	0	129	37	166	269	302
09:45 10:00	0	0	0	0	26	0	17	43	43	28	87	0	115	0	123	52	175	290	333
11:30 11:45	0	0	0	0	28	0	10	38	38	12	93	0	105	0	86	20	106	211	249
11:45 12:00	0	0	0	0	31	0	12	43	43	15	108	0	123	0	100	31	131	254	297
12:00 12:15	0	0	0	0	33	0	20	53	53	14	115	0	129	0	93	28	121	250	303
12:15 12:30	0	0	0	0	31	0	18	49	49	9	104	0	113	0	112	37	150	263	312
12:30 12:45	0	0	0	0	22	0	26	48	48	15	87	0	102	0	141	31	172	274	322
12:45 13:00	0	0	0	0	23	0	10	33	33	16	102	0	118	0	125	36	161	279	312
13:00 13:15	0	0	0	0	23	0	24	47	47	7	94	0	101	0	116	22	138	239	286
13:15 13:30	0	0	0	0	35	0	18	53	53	16	106	0	122	0	113	18	131	253	306
15:00 15:15	0	0	0	0	107	0	64	171	171	10	195	0	205	0	143	24	167	372	543
15:15 15:30	0	0	0	0	92	0	56	148	148	11	168	0	179	0	129	22	151	330	478
15:30 15:45	0	0	0	0	108	0	60	168	168	8	223	0	231	0	147	20	167	398	566
15:45 16:00	0	0	0	0	99	0	60	159	159	10	196	0	206	0	144	26	170	376	535
16:00 16:15	0	0	0	0	125	0	37	162	162	10	214	0	224	0	107	16	123	347	509
16:15 16:30	0	0	0	0	108	0	50	158	158	5	241	0	246	0	116	17	133	379	537
16:30 16:45	0	0	0	0	97	0	39	136	136	5	195	0	200	0	101	21	122	322	458
16:45 17:00	0	0	0	0	68	0	28	96	96	9	216	0	226	0	99	15	114	340	436
17:00 17:15	0	0	0	0	86	0	42	128	128	7	187	0	194	0	121	13	134	328	456
17:15 17:30	0	0	0	0	53	0	34	87	87	5	144	0	149	0	102	17	119	268	355
17:30 17:45	0	0	0	0	56	0	12	68	68	5	129	0	134	0	101	17	118	252	320
17:45 18:00	0	0	0	0	34	0	17	51	51	4	142	0	146	0	79	10	89	235	286
Total:	0	0	0	0	1579	0	783	2362	2362	654	4153	0	4812	0	4556	1443	6000	10812	13,174

Note: U-Turns are included in Totals.



Transportation Services - Traffic Services

Turning Movement Count - Study Results

ROGER GUINDON AVE @ SMYTH RD

Survey Date: Tuesday, January 08, 2019

WO No: 38227

Start Time: 07:00

Device: Miovision

Full Study Cyclist Volume

ROGER GUINDON AVE

SMYTH RD

Time Period	Northbound	Southbound	Street Total	Eastbound	Westbound	Street Total	Grand Total
07:00 07:15	0	0	0	0	0	0	0
07:15 07:30	0	0	0	0	0	0	0
07:30 07:45	0	0	0	0	0	0	0
07:45 08:00	0	0	0	0	1	1	1
08:00 08:15	0	0	0	0	1	1	1
08:15 08:30	0	0	0	0	0	0	0
08:30 08:45	0	0	0	0	0	0	0
08:45 09:00	0	0	0	0	0	0	0
09:00 09:15	0	0	0	0	0	0	0
09:15 09:30	0	0	0	0	0	0	0
09:30 09:45	0	0	0	0	0	0	0
09:45 10:00	0	0	0	0	0	0	0
11:30 11:45	0	0	0	0	0	0	0
11:45 12:00	0	0	0	0	0	0	0
12:00 12:15	0	0	0	0	0	0	0
12:15 12:30	0	0	0	0	0	0	0
12:30 12:45	0	0	0	0	0	0	0
12:45 13:00	0	0	0	0	0	0	0
13:00 13:15	0	0	0	0	0	0	0
13:15 13:30	0	0	0	0	0	0	0
15:00 15:15	0	0	0	0	0	0	0
15:15 15:30	0	0	0	0	0	0	0
15:30 15:45	0	1	1	0	1	1	2
15:45 16:00	0	0	0	0	0	0	0
16:00 16:15	0	0	0	0	0	0	0
16:15 16:30	0	0	0	0	0	0	0
16:30 16:45	0	0	0	0	0	0	0
16:45 17:00	0	0	0	0	0	0	0
17:00 17:15	0	0	0	0	0	0	0
17:15 17:30	0	0	0	0	0	0	0
17:30 17:45	0	0	0	0	0	0	0
17:45 18:00	0	0	0	0	0	0	0
Total	0	1	1	0	3	3	4



Transportation Services - Traffic Services

Turning Movement Count - Study Results

ROGER GUINDON AVE @ SMYTH RD

Survey Date: Tuesday, January 08, 2019

WO No: 38227

Start Time: 07:00

Device: Miovision

Full Study Pedestrian Volume

ROGER GUINDON AVE

SMYTH RD

Time Period	NB Approach (E or W Crossing)	SB Approach (E or W Crossing)	Total	EB Approach (N or S Crossing)	WB Approach (N or S Crossing)	Total	Grand Total
07:00 07:15	0	1	1	0	1	1	2
07:15 07:30	0	0	0	0	1	1	1
07:30 07:45	0	3	3	0	0	0	3
07:45 08:00	0	4	4	0	3	3	7
08:00 08:15	0	1	1	0	0	0	1
08:15 08:30	0	1	1	1	4	5	6
08:30 08:45	0	5	5	1	5	6	11
08:45 09:00	0	3	3	2	20	22	25
09:00 09:15	0	3	3	4	0	4	7
09:15 09:30	0	2	2	1	0	1	3
09:30 09:45	0	0	0	0	0	0	0
09:45 10:00	0	0	0	0	0	0	0
11:30 11:45	0	2	2	0	0	0	2
11:45 12:00	0	1	1	0	6	6	7
12:00 12:15	0	12	12	10	6	16	28
12:15 12:30	0	2	2	3	5	8	10
12:30 12:45	0	0	0	0	4	4	4
12:45 13:00	0	3	3	1	8	9	12
13:00 13:15	0	1	1	0	2	2	3
13:15 13:30	0	1	1	1	0	1	2
15:00 15:15	0	3	3	3	2	5	8
15:15 15:30	0	4	4	0	2	2	6
15:30 15:45	0	10	10	3	33	36	46
15:45 16:00	0	13	13	3	20	23	36
16:00 16:15	0	7	7	1	2	3	10
16:15 16:30	0	1	1	3	3	6	7
16:30 16:45	0	6	6	1	1	2	8
16:45 17:00	0	3	3	1	1	2	5
17:00 17:15	0	1	1	1	2	3	4
17:15 17:30	0	1	1	1	1	2	3
17:30 17:45	0	4	4	3	2	5	9
17:45 18:00	0	0	0	0	1	1	1
Total	0	98	98	44	135	179	277



Transportation Services - Traffic Services

Turning Movement Count - Study Results

ROGER GUINDON AVE @ SMYTH RD

Survey Date: Tuesday, January 08, 2019

WO No: 38227

Start Time: 07:00

Device: Miovision

Full Study Heavy Vehicles

ROGER GUINDON AVE

SMYTH RD

Northbound Southbound Eastbound Westbound

Time Period	Northbound				Southbound				Eastbound				Westbound				Grand Total		
	LT	ST	RT	N TOT	LT	ST	RT	S TOT	STR TOT	LT	ST	RT	E TOT	LT	ST	RT		W TOT	STR TOT
07:00 07:15	0	0	0	0	1	0	0	5	5	2	2	0	8	0	4	2	9	17	11
07:15 07:30	0	0	0	0	2	0	1	3	3	0	3	0	9	0	5	0	10	19	11
07:30 07:45	0	0	0	0	1	0	0	2	2	1	3	0	10	0	6	0	10	20	11
07:45 08:00	0	0	0	0	2	0	0	2	2	0	3	0	6	0	3	0	8	14	8
08:00 08:15	0	0	0	0	0	0	0	1	1	0	6	0	10	0	4	1	11	21	11
08:15 08:30	0	0	0	0	1	0	0	1	1	0	4	0	15	0	11	0	16	31	16
08:30 08:45	0	0	0	0	2	0	1	6	6	1	1	0	7	0	4	2	9	16	11
08:45 09:00	0	0	0	0	2	0	1	6	6	1	13	0	22	0	7	2	24	46	26
09:00 09:15	0	0	0	0	13	0	3	19	19	0	15	0	25	0	7	3	38	63	41
09:15 09:30	0	0	0	0	5	0	0	6	6	0	5	0	11	0	6	1	17	28	17
09:30 09:45	0	0	0	0	4	0	1	7	7	1	5	0	14	0	7	1	17	31	19
09:45 10:00	0	0	0	0	2	0	1	4	4	1	3	0	15	0	10	0	15	30	17
11:30 11:45	0	0	0	0	1	0	1	2	2	0	8	0	13	0	4	0	13	26	14
11:45 12:00	0	0	0	0	1	0	0	3	3	1	3	0	8	0	4	1	9	17	10
12:00 12:15	0	0	0	0	0	0	1	1	1	0	4	0	9	0	4	0	8	17	9
12:15 12:30	0	0	0	0	0	0	1	3	3	0	3	0	9	0	5	2	10	19	11
12:30 12:45	0	0	0	0	3	0	1	6	6	1	2	0	11	0	7	1	13	24	15
12:45 13:00	0	0	0	0	2	0	0	3	3	0	6	0	10	0	4	1	13	23	13
13:00 13:15	0	0	0	0	0	0	1	3	3	1	5	0	10	0	3	1	9	19	11
13:15 13:30	0	0	0	0	0	0	1	3	3	1	5	0	12	0	5	1	11	23	13
15:00 15:15	0	0	0	0	1	0	0	4	4	1	6	0	11	0	4	2	13	24	14
15:15 15:30	0	0	0	0	1	0	1	2	2	0	6	0	9	0	2	0	9	18	10
15:30 15:45	0	0	0	0	0	0	0	0	0	0	7	0	11	0	4	0	11	22	11
15:45 16:00	0	0	0	0	17	0	7	25	25	1	7	0	19	0	4	0	28	47	36
16:00 16:15	0	0	0	0	0	0	0	1	1	1	4	0	13	0	8	0	12	25	13
16:15 16:30	0	0	0	0	0	0	1	1	1	0	5	0	8	0	2	0	7	15	8
16:30 16:45	0	0	0	0	1	0	0	1	1	0	3	0	6	0	3	0	7	13	7
16:45 17:00	0	0	0	0	0	0	0	0	0	0	2	0	4	0	2	0	4	8	4
17:00 17:15	0	0	0	0	1	0	0	1	1	0	3	0	6	0	3	0	7	13	7
17:15 17:30	0	0	0	0	1	0	0	2	2	1	3	0	5	0	1	0	5	10	6
17:30 17:45	0	0	0	0	0	0	0	0	0	0	3	0	8	0	5	0	8	16	8
17:45 18:00	0	0	0	0	0	0	1	1	1	0	4	0	8	0	3	0	7	15	8
Total: None	0	0	0	0	64	0	24	124	124	15	152	0	342	0	151	21	388	730	427



Transportation Services - Traffic Services

Turning Movement Count - Study Results

ROGER GUINDON AVE @ SMYTH RD

Survey Date: Tuesday, January 08, 2019

WO No: 38227

Start Time: 07:00

Device: Miovision

Full Study 15 Minute U-Turn Total

ROGER GUINDON AVE

SMYTH RD

Time Period		Northbound U-Turn Total	Southbound U-Turn Total	Eastbound U-Turn Total	Westbound U-Turn Total	Total
07:00	07:15	0	0	0	0	0
07:15	07:30	0	0	2	0	2
07:30	07:45	0	0	0	0	0
07:45	08:00	0	0	1	0	1
08:00	08:15	0	0	1	0	1
08:15	08:30	0	0	0	0	0
08:30	08:45	0	0	0	0	0
08:45	09:00	0	0	0	0	0
09:00	09:15	0	0	0	0	0
09:15	09:30	0	0	0	0	0
09:30	09:45	0	0	0	0	0
09:45	10:00	0	0	0	0	0
11:30	11:45	0	0	0	0	0
11:45	12:00	0	0	0	0	0
12:00	12:15	0	0	0	0	0
12:15	12:30	0	0	0	1	1
12:30	12:45	0	0	0	0	0
12:45	13:00	0	0	0	0	0
13:00	13:15	0	0	0	0	0
13:15	13:30	0	0	0	0	0
15:00	15:15	0	0	0	0	0
15:15	15:30	0	0	0	0	0
15:30	15:45	0	0	0	0	0
15:45	16:00	0	0	0	0	0
16:00	16:15	0	0	0	0	0
16:15	16:30	0	0	0	0	0
16:30	16:45	0	0	0	0	0
16:45	17:00	0	0	1	0	1
17:00	17:15	0	0	0	0	0
17:15	17:30	0	0	0	0	0
17:30	17:45	0	0	0	0	0
17:45	18:00	0	0	0	0	0
Total		0	0	5	1	6

Turning Movement Count - Study Results

HOSPITAL LINK RD/RING RD @ RING RD

Survey Date: Thursday, February 20, 2020

WO No: 39524

Start Time: 07:00

Device: Miovision

Full Study Diagram

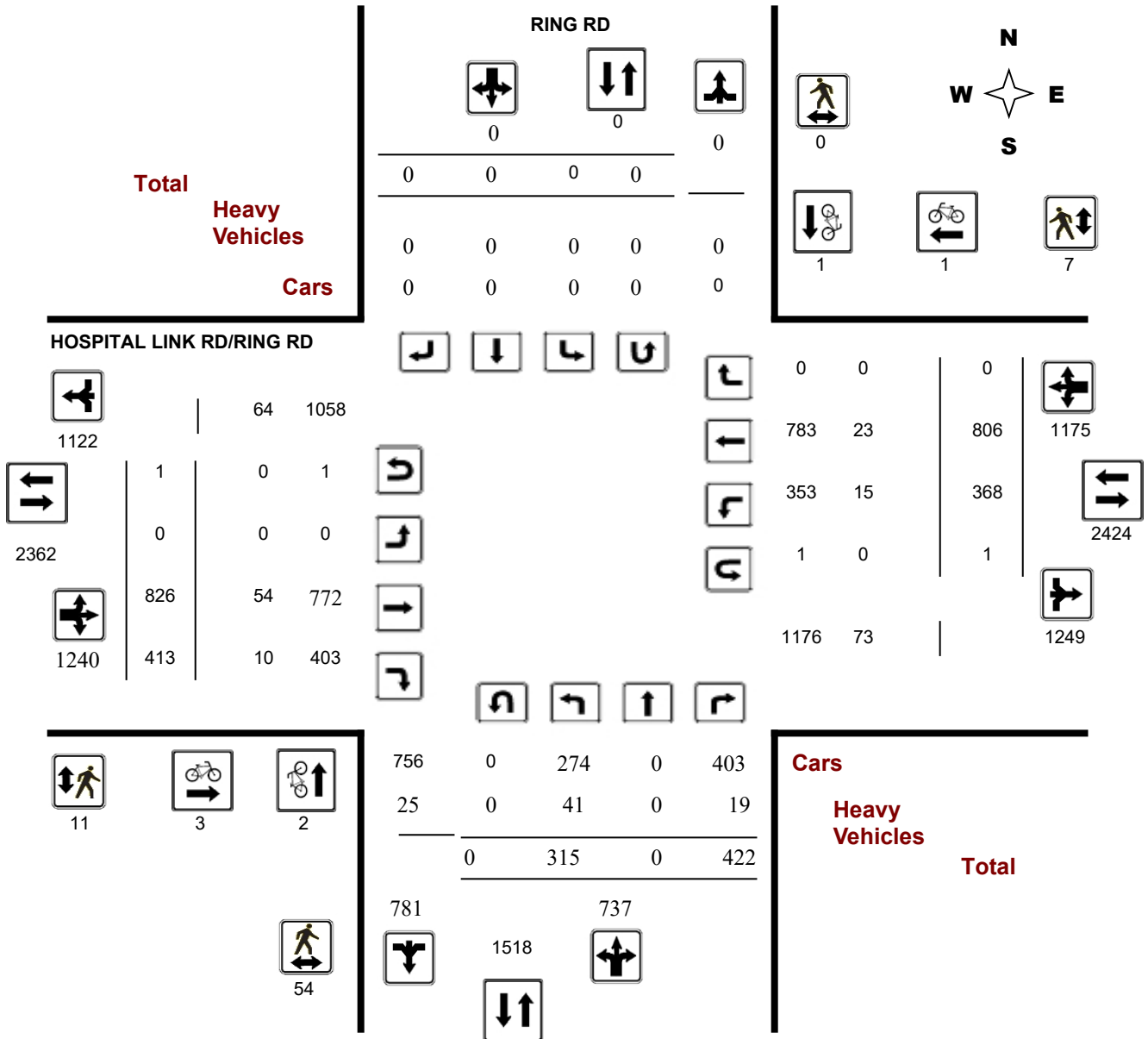

5473326 - HOSPITAL LINK RD & RING RD - THURS FEB 20, 2020 - 8HRS - LAUREN O'GRADY

Turning Movement Count - Study Results

HOSPITAL LINK RD/RING RD @ RING RD

Survey Date: Thursday, February 20, 2020

WO No: 39524

Start Time: 07:00

Device: Miovision

Full Study Peak Hour Diagram

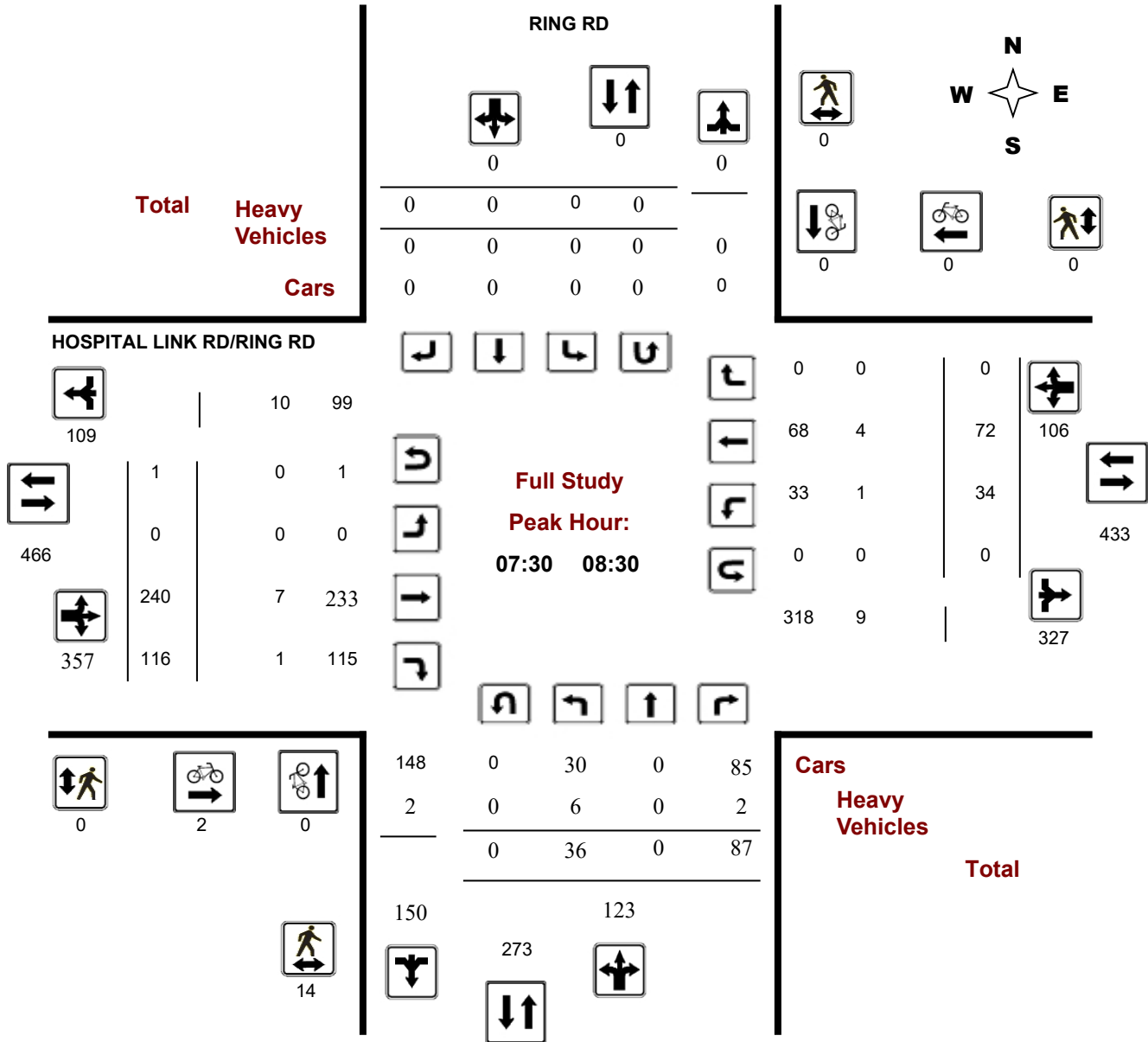

5473326 - HOSPITAL LINK RD & RING RD - THURS FEB 20, 2020 - 8HRS - LAUREN O'GRADY

Turning Movement Count - Peak Hour Diagram

HOSPITAL LINK RD/RING RD @ RING RD

Survey Date: Thursday, February 20, 2020

Start Time: 07:00

WO No: 39524

Device: Miovision

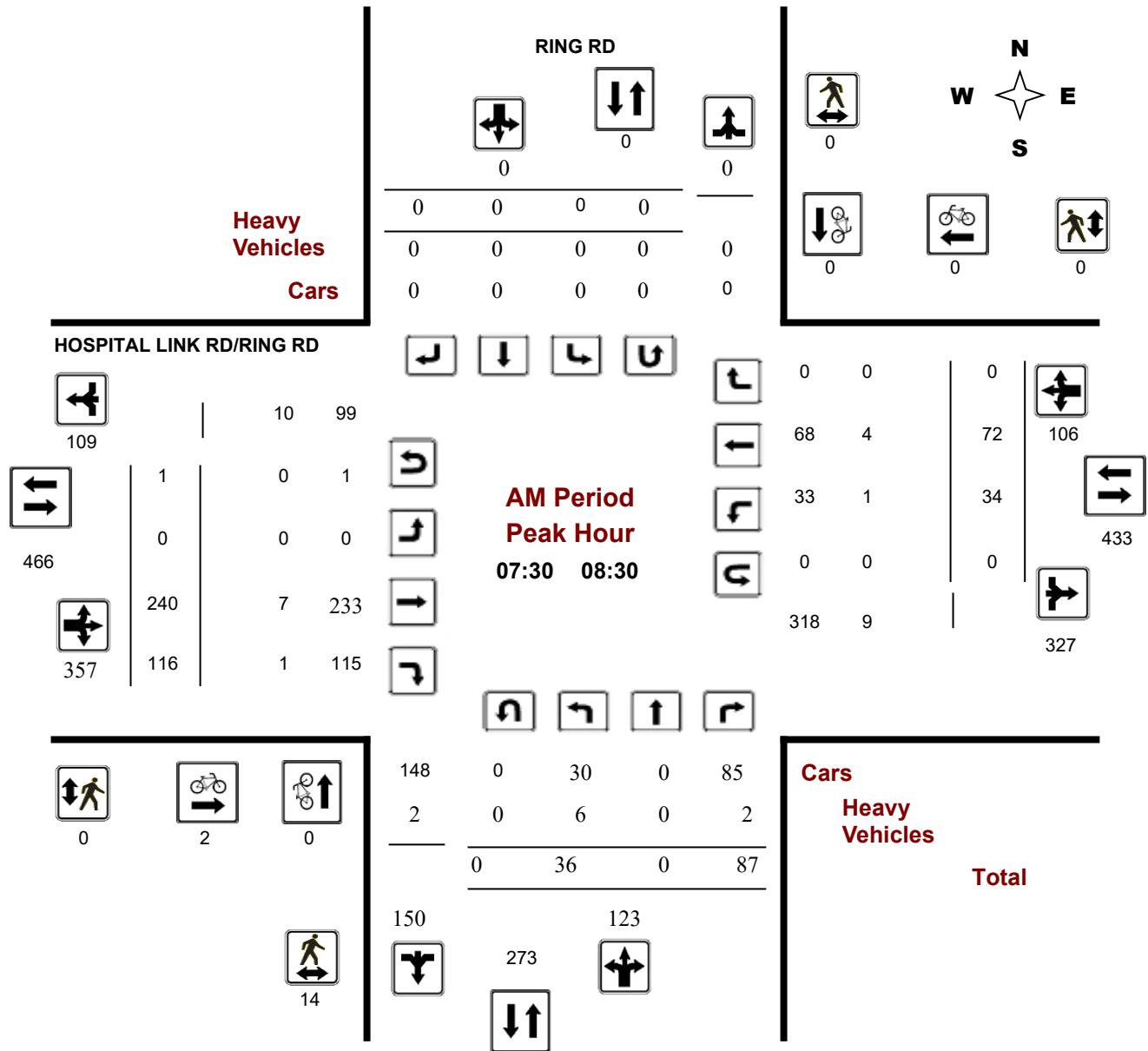

Comments 5473326 - HOSPITAL LINK RD & RING RD - THURS FEB 20, 2020 - 8HRS - LAUREN O'GRADY



Transportation Services - Traffic Services

Turning Movement Count - Peak Hour Diagram

HOSPITAL LINK RD/RING RD @ RING RD

Survey Date: Thursday, February 20, 2020

Start Time: 07:00

WO No: 39524

Device: Miovision

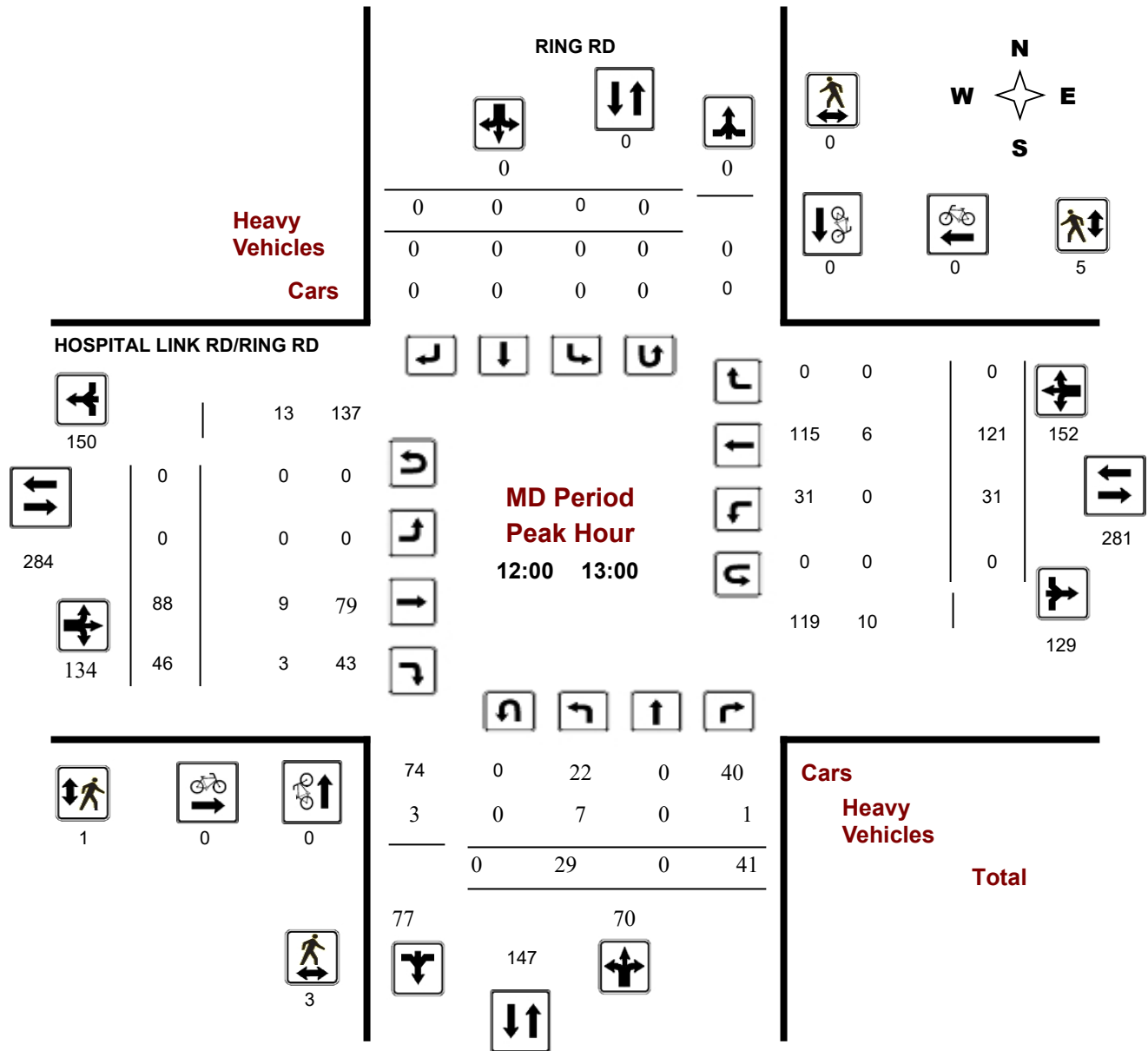

Comments 5473326 - HOSPITAL LINK RD & RING RD - THURS FEB 20, 2020 - 8HRS - LAUREN O'GRADY



Transportation Services - Traffic Services

Turning Movement Count - Peak Hour Diagram

HOSPITAL LINK RD/RING RD @ RING RD

Survey Date: Thursday, February 20, 2020

Start Time: 07:00

WO No: 39524

Device: Miovision

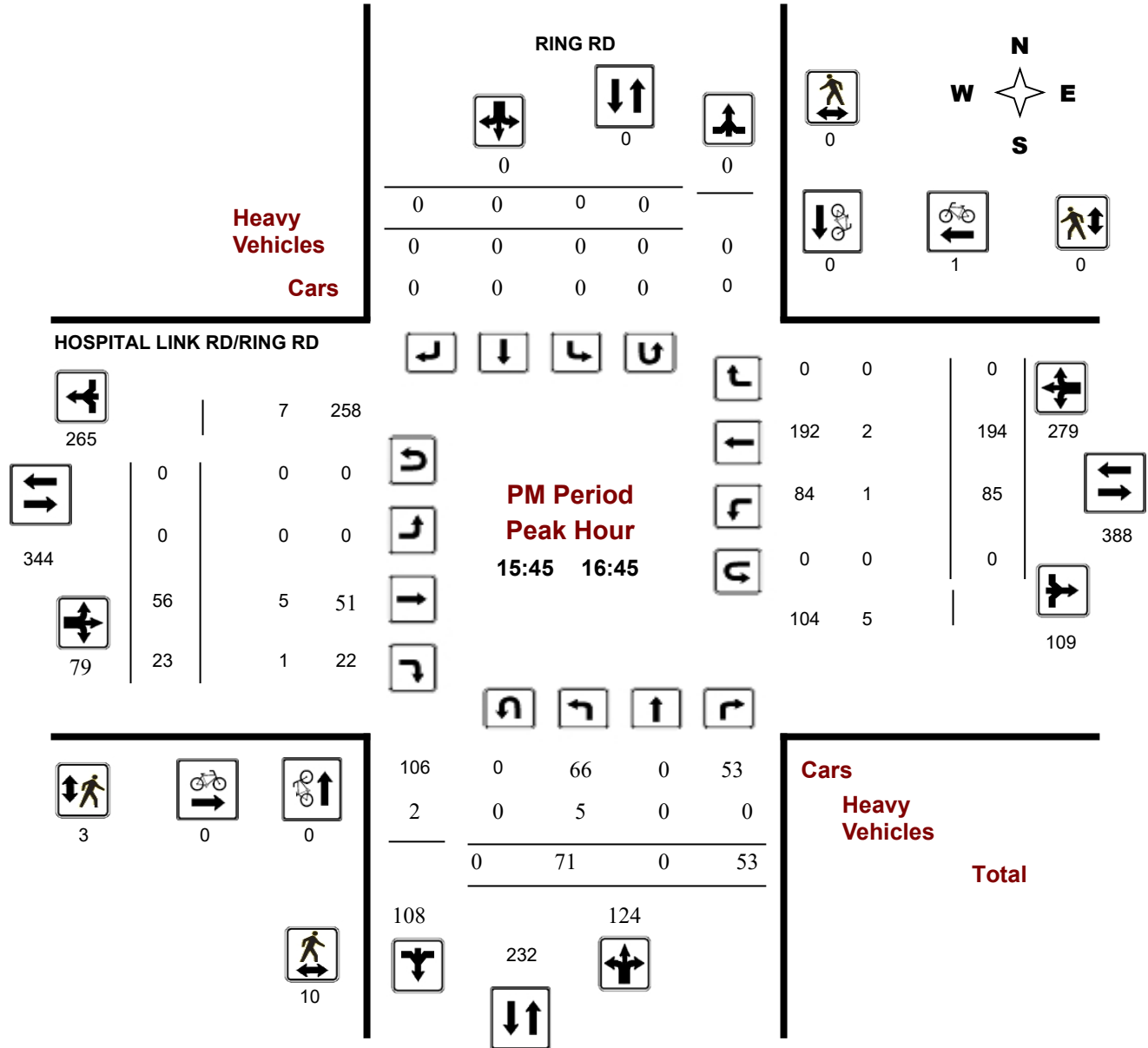

Comments 5473326 - HOSPITAL LINK RD & RING RD - THURS FEB 20, 2020 - 8HRS - LAUREN O'GRADY



Transportation Services - Traffic Services

Turning Movement Count - Study Results

HOSPITAL LINK RD/RING RD @ RING RD

Survey Date: Thursday, February 20, 2020

WO No: 39524

Start Time: 07:00

Device: Miovision

Full Study Summary (8 HR Standard)

Survey Date: Thursday, February 20, 2020

Total Observed U-Turns

AADT Factor

Northbound: 0 Southbound: 0

.90

Eastbound: 1 Westbound: 1

Period	RING RD										HOSPITAL LINK RD/RING RD										Grand Total
	Northbound					Southbound					Eastbound					Westbound					
	LT	ST	RT	NB TOT	STR TOT	LT	ST	RT	SB TOT	STR TOT	LT	ST	RT	EB TOT	STR TOT	LT	ST	RT	WB TOT	STR TOT	
07:00 08:00	24	0	70	94	94	0	0	0	0	0	0	221	106	327	327	28	49	0	77	404	498
08:00 09:00	32	0	91	123	123	0	0	0	0	0	0	180	105	285	285	45	69	0	114	399	522
09:00 10:00	26	0	61	87	87	0	0	0	0	0	0	129	53	182	182	34	49	0	83	265	352
11:30 12:30	25	0	44	69	69	0	0	0	0	0	0	58	30	88	88	24	99	0	123	211	280
12:30 13:30	30	0	46	76	76	0	0	0	0	0	0	91	47	138	138	31	76	0	107	245	321
15:00 16:00	61	0	33	94	94	0	0	0	0	0	0	61	30	91	91	65	170	0	235	326	420
16:00 17:00	74	0	53	127	127	0	0	0	0	0	0	56	18	74	74	83	187	0	270	344	471
17:00 18:00	43	0	24	67	67	0	0	0	0	0	0	30	24	54	54	58	107	0	165	219	286
Sub Total	315	0	422	737	737	0	0	0	0	0	0	826	413	1239	1239	368	806	0	1174	2413	3150
U Turns				0	0				0	0				1	1			1	2	2	2
Total	315	0	422	737	737	0	0	0	0	0	0	826	413	1240	1240	368	806	0	1175	2415	3152
EQ 12Hr	438	0	587	1024	1024	0	0	0	0	0	0	1148	574	1724	1724	512	1120	0	1633	3357	4381
Note: These values are calculated by multiplying the totals by the appropriate expansion factor.														1.39							
AVG 12Hr	394	0	528	922	922	0	0	0	0	0	0	1033	517	1552	1552	461	1008	0	1470	3021	3943
Note: These volumes are calculated by multiplying the Equivalent 12 hr. totals by the AADT factor.														.90							
AVG 24Hr	516	0	692	1208	1208	0	0	0	0	0	0	1353	677	2033	2033	604	1320	0	1926	3958	5165
Note: These volumes are calculated by multiplying the Average Daily 12 hr. totals by 12 to 24 expansion factor.														1.31							
Note: U-Turns provided for approach totals. Refer to 'U-Turn' Report for specific breakdown.																					



Transportation Services - Traffic Services

Turning Movement Count - Study Results

HOSPITAL LINK RD/RING RD @ RING RD

Survey Date: Thursday, February 20, 2020

WO No: 39524

Start Time: 07:00

Device: Miovision

Full Study 15 Minute Increments

		RING RD									HOSPITAL LINK RD/RING RD										
		Northbound			Southbound			S			STR			Eastbound			Westbound				
Time Period		LT	ST	RT	N TOT	LT	ST	RT	S TOT	STR TOT	LT	ST	RT	E TOT	LT	ST	RT	W TOT	STR TOT	Grand Total	
07:00	07:15	2	0	12	14	0	0	0	0	14	0	43	23	66	4	7	0	11	77	91	
07:15	07:30	2	0	18	20	0	0	0	0	20	0	48	25	73	9	10	0	19	92	112	
07:30	07:45	9	0	17	26	0	0	0	0	26	0	72	18	90	9	18	0	27	117	143	
07:45	08:00	11	0	23	34	0	0	0	0	34	0	58	40	99	6	14	0	20	119	153	
08:00	08:15	7	0	23	30	0	0	0	0	30	0	43	31	74	10	18	0	28	102	132	
08:15	08:30	9	0	24	33	0	0	0	0	33	0	67	27	94	9	22	0	31	125	158	
08:30	08:45	9	0	22	31	0	0	0	0	31	0	33	23	56	13	14	0	27	83	114	
08:45	09:00	7	0	22	29	0	0	0	0	29	0	37	24	61	13	15	0	28	89	118	
09:00	09:15	10	0	17	27	0	0	0	0	27	0	46	11	57	11	11	0	22	79	106	
09:15	09:30	8	0	12	20	0	0	0	0	20	0	24	10	34	7	8	0	15	49	69	
09:30	09:45	4	0	14	18	0	0	0	0	18	0	27	17	44	5	14	0	19	63	81	
09:45	10:00	4	0	18	22	0	0	0	0	22	0	32	15	47	11	16	0	27	74	96	
11:30	11:45	6	0	10	16	0	0	0	0	16	0	13	6	19	5	14	0	19	38	54	
11:45	12:00	5	0	12	17	0	0	0	0	17	0	10	6	16	6	12	0	18	34	51	
12:00	12:15	9	0	12	21	0	0	0	0	21	0	14	12	26	5	41	0	46	72	93	
12:15	12:30	5	0	10	15	0	0	0	0	15	0	21	6	27	8	32	0	40	67	82	
12:30	12:45	9	0	9	18	0	0	0	0	18	0	20	7	27	11	28	0	39	66	84	
12:45	13:00	6	0	10	16	0	0	0	0	16	0	33	21	54	7	20	0	27	81	97	
13:00	13:15	13	0	11	24	0	0	0	0	24	0	20	6	26	5	16	0	21	47	71	
13:15	13:30	2	0	16	18	0	0	0	0	18	0	18	13	31	8	12	0	20	51	69	
15:00	15:15	18	0	8	26	0	0	0	0	26	0	26	6	32	18	40	0	58	90	116	
15:15	15:30	13	0	9	22	0	0	0	0	22	0	16	11	27	20	43	0	63	90	112	
15:30	15:45	18	0	8	26	0	0	0	0	26	0	7	6	13	11	51	0	62	75	101	
15:45	16:00	12	0	8	20	0	0	0	0	20	0	12	7	19	16	36	0	52	71	91	
16:00	16:15	28	0	17	45	0	0	0	0	45	0	13	7	20	31	65	0	96	116	161	
16:15	16:30	14	0	15	29	0	0	0	0	29	0	18	4	22	20	45	0	65	87	116	
16:30	16:45	17	0	13	30	0	0	0	0	30	0	13	5	18	18	48	0	66	84	114	
16:45	17:00	15	0	8	23	0	0	0	0	23	0	12	2	14	14	29	0	44	58	81	
17:00	17:15	16	0	8	24	0	0	0	0	24	0	7	2	9	32	35	0	67	76	100	
17:15	17:30	14	0	5	19	0	0	0	0	19	0	9	6	15	10	30	0	40	55	74	
17:30	17:45	8	0	7	15	0	0	0	0	15	0	8	7	15	7	19	0	26	41	56	
17:45	18:00	5	0	4	9	0	0	0	0	9	0	6	9	15	9	23	0	32	47	56	
Total:		315	0	422	737	0	0	0	0	737	0	826	413	1240	368	806	0	1175	2415	3,152	

Note: U-Turns are included in Totals.



Transportation Services - Traffic Services

Turning Movement Count - Study Results

HOSPITAL LINK RD/RING RD @ RING RD

Survey Date: Thursday, February 20, 2020

WO No: 39524

Start Time: 07:00

Device: Miovision

Full Study Cyclist Volume

Time Period	RING RD			HOSPITAL LINK RD/RING RD			Grand Total
	Northbound	Southbound	Street Total	Eastbound	Westbound	Street Total	
07:00 07:15	1	0	1	1	0	1	2
07:15 07:30	0	0	0	0	0	0	0
07:30 07:45	0	0	0	0	0	0	0
07:45 08:00	0	0	0	0	0	0	0
08:00 08:15	0	0	0	0	0	0	0
08:15 08:30	0	0	0	2	0	2	2
08:30 08:45	0	0	0	0	0	0	0
08:45 09:00	0	0	0	0	0	0	0
09:00 09:15	0	0	0	0	0	0	0
09:15 09:30	0	0	0	0	0	0	0
09:30 09:45	0	0	0	0	0	0	0
09:45 10:00	0	0	0	0	0	0	0
11:30 11:45	0	0	0	0	0	0	0
11:45 12:00	0	0	0	0	0	0	0
12:00 12:15	0	0	0	0	0	0	0
12:15 12:30	0	0	0	0	0	0	0
12:30 12:45	0	0	0	0	0	0	0
12:45 13:00	0	0	0	0	0	0	0
13:00 13:15	0	0	0	0	0	0	0
13:15 13:30	0	0	0	0	0	0	0
15:00 15:15	0	0	0	0	0	0	0
15:15 15:30	0	0	0	0	0	0	0
15:30 15:45	0	1	1	0	0	0	1
15:45 16:00	0	0	0	0	0	0	0
16:00 16:15	0	0	0	0	0	0	0
16:15 16:30	0	0	0	0	1	1	1
16:30 16:45	0	0	0	0	0	0	0
16:45 17:00	0	0	0	0	0	0	0
17:00 17:15	0	0	0	0	0	0	0
17:15 17:30	1	0	1	0	0	0	1
17:30 17:45	0	0	0	0	0	0	0
17:45 18:00	0	0	0	0	0	0	0
Total	2	1	3	3	1	4	7



Transportation Services - Traffic Services

Turning Movement Count - Study Results

HOSPITAL LINK RD/RING RD @ RING RD

Survey Date: Thursday, February 20, 2020

WO No: 39524

Start Time: 07:00

Device: Miovision

Full Study Pedestrian Volume

Time Period	RING RD		Total	HOSPITAL LINK RD/RING RD		Total	Grand Total
	NB Approach (E or W Crossing)	SB Approach (E or W Crossing)		EB Approach (N or S Crossing)	WB Approach (N or S Crossing)		
07:00 07:15	1	0	1	0	0	0	1
07:15 07:30	3	0	3	0	1	1	4
07:30 07:45	5	0	5	0	0	0	5
07:45 08:00	3	0	3	0	0	0	3
08:00 08:15	4	0	4	0	0	0	4
08:15 08:30	2	0	2	0	0	0	2
08:30 08:45	3	0	3	0	0	0	3
08:45 09:00	4	0	4	0	0	0	4
09:00 09:15	1	0	1	0	0	0	1
09:15 09:30	1	0	1	0	0	0	1
09:30 09:45	0	0	0	0	0	0	0
09:45 10:00	0	0	0	3	0	3	3
11:30 11:45	0	0	0	0	0	0	0
11:45 12:00	0	0	0	0	0	0	0
12:00 12:15	0	0	0	1	2	3	3
12:15 12:30	2	0	2	0	1	1	3
12:30 12:45	0	0	0	0	2	2	2
12:45 13:00	1	0	1	0	0	0	1
13:00 13:15	0	0	0	0	0	0	0
13:15 13:30	1	0	1	1	1	2	3
15:00 15:15	1	0	1	0	0	0	1
15:15 15:30	1	0	1	1	0	1	2
15:30 15:45	3	0	3	0	0	0	3
15:45 16:00	2	0	2	0	0	0	2
16:00 16:15	1	0	1	2	0	2	3
16:15 16:30	5	0	5	0	0	0	5
16:30 16:45	2	0	2	1	0	1	3
16:45 17:00	3	0	3	0	0	0	3
17:00 17:15	1	0	1	0	0	0	1
17:15 17:30	3	0	3	0	0	0	3
17:30 17:45	1	0	1	1	0	1	2
17:45 18:00	0	0	0	1	0	1	1
Total	54	0	54	11	7	18	72

5473326 - HOSPITAL LINK RD & RING RD - THURS FEB 20, 2020 - 8HRS - LAUREN O'GRADY



Transportation Services - Traffic Services

Turning Movement Count - Study Results

HOSPITAL LINK RD/RING RD @ RING RD

Survey Date: Thursday, February 20, 2020

WO No: 39524

Start Time: 07:00

Device: Miovision

Full Study Heavy Vehicles

		RING RD								HOSPITAL LINK RD/RING RD										
		Northbound				Southbound				Eastbound				Westbound						
Time Period		LT	ST	RT	N TOT	LT	ST	RT	S TOT	STR TOT	LT	ST	RT	E TOT	LT	ST	RT	W TOT	STR TOT	Grand Total
07:00	07:15	1	0	1	2	0	0	0	0	2	0	1	0	3	0	1	0	3	6	4
07:15	07:30	0	0	0	0	0	0	0	0	0	0	1	0	2	0	1	0	2	4	2
07:30	07:45	2	0	0	2	0	0	0	0	2	0	2	0	5	0	1	0	3	8	5
07:45	08:00	2	0	0	3	0	0	0	0	3	0	1	0	4	1	1	0	3	7	5
08:00	08:15	1	0	1	2	0	0	0	0	2	0	2	0	4	0	1	0	4	8	5
08:15	08:30	1	0	1	3	0	0	0	0	3	0	2	1	5	0	1	0	4	9	6
08:30	08:45	1	0	1	3	0	0	0	0	3	0	1	0	3	1	1	0	4	7	5
08:45	09:00	2	0	1	8	0	0	0	0	8	0	3	1	6	4	0	0	8	14	11
09:00	09:15	1	0	2	3	0	0	0	0	3	0	1	0	4	0	2	0	5	9	6
09:15	09:30	1	0	2	3	0	0	0	0	3	0	2	0	3	0	0	0	4	7	5
09:30	09:45	2	0	2	4	0	0	0	0	4	0	2	0	5	0	1	0	5	10	7
09:45	10:00	1	0	2	8	0	0	0	0	8	0	2	1	5	4	1	0	9	14	11
11:30	11:45	2	0	1	4	0	0	0	0	4	0	2	0	4	1	0	0	4	8	6
11:45	12:00	1	0	0	2	0	0	0	0	2	0	2	0	4	1	1	0	4	8	5
12:00	12:15	3	0	0	4	0	0	0	0	4	0	3	1	9	0	2	0	5	14	9
12:15	12:30	1	0	1	3	0	0	0	0	3	0	2	1	5	0	1	0	4	9	6
12:30	12:45	2	0	0	3	0	0	0	0	3	0	2	1	6	0	1	0	3	9	6
12:45	13:00	1	0	0	1	0	0	0	0	1	0	2	0	5	0	2	0	4	9	5
13:00	13:15	1	0	1	2	0	0	0	0	2	0	2	0	3	0	0	0	3	6	4
13:15	13:30	1	0	2	4	0	0	0	0	4	0	1	0	2	1	0	0	4	6	5
15:00	15:15	1	0	1	3	0	0	0	0	3	0	3	0	4	1	0	0	5	9	6
15:15	15:30	1	0	0	2	0	0	0	0	2	0	2	1	6	0	2	0	4	10	6
15:30	15:45	2	0	0	3	0	0	0	0	3	0	1	1	4	0	0	0	1	5	4
15:45	16:00	0	0	0	0	0	0	0	0	0	0	1	0	2	0	1	0	2	4	2
16:00	16:15	2	0	0	2	0	0	0	0	2	0	1	0	4	0	1	0	2	6	4
16:15	16:30	1	0	0	1	0	0	0	0	1	0	1	0	2	0	0	0	1	3	2
16:30	16:45	2	0	0	4	0	0	0	0	4	0	2	1	5	1	0	0	3	8	6
16:45	17:00	1	0	0	1	0	0	0	0	1	0	1	0	2	0	0	0	1	3	2
17:00	17:15	1	0	0	1	0	0	0	0	1	0	2	0	3	0	0	0	2	5	3
17:15	17:30	0	0	0	0	0	0	0	0	0	0	2	0	2	0	0	0	2	4	2
17:30	17:45	1	0	0	2	0	0	0	0	2	0	1	1	4	0	1	0	2	6	4
17:45	18:00	2	0	0	2	0	0	0	0	2	0	1	0	3	0	0	0	1	4	3
Total:	None	41	0	19	85	0	0	0	0	85	0	54	10	128	15	23	0	111	239	162



Transportation Services - Traffic Services

Turning Movement Count - Study Results

HOSPITAL LINK RD/RING RD @ RING RD

Survey Date: Thursday, February 20, 2020

WO No: 39524

Start Time: 07:00

Device: Miovision

Full Study 15 Minute U-Turn Total

RING RD

HOSPITAL LINK RD/RING RD

Time Period		Northbound U-Turn Total	Southbound U-Turn Total	Eastbound U-Turn Total	Westbound U-Turn Total	Total
07:00	07:15	0	0	0	0	0
07:15	07:30	0	0	0	0	0
07:30	07:45	0	0	0	0	0
07:45	08:00	0	0	1	0	1
08:00	08:15	0	0	0	0	0
08:15	08:30	0	0	0	0	0
08:30	08:45	0	0	0	0	0
08:45	09:00	0	0	0	0	0
09:00	09:15	0	0	0	0	0
09:15	09:30	0	0	0	0	0
09:30	09:45	0	0	0	0	0
09:45	10:00	0	0	0	0	0
11:30	11:45	0	0	0	0	0
11:45	12:00	0	0	0	0	0
12:00	12:15	0	0	0	0	0
12:15	12:30	0	0	0	0	0
12:30	12:45	0	0	0	0	0
12:45	13:00	0	0	0	0	0
13:00	13:15	0	0	0	0	0
13:15	13:30	0	0	0	0	0
15:00	15:15	0	0	0	0	0
15:15	15:30	0	0	0	0	0
15:30	15:45	0	0	0	0	0
15:45	16:00	0	0	0	0	0
16:00	16:15	0	0	0	0	0
16:15	16:30	0	0	0	0	0
16:30	16:45	0	0	0	0	0
16:45	17:00	0	0	0	1	1
17:00	17:15	0	0	0	0	0
17:15	17:30	0	0	0	0	0
17:30	17:45	0	0	0	0	0
17:45	18:00	0	0	0	0	0
Total		0	0	1	1	2

Study Name AMRC TIS-Ottawa_CA00995601
 Start Date 11/03/2023
 Start Time 7:00 AM
 Site Code AMRC TIS
 Project CA0009956.0165
 Intersection Ring Road / uOttawa-Rehab W Access

Type Road
 Classification Cars

Start Time	n/a Southbound				Ring Road Westbound			Rehabilitation Centre Access Northbound				Ring Road Eastbound				
	Right	Thru	Left	U-Turn	Right	Thru	Left	U-Turn	Right	Thru	Left	U-Turn	Right	Thru	Left	U-Turn
7:00 AM						6	2	0	2		5	0	17	35		0
7:15 AM						9	5	0	0		0	0	16	26		0
7:30 AM						9	16	0	2		0	0	31	45		0
7:45 AM						15	18	0	0		1	0	24	64		0
8:00 AM						15	29	0	3		0	0	37	33		0
8:15 AM						22	30	0	1		0	0	56	34		0
8:30 AM						19	7	0	1		1	0	25	37		0
8:45 AM						20	10	0	1		0	0	28	32		0
9:00 AM						16	6	0	4		1	0	22	27		0
9:15 AM						10	6	0	0		1	0	24	15		1
9:30 AM						18	9	0	1		2	0	23	20		0
9:45 AM						17	14	0	1		10	0	13	17		0
10:00 AM						10	5	0	2		3	0	21	16		0
10:15 AM						9	2	0	2		1	0	6	10		1
10:30 AM						13	3	0	2		6	0	11	20		0
10:45 AM						24	13	0	3		3	0	14	17		0
11:00 AM						16	2	0	4		7	0	11	11		0
11:15 AM						12	3	0	4		7	0	7	11		0
11:30 AM						16	3	0	5		7	0	4	9		0
11:45 AM						16	1	0	2		5	0	5	16		0
12:00 PM						15	7	0	7		24	0	7	11		0
12:15 PM						28	5	0	2		10	0	8	18		0
12:30 PM						23	5	0	5		7	0	20	14		0
12:45 PM						15	12	0	2		6	0	19	18		0
1:00 PM						15	7	0	3		6	0	11	11		0
1:15 PM						13	1	0	1		4	0	6	16		0
1:30 PM						10	10	0	4		9	0	7	22		0
1:45 PM						11	8	0	6		11	0	6	12		0
2:00 PM						23	4	0	8		11	0	6	11		0
2:15 PM						17	5	0	1		4	0	4	13		0
2:30 PM						22	5	0	7		9	0	8	15		0
2:45 PM						20	3	0	6		11	0	7	15		0
3:00 PM						26	3	0	5		25	0	9	10		0
3:15 PM						26	4	0	8		13	0	7	13		0
3:30 PM						28	1	0	8		15	0	8	11		0
3:45 PM						52	7	0	4		14	0	5	12		0
4:00 PM						48	2	0	14		45	0	3	13		0
4:15 PM						27	6	0	10		25	0	4	9		0
4:30 PM						14	1	0	4		13	0	1	7		0
4:45 PM						13	4	0	7		19	0	5	12		0
5:00 PM						29	4	0	5		13	0	6	4		0
5:15 PM						10	3	0	5		8	0	1	8		0
5:30 PM						13	3	0	5		7	0	3	7		0
5:45 PM						10	0	0	3		9	0	5	3		0
6:00 PM						14	5	0	2		9	0	3	2		0
6:15 PM						12	0	0	2		5	0	3	6		0
6:30 PM						8	7	0	0		5	0	5	11		0
6:45 PM						8	1	0	2		9	0	1	8		0

Study Name AMRC TIS-Ottawa_CA00995601
 Start Date 11/03/2023
 Start Time 7:00 AM
 Site Code AMRC TIS
 Project CA0009956.0165
 Intersection Ring Road / uOttawa-Rehab W Access

Type Road
Classification Trucks

Start Time	n/a Southbound				Ring Road Westbound			Rehabilitation Centre Access Northbound				Ring Road Eastbound				
	Right	Thru	Left	U-Turn	Right	Thru	Left	U-Turn	Right	Thru	Left	U-Turn	Right	Thru	Left	U-Turn
7:00 AM						0	0	0	0			0	0	1		0
7:15 AM						2	0	0	0			0	0	0		0
7:30 AM						1	0	0	0			0	0	1		0
7:45 AM						1	0	0	0			0	0	1		0
8:00 AM						1	0	0	0			0	0	2		0
8:15 AM						2	0	0	0			0	0	3		0
8:30 AM						3	0	0	0			0	0	2		0
8:45 AM						4	0	0	0			0	0	0		0
9:00 AM						1	0	0	0			0	0	0		0
9:15 AM						0	0	0	0			0	0	1	0	0
9:30 AM						0	1	0	1			1	0	2		0
9:45 AM						2	0	0	0			0	0	0		0
10:00 AM						3	0	0	0			0	0	2		0
10:15 AM						1	0	0	0			0	0	1		0
10:30 AM						2	0	0	0			0	0	1		0
10:45 AM						0	0	0	0			0	0	1		0
11:00 AM						1	0	0	0			0	0	1		0
11:15 AM						2	0	0	0			0	0	0		0
11:30 AM						0	0	0	0			0	0	0		0
11:45 AM						1	0	0	0			0	0	0		0
12:00 PM						0	0	0	0			0	0	1		0
12:15 PM						1	0	0	0			0	0	1		0
12:30 PM						1	0	0	0			0	0	1		0
12:45 PM						0	0	0	0			0	0	0		0
1:00 PM						1	0	0	0			0	0	1		0
1:15 PM						0	0	0	0			0	0	0		0
1:30 PM						0	0	0	0			0	0	0		0
1:45 PM						1	0	0	0			0	0	0		0
2:00 PM						1	0	0	0			0	0	1		0
2:15 PM						1	0	0	0			0	0	0		0
2:30 PM						0	0	0	0			0	0	3		0
2:45 PM						1	0	0	0			0	0	0		0
3:00 PM						1	0	0	0			0	0	1		0
3:15 PM						3	0	0	0			0	0	0		0
3:30 PM						0	0	0	0			0	0	2		0
3:45 PM						0	0	0	0			0	0	0		0
4:00 PM						0	0	0	0			0	0	2		0
4:15 PM						0	0	0	0			0	0	0		0
4:30 PM						0	0	0	0			0	0	0		0
4:45 PM						2	0	0	0			0	0	0		0
5:00 PM						0	0	0	0			0	0	0		0
5:15 PM						0	0	0	0			0	0	0		0
5:30 PM						0	0	0	0			0	0	0		0
5:45 PM						0	0	0	0			0	0	0		0
6:00 PM						0	0	0	0			0	0	0		0
6:15 PM						1	0	0	0			0	0	0		0
6:30 PM						0	1	0	0			0	0	1		0
6:45 PM						0	0	0	0			0	0	0		0

Study Name AMRC TIS-Ottawa_CA00995601
 Start Date 11/03/2023
 Start Time 7:00 AM
 Site Code AMRC TIS
 Project CA0009956.0165
 Intersection Ring Road / uOttawa-Rehab W Access

Type Crosswalk

Classification Peds

Start Time	n/a Southbound			Ring Road Westbound			Rehabilitation Centre Access Northbound			Ring Road Eastbound		
	Peds CW	Peds CCW	Peds Combined	Peds CW	Peds CCW	Peds Combined	Peds CW	Peds CCW	Peds Combined	Peds CW	Peds CCW	Peds Combined
7:00 AM				0	0		0	0		0	0	
7:15 AM				0	0		0	0		0	0	
7:30 AM				0	0		0	0		0	0	
7:45 AM				0	0		0	1		0	0	
8:00 AM				0	0		0	0		0	0	
8:15 AM				0	0		0	0		0	0	
8:30 AM				0	0		0	1		0	0	
8:45 AM				0	0		0	0		0	0	
9:00 AM				0	0		0	1		0	0	
9:15 AM				0	0		0	0		0	0	
9:30 AM				0	0		0	0		0	0	
9:45 AM				0	0		0	0		0	0	
10:00 AM				0	0		2	1		0	0	
10:15 AM				0	0		0	0		0	0	
10:30 AM				0	0		0	1		0	0	
10:45 AM				0	0		0	0		0	0	
11:00 AM				0	0		0	0		0	0	
11:15 AM				0	0		0	0		0	0	
11:30 AM				0	0		0	0		0	0	
11:45 AM				0	0		0	0		0	0	
12:00 PM				0	0		0	0		0	0	
12:15 PM				0	0		0	0		0	0	
12:30 PM				0	0		0	0		0	0	
12:45 PM				0	0		0	0		0	0	
1:00 PM				0	0		0	0		0	0	
1:15 PM				0	0		0	0		0	0	
1:30 PM				0	0		0	1		0	0	
1:45 PM				0	0		0	0		0	0	
2:00 PM				0	0		0	0		0	0	
2:15 PM				0	0		1	1		0	0	
2:30 PM				0	0		0	0		0	0	
2:45 PM				0	0		0	0		0	0	
3:00 PM				0	0		0	0		0	0	
3:15 PM				0	0		0	0		0	0	
3:30 PM				0	0		0	0		0	0	
3:45 PM				0	0		0	0		0	0	
4:00 PM				0	0		0	0		0	0	
4:15 PM				0	0		0	0		0	0	
4:30 PM				0	0		0	1		0	0	
4:45 PM				0	0		0	0		0	0	
5:00 PM				0	0		0	0		0	0	
5:15 PM				0	0		1	0		0	0	
5:30 PM				0	0		0	1		0	0	
5:45 PM				0	0		0	0		0	0	
6:00 PM				0	0		0	0		0	0	
6:15 PM				0	0		0	0		0	0	
6:30 PM				0	0		0	1		0	0	
6:45 PM				0	0		0	0		0	0	

Study Name AMRC TIS-Ottawa_CA00995601
 Start Date 11/03/2023
 Start Time 7:00 AM
 Site Code AMRC TIS
 Project CA0009956.0165
 Intersection Ring Road / uOttawa-Rehab W Access

Type Crosswalk
 Classification Bicycles

Start Time	n/a Southbound			Ring Road Westbound			Rehabilitation Centre Access Northbound			Ring Road Eastbound		
	Peds CW	Peds CCW	Peds Combined	Peds CW	Peds CCW	Peds Combined	Peds CW	Peds CCW	Peds Combined	Peds CW	Peds CCW	Peds Combined
7:00 AM				0	0		0	0		0	0	
7:15 AM				0	0		0	0		0	0	
7:30 AM				0	0		0	0		0	0	
7:45 AM				0	0		0	0		0	0	
8:00 AM				0	0		0	0		0	0	
8:15 AM				0	0		0	0		0	0	
8:30 AM				0	0		0	0		0	0	
8:45 AM				0	0		0	0		0	0	
9:00 AM				0	0		0	1		0	0	
9:15 AM				0	0		0	0		0	0	
9:30 AM				0	0		0	0		0	0	
9:45 AM				0	0		0	0		0	0	
10:00 AM				0	0		0	0		0	0	
10:15 AM				0	0		0	0		0	0	
10:30 AM				0	0		0	1		0	0	
10:45 AM				0	0		0	0		0	0	
11:00 AM				0	0		0	0		0	0	
11:15 AM				0	0		0	1		0	0	
11:30 AM				0	0		0	0		0	0	
11:45 AM				0	0		0	0		0	0	
12:00 PM				0	0		0	0		0	0	
12:15 PM				0	0		0	0		0	0	
12:30 PM				0	0		0	0		0	0	
12:45 PM				0	0		0	0		0	0	
1:00 PM				0	0		0	0		0	0	
1:15 PM				0	0		0	0		0	0	
1:30 PM				0	0		0	0		0	0	
1:45 PM				0	0		0	0		0	0	
2:00 PM				0	0		0	0		0	0	
2:15 PM				0	0		0	0		0	0	
2:30 PM				0	0		0	0		0	0	
2:45 PM				0	0		0	0		0	0	
3:00 PM				0	0		0	0		0	0	
3:15 PM				0	0		0	0		0	0	
3:30 PM				0	0		0	0		0	0	
3:45 PM				0	0		0	0		0	0	
4:00 PM				0	0		0	0		0	0	
4:15 PM				0	0		0	0		0	0	
4:30 PM				0	0		0	0		0	0	
4:45 PM				0	0		0	0		0	0	
5:00 PM				0	0		0	0		0	0	
5:15 PM				0	0		0	0		0	0	
5:30 PM				0	0		0	0		0	0	
5:45 PM				0	0		0	0		0	0	
6:00 PM				0	0		0	0		0	0	
6:15 PM				0	0		0	0		0	0	
6:30 PM				0	0		0	0		0	0	
6:45 PM				0	0		0	0		0	0	

Study Name AMRC TIS-Ottawa_CA00995601
 Start Date 11/03/2023
 Start Time 7:00 AM
 Site Code AMRC TIS
 Project CA0009956.0165
 Intersection Ring Road / uOttawa-Rehab W Access

Type Road
 Classification Totals

Start Time	n/a Southbound				Ring Road Westbound				Rehabilitation Centre Access Northbound				Ring Road Eastbound			
	Right	Thru	Left	U-Turn	Right	Thru	Left	U-Turn	Right	Thru	Left	U-Turn	Right	Thru	Left	U-Turn
7:00 AM	0	0	0	0	0	6	3	0	2	0	5	0	18	36	0	0
7:15 AM	0	0	0	0	0	11	5	0	0	0	0	0	17	26	0	0
7:30 AM	0	0	0	0	0	10	17	0	2	0	0	0	32	46	0	0
7:45 AM	0	0	0	0	0	16	18	0	0	0	1	0	25	65	0	0
8:00 AM	0	0	0	0	0	16	29	0	3	0	0	0	38	35	0	0
8:15 AM	0	0	0	0	0	24	31	0	1	0	0	0	57	37	0	0
8:30 AM	0	0	0	0	0	22	7	0	1	0	1	0	26	39	0	0
8:45 AM	0	0	0	0	0	24	11	0	1	0	0	0	29	32	0	0
9:00 AM	0	0	0	0	0	17	7	0	4	0	1	0	23	27	0	0
9:15 AM	0	0	0	0	0	10	6	0	0	0	1	0	27	15	0	1
9:30 AM	0	0	0	0	0	18	10	0	2	0	3	0	24	22	0	0
9:45 AM	0	0	0	0	0	19	15	0	1	0	10	0	14	17	0	0
10:00 AM	0	0	0	0	0	13	5	0	2	0	3	0	22	18	0	0
10:15 AM	0	0	0	0	0	10	3	0	2	0	1	0	7	12	0	1
10:30 AM	0	0	0	0	0	15	3	0	2	0	6	0	12	21	0	0
10:45 AM	0	0	0	0	0	24	14	0	3	0	3	0	15	18	0	0
11:00 AM	0	0	0	0	0	17	2	0	4	0	7	0	12	12	0	0
11:15 AM	0	0	0	0	0	14	4	0	4	0	7	0	9	11	0	0
11:30 AM	0	0	0	0	0	16	3	0	5	0	7	0	5	9	0	0
11:45 AM	0	0	0	0	0	17	2	0	2	0	5	0	6	16	0	0
12:00 PM	0	0	0	0	0	15	7	0	7	0	24	0	9	12	0	0
12:15 PM	0	0	0	0	0	30	6	0	2	0	10	0	9	19	0	0
12:30 PM	0	0	0	0	0	24	6	0	5	0	7	0	21	15	0	0
12:45 PM	0	0	0	0	0	15	13	0	2	0	6	0	20	18	0	0
1:00 PM	0	0	0	0	0	17	7	0	3	0	6	0	12	12	0	0
1:15 PM	0	0	0	0	0	13	2	0	1	0	4	0	7	16	0	0
1:30 PM	0	0	0	0	0	10	11	0	4	0	9	0	8	22	0	0
1:45 PM	0	0	0	0	0	12	8	0	6	0	11	0	7	12	0	0
2:00 PM	0	0	0	0	0	24	5	0	8	0	11	0	7	13	0	0
2:15 PM	0	0	0	0	0	18	5	0	1	0	4	0	6	13	0	0
2:30 PM	0	0	0	0	0	22	6	0	7	0	9	0	9	18	0	0
2:45 PM	0	0	0	0	0	21	3	0	6	0	11	0	8	15	0	0
3:00 PM	0	0	0	0	0	27	3	0	5	0	25	0	10	11	0	0
3:15 PM	0	0	0	0	0	29	5	0	8	0	13	0	8	13	0	0
3:30 PM	0	0	0	0	0	28	1	0	8	0	15	0	9	13	0	0
3:45 PM	0	0	0	0	0	52	8	0	4	0	14	0	6	12	0	0
4:00 PM	0	0	0	0	0	48	2	0	14	0	45	0	4	15	0	0
4:15 PM	0	0	0	0	0	27	7	0	10	0	25	0	5	9	0	0
4:30 PM	0	0	0	0	0	14	1	0	4	0	13	0	2	7	0	0
4:45 PM	0	0	0	0	0	16	5	0	7	0	19	0	6	12	0	0
5:00 PM	0	0	0	0	0	29	4	0	5	0	13	0	6	4	0	0
5:15 PM	0	0	0	0	0	11	4	0	5	0	8	0	2	8	0	0
5:30 PM	0	0	0	0	0	13	3	0	5	0	7	0	4	8	0	0
5:45 PM	0	0	0	0	0	10	0	0	3	0	9	0	6	3	0	0
6:00 PM	0	0	0	0	0	14	5	0	2	0	9	0	3	2	0	0
6:15 PM	0	0	0	0	0	13	0	0	2	0	5	0	4	6	0	0
6:30 PM	0	0	0	0	0	8	8	0	0	0	5	0	6	12	0	0
6:45 PM	0	0	0	0	0	8	1	0	2	0	9	0	1	8	0	0

Study Name AMRC TIS-Ottawa_CA00995601
 Start Date 11/03/2023
 Start Time 7:00 AM
 Site Code AMRC TIS
 Project CA0009956.0165
 Intersection Ring Road / uOttawa-Rehab E Access

Type Road
 Classification Cars

Start Time	n/a Southbound				Ring Road Westbound			Exit 1 Northbound				Ring Road Eastbound				
	Right	Thru	Left	U-Turn	Right	Thru	Left	U-Turn	Right	Thru	Left	U-Turn	Right	Thru	Left	U-Turn
7:00 AM						4	0	0	1		4	0	0	0	37	0
7:15 AM						11	0	0	0		1	0	0	0	24	1
7:30 AM						23	0	1	3		3	0	0	0	44	0
7:45 AM						29	0	0	4		4	0	0	0	62	0
8:00 AM						37	0	0	5		8	0	0	0	39	0
8:15 AM						39	0	0	5		11	0	0	0	37	0
8:30 AM						22	0	0	1		7	0	0	0	34	0
8:45 AM						24	0	0	1		6	0	0	0	37	0
9:00 AM						20	0	0	4		3	0	0	0	28	0
9:15 AM						11	0	0	2		6	0	0	0	19	0
9:30 AM						16	0	1	3		10	0	0	0	20	0
9:45 AM						30	0	0	3		1	0	0	0	17	0
10:00 AM						10	0	0	2		5	0	0	0	19	0
10:15 AM						9	0	0	4		2	0	0	0	12	0
10:30 AM						13	0	0	2		3	0	0	0	23	0
10:45 AM						26	0	0	4		11	0	1	0	19	0
11:00 AM						14	0	0	2		3	0	0	0	12	0
11:15 AM						15	0	0	2		3	0	0	0	17	0
11:30 AM						17	0	0	2		1	0	0	0	14	0
11:45 AM						14	0	0	1		2	0	0	0	19	0
12:00 PM						19	0	0	6		5	0	0	0	17	0
12:15 PM						28	0	1	4		5	0	0	0	20	0
12:30 PM						20	0	0	2		8	0	0	0	22	0
12:45 PM						24	0	0	4		3	0	0	0	19	1
1:00 PM						18	0	0	3		4	0	0	0	11	0
1:15 PM						10	0	0	1		3	0	0	0	19	0
1:30 PM						15	0	0	0		4	0	0	0	24	1
1:45 PM						16	0	0	6		2	0	0	0	21	0
2:00 PM						24	0	0	3		4	0	0	0	17	0
2:15 PM						20	0	1	4		3	0	0	0	13	0
2:30 PM						24	0	0	3		2	0	0	0	23	1
2:45 PM						21	0	0	2		2	0	0	0	19	0
3:00 PM						20	0	0	2		9	0	0	0	16	0
3:15 PM						25	0	0	1		6	0	0	0	19	0
3:30 PM						27	0	0	2		2	0	0	0	19	0
3:45 PM						51	0	0	2		8	0	0	0	17	0
4:00 PM						44	0	0	4		6	0	0	0	25	0
4:15 PM						30	0	0	1		3	0	0	0	20	0
4:30 PM						13	0	0	4		0	0	0	0	12	0
4:45 PM						18	0	0	2		1	0	0	0	17	0
5:00 PM						25	0	0	3		8	0	0	0	9	0
5:15 PM						10	0	0	1		2	0	0	0	13	0
5:30 PM						15	0	0	0		3	0	0	0	14	0
5:45 PM						10	0	0	0		0	0	0	0	7	0
6:00 PM						16	0	0	1		3	0	0	0	4	0
6:15 PM						10	0	0	0		1	0	0	0	8	0
6:30 PM						14	0	0	2		2	0	0	0	11	0
6:45 PM						4	0	0	1		4	0	0	0	10	0

Study Name AMRC TIS-Ottawa_CA00995601
 Start Date 11/03/2023
 Start Time 7:00 AM
 Site Code AMRC TIS
 Project CA0009956.0165
 Intersection Ring Road / uOttawa-Rehab E Access

Type Road
Classification Trucks

Start Time	n/a Southbound				Ring Road Westbound				Exit 1 Northbound				Ring Road Eastbound				
	Right	Thru	Left	U-Turn	Right	Thru	Left	U-Turn	Right	Thru	Left	U-Turn	Right	Thru	Left	U-Turn	
7:00 AM						0	0	0	0				0		1		0
7:15 AM						2	0	0	0				0		0		0
7:30 AM						1	0	0	0				0		1		0
7:45 AM						1	0	0	0				0		1		0
8:00 AM						1	0	0	0				0		2		0
8:15 AM						2	0	0	0				0		3		0
8:30 AM						1	0	0	0				0		2		0
8:45 AM						5	0	0	1				0		0		0
9:00 AM						1	0	0	0				0		0		0
9:15 AM						0	0	0	0				0		0		0
9:30 AM						2	0	0	0				0		2		0
9:45 AM						2	0	0	0				0		1		0
10:00 AM						3	0	0	0				0		2		0
10:15 AM						1	0	0	0				0		0		0
10:30 AM						2	0	0	0				0		3		0
10:45 AM						0	0	0	0				0		1		0
11:00 AM						1	0	0	0				0		1		0
11:15 AM						1	0	0	0				0		0		0
11:30 AM						0	0	0	0				0		0		0
11:45 AM						1	0	0	0				0		0		0
12:00 PM						0	0	0	0				0		1		0
12:15 PM						1	0	0	0				0		1		0
12:30 PM						1	0	0	0				0		1		0
12:45 PM						1	0	0	0				0		0		0
1:00 PM						0	0	0	0				0		1		0
1:15 PM						2	0	0	0				0		0		0
1:30 PM						0	0	0	0				0		0		0
1:45 PM						1	0	0	0				0		0		0
2:00 PM						1	0	0	0				0		1		0
2:15 PM						1	0	0	0				0		0		0
2:30 PM						0	0	0	0				0		2		0
2:45 PM						1	0	0	0				0		1		0
3:00 PM						1	0	0	0				0		1		0
3:15 PM						3	0	0	0				0		0		0
3:30 PM						0	0	0	0				0		2		0
3:45 PM						0	0	0	0				0		0		0
4:00 PM						0	0	0	0				0		2		0
4:15 PM						0	0	0	0				0		0		0
4:30 PM						0	0	0	0				0		0		0
4:45 PM						1	0	0	0				0		0		0
5:00 PM						0	0	0	0				0		0		0
5:15 PM						0	0	0	0				0		0		0
5:30 PM						0	0	0	0				0		0		0
5:45 PM						0	0	0	0				0		0		0
6:00 PM						0	0	0	0				0		0		0
6:15 PM						1	0	0	0				1		0		0
6:30 PM						0	0	0	0				0		0		0
6:45 PM						0	0	0	0				0		0		0

Study Name AMRC TIS-Ottawa_CA00995601
 Start Date 11/03/2023
 Start Time 7:00 AM
 Site Code AMRC TIS
 Project CA0009956.0165
 Intersection Ring Road / uOttawa-Rehab E Access

Type Road
Classification Buses

Start Time	n/a Southbound				Ring Road Westbound			Exit 1 Northbound				Ring Road Eastbound				
	Right	Thru	Left	U-Turn	Right	Thru	Left	U-Turn	Right	Thru	Left	U-Turn	Right	Thru	Left	U-Turn
7:00 AM						1	0	0	1		0	0	0	0	0	0
7:15 AM						0	0	0	2		0	0	0	0	0	0
7:30 AM						1	0	0	1		0	0	0	0	0	0
7:45 AM						0	0	0	2		0	0	0	0	0	0
8:00 AM						0	0	0	1		0	0	0	0	0	0
8:15 AM						1	0	0	2		0	0	0	0	0	0
8:30 AM						0	0	0	1		0	0	0	0	0	0
8:45 AM						1	0	0	2		0	0	0	0	0	0
9:00 AM						1	0	0	1		0	0	0	0	0	0
9:15 AM						0	0	0	2		0	0	0	0	0	0
9:30 AM						0	0	0	2		0	0	0	0	0	0
9:45 AM						1	0	0	1		0	0	0	0	0	0
10:00 AM						0	0	0	2		0	0	0	0	0	0
10:15 AM						1	0	0	1		0	0	0	1	0	0
10:30 AM						0	0	0	2		0	0	0	0	0	0
10:45 AM						1	0	0	1		0	0	0	0	0	0
11:00 AM						0	0	0	2		0	0	0	0	0	0
11:15 AM						1	0	0	1		1	0	0	0	0	0
11:30 AM						0	0	0	2		0	0	0	0	0	0
11:45 AM						1	0	0	1		0	0	0	0	0	0
12:00 PM						0	0	0	3		0	0	0	0	0	0
12:15 PM						1	0	0	1		1	0	0	0	0	0
12:30 PM						1	0	0	2		0	0	0	0	0	0
12:45 PM						1	0	0	1		0	0	0	0	0	0
1:00 PM						0	0	0	1		1	0	0	0	0	0
1:15 PM						1	0	0	2		0	0	0	0	0	0
1:30 PM						1	0	0	1		0	0	0	0	0	0
1:45 PM						0	0	0	2		0	0	0	0	0	0
2:00 PM						1	0	0	1		0	0	0	1	0	0
2:15 PM						0	0	0	1		1	0	0	0	0	0
2:30 PM						1	0	0	2		0	0	0	0	0	0
2:45 PM						0	0	0	2		0	0	0	0	0	0
3:00 PM						0	0	0	1		0	0	0	0	0	0
3:15 PM						1	0	0	1		0	0	0	0	0	0
3:30 PM						0	0	0	1		0	0	0	0	0	0
3:45 PM						1	0	0	1		0	0	0	0	0	0
4:00 PM						0	0	0	2		0	0	0	0	0	0
4:15 PM						1	0	0	1		0	0	0	0	0	0
4:30 PM						1	0	0	2		0	0	0	0	0	0
4:45 PM						1	0	0	1		1	0	0	0	0	0
5:00 PM						0	0	0	0		0	0	0	0	0	0
5:15 PM						1	0	0	1		1	0	0	0	0	0
5:30 PM						0	0	0	1		0	0	0	1	0	0
5:45 PM						0	0	0	1		0	0	0	0	0	0
6:00 PM						0	0	0	0		0	0	0	0	0	0
6:15 PM						0	0	0	1		0	0	0	0	0	0
6:30 PM						0	0	0	1		0	0	0	1	0	0
6:45 PM						0	0	0	0		0	0	0	0	0	0

Study Name AMRC TIS-Ottawa_CA00995601
 Start Date 11/03/2023
 Start Time 7:00 AM
 Site Code AMRC TIS
 Project CA0009956.0165
 Intersection Ring Road / uOttawa-Rehab E Access

Type Crosswalk
 Classification Bicycles

Start Time	n/a Southbound			Ring Road Westbound			Exit 1 Northbound			Ring Road Eastbound		
	Peds CW	Peds CCW	Peds Combined	Peds CW	Peds CCW	Peds Combined	Peds CW	Peds CCW	Peds Combined	Peds CW	Peds CCW	Peds Combined
7:00 AM				0	0		0	0		0	0	
7:15 AM				0	0		0	0		0	0	
7:30 AM				0	0		0	0		0	0	
7:45 AM				0	0		1	0		0	0	
8:00 AM				0	0		0	0		0	0	
8:15 AM				0	0		2	0		0	0	
8:30 AM				0	0		0	0		0	0	
8:45 AM				0	0		0	0		0	0	
9:00 AM				0	0		0	1		0	0	
9:15 AM				0	0		0	0		0	0	
9:30 AM				0	0		1	0		0	0	
9:45 AM				0	0		0	0		0	0	
10:00 AM				1	0		0	0		0	0	
10:15 AM				0	0		0	0		0	0	
10:30 AM				0	0		0	0		0	0	
10:45 AM				0	0		0	0		0	0	
11:00 AM				0	0		0	0		0	0	
11:15 AM				0	0		0	1		0	0	
11:30 AM				0	0		0	0		0	0	
11:45 AM				0	0		0	0		0	0	
12:00 PM				0	0		0	0		0	0	
12:15 PM				0	0		0	0		0	0	
12:30 PM				0	0		1	0		0	0	
12:45 PM				0	0		1	1		0	0	
1:00 PM				0	0		0	0		0	0	
1:15 PM				0	0		0	0		0	0	
1:30 PM				0	0		0	0		0	0	
1:45 PM				0	0		0	0		0	0	
2:00 PM				0	0		0	0		0	0	
2:15 PM				0	0		0	0		0	0	
2:30 PM				0	0		1	0		0	0	
2:45 PM				0	0		0	0		0	0	
3:00 PM				0	0		0	0		0	0	
3:15 PM				0	0		0	0		0	0	
3:30 PM				0	0		0	0		0	0	
3:45 PM				0	0		0	0		0	0	
4:00 PM				0	0		0	0		0	0	
4:15 PM				0	0		0	0		0	0	
4:30 PM				0	0		0	0		0	0	
4:45 PM				0	0		0	0		0	0	
5:00 PM				0	0		0	0		0	0	
5:15 PM				0	0		0	0		0	0	
5:30 PM				0	0		0	0		0	0	
5:45 PM				0	0		0	0		0	0	
6:00 PM				0	0		0	0		0	0	
6:15 PM				0	0		0	0		0	0	
6:30 PM				0	0		0	0		0	0	
6:45 PM				0	0		0	0		0	0	

Study Name AMRC TIS-Ottawa_CA00995601
 Start Date 11/03/2023
 Start Time 7:00 AM
 Site Code AMRC TIS
 Project CA0009956.0165
 Intersection Ring Road / uOttawa-Rehab E Access

Type Road
 Classification Totals

Start Time	n/a Southbound				Ring Road Westbound				Exit 1 Northbound				Ring Road Eastbound			
	Right	Thru	Left	U-Turn	Right	Thru	Left	U-Turn	Right	Thru	Left	U-Turn	Right	Thru	Left	U-Turn
7:00 AM	0	0	0	0	0	5	0	0	2	0	4	0	0	38	0	0
7:15 AM	0	0	0	0	0	13	0	0	2	0	1	0	0	24	0	1
7:30 AM	0	0	0	0	0	25	0	1	4	0	3	0	0	45	0	0
7:45 AM	0	0	0	0	0	30	0	0	6	0	4	0	0	63	0	0
8:00 AM	0	0	0	0	0	38	0	0	6	0	8	0	0	41	0	0
8:15 AM	0	0	0	0	0	42	0	0	7	0	11	0	0	40	0	0
8:30 AM	0	0	0	0	0	23	0	0	2	0	7	0	0	36	0	0
8:45 AM	0	0	0	0	0	30	0	0	4	0	6	0	0	37	0	0
9:00 AM	0	0	0	0	0	22	0	0	5	0	3	0	0	28	0	0
9:15 AM	0	0	0	0	0	11	0	0	4	0	6	0	0	19	0	0
9:30 AM	0	0	0	0	0	18	0	1	5	0	10	0	0	22	0	0
9:45 AM	0	0	0	0	0	33	0	0	4	0	1	0	0	18	0	0
10:00 AM	0	0	0	0	0	13	0	0	4	0	5	0	0	21	0	0
10:15 AM	0	0	0	0	0	11	0	0	5	0	2	0	0	13	0	0
10:30 AM	0	0	0	0	0	15	0	0	4	0	3	0	0	26	0	0
10:45 AM	0	0	0	0	0	27	0	0	5	0	11	0	1	20	0	0
11:00 AM	0	0	0	0	0	15	0	0	4	0	3	0	0	13	0	0
11:15 AM	0	0	0	0	0	17	0	0	3	0	4	0	0	17	0	0
11:30 AM	0	0	0	0	0	17	0	0	4	0	1	0	0	14	0	0
11:45 AM	0	0	0	0	0	16	0	0	2	0	2	0	0	19	0	0
12:00 PM	0	0	0	0	0	19	0	0	9	0	5	0	0	18	0	0
12:15 PM	0	0	0	0	0	30	0	1	5	0	6	0	0	21	0	0
12:30 PM	0	0	0	0	0	22	0	0	4	0	8	0	0	23	0	0
12:45 PM	0	0	0	0	0	26	0	0	5	0	3	0	0	19	0	1
1:00 PM	0	0	0	0	0	18	0	0	4	0	5	0	0	12	0	0
1:15 PM	0	0	0	0	0	13	0	0	3	0	3	0	0	19	0	0
1:30 PM	0	0	0	0	0	16	0	0	1	0	4	0	0	24	0	1
1:45 PM	0	0	0	0	0	17	0	0	8	0	2	0	0	21	0	0
2:00 PM	0	0	0	0	0	26	0	0	4	0	4	0	0	19	0	0
2:15 PM	0	0	0	0	0	21	0	1	5	0	4	0	0	13	0	0
2:30 PM	0	0	0	0	0	25	0	0	5	0	2	0	0	25	0	1
2:45 PM	0	0	0	0	0	22	0	0	4	0	2	0	0	20	0	0
3:00 PM	0	0	0	0	0	21	0	0	3	0	9	0	0	17	0	0
3:15 PM	0	0	0	0	0	29	0	0	2	0	6	0	0	19	0	0
3:30 PM	0	0	0	0	0	27	0	0	3	0	2	0	0	21	0	0
3:45 PM	0	0	0	0	0	52	0	0	3	0	8	0	0	17	0	0
4:00 PM	0	0	0	0	0	44	0	0	6	0	6	0	0	27	0	0
4:15 PM	0	0	0	0	0	31	0	0	2	0	3	0	0	20	0	0
4:30 PM	0	0	0	0	0	14	0	0	6	0	0	0	0	12	0	0
4:45 PM	0	0	0	0	0	20	0	0	3	0	2	0	0	17	0	0
5:00 PM	0	0	0	0	0	25	0	0	3	0	8	0	0	9	0	0
5:15 PM	0	0	0	0	0	11	0	0	2	0	3	0	0	13	0	0
5:30 PM	0	0	0	0	0	15	0	0	1	0	3	0	0	15	0	0
5:45 PM	0	0	0	0	0	10	0	0	1	0	0	0	0	7	0	0
6:00 PM	0	0	0	0	0	16	0	0	1	0	3	0	0	4	0	0
6:15 PM	0	0	0	0	0	11	0	0	1	0	2	0	0	8	0	0
6:30 PM	0	0	0	0	0	14	0	0	3	0	2	0	0	12	0	0
6:45 PM	0	0	0	0	0	4	0	0	1	0	4	0	0	10	0	0

Appendix E

COLLISION RECORDS

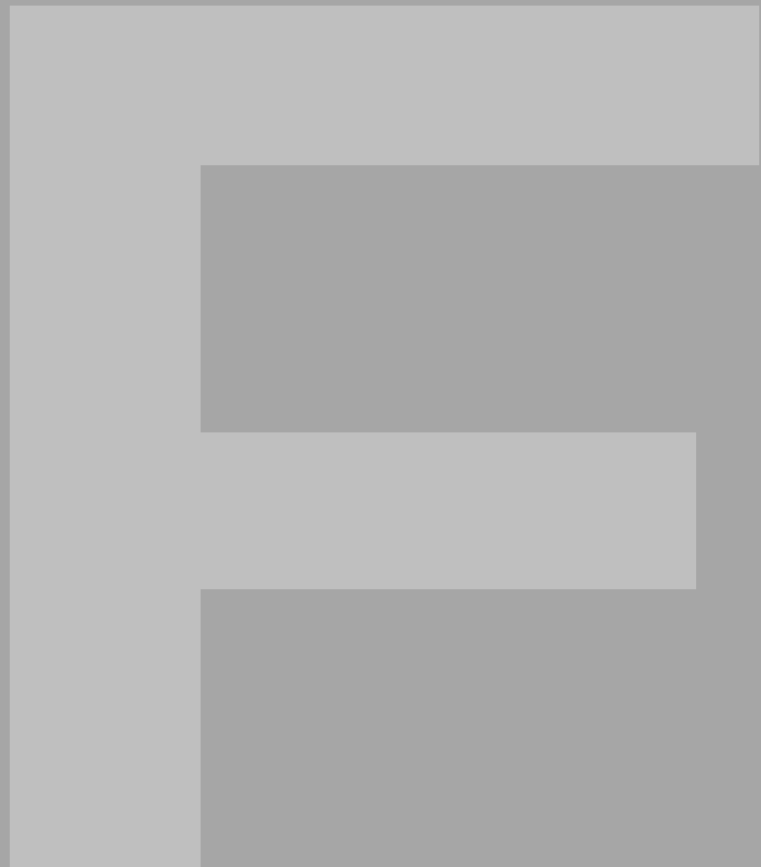

Appendix E-1

OPEN DATA COLLISIONS



OPEN DATA COLLISIONS – 2013 TO 2020

The latest collision history (January 1, 2013 through December 31, 2020) available on the City of Ottawa Open Data website was reviewed for the study area, which provides yearly total collisions by locations for all modes. It is noted that the Open Data information included collision records along Smyth Road and Alta Vista Drive but did not include any historical collision records on Ring Road. **Figure 1** summarizes the open data collision history on the study area roads and intersections (blue highlighted locations included in the review), and **Table 1** summarizes the study area collisions by location and year.

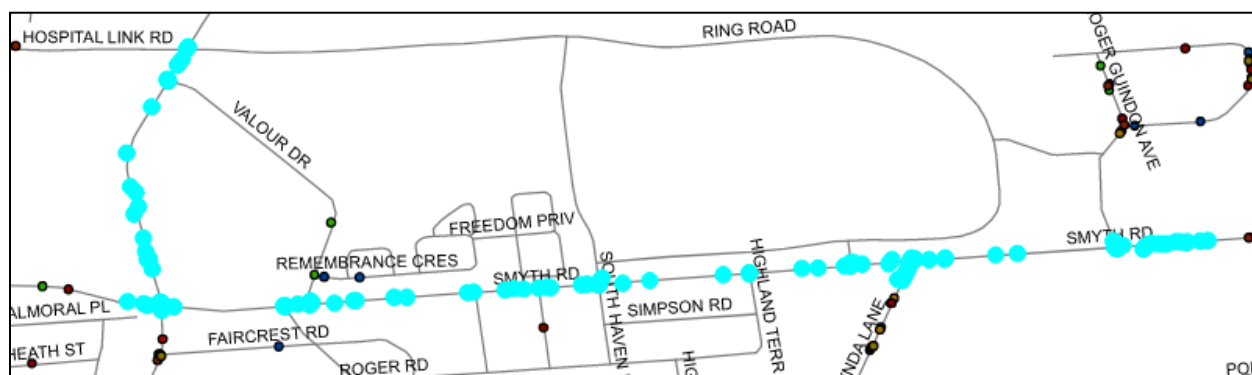

Figure 1: Historical Collision Locations 2013-2020

Table 1: Historical Collisions 2013-2020 by Location and Year

	2013	2014	2015	2016	2017	2018	2019	2020	TOTAL
Signalized Intersections	38	38	45	27	26	27	33	10	244
ALTA VISTA DR @ HOSPITAL LINK RD							1		1
ALTA VISTA DR @ SMYTH RD	25	31	29	16	17	16	20	4	158
ROGER GUINDON AVE @ SMYTH RD	2	3	6	3	2	3	2	1	22
SMYTH RD @ GENERAL HOSPITAL E	5	1	2	3	1	5	4	4	25
SMYTH RD @ SOUTH HAVEN PL/GENERAL HOSPITAL ENTRANCE W	3	2	4	5	5	1	5	1	26
VALOUR DR @ SMYTH RD	3	1	4		1	2	1		12
Unsignalized Intersections	6	4	7	5	6	10	4	4	46
ALTA VISTA DR @ VALOUR DR		1	2	1		4	1		9
BROADMOOR AVE @ SMYTH RD						1			1
FAIRBANKS AVE @ SMYTH RD	1		1	2	1				5
FREEDOM PRIV @ SMYTH RD			1						1
HIGHLAND TER @ SMYTH RD				1	1			1	3
LYNDA LANE @ SMYTH RD	5	3	3	1	4	4	3	3	26

	2013	2014	2015	2016	2017	2018	2019	2020	TOTAL
SMYTH RD @ BARNHART PL						1			1
Midblock Segments	9	14	9	12	8	7	9	1	69
ALTA VISTA DR btwn FAIRCREST RD & SMYTH RD			1						1
ALTA VISTA DR btwn SMYTH RD & VALOUR DR		3	4	1	2	1	1		12
ALTA VISTA DR btwn VALOUR DR & BALFOUR AVE	2					1		1	4
LYNDA LANE btwn BILLINGS AVE & SMYTH RD		1	1	2		1	2		7
ROGER GUINDON AVE btwn SMYTH RD & PETER MORAND CRES				1					1
SMYTH RD btwn ALTA VISTA DR & FAIRBANKS AVE		1							1
SMYTH RD btwn BARNHART PL & FREEDOM PRIV		1				1			2
SMYTH RD btwn BROADMOOR AVE & SOUTH HAVEN PL	1	1	1	1					4
SMYTH RD btwn FAIRBANKS AVE & VALOUR DR		1							1
SMYTH RD btwn GENERAL HOSPITAL & HIGHLAND TER					1	1	1		3
SMYTH RD btwn GENERAL HOSPITAL & LYNDA LANE	1			1			1		3
SMYTH RD btwn LYNDA LANE & ROGER GUINDON AVE		1	1		2		1		5
SMYTH RD btwn RIVERSIDE HOSPITAL & ALTA VISTA DR	1	1		1					3
SMYTH RD btwn ROGER GUINDON AVE & BOTSFORD ST	3	2		3	3	1	1		13
SMYTH RD btwn SOUTH HAVEN PL & HIGHLAND TER	1			2					3
SMYTH RD btwn VALOUR DR & BARNHART PL		2	1			1	2		6
Total	53	56	61	44	40	44	46	15	359

The open data summary included a total of 359 collisions in the study area between 2013 and 2020. Of these, 244 (68%) were at signalized intersections, 46 (13%) were at unsignalized intersections, and 69 (19%) were on midblock segments. The most frequent collision location was the intersection of Alta Vista Drive and Smyth Road, with 158 collisions, representing 44% of recorded collisions in the study area. The number of collisions per year in the study area has fallen slightly from over 60 in 2015 to less than 50 in the following years; the significant decrease in 2020 is a result of the COVID-19 pandemic and there is not yet available data to confirm post-pandemic collision trends. It is noted that Hospital Link Road opened in August 2019 and has only one recorded collision in the open data information.

The historical collisions included 79 injury collisions, 280 property damage only collisions and no fatalities. 56 (70%) of the injury collisions occurred at signalized intersections, 37 (47%) occurring at the Alta Vista Drive / Smyth Road intersection.

The historical 2013-2020 collisions are summarized by reported cause / behaviour in **Table 2**.

Table 2: Historical Collisions 2013-2020 by Location and Cause

	APPROACHING	ANGLE	REAR END	SIDESWIPE	TURNING MOVEMENT	SMV UNATTENDED VEHICLE	SMV OTHER	OTHER	TOTAL
Signalized Intersections	1	14	92	28	94		10	5	244
ALTA VISTA DR @ HOSPITAL LINK RD				1					1
ALTA VISTA DR @ SMYTH RD	1	7	59	13	71		3	4	158
ROGER GUINDON AVE @ SMYTH RD		1	8	1	7		4	1	22
SMYTH RD @ GENERAL HOSPITAL E			11	5	7		2		25
SMYTH RD @ SOUTH HAVEN PL/GENERAL HOSPITAL ENTRANCE W		2	10	5	9				26
VALOUR DR @ SMYTH RD		4	4	3			1		12
Unsignalized Intersection		19	13	6	3	1	3	1	46
ALTA VISTA DR @ VALOUR DR		2	5				2		9
BROADMOOR AVE @ SMYTH RD			1						1
FAIRBANKS AVE @ SMYTH RD		4			1				5
FREEDOM PRIV @ SMYTH RD				1					1
HIGHLAND TER @ SMYTH RD				1	1		1		3
LYNDA LANE @ SMYTH RD		13	6	4	1	1		1	26
SMYTH RD @ BARNHART PL			1						1
Midblock Segments	1	11	21	11	3	5	15	2	69
ALTA VISTA DR btwn FAIRCREST RD & SMYTH RD			1						1
ALTA VISTA DR btwn SMYTH RD & VALOUR DR	1	2	6				3		12
ALTA VISTA DR btwn VALOUR DR & BALFOUR AVE			2				2		4
LYNDA LANE btwn BILLINGS AVE & SMYTH RD					1	4	1	1	7
ROGER GUINDON AVE btwn SMYTH RD & PETER MORAND CRES							1		1

	APPROACHING	ANGLE	REAR END	SIDESWIPE	TURNING MOVEMENT	SMV UNATTENDED VEHICLE	SMV OTHER	OTHER	TOTAL
SMYTH RD btwn ALTA VISTA DR & FAIRBANKS AVE				1					1
SMYTH RD btwn BARNHART PL & FREEDOM PRIV			1				1		2
SMYTH RD btwn BROADMOOR AVE & SOUTH HAVEN PL			1	1			2		4
SMYTH RD btwn FAIRBANKS AVE & VALOUR DR				1					1
SMYTH RD btwn GENERAL HOSPITAL & HIGHLAND TER			1	2					3
SMYTH RD btwn GENERAL HOSPITAL & LYNDA LANE			1	2					3
SMYTH RD btwn LYNDA LANE & ROGER GUINDON AVE		1	2		1	1			5
SMYTH RD btwn RIVERSIDE HOSPITAL & ALTA VISTA DR			1	1			1		3
SMYTH RD btwn ROGER GUINDON AVE & BOTSFORD ST		7	3	1			2		13
SMYTH RD btwn SOUTH HAVEN PL & HIGHLAND TER			2		1				3
SMYTH RD btwn VALOUR DR & BARNHART PL		1		2			2	1	6
Total	2	44	126	45	100	6	28	8	359

Of the historical collisions in the study area, rear end collisions were most common overall representing 126 (35%) of the 359 recorded and were the most common collision type for midblock locations. At signalized intersections, turning movement collisions were the most common but occurring at nearly the same frequency as rear end collisions. At unsignalized intersections, angle collisions were the most common, with most occurring at the unsignalized intersection of Smyth Road with Lynda Lane.

Overall, the collision history indicates collision patterns that are consistent with the traffic volumes and vehicle movements where they have been occurring. The busy of Alta Vista Drive and Smyth Road experiences the highest frequency of collisions, likely resulting from the high traffic volumes and number of congestion points within the intersection. Rear end collisions have been recorded at intersection and midblock locations across the study area and may be a product of traffic volumes and travel speeds on the arterial and collector roadways. It is noted that the Hospital Link intersection with Alta Vista has experienced few collisions recorded in the data since opening, but as a result of the recent opening of this facility and the COVID-19 pandemic this is not likely to imply a trend; however, the restriction of many turning movements at this intersection will serve to eliminate to conflict points and reduce the risk of collisions at this location compared with other intersections.

Appendix E-2

DETAILED COLLISION DATA





Transportation Services - Traffic Services

Collision Details Report - Public Version

From: January 1, 2017 To: December 31, 2021

Location: BROADMOOR AVE @ SMYTH RD

Traffic Control: Stop sign

Total Collisions: 1

Date/Day/Time	Environment	Impact Type	Classification	Surface Cond'n	Veh. Dir	Vehicle Manoeuver	Vehicle type	First Event	No. Ped
2018-Sep-21, Fri,08:07	Rain	Rear end	P.D. only	Wet	West	Unknown	Unknown	Other motor vehicle	0
					West	Stopped	Automobile, station wagon	Other motor vehicle	

Location: FAIRBANKS AVE @ SMYTH RD

Traffic Control: Stop sign

Total Collisions: 1

Date/Day/Time	Environment	Impact Type	Classification	Surface Cond'n	Veh. Dir	Vehicle Manoeuver	Vehicle type	First Event	No. Ped
2017-Sep-22, Fri,17:57	Clear	Angle	P.D. only	Dry	North	Turning left	Automobile, station wagon	Other motor vehicle	0
					East	Going ahead	Passenger van	Other motor vehicle	

Location: HIGHLAND TER @ SMYTH RD

Traffic Control: Stop sign

Total Collisions: 2

Date/Day/Time	Environment	Impact Type	Classification	Surface Cond'n	Veh. Dir	Vehicle Manoeuver	Vehicle type	First Event	No. Ped
2017-May-17, Wed,16:06	Clear	Sideswipe	P.D. only	Dry	West	Changing lanes	Pick-up truck	Other motor vehicle	0
					West	Going ahead	Pick-up truck	Other motor vehicle	
					West	Stopped	Automobile, station wagon	Other motor vehicle	
2020-Nov-20, Fri,18:08	Clear	Turning movement	Non-fatal injury	Dry	West	Turning left	Pick-up truck	Other motor vehicle	0
					West	Overtaking	Police vehicle	Other motor vehicle	

Location: LYNDA LANE @ SMYTH RD

Traffic Control: Stop sign

Total Collisions: 15

Date/Day/Time	Environment	Impact Type	Classification	Surface Cond'n	Veh. Dir	Vehicle Manoeuver	Vehicle type	First Event	No. Ped
2017-Jan-17, Tue,15:49	Clear	Rear end	Non-fatal injury	Dry	West	Going ahead	Pick-up truck	Other motor vehicle	0
					West	Stopped	Pick-up truck	Other motor vehicle	
2017-Feb-17, Fri,00:00	Clear	SMV unattended vehicle	P.D. only	Packed snow	Unknown	Unknown	Unknown	Unattended vehicle	0



Transportation Services - Traffic Services

Collision Details Report - Public Version

From: January 1, 2017 To: December 31, 2021

Location: LYNDA LANE @ SMYTH RD

Traffic Control: Stop sign

Total Collisions: 15

Date/Day/Time	Environment	Impact Type	Classification	Surface Cond'n	Veh. Dir	Vehicle Manoeuvre	Vehicle type	First Event	No. Ped
2017-Mar-27, Mon,14:01	Rain	Angle	Non-fatal injury	Wet	North	Turning left	Automobile, station wagon	Other motor vehicle	0
					East	Going ahead	Pick-up truck	Other motor vehicle	
2017-Dec-08, Fri,09:01	Clear	Turning movement	P.D. only	Dry	West	Turning left	Automobile, station wagon	Other motor vehicle	0
					East	Going ahead	Automobile, station wagon	Other motor vehicle	
2018-Jan-31, Wed,09:11	Clear	Angle	P.D. only	Dry	North	Turning left	Automobile, station wagon	Other motor vehicle	0
					East	Going ahead	Automobile, station wagon	Other motor vehicle	
					West	Stopped	Automobile, station wagon	Other motor vehicle	
2018-Mar-22, Thu,15:56	Clear	Sideswipe	Non-fatal injury	Dry	West	Changing lanes	Automobile, station wagon	Other motor vehicle	0
					West	Going ahead	Automobile, station wagon	Other motor vehicle	
					West	Turning left	Automobile, station wagon	Other motor vehicle	
2018-Aug-16, Thu,13:33	Clear	Angle	P.D. only	Dry	East	Turning right	Automobile, station wagon	Other motor vehicle	0
					North	Stopped	Automobile, station wagon	Other motor vehicle	
2018-Oct-21, Sun,18:23	Clear	Sideswipe	P.D. only	Dry	North	Pulling away from shoulder or curb	Automobile, station wagon	Other motor vehicle	0
					North	Going ahead	Automobile, station wagon	Other motor vehicle	
2019-Apr-17, Wed,09:45	Clear	Angle	P.D. only	Dry	North	Turning left	Automobile, station wagon	Other motor vehicle	0
					West	Going ahead	Automobile, station wagon	Other motor vehicle	
2019-Sep-19, Thu,17:21	Clear	Rear end	P.D. only	Dry	West	Going ahead	Automobile, station wagon	Other motor vehicle	0
					West	Turning left	Automobile, station wagon	Other motor vehicle	
2019-Nov-05, Tue,15:35	Clear	Sideswipe	P.D. only	Dry	West	Unknown	Automobile, station wagon	Other motor vehicle	0
					West	Unknown	Automobile, station wagon	Other motor vehicle	
2020-Jan-30, Thu,17:09	Clear	Sideswipe	P.D. only	Dry	East	Changing lanes	Automobile, station wagon	Other motor vehicle	0
					East	Going ahead	Unknown	Other motor vehicle	



Transportation Services - Traffic Services

Collision Details Report - Public Version

From: January 1, 2017 To: December 31, 2021

Location: LYNDA LANE @ SMYTH RD

Traffic Control: Stop sign

Total Collisions: 15

Date/Day/Time	Environment	Impact Type	Classification	Surface Cond'n	Veh. Dir	Vehicle Manoeuver	Vehicle type	First Event	No. Ped
2020-Jul-14, Tue,11:45	Clear	Angle	Non-fatal injury	Dry	North	Turning left	Passenger van	Other motor vehicle	0
					East	Going ahead	Automobile, station wagon	Other motor vehicle	
2020-Aug-19, Wed,18:00	Clear	Angle	P.D. only	Dry	North	Turning left	Pick-up truck	Other motor vehicle	0
					West	Going ahead	Pick-up truck	Other motor vehicle	
2021-Oct-29, Fri,16:04	Clear	Rear end	Non-fatal injury	Dry	North	Turning right	Pick-up truck	Other motor vehicle	0
					North	Turning left	Automobile, station wagon	Other motor vehicle	

Location: ROGER GUINDON AVE @ SMYTH RD

Traffic Control: Traffic signal

Total Collisions: 8

Date/Day/Time	Environment	Impact Type	Classification	Surface Cond'n	Veh. Dir	Vehicle Manoeuver	Vehicle type	First Event	No. Ped
2017-Oct-27, Fri,07:26	Clear	Turning movement	P.D. only	Dry	South	Stopped	Automobile, station wagon	Other motor vehicle	0
					South	Turning right	Truck - tractor	Other motor vehicle	
2017-Oct-27, Fri,19:10	Clear	Rear end	P.D. only	Dry	East	Going ahead	Automobile, station wagon	Other motor vehicle	0
					East	Stopped	Automobile, station wagon	Other motor vehicle	
2018-Feb-12, Mon,09:44	Snow	Turning movement	P.D. only	Packed snow	West	Going ahead	Automobile, station wagon	Other motor vehicle	0
					East	Turning left	Automobile, station wagon	Other motor vehicle	
2018-Apr-12, Thu,16:00	Rain	Rear end	P.D. only	Wet	West	Slowing or stopping	Delivery van	Other motor vehicle	0
					West	Turning right	Automobile, station wagon	Other motor vehicle	
2018-Nov-21, Wed,10:57	Clear	Turning movement	Non-fatal injury	Wet	East	Turning left	Automobile, station wagon	Other motor vehicle	0
					West	Going ahead	Passenger van	Other motor vehicle	
2019-Jul-15, Mon,07:30	Clear	Turning movement	P.D. only	Dry	East	Turning left	Passenger van	Other motor vehicle	0
					West	Going ahead	Automobile, station wagon	Other motor vehicle	
2019-Oct-30, Wed,18:00	Clear	Rear end	P.D. only	Dry	East	Unknown	Automobile, station wagon	Other motor vehicle	0
					East	Stopped	Automobile, station wagon	Other motor vehicle	



Transportation Services - Traffic Services

Collision Details Report - Public Version

From: January 1, 2017 To: December 31, 2021

Location: ROGER GUINDON AVE @ SMYTH RD

Traffic Control: Traffic signal

Total Collisions: 8

Date/Day/Time	Environment	Impact Type	Classification	Surface Cond'n	Veh. Dir	Vehicle Manoeuvre	Vehicle type	First Event	No. Ped
2020-Mar-13, Fri,15:09	Clear	Other	P.D. only	Dry	West	Reversing	Automobile, station wagon	Other motor vehicle	0
					East	Stopped	Automobile, station wagon	Other motor vehicle	

Location: SMYTH RD @ BARNHART PL

Traffic Control: Stop sign

Total Collisions: 1

Date/Day/Time	Environment	Impact Type	Classification	Surface Cond'n	Veh. Dir	Vehicle Manoeuvre	Vehicle type	First Event	No. Ped
2018-Feb-16, Fri,08:11	Rain	Rear end	P.D. only	Wet	East	Going ahead	Automobile, station wagon	Other motor vehicle	0
					East	Stopped	Automobile, station wagon	Other motor vehicle	
					East	Stopped	Automobile, station wagon	Other motor vehicle	

Location: SMYTH RD @ GENERAL HOSPITAL E

Traffic Control: Traffic signal

Total Collisions: 17

Date/Day/Time	Environment	Impact Type	Classification	Surface Cond'n	Veh. Dir	Vehicle Manoeuvre	Vehicle type	First Event	No. Ped
2017-Dec-08, Fri,06:52	Clear	Rear end	P.D. only	Dry	West	Turning left	Automobile, station wagon	Other motor vehicle	0
					West	Turning left	Automobile, station wagon	Other motor vehicle	
					West	Turning left	Automobile, station wagon	Other motor vehicle	
					West	Turning left	Automobile, station wagon	Other motor vehicle	
2018-Jan-26, Fri,08:30	Clear	Rear end	P.D. only	Loose snow	East	Unknown	Unknown	Other motor vehicle	0
					East	Stopped	Automobile, station wagon	Other motor vehicle	
2018-Jun-27, Wed,07:32	Clear	Turning movement	P.D. only	Dry	East	Turning left	Automobile, station wagon	Other motor vehicle	0
					West	Going ahead	Automobile, station wagon	Other motor vehicle	
2018-Jul-06, Fri,07:29	Clear	Rear end	P.D. only	Dry	South	Going ahead	Automobile, station wagon	Other motor vehicle	0
					South	Stopped	Automobile, station wagon	Other motor vehicle	
2018-Oct-17, Wed,11:10	Clear	Sideswipe	P.D. only	Dry	South	Unknown	Unknown	Other motor vehicle	0
					South	Stopped	Automobile, station wagon	Other motor vehicle	



Transportation Services - Traffic Services

Collision Details Report - Public Version

From: January 1, 2017 **To:** December 31, 2021

Location: SMYTH RD @ GENERAL HOSPITAL E

Traffic Control: Traffic signal

Total Collisions: 17

Date/Day/Time	Environment	Impact Type	Classification	Surface Cond'n	Veh. Dir	Vehicle Manoeuvre	Vehicle type	First Event	No. Ped
2018-Nov-30, Fri,15:32	Clear	Turning movement	Non-fatal injury	Dry	West	Going ahead	Automobile, station wagon	Other motor vehicle	0
					East	Turning left	Automobile, station wagon	Other motor vehicle	
2019-Jan-23, Wed,07:15	Snow	Sideswipe	Non-reportable	Packed snow	East	Changing lanes	Unknown	Other motor vehicle	0
					East	Going ahead	Automobile, station wagon	Other motor vehicle	
2019-Sep-05, Thu,07:57	Clear	Turning movement	P.D. only	Dry	East	Turning left	Automobile, station wagon	Other motor vehicle	0
					West	Going ahead	Automobile, station wagon	Other motor vehicle	
2019-Sep-10, Tue,09:00	Clear	Rear end	P.D. only	Dry	West	Going ahead	Truck - dump	Other motor vehicle	0
					West	Stopped	Automobile, station wagon	Other motor vehicle	
					West	Unknown	Unknown	Other motor vehicle	
2019-Dec-14, Sat,22:42	Snow	SMV other	P.D. only	Packed snow	East	Going ahead	Automobile, station wagon	Pole (utility, power)	0
2019-Dec-20, Fri,16:22	Clear	Sideswipe	P.D. only	Dry	South	Going ahead	Pick-up truck	Other motor vehicle	0
					South	Going ahead	Automobile, station wagon	Other motor vehicle	
2020-Jan-15, Wed,18:00	Clear	Rear end	P.D. only	Dry	South	Going ahead	Municipal transit bus	Other motor vehicle	0
					South	Stopped	Automobile, station wagon	Other motor vehicle	
2020-Jan-27, Mon,16:09	Clear	Rear end	P.D. only	Dry	South	Turning left	Automobile, station wagon	Other motor vehicle	0
					South	Turning left	Automobile, station wagon	Other motor vehicle	
2020-Mar-03, Tue,11:30	Clear	Rear end	P.D. only	Loose snow	West	Going ahead	School van	Other motor vehicle	0
					West	Slowing or stopping	Automobile, station wagon	Other motor vehicle	
2020-Mar-10, Tue,09:10	Rain	Sideswipe	P.D. only	Wet	East	Going ahead	Unknown	Other motor vehicle	0
					East	Turning left	Automobile, station wagon	Other motor vehicle	
2021-Feb-03, Wed,06:40	Snow	Sideswipe	P.D. only	Slush	South	Turning left	Pick-up truck	Other motor vehicle	0
					South	Turning left	Ambulance	Other motor vehicle	



Transportation Services - Traffic Services

Collision Details Report - Public Version

From: January 1, 2017 To: December 31, 2021

Location: SMYTH RD @ GENERAL HOSPITAL E

Traffic Control: Traffic signal

Total Collisions: 17

Date/Day/Time	Environment	Impact Type	Classification	Surface Cond'n	Veh. Dir	Vehicle Manoeuvre	Vehicle type	First Event	No. Ped
2021-Nov-26, Fri,07:10	Rain	Turning movement	P.D. only	Wet	East	Turning left	Automobile, station wagon	Other motor vehicle	0
					West	Going ahead	Automobile, station wagon	Other motor vehicle	

Location: SMYTH RD @ SOUTH HAVEN PL/GENERAL HOSPITAL ENTRANCE W

Traffic Control: Traffic signal

Total Collisions: 13

Date/Day/Time	Environment	Impact Type	Classification	Surface Cond'n	Veh. Dir	Vehicle Manoeuvre	Vehicle type	First Event	No. Ped
2017-Jan-27, Fri,09:43	Clear	Rear end	P.D. only	Dry	South	Going ahead	Automobile, station wagon	Other motor vehicle	0
					South	Stopped	Automobile, station wagon	Other motor vehicle	
2017-Jun-27, Tue,12:44	Clear	Turning movement	P.D. only	Dry	West	Turning left	Automobile, station wagon	Other motor vehicle	0
					East	Going ahead	Pick-up truck	Other motor vehicle	
2017-Jun-27, Tue,13:43	Rain	Turning movement	P.D. only	Wet	West	Turning left	Automobile, station wagon	Other motor vehicle	0
					East	Going ahead	Pick-up truck	Other motor vehicle	
2017-Aug-06, Sun,19:50	Clear	Rear end	P.D. only	Dry	East	Going ahead	Automobile, station wagon	Other motor vehicle	0
					East	Stopped	Automobile, station wagon	Other motor vehicle	
2017-Nov-03, Fri,19:44	Clear	Turning movement	P.D. only	Dry	South	Going ahead	Automobile, station wagon	Other motor vehicle	0
					North	Turning left	Bus (other)	Other motor vehicle	
2018-Nov-07, Wed,18:00	Rain	Rear end	P.D. only	Wet	East	Going ahead	Automobile, station wagon	Other motor vehicle	0
					East	Stopped	Automobile, station wagon	Other motor vehicle	
2019-Jan-07, Mon,08:35	Clear	Turning movement	P.D. only	Ice	West	Turning left	Passenger van	Other motor vehicle	0
					East	Going ahead	Automobile, station wagon	Other motor vehicle	
2019-Jan-22, Tue,10:40	Clear	Angle	P.D. only	Packed snow	East	Going ahead	Unknown	Other motor vehicle	0
					North	Going ahead	Passenger van	Other motor vehicle	
2019-Aug-12, Mon,14:40	Clear	Sideswipe	P.D. only	Dry	East	Unknown	Unknown	Other motor vehicle	0
					East	Going ahead	Automobile, station wagon	Other motor vehicle	



Transportation Services - Traffic Services

Collision Details Report - Public Version

From: January 1, 2017 To: December 31, 2021

Location: SMYTH RD @ SOUTH HAVEN PL/GENERAL HOSPITAL ENTRANCE W

Traffic Control: Traffic signal

Total Collisions: 13

Date/Day/Time	Environment	Impact Type	Classification	Surface Cond'n	Veh. Dir	Vehicle Manoeuvre	Vehicle type	First Event	No. Ped
2019-Nov-29, Fri,16:49	Clear	Sideswipe	P.D. only	Dry	East	Changing lanes	Automobile, station wagon	Other motor vehicle	0
					East	Going ahead	Automobile, station wagon	Other motor vehicle	
2019-Dec-04, Wed,09:50	Snow	Rear end	P.D. only	Wet	East	Changing lanes	Automobile, station wagon	Other motor vehicle	0
					East	Going ahead	Automobile, station wagon	Other motor vehicle	
2020-Sep-29, Tue,19:59	Clear	Turning movement	Non-fatal injury	Dry	East	Turning left	Automobile, station wagon	Other motor vehicle	0
					West	Going ahead	Automobile, station wagon	Other motor vehicle	
2021-Mar-23, Tue,09:36	Clear	Sideswipe	P.D. only	Dry	East	Changing lanes	Pick-up truck	Other motor vehicle	0
					East	Going ahead	Automobile, station wagon	Other motor vehicle	

Location: SMYTH RD btwn BARNHART PL & FREEDOM PRIV

Traffic Control: No control

Total Collisions: 1

Date/Day/Time	Environment	Impact Type	Classification	Surface Cond'n	Veh. Dir	Vehicle Manoeuvre	Vehicle type	First Event	No. Ped
2018-Jan-03, Wed,18:45	Clear	SMV other	P.D. only	Packed snow	East	Going ahead	Automobile, station wagon	Snowbank/drift	0

Location: SMYTH RD btwn BROADMOOR AVE & SOUTH HAVEN PL

Traffic Control: No control

Total Collisions: 1

Date/Day/Time	Environment	Impact Type	Classification	Surface Cond'n	Veh. Dir	Vehicle Manoeuvre	Vehicle type	First Event	No. Ped
2021-Nov-23, Tue,18:09	Clear	SMV other	P.D. only	Dry	East	Going ahead	Pick-up truck	Animal - domestic	0

Location: SMYTH RD btwn HIGHLAND TERR & RING RD/GENERAL HOSPITAL

Traffic Control: No control

Total Collisions: 3

Date/Day/Time	Environment	Impact Type	Classification	Surface Cond'n	Veh. Dir	Vehicle Manoeuvre	Vehicle type	First Event	No. Ped
2017-Nov-15, Wed,17:00	Rain	Sideswipe	P.D. only	Wet	East	Unknown	Unknown	Other motor vehicle	0
					East	Going ahead	Pick-up truck	Other motor vehicle	



Transportation Services - Traffic Services

Collision Details Report - Public Version

From: January 1, 2017 To: December 31, 2021

Location: SMYTH RD btwn HIGHLAND TERR & RING RD/GENERAL HOSPITAL

Traffic Control: No control

Total Collisions: 3

Date/Day/Time	Environment	Impact Type	Classification	Surface Cond'n	Veh. Dir	Vehicle Manoeuver	Vehicle type	First Event	No. Ped
2018-Oct-03, Wed,23:50	Clear	Rear end	P.D. only	Dry	East	Pulling onto shoulder or toward curb	Automobile, station wagon	Other motor vehicle	0
					East	Overtaking	Police vehicle	Other motor vehicle	
2019-Apr-18, Thu,16:45	Clear	Sideswipe	P.D. only	Dry	East	Unknown	Unknown	Other motor vehicle	0
					East	Changing lanes	Automobile, station wagon	Other motor vehicle	

Location: SMYTH RD btwn LYNDA LANE & ROGER GUINDON AVE

Traffic Control: No control

Total Collisions: 3

Date/Day/Time	Environment	Impact Type	Classification	Surface Cond'n	Veh. Dir	Vehicle Manoeuver	Vehicle type	First Event	No. Ped
2017-Feb-09, Thu,18:15	Clear	Rear end	P.D. only	Dry	West	Going ahead	Automobile, station wagon	Other motor vehicle	0
					West	Stopped	Automobile, station wagon	Other motor vehicle	
2017-Mar-06, Mon,00:00	Rain	SMV unattended vehicle	P.D. only	Slush	East	Unknown	Unknown	Unattended vehicle	0
2019-Nov-26, Tue,15:40	Clear	Turning movement	P.D. only	Dry	West	Making "U" turn	Automobile, station wagon	Other motor vehicle	0
					West	Going ahead	Automobile, station wagon	Other motor vehicle	

Location: SMYTH RD btwn RING RD/GENERAL HOSPITAL & LYNDA LANE

Traffic Control: No control

Total Collisions: 1

Date/Day/Time	Environment	Impact Type	Classification	Surface Cond'n	Veh. Dir	Vehicle Manoeuver	Vehicle type	First Event	No. Ped
2019-Apr-09, Tue,10:15	Freezing Rain	Rear end	P.D. only	Ice	East	Slowing or stopping	Automobile, station wagon	Other motor vehicle	0
					East	Stopped	Delivery van	Other motor vehicle	

Location: SMYTH RD btwn VALOUR DR & BARNHART PL

Traffic Control: No control

Total Collisions: 3

Date/Day/Time	Environment	Impact Type	Classification	Surface Cond'n	Veh. Dir	Vehicle Manoeuver	Vehicle type	First Event	No. Ped
2018-Jun-26, Tue,09:16	Clear	SMV other	P.D. only	Dry	West	Going ahead	Delivery van	Curb	0



Transportation Services - Traffic Services

Collision Details Report - Public Version

From: January 1, 2017 To: December 31, 2021

Location: SMYTH RD btwn VALOUR DR & BARNHART PL

Traffic Control: No control

Total Collisions: 3

Date/Day/Time	Environment	Impact Type	Classification	Surface Cond'n	Veh. Dir	Vehicle Manoeuvre	Vehicle type	First Event	No. Ped
2019-Feb-23, Sat,01:15	Clear	Sideswipe	Non-fatal injury	Dry	West	Changing lanes	Automobile, station wagon	Other motor vehicle	0
					West	Going ahead	Automobile, station wagon	Other motor vehicle	
2019-Mar-13, Wed,19:50	Snow	Angle	P.D. only	Slush	South	Reversing	Automobile, station wagon	Other motor vehicle	0
					West	Going ahead	Automobile, station wagon	Other motor vehicle	

Location: VALOUR DR @ SMYTH RD

Traffic Control: Traffic signal

Total Collisions: 4

Date/Day/Time	Environment	Impact Type	Classification	Surface Cond'n	Veh. Dir	Vehicle Manoeuvre	Vehicle type	First Event	No. Ped
2017-Apr-09, Sun,17:07	Clear	Angle	Non-fatal injury	Dry	West	Going ahead	Automobile, station wagon	Other motor vehicle	0
					South	Turning left	Automobile, station wagon	Other motor vehicle	
2018-Jun-26, Tue,14:49	Clear	Rear end	Non-fatal injury	Dry	East	Going ahead	Automobile, station wagon	Other motor vehicle	0
					East	Stopped	Automobile, station wagon	Other motor vehicle	
2018-Dec-19, Wed,07:19	Clear	Sideswipe	Non-fatal injury	Dry	East	Going ahead	Automobile, station wagon	Other motor vehicle	0
					East	Turning left	Automobile, station wagon	Other motor vehicle	
					East	Going ahead	Automobile, station wagon	Other motor vehicle	
2019-Feb-21, Thu,08:50	Snow	Sideswipe	P.D. only	Packed snow	West	Unknown	Unknown	Other motor vehicle	0
					West	Going ahead	Automobile, station wagon	Other motor vehicle	



Transportation Services - Traffic Services

Collision Details Report - Public Version

From: January 1, 2017 To: December 31, 2021

Location: ALTA VISTA DR @ HOSPITAL LINK RD

Traffic Control: Traffic signal

Total Collisions: 2

Date/Day/Time	Environment	Impact Type	Classification	Surface Cond'n	Veh. Dir	Vehicle Manoeuvre	Vehicle type	First Event	No. Ped
2019-Nov-15, Fri,10:13	Snow	Sideswipe	P.D. only	Wet	North	Changing lanes	Pick-up truck	Other motor vehicle	0
					North	Changing lanes	Automobile, station wagon	Other motor vehicle	
2021-Aug-24, Tue,19:10	Clear	Rear end	Non-fatal injury	Dry	South	Going ahead	Automobile, station wagon	Other motor vehicle	0
					South	Stopped	Pick-up truck	Other motor vehicle	

Location: ALTA VISTA DR @ SMYTH RD

Traffic Control: Traffic signal

Total Collisions: 66

Date/Day/Time	Environment	Impact Type	Classification	Surface Cond'n	Veh. Dir	Vehicle Manoeuvre	Vehicle type	First Event	No. Ped
2017-Jan-13, Fri,17:45	Clear	Turning movement	Non-fatal injury	Dry	West	Turning left	Automobile, station wagon	Other motor vehicle	0
					East	Going ahead	Automobile, station wagon	Other motor vehicle	
2017-Feb-09, Thu,17:43	Clear	Turning movement	P.D. only	Dry	East	Going ahead	Automobile, station wagon	Other motor vehicle	0
					West	Turning left	Automobile, station wagon	Other motor vehicle	
2017-Feb-10, Fri,17:58	Clear	Turning movement	P.D. only	Dry	West	Turning left	Pick-up truck	Other motor vehicle	0
					East	Going ahead	Automobile, station wagon	Other motor vehicle	
					North	Stopped	Automobile, station wagon	Other motor vehicle	
2017-Feb-22, Wed,08:55	Clear	Turning movement	P.D. only	Dry	West	Turning left	Automobile, station wagon	Other motor vehicle	0
					East	Going ahead	Automobile, station wagon	Other motor vehicle	
2017-Mar-08, Wed,14:43	Clear	Angle	Non-fatal injury	Dry	West	Turning left	Automobile, station wagon	Other motor vehicle	0
					North	Going ahead	Automobile, station wagon	Other motor vehicle	
2017-Apr-06, Thu,06:16	Clear	Turning movement	Non-fatal injury	Dry	South	Turning left	Automobile, station wagon	Other motor vehicle	0
					North	Going ahead	Automobile, station wagon	Other motor vehicle	
2017-May-19, Fri,14:58	Clear	Rear end	Non-fatal injury	Dry	North	Turning right	Automobile, station wagon	Other motor vehicle	0
					North	Turning right	Automobile, station wagon	Other motor vehicle	



Transportation Services - Traffic Services

Collision Details Report - Public Version

From: January 1, 2017 To: December 31, 2021

Location: ALTA VISTA DR @ SMYTH RD

Traffic Control: Traffic signal

Total Collisions: 66

Date/Day/Time	Environment	Impact Type	Classification	Surface Cond'n	Veh. Dir	Vehicle Manoeuvre	Vehicle type	First Event	No. Ped
2017-Jun-14, Wed,16:46	Clear	Rear end	P.D. only	Dry	West	Turning right	Pick-up truck	Other motor vehicle	0
					West	Turning right	Pick-up truck	Other motor vehicle	
2017-Jul-28, Fri,22:10	Clear	Turning movement	P.D. only	Dry	South	Turning left	Automobile, station wagon	Other motor vehicle	0
					North	Going ahead	Automobile, station wagon	Other motor vehicle	
2017-Aug-16, Wed,09:53	Clear	Rear end	P.D. only	Dry	East	Unknown	Pick-up truck	Other motor vehicle	0
					East	Unknown	Automobile, station wagon	Other motor vehicle	
2017-Aug-29, Tue,12:07	Clear	Rear end	P.D. only	Dry	West	Going ahead	Automobile, station wagon	Other motor vehicle	0
					West	Stopped	Passenger van	Other motor vehicle	
2017-Sep-10, Sun,18:25	Clear	Turning movement	P.D. only	Dry	North	Turning left	Automobile, station wagon	Other motor vehicle	0
					South	Going ahead	Automobile, station wagon	Other motor vehicle	
2017-Sep-26, Tue,10:05	Clear	Turning movement	P.D. only	Dry	West	Turning left	Automobile, station wagon	Other motor vehicle	0
					East	Going ahead	Automobile, station wagon	Other motor vehicle	
2017-Oct-30, Mon,08:20	Rain	Other	P.D. only	Wet	West	Reversing	Unknown	Other motor vehicle	0
					East	Stopped	Pick-up truck	Other motor vehicle	
2017-Nov-12, Sun,20:14	Clear	Turning movement	P.D. only	Dry	West	Turning left	Automobile, station wagon	Other motor vehicle	0
					East	Going ahead	Pick-up truck	Other motor vehicle	
2017-Dec-12, Tue,06:55	Snow	Turning movement	P.D. only	Loose snow	East	Turning left	Automobile, station wagon	Other motor vehicle	0
					West	Going ahead	Automobile, station wagon	Other motor vehicle	
2017-Dec-29, Fri,12:58	Clear	Turning movement	P.D. only	Dry	East	Turning left	Automobile, station wagon	Other motor vehicle	0
					West	Going ahead	Passenger van	Other motor vehicle	
2018-Jan-16, Tue,14:00	Clear	Turning movement	P.D. only	Wet	East	Turning left	Passenger van	Other motor vehicle	0
					West	Going ahead	Automobile, station wagon	Other motor vehicle	
2018-Feb-10, Sat,22:38	Snow	Turning movement	P.D. only	Slush	West	Turning left	Automobile, station wagon	Other motor vehicle	0
					East	Going ahead	Automobile, station wagon	Other motor vehicle	



Transportation Services - Traffic Services

Collision Details Report - Public Version

From: January 1, 2017 To: December 31, 2021

Location: ALTA VISTA DR @ SMYTH RD

Traffic Control: Traffic signal

Total Collisions: 66

Date/Day/Time	Environment	Impact Type	Classification	Surface Cond'n	Veh. Dir	Vehicle Manoeuvre	Vehicle type	First Event	No. Ped
2018-Feb-25, Sun,09:45	Freezing Rain	Rear end	Non-fatal injury	Ice	North	Turning left	Passenger van	Skidding/sliding	0
					North	Turning left	Passenger van	Other motor vehicle	
2018-Mar-08, Thu,18:53	Snow	Rear end	P.D. only	Ice	North	Slowing or stopping	Automobile, station wagon	Skidding/sliding	0
					North	Stopped	Automobile, station wagon	Other motor vehicle	
2018-Mar-29, Thu,14:33	Rain	Sideswipe	P.D. only	Wet	East	Merging	Automobile, station wagon	Other motor vehicle	0
					East	Going ahead	Truck - dump	Other motor vehicle	
2018-May-26, Sat,11:13	Clear	Turning movement	P.D. only	Wet	South	Turning left	Automobile, station wagon	Other motor vehicle	0
					North	Going ahead	Automobile, station wagon	Other motor vehicle	
2018-May-30, Wed,13:00	Clear	Turning movement	P.D. only	Dry	East	Turning left	Automobile, station wagon	Other motor vehicle	0
					West	Going ahead	Pick-up truck	Other motor vehicle	
2018-Jun-26, Tue,08:50	Clear	Turning movement	P.D. only	Dry	West	Turning left	Automobile, station wagon	Other motor vehicle	0
					East	Going ahead	Automobile, station wagon	Other motor vehicle	
2018-Jul-12, Thu,22:16	Clear	Turning movement	P.D. only	Dry	North	Turning left	Automobile, station wagon	Other motor vehicle	0
					South	Going ahead	Automobile, station wagon	Other motor vehicle	
2018-Jul-17, Tue,12:11	Clear	Sideswipe	P.D. only	Dry	West	Changing lanes	Unknown	Other motor vehicle	0
					West	Stopped	Automobile, station wagon	Other motor vehicle	
2018-Sep-03, Mon,21:01	Clear	Turning movement	P.D. only	Dry	West	Turning left	Automobile, station wagon	Other motor vehicle	0
					East	Going ahead	Automobile, station wagon	Other motor vehicle	
2018-Sep-17, Mon,17:30	Clear	Turning movement	Non-fatal injury	Dry	East	Turning left	Automobile, station wagon	Other motor vehicle	0
					West	Going ahead	Automobile, station wagon	Other motor vehicle	
2018-Sep-19, Wed,12:30	Clear	Turning movement	P.D. only	Dry	South	Turning left	Automobile, station wagon	Other motor vehicle	0
					North	Going ahead	Passenger van	Other motor vehicle	
2018-Nov-17, Sat,17:13	Clear	Turning movement	P.D. only	Wet	East	Turning left	Automobile, station wagon	Other motor vehicle	0
					West	Going ahead	Automobile, station wagon	Other motor vehicle	



Transportation Services - Traffic Services

Collision Details Report - Public Version

From: January 1, 2017 To: December 31, 2021

Location: ALTA VISTA DR @ SMYTH RD

Traffic Control: Traffic signal

Total Collisions: 66

Date/Day/Time	Environment	Impact Type	Classification	Surface Cond'n	Veh. Dir	Vehicle Manoeuvre	Vehicle type	First Event	No. Ped
2018-Nov-26, Mon,17:20	Rain	Turning movement	P.D. only	Wet	East	Turning left	Passenger van	Other motor vehicle	0
					West	Going ahead	Automobile, station wagon	Other motor vehicle	
2018-Dec-06, Thu,10:15	Clear	Sideswipe	P.D. only	Wet	East	Changing lanes	Automobile, station wagon	Other motor vehicle	0
					East	Going ahead	Automobile, station wagon	Other motor vehicle	
2019-Apr-09, Tue,06:48	Snow	Rear end	P.D. only	Ice	East	Slowing or stopping	Automobile, station wagon	Other motor vehicle	0
					East	Stopped	Automobile, station wagon	Other motor vehicle	
2019-Apr-16, Tue,07:43	Clear	Rear end	P.D. only	Dry	North	Going ahead	Automobile, station wagon	Other motor vehicle	0
					North	Stopped	Automobile, station wagon	Other motor vehicle	
2019-Apr-24, Wed,19:05	Clear	Rear end	P.D. only	Dry	East	Turning right	Automobile, station wagon	Other motor vehicle	0
					East	Turning right	Automobile, station wagon	Other motor vehicle	
2019-May-04, Sat,23:06	Clear	Turning movement	P.D. only	Dry	North	Turning left	Automobile, station wagon	Other motor vehicle	0
					South	Going ahead	Automobile, station wagon	Other motor vehicle	
2019-May-07, Tue,19:25	Clear	Rear end	P.D. only	Dry	South	Turning right	Automobile, station wagon	Other motor vehicle	0
					South	Turning right	Automobile, station wagon	Other motor vehicle	
2019-Jul-09, Tue,09:30	Clear	Rear end	P.D. only	Dry	South	Going ahead	Pick-up truck	Other motor vehicle	0
					South	Stopped	Automobile, station wagon	Other motor vehicle	
2019-Jul-11, Thu,19:50	Clear	Rear end	P.D. only	Dry	East	Turning right	Automobile, station wagon	Other motor vehicle	0
					East	Turning right	Unknown	Other motor vehicle	
2019-Jul-17, Wed,17:10	Clear	Turning movement	P.D. only	Dry	East	Turning left	Automobile, station wagon	Other motor vehicle	0
					West	Going ahead	Automobile, station wagon	Other motor vehicle	
2019-Aug-01, Thu,16:58	Clear	Turning movement	P.D. only	Dry	South	Turning left	Automobile, station wagon	Other motor vehicle	0
					North	Going ahead	Automobile, station wagon	Other motor vehicle	
2019-Aug-05, Mon,16:25	Clear	Rear end	P.D. only	Dry	East	Turning right	Automobile, station wagon	Other motor vehicle	0
					East	Turning right	Passenger van	Other motor vehicle	



Transportation Services - Traffic Services

Collision Details Report - Public Version

From: January 1, 2017 To: December 31, 2021

Location: ALTA VISTA DR @ SMYTH RD

Traffic Control: Traffic signal

Total Collisions: 66

Date/Day/Time	Environment	Impact Type	Classification	Surface Cond'n	Veh. Dir	Vehicle Manoeuver	Vehicle type	First Event	No. Ped
2019-Aug-13, Tue,19:33	Clear	Rear end	P.D. only	Dry	East	Turning right	Automobile, station wagon	Other motor vehicle	0
					East	Turning right	Automobile, station wagon	Other motor vehicle	
2019-Aug-28, Wed,16:30	Clear	Rear end	P.D. only	Dry	North	Slowing or stopping	Automobile, station wagon	Other motor vehicle	0
					North	Stopped	Automobile, station wagon	Other motor vehicle	
2019-Sep-27, Fri,07:38	Clear	Turning movement	P.D. only	Dry	West	Turning left	Automobile, station wagon	Other motor vehicle	0
					East	Going ahead	Automobile, station wagon	Other motor vehicle	
2019-Sep-30, Mon,23:09	Rain	Turning movement	Non-fatal injury	Wet	West	Turning left	Automobile, station wagon	Other motor vehicle	0
					East	Going ahead	Automobile, station wagon	Other motor vehicle	
2019-Oct-09, Wed,19:03	Clear	Turning movement	Non-fatal injury	Dry	South	Turning left	Automobile, station wagon	Other motor vehicle	0
					North	Going ahead	Automobile, station wagon	Other motor vehicle	
2019-Oct-22, Tue,17:00	Rain	Turning movement	Non-fatal injury	Wet	West	Turning left	Automobile, station wagon	Other motor vehicle	0
					East	Going ahead	Automobile, station wagon	Other motor vehicle	
2019-Oct-25, Fri,13:40	Clear	Turning movement	Non-fatal injury	Dry	West	Turning left	Delivery van	Other motor vehicle	0
					East	Going ahead	Automobile, station wagon	Other motor vehicle	
2019-Nov-25, Mon,17:03	Clear	Turning movement	P.D. only	Dry	East	Turning left	Passenger van	Other motor vehicle	0
					West	Going ahead	Automobile, station wagon	Other motor vehicle	
2019-Nov-29, Fri,08:38	Clear	Angle	Non-fatal injury	Dry	East	Going ahead	Automobile, station wagon	Other motor vehicle	0
					North	Turning left	Automobile, station wagon	Other motor vehicle	
					South	Turning left	Automobile, station wagon	Other motor vehicle	
2019-Nov-30, Sat,12:00	Clear	Rear end	P.D. only	Dry	East	Turning right	Automobile, station wagon	Other motor vehicle	0
					East	Stopped	Unknown	Other motor vehicle	
2020-Jan-19, Sun,21:01	Clear	Angle	Non-fatal injury	Loose snow	North	Going ahead	Automobile, station wagon	Other motor vehicle	0
					West	Going ahead	Automobile, station wagon	Other motor vehicle	



Transportation Services - Traffic Services

Collision Details Report - Public Version

From: January 1, 2017 **To:** December 31, 2021

Location: ALTA VISTA DR @ SMYTH RD

Traffic Control: Traffic signal

Total Collisions: 66

Date/Day/Time	Environment	Impact Type	Classification	Surface Cond'n	Veh. Dir	Vehicle Manoeuver	Vehicle type	First Event	No. Ped
2020-Mar-27, Fri,14:30	Clear	Rear end	P.D. only	Dry	North	Going ahead	Automobile, station wagon	Other motor vehicle	0
					North	Stopped	Pick-up truck	Other motor vehicle	
2020-Jun-17, Wed,12:26	Clear	Angle	P.D. only	Dry	North	Turning right	Automobile, station wagon	Other motor vehicle	0
					East	Going ahead	Ambulance	Other motor vehicle	
2020-Aug-07, Fri,15:01	Clear	Rear end	P.D. only	Dry	West	Going ahead	Pick-up truck	Other motor vehicle	0
					West	Slowing or stopping	Automobile, station wagon	Other motor vehicle	
2021-Feb-16, Tue,15:57	Snow	Turning movement	P.D. only	Loose snow	West	Turning left	Passenger van	Other motor vehicle	0
					East	Going ahead	Automobile, station wagon	Other motor vehicle	
2021-Jul-26, Mon,21:00	Clear	Angle	P.D. only	Dry	East	Going ahead	Automobile, station wagon	Other motor vehicle	0
					South	Going ahead	Automobile, station wagon	Other motor vehicle	
2021-Sep-16, Thu,11:30	Clear	Turning movement	P.D. only	Dry	North	Turning left	Automobile, station wagon	Other motor vehicle	0
					South	Going ahead	Automobile, station wagon	Other motor vehicle	
2021-Oct-10, Sun,16:25	Clear	Rear end	P.D. only	Dry	South	Going ahead	Unknown	Other motor vehicle	0
					South	Stopped	Pick-up truck	Other motor vehicle	
2021-Nov-10, Wed,08:15	Clear	Rear end	P.D. only	Dry	North	Turning right	Pick-up truck	Other motor vehicle	0
					North	Turning right	Pick-up truck	Other motor vehicle	
2021-Nov-11, Thu,07:56	Clear	SMV other	Non-fatal injury	Dry	South	Turning left	Unknown	Pedestrian	1
2021-Nov-23, Tue,21:00	Clear	Rear end	P.D. only	Dry	East	Slowing or stopping	Automobile, station wagon	Other motor vehicle	0
					East	Stopped	Automobile, station wagon	Other motor vehicle	
2021-Dec-02, Thu,06:40	Clear	Rear end	Non-fatal injury	Dry	East	Slowing or stopping	Automobile, station wagon	Other motor vehicle	0
					East	Stopped	Automobile, station wagon	Other motor vehicle	
2021-Dec-10, Fri,08:06	Clear	Turning movement	Non-fatal injury	Slush	West	Turning left	Automobile, station wagon	Other motor vehicle	0
					East	Going ahead	Automobile, station wagon	Other motor vehicle	



Transportation Services - Traffic Services

Collision Details Report - Public Version

From: January 1, 2017 To: December 31, 2021

Location: ALTA VISTA DR @ VALOUR DR

Traffic Control: Stop sign

Total Collisions: 5

Date/Day/Time	Environment	Impact Type	Classification	Surface Cond'n	Veh. Dir	Vehicle Manoeuver	Vehicle type	First Event	No. Ped
2018-Jan-29, Mon,08:25	Clear	Rear end	P.D. only	Wet	South	Going ahead	Automobile, station wagon	Other motor vehicle	0
					South	Stopped	Automobile, station wagon	Other motor vehicle	
					South	Stopped	Automobile, station wagon	Other motor vehicle	
2018-Sep-04, Tue,07:45	Clear	Rear end	P.D. only	Dry	North	Going ahead	Passenger van	Other motor vehicle	0
					North	Stopped	Automobile, station wagon	Other motor vehicle	
2018-Nov-14, Wed,14:40	Clear	Rear end	P.D. only	Dry	West	Slowing or stopping	Pick-up truck	Other motor vehicle	0
					West	Stopped	Automobile, station wagon	Other motor vehicle	
2018-Dec-30, Sun,11:20	Clear	Angle	P.D. only	Dry	East	Turning right	Automobile, station wagon	Other motor vehicle	0
					South	Going ahead	Automobile, station wagon	Other motor vehicle	
2019-Oct-27, Sun,13:01	Rain	Angle	P.D. only	Wet	East	Turning right	Automobile, station wagon	Other motor vehicle	0
					South	Going ahead	Automobile, station wagon	Other motor vehicle	

Location: ALTA VISTA DR btwn SMYTH RD & VALOUR DR

Traffic Control: No control

Total Collisions: 4

Date/Day/Time	Environment	Impact Type	Classification	Surface Cond'n	Veh. Dir	Vehicle Manoeuver	Vehicle type	First Event	No. Ped
2017-Mar-17, Fri,08:34	Clear	Rear end	P.D. only	Dry	North	Slowing or stopping	Automobile, station wagon	Other motor vehicle	0
					North	Stopped	Automobile, station wagon	Other motor vehicle	
					North	Stopped	Pick-up truck	Other motor vehicle	
2017-Nov-21, Tue,07:55	Clear	Approaching	P.D. only	Dry	South	Going ahead	Automobile, station wagon	Other motor vehicle	0
					North	Going ahead	Automobile, station wagon	Other motor vehicle	
2018-Jan-13, Sat,12:30	Drifting Snow	SMV other	P.D. only	Packed snow	South	Going ahead	Automobile, station wagon	Snowbank/drift	0
2019-Oct-11, Fri,12:20	Clear	Rear end	P.D. only	Dry	North	Slowing or stopping	Automobile, station wagon	Other motor vehicle	0
					North	Stopped	Automobile, station wagon	Other motor vehicle	



Transportation Services - Traffic Services

Collision Details Report - Public Version

From: January 1, 2017 To: December 31, 2021

Location: ALTA VISTA DR btwn VALOUR DR & BALFOUR AVE

Traffic Control: No control

Total Collisions: 2

Date/Day/Time	Environment	Impact Type	Classification	Surface Cond'n	Veh. Dir	Vehicle Manoeuver	Vehicle type	First Event	No. Ped
2018-May-09, Wed,05:07	Clear	SMV other	P.D. only	Dry	North	Going ahead	Automobile, station wagon	Pole (utility, power)	0
2020-Feb-15, Sat,07:11	Clear	SMV other	Non-fatal injury	Dry	North	Going ahead	Automobile, station wagon	Construction marker	0

Appendix E-3

COLLISION DIAGRAMS



Alta Vista Dr @ Smyth Rd Collision Diagram

Jurisdiction: City of Ottawa

Period From: 2017-01-01

Location Description: Alta Vista Dr @ Smyth Rd

Period To: 2021-12-31

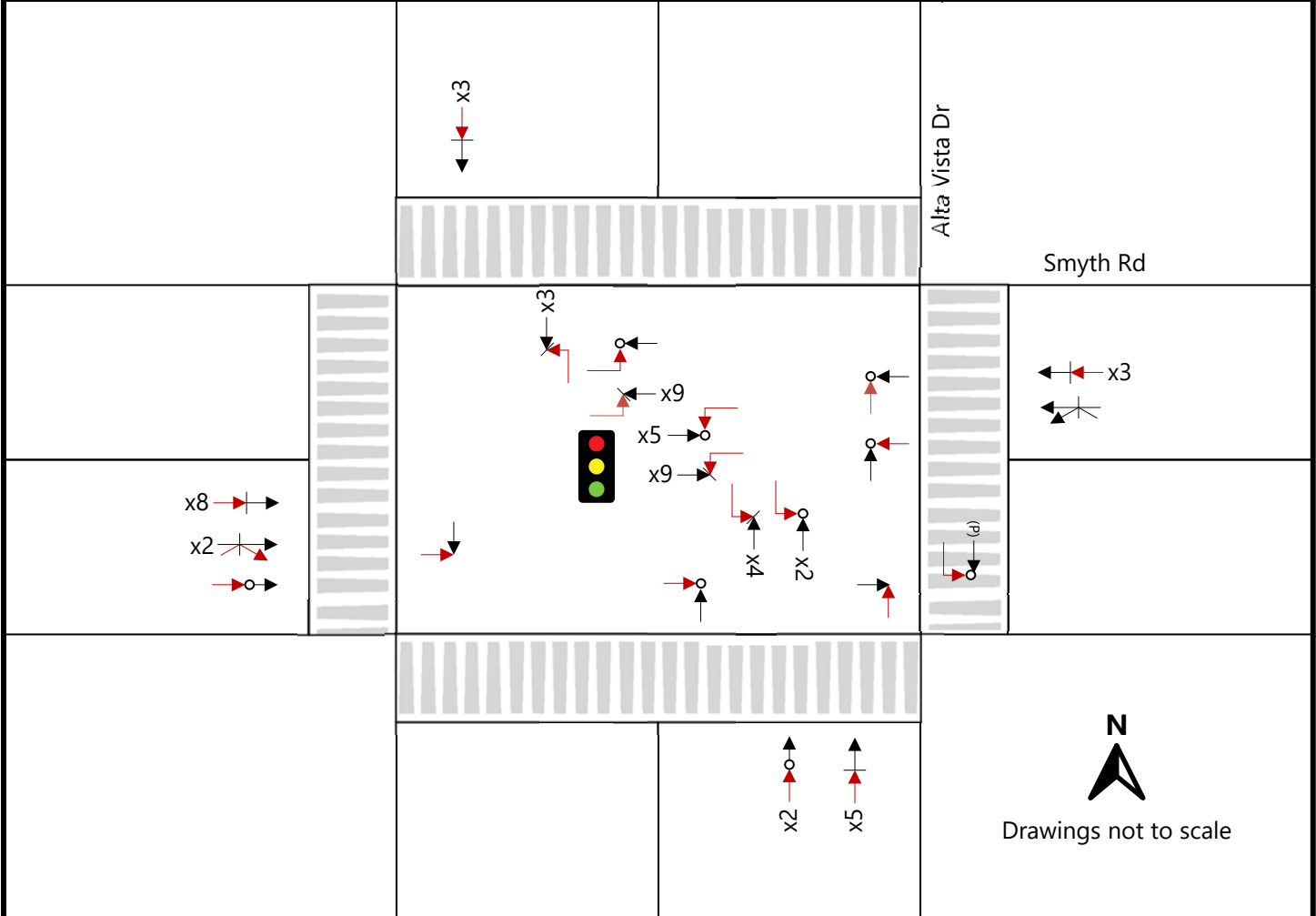

Notes:

- Total # of collisions: **66**
- # of collisions involving pedestrians/cyclists: **1**
- # of collisions not shown due to insufficient info: **1**

Legend

Traffic Control

- Stop sign
- Traffic signal
- Bike Lane
- Ped Crossing

Vehicle Movement

- Left
- Straight
- Right
- Reversing

Vehicle type

- Automobile
- (T) Truck
- (B) Bus/Transit
- (C) Bicycle
- (P) Pedestrian

Collision Type

- Rear-end
- Turning
- Fixed object
- Animal
- Out of control
- Angle
- Sideswipe
- Approaching
- Vehicle 1

Crash Severity

- Property damage only
- Non-fatal injury
- Fatality
- Vehicle 1 (normally at fault)

Data Source: OPD

Disclaimer: The data depicted is approximate and is not to be used for any other purposes beyond the scope of this project.

General Hospital (W)/S Haven PI @ Smyth Rd Collision Diagram

Jurisdiction: City of Ottawa

Period From: 2017-01-01

Location Description: General Hospital (W)/ S Haven PI @ Smyth Rd

Period To: 2021-12-31

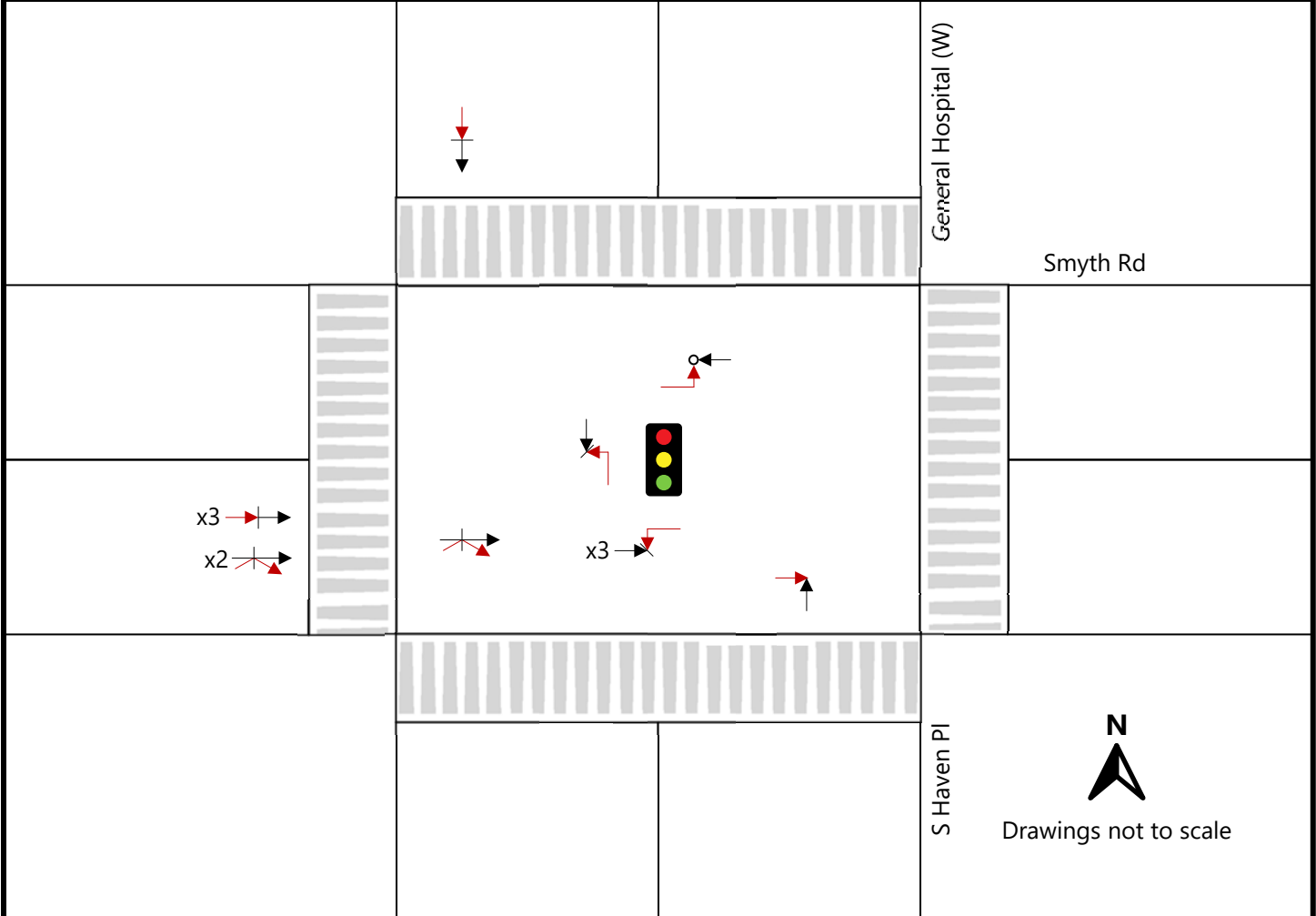

Notes:

- Total # of collisions: **13**
- # of collisions involving pedestrians/cyclists: **0**
- # of collisions not shown due to insufficient info: **0**

Legend

Traffic Control



Stop sign



Traffic signal



Bike Lane



Ped Crossing

Vehicle Movement

- ↑ Left
- Straight
- ↓ Right
- ↔ Reversing

Vehicle type

- Automobile
- (T) → Truck
- (B) → Bus/Transit
- (C) → Bicycle
- (P) → Pedestrian

Collision Type

- |→ Rear-end
- |↘ Turning
- |□ Fixed object
- |A Animal
- ↘ Out of control
- |↘ Angle
- ↘|↘ Sideswipe
- |↔ Approaching
- Vehicle 1

Crash Severity

- |→ Property damage only
- |○ Non-fatal injury
- |● Fatality
- Vehicle 1 (normally at fault)

Data Source: OPD

Disclaimer: The data depicted is approximate and is not to be used for any other purposes beyond the scope of this project.

General Hospital (E) @ Smyth Rd Collision Diagram

Jurisdiction: City of Ottawa

Period From: 2017-01-01

Location Description: General Hospital (E) @ Smyth Rd

Period To: 2021-12-31

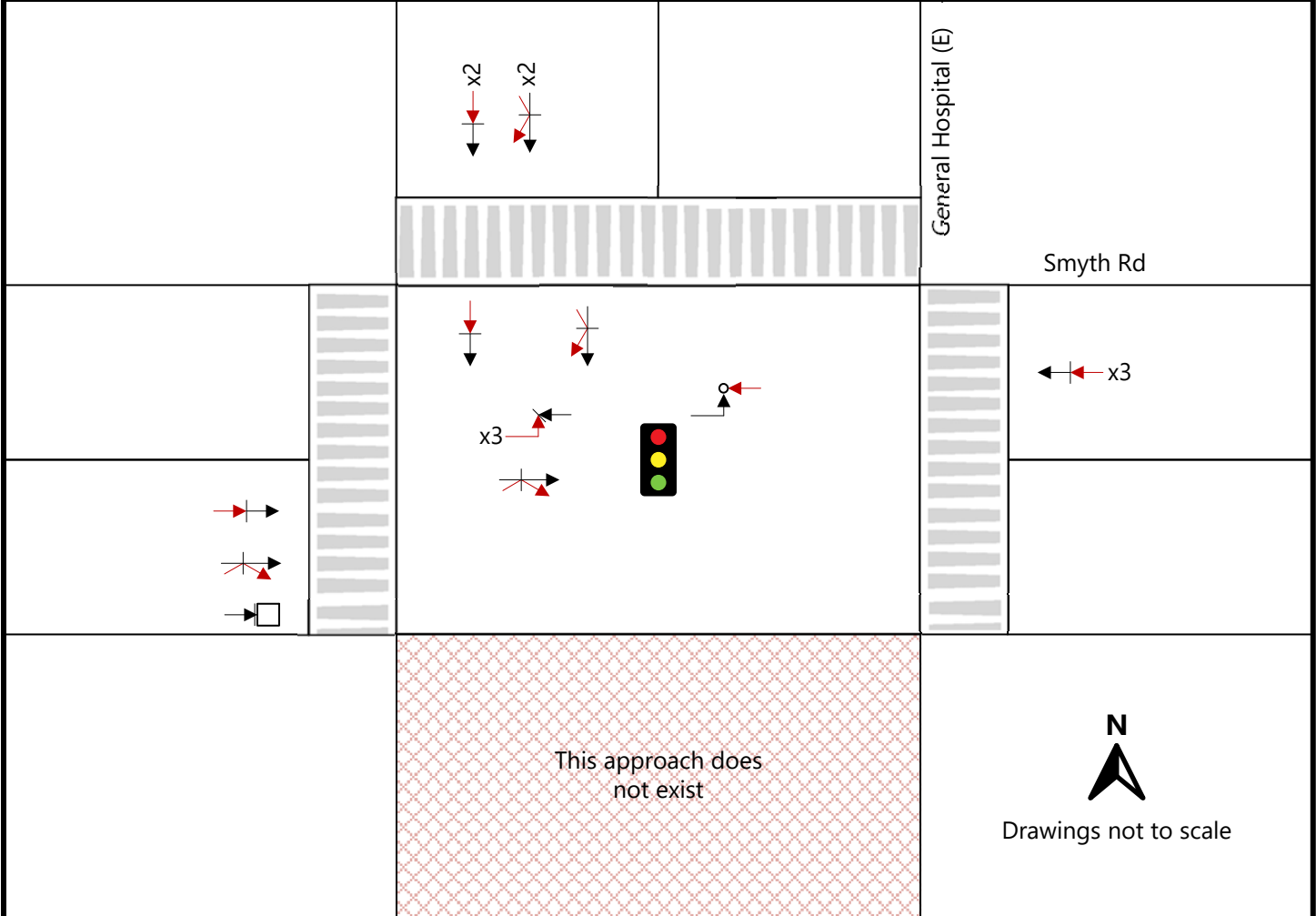

Notes:

- Total # of collisions: **17**
- # of collisions involving pedestrians/cyclists: **0**
- # of collisions not shown due to insufficient info: **0**

Legend

Traffic Control



Stop sign



Traffic signal



Bike Lane



Ped Crossing

Vehicle Movement



Left



Straight



Right



Reversing

Vehicle type

→ Automobile

(T) → Truck

(B) → Bus/Transit

(C) → Bicycle

(P) → Pedestrian

Collision Type



Rear-end



Turning



Fixed object



Animal



Out of control



Angle



Sideswipe



Approaching



Vehicle 1

Crash Severity



Property damage only



Non-fatal injury



Fatality



Vehicle 1 (normally at fault)

Data Source: OPD

Disclaimer: The data depicted is approximate and is not to be used for any other purposes beyond the scope of this project.

Lynda Ln @ Smyth Rd Collision Diagram

Jurisdiction: City of Ottawa

Period From: 2017-01-01

Location Description: Lynda Ln @ Smyth Rd

Period To: 2021-12-31



Notes:

- Total # of collisions: **15**
- # of collisions involving pedestrians/cyclists: **0**
- # of collisions not shown due to insufficient info: **1**

Legend

Traffic Control

- Stop sign
- Traffic signal
- Bike Lane
- Ped Crossing

Vehicle Movement

- Left
- Straight
- Right
- Reversing

Vehicle type

- Automobile
- (T) Truck
- (B) Bus/Transit
- (C) Bicycle
- (P) Pedestrian

Collision Type

- Rear-end
- Turning
- Fixed object
- Animal
- Out of control
- Angle
- Sideswipe
- Approaching
- Vehicle 1

Crash Severity

- Property damage only
- Non-fatal injury
- Fatality
- Vehicle 1 (normally at fault)

Data Source: OPD

Disclaimer: The data depicted is approximate and is not to be used for any other purposes beyond the scope of this project.

Roger Guindon Ave @ Smyth Road Collision Diagram

Jurisdiction: City of Ottawa

Period From: 2017-01-01

Location Description: Roger Guindon Ave @ Smyth Rd

Period To: 2021-12-31

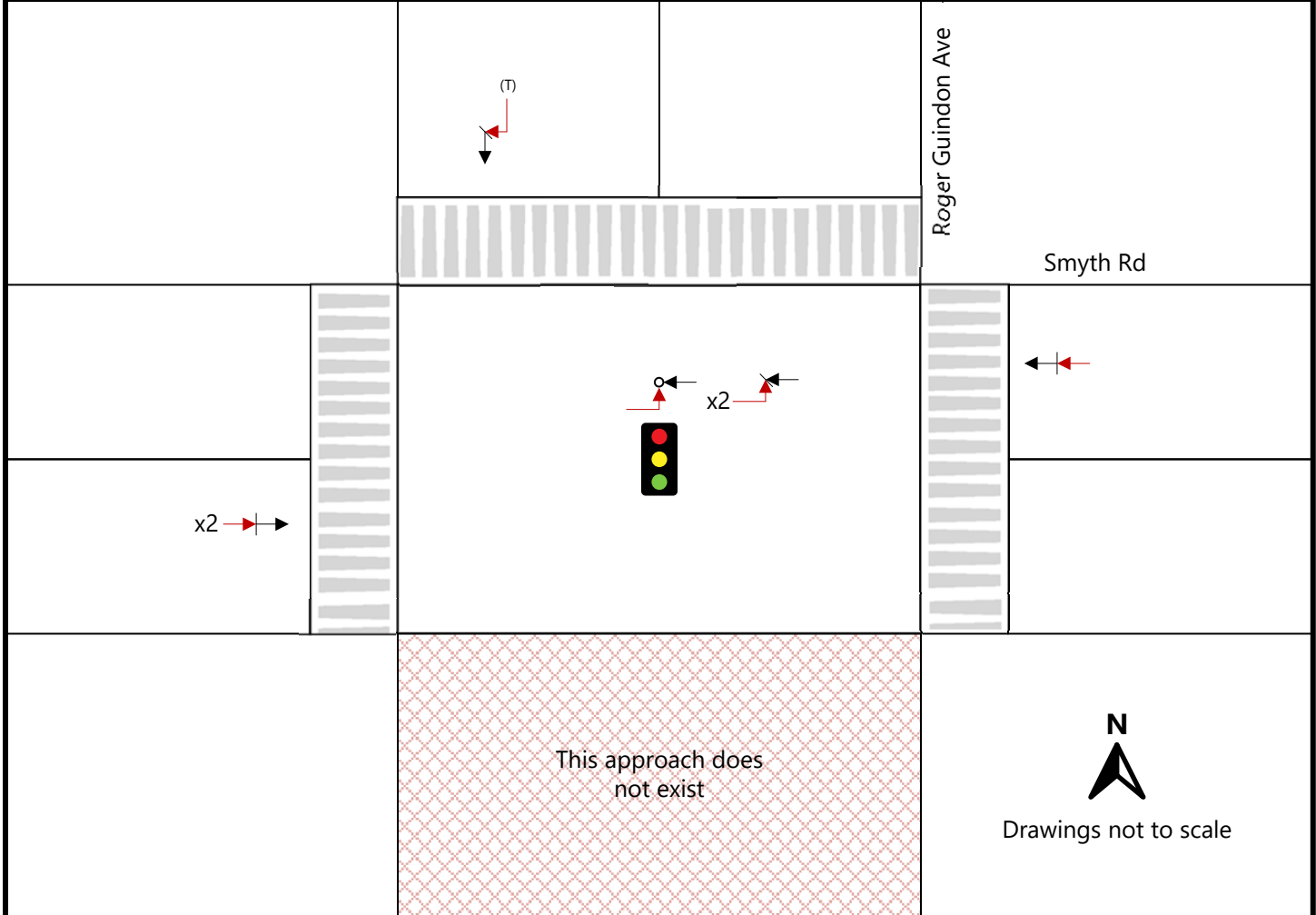

Notes:

- Total # of collisions: **8**
- # of collisions involving pedestrians/cyclists: **0**
- # of collisions not shown due to insufficient info: **1**

Legend

Traffic Control

- Stop sign
- Traffic signal
- Bike Lane
- Ped Crossing

Vehicle Movement

- Left
- Straight
- Right
- Reversing

Vehicle type

- Automobile
- (T) Truck
- (B) Bus/Transit
- (C) Bicycle
- (P) Pedestrian

Collision Type

- Rear-end
- Turning
- Fixed object
- Animal
- Out of control
- Angle
- Sideswipe
- Approaching
- Vehicle 1

Crash Severity

- Property damage only
- Non-fatal injury
- Fatality
- Vehicle 1 (normally at fault)

Data Source: OPD

Disclaimer: The data depicted is approximate and is not to be used for any other purposes beyond the scope of this project.

Appendix F

RELATED TIA EXCERPTS



Vehicle Trip Generation

Using the rates noted in **Table 7** above, EXP estimated the number of site-generated auto-trips. The estimated site-generated auto trips are shown in **Table 8**. Also, the City of Ottawa’s typical method of calculating person-trips was not completed as the proposed development is a parking garage and will only serve auto trips.

Table 8: Site-Generated Trips

Land Use Code	Trip Type	Weekday AM Peak Hour			Weekday PM Peak Hour		
		Total	In	Out	Total	In	Out
Hospital (610)	Auto Trips	101	73	28	101	30	71

While 360 staff are on the parking waitlist, the ITE auto trip rate was still applied to the number of employees as all vehicle trips are not anticipated to occur during the peak hours and are expected to be spread throughout the day. It should be noted that the 360 staff on the waitlist for future parking use were assumed to be spread out throughout the day due to the nature of shift work schedules. The first two floors of the new parking garage provide spaces for visitors this will accommodate the existing visitor parking spaces being eliminated in the future. A total of 770 of staff parking spaces will be provided.

3.1.2. Trip Distribution

The distribution of site-generated traffic entering/exiting the site was developed using traffic data from the intersections of Smyth Road / Ring Road (N-S), Smyth Road / General Hospital Access Road, and Hospital Link Road / Ring Road (N-S). Key movements from these traffic counts were used to develop the proportion of traffic entering/exiting the site from each direction. The trip distribution percentages for site-generated traffic are presented in **Table 9**.

Table 9: Trip Distribution Percentages

	Intersection	Movement	AM Peak Hour %	PM Peak Hour %
Entering	Smyth Road / South Haven Place	Eastbound left	30	26
	Smyth Road / General Hospital Access Road	Eastbound left	10	10
	Smyth Road / General Hospital Access Road	Westbound right	47	55
	Hospital Link Road / Ring Road (N-S)	Eastbound right	13	9
Exiting	Smyth Road / South Haven Place	Southbound right	10	30
		Westbound through	6	14
	Smyth Road / General Hospital Access Road	Southbound left	64	46
	Hospital Link Road / Ring Road (N-S)	Northbound left	20	10

The AM and PM peak hour site-generated traffic distribution are presented by cardinal direction in **Figure 7**.

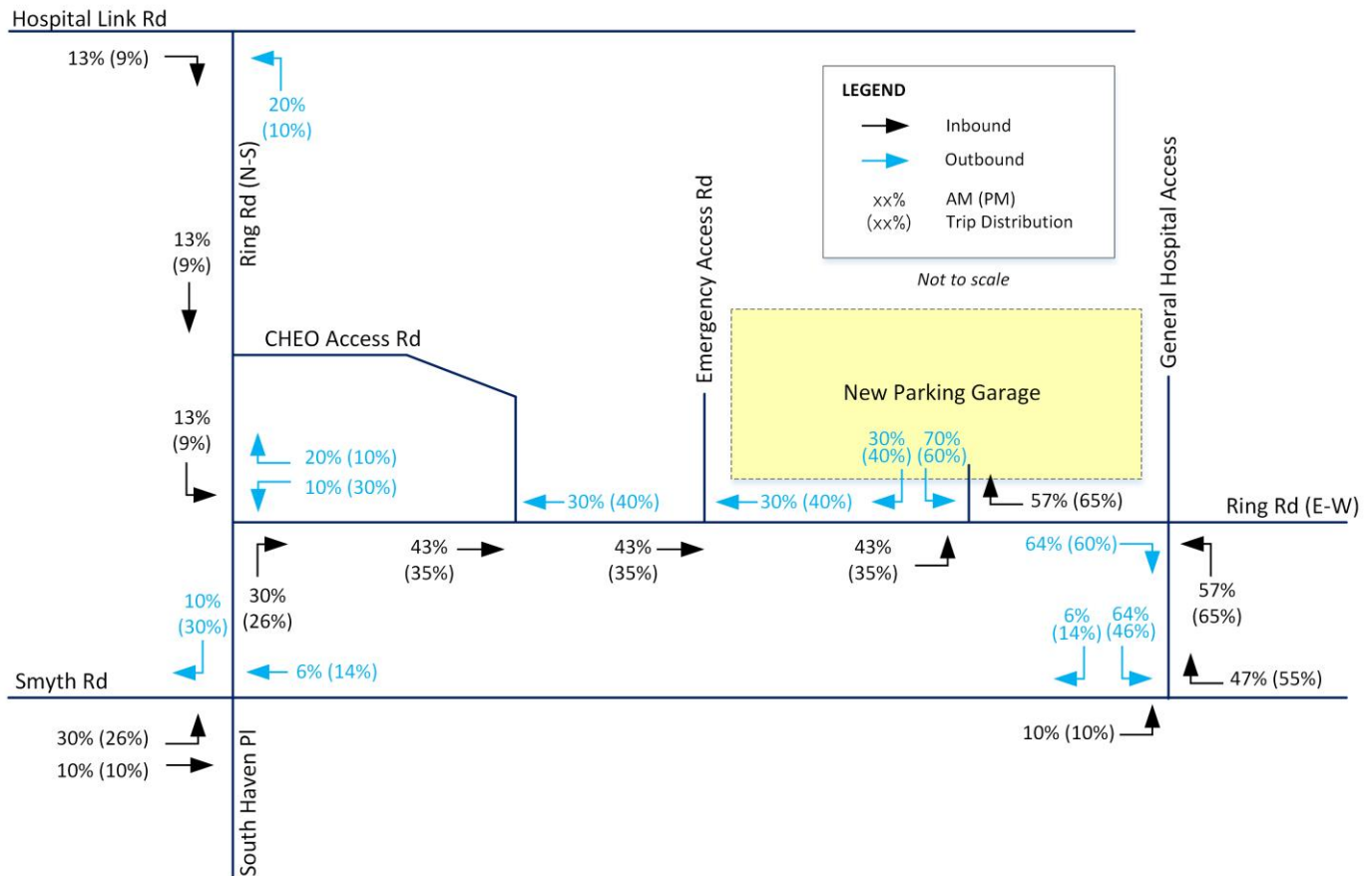

Figure 7: AM and PM Peak Hour Site Generated Trips Distribution

3.1.3. Trip Assignment

Site-generated trips were then assigned to the road network based on the proportions developed in **Section 3.1.2**. The AM and PM peak hour site-generated traffic volumes are presented in **Figure 8**.

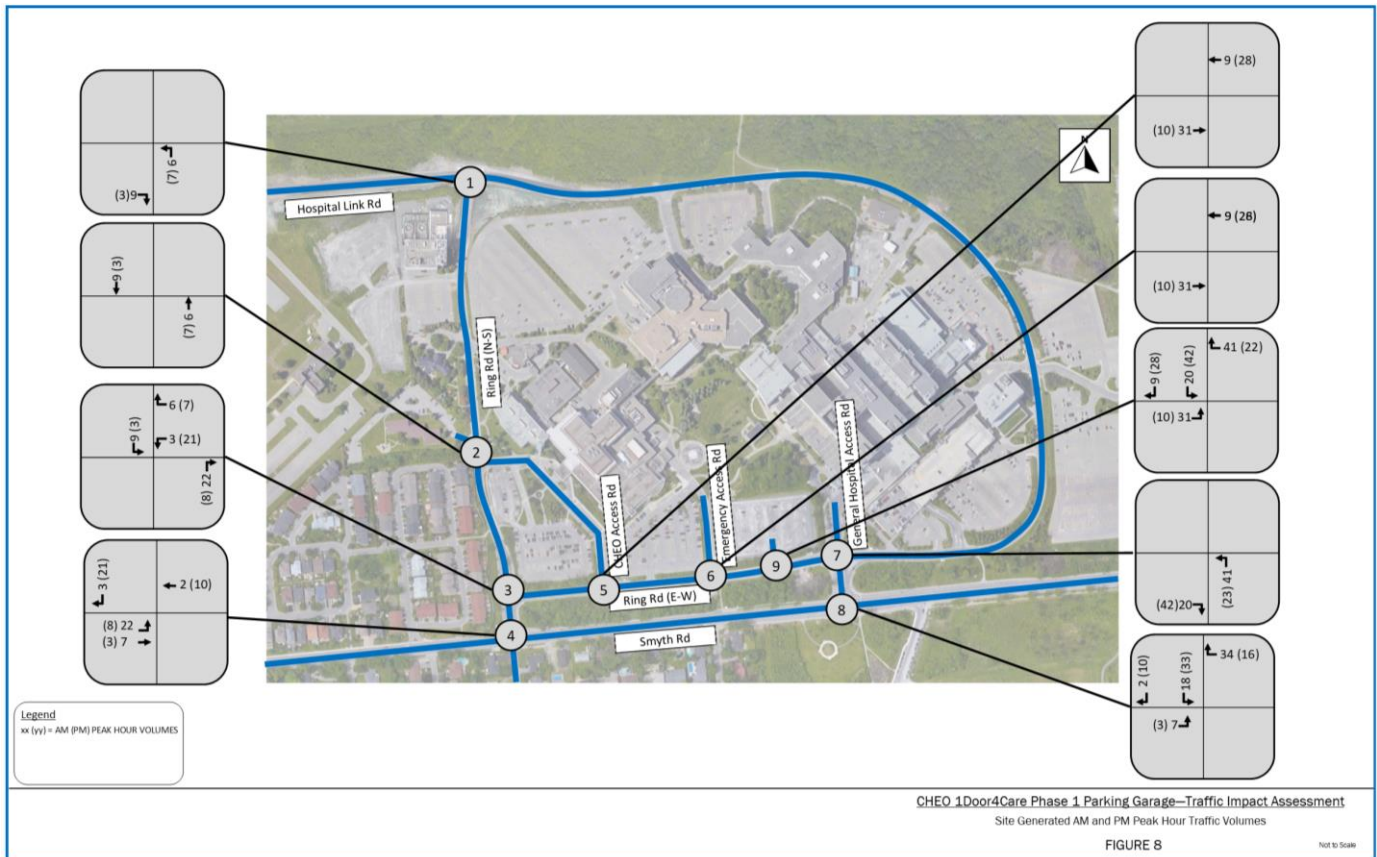

Figure 8: AM and PM Peak Hour Site Generated Trips

Appendix G

TDM CHECKLISTS



TDM-Supportive Development Design and Infrastructure Checklist: Non-Residential Developments (office, institutional, retail or industrial)

Legend	
REQUIRED	The Official Plan or Zoning By-law provides related guidance that must be followed
BASIC	The measure is generally feasible and effective, and in most cases would benefit the development and its users
BETTER	The measure could maximize support for users of sustainable modes, and optimize development performance

TDM-supportive design & infrastructure measures: <i>Non-residential developments</i>		Check if completed & add descriptions, explanations or plan/drawing references
1. WALKING & CYCLING: ROUTES		
1.1 Building location & access points		
BASIC	1.1.1 Locate building close to the street, and do not locate parking areas between the street and building entrances	<input checked="" type="checkbox"/>
BASIC	1.1.2 Locate building entrances in order to minimize walking distances to sidewalks and transit stops/stations	<input checked="" type="checkbox"/>
BASIC	1.1.3 Locate building doors and windows to ensure visibility of pedestrians from the building, for their security and comfort	<input checked="" type="checkbox"/>
1.2 Facilities for walking & cycling		
REQUIRED	1.2.1 Provide convenient, direct access to stations or major stops along rapid transit routes within 600 metres; minimize walking distances from buildings to rapid transit; provide pedestrian-friendly, weather-protected (where possible) environment between rapid transit accesses and building entrances; ensure quality linkages from sidewalks through building entrances to integrated stops/stations (see <i>Official Plan policy 4.3.3</i>)	<input type="checkbox"/> N/A - Smyth and Lycée Claudel stations are the nearest to the site, but are not within 600m.
REQUIRED	1.2.2 Provide safe, direct and attractive pedestrian access from public sidewalks to building entrances through such measures as: reducing distances between public sidewalks and major building entrances; providing walkways from public streets to major building entrances; within a site, providing walkways along the front of adjoining buildings, between adjacent buildings, and connecting areas where people may congregate, such as courtyards and transit stops; and providing weather protection through canopies, colonnades, and other design elements wherever possible (see <i>Official Plan policy 4.3.12</i>)	<input checked="" type="checkbox"/> Proposed sidewalks connect the main and parking entrances directly to the existing asphalt sidewalk adjacent to the site on the south side of Ring Road. The development will incorporate and expand the existing pedestrian infrastructure fronting the building to provide connections to building entrances.

TDM-supportive design & infrastructure measures: <i>Non-residential developments</i>		Check if completed & add descriptions, explanations or plan/drawing references
REQUIRED	1.2.3 Provide sidewalks of smooth, well-drained walking surfaces of contrasting materials or treatments to differentiate pedestrian areas from vehicle areas, and provide marked pedestrian crosswalks at intersection sidewalks (see <i>Official Plan policy 4.3.10</i>)	<input checked="" type="checkbox"/> The proposed sidewalks are horizontally or curb separated from access roadway with crosswalks provided at the crossing of an internal parking lot access and the access on Ring Road.
REQUIRED	1.2.4 Make sidewalks and open space areas easily accessible through features such as gradual grade transition, depressed curbs at street corners and convenient access to extra-wide parking spaces and ramps (see <i>Official Plan policy 4.3.10</i>)	<input checked="" type="checkbox"/> 6 accessible parking spaces are proposed near a building entrance with supporting infrastructure (depressed curb ramps) ensuring convenient access to sidewalks
REQUIRED	1.2.5 Include adequately spaced inter-block/street cycling and pedestrian connections to facilitate travel by active transportation. Provide links to the existing or planned network of public sidewalks, multi-use pathways and on-road cycle routes. Where public sidewalks and multi-use pathways intersect with roads, consider providing traffic control devices to give priority to cyclists and pedestrians (see <i>Official Plan policy 4.3.11</i>)	<input checked="" type="checkbox"/> Proposed sidewalks link the site directly to the existing asphalt sidewalk adjacent to the site on the south side of Ring Road. Existing intersections adjacent to site provide some level of pedestrian and cycling crossings and there are no gaps in facilities leading to the proposed development. It is assumed that upon completion, the site access intersection on Ring Road will be stop controlled for the side street for pedestrian safety and that a crosswalk/continuous sidewalk will be provided at the south leg.
BASIC	1.2.6 Provide safe, direct and attractive walking routes from building entrances to nearby transit stops	<input checked="" type="checkbox"/> A proposed sidewalk from the main entrance is provided to the shuttle bus stop and OC Transpo Stop #1591, both located within 200 m
BASIC	1.2.7 Ensure that walking routes to transit stops are secure, visible, lighted, shaded and wind-protected wherever possible	<input checked="" type="checkbox"/>
BASIC	1.2.8 Design roads used for access or circulation by cyclists using a target operating speed of no more than 30 km/h, or provide a separated cycling facility	<input checked="" type="checkbox"/>
1.3 Amenities for walking & cycling		
BASIC	1.3.1 Provide lighting, landscaping and benches along walking and cycling routes between building entrances and streets, sidewalks and trails	<input checked="" type="checkbox"/>
BASIC	1.3.2 Provide wayfinding signage for site access (where required, e.g. when multiple buildings or entrances exist) and egress (where warranted, such as when directions to reach transit stops/stations, trails or other common destinations are not obvious)	<input checked="" type="checkbox"/>

TDM-supportive design & infrastructure measures: <i>Non-residential developments</i>		Check if completed & add descriptions, explanations or plan/drawing references
2. WALKING & CYCLING: END-OF-TRIP FACILITIES		
2.1 Bicycle parking		
REQUIRED	2.1.1 Provide bicycle parking in highly visible and lighted areas, sheltered from the weather wherever possible (see <i>Official Plan policy 4.3.6</i>)	<input checked="" type="checkbox"/> 186 dedicated bicycle parking spaces are covered by building canopies.
REQUIRED	2.1.2 Provide the number of bicycle parking spaces specified for various land uses in different parts of Ottawa; provide convenient access to main entrances or well-used areas (see <i>Zoning By-law Section 111</i>)	<input checked="" type="checkbox"/> Refer to Table 3-2 in TIA Report. Spaces are outdoor bicycle racks located within reasonable distance of building entrances.
REQUIRED	2.1.3 Ensure that bicycle parking spaces and access aisles meet minimum dimensions; that no more than 50% of spaces are vertical spaces; and that parking racks are securely anchored (see <i>Zoning By-law Section 111</i>)	<input checked="" type="checkbox"/> All bike parking spaces are horizontal.
BASIC	2.1.4 Provide bicycle parking spaces equivalent to the expected number of commuter cyclists (assuming the cycling mode share target is met), plus the expected peak number of customer/visitor cyclists	<input checked="" type="checkbox"/>
BETTER	2.1.5 Provide bicycle parking spaces equivalent to the expected number of commuter and customer/visitor cyclists, plus an additional buffer (e.g. 25 percent extra) to encourage other cyclists and ensure adequate capacity in peak cycling season	<input checked="" type="checkbox"/> Total expected development inbound bicycle trips is 35. The 222 proposed spaces greatly exceed this value.
2.2 Secure bicycle parking		
REQUIRED	2.2.1 Where more than 50 bicycle parking spaces are provided for a single office building, locate at least 25% of spaces within a building/structure, a secure area (e.g. supervised parking lot or enclosure) or bicycle lockers (see <i>Zoning By-law Section 111</i>)	<input type="checkbox"/> n/a - building use is institutional
BETTER	2.2.2 Provide secure bicycle parking spaces equivalent to the expected number of commuter cyclists (assuming the cycling mode share target is met)	<input type="checkbox"/>
2.3 Shower & change facilities		
BASIC	2.3.1 Provide shower and change facilities for the use of active commuters	<input type="checkbox"/>
BETTER	2.3.2 In addition to shower and change facilities, provide dedicated lockers, grooming stations, drying racks and laundry facilities for the use of active commuters	<input type="checkbox"/>
2.4 Bicycle repair station		
BETTER	2.4.1 Provide a permanent bike repair station, with commonly used tools and an air pump, adjacent to the main bicycle parking area (or secure bicycle parking area, if provided)	<input type="checkbox"/>

TDM-supportive design & infrastructure measures: <i>Non-residential developments</i>		Check if completed & add descriptions, explanations or plan/drawing references
3. TRANSIT		
3.1 Customer amenities		
BASIC	3.1.1 Provide shelters, lighting and benches at any on-site transit stops	<input type="checkbox"/> N/A
BASIC	3.1.2 Where the site abuts an off-site transit stop and insufficient space exists for a transit shelter in the public right-of-way, protect land for a shelter and/or install a shelter	<input type="checkbox"/> N/A
BETTER	3.1.3 Provide a secure and comfortable interior waiting area by integrating any on-site transit stops into the building	<input type="checkbox"/> N/A
4. RIDESHARING		
4.1 Pick-up & drop-off facilities		
BASIC	4.1.1 Provide a designated area for carpool drivers (plus taxis and ride-hailing services) to drop off or pick up passengers without using fire lanes or other no-stopping zones	<input checked="" type="checkbox"/> Lay-by pick-up/drop-off located at main entrance of building.
4.2 Carpool parking		
BASIC	4.2.1 Provide signed parking spaces for carpools in a priority location close to a major building entrance, sufficient in number to accommodate the mode share target for carpools	<input type="checkbox"/>
BETTER	4.2.2 At large developments, provide spaces for carpools in a separate, access-controlled parking area to simplify enforcement	<input type="checkbox"/>
5. CARSHARING & BIKESHARING		
5.1 Carshare parking spaces		
BETTER	5.1.1 Provide carshare parking spaces in permitted non-residential zones, occupying either required or provided parking spaces (<i>see Zoning By-law Section 94</i>)	<input type="checkbox"/>
5.2 Bikeshare station location		
BETTER	5.2.1 Provide a designated bikeshare station area near a major building entrance, preferably lighted and sheltered with a direct walkway connection	<input type="checkbox"/>

TDM-supportive design & infrastructure measures: <i>Non-residential developments</i>		Check if completed & add descriptions, explanations or plan/drawing references
6. PARKING		
6.1 Number of parking spaces		
REQUIRED	6.1.1 Do not provide more parking than permitted by zoning, nor less than required by zoning, unless a variance is being applied for	<input checked="" type="checkbox"/> Refer to Table 3-2 in TIA Report
BASIC	6.1.2 Provide parking for long-term and short-term users that is consistent with mode share targets, considering the potential for visitors to use off-site public parking	<input type="checkbox"/>
BASIC	6.1.3 Where a site features more than one use, provide shared parking and reduce the cumulative number of parking spaces accordingly (<i>see Zoning By-law Section 104</i>)	<input type="checkbox"/> Refer to 6.1.1
BETTER	6.1.4 Reduce the minimum number of parking spaces required by zoning by one space for each 13 square metres of gross floor area provided as shower rooms, change rooms, locker rooms and other facilities for cyclists in conjunction with bicycle parking (<i>see Zoning By-law Section 111</i>)	<input type="checkbox"/>
6.2 Separate long-term & short-term parking areas		
BETTER	6.2.1 Separate short-term and long-term parking areas using signage or physical barriers, to permit access controls and simplify enforcement (i.e. to discourage employees from parking in visitor spaces, and vice versa)	<input type="checkbox"/>
7. OTHER		
7.1 On-site amenities to minimize off-site trips		
BETTER	7.1.1 Provide on-site amenities to minimize mid-day or mid-commute errands	<input type="checkbox"/>

TDM Measures Checklist:
Non-Residential Developments (office, institutional, retail or industrial)

Legend	
BASIC	The measure is generally feasible and effective, and in most cases would benefit the development and its users
BETTER	The measure could maximize support for users of sustainable modes, and optimize development performance
★	The measure is one of the most dependably effective tools to encourage the use of sustainable modes

TDM measures: <i>Non-residential developments</i>		Check if proposed & add descriptions
1. TDM PROGRAM MANAGEMENT		
1.1 Program coordinator		
BASIC	★	1.1.1 Designate an internal coordinator, or contract with an external coordinator <input type="checkbox"/>
1.2 Travel surveys		
BETTER		1.2.1 Conduct periodic surveys to identify travel-related behaviours, attitudes, challenges and solutions, and to track progress <input type="checkbox"/>
2. WALKING AND CYCLING		
2.1 Information on walking/cycling routes & destinations		
BASIC		2.1.1 Display local area maps with walking/cycling access routes and key destinations at major entrances <input checked="" type="checkbox"/>
2.2 Bicycle skills training		
<i>Commuter travel</i>		
BETTER	★	2.2.1 Offer on-site cycling courses for commuters, or subsidize off-site courses <input type="checkbox"/>
2.3 Valet bike parking		
<i>Visitor travel</i>		
BETTER		2.3.1 Offer secure valet bike parking during public events when demand exceeds fixed supply (e.g. for festivals, concerts, games) <input type="checkbox"/>

TDM measures: <i>Non-residential developments</i>		Check if proposed & add descriptions
3. TRANSIT		
3.1 Transit information		
BASIC	3.1.1 Display relevant transit schedules and route maps at entrances	<input checked="" type="checkbox"/>
BASIC	3.1.2 Provide online links to OC Transpo and STO information	<input type="checkbox"/>
BETTER	3.1.3 Provide real-time arrival information display at entrances	<input type="checkbox"/>
3.2 Transit fare incentives		
<i>Commuter travel</i>		
BETTER	3.2.1 Offer preloaded PRESTO cards to encourage commuters to use transit	<input type="checkbox"/>
BETTER ★	3.2.2 Subsidize or reimburse monthly transit pass purchases by employees	<input type="checkbox"/>
<i>Visitor travel</i>		
BETTER	3.2.3 Arrange inclusion of same-day transit fare in price of tickets (e.g. for festivals, concerts, games)	<input type="checkbox"/>
3.3 Enhanced public transit service		
<i>Commuter travel</i>		
BETTER	3.3.1 Contract with OC Transpo to provide enhanced transit services (e.g. for shift changes, weekends)	<input type="checkbox"/>
<i>Visitor travel</i>		
BETTER	3.3.2 Contract with OC Transpo to provide enhanced transit services (e.g. for festivals, concerts, games)	<input type="checkbox"/>
3.4 Private transit service		
<i>Commuter travel</i>		
BETTER	3.4.1 Provide shuttle service when OC Transpo cannot offer sufficient quality or capacity to serve demand (e.g. for shift changes, weekends)	<input checked="" type="checkbox"/> Shuttle service exists between campuses
<i>Visitor travel</i>		
BETTER	3.4.2 Provide shuttle service when OC Transpo cannot offer sufficient quality or capacity to serve demand (e.g. for festivals, concerts, games)	<input type="checkbox"/>

TDM measures: <i>Non-residential developments</i>		Check if proposed & add descriptions
4. RIDESHARING		
4.1 Ridematching service		
<i>Commuter travel</i>		
BASIC	★ 4.1.1 Provide a dedicated ridematching portal at OttawaRideMatch.com	<input type="checkbox"/>
4.2 Carpool parking price incentives		
<i>Commuter travel</i>		
BETTER	4.2.1 Provide discounts on parking costs for registered carpools	<input type="checkbox"/>
4.3 Vanpool service		
<i>Commuter travel</i>		
BETTER	4.3.1 Provide a vanpooling service for long-distance commuters	<input type="checkbox"/>
5. CARSHARING & BIKESHARING		
5.1 Bikeshare stations & memberships		
BETTER	5.1.1 Contract with provider to install on-site bikeshare station for use by commuters and visitors	<input type="checkbox"/>
<i>Commuter travel</i>		
BETTER	5.1.2 Provide employees with bikeshare memberships for local business travel	<input type="checkbox"/>
5.2 Carshare vehicles & memberships		
<i>Commuter travel</i>		
BETTER	5.2.1 Contract with provider to install on-site carshare vehicles and promote their use by tenants	<input type="checkbox"/>
BETTER	5.2.2 Provide employees with carshare memberships for local business travel	<input type="checkbox"/>
6. PARKING		
6.1 Priced parking		
<i>Commuter travel</i>		
BASIC	★ 6.1.1 Charge for long-term parking (daily, weekly, monthly)	<input checked="" type="checkbox"/> Paid parking very likely
BASIC	6.1.2 Unbundle parking cost from lease rates at multi-tenant sites	<input type="checkbox"/>
<i>Visitor travel</i>		
BETTER	6.1.3 Charge for short-term parking (hourly)	<input checked="" type="checkbox"/> Paid parking very likely

TDM measures: <i>Non-residential developments</i>		Check if proposed & add descriptions
7. TDM MARKETING & COMMUNICATIONS		
7.1 Multimodal travel information		
<i>Commuter travel</i>		
BASIC ★	7.1.1 Provide a multimodal travel option information package to new/relocating employees and students	<input checked="" type="checkbox"/>
<i>Visitor travel</i>		
BETTER ★	7.1.2 Include multimodal travel option information in invitations or advertising that attract visitors or customers (e.g. for festivals, concerts, games)	<input type="checkbox"/>
7.2 Personalized trip planning		
<i>Commuter travel</i>		
BETTER ★	7.2.1 Offer personalized trip planning to new/relocating employees	<input type="checkbox"/>
7.3 Promotions		
<i>Commuter travel</i>		
BETTER	7.3.1 Deliver promotions and incentives to maintain awareness, build understanding, and encourage trial of sustainable modes	<input type="checkbox"/>
8. OTHER INCENTIVES & AMENITIES		
8.1 Emergency ride home		
<i>Commuter travel</i>		
BETTER ★	8.1.1 Provide emergency ride home service to non-driving commuters	<input type="checkbox"/>
8.2 Alternative work arrangements		
<i>Commuter travel</i>		
BASIC ★	8.2.1 Encourage flexible work hours	<input type="checkbox"/>
BETTER	8.2.2 Encourage compressed workweeks	<input type="checkbox"/>
BETTER ★	8.2.3 Encourage telework	<input type="checkbox"/>
8.3 Local business travel options		
<i>Commuter travel</i>		
BASIC ★	8.3.1 Provide local business travel options that minimize the need for employees to bring a personal car to work	<input type="checkbox"/>
8.4 Commuter incentives		
<i>Commuter travel</i>		
BETTER	8.4.1 Offer employees a taxable, mode-neutral commuting allowance	<input type="checkbox"/>
8.5 On-site amenities		
<i>Commuter travel</i>		
BETTER	8.5.1 Provide on-site amenities/services to minimize mid-day or mid-commute errands	<input type="checkbox"/>

Appendix H

AUTOTURN SWEPT PATHS

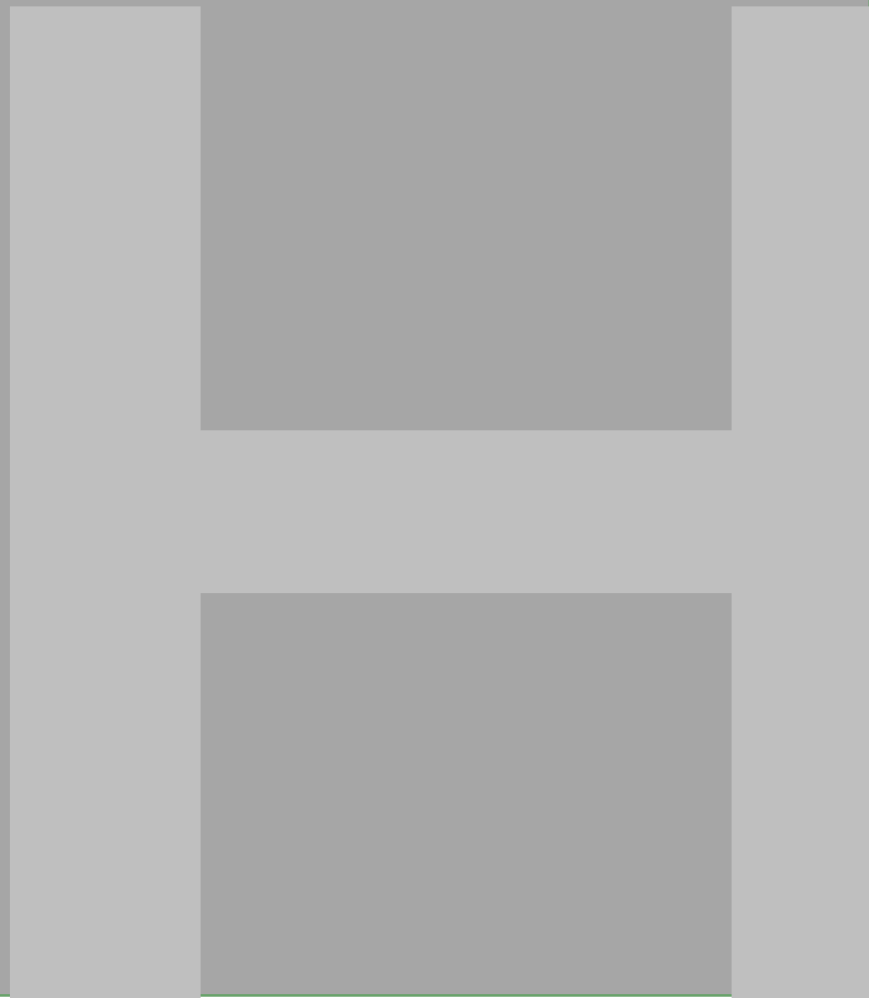

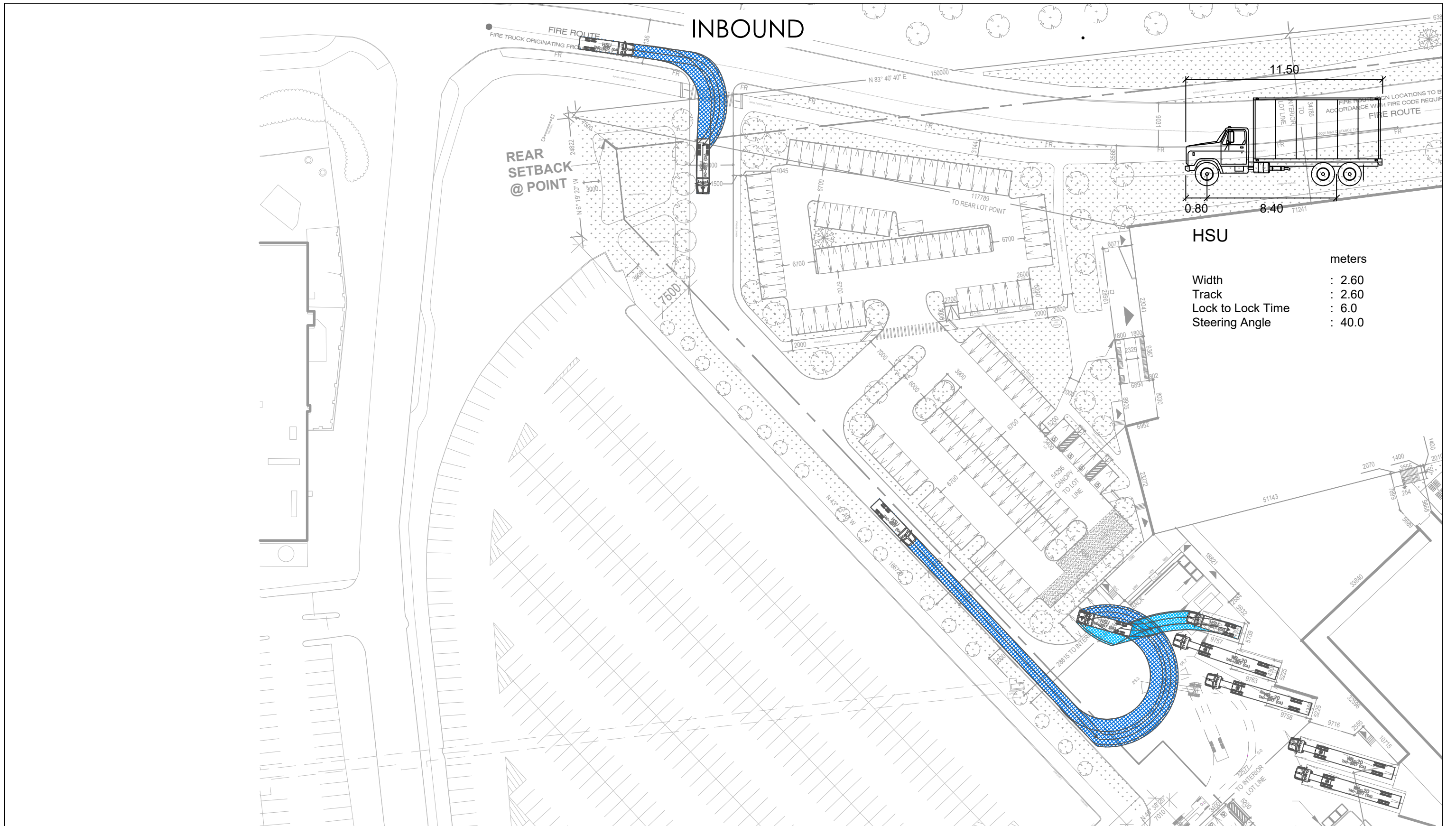

Date Site Plan Received: 2024-04-10

Scale: 1:750



TOH General Campus
HSU Truck Inbound Manuever - AMRC Corner Dock

C:\Users\cass045473\WSP_0365\CA000956.0165 Advanced Medical Research Centre (AMRC) - Project Folders\05_Technical\5.09 Transportation\AutoTurn

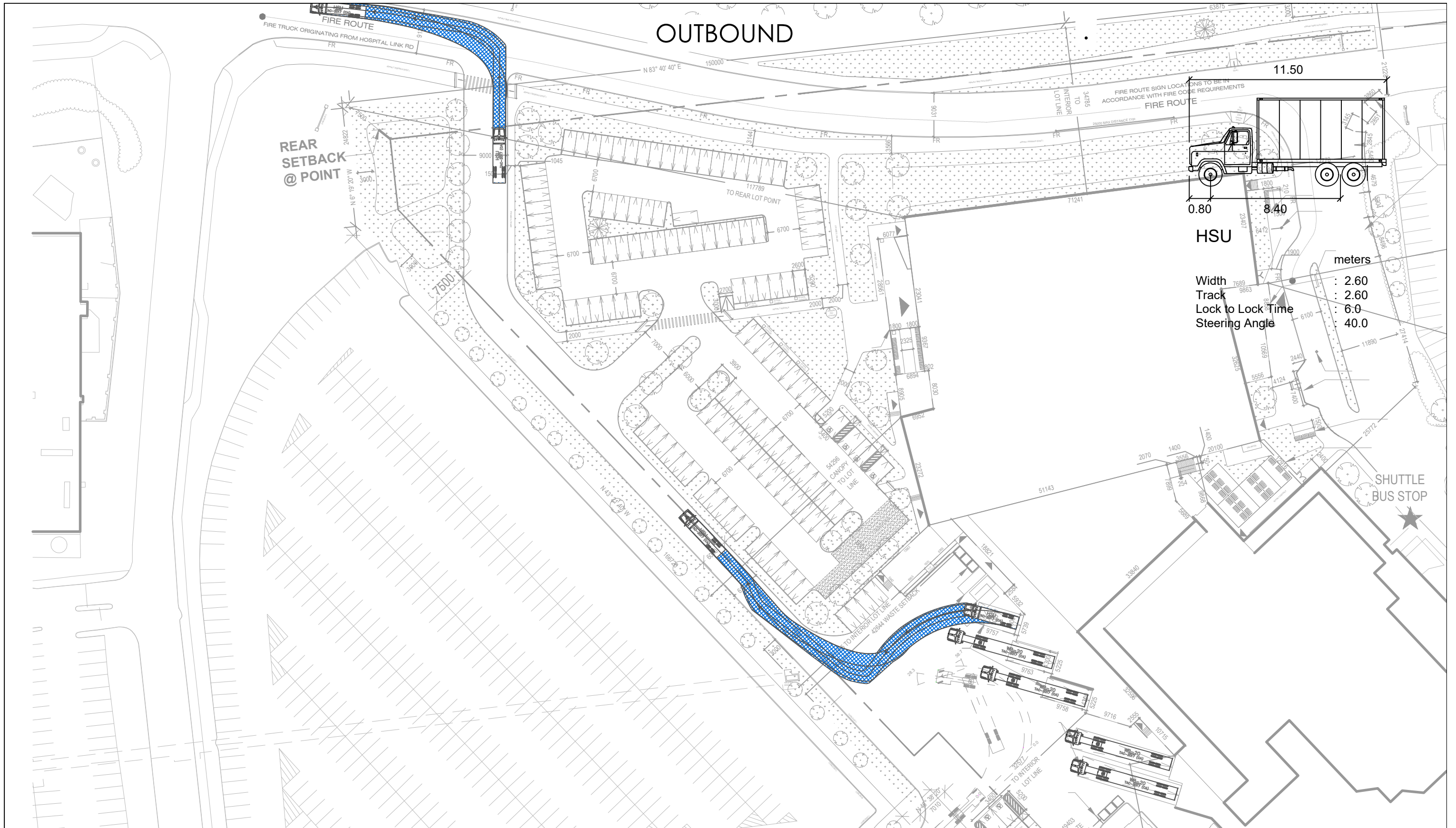

Date Site Plan Received: 2024-04-10

Scale: 1:750



TOH General Campus HSU Truck Outbound Manuever - AMRC Corner Dock

C:\Users\cass045473\WSP_03665\CA0009956.0165 Advanced Medical Research Centre (AMRC) - Project Folders\05_Technical\5.09 Transportation\AutoTurn

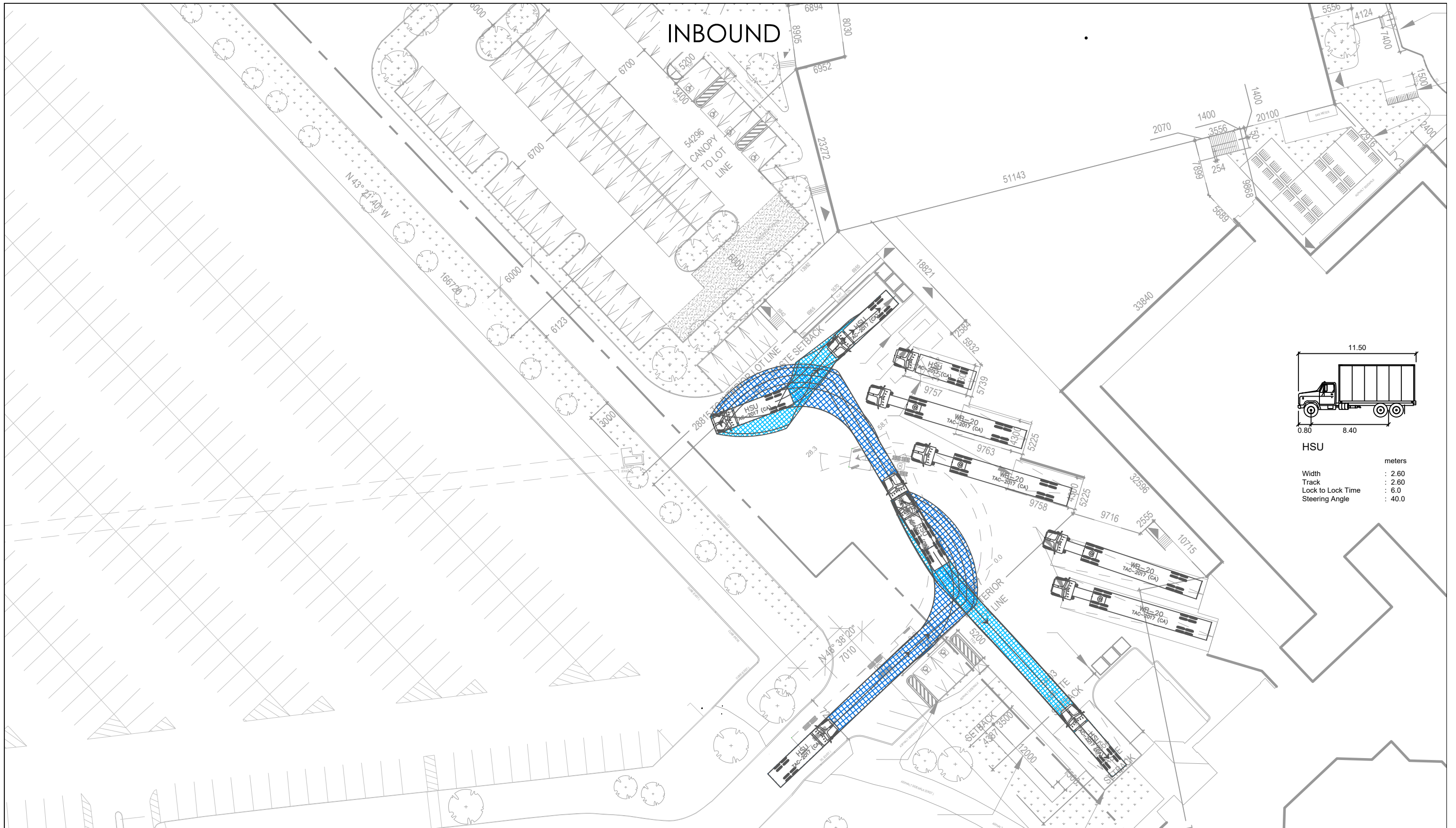

Date Site Plan Received: 2024-04-10

Scale: 1:500



TOH General Campus
HSU (Waste) Truck Inbound Manuever

C:\Users\cass045473\WSP_0365\CA0009956.0165 Advanced Medical Research Centre (AMRC) - Project Folders\05_Technical\5.09 Transportation\AutoTurn

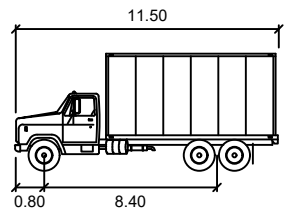
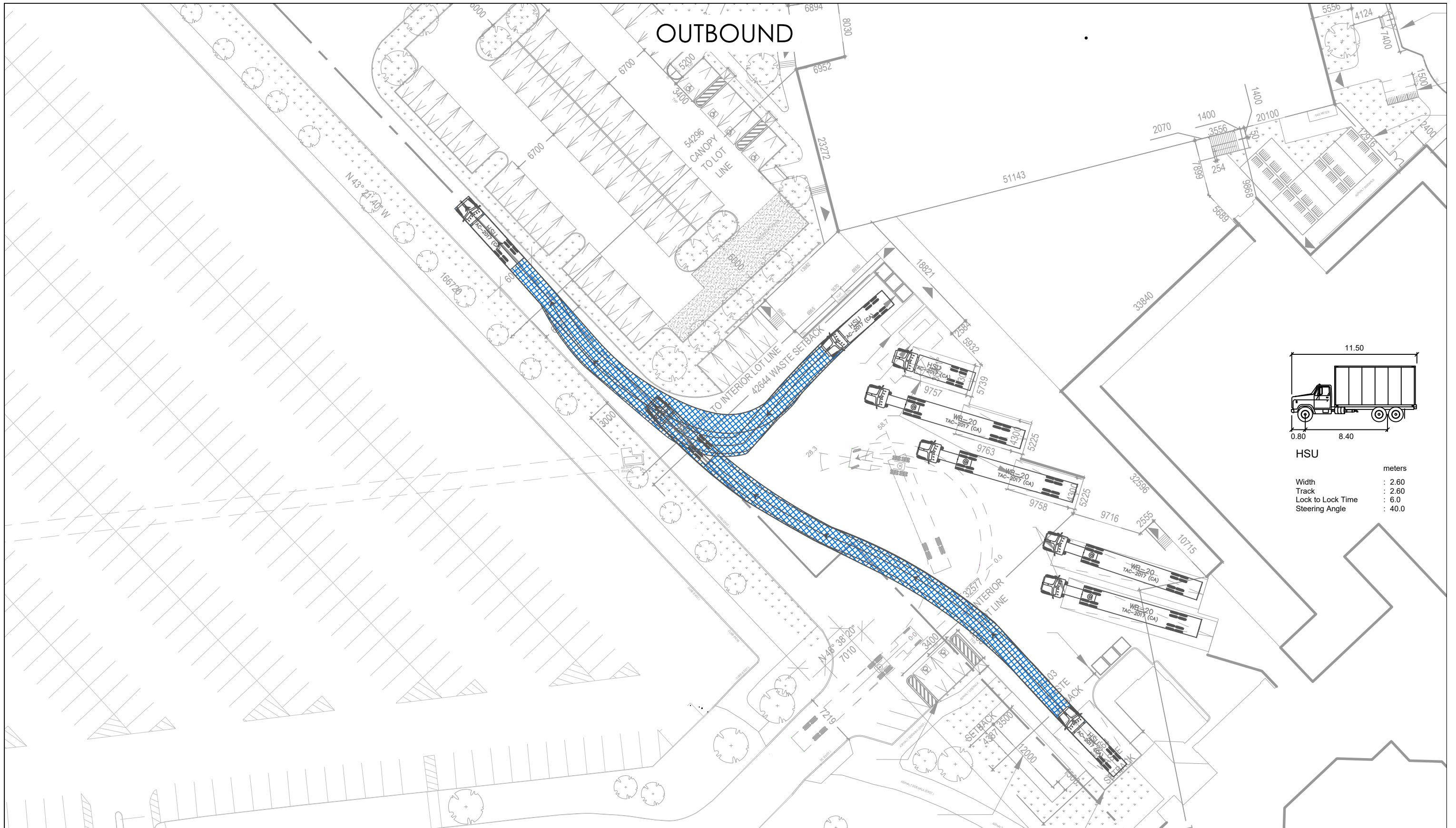

HSU

	units
Width	: 2.60
Track	: 2.60
Lock to Lock Time	: 6.0
Steering Angle	: 40.0

Date Site Plan Received: 2024-04-10

Scale: 1:500



TOH General Campus HSU (Waste) Truck Outbound Manuever

INBOUND

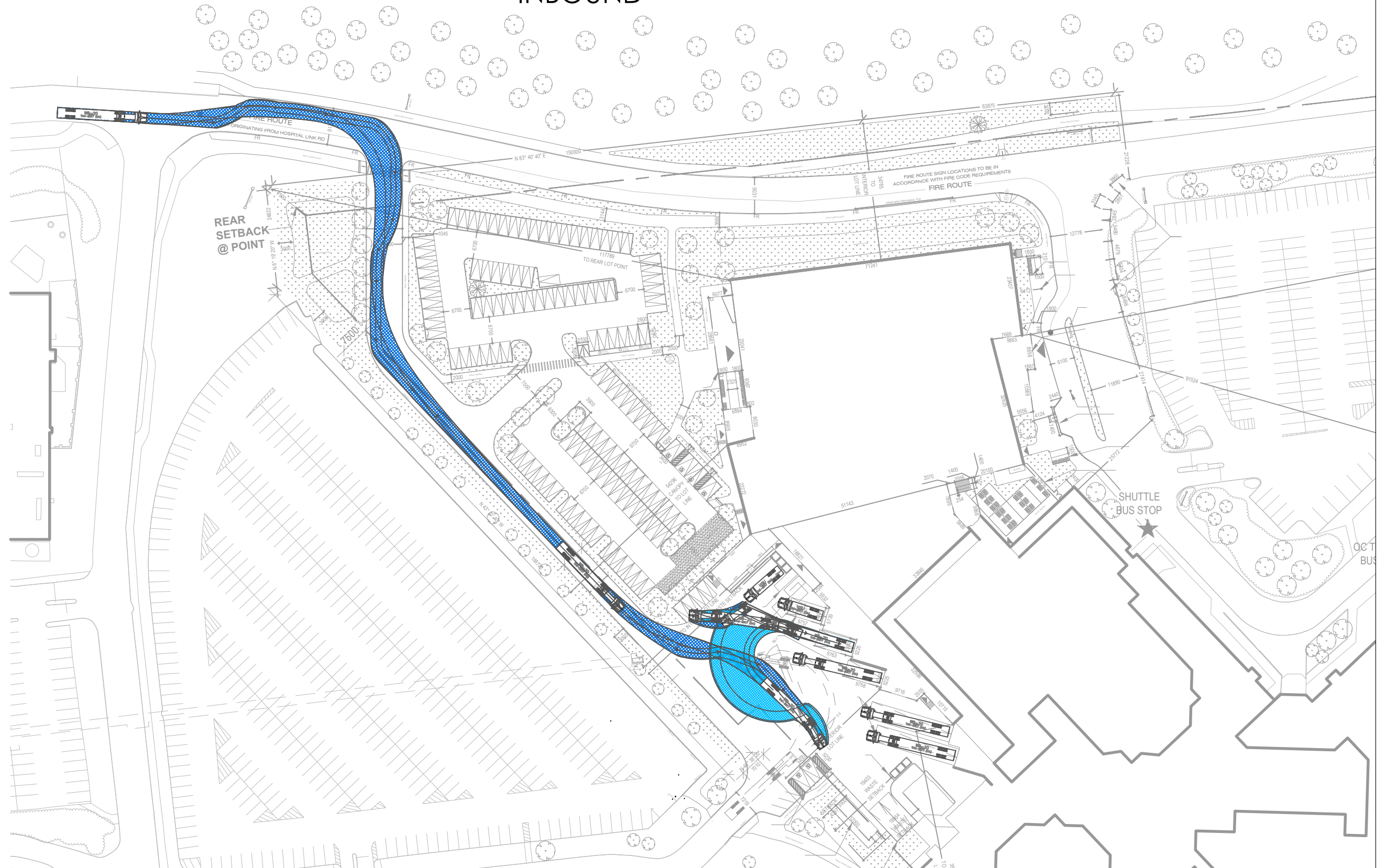

Date Site Plan Received: 2024-04-10

Scale: 1:1000



TOH General Campus WB-20 Truck Inbound Manuever (from North)- Clean Dock

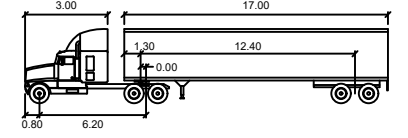
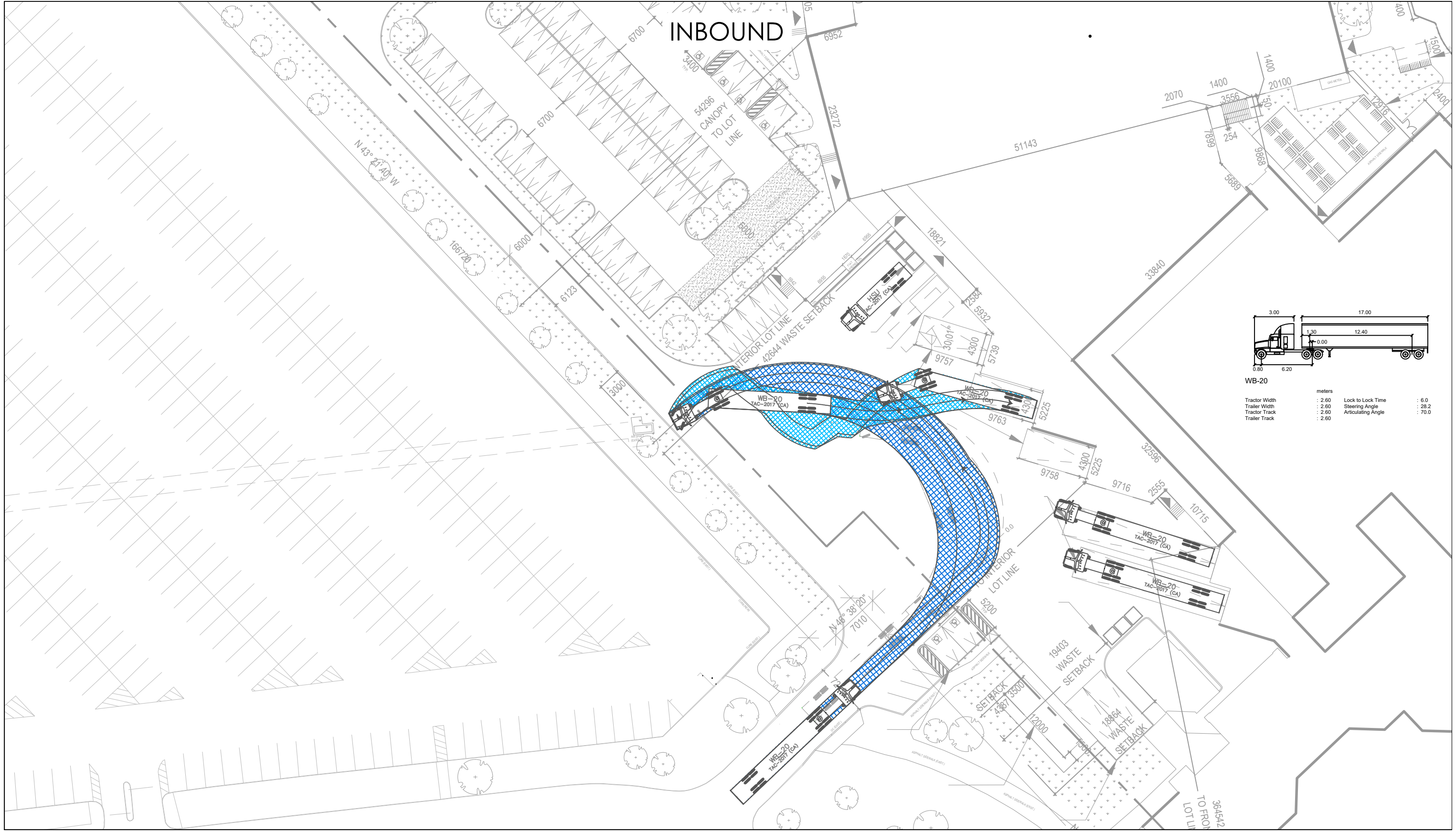

WB-20

meters	
Tractor Width	: 2.60
Tractor Track	: 2.60
Trailer Width	: 2.60
Trailer Track	: 2.60
Lock to Lock Time	: 6.0
Steering Angle	: 28.2
Articulating Angle	: 70.0

Date Site Plan Received: 2024-04-10

Scale: 1:500



TOH General Campus
WB-20 Truck Inbound Manuever (from West) - Clean Dock

OUTBOUND

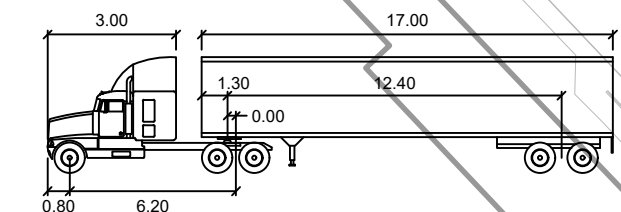
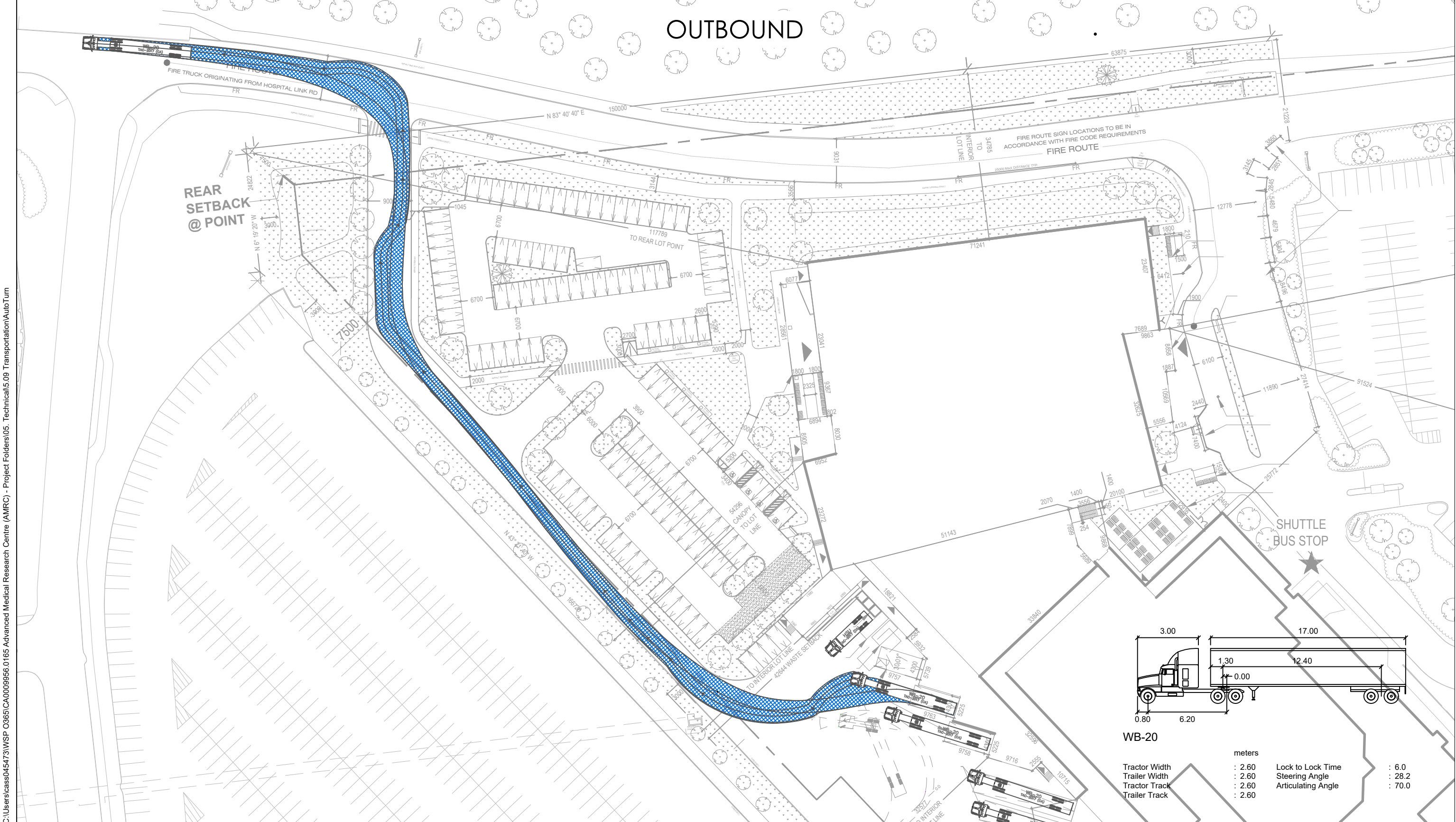

WB-20

	Tractor Width	Trailer Width	Tractor Track	Trailer Track	Lock to Lock Time	Steering Angle	Articulating Angle
Dimensions (meters)	: 2.60	: 2.60	: 2.60	: 2.60	: 6.0	: 28.2	: 70.0

Date Site Plan Received: 2024-04-10

Scale: 1:750



TOH General Campus WB-20 Truck Outbound Maneuver - Clean Dock

INBOUND

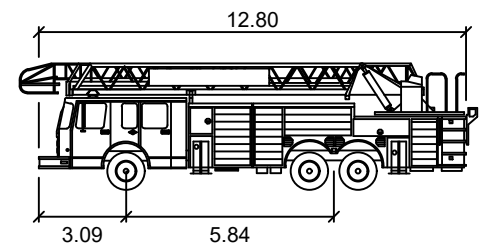
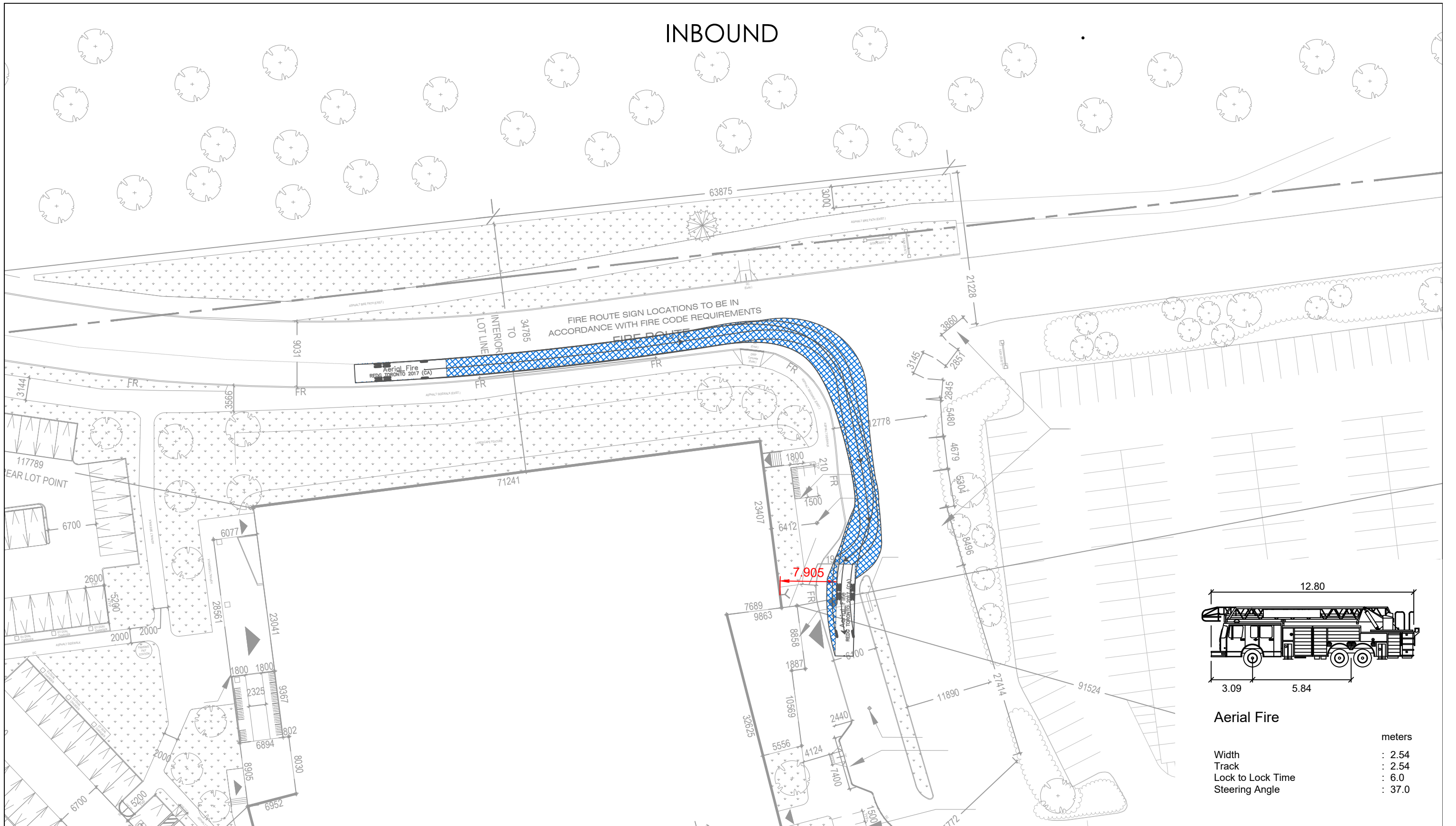

Aerial Fire	
Width	: 2.54
Track	: 2.54
Lock to Lock Time	: 6.0
Steering Angle	: 37.0

Date Site Plan Received: 2024-04-10

Scale: 1:500



TOH General Campus Aerial Fire Truck Inbound Manuever

OUTBOUND

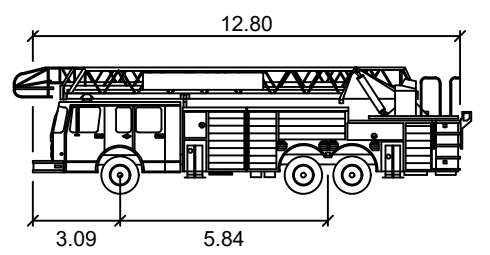
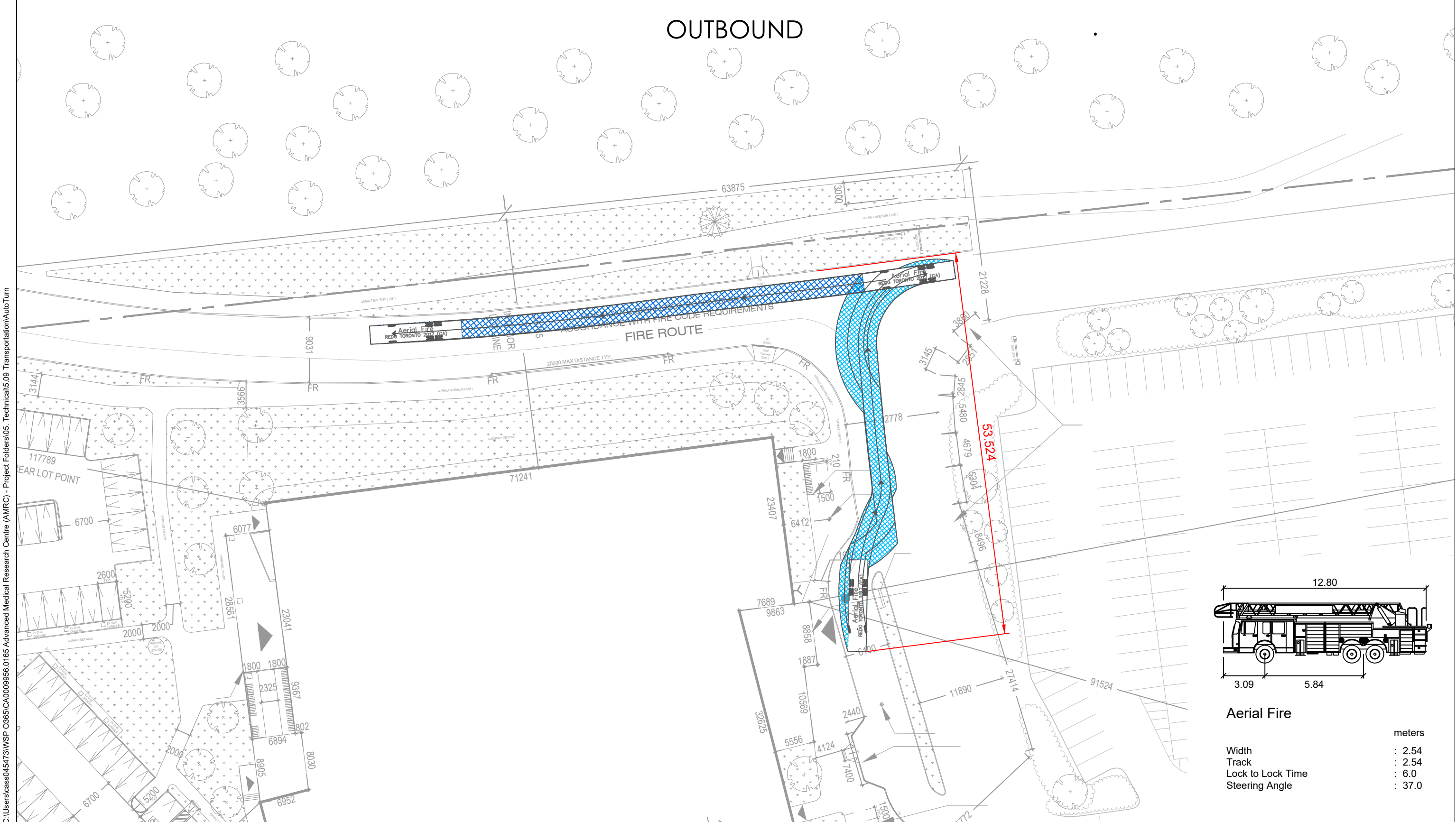

Aerial Fire		units
Width	: 2.54	meters
Track	: 2.54	meters
Lock to Lock Time	: 6.0	seconds
Steering Angle	: 37.0	degrees

Date Site Plan Received: 2024-04-10

Scale: 1:500



TOH General Campus Aerial Fire Truck Outbound Manuever

INBOUND

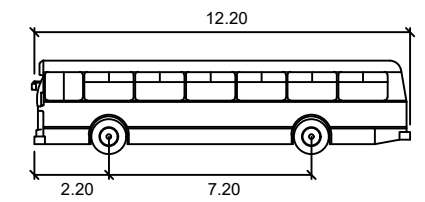
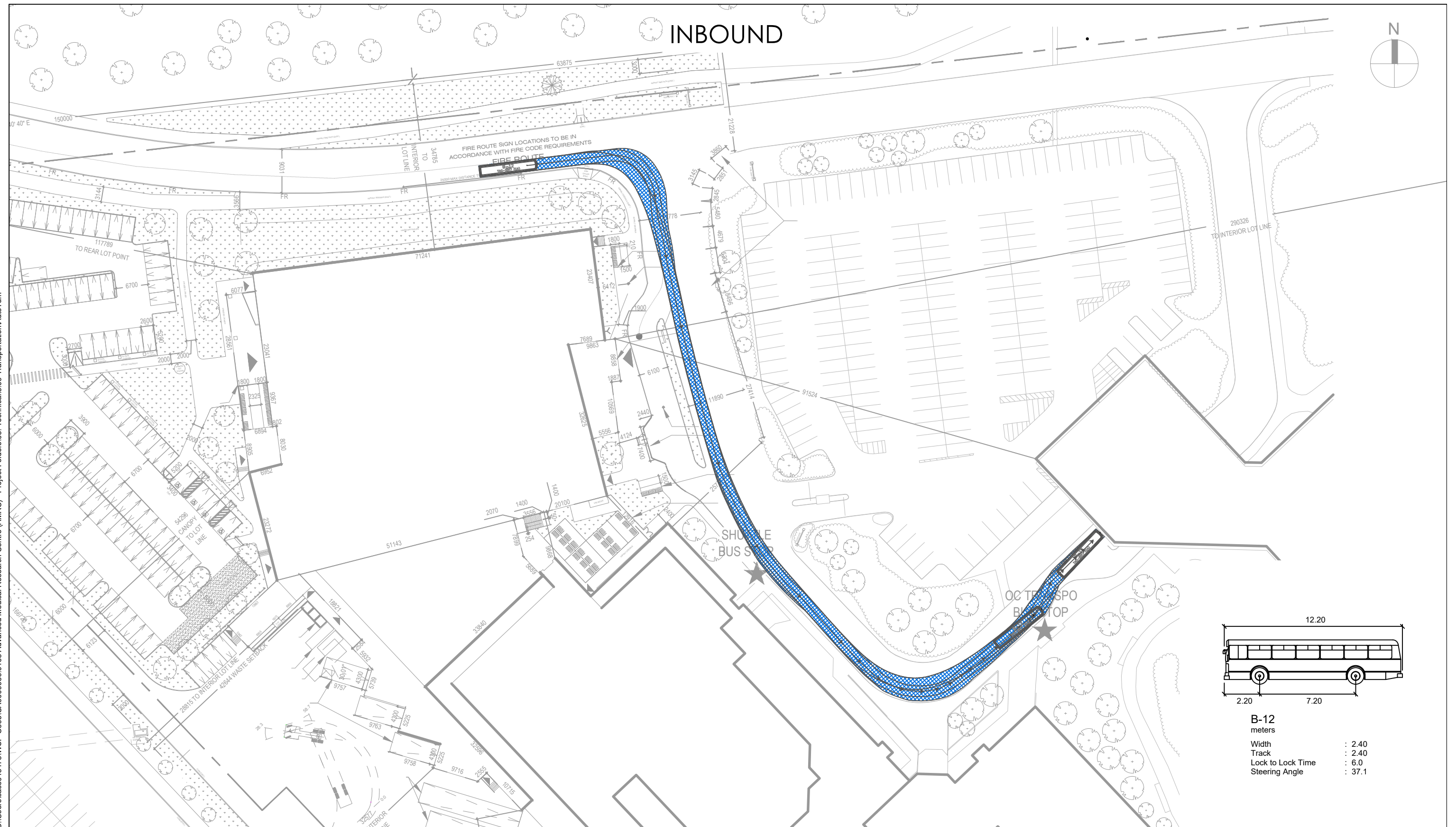

B-12	
meters	
Width	: 2.40
Track	: 2.40
Lock to Lock Time	: 6.0
Steering Angle	: 37.1

Date Site Plan Received: 2024-04-10

Scale: 1:750



TOH General Campus B-12 Bus Circulation

INBOUND

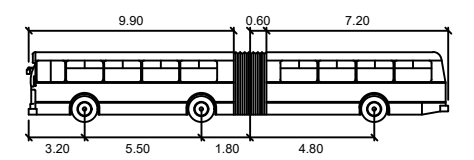
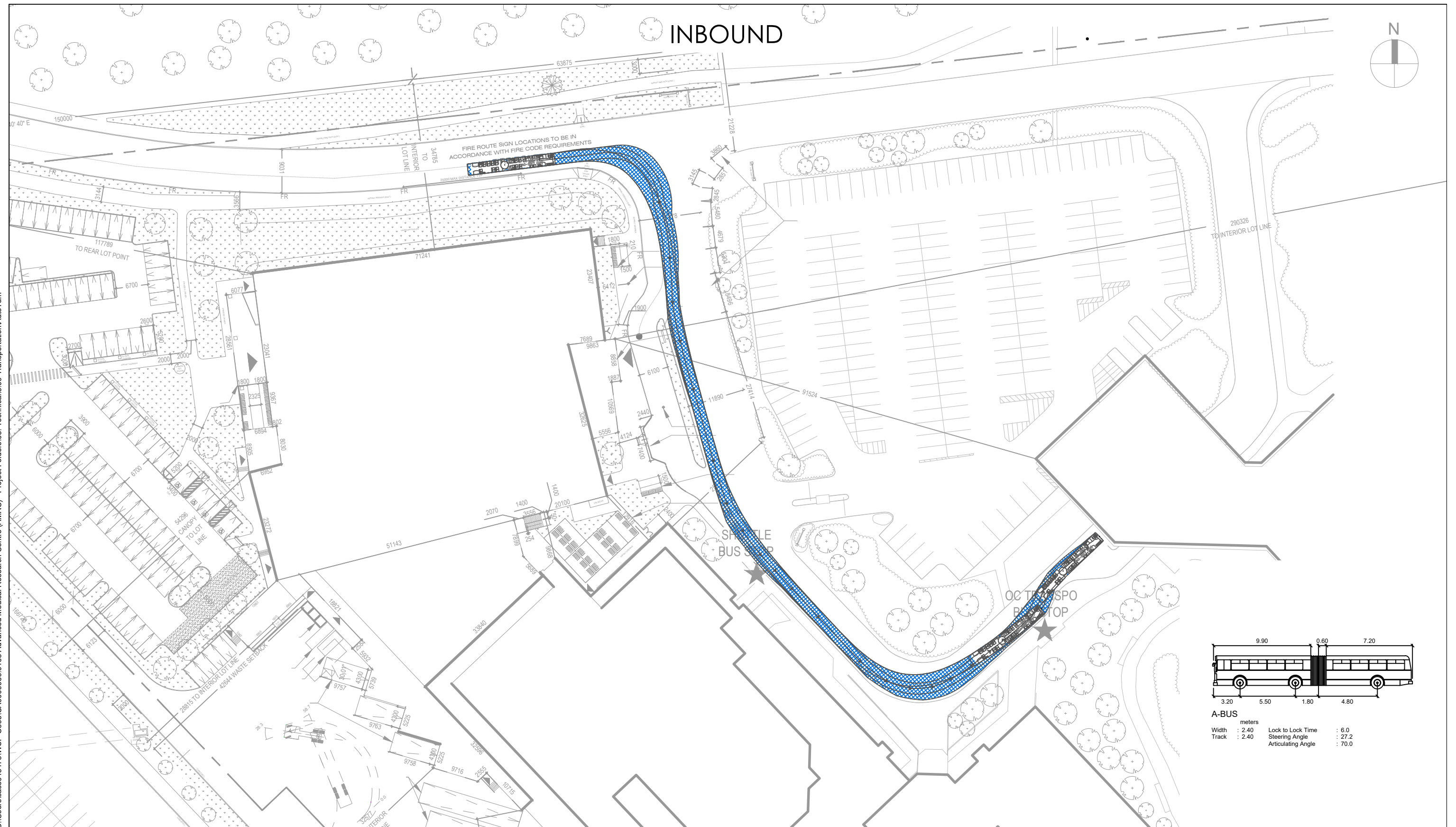

A-BUS	
meters	
Width	: 2.40
Track	: 2.40
Lock to Lock Time	: 6.0
Steering Angle	: 27.2
Articulating Angle	: 70.0

Date Site Plan Received: 2024-04-10

Scale: 1:750



TOH General Campus A-Bus Circulation

INBOUND

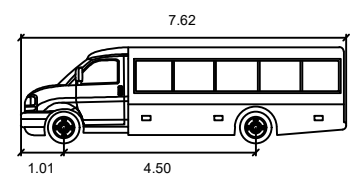
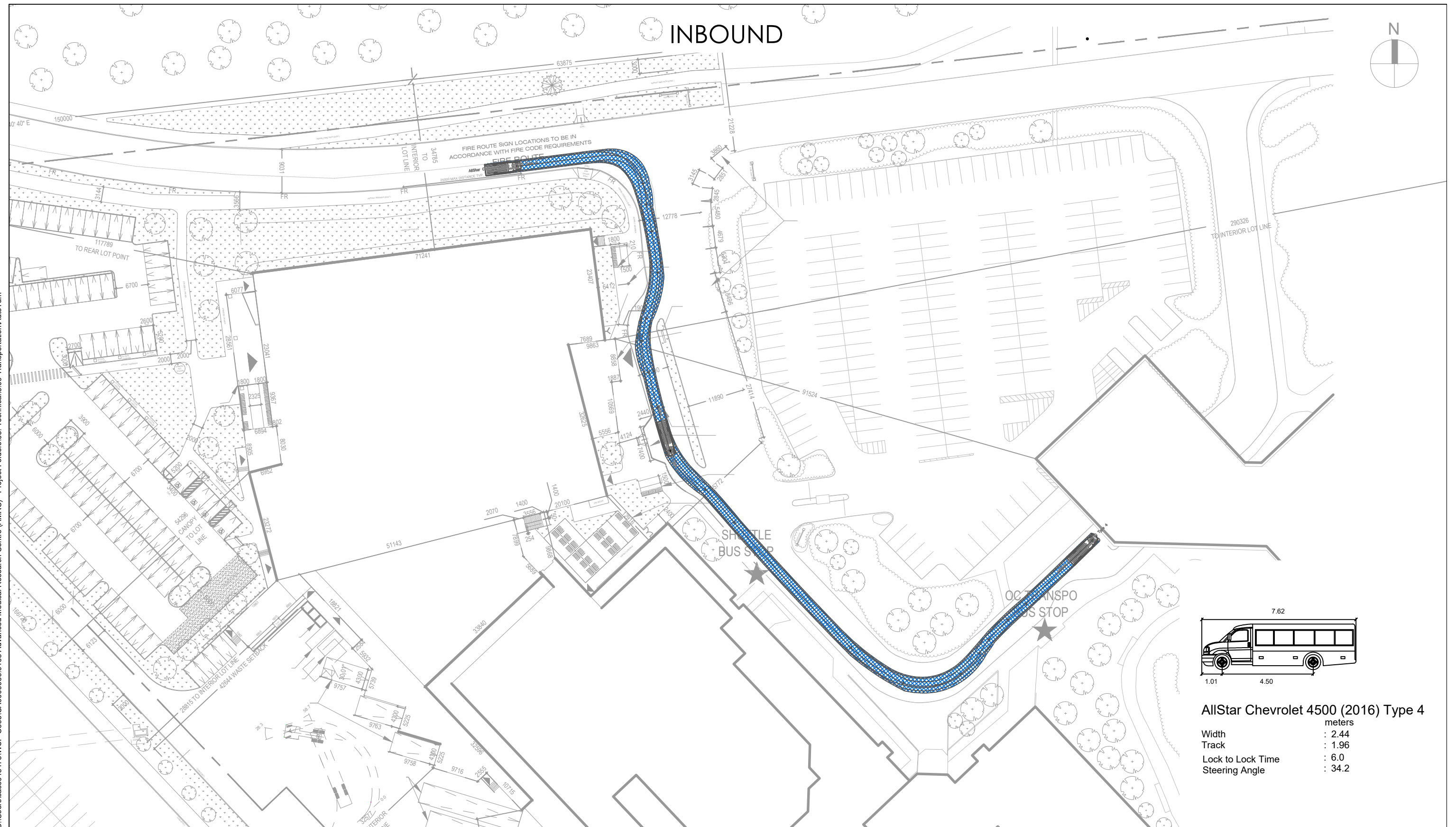

AllStar Chevrolet 4500 (2016) Type 4
meters
Width : 2.44
Track : 1.96
Lock to Lock Time : 6.0
Steering Angle : 34.2

Date Site Plan Received: 2024-04-10

Scale: 1:750



TOH General Campus Para Transpo Circulation

INBOUND

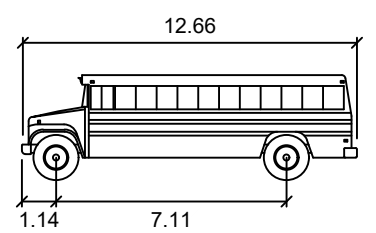
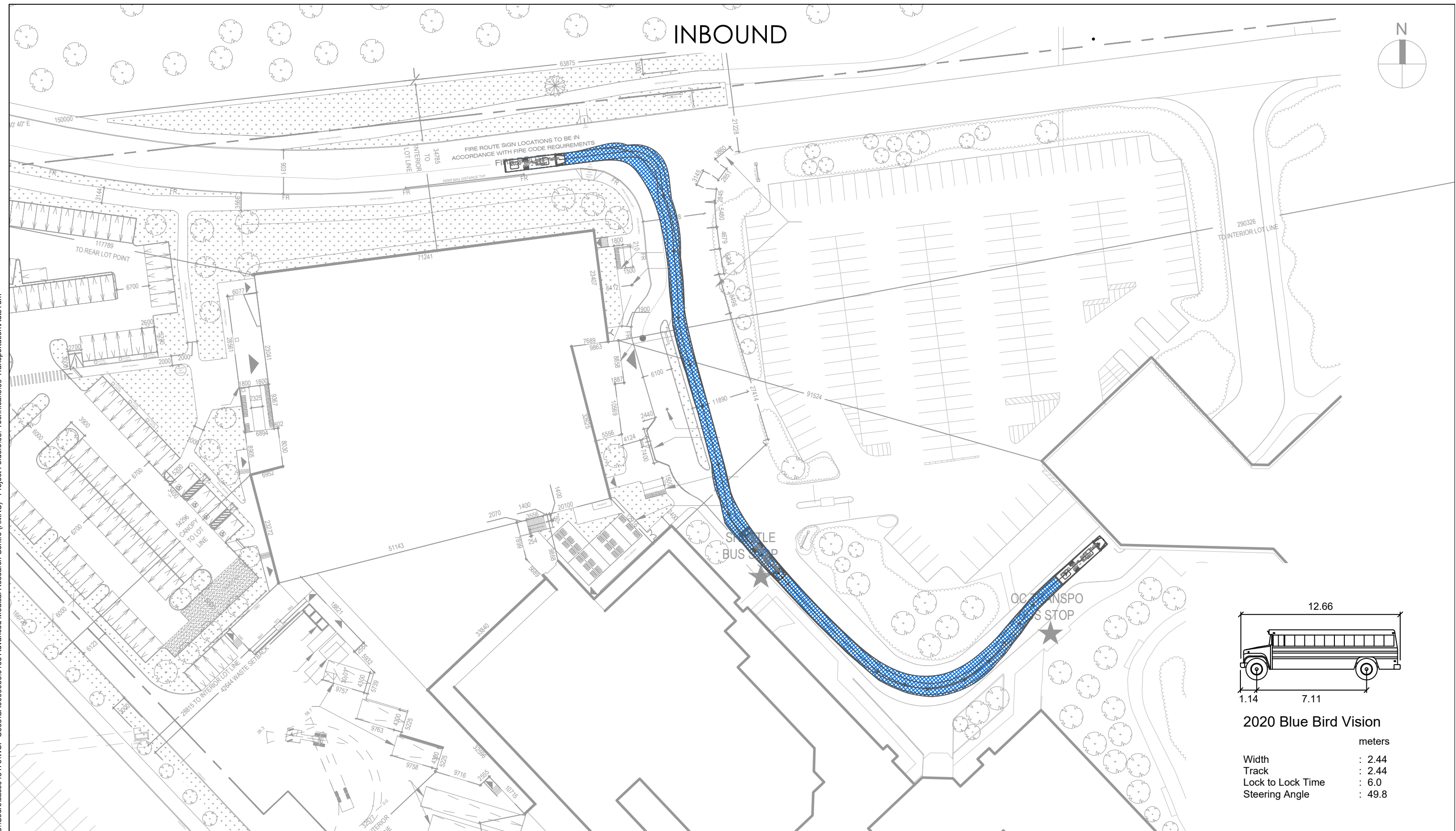

2020 Blue Bird Vision

	meters
Width	: 2.44
Track	: 2.44
Lock to Lock Time	: 6.0
Steering Angle	: 49.8

Date Site Plan Received: 2024-04-10

Scale: 1:750



TOH General Campus uOttawa Shuttle Bus Circulation

C:\Users\cass045473\WSP_03665\CA0009956.0165 Advanced Medical Research Centre (AMRC) - Project Folders\05_Technical\5.09 Transportation\AutoTurn

Appendix I

MMLOS SHEETS



Multi-Modal Level of Service - Segments Form

Consultant	WSP Canada Inc.
Scenario	All Scenarios - AM/PM Peak Hours
Comments	AMRC TIA Strategy Report

Project Date	CA0009956.0165 2023-12-13
--------------	------------------------------

SEGMENTS	Hospital Link Rd / Ring Rd	Alta Vista Dr to Ring Rd		Ring Rd to uOttawa/Rehab W Access		uOttawa/Rehab W Access to uOttawa/Rehab E Access		Section	Section	Section	Section	Section	Section
		EB	WB	EB	WB	EB	WB	7	8	9	10	11	12
Pedestrian	Sidewalk Width	≥ 2 m	no sidewalk	≥ 2 m	≥ 2 m	no sidewalk	≥ 2 m						
	Boulevard Width	> 2 m	n/a	0.5 - 2 m	< 0.5	n/a	> 2 m						
	Avg Daily Curb Lane Traffic Volume	≤ 3000	≤ 3000	≤ 3000	≤ 3000	≤ 3000	≤ 3000						
	Operating Speed	> 50 to 60 km/h	> 50 to 60 km/h	> 30 to 50 km/h	> 30 to 50 km/h	> 30 to 50 km/h	> 30 to 50 km/h						
	On-Street Parking	no	no	no	no	no	no						
	Exposure to Traffic PLoS	A	F	A	B	F	A	-	-	-	-	-	-
	Effective Sidewalk Width	3.0 m		3.0 m	3.0 m		3.0 m						
Pedestrian Volume	250 ped/hr		250 ped/hr	250 ped/hr		250 ped/hr							
Crowding PLoS	A	-	A	A	-	A	-	-	-	-	-	-	
Level of Service	A	-	A	B	-	A	-	-	-	-	-	-	
Bicycle	Type of Cycling Facility	Physically Separated	Mixed Traffic	Mixed Traffic	Physically Separated	Mixed Traffic	Physically Separated						
	Number of Travel Lanes		2-3 lanes total	2-3 lanes total		2-3 lanes total							
	Operating Speed		≥ 50 to 60 km/h	>40 to <50 km/h		>40 to <50 km/h							
	# of Lanes & Operating Speed LoS	-	E	D	-	D	-	-	-	-	-	-	
	Bike Lane (+ Parking Lane) Width												
	Bike Lane Width LoS	-	-	-	-	-	-	-	-	-	-	-	
	Bike Lane Blockages												
	Blockage LoS	-	-	-	-	-	-	-	-	-	-	-	
	Median Refuge Width (no median = < 1.8 m)		< 1.8 m refuge	< 1.8 m refuge		< 1.8 m refuge							
	No. of Lanes at Unsignalized Crossing		≤ 3 lanes	≤ 3 lanes		≤ 3 lanes							
Sidestreet Operating Speed		≤ 40 km/h	≤ 40 km/h		≤ 40 km/h								
Unsignalized Crossing - Lowest LoS	A	A	A	A	A	A	-	-	-	-	-		
Level of Service	A	E	D	A	D	A	-	-	-	-	-		
Transit	Facility Type	Mixed Traffic	Mixed Traffic	Mixed Traffic	Mixed Traffic	Mixed Traffic	Mixed Traffic						
	Friction or Ratio Transit:Posted Speed	Vt/Vp ≥ 0.8	Vt/Vp ≥ 0.8	Vt/Vp ≥ 0.8	Vt/Vp ≥ 0.8	Vt/Vp ≥ 0.8	Vt/Vp ≥ 0.8						
Level of Service	D	D	D	D	D	D	-	-	-	-	-		
Truck	Truck Lane Width												
	Travel Lanes per Direction												
Level of Service	-	-	-	-	-	-	-	-	-	-	-		
Auto	Level of Service	Not Applicable											

Multi-Modal Level of Service - Intersections Form

Consultant	WSP Canada Inc.	Project	CA0009956.0165
Scenario	Existing 2023 AM	Date	2023-12-13
Comments	AMRC TIA Strategy Report		

To add intersections
Select columns LMNO, right-click and Copy;
Then select column P, right-click and Insert Copied Cells

INTERSECTIONS		Alta Vista Dr / Hospital Link Rd				Smyth Rd / Alta Vista Dr				Smyth Rd / Valour Dr				Smyth Rd / Ring Rd-South Haven Pl				Smyth Rd / Hospital Main Access				Smyth Rd / Roger Guindon Ave			
Crossing Side		NORTH	SOUTH	EAST	WEST	NORTH	SOUTH	EAST	WEST	NORTH	SOUTH	EAST	WEST	NORTH	SOUTH	EAST	WEST	NORTH	SOUTH	EAST	WEST	NORTH	SOUTH	EAST	WEST
Pedestrian	Lanes	5	5	5	5	6	6	7	7	4		5	5	4	0-2	4	4	6		6	5	4		5	5
	Median	No Median - 2.4 m	No Median - 2.4 m	No Median - 2.4 m	No Median - 2.4 m	No Median - 2.4 m	No Median - 2.4 m	No Median - 2.4 m	No Median - 2.4 m	No Median - 2.4 m		No Median - 2.4 m	No Median - 2.4 m	No Median - 2.4 m	No Median - 2.4 m	No Median - 2.4 m	No Median - 2.4 m	No Median - 2.4 m		No Median - 2.4 m	No Median - 2.4 m	No Median - 2.4 m		No Median - 2.4 m	No Median - 2.4 m
	Conflicting Left Turns	No left turn / Prohib.	Protected	No left turn / Prohib.	Permissive	Protected/ Permissive	Protected/ Permissive	Protected/ Permissive	Protected/ Permissive	Permissive		Permissive	Permissive	Protected/ Permissive	Permissive	Permissive	Permissive	Protected/ Permissive		Protected	No left turn / Prohib.	Protected/ Permissive		Permissive	No left turn / Prohib.
	Conflicting Right Turns	No right turn	Permissive or yield control	Permissive or yield control	Permissive or yield control	Permissive or yield control	Permissive or yield control	Permissive or yield control	Permissive or yield control	Permissive or yield control		No right turn	Permissive or yield control	Permissive or yield control	Permissive or yield control	Permissive or yield control	Permissive or yield control	Permissive or yield control		No right turn	Protected/ Permissive	Permissive or yield control		No right turn	Permissive or yield control
	Right Turns on Red (RTOR) ?	RTOR allowed	RTOR allowed	RTOR prohibited	RTOR prohibited	RTOR prohibited	RTOR prohibited	RTOR prohibited	RTOR prohibited	RTOR allowed		RTOR allowed	RTOR prohibited	RTOR allowed	RTOR allowed	RTOR allowed	RTOR allowed	RTOR allowed		RTOR allowed	RTOR prohibited	RTOR allowed		RTOR allowed	RTOR prohibited
	Ped Signal Leading Interval?	No	No	No	No	No	No	No	No	No		No	No	No	No	No	No	No		No	No	No		Yes	Yes
	Right Turn Channel	No Channel	Smart Channel	No Channel	No Channel	Conv'tl without Receiving Lane	Conv'tl without Receiving Lane	Conv'tl without Receiving Lane	Conv'tl without Receiving Lane	No Channel		No Right Turn	No Channel	No Channel	No Channel	No Channel	No Channel	No Channel		No Right Turn	No Channel	No Channel		No Right Turn	No Channel
	Corner Radius	10-15m	10-15m	15-25m	10-15m	15-25m	15-25m	10-15m	15-25m	5-10m		No Right Turn	10-15m	10-15m	5-10m	5-10m	5-10m	10-15m		No Right Turn	5-10m	10-15m		No Right Turn	10-15m
	Crosswalk Type	Std transverse markings	Std transverse markings	Std transverse markings	Std transverse markings	Zebra stripe hi-vis markings	Zebra stripe hi-vis markings	Zebra stripe hi-vis markings	Zebra stripe hi-vis markings	Std transverse markings		Std transverse markings	Std transverse markings	Std transverse markings	Std transverse markings	Std transverse markings	Std transverse markings	Std transverse markings		Std transverse markings	Std transverse markings	Zebra stripe hi-vis markings		Zebra stripe hi-vis markings	Zebra stripe hi-vis markings
	PETSI Score	50	51	46	40	28	28	14	12	54		52	40	53	86	54	54	20		43	49	56		57	53
Ped. Exposure to Traffic LoS	D	D	D	E	F	F	F	F	D	-	D	E	D	B	D	D	F	-	E	D	D	-	D	D	
Cycle Length	114	114	114	114	115	115	115	115	115		115	115	115	115	115	115	115		115	115	85		85	85	
Effective Walk Time	30	8	41	41	20	20	15	15	62		10	10	17	59	10	10	8		23	23	17		17	17	
Average Pedestrian Delay	31	49	23	23	39	39	43	43	12		48	48	42	14	48	48	50		37	37	27		27	27	
Pedestrian Delay LoS	D	E	C	C	D	D	E	E	B	-	E	E	E	B	E	E	E	-	D	D	C	-	C	C	
Level of Service	E				F				E				E				F				D				
Approach From		NORTH	SOUTH	EAST	WEST	NORTH	SOUTH	EAST	WEST	NORTH	SOUTH	EAST	WEST	NORTH	SOUTH	EAST	WEST	NORTH	SOUTH	EAST	WEST	NORTH	SOUTH	EAST	WEST
Bicycle	Bicycle Lane Arrangement on Approach	Curb Bike Lane, Cycletrack or MUP	Curb Bike Lane, Cycletrack or MUP	Curb Bike Lane, Cycletrack or MUP	Curb Bike Lane, Cycletrack or MUP	Pocket Bike Lane	Pocket Bike Lane	Mixed Traffic	Mixed Traffic	Mixed Traffic		Mixed Traffic	Mixed Traffic	Mixed Traffic	Mixed Traffic	Mixed Traffic	Mixed Traffic	Mixed Traffic		Mixed Traffic	Mixed Traffic	Curb Bike Lane, Cycletrack or MUP		Mixed Traffic	Mixed Traffic
	IF Dedicated Right Turn Lane, THEN Right Turn Configuration, ELSE <blank>	Not Applicable	Not Applicable	Not Applicable	Not Applicable	≤ 50 m Introduced right turn lane	≤ 50 m Introduced right turn lane	≤ 50 m	> 50 m					≤ 50 m				≤ 50 m		> 50 m		Not Applicable			
	Dedicated Right Turning Speed	Not Applicable	Not Applicable	Not Applicable	Not Applicable	>25 to 30 km/h	>25 to 30 km/h	>25 km/h	>25 km/h	≤ 25 km/h		≤ 25 km/h		≤ 25 km/h	≤ 25 km/h	≤ 25 km/h	≤ 25 km/h	≤ 25 km/h		≤ 25 km/h		Not Applicable		≤ 25 km/h	
	Cyclist Through Movement	Not Applicable	Not Applicable	Not Applicable	Not Applicable	C	C	E	F	-		-	-	D	-	-	-	D	-	F	-	Not Applicable	-	-	-
	Separated or Mixed Traffic	Separated	Separated	Separated	Separated	Separated	Separated	Mixed Traffic	Mixed Traffic	Mixed Traffic	-	Mixed Traffic	Mixed Traffic	Mixed Traffic	Mixed Traffic	Mixed Traffic	Mixed Traffic	Mixed Traffic	-	Mixed Traffic	Mixed Traffic	Separated	-	Mixed Traffic	Mixed Traffic
	Left Turn Approach	No lane crossed	1 lane crossed	2-stage, LT box	No lane crossed	1 lane crossed	1 lane crossed	≥ 2 lanes crossed	≥ 2 lanes crossed	One lane crossed		≥ 2 lanes crossed	≥ 2 lanes crossed	One lane crossed	No lane crossed	One lane crossed	One lane crossed	No lane crossed		≥ 2 lanes crossed	≥ 2 lanes crossed	No lane crossed		≥ 2 lanes crossed	≥ 2 lanes crossed
Operating Speed	> 50 to < 60 km/h	> 50 to < 60 km/h	> 50 to < 60 km/h	> 50 to < 60 km/h	> 50 to < 60 km/h	> 50 to < 60 km/h	> 50 to < 60 km/h	> 50 to < 60 km/h	≤ 40 km/h		> 50 to < 60 km/h	> 50 to < 60 km/h	> 40 to ≤ 50 km/h	≤ 40 km/h	> 50 to < 60 km/h	> 50 to < 60 km/h	> 40 to ≤ 50 km/h		> 50 to < 60 km/h	> 50 to < 60 km/h	> 40 to ≤ 50 km/h		> 50 to < 60 km/h	> 50 to < 60 km/h	
Left Turning Cyclist	C	D	A	C	D	D	F	F	B	-	-	F	D	B	E	E	B	-	-	F	B	-	-	F	
Level of Service	C				D				B				D				D				B				
Transit	Average Signal Delay	≤ 40 sec	> 40 sec	≤ 20 sec	≤ 40 sec	≤ 40 sec	> 40 sec	≤ 30 sec	≤ 40 sec			≤ 10 sec	≤ 10 sec	≤ 20 sec		≤ 10 sec	≤ 20 sec	> 40 sec		≤ 10 sec	≤ 10 sec			≤ 20 sec	≤ 10 sec
	Level of Service	E	F	C	E	E	F	D	E	-	-	B	B	C	-	B	C	F	-	B	B	-	-	C	B
Truck	Effective Corner Radius					> 15 m	10 - 15 m	> 15 m	> 15 m					< 10 m		10 - 15 m									
	Number of Receiving Lanes on Departure from Intersection					≥ 2	≥ 2	1	1					≥ 2		≥ 2									
Level of Service	-				A				-				D				-				-				
Auto	Volume to Capacity Ratio	0.71 - 0.80				0.71 - 0.80				0.0 - 0.60				0.71 - 0.80				0.61 - 0.70				0.71 - 0.80			
	Level of Service	C				C				A				C				B				C			

Multi-Modal Level of Service - Intersections Form

Consultant	WSP Canada Inc.	Project	CA0009956.0165
Scenario	Existing 2023 PM	Date	2023-12-13
Comments	AMRC TIA Strategy Report		

To add intersections
Select columns LMNO, right-click and Copy;
Then select column P, right-click and Insert Copied Cells

INTERSECTIONS		Alta Vista Dr / Hospital Link Rd				Smyth Rd / Alta Vista Dr				Smyth Rd / Valour Dr				Smyth Rd / Ring Rd-South Haven Pl				Smyth Rd / Hospital Main Access				Smyth Rd / Roger Guindon Ave			
Crossing Side		NORTH	SOUTH	EAST	WEST	NORTH	SOUTH	EAST	WEST	NORTH	SOUTH	EAST	WEST	NORTH	SOUTH	EAST	WEST	NORTH	SOUTH	EAST	WEST	NORTH	SOUTH	EAST	WEST
Pedestrian	Lanes	5	5	5	5	6	6	7	7	4		5	5	4	0-2	4	4	6		6	5	4		5	5
	Median	No Median - 2.4 m	No Median - 2.4 m	No Median - 2.4 m	No Median - 2.4 m	No Median - 2.4 m	No Median - 2.4 m	No Median - 2.4 m	No Median - 2.4 m	No Median - 2.4 m		No Median - 2.4 m	No Median - 2.4 m	No Median - 2.4 m	No Median - 2.4 m	No Median - 2.4 m	No Median - 2.4 m	No Median - 2.4 m		No Median - 2.4 m	No Median - 2.4 m	No Median - 2.4 m		No Median - 2.4 m	No Median - 2.4 m
	Conflicting Left Turns	No left turn / Prohib.	Protected	No left turn / Prohib.	Permissive	Protected/ Permissive	Protected/ Permissive	Protected/ Permissive	Protected/ Permissive	Permissive		Permissive	Permissive	Protected/ Permissive	Permissive	Permissive	Permissive	Protected/ Permissive		Protected	No left turn / Prohib.	Protected/ Permissive		Permissive	No left turn / Prohib.
	Conflicting Right Turns	No right turn	Permissive or yield control	Permissive or yield control	Permissive or yield control	Permissive or yield control	Permissive or yield control	Permissive or yield control	Permissive or yield control	Permissive or yield control		No right turn	Permissive or yield control	Permissive or yield control	Permissive or yield control	Permissive or yield control	Permissive or yield control	Permissive or yield control		No right turn	Protected/ Permissive	Permissive or yield control		No right turn	Permissive or yield control
	Right Turns on Red (RTOR) ?	RTOR allowed	RTOR allowed	RTOR prohibited	RTOR prohibited	RTOR prohibited	RTOR prohibited	RTOR prohibited	RTOR prohibited	RTOR allowed		RTOR allowed	RTOR prohibited	RTOR allowed	RTOR allowed	RTOR allowed	RTOR allowed	RTOR allowed		RTOR allowed	RTOR prohibited	RTOR allowed		RTOR allowed	RTOR prohibited
	Ped Signal Leading Interval?	No	No	No	No	No	No	No	No	No		No	No	No	No	No	No	No		No	No	No		Yes	Yes
	Right Turn Channel	No Channel	Smart Channel	No Channel	No Channel	Conv'tl without Receiving Lane	Conv'tl without Receiving Lane	Conv'tl without Receiving Lane	Conv'tl without Receiving Lane	No Channel		No Right Turn	No Channel	No Channel	No Channel	No Channel	No Channel	No Channel		No Right Turn	No Channel	No Channel		No Right Turn	No Channel
	Corner Radius	10-15m	10-15m	15-25m	10-15m	15-25m	15-25m	10-15m	15-25m	5-10m		No Right Turn	10-15m	10-15m	5-10m	5-10m	5-10m	10-15m		No Right Turn	5-10m	10-15m		No Right Turn	10-15m
	Crosswalk Type	Std transverse markings	Std transverse markings	Std transverse markings	Std transverse markings	Zebra stripe hi-vis markings	Zebra stripe hi-vis markings	Zebra stripe hi-vis markings	Zebra stripe hi-vis markings	Std transverse markings		Std transverse markings	Std transverse markings	Std transverse markings	Std transverse markings	Std transverse markings	Std transverse markings	Std transverse markings		Std transverse markings	Std transverse markings	Zebra stripe hi-vis markings		Zebra stripe hi-vis markings	Zebra stripe hi-vis markings
	PETSI Score	50	51	46	40	28	28	14	12	54		52	40	53	86	54	54	20		43	49	56		57	53
Ped. Exposure to Traffic LoS	D	D	D	E	F	F	F	F	D	-	D	E	D	B	D	D	F	-	E	D	D	-	D	D	
Cycle Length	114	114	114	114	115	115	115	115	115		115	115	115	115	115	115	115		115	115	85		85	85	
Effective Walk Time	30	8	41	41	26	26	9	9	45		9	9	37	53	16	16	9		38	38	21		17	17	
Average Pedestrian Delay	31	49	23	23	34	34	49	49	21		49	49	26	17	43	43	49		26	26	24		27	27	
Pedestrian Delay LoS	D	E	C	C	D	D	E	E	C	-	E	E	C	B	E	E	E	-	C	C	C	-	C	C	
Level of Service	E				F				E				E				F				D				
Approach From		NORTH	SOUTH	EAST	WEST	NORTH	SOUTH	EAST	WEST	NORTH	SOUTH	EAST	WEST	NORTH	SOUTH	EAST	WEST	NORTH	SOUTH	EAST	WEST	NORTH	SOUTH	EAST	WEST
Bicycle	Bicycle Lane Arrangement on Approach	Curb Bike Lane, Cycletrack or MUP	Curb Bike Lane, Cycletrack or MUP	Curb Bike Lane, Cycletrack or MUP	Curb Bike Lane, Cycletrack or MUP	Pocket Bike Lane	Pocket Bike Lane	Mixed Traffic	Mixed Traffic	Mixed Traffic		Mixed Traffic	Mixed Traffic	Mixed Traffic	Mixed Traffic	Mixed Traffic	Mixed Traffic	Mixed Traffic		Mixed Traffic	Mixed Traffic	Curb Bike Lane, Cycletrack or MUP		Mixed Traffic	Mixed Traffic
	IF Dedicated Right Turn Lane, THEN Right Turn Configuration, ELSE <blank>	Not Applicable	Not Applicable	Not Applicable	Not Applicable	≤ 50 m Introduced right turn lane	≤ 50 m Introduced right turn lane	≤ 50 m	> 50 m					≤ 50 m				≤ 50 m		> 50 m		Not Applicable			
	Dedicated Right Turning Speed	Not Applicable	Not Applicable	Not Applicable	Not Applicable	>25 to 30 km/h	>25 to 30 km/h	>25 km/h	>25 km/h	≤ 25 km/h		≤ 25 km/h		≤ 25 km/h	≤ 25 km/h	≤ 25 km/h	≤ 25 km/h	≤ 25 km/h		≤ 25 km/h		Not Applicable		≤ 25 km/h	
	Cyclist Through Movement	Not Applicable	Not Applicable	Not Applicable	Not Applicable	C	C	E	F	-		-	-	D	-	-	-	D	-	F	-	Not Applicable	-	-	-
	Separated or Mixed Traffic	Separated	Separated	Separated	Separated	Separated	Separated	Mixed Traffic	Mixed Traffic	Mixed Traffic	-	Mixed Traffic	Mixed Traffic	Mixed Traffic	Mixed Traffic	Mixed Traffic	Mixed Traffic	Mixed Traffic	-	Mixed Traffic	Mixed Traffic	Separated	-	Mixed Traffic	Mixed Traffic
Left Turn Approach	No lane crossed	1 lane crossed	2-stage, LT box	No lane crossed	1 lane crossed	1 lane crossed	≥ 2 lanes crossed	≥ 2 lanes crossed	One lane crossed		≥ 2 lanes crossed	≥ 2 lanes crossed	One lane crossed	No lane crossed	One lane crossed	One lane crossed	No lane crossed		≥ 2 lanes crossed	≥ 2 lanes crossed	No lane crossed		≥ 2 lanes crossed	≥ 2 lanes crossed	
Operating Speed	> 50 to < 60 km/h	> 50 to < 60 km/h	> 50 to < 60 km/h	> 50 to < 60 km/h	> 50 to < 60 km/h	> 50 to < 60 km/h	> 50 to < 60 km/h	> 50 to < 60 km/h	≤ 40 km/h		> 50 to < 60 km/h	> 50 to < 60 km/h	> 40 to ≤ 50 km/h	≤ 40 km/h	> 50 to < 60 km/h	> 50 to < 60 km/h	> 40 to ≤ 50 km/h		> 50 to < 60 km/h	> 50 to < 60 km/h	> 40 to ≤ 50 km/h		> 50 to < 60 km/h	> 50 to < 60 km/h	
Left Turning Cyclist	C	D	A	C	D	D	F	F	B	-	-	F	D	B	E	E	B	-	-	F	B	-	-	F	
Level of Service	C				D				B				D				D				B				
Transit	Average Signal Delay	≤ 30 sec	> 40 sec	≤ 30 sec	≤ 30 sec	> 40 sec	> 40 sec	≤ 30 sec	≤ 30 sec			≤ 20 sec	≤ 10 sec	≤ 40 sec		≤ 10 sec	≤ 10 sec	> 40 sec		≤ 20 sec	≤ 10 sec			≤ 20 sec	≤ 20 sec
	Level of Service	D	F	D	D	F	F	D	D	-	-	C	B	E	-	B	B	F	-	C	B	-	-	C	C
Truck	Effective Corner Radius					> 15 m	10 - 15 m	> 15 m	> 15 m					< 10 m		10 - 15 m									
	Number of Receiving Lanes on Departure from Intersection					≥ 2	≥ 2	1	1					≥ 2		≥ 2									
Level of Service	-				A				-				D				-				-				
Auto	Volume to Capacity Ratio	0.71 - 0.80				0.71 - 0.80				0.0 - 0.60				0.0 - 0.60				0.0 - 0.60				0.71 - 0.80			
	Level of Service	C				C				A				A				A				C			

Multi-Modal Level of Service - Intersections Form

Consultant	WSP Canada Inc.	Project	CA0009956.0165
Scenario	Future Background 2031 AM	Date	2023-12-13
Comments	AMRC TIA Strategy Report		

To add intersections
Select columns LMNO, right-click and Copy;
Then select column P, right-click and Insert Copied Cells

INTERSECTIONS		Alta Vista Dr / Hospital Link Rd				Smyth Rd / Alta Vista Dr				Smyth Rd / Valour Dr				Smyth Rd / Ring Rd-South Haven Pl				Smyth Rd / Hospital Main Access				Smyth Rd / Roger Guindon Ave			
Crossing Side		NORTH	SOUTH	EAST	WEST	NORTH	SOUTH	EAST	WEST	NORTH	SOUTH	EAST	WEST	NORTH	SOUTH	EAST	WEST	NORTH	SOUTH	EAST	WEST	NORTH	SOUTH	EAST	WEST
Pedestrian	Lanes	5	5	5	5	6	6	7	7	4		5	5	4	0-2	4	4	6		6	5	4		5	5
	Median	No Median - 2.4 m	No Median - 2.4 m	No Median - 2.4 m	No Median - 2.4 m	No Median - 2.4 m	No Median - 2.4 m	No Median - 2.4 m	No Median - 2.4 m	No Median - 2.4 m		No Median - 2.4 m	No Median - 2.4 m	No Median - 2.4 m	No Median - 2.4 m	No Median - 2.4 m	No Median - 2.4 m	No Median - 2.4 m		No Median - 2.4 m	No Median - 2.4 m	No Median - 2.4 m		No Median - 2.4 m	No Median - 2.4 m
	Conflicting Left Turns	No left turn / Prohib.	Protected	No left turn / Prohib.	Permissive	Protected/ Permissive	Protected/ Permissive	Protected/ Permissive	Protected/ Permissive	Permissive		Permissive	Permissive	Protected/ Permissive	Permissive	Permissive	Permissive	Protected/ Permissive		Protected	No left turn / Prohib.	Protected/ Permissive		Permissive	No left turn / Prohib.
	Conflicting Right Turns	No right turn	Permissive or yield control	Permissive or yield control	Permissive or yield control	Permissive or yield control	Permissive or yield control	Permissive or yield control	Permissive or yield control	Permissive or yield control		No right turn	Permissive or yield control	Permissive or yield control	Permissive or yield control	Permissive or yield control	Permissive or yield control	Permissive or yield control		No right turn	Protected/ Permissive	Permissive or yield control		No right turn	Permissive or yield control
	Right Turns on Red (RTOR) ?	RTOR allowed	RTOR allowed	RTOR prohibited	RTOR prohibited	RTOR prohibited	RTOR prohibited	RTOR prohibited	RTOR prohibited	RTOR allowed		RTOR allowed	RTOR prohibited	RTOR allowed	RTOR allowed	RTOR allowed	RTOR allowed	RTOR allowed		RTOR allowed	RTOR prohibited	RTOR allowed		RTOR allowed	RTOR prohibited
	Ped Signal Leading Interval?	No	No	No	No	No	No	No	No	No		No	No	No	No	No	No	No		No	No	No		Yes	Yes
	Right Turn Channel	No Channel	Smart Channel	No Channel	No Channel	Conv'tl without Receiving Lane	Conv'tl without Receiving Lane	Conv'tl without Receiving Lane	Conv'tl without Receiving Lane	No Channel		No Right Turn	No Channel	No Channel	No Channel	No Channel	No Channel	No Channel		No Right Turn	No Channel	No Channel		No Right Turn	No Channel
	Corner Radius	10-15m	10-15m	15-25m	10-15m	15-25m	15-25m	10-15m	15-25m	5-10m		No Right Turn	10-15m	10-15m	5-10m	5-10m	5-10m	10-15m		No Right Turn	5-10m	10-15m		No Right Turn	10-15m
	Crosswalk Type	Std transverse markings	Std transverse markings	Std transverse markings	Std transverse markings	Zebra stripe hi-vis markings	Zebra stripe hi-vis markings	Zebra stripe hi-vis markings	Zebra stripe hi-vis markings	Std transverse markings		Std transverse markings	Std transverse markings	Std transverse markings	Std transverse markings	Std transverse markings	Std transverse markings	Std transverse markings		Std transverse markings	Std transverse markings	Zebra stripe hi-vis markings		Zebra stripe hi-vis markings	Zebra stripe hi-vis markings
	PETSI Score	50	51	46	40	28	28	14	12	54		52	40	53	86	54	54	20		43	49	56		57	53
Ped. Exposure to Traffic LoS	D	D	D	E	F	F	F	F	D	-	D	E	D	B	D	D	F	-	E	D	D	-	D	D	
Cycle Length	114	114	114	114	115	115	115	115	115		115	115	115	115	115	115	115		115	115	85		85	85	
Effective Walk Time	30	8	41	41	20	20	15	15	62		10	10	17	59	10	10	8		23	23	17		17	17	
Average Pedestrian Delay	31	49	23	23	39	39	43	43	12		48	48	42	14	48	48	50		37	37	27		27	27	
Pedestrian Delay LoS	D	E	C	C	D	D	E	E	B	-	E	E	E	B	E	E	E	-	D	D	C	-	C	C	
Level of Service	E				F				E				E				F				D				
Approach From		NORTH	SOUTH	EAST	WEST	NORTH	SOUTH	EAST	WEST	NORTH	SOUTH	EAST	WEST	NORTH	SOUTH	EAST	WEST	NORTH	SOUTH	EAST	WEST	NORTH	SOUTH	EAST	WEST
Bicycle	Bicycle Lane Arrangement on Approach	Curb Bike Lane, Cycletrack or MUP	Curb Bike Lane, Cycletrack or MUP	Curb Bike Lane, Cycletrack or MUP	Curb Bike Lane, Cycletrack or MUP	Pocket Bike Lane	Pocket Bike Lane	Mixed Traffic	Mixed Traffic	Mixed Traffic		Mixed Traffic	Mixed Traffic	Mixed Traffic	Mixed Traffic	Mixed Traffic	Mixed Traffic	Mixed Traffic		Mixed Traffic	Mixed Traffic	Curb Bike Lane, Cycletrack or MUP		Mixed Traffic	Mixed Traffic
	IF Dedicated Right Turn Lane, THEN Right Turn Configuration, ELSE <blank>	Not Applicable	Not Applicable	Not Applicable	Not Applicable	≤ 50 m Introduced right turn lane	≤ 50 m Introduced right turn lane	≤ 50 m	> 50 m					≤ 50 m				≤ 50 m		> 50 m		Not Applicable			
	Dedicated Right Turning Speed	Not Applicable	Not Applicable	Not Applicable	Not Applicable	>25 to 30 km/h	>25 to 30 km/h	>25 km/h	>25 km/h	≤ 25 km/h		≤ 25 km/h		≤ 25 km/h	≤ 25 km/h	≤ 25 km/h	≤ 25 km/h	≤ 25 km/h		≤ 25 km/h		Not Applicable		≤ 25 km/h	
	Cyclist Through Movement	Not Applicable	Not Applicable	Not Applicable	Not Applicable	C	C	E	F	-		-	-	D	-	-	-	D	-	F	-	Not Applicable	-	-	-
	Separated or Mixed Traffic	Separated	Separated	Separated	Separated	Separated	Separated	Mixed Traffic	Mixed Traffic	Mixed Traffic	-	Mixed Traffic	Mixed Traffic	Mixed Traffic	Mixed Traffic	Mixed Traffic	Mixed Traffic	Mixed Traffic	-	Mixed Traffic	Mixed Traffic	Separated	-	Mixed Traffic	Mixed Traffic
Left Turn Approach	No lane crossed	1 lane crossed	2-stage, LT box	No lane crossed	1 lane crossed	1 lane crossed	≥ 2 lanes crossed	≥ 2 lanes crossed	One lane crossed		≥ 2 lanes crossed	≥ 2 lanes crossed	One lane crossed	No lane crossed	One lane crossed	One lane crossed	No lane crossed		≥ 2 lanes crossed	≥ 2 lanes crossed	No lane crossed		≥ 2 lanes crossed	≥ 2 lanes crossed	
Operating Speed	> 50 to < 60 km/h	> 50 to < 60 km/h	> 50 to < 60 km/h	> 50 to < 60 km/h	> 50 to < 60 km/h	> 50 to < 60 km/h	> 50 to < 60 km/h	> 50 to < 60 km/h	≤ 40 km/h		> 50 to < 60 km/h	> 50 to < 60 km/h	> 40 to ≤ 50 km/h	≤ 40 km/h	> 50 to < 60 km/h	> 50 to < 60 km/h	> 40 to ≤ 50 km/h		> 50 to < 60 km/h	> 50 to < 60 km/h	> 40 to ≤ 50 km/h		> 50 to < 60 km/h	> 50 to < 60 km/h	
Left Turning Cyclist	C	D	A	C	D	D	F	F	B	-	-	F	D	B	E	E	B	-	-	F	B	-	-	F	
Level of Service	C				D				B				D				D				B				
Transit	Average Signal Delay	≤ 40 sec	> 40 sec	≤ 30 sec	≤ 40 sec	≤ 40 sec	> 40 sec	≤ 30 sec	≤ 40 sec			≤ 10 sec	≤ 10 sec	≤ 20 sec		≤ 10 sec	≤ 20 sec	> 40 sec		≤ 20 sec	≤ 10 sec			≤ 20 sec	≤ 10 sec
	Level of Service	E	F	D	E	E	F	D	E	-	-	B	B	C	-	B	C	F	-	C	B	-	-	C	B
Truck	Effective Corner Radius					> 15 m	10 - 15 m	> 15 m	> 15 m					< 10 m		10 - 15 m									
	Number of Receiving Lanes on Departure from Intersection					≥ 2	≥ 2	1	1					≥ 2		≥ 2									
Level of Service	-				A				B				D				-				-				
Auto	Volume to Capacity Ratio	0.71 - 0.80				0.71 - 0.80				0.0 - 0.60				0.71 - 0.80				0.61 - 0.70				0.71 - 0.80			
	Level of Service	C				C				A				C				B				C			

Multi-Modal Level of Service - Intersections Form

Consultant	WSP Canada Inc.	Project	CA0009956.0165
Scenario	Future Background 2031 PM	Date	2023-12-13
Comments	AMRC TIA Strategy Report		

To add intersections
Select columns LMNO, right-click and Copy;
Then select column P, right-click and Insert Copied Cells

INTERSECTIONS		Alta Vista Dr / Hospital Link Rd				Smyth Rd / Alta Vista Dr				Smyth Rd / Valour Dr				Smyth Rd / Ring Rd-South Haven Pl				Smyth Rd / Hospital Main Access				Smyth Rd / Roger Guindon Ave			
Crossing Side		NORTH	SOUTH	EAST	WEST	NORTH	SOUTH	EAST	WEST	NORTH	SOUTH	EAST	WEST	NORTH	SOUTH	EAST	WEST	NORTH	SOUTH	EAST	WEST	NORTH	SOUTH	EAST	WEST
Pedestrian	Lanes	5	5	5	5	6	6	7	7	4		5	5	4	0-2	4	4	6		6	5	4		5	5
	Median	No Median - 2.4 m	No Median - 2.4 m	No Median - 2.4 m	No Median - 2.4 m	No Median - 2.4 m	No Median - 2.4 m	No Median - 2.4 m	No Median - 2.4 m	No Median - 2.4 m		No Median - 2.4 m	No Median - 2.4 m	No Median - 2.4 m	No Median - 2.4 m	No Median - 2.4 m	No Median - 2.4 m	No Median - 2.4 m		No Median - 2.4 m	No Median - 2.4 m	No Median - 2.4 m		No Median - 2.4 m	No Median - 2.4 m
	Conflicting Left Turns	No left turn / Prohib.	Protected	No left turn / Prohib.	Permissive	Protected/ Permissive	Protected/ Permissive	Protected/ Permissive	Protected/ Permissive	Permissive		Permissive	Permissive	Protected/ Permissive	Permissive	Permissive	Permissive	Protected/ Permissive		Protected	No left turn / Prohib.	Protected/ Permissive		Permissive	No left turn / Prohib.
	Conflicting Right Turns	No right turn	Permissive or yield control	Permissive or yield control	Permissive or yield control	Permissive or yield control	Permissive or yield control	Permissive or yield control	Permissive or yield control	Permissive or yield control		No right turn	Permissive or yield control	Permissive or yield control	Permissive or yield control	Permissive or yield control	Permissive or yield control	Permissive or yield control		No right turn	Protected/ Permissive	Permissive or yield control		No right turn	Permissive or yield control
	Right Turns on Red (RTOR) ?	RTOR allowed	RTOR allowed	RTOR prohibited	RTOR prohibited	RTOR prohibited	RTOR prohibited	RTOR prohibited	RTOR prohibited	RTOR allowed		RTOR allowed	RTOR prohibited	RTOR allowed	RTOR allowed	RTOR allowed	RTOR allowed	RTOR allowed		RTOR allowed	RTOR prohibited	RTOR allowed		RTOR allowed	RTOR prohibited
	Ped Signal Leading Interval?	No	No	No	No	No	No	No	No	No		No	No	No	No	No	No	No		No	No	No		Yes	Yes
	Right Turn Channel	No Channel	Smart Channel	No Channel	No Channel	Conv'tl without Receiving Lane	Conv'tl without Receiving Lane	Conv'tl without Receiving Lane	Conv'tl without Receiving Lane	No Channel		No Right Turn	No Channel	No Channel	No Channel	No Channel	No Channel	No Channel		No Right Turn	No Channel	No Channel		No Right Turn	No Channel
	Corner Radius	10-15m	10-15m	15-25m	10-15m	15-25m	15-25m	10-15m	15-25m	5-10m		No Right Turn	10-15m	10-15m	5-10m	5-10m	5-10m	10-15m		No Right Turn	5-10m	10-15m		No Right Turn	10-15m
	Crosswalk Type	Std transverse markings	Std transverse markings	Std transverse markings	Std transverse markings	Zebra stripe hi-vis markings	Zebra stripe hi-vis markings	Zebra stripe hi-vis markings	Zebra stripe hi-vis markings	Std transverse markings		Std transverse markings	Std transverse markings	Std transverse markings	Std transverse markings	Std transverse markings	Std transverse markings	Std transverse markings		Std transverse markings	Std transverse markings	Zebra stripe hi-vis markings		Zebra stripe hi-vis markings	Zebra stripe hi-vis markings
	PETSI Score	50	51	46	40	28	28	14	12	54		52	40	53	86	54	54	20		43	49	56		57	53
Ped. Exposure to Traffic LoS	D	D	D	E	F	F	F	F	D	-	D	E	D	B	D	D	F	-	E	D	D	-	D	D	
Cycle Length	114	114	114	114	115	115	115	115	115		115	115	115	115	115	115	115		115	115	85		85	85	
Effective Walk Time	30	8	41	41	26	26	9	9	45		9	9	37	53	16	16	9		38	38	21		17	17	
Average Pedestrian Delay	31	49	23	23	34	34	49	49	21		49	49	26	17	43	43	49		26	26	24		27	27	
Pedestrian Delay LoS	D	E	C	C	D	D	E	E	C	-	E	E	C	B	E	E	E	-	C	C	C	-	C	C	
Level of Service	E				F				E				E				F				D				
Approach From		NORTH	SOUTH	EAST	WEST	NORTH	SOUTH	EAST	WEST	NORTH	SOUTH	EAST	WEST	NORTH	SOUTH	EAST	WEST	NORTH	SOUTH	EAST	WEST	NORTH	SOUTH	EAST	WEST
Bicycle	Bicycle Lane Arrangement on Approach	Curb Bike Lane, Cycletrack or MUP	Curb Bike Lane, Cycletrack or MUP	Curb Bike Lane, Cycletrack or MUP	Curb Bike Lane, Cycletrack or MUP	Pocket Bike Lane	Pocket Bike Lane	Mixed Traffic	Mixed Traffic	Mixed Traffic		Mixed Traffic	Mixed Traffic	Mixed Traffic	Mixed Traffic	Mixed Traffic	Mixed Traffic	Mixed Traffic		Mixed Traffic	Mixed Traffic	Curb Bike Lane, Cycletrack or MUP		Mixed Traffic	Mixed Traffic
	IF Dedicated Right Turn Lane, THEN Right Turn Configuration, ELSE <blank>	Not Applicable	Not Applicable	Not Applicable	Not Applicable	≤ 50 m Introduced right turn lane	≤ 50 m Introduced right turn lane	≤ 50 m	> 50 m					≤ 50 m				≤ 50 m		> 50 m		Not Applicable			
	Dedicated Right Turning Speed	Not Applicable	Not Applicable	Not Applicable	Not Applicable	>25 to 30 km/h	>25 to 30 km/h	>25 km/h	>25 km/h	≤ 25 km/h		≤ 25 km/h		≤ 25 km/h	≤ 25 km/h	≤ 25 km/h	≤ 25 km/h	≤ 25 km/h		≤ 25 km/h		Not Applicable		≤ 25 km/h	
	Cyclist Through Movement	Not Applicable	Not Applicable	Not Applicable	Not Applicable	C	C	E	F	-		-	-	D	-	-	-	D	-	F	-	Not Applicable	-	-	-
	Separated or Mixed Traffic	Separated	Separated	Separated	Separated	Separated	Separated	Mixed Traffic	Mixed Traffic	Mixed Traffic	-	Mixed Traffic	Mixed Traffic	Mixed Traffic	Mixed Traffic	Mixed Traffic	Mixed Traffic	Mixed Traffic	-	Mixed Traffic	Mixed Traffic	Separated	-	Mixed Traffic	Mixed Traffic
Left Turn Approach	No lane crossed	1 lane crossed	2-stage, LT box	No lane crossed	1 lane crossed	1 lane crossed	≥ 2 lanes crossed	≥ 2 lanes crossed	One lane crossed		≥ 2 lanes crossed	≥ 2 lanes crossed	One lane crossed	No lane crossed	One lane crossed	One lane crossed	No lane crossed		≥ 2 lanes crossed	≥ 2 lanes crossed	No lane crossed		≥ 2 lanes crossed	≥ 2 lanes crossed	
Operating Speed	> 50 to < 60 km/h	> 50 to < 60 km/h	> 50 to < 60 km/h	> 50 to < 60 km/h	> 50 to < 60 km/h	> 50 to < 60 km/h	> 50 to < 60 km/h	> 50 to < 60 km/h	≤ 40 km/h		> 50 to < 60 km/h	> 50 to < 60 km/h	> 40 to ≤ 50 km/h	≤ 40 km/h	> 50 to < 60 km/h	> 50 to < 60 km/h	> 40 to ≤ 50 km/h		> 50 to < 60 km/h	> 50 to < 60 km/h	> 40 to ≤ 50 km/h		> 50 to < 60 km/h	> 50 to < 60 km/h	
Left Turning Cyclist	C	D	A	C	D	D	F	F	B	-	-	F	D	B	E	E	B	-	-	F	B	-	-	F	
Level of Service	C				D				B				D				D				B				
Transit	Average Signal Delay	≤ 30 sec	> 40 sec	≤ 30 sec	≤ 30 sec	> 40 sec	> 40 sec	≤ 30 sec	≤ 30 sec			≤ 20 sec	≤ 10 sec	≤ 40 sec		≤ 10 sec	≤ 10 sec	> 40 sec		≤ 20 sec	≤ 10 sec			≤ 20 sec	≤ 20 sec
	Level of Service	D	F	D	D	F	F	D	D	-	-	C	B	E	-	B	B	F	-	C	B	-	-	C	C
Truck	Effective Corner Radius					> 15 m	10 - 15 m	> 15 m	> 15 m					< 10 m		10 - 15 m									
	Number of Receiving Lanes on Departure from Intersection					≥ 2	≥ 2	1	1					≥ 2		≥ 2									
Level of Service	-				A				-				D				-				-				
Auto	Volume to Capacity Ratio	0.71 - 0.80				0.71 - 0.80				0.0 - 0.60				0.0 - 0.60				0.0 - 0.60				0.61 - 0.70			
	Level of Service	C				C				A				A				A				B			

Multi-Modal Level of Service - Intersections Form

Consultant	WSP Canada Inc.	Project	CA0009956.0165
Scenario	Future Total 2031 AM	Date	2023-12-13
Comments	AMRC TIA Strategy Report		

To add intersections
Select columns LMNO, right-click and Copy;
Then select column P, right-click and Insert Copied Cells

INTERSECTIONS		Alta Vista Dr / Hospital Link Rd				Smyth Rd / Alta Vista Dr				Smyth Rd / Valour Dr				Smyth Rd / Ring Rd-South Haven Pl				Smyth Rd / Hospital Main Access				Smyth Rd / Roger Guindon Ave			
Crossing Side		NORTH	SOUTH	EAST	WEST	NORTH	SOUTH	EAST	WEST	NORTH	SOUTH	EAST	WEST	NORTH	SOUTH	EAST	WEST	NORTH	SOUTH	EAST	WEST	NORTH	SOUTH	EAST	WEST
Pedestrian	Lanes	5	5	5	5	6	6	7	7	4		5	5	4	0-2	4	4	6		6	5	4		5	5
	Median	No Median - 2.4 m	No Median - 2.4 m	No Median - 2.4 m	No Median - 2.4 m	No Median - 2.4 m	No Median - 2.4 m	No Median - 2.4 m	No Median - 2.4 m	No Median - 2.4 m		No Median - 2.4 m	No Median - 2.4 m	No Median - 2.4 m	No Median - 2.4 m	No Median - 2.4 m	No Median - 2.4 m	No Median - 2.4 m		No Median - 2.4 m	No Median - 2.4 m	No Median - 2.4 m		No Median - 2.4 m	No Median - 2.4 m
	Conflicting Left Turns	No left turn / Prohib.	Protected	No left turn / Prohib.	Permissive	Protected/ Permissive	Protected/ Permissive	Protected/ Permissive	Protected/ Permissive	Permissive		Permissive	Permissive	Protected/ Permissive	Permissive	Permissive	Permissive	Protected/ Permissive		Protected	No left turn / Prohib.	Protected/ Permissive		Permissive	No left turn / Prohib.
	Conflicting Right Turns	No right turn	Permissive or yield control	Permissive or yield control	Permissive or yield control	Permissive or yield control	Permissive or yield control	Permissive or yield control	Permissive or yield control	Permissive or yield control		No right turn	Permissive or yield control	Permissive or yield control	Permissive or yield control	Permissive or yield control	Permissive or yield control	Permissive or yield control		No right turn	Protected/ Permissive	Permissive or yield control		No right turn	Permissive or yield control
	Right Turns on Red (RTOR) ?	RTOR allowed	RTOR allowed	RTOR prohibited	RTOR prohibited	RTOR prohibited	RTOR prohibited	RTOR prohibited	RTOR prohibited	RTOR allowed		RTOR allowed	RTOR prohibited	RTOR allowed	RTOR allowed	RTOR allowed	RTOR allowed	RTOR allowed		RTOR allowed	RTOR prohibited	RTOR allowed		RTOR allowed	RTOR prohibited
	Ped Signal Leading Interval?	No	No	No	No	No	No	No	No	No		No	No	No	No	No	No	No		No	No	No		Yes	Yes
	Right Turn Channel	No Channel	Smart Channel	No Channel	No Channel	Conv't'l without Receiving Lane	Conv't'l without Receiving Lane	Conv't'l without Receiving Lane	Conv't'l without Receiving Lane	No Channel		No Right Turn	No Channel	No Channel	No Channel	No Channel	No Channel	No Channel		No Right Turn	No Channel	No Channel		No Right Turn	No Channel
	Corner Radius	10-15m	10-15m	15-25m	10-15m	15-25m	15-25m	10-15m	15-25m	5-10m		No Right Turn	10-15m	10-15m	5-10m	5-10m	5-10m	10-15m		No Right Turn	5-10m	10-15m		No Right Turn	10-15m
	Crosswalk Type	Std transverse markings	Std transverse markings	Std transverse markings	Std transverse markings	Zebra stripe hi-vis markings	Zebra stripe hi-vis markings	Zebra stripe hi-vis markings	Zebra stripe hi-vis markings	Std transverse markings		Std transverse markings	Std transverse markings	Std transverse markings	Std transverse markings	Std transverse markings	Std transverse markings	Std transverse markings		Std transverse markings	Std transverse markings	Zebra stripe hi-vis markings		Zebra stripe hi-vis markings	Zebra stripe hi-vis markings
	PETSI Score	50	51	46	40	28	28	14	12	54		52	40	53	86	54	54	20		43	49	56		57	53
Ped. Exposure to Traffic LoS	D	D	D	E	F	F	F	F	D	-	D	E	D	B	D	D	F	-	E	D	D	-	D	D	
Cycle Length	114	114	114	114	115	115	115	115	115		115	115	115	115	115	115	115		115	115	85		85	85	
Effective Walk Time	30	8	41	41	20	20	15	15	62		10	10	17	59	10	10	8		23	23	17		17	17	
Average Pedestrian Delay	31	49	23	23	39	39	43	43	12		48	48	42	14	48	48	50		37	37	27		27	27	
Pedestrian Delay LoS	D	E	C	C	D	D	E	E	B	-	E	E	E	B	E	E	E	-	D	D	C	-	C	C	
Level of Service	E				F				E				E				F				D				
Approach From		NORTH	SOUTH	EAST	WEST	NORTH	SOUTH	EAST	WEST	NORTH	SOUTH	EAST	WEST	NORTH	SOUTH	EAST	WEST	NORTH	SOUTH	EAST	WEST	NORTH	SOUTH	EAST	WEST
Bicycle	Bicycle Lane Arrangement on Approach	Curb Bike Lane, Cycletrack or MUP	Curb Bike Lane, Cycletrack or MUP	Curb Bike Lane, Cycletrack or MUP	Curb Bike Lane, Cycletrack or MUP	Pocket Bike Lane	Pocket Bike Lane	Mixed Traffic	Mixed Traffic	Mixed Traffic		Mixed Traffic	Mixed Traffic	Mixed Traffic	Mixed Traffic	Mixed Traffic	Mixed Traffic	Mixed Traffic		Mixed Traffic	Mixed Traffic	Curb Bike Lane, Cycletrack or MUP		Mixed Traffic	Mixed Traffic
	IF Dedicated Right Turn Lane, THEN Right Turn Configuration, ELSE <blank>	Not Applicable	Not Applicable	Not Applicable	Not Applicable	≤ 50 m Introduced right turn lane	≤ 50 m Introduced right turn lane	≤ 50 m	> 50 m					≤ 50 m				≤ 50 m		> 50 m		Not Applicable			
	Dedicated Right Turning Speed	Not Applicable	Not Applicable	Not Applicable	Not Applicable	>25 to 30 km/h	>25 to 30 km/h	>25 km/h	>25 km/h	≤ 25 km/h		≤ 25 km/h		≤ 25 km/h	≤ 25 km/h	≤ 25 km/h	≤ 25 km/h	≤ 25 km/h		≤ 25 km/h		Not Applicable		≤ 25 km/h	
	Cyclist Through Movement	Not Applicable	Not Applicable	Not Applicable	Not Applicable	C	C	E	F	-		-	-	D	-	-	-	D	-	F	-	Not Applicable	-	-	-
	Separated or Mixed Traffic	Separated	Separated	Separated	Separated	Separated	Separated	Mixed Traffic	Mixed Traffic	Mixed Traffic	-	Mixed Traffic	Mixed Traffic	Mixed Traffic	Mixed Traffic	Mixed Traffic	Mixed Traffic	Mixed Traffic	-	Mixed Traffic	Mixed Traffic	Separated	-	Mixed Traffic	Mixed Traffic
Left Turn Approach	No lane crossed	1 lane crossed	2-stage, LT box	No lane crossed	1 lane crossed	1 lane crossed	≥ 2 lanes crossed	≥ 2 lanes crossed	One lane crossed		≥ 2 lanes crossed	≥ 2 lanes crossed	One lane crossed	No lane crossed	One lane crossed	One lane crossed	No lane crossed		≥ 2 lanes crossed	≥ 2 lanes crossed	No lane crossed		≥ 2 lanes crossed	≥ 2 lanes crossed	
Operating Speed	> 50 to < 60 km/h	> 50 to < 60 km/h	> 50 to < 60 km/h	> 50 to < 60 km/h	> 50 to < 60 km/h	> 50 to < 60 km/h	> 50 to < 60 km/h	> 50 to < 60 km/h	≤ 40 km/h		> 50 to < 60 km/h	> 50 to < 60 km/h	> 40 to ≤ 50 km/h	≤ 40 km/h	> 50 to < 60 km/h	> 50 to < 60 km/h	> 40 to ≤ 50 km/h		> 50 to < 60 km/h	> 50 to < 60 km/h	> 40 to ≤ 50 km/h		> 50 to < 60 km/h	> 50 to < 60 km/h	
Left Turning Cyclist	C	D	A	C	D	D	F	F	B	-	-	F	D	B	E	E	B	-	-	F	B	-	-	F	
Level of Service	C				D				B				D				D				B				
Transit	Average Signal Delay	≤ 40 sec	> 40 sec	≤ 30 sec	> 40 sec	≤ 40 sec	> 40 sec	≤ 30 sec	> 40 sec			≤ 10 sec	≤ 10 sec	≤ 20 sec		≤ 10 sec	≤ 20 sec	> 40 sec		≤ 20 sec	≤ 10 sec			≤ 30 sec	≤ 10 sec
	Level of Service	E	F	D	F	E	F	D	F	-	-	B	B	C	-	B	C	F	-	C	B	-	-	D	B
Truck	Effective Corner Radius					> 15 m	10 - 15 m	> 15 m	> 15 m					< 10 m		10 - 15 m									
	Number of Receiving Lanes on Departure from Intersection					≥ 2	≥ 2	1	1					≥ 2		≥ 2									
Level of Service	-				A				B				D				-				-				
Auto	Volume to Capacity Ratio	0.81 - 0.90				0.81 - 0.90				0.0 - 0.60				0.81 - 0.90				0.61 - 0.70				0.71 - 0.80			
	Level of Service	D				D				A				D				B				C			

Multi-Modal Level of Service - Intersections Form

Consultant	WSP Canada Inc.	Project	CA0009956.0165
Scenario	Future Total 2031 PM	Date	2023-12-13
Comments	AMRC TIA Strategy Report		

To add intersections
Select columns LMNO, right-click and Copy;
Then select column P, right-click and Insert Copied Cells

INTERSECTIONS		Alta Vista Dr / Hospital Link Rd				Smyth Rd / Alta Vista Dr				Smyth Rd / Valour Dr				Smyth Rd / Ring Rd-South Haven Pl				Smyth Rd / Hospital Main Access				Smyth Rd / Roger Guindon Ave			
Crossing Side		NORTH	SOUTH	EAST	WEST	NORTH	SOUTH	EAST	WEST	NORTH	SOUTH	EAST	WEST	NORTH	SOUTH	EAST	WEST	NORTH	SOUTH	EAST	WEST	NORTH	SOUTH	EAST	WEST
Pedestrian	Lanes	5	5	5	5	6	6	7	7	4		5	5	4	0-2	4	4	6		6	5	4		5	5
	Median	No Median - 2.4 m	No Median - 2.4 m	No Median - 2.4 m	No Median - 2.4 m	No Median - 2.4 m	No Median - 2.4 m	No Median - 2.4 m	No Median - 2.4 m	No Median - 2.4 m		No Median - 2.4 m	No Median - 2.4 m	No Median - 2.4 m	No Median - 2.4 m	No Median - 2.4 m	No Median - 2.4 m	No Median - 2.4 m		No Median - 2.4 m	No Median - 2.4 m	No Median - 2.4 m		No Median - 2.4 m	No Median - 2.4 m
	Conflicting Left Turns	No left turn / Prohib.	Protected	No left turn / Prohib.	Permissive	Protected/ Permissive	Protected/ Permissive	Protected/ Permissive	Protected/ Permissive	Permissive		Permissive	Permissive	Protected/ Permissive	Permissive	Permissive	Permissive	Protected/ Permissive		Protected	No left turn / Prohib.	Protected/ Permissive		Permissive	No left turn / Prohib.
	Conflicting Right Turns	No right turn	Permissive or yield control	Permissive or yield control	Permissive or yield control	Permissive or yield control	Permissive or yield control	Permissive or yield control	Permissive or yield control	Permissive or yield control		No right turn	Permissive or yield control	Permissive or yield control	Permissive or yield control	Permissive or yield control	Permissive or yield control	Permissive or yield control		No right turn	Protected/ Permissive	Permissive or yield control		No right turn	Permissive or yield control
	Right Turns on Red (RTOR) ?	RTOR allowed	RTOR allowed	RTOR prohibited	RTOR prohibited	RTOR prohibited	RTOR prohibited	RTOR prohibited	RTOR prohibited	RTOR allowed		RTOR allowed	RTOR prohibited	RTOR allowed	RTOR allowed	RTOR allowed	RTOR allowed	RTOR allowed		RTOR allowed	RTOR prohibited	RTOR allowed		RTOR allowed	RTOR prohibited
	Ped Signal Leading Interval?	No	No	No	No	No	No	No	No	No		No	No	No	No	No	No	No		No	No	No		Yes	Yes
	Right Turn Channel	No Channel	Smart Channel	No Channel	No Channel	Conv'tl without Receiving Lane	Conv'tl without Receiving Lane	Conv'tl without Receiving Lane	Conv'tl without Receiving Lane	No Channel		No Right Turn	No Channel	No Channel	No Channel	No Channel	No Channel	No Channel		No Right Turn	No Channel	No Channel		No Right Turn	No Channel
	Corner Radius	10-15m	10-15m	15-25m	10-15m	15-25m	15-25m	10-15m	15-25m	5-10m		No Right Turn	10-15m	10-15m	5-10m	5-10m	5-10m	10-15m		No Right Turn	5-10m	10-15m		No Right Turn	10-15m
	Crosswalk Type	Std transverse markings	Std transverse markings	Std transverse markings	Std transverse markings	Zebra stripe hi-vis markings	Zebra stripe hi-vis markings	Zebra stripe hi-vis markings	Zebra stripe hi-vis markings	Std transverse markings		Std transverse markings	Std transverse markings	Std transverse markings	Std transverse markings	Std transverse markings	Std transverse markings	Std transverse markings		Std transverse markings	Std transverse markings	Zebra stripe hi-vis markings		Zebra stripe hi-vis markings	Zebra stripe hi-vis markings
	PETSI Score	50	51	46	40	28	28	14	12	54		52	40	53	86	54	54	20		43	49	56		57	53
Ped. Exposure to Traffic LoS	D	D	D	E	F	F	F	F	D	-	D	E	D	B	D	D	F	-	E	D	D	-	D	D	
Cycle Length	114	114	114	114	115	115	115	115	115		115	115	115	115	115	115	115		115	115	85		85	85	
Effective Walk Time	30	8	41	41	26	26	9	9	45		9	9	37	53	16	16	9		38	38	21		17	17	
Average Pedestrian Delay	31	49	23	23	34	34	49	49	21		49	49	26	17	43	43	49		26	26	24		27	27	
Pedestrian Delay LoS	D	E	C	C	D	D	E	E	C	-	E	E	C	B	E	E	E	-	C	C	C	-	C	C	
Level of Service	E				F				E				E				F				D				
Approach From		NORTH	SOUTH	EAST	WEST	NORTH	SOUTH	EAST	WEST	NORTH	SOUTH	EAST	WEST	NORTH	SOUTH	EAST	WEST	NORTH	SOUTH	EAST	WEST	NORTH	SOUTH	EAST	WEST
Bicycle	Bicycle Lane Arrangement on Approach	Curb Bike Lane, Cycletrack or MUP	Curb Bike Lane, Cycletrack or MUP	Curb Bike Lane, Cycletrack or MUP	Curb Bike Lane, Cycletrack or MUP	Pocket Bike Lane	Pocket Bike Lane	Mixed Traffic	Mixed Traffic	Mixed Traffic		Mixed Traffic	Mixed Traffic	Mixed Traffic	Mixed Traffic	Mixed Traffic	Mixed Traffic	Mixed Traffic		Mixed Traffic	Mixed Traffic	Curb Bike Lane, Cycletrack or MUP		Mixed Traffic	Mixed Traffic
	IF Dedicated Right Turn Lane, THEN Right Turn Configuration, ELSE <blank>	Not Applicable	Not Applicable	Not Applicable	Not Applicable	≤ 50 m Introduced right turn lane	≤ 50 m Introduced right turn lane	≤ 50 m	> 50 m					≤ 50 m				≤ 50 m		> 50 m		Not Applicable			
	Dedicated Right Turning Speed	Not Applicable	Not Applicable	Not Applicable	Not Applicable	>25 to 30 km/h	>25 to 30 km/h	>25 km/h	>25 km/h	≤ 25 km/h		≤ 25 km/h		≤ 25 km/h	≤ 25 km/h	≤ 25 km/h	≤ 25 km/h	≤ 25 km/h		≤ 25 km/h		Not Applicable		≤ 25 km/h	
	Cyclist Through Movement	Not Applicable	Not Applicable	Not Applicable	Not Applicable	C	C	E	F	-		-	-	D	-	-	-	D	-	F	-	Not Applicable	-	-	-
	Separated or Mixed Traffic	Separated	Separated	Separated	Separated	Separated	Separated	Mixed Traffic	Mixed Traffic	Mixed Traffic	-	Mixed Traffic	Mixed Traffic	Mixed Traffic	Mixed Traffic	Mixed Traffic	Mixed Traffic	Mixed Traffic	-	Mixed Traffic	Mixed Traffic	Separated	-	Mixed Traffic	Mixed Traffic
Left Turn Approach	No lane crossed	1 lane crossed	2-stage, LT box	No lane crossed	1 lane crossed	1 lane crossed	≥ 2 lanes crossed	≥ 2 lanes crossed	One lane crossed		≥ 2 lanes crossed	≥ 2 lanes crossed	One lane crossed	No lane crossed	One lane crossed	One lane crossed	No lane crossed		≥ 2 lanes crossed	≥ 2 lanes crossed	No lane crossed		≥ 2 lanes crossed	≥ 2 lanes crossed	
Operating Speed	> 50 to < 60 km/h	> 50 to < 60 km/h	> 50 to < 60 km/h	> 50 to < 60 km/h	> 50 to < 60 km/h	> 50 to < 60 km/h	> 50 to < 60 km/h	> 50 to < 60 km/h	≤ 40 km/h		> 50 to < 60 km/h	> 50 to < 60 km/h	> 40 to ≤ 50 km/h	≤ 40 km/h	> 50 to < 60 km/h	> 50 to < 60 km/h	> 40 to ≤ 50 km/h		> 50 to < 60 km/h	> 50 to < 60 km/h	> 40 to ≤ 50 km/h		> 50 to < 60 km/h	> 50 to < 60 km/h	
Left Turning Cyclist	C	D	A	C	D	D	F	F	B	-	-	F	D	B	E	E	B	-	-	F	B	-	-	F	
Level of Service	C				D				B				D				D				B				
Transit	Average Signal Delay	≤ 30 sec	> 40 sec	≤ 30 sec	≤ 30 sec	> 40 sec	> 40 sec	≤ 30 sec	≤ 40 sec			≤ 20 sec	≤ 10 sec	> 40 sec		≤ 10 sec	≤ 10 sec	> 40 sec		≤ 20 sec	≤ 10 sec			≤ 20 sec	≤ 20 sec
	Level of Service	D	F	D	D	F	F	D	E	-	-	C	B	F	-	B	B	F	-	C	B	-	-	C	C
Truck	Effective Corner Radius					> 15 m	10 - 15 m	> 15 m	> 15 m					< 10 m		10 - 15 m									
	Number of Receiving Lanes on Departure from Intersection					≥ 2	≥ 2	1	1					≥ 2		≥ 2									
Level of Service	-				A				B				D				-				-				
Auto	Volume to Capacity Ratio	0.71 - 0.80				0.71 - 0.80				0.0 - 0.60				0.0 - 0.60				0.0 - 0.60				0.71 - 0.80			
	Level of Service	C				C				A				A				A				C			

Appendix J

SYNCHRO RESULTS



Lanes, Volumes, Timings

1: Alta Vista Dr & Hospital Link Rd

12/15/2023



Lane Group	EBL	EBT	EBR	WBL	WBT	WBR	NBL	NBT	NBR	SBL	SBT	SBR
Lane Configurations												
Traffic Volume (vph)	2	295	45	20	55	7	39	585	53	15	583	22
Future Volume (vph)	2	295	45	20	55	7	39	585	53	15	583	22
Ideal Flow (vphpl)	1800	1800	1800	1800	1800	1800	1800	1800	1800	1800	1800	1800
Storage Length (m)	0.0		0.0	25.0		40.0	30.0		0.0	25.0		0.0
Storage Lanes	1		0	1		1	1		0	1		0
Taper Length (m)	7.5			7.5			7.5			7.5		
Lane Util. Factor	1.00	1.00	1.00	1.00	1.00	1.00	1.00	1.00	1.00	1.00	1.00	1.00
Ped Bike Factor	0.99	0.99		0.99		0.97		1.00			1.00	
Frt		0.980				0.850		0.988			0.995	
Flt Protected	0.950			0.950			0.950			0.950		
Satd. Flow (prot)	1710	1695	0	1583	1579	1530	1710	1692	0	1710	1736	0
Flt Permitted	0.717			0.188			0.248			0.222		
Satd. Flow (perm)	1282	1695	0	309	1579	1489	446	1692	0	400	1736	0
Right Turn on Red			Yes			Yes			Yes			Yes
Satd. Flow (RTOR)		6				31		6			2	
Link Speed (k/h)		50			50			50			50	
Link Distance (m)		148.1			598.8			586.9			279.5	
Travel Time (s)		10.7			43.1			42.3			20.1	
Confl. Peds. (#/hr)	3		20	20		3	5		7	7		5
Confl. Bikes (#/hr)									1			
Peak Hour Factor	0.90	0.90	0.90	0.90	0.90	0.90	0.90	0.90	0.90	0.90	0.90	0.90
Heavy Vehicles (%)	0%	3%	4%	8%	14%	0%	0%	5%	2%	0%	3%	4%
Adj. Flow (vph)	2	328	50	22	61	8	43	650	59	17	648	24
Shared Lane Traffic (%)												
Lane Group Flow (vph)	2	378	0	22	61	8	43	709	0	17	672	0
Enter Blocked Intersection	No	No	No	No	No	No	No	No	No	No	No	No
Lane Alignment	Left	Left	Right	Left	Left	Right	Left	Left	Right	Left	Left	Right
Median Width(m)		3.6			3.6			3.6			3.6	
Link Offset(m)		0.0			0.0			0.0			0.0	
Crosswalk Width(m)		4.8			4.8			4.8			4.8	
Two way Left Turn Lane												
Headway Factor	1.07	1.07	1.07	1.07	1.07	1.07	1.07	1.07	1.07	1.07	1.07	1.07
Turning Speed (k/h)	25		15	25		15	25		15	25		15
Number of Detectors	1	2		1	2	1	1	2		1	2	
Detector Template	Left	Thru		Left	Thru	Right	Left	Thru		Left	Thru	
Leading Detector (m)	2.0	10.0		2.0	10.0	2.0	2.0	10.0		2.0	10.0	
Trailing Detector (m)	0.0	0.0		0.0	0.0	0.0	0.0	0.0		0.0	0.0	
Detector 1 Position(m)	0.0	0.0		0.0	0.0	0.0	0.0	0.0		0.0	0.0	
Detector 1 Size(m)	2.0	0.6		2.0	0.6	2.0	2.0	0.6		2.0	0.6	
Detector 1 Type	CI+Ex	CI+Ex		CI+Ex	CI+Ex	CI+Ex	CI+Ex	CI+Ex		CI+Ex	CI+Ex	
Detector 1 Channel												
Detector 1 Extend (s)	0.0	0.0		0.0	0.0	0.0	0.0	0.0		0.0	0.0	
Detector 1 Queue (s)	0.0	0.0		0.0	0.0	0.0	0.0	0.0		0.0	0.0	
Detector 1 Delay (s)	0.0	0.0		0.0	0.0	0.0	0.0	0.0		0.0	0.0	
Detector 2 Position(m)		9.4			9.4			9.4			9.4	
Detector 2 Size(m)		0.6			0.6			0.6			0.6	
Detector 2 Type		CI+Ex			CI+Ex			CI+Ex			CI+Ex	
Detector 2 Channel												
Detector 2 Extend (s)		0.0			0.0			0.0			0.0	
Turn Type	Perm	NA		pm+pt	NA	Perm	Perm	NA		Perm	NA	
Protected Phases		2		1	6			8			4	
Permitted Phases	2			6		6	8			4		

Lanes, Volumes, Timings

1: Alta Vista Dr & Hospital Link Rd

12/15/2023



Lane Group	EBL	EBT	EBR	WBL	WBT	WBR	NBL	NBT	NBR	SBL	SBT	SBR
Detector Phase	2	2		1	6	6	8	8		4	4	
Switch Phase												
Minimum Initial (s)	10.0	10.0		5.0	10.0	10.0	10.0	10.0		10.0	10.0	
Minimum Split (s)	30.5	30.5		11.5	30.5	30.5	27.3	27.3		27.3	27.3	
Total Split (s)	31.5	31.5		21.5	53.0	53.0	61.3	61.3		61.3	61.3	
Total Split (%)	27.6%	27.6%		18.8%	46.4%	46.4%	53.6%	53.6%		53.6%	53.6%	
Maximum Green (s)	25.0	25.0		15.0	46.5	46.5	55.0	55.0		55.0	55.0	
Yellow Time (s)	3.3	3.3		3.3	3.3	3.3	3.3	3.3		3.3	3.3	
All-Red Time (s)	3.2	3.2		3.2	3.2	3.2	3.0	3.0		3.0	3.0	
Lost Time Adjust (s)	0.0	0.0		0.0	0.0	0.0	0.0	0.0		0.0	0.0	
Total Lost Time (s)	6.5	6.5		6.5	6.5	6.5	6.3	6.3		6.3	6.3	
Lead/Lag	Lag	Lag		Lead								
Lead-Lag Optimize?	Yes	Yes		Yes								
Vehicle Extension (s)	3.0	3.0		3.0	3.0	3.0	3.0	3.0		3.0	3.0	
Recall Mode	None	None		None	None	None	Max	Max		Max	Max	
Walk Time (s)	7.0	7.0		7.0	7.0	7.0	7.0	7.0		7.0	7.0	
Flash Dont Walk (s)	17.0	17.0		17.0	17.0	14.0	14.0	14.0		14.0	14.0	
Pedestrian Calls (#/hr)	23	23		23	23	12	12	12		12	12	
Act Effct Green (s)	25.1	25.1		30.3	30.3	30.3	55.3	55.3		55.3	55.3	
Actuated g/C Ratio	0.26	0.26		0.31	0.31	0.31	0.56	0.56		0.56	0.56	
v/c Ratio	0.01	0.86		0.12	0.13	0.02	0.17	0.74		0.08	0.69	
Control Delay	31.0	56.7		24.2	24.4	0.0	14.8	23.7		13.4	21.4	
Queue Delay	0.0	0.0		0.0	0.0	0.0	0.0	0.0		0.0	0.0	
Total Delay	31.0	56.7		24.2	24.4	0.0	14.8	23.7		13.4	21.4	
LOS	C	E		C	C	A	B	C		B	C	
Approach Delay		56.6			22.2			23.2			21.2	
Approach LOS		E			C			C			C	

Intersection Summary

Area Type:	Other
Cycle Length:	114.3
Actuated Cycle Length:	98.4
Natural Cycle:	90
Control Type:	Semi Act-Uncoord
Maximum v/c Ratio:	0.86
Intersection Signal Delay:	29.0
Intersection LOS:	C
Intersection Capacity Utilization:	69.8%
ICU Level of Service:	C
Analysis Period (min):	15

Splits and Phases: 1: Alta Vista Dr & Hospital Link Rd

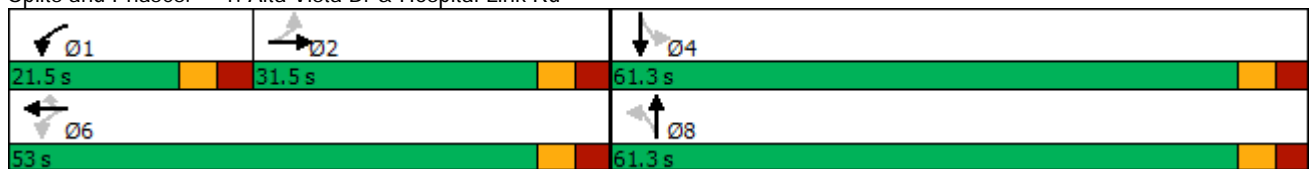

Queues

1: Alta Vista Dr & Hospital Link Rd

12/15/2023



Lane Group	EBL	EBT	WBL	WBT	WBR	NBL	NBT	SBL	SBT
Lane Group Flow (vph)	2	378	22	61	8	43	709	17	672
v/c Ratio	0.01	0.86	0.12	0.13	0.02	0.17	0.74	0.08	0.69
Control Delay	31.0	56.7	24.2	24.4	0.0	14.8	23.7	13.4	21.4
Queue Delay	0.0	0.0	0.0	0.0	0.0	0.0	0.0	0.0	0.0
Total Delay	31.0	56.7	24.2	24.4	0.0	14.8	23.7	13.4	21.4
Queue Length 50th (m)	0.3	65.7	3.1	8.7	0.0	3.4	85.5	1.3	77.4
Queue Length 95th (m)	2.4	#140.8	8.6	18.2	0.1	12.4	181.1	5.9	161.8
Internal Link Dist (m)		124.1		574.8			562.9		255.5
Turn Bay Length (m)			25.0		40.0	30.0		25.0	
Base Capacity (vph)	327	437	290	749	723	250	953	224	975
Starvation Cap Reductn	0	0	0	0	0	0	0	0	0
Spillback Cap Reductn	0	0	0	0	0	0	0	0	0
Storage Cap Reductn	0	0	0	0	0	0	0	0	0
Reduced v/c Ratio	0.01	0.86	0.08	0.08	0.01	0.17	0.74	0.08	0.69

Intersection Summary

95th percentile volume exceeds capacity, queue may be longer.
 Queue shown is maximum after two cycles.

Lanes, Volumes, Timings
2: Alta Vista Dr & Smyth Rd

12/15/2023



Lane Group	EBL	EBT	EBR	WBL	WBT	WBR	NBL	NBT	NBR	SBL	SBT	SBR
Lane Configurations												
Traffic Volume (vph)	151	777	103	79	462	154	324	372	157	222	198	113
Future Volume (vph)	151	777	103	79	462	154	324	372	157	222	198	113
Ideal Flow (vphpl)	1800	1800	1800	1800	1800	1800	1800	1800	1800	1800	1800	1800
Storage Length (m)	30.0		25.0	61.0		10.0	87.0		30.0	44.0		25.0
Storage Lanes	1		1	1		1	1		1	1		1
Taper Length (m)	7.5			7.5			7.5			7.5		
Lane Util. Factor	1.00	0.95	1.00	1.00	0.95	1.00	1.00	1.00	1.00	1.00	1.00	1.00
Ped Bike Factor	0.96		0.91			0.89	0.98		0.97	0.99		0.96
Frts			0.850			0.850			0.850			0.850
Flt Protected	0.950			0.950			0.950			0.950		
Satd. Flow (prot)	1710	3353	1485	1644	3320	1500	1710	1731	1500	1676	1731	1530
Flt Permitted	0.315			0.179			0.503			0.208		
Satd. Flow (perm)	547	3353	1350	310	3320	1332	890	1731	1458	365	1731	1473
Right Turn on Red			Yes			Yes			Yes			Yes
Satd. Flow (RTOR)			139			139			137			137
Link Speed (k/h)		50			50			50			50	
Link Distance (m)		339.0			234.1			204.1			586.9	
Travel Time (s)		24.4			16.9			14.7			42.3	
Confl. Peds. (#/hr)	31		24	24		31	17		11	11		17
Peak Hour Factor	0.90	0.90	0.90	0.90	0.90	0.90	0.90	0.90	0.90	0.90	0.90	0.90
Heavy Vehicles (%)	0%	2%	3%	4%	3%	2%	0%	4%	2%	2%	4%	0%
Adj. Flow (vph)	168	863	114	88	513	171	360	413	174	247	220	126
Shared Lane Traffic (%)												
Lane Group Flow (vph)	168	863	114	88	513	171	360	413	174	247	220	126
Enter Blocked Intersection	No	No	No	No	No	No	No	No	No	No	No	No
Lane Alignment	Left	Left	Right	Left	Left	Right	Left	Left	Right	Left	Left	Right
Median Width(m)		3.6			3.6			3.6			3.6	
Link Offset(m)		0.0			0.0			0.0			0.0	
Crosswalk Width(m)		4.8			4.8			4.8			4.8	
Two way Left Turn Lane												
Headway Factor	1.07	1.07	1.07	1.07	1.07	1.07	1.07	1.07	1.07	1.07	1.07	1.07
Turning Speed (k/h)	25		15	25		15	25		15	25		15
Number of Detectors	1	2	1	1	2	1	1	2	1	1	2	1
Detector Template	Left	Thru	Right	Left	Thru	Right	Left	Thru	Right	Left	Thru	Right
Leading Detector (m)	2.0	10.0	2.0	2.0	10.0	2.0	2.0	10.0	2.0	2.0	10.0	2.0
Trailing Detector (m)	0.0	0.0	0.0	0.0	0.0	0.0	0.0	0.0	0.0	0.0	0.0	0.0
Detector 1 Position(m)	0.0	0.0	0.0	0.0	0.0	0.0	0.0	0.0	0.0	0.0	0.0	0.0
Detector 1 Size(m)	2.0	0.6	2.0	2.0	0.6	2.0	2.0	0.6	2.0	2.0	0.6	2.0
Detector 1 Type	CI+Ex	CI+Ex	CI+Ex	CI+Ex	CI+Ex	CI+Ex	CI+Ex	CI+Ex	CI+Ex	CI+Ex	CI+Ex	CI+Ex
Detector 1 Channel												
Detector 1 Extend (s)	0.0	0.0	0.0	0.0	0.0	0.0	0.0	0.0	0.0	0.0	0.0	0.0
Detector 1 Queue (s)	0.0	0.0	0.0	0.0	0.0	0.0	0.0	0.0	0.0	0.0	0.0	0.0
Detector 1 Delay (s)	0.0	0.0	0.0	0.0	0.0	0.0	0.0	0.0	0.0	0.0	0.0	0.0
Detector 2 Position(m)		9.4			9.4			9.4			9.4	
Detector 2 Size(m)		0.6			0.6			0.6			0.6	
Detector 2 Type		CI+Ex			CI+Ex			CI+Ex			CI+Ex	
Detector 2 Channel												
Detector 2 Extend (s)		0.0			0.0			0.0			0.0	
Turn Type	pm+pt	NA	Perm	pm+pt	NA	Perm	pm+pt	NA	Perm	pm+pt	NA	Perm
Protected Phases	5	2		1	6		3	8		7	4	
Permitted Phases	2		2	6		6	8		8	4		4
Detector Phase	5	2	2	1	6	6	3	8	8	7	4	4

Lanes, Volumes, Timings
2: Alta Vista Dr & Smyth Rd

12/15/2023



Lane Group	EBL	EBT	EBR	WBL	WBT	WBR	NBL	NBT	NBR	SBL	SBT	SBR
Switch Phase												
Minimum Initial (s)	5.0	10.0	10.0	5.0	10.0	10.0	5.0	10.0	10.0	5.0	10.0	10.0
Minimum Split (s)	10.5	24.8	24.8	10.5	24.8	24.8	11.1	29.1	29.1	11.1	29.1	29.1
Total Split (s)	20.0	38.0	38.0	20.0	38.0	38.0	20.0	37.0	37.0	20.0	37.0	37.0
Total Split (%)	17.4%	33.0%	33.0%	17.4%	33.0%	33.0%	17.4%	32.2%	32.2%	17.4%	32.2%	32.2%
Maximum Green (s)	14.5	32.2	32.2	14.5	32.2	32.2	13.9	30.9	30.9	13.9	30.9	30.9
Yellow Time (s)	3.3	3.3	3.3	3.3	3.3	3.3	3.3	3.3	3.3	3.3	3.3	3.3
All-Red Time (s)	2.2	2.5	2.5	2.2	2.5	2.5	2.8	2.8	2.8	2.8	2.8	2.8
Lost Time Adjust (s)	0.0	0.0	0.0	0.0	0.0	0.0	0.0	0.0	0.0	0.0	0.0	0.0
Total Lost Time (s)	5.5	5.8	5.8	5.5	5.8	5.8	6.1	6.1	6.1	6.1	6.1	6.1
Lead/Lag	Lead	Lag	Lag	Lead	Lag	Lag	Lead	Lag	Lag	Lead	Lag	Lag
Lead-Lag Optimize?	Yes	Yes	Yes	Yes	Yes	Yes	Yes	Yes	Yes	Yes	Yes	Yes
Vehicle Extension (s)	3.0	3.0	3.0	3.0	3.0	3.0	3.0	3.0	3.0	3.0	3.0	3.0
Recall Mode	None	C-Max	C-Max	None	C-Max	C-Max	None	Max	Max	None	Max	Max
Walk Time (s)		7.0	7.0		7.0	7.0		7.0	7.0		7.0	7.0
Flash Dont Walk (s)		12.0	12.0		12.0	12.0		16.0	16.0		16.0	16.0
Pedestrian Calls (#/hr)		55	55		55	55		28	28		28	28
Act Effct Green (s)	50.6	40.0	40.0	44.1	34.8	34.8	45.1	31.2	31.2	44.5	30.9	30.9
Actuated g/C Ratio	0.44	0.35	0.35	0.38	0.30	0.30	0.39	0.27	0.27	0.39	0.27	0.27
v/c Ratio	0.47	0.74	0.20	0.39	0.51	0.34	0.81	0.88	0.35	0.83	0.47	0.25
Control Delay	23.5	38.8	3.8	29.4	30.5	13.7	40.5	61.5	11.3	46.9	39.3	5.9
Queue Delay	0.0	0.0	0.0	0.0	0.0	0.0	0.0	0.0	0.0	0.0	0.0	0.0
Total Delay	23.5	38.8	3.8	29.4	30.5	13.7	40.5	61.5	11.3	46.9	39.3	5.9
LOS	C	D	A	C	C	B	D	E	B	D	D	A
Approach Delay		33.1			26.7			44.3			35.4	
Approach LOS		C			C			D			D	

Intersection Summary

Area Type:	Other
Cycle Length:	115
Actuated Cycle Length:	115
Offset:	2 (2%), Referenced to phase 2:EBTL and 6:WBTL, Start of Green
Natural Cycle:	90
Control Type:	Actuated-Coordinated
Maximum v/c Ratio:	0.88
Intersection Signal Delay:	35.1
Intersection LOS:	D
Intersection Capacity Utilization	85.0%
ICU Level of Service	E
Analysis Period (min)	15

Splits and Phases: 2: Alta Vista Dr & Smyth Rd

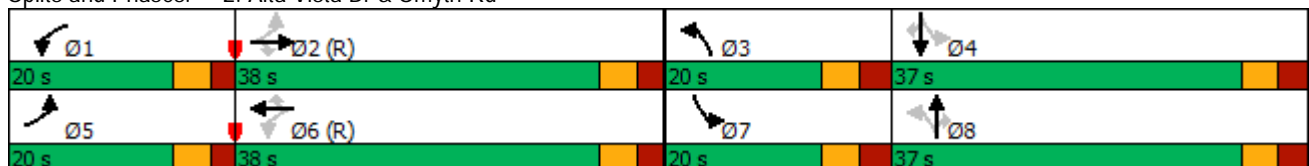

Queues

2: Alta Vista Dr & Smyth Rd

12/15/2023



Lane Group	EBL	EBT	EBR	WBL	WBT	WBR	NBL	NBT	NBR	SBL	SBT	SBR
Lane Group Flow (vph)	168	863	114	88	513	171	360	413	174	247	220	126
v/c Ratio	0.47	0.74	0.20	0.39	0.51	0.34	0.81	0.88	0.35	0.83	0.47	0.25
Control Delay	23.5	38.8	3.8	29.4	30.5	13.7	40.5	61.5	11.3	46.9	39.3	5.9
Queue Delay	0.0	0.0	0.0	0.0	0.0	0.0	0.0	0.0	0.0	0.0	0.0	0.0
Total Delay	23.5	38.8	3.8	29.4	30.5	13.7	40.5	61.5	11.3	46.9	39.3	5.9
Queue Length 50th (m)	23.4	96.8	0.0	5.9	29.4	0.1	58.9	94.1	6.6	37.4	43.7	0.0
Queue Length 95th (m)	38.2	#129.0	8.9	33.1	67.3	33.1	#98.3	#151.8	25.2	#74.6	68.4	12.6
Internal Link Dist (m)		315.0			210.1			180.1			562.9	
Turn Bay Length (m)	30.0		25.0	61.0		10.0	87.0		30.0	44.0		25.0
Base Capacity (vph)	392	1166	560	301	1003	499	447	469	494	300	465	495
Starvation Cap Reductn	0	0	0	0	0	0	0	0	0	0	0	0
Spillback Cap Reductn	0	0	0	0	0	0	0	0	0	0	0	0
Storage Cap Reductn	0	0	0	0	0	0	0	0	0	0	0	0
Reduced v/c Ratio	0.43	0.74	0.20	0.29	0.51	0.34	0.81	0.88	0.35	0.82	0.47	0.25

Intersection Summary

95th percentile volume exceeds capacity, queue may be longer.
 Queue shown is maximum after two cycles.

Lanes, Volumes, Timings
3: Smyth Rd & Valour Dr

12/15/2023

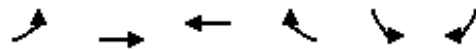

Lane Group	EBL	EBT	WBT	WBR	SBL	SBR
Lane Configurations	↕	↕↕	↕↕		↕	↕
Traffic Volume (vph)	33	1123	676	12	16	20
Future Volume (vph)	33	1123	676	12	16	20
Ideal Flow (vphpl)	1800	1800	1800	1800	1800	1800
Storage Length (m)	55.0			0.0	32.0	0.0
Storage Lanes	1			0	1	1
Taper Length (m)	7.5				7.5	
Lane Util. Factor	1.00	0.95	0.95	0.95	1.00	1.00
Ped Bike Factor	0.99		1.00			0.98
Frt			0.997			0.850
Flt Protected	0.950				0.950	
Satd. Flow (prot)	1613	3386	3306	0	1527	1457
Flt Permitted	0.362				0.950	
Satd. Flow (perm)	609	3386	3306	0	1527	1433
Right Turn on Red				Yes		Yes
Satd. Flow (RTOR)			3			22
Link Speed (k/h)		50	50		50	
Link Distance (m)		234.1	461.7		195.1	
Travel Time (s)		16.9	33.2		14.0	
Confl. Peds. (#/hr)	11			11		3
Peak Hour Factor	0.90	0.90	0.90	0.90	0.90	0.90
Heavy Vehicles (%)	6%	1%	3%	6%	12%	5%
Adj. Flow (vph)	37	1248	751	13	18	22
Shared Lane Traffic (%)						
Lane Group Flow (vph)	37	1248	764	0	18	22
Enter Blocked Intersection	No	No	No	No	No	No
Lane Alignment	Left	Left	Left	Right	Left	Right
Median Width(m)		3.6	3.6		3.6	
Link Offset(m)		0.0	0.0		0.0	
Crosswalk Width(m)		4.8	4.8		4.8	
Two way Left Turn Lane						
Headway Factor	1.07	1.07	1.07	1.07	1.07	1.07
Turning Speed (k/h)	25			15	25	15
Number of Detectors	1	2	2		1	1
Detector Template	Left	Thru	Thru		Left	Right
Leading Detector (m)	2.0	10.0	10.0		2.0	2.0
Trailing Detector (m)	0.0	0.0	0.0		0.0	0.0
Detector 1 Position(m)	0.0	0.0	0.0		0.0	0.0
Detector 1 Size(m)	2.0	0.6	0.6		2.0	2.0
Detector 1 Type	CI+Ex	CI+Ex	CI+Ex		CI+Ex	CI+Ex
Detector 1 Channel						
Detector 1 Extend (s)	0.0	0.0	0.0		0.0	0.0
Detector 1 Queue (s)	0.0	0.0	0.0		0.0	0.0
Detector 1 Delay (s)	0.0	0.0	0.0		0.0	0.0
Detector 2 Position(m)		9.4	9.4			
Detector 2 Size(m)		0.6	0.6			
Detector 2 Type		CI+Ex	CI+Ex			
Detector 2 Channel						
Detector 2 Extend (s)		0.0	0.0			
Turn Type	Perm	NA	NA		Prot	Perm
Protected Phases		2	6		4	
Permitted Phases	2					4
Detector Phase	2	2	6		4	4

Lanes, Volumes, Timings
3: Smyth Rd & Valour Dr

12/15/2023

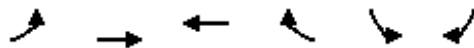

Lane Group	EBL	EBT	WBT	WBR	SBL	SBR
Switch Phase						
Minimum Initial (s)	10.0	10.0	10.0		5.0	5.0
Minimum Split (s)	29.5	29.5	29.5		28.5	28.5
Total Split (s)	84.0	84.0	84.0		31.0	31.0
Total Split (%)	73.0%	73.0%	73.0%		27.0%	27.0%
Maximum Green (s)	77.5	77.5	77.5		24.5	24.5
Yellow Time (s)	3.3	3.3	3.3		3.3	3.3
All-Red Time (s)	3.2	3.2	3.2		3.2	3.2
Lost Time Adjust (s)	0.0	0.0	0.0		0.0	0.0
Total Lost Time (s)	6.5	6.5	6.5		6.5	6.5
Lead/Lag						
Lead-Lag Optimize?						
Vehicle Extension (s)	3.0	3.0	3.0		3.0	3.0
Recall Mode	C-Max	C-Max	C-Max		None	None
Walk Time (s)	7.0	7.0	7.0		7.0	7.0
Flash Dont Walk (s)	16.0	16.0	16.0		15.0	15.0
Pedestrian Calls (#/hr)	11	11	11		3	3
Act Effct Green (s)	99.9	99.9	99.9		9.6	9.6
Actuated g/C Ratio	0.87	0.87	0.87		0.08	0.08
v/c Ratio	0.07	0.42	0.27		0.14	0.16
Control Delay	1.2	1.2	8.6		47.8	18.9
Queue Delay	0.0	0.0	0.0		0.0	0.0
Total Delay	1.2	1.2	8.6		47.8	18.9
LOS	A	A	A		D	B
Approach Delay		1.2	8.6		31.9	
Approach LOS		A	A		C	

Intersection Summary	
Area Type:	Other
Cycle Length:	115
Actuated Cycle Length:	115
Offset:	12 (10%), Referenced to phase 2:EBTL and 6:WBT, Start of Green
Natural Cycle:	60
Control Type:	Actuated-Coordinated
Maximum v/c Ratio:	0.42
Intersection Signal Delay:	4.5
Intersection Capacity Utilization	49.1%
Analysis Period (min)	15
Intersection LOS:	A
ICU Level of Service	A

Splits and Phases: 3: Smyth Rd & Valour Dr



Queues

3: Smyth Rd & Valour Dr

12/15/2023



Lane Group	EBL	EBT	WBT	SBL	SBR
Lane Group Flow (vph)	37	1248	764	18	22
v/c Ratio	0.07	0.42	0.27	0.14	0.16
Control Delay	1.2	1.2	8.6	47.8	18.9
Queue Delay	0.0	0.0	0.0	0.0	0.0
Total Delay	1.2	1.2	8.6	47.8	18.9
Queue Length 50th (m)	0.4	7.5	45.6	4.2	0.0
Queue Length 95th (m)	m0.9	12.8	86.0	10.2	7.4
Internal Link Dist (m)		210.1	437.7	171.1	
Turn Bay Length (m)	55.0			32.0	
Base Capacity (vph)	529	2941	2872	325	322
Starvation Cap Reductn	0	0	0	0	0
Spillback Cap Reductn	0	0	0	0	0
Storage Cap Reductn	0	0	0	0	0
Reduced v/c Ratio	0.07	0.42	0.27	0.06	0.07

Intersection Summary

m Volume for 95th percentile queue is metered by upstream signal.

Lanes, Volumes, Timings
4: S Haven Pl/Ring Rd & Smyth Rd

12/15/2023



Lane Group	EBL	EBT	EBR	WBL	WBT	WBR	NBL	NBT	NBR	SBL	SBT	SBR
Lane Configurations		↕↕			↕↕			↕↕			↕↕	↕↕
Traffic Volume (vph)	366	771	2	1	562	104	6	0	0	28	0	120
Future Volume (vph)	366	771	2	1	562	104	6	0	0	28	0	120
Ideal Flow (vphpl)	1800	1800	1800	1800	1800	1800	1800	1800	1800	1800	1800	1800
Lane Util. Factor	0.95	0.95	0.95	0.95	0.95	0.95	1.00	1.00	1.00	1.00	1.00	1.00
Ped Bike Factor		1.00			0.99						0.99	0.99
Frt					0.977							0.850
Flt Protected		0.984						0.950			0.950	
Satd. Flow (prot)	0	3332	0	0	3227	0	0	1710	0	0	1660	1443
Flt Permitted		0.601			0.954			0.737			0.753	
Satd. Flow (perm)	0	2032	0	0	3078	0	0	1327	0	0	1304	1423
Right Turn on Red			Yes			Yes			Yes			Yes
Satd. Flow (RTOR)					19							133
Link Speed (k/h)		50			50			50			50	
Link Distance (m)		461.7			394.3			74.8			50.7	
Travel Time (s)		33.2			28.4			5.4			3.7	
Confl. Peds. (#/hr)	11		2	2		11			6	6		
Confl. Bikes (#/hr)			8						4			2
Peak Hour Factor	0.90	0.90	0.90	0.90	0.90	0.90	0.90	0.90	0.90	0.90	0.90	0.90
Heavy Vehicles (%)	1%	1%	0%	0%	3%	2%	0%	0%	0%	3%	0%	6%
Adj. Flow (vph)	407	857	2	1	624	116	7	0	0	31	0	133
Shared Lane Traffic (%)												
Lane Group Flow (vph)	0	1266	0	0	741	0	0	7	0	0	31	133
Enter Blocked Intersection	No	No	No	No	No	No	No	No	No	No	No	No
Lane Alignment	Left	Left	Right	Left	Left	Right	Left	Left	Right	Left	Left	Right
Median Width(m)		3.6			3.6			0.0			0.0	
Link Offset(m)		0.0			0.0			0.0			0.0	
Crosswalk Width(m)		4.8			4.8			4.8			4.8	
Two way Left Turn Lane												
Headway Factor	1.07	1.07	1.07	1.07	1.07	1.07	1.07	1.07	1.07	1.07	1.07	1.07
Turning Speed (k/h)	25		15	25		15	25		15	25		15
Number of Detectors	1	2		1	2		1	2		1	2	1
Detector Template	Left	Thru		Left	Thru		Left	Thru		Left	Thru	Right
Leading Detector (m)	2.0	10.0		2.0	10.0		2.0	10.0		2.0	10.0	2.0
Trailing Detector (m)	0.0	0.0		0.0	0.0		0.0	0.0		0.0	0.0	0.0
Detector 1 Position(m)	0.0	0.0		0.0	0.0		0.0	0.0		0.0	0.0	0.0
Detector 1 Size(m)	2.0	0.6		2.0	0.6		2.0	0.6		2.0	0.6	2.0
Detector 1 Type	CI+Ex	CI+Ex		CI+Ex	CI+Ex		CI+Ex	CI+Ex		CI+Ex	CI+Ex	CI+Ex
Detector 1 Channel												
Detector 1 Extend (s)	0.0	0.0		0.0	0.0		0.0	0.0		0.0	0.0	0.0
Detector 1 Queue (s)	0.0	0.0		0.0	0.0		0.0	0.0		0.0	0.0	0.0
Detector 1 Delay (s)	0.0	0.0		0.0	0.0		0.0	0.0		0.0	0.0	0.0
Detector 2 Position(m)		9.4			9.4			9.4			9.4	
Detector 2 Size(m)		0.6			0.6			0.6			0.6	
Detector 2 Type		CI+Ex			CI+Ex			CI+Ex			CI+Ex	
Detector 2 Channel												
Detector 2 Extend (s)		0.0			0.0			0.0			0.0	
Turn Type	pm+pt	NA		Perm	NA		Perm	NA		Perm	NA	Perm
Protected Phases	5	2			6			8			4	
Permitted Phases	2			6			8			4		4
Detector Phase	5	2		6	6		8	8		4	4	4
Switch Phase												
Minimum Initial (s)	5.0	10.0		10.0	10.0		10.0	10.0		10.0	10.0	10.0

Lanes, Volumes, Timings
4: S Haven Pl/Ring Rd & Smyth Rd

12/15/2023



Lane Group	EBL	EBT	EBR	WBL	WBT	WBR	NBL	NBT	NBR	SBL	SBT	SBR
Minimum Split (s)	10.6	31.7		31.7	31.7		28.5	28.5		28.5	28.5	28.5
Total Split (s)	42.0	84.0		42.0	42.0		31.0	31.0		31.0	31.0	31.0
Total Split (%)	36.5%	73.0%		36.5%	36.5%		27.0%	27.0%		27.0%	27.0%	27.0%
Maximum Green (s)	36.4	78.3		36.3	36.3		25.5	25.5		25.5	25.5	25.5
Yellow Time (s)	3.3	3.3		3.3	3.3		3.3	3.3		3.3	3.3	3.3
All-Red Time (s)	2.3	2.4		2.4	2.4		2.2	2.2		2.2	2.2	2.2
Lost Time Adjust (s)		0.0			0.0			0.0			0.0	0.0
Total Lost Time (s)		5.7			5.7			5.5			5.5	5.5
Lead/Lag	Lead			Lag								
Lead-Lag Optimize?	Yes			Yes								
Vehicle Extension (s)	3.0	3.0		3.0	3.0		3.0	3.0		3.0	3.0	3.0
Recall Mode	None	C-Max		C-Max	C-Max		None	None		None	None	None
Walk Time (s)		7.0		7.0	7.0		7.0	7.0		7.0	7.0	7.0
Flash Dont Walk (s)		19.0		19.0	19.0		16.0	16.0		16.0	16.0	16.0
Pedestrian Calls (#/hr)		13		13	13		6	6		6	6	6
Act Effct Green (s)		91.2			91.2			12.6			12.6	12.6
Actuated g/C Ratio		0.79			0.79			0.11			0.11	0.11
v/c Ratio		0.79			0.30			0.05			0.22	0.49
Control Delay		15.6			2.5			43.2			48.3	13.4
Queue Delay		0.0			0.0			0.0			0.0	0.0
Total Delay		15.6			2.5			43.2			48.3	13.4
LOS		B			A			D			D	B
Approach Delay		15.6			2.5			43.2			20.0	
Approach LOS		B			A			D			C	

Intersection Summary

Area Type:	Other
Cycle Length:	115
Actuated Cycle Length:	115
Offset:	66 (57%), Referenced to phase 2:EBTL and 6:WBTL, Start of Green
Natural Cycle:	90
Control Type:	Actuated-Coordinated
Maximum v/c Ratio:	0.79
Intersection Signal Delay:	11.6
Intersection LOS:	B
Intersection Capacity Utilization:	79.8%
ICU Level of Service:	D
Analysis Period (min):	15

Splits and Phases: 4: S Haven Pl/Ring Rd & Smyth Rd

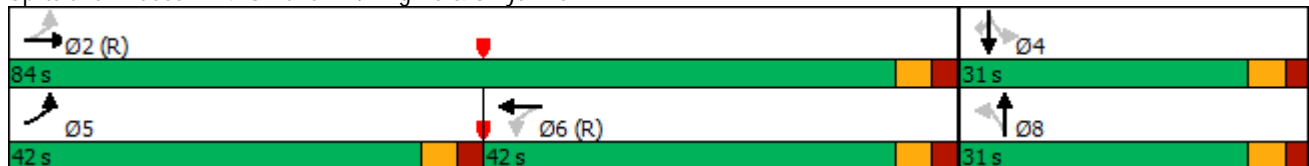

Queues

4: S Haven Pl/Ring Rd & Smyth Rd

12/15/2023



Lane Group	EBT	WBT	NBT	SBT	SBR
Lane Group Flow (vph)	1266	741	7	31	133
v/c Ratio	0.79	0.30	0.05	0.22	0.49
Control Delay	15.6	2.5	43.2	48.3	13.4
Queue Delay	0.0	0.0	0.0	0.0	0.0
Total Delay	15.6	2.5	43.2	48.3	13.4
Queue Length 50th (m)	71.0	10.5	1.6	7.0	0.0
Queue Length 95th (m)	#80.9	16.7	5.5	15.0	16.6
Internal Link Dist (m)	437.7	370.3	50.8	26.7	
Turn Bay Length (m)					
Base Capacity (vph)	1611	2445	294	289	419
Starvation Cap Reductn	0	0	0	0	0
Spillback Cap Reductn	0	0	0	0	0
Storage Cap Reductn	0	0	0	0	0
Reduced v/c Ratio	0.79	0.30	0.02	0.11	0.32

Intersection Summary

95th percentile volume exceeds capacity, queue may be longer.
 Queue shown is maximum after two cycles.

Lanes, Volumes, Timings
5: Smyth Rd & Hospital Main Access

12/15/2023

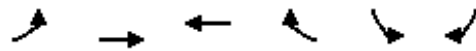

Lane Group	EBL	EBT	WBT	WBR	SBL	SBR
Lane Configurations	↖	↗↗	↗↗	↗	↘↘	↘
Traffic Volume (vph)	375	423	529	426	115	138
Future Volume (vph)	375	423	529	426	115	138
Ideal Flow (vphpl)	1800	1800	1800	1800	1800	1800
Storage Length (m)	60.0			178.0	0.0	0.0
Storage Lanes	1			1	2	1
Taper Length (m)	7.5				7.5	
Lane Util. Factor	1.00	0.95	0.95	1.00	0.97	1.00
Ped Bike Factor	1.00			0.97	0.88	0.97
Fr _t				0.850		0.850
Fl _t Protected	0.950				0.950	
Satd. Flow (prot)	1693	3353	3320	1515	3252	1515
Fl _t Permitted	0.353				0.950	
Satd. Flow (perm)	628	3353	3320	1471	2846	1468
Right Turn on Red				Yes		Yes
Satd. Flow (RTOR)				206		85
Link Speed (k/h)		50	50		50	
Link Distance (m)		394.3	413.0		60.1	
Travel Time (s)		28.4	29.7		4.3	
Confl. Peds. (#/hr)	3			3	50	13
Confl. Bikes (#/hr)				3		
Peak Hour Factor	0.90	0.90	0.90	0.90	0.90	0.90
Heavy Vehicles (%)	1%	2%	3%	1%	2%	1%
Adj. Flow (vph)	417	470	588	473	128	153
Shared Lane Traffic (%)						
Lane Group Flow (vph)	417	470	588	473	128	153
Enter Blocked Intersection	No	No	No	No	No	No
Lane Alignment	Left	Left	Left	Right	Left	Right
Median Width(m)		3.6	3.6		7.2	
Link Offset(m)		0.0	0.0		0.0	
Crosswalk Width(m)		4.8	4.8		4.8	
Two way Left Turn Lane						
Headway Factor	1.07	1.07	1.07	1.07	1.07	1.07
Turning Speed (k/h)	25			15	25	15
Number of Detectors	1	2	2	1	1	1
Detector Template	Left	Thru	Thru	Right	Left	Right
Leading Detector (m)	2.0	10.0	10.0	2.0	2.0	2.0
Trailing Detector (m)	0.0	0.0	0.0	0.0	0.0	0.0
Detector 1 Position(m)	0.0	0.0	0.0	0.0	0.0	0.0
Detector 1 Size(m)	2.0	0.6	0.6	2.0	2.0	2.0
Detector 1 Type	CI+Ex	CI+Ex	CI+Ex	CI+Ex	CI+Ex	CI+Ex
Detector 1 Channel						
Detector 1 Extend (s)	0.0	0.0	0.0	0.0	0.0	0.0
Detector 1 Queue (s)	0.0	0.0	0.0	0.0	0.0	0.0
Detector 1 Delay (s)	0.0	0.0	0.0	0.0	0.0	0.0
Detector 2 Position(m)		9.4	9.4			
Detector 2 Size(m)		0.6	0.6			
Detector 2 Type		CI+Ex	CI+Ex			
Detector 2 Channel						
Detector 2 Extend (s)		0.0	0.0			
Turn Type	pm+pt	NA	NA	pm+ov	Prot	pm+ov
Protected Phases	5	2	6	4	4	5
Permitted Phases	2			6		4

Lanes, Volumes, Timings

5: Smyth Rd & Hospital Main Access

12/15/2023

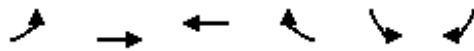

Lane Group	EBL	EBT	WBT	WBR	SBL	SBR
Detector Phase	5	2	6	4	4	5
Switch Phase						
Minimum Initial (s)	5.0	10.0	10.0	5.0	5.0	5.0
Minimum Split (s)	15.9	34.4	41.4	29.3	29.3	15.9
Total Split (s)	28.0	70.0	42.0	45.0	45.0	28.0
Total Split (%)	24.3%	60.9%	36.5%	39.1%	39.1%	24.3%
Maximum Green (s)	22.1	63.6	35.6	38.7	38.7	22.1
Yellow Time (s)	3.3	3.3	3.3	3.3	3.3	3.3
All-Red Time (s)	2.6	3.1	3.1	3.0	3.0	2.6
Lost Time Adjust (s)	0.0	0.0	0.0	0.0	0.0	0.0
Total Lost Time (s)	5.9	6.4	6.4	6.3	6.3	5.9
Lead/Lag	Lead		Lag			Lead
Lead-Lag Optimize?	Yes		Yes			Yes
Vehicle Extension (s)	3.0	3.0	3.0	3.0	3.0	3.0
Recall Mode	None	C-Max	C-Max	None	None	None
Walk Time (s)		7.0	7.0	7.0	7.0	
Flash Dont Walk (s)		21.0	28.0	16.0	16.0	
Pedestrian Calls (#/hr)		3	3	63	63	
Act Effct Green (s)	83.0	82.5	57.6	77.5	19.8	39.2
Actuated g/C Ratio	0.72	0.72	0.50	0.67	0.17	0.34
v/c Ratio	0.66	0.20	0.35	0.44	0.23	0.27
Control Delay	17.0	9.9	20.3	5.4	40.6	10.0
Queue Delay	0.0	0.0	0.0	0.0	0.0	0.0
Total Delay	17.0	9.9	20.3	5.4	40.6	10.0
LOS	B	A	C	A	D	A
Approach Delay		13.2	13.6		23.9	
Approach LOS		B	B		C	

Intersection Summary

Area Type:	Other
Cycle Length:	115
Actuated Cycle Length:	115
Offset:	43 (37%), Referenced to phase 2:EBTL and 6:WBT, Start of Green
Natural Cycle:	90
Control Type:	Actuated-Coordinated
Maximum v/c Ratio:	0.66
Intersection Signal Delay:	14.8
Intersection LOS:	B
Intersection Capacity Utilization	76.0%
ICU Level of Service	D
Analysis Period (min)	15

Splits and Phases: 5: Smyth Rd & Hospital Main Access

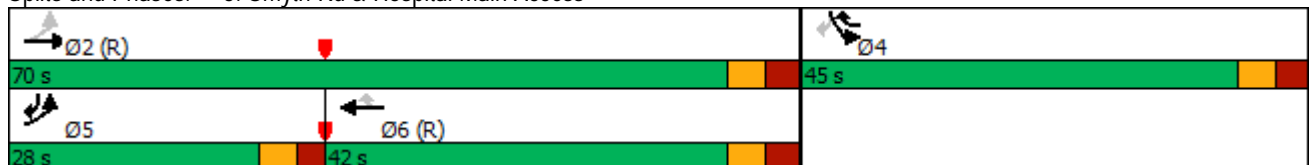

Queues

5: Smyth Rd & Hospital Main Access

12/15/2023

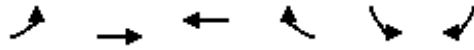

Lane Group	EBL	EBT	WBT	WBR	SBL	SBR
Lane Group Flow (vph)	417	470	588	473	128	153
v/c Ratio	0.66	0.20	0.35	0.44	0.23	0.27
Control Delay	17.0	9.9	20.3	5.4	40.6	10.0
Queue Delay	0.0	0.0	0.0	0.0	0.0	0.0
Total Delay	17.0	9.9	20.3	5.4	40.6	10.0
Queue Length 50th (m)	68.1	32.3	45.1	17.8	13.1	9.7
Queue Length 95th (m)	m90.2	m37.8	70.0	46.7	22.0	19.7
Internal Link Dist (m)		370.3	389.0		36.1	
Turn Bay Length (m)	60.0			178.0		
Base Capacity (vph)	669	2405	1663	1261	1094	618
Starvation Cap Reductn	0	0	0	0	0	0
Spillback Cap Reductn	0	0	0	0	0	0
Storage Cap Reductn	0	0	0	0	0	0
Reduced v/c Ratio	0.62	0.20	0.35	0.38	0.12	0.25

Intersection Summary

m Volume for 95th percentile queue is metered by upstream signal.

Lanes, Volumes, Timings
6: Smyth Rd & Roger Guindon Ave

12/15/2023

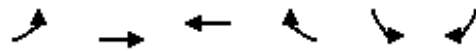

Lane Group	EBL	EBT	WBT	WBR	SBL	SBR	Ø3
Lane Configurations							
Traffic Volume (vph)	183	356	914	430	101	41	
Future Volume (vph)	183	356	914	430	101	41	
Ideal Flow (vphpl)	1800	1800	1800	1800	1800	1800	
Storage Length (m)	67.0			0.0	35.0	0.0	
Storage Lanes	1			0	1	1	
Taper Length (m)	7.5				7.5		
Lane Util. Factor	1.00	0.95	0.95	0.95	1.00	1.00	
Ped Bike Factor			0.99		0.99	0.99	
Frt			0.952			0.850	
Flt Protected	0.950				0.950		
Satd. Flow (prot)	1710	3288	3173	0	1644	1530	
Flt Permitted	0.074				0.950		
Satd. Flow (perm)	133	3288	3173	0	1629	1510	
Right Turn on Red				Yes		Yes	
Satd. Flow (RTOR)			97			46	
Link Speed (k/h)		50	50		50		
Link Distance (m)		413.0	277.5		141.9		
Travel Time (s)		29.7	20.0		10.2		
Confl. Peds. (#/hr)	9			9	7	1	
Confl. Bikes (#/hr)				2			
Peak Hour Factor	0.90	0.90	0.90	0.90	0.90	0.90	
Heavy Vehicles (%)	0%	4%	2%	0%	4%	0%	
Adj. Flow (vph)	203	396	1016	478	112	46	
Shared Lane Traffic (%)							
Lane Group Flow (vph)	203	396	1494	0	112	46	
Enter Blocked Intersection	No	No	No	No	No	No	
Lane Alignment	Left	Left	Left	Right	Left	Right	
Median Width(m)		3.6	3.6		3.6		
Link Offset(m)		0.0	0.0		0.0		
Crosswalk Width(m)		4.8	4.8		4.8		
Two way Left Turn Lane							
Headway Factor	1.07	1.07	1.07	1.07	1.07	1.07	
Turning Speed (k/h)	25			15	25	15	
Number of Detectors	1	2	2		1	1	
Detector Template	Left	Thru	Thru		Left	Right	
Leading Detector (m)	2.0	10.0	10.0		2.0	2.0	
Trailing Detector (m)	0.0	0.0	0.0		0.0	0.0	
Detector 1 Position(m)	0.0	0.0	0.0		0.0	0.0	
Detector 1 Size(m)	2.0	0.6	0.6		2.0	2.0	
Detector 1 Type	CI+Ex	CI+Ex	CI+Ex		CI+Ex	CI+Ex	
Detector 1 Channel							
Detector 1 Extend (s)	0.0	0.0	0.0		0.0	0.0	
Detector 1 Queue (s)	0.0	0.0	0.0		0.0	0.0	
Detector 1 Delay (s)	0.0	0.0	0.0		0.0	0.0	
Detector 2 Position(m)		9.4	9.4				
Detector 2 Size(m)		0.6	0.6				
Detector 2 Type		CI+Ex	CI+Ex				
Detector 2 Channel							
Detector 2 Extend (s)		0.0	0.0				
Turn Type	pm+pt	NA	NA		Prot	Perm	
Protected Phases	5	2	6		4		3
Permitted Phases	2					4	

Lanes, Volumes, Timings
6: Smyth Rd & Roger Guindon Ave

12/15/2023

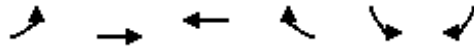

Lane Group	EBL	EBT	WBT	WBR	SBL	SBR	Ø3
Detector Phase	5	2	6		4	4	
Switch Phase							
Minimum Initial (s)	5.0	10.0	10.0		5.0	5.0	1.0
Minimum Split (s)	10.5	23.8	30.8		31.6	31.6	5.0
Total Split (s)	15.0	53.0	38.0		32.0	32.0	5.0
Total Split (%)	16.7%	58.9%	42.2%		35.6%	35.6%	6%
Maximum Green (s)	9.5	47.2	32.2		26.4	26.4	3.0
Yellow Time (s)	3.3	3.3	3.3		3.3	3.3	2.0
All-Red Time (s)	2.2	2.5	2.5		2.3	2.3	0.0
Lost Time Adjust (s)	0.0	0.0	0.0		0.0	0.0	
Total Lost Time (s)	5.5	5.8	5.8		5.6	5.6	
Lead/Lag	Lead		Lag		Lag	Lag	Lead
Lead-Lag Optimize?	Yes		Yes				
Vehicle Extension (s)	3.0	3.0	3.0		3.0	3.0	3.0
Recall Mode	None	C-Max	C-Max		None	None	None
Walk Time (s)			10.0		7.0	7.0	3.0
Flash Dont Walk (s)			15.0		14.0	14.0	0.0
Pedestrian Calls (#/hr)			9		8	8	8
Act Effct Green (s)	67.9	68.8	51.7		12.5	12.5	
Actuated g/C Ratio	0.75	0.76	0.57		0.14	0.14	
v/c Ratio	0.72	0.16	0.80		0.49	0.19	
Control Delay	31.8	4.8	22.2		41.8	11.1	
Queue Delay	0.0	0.0	0.0		0.0	0.0	
Total Delay	31.8	4.8	22.2		41.8	11.1	
LOS	C	A	C		D	B	
Approach Delay		14.0	22.2		32.9		
Approach LOS		B	C		C		

Intersection Summary

Area Type:	Other
Cycle Length:	90
Actuated Cycle Length:	90
Offset:	12 (13%), Referenced to phase 2:EBTL and 6:WBT, Start of Green
Natural Cycle:	100
Control Type:	Actuated-Coordinated
Maximum v/c Ratio:	0.80
Intersection Signal Delay:	20.8
Intersection LOS:	C
Intersection Capacity Utilization	72.6%
ICU Level of Service	C
Analysis Period (min)	15

Splits and Phases: 6: Smyth Rd & Roger Guindon Ave

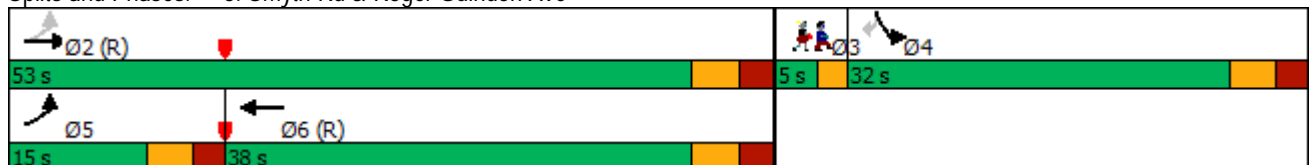

Queues

6: Smyth Rd & Roger Guindon Ave

12/15/2023



Lane Group	EBL	EBT	WBT	SBL	SBR
Lane Group Flow (vph)	203	396	1494	112	46
v/c Ratio	0.72	0.16	0.80	0.49	0.19
Control Delay	31.8	4.8	22.2	41.8	11.1
Queue Delay	0.0	0.0	0.0	0.0	0.0
Total Delay	31.8	4.8	22.2	41.8	11.1
Queue Length 50th (m)	18.7	8.8	98.4	19.4	0.0
Queue Length 95th (m)	45.8	23.8	#218.6	31.9	8.6
Internal Link Dist (m)		389.0	253.5	117.9	
Turn Bay Length (m)	67.0			35.0	
Base Capacity (vph)	298	2512	1863	482	475
Starvation Cap Reductn	0	0	0	0	0
Spillback Cap Reductn	0	0	0	0	0
Storage Cap Reductn	0	0	0	0	0
Reduced v/c Ratio	0.68	0.16	0.80	0.23	0.10

Intersection Summary

95th percentile volume exceeds capacity, queue may be longer.
 Queue shown is maximum after two cycles.

HCM Unsignalized Intersection Capacity Analysis

7: Ring Rd & Hospital Link Rd

04-11-2024



Movement	EBT	EBR	WBL	WBT	NBL	NBR
Lane Configurations	↩			↩	↩	
Sign Control	Stop			Stop	Stop	
Traffic Volume (vph)	246	117	21	46	36	89
Future Volume (vph)	246	117	21	46	36	89
Peak Hour Factor	0.90	0.90	0.90	0.90	0.90	0.90
Hourly flow rate (vph)	273	130	23	51	40	99

Direction, Lane #	EB 1	WB 1	NB 1
Volume Total (vph)	403	74	139
Volume Left (vph)	0	23	40
Volume Right (vph)	130	0	99
Hadj (s)	-0.17	0.13	-0.27
Departure Headway (s)	4.2	4.8	4.7
Degree Utilization, x	0.47	0.10	0.18
Capacity (veh/h)	843	706	705
Control Delay (s)	10.8	8.3	8.7
Approach Delay (s)	10.8	8.3	8.7
Approach LOS	B	A	A

Intersection Summary			
Delay		10.0	
Level of Service		B	
Intersection Capacity Utilization	36.7%		ICU Level of Service A
Analysis Period (min)		15	

HCM Unsignalized Intersection Capacity Analysis

8: uOttawa-Rehab W Access & Hospital Link Rd

04-11-2024

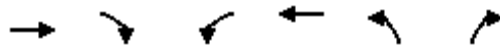

Movement	EBT	EBR	WBL	WBT	NBL	NBR
Lane Configurations						
Traffic Volume (veh/h)	183	152	95	66	1	6
Future Volume (Veh/h)	183	152	95	66	1	6
Sign Control	Free			Free	Stop	
Grade	0%			0%	0%	
Peak Hour Factor	0.90	0.90	0.90	0.90	0.90	0.90
Hourly flow rate (vph)	203	169	106	73	1	7
Pedestrians					1	
Lane Width (m)					3.6	
Walking Speed (m/s)					1.2	
Percent Blockage					0	
Right turn flare (veh)						
Median type	None		None			
Median storage veh						
Upstream signal (m)						
pX, platoon unblocked						
vC, conflicting volume			373		574	288
vC1, stage 1 conf vol						
vC2, stage 2 conf vol						
vCu, unblocked vol			373		574	288
tC, single (s)			4.1		6.4	6.2
tC, 2 stage (s)						
tF (s)			2.2		3.5	3.3
p0 queue free %			91		100	99
cM capacity (veh/h)			1185		440	755
Direction, Lane #	EB 1	WB 1	NB 1			
Volume Total	372	179	8			
Volume Left	0	106	1			
Volume Right	169	0	7			
cSH	1700	1185	693			
Volume to Capacity	0.22	0.09	0.01			
Queue Length 95th (m)	0.0	2.4	0.3			
Control Delay (s)	0.0	5.3	10.3			
Lane LOS			A	B		
Approach Delay (s)	0.0	5.3	10.3			
Approach LOS			B			
Intersection Summary						
Average Delay			1.8			
Intersection Capacity Utilization			42.6%	ICU Level of Service	A	
Analysis Period (min)			15			

HCM Unsignalized Intersection Capacity Analysis

9: uOttawa-Rehab E Access & Hospital Link Rd

04-11-2024



Movement	EBT	EBR	WBL	WBT	NBL	NBR
Lane Configurations	↑			↑	↘	↘
Sign Control	Stop			Stop	Stop	
Traffic Volume (vph)	189	0	0	135	26	23
Future Volume (vph)	189	0	0	135	26	23
Peak Hour Factor	0.90	0.90	0.90	0.90	0.90	0.90
Hourly flow rate (vph)	210	0	0	150	29	26
Direction, Lane #	EB 1	WB 1	NB 1			
Volume Total (vph)	210	150	55			
Volume Left (vph)	0	0	29			
Volume Right (vph)	0	0	26			
Hadj (s)	0.05	0.09	0.03			
Departure Headway (s)	4.2	4.3	4.7			
Degree Utilization, x	0.25	0.18	0.07			
Capacity (veh/h)	830	802	705			
Control Delay (s)	8.6	8.3	8.1			
Approach Delay (s)	8.6	8.3	8.1			
Approach LOS	A	A	A			
Intersection Summary						
Delay			8.4			
Level of Service			A			
Intersection Capacity Utilization			20.8%	ICU Level of Service	A	
Analysis Period (min)			15			

Lanes, Volumes, Timings

1: Alta Vista Dr & Hospital Link Rd

12/15/2023



Lane Group	EBL	EBT	EBR	WBL	WBT	WBR	NBL	NBT	NBR	SBL	SBT	SBR
Lane Configurations												
Traffic Volume (vph)	0	49	35	38	195	16	21	767	11	1	534	11
Future Volume (vph)	0	49	35	38	195	16	21	767	11	1	534	11
Ideal Flow (vphpl)	1900	1900	1900	1900	1900	1900	1900	1900	1900	1900	1900	1900
Storage Length (m)	0.0		0.0	25.0		40.0	30.0		0.0	25.0		0.0
Storage Lanes	1		0	1		1	1		0	1		0
Taper Length (m)	7.5			7.5			7.5			7.5		
Lane Util. Factor	1.00	1.00	1.00	1.00	1.00	1.00	1.00	1.00	1.00	1.00	1.00	1.00
Ped Bike Factor		0.98		0.98		0.95		1.00			1.00	
Frt		0.937				0.850		0.998			0.997	
Flt Protected				0.950			0.950			0.950		
Satd. Flow (prot)	1900	1700	0	1719	1845	1524	1805	1858	0	1805	1839	0
Flt Permitted				0.494			0.331			0.161		
Satd. Flow (perm)	1900	1700	0	879	1845	1450	629	1858	0	306	1839	0
Right Turn on Red			Yes			Yes			Yes			Yes
Satd. Flow (RTOR)		29				31		1			1	
Link Speed (k/h)		50			50			50			50	
Link Distance (m)		148.1			598.8			586.9			279.5	
Travel Time (s)		10.7			43.1			42.3			20.1	
Confl. Peds. (#/hr)	12		9	9		12	9		14	14		9
Peak Hour Factor	0.90	0.90	0.90	0.90	0.90	0.90	0.90	0.90	0.90	0.90	0.90	0.90
Heavy Vehicles (%)	0%	5%	0%	5%	3%	6%	0%	2%	0%	0%	3%	0%
Adj. Flow (vph)	0	54	39	42	217	18	23	852	12	1	593	12
Shared Lane Traffic (%)												
Lane Group Flow (vph)	0	93	0	42	217	18	23	864	0	1	605	0
Enter Blocked Intersection	No	No	No	No	No	No	No	No	No	No	No	No
Lane Alignment	Left	Left	Right	Left	Left	Right	Left	Left	Right	Left	Left	Right
Median Width(m)		3.6			3.6			3.6			3.6	
Link Offset(m)		0.0			0.0			0.0			0.0	
Crosswalk Width(m)		4.8			4.8			4.8			4.8	
Two way Left Turn Lane												
Headway Factor	1.00	1.00	1.00	1.00	1.00	1.00	1.00	1.00	1.00	1.00	1.00	1.00
Turning Speed (k/h)	25		15	25		15	25		15	25		15
Number of Detectors	1	2		1	2	1	1	2		1	2	
Detector Template	Left	Thru		Left	Thru	Right	Left	Thru		Left	Thru	
Leading Detector (m)	2.0	10.0		2.0	10.0	2.0	2.0	10.0		2.0	10.0	
Trailing Detector (m)	0.0	0.0		0.0	0.0	0.0	0.0	0.0		0.0	0.0	
Detector 1 Position(m)	0.0	0.0		0.0	0.0	0.0	0.0	0.0		0.0	0.0	
Detector 1 Size(m)	2.0	0.6		2.0	0.6	2.0	2.0	0.6		2.0	0.6	
Detector 1 Type	CI+Ex	CI+Ex		CI+Ex	CI+Ex	CI+Ex	CI+Ex	CI+Ex		CI+Ex	CI+Ex	
Detector 1 Channel												
Detector 1 Extend (s)	0.0	0.0		0.0	0.0	0.0	0.0	0.0		0.0	0.0	
Detector 1 Queue (s)	0.0	0.0		0.0	0.0	0.0	0.0	0.0		0.0	0.0	
Detector 1 Delay (s)	0.0	0.0		0.0	0.0	0.0	0.0	0.0		0.0	0.0	
Detector 2 Position(m)		9.4			9.4			9.4			9.4	
Detector 2 Size(m)		0.6			0.6			0.6			0.6	
Detector 2 Type		CI+Ex			CI+Ex			CI+Ex			CI+Ex	
Detector 2 Channel												
Detector 2 Extend (s)		0.0			0.0			0.0			0.0	
Turn Type	Perm	NA		pm+pt	NA	Perm	Perm	NA		Perm	NA	
Protected Phases		2		1	6			8			4	
Permitted Phases	2			6		6	8			4		
Detector Phase	2	2		1	6	6	8	8		4	4	

Lanes, Volumes, Timings
1: Alta Vista Dr & Hospital Link Rd

12/15/2023



Lane Group	EBL	EBT	EBR	WBL	WBT	WBR	NBL	NBT	NBR	SBL	SBT	SBR
Switch Phase												
Minimum Initial (s)	10.0	10.0		5.0	10.0	10.0	10.0	10.0		10.0	10.0	
Minimum Split (s)	30.5	30.5		11.5	30.5	30.5	27.3	27.3		27.3	27.3	
Total Split (s)	31.5	31.5		21.5	53.0	53.0	61.3	61.3		61.3	61.3	
Total Split (%)	27.6%	27.6%		18.8%	46.4%	46.4%	53.6%	53.6%		53.6%	53.6%	
Maximum Green (s)	25.0	25.0		15.0	46.5	46.5	55.0	55.0		55.0	55.0	
Yellow Time (s)	3.3	3.3		3.3	3.3	3.3	3.3	3.3		3.3	3.3	
All-Red Time (s)	3.2	3.2		3.2	3.2	3.2	3.0	3.0		3.0	3.0	
Lost Time Adjust (s)	0.0	0.0		0.0	0.0	0.0	0.0	0.0		0.0	0.0	
Total Lost Time (s)	6.5	6.5		6.5	6.5	6.5	6.3	6.3		6.3	6.3	
Lead/Lag	Lag	Lag		Lead								
Lead-Lag Optimize?	Yes	Yes		Yes								
Vehicle Extension (s)	3.0	3.0		3.0	3.0	3.0	3.0	3.0		3.0	3.0	
Recall Mode	None	None		None	None	None	Max	Max		Max	Max	
Walk Time (s)	7.0	7.0		7.0	7.0	7.0	7.0	7.0		7.0	7.0	
Flash Dont Walk (s)	17.0	17.0		17.0	17.0	14.0	14.0	14.0		14.0	14.0	
Pedestrian Calls (#/hr)	21	21		21	21	23	23	23		23	23	
Act Effct Green (s)		15.8		23.8	23.8	23.8	56.8	56.8		56.8	56.8	
Actuated g/C Ratio		0.17		0.25	0.25	0.25	0.61	0.61		0.61	0.61	
v/c Ratio		0.30		0.15	0.46	0.05	0.06	0.77		0.01	0.54	
Control Delay		27.4		24.8	31.0	4.1	12.4	23.0		13.0	15.9	
Queue Delay		0.0		0.0	0.0	0.0	0.0	0.0		0.0	0.0	
Total Delay		27.4		24.8	31.0	4.1	12.4	23.0		13.0	15.9	
LOS		C		C	C	A	B	C		B	B	
Approach Delay		27.4		28.3				22.7			15.9	
Approach LOS		C		C				C			B	

Intersection Summary

Area Type:	Other
Cycle Length:	114.3
Actuated Cycle Length:	93.6
Natural Cycle:	90
Control Type:	Semi Act-Uncoord
Maximum v/c Ratio:	0.77
Intersection Signal Delay:	21.6
Intersection LOS:	C
Intersection Capacity Utilization:	65.2%
ICU Level of Service:	C
Analysis Period (min):	15

Splits and Phases: 1: Alta Vista Dr & Hospital Link Rd

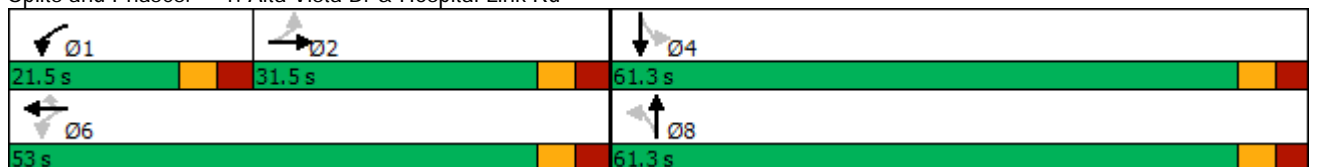

Queues

1: Alta Vista Dr & Hospital Link Rd

12/15/2023



Lane Group	EBT	WBL	WBT	WBR	NBL	NBT	SBL	SBT
Lane Group Flow (vph)	93	42	217	18	23	864	1	605
v/c Ratio	0.30	0.15	0.46	0.05	0.06	0.77	0.01	0.54
Control Delay	27.4	24.8	31.0	4.1	12.4	23.0	13.0	15.9
Queue Delay	0.0	0.0	0.0	0.0	0.0	0.0	0.0	0.0
Total Delay	27.4	24.8	31.0	4.1	12.4	23.0	13.0	15.9
Queue Length 50th (m)	11.1	5.9	33.8	0.0	1.6	109.1	0.1	60.9
Queue Length 95th (m)	26.0	13.7	53.4	2.9	7.1	#255.8	1.1	132.4
Internal Link Dist (m)	124.1		574.8			562.9		255.5
Turn Bay Length (m)		25.0		40.0	30.0		25.0	
Base Capacity (vph)	482	375	930	746	381	1127	185	1116
Starvation Cap Reductn	0	0	0	0	0	0	0	0
Spillback Cap Reductn	0	0	0	0	0	0	0	0
Storage Cap Reductn	0	0	0	0	0	0	0	0
Reduced v/c Ratio	0.19	0.11	0.23	0.02	0.06	0.77	0.01	0.54

Intersection Summary

95th percentile volume exceeds capacity, queue may be longer.
 Queue shown is maximum after two cycles.

Lanes, Volumes, Timings
2: Alta Vista Dr & Smyth Rd

12/15/2023



Lane Group	EBL	EBT	EBR	WBL	WBT	WBR	NBL	NBT	NBR	SBL	SBT	SBR
Lane Configurations												
Traffic Volume (vph)	173	453	204	218	796	243	101	282	68	117	404	204
Future Volume (vph)	173	453	204	218	796	243	101	282	68	117	404	204
Ideal Flow (vphpl)	1900	1900	1900	1900	1900	1900	1900	1900	1900	1900	1900	1900
Storage Length (m)	30.0		25.0	61.0		10.0	87.0		30.0	44.0		25.0
Storage Lanes	1		1	1		1	1		1	1		1
Taper Length (m)	7.5			7.5			7.5			7.5		
Lane Util. Factor	1.00	0.95	1.00	1.00	0.95	1.00	1.00	1.00	1.00	1.00	1.00	1.00
Ped Bike Factor			0.95	0.99		0.81			0.98	0.99		0.97
Frt			0.850			0.850			0.850			0.850
Flt Protected	0.950			0.950			0.950			0.950		
Satd. Flow (prot)	1787	3438	1615	1805	3539	1583	1770	1845	1568	1752	1845	1599
Flt Permitted	0.179			0.376			0.152			0.295		
Satd. Flow (perm)	337	3438	1538	707	3539	1283	283	1845	1529	541	1845	1553
Right Turn on Red			Yes			Yes			Yes			Yes
Satd. Flow (RTOR)			166			139			137			137
Link Speed (k/h)		50			50			50			50	
Link Distance (m)		339.0			234.1			204.1			586.9	
Travel Time (s)		24.4			16.9			14.7			42.3	
Confl. Peds. (#/hr)	56		9	9		56	10		8	8		10
Confl. Bikes (#/hr)			1			4			1			2
Peak Hour Factor	0.90	0.90	0.90	0.90	0.90	0.90	0.90	0.90	0.90	0.90	0.90	0.90
Heavy Vehicles (%)	1%	5%	0%	0%	2%	2%	2%	3%	3%	3%	3%	1%
Adj. Flow (vph)	192	503	227	242	884	270	112	313	76	130	449	227
Shared Lane Traffic (%)												
Lane Group Flow (vph)	192	503	227	242	884	270	112	313	76	130	449	227
Enter Blocked Intersection	No	No	No	No	No	No	No	No	No	No	No	No
Lane Alignment	Left	Left	Right	Left	Left	Right	Left	Left	Right	Left	Left	Right
Median Width(m)		3.6			3.6			3.6			3.6	
Link Offset(m)		0.0			0.0			0.0			0.0	
Crosswalk Width(m)		4.8			4.8			4.8			4.8	
Two way Left Turn Lane												
Headway Factor	1.00	1.00	1.00	1.00	1.00	1.00	1.00	1.00	1.00	1.00	1.00	1.00
Turning Speed (k/h)	25		15	25		15	25		15	25		15
Number of Detectors	1	2	1	1	2	1	1	2	1	1	2	1
Detector Template	Left	Thru	Right	Left	Thru	Right	Left	Thru	Right	Left	Thru	Right
Leading Detector (m)	2.0	10.0	2.0	2.0	10.0	2.0	2.0	10.0	2.0	2.0	10.0	2.0
Trailing Detector (m)	0.0	0.0	0.0	0.0	0.0	0.0	0.0	0.0	0.0	0.0	0.0	0.0
Detector 1 Position(m)	0.0	0.0	0.0	0.0	0.0	0.0	0.0	0.0	0.0	0.0	0.0	0.0
Detector 1 Size(m)	2.0	0.6	2.0	2.0	0.6	2.0	2.0	0.6	2.0	2.0	0.6	2.0
Detector 1 Type	CI+Ex	CI+Ex	CI+Ex	CI+Ex	CI+Ex	CI+Ex	CI+Ex	CI+Ex	CI+Ex	CI+Ex	CI+Ex	CI+Ex
Detector 1 Channel												
Detector 1 Extend (s)	0.0	0.0	0.0	0.0	0.0	0.0	0.0	0.0	0.0	0.0	0.0	0.0
Detector 1 Queue (s)	0.0	0.0	0.0	0.0	0.0	0.0	0.0	0.0	0.0	0.0	0.0	0.0
Detector 1 Delay (s)	0.0	0.0	0.0	0.0	0.0	0.0	0.0	0.0	0.0	0.0	0.0	0.0
Detector 2 Position(m)		9.4			9.4			9.4			9.4	
Detector 2 Size(m)		0.6			0.6			0.6			0.6	
Detector 2 Type		CI+Ex			CI+Ex			CI+Ex			CI+Ex	
Detector 2 Channel												
Detector 2 Extend (s)		0.0			0.0			0.0			0.0	
Turn Type	pm+pt	NA	Perm	pm+pt	NA	Perm	pm+pt	NA	Perm	pm+pt	NA	Perm
Protected Phases	5	2		1	6		3	8		7	4	
Permitted Phases	2		2	6		6	8		8	4		4

Lanes, Volumes, Timings
2: Alta Vista Dr & Smyth Rd

12/15/2023



Lane Group	EBL	EBT	EBR	WBL	WBT	WBR	NBL	NBT	NBR	SBL	SBT	SBR
Detector Phase	5	2	2	1	6	6	3	8	8	7	4	4
Switch Phase												
Minimum Initial (s)	5.0	10.0	10.0	5.0	10.0	10.0	5.0	10.0	10.0	5.0	10.0	10.0
Minimum Split (s)	10.5	24.8	24.8	10.5	24.8	24.8	11.1	29.1	29.1	11.1	29.1	29.1
Total Split (s)	22.0	44.0	44.0	22.0	44.0	44.0	18.0	31.0	31.0	18.0	31.0	31.0
Total Split (%)	19.1%	38.3%	38.3%	19.1%	38.3%	38.3%	15.7%	27.0%	27.0%	15.7%	27.0%	27.0%
Maximum Green (s)	16.5	38.2	38.2	16.5	38.2	38.2	11.9	24.9	24.9	11.9	24.9	24.9
Yellow Time (s)	3.3	3.3	3.3	3.3	3.3	3.3	3.3	3.3	3.3	3.3	3.3	3.3
All-Red Time (s)	2.2	2.5	2.5	2.2	2.5	2.5	2.8	2.8	2.8	2.8	2.8	2.8
Lost Time Adjust (s)	0.0	0.0	0.0	0.0	0.0	0.0	0.0	0.0	0.0	0.0	0.0	0.0
Total Lost Time (s)	5.5	5.8	5.8	5.5	5.8	5.8	6.1	6.1	6.1	6.1	6.1	6.1
Lead/Lag	Lead	Lag	Lag	Lead	Lag	Lag	Lead	Lag	Lag	Lead	Lag	Lag
Lead-Lag Optimize?	Yes	Yes	Yes	Yes	Yes	Yes	Yes	Yes	Yes	Yes	Yes	Yes
Vehicle Extension (s)	3.0	3.0	3.0	3.0	3.0	3.0	3.0	3.0	3.0	3.0	3.0	3.0
Recall Mode	None	C-Max	C-Max	None	C-Max	C-Max	None	Max	Max	None	Max	Max
Walk Time (s)		7.0	7.0		7.0	7.0		7.0	7.0		7.0	7.0
Flash Dont Walk (s)		12.0	12.0		12.0	12.0		16.0	16.0		16.0	16.0
Pedestrian Calls (#/hr)		65	65		65	65		18	18		18	18
Act Effct Green (s)	53.7	41.1	41.1	56.3	42.4	42.4	36.3	26.4	26.4	37.3	26.8	26.8
Actuated g/C Ratio	0.47	0.36	0.36	0.49	0.37	0.37	0.32	0.23	0.23	0.32	0.23	0.23
v/c Ratio	0.62	0.41	0.35	0.51	0.68	0.48	0.51	0.74	0.17	0.46	1.04	0.49
Control Delay	24.2	29.6	10.0	20.0	30.4	16.1	33.3	53.5	1.0	30.2	98.9	19.6
Queue Delay	0.0	0.0	0.0	0.0	0.0	0.0	0.0	0.0	0.0	0.0	0.0	0.0
Total Delay	24.2	29.6	10.0	20.0	30.4	16.1	33.3	53.5	1.0	30.2	98.9	19.6
LOS	C	C	B	B	C	B	C	D	A	C	F	B
Approach Delay		23.6			25.9			41.0			65.5	
Approach LOS		C			C			D			E	

Intersection Summary

Area Type:	Other
Cycle Length:	115
Actuated Cycle Length:	115
Offset:	0 (0%), Referenced to phase 2:EBTL and 6:WBTL, Start of Green
Natural Cycle:	90
Control Type:	Actuated-Coordinated
Maximum v/c Ratio:	1.04
Intersection Signal Delay:	36.2
Intersection LOS:	D
Intersection Capacity Utilization	78.0%
ICU Level of Service	D
Analysis Period (min)	15

Splits and Phases: 2: Alta Vista Dr & Smyth Rd

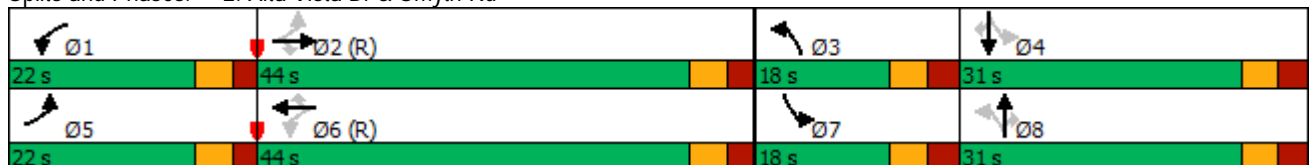

Queues

2: Alta Vista Dr & Smyth Rd

12/15/2023



Lane Group	EBL	EBT	EBR	WBL	WBT	WBR	NBL	NBT	NBR	SBL	SBT	SBR
Lane Group Flow (vph)	192	503	227	242	884	270	112	313	76	130	449	227
v/c Ratio	0.62	0.41	0.35	0.51	0.68	0.48	0.51	0.74	0.17	0.46	1.04	0.49
Control Delay	24.2	29.6	10.0	20.0	30.4	16.1	33.3	53.5	1.0	30.2	98.9	19.6
Queue Delay	0.0	0.0	0.0	0.0	0.0	0.0	0.0	0.0	0.0	0.0	0.0	0.0
Total Delay	24.2	29.6	10.0	20.0	30.4	16.1	33.3	53.5	1.0	30.2	98.9	19.6
Queue Length 50th (m)	23.2	47.0	9.6	24.6	48.4	4.6	17.6	69.9	0.0	20.6	~116.7	17.5
Queue Length 95th (m)	37.0	64.8	29.8	62.2	98.6	52.4	30.9	#112.7	0.6	35.5	#187.7	43.2
Internal Link Dist (m)		315.0			210.1			180.1			562.9	
Turn Bay Length (m)	30.0		25.0	61.0		10.0	87.0		30.0	44.0		25.0
Base Capacity (vph)	377	1228	656	517	1304	560	248	422	456	307	430	467
Starvation Cap Reductn	0	0	0	0	0	0	0	0	0	0	0	0
Spillback Cap Reductn	0	0	0	0	0	0	0	0	0	0	0	0
Storage Cap Reductn	0	0	0	0	0	0	0	0	0	0	0	0
Reduced v/c Ratio	0.51	0.41	0.35	0.47	0.68	0.48	0.45	0.74	0.17	0.42	1.04	0.49

Intersection Summary

- ~ Volume exceeds capacity, queue is theoretically infinite.
Queue shown is maximum after two cycles.
- # 95th percentile volume exceeds capacity, queue may be longer.
Queue shown is maximum after two cycles.

Lanes, Volumes, Timings 3: Smyth Rd & Valour Dr

12/15/2023

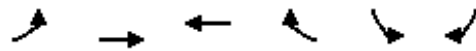

Lane Group	EBL	EBT	WBT	WBR	SBL	SBR
Lane Configurations						
Traffic Volume (vph)	30	608	1207	12	14	50
Future Volume (vph)	30	608	1207	12	14	50
Ideal Flow (vphpl)	1900	1900	1900	1900	1900	1900
Storage Length (m)	55.0			0.0	32.0	0.0
Storage Lanes	1			0	1	1
Taper Length (m)	7.5				7.5	
Lane Util. Factor	1.00	0.95	0.95	0.95	1.00	1.00
Ped Bike Factor			1.00		1.00	0.99
Frt			0.999			0.850
Flt Protected	0.950				0.950	
Satd. Flow (prot)	1752	3471	3527	0	1703	1583
Flt Permitted	0.158				0.950	
Satd. Flow (perm)	291	3471	3527	0	1695	1562
Right Turn on Red				Yes		Yes
Satd. Flow (RTOR)			1			56
Link Speed (k/h)		50	50		50	
Link Distance (m)		234.1	461.7		195.1	
Travel Time (s)		16.9	33.2		14.0	
Confl. Peds. (#/hr)	15			15	3	1
Peak Hour Factor	0.90	0.90	0.90	0.90	0.90	0.90
Heavy Vehicles (%)	3%	4%	2%	23%	6%	2%
Adj. Flow (vph)	33	676	1341	13	16	56
Shared Lane Traffic (%)						
Lane Group Flow (vph)	33	676	1354	0	16	56
Enter Blocked Intersection	No	No	No	No	No	No
Lane Alignment	Left	Left	Left	Right	Left	Right
Median Width(m)		3.6	3.6		3.6	
Link Offset(m)		0.0	0.0		0.0	
Crosswalk Width(m)		4.8	4.8		4.8	
Two way Left Turn Lane						
Headway Factor	1.00	1.00	1.00	1.00	1.00	1.00
Turning Speed (k/h)	25			15	25	15
Number of Detectors	1	2	2		1	1
Detector Template	Left	Thru	Thru		Left	Right
Leading Detector (m)	2.0	10.0	10.0		2.0	2.0
Trailing Detector (m)	0.0	0.0	0.0		0.0	0.0
Detector 1 Position(m)	0.0	0.0	0.0		0.0	0.0
Detector 1 Size(m)	2.0	0.6	0.6		2.0	2.0
Detector 1 Type	CI+Ex	CI+Ex	CI+Ex		CI+Ex	CI+Ex
Detector 1 Channel						
Detector 1 Extend (s)	0.0	0.0	0.0		0.0	0.0
Detector 1 Queue (s)	0.0	0.0	0.0		0.0	0.0
Detector 1 Delay (s)	0.0	0.0	0.0		0.0	0.0
Detector 2 Position(m)		9.4	9.4			
Detector 2 Size(m)		0.6	0.6			
Detector 2 Type		CI+Ex	CI+Ex			
Detector 2 Channel						
Detector 2 Extend (s)		0.0	0.0			
Turn Type	pm+pt	NA	NA		Prot	Perm
Protected Phases	5	2	6		4	
Permitted Phases	2					4
Detector Phase	5	2	6		4	4

Lanes, Volumes, Timings

3: Smyth Rd & Valour Dr

12/15/2023

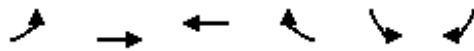

Lane Group	EBL	EBT	WBT	WBR	SBL	SBR
Switch Phase						
Minimum Initial (s)	5.0	10.0	10.0		5.0	5.0
Minimum Split (s)	10.7	29.5	29.5		28.5	28.5
Total Split (s)	18.0	85.0	67.0		30.0	30.0
Total Split (%)	15.7%	73.9%	58.3%		26.1%	26.1%
Maximum Green (s)	12.3	78.5	60.5		23.5	23.5
Yellow Time (s)	3.3	3.3	3.3		3.3	3.3
All-Red Time (s)	2.4	3.2	3.2		3.2	3.2
Lost Time Adjust (s)	0.0	0.0	0.0		0.0	0.0
Total Lost Time (s)	5.7	6.5	6.5		6.5	6.5
Lead/Lag	Lead		Lag			
Lead-Lag Optimize?	Yes		Yes			
Vehicle Extension (s)	3.0	3.0	3.0		3.0	3.0
Recall Mode	None	C-Max	C-Max		None	None
Walk Time (s)		7.0	7.0		7.0	7.0
Flash Dont Walk (s)		16.0	16.0		15.0	15.0
Pedestrian Calls (#/hr)		15	15		4	4
Act Effct Green (s)	95.8	96.3	89.1		9.4	9.4
Actuated g/C Ratio	0.83	0.84	0.77		0.08	0.08
v/c Ratio	0.10	0.23	0.50		0.12	0.31
Control Delay	1.5	0.9	14.1		46.9	16.1
Queue Delay	0.0	0.0	0.0		0.0	0.0
Total Delay	1.5	0.9	14.1		46.9	16.1
LOS	A	A	B		D	B
Approach Delay		0.9	14.1		22.9	
Approach LOS		A	B		C	

Intersection Summary

Area Type:	Other
Cycle Length:	115
Actuated Cycle Length:	115
Offset:	12 (10%), Referenced to phase 2:EBTL and 6:WBT, Start of Green
Natural Cycle:	80
Control Type:	Actuated-Coordinated
Maximum v/c Ratio:	0.50
Intersection Signal Delay:	10.1
Intersection LOS:	B
Intersection Capacity Utilization:	49.2%
ICU Level of Service:	A
Analysis Period (min):	15

Splits and Phases: 3: Smyth Rd & Valour Dr



Queues

3: Smyth Rd & Valour Dr

12/15/2023



Lane Group	EBL	EBT	WBT	SBL	SBR
Lane Group Flow (vph)	33	676	1354	16	56
v/c Ratio	0.10	0.23	0.50	0.12	0.31
Control Delay	1.5	0.9	14.1	46.9	16.1
Queue Delay	0.0	0.0	0.0	0.0	0.0
Total Delay	1.5	0.9	14.1	46.9	16.1
Queue Length 50th (m)	0.3	3.3	92.6	3.7	0.0
Queue Length 95th (m)	1.4	8.8	167.7	9.6	11.4
Internal Link Dist (m)		210.1	437.7	171.1	
Turn Bay Length (m)	55.0			32.0	
Base Capacity (vph)	398	2906	2733	348	363
Starvation Cap Reductn	0	0	0	0	0
Spillback Cap Reductn	0	0	0	0	0
Storage Cap Reductn	0	0	0	0	0
Reduced v/c Ratio	0.08	0.23	0.50	0.05	0.15
Intersection Summary					

Lanes, Volumes, Timings
4: S Haven Pl/Ring Rd & Smyth Rd

12/15/2023



Lane Group	EBL	EBT	EBR	WBL	WBT	WBR	NBL	NBT	NBR	SBL	SBT	SBR
Lane Configurations		↕↕			↕↕			↕↕			↕	↕
Traffic Volume (vph)	92	526	4	4	887	11	5	0	4	128	1	327
Future Volume (vph)	92	526	4	4	887	11	5	0	4	128	1	327
Ideal Flow (vphpl)	1900	1900	1900	1900	1900	1900	1900	1900	1900	1900	1900	1900
Lane Util. Factor	0.95	0.95	0.95	0.95	0.95	0.95	1.00	1.00	1.00	1.00	1.00	1.00
Ped Bike Factor		1.00			1.00			0.99			0.99	0.97
Frt		0.999			0.998			0.946				0.850
Flt Protected		0.993						0.971			0.953	
Satd. Flow (prot)	0	3472	0	0	3531	0	0	1731	0	0	1793	1599
Flt Permitted		0.657			0.953			0.853			0.721	
Satd. Flow (perm)	0	2296	0	0	3365	0	0	1517	0	0	1344	1555
Right Turn on Red			Yes			Yes			Yes			Yes
Satd. Flow (RTOR)		1			1			79				228
Link Speed (k/h)		50			50			50			50	
Link Distance (m)		461.7			394.3			74.8			50.7	
Travel Time (s)		33.2			28.4			5.4			3.7	
Confl. Peds. (#/hr)	14		6	6		14	3		6	6		3
Confl. Bikes (#/hr)			2			4						14
Peak Hour Factor	0.90	0.90	0.90	0.90	0.90	0.90	0.90	0.90	0.90	0.90	0.90	0.90
Heavy Vehicles (%)	4%	3%	0%	0%	2%	0%	0%	0%	0%	1%	0%	1%
Adj. Flow (vph)	102	584	4	4	986	12	6	0	4	142	1	363
Shared Lane Traffic (%)												
Lane Group Flow (vph)	0	690	0	0	1002	0	0	10	0	0	143	363
Enter Blocked Intersection	No	No	No	No	No	No	No	No	No	No	No	No
Lane Alignment	Left	Left	Right	Left	Left	Right	Left	Left	Right	Left	Left	Right
Median Width(m)		3.6			3.6			0.0			0.0	
Link Offset(m)		0.0			0.0			0.0			0.0	
Crosswalk Width(m)		4.8			4.8			4.8			4.8	
Two way Left Turn Lane												
Headway Factor	1.00	1.00	1.00	1.00	1.00	1.00	1.00	1.00	1.00	1.00	1.00	1.00
Turning Speed (k/h)	25		15	25		15	25		15	25		15
Number of Detectors	1	2		1	2		1	2		1	2	1
Detector Template	Left	Thru		Left	Thru		Left	Thru		Left	Thru	Right
Leading Detector (m)	2.0	10.0		2.0	10.0		2.0	10.0		2.0	10.0	2.0
Trailing Detector (m)	0.0	0.0		0.0	0.0		0.0	0.0		0.0	0.0	0.0
Detector 1 Position(m)	0.0	0.0		0.0	0.0		0.0	0.0		0.0	0.0	0.0
Detector 1 Size(m)	2.0	0.6		2.0	0.6		2.0	0.6		2.0	0.6	2.0
Detector 1 Type	CI+Ex	CI+Ex		CI+Ex	CI+Ex		CI+Ex	CI+Ex		CI+Ex	CI+Ex	CI+Ex
Detector 1 Channel												
Detector 1 Extend (s)	0.0	0.0		0.0	0.0		0.0	0.0		0.0	0.0	0.0
Detector 1 Queue (s)	0.0	0.0		0.0	0.0		0.0	0.0		0.0	0.0	0.0
Detector 1 Delay (s)	0.0	0.0		0.0	0.0		0.0	0.0		0.0	0.0	0.0
Detector 2 Position(m)		9.4			9.4			9.4			9.4	
Detector 2 Size(m)		0.6			0.6			0.6			0.6	
Detector 2 Type		CI+Ex			CI+Ex			CI+Ex			CI+Ex	
Detector 2 Channel												
Detector 2 Extend (s)		0.0			0.0			0.0			0.0	
Turn Type	pm+pt	NA		Perm	NA		Perm	NA		Perm	NA	Perm
Protected Phases	5	2			6			8			4	
Permitted Phases	2			6			8			4		4
Detector Phase	5	2		6	6		8	8		4	4	4
Switch Phase												
Minimum Initial (s)	5.0	10.0		10.0	10.0		10.0	10.0		10.0	10.0	10.0

Lanes, Volumes, Timings
4: S Haven Pl/Ring Rd & Smyth Rd

12/15/2023



Lane Group	EBL	EBT	EBR	WBL	WBT	WBR	NBL	NBT	NBR	SBL	SBT	SBR
Minimum Split (s)	10.6	31.7		31.7	31.7		28.5	28.5		28.5	28.5	28.5
Total Split (s)	16.0	78.0		62.0	62.0		37.0	37.0		37.0	37.0	37.0
Total Split (%)	13.9%	67.8%		53.9%	53.9%		32.2%	32.2%		32.2%	32.2%	32.2%
Maximum Green (s)	10.4	72.3		56.3	56.3		31.5	31.5		31.5	31.5	31.5
Yellow Time (s)	3.3	3.3		3.3	3.3		3.3	3.3		3.3	3.3	3.3
All-Red Time (s)	2.3	2.4		2.4	2.4		2.2	2.2		2.2	2.2	2.2
Lost Time Adjust (s)		0.0			0.0			0.0			0.0	0.0
Total Lost Time (s)		5.7			5.7			5.5			5.5	5.5
Lead/Lag	Lead			Lag			Lag			Lag		
Lead-Lag Optimize?	Yes			Yes			Yes			Yes		
Vehicle Extension (s)	3.0	3.0		3.0	3.0		3.0	3.0		3.0	3.0	3.0
Recall Mode	None	C-Max		C-Max	C-Max		None	None		None	None	None
Walk Time (s)		7.0		7.0	7.0		7.0	7.0		7.0	7.0	7.0
Flash Dont Walk (s)		19.0		19.0	19.0		16.0	16.0		16.0	16.0	16.0
Pedestrian Calls (#/hr)		20		20	20		9	9		9	9	9
Act Effct Green (s)		85.0		85.0	85.0		18.8	18.8		18.8	18.8	18.8
Actuated g/C Ratio		0.74		0.74	0.74		0.16	0.16		0.16	0.16	0.16
v/c Ratio		0.41		0.40	0.40		0.03	0.03		0.65	0.82	0.82
Control Delay		4.2		6.2	6.2		0.2	0.2		57.5	31.3	31.3
Queue Delay		0.0		0.0	0.0		0.0	0.0		0.0	0.0	0.0
Total Delay		4.2		6.2	6.2		0.2	0.2		57.5	31.3	31.3
LOS		A		A	A		A	A		E	C	C
Approach Delay		4.2		6.2	6.2		0.2	0.2		38.7		
Approach LOS		A		A	A		A	A		D		

Intersection Summary

Area Type:	Other
Cycle Length:	115
Actuated Cycle Length:	115
Offset:	62 (54%), Referenced to phase 2:EBTL and 6:WBTL, Start of Green
Natural Cycle:	75
Control Type:	Actuated-Coordinated
Maximum v/c Ratio:	0.82
Intersection Signal Delay:	13.0
Intersection LOS:	B
Intersection Capacity Utilization:	72.9%
ICU Level of Service:	C
Analysis Period (min):	15

Splits and Phases: 4: S Haven Pl/Ring Rd & Smyth Rd

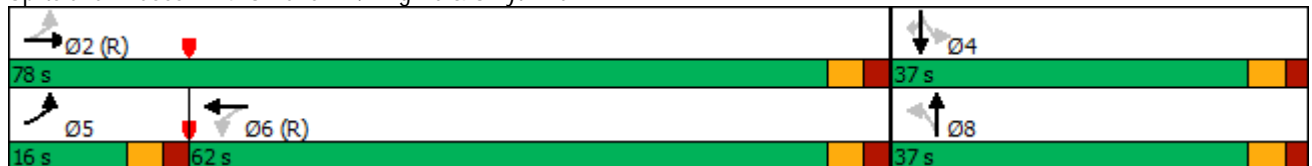

Queues

4: S Haven Pl/Ring Rd & Smyth Rd

12/15/2023



Lane Group	EBT	WBT	NBT	SBT	SBR
Lane Group Flow (vph)	690	1002	10	143	363
v/c Ratio	0.41	0.40	0.03	0.65	0.82
Control Delay	4.2	6.2	0.2	57.5	31.3
Queue Delay	0.0	0.0	0.0	0.0	0.0
Total Delay	4.2	6.2	0.2	57.5	31.3
Queue Length 50th (m)	15.5	46.2	0.0	32.5	31.8
Queue Length 95th (m)	18.0	59.1	0.0	48.5	61.3
Internal Link Dist (m)	437.7	370.3	50.8	26.7	
Turn Bay Length (m)					
Base Capacity (vph)	1697	2487	472	368	591
Starvation Cap Reductn	0	0	0	0	0
Spillback Cap Reductn	0	0	0	0	0
Storage Cap Reductn	0	0	0	0	0
Reduced v/c Ratio	0.41	0.40	0.02	0.39	0.61
Intersection Summary					

Lanes, Volumes, Timings
5: Smyth Rd & Hospital Main Access

12/15/2023

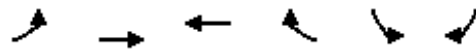

Lane Group	EBL	EBT	WBT	WBR	SBL	SBR
Lane Configurations						
Traffic Volume (vph)	94	564	533	144	337	369
Future Volume (vph)	94	564	533	144	337	369
Ideal Flow (vphpl)	1900	1900	1900	1900	1900	1900
Storage Length (m)	60.0			178.0	0.0	0.0
Storage Lanes	1			1	2	1
Taper Length (m)	7.5				7.5	
Lane Util. Factor	1.00	0.95	0.95	1.00	0.97	1.00
Ped Bike Factor	0.99			0.95	0.82	0.97
Fr t				0.850		0.850
Flt Protected	0.950				0.950	
Satd. Flow (prot)	1719	3505	3539	1568	3502	1583
Flt Permitted	0.371				0.950	
Satd. Flow (perm)	667	3505	3539	1493	2889	1531
Right Turn on Red				Yes		Yes
Satd. Flow (RTOR)				160		97
Link Speed (k/h)		50	50		50	
Link Distance (m)		394.3	413.0		60.1	
Travel Time (s)		28.4	29.7		4.3	
Confl. Peds. (#/hr)	11			11	70	14
Confl. Bikes (#/hr)				2		1
Peak Hour Factor	0.90	0.90	0.90	0.90	0.90	0.90
Heavy Vehicles (%)	5%	3%	2%	3%	0%	2%
Adj. Flow (vph)	104	627	592	160	374	410
Shared Lane Traffic (%)						
Lane Group Flow (vph)	104	627	592	160	374	410
Enter Blocked Intersection	No	No	No	No	No	No
Lane Alignment	Left	Left	Left	Right	Left	Right
Median Width(m)		3.6	3.6		7.2	
Link Offset(m)		0.0	0.0		0.0	
Crosswalk Width(m)		4.8	4.8		4.8	
Two way Left Turn Lane						
Headway Factor	1.00	1.00	1.00	1.00	1.00	1.00
Turning Speed (k/h)	25			15	25	15
Number of Detectors	1	2	2	1	1	1
Detector Template	Left	Thru	Thru	Right	Left	Right
Leading Detector (m)	2.0	10.0	10.0	2.0	2.0	2.0
Trailing Detector (m)	0.0	0.0	0.0	0.0	0.0	0.0
Detector 1 Position(m)	0.0	0.0	0.0	0.0	0.0	0.0
Detector 1 Size(m)	2.0	0.6	0.6	2.0	2.0	2.0
Detector 1 Type	CI+Ex	CI+Ex	CI+Ex	CI+Ex	CI+Ex	CI+Ex
Detector 1 Channel						
Detector 1 Extend (s)	0.0	0.0	0.0	0.0	0.0	0.0
Detector 1 Queue (s)	0.0	0.0	0.0	0.0	0.0	0.0
Detector 1 Delay (s)	0.0	0.0	0.0	0.0	0.0	0.0
Detector 2 Position(m)		9.4	9.4			
Detector 2 Size(m)		0.6	0.6			
Detector 2 Type		CI+Ex	CI+Ex			
Detector 2 Channel						
Detector 2 Extend (s)		0.0	0.0			
Turn Type	pm+pt	NA	NA	pm+ov	Prot	pm+ov
Protected Phases	5	2	6	4	4	5
Permitted Phases	2			6		4

Lanes, Volumes, Timings

5: Smyth Rd & Hospital Main Access

12/15/2023

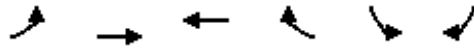

Lane Group	EBL	EBT	WBT	WBR	SBL	SBR
Detector Phase	5	2	6	4	4	5
Switch Phase						
Minimum Initial (s)	5.0	10.0	10.0	5.0	5.0	5.0
Minimum Split (s)	9.5	34.4	39.5	29.3	29.3	9.5
Total Split (s)	12.0	55.0	43.0	60.0	60.0	12.0
Total Split (%)	10.4%	47.8%	37.4%	52.2%	52.2%	10.4%
Maximum Green (s)	7.7	48.6	38.7	53.7	53.7	7.7
Yellow Time (s)	3.3	3.3	3.3	3.3	3.3	3.3
All-Red Time (s)	1.0	3.1	1.0	3.0	3.0	1.0
Lost Time Adjust (s)	0.0	0.0	0.0	0.0	0.0	0.0
Total Lost Time (s)	4.3	6.4	4.3	6.3	6.3	4.3
Lead/Lag	Lead		Lag			Lead
Lead-Lag Optimize?	Yes		Yes			Yes
Vehicle Extension (s)	3.0	3.0	3.0	3.0	3.0	3.0
Recall Mode	None	C-Max	C-Max	None	None	None
Walk Time (s)		7.0	7.0	7.0	7.0	
Flash Dont Walk (s)		21.0	28.0	16.0	16.0	
Pedestrian Calls (#/hr)		11	11	84	84	
Act Effct Green (s)	83.4	81.3	69.2	88.3	21.0	32.9
Actuated g/C Ratio	0.73	0.71	0.60	0.77	0.18	0.29
v/c Ratio	0.18	0.25	0.28	0.13	0.58	0.80
Control Delay	5.9	6.6	12.4	0.8	46.5	37.8
Queue Delay	0.0	0.0	0.0	0.0	0.0	0.0
Total Delay	5.9	6.6	12.4	0.8	46.5	37.8
LOS	A	A	B	A	D	D
Approach Delay		6.5	10.0		42.0	
Approach LOS		A	A		D	

Intersection Summary

Area Type:	Other
Cycle Length:	115
Actuated Cycle Length:	115
Offset:	59 (51%), Referenced to phase 2:EBTL and 6:WBT, Start of Green
Natural Cycle:	80
Control Type:	Actuated-Coordinated
Maximum v/c Ratio:	0.80
Intersection Signal Delay:	19.9
Intersection LOS:	B
Intersection Capacity Utilization	60.6%
ICU Level of Service	B
Analysis Period (min)	15

Splits and Phases: 5: Smyth Rd & Hospital Main Access

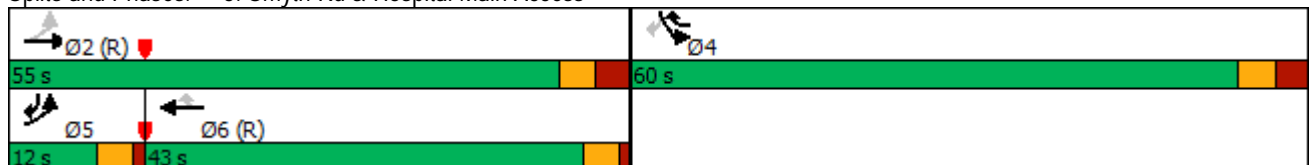

Queues

5: Smyth Rd & Hospital Main Access

12/15/2023

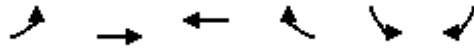

Lane Group	EBL	EBT	WBT	WBR	SBL	SBR
Lane Group Flow (vph)	104	627	592	160	374	410
v/c Ratio	0.18	0.25	0.28	0.13	0.58	0.80
Control Delay	5.9	6.6	12.4	0.8	46.5	37.8
Queue Delay	0.0	0.0	0.0	0.0	0.0	0.0
Total Delay	5.9	6.6	12.4	0.8	46.5	37.8
Queue Length 50th (m)	4.9	20.3	32.8	0.0	41.2	65.9
Queue Length 95th (m)	14.1	40.5	54.8	4.9	57.0	88.0
Internal Link Dist (m)		370.3	389.0		36.1	
Turn Bay Length (m)	60.0			178.0		
Base Capacity (vph)	577	2476	2130	1454	1635	517
Starvation Cap Reductn	0	0	0	0	0	0
Spillback Cap Reductn	0	0	0	0	0	0
Storage Cap Reductn	0	0	0	0	0	0
Reduced v/c Ratio	0.18	0.25	0.28	0.11	0.23	0.79
Intersection Summary						

Lanes, Volumes, Timings
6: Smyth Rd & Roger Guindon Ave

12/15/2023

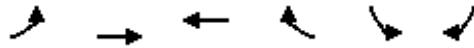

Lane Group	EBL	EBT	WBT	WBR	SBL	SBR	Ø3
Lane Configurations	↖	↕	↗		↙	↘	
Traffic Volume (vph)	33	868	482	81	449	194	
Future Volume (vph)	33	868	482	81	449	194	
Ideal Flow (vphpl)	1900	1900	1900	1900	1900	1900	
Storage Length (m)	67.0			0.0	35.0	0.0	
Storage Lanes	1			0	1	1	
Taper Length (m)	7.5				7.5		
Lane Util. Factor	1.00	0.95	0.95	0.95	1.00	1.00	
Ped Bike Factor	0.98		0.99		0.93	0.97	
Frt			0.978			0.850	
Flt Protected	0.950				0.950		
Satd. Flow (prot)	1703	3505	3377	0	1736	1553	
Flt Permitted	0.305				0.950		
Satd. Flow (perm)	537	3505	3377	0	1606	1514	
Right Turn on Red				Yes		Yes	
Satd. Flow (RTOR)			23			216	
Link Speed (k/h)		50	50		50		
Link Distance (m)		413.0	277.5		141.9		
Travel Time (s)		29.7	20.0		10.2		
Confl. Peds. (#/hr)	31			31	58	10	
Confl. Bikes (#/hr)				1		1	
Peak Hour Factor	0.90	0.90	0.90	0.90	0.90	0.90	
Heavy Vehicles (%)	6%	3%	4%	0%	4%	4%	
Adj. Flow (vph)	37	964	536	90	499	216	
Shared Lane Traffic (%)							
Lane Group Flow (vph)	37	964	626	0	499	216	
Enter Blocked Intersection	No	No	No	No	No	No	
Lane Alignment	Left	Left	Left	Right	Left	Right	
Median Width(m)		3.6	3.6		3.6		
Link Offset(m)		0.0	0.0		0.0		
Crosswalk Width(m)		4.8	4.8		4.8		
Two way Left Turn Lane							
Headway Factor	1.00	1.00	1.00	1.00	1.00	1.00	
Turning Speed (k/h)	25			15	25	15	
Number of Detectors	1	2	2		1	1	
Detector Template	Left	Thru	Thru		Left	Right	
Leading Detector (m)	2.0	10.0	10.0		2.0	2.0	
Trailing Detector (m)	0.0	0.0	0.0		0.0	0.0	
Detector 1 Position(m)	0.0	0.0	0.0		0.0	0.0	
Detector 1 Size(m)	2.0	0.6	0.6		2.0	2.0	
Detector 1 Type	CI+Ex	CI+Ex	CI+Ex		CI+Ex	CI+Ex	
Detector 1 Channel							
Detector 1 Extend (s)	0.0	0.0	0.0		0.0	0.0	
Detector 1 Queue (s)	0.0	0.0	0.0		0.0	0.0	
Detector 1 Delay (s)	0.0	0.0	0.0		0.0	0.0	
Detector 2 Position(m)		9.4	9.4				
Detector 2 Size(m)		0.6	0.6				
Detector 2 Type		CI+Ex	CI+Ex				
Detector 2 Channel							
Detector 2 Extend (s)		0.0	0.0				
Turn Type	pm+pt	NA	NA		Prot	Perm	
Protected Phases	5	2	6		4		3
Permitted Phases	2					4	

Lanes, Volumes, Timings
6: Smyth Rd & Roger Guindon Ave

12/15/2023

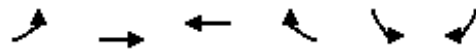

Lane Group	EBL	EBT	WBT	WBR	SBL	SBR	Ø3
Detector Phase	5	2	6		4	4	
Switch Phase							
Minimum Initial (s)	5.0	10.0	10.0		5.0	5.0	1.0
Minimum Split (s)	10.5	23.8	30.8		31.6	31.6	5.0
Total Split (s)	15.0	53.0	38.0		32.0	32.0	5.0
Total Split (%)	16.7%	58.9%	42.2%		35.6%	35.6%	6%
Maximum Green (s)	9.5	47.2	32.2		26.4	26.4	3.0
Yellow Time (s)	3.3	3.3	3.3		3.3	3.3	2.0
All-Red Time (s)	2.2	2.5	2.5		2.3	2.3	0.0
Lost Time Adjust (s)	0.0	0.0	0.0		0.0	0.0	
Total Lost Time (s)	5.5	5.8	5.8		5.6	5.6	
Lead/Lag	Lead		Lag		Lag	Lag	Lead
Lead-Lag Optimize?	Yes		Yes				
Vehicle Extension (s)	3.0	3.0	3.0		3.0	3.0	3.0
Recall Mode	None	C-Max	C-Max		None	None	None
Walk Time (s)			10.0		7.0	7.0	3.0
Flash Dont Walk (s)			15.0		14.0	14.0	0.0
Pedestrian Calls (#/hr)			31		68	68	68
Act Effct Green (s)	48.1	47.8	40.3		26.8	26.8	
Actuated g/C Ratio	0.53	0.53	0.45		0.30	0.30	
v/c Ratio	0.10	0.52	0.41		0.97	0.36	
Control Delay	10.9	15.1	18.6		64.9	5.4	
Queue Delay	0.0	0.0	0.0		0.0	0.0	
Total Delay	10.9	15.1	18.6		64.9	5.4	
LOS	B	B	B		E	A	
Approach Delay		14.9	18.6		47.0		
Approach LOS		B	B		D		

Intersection Summary

Area Type:	Other
Cycle Length:	90
Actuated Cycle Length:	90
Offset:	12 (13%), Referenced to phase 2:EBTL and 6:WBT, Start of Green
Natural Cycle:	80
Control Type:	Actuated-Coordinated
Maximum v/c Ratio:	0.97
Intersection Signal Delay:	25.7
Intersection LOS:	C
Intersection Capacity Utilization	61.8%
ICU Level of Service	B
Analysis Period (min)	15

Splits and Phases: 6: Smyth Rd & Roger Guindon Ave

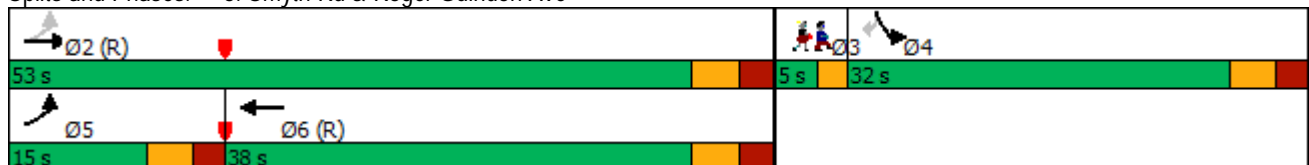

Queues

6: Smyth Rd & Roger Guindon Ave

12/15/2023



Lane Group	EBL	EBT	WBT	SBL	SBR
Lane Group Flow (vph)	37	964	626	499	216
v/c Ratio	0.10	0.52	0.41	0.97	0.36
Control Delay	10.9	15.1	18.6	64.9	5.4
Queue Delay	0.0	0.0	0.0	0.0	0.0
Total Delay	10.9	15.1	18.6	64.9	5.4
Queue Length 50th (m)	3.1	57.2	41.8	89.7	0.0
Queue Length 95th (m)	7.7	74.5	59.1	#154.3	16.1
Internal Link Dist (m)		389.0	253.5	117.9	
Turn Bay Length (m)	67.0			35.0	
Base Capacity (vph)	409	1860	1523	517	602
Starvation Cap Reductn	0	0	0	0	0
Spillback Cap Reductn	0	0	0	0	0
Storage Cap Reductn	0	0	0	0	0
Reduced v/c Ratio	0.09	0.52	0.41	0.97	0.36

Intersection Summary

95th percentile volume exceeds capacity, queue may be longer.
 Queue shown is maximum after two cycles.

HCM Unsignalized Intersection Capacity Analysis

7: Ring Rd & Hospital Link Rd

04-11-2024



Movement	EBT	EBR	WBL	WBT	NBL	NBR
Lane Configurations	↑			↑	↑	
Sign Control	Stop			Stop	Stop	
Traffic Volume (vph)	38	23	77	177	72	35
Future Volume (vph)	38	23	77	177	72	35
Peak Hour Factor	0.90	0.90	0.90	0.90	0.90	0.90
Hourly flow rate (vph)	42	26	86	197	80	39

Direction, Lane #	EB 1	WB 1	NB 1
Volume Total (vph)	68	283	119
Volume Left (vph)	0	86	80
Volume Right (vph)	26	0	39
Hadj (s)	-0.11	0.08	0.02
Departure Headway (s)	4.4	4.4	4.7
Degree Utilization, x	0.08	0.34	0.16
Capacity (veh/h)	782	798	713
Control Delay (s)	7.8	9.6	8.6
Approach Delay (s)	7.8	9.6	8.6
Approach LOS	A	A	A

Intersection Summary			
Delay		9.1	
Level of Service		A	
Intersection Capacity Utilization	33.0%	ICU Level of Service	A
Analysis Period (min)	15		

HCM Unsignalized Intersection Capacity Analysis

8: uOttawa-Rehab W Access & Hospital Link Rd

04-11-2024

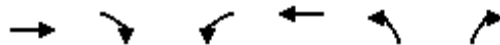

Movement	EBT	EBR	WBL	WBT	NBL	NBR
Lane Configurations						
Traffic Volume (veh/h)	49	24	18	155	99	36
Future Volume (Veh/h)	49	24	18	155	99	36
Sign Control	Free			Free	Stop	
Grade	0%			0%	0%	
Peak Hour Factor	0.90	0.90	0.90	0.90	0.90	0.90
Hourly flow rate (vph)	54	27	20	172	110	40
Pedestrians						
Lane Width (m)						
Walking Speed (m/s)						
Percent Blockage						
Right turn flare (veh)						
Median type	None			None		
Median storage veh						
Upstream signal (m)						
pX, platoon unblocked						
vC, conflicting volume			81		280	68
vC1, stage 1 conf vol						
vC2, stage 2 conf vol						
vCu, unblocked vol			81		280	68
tC, single (s)			4.2		6.4	6.2
tC, 2 stage (s)						
tF (s)			2.3		3.5	3.3
p0 queue free %			99		84	96
cM capacity (veh/h)			1462		705	1002
Direction, Lane #	EB 1	WB 1	NB 1			
Volume Total	81	192	150			
Volume Left	0	20	110			
Volume Right	27	0	40			
cSH	1700	1462	765			
Volume to Capacity	0.05	0.01	0.20			
Queue Length 95th (m)	0.0	0.3	5.8			
Control Delay (s)	0.0	0.9	10.8			
Lane LOS			A			B
Approach Delay (s)	0.0	0.9	10.8			
Approach LOS			B			
Intersection Summary						
Average Delay			4.2			
Intersection Capacity Utilization			30.2%	ICU Level of Service	A	
Analysis Period (min)			15			

HCM Unsignalized Intersection Capacity Analysis
 9: uOttawa-Rehab E Access & Hospital Link Rd

04-11-2024



Movement	EBT	EBR	WBL	WBT	NBL	NBR
Lane Configurations	↑			↑	↘	
Sign Control	Stop			Stop	Stop	
Traffic Volume (vph)	85	0	0	154	19	14
Future Volume (vph)	85	0	0	154	19	14
Peak Hour Factor	0.90	0.90	0.90	0.90	0.90	0.90
Hourly flow rate (vph)	94	0	0	171	21	16
Direction, Lane #	EB 1	WB 1	NB 1			
Volume Total (vph)	94	171	37			
Volume Left (vph)	0	0	21			
Volume Right (vph)	0	0	16			
Hadj (s)	0.09	0.02	0.12			
Departure Headway (s)	4.2	4.1	4.6			
Degree Utilization, x	0.11	0.19	0.05			
Capacity (veh/h)	831	864	735			
Control Delay (s)	7.8	8.1	7.8			
Approach Delay (s)	7.8	8.1	7.8			
Approach LOS	A	A	A			
Intersection Summary						
Delay			8.0			
Level of Service			A			
Intersection Capacity Utilization			18.8%	ICU Level of Service	A	
Analysis Period (min)			15			

Lanes, Volumes, Timings

1: Alta Vista Dr & Hospital Link Rd

12/15/2023



Lane Group	EBL	EBT	EBR	WBL	WBT	WBR	NBL	NBT	NBR	SBL	SBT	SBR
Lane Configurations												
Traffic Volume (vph)	2	304	46	21	56	7	40	603	54	16	601	23
Future Volume (vph)	2	304	46	21	56	7	40	603	54	16	601	23
Ideal Flow (vphpl)	1800	1800	1800	1800	1800	1800	1800	1800	1800	1800	1800	1800
Storage Length (m)	0.0		0.0	25.0		40.0	30.0		0.0	25.0		0.0
Storage Lanes	1		0	1		1	1		0	1		0
Taper Length (m)	7.5			7.5			7.5			7.5		
Lane Util. Factor	1.00	1.00	1.00	1.00	1.00	1.00	1.00	1.00	1.00	1.00	1.00	1.00
Ped Bike Factor	0.99	0.99		0.98		0.97		1.00			1.00	
Frt		0.980				0.850		0.988			0.994	
Flt Protected	0.950			0.950			0.950			0.950		
Satd. Flow (prot)	1710	1695	0	1583	1579	1530	1710	1692	0	1710	1734	0
Flt Permitted	0.720			0.212			0.289			0.265		
Satd. Flow (perm)	1287	1695	0	348	1579	1489	520	1692	0	477	1734	0
Right Turn on Red			Yes			Yes			Yes			Yes
Satd. Flow (RTOR)		6				31		5			2	
Link Speed (k/h)		50			50			50			50	
Link Distance (m)		148.1			598.8			586.9			279.5	
Travel Time (s)		10.7			43.1			42.3			20.1	
Confl. Peds. (#/hr)	3		20	20		3	5		7	7		5
Confl. Bikes (#/hr)									1			
Peak Hour Factor	1.00	1.00	1.00	1.00	1.00	1.00	1.00	1.00	1.00	1.00	1.00	1.00
Heavy Vehicles (%)	0%	3%	4%	8%	14%	0%	0%	5%	2%	0%	3%	4%
Adj. Flow (vph)	2	304	46	21	56	7	40	603	54	16	601	23
Shared Lane Traffic (%)												
Lane Group Flow (vph)	2	350	0	21	56	7	40	657	0	16	624	0
Enter Blocked Intersection	No	No	No	No	No	No	No	No	No	No	No	No
Lane Alignment	Left	Left	Right	Left	Left	Right	Left	Left	Right	Left	Left	Right
Median Width(m)		3.6			3.6			3.6			3.6	
Link Offset(m)		0.0			0.0			0.0			0.0	
Crosswalk Width(m)		4.8			4.8			4.8			4.8	
Two way Left Turn Lane												
Headway Factor	1.07	1.07	1.07	1.07	1.07	1.07	1.07	1.07	1.07	1.07	1.07	1.07
Turning Speed (k/h)	25		15	25		15	25		15	25		15
Number of Detectors	1	2		1	2	1	1	2		1	2	
Detector Template	Left	Thru		Left	Thru	Right	Left	Thru		Left	Thru	
Leading Detector (m)	2.0	10.0		2.0	10.0	2.0	2.0	10.0		2.0	10.0	
Trailing Detector (m)	0.0	0.0		0.0	0.0	0.0	0.0	0.0		0.0	0.0	
Detector 1 Position(m)	0.0	0.0		0.0	0.0	0.0	0.0	0.0		0.0	0.0	
Detector 1 Size(m)	2.0	0.6		2.0	0.6	2.0	2.0	0.6		2.0	0.6	
Detector 1 Type	CI+Ex	CI+Ex		CI+Ex	CI+Ex	CI+Ex	CI+Ex	CI+Ex		CI+Ex	CI+Ex	
Detector 1 Channel												
Detector 1 Extend (s)	0.0	0.0		0.0	0.0	0.0	0.0	0.0		0.0	0.0	
Detector 1 Queue (s)	0.0	0.0		0.0	0.0	0.0	0.0	0.0		0.0	0.0	
Detector 1 Delay (s)	0.0	0.0		0.0	0.0	0.0	0.0	0.0		0.0	0.0	
Detector 2 Position(m)		9.4			9.4			9.4			9.4	
Detector 2 Size(m)		0.6			0.6			0.6			0.6	
Detector 2 Type		CI+Ex			CI+Ex			CI+Ex			CI+Ex	
Detector 2 Channel												
Detector 2 Extend (s)		0.0			0.0			0.0			0.0	
Turn Type	Perm	NA		pm+pt	NA	Perm	Perm	NA		Perm	NA	
Protected Phases		2		1	6			8			4	
Permitted Phases	2			6		6	8			4		

Lanes, Volumes, Timings
1: Alta Vista Dr & Hospital Link Rd

12/15/2023



Lane Group	EBL	EBT	EBR	WBL	WBT	WBR	NBL	NBT	NBR	SBL	SBT	SBR
Detector Phase	2	2		1	6	6	8	8		4	4	
Switch Phase												
Minimum Initial (s)	10.0	10.0		5.0	10.0	10.0	10.0	10.0		10.0	10.0	
Minimum Split (s)	30.5	30.5		11.5	30.5	30.5	27.3	27.3		27.3	27.3	
Total Split (s)	31.5	31.5		21.5	53.0	53.0	61.3	61.3		61.3	61.3	
Total Split (%)	27.6%	27.6%		18.8%	46.4%	46.4%	53.6%	53.6%		53.6%	53.6%	
Maximum Green (s)	25.0	25.0		15.0	46.5	46.5	55.0	55.0		55.0	55.0	
Yellow Time (s)	3.3	3.3		3.3	3.3	3.3	3.3	3.3		3.3	3.3	
All-Red Time (s)	3.2	3.2		3.2	3.2	3.2	3.0	3.0		3.0	3.0	
Lost Time Adjust (s)	0.0	0.0		0.0	0.0	0.0	0.0	0.0		0.0	0.0	
Total Lost Time (s)	6.5	6.5		6.5	6.5	6.5	6.3	6.3		6.3	6.3	
Lead/Lag	Lag	Lag		Lead								
Lead-Lag Optimize?	Yes	Yes		Yes								
Vehicle Extension (s)	3.0	3.0		3.0	3.0	3.0	3.0	3.0		3.0	3.0	
Recall Mode	None	None		None	None	None	Max	Max		Max	Max	
Walk Time (s)	7.0	7.0		7.0	7.0	7.0	7.0	7.0		7.0	7.0	
Flash Dont Walk (s)	17.0	17.0		17.0	17.0	17.0	14.0	14.0		14.0	14.0	
Pedestrian Calls (#/hr)	23	23		23	23	23	12	12		12	12	
Act Effct Green (s)	24.0	24.0		29.0	29.0	29.0	55.4	55.4		55.4	55.4	
Actuated g/C Ratio	0.25	0.25		0.30	0.30	0.30	0.57	0.57		0.57	0.57	
v/c Ratio	0.01	0.83		0.11	0.12	0.02	0.14	0.68		0.06	0.63	
Control Delay	31.0	53.2		24.1	24.3	0.0	13.8	20.9		12.9	19.4	
Queue Delay	0.0	0.0		0.0	0.0	0.0	0.0	0.0		0.0	0.0	
Total Delay	31.0	53.2		24.1	24.3	0.0	13.8	20.9		12.9	19.4	
LOS	C	D		C	C	A	B	C		B	B	
Approach Delay		53.1			22.2			20.5			19.2	
Approach LOS		D			C			C			B	

Intersection Summary

Area Type:	Other
Cycle Length:	114.3
Actuated Cycle Length:	97.3
Natural Cycle:	80
Control Type:	Semi Act-Uncoord
Maximum v/c Ratio:	0.83
Intersection Signal Delay:	26.6
Intersection LOS:	C
Intersection Capacity Utilization	70.9%
ICU Level of Service	C
Analysis Period (min)	15

Splits and Phases: 1: Alta Vista Dr & Hospital Link Rd

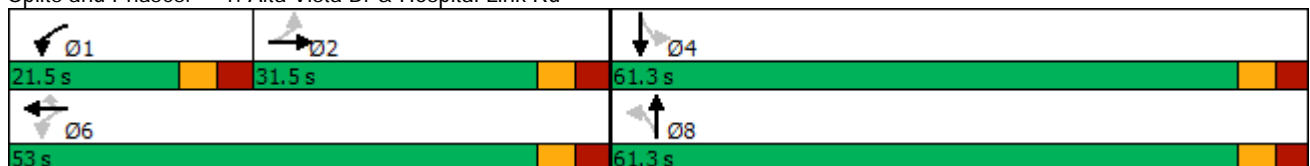

Queues

1: Alta Vista Dr & Hospital Link Rd

12/15/2023



Lane Group	EBL	EBT	WBL	WBT	WBR	NBL	NBT	SBL	SBT
Lane Group Flow (vph)	2	350	21	56	7	40	657	16	624
v/c Ratio	0.01	0.83	0.11	0.12	0.02	0.14	0.68	0.06	0.63
Control Delay	31.0	53.2	24.1	24.3	0.0	13.8	20.9	12.9	19.4
Queue Delay	0.0	0.0	0.0	0.0	0.0	0.0	0.0	0.0	0.0
Total Delay	31.0	53.2	24.1	24.3	0.0	13.8	20.9	12.9	19.4
Queue Length 50th (m)	0.3	59.5	2.9	8.0	0.0	3.1	75.3	1.2	68.7
Queue Length 95th (m)	2.4	#125.6	8.4	16.9	0.0	11.2	158.5	5.6	143.5
Internal Link Dist (m)		124.1		574.8			562.9		255.5
Turn Bay Length (m)			25.0		40.0	30.0		25.0	
Base Capacity (vph)	332	443	295	759	732	296	965	271	987
Starvation Cap Reductn	0	0	0	0	0	0	0	0	0
Spillback Cap Reductn	0	0	0	0	0	0	0	0	0
Storage Cap Reductn	0	0	0	0	0	0	0	0	0
Reduced v/c Ratio	0.01	0.79	0.07	0.07	0.01	0.14	0.68	0.06	0.63

Intersection Summary

95th percentile volume exceeds capacity, queue may be longer.
 Queue shown is maximum after two cycles.

Lanes, Volumes, Timings
2: Alta Vista Dr & Smyth Rd

12/15/2023



Lane Group	EBL	EBT	EBR	WBL	WBT	WBR	NBL	NBT	NBR	SBL	SBT	SBR
Lane Configurations												
Traffic Volume (vph)	156	800	106	81	476	159	334	383	161	229	204	117
Future Volume (vph)	156	800	106	81	476	159	334	383	161	229	204	117
Ideal Flow (vphpl)	1800	1800	1800	1800	1800	1800	1800	1800	1800	1800	1800	1800
Storage Length (m)	30.0		25.0	61.0		10.0	87.0		30.0	44.0		25.0
Storage Lanes	1		1	1		1	1		1	1		1
Taper Length (m)	7.5			7.5			7.5			7.5		
Lane Util. Factor	1.00	0.95	1.00	1.00	0.95	1.00	1.00	1.00	1.00	1.00	1.00	1.00
Ped Bike Factor	0.96		0.91			0.89	0.98		0.97	0.99		0.96
Fr't			0.850			0.850			0.850			0.850
Flt Protected	0.950			0.950			0.950			0.950		
Satd. Flow (prot)	1710	3353	1485	1644	3320	1500	1710	1731	1500	1676	1731	1530
Flt Permitted	0.344			0.217			0.525			0.260		
Satd. Flow (perm)	595	3353	1350	376	3320	1332	929	1731	1458	456	1731	1473
Right Turn on Red			Yes			Yes			Yes			Yes
Satd. Flow (RTOR)			139			139			137			137
Link Speed (k/h)		50			50			50			50	
Link Distance (m)		339.0			234.1			204.1			586.9	
Travel Time (s)		24.4			16.9			14.7			42.3	
Confl. Peds. (#/hr)	31		24	24		31	17		11	11		17
Peak Hour Factor	1.00	1.00	1.00	1.00	1.00	1.00	1.00	1.00	1.00	1.00	1.00	1.00
Heavy Vehicles (%)	0%	2%	3%	4%	3%	2%	0%	4%	2%	2%	4%	0%
Adj. Flow (vph)	156	800	106	81	476	159	334	383	161	229	204	117
Shared Lane Traffic (%)												
Lane Group Flow (vph)	156	800	106	81	476	159	334	383	161	229	204	117
Enter Blocked Intersection	No	No	No	No	No	No	No	No	No	No	No	No
Lane Alignment	Left	Left	Right	Left	Left	Right	Left	Left	Right	Left	Left	Right
Median Width(m)		3.6			3.6			3.6			3.6	
Link Offset(m)		0.0			0.0			0.0			0.0	
Crosswalk Width(m)		4.8			4.8			4.8			4.8	
Two way Left Turn Lane												
Headway Factor	1.07	1.07	1.07	1.07	1.07	1.07	1.07	1.07	1.07	1.07	1.07	1.07
Turning Speed (k/h)	25		15	25		15	25		15	25		15
Number of Detectors	1	2	1	1	2	1	1	2	1	1	2	1
Detector Template	Left	Thru	Right	Left	Thru	Right	Left	Thru	Right	Left	Thru	Right
Leading Detector (m)	2.0	10.0	2.0	2.0	10.0	2.0	2.0	10.0	2.0	2.0	10.0	2.0
Trailing Detector (m)	0.0	0.0	0.0	0.0	0.0	0.0	0.0	0.0	0.0	0.0	0.0	0.0
Detector 1 Position(m)	0.0	0.0	0.0	0.0	0.0	0.0	0.0	0.0	0.0	0.0	0.0	0.0
Detector 1 Size(m)	2.0	0.6	2.0	2.0	0.6	2.0	2.0	0.6	2.0	2.0	0.6	2.0
Detector 1 Type	CI+Ex	CI+Ex	CI+Ex	CI+Ex	CI+Ex	CI+Ex	CI+Ex	CI+Ex	CI+Ex	CI+Ex	CI+Ex	CI+Ex
Detector 1 Channel												
Detector 1 Extend (s)	0.0	0.0	0.0	0.0	0.0	0.0	0.0	0.0	0.0	0.0	0.0	0.0
Detector 1 Queue (s)	0.0	0.0	0.0	0.0	0.0	0.0	0.0	0.0	0.0	0.0	0.0	0.0
Detector 1 Delay (s)	0.0	0.0	0.0	0.0	0.0	0.0	0.0	0.0	0.0	0.0	0.0	0.0
Detector 2 Position(m)		9.4			9.4			9.4			9.4	
Detector 2 Size(m)		0.6			0.6			0.6			0.6	
Detector 2 Type		CI+Ex			CI+Ex			CI+Ex			CI+Ex	
Detector 2 Channel												
Detector 2 Extend (s)		0.0			0.0			0.0			0.0	
Turn Type	pm+pt	NA	Perm	pm+pt	NA	Perm	pm+pt	NA	Perm	pm+pt	NA	Perm
Protected Phases	5	2		1	6		3	8		7	4	
Permitted Phases	2		2	6		6	8		8	4		4
Detector Phase	5	2	2	1	6	6	3	8	8	7	4	4

Lanes, Volumes, Timings
2: Alta Vista Dr & Smyth Rd

12/15/2023



Lane Group	EBL	EBT	EBR	WBL	WBT	WBR	NBL	NBT	NBR	SBL	SBT	SBR
Switch Phase												
Minimum Initial (s)	5.0	10.0	10.0	5.0	10.0	10.0	5.0	10.0	10.0	5.0	10.0	10.0
Minimum Split (s)	10.5	24.8	24.8	10.5	24.8	24.8	11.1	29.1	29.1	11.1	29.1	29.1
Total Split (s)	20.0	38.0	38.0	20.0	38.0	38.0	20.0	37.0	37.0	20.0	37.0	37.0
Total Split (%)	17.4%	33.0%	33.0%	17.4%	33.0%	33.0%	17.4%	32.2%	32.2%	17.4%	32.2%	32.2%
Maximum Green (s)	14.5	32.2	32.2	14.5	32.2	32.2	13.9	30.9	30.9	13.9	30.9	30.9
Yellow Time (s)	3.3	3.3	3.3	3.3	3.3	3.3	3.3	3.3	3.3	3.3	3.3	3.3
All-Red Time (s)	2.2	2.5	2.5	2.2	2.5	2.5	2.8	2.8	2.8	2.8	2.8	2.8
Lost Time Adjust (s)	0.0	0.0	0.0	0.0	0.0	0.0	0.0	0.0	0.0	0.0	0.0	0.0
Total Lost Time (s)	5.5	5.8	5.8	5.5	5.8	5.8	6.1	6.1	6.1	6.1	6.1	6.1
Lead/Lag	Lead	Lag	Lag	Lead	Lag	Lag	Lead	Lag	Lag	Lead	Lag	Lag
Lead-Lag Optimize?	Yes	Yes	Yes	Yes	Yes	Yes	Yes	Yes	Yes	Yes	Yes	Yes
Vehicle Extension (s)	3.0	3.0	3.0	3.0	3.0	3.0	3.0	3.0	3.0	3.0	3.0	3.0
Recall Mode	None	C-Max	C-Max	None	C-Max	C-Max	None	Max	Max	None	Max	Max
Walk Time (s)		7.0	7.0		7.0	7.0		7.0	7.0		7.0	7.0
Flash Dont Walk (s)		12.0	12.0		12.0	12.0		16.0	16.0		16.0	16.0
Pedestrian Calls (#/hr)		55	55		55	55		28	28		28	28
Act Effct Green (s)	50.5	40.3	40.3	44.2	35.2	35.2	45.4	31.5	31.5	44.2	30.9	30.9
Actuated g/C Ratio	0.44	0.35	0.35	0.38	0.31	0.31	0.39	0.27	0.27	0.38	0.27	0.27
v/c Ratio	0.42	0.68	0.19	0.34	0.47	0.32	0.72	0.81	0.32	0.73	0.44	0.24
Control Delay	22.5	36.6	3.0	24.3	29.9	12.9	34.4	53.7	9.9	35.9	38.5	4.9
Queue Delay	0.0	0.0	0.0	0.0	0.0	0.0	0.0	0.0	0.0	0.0	0.0	0.0
Total Delay	22.5	36.6	3.0	24.3	29.9	12.9	34.4	53.7	9.9	35.9	38.5	4.9
LOS	C	D	A	C	C	B	C	D	A	D	D	A
Approach Delay		31.2			25.5			38.3			30.3	
Approach LOS		C			C			D			C	

Intersection Summary

Area Type:	Other
Cycle Length:	115
Actuated Cycle Length:	115
Offset:	2 (2%), Referenced to phase 2:EBTL and 6:WBTL, Start of Green
Natural Cycle:	80
Control Type:	Actuated-Coordinated
Maximum v/c Ratio:	0.81
Intersection Signal Delay:	31.7
Intersection LOS:	C
Intersection Capacity Utilization	86.4%
ICU Level of Service	E
Analysis Period (min)	15

Splits and Phases: 2: Alta Vista Dr & Smyth Rd

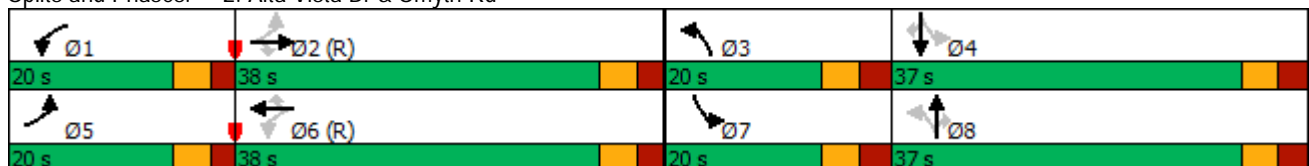

Queues

2: Alta Vista Dr & Smyth Rd

12/15/2023



Lane Group	EBL	EBT	EBR	WBL	WBT	WBR	NBL	NBT	NBR	SBL	SBT	SBR
Lane Group Flow (vph)	156	800	106	81	476	159	334	383	161	229	204	117
v/c Ratio	0.42	0.68	0.19	0.34	0.47	0.32	0.72	0.81	0.32	0.73	0.44	0.24
Control Delay	22.5	36.6	3.0	24.3	29.9	12.9	34.4	53.7	9.9	35.9	38.5	4.9
Queue Delay	0.0	0.0	0.0	0.0	0.0	0.0	0.0	0.0	0.0	0.0	0.0	0.0
Total Delay	22.5	36.6	3.0	24.3	29.9	12.9	34.4	53.7	9.9	35.9	38.5	4.9
Queue Length 50th (m)	21.5	87.2	0.0	5.1	31.3	0.9	53.6	85.3	4.2	34.3	40.2	0.0
Queue Length 95th (m)	35.8	115.1	7.1	29.1	61.7	28.6	79.4	#135.5	21.5	#55.0	63.5	10.5
Internal Link Dist (m)		315.0			210.1			180.1			562.9	
Turn Bay Length (m)	30.0		25.0	61.0		10.0	87.0		30.0	44.0		25.0
Base Capacity (vph)	409	1174	563	322	1015	503	461	474	499	325	465	495
Starvation Cap Reductn	0	0	0	0	0	0	0	0	0	0	0	0
Spillback Cap Reductn	0	0	0	0	0	0	0	0	0	0	0	0
Storage Cap Reductn	0	0	0	0	0	0	0	0	0	0	0	0
Reduced v/c Ratio	0.38	0.68	0.19	0.25	0.47	0.32	0.72	0.81	0.32	0.70	0.44	0.24

Intersection Summary

95th percentile volume exceeds capacity, queue may be longer.
 Queue shown is maximum after two cycles.

Lanes, Volumes, Timings 3: Smyth Rd & Valour Dr

12/15/2023

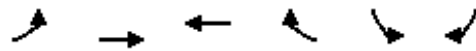

Lane Group	EBL	EBT	WBT	WBR	SBL	SBR
Lane Configurations						
Traffic Volume (vph)	34	1156	696	12	16	20
Future Volume (vph)	34	1156	696	12	16	20
Ideal Flow (vphpl)	1800	1800	1800	1800	1800	1800
Storage Length (m)	55.0			0.0	32.0	0.0
Storage Lanes	1			0	1	1
Taper Length (m)	7.5				7.5	
Lane Util. Factor	1.00	0.95	0.95	0.95	1.00	1.00
Ped Bike Factor	0.99		1.00			0.98
Frt			0.997			0.850
Flt Protected	0.950				0.950	
Satd. Flow (prot)	1613	3386	3306	0	1527	1457
Flt Permitted	0.382				0.950	
Satd. Flow (perm)	642	3386	3306	0	1527	1433
Right Turn on Red				Yes		Yes
Satd. Flow (RTOR)			3			20
Link Speed (k/h)		50	50		50	
Link Distance (m)		234.1	461.7		195.1	
Travel Time (s)		16.9	33.2		14.0	
Confl. Peds. (#/hr)	11			11		3
Peak Hour Factor	1.00	1.00	1.00	1.00	1.00	1.00
Heavy Vehicles (%)	6%	1%	3%	6%	12%	5%
Adj. Flow (vph)	34	1156	696	12	16	20
Shared Lane Traffic (%)						
Lane Group Flow (vph)	34	1156	708	0	16	20
Enter Blocked Intersection	No	No	No	No	No	No
Lane Alignment	Left	Left	Left	Right	Left	Right
Median Width(m)		3.6	3.6		3.6	
Link Offset(m)		0.0	0.0		0.0	
Crosswalk Width(m)		4.8	4.8		4.8	
Two way Left Turn Lane						
Headway Factor	1.07	1.07	1.07	1.07	1.07	1.07
Turning Speed (k/h)	25			15	25	15
Number of Detectors	1	2	2		1	1
Detector Template	Left	Thru	Thru		Left	Right
Leading Detector (m)	2.0	10.0	10.0		2.0	2.0
Trailing Detector (m)	0.0	0.0	0.0		0.0	0.0
Detector 1 Position(m)	0.0	0.0	0.0		0.0	0.0
Detector 1 Size(m)	2.0	0.6	0.6		2.0	2.0
Detector 1 Type	CI+Ex	CI+Ex	CI+Ex		CI+Ex	CI+Ex
Detector 1 Channel						
Detector 1 Extend (s)	0.0	0.0	0.0		0.0	0.0
Detector 1 Queue (s)	0.0	0.0	0.0		0.0	0.0
Detector 1 Delay (s)	0.0	0.0	0.0		0.0	0.0
Detector 2 Position(m)		9.4	9.4			
Detector 2 Size(m)		0.6	0.6			
Detector 2 Type		CI+Ex	CI+Ex			
Detector 2 Channel						
Detector 2 Extend (s)		0.0	0.0			
Turn Type	Perm	NA	NA		Prot	Perm
Protected Phases		2	6		4	
Permitted Phases	2					4
Detector Phase	2	2	6		4	4

Lanes, Volumes, Timings

3: Smyth Rd & Valour Dr

12/15/2023

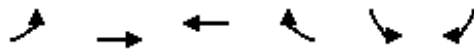

Lane Group	EBL	EBT	WBT	WBR	SBL	SBR
Switch Phase						
Minimum Initial (s)	10.0	10.0	10.0		5.0	5.0
Minimum Split (s)	29.5	29.5	29.5		28.5	28.5
Total Split (s)	84.0	84.0	84.0		31.0	31.0
Total Split (%)	73.0%	73.0%	73.0%		27.0%	27.0%
Maximum Green (s)	77.5	77.5	77.5		24.5	24.5
Yellow Time (s)	3.3	3.3	3.3		3.3	3.3
All-Red Time (s)	3.2	3.2	3.2		3.2	3.2
Lost Time Adjust (s)	0.0	0.0	0.0		0.0	0.0
Total Lost Time (s)	6.5	6.5	6.5		6.5	6.5
Lead/Lag						
Lead-Lag Optimize?						
Vehicle Extension (s)	3.0	3.0	3.0		3.0	3.0
Recall Mode	C-Max	C-Max	C-Max		None	None
Walk Time (s)	7.0	7.0	7.0		7.0	7.0
Flash Dont Walk (s)	16.0	16.0	16.0		15.0	15.0
Pedestrian Calls (#/hr)	11	11	11		3	3
Act Effct Green (s)	100.0	100.0	100.0		9.5	9.5
Actuated g/C Ratio	0.87	0.87	0.87		0.08	0.08
v/c Ratio	0.06	0.39	0.25		0.13	0.15
Control Delay	1.2	1.1	8.3		47.4	19.1
Queue Delay	0.0	0.0	0.0		0.0	0.0
Total Delay	1.2	1.1	8.3		47.4	19.1
LOS	A	A	A		D	B
Approach Delay		1.1	8.3		31.7	
Approach LOS		A	A		C	

Intersection Summary	
Area Type:	Other
Cycle Length:	115
Actuated Cycle Length:	115
Offset:	12 (10%), Referenced to phase 2:EBTL and 6:WBT, Start of Green
Natural Cycle:	60
Control Type:	Actuated-Coordinated
Maximum v/c Ratio:	0.39
Intersection Signal Delay:	4.3
Intersection Capacity Utilization	50.1%
Analysis Period (min)	15
Intersection LOS:	A
ICU Level of Service	A

Splits and Phases: 3: Smyth Rd & Valour Dr



Queues

3: Smyth Rd & Valour Dr

12/15/2023



Lane Group	EBL	EBT	WBT	SBL	SBR
Lane Group Flow (vph)	34	1156	708	16	20
v/c Ratio	0.06	0.39	0.25	0.13	0.15
Control Delay	1.2	1.1	8.3	47.4	19.1
Queue Delay	0.0	0.0	0.0	0.0	0.0
Total Delay	1.2	1.1	8.3	47.4	19.1
Queue Length 50th (m)	0.4	6.7	32.8	3.7	0.0
Queue Length 95th (m)	m1.0	13.1	78.7	9.6	6.9
Internal Link Dist (m)		210.1	437.7	171.1	
Turn Bay Length (m)	55.0			32.0	
Base Capacity (vph)	558	2943	2874	325	321
Starvation Cap Reductn	0	0	0	0	0
Spillback Cap Reductn	0	0	0	0	0
Storage Cap Reductn	0	0	0	0	0
Reduced v/c Ratio	0.06	0.39	0.25	0.05	0.06

Intersection Summary

m Volume for 95th percentile queue is metered by upstream signal.

Lanes, Volumes, Timings
4: S Haven Pl/Ring Rd & Smyth Rd

12/15/2023



Lane Group	EBL	EBT	EBR	WBL	WBT	WBR	NBL	NBT	NBR	SBL	SBT	SBR
Lane Configurations		↕↕			↕↕			↕↕			↕	↕
Traffic Volume (vph)	377	794	2	1	578	107	6	0	0	29	0	124
Future Volume (vph)	377	794	2	1	578	107	6	0	0	29	0	124
Ideal Flow (vphpl)	1800	1800	1800	1800	1800	1800	1800	1800	1800	1800	1800	1800
Lane Util. Factor	0.95	0.95	0.95	0.95	0.95	0.95	1.00	1.00	1.00	1.00	1.00	1.00
Ped Bike Factor		1.00			0.99						0.99	0.99
Frt					0.977							0.850
Flt Protected		0.984						0.950			0.950	
Satd. Flow (prot)	0	3332	0	0	3227	0	0	1710	0	0	1660	1443
Flt Permitted		0.615			0.954			0.738			0.754	
Satd. Flow (perm)	0	2079	0	0	3078	0	0	1328	0	0	1306	1423
Right Turn on Red			Yes			Yes			Yes			Yes
Satd. Flow (RTOR)					19							124
Link Speed (k/h)		50			50			50			50	
Link Distance (m)		461.7			394.3			74.8			50.7	
Travel Time (s)		33.2			28.4			5.4			3.7	
Confl. Peds. (#/hr)	11		2	2		11			6	6		
Confl. Bikes (#/hr)			8						4			2
Peak Hour Factor	1.00	1.00	1.00	1.00	1.00	1.00	1.00	1.00	1.00	1.00	1.00	1.00
Heavy Vehicles (%)	1%	1%	0%	0%	3%	2%	0%	0%	0%	3%	0%	6%
Adj. Flow (vph)	377	794	2	1	578	107	6	0	0	29	0	124
Shared Lane Traffic (%)												
Lane Group Flow (vph)	0	1173	0	0	686	0	0	6	0	0	29	124
Enter Blocked Intersection	No	No	No	No	No	No	No	No	No	No	No	No
Lane Alignment	Left	Left	Right	Left	Left	Right	Left	Left	Right	Left	Left	Right
Median Width(m)		3.6			3.6			0.0			0.0	
Link Offset(m)		0.0			0.0			0.0			0.0	
Crosswalk Width(m)		4.8			4.8			4.8			4.8	
Two way Left Turn Lane												
Headway Factor	1.07	1.07	1.07	1.07	1.07	1.07	1.07	1.07	1.07	1.07	1.07	1.07
Turning Speed (k/h)	25		15	25		15	25		15	25		15
Number of Detectors	1	2		1	2		1	2		1	2	1
Detector Template	Left	Thru		Left	Thru		Left	Thru		Left	Thru	Right
Leading Detector (m)	2.0	10.0		2.0	10.0		2.0	10.0		2.0	10.0	2.0
Trailing Detector (m)	0.0	0.0		0.0	0.0		0.0	0.0		0.0	0.0	0.0
Detector 1 Position(m)	0.0	0.0		0.0	0.0		0.0	0.0		0.0	0.0	0.0
Detector 1 Size(m)	2.0	0.6		2.0	0.6		2.0	0.6		2.0	0.6	2.0
Detector 1 Type	CI+Ex	CI+Ex		CI+Ex	CI+Ex		CI+Ex	CI+Ex		CI+Ex	CI+Ex	CI+Ex
Detector 1 Channel												
Detector 1 Extend (s)	0.0	0.0		0.0	0.0		0.0	0.0		0.0	0.0	0.0
Detector 1 Queue (s)	0.0	0.0		0.0	0.0		0.0	0.0		0.0	0.0	0.0
Detector 1 Delay (s)	0.0	0.0		0.0	0.0		0.0	0.0		0.0	0.0	0.0
Detector 2 Position(m)		9.4			9.4			9.4			9.4	
Detector 2 Size(m)		0.6			0.6			0.6			0.6	
Detector 2 Type		CI+Ex			CI+Ex			CI+Ex			CI+Ex	
Detector 2 Channel												
Detector 2 Extend (s)		0.0			0.0			0.0			0.0	
Turn Type	pm+pt	NA		Perm	NA		Perm	NA		Perm	NA	Perm
Protected Phases	5	2			6			8			4	
Permitted Phases	2			6			8			4		4
Detector Phase	5	2		6	6		8	8		4	4	4
Switch Phase												
Minimum Initial (s)	5.0	10.0		10.0	10.0		10.0	10.0		10.0	10.0	10.0

Lanes, Volumes, Timings
4: S Haven Pl/Ring Rd & Smyth Rd

12/15/2023



Lane Group	EBL	EBT	EBR	WBL	WBT	WBR	NBL	NBT	NBR	SBL	SBT	SBR
Minimum Split (s)	10.6	31.7		31.7	31.7		28.5	28.5		28.5	28.5	28.5
Total Split (s)	42.0	84.0		42.0	42.0		31.0	31.0		31.0	31.0	31.0
Total Split (%)	36.5%	73.0%		36.5%	36.5%		27.0%	27.0%		27.0%	27.0%	27.0%
Maximum Green (s)	36.4	78.3		36.3	36.3		25.5	25.5		25.5	25.5	25.5
Yellow Time (s)	3.3	3.3		3.3	3.3		3.3	3.3		3.3	3.3	3.3
All-Red Time (s)	2.3	2.4		2.4	2.4		2.2	2.2		2.2	2.2	2.2
Lost Time Adjust (s)		0.0			0.0			0.0			0.0	0.0
Total Lost Time (s)		5.7			5.7			5.5			5.5	5.5
Lead/Lag	Lead			Lag			Lag			Lag		
Lead-Lag Optimize?	Yes			Yes			Yes			Yes		
Vehicle Extension (s)	3.0	3.0		3.0	3.0		3.0	3.0		3.0	3.0	3.0
Recall Mode	None	C-Max		C-Max	C-Max		None	None		None	None	None
Walk Time (s)		7.0		7.0	7.0		7.0	7.0		7.0	7.0	7.0
Flash Dont Walk (s)		19.0		19.0	19.0		16.0	16.0		16.0	16.0	16.0
Pedestrian Calls (#/hr)		13		13	13		6	6		6	6	6
Act Effct Green (s)		91.2			91.2			12.6			12.6	12.6
Actuated g/C Ratio		0.79			0.79			0.11			0.11	0.11
v/c Ratio		0.71			0.28			0.04			0.20	0.47
Control Delay		11.5			2.3			42.8			47.9	13.5
Queue Delay		0.0			0.0			0.0			0.0	0.0
Total Delay		11.5			2.3			42.8			47.9	13.5
LOS		B			A			D			D	B
Approach Delay		11.5			2.3			42.8			20.0	
Approach LOS		B			A			D			B	

Intersection Summary

Area Type:	Other
Cycle Length:	115
Actuated Cycle Length:	115
Offset:	66 (57%), Referenced to phase 2:EBTL and 6:WBTL, Start of Green
Natural Cycle:	90
Control Type:	Actuated-Coordinated
Maximum v/c Ratio:	0.71
Intersection Signal Delay:	9.1
Intersection LOS:	A
Intersection Capacity Utilization	80.8%
ICU Level of Service	D
Analysis Period (min)	15

Splits and Phases: 4: S Haven Pl/Ring Rd & Smyth Rd

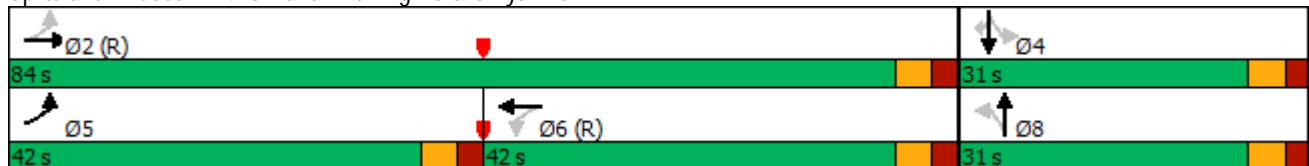

Queues

4: S Haven Pl/Ring Rd & Smyth Rd

12/15/2023



Lane Group	EBT	WBT	NBT	SBT	SBR
Lane Group Flow (vph)	1173	686	6	29	124
v/c Ratio	0.71	0.28	0.04	0.20	0.47
Control Delay	11.5	2.3	42.8	47.9	13.5
Queue Delay	0.0	0.0	0.0	0.0	0.0
Total Delay	11.5	2.3	42.8	47.9	13.5
Queue Length 50th (m)	52.3	8.1	1.3	6.5	0.0
Queue Length 95th (m)	62.5	15.3	5.1	14.4	16.0
Internal Link Dist (m)	437.7	370.3	50.8	26.7	
Turn Bay Length (m)					
Base Capacity (vph)	1648	2445	294	289	412
Starvation Cap Reductn	0	0	0	0	0
Spillback Cap Reductn	0	0	0	0	0
Storage Cap Reductn	0	0	0	0	0
Reduced v/c Ratio	0.71	0.28	0.02	0.10	0.30
Intersection Summary					

Lanes, Volumes, Timings
5: Smyth Rd & Hospital Main Access

12/15/2023

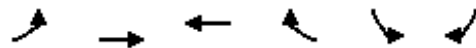

Lane Group	EBL	EBT	WBT	WBR	SBL	SBR
Lane Configurations	↖	↗↗	↗↗	↗	↖↖	↖
Traffic Volume (vph)	387	436	545	439	119	142
Future Volume (vph)	387	436	545	439	119	142
Ideal Flow (vphpl)	1800	1800	1800	1800	1800	1800
Storage Length (m)	60.0			178.0	0.0	0.0
Storage Lanes	1			1	2	1
Taper Length (m)	7.5				7.5	
Lane Util. Factor	1.00	0.95	0.95	1.00	0.97	1.00
Ped Bike Factor	1.00			0.97	0.88	0.97
Fr _t				0.850		0.850
Fl _t Protected	0.950				0.950	
Satd. Flow (prot)	1693	3353	3320	1515	3252	1515
Fl _t Permitted	0.383				0.950	
Satd. Flow (perm)	681	3353	3320	1471	2846	1468
Right Turn on Red				Yes		Yes
Satd. Flow (RTOR)				247		103
Link Speed (k/h)		50	50		50	
Link Distance (m)		394.3	413.0		60.1	
Travel Time (s)		28.4	29.7		4.3	
Confl. Peds. (#/hr)	3			3	50	13
Confl. Bikes (#/hr)				3		
Peak Hour Factor	1.00	1.00	1.00	1.00	1.00	1.00
Heavy Vehicles (%)	1%	2%	3%	1%	2%	1%
Adj. Flow (vph)	387	436	545	439	119	142
Shared Lane Traffic (%)						
Lane Group Flow (vph)	387	436	545	439	119	142
Enter Blocked Intersection	No	No	No	No	No	No
Lane Alignment	Left	Left	Left	Right	Left	Right
Median Width(m)		3.6	3.6		7.2	
Link Offset(m)		0.0	0.0		0.0	
Crosswalk Width(m)		4.8	4.8		4.8	
Two way Left Turn Lane						
Headway Factor	1.07	1.07	1.07	1.07	1.07	1.07
Turning Speed (k/h)	25			15	25	15
Number of Detectors	1	2	2	1	1	1
Detector Template	Left	Thru	Thru	Right	Left	Right
Leading Detector (m)	2.0	10.0	10.0	2.0	2.0	2.0
Trailing Detector (m)	0.0	0.0	0.0	0.0	0.0	0.0
Detector 1 Position(m)	0.0	0.0	0.0	0.0	0.0	0.0
Detector 1 Size(m)	2.0	0.6	0.6	2.0	2.0	2.0
Detector 1 Type	CI+Ex	CI+Ex	CI+Ex	CI+Ex	CI+Ex	CI+Ex
Detector 1 Channel						
Detector 1 Extend (s)	0.0	0.0	0.0	0.0	0.0	0.0
Detector 1 Queue (s)	0.0	0.0	0.0	0.0	0.0	0.0
Detector 1 Delay (s)	0.0	0.0	0.0	0.0	0.0	0.0
Detector 2 Position(m)		9.4	9.4			
Detector 2 Size(m)		0.6	0.6			
Detector 2 Type		CI+Ex	CI+Ex			
Detector 2 Channel						
Detector 2 Extend (s)		0.0	0.0			
Turn Type	pm+pt	NA	NA	pm+ov	Prot	pm+ov
Protected Phases	5	2	6	4	4	5
Permitted Phases	2			6		4

Lanes, Volumes, Timings

5: Smyth Rd & Hospital Main Access

12/15/2023

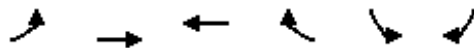

Lane Group	EBL	EBT	WBT	WBR	SBL	SBR
Detector Phase	5	2	6	4	4	5
Switch Phase						
Minimum Initial (s)	5.0	10.0	10.0	5.0	5.0	5.0
Minimum Split (s)	15.9	34.4	41.4	29.3	29.3	15.9
Total Split (s)	28.0	70.0	42.0	45.0	45.0	28.0
Total Split (%)	24.3%	60.9%	36.5%	39.1%	39.1%	24.3%
Maximum Green (s)	22.1	63.6	35.6	38.7	38.7	22.1
Yellow Time (s)	3.3	3.3	3.3	3.3	3.3	3.3
All-Red Time (s)	2.6	3.1	3.1	3.0	3.0	2.6
Lost Time Adjust (s)	0.0	0.0	0.0	0.0	0.0	0.0
Total Lost Time (s)	5.9	6.4	6.4	6.3	6.3	5.9
Lead/Lag	Lead		Lag			Lead
Lead-Lag Optimize?	Yes		Yes			Yes
Vehicle Extension (s)	3.0	3.0	3.0	3.0	3.0	3.0
Recall Mode	None	C-Max	C-Max	None	None	None
Walk Time (s)		7.0	7.0	7.0	7.0	
Flash Dont Walk (s)		21.0	28.0	16.0	16.0	
Pedestrian Calls (#/hr)		3	3	63	63	
Act Effct Green (s)	83.0	82.5	60.7	80.6	19.8	36.1
Actuated g/C Ratio	0.72	0.72	0.53	0.70	0.17	0.31
v/c Ratio	0.61	0.18	0.31	0.39	0.21	0.26
Control Delay	16.4	10.6	17.6	3.4	40.3	8.1
Queue Delay	0.0	0.0	0.0	0.0	0.0	0.0
Total Delay	16.4	10.6	17.6	3.4	40.3	8.1
LOS	B	B	B	A	D	A
Approach Delay		13.3	11.3		22.8	
Approach LOS		B	B		C	

Intersection Summary

Area Type:	Other
Cycle Length:	115
Actuated Cycle Length:	115
Offset:	43 (37%), Referenced to phase 2:EBTL and 6:WBT, Start of Green
Natural Cycle:	90
Control Type:	Actuated-Coordinated
Maximum v/c Ratio:	0.61
Intersection Signal Delay:	13.6
Intersection LOS:	B
Intersection Capacity Utilization	76.7%
ICU Level of Service	D
Analysis Period (min)	15

Splits and Phases: 5: Smyth Rd & Hospital Main Access

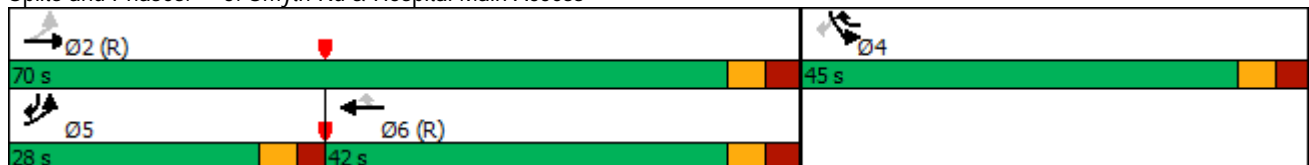

Queues

5: Smyth Rd & Hospital Main Access

12/15/2023

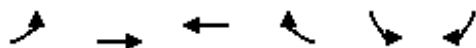

Lane Group	EBL	EBT	WBT	WBR	SBL	SBR
Lane Group Flow (vph)	387	436	545	439	119	142
v/c Ratio	0.61	0.18	0.31	0.39	0.21	0.26
Control Delay	16.4	10.6	17.6	3.4	40.3	8.1
Queue Delay	0.0	0.0	0.0	0.0	0.0	0.0
Total Delay	16.4	10.6	17.6	3.4	40.3	8.1
Queue Length 50th (m)	70.8	33.4	39.4	10.9	12.1	5.7
Queue Length 95th (m)	82.5	36.4	57.9	27.0	20.6	17.4
Internal Link Dist (m)		370.3	389.0		36.1	
Turn Bay Length (m)	60.0			178.0		
Base Capacity (vph)	686	2406	1752	1298	1094	614
Starvation Cap Reductn	0	0	0	0	0	0
Spillback Cap Reductn	0	0	0	0	0	0
Storage Cap Reductn	0	0	0	0	0	0
Reduced v/c Ratio	0.56	0.18	0.31	0.34	0.11	0.23
Intersection Summary						

Lanes, Volumes, Timings
6: Smyth Rd & Roger Guindon Ave

12/15/2023

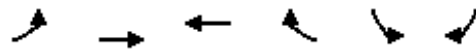

Lane Group	EBL	EBT	WBT	WBR	SBL	SBR	Ø3
Lane Configurations							
Traffic Volume (vph)	188	367	941	443	104	43	
Future Volume (vph)	188	367	941	443	104	43	
Ideal Flow (vphpl)	1800	1800	1800	1800	1800	1800	
Storage Length (m)	67.0			0.0	35.0	0.0	
Storage Lanes	1			0	1	1	
Taper Length (m)	7.5				7.5		
Lane Util. Factor	1.00	0.95	0.95	0.95	1.00	1.00	
Ped Bike Factor			0.99		0.99	0.99	
Frt			0.952			0.850	
Flt Protected	0.950				0.950		
Satd. Flow (prot)	1710	3288	3173	0	1644	1530	
Flt Permitted	0.100				0.950		
Satd. Flow (perm)	180	3288	3173	0	1629	1510	
Right Turn on Red				Yes		Yes	
Satd. Flow (RTOR)			97			43	
Link Speed (k/h)		50	50		50		
Link Distance (m)		413.0	277.5		141.9		
Travel Time (s)		29.7	20.0		10.2		
Confl. Peds. (#/hr)	9			9	7	1	
Confl. Bikes (#/hr)				2			
Peak Hour Factor	1.00	1.00	1.00	1.00	1.00	1.00	
Heavy Vehicles (%)	0%	4%	2%	0%	4%	0%	
Adj. Flow (vph)	188	367	941	443	104	43	
Shared Lane Traffic (%)							
Lane Group Flow (vph)	188	367	1384	0	104	43	
Enter Blocked Intersection	No	No	No	No	No	No	
Lane Alignment	Left	Left	Left	Right	Left	Right	
Median Width(m)		3.6	3.6		3.6		
Link Offset(m)		0.0	0.0		0.0		
Crosswalk Width(m)		4.8	4.8		4.8		
Two way Left Turn Lane							
Headway Factor	1.07	1.07	1.07	1.07	1.07	1.07	
Turning Speed (k/h)	25			15	25	15	
Number of Detectors	1	2	2		1	1	
Detector Template	Left	Thru	Thru		Left	Right	
Leading Detector (m)	2.0	10.0	10.0		2.0	2.0	
Trailing Detector (m)	0.0	0.0	0.0		0.0	0.0	
Detector 1 Position(m)	0.0	0.0	0.0		0.0	0.0	
Detector 1 Size(m)	2.0	0.6	0.6		2.0	2.0	
Detector 1 Type	CI+Ex	CI+Ex	CI+Ex		CI+Ex	CI+Ex	
Detector 1 Channel							
Detector 1 Extend (s)	0.0	0.0	0.0		0.0	0.0	
Detector 1 Queue (s)	0.0	0.0	0.0		0.0	0.0	
Detector 1 Delay (s)	0.0	0.0	0.0		0.0	0.0	
Detector 2 Position(m)		9.4	9.4				
Detector 2 Size(m)		0.6	0.6				
Detector 2 Type		CI+Ex	CI+Ex				
Detector 2 Channel							
Detector 2 Extend (s)		0.0	0.0				
Turn Type	pm+pt	NA	NA		Prot	Perm	
Protected Phases	5	2	6		4		3
Permitted Phases	2					4	

Lanes, Volumes, Timings
6: Smyth Rd & Roger Guindon Ave

12/15/2023

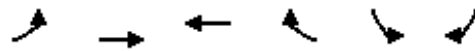

Lane Group	EBL	EBT	WBT	WBR	SBL	SBR	Ø3
Detector Phase	5	2	6		4	4	
Switch Phase							
Minimum Initial (s)	5.0	10.0	10.0		5.0	5.0	1.0
Minimum Split (s)	10.5	23.8	30.8		31.6	31.6	5.0
Total Split (s)	15.0	53.0	38.0		32.0	32.0	5.0
Total Split (%)	16.7%	58.9%	42.2%		35.6%	35.6%	6%
Maximum Green (s)	9.5	47.2	32.2		26.4	26.4	3.0
Yellow Time (s)	3.3	3.3	3.3		3.3	3.3	2.0
All-Red Time (s)	2.2	2.5	2.5		2.3	2.3	0.0
Lost Time Adjust (s)	0.0	0.0	0.0		0.0	0.0	
Total Lost Time (s)	5.5	5.8	5.8		5.6	5.6	
Lead/Lag	Lead		Lag		Lag	Lag	Lead
Lead-Lag Optimize?	Yes		Yes				
Vehicle Extension (s)	3.0	3.0	3.0		3.0	3.0	3.0
Recall Mode	None	C-Max	C-Max		None	None	None
Walk Time (s)			10.0		7.0	7.0	3.0
Flash Dont Walk (s)			15.0		14.0	14.0	0.0
Pedestrian Calls (#/hr)			9		8	8	8
Act Effct Green (s)	68.2	69.1	52.6		12.1	12.1	
Actuated g/C Ratio	0.76	0.77	0.58		0.13	0.13	
v/c Ratio	0.62	0.15	0.73		0.47	0.18	
Control Delay	19.9	4.7	19.4		41.4	11.3	
Queue Delay	0.0	0.0	0.0		0.0	0.0	
Total Delay	19.9	4.7	19.4		41.4	11.3	
LOS	B	A	B		D	B	
Approach Delay		9.8	19.4		32.6		
Approach LOS		A	B		C		

Intersection Summary

Area Type:	Other
Cycle Length:	90
Actuated Cycle Length:	90
Offset:	12 (13%), Referenced to phase 2:EBTL and 6:WBT, Start of Green
Natural Cycle:	90
Control Type:	Actuated-Coordinated
Maximum v/c Ratio:	0.73
Intersection Signal Delay:	17.8
Intersection LOS:	B
Intersection Capacity Utilization	74.3%
ICU Level of Service	D
Analysis Period (min)	15

Splits and Phases: 6: Smyth Rd & Roger Guindon Ave



Queues

6: Smyth Rd & Roger Guindon Ave

12/15/2023



Lane Group	EBL	EBT	WBT	SBL	SBR
Lane Group Flow (vph)	188	367	1384	104	43
v/c Ratio	0.62	0.15	0.73	0.47	0.18
Control Delay	19.9	4.7	19.4	41.4	11.3
Queue Delay	0.0	0.0	0.0	0.0	0.0
Total Delay	19.9	4.7	19.4	41.4	11.3
Queue Length 50th (m)	8.8	7.9	80.5	18.0	0.0
Queue Length 95th (m)	37.0	22.1	#195.6	29.9	8.3
Internal Link Dist (m)		389.0	253.5	117.9	
Turn Bay Length (m)	67.0			35.0	
Base Capacity (vph)	323	2523	1895	482	473
Starvation Cap Reductn	0	0	0	0	0
Spillback Cap Reductn	0	0	0	0	0
Storage Cap Reductn	0	0	0	0	0
Reduced v/c Ratio	0.58	0.15	0.73	0.22	0.09

Intersection Summary

95th percentile volume exceeds capacity, queue may be longer.
 Queue shown is maximum after two cycles.

HCM Unsignalized Intersection Capacity Analysis

7: Ring Rd & Hospital Link Rd

04-11-2024



Movement	EBT	EBR	WBL	WBT	NBL	NBR
Lane Configurations	→			←	↘	↙
Sign Control	Stop			Stop	Stop	
Traffic Volume (vph)	253	121	22	47	37	92
Future Volume (vph)	253	121	22	47	37	92
Peak Hour Factor	1.00	1.00	1.00	1.00	1.00	1.00
Hourly flow rate (vph)	253	121	22	47	37	92

Direction, Lane #	EB 1	WB 1	NB 1
Volume Total (vph)	374	69	129
Volume Left (vph)	0	22	37
Volume Right (vph)	121	0	92
Hadj (s)	-0.17	0.13	-0.27
Departure Headway (s)	4.1	4.7	4.6
Degree Utilization, x	0.43	0.09	0.16
Capacity (veh/h)	851	718	720
Control Delay (s)	10.2	8.2	8.5
Approach Delay (s)	10.2	8.2	8.5
Approach LOS	B	A	A

Intersection Summary			
Delay		9.6	
Level of Service		A	
Intersection Capacity Utilization	37.9%		ICU Level of Service A
Analysis Period (min)		15	

HCM Unsignalized Intersection Capacity Analysis

8: uOttawa-Rehab W Access & Hospital Link Rd

04-11-2024

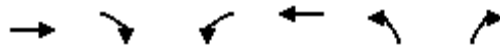

Movement	EBT	EBR	WBL	WBT	NBL	NBR
Lane Configurations						
Traffic Volume (veh/h)	188	157	98	68	1	6
Future Volume (Veh/h)	188	157	98	68	1	6
Sign Control	Free			Free	Stop	
Grade	0%			0%	0%	
Peak Hour Factor	1.00	1.00	1.00	1.00	1.00	1.00
Hourly flow rate (vph)	188	157	98	68	1	6
Pedestrians						1
Lane Width (m)						3.6
Walking Speed (m/s)						1.2
Percent Blockage						0
Right turn flare (veh)						
Median type	None			None		
Median storage veh)						
Upstream signal (m)						
pX, platoon unblocked						
vC, conflicting volume			346		532	268
vC1, stage 1 conf vol						
vC2, stage 2 conf vol						
vCu, unblocked vol			346		532	268
tC, single (s)			4.1		6.4	6.2
tC, 2 stage (s)						
tF (s)			2.2		3.5	3.3
p0 queue free %			92		100	99
cM capacity (veh/h)			1212		470	775
Direction, Lane #	EB 1	WB 1	NB 1			
Volume Total	345	166	7			
Volume Left	0	98	1			
Volume Right	157	0	6			
cSH	1700	1212	710			
Volume to Capacity	0.20	0.08	0.01			
Queue Length 95th (m)	0.0	2.1	0.2			
Control Delay (s)	0.0	5.1	10.1			
Lane LOS			A			B
Approach Delay (s)	0.0	5.1	10.1			
Approach LOS				B		
Intersection Summary						
Average Delay			1.8			
Intersection Capacity Utilization			43.5%	ICU Level of Service	A	
Analysis Period (min)			15			

HCM Unsignalized Intersection Capacity Analysis
 9: uOttawa-Rehab E Access & Hospital Link Rd

04-11-2024



Movement	EBT	EBR	WBL	WBT	NBL	NBR
Lane Configurations	↑			↑	↘	
Sign Control	Stop			Stop	Stop	
Traffic Volume (vph)	195	0	0	139	27	24
Future Volume (vph)	195	0	0	139	27	24
Peak Hour Factor	1.00	1.00	1.00	1.00	1.00	1.00
Hourly flow rate (vph)	195	0	0	139	27	24

Direction, Lane #	EB 1	WB 1	NB 1
Volume Total (vph)	195	139	51
Volume Left (vph)	0	0	27
Volume Right (vph)	0	0	24
Hadj (s)	0.05	0.09	0.03
Departure Headway (s)	4.2	4.3	4.7
Degree Utilization, x	0.23	0.17	0.07
Capacity (veh/h)	836	818	717
Control Delay (s)	8.5	8.2	8.0
Approach Delay (s)	8.5	8.2	8.0
Approach LOS	A	A	A

Intersection Summary		
Delay		8.3
Level of Service		A
Intersection Capacity Utilization	21.1%	ICU Level of Service
Analysis Period (min)		15

Lanes, Volumes, Timings
1: Alta Vista Dr & Hospital Link Rd

12/15/2023



Lane Group	EBL	EBT	EBR	WBL	WBT	WBR	NBL	NBT	NBR	SBL	SBT	SBR
Lane Configurations												
Traffic Volume (vph)	0	50	36	39	201	16	22	790	12	1	551	12
Future Volume (vph)	0	50	36	39	201	16	22	790	12	1	551	12
Ideal Flow (vphpl)	1900	1900	1900	1900	1900	1900	1900	1900	1900	1900	1900	1900
Storage Length (m)	0.0		0.0	25.0		40.0	30.0		0.0	25.0		0.0
Storage Lanes	1		0	1		1	1		0	1		0
Taper Length (m)	7.5			7.5			7.5			7.5		
Lane Util. Factor	1.00	1.00	1.00	1.00	1.00	1.00	1.00	1.00	1.00	1.00	1.00	1.00
Ped Bike Factor		0.98		0.98		0.95	0.99	1.00			1.00	
Frt		0.937				0.850		0.998			0.997	
Flt Protected				0.950			0.950			0.950		
Satd. Flow (prot)	1900	1700	0	1719	1845	1524	1805	1858	0	1805	1839	0
Flt Permitted				0.495			0.361			0.203		
Satd. Flow (perm)	1900	1700	0	881	1845	1450	682	1858	0	386	1839	0
Right Turn on Red			Yes			Yes			Yes			Yes
Satd. Flow (RTOR)		29				31		1			1	
Link Speed (k/h)		50			50			50			50	
Link Distance (m)		148.1			598.8			586.9			279.5	
Travel Time (s)		10.7			43.1			42.3			20.1	
Confl. Peds. (#/hr)	12		9	9		12	9		14	14		9
Peak Hour Factor	1.00	1.00	1.00	1.00	1.00	1.00	1.00	1.00	1.00	1.00	1.00	1.00
Heavy Vehicles (%)	0%	5%	0%	5%	3%	6%	0%	2%	0%	0%	3%	0%
Adj. Flow (vph)	0	50	36	39	201	16	22	790	12	1	551	12
Shared Lane Traffic (%)												
Lane Group Flow (vph)	0	86	0	39	201	16	22	802	0	1	563	0
Enter Blocked Intersection	No	No	No	No	No	No	No	No	No	No	No	No
Lane Alignment	Left	Left	Right	Left	Left	Right	Left	Left	Right	Left	Left	Right
Median Width(m)		3.6			3.6			3.6			3.6	
Link Offset(m)		0.0			0.0			0.0			0.0	
Crosswalk Width(m)		4.8			4.8			4.8			4.8	
Two way Left Turn Lane												
Headway Factor	1.00	1.00	1.00	1.00	1.00	1.00	1.00	1.00	1.00	1.00	1.00	1.00
Turning Speed (k/h)	25		15	25		15	25		15	25		15
Number of Detectors	1	2		1	2	1	1	2		1	2	
Detector Template	Left	Thru		Left	Thru	Right	Left	Thru		Left	Thru	
Leading Detector (m)	2.0	10.0		2.0	10.0	2.0	2.0	10.0		2.0	10.0	
Trailing Detector (m)	0.0	0.0		0.0	0.0	0.0	0.0	0.0		0.0	0.0	
Detector 1 Position(m)	0.0	0.0		0.0	0.0	0.0	0.0	0.0		0.0	0.0	
Detector 1 Size(m)	2.0	0.6		2.0	0.6	2.0	2.0	0.6		2.0	0.6	
Detector 1 Type	CI+Ex	CI+Ex		CI+Ex	CI+Ex	CI+Ex	CI+Ex	CI+Ex		CI+Ex	CI+Ex	
Detector 1 Channel												
Detector 1 Extend (s)	0.0	0.0		0.0	0.0	0.0	0.0	0.0		0.0	0.0	
Detector 1 Queue (s)	0.0	0.0		0.0	0.0	0.0	0.0	0.0		0.0	0.0	
Detector 1 Delay (s)	0.0	0.0		0.0	0.0	0.0	0.0	0.0		0.0	0.0	
Detector 2 Position(m)		9.4			9.4			9.4			9.4	
Detector 2 Size(m)		0.6			0.6			0.6			0.6	
Detector 2 Type		CI+Ex			CI+Ex			CI+Ex			CI+Ex	
Detector 2 Channel												
Detector 2 Extend (s)		0.0			0.0			0.0			0.0	
Turn Type	Perm	NA		pm+pt	NA	Perm	Perm	NA		Perm	NA	
Protected Phases		2		1	6			8			4	
Permitted Phases	2			6		6	8			4		
Detector Phase	2	2		1	6	6	8	8		4	4	

Lanes, Volumes, Timings
1: Alta Vista Dr & Hospital Link Rd

12/15/2023



Lane Group	EBL	EBT	EBR	WBL	WBT	WBR	NBL	NBT	NBR	SBL	SBT	SBR
Switch Phase												
Minimum Initial (s)	10.0	10.0		5.0	10.0	10.0	10.0	10.0		10.0	10.0	
Minimum Split (s)	30.5	30.5		11.5	30.5	30.5	27.3	27.3		27.3	27.3	
Total Split (s)	31.5	31.5		21.5	53.0	53.0	61.3	61.3		61.3	61.3	
Total Split (%)	27.6%	27.6%		18.8%	46.4%	46.4%	53.6%	53.6%		53.6%	53.6%	
Maximum Green (s)	25.0	25.0		15.0	46.5	46.5	55.0	55.0		55.0	55.0	
Yellow Time (s)	3.3	3.3		3.3	3.3	3.3	3.3	3.3		3.3	3.3	
All-Red Time (s)	3.2	3.2		3.2	3.2	3.2	3.0	3.0		3.0	3.0	
Lost Time Adjust (s)	0.0	0.0		0.0	0.0	0.0	0.0	0.0		0.0	0.0	
Total Lost Time (s)	6.5	6.5		6.5	6.5	6.5	6.3	6.3		6.3	6.3	
Lead/Lag	Lag	Lag		Lead								
Lead-Lag Optimize?	Yes	Yes		Yes								
Vehicle Extension (s)	3.0	3.0		3.0	3.0	3.0	3.0	3.0		3.0	3.0	
Recall Mode	None	None		None	None	None	Max	Max		Max	Max	
Walk Time (s)	7.0	7.0		7.0	7.0	7.0	7.0	7.0		7.0	7.0	
Flash Dont Walk (s)	17.0	17.0		17.0	17.0	14.0	14.0	14.0		14.0	14.0	
Pedestrian Calls (#/hr)	21	21		21	21	23	23	23		23	23	
Act Effct Green (s)		15.6		23.6	23.6	23.6	57.3	57.3		57.3	57.3	
Actuated g/C Ratio		0.17		0.25	0.25	0.25	0.61	0.61		0.61	0.61	
v/c Ratio		0.28		0.14	0.43	0.04	0.05	0.71		0.00	0.50	
Control Delay		26.5		24.7	30.6	3.8	12.2	20.4		12.0	15.0	
Queue Delay		0.0		0.0	0.0	0.0	0.0	0.0		0.0	0.0	
Total Delay		26.5		24.7	30.6	3.8	12.2	20.4		12.0	15.0	
LOS		C		C	C	A	B	C		B	B	
Approach Delay		26.5			28.0			20.2			15.0	
Approach LOS		C			C			C			B	

Intersection Summary

Area Type:	Other
Cycle Length:	114.3
Actuated Cycle Length:	93.8
Natural Cycle:	90
Control Type:	Semi Act-Uncoord
Maximum v/c Ratio:	0.71
Intersection Signal Delay:	20.0
Intersection LOS:	B
Intersection Capacity Utilization:	66.7%
ICU Level of Service:	C
Analysis Period (min):	15

Splits and Phases: 1: Alta Vista Dr & Hospital Link Rd

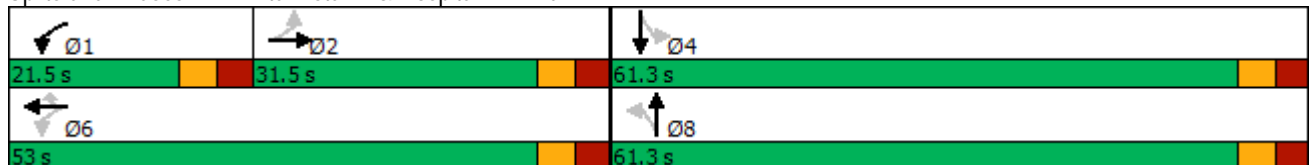

Queues

1: Alta Vista Dr & Hospital Link Rd

12/15/2023



Lane Group	EBT	WBL	WBT	WBR	NBL	NBT	SBL	SBT
Lane Group Flow (vph)	86	39	201	16	22	802	1	563
v/c Ratio	0.28	0.14	0.43	0.04	0.05	0.71	0.00	0.50
Control Delay	26.5	24.7	30.6	3.8	12.2	20.4	12.0	15.0
Queue Delay	0.0	0.0	0.0	0.0	0.0	0.0	0.0	0.0
Total Delay	26.5	24.7	30.6	3.8	12.2	20.4	12.0	15.0
Queue Length 50th (m)	9.9	5.5	31.0	0.0	1.5	95.0	0.1	54.5
Queue Length 95th (m)	23.8	12.9	49.6	2.5	6.8	#211.6	1.1	118.6
Internal Link Dist (m)	124.1		574.8			562.9		255.5
Turn Bay Length (m)		25.0		40.0	30.0		25.0	
Base Capacity (vph)	480	373	927	743	416	1134	235	1123
Starvation Cap Reductn	0	0	0	0	0	0	0	0
Spillback Cap Reductn	0	0	0	0	0	0	0	0
Storage Cap Reductn	0	0	0	0	0	0	0	0
Reduced v/c Ratio	0.18	0.10	0.22	0.02	0.05	0.71	0.00	0.50

Intersection Summary

95th percentile volume exceeds capacity, queue may be longer.
 Queue shown is maximum after two cycles.

Lanes, Volumes, Timings
2: Alta Vista Dr & Smyth Rd

12/15/2023



Lane Group	EBL	EBT	EBR	WBL	WBT	WBR	NBL	NBT	NBR	SBL	SBT	SBR
Lane Configurations												
Traffic Volume (vph)	178	467	210	225	820	251	104	291	70	121	416	210
Future Volume (vph)	178	467	210	225	820	251	104	291	70	121	416	210
Ideal Flow (vphpl)	1900	1900	1900	1900	1900	1900	1900	1900	1900	1900	1900	1900
Storage Length (m)	30.0		25.0	61.0		10.0	87.0		30.0	44.0		25.0
Storage Lanes	1		1	1		1	1		1	1		1
Taper Length (m)	7.5			7.5			7.5			7.5		
Lane Util. Factor	1.00	0.95	1.00	1.00	0.95	1.00	1.00	1.00	1.00	1.00	1.00	1.00
Ped Bike Factor	0.97		0.95	0.99		0.81	1.00		0.98	0.99		0.97
Frt			0.850			0.850			0.850			0.850
Flt Protected	0.950			0.950			0.950			0.950		
Satd. Flow (prot)	1787	3438	1615	1805	3539	1583	1770	1845	1568	1752	1845	1599
Flt Permitted	0.215			0.403			0.150			0.336		
Satd. Flow (perm)	393	3438	1538	757	3539	1283	278	1845	1529	616	1845	1553
Right Turn on Red			Yes			Yes			Yes			Yes
Satd. Flow (RTOR)			165			139			137			137
Link Speed (k/h)		50			50			50			50	
Link Distance (m)		339.0			234.1			204.1			586.9	
Travel Time (s)		24.4			16.9			14.7			42.3	
Confl. Peds. (#/hr)	56		9	9		56	10		8	8		10
Confl. Bikes (#/hr)			1			4			1			2
Peak Hour Factor	1.00	1.00	1.00	1.00	1.00	1.00	1.00	1.00	1.00	1.00	1.00	1.00
Heavy Vehicles (%)	1%	5%	0%	0%	2%	2%	2%	3%	3%	3%	3%	1%
Adj. Flow (vph)	178	467	210	225	820	251	104	291	70	121	416	210
Shared Lane Traffic (%)												
Lane Group Flow (vph)	178	467	210	225	820	251	104	291	70	121	416	210
Enter Blocked Intersection	No	No	No	No	No	No	No	No	No	No	No	No
Lane Alignment	Left	Left	Right	Left	Left	Right	Left	Left	Right	Left	Left	Right
Median Width(m)		3.6			3.6			3.6			3.6	
Link Offset(m)		0.0			0.0			0.0			0.0	
Crosswalk Width(m)		4.8			4.8			4.8			4.8	
Two way Left Turn Lane												
Headway Factor	1.00	1.00	1.00	1.00	1.00	1.00	1.00	1.00	1.00	1.00	1.00	1.00
Turning Speed (k/h)	25		15	25		15	25		15	25		15
Number of Detectors	1	2	1	1	2	1	1	2	1	1	2	1
Detector Template	Left	Thru	Right	Left	Thru	Right	Left	Thru	Right	Left	Thru	Right
Leading Detector (m)	2.0	10.0	2.0	2.0	10.0	2.0	2.0	10.0	2.0	2.0	10.0	2.0
Trailing Detector (m)	0.0	0.0	0.0	0.0	0.0	0.0	0.0	0.0	0.0	0.0	0.0	0.0
Detector 1 Position(m)	0.0	0.0	0.0	0.0	0.0	0.0	0.0	0.0	0.0	0.0	0.0	0.0
Detector 1 Size(m)	2.0	0.6	2.0	2.0	0.6	2.0	2.0	0.6	2.0	2.0	0.6	2.0
Detector 1 Type	CI+Ex	CI+Ex	CI+Ex	CI+Ex	CI+Ex	CI+Ex	CI+Ex	CI+Ex	CI+Ex	CI+Ex	CI+Ex	CI+Ex
Detector 1 Channel												
Detector 1 Extend (s)	0.0	0.0	0.0	0.0	0.0	0.0	0.0	0.0	0.0	0.0	0.0	0.0
Detector 1 Queue (s)	0.0	0.0	0.0	0.0	0.0	0.0	0.0	0.0	0.0	0.0	0.0	0.0
Detector 1 Delay (s)	0.0	0.0	0.0	0.0	0.0	0.0	0.0	0.0	0.0	0.0	0.0	0.0
Detector 2 Position(m)		9.4			9.4			9.4			9.4	
Detector 2 Size(m)		0.6			0.6			0.6			0.6	
Detector 2 Type		CI+Ex			CI+Ex			CI+Ex			CI+Ex	
Detector 2 Channel												
Detector 2 Extend (s)		0.0			0.0			0.0			0.0	
Turn Type	pm+pt	NA	Perm	pm+pt	NA	Perm	pm+pt	NA	Perm	pm+pt	NA	Perm
Protected Phases	5	2		1	6		3	8		7	4	
Permitted Phases	2		2	6		6	8		8	4		4

Lanes, Volumes, Timings
2: Alta Vista Dr & Smyth Rd

12/15/2023



Lane Group	EBL	EBT	EBR	WBL	WBT	WBR	NBL	NBT	NBR	SBL	SBT	SBR
Detector Phase	5	2	2	1	6	6	3	8	8	7	4	4
Switch Phase												
Minimum Initial (s)	5.0	10.0	10.0	5.0	10.0	10.0	5.0	10.0	10.0	5.0	10.0	10.0
Minimum Split (s)	10.5	24.8	24.8	10.5	24.8	24.8	11.1	29.1	29.1	11.1	29.1	29.1
Total Split (s)	22.0	44.0	44.0	22.0	44.0	44.0	18.0	31.0	31.0	18.0	31.0	31.0
Total Split (%)	19.1%	38.3%	38.3%	19.1%	38.3%	38.3%	15.7%	27.0%	27.0%	15.7%	27.0%	27.0%
Maximum Green (s)	16.5	38.2	38.2	16.5	38.2	38.2	11.9	24.9	24.9	11.9	24.9	24.9
Yellow Time (s)	3.3	3.3	3.3	3.3	3.3	3.3	3.3	3.3	3.3	3.3	3.3	3.3
All-Red Time (s)	2.2	2.5	2.5	2.2	2.5	2.5	2.8	2.8	2.8	2.8	2.8	2.8
Lost Time Adjust (s)	0.0	0.0	0.0	0.0	0.0	0.0	0.0	0.0	0.0	0.0	0.0	0.0
Total Lost Time (s)	5.5	5.8	5.8	5.5	5.8	5.8	6.1	6.1	6.1	6.1	6.1	6.1
Lead/Lag	Lead	Lag	Lag	Lead	Lag	Lag	Lead	Lag	Lag	Lead	Lag	Lag
Lead-Lag Optimize?	Yes	Yes	Yes	Yes	Yes	Yes	Yes	Yes	Yes	Yes	Yes	Yes
Vehicle Extension (s)	3.0	3.0	3.0	3.0	3.0	3.0	3.0	3.0	3.0	3.0	3.0	3.0
Recall Mode	None	C-Max	C-Max	None	C-Max	C-Max	None	Max	Max	None	Max	Max
Walk Time (s)		7.0	7.0		7.0	7.0		7.0	7.0		7.0	7.0
Flash Dont Walk (s)		12.0	12.0		12.0	12.0		16.0	16.0		16.0	16.0
Pedestrian Calls (#/hr)		65	65		65	65		18	18		18	18
Act Effct Green (s)	53.6	41.6	41.6	56.4	43.0	43.0	36.3	26.6	26.6	37.3	27.1	27.1
Actuated g/C Ratio	0.47	0.36	0.36	0.49	0.37	0.37	0.32	0.23	0.23	0.32	0.24	0.24
v/c Ratio	0.55	0.38	0.32	0.46	0.62	0.44	0.49	0.68	0.15	0.40	0.96	0.45
Control Delay	21.6	28.7	8.6	18.8	28.8	14.8	32.5	50.2	0.7	28.8	78.6	17.5
Queue Delay	0.0	0.0	0.0	0.0	0.0	0.0	0.0	0.0	0.0	0.0	0.0	0.0
Total Delay	21.6	28.7	8.6	18.8	28.8	14.8	32.5	50.2	0.7	28.8	78.6	17.5
LOS	C	C	A	B	C	B	C	D	A	C	E	B
Approach Delay		22.3			24.4			38.8			53.4	
Approach LOS		C			C			D			D	

Intersection Summary

Area Type:	Other
Cycle Length:	115
Actuated Cycle Length:	115
Offset:	0 (0%), Referenced to phase 2:EBTL and 6:WBTL, Start of Green
Natural Cycle:	80
Control Type:	Actuated-Coordinated
Maximum v/c Ratio:	0.96
Intersection Signal Delay:	32.3
Intersection LOS:	C
Intersection Capacity Utilization	79.8%
ICU Level of Service	D
Analysis Period (min)	15

Splits and Phases: 2: Alta Vista Dr & Smyth Rd

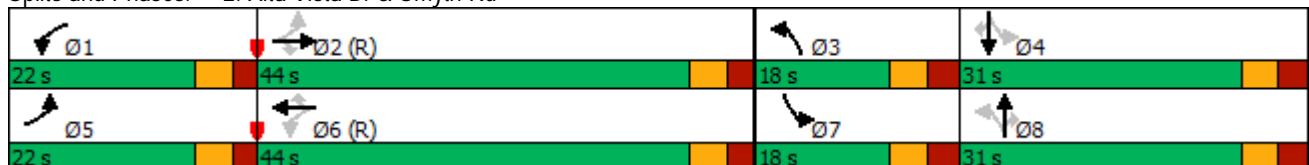

Queues

2: Alta Vista Dr & Smyth Rd

12/15/2023



Lane Group	EBL	EBT	EBR	WBL	WBT	WBR	NBL	NBT	NBR	SBL	SBT	SBR
Lane Group Flow (vph)	178	467	210	225	820	251	104	291	70	121	416	210
v/c Ratio	0.55	0.38	0.32	0.46	0.62	0.44	0.49	0.68	0.15	0.40	0.96	0.45
Control Delay	21.6	28.7	8.6	18.8	28.8	14.8	32.5	50.2	0.7	28.8	78.6	17.5
Queue Delay	0.0	0.0	0.0	0.0	0.0	0.0	0.0	0.0	0.0	0.0	0.0	0.0
Total Delay	21.6	28.7	8.6	18.8	28.8	14.8	32.5	50.2	0.7	28.8	78.6	17.5
Queue Length 50th (m)	21.3	42.6	7.0	24.0	47.2	5.5	16.2	63.7	0.0	19.1	98.1	14.0
Queue Length 95th (m)	34.4	60.0	25.6	55.7	89.3	47.0	29.1	#97.5	0.0	33.1	#169.9	37.8
Internal Link Dist (m)		315.0			210.1			180.1			562.9	
Turn Bay Length (m)	30.0		25.0	61.0		10.0	87.0		30.0	44.0		25.0
Base Capacity (vph)	398	1244	661	539	1324	566	247	426	458	326	434	470
Starvation Cap Reductn	0	0	0	0	0	0	0	0	0	0	0	0
Spillback Cap Reductn	0	0	0	0	0	0	0	0	0	0	0	0
Storage Cap Reductn	0	0	0	0	0	0	0	0	0	0	0	0
Reduced v/c Ratio	0.45	0.38	0.32	0.42	0.62	0.44	0.42	0.68	0.15	0.37	0.96	0.45

Intersection Summary

95th percentile volume exceeds capacity, queue may be longer.
 Queue shown is maximum after two cycles.

Lanes, Volumes, Timings 3: Smyth Rd & Valour Dr

12/15/2023

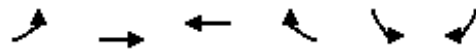

Lane Group	EBL	EBT	WBT	WBR	SBL	SBR
Lane Configurations						
Traffic Volume (vph)	31	627	1243	12	14	52
Future Volume (vph)	31	627	1243	12	14	52
Ideal Flow (vphpl)	1900	1900	1900	1900	1900	1900
Storage Length (m)	55.0			0.0	32.0	0.0
Storage Lanes	1			0	1	1
Taper Length (m)	7.5				7.5	
Lane Util. Factor	1.00	0.95	0.95	0.95	1.00	1.00
Ped Bike Factor			1.00		1.00	0.99
Frt			0.999			0.850
Flt Protected	0.950				0.950	
Satd. Flow (prot)	1752	3471	3527	0	1703	1583
Flt Permitted	0.180				0.950	
Satd. Flow (perm)	332	3471	3527	0	1695	1562
Right Turn on Red				Yes		Yes
Satd. Flow (RTOR)			1			52
Link Speed (k/h)		50	50		50	
Link Distance (m)		234.1	461.7		195.1	
Travel Time (s)		16.9	33.2		14.0	
Confl. Peds. (#/hr)	15			15	3	1
Peak Hour Factor	1.00	1.00	1.00	1.00	1.00	1.00
Heavy Vehicles (%)	3%	4%	2%	23%	6%	2%
Adj. Flow (vph)	31	627	1243	12	14	52
Shared Lane Traffic (%)						
Lane Group Flow (vph)	31	627	1255	0	14	52
Enter Blocked Intersection	No	No	No	No	No	No
Lane Alignment	Left	Left	Left	Right	Left	Right
Median Width(m)		3.6	3.6		3.6	
Link Offset(m)		0.0	0.0		0.0	
Crosswalk Width(m)		4.8	4.8		4.8	
Two way Left Turn Lane						
Headway Factor	1.00	1.00	1.00	1.00	1.00	1.00
Turning Speed (k/h)	25			15	25	15
Number of Detectors	1	2	2		1	1
Detector Template	Left	Thru	Thru		Left	Right
Leading Detector (m)	2.0	10.0	10.0		2.0	2.0
Trailing Detector (m)	0.0	0.0	0.0		0.0	0.0
Detector 1 Position(m)	0.0	0.0	0.0		0.0	0.0
Detector 1 Size(m)	2.0	0.6	0.6		2.0	2.0
Detector 1 Type	CI+Ex	CI+Ex	CI+Ex		CI+Ex	CI+Ex
Detector 1 Channel						
Detector 1 Extend (s)	0.0	0.0	0.0		0.0	0.0
Detector 1 Queue (s)	0.0	0.0	0.0		0.0	0.0
Detector 1 Delay (s)	0.0	0.0	0.0		0.0	0.0
Detector 2 Position(m)		9.4	9.4			
Detector 2 Size(m)		0.6	0.6			
Detector 2 Type		CI+Ex	CI+Ex			
Detector 2 Channel						
Detector 2 Extend (s)		0.0	0.0			
Turn Type	pm+pt	NA	NA		Prot	Perm
Protected Phases	5	2	6		4	
Permitted Phases	2					4
Detector Phase	5	2	6		4	4

Lanes, Volumes, Timings

3: Smyth Rd & Valour Dr

12/15/2023

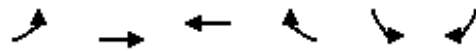

Lane Group	EBL	EBT	WBT	WBR	SBL	SBR
Switch Phase						
Minimum Initial (s)	5.0	10.0	10.0		5.0	5.0
Minimum Split (s)	10.7	29.5	29.5		28.5	28.5
Total Split (s)	18.0	85.0	67.0		30.0	30.0
Total Split (%)	15.7%	73.9%	58.3%		26.1%	26.1%
Maximum Green (s)	12.3	78.5	60.5		23.5	23.5
Yellow Time (s)	3.3	3.3	3.3		3.3	3.3
All-Red Time (s)	2.4	3.2	3.2		3.2	3.2
Lost Time Adjust (s)	0.0	0.0	0.0		0.0	0.0
Total Lost Time (s)	5.7	6.5	6.5		6.5	6.5
Lead/Lag	Lead		Lag			
Lead-Lag Optimize?	Yes		Yes			
Vehicle Extension (s)	3.0	3.0	3.0		3.0	3.0
Recall Mode	None	C-Max	C-Max		None	None
Walk Time (s)		7.0	7.0		7.0	7.0
Flash Dont Walk (s)		16.0	16.0		15.0	15.0
Pedestrian Calls (#/hr)		15	15		4	4
Act Effct Green (s)	95.9	96.4	89.2		9.3	9.3
Actuated g/C Ratio	0.83	0.84	0.78		0.08	0.08
v/c Ratio	0.09	0.22	0.46		0.10	0.30
Control Delay	1.4	0.9	13.3		46.6	16.3
Queue Delay	0.0	0.0	0.0		0.0	0.0
Total Delay	1.4	0.9	13.3		46.6	16.3
LOS	A	A	B		D	B
Approach Delay		0.9	13.3		22.7	
Approach LOS		A	B		C	

Intersection Summary

Area Type:	Other
Cycle Length:	115
Actuated Cycle Length:	115
Offset:	12 (10%), Referenced to phase 2:EBTL and 6:WBT, Start of Green
Natural Cycle:	75
Control Type:	Actuated-Coordinated
Maximum v/c Ratio:	0.46
Intersection Signal Delay:	9.5
Intersection LOS:	A
Intersection Capacity Utilization	50.2%
ICU Level of Service	A
Analysis Period (min)	15

Splits and Phases: 3: Smyth Rd & Valour Dr



Queues

3: Smyth Rd & Valour Dr

12/15/2023

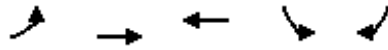

Lane Group	EBL	EBT	WBT	SBL	SBR
Lane Group Flow (vph)	31	627	1255	14	52
v/c Ratio	0.09	0.22	0.46	0.10	0.30
Control Delay	1.4	0.9	13.3	46.6	16.3
Queue Delay	0.0	0.0	0.0	0.0	0.0
Total Delay	1.4	0.9	13.3	46.6	16.3
Queue Length 50th (m)	0.4	3.1	77.2	3.2	0.0
Queue Length 95th (m)	1.4	8.1	158.3	8.5	10.8
Internal Link Dist (m)		210.1	437.7	171.1	
Turn Bay Length (m)	55.0			32.0	
Base Capacity (vph)	428	2909	2736	348	360
Starvation Cap Reductn	0	0	0	0	0
Spillback Cap Reductn	0	0	0	0	0
Storage Cap Reductn	0	0	0	0	0
Reduced v/c Ratio	0.07	0.22	0.46	0.04	0.14
Intersection Summary					

Lanes, Volumes, Timings
4: S Haven Pl/Ring Rd & Smyth Rd

12/15/2023



Lane Group	EBL	EBT	EBR	WBL	WBT	WBR	NBL	NBT	NBR	SBL	SBT	SBR
Lane Configurations		↕↕			↕↕			↕↕			↕	↕
Traffic Volume (vph)	95	542	4	4	913	11	5	0	4	132	1	337
Future Volume (vph)	95	542	4	4	913	11	5	0	4	132	1	337
Ideal Flow (vphpl)	1900	1900	1900	1900	1900	1900	1900	1900	1900	1900	1900	1900
Lane Util. Factor	0.95	0.95	0.95	0.95	0.95	0.95	1.00	1.00	1.00	1.00	1.00	1.00
Ped Bike Factor		1.00			1.00			0.99			0.99	0.97
Frt		0.999			0.998			0.940				0.850
Flt Protected		0.993						0.973			0.953	
Satd. Flow (prot)	0	3472	0	0	3531	0	0	1722	0	0	1793	1599
Flt Permitted		0.683			0.953			0.863			0.722	
Satd. Flow (perm)	0	2386	0	0	3365	0	0	1524	0	0	1346	1555
Right Turn on Red			Yes			Yes			Yes			Yes
Satd. Flow (RTOR)		1			1			79				242
Link Speed (k/h)		50			50			50			50	
Link Distance (m)		461.7			394.3			74.8			50.7	
Travel Time (s)		33.2			28.4			5.4			3.7	
Confl. Peds. (#/hr)	14		6	6		14	3		6	6		3
Confl. Bikes (#/hr)			2			4						14
Peak Hour Factor	1.00	1.00	1.00	1.00	1.00	1.00	1.00	1.00	1.00	1.00	1.00	1.00
Heavy Vehicles (%)	4%	3%	0%	0%	2%	0%	0%	0%	0%	1%	0%	1%
Adj. Flow (vph)	95	542	4	4	913	11	5	0	4	132	1	337
Shared Lane Traffic (%)												
Lane Group Flow (vph)	0	641	0	0	928	0	0	9	0	0	133	337
Enter Blocked Intersection	No	No	No	No	No	No	No	No	No	No	No	No
Lane Alignment	Left	Left	Right	Left	Left	Right	Left	Left	Right	Left	Left	Right
Median Width(m)		3.6			3.6			0.0			0.0	
Link Offset(m)		0.0			0.0			0.0			0.0	
Crosswalk Width(m)		4.8			4.8			4.8			4.8	
Two way Left Turn Lane												
Headway Factor	1.00	1.00	1.00	1.00	1.00	1.00	1.00	1.00	1.00	1.00	1.00	1.00
Turning Speed (k/h)	25		15	25		15	25		15	25		15
Number of Detectors	1	2		1	2		1	2		1	2	1
Detector Template	Left	Thru		Left	Thru		Left	Thru		Left	Thru	Right
Leading Detector (m)	2.0	10.0		2.0	10.0		2.0	10.0		2.0	10.0	2.0
Trailing Detector (m)	0.0	0.0		0.0	0.0		0.0	0.0		0.0	0.0	0.0
Detector 1 Position(m)	0.0	0.0		0.0	0.0		0.0	0.0		0.0	0.0	0.0
Detector 1 Size(m)	2.0	0.6		2.0	0.6		2.0	0.6		2.0	0.6	2.0
Detector 1 Type	CI+Ex	CI+Ex		CI+Ex	CI+Ex		CI+Ex	CI+Ex		CI+Ex	CI+Ex	CI+Ex
Detector 1 Channel												
Detector 1 Extend (s)	0.0	0.0		0.0	0.0		0.0	0.0		0.0	0.0	0.0
Detector 1 Queue (s)	0.0	0.0		0.0	0.0		0.0	0.0		0.0	0.0	0.0
Detector 1 Delay (s)	0.0	0.0		0.0	0.0		0.0	0.0		0.0	0.0	0.0
Detector 2 Position(m)		9.4			9.4			9.4			9.4	
Detector 2 Size(m)		0.6			0.6			0.6			0.6	
Detector 2 Type		CI+Ex			CI+Ex			CI+Ex			CI+Ex	
Detector 2 Channel												
Detector 2 Extend (s)		0.0			0.0			0.0			0.0	
Turn Type	pm+pt	NA		Perm	NA		Perm	NA		Perm	NA	Perm
Protected Phases	5	2			6			8			4	
Permitted Phases	2			6			8		4			4
Detector Phase	5	2		6	6		8	8	4	4		4
Switch Phase												
Minimum Initial (s)	5.0	10.0		10.0	10.0		10.0	10.0		10.0	10.0	10.0

Lanes, Volumes, Timings
4: S Haven Pl/Ring Rd & Smyth Rd

12/15/2023



Lane Group	EBL	EBT	EBR	WBL	WBT	WBR	NBL	NBT	NBR	SBL	SBT	SBR
Minimum Split (s)	10.6	31.7		31.7	31.7		28.5	28.5		28.5	28.5	28.5
Total Split (s)	16.0	78.0		62.0	62.0		37.0	37.0		37.0	37.0	37.0
Total Split (%)	13.9%	67.8%		53.9%	53.9%		32.2%	32.2%		32.2%	32.2%	32.2%
Maximum Green (s)	10.4	72.3		56.3	56.3		31.5	31.5		31.5	31.5	31.5
Yellow Time (s)	3.3	3.3		3.3	3.3		3.3	3.3		3.3	3.3	3.3
All-Red Time (s)	2.3	2.4		2.4	2.4		2.2	2.2		2.2	2.2	2.2
Lost Time Adjust (s)		0.0			0.0			0.0			0.0	0.0
Total Lost Time (s)		5.7			5.7			5.5			5.5	5.5
Lead/Lag	Lead			Lag			Lag					
Lead-Lag Optimize?	Yes			Yes			Yes					
Vehicle Extension (s)	3.0	3.0		3.0	3.0		3.0	3.0		3.0	3.0	3.0
Recall Mode	None	C-Max		C-Max	C-Max		None	None		None	None	None
Walk Time (s)		7.0		7.0	7.0		7.0	7.0		7.0	7.0	7.0
Flash Dont Walk (s)		19.0		19.0	19.0		16.0	16.0		16.0	16.0	16.0
Pedestrian Calls (#/hr)		20		20	20		9	9		9	9	9
Act Effct Green (s)		86.6			86.6			17.2			17.2	17.2
Actuated g/C Ratio		0.75			0.75			0.15			0.15	0.15
v/c Ratio		0.36			0.37			0.03			0.66	0.77
Control Delay		3.4			5.5			0.2			60.6	25.4
Queue Delay		0.0			0.0			0.0			0.0	0.0
Total Delay		3.4			5.5			0.2			60.6	25.4
LOS		A			A			A			E	C
Approach Delay		3.4			5.5			0.2			35.4	
Approach LOS		A			A			A			D	

Intersection Summary

Area Type:	Other
Cycle Length:	115
Actuated Cycle Length:	115
Offset:	62 (54%), Referenced to phase 2:EBTL and 6:WBTL, Start of Green
Natural Cycle:	75
Control Type:	Actuated-Coordinated
Maximum v/c Ratio:	0.77
Intersection Signal Delay:	11.7
Intersection LOS:	B
Intersection Capacity Utilization	74.0%
ICU Level of Service	D
Analysis Period (min)	15

Splits and Phases: 4: S Haven Pl/Ring Rd & Smyth Rd

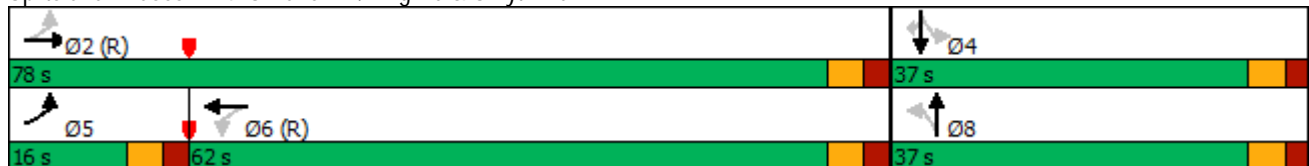

Queues

4: S Haven Pl/Ring Rd & Smyth Rd

12/15/2023



Lane Group	EBT	WBT	NBT	SBT	SBR
Lane Group Flow (vph)	641	928	9	133	337
v/c Ratio	0.36	0.37	0.03	0.66	0.77
Control Delay	3.4	5.5	0.2	60.6	25.4
Queue Delay	0.0	0.0	0.0	0.0	0.0
Total Delay	3.4	5.5	0.2	60.6	25.4
Queue Length 50th (m)	10.5	39.7	0.0	30.3	20.8
Queue Length 95th (m)	13.5	50.4	0.0	47.1	51.0
Internal Link Dist (m)	437.7	370.3	50.8	26.7	
Turn Bay Length (m)					
Base Capacity (vph)	1796	2532	474	368	601
Starvation Cap Reductn	0	0	0	0	0
Spillback Cap Reductn	0	0	0	0	0
Storage Cap Reductn	0	0	0	0	0
Reduced v/c Ratio	0.36	0.37	0.02	0.36	0.56
Intersection Summary					

Lanes, Volumes, Timings
5: Smyth Rd & Hospital Main Access

12/15/2023

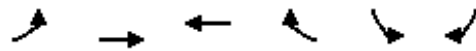

Lane Group	EBL	EBT	WBT	WBR	SBL	SBR
Lane Configurations	↖	↗↗	↗↗	↗	↖↖	↖
Traffic Volume (vph)	97	581	549	148	347	380
Future Volume (vph)	97	581	549	148	347	380
Ideal Flow (vphpl)	1900	1900	1900	1900	1900	1900
Storage Length (m)	60.0			178.0	0.0	0.0
Storage Lanes	1			1	2	1
Taper Length (m)	7.5				7.5	
Lane Util. Factor	1.00	0.95	0.95	1.00	0.97	1.00
Ped Bike Factor	0.99			0.95	0.82	0.97
Fr _t				0.850		0.850
Fl _t Protected	0.950				0.950	
Satd. Flow (prot)	1719	3505	3539	1568	3502	1583
Fl _t Permitted	0.395				0.950	
Satd. Flow (perm)	710	3505	3539	1493	2889	1531
Right Turn on Red				Yes		Yes
Satd. Flow (RTOR)				148		115
Link Speed (k/h)		50	50		50	
Link Distance (m)		394.3	413.0		60.1	
Travel Time (s)		28.4	29.7		4.3	
Confl. Peds. (#/hr)	11			11	70	14
Confl. Bikes (#/hr)				2		1
Peak Hour Factor	1.00	1.00	1.00	1.00	1.00	1.00
Heavy Vehicles (%)	5%	3%	2%	3%	0%	2%
Adj. Flow (vph)	97	581	549	148	347	380
Shared Lane Traffic (%)						
Lane Group Flow (vph)	97	581	549	148	347	380
Enter Blocked Intersection	No	No	No	No	No	No
Lane Alignment	Left	Left	Left	Right	Left	Right
Median Width(m)		3.6	3.6		7.2	
Link Offset(m)		0.0	0.0		0.0	
Crosswalk Width(m)		4.8	4.8		4.8	
Two way Left Turn Lane						
Headway Factor	1.00	1.00	1.00	1.00	1.00	1.00
Turning Speed (k/h)	25			15	25	15
Number of Detectors	1	2	2	1	1	1
Detector Template	Left	Thru	Thru	Right	Left	Right
Leading Detector (m)	2.0	10.0	10.0	2.0	2.0	2.0
Trailing Detector (m)	0.0	0.0	0.0	0.0	0.0	0.0
Detector 1 Position(m)	0.0	0.0	0.0	0.0	0.0	0.0
Detector 1 Size(m)	2.0	0.6	0.6	2.0	2.0	2.0
Detector 1 Type	CI+Ex	CI+Ex	CI+Ex	CI+Ex	CI+Ex	CI+Ex
Detector 1 Channel						
Detector 1 Extend (s)	0.0	0.0	0.0	0.0	0.0	0.0
Detector 1 Queue (s)	0.0	0.0	0.0	0.0	0.0	0.0
Detector 1 Delay (s)	0.0	0.0	0.0	0.0	0.0	0.0
Detector 2 Position(m)		9.4	9.4			
Detector 2 Size(m)		0.6	0.6			
Detector 2 Type		CI+Ex	CI+Ex			
Detector 2 Channel						
Detector 2 Extend (s)		0.0	0.0			
Turn Type	pm+pt	NA	NA	pm+ov	Prot	pm+ov
Protected Phases	5	2	6	4	4	5
Permitted Phases	2			6		4

Lanes, Volumes, Timings

5: Smyth Rd & Hospital Main Access

12/15/2023

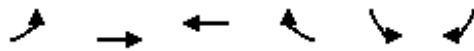

Lane Group	EBL	EBT	WBT	WBR	SBL	SBR
Detector Phase	5	2	6	4	4	5
Switch Phase						
Minimum Initial (s)	5.0	10.0	10.0	5.0	5.0	5.0
Minimum Split (s)	9.5	34.4	39.5	29.3	29.3	9.5
Total Split (s)	12.0	55.0	43.0	60.0	60.0	12.0
Total Split (%)	10.4%	47.8%	37.4%	52.2%	52.2%	10.4%
Maximum Green (s)	7.7	48.6	38.7	53.7	53.7	7.7
Yellow Time (s)	3.3	3.3	3.3	3.3	3.3	3.3
All-Red Time (s)	1.0	3.1	1.0	3.0	3.0	1.0
Lost Time Adjust (s)	0.0	0.0	0.0	0.0	0.0	0.0
Total Lost Time (s)	4.3	6.4	4.3	6.3	6.3	4.3
Lead/Lag	Lead		Lag			Lead
Lead-Lag Optimize?	Yes		Yes			Yes
Vehicle Extension (s)	3.0	3.0	3.0	3.0	3.0	3.0
Recall Mode	None	C-Max	C-Max	None	None	None
Walk Time (s)		7.0	7.0	7.0	7.0	
Flash Dont Walk (s)		21.0	28.0	16.0	16.0	
Pedestrian Calls (#/hr)		11	11	84	84	
Act Effct Green (s)	83.5	81.4	70.9	89.8	20.9	31.2
Actuated g/C Ratio	0.73	0.71	0.62	0.78	0.18	0.27
v/c Ratio	0.16	0.23	0.25	0.12	0.55	0.76
Control Delay	4.9	5.6	11.2	0.6	45.7	33.5
Queue Delay	0.0	0.0	0.0	0.0	0.0	0.0
Total Delay	4.9	5.6	11.2	0.6	45.7	33.5
LOS	A	A	B	A	D	C
Approach Delay		5.5	8.9		39.3	
Approach LOS		A	A		D	

Intersection Summary

Area Type:	Other
Cycle Length:	115
Actuated Cycle Length:	115
Offset:	59 (51%), Referenced to phase 2:EBTL and 6:WBT, Start of Green
Natural Cycle:	80
Control Type:	Actuated-Coordinated
Maximum v/c Ratio:	0.76
Intersection Signal Delay:	18.3
Intersection LOS:	B
Intersection Capacity Utilization:	61.3%
ICU Level of Service:	B
Analysis Period (min):	15

Splits and Phases: 5: Smyth Rd & Hospital Main Access

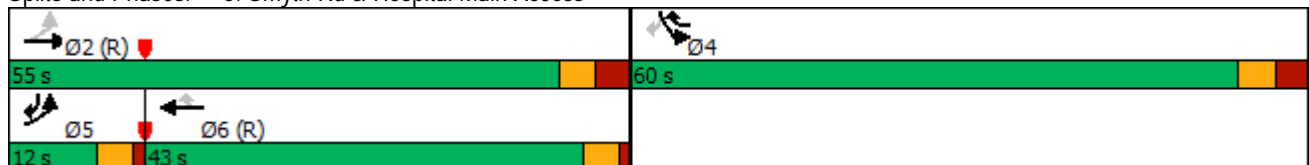

Queues

5: Smyth Rd & Hospital Main Access

12/15/2023

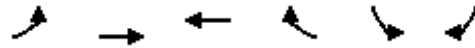

Lane Group	EBL	EBT	WBT	WBR	SBL	SBR
Lane Group Flow (vph)	97	581	549	148	347	380
v/c Ratio	0.16	0.23	0.25	0.12	0.55	0.76
Control Delay	4.9	5.6	11.2	0.6	45.7	33.5
Queue Delay	0.0	0.0	0.0	0.0	0.0	0.0
Total Delay	4.9	5.6	11.2	0.6	45.7	33.5
Queue Length 50th (m)	4.7	17.8	29.9	0.0	37.9	54.0
Queue Length 95th (m)	11.8	34.8	45.4	3.7	52.9	81.6
Internal Link Dist (m)		370.3	389.0		36.1	
Turn Bay Length (m)	60.0			178.0		
Base Capacity (vph)	594	2481	2181	1454	1635	510
Starvation Cap Reductn	0	0	0	0	0	0
Spillback Cap Reductn	0	0	0	0	0	0
Storage Cap Reductn	0	0	0	0	0	0
Reduced v/c Ratio	0.16	0.23	0.25	0.10	0.21	0.75
Intersection Summary						

Lanes, Volumes, Timings
6: Smyth Rd & Roger Guindon Ave

12/15/2023

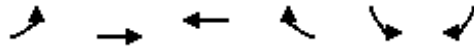

Lane Group	EBL	EBT	WBT	WBR	SBL	SBR	Ø3
Lane Configurations							
Traffic Volume (vph)	34	894	497	83	462	200	
Future Volume (vph)	34	894	497	83	462	200	
Ideal Flow (vphpl)	1900	1900	1900	1900	1900	1900	
Storage Length (m)	67.0			0.0	35.0	0.0	
Storage Lanes	1			0	1	1	
Taper Length (m)	7.5				7.5		
Lane Util. Factor	1.00	0.95	0.95	0.95	1.00	1.00	
Ped Bike Factor	0.98		0.99		0.93	0.97	
Frt			0.979			0.850	
Flt Protected	0.950				0.950		
Satd. Flow (prot)	1703	3505	3380	0	1736	1553	
Flt Permitted	0.335				0.950		
Satd. Flow (perm)	589	3505	3380	0	1606	1514	
Right Turn on Red				Yes		Yes	
Satd. Flow (RTOR)			23			200	
Link Speed (k/h)		50	50		50		
Link Distance (m)		413.0	277.5		141.9		
Travel Time (s)		29.7	20.0		10.2		
Confl. Peds. (#/hr)	31			31	58	10	
Confl. Bikes (#/hr)				1		1	
Peak Hour Factor	1.00	1.00	1.00	1.00	1.00	1.00	
Heavy Vehicles (%)	6%	3%	4%	0%	4%	4%	
Adj. Flow (vph)	34	894	497	83	462	200	
Shared Lane Traffic (%)							
Lane Group Flow (vph)	34	894	580	0	462	200	
Enter Blocked Intersection	No	No	No	No	No	No	
Lane Alignment	Left	Left	Left	Right	Left	Right	
Median Width(m)		3.6	3.6		3.6		
Link Offset(m)		0.0	0.0		0.0		
Crosswalk Width(m)		4.8	4.8		4.8		
Two way Left Turn Lane							
Headway Factor	1.00	1.00	1.00	1.00	1.00	1.00	
Turning Speed (k/h)	25			15	25	15	
Number of Detectors	1	2	2		1	1	
Detector Template	Left	Thru	Thru		Left	Right	
Leading Detector (m)	2.0	10.0	10.0		2.0	2.0	
Trailing Detector (m)	0.0	0.0	0.0		0.0	0.0	
Detector 1 Position(m)	0.0	0.0	0.0		0.0	0.0	
Detector 1 Size(m)	2.0	0.6	0.6		2.0	2.0	
Detector 1 Type	CI+Ex	CI+Ex	CI+Ex		CI+Ex	CI+Ex	
Detector 1 Channel							
Detector 1 Extend (s)	0.0	0.0	0.0		0.0	0.0	
Detector 1 Queue (s)	0.0	0.0	0.0		0.0	0.0	
Detector 1 Delay (s)	0.0	0.0	0.0		0.0	0.0	
Detector 2 Position(m)		9.4	9.4				
Detector 2 Size(m)		0.6	0.6				
Detector 2 Type		CI+Ex	CI+Ex				
Detector 2 Channel							
Detector 2 Extend (s)		0.0	0.0				
Turn Type	pm+pt	NA	NA		Prot	Perm	
Protected Phases	5	2	6		4		3
Permitted Phases	2					4	

Lanes, Volumes, Timings
6: Smyth Rd & Roger Guindon Ave

12/15/2023

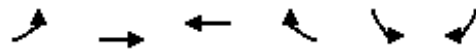

Lane Group	EBL	EBT	WBT	WBR	SBL	SBR	Ø3
Detector Phase	5	2	6		4	4	
Switch Phase							
Minimum Initial (s)	5.0	10.0	10.0		5.0	5.0	1.0
Minimum Split (s)	10.5	23.8	30.8		31.6	31.6	5.0
Total Split (s)	15.0	53.0	38.0		32.0	32.0	5.0
Total Split (%)	16.7%	58.9%	42.2%		35.6%	35.6%	6%
Maximum Green (s)	9.5	47.2	32.2		26.4	26.4	3.0
Yellow Time (s)	3.3	3.3	3.3		3.3	3.3	2.0
All-Red Time (s)	2.2	2.5	2.5		2.3	2.3	0.0
Lost Time Adjust (s)	0.0	0.0	0.0		0.0	0.0	
Total Lost Time (s)	5.5	5.8	5.8		5.6	5.6	
Lead/Lag	Lead		Lag		Lag	Lag	Lead
Lead-Lag Optimize?	Yes		Yes				
Vehicle Extension (s)	3.0	3.0	3.0		3.0	3.0	3.0
Recall Mode	None	C-Max	C-Max		None	None	None
Walk Time (s)			10.0		7.0	7.0	3.0
Flash Dont Walk (s)			15.0		14.0	14.0	0.0
Pedestrian Calls (#/hr)			31		68	68	68
Act Effct Green (s)	49.2	48.9	41.5		25.7	25.7	
Actuated g/C Ratio	0.55	0.54	0.46		0.29	0.29	
v/c Ratio	0.08	0.47	0.37		0.93	0.35	
Control Delay	10.8	14.0	17.7		59.7	5.6	
Queue Delay	0.0	0.0	0.0		0.0	0.0	
Total Delay	10.8	14.0	17.7		59.7	5.6	
LOS	B	B	B		E	A	
Approach Delay		13.9	17.7		43.4		
Approach LOS		B	B		D		

Intersection Summary

Area Type:	Other
Cycle Length:	90
Actuated Cycle Length:	90
Offset:	12 (13%), Referenced to phase 2:EBTL and 6:WBT, Start of Green
Natural Cycle:	80
Control Type:	Actuated-Coordinated
Maximum v/c Ratio:	0.93
Intersection Signal Delay:	23.9
Intersection LOS:	C
Intersection Capacity Utilization	63.4%
ICU Level of Service	B
Analysis Period (min)	15

Splits and Phases: 6: Smyth Rd & Roger Guindon Ave

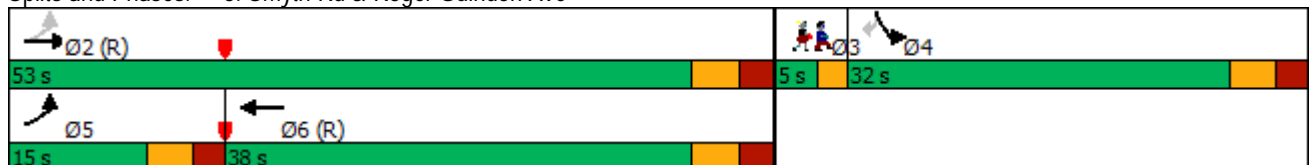

Queues

6: Smyth Rd & Roger Guindon Ave

12/15/2023



Lane Group	EBL	EBT	WBT	SBL	SBR
Lane Group Flow (vph)	34	894	580	462	200
v/c Ratio	0.08	0.47	0.37	0.93	0.35
Control Delay	10.8	14.0	17.7	59.7	5.6
Queue Delay	0.0	0.0	0.0	0.0	0.0
Total Delay	10.8	14.0	17.7	59.7	5.6
Queue Length 50th (m)	2.8	51.7	38.0	80.6	0.0
Queue Length 95th (m)	7.4	67.6	54.1	#138.6	15.5
Internal Link Dist (m)		389.0	253.5	117.9	
Turn Bay Length (m)	67.0			35.0	
Base Capacity (vph)	439	1906	1570	509	585
Starvation Cap Reductn	0	0	0	0	0
Spillback Cap Reductn	0	0	0	0	0
Storage Cap Reductn	0	0	0	0	0
Reduced v/c Ratio	0.08	0.47	0.37	0.91	0.34

Intersection Summary

95th percentile volume exceeds capacity, queue may be longer.
 Queue shown is maximum after two cycles.

HCM Unsignalized Intersection Capacity Analysis

7: Ring Rd & Hospital Link Rd

04-11-2024



Movement	EBT	EBR	WBL	WBT	NBL	NBR
Lane Configurations	↑			↑	↑	
Sign Control	Stop			Stop	Stop	
Traffic Volume (vph)	39	24	80	182	74	37
Future Volume (vph)	39	24	80	182	74	37
Peak Hour Factor	1.00	1.00	1.00	1.00	1.00	1.00
Hourly flow rate (vph)	39	24	80	182	74	37
Direction, Lane #	EB 1	WB 1	NB 1			
Volume Total (vph)	63	262	111			
Volume Left (vph)	0	80	74			
Volume Right (vph)	24	0	37			
Hadj (s)	-0.11	0.08	0.01			
Departure Headway (s)	4.4	4.3	4.6			
Degree Utilization, x	0.08	0.31	0.14			
Capacity (veh/h)	793	804	725			
Control Delay (s)	7.7	9.3	8.4			
Approach Delay (s)	7.7	9.3	8.4			
Approach LOS	A	A	A			
Intersection Summary						
Delay			8.8			
Level of Service			A			
Intersection Capacity Utilization			33.7%	ICU Level of Service	A	
Analysis Period (min)			15			

HCM Unsignalized Intersection Capacity Analysis

8: uOttawa-Rehab W Access & Hospital Link Rd

04-11-2024



Movement	EBT	EBR	WBL	WBT	NBL	NBR
Lane Configurations						
Traffic Volume (veh/h)	50	25	19	160	102	37
Future Volume (Veh/h)	50	25	19	160	102	37
Sign Control	Free			Free	Stop	
Grade	0%			0%	0%	
Peak Hour Factor	1.00	1.00	1.00	1.00	1.00	1.00
Hourly flow rate (vph)	50	25	19	160	102	37
Pedestrians						
Lane Width (m)						
Walking Speed (m/s)						
Percent Blockage						
Right turn flare (veh)						
Median type	None			None		
Median storage veh						
Upstream signal (m)						
pX, platoon unblocked						
vC, conflicting volume			75		260	62
vC1, stage 1 conf vol						
vC2, stage 2 conf vol						
vCu, unblocked vol			75		260	62
tC, single (s)			4.2		6.4	6.2
tC, 2 stage (s)						
tF (s)			2.3		3.5	3.3
p0 queue free %			99		86	96
cM capacity (veh/h)			1469		723	1008
Direction, Lane #	EB 1	WB 1	NB 1			
Volume Total	75	179	139			
Volume Left	0	19	102			
Volume Right	25	0	37			
cSH	1700	1469	782			
Volume to Capacity	0.04	0.01	0.18			
Queue Length 95th (m)	0.0	0.3	5.1			
Control Delay (s)	0.0	0.9	10.6			
Lane LOS			A			B
Approach Delay (s)	0.0	0.9	10.6			
Approach LOS			B			
Intersection Summary						
Average Delay			4.2			
Intersection Capacity Utilization			30.7%	ICU Level of Service	A	
Analysis Period (min)			15			

HCM Unsignalized Intersection Capacity Analysis

9: uOttawa-Rehab E Access & Hospital Link Rd

04-11-2024



Movement	EBT	EBR	WBL	WBT	NBL	NBR
Lane Configurations	↑			↑	↘	↘
Sign Control	Stop			Stop	Stop	
Traffic Volume (vph)	88	0	0	159	20	14
Future Volume (vph)	88	0	0	159	20	14
Peak Hour Factor	1.00	1.00	1.00	1.00	1.00	1.00
Hourly flow rate (vph)	88	0	0	159	20	14
Direction, Lane #	EB 1	WB 1	NB 1			
Volume Total (vph)	88	159	34			
Volume Left (vph)	0	0	20			
Volume Right (vph)	0	0	14			
Hadj (s)	0.09	0.02	0.12			
Departure Headway (s)	4.2	4.1	4.6			
Degree Utilization, x	0.10	0.18	0.04			
Capacity (veh/h)	836	868	743			
Control Delay (s)	7.7	8.0	7.8			
Approach Delay (s)	7.7	8.0	7.8			
Approach LOS	A	A	A			
Intersection Summary						
Delay			7.9			
Level of Service			A			
Intersection Capacity Utilization			19.0%	ICU Level of Service	A	
Analysis Period (min)			15			

Lanes, Volumes, Timings

1: Alta Vista Dr & Hospital Link Rd

12/15/2023



Lane Group	EBL	EBT	EBR	WBL	WBT	WBR	NBL	NBT	NBR	SBL	SBT	SBR
Lane Configurations												
Traffic Volume (vph)	2	328	48	22	65	8	42	632	57	16	630	24
Future Volume (vph)	2	328	48	22	65	8	42	632	57	16	630	24
Ideal Flow (vphpl)	1800	1800	1800	1800	1800	1800	1800	1800	1800	1800	1800	1800
Storage Length (m)	0.0		0.0	25.0		40.0	30.0		0.0	25.0		0.0
Storage Lanes	1		0	1		1	1		0	1		0
Taper Length (m)	7.5			7.5			7.5			7.5		
Lane Util. Factor	1.00	1.00	1.00	1.00	1.00	1.00	1.00	1.00	1.00	1.00	1.00	1.00
Ped Bike Factor	0.99	0.99		0.99		0.97		1.00			1.00	
Frt		0.981				0.850		0.988			0.994	
Flt Protected	0.950			0.950			0.950			0.950		
Satd. Flow (prot)	1710	1698	0	1583	1579	1530	1710	1692	0	1710	1734	0
Flt Permitted	0.715			0.191			0.261			0.236		
Satd. Flow (perm)	1279	1698	0	314	1579	1489	470	1692	0	425	1734	0
Right Turn on Red			Yes			Yes			Yes			Yes
Satd. Flow (RTOR)		6				31		5			2	
Link Speed (k/h)		50			50			50			50	
Link Distance (m)		148.1			598.8			586.9			279.5	
Travel Time (s)		10.7			43.1			42.3			20.1	
Confl. Peds. (#/hr)	3		20	20		3	5		7	7		5
Confl. Bikes (#/hr)									1			
Peak Hour Factor	1.00	1.00	1.00	1.00	1.00	1.00	1.00	1.00	1.00	1.00	1.00	1.00
Heavy Vehicles (%)	0%	3%	4%	8%	14%	0%	0%	5%	2%	0%	3%	4%
Adj. Flow (vph)	2	328	48	22	65	8	42	632	57	16	630	24
Shared Lane Traffic (%)												
Lane Group Flow (vph)	2	376	0	22	65	8	42	689	0	16	654	0
Enter Blocked Intersection	No	No	No	No	No	No	No	No	No	No	No	No
Lane Alignment	Left	Left	Right	Left	Left	Right	Left	Left	Right	Left	Left	Right
Median Width(m)		3.6			3.6			3.6			3.6	
Link Offset(m)		0.0			0.0			0.0			0.0	
Crosswalk Width(m)		4.8			4.8			4.8			4.8	
Two way Left Turn Lane												
Headway Factor	1.07	1.07	1.07	1.07	1.07	1.07	1.07	1.07	1.07	1.07	1.07	1.07
Turning Speed (k/h)	25		15	25		15	25		15	25		15
Number of Detectors	1	2		1	2	1	1	2		1	2	
Detector Template	Left	Thru		Left	Thru	Right	Left	Thru		Left	Thru	
Leading Detector (m)	2.0	10.0		2.0	10.0	2.0	2.0	10.0		2.0	10.0	
Trailing Detector (m)	0.0	0.0		0.0	0.0	0.0	0.0	0.0		0.0	0.0	
Detector 1 Position(m)	0.0	0.0		0.0	0.0	0.0	0.0	0.0		0.0	0.0	
Detector 1 Size(m)	2.0	0.6		2.0	0.6	2.0	2.0	0.6		2.0	0.6	
Detector 1 Type	CI+Ex	CI+Ex		CI+Ex	CI+Ex	CI+Ex	CI+Ex	CI+Ex		CI+Ex	CI+Ex	
Detector 1 Channel												
Detector 1 Extend (s)	0.0	0.0		0.0	0.0	0.0	0.0	0.0		0.0	0.0	
Detector 1 Queue (s)	0.0	0.0		0.0	0.0	0.0	0.0	0.0		0.0	0.0	
Detector 1 Delay (s)	0.0	0.0		0.0	0.0	0.0	0.0	0.0		0.0	0.0	
Detector 2 Position(m)		9.4			9.4			9.4			9.4	
Detector 2 Size(m)		0.6			0.6			0.6			0.6	
Detector 2 Type		CI+Ex			CI+Ex			CI+Ex			CI+Ex	
Detector 2 Channel												
Detector 2 Extend (s)		0.0			0.0			0.0			0.0	
Turn Type	Perm	NA		pm+pt	NA	Perm	Perm	NA		Perm	NA	
Protected Phases		2		1	6			8			4	
Permitted Phases	2			6		6	8			4		

Lanes, Volumes, Timings

1: Alta Vista Dr & Hospital Link Rd

12/15/2023



Lane Group	EBL	EBT	EBR	WBL	WBT	WBR	NBL	NBT	NBR	SBL	SBT	SBR
Detector Phase	2	2		1	6	6	8	8		4	4	
Switch Phase												
Minimum Initial (s)	10.0	10.0		5.0	10.0	10.0	10.0	10.0		10.0	10.0	
Minimum Split (s)	30.5	30.5		11.5	30.5	30.5	27.3	27.3		27.3	27.3	
Total Split (s)	31.5	31.5		21.5	53.0	53.0	61.3	61.3		61.3	61.3	
Total Split (%)	27.6%	27.6%		18.8%	46.4%	46.4%	53.6%	53.6%		53.6%	53.6%	
Maximum Green (s)	25.0	25.0		15.0	46.5	46.5	55.0	55.0		55.0	55.0	
Yellow Time (s)	3.3	3.3		3.3	3.3	3.3	3.3	3.3		3.3	3.3	
All-Red Time (s)	3.2	3.2		3.2	3.2	3.2	3.0	3.0		3.0	3.0	
Lost Time Adjust (s)	0.0	0.0		0.0	0.0	0.0	0.0	0.0		0.0	0.0	
Total Lost Time (s)	6.5	6.5		6.5	6.5	6.5	6.3	6.3		6.3	6.3	
Lead/Lag	Lag	Lag		Lead								
Lead-Lag Optimize?	Yes	Yes		Yes								
Vehicle Extension (s)	3.0	3.0		3.0	3.0	3.0	3.0	3.0		3.0	3.0	
Recall Mode	None	None		None	None	None	Max	Max		Max	Max	
Walk Time (s)	7.0	7.0		7.0	7.0	7.0	7.0	7.0		7.0	7.0	
Flash Dont Walk (s)	17.0	17.0		17.0	17.0	17.0	14.0	14.0		14.0	14.0	
Pedestrian Calls (#/hr)	23	23		23	23	23	12	12		12	12	
Act Effct Green (s)	25.1	25.1		30.3	30.3	30.3	55.3	55.3		55.3	55.3	
Actuated g/C Ratio	0.26	0.26		0.31	0.31	0.31	0.56	0.56		0.56	0.56	
v/c Ratio	0.01	0.86		0.12	0.13	0.02	0.16	0.72		0.07	0.67	
Control Delay	31.0	56.1		24.3	24.5	0.1	14.4	22.8		13.2	20.8	
Queue Delay	0.0	0.0		0.0	0.0	0.0	0.0	0.0		0.0	0.0	
Total Delay	31.0	56.1		24.3	24.5	0.1	14.4	22.8		13.2	20.8	
LOS	C	E		C	C	A	B	C		B	C	
Approach Delay		56.0			22.4			22.3			20.6	
Approach LOS		E			C			C			C	

Intersection Summary

Area Type:	Other
Cycle Length:	114.3
Actuated Cycle Length:	98.4
Natural Cycle:	90
Control Type:	Semi Act-Uncoord
Maximum v/c Ratio:	0.86
Intersection Signal Delay:	28.5
Intersection LOS:	C
Intersection Capacity Utilization:	72.7%
ICU Level of Service:	C
Analysis Period (min):	15

Splits and Phases: 1: Alta Vista Dr & Hospital Link Rd

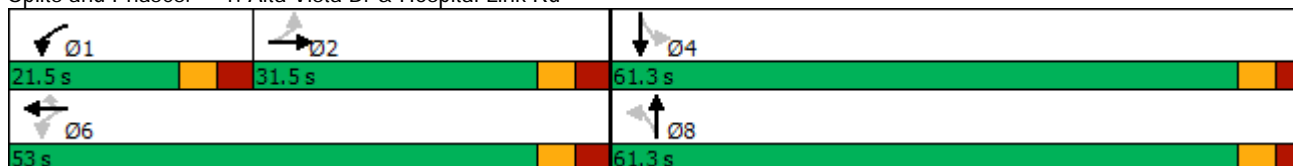

Queues

1: Alta Vista Dr & Hospital Link Rd

12/15/2023



Lane Group	EBL	EBT	WBL	WBT	WBR	NBL	NBT	SBL	SBT
Lane Group Flow (vph)	2	376	22	65	8	42	689	16	654
v/c Ratio	0.01	0.86	0.12	0.13	0.02	0.16	0.72	0.07	0.67
Control Delay	31.0	56.1	24.3	24.5	0.1	14.4	22.8	13.2	20.8
Queue Delay	0.0	0.0	0.0	0.0	0.0	0.0	0.0	0.0	0.0
Total Delay	31.0	56.1	24.3	24.5	0.1	14.4	22.8	13.2	20.8
Queue Length 50th (m)	0.3	65.2	3.1	9.3	0.0	3.3	81.4	1.2	74.0
Queue Length 95th (m)	2.4	#139.7	8.6	19.1	0.1	12.1	172.3	5.7	155.0
Internal Link Dist (m)		124.1		574.8			562.9		255.5
Turn Bay Length (m)			25.0		40.0	30.0		25.0	
Base Capacity (vph)	326	437	290	749	723	264	952	238	974
Starvation Cap Reductn	0	0	0	0	0	0	0	0	0
Spillback Cap Reductn	0	0	0	0	0	0	0	0	0
Storage Cap Reductn	0	0	0	0	0	0	0	0	0
Reduced v/c Ratio	0.01	0.86	0.08	0.09	0.01	0.16	0.72	0.07	0.67

Intersection Summary

95th percentile volume exceeds capacity, queue may be longer.
 Queue shown is maximum after two cycles.

Lanes, Volumes, Timings
2: Alta Vista Dr & Smyth Rd

12/15/2023

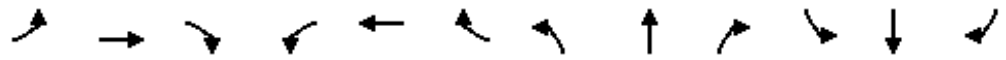

Lane Group	EBL	EBT	EBR	WBL	WBT	WBR	NBL	NBT	NBR	SBL	SBT	SBR
Lane Configurations												
Traffic Volume (vph)	164	856	111	86	503	167	350	402	182	240	214	122
Future Volume (vph)	164	856	111	86	503	167	350	402	182	240	214	122
Ideal Flow (vphpl)	1800	1800	1800	1800	1800	1800	1800	1800	1800	1800	1800	1800
Storage Length (m)	30.0		25.0	61.0		10.0	87.0		30.0	44.0		25.0
Storage Lanes	1		1	1		1	1		1	1		1
Taper Length (m)	7.5			7.5			7.5			7.5		
Lane Util. Factor	1.00	0.95	1.00	1.00	0.95	1.00	1.00	1.00	1.00	1.00	1.00	1.00
Ped Bike Factor	0.96		0.91			0.89	0.98		0.97	0.99		0.96
Fr't			0.850			0.850			0.850			0.850
Flt Protected	0.950			0.950			0.950			0.950		
Satd. Flow (prot)	1710	3353	1485	1644	3320	1500	1710	1731	1500	1676	1731	1530
Flt Permitted	0.322			0.184			0.512			0.227		
Satd. Flow (perm)	559	3353	1350	318	3320	1332	906	1731	1458	398	1731	1473
Right Turn on Red			Yes			Yes			Yes			Yes
Satd. Flow (RTOR)			139			139			137			137
Link Speed (k/h)		50			50			50			50	
Link Distance (m)		339.0			234.1			204.1			586.9	
Travel Time (s)		24.4			16.9			14.7			42.3	
Confl. Peds. (#/hr)	31		24	24		31	17		11	11		17
Peak Hour Factor	1.00	1.00	1.00	1.00	1.00	1.00	1.00	1.00	1.00	1.00	1.00	1.00
Heavy Vehicles (%)	0%	2%	3%	4%	3%	2%	0%	4%	2%	2%	4%	0%
Adj. Flow (vph)	164	856	111	86	503	167	350	402	182	240	214	122
Shared Lane Traffic (%)												
Lane Group Flow (vph)	164	856	111	86	503	167	350	402	182	240	214	122
Enter Blocked Intersection	No	No	No	No	No	No	No	No	No	No	No	No
Lane Alignment	Left	Left	Right	Left	Left	Right	Left	Left	Right	Left	Left	Right
Median Width(m)		3.6			3.6			3.6			3.6	
Link Offset(m)		0.0			0.0			0.0			0.0	
Crosswalk Width(m)		4.8			4.8			4.8			4.8	
Two way Left Turn Lane												
Headway Factor	1.07	1.07	1.07	1.07	1.07	1.07	1.07	1.07	1.07	1.07	1.07	1.07
Turning Speed (k/h)	25		15	25		15	25		15	25		15
Number of Detectors	1	2	1	1	2	1	1	2	1	1	2	1
Detector Template	Left	Thru	Right	Left	Thru	Right	Left	Thru	Right	Left	Thru	Right
Leading Detector (m)	2.0	10.0	2.0	2.0	10.0	2.0	2.0	10.0	2.0	2.0	10.0	2.0
Trailing Detector (m)	0.0	0.0	0.0	0.0	0.0	0.0	0.0	0.0	0.0	0.0	0.0	0.0
Detector 1 Position(m)	0.0	0.0	0.0	0.0	0.0	0.0	0.0	0.0	0.0	0.0	0.0	0.0
Detector 1 Size(m)	2.0	0.6	2.0	2.0	0.6	2.0	2.0	0.6	2.0	2.0	0.6	2.0
Detector 1 Type	CI+Ex	CI+Ex	CI+Ex	CI+Ex	CI+Ex	CI+Ex	CI+Ex	CI+Ex	CI+Ex	CI+Ex	CI+Ex	CI+Ex
Detector 1 Channel												
Detector 1 Extend (s)	0.0	0.0	0.0	0.0	0.0	0.0	0.0	0.0	0.0	0.0	0.0	0.0
Detector 1 Queue (s)	0.0	0.0	0.0	0.0	0.0	0.0	0.0	0.0	0.0	0.0	0.0	0.0
Detector 1 Delay (s)	0.0	0.0	0.0	0.0	0.0	0.0	0.0	0.0	0.0	0.0	0.0	0.0
Detector 2 Position(m)		9.4			9.4			9.4			9.4	
Detector 2 Size(m)		0.6			0.6			0.6			0.6	
Detector 2 Type		CI+Ex			CI+Ex			CI+Ex			CI+Ex	
Detector 2 Channel												
Detector 2 Extend (s)		0.0			0.0			0.0			0.0	
Turn Type	pm+pt	NA	Perm	pm+pt	NA	Perm	pm+pt	NA	Perm	pm+pt	NA	Perm
Protected Phases	5	2		1	6		3	8		7	4	
Permitted Phases	2		2	6		6	8		8	4		4
Detector Phase	5	2	2	1	6	6	3	8	8	7	4	4

Lanes, Volumes, Timings
2: Alta Vista Dr & Smyth Rd

12/15/2023



Lane Group	EBL	EBT	EBR	WBL	WBT	WBR	NBL	NBT	NBR	SBL	SBT	SBR
Switch Phase												
Minimum Initial (s)	5.0	10.0	10.0	5.0	10.0	10.0	5.0	10.0	10.0	5.0	10.0	10.0
Minimum Split (s)	10.5	24.8	24.8	10.5	24.8	24.8	11.1	29.1	29.1	11.1	29.1	29.1
Total Split (s)	20.0	38.0	38.0	20.0	38.0	38.0	20.0	37.0	37.0	20.0	37.0	37.0
Total Split (%)	17.4%	33.0%	33.0%	17.4%	33.0%	33.0%	17.4%	32.2%	32.2%	17.4%	32.2%	32.2%
Maximum Green (s)	14.5	32.2	32.2	14.5	32.2	32.2	13.9	30.9	30.9	13.9	30.9	30.9
Yellow Time (s)	3.3	3.3	3.3	3.3	3.3	3.3	3.3	3.3	3.3	3.3	3.3	3.3
All-Red Time (s)	2.2	2.5	2.5	2.2	2.5	2.5	2.8	2.8	2.8	2.8	2.8	2.8
Lost Time Adjust (s)	0.0	0.0	0.0	0.0	0.0	0.0	0.0	0.0	0.0	0.0	0.0	0.0
Total Lost Time (s)	5.5	5.8	5.8	5.5	5.8	5.8	6.1	6.1	6.1	6.1	6.1	6.1
Lead/Lag	Lead	Lag	Lag	Lead	Lag	Lag	Lead	Lag	Lag	Lead	Lag	Lag
Lead-Lag Optimize?	Yes	Yes	Yes	Yes	Yes	Yes	Yes	Yes	Yes	Yes	Yes	Yes
Vehicle Extension (s)	3.0	3.0	3.0	3.0	3.0	3.0	3.0	3.0	3.0	3.0	3.0	3.0
Recall Mode	None	C-Max	C-Max	None	C-Max	C-Max	None	Max	Max	None	Max	Max
Walk Time (s)		7.0	7.0		7.0	7.0		7.0	7.0		7.0	7.0
Flash Dont Walk (s)		12.0	12.0		12.0	12.0		16.0	16.0		16.0	16.0
Pedestrian Calls (#/hr)		55	55		55	55		28	28		28	28
Act Effct Green (s)	50.5	40.1	40.1	44.2	34.9	34.9	45.2	31.3	31.3	44.4	30.9	30.9
Actuated g/C Ratio	0.44	0.35	0.35	0.38	0.30	0.30	0.39	0.27	0.27	0.39	0.27	0.27
v/c Ratio	0.45	0.73	0.20	0.38	0.50	0.33	0.77	0.85	0.37	0.79	0.46	0.25
Control Delay	23.2	38.5	3.5	28.2	30.4	13.4	37.7	58.1	12.3	42.0	39.0	5.4
Queue Delay	0.0	0.0	0.0	0.0	0.0	0.0	0.0	0.0	0.0	0.0	0.0	0.0
Total Delay	23.2	38.5	3.5	28.2	30.4	13.4	37.7	58.1	12.3	42.0	39.0	5.4
LOS	C	D	A	C	C	B	D	E	B	D	D	A
Approach Delay		32.9			26.4			41.5			33.1	
Approach LOS		C			C			D			C	

Intersection Summary

Area Type:	Other
Cycle Length:	115
Actuated Cycle Length:	115
Offset:	2 (2%), Referenced to phase 2:EBTL and 6:WBTL, Start of Green
Natural Cycle:	90
Control Type:	Actuated-Coordinated
Maximum v/c Ratio:	0.85
Intersection Signal Delay:	33.9
Intersection LOS:	C
Intersection Capacity Utilization	89.2%
ICU Level of Service	E
Analysis Period (min)	15

Splits and Phases: 2: Alta Vista Dr & Smyth Rd

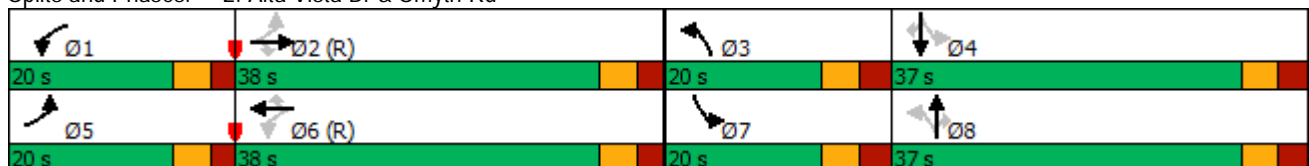

Queues

2: Alta Vista Dr & Smyth Rd

12/15/2023



Lane Group	EBL	EBT	EBR	WBL	WBT	WBR	NBL	NBT	NBR	SBL	SBT	SBR
Lane Group Flow (vph)	164	856	111	86	503	167	350	402	182	240	214	122
v/c Ratio	0.45	0.73	0.20	0.38	0.50	0.33	0.77	0.85	0.37	0.79	0.46	0.25
Control Delay	23.2	38.5	3.5	28.2	30.4	13.4	37.7	58.1	12.3	42.0	39.0	5.4
Queue Delay	0.0	0.0	0.0	0.0	0.0	0.0	0.0	0.0	0.0	0.0	0.0	0.0
Total Delay	23.2	38.5	3.5	28.2	30.4	13.4	37.7	58.1	12.3	42.0	39.0	5.4
Queue Length 50th (m)	22.8	95.7	0.0	5.7	29.7	0.1	56.8	90.9	8.1	36.2	42.4	0.0
Queue Length 95th (m)	37.5	126.0	8.2	32.3	65.7	31.9	#90.1	#145.8	27.3	#66.4	66.6	11.8
Internal Link Dist (m)		315.0			210.1			180.1			562.9	
Turn Bay Length (m)	30.0		25.0	61.0		10.0	87.0		30.0	44.0		25.0
Base Capacity (vph)	396	1168	560	304	1007	501	453	472	496	309	465	495
Starvation Cap Reductn	0	0	0	0	0	0	0	0	0	0	0	0
Spillback Cap Reductn	0	0	0	0	0	0	0	0	0	0	0	0
Storage Cap Reductn	0	0	0	0	0	0	0	0	0	0	0	0
Reduced v/c Ratio	0.41	0.73	0.20	0.28	0.50	0.33	0.77	0.85	0.37	0.78	0.46	0.25

Intersection Summary

95th percentile volume exceeds capacity, queue may be longer.
 Queue shown is maximum after two cycles.

Lanes, Volumes, Timings
3: Smyth Rd & Valour Dr

12/15/2023

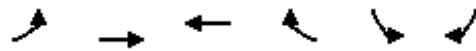

Lane Group	EBL	EBT	WBT	WBR	SBL	SBR
Lane Configurations						
Traffic Volume (vph)	36	1242	735	13	17	21
Future Volume (vph)	36	1242	735	13	17	21
Ideal Flow (vphpl)	1800	1800	1800	1800	1800	1800
Storage Length (m)	55.0			0.0	32.0	0.0
Storage Lanes	1			0	1	1
Taper Length (m)	7.5				7.5	
Lane Util. Factor	1.00	0.95	0.95	0.95	1.00	1.00
Ped Bike Factor	0.99		1.00			0.98
Frt			0.997			0.850
Flt Protected	0.950				0.950	
Satd. Flow (prot)	1613	3386	3306	0	1527	1457
Flt Permitted	0.368				0.950	
Satd. Flow (perm)	619	3386	3306	0	1527	1433
Right Turn on Red				Yes		Yes
Satd. Flow (RTOR)			3			21
Link Speed (k/h)		50	50		50	
Link Distance (m)		234.1	461.7		195.1	
Travel Time (s)		16.9	33.2		14.0	
Confl. Peds. (#/hr)	11			11		3
Peak Hour Factor	1.00	1.00	1.00	1.00	1.00	1.00
Heavy Vehicles (%)	6%	1%	3%	6%	12%	5%
Adj. Flow (vph)	36	1242	735	13	17	21
Shared Lane Traffic (%)						
Lane Group Flow (vph)	36	1242	748	0	17	21
Enter Blocked Intersection	No	No	No	No	No	No
Lane Alignment	Left	Left	Left	Right	Left	Right
Median Width(m)		3.6	3.6		3.6	
Link Offset(m)		0.0	0.0		0.0	
Crosswalk Width(m)		4.8	4.8		4.8	
Two way Left Turn Lane						
Headway Factor	1.07	1.07	1.07	1.07	1.07	1.07
Turning Speed (k/h)	25			15	25	15
Number of Detectors	1	2	2		1	1
Detector Template	Left	Thru	Thru		Left	Right
Leading Detector (m)	2.0	10.0	10.0		2.0	2.0
Trailing Detector (m)	0.0	0.0	0.0		0.0	0.0
Detector 1 Position(m)	0.0	0.0	0.0		0.0	0.0
Detector 1 Size(m)	2.0	0.6	0.6		2.0	2.0
Detector 1 Type	CI+Ex	CI+Ex	CI+Ex		CI+Ex	CI+Ex
Detector 1 Channel						
Detector 1 Extend (s)	0.0	0.0	0.0		0.0	0.0
Detector 1 Queue (s)	0.0	0.0	0.0		0.0	0.0
Detector 1 Delay (s)	0.0	0.0	0.0		0.0	0.0
Detector 2 Position(m)		9.4	9.4			
Detector 2 Size(m)		0.6	0.6			
Detector 2 Type		CI+Ex	CI+Ex			
Detector 2 Channel						
Detector 2 Extend (s)		0.0	0.0			
Turn Type	Perm	NA	NA		Prot	Perm
Protected Phases		2	6		4	
Permitted Phases	2					4
Detector Phase	2	2	6		4	4

Lanes, Volumes, Timings

3: Smyth Rd & Valour Dr

12/15/2023

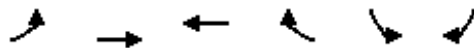

Lane Group	EBL	EBT	WBT	WBR	SBL	SBR
Switch Phase						
Minimum Initial (s)	10.0	10.0	10.0		5.0	5.0
Minimum Split (s)	29.5	29.5	29.5		28.5	28.5
Total Split (s)	84.0	84.0	84.0		31.0	31.0
Total Split (%)	73.0%	73.0%	73.0%		27.0%	27.0%
Maximum Green (s)	77.5	77.5	77.5		24.5	24.5
Yellow Time (s)	3.3	3.3	3.3		3.3	3.3
All-Red Time (s)	3.2	3.2	3.2		3.2	3.2
Lost Time Adjust (s)	0.0	0.0	0.0		0.0	0.0
Total Lost Time (s)	6.5	6.5	6.5		6.5	6.5
Lead/Lag						
Lead-Lag Optimize?						
Vehicle Extension (s)	3.0	3.0	3.0		3.0	3.0
Recall Mode	C-Max	C-Max	C-Max		None	None
Walk Time (s)	7.0	7.0	7.0		7.0	7.0
Flash Dont Walk (s)	16.0	16.0	16.0		15.0	15.0
Pedestrian Calls (#/hr)	11	11	11		3	3
Act Effct Green (s)	99.9	99.9	99.9		9.5	9.5
Actuated g/C Ratio	0.87	0.87	0.87		0.08	0.08
v/c Ratio	0.07	0.42	0.26		0.13	0.15
Control Delay	1.2	1.1	8.6		47.5	18.8
Queue Delay	0.0	0.0	0.0		0.0	0.0
Total Delay	1.2	1.1	8.6		47.5	18.8
LOS	A	A	A		D	B
Approach Delay		1.1	8.6		31.7	
Approach LOS		A	A		C	

Intersection Summary	
Area Type:	Other
Cycle Length:	115
Actuated Cycle Length:	115
Offset:	12 (10%), Referenced to phase 2:EBTL and 6:WBT, Start of Green
Natural Cycle:	60
Control Type:	Actuated-Coordinated
Maximum v/c Ratio:	0.42
Intersection Signal Delay:	4.4
Intersection Capacity Utilization	52.6%
Analysis Period (min)	15
Intersection LOS:	A
ICU Level of Service	A

Splits and Phases: 3: Smyth Rd & Valour Dr



Queues

3: Smyth Rd & Valour Dr

12/15/2023



Lane Group	EBL	EBT	WBT	SBL	SBR
Lane Group Flow (vph)	36	1242	748	17	21
v/c Ratio	0.07	0.42	0.26	0.13	0.15
Control Delay	1.2	1.1	8.6	47.5	18.8
Queue Delay	0.0	0.0	0.0	0.0	0.0
Total Delay	1.2	1.1	8.6	47.5	18.8
Queue Length 50th (m)	0.4	7.5	42.3	3.9	0.0
Queue Length 95th (m)	m1.0	13.2	84.2	10.0	7.1
Internal Link Dist (m)		210.1	437.7	171.1	
Turn Bay Length (m)	55.0			32.0	
Base Capacity (vph)	538	2942	2873	325	321
Starvation Cap Reductn	0	0	0	0	0
Spillback Cap Reductn	0	0	0	0	0
Storage Cap Reductn	0	0	0	0	0
Reduced v/c Ratio	0.07	0.42	0.26	0.05	0.07

Intersection Summary

m Volume for 95th percentile queue is metered by upstream signal.

Lanes, Volumes, Timings
4: S Haven Pl/Ring Rd & Smyth Rd

12/15/2023



Lane Group	EBL	EBT	EBR	WBL	WBT	WBR	NBL	NBT	NBR	SBL	SBT	SBR
Lane Configurations		↕↕			↕↕			↕↕			↕	↕
Traffic Volume (vph)	417	839	2	1	608	112	7	0	0	31	0	133
Future Volume (vph)	417	839	2	1	608	112	7	0	0	31	0	133
Ideal Flow (vphpl)	1800	1800	1800	1800	1800	1800	1800	1800	1800	1800	1800	1800
Lane Util. Factor	0.95	0.95	0.95	0.95	0.95	0.95	1.00	1.00	1.00	1.00	1.00	1.00
Ped Bike Factor		1.00			0.99						0.99	0.99
Frt					0.977							0.850
Flt Protected		0.984						0.950			0.950	
Satd. Flow (prot)	0	3332	0	0	3227	0	0	1710	0	0	1660	1443
Flt Permitted		0.603			0.954			0.737			0.753	
Satd. Flow (perm)	0	2038	0	0	3078	0	0	1327	0	0	1304	1423
Right Turn on Red			Yes			Yes			Yes			Yes
Satd. Flow (RTOR)					19							133
Link Speed (k/h)		50			50			50			50	
Link Distance (m)		461.7			394.3			74.8			50.7	
Travel Time (s)		33.2			28.4			5.4			3.7	
Confl. Peds. (#/hr)	11		2	2		11			6	6		
Confl. Bikes (#/hr)			8						4			2
Peak Hour Factor	1.00	1.00	1.00	1.00	1.00	1.00	1.00	1.00	1.00	1.00	1.00	1.00
Heavy Vehicles (%)	1%	1%	0%	0%	3%	2%	0%	0%	0%	3%	0%	6%
Adj. Flow (vph)	417	839	2	1	608	112	7	0	0	31	0	133
Shared Lane Traffic (%)												
Lane Group Flow (vph)	0	1258	0	0	721	0	0	7	0	0	31	133
Enter Blocked Intersection	No	No	No	No	No	No	No	No	No	No	No	No
Lane Alignment	Left	Left	Right	Left	Left	Right	Left	Left	Right	Left	Left	Right
Median Width(m)		3.6			3.6			0.0			0.0	
Link Offset(m)		0.0			0.0			0.0			0.0	
Crosswalk Width(m)		4.8			4.8			4.8			4.8	
Two way Left Turn Lane												
Headway Factor	1.07	1.07	1.07	1.07	1.07	1.07	1.07	1.07	1.07	1.07	1.07	1.07
Turning Speed (k/h)	25		15	25		15	25		15	25		15
Number of Detectors	1	2		1	2		1	2		1	2	1
Detector Template	Left	Thru		Left	Thru		Left	Thru		Left	Thru	Right
Leading Detector (m)	2.0	10.0		2.0	10.0		2.0	10.0		2.0	10.0	2.0
Trailing Detector (m)	0.0	0.0		0.0	0.0		0.0	0.0		0.0	0.0	0.0
Detector 1 Position(m)	0.0	0.0		0.0	0.0		0.0	0.0		0.0	0.0	0.0
Detector 1 Size(m)	2.0	0.6		2.0	0.6		2.0	0.6		2.0	0.6	2.0
Detector 1 Type	CI+Ex	CI+Ex		CI+Ex	CI+Ex		CI+Ex	CI+Ex		CI+Ex	CI+Ex	CI+Ex
Detector 1 Channel												
Detector 1 Extend (s)	0.0	0.0		0.0	0.0		0.0	0.0		0.0	0.0	0.0
Detector 1 Queue (s)	0.0	0.0		0.0	0.0		0.0	0.0		0.0	0.0	0.0
Detector 1 Delay (s)	0.0	0.0		0.0	0.0		0.0	0.0		0.0	0.0	0.0
Detector 2 Position(m)		9.4			9.4			9.4			9.4	
Detector 2 Size(m)		0.6			0.6			0.6			0.6	
Detector 2 Type		CI+Ex			CI+Ex			CI+Ex			CI+Ex	
Detector 2 Channel												
Detector 2 Extend (s)		0.0			0.0			0.0			0.0	
Turn Type	pm+pt	NA		Perm	NA		Perm	NA		Perm	NA	Perm
Protected Phases	5	2			6			8			4	
Permitted Phases	2			6			8			4		4
Detector Phase	5	2		6	6		8	8		4	4	4
Switch Phase												
Minimum Initial (s)	5.0	10.0		10.0	10.0		10.0	10.0		10.0	10.0	10.0

Lanes, Volumes, Timings
4: S Haven Pl/Ring Rd & Smyth Rd

12/15/2023



Lane Group	EBL	EBT	EBR	WBL	WBT	WBR	NBL	NBT	NBR	SBL	SBT	SBR
Minimum Split (s)	10.6	31.7		31.7	31.7		28.5	28.5		28.5	28.5	28.5
Total Split (s)	42.0	84.0		42.0	42.0		31.0	31.0		31.0	31.0	31.0
Total Split (%)	36.5%	73.0%		36.5%	36.5%		27.0%	27.0%		27.0%	27.0%	27.0%
Maximum Green (s)	36.4	78.3		36.3	36.3		25.5	25.5		25.5	25.5	25.5
Yellow Time (s)	3.3	3.3		3.3	3.3		3.3	3.3		3.3	3.3	3.3
All-Red Time (s)	2.3	2.4		2.4	2.4		2.2	2.2		2.2	2.2	2.2
Lost Time Adjust (s)		0.0			0.0			0.0			0.0	0.0
Total Lost Time (s)		5.7			5.7			5.5			5.5	5.5
Lead/Lag	Lead			Lag			Lag					
Lead-Lag Optimize?	Yes			Yes			Yes					
Vehicle Extension (s)	3.0	3.0		3.0	3.0		3.0	3.0		3.0	3.0	3.0
Recall Mode	None	C-Max		C-Max	C-Max		None	None		None	None	None
Walk Time (s)		7.0		7.0	7.0		7.0	7.0		7.0	7.0	7.0
Flash Dont Walk (s)		19.0		19.0	19.0		16.0	16.0		16.0	16.0	16.0
Pedestrian Calls (#/hr)		13		13	13		6	6		6	6	6
Act Effct Green (s)		91.2			91.2			12.6			12.6	12.6
Actuated g/C Ratio		0.79			0.79			0.11			0.11	0.11
v/c Ratio		0.78			0.29			0.05			0.22	0.49
Control Delay		15.1			2.5			43.1			48.3	13.5
Queue Delay		0.0			0.0			0.0			0.0	0.0
Total Delay		15.1			2.5			43.1			48.3	13.5
LOS		B			A			D			D	B
Approach Delay		15.1			2.5			43.1			20.0	
Approach LOS		B			A			D			C	

Intersection Summary

Area Type:	Other
Cycle Length:	115
Actuated Cycle Length:	115
Offset:	66 (57%), Referenced to phase 2:EBTL and 6:WBTL, Start of Green
Natural Cycle:	90
Control Type:	Actuated-Coordinated
Maximum v/c Ratio:	0.78
Intersection Signal Delay:	11.3
Intersection LOS:	B
Intersection Capacity Utilization:	83.4%
ICU Level of Service:	E
Analysis Period (min):	15

Splits and Phases: 4: S Haven Pl/Ring Rd & Smyth Rd

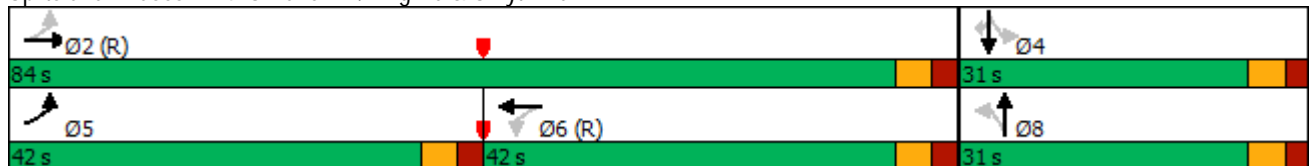

Queues

4: S Haven Pl/Ring Rd & Smyth Rd

12/15/2023



Lane Group	EBT	WBT	NBT	SBT	SBR
Lane Group Flow (vph)	1258	721	7	31	133
v/c Ratio	0.78	0.29	0.05	0.22	0.49
Control Delay	15.1	2.5	43.1	48.3	13.5
Queue Delay	0.0	0.0	0.0	0.0	0.0
Total Delay	15.1	2.5	43.1	48.3	13.5
Queue Length 50th (m)	59.8	9.8	1.6	7.0	0.0
Queue Length 95th (m)	73.3	16.4	5.5	15.0	16.6
Internal Link Dist (m)	437.7	370.3	50.8	26.7	
Turn Bay Length (m)					
Base Capacity (vph)	1616	2445	294	289	419
Starvation Cap Reductn	0	0	0	0	0
Spillback Cap Reductn	0	0	0	0	0
Storage Cap Reductn	0	0	0	0	0
Reduced v/c Ratio	0.78	0.29	0.02	0.11	0.32
Intersection Summary					

Lanes, Volumes, Timings
5: Smyth Rd & Hospital Main Access

12/15/2023

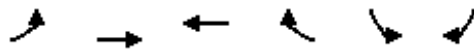

Lane Group	EBL	EBT	WBT	WBR	SBL	SBR
Lane Configurations	↖	↗↗	↖↖	↗	↖↖	↗
Traffic Volume (vph)	412	457	571	494	142	151
Future Volume (vph)	412	457	571	494	142	151
Ideal Flow (vphpl)	1800	1800	1800	1800	1800	1800
Storage Length (m)	60.0			178.0	0.0	0.0
Storage Lanes	1			1	2	1
Taper Length (m)	7.5				7.5	
Lane Util. Factor	1.00	0.95	0.95	1.00	0.97	1.00
Ped Bike Factor	1.00			0.97	0.88	0.97
Fr _t				0.850		0.850
Fl _t Protected	0.950				0.950	
Satd. Flow (prot)	1693	3353	3320	1515	3252	1515
Fl _t Permitted	0.364				0.950	
Satd. Flow (perm)	648	3353	3320	1471	2846	1468
Right Turn on Red				Yes		Yes
Satd. Flow (RTOR)				215		92
Link Speed (k/h)		50	50		50	
Link Distance (m)		394.3	413.0		60.1	
Travel Time (s)		28.4	29.7		4.3	
Confl. Peds. (#/hr)	3			3	50	13
Confl. Bikes (#/hr)				3		
Peak Hour Factor	1.00	1.00	1.00	1.00	1.00	1.00
Heavy Vehicles (%)	1%	2%	3%	1%	2%	1%
Adj. Flow (vph)	412	457	571	494	142	151
Shared Lane Traffic (%)						
Lane Group Flow (vph)	412	457	571	494	142	151
Enter Blocked Intersection	No	No	No	No	No	No
Lane Alignment	Left	Left	Left	Right	Left	Right
Median Width(m)		3.6	3.6		7.2	
Link Offset(m)		0.0	0.0		0.0	
Crosswalk Width(m)		4.8	4.8		4.8	
Two way Left Turn Lane						
Headway Factor	1.07	1.07	1.07	1.07	1.07	1.07
Turning Speed (k/h)	25			15	25	15
Number of Detectors	1	2	2	1	1	1
Detector Template	Left	Thru	Thru	Right	Left	Right
Leading Detector (m)	2.0	10.0	10.0	2.0	2.0	2.0
Trailing Detector (m)	0.0	0.0	0.0	0.0	0.0	0.0
Detector 1 Position(m)	0.0	0.0	0.0	0.0	0.0	0.0
Detector 1 Size(m)	2.0	0.6	0.6	2.0	2.0	2.0
Detector 1 Type	CI+Ex	CI+Ex	CI+Ex	CI+Ex	CI+Ex	CI+Ex
Detector 1 Channel						
Detector 1 Extend (s)	0.0	0.0	0.0	0.0	0.0	0.0
Detector 1 Queue (s)	0.0	0.0	0.0	0.0	0.0	0.0
Detector 1 Delay (s)	0.0	0.0	0.0	0.0	0.0	0.0
Detector 2 Position(m)		9.4	9.4			
Detector 2 Size(m)		0.6	0.6			
Detector 2 Type		CI+Ex	CI+Ex			
Detector 2 Channel						
Detector 2 Extend (s)		0.0	0.0			
Turn Type	pm+pt	NA	NA	pm+ov	Prot	pm+ov
Protected Phases	5	2	6	4	4	5
Permitted Phases	2			6		4

Lanes, Volumes, Timings

5: Smyth Rd & Hospital Main Access

12/15/2023

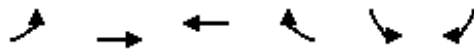

Lane Group	EBL	EBT	WBT	WBR	SBL	SBR
Detector Phase	5	2	6	4	4	5
Switch Phase						
Minimum Initial (s)	5.0	10.0	10.0	5.0	5.0	5.0
Minimum Split (s)	15.9	34.4	41.4	29.3	29.3	15.9
Total Split (s)	28.0	70.0	42.0	45.0	45.0	28.0
Total Split (%)	24.3%	60.9%	36.5%	39.1%	39.1%	24.3%
Maximum Green (s)	22.1	63.6	35.6	38.7	38.7	22.1
Yellow Time (s)	3.3	3.3	3.3	3.3	3.3	3.3
All-Red Time (s)	2.6	3.1	3.1	3.0	3.0	2.6
Lost Time Adjust (s)	0.0	0.0	0.0	0.0	0.0	0.0
Total Lost Time (s)	5.9	6.4	6.4	6.3	6.3	5.9
Lead/Lag	Lead		Lag			Lead
Lead-Lag Optimize?	Yes		Yes			Yes
Vehicle Extension (s)	3.0	3.0	3.0	3.0	3.0	3.0
Recall Mode	None	C-Max	C-Max	None	None	None
Walk Time (s)		7.0	7.0	7.0	7.0	
Flash Dont Walk (s)		21.0	28.0	16.0	16.0	
Pedestrian Calls (#/hr)		3	3	63	63	
Act Effct Green (s)	82.9	82.4	58.4	78.4	19.9	38.4
Actuated g/C Ratio	0.72	0.72	0.51	0.68	0.17	0.33
v/c Ratio	0.65	0.19	0.34	0.46	0.25	0.27
Control Delay	16.6	9.9	19.5	5.2	41.0	9.4
Queue Delay	0.0	0.0	0.0	0.0	0.0	0.0
Total Delay	16.6	9.9	19.5	5.2	41.0	9.4
LOS	B	A	B	A	D	A
Approach Delay		13.1	12.9		24.7	
Approach LOS		B	B		C	

Intersection Summary

Area Type:	Other
Cycle Length:	115
Actuated Cycle Length:	115
Offset:	43 (37%), Referenced to phase 2:EBTL and 6:WBT, Start of Green
Natural Cycle:	90
Control Type:	Actuated-Coordinated
Maximum v/c Ratio:	0.65
Intersection Signal Delay:	14.5
Intersection LOS:	B
Intersection Capacity Utilization	78.3%
ICU Level of Service	D
Analysis Period (min)	15

Splits and Phases: 5: Smyth Rd & Hospital Main Access

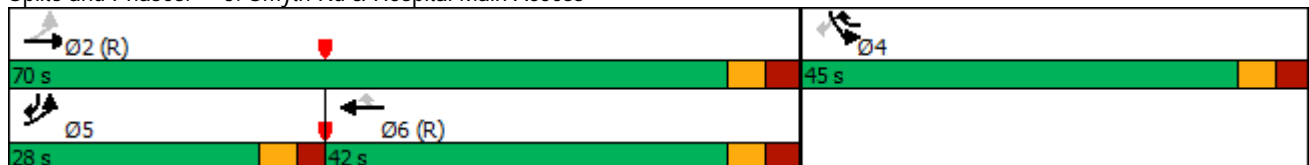

Queues

5: Smyth Rd & Hospital Main Access

12/15/2023

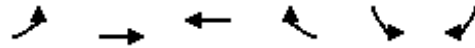

Lane Group	EBL	EBT	WBT	WBR	SBL	SBR
Lane Group Flow (vph)	412	457	571	494	142	151
v/c Ratio	0.65	0.19	0.34	0.46	0.25	0.27
Control Delay	16.6	9.9	19.5	5.2	41.0	9.4
Queue Delay	0.0	0.0	0.0	0.0	0.0	0.0
Total Delay	16.6	9.9	19.5	5.2	41.0	9.4
Queue Length 50th (m)	67.5	31.5	43.2	18.4	14.6	8.4
Queue Length 95th (m)	m88.5	m36.8	65.5	46.2	24.0	19.2
Internal Link Dist (m)		370.3	389.0		36.1	
Turn Bay Length (m)	60.0			178.0		
Base Capacity (vph)	675	2403	1685	1271	1094	618
Starvation Cap Reductn	0	0	0	0	0	0
Spillback Cap Reductn	0	0	0	0	0	0
Storage Cap Reductn	0	0	0	0	0	0
Reduced v/c Ratio	0.61	0.19	0.34	0.39	0.13	0.24

Intersection Summary

m Volume for 95th percentile queue is metered by upstream signal.

Lanes, Volumes, Timings
6: Smyth Rd & Roger Guindon Ave

12/15/2023

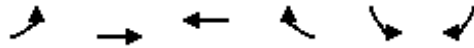

Lane Group	EBL	EBT	WBT	WBR	SBL	SBR	Ø3
Lane Configurations	↖	↕	↕		↖	↗	
Traffic Volume (vph)	197	402	1021	465	109	45	
Future Volume (vph)	197	402	1021	465	109	45	
Ideal Flow (vphpl)	1800	1800	1800	1800	1800	1800	
Storage Length (m)	67.0			0.0	35.0	0.0	
Storage Lanes	1			0	1	1	
Taper Length (m)	7.5				7.5		
Lane Util. Factor	1.00	0.95	0.95	0.95	1.00	1.00	
Ped Bike Factor			0.99		0.99	0.99	
Frt			0.953			0.850	
Flt Protected	0.950				0.950		
Satd. Flow (prot)	1710	3288	3177	0	1644	1530	
Flt Permitted	0.077				0.950		
Satd. Flow (perm)	139	3288	3177	0	1629	1510	
Right Turn on Red				Yes		Yes	
Satd. Flow (RTOR)			91			45	
Link Speed (k/h)		50	50		50		
Link Distance (m)		413.0	277.5		141.9		
Travel Time (s)		29.7	20.0		10.2		
Confl. Peds. (#/hr)	9			9	7	1	
Confl. Bikes (#/hr)				2			
Peak Hour Factor	1.00	1.00	1.00	1.00	1.00	1.00	
Heavy Vehicles (%)	0%	4%	2%	0%	4%	0%	
Adj. Flow (vph)	197	402	1021	465	109	45	
Shared Lane Traffic (%)							
Lane Group Flow (vph)	197	402	1486	0	109	45	
Enter Blocked Intersection	No	No	No	No	No	No	
Lane Alignment	Left	Left	Left	Right	Left	Right	
Median Width(m)		3.6	3.6		3.6		
Link Offset(m)		0.0	0.0		0.0		
Crosswalk Width(m)		4.8	4.8		4.8		
Two way Left Turn Lane							
Headway Factor	1.07	1.07	1.07	1.07	1.07	1.07	
Turning Speed (k/h)	25			15	25	15	
Number of Detectors	1	2	2		1	1	
Detector Template	Left	Thru	Thru		Left	Right	
Leading Detector (m)	2.0	10.0	10.0		2.0	2.0	
Trailing Detector (m)	0.0	0.0	0.0		0.0	0.0	
Detector 1 Position(m)	0.0	0.0	0.0		0.0	0.0	
Detector 1 Size(m)	2.0	0.6	0.6		2.0	2.0	
Detector 1 Type	CI+Ex	CI+Ex	CI+Ex		CI+Ex	CI+Ex	
Detector 1 Channel							
Detector 1 Extend (s)	0.0	0.0	0.0		0.0	0.0	
Detector 1 Queue (s)	0.0	0.0	0.0		0.0	0.0	
Detector 1 Delay (s)	0.0	0.0	0.0		0.0	0.0	
Detector 2 Position(m)		9.4	9.4				
Detector 2 Size(m)		0.6	0.6				
Detector 2 Type		CI+Ex	CI+Ex				
Detector 2 Channel							
Detector 2 Extend (s)		0.0	0.0				
Turn Type	pm+pt	NA	NA		Prot	Perm	
Protected Phases	5	2	6		4		3
Permitted Phases	2					4	

Lanes, Volumes, Timings
6: Smyth Rd & Roger Guindon Ave

12/15/2023

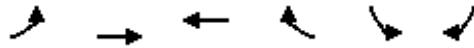

Lane Group	EBL	EBT	WBT	WBR	SBL	SBR	Ø3
Detector Phase	5	2	6		4	4	
Switch Phase							
Minimum Initial (s)	5.0	10.0	10.0		5.0	5.0	1.0
Minimum Split (s)	10.5	23.8	30.8		31.6	31.6	5.0
Total Split (s)	15.0	53.0	38.0		32.0	32.0	5.0
Total Split (%)	16.7%	58.9%	42.2%		35.6%	35.6%	6%
Maximum Green (s)	9.5	47.2	32.2		26.4	26.4	3.0
Yellow Time (s)	3.3	3.3	3.3		3.3	3.3	2.0
All-Red Time (s)	2.2	2.5	2.5		2.3	2.3	0.0
Lost Time Adjust (s)	0.0	0.0	0.0		0.0	0.0	
Total Lost Time (s)	5.5	5.8	5.8		5.6	5.6	
Lead/Lag	Lead		Lag		Lag	Lag	Lead
Lead-Lag Optimize?	Yes		Yes				
Vehicle Extension (s)	3.0	3.0	3.0		3.0	3.0	3.0
Recall Mode	None	C-Max	C-Max		None	None	None
Walk Time (s)			10.0		7.0	7.0	3.0
Flash Dont Walk (s)			15.0		14.0	14.0	0.0
Pedestrian Calls (#/hr)			9		8	8	8
Act Effct Green (s)	68.0	68.9	52.1		12.3	12.3	
Actuated g/C Ratio	0.76	0.77	0.58		0.14	0.14	
v/c Ratio	0.70	0.16	0.79		0.48	0.18	
Control Delay	29.6	4.8	21.6		41.7	11.1	
Queue Delay	0.0	0.0	0.0		0.0	0.0	
Total Delay	29.6	4.8	21.6		41.7	11.1	
LOS	C	A	C		D	B	
Approach Delay		12.9	21.6		32.8		
Approach LOS		B	C		C		

Intersection Summary

Area Type:	Other
Cycle Length:	90
Actuated Cycle Length:	90
Offset:	12 (13%), Referenced to phase 2:EBTL and 6:WBT, Start of Green
Natural Cycle:	100
Control Type:	Actuated-Coordinated
Maximum v/c Ratio:	0.79
Intersection Signal Delay:	20.1
Intersection LOS:	C
Intersection Capacity Utilization	78.1%
ICU Level of Service	D
Analysis Period (min)	15

Splits and Phases: 6: Smyth Rd & Roger Guindon Ave

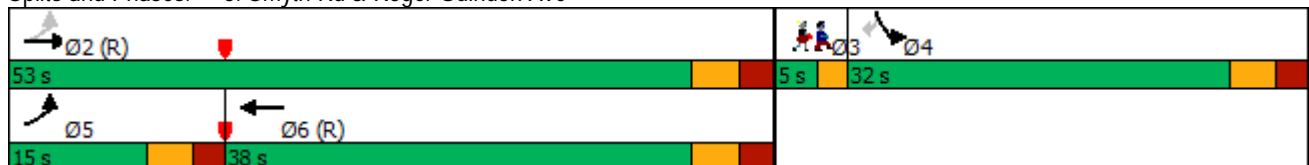

Queues

6: Smyth Rd & Roger Guindon Ave

12/15/2023



Lane Group	EBL	EBT	WBT	SBL	SBR
Lane Group Flow (vph)	197	402	1486	109	45
v/c Ratio	0.70	0.16	0.79	0.48	0.18
Control Delay	29.6	4.8	21.6	41.7	11.1
Queue Delay	0.0	0.0	0.0	0.0	0.0
Total Delay	29.6	4.8	21.6	41.7	11.1
Queue Length 50th (m)	16.6	8.9	95.5	18.9	0.0
Queue Length 95th (m)	43.6	24.2	#217.6	31.2	8.6
Internal Link Dist (m)		389.0	253.5	117.9	
Turn Bay Length (m)	67.0			35.0	
Base Capacity (vph)	299	2517	1878	482	474
Starvation Cap Reductn	0	0	0	0	0
Spillback Cap Reductn	0	0	0	0	0
Storage Cap Reductn	0	0	0	0	0
Reduced v/c Ratio	0.66	0.16	0.79	0.23	0.09

Intersection Summary

95th percentile volume exceeds capacity, queue may be longer.
 Queue shown is maximum after two cycles.

HCM Unsignalized Intersection Capacity Analysis

7: Ring Rd & Hospital Link Rd

04-11-2024



Movement	EBT	EBR	WBL	WBT	NBL	NBR
Lane Configurations	↔			↔	↔	
Sign Control	Stop			Stop	Stop	
Traffic Volume (vph)	266	136	23	49	45	96
Future Volume (vph)	266	136	23	49	45	96
Peak Hour Factor	1.00	1.00	1.00	1.00	1.00	1.00
Hourly flow rate (vph)	266	136	23	49	45	96

Direction, Lane #	EB 1	WB 1	NB 1
Volume Total (vph)	402	72	141
Volume Left (vph)	0	23	45
Volume Right (vph)	136	0	96
Hadj (s)	-0.18	0.13	-0.23
Departure Headway (s)	4.2	4.8	4.7
Degree Utilization, x	0.47	0.10	0.18
Capacity (veh/h)	844	705	702
Control Delay (s)	10.7	8.3	8.8
Approach Delay (s)	10.7	8.3	8.8
Approach LOS	B	A	A

Intersection Summary			
Delay		10.0	
Level of Service		B	
Intersection Capacity Utilization	39.7%		ICU Level of Service A
Analysis Period (min)		15	

HCM Unsignalized Intersection Capacity Analysis

8: uOttawa-Rehab W Access & Hospital Link Rd

04-11-2024



Movement	EBT	EBR	WBL	WBT	NBL	NBR
Lane Configurations						
Traffic Volume (veh/h)	198	164	103	71	1	6
Future Volume (Veh/h)	198	164	103	71	1	6
Sign Control	Free			Free	Stop	
Grade	0%			0%	0%	
Peak Hour Factor	1.00	1.00	1.00	1.00	1.00	1.00
Hourly flow rate (vph)	198	164	103	71	1	6
Pedestrians					1	
Lane Width (m)					3.6	
Walking Speed (m/s)					1.2	
Percent Blockage					0	
Right turn flare (veh)						
Median type	None			None		
Median storage veh						
Upstream signal (m)						
pX, platoon unblocked						
vC, conflicting volume			363		558	281
vC1, stage 1 conf vol						
vC2, stage 2 conf vol						
vCu, unblocked vol			363		558	281
tC, single (s)			4.1		6.4	6.2
tC, 2 stage (s)						
tF (s)			2.2		3.5	3.3
p0 queue free %			91		100	99
cM capacity (veh/h)			1195		451	762
Direction, Lane #	EB 1	WB 1	NB 1			
Volume Total	362	174	7			
Volume Left	0	103	1			
Volume Right	164	0	6			
cSH	1700	1195	694			
Volume to Capacity	0.21	0.09	0.01			
Queue Length 95th (m)	0.0	2.3	0.2			
Control Delay (s)	0.0	5.2	10.2			
Lane LOS			A			B
Approach Delay (s)	0.0	5.2	10.2			
Approach LOS			B			
Intersection Summary						
Average Delay			1.8			
Intersection Capacity Utilization			44.9%	ICU Level of Service	A	
Analysis Period (min)			15			

HCM Unsignalized Intersection Capacity Analysis
 9: uOttawa-Rehab E Access & Hospital Link Rd

04-11-2024



Movement	EBT	EBR	WBL	WBT	NBL	NBR
Lane Configurations	↑			↑	↘	
Sign Control	Stop			Stop	Stop	
Traffic Volume (vph)	204	0	0	146	28	25
Future Volume (vph)	204	0	0	146	28	25
Peak Hour Factor	1.00	1.00	1.00	1.00	1.00	1.00
Hourly flow rate (vph)	204	0	0	146	28	25

Direction, Lane #	EB 1	WB 1	NB 1
Volume Total (vph)	204	146	53
Volume Left (vph)	0	0	28
Volume Right (vph)	0	0	25
Hadj (s)	0.05	0.08	0.03
Departure Headway (s)	4.2	4.3	4.7
Degree Utilization, x	0.24	0.18	0.07
Capacity (veh/h)	833	814	710
Control Delay (s)	8.6	8.2	8.1
Approach Delay (s)	8.6	8.2	8.1
Approach LOS	A	A	A

Intersection Summary			
Delay		8.4	
Level of Service		A	
Intersection Capacity Utilization	21.5%		ICU Level of Service A
Analysis Period (min)		15	

Lanes, Volumes, Timings
1: Alta Vista Dr & Hospital Link Rd

12/15/2023



Lane Group	EBL	EBT	EBR	WBL	WBT	WBR	NBL	NBT	NBR	SBL	SBT	SBR
Lane Configurations												
Traffic Volume (vph)	0	55	37	41	217	17	23	828	12	1	577	12
Future Volume (vph)	0	55	37	41	217	17	23	828	12	1	577	12
Ideal Flow (vphpl)	1900	1900	1900	1900	1900	1900	1900	1900	1900	1900	1900	1900
Storage Length (m)	0.0		0.0	25.0		40.0	30.0		0.0	25.0		0.0
Storage Lanes	1		0	1		1	1		0	1		0
Taper Length (m)	7.5			7.5			7.5			7.5		
Lane Util. Factor	1.00	1.00	1.00	1.00	1.00	1.00	1.00	1.00	1.00	1.00	1.00	1.00
Ped Bike Factor		0.98		0.98		0.95		1.00			1.00	
Frt		0.940				0.850		0.998			0.997	
Flt Protected				0.950			0.950			0.950		
Satd. Flow (prot)	1900	1706	0	1719	1845	1524	1805	1858	0	1805	1839	0
Flt Permitted				0.494			0.342			0.176		
Satd. Flow (perm)	1900	1706	0	879	1845	1450	650	1858	0	334	1839	0
Right Turn on Red			Yes			Yes			Yes			Yes
Satd. Flow (RTOR)		27				31		1			1	
Link Speed (k/h)		50			50			50			50	
Link Distance (m)		148.1			598.8			586.9			279.5	
Travel Time (s)		10.7			43.1			42.3			20.1	
Confl. Peds. (#/hr)	12		9	9		12	9		14	14		9
Peak Hour Factor	1.00	1.00	1.00	1.00	1.00	1.00	1.00	1.00	1.00	1.00	1.00	1.00
Heavy Vehicles (%)	0%	5%	0%	5%	3%	6%	0%	2%	0%	0%	3%	0%
Adj. Flow (vph)	0	55	37	41	217	17	23	828	12	1	577	12
Shared Lane Traffic (%)												
Lane Group Flow (vph)	0	92	0	41	217	17	23	840	0	1	589	0
Enter Blocked Intersection	No	No	No	No	No	No	No	No	No	No	No	No
Lane Alignment	Left	Left	Right	Left	Left	Right	Left	Left	Right	Left	Left	Right
Median Width(m)		3.6			3.6			3.6			3.6	
Link Offset(m)		0.0			0.0			0.0			0.0	
Crosswalk Width(m)		4.8			4.8			4.8			4.8	
Two way Left Turn Lane												
Headway Factor	1.00	1.00	1.00	1.00	1.00	1.00	1.00	1.00	1.00	1.00	1.00	1.00
Turning Speed (k/h)	25		15	25		15	25		15	25		15
Number of Detectors	1	2		1	2	1	1	2		1	2	
Detector Template	Left	Thru		Left	Thru	Right	Left	Thru		Left	Thru	
Leading Detector (m)	2.0	10.0		2.0	10.0	2.0	2.0	10.0		2.0	10.0	
Trailing Detector (m)	0.0	0.0		0.0	0.0	0.0	0.0	0.0		0.0	0.0	
Detector 1 Position(m)	0.0	0.0		0.0	0.0	0.0	0.0	0.0		0.0	0.0	
Detector 1 Size(m)	2.0	0.6		2.0	0.6	2.0	2.0	0.6		2.0	0.6	
Detector 1 Type	CI+Ex	CI+Ex		CI+Ex	CI+Ex	CI+Ex	CI+Ex	CI+Ex		CI+Ex	CI+Ex	
Detector 1 Channel												
Detector 1 Extend (s)	0.0	0.0		0.0	0.0	0.0	0.0	0.0		0.0	0.0	
Detector 1 Queue (s)	0.0	0.0		0.0	0.0	0.0	0.0	0.0		0.0	0.0	
Detector 1 Delay (s)	0.0	0.0		0.0	0.0	0.0	0.0	0.0		0.0	0.0	
Detector 2 Position(m)		9.4			9.4			9.4			9.4	
Detector 2 Size(m)		0.6			0.6			0.6			0.6	
Detector 2 Type		CI+Ex			CI+Ex			CI+Ex			CI+Ex	
Detector 2 Channel												
Detector 2 Extend (s)		0.0			0.0			0.0			0.0	
Turn Type	Perm	NA		pm+pt	NA	Perm	Perm	NA		Perm	NA	
Protected Phases		2		1	6			8			4	
Permitted Phases	2			6		6	8			4		
Detector Phase	2	2		1	6	6	8	8		4	4	

Lanes, Volumes, Timings

1: Alta Vista Dr & Hospital Link Rd

12/15/2023



Lane Group	EBL	EBT	EBR	WBL	WBT	WBR	NBL	NBT	NBR	SBL	SBT	SBR
Switch Phase												
Minimum Initial (s)	10.0	10.0		5.0	10.0	10.0	10.0	10.0		10.0	10.0	
Minimum Split (s)	30.5	30.5		11.5	30.5	30.5	27.3	27.3		27.3	27.3	
Total Split (s)	31.5	31.5		21.5	53.0	53.0	61.3	61.3		61.3	61.3	
Total Split (%)	27.6%	27.6%		18.8%	46.4%	46.4%	53.6%	53.6%		53.6%	53.6%	
Maximum Green (s)	25.0	25.0		15.0	46.5	46.5	55.0	55.0		55.0	55.0	
Yellow Time (s)	3.3	3.3		3.3	3.3	3.3	3.3	3.3		3.3	3.3	
All-Red Time (s)	3.2	3.2		3.2	3.2	3.2	3.0	3.0		3.0	3.0	
Lost Time Adjust (s)	0.0	0.0		0.0	0.0	0.0	0.0	0.0		0.0	0.0	
Total Lost Time (s)	6.5	6.5		6.5	6.5	6.5	6.3	6.3		6.3	6.3	
Lead/Lag	Lag	Lag		Lead								
Lead-Lag Optimize?	Yes	Yes		Yes								
Vehicle Extension (s)	3.0	3.0		3.0	3.0	3.0	3.0	3.0		3.0	3.0	
Recall Mode	None	None		None	None	None	Max	Max		Max	Max	
Walk Time (s)	7.0	7.0			7.0	7.0	7.0	7.0		7.0	7.0	
Flash Dont Walk (s)	17.0	17.0			17.0	17.0	14.0	14.0		14.0	14.0	
Pedestrian Calls (#/hr)	21	21			21	21	23	23		23	23	
Act Effct Green (s)		15.8		23.8	23.8	23.8	56.8	56.8		56.8	56.8	
Actuated g/C Ratio		0.17		0.25	0.25	0.25	0.61	0.61		0.61	0.61	
v/c Ratio		0.30		0.14	0.46	0.04	0.06	0.74		0.00	0.53	
Control Delay		27.8		24.8	31.0	3.9	12.4	22.0		13.0	15.6	
Queue Delay		0.0		0.0	0.0	0.0	0.0	0.0		0.0	0.0	
Total Delay		27.8		24.8	31.0	3.9	12.4	22.0		13.0	15.6	
LOS		C		C	C	A	B	C		B	B	
Approach Delay		27.8			28.4			21.7			15.6	
Approach LOS		C			C			C			B	

Intersection Summary

Area Type:	Other
Cycle Length:	114.3
Actuated Cycle Length:	93.6
Natural Cycle:	90
Control Type:	Semi Act-Uncoord
Maximum v/c Ratio:	0.74
Intersection Signal Delay:	21.1
Intersection LOS:	C
Intersection Capacity Utilization:	69.2%
ICU Level of Service:	C
Analysis Period (min):	15

Splits and Phases: 1: Alta Vista Dr & Hospital Link Rd

Ø1	Ø2	Ø4
21.5 s	31.5 s	61.3 s
Ø6		Ø8
53 s		61.3 s

Queues

1: Alta Vista Dr & Hospital Link Rd

12/15/2023



Lane Group	EBT	WBL	WBT	WBR	NBL	NBT	SBL	SBT
Lane Group Flow (vph)	92	41	217	17	23	840	1	589
v/c Ratio	0.30	0.14	0.46	0.04	0.06	0.74	0.00	0.53
Control Delay	27.8	24.8	31.0	3.9	12.4	22.0	13.0	15.6
Queue Delay	0.0	0.0	0.0	0.0	0.0	0.0	0.0	0.0
Total Delay	27.8	24.8	31.0	3.9	12.4	22.0	13.0	15.6
Queue Length 50th (m)	11.3	5.8	33.8	0.0	1.6	103.4	0.1	58.5
Queue Length 95th (m)	25.9	13.4	53.4	2.7	7.1	#243.1	1.1	126.9
Internal Link Dist (m)	124.1		574.8			562.9		255.5
Turn Bay Length (m)		25.0		40.0	30.0		25.0	
Base Capacity (vph)	482	375	930	746	394	1128	202	1116
Starvation Cap Reductn	0	0	0	0	0	0	0	0
Spillback Cap Reductn	0	0	0	0	0	0	0	0
Storage Cap Reductn	0	0	0	0	0	0	0	0
Reduced v/c Ratio	0.19	0.11	0.23	0.02	0.06	0.74	0.00	0.53

Intersection Summary

95th percentile volume exceeds capacity, queue may be longer.
 Queue shown is maximum after two cycles.

Lanes, Volumes, Timings
2: Alta Vista Dr & Smyth Rd

12/15/2023



Lane Group	EBL	EBT	EBR	WBL	WBT	WBR	NBL	NBT	NBR	SBL	SBT	SBR
Lane Configurations												
Traffic Volume (vph)	187	497	220	249	878	263	109	305	77	127	436	220
Future Volume (vph)	187	497	220	249	878	263	109	305	77	127	436	220
Ideal Flow (vphpl)	1900	1900	1900	1900	1900	1900	1900	1900	1900	1900	1900	1900
Storage Length (m)	30.0		25.0	61.0		10.0	87.0		30.0	44.0		25.0
Storage Lanes	1		1	1		1	1		1	1		1
Taper Length (m)	7.5			7.5			7.5			7.5		
Lane Util. Factor	1.00	0.95	1.00	1.00	0.95	1.00	1.00	1.00	1.00	1.00	1.00	1.00
Ped Bike Factor			0.95	0.99		0.81	1.00		0.98	0.99		0.97
Frt			0.850			0.850			0.850			0.850
Flt Protected	0.950			0.950			0.950			0.950		
Satd. Flow (prot)	1787	3438	1615	1805	3539	1583	1770	1845	1568	1752	1845	1599
Flt Permitted	0.185			0.376			0.152			0.308		
Satd. Flow (perm)	348	3438	1538	707	3539	1283	282	1845	1529	565	1845	1553
Right Turn on Red			Yes			Yes			Yes			Yes
Satd. Flow (RTOR)			162			139			137			137
Link Speed (k/h)		50			50			50			50	
Link Distance (m)		339.0			234.1			204.1			586.9	
Travel Time (s)		24.4			16.9			14.7			42.3	
Confl. Peds. (#/hr)	56		9	9		56	10		8	8		10
Confl. Bikes (#/hr)			1			4			1			2
Peak Hour Factor	1.00	1.00	1.00	1.00	1.00	1.00	1.00	1.00	1.00	1.00	1.00	1.00
Heavy Vehicles (%)	1%	5%	0%	0%	2%	2%	2%	3%	3%	3%	3%	1%
Adj. Flow (vph)	187	497	220	249	878	263	109	305	77	127	436	220
Shared Lane Traffic (%)												
Lane Group Flow (vph)	187	497	220	249	878	263	109	305	77	127	436	220
Enter Blocked Intersection	No	No	No	No	No	No	No	No	No	No	No	No
Lane Alignment	Left	Left	Right	Left	Left	Right	Left	Left	Right	Left	Left	Right
Median Width(m)		3.6			3.6			3.6			3.6	
Link Offset(m)		0.0			0.0			0.0			0.0	
Crosswalk Width(m)		4.8			4.8			4.8			4.8	
Two way Left Turn Lane												
Headway Factor	1.00	1.00	1.00	1.00	1.00	1.00	1.00	1.00	1.00	1.00	1.00	1.00
Turning Speed (k/h)	25		15	25		15	25		15	25		15
Number of Detectors	1	2	1	1	2	1	1	2	1	1	2	1
Detector Template	Left	Thru	Right	Left	Thru	Right	Left	Thru	Right	Left	Thru	Right
Leading Detector (m)	2.0	10.0	2.0	2.0	10.0	2.0	2.0	10.0	2.0	2.0	10.0	2.0
Trailing Detector (m)	0.0	0.0	0.0	0.0	0.0	0.0	0.0	0.0	0.0	0.0	0.0	0.0
Detector 1 Position(m)	0.0	0.0	0.0	0.0	0.0	0.0	0.0	0.0	0.0	0.0	0.0	0.0
Detector 1 Size(m)	2.0	0.6	2.0	2.0	0.6	2.0	2.0	0.6	2.0	2.0	0.6	2.0
Detector 1 Type	CI+Ex	CI+Ex	CI+Ex	CI+Ex	CI+Ex	CI+Ex	CI+Ex	CI+Ex	CI+Ex	CI+Ex	CI+Ex	CI+Ex
Detector 1 Channel												
Detector 1 Extend (s)	0.0	0.0	0.0	0.0	0.0	0.0	0.0	0.0	0.0	0.0	0.0	0.0
Detector 1 Queue (s)	0.0	0.0	0.0	0.0	0.0	0.0	0.0	0.0	0.0	0.0	0.0	0.0
Detector 1 Delay (s)	0.0	0.0	0.0	0.0	0.0	0.0	0.0	0.0	0.0	0.0	0.0	0.0
Detector 2 Position(m)		9.4			9.4			9.4			9.4	
Detector 2 Size(m)		0.6			0.6			0.6			0.6	
Detector 2 Type		CI+Ex			CI+Ex			CI+Ex			CI+Ex	
Detector 2 Channel												
Detector 2 Extend (s)		0.0			0.0			0.0			0.0	
Turn Type	pm+pt	NA	Perm	pm+pt	NA	Perm	pm+pt	NA	Perm	pm+pt	NA	Perm
Protected Phases	5	2		1	6		3	8		7	4	
Permitted Phases	2		2	6		6	8		8	4		4

Lanes, Volumes, Timings
2: Alta Vista Dr & Smyth Rd

12/15/2023



Lane Group	EBL	EBT	EBR	WBL	WBT	WBR	NBL	NBT	NBR	SBL	SBT	SBR
Detector Phase	5	2	2	1	6	6	3	8	8	7	4	4
Switch Phase												
Minimum Initial (s)	5.0	10.0	10.0	5.0	10.0	10.0	5.0	10.0	10.0	5.0	10.0	10.0
Minimum Split (s)	10.5	24.8	24.8	10.5	24.8	24.8	11.1	29.1	29.1	11.1	29.1	29.1
Total Split (s)	22.0	44.0	44.0	22.0	44.0	44.0	18.0	31.0	31.0	18.0	31.0	31.0
Total Split (%)	19.1%	38.3%	38.3%	19.1%	38.3%	38.3%	15.7%	27.0%	27.0%	15.7%	27.0%	27.0%
Maximum Green (s)	16.5	38.2	38.2	16.5	38.2	38.2	11.9	24.9	24.9	11.9	24.9	24.9
Yellow Time (s)	3.3	3.3	3.3	3.3	3.3	3.3	3.3	3.3	3.3	3.3	3.3	3.3
All-Red Time (s)	2.2	2.5	2.5	2.2	2.5	2.5	2.8	2.8	2.8	2.8	2.8	2.8
Lost Time Adjust (s)	0.0	0.0	0.0	0.0	0.0	0.0	0.0	0.0	0.0	0.0	0.0	0.0
Total Lost Time (s)	5.5	5.8	5.8	5.5	5.8	5.8	6.1	6.1	6.1	6.1	6.1	6.1
Lead/Lag	Lead	Lag	Lag	Lead	Lag	Lag	Lead	Lag	Lag	Lead	Lag	Lag
Lead-Lag Optimize?	Yes	Yes	Yes	Yes	Yes	Yes	Yes	Yes	Yes	Yes	Yes	Yes
Vehicle Extension (s)	3.0	3.0	3.0	3.0	3.0	3.0	3.0	3.0	3.0	3.0	3.0	3.0
Recall Mode	None	C-Max	C-Max	None	C-Max	C-Max	None	Max	Max	None	Max	Max
Walk Time (s)		7.0	7.0		7.0	7.0		7.0	7.0		7.0	7.0
Flash Dont Walk (s)		12.0	12.0		12.0	12.0		16.0	16.0		16.0	16.0
Pedestrian Calls (#/hr)		65	65		65	65		18	18		18	18
Act Effct Green (s)	53.3	40.9	40.9	56.7	42.6	42.6	36.3	26.4	26.4	37.3	26.9	26.9
Actuated g/C Ratio	0.46	0.36	0.36	0.49	0.37	0.37	0.32	0.23	0.23	0.32	0.23	0.23
v/c Ratio	0.60	0.41	0.34	0.52	0.67	0.47	0.50	0.72	0.17	0.44	1.01	0.47
Control Delay	23.5	29.7	9.9	20.4	30.3	15.7	32.9	52.2	1.1	29.7	90.7	18.7
Queue Delay	0.0	0.0	0.0	0.0	0.0	0.0	0.0	0.0	0.0	0.0	0.0	0.0
Total Delay	23.5	29.7	9.9	20.4	30.3	15.7	32.9	52.2	1.1	29.7	90.7	18.7
LOS	C	C	A	C	C	B	C	D	A	C	F	B
Approach Delay		23.6			25.8			39.9			60.6	
Approach LOS		C			C			D			E	

Intersection Summary

Area Type: Other
 Cycle Length: 115
 Actuated Cycle Length: 115
 Offset: 0 (0%), Referenced to phase 2:EBTL and 6:WBTL, Start of Green
 Natural Cycle: 80
 Control Type: Actuated-Coordinated
 Maximum v/c Ratio: 1.01
 Intersection Signal Delay: 34.8
 Intersection LOS: C
 Intersection Capacity Utilization 83.2%
 ICU Level of Service E
 Analysis Period (min) 15

Splits and Phases: 2: Alta Vista Dr & Smyth Rd

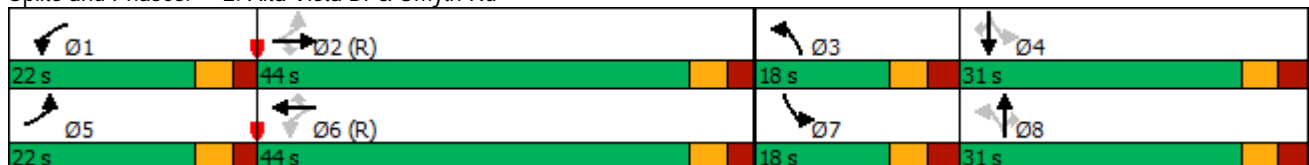

Queues

2: Alta Vista Dr & Smyth Rd

12/15/2023



Lane Group	EBL	EBT	EBR	WBL	WBT	WBR	NBL	NBT	NBR	SBL	SBT	SBR
Lane Group Flow (vph)	187	497	220	249	878	263	109	305	77	127	436	220
v/c Ratio	0.60	0.41	0.34	0.52	0.67	0.47	0.50	0.72	0.17	0.44	1.01	0.47
Control Delay	23.5	29.7	9.9	20.4	30.3	15.7	32.9	52.2	1.1	29.7	90.7	18.7
Queue Delay	0.0	0.0	0.0	0.0	0.0	0.0	0.0	0.0	0.0	0.0	0.0	0.0
Total Delay	23.5	29.7	9.9	20.4	30.3	15.7	32.9	52.2	1.1	29.7	90.7	18.7
Queue Length 50th (m)	22.5	46.5	9.2	25.2	48.0	2.9	17.1	67.6	0.0	20.1	~109.9	16.1
Queue Length 95th (m)	36.1	64.1	28.9	64.0	97.6	50.5	30.4	#108.2	0.9	34.7	#180.3	41.1
Internal Link Dist (m)		315.0			210.1			180.1			562.9	
Turn Bay Length (m)	30.0		25.0	61.0		10.0	87.0		30.0	44.0		25.0
Base Capacity (vph)	380	1222	651	518	1310	562	248	424	457	313	431	468
Starvation Cap Reductn	0	0	0	0	0	0	0	0	0	0	0	0
Spillback Cap Reductn	0	0	0	0	0	0	0	0	0	0	0	0
Storage Cap Reductn	0	0	0	0	0	0	0	0	0	0	0	0
Reduced v/c Ratio	0.49	0.41	0.34	0.48	0.67	0.47	0.44	0.72	0.17	0.41	1.01	0.47

Intersection Summary

- ~ Volume exceeds capacity, queue is theoretically infinite.
Queue shown is maximum after two cycles.
- # 95th percentile volume exceeds capacity, queue may be longer.
Queue shown is maximum after two cycles.

Lanes, Volumes, Timings 3: Smyth Rd & Valour Dr

12/15/2023

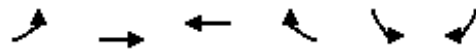

Lane Group	EBL	EBT	WBT	WBR	SBL	SBR
Lane Configurations						
Traffic Volume (vph)	32	668	1335	13	15	55
Future Volume (vph)	32	668	1335	13	15	55
Ideal Flow (vphpl)	1900	1900	1900	1900	1900	1900
Storage Length (m)	55.0			0.0	32.0	0.0
Storage Lanes	1			0	1	1
Taper Length (m)	7.5				7.5	
Lane Util. Factor	1.00	0.95	0.95	0.95	1.00	1.00
Ped Bike Factor			1.00		1.00	0.99
Frt			0.999			0.850
Flt Protected	0.950				0.950	
Satd. Flow (prot)	1752	3471	3527	0	1703	1583
Flt Permitted	0.159				0.950	
Satd. Flow (perm)	293	3471	3527	0	1695	1562
Right Turn on Red				Yes		Yes
Satd. Flow (RTOR)			1			55
Link Speed (k/h)		50	50		50	
Link Distance (m)		234.1	461.7		195.1	
Travel Time (s)		16.9	33.2		14.0	
Confl. Peds. (#/hr)	15			15	3	1
Peak Hour Factor	1.00	1.00	1.00	1.00	1.00	1.00
Heavy Vehicles (%)	3%	4%	2%	23%	6%	2%
Adj. Flow (vph)	32	668	1335	13	15	55
Shared Lane Traffic (%)						
Lane Group Flow (vph)	32	668	1348	0	15	55
Enter Blocked Intersection	No	No	No	No	No	No
Lane Alignment	Left	Left	Left	Right	Left	Right
Median Width(m)		3.6	3.6		3.6	
Link Offset(m)		0.0	0.0		0.0	
Crosswalk Width(m)		4.8	4.8		4.8	
Two way Left Turn Lane						
Headway Factor	1.00	1.00	1.00	1.00	1.00	1.00
Turning Speed (k/h)	25			15	25	15
Number of Detectors	1	2	2		1	1
Detector Template	Left	Thru	Thru		Left	Right
Leading Detector (m)	2.0	10.0	10.0		2.0	2.0
Trailing Detector (m)	0.0	0.0	0.0		0.0	0.0
Detector 1 Position(m)	0.0	0.0	0.0		0.0	0.0
Detector 1 Size(m)	2.0	0.6	0.6		2.0	2.0
Detector 1 Type	CI+Ex	CI+Ex	CI+Ex		CI+Ex	CI+Ex
Detector 1 Channel						
Detector 1 Extend (s)	0.0	0.0	0.0		0.0	0.0
Detector 1 Queue (s)	0.0	0.0	0.0		0.0	0.0
Detector 1 Delay (s)	0.0	0.0	0.0		0.0	0.0
Detector 2 Position(m)		9.4	9.4			
Detector 2 Size(m)		0.6	0.6			
Detector 2 Type		CI+Ex	CI+Ex			
Detector 2 Channel						
Detector 2 Extend (s)		0.0	0.0			
Turn Type	pm+pt	NA	NA		Prot	Perm
Protected Phases	5	2	6		4	
Permitted Phases	2					4
Detector Phase	5	2	6		4	4

Lanes, Volumes, Timings

3: Smyth Rd & Valour Dr

12/15/2023

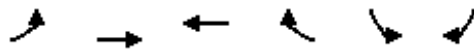

Lane Group	EBL	EBT	WBT	WBR	SBL	SBR
Switch Phase						
Minimum Initial (s)	5.0	10.0	10.0		5.0	5.0
Minimum Split (s)	10.7	29.5	29.5		28.5	28.5
Total Split (s)	18.0	85.0	67.0		30.0	30.0
Total Split (%)	15.7%	73.9%	58.3%		26.1%	26.1%
Maximum Green (s)	12.3	78.5	60.5		23.5	23.5
Yellow Time (s)	3.3	3.3	3.3		3.3	3.3
All-Red Time (s)	2.4	3.2	3.2		3.2	3.2
Lost Time Adjust (s)	0.0	0.0	0.0		0.0	0.0
Total Lost Time (s)	5.7	6.5	6.5		6.5	6.5
Lead/Lag	Lead		Lag			
Lead-Lag Optimize?	Yes		Yes			
Vehicle Extension (s)	3.0	3.0	3.0		3.0	3.0
Recall Mode	None	C-Max	C-Max		None	None
Walk Time (s)		7.0	7.0		7.0	7.0
Flash Dont Walk (s)		16.0	16.0		15.0	15.0
Pedestrian Calls (#/hr)		15	15		4	4
Act Effct Green (s)	95.8	96.3	89.2		9.4	9.4
Actuated g/C Ratio	0.83	0.84	0.78		0.08	0.08
v/c Ratio	0.10	0.23	0.49		0.11	0.31
Control Delay	1.5	0.9	14.1		46.7	16.1
Queue Delay	0.0	0.0	0.0		0.0	0.0
Total Delay	1.5	0.9	14.1		46.7	16.1
LOS	A	A	B		D	B
Approach Delay		0.9	14.1		22.7	
Approach LOS		A	B		C	

Intersection Summary

Area Type:	Other
Cycle Length:	115
Actuated Cycle Length:	115
Offset:	12 (10%), Referenced to phase 2:EBTL and 6:WBT, Start of Green
Natural Cycle:	80
Control Type:	Actuated-Coordinated
Maximum v/c Ratio:	0.49
Intersection Signal Delay:	10.0
Intersection LOS:	B
Intersection Capacity Utilization	52.8%
ICU Level of Service	A
Analysis Period (min)	15

Splits and Phases: 3: Smyth Rd & Valour Dr



Queues

3: Smyth Rd & Valour Dr

12/15/2023

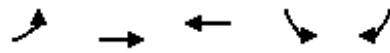

Lane Group	EBL	EBT	WBT	SBL	SBR
Lane Group Flow (vph)	32	668	1348	15	55
v/c Ratio	0.10	0.23	0.49	0.11	0.31
Control Delay	1.5	0.9	14.1	46.7	16.1
Queue Delay	0.0	0.0	0.0	0.0	0.0
Total Delay	1.5	0.9	14.1	46.7	16.1
Queue Length 50th (m)	0.3	3.3	92.2	3.5	0.0
Queue Length 95th (m)	1.4	8.7	165.3	9.1	11.2
Internal Link Dist (m)		210.1	437.7	171.1	
Turn Bay Length (m)	55.0			32.0	
Base Capacity (vph)	400	2907	2735	348	362
Starvation Cap Reductn	0	0	0	0	0
Spillback Cap Reductn	0	0	0	0	0
Storage Cap Reductn	0	0	0	0	0
Reduced v/c Ratio	0.08	0.23	0.49	0.04	0.15
Intersection Summary					

Lanes, Volumes, Timings
4: S Haven Pl/Ring Rd & Smyth Rd

12/15/2023



Lane Group	EBL	EBT	EBR	WBL	WBT	WBR	NBL	NBT	NBR	SBL	SBT	SBR
Lane Configurations		↕↕			↕↕			↕↕			↕↕	↕↕
Traffic Volume (vph)	107	571	4	4	968	12	5	0	4	139	1	374
Future Volume (vph)	107	571	4	4	968	12	5	0	4	139	1	374
Ideal Flow (vphpl)	1900	1900	1900	1900	1900	1900	1900	1900	1900	1900	1900	1900
Lane Util. Factor	0.95	0.95	0.95	0.95	0.95	0.95	1.00	1.00	1.00	1.00	1.00	1.00
Ped Bike Factor		1.00			1.00			0.99			0.99	0.97
Frt		0.999			0.998			0.940				0.850
Flt Protected		0.992						0.973			0.953	
Satd. Flow (prot)	0	3468	0	0	3531	0	0	1722	0	0	1793	1599
Flt Permitted		0.648			0.953			0.869			0.722	
Satd. Flow (perm)	0	2264	0	0	3365	0	0	1535	0	0	1346	1555
Right Turn on Red			Yes			Yes			Yes			Yes
Satd. Flow (RTOR)		1			1			79				231
Link Speed (k/h)		50			50			50			50	
Link Distance (m)		461.7			394.3			74.8			50.7	
Travel Time (s)		33.2			28.4			5.4			3.7	
Confl. Peds. (#/hr)	14		6	6		14	3		6	6		3
Confl. Bikes (#/hr)			2			4						14
Peak Hour Factor	1.00	1.00	1.00	1.00	1.00	1.00	1.00	1.00	1.00	1.00	1.00	1.00
Heavy Vehicles (%)	4%	3%	0%	0%	2%	0%	0%	0%	0%	1%	0%	1%
Adj. Flow (vph)	107	571	4	4	968	12	5	0	4	139	1	374
Shared Lane Traffic (%)												
Lane Group Flow (vph)	0	682	0	0	984	0	0	9	0	0	140	374
Enter Blocked Intersection	No	No	No	No	No	No	No	No	No	No	No	No
Lane Alignment	Left	Left	Right	Left	Left	Right	Left	Left	Right	Left	Left	Right
Median Width(m)		3.6			3.6			0.0			0.0	
Link Offset(m)		0.0			0.0			0.0			0.0	
Crosswalk Width(m)		4.8			4.8			4.8			4.8	
Two way Left Turn Lane												
Headway Factor	1.00	1.00	1.00	1.00	1.00	1.00	1.00	1.00	1.00	1.00	1.00	1.00
Turning Speed (k/h)	25		15	25		15	25		15	25		15
Number of Detectors	1	2		1	2		1	2		1	2	1
Detector Template	Left	Thru		Left	Thru		Left	Thru		Left	Thru	Right
Leading Detector (m)	2.0	10.0		2.0	10.0		2.0	10.0		2.0	10.0	2.0
Trailing Detector (m)	0.0	0.0		0.0	0.0		0.0	0.0		0.0	0.0	0.0
Detector 1 Position(m)	0.0	0.0		0.0	0.0		0.0	0.0		0.0	0.0	0.0
Detector 1 Size(m)	2.0	0.6		2.0	0.6		2.0	0.6		2.0	0.6	2.0
Detector 1 Type	CI+Ex	CI+Ex		CI+Ex	CI+Ex		CI+Ex	CI+Ex		CI+Ex	CI+Ex	CI+Ex
Detector 1 Channel												
Detector 1 Extend (s)	0.0	0.0		0.0	0.0		0.0	0.0		0.0	0.0	0.0
Detector 1 Queue (s)	0.0	0.0		0.0	0.0		0.0	0.0		0.0	0.0	0.0
Detector 1 Delay (s)	0.0	0.0		0.0	0.0		0.0	0.0		0.0	0.0	0.0
Detector 2 Position(m)		9.4			9.4			9.4			9.4	
Detector 2 Size(m)		0.6			0.6			0.6			0.6	
Detector 2 Type		CI+Ex			CI+Ex			CI+Ex			CI+Ex	
Detector 2 Channel												
Detector 2 Extend (s)		0.0			0.0			0.0			0.0	
Turn Type	pm+pt	NA		Perm	NA		Perm	NA		Perm	NA	Perm
Protected Phases	5	2			6			8			4	
Permitted Phases	2			6			8		4			4
Detector Phase	5	2		6	6		8	8	4	4		4
Switch Phase												
Minimum Initial (s)	5.0	10.0		10.0	10.0		10.0	10.0		10.0	10.0	10.0

Lanes, Volumes, Timings
4: S Haven Pl/Ring Rd & Smyth Rd

12/15/2023



Lane Group	EBL	EBT	EBR	WBL	WBT	WBR	NBL	NBT	NBR	SBL	SBT	SBR
Minimum Split (s)	10.6	31.7		31.7	31.7		28.5	28.5		28.5	28.5	28.5
Total Split (s)	16.0	78.0		62.0	62.0		37.0	37.0		37.0	37.0	37.0
Total Split (%)	13.9%	67.8%		53.9%	53.9%		32.2%	32.2%		32.2%	32.2%	32.2%
Maximum Green (s)	10.4	72.3		56.3	56.3		31.5	31.5		31.5	31.5	31.5
Yellow Time (s)	3.3	3.3		3.3	3.3		3.3	3.3		3.3	3.3	3.3
All-Red Time (s)	2.3	2.4		2.4	2.4		2.2	2.2		2.2	2.2	2.2
Lost Time Adjust (s)		0.0			0.0			0.0			0.0	0.0
Total Lost Time (s)		5.7			5.7			5.5			5.5	5.5
Lead/Lag	Lead			Lag			Lag			Lag		
Lead-Lag Optimize?	Yes			Yes			Yes			Yes		
Vehicle Extension (s)	3.0	3.0		3.0	3.0		3.0	3.0		3.0	3.0	3.0
Recall Mode	None	C-Max		C-Max	C-Max		None	None		None	None	None
Walk Time (s)		7.0		7.0	7.0		7.0	7.0		7.0	7.0	7.0
Flash Dont Walk (s)		19.0		19.0	19.0		16.0	16.0		16.0	16.0	16.0
Pedestrian Calls (#/hr)		20		20	20		9	9		9	9	9
Act Effct Green (s)		84.7		84.7	84.7		19.1	19.1		19.1	19.1	19.1
Actuated g/C Ratio		0.74		0.74	0.74		0.17	0.17		0.17	0.17	0.17
v/c Ratio		0.41		0.40	0.40		0.03	0.03		0.63	0.83	0.83
Control Delay		4.3		6.4	6.4		0.1	0.1		55.4	32.5	32.5
Queue Delay		0.0		0.0	0.0		0.0	0.0		0.0	0.0	0.0
Total Delay		4.3		6.4	6.4		0.1	0.1		55.4	32.5	32.5
LOS		A		A	A		A	A		E	C	C
Approach Delay		4.3		6.4	6.4		0.1	0.1		38.7		
Approach LOS		A		A	A		A	A		D		

Intersection Summary

Area Type:	Other
Cycle Length:	115
Actuated Cycle Length:	115
Offset:	62 (54%), Referenced to phase 2:EBTL and 6:WBTL, Start of Green
Natural Cycle:	75
Control Type:	Actuated-Coordinated
Maximum v/c Ratio:	0.83
Intersection Signal Delay:	13.3
Intersection LOS:	B
Intersection Capacity Utilization	76.1%
ICU Level of Service	D
Analysis Period (min)	15

Splits and Phases: 4: S Haven Pl/Ring Rd & Smyth Rd

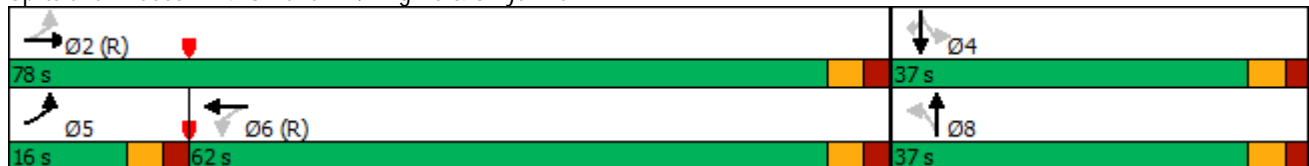

Queues

4: S Haven Pl/Ring Rd & Smyth Rd

12/15/2023



Lane Group	EBT	WBT	NBT	SBT	SBR
Lane Group Flow (vph)	682	984	9	140	374
v/c Ratio	0.41	0.40	0.03	0.63	0.83
Control Delay	4.3	6.4	0.1	55.4	32.5
Queue Delay	0.0	0.0	0.0	0.0	0.0
Total Delay	4.3	6.4	0.1	55.4	32.5
Queue Length 50th (m)	16.3	45.4	0.0	31.6	34.0
Queue Length 95th (m)	18.7	59.5	0.0	46.9	63.8
Internal Link Dist (m)	437.7	370.3	50.8	26.7	
Turn Bay Length (m)					
Base Capacity (vph)	1667	2478	477	368	593
Starvation Cap Reductn	0	0	0	0	0
Spillback Cap Reductn	0	0	0	0	0
Storage Cap Reductn	0	0	0	0	0
Reduced v/c Ratio	0.41	0.40	0.02	0.38	0.63
Intersection Summary					

Lanes, Volumes, Timings
5: Smyth Rd & Hospital Main Access

12/15/2023

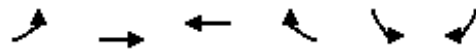

Lane Group	EBL	EBT	WBT	WBR	SBL	SBR
Lane Configurations	↖	↗↗	↗↗	↗	↖↖	↖
Traffic Volume (vph)	105	609	576	171	397	408
Future Volume (vph)	105	609	576	171	397	408
Ideal Flow (vphpl)	1900	1900	1900	1900	1900	1900
Storage Length (m)	60.0			178.0	0.0	0.0
Storage Lanes	1			1	2	1
Taper Length (m)	7.5				7.5	
Lane Util. Factor	1.00	0.95	0.95	1.00	0.97	1.00
Ped Bike Factor	0.99			0.95	0.82	0.97
Fr _t				0.850		0.850
Fl _t Protected	0.950				0.950	
Satd. Flow (prot)	1719	3505	3539	1568	3502	1583
Fl _t Permitted	0.379				0.950	
Satd. Flow (perm)	681	3505	3539	1493	2889	1531
Right Turn on Red				Yes		Yes
Satd. Flow (RTOR)				171		103
Link Speed (k/h)		50	50		50	
Link Distance (m)		394.3	413.0		60.1	
Travel Time (s)		28.4	29.7		4.3	
Confl. Peds. (#/hr)	11			11	70	14
Confl. Bikes (#/hr)				2		1
Peak Hour Factor	1.00	1.00	1.00	1.00	1.00	1.00
Heavy Vehicles (%)	5%	3%	2%	3%	0%	2%
Adj. Flow (vph)	105	609	576	171	397	408
Shared Lane Traffic (%)						
Lane Group Flow (vph)	105	609	576	171	397	408
Enter Blocked Intersection	No	No	No	No	No	No
Lane Alignment	Left	Left	Left	Right	Left	Right
Median Width(m)		3.6	3.6		7.2	
Link Offset(m)		0.0	0.0		0.0	
Crosswalk Width(m)		4.8	4.8		4.8	
Two way Left Turn Lane						
Headway Factor	1.00	1.00	1.00	1.00	1.00	1.00
Turning Speed (k/h)	25			15	25	15
Number of Detectors	1	2	2	1	1	1
Detector Template	Left	Thru	Thru	Right	Left	Right
Leading Detector (m)	2.0	10.0	10.0	2.0	2.0	2.0
Trailing Detector (m)	0.0	0.0	0.0	0.0	0.0	0.0
Detector 1 Position(m)	0.0	0.0	0.0	0.0	0.0	0.0
Detector 1 Size(m)	2.0	0.6	0.6	2.0	2.0	2.0
Detector 1 Type	CI+Ex	CI+Ex	CI+Ex	CI+Ex	CI+Ex	CI+Ex
Detector 1 Channel						
Detector 1 Extend (s)	0.0	0.0	0.0	0.0	0.0	0.0
Detector 1 Queue (s)	0.0	0.0	0.0	0.0	0.0	0.0
Detector 1 Delay (s)	0.0	0.0	0.0	0.0	0.0	0.0
Detector 2 Position(m)		9.4	9.4			
Detector 2 Size(m)		0.6	0.6			
Detector 2 Type		CI+Ex	CI+Ex			
Detector 2 Channel						
Detector 2 Extend (s)		0.0	0.0			
Turn Type	pm+pt	NA	NA	pm+ov	Prot	pm+ov
Protected Phases	5	2	6	4	4	5
Permitted Phases	2			6		4

Lanes, Volumes, Timings

5: Smyth Rd & Hospital Main Access

12/15/2023

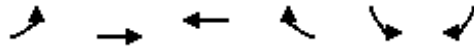

Lane Group	EBL	EBT	WBT	WBR	SBL	SBR
Detector Phase	5	2	6	4	4	5
Switch Phase						
Minimum Initial (s)	5.0	10.0	10.0	5.0	5.0	5.0
Minimum Split (s)	9.5	34.4	39.5	29.3	29.3	9.5
Total Split (s)	12.0	55.0	43.0	60.0	60.0	12.0
Total Split (%)	10.4%	47.8%	37.4%	52.2%	52.2%	10.4%
Maximum Green (s)	7.7	48.6	38.7	53.7	53.7	7.7
Yellow Time (s)	3.3	3.3	3.3	3.3	3.3	3.3
All-Red Time (s)	1.0	3.1	1.0	3.0	3.0	1.0
Lost Time Adjust (s)	0.0	0.0	0.0	0.0	0.0	0.0
Total Lost Time (s)	4.3	6.4	4.3	6.3	6.3	4.3
Lead/Lag	Lead		Lag			Lead
Lead-Lag Optimize?	Yes		Yes			Yes
Vehicle Extension (s)	3.0	3.0	3.0	3.0	3.0	3.0
Recall Mode	None	C-Max	C-Max	None	None	None
Walk Time (s)		7.0	7.0	7.0	7.0	
Flash Dont Walk (s)		21.0	28.0	16.0	16.0	
Pedestrian Calls (#/hr)		11	11	84	84	
Act Effct Green (s)	83.1	81.0	69.4	88.7	21.3	32.7
Actuated g/C Ratio	0.72	0.70	0.60	0.77	0.19	0.28
v/c Ratio	0.18	0.25	0.27	0.14	0.61	0.80
Control Delay	6.1	6.8	12.2	0.7	47.0	36.9
Queue Delay	0.0	0.0	0.0	0.0	0.0	0.0
Total Delay	6.1	6.8	12.2	0.7	47.0	36.9
LOS	A	A	B	A	D	D
Approach Delay		6.7	9.5		41.9	
Approach LOS		A	A		D	

Intersection Summary

Area Type:	Other
Cycle Length:	115
Actuated Cycle Length:	115
Offset:	59 (51%), Referenced to phase 2:EBTL and 6:WBT, Start of Green
Natural Cycle:	80
Control Type:	Actuated-Coordinated
Maximum v/c Ratio:	0.80
Intersection Signal Delay:	20.1
Intersection LOS:	C
Intersection Capacity Utilization	63.0%
ICU Level of Service	B
Analysis Period (min)	15

Splits and Phases: 5: Smyth Rd & Hospital Main Access

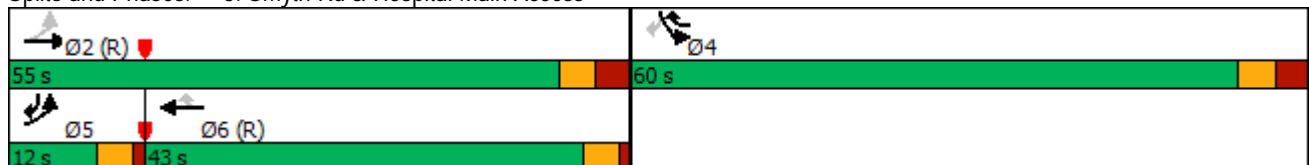

Queues

5: Smyth Rd & Hospital Main Access

12/15/2023

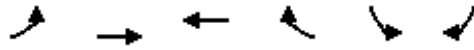

Lane Group	EBL	EBT	WBT	WBR	SBL	SBR
Lane Group Flow (vph)	105	609	576	171	397	408
v/c Ratio	0.18	0.25	0.27	0.14	0.61	0.80
Control Delay	6.1	6.8	12.2	0.7	47.0	36.9
Queue Delay	0.0	0.0	0.0	0.0	0.0	0.0
Total Delay	6.1	6.8	12.2	0.7	47.0	36.9
Queue Length 50th (m)	5.1	20.4	31.7	0.0	44.1	64.0
Queue Length 95th (m)	14.8	39.5	52.2	4.7	59.9	87.8
Internal Link Dist (m)		370.3	389.0		36.1	
Turn Bay Length (m)	60.0			178.0		
Base Capacity (vph)	581	2468	2136	1455	1635	519
Starvation Cap Reductn	0	0	0	0	0	0
Spillback Cap Reductn	0	0	0	0	0	0
Storage Cap Reductn	0	0	0	0	0	0
Reduced v/c Ratio	0.18	0.25	0.27	0.12	0.24	0.79
Intersection Summary						

Lanes, Volumes, Timings
6: Smyth Rd & Roger Guindon Ave

12/15/2023

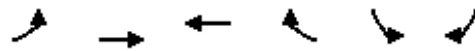

Lane Group	EBL	EBT	WBT	WBR	SBL	SBR	Ø3
Lane Configurations	↖	↕	↕		↖	↗	
Traffic Volume (vph)	35	970	537	87	485	210	
Future Volume (vph)	35	970	537	87	485	210	
Ideal Flow (vphpl)	1900	1900	1900	1900	1900	1900	
Storage Length (m)	67.0			0.0	35.0	0.0	
Storage Lanes	1			0	1	1	
Taper Length (m)	7.5				7.5		
Lane Util. Factor	1.00	0.95	0.95	0.95	1.00	1.00	
Ped Bike Factor	0.98		0.99		0.93	0.97	
Frt			0.979			0.850	
Flt Protected	0.950				0.950		
Satd. Flow (prot)	1703	3505	3381	0	1736	1553	
Flt Permitted	0.309				0.950		
Satd. Flow (perm)	544	3505	3381	0	1606	1514	
Right Turn on Red				Yes		Yes	
Satd. Flow (RTOR)			22			210	
Link Speed (k/h)		50	50		50		
Link Distance (m)		413.0	277.5		141.9		
Travel Time (s)		29.7	20.0		10.2		
Confl. Peds. (#/hr)	31			31	58	10	
Confl. Bikes (#/hr)				1		1	
Peak Hour Factor	1.00	1.00	1.00	1.00	1.00	1.00	
Heavy Vehicles (%)	6%	3%	4%	0%	4%	4%	
Adj. Flow (vph)	35	970	537	87	485	210	
Shared Lane Traffic (%)							
Lane Group Flow (vph)	35	970	624	0	485	210	
Enter Blocked Intersection	No	No	No	No	No	No	
Lane Alignment	Left	Left	Left	Right	Left	Right	
Median Width(m)		3.6	3.6		3.6		
Link Offset(m)		0.0	0.0		0.0		
Crosswalk Width(m)		4.8	4.8		4.8		
Two way Left Turn Lane							
Headway Factor	1.00	1.00	1.00	1.00	1.00	1.00	
Turning Speed (k/h)	25			15	25	15	
Number of Detectors	1	2	2		1	1	
Detector Template	Left	Thru	Thru		Left	Right	
Leading Detector (m)	2.0	10.0	10.0		2.0	2.0	
Trailing Detector (m)	0.0	0.0	0.0		0.0	0.0	
Detector 1 Position(m)	0.0	0.0	0.0		0.0	0.0	
Detector 1 Size(m)	2.0	0.6	0.6		2.0	2.0	
Detector 1 Type	CI+Ex	CI+Ex	CI+Ex		CI+Ex	CI+Ex	
Detector 1 Channel							
Detector 1 Extend (s)	0.0	0.0	0.0		0.0	0.0	
Detector 1 Queue (s)	0.0	0.0	0.0		0.0	0.0	
Detector 1 Delay (s)	0.0	0.0	0.0		0.0	0.0	
Detector 2 Position(m)		9.4	9.4				
Detector 2 Size(m)		0.6	0.6				
Detector 2 Type		CI+Ex	CI+Ex				
Detector 2 Channel							
Detector 2 Extend (s)		0.0	0.0				
Turn Type	pm+pt	NA	NA		Prot	Perm	
Protected Phases	5	2	6		4		3
Permitted Phases	2					4	

Lanes, Volumes, Timings
6: Smyth Rd & Roger Guindon Ave

12/15/2023

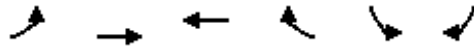

Lane Group	EBL	EBT	WBT	WBR	SBL	SBR	Ø3
Detector Phase	5	2	6		4	4	
Switch Phase							
Minimum Initial (s)	5.0	10.0	10.0		5.0	5.0	1.0
Minimum Split (s)	10.5	23.8	30.8		31.6	31.6	5.0
Total Split (s)	15.0	53.0	38.0		32.0	32.0	5.0
Total Split (%)	16.7%	58.9%	42.2%		35.6%	35.6%	6%
Maximum Green (s)	9.5	47.2	32.2		26.4	26.4	3.0
Yellow Time (s)	3.3	3.3	3.3		3.3	3.3	2.0
All-Red Time (s)	2.2	2.5	2.5		2.3	2.3	0.0
Lost Time Adjust (s)	0.0	0.0	0.0		0.0	0.0	
Total Lost Time (s)	5.5	5.8	5.8		5.6	5.6	
Lead/Lag	Lead		Lag		Lag	Lag	Lead
Lead-Lag Optimize?	Yes		Yes				
Vehicle Extension (s)	3.0	3.0	3.0		3.0	3.0	3.0
Recall Mode	None	C-Max	C-Max		None	None	None
Walk Time (s)			10.0		7.0	7.0	3.0
Flash Dont Walk (s)			15.0		14.0	14.0	0.0
Pedestrian Calls (#/hr)			31		68	68	68
Act Effct Green (s)	48.7	48.4	40.9		26.2	26.2	
Actuated g/C Ratio	0.54	0.54	0.45		0.29	0.29	
v/c Ratio	0.09	0.51	0.40		0.96	0.36	
Control Delay	10.9	14.8	18.3		64.3	5.5	
Queue Delay	0.0	0.0	0.0		0.0	0.0	
Total Delay	10.9	14.8	18.3		64.3	5.5	
LOS	B	B	B		E	A	
Approach Delay		14.7	18.3		46.6		
Approach LOS		B	B		D		

Intersection Summary

Area Type:	Other
Cycle Length:	90
Actuated Cycle Length:	90
Offset:	12 (13%), Referenced to phase 2:EBTL and 6:WBT, Start of Green
Natural Cycle:	80
Control Type:	Actuated-Coordinated
Maximum v/c Ratio:	0.96
Intersection Signal Delay:	25.2
Intersection LOS:	C
Intersection Capacity Utilization	65.5%
ICU Level of Service	C
Analysis Period (min)	15

Splits and Phases: 6: Smyth Rd & Roger Guindon Ave

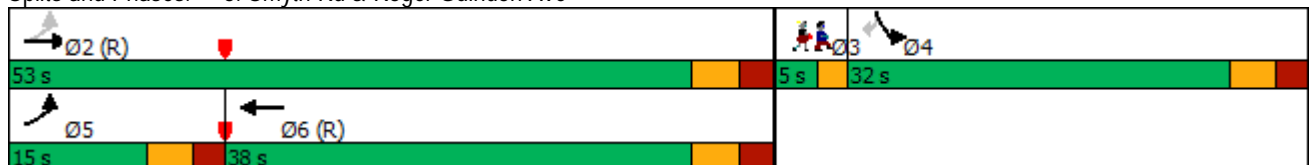

Queues

6: Smyth Rd & Roger Guindon Ave

12/15/2023



Lane Group	EBL	EBT	WBT	SBL	SBR
Lane Group Flow (vph)	35	970	624	485	210
v/c Ratio	0.09	0.51	0.40	0.96	0.36
Control Delay	10.9	14.8	18.3	64.3	5.5
Queue Delay	0.0	0.0	0.0	0.0	0.0
Total Delay	10.9	14.8	18.3	64.3	5.5
Queue Length 50th (m)	2.9	57.6	41.8	86.2	0.0
Queue Length 95th (m)	7.4	75.1	58.9	#148.6	15.9
Internal Link Dist (m)		389.0	253.5	117.9	
Turn Bay Length (m)	67.0			35.0	
Base Capacity (vph)	416	1884	1549	509	592
Starvation Cap Reductn	0	0	0	0	0
Spillback Cap Reductn	0	0	0	0	0
Storage Cap Reductn	0	0	0	0	0
Reduced v/c Ratio	0.08	0.51	0.40	0.95	0.35

Intersection Summary

95th percentile volume exceeds capacity, queue may be longer.
 Queue shown is maximum after two cycles.

HCM Unsignalized Intersection Capacity Analysis

7: Ring Rd & Hospital Link Rd

04-11-2024



Movement	EBT	EBR	WBL	WBT	NBL	NBR
Lane Configurations	↑			↑	↑	
Sign Control	Stop			Stop	Stop	
Traffic Volume (vph)	41	28	84	191	84	38
Future Volume (vph)	41	28	84	191	84	38
Peak Hour Factor	1.00	1.00	1.00	1.00	1.00	1.00
Hourly flow rate (vph)	41	28	84	191	84	38
Direction, Lane #	EB 1	WB 1	NB 1			
Volume Total (vph)	69	275	122			
Volume Left (vph)	0	84	84			
Volume Right (vph)	28	0	38			
Hadj (s)	-0.12	0.08	0.03			
Departure Headway (s)	4.4	4.4	4.7			
Degree Utilization, x	0.08	0.33	0.16			
Capacity (veh/h)	785	796	714			
Control Delay (s)	7.8	9.5	8.6			
Approach Delay (s)	7.8	9.5	8.6			
Approach LOS	A	A	A			
Intersection Summary						
Delay			9.0			
Level of Service			A			
Intersection Capacity Utilization			35.0%	ICU Level of Service	A	
Analysis Period (min)			15			

HCM Unsignalized Intersection Capacity Analysis

8: uOttawa-Rehab W Access & Hospital Link Rd

04-11-2024

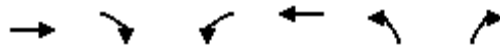

Movement	EBT	EBR	WBL	WBT	NBL	NBR
Lane Configurations	→			←	↘	↙
Traffic Volume (veh/h)	53	26	19	167	107	39
Future Volume (Veh/h)	53	26	19	167	107	39
Sign Control	Free			Free	Stop	
Grade	0%			0%	0%	
Peak Hour Factor	1.00	1.00	1.00	1.00	1.00	1.00
Hourly flow rate (vph)	53	26	19	167	107	39
Pedestrians						
Lane Width (m)						
Walking Speed (m/s)						
Percent Blockage						
Right turn flare (veh)						
Median type	None			None		
Median storage (veh)						
Upstream signal (m)						
pX, platoon unblocked						
vC, conflicting volume			79		271	66
vC1, stage 1 conf vol						
vC2, stage 2 conf vol						
vCu, unblocked vol			79		271	66
tC, single (s)			4.2		6.4	6.2
tC, 2 stage (s)						
tF (s)			2.3		3.5	3.3
p0 queue free %			99		85	96
cM capacity (veh/h)			1464		713	1003
Direction, Lane #	EB 1	WB 1	NB 1			
Volume Total	79	186	146			
Volume Left	0	19	107			
Volume Right	26	0	39			
cSH	1700	1464	773			
Volume to Capacity	0.05	0.01	0.19			
Queue Length 95th (m)	0.0	0.3	5.5			
Control Delay (s)	0.0	0.9	10.7			
Lane LOS		A	B			
Approach Delay (s)	0.0	0.9	10.7			
Approach LOS			B			
Intersection Summary						
Average Delay			4.2			
Intersection Capacity Utilization			31.5%	ICU Level of Service	A	
Analysis Period (min)			15			

HCM Unsignalized Intersection Capacity Analysis
 9: uOttawa-Rehab E Access & Hospital Link Rd

04-11-2024



Movement	EBT	EBR	WBL	WBT	NBL	NBR
Lane Configurations	↑			↑	↘	
Sign Control	Stop			Stop	Stop	
Traffic Volume (vph)	92	0	0	166	21	15
Future Volume (vph)	92	0	0	166	21	15
Peak Hour Factor	1.00	1.00	1.00	1.00	1.00	1.00
Hourly flow rate (vph)	92	0	0	166	21	15

Direction, Lane #	EB 1	WB 1	NB 1
Volume Total (vph)	92	166	36
Volume Left (vph)	0	0	21
Volume Right (vph)	0	0	15
Hadj (s)	0.08	0.02	0.12
Departure Headway (s)	4.2	4.1	4.6
Degree Utilization, x	0.11	0.19	0.05
Capacity (veh/h)	833	865	738
Control Delay (s)	7.7	8.1	7.8
Approach Delay (s)	7.7	8.1	7.8
Approach LOS	A	A	A

Intersection Summary			
Delay		7.9	
Level of Service		A	
Intersection Capacity Utilization	19.4%		ICU Level of Service A
Analysis Period (min)		15	

Lanes, Volumes, Timings

1: Alta Vista Dr & Hospital Link Rd

02/23/2024



Lane Group	EBL	EBT	EBR	WBL	WBT	WBR	NBL	NBT	NBR	SBL	SBT	SBR
Lane Configurations												
Traffic Volume (vph)	2	351	46	36	74	7	40	603	75	16	601	23
Future Volume (vph)	2	351	46	36	74	7	40	603	75	16	601	23
Ideal Flow (vphpl)	1800	1800	1800	1800	1800	1800	1800	1800	1800	1800	1800	1800
Storage Length (m)	0.0		0.0	25.0		40.0	30.0		0.0	25.0		0.0
Storage Lanes	1		0	1		1	1		0	1		0
Taper Length (m)	7.5			7.5			7.5			7.5		
Lane Util. Factor	1.00	1.00	1.00	1.00	1.00	1.00	1.00	1.00	1.00	1.00	1.00	1.00
Ped Bike Factor	0.99	0.99				0.97		1.00			1.00	
Frt		0.983				0.850		0.983			0.994	
Flt Protected	0.950			0.950			0.950			0.950		
Satd. Flow (prot)	1710	1703	0	1583	1579	1530	1710	1683	0	1710	1734	0
Flt Permitted	0.709			0.154			0.276			0.236		
Satd. Flow (perm)	1268	1703	0	257	1579	1489	497	1683	0	425	1734	0
Right Turn on Red			Yes			Yes			Yes			Yes
Satd. Flow (RTOR)		5				31		8			2	
Link Speed (k/h)		50			50			50			50	
Link Distance (m)		148.1			598.8			586.9			279.5	
Travel Time (s)		10.7			43.1			42.3			20.1	
Confl. Peds. (#/hr)	3		20	20		3	5		7	7		5
Confl. Bikes (#/hr)									1			
Peak Hour Factor	1.00	1.00	1.00	1.00	1.00	1.00	1.00	1.00	1.00	1.00	1.00	1.00
Heavy Vehicles (%)	0%	3%	4%	8%	14%	0%	0%	5%	2%	0%	3%	4%
Adj. Flow (vph)	2	351	46	36	74	7	40	603	75	16	601	23
Shared Lane Traffic (%)												
Lane Group Flow (vph)	2	397	0	36	74	7	40	678	0	16	624	0
Enter Blocked Intersection	No	No	No	No	No	No	No	No	No	No	No	No
Lane Alignment	Left	Left	Right	Left	Left	Right	Left	Left	Right	Left	Left	Right
Median Width(m)		3.6			3.6			3.6			3.6	
Link Offset(m)		0.0			0.0			0.0			0.0	
Crosswalk Width(m)		4.8			4.8			4.8			4.8	
Two way Left Turn Lane												
Headway Factor	1.07	1.07	1.07	1.07	1.07	1.07	1.07	1.07	1.07	1.07	1.07	1.07
Turning Speed (k/h)	25		15	25		15	25		15	25		15
Number of Detectors	1	2		1	2	1	1	2		1	2	
Detector Template	Left	Thru		Left	Thru	Right	Left	Thru		Left	Thru	
Leading Detector (m)	2.0	10.0		2.0	10.0	2.0	2.0	10.0		2.0	10.0	
Trailing Detector (m)	0.0	0.0		0.0	0.0	0.0	0.0	0.0		0.0	0.0	
Detector 1 Position(m)	0.0	0.0		0.0	0.0	0.0	0.0	0.0		0.0	0.0	
Detector 1 Size(m)	2.0	0.6		2.0	0.6	2.0	2.0	0.6		2.0	0.6	
Detector 1 Type	CI+Ex	CI+Ex		CI+Ex	CI+Ex	CI+Ex	CI+Ex	CI+Ex		CI+Ex	CI+Ex	
Detector 1 Channel												
Detector 1 Extend (s)	0.0	0.0		0.0	0.0	0.0	0.0	0.0		0.0	0.0	
Detector 1 Queue (s)	0.0	0.0		0.0	0.0	0.0	0.0	0.0		0.0	0.0	
Detector 1 Delay (s)	0.0	0.0		0.0	0.0	0.0	0.0	0.0		0.0	0.0	
Detector 2 Position(m)		9.4			9.4			9.4			9.4	
Detector 2 Size(m)		0.6			0.6			0.6			0.6	
Detector 2 Type		CI+Ex			CI+Ex			CI+Ex			CI+Ex	
Detector 2 Channel												
Detector 2 Extend (s)		0.0			0.0			0.0			0.0	
Turn Type	Perm	NA		pm+pt	NA	Perm	Perm	NA		Perm	NA	
Protected Phases		2		1	6			8			4	
Permitted Phases	2			6		6	8			4		

Lanes, Volumes, Timings
1: Alta Vista Dr & Hospital Link Rd

02/23/2024



Lane Group	EBL	EBT	EBR	WBL	WBT	WBR	NBL	NBT	NBR	SBL	SBT	SBR
Detector Phase	2	2		1	6	6	8	8		4	4	
Switch Phase												
Minimum Initial (s)	10.0	10.0		5.0	10.0	10.0	10.0	10.0		10.0	10.0	
Minimum Split (s)	30.5	30.5		11.5	30.5	30.5	27.3	27.3		27.3	27.3	
Total Split (s)	31.5	31.5		21.5	53.0	53.0	61.3	61.3		61.3	61.3	
Total Split (%)	27.6%	27.6%		18.8%	46.4%	46.4%	53.6%	53.6%		53.6%	53.6%	
Maximum Green (s)	25.0	25.0		15.0	46.5	46.5	55.0	55.0		55.0	55.0	
Yellow Time (s)	3.3	3.3		3.3	3.3	3.3	3.3	3.3		3.3	3.3	
All-Red Time (s)	3.2	3.2		3.2	3.2	3.2	3.0	3.0		3.0	3.0	
Lost Time Adjust (s)	0.0	0.0		0.0	0.0	0.0	0.0	0.0		0.0	0.0	
Total Lost Time (s)	6.5	6.5		6.5	6.5	6.5	6.3	6.3		6.3	6.3	
Lead/Lag	Lag	Lag		Lead								
Lead-Lag Optimize?	Yes	Yes		Yes								
Vehicle Extension (s)	3.0	3.0		3.0	3.0	3.0	3.0	3.0		3.0	3.0	
Recall Mode	None	None		None	None	None	Max	Max		Max	Max	
Walk Time (s)	7.0	7.0		7.0	7.0	7.0	7.0	7.0		7.0	7.0	
Flash Dont Walk (s)	17.0	17.0		17.0	17.0	17.0	14.0	14.0		14.0	14.0	
Pedestrian Calls (#/hr)	23	23		23	23	23	12	12		12	12	
Act Effct Green (s)	25.1	25.1		33.3	33.3	33.3	55.3	55.3		55.3	55.3	
Actuated g/C Ratio	0.25	0.25		0.33	0.33	0.33	0.54	0.54		0.54	0.54	
v/c Ratio	0.01	0.93		0.20	0.14	0.01	0.15	0.74		0.07	0.66	
Control Delay	32.0	69.2		25.1	23.9	0.0	15.4	24.9		14.4	22.0	
Queue Delay	0.0	0.0		0.0	0.0	0.0	0.0	0.0		0.0	0.0	
Total Delay	32.0	69.2		25.1	23.9	0.0	15.4	24.9		14.4	22.0	
LOS	C	E		C	C	A	B	C		B	C	
Approach Delay		69.0			22.8			24.4			21.8	
Approach LOS		E			C			C			C	

Intersection Summary

Area Type:	Other
Cycle Length:	114.3
Actuated Cycle Length:	101.5
Natural Cycle:	90
Control Type:	Semi Act-Uncoord
Maximum v/c Ratio:	0.93
Intersection Signal Delay:	32.9
Intersection LOS:	C
Intersection Capacity Utilization	80.6%
ICU Level of Service	D
Analysis Period (min)	15

Splits and Phases: 1: Alta Vista Dr & Hospital Link Rd

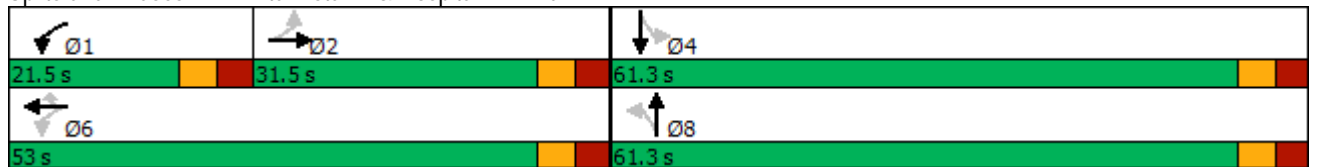

Queues

1: Alta Vista Dr & Hospital Link Rd

02/23/2024



Lane Group	EBL	EBT	WBL	WBT	WBR	NBL	NBT	SBL	SBT
Lane Group Flow (vph)	2	397	36	74	7	40	678	16	624
v/c Ratio	0.01	0.93	0.20	0.14	0.01	0.15	0.74	0.07	0.66
Control Delay	32.0	69.2	25.1	23.9	0.0	15.4	24.9	14.4	22.0
Queue Delay	0.0	0.0	0.0	0.0	0.0	0.0	0.0	0.0	0.0
Total Delay	32.0	69.2	25.1	23.9	0.0	15.4	24.9	14.4	22.0
Queue Length 50th (m)	0.3	85.5	5.1	10.7	0.0	4.4	112.9	1.7	97.9
Queue Length 95th (m)	2.4	#152.6	12.2	21.1	0.0	11.6	171.7	5.8	146.9
Internal Link Dist (m)		124.1		574.8			562.9		255.5
Turn Bay Length (m)			25.0		40.0	30.0		25.0	
Base Capacity (vph)	313	425	281	727	702	270	920	231	945
Starvation Cap Reductn	0	0	0	0	0	0	0	0	0
Spillback Cap Reductn	0	0	0	0	0	0	0	0	0
Storage Cap Reductn	0	0	0	0	0	0	0	0	0
Reduced v/c Ratio	0.01	0.93	0.13	0.10	0.01	0.15	0.74	0.07	0.66

Intersection Summary

95th percentile volume exceeds capacity, queue may be longer.
 Queue shown is maximum after two cycles.

Lanes, Volumes, Timings
2: Alta Vista Dr & Smyth Rd

02/23/2024



Lane Group	EBL	EBT	EBR	WBL	WBT	WBR	NBL	NBT	NBR	SBL	SBT	SBR
Lane Configurations												
Traffic Volume (vph)	168	849	106	87	491	159	334	392	198	229	208	128
Future Volume (vph)	168	849	106	87	491	159	334	392	198	229	208	128
Ideal Flow (vphpl)	1800	1800	1800	1800	1800	1800	1800	1800	1800	1800	1800	1800
Storage Length (m)	30.0		25.0	61.0		10.0	87.0		30.0	44.0		25.0
Storage Lanes	1		1	1		1	1		1	1		1
Taper Length (m)	7.5			7.5			7.5			7.5		
Lane Util. Factor	1.00	0.95	1.00	1.00	0.95	1.00	1.00	1.00	1.00	1.00	1.00	1.00
Ped Bike Factor	0.96		0.91			0.89	0.98		0.97	0.99		0.96
Fr't			0.850			0.850			0.850			0.850
Flt Protected	0.950			0.950			0.950			0.950		
Satd. Flow (prot)	1710	3353	1485	1644	3320	1500	1710	1731	1500	1676	1731	1530
Flt Permitted	0.329			0.188			0.518			0.246		
Satd. Flow (perm)	570	3353	1350	325	3320	1332	916	1731	1458	432	1731	1473
Right Turn on Red			Yes			Yes			Yes			Yes
Satd. Flow (RTOR)			139			139			137			137
Link Speed (k/h)		50			50			50			50	
Link Distance (m)		339.0			234.1			204.1			586.9	
Travel Time (s)		24.4			16.9			14.7			42.3	
Confl. Peds. (#/hr)	31		24	24		31	17		11	11		17
Peak Hour Factor	1.00	1.00	1.00	1.00	1.00	1.00	1.00	1.00	1.00	1.00	1.00	1.00
Heavy Vehicles (%)	0%	2%	3%	4%	3%	2%	0%	4%	2%	2%	4%	0%
Adj. Flow (vph)	168	849	106	87	491	159	334	392	198	229	208	128
Shared Lane Traffic (%)												
Lane Group Flow (vph)	168	849	106	87	491	159	334	392	198	229	208	128
Enter Blocked Intersection	No	No	No	No	No	No	No	No	No	No	No	No
Lane Alignment	Left	Left	Right	Left	Left	Right	Left	Left	Right	Left	Left	Right
Median Width(m)		3.6			3.6			3.6			3.6	
Link Offset(m)		0.0			0.0			0.0			0.0	
Crosswalk Width(m)		4.8			4.8			4.8			4.8	
Two way Left Turn Lane												
Headway Factor	1.07	1.07	1.07	1.07	1.07	1.07	1.07	1.07	1.07	1.07	1.07	1.07
Turning Speed (k/h)	25		15	25		15	25		15	25		15
Number of Detectors	1	2	1	1	2	1	1	2	1	1	2	1
Detector Template	Left	Thru	Right	Left	Thru	Right	Left	Thru	Right	Left	Thru	Right
Leading Detector (m)	2.0	10.0	2.0	2.0	10.0	2.0	2.0	10.0	2.0	2.0	10.0	2.0
Trailing Detector (m)	0.0	0.0	0.0	0.0	0.0	0.0	0.0	0.0	0.0	0.0	0.0	0.0
Detector 1 Position(m)	0.0	0.0	0.0	0.0	0.0	0.0	0.0	0.0	0.0	0.0	0.0	0.0
Detector 1 Size(m)	2.0	0.6	2.0	2.0	0.6	2.0	2.0	0.6	2.0	2.0	0.6	2.0
Detector 1 Type	CI+Ex	CI+Ex	CI+Ex	CI+Ex	CI+Ex	CI+Ex	CI+Ex	CI+Ex	CI+Ex	CI+Ex	CI+Ex	CI+Ex
Detector 1 Channel												
Detector 1 Extend (s)	0.0	0.0	0.0	0.0	0.0	0.0	0.0	0.0	0.0	0.0	0.0	0.0
Detector 1 Queue (s)	0.0	0.0	0.0	0.0	0.0	0.0	0.0	0.0	0.0	0.0	0.0	0.0
Detector 1 Delay (s)	0.0	0.0	0.0	0.0	0.0	0.0	0.0	0.0	0.0	0.0	0.0	0.0
Detector 2 Position(m)		9.4			9.4			9.4			9.4	
Detector 2 Size(m)		0.6			0.6			0.6			0.6	
Detector 2 Type		CI+Ex			CI+Ex			CI+Ex			CI+Ex	
Detector 2 Channel												
Detector 2 Extend (s)		0.0			0.0			0.0			0.0	
Turn Type	pm+pt	NA	Perm	pm+pt	NA	Perm	pm+pt	NA	Perm	pm+pt	NA	Perm
Protected Phases	5	2		1	6		3	8		7	4	
Permitted Phases	2		2	6		6	8		8	4		4
Detector Phase	5	2	2	1	6	6	3	8	8	7	4	4

Lanes, Volumes, Timings
2: Alta Vista Dr & Smyth Rd

02/23/2024



Lane Group	EBL	EBT	EBR	WBL	WBT	WBR	NBL	NBT	NBR	SBL	SBT	SBR
Switch Phase												
Minimum Initial (s)	5.0	10.0	10.0	5.0	10.0	10.0	5.0	10.0	10.0	5.0	10.0	10.0
Minimum Split (s)	10.5	24.8	24.8	10.5	24.8	24.8	11.1	29.1	29.1	11.1	29.1	29.1
Total Split (s)	20.0	38.0	38.0	20.0	38.0	38.0	20.0	37.0	37.0	20.0	37.0	37.0
Total Split (%)	17.4%	33.0%	33.0%	17.4%	33.0%	33.0%	17.4%	32.2%	32.2%	17.4%	32.2%	32.2%
Maximum Green (s)	14.5	32.2	32.2	14.5	32.2	32.2	13.9	30.9	30.9	13.9	30.9	30.9
Yellow Time (s)	3.3	3.3	3.3	3.3	3.3	3.3	3.3	3.3	3.3	3.3	3.3	3.3
All-Red Time (s)	2.2	2.5	2.5	2.2	2.5	2.5	2.8	2.8	2.8	2.8	2.8	2.8
Lost Time Adjust (s)	0.0	0.0	0.0	0.0	0.0	0.0	0.0	0.0	0.0	0.0	0.0	0.0
Total Lost Time (s)	5.5	5.8	5.8	5.5	5.8	5.8	6.1	6.1	6.1	6.1	6.1	6.1
Lead/Lag	Lead	Lag	Lag	Lead	Lag	Lag	Lead	Lag	Lag	Lead	Lag	Lag
Lead-Lag Optimize?	Yes	Yes	Yes	Yes	Yes	Yes	Yes	Yes	Yes	Yes	Yes	Yes
Vehicle Extension (s)	3.0	3.0	3.0	3.0	3.0	3.0	3.0	3.0	3.0	3.0	3.0	3.0
Recall Mode	None	C-Max	C-Max	None	C-Max	C-Max	None	Max	Max	None	Max	Max
Walk Time (s)		7.0	7.0		7.0	7.0		7.0	7.0		7.0	7.0
Flash Dont Walk (s)		12.0	12.0		12.0	12.0		16.0	16.0		16.0	16.0
Pedestrian Calls (#/hr)		55	55		55	55		28	28		28	28
Act Effct Green (s)	50.6	40.1	40.1	44.0	34.8	34.8	45.4	31.5	31.5	44.2	30.9	30.9
Actuated g/C Ratio	0.44	0.35	0.35	0.38	0.30	0.30	0.39	0.27	0.27	0.38	0.27	0.27
v/c Ratio	0.46	0.73	0.19	0.38	0.49	0.32	0.73	0.83	0.40	0.74	0.45	0.26
Control Delay	23.2	38.3	3.0	27.5	30.6	13.1	34.8	55.5	14.1	37.2	38.6	6.1
Queue Delay	0.0	0.0	0.0	0.0	0.0	0.0	0.0	0.0	0.0	0.0	0.0	0.0
Total Delay	23.2	38.3	3.0	27.5	30.6	13.1	34.8	55.5	14.1	37.2	38.6	6.1
LOS	C	D	A	C	C	B	C	E	B	D	D	A
Approach Delay		32.7			26.5			39.2			30.7	
Approach LOS		C			C			D			C	

Intersection Summary

Area Type:	Other
Cycle Length:	115
Actuated Cycle Length:	115
Offset:	2 (2%), Referenced to phase 2:EBTL and 6:WBTL, Start of Green
Natural Cycle:	90
Control Type:	Actuated-Coordinated
Maximum v/c Ratio:	0.83
Intersection Signal Delay:	32.8
Intersection LOS:	C
Intersection Capacity Utilization	88.1%
ICU Level of Service	E
Analysis Period (min)	15

Splits and Phases: 2: Alta Vista Dr & Smyth Rd

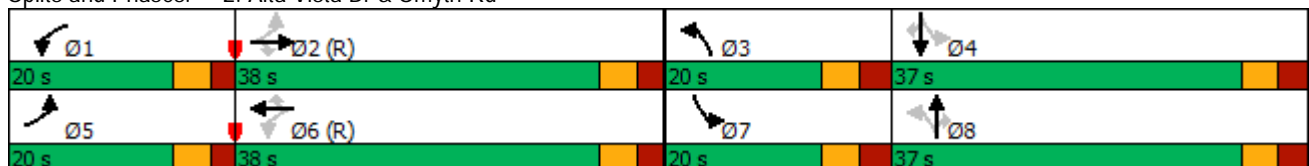

Queues

2: Alta Vista Dr & Smyth Rd

02/23/2024



Lane Group	EBL	EBT	EBR	WBL	WBT	WBR	NBL	NBT	NBR	SBL	SBT	SBR
Lane Group Flow (vph)	168	849	106	87	491	159	334	392	198	229	208	128
v/c Ratio	0.46	0.73	0.19	0.38	0.49	0.32	0.73	0.83	0.40	0.74	0.45	0.26
Control Delay	23.2	38.3	3.0	27.5	30.6	13.1	34.8	55.5	14.1	37.2	38.6	6.1
Queue Delay	0.0	0.0	0.0	0.0	0.0	0.0	0.0	0.0	0.0	0.0	0.0	0.0
Total Delay	23.2	38.3	3.0	27.5	30.6	13.1	34.8	55.5	14.1	37.2	38.6	6.1
Queue Length 50th (m)	23.4	94.6	0.0	5.7	30.5	0.1	53.6	88.0	11.1	34.3	41.0	0.0
Queue Length 95th (m)	38.2	124.6	7.2	32.7	64.0	30.0	79.4	#140.4	32.1	#55.1	64.8	13.1
Internal Link Dist (m)		315.0			210.1			180.1			562.9	
Turn Bay Length (m)	30.0		25.0	61.0		10.0	87.0		30.0	44.0		25.0
Base Capacity (vph)	399	1168	560	306	1003	499	457	474	498	318	465	495
Starvation Cap Reductn	0	0	0	0	0	0	0	0	0	0	0	0
Spillback Cap Reductn	0	0	0	0	0	0	0	0	0	0	0	0
Storage Cap Reductn	0	0	0	0	0	0	0	0	0	0	0	0
Reduced v/c Ratio	0.42	0.73	0.19	0.28	0.49	0.32	0.73	0.83	0.40	0.72	0.45	0.26

Intersection Summary

95th percentile volume exceeds capacity, queue may be longer.
 Queue shown is maximum after two cycles.

Lanes, Volumes, Timings

3: Smyth Rd & Valour Dr

02/23/2024

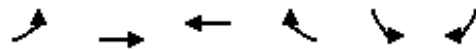

Lane Group	EBL	EBT	WBT	WBR	SBL	SBR
Lane Configurations	↖	↗↗	↖↖		↘	↖
Traffic Volume (vph)	34	1241	717	12	16	20
Future Volume (vph)	34	1241	717	12	16	20
Ideal Flow (vphpl)	1800	1800	1800	1800	1800	1800
Storage Length (m)	55.0			0.0	32.0	0.0
Storage Lanes	1			0	1	1
Taper Length (m)	7.5				7.5	
Lane Util. Factor	1.00	0.95	0.95	0.95	1.00	1.00
Ped Bike Factor	0.99		1.00			0.98
Frt			0.998			0.850
Flt Protected	0.950				0.950	
Satd. Flow (prot)	1613	3386	3310	0	1527	1457
Flt Permitted	0.375				0.950	
Satd. Flow (perm)	631	3386	3310	0	1527	1433
Right Turn on Red				Yes		Yes
Satd. Flow (RTOR)			3			20
Link Speed (k/h)		50	50		50	
Link Distance (m)		234.1	461.7		195.1	
Travel Time (s)		16.9	33.2		14.0	
Confl. Peds. (#/hr)	11			11		3
Peak Hour Factor	1.00	1.00	1.00	1.00	1.00	1.00
Heavy Vehicles (%)	6%	1%	3%	6%	12%	5%
Adj. Flow (vph)	34	1241	717	12	16	20
Shared Lane Traffic (%)						
Lane Group Flow (vph)	34	1241	729	0	16	20
Enter Blocked Intersection	No	No	No	No	No	No
Lane Alignment	Left	Left	Left	Right	Left	Right
Median Width(m)		3.6	3.6		3.6	
Link Offset(m)		0.0	0.0		0.0	
Crosswalk Width(m)		4.8	4.8		4.8	
Two way Left Turn Lane						
Headway Factor	1.07	1.07	1.07	1.07	1.07	1.07
Turning Speed (k/h)	25			15	25	15
Number of Detectors	1	2	2		1	1
Detector Template	Left	Thru	Thru		Left	Right
Leading Detector (m)	2.0	10.0	10.0		2.0	2.0
Trailing Detector (m)	0.0	0.0	0.0		0.0	0.0
Detector 1 Position(m)	0.0	0.0	0.0		0.0	0.0
Detector 1 Size(m)	2.0	0.6	0.6		2.0	2.0
Detector 1 Type	CI+Ex	CI+Ex	CI+Ex		CI+Ex	CI+Ex
Detector 1 Channel						
Detector 1 Extend (s)	0.0	0.0	0.0		0.0	0.0
Detector 1 Queue (s)	0.0	0.0	0.0		0.0	0.0
Detector 1 Delay (s)	0.0	0.0	0.0		0.0	0.0
Detector 2 Position(m)		9.4	9.4			
Detector 2 Size(m)		0.6	0.6			
Detector 2 Type		CI+Ex	CI+Ex			
Detector 2 Channel						
Detector 2 Extend (s)		0.0	0.0			
Turn Type	Perm	NA	NA		Prot	Perm
Protected Phases		2	6		4	
Permitted Phases	2					4
Detector Phase	2	2	6		4	4

Lanes, Volumes, Timings

3: Smyth Rd & Valour Dr

02/23/2024

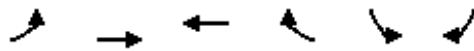

Lane Group	EBL	EBT	WBT	WBR	SBL	SBR
Switch Phase						
Minimum Initial (s)	10.0	10.0	10.0		5.0	5.0
Minimum Split (s)	29.5	29.5	29.5		28.5	28.5
Total Split (s)	84.0	84.0	84.0		31.0	31.0
Total Split (%)	73.0%	73.0%	73.0%		27.0%	27.0%
Maximum Green (s)	77.5	77.5	77.5		24.5	24.5
Yellow Time (s)	3.3	3.3	3.3		3.3	3.3
All-Red Time (s)	3.2	3.2	3.2		3.2	3.2
Lost Time Adjust (s)	0.0	0.0	0.0		0.0	0.0
Total Lost Time (s)	6.5	6.5	6.5		6.5	6.5
Lead/Lag						
Lead-Lag Optimize?						
Vehicle Extension (s)	3.0	3.0	3.0		3.0	3.0
Recall Mode	C-Max	C-Max	C-Max		None	None
Walk Time (s)	7.0	7.0	7.0		7.0	7.0
Flash Dont Walk (s)	16.0	16.0	16.0		15.0	15.0
Pedestrian Calls (#/hr)	11	11	11		3	3
Act Effct Green (s)	100.0	100.0	100.0		9.5	9.5
Actuated g/C Ratio	0.87	0.87	0.87		0.08	0.08
v/c Ratio	0.06	0.42	0.25		0.13	0.15
Control Delay	1.2	1.1	8.5		47.4	19.1
Queue Delay	0.0	0.0	0.0		0.0	0.0
Total Delay	1.2	1.1	8.5		47.4	19.1
LOS	A	A	A		D	B
Approach Delay		1.1	8.5		31.7	
Approach LOS		A	A		C	

Intersection Summary	
Area Type:	Other
Cycle Length:	115
Actuated Cycle Length:	115
Offset:	12 (10%), Referenced to phase 2:EBTL and 6:WBT, Start of Green
Natural Cycle:	60
Control Type:	Actuated-Coordinated
Maximum v/c Ratio:	0.42
Intersection Signal Delay:	4.3
Intersection LOS:	A
Intersection Capacity Utilization	52.6%
ICU Level of Service	A
Analysis Period (min)	15

Splits and Phases: 3: Smyth Rd & Valour Dr



Queues

3: Smyth Rd & Valour Dr

02/23/2024



Lane Group	EBL	EBT	WBT	SBL	SBR
Lane Group Flow (vph)	34	1241	729	16	20
v/c Ratio	0.06	0.42	0.25	0.13	0.15
Control Delay	1.2	1.1	8.5	47.4	19.1
Queue Delay	0.0	0.0	0.0	0.0	0.0
Total Delay	1.2	1.1	8.5	47.4	19.1
Queue Length 50th (m)	0.3	7.6	37.6	3.7	0.0
Queue Length 95th (m)	m1.0	13.7	82.0	9.6	6.9
Internal Link Dist (m)		210.1	437.7	171.1	
Turn Bay Length (m)	55.0			32.0	
Base Capacity (vph)	548	2943	2878	325	321
Starvation Cap Reductn	0	0	0	0	0
Spillback Cap Reductn	0	0	0	0	0
Storage Cap Reductn	0	0	0	0	0
Reduced v/c Ratio	0.06	0.42	0.25	0.05	0.06

Intersection Summary

m Volume for 95th percentile queue is metered by upstream signal.

Lanes, Volumes, Timings
4: S Haven Pl/Ring Rd & Smyth Rd

02/23/2024



Lane Group	EBL	EBT	EBR	WBL	WBT	WBR	NBL	NBT	NBR	SBL	SBT	SBR
Lane Configurations		↕↕			↕↕			↕↕			↕	↕
Traffic Volume (vph)	440	815	2	1	578	119	6	0	0	32	0	144
Future Volume (vph)	440	815	2	1	578	119	6	0	0	32	0	144
Ideal Flow (vphpl)	1800	1800	1800	1800	1800	1800	1800	1800	1800	1800	1800	1800
Lane Util. Factor	0.95	0.95	0.95	0.95	0.95	0.95	1.00	1.00	1.00	1.00	1.00	1.00
Ped Bike Factor		1.00			0.99						0.99	0.99
Frt					0.974							0.850
Flt Protected		0.983						0.950			0.950	
Satd. Flow (prot)	0	3328	0	0	3215	0	0	1710	0	0	1660	1443
Flt Permitted		0.603			0.954			0.736			0.754	
Satd. Flow (perm)	0	2038	0	0	3067	0	0	1325	0	0	1306	1423
Right Turn on Red			Yes			Yes			Yes			Yes
Satd. Flow (RTOR)					22							144
Link Speed (k/h)		50			50			50			50	
Link Distance (m)		461.7			394.3			74.8			50.7	
Travel Time (s)		33.2			28.4			5.4			3.7	
Confl. Peds. (#/hr)	11		2	2		11			6	6		
Confl. Bikes (#/hr)			8						4			2
Peak Hour Factor	1.00	1.00	1.00	1.00	1.00	1.00	1.00	1.00	1.00	1.00	1.00	1.00
Heavy Vehicles (%)	1%	1%	0%	0%	3%	2%	0%	0%	0%	3%	0%	6%
Adj. Flow (vph)	440	815	2	1	578	119	6	0	0	32	0	144
Shared Lane Traffic (%)												
Lane Group Flow (vph)	0	1257	0	0	698	0	0	6	0	0	32	144
Enter Blocked Intersection	No	No	No	No	No	No	No	No	No	No	No	No
Lane Alignment	Left	Left	Right	Left	Left	Right	Left	Left	Right	Left	Left	Right
Median Width(m)		3.6			3.6			0.0			0.0	
Link Offset(m)		0.0			0.0			0.0			0.0	
Crosswalk Width(m)		4.8			4.8			4.8			4.8	
Two way Left Turn Lane												
Headway Factor	1.07	1.07	1.07	1.07	1.07	1.07	1.07	1.07	1.07	1.07	1.07	1.07
Turning Speed (k/h)	25		15	25		15	25		15	25		15
Number of Detectors	1	2		1	2		1	2		1	2	1
Detector Template	Left	Thru		Left	Thru		Left	Thru		Left	Thru	Right
Leading Detector (m)	2.0	10.0		2.0	10.0		2.0	10.0		2.0	10.0	2.0
Trailing Detector (m)	0.0	0.0		0.0	0.0		0.0	0.0		0.0	0.0	0.0
Detector 1 Position(m)	0.0	0.0		0.0	0.0		0.0	0.0		0.0	0.0	0.0
Detector 1 Size(m)	2.0	0.6		2.0	0.6		2.0	0.6		2.0	0.6	2.0
Detector 1 Type	CI+Ex	CI+Ex		CI+Ex	CI+Ex		CI+Ex	CI+Ex		CI+Ex	CI+Ex	CI+Ex
Detector 1 Channel												
Detector 1 Extend (s)	0.0	0.0		0.0	0.0		0.0	0.0		0.0	0.0	0.0
Detector 1 Queue (s)	0.0	0.0		0.0	0.0		0.0	0.0		0.0	0.0	0.0
Detector 1 Delay (s)	0.0	0.0		0.0	0.0		0.0	0.0		0.0	0.0	0.0
Detector 2 Position(m)		9.4			9.4			9.4			9.4	
Detector 2 Size(m)		0.6			0.6			0.6			0.6	
Detector 2 Type		CI+Ex			CI+Ex			CI+Ex			CI+Ex	
Detector 2 Channel												
Detector 2 Extend (s)		0.0			0.0			0.0			0.0	
Turn Type	pm+pt	NA		Perm	NA		Perm	NA		Perm	NA	Perm
Protected Phases	5	2			6			8			4	
Permitted Phases	2			6			8			4		4
Detector Phase	5	2		6	6		8	8		4	4	4
Switch Phase												
Minimum Initial (s)	5.0	10.0		10.0	10.0		10.0	10.0		10.0	10.0	10.0

Lanes, Volumes, Timings
4: S Haven Pl/Ring Rd & Smyth Rd

02/23/2024



Lane Group	EBL	EBT	EBR	WBL	WBT	WBR	NBL	NBT	NBR	SBL	SBT	SBR
Minimum Split (s)	10.6	31.7		31.7	31.7		28.5	28.5		28.5	28.5	28.5
Total Split (s)	42.0	84.0		42.0	42.0		31.0	31.0		31.0	31.0	31.0
Total Split (%)	36.5%	73.0%		36.5%	36.5%		27.0%	27.0%		27.0%	27.0%	27.0%
Maximum Green (s)	36.4	78.3		36.3	36.3		25.5	25.5		25.5	25.5	25.5
Yellow Time (s)	3.3	3.3		3.3	3.3		3.3	3.3		3.3	3.3	3.3
All-Red Time (s)	2.3	2.4		2.4	2.4		2.2	2.2		2.2	2.2	2.2
Lost Time Adjust (s)		0.0			0.0			0.0			0.0	0.0
Total Lost Time (s)		5.7			5.7			5.5			5.5	5.5
Lead/Lag	Lead			Lag								
Lead-Lag Optimize?	Yes			Yes								
Vehicle Extension (s)	3.0	3.0		3.0	3.0		3.0	3.0		3.0	3.0	3.0
Recall Mode	None	C-Max		C-Max	C-Max		None	None		None	None	None
Walk Time (s)		7.0		7.0	7.0		7.0	7.0		7.0	7.0	7.0
Flash Dont Walk (s)		19.0		19.0	19.0		16.0	16.0		16.0	16.0	16.0
Pedestrian Calls (#/hr)		13		13	13		6	6		6	6	6
Act Effct Green (s)		91.2			91.2			12.6			12.6	12.6
Actuated g/C Ratio		0.79			0.79			0.11			0.11	0.11
v/c Ratio		0.78			0.29			0.04			0.22	0.51
Control Delay		14.9			2.4			42.8			48.5	13.5
Queue Delay		0.0			0.0			0.0			0.0	0.0
Total Delay		14.9			2.4			42.8			48.5	13.5
LOS		B			A			D			D	B
Approach Delay		14.9			2.4			42.8			19.8	
Approach LOS		B			A			D			B	

Intersection Summary

Area Type:	Other
Cycle Length:	115
Actuated Cycle Length:	115
Offset:	66 (57%), Referenced to phase 2:EBTL and 6:WBTL, Start of Green
Natural Cycle:	90
Control Type:	Actuated-Coordinated
Maximum v/c Ratio:	0.78
Intersection Signal Delay:	11.3
Intersection LOS:	B
Intersection Capacity Utilization:	83.4%
ICU Level of Service:	E
Analysis Period (min):	15

Splits and Phases: 4: S Haven Pl/Ring Rd & Smyth Rd

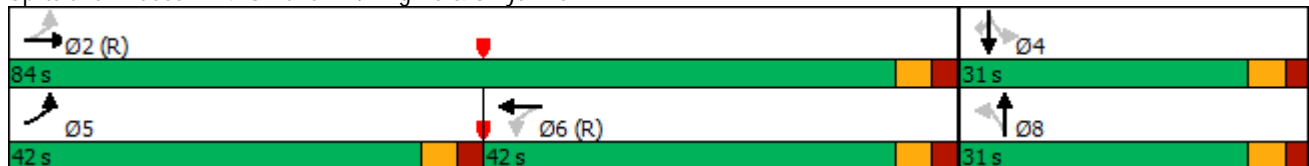

Queues

4: S Haven Pl/Ring Rd & Smyth Rd

02/23/2024



Lane Group	EBT	WBT	NBT	SBT	SBR
Lane Group Flow (vph)	1257	698	6	32	144
v/c Ratio	0.78	0.29	0.04	0.22	0.51
Control Delay	14.9	2.4	42.8	48.5	13.5
Queue Delay	0.0	0.0	0.0	0.0	0.0
Total Delay	14.9	2.4	42.8	48.5	13.5
Queue Length 50th (m)	55.3	8.4	1.3	7.2	0.0
Queue Length 95th (m)	71.6	15.2	5.1	15.4	17.3
Internal Link Dist (m)	437.7	370.3	50.8	26.7	
Turn Bay Length (m)					
Base Capacity (vph)	1616	2436	293	289	427
Starvation Cap Reductn	0	0	0	0	0
Spillback Cap Reductn	0	0	0	0	0
Storage Cap Reductn	0	0	0	0	0
Reduced v/c Ratio	0.78	0.29	0.02	0.11	0.34
Intersection Summary					

Lanes, Volumes, Timings
5: Smyth Rd & Hospital Main Access

02/23/2024

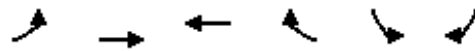

Lane Group	EBL	EBT	WBT	WBR	SBL	SBR
Lane Configurations	↖	↕	↕	↗	↖	↗
Traffic Volume (vph)	401	445	556	449	119	142
Future Volume (vph)	401	445	556	449	119	142
Ideal Flow (vphpl)	1800	1800	1800	1800	1800	1800
Storage Length (m)	60.0			178.0	0.0	0.0
Storage Lanes	1			1	2	1
Taper Length (m)	7.5				7.5	
Lane Util. Factor	1.00	0.95	0.95	1.00	0.97	1.00
Ped Bike Factor	1.00			0.97	0.88	0.97
Fr _t				0.850		0.850
Fl _t Protected	0.950				0.950	
Satd. Flow (prot)	1693	3353	3320	1515	3252	1515
Fl _t Permitted	0.374				0.950	
Satd. Flow (perm)	665	3353	3320	1471	2846	1468
Right Turn on Red				Yes		Yes
Satd. Flow (RTOR)				229		98
Link Speed (k/h)		50	50		50	
Link Distance (m)		394.3	413.0		60.1	
Travel Time (s)		28.4	29.7		4.3	
Confl. Peds. (#/hr)	3			3	50	13
Confl. Bikes (#/hr)				3		
Peak Hour Factor	1.00	1.00	1.00	1.00	1.00	1.00
Heavy Vehicles (%)	1%	2%	3%	1%	2%	1%
Adj. Flow (vph)	401	445	556	449	119	142
Shared Lane Traffic (%)						
Lane Group Flow (vph)	401	445	556	449	119	142
Enter Blocked Intersection	No	No	No	No	No	No
Lane Alignment	Left	Left	Left	Right	Left	Right
Median Width(m)		3.6	3.6		7.2	
Link Offset(m)		0.0	0.0		0.0	
Crosswalk Width(m)		4.8	4.8		4.8	
Two way Left Turn Lane						
Headway Factor	1.07	1.07	1.07	1.07	1.07	1.07
Turning Speed (k/h)	25			15	25	15
Number of Detectors	1	2	2	1	1	1
Detector Template	Left	Thru	Thru	Right	Left	Right
Leading Detector (m)	2.0	10.0	10.0	2.0	2.0	2.0
Trailing Detector (m)	0.0	0.0	0.0	0.0	0.0	0.0
Detector 1 Position(m)	0.0	0.0	0.0	0.0	0.0	0.0
Detector 1 Size(m)	2.0	0.6	0.6	2.0	2.0	2.0
Detector 1 Type	CI+Ex	CI+Ex	CI+Ex	CI+Ex	CI+Ex	CI+Ex
Detector 1 Channel						
Detector 1 Extend (s)	0.0	0.0	0.0	0.0	0.0	0.0
Detector 1 Queue (s)	0.0	0.0	0.0	0.0	0.0	0.0
Detector 1 Delay (s)	0.0	0.0	0.0	0.0	0.0	0.0
Detector 2 Position(m)		9.4	9.4			
Detector 2 Size(m)		0.6	0.6			
Detector 2 Type		CI+Ex	CI+Ex			
Detector 2 Channel						
Detector 2 Extend (s)		0.0	0.0			
Turn Type	pm+pt	NA	NA	pm+ov	Prot	pm+ov
Protected Phases	5	2	6	4	4	5
Permitted Phases	2			6		4

Lanes, Volumes, Timings
5: Smyth Rd & Hospital Main Access

02/23/2024

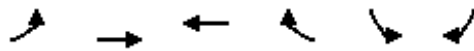

Lane Group	EBL	EBT	WBT	WBR	SBL	SBR
Detector Phase	5	2	6	4	4	5
Switch Phase						
Minimum Initial (s)	5.0	10.0	10.0	5.0	5.0	5.0
Minimum Split (s)	15.9	34.4	41.4	29.3	29.3	15.9
Total Split (s)	28.0	70.0	42.0	45.0	45.0	28.0
Total Split (%)	24.3%	60.9%	36.5%	39.1%	39.1%	24.3%
Maximum Green (s)	22.1	63.6	35.6	38.7	38.7	22.1
Yellow Time (s)	3.3	3.3	3.3	3.3	3.3	3.3
All-Red Time (s)	2.6	3.1	3.1	3.0	3.0	2.6
Lost Time Adjust (s)	0.0	0.0	0.0	0.0	0.0	0.0
Total Lost Time (s)	5.9	6.4	6.4	6.3	6.3	5.9
Lead/Lag	Lead		Lag			Lead
Lead-Lag Optimize?	Yes		Yes			Yes
Vehicle Extension (s)	3.0	3.0	3.0	3.0	3.0	3.0
Recall Mode	None	C-Max	C-Max	None	None	None
Walk Time (s)		7.0	7.0	7.0	7.0	
Flash Dont Walk (s)		21.0	28.0	16.0	16.0	
Pedestrian Calls (#/hr)		3	3	63	63	
Act Effct Green (s)	83.0	82.5	59.5	79.4	19.8	37.3
Actuated g/C Ratio	0.72	0.72	0.52	0.69	0.17	0.32
v/c Ratio	0.63	0.18	0.32	0.41	0.21	0.26
Control Delay	15.8	9.8	18.6	4.1	40.3	8.3
Queue Delay	0.0	0.0	0.0	0.0	0.0	0.0
Total Delay	15.8	9.8	18.6	4.1	40.3	8.3
LOS	B	A	B	A	D	A
Approach Delay		12.6	12.1		22.9	
Approach LOS		B	B		C	

Intersection Summary

Area Type:	Other
Cycle Length:	115
Actuated Cycle Length:	115
Offset:	43 (37%), Referenced to phase 2:EBTL and 6:WBT, Start of Green
Natural Cycle:	90
Control Type:	Actuated-Coordinated
Maximum v/c Ratio:	0.63
Intersection Signal Delay:	13.6
Intersection LOS:	B
Intersection Capacity Utilization	77.6%
ICU Level of Service	D
Analysis Period (min)	15

Splits and Phases: 5: Smyth Rd & Hospital Main Access

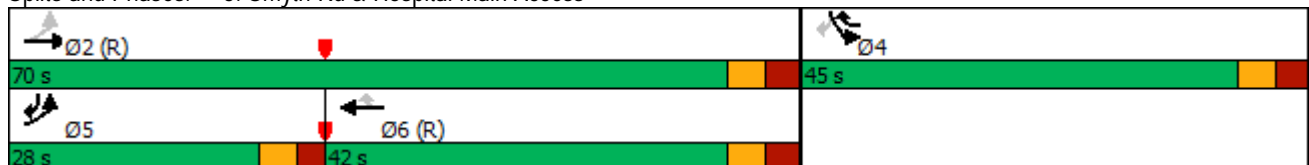

Queues

5: Smyth Rd & Hospital Main Access

02/23/2024

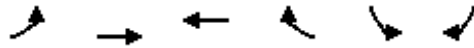

Lane Group	EBL	EBT	WBT	WBR	SBL	SBR
Lane Group Flow (vph)	401	445	556	449	119	142
v/c Ratio	0.63	0.18	0.32	0.41	0.21	0.26
Control Delay	15.8	9.8	18.6	4.1	40.3	8.3
Queue Delay	0.0	0.0	0.0	0.0	0.0	0.0
Total Delay	15.8	9.8	18.6	4.1	40.3	8.3
Queue Length 50th (m)	64.6	30.5	41.2	13.4	12.1	6.3
Queue Length 95th (m)	m83.6	m35.7	61.5	33.5	20.6	17.4
Internal Link Dist (m)		370.3	389.0		36.1	
Turn Bay Length (m)	60.0			178.0		
Base Capacity (vph)	681	2406	1718	1284	1094	616
Starvation Cap Reductn	0	0	0	0	0	0
Spillback Cap Reductn	0	0	0	0	0	0
Storage Cap Reductn	0	0	0	0	0	0
Reduced v/c Ratio	0.59	0.18	0.32	0.35	0.11	0.23

Intersection Summary

m Volume for 95th percentile queue is metered by upstream signal.

Lanes, Volumes, Timings
6: Smyth Rd & Roger Guindon Ave

02/23/2024

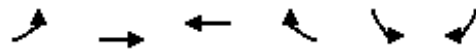

Lane Group	EBL	EBT	WBT	WBR	SBL	SBR	Ø3
Lane Configurations	↖	↕	↕		↖	↗	
Traffic Volume (vph)	195	369	963	490	113	43	
Future Volume (vph)	195	369	963	490	113	43	
Ideal Flow (vphpl)	1800	1800	1800	1800	1800	1800	
Storage Length (m)	67.0			0.0	35.0	0.0	
Storage Lanes	1			0	1	1	
Taper Length (m)	7.5				7.5		
Lane Util. Factor	1.00	0.95	0.95	0.95	1.00	1.00	
Ped Bike Factor			0.99		0.99	0.99	
Frt			0.949			0.850	
Flt Protected	0.950				0.950		
Satd. Flow (prot)	1710	3288	3162	0	1644	1530	
Flt Permitted	0.083				0.950		
Satd. Flow (perm)	149	3288	3162	0	1629	1510	
Right Turn on Red				Yes		Yes	
Satd. Flow (RTOR)			111			43	
Link Speed (k/h)		50	50		50		
Link Distance (m)		413.0	277.5		141.9		
Travel Time (s)		29.7	20.0		10.2		
Confl. Peds. (#/hr)	9			9	7	1	
Confl. Bikes (#/hr)				2			
Peak Hour Factor	1.00	1.00	1.00	1.00	1.00	1.00	
Heavy Vehicles (%)	0%	4%	2%	0%	4%	0%	
Adj. Flow (vph)	195	369	963	490	113	43	
Shared Lane Traffic (%)							
Lane Group Flow (vph)	195	369	1453	0	113	43	
Enter Blocked Intersection	No	No	No	No	No	No	
Lane Alignment	Left	Left	Left	Right	Left	Right	
Median Width(m)		3.6	3.6		3.6		
Link Offset(m)		0.0	0.0		0.0		
Crosswalk Width(m)		4.8	4.8		4.8		
Two way Left Turn Lane							
Headway Factor	1.07	1.07	1.07	1.07	1.07	1.07	
Turning Speed (k/h)	25			15	25	15	
Number of Detectors	1	2	2		1	1	
Detector Template	Left	Thru	Thru		Left	Right	
Leading Detector (m)	2.0	10.0	10.0		2.0	2.0	
Trailing Detector (m)	0.0	0.0	0.0		0.0	0.0	
Detector 1 Position(m)	0.0	0.0	0.0		0.0	0.0	
Detector 1 Size(m)	2.0	0.6	0.6		2.0	2.0	
Detector 1 Type	CI+Ex	CI+Ex	CI+Ex		CI+Ex	CI+Ex	
Detector 1 Channel							
Detector 1 Extend (s)	0.0	0.0	0.0		0.0	0.0	
Detector 1 Queue (s)	0.0	0.0	0.0		0.0	0.0	
Detector 1 Delay (s)	0.0	0.0	0.0		0.0	0.0	
Detector 2 Position(m)		9.4	9.4				
Detector 2 Size(m)		0.6	0.6				
Detector 2 Type		CI+Ex	CI+Ex				
Detector 2 Channel							
Detector 2 Extend (s)		0.0	0.0				
Turn Type	pm+pt	NA	NA		Prot	Perm	
Protected Phases	5	2	6		4		3
Permitted Phases	2					4	

Future Total (2026) AM

Lanes, Volumes, Timings
6: Smyth Rd & Roger Guindon Ave

02/23/2024

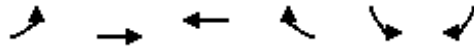

Lane Group	EBL	EBT	WBT	WBR	SBL	SBR	Ø3
Detector Phase	5	2	6		4	4	
Switch Phase							
Minimum Initial (s)	5.0	10.0	10.0		5.0	5.0	1.0
Minimum Split (s)	10.5	23.8	30.8		31.6	31.6	5.0
Total Split (s)	15.0	53.0	38.0		32.0	32.0	5.0
Total Split (%)	16.7%	58.9%	42.2%		35.6%	35.6%	6%
Maximum Green (s)	9.5	47.2	32.2		26.4	26.4	3.0
Yellow Time (s)	3.3	3.3	3.3		3.3	3.3	2.0
All-Red Time (s)	2.2	2.5	2.5		2.3	2.3	0.0
Lost Time Adjust (s)	0.0	0.0	0.0		0.0	0.0	
Total Lost Time (s)	5.5	5.8	5.8		5.6	5.6	
Lead/Lag	Lead		Lag		Lag	Lag	Lead
Lead-Lag Optimize?	Yes		Yes				
Vehicle Extension (s)	3.0	3.0	3.0		3.0	3.0	3.0
Recall Mode	None	C-Max	C-Max		None	None	None
Walk Time (s)			10.0		7.0	7.0	3.0
Flash Dont Walk (s)			15.0		14.0	14.0	0.0
Pedestrian Calls (#/hr)			9		8	8	8
Act Effct Green (s)	67.9	68.8	52.1		12.5	12.5	
Actuated g/C Ratio	0.75	0.76	0.58		0.14	0.14	
v/c Ratio	0.68	0.15	0.77		0.50	0.17	
Control Delay	26.7	4.8	20.8		41.9	11.2	
Queue Delay	0.0	0.0	0.0		0.0	0.0	
Total Delay	26.7	4.8	20.8		41.9	11.2	
LOS	C	A	C		D	B	
Approach Delay		12.4	20.8		33.5		
Approach LOS		B	C		C		

Intersection Summary

Area Type:	Other
Cycle Length:	90
Actuated Cycle Length:	90
Offset:	12 (13%), Referenced to phase 2:EBTL and 6:WBT, Start of Green
Natural Cycle:	100
Control Type:	Actuated-Coordinated
Maximum v/c Ratio:	0.77
Intersection Signal Delay:	19.5
Intersection LOS:	B
Intersection Capacity Utilization	77.4%
ICU Level of Service	D
Analysis Period (min)	15

Splits and Phases: 6: Smyth Rd & Roger Guindon Ave

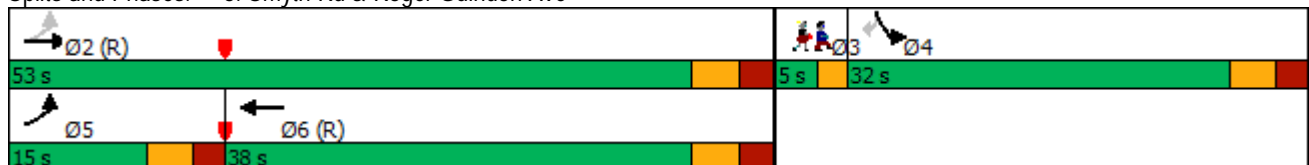

Queues

6: Smyth Rd & Roger Guindon Ave

02/23/2024

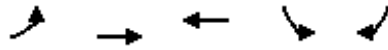

Lane Group	EBL	EBT	WBT	SBL	SBR
Lane Group Flow (vph)	195	369	1453	113	43
v/c Ratio	0.68	0.15	0.77	0.50	0.17
Control Delay	26.7	4.8	20.8	41.9	11.2
Queue Delay	0.0	0.0	0.0	0.0	0.0
Total Delay	26.7	4.8	20.8	41.9	11.2
Queue Length 50th (m)	14.9	8.2	90.3	19.6	0.0
Queue Length 95th (m)	41.9	22.2	#208.7	32.3	8.3
Internal Link Dist (m)		389.0	253.5	117.9	
Turn Bay Length (m)	67.0			35.0	
Base Capacity (vph)	304	2512	1876	482	473
Starvation Cap Reductn	0	0	0	0	0
Spillback Cap Reductn	0	0	0	0	0
Storage Cap Reductn	0	0	0	0	0
Reduced v/c Ratio	0.64	0.15	0.77	0.23	0.09

Intersection Summary

95th percentile volume exceeds capacity, queue may be longer.
 Queue shown is maximum after two cycles.

HCM Unsignalized Intersection Capacity Analysis

7: Ring Rd & Hospital Link Rd

04/10/2024



Movement	EBT	EBR	WBL	WBT	NBL	NBR
Lane Configurations	↻			↻	↻	
Sign Control	Stop			Stop	Stop	
Traffic Volume (vph)	223	218	45	79	38	121
Future Volume (vph)	223	218	45	79	38	121
Peak Hour Factor	1.00	1.00	1.00	1.00	1.00	1.00
Hourly flow rate (vph)	223	218	45	79	38	121

Direction, Lane #	EB 1	WB 1	NB 1
Volume Total (vph)	441	124	159
Volume Left (vph)	0	45	38
Volume Right (vph)	218	0	121
Hadj (s)	-0.28	0.14	-0.32
Departure Headway (s)	4.2	4.9	4.8
Degree Utilization, x	0.51	0.17	0.21
Capacity (veh/h)	827	689	668
Control Delay (s)	11.5	8.9	9.1
Approach Delay (s)	11.5	8.9	9.1
Approach LOS	B	A	A

Intersection Summary			
Delay		10.5	
Level of Service		B	
Intersection Capacity Utilization	54.3%		ICU Level of Service A
Analysis Period (min)		15	

HCM Unsignalized Intersection Capacity Analysis

8: uOttawa-Rehab W Access & Hospital Link Rd

04/10/2024

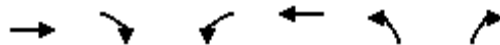

Movement	EBT	EBR	WBL	WBT	NBL	NBR
Lane Configurations						
Traffic Volume (veh/h)	194	61	33	117	1	2
Future Volume (Veh/h)	194	61	33	117	1	2
Sign Control	Free			Free	Stop	
Grade	0%			0%	0%	
Peak Hour Factor	1.00	1.00	1.00	1.00	1.00	1.00
Hourly flow rate (vph)	194	61	33	117	1	2
Pedestrians					1	
Lane Width (m)					3.6	
Walking Speed (m/s)					1.2	
Percent Blockage					0	
Right turn flare (veh)						
Median type	None			None		
Median storage veh						
Upstream signal (m)						
pX, platoon unblocked						
vC, conflicting volume			256		408	226
vC1, stage 1 conf vol						
vC2, stage 2 conf vol						
vCu, unblocked vol			256		408	226
tC, single (s)			4.1		6.4	6.2
tC, 2 stage (s)						
tF (s)			2.2		3.5	3.3
p0 queue free %			97		100	100
cM capacity (veh/h)			1308		587	818
Direction, Lane #	EB 1	WB 1	NB 1			
Volume Total	255	150	3			
Volume Left	0	33	1			
Volume Right	61	0	2			
cSH	1700	1308	723			
Volume to Capacity	0.15	0.03	0.00			
Queue Length 95th (m)	0.0	0.6	0.1			
Control Delay (s)	0.0	1.9	10.0			
Lane LOS			A			
Approach Delay (s)	0.0	1.9	10.0			
Approach LOS			A			
Intersection Summary						
Average Delay			0.8			
Intersection Capacity Utilization			36.5%	ICU Level of Service	A	
Analysis Period (min)			15			

HCM Unsignalized Intersection Capacity Analysis

9: uOttawa-Rehab E Access & Hospital Link Rd

04-11-2024



Movement	EBT	EBR	WBL	WBT	NBL	NBR
Lane Configurations	↑			↑	↘	↘
Sign Control	Stop			Stop	Stop	
Traffic Volume (vph)	197	0	0	106	44	26
Future Volume (vph)	197	0	0	106	44	26
Peak Hour Factor	1.00	1.00	1.00	1.00	1.00	1.00
Hourly flow rate (vph)	197	0	0	106	44	26

Direction, Lane #	EB 1	WB 1	NB 1
Volume Total (vph)	197	106	70
Volume Left (vph)	0	0	44
Volume Right (vph)	0	0	26
Hadj (s)	0.05	0.08	0.07
Departure Headway (s)	4.2	4.4	4.6
Degree Utilization, x	0.23	0.13	0.09
Capacity (veh/h)	831	804	725
Control Delay (s)	8.5	8.0	8.1
Approach Delay (s)	8.5	8.0	8.1
Approach LOS	A	A	A

Intersection Summary		
Delay		8.3
Level of Service		A
Intersection Capacity Utilization	22.1%	ICU Level of Service
Analysis Period (min)		15

HCM Unsignalized Intersection Capacity Analysis

10: AMRC Driveway & Hospital Link Rd

04/10/2024



Movement	EBT	EBR	WBL	WBT	NBL	NBR
Lane Configurations						
Traffic Volume (veh/h)	249	94	32	87	38	6
Future Volume (Veh/h)	249	94	32	87	38	6
Sign Control	Free			Free	Stop	
Grade	0%			0%	0%	
Peak Hour Factor	1.00	1.00	1.00	1.00	1.00	1.00
Hourly flow rate (vph)	249	94	32	87	38	6
Pedestrians						
Lane Width (m)						
Walking Speed (m/s)						
Percent Blockage						
Right turn flare (veh)						
Median type	None			None		
Median storage veh						
Upstream signal (m)						
pX, platoon unblocked						
vC, conflicting volume			343		447	296
vC1, stage 1 conf vol						
vC2, stage 2 conf vol						
vCu, unblocked vol			343		447	296
tC, single (s)			4.1		6.4	6.2
tC, 2 stage (s)						
tF (s)			2.2		3.5	3.3
p0 queue free %			97		93	99
cM capacity (veh/h)			1216		554	743
Direction, Lane #	EB 1	WB 1	NB 1			
Volume Total	343	119	44			
Volume Left	0	32	38			
Volume Right	94	0	6			
cSH	1700	1216	574			
Volume to Capacity	0.20	0.03	0.08			
Queue Length 95th (m)	0.0	0.6	2.0			
Control Delay (s)	0.0	2.3	11.8			
Lane LOS		A	B			
Approach Delay (s)	0.0	2.3	11.8			
Approach LOS			B			
Intersection Summary						
Average Delay			1.6			
Intersection Capacity Utilization			39.9%	ICU Level of Service	A	
Analysis Period (min)			15			

Lanes, Volumes, Timings

1: Alta Vista Dr & Hospital Link Rd

02/23/2024



Lane Group	EBL	EBT	EBR	WBL	WBT	WBR	NBL	NBT	NBR	SBL	SBT	SBR
Lane Configurations												
Traffic Volume (vph)	0	64	36	60	250	16	22	790	31	1	551	12
Future Volume (vph)	0	64	36	60	250	16	22	790	31	1	551	12
Ideal Flow (vphpl)	1900	1900	1900	1900	1900	1900	1900	1900	1900	1900	1900	1900
Storage Length (m)	0.0		0.0	25.0		40.0	30.0		0.0	25.0		0.0
Storage Lanes	1		0	1		1	1		0	1		0
Taper Length (m)	7.5			7.5			7.5			7.5		
Lane Util. Factor	1.00	1.00	1.00	1.00	1.00	1.00	1.00	1.00	1.00	1.00	1.00	1.00
Ped Bike Factor		0.99		0.98		0.95	0.99	1.00			1.00	
Frt		0.946				0.850		0.994			0.997	
Flt Protected				0.950			0.950			0.950		
Satd. Flow (prot)	1900	1716	0	1719	1845	1524	1805	1849	0	1805	1839	0
Flt Permitted				0.487			0.352			0.176		
Satd. Flow (perm)	1900	1716	0	867	1845	1450	665	1849	0	334	1839	0
Right Turn on Red			Yes			Yes			Yes			Yes
Satd. Flow (RTOR)		23				31		2			1	
Link Speed (k/h)		50			50			50			50	
Link Distance (m)		148.1			598.8			586.9			279.5	
Travel Time (s)		10.7			43.1			42.3			20.1	
Confl. Peds. (#/hr)	12		9	9		12	9		14	14		9
Peak Hour Factor	1.00	1.00	1.00	1.00	1.00	1.00	1.00	1.00	1.00	1.00	1.00	1.00
Heavy Vehicles (%)	0%	5%	0%	5%	3%	6%	0%	2%	0%	0%	3%	0%
Adj. Flow (vph)	0	64	36	60	250	16	22	790	31	1	551	12
Shared Lane Traffic (%)												
Lane Group Flow (vph)	0	100	0	60	250	16	22	821	0	1	563	0
Enter Blocked Intersection	No	No	No	No	No	No	No	No	No	No	No	No
Lane Alignment	Left	Left	Right	Left	Left	Right	Left	Left	Right	Left	Left	Right
Median Width(m)		3.6			3.6			3.6			3.6	
Link Offset(m)		0.0			0.0			0.0			0.0	
Crosswalk Width(m)		4.8			4.8			4.8			4.8	
Two way Left Turn Lane												
Headway Factor	1.00	1.00	1.00	1.00	1.00	1.00	1.00	1.00	1.00	1.00	1.00	1.00
Turning Speed (k/h)	25		15	25		15	25		15	25		15
Number of Detectors	1	2		1	2	1	1	2		1	2	
Detector Template	Left	Thru		Left	Thru	Right	Left	Thru		Left	Thru	
Leading Detector (m)	2.0	10.0		2.0	10.0	2.0	2.0	10.0		2.0	10.0	
Trailing Detector (m)	0.0	0.0		0.0	0.0	0.0	0.0	0.0		0.0	0.0	
Detector 1 Position(m)	0.0	0.0		0.0	0.0	0.0	0.0	0.0		0.0	0.0	
Detector 1 Size(m)	2.0	0.6		2.0	0.6	2.0	2.0	0.6		2.0	0.6	
Detector 1 Type	CI+Ex	CI+Ex		CI+Ex	CI+Ex	CI+Ex	CI+Ex	CI+Ex		CI+Ex	CI+Ex	
Detector 1 Channel												
Detector 1 Extend (s)	0.0	0.0		0.0	0.0	0.0	0.0	0.0		0.0	0.0	
Detector 1 Queue (s)	0.0	0.0		0.0	0.0	0.0	0.0	0.0		0.0	0.0	
Detector 1 Delay (s)	0.0	0.0		0.0	0.0	0.0	0.0	0.0		0.0	0.0	
Detector 2 Position(m)		9.4			9.4			9.4			9.4	
Detector 2 Size(m)		0.6			0.6			0.6			0.6	
Detector 2 Type		CI+Ex			CI+Ex			CI+Ex			CI+Ex	
Detector 2 Channel												
Detector 2 Extend (s)		0.0			0.0			0.0			0.0	
Turn Type	Perm	NA		pm+pt	NA	Perm	Perm	NA		Perm	NA	
Protected Phases		2		1	6			8			4	
Permitted Phases	2			6		6	8			4		
Detector Phase	2	2		1	6	6	8	8		4	4	

Lanes, Volumes, Timings

1: Alta Vista Dr & Hospital Link Rd

02/23/2024



Lane Group	EBL	EBT	EBR	WBL	WBT	WBR	NBL	NBT	NBR	SBL	SBT	SBR
Switch Phase												
Minimum Initial (s)	10.0	10.0		5.0	10.0	10.0	10.0	10.0		10.0	10.0	
Minimum Split (s)	30.5	30.5		11.5	30.5	30.5	27.3	27.3		27.3	27.3	
Total Split (s)	31.5	31.5		21.5	53.0	53.0	61.3	61.3		61.3	61.3	
Total Split (%)	27.6%	27.6%		18.8%	46.4%	46.4%	53.6%	53.6%		53.6%	53.6%	
Maximum Green (s)	25.0	25.0		15.0	46.5	46.5	55.0	55.0		55.0	55.0	
Yellow Time (s)	3.3	3.3		3.3	3.3	3.3	3.3	3.3		3.3	3.3	
All-Red Time (s)	3.2	3.2		3.2	3.2	3.2	3.0	3.0		3.0	3.0	
Lost Time Adjust (s)	0.0	0.0		0.0	0.0	0.0	0.0	0.0		0.0	0.0	
Total Lost Time (s)	6.5	6.5		6.5	6.5	6.5	6.3	6.3		6.3	6.3	
Lead/Lag	Lag	Lag		Lead								
Lead-Lag Optimize?	Yes	Yes		Yes								
Vehicle Extension (s)	3.0	3.0		3.0	3.0	3.0	3.0	3.0		3.0	3.0	
Recall Mode	None	None		None	None	None	Max	Max		Max	Max	
Walk Time (s)	7.0	7.0			7.0	7.0	7.0	7.0		7.0	7.0	
Flash Dont Walk (s)	17.0	17.0			17.0	17.0	14.0	14.0		14.0	14.0	
Pedestrian Calls (#/hr)	21	21			21	21	23	23		23	23	
Act Effct Green (s)		15.4		26.9	26.9	26.9	55.8	55.8		55.8	55.8	
Actuated g/C Ratio		0.16		0.28	0.28	0.28	0.58	0.58		0.58	0.58	
v/c Ratio		0.34		0.19	0.48	0.04	0.06	0.76		0.01	0.52	
Control Delay		31.4		25.0	30.6	3.6	12.8	23.8		13.0	16.6	
Queue Delay		0.0		0.0	0.0	0.0	0.0	0.0		0.0	0.0	
Total Delay		31.4		25.0	30.6	3.6	12.8	23.8		13.0	16.6	
LOS		C		C	C	A	B	C		B	B	
Approach Delay		31.4			28.2			23.5			16.6	
Approach LOS		C			C			C			B	

Intersection Summary

Area Type:	Other
Cycle Length:	114.3
Actuated Cycle Length:	95.7
Natural Cycle:	90
Control Type:	Semi Act-Uncoord
Maximum v/c Ratio:	0.76
Intersection Signal Delay:	22.6
Intersection LOS:	C
Intersection Capacity Utilization:	69.6%
ICU Level of Service:	C
Analysis Period (min):	15

Splits and Phases: 1: Alta Vista Dr & Hospital Link Rd

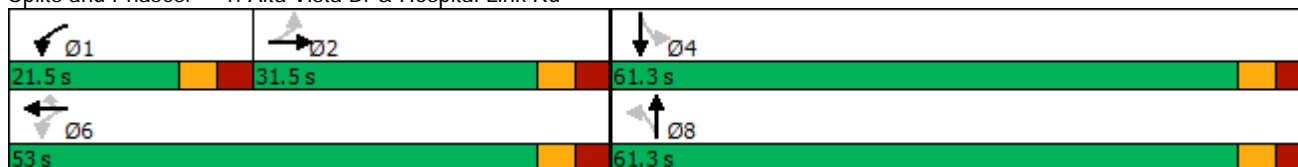

Queues

1: Alta Vista Dr & Hospital Link Rd

02/23/2024



Lane Group	EBT	WBL	WBT	WBR	NBL	NBT	SBL	SBT
Lane Group Flow (vph)	100	60	250	16	22	821	1	563
v/c Ratio	0.34	0.19	0.48	0.04	0.06	0.76	0.01	0.52
Control Delay	31.4	25.0	30.6	3.6	12.8	23.8	13.0	16.6
Queue Delay	0.0	0.0	0.0	0.0	0.0	0.0	0.0	0.0
Total Delay	31.4	25.0	30.6	3.6	12.8	23.8	13.0	16.6
Queue Length 50th (m)	13.7	8.6	39.8	0.0	1.6	102.1	0.1	56.2
Queue Length 95th (m)	29.5	17.7	61.5	2.5	6.9	#239.8	1.0	122.2
Internal Link Dist (m)	124.1		574.8			562.9		255.5
Turn Bay Length (m)		25.0		40.0	30.0		25.0	
Base Capacity (vph)	471	387	908	730	388	1079	194	1073
Starvation Cap Reductn	0	0	0	0	0	0	0	0
Spillback Cap Reductn	0	0	0	0	0	0	0	0
Storage Cap Reductn	0	0	0	0	0	0	0	0
Reduced v/c Ratio	0.21	0.16	0.28	0.02	0.06	0.76	0.01	0.52

Intersection Summary

95th percentile volume exceeds capacity, queue may be longer.
 Queue shown is maximum after two cycles.

Lanes, Volumes, Timings
2: Alta Vista Dr & Smyth Rd

02/23/2024

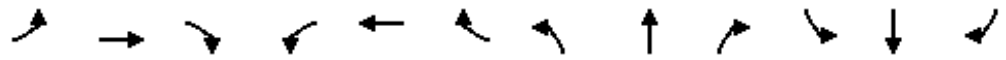

Lane Group	EBL	EBT	EBR	WBL	WBT	WBR	NBL	NBT	NBR	SBL	SBT	SBR
Lane Configurations												
Traffic Volume (vph)	192	474	210	257	866	251	104	297	73	121	425	222
Future Volume (vph)	192	474	210	257	866	251	104	297	73	121	425	222
Ideal Flow (vphpl)	1900	1900	1900	1900	1900	1900	1900	1900	1900	1900	1900	1900
Storage Length (m)	30.0		25.0	61.0		10.0	87.0		30.0	44.0		25.0
Storage Lanes	1		1	1		1	1		1	1		1
Taper Length (m)	7.5			7.5			7.5			7.5		
Lane Util. Factor	1.00	0.95	1.00	1.00	0.95	1.00	1.00	1.00	1.00	1.00	1.00	1.00
Ped Bike Factor			0.95	0.99		0.81	1.00		0.98	0.99		0.97
Frt			0.850			0.850			0.850			0.850
Flt Protected	0.950			0.950			0.950			0.950		
Satd. Flow (prot)	1787	3438	1615	1805	3539	1583	1770	1845	1568	1752	1845	1599
Flt Permitted	0.191			0.391			0.150			0.325		
Satd. Flow (perm)	359	3438	1538	734	3539	1283	278	1845	1529	596	1845	1553
Right Turn on Red			Yes			Yes			Yes			Yes
Satd. Flow (RTOR)			163			139			137			137
Link Speed (k/h)		50			50			50			50	
Link Distance (m)		339.0			234.1			204.1			586.9	
Travel Time (s)		24.4			16.9			14.7			42.3	
Confl. Peds. (#/hr)	56		9	9		56	10		8	8		10
Confl. Bikes (#/hr)			1			4			1			2
Peak Hour Factor	1.00	1.00	1.00	1.00	1.00	1.00	1.00	1.00	1.00	1.00	1.00	1.00
Heavy Vehicles (%)	1%	5%	0%	0%	2%	2%	2%	3%	3%	3%	3%	1%
Adj. Flow (vph)	192	474	210	257	866	251	104	297	73	121	425	222
Shared Lane Traffic (%)												
Lane Group Flow (vph)	192	474	210	257	866	251	104	297	73	121	425	222
Enter Blocked Intersection	No	No	No	No	No	No	No	No	No	No	No	No
Lane Alignment	Left	Left	Right	Left	Left	Right	Left	Left	Right	Left	Left	Right
Median Width(m)		3.6			3.6			3.6			3.6	
Link Offset(m)		0.0			0.0			0.0			0.0	
Crosswalk Width(m)		4.8			4.8			4.8			4.8	
Two way Left Turn Lane												
Headway Factor	1.00	1.00	1.00	1.00	1.00	1.00	1.00	1.00	1.00	1.00	1.00	1.00
Turning Speed (k/h)	25		15	25		15	25		15	25		15
Number of Detectors	1	2	1	1	2	1	1	2	1	1	2	1
Detector Template	Left	Thru	Right	Left	Thru	Right	Left	Thru	Right	Left	Thru	Right
Leading Detector (m)	2.0	10.0	2.0	2.0	10.0	2.0	2.0	10.0	2.0	2.0	10.0	2.0
Trailing Detector (m)	0.0	0.0	0.0	0.0	0.0	0.0	0.0	0.0	0.0	0.0	0.0	0.0
Detector 1 Position(m)	0.0	0.0	0.0	0.0	0.0	0.0	0.0	0.0	0.0	0.0	0.0	0.0
Detector 1 Size(m)	2.0	0.6	2.0	2.0	0.6	2.0	2.0	0.6	2.0	2.0	0.6	2.0
Detector 1 Type	CI+Ex	CI+Ex	CI+Ex	CI+Ex	CI+Ex	CI+Ex	CI+Ex	CI+Ex	CI+Ex	CI+Ex	CI+Ex	CI+Ex
Detector 1 Channel												
Detector 1 Extend (s)	0.0	0.0	0.0	0.0	0.0	0.0	0.0	0.0	0.0	0.0	0.0	0.0
Detector 1 Queue (s)	0.0	0.0	0.0	0.0	0.0	0.0	0.0	0.0	0.0	0.0	0.0	0.0
Detector 1 Delay (s)	0.0	0.0	0.0	0.0	0.0	0.0	0.0	0.0	0.0	0.0	0.0	0.0
Detector 2 Position(m)		9.4			9.4			9.4			9.4	
Detector 2 Size(m)		0.6			0.6			0.6			0.6	
Detector 2 Type		CI+Ex			CI+Ex			CI+Ex			CI+Ex	
Detector 2 Channel												
Detector 2 Extend (s)		0.0			0.0			0.0			0.0	
Turn Type	pm+pt	NA	Perm	pm+pt	NA	Perm	pm+pt	NA	Perm	pm+pt	NA	Perm
Protected Phases	5	2		1	6		3	8		7	4	
Permitted Phases	2		2	6		6	8		8	4		4

Lanes, Volumes, Timings

2: Alta Vista Dr & Smyth Rd

02/23/2024



Lane Group	EBL	EBT	EBR	WBL	WBT	WBR	NBL	NBT	NBR	SBL	SBT	SBR
Detector Phase	5	2	2	1	6	6	3	8	8	7	4	4
Switch Phase												
Minimum Initial (s)	5.0	10.0	10.0	5.0	10.0	10.0	5.0	10.0	10.0	5.0	10.0	10.0
Minimum Split (s)	10.5	24.8	24.8	10.5	24.8	24.8	11.1	29.1	29.1	11.1	29.1	29.1
Total Split (s)	22.0	44.0	44.0	22.0	44.0	44.0	18.0	31.0	31.0	18.0	31.0	31.0
Total Split (%)	19.1%	38.3%	38.3%	19.1%	38.3%	38.3%	15.7%	27.0%	27.0%	15.7%	27.0%	27.0%
Maximum Green (s)	16.5	38.2	38.2	16.5	38.2	38.2	11.9	24.9	24.9	11.9	24.9	24.9
Yellow Time (s)	3.3	3.3	3.3	3.3	3.3	3.3	3.3	3.3	3.3	3.3	3.3	3.3
All-Red Time (s)	2.2	2.5	2.5	2.2	2.5	2.5	2.8	2.8	2.8	2.8	2.8	2.8
Lost Time Adjust (s)	0.0	0.0	0.0	0.0	0.0	0.0	0.0	0.0	0.0	0.0	0.0	0.0
Total Lost Time (s)	5.5	5.8	5.8	5.5	5.8	5.8	6.1	6.1	6.1	6.1	6.1	6.1
Lead/Lag	Lead	Lag	Lag	Lead	Lag	Lag	Lead	Lag	Lag	Lead	Lag	Lag
Lead-Lag Optimize?	Yes	Yes	Yes	Yes	Yes	Yes	Yes	Yes	Yes	Yes	Yes	Yes
Vehicle Extension (s)	3.0	3.0	3.0	3.0	3.0	3.0	3.0	3.0	3.0	3.0	3.0	3.0
Recall Mode	None	C-Max	C-Max	None	C-Max	C-Max	None	Max	Max	None	Max	Max
Walk Time (s)		7.0	7.0		7.0	7.0		7.0	7.0		7.0	7.0
Flash Dont Walk (s)		12.0	12.0		12.0	12.0		16.0	16.0		16.0	16.0
Pedestrian Calls (#/hr)		65	65		65	65		18	18		18	18
Act Effct Green (s)	53.2	40.7	40.7	56.8	42.5	42.5	36.3	26.6	26.6	37.3	27.1	27.1
Actuated g/C Ratio	0.46	0.35	0.35	0.49	0.37	0.37	0.32	0.23	0.23	0.32	0.24	0.24
v/c Ratio	0.61	0.39	0.32	0.52	0.66	0.45	0.49	0.70	0.16	0.41	0.98	0.47
Control Delay	23.6	29.5	9.0	20.5	30.2	15.1	32.5	50.9	0.7	29.0	83.2	18.9
Queue Delay	0.0	0.0	0.0	0.0	0.0	0.0	0.0	0.0	0.0	0.0	0.0	0.0
Total Delay	23.6	29.5	9.0	20.5	30.2	15.1	32.5	50.9	0.7	29.0	83.2	18.9
LOS	C	C	A	C	C	B	C	D	A	C	F	B
Approach Delay		23.3			25.6			39.2			56.1	
Approach LOS		C			C			D			E	

Intersection Summary

Area Type:	Other
Cycle Length:	115
Actuated Cycle Length:	115
Offset:	0 (0%), Referenced to phase 2:EBTL and 6:WBTL, Start of Green
Natural Cycle:	80
Control Type:	Actuated-Coordinated
Maximum v/c Ratio:	0.98
Intersection Signal Delay:	33.6
Intersection LOS:	C
Intersection Capacity Utilization:	82.3%
ICU Level of Service:	E
Analysis Period (min):	15

Splits and Phases: 2: Alta Vista Dr & Smyth Rd

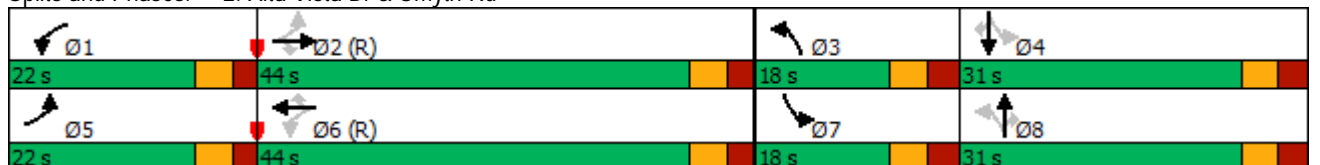

Queues

2: Alta Vista Dr & Smyth Rd

02/23/2024



Lane Group	EBL	EBT	EBR	WBL	WBT	WBR	NBL	NBT	NBR	SBL	SBT	SBR
Lane Group Flow (vph)	192	474	210	257	866	251	104	297	73	121	425	222
v/c Ratio	0.61	0.39	0.32	0.52	0.66	0.45	0.49	0.70	0.16	0.41	0.98	0.47
Control Delay	23.6	29.5	9.0	20.5	30.2	15.1	32.5	50.9	0.7	29.0	83.2	18.9
Queue Delay	0.0	0.0	0.0	0.0	0.0	0.0	0.0	0.0	0.0	0.0	0.0	0.0
Total Delay	23.6	29.5	9.0	20.5	30.2	15.1	32.5	50.9	0.7	29.0	83.2	18.9
Queue Length 50th (m)	23.2	44.2	7.4	25.4	46.0	2.8	16.2	65.3	0.0	19.1	100.8	16.4
Queue Length 95th (m)	37.0	61.0	26.1	65.7	96.0	47.3	29.1	#103.8	0.0	33.1	#174.9	41.7
Internal Link Dist (m)		315.0			210.1			180.1			562.9	
Turn Bay Length (m)	30.0		25.0	61.0		10.0	87.0		30.0	44.0		25.0
Base Capacity (vph)	383	1215	649	527	1306	561	247	426	458	321	434	470
Starvation Cap Reductn	0	0	0	0	0	0	0	0	0	0	0	0
Spillback Cap Reductn	0	0	0	0	0	0	0	0	0	0	0	0
Storage Cap Reductn	0	0	0	0	0	0	0	0	0	0	0	0
Reduced v/c Ratio	0.50	0.39	0.32	0.49	0.66	0.45	0.42	0.70	0.16	0.38	0.98	0.47

Intersection Summary

95th percentile volume exceeds capacity, queue may be longer.
 Queue shown is maximum after two cycles.

Lanes, Volumes, Timings 3: Smyth Rd & Valour Dr

02/23/2024

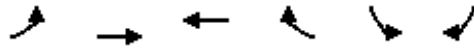

Lane Group	EBL	EBT	WBT	WBR	SBL	SBR
Lane Configurations	↖	↗	↖		↘	↘
Traffic Volume (vph)	31	637	1322	12	14	52
Future Volume (vph)	31	637	1322	12	14	52
Ideal Flow (vphpl)	1900	1900	1900	1900	1900	1900
Storage Length (m)	55.0			0.0	32.0	0.0
Storage Lanes	1			0	1	1
Taper Length (m)	7.5				7.5	
Lane Util. Factor	1.00	0.95	0.95	0.95	1.00	1.00
Ped Bike Factor			1.00		1.00	0.99
Frt			0.999			0.850
Flt Protected	0.950				0.950	
Satd. Flow (prot)	1752	3471	3527	0	1703	1583
Flt Permitted	0.162				0.950	
Satd. Flow (perm)	299	3471	3527	0	1695	1562
Right Turn on Red				Yes		Yes
Satd. Flow (RTOR)			1			52
Link Speed (k/h)		50	50		50	
Link Distance (m)		234.1	461.7		195.1	
Travel Time (s)		16.9	33.2		14.0	
Confl. Peds. (#/hr)	15			15	3	1
Peak Hour Factor	1.00	1.00	1.00	1.00	1.00	1.00
Heavy Vehicles (%)	3%	4%	2%	23%	6%	2%
Adj. Flow (vph)	31	637	1322	12	14	52
Shared Lane Traffic (%)						
Lane Group Flow (vph)	31	637	1334	0	14	52
Enter Blocked Intersection	No	No	No	No	No	No
Lane Alignment	Left	Left	Left	Right	Left	Right
Median Width(m)		3.6	3.6		3.6	
Link Offset(m)		0.0	0.0		0.0	
Crosswalk Width(m)		4.8	4.8		4.8	
Two way Left Turn Lane						
Headway Factor	1.00	1.00	1.00	1.00	1.00	1.00
Turning Speed (k/h)	25			15	25	15
Number of Detectors	1	2	2		1	1
Detector Template	Left	Thru	Thru		Left	Right
Leading Detector (m)	2.0	10.0	10.0		2.0	2.0
Trailing Detector (m)	0.0	0.0	0.0		0.0	0.0
Detector 1 Position(m)	0.0	0.0	0.0		0.0	0.0
Detector 1 Size(m)	2.0	0.6	0.6		2.0	2.0
Detector 1 Type	CI+Ex	CI+Ex	CI+Ex		CI+Ex	CI+Ex
Detector 1 Channel						
Detector 1 Extend (s)	0.0	0.0	0.0		0.0	0.0
Detector 1 Queue (s)	0.0	0.0	0.0		0.0	0.0
Detector 1 Delay (s)	0.0	0.0	0.0		0.0	0.0
Detector 2 Position(m)		9.4	9.4			
Detector 2 Size(m)		0.6	0.6			
Detector 2 Type		CI+Ex	CI+Ex			
Detector 2 Channel						
Detector 2 Extend (s)		0.0	0.0			
Turn Type	pm+pt	NA	NA		Prot	Perm
Protected Phases	5	2	6		4	
Permitted Phases	2					4
Detector Phase	5	2	6		4	4

Lanes, Volumes, Timings

3: Smyth Rd & Valour Dr

02/23/2024

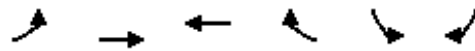

Lane Group	EBL	EBT	WBT	WBR	SBL	SBR
Switch Phase						
Minimum Initial (s)	5.0	10.0	10.0		5.0	5.0
Minimum Split (s)	10.7	29.5	29.5		28.5	28.5
Total Split (s)	18.0	85.0	67.0		30.0	30.0
Total Split (%)	15.7%	73.9%	58.3%		26.1%	26.1%
Maximum Green (s)	12.3	78.5	60.5		23.5	23.5
Yellow Time (s)	3.3	3.3	3.3		3.3	3.3
All-Red Time (s)	2.4	3.2	3.2		3.2	3.2
Lost Time Adjust (s)	0.0	0.0	0.0		0.0	0.0
Total Lost Time (s)	5.7	6.5	6.5		6.5	6.5
Lead/Lag	Lead		Lag			
Lead-Lag Optimize?	Yes		Yes			
Vehicle Extension (s)	3.0	3.0	3.0		3.0	3.0
Recall Mode	None	C-Max	C-Max		None	None
Walk Time (s)		7.0	7.0		7.0	7.0
Flash Dont Walk (s)		16.0	16.0		15.0	15.0
Pedestrian Calls (#/hr)		15	15		4	4
Act Effct Green (s)	95.9	96.4	89.2		9.3	9.3
Actuated g/C Ratio	0.83	0.84	0.78		0.08	0.08
v/c Ratio	0.10	0.22	0.49		0.10	0.30
Control Delay	1.5	0.9	14.2		46.6	16.3
Queue Delay	0.0	0.0	0.0		0.0	0.0
Total Delay	1.5	0.9	14.2		46.6	16.3
LOS	A	A	B		D	B
Approach Delay		0.9	14.2		22.7	
Approach LOS		A	B		C	

Intersection Summary

Area Type:	Other
Cycle Length:	115
Actuated Cycle Length:	115
Offset:	12 (10%), Referenced to phase 2:EBTL and 6:WBT, Start of Green
Natural Cycle:	80
Control Type:	Actuated-Coordinated
Maximum v/c Ratio:	0.49
Intersection Signal Delay:	10.2
Intersection LOS:	B
Intersection Capacity Utilization:	52.4%
ICU Level of Service:	A
Analysis Period (min):	15

Splits and Phases: 3: Smyth Rd & Valour Dr



Queues

3: Smyth Rd & Valour Dr

02/23/2024



Lane Group	EBL	EBT	WBT	SBL	SBR
Lane Group Flow (vph)	31	637	1334	14	52
v/c Ratio	0.10	0.22	0.49	0.10	0.30
Control Delay	1.5	0.9	14.2	46.6	16.3
Queue Delay	0.0	0.0	0.0	0.0	0.0
Total Delay	1.5	0.9	14.2	46.6	16.3
Queue Length 50th (m)	0.4	3.2	93.7	3.2	0.0
Queue Length 95th (m)	1.4	8.2	160.9	8.5	10.8
Internal Link Dist (m)		210.1	437.7	171.1	
Turn Bay Length (m)	55.0			32.0	
Base Capacity (vph)	404	2909	2736	348	360
Starvation Cap Reductn	0	0	0	0	0
Spillback Cap Reductn	0	0	0	0	0
Storage Cap Reductn	0	0	0	0	0
Reduced v/c Ratio	0.08	0.22	0.49	0.04	0.14
Intersection Summary					

Lanes, Volumes, Timings
4: S Haven Pl/Ring Rd & Smyth Rd

02/23/2024



Lane Group	EBL	EBT	EBR	WBL	WBT	WBR	NBL	NBT	NBR	SBL	SBT	SBR
Lane Configurations		↕↕			↕↕			↕↕			↕	↕
Traffic Volume (vph)	105	542	4	4	934	13	5	0	4	145	1	395
Future Volume (vph)	105	542	4	4	934	13	5	0	4	145	1	395
Ideal Flow (vphpl)	1900	1900	1900	1900	1900	1900	1900	1900	1900	1900	1900	1900
Lane Util. Factor	0.95	0.95	0.95	0.95	0.95	0.95	1.00	1.00	1.00	1.00	1.00	1.00
Ped Bike Factor		1.00			1.00			0.99			0.99	0.97
Frt		0.999			0.998			0.940				0.850
Flt Protected		0.992						0.973			0.953	
Satd. Flow (prot)	0	3468	0	0	3531	0	0	1722	0	0	1793	1599
Flt Permitted		0.654			0.953			0.871			0.722	
Satd. Flow (perm)	0	2285	0	0	3365	0	0	1538	0	0	1346	1555
Right Turn on Red			Yes			Yes			Yes			Yes
Satd. Flow (RTOR)		1			2			79				237
Link Speed (k/h)		50			50			50			50	
Link Distance (m)		461.7			394.3			74.8			50.7	
Travel Time (s)		33.2			28.4			5.4			3.7	
Confl. Peds. (#/hr)	14		6	6		14	3		6	6		3
Confl. Bikes (#/hr)			2			4						14
Peak Hour Factor	1.00	1.00	1.00	1.00	1.00	1.00	1.00	1.00	1.00	1.00	1.00	1.00
Heavy Vehicles (%)	4%	3%	0%	0%	2%	0%	0%	0%	0%	1%	0%	1%
Adj. Flow (vph)	105	542	4	4	934	13	5	0	4	145	1	395
Shared Lane Traffic (%)												
Lane Group Flow (vph)	0	651	0	0	951	0	0	9	0	0	146	395
Enter Blocked Intersection	No	No	No	No	No	No	No	No	No	No	No	No
Lane Alignment	Left	Left	Right	Left	Left	Right	Left	Left	Right	Left	Left	Right
Median Width(m)		3.6			3.6			0.0			0.0	
Link Offset(m)		0.0			0.0			0.0			0.0	
Crosswalk Width(m)		4.8			4.8			4.8			4.8	
Two way Left Turn Lane												
Headway Factor	1.00	1.00	1.00	1.00	1.00	1.00	1.00	1.00	1.00	1.00	1.00	1.00
Turning Speed (k/h)	25		15	25		15	25		15	25		15
Number of Detectors	1	2		1	2		1	2		1	2	1
Detector Template	Left	Thru		Left	Thru		Left	Thru		Left	Thru	Right
Leading Detector (m)	2.0	10.0		2.0	10.0		2.0	10.0		2.0	10.0	2.0
Trailing Detector (m)	0.0	0.0		0.0	0.0		0.0	0.0		0.0	0.0	0.0
Detector 1 Position(m)	0.0	0.0		0.0	0.0		0.0	0.0		0.0	0.0	0.0
Detector 1 Size(m)	2.0	0.6		2.0	0.6		2.0	0.6		2.0	0.6	2.0
Detector 1 Type	CI+Ex	CI+Ex		CI+Ex	CI+Ex		CI+Ex	CI+Ex		CI+Ex	CI+Ex	CI+Ex
Detector 1 Channel												
Detector 1 Extend (s)	0.0	0.0		0.0	0.0		0.0	0.0		0.0	0.0	0.0
Detector 1 Queue (s)	0.0	0.0		0.0	0.0		0.0	0.0		0.0	0.0	0.0
Detector 1 Delay (s)	0.0	0.0		0.0	0.0		0.0	0.0		0.0	0.0	0.0
Detector 2 Position(m)		9.4			9.4			9.4			9.4	
Detector 2 Size(m)		0.6			0.6			0.6			0.6	
Detector 2 Type		CI+Ex			CI+Ex			CI+Ex			CI+Ex	
Detector 2 Channel												
Detector 2 Extend (s)		0.0			0.0			0.0			0.0	
Turn Type	pm+pt	NA		Perm	NA		Perm	NA		Perm	NA	Perm
Protected Phases	5	2			6			8			4	
Permitted Phases	2			6			8			4		4
Detector Phase	5	2		6	6		8	8		4	4	4
Switch Phase												
Minimum Initial (s)	5.0	10.0		10.0	10.0		10.0	10.0		10.0	10.0	10.0

Lanes, Volumes, Timings
4: S Haven Pl/Ring Rd & Smyth Rd

02/23/2024



Lane Group	EBL	EBT	EBR	WBL	WBT	WBR	NBL	NBT	NBR	SBL	SBT	SBR
Minimum Split (s)	10.6	31.7		31.7	31.7		28.5	28.5		28.5	28.5	28.5
Total Split (s)	16.0	78.0		62.0	62.0		37.0	37.0		37.0	37.0	37.0
Total Split (%)	13.9%	67.8%		53.9%	53.9%		32.2%	32.2%		32.2%	32.2%	32.2%
Maximum Green (s)	10.4	72.3		56.3	56.3		31.5	31.5		31.5	31.5	31.5
Yellow Time (s)	3.3	3.3		3.3	3.3		3.3	3.3		3.3	3.3	3.3
All-Red Time (s)	2.3	2.4		2.4	2.4		2.2	2.2		2.2	2.2	2.2
Lost Time Adjust (s)		0.0			0.0			0.0			0.0	0.0
Total Lost Time (s)		5.7			5.7			5.5			5.5	5.5
Lead/Lag	Lead			Lag			Lag					
Lead-Lag Optimize?	Yes			Yes			Yes					
Vehicle Extension (s)	3.0	3.0		3.0	3.0		3.0	3.0		3.0	3.0	3.0
Recall Mode	None	C-Max		C-Max	C-Max		None	None		None	None	None
Walk Time (s)		7.0		7.0	7.0		7.0	7.0		7.0	7.0	7.0
Flash Dont Walk (s)		19.0		19.0	19.0		16.0	16.0		16.0	16.0	16.0
Pedestrian Calls (#/hr)		20		20	20		9	9		9	9	9
Act Effct Green (s)		83.7			83.7			20.1			20.1	20.1
Actuated g/C Ratio		0.73			0.73			0.17			0.17	0.17
v/c Ratio		0.39			0.39			0.03			0.62	0.85
Control Delay		4.3			6.8			0.1			54.0	34.1
Queue Delay		0.0			0.0			0.0			0.0	0.0
Total Delay		4.3			6.8			0.1			54.0	34.1
LOS		A			A			A			D	C
Approach Delay		4.3			6.8			0.1			39.5	
Approach LOS		A			A			A			D	

Intersection Summary

Area Type:	Other
Cycle Length:	115
Actuated Cycle Length:	115
Offset:	62 (54%), Referenced to phase 2:EBTL and 6:WBTL, Start of Green
Natural Cycle:	75
Control Type:	Actuated-Coordinated
Maximum v/c Ratio:	0.85
Intersection Signal Delay:	14.2
Intersection LOS:	B
Intersection Capacity Utilization	75.7%
ICU Level of Service	D
Analysis Period (min)	15

Splits and Phases: 4: S Haven Pl/Ring Rd & Smyth Rd

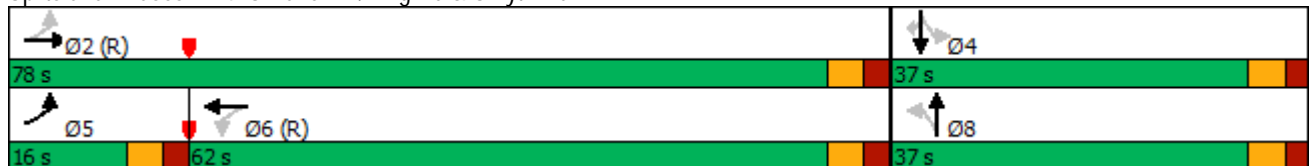

Queues

4: S Haven Pl/Ring Rd & Smyth Rd

02/23/2024



Lane Group	EBT	WBT	NBT	SBT	SBR
Lane Group Flow (vph)	651	951	9	146	395
v/c Ratio	0.39	0.39	0.03	0.62	0.85
Control Delay	4.3	6.8	0.1	54.0	34.1
Queue Delay	0.0	0.0	0.0	0.0	0.0
Total Delay	4.3	6.8	0.1	54.0	34.1
Queue Length 50th (m)	14.0	43.1	0.0	32.7	38.0
Queue Length 95th (m)	74.3	58.4	0.0	48.0	68.5
Internal Link Dist (m)	437.7	370.3	50.8	26.7	
Turn Bay Length (m)					
Base Capacity (vph)	1664	2450	478	368	598
Starvation Cap Reductn	0	0	0	0	0
Spillback Cap Reductn	0	0	0	0	0
Storage Cap Reductn	0	0	0	0	0
Reduced v/c Ratio	0.39	0.39	0.02	0.40	0.66
Intersection Summary					

Lanes, Volumes, Timings
5: Smyth Rd & Hospital Main Access

02/23/2024

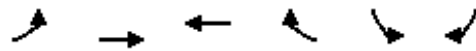

Lane Group	EBL	EBT	WBT	WBR	SBL	SBR
Lane Configurations	↖	↗↗	↗↗	↖	↖↖	↖
Traffic Volume (vph)	97	594	558	148	354	393
Future Volume (vph)	97	594	558	148	354	393
Ideal Flow (vphpl)	1900	1900	1900	1900	1900	1900
Storage Length (m)	60.0			178.0	0.0	0.0
Storage Lanes	1			1	2	1
Taper Length (m)	7.5				7.5	
Lane Util. Factor	1.00	0.95	0.95	1.00	0.97	1.00
Ped Bike Factor	0.99			0.95	0.82	0.97
Fr _t				0.850		0.850
Fl _t Protected	0.950				0.950	
Satd. Flow (prot)	1719	3505	3539	1568	3502	1583
Fl _t Permitted	0.390				0.950	
Satd. Flow (perm)	701	3505	3539	1493	2889	1531
Right Turn on Red				Yes		Yes
Satd. Flow (RTOR)				148		111
Link Speed (k/h)		50	50		50	
Link Distance (m)		394.3	413.0		60.1	
Travel Time (s)		28.4	29.7		4.3	
Confl. Peds. (#/hr)	11			11	70	14
Confl. Bikes (#/hr)				2		1
Peak Hour Factor	1.00	1.00	1.00	1.00	1.00	1.00
Heavy Vehicles (%)	5%	3%	2%	3%	0%	2%
Adj. Flow (vph)	97	594	558	148	354	393
Shared Lane Traffic (%)						
Lane Group Flow (vph)	97	594	558	148	354	393
Enter Blocked Intersection	No	No	No	No	No	No
Lane Alignment	Left	Left	Left	Right	Left	Right
Median Width(m)		3.6	3.6		7.2	
Link Offset(m)		0.0	0.0		0.0	
Crosswalk Width(m)		4.8	4.8		4.8	
Two way Left Turn Lane						
Headway Factor	1.00	1.00	1.00	1.00	1.00	1.00
Turning Speed (k/h)	25			15	25	15
Number of Detectors	1	2	2	1	1	1
Detector Template	Left	Thru	Thru	Right	Left	Right
Leading Detector (m)	2.0	10.0	10.0	2.0	2.0	2.0
Trailing Detector (m)	0.0	0.0	0.0	0.0	0.0	0.0
Detector 1 Position(m)	0.0	0.0	0.0	0.0	0.0	0.0
Detector 1 Size(m)	2.0	0.6	0.6	2.0	2.0	2.0
Detector 1 Type	CI+Ex	CI+Ex	CI+Ex	CI+Ex	CI+Ex	CI+Ex
Detector 1 Channel						
Detector 1 Extend (s)	0.0	0.0	0.0	0.0	0.0	0.0
Detector 1 Queue (s)	0.0	0.0	0.0	0.0	0.0	0.0
Detector 1 Delay (s)	0.0	0.0	0.0	0.0	0.0	0.0
Detector 2 Position(m)		9.4	9.4			
Detector 2 Size(m)		0.6	0.6			
Detector 2 Type		CI+Ex	CI+Ex			
Detector 2 Channel						
Detector 2 Extend (s)		0.0	0.0			
Turn Type	pm+pt	NA	NA	pm+ov	Prot	pm+ov
Protected Phases	5	2	6	4	4	5
Permitted Phases	2			6		4

Lanes, Volumes, Timings

5: Smyth Rd & Hospital Main Access

02/23/2024

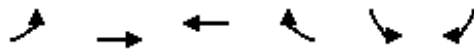

Lane Group	EBL	EBT	WBT	WBR	SBL	SBR
Detector Phase	5	2	6	4	4	5
Switch Phase						
Minimum Initial (s)	5.0	10.0	10.0	5.0	5.0	5.0
Minimum Split (s)	9.5	34.4	39.5	29.3	29.3	9.5
Total Split (s)	12.0	55.0	43.0	60.0	60.0	12.0
Total Split (%)	10.4%	47.8%	37.4%	52.2%	52.2%	10.4%
Maximum Green (s)	7.7	48.6	38.7	53.7	53.7	7.7
Yellow Time (s)	3.3	3.3	3.3	3.3	3.3	3.3
All-Red Time (s)	1.0	3.1	1.0	3.0	3.0	1.0
Lost Time Adjust (s)	0.0	0.0	0.0	0.0	0.0	0.0
Total Lost Time (s)	4.3	6.4	4.3	6.3	6.3	4.3
Lead/Lag	Lead		Lag			Lead
Lead-Lag Optimize?	Yes		Yes			Yes
Vehicle Extension (s)	3.0	3.0	3.0	3.0	3.0	3.0
Recall Mode	None	C-Max	C-Max	None	None	None
Walk Time (s)		7.0	7.0	7.0	7.0	
Flash Dont Walk (s)		21.0	28.0	16.0	16.0	
Pedestrian Calls (#/hr)		11	11	84	84	
Act Effct Green (s)	83.5	81.4	70.4	89.4	20.9	31.7
Actuated g/C Ratio	0.73	0.71	0.61	0.78	0.18	0.28
v/c Ratio	0.17	0.24	0.26	0.12	0.56	0.78
Control Delay	5.6	6.2	11.5	0.7	45.9	35.2
Queue Delay	0.0	0.0	0.0	0.0	0.0	0.0
Total Delay	5.6	6.2	11.5	0.7	45.9	35.2
LOS	A	A	B	A	D	D
Approach Delay		6.1	9.2		40.3	
Approach LOS		A	A		D	

Intersection Summary

Area Type:	Other
Cycle Length:	115
Actuated Cycle Length:	115
Offset:	59 (51%), Referenced to phase 2:EBTL and 6:WBT, Start of Green
Natural Cycle:	80
Control Type:	Actuated-Coordinated
Maximum v/c Ratio:	0.78
Intersection Signal Delay:	19.0
Intersection LOS:	B
Intersection Capacity Utilization:	62.1%
ICU Level of Service:	B
Analysis Period (min):	15

Splits and Phases: 5: Smyth Rd & Hospital Main Access

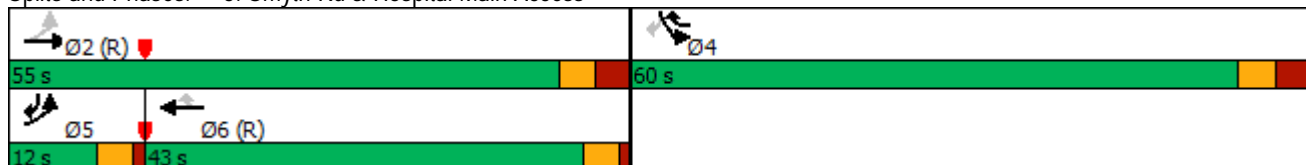

Queues

5: Smyth Rd & Hospital Main Access

02/23/2024

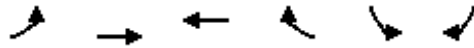

Lane Group	EBL	EBT	WBT	WBR	SBL	SBR
Lane Group Flow (vph)	97	594	558	148	354	393
v/c Ratio	0.17	0.24	0.26	0.12	0.56	0.78
Control Delay	5.6	6.2	11.5	0.7	45.9	35.2
Queue Delay	0.0	0.0	0.0	0.0	0.0	0.0
Total Delay	5.6	6.2	11.5	0.7	45.9	35.2
Queue Length 50th (m)	4.6	17.7	30.5	0.0	38.8	58.2
Queue Length 95th (m)	12.8	37.1	48.0	4.0	54.0	84.4
Internal Link Dist (m)		370.3	389.0		36.1	
Turn Bay Length (m)	60.0			178.0		
Base Capacity (vph)	591	2479	2167	1454	1635	513
Starvation Cap Reductn	0	0	0	0	0	0
Spillback Cap Reductn	0	0	0	0	0	0
Storage Cap Reductn	0	0	0	0	0	0
Reduced v/c Ratio	0.16	0.24	0.26	0.10	0.22	0.77
Intersection Summary						

Lanes, Volumes, Timings
6: Smyth Rd & Roger Guindon Ave

02/23/2024

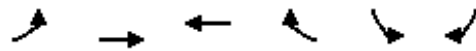

Lane Group	EBL	EBT	WBT	WBR	SBL	SBR	Ø3
Lane Configurations	↖	↕	↕		↖	↗	
Traffic Volume (vph)	34	915	499	94	507	207	
Future Volume (vph)	34	915	499	94	507	207	
Ideal Flow (vphpl)	1900	1900	1900	1900	1900	1900	
Storage Length (m)	67.0			0.0	35.0	0.0	
Storage Lanes	1			0	1	1	
Taper Length (m)	7.5				7.5		
Lane Util. Factor	1.00	0.95	0.95	0.95	1.00	1.00	
Ped Bike Factor	0.98		0.99		0.93	0.97	
Frt			0.976			0.850	
Flt Protected	0.950				0.950		
Satd. Flow (prot)	1703	3505	3368	0	1736	1553	
Flt Permitted	0.321				0.950		
Satd. Flow (perm)	565	3505	3368	0	1606	1514	
Right Turn on Red				Yes		Yes	
Satd. Flow (RTOR)			27			207	
Link Speed (k/h)		50	50		50		
Link Distance (m)		413.0	277.5		141.9		
Travel Time (s)		29.7	20.0		10.2		
Confl. Peds. (#/hr)	31			31	58	10	
Confl. Bikes (#/hr)				1		1	
Peak Hour Factor	1.00	1.00	1.00	1.00	1.00	1.00	
Heavy Vehicles (%)	6%	3%	4%	0%	4%	4%	
Adj. Flow (vph)	34	915	499	94	507	207	
Shared Lane Traffic (%)							
Lane Group Flow (vph)	34	915	593	0	507	207	
Enter Blocked Intersection	No	No	No	No	No	No	
Lane Alignment	Left	Left	Left	Right	Left	Right	
Median Width(m)		3.6	3.6		3.6		
Link Offset(m)		0.0	0.0		0.0		
Crosswalk Width(m)		4.8	4.8		4.8		
Two way Left Turn Lane							
Headway Factor	1.00	1.00	1.00	1.00	1.00	1.00	
Turning Speed (k/h)	25			15	25	15	
Number of Detectors	1	2	2		1	1	
Detector Template	Left	Thru	Thru		Left	Right	
Leading Detector (m)	2.0	10.0	10.0		2.0	2.0	
Trailing Detector (m)	0.0	0.0	0.0		0.0	0.0	
Detector 1 Position(m)	0.0	0.0	0.0		0.0	0.0	
Detector 1 Size(m)	2.0	0.6	0.6		2.0	2.0	
Detector 1 Type	CI+Ex	CI+Ex	CI+Ex		CI+Ex	CI+Ex	
Detector 1 Channel							
Detector 1 Extend (s)	0.0	0.0	0.0		0.0	0.0	
Detector 1 Queue (s)	0.0	0.0	0.0		0.0	0.0	
Detector 1 Delay (s)	0.0	0.0	0.0		0.0	0.0	
Detector 2 Position(m)		9.4	9.4				
Detector 2 Size(m)		0.6	0.6				
Detector 2 Type		CI+Ex	CI+Ex				
Detector 2 Channel							
Detector 2 Extend (s)		0.0	0.0				
Turn Type	pm+pt	NA	NA		Prot	Perm	
Protected Phases	5	2	6		4		3
Permitted Phases	2					4	

Lanes, Volumes, Timings
6: Smyth Rd & Roger Guindon Ave

02/23/2024

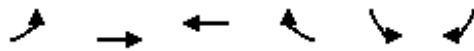

Lane Group	EBL	EBT	WBT	WBR	SBL	SBR	Ø3
Detector Phase	5	2	6		4	4	
Switch Phase							
Minimum Initial (s)	5.0	10.0	10.0		5.0	5.0	1.0
Minimum Split (s)	10.5	23.8	30.8		31.6	31.6	5.0
Total Split (s)	15.0	53.0	38.0		32.0	32.0	5.0
Total Split (%)	16.7%	58.9%	42.2%		35.6%	35.6%	6%
Maximum Green (s)	9.5	47.2	32.2		26.4	26.4	3.0
Yellow Time (s)	3.3	3.3	3.3		3.3	3.3	2.0
All-Red Time (s)	2.2	2.5	2.5		2.3	2.3	0.0
Lost Time Adjust (s)	0.0	0.0	0.0		0.0	0.0	
Total Lost Time (s)	5.5	5.8	5.8		5.6	5.6	
Lead/Lag	Lead		Lag		Lag	Lag	Lead
Lead-Lag Optimize?	Yes		Yes				
Vehicle Extension (s)	3.0	3.0	3.0		3.0	3.0	3.0
Recall Mode	None	C-Max	C-Max		None	None	None
Walk Time (s)			10.0		7.0	7.0	3.0
Flash Dont Walk (s)			15.0		14.0	14.0	0.0
Pedestrian Calls (#/hr)			31		68	68	68
Act Effct Green (s)	47.7	47.4	39.9		27.2	27.2	
Actuated g/C Ratio	0.53	0.53	0.44		0.30	0.30	
v/c Ratio	0.09	0.50	0.39		0.97	0.34	
Control Delay	10.9	14.9	18.2		64.9	5.4	
Queue Delay	0.0	0.0	0.0		0.0	0.0	
Total Delay	10.9	14.9	18.2		64.9	5.4	
LOS	B	B	B		E	A	
Approach Delay		14.7	18.2		47.6		
Approach LOS		B	B		D		

Intersection Summary

Area Type:	Other
Cycle Length:	90
Actuated Cycle Length:	90
Offset:	12 (13%), Referenced to phase 2:EBTL and 6:WBT, Start of Green
Natural Cycle:	80
Control Type:	Actuated-Coordinated
Maximum v/c Ratio:	0.97
Intersection Signal Delay:	26.1
Intersection LOS:	C
Intersection Capacity Utilization	65.8%
ICU Level of Service	C
Analysis Period (min)	15

Splits and Phases: 6: Smyth Rd & Roger Guindon Ave

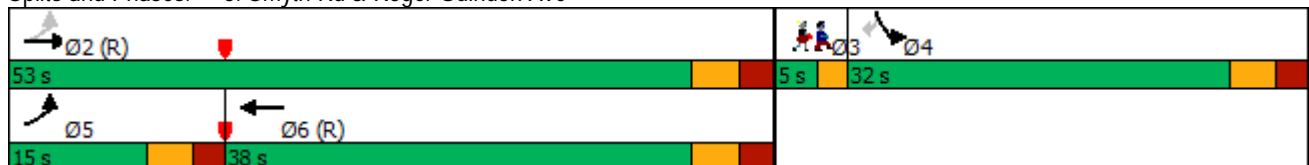

Queues

6: Smyth Rd & Roger Guindon Ave

02/23/2024



Lane Group	EBL	EBT	WBT	SBL	SBR
Lane Group Flow (vph)	34	915	593	507	207
v/c Ratio	0.09	0.50	0.39	0.97	0.34
Control Delay	10.9	14.9	18.2	64.9	5.4
Queue Delay	0.0	0.0	0.0	0.0	0.0
Total Delay	10.9	14.9	18.2	64.9	5.4
Queue Length 50th (m)	2.8	53.3	38.8	91.8	0.0
Queue Length 95th (m)	7.4	69.7	55.1	#157.7	15.8
Internal Link Dist (m)		389.0	253.5	117.9	
Turn Bay Length (m)	67.0			35.0	
Base Capacity (vph)	419	1844	1508	525	602
Starvation Cap Reductn	0	0	0	0	0
Spillback Cap Reductn	0	0	0	0	0
Storage Cap Reductn	0	0	0	0	0
Reduced v/c Ratio	0.08	0.50	0.39	0.97	0.34

Intersection Summary

95th percentile volume exceeds capacity, queue may be longer.
 Queue shown is maximum after two cycles.

HCM Unsignalized Intersection Capacity Analysis

7: Ring Rd & Hospital Link Rd

04/10/2024



Movement	EBT	EBR	WBL	WBT	NBL	NBR
Lane Configurations	➔			➔	➔	
Sign Control	Stop			Stop	Stop	
Traffic Volume (vph)	63	33	114	186	140	40
Future Volume (vph)	63	33	114	186	140	40
Peak Hour Factor	1.00	1.00	1.00	1.00	1.00	1.00
Hourly flow rate (vph)	63	33	114	186	140	40
Direction, Lane #	EB 1	WB 1	NB 1			
Volume Total (vph)	96	300	180			
Volume Left (vph)	0	114	140			
Volume Right (vph)	33	0	40			
Hadj (s)	-0.08	0.09	0.11			
Departure Headway (s)	4.7	4.6	5.0			
Degree Utilization, x	0.12	0.38	0.25			
Capacity (veh/h)	722	752	681			
Control Delay (s)	8.3	10.4	9.6			
Approach Delay (s)	8.3	10.4	9.6			
Approach LOS	A	B	A			
Intersection Summary						
Delay			9.8			
Level of Service			A			
Intersection Capacity Utilization			39.6%	ICU Level of Service	A	
Analysis Period (min)			15			

HCM Unsignalized Intersection Capacity Analysis

8: uOttawa-Rehab W Access & Hospital Link Rd

04/10/2024



Movement	EBT	EBR	WBL	WBT	NBL	NBR
Lane Configurations	↩			↩	↩	
Traffic Volume (veh/h)	80	23	9	169	42	14
Future Volume (Veh/h)	80	23	9	169	42	14
Sign Control	Free			Free	Stop	
Grade	0%			0%	0%	
Peak Hour Factor	1.00	1.00	1.00	1.00	1.00	1.00
Hourly flow rate (vph)	80	23	9	169	42	14
Pedestrians						
Lane Width (m)						
Walking Speed (m/s)						
Percent Blockage						
Right turn flare (veh)						
Median type	None			None		
Median storage veh						
Upstream signal (m)						
pX, platoon unblocked						
vC, conflicting volume			103		278	92
vC1, stage 1 conf vol						
vC2, stage 2 conf vol						
vCu, unblocked vol			103		278	92
tC, single (s)			4.2		6.4	6.2
tC, 2 stage (s)						
tF (s)			2.3		3.5	3.3
p0 queue free %			99		94	99
cM capacity (veh/h)			1434		711	971
Direction, Lane #	EB 1	WB 1	NB 1			
Volume Total	103	178	56			
Volume Left	0	9	42			
Volume Right	23	0	14			
cSH	1700	1434	762			
Volume to Capacity	0.06	0.01	0.07			
Queue Length 95th (m)	0.0	0.2	1.9			
Control Delay (s)	0.0	0.4	10.1			
Lane LOS			A			B
Approach Delay (s)	0.0	0.4	10.1			
Approach LOS			B			
Intersection Summary						
Average Delay			1.9			
Intersection Capacity Utilization			26.1%	ICU Level of Service	A	
Analysis Period (min)			15			

HCM Unsignalized Intersection Capacity Analysis

9: uOttawa-Rehab E Access & Hospital Link Rd

04-11-2024

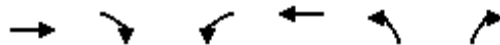

Movement	EBT	EBR	WBL	WBT	NBL	NBR
Lane Configurations	↑			↑	↘	↘
Sign Control	Stop			Stop	Stop	
Traffic Volume (vph)	94	0	0	157	22	16
Future Volume (vph)	94	0	0	157	22	16
Peak Hour Factor	1.00	1.00	1.00	1.00	1.00	1.00
Hourly flow rate (vph)	94	0	0	157	22	16
Direction, Lane #	EB 1	WB 1	NB 1			
Volume Total (vph)	94	157	38			
Volume Left (vph)	0	0	22			
Volume Right (vph)	0	0	16			
Hadj (s)	0.09	0.02	0.12			
Departure Headway (s)	4.2	4.1	4.6			
Degree Utilization, x	0.11	0.18	0.05			
Capacity (veh/h)	833	863	742			
Control Delay (s)	7.8	8.0	7.8			
Approach Delay (s)	7.8	8.0	7.8			
Approach LOS	A	A	A			
Intersection Summary						
Delay			7.9			
Level of Service			A			
Intersection Capacity Utilization			18.9%	ICU Level of Service	A	
Analysis Period (min)			15			

HCM Unsignalized Intersection Capacity Analysis

10: AMRC Driveway & Hospital Link Rd

04/10/2024



Movement	EBT	EBR	WBL	WBT	NBL	NBR
Lane Configurations	↩			↩	↩	
Traffic Volume (veh/h)	74	30	7	204	96	30
Future Volume (Veh/h)	74	30	7	204	96	30
Sign Control	Free			Free	Stop	
Grade	0%			0%	0%	
Peak Hour Factor	1.00	1.00	1.00	1.00	1.00	1.00
Hourly flow rate (vph)	74	30	7	204	96	30
Pedestrians						
Lane Width (m)						
Walking Speed (m/s)						
Percent Blockage						
Right turn flare (veh)						
Median type	None			None		
Median storage veh						
Upstream signal (m)						
pX, platoon unblocked						
vC, conflicting volume			104		307	89
vC1, stage 1 conf vol						
vC2, stage 2 conf vol						
vCu, unblocked vol			104		307	89
tC, single (s)			4.1		6.4	6.2
tC, 2 stage (s)						
tF (s)			2.2		3.5	3.3
p0 queue free %			100		86	97
cM capacity (veh/h)			1488		682	969
Direction, Lane #	EB 1	WB 1	NB 1			
Volume Total	104	211	126			
Volume Left	0	7	96			
Volume Right	30	0	30			
cSH	1700	1488	734			
Volume to Capacity	0.06	0.00	0.17			
Queue Length 95th (m)	0.0	0.1	4.9			
Control Delay (s)	0.0	0.3	10.9			
Lane LOS		A	B			
Approach Delay (s)	0.0	0.3	10.9			
Approach LOS			B			
Intersection Summary						
Average Delay			3.3			
Intersection Capacity Utilization			31.5%	ICU Level of Service	A	
Analysis Period (min)			15			

Lanes, Volumes, Timings

1: Alta Vista Dr & Hospital Link Rd

02/23/2024



Lane Group	EBL	EBT	EBR	WBL	WBT	WBR	NBL	NBT	NBR	SBL	SBT	SBR
Lane Configurations												
Traffic Volume (vph)	2	375	48	37	83	8	42	632	77	16	630	24
Future Volume (vph)	2	375	48	37	83	8	42	632	77	16	630	24
Ideal Flow (vphpl)	1800	1800	1800	1800	1800	1800	1800	1800	1800	1800	1800	1800
Storage Length (m)	0.0		0.0	25.0		40.0	30.0		0.0	25.0		0.0
Storage Lanes	1		0	1		1	1		0	1		0
Taper Length (m)	7.5			7.5			7.5			7.5		
Lane Util. Factor	1.00	1.00	1.00	1.00	1.00	1.00	1.00	1.00	1.00	1.00	1.00	1.00
Ped Bike Factor	0.99	0.99				0.97		1.00			1.00	
Frt		0.983				0.850		0.984			0.994	
Flt Protected	0.950			0.950			0.950			0.950		
Satd. Flow (prot)	1710	1703	0	1583	1579	1530	1710	1685	0	1710	1734	0
Flt Permitted	0.703			0.127			0.253			0.213		
Satd. Flow (perm)	1257	1703	0	212	1579	1489	455	1685	0	383	1734	0
Right Turn on Red			Yes			Yes			Yes			Yes
Satd. Flow (RTOR)		5				31		7			2	
Link Speed (k/h)		50			50			50			50	
Link Distance (m)		148.1			598.8			586.9			279.5	
Travel Time (s)		10.7			43.1			42.3			20.1	
Confl. Peds. (#/hr)	3		20	20		3	5		7	7		5
Confl. Bikes (#/hr)									1			
Peak Hour Factor	1.00	1.00	1.00	1.00	1.00	1.00	1.00	1.00	1.00	1.00	1.00	1.00
Heavy Vehicles (%)	0%	3%	4%	8%	14%	0%	0%	5%	2%	0%	3%	4%
Adj. Flow (vph)	2	375	48	37	83	8	42	632	77	16	630	24
Shared Lane Traffic (%)												
Lane Group Flow (vph)	2	423	0	37	83	8	42	709	0	16	654	0
Enter Blocked Intersection	No	No	No	No	No	No	No	No	No	No	No	No
Lane Alignment	Left	Left	Right	Left	Left	Right	Left	Left	Right	Left	Left	Right
Median Width(m)		3.6			3.6			3.6			3.6	
Link Offset(m)		0.0			0.0			0.0			0.0	
Crosswalk Width(m)		4.8			4.8			4.8			4.8	
Two way Left Turn Lane												
Headway Factor	1.07	1.07	1.07	1.07	1.07	1.07	1.07	1.07	1.07	1.07	1.07	1.07
Turning Speed (k/h)	25		15	25		15	25		15	25		15
Number of Detectors	1	2		1	2	1	1	2		1	2	
Detector Template	Left	Thru		Left	Thru	Right	Left	Thru		Left	Thru	
Leading Detector (m)	2.0	10.0		2.0	10.0	2.0	2.0	10.0		2.0	10.0	
Trailing Detector (m)	0.0	0.0		0.0	0.0	0.0	0.0	0.0		0.0	0.0	
Detector 1 Position(m)	0.0	0.0		0.0	0.0	0.0	0.0	0.0		0.0	0.0	
Detector 1 Size(m)	2.0	0.6		2.0	0.6	2.0	2.0	0.6		2.0	0.6	
Detector 1 Type	CI+Ex	CI+Ex		CI+Ex	CI+Ex	CI+Ex	CI+Ex	CI+Ex		CI+Ex	CI+Ex	
Detector 1 Channel												
Detector 1 Extend (s)	0.0	0.0		0.0	0.0	0.0	0.0	0.0		0.0	0.0	
Detector 1 Queue (s)	0.0	0.0		0.0	0.0	0.0	0.0	0.0		0.0	0.0	
Detector 1 Delay (s)	0.0	0.0		0.0	0.0	0.0	0.0	0.0		0.0	0.0	
Detector 2 Position(m)		9.4			9.4			9.4			9.4	
Detector 2 Size(m)		0.6			0.6			0.6			0.6	
Detector 2 Type		CI+Ex			CI+Ex			CI+Ex			CI+Ex	
Detector 2 Channel												
Detector 2 Extend (s)		0.0			0.0			0.0			0.0	
Turn Type	Perm	NA		pm+pt	NA	Perm	Perm	NA		Perm	NA	
Protected Phases		2		1	6			8			4	
Permitted Phases	2			6		6	8			4		

Lanes, Volumes, Timings
1: Alta Vista Dr & Hospital Link Rd

02/23/2024



Lane Group	EBL	EBT	EBR	WBL	WBT	WBR	NBL	NBT	NBR	SBL	SBT	SBR
Detector Phase	2	2		1	6	6	8	8		4	4	
Switch Phase												
Minimum Initial (s)	10.0	10.0		5.0	10.0	10.0	10.0	10.0		10.0	10.0	
Minimum Split (s)	30.5	30.5		11.5	30.5	30.5	27.3	27.3		27.3	27.3	
Total Split (s)	31.5	31.5		21.5	53.0	53.0	61.3	61.3		61.3	61.3	
Total Split (%)	27.6%	27.6%		18.8%	46.4%	46.4%	53.6%	53.6%		53.6%	53.6%	
Maximum Green (s)	25.0	25.0		15.0	46.5	46.5	55.0	55.0		55.0	55.0	
Yellow Time (s)	3.3	3.3		3.3	3.3	3.3	3.3	3.3		3.3	3.3	
All-Red Time (s)	3.2	3.2		3.2	3.2	3.2	3.0	3.0		3.0	3.0	
Lost Time Adjust (s)	0.0	0.0		0.0	0.0	0.0	0.0	0.0		0.0	0.0	
Total Lost Time (s)	6.5	6.5		6.5	6.5	6.5	6.3	6.3		6.3	6.3	
Lead/Lag	Lag	Lag		Lead								
Lead-Lag Optimize?	Yes	Yes		Yes								
Vehicle Extension (s)	3.0	3.0		3.0	3.0	3.0	3.0	3.0		3.0	3.0	
Recall Mode	None	None		None	None	None	Max	Max		Max	Max	
Walk Time (s)	7.0	7.0		7.0	7.0	7.0	7.0	7.0		7.0	7.0	
Flash Dont Walk (s)	17.0	17.0		17.0	17.0	14.0	14.0	14.0		14.0	14.0	
Pedestrian Calls (#/hr)	23	23		23	23	12	12	12		12	12	
Act Effct Green (s)	25.1	25.1		33.4	33.4	33.4	55.3	55.3		55.3	55.3	
Actuated g/C Ratio	0.25	0.25		0.33	0.33	0.33	0.54	0.54		0.54	0.54	
v/c Ratio	0.01	1.00		0.22	0.16	0.02	0.17	0.77		0.08	0.69	
Control Delay	32.0	82.8		25.6	24.2	0.0	16.0	26.6		14.7	23.1	
Queue Delay	0.0	0.0		0.0	0.0	0.0	0.0	0.0		0.0	0.0	
Total Delay	32.0	82.8		25.6	24.2	0.0	16.0	26.6		14.7	23.1	
LOS	C	F		C	C	A	B	C		B	C	
Approach Delay		82.6			23.1			26.0			22.9	
Approach LOS		F			C			C			C	

Intersection Summary

Area Type:	Other
Cycle Length:	114.3
Actuated Cycle Length:	101.5
Natural Cycle:	90
Control Type:	Semi Act-Uncoord
Maximum v/c Ratio:	1.00
Intersection Signal Delay:	37.0
Intersection LOS:	D
Intersection Capacity Utilization	83.2%
ICU Level of Service	E
Analysis Period (min)	15

Splits and Phases: 1: Alta Vista Dr & Hospital Link Rd

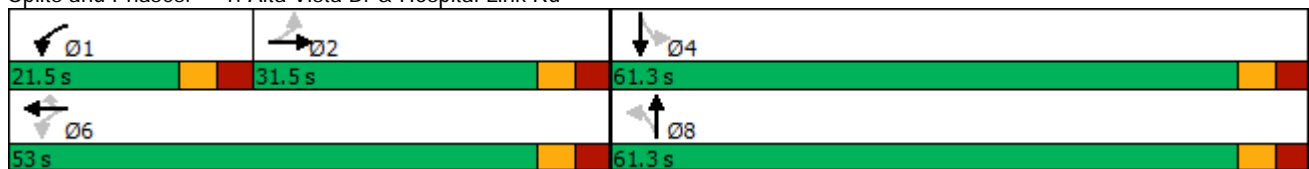

Queues

1: Alta Vista Dr & Hospital Link Rd

02/23/2024



Lane Group	EBL	EBT	WBL	WBT	WBR	NBL	NBT	SBL	SBT
Lane Group Flow (vph)	2	423	37	83	8	42	709	16	654
v/c Ratio	0.01	1.00	0.22	0.16	0.02	0.17	0.77	0.08	0.69
Control Delay	32.0	82.8	25.6	24.2	0.0	16.0	26.6	14.7	23.1
Queue Delay	0.0	0.0	0.0	0.0	0.0	0.0	0.0	0.0	0.0
Total Delay	32.0	82.8	25.6	24.2	0.0	16.0	26.6	14.7	23.1
Queue Length 50th (m)	0.3	-99.9	5.2	12.1	0.0	4.7	122.2	1.7	105.7
Queue Length 95th (m)	2.4	#166.5	12.5	23.1	0.1	12.3	#189.1	5.9	158.2
Internal Link Dist (m)		124.1		574.8			562.9		255.5
Turn Bay Length (m)			25.0		40.0	30.0		25.0	
Base Capacity (vph)	311	425	273	727	702	247	920	208	945
Starvation Cap Reductn	0	0	0	0	0	0	0	0	0
Spillback Cap Reductn	0	0	0	0	0	0	0	0	0
Storage Cap Reductn	0	0	0	0	0	0	0	0	0
Reduced v/c Ratio	0.01	1.00	0.14	0.11	0.01	0.17	0.77	0.08	0.69

Intersection Summary

- ~ Volume exceeds capacity, queue is theoretically infinite.
Queue shown is maximum after two cycles.
- # 95th percentile volume exceeds capacity, queue may be longer.
Queue shown is maximum after two cycles.

Lanes, Volumes, Timings
2: Alta Vista Dr & Smyth Rd

02/23/2024



Lane Group	EBL	EBT	EBR	WBL	WBT	WBR	NBL	NBT	NBR	SBL	SBT	SBR
Lane Configurations												
Traffic Volume (vph)	175	904	111	92	518	167	350	410	218	240	218	133
Future Volume (vph)	175	904	111	92	518	167	350	410	218	240	218	133
Ideal Flow (vphpl)	1800	1800	1800	1800	1800	1800	1800	1800	1800	1800	1800	1800
Storage Length (m)	30.0		25.0	61.0		10.0	87.0		30.0	44.0		25.0
Storage Lanes	1		1	1		1	1		1	1		1
Taper Length (m)	7.5			7.5			7.5			7.5		
Lane Util. Factor	1.00	0.95	1.00	1.00	0.95	1.00	1.00	1.00	1.00	1.00	1.00	1.00
Ped Bike Factor	0.97		0.91			0.89	0.98		0.97	0.99		0.96
Frts			0.850			0.850			0.850			0.850
Flt Protected	0.950			0.950			0.950			0.950		
Satd. Flow (prot)	1710	3353	1485	1644	3320	1500	1710	1731	1500	1676	1731	1530
Flt Permitted	0.318			0.141			0.505			0.215		
Satd. Flow (perm)	552	3353	1350	244	3320	1332	894	1731	1458	377	1731	1473
Right Turn on Red			Yes			Yes			Yes			Yes
Satd. Flow (RTOR)			139			139			137			137
Link Speed (k/h)		50			50			50			50	
Link Distance (m)		339.0			234.1			204.1			586.9	
Travel Time (s)		24.4			16.9			14.7			42.3	
Confl. Peds. (#/hr)	31		24	24		31	17		11	11		17
Peak Hour Factor	1.00	1.00	1.00	1.00	1.00	1.00	1.00	1.00	1.00	1.00	1.00	1.00
Heavy Vehicles (%)	0%	2%	3%	4%	3%	2%	0%	4%	2%	2%	4%	0%
Adj. Flow (vph)	175	904	111	92	518	167	350	410	218	240	218	133
Shared Lane Traffic (%)												
Lane Group Flow (vph)	175	904	111	92	518	167	350	410	218	240	218	133
Enter Blocked Intersection	No	No	No	No	No	No	No	No	No	No	No	No
Lane Alignment	Left	Left	Right	Left	Left	Right	Left	Left	Right	Left	Left	Right
Median Width(m)		3.6			3.6			3.6			3.6	
Link Offset(m)		0.0			0.0			0.0			0.0	
Crosswalk Width(m)		4.8			4.8			4.8			4.8	
Two way Left Turn Lane												
Headway Factor	1.07	1.07	1.07	1.07	1.07	1.07	1.07	1.07	1.07	1.07	1.07	1.07
Turning Speed (k/h)	25		15	25		15	25		15	25		15
Number of Detectors	1	2	1	1	2	1	1	2	1	1	2	1
Detector Template	Left	Thru	Right	Left	Thru	Right	Left	Thru	Right	Left	Thru	Right
Leading Detector (m)	2.0	10.0	2.0	2.0	10.0	2.0	2.0	10.0	2.0	2.0	10.0	2.0
Trailing Detector (m)	0.0	0.0	0.0	0.0	0.0	0.0	0.0	0.0	0.0	0.0	0.0	0.0
Detector 1 Position(m)	0.0	0.0	0.0	0.0	0.0	0.0	0.0	0.0	0.0	0.0	0.0	0.0
Detector 1 Size(m)	2.0	0.6	2.0	2.0	0.6	2.0	2.0	0.6	2.0	2.0	0.6	2.0
Detector 1 Type	CI+Ex	CI+Ex	CI+Ex	CI+Ex	CI+Ex	CI+Ex	CI+Ex	CI+Ex	CI+Ex	CI+Ex	CI+Ex	CI+Ex
Detector 1 Channel												
Detector 1 Extend (s)	0.0	0.0	0.0	0.0	0.0	0.0	0.0	0.0	0.0	0.0	0.0	0.0
Detector 1 Queue (s)	0.0	0.0	0.0	0.0	0.0	0.0	0.0	0.0	0.0	0.0	0.0	0.0
Detector 1 Delay (s)	0.0	0.0	0.0	0.0	0.0	0.0	0.0	0.0	0.0	0.0	0.0	0.0
Detector 2 Position(m)		9.4			9.4			9.4			9.4	
Detector 2 Size(m)		0.6			0.6			0.6			0.6	
Detector 2 Type		CI+Ex			CI+Ex			CI+Ex			CI+Ex	
Detector 2 Channel												
Detector 2 Extend (s)		0.0			0.0			0.0			0.0	
Turn Type	pm+pt	NA	Perm	pm+pt	NA	Perm	pm+pt	NA	Perm	pm+pt	NA	Perm
Protected Phases	5	2		1	6		3	8		7	4	
Permitted Phases	2		2	6		6	8		8	4		4
Detector Phase	5	2	2	1	6	6	3	8	8	7	4	4

Lanes, Volumes, Timings
2: Alta Vista Dr & Smyth Rd

02/23/2024



Lane Group	EBL	EBT	EBR	WBL	WBT	WBR	NBL	NBT	NBR	SBL	SBT	SBR
Switch Phase												
Minimum Initial (s)	5.0	10.0	10.0	5.0	10.0	10.0	5.0	10.0	10.0	5.0	10.0	10.0
Minimum Split (s)	10.5	24.8	24.8	10.5	24.8	24.8	11.1	29.1	29.1	11.1	29.1	29.1
Total Split (s)	20.0	38.0	38.0	20.0	38.0	38.0	20.0	37.0	37.0	20.0	37.0	37.0
Total Split (%)	17.4%	33.0%	33.0%	17.4%	33.0%	33.0%	17.4%	32.2%	32.2%	17.4%	32.2%	32.2%
Maximum Green (s)	14.5	32.2	32.2	14.5	32.2	32.2	13.9	30.9	30.9	13.9	30.9	30.9
Yellow Time (s)	3.3	3.3	3.3	3.3	3.3	3.3	3.3	3.3	3.3	3.3	3.3	3.3
All-Red Time (s)	2.2	2.5	2.5	2.2	2.5	2.5	2.8	2.8	2.8	2.8	2.8	2.8
Lost Time Adjust (s)	0.0	0.0	0.0	0.0	0.0	0.0	0.0	0.0	0.0	0.0	0.0	0.0
Total Lost Time (s)	5.5	5.8	5.8	5.5	5.8	5.8	6.1	6.1	6.1	6.1	6.1	6.1
Lead/Lag	Lead	Lag	Lag	Lead	Lag	Lag	Lead	Lag	Lag	Lead	Lag	Lag
Lead-Lag Optimize?	Yes	Yes	Yes	Yes	Yes	Yes	Yes	Yes	Yes	Yes	Yes	Yes
Vehicle Extension (s)	3.0	3.0	3.0	3.0	3.0	3.0	3.0	3.0	3.0	3.0	3.0	3.0
Recall Mode	None	C-Max	C-Max	None	C-Max	C-Max	None	Max	Max	None	Max	Max
Walk Time (s)		7.0	7.0		7.0	7.0		7.0	7.0		7.0	7.0
Flash Dont Walk (s)		12.0	12.0		12.0	12.0		16.0	16.0		16.0	16.0
Pedestrian Calls (#/hr)		55	55		55	55		28	28		28	28
Act Effct Green (s)	50.0	37.5	37.5	44.0	34.5	34.5	45.2	31.3	31.3	44.4	30.9	30.9
Actuated g/C Ratio	0.43	0.33	0.33	0.38	0.30	0.30	0.39	0.27	0.27	0.39	0.27	0.27
v/c Ratio	0.48	0.83	0.21	0.45	0.52	0.34	0.78	0.87	0.44	0.81	0.47	0.27
Control Delay	23.9	43.9	3.6	36.2	30.8	13.4	38.2	60.2	16.4	43.8	39.2	6.6
Queue Delay	0.0	0.0	0.0	0.0	0.0	0.0	0.0	0.0	0.0	0.0	0.0	0.0
Total Delay	23.9	43.9	3.6	36.2	30.8	13.4	38.2	60.2	16.4	43.8	39.2	6.6
LOS	C	D	A	D	C	B	D	E	B	D	D	A
Approach Delay		37.2			27.7			42.6			33.7	
Approach LOS		D			C			D			C	

Intersection Summary

Area Type:	Other
Cycle Length:	115
Actuated Cycle Length:	115
Offset:	2 (2%), Referenced to phase 2:EBTL and 6:WBTL, Start of Green
Natural Cycle:	90
Control Type:	Actuated-Coordinated
Maximum v/c Ratio:	0.87
Intersection Signal Delay:	36.0
Intersection LOS:	D
Intersection Capacity Utilization	91.0%
ICU Level of Service	E
Analysis Period (min)	15

Splits and Phases: 2: Alta Vista Dr & Smyth Rd

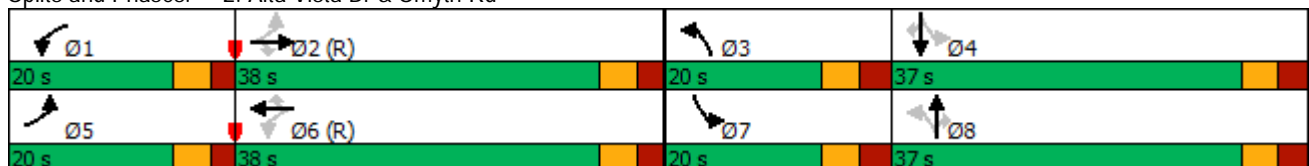

Queues

2: Alta Vista Dr & Smyth Rd

02/23/2024



Lane Group	EBL	EBT	EBR	WBL	WBT	WBR	NBL	NBT	NBR	SBL	SBT	SBR
Lane Group Flow (vph)	175	904	111	92	518	167	350	410	218	240	218	133
v/c Ratio	0.48	0.83	0.21	0.45	0.52	0.34	0.78	0.87	0.44	0.81	0.47	0.27
Control Delay	23.9	43.9	3.6	36.2	30.8	13.4	38.2	60.2	16.4	43.8	39.2	6.6
Queue Delay	0.0	0.0	0.0	0.0	0.0	0.0	0.0	0.0	0.0	0.0	0.0	0.0
Total Delay	23.9	43.9	3.6	36.2	30.8	13.4	38.2	60.2	16.4	43.8	39.2	6.6
Queue Length 50th (m)	24.5	103.5	0.0	7.5	28.4	0.1	56.8	93.4	14.9	36.2	43.3	0.0
Queue Length 95th (m)	39.7	#145.4	8.2	35.3	67.9	32.1	#91.2	#149.8	38.2	#69.1	67.9	14.3
Internal Link Dist (m)		315.0			210.1			180.1			562.9	
Turn Bay Length (m)	30.0		25.0	61.0		10.0	87.0		30.0	44.0		25.0
Base Capacity (vph)	393	1092	533	280	996	497	449	471	496	303	465	495
Starvation Cap Reductn	0	0	0	0	0	0	0	0	0	0	0	0
Spillback Cap Reductn	0	0	0	0	0	0	0	0	0	0	0	0
Storage Cap Reductn	0	0	0	0	0	0	0	0	0	0	0	0
Reduced v/c Ratio	0.45	0.83	0.21	0.33	0.52	0.34	0.78	0.87	0.44	0.79	0.47	0.27

Intersection Summary

95th percentile volume exceeds capacity, queue may be longer.
 Queue shown is maximum after two cycles.

Lanes, Volumes, Timings 3: Smyth Rd & Valour Dr

02/23/2024

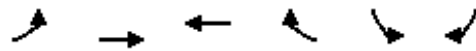

Lane Group	EBL	EBT	WBT	WBR	SBL	SBR
Lane Configurations						
Traffic Volume (vph)	36	1326	755	13	17	21
Future Volume (vph)	36	1326	755	13	17	21
Ideal Flow (vphpl)	1800	1800	1800	1800	1800	1800
Storage Length (m)	55.0			0.0	32.0	0.0
Storage Lanes	1			0	1	1
Taper Length (m)	7.5				7.5	
Lane Util. Factor	1.00	0.95	0.95	0.95	1.00	1.00
Ped Bike Factor	0.99		1.00			0.98
Frt			0.997			0.850
Flt Protected	0.950				0.950	
Satd. Flow (prot)	1613	3386	3306	0	1527	1457
Flt Permitted	0.361				0.950	
Satd. Flow (perm)	608	3386	3306	0	1527	1433
Right Turn on Red				Yes		Yes
Satd. Flow (RTOR)			3			21
Link Speed (k/h)		50	50		50	
Link Distance (m)		234.1	461.7		195.1	
Travel Time (s)		16.9	33.2		14.0	
Confl. Peds. (#/hr)	11			11		3
Peak Hour Factor	1.00	1.00	1.00	1.00	1.00	1.00
Heavy Vehicles (%)	6%	1%	3%	6%	12%	5%
Adj. Flow (vph)	36	1326	755	13	17	21
Shared Lane Traffic (%)						
Lane Group Flow (vph)	36	1326	768	0	17	21
Enter Blocked Intersection	No	No	No	No	No	No
Lane Alignment	Left	Left	Left	Right	Left	Right
Median Width(m)		3.6	3.6		3.6	
Link Offset(m)		0.0	0.0		0.0	
Crosswalk Width(m)		4.8	4.8		4.8	
Two way Left Turn Lane						
Headway Factor	1.07	1.07	1.07	1.07	1.07	1.07
Turning Speed (k/h)	25			15	25	15
Number of Detectors	1	2	2		1	1
Detector Template	Left	Thru	Thru		Left	Right
Leading Detector (m)	2.0	10.0	10.0		2.0	2.0
Trailing Detector (m)	0.0	0.0	0.0		0.0	0.0
Detector 1 Position(m)	0.0	0.0	0.0		0.0	0.0
Detector 1 Size(m)	2.0	0.6	0.6		2.0	2.0
Detector 1 Type	CI+Ex	CI+Ex	CI+Ex		CI+Ex	CI+Ex
Detector 1 Channel						
Detector 1 Extend (s)	0.0	0.0	0.0		0.0	0.0
Detector 1 Queue (s)	0.0	0.0	0.0		0.0	0.0
Detector 1 Delay (s)	0.0	0.0	0.0		0.0	0.0
Detector 2 Position(m)		9.4	9.4			
Detector 2 Size(m)		0.6	0.6			
Detector 2 Type		CI+Ex	CI+Ex			
Detector 2 Channel						
Detector 2 Extend (s)		0.0	0.0			
Turn Type	Perm	NA	NA		Prot	Perm
Protected Phases		2	6		4	
Permitted Phases	2					4
Detector Phase	2	2	6		4	4

Future Total (2031) AM

Lanes, Volumes, Timings

3: Smyth Rd & Valour Dr

02/23/2024

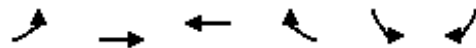

Lane Group	EBL	EBT	WBT	WBR	SBL	SBR
Switch Phase						
Minimum Initial (s)	10.0	10.0	10.0		5.0	5.0
Minimum Split (s)	29.5	29.5	29.5		28.5	28.5
Total Split (s)	84.0	84.0	84.0		31.0	31.0
Total Split (%)	73.0%	73.0%	73.0%		27.0%	27.0%
Maximum Green (s)	77.5	77.5	77.5		24.5	24.5
Yellow Time (s)	3.3	3.3	3.3		3.3	3.3
All-Red Time (s)	3.2	3.2	3.2		3.2	3.2
Lost Time Adjust (s)	0.0	0.0	0.0		0.0	0.0
Total Lost Time (s)	6.5	6.5	6.5		6.5	6.5
Lead/Lag						
Lead-Lag Optimize?						
Vehicle Extension (s)	3.0	3.0	3.0		3.0	3.0
Recall Mode	C-Max	C-Max	C-Max		None	None
Walk Time (s)	7.0	7.0	7.0		7.0	7.0
Flash Dont Walk (s)	16.0	16.0	16.0		15.0	15.0
Pedestrian Calls (#/hr)	11	11	11		3	3
Act Effct Green (s)	99.9	99.9	99.9		9.5	9.5
Actuated g/C Ratio	0.87	0.87	0.87		0.08	0.08
v/c Ratio	0.07	0.45	0.27		0.13	0.15
Control Delay	1.3	1.4	8.5		47.5	18.8
Queue Delay	0.0	0.2	0.0		0.0	0.0
Total Delay	1.3	1.6	8.5		47.5	18.8
LOS	A	A	A		D	B
Approach Delay		1.6	8.5		31.7	
Approach LOS		A	A		C	

Intersection Summary	
Area Type:	Other
Cycle Length:	115
Actuated Cycle Length:	115
Offset:	12 (10%), Referenced to phase 2:EBTL and 6:WBT, Start of Green
Natural Cycle:	60
Control Type:	Actuated-Coordinated
Maximum v/c Ratio:	0.45
Intersection Signal Delay:	4.6
Intersection LOS:	A
Intersection Capacity Utilization	55.0%
ICU Level of Service	B
Analysis Period (min)	15

Splits and Phases: 3: Smyth Rd & Valour Dr



Queues

3: Smyth Rd & Valour Dr

02/23/2024



Lane Group	EBL	EBT	WBT	SBL	SBR
Lane Group Flow (vph)	36	1326	768	17	21
v/c Ratio	0.07	0.45	0.27	0.13	0.15
Control Delay	1.3	1.4	8.5	47.5	18.8
Queue Delay	0.0	0.2	0.0	0.0	0.0
Total Delay	1.3	1.6	8.5	47.5	18.8
Queue Length 50th (m)	0.4	8.2	48.3	3.9	0.0
Queue Length 95th (m)	m0.9	15.0	85.1	10.0	7.1
Internal Link Dist (m)		210.1	437.7	171.1	
Turn Bay Length (m)	55.0			32.0	
Base Capacity (vph)	528	2942	2873	325	321
Starvation Cap Reductn	0	653	0	0	0
Spillback Cap Reductn	0	0	0	0	0
Storage Cap Reductn	0	0	0	0	0
Reduced v/c Ratio	0.07	0.58	0.27	0.05	0.07

Intersection Summary

m Volume for 95th percentile queue is metered by upstream signal.

Lanes, Volumes, Timings
4: S Haven Pl/Ring Rd & Smyth Rd

02/23/2024



Lane Group	EBL	EBT	EBR	WBL	WBT	WBR	NBL	NBT	NBR	SBL	SBT	SBR
Lane Configurations		↕↕			↕↕			↕↕			↕	↕
Traffic Volume (vph)	481	860	2	1	608	124	7	0	0	33	0	153
Future Volume (vph)	481	860	2	1	608	124	7	0	0	33	0	153
Ideal Flow (vphpl)	1800	1800	1800	1800	1800	1800	1800	1800	1800	1800	1800	1800
Lane Util. Factor	0.95	0.95	0.95	0.95	0.95	0.95	1.00	1.00	1.00	1.00	1.00	1.00
Ped Bike Factor		1.00			0.99						0.99	0.99
Frt					0.975							0.850
Flt Protected		0.982						0.950			0.950	
Satd. Flow (prot)	0	3325	0	0	3219	0	0	1710	0	0	1660	1443
Flt Permitted		0.592			0.954			0.736			0.753	
Satd. Flow (perm)	0	2001	0	0	3071	0	0	1325	0	0	1304	1423
Right Turn on Red			Yes			Yes			Yes			Yes
Satd. Flow (RTOR)					22							153
Link Speed (k/h)		50			50			50			50	
Link Distance (m)		461.7			394.3			74.8			50.7	
Travel Time (s)		33.2			28.4			5.4			3.7	
Confl. Peds. (#/hr)	11		2	2		11			6	6		
Confl. Bikes (#/hr)			8						4			2
Peak Hour Factor	1.00	1.00	1.00	1.00	1.00	1.00	1.00	1.00	1.00	1.00	1.00	1.00
Heavy Vehicles (%)	1%	1%	0%	0%	3%	2%	0%	0%	0%	3%	0%	6%
Adj. Flow (vph)	481	860	2	1	608	124	7	0	0	33	0	153
Shared Lane Traffic (%)												
Lane Group Flow (vph)	0	1343	0	0	733	0	0	7	0	0	33	153
Enter Blocked Intersection	No	No	No	No	No	No	No	No	No	No	No	No
Lane Alignment	Left	Left	Right	Left	Left	Right	Left	Left	Right	Left	Left	Right
Median Width(m)		3.6			3.6			0.0			0.0	
Link Offset(m)		0.0			0.0			0.0			0.0	
Crosswalk Width(m)		4.8			4.8			4.8			4.8	
Two way Left Turn Lane												
Headway Factor	1.07	1.07	1.07	1.07	1.07	1.07	1.07	1.07	1.07	1.07	1.07	1.07
Turning Speed (k/h)	25		15	25		15	25		15	25		15
Number of Detectors	1	2		1	2		1	2		1	2	1
Detector Template	Left	Thru		Left	Thru		Left	Thru		Left	Thru	Right
Leading Detector (m)	2.0	10.0		2.0	10.0		2.0	10.0		2.0	10.0	2.0
Trailing Detector (m)	0.0	0.0		0.0	0.0		0.0	0.0		0.0	0.0	0.0
Detector 1 Position(m)	0.0	0.0		0.0	0.0		0.0	0.0		0.0	0.0	0.0
Detector 1 Size(m)	2.0	0.6		2.0	0.6		2.0	0.6		2.0	0.6	2.0
Detector 1 Type	CI+Ex	CI+Ex		CI+Ex	CI+Ex		CI+Ex	CI+Ex		CI+Ex	CI+Ex	CI+Ex
Detector 1 Channel												
Detector 1 Extend (s)	0.0	0.0		0.0	0.0		0.0	0.0		0.0	0.0	0.0
Detector 1 Queue (s)	0.0	0.0		0.0	0.0		0.0	0.0		0.0	0.0	0.0
Detector 1 Delay (s)	0.0	0.0		0.0	0.0		0.0	0.0		0.0	0.0	0.0
Detector 2 Position(m)		9.4			9.4			9.4			9.4	
Detector 2 Size(m)		0.6			0.6			0.6			0.6	
Detector 2 Type		CI+Ex			CI+Ex			CI+Ex			CI+Ex	
Detector 2 Channel												
Detector 2 Extend (s)		0.0			0.0			0.0			0.0	
Turn Type	pm+pt	NA		Perm	NA		Perm	NA		Perm	NA	Perm
Protected Phases	5	2			6			8			4	
Permitted Phases	2			6			8			4		4
Detector Phase	5	2		6	6		8	8		4	4	4
Switch Phase												
Minimum Initial (s)	5.0	10.0		10.0	10.0		10.0	10.0		10.0	10.0	10.0

Lanes, Volumes, Timings
4: S Haven Pl/Ring Rd & Smyth Rd

02/23/2024



Lane Group	EBL	EBT	EBR	WBL	WBT	WBR	NBL	NBT	NBR	SBL	SBT	SBR
Minimum Split (s)	10.6	31.7		31.7	31.7		28.5	28.5		28.5	28.5	28.5
Total Split (s)	42.0	84.0		42.0	42.0		31.0	31.0		31.0	31.0	31.0
Total Split (%)	36.5%	73.0%		36.5%	36.5%		27.0%	27.0%		27.0%	27.0%	27.0%
Maximum Green (s)	36.4	78.3		36.3	36.3		25.5	25.5		25.5	25.5	25.5
Yellow Time (s)	3.3	3.3		3.3	3.3		3.3	3.3		3.3	3.3	3.3
All-Red Time (s)	2.3	2.4		2.4	2.4		2.2	2.2		2.2	2.2	2.2
Lost Time Adjust (s)		0.0			0.0			0.0			0.0	0.0
Total Lost Time (s)		5.7			5.7			5.5			5.5	5.5
Lead/Lag	Lead			Lag			Lag					
Lead-Lag Optimize?	Yes			Yes			Yes					
Vehicle Extension (s)	3.0	3.0		3.0	3.0		3.0	3.0		3.0	3.0	3.0
Recall Mode	None	C-Max		C-Max	C-Max		None	None		None	None	None
Walk Time (s)		7.0		7.0	7.0		7.0	7.0		7.0	7.0	7.0
Flash Dont Walk (s)		19.0		19.0	19.0		16.0	16.0		16.0	16.0	16.0
Pedestrian Calls (#/hr)		13		13	13		6	6		6	6	6
Act Effct Green (s)		91.2			91.2			12.6			12.6	12.6
Actuated g/C Ratio		0.79			0.79			0.11			0.11	0.11
v/c Ratio		0.92dl			0.30			0.05			0.23	0.52
Control Delay		19.6			2.5			43.1			48.7	13.5
Queue Delay		0.0			0.0			0.0			0.0	0.0
Total Delay		19.6			2.5			43.1			48.7	13.5
LOS		B			A			D			D	B
Approach Delay		19.6			2.5			43.1			19.8	
Approach LOS		B			A			D			B	

Intersection Summary

Area Type: Other
 Cycle Length: 115
 Actuated Cycle Length: 115
 Offset: 66 (57%), Referenced to phase 2:EBTL and 6:WBTL, Start of Green
 Natural Cycle: 100
 Control Type: Actuated-Coordinated
 Maximum v/c Ratio: 0.85
 Intersection Signal Delay: 14.1 Intersection LOS: B
 Intersection Capacity Utilization 86.4% ICU Level of Service E
 Analysis Period (min) 15
 dl Defacto Left Lane. Recode with 1 though lane as a left lane.

Splits and Phases: 4: S Haven Pl/Ring Rd & Smyth Rd

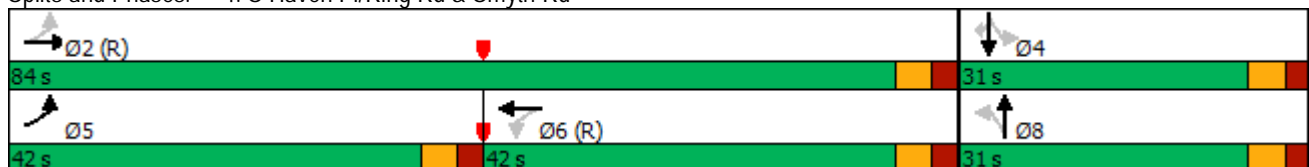

Queues

4: S Haven Pl/Ring Rd & Smyth Rd

02/23/2024



Lane Group	EBT	WBT	NBT	SBT	SBR
Lane Group Flow (vph)	1343	733	7	33	153
v/c Ratio	0.92dl	0.30	0.05	0.23	0.52
Control Delay	19.6	2.5	43.1	48.7	13.5
Queue Delay	0.0	0.0	0.0	0.0	0.0
Total Delay	19.6	2.5	43.1	48.7	13.5
Queue Length 50th (m)	81.5	10.1	1.6	7.5	0.0
Queue Length 95th (m)	#205.4	16.1	5.5	15.6	17.7
Internal Link Dist (m)	437.7	370.3	50.8	26.7	
Turn Bay Length (m)					
Base Capacity (vph)	1587	2439	293	289	434
Starvation Cap Reductn	0	0	0	0	0
Spillback Cap Reductn	0	0	0	0	0
Storage Cap Reductn	0	0	0	0	0
Reduced v/c Ratio	0.85	0.30	0.02	0.11	0.35

Intersection Summary

- # 95th percentile volume exceeds capacity, queue may be longer.
Queue shown is maximum after two cycles.
- dl Defacto Left Lane. Recode with 1 though lane as a left lane.

Lanes, Volumes, Timings
5: Smyth Rd & Hospital Main Access

02/23/2024

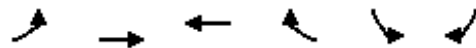

Lane Group	EBL	EBT	WBT	WBR	SBL	SBR
Lane Configurations	↖	↗↗	↗↗	↗	↖↖	↗
Traffic Volume (vph)	427	467	582	505	142	151
Future Volume (vph)	427	467	582	505	142	151
Ideal Flow (vphpl)	1800	1800	1800	1800	1800	1800
Storage Length (m)	60.0			178.0	0.0	0.0
Storage Lanes	1			1	2	1
Taper Length (m)	7.5				7.5	
Lane Util. Factor	1.00	0.95	0.95	1.00	0.97	1.00
Ped Bike Factor	1.00			0.97	0.88	0.97
Fr _t				0.850		0.850
Fl _t Protected	0.950				0.950	
Satd. Flow (prot)	1693	3353	3320	1515	3252	1515
Fl _t Permitted	0.354				0.950	
Satd. Flow (perm)	630	3353	3320	1471	2846	1468
Right Turn on Red				Yes		Yes
Satd. Flow (RTOR)				198		87
Link Speed (k/h)		50	50		50	
Link Distance (m)		394.3	413.0		60.1	
Travel Time (s)		28.4	29.7		4.3	
Confl. Peds. (#/hr)	3			3	50	13
Confl. Bikes (#/hr)				3		
Peak Hour Factor	1.00	1.00	1.00	1.00	1.00	1.00
Heavy Vehicles (%)	1%	2%	3%	1%	2%	1%
Adj. Flow (vph)	427	467	582	505	142	151
Shared Lane Traffic (%)						
Lane Group Flow (vph)	427	467	582	505	142	151
Enter Blocked Intersection	No	No	No	No	No	No
Lane Alignment	Left	Left	Left	Right	Left	Right
Median Width(m)		3.6	3.6		7.2	
Link Offset(m)		0.0	0.0		0.0	
Crosswalk Width(m)		4.8	4.8		4.8	
Two way Left Turn Lane						
Headway Factor	1.07	1.07	1.07	1.07	1.07	1.07
Turning Speed (k/h)	25			15	25	15
Number of Detectors	1	2	2	1	1	1
Detector Template	Left	Thru	Thru	Right	Left	Right
Leading Detector (m)	2.0	10.0	10.0	2.0	2.0	2.0
Trailing Detector (m)	0.0	0.0	0.0	0.0	0.0	0.0
Detector 1 Position(m)	0.0	0.0	0.0	0.0	0.0	0.0
Detector 1 Size(m)	2.0	0.6	0.6	2.0	2.0	2.0
Detector 1 Type	CI+Ex	CI+Ex	CI+Ex	CI+Ex	CI+Ex	CI+Ex
Detector 1 Channel						
Detector 1 Extend (s)	0.0	0.0	0.0	0.0	0.0	0.0
Detector 1 Queue (s)	0.0	0.0	0.0	0.0	0.0	0.0
Detector 1 Delay (s)	0.0	0.0	0.0	0.0	0.0	0.0
Detector 2 Position(m)		9.4	9.4			
Detector 2 Size(m)		0.6	0.6			
Detector 2 Type		CI+Ex	CI+Ex			
Detector 2 Channel						
Detector 2 Extend (s)		0.0	0.0			
Turn Type	pm+pt	NA	NA	pm+ov	Prot	pm+ov
Protected Phases	5	2	6	4	4	5
Permitted Phases	2			6		4

Lanes, Volumes, Timings
5: Smyth Rd & Hospital Main Access

02/23/2024

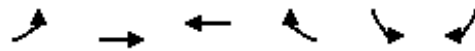

Lane Group	EBL	EBT	WBT	WBR	SBL	SBR
Detector Phase	5	2	6	4	4	5
Switch Phase						
Minimum Initial (s)	5.0	10.0	10.0	5.0	5.0	5.0
Minimum Split (s)	15.9	34.4	41.4	29.3	29.3	15.9
Total Split (s)	28.0	70.0	42.0	45.0	45.0	28.0
Total Split (%)	24.3%	60.9%	36.5%	39.1%	39.1%	24.3%
Maximum Green (s)	22.1	63.6	35.6	38.7	38.7	22.1
Yellow Time (s)	3.3	3.3	3.3	3.3	3.3	3.3
All-Red Time (s)	2.6	3.1	3.1	3.0	3.0	2.6
Lost Time Adjust (s)	0.0	0.0	0.0	0.0	0.0	0.0
Total Lost Time (s)	5.9	6.4	6.4	6.3	6.3	5.9
Lead/Lag	Lead		Lag			Lead
Lead-Lag Optimize?	Yes		Yes			Yes
Vehicle Extension (s)	3.0	3.0	3.0	3.0	3.0	3.0
Recall Mode	None	C-Max	C-Max	None	None	None
Walk Time (s)		7.0	7.0	7.0	7.0	
Flash Dont Walk (s)		21.0	28.0	16.0	16.0	
Pedestrian Calls (#/hr)		3	3	63	63	
Act Effct Green (s)	82.9	82.4	56.8	76.8	19.9	40.0
Actuated g/C Ratio	0.72	0.72	0.49	0.67	0.17	0.35
v/c Ratio	0.67	0.19	0.36	0.48	0.25	0.26
Control Delay	15.9	9.3	20.8	6.2	41.0	9.3
Queue Delay	0.0	0.0	0.0	0.0	0.0	0.0
Total Delay	15.9	9.3	20.8	6.2	41.0	9.3
LOS	B	A	C	A	D	A
Approach Delay		12.4	14.0		24.7	
Approach LOS		B	B		C	

Intersection Summary

Area Type:	Other
Cycle Length:	115
Actuated Cycle Length:	115
Offset:	43 (37%), Referenced to phase 2:EBTL and 6:WBT, Start of Green
Natural Cycle:	90
Control Type:	Actuated-Coordinated
Maximum v/c Ratio:	0.67
Intersection Signal Delay:	14.8
Intersection LOS:	B
Intersection Capacity Utilization	79.1%
ICU Level of Service	D
Analysis Period (min)	15

Splits and Phases: 5: Smyth Rd & Hospital Main Access

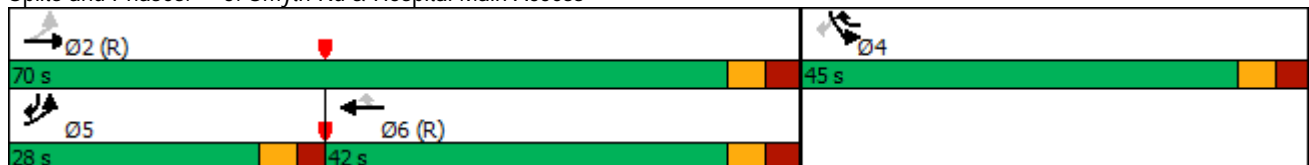

Queues

5: Smyth Rd & Hospital Main Access

02/23/2024

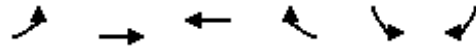

Lane Group	EBL	EBT	WBT	WBR	SBL	SBR
Lane Group Flow (vph)	427	467	582	505	142	151
v/c Ratio	0.67	0.19	0.36	0.48	0.25	0.26
Control Delay	15.9	9.3	20.8	6.2	41.0	9.3
Queue Delay	0.0	0.0	0.0	0.0	0.0	0.0
Total Delay	15.9	9.3	20.8	6.2	41.0	9.3
Queue Length 50th (m)	62.2	29.1	45.3	22.1	14.6	9.0
Queue Length 95th (m)	m83.3	m34.1	70.1	55.9	24.0	18.8
Internal Link Dist (m)		370.3	389.0		36.1	
Turn Bay Length (m)	60.0			178.0		
Base Capacity (vph)	671	2403	1639	1253	1094	622
Starvation Cap Reductn	0	0	0	0	0	0
Spillback Cap Reductn	0	0	0	0	0	0
Storage Cap Reductn	0	0	0	0	0	0
Reduced v/c Ratio	0.64	0.19	0.36	0.40	0.13	0.24

Intersection Summary

m Volume for 95th percentile queue is metered by upstream signal.

Lanes, Volumes, Timings
6: Smyth Rd & Roger Guindon Ave

02/23/2024

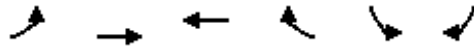

Lane Group	EBL	EBT	WBT	WBR	SBL	SBR	Ø3
Lane Configurations	↖	↕	↕		↖	↗	
Traffic Volume (vph)	204	405	1042	512	118	45	
Future Volume (vph)	204	405	1042	512	118	45	
Ideal Flow (vphpl)	1800	1800	1800	1800	1800	1800	
Storage Length (m)	67.0			0.0	35.0	0.0	
Storage Lanes	1			0	1	1	
Taper Length (m)	7.5				7.5		
Lane Util. Factor	1.00	0.95	0.95	0.95	1.00	1.00	
Ped Bike Factor			0.99		0.99	0.99	
Frt			0.951			0.850	
Flt Protected	0.950				0.950		
Satd. Flow (prot)	1710	3288	3169	0	1644	1530	
Flt Permitted	0.076				0.950		
Satd. Flow (perm)	137	3288	3169	0	1629	1510	
Right Turn on Red				Yes		Yes	
Satd. Flow (RTOR)			104			45	
Link Speed (k/h)		50	50		50		
Link Distance (m)		413.0	277.5		141.9		
Travel Time (s)		29.7	20.0		10.2		
Confl. Peds. (#/hr)	9			9	7	1	
Confl. Bikes (#/hr)				2			
Peak Hour Factor	1.00	1.00	1.00	1.00	1.00	1.00	
Heavy Vehicles (%)	0%	4%	2%	0%	4%	0%	
Adj. Flow (vph)	204	405	1042	512	118	45	
Shared Lane Traffic (%)							
Lane Group Flow (vph)	204	405	1554	0	118	45	
Enter Blocked Intersection	No	No	No	No	No	No	
Lane Alignment	Left	Left	Left	Right	Left	Right	
Median Width(m)		3.6	3.6		3.6		
Link Offset(m)		0.0	0.0		0.0		
Crosswalk Width(m)		4.8	4.8		4.8		
Two way Left Turn Lane							
Headway Factor	1.07	1.07	1.07	1.07	1.07	1.07	
Turning Speed (k/h)	25			15	25	15	
Number of Detectors	1	2	2		1	1	
Detector Template	Left	Thru	Thru		Left	Right	
Leading Detector (m)	2.0	10.0	10.0		2.0	2.0	
Trailing Detector (m)	0.0	0.0	0.0		0.0	0.0	
Detector 1 Position(m)	0.0	0.0	0.0		0.0	0.0	
Detector 1 Size(m)	2.0	0.6	0.6		2.0	2.0	
Detector 1 Type	CI+Ex	CI+Ex	CI+Ex		CI+Ex	CI+Ex	
Detector 1 Channel							
Detector 1 Extend (s)	0.0	0.0	0.0		0.0	0.0	
Detector 1 Queue (s)	0.0	0.0	0.0		0.0	0.0	
Detector 1 Delay (s)	0.0	0.0	0.0		0.0	0.0	
Detector 2 Position(m)		9.4	9.4				
Detector 2 Size(m)		0.6	0.6				
Detector 2 Type		CI+Ex	CI+Ex				
Detector 2 Channel							
Detector 2 Extend (s)		0.0	0.0				
Turn Type	pm+pt	NA	NA		Prot	Perm	
Protected Phases	5	2	6		4		3
Permitted Phases	2					4	

Lanes, Volumes, Timings
6: Smyth Rd & Roger Guindon Ave

02/23/2024

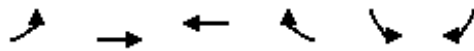

Lane Group	EBL	EBT	WBT	WBR	SBL	SBR	Ø3
Detector Phase	5	2	6		4	4	
Switch Phase							
Minimum Initial (s)	5.0	10.0	10.0		5.0	5.0	1.0
Minimum Split (s)	10.5	23.8	30.8		31.6	31.6	5.0
Total Split (s)	15.0	53.0	38.0		32.0	32.0	5.0
Total Split (%)	16.7%	58.9%	42.2%		35.6%	35.6%	6%
Maximum Green (s)	9.5	47.2	32.2		26.4	26.4	3.0
Yellow Time (s)	3.3	3.3	3.3		3.3	3.3	2.0
All-Red Time (s)	2.2	2.5	2.5		2.3	2.3	0.0
Lost Time Adjust (s)	0.0	0.0	0.0		0.0	0.0	
Total Lost Time (s)	5.5	5.8	5.8		5.6	5.6	
Lead/Lag	Lead		Lag		Lag	Lag	Lead
Lead-Lag Optimize?	Yes		Yes				
Vehicle Extension (s)	3.0	3.0	3.0		3.0	3.0	3.0
Recall Mode	None	C-Max	C-Max		None	None	None
Walk Time (s)			10.0		7.0	7.0	3.0
Flash Dont Walk (s)			15.0		14.0	14.0	0.0
Pedestrian Calls (#/hr)			9		8	8	8
Act Effct Green (s)	65.2	64.9	48.7		12.7	12.7	
Actuated g/C Ratio	0.72	0.72	0.54		0.14	0.14	
v/c Ratio	0.71	0.17	0.88		0.51	0.18	
Control Delay	31.2	5.1	26.6		42.3	11.0	
Queue Delay	0.0	0.0	0.0		0.0	0.0	
Total Delay	31.2	5.1	26.6		42.3	11.0	
LOS	C	A	C		D	B	
Approach Delay		13.9	26.6		33.6		
Approach LOS		B	C		C		

Intersection Summary

Area Type:	Other
Cycle Length:	90
Actuated Cycle Length:	90
Offset:	12 (13%), Referenced to phase 2:EBTL and 6:WBT, Start of Green
Natural Cycle:	110
Control Type:	Actuated-Coordinated
Maximum v/c Ratio:	0.88
Intersection Signal Delay:	23.8
Intersection LOS:	C
Intersection Capacity Utilization	81.3%
ICU Level of Service	D
Analysis Period (min)	15

Splits and Phases: 6: Smyth Rd & Roger Guindon Ave



Queues

6: Smyth Rd & Roger Guindon Ave

02/23/2024

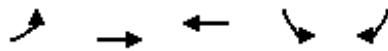

Lane Group	EBL	EBT	WBT	SBL	SBR
Lane Group Flow (vph)	204	405	1554	118	45
v/c Ratio	0.71	0.17	0.88	0.51	0.18
Control Delay	31.2	5.1	26.6	42.3	11.0
Queue Delay	0.0	0.0	0.0	0.0	0.0
Total Delay	31.2	5.1	26.6	42.3	11.0
Queue Length 50th (m)	18.4	9.3	107.5	20.4	0.0
Queue Length 95th (m)	45.9	24.4	#230.6	33.3	8.6
Internal Link Dist (m)		389.0	253.5	117.9	
Turn Bay Length (m)	67.0			35.0	
Base Capacity (vph)	297	2372	1763	482	474
Starvation Cap Reductn	0	0	0	0	0
Spillback Cap Reductn	0	0	0	0	0
Storage Cap Reductn	0	0	0	0	0
Reduced v/c Ratio	0.69	0.17	0.88	0.24	0.09

Intersection Summary

95th percentile volume exceeds capacity, queue may be longer.
 Queue shown is maximum after two cycles.

HCM Unsignalized Intersection Capacity Analysis

7: Ring Rd & Hospital Link Rd

04/10/2024



Movement	EBT	EBR	WBL	WBT	NBL	NBR
Lane Configurations	↔			↔	↔	
Sign Control	Stop			Stop	Stop	
Traffic Volume (vph)	231	237	46	82	46	124
Future Volume (vph)	231	237	46	82	46	124
Peak Hour Factor	1.00	1.00	1.00	1.00	1.00	1.00
Hourly flow rate (vph)	231	237	46	82	46	124

Direction, Lane #	EB 1	WB 1	NB 1
Volume Total (vph)	468	128	170
Volume Left (vph)	0	46	46
Volume Right (vph)	237	0	124
Hadj (s)	-0.29	0.14	-0.29
Departure Headway (s)	4.2	5.0	4.9
Degree Utilization, x	0.55	0.18	0.23
Capacity (veh/h)	821	677	654
Control Delay (s)	12.3	9.1	9.4
Approach Delay (s)	12.3	9.1	9.4
Approach LOS	B	A	A

Intersection Summary			
Delay		11.1	
Level of Service		B	
Intersection Capacity Utilization	56.8%		ICU Level of Service B
Analysis Period (min)		15	

HCM Unsignalized Intersection Capacity Analysis

8: uOttawa-Rehab W Access & Hospital Link Rd

04/10/2024

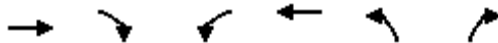

Movement	EBT	EBR	WBL	WBT	NBL	NBR
Lane Configurations	↻			↻	↻	
Traffic Volume (veh/h)	204	63	35	120	1	2
Future Volume (Veh/h)	204	63	35	120	1	2
Sign Control	Free			Free	Stop	
Grade	0%			0%	0%	
Peak Hour Factor	1.00	1.00	1.00	1.00	1.00	1.00
Hourly flow rate (vph)	204	63	35	120	1	2
Pedestrians					1	
Lane Width (m)					3.6	
Walking Speed (m/s)					1.2	
Percent Blockage					0	
Right turn flare (veh)						
Median type	None			None		
Median storage veh						
Upstream signal (m)						
pX, platoon unblocked						
vC, conflicting volume			268		426	236
vC1, stage 1 conf vol						
vC2, stage 2 conf vol						
vCu, unblocked vol			268		426	236
tC, single (s)			4.1		6.4	6.2
tC, 2 stage (s)						
tF (s)			2.2		3.5	3.3
p0 queue free %			97		100	100
cM capacity (veh/h)			1295		572	807
Direction, Lane #	EB 1	WB 1	NB 1			
Volume Total	267	155	3			
Volume Left	0	35	1			
Volume Right	63	0	2			
cSH	1700	1295	710			
Volume to Capacity	0.16	0.03	0.00			
Queue Length 95th (m)	0.0	0.7	0.1			
Control Delay (s)	0.0	2.0	10.1			
Lane LOS			A			B
Approach Delay (s)	0.0	2.0	10.1			
Approach LOS			B			
Intersection Summary						
Average Delay			0.8			
Intersection Capacity Utilization			37.4%	ICU Level of Service	A	
Analysis Period (min)			15			

HCM Unsignalized Intersection Capacity Analysis

9: uOttawa-Rehab E Access & Hospital Link Rd

04-11-2024



Movement	EBT	EBR	WBL	WBT	NBL	NBR
Lane Configurations	↑			↑	↘	↘
Sign Control	Stop			Stop	Stop	
Traffic Volume (vph)	206	0	0	110	46	27
Future Volume (vph)	206	0	0	110	46	27
Peak Hour Factor	1.00	1.00	1.00	1.00	1.00	1.00
Hourly flow rate (vph)	206	0	0	110	46	27
Direction, Lane #	EB 1	WB 1	NB 1			
Volume Total (vph)	206	110	73			
Volume Left (vph)	0	0	46			
Volume Right (vph)	0	0	27			
Hadj (s)	0.05	0.09	0.07			
Departure Headway (s)	4.3	4.4	4.7			
Degree Utilization, x	0.24	0.13	0.09			
Capacity (veh/h)	828	800	720			
Control Delay (s)	8.6	8.1	8.2			
Approach Delay (s)	8.6	8.1	8.2			
Approach LOS	A	A	A			
Intersection Summary						
Delay			8.4			
Level of Service			A			
Intersection Capacity Utilization			22.7%	ICU Level of Service	A	
Analysis Period (min)			15			

HCM Unsignalized Intersection Capacity Analysis

10: AMRC Driveway & Hospital Link Rd

04/10/2024



Movement	EBT	EBR	WBL	WBT	NBL	NBR
Lane Configurations	→			←	↔	↔
Traffic Volume (veh/h)	261	94	32	90	38	6
Future Volume (Veh/h)	261	94	32	90	38	6
Sign Control	Free			Free	Stop	
Grade	0%			0%	0%	
Peak Hour Factor	1.00	1.00	1.00	1.00	1.00	1.00
Hourly flow rate (vph)	261	94	32	90	38	6
Pedestrians						
Lane Width (m)						
Walking Speed (m/s)						
Percent Blockage						
Right turn flare (veh)						
Median type	None			None		
Median storage veh						
Upstream signal (m)						
pX, platoon unblocked						
vC, conflicting volume			355		462	308
vC1, stage 1 conf vol						
vC2, stage 2 conf vol						
vCu, unblocked vol			355		462	308
tC, single (s)			4.1		6.4	6.2
tC, 2 stage (s)						
tF (s)			2.2		3.5	3.3
p0 queue free %			97		93	99
cM capacity (veh/h)			1204		543	732
Direction, Lane #	EB 1	WB 1	NB 1			
Volume Total	355	122	44			
Volume Left	0	32	38			
Volume Right	94	0	6			
cSH	1700	1204	563			
Volume to Capacity	0.21	0.03	0.08			
Queue Length 95th (m)	0.0	0.7	2.0			
Control Delay (s)	0.0	2.3	11.9			
Lane LOS		A	B			
Approach Delay (s)	0.0	2.3	11.9			
Approach LOS			B			
Intersection Summary						
Average Delay			1.5			
Intersection Capacity Utilization			40.7%	ICU Level of Service	A	
Analysis Period (min)			15			

Lanes, Volumes, Timings
1: Alta Vista Dr & Hospital Link Rd

02/23/2024



Lane Group	EBL	EBT	EBR	WBL	WBT	WBR	NBL	NBT	NBR	SBL	SBT	SBR
Lane Configurations												
Traffic Volume (vph)	0	69	37	61	267	17	23	828	32	1	577	12
Future Volume (vph)	0	69	37	61	267	17	23	828	32	1	577	12
Ideal Flow (vphpl)	1900	1900	1900	1900	1900	1900	1900	1900	1900	1900	1900	1900
Storage Length (m)	0.0		0.0	25.0		40.0	30.0		0.0	25.0		0.0
Storage Lanes	1		0	1		1	1		0	1		0
Taper Length (m)	7.5			7.5			7.5			7.5		
Lane Util. Factor	1.00	1.00	1.00	1.00	1.00	1.00	1.00	1.00	1.00	1.00	1.00	1.00
Ped Bike Factor		0.99		0.98		0.95		1.00			1.00	
Frt		0.948				0.850		0.994			0.997	
Flt Protected				0.950			0.950			0.950		
Satd. Flow (prot)	1900	1719	0	1719	1845	1524	1805	1849	0	1805	1839	0
Flt Permitted				0.485			0.333			0.149		
Satd. Flow (perm)	1900	1719	0	864	1845	1450	633	1849	0	283	1839	0
Right Turn on Red			Yes			Yes			Yes			Yes
Satd. Flow (RTOR)		22				31		2			1	
Link Speed (k/h)		50			50			50			50	
Link Distance (m)		148.1			598.8			586.9			279.5	
Travel Time (s)		10.7			43.1			42.3			20.1	
Confl. Peds. (#/hr)	12		9	9		12	9		14	14		9
Peak Hour Factor	1.00	1.00	1.00	1.00	1.00	1.00	1.00	1.00	1.00	1.00	1.00	1.00
Heavy Vehicles (%)	0%	5%	0%	5%	3%	6%	0%	2%	0%	0%	3%	0%
Adj. Flow (vph)	0	69	37	61	267	17	23	828	32	1	577	12
Shared Lane Traffic (%)												
Lane Group Flow (vph)	0	106	0	61	267	17	23	860	0	1	589	0
Enter Blocked Intersection	No	No	No	No	No	No	No	No	No	No	No	No
Lane Alignment	Left	Left	Right	Left	Left	Right	Left	Left	Right	Left	Left	Right
Median Width(m)		3.6			3.6			3.6			3.6	
Link Offset(m)		0.0			0.0			0.0			0.0	
Crosswalk Width(m)		4.8			4.8			4.8			4.8	
Two way Left Turn Lane												
Headway Factor	1.00	1.00	1.00	1.00	1.00	1.00	1.00	1.00	1.00	1.00	1.00	1.00
Turning Speed (k/h)	25		15	25		15	25		15	25		15
Number of Detectors	1	2		1	2	1	1	2		1	2	
Detector Template	Left	Thru		Left	Thru	Right	Left	Thru		Left	Thru	
Leading Detector (m)	2.0	10.0		2.0	10.0	2.0	2.0	10.0		2.0	10.0	
Trailing Detector (m)	0.0	0.0		0.0	0.0	0.0	0.0	0.0		0.0	0.0	
Detector 1 Position(m)	0.0	0.0		0.0	0.0	0.0	0.0	0.0		0.0	0.0	
Detector 1 Size(m)	2.0	0.6		2.0	0.6	2.0	2.0	0.6		2.0	0.6	
Detector 1 Type	CI+Ex	CI+Ex		CI+Ex	CI+Ex	CI+Ex	CI+Ex	CI+Ex		CI+Ex	CI+Ex	
Detector 1 Channel												
Detector 1 Extend (s)	0.0	0.0		0.0	0.0	0.0	0.0	0.0		0.0	0.0	
Detector 1 Queue (s)	0.0	0.0		0.0	0.0	0.0	0.0	0.0		0.0	0.0	
Detector 1 Delay (s)	0.0	0.0		0.0	0.0	0.0	0.0	0.0		0.0	0.0	
Detector 2 Position(m)		9.4			9.4			9.4			9.4	
Detector 2 Size(m)		0.6			0.6			0.6			0.6	
Detector 2 Type		CI+Ex			CI+Ex			CI+Ex			CI+Ex	
Detector 2 Channel												
Detector 2 Extend (s)		0.0			0.0			0.0			0.0	
Turn Type	Perm	NA		pm+pt	NA	Perm	Perm	NA		Perm	NA	
Protected Phases		2		1	6			8			4	
Permitted Phases	2			6		6	8			4		
Detector Phase	2	2		1	6	6	8	8		4	4	

Lanes, Volumes, Timings

1: Alta Vista Dr & Hospital Link Rd

02/23/2024



Lane Group	EBL	EBT	EBR	WBL	WBT	WBR	NBL	NBT	NBR	SBL	SBT	SBR
Switch Phase												
Minimum Initial (s)	10.0	10.0		5.0	10.0	10.0	10.0	10.0		10.0	10.0	
Minimum Split (s)	30.5	30.5		11.5	30.5	30.5	27.3	27.3		27.3	27.3	
Total Split (s)	31.5	31.5		21.5	53.0	53.0	61.3	61.3		61.3	61.3	
Total Split (%)	27.6%	27.6%		18.8%	46.4%	46.4%	53.6%	53.6%		53.6%	53.6%	
Maximum Green (s)	25.0	25.0		15.0	46.5	46.5	55.0	55.0		55.0	55.0	
Yellow Time (s)	3.3	3.3		3.3	3.3	3.3	3.3	3.3		3.3	3.3	
All-Red Time (s)	3.2	3.2		3.2	3.2	3.2	3.0	3.0		3.0	3.0	
Lost Time Adjust (s)	0.0	0.0		0.0	0.0	0.0	0.0	0.0		0.0	0.0	
Total Lost Time (s)	6.5	6.5		6.5	6.5	6.5	6.3	6.3		6.3	6.3	
Lead/Lag	Lag	Lag		Lead								
Lead-Lag Optimize?	Yes	Yes		Yes								
Vehicle Extension (s)	3.0	3.0		3.0	3.0	3.0	3.0	3.0		3.0	3.0	
Recall Mode	None	None		None	None	None	Max	Max		Max	Max	
Walk Time (s)	7.0	7.0			7.0	7.0	7.0	7.0		7.0	7.0	
Flash Dont Walk (s)	17.0	17.0			17.0	17.0	14.0	14.0		14.0	14.0	
Pedestrian Calls (#/hr)	21	21			21	21	23	23		23	23	
Act Effct Green (s)		15.5		27.1	27.1	27.1	55.8	55.8		55.8	55.8	
Actuated g/C Ratio		0.16		0.28	0.28	0.28	0.58	0.58		0.58	0.58	
v/c Ratio		0.36		0.19	0.51	0.04	0.06	0.80		0.01	0.55	
Control Delay		32.4		25.0	31.3	3.7	13.0	25.7		13.0	17.1	
Queue Delay		0.0		0.0	0.0	0.0	0.0	0.0		0.0	0.0	
Total Delay		32.4		25.0	31.3	3.7	13.0	25.7		13.0	17.1	
LOS		C		C	C	A	B	C		B	B	
Approach Delay		32.4			28.8			25.4			17.1	
Approach LOS		C			C			C			B	

Intersection Summary

Area Type:	Other
Cycle Length:	114.3
Actuated Cycle Length:	95.8
Natural Cycle:	90
Control Type:	Semi Act-Uncoord
Maximum v/c Ratio:	0.80
Intersection Signal Delay:	23.8
Intersection LOS:	C
Intersection Capacity Utilization	72.2%
ICU Level of Service	C
Analysis Period (min)	15

Splits and Phases: 1: Alta Vista Dr & Hospital Link Rd

Ø1	Ø2	Ø4
21.5 s	31.5 s	61.3 s
Ø6		Ø8
53 s		61.3 s

Queues

1: Alta Vista Dr & Hospital Link Rd

02/23/2024



Lane Group	EBT	WBL	WBT	WBR	NBL	NBT	SBL	SBT
Lane Group Flow (vph)	106	61	267	17	23	860	1	589
v/c Ratio	0.36	0.19	0.51	0.04	0.06	0.80	0.01	0.55
Control Delay	32.4	25.0	31.3	3.7	13.0	25.7	13.0	17.1
Queue Delay	0.0	0.0	0.0	0.0	0.0	0.0	0.0	0.0
Total Delay	32.4	25.0	31.3	3.7	13.0	25.7	13.0	17.1
Queue Length 50th (m)	15.0	8.7	42.9	0.0	1.7	111.2	0.1	59.9
Queue Length 95th (m)	31.2	18.1	65.7	2.7	7.2	#259.3	1.0	130.2
Internal Link Dist (m)	124.1		574.8			562.9		255.5
Turn Bay Length (m)		25.0		40.0	30.0		25.0	
Base Capacity (vph)	471	387	908	729	368	1077	164	1071
Starvation Cap Reductn	0	0	0	0	0	0	0	0
Spillback Cap Reductn	0	0	0	0	0	0	0	0
Storage Cap Reductn	0	0	0	0	0	0	0	0
Reduced v/c Ratio	0.23	0.16	0.29	0.02	0.06	0.80	0.01	0.55

Intersection Summary

95th percentile volume exceeds capacity, queue may be longer.
 Queue shown is maximum after two cycles.

Lanes, Volumes, Timings
2: Alta Vista Dr & Smyth Rd

02/23/2024



Lane Group	EBL	EBT	EBR	WBL	WBT	WBR	NBL	NBT	NBR	SBL	SBT	SBR
Lane Configurations												
Traffic Volume (vph)	200	504	220	281	924	263	109	311	80	127	445	232
Future Volume (vph)	200	504	220	281	924	263	109	311	80	127	445	232
Ideal Flow (vphpl)	1900	1900	1900	1900	1900	1900	1900	1900	1900	1900	1900	1900
Storage Length (m)	30.0		25.0	61.0		10.0	87.0		30.0	44.0		25.0
Storage Lanes	1		1	1		1	1		1	1		1
Taper Length (m)	7.5			7.5			7.5			7.5		
Lane Util. Factor	1.00	0.95	1.00	1.00	0.95	1.00	1.00	1.00	1.00	1.00	1.00	1.00
Ped Bike Factor			0.95	0.99		0.81			0.98	0.99		0.97
Frt			0.850			0.850			0.850			0.850
Flt Protected	0.950			0.950			0.950			0.950		
Satd. Flow (prot)	1787	3438	1615	1805	3539	1583	1770	1845	1568	1752	1845	1599
Flt Permitted	0.159			0.367			0.152			0.297		
Satd. Flow (perm)	299	3438	1538	690	3539	1283	283	1845	1529	545	1845	1553
Right Turn on Red			Yes			Yes			Yes			Yes
Satd. Flow (RTOR)			161			139			137			137
Link Speed (k/h)		50			50			50			50	
Link Distance (m)		339.0			234.1			204.1			586.9	
Travel Time (s)		24.4			16.9			14.7			42.3	
Confl. Peds. (#/hr)	56		9	9		56	10		8	8		10
Confl. Bikes (#/hr)			1			4			1			2
Peak Hour Factor	1.00	1.00	1.00	1.00	1.00	1.00	1.00	1.00	1.00	1.00	1.00	1.00
Heavy Vehicles (%)	1%	5%	0%	0%	2%	2%	2%	3%	3%	3%	3%	1%
Adj. Flow (vph)	200	504	220	281	924	263	109	311	80	127	445	232
Shared Lane Traffic (%)												
Lane Group Flow (vph)	200	504	220	281	924	263	109	311	80	127	445	232
Enter Blocked Intersection	No	No	No	No	No	No	No	No	No	No	No	No
Lane Alignment	Left	Left	Right	Left	Left	Right	Left	Left	Right	Left	Left	Right
Median Width(m)		3.6			3.6			3.6			3.6	
Link Offset(m)		0.0			0.0			0.0			0.0	
Crosswalk Width(m)		4.8			4.8			4.8			4.8	
Two way Left Turn Lane												
Headway Factor	1.00	1.00	1.00	1.00	1.00	1.00	1.00	1.00	1.00	1.00	1.00	1.00
Turning Speed (k/h)	25		15	25		15	25		15	25		15
Number of Detectors	1	2	1	1	2	1	1	2	1	1	2	1
Detector Template	Left	Thru	Right	Left	Thru	Right	Left	Thru	Right	Left	Thru	Right
Leading Detector (m)	2.0	10.0	2.0	2.0	10.0	2.0	2.0	10.0	2.0	2.0	10.0	2.0
Trailing Detector (m)	0.0	0.0	0.0	0.0	0.0	0.0	0.0	0.0	0.0	0.0	0.0	0.0
Detector 1 Position(m)	0.0	0.0	0.0	0.0	0.0	0.0	0.0	0.0	0.0	0.0	0.0	0.0
Detector 1 Size(m)	2.0	0.6	2.0	2.0	0.6	2.0	2.0	0.6	2.0	2.0	0.6	2.0
Detector 1 Type	CI+Ex	CI+Ex	CI+Ex	CI+Ex	CI+Ex	CI+Ex	CI+Ex	CI+Ex	CI+Ex	CI+Ex	CI+Ex	CI+Ex
Detector 1 Channel												
Detector 1 Extend (s)	0.0	0.0	0.0	0.0	0.0	0.0	0.0	0.0	0.0	0.0	0.0	0.0
Detector 1 Queue (s)	0.0	0.0	0.0	0.0	0.0	0.0	0.0	0.0	0.0	0.0	0.0	0.0
Detector 1 Delay (s)	0.0	0.0	0.0	0.0	0.0	0.0	0.0	0.0	0.0	0.0	0.0	0.0
Detector 2 Position(m)		9.4			9.4			9.4			9.4	
Detector 2 Size(m)		0.6			0.6			0.6			0.6	
Detector 2 Type		CI+Ex			CI+Ex			CI+Ex			CI+Ex	
Detector 2 Channel												
Detector 2 Extend (s)		0.0			0.0			0.0			0.0	
Turn Type	pm+pt	NA	Perm	pm+pt	NA	Perm	pm+pt	NA	Perm	pm+pt	NA	Perm
Protected Phases	5	2		1	6		3	8		7	4	
Permitted Phases	2		2	6		6	8		8	4		4

Lanes, Volumes, Timings

2: Alta Vista Dr & Smyth Rd

02/23/2024



Lane Group	EBL	EBT	EBR	WBL	WBT	WBR	NBL	NBT	NBR	SBL	SBT	SBR
Detector Phase	5	2	2	1	6	6	3	8	8	7	4	4
Switch Phase												
Minimum Initial (s)	5.0	10.0	10.0	5.0	10.0	10.0	5.0	10.0	10.0	5.0	10.0	10.0
Minimum Split (s)	10.5	24.8	24.8	10.5	24.8	24.8	11.1	29.1	29.1	11.1	29.1	29.1
Total Split (s)	22.0	44.0	44.0	22.0	44.0	44.0	18.0	31.0	31.0	18.0	31.0	31.0
Total Split (%)	19.1%	38.3%	38.3%	19.1%	38.3%	38.3%	15.7%	27.0%	27.0%	15.7%	27.0%	27.0%
Maximum Green (s)	16.5	38.2	38.2	16.5	38.2	38.2	11.9	24.9	24.9	11.9	24.9	24.9
Yellow Time (s)	3.3	3.3	3.3	3.3	3.3	3.3	3.3	3.3	3.3	3.3	3.3	3.3
All-Red Time (s)	2.2	2.5	2.5	2.2	2.5	2.5	2.8	2.8	2.8	2.8	2.8	2.8
Lost Time Adjust (s)	0.0	0.0	0.0	0.0	0.0	0.0	0.0	0.0	0.0	0.0	0.0	0.0
Total Lost Time (s)	5.5	5.8	5.8	5.5	5.8	5.8	6.1	6.1	6.1	6.1	6.1	6.1
Lead/Lag	Lead	Lag	Lag	Lead	Lag	Lag	Lead	Lag	Lag	Lead	Lag	Lag
Lead-Lag Optimize?	Yes	Yes	Yes	Yes	Yes	Yes	Yes	Yes	Yes	Yes	Yes	Yes
Vehicle Extension (s)	3.0	3.0	3.0	3.0	3.0	3.0	3.0	3.0	3.0	3.0	3.0	3.0
Recall Mode	None	C-Max	C-Max	None	C-Max	C-Max	None	Max	Max	None	Max	Max
Walk Time (s)		7.0	7.0		7.0	7.0		7.0	7.0		7.0	7.0
Flash Dont Walk (s)		12.0	12.0		12.0	12.0		16.0	16.0		16.0	16.0
Pedestrian Calls (#/hr)		65	65		65	65		18	18		18	18
Act Effct Green (s)	53.3	40.1	40.1	56.7	41.9	41.9	36.3	26.4	26.4	37.3	26.9	26.9
Actuated g/C Ratio	0.46	0.35	0.35	0.49	0.36	0.36	0.32	0.23	0.23	0.32	0.23	0.23
v/c Ratio	0.66	0.42	0.34	0.58	0.72	0.47	0.50	0.73	0.18	0.45	1.03	0.50
Control Delay	27.6	30.3	10.1	23.3	31.6	15.9	32.9	53.1	1.4	29.9	95.6	20.1
Queue Delay	0.0	0.0	0.0	0.0	0.0	0.0	0.0	0.0	0.0	0.0	0.0	0.0
Total Delay	27.6	30.3	10.1	23.3	31.6	15.9	32.9	53.1	1.4	29.9	95.6	20.1
LOS	C	C	B	C	C	B	C	D	A	C	F	C
Approach Delay		24.9			27.2			40.4			63.5	
Approach LOS		C			C			D			E	

Intersection Summary

Area Type:	Other
Cycle Length:	115
Actuated Cycle Length:	115
Offset:	0 (0%), Referenced to phase 2:EBTL and 6:WBTL, Start of Green
Natural Cycle:	90
Control Type:	Actuated-Coordinated
Maximum v/c Ratio:	1.03
Intersection Signal Delay:	36.3
Intersection LOS:	D
Intersection Capacity Utilization:	85.7%
ICU Level of Service:	E
Analysis Period (min):	15

Splits and Phases: 2: Alta Vista Dr & Smyth Rd

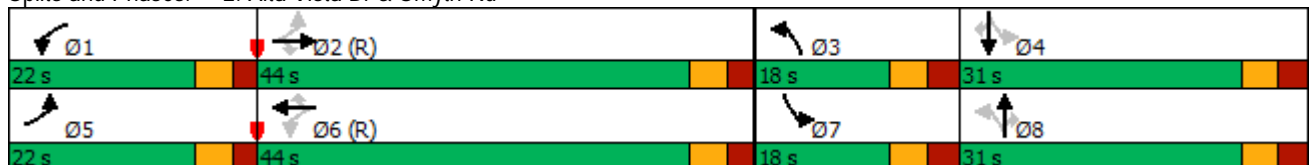

Queues

2: Alta Vista Dr & Smyth Rd

02/23/2024



Lane Group	EBL	EBT	EBR	WBL	WBT	WBR	NBL	NBT	NBR	SBL	SBT	SBR
Lane Group Flow (vph)	200	504	220	281	924	263	109	311	80	127	445	232
v/c Ratio	0.66	0.42	0.34	0.58	0.72	0.47	0.50	0.73	0.18	0.45	1.03	0.50
Control Delay	27.6	30.3	10.1	23.3	31.6	15.9	32.9	53.1	1.4	29.9	95.6	20.1
Queue Delay	0.0	0.0	0.0	0.0	0.0	0.0	0.0	0.0	0.0	0.0	0.0	0.0
Total Delay	27.6	30.3	10.1	23.3	31.6	15.9	32.9	53.1	1.4	29.9	95.6	20.1
Queue Length 50th (m)	24.3	48.2	9.5	22.7	40.4	4.0	17.1	69.3	0.0	20.1	~114.3	18.5
Queue Length 95th (m)	42.1	65.1	29.1	74.3	104.3	51.2	30.4	#111.7	1.7	34.7	#185.2	44.9
Internal Link Dist (m)		315.0			210.1			180.1			562.9	
Turn Bay Length (m)	30.0		25.0	61.0		10.0	87.0		30.0	44.0		25.0
Base Capacity (vph)	361	1200	641	508	1288	555	248	424	457	308	431	468
Starvation Cap Reductn	0	0	0	0	0	0	0	0	0	0	0	0
Spillback Cap Reductn	0	0	0	0	0	0	0	0	0	0	0	0
Storage Cap Reductn	0	0	0	0	0	0	0	0	0	0	0	0
Reduced v/c Ratio	0.55	0.42	0.34	0.55	0.72	0.47	0.44	0.73	0.18	0.41	1.03	0.50

Intersection Summary

~ Volume exceeds capacity, queue is theoretically infinite.

Queue shown is maximum after two cycles.

95th percentile volume exceeds capacity, queue may be longer.

Queue shown is maximum after two cycles.

Lanes, Volumes, Timings

3: Smyth Rd & Valour Dr

02/23/2024

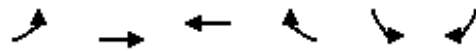

Lane Group	EBL	EBT	WBT	WBR	SBL	SBR
Lane Configurations						
Traffic Volume (vph)	32	679	1413	13	15	55
Future Volume (vph)	32	679	1413	13	15	55
Ideal Flow (vphpl)	1900	1900	1900	1900	1900	1900
Storage Length (m)	55.0			0.0	32.0	0.0
Storage Lanes	1			0	1	1
Taper Length (m)	7.5				7.5	
Lane Util. Factor	1.00	0.95	0.95	0.95	1.00	1.00
Ped Bike Factor			1.00		1.00	0.99
Frt			0.999			0.850
Flt Protected	0.950				0.950	
Satd. Flow (prot)	1752	3471	3527	0	1703	1583
Flt Permitted	0.143				0.950	
Satd. Flow (perm)	264	3471	3527	0	1695	1562
Right Turn on Red				Yes		Yes
Satd. Flow (RTOR)			1			55
Link Speed (k/h)		50	50		50	
Link Distance (m)		234.1	461.7		195.1	
Travel Time (s)		16.9	33.2		14.0	
Confl. Peds. (#/hr)	15			15	3	1
Peak Hour Factor	1.00	1.00	1.00	1.00	1.00	1.00
Heavy Vehicles (%)	3%	4%	2%	23%	6%	2%
Adj. Flow (vph)	32	679	1413	13	15	55
Shared Lane Traffic (%)						
Lane Group Flow (vph)	32	679	1426	0	15	55
Enter Blocked Intersection	No	No	No	No	No	No
Lane Alignment	Left	Left	Left	Right	Left	Right
Median Width(m)		3.6	3.6		3.6	
Link Offset(m)		0.0	0.0		0.0	
Crosswalk Width(m)		4.8	4.8		4.8	
Two way Left Turn Lane						
Headway Factor	1.00	1.00	1.00	1.00	1.00	1.00
Turning Speed (k/h)	25			15	25	15
Number of Detectors	1	2	2		1	1
Detector Template	Left	Thru	Thru		Left	Right
Leading Detector (m)	2.0	10.0	10.0		2.0	2.0
Trailing Detector (m)	0.0	0.0	0.0		0.0	0.0
Detector 1 Position(m)	0.0	0.0	0.0		0.0	0.0
Detector 1 Size(m)	2.0	0.6	0.6		2.0	2.0
Detector 1 Type	CI+Ex	CI+Ex	CI+Ex		CI+Ex	CI+Ex
Detector 1 Channel						
Detector 1 Extend (s)	0.0	0.0	0.0		0.0	0.0
Detector 1 Queue (s)	0.0	0.0	0.0		0.0	0.0
Detector 1 Delay (s)	0.0	0.0	0.0		0.0	0.0
Detector 2 Position(m)		9.4	9.4			
Detector 2 Size(m)		0.6	0.6			
Detector 2 Type		CI+Ex	CI+Ex			
Detector 2 Channel						
Detector 2 Extend (s)		0.0	0.0			
Turn Type	pm+pt	NA	NA		Prot	Perm
Protected Phases	5	2	6		4	
Permitted Phases	2					4
Detector Phase	5	2	6		4	4

Lanes, Volumes, Timings

3: Smyth Rd & Valour Dr

02/23/2024

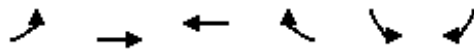

Lane Group	EBL	EBT	WBT	WBR	SBL	SBR
Switch Phase						
Minimum Initial (s)	5.0	10.0	10.0		5.0	5.0
Minimum Split (s)	10.7	29.5	29.5		28.5	28.5
Total Split (s)	18.0	85.0	67.0		30.0	30.0
Total Split (%)	15.7%	73.9%	58.3%		26.1%	26.1%
Maximum Green (s)	12.3	78.5	60.5		23.5	23.5
Yellow Time (s)	3.3	3.3	3.3		3.3	3.3
All-Red Time (s)	2.4	3.2	3.2		3.2	3.2
Lost Time Adjust (s)	0.0	0.0	0.0		0.0	0.0
Total Lost Time (s)	5.7	6.5	6.5		6.5	6.5
Lead/Lag	Lead		Lag			
Lead-Lag Optimize?	Yes		Yes			
Vehicle Extension (s)	3.0	3.0	3.0		3.0	3.0
Recall Mode	None	C-Max	C-Max		None	None
Walk Time (s)		7.0	7.0		7.0	7.0
Flash Dont Walk (s)		16.0	16.0		15.0	15.0
Pedestrian Calls (#/hr)		15	15		4	4
Act Effct Green (s)	95.8	96.3	89.2		9.4	9.4
Actuated g/C Ratio	0.83	0.84	0.78		0.08	0.08
v/c Ratio	0.11	0.23	0.52		0.11	0.31
Control Delay	1.8	0.9	15.3		46.7	16.1
Queue Delay	0.0	0.0	0.0		0.0	0.0
Total Delay	1.8	0.9	15.3		46.7	16.1
LOS	A	A	B		D	B
Approach Delay		1.0	15.3		22.7	
Approach LOS		A	B		C	

Intersection Summary

Area Type:	Other
Cycle Length:	115
Actuated Cycle Length:	115
Offset:	12 (10%), Referenced to phase 2:EBTL and 6:WBT, Start of Green
Natural Cycle:	80
Control Type:	Actuated-Coordinated
Maximum v/c Ratio:	0.52
Intersection Signal Delay:	10.9
Intersection LOS:	B
Intersection Capacity Utilization	55.0%
ICU Level of Service	A
Analysis Period (min)	15

Splits and Phases: 3: Smyth Rd & Valour Dr



Queues

3: Smyth Rd & Valour Dr

02/23/2024



Lane Group	EBL	EBT	WBT	SBL	SBR
Lane Group Flow (vph)	32	679	1426	15	55
v/c Ratio	0.11	0.23	0.52	0.11	0.31
Control Delay	1.8	0.9	15.3	46.7	16.1
Queue Delay	0.0	0.0	0.0	0.0	0.0
Total Delay	1.8	0.9	15.3	46.7	16.1
Queue Length 50th (m)	0.3	3.3	122.1	3.5	0.0
Queue Length 95th (m)	1.5	9.2	168.1	9.1	11.2
Internal Link Dist (m)		210.1	437.7	171.1	
Turn Bay Length (m)	55.0			32.0	
Base Capacity (vph)	379	2907	2735	348	362
Starvation Cap Reductn	0	0	0	0	0
Spillback Cap Reductn	0	0	0	0	0
Storage Cap Reductn	0	0	0	0	0
Reduced v/c Ratio	0.08	0.23	0.52	0.04	0.15
Intersection Summary					

Lanes, Volumes, Timings
4: S Haven Pl/Ring Rd & Smyth Rd

02/23/2024



Lane Group	EBL	EBT	EBR	WBL	WBT	WBR	NBL	NBT	NBR	SBL	SBT	SBR
Lane Configurations		↕↕			↕↕			↕↕			↕	↕
Traffic Volume (vph)	118	571	4	4	988	14	5	0	4	151	1	432
Future Volume (vph)	118	571	4	4	988	14	5	0	4	151	1	432
Ideal Flow (vphpl)	1900	1900	1900	1900	1900	1900	1900	1900	1900	1900	1900	1900
Lane Util. Factor	0.95	0.95	0.95	0.95	0.95	0.95	1.00	1.00	1.00	1.00	1.00	1.00
Ped Bike Factor		1.00			1.00			0.99			0.99	0.97
Frt		0.999			0.998			0.940				0.850
Flt Protected		0.992						0.973			0.953	
Satd. Flow (prot)	0	3468	0	0	3531	0	0	1722	0	0	1793	1599
Flt Permitted		0.615			0.953			0.877			0.722	
Satd. Flow (perm)	0	2148	0	0	3365	0	0	1549	0	0	1346	1555
Right Turn on Red			Yes			Yes			Yes			Yes
Satd. Flow (RTOR)		1			2			79				228
Link Speed (k/h)		50			50			50			50	
Link Distance (m)		461.7			394.3			74.8			50.7	
Travel Time (s)		33.2			28.4			5.4			3.7	
Confl. Peds. (#/hr)	14		6	6		14	3		6	6		3
Confl. Bikes (#/hr)			2			4						14
Peak Hour Factor	1.00	1.00	1.00	1.00	1.00	1.00	1.00	1.00	1.00	1.00	1.00	1.00
Heavy Vehicles (%)	4%	3%	0%	0%	2%	0%	0%	0%	0%	1%	0%	1%
Adj. Flow (vph)	118	571	4	4	988	14	5	0	4	151	1	432
Shared Lane Traffic (%)												
Lane Group Flow (vph)	0	693	0	0	1006	0	0	9	0	0	152	432
Enter Blocked Intersection	No	No	No	No	No	No	No	No	No	No	No	No
Lane Alignment	Left	Left	Right	Left	Left	Right	Left	Left	Right	Left	Left	Right
Median Width(m)		3.6			3.6			0.0			0.0	
Link Offset(m)		0.0			0.0			0.0			0.0	
Crosswalk Width(m)		4.8			4.8			4.8			4.8	
Two way Left Turn Lane												
Headway Factor	1.00	1.00	1.00	1.00	1.00	1.00	1.00	1.00	1.00	1.00	1.00	1.00
Turning Speed (k/h)	25		15	25		15	25		15	25		15
Number of Detectors	1	2		1	2		1	2		1	2	1
Detector Template	Left	Thru		Left	Thru		Left	Thru		Left	Thru	Right
Leading Detector (m)	2.0	10.0		2.0	10.0		2.0	10.0		2.0	10.0	2.0
Trailing Detector (m)	0.0	0.0		0.0	0.0		0.0	0.0		0.0	0.0	0.0
Detector 1 Position(m)	0.0	0.0		0.0	0.0		0.0	0.0		0.0	0.0	0.0
Detector 1 Size(m)	2.0	0.6		2.0	0.6		2.0	0.6		2.0	0.6	2.0
Detector 1 Type	CI+Ex	CI+Ex		CI+Ex	CI+Ex		CI+Ex	CI+Ex		CI+Ex	CI+Ex	CI+Ex
Detector 1 Channel												
Detector 1 Extend (s)	0.0	0.0		0.0	0.0		0.0	0.0		0.0	0.0	0.0
Detector 1 Queue (s)	0.0	0.0		0.0	0.0		0.0	0.0		0.0	0.0	0.0
Detector 1 Delay (s)	0.0	0.0		0.0	0.0		0.0	0.0		0.0	0.0	0.0
Detector 2 Position(m)		9.4			9.4			9.4			9.4	
Detector 2 Size(m)		0.6			0.6			0.6			0.6	
Detector 2 Type		CI+Ex			CI+Ex			CI+Ex			CI+Ex	
Detector 2 Channel												
Detector 2 Extend (s)		0.0			0.0			0.0			0.0	
Turn Type	pm+pt	NA		Perm	NA		Perm	NA		Perm	NA	Perm
Protected Phases	5	2			6			8			4	
Permitted Phases	2			6			8			4		4
Detector Phase	5	2		6	6		8	8		4	4	4
Switch Phase												
Minimum Initial (s)	5.0	10.0		10.0	10.0		10.0	10.0		10.0	10.0	10.0

Lanes, Volumes, Timings
4: S Haven Pl/Ring Rd & Smyth Rd

02/23/2024



Lane Group	EBL	EBT	EBR	WBL	WBT	WBR	NBL	NBT	NBR	SBL	SBT	SBR
Minimum Split (s)	10.6	31.7		31.7	31.7		28.5	28.5		28.5	28.5	28.5
Total Split (s)	16.0	78.0		62.0	62.0		37.0	37.0		37.0	37.0	37.0
Total Split (%)	13.9%	67.8%		53.9%	53.9%		32.2%	32.2%		32.2%	32.2%	32.2%
Maximum Green (s)	10.4	72.3		56.3	56.3		31.5	31.5		31.5	31.5	31.5
Yellow Time (s)	3.3	3.3		3.3	3.3		3.3	3.3		3.3	3.3	3.3
All-Red Time (s)	2.3	2.4		2.4	2.4		2.2	2.2		2.2	2.2	2.2
Lost Time Adjust (s)		0.0			0.0			0.0			0.0	0.0
Total Lost Time (s)		5.7			5.7			5.5			5.5	5.5
Lead/Lag	Lead			Lag			Lag			Lag		
Lead-Lag Optimize?	Yes			Yes			Yes			Yes		
Vehicle Extension (s)	3.0	3.0		3.0	3.0		3.0	3.0		3.0	3.0	3.0
Recall Mode	None	C-Max		C-Max	C-Max		None	None		None	None	None
Walk Time (s)		7.0		7.0	7.0		7.0	7.0		7.0	7.0	7.0
Flash Dont Walk (s)		19.0		19.0	19.0		16.0	16.0		16.0	16.0	16.0
Pedestrian Calls (#/hr)		20		20	20		9	9		9	9	9
Act Effct Green (s)		81.3		81.3	81.3		22.5	22.5		22.5	22.5	22.5
Actuated g/C Ratio		0.71		0.71	0.71		0.20	0.20		0.20	0.20	0.20
v/c Ratio		0.46		0.42	0.42		0.02	0.02		0.58	0.89	0.89
Control Delay		5.6		7.8	7.8		0.1	0.1		49.1	40.6	40.6
Queue Delay		0.0		0.0	0.0		0.0	0.0		0.0	0.0	0.0
Total Delay		5.6		7.8	7.8		0.1	0.1		49.1	40.6	40.6
LOS		A		A	A		A	A		D	D	D
Approach Delay		5.6		7.8	7.8		0.1	0.1		42.8		
Approach LOS		A		A	A		A	A		D		

Intersection Summary

Area Type:	Other
Cycle Length:	115
Actuated Cycle Length:	115
Offset:	62 (54%), Referenced to phase 2:EBTL and 6:WBTL, Start of Green
Natural Cycle:	75
Control Type:	Actuated-Coordinated
Maximum v/c Ratio:	0.89
Intersection Signal Delay:	16.0
Intersection LOS:	B
Intersection Capacity Utilization	79.2%
ICU Level of Service	D
Analysis Period (min)	15

Splits and Phases: 4: S Haven Pl/Ring Rd & Smyth Rd

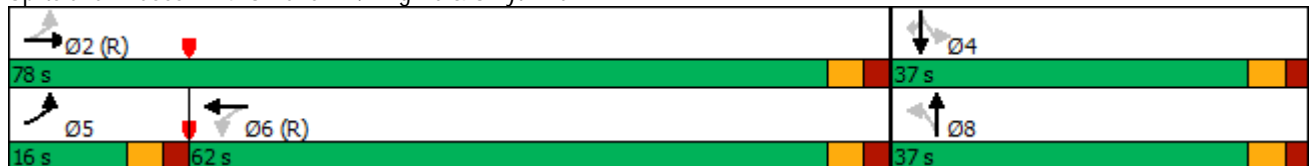

Queues

4: S Haven Pl/Ring Rd & Smyth Rd

02/23/2024



Lane Group	EBT	WBT	NBT	SBT	SBR
Lane Group Flow (vph)	693	1006	9	152	432
v/c Ratio	0.46	0.42	0.02	0.58	0.89
Control Delay	5.6	7.8	0.1	49.1	40.6
Queue Delay	0.0	0.0	0.0	0.0	0.0
Total Delay	5.6	7.8	0.1	49.1	40.6
Queue Length 50th (m)	19.9	48.8	0.0	32.7	49.6
Queue Length 95th (m)	82.8	61.5	0.0	50.1	85.1
Internal Link Dist (m)	437.7	370.3	50.8	26.7	
Turn Bay Length (m)					
Base Capacity (vph)	1518	2379	481	368	591
Starvation Cap Reductn	0	0	0	0	0
Spillback Cap Reductn	0	0	0	0	0
Storage Cap Reductn	0	0	0	0	0
Reduced v/c Ratio	0.46	0.42	0.02	0.41	0.73
Intersection Summary					

Lanes, Volumes, Timings
5: Smyth Rd & Hospital Main Access

02/23/2024

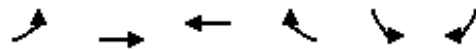

Lane Group	EBL	EBT	WBT	WBR	SBL	SBR
Lane Configurations	↖	↗↗	↗↗	↗	↖↖	↖
Traffic Volume (vph)	105	622	584	171	404	421
Future Volume (vph)	105	622	584	171	404	421
Ideal Flow (vphpl)	1900	1900	1900	1900	1900	1900
Storage Length (m)	60.0			178.0	0.0	0.0
Storage Lanes	1			1	2	1
Taper Length (m)	7.5				7.5	
Lane Util. Factor	1.00	0.95	0.95	1.00	0.97	1.00
Ped Bike Factor	0.99			0.95	0.82	0.97
Fr _t				0.850		0.850
Fl _t Protected	0.950				0.950	
Satd. Flow (prot)	1719	3505	3539	1568	3502	1583
Fl _t Permitted	0.374				0.950	
Satd. Flow (perm)	673	3505	3539	1493	2889	1531
Right Turn on Red				Yes		Yes
Satd. Flow (RTOR)				171		100
Link Speed (k/h)		50	50		50	
Link Distance (m)		394.3	413.0		60.1	
Travel Time (s)		28.4	29.7		4.3	
Confl. Peds. (#/hr)	11			11	70	14
Confl. Bikes (#/hr)				2		1
Peak Hour Factor	1.00	1.00	1.00	1.00	1.00	1.00
Heavy Vehicles (%)	5%	3%	2%	3%	0%	2%
Adj. Flow (vph)	105	622	584	171	404	421
Shared Lane Traffic (%)						
Lane Group Flow (vph)	105	622	584	171	404	421
Enter Blocked Intersection	No	No	No	No	No	No
Lane Alignment	Left	Left	Left	Right	Left	Right
Median Width(m)		3.6	3.6		7.2	
Link Offset(m)		0.0	0.0		0.0	
Crosswalk Width(m)		4.8	4.8		4.8	
Two way Left Turn Lane						
Headway Factor	1.00	1.00	1.00	1.00	1.00	1.00
Turning Speed (k/h)	25			15	25	15
Number of Detectors	1	2	2	1	1	1
Detector Template	Left	Thru	Thru	Right	Left	Right
Leading Detector (m)	2.0	10.0	10.0	2.0	2.0	2.0
Trailing Detector (m)	0.0	0.0	0.0	0.0	0.0	0.0
Detector 1 Position(m)	0.0	0.0	0.0	0.0	0.0	0.0
Detector 1 Size(m)	2.0	0.6	0.6	2.0	2.0	2.0
Detector 1 Type	CI+Ex	CI+Ex	CI+Ex	CI+Ex	CI+Ex	CI+Ex
Detector 1 Channel						
Detector 1 Extend (s)	0.0	0.0	0.0	0.0	0.0	0.0
Detector 1 Queue (s)	0.0	0.0	0.0	0.0	0.0	0.0
Detector 1 Delay (s)	0.0	0.0	0.0	0.0	0.0	0.0
Detector 2 Position(m)		9.4	9.4			
Detector 2 Size(m)		0.6	0.6			
Detector 2 Type		CI+Ex	CI+Ex			
Detector 2 Channel						
Detector 2 Extend (s)		0.0	0.0			
Turn Type	pm+pt	NA	NA	pm+ov	Prot	pm+ov
Protected Phases	5	2	6	4	4	5
Permitted Phases	2			6		4

Lanes, Volumes, Timings

5: Smyth Rd & Hospital Main Access

02/23/2024

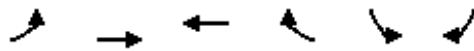

Lane Group	EBL	EBT	WBT	WBR	SBL	SBR
Detector Phase	5	2	6	4	4	5
Switch Phase						
Minimum Initial (s)	5.0	10.0	10.0	5.0	5.0	5.0
Minimum Split (s)	9.5	34.4	39.5	29.3	29.3	9.5
Total Split (s)	12.0	55.0	43.0	60.0	60.0	12.0
Total Split (%)	10.4%	47.8%	37.4%	52.2%	52.2%	10.4%
Maximum Green (s)	7.7	48.6	38.7	53.7	53.7	7.7
Yellow Time (s)	3.3	3.3	3.3	3.3	3.3	3.3
All-Red Time (s)	1.0	3.1	1.0	3.0	3.0	1.0
Lost Time Adjust (s)	0.0	0.0	0.0	0.0	0.0	0.0
Total Lost Time (s)	4.3	6.4	4.3	6.3	6.3	4.3
Lead/Lag	Lead		Lag			Lead
Lead-Lag Optimize?	Yes		Yes			Yes
Vehicle Extension (s)	3.0	3.0	3.0	3.0	3.0	3.0
Recall Mode	None	C-Max	C-Max	None	None	None
Walk Time (s)		7.0	7.0	7.0	7.0	
Flash Dont Walk (s)		21.0	28.0	16.0	16.0	
Pedestrian Calls (#/hr)		11	11	84	84	
Act Effct Green (s)	83.0	80.9	68.7	88.1	21.4	33.4
Actuated g/C Ratio	0.72	0.70	0.60	0.77	0.19	0.29
v/c Ratio	0.18	0.25	0.28	0.14	0.62	0.81
Control Delay	6.9	7.6	12.7	0.8	47.1	37.9
Queue Delay	0.0	0.0	0.0	0.0	0.0	0.0
Total Delay	6.9	7.6	12.7	0.8	47.1	37.9
LOS	A	A	B	A	D	D
Approach Delay		7.5	10.0		42.4	
Approach LOS		A	B		D	

Intersection Summary

Area Type:	Other
Cycle Length:	115
Actuated Cycle Length:	115
Offset:	59 (51%), Referenced to phase 2:EBTL and 6:WBT, Start of Green
Natural Cycle:	80
Control Type:	Actuated-Coordinated
Maximum v/c Ratio:	0.81
Intersection Signal Delay:	20.8
Intersection LOS:	C
Intersection Capacity Utilization:	63.8%
ICU Level of Service:	B
Analysis Period (min):	15

Splits and Phases: 5: Smyth Rd & Hospital Main Access

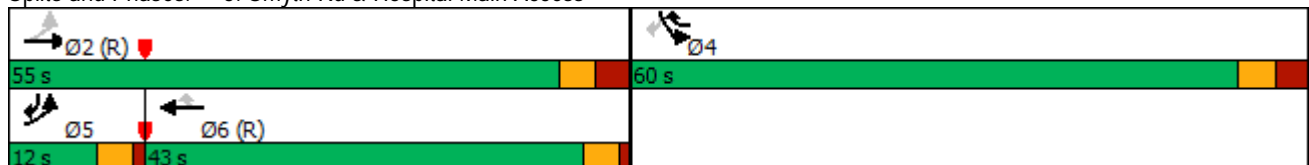

Queues

5: Smyth Rd & Hospital Main Access

02/23/2024

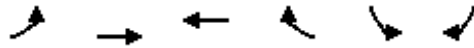

Lane Group	EBL	EBT	WBT	WBR	SBL	SBR
Lane Group Flow (vph)	105	622	584	171	404	421
v/c Ratio	0.18	0.25	0.28	0.14	0.62	0.81
Control Delay	6.9	7.6	12.7	0.8	47.1	37.9
Queue Delay	0.0	0.0	0.0	0.0	0.0	0.0
Total Delay	6.9	7.6	12.7	0.8	47.1	37.9
Queue Length 50th (m)	6.3	25.4	32.2	0.0	44.9	68.3
Queue Length 95th (m)	16.7	43.3	55.0	5.0	60.8	89.7
Internal Link Dist (m)		370.3	389.0		36.1	
Turn Bay Length (m)	60.0			178.0		
Base Capacity (vph)	581	2465	2114	1455	1635	526
Starvation Cap Reductn	0	0	0	0	0	0
Spillback Cap Reductn	0	0	0	0	0	0
Storage Cap Reductn	0	0	0	0	0	0
Reduced v/c Ratio	0.18	0.25	0.28	0.12	0.25	0.80
Intersection Summary						

Lanes, Volumes, Timings
6: Smyth Rd & Roger Guindon Ave

02/23/2024

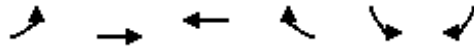

Lane Group	EBL	EBT	WBT	WBR	SBL	SBR	Ø3
Lane Configurations	↖	↗	↗		↖	↗	
Traffic Volume (vph)	35	991	539	98	530	217	
Future Volume (vph)	35	991	539	98	530	217	
Ideal Flow (vphpl)	1900	1900	1900	1900	1900	1900	
Storage Length (m)	67.0			0.0	35.0	0.0	
Storage Lanes	1			0	1	1	
Taper Length (m)	7.5				7.5		
Lane Util. Factor	1.00	0.95	0.95	0.95	1.00	1.00	
Ped Bike Factor	0.98		0.99		0.93	0.97	
Frt			0.977			0.850	
Flt Protected	0.950				0.950		
Satd. Flow (prot)	1703	3505	3372	0	1736	1553	
Flt Permitted	0.296				0.950		
Satd. Flow (perm)	522	3505	3372	0	1606	1514	
Right Turn on Red				Yes		Yes	
Satd. Flow (RTOR)			26			217	
Link Speed (k/h)		50	50		50		
Link Distance (m)		413.0	277.5		141.9		
Travel Time (s)		29.7	20.0		10.2		
Confl. Peds. (#/hr)	31			31	58	10	
Confl. Bikes (#/hr)				1		1	
Peak Hour Factor	1.00	1.00	1.00	1.00	1.00	1.00	
Heavy Vehicles (%)	6%	3%	4%	0%	4%	4%	
Adj. Flow (vph)	35	991	539	98	530	217	
Shared Lane Traffic (%)							
Lane Group Flow (vph)	35	991	637	0	530	217	
Enter Blocked Intersection	No	No	No	No	No	No	
Lane Alignment	Left	Left	Left	Right	Left	Right	
Median Width(m)		3.6	3.6		3.6		
Link Offset(m)		0.0	0.0		0.0		
Crosswalk Width(m)		4.8	4.8		4.8		
Two way Left Turn Lane							
Headway Factor	1.00	1.00	1.00	1.00	1.00	1.00	
Turning Speed (k/h)	25			15	25	15	
Number of Detectors	1	2	2		1	1	
Detector Template	Left	Thru	Thru		Left	Right	
Leading Detector (m)	2.0	10.0	10.0		2.0	2.0	
Trailing Detector (m)	0.0	0.0	0.0		0.0	0.0	
Detector 1 Position(m)	0.0	0.0	0.0		0.0	0.0	
Detector 1 Size(m)	2.0	0.6	0.6		2.0	2.0	
Detector 1 Type	CI+Ex	CI+Ex	CI+Ex		CI+Ex	CI+Ex	
Detector 1 Channel							
Detector 1 Extend (s)	0.0	0.0	0.0		0.0	0.0	
Detector 1 Queue (s)	0.0	0.0	0.0		0.0	0.0	
Detector 1 Delay (s)	0.0	0.0	0.0		0.0	0.0	
Detector 2 Position(m)		9.4	9.4				
Detector 2 Size(m)		0.6	0.6				
Detector 2 Type		CI+Ex	CI+Ex				
Detector 2 Channel							
Detector 2 Extend (s)		0.0	0.0				
Turn Type	pm+pt	NA	NA		Prot	Perm	
Protected Phases	5	2	6		4		3
Permitted Phases	2					4	

Lanes, Volumes, Timings
6: Smyth Rd & Roger Guindon Ave

02/23/2024

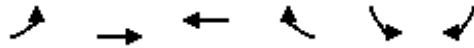

Lane Group	EBL	EBT	WBT	WBR	SBL	SBR	Ø3
Detector Phase	5	2	6		4	4	
Switch Phase							
Minimum Initial (s)	5.0	10.0	10.0		5.0	5.0	1.0
Minimum Split (s)	10.5	23.8	30.8		31.6	31.6	5.0
Total Split (s)	15.0	53.0	38.0		32.0	32.0	5.0
Total Split (%)	16.7%	58.9%	42.2%		35.6%	35.6%	6%
Maximum Green (s)	9.5	47.2	32.2		26.4	26.4	3.0
Yellow Time (s)	3.3	3.3	3.3		3.3	3.3	2.0
All-Red Time (s)	2.2	2.5	2.5		2.3	2.3	0.0
Lost Time Adjust (s)	0.0	0.0	0.0		0.0	0.0	
Total Lost Time (s)	5.5	5.8	5.8		5.6	5.6	
Lead/Lag	Lead		Lag		Lag	Lag	Lead
Lead-Lag Optimize?	Yes		Yes				
Vehicle Extension (s)	3.0	3.0	3.0		3.0	3.0	3.0
Recall Mode	None	C-Max	C-Max		None	None	None
Walk Time (s)			10.0		7.0	7.0	3.0
Flash Dont Walk (s)			15.0		14.0	14.0	0.0
Pedestrian Calls (#/hr)			31		68	68	68
Act Effct Green (s)	47.5	47.2	39.7		27.4	27.4	
Actuated g/C Ratio	0.53	0.52	0.44		0.30	0.30	
v/c Ratio	0.10	0.54	0.42		1.00	0.36	
Control Delay	10.9	15.6	18.8		73.9	5.4	
Queue Delay	0.0	0.0	0.0		0.0	0.0	
Total Delay	10.9	15.6	18.8		73.9	5.4	
LOS	B	B	B		E	A	
Approach Delay		15.4	18.8		54.0		
Approach LOS		B	B		D		

Intersection Summary

Area Type:	Other
Cycle Length:	90
Actuated Cycle Length:	90
Offset:	12 (13%), Referenced to phase 2:EBTL and 6:WBT, Start of Green
Natural Cycle:	80
Control Type:	Actuated-Coordinated
Maximum v/c Ratio:	1.00
Intersection Signal Delay:	28.2
Intersection LOS:	C
Intersection Capacity Utilization:	67.9%
ICU Level of Service:	C
Analysis Period (min):	15

Splits and Phases: 6: Smyth Rd & Roger Guindon Ave

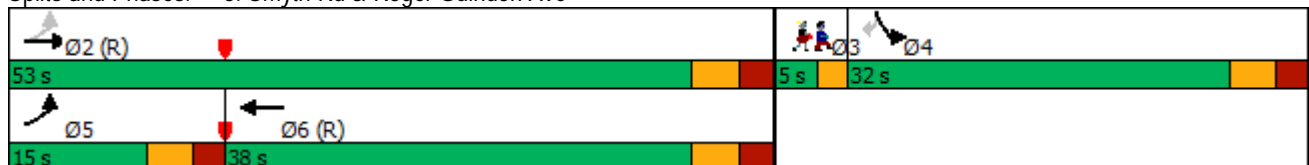

Queues

6: Smyth Rd & Roger Guindon Ave

02/23/2024



Lane Group	EBL	EBT	WBT	SBL	SBR
Lane Group Flow (vph)	35	991	637	530	217
v/c Ratio	0.10	0.54	0.42	1.00	0.36
Control Delay	10.9	15.6	18.8	73.9	5.4
Queue Delay	0.0	0.0	0.0	0.0	0.0
Total Delay	10.9	15.6	18.8	73.9	5.4
Queue Length 50th (m)	2.9	59.5	42.5	~105.3	0.0
Queue Length 95th (m)	7.4	77.4	60.0	#167.7	16.1
Internal Link Dist (m)		389.0	253.5	117.9	
Turn Bay Length (m)	67.0			35.0	
Base Capacity (vph)	400	1838	1503	528	611
Starvation Cap Reductn	0	0	0	0	0
Spillback Cap Reductn	0	0	0	0	0
Storage Cap Reductn	0	0	0	0	0
Reduced v/c Ratio	0.09	0.54	0.42	1.00	0.36

Intersection Summary

- ~ Volume exceeds capacity, queue is theoretically infinite.
Queue shown is maximum after two cycles.
- # 95th percentile volume exceeds capacity, queue may be longer.
Queue shown is maximum after two cycles.

HCM Unsignalized Intersection Capacity Analysis

7: Ring Rd & Hospital Link Rd

04/10/2024



Movement	EBT	EBR	WBL	WBT	NBL	NBR
Lane Configurations	↑			↑	↑	
Sign Control	Stop			Stop	Stop	
Traffic Volume (vph)	64	38	117	192	153	42
Future Volume (vph)	64	38	117	192	153	42
Peak Hour Factor	1.00	1.00	1.00	1.00	1.00	1.00
Hourly flow rate (vph)	64	38	117	192	153	42
Direction, Lane #	EB 1	WB 1	NB 1			
Volume Total (vph)	102	309	195			
Volume Left (vph)	0	117	153			
Volume Right (vph)	38	0	42			
Hadj (s)	-0.10	0.09	0.12			
Departure Headway (s)	4.7	4.6	5.0			
Degree Utilization, x	0.13	0.40	0.27			
Capacity (veh/h)	714	743	674			
Control Delay (s)	8.4	10.7	9.9			
Approach Delay (s)	8.4	10.7	9.9			
Approach LOS	A	B	A			
Intersection Summary						
Delay			10.0			
Level of Service			B			
Intersection Capacity Utilization			40.9%	ICU Level of Service	A	
Analysis Period (min)			15			

HCM Unsignalized Intersection Capacity Analysis

8: uOttawa-Rehab W Access & Hospital Link Rd

04/10/2024

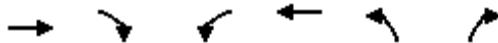

Movement	EBT	EBR	WBL	WBT	NBL	NBR
Lane Configurations	↻			↻	↻	
Traffic Volume (veh/h)	83	24	10	177	44	15
Future Volume (Veh/h)	83	24	10	177	44	15
Sign Control	Free			Free	Stop	
Grade	0%			0%	0%	
Peak Hour Factor	1.00	1.00	1.00	1.00	1.00	1.00
Hourly flow rate (vph)	83	24	10	177	44	15
Pedestrians						
Lane Width (m)						
Walking Speed (m/s)						
Percent Blockage						
Right turn flare (veh)						
Median type	None			None		
Median storage veh						
Upstream signal (m)						
pX, platoon unblocked						
vC, conflicting volume			107		292	95
vC1, stage 1 conf vol						
vC2, stage 2 conf vol						
vCu, unblocked vol			107		292	95
tC, single (s)			4.2		6.4	6.2
tC, 2 stage (s)						
tF (s)			2.3		3.5	3.3
p0 queue free %			99		94	98
cM capacity (veh/h)			1429		698	967
Direction, Lane #	EB 1	WB 1	NB 1			
Volume Total	107	187	59			
Volume Left	0	10	44			
Volume Right	24	0	15			
cSH	1700	1429	751			
Volume to Capacity	0.06	0.01	0.08			
Queue Length 95th (m)	0.0	0.2	2.0			
Control Delay (s)	0.0	0.5	10.2			
Lane LOS		A	B			
Approach Delay (s)	0.0	0.5	10.2			
Approach LOS			B			
Intersection Summary						
Average Delay			1.9			
Intersection Capacity Utilization			26.6%	ICU Level of Service	A	
Analysis Period (min)			15			

HCM Unsignalized Intersection Capacity Analysis
 9: uOttawa-Rehab E Access & Hospital Link Rd

04-11-2024



Movement	EBT	EBR	WBL	WBT	NBL	NBR
Lane Configurations	↑			↑	↘	
Sign Control	Stop			Stop	Stop	
Traffic Volume (vph)	97	0	0	164	23	16
Future Volume (vph)	97	0	0	164	23	16
Peak Hour Factor	1.00	1.00	1.00	1.00	1.00	1.00
Hourly flow rate (vph)	97	0	0	164	23	16
Direction, Lane #	EB 1	WB 1	NB 1			
Volume Total (vph)	97	164	39			
Volume Left (vph)	0	0	23			
Volume Right (vph)	0	0	16			
Hadj (s)	0.08	0.02	0.12			
Departure Headway (s)	4.2	4.1	4.6			
Degree Utilization, x	0.11	0.19	0.05			
Capacity (veh/h)	831	862	737			
Control Delay (s)	7.8	8.1	7.8			
Approach Delay (s)	7.8	8.1	7.8			
Approach LOS	A	A	A			
Intersection Summary						
Delay			7.9			
Level of Service			A			
Intersection Capacity Utilization			19.3%	ICU Level of Service	A	
Analysis Period (min)			15			

HCM Unsignalized Intersection Capacity Analysis

10: AMRC Driveway & Hospital Link Rd

04/10/2024



Movement	EBT	EBR	WBL	WBT	NBL	NBR
Lane Configurations	↩			↩	↩	
Traffic Volume (veh/h)	76	30	7	213	96	30
Future Volume (Veh/h)	76	30	7	213	96	30
Sign Control	Free			Free	Stop	
Grade	0%			0%	0%	
Peak Hour Factor	1.00	1.00	1.00	1.00	1.00	1.00
Hourly flow rate (vph)	76	30	7	213	96	30
Pedestrians						
Lane Width (m)						
Walking Speed (m/s)						
Percent Blockage						
Right turn flare (veh)						
Median type	None			None		
Median storage veh						
Upstream signal (m)						
pX, platoon unblocked						
vC, conflicting volume			106		318	91
vC1, stage 1 conf vol						
vC2, stage 2 conf vol						
vCu, unblocked vol			106		318	91
tC, single (s)			4.1		6.4	6.2
tC, 2 stage (s)						
tF (s)			2.2		3.5	3.3
p0 queue free %			100		86	97
cM capacity (veh/h)			1485		672	967
Direction, Lane #	EB 1	WB 1	NB 1			
Volume Total	106	220	126			
Volume Left	0	7	96			
Volume Right	30	0	30			
cSH	1700	1485	725			
Volume to Capacity	0.06	0.00	0.17			
Queue Length 95th (m)	0.0	0.1	5.0			
Control Delay (s)	0.0	0.3	11.0			
Lane LOS		A	B			
Approach Delay (s)	0.0	0.3	11.0			
Approach LOS			B			
Intersection Summary						
Average Delay			3.2			
Intersection Capacity Utilization			32.0%	ICU Level of Service	A	
Analysis Period (min)			15			