

Engineering

Land/Site
Development

Municipal
Infrastructure

Environmental/
Water Resources

Traffic/
Transportation

Recreational

Planning

Land/Site
Development

Planning Application
Management

Municipal Planning

Urban Design

Expert Witness
(LPAT)

Wireless Industry

Landscape Architecture

Streetscapes &
Public Amenities

Open Space, Parks &
Recreation

Community &
Residential

Commercial &
Institutional

Environmental
Restoration



Proposed Residential Development 2026 Scott Street, Ottawa Transportation Impact Assessment

**Proposed Residential Development
2026 Scott Street
Transportation Impact Assessment**

Prepared By:

NOVATECH

Suite 200, 240 Michael Cowpland Drive
Ottawa, Ontario
K2M 1P6

Dated: April 2022

Revised: September 2022

Revised: February 2023

Revised: October 2023

Novatech File: 121302

Ref: R-2021-168

October 13, 2023

City of Ottawa
Planning, Real Estate, and Economic Development Department
110 Laurier Ave. W., 4th Floor,
Ottawa, Ontario K1P 1J1

Attention: Mr. Wally Dubyk
Project Manager, Infrastructure Approvals

Dear Mr. Dubyk:

Reference: 2026 Scott Street
Revised Transportation Impact Assessment
Novatech File No. 121302

We are pleased to submit the following revised Transportation Impact Assessment (TIA) in support of a Site Plan Control application for the property at 2006 Scott Street, 2020 Scott Street, 2026 Scott Street, 314 Athlone Avenue, 316 Athlone Avenue, and 318 Athlone Avenue (referred to as '2026 Scott Street' in this report), for your review and signoff. The structure and format of this report is in accordance with the City of Ottawa's *Transportation Impact Assessment Guidelines (June 2017)*.

The original TIA in support of a Zoning By-Law Amendment application was submitted in April 2022 and resubmitted in September 2022 (City Application No. D02-02-22-0037). This TIA has since been resubmitted in February 2023 along with this submission to reflect updated plans, and includes a review of Site Plan aspects that were not determined at the time of the previous application.

If you have any questions or comments regarding this report, please feel free to contact Brad Byvelds or the undersigned.

Yours truly,

NOVATECH



Joshua Audia, P.Eng.
Project Engineer | Transportation



TIA Plan Reports

On 14 June 2017, the Council of the City of Ottawa adopted new Transportation Impact Assessment (TIA) Guidelines. In adopting the guidelines, Council established a requirement for those preparing and delivering transportation impact assessments and reports to sign a letter of certification.

Individuals submitting TIA reports will be responsible for all aspects of development-related transportation assessment and reporting, and undertaking such work, in accordance and compliance with the City of Ottawa's Official Plan, the Transportation Master Plan and the Transportation Impact Assessment (2017) Guidelines.

By submitting the attached TIA report (and any associated documents) and signing this document, the individual acknowledges that s/he meets the four criteria listed below.

CERTIFICATION

1. I have reviewed and have a sound understanding of the objectives, needs and requirements of the City of Ottawa's Official Plan, Transportation Master Plan and the Transportation Impact Assessment (2017) Guidelines;
2. I have a sound knowledge of industry standard practice with respect to the preparation of transportation impact assessment reports, including multi modal level of service review;
3. I have substantial experience (more than 5 years) in undertaking and delivering transportation impact studies (analysis, reporting and geometric design) with strong background knowledge in transportation planning, engineering or traffic operations; and
4. I am either a licensed¹ or registered² professional in good standing, whose field of expertise [check appropriate field(s)] is either transportation engineering or transportation planning .

1,2 License of registration body that oversees the profession is required to have a code of conduct and ethics guidelines that will ensure appropriate conduct and representation for transportation planning and/or transportation engineering works.

City Of Ottawa
Infrastructure Services and Community
Sustainability
Planning and Growth Management
110 Laurier Avenue West, 4th fl.
Ottawa, ON K1P 1J1
Tel. : 613-580-2424
Fax: 613-560-6006

Ville d'Ottawa
Services d'infrastructure et Viabilité des
collectivités
Urbanisme et Gestion de la croissance
110, avenue Laurier Ouest
Ottawa (Ontario) K1P 1J1
Tél. : 613-580-2424
Télécopieur: 613-560-6006

Dated at Ottawa this 13th day of October, 2023.
(City)

Name: Brad Byvelds, P.Eng.
(Please Print)

Professional Title: Project Manager, Transportation

B. Byvelds

Signature of Individual certifier that s/he meets the above four criteria

Office Contact Information (Please Print)	
Address:	240 Michael Cowpland Drive, Suite 200
City / Postal Code:	Ottawa, ON, K2M 1P6
Telephone / Extension:	613-254-9643 x 286
E-Mail Address:	b.byvelds@novatech-eng.com

TABLE OF CONTENTS

EXECUTIVE SUMMARY I

1.0 SCREENING..... 1

 1.1 INTRODUCTION 1

 1.2 PROPOSED DEVELOPMENT 1

 1.3 SCREENING FORM 2

2.0 SCOPING..... 4

 2.1 EXISTING CONDITIONS 4

 2.1.1 Roadways..... 4

 2.1.2 Intersections 6

 2.1.3 Driveways..... 7

 2.1.4 Pedestrian and Cycling Facilities 8

 2.1.5 Area Traffic Management..... 8

 2.1.6 Transit..... 8

 2.1.7 Existing Traffic Volumes 11

 2.1.8 Collision Records..... 11

 2.2 PLANNED CONDITIONS 13

 2.2.1 Planned Infrastructure Projects..... 13

 2.2.2 Other Area Developments..... 15

 2.3 STUDY AREA AND TIME PERIODS 16

 2.4 EXEMPTIONS REVIEW 16

3.0 FORECASTING 17

 3.1 DEVELOPMENT-GENERATED TRAVEL DEMAND 17

 3.1.1 Trip Generation..... 17

 3.1.2 Trip Distribution and Assignment 23

 3.2 BACKGROUND TRAFFIC..... 24

 3.2.1 Other Area Developments..... 24

 3.2.2 General Background Growth Rate 30

 3.3 FUTURE TRAFFIC CONDITIONS 30

 3.4 DEMAND RATIONALIZATION 35

 3.4.1 Existing Intersection Operations..... 35

 3.4.2 2026/2031 Background Intersection Operations 36

4.0 ANALYSIS..... 36

 4.1 DEVELOPMENT DESIGN..... 36

 4.1.1 Design for Sustainable Modes 36

 4.1.2 Circulation and Access 37

 4.2 PARKING 43

 4.3 BOUNDARY STREETS 43

 4.4 ACCESS INTERSECTIONS..... 45

 4.5 TRANSPORTATION DEMAND MANAGEMENT..... 48

 4.5.1 Context for TDM 48

 4.5.2 Need and Opportunity..... 48

 4.5.3 TDM Program 48

4.6 NEIGHBOURHOOD TRAFFIC MANAGEMENT49

4.7 TRANSIT.....49

4.8 INTERSECTION DESIGN53

 4.8.1 Intersection MMLOS Review.....53

 4.8.2 2026 Total Intersection Operations55

 4.8.3 2031 Total Intersection Operations55

5.0 CONCLUSIONS.....56

Figures

Figure 1: View of the Subject Site 2

Figure 2: Site Context Figure 3

Figure 3: Roadway Network 5

Figure 4: OC Transpo Bus Stop Locations 9

Figure 5: Existing Traffic Volumes.....12

Figure 6: LRT Phase 2 – Confederation Line Extension West.....14

Figure 7: Existing Site-Generated Traffic Volumes.....25

Figure 8: Proposed Site-Generated Traffic Volumes (2026).....26

Figure 9: Proposed Site-Generated Traffic Volumes (2031).....27

Figure 10: Net Site-Generated Traffic Volumes (2026).....28

Figure 11: Net Site-Generated Traffic Volumes (2031).....29

Figure 12: Other Area Development-Generated Traffic Volumes31

Figure 13: 2026 and 2031 Background Traffic Volumes.....32

Figure 14: 2026 Total Traffic Volumes33

Figure 15: 2031 Total Traffic Volumes34

Figure 16: Bus Stop and Site Access Conflict38

Figure 17: MSU Turning Movements 1.....39

Figure 18: MSU Turning Movements 2.....40

Figure 19: MSU Turning Movements 3.....41

Figure 20: MSU Turning Movements 4.....42

Tables

Table 1: OC Transpo Transit Stops..... 9
 Table 2: OC Transpo Route Information10
 Table 3: Reported Collisions11
 Table 4: TIA Exemptions.....16
 Table 5: Existing Development – Peak Hour Person Trip Generation18
 Table 6: Existing Development – Peak Hour Trips by Mode Share18
 Table 7: Proposed Residential – Peak Period Trip Generation.....19
 Table 8: Proposed Residential – Peak Period Trips by Mode Share20
 Table 9: Proposed Residential – Peak Hour Trips by Mode Share.....20
 Table 10: Proposed Commercial – Peak Hour Trip Generation.....21
 Table 11: Proposed Commercial – Peak Hour Trips by Mode Share.....21
 Table 12: Net Person Trip Generation.....22
 Table 13: Existing Traffic Operations35
 Table 14: 2026/2031 Background Traffic Operations36
 Table 15: Parking Review43
 Table 16: Segment MMLOS Summary.....44
 Table 17: Access Intersection Operations47
 Table 18: Transit Utilization.....50
 Table 19: Intersection MMLOS Summary.....53
 Table 20: 2026 Total Traffic Operations55
 Table 21: 2031 Total Traffic Operations56

Appendices

Appendix A: Site Plan
 Appendix B: TIA Screening Form
 Appendix C: OC Transpo System Information
 Appendix D: Traffic Count Data
 Appendix E: Collision Records
 Appendix F: Relevant Excerpts of *TRANS Trip Generation Manual* (WSP, 2020)
 Appendix G: Other Area Developments
 Appendix H: Strategic Long-Range Model
 Appendix I: Signal Timing Plans
 Appendix J: Existing Synchro Analysis
 Appendix K: Background Synchro Analysis
 Appendix L: Transportation Demand Management
 Appendix M: MMLOS Analysis
 Appendix N: Total Synchro Analysis

EXECUTIVE SUMMARY

This Transportation Impact Assessment (TIA) has been prepared in support of a Site Plan application for a proposed development at 2006 Scott Street, 2020 Scott Street, 2026 Scott Street, 314 Athlone Avenue, 316 Athlone Avenue, and 318 Athlone Avenue.

The subject site is surrounded by the following:

- Scott Street and the OC Transpo East-West Transitway to the north;
- Ashton Avenue, Lion's Park, and residential properties fronting Athlone Avenue to the south;
- Athlone Avenue and residential uses to the east; and
- Various existing low-rise retail uses along Scott Street to the west. A residential development is proposed at 2050 Scott Street, directly abutting the subject site to the west.

The property at 2026 Scott Street is currently occupied by the Granite Curling Club, which will be relocated to 2740 Queensview Drive. The site is currently served by an existing full-movement access to Scott Street and a rear access at the eastern terminus of Ashton Avenue.

The property at 2020 Scott Street was previously occupied by a used car dealer, with access to Scott Street. The property at 2006 Scott Street was previously occupied by a retail store, with access to Scott Street. The property at 314 Athlone Avenue is currently being used as an office space, while the properties at 316 and 318 Athlone Avenue are residential homes. All existing buildings on-site will be demolished as part of this application.

The subject site is designated as 'Corridor – Mainstreet' (Scott Street) in Schedule B2 of the City of Ottawa's Official Plan and zoned as 'Traditional Mainstreet' (TM[2829]). The original TIA in support of a Zoning By-Law Amendment application for this development was submitted in April 2022 and resubmitted in September 2022 (City Application No. D02-02-22-0037).

The proposed development consists of two 40-storey towers with a total of 901 dwelling units and approximately 3,100 ft² of ground-floor commercial space. Phase 1 of the development includes the East Building, which consists of 422 dwellings and 1,180 ft² of commercial space. Phase 2 of the development includes the West Building, which consists of 479 dwellings and 1,920 ft² of commercial space. An underground parking garage with a total of 378 parking spaces will be provided beneath the entire development. The development will be accessed via one full-movement driveway to Scott Street and one full-movement driveway to Athlone Avenue. While the east and west buildings will be completed in separate phases, the entire parking garage will be constructed in a single phase. Buildout of Phase 1 is anticipated to occur in 2026 and buildout of Phase 2 is anticipated to occur in 2029.

The study area intersections include the proposed accesses and the intersections of Scott Street/Churchill Avenue, Scott Street/Winona Avenue, Scott Street/Athlone Avenue, Scott Street/Tweedsmuir Avenue, and Scott Street/McRae Avenue. This study area is consistent with the City's 2017 TIA Guidelines, which outlines that all arterial signalized intersections within 400m should be included.

The selected time periods for the analysis are the weekday AM and PM peak hours, as they represent the 'worst case' combination of site generated traffic and adjacent street traffic. Analysis will be completed for the Phase 1 build-out year (2026) and 5-year horizon (2031). Phase 2 is assumed to be built-out prior to the five-year horizon of Phase 1. Due to the extended build-out time frame for Phase 2, this report will forego the five-year horizon beyond Phase 2.

The conclusions and recommendations of this TIA can be summarized as follows:

Forecasting

- The ultimate proposed development is projected to generate 404 person trips (including 55 vehicle trips) during the AM peak hour, and 414 person trips (including 58 vehicle trips) during the PM peak hour.
- Accounting for the existing development, the ultimate proposed development is projected to generate an additional 365 person trips (including 24 additional vehicle trips) during the AM peak hour, and an additional 341 person trips (but one fewer vehicle trip) during the PM peak hour.

Development Design and Parking

- Sidewalks will be maintained along the subject site's frontages to Scott Street and Athlone Avenue, and internal walkways will be provided around the perimeter of each building, connecting to the sidewalks on Scott Street and Athlone Avenue. Landscaped walkways and central amenity space will also provide pedestrian connectivity between Scott Street, Athlone Avenue, Ashton Avenue, and the Lion's Park land to the immediate south of the subject site.
- A total of ten exterior bicycle parking spaces are proposed on-site, with another 786 bicycle parking spaces within the underground parking levels or the ground floor.
- The proposed development will remove the two existing accesses to Scott Street and provide one new access, which will require a relocation of the temporary transitway platform by 7m to the east. City staff have advised that the required modifications to the transitway platform are to be constructed as part of the proposed development.
- All required Transportation Demand Management (TDM)-supportive design and infrastructure measures in the TDM checklist for residential developments will be met.
- Garbage rooms will be located on the first level of the underground parking garage, and move-in rooms are located on the ground floor of each building. For the east building, the move-in room will be accessed at the south face, adjacent to the parking garage ramp. Garbage collection will occur curbside along Athlone Avenue near the parking garage access. For the west building, the move-in room will be accessed at the west face. Garbage collection will occur curbside along Scott Street.
- There is no proposed on-site fire route for either building, as the main entrances to each building will front onto Scott Street.

- The proposed development will meet the minimum vehicle parking, maximum vehicle parking, and minimum bicycle parking requirements outlined in the City's *Zoning By-Law* (ZBL). There is no requirement to provide any loading spaces under the ZBL.

Boundary Streets

- The results of the segment MMLOS analysis can be summarized as follows:
 - Neither boundary street meets the target pedestrian level of service (PLOS) A;
 - Scott Street meets the target bicycle level of service (BLOS) A, while Athlone Avenue does not meet the target BLOS D;
 - Scott Street does not meet the target transit level of service (TLOS) A;
 - Scott Street meets the target truck level of service (TkLOS) D.
- Scott Street cannot achieve the target PLOS A on either side of the roadway without reducing the operating speed to 30 km/h or slower, based on the existing traffic volumes.
- Athlone Avenue can achieve the target PLOS A and BLOS A through a reduction in the operating speed of the roadway to 30 km/h. The planned integrated renewal of Athlone Avenue is anticipated to include traffic calming to achieve this operating speed.

Access Intersections

- Access to the proposed underground parking garage will be provided via one full-movement driveway to Scott Street and one full-movement driveway to Athlone Avenue. Access to the loading area for the east building will be provided via the proposed access to Athlone Avenue, and access to the loading area for the west building will be provided via the proposed access to Scott Street. All driveways are anticipated to be constructed as part of the first phase.
- The design of the proposed accesses have been evaluated using the relevant provisions of the City's *Private Approach By-Law* (PABL) and Transportation Association of Canada (TAC)'s *Geometric Design Guide for Canadian Roads*. The proposed accesses will meet all relevant requirements, except for the following.
- Section 25(c) of the PABL identifies a maximum width requirement of 9m for any two-way private approach, as measured at the street line. Section 107(1)(a) of the ZBL requires any two-way private approach serving an apartment parking garage with 20 or more parking spaces to have a minimum width of 6.0m and a maximum width of 6.7m. While the underground parking garage ramp to Scott Street will have a width of 6.5m, the overall access width at the street line will be 11.3m, in order to also facilitate access to the loading area on the west side of the west building. It is requested that the requirements of Section 25(c) of the PABL be waived for the proposed access to Scott Street.
- Based on Section 25(m)(ii) of the PABL, the nearest edge of any private approach that serves 300 or more parking spaces must be a minimum of 60m from the nearest intersecting street line or any other private approach, when it is a residential development within 46m of an arterial roadway. The minimum requirement is not met by the proposed underground garage access to Athlone Avenue, as less than 60m of frontage is provided on that roadway. The site plan shows the garage access to Athlone Avenue will be located approximately 44m south of Scott Street, and approximately as far south as possible.

- Based on Section 25(p) of the PABL, the nearest edge of any private approach must be a minimum of 3m from the adjacent property line. Section 25(r) suggests that a private approach may be constructed within 3m from the adjacent property line if it is approved through Site Plan Control. The western edge of the proposed loading access to Scott Street will be located approximately 1.0m from the nearest property line. The adjacent site at 2050 Scott Street is currently under construction. As the future access to this development will be located approximately 5.75m from the property line, it is requested that this requirement be waived for the proposed access to Scott Street. The southern edge of the proposed access to Athlone Avenue will be located approximately 2.7m from the nearest property line. As the existing driveway to the adjacent house at 322 Athlone Avenue is located approximately 5.0m from the property line, it is requested that this requirement also be waived for the proposed access to Athlone Avenue.
- Section 25(u) of the PABL identifies that a maximum grade of 2% to 6% for the first 9m inside the property line, for any private approach serving a parking area with more than 50 parking spaces. The Athlone Avenue garage access meets the requirement, as it will have a proposed maximum grade of 6% (descending towards the roadway for drainage purposes) for the first 6m within the property line, followed by a flat area before transitioning down to the parking garage. The Scott Street garage access meets this requirement, as it will have a proposed maximum grade of 4% for the first 4m within the property line and the garage door, followed by a 5m flat area within the building.
- As Athlone Avenue and Scott Street are straight and generally level roadways, adequate sightlines can be provided at both proposed access locations. In the interim condition, it is anticipated that OC Transpo buses stopped at the temporary eastbound platform will periodically obscure outbound drivers at the access to Scott Street. Sightlines will therefore improve at this access when the platform is decommissioned.
- Providing vehicular access to both Scott Street and Athlone Avenue are recommended, based on the overall size and density of the site. This provides future users with an alternative route should an accident occur along Athlone Avenue, or in the event that there are operational issues with one of the garage doors. The subject site is very large (approximately 6,600 m² in area), and spans over 100m of frontage on Scott Street. The proposed development will contain two buildings with 901 dwellings, approximately 3,100 ft² GFA of ground-floor commercial or retail space, and 378 parking spaces in an underground garage.
- The proposed accesses are anticipated to operate with an acceptable vehicular level of service (Auto LOS).

Transportation Demand Management

- The proponent will provide the following residential TDM measures:
 - Display local area maps with walking/cycling access routes and key destinations at major entrances;
 - Display relevant transit schedules and route maps at entrances;
 - Unbundle parking cost from monthly rent;
 - Provide a multi-modal travel information package to new residents.

- The subject site is across Scott Street from a future LRT station. Providing limited parking near transit stations act as a strong incentive for residents, visitors, and patrons of the proposed development to travel to/from the site via transit. Further, a total of 796 bicycle parking spaces are proposed, equating to 0.88 bicycle spaces per unit and exceeding the minimum requirements of the ZBL.

Neighbourhood Traffic Management

- Based on the existing traffic count data at Scott Street/Athlone Avenue, the two-way peak hour traffic volumes on Athlone Avenue are approximately 62 vehicles during the AM peak hour and 72 vehicles during the PM peak hour, and the average annual daily traffic is approximately 740 vehicles.
- Ultimate buildout of the proposed development is anticipated to increase peak hour traffic volumes on Athlone Avenue by approximately five vehicles. Therefore, the NTM thresholds are not anticipated to be met in the future as a result of this development, and no Neighbourhood Traffic Management (NTM) measures are identified.

Transit

- Phase 1 of the proposed development is projected to generate a net additional 100 transit trips during the AM peak hour and 96 transit trips during the PM peak hour.
- The ultimate proposed development is projected to generate a net additional 219 transit trips during the AM peak hour and 217 transit trips during the PM peak hour.
- The need for more frequent service on the future LRT, or existing routes 16, 50, 81, and 153 is not anticipated as a result of the proposed development.

Intersection MMLOS

- The results of the intersection MMLOS analysis can be summarized as follows:
 - No study area intersections meet the target PLOS;
 - Scott Street/Churchill Avenue meet the target BLOS, while Scott Street/Athlone Avenue and Scott Street/Tweedsmuir Avenue do not;
 - No study area intersections meet the target TLOS;
 - Scott Street/Churchill Avenue does not meet the target TkLOS.
- No approaches at any study area intersection achieves the target PLOS A. Without reducing the crossing width to an equivalent of two 3.5m-wide lanes (i.e. 7.0m or less), the target PLOS A cannot be achieved. Therefore, no recommendations are identified.
- The south and east approaches do not meet the target BLOS A based on left turn characteristics. The south approach consists of a single lane and is stop-controlled, and left-turning cyclists from this approach can queue with vehicles to make their left turn. For cyclists at the east approach, the target BLOS A can only be met by providing a two-stage, left-turn bike box. However, a bicycle signal would be required, as the existing intersection is only an intersection pedestrian signal. This is identified for the City's consideration.

- The south and east approaches do not meet the target BLOS A based on left turn characteristics. The south approach consists of a single lane and is stop-controlled, and left-turning cyclists from this approach can queue with vehicles to make their left turn. For cyclists at the east approach, a bicycle signal would be required, as the existing intersection is only an intersection pedestrian signal. This is identified for the City's consideration.
- The target TLOS A equates to grade-separated ROW for transit facilities. This is addressed by the planned extension of the Confederation Line LRT, which will serve the study area at Westboro Station.
- As Scott Street and Churchill Avenue are truck routes, trucks are required to perform northbound right turns and westbound left turns at this intersection. A compound curve has been implemented at this corner to accommodate the northbound right turn movement for heavy vehicles. Therefore, no recommendations are identified.

Existing Traffic Operations

- All approaches within the study area meet the target Auto LOS E, except for the transit-only approach at Scott Street/Tweedsmuir Avenue. It is noted that this approach is currently closed due to Stage 2 LRT construction, and that bus operations at this station may be reduced once Westboro Station is served by LRT, resulting in improved operations at this approach. Further, when the pedestrian phase is actuated at this intersection, southbound buses utilizing this approach would be able to turn right onto Scott Street unimpeded, or turn left onto Scott Street once pedestrians had completed their crossing.

Background Traffic Operations

- After the addition of background traffic volumes, all approaches within the study area continues to meet the target Auto LOS E, except for the transit-only approach at Scott Street/Tweedsmuir Avenue.

Total Traffic Operations

- After the addition of site-generated traffic volumes, all approaches within the study area continues to meet the target Auto LOS E, except for the transit-only approach at Scott Street/Tweedsmuir Avenue. The addition of site-generated traffic is anticipated to have marginal effects on traffic operations within the study area.
- The proposed development is recommended from a transportation perspective.

1.0 SCREENING

1.1 Introduction

This Transportation Impact Assessment (TIA) has been prepared in support of a Site Plan application for a proposed development at 2006 Scott Street, 2020 Scott Street, 2026 Scott Street, 314 Athlone Avenue, 316 Athlone Avenue, and 318 Athlone Avenue.

The subject site is surrounded by the following:

- Scott Street and the OC Transpo East-West Transitway to the north;
- Ashton Avenue, Lion's Park, and residential properties fronting Athlone Avenue to the south;
- Athlone Avenue and residential uses to the east; and
- Various existing low-rise retail uses along Scott Street to the west. A residential development is proposed at 2050 Scott Street, directly abutting the subject site to the west.

A view of the subject site is provided in **Figure 1**.

The property at 2026 Scott Street is currently occupied by the Granite Curling Club, which will be relocated to 2740 Queensview Drive. The site is currently served by an existing full-movement access to Scott Street and a rear access at the eastern terminus of Ashton Avenue.

The property at 2020 Scott Street was previously occupied by a used car dealer, with access to Scott Street. The property at 2006 Scott Street was previously occupied by a retail store, with access to Scott Street. The property at 314 Athlone Avenue is currently being used as an office space, while the properties at 316 and 318 Athlone Avenue are residential homes. All existing buildings on-site will be demolished as part of this application.

1.2 Proposed Development

The subject site is designated as 'Corridor – Mainstreet' (Scott Street) in Schedule B2 of the City of Ottawa's Official Plan and zoned as 'Traditional Mainstreet' (TM[2829]). The original TIA in support of a Zoning By-Law Amendment application for this development was submitted in April 2022 and resubmitted in September 2022 (City Application No. D02-02-22-0037).

The proposed development consists of two 40-storey towers with a total of 901 dwelling units and approximately 3,100 ft² of ground-floor commercial space. Phase 1 of the development includes the East Building, which consists of 422 dwellings and 1,180 ft² of commercial space. Phase 2 of the development includes the West Building, which consists of 479 dwellings and 1,920 ft² of commercial space. An underground parking garage with a total of 378 parking spaces will be provided beneath the entire development. The development will be accessed via one full-movement driveway to Scott Street and one full-movement driveway to Athlone Avenue. While the east and west buildings will be completed in separate phases, the entire parking garage will be constructed in a single phase. Buildout of Phase 1 is anticipated to occur in 2026 and buildout of Phase 2 is anticipated to occur in 2029.

A copy of the site plan is included in **Appendix A**. A site context plan, which includes the site plan and shows all details of the roadway network immediately surrounding the site, is included in **Figure 2**.

Figure 1: View of the Subject Site

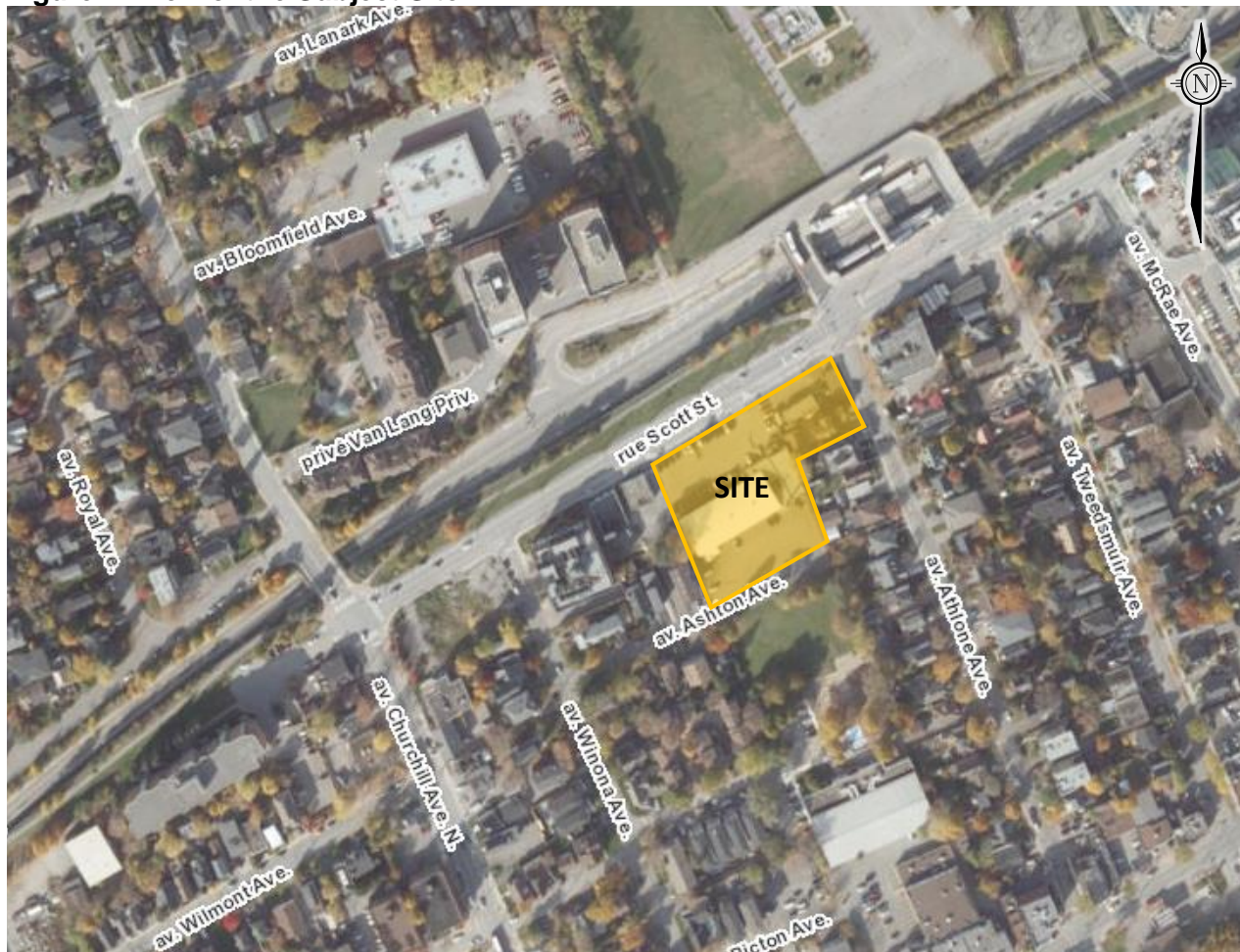

1.3 Screening Form

The City's 2017 TIA Guidelines identify three triggers for completing a TIA report, including trip generation, location, and safety. The criteria for each trigger are outlined in the City's TIA Screening Form. The trigger results are as follows:

- Trip Generation Trigger – The development is anticipated to generate over 60 peak hour person trips; further assessment is **required** based on this trigger.
- Location Trigger – The development proposes a new driveway to a Spine Cycling Route (Scott Street). The development is also located in a Transit-Oriented Development (TOD) Zone (within 600m of Westboro and Dominion Transit Stations) and a Design Priority Area (DPA); further assessment is **required** based on this trigger.
- Safety Trigger – The development proposes a new driveway within the area of influence of an adjacent traffic signal; further assessment is **required** based on this trigger.

The proposed development satisfies all three triggers for completing a TIA. A copy of the TIA Screening Form is included in **Appendix B**.

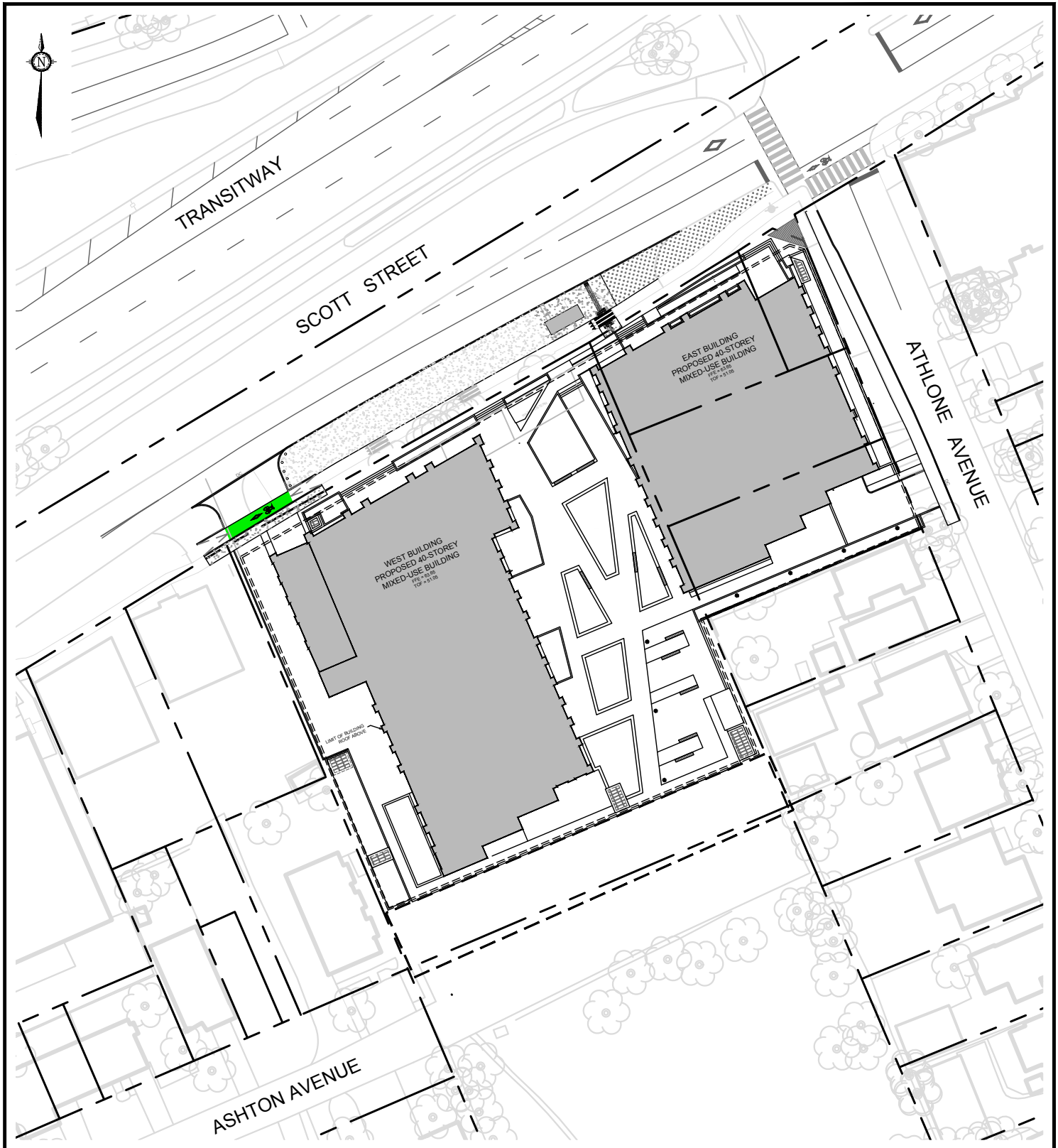

C:\temp\AcPublish_15588\Context.dwg, Context, Oct 11, 2023 - 5:05pm, millier



Engineers, Planners & Landscape Architects
 Suite 200, 240 Michael Cowpland Drive
 Ottawa, Ontario, Canada K2M 1P6

Telephone (613) 254-9643
 Facsimile (613) 254-5867
 Website www.novatech-eng.com

2026 SCOTT STREET

CONTEXT PLAN

SCALE N.T.S.

DATE OCT 2023

JOB 121302

FIGURE FIGURE 2

2.0 SCOPING

2.1 Existing Conditions

2.1.1 Roadways

All roadways within the study area fall under the jurisdiction of the City of Ottawa.

Scott Street is classified as an arterial roadway east of Churchill Avenue, and a local roadway west of Churchill Avenue. It runs on an east-west alignment from Bayview Station Road/Albert Street to Churchill Avenue. Transit vehicles are able to travel on a temporary detour route west of Churchill Avenue, which connects to the Sir John A. Macdonald Parkway. East of Churchill Avenue, Scott Street has a two-lane semi-urban cross section with a curb/sidewalk on the south side. On-street parking is not permitted on Scott Street within the study area. Scott Street has a posted speed limit of 50km/h. East of Churchill Avenue, it is also designated as a truck route, permitting full loads. The Official Plan reserves a 26m right-of-way (ROW) for Scott Street; a widening is required as part of this application.

Churchill Avenue is classified as a major collector roadway between Carling Avenue and Richmond Road, an arterial roadway between Richmond Road and Scott Street, a collector roadway between Scott Street and Lanark Avenue, and a local roadway north of Lanark Avenue. It runs on a north-south alignment between Carling Avenue and north of Ferndale Avenue. In the vicinity of the subject site, Churchill Avenue has a two-lane undivided urban cross section with a regulatory speed limit of 50km/h. Churchill Avenue is designated as a truck route between Carling Avenue and Scott Street, permitting full loads. Parking bays are provided and on-street parking is permitted on both sides of Churchill Avenue between Richmond Road and Scott Street.

Winona Avenue is a north-south local roadway that runs from Scott Street to Richmond Road. The roadway has a two-lane undivided urban cross-section with a posted speed limit of 40km/h. On-street parking is permitted along the west side of the roadway.

Ashton Avenue is an east-west local roadway that runs from Winona Avenue to the rear of the subject site. The roadway has a two-lane undivided cross-section with a regulatory speed limit of 50km/h. On-street parking is permitted along the north side of the roadway.

Athlone Avenue is a north-south local roadway that runs from Scott Street to Clare Gardens Park. Within the study area, the roadway has a two-lane undivided semi-urban cross-section, sidewalks on the west side, and a regulatory speed limit of 50km/h. On-street parking is permitted along both sides of the roadway. Athlone Avenue is not designated as a truck route, and 'No Heavy Trucks' (Rb-62) signage is provided at Scott Street. The City's Official Plan does not reserve any additional ROW protections for Athlone Avenue.

Tweedsmuir Avenue is a north-south local roadway that runs from Scott Street to Currell Avenue. Within the study area, the roadway has a two-lane undivided urban cross-section, sidewalks on the east side, and a regulatory speed limit of 50km/h. On-street parking is permitted along the west side of the roadway. Tweedsmuir Avenue is not designated as a truck route, and 'No Heavy Trucks' (Rb-62) signage is provided at Scott Street.

McRae Avenue is a north-south local roadway that runs from Scott Street to Richmond Road. The roadway has a two-lane undivided urban cross-section, sidewalks on both sides, and a regulatory speed limit of 50km/h. Parking is restricted on both sides. McRae Avenue is a restricted loads truck route.

The roadway network of the greater area surrounding the subject site is illustrated in **Figure 3**.

Figure 3: Roadway Network

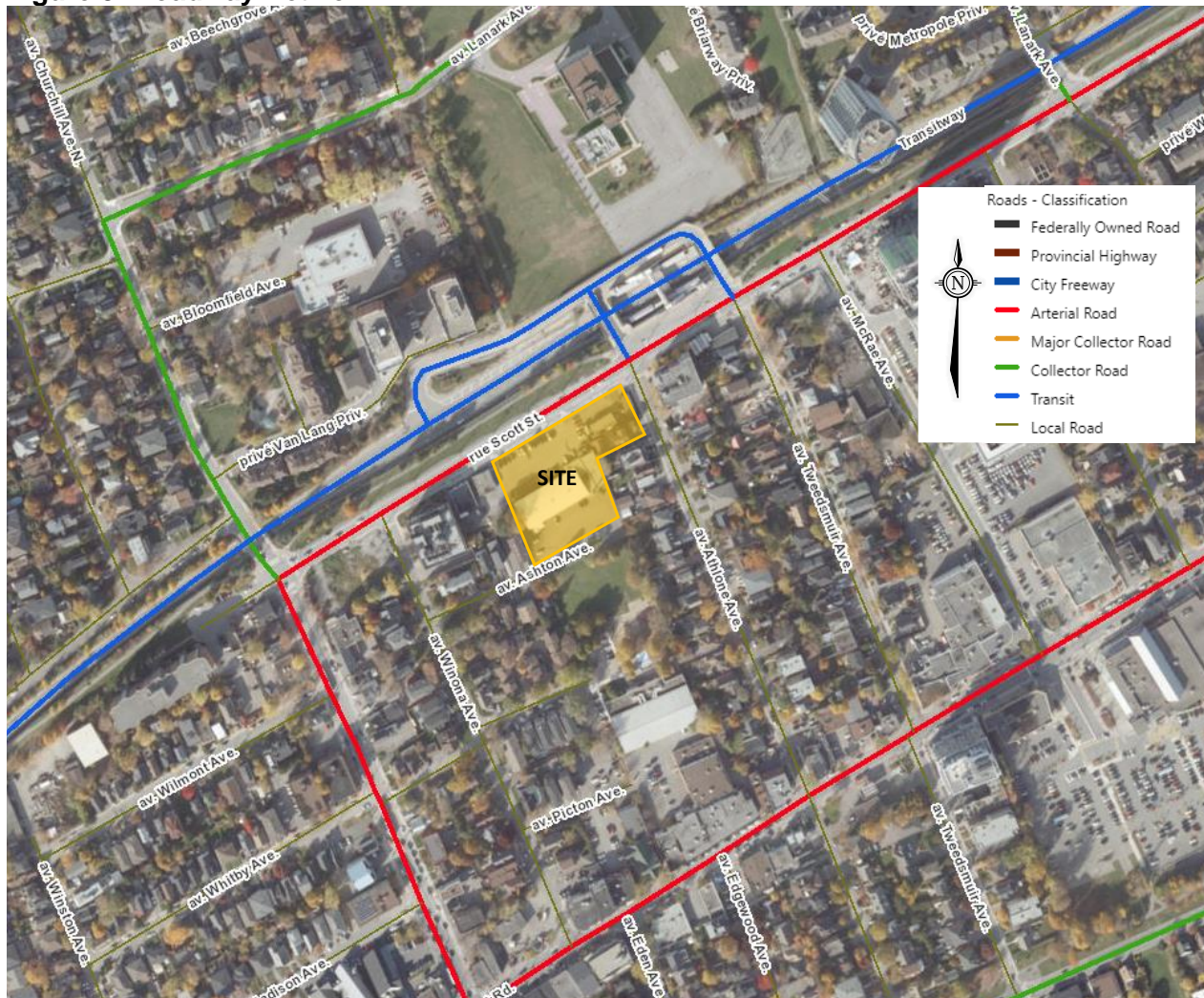

2.1.2 Intersections

Scott Street/Churchill Avenue

- Signalized intersection
- North approach consists of one shared left turn/through/right turn lane
- South approach consists of one shared left turn/through lane and one right turn lane (right turns on red prohibited)
- East approach consists of one left turn lane and one shared through/right turn lane
- West approach consists of one shared through/right turn lane (left turns prohibited)
- Ladder crosswalks/crossrides on all approaches
- Cycle tracks on east and west approaches



Scott Street/Winona Avenue

- Unsignalized, with stop control on the minor approach (Winona Avenue)
- One shared lane on all approaches
- Ladder crosswalk/crossride on south approach
- Cycle tracks on east and west approaches



Scott Street/Athlone Avenue

- Unsignalized, with stop control on the minor approach (Athlone Avenue)
- Intersection pedestrian signal is provided on the west approach
- One shared lane on south and west approaches (northbound left turn movement is prohibited)
- East approach consists of one shared left turn/through lane and one transit-only through lane
- Ladder crosswalks on south and west approaches
- Crossride on south approach
- Cycle tracks on east/west approaches



Scott Street/Tweedsmuir Avenue

- Unsignalized, with stop control on the minor approach (Tweedsmuir Avenue)
- Intersection pedestrian signal is provided on the east approach
- One shared lane on south and west approaches
- East approach consists of one shared left turn/through lane and one transit-only through lane
- Ladder crosswalks on south and east approaches
- Crossride on south approach
- Cycle tracks on east/west approaches

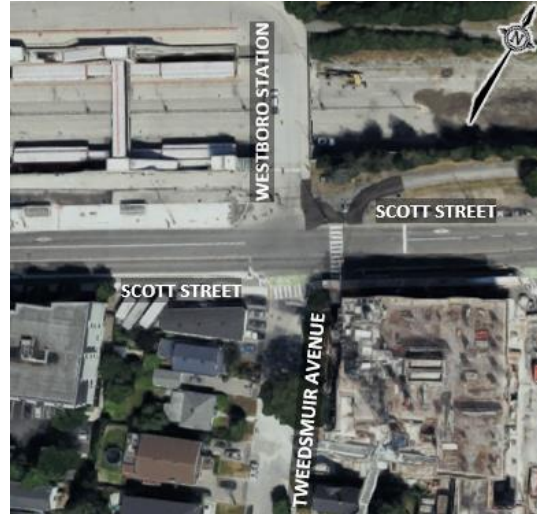

Scott Street/McRae Avenue

- Unsignalized, with stop control on the minor approach (McRae Avenue)
- One shared lane on all approaches
- Cycle tracks on east/west approaches



2.1.3 Driveways

In accordance with the City’s 2017 TIA Guidelines, a review of adjacent driveways along the boundary roads (within 200m of the subject site) are provided as follows:

Ashton Avenue, North Side:

- Two driveways to the residential building at 295 Ashton Avenue
- Four driveways to the residential dwellings at 297/299, 301, 305, and 307 Ashton Avenue

Ashton Avenue, South Side:

- Four driveways to the residential dwellings at 294/298, 300, 302, and 306 Ashton Avenue

Athlone Avenue, East Side:

- One driveway to the parking lot serving the apartment building at 2000 Scott Street
- Thirteen driveways to residential dwellings at 315, 317, 319, 327, 329/331, 333, 335, 341, 345, 347, 349, 353, and 357 Athlone Avenue

Athlone Avenue, West Side:

- Ten driveways to residential dwellings at 322, 326, 330, 334, 338, 342, 346, 350, 354, and 358 Athlone Avenue

Scott Street, North Side:

- None

Scott Street, South Side:

- Two gated accesses to the vacant land at 2070 Scott Street (to be developed)
- One driveway to the garage at 2046 Scott Street (to be redeveloped)
- One driveway to the hot tub/sauna store at 2050 Scott Street (to be redeveloped)
- Access to the parking area for a moving company at 1994 Scott Street

2.1.4 Pedestrian and Cycling Facilities

Within the study area, sidewalks are currently provided on both sides of Scott Street, both sides of Churchill Avenue, the west side of Athlone Avenue, the east side of Tweedsmuir Avenue, and both sides of McRae Avenue. A pedestrian crossover is located mid-block on McRae Avenue, approximately 70m south of Scott Street. Intersection pedestrian signals are provided along Scott Street, east of Tweedsmuir Avenue and west of Athlone Avenue, providing easy pedestrian access to the Westboro Transit Station.

Cycle tracks are provided along both sides for Scott Street east of Churchill Avenue. West of Churchill Avenue, an asphalt multi-use pathway (MUP) is provided along the south side of Scott Street and the temporary transitway detour. The cycle tracks on the north side provides connectivity to Tunney's Pasture Station and the MUP system along Sir John A. Macdonald Parkway to the east, and the cycle tracks/MUP on the south side provides connectivity to Dominion Station to the west.

Scott Street and Churchill Avenue (south of Scott Street) are designated as Spine Routes in the City's Ultimate Cycling Network. Churchill Avenue north of Scott Street is designated as a Local Route. Cross-town Bikeway #2 runs east-west through the study area and utilizes Scott Street and Churchill Avenue.

2.1.5 Area Traffic Management

There are no Area Traffic Management (ATM) studies within the study area that are currently in progress. Seasonal flex-posts are implemented along Churchill Avenue at Roy Duncan Park, north of Workman Avenue.

An integrated renewal of Winona Avenue, Wilmont Avenue, Elmgrove Avenue, and Picton Avenue is scheduled for construction in 2024, and an integrated renewal of Athlone Avenue from Scott Street to Byron Avenue is tentatively scheduled for construction in 2025. These projects will require full reconstruction of these roadways to replace watermain and sewer infrastructure, and traffic calming measures to reduce the operating speed to 30 km/h will be incorporated when the roadways are rebuilt.

2.1.6 Transit

The locations of OC Transpo bus stops in the vicinity of the subject site are described in **Table 1**, and are shown in **Figure 4**. A summary of the various routes which serve the study area is included in **Table 2**. Detailed route information and an excerpt from the OC Transpo System Map are included in **Appendix C**.

Table 1: OC Transpo Transit Stops

Stop	Location	Routes Served
#3012 (Westboro)	North side of Scott Street, between Athlone Avenue and Tweedsmuir Avenue; temporary platforms currently along Scott Street during LRT construction	16, 50, 57, 61, 62, 63, 64, 66, 67, 73, 74, 75, 82, 87, 153, 164, 252, 256, 257, 258, 261, 262, 263, 264, 265, 267, 268, 282, 404
#4841	East side of McRae Avenue, south of Scott Street	81, 153
#4884	East side of Churchill Avenue, north of Scott Street	16, 153
#4893	West side of McRae Avenue, south of Scott Street	81, 153
#5615	West side of Churchill Avenue, north of Scott Street	16, 153
#7379	East side of Churchill Avenue, south of Scott Street	50
#7380	West side of Churchill Avenue, south of Scott Street	50

Figure 4: OC Transpo Bus Stop Locations

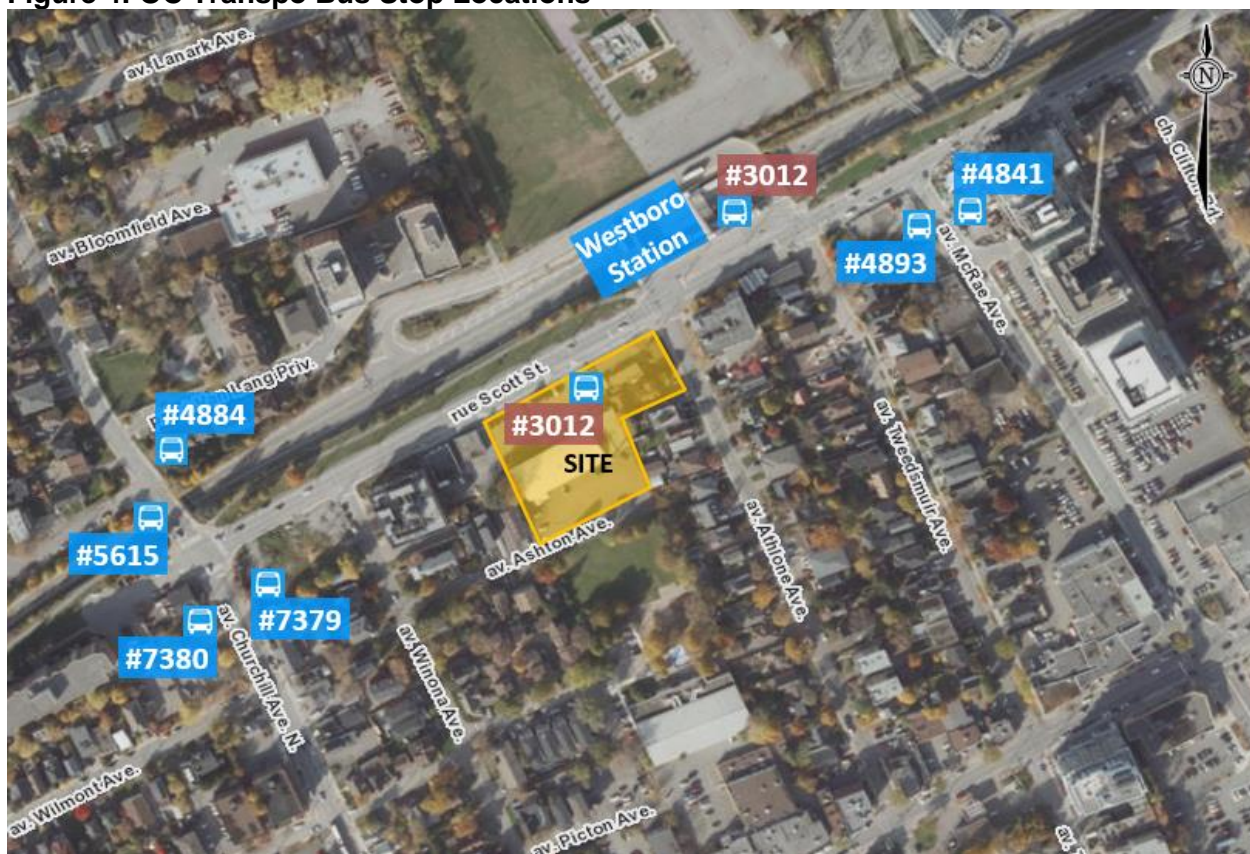

Note: Temporary bus platforms on Scott Street are provided for Westboro Station (stop #3012) during construction of the Confederation Line LRT extension. The eastbound platform is located along the subject site's frontage, and the westbound platform is located between Athlone Avenue and Tweedsmuir Avenue.

Table 2: OC Transpo Route Information

Route	From ↔ To	Frequency
16	Main ↔ Tunney's Pasture / Westboro	30 minute headways, 7 days per week, all day service
50	Tunney's Pasture ↔ Lincoln Fields	30 minute headways, Mon-Sat
57	Tunney's Pasture ↔ N Rideau	30 minute headways, 7 days per week, all day service
61	Terry Fox / Stittsville ↔ Tunney's Pasture / Gatineau	20 minute headways, 7 days per week, all day service
62	Terry Fox / Stittsville ↔ Tunney's Pasture	30 minute headways, 7 days per week, all day service
63	Briarbrook ↔ Tunney's Pasture / Gatineau	5-10 minute headways during peak periods, 7-days per week, all day service
64	Morgan's Grant ↔ Tunney's Pasture	15 minute headways during peak periods, Mon-Fri, all day service
66	Kanata / Solandt ↔ Gatineau/Tunney's Pasture	15 minute headways, Mon-Fri, peak periods only
67	Terry Fox / Tunney's Pasture ↔ Cope	30 minute headways, Mon-Fri, all day service
73	Leikin ↔ Tunney's Pasture	30 minute headways, Mon-Fri, peak periods only
74	Nepean Woods ↔ Tunney's Pasture	30 minute headways, 7 days per week, all day service
75	Tunney's Pasture / Gatineau ↔ Barrhaven Centre / Cambrian	15 minute headways, 7 days per week, all day service
81	Tunney's Pasture ↔ Clyde	30 minute headways, 7 days per week, no evening service on weekends
82	Lincoln Fields / Tunney's Pasture ↔ Bayshore	30 minute headways, 7 days per week, all day service
87	Tunney's Pasture ↔ Baseline	15 minute headways, 7 days per week, all day service
153	Tunney's Pasture / Carlingwood ↔ Lincoln Fields	60 minute headways, 7 days per week, select time periods
164	Hope Side ↔ Terry Fox	60 minute headways, Mon-Fri, peak periods only
252	Tunney's Pasture ↔ Templeford	30 minute headways, Mon-Fri, peak periods only
256	Tunney's Pasture ↔ Bridlewood	30 minute headways, Mon-Fri, peak periods only
257	Tunney's Pasture ↔ Bridlewood	30 minute headways, Mon-Fri, peak periods only
258	Grandview ↔ Tunney's Pasture	30 minute headways, Mon-Fri, peak periods only
261	Tunney's Pasture ↔ Stittsville Main	30-60 minute headways, Mon-Fri, peak periods only
262	Tunney's Pasture ↔ West Ridge	30 minute headways, Mon-Fri, peak periods only
263	Tunney's Pasture ↔ Stanley Corners	60 minute headways, Mon-Fri, peak periods only
264	Tunney's Pasture ↔ Terry Fox	60 minute headways, Mon-Fri, peak periods only
265	Tunney's Pasture ↔ Beaverbrook	60 minute headways, Mon-Fri, peak periods only
267	Tunney's Pasture ↔ Glen Cairn	30 minute headways, Mon-Fri, peak periods only
268	Tunney's Pasture ↔ Kanata Lakes	30 minute headways, Mon-Fri, peak periods only
282	Trend-Arlington ↔ Tunney's Pasture	30 minute headways, Mon-Fri, peak periods only
404	Canadian Tire Centre ↔ Tunney's Pasture	5-20 minute headways, only during periods before or after events at the Canadian Tire Centre

2.1.7 Existing Traffic Volumes

Weekday traffic counts were completed by the City of Ottawa or for recent TIA studies and have been used to determine the existing pedestrian, cyclist, and vehicular traffic volumes at the study area intersections. All counts were conducted prior to the Scott Street detour that was completed in 2022. The traffic counts were completed on the following dates.

<u>Intersection</u>	<u>Count Date</u>	<u>Source</u>
• Scott Street/Churchill Avenue	August 13, 2019	(City Count)
• Scott Street/Winona Avenue	October 16, 2019	(City Count)
• Scott Street/Athlone Avenue	November 22, 2017	(City Count)
• Scott Street/Tweedsmuir Avenue	March 28, 2017	(City Count)
• Scott Street/Tweedsmuir Avenue	July 18, 2019	(2020 TIA, 320 McRae Ave)
• Scott Street/McRae Avenue	July 18, 2019	(2020 TIA, 320 McRae Ave)

Existing traffic volumes along the study area roadways are shown in **Figure 5**. Peak hour summary sheets of the above traffic counts are included in **Appendix D**.

Peak hour pedestrian/cyclist volumes were not included in the summary sheets for the July 2019 Scott Street/McRae Avenue and Scott Street/Tweedsmuir Avenue counts. Peak hour vehicle volumes from the July 2019 count and peak hour pedestrian/cyclist volumes from the March 2017 have been shown at Scott Street/Tweedsmuir Avenue.

2.1.8 Collision Records

Historical collision data has been obtained from the City’s Public Works and Service Department for the study area intersections. Copies of the collision summary report are included in **Appendix E**.

The collision data has been evaluated to determine if there are any identifiable collision patterns, which are defined in the City’s *2017 TIA Guidelines* as ‘more than six collisions in five years for any one movement.’ A summary of the number of collisions at each intersection from January 1, 2015 to December 31, 2019 is shown in **Table 3**.

Table 3: Reported Collisions

Intersection	Impact Types					Total
	Angle	Sideswipe	Rear End	Turning Mvmt	SMV ¹ /Other	
Scott Street/McRae Avenue	5	-	1	-	-	6
Scott Street/Churchill Avenue	-	1	-	-	4	5
Scott Street/Athlone Avenue	-	-	1	1	1	3
Scott Street/Tweedsmuir Avenue	1	-	2	-	-	3
Scott Street/Winona Avenue	-	1	-	-	-	1

1. SMV = Single Motor Vehicle

Figure 5: Existing Traffic Volumes

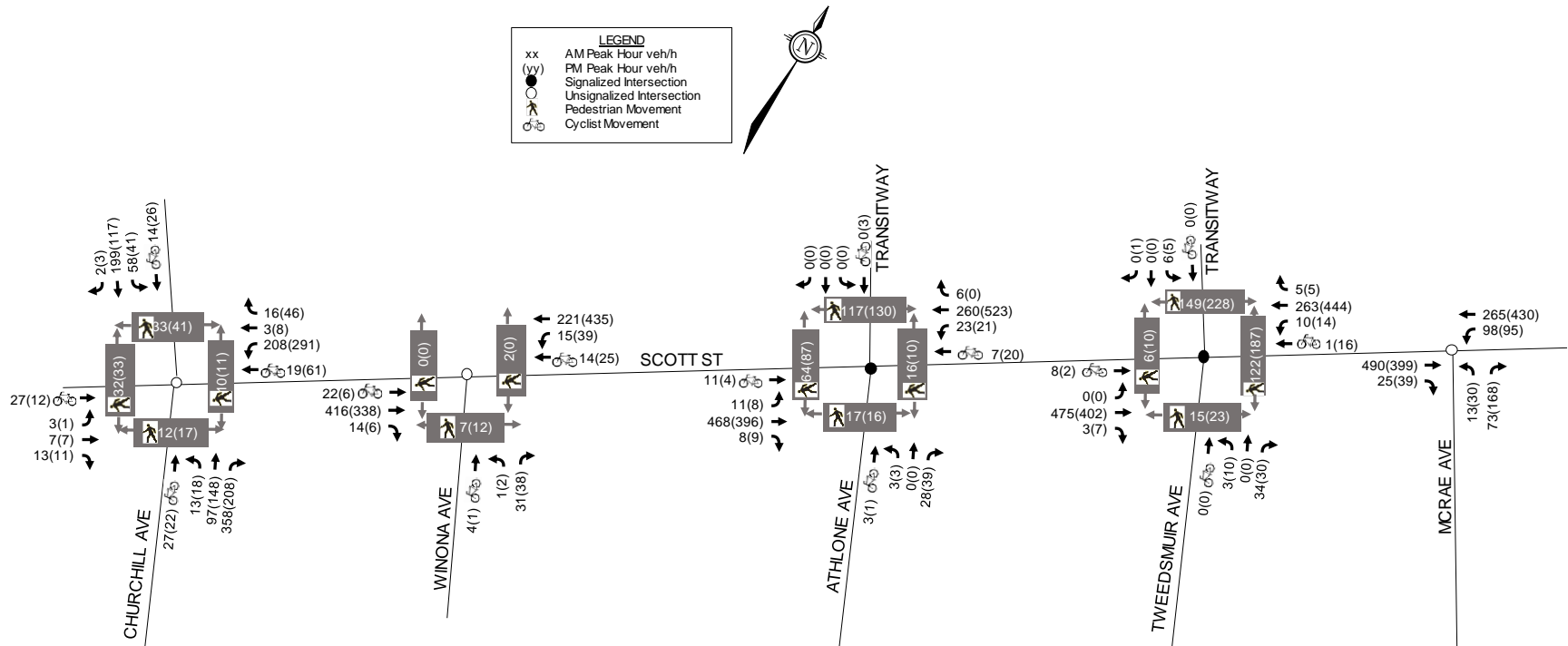

Scott Street/McRae Avenue

A total of six collisions were reported at this intersection over the course of the last five years. Of these, there were five angle impacts and one rear end collision. Of the five angle impacts, two involved northbound left turning vehicles, two involved northbound right turning vehicles, and one involved an eastbound left turning vehicle. One of the collisions caused injuries, but none caused fatalities.

Scott Street/Churchill Avenue

A total of five collisions were reported at this intersection over the course of the last five years. Of these, there was one sideswipe impact and four 'other' impacts. Two of the collisions involved a pedestrian. Two of the collisions caused injuries, but none caused fatalities.

Scott Street/Athlone Avenue

A total of three collisions were reported at this intersection over the course of the last five years. Of these, there was one rear end collision, one turning movement collision, and one 'other' impact. One of the collisions involved a cyclist and one involved a pedestrian. Two of the collisions caused injuries, but none caused fatalities.

Scott Street/Tweedsmuir Avenue

A total of three collisions were reported at this intersection over the course of the last five years. Of these, there were two rear end collisions and one angle impact. One of the collisions caused injuries, but none caused fatalities.

Scott Street/Winona Avenue

One collision was reported at this intersection over the course of the last five years. The reported collision was a sideswipe collision and caused property damage only.

2.2 Planned Conditions

2.2.1 Planned Infrastructure Projects

The City of Ottawa's Transportation Master Plan (TMP) 2031 Affordable Rapid Transit and Transit Priority (RTTP) Network identifies the extension of Light Rail Transit (LRT) to the east, west, and south (Phase 2). Construction for Phase 2 of the LRT (i.e. the Confederation Line Extension West) began in 2019, and is anticipated to be completed in 2025. This project involves extending the western LRT terminus from Tunney's Pasture Station to both Moodie Station and Algonquin College. As part of this project, the Westboro Transit Station will be converted to Westboro LRT Station. The proposed western Confederation Line extension is shown in **Figure 6**.

During the LRT Phase 2 construction, buses are routed off the existing Transitway onto Scott Street, which has been extended west of Churchill Avenue to Roosevelt Avenue, crossing to the north side of the Transitway on a temporary bridge at Roosevelt Avenue and extended westerly from Workman Avenue to the Sir John A. Macdonald Parkway. This detour is anticipated to be used by buses until 2025 (i.e. the estimated completion time for Phase 2 LRT). It is acknowledged that the temporary Westboro Station platforms on Scott Street may remain in place for a period after rail service begins.

Figure 6: LRT Phase 2 – Confederation Line Extension West

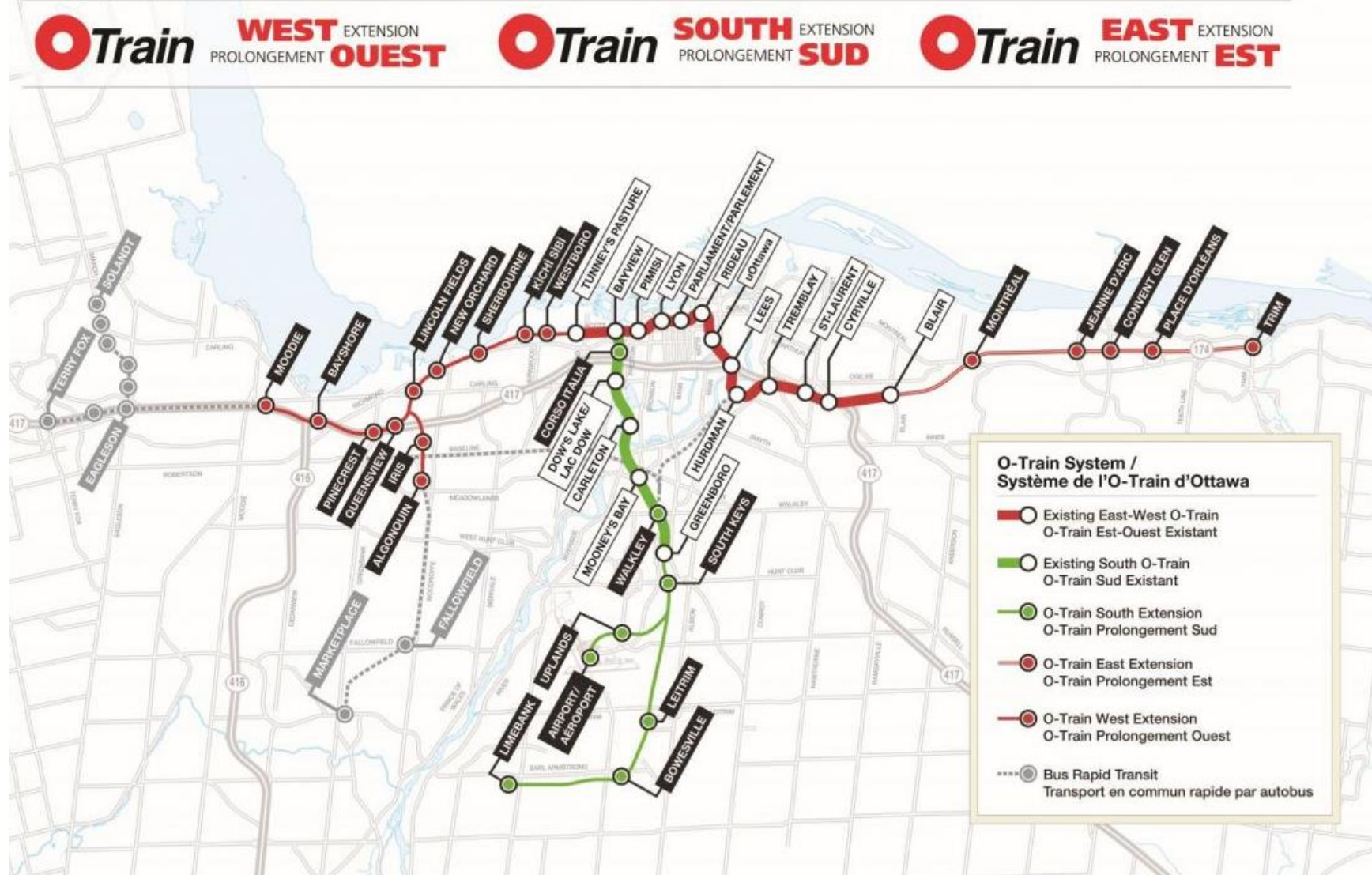

2.2.2 Other Area Developments

A review of the City's Development Application Search Tool has been conducted to identify any developments in the vicinity of the subject site that are being constructed, are approved, or are in the approval process. Other developments in the area are described as follows:

335 Roosevelt Avenue

A residential development is proposed at 335 Roosevelt Avenue. The development proposes two high-rise residential buildings with 246 units and two mid-rise residential buildings with 17 units. A TIA report, dated December 2020 and revised March 2022, was prepared by Novatech in support of Official Plan Amendment and Zoning By-Law Amendment applications for this site. The estimated date of full occupancy is 2026.

319-327 Richmond Road, 380 Winona Avenue, and 381 Churchill Avenue

A mixed-use development is proposed at 319-327 Richmond Road, 380 Winona Avenue, and 381 Churchill Avenue. This development proposes 184 apartment units and 1,738m² of retail space. Access is proposed on Churchill Avenue and Winona Avenue. A TIA was prepared by CGH Transportation, dated May 2020, in support of this development. The estimated date of occupancy was 2022.

320 McRae Avenue

A mixed-use development is proposed at 320 McRae Avenue. This development proposes 307 apartment units, 11 townhouses, and 9,494ft² of commercial land uses. A TIA, dated January 2020, was prepared by CGH Transportation in support of a Site Plan application for this development. The estimated date of full occupancy was 2022.

1946 Scott Street

A residential development is proposed at 1946 Scott Street. This development proposes a 12-storey building with approximately 60 apartment units. A TIA was prepared by Parsons, dated August 2017, in support of this development. The estimated date of full occupancy was 2019.

1950 Scott Street

A residential development is proposed at 1950 Scott Street. This development proposes a 20-storey building with approximately 141 condominium/apartment units. A Transportation Brief, written by Parsons, was submitted in July 2018 in support of this development. The estimated date of full occupancy was 2020.

2050 Scott Street

A mixed-use development is proposed directly west of the subject site. The development proposes a 30-storey residential building on three- and six- storey podiums with approximately 353 units and 233m² of ground floor commercial/office. Access is proposed via Scott Street. A TIA report was prepared by Parsons, dated February 2021, in support of a Zoning By-Law Amendment for the proposed development. The estimated date of occupancy was 2021.

2070 Scott Street

A mixed-use development is proposed at the southeast corner of the Scott Street/Churchill Avenue intersection. The development proposes a 23-storey tower with 241 units and 5,500ft² of retail. An underground parking garage with access to Winona Avenue is proposed. A TIA was prepared by Stantec, dated November 2019, in support of a Zoning By-Law Amendment and Site Plan Control for this development. The estimated date of occupancy was 2022.

2.3 Study Area and Time Periods

The study area intersections include the proposed accesses and the intersections of Scott Street/Churchill Avenue, Scott Street/Winona Avenue, Scott Street/Athlone Avenue, Scott Street/Tweedsmuir Avenue, and Scott Street/McRae Avenue. This study area is consistent with the City’s 2017 TIA Guidelines, which outlines that all arterial signalized intersections within 400m should be included.

The selected time periods for the analysis are the weekday AM and PM peak hours, as they represent the ‘worst case’ combination of site generated traffic and adjacent street traffic. Analysis will be completed for the Phase 1 build-out year (2026) and 5-year horizon (2031). Phase 2 is assumed to be built-out prior to the five-year horizon of Phase 1. Due to the extended build-out time frame for Phase 2, this report will forego the five-year horizon beyond Phase 2.

2.4 Exemptions Review

This module reviews possible exemptions from the final TIA, as outlined in the 2017 TIA Guidelines. The applicable exemptions for this site are shown in **Table 4**.

Table 4: TIA Exemptions

Module	Element	Exemption Criteria	Status
Design Review Component			
4.1 Development Design	4.1.2 Circulation and Access	<ul style="list-style-type: none"> Only required for site plans 	Not Exempt
	4.1.3 New Street Networks	<ul style="list-style-type: none"> Only required for plans of subdivision 	Exempt
4.2 Parking	4.2.1 Parking Supply	<ul style="list-style-type: none"> Only required for site plans 	Not Exempt
	4.2.2 Spillover Parking	<ul style="list-style-type: none"> Only required for site plans where parking supply is 15% below unconstrained demand 	Exempt
Network Impact Component			
4.5 Transportation Demand Management	<i>All elements</i>	<ul style="list-style-type: none"> Not required for site plans expected to have fewer than 60 employees and/or students on location at any given time 	Not Exempt
4.6 Neighbourhood Traffic Management	4.6.1 Adjacent Neighbourhoods	<ul style="list-style-type: none"> Only required when the development relies on local or collector streets for access and total volumes exceed ATM capacity thresholds 	Not Exempt
4.8 Network Concept	<i>All elements</i>	<ul style="list-style-type: none"> Only required when proposed development generates more than 200 person-trips during the peak hour in excess of the equivalent volume permitted by the established zoning 	Exempt

The proposed development conforms to the recent rezoning of the subject site, and therefore Module 4.8: Network Concept is exempt from further review. Based on the foregoing, the following modules will be included in the TIA report:

Design Review Component

- Module 4.1: Development Design
- Module 4.2: Parking
- Module 4.3: Boundary Streets
- Module 4.4: Access Design

Network Impact Component

- Module 4.5: Transportation Demand Management
- Module 4.6: Neighbourhood Traffic Management
- Module 4.7: Transit
- Module 4.9: Intersection Design

3.0 FORECASTING

3.1 Development-Generated Travel Demand

3.1.1 Trip Generation

Existing Trip Generation

As discussed in Section 1.1, the subject site has most recently been occupied by the Granite Curling Club (2026 Scott Street), a used car dealership (2020 Scott Street), a retail store (2006 Scott Street), office space (314 Athlone Avenue), and two semi-detached dwellings (316-318 Athlone Avenue). Based on street-level photography, the retail space appears to have been vacant since at least May 2016 and the car dealership appears to have been vacant since at least June 2019. It has been assumed that the buildings at 2006 and 2020 Scott Street are vacant for the purposes of estimating the number of trips generated by the existing uses. In addition, the two semi-detached dwellings are not assumed to generate any peak hour trips. These are both conservative assumptions that reduce the estimated number of existing trips generated.

Trips generated by the existing curling club are based on the number of ice sheets and maximum number of players. The club includes four ice sheets, which can have a maximum of eight players per sheet (consisting of two teams of four). Games are scheduled to be two hours each, starting at 9:00am and running until 11:00pm. Outside of a two-hour game, people are assumed to arrive five to 15 minutes before the scheduled start, and depart up to 30 minutes after finishing to socialize. Therefore, overlap between earlier players departing and later players arriving is assumed to occur every two hours (i.e. at 11:00am, 1:00pm, 3:00pm, 5:00pm, 7:00pm, and 9:00pm). Based on the above, it has been assumed that AM peak hour trips consist of 32 players arriving for the first game of the day, and PM peak hour trips consist of 32 players arriving for an afternoon game and 32 players departing after playing the previous game.

Trips generated by the existing office space at 314 Athlone Avenue have been estimated using the trip generation rates for the Small Office Building (land use code 712), as outlined in the *ITE Trip Generation Manual, 11th Edition*. Using aerial photography, the gross floor area (GFA) of the office space is estimated to be approximately 3,000 ft². Trips estimated using the *ITE Trip Generation Manual* have been converted to person trips using an adjustment factor of 1.28, consistent with the City's *2017 TIA Guidelines*.

The estimated number of person trips generated by the existing curling club and small office space are shown in **Table 5**.

Table 5: Existing Development – Peak Hour Person Trip Generation

Land Use	ITE Code	Units/GFA	AM Peak Hour (pph) ⁽¹⁾			PM Peak Hour (pph)		
			IN	OUT	TOT	IN	OUT	TOT
Curling Club	-	4 ice sheets	32	-	32	32	32	64
Small Office Building	712	3,000 ft ²	6	1	7	3	6	9
Total			38	1	39	35	38	73

1. pph: person trips per hour

It is anticipated that most patrons of the curling club arrive and depart in their own personal vehicle, based on Novatech’s experience on the proposed development application for the new Granite Curling Club location at 2730 Queensview Drive. Therefore, the assumed mode shares for the curling club are summarized as 85% auto driver, 5% auto passenger, 5% transit, and 5% pedestrian.

The *TRANS Trip Generation Manual Summary Report*, prepared in October 2020 by WSP, includes AM peak hour data to estimate the mode shares for employment trip generators, based on location. For the purposes of this analysis, trips generated by the small office space are assumed to generally follow the mode shares of the Ottawa West district, which is summarized as 54% auto driver, 8% auto passenger, 28% transit, 5% cyclist, and 5% pedestrian.

A breakdown of the existing trips by modal share is shown in **Table 6**.

Table 6: Existing Development – Peak Hour Trips by Mode Share

Travel Mode	Mode Share	AM Peak Hour			PM Peak Hour		
		IN	OUT	TOT	IN	OUT	TOT
Curling Club Person Trips		32	0	32	32	32	64
Auto Driver	85%	27	-	27	27	27	54
Auto Passenger	5%	2	-	2	2	2	4
Transit	5%	2	-	2	2	2	4
Cyclist	0%	-	-	0	-	-	0
Pedestrian	5%	1	-	1	1	1	2
Small Office Person Trips		6	1	7	3	6	9
Auto Driver	54%	3	1	4	2	3	5
Auto Passenger	8%	1	-	1	-	1	1
Transit	28%	2	-	2	1	2	3
Cyclist	5%	-	-	0	-	-	0
Pedestrian	5%	-	-	0	-	-	0
Total Existing Person Trips		38	1	39	35	38	73
Auto Driver		30	1	31	29	30	59
Auto Passenger		3	-	3	2	3	5
Transit		4	-	4	3	4	7
Cyclist		-	-	0	-	-	0
Pedestrian		1	-	1	1	1	2

From the previous tables, the existing uses on the subject site are estimated to generate 39 person trips (including 31 vehicle trips) during the AM peak hour, and 73 person trips (including 59 vehicle trips) during the PM peak hour.

Proposed Residential Trip Generation

The number of person trips generated by the proposed residential dwellings have been estimated using the *TRANS Trip Generation Manual*, which present peak hour trip generation rates and mode shares for different types of housing for the AM and PM peak periods. The data is divided into rates and mode shares for Single-Family Detached Housing, Low-Rise Multifamily Housing (one or two storeys), and High-Rise Multifamily Housing (three or more storeys). For the High-Rise Multifamily Housing land use, the process of converting the trip generation estimates from peak period to peak hour is shown below.

The *TRANS Trip Generation Manual* identifies the subject site as being located within the Ottawa West district, which has the following observed mode shares for high-rise multifamily housing during the peak hours:

- Auto Driver: 28% AM peak, 33% PM peak;
- Auto Passenger: 11% AM peak, 11% PM peak;
- Transit: 41% AM peak, 26% PM peak;
- Cyclist: 3% AM peak, 7% PM peak;
- Pedestrian: 16% AM peak, 23% PM peak.

The subject site is located within a Transit-Oriented Development (TOD) zone. The City has provided target mode shares for any transit-oriented developments, which are the following:

- Auto Driver: 15% during both peak hours;
- Auto Passenger: 5% during both peak hours;
- Transit: 65% during both peak hours;
- Non-Auto: 15% during both peak hours.

It is assumed that both the proposed residential and commercial uses will generally be consistent to the TOD mode shares with an increase to the pedestrian mode share, reflecting the higher number of pedestrians within the Ottawa West area.

The estimated number of person trips generated by the proposed dwellings for the AM and PM peak periods are shown in **Table 7**. A breakdown of these trips by modal share is shown in **Table 8**.

Table 7: Proposed Residential – Peak Period Trip Generation

Land Use	TRANS Rate	Units	AM Peak Period (ppp) ⁽¹⁾			PM Peak Period (ppp)		
			IN	OUT	TOT	IN	OUT	TOT
<i>Phase 1, buildout year 2026</i>								
High-Rise Multifamily Housing	AM: 0.80 PM: 0.90	422 units	105	233	338	220	160	380
<i>Phase 2, buildout year 2029</i>								
High-Rise Multifamily Housing	AM: 0.80 PM: 0.90	479 units	119	264	383	250	181	431
Total			224	497	721	470	341	811

1. ppp: person trips per peak period

Table 8: Proposed Residential – Peak Period Trips by Mode Share

Travel Mode	Mode Share	AM Peak Period			PM Peak Period		
		IN	OUT	TOT	IN	OUT	TOT
Phase 1 Person Trips		105	233	338	220	160	380
Auto Driver	15%	16	34	50	33	24	57
Auto Passenger	5%	5	12	17	11	8	19
Transit	55%	58	128	186	121	88	209
Cyclist	5%	5	12	17	11	8	19
Pedestrian	20%	21	47	68	44	32	76
Phase 2 Person Trips		119	264	383	250	181	431
Auto Driver	15%	18	39	57	37	27	64
Auto Passenger	5%	6	13	19	13	9	22
Transit	55%	66	145	211	137	100	237
Cyclist	5%	6	13	19	13	9	22
Pedestrian	20%	23	54	77	50	36	86
Auto Driver (Total)		34	73	107	70	51	121
Auto Passenger (Total)		11	25	36	24	17	41
Transit (Total)		124	273	397	258	188	446
Cyclist (Total)		11	25	36	24	17	41
Pedestrian (Total)		44	101	145	94	68	162

Table 4 of the *TRANS Trip Generation Manual* includes adjustment factors to convert the estimated number of trips generated for each mode from peak period to peak hour. A breakdown of the peak hour trips by mode is shown in **Table 9**.

Table 9: Proposed Residential – Peak Hour Trips by Mode Share

Travel Mode	Adj. Factor ⁽¹⁾		AM Peak Hour			PM Peak Hour		
	AM	PM	IN	OUT	TOT	IN	OUT	TOT
Auto Driver	0.48	0.44	8	17	25	15	11	26
Auto Passenger	0.48	0.44	3	6	9	5	4	9
Transit	0.55	0.47	32	70	102	57	41	98
Cyclist	0.58	0.48	3	7	10	5	4	9
Pedestrian	0.58	0.52	12	27	39	23	17	40
Phase 1 Person Trips			58	127	185	105	77	182
Auto Driver	0.48	0.44	9	19	28	17	12	29
Auto Passenger	0.48	0.44	3	6	9	6	4	10
Transit	0.55	0.47	36	80	116	65	47	112
Cyclist	0.58	0.48	3	8	11	6	4	10
Pedestrian	0.58	0.52	14	31	45	26	19	45
Phase 2 Person Trips			65	144	209	120	86	206
Auto Driver	(Phase 1+2)		17	36	53	32	23	55
Auto Passenger	(Phase 1+2)		6	12	18	11	8	19
Transit	(Phase 1+2)		68	150	218	122	88	210
Cyclist	(Phase 1+2)		6	15	21	11	8	19
Pedestrian	(Phase 1+2)		26	58	84	49	36	85
Total Proposed Person Trips			123	271	394	225	163	388

From the previous table, the proposed Phase 1 residences are estimated to generate 185 person trips (including 25 vehicle trips) during the AM peak hour and 182 person trips (including 26 vehicle trips) during the PM peak hour. At full buildout, the proposed residences are estimated to generate 394 person trips (including 53 vehicle trips) during the AM peak hour and 388 person trips (including 55 vehicle trips) during the PM peak hour.

Proposed Commercial Trip Generation

The number of person trips generated by the proposed ground-floor commercial/retail units has been estimated using the trip generation rates in the *ITE Trip Generation Manual, 11th Edition*, corresponding to the Strip Retail Plaza (code 822) land use. Trips estimated using the *ITE Trip Generation Manual* have been converted to person trips using an adjustment factor of 1.28, consistent with the City’s *2017 TIA Guidelines*. As discussed prior, it assumed that the proposed commercial trips will follow the same mode shares as the proposed residential trips.

The estimated number of person trips generated by the proposed commercial uses are shown in **Table 10**, and broken down by mode share in **Table 11**.

Table 10: Proposed Commercial – Peak Hour Trip Generation

Land Use	ITE Code	Area	AM Peak Hour (pph) ⁽¹⁾			PM Peak Hour (pph)		
			IN	OUT	TOT	IN	OUT	TOT
<i>Phase 1, buildout year 2026</i>								
Strip Retail Plaza	822	1,180 ft ²	3	1	4	5	5	10
<i>Phase 2, buildout year 2029</i>								
Strip Retail Plaza	822	1,920 ft ²	4	2	6	8	8	16
Total			7	3	10	13	13	26

1. pph: person trips per peak hour

Table 11: Proposed Commercial – Peak Hour Trips by Mode Share

Travel Mode	Mode Share	AM Peak Hour			PM Peak Hour		
		IN	OUT	TOT	IN	OUT	TOT
Phase 1 Person Trips		3	1	4	5	5	10
Auto Driver	15%	1	-	1	1	-	1
Auto Passenger	5%	-	-	0	1	-	1
Transit	55%	1	1	2	2	3	5
Cyclist	5%	-	-	0	-	1	1
Pedestrian	20%	1	-	1	1	1	2
Phase 2 Person Trips		4	2	6	8	8	16
Auto Driver	15%	1	-	1	1	1	2
Auto Passenger	5%	-	-	0	-	1	1
Transit	55%	2	1	3	4	5	9
Cyclist	5%	1	-	1	1	-	1
Pedestrian	20%	-	1	1	2	1	3
Auto Driver	(Phase 1+2)	2	-	2	2	1	3
Auto Passenger	(Phase 1+2)	-	-	0	1	1	2
Transit	(Phase 1+2)	3	2	5	6	8	14
Cyclist	(Phase 1+2)	1	-	1	1	1	2
Pedestrian	(Phase 1+2)	1	1	2	3	2	5
Total Proposed Person Trips		7	3	10	13	13	26

From the previous table, the proposed Phase 1 ground-floor commercial spaces are estimated to generate four person trips (including one vehicle trip) during the AM peak hour and ten person trips (including one vehicle trip) during the PM peak hour. At full buildout, the proposed ground-floor commercial spaces are estimated to generate ten person trips (including two vehicle trips) during the AM peak hour and 26 person trips (including three vehicle trips) during the PM peak hour.

Net Trip Generation

To determine the estimated net number of new trips generated by the proposed development, the existing trip generation estimates shown in **Table 6** have been subtracted from the proposed trip generation estimates shown in **Table 9** and **Table 11**. The results of this calculation are presented in **Table 12**.

Table 12: Net Person Trip Generation

Travel Mode	AM Peak Hour			PM Peak Hour		
	IN	OUT	TOT	IN	OUT	TOT
Existing Trips	38	1	39	35	38	73
Auto Driver	30	1	31	29	30	59
Auto Passenger	3	-	3	2	3	5
Transit	4	-	4	3	4	7
Cyclist	-	-	0	-	-	0
Pedestrian	1	-	1	1	1	2
Proposed Residential Trips	123	271	394	225	163	388
Auto Driver	17	36	53	32	23	55
Auto Passenger	6	12	18	11	8	19
Transit	68	150	218	122	88	210
Cyclist	6	15	21	11	8	19
Pedestrian	26	58	84	49	36	85
Proposed Commercial Trips	7	3	10	13	13	26
Auto Driver	2	-	2	2	1	3
Auto Passenger	-	-	0	1	1	2
Transit	3	2	5	6	8	14
Cyclist	1	-	1	1	1	2
Pedestrian	1	1	2	3	2	5
Net Additional Person Trips	92	273	365	203	138	341
Auto Driver	-11	35	24	5	-6	-1
Auto Passenger	3	12	15	10	6	16
Transit	67	152	219	125	92	217
Cyclist	7	15	22	12	9	21
Pedestrian	26	59	85	51	37	88

From the previous table, the ultimate proposed development is projected to generate an additional 365 person trips (including 24 additional vehicle trips) during the AM peak hour, and an additional 341 person trips (but one fewer vehicle trip) during the PM peak hour.

While it is probable that some trips generated by the proposed development will be internally captured (i.e. residents may travel between their dwelling and commercial units on the ground floor), it has conservatively been assumed that all site-generated trips are external to the study area. Similarly, it is assumed that the ground-floor commercial units will not generate any pass-by trips, as all parking spaces on-site will be located within an underground parking garage.

3.1.2 Trip Distribution and Assignment

The assumed distribution of trips generated by the existing and proposed developments have been derived from existing traffic patterns within the study area and logical trip routing. Different distributions have been assumed for the existing curling club, existing office space, proposed residences, and proposed commercial, as described below.

Existing Curling Club

Site-generated curling trips have been distributed based on the two-way off-peak traffic patterns of the study area, as trips to/from the curling club are not anticipated to follow the commuter traffic patterns observed during the AM and PM peak hour. The assumed trip distribution for the existing curling club can be summarized as follows:

- 10% to/from the north via Churchill Avenue;
- 40% to/from the south via Winona Avenue;
- 10% to/from the south via McRae Avenue;
- 40% to/from the east via Scott Street.

All trips to/from the south via Winona Avenue have been assigned to the access on Ashton Avenue, at the back of the curling club. All trips to/from the north via Churchill Avenue, south via McRae Avenue, and east via Scott Street have been assigned to the access on Scott Street.

Existing Office Space

Site-generated office trips have been distributed based on the traffic patterns associated with the typical commute to/from a place of employment (i.e. inbound trips during the AM peak hour and outbound trips during the PM peak hour). The assumed trip distribution for the existing office building can be summarized as follows:

- 10% to/from the north via Churchill Avenue;
- 35% to/from the south via Churchill Avenue;
- 10% to/from the south via Athlone Avenue;
- 45% to/from the east via Scott Street.

All trips generated by the existing office space have been assigned to the access on Athlone Avenue.

Proposed Residential

Site-generated residential trips have been distributed based on the traffic patterns associated with the typical commute to/from home (i.e. outbound trips during the AM peak hour and inbound trips during the PM peak hour). The assumed trip distribution for the proposed development can be summarized as follows:

- 30% to/from the south via Churchill Avenue;
- 10% to/from the south via Athlone Avenue;
- 15% to/from the south via McRae Avenue;
- 45% to/from the east via Scott Street.

All peak hour trips generated by the proposed residences have been assigned to the two underground parking garage ramps, as the entire parking garage will be constructed in a single phase. All trips to/from the south via Athlone Avenue have been assigned to the proposed Athlone Avenue ramp, and all trips to/from the south via Churchill Avenue or McRae Avenue and all trips to/from the east via Scott Street have been assigned to the proposed Scott Street ramp.

Proposed Commercial

Site-generated commercial trips have been distributed based on the two-way off-peak traffic patterns of the study area. The assumed trip distribution for the proposed can be summarized as follows:

- 10% to/from the north via Churchill Avenue;
- 40% to/from the south via Churchill Avenue;
- 10% to/from the south via McRae Avenue;
- 40% to/from the east via Scott Street.

All peak hour trips generated by the proposed commercial units have been assigned to the proposed Scott Street ramp.

Volume Figures

Traffic volumes generated by the existing uses are shown in **Figure 7**.

The new traffic volumes generated by the proposed development in the Phase 1 year 2026 and the horizon year 2031 are shown in **Figure 8** and **Figure 9**, respectively.

The net traffic volumes generated by the subject site in 2026 and 2031 (i.e. the existing site-generated traffic is subtracted) are shown in **Figure 10** and **Figure 11**, respectively.

3.2 Background Traffic

3.2.1 Other Area Developments

Traffic generated by the following proposed developments have been added to the future background volumes. Relevant excerpts from their associated traffic studies are included in **Appendix G**.

335 Roosevelt Avenue

The development proposes 246 high-rise dwellings and 17 mid-rise dwellings. The TIA report, prepared in December 2020 and revised in March 2022 by Novatech, estimated that full buildout of the development would occur in 2026. Therefore, traffic generated by this development has been added to the 2026 and 2031 background volumes.

319-327 Richmond Road, 380 Winona Avenue, and 381 Churchill Avenue

The development proposes 184 apartment dwellings and 1,738m² of retail space. The TIA report, prepared in May 2020 by CGH Transportation, estimated that full buildout of the development would occur in 2022. Therefore, traffic generated by this development has been added to the 2026 and 2031 background volumes.

Figure 7: Existing Site-Generated Traffic Volumes

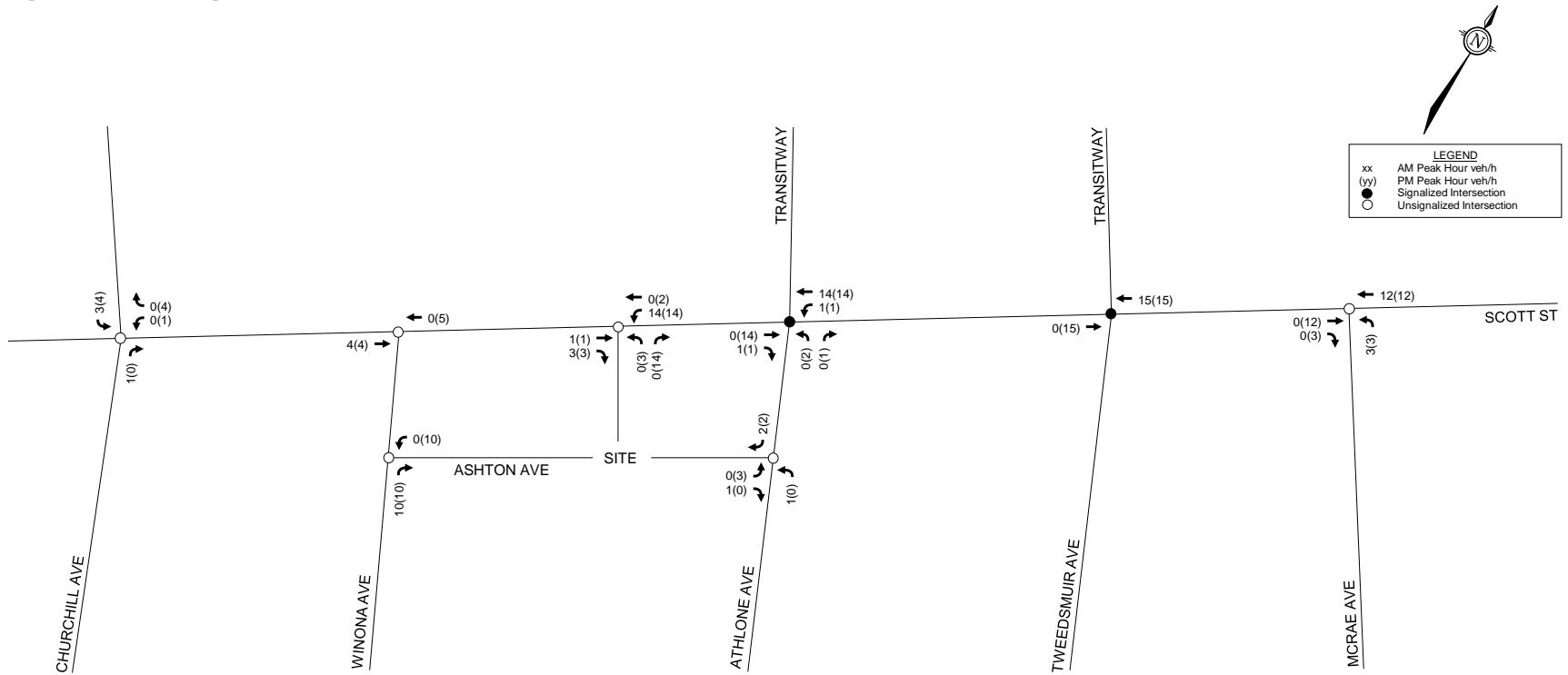

Figure 8: Proposed Site-Generated Traffic Volumes (2026)

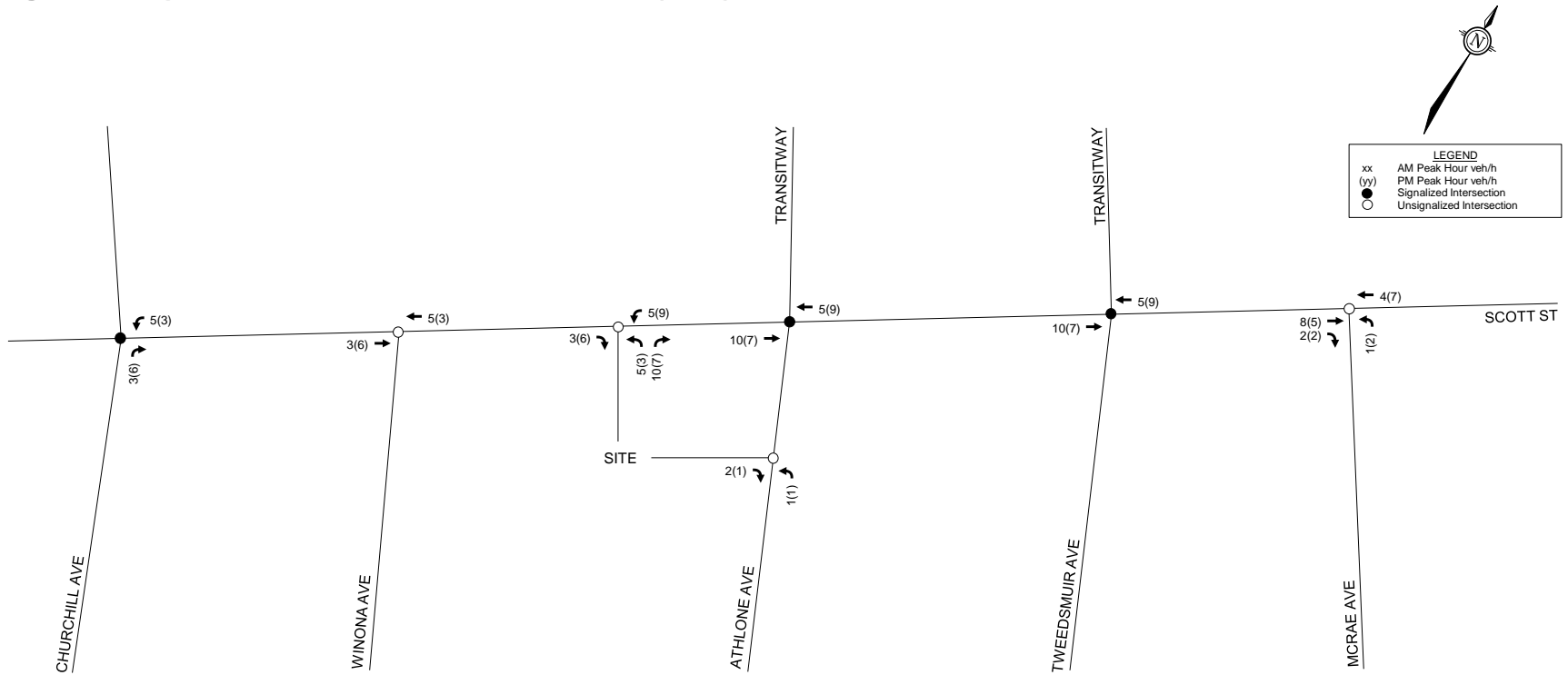

Figure 9: Proposed Site-Generated Traffic Volumes (2031)

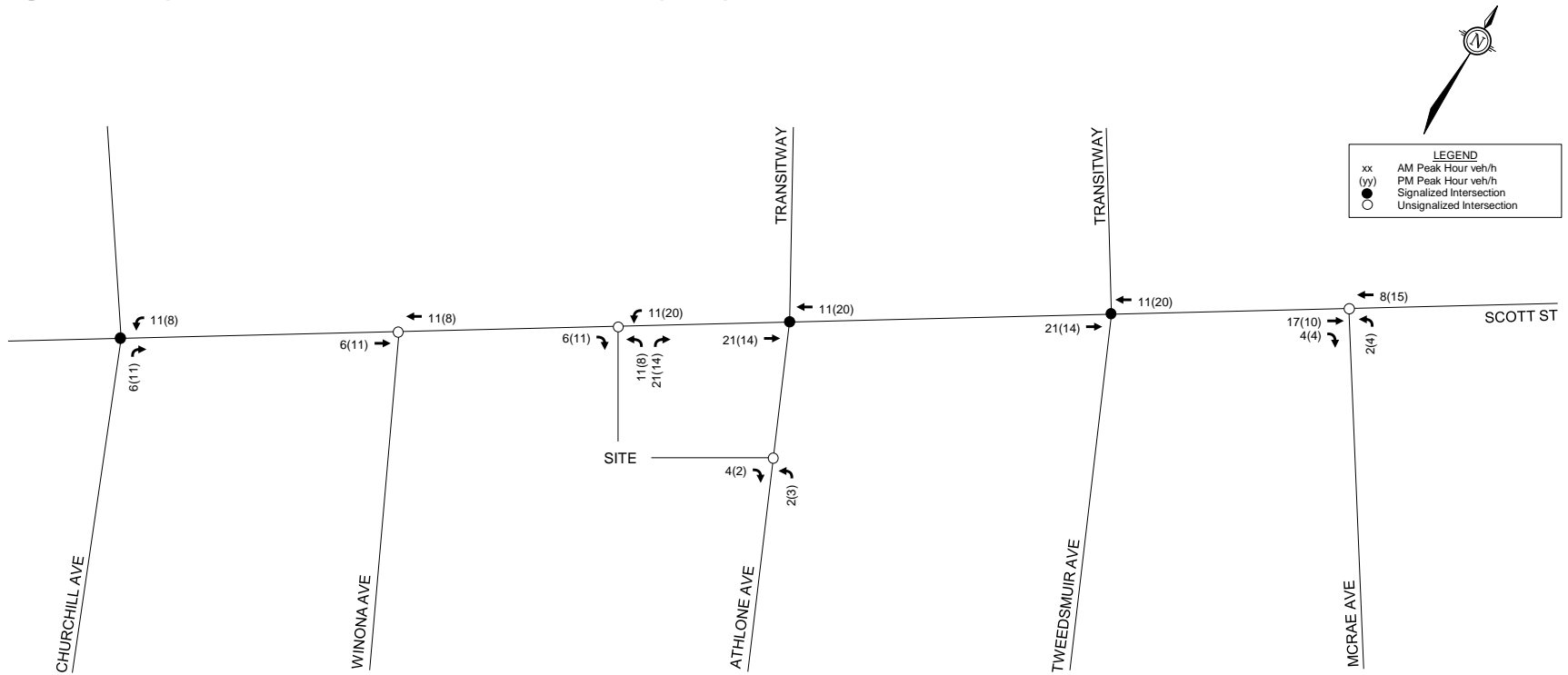

Figure 10: Net Site-Generated Traffic Volumes (2026)

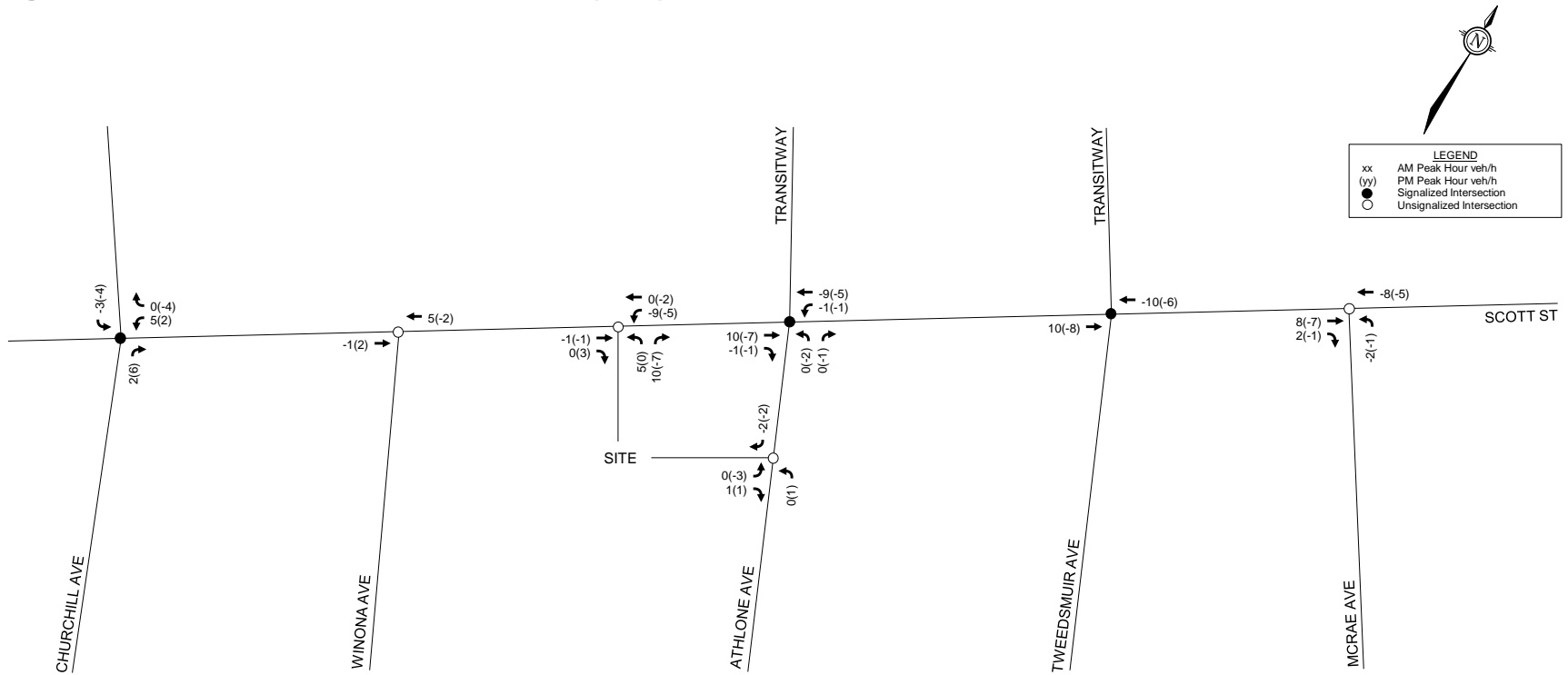
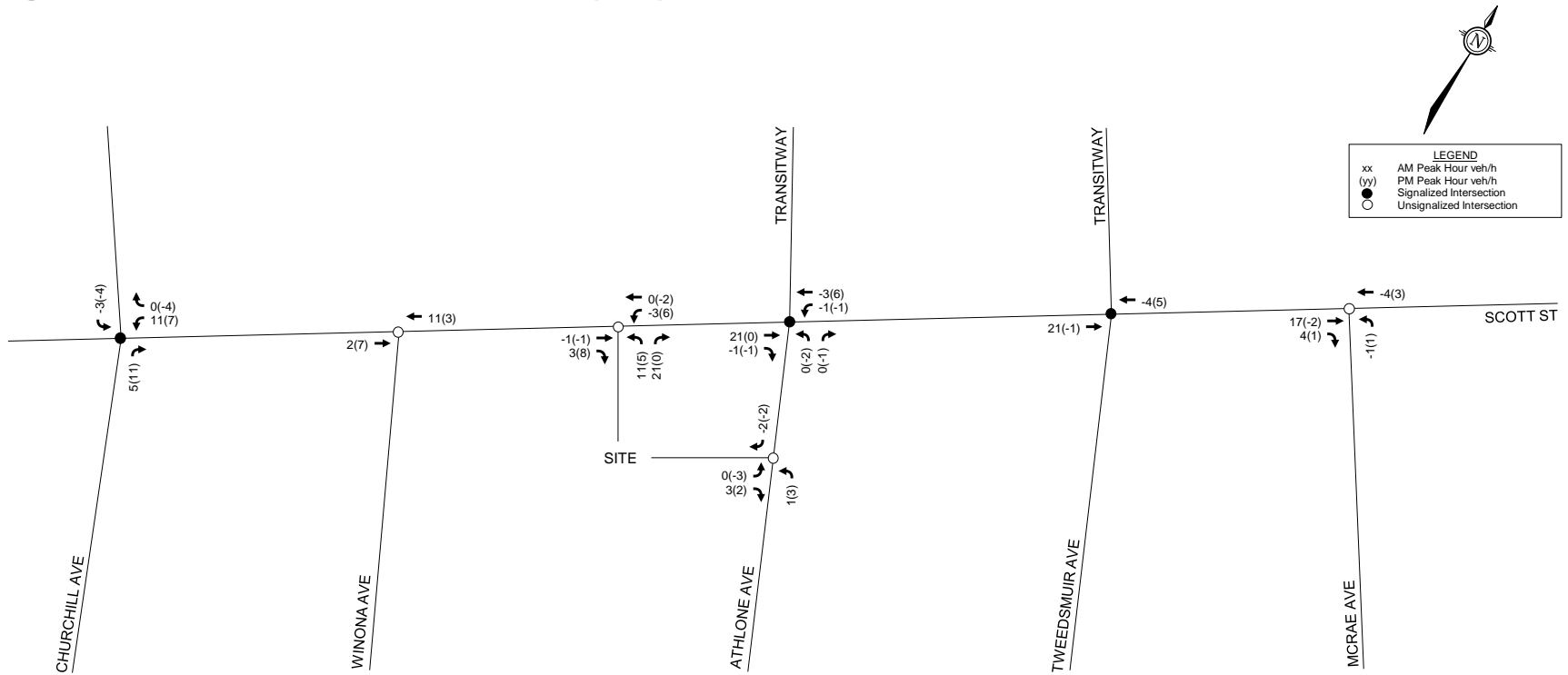

Figure 11: Net Site-Generated Traffic Volumes (2031)



320 McRae Avenue

The development proposes 307 apartment dwellings, 11 townhouses, and 9,494ft² of commercial land uses. The TIA report, prepared in January 2020 by CGH Transportation, estimated that full buildout of the development would occur in 2022. Therefore, traffic generated by this development has been added to the 2026 and 2031 background volumes.

1950 Scott Street

The development proposes 141 condominium/apartment dwellings. The TIA report, prepared in July 2018 by Parsons, estimated that full buildout of the development would occur in 2020. Therefore, traffic generated by this development has been added to the 2026 and 2031 background volumes.

2050 Scott Street

The development proposes 353 apartment dwellings and 233m² of ground floor commercial/office space. The TIA report, prepared in February 2021 by Parsons, estimates that full buildout of the development would occur in 2021. Therefore, traffic generated by this development has been added to the 2026 and 2031 background volumes.

2070 Scott Street

The development proposes 241 apartment dwellings and 5,500ft² of retail space. The TIA report, prepared in November 2019 by Stantec, estimates that full buildout of the development would occur in 2022. Therefore, traffic generated by this development has been added to the 2026 and 2031 background volumes.

3.2.2 General Background Growth Rate

A review of the City's *Strategic Long-Range Model* has been conducted, comparing snapshots of the 2011 and 2031 AM peak hour traffic volumes. The long-range snapshots are included in **Appendix H**.

Within the study area, the long-range snapshots identify generally negative growth on Scott Street between 2011 and 2031. It is anticipated that the transit and non-auto infrastructure upgrades along Scott Street, which includes improvements such as the extension of the Confederation Line LRT and cycle tracks along Scott Street, will increase the use of active transportation modes. To maintain a conservative analysis, an annual growth rate of 0% for vehicular traffic volumes within the study area has been applied, and the traffic volumes generated by the other area developments described in the previous section have been added directly.

3.3 Future Traffic Conditions

The figures below present the following future traffic conditions:

- Other area development-generated volumes in 2026 and 2031 are shown in **Figure 12**;
- Background traffic volumes in 2026 and 2031 are shown in **Figure 13**;
- Total traffic volumes in 2026 are shown in **Figure 14**;
- Total traffic volumes in 2031 are shown in **Figure 15**.

Figure 12: Other Area Development-Generated Traffic Volumes

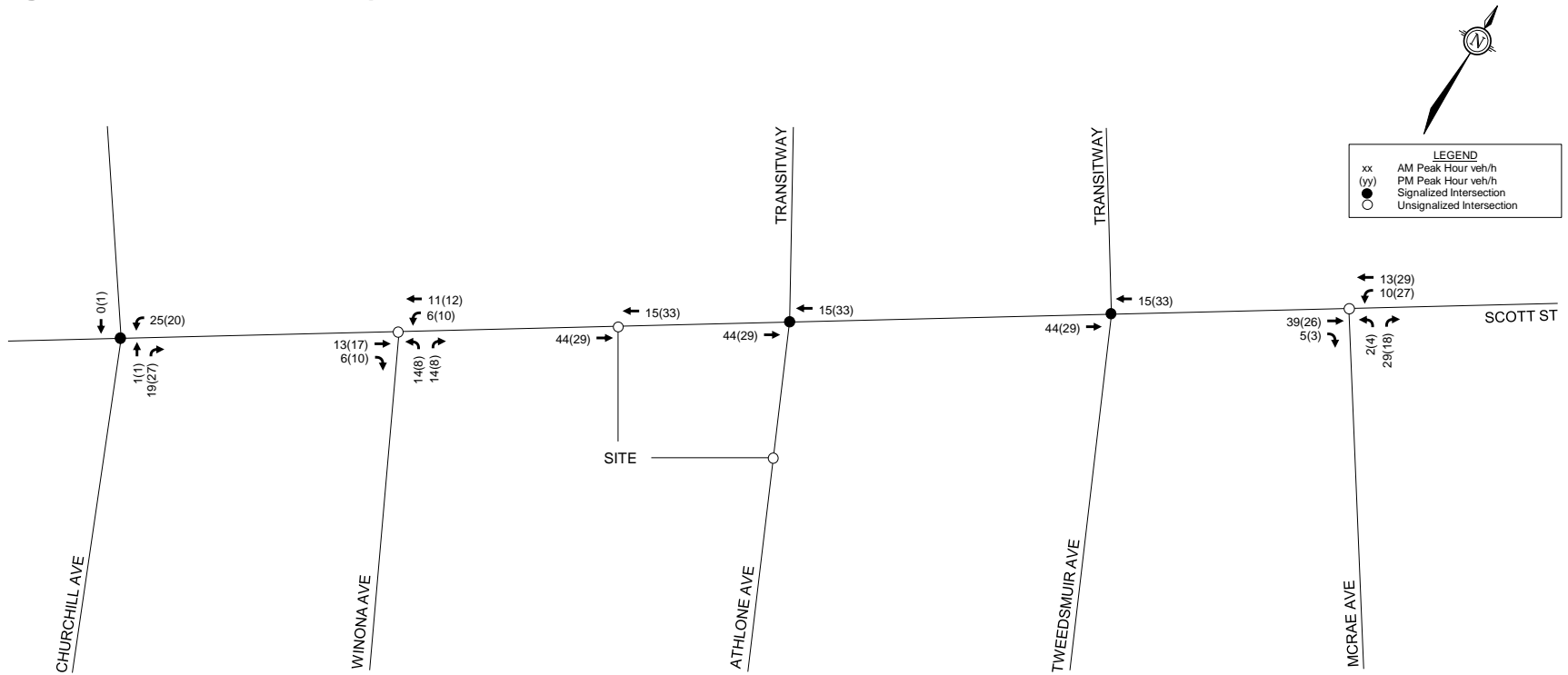

Figure 13: 2026 and 2031 Background Traffic Volumes

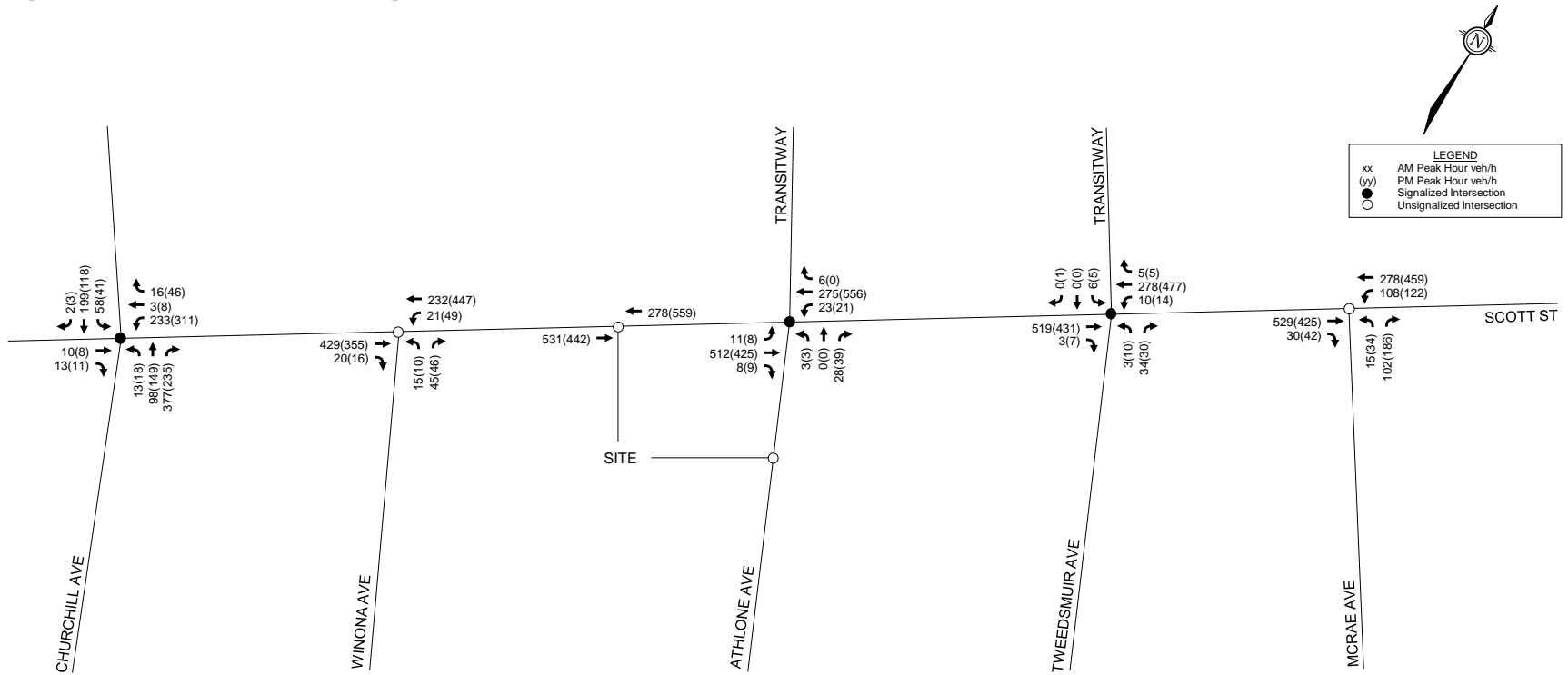

Figure 14: 2026 Total Traffic Volumes

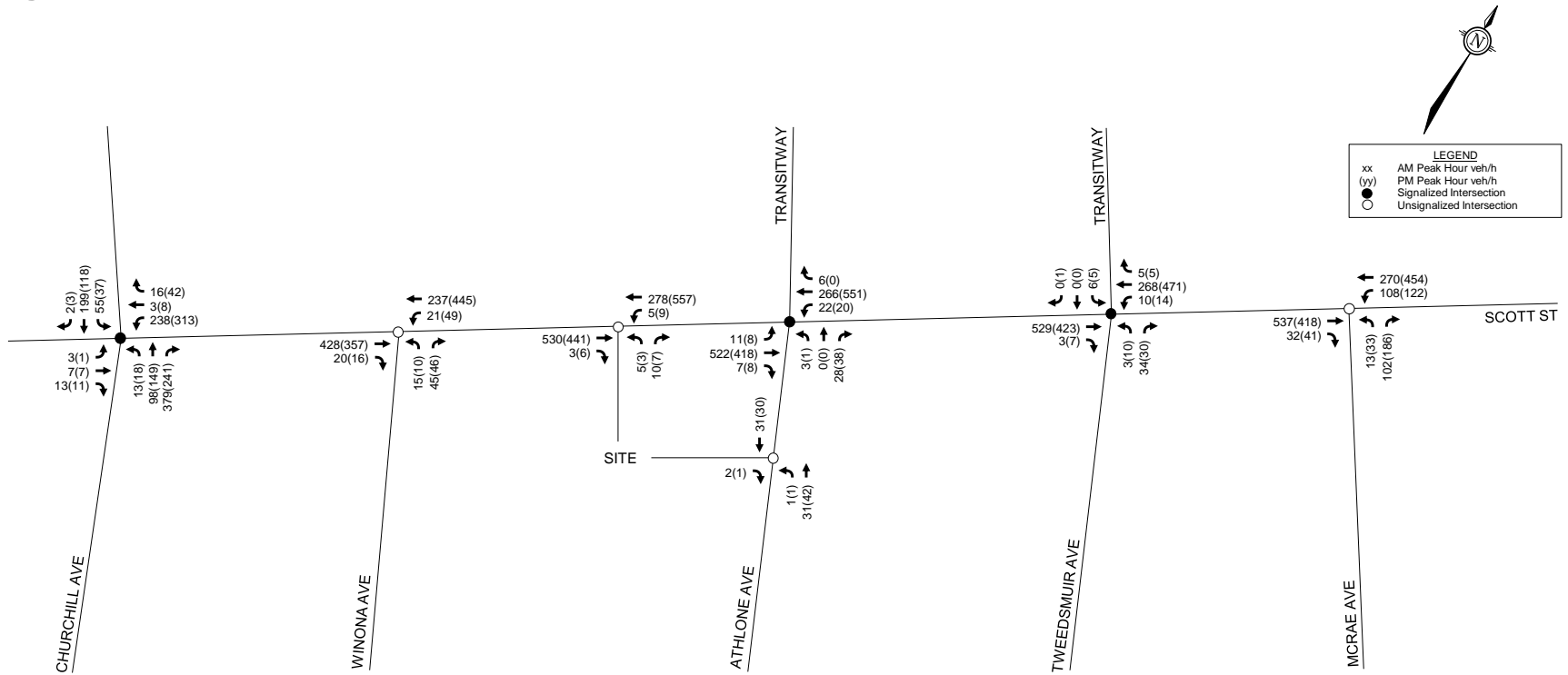
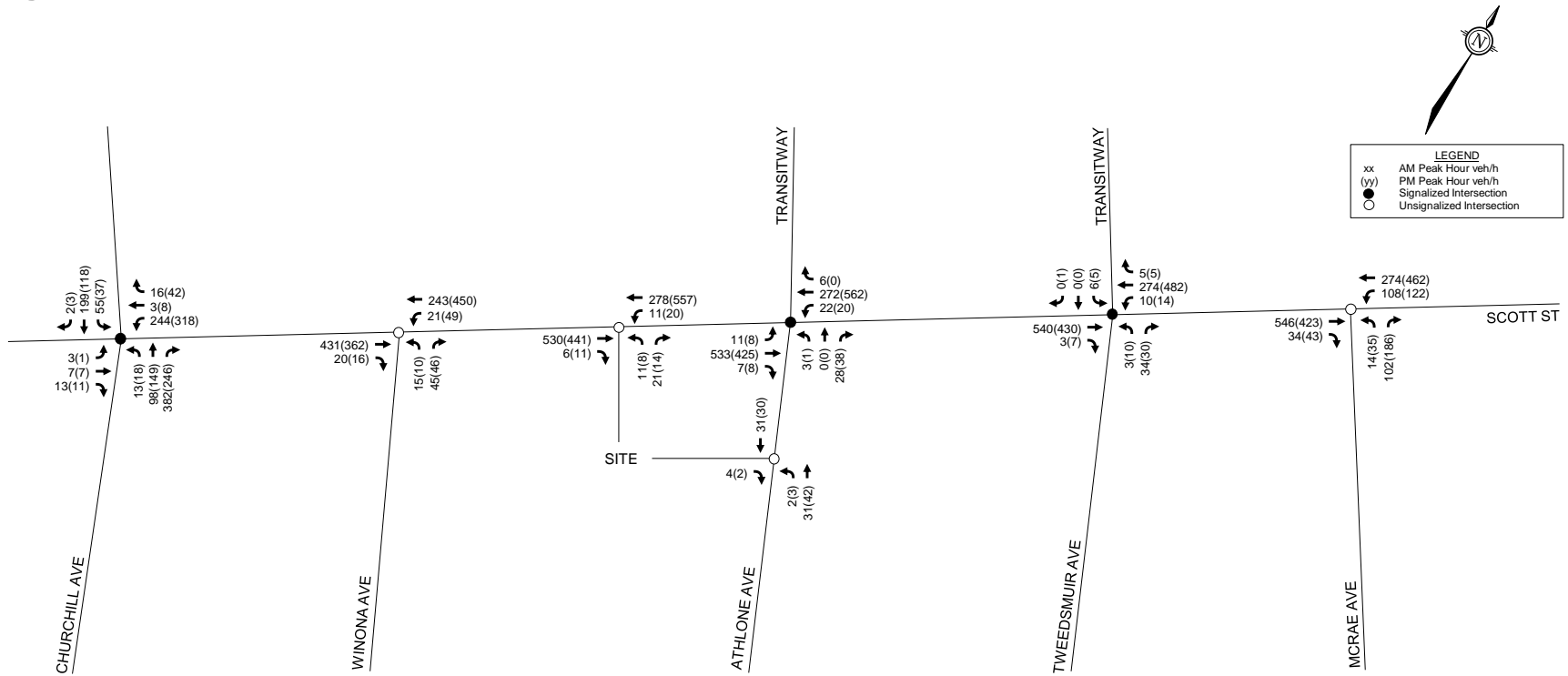

Figure 15: 2031 Total Traffic Volumes



3.4 Demand Rationalization

A review of the existing and background intersection operations has been conducted using Synchro 11, to determine if and when traffic volumes exceed capacity within the study area. The intersection parameters used in the analysis are consistent with the City’s 2017 TIA Guidelines (Saturated Flow Rate: 1,800 vphpl, Peak Hour Factor: 0.9 in existing conditions and 1.0 in future conditions). Signal timing plans for the signalized intersection at Scott Street/Churchill Avenue and signalized pedestrian crossings at Scott Street/Athlone Avenue, and Scott Street/Tweedsmuir Avenue are included in **Appendix I**. All study area intersections are within 600m of a rapid transit station. Per Exhibit 22 of the *Multi-Modal Level of Service (MMLOS) Guidelines* (produced by IBI Group in October 2015), the target vehicular level of service (Auto LOS) at all study area intersections is an Auto LOS E, which equates to a maximum vehicle-to-capacity (v/c) ratio of 1.00 or maximum approach delay of 50 seconds.

The intersections at Scott Street/Athlone Avenue and Scott Street/Tweedsmuir Avenue are four-legged unsignalized intersections, but include pedestrian-actuated crossing signals at one approach of each intersection. Due to limitations in Synchro, these intersections are modelled as both a two-legged pedestrian-actuated signal and a four-legged unsignalized intersection. This approach has been taken to adequately model the traffic operations for both the major street (Scott Street) and minor streets (Athlone Avenue or Tweedsmuir Avenue).

3.4.1 Existing Intersection Operations

Intersection capacity analysis has been conducted for the existing traffic conditions. The results of the analysis are summarized in **Table 11** for the weekday AM and PM peak hours. Detailed reports are included in **Appendix J**.

Table 13: Existing Traffic Operations

Intersection	AM Peak Hour			PM Peak Hour		
	Max v/c or Delay	LOS	Mvmt	Max v/c or Delay	LOS	Mvmt
Scott Street/Churchill Avenue	0.90	D	SBL/T/R	0.76	C	NBR
Scott Street/Winona Avenue	12 sec	B	NBL/R	12 sec	B	NBL/R
Scott Street/Athlone Avenue	(1) 0.45	A	EBL/T/R	0.50	A	WBL/T/R
	(2) 14 sec	B	NBL/T/R	14 sec	B	NBL/T/R
Scott Street/Tweedsmuir Avenue	(1) 0.44	A	EBL/T/R	0.44	A	WBL/T/R
	(2) 69 sec	F	SBL/T/R	140 sec	F	SBL/T/R
Scott Street/McRae Avenue	17 sec	C	NBL/R	24 sec	C	NBL/R

1. Intersection modelled as a two-legged pedestrian crossing; results identify maximum v/c ratio for through traffic on Scott Street
 2. Intersection modelled as a side-street stop-controlled intersection; results identify maximum approach delay for side street

From the previous table, all approaches within the study area meet the target Auto LOS E, except for the transit-only approach at Scott Street/Tweedsmuir Avenue. It is noted that this approach is currently closed due to Stage 2 LRT construction. Bus operations at Westboro Station may be reduced once the station is served by LRT, resulting in improved operations at the southbound approach. Further, when the pedestrian phase is actuated at this intersection, southbound buses utilizing this approach would be able to turn right onto Scott Street unimpeded, or turn left onto Scott Street once pedestrians had completed their crossing.

3.4.2 2026/2031 Background Intersection Operations

Intersection capacity analysis has been conducted for the 2026/2031 background traffic conditions. The results of the analysis are summarized in **Table 12** for the weekday AM and PM peak hours. Detailed reports are included in **Appendix K**.

Table 14: 2026/2031 Background Traffic Operations

Intersection	AM Peak Hour			PM Peak Hour		
	Max v/c or Delay	LOS	Mvmt	Max v/c or Delay	LOS	Mvmt
Scott Street/Churchill Avenue	0.87	D	NBR	0.76	C	NBR
Scott Street/Winona Avenue	13 sec	B	NBL/R	13 sec	B	NBL/R
Scott Street/Athlone Avenue	(1) 0.44	A	EBL/T/R	0.48	A	WBL/T/R
	(2) 14 sec	B	NBL/T/R	14 sec	B	NBL/T/R
Scott Street/Tweedsmuir Avenue	(1) 0.43	A	EBL/T/R	0.42	A	WBL/T/R
	(2) 69 sec	F	SBL/T/R	135 sec	F	SBL/T/R
Scott Street/McRae Avenue	18 sec	C	NBL/R	25 sec	C	NBL/R

1. Intersection modelled as a two-legged pedestrian crossing; results identify maximum v/c ratio for through traffic on Scott Street
 2. Intersection modelled as a side-street stop-controlled intersection; results identify maximum approach delay for side street

From the previous table, all approaches within the study area continue to meet the target Auto LOS E, except for the transit-only approach at Scott Street/Tweedsmuir Avenue.

4.0 ANALYSIS

4.1 Development Design

4.1.1 Design for Sustainable Modes

Sidewalks will be maintained along the subject site’s frontages to Scott Street and Athlone Avenue, and internal walkways will be provided around the perimeter of each building, connecting to the sidewalks on Scott Street and Athlone Avenue. Landscaped walkways and central amenity space will also provide pedestrian connectivity between Scott Street, Athlone Avenue, Ashton Avenue, and the Lion’s Park land to the immediate south of the subject site.

A total of ten exterior bicycle parking spaces are proposed on-site, with another 786 bicycle parking spaces within the underground parking levels or the ground floor. The total number of bicycle parking spaces will meet the minimum required number of bicycle spaces per the City’s ZBL. A review of the minimum requirements outlined in the City’s ZBL is included in Section 4.2.

OC Transpo’s service design guideline for peak period service is to provide service within a five-minute (400m) walk of home, work, or school for 95% of urban residents. Main entrances to both proposed buildings are anticipated to be within 400m walking distance of Westboro Station and bus stops on Churchill Avenue and McRae Avenue. These stops are discussed in Section 2.1.6 and shown in **Figure 4**.

OC Transpo temporary bus stop #3012 for eastbound buses is located on Scott Street, between the existing eastern access to the subject site and the western access that is currently shared between the neighbouring property and the subject site. The proposed development will remove the two existing accesses and provide one new access, which will require a relocation of the temporary transitway platform by 7m to the east. City staff have advised that the required modifications to the transitway platform are to be constructed as part of the proposed development. Relocation of the platform will also include the relocation of bollards at the western end of the platform and directional/attention tactile walking surface indicators (TWSIs) to the new eastern end of the platform, removal of the existing curb depression to bring the platform to full height, and the provision of a standard shelter at the eastern end of the platform. The impacts of the proposed driveway to the temporary bus stop are shown in **Figure 16**.

A review of the *Transportation Demand Management (TDM)-Supportive Development Design and Infrastructure Checklist* has been conducted, and is included in **Appendix L**. All required TDM-supportive design and infrastructure measures in the TDM checklist for residential developments will be met. In addition to the required measures, it is anticipated that the following 'basic' or 'better' measures will be met:

- Locate building close to the street, and do not locate parking areas between the street and building entrances;
- Locate building entrances in order to minimize walking distances to sidewalks and transit stops/stations;
- Locate building doors and windows to ensure visibility of pedestrians from the building, for their security and comfort;
- Provide safe, direct, and attractive walking routes from building entrances to nearby transit stops.

4.1.2 Circulation and Access

Garbage rooms will be located on the first level of the underground parking garage, and move-in rooms are located on the ground floor of each building. For the east building, the move-in room will be accessed at the south face, adjacent to the parking garage ramp. Garbage collection will occur curbside along Athlone Avenue near the parking garage access. For the west building, the move-in room will be accessed at the west face. Garbage collection will occur curbside along Scott Street. Vehicle turning movements at the proposed loading areas are shown in **Figures 17, 18, 19, and 20**.

There is no proposed on-site fire route for either building, as the main entrances to each building will front onto Scott Street.

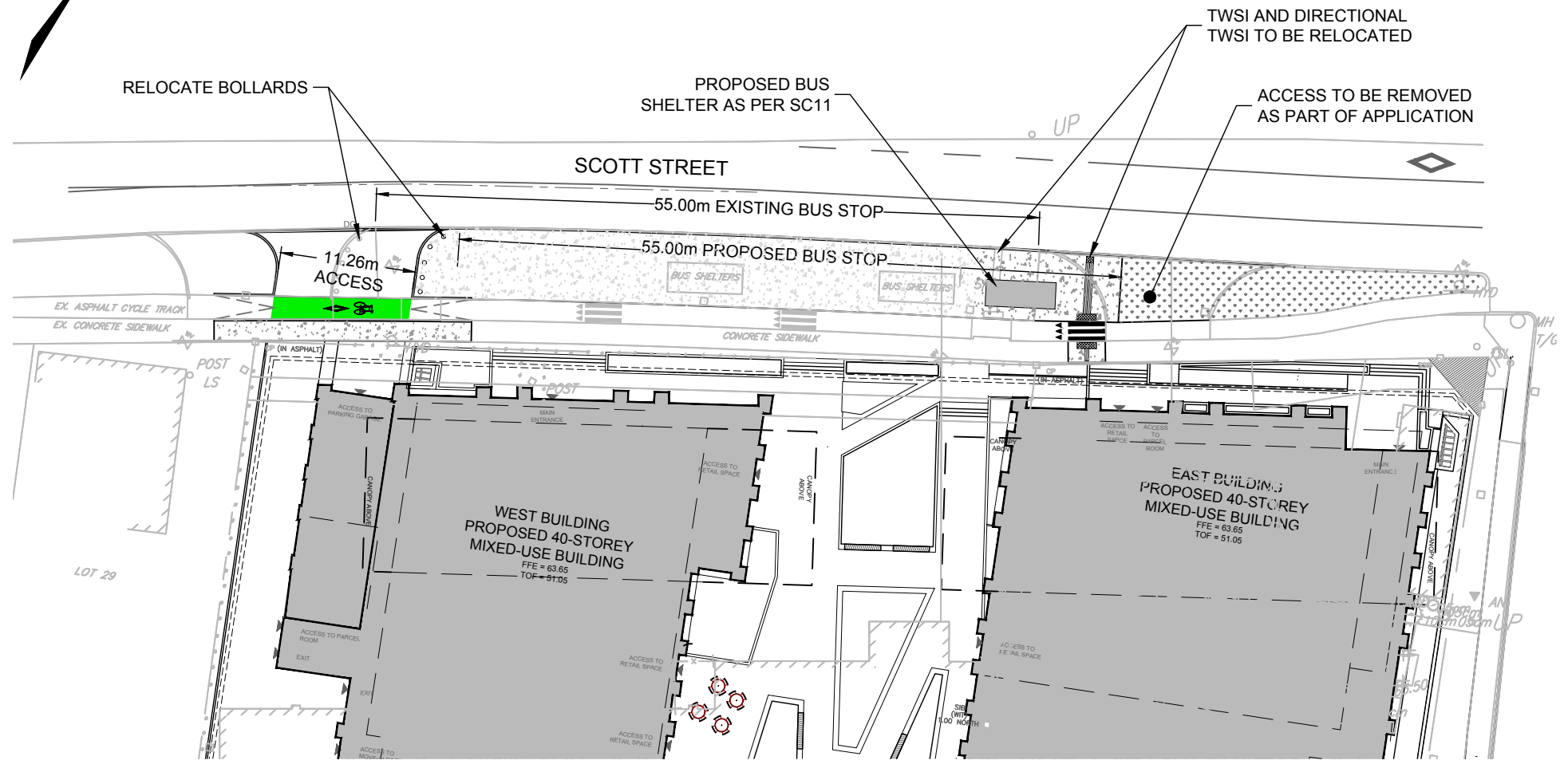
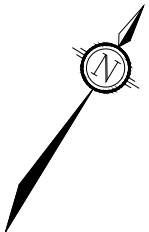

C:\temp\AcPublish\15568121302-FD.dwg, Fig16, Oct 12, 2023 - 11:40am, rhillier



Engineers, Planners & Landscape Architects
 Suite 200, 240 Michael Cowpland Drive
 Ottawa, Ontario, Canada K2M 1P6

Telephone (613) 254-9643
 Facsimile (613) 254-5867
 Website www.novatech-eng.com

LEGEND

- EXISTING CONCRETE
- PROPOSED CONCRETE
- PROPOSED TOPSOIL/SOD
- PROPOSED TACTILE WALKING SURFACE INDICATOR (TWSI)

2026 SCOTT STREET

BUS STOP AND SITE ACCESS CONFLICT



DATE OCT 2023	JOB 121302	FIGURE FIGURE 16
-------------------------	----------------------	----------------------------

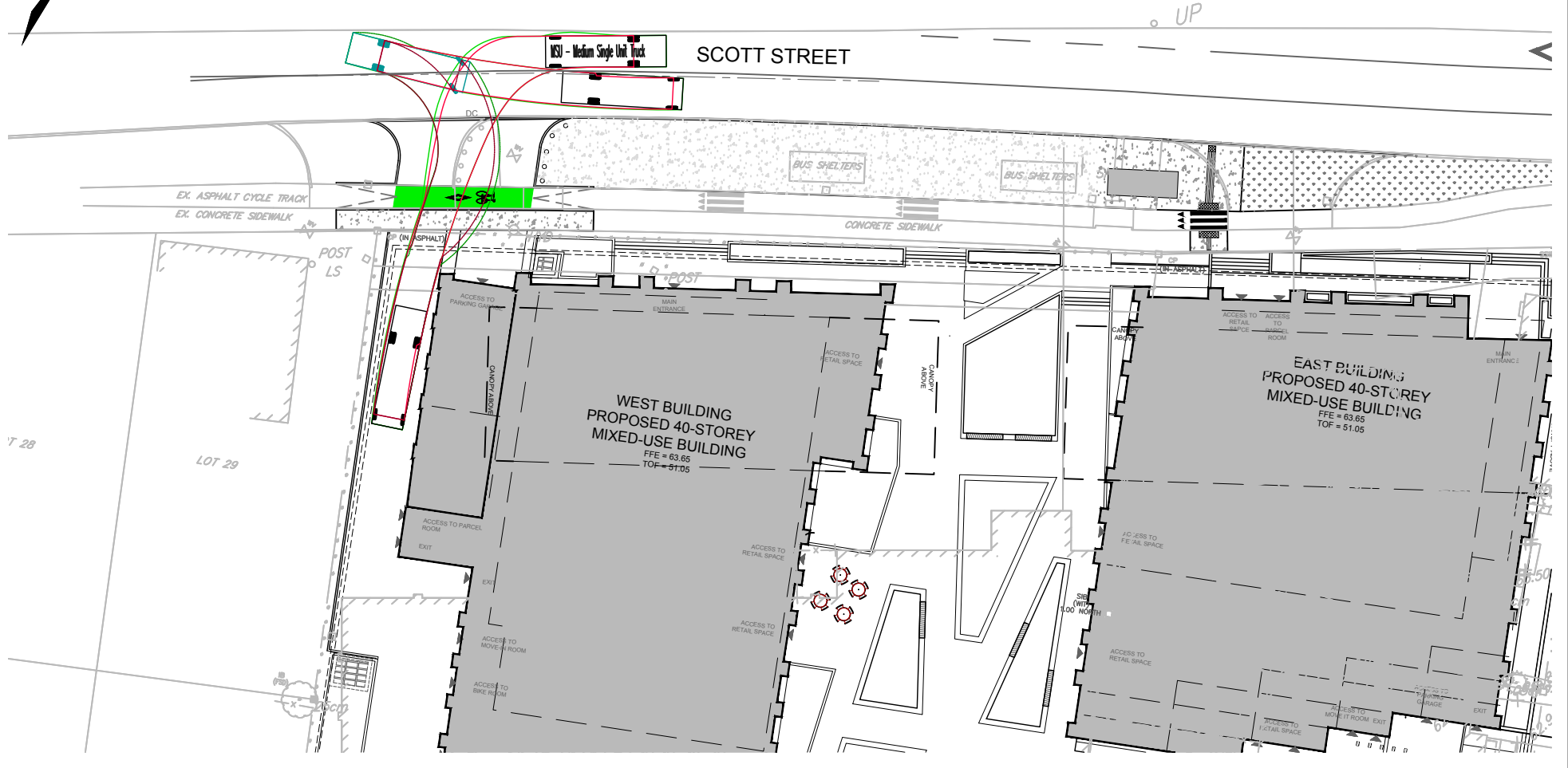

Engineers, Planners & Landscape Architects
 Suite 200, 240 Michael Cowpland Drive
 Ottawa, Ontario, Canada K2M 1P6

Telephone (613) 254-9643
 Facsimile (613) 254-5867
 Website www.novatech-eng.com

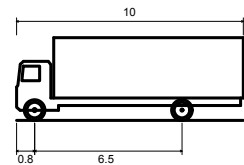

MSU - Medium Single Unit Truck

Overall Length	10.000m
Overall Width	2.600m
Overall Body Height	3.650m
Min Body Ground Clearance	0.445m
Track Width	2.600m
Lock-to-lock time	4.00s
Curb to Curb Turning Radius	11.100m

2026 SCOTT STREET

TURNING MOVEMENT (MSU)

SCALE 1 : 500



DATE	JOB	FIGURE
OCT 2023	121302	FIGURE 17

C:\temp\AcPublish_15568121302-FD.dwg, Fig17, Oct 12, 2023 - 11:40am, rhillier

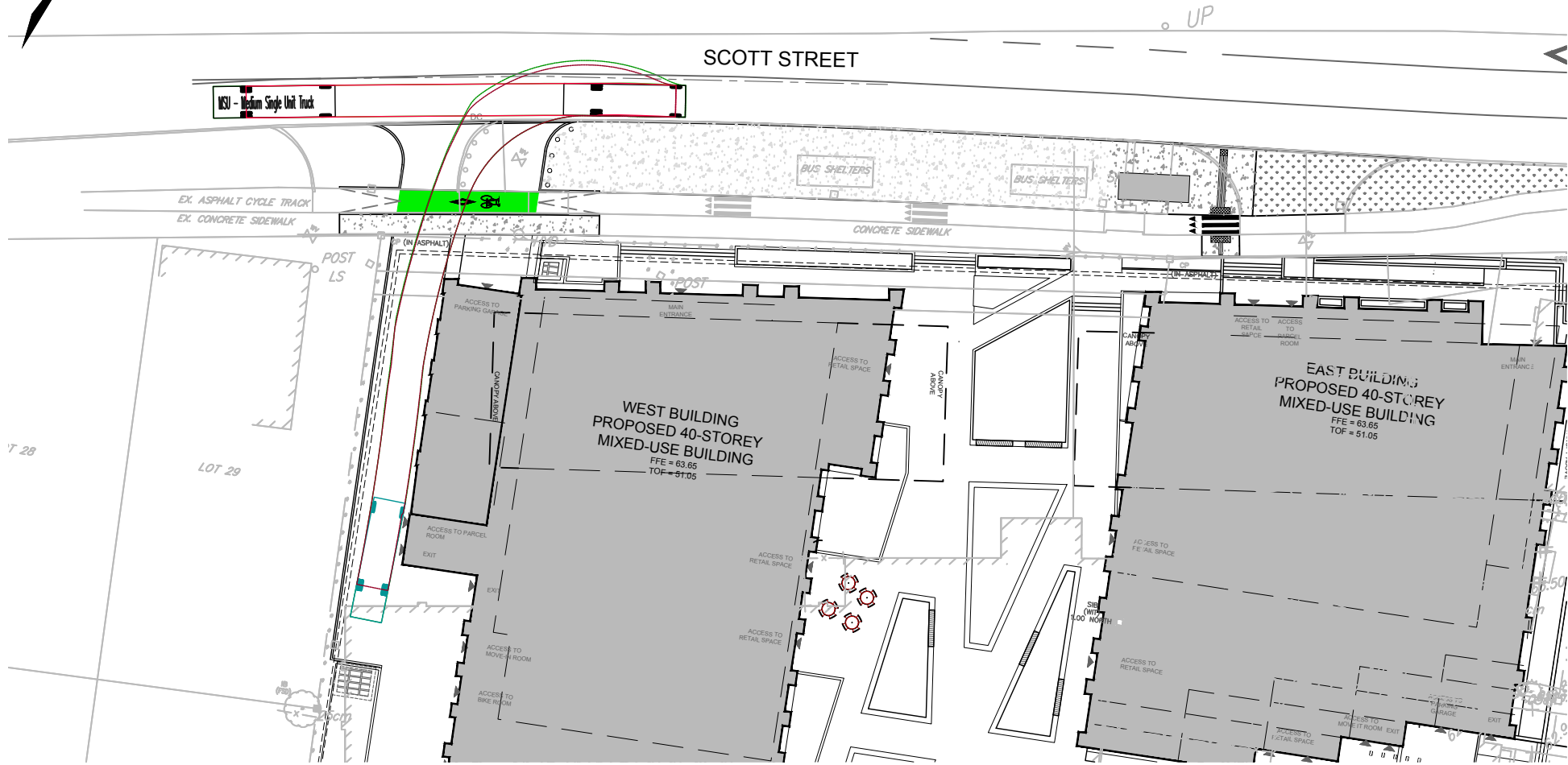
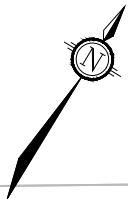

Engineers, Planners & Landscape Architects
 Suite 200, 240 Michael Cowpland Drive
 Ottawa, Ontario, Canada K2M 1P6

Telephone (613) 254-9643
 Facsimile (613) 254-5867
 Website www.novatech-eng.com

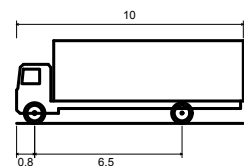

MSU - Medium Single Unit Truck

Overall Length	10.000m
Overall Width	2.600m
Overall Body Height	3.650m
Min Body Ground Clearance	0.445m
Track Width	2.600m
Lock-to-lock time	4.00s
Curb to Curb Turning Radius	11.100m

2026 SCOTT STREET

TURNING MOVEMENT (MSU)



DATE OCT 2023	JOB 121302	FIGURE FIGURE 18
------------------	---------------	---------------------

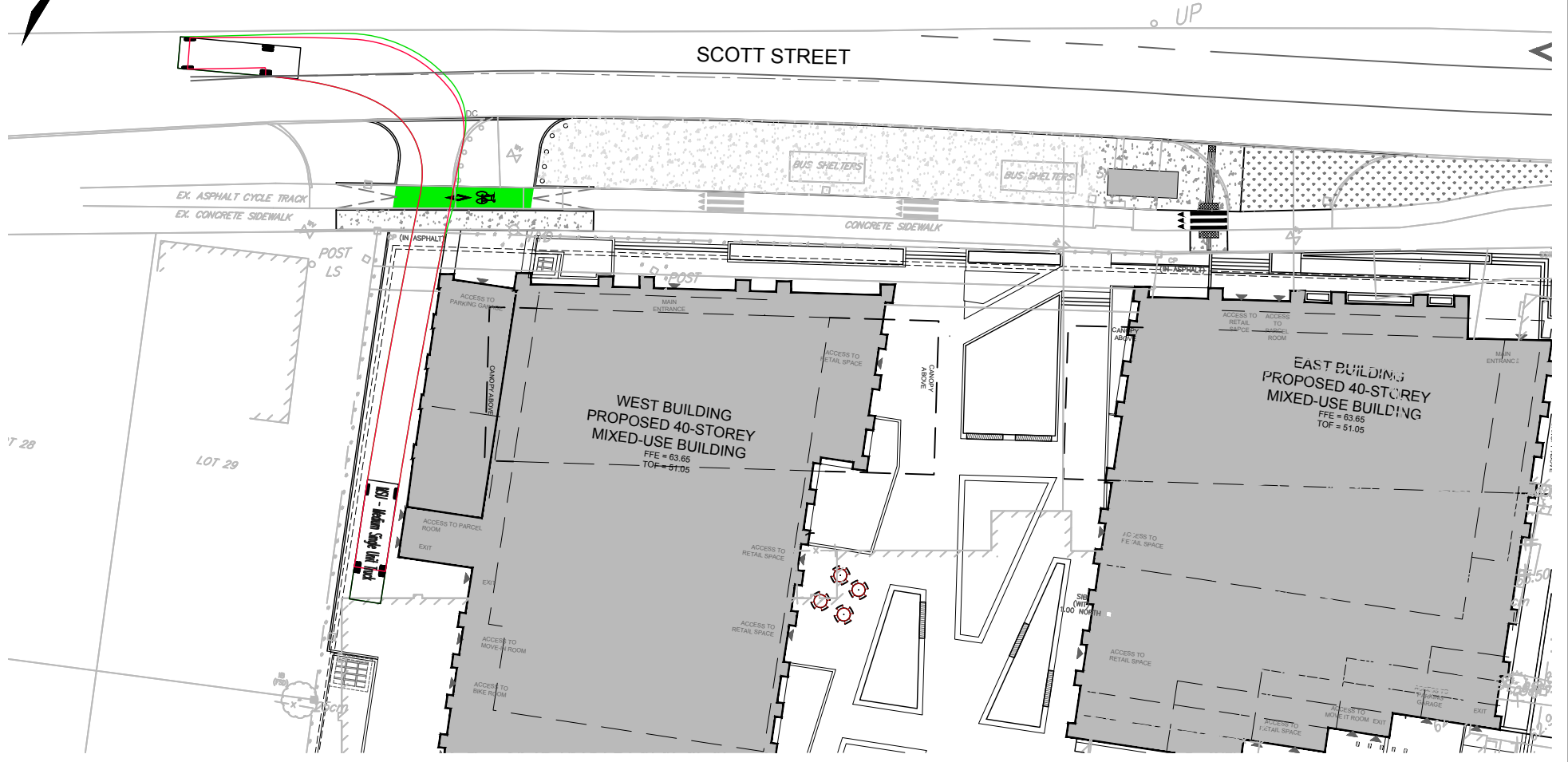

Engineers, Planners & Landscape Architects
 Suite 200, 240 Michael Cowpland Drive
 Ottawa, Ontario, Canada K2M 1P6

Telephone (613) 254-9643
 Facsimile (613) 254-5867
 Website www.novatech-eng.com

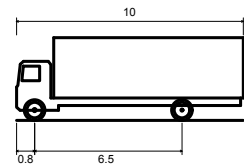

MSU - Medium Single Unit Truck

Overall Length	10.000m
Overall Width	2.600m
Overall Body Height	3.650m
Min Body Ground Clearance	0.445m
Track Width	2.600m
Lock-to-lock time	4.00s
Curb to Curb Turning Radius	11.100m

2026 SCOTT STREET

TURNING MOVEMENT (MSU)

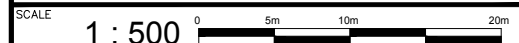

DATE	JOB	FIGURE
OCT 2023	121302	FIGURE 19

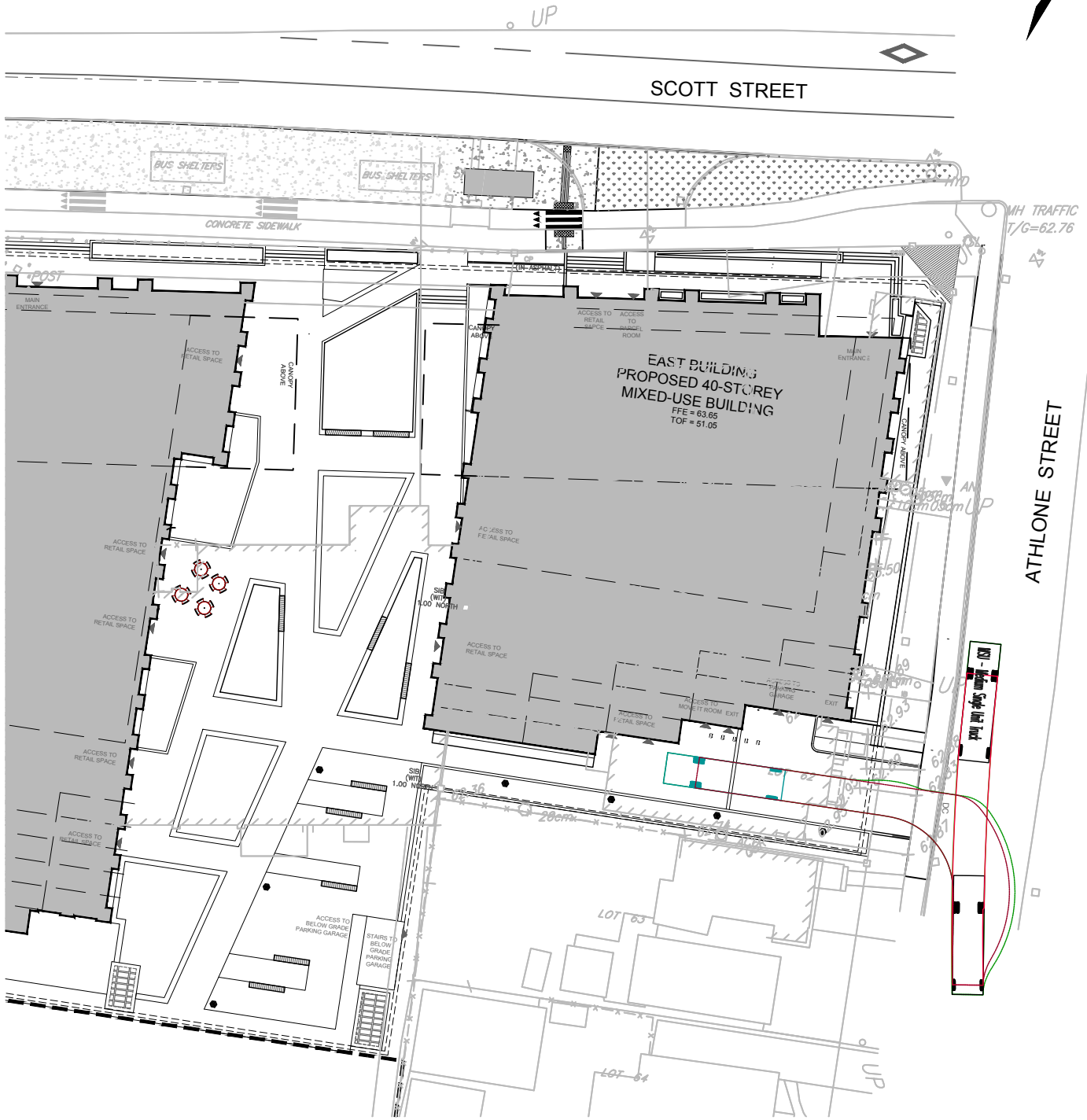

C:\temp\AcPublish_15588121302-FD.dwg, Fig20, Oct 12, 2023 - 11:40am, millier



Engineers, Planners & Landscape Architects
 Suite 200, 240 Michael Cowpland Drive
 Ottawa, Ontario, Canada K2M 1P6

Telephone (613) 254-9643
 Facsimile (613) 254-5867
 Website www.novatech-eng.com

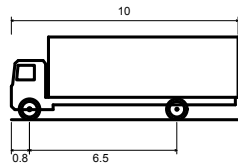

MSU - Medium Single Unit Truck

Overall Length	10.000m
Overall Body Height	2.600m
Overall Body Width	3.650m
Min Body Ground Clearance	0.445m
Track Width	2.600m
Lock-to-lock time	4.00s
Curb to Curb Turning Radius	11.100m

2026 SCOTT STREET

TURNING MOVEMENT (MSU)



DATE	OCT 2023	JOB	121302	FIGURE	FIGURE 20
------	----------	-----	--------	--------	-----------

4.2 Parking

The subject site is located in Area B of Schedule 1 and Area Y of Schedule 1A of the City's ZBL, and is located within 600m of a rapid transit station identified in Schedule 2A of the City's ZBL. The minimum vehicular, maximum vehicular, minimum bicycle parking, and minimum loading spaces rates for the proposed development are identified in Sections 101, 102, 103, 111, and 113 of the ZBL.

A review of the proposed parking supply versus the minimum/maximum parking requirements per the City's ZBL are shown in **Table 13**.

Table 15: Parking Review

Land Use	Rate	Units	Required	Provided
<i>Minimum Resident and Visitor Vehicle Parking (Section 101/102 of ZBL)</i>				
Apartment, High-Rise	No minimum residential parking rate, per ZBL Urban Exception 2829	901 units	0 (resident)	318
	0.1 spaces per dwelling unit after the first 12 units and up to a maximum of 30 spaces per building		60 (visitor)	60
Retail Store	No minimum retail parking rate, as it is located entirely on the ground floor and is less than 500 m ² GFA	288 m ²	0	0
Total			60	378
<i>Maximum Vehicle Parking (Section 103 of ZBL)</i>				
Apartment, High-Rise	0.6 spaces per dwelling unit, per ZBL Urban Exception 2829 (combined resident and visitor parking)	901 units	541	378
Retail Store	3.6 spaces per 100 m ² GFA	288 m ²	10	0
Total			551	378
<i>Minimum Bicycle Parking (Section 111 of ZBL)</i>				
Apartment, High-Rise	0.5 spaces per dwelling unit	901 units	451	786
Retail Store	1.0 space per 250 m ² GFA	288 m ²	1	10
Total			452	796
<i>Minimum Loading (Section 113 of ZBL)</i>				
Apartment, High-Rise	No spaces required	901 units	0	0
Retail Store	No spaces required when GFA is less than 2,000 m ²	288 m ²	0	0
Total			0	0

Based on the previous table, the proposed development will meet the minimum vehicle parking, maximum vehicle parking, and minimum bicycle parking requirements outlined in the ZBL. There is no requirement to provide any loading spaces under Section 113 of the ZBL.

4.3 Boundary Streets

This section provides a review of the boundary streets Scott Street and Athlone Avenue, using complete streets principles. The *MMLOS Guidelines*, produced by IBI Group in October 2015, were used to evaluate the levels of service for each alternative mode of transportation on the boundary streets. An MMLOS review has been conducted for Scott Street and Athlone Avenue, based on existing conditions.

Based on Exhibit 22 of the *MMLOS Guidelines*, the boundary streets have been evaluated using the targets for roadways ‘within 600m of a rapid transit station.’ A detailed MMLOS review of the boundary streets is included in **Appendix M**. A summary of the segment MMLOS results for Scott Street and Athlone Avenue is provided in **Table 14**.

Table 16: Segment MMLOS Summary

Segment	PLOS		BLOS		TLOS		TkLOS	
	Actual	Target	Actual	Target	Actual	Target	Actual	Target
Scott Street	D	A	A	A	D	A	B	D
Athlone Avenue	F		F	D	-	-	-	-

The results of the segment MMLOS analysis can be summarized as follows:

- Neither boundary street meets the target pedestrian level of service (PLOS) A;
- Scott Street meets the target bicycle level of service (BLOS) A, while Athlone Avenue does not meet the target BLOS D;
- Scott Street does not meet the target transit level of service (TLOS) A;
- Scott Street meets the target truck level of service (TkLOS) D.

Scott Street, between Winona Avenue and Athlone Avenue

The street does not meet the target PLOS A, BLOS A, or TLOS A.

Per Exhibit 4 of the *MMLOS Guidelines*, Scott Street cannot achieve the target PLOS A on either side of the roadway without reducing the operating speed to 30 km/h or slower, based on the existing traffic volumes.

Per Exhibit 15 of the *MMLOS Guidelines*, Scott Street can only achieve the target TLOS A by providing segregated transit facilities. Once Stage 2 of the Confederation Line LRT is complete, the bus detour will not need to run along Scott Street, and light rail transit will be provided immediately north of the roadway. Therefore, the target TLOS will be met.

Athlone Avenue, between Scott Street and Richmond Road

The street does not meet the target PLOS A or BLOS D.

Per Exhibit 4 of the *MMLOS Guidelines*, Athlone Avenue can achieve the target PLOS A through a reduction in the operating speed of the roadway to 30 km/h. The planned integrated renewal of Athlone Avenue is anticipated to include traffic calming to achieve this operating speed.

Per Exhibit 11 of the *MMLOS Guidelines*, Athlone Avenue can achieve the target BLOS D by reducing the operating speed to 50 km/h. The planned integrated renewal of Athlone Avenue is anticipated to include traffic calming that will reduce the operating speed to 30 km/h, which would improve the level of service to a BLOS A.

4.4 Access Intersections

Access to the proposed underground parking garage will be provided via one full-movement driveway to Scott Street and one full-movement driveway to Athlone Avenue. Access to the loading area for the east building will be provided via the proposed access to Athlone Avenue, and access to the loading area for the west building will be provided via the proposed access to Scott Street. All driveways are anticipated to be constructed as part of the first phase.

Access Design

The design of the proposed accesses have been evaluated using the relevant provisions of the City's *Private Approach By-Law (PABL)* and Transportation Association of Canada (TAC)'s *Geometric Design Guide for Canadian Roads*.

The proposed access locations meet the provisions of Section 25(a) of the PABL, which outlines that a maximum of two two-way private approaches can be provided to any roadway where 46m to 150m of frontage is provided.

Section 25(c) of the PABL identifies a maximum width requirement of 9m for any two-way private approach, as measured at the street line. Section 107(1)(a) of the ZBL requires any two-way private approach serving an apartment parking garage with 20 or more parking spaces to have a minimum width of 6.0m and a maximum width of 6.7m. The proposed access to Athlone Avenue conforms to these standards. While the underground parking garage ramp to Scott Street will have a width of 6.5m, the overall access width at the street line will be 11.3m, in order to also facilitate access to the loading area on the west side of the west building. It is requested that the requirements of Section 25(c) of the PABL be waived for the proposed access to Scott Street.

Based on Section 25(m)(ii) of the PABL, the nearest edge of any private approach that serves 300 or more parking spaces must be a minimum of 60m from the nearest intersecting street line or any other private approach, when it is a residential development within 46m of an arterial roadway.

The minimum requirement of 60m to the nearest intersecting street line is met by the proposed underground garage access to Scott Street, which is approximately 90m west of Athlone Avenue. However, the minimum requirement is not met by the proposed underground garage access to Athlone Avenue, as less than 60m of frontage is provided on that roadway. The site plan shows the garage access to Athlone Avenue will be located approximately 44m south of Scott Street, and approximately as far south as possible.

Based on Section 25(p) of the PABL, the nearest edge of any private approach must be a minimum of 3m from the adjacent property line. Section 25(r) suggests that a private approach may be constructed within 3m from the adjacent property line if it is approved through Site Plan Control.

The western edge of the proposed loading access to Scott Street will be located approximately 1.0m from the nearest property line. The adjacent site at 2050 Scott Street is currently under construction. As the future access to this development will be located approximately 5.75m from the property line, it is requested that this requirement be waived for the proposed access to Scott Street. The southern edge of the proposed access to Athlone Avenue will be located approximately 2.7m from the nearest property line. As the existing driveway to the adjacent house at 322 Athlone Avenue is located approximately 5.0m from the property line, it is requested that this requirement also be waived for the proposed access to Athlone Avenue.

TAC's *Geometric Design Guide* identifies minimum corner clearance requirements between a private approach and an existing intersection, measuring nearest edge to nearest edge. For signalized intersections, TAC identifies a minimum corner clearance of 70m for full-movement accesses to arterial roadways and a minimum corner clearance of 15m for full-movement accesses to local roadways. The concept plan shows that the proposed underground garage accesses to Scott Street and Athlone Avenue will meet these requirements.

Section 25(u) of the PABL identifies that a maximum grade of 2% to 6% for the first 9m inside the property line, for any private approach serving a parking area with more than 50 parking spaces. The Athlone Avenue garage access meets the requirement, as it will have a proposed maximum grade of 6% (descending towards the roadway for drainage purposes) for the first 6m within the property line, followed by a flat area before transitioning down to the parking garage. The Scott Street garage access meets this requirement, as it will have a proposed maximum grade of 4% for the first 4m within the property line and the garage door, followed by a 5m flat area within the building.

TAC's *Geometric Design Guide* identifies minimum stopping sight distance (SSD) and intersection sight distance (ISD) requirements, based on the roadway grade and design speed (taken as the speed limit plus 10 km/h). Level grades and design speeds of 40 km/h for Athlone Avenue and 60 km/h for Scott Street have been assumed in this review. The SSD and ISD requirements for each roadway are summarized as follows:

- SSD: 50m for Athlone Avenue and 85m for Scott Street;
- ISD, left turns: 85m for Athlone Avenue and 130m for Scott Street;
- ISD, right turns: 75m for Athlone Avenue and 110m for Scott Street.

As Athlone Avenue and Scott Street are straight and generally level roadways, adequate SSD can be provided at both proposed access locations. It is anticipated that adequate ISD can be provided for any vehicles turning left or right from the proposed accesses as well, as there is very limited vegetations on neighbouring properties that could obscure sightlines for outbound drivers. In the interim condition, it is anticipated that OC Transpo buses stopped at the temporary eastbound platform will periodically obscure outbound drivers at the access to Scott Street. Sightlines will therefore improve at this access when the platform is decommissioned.

Access Justification

Schedule B2 of the City’s Official Plan identifies Scott Street as a Mainstreet Corridor. Policy 6.2.1.4(b) of the Official Plan prescribes that in the case of developments that front onto both a corridor and a side street, that vehicular access ‘shall generally be provided from the side street.’ Policy 4.1.2.4(4) of the Official Plan states that ‘development of land abutting an existing or planned cycling facility identified in the TMP and associated plans will be designed to minimum vehicle access across the cycling facility in order to reduce potential conflict point, such as by providing vehicular access to parking and service areas from side streets or rear lanes.’ Providing an access to Scott Street is not prohibited based on these policies, but it is noted that any proposed accesses along Scott Street should require appropriate justification.

The subject site is very large (approximately 6,600 m² in area), and spans over 100m of frontage on Scott Street. The proposed development will contain two buildings with 901 dwellings, approximately 3,100 ft² GFA of ground-floor commercial or retail space, and 378 parking spaces in an underground garage. As the development is located within a TOD zone, it has been assumed that the majority of residents or patrons will use transit during peak hours. However, higher vehicle usage may occur for the personal use of residents outside of peak hours. Proposing more than the single access to Athlone Avenue provides future users with an alternative route should an accident occur along Athlone Avenue, or in the event that there are operational issues with one of the garage doors.

For these reasons, two accesses for vehicles are recommended, based on the overall size and density of the site. The proposed access to Scott Street adheres to the spacing requirements of TAC’s *Geometric Design Guide* and Section 25(m)(ii) of the City’s PABL, and therefore should be permitted.

Access Operations

Analysis of the access intersection operations have been conducted in Synchro, with the results summarized in **Table 15**. The intersection parameters used in the analysis are consistent with the *2017 TIA Guidelines* (Saturated Flow Rate: 1,800 vphpl, Peak Hour Factor: 1.0 for future conditions). Detailed Synchro reports at the accesses are included in **Appendix N**.

Table 17: Access Intersection Operations

Intersection		AM Peak Hour			PM Peak Hour		
		Delay	LOS	Mvmt	Delay	LOS	Mvmt
Site Access to Scott Street	2026 (Phase 1)	14 sec	B	NBL/R	14 sec	B	NBL/R
	2031 (Ultimate)	14 sec	B	NBL/R	16 sec	C	NBL/R
Site Access to Athlone Avenue	2026 (Phase 1)	9 sec	A	EBL/R	9 sec	A	EBL/R
	2031 (Ultimate)	9 sec	A	EBL/R	9 sec	A	EBL/R

Based on the previous table, the proposed accesses are anticipated to operate with an acceptable Auto LOS.

4.5 Transportation Demand Management

4.5.1 Context for TDM

The two proposed buildings will be constructed in separate phases. The unit count and breakdown for each building can be summarized as follows.

East Building

- 101 studio units;
- 174 one-bedroom units;
- 141 two-bedroom units;
- 6 three-bedroom units; and
- 1,180 ft² of commercial/retail space.

West Building

- 80 studio units;
- 225 one-bedroom units;
- 166 two-bedroom units;
- 8 three-bedroom units; and
- 1,920 ft² of commercial/retail space.

4.5.2 Need and Opportunity

The subject site is designated as 'Corridor – Mainstreet' on Schedule B2 of the City's Official Plan, and within the Scott Street Traditional Main Street DPA. As shown in Section 3.1.1, the peak hour driver shares observed within the Ottawa West district (28% in AM peak and 33% in PM peak for residential generators, and 55% in AM peak and 50% in PM peak for commercial generators) are significantly greater than the driver share target for Transit-Oriented Developments (15% in both peaks). If the proposed development has a driver share of 30% during the peak hours (i.e. more consistent with the observed residential shares within the Ottawa West district), rather than the assumed driver share of 15%, this would equate to an increase of approximately 55 to 58 vehicles during the peak hours.

A failure to meet the mode share targets (included in Section 3.1.1) is not anticipated to result in failing operations within the study area. It is anticipated that the mode share targets are attainable, as the subject site is proximally located to commercial areas, parks, and recreation areas, and across Scott Street from future LRT service.

4.5.3 TDM Program

A review of the City's *TDM Measures Checklist* has been conducted by the proponent. A copy of the completed residential checklist is included in **Appendix L**. The proponent will provide the following TDM measures:

- Display local area maps with walking/cycling access routes and key destinations at major entrances;
- Display relevant transit schedules and route maps at entrances;
- Unbundle parking cost from monthly rent;
- Provide a multi-modal travel information package to new residents.

The proposed parking supply would be approximately 115 spaces short of the minimum requirement, based on rates for Area Y within the City's ZBL. The subject site is across Scott Street from a future LRT station. Providing limited parking near transit stations act as a strong incentive for residents, visitors, and patrons of the proposed development to travel to/from the site via transit. Further, a total of 796 bicycle parking spaces are proposed, equating to 0.88 bicycle spaces per unit and exceeding the minimum requirements of the ZBL.

4.6 Neighbourhood Traffic Management

The *2017 TIA Guidelines* identify two-way peak hour traffic volume thresholds for considering when a Neighbourhood Traffic Management (NTM) plan should be developed, in cases where a site relies on local or collector roadways for access. Since an access to Athlone Avenue (i.e. a local roadway) is proposed, this module is included in this TIA.

The NTM two-way volume thresholds are as follows:

- Local: Maximum of 1,000 vehicles per day, or 120 vehicles during the peak hour;
- Collector: Maximum of 2,500 vehicles per day, or 300 vehicles during the peak hour;
- Major Collector: Maximum of 5,000 vehicles per day, or 600 vehicles during the peak hour.

Based on the existing traffic count data at Scott Street/Athlone Avenue, the two-way peak hour traffic volumes on Athlone Avenue are approximately 62 vehicles during the AM peak hour and 72 vehicles during the PM peak hour, and the average annual daily traffic is approximately 740 vehicles.

As shown in **Figure 9**, ultimate buildout of the proposed development is anticipated to increase peak hour traffic volumes on Athlone Avenue by approximately five vehicles. Therefore, the NTM thresholds are not anticipated to be met in the future as a result of this development, and no NTM measures are identified.

4.7 Transit

Based on the trip generation estimates presented in Section 3.1, the proposed development is anticipated to generate the following number of net additional transit trips during the peak hours:

- Phase 1 (2026)
 - 100 additional transit trips during the AM peak hour (29 in, 71 out);
 - 96 additional transit trips during the PM peak hour (56 in, 40 out).
- Ultimate Development (2029)
 - 219 additional transit trips during the AM peak hour (67 in, 152 out);
 - 217 additional transit trips during the PM peak hour (125 in, 92 out).

For the purposes of this transit review, only the ultimate development has been considered to estimate if transit capacity constraints will occur within the study area.

The origin-destination data for Ottawa West from the City's 2011 *TRANS O-D Survey Report* was considered in determining where transit trips will travel to/from the proposed development. It is anticipated that most transit trips will arrive or depart via future LRT service at Westboro Station. It is also anticipated that any transit trips via bus will board and alight at bus stops at Scott Street/Churchill Avenue or Scott Street/McRae Avenue.

The assumed distribution of transit trips to/from the development can be summarized as follows.

AM Peak Hour

- 45% to/from the east via OC Route 1;
- 30% to/from the west via OC Route 1;
- 15% to/from the south via OC Route 50;
- 10% to/from the south via OC Route 81.

PM Peak Hour

- 40% to/from the east via OC Route 1;
- 30% to/from the west via OC Route 1;
- 15% to/from the south via OC Route 50;
- 10% to/from the south via OC Route 81;
- 5% to/from the east via OC Route 153.

Transit utilization data from the Winter 2020 period (January 5 to March 7) has been obtained from OC Transpo, and is included in **Appendix C**. This period is considered the most recent ‘normal’ ridership period, before ridership was impacted by the ongoing COVID-19 pandemic. Average peak period (6:00am to 9:00am and 3:00pm to 6:00pm) boarding, alighting, and bus load at departure information was obtained for stops within the study area.

By the Phase 1 buildout year of 2026, the Confederation Line Extension will be completed. Westboro Station is assumed to still be served by buses for the local OC Transpo Routes 16, 50, and 153, with all other trips being served by LRT. Therefore, transit ridership for the LRT at Westboro Station has been estimated by accumulating the existing boarding and alighting trips for all routes that use the transitway, as of the Winter 2020 period.

As shown in **Appendix C**, this is assumed to include OC Transpo Routes 57, 58, 61, 62, 63, 64, 66, 73, 74, 75, 82, 83, 84, 87, 164, 251, 252, 256, 257, 258, 261, 262, 263, 264, 265, 266, 267, 268, 270, 271, 272, 273, 275, 277, 278, 282, 283, and 284. To determine the average load at departure for the future LRT, the average loads at departure for each bus route listed above have been multiplied by the number of times that route serves Westboro Station in the peak hours, and then divided by 12 to reflect an assumed five-minute headway for the future LRT.

Existing and projected boarding and alighting information is summarized in **Table 16**. Any zero (0) values in the table indicate a measured average boarding and alighting value of zero, rather than an absence of data. Peak period boarding and alighting data have been converted to peak hour boardings and alightings, using factors of 0.55 for the AM peak hour and 0.47 for the PM peak hour (per the *TRANS Trip Generation Manual*).

Table 18: Transit Utilization

Stop	Location	Route	Dir	Boarding (tph) ⁽¹⁾			Alighting (tph) ⁽¹⁾		
				Existing	Ultimate	Total	Existing	Ultimate	Total
AM Peak Hour									
#3012	Westboro Station	1	EB	163	68	231	59	30	89
		1	WB	81	46	127	58	20	78
		16	EB	6	-	6	0	-	0
		16	WB	0	-	0	8	-	8
		50	EB	1	-	1	7	-	7
		50	WB	3	-	3	1	-	1
#4841	Scott/McRae	81	EB	0	-	0	6	7	13
#4893		81	WB	0	15	15	1	-	1
#4884	Churchill/Workman	16	EB	5	-	5	0	-	0
#5615	Churchill/Transit Bridge	16	WB	0	-	0	3	-	3
#7379	Churchill/Scott	50	EB	3	-	3	0	10	10
#7380		50	WB	1	23	24	1	-	1

Stop	Location	Route	Dir	Boarding (tph) ⁽¹⁾			Alighting (tph) ⁽¹⁾		
				Existing	Ultimate	Total	Existing	Ultimate	Total
PM Peak Hour									
#3012	Westboro Station	1	EB	100	37	137	62	50	112
		1	WB	97	27	124	157	38	195
		16	EB	3	-	3	0	-	0
		16	WB	0	-	0	7	-	7
		50	EB	0	-	0	4	-	4
		50	WB	5	-	5	4	-	4
		153	EB	0	-	0	0	-	0
		153	WB	0	-	0	0	-	0
#4841	Scott/McRae	81	EB	1	-	1	3	12	15
		153	WB	1	-	1	1	6	7
#4893		81	WB	2	9	11	2	-	2
		153	EB	0	5	5	0	-	0
#4884	Churchill/Workman	16	EB	1	-	1	0	-	0
#5615	Churchill/Transit Bridge	16	WB	0	-	0	3	-	3
#7379	Churchill/Scott	50	EB	0	-	0	1	19	20
		153	EB	1	-	1	1	-	1
#7380		50	WB	1	14	15	1	-	1
		153	WB	0	-	0	0	-	0

1. tph: transit trips per hour

The site-generated impacts to OC Routes 1, 16, 50, 81, and 153 during the weekday peak hours can be summarized.

Route 1 (Confederation Line Eastbound)

At Westboro Station, the proposed development is projected to generate an additional 68 AM boarding trips, 30 AM alighting trips, 37 PM boarding trips, and 50 PM alighting trips. As Route 1 is assumed to run on approximately 5-minute headways, this equates to six AM boardings, three AM alightings, four PM boardings, and five PM alightings per train.

For the eastbound platform, the existing average train loads at departure are estimated to be approximately 207 riders in the AM peak and 71 riders in the PM peak. Accounting for the above trips, the average loads when departing Westboro Station are anticipated to increase from 207 riders to 213 riders during the AM peak hour, and from 71 riders to 75 riders during the PM peak hour. Therefore, the proposed development is not anticipated to require more frequent service for Route 1.

Route 1 (Confederation Line Westbound)

At Westboro Station, the proposed development is projected to generate an additional 46 AM boarding trips, 20 AM alighting trips, 27 PM boarding trips, and 38 PM alighting trips. As Route 1 is assumed to run on approximately 5-minute headways, this equates to four AM boardings, two AM alightings, three PM boardings, and four PM alightings per train.

For the westbound platform, the existing average train loads at departure are estimated to be approximately 54 riders in the AM peak and 125 riders in the PM peak. Accounting for the above trips, the average loads when departing Westboro Station are anticipated to increase from 54 riders to 58 riders during the AM peak hour, and from 125 riders to 128 riders during the PM peak hour. Therefore, the proposed development is not anticipated to require more frequent service for Route 1.

Route 16 (to Main or Scott/Churchill)

The proposed development is not anticipated to generate any transit trips that will travel on OC Route 16, which serves the study area at stops #4884 and #5615. It is anticipated that any site-generated trips that would use this route will travel on Route 1 instead, as both routes converge at Tunney's Pasture Station.

The existing average loads at departure for Route 16 within the study area (approximately one to three riders at stops #4884 and #5615) does not identify a need for more frequent service of this route.

Route 50 (to Tunney's Pasture)

At stop #7379, the proposed development is projected to generate an additional ten AM alighting trips and 19 PM alighting trips. As Route 50 runs on approximately 30-minute headways, this equates to five AM alightings and ten PM alightings per bus.

The existing average bus loads at departure are 21 riders in the AM peak and ten riders in the PM peak. Accounting for the above trips, the average bus loads when arriving at stop #7379 are anticipated to increase from 21 riders to 26 riders during the AM peak hour, and from ten to 20 riders during the PM peak hour. Therefore, more frequent service for Route 50 is not anticipated as a result of the proposed development.

Route 50 (to Lincoln Fields)

At stop #7380, the proposed development is projected to generate an additional 23 AM boarding trips and 14 PM boarding trips. As Route 50 runs on approximately 30-minute headways, this equates to 12 AM boardings and seven PM boardings per bus.

The existing average bus loads at departure are 12 riders in the AM peak and 16 riders in the PM peak. Accounting for the above trips, the average bus loads when departing stop #7380 are anticipated to increase from 12 riders to 24 riders during the AM peak hour, and from 16 riders to 23 riders during the PM peak hour. Therefore, more frequent service for Route 50 is not anticipated as a result of the proposed development.

Route 81 (to Tunney's Pasture)

At stop #4841, the proposed development is projected to generate an additional seven AM alighting trips and 12 PM alighting trips. As Route 81 runs on approximately 30-minute headways, this equates to four AM alightings and six PM alightings per bus.

The existing average bus loads at departure are 15 riders in the AM peak and six riders in the PM peak. Accounting for the above trips, the average bus loads when arriving at stop #4841 are anticipated to increase from 15 riders to 19 riders during the AM peak hour, and from six to 12 riders during the PM peak hour. Therefore, more frequent service for Route 81 is not anticipated as a result of the proposed development.

Route 81 (to Clyde)

At stop #4893, the proposed development is projected to generate an additional 15 AM boarding trips and nine PM boarding trips. As Route 81 runs on approximately 30-minute headways, this equates to eight AM boardings and five PM boardings per bus.

The existing average bus loads at departure are five riders in the AM peak and 14 riders in the PM peak. Accounting for the above trips, the average bus loads when departing stop #4893 are anticipated to increase from five riders to 13 riders during the AM peak hour, and from 14 riders to 19 riders during the PM peak hour. Therefore, more frequent service for Route 81 is not anticipated as a result of the proposed development.

Route 153 (to Tunney's Pasture)

At stop #4893, the proposed development is projected to generate an additional five PM boarding trips. This route does not serve the study area during the AM peak hour. As Route 153 runs on approximately 60-minute headways, these trips will all board the same bus during the PM peak hour.

The existing average bus load at departure is five riders in the PM peak. Accounting for the above trips, the average bus load when departing stop #4893 is anticipated to increase from five riders to ten riders during the PM peak hour. Therefore, more frequent service for Route 153 is not anticipated as a result of the proposed development.

Route 153 (to Lincoln Fields)

At stop #4841, the proposed development is projected to generate an additional six PM alighting trips. As Route 153 runs on approximately 60-minute headways, these trips will all board the same bus during the PM peak hour.

The existing average bus load at departure is five riders in the AM peak. Accounting for the above trips, the average bus load when arriving at stop #4841 is anticipated to increase from five riders to 11 riders during the PM peak hour. Therefore, more frequent service for Route 153 is not anticipated as a result of the proposed development.

4.8 Intersection Design

4.8.1 Intersection MMLOS Review

This section provides a review of the signalized study area intersections using complete streets principles. The signalized intersections within the study area have been evaluated for PLOS, BLOS, TLOS, and TkLOS. The MMLOS targets associated for intersections 'within 600m of a rapid transit station' have been used to evaluate the existing conditions at Scott Street/Churchill Avenue, Scott Street/Athlone Avenue, and Scott Street/Tweedsmuir Avenue. The full intersection MMLOS analysis is included in **Appendix M**. A summary of the results is shown in **Table 18**.

Table 19: Intersection MMLOS Summary

Intersection	PLOS		BLOS		TLOS		TkLOS	
	Actual	Target	Actual	Target	Actual	Target	Actual	Target
Scott Street/Churchill Avenue	E		A		D		F	D
Scott Street/Athlone Avenue	C	A	D	A	B	A	-	-
Scott Street/Tweedsmuir Avenue	C		D		B		-	-

The results of the intersection MMLOS analysis can be summarized as follows:

- No study area intersections meet the target PLOS;
- Scott Street/Churchill Avenue meets the target BLOS, while Scott Street/Athlone Avenue and Scott Street/Tweedsmuir Avenue do not;
- No study area intersections meet the target TLOS;
- Scott Street/Churchill Avenue does not meet the target TkLOS.

Each intersection is discussed in greater detail below.

Scott Street/Churchill Avenue

The intersection does not meet the target PLOS A, TLOS A, or TkLOS D.

No approaches achieve the target PLOS A. Without reducing the crossing width to an equivalent of two 3.5m-wide lanes (i.e. 7.0m or less), the target PLOS A cannot be achieved. Therefore, no recommendations are identified.

The north, south, and east approaches do not meet the target TLOS A, which equates to grade-separated ROW for transit facilities. This is addressed by the planned extension of the Confederation Line LRT, which will serve the study area at Westboro Station.

All approaches do not meet the target TkLOS D. This intersection forms part of the truck route of Scott Street and Churchill Avenue, requiring trucks to perform northbound right turns and westbound left turns. A compound curve has been implemented at this corner to accommodate the northbound right turn movement for heavy vehicles. Therefore, no recommendations are identified.

Scott Street/Athlone Avenue

The intersection does not meet the target PLOS A, BLOS A, or TLOS A.

All crosswalks at this intersection have a crossing width equivalent to three or four 3.5m-wide lanes. There is limited opportunity in improving to the target PLOS A at each approach without reducing the crossing distance significantly or restricting turning movements.

The south and east approaches do not meet the target BLOS A based on left turn characteristics. The south approach consists of a single lane and is stop-controlled, and left-turning cyclists from this approach can queue with vehicles to make their left turn. For cyclists at the east approach, Exhibit 12 of the *MMLOS Guidelines* indicates that the target BLOS A can only be met by providing a two-stage, left-turn bike box. However, a bicycle signal would be required, as the existing intersection is only an intersection pedestrian signal. This is identified for the City's consideration.

The east and west approaches do not meet the target TLOS A, which equates to grade-separated ROW for transit facilities. This is addressed by the planned extension of the Confederation Line LRT, which will serve the study area at Westboro Station.

Scott Street/Tweedsmuir Avenue

The intersection does not meet the target PLOS A, BLOS A, or TLOS A.

All crosswalks at this intersection have a crossing width equivalent to three to five 3.5m-wide lanes. There is limited opportunity in improving to the target PLOS A at each approach without reducing the crossing distance significantly or restricting turning movements.

The south and east approaches do not meet the target BLOS A based on left turn characteristics. The south approach consists of a single lane and is stop-controlled, and left-turning cyclists from this approach can queue with vehicles to make their left turn. For cyclists at the east approach, a bicycle signal would be required, as the existing intersection is only an intersection pedestrian signal. This is identified for the City’s consideration.

The east and west approaches do not meet the target TLOS A, which equates to grade-separated ROW for transit facilities. This is addressed by the planned extension of the Confederation Line LRT, which will serve the study area at Westboro Station.

4.8.2 2026 Total Intersection Operations

Intersection capacity analysis has been conducted for the 2026 total traffic conditions. The results of the analysis are summarized in **Table 19** for the weekday AM and PM peak hours. Detailed reports are included in **Appendix N**.

Table 20: 2026 Total Traffic Operations

Intersection	AM Peak Hour			PM Peak Hour		
	Max v/c or Delay	LOS	Mvmt	Max v/c or Delay	LOS	Mvmt
Scott Street/Churchill Avenue	0.87	D	NBR	0.77	C	NBR
Scott Street/Winona Avenue	13 sec	B	NBL/R	13 sec	B	NBL/R
Scott Street/Athlone Avenue	(1) 0.45	A	EBL/T/R	0.47	A	WBL/T/R
	(2) 14 sec	B	NBL/T/R	12 sec	B	NBL/T/R
Scott Street/Tweedsmuir Avenue	(1) 0.44	A	EBL/T/R	0.41	A	WBL/T/R
	(2) 69 sec	F	SBL/T/R	131 sec	F	SBL/T/R
Scott Street/McRae Avenue	17 sec	C	NBL/R	24 sec	C	NBL/R

1. Intersection modelled as a two-legged pedestrian crossing; results identify maximum v/c ratio for through traffic on Scott Street
2. Intersection modelled as a side-street stop-controlled intersection; results identify maximum approach delay for side street

Compared to the 2026 background conditions, the addition of site-generated traffic is anticipated to have marginal effects on traffic operations within the study area.

4.8.3 2031 Total Intersection Operations

Intersection capacity analysis has been conducted for the 2031 total traffic conditions. The results of the analysis are summarized in **Table 20** for the weekday AM and PM peak hours. Detailed reports are included in **Appendix N**.

Table 21: 2031 Total Traffic Operations

Intersection	AM Peak Hour			PM Peak Hour		
	Max v/c or Delay	LOS	Mvmt	Max v/c or Delay	LOS	Mvmt
Scott Street/Churchill Avenue	0.87	D	NBR	0.78	C	NBR
Scott Street/Winona Avenue	13 sec	B	NBL/R	13 sec	B	NBL/R
Scott Street/Athlone Avenue	(1) 0.46	A	EBL/T/R	0.48	A	WBL/T/R
	(2) 14 sec	B	NBL/T/R	12 sec	B	NBL/T/R
Scott Street/Tweedsmuir Avenue	(1) 0.45	A	EBL/T/R	0.42	A	WBL/T/R
	(2) 71 sec	F	SBL/T/R	137 sec	F	SBL/T/R
Scott Street/McRae Avenue	18 sec	C	NBL/R	26 sec	D	NBL/R

1. Intersection modelled as a two-legged pedestrian crossing; results identify maximum v/c ratio for through traffic on Scott Street
 2. Intersection modelled as a side-street stop-controlled intersection; results identify maximum approach delay for side street

Compared to the 2031 background conditions, the addition of site-generated traffic is anticipated to have marginal effects on traffic operations within the study area.

5.0 CONCLUSIONS

Based on the foregoing, the conclusions of this TIA can be summarized as follows:

Forecasting

- The ultimate proposed development is projected to generate 404 person trips (including 55 vehicle trips) during the AM peak hour, and 414 person trips (including 58 vehicle trips) during the PM peak hour.
- Accounting for the existing development, the ultimate proposed development is projected to generate an additional 365 person trips (including 24 additional vehicle trips) during the AM peak hour, and an additional 341 person trips (but one fewer vehicle trip) during the PM peak hour.

Development Design and Parking

- Sidewalks will be maintained along the subject site’s frontages to Scott Street and Athlone Avenue, and internal walkways will be provided around the perimeter of each building, connecting to the sidewalks on Scott Street and Athlone Avenue. Landscaped walkways and central amenity space will also provide pedestrian connectivity between Scott Street, Athlone Avenue, Ashton Avenue, and the Lion’s Park land to the immediate south of the subject site.
- A total of ten exterior bicycle parking spaces are proposed on-site, with another 786 bicycle parking spaces within the underground parking levels or the ground floor.
- The proposed development will remove the two existing accesses to Scott Street and provide one new access, which will require a relocation of the temporary transitway platform by 7m to the east. City staff have advised that the required modifications to the transitway platform are to be constructed as part of the proposed development.

- All required Transportation Demand Management (TDM)-supportive design and infrastructure measures in the TDM checklist for residential developments will be met.
- Garbage rooms will be located on the first level of the underground parking garage, and move-in rooms are located on the ground floor of each building. For the east building, the move-in room will be accessed at the south face, adjacent to the parking garage ramp. Garbage collection will occur curbside along Athlone Avenue near the parking garage access. For the west building, the move-in room will be accessed at the west face. Garbage collection will occur curbside along Scott Street.
- There is no proposed on-site fire route for either building, as the main entrances to each building will front onto Scott Street.
- The proposed development will meet the minimum vehicle parking, maximum vehicle parking, and minimum bicycle parking requirements outlined in the City's *Zoning By-Law* (ZBL). There is no requirement to provide any loading spaces under the ZBL.

Boundary Streets

- The results of the segment MMLOS analysis can be summarized as follows:
 - Neither boundary street meets the target pedestrian level of service (PLOS) A;
 - Scott Street meets the target bicycle level of service (BLOS) A, while Athlone Avenue does not meet the target BLOS D;
 - Scott Street does not meet the target transit level of service (TLOS) A;
 - Scott Street meets the target truck level of service (TkLOS) D.
- Scott Street cannot achieve the target PLOS A on either side of the roadway without reducing the operating speed to 30 km/h or slower, based on the existing traffic volumes.
- Athlone Avenue can achieve the target PLOS A and BLOS A through a reduction in the operating speed of the roadway to 30 km/h. The planned integrated renewal of Athlone Avenue is anticipated to include traffic calming to achieve this operating speed.

Access Intersections

- Access to the proposed underground parking garage will be provided via one full-movement driveway to Scott Street and one full-movement driveway to Athlone Avenue. Access to the loading area for the east building will be provided via the proposed access to Athlone Avenue, and access to the loading area for the west building will be provided via the proposed access to Scott Street. All driveways are anticipated to be constructed as part of the first phase.
- The design of the proposed accesses have been evaluated using the relevant provisions of the City's *Private Approach By-Law* (PABL) and Transportation Association of Canada (TAC)'s *Geometric Design Guide for Canadian Roads*. The proposed accesses will meet all relevant requirements, except for the following.

- Section 25(c) of the PABL identifies a maximum width requirement of 9m for any two-way private approach, as measured at the street line. Section 107(1)(a) of the ZBL requires any two-way private approach serving an apartment parking garage with 20 or more parking spaces to have a minimum width of 6.0m and a maximum width of 6.7m. While the underground parking garage ramp to Scott Street will have a width of 6.5m, the overall access width at the street line will be 11.3m, in order to also facilitate access to the loading area on the west side of the west building. It is requested that the requirements of Section 25(c) of the PABL be waived for the proposed access to Scott Street.
- Based on Section 25(m)(ii) of the PABL, the nearest edge of any private approach that serves 300 or more parking spaces must be a minimum of 60m from the nearest intersecting street line or any other private approach, when it is a residential development within 46m of an arterial roadway. The minimum requirement is not met by the proposed underground garage access to Athlone Avenue, as less than 60m of frontage is provided on that roadway. The site plan shows the garage access to Athlone Avenue will be located approximately 44m south of Scott Street, and approximately as far south as possible.
- Based on Section 25(p) of the PABL, the nearest edge of any private approach must be a minimum of 3m from the adjacent property line. Section 25(r) suggests that a private approach may be constructed within 3m from the adjacent property line if it is approved through Site Plan Control. The western edge of the proposed loading access to Scott Street will be located approximately 1.0m from the nearest property line. The adjacent site at 2050 Scott Street is currently under construction. As the future access to this development will be located approximately 5.75m from the property line, it is requested that this requirement be waived for the proposed access to Scott Street. The southern edge of the proposed access to Athlone Avenue will be located approximately 2.7m from the nearest property line. As the existing driveway to the adjacent house at 322 Athlone Avenue is located approximately 5.0m from the property line, it is requested that this requirement also be waived for the proposed access to Athlone Avenue.
- Section 25(u) of the PABL identifies that a maximum grade of 2% to 6% for the first 9m inside the property line, for any private approach serving a parking area with more than 50 parking spaces. The Athlone Avenue garage access meets the requirement, as it will have a proposed maximum grade of 6% (descending towards the roadway for drainage purposes) for the first 6m within the property line, followed by a flat area before transitioning down to the parking garage. The Scott Street garage access meets this requirement, as it will have a proposed maximum grade of 4% for the first 4m within the property line and the garage door, followed by a 5m flat area within the building.
- As Athlone Avenue and Scott Street are straight and generally level roadways, adequate sightlines can be provided at both proposed access locations. In the interim condition, it is anticipated that OC Transpo buses stopped at the temporary eastbound platform will periodically obscure outbound drivers at the access to Scott Street. Sightlines will therefore improve at this access when the platform is decommissioned.

- Providing vehicular access to both Scott Street and Athlone Avenue are recommended, based on the overall size and density of the site. This provides future users with an alternative route should an accident occur along Athlone Avenue, or in the event that there are operational issues with one of the garage doors. The subject site is very large (approximately 6,600 m² in area), and spans over 100m of frontage on Scott Street. The proposed development will contain two buildings with 901 dwellings, approximately 3,100 ft² GFA of ground-floor commercial or retail space, and 378 parking spaces in an underground garage.
- The proposed accesses are anticipated to operate with an acceptable vehicular level of service (Auto LOS).

Transportation Demand Management

- The proponent will provide the following residential TDM measures:
 - Display local area maps with walking/cycling access routes and key destinations at major entrances;
 - Display relevant transit schedules and route maps at entrances;
 - Unbundle parking cost from monthly rent;
 - Provide a multi-modal travel information package to new residents.
- The subject site is across Scott Street from a future LRT station. Providing limited parking near transit stations act as a strong incentive for residents, visitors, and patrons of the proposed development to travel to/from the site via transit. Further, a total of 796 bicycle parking spaces are proposed, equating to 0.88 bicycle spaces per unit and exceeding the minimum requirements of the ZBL.

Neighbourhood Traffic Management

- Based on the existing traffic count data at Scott Street/Athlone Avenue, the two-way peak hour traffic volumes on Athlone Avenue are approximately 62 vehicles during the AM peak hour and 72 vehicles during the PM peak hour, and the average annual daily traffic is approximately 740 vehicles.
- Ultimate buildout of the proposed development is anticipated to increase peak hour traffic volumes on Athlone Avenue by approximately five vehicles. Therefore, the NTM thresholds are not anticipated to be met in the future as a result of this development, and no Neighbourhood Traffic Management (NTM) measures are identified.

Transit

- Phase 1 of the proposed development is projected to generate a net additional 100 transit trips during the AM peak hour and 96 transit trips during the PM peak hour.
- The ultimate proposed development is projected to generate a net additional 219 transit trips during the AM peak hour and 217 transit trips during the PM peak hour.
- The need for more frequent service on the future LRT, or existing routes 16, 50, 81, and 153 is not anticipated as a result of the proposed development.

Intersection MMLoS

- The results of the intersection MMLoS analysis can be summarized as follows:
 - No study area intersections meet the target PLOS;
 - Scott Street/Churchill Avenue meet the target BLOS, while Scott Street/Athlone Avenue and Scott Street/Tweedsmuir Avenue do not;
 - No study area intersections meet the target TLOS;
 - Scott Street/Churchill Avenue does not meet the target TkLOS.
- No approaches at any study area intersection achieves the target PLOS A. Without reducing the crossing width to an equivalent of two 3.5m-wide lanes (i.e. 7.0m or less), the target PLOS A cannot be achieved. Therefore, no recommendations are identified.
- The south and east approaches do not meet the target BLOS A based on left turn characteristics. The south approach consists of a single lane and is stop-controlled, and left-turning cyclists from this approach can queue with vehicles to make their left turn. For cyclists at the east approach, the target BLOS A can only be met by providing a two-stage, left-turn bike box. However, a bicycle signal would be required, as the existing intersection is only an intersection pedestrian signal. This is identified for the City's consideration.
- The south and east approaches do not meet the target BLOS A based on left turn characteristics. The south approach consists of a single lane and is stop-controlled, and left-turning cyclists from this approach can queue with vehicles to make their left turn. For cyclists at the east approach, a bicycle signal would be required, as the existing intersection is only an intersection pedestrian signal. This is identified for the City's consideration.
- The target TLOS A equates to grade-separated ROW for transit facilities. This is addressed by the planned extension of the Confederation Line LRT, which will serve the study area at Westboro Station.
- As Scott Street and Churchill Avenue are truck routes, trucks are required to perform northbound right turns and westbound left turns at this intersection. A compound curve has been implemented at this corner to accommodate the northbound right turn movement for heavy vehicles. Therefore, no recommendations are identified.

Existing Traffic Operations

- All approaches within the study area meet the target Auto LOS E, except for the transit-only approach at Scott Street/Tweedsmuir Avenue. It is noted that this approach is currently closed due to Stage 2 LRT construction, and that bus operations at this station may be reduced once Westboro Station is served by LRT, resulting in improved operations at this approach. Further, when the pedestrian phase is actuated at this intersection, southbound buses utilizing this approach would be able to turn right onto Scott Street unimpeded, or turn left onto Scott Street once pedestrians had completed their crossing.

Background Traffic Operations

- After the addition of background traffic volumes, all approaches within the study area continues to meet the target Auto LOS E, except for the transit-only approach at Scott Street/Tweedsmuir Avenue.

Total Traffic Operations

- After the addition of site-generated traffic volumes, all approaches within the study area continues to meet the target Auto LOS E, except for the transit-only approach at Scott Street/Tweedsmuir Avenue. The addition of site-generated traffic is anticipated to have marginal effects on traffic operations within the study area.

Based on the foregoing, the proposed development is recommended from a transportation perspective.

NOVATECH

Prepared by:



Joshua Audia, P.Eng.
Project Engineer | Transportation

Reviewed by:



Brad Byvelds, P.Eng.
Project Manager | Transportation

APPENDIX A

Site Plan

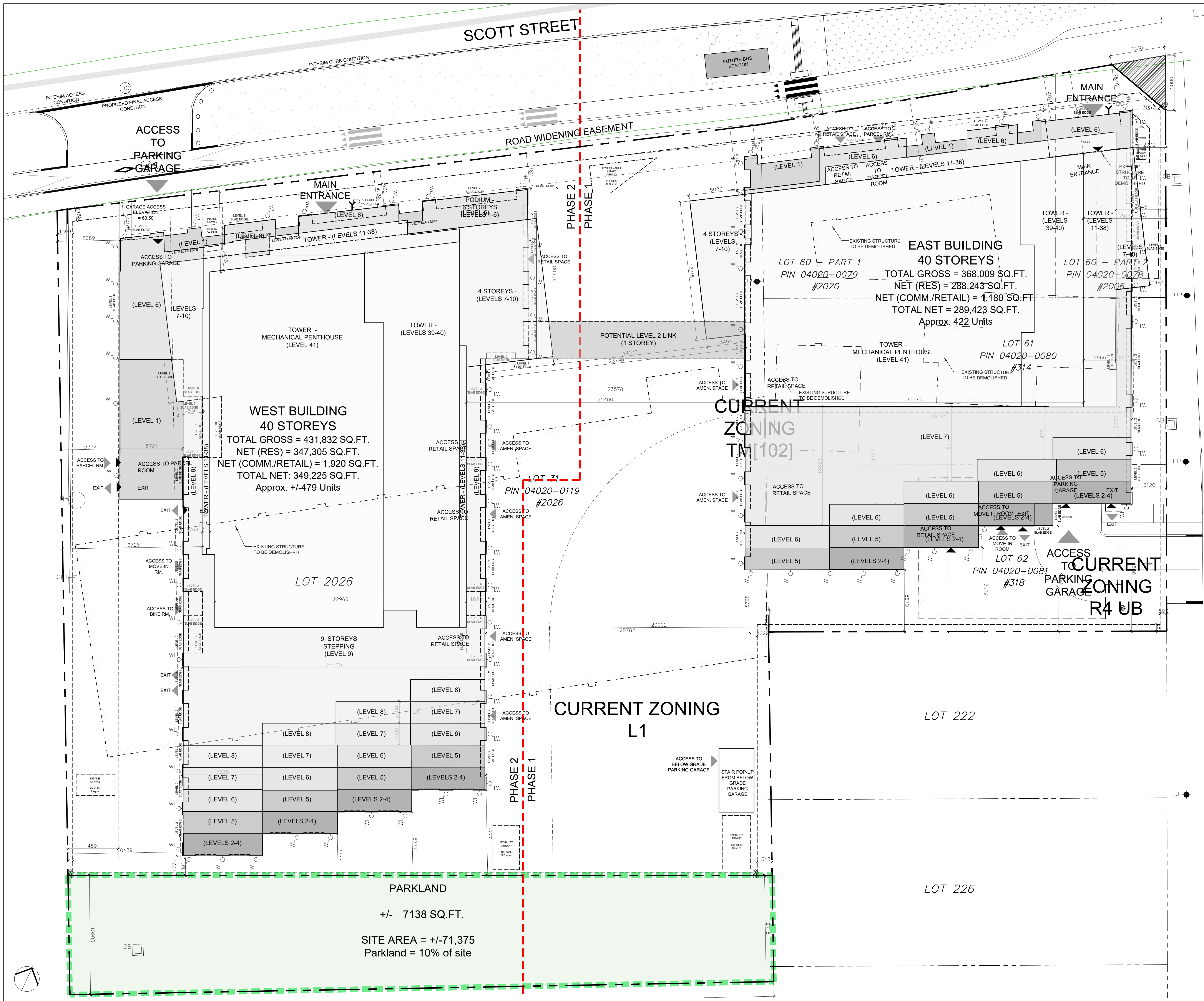

LOCATION PLAN 1:2000

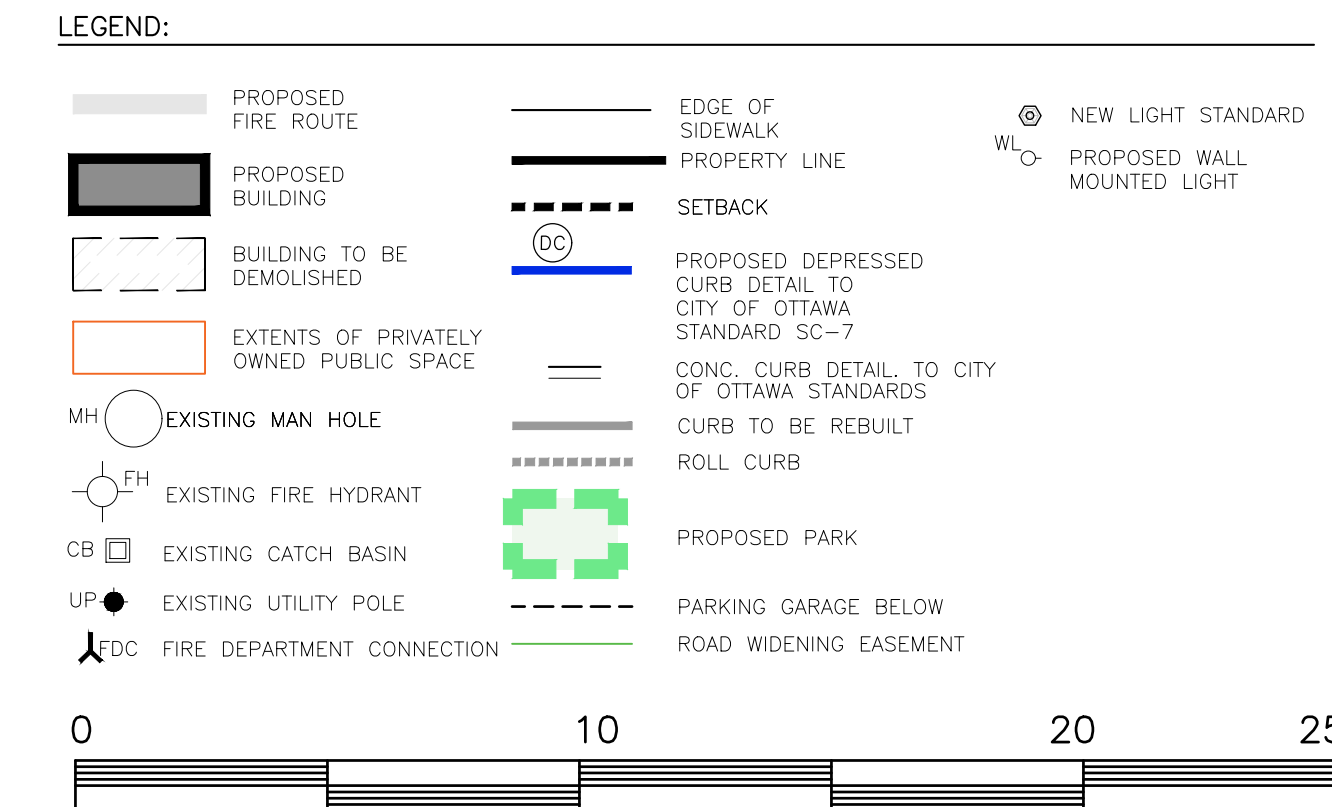
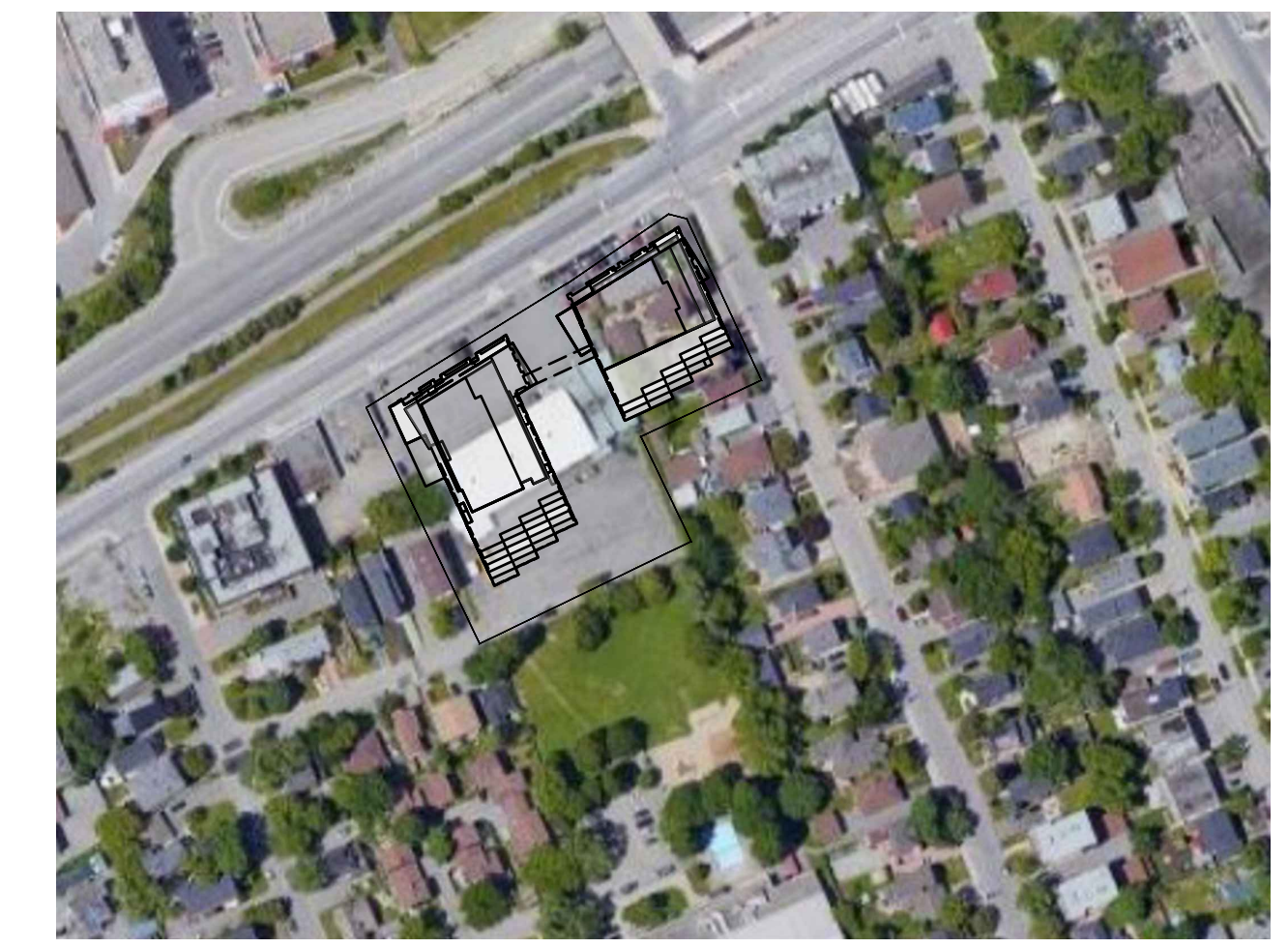

SCALE 1 : 150

ZONING NOTES:

CURRENT ZONING: WEST PARCEL L1, EAST PARCELS TM[102]

DEVELOPMENT STATS PHASE 1 + PHASE 2	REQUIRED	PROPOSED
LOT WIDTH		101.4m IRREGULAR
LOT DEPTH		75.3m IRREGULAR
FRONT YARD SETBACK	SCOTT STREET 3m	VARIES - 2.7-7.5m
REAR YARD SETBACK	7.5m	VARIES-5.4-18.1m
SIDE YARD SETBACK	ATHLONE AVE. 3m	3.0m
INTERIOR SIDE YARD SETBACK	7.5m	VARIES-6.0-11.2m

AMENITY SPACE REQUIREMENTS	REQUIRED PER UNIT	PROVIDED
REQUIRED AMENITY SPACE	6 m ²	6.4 m ²
901 UNITS X 6 SQ.M. = 5,406 SQ.M. TOTAL AMENITY REQUIRED		
REQUIRED AMENITY SPACE TO BE COMMON	2703 SQ.M.	
PROVIDED AMENITY SPACE TO BE COMMON		2703 SQ.M.

BUILDING B (WEST BUILDING) - PHASE 2	PROPOSED
NO. OF STOREYS	40 STOREYS
BUILDING HEIGHT	123m
FRONT YARD SETBACK	SCOTT STREET VARIES - 3.1-7.5m
REAR YARD SETBACK	FROM PROPERTY LINE VARIES-1.7-7.7m
INTERIOR SIDE YARD SETBACK	PODIUM SEPARATION FROM B2 23.5m
SIDE YARD SETBACK	FROM PROPERTY LINE VARIES-6.0-11.2m
	ADJACENT PROP. TOWER SEPARATION (ABOVE LEVEL 10) 12.7m

BUILDING A (EAST BUILDING) - PHASE 1	PROPOSED
NO. OF STOREYS	40 STOREYS
BUILDING HEIGHT	123m
FRONT YARD SETBACK	SCOTT STREET VARIES-3.0-7.5m
REAR YARD SETBACK	FROM PROPERTY LINE VARIES-5.4-11.5m
SIDE YARD SETBACK	ATHLONE AVE. 3.0m
INTERIOR SIDE YARD SETBACK	PODIUM SEPARATION FROM B1 23.5m
	TOWER SEPARATION FROM B1 (ABOVE LEVEL 10) 25.5m

NOTE: ALL EXISTING SITE INFORMATION AS PER TOPOGRAPHICAL SURVEY PLAN DATED MARCH 1, 2022
 PREPARED BY STANTEC GEOMATICS LTD.
 PART OF LOT 60 AND ALL OF LOTS 61 & 62 REGISTERED PLAN 263 AND PART OF LOT 31 CONCESSION 1 (OTTAWA FRONT), (GEOGRAPHIC TOWNSHIP OF NEPEAN)

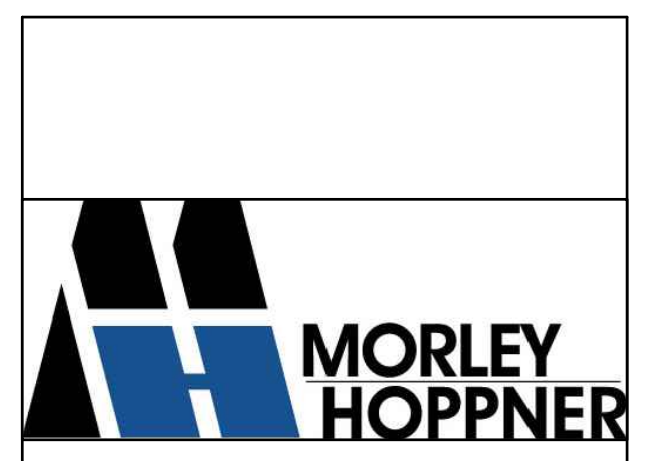

PROJECT TEAM

ARCHITECT
 HOBIN ARCHITECTURE
 PATRICK BISSON
 T 613-238-7200

PLANNING
 FOTENY CONSULTANTS INC.
 ANGELO TREMBLAY
 T 613-730-5709

CIVIL
 NOVATECH
 LEE SHEETS
 T 613-254-9643 X209

LANDSCAPE ARCHITECT
 PROJECT PAVILION
 SERGE GALLAN
 T 613-891-5442

TRANSPORTATION
 NOVATECH
 JENNIFER LUCING
 T 613-254-9643 X254

ENVIRONMENTAL
 GRADIENT WIND ENGINEERING
 JOSHUA FOSTER
 T 613-836-0634

SURVEYOR
 STANTEC
 BRIAN WEBSTER
 T 613-229-7644

WEST BUILDING - PHASE 2	REQUIRED	PROPOSED	+/-
TOTAL UNIT COUNT			+/-479
STUDIOS	80	17%	
1 INTERNAL BEDROOM	10	2%	
1 BEDROOM	192	40%	
1 BEDROOM + DEN	23	5%	
2 BEDROOM (1 INTERNAL)	16	4%	
2 BEDROOM	144	30%	
2 BEDROOM + DEN	4	1%	
3 BEDROOM + DEN	8	2%	
MAXIMUM HEIGHT		123m	
NUMBER OF STOREYS		40 STOREYS	
AREA - BUILDING AREA		1693 SQ.M.	
AREA - TYPICAL PODIUM		1608 SQ.M.	
AREA - TYPICAL PLATE		848 SQ.M.	
AREA - TOTAL GROSS BUILDING AREA (GBA)		+/- 40,119 SQ.M.	
AREA - TOTAL GROSS FLOOR AREA (GFA - CITY DEFINITION)		+/- 32,444 SQ.M.	

BUILDING A (EAST BUILDING) - PHASE 1	REQUIRED	PROPOSED	+/-
TOTAL UNIT COUNT			+/- 422
STUDIOS	101	24%	
1 INTERNAL BEDROOM	7	1.7%	
1 BEDROOM	161	38%	
1 BEDROOM + DEN	6	1%	
2 BEDROOM (1 INTERNAL)	16	4%	
2 BEDROOM	122	29%	
2 BEDROOM + DEN	3	1%	
3 BEDROOM + DEN	6	1.4%	
MAXIMUM HEIGHT		123m	
NUMBER OF STOREYS		40 STOREYS	
AREA - BUILDING AREA		1256 SQ.M.	
AREA - TYPICAL PODIUM		1284 SQ.M.	
AREA - TYPICAL PLATE		769 SQ.M.	
AREA - TOTAL GROSS BUILDING AREA (GBA)		+/- 34,189 SQ.M.	
AREA - TOTAL GROSS FLOOR AREA (GFA - CITY DEFINITION)		+/- 26,888 SQ.M.	

BUILDING A + B BICYCLE PARKING REQUIREMENTS: 901 units * 0.5 = 451
 PROVIDED BICYCLE PARKING
 796 (374 VERTICAL + 422 HORIZONTAL) + 10 AT EXT. GRADE) BICYCLE PARKING SPACES PROVIDED FOR 901 UNITS (0.88/UNIT)
 * LOCATED IN UNDERGROUND PARKING GARAGE, AT GROUND LEVEL (INT.), AT AT GRADE (EXT.)

BUILDING A + BUILDING B (COMBINED) PARKING REQUIREMENTS: Maximum parking = 0.6 per dwelling unit = (901*0.6 = 541 parking spaces maximum)	PROVIDED RESIDENTIAL VEHICLE PARKING
LAND USE	
APARTMENT	316 RESIDENTIAL PARKING SPACES PROVIDED FOR 901 UNITS (0.35/UNIT)
2. REQUIRED VISITOR PARKING	
LAND USE	
APARTMENT	60 VISITOR PARKING SPACES PROVIDED FOR 901 UNITS (0.07/UNIT - Max. 30 spaces per building)* LOCATED IN PARKING GARAGE
TOTAL PARKING PROVIDED	376 TOTAL PARKING SPACES PROVIDED (ALL BELOW GRADE)

no.	date	revision
4	23-10-13	REISSUED FOR SPC
3	23-02-22	ISSUED FOR SPC
2	22-04-07	ISSUED FOR REZONING
1	21-06-08	CITY OF OTTAWA PRECONSULTATION

It is the responsibility of the appropriate contractor to check and verify all dimensions on site and report all errors and/or omissions to the architect.
 All contractors must comply with all pertinent codes and by-laws.
 Do not scale drawings.
 This drawing may not be used for construction until signed.
 Copyright reserved.

Hobin Architecture Incorporated
 63 Pamela Street
 Ottawa, Ontario
 Canada K1S 3K7
 T: 613 238 7200
 F: 613 235 2005
 E: mail@hobin.com
 hobin.com

PROJECT LOCATION:
MORLEY HOPPNER LTD.
 314 & 318 ATHLONE AVE., 2006, 2020, 2026 SCOTT ST.
 OTTAWA, ON.

DRAWING TITLE:
SITE PLAN

DRAWN BY: DATE: SCALE:
 PB 23-10-13 1:150

PROJECT: 1937
 DRAWING NO.: A1.00

REVISION NO.:

APPENDIX B

TIA Screening Form

City of Ottawa 2017 TIA Guidelines Screening Form

1. Description of Proposed Development

Municipal Address	2006/2020/2026 Scott Street and 314/316/318 Athlone Avenue
Description of Location	Southwest corner of Scott Street/Athlone Avenue
Land Use Classification	Residential with Ground-Floor Commercial (two high-rise towers)
Development Size (units)	901 units (422 units in Phase 1, 479 units in Phase 2)
Development Size (m ²)	3,100 ft² commercial (1,180 ft² in Phase 1, 1,920 ft² in Phase 2)
Number of Accesses & Locations	Two accesses (one to Athlone Avenue and one to Scott Street)
Phase of Development	2
Buildout Year	Phase 1 – 2026 Phase 2 – 2029

If available, please attach a sketch of the development or site plan to this form.

2. Trip Generation Trigger

Considering the Development's Land Use type and Size (as filled out in the previous section), please refer to the Trip Generation Trigger checks below.

Land Use Type	Minimum Development Size
Single-family homes	40 units
Townhomes or apartments	90 units
Office	3,500 m ²
Industrial	5,000 m ²
Fast-food restaurant or coffee shop	100 m ²
Destination retail	1,000 m ²
Gas station or convenience market	75 m ²

** If the development has a land use type other than what is presented in the table above, estimates of person-trip generation may be made based on average trip generation characteristics represented in the current edition of the Institute of Transportation Engineers (ITE) Trip Generation Manual.*

If the proposed development size is greater than the sizes identified above, the Trip Generation Trigger is satisfied.

3. Location Triggers

	Yes	No
Does the development propose a new driveway to a boundary street that is designated as part of the City's Transit Priority, Rapid Transit or Spine Bicycle Networks?	X	
Is the development in a Design Priority Area (DPA) or Transit-oriented Development (TOD) zone?*	X	

**DPA and TOD are identified in the City of Ottawa Official Plan (DPA in Section 2.5.1 and Schedules A and B; TOD in Annex 6). See Chapter 4 for a list of City of Ottawa Planning and Engineering documents that support the completion of TIA).*

If any of the above questions were answered with 'Yes,' the Location Trigger is satisfied.

4. Safety Triggers

	Yes	No
Are posted speed limits on a boundary street 80 km/hr or greater?		X
Are there any horizontal/vertical curvatures on a boundary street limits sight lines at a proposed driveway?		X
Is the proposed driveway within the area of influence of an adjacent traffic signal or roundabout (i.e. within 300 m of intersection in rural conditions, or within 150 m of intersection in urban/suburban conditions)?	X	
Is the proposed driveway within auxiliary lanes of an intersection?		X
Does the proposed driveway make use of an existing median break that serves an existing site?		X
Is there is a documented history of traffic operations or safety concerns on the boundary streets within 500 m of the development?		
Does the development include a drive-thru facility?		X

If any of the above questions were answered with 'Yes,' the Safety Trigger is satisfied.

5. Summary

	Yes	No
Does the development satisfy the Trip Generation Trigger?	X	
Does the development satisfy the Location Trigger?	X	
Does the development satisfy the Safety Trigger?	X	

If none of the triggers are satisfied, the TIA Study is complete. If one or more of the triggers is satisfied, the TIA Study must continue into the next stage (Screening and Scoping).

APPENDIX C

OC Transpo System Information

**AM Connexion Routes*
Circuits* Connexion le matin**

LIMITED SERVICE UNTIL TUNNEY'S PASTURE STATION

Service from the west is **off-peak** at the following stations: Moodie, Pinecrest, Queensway, Lincoln Fields, Dominion and Westboro.

Service from the southwest is **off-peak** at the following stations: Baseline, Iris, Queensway, Lincoln Fields, Dominion and Westboro.
*Except Routes 258 and 282 which offer full service.

SERVICE LIMITÉ JUSQU'À LA STATION TUNNEY'S PASTURE

Les circuits en provenance de l'ouest offrent le service de **débarquement, seulement**, aux stations suivantes : Moodie, Pinecrest, Queensway, Lincoln Fields, Dominion et Westboro.

Les circuits en provenance du sud-ouest offrent le service de **débarquement, seulement**, aux stations suivantes : Baseline, Iris, Queensway, Lincoln Fields, Dominion et Westboro.
*Sauf les circuits 258 et 282 qui offrent un service complet.

**PM Connexion Routes
Circuits Connexion en après-midi**

LIMITED SERVICE AFTER TUNNEY'S PASTURE STATION

No service from Westboro Station to Pinecrest Station
Routes 252, 256, 257, 261, 262, 263, 264, 265, 267 and 268

No service from Westboro Station to Baseline Station
Routes 270, 271, 272, 273, 277 and 278

No service from Westboro Station to Dominion Station
Route 283

SERVICE LIMITÉ APRES LA STATION TUNNEY'S PASTURE

Pas de service de la station Westboro à la station Pinecrest
Circuits 252, 256, 257, 261, 262, 263, 264, 265, 267 et 268

Pas de service de la station Westboro à la station Baseline
Circuits 270, 271, 272, 273, 277 et 278

Pas de service de la station Westboro à la station Dominion
Circuit 283

Tunney's Pasture

1
57 61 62 63 74 75
11 14 51 53 80 87
16 50 54 56 64 66
73 81 82 86 89 153
252 256 257 258 261 262
263 264 265 267 268 270
271 272 273 277 278 282
283

Lincoln Fields

57 61 62 63 74 75
11 51 85
153 50 58 64 65 73 82
154 183
261 258 282 283
267 301 303 305

57 61 62 63 74 75
64 66 73 82
252 256 257 258 261 262 263
264 265 267 268 270 271 272
273 277 278 282 283

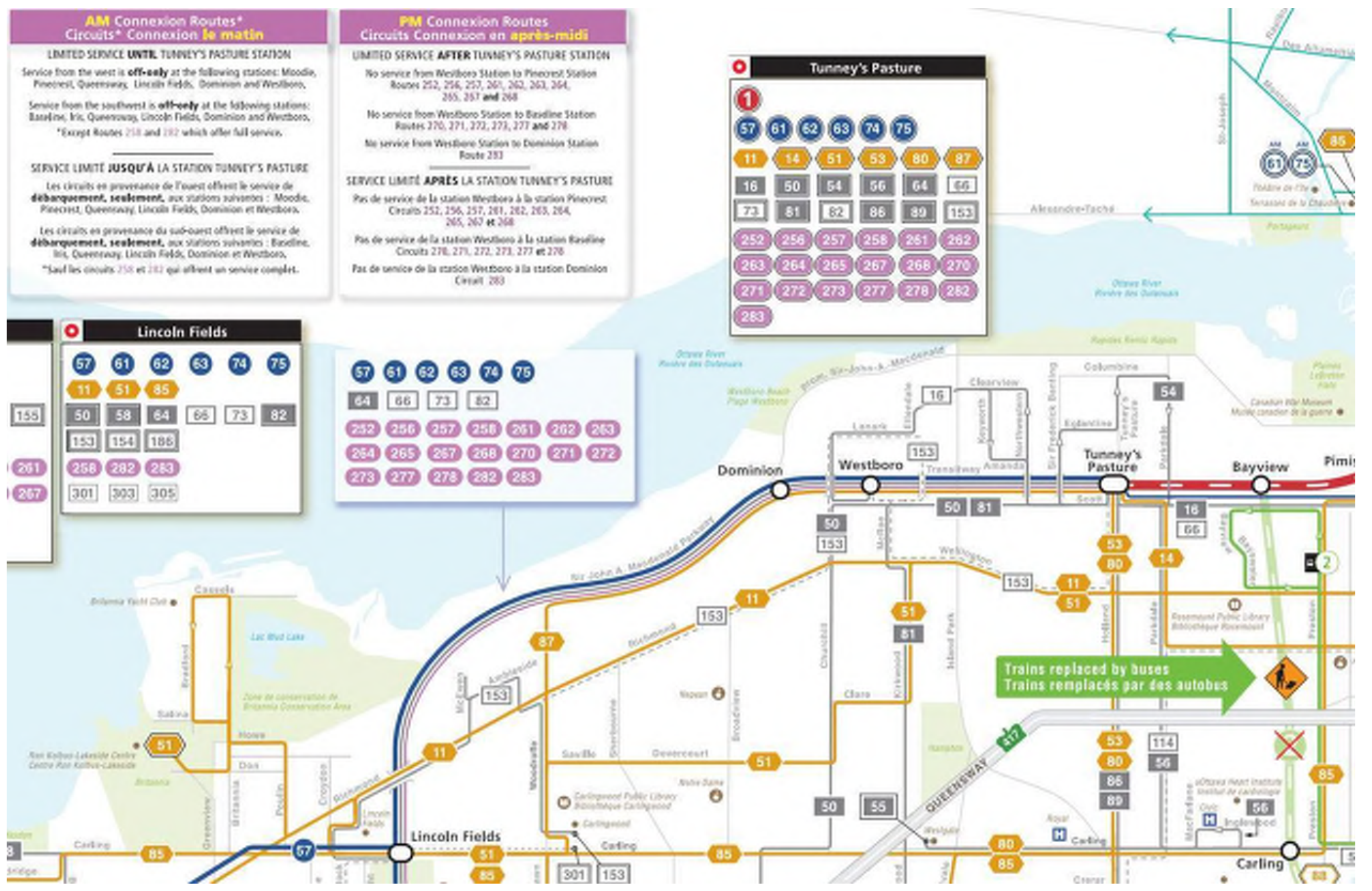

**Trains replaced by buses
Trains remplacés par des autobus**

LEGEND / LÉGENDE

2A

Bus stops / Arrêts d'autobus



Bus only / Autobus seulement



Bike rack / Support à vélo



Taxi pickup / Poste d'attente de taxis



Accessible area / Zone accessible



Walking Paths-sidewalks / Sentiers et trottoirs

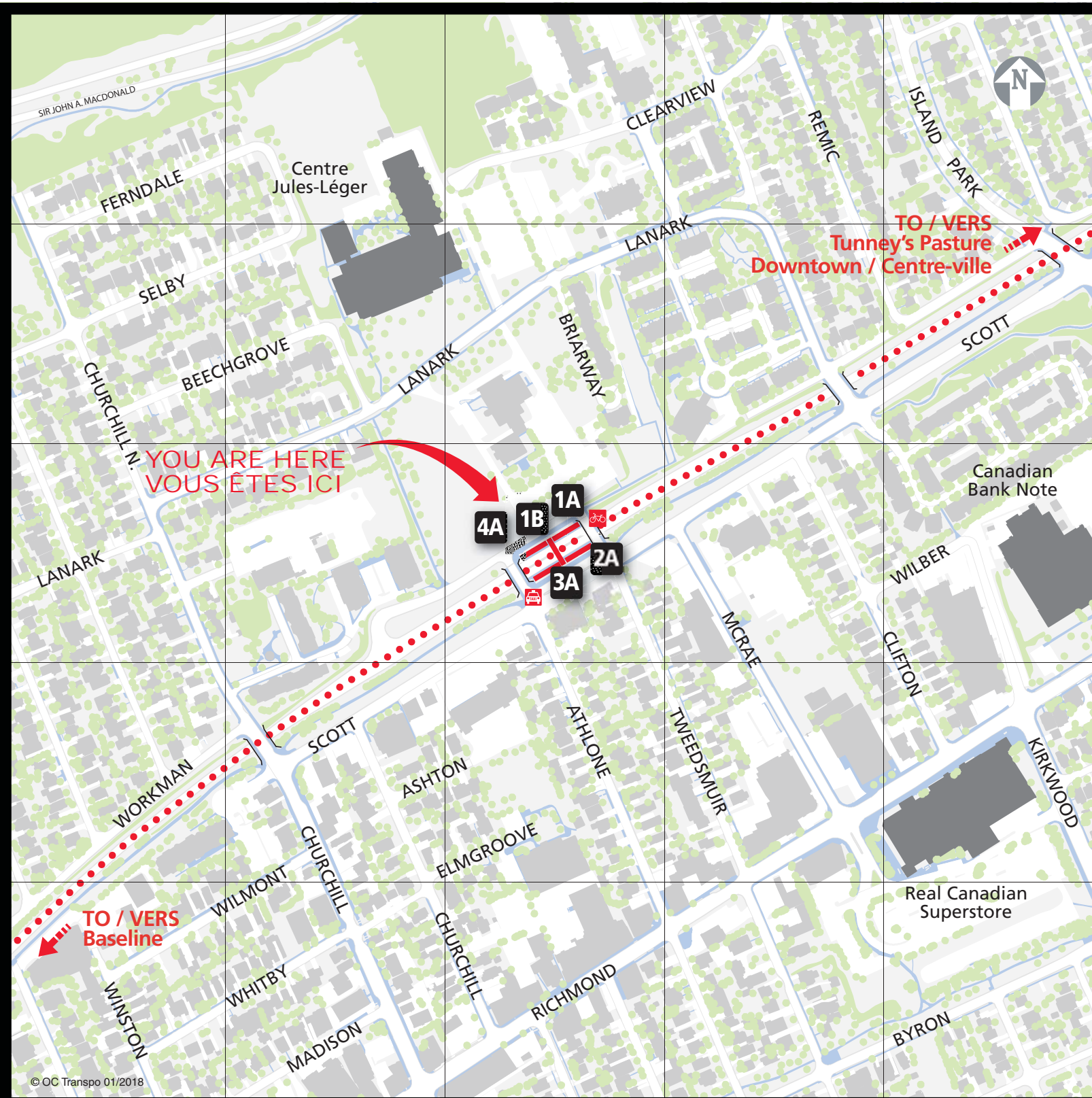

16

MAIN TUNNEY'S PASTURE WESTBORO

7 days a week / 7 jours par semaine
All day service
Service toute la journée

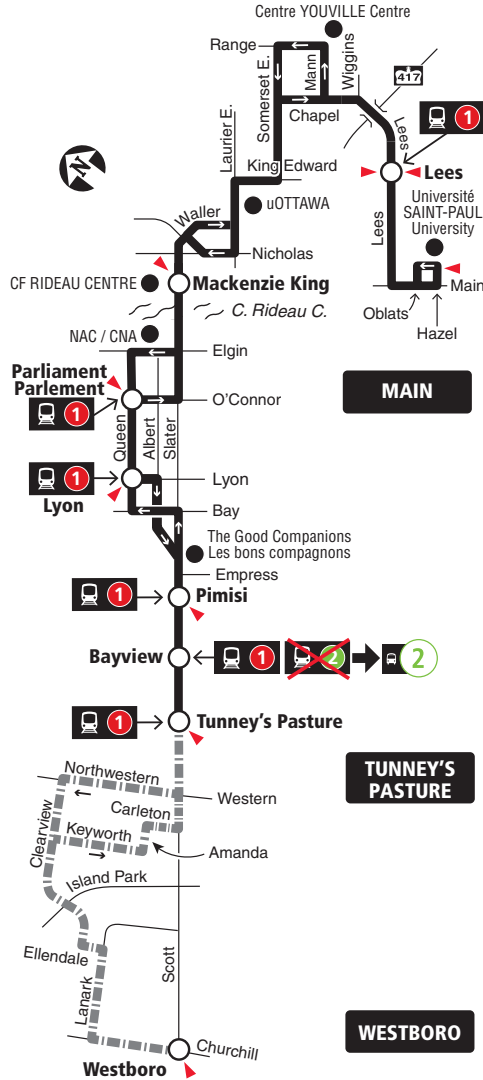

- Station
- No Sunday service / Aucun service le dimanche
- ▲ Timepoint / Heures de passage

2020.04

 **Schedule / Horaire..... 613-560-1000**
Text / Texto560560
plus your four digit bus stop number / plus votre numéro d'arrêt à quatre chiffres

Customer Service
 Service à la clientèle 613-741-4390
 Lost and Found / Objets perdus..... 613-563-4011
 Security / Sécurité 613-741-2478

Effective May 3, 2020
En vigueur 3 mai 2020



50

LINCOLN FIELDS TUNNEY'S PASTURE

Local

Monday to Saturday / Lundi au samedi
No service Sat. eve. or all day Sunday / Aucun service le soir le sam. ou toute la journée dimanche

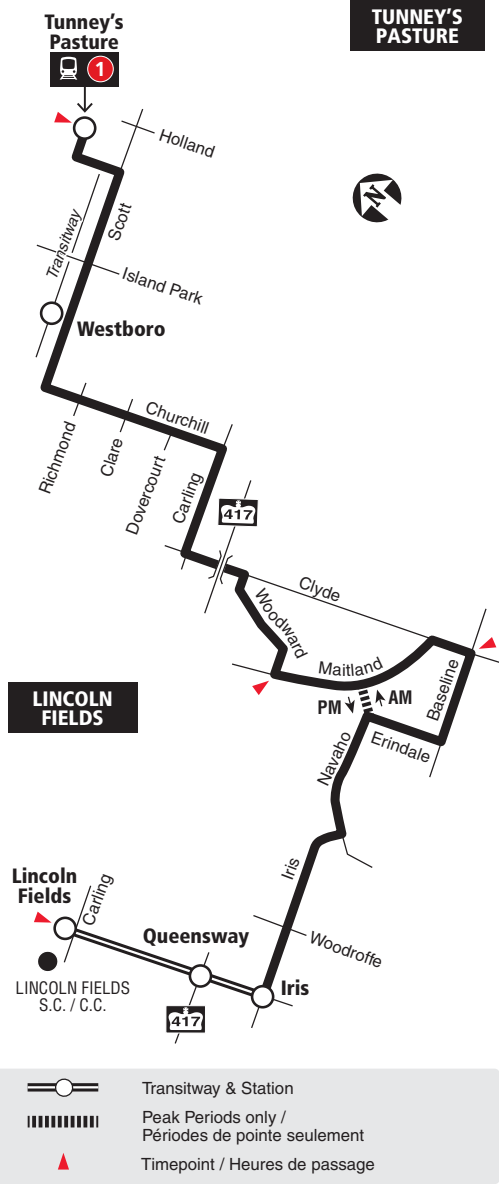

2019.06

Schedule / Horaire613-560-1000
Text / Texto560560

plus your four digit bus stop number / plus votre numéro d'arrêt à quatre chiffres

Customer Service
Service à la clientèle **613-842-3600**
Lost and Found / Objets perdus..... **613-563-4011**
Security / Sécurité **613-741-2478**

Effective April 24, 2017
En vigueur 24 avril 2017



BAYSHORE CRYSTAL BAY TUNNEY'S PASTURE

Rapid^e

7 days a week / 7 jours par semaine

All day and limited overnight service
Service toute la journée et limité la nuit



TUNNEY'S PASTURE

BAYSHORE

CRYSTAL BAY

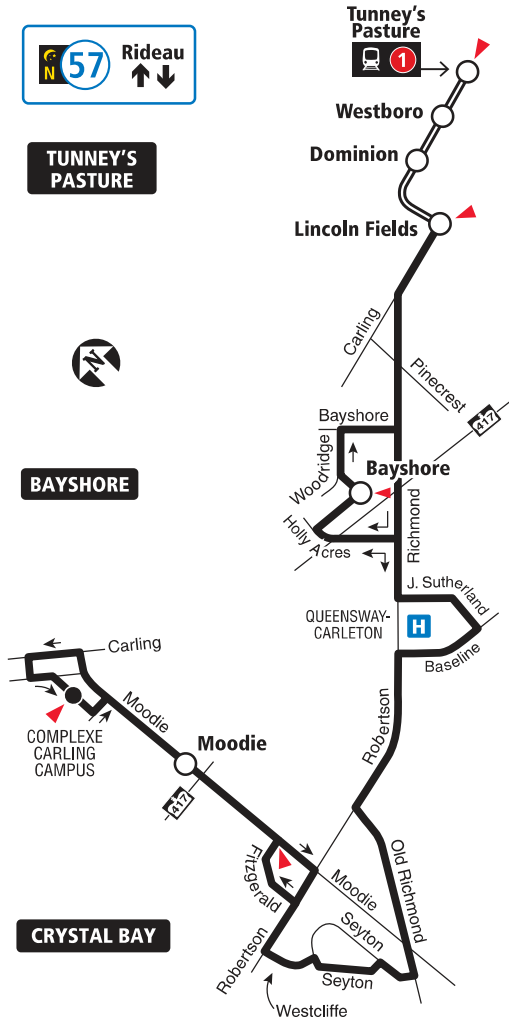

- Transitway & Station
- Timepoint | Heures de passage

When O-Train Line 1 is not running overnight, Route 57 will be extended downtown to Rideau Station. / Lorsque la Ligne 1 de l'O-Train ne circule pas la nuit, le circuit 57 sera prolongée au centre-ville jusqu'à la station Rideau.

2021.09



Schedule / Horaire 613-560-1000

Text / Texto* 560560

plus your four digit bus stop number / plus votre numéro d'arrêt à quatre chiffres

*Standard message rates may apply / Les tarifs réguliers de messagerie texte peuvent s'appliquer

Customer Service
Service à la clientèle 613-560-5000

Lost and Found / Objets perdus..... 613-563-4011

Security / Sécurité 613-741-2478

Effective September 5, 2021

En vigueur 5 septembre 2021



INFO 613-560-5000
octranspo.com



**TERRY FOX
STITTSVILLE**
**TUNNEY'S PASTURE
GATINEAU**

Rapide

7 days a week / 7 jours par semaine

All day service and limited overnight
Service toute la journée et limité la nuit

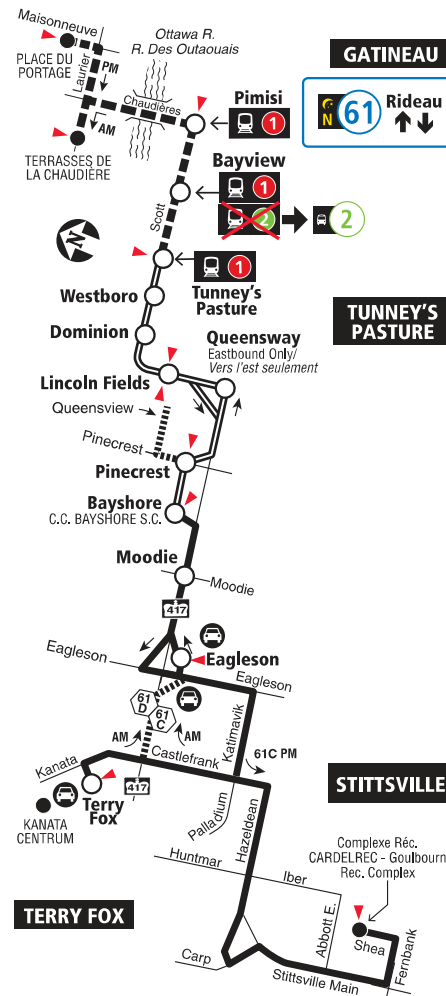

- Transitway & Station
- Peak trips / Trajets de pointe
- Selected time periods / Périodes sélectionnées
- Park & Ride / Parc-o-bus
- Timepoint / Heures de passage

61 When O-Train Line 1 is not running overnight, Route 61 will be extended downtown to Rideau Station. / Lorsque la Ligne 1 de l'O-Train ne circule pas la nuit, le circuit 61 sera prolongée au centre-ville jusqu'à la station Rideau.

2021.09

Schedule / Horaire 613-560-1000
Text / Texto* 560560
plus your four digit bus stop number / plus votre numéro d'arrêt à quatre chiffres

Customer Service
Service à la clientèle **613-560-5000**
Lost and Found / Objets perdus..... **613-563-4011**
Security / Sécurité **613-741-2478**

Effective September 5, 2021
En vigueur 5 septembre 2021

OC Transpo INFO 613-560-5000
octranspo.com



**TERRY FOX
STITTSVILLE
TUNNEY'S PASTURE**

TUNNEY'S PASTURE

TERRY FOX

STITTSVILLE

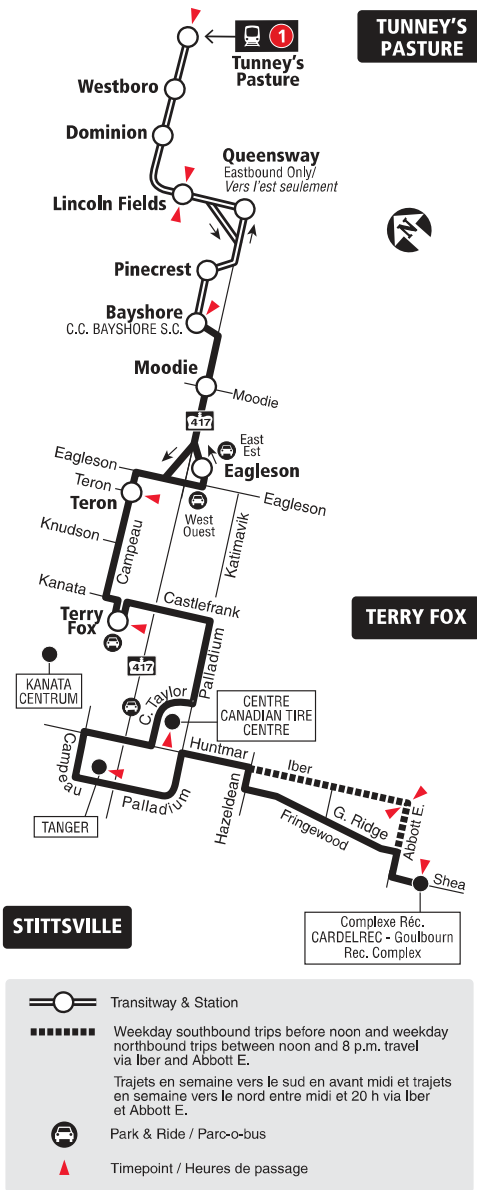

7 days a week / 7 jours par semaine
All day service
Service toute la journée

2021.09

Schedule / Horaire 613-560-1000
Text / Texto* 560560
plus your four digit bus stop number / plus votre numéro d'arrêt à quatre chiffres

*Standard message rates may apply / Les tarifs réguliers de messagerie texte peuvent s'appliquer

Customer Service
Service à la clientèle **613-560-5000**
Lost and Found / Objets perdus **613-563-4011**
Security / Sécurité **613-741-2478**

Effective September 5, 2021
En vigueur 5 septembre 2021

OC Transpo INFO 613-560-5000
octranspo.com



**INNOVATION
BRIARBROOK
TUNNEY'S PASTURE
GATINEAU**

7 days a week / 7 jours par semaine
All day service
Service toute la journée

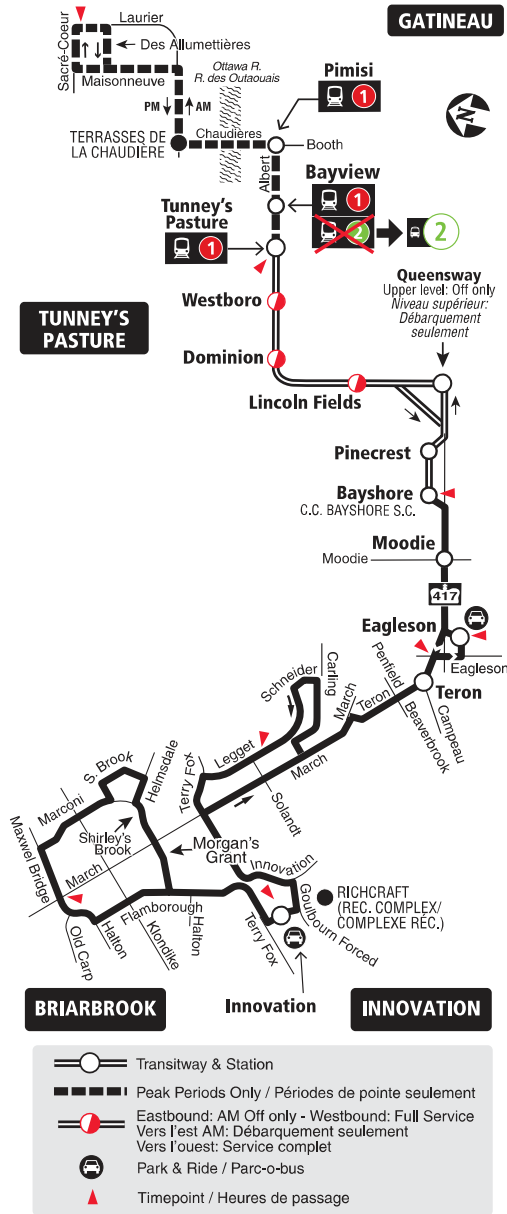

2021.09

Schedule / Horaire 613-560-1000
Text / Texto* 560560
plus your four digit bus stop number / plus votre numéro d'arrêt à quatre chiffres
*Standard message rates may apply / Les tarifs réguliers de messagerie texte peuvent s'appliquer

Customer Service
 Service à la clientèle **613-560-5000**

Lost and Found / Objets perdus..... 613-563-4011

Security / Sécurité 613-741-2478

Effective September 5, 2021
En vigueur 5 septembre 2021

OC Transpo INFO 613-560-5000
 octranspo.com



64

MORGAN'S GRANT INNOVATION TUNNEY'S PASTURE

Local

Monday to Friday / Lundi au vendredi

All day service
Service toute la journée

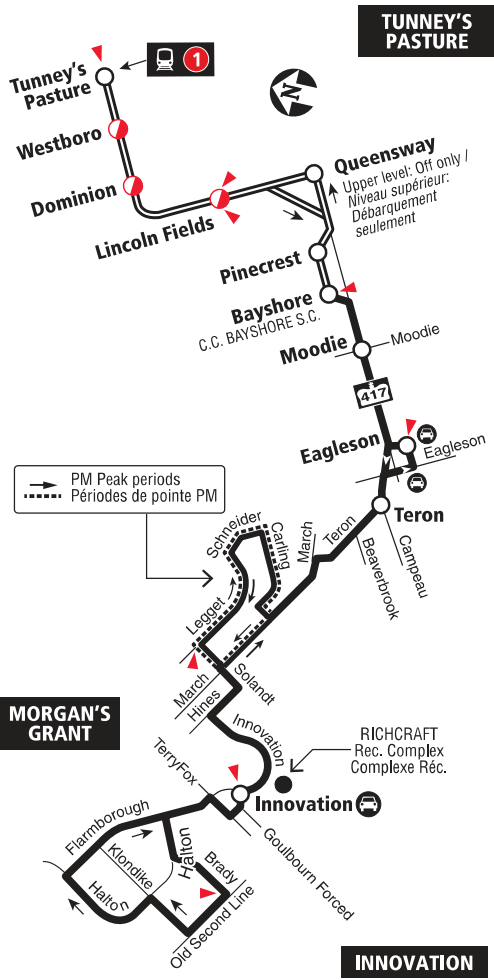

- Transitway & Station
- Eastbound: AM Off only - Westbound: Full Service
Vers l'est AM: Débarquement seulement
Vers l'ouest: Service complet
- Park & Ride / Parc-o-bus
- Timepoint / Heures de passage

2021.09

Schedule / Horaire 613-560-1000
Text / Texto* 560560
plus your four digit bus stop number / plus votre numéro d'arrêt à quatre chiffres
*Standard message rates may apply / Les tarifs réguliers de messagerie texte peuvent s'appliquer

Customer Service
Service à la clientèle **613-560-5000**
 Lost and Found / Objets perdus **613-563-4011**
 Security / Sécurité **613-741-2478**

Effective September 5, 2021
En vigueur 5 septembre 2021

66

KANATA TUNNEY'S PASTURE GATINEAU

Local

Monday to Friday / Lundi au vendredi

Peak periods only

Périodes de pointe seulement

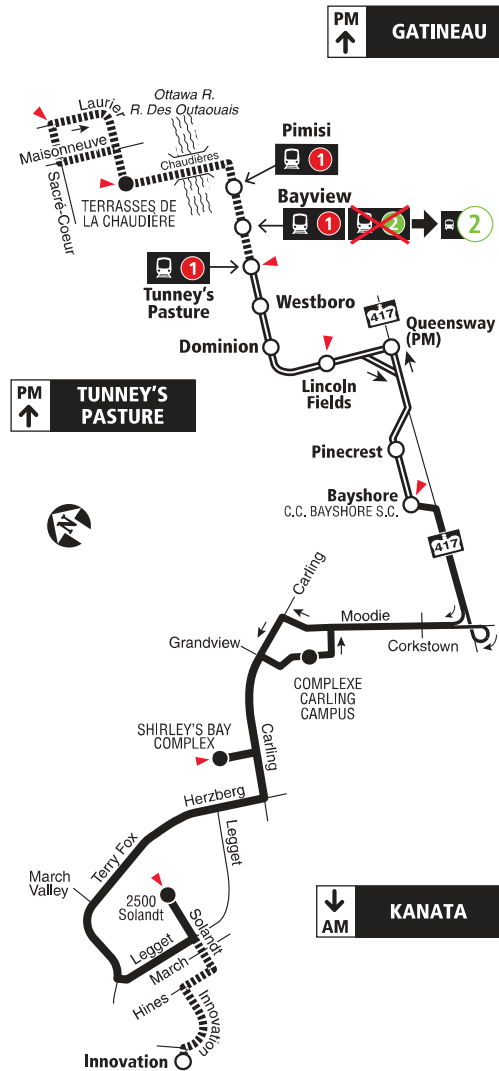

- Transitway & Station
- Some trips / Quelques trajets
- Timepoint / Heures de passage

2021.09

Schedule / Horaire 613-560-1000
Text / Texto* 560560
plus your four digit bus stop number / plus votre numéro d'arrêt à quatre chiffres
*Standard message rates may apply / Les tarifs réguliers de messagerie texte peuvent s'appliquer

Customer Service
 Service à la clientèle 613-560-5000

Lost and Found / Objets perdus..... 613-563-4011

Security / Sécurité 613-741-2478

Effective September 5, 2021
En vigueur 5 septembre 2021

INFO 613-560-5000
 octranspo.com



67

COPE TUNNEY'S PASTURE TERRY FOX

Local

Monday to Friday / lundi au vendredi
All day service
Service toute la journée

TUNNEY'S PASTURE

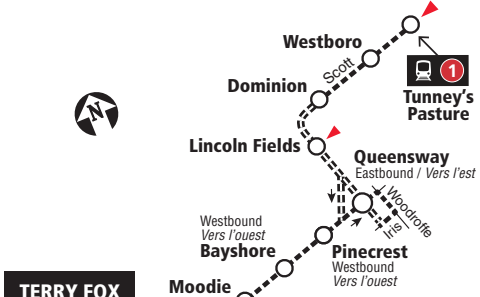

TERRY FOX

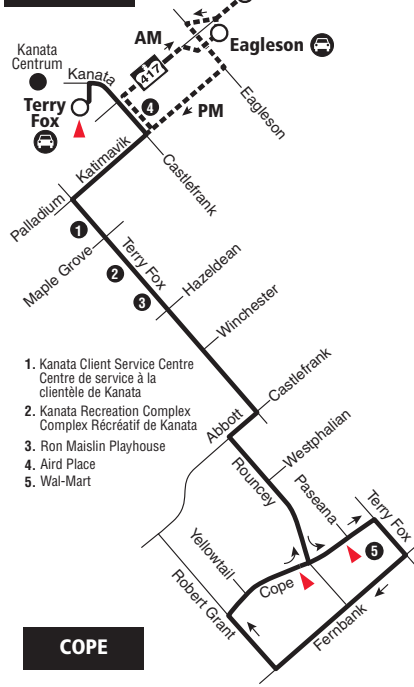

- 1. Kanata Client Service Centre
Centre de service à la clientèle de Kanata
- 2. Kanata Recreation Complex
Complex Récréatif de Kanata
- 3. Ron Maislin Playhouse
- 4. Aird Place
- 5. Wal-Mart

COPE

- Transitway & Station
- Peak Periods Only / Périodes de pointe seulement
- Park & Ride / Parc-o-bus
- Timepoint / Heures de passage

2022.05

2022.06

Schedule / Horaire 613-560-1000

Text / Texto* 560560

plus your four digit bus stop number / plus votre numéro d'arrêt à quatre chiffres

*Standard message rates may apply / Les tarifs réguliers de messagerie texte peuvent s'appliquer

Customer Service
Service à la clientèle **613-560-5000**

Lost and Found / Objets perdus **613-563-4011**

Security / Sécurité **613-741-2478**

Effective June 26, 2022
En vigueur 26 juin 2022

INFO 613-560-5000
octranspo.com



73

LEIKIN TUNNEY'S PASTURE

Local

Monday to Friday / Lundi au vendredi

Peak periods only

Périodes de pointe seulement

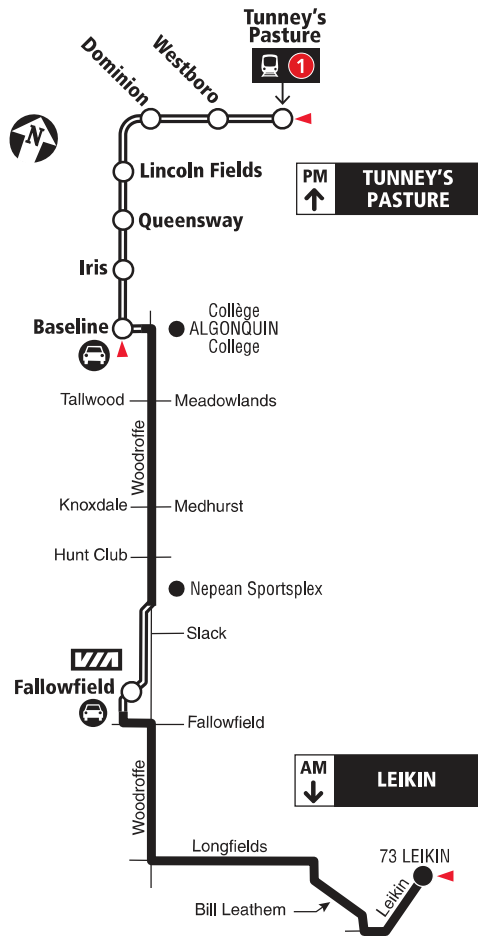

	Transitway & Station
	Park & Ride / Parc-o-bus
	Timepoint / Heures de passage

2019.07

Future route after O-Train Line 1 is open
Trajet du circuit après l'ouverture de la Ligne 1 de l'O-Train

Lost and Found / Objets perdus..... 613-563-4011
 Security / Sécurité 613-741-2478

INFO 613-741-4390
 octranspo.com



**NEPEAN WOODS
TUNNEY'S PASTURE**

Rapid

7 days a week / 7 jours par semaine

All day service
Service toute la journée

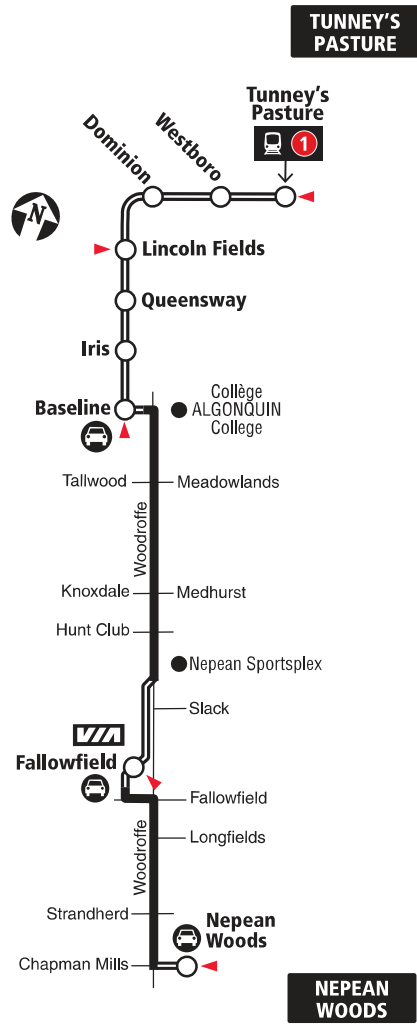

2021.06

Schedule / Horaire 613-560-1000
Text / Texto* 560560
plus your four digit bus stop number / plus votre numéro d'arrêt à quatre chiffres
*Standard message rates may apply / Les tarifs réguliers de messagerie texte peuvent s'appliquer

- Customer Service / Service à la clientèle 613-560-5000
- Lost and Found / Objets perdus 613-563-4011
- Security / Sécurité 613-741-2478

**Effective June 20, 2021
En vigueur 20 juin 2021**



**CAMBRIAN
BARRHAVEN C.
TUNNEY'S PASTURE
GATINEAU**

7 days a week / 7 jours par semaine
All day service and limited overnight
Service toute la journée et limité la nuit

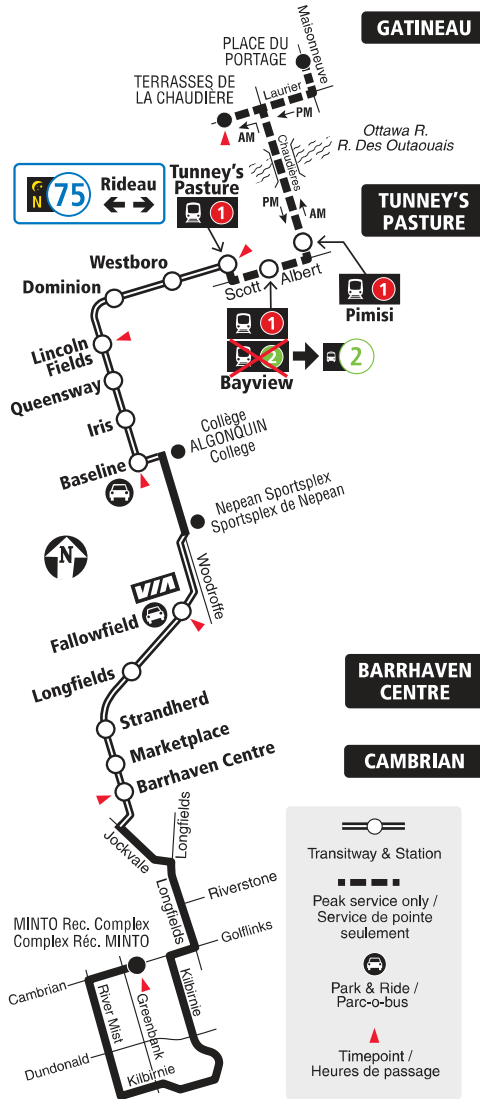

75 When O-Train Line 1 is not running overnight, Route 75 will be extended downtown to Rideau Station. / Lorsque la ligne 1 de l'O-Train ne circule pas la nuit, le circuit 75 sera prolongée au centre-ville jusqu'à la station Rideau.

2020.04

Schedule / Horaire.....613-560-1000
Text / Texto560560
plus your four digit bus stop number / plus votre numéro d'arrêt à quatre chiffres

Customer Service
Service à la clientèle **613-741-4390**
Lost and Found / Objets perdus..... **613-563-4011**
Security / Sécurité..... **613-741-2478**

Effective May 3, 2020
En vigueur 3 mai 2020



81

CLYDE TUNNEY'S PASTURE

Local

7 days a week / 7 jours par semaine

No service in the evening on weekends
Aucun service le soir les fins de semaine

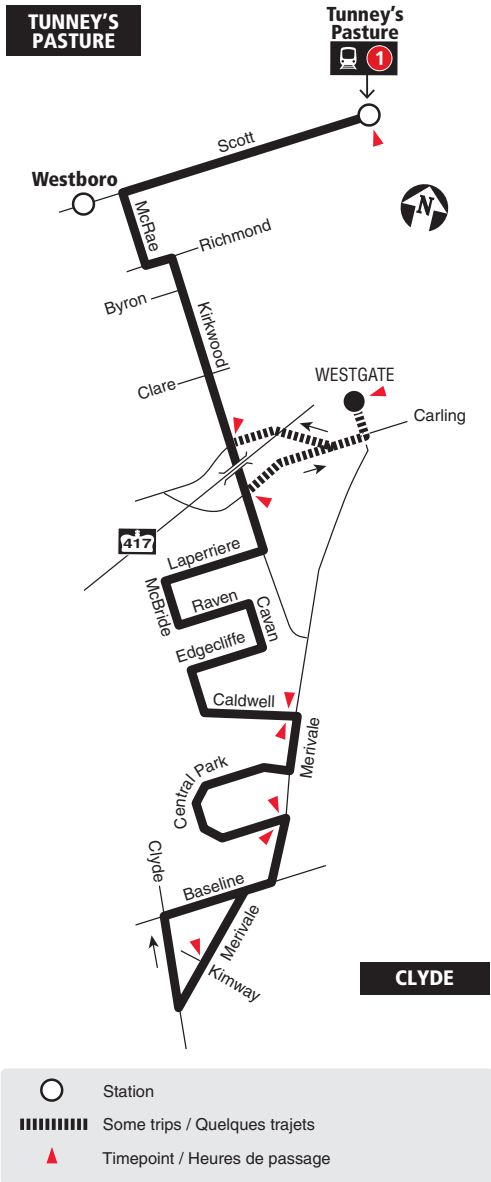

2019.07

**Future route after O-Train Line 1 is open
Trajet du circuit après l'ouverture
de la Ligne 1 de l'O-Train**

Lost and Found / Objets perdus..... 613-563-4011
 Security / Sécurité..... 613-741-2478

OC Transpo INFO 613-741-4390
 octranspo.com



82

BAYSHORE LINCOLN FIELDS TUNNEY'S PASTURE

Local

7 days a week / 7 jours par semaine

All day service
Service toute la journée

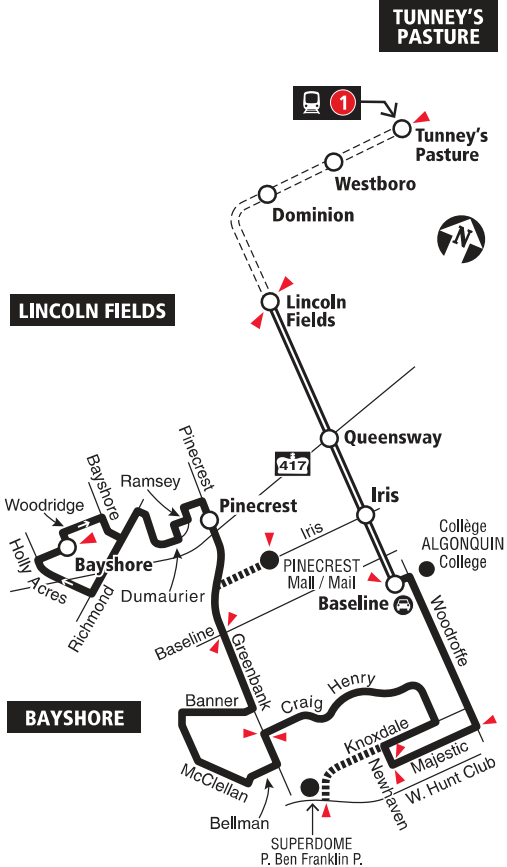

- Transitway & Station
- Transitway & Station (Peak periods / périodes de pointe)
- Park & Ride / Parc-o-bus
- Some trips / Quelques trajets
- Timepoint / Heures de passage

2021.06

Schedule / Horaire 613-560-1000
Text / Texto* 560560
plus your four digit bus stop number / plus votre numéro d'arrêt à quatre chiffres
*Standard message rates may apply / Les tarifs réguliers de messagerie texte peuvent s'appliquer

Customer Service
Service à la clientèle **613-741-4390**
 Lost and Found / Objets perdus..... **613-563-4011**
 Security / Sécurité **613-741-2478**

Effective June 20, 2021
En vigueur 20 juin 2021



87

BASELINE TUNNEY'S PASTURE

Fréquent

7 days a week / 7 jours par semaine

All day service
Service toute la journée

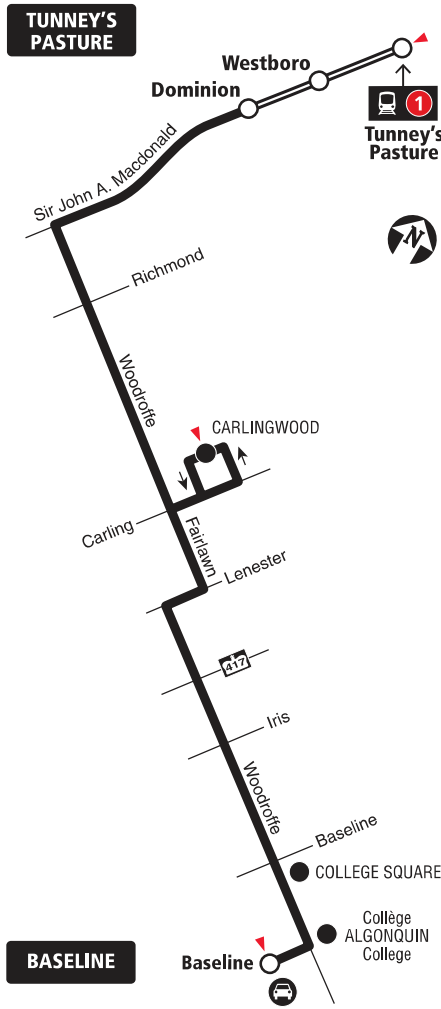

- Transitway & Station
- Park & Ride / Parc-o-bus
- Timepoint / Heures de passage

2019.07

Future route after O-Train Line 1 is open
Trajet du circuit après l'ouverture de la Ligne 1 de l'O-Train

Lost and Found / Objets perdus..... 613-563-4011
 Security / Sécurité..... 613-741-2478

OC Transpo INFO 613-741-4390
 octranspo.com



153

LINCOLN FIELDS TUNNEY'S PASTURE CARLINGWOOD

Local

7 days a week / 7 jours par semaine

Selected time periods only
Périodes sélectionnées seulement



- Station
- Some trips / Quelques trajets
- ▲ Timepoint / Heures de passage

2019.10

 **Schedule / Horaire.....613-560-1000**
Text / Texto560560
plus your four digit bus stop number / plus votre numéro d'arrêt à quatre chiffres

Customer Relations
 Service à la clientèle **613-842-3600**
 Lost and Found / Objets perdus..... **613-563-4011**
 Security / Sécurité **613-741-2478**

Effective October 6, 2019
En vigueur 6 octobre 2019

 **INFO 613-741-4390**
 octranspo.com



164

TERRY FOX HOPE SIDE

Local

Monday to Friday/ Lundi au vendredi

Peak periods only
Périodes de pointe seulement

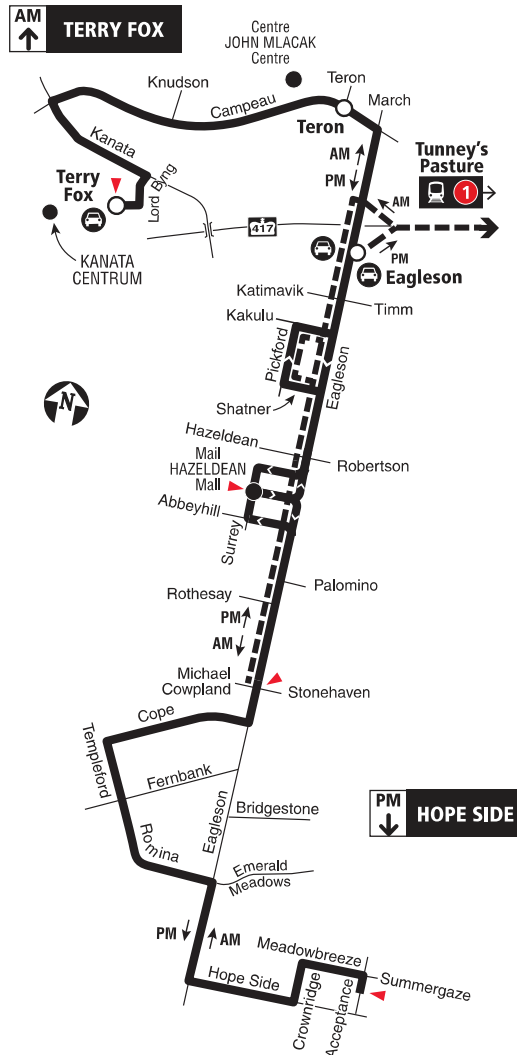

2020.12



Schedule / Horaire.....613-560-1000

Text / Texto560560

plus your four digit bus stop number / plus votre numéro d'arrêt à quatre chiffres

Customer Service
Service à la clientèle 613-741-4390

Lost and Found / Objets perdus..... 613-563-4011

Security / Sécurité..... 613-741-2478

Effective December 21, 2020

En vigueur 21 décembre 2020



INFO 613-741-4390
octranspo.com



252

TUNNEY'S PASTURE TEMPLEFORD

Connexion

Monday to Friday / Lundi au vendredi

Peak periods only

Périodes de pointe seulement

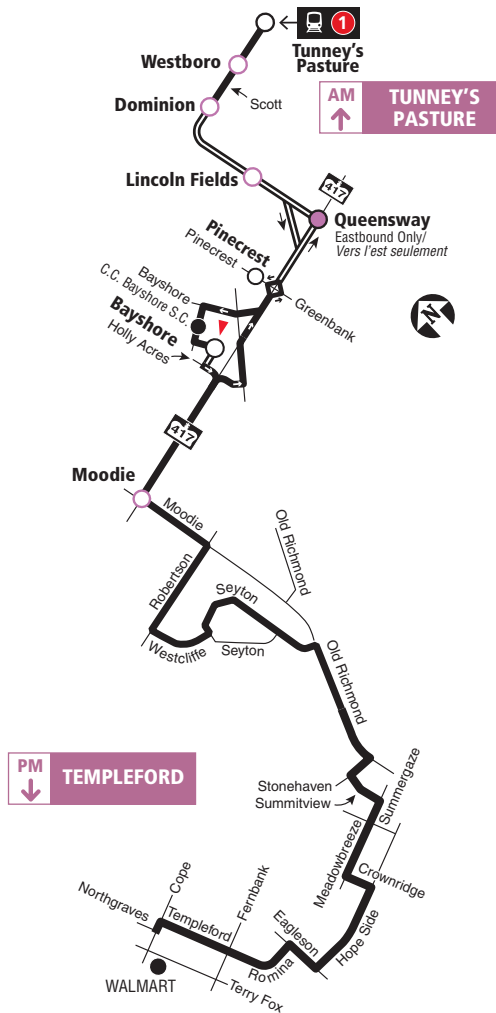

- Transitway & Station
- Limited stops: Off only in AM / No stop in PM
Arrêts limités : débarquement en AM seul. / aucun arrêt en PM
- AM: Off only - PM: Full Service
AM : débarquement seul. - PM : service complet

2022.06



Schedule / Horaire 613-560-1000

Text / Texto* 560560

plus your four digit bus stop number / plus votre numéro d'arrêt à quatre chiffres

*Standard message rates may apply / Les tarifs réguliers de messagerie texte peuvent s'appliquer

Customer Service

Service à la clientèle 613-560-5000

Lost and Found / Objets perdus 613-563-4011

Security / Sécurité 613-741-2478

Effective June 26, 2022

En vigueur 26 juin 2022



INFO 613-560-5000
octranspo.com



256

BRIDLEWOOD TUNNEY'S PASTURE

Connexion

Monday to Friday / Lundi au vendredi

Peak periods only

Périodes de pointe seulement

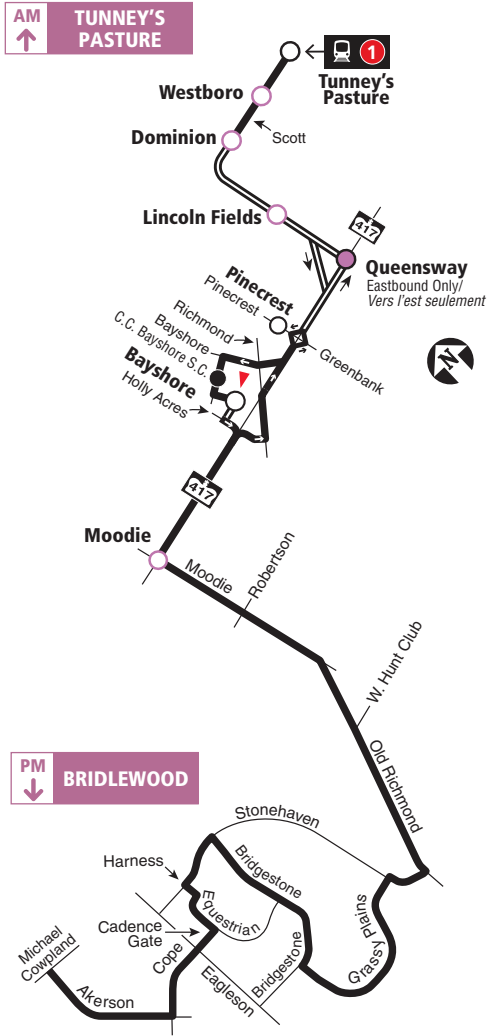

- Transitway & Station
- Limited stops: Off only in AM / No stop in PM
Arrêts limités : débarquement en AM seulement / aucun arrêt en PM
- AM: Off only - PM: Full Service
AM : débarquement seul. - PM : service complet

2022.06

Schedule / Horaire 613-560-1000

Text / Texto* 560560

plus your four digit bus stop number / plus votre numéro d'arrêt à quatre chiffres

*Standard message rates may apply / Les tarifs réguliers de messagerie texte peuvent s'appliquer

Customer Service
Service à la clientèle **613-560-5000**

Lost and Found / Objets perdus **613-563-4011**

Security / Sécurité **613-741-2478**

Effective June 26, 2022
En vigueur 26 juin 2022

INFO 613-560-5000
octranspo.com



257

BRIDLEWOOD TUNNEY'S PASTURE

Connexion

Monday to Friday / Lundi au vendredi

Peak periods only

Périodes de pointe seulement

AM
↑
TUNNEY'S PASTURE

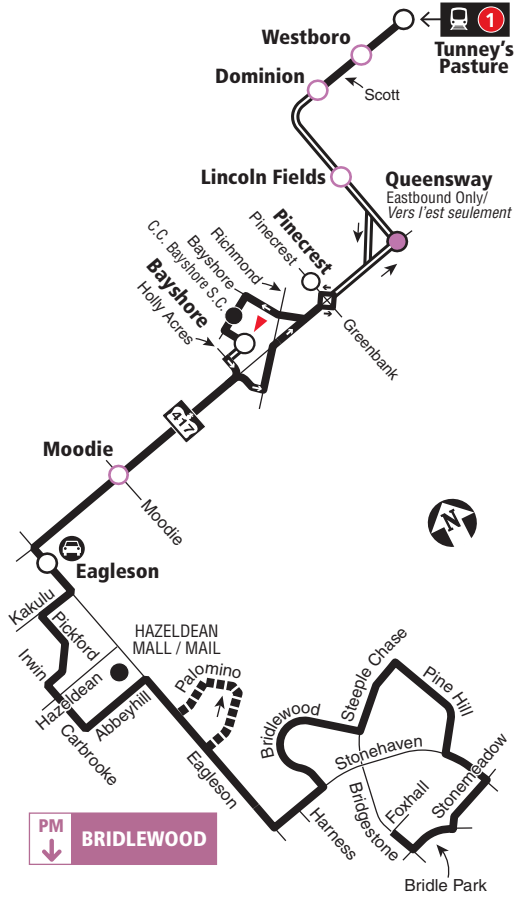

PM
↓
BRIDLEWOOD

2022.06

- Transitway & Station
- Limited stops: Off only in AM / No stop in PM
Arrêts limités : débarquement en AM seulement / aucun arrêt en PM
- AM: Off only - PM: Full Service
AM : débarquement seul. - PM : service complet
- Limited service (AM only)
Service limité (AM seulement)
- Park & Ride / Parc-o-bus

2022.06

Schedule / Horaire 613-560-1000
Text / Texto* 560560
plus your four digit bus stop number / plus votre numéro d'arrêt à quatre chiffres
*Standard message rates may apply / Les tarifs réguliers de messagerie texte peuvent s'appliquer

Customer Service
Service à la clientèle **613-560-5000**

Lost and Found / Objets perdus **613-563-4011**

Security / Sécurité **613-741-2478**

Effective June 26, 2022
En vigueur 26 juin 2022



258

GRANDVIEW TUNNEY'S PASTURE

Connexion

Monday to Friday / Lundi au vendredi

Peak periods only

Périodes de pointe seulement

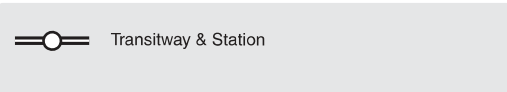
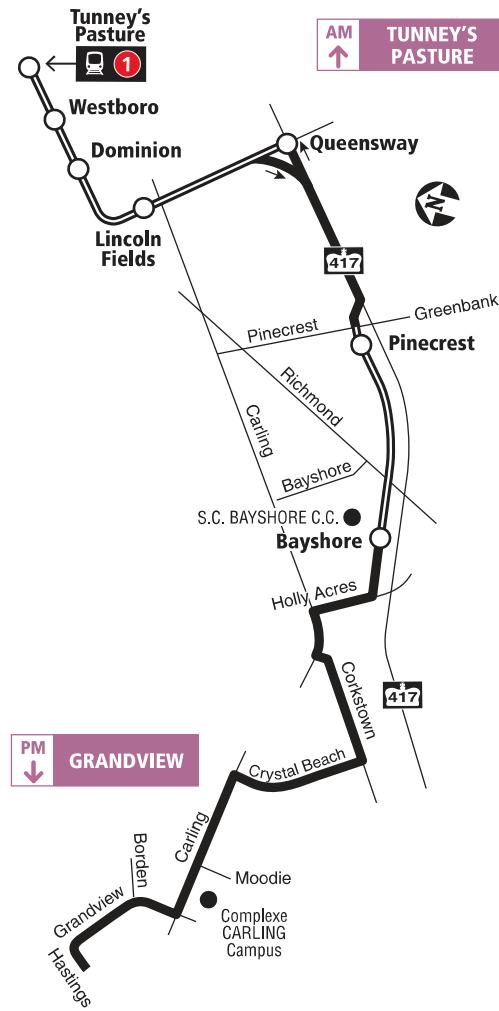

2020.01

Schedule / Horaire.....613-560-1000
Text / Texto560560
plus your four digit bus stop number / plus votre numéro d'arrêt à quatre chiffres

Customer Service
 Service à la clientèle **613-741-4390**

Lost and Found / Objets perdus..... **613-563-4011**
 Security / Sécurité **613-741-2478**

Effective January 5, 2020
En vigueur 5 janvier 2020

INFO 613-741-4390
 octranspo.com

261

STITTSVILLE MAIN TUNNEY'S PASTURE

Connexion

Monday to Friday / Lundi au vendredi

Peak periods only
Périodes de pointe seulement

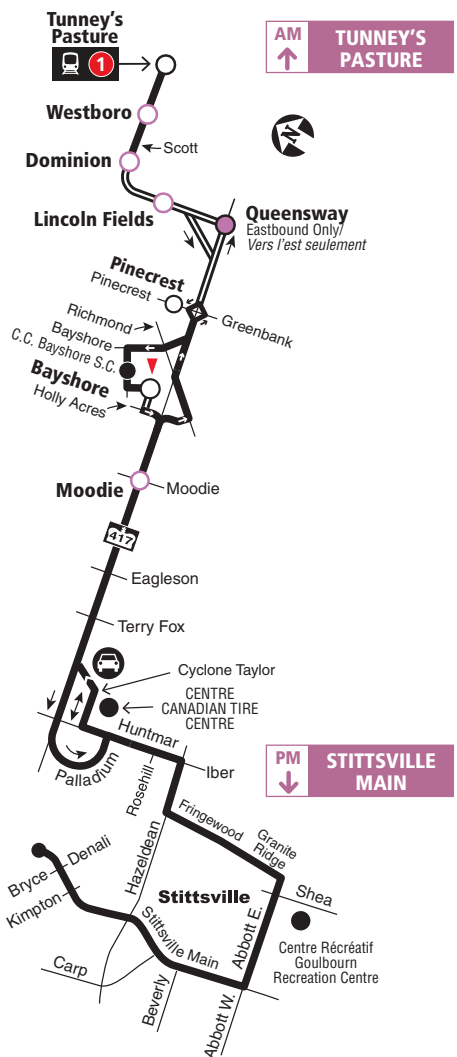

- Transitway & Station
- Limited stops: Off only in AM / No stop in PM
Arrêts limités : débarquement en AM seul. / aucun arrêt en PM
- AM: Off only - PM: Full Service
AM : débarquement seul. - PM : service complet
- Park & Ride / Parc-o-bus

2022.06

2022.06

Schedule / Horaire 613-560-1000
Text / Texto* 560560
plus your four digit bus stop number / plus votre numéro d'arrêt à quatre chiffres
*Standard message rates may apply / Les tarifs réguliers de messagerie texte peuvent s'appliquer

- Customer Service / Service à la clientèle **613-560-5000**
- Lost and Found / Objets perdus **613-563-4011**
- Security / Sécurité **613-741-2478**

**Effective June 26, 2022
En vigueur 26 juin 2022**



262

WEST RIDGE TUNNEY'S PASTURE

Connexion

Monday to Friday / Lundi au vendredi

Peak periods only
Périodes de pointe seulement

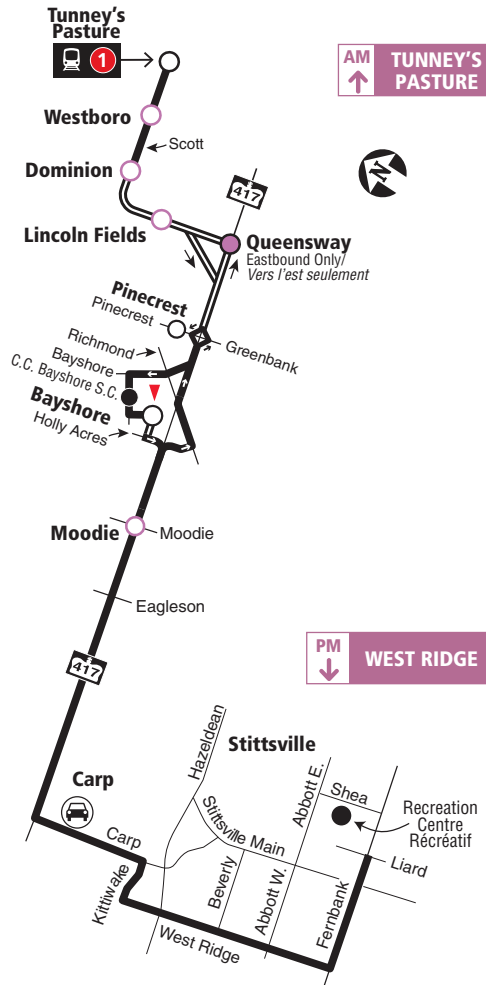

- Transitway & Station
- Limited stops: Off only in AM / No stop in PM
Arrêts limités : débarquement en AM seul. / aucun arrêt en PM
- AM: Off only - PM: Full Service
AM : débarquement seul. - PM : service complet
- Park & Ride / Parc-o-bus

2022.06

2022.06

Schedule / Horaire 613-560-1000
Text / Texto* 560560
plus your four digit bus stop number / plus votre numéro d'arrêt à quatre chiffres
*Standard message rates may apply / Les tarifs réguliers de messagerie texte peuvent s'appliquer

Customer Service
 Service à la clientèle **613-560-5000**
 Lost and Found / Objets perdus **613-563-4011**
 Security / Sécurité **613-741-2478**

Effective June 26, 2022
En vigueur 26 juin 2022



263

STANLEY CORNERS TUNNEY'S PASTURE

Connexion

Monday to Friday / Lundi au vendredi

Peak periods only

Périodes de pointe seulement

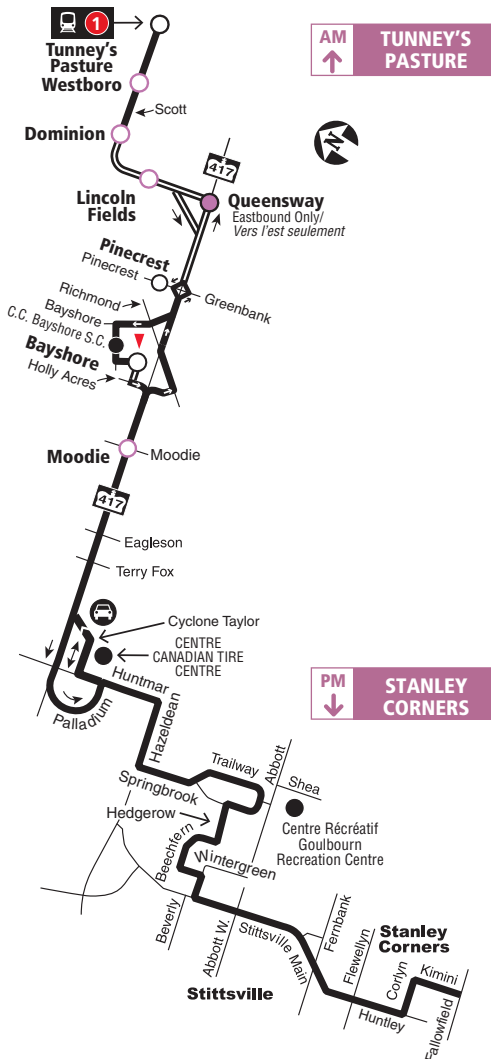

2022.06



Schedule / Horaire 613-560-1000

Text / Texto* 560560

plus your four digit bus stop number / plus votre numéro d'arrêt à quatre chiffres

*Standard message rates may apply / Les tarifs réguliers de messagerie texte peuvent s'appliquer

Customer Service

Service à la clientèle 613-560-5000

Lost and Found / Objets perdus..... 613-563-4011

Security / Sécurité 613-741-2478

Effective June 26, 2022

En vigueur 26 juin 2022



INFO 613-560-5000
octranspo.com



264

TERRY FOX TUNNEY'S PASTURE

Connexion

Monday to Friday / Lundi au vendredi

Peak periods only

Périodes de pointe seulement

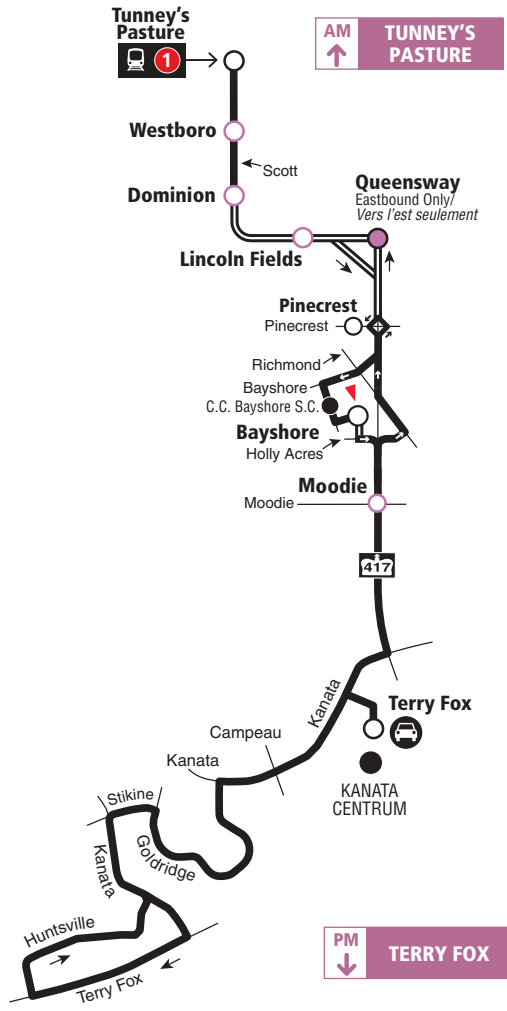

2022.06

- Transitway & Station
- Limited stops: Off only in AM / No stop in PM
Arrêts limités : débarquement en AM seul. / aucun arrêt en PM
- AM: Off only - PM: Full Service
AM : débarquement seul. - PM : service complet
- Park & Ride / Parc-o-bus

2022.06

Schedule / Horaire 613-560-1000
Text / Texto* 560560
plus your four digit bus stop number / plus votre numéro d'arrêt à quatre chiffres
*Standard message rates may apply / Les tarifs réguliers de messagerie texte peuvent s'appliquer

Customer Service
 Service à la clientèle 613-560-5000
 Lost and Found / Objets perdus 613-563-4011
 Security / Sécurité 613-741-2478

Effective June 26, 2022
En vigueur 26 juin 2022



265

BEAVERBROOK TUNNEY'S PASTURE

Connexion

Monday to Friday / Lundi au vendredi

Peak periods only

Périodes de pointe seulement

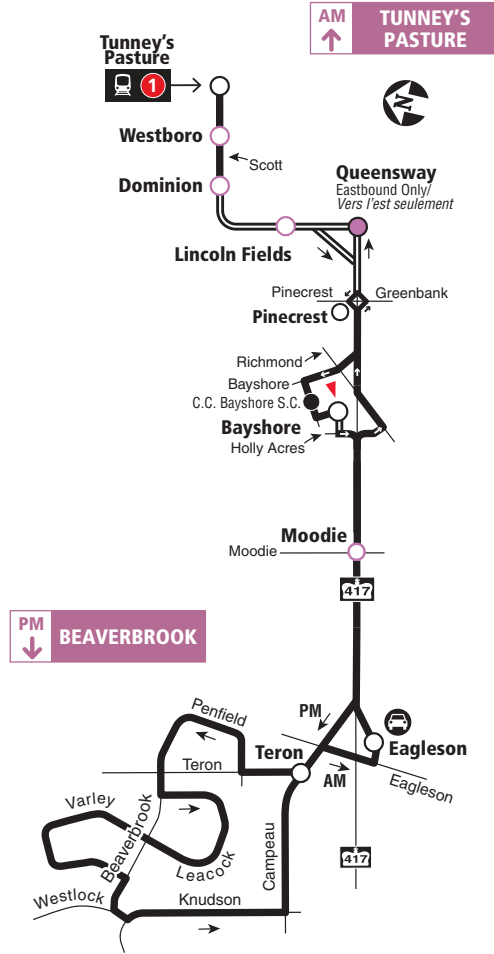

2022.06

- Transitway & Station
- Limited stops: Off only in AM / No stop in PM
Arrêts limités : débarquement en AM seul. / aucun arrêt en PM
- AM: Off only - PM: Full Service
AM : débarquement seul. - PM : service complet
- Park & Ride / Parc-o-bus

2022.06

Schedule / Horaire 613-560-1000
Text / Texto* 560560
plus your four digit bus stop number / plus votre numéro d'arrêt à quatre chiffres
*Standard message rates may apply / Les tarifs réguliers de messagerie texte peuvent s'appliquer

Customer Service
 Service à la clientèle **613-560-5000**
 Lost and Found / Objets perdus **613-563-4011**
 Security / Sécurité **613-741-2478**

Effective June 26, 2022
En vigueur 26 juin 2022



267

GLEN CAIRN TUNNEY'S PASTURE

Connexion

Monday to Friday / Lundi au vendredi

Peak periods only

Périodes de pointe seulement

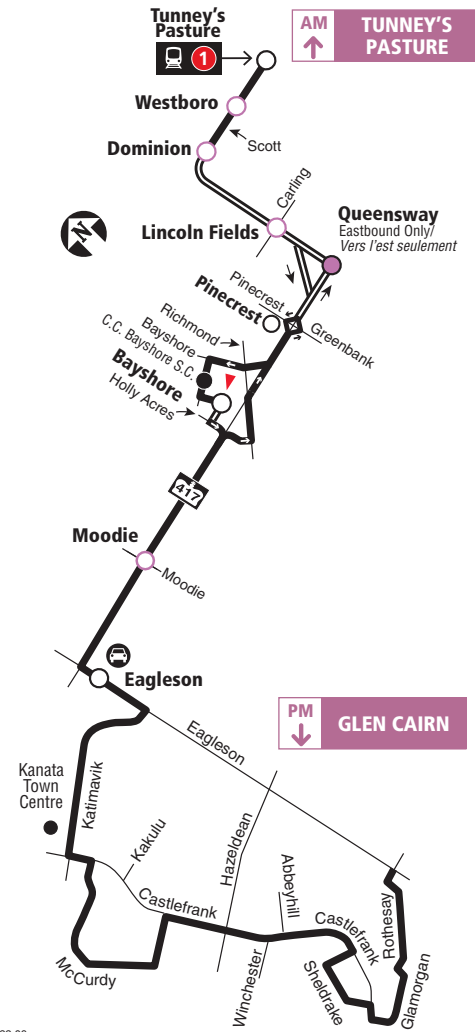

2022.06

- Transitway & Station
- Limited stops: Off only in AM / No stop in PM
Arrêts limités : débarquement en AM seul. / aucun arrêt en PM
- AM: Off only - PM: Full Service
AM : débarquement seul. - PM : service complet
- Park & Ride / Parc-o-bus

2022.06

Schedule / Horaire 613-560-1000
Text / Texto* 560560
plus your four digit bus stop number / plus votre numéro d'arrêt à quatre chiffres
*Standard message rates may apply / Les tarifs réguliers de messagerie texte peuvent s'appliquer

Customer Service
 Service à la clientèle 613-560-5000
 Lost and Found / Objets perdus..... 613-563-4011
 Security / Sécurité 613-741-2478

Effective June 26, 2022
En vigueur 26 juin 2022



268

KANATA LAKES TUNNEY'S PASTURE

Connexion

Monday to Friday / Lundi au vendredi

Peak periods only

Périodes de pointe seulement

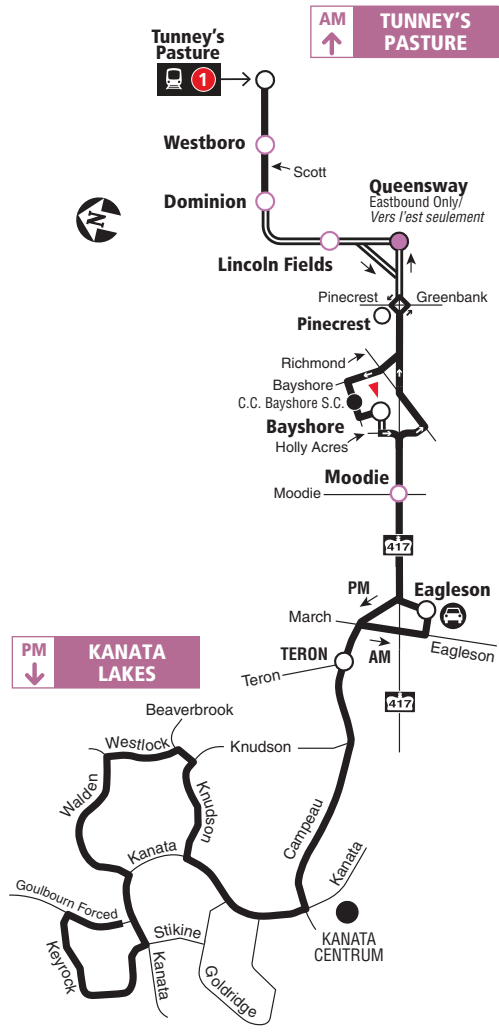

PM
↓
KANATA LAKES

AM
↑
TUNNEY'S PASTURE

2022.06

- Transitway & Station
- Limited stops: Off only in AM / No stop in PM
Arrêts limités : débarquement en AM seul. / aucun arrêt en PM
- AM: Off only - PM: Full Service
AM : débarquement seul. - PM : service complet
- Park & Ride / Parc-o-bus

2022.06

Schedule / Horaire 613-560-1000
Text / Texto* 560560
plus your four digit bus stop number / plus votre numéro d'arrêt à quatre chiffres
*Standard message rates may apply / Les tarifs réguliers de messagerie texte peuvent s'appliquer

Customer Service
 Service à la clientèle **613-560-5000**
 Lost and Found / Objets perdus **613-563-4011**
 Security / Sécurité **613-741-2478**

Effective June 26, 2022
En vigueur 26 juin 2022



282

TREND-ARLINGTON TUNNEY'S PASTURE

Connexion

Monday to Friday / Lundi au vendredi

Peak periods only

Périodes de pointe seulement

AM
↑
TUNNEY'S PASTURE

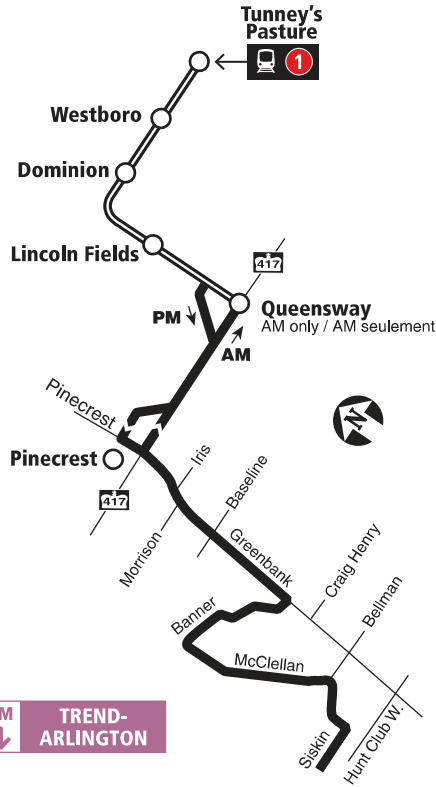

PM
↓
TREND-ARLINGTON

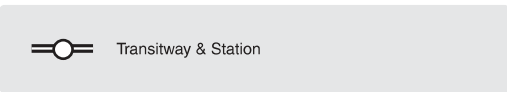

2020.01



Schedule / Horaire..... 613-560-1000

Text / Texto560560

plus your four digit bus stop number / plus votre numéro d'arrêt à quatre chiffres

Customer Service

Service à la clientèle **613-741-4390**

Lost and Found / Objets perdus..... **613-563-4011**

Security / Sécurité **613-741-2478**

Effective January 5, 2020

En vigueur 5 janvier 2020



INFO 613-741-4390
octranspo.com

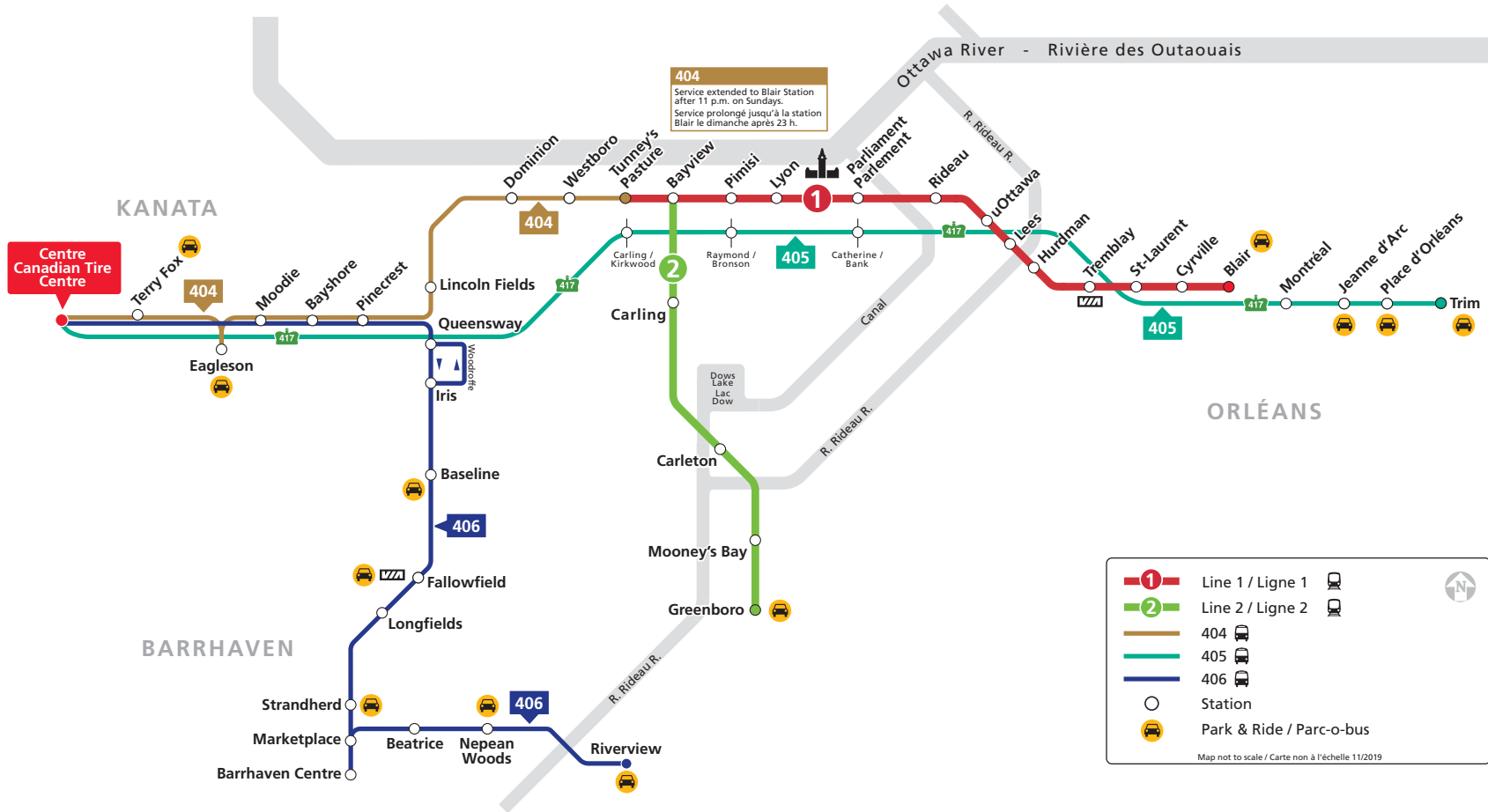

Joshua Audia

Subject: Request for Transit Data - Westboro/Scott St (2026 Scott Street)

From: Rathwell, Graham <graham.rathwell@ottawa.ca>

Sent: Monday, December 20, 2021 4:58:52 PM

To: Rochelle Fortier <r.fortier@novatech-eng.com>

Cc: Patrick Hatton <p.hatton@novatech-eng.com>; Brad Byvelds <B.Byvelds@novatech-eng.com>; Jennifer Luong <j.luong@novatech-eng.com>

Subject: RE: Request for Transit Data - Westboro/Scott St (2026 Scott Street)

And here is the table for 2026 Scott. All of the same comments apply. Please let me know if there are any questions.

Stop	Stop Location	Route	Dir	AM (6:00-9:00)			PM (15:00-18:00)			24-hr		
				Boardings	Alightings	Avg Load at Departure	Boardings	Alightings	Avg Load at Departure	Boardings	Alightings	Avg Load at Departure
4841	MCRAE / SCOTT	81	EB	0	10	15	1	6	6	7	27	7
		153	WB	-	-	-	2	1	5	3	1	5
4864	RICHMOND / EDEN	11	WB	1	13	8	1	7	21	6	31	12
4865	RICHMOND / EDGEWOOD	11	EB	4	0	17	4	0	13	12	3	11
4884	CHURCHILL / WORKMAN	16	EB	8	0	3	1	0	1	18	0	1
4893	MCRAE / SCOTT	81	WB	0	2	5	3	3	14	6	8	8
		153	EB	-	-	-	0	0	5	1	0	3
5615	CHURCHILL / TRANSIT BRIDGE	16	WB	0	5	3	0	6	2	0	21	2
7379	CHURCHILL / SCOTT	50	EB	5	0	21	0	3	10	8	3	11
		153	EB	-	-	-	1	1	4	3	1	3
7380	CHURCHILL / SCOTT	50	WB	2	2	12	1	3	16	4	10	10
		153	WB	-	-	-	0	0	5	0	0	4
3012	WESTBORO 1A	57	WB	3	12	8	15	45	33	34	101	16
		58	EB	6	0	7	2	0	15	8	0	11
		61	WB	10	10	15	45	111	43	81	185	31
		62	WB	4	1	21	13	25	30	21	54	22
		63	IB	22	16	13	12	47	33	40	103	19
		64	IB	11	12	12	16	17	20	29	50	14
66	WB	21	25	30	-	-	-	23	29	29		
3012	WESTBORO 1B	73	SB	7	0	9	-	-	-	7	0	8
		74	SB	5	2	7	5	3	17	31	15	19
		75	SB	12	3	15	62	64	22	111	104	21
		82	WB	0	1	9	7	4	16	6	5	13

		83	NB	1	1	8	8	0	10	12	2	8
		84	WB	4	2	15	5	0	11	18	3	12
		87	NB	1	3	4	49	14	19	69	23	10
		164	SB	0	4	2	-	-	-	0	4	2
		258	OB	-	-	-	1	0	7	2	0	7
		282	OB	-	-	-	1	0	25	1	0	23
		284	SB	-	-	-	0	2	8	0	2	8
3012	WESTBORO 2A	57	EB	15	9	38	14	8	12	75	31	14
		58	WB	11	2	26	4	1	12	18	4	18
		61	EB	45	8	34	7	11	24	73	29	22
		62	EB	0	0	13	17	6	28	38	19	15
		63	OB	18	1	39	16	12	21	58	24	21
		64	OB	12	6	28	9	7	12	36	13	15
		66	EB	-	-	-	18	23	28	23	27	24
		73	NB	-	-	-	16	11	19	16	11	17
		74	NB	14	9	36	11	12	22	55	51	29
		75	NB	58	15	47	18	13	34	131	87	30
		82	EB	20	1	29	8	5	15	30	6	20
		83	SB	7	7	21	4	5	11	27	19	17
		84	EB	12	3	27	21	9	19	34	14	20
		87	SB	30	7	22	17	3	11	73	22	10
		164	NB	-	-	-	<i>No data</i>			<i>No data</i>		
		251	IB	4	0	11	-	-	-	4	0	11
		252	IB	2	4	19	-	-	-	6	5	20
		256	IB	4	3	34	-	-	-	4	3	35
		257	IB	7	4	35	-	-	-	7	4	35
		258	IB	19	0	16	-	-	-	19	0	17
		261	IB	2	1	33	-	-	-	2	1	33
		262	IB	0	0	38	-	-	-	0	0	38
		263	IB	0	0	30	-	-	-	0	0	30
		264	IB	0	0	31	-	-	-	0	0	31
		265	IB	0	1	25	-	-	-	0	1	25
		266	IB	5	0	25	-	-	-	5	0	25
		267	IB	2	1	40	-	-	-	3	2	39
		268	IB	1	1	37	-	-	-	1	2	37
282	IB	10	5	33	-	-	-	12	5	33		
283	IB	0	0	3	-	-	-	0	0	3		
284	NB	5	3	19	-	-	-	5	3	17		
3012	WESTBORO 3A	16	EB	11	0	2	6	0	1	30	0	1
		50	WB	6	1	11	12	8	16	24	10	10
		153	WB	-	-	-	0	0	5	0	0	5
3012	WESTBORO 4A	16	WB	0	15	0	0	14	0	0	54	0
		50	EB	2	12	21	0	8	9	2	28	11
		153	EB	-	-	-	0	0	4	0	0	3

3012	WESTBORO STN OFF ONLY	270	IB	6	0	40	-	-	-	5	0	40
		271	IB	1	6	57	-	-	-	1	6	57
		272	IB	3	3	50	-	-	-	4	4	49
		273	IB	5	2	48	-	-	-	5	2	46
		275	IB	5	3	59	-	-	-	8	4	55
		277	IB	7	12	55	-	-	-	9	14	55
		278	IB	3	4	36	-	-	-	4	4	34

Best,

Graham Rathwell

Transit Planner, Network Service Design
 Service Planning Branch
 Transit Services Department
 OC Transpo | City of Ottawa

From: Rathwell, Graham
Sent: December 20, 2021 4:35 PM
To: Rochelle Fortier <r.fortier@novatech-eng.com>
Cc: Patrick Hatton <p.hatton@novatech-eng.com>; Brad Byvelds <B.Byvelds@novatech-eng.com>; Jennifer Luong <j.luong@novatech-eng.com>
Subject: RE: Request for Transit Data - Westboro/Scott St (1950 Scott Street)

Hi again Rochelle,

The technical issues have finally been resolved. Please find below the requested data for 1950 Scott Street in the table below. I will follow-up shortly with a separate email for 2026 Scott Street.

Data was sampled from the period of January 5 to March 16 2020, which is the last 'normal' ridership period before pandemic-related impacts began. Please note that cells with a zero (0) value indicate a measured average value of zero, based on available APC data, rather than an absence of data. Cells with a dash (-) indicate that the route in question does not serve the stop in the given time period.

Further, please note the following for Connexion (200-series) routes serving Westboro Station:

- Routes 258, 282, and 284 are the only Connexion routes that are planned to serve Westboro Station in both directions (inbound AM, outbound PM).
- All other Connexion routes (250s, 260s, 270s, and 280s not listed above) drop-off customers on request only in the AM, and bypass Westboro in the PM.
- Customers are permitted to board these routes in the AM only if they are already stopping to let customers off, otherwise they do not stop.
- AM Connexion service is split between two stops on the same inbound platform: 2A (the main inbound stop with 250s, 260s, 280s), and an off-only stop at the far west end of the platform (270s). These are listed separately in the table below.

- While Connexion routes do not provide an even or consistent level of service at Westboro in the peak periods, it's still important to include the ridership data: taken together, they contribute to the overall total customer flows to/from Westboro that would otherwise need to be accommodated on mainline routes.

Stop	Stop Location	Route	Dir	AM (6:00-9:00)			PM (15:00-18:00)			24-hr		
				Boardings	Alightings	Avg Load at Departure	Boardings	Alightings	Avg Load at Departure	Boardings	Alightings	Avg Load at Departure
0428	SCOTT / LANARK	50	EB	4	2	21	0	3	8	5	4	11
		81	EB	3	0	15	0	0	7	7	1	7
2356	RICHMOND / MCRAE	11	WB	9	15	9	34	52	22	111	171	13
		81	EB	0	8	16	3	9	7	9	36	7
		153	WB	-	-	-	4	1	5	6	3	4
2389	RICHMOND / KIRKWOOD	11	EB	7	2	17	30	7	15	138	23	12
		81	WB	2	0	5	16	4	14	38	7	9
		153	EB	-	-	-	1	0	5	6	1	4
4841	MCRAE / SCOTT	81	EB	0	10	15	1	6	6	7	27	7
		153	WB	-	-	-	2	1	5	3	1	5
4893	MCRAE / SCOTT	81	WB	0	2	5	3	3	14	6	8	8
		153	EB	-	-	-	0	0	5	1	0	3
7375	SCOTT / CLIFTON	50	WB	1	0	11	0	1	16	1	9	10
		81	WB	0	0	5	0	4	14	1	9	8
3012	WESTBORO 1A	57	WB	3	12	8	15	45	33	34	101	16
		58	EB	6	0	7	2	0	15	8	0	11
		61	WB	10	10	15	45	111	43	81	185	31
		62	WB	4	1	21	13	25	30	21	54	22
		63	IB	22	16	13	12	47	33	40	103	19
		64	IB	11	12	12	16	17	20	29	50	14
3012	WESTBORO 1B	66	WB	21	25	30	-	-	-	23	29	29
		73	SB	7	0	9	-	-	-	7	0	8
		74	SB	5	2	7	5	3	17	31	15	19
		75	SB	12	3	15	62	64	22	111	104	21
		82	WB	0	1	9	7	4	16	6	5	13
		83	NB	1	1	8	8	0	10	12	2	8
		84	WB	4	2	15	5	0	11	18	3	12
		87	NB	1	3	4	49	14	19	69	23	10
		164	SB	0	4	2	-	-	-	0	4	2
		258	OB	-	-	-	1	0	7	2	0	7
		282	OB	-	-	-	1	0	25	1	0	23
284	SB	-	-	-	0	2	8	0	2	8		
3012	WESTBORO 2A	57	EB	15	9	38	14	8	12	75	31	14
		58	WB	11	2	26	4	1	12	18	4	18
		61	EB	45	8	34	7	11	24	73	29	22
		62	EB	0	0	13	17	6	28	38	19	15
		63	OB	18	1	39	16	12	21	58	24	21
		64	OB	12	6	28	9	7	12	36	13	15

		66	EB	-	-	-	18	23	28	23	27	24
		73	NB	-	-	-	16	11	19	16	11	17
		74	NB	14	9	36	11	12	22	55	51	29
		75	NB	58	15	47	18	13	34	131	87	30
		82	EB	20	1	29	8	5	15	30	6	20
		83	SB	7	7	21	4	5	11	27	19	17
		84	EB	12	3	27	21	9	19	34	14	20
		87	SB	30	7	22	17	3	11	73	22	10
		164	NB	-	-	-	<i>No data</i>			<i>No data</i>		
		251	IB	4	0	11	-	-	-	4	0	11
		252	IB	2	4	19	-	-	-	6	5	20
		256	IB	4	3	34	-	-	-	4	3	35
		257	IB	7	4	35	-	-	-	7	4	35
		258	IB	19	0	16	-	-	-	19	0	17
		261	IB	2	1	33	-	-	-	2	1	33
		262	IB	0	0	38	-	-	-	0	0	38
		263	IB	0	0	30	-	-	-	0	0	30
		264	IB	0	0	31	-	-	-	0	0	31
		265	IB	0	1	25	-	-	-	0	1	25
		266	IB	5	0	25	-	-	-	5	0	25
		267	IB	2	1	40	-	-	-	3	2	39
		268	IB	1	1	37	-	-	-	1	2	37
		282	IB	10	5	33	-	-	-	12	5	33
		283	IB	0	0	3	-	-	-	0	0	3
		284	NB	5	3	19	-	-	-	5	3	17
3012	WESTBORO 3A	16	EB	11	0	2	6	0	1	30	0	1
		50	WB	6	1	11	12	8	16	24	10	10
		153	WB	-	-	-	0	0	5	0	0	5
3012	WESTBORO 4A	16	WB	0	15	0	0	14	0	0	54	0
		50	EB	2	12	21	0	8	9	2	28	11
		153	EB	-	-	-	0	0	4	0	0	3
3012	WESTBORO STN OFF ONLY	270	IB	6	0	40	-	-	-	5	0	40
		271	IB	1	6	57	-	-	-	1	6	57
		272	IB	3	3	50	-	-	-	4	4	49
		273	IB	5	2	48	-	-	-	5	2	46
		275	IB	5	3	59	-	-	-	8	4	55
		277	IB	7	12	55	-	-	-	9	14	55
		278	IB	3	4	36	-	-	-	4	4	34

APPENDIX D

Traffic Count Data



Transportation Services - Traffic Services

Turning Movement Count - Full Study Peak Hour Diagram

CHURCHILL AVE @ SCOTT ST

Survey Date: Tuesday, August 13, 2019

Start Time: 07:00

WO No: 38699

Device: Miovision

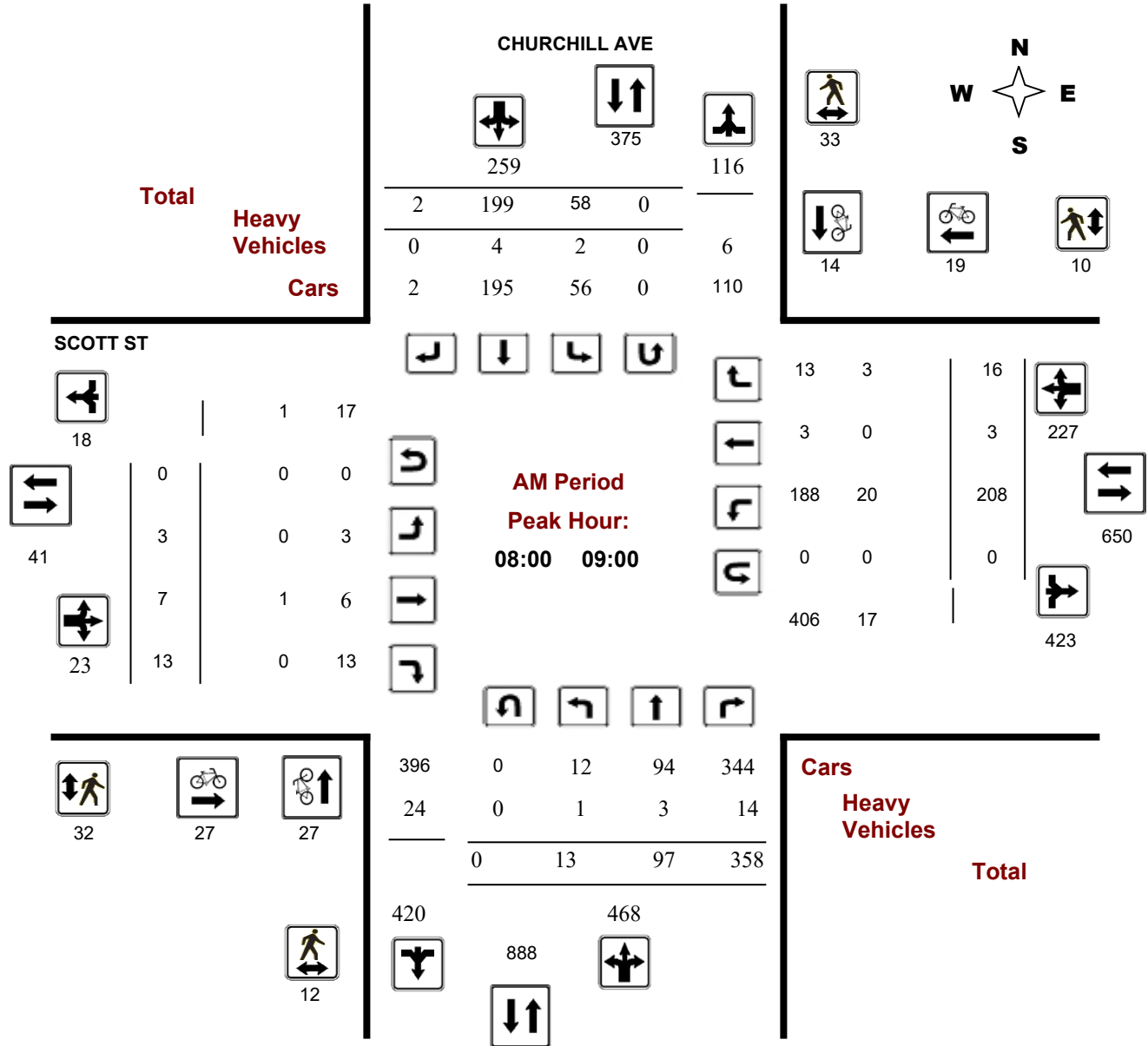



Transportation Services - Traffic Services

Turning Movement Count - Full Study Peak Hour Diagram

CHURCHILL AVE @ SCOTT ST

Survey Date: Tuesday, August 13, 2019

Start Time: 07:00

WO No: 38699

Device: Miovision

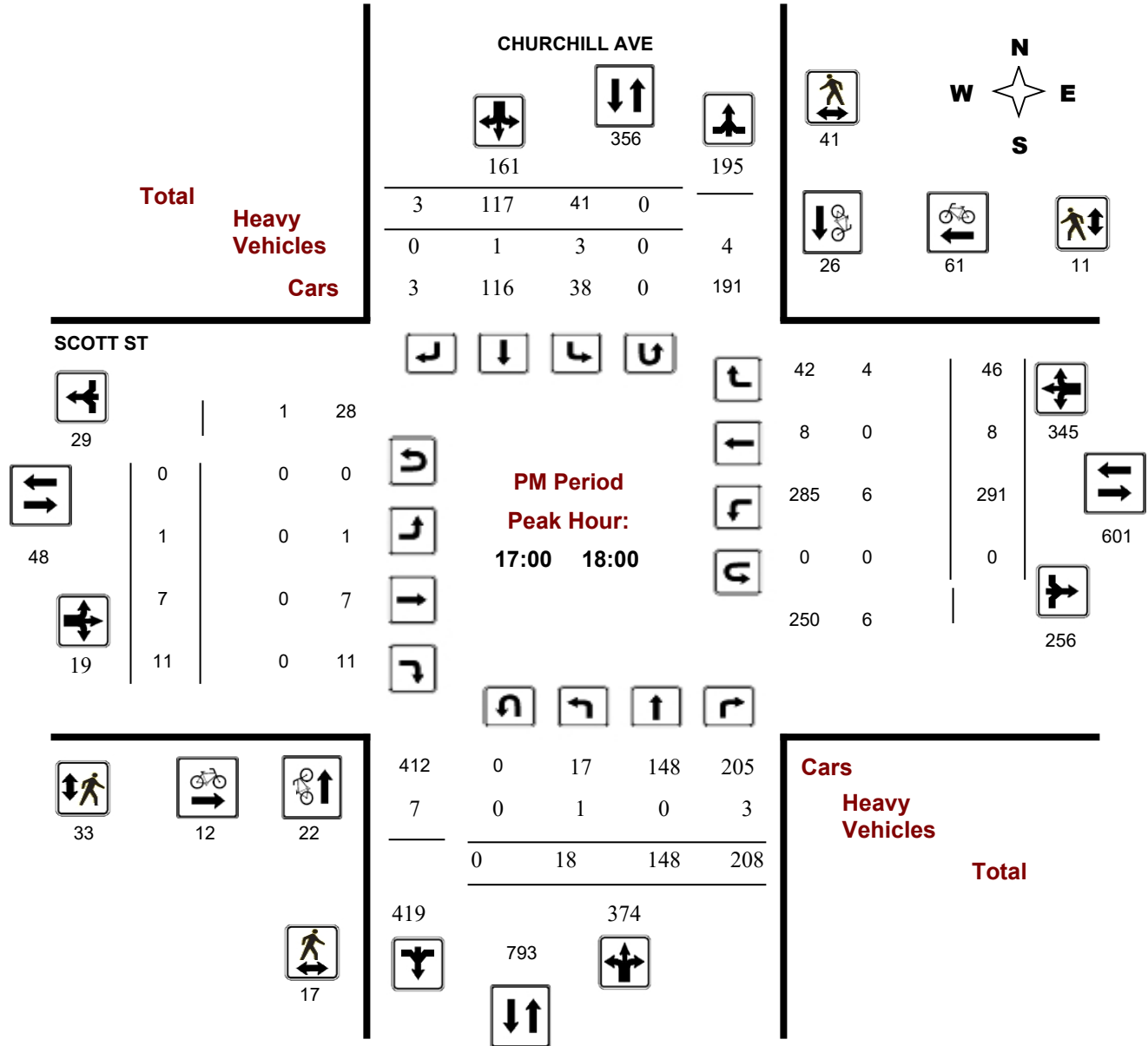

Comments

Turning Movement Count - Peak Hour Diagram

SCOTT ST @ WINONA AVE

Survey Date: Wednesday, October 16, 2019

Start Time: 07:00

WO No: 38864

Device: Miovision

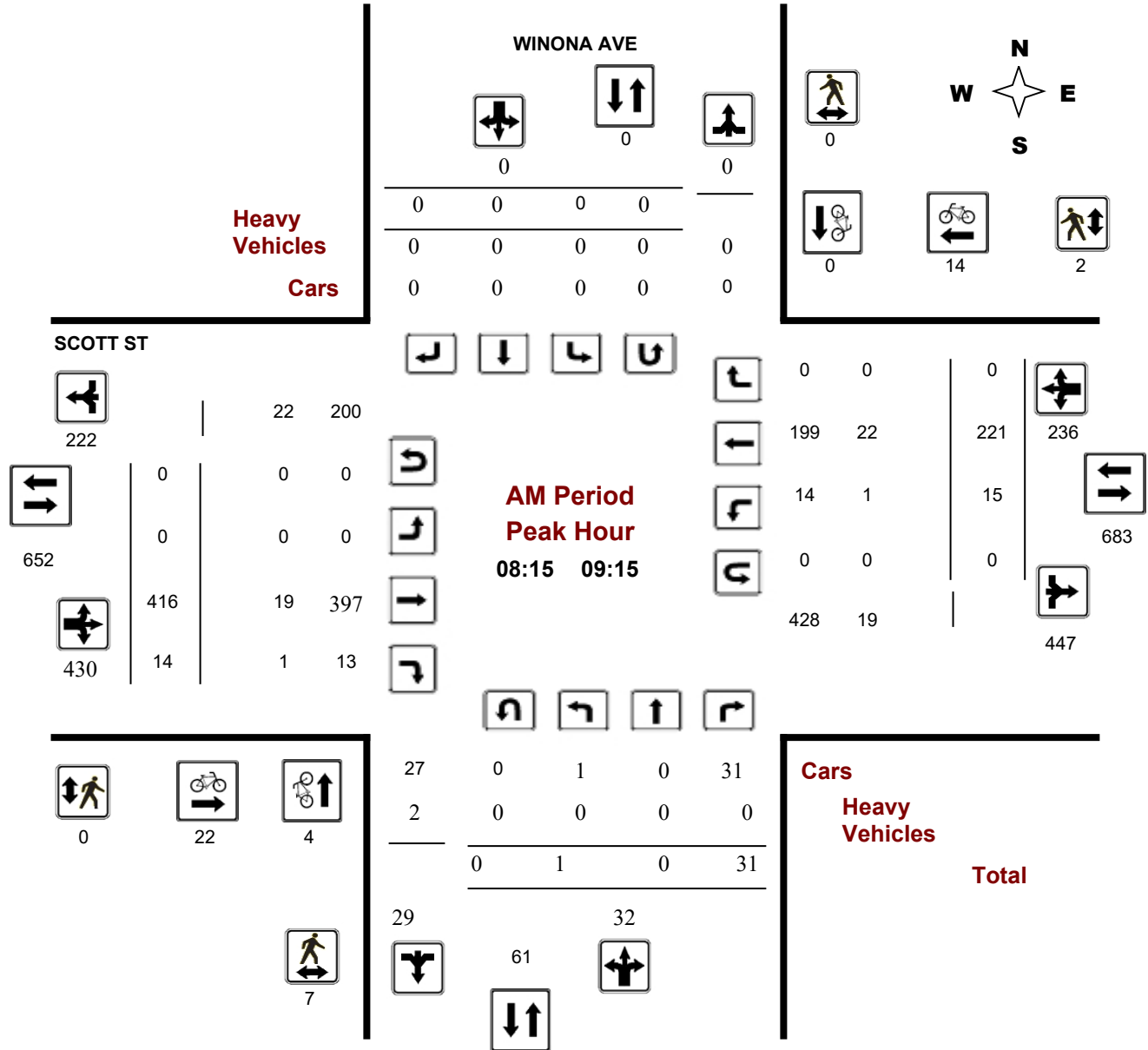

Turning Movement Count - Peak Hour Diagram

SCOTT ST @ WINONA AVE

Survey Date: Wednesday, October 16, 2019

Start Time: 07:00

WO No: 38864

Device: Miovision

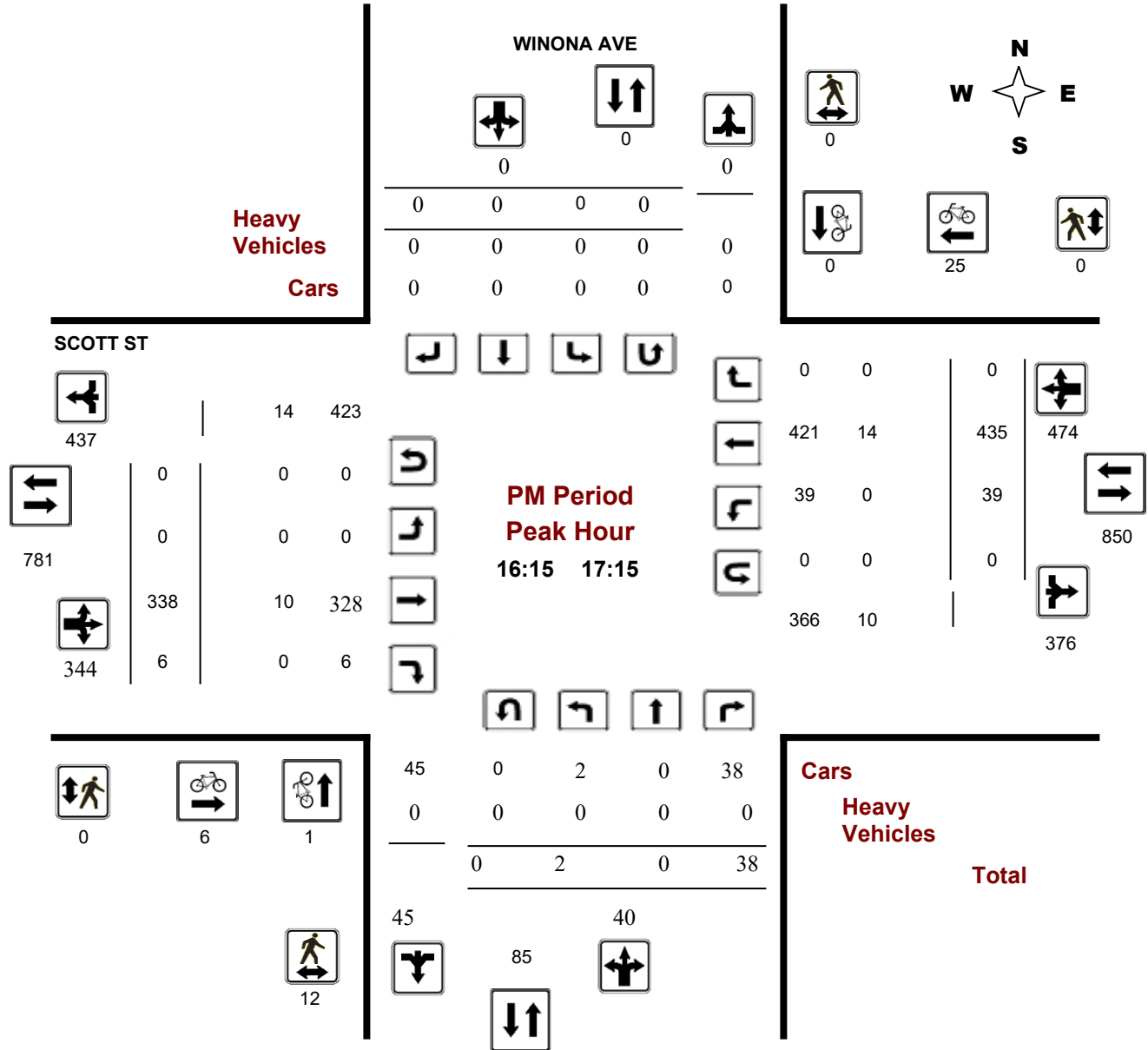

Turning Movement Count - Peak Hour Diagram

ATHLONE AVE @ SCOTT ST

Survey Date: Wednesday, November 22, 2017

Start Time: 07:00

WO No: 37320

Device: Miovision

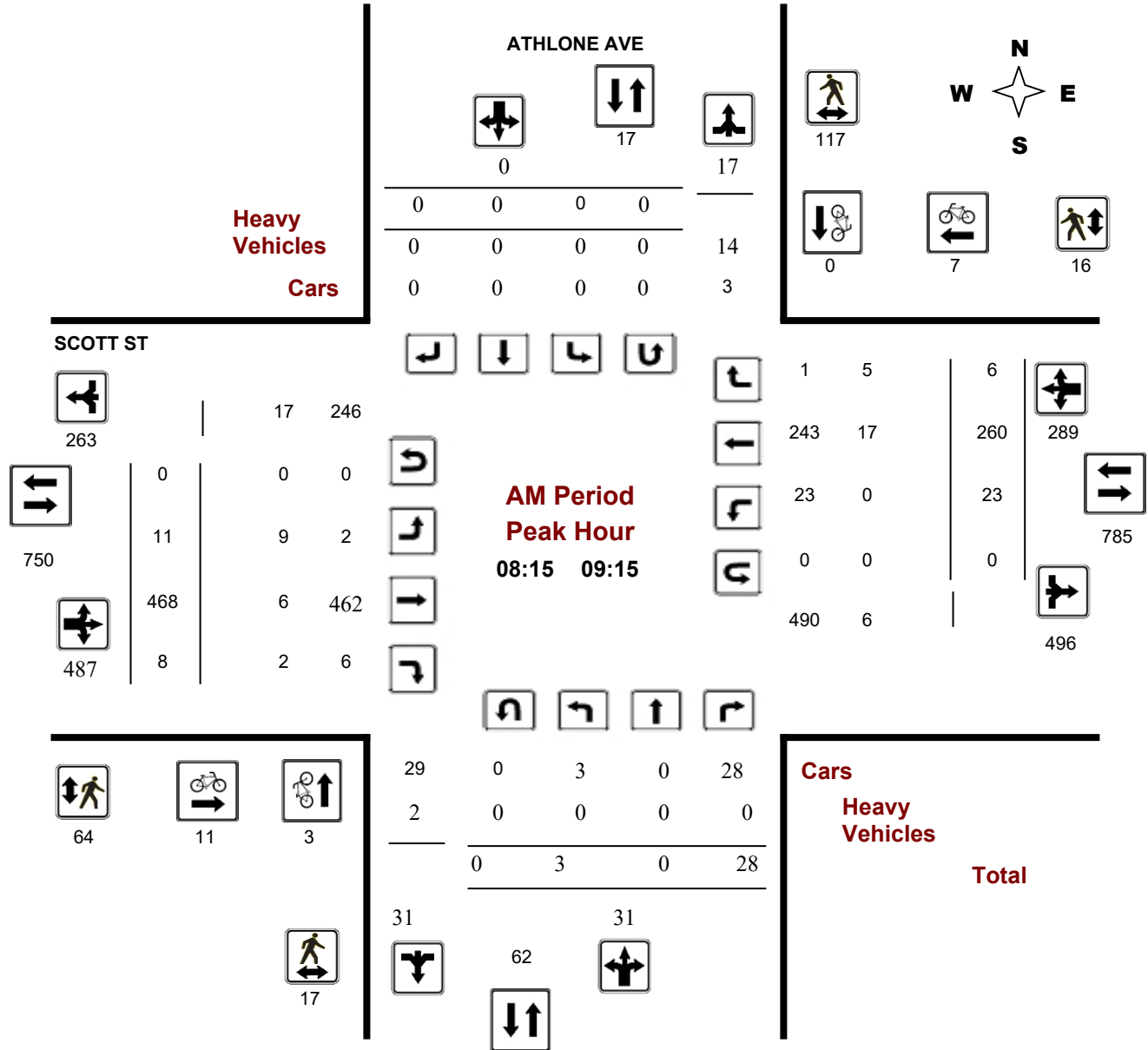

Turning Movement Count - Peak Hour Diagram

ATHLONE AVE @ SCOTT ST

Survey Date: Wednesday, November 22, 2017

Start Time: 07:00

WO No: 37320

Device: Miovision

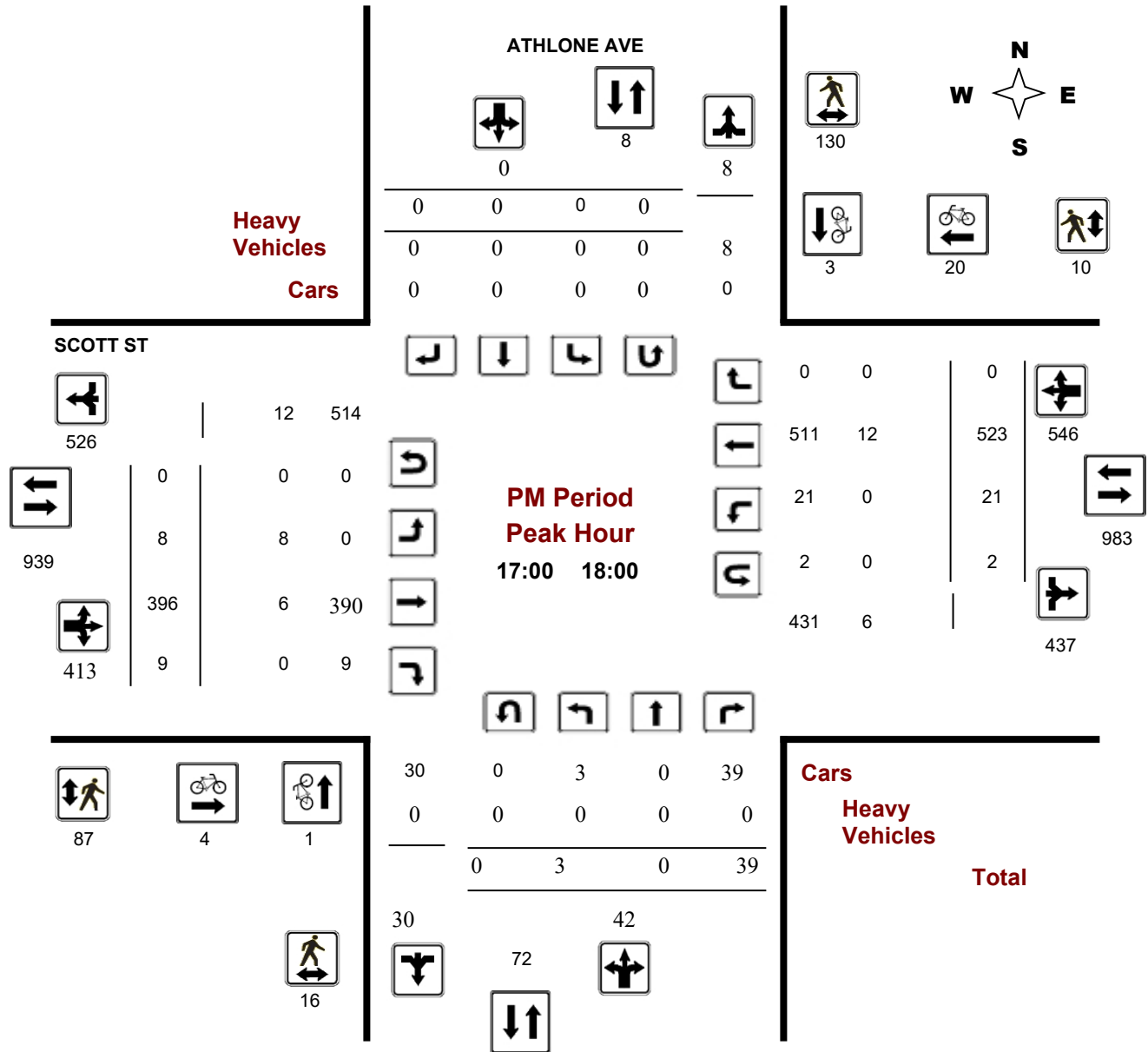

Comments



Transportation Services - Traffic Services

Turning Movement Count - Study Results

ATHLONE AVE @ SCOTT ST

Survey Date: Wednesday, November 22, 2017

WO No: 37320

Start Time: 07:00

Device: Miovision

Full Study Summary (8 HR Standard)

Survey Date: Wednesday, November 22, 2017

Total Observed U-Turns
 Northbound: 1 Southbound: 0
 Eastbound: 0 Westbound: 4

AADT Factor

.90

ATHLONE AVE

SCOTT ST

Period	ATHLONE AVE Northbound					ATHLONE AVE Southbound					SCOTT ST Eastbound					SCOTT ST Westbound					Grand Total
	LT	ST	RT	NB TOT	STR TOT	LT	ST	RT	SB TOT	STR TOT	LT	ST	RT	EB TOT	STR TOT	LT	ST	RT	WB TOT	STR TOT	
07:00 08:00	5	0	24	29	29	0	0	0	0	29	9	326	4	339	339	5	210	5	220	559	588
08:00 09:00	7	0	28	35	35	0	0	0	0	35	9	461	9	479	479	22	249	6	277	756	791
09:00 10:00	2	0	22	24	24	0	0	0	0	24	9	312	4	325	325	15	248	1	264	589	613
11:30 12:30	9	0	22	31	31	0	0	0	0	31	6	269	15	290	290	20	281	3	304	594	625
12:30 13:30	9	0	30	39	39	0	0	0	0	39	10	252	7	269	269	8	244	0	252	521	560
15:00 16:00	3	0	19	22	22	0	0	0	0	22	7	301	6	314	314	11	409	2	422	736	758
16:00 17:00	10	0	24	34	34	0	0	0	0	34	10	319	12	341	341	19	464	1	484	825	859
17:00 18:00	3	0	39	42	42	0	0	0	0	42	8	396	9	413	413	21	523	0	544	957	999
Sub Total	48	0	208	256	256	0	0	0	0	256	68	2636	66	2770	2770	121	2628	18	2767	5537	5793
U Turns	1			1	1	0			0	1	0			0	0	4			4	4	5
Total	49	0	208	257	257	0	0	0	0	257	68	2636	66	2770	2770	125	2628	18	2771	5541	5798
EQ 12Hr	68	0	289	357	357	0	0	0	0	357	95	3664	92	3851	3851	174	3653	25	3852	7703	8060
Note: These values are calculated by multiplying the totals by the appropriate expansion factor.																1.39					
AVG 12Hr	61	0	260	321	321	0	0	0	0	321	86	3298	83	3467	3467	157	3288	22	3467	6934	7255
Note: These volumes are calculated by multiplying the Equivalent 12 hr. totals by the AADT factor.																.90					
AVG 24Hr	80	0	341	421	421	0	0	0	0	421	113	4320	109	4542	4542	206	4307	29	4542	9084	9505
Note: These volumes are calculated by multiplying the Average Daily 12 hr. totals by 12 to 24 expansion factor.																1.31					

Note: U-Turns provided for approach totals. Refer to 'U-Turn' Report for specific breakdown.



Transportation Services - Traffic Services

Turning Movement Count - Peak Hour Diagram TWEEDSMUIR AVE @ SCOTT ST

Survey Date: Tuesday, March 28, 2017

Start Time: 07:00

WO No: 36806

Device: Miovision

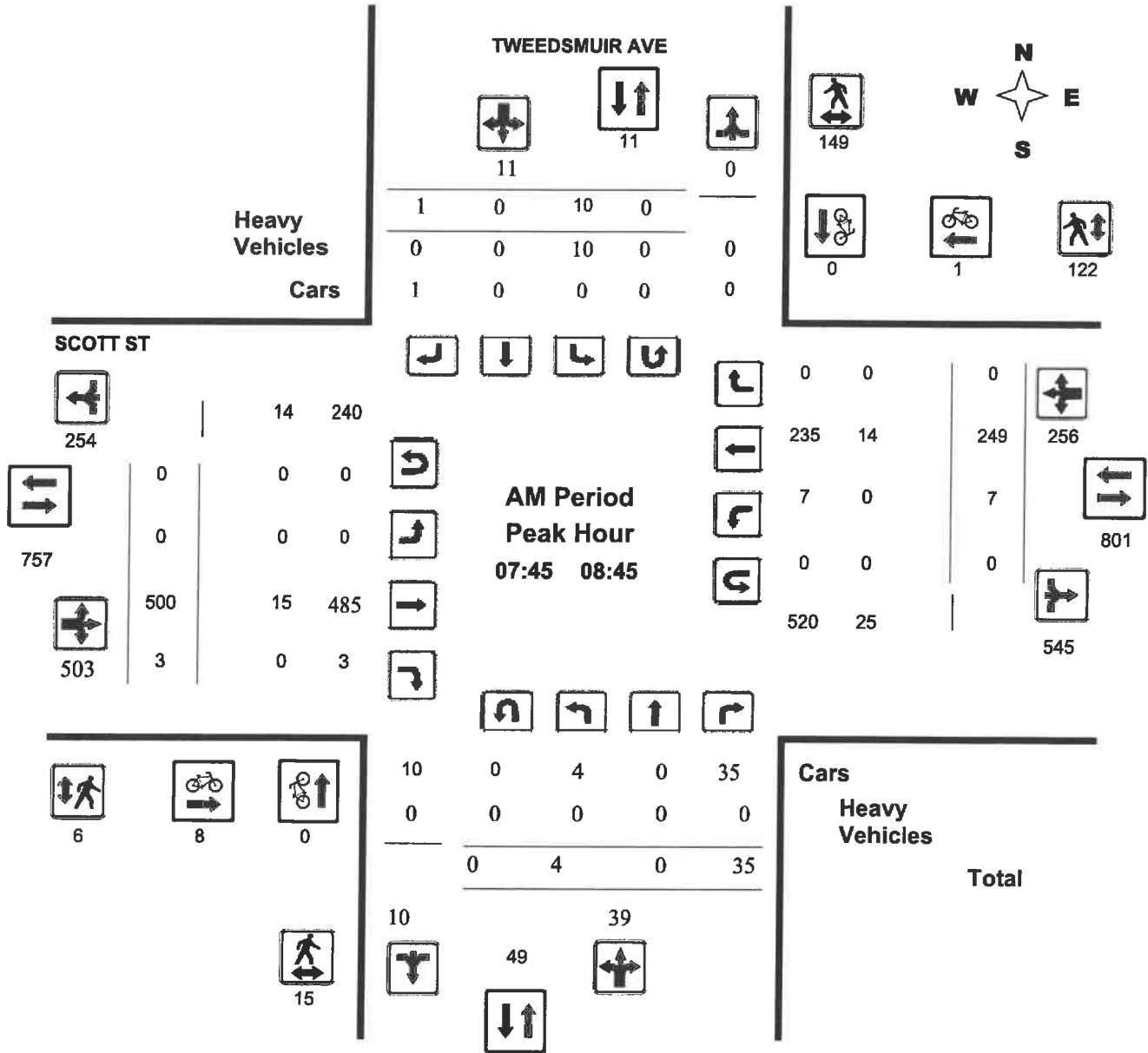

Comments



Transportation Services - Traffic Services

Turning Movement Count - Peak Hour Diagram

TWEEDSMUIR AVE @ SCOTT ST

Survey Date: Tuesday, March 28, 2017

Start Time: 07:00

WO No: 36806

Device: Miovision

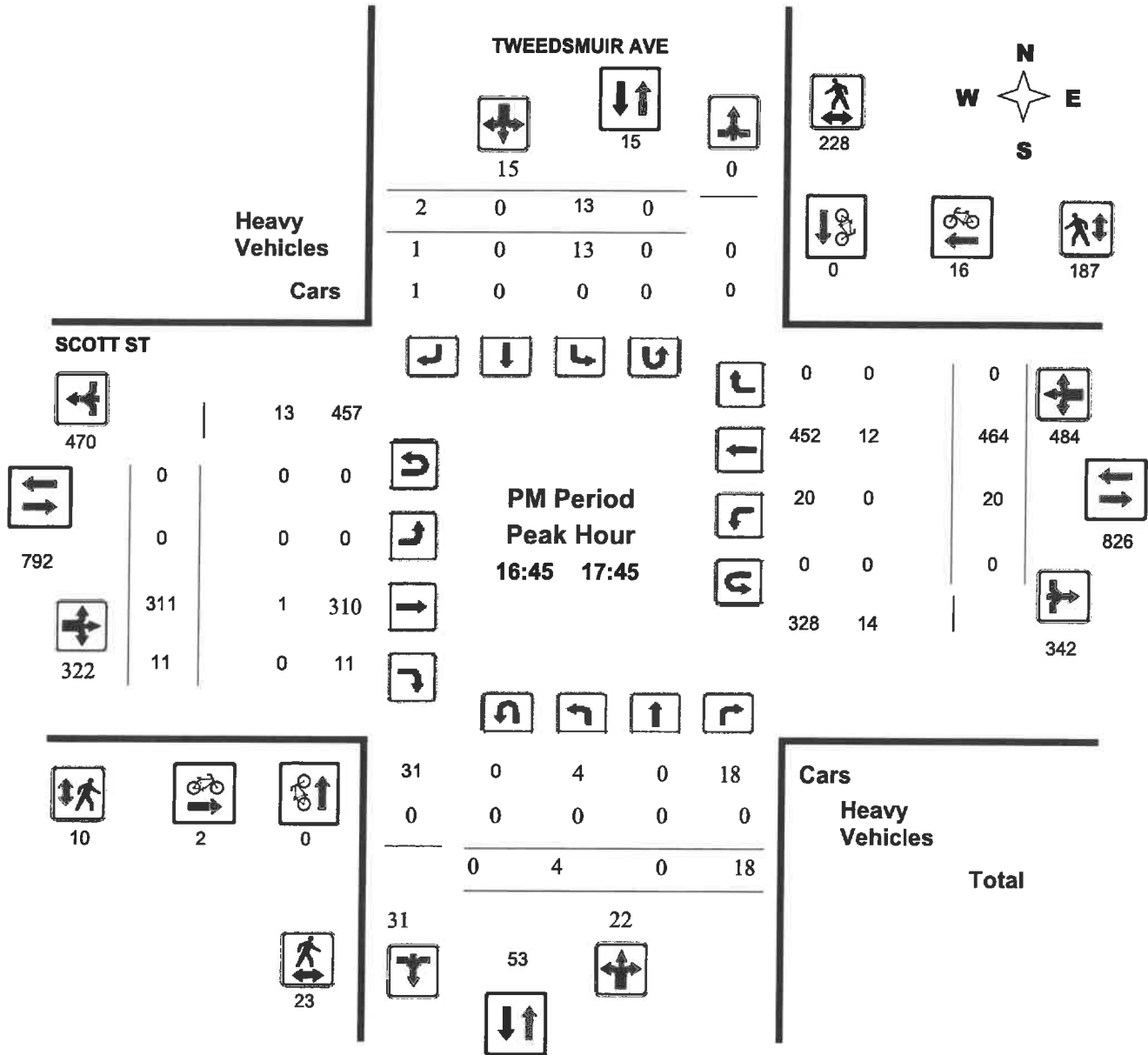



Turning Movement Count Summary, AM and PM Peak Hour Flow Diagrams

Automobiles, Taxis, Light Trucks, Vans, SUV's, Motorcycles, Heavy Trucks, Buses, and School Buses

Scott Street & Tweedsmuir Avenue

Ottawa, ON

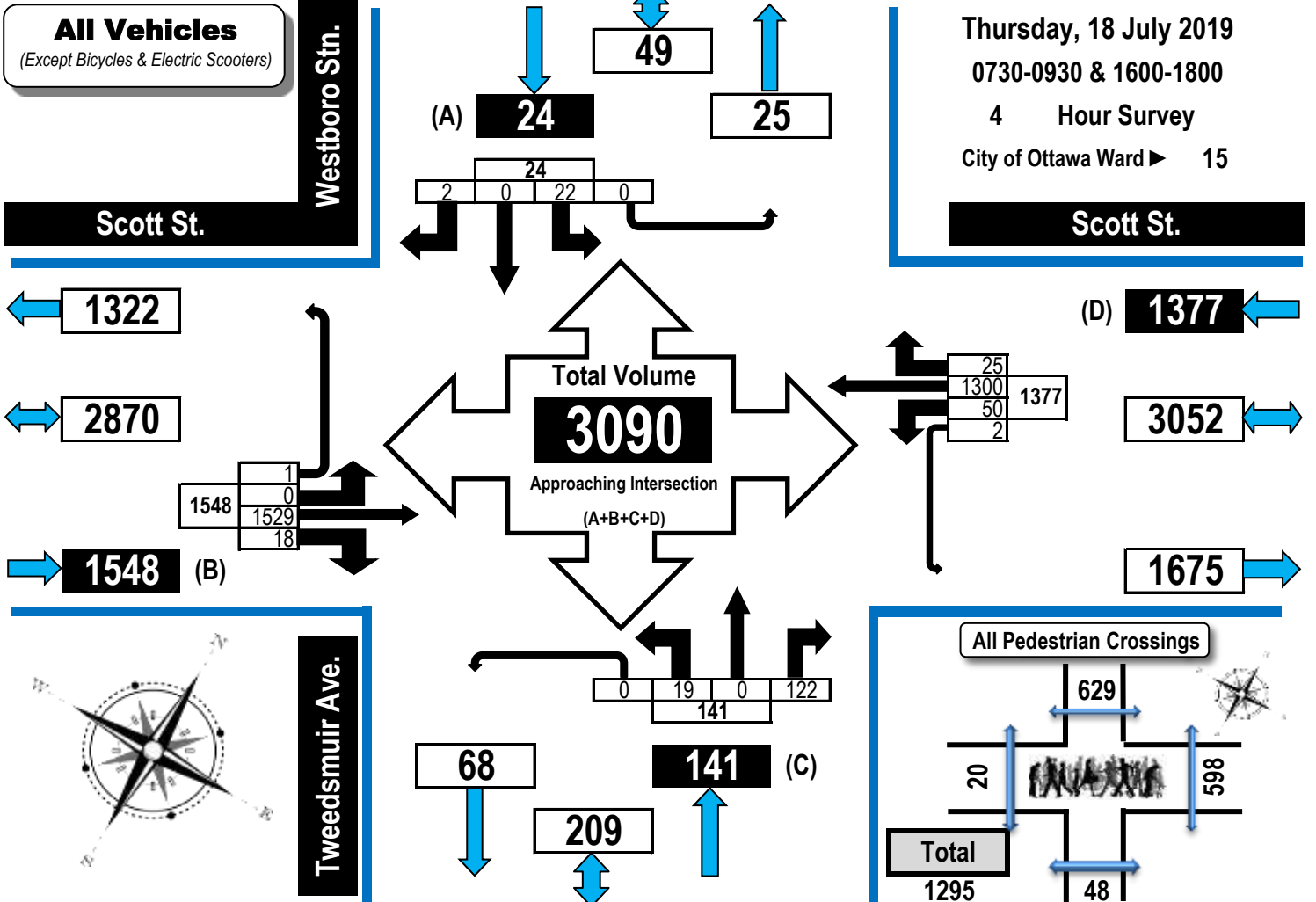

AM Peak Hour Flow Diagram PM Peak Hour Flow Diagram

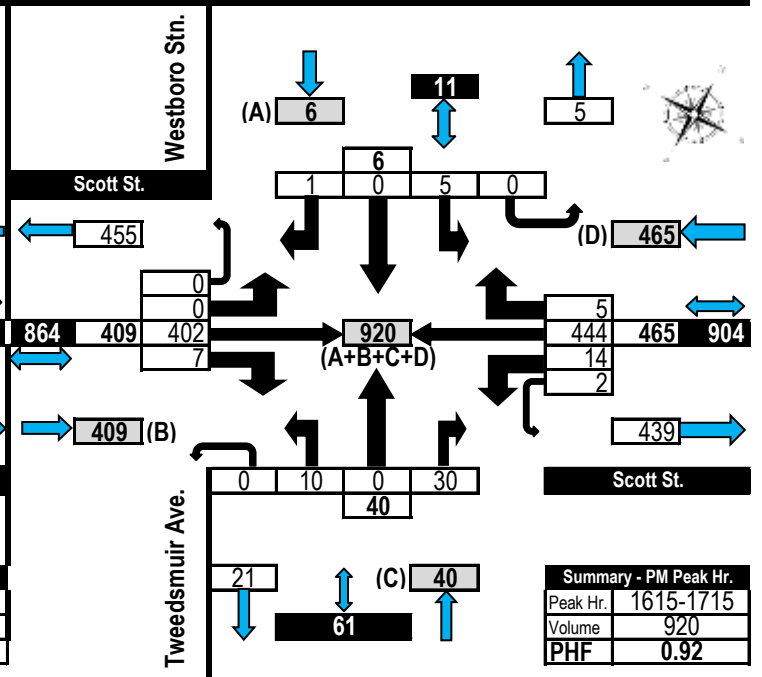
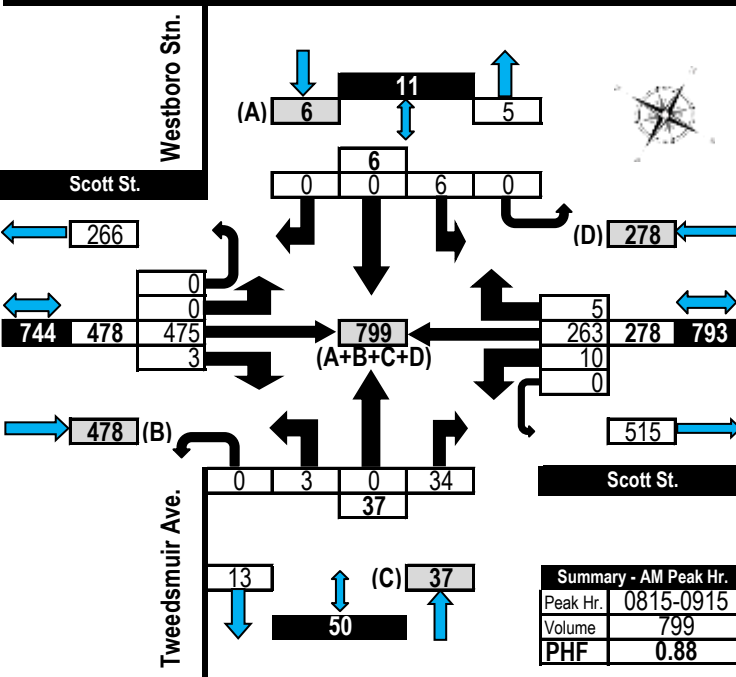



Turning Movement Count Summary, AM and PM Peak Hour Flow Diagrams

Automobiles, Taxis, Light Trucks, Vans, SUV's, Motorcycles, Heavy Trucks, Buses, and School Buses

McRae Avenue & Scott Street Ottawa, ON

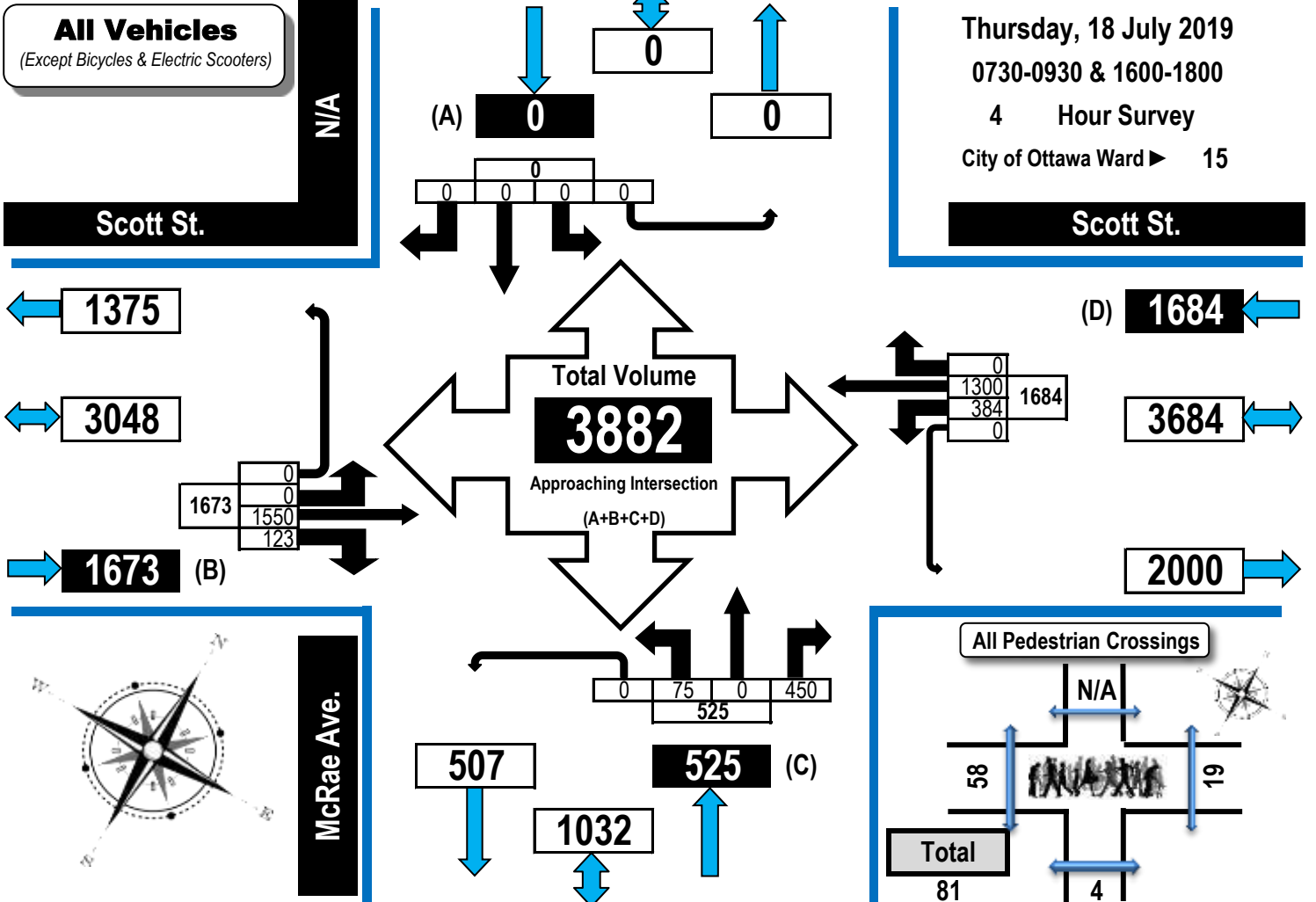

AM Peak Hour Flow Diagram PM Peak Hour Flow Diagram

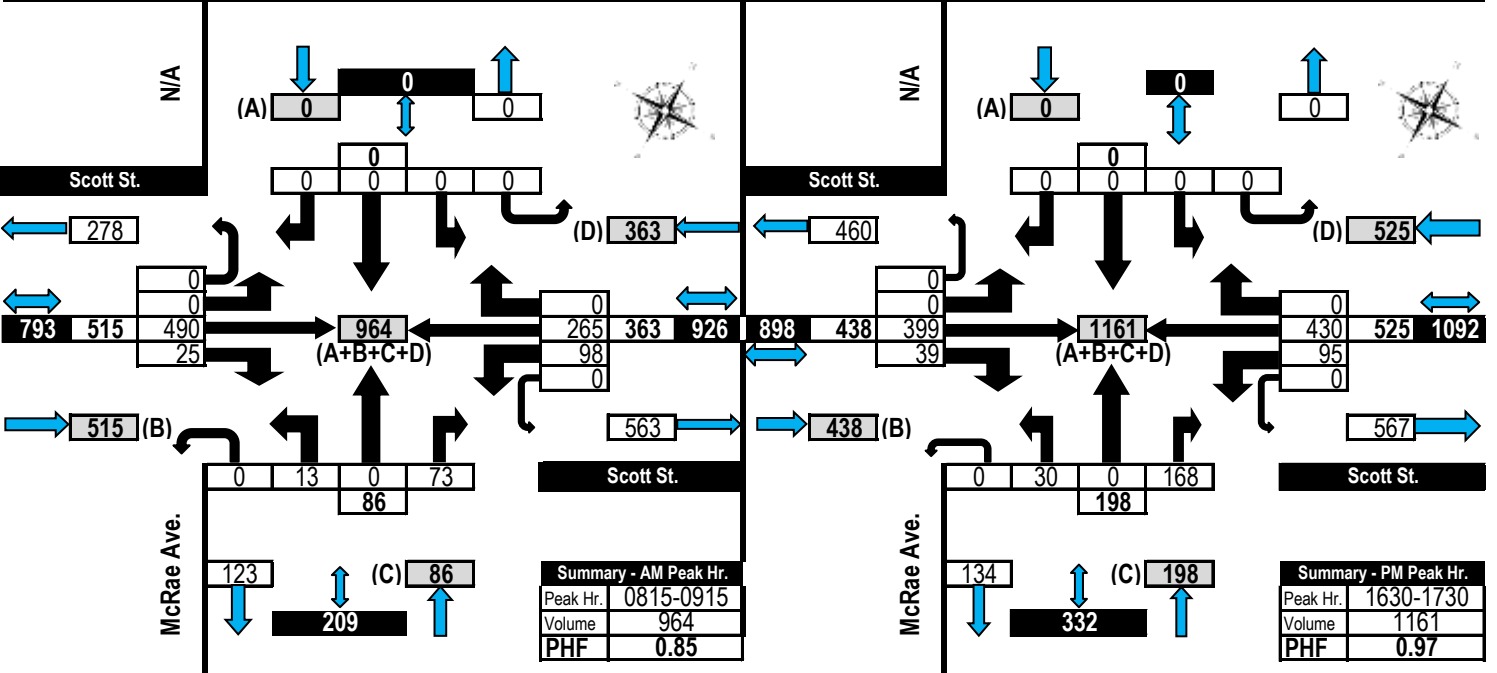

APPENDIX E

Collision Records



Transportation Services - Traffic Services

Collision Details Report - Public Version

From: January 1, 2015 To: December 31, 2019

Location: ATHLONE AVE @ SCOTT ST

Traffic Control: Traffic signal

Total Collisions: 3

Date/Day/Time	Environment	Impact Type	Classification	Surface Cond'n	Veh. Dir	Vehicle Manoeuvre	Vehicle type	First Event	No. Ped
2016-Aug-12, Fri,08:27	Rain	Turning movement	Non-fatal injury	Wet	West	Turning left	Automobile, station wagon	Cyclist	0
					East	Going ahead	Bicycle	Other motor vehicle	
2017-Oct-04, Wed,16:57	Rain	SMV other	Non-fatal injury	Wet	West	Turning left	Automobile, station wagon	Pedestrian	1
2019-Nov-22, Fri,07:15	Clear	Rear end	P.D. only	Dry	East	Going ahead	Automobile, station wagon	Other motor vehicle	0
					East	Stopped	Automobile, station wagon	Other motor vehicle	
					East	Stopped	Automobile, station wagon	Other motor vehicle	

Location: CHURCHILL AVE @ SCOTT ST

Traffic Control: Stop sign

Total Collisions: 5

Date/Day/Time	Environment	Impact Type	Classification	Surface Cond'n	Veh. Dir	Vehicle Manoeuvre	Vehicle type	First Event	No. Ped
2016-Feb-18, Thu,07:15	Clear	SMV other	P.D. only	Ice	North	Pulling away from shoulder or curb	Automobile, station wagon	Skidding/sliding	0
2017-Feb-10, Fri,00:00	Clear	SMV unattended vehicle	P.D. only	Dry	East	Unknown	Unknown	Unattended vehicle	0
2018-Jan-15, Mon,19:15	Clear	Sideswipe	P.D. only	Loose snow	North	Stopped	Automobile, station wagon	Other motor vehicle	0
					North	Going ahead	Automobile, station wagon	Other motor vehicle	
2018-Feb-05, Mon,16:24	Clear	SMV other	Non-fatal injury	Dry	West	Going ahead	Automobile, station wagon	Pedestrian	1
2019-Feb-12, Tue,16:00	Snow	SMV other	Non-fatal injury	Loose snow	North	Going ahead	Unknown	Pedestrian	1

Location: MCRAE AVE @ SCOTT ST

Traffic Control: Stop sign

Total Collisions: 6

Date/Day/Time	Environment	Impact Type	Classification	Surface Cond'n	Veh. Dir	Vehicle Manoeuvre	Vehicle type	First Event	No. Ped
2015-Feb-05, Thu,13:15	Clear	Angle	P.D. only	Wet	West	Reversing	Snow plow	Other motor vehicle	0
					North	Turning right	Pick-up truck	Other motor vehicle	
2016-Aug-08, Mon,13:00	Clear	Angle	P.D. only	Dry	North	Turning left	Automobile, station wagon	Other motor vehicle	0
					East	Going ahead	Pick-up truck	Other motor vehicle	



Transportation Services - Traffic Services

Collision Details Report - Public Version

From: January 1, 2015 To: December 31, 2019

Location: MCRAE AVE @ SCOTT ST

Traffic Control: Stop sign

Total Collisions: 6

Date/Day/Time	Environment	Impact Type	Classification	Surface Cond'n	Veh. Dir	Vehicle Manoeuvre	Vehicle type	First Event	No. Ped
2016-Sep-02, Fri,10:10	Clear	Angle	P.D. only	Dry	East	Turning left	Automobile, station wagon	Other motor vehicle	0
					North	Going ahead	Automobile, station wagon	Other motor vehicle	
2017-Jun-05, Mon,13:09	Clear	Angle	Non-fatal injury	Dry	North	Turning right	Automobile, station wagon	Other motor vehicle	0
					East	Going ahead	Automobile, station wagon	Other motor vehicle	
2019-Dec-11, Wed,17:40	Snow	Rear end	P.D. only	Packed snow	West	Going ahead	Unknown	Other motor vehicle	0
					West	Stopped	Automobile, station wagon	Other motor vehicle	
2019-Dec-31, Tue,16:00	Snow	Angle	P.D. only	Slush	North	Turning left	Automobile, station wagon	Other motor vehicle	0
					East	Going ahead	Automobile, station wagon	Other motor vehicle	

Location: SCOTT ST @ WINONA AVE

Traffic Control: Stop sign

Total Collisions: 1

Date/Day/Time	Environment	Impact Type	Classification	Surface Cond'n	Veh. Dir	Vehicle Manoeuvre	Vehicle type	First Event	No. Ped
2018-Aug-19, Sun,14:13	Clear	Sideswipe	P.D. only	Dry	West	Pulling away from shoulder or curb	Automobile, station wagon	Other motor vehicle	0
					West	Going ahead	Automobile, station wagon	Other motor vehicle	

Location: TWEEDSMUIR AVE @ SCOTT ST

Traffic Control: Traffic signal

Total Collisions: 3

Date/Day/Time	Environment	Impact Type	Classification	Surface Cond'n	Veh. Dir	Vehicle Manoeuvre	Vehicle type	First Event	No. Ped
2015-Jun-21, Sun,12:50	Clear	Rear end	P.D. only	Dry	West	Slowing or stopping	Automobile, station wagon	Other motor vehicle	0
					West	Stopped	Pick-up truck	Other motor vehicle	
2016-Jun-09, Thu,12:15	Clear	Angle	P.D. only	Dry	North	Slowing or stopping	Automobile, station wagon	Other motor vehicle	0
					East	Going ahead	Pick-up truck	Other motor vehicle	
2016-Oct-03, Mon,08:03	Clear	Rear end	Non-fatal injury	Dry	East	Stopped	Automobile, station wagon	Other motor vehicle	0
					East	Going ahead	Automobile, station wagon	Other motor vehicle	

APPENDIX F

Relevant Excerpts of *TRANS Trip Generation Manual* (WSP, 2020)

to make use of this resource while considering the local land use context and trip characteristics for all travel modes through local and regional data.

Table 2: Person-Trip Conversion Factor

Factor	Application	Apply To	Period	Value
Person-Trip Conversion Factor	Vehicle to person-trip conversion, to normalize the measure of trip rates to account for all modes. Applicable to the ITE trip generation rates, which are mainly reported as vehicle trip rates.	Vehicle trip rates	All	1.28

3 RESIDENTIAL TRIP GENERATION RATES

3.1 Development of Residential Trip Rates

The residential trip generation rates in this manual are reflect the number of **person-trips per household** during the **peak period**. The morning peak period is from 7:00 AM to 9:30 AM, while the afternoon peak period is from 3:30 PM to 6:00 PM.

A geographic review of trip generation rates found that rates varied by dwelling type but not significantly by the geographic sectors and districts used in the 2009 TRANS Trip Generation Study¹. As such, residential trip generation rates in this manual are defined for the following three dwelling types:

- Single-Family Detached Housing
- Multifamily Housing (Low-Rise)
- Multifamily Housing (High-Rise)

Low-rise housing refers to any building that houses multiple families that is two storeys or less (e.g. semi-detached homes, townhouses). High-rise housing refers to any building that houses multiple families that is three or more storeys (e.g. apartments and condo buildings). These dwelling types are from the TRANS Origin-Destination Survey but are organized to be equivalent to the categories of the ITE *Trip Generation Manual* and local generator surveys.

¹ While person trip rates were not found to vary significantly with geographic area, location does have an impact on mode share as discussed in Section 4.2. As a result, vehicular trip rates do vary by geography as reflected in previous versions of the manual. The variation by dwelling type, in part, reflects differences in the number of persons per dwelling.

3.2 Recommended Residential Trip Generation Rates

A blended trip rate was developed from the three data sources through application of a rank-sum weighting process, considering the strengths and weaknesses of each dataset for the dwelling type in question. The recommended blended **residential person-trip rates** are presented in **Table 3**. All rates represent person-trips per dwelling unit and are to be applied to the **AM or PM peak period**.

Table 3: Recommended Residential Person-trip Rates

ITE Land Use Code	Dwelling Unit Type	Period	Person-Trip Rate
210	Single-detached	AM	2.05
		PM	2.48
220	Multi-Unit (Low-Rise)	AM	1.35
		PM	1.58
221 & 222	Multi-Unit (High-Rise)	AM	0.80
		PM	0.90

3.3 Adjustment Factors – Peak Period to Peak Hour

The various trip generation data sources require some adjustment to standardize the data for developing robust blended trip rates. The peak period conversion factor in **Table 4** may be used where applicable to develop trip generation rate estimates in the desired format.

Table 4: Adjustment Factors for Residential Trip Generation Rates

Factor	Application	Apply To	Period	Value
Peak Period Conversion Factor	Peak period to peak hour conversion. Because the 2020 TRANS Trip Generation Study reports trip generation rates by peak period, factors must be applied if the practitioner requires peak hour rates. In practice, the conversion to peak hour trip rates should occur after the application of modal shares.	Person-trip rates per peak period	AM	0.50
			PM	0.44
		Vehicle trip rates per peak period	AM	0.48
			PM	0.44
		Transit trip rates per peak period	AM	0.55
			PM	0.47
		Cycling trip rates per peak period	AM	0.58
			PM	0.48
		Walking trip rates per peak period	AM	0.58
			PM	0.52

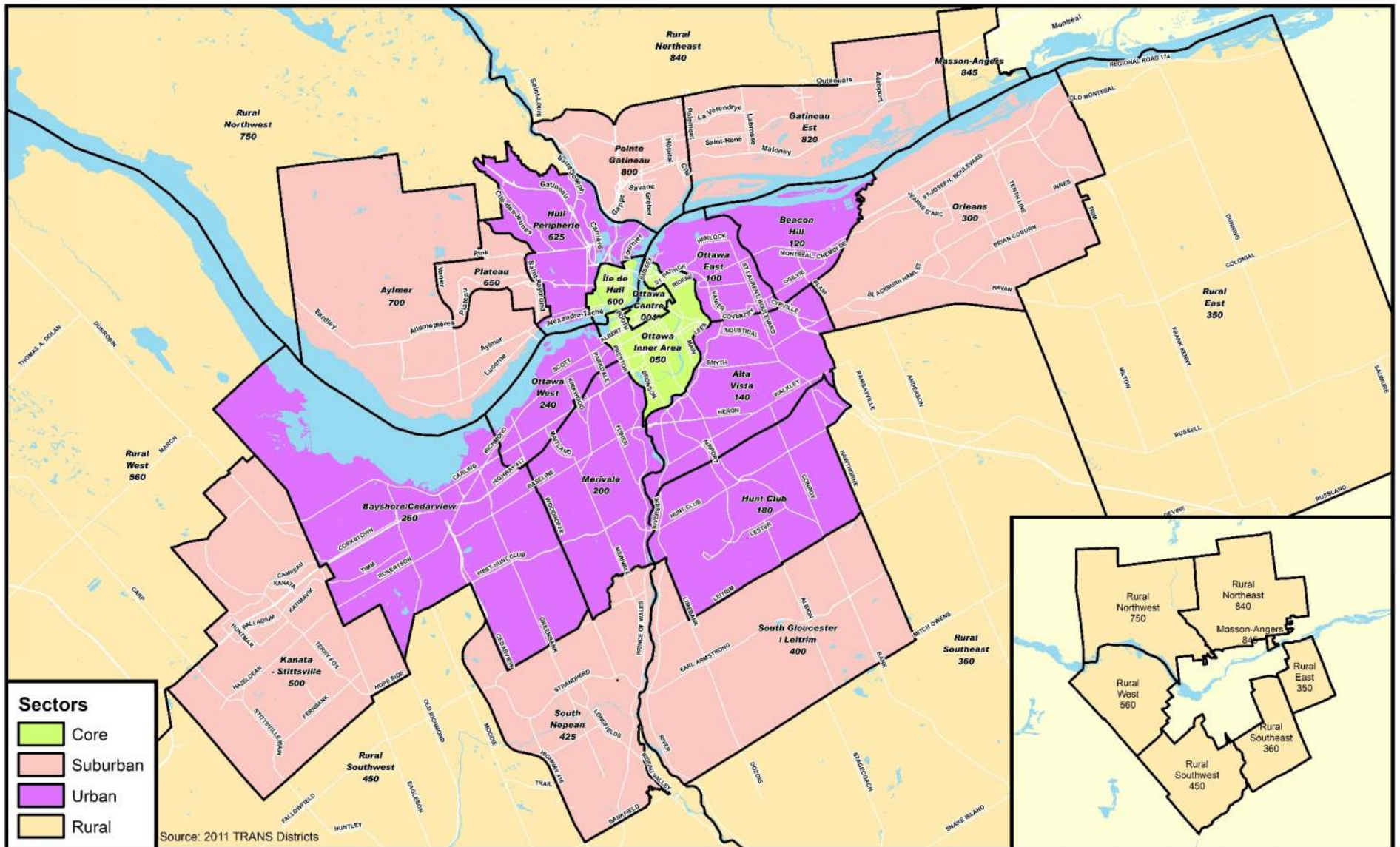

Figure 1: National Capital Region by Sector

Table 8: Residential Mode Share for High-Rise Multifamily Housing

District	Period	Mode				
		Auto Driver	Auto Pass.	Transit	Cycling	Walking
Ottawa Centre	AM	18%	2%	26%	1%	52%
	PM	17%	9%	21%	1%	52%
Ottawa Inner Area	AM	26%	6%	28%	5%	34%
	PM	25%	8%	21%	6%	39%
Île de Hull	AM	27%	3%	37%	12%	21%
	PM	26%	8%	27%	11%	28%
Ottawa East	AM	39%	7%	38%	2%	13%
	PM	40%	14%	28%	3%	15%
Beacon Hill	AM	48%	9%	30%	3%	10%
	PM	52%	16%	28%	0%	4%
Alta Vista	AM	38%	12%	42%	2%	7%
	PM	45%	16%	28%	2%	9%
Hunt Club	AM	39%	6%	44%	1%	9%
	PM	44%	11%	35%	2%	9%
Merivale	AM	41%	6%	42%	2%	8%
	PM	41%	11%	33%	2%	13%
Ottawa West	AM	28%	11%	41%	3%	16%
	PM	33%	11%	26%	7%	23%
Bayshore/Cedarview	AM	40%	12%	38%	2%	8%
	PM	40%	15%	33%	1%	11%
Hull Périphérie	AM	48%	11%	30%	1%	10%
	PM	47%	15%	23%	3%	13%
Orleans	AM	54%	7%	29%	0%	10%
	PM	61%	13%	21%	0%	6%
South Gloucester / Leitrim	AM	50%	15%	25%	1%	9%
	PM	53%	17%	21%	1%	9%
South Nepean	AM	58%	6%	30%	2%	4%
	PM	54%	15%	25%	0%	7%
Kanata - Stittsville	AM	43%	26%	28%	0%	4%
	PM	55%	19%	21%	0%	5%
Plateau	AM	53%	9%	35%	3%	1%
	PM	65%	7%	25%	2%	1%
Aylmer	AM	45%	17%	25%	0%	13%
	PM	31%	21%	23%	4%	20%
Pointe Gatineau	AM	44%	15%	24%	3%	14%
	PM	52%	15%	20%	2%	11%
Gatineau Est	AM	53%	10%	25%	0%	12%
	PM	61%	10%	25%	0%	4%
Masson-Angers	AM	63%	15%	19%	0%	3%
	PM	64%	18%	16%	0%	1%
Other Rural Districts	AM	63%	15%	19%	0%	3%
	PM	64%	18%	16%	0%	1%

5 RESIDENTIAL DIRECTIONAL SPLITS

After calculating the total person trips generated by the development and applying the appropriate modal shares, directional factors can be applied to estimate the number of inbound and outbound trips by vehicle. The vehicle trip directional splits were developed for both the AM and PM peak periods². The vehicle trip directional splits, as shown in **Table 9**, have been developed for the NCR based on a review of the local trip generator surveys as well as the latest published data in the *ITE Trip Generation Manual* (10th Edition).

Table 9: Recommended Vehicle Trip Directional Splits (Peak Period)

ITE Land Use Code	Dwelling Unit Type	Period	Inbound	Outbound
210	Single-detached	AM	30%	70%
		PM	62%	38%
220	Multi-Unit (Low-Rise)	AM	30%	70%
		PM	56%	44%
221 & 222	Multi-Unit (High-Rise)	AM	31%	69%
		PM	58%	42%

6 NON-RESIDENTIAL MODE SHARE

Mode shares were developed for three types of non-residential development: schools (elementary and high school); employment generators; and commercial (retail) generators. These mode shares were developed through data provided by the Ville de Gatineau from local school surveys as well as the TRANS Origin-Destination Survey. The non-residential mode shares presented below are limited and do not capture all development types. For data on the travel characteristics associated with colleges and universities, transportation terminals, and sports and entertainment venues in the National Capital Region, practitioners should refer to the various reports for the TRANS *Special Generators Survey* (2013), which are posted on the TRANS website. For other development types, practitioners may need to carry out their own local generator data collection where necessary.

² A directional split for active transportation was calculated based on the local generator surveys for low-rise and mid-rise land uses. The splits are mostly in-line with the vehicle directional splits, which could be used as a rough assumption for areas with lower vehicle mode share.

6.2 Employment Generators

Mode shares for trips to employment generators were developed from the 2011 TRANS Origin-Destination Survey by isolating the ‘travel to work’ trips. However, with the way the data is collected, employment related trips departing the workplace could not be isolated to identify mode share. As a result, peak direction mode shares could only be calculated for the AM peak period. **Table 12** provides the mode share by district during the AM peak period for employment trips in the peak inbound direction. These trips represent trips to the workplace and do not include work-related trips (e.g. for business meetings) or trips classified as working on the road (e.g. delivery trips). Multi-modal trips for employment generators were classified by the mode used to arrive at the workplace (e.g. a park-and-ride trip would be classified as a transit trip since the person arrived at the workplace on transit). Considering the strong likelihood of employees using the same mode of transportation when leaving work, it is fair to equivocate the PM peak period employment generator mode with the AM peak period.

Table 12: Employment Generator Mode Share by District (AM Peak Period)

District	Mode				
	Auto Driver	Auto Pass.	Transit	Cycling	Walking
Ottawa Centre	24%	7%	54%	4%	11%
Ottawa Inner Area	45%	7%	29%	8%	11%
Île de Hull	40%	9%	40%	5%	6%
Ottawa East	66%	7%	20%	2%	5%
Beacon Hill	73%	6%	16%	2%	3%
Alta Vista	69%	7%	18%	3%	3%
Hunt Club	83%	5%	10%	1%	1%
Merivale	70%	7%	16%	3%	4%
Ottawa West	54%	8%	28%	5%	5%
Bayshore/Cedarview	77%	6%	10%	3%	4%
Hull Périphérie	75%	7%	12%	3%	3%
Orleans	71%	7%	13%	1%	8%
South Gloucester / Leitrim	89%	7%	2%	1%	1%
South Nepean	80%	10%	5%	1%	4%
Kanata - Stittsville	84%	4%	8%	1%	3%
Plateau	82%	6%	7%	1%	4%
Aylmer	83%	3%	5%	4%	5%
Pointe Gatineau	80%	9%	4%	2%	5%
Gatineau Est	88%	6%	4%	0%	2%

APPENDIX G

Other Area Developments

Residential Development
335 Roosevelt Avenue
Transportation Impact Assessment

Prepared By:

NOVATECH

Suite 200, 240 Michael Cowpland Drive
Ottawa, Ontario
K2M 1P6

July 2020

Revised December 2020
Revised March 2022

Novatech File: 110098
Ref: R-2020-053

1.0 SCREENING

1.1 Introduction

This Transportation Impact Assessment (TIA) report has been prepared in support of Official Plan Amendment and Zoning By-law Amendment applications for 335 Roosevelt Avenue.

The subject site is surrounded by the following:

- A Multi-Use Pathway (MUP) and the OC Transpo East-West Transitway to the north;
- Wilmont Avenue and low density residential development to the south;
- A high density residential apartment building to the east; and
- Roosevelt Avenue and low density residential development to the west.

A view of the subject site is provided in **Figure 1**.

The site currently has gated accesses at Roosevelt Avenue and at Wilmont Avenue, restricting local traffic from shortcutting between Richmond Road and Churchill Avenue.

Figure 1: View of the Subject Site

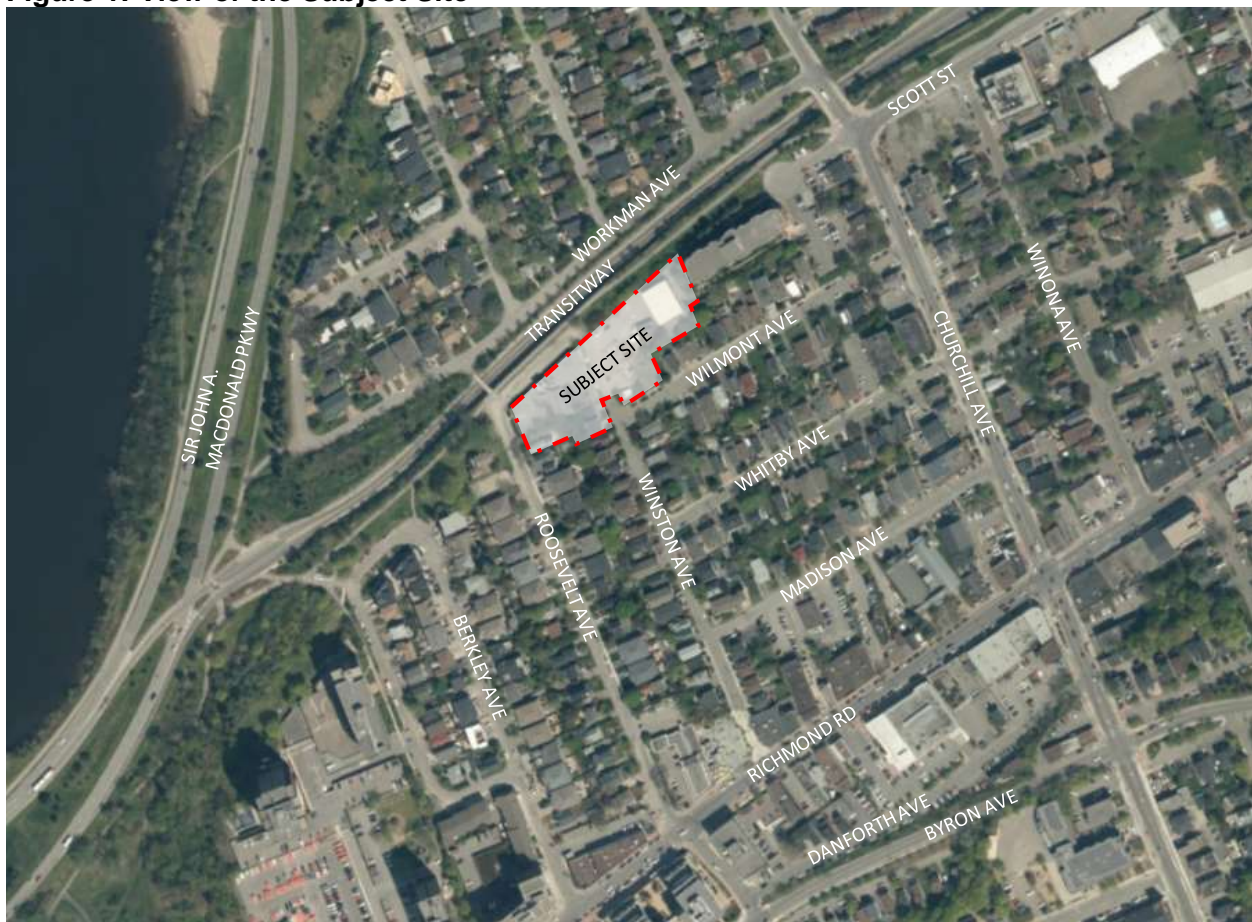
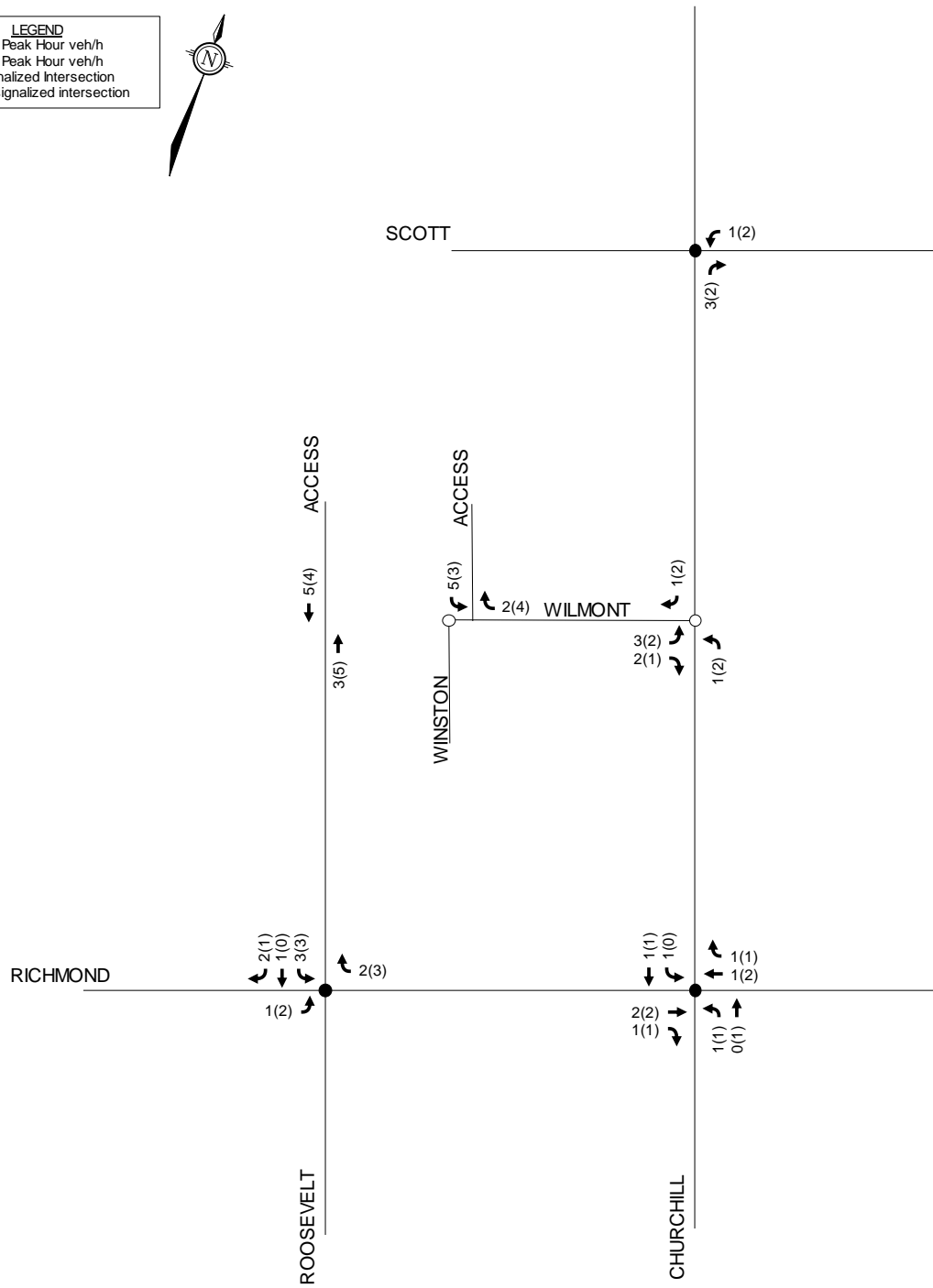

Figure 8: Site Generated Traffic

LEGEND	
xx	AM Peak Hour veh/h
(yy)	PM Peak Hour veh/h
●	Signalized Intersection
○	Unsignalized intersection



319-327 Richmond Road, 380 Winona Avenue, & 381 Churchill Avenue

Transportation Impact Assessment

Step 1 Screening Report

Step 2 Scoping Report

Step 3 Forecasting Report

Step 4 Analysis Report

Prepared for:

Richmond Churchill Limited Partnership
485 Bank Street, Suite 207
Ottawa, ON K2P 1Z2

Prepared by:



13 Markham Avenue
Ottawa, ON K2G 3Z1

May 2020

PN: 2019-03

1 Screening

This study has been prepared according to the City of Ottawa's 2017 Transportation Impact Assessment (TIA) Guidelines. Accordingly, a Step 1 Screening Form has been prepared and is included as Appendix A, along with the Certification Form for TIA Study PM. As shown in the Screening Form, a TIA is required including the Design Review Component and the Network Impact Component.

2 Existing and Planned Conditions

2.1 Proposed Development

The proposed development, located at 381 Churchill Avenue, 380 Winona Avenue, 319, 325, and 327 Richmond Road, is currently zoned as part Traditional Mainstreet (TM H15), part General Mixed Use (GM1), and part Residential Fourth Density (R4). The existing land uses include a car garage and maintenance shop, two small retail stores and a residential apartment with six units. TOD principles apply to the proposed development Study Area.

The proposed development is a nine-storey building with 184 apartment units, 1738 square metres of retail space, 130 vehicle parking spots, and 99 bicycle parking spaces. The site is proposed to have two accesses; one of which is a full movement access on Churchill Avenue approximately 65 metres north of the Churchill Avenue / Richmond Road intersection (measured from access centreline to intersection centre). The second access is located on Winona Avenue approximately 50 metres north of the Winona Avenue / Richmond Road intersection (measured from access centreline to intersection centre) and is a loading entrance with access solely to loading aisles. The anticipated full build-out and occupancy horizon is 2022. Figure 1 illustrates the Study Area context. Figure 2 illustrates the proposed site plan of the development.

Figure 1: Area Context Plan

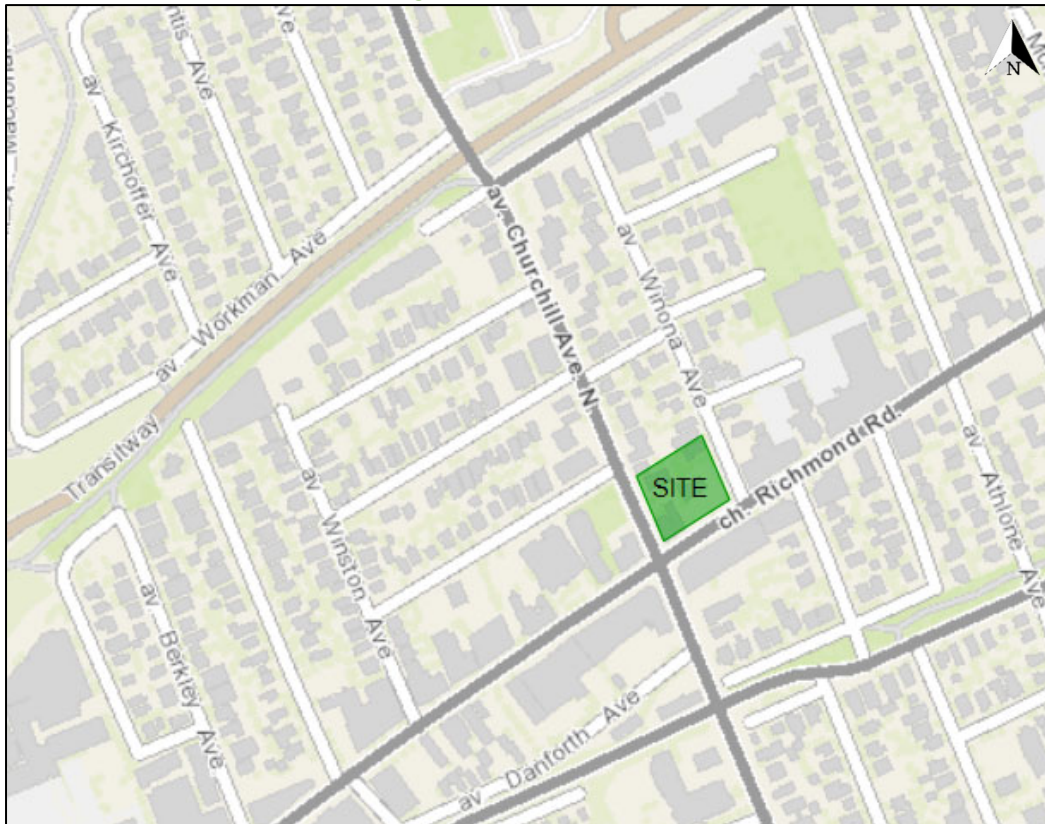
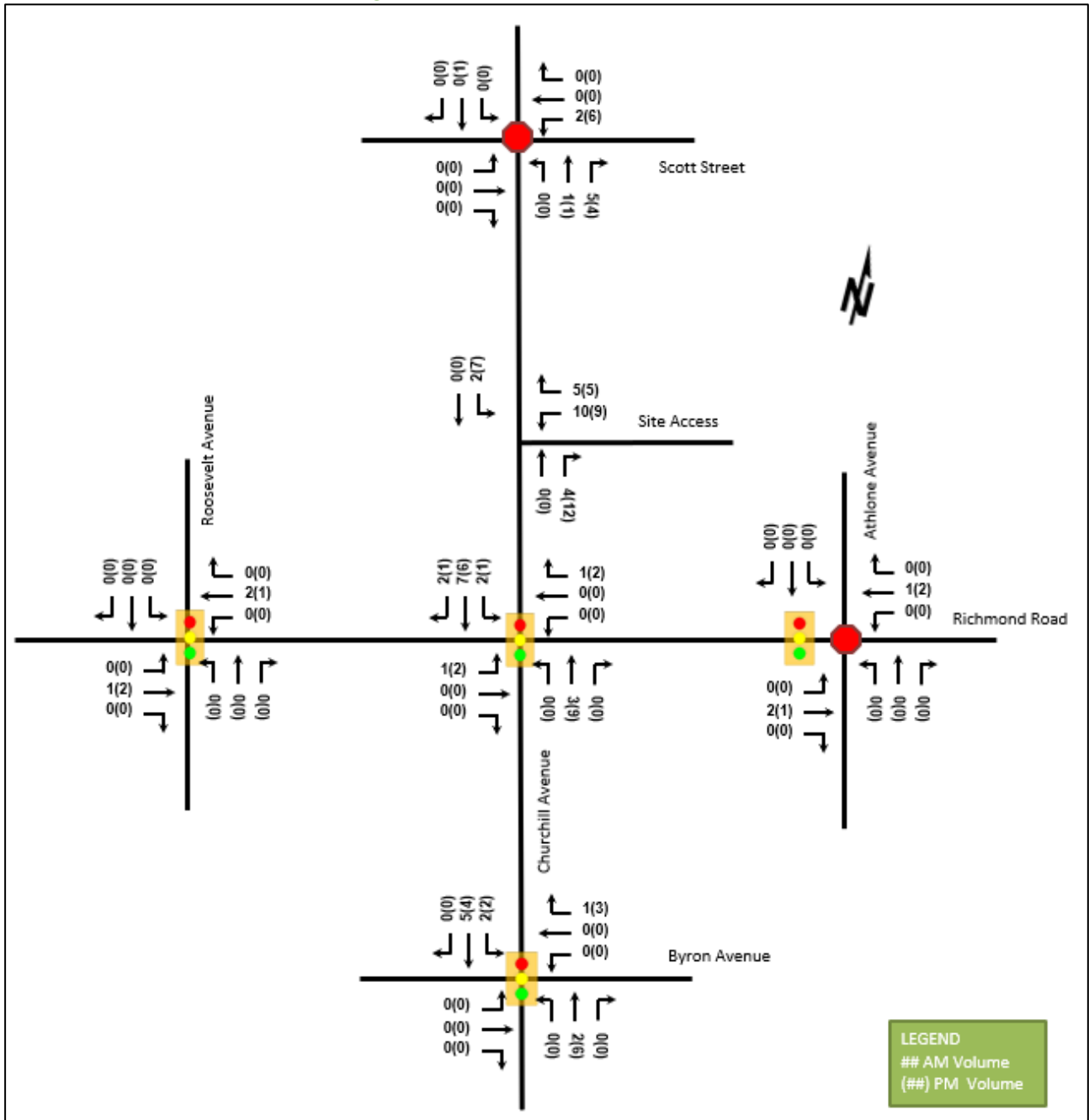

Figure 13: New Site Generation Auto Volumes



6 Background Network Travel Demands

6.1 Transportation Network Plans

The transportation network plans were discussed in Section 2.3.1. Both TOD policies and the opening of the Westboro LRT station and Dominion LRT station have been accounted for within the modal share assumptions. No road improvements are noted for this area with the exception of future road sewer, and water work along Winona Avenue.

320 McRae

Transportation Impact Assessment

Step 1 Screening Report

Step 2 Scoping Report

Step 3 Forecasting Report

Step 4 Strategy Report

Prepared for:

GWL Realty Advisors
33 Yonge Street Suite 1000
Toronto, ON M5E 1G4

Prepared by:



13 Markham Avenue
Ottawa, ON K2G 3Z1

January 2020

PN: 2019-29

1 Screening

This study has been prepared according to the City of Ottawa’s 2017 Transportation Impact Assessment (TIA) Guidelines. Accordingly, a Step 1 Screening Form has been prepared and is included as Appendix A, along with the Certification Form for TIA Study PM. As shown in the Screening Form, a TIA is required including the Design Review component and the Network Impact Component. This study has been prepared to support a site plan application for 320 McRae Avenue.

2 Existing and Planned Conditions

2.1 Proposed Development

The proposed development located at 320 McRae Avenue is currently a mix of residential and commercial buildings. The site is in an area that is zoned as part Traditional Mainstreet (TM 2489 S382-h), part Parks and Open Space (O 1) and part General Mixed Zone (GM2490 H (15) h). The proposed development is within 400 metres of the future Westboro LRT Station to be built by 2025 and therefore TOD principles apply to the applicable future horizons.

The proposed development is made up of a four-storey commercial / residential tower, and a commercial / residential tower with both a 26-storey and a six-storey component. The development is expected to have 882 square metres (9,494 square feet) of commercial space, 307 apartment units, 11 townhouse units, 185 underground automobile parking spaces and 163 bicycle parking spaces. Of the 163 bicycle spaces, 123 will be underground and due to space restrictions, 15 bicycle parking spaces will be slightly off the property and 25 will be in the loading area. The site is proposed to have two full-movement accesses, one approximately 40 metres, curb to curb, south of Scott Street on Tweedsmuir Avenue (Site Access #1) and the second approximately 120 metres, curb to curb, south of Scott Street on McRae Avenue (Site Access #2). Site Access #2 is a loading access and is intended for truck use only. A drop-off area is located on McRae Avenue, approximately 23 metres, curb to curb, south of Scott Street. The anticipated full build-out and occupancy horizon is 2022. Figure 1 illustrates the Study Area Context. Figure 2 illustrates the proposed concept plan.

Figure 1: Area Context Plan

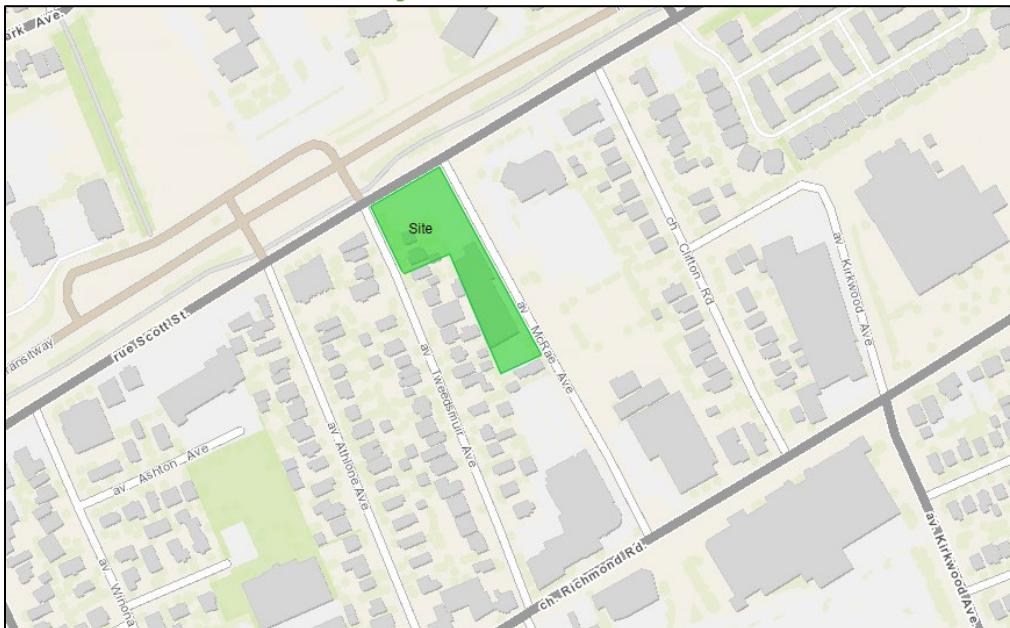
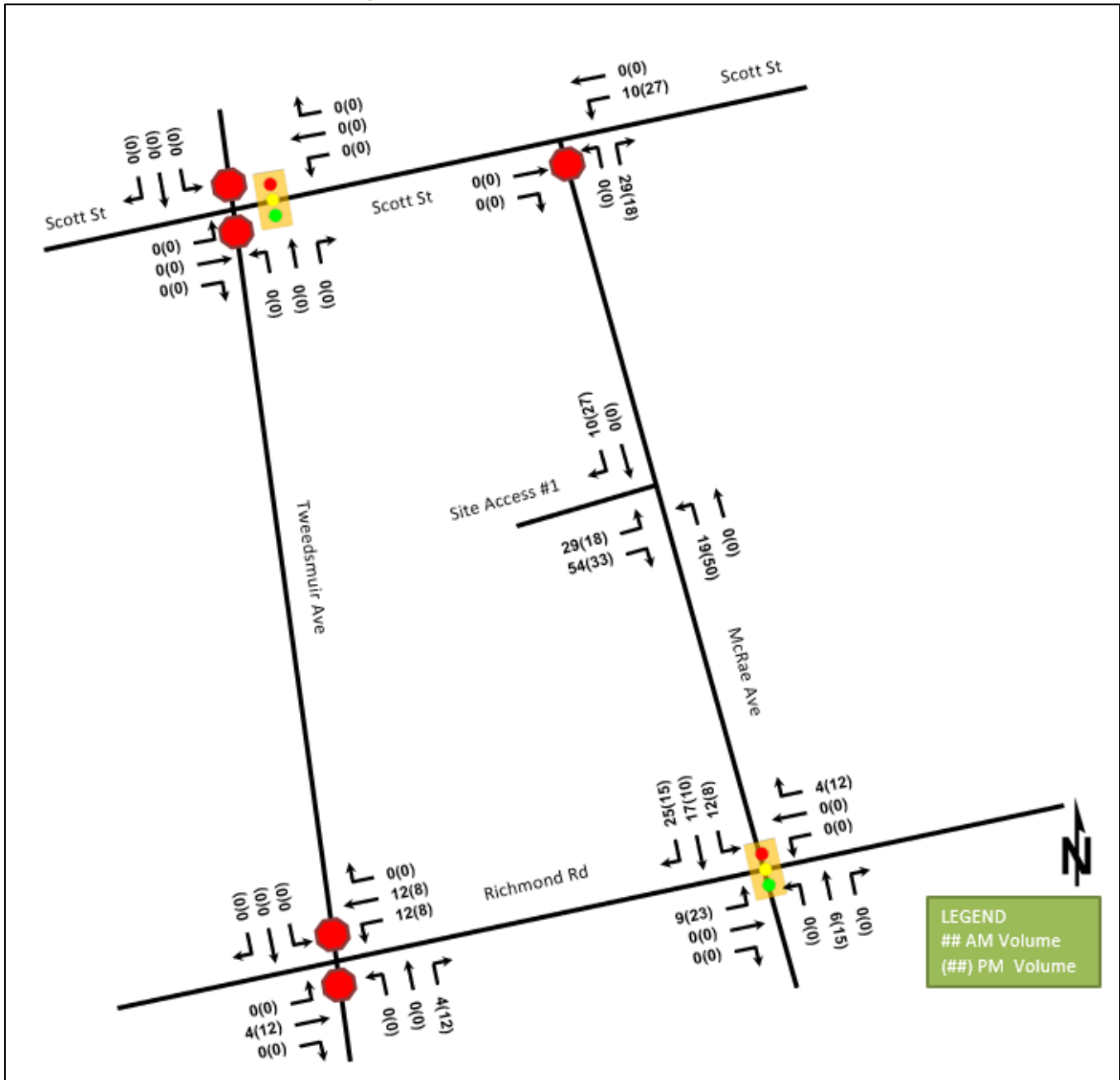

Figure 13: New 2022 Site Generation Auto Volumes



1950 Scott Street

TIA Strategy Report

prepared for:
EBC inc.
740 Notre-Dame Ouest, Bureau 750
Montreal, QC H3C 3X6

prepared by:
PARSONS
1223 Michael Street N
Suite 100
Ottawa, ON K1J 7T2

July 12, 2018

476658 - 01000

TIA Strategy Report

1. SCREENING FORM

The Screening Form is provided as Appendix A. The trip generation trigger was met based on the development size, the location trigger was met based on the development being in a Design Priority Area (DPA), and the safety trigger was met based on the proposed site driveway's proximity to the Scott/Lanark signalized intersection. As triggers have been met, the TIA process continued with the Scoping and Forecasting reports, provided herein.

2. SCOPING REPORT

2.1. EXISTING AND PLANNED CONDITIONS

2.1.1. PROPOSED DEVELOPMENT

Based on the proposed Site Plan, it is our understanding that the proponent is proposing a single-phase residential development located at 1950 Scott Street with an expected occupancy date in 2020. The proposed residential development will consist of approximately 141 condominium/apartment units with 162 proposed residential parking spaces and 10 visitor parking spaces. A single full-movement vehicle access is proposed to Clifton Road at the southern boundary of the site. The site is located on three property parcels, which are currently occupied by a single occupant one-story building and single-family homes and are zoned as Residential Fifth Density and Residential Third Density. The local context of the site is provided as Figure 1 and the proposed Site Plan is provided as Figure 2.

Figure 1: Local Context



Figure 9: 'New' Site-Generated Traffic

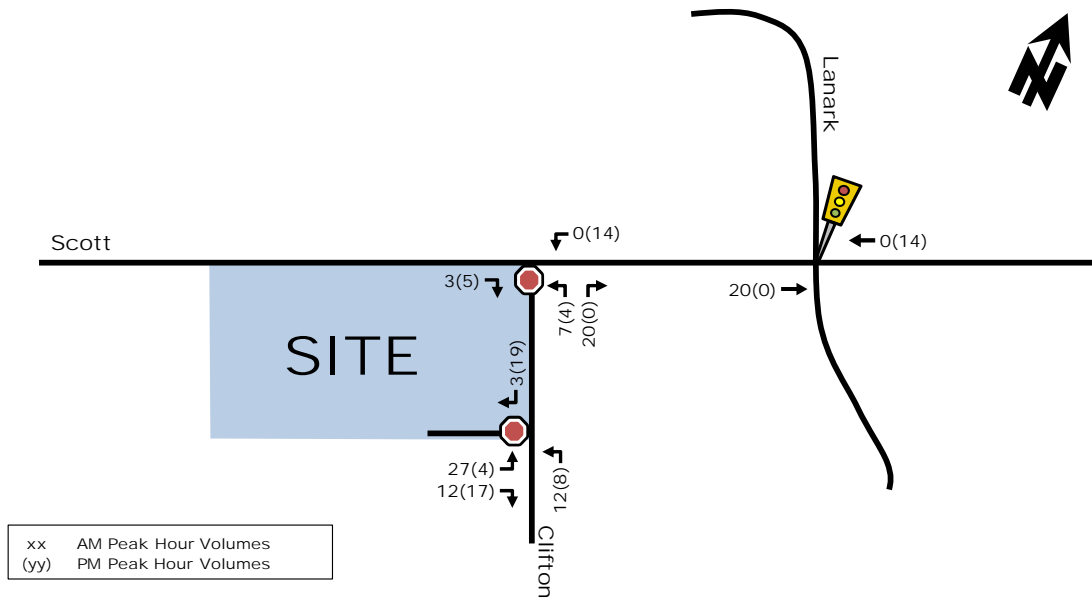

It is noteworthy that the existing turn restrictions are understood to be in place to help prevent cut-through traffic through the neighbourhood. Based on the existing count data at the Clifton/Scott intersection, there are a number of drivers that do not comply with these existing turn restrictions. Some site-generated traffic originating/destined from/to the east will be required to travel along the southern portion on Clifton Road during the peak hours to comply with the existing turn restrictions. This is represented in Figure 9.

3.2. BACKGROUND NETWORK TRAVEL DEMANDS

3.2.1. TRANSPORTATION NETWORK PLANS

Refer to section 2.1.3 Planned Conditions – Planned Study Area Transportation Network Changes.

3.2.2. BACKGROUND GROWTH

Background traffic growth for the area is expected to grow based on significant planned area developments. However, given Stage 2 LRT construction, the City is expecting to see negative vehicle growth along Scott Street in the future (see map attached as Appendix E). As such, for background traffic projections, the projected vehicle volumes from the planned area developments (1960 Scott Street and 320 McRae) were layered onto the existing traffic volumes for the build out year 2020. As the City expects to see a significant increase in transit modes once Stage 2 LRT is constructed in this area (2023) and a decline in traffic volumes, and as there is likely to be continued development growth in the area, the vehicle traffic volumes for horizon year 2025 is assumed to be the same as year 2020.

2050 Scott Street

TIA Report

prepared for:
Scott Street Developments Inc.
88 Spadina Avenue
Ottawa, ON K1Y 2C1

prepared by:
PARSONS
1223 Michael Street North
Suite 100
Ottawa, ON K1J 7T2

February 12, 2021

477330-01000

TIA STRATEGY REPORT

The following Strategy Report has been prepared in support of a Zoning By-Law Amendment (ZBLA) for the proposed residential development located at 2050 Scott Street. This document follows the TIA process, as outlined in the City Transportation Impact Assessment (TIA) Guidelines (2017). City comments and responses have been included as Appendix A.

1. SCREENING FORM

The completed Screening Form for the proposed residential development at 2050 Scott Street confirmed the need for a TIA in support of the proposed development based on the Trip Generation, Location and Safety triggers. The proposed development consists of approximately 355 residential units; is located in a Design Priority Area (DPA) and Transit Oriented Development (TOD) area; and has a proposed driveway within the influence area of an adjacent traffic signal. The Screening Form is provided in Appendix B.

2. SCOPING REPORT

2.1. EXISTING AND PLANNED CONDITIONS

2.1.1. PROPOSED DEVELOPMENT

It is our understanding that the proponent is proposing to construct a residential development located at 2050 Scott Street. A single-phased project is proposed with assumed buildout year of 2021. The development will consist of a 30-storey residential building on a 3- and 6-storey podiums with approximately 353 units and 233 m² of ground commercial/office. The taller portion of the building is located closer to Scott Street while the 3- and 6-storey podiums extend towards Ashton Avenue. Vehicle access is proposed at Scott Street via a single all movement driveway. An underground parking lot with 204 vehicle spaces and 292 bicycle spaces are proposed. The site is located between 2 different land zonings, TM[103] fronting Scott Street and R4G on the south portion of the parcel towards Ashton Avenue. This TIA is in support of a Zoning By-Law Amendment (ZBLA) to vary the height schedule from 6-storeys (18 meters) to 30-storeys within the TM zoning and from 4-storeys (11 meters) to 6-storeys within the R4 zoning. Height step-backs (staggering) are proposed to assist in the transition from low-rise to mid- and high-rise from south to north. This TIA is also in support of a Site Plan Application (SPA). The site is currently occupied by a mechanic garage, a hot tub retailer and 3 residential houses. The local context of the site is provided as **Figure 1** and the proposed Site Plan is provided as **Figure 2**.

Figure 1: Local Context



Figure 9: 'New' Site-Generated Traffic

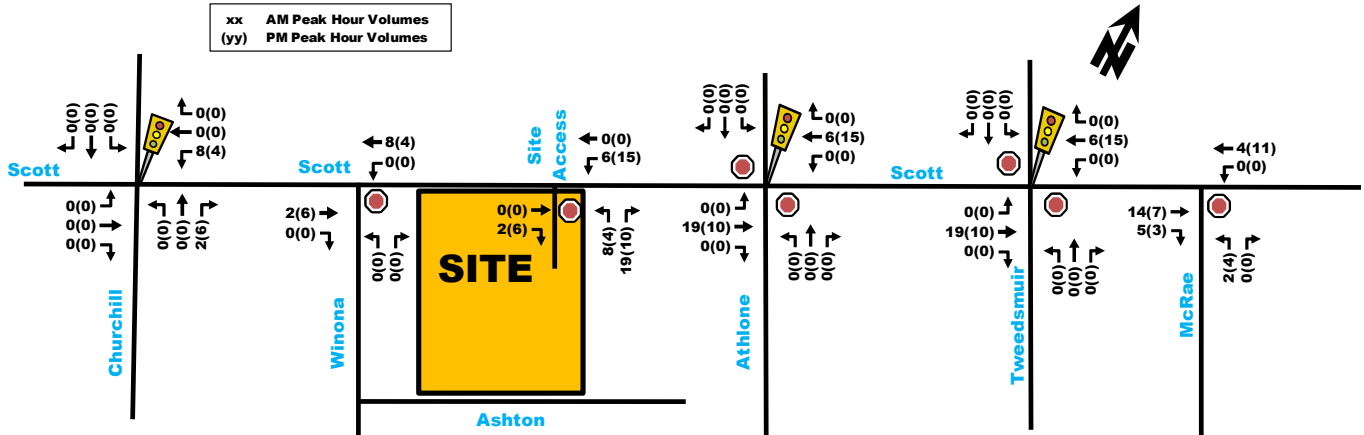

3.2. BACKGROUND NETWORK TRAVEL DEMANDS

3.2.1. TRANSPORTATION NETWORK PLANS

As mentioned in Section 2.1.3 Planned Conditions, 210 to 225 buses will be detoured on to Scott Street for the AM and PM peak periods respectively as part of the Stage 2 LRT West Extension construction. These buses were layered on to the study area intersections for the duration of anticipated construction (2021 to 2025) and are exhibited in **Figure 10**. Note that as part of the bus detours, Churchill/Scott intersection will be upgraded to a signalized intersection.

Figure 10: Buses Detoured on Scott Street

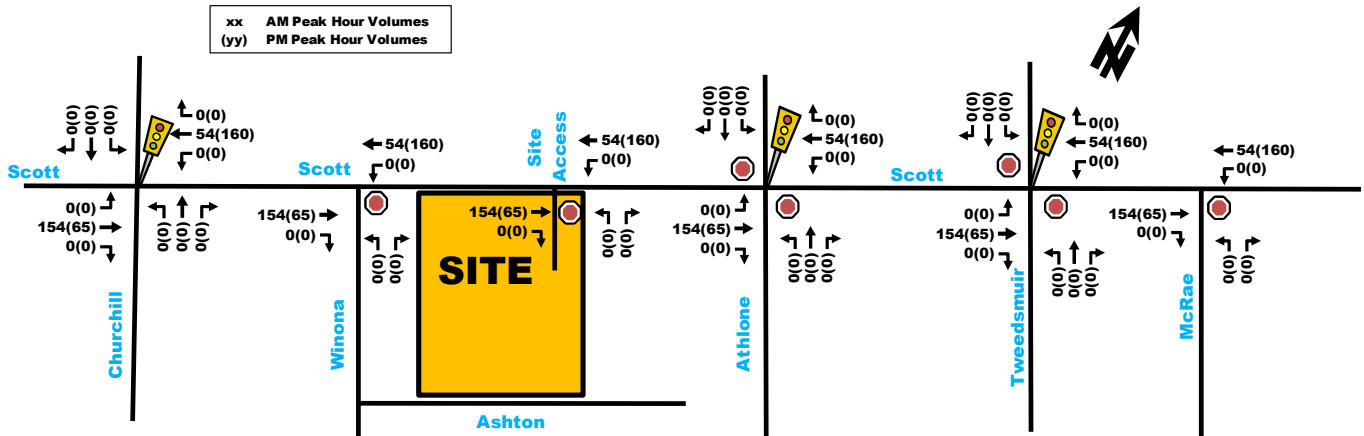

3.2.2. BACKGROUND GROWTH & OTHER DEVELOPMENTS

The emphasis in the City's recent Official Plan and Transportation Master Plan is to place priority on transit, encourage intensification around transit stations, encourage mixed-use developments and provide "complete streets" that better accommodate the active transportation needs of its residents and reduce the use of the private auto. Given the location of the site near future Confederation Line LRT Extension and future Scott Street 'Complete Street' plan, the trips generated from this development as well as nearby developments will likely choose alternate modes of transportation over driving. It is expected to see a decrease in vehicle traffic along Scott Street in the future as the public transportation network near the site becomes mature and alternate modes of transportation become more desirable (see map of anticipated background growth attached as Appendix F). As such, the background vehicle traffic volumes for horizon year 2026 is assumed to be the same as year 2021.

The projected vehicle volumes from the planned area developments as discussed in Section 2.1.3. 'Planned Conditions – Other Area Developments' were added to the study area intersections and are shown in **Figure 11**. The volumes from the other area development along with detoured buses were layered onto the existing traffic volumes for the future interim analysis volumes. Since the bus detour are anticipated between 2021 and 2025, they have been removed from 2026



2070 Scott Street

**Transportation Impact
Assessment**

Strategy Report

November 1st, 2019

Prepared for:

Azure Urban Developments Inc.

Prepared by:

Stantec Consulting Ltd.

DRAFT

Figure 1 - Site Location



Figure 12 - Site Trips

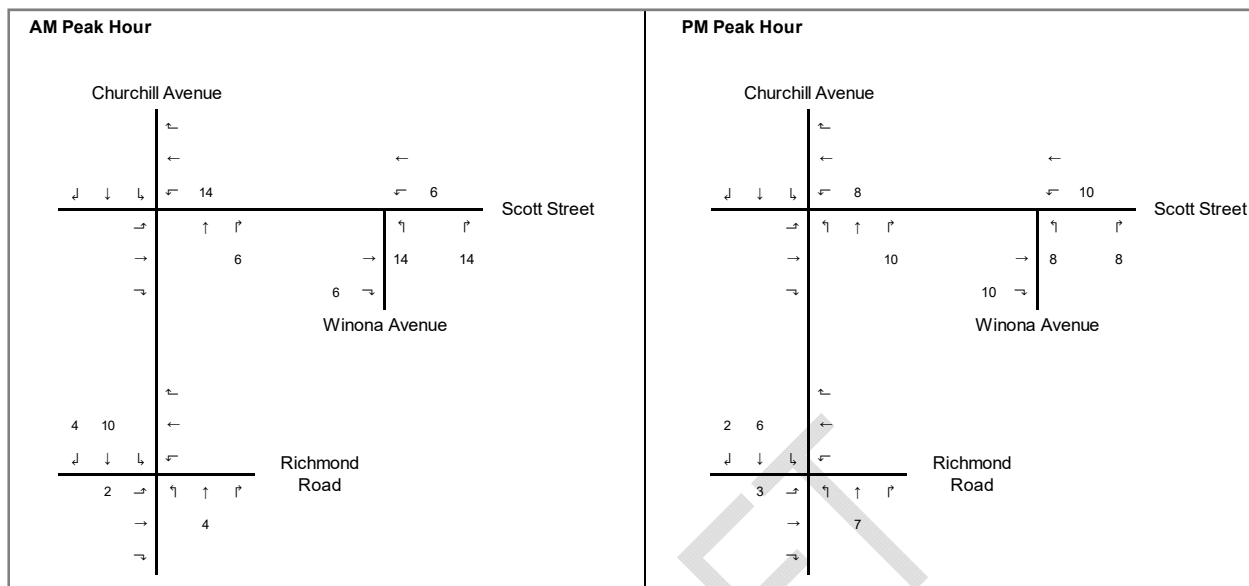

3.2 BACKGROUND NETWORK TRAVEL DEMAND

3.2.1 Transportation Network Plans

As outlined in **Table 4** in **Section 2.1.3.1**, there are two transit projects that are expected to occur within the vicinity of the proposed development; Western Light Rail Transit and the Richmond Road Transit Signal Priority. Based on direction from the City of Ottawa, the Western LRT is planned to be implemented by the 2027 ultimate horizon of the subject development.

3.2.2 Background Growth

The City of Ottawa provided **Figure 13** below, which outlines the average annual growth rates based on trend lines. As illustrated in this figure, the average annual growth in the Westboro neighbourhood is in the range of 0.2% - 2.0%. To be conservative, a 2% annual background growth rate was used in the subject analysis.



APPENDIX H

Strategic Long-Range Model

TRANS Regional Model

Version 2.15 - Assigned Oct, 2021

AM Peak Hour Total Traffic Volume

Westboro

2011 Model - Basecase

N/A

User Initials: TIMW

Plot Prepared: Oct, 2021

EMME Scenario: 21713



Legend

AM Peak Hour Total Traffic Volume

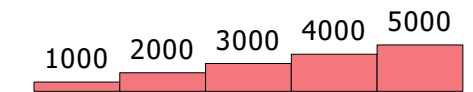

Distance (m)

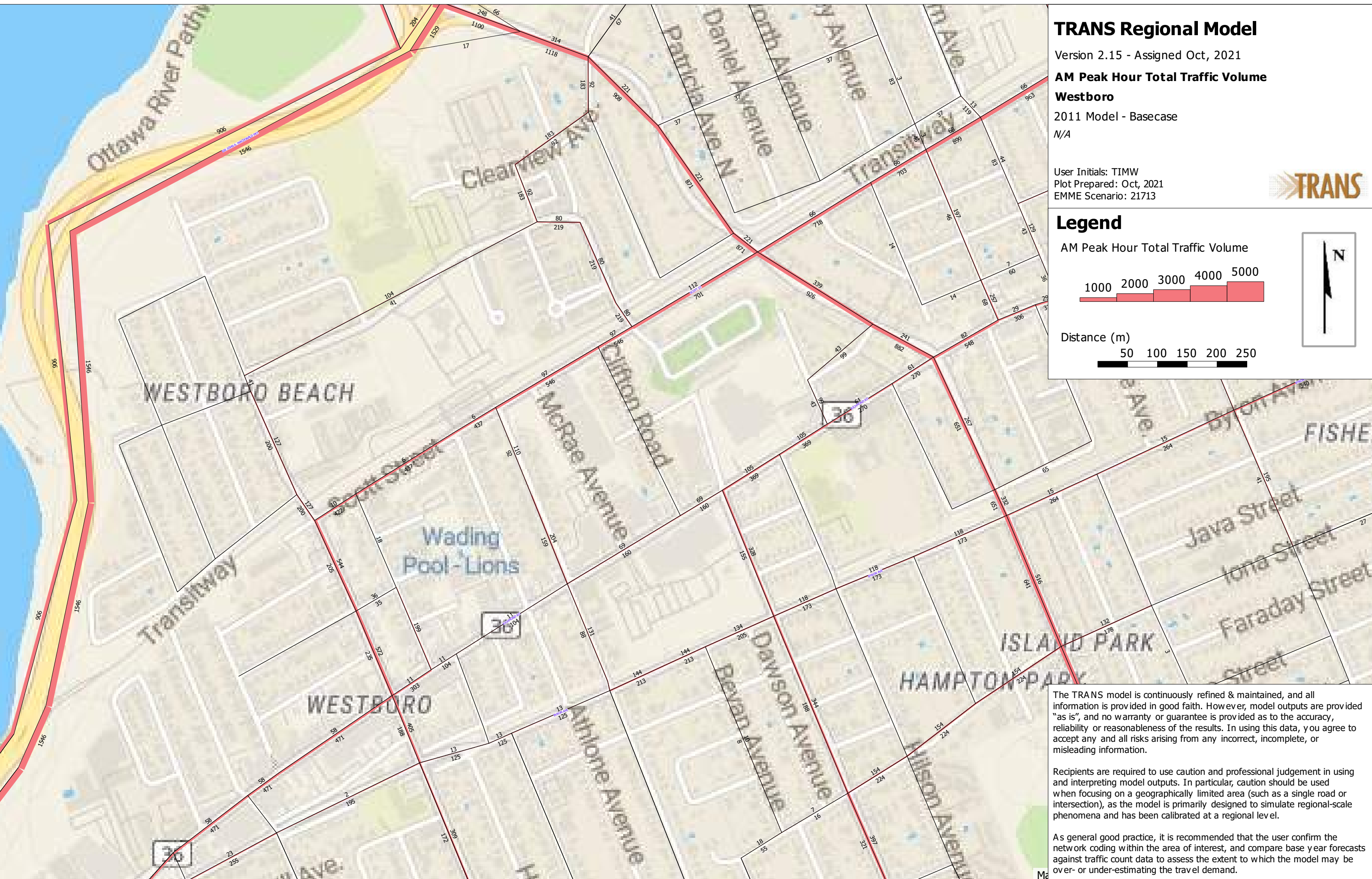
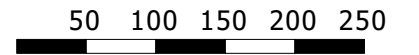

The TRANS model is continuously refined & maintained, and all information is provided in good faith. However, model outputs are provided "as is", and no warranty or guarantee is provided as to the accuracy, reliability or reasonableness of the results. In using this data, you agree to accept any and all risks arising from any incorrect, incomplete, or misleading information.

Recipients are required to use caution and professional judgement in using and interpreting model outputs. In particular, caution should be used when focusing on a geographically limited area (such as a single road or intersection), as the model is primarily designed to simulate regional-scale phenomena and has been calibrated at a regional level.

As general good practice, it is recommended that the user confirm the network coding within the area of interest, and compare base year forecasts against traffic count data to assess the extent to which the model may be over- or under-estimating the travel demand.

TRANS Regional Model

Version 2.15 - Assigned Oct, 2021

AM Peak Hour Total Traffic Volume

Westboro

2031 Model - Basecase

N/A

User Initials: TIMW
Plot Prepared: Oct, 2021
EMME Scenario: 23711



Legend

AM Peak Hour Total Traffic Volume

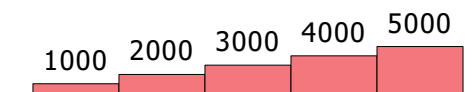

Distance (m)

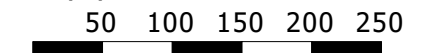

The TRANS model is continuously refined & maintained, and all information is provided in good faith. However, model outputs are provided "as is", and no warranty or guarantee is provided as to the accuracy, reliability or reasonableness of the results. In using this data, you agree to accept any and all risks arising from any incorrect, incomplete, or misleading information.

Recipients are required to use caution and professional judgement in using and interpreting model outputs. In particular, caution should be used when focusing on a geographically limited area (such as a single road or intersection), as the model is primarily designed to simulate regional-scale phenomena and has been calibrated at a regional level.

As general good practice, it is recommended that the user confirm the network coding within the area of interest, and compare base year forecasts against traffic count data to assess the extent to which the model may be over- or under-estimating the travel demand.

APPENDIX I

Signal Timing Plans

Traffic Signal Timing

City of Ottawa, Public Works Department

Traffic Signal Operations Unit

Intersection:	<i>Main:</i> Scott	<i>Side:</i> Churchill
Controller:	ATC 3	TSD: 6040
Author:	Matthew Andeson	Date: 16-Jan-2023

Existing Timing Plans†

	Plan					Ped Minimum Time		
	AM Peak 1	Off Peak 2	PM Peak 3	Night 4	Weekend 5	Walk	DW	A+R
Cycle	95	85	95	85	85			
Offset	X	X	X	X	X			
EB Thru	26	30	30	30	30	7	11	3.0+4.4
WB Thru	26	30	30	30	30	7	11	3.0+4.4
NB Thru	28	28	33	28	28	7	14	3.3+3.1
SB Thru	28	28	33	28	28	7	14	3.3+3.1
WB Left	41	27	32	27	27	-	-	3.0+3.8
NB Right (fp)	41	27	32	27	27	-	-	3.0+3.8

Phasing Sequence‡

Plan:

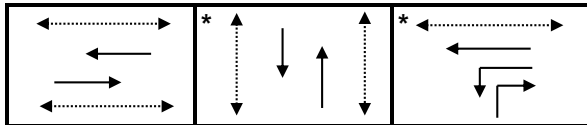

- Notes:**
- 1) The WB left turn/NB right turn has a min recall of 5s green
 - 2) The NB right turn is prohibited on red
 - 3) The EB left turn is prohibited

Schedule

Weekday

Time	Plan
0:15	4
6:30	1
9:30	2
15:00	3
18:30	2
22:30	4

Saturday

Time	Plan
0:15	4
6:30	2
9:00	5
18:30	2
22:30	4

Sunday

Time	Plan
0:15	4
6:30	2
9:00	5
18:00	2
22:30	4

Notes

†: Time for each direction includes amber and all red intervals

‡: Start of first phase should be used as reference point for offset

Asterisk (*) Indicates actuated phase

(fp): Fully Protected Left Turn

←.....→ Pedestrian signal

Cost is \$61.16 (\$54.12 + HST)

Traffic Signal Timing

City of Ottawa, Public Works & Environmental Services Department

Traffic Signal Operations Unit

Intersection:	<i>Main:</i> Scott	<i>Side:</i> Athlone
Controller:	ATC 3	TSD: 6584
Author:	Kymen Kwan	Date: 06-Dec-2021

Existing Timing Plans†

	Plan					Ped Minimum Time		
	AM Peak 1	Off Peak 2	PM Peak 3	Night 4	Weekend 5	Walk	DW	A+R
Cycle	Free	Free	Free	Free	Free			
Offset	X	X	X	X	X			
EB Thru	30.8	30.8	30.8	30.8	30.8	-	-	3.3+2.5
WB Thru	30.8	30.8	30.8	30.8	30.8	-	-	3.3+2.5
NS Ped	24	24	24	24	24	7	11	3.0+1.0

Phasing Sequence‡

Plan: All

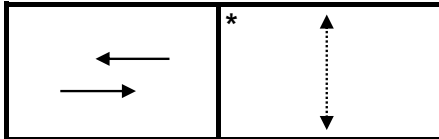

Schedule

Weekday

Time	Plan
0:15	4
6:30	1
9:30	2
15:00	3
18:30	2
21:30	4

Weekend

Time	Plan
0:15	4
6:30	2
11:00	5
19:30	2
22:00	4

Notes

†: Time for each direction includes amber and all red intervals

‡: Start of first phase should be used as reference point for offset

Asterisk (*) Indicates actuated phase

(fp): Fully Protected Left Turn

◄.....► Pedestrian signal

Cost is \$59.96 (\$53.06 + HST)

Traffic Signal Timing

City of Ottawa, Public Works & Environmental Services Department

Traffic Signal Operations Unit

Intersection:	<i>Main:</i> Scott	<i>Side:</i> Tweedsmuir
Controller:	ATC 3	TSD: 5781
Author:	Kymen Kwan	Date: 06-Dec-2021

Existing Timing Plans†

	Plan					Ped Minimum Time		
	AM Peak 1	Off Peak 2	PM Peak 3	Night 4	Weekend 5	Walk	DW	A+R
Cycle	50	50	50	50	50			
Offset	X	X	X	X	X			
EB Thru	28	25	28	25	25	-	-	3.3+2.5
WB Thru	28	25	28	25	25	-	-	3.3+2.5
NS Ped	22	25	22	25	25	7	11	3.0+1.0

Phasing Sequence‡

Plan: All

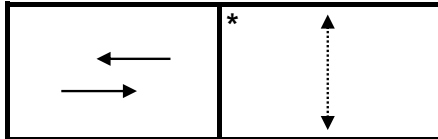

Schedule

Weekday		Saturday		Sunday	
Time	Plan	Time	Plan	Time	Plan
0:15	4	0:15	4	0:15	4
6:30	1	6:30	2	6:30	2
9:30	2	9:00	5	9:00	5
15:00	3	18:30	2	18:00	2
18:30	2	22:30	4	22:30	4
22:30	4				

Notes

- †: Time for each direction includes amber and all red intervals
- ‡: Start of first phase should be used as reference point for offset
- Asterisk (*) Indicates actuated phase
- (fp): Fully Protected Left Turn
- ◄.....► Pedestrian signal



















Cost is \$59.96 (\$53.06 + HST)

APPENDIX J

Existing Synchro Analysis

1: Churchill & Scott
AM Peak Hour

2026 Scott Street
Existing Traffic

												
Lane Group	EBL	EBT	EBR	WBL	WBT	WBR	NBL	NBT	NBR	SBL	SBT	SBR
Lane Configurations												
Traffic Volume (vph)	0	7	13	208	3	16	13	97	358	58	199	2
Future Volume (vph)	0	7	13	208	3	16	13	97	358	58	199	2
Ideal Flow (vphpl)	1800	1800	1800	1800	1800	1800	1800	1800	1800	1800	1800	1800
Storage Length (m)	0.0		0.0	0.0		0.0	0.0		40.0	0.0		0.0
Storage Lanes	0		0	1		0	0		1	0		0
Taper Length (m)	10.0			30.0			10.0			10.0		
Lane Util. Factor	1.00	1.00	1.00	1.00	1.00	1.00	1.00	1.00	1.00	1.00	1.00	1.00
Ped Bike Factor		0.94		0.98	0.90			1.00				0.99
Frt		0.914			0.871				0.850			0.999
Flt Protected				0.950				0.994				0.989
Satd. Flow (prot)	0	1364	0	1461	1175	0	0	1624	1383	0	1631	0
Flt Permitted				0.569				0.937				0.888
Satd. Flow (perm)	0	1364	0	853	1175	0	0	1524	1383	0	1458	0
Right Turn on Red			Yes			Yes			No			Yes
Satd. Flow (RTOR)		14			18							
Link Speed (k/h)		50			50			50			50	
Link Distance (m)		77.3			83.9			315.3			273.6	
Travel Time (s)		5.6			6.0			22.7			19.7	
Confl. Peds. (#/hr)	33		12	12		33	32		10	10		32
Confl. Bikes (#/hr)			27			19			27			14
Peak Hour Factor	0.90	0.90	0.90	0.90	0.90	0.90	0.90	0.90	0.90	0.90	0.90	0.90
Heavy Vehicles (%)	1%	15%	1%	10%	1%	15%	8%	3%	4%	4%	2%	1%
Adj. Flow (vph)	0	8	14	231	3	18	14	108	398	64	221	2
Shared Lane Traffic (%)												
Lane Group Flow (vph)	0	22	0	231	21	0	0	122	398	0	287	0
Enter Blocked Intersection	No	No	No	No	No	No	No	No	No	No	No	No
Lane Alignment	Left	Left	Right	Left	Left	Right	Left	Left	Right	Left	Left	Right
Median Width(m)		4.0			4.0			0.0			0.0	
Link Offset(m)		0.0			0.0			0.0			0.0	
Crosswalk Width(m)		5.0			5.0			5.0			5.0	
Two way Left Turn Lane												
Headway Factor	1.16	1.16	1.16	1.16	1.16	1.16	1.16	1.16	1.16	1.16	1.16	1.16
Turning Speed (k/h)	24		14	24		14	24		14	24		14
Number of Detectors		2		1		2		1	2		1	2
Detector Template		Thru		Left	Thru		Left	Thru	Right	Left	Thru	
Leading Detector (m)		30.5		6.1	30.5		6.1	30.5	6.1	6.1	30.5	
Trailing Detector (m)		0.0		0.0	0.0		0.0	0.0	0.0	0.0	0.0	
Detector 1 Position(m)		0.0		0.0	0.0		0.0	0.0	0.0	0.0	0.0	
Detector 1 Size(m)		1.8		6.1	1.8		6.1	1.8	6.1	6.1	1.8	
Detector 1 Type		Cl+Ex		Cl+Ex	Cl+Ex		Cl+Ex	Cl+Ex	Cl+Ex	Cl+Ex	Cl+Ex	
Detector 1 Channel												
Detector 1 Extend (s)		0.0		0.0	0.0		0.0	0.0	0.0	0.0	0.0	
Detector 1 Queue (s)		0.0		0.0	0.0		0.0	0.0	0.0	0.0	0.0	
Detector 1 Delay (s)		0.0		0.0	0.0		0.0	0.0	0.0	0.0	0.0	
Detector 2 Position(m)		28.7			28.7			28.7			28.7	
Detector 2 Size(m)		1.8			1.8			1.8			1.8	
Detector 2 Type		Cl+Ex			Cl+Ex			Cl+Ex			Cl+Ex	
Detector 2 Channel												
Detector 2 Extend (s)		0.0			0.0			0.0			0.0	
Turn Type		NA		pm+pt	NA		Perm	NA	Over	Perm	NA	
Protected Phases		2		1	6			8	1		4	
Permitted Phases				6			8			4		
Detector Phase		2		1	6		8	8	1	4	4	



Lane Group	EBL	EBT	EBR	WBL	WBT	WBR	NBL	NBT	NBR	SBL	SBT	SBR
Switch Phase												
Minimum Initial (s)		10.0		5.0	10.0		10.0	10.0	5.0	10.0	10.0	
Minimum Split (s)		25.4		11.8	25.4		27.4	27.4	11.8	27.4	27.4	
Total Split (s)		26.0		41.0	67.0		28.0	28.0	41.0	28.0	28.0	
Total Split (%)		27.4%		43.2%	70.5%		29.5%	29.5%	43.2%	29.5%	29.5%	
Maximum Green (s)		18.6		34.2	59.6		21.6	21.6	34.2	21.6	21.6	
Yellow Time (s)		3.0		3.0	3.0		3.3	3.3	3.0	3.3	3.3	
All-Red Time (s)		4.4		3.8	4.4		3.1	3.1	3.8	3.1	3.1	
Lost Time Adjust (s)		0.0		0.0	0.0			0.0	0.0		0.0	
Total Lost Time (s)		7.4		6.8	7.4			6.4	6.8		6.4	
Lead/Lag		Lag		Lead					Lead			
Lead-Lag Optimize?		Yes		Yes					Yes			
Vehicle Extension (s)		3.0		3.0	3.0		3.0	3.0	3.0	3.0	3.0	
Recall Mode		Max		Min	Max		None	None	Min	None	None	
Walk Time (s)		7.0			7.0		7.0	7.0		7.0	7.0	
Flash Dont Walk (s)		11.0			11.0		14.0	14.0		14.0	14.0	
Pedestrian Calls (#/hr)		40			40		40	40		40	40	
Act Effct Green (s)		22.3		60.2	59.6			20.6	30.5		20.6	
Actuated g/C Ratio		0.24		0.64	0.63			0.22	0.32		0.22	
v/c Ratio		0.07		0.31	0.03			0.37	0.89		0.90	
Control Delay		19.5		8.7	3.5			34.7	52.8		67.5	
Queue Delay		0.0		0.0	0.0			0.0	0.0		0.0	
Total Delay		19.5		8.7	3.5			34.7	52.8		67.5	
LOS		B		A	A			C	D		E	
Approach Delay		19.5			8.3			48.5			67.5	
Approach LOS		B			A			D			E	
Queue Length 50th (m)		1.1		15.4	0.2			17.4	60.6		46.9	
Queue Length 95th (m)		6.8		25.6	2.5			32.1	#103.1		#87.6	
Internal Link Dist (m)		53.3			59.9			291.3			249.6	
Turn Bay Length (m)									40.0			
Base Capacity (vph)		334		767	751			350	502		335	
Starvation Cap Reductn		0		0	0			0	0		0	
Spillback Cap Reductn		0		0	0			0	0		0	
Storage Cap Reductn		0		0	0			0	0		0	
Reduced v/c Ratio		0.07		0.30	0.03			0.35	0.79		0.86	

Intersection Summary

Area Type: CBD
 Cycle Length: 95
 Actuated Cycle Length: 94
 Natural Cycle: 90
 Control Type: Semi Act-Uncoord
 Maximum v/c Ratio: 0.90
 Intersection Signal Delay: 43.6
 Intersection LOS: D
 Intersection Capacity Utilization 76.3%
 ICU Level of Service D
 Analysis Period (min) 15
 # 95th percentile volume exceeds capacity, queue may be longer.
 Queue shown is maximum after two cycles.

Splits and Phases: 1: Churchill & Scott

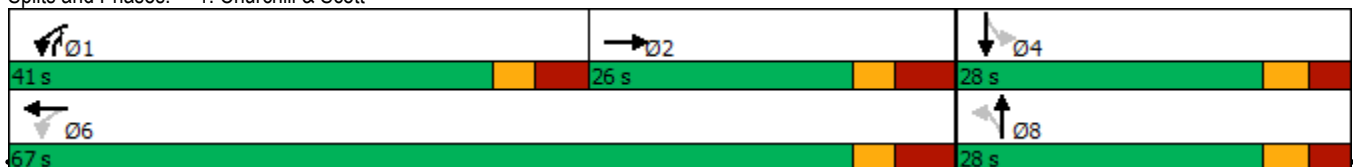



Lane Group	EBT	EBR	WBL	WBT	NBL	NBR
Lane Configurations						
Traffic Volume (vph)	416	14	15	221	1	31
Future Volume (vph)	416	14	15	221	1	31
Ideal Flow (vphpl)	1800	1800	1800	1800	1800	1800
Storage Length (m)		0.0	10.0		0.0	0.0
Storage Lanes		0	1		1	0
Taper Length (m)			30.0		10.0	
Lane Util. Factor	1.00	1.00	0.95	0.95	1.00	1.00
Ped Bike Factor						
Frt	0.995				0.869	
Flt Protected				0.997	0.999	
Satd. Flow (prot)	1617	0	0	2921	1454	0
Flt Permitted				0.997	0.999	
Satd. Flow (perm)	1617	0	0	2921	1454	0
Link Speed (k/h)	50			50	40	
Link Distance (m)	83.9			194.8	233.8	
Travel Time (s)	6.0			14.0	21.0	
Confl. Peds. (#/hr)		7	7			2
Confl. Bikes (#/hr)		22				4
Peak Hour Factor	0.90	0.90	0.90	0.90	0.90	0.90
Heavy Vehicles (%)	4%	8%	6%	10%	1%	1%
Adj. Flow (vph)	462	16	17	246	1	34
Shared Lane Traffic (%)						
Lane Group Flow (vph)	478	0	0	263	35	0
Enter Blocked Intersection	No	No	No	No	No	No
Lane Alignment	Left	Right	Left	Left	Left	Right
Median Width(m)	0.0			0.0	4.0	
Link Offset(m)	0.0			0.0	0.0	
Crosswalk Width(m)	5.0			5.0	5.0	
Two way Left Turn Lane						
Headway Factor	1.16	1.16	1.16	1.16	1.16	1.16
Turning Speed (k/h)		14	24		24	14
Sign Control	Free			Free	Stop	

Intersection Summary

Area Type:	CBD
Control Type:	Unsignalized
Intersection Capacity Utilization	37.3%
ICU Level of Service	A
Analysis Period (min)	15

3: Athlone & Scott
AM Peak Hour

2026 Scott Street
Existing Traffic



Lane Group	EBL	EBT	EBR	WBL	WBT	WBR	NBL	NBT	NBR	SBL	SBT	SBR
Lane Configurations												
Traffic Volume (vph)	11	468	8	23	260	6	0	0	0	0	0	0
Future Volume (vph)	11	468	8	23	260	6	0	0	0	0	0	0
Ideal Flow (vphpl)	1800	1800	1800	1800	1800	1800	1800	1800	1800	1800	1800	1800
Lane Util. Factor	1.00	1.00	1.00	1.00	1.00	1.00	1.00	1.00	1.00	1.00	1.00	1.00
Ped Bike Factor	1.00		1.00		1.00		1.00		1.00		1.00	
Flt Protected	0.998		0.997		0.996		0.995		0.994		0.993	
Satd. Flow (prot)	0	1613	0	0	1543	0	0	0	0	0	0	0
Flt Permitted	0.992		0.945		0.898		0.851		0.804		0.757	
Satd. Flow (perm)	0	1599	0	0	1463	0	0	0	0	0	0	0
Right Turn on Red			Yes		Yes		Yes		Yes		Yes	
Satd. Flow (RTOR)	2		3		4		5		6		7	
Link Speed (k/h)	50		50		50		50		50		50	
Link Distance (m)	194.8		84.2		256.4		54.4		14.0		3.9	
Travel Time (s)	14.0		6.1		18.5		3.9		1.1		0.3	
Confl. Peds. (#/hr)	117		17	17		117	64		16	16		64
Confl. Bikes (#/hr)			11			7			3			
Peak Hour Factor	0.90	0.90	0.90	0.90	0.90	0.90	0.90	0.90	0.90	0.90	0.90	0.90
Heavy Vehicles (%)	100%	2%	20%	1%	7%	100%	1%	100%	1%	100%	100%	100%
Adj. Flow (vph)	12	520	9	26	289	7	0	0	0	0	0	0
Shared Lane Traffic (%)												
Lane Group Flow (vph)	0	541	0	0	322	0	0	0	0	0	0	0
Enter Blocked Intersection	No	No	No	No	No	No	No	No	No	No	No	No
Lane Alignment	Left	Left	Right	Left	Left	Right	Left	Left	Right	Left	Left	Right
Median Width(m)	4.0		4.0		0.0		0.0		0.0		0.0	
Link Offset(m)	0.0		0.0		0.0		0.0		0.0		0.0	
Crosswalk Width(m)	5.0		5.0		5.0		5.0		5.0		5.0	
Two way Left Turn Lane												
Headway Factor	1.16	1.16	1.16	1.16	1.16	1.16	1.16	1.16	1.16	1.16	1.16	1.16
Turning Speed (k/h)	24		14	24		14	24		14	24		14
Number of Detectors	1	2		1	2							
Detector Template	Left	Thru		Left	Thru							
Leading Detector (m)	6.1	30.5		6.1	30.5							
Trailing Detector (m)	0.0	0.0		0.0	0.0							
Detector 1 Position(m)	0.0	0.0		0.0	0.0							
Detector 1 Size(m)	6.1	1.8		6.1	1.8							
Detector 1 Type	CI+Ex	CI+Ex		CI+Ex	CI+Ex							
Detector 1 Channel												
Detector 1 Extend (s)	0.0	0.0		0.0	0.0							
Detector 1 Queue (s)	0.0	0.0		0.0	0.0							
Detector 1 Delay (s)	0.0	0.0		0.0	0.0							
Detector 2 Position(m)	28.7		28.7		28.7		28.7		28.7		28.7	
Detector 2 Size(m)	1.8		1.8		1.8		1.8		1.8		1.8	
Detector 2 Type	CI+Ex		CI+Ex		CI+Ex		CI+Ex		CI+Ex		CI+Ex	
Detector 2 Channel												
Detector 2 Extend (s)	0.0		0.0		0.0		0.0		0.0		0.0	
Turn Type	Perm	NA		Perm	NA							
Protected Phases	2		6		6		6		6		6	
Permitted Phases	2		6		6		6		6		6	
Detector Phase	2	2		6	6							
Switch Phase												
Minimum Initial (s)	10.0	10.0		10.0	10.0							
Minimum Split (s)	15.8	15.8		15.8	15.8							

Lane Group	Ø4
Lane Configurations	
Traffic Volume (vph)	
Future Volume (vph)	
Ideal Flow (vphpl)	
Lane Util. Factor	
Ped Bike Factor	
Frt	
Flt Protected	
Satd. Flow (prot)	
Flt Permitted	
Satd. Flow (perm)	
Right Turn on Red	
Satd. Flow (RTOR)	
Link Speed (k/h)	
Link Distance (m)	
Travel Time (s)	
Confl. Peds. (#/hr)	
Confl. Bikes (#/hr)	
Peak Hour Factor	
Heavy Vehicles (%)	
Adj. Flow (vph)	
Shared Lane Traffic (%)	
Lane Group Flow (vph)	
Enter Blocked Intersection	
Lane Alignment	
Median Width(m)	
Link Offset(m)	
Crosswalk Width(m)	
Two way Left Turn Lane	
Headway Factor	
Turning Speed (k/h)	
Number of Detectors	
Detector Template	
Leading Detector (m)	
Trailing Detector (m)	
Detector 1 Position(m)	
Detector 1 Size(m)	
Detector 1 Type	
Detector 1 Channel	
Detector 1 Extend (s)	
Detector 1 Queue (s)	
Detector 1 Delay (s)	
Detector 2 Position(m)	
Detector 2 Size(m)	
Detector 2 Type	
Detector 2 Channel	
Detector 2 Extend (s)	
Turn Type	
Protected Phases	4
Permitted Phases	
Detector Phase	
Switch Phase	
Minimum Initial (s)	20.0
Minimum Split (s)	24.0

3: Athlone & Scott
AM Peak Hour

2026 Scott Street
Existing Traffic



Lane Group	EBL	EBT	EBR	WBL	WBT	WBR	NBL	NBT	NBR	SBL	SBT	SBR
Total Split (s)	30.8	30.8		30.8	30.8							
Total Split (%)	56.2%	56.2%		56.2%	56.2%							
Maximum Green (s)	25.0	25.0		25.0	25.0							
Yellow Time (s)	3.3	3.3		3.3	3.3							
All-Red Time (s)	2.5	2.5		2.5	2.5							
Lost Time Adjust (s)		0.0			0.0							
Total Lost Time (s)		5.8			5.8							
Lead/Lag												
Lead-Lag Optimize?												
Vehicle Extension (s)	3.0	3.0		3.0	3.0							
Recall Mode	Max	Max		Max	Max							
Walk Time (s)												
Flash Dont Walk (s)												
Pedestrian Calls (#/hr)												
Act Effct Green (s)		44.8			44.8							
Actuated g/C Ratio		0.74			0.74							
v/c Ratio		0.45			0.30							
Control Delay		9.1			7.5							
Queue Delay		0.0			0.3							
Total Delay		9.1			7.8							
LOS		A			A							
Approach Delay		9.1			7.8							
Approach LOS		A			A							
Queue Length 50th (m)		37.7			18.9							
Queue Length 95th (m)		62.8			33.0							
Internal Link Dist (m)		170.8			60.2			232.4			30.4	
Turn Bay Length (m)												
Base Capacity (vph)		1190			1089							
Starvation Cap Reductn		0			316							
Spillback Cap Reductn		0			0							
Storage Cap Reductn		0			0							
Reduced v/c Ratio		0.45			0.42							

Intersection Summary

Area Type:	CBD
Cycle Length:	54.8
Actuated Cycle Length:	60.2
Natural Cycle:	60
Control Type:	Semi Act-Uncoord
Maximum v/c Ratio:	0.45
Intersection Signal Delay:	8.6
Intersection LOS:	A
Intersection Capacity Utilization:	37.5%
ICU Level of Service:	A
Analysis Period (min):	15



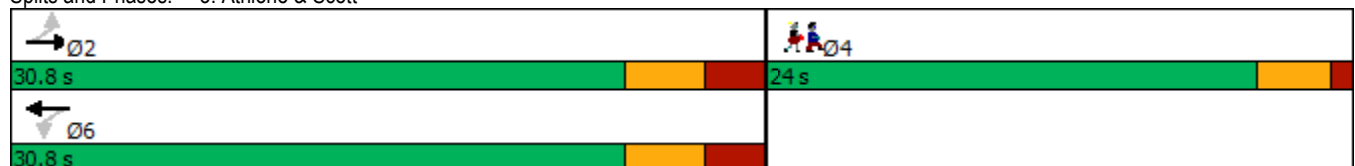











Splits and Phases: 3: Athlone & Scott



Lane Group	Ø4
Total Split (s)	24.0
Total Split (%)	44%
Maximum Green (s)	20.0
Yellow Time (s)	3.0
All-Red Time (s)	1.0
Lost Time Adjust (s)	
Total Lost Time (s)	
Lead/Lag	
Lead-Lag Optimize?	
Vehicle Extension (s)	3.0
Recall Mode	None
Walk Time (s)	7.0
Flash Dont Walk (s)	11.0
Pedestrian Calls (#/hr)	100
Act Effct Green (s)	
Actuated g/C Ratio	
v/c Ratio	
Control Delay	
Queue Delay	
Total Delay	
LOS	
Approach Delay	
Approach LOS	
Queue Length 50th (m)	
Queue Length 95th (m)	
Internal Link Dist (m)	
Turn Bay Length (m)	
Base Capacity (vph)	
Starvation Cap Reductn	
Spillback Cap Reductn	
Storage Cap Reductn	
Reduced v/c Ratio	
Intersection Summary	

4: Tweedsmuir & Scott
AM Peak Hour

2026 Scott Street
Existing Traffic

												
Lane Group	EBL	EBT	EBR	WBL	WBT	WBR	NBL	NBT	NBR	SBL	SBT	SBR
Lane Configurations												
Traffic Volume (vph)	0	475	3	10	263	5	0	0	0	0	0	0
Future Volume (vph)	0	475	3	10	263	5	0	0	0	0	0	0
Ideal Flow (vphpl)	1800	1800	1800	1800	1800	1800	1800	1800	1800	1800	1800	1800
Lane Util. Factor	1.00	1.00	1.00	1.00	1.00	1.00	1.00	1.00	1.00	1.00	1.00	1.00
Ped Bike Factor		1.00			1.00							
Frt		0.999			0.997							
Flt Protected					0.998							
Satd. Flow (prot)	0	1641	0	0	1558	0	0	0	0	0	0	0
Flt Permitted					0.981							
Satd. Flow (perm)	0	1641	0	0	1531	0	0	0	0	0	0	0
Right Turn on Red			Yes			Yes			Yes			Yes
Satd. Flow (RTOR)		1			3							
Link Speed (k/h)		50			50			50			50	
Link Distance (m)		84.2			67.4			275.0			51.7	
Travel Time (s)		6.1			4.9			19.8			3.7	
Confl. Peds. (#/hr)	149		15	15		149	6		122	122		6
Confl. Bikes (#/hr)			8			1						
Peak Hour Factor	0.90	0.90	0.90	0.90	0.90	0.90	0.90	0.90	0.90	0.90	0.90	0.90
Heavy Vehicles (%)	100%	3%	1%	1%	6%	100%	1%	1%	1%	100%	100%	100%
Adj. Flow (vph)	0	528	3	11	292	6	0	0	0	0	0	0
Shared Lane Traffic (%)												
Lane Group Flow (vph)	0	531	0	0	309	0	0	0	0	0	0	0
Enter Blocked Intersection	No	No	No	No	No	No	No	No	No	No	No	No
Lane Alignment	Left	Left	Right	Left	Left	Right	Left	Left	Right	Left	Left	Right
Median Width(m)		0.0			0.0			0.0			0.0	
Link Offset(m)		0.0			0.0			0.0			0.0	
Crosswalk Width(m)		5.0			5.0			5.0			5.0	
Two way Left Turn Lane												
Headway Factor	1.16	1.16	1.16	1.16	1.16	1.16	1.16	1.16	1.16	1.16	1.16	1.16
Turning Speed (k/h)	24		14	24		14	24		14	24		14
Number of Detectors	1	2		1	2							
Detector Template	Left	Thru		Left	Thru							
Leading Detector (m)	6.1	30.5		6.1	30.5							
Trailing Detector (m)	0.0	0.0		0.0	0.0							
Detector 1 Position(m)	0.0	0.0		0.0	0.0							
Detector 1 Size(m)	6.1	1.8		6.1	1.8							
Detector 1 Type	CI+Ex	CI+Ex		CI+Ex	CI+Ex							
Detector 1 Channel												
Detector 1 Extend (s)	0.0	0.0		0.0	0.0							
Detector 1 Queue (s)	0.0	0.0		0.0	0.0							
Detector 1 Delay (s)	0.0	0.0		0.0	0.0							
Detector 2 Position(m)		28.7			28.7							
Detector 2 Size(m)		1.8			1.8							
Detector 2 Type		CI+Ex			CI+Ex							
Detector 2 Channel												
Detector 2 Extend (s)		0.0			0.0							
Turn Type		NA		Perm	NA							
Protected Phases		2			6							
Permitted Phases	2			6								
Detector Phase	2	2		6	6							
Switch Phase												
Minimum Initial (s)	10.0	10.0		10.0	10.0							
Minimum Split (s)	15.8	15.8		15.8	15.8							

Lane Group	Ø4
Lane Configurations	
Traffic Volume (vph)	
Future Volume (vph)	
Ideal Flow (vphpl)	
Lane Util. Factor	
Ped Bike Factor	
Frt	
Flt Protected	
Satd. Flow (prot)	
Flt Permitted	
Satd. Flow (perm)	
Right Turn on Red	
Satd. Flow (RTOR)	
Link Speed (k/h)	
Link Distance (m)	
Travel Time (s)	
Confl. Peds. (#/hr)	
Confl. Bikes (#/hr)	
Peak Hour Factor	
Heavy Vehicles (%)	
Adj. Flow (vph)	
Shared Lane Traffic (%)	
Lane Group Flow (vph)	
Enter Blocked Intersection	
Lane Alignment	
Median Width(m)	
Link Offset(m)	
Crosswalk Width(m)	
Two way Left Turn Lane	
Headway Factor	
Turning Speed (k/h)	
Number of Detectors	
Detector Template	
Leading Detector (m)	
Trailing Detector (m)	
Detector 1 Position(m)	
Detector 1 Size(m)	
Detector 1 Type	
Detector 1 Channel	
Detector 1 Extend (s)	
Detector 1 Queue (s)	
Detector 1 Delay (s)	
Detector 2 Position(m)	
Detector 2 Size(m)	
Detector 2 Type	
Detector 2 Channel	
Detector 2 Extend (s)	
Turn Type	
Protected Phases	4
Permitted Phases	
Detector Phase	
Switch Phase	
Minimum Initial (s)	10.0
Minimum Split (s)	22.0

4: Tweedsmuir & Scott
AM Peak Hour

2026 Scott Street
Existing Traffic



Lane Group	EBL	EBT	EBR	WBL	WBT	WBR	NBL	NBT	NBR	SBL	SBT	SBR
Total Split (s)	28.0	28.0		28.0	28.0							
Total Split (%)	56.0%	56.0%		56.0%	56.0%							
Maximum Green (s)	22.2	22.2		22.2	22.2							
Yellow Time (s)	3.3	3.3		3.3	3.3							
All-Red Time (s)	2.5	2.5		2.5	2.5							
Lost Time Adjust (s)		0.0			0.0							
Total Lost Time (s)		5.8			5.8							
Lead/Lag												
Lead-Lag Optimize?												
Vehicle Extension (s)	3.0	3.0		3.0	3.0							
Recall Mode	Max	Max		Max	Max							
Walk Time (s)												
Flash Dont Walk (s)												
Pedestrian Calls (#/hr)												
Act Effct Green (s)		41.8			41.8							
Actuated g/C Ratio		0.74			0.74							
v/c Ratio		0.44			0.27							
Control Delay		8.4			6.8							
Queue Delay		0.5			0.0							
Total Delay		8.9			6.8							
LOS		A			A							
Approach Delay		8.9			6.8							
Approach LOS		A			A							
Queue Length 50th (m)		33.3			16.2							
Queue Length 95th (m)		56.1			28.8							
Internal Link Dist (m)		60.2			43.4			251.0			27.7	
Turn Bay Length (m)												
Base Capacity (vph)		1220			1139							
Starvation Cap Reductn		313			0							
Spillback Cap Reductn		0			0							
Storage Cap Reductn		0			0							
Reduced v/c Ratio		0.59			0.27							

Intersection Summary

Area Type:	CBD
Cycle Length:	50
Actuated Cycle Length:	56.2
Natural Cycle:	55
Control Type:	Semi Act-Uncoord
Maximum v/c Ratio:	0.44
Intersection Signal Delay:	8.1
Intersection LOS:	A
Intersection Capacity Utilization:	34.4%
ICU Level of Service:	A
Analysis Period (min):	15

Splits and Phases: 4: Tweedsmuir & Scott

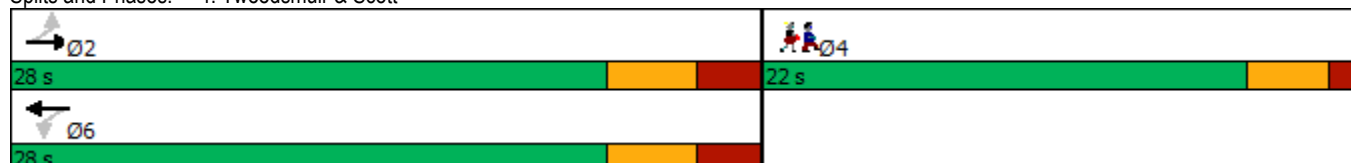

Lane Group	Ø4
Total Split (s)	22.0
Total Split (%)	44%
Maximum Green (s)	18.0
Yellow Time (s)	3.0
All-Red Time (s)	1.0
Lost Time Adjust (s)	
Total Lost Time (s)	
Lead/Lag	
Lead-Lag Optimize?	
Vehicle Extension (s)	3.0
Recall Mode	None
Walk Time (s)	7.0
Flash Dont Walk (s)	11.0
Pedestrian Calls (#/hr)	100
Act Effct Green (s)	
Actuated g/C Ratio	
v/c Ratio	
Control Delay	
Queue Delay	
Total Delay	
LOS	
Approach Delay	
Approach LOS	
Queue Length 50th (m)	
Queue Length 95th (m)	
Internal Link Dist (m)	
Turn Bay Length (m)	
Base Capacity (vph)	
Starvation Cap Reductn	
Spillback Cap Reductn	
Storage Cap Reductn	
Reduced v/c Ratio	
Intersection Summary	



Lane Group	EBT	EBR	WBL	WBT	NBL	NBR
Lane Configurations						
Traffic Volume (vph)	490	25	98	265	13	73
Future Volume (vph)	490	25	98	265	13	73
Ideal Flow (vphpl)	1800	1800	1800	1800	1800	1800
Lane Util. Factor	1.00	1.00	1.00	1.00	1.00	1.00
Ped Bike Factor						
Frt	0.993				0.885	
Flt Protected				0.987	0.993	
Satd. Flow (prot)	1633	0	0	1607	1472	0
Flt Permitted				0.987	0.993	
Satd. Flow (perm)	1633	0	0	1607	1472	0
Link Speed (k/h)	50				50	50
Link Distance (m)	67.4				200.5	303.1
Travel Time (s)	4.9				14.4	21.8
Confl. Peds. (#/hr)	50		50			
Confl. Bikes (#/hr)	10			5		
Peak Hour Factor	0.90	0.90	0.90	0.90	0.90	0.90
Heavy Vehicles (%)	3%	1%	1%	5%	1%	1%
Adj. Flow (vph)	544	28	109	294	14	81
Shared Lane Traffic (%)						
Lane Group Flow (vph)	572	0	0	403	95	0
Enter Blocked Intersection	No	No	No	No	No	No
Lane Alignment	Left	Right	Left	Left	Left	Right
Median Width(m)	0.0				0.0	4.0
Link Offset(m)	0.0				0.0	0.0
Crosswalk Width(m)	5.0				5.0	5.0
Two way Left Turn Lane						
Headway Factor	1.16	1.16	1.16	1.16	1.16	1.16
Turning Speed (k/h)	14		24	24		14
Sign Control	Free			Free	Stop	

Intersection Summary

Area Type: CBD

















Control Type: Unsignalized

Intersection Capacity Utilization 71.1% ICU Level of Service C

Analysis Period (min) 15

















3: Athlone & Scott
AM Peak Hour

2026 Scott Street
Existing Traffic

												
Lane Group	EBL	EBT	EBR	WBL	WBT	WBR	NBL	NBT	NBR	SBL	SBT	SBR
Lane Configurations												
Traffic Volume (vph)	11	468	8	23	260	6	3	0	28	0	0	0
Future Volume (vph)	11	468	8	23	260	6	3	0	28	0	0	0
Ideal Flow (vphpl)	1800	1800	1800	1800	1800	1800	1800	1800	1800	1800	1800	1800
Lane Util. Factor	1.00	1.00	1.00	1.00	1.00	1.00	1.00	1.00	1.00	1.00	1.00	1.00
Ped Bike Factor												
Frt		0.998			0.997			0.877				
Flt Protected		0.999			0.996			0.996				
Satd. Flow (prot)	0	1615	0	0	1548	0	0	1463	0	0	846	0
Flt Permitted		0.999			0.996			0.996				
Satd. Flow (perm)	0	1615	0	0	1548	0	0	1463	0	0	846	0
Link Speed (k/h)		50			50			50			50	
Link Distance (m)		194.8			84.2			256.4			54.4	
Travel Time (s)		14.0			6.1			18.5			3.9	
Confl. Peds. (#/hr)	117		17	17		117	64		16	16		64
Confl. Bikes (#/hr)			11			7			3			
Peak Hour Factor	0.90	0.90	0.90	0.90	0.90	0.90	0.90	0.90	0.90	0.90	0.90	0.90
Heavy Vehicles (%)	100%	2%	20%	1%	7%	100%	1%	100%	1%	100%	100%	100%
Adj. Flow (vph)	12	520	9	26	289	7	3	0	31	0	0	0
Shared Lane Traffic (%)												
Lane Group Flow (vph)	0	541	0	0	322	0	0	34	0	0	0	0
Enter Blocked Intersection	No	No	No	No	No	No	No	No	No	No	No	No
Lane Alignment	Left	Left	Right	Left	Left	Right	Left	Left	Right	Left	Left	Right
Median Width(m)		4.0			4.0			0.0			0.0	
Link Offset(m)		0.0			0.0			0.0			0.0	
Crosswalk Width(m)		5.0			5.0			5.0			5.0	
Two way Left Turn Lane												
Headway Factor	1.16	1.16	1.16	1.16	1.16	1.16	1.16	1.16	1.16	1.16	1.16	1.16
Turning Speed (k/h)	24		14	24		14	24		14	24		14
Sign Control		Free			Free			Stop			Stop	
Intersection Summary												
Area Type:	CBD											
Control Type:	Unsignalized											
Intersection Capacity Utilization 51.4%	ICU Level of Service A											
Analysis Period (min) 15												

4: Tweedsmuir & Scott
AM Peak Hour

2026 Scott Street
Existing Traffic

												
Lane Group	EBL	EBT	EBR	WBL	WBT	WBR	NBL	NBT	NBR	SBL	SBT	SBR
Lane Configurations												
Traffic Volume (vph)	0	475	3	10	263	5	3	0	34	6	0	0
Future Volume (vph)	0	475	3	10	263	5	3	0	34	6	0	0
Ideal Flow (vphpl)	1800	1800	1800	1800	1800	1800	1800	1800	1800	1800	1800	1800
Lane Util. Factor	1.00	1.00	1.00	1.00	1.00	1.00	1.00	1.00	1.00	1.00	1.00	1.00
Ped Bike Factor												
Frt		0.999			0.997			0.875				
Flt Protected					0.998			0.996			0.950	
Satd. Flow (prot)	0	1641	0	0	1564	0	0	1460	0	0	804	0
Flt Permitted					0.998			0.996			0.950	
Satd. Flow (perm)	0	1641	0	0	1564	0	0	1460	0	0	804	0
Link Speed (k/h)		50			50			50			50	
Link Distance (m)		84.2			67.4			275.0			51.7	
Travel Time (s)		6.1			4.9			19.8			3.7	
Confl. Peds. (#/hr)	149		15	15		149	6		122	122		6
Confl. Bikes (#/hr)			8			1						
Peak Hour Factor	0.90	0.90	0.90	0.90	0.90	0.90	0.90	0.90	0.90	0.90	0.90	0.90
Heavy Vehicles (%)	100%	3%	1%	1%	6%	100%	1%	1%	1%	100%	100%	100%
Adj. Flow (vph)	0	528	3	11	292	6	3	0	38	7	0	0
Shared Lane Traffic (%)												
Lane Group Flow (vph)	0	531	0	0	309	0	0	41	0	0	7	0
Enter Blocked Intersection	No	No	No	No	No	No	No	No	No	No	No	No
Lane Alignment	Left	Left	Right	Left	Left	Right	Left	Left	Right	Left	Left	Right
Median Width(m)		0.0			0.0			0.0			0.0	
Link Offset(m)		0.0			0.0			0.0			0.0	
Crosswalk Width(m)		5.0			5.0			5.0			5.0	
Two way Left Turn Lane												
Headway Factor	1.16	1.16	1.16	1.16	1.16	1.16	1.16	1.16	1.16	1.16	1.16	1.16
Turning Speed (k/h)	24		14	24		14	24		14	24		14
Sign Control		Free			Free			Stop			Stop	
Intersection Summary												
Area Type:	CBD											
Control Type:	Unsignalized											
Intersection Capacity Utilization 49.5%	ICU Level of Service A											
Analysis Period (min) 15												

1: Churchill & Scott
PM Peak Hour

2026 Scott Street
Existing Traffic



Lane Group	EBL	EBT	EBR	WBL	WBT	WBR	NBL	NBT	NBR	SBL	SBT	SBR
Lane Configurations												
Traffic Volume (vph)	0	7	11	291	8	46	18	148	208	41	117	3
Future Volume (vph)	0	7	11	291	8	46	18	148	208	41	117	3
Ideal Flow (vphpl)	1800	1800	1800	1800	1800	1800	1800	1800	1800	1800	1800	1800
Storage Length (m)	0.0		0.0	0.0		0.0	0.0		40.0	0.0		0.0
Storage Lanes	0		0	1		0	0		1	0		0
Taper Length (m)	10.0			10.0			10.0			10.0		
Lane Util. Factor	1.00	1.00	1.00	1.00	1.00	1.00	1.00	1.00	1.00	1.00	1.00	1.00
Ped Bike Factor		0.95		0.96	0.86			0.99			0.99	
Frt		0.919			0.872				0.850		0.998	
Flt Protected				0.950				0.995			0.987	
Satd. Flow (prot)	0	1464	0	1576	1181	0	0	1660	1410	0	1618	0
Flt Permitted				0.605				0.955			0.815	
Satd. Flow (perm)	0	1464	0	968	1181	0	0	1584	1410	0	1330	0
Right Turn on Red			Yes			Yes			No			Yes
Satd. Flow (RTOR)		12			51							1
Link Speed (k/h)		50			50			50			50	
Link Distance (m)		77.3			83.9			315.3			273.6	
Travel Time (s)		5.6			6.0			22.7			19.7	
Confl. Peds. (#/hr)	41		17	17		41	33		11	11		33
Confl. Bikes (#/hr)			12			61			22			26
Peak Hour Factor	0.90	0.90	0.90	0.90	0.90	0.90	0.90	0.90	0.90	0.90	0.90	0.90
Heavy Vehicles (%)	1%	1%	1%	2%	1%	9%	5%	1%	2%	8%	1%	1%
Adj. Flow (vph)	0	8	12	323	9	51	20	164	231	46	130	3
Shared Lane Traffic (%)												
Lane Group Flow (vph)	0	20	0	323	60	0	0	184	231	0	179	0
Enter Blocked Intersection	No	No	No	No	No	No	No	No	No	No	No	No
Lane Alignment	Left	Left	Right	Left	Left	Right	Left	Left	Right	Left	Left	Right
Median Width(m)		4.0			4.0			0.0			0.0	
Link Offset(m)		0.0			0.0			0.0			0.0	
Crosswalk Width(m)		5.0			5.0			5.0			5.0	
Two way Left Turn Lane												
Headway Factor	1.16	1.16	1.16	1.16	1.16	1.16	1.16	1.16	1.16	1.16	1.16	1.16
Turning Speed (k/h)	24		14	24		14	24		14	24		14
Number of Detectors		2		1	2		1	2	1	1		2
Detector Template		Thru		Left	Thru		Left	Thru	Right	Left		Thru
Leading Detector (m)		30.5		6.1	30.5		6.1	30.5	6.1	6.1		30.5
Trailing Detector (m)		0.0		0.0	0.0		0.0	0.0	0.0	0.0		0.0
Detector 1 Position(m)		0.0		0.0	0.0		0.0	0.0	0.0	0.0		0.0
Detector 1 Size(m)		1.8		6.1	1.8		6.1	1.8	6.1	6.1		1.8
Detector 1 Type		Cl+Ex		Cl+Ex	Cl+Ex		Cl+Ex	Cl+Ex	Cl+Ex	Cl+Ex		Cl+Ex
Detector 1 Channel												
Detector 1 Extend (s)		0.0		0.0	0.0		0.0	0.0	0.0	0.0		0.0
Detector 1 Queue (s)		0.0		0.0	0.0		0.0	0.0	0.0	0.0		0.0
Detector 1 Delay (s)		0.0		0.0	0.0		0.0	0.0	0.0	0.0		0.0
Detector 2 Position(m)		28.7			28.7			28.7				28.7
Detector 2 Size(m)		1.8			1.8			1.8				1.8
Detector 2 Type		Cl+Ex			Cl+Ex			Cl+Ex				Cl+Ex
Detector 2 Channel												
Detector 2 Extend (s)		0.0			0.0			0.0				0.0
Turn Type		NA		pm+pt	NA		Perm	NA	Over	Perm		NA
Protected Phases		2		1	6			8	1			4
Permitted Phases				6			8			4		
Detector Phase		2		1	6		8	8	1	4		4

1: Churchill & Scott
PM Peak Hour

2026 Scott Street
Existing Traffic



Lane Group	EBL	EBT	EBR	WBL	WBT	WBR	NBL	NBT	NBR	SBL	SBT	SBR
Switch Phase												
Minimum Initial (s)		10.0		5.0	10.0		10.0	10.0	5.0	10.0	10.0	
Minimum Split (s)		25.4		11.8	25.4		27.4	27.4	11.8	27.4	27.4	
Total Split (s)		30.0		32.0	62.0		33.0	33.0	32.0	33.0	33.0	
Total Split (%)		31.6%		33.7%	65.3%		34.7%	34.7%	33.7%	34.7%	34.7%	
Maximum Green (s)		22.6		25.2	54.6		26.6	26.6	25.2	26.6	26.6	
Yellow Time (s)		3.0		3.0	3.0		3.3	3.3	3.0	3.3	3.3	
All-Red Time (s)		4.4		3.8	4.4		3.1	3.1	3.8	3.1	3.1	
Lost Time Adjust (s)		0.0		0.0	0.0			0.0	0.0		0.0	
Total Lost Time (s)		7.4		6.8	7.4			6.4	6.8		6.4	
Lead/Lag		Lag		Lead					Lead			
Lead-Lag Optimize?		Yes		Yes					Yes			
Vehicle Extension (s)		3.0		3.0	3.0		3.0	3.0	3.0	3.0	3.0	
Recall Mode		Max		Min	Max		None	None	Min	None	None	
Walk Time (s)		7.0			7.0		7.0	7.0		7.0	7.0	
Flash Dont Walk (s)		11.0			11.0		14.0	14.0		14.0	14.0	
Pedestrian Calls (#/hr)		40			40		40	40		40	40	
Act Effct Green (s)		29.4		55.4	54.8			17.3	18.6		17.3	
Actuated g/c Ratio		0.34		0.64	0.64			0.20	0.22		0.20	
v/c Ratio		0.04		0.43	0.08			0.58	0.76		0.67	
Control Delay		16.5		9.7	3.1			38.2	47.8		43.8	
Queue Delay		0.0		0.0	0.0			0.0	0.0		0.0	
Total Delay		16.5		9.7	3.1			38.2	47.8		43.8	
LOS		B		A	A			D	D		D	
Approach Delay		16.5			8.7			43.5			43.8	
Approach LOS		B			A			D			D	
Queue Length 50th (m)		0.9		22.3	0.5			25.2	34.2		25.0	
Queue Length 95th (m)		6.0		38.0	4.8			43.5	54.5		43.8	
Internal Link Dist (m)		53.3			59.9			291.3			249.6	
Turn Bay Length (m)									40.0			
Base Capacity (vph)		508		802	771			491	414		413	
Starvation Cap Reductn		0		0	0			0	0		0	
Spillback Cap Reductn		0		0	0			0	0		0	
Storage Cap Reductn		0		0	0			0	0		0	
Reduced v/c Ratio		0.04		0.40	0.08			0.37	0.56		0.43	

Intersection Summary

Area Type: CBD
 Cycle Length: 95
 Actuated Cycle Length: 86
 Natural Cycle: 75
 Control Type: Semi Act-Uncoord
 Maximum v/c Ratio: 0.76
 Intersection Signal Delay: 29.6
 Intersection Capacity Utilization 70.0%
 Analysis Period (min) 15
 Intersection LOS: C
 ICU Level of Service C

Splits and Phases: 1: Churchill & Scott

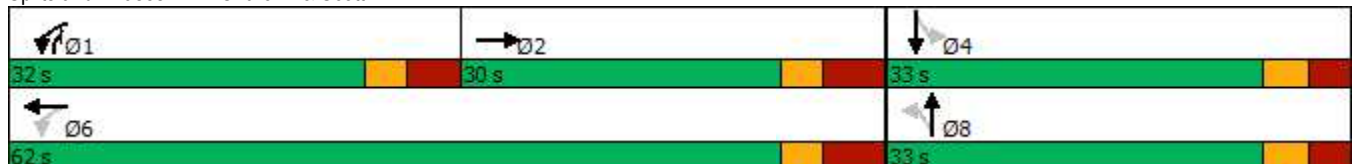



Lane Group	EBT	EBR	WBL	WBT	NBL	NBR
Lane Configurations						
Traffic Volume (vph)	338	6	39	435	2	38
Future Volume (vph)	338	6	39	435	2	38
Ideal Flow (vphpl)	1800	1800	1800	1800	1800	1800
Storage Length (m)		0.0	10.0		0.0	0.0
Storage Lanes		0	1		1	0
Taper Length (m)			30.0		10.0	
Lane Util. Factor	1.00	1.00	0.95	0.95	1.00	1.00
Ped Bike Factor						
Frt	0.998				0.871	
Flt Protected				0.996	0.998	
Satd. Flow (prot)	1640	0	0	3114	1456	0
Flt Permitted				0.996	0.998	
Satd. Flow (perm)	1640	0	0	3114	1456	0
Link Speed (k/h)	50			50	40	
Link Distance (m)	83.9			194.8	233.8	
Travel Time (s)	6.0			14.0	21.0	
Confl. Peds. (#/hr)		12	12			
Confl. Bikes (#/hr)		6				1
Peak Hour Factor	0.90	0.90	0.90	0.90	0.90	0.90
Heavy Vehicles (%)	3%	1%	1%	3%	1%	1%
Adj. Flow (vph)	376	7	43	483	2	42
Shared Lane Traffic (%)						
Lane Group Flow (vph)	383	0	0	526	44	0
Enter Blocked Intersection	No	No	No	No	No	No
Lane Alignment	Left	Right	Left	Left	Left	Right
Median Width(m)	0.0			0.0	4.0	
Link Offset(m)	0.0			0.0	0.0	
Crosswalk Width(m)	5.0			5.0	5.0	
Two way Left Turn Lane						
Headway Factor	1.16	1.16	1.16	1.16	1.16	1.16
Turning Speed (k/h)		14	24		24	14
Sign Control	Free			Free	Stop	

Intersection Summary

Area Type:	CBD
Control Type:	Unsignalized
Intersection Capacity Utilization	50.1%
ICU Level of Service	A
Analysis Period (min)	15

3: Athlone & Scott
PM Peak Hour

2026 Scott Street
Existing Traffic



Lane Group	EBL	EBT	EBR	WBL	WBT	WBR	NBL	NBT	NBR	SBL	SBT	SBR
Lane Configurations												
Traffic Volume (vph)	8	396	9	21	523	0	0	0	0	0	0	0
Future Volume (vph)	8	396	9	21	523	0	0	0	0	0	0	0
Ideal Flow (vphpl)	1800	1800	1800	1800	1800	1800	1800	1800	1800	1800	1800	1800
Lane Util. Factor	1.00	1.00	1.00	1.00	1.00	1.00	1.00	1.00	1.00	1.00	1.00	1.00
Ped Bike Factor		1.00			1.00							
Frt		0.997										
Flt Protected		0.999			0.998							
Satd. Flow (prot)	0	1621	0	0	1656	0	0	0	0	0	0	0
Flt Permitted		0.989			0.977							
Satd. Flow (perm)	0	1603	0	0	1621	0	0	0	0	0	0	0
Right Turn on Red			Yes			Yes			Yes			Yes
Satd. Flow (RTOR)		3										
Link Speed (k/h)		50			50			50				50
Link Distance (m)		194.8			84.2			256.4				54.4
Travel Time (s)		14.0			6.1			18.5				3.9
Confl. Peds. (#/hr)	130		16	16		130	87		10	10		87
Confl. Bikes (#/hr)			4			20			1			3
Peak Hour Factor	0.90	0.90	0.90	0.90	0.90	0.90	0.90	0.90	0.90	0.90	0.90	0.90
Heavy Vehicles (%)	100%	2%	1%	1%	2%	100%	1%	100%	1%	100%	100%	100%
Adj. Flow (vph)	9	440	10	23	581	0	0	0	0	0	0	0
Shared Lane Traffic (%)												
Lane Group Flow (vph)	0	459	0	0	604	0	0	0	0	0	0	0
Enter Blocked Intersection	No	No	No	No	No	No	No	No	No	No	No	No
Lane Alignment	Left	Left	Right	Left	Left	Right	Left	Left	Right	Left	Left	Right
Median Width(m)		4.0			4.0			0.0				0.0
Link Offset(m)		0.0			0.0			0.0				0.0
Crosswalk Width(m)		5.0			5.0			5.0				5.0
Two way Left Turn Lane												
Headway Factor	1.16	1.16	1.16	1.16	1.16	1.16	1.16	1.16	1.16	1.16	1.16	1.16
Turning Speed (k/h)	24		14	24		14	24		14	24		14
Number of Detectors	1	2		1	2							
Detector Template	Left	Thru		Left	Thru							
Leading Detector (m)	6.1	30.5		6.1	30.5							
Trailing Detector (m)	0.0	0.0		0.0	0.0							
Detector 1 Position(m)	0.0	0.0		0.0	0.0							
Detector 1 Size(m)	6.1	1.8		6.1	1.8							
Detector 1 Type	CI+Ex	CI+Ex		CI+Ex	CI+Ex							
Detector 1 Channel												
Detector 1 Extend (s)	0.0	0.0		0.0	0.0							
Detector 1 Queue (s)	0.0	0.0		0.0	0.0							
Detector 1 Delay (s)	0.0	0.0		0.0	0.0							
Detector 2 Position(m)		28.7			28.7							
Detector 2 Size(m)		1.8			1.8							
Detector 2 Type		CI+Ex			CI+Ex							
Detector 2 Channel												
Detector 2 Extend (s)		0.0			0.0							
Turn Type	Perm	NA		Perm	NA							
Protected Phases		2			6							
Permitted Phases	2			6								
Detector Phase	2	2		6	6							
Switch Phase												
Minimum Initial (s)	10.0	10.0		10.0	10.0							
Minimum Split (s)	15.8	15.8		15.8	15.8							

Lane Group	Ø4
Lane Configurations	
Traffic Volume (vph)	
Future Volume (vph)	
Ideal Flow (vphpl)	
Lane Util. Factor	
Ped Bike Factor	
Frt	
Flt Protected	
Satd. Flow (prot)	
Flt Permitted	
Satd. Flow (perm)	
Right Turn on Red	
Satd. Flow (RTOR)	
Link Speed (k/h)	
Link Distance (m)	
Travel Time (s)	
Confl. Peds. (#/hr)	
Confl. Bikes (#/hr)	
Peak Hour Factor	
Heavy Vehicles (%)	
Adj. Flow (vph)	
Shared Lane Traffic (%)	
Lane Group Flow (vph)	
Enter Blocked Intersection	
Lane Alignment	
Median Width(m)	
Link Offset(m)	
Crosswalk Width(m)	
Two way Left Turn Lane	
Headway Factor	
Turning Speed (k/h)	
Number of Detectors	
Detector Template	
Leading Detector (m)	
Trailing Detector (m)	
Detector 1 Position(m)	
Detector 1 Size(m)	
Detector 1 Type	
Detector 1 Channel	
Detector 1 Extend (s)	
Detector 1 Queue (s)	
Detector 1 Delay (s)	
Detector 2 Position(m)	
Detector 2 Size(m)	
Detector 2 Type	
Detector 2 Channel	
Detector 2 Extend (s)	
Turn Type	
Protected Phases	4
Permitted Phases	
Detector Phase	
Switch Phase	
Minimum Initial (s)	20.0
Minimum Split (s)	24.0

3: Athlone & Scott
PM Peak Hour

2026 Scott Street
Existing Traffic



Lane Group	EBL	EBT	EBR	WBL	WBT	WBR	NBL	NBT	NBR	SBL	SBT	SBR
Total Split (s)	30.8	30.8		30.8	30.8							
Total Split (%)	56.2%	56.2%		56.2%	56.2%							
Maximum Green (s)	25.0	25.0		25.0	25.0							
Yellow Time (s)	3.3	3.3		3.3	3.3							
All-Red Time (s)	2.5	2.5		2.5	2.5							
Lost Time Adjust (s)		0.0			0.0							
Total Lost Time (s)		5.8			5.8							
Lead/Lag												
Lead-Lag Optimize?												
Vehicle Extension (s)	3.0	3.0		3.0	3.0							
Recall Mode	Max	Max		Max	Max							
Walk Time (s)												
Flash Dont Walk (s)												
Pedestrian Calls (#/hr)												
Act Effct Green (s)		44.8			44.8							
Actuated g/C Ratio		0.74			0.74							
v/c Ratio		0.38			0.50							
Control Delay		8.2			9.9							
Queue Delay		0.0			0.7							
Total Delay		8.2			10.6							
LOS		A			B							
Approach Delay		8.2			10.6							
Approach LOS		A			B							
Queue Length 50th (m)		29.5			44.6							
Queue Length 95th (m)		49.1			74.0							
Internal Link Dist (m)		170.8			60.2			232.4			30.4	
Turn Bay Length (m)												
Base Capacity (vph)		1193			1205							
Starvation Cap Reductn		0			299							
Spillback Cap Reductn		0			0							
Storage Cap Reductn		0			0							
Reduced v/c Ratio		0.38			0.67							

Intersection Summary

Area Type: CBD
 Cycle Length: 54.8
 Actuated Cycle Length: 60.2
 Natural Cycle: 60
 Control Type: Actuated-Uncoordinated
 Maximum v/c Ratio: 0.50
 Intersection Signal Delay: 9.6
 Intersection Capacity Utilization 49.9%
 Analysis Period (min) 15
 Intersection LOS: A
 ICU Level of Service A

Splits and Phases: 3: Athlone & Scott

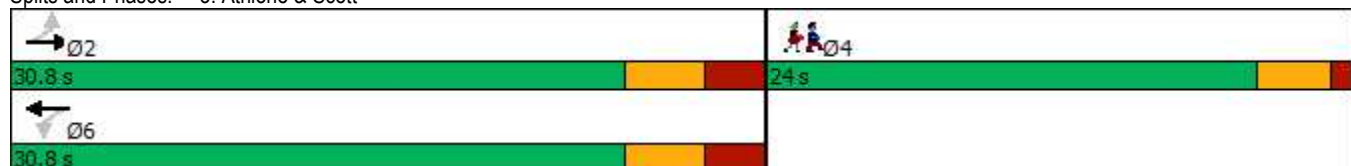

Lane Group	Ø4
Total Split (s)	24.0
Total Split (%)	44%
Maximum Green (s)	20.0
Yellow Time (s)	3.0
All-Red Time (s)	1.0
Lost Time Adjust (s)	
Total Lost Time (s)	
Lead/Lag	
Lead-Lag Optimize?	
Vehicle Extension (s)	3.0
Recall Mode	None
Walk Time (s)	7.0
Flash Dont Walk (s)	11.0
Pedestrian Calls (#/hr)	100
Act Effct Green (s)	
Actuated g/C Ratio	
v/c Ratio	
Control Delay	
Queue Delay	
Total Delay	
LOS	
Approach Delay	
Approach LOS	
Queue Length 50th (m)	
Queue Length 95th (m)	
Internal Link Dist (m)	
Turn Bay Length (m)	
Base Capacity (vph)	
Starvation Cap Reductn	
Spillback Cap Reductn	
Storage Cap Reductn	
Reduced v/c Ratio	
Intersection Summary	

4: Tweedsmuir & Scott
PM Peak Hour

2026 Scott Street
Existing Traffic



Lane Group	EBL	EBT	EBR	WBL	WBT	WBR	NBL	NBT	NBR	SBL	SBT	SBR
Lane Configurations												
Traffic Volume (vph)	0	402	7	14	444	5	0	0	0	0	0	0
Future Volume (vph)	0	402	7	14	444	5	0	0	0	0	0	0
Ideal Flow (vphpl)	1800	1800	1800	1800	1800	1800	1800	1800	1800	1800	1800	1800
Lane Util. Factor	1.00	1.00	1.00	1.00	1.00	1.00	1.00	1.00	1.00	1.00	1.00	1.00
Ped Bike Factor		1.00			1.00							
Flt		0.998			0.998							
Flt Protected					0.998							
Satd. Flow (prot)	0	1671	0	0	1614	0	0	0	0	0	0	0
Flt Permitted					0.984							
Satd. Flow (perm)	0	1671	0	0	1591	0	0	0	0	0	0	0
Right Turn on Red			Yes			Yes			Yes			Yes
Satd. Flow (RTOR)		2			2							
Link Speed (k/h)		50			50			50				50
Link Distance (m)		84.2			67.4			275.0				51.7
Travel Time (s)		6.1			4.9			19.8				3.7
Confl. Peds. (#/hr)	228		23	23		228	10		187	187		10
Confl. Bikes (#/hr)			2			16						
Peak Hour Factor	0.90	0.90	0.90	0.90	0.90	0.90	0.90	0.90	0.90	0.90	0.90	0.90
Heavy Vehicles (%)	100%	1%	1%	1%	3%	100%	1%	1%	1%	100%	100%	100%
Adj. Flow (vph)	0	447	8	16	493	6	0	0	0	0	0	0
Shared Lane Traffic (%)												
Lane Group Flow (vph)	0	455	0	0	515	0	0	0	0	0	0	0
Enter Blocked Intersection	No	No	No	No	No	No	No	No	No	No	No	No
Lane Alignment	Left	Left	Right	Left	Left	Right	Left	Left	Right	Left	Left	Right
Median Width(m)		0.0			0.0			0.0				0.0
Link Offset(m)		0.0			0.0			0.0				0.0
Crosswalk Width(m)		5.0			5.0			5.0				5.0
Two way Left Turn Lane												
Headway Factor	1.16	1.16	1.16	1.16	1.16	1.16	1.16	1.16	1.16	1.16	1.16	1.16
Turning Speed (k/h)	24		14	24		14	24		14	24		14
Number of Detectors	1	2		1	2							
Detector Template	Left	Thru		Left	Thru							
Leading Detector (m)	6.1	30.5		6.1	30.5							
Trailing Detector (m)	0.0	0.0		0.0	0.0							
Detector 1 Position(m)	0.0	0.0		0.0	0.0							
Detector 1 Size(m)	6.1	1.8		6.1	1.8							
Detector 1 Type	CI+Ex	CI+Ex		CI+Ex	CI+Ex							
Detector 1 Channel												
Detector 1 Extend (s)	0.0	0.0		0.0	0.0							
Detector 1 Queue (s)	0.0	0.0		0.0	0.0							
Detector 1 Delay (s)	0.0	0.0		0.0	0.0							
Detector 2 Position(m)		28.7			28.7							
Detector 2 Size(m)		1.8			1.8							
Detector 2 Type		CI+Ex			CI+Ex							
Detector 2 Channel												
Detector 2 Extend (s)		0.0			0.0							
Turn Type		NA		Perm	NA							
Protected Phases		2			6							
Permitted Phases	2			6								
Detector Phase	2	2		6	6							
Switch Phase												
Minimum Initial (s)	10.0	10.0		10.0	10.0							
Minimum Split (s)	15.8	15.8		15.8	15.8							

Lane Group	Ø4
Lane Configurations	
Traffic Volume (vph)	
Future Volume (vph)	
Ideal Flow (vphpl)	
Lane Util. Factor	
Ped Bike Factor	
Frt	
Flt Protected	
Satd. Flow (prot)	
Flt Permitted	
Satd. Flow (perm)	
Right Turn on Red	
Satd. Flow (RTOR)	
Link Speed (k/h)	
Link Distance (m)	
Travel Time (s)	
Confl. Peds. (#/hr)	
Confl. Bikes (#/hr)	
Peak Hour Factor	
Heavy Vehicles (%)	
Adj. Flow (vph)	
Shared Lane Traffic (%)	
Lane Group Flow (vph)	
Enter Blocked Intersection	
Lane Alignment	
Median Width(m)	
Link Offset(m)	
Crosswalk Width(m)	
Two way Left Turn Lane	
Headway Factor	
Turning Speed (k/h)	
Number of Detectors	
Detector Template	
Leading Detector (m)	
Trailing Detector (m)	
Detector 1 Position(m)	
Detector 1 Size(m)	
Detector 1 Type	
Detector 1 Channel	
Detector 1 Extend (s)	
Detector 1 Queue (s)	
Detector 1 Delay (s)	
Detector 2 Position(m)	
Detector 2 Size(m)	
Detector 2 Type	
Detector 2 Channel	
Detector 2 Extend (s)	
Turn Type	
Protected Phases	4
Permitted Phases	
Detector Phase	
Switch Phase	
Minimum Initial (s)	10.0
Minimum Split (s)	22.0

4: Tweedsmuir & Scott
PM Peak Hour

2026 Scott Street
Existing Traffic



Lane Group	EBL	EBT	EBR	WBL	WBT	WBR	NBL	NBT	NBR	SBL	SBT	SBR
Total Split (s)	28.0	28.0		28.0	28.0							
Total Split (%)	56.0%	56.0%		56.0%	56.0%							
Maximum Green (s)	22.2	22.2		22.2	22.2							
Yellow Time (s)	3.3	3.3		3.3	3.3							
All-Red Time (s)	2.5	2.5		2.5	2.5							
Lost Time Adjust (s)		0.0			0.0							
Total Lost Time (s)		5.8			5.8							
Lead/Lag												
Lead-Lag Optimize?												
Vehicle Extension (s)	3.0	3.0		3.0	3.0							
Recall Mode	Max	Max		Max	Max							
Walk Time (s)												
Flash Dont Walk (s)												
Pedestrian Calls (#/hr)												
Act Effct Green (s)		41.8			41.8							
Actuated g/C Ratio		0.74			0.74							
v/c Ratio		0.37			0.44							
Control Delay		7.5			8.5							
Queue Delay		0.4			0.0							
Total Delay		7.9			8.5							
LOS		A			A							
Approach Delay		7.9			8.5							
Approach LOS		A			A							
Queue Length 50th (m)		26.4			32.1							
Queue Length 95th (m)		44.3			54.8							
Internal Link Dist (m)		60.2			43.4			251.0			27.7	
Turn Bay Length (m)												
Base Capacity (vph)		1243			1183							
Starvation Cap Reductn		354			0							
Spillback Cap Reductn		0			0							
Storage Cap Reductn		0			0							
Reduced v/c Ratio		0.51			0.44							

Intersection Summary

Area Type:	CBD
Cycle Length:	50
Actuated Cycle Length:	56.2
Natural Cycle:	55
Control Type:	Actuated-Uncoordinated
Maximum v/c Ratio:	0.44
Intersection Signal Delay:	8.2
Intersection LOS:	A
Intersection Capacity Utilization:	45.9%
ICU Level of Service:	A
Analysis Period (min):	15

Splits and Phases: 4: Tweedsmuir & Scott

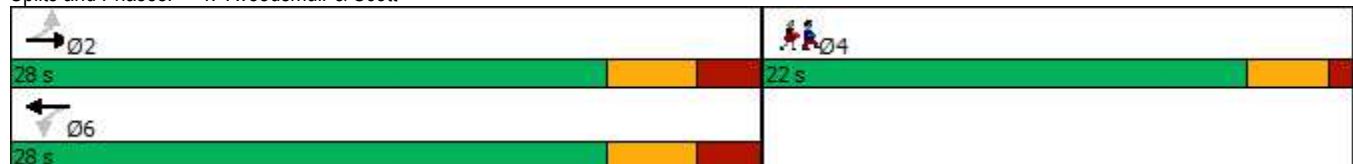

Lane Group	Ø4
Total Split (s)	22.0
Total Split (%)	44%
Maximum Green (s)	18.0
Yellow Time (s)	3.0
All-Red Time (s)	1.0
Lost Time Adjust (s)	
Total Lost Time (s)	
Lead/Lag	
Lead-Lag Optimize?	
Vehicle Extension (s)	3.0
Recall Mode	None
Walk Time (s)	7.0
Flash Dont Walk (s)	11.0
Pedestrian Calls (#/hr)	100
Act Effct Green (s)	
Actuated g/C Ratio	
v/c Ratio	
Control Delay	
Queue Delay	
Total Delay	
LOS	
Approach Delay	
Approach LOS	
Queue Length 50th (m)	
Queue Length 95th (m)	
Internal Link Dist (m)	
Turn Bay Length (m)	
Base Capacity (vph)	
Starvation Cap Reductn	
Spillback Cap Reductn	
Storage Cap Reductn	
Reduced v/c Ratio	
Intersection Summary	

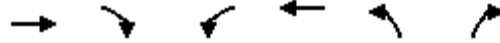

Lane Group	EBT	EBR	WBL	WBT	NBL	NBR
Lane Configurations						
Traffic Volume (vph)	399	39	95	430	30	168
Future Volume (vph)	399	39	95	430	30	168
Ideal Flow (vphpl)	1800	1800	1800	1800	1800	1800
Lane Util. Factor	1.00	1.00	1.00	1.00	1.00	1.00
Ped Bike Factor						
Frt	0.988				0.885	
Flt Protected				0.991	0.993	
Satd. Flow (prot)	1640	0	0	1647	1472	0
Flt Permitted				0.991	0.993	
Satd. Flow (perm)	1640	0	0	1647	1472	0
Link Speed (k/h)	50				50	50
Link Distance (m)	67.4				200.5	303.1
Travel Time (s)	4.9				14.4	21.8
Confl. Peds. (#/hr)	50		50			
Confl. Bikes (#/hr)	10			5		
Peak Hour Factor	0.90	0.90	0.90	0.90	0.90	0.90
Heavy Vehicles (%)	2%	1%	1%	2%	1%	1%
Adj. Flow (vph)	443	43	106	478	33	187
Shared Lane Traffic (%)						
Lane Group Flow (vph)	486	0	0	584	220	0
Enter Blocked Intersection	No	No	No	No	No	No
Lane Alignment	Left	Right	Left	Left	Left	Right
Median Width(m)	0.0				0.0	4.0
Link Offset(m)	0.0				0.0	0.0
Crosswalk Width(m)	5.0				5.0	5.0
Two way Left Turn Lane						
Headway Factor	1.16	1.16	1.16	1.16	1.16	1.16
Turning Speed (k/h)	14		24	24		14
Sign Control	Free			Free	Stop	

Intersection Summary

Area Type: CBD

Control Type: Unsignalized

Intersection Capacity Utilization 84.6% ICU Level of Service E

Analysis Period (min) 15

3: Athlone & Scott
PM Peak Hour

2026 Scott Street
Existing Traffic

Lane Group	EBL	EBT	EBR	WBL	WBT	WBR	NBL	NBT	NBR	SBL	SBT	SBR
Lane Configurations												
Traffic Volume (vph)	8	396	9	21	523	0	3	0	39	0	0	0
Future Volume (vph)	8	396	9	21	523	0	3	0	39	0	0	0
Ideal Flow (vphpl)	1800	1800	1800	1800	1800	1800	1800	1800	1800	1800	1800	1800
Lane Util. Factor	1.00	1.00	1.00	1.00	1.00	1.00	1.00	1.00	1.00	1.00	1.00	1.00
Ped Bike Factor												
Frt		0.997						0.874				
Flt Protected		0.999			0.998			0.997				
Satd. Flow (prot)	0	1622	0	0	1656	0	0	1460	0	0	846	0
Flt Permitted		0.999			0.998			0.997				
Satd. Flow (perm)	0	1622	0	0	1656	0	0	1460	0	0	846	0
Link Speed (k/h)		50			50			50			50	
Link Distance (m)		194.8			84.2			256.4			54.4	
Travel Time (s)		14.0			6.1			18.5			3.9	
Confl. Peds. (#/hr)	130		16	16		130	87		10	10		87
Confl. Bikes (#/hr)			4			20			1			3
Peak Hour Factor	0.90	0.90	0.90	0.90	0.90	0.90	0.90	0.90	0.90	0.90	0.90	0.90
Heavy Vehicles (%)	100%	2%	1%	1%	2%	100%	1%	100%	1%	100%	100%	100%
Adj. Flow (vph)	9	440	10	23	581	0	3	0	43	0	0	0
Shared Lane Traffic (%)												
Lane Group Flow (vph)	0	459	0	0	604	0	0	46	0	0	0	0
Enter Blocked Intersection	No	No	No	No	No	No	No	No	No	No	No	No
Lane Alignment	Left	Left	Right	Left	Left	Right	Left	Left	Right	Left	Left	Right
Median Width(m)		4.0			4.0			0.0			0.0	
Link Offset(m)		0.0			0.0			0.0			0.0	
Crosswalk Width(m)		5.0			5.0			5.0			5.0	
Two way Left Turn Lane												
Headway Factor	1.16	1.16	1.16	1.16	1.16	1.16	1.16	1.16	1.16	1.16	1.16	1.16
Turning Speed (k/h)	24		14	24		14	24		14	24		14
Sign Control		Free			Free			Stop			Stop	
Intersection Summary												
Area Type:	CBD											
Control Type:	Unsignalized											
Intersection Capacity Utilization	64.6%						ICU Level of Service C					
Analysis Period (min)	15											

4: Tweedsmuir & Scott
PM Peak Hour

2026 Scott Street
Existing Traffic

Lane Group	EBL	EBT	EBR	WBL	WBT	WBR	NBL	NBT	NBR	SBL	SBT	SBR
Lane Configurations												
Traffic Volume (vph)	0	402	7	14	444	5	10	0	30	5	0	1
Future Volume (vph)	0	402	7	14	444	5	10	0	30	5	0	1
Ideal Flow (vphpl)	1800	1800	1800	1800	1800	1800	1800	1800	1800	1800	1800	1800
Lane Util. Factor	1.00	1.00	1.00	1.00	1.00	1.00	1.00	1.00	1.00	1.00	1.00	1.00
Ped Bike Factor												
Frt		0.998			0.998			0.899			0.981	
Flt Protected					0.998			0.988			0.959	
Satd. Flow (prot)	0	1672	0	0	1619	0	0	1488	0	0	796	0
Flt Permitted					0.998			0.988			0.959	
Satd. Flow (perm)	0	1672	0	0	1619	0	0	1488	0	0	796	0
Link Speed (k/h)		50			50			50			50	
Link Distance (m)		84.2			67.4			275.0			51.7	
Travel Time (s)		6.1			4.9			19.8			3.7	
Confl. Peds. (#/hr)	228		23	23		228	10		187	187		10
Confl. Bikes (#/hr)			2			16						
Peak Hour Factor	0.90	0.90	0.90	0.90	0.90	0.90	0.90	0.90	0.90	0.90	0.90	0.90
Heavy Vehicles (%)	100%	1%	1%	1%	3%	100%	1%	1%	1%	100%	100%	100%
Adj. Flow (vph)	0	447	8	16	493	6	11	0	33	6	0	1
Shared Lane Traffic (%)												
Lane Group Flow (vph)	0	455	0	0	515	0	0	44	0	0	7	0
Enter Blocked Intersection	No	No	No	No	No	No	No	No	No	No	No	No
Lane Alignment	Left	Left	Right	Left	Left	Right	Left	Left	Right	Left	Left	Right
Median Width(m)		0.0			0.0			0.0			0.0	
Link Offset(m)		0.0			0.0			0.0			0.0	
Crosswalk Width(m)		5.0			5.0			5.0			5.0	
Two way Left Turn Lane												
Headway Factor	1.16	1.16	1.16	1.16	1.16	1.16	1.16	1.16	1.16	1.16	1.16	1.16
Turning Speed (k/h)	24		14	24		14	24		14	24		14
Sign Control		Free			Free			Stop			Stop	
Intersection Summary												
Area Type:	CBD											
Control Type:	Unsignalized											
Intersection Capacity Utilization	61.1%						ICU Level of Service B					
Analysis Period (min)	15											

APPENDIX K

Background Synchro Analysis

1: Churchill & Scott
AM Peak Hour

2026 Scott Street
2026/2031 Background Traffic



Lane Group	EBL	EBT	EBR	WBL	WBT	WBR	NBL	NBT	NBR	SBL	SBT	SBR
Lane Configurations												
Traffic Volume (vph)	0	10	13	233	3	16	13	98	377	58	199	2
Future Volume (vph)	0	10	13	233	3	16	13	98	377	58	199	2
Ideal Flow (vphpl)	1800	1800	1800	1800	1800	1800	1800	1800	1800	1800	1800	1800
Storage Length (m)	0.0		0.0	0.0		0.0	0.0		40.0	0.0		0.0
Storage Lanes	0		0	1		0	0		1	0		0
Taper Length (m)	10.0			30.0			10.0			10.0		
Lane Util. Factor	1.00	1.00	1.00	1.00	1.00	1.00	1.00	1.00	1.00	1.00	1.00	1.00
Ped Bike Factor		0.93		0.96	0.89			0.99			0.99	
Frt		0.924			0.874				0.850		0.999	
Flt Protected				0.950				0.994			0.989	
Satd. Flow (prot)	0	1356	0	1461	1163	0	0	1624	1383	0	1630	0
Flt Permitted				0.577				0.944			0.891	
Satd. Flow (perm)	0	1356	0	851	1163	0	0	1533	1383	0	1456	0
Right Turn on Red			Yes			Yes			No			Yes
Satd. Flow (RTOR)		13			16							
Link Speed (k/h)		50			50			50			50	
Link Distance (m)		77.3			83.9			315.3			273.6	
Travel Time (s)		5.6			6.0			22.7			19.7	
Confl. Peds. (#/hr)	40		20	20		40	40		20	20		40
Confl. Bikes (#/hr)			30			20			30			20
Peak Hour Factor	1.00	1.00	1.00	1.00	1.00	1.00	1.00	1.00	1.00	1.00	1.00	1.00
Heavy Vehicles (%)	1%	15%	1%	10%	1%	15%	8%	3%	4%	4%	2%	1%
Adj. Flow (vph)	0	10	13	233	3	16	13	98	377	58	199	2
Shared Lane Traffic (%)												
Lane Group Flow (vph)	0	23	0	233	19	0	0	111	377	0	259	0
Enter Blocked Intersection	No	No	No	No	No	No	No	No	No	No	No	No
Lane Alignment	Left	Left	Right	Left	Left	Right	Left	Left	Right	Left	Left	Right
Median Width(m)		4.0			4.0			0.0			0.0	
Link Offset(m)		0.0			0.0			0.0			0.0	
Crosswalk Width(m)		5.0			5.0			5.0			5.0	
Two way Left Turn Lane												
Headway Factor	1.16	1.16	1.16	1.16	1.16	1.16	1.16	1.16	1.16	1.16	1.16	1.16
Turning Speed (k/h)	24		14	24		14	24		14	24		14
Number of Detectors		2		1		2		1	2		1	2
Detector Template		Thru		Left	Thru		Left	Thru	Right	Left	Thru	
Leading Detector (m)		30.5		6.1	30.5		6.1	30.5	6.1	6.1	30.5	
Trailing Detector (m)		0.0		0.0	0.0		0.0	0.0	0.0	0.0	0.0	
Detector 1 Position(m)		0.0		0.0	0.0		0.0	0.0	0.0	0.0	0.0	
Detector 1 Size(m)		1.8		6.1	1.8		6.1	1.8	6.1	6.1	1.8	
Detector 1 Type		Cl+Ex		Cl+Ex	Cl+Ex		Cl+Ex	Cl+Ex	Cl+Ex	Cl+Ex	Cl+Ex	
Detector 1 Channel												
Detector 1 Extend (s)		0.0		0.0	0.0		0.0	0.0	0.0	0.0	0.0	
Detector 1 Queue (s)		0.0		0.0	0.0		0.0	0.0	0.0	0.0	0.0	
Detector 1 Delay (s)		0.0		0.0	0.0		0.0	0.0	0.0	0.0	0.0	
Detector 2 Position(m)		28.7			28.7			28.7			28.7	
Detector 2 Size(m)		1.8			1.8			1.8			1.8	
Detector 2 Type		Cl+Ex			Cl+Ex			Cl+Ex			Cl+Ex	
Detector 2 Channel												
Detector 2 Extend (s)		0.0			0.0			0.0			0.0	
Turn Type		NA		pm+pt	NA		Perm	NA	Over	Perm	NA	
Protected Phases		2		1	6			8	1		4	
Permitted Phases				6			8			4		
Detector Phase		2		1	6		8	8	1	4	4	



Lane Group	EBL	EBT	EBR	WBL	WBT	WBR	NBL	NBT	NBR	SBL	SBT	SBR
Switch Phase												
Minimum Initial (s)		10.0		5.0	10.0		10.0	10.0	5.0	10.0	10.0	
Minimum Split (s)		25.4		11.8	25.4		27.4	27.4	11.8	27.4	27.4	
Total Split (s)		26.0		41.0	67.0		28.0	28.0	41.0	28.0	28.0	
Total Split (%)		27.4%		43.2%	70.5%		29.5%	29.5%	43.2%	29.5%	29.5%	
Maximum Green (s)		18.6		34.2	59.6		21.6	21.6	34.2	21.6	21.6	
Yellow Time (s)		3.0		3.0	3.0		3.3	3.3	3.0	3.3	3.3	
All-Red Time (s)		4.4		3.8	4.4		3.1	3.1	3.8	3.1	3.1	
Lost Time Adjust (s)		0.0		0.0	0.0			0.0	0.0		0.0	
Total Lost Time (s)		7.4		6.8	7.4			6.4	6.8		6.4	
Lead/Lag		Lag		Lead					Lead			
Lead-Lag Optimize?		Yes		Yes					Yes			
Vehicle Extension (s)		3.0		3.0	3.0		3.0	3.0	3.0	3.0	3.0	
Recall Mode		Max		Min	Max		None	None	Min	None	None	
Walk Time (s)		7.0			7.0		7.0	7.0		7.0	7.0	
Flash Dont Walk (s)		11.0			11.0		14.0	14.0		14.0	14.0	
Pedestrian Calls (#/hr)		40			40		40	40		40	40	
Act Effct Green (s)		23.7		60.3	59.7			19.5	29.2		19.5	
Actuated g/C Ratio		0.25		0.65	0.64			0.21	0.31		0.21	
v/c Ratio		0.06		0.31	0.03			0.35	0.87		0.85	
Control Delay		20.5		8.5	3.6			34.4	50.8		60.8	
Queue Delay		0.0		0.0	0.0			0.0	0.0		0.0	
Total Delay		20.5		8.5	3.6			34.4	50.8		60.8	
LOS		C		A	A			C	D		E	
Approach Delay		20.5			8.2			47.0			60.8	
Approach LOS		C			A			D			E	
Queue Length 50th (m)		1.3		15.6	0.2			15.7	58.0		41.3	
Queue Length 95th (m)		7.4		25.7	2.4			29.4	#94.9		#76.0	
Internal Link Dist (m)		53.3			59.9			291.3			249.6	
Turn Bay Length (m)									40.0			
Base Capacity (vph)		354		776	752			356	509		338	
Starvation Cap Reductn		0		0	0			0	0		0	
Spillback Cap Reductn		0		0	0			0	0		0	
Storage Cap Reductn		0		0	0			0	0		0	
Reduced v/c Ratio		0.06		0.30	0.03			0.31	0.74		0.77	

Intersection Summary

Area Type: CBD
 Cycle Length: 95
 Actuated Cycle Length: 93
 Natural Cycle: 80
 Control Type: Semi Act-Uncoord
 Maximum v/c Ratio: 0.87
 Intersection Signal Delay: 40.3
 Intersection LOS: D
 Intersection Capacity Utilization 78.6%
 ICU Level of Service D
 Analysis Period (min) 15
 # 95th percentile volume exceeds capacity, queue may be longer.
 Queue shown is maximum after two cycles.

Splits and Phases: 1: Churchill & Scott

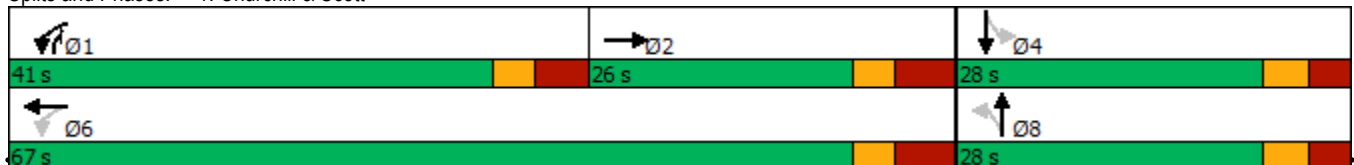

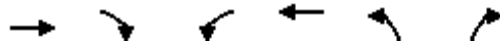

Lane Group	EBT	EBR	WBL	WBT	NBL	NBR
Lane Configurations						
Traffic Volume (vph)	429	20	21	232	15	45
Future Volume (vph)	429	20	21	232	15	45
Ideal Flow (vphpl)	1800	1800	1800	1800	1800	1800
Storage Length (m)		0.0	10.0		0.0	0.0
Storage Lanes		0	1		1	0
Taper Length (m)			30.0		10.0	
Lane Util. Factor	1.00	1.00	0.95	0.95	1.00	1.00
Ped Bike Factor						
Frt	0.994				0.899	
Flt Protected				0.996	0.988	
Satd. Flow (prot)	1614	0	0	2920	1488	0
Flt Permitted				0.996	0.988	
Satd. Flow (perm)	1614	0	0	2920	1488	0
Link Speed (k/h)	50			50	30	
Link Distance (m)	83.9			194.8	233.8	
Travel Time (s)	6.0			14.0	28.1	
Confl. Peds. (#/hr)		10	10			
Confl. Bikes (#/hr)		30				5
Peak Hour Factor	1.00	1.00	1.00	1.00	1.00	1.00
Heavy Vehicles (%)	4%	8%	6%	10%	1%	1%
Adj. Flow (vph)	429	20	21	232	15	45
Shared Lane Traffic (%)						
Lane Group Flow (vph)	449	0	0	253	60	0
Enter Blocked Intersection	No	No	No	No	No	No
Lane Alignment	Left	Right	Left	Left	Left	Right
Median Width(m)	0.0			0.0	4.0	
Link Offset(m)	0.0			0.0	0.0	
Crosswalk Width(m)	5.0			5.0	5.0	
Two way Left Turn Lane						
Headway Factor	1.16	1.16	1.16	1.16	1.16	1.16
Turning Speed (k/h)		14	24		24	14
Sign Control	Free			Free	Stop	

Intersection Summary

Area Type:	CBD
Control Type:	Unsignalized
Intersection Capacity Utilization	38.8%
ICU Level of Service	A
Analysis Period (min)	15

3: Athlone & Scott
AM Peak Hour

2026 Scott Street
2026/2031 Background Traffic



Lane Group	EBL	EBT	EBR	WBL	WBT	WBR	NBL	NBT	NBR	SBL	SBT	SBR
Lane Configurations												
Traffic Volume (vph)	11	512	8	23	275	6	0	0	0	0	0	0
Future Volume (vph)	11	512	8	23	275	6	0	0	0	0	0	0
Ideal Flow (vphpl)	1800	1800	1800	1800	1800	1800	1800	1800	1800	1800	1800	1800
Lane Util. Factor	1.00	1.00	1.00	1.00	1.00	1.00	1.00	1.00	1.00	1.00	1.00	1.00
Ped Bike Factor	1.00		1.00		1.00		1.00		1.00		1.00	
Flt Protected	0.998		0.997		0.996		0.993		0.951		0.951	
Satd. Flow (prot)	0	1616	0	0	1545	0	0	0	0	0	0	0
Flt Permitted	0.993		0.951		0.951		0.951		0.951		0.951	
Satd. Flow (perm)	0	1604	0	0	1475	0	0	0	0	0	0	0
Right Turn on Red			Yes		Yes		Yes		Yes		Yes	
Satd. Flow (RTOR)	2		2		2		2		2		2	
Link Speed (k/h)	50		50		50		30		30		50	
Link Distance (m)	194.8		84.2		84.2		256.4		256.4		54.4	
Travel Time (s)	14.0		6.1		6.1		30.8		30.8		3.9	
Confl. Peds. (#/hr)	120		20	20		120	70		20	20		70
Confl. Bikes (#/hr)			15			10			5			
Peak Hour Factor	1.00	1.00	1.00	1.00	1.00	1.00	1.00	1.00	1.00	1.00	1.00	1.00
Heavy Vehicles (%)	100%	2%	20%	1%	7%	100%	1%	100%	1%	100%	100%	100%
Adj. Flow (vph)	11	512	8	23	275	6	0	0	0	0	0	0
Shared Lane Traffic (%)												
Lane Group Flow (vph)	0	531	0	0	304	0	0	0	0	0	0	0
Enter Blocked Intersection	No	No	No	No	No	No	No	No	No	No	No	No
Lane Alignment	Left	Left	Right	Left	Left	Right	Left	Left	Right	Left	Left	Right
Median Width(m)	4.0		4.0		4.0		0.0		0.0		0.0	
Link Offset(m)	0.0		0.0		0.0		0.0		0.0		0.0	
Crosswalk Width(m)	5.0		5.0		5.0		5.0		5.0		5.0	
Two way Left Turn Lane												
Headway Factor	1.16	1.16	1.16	1.16	1.16	1.16	1.16	1.16	1.16	1.16	1.16	1.16
Turning Speed (k/h)	24		14	24		14	24		14	24		14
Number of Detectors	1	2		1	2							
Detector Template	Left	Thru		Left	Thru							
Leading Detector (m)	6.1	30.5		6.1	30.5							
Trailing Detector (m)	0.0	0.0		0.0	0.0							
Detector 1 Position(m)	0.0	0.0		0.0	0.0							
Detector 1 Size(m)	6.1	1.8		6.1	1.8							
Detector 1 Type	CI+Ex	CI+Ex		CI+Ex	CI+Ex							
Detector 1 Channel												
Detector 1 Extend (s)	0.0	0.0		0.0	0.0							
Detector 1 Queue (s)	0.0	0.0		0.0	0.0							
Detector 1 Delay (s)	0.0	0.0		0.0	0.0							
Detector 2 Position(m)	28.7		28.7		28.7		28.7		28.7		28.7	
Detector 2 Size(m)	1.8		1.8		1.8		1.8		1.8		1.8	
Detector 2 Type	CI+Ex		CI+Ex		CI+Ex		CI+Ex		CI+Ex		CI+Ex	
Detector 2 Channel												
Detector 2 Extend (s)	0.0		0.0		0.0		0.0		0.0		0.0	
Turn Type	Perm	NA		Perm	NA							
Protected Phases	2		6		6		6		6		6	
Permitted Phases	2		6		6		6		6		6	
Detector Phase	2	2		6	6							
Switch Phase												
Minimum Initial (s)	10.0	10.0		10.0	10.0							
Minimum Split (s)	15.8	15.8		15.8	15.8							

Lane Group	Ø4
Lane Configurations	
Traffic Volume (vph)	
Future Volume (vph)	
Ideal Flow (vphpl)	
Lane Util. Factor	
Ped Bike Factor	
Frt	
Flt Protected	
Satd. Flow (prot)	
Flt Permitted	
Satd. Flow (perm)	
Right Turn on Red	
Satd. Flow (RTOR)	
Link Speed (k/h)	
Link Distance (m)	
Travel Time (s)	
Confl. Peds. (#/hr)	
Confl. Bikes (#/hr)	
Peak Hour Factor	
Heavy Vehicles (%)	
Adj. Flow (vph)	
Shared Lane Traffic (%)	
Lane Group Flow (vph)	
Enter Blocked Intersection	
Lane Alignment	
Median Width(m)	
Link Offset(m)	
Crosswalk Width(m)	
Two way Left Turn Lane	
Headway Factor	
Turning Speed (k/h)	
Number of Detectors	
Detector Template	
Leading Detector (m)	
Trailing Detector (m)	
Detector 1 Position(m)	
Detector 1 Size(m)	
Detector 1 Type	
Detector 1 Channel	
Detector 1 Extend (s)	
Detector 1 Queue (s)	
Detector 1 Delay (s)	
Detector 2 Position(m)	
Detector 2 Size(m)	
Detector 2 Type	
Detector 2 Channel	
Detector 2 Extend (s)	
Turn Type	
Protected Phases	4
Permitted Phases	
Detector Phase	
Switch Phase	
Minimum Initial (s)	20.0
Minimum Split (s)	24.0

3: Athlone & Scott
AM Peak Hour

2026 Scott Street
2026/2031 Background Traffic



Lane Group	EBL	EBT	EBR	WBL	WBT	WBR	NBL	NBT	NBR	SBL	SBT	SBR
Total Split (s)	30.8	30.8		30.8	30.8							
Total Split (%)	56.2%	56.2%		56.2%	56.2%							
Maximum Green (s)	25.0	25.0		25.0	25.0							
Yellow Time (s)	3.3	3.3		3.3	3.3							
All-Red Time (s)	2.5	2.5		2.5	2.5							
Lost Time Adjust (s)		0.0			0.0							
Total Lost Time (s)		5.8			5.8							
Lead/Lag												
Lead-Lag Optimize?												
Vehicle Extension (s)	3.0	3.0		3.0	3.0							
Recall Mode	Max	Max		Max	Max							
Walk Time (s)												
Flash Dont Walk (s)												
Pedestrian Calls (#/hr)												
Act Effct Green (s)		44.8			44.8							
Actuated g/C Ratio		0.74			0.74							
v/c Ratio		0.44			0.28							
Control Delay		9.0			7.3							
Queue Delay		0.0			0.3							
Total Delay		9.0			7.6							
LOS		A			A							
Approach Delay		9.0			7.6							
Approach LOS		A			A							
Queue Length 50th (m)		36.6			17.6							
Queue Length 95th (m)		60.7			30.7							
Internal Link Dist (m)		170.8			60.2			232.4			30.4	
Turn Bay Length (m)												
Base Capacity (vph)		1194			1098							
Starvation Cap Reductn		0			328							
Spillback Cap Reductn		0			0							
Storage Cap Reductn		0			0							
Reduced v/c Ratio		0.44			0.39							

Intersection Summary

Area Type: CBD
 Cycle Length: 54.8
 Actuated Cycle Length: 60.2
 Natural Cycle: 60
 Control Type: Semi Act-Uncoord
 Maximum v/c Ratio: 0.44
 Intersection Signal Delay: 8.5
 Intersection Capacity Utilization 40.3%
 Analysis Period (min) 15
 Intersection LOS: A
 ICU Level of Service A

Splits and Phases: 3: Athlone & Scott

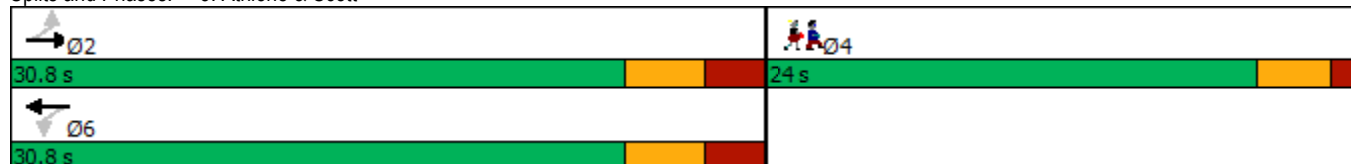

Lane Group	Ø4
Total Split (s)	24.0
Total Split (%)	44%
Maximum Green (s)	20.0
Yellow Time (s)	3.0
All-Red Time (s)	1.0
Lost Time Adjust (s)	
Total Lost Time (s)	
Lead/Lag	
Lead-Lag Optimize?	
Vehicle Extension (s)	3.0
Recall Mode	None
Walk Time (s)	7.0
Flash Dont Walk (s)	11.0
Pedestrian Calls (#/hr)	100
Act Effct Green (s)	
Actuated g/C Ratio	
v/c Ratio	
Control Delay	
Queue Delay	
Total Delay	
LOS	
Approach Delay	
Approach LOS	
Queue Length 50th (m)	
Queue Length 95th (m)	
Internal Link Dist (m)	
Turn Bay Length (m)	
Base Capacity (vph)	
Starvation Cap Reductn	
Spillback Cap Reductn	
Storage Cap Reductn	
Reduced v/c Ratio	
Intersection Summary	

4: Tweedsmuir & Scott
AM Peak Hour

2026 Scott Street
2026/2031 Background Traffic



Lane Group	EBL	EBT	EBR	WBL	WBT	WBR	NBL	NBT	NBR	SBL	SBT	SBR
Lane Configurations												
Traffic Volume (vph)	0	519	3	10	278	5	0	0	0	0	0	0
Future Volume (vph)	0	519	3	10	278	5	0	0	0	0	0	0
Ideal Flow (vphpl)	1800	1800	1800	1800	1800	1800	1800	1800	1800	1800	1800	1800
Lane Util. Factor	1.00	1.00	1.00	1.00	1.00	1.00	1.00	1.00	1.00	1.00	1.00	1.00
Ped Bike Factor		1.00			1.00							
Flt		0.999			0.998							
Flt Protected					0.998							
Satd. Flow (prot)	0	1641	0	0	1563	0	0	0	0	0	0	0
Flt Permitted					0.983							
Satd. Flow (perm)	0	1641	0	0	1539	0	0	0	0	0	0	0
Right Turn on Red			Yes			Yes			Yes			Yes
Satd. Flow (RTOR)		1			2							
Link Speed (k/h)		50			50			50			50	
Link Distance (m)		84.2			67.4			275.0			51.7	
Travel Time (s)		6.1			4.9			19.8			3.7	
Confl. Peds. (#/hr)	160		20	20		160	10		130	130		10
Confl. Bikes (#/hr)			10			5						
Peak Hour Factor	1.00	1.00	1.00	1.00	1.00	1.00	1.00	1.00	1.00	1.00	1.00	1.00
Heavy Vehicles (%)	100%	3%	1%	1%	6%	100%	1%	1%	1%	100%	100%	100%
Adj. Flow (vph)	0	519	3	10	278	5	0	0	0	0	0	0
Shared Lane Traffic (%)												
Lane Group Flow (vph)	0	522	0	0	293	0	0	0	0	0	0	0
Enter Blocked Intersection	No	No	No	No	No	No	No	No	No	No	No	No
Lane Alignment	Left	Left	Right	Left	Left	Right	Left	Left	Right	Left	Left	Right
Median Width(m)		0.0			0.0			0.0			0.0	
Link Offset(m)		0.0			0.0			0.0			0.0	
Crosswalk Width(m)		5.0			5.0			5.0			5.0	
Two way Left Turn Lane												
Headway Factor	1.16	1.16	1.16	1.16	1.16	1.16	1.16	1.16	1.16	1.16	1.16	1.16
Turning Speed (k/h)	24		14	24		14	24		14	24		14
Number of Detectors	1	2		1	2							
Detector Template	Left	Thru		Left	Thru							
Leading Detector (m)	6.1	30.5		6.1	30.5							
Trailing Detector (m)	0.0	0.0		0.0	0.0							
Detector 1 Position(m)	0.0	0.0		0.0	0.0							
Detector 1 Size(m)	6.1	1.8		6.1	1.8							
Detector 1 Type	CI+Ex	CI+Ex		CI+Ex	CI+Ex							
Detector 1 Channel												
Detector 1 Extend (s)	0.0	0.0		0.0	0.0							
Detector 1 Queue (s)	0.0	0.0		0.0	0.0							
Detector 1 Delay (s)	0.0	0.0		0.0	0.0							
Detector 2 Position(m)		28.7			28.7							
Detector 2 Size(m)		1.8			1.8							
Detector 2 Type		CI+Ex			CI+Ex							
Detector 2 Channel												
Detector 2 Extend (s)		0.0			0.0							
Turn Type		NA		Perm	NA							
Protected Phases		2			6							
Permitted Phases	2			6								
Detector Phase	2	2		6	6							
Switch Phase												
Minimum Initial (s)	10.0	10.0		10.0	10.0							
Minimum Split (s)	15.8	15.8		15.8	15.8							

Lane Group	Ø4
Lane Configurations	
Traffic Volume (vph)	
Future Volume (vph)	
Ideal Flow (vphpl)	
Lane Util. Factor	
Ped Bike Factor	
Frt	
Flt Protected	
Satd. Flow (prot)	
Flt Permitted	
Satd. Flow (perm)	
Right Turn on Red	
Satd. Flow (RTOR)	
Link Speed (k/h)	
Link Distance (m)	
Travel Time (s)	
Confl. Peds. (#/hr)	
Confl. Bikes (#/hr)	
Peak Hour Factor	
Heavy Vehicles (%)	
Adj. Flow (vph)	
Shared Lane Traffic (%)	
Lane Group Flow (vph)	
Enter Blocked Intersection	
Lane Alignment	
Median Width(m)	
Link Offset(m)	
Crosswalk Width(m)	
Two way Left Turn Lane	
Headway Factor	
Turning Speed (k/h)	
Number of Detectors	
Detector Template	
Leading Detector (m)	
Trailing Detector (m)	
Detector 1 Position(m)	
Detector 1 Size(m)	
Detector 1 Type	
Detector 1 Channel	
Detector 1 Extend (s)	
Detector 1 Queue (s)	
Detector 1 Delay (s)	
Detector 2 Position(m)	
Detector 2 Size(m)	
Detector 2 Type	
Detector 2 Channel	
Detector 2 Extend (s)	
Turn Type	
Protected Phases	4
Permitted Phases	
Detector Phase	
Switch Phase	
Minimum Initial (s)	10.0
Minimum Split (s)	22.0

4: Tweedsmuir & Scott
AM Peak Hour

2026 Scott Street
2026/2031 Background Traffic



Lane Group	EBL	EBT	EBR	WBL	WBT	WBR	NBL	NBT	NBR	SBL	SBT	SBR
Total Split (s)	28.0	28.0		28.0	28.0							
Total Split (%)	56.0%	56.0%		56.0%	56.0%							
Maximum Green (s)	22.2	22.2		22.2	22.2							
Yellow Time (s)	3.3	3.3		3.3	3.3							
All-Red Time (s)	2.5	2.5		2.5	2.5							
Lost Time Adjust (s)		0.0			0.0							
Total Lost Time (s)		5.8			5.8							
Lead/Lag												
Lead-Lag Optimize?												
Vehicle Extension (s)	3.0	3.0		3.0	3.0							
Recall Mode	Max	Max		Max	Max							
Walk Time (s)												
Flash Dont Walk (s)												
Pedestrian Calls (#/hr)												
Act Effct Green (s)		41.8			41.8							
Actuated g/C Ratio		0.74			0.74							
v/c Ratio		0.43			0.26							
Control Delay		8.3			6.7							
Queue Delay		0.5			0.0							
Total Delay		8.8			6.7							
LOS		A			A							
Approach Delay		8.8			6.7							
Approach LOS		A			A							
Queue Length 50th (m)		32.4			15.2							
Queue Length 95th (m)		54.6			27.1							
Internal Link Dist (m)		60.2			43.4			251.0			27.7	
Turn Bay Length (m)												
Base Capacity (vph)		1220			1144							
Starvation Cap Reductn		316			0							
Spillback Cap Reductn		0			0							
Storage Cap Reductn		0			0							
Reduced v/c Ratio		0.58			0.26							

Intersection Summary

Area Type: CBD
 Cycle Length: 50
 Actuated Cycle Length: 56.2
 Natural Cycle: 55
 Control Type: Semi Act-Uncoord
 Maximum v/c Ratio: 0.43
 Intersection Signal Delay: 8.0
 Intersection LOS: A
 Intersection Capacity Utilization 37.1%
 ICU Level of Service A
 Analysis Period (min) 15

Splits and Phases: 4: Tweedsmuir & Scott

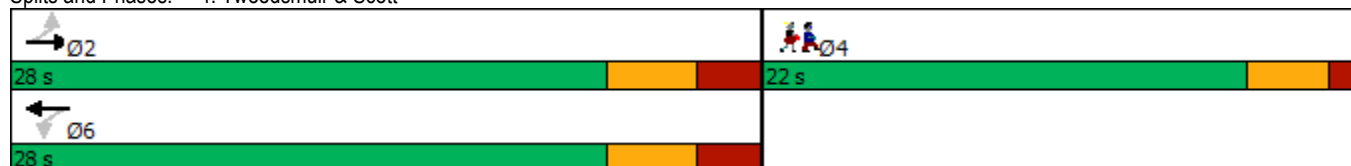

Lane Group	Ø4
Total Split (s)	22.0
Total Split (%)	44%
Maximum Green (s)	18.0
Yellow Time (s)	3.0
All-Red Time (s)	1.0
Lost Time Adjust (s)	
Total Lost Time (s)	
Lead/Lag	
Lead-Lag Optimize?	
Vehicle Extension (s)	3.0
Recall Mode	None
Walk Time (s)	7.0
Flash Dont Walk (s)	11.0
Pedestrian Calls (#/hr)	100
Act Effct Green (s)	
Actuated g/C Ratio	
v/c Ratio	
Control Delay	
Queue Delay	
Total Delay	
LOS	
Approach Delay	
Approach LOS	
Queue Length 50th (m)	
Queue Length 95th (m)	
Internal Link Dist (m)	
Turn Bay Length (m)	
Base Capacity (vph)	
Starvation Cap Reductn	
Spillback Cap Reductn	
Storage Cap Reductn	
Reduced v/c Ratio	
Intersection Summary	



Lane Group	EBT	EBR	WBL	WBT	NBL	NBR
Lane Configurations						
Traffic Volume (vph)	529	30	108	278	15	102
Future Volume (vph)	529	30	108	278	15	102
Ideal Flow (vphpl)	1800	1800	1800	1800	1800	1800
Lane Util. Factor	1.00	1.00	1.00	1.00	1.00	1.00
Ped Bike Factor						
Frt	0.993				0.882	
Flt Protected				0.986	0.994	
Satd. Flow (prot)	1633	0	0	1606	1469	0
Flt Permitted				0.986	0.994	
Satd. Flow (perm)	1633	0	0	1606	1469	0
Link Speed (k/h)	50				50	50
Link Distance (m)	67.4				200.5	303.1
Travel Time (s)	4.9				14.4	21.8
Confl. Peds. (#/hr)	60		60			
Confl. Bikes (#/hr)	10			5		
Peak Hour Factor	1.00	1.00	1.00	1.00	1.00	1.00
Heavy Vehicles (%)	3%	1%	1%	5%	1%	1%
Adj. Flow (vph)	529	30	108	278	15	102
Shared Lane Traffic (%)						
Lane Group Flow (vph)	559	0	0	386	117	0
Enter Blocked Intersection	No	No	No	No	No	No
Lane Alignment	Left	Right	Left	Left	Left	Right
Median Width(m)	0.0				0.0	4.0
Link Offset(m)	0.0				0.0	0.0
Crosswalk Width(m)	5.0				5.0	5.0
Two way Left Turn Lane						
Headway Factor	1.16	1.16	1.16	1.16	1.16	1.16
Turning Speed (k/h)	14		24	24		14
Sign Control	Free			Free	Stop	

Intersection Summary

Area Type: CBD

















Control Type: Unsignalized

Intersection Capacity Utilization 77.6% ICU Level of Service D

Analysis Period (min) 15

















3: Athlone & Scott
AM Peak Hour

2026 Scott Street
2026/2031 Background Traffic

													
Lane Group	EBL	EBT	EBR	WBL	WBT	WBR	NBL	NBT	NBR	SBL	SBT	SBR	
Lane Configurations													
Traffic Volume (vph)	11	512	8	23	275	6	3	0	28	0	0	0	
Future Volume (vph)	11	512	8	23	275	6	3	0	28	0	0	0	
Ideal Flow (vphpl)	1800	1800	1800	1800	1800	1800	1800	1800	1800	1800	1800	1800	
Lane Util. Factor	1.00	1.00	1.00	1.00	1.00	1.00	1.00	1.00	1.00	1.00	1.00	1.00	
Ped Bike Factor													
Frt		0.998			0.997			0.878					
Flt Protected		0.999			0.996			0.995					
Satd. Flow (prot)	0	1617	0	0	1550	0	0	1464	0	0	846	0	
Flt Permitted		0.999			0.996			0.995					
Satd. Flow (perm)	0	1617	0	0	1550	0	0	1464	0	0	846	0	
Link Speed (k/h)		50			50			30			50		
Link Distance (m)		194.8			84.2			256.4			54.4		
Travel Time (s)		14.0			6.1			30.8			3.9		
Confl. Peds. (#/hr)	120		20	20		120	70		20	20		70	
Confl. Bikes (#/hr)			15			10			5				
Peak Hour Factor	1.00	1.00	1.00	1.00	1.00	1.00	1.00	1.00	1.00	1.00	1.00	1.00	
Heavy Vehicles (%)	100%	2%	20%	1%	7%	100%	1%	100%	1%	100%	100%	100%	
Adj. Flow (vph)	11	512	8	23	275	6	3	0	28	0	0	0	
Shared Lane Traffic (%)													
Lane Group Flow (vph)	0	531	0	0	304	0	0	31	0	0	0	0	
Enter Blocked Intersection	No	No	No	No	No	No	No	No	No	No	No	No	
Lane Alignment	Left	Left	Right	Left	Left	Right	Left	Left	Right	Left	Left	Right	
Median Width(m)		4.0			4.0			0.0			0.0		
Link Offset(m)		0.0			0.0			0.0			0.0		
Crosswalk Width(m)		5.0			5.0			5.0			5.0		
Two way Left Turn Lane													
Headway Factor	1.16	1.16	1.16	1.16	1.16	1.16	1.16	1.16	1.16	1.16	1.16	1.16	
Turning Speed (k/h)	24		14	24		14	24		14	24		14	
Sign Control		Free			Free			Stop			Stop		
Intersection Summary													
Area Type:	CBD												
Control Type:	Unsignalized												
Intersection Capacity Utilization 54.5%	ICU Level of Service A												
Analysis Period (min) 15													

4: Tweedsmuir & Scott
AM Peak Hour

2026 Scott Street
2026/2031 Background Traffic

												
Lane Group	EBL	EBT	EBR	WBL	WBT	WBR	NBL	NBT	NBR	SBL	SBT	SBR
Lane Configurations												
Traffic Volume (vph)	0	519	3	10	278	5	3	0	34	6	0	0
Future Volume (vph)	0	519	3	10	278	5	3	0	34	6	0	0
Ideal Flow (vphpl)	1800	1800	1800	1800	1800	1800	1800	1800	1800	1800	1800	1800
Lane Util. Factor	1.00	1.00	1.00	1.00	1.00	1.00	1.00	1.00	1.00	1.00	1.00	1.00
Ped Bike Factor												
Frt		0.999			0.998			0.876				
Flt Protected					0.998			0.996			0.950	
Satd. Flow (prot)	0	1641	0	0	1569	0	0	1462	0	0	804	0
Flt Permitted					0.998			0.996			0.950	
Satd. Flow (perm)	0	1641	0	0	1569	0	0	1462	0	0	804	0
Link Speed (k/h)		50			50			50			50	
Link Distance (m)		84.2			67.4			275.0			51.7	
Travel Time (s)		6.1			4.9			19.8			3.7	
Confl. Peds. (#/hr)	160			20			160	10		130	130	
Confl. Bikes (#/hr)			10				5					
Peak Hour Factor	1.00	1.00	1.00	1.00	1.00	1.00	1.00	1.00	1.00	1.00	1.00	1.00
Heavy Vehicles (%)	100%	3%	1%	1%	6%	100%	1%	1%	1%	100%	100%	100%
Adj. Flow (vph)	0	519	3	10	278	5	3	0	34	6	0	0
Shared Lane Traffic (%)												
Lane Group Flow (vph)	0	522	0	0	293	0	0	37	0	0	6	0
Enter Blocked Intersection	No	No	No	No	No	No	No	No	No	No	No	No
Lane Alignment	Left	Left	Right	Left	Left	Right	Left	Left	Right	Left	Left	Right
Median Width(m)		0.0			0.0			0.0			0.0	
Link Offset(m)		0.0			0.0			0.0			0.0	
Crosswalk Width(m)		5.0			5.0			5.0			5.0	
Two way Left Turn Lane												
Headway Factor	1.16	1.16	1.16	1.16	1.16	1.16	1.16	1.16	1.16	1.16	1.16	1.16
Turning Speed (k/h)	24		14	24		14	24		14	24		14
Sign Control		Free			Free			Stop			Stop	
Intersection Summary												
Area Type:	CBD											
Control Type:	Unsignalized											
Intersection Capacity Utilization 52.2%	ICU Level of Service A											
Analysis Period (min) 15												

1: Churchill & Scott
PM Peak Hour

2026 Scott Street
2026/2031 Background Traffic



Lane Group	EBL	EBT	EBR	WBL	WBT	WBR	NBL	NBT	NBR	SBL	SBT	SBR
Lane Configurations												
Traffic Volume (vph)	0	8	11	311	8	46	18	149	235	41	118	3
Future Volume (vph)	0	8	11	311	8	46	18	149	235	41	118	3
Ideal Flow (vphpl)	1800	1800	1800	1800	1800	1800	1800	1800	1800	1800	1800	1800
Storage Length (m)	0.0		0.0	0.0		0.0	0.0		40.0	0.0		0.0
Storage Lanes	0		0	1		0	0		1	0		0
Taper Length (m)	10.0			10.0			10.0			10.0		
Lane Util. Factor	1.00	1.00	1.00	1.00	1.00	1.00	1.00	1.00	1.00	1.00	1.00	1.00
Ped Bike Factor		0.95		0.96	0.84			0.99			0.99	
Frt		0.922			0.872				0.850		0.997	
Flt Protected				0.950				0.995			0.988	
Satd. Flow (prot)	0	1461	0	1576	1149	0	0	1660	1410	0	1617	0
Flt Permitted				0.605				0.956			0.867	
Satd. Flow (perm)	0	1461	0	962	1149	*1	0	1584	1410	0	1407	0
Right Turn on Red			Yes			Yes			No			Yes
Satd. Flow (RTOR)		11			46							1
Link Speed (k/h)		50			50			50			50	
Link Distance (m)		77.3			83.9			315.3			273.6	
Travel Time (s)		5.6			6.0			22.7			19.7	
Confl. Peds. (#/hr)	50		20	20		50	40		20	20		40
Confl. Bikes (#/hr)			15			70			25			30
Peak Hour Factor	1.00	1.00	1.00	1.00	1.00	1.00	1.00	1.00	1.00	1.00	1.00	1.00
Heavy Vehicles (%)	1%	1%	1%	2%	1%	9%	5%	1%	2%	8%	1%	1%
Adj. Flow (vph)	0	8	11	311	8	46	18	149	235	41	118	3
Shared Lane Traffic (%)												
Lane Group Flow (vph)	0	19	0	311	54	0	0	167	235	0	162	0
Enter Blocked Intersection	No	No	No	No	No	No	No	No	No	No	No	No
Lane Alignment	Left	Left	Right	Left	Left	Right	Left	Left	Right	Left	Left	Right
Median Width(m)		4.0			4.0			0.0			0.0	
Link Offset(m)		0.0			0.0			0.0			0.0	
Crosswalk Width(m)		5.0			5.0			5.0			5.0	
Two way Left Turn Lane												
Headway Factor	1.16	1.16	1.16	1.16	1.16	1.16	1.16	1.16	1.16	1.16	1.16	1.16
Turning Speed (k/h)	24		14	24		14	24		14	24		14
Number of Detectors		2		1	2		1	2	1	1		2
Detector Template		Thru		Left	Thru		Left	Thru	Right	Left		Thru
Leading Detector (m)		30.5		6.1	30.5		6.1	30.5	6.1	6.1		30.5
Trailing Detector (m)		0.0		0.0	0.0		0.0	0.0	0.0	0.0		0.0
Detector 1 Position(m)		0.0		0.0	0.0		0.0	0.0	0.0	0.0		0.0
Detector 1 Size(m)		1.8		6.1	1.8		6.1	1.8	6.1	6.1		1.8
Detector 1 Type		Cl+Ex		Cl+Ex	Cl+Ex		Cl+Ex	Cl+Ex	Cl+Ex	Cl+Ex		Cl+Ex
Detector 1 Channel												
Detector 1 Extend (s)		0.0		0.0	0.0		0.0	0.0	0.0	0.0		0.0
Detector 1 Queue (s)		0.0		0.0	0.0		0.0	0.0	0.0	0.0		0.0
Detector 1 Delay (s)		0.0		0.0	0.0		0.0	0.0	0.0	0.0		0.0
Detector 2 Position(m)		28.7			28.7			28.7				28.7
Detector 2 Size(m)		1.8			1.8			1.8				1.8
Detector 2 Type		Cl+Ex			Cl+Ex			Cl+Ex				Cl+Ex
Detector 2 Channel												
Detector 2 Extend (s)		0.0			0.0			0.0				0.0
Turn Type		NA		pm+pt	NA		Perm	NA	Over	Perm		NA
Protected Phases		2		1	6			8	1			4
Permitted Phases				6			8			4		
Detector Phase		2		1	6		8	8	1	4		4

1: Churchill & Scott
PM Peak Hour

2026 Scott Street
2026/2031 Background Traffic



Lane Group	EBL	EBT	EBR	WBL	WBT	WBR	NBL	NBT	NBR	SBL	SBT	SBR
Switch Phase												
Minimum Initial (s)		10.0		5.0	10.0		10.0	10.0	5.0	10.0	10.0	
Minimum Split (s)		25.4		11.8	25.4		27.4	27.4	11.8	27.4	27.4	
Total Split (s)		30.0		32.0	62.0		33.0	33.0	32.0	33.0	33.0	
Total Split (%)		31.6%		33.7%	65.3%		34.7%	34.7%	33.7%	34.7%	34.7%	
Maximum Green (s)		22.6		25.2	54.6		26.6	26.6	25.2	26.6	26.6	
Yellow Time (s)		3.0		3.0	3.0		3.3	3.3	3.0	3.3	3.3	
All-Red Time (s)		4.4		3.8	4.4		3.1	3.1	3.8	3.1	3.1	
Lost Time Adjust (s)		0.0		0.0	0.0			0.0	0.0		0.0	
Total Lost Time (s)		7.4		6.8	7.4			6.4	6.8		6.4	
Lead/Lag		Lag		Lead					Lead			
Lead-Lag Optimize?		Yes		Yes					Yes			
Vehicle Extension (s)		3.0		3.0	3.0		3.0	3.0	3.0	3.0	3.0	
Recall Mode		Max		Min	Max		None	None	Min	None	None	
Walk Time (s)		7.0			7.0		7.0	7.0		7.0	7.0	
Flash Dont Walk (s)		11.0			11.0		14.0	14.0		14.0	14.0	
Pedestrian Calls (#/hr)		40			40		40	40		40	40	
Act Effct Green (s)		29.2		55.4	54.8			16.8	18.7		16.8	
Actuated g/C Ratio		0.34		0.65	0.64			0.20	0.22		0.20	
v/c Ratio		0.04		0.41	0.07			0.54	0.76		0.58	
Control Delay		16.5		9.2	3.0			37.1	47.3		39.6	
Queue Delay		0.0		0.0	0.0			0.0	0.0		0.0	
Total Delay		16.5		9.2	3.0			37.1	47.3		39.6	
LOS		B		A	A			D	D		D	
Approach Delay		16.5			8.3			43.1			39.6	
Approach LOS		B			A			D			D	
Queue Length 50th (m)		0.9		21.3	0.5			22.6	34.8		22.1	
Queue Length 95th (m)		5.8		34.6	4.4			39.9	54.2		39.6	
Internal Link Dist (m)		53.3			59.9			291.3			249.6	
Turn Bay Length (m)									40.0			
Base Capacity (vph)		507		805	753			494	417		440	
Starvation Cap Reductn		0		0	0			0	0		0	
Spillback Cap Reductn		0		0	0			0	0		0	
Storage Cap Reductn		0		0	0			0	0		0	
Reduced v/c Ratio		0.04		0.39	0.07			0.34	0.56		0.37	

Intersection Summary

Area Type:	CBD
Cycle Length:	95
Actuated Cycle Length:	85.4
Natural Cycle:	75
Control Type:	Semi Act-Uncoord
Maximum v/c Ratio:	0.76
Intersection Signal Delay:	28.6
Intersection Capacity Utilization:	73.1%
Analysis Period (min):	15
Intersection LOS:	C
ICU Level of Service:	D
* User Entered Value	

Splits and Phases: 1: Churchill & Scott

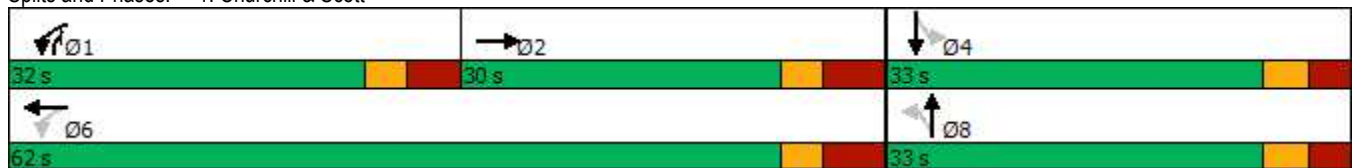



Lane Group	EBT	EBR	WBL	WBT	NBL	NBR
Lane Configurations						
Traffic Volume (vph)	355	16	49	447	10	46
Future Volume (vph)	355	16	49	447	10	46
Ideal Flow (vphpl)	1800	1800	1800	1800	1800	1800
Storage Length (m)		0.0	10.0		0.0	0.0
Storage Lanes		0	1		1	0
Taper Length (m)			30.0		10.0	
Lane Util. Factor	1.00	1.00	0.95	0.95	1.00	1.00
Ped Bike Factor						
Frt	0.994				0.889	
Flt Protected				0.995	0.991	
Satd. Flow (prot)	1634	0	0	3112	1476	0
Flt Permitted				0.995	0.991	
Satd. Flow (perm)	1634	0	0	3112	1476	0
Link Speed (k/h)	50			50	30	
Link Distance (m)	83.9			194.8	233.8	
Travel Time (s)	6.0			14.0	28.1	
Confl. Peds. (#/hr)		20	20			
Confl. Bikes (#/hr)		10				5
Peak Hour Factor	1.00	1.00	1.00	1.00	1.00	1.00
Heavy Vehicles (%)	3%	1%	1%	3%	1%	1%
Adj. Flow (vph)	355	16	49	447	10	46
Shared Lane Traffic (%)						
Lane Group Flow (vph)	371	0	0	496	56	0
Enter Blocked Intersection	No	No	No	No	No	No
Lane Alignment	Left	Right	Left	Left	Left	Right
Median Width(m)	0.0			0.0	4.0	
Link Offset(m)	0.0			0.0	0.0	
Crosswalk Width(m)	5.0			5.0	5.0	
Two way Left Turn Lane						
Headway Factor	1.16	1.16	1.16	1.16	1.16	1.16
Turning Speed (k/h)		14	24		24	14
Sign Control	Free			Free	Stop	

Intersection Summary

Area Type:	CBD
Control Type:	Unsignalized
Intersection Capacity Utilization	53.3%
ICU Level of Service	A
Analysis Period (min)	15

3: Athlone & Scott
PM Peak Hour

2026 Scott Street
2026/2031 Background Traffic



Lane Group	EBL	EBT	EBR	WBL	WBT	WBR	NBL	NBT	NBR	SBL	SBT	SBR
Lane Configurations												
Traffic Volume (vph)	8	425	9	21	556	0	0	0	0	0	0	0
Future Volume (vph)	8	425	9	21	556	0	0	0	0	0	0	0
Ideal Flow (vphpl)	1800	1800	1800	1800	1800	1800	1800	1800	1800	1800	1800	1800
Lane Util. Factor	1.00	1.00	1.00	1.00	1.00	1.00	1.00	1.00	1.00	1.00	1.00	1.00
Ped Bike Factor		1.00			1.00							
Frt		0.997										
Flt Protected		0.999			0.998							
Satd. Flow (prot)	0	1623	0	0	1656	0	0	0	0	0	0	0
Flt Permitted		0.991			0.979							
Satd. Flow (perm)	0	1608	0	0	1624	0	0	0	0	0	0	0
Right Turn on Red			Yes			Yes			Yes			Yes
Satd. Flow (RTOR)		3										
Link Speed (k/h)		50			50			30				50
Link Distance (m)		194.8			84.2			256.4				54.4
Travel Time (s)		14.0			6.1			30.8				3.9
Confl. Peds. (#/hr)	140		20	20		140	90		10	10		90
Confl. Bikes (#/hr)			5			25			5			
Peak Hour Factor	1.00	1.00	1.00	1.00	1.00	1.00	1.00	1.00	1.00	1.00	1.00	1.00
Heavy Vehicles (%)	100%	2%	1%	1%	2%	100%	1%	100%	1%	100%	100%	100%
Adj. Flow (vph)	8	425	9	21	556	0	0	0	0	0	0	0
Shared Lane Traffic (%)												
Lane Group Flow (vph)	0	442	0	0	577	0	0	0	0	0	0	0
Enter Blocked Intersection	No	No	No	No	No	No	No	No	No	No	No	No
Lane Alignment	Left	Left	Right	Left	Left	Right	Left	Left	Right	Left	Left	Right
Median Width(m)		4.0			4.0			0.0				0.0
Link Offset(m)		0.0			0.0			0.0				0.0
Crosswalk Width(m)		5.0			5.0			5.0				5.0
Two way Left Turn Lane												
Headway Factor	1.16	1.16	1.16	1.16	1.16	1.16	1.16	1.16	1.16	1.16	1.16	1.16
Turning Speed (k/h)	24		14	24		14	24		14	24		14
Number of Detectors	1	2		1	2							
Detector Template	Left	Thru		Left	Thru							
Leading Detector (m)	6.1	30.5		6.1	30.5							
Trailing Detector (m)	0.0	0.0		0.0	0.0							
Detector 1 Position(m)	0.0	0.0		0.0	0.0							
Detector 1 Size(m)	6.1	1.8		6.1	1.8							
Detector 1 Type	CI+Ex	CI+Ex		CI+Ex	CI+Ex							
Detector 1 Channel												
Detector 1 Extend (s)	0.0	0.0		0.0	0.0							
Detector 1 Queue (s)	0.0	0.0		0.0	0.0							
Detector 1 Delay (s)	0.0	0.0		0.0	0.0							
Detector 2 Position(m)		28.7			28.7							
Detector 2 Size(m)		1.8			1.8							
Detector 2 Type		CI+Ex			CI+Ex							
Detector 2 Channel												
Detector 2 Extend (s)		0.0			0.0							
Turn Type	Perm	NA		Perm	NA							
Protected Phases		2			6							
Permitted Phases	2			6								
Detector Phase	2	2		6	6							
Switch Phase												
Minimum Initial (s)	10.0	10.0		10.0	10.0							
Minimum Split (s)	15.8	15.8		15.8	15.8							

Lane Group	Ø4
Lane Configurations	
Traffic Volume (vph)	
Future Volume (vph)	
Ideal Flow (vphpl)	
Lane Util. Factor	
Ped Bike Factor	
Frt	
Flt Protected	
Satd. Flow (prot)	
Flt Permitted	
Satd. Flow (perm)	
Right Turn on Red	
Satd. Flow (RTOR)	
Link Speed (k/h)	
Link Distance (m)	
Travel Time (s)	
Confl. Peds. (#/hr)	
Confl. Bikes (#/hr)	
Peak Hour Factor	
Heavy Vehicles (%)	
Adj. Flow (vph)	
Shared Lane Traffic (%)	
Lane Group Flow (vph)	
Enter Blocked Intersection	
Lane Alignment	
Median Width(m)	
Link Offset(m)	
Crosswalk Width(m)	
Two way Left Turn Lane	
Headway Factor	
Turning Speed (k/h)	
Number of Detectors	
Detector Template	
Leading Detector (m)	
Trailing Detector (m)	
Detector 1 Position(m)	
Detector 1 Size(m)	
Detector 1 Type	
Detector 1 Channel	
Detector 1 Extend (s)	
Detector 1 Queue (s)	
Detector 1 Delay (s)	
Detector 2 Position(m)	
Detector 2 Size(m)	
Detector 2 Type	
Detector 2 Channel	
Detector 2 Extend (s)	
Turn Type	
Protected Phases	4
Permitted Phases	
Detector Phase	
Switch Phase	
Minimum Initial (s)	20.0
Minimum Split (s)	24.0

3: Athlone & Scott
PM Peak Hour

2026 Scott Street
2026/2031 Background Traffic



Lane Group	EBL	EBT	EBR	WBL	WBT	WBR	NBL	NBT	NBR	SBL	SBT	SBR
Total Split (s)	30.8	30.8		30.8	30.8							
Total Split (%)	56.2%	56.2%		56.2%	56.2%							
Maximum Green (s)	25.0	25.0		25.0	25.0							
Yellow Time (s)	3.3	3.3		3.3	3.3							
All-Red Time (s)	2.5	2.5		2.5	2.5							
Lost Time Adjust (s)		0.0			0.0							
Total Lost Time (s)		5.8			5.8							
Lead/Lag												
Lead-Lag Optimize?												
Vehicle Extension (s)	3.0	3.0		3.0	3.0							
Recall Mode	Max	Max		Max	Max							
Walk Time (s)												
Flash Dont Walk (s)												
Pedestrian Calls (#/hr)												
Act Effct Green (s)		44.8			44.8							
Actuated g/C Ratio		0.74			0.74							
v/c Ratio		0.37			0.48							
Control Delay		8.0			9.5							
Queue Delay		0.0			0.7							
Total Delay		8.0			10.2							
LOS		A			B							
Approach Delay		8.0			10.2							
Approach LOS		A			B							
Queue Length 50th (m)		28.1			41.5							
Queue Length 95th (m)		46.6			68.8							
Internal Link Dist (m)		170.8			60.2			232.4			30.4	
Turn Bay Length (m)												
Base Capacity (vph)		1196			1208							
Starvation Cap Reductn		0			310							
Spillback Cap Reductn		0			0							
Storage Cap Reductn		0			0							
Reduced v/c Ratio		0.37			0.64							

Intersection Summary

Area Type:	CBD
Cycle Length:	54.8
Actuated Cycle Length:	60.2
Natural Cycle:	60
Control Type:	Actuated-Uncoordinated
Maximum v/c Ratio:	0.48
Intersection Signal Delay:	9.2
Intersection LOS:	A
Intersection Capacity Utilization:	52.3%
ICU Level of Service:	A
Analysis Period (min):	15

Splits and Phases: 3: Athlone & Scott

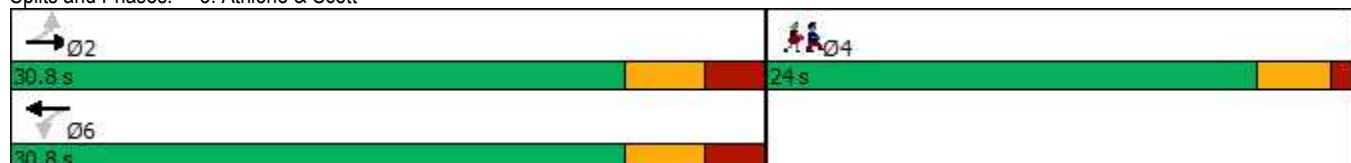

Lane Group	Ø4
Total Split (s)	24.0
Total Split (%)	44%
Maximum Green (s)	20.0
Yellow Time (s)	3.0
All-Red Time (s)	1.0
Lost Time Adjust (s)	
Total Lost Time (s)	
Lead/Lag	
Lead-Lag Optimize?	
Vehicle Extension (s)	3.0
Recall Mode	None
Walk Time (s)	7.0
Flash Dont Walk (s)	11.0
Pedestrian Calls (#/hr)	100
Act Effct Green (s)	
Actuated g/C Ratio	
v/c Ratio	
Control Delay	
Queue Delay	
Total Delay	
LOS	
Approach Delay	
Approach LOS	
Queue Length 50th (m)	
Queue Length 95th (m)	
Internal Link Dist (m)	
Turn Bay Length (m)	
Base Capacity (vph)	
Starvation Cap Reductn	
Spillback Cap Reductn	
Storage Cap Reductn	
Reduced v/c Ratio	
Intersection Summary	

4: Tweedsmuir & Scott
PM Peak Hour

2026 Scott Street
2026/2031 Background Traffic



Lane Group	EBL	EBT	EBR	WBL	WBT	WBR	NBL	NBT	NBR	SBL	SBT	SBR
Lane Configurations												
Traffic Volume (vph)	0	431	7	14	477	5	0	0	0	0	0	0
Future Volume (vph)	0	431	7	14	477	5	0	0	0	0	0	0
Ideal Flow (vphpl)	1800	1800	1800	1800	1800	1800	1800	1800	1800	1800	1800	1800
Lane Util. Factor	1.00	1.00	1.00	1.00	1.00	1.00	1.00	1.00	1.00	1.00	1.00	1.00
Ped Bike Factor		1.00			1.00							
Flt		0.998			0.999							
Flt Protected					0.999							
Satd. Flow (prot)	0	1670	0	0	1620	0	0	0	0	0	0	0
Flt Permitted					0.986							
Satd. Flow (perm)	0	1670	0	0	1598	0	0	0	0	0	0	0
Right Turn on Red			Yes			Yes			Yes			Yes
Satd. Flow (RTOR)		2			1							
Link Speed (k/h)		50			50			50			50	
Link Distance (m)		84.2			67.4			275.0			51.7	
Travel Time (s)		6.1			4.9			19.8			3.7	
Confl. Peds. (#/hr)	240		30	30		240	10		200	200		10
Confl. Bikes (#/hr)			5			20			5			
Peak Hour Factor	1.00	1.00	1.00	1.00	1.00	1.00	1.00	1.00	1.00	1.00	1.00	1.00
Heavy Vehicles (%)	100%	1%	1%	1%	3%	100%	1%	1%	1%	100%	100%	100%
Adj. Flow (vph)	0	431	7	14	477	5	0	0	0	0	0	0
Shared Lane Traffic (%)												
Lane Group Flow (vph)	0	438	0	0	496	0	0	0	0	0	0	0
Enter Blocked Intersection	No	No	No	No	No	No	No	No	No	No	No	No
Lane Alignment	Left	Left	Right	Left	Left	Right	Left	Left	Right	Left	Left	Right
Median Width(m)		0.0			0.0			0.0			0.0	
Link Offset(m)		0.0			0.0			0.0			0.0	
Crosswalk Width(m)		5.0			5.0			5.0			5.0	
Two way Left Turn Lane												
Headway Factor	1.16	1.16	1.16	1.16	1.16	1.16	1.16	1.16	1.16	1.16	1.16	1.16
Turning Speed (k/h)	24		14	24		14	24		14	24		14
Number of Detectors	1	2		1	2							
Detector Template	Left	Thru		Left	Thru							
Leading Detector (m)	6.1	30.5		6.1	30.5							
Trailing Detector (m)	0.0	0.0		0.0	0.0							
Detector 1 Position(m)	0.0	0.0		0.0	0.0							
Detector 1 Size(m)	6.1	1.8		6.1	1.8							
Detector 1 Type	CI+Ex	CI+Ex		CI+Ex	CI+Ex							
Detector 1 Channel												
Detector 1 Extend (s)	0.0	0.0		0.0	0.0							
Detector 1 Queue (s)	0.0	0.0		0.0	0.0							
Detector 1 Delay (s)	0.0	0.0		0.0	0.0							
Detector 2 Position(m)		28.7			28.7							
Detector 2 Size(m)		1.8			1.8							
Detector 2 Type		CI+Ex			CI+Ex							
Detector 2 Channel												
Detector 2 Extend (s)		0.0			0.0							
Turn Type		NA		Perm	NA							
Protected Phases		2			6							
Permitted Phases	2			6								
Detector Phase	2	2		6	6							
Switch Phase												
Minimum Initial (s)	10.0	10.0		10.0	10.0							
Minimum Split (s)	15.8	15.8		15.8	15.8							

Lane Group	Ø4
Lane Configurations	
Traffic Volume (vph)	
Future Volume (vph)	
Ideal Flow (vphpl)	
Lane Util. Factor	
Ped Bike Factor	
Frt	
Flt Protected	
Satd. Flow (prot)	
Flt Permitted	
Satd. Flow (perm)	
Right Turn on Red	
Satd. Flow (RTOR)	
Link Speed (k/h)	
Link Distance (m)	
Travel Time (s)	
Confl. Peds. (#/hr)	
Confl. Bikes (#/hr)	
Peak Hour Factor	
Heavy Vehicles (%)	
Adj. Flow (vph)	
Shared Lane Traffic (%)	
Lane Group Flow (vph)	
Enter Blocked Intersection	
Lane Alignment	
Median Width(m)	
Link Offset(m)	
Crosswalk Width(m)	
Two way Left Turn Lane	
Headway Factor	
Turning Speed (k/h)	
Number of Detectors	
Detector Template	
Leading Detector (m)	
Trailing Detector (m)	
Detector 1 Position(m)	
Detector 1 Size(m)	
Detector 1 Type	
Detector 1 Channel	
Detector 1 Extend (s)	
Detector 1 Queue (s)	
Detector 1 Delay (s)	
Detector 2 Position(m)	
Detector 2 Size(m)	
Detector 2 Type	
Detector 2 Channel	
Detector 2 Extend (s)	
Turn Type	
Protected Phases	4
Permitted Phases	
Detector Phase	
Switch Phase	
Minimum Initial (s)	10.0
Minimum Split (s)	22.0

4: Tweedsmuir & Scott
PM Peak Hour

2026 Scott Street
2026/2031 Background Traffic



Lane Group	EBL	EBT	EBR	WBL	WBT	WBR	NBL	NBT	NBR	SBL	SBT	SBR
Total Split (s)	28.0	28.0		28.0	28.0							
Total Split (%)	56.0%	56.0%		56.0%	56.0%							
Maximum Green (s)	22.2	22.2		22.2	22.2							
Yellow Time (s)	3.3	3.3		3.3	3.3							
All-Red Time (s)	2.5	2.5		2.5	2.5							
Lost Time Adjust (s)		0.0			0.0							
Total Lost Time (s)		5.8			5.8							
Lead/Lag												
Lead-Lag Optimize?												
Vehicle Extension (s)	3.0	3.0		3.0	3.0							
Recall Mode	Max	Max		Max	Max							
Walk Time (s)												
Flash Dont Walk (s)												
Pedestrian Calls (#/hr)												
Act Effct Green (s)		41.8			41.8							
Actuated g/C Ratio		0.74			0.74							
v/c Ratio		0.35			0.42							
Control Delay		7.4			8.2							
Queue Delay		0.4			0.0							
Total Delay		7.8			8.2							
LOS		A			A							
Approach Delay		7.8			8.2							
Approach LOS		A			A							
Queue Length 50th (m)		25.1			30.5							
Queue Length 95th (m)		42.1			51.8							
Internal Link Dist (m)		60.2			43.4			251.0			27.7	
Turn Bay Length (m)												
Base Capacity (vph)		1242			1188							
Starvation Cap Reductn		358			0							
Spillback Cap Reductn		0			0							
Storage Cap Reductn		0			0							
Reduced v/c Ratio		0.50			0.42							

Intersection Summary

Area Type: CBD
 Cycle Length: 50
 Actuated Cycle Length: 56.2
 Natural Cycle: 55
 Control Type: Actuated-Uncoordinated
 Maximum v/c Ratio: 0.42
 Intersection Signal Delay: 8.0
 Intersection Capacity Utilization 48.0%
 Analysis Period (min) 15
 Intersection LOS: A
 ICU Level of Service A

Splits and Phases: 4: Tweedsmuir & Scott

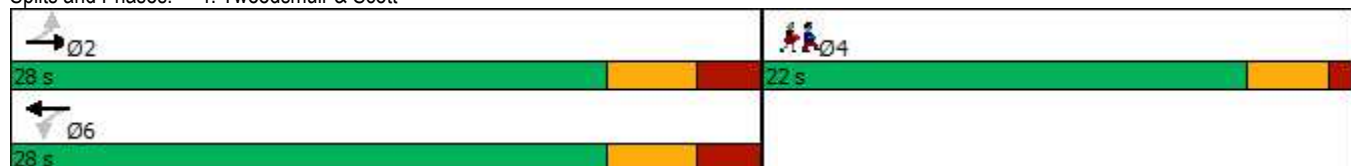

Lane Group	Ø4
Total Split (s)	22.0
Total Split (%)	44%
Maximum Green (s)	18.0
Yellow Time (s)	3.0
All-Red Time (s)	1.0
Lost Time Adjust (s)	
Total Lost Time (s)	
Lead/Lag	
Lead-Lag Optimize?	
Vehicle Extension (s)	3.0
Recall Mode	None
Walk Time (s)	7.0
Flash Dont Walk (s)	11.0
Pedestrian Calls (#/hr)	100
Act Effct Green (s)	
Actuated g/C Ratio	
v/c Ratio	
Control Delay	
Queue Delay	
Total Delay	
LOS	
Approach Delay	
Approach LOS	
Queue Length 50th (m)	
Queue Length 95th (m)	
Internal Link Dist (m)	
Turn Bay Length (m)	
Base Capacity (vph)	
Starvation Cap Reductn	
Spillback Cap Reductn	
Storage Cap Reductn	
Reduced v/c Ratio	
Intersection Summary	



Lane Group	EBT	EBR	WBL	WBT	NBL	NBR
Lane Configurations						
Traffic Volume (vph)	425	42	122	459	34	186
Future Volume (vph)	425	42	122	459	34	186
Ideal Flow (vphpl)	1800	1800	1800	1800	1800	1800
Lane Util. Factor	1.00	1.00	1.00	1.00	1.00	1.00
Ped Bike Factor						
Frt	0.988				0.886	
Flt Protected				0.990	0.992	
Satd. Flow (prot)	1640	0	0	1646	1472	0
Flt Permitted				0.990	0.992	
Satd. Flow (perm)	1640	0	0	1646	1472	0
Link Speed (k/h)	50				50	50
Link Distance (m)	67.4				200.5	303.1
Travel Time (s)	4.9				14.4	21.8
Confl. Peds. (#/hr)	60		60			
Confl. Bikes (#/hr)	10					
Peak Hour Factor	1.00	1.00	1.00	1.00	1.00	1.00
Heavy Vehicles (%)	2%	1%	1%	2%	1%	1%
Adj. Flow (vph)	425	42	122	459	34	186
Shared Lane Traffic (%)						
Lane Group Flow (vph)	467	0	0	581	220	0
Enter Blocked Intersection	No	No	No	No	No	No
Lane Alignment	Left	Right	Left	Left	Left	Right
Median Width(m)	0.0				0.0	4.0
Link Offset(m)	0.0				0.0	0.0
Crosswalk Width(m)	5.0				5.0	5.0
Two way Left Turn Lane						
Headway Factor	1.16	1.16	1.16	1.16	1.16	1.16
Turning Speed (k/h)	14		24	24		14
Sign Control	Free				Free	Stop

Intersection Summary

Area Type: CBD

















Control Type: Unsignalized

Intersection Capacity Utilization 91.5% ICU Level of Service F

Analysis Period (min) 15

















3: Athlone & Scott
PM Peak Hour

2026 Scott Street
2026/2031 Background Traffic

												
Lane Group	EBL	EBT	EBR	WBL	WBT	WBR	NBL	NBT	NBR	SBL	SBT	SBR
Lane Configurations												
Traffic Volume (vph)	8	425	9	21	556	0	3	0	39	0	0	0
Future Volume (vph)	8	425	9	21	556	0	3	0	39	0	0	0
Ideal Flow (vphpl)	1800	1800	1800	1800	1800	1800	1800	1800	1800	1800	1800	1800
Lane Util. Factor	1.00	1.00	1.00	1.00	1.00	1.00	1.00	1.00	1.00	1.00	1.00	1.00
Ped Bike Factor												
Frt		0.997						0.875				
Flt Protected		0.999			0.998			0.996				
Satd. Flow (prot)	0	1624	0	0	1656	0	0	1460	0	0	846	0
Flt Permitted		0.999			0.998			0.996				
Satd. Flow (perm)	0	1624	0	0	1656	0	0	1460	0	0	846	0
Link Speed (k/h)		50			50			30			50	
Link Distance (m)		194.8			84.2			256.4			54.4	
Travel Time (s)		14.0			6.1			30.8			3.9	
Confl. Peds. (#/hr)	140		20	20		140	90		10	10		90
Confl. Bikes (#/hr)			5			25			5			
Peak Hour Factor	1.00	1.00	1.00	1.00	1.00	1.00	1.00	1.00	1.00	1.00	1.00	1.00
Heavy Vehicles (%)	100%	2%	1%	1%	2%	100%	1%	100%	1%	100%	100%	100%
Adj. Flow (vph)	8	425	9	21	556	0	3	0	39	0	0	0
Shared Lane Traffic (%)												
Lane Group Flow (vph)	0	442	0	0	577	0	0	42	0	0	0	0
Enter Blocked Intersection	No	No	No	No	No	No	No	No	No	No	No	No
Lane Alignment	Left	Left	Right	Left	Left	Right	Left	Left	Right	Left	Left	Right
Median Width(m)		4.0			4.0			0.0			0.0	
Link Offset(m)		0.0			0.0			0.0			0.0	
Crosswalk Width(m)		5.0			5.0			5.0			5.0	
Two way Left Turn Lane												
Headway Factor	1.16	1.16	1.16	1.16	1.16	1.16	1.16	1.16	1.16	1.16	1.16	1.16
Turning Speed (k/h)	24		14	24		14	24		14	24		14
Sign Control		Free			Free			Stop			Stop	
Intersection Summary												
Area Type:	CBD											
Control Type:	Unsignalized											
Intersection Capacity Utilization 66.9%	ICU Level of Service C											
Analysis Period (min) 15												

4: Tweedsmuir & Scott
PM Peak Hour

2026 Scott Street
2026/2031 Background Traffic

												
Lane Group	EBL	EBT	EBR	WBL	WBT	WBR	NBL	NBT	NBR	SBL	SBT	SBR
Lane Configurations												
Traffic Volume (vph)	0	431	7	14	477	5	10	0	30	5	0	1
Future Volume (vph)	0	431	7	14	477	5	10	0	30	5	0	1
Ideal Flow (vphpl)	1800	1800	1800	1800	1800	1800	1800	1800	1800	1800	1800	1800
Lane Util. Factor	1.00	1.00	1.00	1.00	1.00	1.00	1.00	1.00	1.00	1.00	1.00	1.00
Ped Bike Factor												
Frt		0.998			0.999			0.899			0.977	
Flt Protected					0.999			0.988			0.960	
Satd. Flow (prot)	0	1672	0	0	1625	0	0	1488	0	0	793	0
Flt Permitted					0.999			0.988			0.960	
Satd. Flow (perm)	0	1672	0	0	1625	0	0	1488	0	0	793	0
Link Speed (k/h)		50			50			50			50	
Link Distance (m)		84.2			67.4			275.0			51.7	
Travel Time (s)		6.1			4.9			19.8			3.7	
Confl. Peds. (#/hr)	240		30	30		240	10		200	200		10
Confl. Bikes (#/hr)			5			20			5			
Peak Hour Factor	1.00	1.00	1.00	1.00	1.00	1.00	1.00	1.00	1.00	1.00	1.00	1.00
Heavy Vehicles (%)	100%	1%	1%	1%	3%	100%	1%	1%	1%	100%	100%	100%
Adj. Flow (vph)	0	431	7	14	477	5	10	0	30	5	0	1
Shared Lane Traffic (%)												
Lane Group Flow (vph)	0	438	0	0	496	0	0	40	0	0	6	0
Enter Blocked Intersection	No	No	No	No	No	No	No	No	No	No	No	No
Lane Alignment	Left	Left	Right	Left	Left	Right	Left	Left	Right	Left	Left	Right
Median Width(m)		0.0			0.0			0.0			0.0	
Link Offset(m)		0.0			0.0			0.0			0.0	
Crosswalk Width(m)		5.0			5.0			5.0			5.0	
Two way Left Turn Lane												
Headway Factor	1.16	1.16	1.16	1.16	1.16	1.16	1.16	1.16	1.16	1.16	1.16	1.16
Turning Speed (k/h)	24		14	24		14	24		14	24		14
Sign Control		Free			Free			Stop			Stop	
Intersection Summary												
Area Type:	CBD											
Control Type:	Unsignalized											
Intersection Capacity Utilization	63.1%						ICU Level of Service B					
Analysis Period (min)	15											

APPENDIX L

Transportation Demand Management

TDM-Supportive Development Design and Infrastructure Checklist: *Residential Developments (multi-family or condominium)*

Legend	
REQUIRED	The Official Plan or Zoning By-law provides related guidance that must be followed
BASIC	The measure is generally feasible and effective, and in most cases would benefit the development and its users
BETTER	The measure could maximize support for users of sustainable modes, and optimize development performance

TDM-supportive design & infrastructure measures: <i>Residential developments</i>		Check if completed & add descriptions, explanations or plan/drawing references
1. WALKING & CYCLING: ROUTES		
1.1 Building location & access points		
BASIC	1.1.1 Locate building close to the street, and do not locate parking areas between the street and building entrances	<input checked="" type="checkbox"/>
BASIC	1.1.2 Locate building entrances in order to minimize walking distances to sidewalks and transit stops/stations	<input checked="" type="checkbox"/>
BASIC	1.1.3 Locate building doors and windows to ensure visibility of pedestrians from the building, for their security and comfort	<input checked="" type="checkbox"/>
1.2 Facilities for walking & cycling		
REQUIRED	1.2.1 Provide convenient, direct access to stations or major stops along rapid transit routes within 600 metres; minimize walking distances from buildings to rapid transit; provide pedestrian-friendly, weather-protected (where possible) environment between rapid transit accesses and building entrances; ensure quality linkages from sidewalks through building entrances to integrated stops/stations (<i>see Official Plan policy 4.3.3</i>)	<input checked="" type="checkbox"/>
REQUIRED	1.2.2 Provide safe, direct and attractive pedestrian access from public sidewalks to building entrances through such measures as: reducing distances between public sidewalks and major building entrances; providing walkways from public streets to major building entrances; within a site, providing walkways along the front of adjoining buildings, between adjacent buildings, and connecting areas where people may congregate, such as courtyards and transit stops; and providing weather protection through canopies, colonnades, and other design elements wherever possible (<i>see Official Plan policy 4.3.12</i>)	<input checked="" type="checkbox"/>

TDM-supportive design & infrastructure measures: <i>Residential developments</i>		Check if completed & add descriptions, explanations or plan/drawing references
REQUIRED	1.2.3 Provide sidewalks of smooth, well-drained walking surfaces of contrasting materials or treatments to differentiate pedestrian areas from vehicle areas, and provide marked pedestrian crosswalks at intersection sidewalks (<i>see Official Plan policy 4.3.10</i>)	<input checked="" type="checkbox"/>
REQUIRED	1.2.4 Make sidewalks and open space areas easily accessible through features such as gradual grade transition, depressed curbs at street corners and convenient access to extra-wide parking spaces and ramps (<i>see Official Plan policy 4.3.10</i>)	<input checked="" type="checkbox"/>
REQUIRED	1.2.5 Include adequately spaced inter-block/street cycling and pedestrian connections to facilitate travel by active transportation. Provide links to the existing or planned network of public sidewalks, multi-use pathways and on-road cycle routes. Where public sidewalks and multi-use pathways intersect with roads, consider providing traffic control devices to give priority to cyclists and pedestrians (<i>see Official Plan policy 4.3.11</i>)	<input checked="" type="checkbox"/>
BASIC	1.2.6 Provide safe, direct and attractive walking routes from building entrances to nearby transit stops	<input checked="" type="checkbox"/>
BASIC	1.2.7 Ensure that walking routes to transit stops are secure, visible, lighted, shaded and wind-protected wherever possible	<input type="checkbox"/>
BASIC	1.2.8 Design roads used for access or circulation by cyclists using a target operating speed of no more than 30 km/h, or provide a separated cycling facility	<input type="checkbox"/>
1.3 Amenities for walking & cycling		
BASIC	1.3.1 Provide lighting, landscaping and benches along walking and cycling routes between building entrances and streets, sidewalks and trails	<input type="checkbox"/>
BASIC	1.3.2 Provide wayfinding signage for site access (where required, e.g. when multiple buildings or entrances exist) and egress (where warranted, such as when directions to reach transit stops/stations, trails or other common destinations are not obvious)	<input type="checkbox"/>

TDM-supportive design & infrastructure measures: <i>Residential developments</i>		Check if completed & add descriptions, explanations or plan/drawing references
2. WALKING & CYCLING: END-OF-TRIP FACILITIES		
2.1 Bicycle parking		
REQUIRED	2.1.1 Provide bicycle parking in highly visible and lighted areas, sheltered from the weather wherever possible (see <i>Official Plan policy 4.3.6</i>)	<input checked="" type="checkbox"/>
REQUIRED	2.1.2 Provide the number of bicycle parking spaces specified for various land uses in different parts of Ottawa; provide convenient access to main entrances or well-used areas (see <i>Zoning By-law Section 111</i>)	<input checked="" type="checkbox"/>
REQUIRED	2.1.3 Ensure that bicycle parking spaces and access aisles meet minimum dimensions; that no more than 50% of spaces are vertical spaces; and that parking racks are securely anchored (see <i>Zoning By-law Section 111</i>)	<input checked="" type="checkbox"/>
BASIC	2.1.4 Provide bicycle parking spaces equivalent to the expected number of resident-owned bicycles, plus the expected peak number of visitor cyclists	<input type="checkbox"/>
2.2 Secure bicycle parking		
REQUIRED	2.2.1 Where more than 50 bicycle parking spaces are provided for a single residential building, locate at least 25% of spaces within a building/structure, a secure area (e.g. supervised parking lot or enclosure) or bicycle lockers (see <i>Zoning By-law Section 111</i>)	<input checked="" type="checkbox"/>
BETTER	2.2.2 Provide secure bicycle parking spaces equivalent to at least the number of units at condominiums or multi-family residential developments	<input type="checkbox"/>
2.3 Bicycle repair station		
BETTER	2.3.1 Provide a permanent bike repair station, with commonly used tools and an air pump, adjacent to the main bicycle parking area (or secure bicycle parking area, if provided)	<input type="checkbox"/>
3. TRANSIT		
3.1 Customer amenities		
BASIC	3.1.1 Provide shelters, lighting and benches at any on-site transit stops	<input type="checkbox"/>
BASIC	3.1.2 Where the site abuts an off-site transit stop and insufficient space exists for a transit shelter in the public right-of-way, protect land for a shelter and/or install a shelter	<input type="checkbox"/>
BETTER	3.1.3 Provide a secure and comfortable interior waiting area by integrating any on-site transit stops into the building	<input type="checkbox"/>

TDM-supportive design & infrastructure measures: <i>Residential developments</i>		Check if completed & add descriptions, explanations or plan/drawing references
4. RIDESHARING		
4.1 Pick-up & drop-off facilities		
BASIC	4.1.1 Provide a designated area for carpool drivers (plus taxis and ride-hailing services) to drop off or pick up passengers without using fire lanes or other no-stopping zones	<input type="checkbox"/>
5. CARSHARING & BIKESHARING		
5.1 Carshare parking spaces		
BETTER	5.1.1 Provide up to three carshare parking spaces in an R3, R4 or R5 Zone for specified residential uses (see <i>Zoning By-law Section 94</i>)	<input type="checkbox"/>
5.2 Bikeshare station location		
BETTER	5.2.1 Provide a designated bikeshare station area near a major building entrance, preferably lighted and sheltered with a direct walkway connection	<input type="checkbox"/>
6. PARKING		
6.1 Number of parking spaces		
REQUIRED	6.1.1 Do not provide more parking than permitted by zoning, nor less than required by zoning, unless a variance is being applied for	<input checked="" type="checkbox"/>
BASIC	6.1.2 Provide parking for long-term and short-term users that is consistent with mode share targets, considering the potential for visitors to use off-site public parking	<input type="checkbox"/>
BASIC	6.1.3 Where a site features more than one use, provide shared parking and reduce the cumulative number of parking spaces accordingly (see <i>Zoning By-law Section 104</i>)	<input type="checkbox"/>
BETTER	6.1.4 Reduce the minimum number of parking spaces required by zoning by one space for each 13 square metres of gross floor area provided as shower rooms, change rooms, locker rooms and other facilities for cyclists in conjunction with bicycle parking (see <i>Zoning By-law Section 111</i>)	<input type="checkbox"/>
6.2 Separate long-term & short-term parking areas		
BETTER	6.2.1 Provide separate areas for short-term and long-term parking (using signage or physical barriers) to permit access controls and simplify enforcement (i.e. to discourage residents from parking in visitor spaces, and vice versa)	<input type="checkbox"/>

TDM Measures Checklist:
Residential Developments (multi-family, condominium or subdivision)

Legend	
BASIC	The measure is generally feasible and effective, and in most cases would benefit the development and its users
BETTER	The measure could maximize support for users of sustainable modes, and optimize development performance
★	The measure is one of the most dependably effective tools to encourage the use of sustainable modes

TDM measures: <i>Residential developments</i>		Check if proposed & add descriptions
1. TDM PROGRAM MANAGEMENT		
1.1 Program coordinator		
BASIC	★	1.1.1 Designate an internal coordinator, or contract with an external coordinator <input type="checkbox"/>
1.2 Travel surveys		
BETTER		1.2.1 Conduct periodic surveys to identify travel-related behaviours, attitudes, challenges and solutions, and to track progress <input type="checkbox"/>
2. WALKING AND CYCLING		
2.1 Information on walking/cycling routes & destinations		
BASIC		2.1.1 Display local area maps with walking/cycling access routes and key destinations at major entrances (<i>multi-family, condominium</i>) <input checked="" type="checkbox"/>
2.2 Bicycle skills training		
BETTER		2.2.1 Offer on-site cycling courses for residents, or subsidize off-site courses <input type="checkbox"/>

TDM measures: <i>Residential developments</i>		Check if proposed & add descriptions
3. TRANSIT		
3.1 Transit information		
BASIC	3.1.1 Display relevant transit schedules and route maps at entrances (<i>multi-family, condominium</i>)	<input checked="" type="checkbox"/>
BETTER	3.1.2 Provide real-time arrival information display at entrances (<i>multi-family, condominium</i>)	<input type="checkbox"/>
3.2 Transit fare incentives		
BASIC ★	3.2.1 Offer PRESTO cards preloaded with one monthly transit pass on residence purchase/move-in, to encourage residents to use transit	<input type="checkbox"/>
BETTER	3.2.2 Offer at least one year of free monthly transit passes on residence purchase/move-in	<input type="checkbox"/>
3.3 Enhanced public transit service		
BETTER ★	3.3.1 Contract with OC Transpo to provide early transit services until regular services are warranted by occupancy levels (<i>subdivision</i>)	<input type="checkbox"/>
3.4 Private transit service		
BETTER	3.4.1 Provide shuttle service for seniors homes or lifestyle communities (e.g. scheduled mall or supermarket runs)	<input type="checkbox"/>
4. CARSHARING & BIKESHARING		
4.1 Bikeshare stations & memberships		
BETTER	4.1.1 Contract with provider to install on-site bikeshare station (<i>multi-family</i>)	<input type="checkbox"/>
BETTER	4.1.2 Provide residents with bikeshare memberships, either free or subsidized (<i>multi-family</i>)	<input type="checkbox"/>
4.2 Carshare vehicles & memberships		
BETTER	4.2.1 Contract with provider to install on-site carshare vehicles and promote their use by residents	<input type="checkbox"/>
BETTER	4.2.2 Provide residents with carshare memberships, either free or subsidized	<input type="checkbox"/>
5. PARKING		
5.1 Priced parking		
BASIC ★	5.1.1 Unbundle parking cost from purchase price (<i>condominium</i>)	<input type="checkbox"/>
BASIC ★	5.1.2 Unbundle parking cost from monthly rent (<i>multi-family</i>)	<input checked="" type="checkbox"/>

TDM measures: <i>Residential developments</i>		Check if proposed & add descriptions
6. TDM MARKETING & COMMUNICATIONS		
6.1 Multimodal travel information		
BASIC ★	6.1.1 Provide a multimodal travel option information package to new residents	<input checked="" type="checkbox"/>
6.2 Personalized trip planning		
BETTER ★	6.2.1 Offer personalized trip planning to new residents	<input type="checkbox"/>

APPENDIX M

MMLOS Analysis

Segment MMLOS Analysis

This section provides a review of the boundary streets Scott Street and Athlone Avenue, using complete streets principles. The *Multi-Modal Level of Service (MMLOS) Guidelines*, produced by IBI Group in October 2015, were used to evaluate the levels of service for each alternative mode of transportation, based on the targets for roadways 'within 600m of a rapid transit station.'

Exhibit 4 of the *MMLOS Guidelines* has been used to evaluate the segment pedestrian level of service (PLOS) of the boundary streets. Exhibit 22 of the *MMLOS Guidelines* suggest a target PLOS A for all roadways within 600m of a rapid transit station. The results of the segment PLOS analysis are summarized in **Table 1**.

Exhibit 11 of the *MMLOS Guidelines* has been used to evaluate the segment bicycle level of service (BLOS) of the boundary streets. Exhibit 22 of the *MMLOS Guidelines* suggest a target BLOS A for Crosstown Bikeways within 600m of a rapid transit station (Scott Street), and a target BLOS D for all roadways with no cycling designation within 600m of a rapid transit station (Athlone Avenue). The results of the segment BLOS analysis are summarized in **Table 2**.

Exhibit 15 of the *MMLOS Guidelines* has been used to evaluate the segment transit level of service (TLOS) of Scott Street only, as transit service is not provided on Athlone Avenue. Exhibit 22 of the *MMLOS Guidelines* suggest a target TLOS A for Rapid Transit Corridors within 600m of a rapid transit station. The results of the segment TLOS analysis are summarized in **Table 3**.

Exhibit 20 of the *MMLOS Guidelines* has been used to evaluate the segment truck level of service (TkLOS) of Scott Street only, as Athlone Avenue is not a truck route. Exhibit 22 of the *MMLOS Guidelines* suggest a target TkLOS D for Truck Routes within 600m of a rapid transit station. The results of the segment TkLOS analysis are summarized in **Table 4**.

Table 1: PLOS Segment Analysis

Sidewalk Width	Boulevard Width	Avg. Daily Curb Lane Traffic Volume	Presence of On-Street Parking	Operating Speed ⁽¹⁾	PLOS
Scott Street (north side, Winona Avenue to Athlone Avenue)					
≥ 2.0m	> 2.0m	> 3,000 vpd	No	60 km/h	C
Scott Street (south side, Winona Avenue to Athlone Avenue)					
1.8m	> 2.0m	> 3,000 vpd	No	60 km/h	D
Athlone Avenue (east side, Scott Street to Richmond Road)					
No sidewalk		≤ 3,000 vpd	Yes	60 km/h	F
Athlone Avenue (west side, Scott Street to Richmond Road)					
≥ 2.0m	0m	≤ 3,000 vpd	Yes	60 km/h	C

1. Operating speed taken as the speed limit plus 10 km/h.

Table 2: BLOS Segment Analysis

Road Class	Bike Route	Type of Bikeway	Travel Lanes	Operating Speed	BLOS
Scott Street (north side, Winona Avenue to Athlone Avenue)					
Arterial	Crosstown Bikeway	Cycle Track	2	60 km/h	A
Athlone Avenue (both sides, Scott Street to Richmond Road)					
Local	No Class	Mixed Traffic	2	60 km/h	F

Table 3: TLOS Segment Analysis

Facility Type	Exposure to Congestion Delay, Friction, and Incidents			TLOS
	Congestion	Friction	Incident Potential	
Scott Street (Winona Avenue to Athlone Avenue)				
Mixed Traffic – Limited Parking/Driveway Friction	Yes	Low	Medium	D

Table 4: TkLOS Segment Analysis

Curb Lane Width	Number of Travel Lanes Per Direction	TkLOS
Scott Street (Winona Avenue to Athlone Avenue)		
3.5m to 3.7m	1	B

Intersection MMLOS Analysis

The following provides a review of the signalized intersections within the study area, using complete streets principles. All study area intersections are within 600m of a rapid transit station, and therefore those MMLOS targets have been used to evaluate each intersection. Scott Street/Churchill Avenue has been evaluated based on the future signal planned for that intersection. Scott Street/Athlone Avenue and Scott Street/Tweedsmuir Avenue have been evaluated based on existing conditions.

Exhibit 5 of the Addendum to the *MMLOS Guidelines* has been used to evaluate the existing PLOS of the study area intersections. Exhibit 22 of the *MMLOS Guidelines* suggests a target PLOS A for all roadways within 600m of a rapid transit station. The future signal at Scott Street/Churchill Avenue has not been evaluated for delay score. The results of the intersection PLOS analysis are summarized in **Table 5** through **Table 7**.

Exhibit 12 of the *MMLOS Guidelines* has been used to evaluate the existing BLOS of the study area intersections. Exhibit 22 of the *MMLOS Guidelines* suggests a target BLOS A for Crosstown Bikeways within 600m of a rapid transit station (Scott Street, Churchill Avenue), and a target BLOS D for all roadways with no cycling route designation within 600m of a rapid transit station (Athlone Avenue, Tweedsmuir Avenue). The results of the intersection BLOS analysis are summarized in **Table 9**.

Exhibit 16 of the *MMLOS Guidelines* has been used to evaluate the existing TLOS of the study area intersections. Exhibit 22 of the *MMLOS Guidelines* suggests a target TLOS A for Rapid Transit Corridors within 600m of a rapid transit station (east approach of Scott Street, south approach of Churchill Avenue), and does not identify a target TLOS for roadways without a Rapid Transit or Transit Priority designation (west approach of Scott Street, north approach of Churchill Avenue, Athlone Avenue, Tweedsmuir Avenue). The results of the intersection TLOS analysis are summarized in **Table 10**.

Exhibit 21 of the *MMLOS Guidelines* has been used to evaluate the existing TkLOS of the study area intersections. Exhibit 22 of the *MMLOS Guidelines* identifies a target TkLOS D for arterial truck routes within 600m of a rapid transit station (east approach of Scott Street, south approach of Churchill Avenue). No target is identified for local roadways with no truck route designations within 600m of a rapid transit station (Athlone Avenue, Tweedsmuir Avenue). Therefore, only the intersection of Scott Street/Churchill Avenue has been evaluated for TkLOS. The results of the intersection TkLOS analysis are summarized in **Table 11**.

Table 5: PLOS Intersection Analysis – Scott Street/Churchill Avenue

CRITERIA	North Approach		South Approach		East Approach		West Approach	
PETSI SCORE								
<i>CROSSING DISTANCE CONDITIONS</i>								
Median > 2.4m in Width	No	88	No	88	No	72	No	88
Lanes Crossed (3.5m Lane Width)	4		4		5		4	
<i>SIGNAL PHASING AND TIMING</i>								
Left Turn Conflict	No Left Turn/Prohibited	0	Perm + Prot	-8	Permissive	-8	Permissive	-8
Right Turn Conflict	Permissive or Yield	-5	Permissive or Yield	-5	Protected	0	Permissive or Yield	-5
Right Turn on Red	RTOR Allowed	-3	RTOR Prohibited	0	RTOR Allowed	-3	RTOR Allowed	-3
Leading Pedestrian Interval	No	-2	No	-2	No	-2	No	-2
<i>CORNER RADIUS</i>								
Parallel Radius	> 5m to 10m	-5	> 5m to 10m	-5	> 10m to 15m	-6	> 5m to 10m	-5
Parallel Right Turn Channel	No Right Turn Channel	-4	No Right Turn Channel	-4	No Right Turn Channel	-4	No Right Turn Channel	-4
Perpendicular Radius	N/A	0	N/A	0	N/A	0	N/A	0
Perpendicular Right Turn Channel	N/A	0	N/A	0	N/A	0	N/A	0
<i>CROSSING TREATMENT</i>								
Treatment	Zebra Stripe	-4	Zebra Stripe	-4	Zebra Stripe	-4	Zebra Stripe	-4
	PETSI SCORE	65	PETSI SCORE	60	PETSI SCORE	45	PETSI SCORE	57
	LOS	C	LOS	C	LOS	D	LOS	D
DELAY SCORE								
Cycle Length		95		95		95		95
Pedestrian Walk Time		48.6		7.6		7.6		7.6
	DELAY SCORE	11.3	DELAY SCORE	40.2	DELAY SCORE	40.2	DELAY SCORE	40.2
	LOS	B	LOS	E	LOS	E	LOS	E
	OVERALL	C	OVERALL	E	OVERALL	E	OVERALL	E

Table 6: PLOS Intersection Analysis – Scott Street/Athlone Avenue

CRITERIA	North Approach		South Approach		East Approach		West Approach	
PETSI SCORE								
<i>CROSSING DISTANCE CONDITIONS</i>								
Median > 2.4m in Width	N/A	0	No	105	N/A	0	No	88
Lanes Crossed (3.5m Lane Width)	N/A		3		N/A		4	
<i>SIGNAL PHASING AND TIMING</i>								
Left Turn Conflict	N/A	0	Permissive	-8	N/A	0	Permissive	-8
Right Turn Conflict	N/A	0	Permissive or Yield	-5	N/A	0	No Right Turn/Prohibited	0
Right Turn on Red	N/A	0	RTOR Prohibited	0	N/A	0	N/A	0
Leading Pedestrian Interval	N/A	0	No	-2	N/A	0	No	-2
<i>CORNER RADIUS</i>								
Parallel Radius	N/A	0	<3m	-3	N/A	0	No Right Turn	0
Parallel Right Turn Channel	N/A	0	No Right Turn Channel	-4	N/A	0	No Right Turn	0
Perpendicular Radius	N/A	0	N/A	0	N/A	0	N/A	0
Perpendicular Right Turn Channel	N/A	0	N/A	0	N/A	0	N/A	0
<i>CROSSING TREATMENT</i>								
Treatment	N/A	0	Zebra Stripe	-4	N/A	0	Zebra Stripe	-4
	PETSI SCORE	-	PETSI SCORE	79	PETSI SCORE	-	PETSI SCORE	74
	LOS	-	LOS	B	LOS	-	LOS	C
DELAY SCORE								
Cycle Length		0		0		0		54.8
Pedestrian Walk Time		0.0		0.0		0.0		9.0
	DELAY SCORE	-	DELAY SCORE	-	DELAY SCORE	-	DELAY SCORE	19.1
	LOS	-	LOS	-	LOS	-	LOS	B
	OVERALL	-	OVERALL	B	OVERALL	-	OVERALL	C

Table 7: PLOS Intersection Analysis – Scott Street/Tweedsmuir Avenue

CRITERIA	North Approach		South Approach		East Approach		West Approach	
PETSI SCORE								
<i>CROSSING DISTANCE CONDITIONS</i>								
Median > 2.4m in Width	N/A	0	No	105	No	88	N/A	0
Lanes Crossed (3.5m Lane Width)	N/A		3		4			
<i>SIGNAL PHASING AND TIMING</i>								
Left Turn Conflict	N/A	0	Permissive	-8	No Left Turn/Prohibited	0	N/A	0
Right Turn Conflict	N/A	0	Permissive or Yield	-5	Permissive or Yield	-5	N/A	0
Right Turn on Red	N/A	0	RTOR Allowed	-3	RTOR Prohibited	0	N/A	0
Leading Pedestrian Interval	N/A	0	No	-2	No	-2	N/A	0
<i>CORNER RADIUS</i>								
Parallel Radius	N/A	0	> 5m to 10m	-5	> 5m to 10m	-5	N/A	0
Parallel Right Turn Channel	N/A	0	No Right Turn Channel	-4	No Right Turn Channel	-4	N/A	0
Perpendicular Radius	N/A	0	N/A	0	N/A	0	N/A	0
Perpendicular Right Turn Channel	N/A	0	N/A	0	N/A	0	N/A	0
<i>CROSSING TREATMENT</i>								
Treatment	N/A	0	Zebra Stripe	-4	Zebra Stripe	-4	N/A	0
PETSI SCORE		-		74		68		-
LOS		-		C		C		-
DELAY SCORE								
Cycle Length		0		0		50		0
Pedestrian Walk Time		0.0		0.0		7.0		0.0
DELAY SCORE		-		-		18.5		-
LOS		-		-		B		-
OVERALL		-		C		C		-

Table 8: BLOS Intersection Analysis

Approach	Facility Type	Criteria	Travel Lanes and/or Speed	BLOS
Scott Street/Churchill Avenue				
North Approach	Mixed Traffic	Right Turn Lane Characteristics	Protected intersection	A
		Left Turn Accommodation		
South Approach	Mixed Traffic	Right Turn Lane Characteristics	Protected intersection	A
		Left Turn Accommodation		
East Approach	Cycle Track	Right Turn Lane Characteristics	Protected intersection	A
		Left Turn Accommodation		
West Approach	Cycle Track	Right Turn Lane Characteristics	Protected intersection	A
		Left Turn Accommodation		
Scott Street/Athlone Avenue				
North Approach	N/A	Right Turn Lane Characteristics	Cyclists prohibited; transit approach only (currently closed)	-
		Left Turn Accommodation		
South Approach	Mixed Traffic	Right Turn Lane Characteristics	Shared left turn/through/right turn lane	A
		Left Turn Accommodation	No lanes crossed; ≥ 60 km/h	D
East Approach	Cycle Track	Right Turn Lane Characteristics	Cyclists prohibited; transit only	-
		Left Turn Accommodation	No lanes crossed; ≥ 60 km/h	C
West Approach	Cycle Track	Right Turn Lane Characteristics	Shared through/right turn lane	A
		Left Turn Accommodation	Cyclists prohibited; transit only	-
Scott Street/Tweedsmuir Avenue				
North Approach	N/A	Right Turn Lane Characteristics	Cyclists prohibited; transit approach only (currently closed)	-
		Left Turn Accommodation		
South Approach	Mixed Traffic	Right Turn Lane Characteristics	Shared left turn/through/right turn lane	A
		Left Turn Accommodation	No lanes crossed; ≥ 60 km/h	D
East Approach	Cycle Track	Right Turn Lane Characteristics	Cyclists prohibited; transit only	-
		Left Turn Accommodation	No lanes crossed; ≥ 60 km/h	C
West Approach	Cycle Track	Right Turn Lane Characteristics	Shared through/right turn lane	A
		Left Turn Accommodation	Cyclists prohibited; transit only	-

Table 9: TLOS Intersection Analysis

Approach	Delay ⁽¹⁾		TLOS
	AM Peak	PM Peak	
Scott Street/Churchill Avenue			
North Approach	60 sec	39 sec	F
South Approach	35 sec	27 sec	E
East Approach	9 sec	9 sec	B
Scott Street/Athlone Avenue			
East Approach	8 sec	10 sec	B
West Approach	9 sec	8 sec	B
Scott Street/Tweedsmuir Avenue			
East Approach	7 sec	8 sec	B
West Approach	9 sec	8 sec	B

1. Delay based on outputs from Synchro analysis of 2031 total conditions

Table 10: TkLOS Intersection Analysis

Approach	Effective Corner Radius	Number of Receiving Lanes Departing Intersection	TkLOS
Scott Street/Churchill Avenue			
North Approach	< 10m	1	F
South Approach	10m to 15m	1	E
East Approach	< 10m	1	F
West Approach	< 10m	1	F

APPENDIX N

Total Synchro Analysis

1: Churchill & Scott
AM Peak Hour

2026 Scott Street
2026 Total Traffic



Lane Group	EBL	EBT	EBR	WBL	WBT	WBR	NBL	NBT	NBR	SBL	SBT	SBR
Lane Configurations												
Traffic Volume (vph)	0	10	13	238	3	16	13	98	379	55	199	2
Future Volume (vph)	0	10	13	238	3	16	13	98	379	55	199	2
Ideal Flow (vphpl)	1800	1800	1800	1800	1800	1800	1800	1800	1800	1800	1800	1800
Storage Length (m)	0.0		0.0	0.0		0.0	0.0		40.0	0.0		0.0
Storage Lanes	0		0	1		0	0		1	0		0
Taper Length (m)	10.0			30.0			10.0			10.0		
Lane Util. Factor	1.00	1.00	1.00	1.00	1.00	1.00	1.00	1.00	1.00	1.00	1.00	1.00
Ped Bike Factor		0.93		0.96	0.89			0.99			0.99	
Frt		0.924			0.874				0.850		0.999	
Flt Protected				0.950				0.994			0.989	
Satd. Flow (prot)	0	1356	0	1461	1163	0	0	1624	1383	0	1630	0
Flt Permitted				0.577				0.944			0.896	
Satd. Flow (perm)	0	1356	0	851	1163	0	0	1533	1383	0	1465	0
Right Turn on Red			Yes			Yes			No			Yes
Satd. Flow (RTOR)		13			16							
Link Speed (k/h)		50			50			50			50	
Link Distance (m)		77.3			83.9			315.3			273.6	
Travel Time (s)		5.6			6.0			22.7			19.7	
Confl. Peds. (#/hr)	40		20	20		40	40		20	20		40
Confl. Bikes (#/hr)			30			20			30			20
Peak Hour Factor	1.00	1.00	1.00	1.00	1.00	1.00	1.00	1.00	1.00	1.00	1.00	1.00
Heavy Vehicles (%)	1%	15%	1%	10%	1%	15%	8%	3%	4%	4%	2%	1%
Adj. Flow (vph)	0	10	13	238	3	16	13	98	379	55	199	2
Shared Lane Traffic (%)												
Lane Group Flow (vph)	0	23	0	238	19	0	0	111	379	0	256	0
Enter Blocked Intersection	No	No	No	No	No	No	No	No	No	No	No	No
Lane Alignment	Left	Left	Right	Left	Left	Right	Left	Left	Right	Left	Left	Right
Median Width(m)		4.0			4.0			0.0			0.0	
Link Offset(m)		0.0			0.0			0.0			0.0	
Crosswalk Width(m)		5.0			5.0			5.0			5.0	
Two way Left Turn Lane												
Headway Factor	1.16	1.16	1.16	1.16	1.16	1.16	1.16	1.16	1.16	1.16	1.16	1.16
Turning Speed (k/h)	24		14	24		14	24		14	24		14
Number of Detectors		2		1	2		1	2	1	1		2
Detector Template		Thru		Left	Thru		Left	Thru	Right	Left		Thru
Leading Detector (m)		30.5		6.1	30.5		6.1	30.5	6.1	6.1		30.5
Trailing Detector (m)		0.0		0.0	0.0		0.0	0.0	0.0	0.0		0.0
Detector 1 Position(m)		0.0		0.0	0.0		0.0	0.0	0.0	0.0		0.0
Detector 1 Size(m)		1.8		6.1	1.8		6.1	1.8	6.1	6.1		1.8
Detector 1 Type		Cl+Ex		Cl+Ex	Cl+Ex		Cl+Ex	Cl+Ex	Cl+Ex	Cl+Ex		Cl+Ex
Detector 1 Channel												
Detector 1 Extend (s)		0.0		0.0	0.0		0.0	0.0	0.0	0.0		0.0
Detector 1 Queue (s)		0.0		0.0	0.0		0.0	0.0	0.0	0.0		0.0
Detector 1 Delay (s)		0.0		0.0	0.0		0.0	0.0	0.0	0.0		0.0
Detector 2 Position(m)		28.7			28.7			28.7				28.7
Detector 2 Size(m)		1.8			1.8			1.8				1.8
Detector 2 Type		Cl+Ex			Cl+Ex			Cl+Ex				Cl+Ex
Detector 2 Channel												
Detector 2 Extend (s)		0.0			0.0			0.0				0.0
Turn Type		NA		pm+pt	NA		Perm	NA	Over	Perm		NA
Protected Phases		2		1	6			8	1			4
Permitted Phases				6			8			4		
Detector Phase		2		1	6		8	8	1	4		4



Lane Group	EBL	EBT	EBR	WBL	WBT	WBR	NBL	NBT	NBR	SBL	SBT	SBR
Switch Phase												
Minimum Initial (s)		10.0		5.0	10.0		10.0	10.0	5.0	10.0	10.0	
Minimum Split (s)		25.4		11.8	25.4		27.4	27.4	11.8	27.4	27.4	
Total Split (s)		26.0		41.0	67.0		28.0	28.0	41.0	28.0	28.0	
Total Split (%)		27.4%		43.2%	70.5%		29.5%	29.5%	43.2%	29.5%	29.5%	
Maximum Green (s)		18.6		34.2	59.6		21.6	21.6	34.2	21.6	21.6	
Yellow Time (s)		3.0		3.0	3.0		3.3	3.3	3.0	3.3	3.3	
All-Red Time (s)		4.4		3.8	4.4		3.1	3.1	3.8	3.1	3.1	
Lost Time Adjust (s)		0.0		0.0	0.0			0.0	0.0		0.0	
Total Lost Time (s)		7.4		6.8	7.4			6.4	6.8		6.4	
Lead/Lag		Lag		Lead					Lead			
Lead-Lag Optimize?		Yes		Yes					Yes			
Vehicle Extension (s)		3.0		3.0	3.0		3.0	3.0	3.0	3.0	3.0	
Recall Mode		Max		Min	Max		None	None	Min	None	None	
Walk Time (s)		7.0			7.0		7.0	7.0		7.0	7.0	
Flash Dont Walk (s)		11.0			11.0		14.0	14.0		14.0	14.0	
Pedestrian Calls (#/hr)		40			40		40	40		40	40	
Act Effct Green (s)		23.6		60.3	59.7			19.3	29.2		19.3	
Actuated g/C Ratio		0.25		0.65	0.64			0.21	0.31		0.21	
v/c Ratio		0.06		0.32	0.03			0.35	0.87		0.84	
Control Delay		20.5		8.6	3.6			34.5	50.9		59.5	
Queue Delay		0.0		0.0	0.0			0.0	0.0		0.0	
Total Delay		20.5		8.6	3.6			34.5	50.9		59.5	
LOS		C		A	A			C	D		E	
Approach Delay		20.5			8.2			47.2			59.5	
Approach LOS		C			A			D			E	
Queue Length 50th (m)		1.3		15.9	0.2			15.7	58.2		40.7	
Queue Length 95th (m)		7.4		26.3	2.4			29.4	#95.3		#74.2	
Internal Link Dist (m)		53.3			59.9			291.3			249.6	
Turn Bay Length (m)									40.0			
Base Capacity (vph)		354		777	753			357	510		341	
Starvation Cap Reductn		0		0	0			0	0		0	
Spillback Cap Reductn		0		0	0			0	0		0	
Storage Cap Reductn		0		0	0			0	0		0	
Reduced v/c Ratio		0.06		0.31	0.03			0.31	0.74		0.75	

Intersection Summary

Area Type: CBD
 Cycle Length: 95
 Actuated Cycle Length: 92.8
 Natural Cycle: 80
 Control Type: Semi Act-Uncoord
 Maximum v/c Ratio: 0.87
 Intersection Signal Delay: 39.9
 Intersection Capacity Utilization 78.7%
 Analysis Period (min) 15
 # 95th percentile volume exceeds capacity, queue may be longer.
 Queue shown is maximum after two cycles.

Splits and Phases: 1: Churchill & Scott

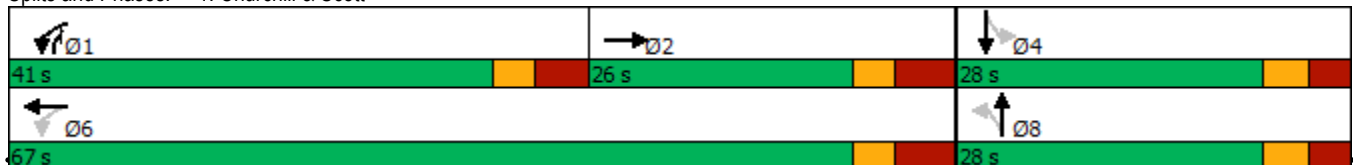

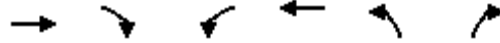

Lane Group	EBT	EBR	WBL	WBT	NBL	NBR
Lane Configurations						
Traffic Volume (vph)	428	20	21	237	15	45
Future Volume (vph)	428	20	21	237	15	45
Ideal Flow (vphpl)	1800	1800	1800	1800	1800	1800
Storage Length (m)		0.0	10.0		0.0	0.0
Storage Lanes		0	1		1	0
Taper Length (m)			30.0		10.0	
Lane Util. Factor	1.00	1.00	0.95	0.95	1.00	1.00
Ped Bike Factor						
Frt	0.994				0.899	
Flt Protected				0.996	0.988	
Satd. Flow (prot)	1614	0	0	2919	1488	0
Flt Permitted				0.996	0.988	
Satd. Flow (perm)	1614	0	0	2919	1488	0
Link Speed (k/h)	50			50	30	
Link Distance (m)	83.9			86.1	233.8	
Travel Time (s)	6.0			6.2	28.1	
Confl. Peds. (#/hr)		10	10			
Confl. Bikes (#/hr)		30				5
Peak Hour Factor	1.00	1.00	1.00	1.00	1.00	1.00
Heavy Vehicles (%)	4%	8%	6%	10%	1%	1%
Adj. Flow (vph)	428	20	21	237	15	45
Shared Lane Traffic (%)						
Lane Group Flow (vph)	448	0	0	258	60	0
Enter Blocked Intersection	No	No	No	No	No	No
Lane Alignment	Left	Right	Left	Left	Left	Right
Median Width(m)	0.0			0.0	4.0	
Link Offset(m)	0.0			0.0	0.0	
Crosswalk Width(m)	5.0			5.0	5.0	
Two way Left Turn Lane						
Headway Factor	1.16	1.16	1.16	1.16	1.16	1.16
Turning Speed (k/h)		14	24		24	14
Sign Control	Free			Free	Stop	

Intersection Summary

Area Type:	CBD
Control Type:	Unsignalized
Intersection Capacity Utilization	38.8%
ICU Level of Service	A
Analysis Period (min)	15

3: Athlone & Scott
AM Peak Hour

2026 Scott Street
2026 Total Traffic



Lane Group	EBL	EBT	EBR	WBL	WBT	WBR	NBL	NBT	NBR	SBL	SBT	SBR
Lane Configurations												
Traffic Volume (vph)	11	523	7	22	266	6	0	0	0	0	0	0
Future Volume (vph)	11	523	7	22	266	6	0	0	0	0	0	0
Ideal Flow (vphpl)	1800	1800	1800	1800	1800	1800	1800	1800	1800	1800	1800	1800
Lane Util. Factor	1.00	1.00	1.00	1.00	1.00	1.00	1.00	1.00	1.00	1.00	1.00	1.00
Ped Bike Factor	1.00				1.00							
Flt	0.998				0.997							
Flt Protected	0.999				0.996							
Satd. Flow (prot)	0	1617	0	0	1544	0	0	0	0	0	0	0
Flt Permitted	0.993				0.952							
Satd. Flow (perm)	0	1605	0	0	1475	0	0	0	0	0	0	0
Right Turn on Red			Yes				Yes				Yes	
Satd. Flow (RTOR)	2				3							
Link Speed (k/h)	50				50				30			
Link Distance (m)	108.8				84.2				62.0			
Travel Time (s)	7.8				6.1				7.4			
Confl. Peds. (#/hr)	120		20	20		120	70		20	20		70
Confl. Bikes (#/hr)			15			10			5			
Peak Hour Factor	1.00	1.00	1.00	1.00	1.00	1.00	1.00	1.00	1.00	1.00	1.00	1.00
Heavy Vehicles (%)	100%	2%	20%	1%	7%	100%	1%	100%	1%	100%	100%	100%
Adj. Flow (vph)	11	523	7	22	266	6	0	0	0	0	0	0
Shared Lane Traffic (%)												
Lane Group Flow (vph)	0	541	0	0	294	0	0	0	0	0	0	0
Enter Blocked Intersection	No	No	No	No	No	No	No	No	No	No	No	No
Lane Alignment	Left	Left	Right	Left	Left	Right	Left	Left	Right	Left	Left	Right
Median Width(m)	0.0				0.0				0.0			
Link Offset(m)	0.0				0.0				0.0			
Crosswalk Width(m)	5.0				5.0				5.0			
Two way Left Turn Lane												
Headway Factor	1.16	1.16	1.16	1.16	1.16	1.16	1.16	1.16	1.16	1.16	1.16	1.16
Turning Speed (k/h)	24		14	24		14	24		14	24		14
Number of Detectors	1	2		1	2							
Detector Template	Left	Thru		Left	Thru							
Leading Detector (m)	6.1	30.5		6.1	30.5							
Trailing Detector (m)	0.0	0.0		0.0	0.0							
Detector 1 Position(m)	0.0	0.0		0.0	0.0							
Detector 1 Size(m)	6.1	1.8		6.1	1.8							
Detector 1 Type	CI+Ex	CI+Ex		CI+Ex	CI+Ex							
Detector 1 Channel												
Detector 1 Extend (s)	0.0	0.0		0.0	0.0							
Detector 1 Queue (s)	0.0	0.0		0.0	0.0							
Detector 1 Delay (s)	0.0	0.0		0.0	0.0							
Detector 2 Position(m)	28.7				28.7							
Detector 2 Size(m)	1.8				1.8							
Detector 2 Type	CI+Ex				CI+Ex							
Detector 2 Channel												
Detector 2 Extend (s)	0.0				0.0							
Turn Type	Perm	NA		Perm	NA							
Protected Phases	2				6							
Permitted Phases	2				6							
Detector Phase	2	2		6	6							
Switch Phase												
Minimum Initial (s)	10.0	10.0		10.0	10.0							
Minimum Split (s)	15.8	15.8		15.8	15.8							

Lane Group	Ø4
Lane Configurations	
Traffic Volume (vph)	
Future Volume (vph)	
Ideal Flow (vphpl)	
Lane Util. Factor	
Ped Bike Factor	
Frt	
Flt Protected	
Satd. Flow (prot)	
Flt Permitted	
Satd. Flow (perm)	
Right Turn on Red	
Satd. Flow (RTOR)	
Link Speed (k/h)	
Link Distance (m)	
Travel Time (s)	
Confl. Peds. (#/hr)	
Confl. Bikes (#/hr)	
Peak Hour Factor	
Heavy Vehicles (%)	
Adj. Flow (vph)	
Shared Lane Traffic (%)	
Lane Group Flow (vph)	
Enter Blocked Intersection	
Lane Alignment	
Median Width(m)	
Link Offset(m)	
Crosswalk Width(m)	
Two way Left Turn Lane	
Headway Factor	
Turning Speed (k/h)	
Number of Detectors	
Detector Template	
Leading Detector (m)	
Trailing Detector (m)	
Detector 1 Position(m)	
Detector 1 Size(m)	
Detector 1 Type	
Detector 1 Channel	
Detector 1 Extend (s)	
Detector 1 Queue (s)	
Detector 1 Delay (s)	
Detector 2 Position(m)	
Detector 2 Size(m)	
Detector 2 Type	
Detector 2 Channel	
Detector 2 Extend (s)	
Turn Type	
Protected Phases	4
Permitted Phases	
Detector Phase	
Switch Phase	
Minimum Initial (s)	20.0
Minimum Split (s)	24.0

3: Athlone & Scott
AM Peak Hour

2026 Scott Street
2026 Total Traffic



Lane Group	EBL	EBT	EBR	WBL	WBT	WBR	NBL	NBT	NBR	SBL	SBT	SBR
Total Split (s)	30.8	30.8		30.8	30.8							
Total Split (%)	56.2%	56.2%		56.2%	56.2%							
Maximum Green (s)	25.0	25.0		25.0	25.0							
Yellow Time (s)	3.3	3.3		3.3	3.3							
All-Red Time (s)	2.5	2.5		2.5	2.5							
Lost Time Adjust (s)		0.0			0.0							
Total Lost Time (s)		5.8			5.8							
Lead/Lag												
Lead-Lag Optimize?												
Vehicle Extension (s)	3.0	3.0		3.0	3.0							
Recall Mode	Max	Max		Max	Max							
Walk Time (s)												
Flash Dont Walk (s)												
Pedestrian Calls (#/hr)												
Act Effct Green (s)		44.8			44.8							
Actuated g/C Ratio		0.74			0.74							
v/c Ratio		0.45			0.27							
Control Delay		9.1			7.2							
Queue Delay		0.0			0.3							
Total Delay		9.1			7.5							
LOS		A			A							
Approach Delay		9.1			7.5							
Approach LOS		A			A							
Queue Length 50th (m)		37.6			16.8							
Queue Length 95th (m)		62.5			29.4							
Internal Link Dist (m)		84.8			60.2			38.0			30.4	
Turn Bay Length (m)												
Base Capacity (vph)		1194			1098							
Starvation Cap Reductn		0			331							
Spillback Cap Reductn		0			0							
Storage Cap Reductn		0			0							
Reduced v/c Ratio		0.45			0.38							

Intersection Summary

Area Type:	CBD
Cycle Length:	54.8
Actuated Cycle Length:	60.2
Natural Cycle:	60
Control Type:	Semi Act-Uncoord
Maximum v/c Ratio:	0.45
Intersection Signal Delay:	8.5
Intersection LOS:	A
Intersection Capacity Utilization:	40.9%
ICU Level of Service:	A
Analysis Period (min):	15

Splits and Phases: 3: Athlone & Scott

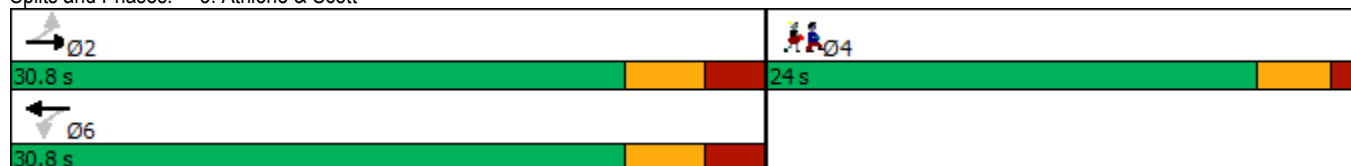

Lane Group	Ø4
Total Split (s)	24.0
Total Split (%)	44%
Maximum Green (s)	20.0
Yellow Time (s)	3.0
All-Red Time (s)	1.0
Lost Time Adjust (s)	
Total Lost Time (s)	
Lead/Lag	
Lead-Lag Optimize?	
Vehicle Extension (s)	3.0
Recall Mode	None
Walk Time (s)	7.0
Flash Dont Walk (s)	11.0
Pedestrian Calls (#/hr)	100
Act Effct Green (s)	
Actuated g/C Ratio	
v/c Ratio	
Control Delay	
Queue Delay	
Total Delay	
LOS	
Approach Delay	
Approach LOS	
Queue Length 50th (m)	
Queue Length 95th (m)	
Internal Link Dist (m)	
Turn Bay Length (m)	
Base Capacity (vph)	
Starvation Cap Reductn	
Spillback Cap Reductn	
Storage Cap Reductn	
Reduced v/c Ratio	
Intersection Summary	

4: Tweedsmuir & Scott
AM Peak Hour

2026 Scott Street
2026 Total Traffic



Lane Group	EBL	EBT	EBR	WBL	WBT	WBR	NBL	NBT	NBR	SBL	SBT	SBR
Lane Configurations												
Traffic Volume (vph)	0	530	3	10	268	5	0	0	0	0	0	0
Future Volume (vph)	0	530	3	10	268	5	0	0	0	0	0	0
Ideal Flow (vphpl)	1800	1800	1800	1800	1800	1800	1800	1800	1800	1800	1800	1800
Lane Util. Factor	1.00	1.00	1.00	1.00	1.00	1.00	1.00	1.00	1.00	1.00	1.00	1.00
Ped Bike Factor		1.00			1.00							
Flt		0.999			0.998							
Flt Protected					0.998							
Satd. Flow (prot)	0	1641	0	0	1562	0	0	0	0	0	0	0
Flt Permitted					0.982							
Satd. Flow (perm)	0	1641	0	0	1537	0	0	0	0	0	0	0
Right Turn on Red			Yes			Yes			Yes			Yes
Satd. Flow (RTOR)		1			2							
Link Speed (k/h)		50			50			50			50	
Link Distance (m)		84.2			67.4			275.0			51.7	
Travel Time (s)		6.1			4.9			19.8			3.7	
Confl. Peds. (#/hr)	160		20	20		160	10		130	130		10
Confl. Bikes (#/hr)			10			5						
Peak Hour Factor	1.00	1.00	1.00	1.00	1.00	1.00	1.00	1.00	1.00	1.00	1.00	1.00
Heavy Vehicles (%)	100%	3%	1%	1%	6%	100%	1%	1%	1%	100%	100%	100%
Adj. Flow (vph)	0	530	3	10	268	5	0	0	0	0	0	0
Shared Lane Traffic (%)												
Lane Group Flow (vph)	0	533	0	0	283	0	0	0	0	0	0	0
Enter Blocked Intersection	No	No	No	No	No	No	No	No	No	No	No	No
Lane Alignment	Left	Left	Right	Left	Left	Right	Left	Left	Right	Left	Left	Right
Median Width(m)		0.0			0.0			0.0			0.0	
Link Offset(m)		0.0			0.0			0.0			0.0	
Crosswalk Width(m)		5.0			5.0			5.0			5.0	
Two way Left Turn Lane												
Headway Factor	1.16	1.16	1.16	1.16	1.16	1.16	1.16	1.16	1.16	1.16	1.16	1.16
Turning Speed (k/h)	24		14	24		14	24		14	24		14
Number of Detectors	1	2		1	2							
Detector Template	Left	Thru		Left	Thru							
Leading Detector (m)	6.1	30.5		6.1	30.5							
Trailing Detector (m)	0.0	0.0		0.0	0.0							
Detector 1 Position(m)	0.0	0.0		0.0	0.0							
Detector 1 Size(m)	6.1	1.8		6.1	1.8							
Detector 1 Type	CI+Ex	CI+Ex		CI+Ex	CI+Ex							
Detector 1 Channel												
Detector 1 Extend (s)	0.0	0.0		0.0	0.0							
Detector 1 Queue (s)	0.0	0.0		0.0	0.0							
Detector 1 Delay (s)	0.0	0.0		0.0	0.0							
Detector 2 Position(m)		28.7			28.7							
Detector 2 Size(m)		1.8			1.8							
Detector 2 Type		CI+Ex			CI+Ex							
Detector 2 Channel												
Detector 2 Extend (s)		0.0			0.0							
Turn Type		NA		Perm	NA							
Protected Phases		2			6							
Permitted Phases	2			6								
Detector Phase	2	2		6	6							
Switch Phase												
Minimum Initial (s)	10.0	10.0		10.0	10.0							
Minimum Split (s)	15.8	15.8		15.8	15.8							

Lane Group	Ø4
Lane Configurations	
Traffic Volume (vph)	
Future Volume (vph)	
Ideal Flow (vphpl)	
Lane Util. Factor	
Ped Bike Factor	
Frt	
Flt Protected	
Satd. Flow (prot)	
Flt Permitted	
Satd. Flow (perm)	
Right Turn on Red	
Satd. Flow (RTOR)	
Link Speed (k/h)	
Link Distance (m)	
Travel Time (s)	
Confl. Peds. (#/hr)	
Confl. Bikes (#/hr)	
Peak Hour Factor	
Heavy Vehicles (%)	
Adj. Flow (vph)	
Shared Lane Traffic (%)	
Lane Group Flow (vph)	
Enter Blocked Intersection	
Lane Alignment	
Median Width(m)	
Link Offset(m)	
Crosswalk Width(m)	
Two way Left Turn Lane	
Headway Factor	
Turning Speed (k/h)	
Number of Detectors	
Detector Template	
Leading Detector (m)	
Trailing Detector (m)	
Detector 1 Position(m)	
Detector 1 Size(m)	
Detector 1 Type	
Detector 1 Channel	
Detector 1 Extend (s)	
Detector 1 Queue (s)	
Detector 1 Delay (s)	
Detector 2 Position(m)	
Detector 2 Size(m)	
Detector 2 Type	
Detector 2 Channel	
Detector 2 Extend (s)	
Turn Type	
Protected Phases	4
Permitted Phases	
Detector Phase	
Switch Phase	
Minimum Initial (s)	10.0
Minimum Split (s)	22.0

4: Tweedsmuir & Scott
AM Peak Hour

2026 Scott Street
2026 Total Traffic



Lane Group	EBL	EBT	EBR	WBL	WBT	WBR	NBL	NBT	NBR	SBL	SBT	SBR
Total Split (s)	28.0	28.0		28.0	28.0							
Total Split (%)	56.0%	56.0%		56.0%	56.0%							
Maximum Green (s)	22.2	22.2		22.2	22.2							
Yellow Time (s)	3.3	3.3		3.3	3.3							
All-Red Time (s)	2.5	2.5		2.5	2.5							
Lost Time Adjust (s)		0.0			0.0							
Total Lost Time (s)		5.8			5.8							
Lead/Lag												
Lead-Lag Optimize?												
Vehicle Extension (s)	3.0	3.0		3.0	3.0							
Recall Mode	Max	Max		Max	Max							
Walk Time (s)												
Flash Dont Walk (s)												
Pedestrian Calls (#/hr)												
Act Effct Green (s)		41.8			41.8							
Actuated g/C Ratio		0.74			0.74							
v/c Ratio		0.44			0.25							
Control Delay		8.4			6.7							
Queue Delay		0.5			0.0							
Total Delay		8.9			6.7							
LOS		A			A							
Approach Delay		8.9			6.7							
Approach LOS		A			A							
Queue Length 50th (m)		33.4			14.6							
Queue Length 95th (m)		56.2			26.0							
Internal Link Dist (m)		60.2			43.4			251.0			27.7	
Turn Bay Length (m)												
Base Capacity (vph)		1220			1143							
Starvation Cap Reductn		312			0							
Spillback Cap Reductn		0			0							
Storage Cap Reductn		0			0							
Reduced v/c Ratio		0.59			0.25							

Intersection Summary

Area Type:	CBD
Cycle Length:	50
Actuated Cycle Length:	56.2
Natural Cycle:	55
Control Type:	Semi Act-Uncoord
Maximum v/c Ratio:	0.44
Intersection Signal Delay:	8.1
Intersection LOS:	A
Intersection Capacity Utilization:	37.8%
ICU Level of Service:	A
Analysis Period (min):	15

Splits and Phases: 4: Tweedsmuir & Scott

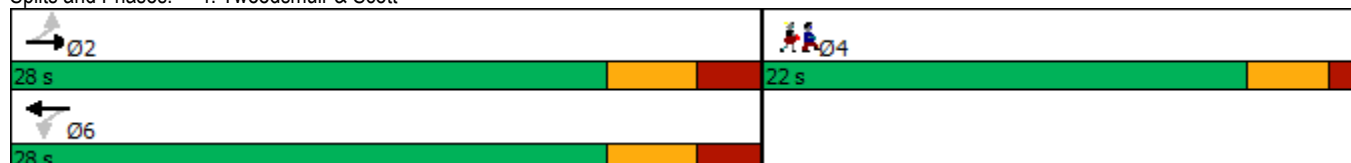

Lane Group	Ø4
Total Split (s)	22.0
Total Split (%)	44%
Maximum Green (s)	18.0
Yellow Time (s)	3.0
All-Red Time (s)	1.0
Lost Time Adjust (s)	
Total Lost Time (s)	
Lead/Lag	
Lead-Lag Optimize?	
Vehicle Extension (s)	3.0
Recall Mode	None
Walk Time (s)	7.0
Flash Dont Walk (s)	11.0
Pedestrian Calls (#/hr)	100
Act Effct Green (s)	
Actuated g/C Ratio	
v/c Ratio	
Control Delay	
Queue Delay	
Total Delay	
LOS	
Approach Delay	
Approach LOS	
Queue Length 50th (m)	
Queue Length 95th (m)	
Internal Link Dist (m)	
Turn Bay Length (m)	
Base Capacity (vph)	
Starvation Cap Reductn	
Spillback Cap Reductn	
Storage Cap Reductn	
Reduced v/c Ratio	
Intersection Summary	



Lane Group	EBT	EBR	WBL	WBT	NBL	NBR
Lane Configurations						
Traffic Volume (vph)	537	33	108	270	13	102
Future Volume (vph)	537	33	108	270	13	102
Ideal Flow (vphpl)	1800	1800	1800	1800	1800	1800
Lane Util. Factor	1.00	1.00	1.00	1.00	1.00	1.00
Ped Bike Factor						
Frt	0.992				0.880	
Flt Protected				0.986	0.994	
Satd. Flow (prot)	1631	0	0	1606	1465	0
Flt Permitted				0.986	0.994	
Satd. Flow (perm)	1631	0	0	1606	1465	0
Link Speed (k/h)	50				50	50
Link Distance (m)	67.4				200.5	303.1
Travel Time (s)	4.9				14.4	21.8
Confl. Peds. (#/hr)	60		60			
Confl. Bikes (#/hr)	10			5		
Peak Hour Factor	1.00	1.00	1.00	1.00	1.00	1.00
Heavy Vehicles (%)	3%	1%	1%	5%	1%	1%
Adj. Flow (vph)	537	33	108	270	13	102
Shared Lane Traffic (%)						
Lane Group Flow (vph)	570	0	0	378	115	0
Enter Blocked Intersection	No	No	No	No	No	No
Lane Alignment	Left	Right	Left	Left	Left	Right
Median Width(m)	0.0				0.0	4.0
Link Offset(m)	0.0				0.0	0.0
Crosswalk Width(m)	5.0				5.0	5.0
Two way Left Turn Lane						
Headway Factor	1.16	1.16	1.16	1.16	1.16	1.16
Turning Speed (k/h)	14		24	24		14
Sign Control	Free				Free	Stop

Intersection Summary	
Area Type:	CBD
Control Type:	Unsignalized
Intersection Capacity Utilization 77.7%	ICU Level of Service D
Analysis Period (min)	15



Lane Group	EBT	EBR	WBL	WBT	NBL	NBR
Lane Configurations						
Traffic Volume (vph)	530	3	5	277	5	11
Future Volume (vph)	530	3	5	277	5	11
Ideal Flow (vphpl)	1800	1800	1800	1800	1800	1800
Lane Util. Factor	1.00	1.00	1.00	1.00	1.00	1.00
Ped Bike Factor						
Frt	0.999			0.907		
Flt Protected				0.999	0.985	
Satd. Flow (prot)	1626	0	0	1539	1497	0
Flt Permitted				0.999	0.985	
Satd. Flow (perm)	1626	0	0	1539	1497	0
Link Speed (k/h)	50			50	30	
Link Distance (m)	86.1			108.8	89.0	
Travel Time (s)	6.2			7.8	10.7	
Confl. Peds. (#/hr)	20		20			
Confl. Bikes (#/hr)	30			5		
Peak Hour Factor	1.00	1.00	1.00	1.00	1.00	1.00
Heavy Vehicles (%)	4%	1%	1%	10%	1%	1%
Adj. Flow (vph)	530	3	5	277	5	11
Shared Lane Traffic (%)						
Lane Group Flow (vph)	533	0	0	282	16	0
Enter Blocked Intersection	No	No	No	No	No	No
Lane Alignment	Left	Right	Left	Left	Left	Right
Median Width(m)	4.0			4.0	4.0	
Link Offset(m)	0.0			0.0	0.0	
Crosswalk Width(m)	5.0			5.0	5.0	
Two way Left Turn Lane						
Headway Factor	1.16	1.16	1.16	1.16	1.16	1.16
Turning Speed (k/h)	14		24	24		14
Sign Control	Free			Free	Stop	

Intersection Summary

Area Type: CBD

Control Type: Unsignalized

Intersection Capacity Utilization 42.9% ICU Level of Service A

Analysis Period (min) 15

7: Athlone & Access
AM Peak Hour

2026 Scott Street
2026 Total Traffic



Lane Group	EBL	EBR	NBL	NBT	SBT	SBR
Lane Configurations						
Traffic Volume (vph)	0	2	1	31	31	0
Future Volume (vph)	0	2	1	31	31	0
Ideal Flow (vphpl)	1800	1800	1800	1800	1800	1800
Lane Util. Factor	1.00	1.00	1.00	1.00	1.00	1.00
Ped Bike Factor						
Frt	0.865					
Flt Protected				0.998		
Satd. Flow (prot)	0	1449	0	1656	1659	0
Flt Permitted	0.998					
Satd. Flow (perm)	0	1449	0	1656	1659	0
Link Speed (k/h)	30			30		30
Link Distance (m)	66.2			194.5		62.0
Travel Time (s)	7.9			23.3		7.4
Confl. Peds. (#/hr)				20		20
Confl. Bikes (#/hr)	5			5		
Peak Hour Factor	1.00	1.00	1.00	1.00	1.00	1.00
Heavy Vehicles (%)	1%	1%	1%	2%	2%	1%
Adj. Flow (vph)	0	2	1	31	31	0
Shared Lane Traffic (%)						
Lane Group Flow (vph)	0	2	0	32	31	0
Enter Blocked Intersection	No	No	No	No	No	No
Lane Alignment	Left	Right	Left	Left	Left	Right
Median Width(m)	0.0			0.0		0.0
Link Offset(m)	0.0			0.0		0.0
Crosswalk Width(m)	5.0			5.0		5.0
Two way Left Turn Lane						
Headway Factor	1.16	1.16	1.16	1.16	1.16	1.16
Turning Speed (k/h)	24	14	24			14
Sign Control	Stop			Free		Free

Intersection Summary

Area Type: CBD

Control Type: Unsignalized

















Intersection Capacity Utilization 18.2%

ICU Level of Service A

Analysis Period (min) 15

















3: Athlone & Scott
AM Peak Hour

2026 Scott Street
2026 Total Traffic

												
Lane Group	EBL	EBT	EBR	WBL	WBT	WBR	NBL	NBT	NBR	SBL	SBT	SBR
Lane Configurations												
Traffic Volume (vph)	11	523	7	22	266	6	3	0	28	0	0	0
Future Volume (vph)	11	523	7	22	266	6	3	0	28	0	0	0
Ideal Flow (vphpl)	1800	1800	1800	1800	1800	1800	1800	1800	1800	1800	1800	1800
Lane Util. Factor	1.00	1.00	1.00	1.00	1.00	1.00	1.00	1.00	1.00	1.00	1.00	1.00
Ped Bike Factor												
Frt		0.998			0.997			0.878				
Flt Protected		0.999			0.996			0.995				
Satd. Flow (prot)	0	1619	0	0	1549	0	0	1464	0	0	846	0
Flt Permitted		0.999			0.996			0.995				
Satd. Flow (perm)	0	1619	0	0	1549	0	0	1464	0	0	846	0
Link Speed (k/h)		50			50			30			50	
Link Distance (m)		108.8			84.2			62.0			54.4	
Travel Time (s)		7.8			6.1			7.4			3.9	
Confl. Peds. (#/hr)	120		20	20		120	70		20	20		70
Confl. Bikes (#/hr)			15			10			5			
Peak Hour Factor	1.00	1.00	1.00	1.00	1.00	1.00	1.00	1.00	1.00	1.00	1.00	1.00
Heavy Vehicles (%)	100%	2%	20%	1%	7%	100%	1%	100%	1%	100%	100%	100%
Adj. Flow (vph)	11	523	7	22	266	6	3	0	28	0	0	0
Shared Lane Traffic (%)												
Lane Group Flow (vph)	0	541	0	0	294	0	0	31	0	0	0	0
Enter Blocked Intersection	No	No	No	No	No	No	No	No	No	No	No	No
Lane Alignment	Left	Left	Right	Left	Left	Right	Left	Left	Right	Left	Left	Right
Median Width(m)		0.0			0.0			0.0			0.0	
Link Offset(m)		0.0			0.0			0.0			0.0	
Crosswalk Width(m)		5.0			5.0			5.0			5.0	
Two way Left Turn Lane												
Headway Factor	1.16	1.16	1.16	1.16	1.16	1.16	1.16	1.16	1.16	1.16	1.16	1.16
Turning Speed (k/h)	24		14	24		14	24		14	24		14
Sign Control		Free			Free			Stop			Stop	
Intersection Summary												
Area Type:	CBD											
Control Type:	Unsignalized											
Intersection Capacity Utilization 55.1%	ICU Level of Service B											
Analysis Period (min)	15											

4: Tweedsmuir & Scott
AM Peak Hour

2026 Scott Street
2026 Total Traffic

												
Lane Group	EBL	EBT	EBR	WBL	WBT	WBR	NBL	NBT	NBR	SBL	SBT	SBR
Lane Configurations												
Traffic Volume (vph)	0	530	3	10	268	5	3	0	34	6	0	0
Future Volume (vph)	0	530	3	10	268	5	3	0	34	6	0	0
Ideal Flow (vphpl)	1800	1800	1800	1800	1800	1800	1800	1800	1800	1800	1800	1800
Lane Util. Factor	1.00	1.00	1.00	1.00	1.00	1.00	1.00	1.00	1.00	1.00	1.00	1.00
Ped Bike Factor												
Frt		0.999			0.998			0.876				
Flt Protected					0.998			0.996			0.950	
Satd. Flow (prot)	0	1641	0	0	1568	0	0	1462	0	0	804	0
Flt Permitted					0.998			0.996			0.950	
Satd. Flow (perm)	0	1641	0	0	1568	0	0	1462	0	0	804	0
Link Speed (k/h)		50			50			50			50	
Link Distance (m)		84.2			67.4			275.0			51.7	
Travel Time (s)		6.1			4.9			19.8			3.7	
Confl. Peds. (#/hr)	160		20	20		160	10		130	130		10
Confl. Bikes (#/hr)			10			5						
Peak Hour Factor	1.00	1.00	1.00	1.00	1.00	1.00	1.00	1.00	1.00	1.00	1.00	1.00
Heavy Vehicles (%)	100%	3%	1%	1%	6%	100%	1%	1%	1%	100%	100%	100%
Adj. Flow (vph)	0	530	3	10	268	5	3	0	34	6	0	0
Shared Lane Traffic (%)												
Lane Group Flow (vph)	0	533	0	0	283	0	0	37	0	0	6	0
Enter Blocked Intersection	No	No	No	No	No	No	No	No	No	No	No	No
Lane Alignment	Left	Left	Right	Left	Left	Right	Left	Left	Right	Left	Left	Right
Median Width(m)		0.0			0.0			0.0			0.0	
Link Offset(m)		0.0			0.0			0.0			0.0	
Crosswalk Width(m)		5.0			5.0			5.0			5.0	
Two way Left Turn Lane												
Headway Factor	1.16	1.16	1.16	1.16	1.16	1.16	1.16	1.16	1.16	1.16	1.16	1.16
Turning Speed (k/h)	24		14	24		14	24		14	24		14
Sign Control		Free			Free			Stop			Stop	
Intersection Summary												
Area Type:	CBD											
Control Type:	Unsignalized											
Intersection Capacity Utilization 52.9%	ICU Level of Service A											
Analysis Period (min) 15												

1: Churchill & Scott
PM Peak Hour

2026 Scott Street
2026 Total Traffic



Lane Group	EBL	EBT	EBR	WBL	WBT	WBR	NBL	NBT	NBR	SBL	SBT	SBR
Lane Configurations												
Traffic Volume (vph)	0	8	11	315	8	42	18	149	240	38	118	3
Future Volume (vph)	0	8	11	315	8	42	18	149	240	38	118	3
Ideal Flow (vphpl)	1800	1800	1800	1800	1800	1800	1800	1800	1800	1800	1800	1800
Storage Length (m)	0.0		0.0	0.0		0.0	0.0		40.0	0.0		0.0
Storage Lanes	0		0	1		0	0		1	0		0
Taper Length (m)	10.0			10.0			10.0			10.0		
Lane Util. Factor	1.00	1.00	1.00	1.00	1.00	1.00	1.00	1.00	1.00	1.00	1.00	1.00
Ped Bike Factor		0.95		0.96	0.84			0.99			0.99	
Frt		0.922			0.874				0.850		0.997	
Flt Protected				0.950				0.995			0.988	
Satd. Flow (prot)	0	1461	0	1576	1155	0	0	1660	1410	0	1619	0
Flt Permitted				0.604				0.956			0.876	
Satd. Flow (perm)	0	1461	0	960	1155	*1	0	1583	1410	0	1423	0
Right Turn on Red			Yes			Yes			No			Yes
Satd. Flow (RTOR)		11			42							1
Link Speed (k/h)		50			50			50			50	
Link Distance (m)		77.3			83.9			315.3			273.6	
Travel Time (s)		5.6			6.0			22.7			19.7	
Confl. Peds. (#/hr)	50		20	20		50	40		20	20		40
Confl. Bikes (#/hr)			15			70			25			30
Peak Hour Factor	1.00	1.00	1.00	1.00	1.00	1.00	1.00	1.00	1.00	1.00	1.00	1.00
Heavy Vehicles (%)	1%	1%	1%	2%	1%	9%	5%	1%	2%	8%	1%	1%
Adj. Flow (vph)	0	8	11	315	8	42	18	149	240	38	118	3
Shared Lane Traffic (%)												
Lane Group Flow (vph)	0	19	0	315	50	0	0	167	240	0	159	0
Enter Blocked Intersection	No	No	No	No	No	No	No	No	No	No	No	No
Lane Alignment	Left	Left	Right	Left	Left	Right	Left	Left	Right	Left	Left	Right
Median Width(m)		4.0			4.0			0.0			0.0	
Link Offset(m)		0.0			0.0			0.0			0.0	
Crosswalk Width(m)		5.0			5.0			5.0			5.0	
Two way Left Turn Lane												
Headway Factor	1.16	1.16	1.16	1.16	1.16	1.16	1.16	1.16	1.16	1.16	1.16	1.16
Turning Speed (k/h)	24		14	24		14	24		14	24		14
Number of Detectors		2		1	2		1	2	1	1		2
Detector Template		Thru		Left	Thru		Left	Thru	Right	Left		Thru
Leading Detector (m)		30.5		6.1	30.5		6.1	30.5	6.1	6.1		30.5
Trailing Detector (m)		0.0		0.0	0.0		0.0	0.0	0.0	0.0		0.0
Detector 1 Position(m)		0.0		0.0	0.0		0.0	0.0	0.0	0.0		0.0
Detector 1 Size(m)		1.8		6.1	1.8		6.1	1.8	6.1	6.1		1.8
Detector 1 Type		Cl+Ex		Cl+Ex	Cl+Ex		Cl+Ex	Cl+Ex	Cl+Ex	Cl+Ex		Cl+Ex
Detector 1 Channel												
Detector 1 Extend (s)		0.0		0.0	0.0		0.0	0.0	0.0	0.0		0.0
Detector 1 Queue (s)		0.0		0.0	0.0		0.0	0.0	0.0	0.0		0.0
Detector 1 Delay (s)		0.0		0.0	0.0		0.0	0.0	0.0	0.0		0.0
Detector 2 Position(m)		28.7			28.7			28.7				28.7
Detector 2 Size(m)		1.8			1.8			1.8				1.8
Detector 2 Type		Cl+Ex			Cl+Ex			Cl+Ex				Cl+Ex
Detector 2 Channel												
Detector 2 Extend (s)		0.0			0.0			0.0				0.0
Turn Type		NA		pm+pt	NA		Perm	NA	Over	Perm		NA
Protected Phases		2		1	6			8	1			4
Permitted Phases				6			8			4		
Detector Phase		2		1	6		8	8	1	4		4

1: Churchill & Scott
PM Peak Hour

2026 Scott Street
2026 Total Traffic



Lane Group	EBL	EBT	EBR	WBL	WBT	WBR	NBL	NBT	NBR	SBL	SBT	SBR
Switch Phase												
Minimum Initial (s)		10.0		5.0	10.0		10.0	10.0	5.0	10.0	10.0	
Minimum Split (s)		25.4		11.8	25.4		27.4	27.4	11.8	27.4	27.4	
Total Split (s)		30.0		32.0	62.0		33.0	33.0	32.0	33.0	33.0	
Total Split (%)		31.6%		33.7%	65.3%		34.7%	34.7%	33.7%	34.7%	34.7%	
Maximum Green (s)		22.6		25.2	54.6		26.6	26.6	25.2	26.6	26.6	
Yellow Time (s)		3.0		3.0	3.0		3.3	3.3	3.0	3.3	3.3	
All-Red Time (s)		4.4		3.8	4.4		3.1	3.1	3.8	3.1	3.1	
Lost Time Adjust (s)		0.0		0.0	0.0			0.0	0.0		0.0	
Total Lost Time (s)		7.4		6.8	7.4			6.4	6.8		6.4	
Lead/Lag		Lag		Lead					Lead			
Lead-Lag Optimize?		Yes		Yes					Yes			
Vehicle Extension (s)		3.0		3.0	3.0		3.0	3.0	3.0	3.0	3.0	
Recall Mode		Max		Min	Max		None	None	Min	None	None	
Walk Time (s)		7.0			7.0		7.0	7.0		7.0	7.0	
Flash Dont Walk (s)		11.0			11.0		14.0	14.0		14.0	14.0	
Pedestrian Calls (#/hr)		40			40		40	40		40	40	
Act Effct Green (s)		29.0		55.4	54.8			16.7	18.9		16.7	
Actuated g/C Ratio		0.34		0.65	0.64			0.20	0.22		0.20	
v/c Ratio		0.04		0.42	0.07			0.54	0.77		0.57	
Control Delay		16.5		9.2	3.1			37.3	47.6		39.0	
Queue Delay		0.0		0.0	0.0			0.0	0.0		0.0	
Total Delay		16.5		9.2	3.1			37.3	47.6		39.0	
LOS		B		A	A			D	D		D	
Approach Delay		16.5			8.4			43.4			39.0	
Approach LOS		B			A			D			D	
Queue Length 50th (m)		0.9		21.6	0.5			22.6	35.6		21.6	
Queue Length 95th (m)		5.9		34.5	4.2			39.9	55.1		38.8	
Internal Link Dist (m)		53.3			59.9			291.3			249.6	
Turn Bay Length (m)									40.0			
Base Capacity (vph)		504		805	756			495	417		446	
Starvation Cap Reductn		0		0	0			0	0		0	
Spillback Cap Reductn		0		0	0			0	0		0	
Storage Cap Reductn		0		0	0			0	0		0	
Reduced v/c Ratio		0.04		0.39	0.07			0.34	0.58		0.36	

Intersection Summary

Area Type:	CBD
Cycle Length:	95
Actuated Cycle Length:	85.3
Natural Cycle:	75
Control Type:	Semi Act-Uncoord
Maximum v/c Ratio:	0.77
Intersection Signal Delay:	28.7
Intersection Capacity Utilization:	73.3%
Analysis Period (min):	15
Intersection LOS:	C
ICU Level of Service:	D
* User Entered Value	

Splits and Phases: 1: Churchill & Scott

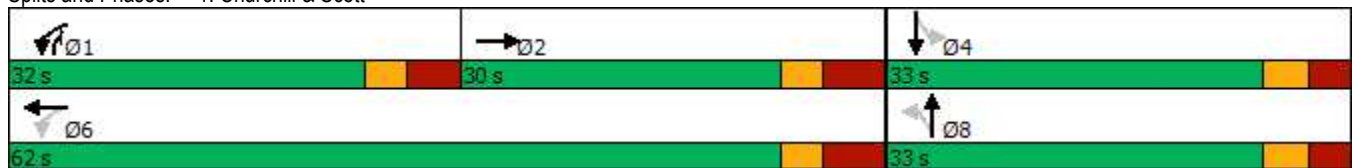



Lane Group	EBT	EBR	WBL	WBT	NBL	NBR
Lane Configurations						
Traffic Volume (vph)	357	16	49	447	10	46
Future Volume (vph)	357	16	49	447	10	46
Ideal Flow (vphpl)	1800	1800	1800	1800	1800	1800
Storage Length (m)		0.0	10.0		0.0	0.0
Storage Lanes		0	1		1	0
Taper Length (m)			30.0		10.0	
Lane Util. Factor	1.00	1.00	0.95	0.95	1.00	1.00
Ped Bike Factor						
Frt	0.994				0.889	
Flt Protected				0.995	0.991	
Satd. Flow (prot)	1634	0	0	3112	1476	0
Flt Permitted				0.995	0.991	
Satd. Flow (perm)	1634	0	0	3112	1476	0
Link Speed (k/h)	50			50	30	
Link Distance (m)	83.9			86.1	233.8	
Travel Time (s)	6.0			6.2	28.1	
Confl. Peds. (#/hr)		20	20			
Confl. Bikes (#/hr)		10				5
Peak Hour Factor	1.00	1.00	1.00	1.00	1.00	1.00
Heavy Vehicles (%)	3%	1%	1%	3%	1%	1%
Adj. Flow (vph)	357	16	49	447	10	46
Shared Lane Traffic (%)						
Lane Group Flow (vph)	373	0	0	496	56	0
Enter Blocked Intersection	No	No	No	No	No	No
Lane Alignment	Left	Right	Left	Left	Left	Right
Median Width(m)	0.0			0.0	4.0	
Link Offset(m)	0.0			0.0	0.0	
Crosswalk Width(m)	5.0			5.0	5.0	
Two way Left Turn Lane						
Headway Factor	1.16	1.16	1.16	1.16	1.16	1.16
Turning Speed (k/h)		14	24		24	14
Sign Control	Free			Free	Stop	

Intersection Summary

Area Type:	CBD
Control Type:	Unsignalized
Intersection Capacity Utilization	53.4%
ICU Level of Service	A
Analysis Period (min)	15

3: Athlone & Scott
PM Peak Hour

2026 Scott Street
2026 Total Traffic



Lane Group	EBL	EBT	EBR	WBL	WBT	WBR	NBL	NBT	NBR	SBL	SBT	SBR
Lane Configurations												
Traffic Volume (vph)	8	419	8	20	551	0	0	0	0	0	0	0
Future Volume (vph)	8	419	8	20	551	0	0	0	0	0	0	0
Ideal Flow (vphpl)	1800	1800	1800	1800	1800	1800	1800	1800	1800	1800	1800	1800
Lane Util. Factor	1.00	1.00	1.00	1.00	1.00	1.00	1.00	1.00	1.00	1.00	1.00	1.00
Ped Bike Factor		1.00			1.00							
Flt Protected		0.998			0.998							
Satd. Flow (prot)	0	1624	0	0	1656	0	0	0	0	0	0	0
Flt Permitted		0.991			0.981							
Satd. Flow (perm)	0	1609	0	0	1627	0	0	0	0	0	0	0
Right Turn on Red			Yes			Yes			Yes			Yes
Satd. Flow (RTOR)		2										
Link Speed (k/h)		50			50			30				50
Link Distance (m)		108.8			84.2			62.0				54.4
Travel Time (s)		7.8			6.1			7.4				3.9
Confl. Peds. (#/hr)	140		20	20		140	90		10	10		90
Confl. Bikes (#/hr)			5			25			5			
Peak Hour Factor	1.00	1.00	1.00	1.00	1.00	1.00	1.00	1.00	1.00	1.00	1.00	1.00
Heavy Vehicles (%)	100%	2%	1%	1%	2%	100%	1%	100%	1%	100%	100%	100%
Adj. Flow (vph)	8	419	8	20	551	0	0	0	0	0	0	0
Shared Lane Traffic (%)												
Lane Group Flow (vph)	0	435	0	0	571	0	0	0	0	0	0	0
Enter Blocked Intersection	No	No	No	No	No	No	No	No	No	No	No	No
Lane Alignment	Left	Left	Right	Left	Left	Right	Left	Left	Right	Left	Left	Right
Median Width(m)		0.0			0.0			0.0				0.0
Link Offset(m)		0.0			0.0			0.0				0.0
Crosswalk Width(m)		5.0			5.0			5.0				5.0
Two way Left Turn Lane												
Headway Factor	1.16	1.16	1.16	1.16	1.16	1.16	1.16	1.16	1.16	1.16	1.16	1.16
Turning Speed (k/h)	24		14	24		14	24		14	24		14
Number of Detectors	1	2		1	2							
Detector Template	Left	Thru		Left	Thru							
Leading Detector (m)	6.1	30.5		6.1	30.5							
Trailing Detector (m)	0.0	0.0		0.0	0.0							
Detector 1 Position(m)	0.0	0.0		0.0	0.0							
Detector 1 Size(m)	6.1	1.8		6.1	1.8							
Detector 1 Type	CI+Ex	CI+Ex		CI+Ex	CI+Ex							
Detector 1 Channel												
Detector 1 Extend (s)	0.0	0.0		0.0	0.0							
Detector 1 Queue (s)	0.0	0.0		0.0	0.0							
Detector 1 Delay (s)	0.0	0.0		0.0	0.0							
Detector 2 Position(m)		28.7			28.7							
Detector 2 Size(m)		1.8			1.8							
Detector 2 Type		CI+Ex			CI+Ex							
Detector 2 Channel												
Detector 2 Extend (s)		0.0			0.0							
Turn Type	Perm	NA		Perm	NA							
Protected Phases		2			6							
Permitted Phases	2			6								
Detector Phase	2	2		6	6							
Switch Phase												
Minimum Initial (s)	10.0	10.0		10.0	10.0							
Minimum Split (s)	15.8	15.8		15.8	15.8							

Lane Group	Ø4
Lane Configurations	
Traffic Volume (vph)	
Future Volume (vph)	
Ideal Flow (vphpl)	
Lane Util. Factor	
Ped Bike Factor	
Frt	
Flt Protected	
Satd. Flow (prot)	
Flt Permitted	
Satd. Flow (perm)	
Right Turn on Red	
Satd. Flow (RTOR)	
Link Speed (k/h)	
Link Distance (m)	
Travel Time (s)	
Confl. Peds. (#/hr)	
Confl. Bikes (#/hr)	
Peak Hour Factor	
Heavy Vehicles (%)	
Adj. Flow (vph)	
Shared Lane Traffic (%)	
Lane Group Flow (vph)	
Enter Blocked Intersection	
Lane Alignment	
Median Width(m)	
Link Offset(m)	
Crosswalk Width(m)	
Two way Left Turn Lane	
Headway Factor	
Turning Speed (k/h)	
Number of Detectors	
Detector Template	
Leading Detector (m)	
Trailing Detector (m)	
Detector 1 Position(m)	
Detector 1 Size(m)	
Detector 1 Type	
Detector 1 Channel	
Detector 1 Extend (s)	
Detector 1 Queue (s)	
Detector 1 Delay (s)	
Detector 2 Position(m)	
Detector 2 Size(m)	
Detector 2 Type	
Detector 2 Channel	
Detector 2 Extend (s)	
Turn Type	
Protected Phases	4
Permitted Phases	
Detector Phase	
Switch Phase	
Minimum Initial (s)	20.0
Minimum Split (s)	24.0

3: Athlone & Scott
PM Peak Hour

2026 Scott Street
2026 Total Traffic



Lane Group	EBL	EBT	EBR	WBL	WBT	WBR	NBL	NBT	NBR	SBL	SBT	SBR
Total Split (s)	30.8	30.8		30.8	30.8							
Total Split (%)	56.2%	56.2%		56.2%	56.2%							
Maximum Green (s)	25.0	25.0		25.0	25.0							
Yellow Time (s)	3.3	3.3		3.3	3.3							
All-Red Time (s)	2.5	2.5		2.5	2.5							
Lost Time Adjust (s)		0.0			0.0							
Total Lost Time (s)		5.8			5.8							
Lead/Lag												
Lead-Lag Optimize?												
Vehicle Extension (s)	3.0	3.0		3.0	3.0							
Recall Mode	Max	Max		Max	Max							
Walk Time (s)												
Flash Dont Walk (s)												
Pedestrian Calls (#/hr)												
Act Effct Green (s)		44.8			44.8							
Actuated g/C Ratio		0.74			0.74							
v/c Ratio		0.36			0.47							
Control Delay		8.0			9.4							
Queue Delay		0.0			0.6							
Total Delay		8.0			10.0							
LOS		A			B							
Approach Delay		8.0			10.0							
Approach LOS		A			B							
Queue Length 50th (m)		27.4			40.8							
Queue Length 95th (m)		45.6			67.4							
Internal Link Dist (m)		84.8			60.2			38.0			30.4	
Turn Bay Length (m)												
Base Capacity (vph)		1197			1210							
Starvation Cap Reductn		0			313							
Spillback Cap Reductn		0			0							
Storage Cap Reductn		0			0							
Reduced v/c Ratio		0.36			0.64							

Intersection Summary

Area Type: CBD

Cycle Length: 54.8

Actuated Cycle Length: 60.2

Natural Cycle: 60

Control Type: Actuated-Uncoordinated

Maximum v/c Ratio: 0.47

Intersection Signal Delay: 9.1

Intersection LOS: A

Intersection Capacity Utilization 51.2%

ICU Level of Service A

Analysis Period (min) 15

Splits and Phases: 3: Athlone & Scott

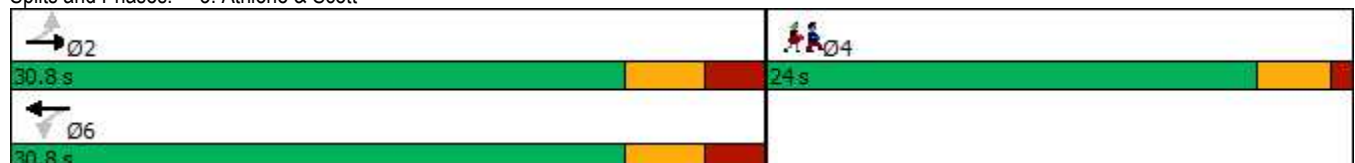

Lane Group	Ø4
Total Split (s)	24.0
Total Split (%)	44%
Maximum Green (s)	20.0
Yellow Time (s)	3.0
All-Red Time (s)	1.0
Lost Time Adjust (s)	
Total Lost Time (s)	
Lead/Lag	
Lead-Lag Optimize?	
Vehicle Extension (s)	3.0
Recall Mode	None
Walk Time (s)	7.0
Flash Dont Walk (s)	11.0
Pedestrian Calls (#/hr)	100
Act Effct Green (s)	
Actuated g/C Ratio	
v/c Ratio	
Control Delay	
Queue Delay	
Total Delay	
LOS	
Approach Delay	
Approach LOS	
Queue Length 50th (m)	
Queue Length 95th (m)	
Internal Link Dist (m)	
Turn Bay Length (m)	
Base Capacity (vph)	
Starvation Cap Reductn	
Spillback Cap Reductn	
Storage Cap Reductn	
Reduced v/c Ratio	
Intersection Summary	

4: Tweedsmuir & Scott
PM Peak Hour

2026 Scott Street
2026 Total Traffic



Lane Group	EBL	EBT	EBR	WBL	WBT	WBR	NBL	NBT	NBR	SBL	SBT	SBR
Lane Configurations												
Traffic Volume (vph)	0	424	7	14	471	5	0	0	0	0	0	0
Future Volume (vph)	0	424	7	14	471	5	0	0	0	0	0	0
Ideal Flow (vphpl)	1800	1800	1800	1800	1800	1800	1800	1800	1800	1800	1800	1800
Lane Util. Factor	1.00	1.00	1.00	1.00	1.00	1.00	1.00	1.00	1.00	1.00	1.00	1.00
Ped Bike Factor		1.00			1.00							
Flt		0.998			0.999							
Flt Protected					0.999							
Satd. Flow (prot)	0	1670	0	0	1620	0	0	0	0	0	0	0
Flt Permitted					0.986							
Satd. Flow (perm)	0	1670	0	0	1598	0	0	0	0	0	0	0
Right Turn on Red			Yes			Yes			Yes			Yes
Satd. Flow (RTOR)		2			1							
Link Speed (k/h)		50			50			50			50	
Link Distance (m)		84.2			67.4			275.0			51.7	
Travel Time (s)		6.1			4.9			19.8			3.7	
Confl. Peds. (#/hr)	240		30	30		240	10		200	200		10
Confl. Bikes (#/hr)			5			20			5			
Peak Hour Factor	1.00	1.00	1.00	1.00	1.00	1.00	1.00	1.00	1.00	1.00	1.00	1.00
Heavy Vehicles (%)	100%	1%	1%	1%	3%	100%	1%	1%	1%	100%	100%	100%
Adj. Flow (vph)	0	424	7	14	471	5	0	0	0	0	0	0
Shared Lane Traffic (%)												
Lane Group Flow (vph)	0	431	0	0	490	0	0	0	0	0	0	0
Enter Blocked Intersection	No	No	No	No	No	No	No	No	No	No	No	No
Lane Alignment	Left	Left	Right	Left	Left	Right	Left	Left	Right	Left	Left	Right
Median Width(m)		0.0			0.0			0.0			0.0	
Link Offset(m)		0.0			0.0			0.0			0.0	
Crosswalk Width(m)		5.0			5.0			5.0			5.0	
Two way Left Turn Lane												
Headway Factor	1.16	1.16	1.16	1.16	1.16	1.16	1.16	1.16	1.16	1.16	1.16	1.16
Turning Speed (k/h)	24		14	24		14	24		14	24		14
Number of Detectors	1	2		1	2							
Detector Template	Left	Thru		Left	Thru							
Leading Detector (m)	6.1	30.5		6.1	30.5							
Trailing Detector (m)	0.0	0.0		0.0	0.0							
Detector 1 Position(m)	0.0	0.0		0.0	0.0							
Detector 1 Size(m)	6.1	1.8		6.1	1.8							
Detector 1 Type	CI+Ex	CI+Ex		CI+Ex	CI+Ex							
Detector 1 Channel												
Detector 1 Extend (s)	0.0	0.0		0.0	0.0							
Detector 1 Queue (s)	0.0	0.0		0.0	0.0							
Detector 1 Delay (s)	0.0	0.0		0.0	0.0							
Detector 2 Position(m)		28.7			28.7							
Detector 2 Size(m)		1.8			1.8							
Detector 2 Type		CI+Ex			CI+Ex							
Detector 2 Channel												
Detector 2 Extend (s)		0.0			0.0							
Turn Type		NA		Perm	NA							
Protected Phases		2			6							
Permitted Phases	2			6								
Detector Phase	2	2		6	6							
Switch Phase												
Minimum Initial (s)	10.0	10.0		10.0	10.0							
Minimum Split (s)	15.8	15.8		15.8	15.8							

Lane Group	Ø4
Lane Configurations	
Traffic Volume (vph)	
Future Volume (vph)	
Ideal Flow (vphpl)	
Lane Util. Factor	
Ped Bike Factor	
Frt	
Flt Protected	
Satd. Flow (prot)	
Flt Permitted	
Satd. Flow (perm)	
Right Turn on Red	
Satd. Flow (RTOR)	
Link Speed (k/h)	
Link Distance (m)	
Travel Time (s)	
Confl. Peds. (#/hr)	
Confl. Bikes (#/hr)	
Peak Hour Factor	
Heavy Vehicles (%)	
Adj. Flow (vph)	
Shared Lane Traffic (%)	
Lane Group Flow (vph)	
Enter Blocked Intersection	
Lane Alignment	
Median Width(m)	
Link Offset(m)	
Crosswalk Width(m)	
Two way Left Turn Lane	
Headway Factor	
Turning Speed (k/h)	
Number of Detectors	
Detector Template	
Leading Detector (m)	
Trailing Detector (m)	
Detector 1 Position(m)	
Detector 1 Size(m)	
Detector 1 Type	
Detector 1 Channel	
Detector 1 Extend (s)	
Detector 1 Queue (s)	
Detector 1 Delay (s)	
Detector 2 Position(m)	
Detector 2 Size(m)	
Detector 2 Type	
Detector 2 Channel	
Detector 2 Extend (s)	
Turn Type	
Protected Phases	4
Permitted Phases	
Detector Phase	
Switch Phase	
Minimum Initial (s)	10.0
Minimum Split (s)	22.0

4: Tweedsmuir & Scott
PM Peak Hour

2026 Scott Street
2026 Total Traffic



Lane Group	EBL	EBT	EBR	WBL	WBT	WBR	NBL	NBT	NBR	SBL	SBT	SBR
Total Split (s)	28.0	28.0		28.0	28.0							
Total Split (%)	56.0%	56.0%		56.0%	56.0%							
Maximum Green (s)	22.2	22.2		22.2	22.2							
Yellow Time (s)	3.3	3.3		3.3	3.3							
All-Red Time (s)	2.5	2.5		2.5	2.5							
Lost Time Adjust (s)		0.0			0.0							
Total Lost Time (s)		5.8			5.8							
Lead/Lag												
Lead-Lag Optimize?												
Vehicle Extension (s)	3.0	3.0		3.0	3.0							
Recall Mode	Max	Max		Max	Max							
Walk Time (s)												
Flash Dont Walk (s)												
Pedestrian Calls (#/hr)												
Act Effct Green (s)		41.8			41.8							
Actuated g/C Ratio		0.74			0.74							
v/c Ratio		0.35			0.41							
Control Delay		7.4			8.2							
Queue Delay		0.4			0.0							
Total Delay		7.7			8.2							
LOS		A			A							
Approach Delay		7.7			8.2							
Approach LOS		A			A							
Queue Length 50th (m)		24.5			29.9							
Queue Length 95th (m)		41.3			50.9							
Internal Link Dist (m)		60.2			43.4			251.0			27.7	
Turn Bay Length (m)												
Base Capacity (vph)		1242			1188							
Starvation Cap Reductn		360			0							
Spillback Cap Reductn		0			0							
Storage Cap Reductn		0			0							
Reduced v/c Ratio		0.49			0.41							

Intersection Summary

Area Type: CBD
 Cycle Length: 50
 Actuated Cycle Length: 56.2
 Natural Cycle: 50
 Control Type: Actuated-Uncoordinated
 Maximum v/c Ratio: 0.41
 Intersection Signal Delay: 8.0
 Intersection Capacity Utilization 47.6%
 Analysis Period (min) 15
 Intersection LOS: A
 ICU Level of Service A

Splits and Phases: 4: Tweedsmuir & Scott

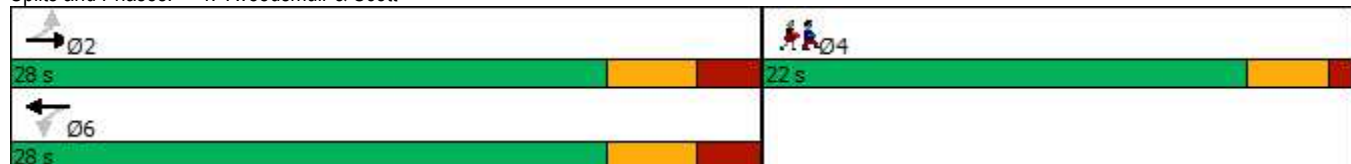

Lane Group	Ø4
Total Split (s)	22.0
Total Split (%)	44%
Maximum Green (s)	18.0
Yellow Time (s)	3.0
All-Red Time (s)	1.0
Lost Time Adjust (s)	
Total Lost Time (s)	
Lead/Lag	
Lead-Lag Optimize?	
Vehicle Extension (s)	3.0
Recall Mode	None
Walk Time (s)	7.0
Flash Dont Walk (s)	11.0
Pedestrian Calls (#/hr)	100
Act Effct Green (s)	
Actuated g/C Ratio	
v/c Ratio	
Control Delay	
Queue Delay	
Total Delay	
LOS	
Approach Delay	
Approach LOS	
Queue Length 50th (m)	
Queue Length 95th (m)	
Internal Link Dist (m)	
Turn Bay Length (m)	
Base Capacity (vph)	
Starvation Cap Reductn	
Spillback Cap Reductn	
Storage Cap Reductn	
Reduced v/c Ratio	
Intersection Summary	

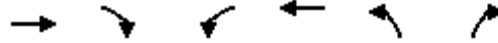

Lane Group	EBT	EBR	WBL	WBT	NBL	NBR
Lane Configurations						
Traffic Volume (vph)	420	40	122	454	33	186
Future Volume (vph)	420	40	122	454	33	186
Ideal Flow (vphpl)	1800	1800	1800	1800	1800	1800
Lane Util. Factor	1.00	1.00	1.00	1.00	1.00	1.00
Ped Bike Factor						
Frt	0.988				0.885	
Flt Protected				0.990	0.993	
Satd. Flow (prot)	1640	0	0	1646	1472	0
Flt Permitted				0.990	0.993	
Satd. Flow (perm)	1640	0	0	1646	1472	0
Link Speed (k/h)	50				50	50
Link Distance (m)	67.4				200.5	303.1
Travel Time (s)	4.9				14.4	21.8
Confl. Peds. (#/hr)	60		60			
Confl. Bikes (#/hr)	10					
Peak Hour Factor	1.00	1.00	1.00	1.00	1.00	1.00
Heavy Vehicles (%)	2%	1%	1%	2%	1%	1%
Adj. Flow (vph)	420	40	122	454	33	186
Shared Lane Traffic (%)						
Lane Group Flow (vph)	460	0	0	576	219	0
Enter Blocked Intersection	No	No	No	No	No	No
Lane Alignment	Left	Right	Left	Left	Left	Right
Median Width(m)	0.0				0.0	4.0
Link Offset(m)	0.0				0.0	0.0
Crosswalk Width(m)	5.0				5.0	5.0
Two way Left Turn Lane						
Headway Factor	1.16	1.16	1.16	1.16	1.16	1.16
Turning Speed (k/h)	14		24	24		14
Sign Control	Free			Free	Stop	

Intersection Summary

Area Type: CBD

Control Type: Unsignalized

Intersection Capacity Utilization 90.7% ICU Level of Service E

Analysis Period (min) 15



Lane Group	EBT	EBR	WBL	WBT	NBL	NBR
Lane Configurations						
Traffic Volume (vph)	441	6	9	557	5	8
Future Volume (vph)	441	6	9	557	5	8
Ideal Flow (vphpl)	1800	1800	1800	1800	1800	1800
Lane Util. Factor	1.00	1.00	1.00	1.00	1.00	1.00
Ped Bike Factor						
Frt	0.998				0.917	
Flt Protected				0.999	0.981	
Satd. Flow (prot)	1640	0	0	1642	1507	0
Flt Permitted				0.999	0.981	
Satd. Flow (perm)	1640	0	0	1642	1507	0
Link Speed (k/h)	50				50	30
Link Distance (m)	86.1				108.8	89.0
Travel Time (s)	6.2				7.8	10.7
Confl. Peds. (#/hr)	20		20			
Confl. Bikes (#/hr)	10			5		
Peak Hour Factor	1.00	1.00	1.00	1.00	1.00	1.00
Heavy Vehicles (%)	3%	1%	1%	3%	1%	1%
Adj. Flow (vph)	441	6	9	557	5	8
Shared Lane Traffic (%)						
Lane Group Flow (vph)	447	0	0	566	13	0
Enter Blocked Intersection	No	No	No	No	No	No
Lane Alignment	Left	Right	Left	Left	Left	Right
Median Width(m)	4.0				4.0	4.0
Link Offset(m)	0.0				0.0	0.0
Crosswalk Width(m)	5.0				5.0	5.0
Two way Left Turn Lane						
Headway Factor	1.16	1.16	1.16	1.16	1.16	1.16
Turning Speed (k/h)	14		24	24		14
Sign Control	Free			Free	Stop	

Intersection Summary

Area Type: CBD

Control Type: Unsignalized

Intersection Capacity Utilization 52.8% ICU Level of Service A

Analysis Period (min) 15



Lane Group	EBL	EBR	NBL	NBT	SBT	SBR
Lane Configurations						
Traffic Volume (vph)	0	1	2	42	30	0
Future Volume (vph)	0	1	2	42	30	0
Ideal Flow (vphpl)	1800	1800	1800	1800	1800	1800
Lane Util. Factor	1.00	1.00	1.00	1.00	1.00	1.00
Ped Bike Factor						
Frt	0.865					
Flt Protected				0.998		
Satd. Flow (prot)	0	1449	0	1672	1675	0
Flt Permitted	0.998					
Satd. Flow (perm)	0	1449	0	1672	1675	0
Link Speed (k/h)	30			30		30
Link Distance (m)	66.2			190.5		62.0
Travel Time (s)	7.9			22.9		7.4
Confl. Peds. (#/hr)				20		20
Confl. Bikes (#/hr)	5			5		
Peak Hour Factor	1.00	1.00	1.00	1.00	1.00	1.00
Heavy Vehicles (%)	1%	1%	1%	1%	1%	1%
Adj. Flow (vph)	0	1	2	42	30	0
Shared Lane Traffic (%)						
Lane Group Flow (vph)	0	1	0	44	30	0
Enter Blocked Intersection	No	No	No	No	No	No
Lane Alignment	Left	Right	Left	Left	Left	Right
Median Width(m)	0.0			0.0		0.0
Link Offset(m)	0.0			0.0		0.0
Crosswalk Width(m)	5.0			5.0		5.0
Two way Left Turn Lane						
Headway Factor	1.16	1.16	1.16	1.16	1.16	1.16
Turning Speed (k/h)	24	14	24			14
Sign Control	Stop			Free		Free

Intersection Summary

Area Type: CBD

Control Type: Unsignalized

Intersection Capacity Utilization 18.2%

ICU Level of Service A

Analysis Period (min) 15

3: Athlone & Scott
PM Peak Hour

2026 Scott Street
2026 Total Traffic

Lane Group	EBL	EBT	EBR	WBL	WBT	WBR	NBL	NBT	NBR	SBL	SBT	SBR
Lane Configurations												
Traffic Volume (vph)	8	419	8	20	551	0	1	0	38	0	0	0
Future Volume (vph)	8	419	8	20	551	0	1	0	38	0	0	0
Ideal Flow (vphpl)	1800	1800	1800	1800	1800	1800	1800	1800	1800	1800	1800	1800
Lane Util. Factor	1.00	1.00	1.00	1.00	1.00	1.00	1.00	1.00	1.00	1.00	1.00	1.00
Ped Bike Factor												
Frt		0.998						0.868				
Flt Protected		0.999			0.998			0.999				
Satd. Flow (prot)	0	1625	0	0	1656	0	0	1453	0	0	846	0
Flt Permitted		0.999			0.998			0.999				
Satd. Flow (perm)	0	1625	0	0	1656	0	0	1453	0	0	846	0
Link Speed (k/h)		50			50			30			50	
Link Distance (m)		108.8			84.2			62.0			54.4	
Travel Time (s)		7.8			6.1			7.4			3.9	
Confl. Peds. (#/hr)	140		20	20		140	90		10	10		90
Confl. Bikes (#/hr)			5			25			5			
Peak Hour Factor	1.00	1.00	1.00	1.00	1.00	1.00	1.00	1.00	1.00	1.00	1.00	1.00
Heavy Vehicles (%)	100%	2%	1%	1%	2%	100%	1%	100%	1%	100%	100%	100%
Adj. Flow (vph)	8	419	8	20	551	0	1	0	38	0	0	0
Shared Lane Traffic (%)												
Lane Group Flow (vph)	0	435	0	0	571	0	0	39	0	0	0	0
Enter Blocked Intersection	No	No	No	No	No	No	No	No	No	No	No	No
Lane Alignment	Left	Left	Right	Left	Left	Right	Left	Left	Right	Left	Left	Right
Median Width(m)		0.0			0.0			0.0			0.0	
Link Offset(m)		0.0			0.0			0.0			0.0	
Crosswalk Width(m)		5.0			5.0			5.0			5.0	
Two way Left Turn Lane												
Headway Factor	1.16	1.16	1.16	1.16	1.16	1.16	1.16	1.16	1.16	1.16	1.16	1.16
Turning Speed (k/h)	24		14	24		14	24		14	24		14
Sign Control		Free			Free			Stop			Stop	
Intersection Summary												
Area Type:	CBD											
Control Type:	Unsignalized											
Intersection Capacity Utilization 65.9%	ICU Level of Service C											
Analysis Period (min)	15											

4: Tweedsmuir & Scott
PM Peak Hour

2026 Scott Street
2026 Total Traffic

Lane Group	EBL	EBT	EBR	WBL	WBT	WBR	NBL	NBT	NBR	SBL	SBT	SBR
Lane Configurations												
Traffic Volume (vph)	0	424	7	14	471	5	10	0	30	5	0	1
Future Volume (vph)	0	424	7	14	471	5	10	0	30	5	0	1
Ideal Flow (vphpl)	1800	1800	1800	1800	1800	1800	1800	1800	1800	1800	1800	1800
Lane Util. Factor	1.00	1.00	1.00	1.00	1.00	1.00	1.00	1.00	1.00	1.00	1.00	1.00
Ped Bike Factor												
Frt		0.998			0.999			0.899			0.977	
Flt Protected					0.999			0.988			0.960	
Satd. Flow (prot)	0	1672	0	0	1625	0	0	1488	0	0	793	0
Flt Permitted					0.999			0.988			0.960	
Satd. Flow (perm)	0	1672	0	0	1625	0	0	1488	0	0	793	0
Link Speed (k/h)		50			50			50			50	
Link Distance (m)		84.2			67.4			275.0			51.7	
Travel Time (s)		6.1			4.9			19.8			3.7	
Confl. Peds. (#/hr)	240		30	30		240	10		200	200		10
Confl. Bikes (#/hr)			5			20			5			
Peak Hour Factor	1.00	1.00	1.00	1.00	1.00	1.00	1.00	1.00	1.00	1.00	1.00	1.00
Heavy Vehicles (%)	100%	1%	1%	1%	3%	100%	1%	1%	1%	100%	100%	100%
Adj. Flow (vph)	0	424	7	14	471	5	10	0	30	5	0	1
Shared Lane Traffic (%)												
Lane Group Flow (vph)	0	431	0	0	490	0	0	40	0	0	6	0
Enter Blocked Intersection	No	No	No	No	No	No	No	No	No	No	No	No
Lane Alignment	Left	Left	Right	Left	Left	Right	Left	Left	Right	Left	Left	Right
Median Width(m)		0.0			0.0			0.0			0.0	
Link Offset(m)		0.0			0.0			0.0			0.0	
Crosswalk Width(m)		5.0			5.0			5.0			5.0	
Two way Left Turn Lane												
Headway Factor	1.16	1.16	1.16	1.16	1.16	1.16	1.16	1.16	1.16	1.16	1.16	1.16
Turning Speed (k/h)	24		14	24		14	24		14	24		14
Sign Control		Free			Free			Stop			Stop	
Intersection Summary												
Area Type:	CBD											
Control Type:	Unsignalized											
Intersection Capacity Utilization 62.8%	ICU Level of Service B											
Analysis Period (min) 15												

1: Churchill & Scott
AM Peak Hour

2026 Scott Street
2031 Total Traffic



Lane Group	EBL	EBT	EBR	WBL	WBT	WBR	NBL	NBT	NBR	SBL	SBT	SBR
Lane Configurations												
Traffic Volume (vph)	0	10	13	245	3	16	13	98	382	55	199	2
Future Volume (vph)	0	10	13	245	3	16	13	98	382	55	199	2
Ideal Flow (vphpl)	1800	1800	1800	1800	1800	1800	1800	1800	1800	1800	1800	1800
Storage Length (m)	0.0		0.0	0.0		0.0	0.0		40.0	0.0		0.0
Storage Lanes	0		0	1		0	0		1	0		0
Taper Length (m)	10.0			30.0			10.0			10.0		
Lane Util. Factor	1.00	1.00	1.00	1.00	1.00	1.00	1.00	1.00	1.00	1.00	1.00	1.00
Ped Bike Factor		0.93		0.96	0.89			0.99			0.99	
Frt		0.924			0.874				0.850		0.999	
Flt Protected				0.950				0.994			0.989	
Satd. Flow (prot)	0	1356	0	1461	1163	0	0	1624	1383	0	1630	0
Flt Permitted				0.576				0.944			0.896	
Satd. Flow (perm)	0	1356	0	849	1163	0	0	1533	1383	0	1465	0
Right Turn on Red			Yes			Yes			No			Yes
Satd. Flow (RTOR)		13			16							
Link Speed (k/h)		50			50			50			50	
Link Distance (m)		77.3			83.9			315.3			273.6	
Travel Time (s)		5.6			6.0			22.7			19.7	
Confl. Peds. (#/hr)	40		20	20		40	40		20	20		40
Confl. Bikes (#/hr)			30			20			30			20
Peak Hour Factor	1.00	1.00	1.00	1.00	1.00	1.00	1.00	1.00	1.00	1.00	1.00	1.00
Heavy Vehicles (%)	1%	15%	1%	10%	1%	15%	8%	3%	4%	4%	2%	1%
Adj. Flow (vph)	0	10	13	245	3	16	13	98	382	55	199	2
Shared Lane Traffic (%)												
Lane Group Flow (vph)	0	23	0	245	19	0	0	111	382	0	256	0
Enter Blocked Intersection	No	No	No	No	No	No	No	No	No	No	No	No
Lane Alignment	Left	Left	Right	Left	Left	Right	Left	Left	Right	Left	Left	Right
Median Width(m)		4.0			4.0			0.0			0.0	
Link Offset(m)		0.0			0.0			0.0			0.0	
Crosswalk Width(m)		5.0			5.0			5.0			5.0	
Two way Left Turn Lane												
Headway Factor	1.16	1.16	1.16	1.16	1.16	1.16	1.16	1.16	1.16	1.16	1.16	1.16
Turning Speed (k/h)	24		14	24		14	24		14	24		14
Number of Detectors		2		1		2		1	2		1	2
Detector Template		Thru		Left	Thru		Left	Thru	Right	Left	Thru	
Leading Detector (m)		30.5		6.1	30.5		6.1	30.5	6.1	6.1	30.5	
Trailing Detector (m)		0.0		0.0	0.0		0.0	0.0	0.0	0.0	0.0	
Detector 1 Position(m)		0.0		0.0	0.0		0.0	0.0	0.0	0.0	0.0	
Detector 1 Size(m)		1.8		6.1	1.8		6.1	1.8	6.1	6.1	1.8	
Detector 1 Type		Cl+Ex		Cl+Ex	Cl+Ex		Cl+Ex	Cl+Ex	Cl+Ex	Cl+Ex	Cl+Ex	
Detector 1 Channel												
Detector 1 Extend (s)		0.0		0.0	0.0		0.0	0.0	0.0	0.0	0.0	
Detector 1 Queue (s)		0.0		0.0	0.0		0.0	0.0	0.0	0.0	0.0	
Detector 1 Delay (s)		0.0		0.0	0.0		0.0	0.0	0.0	0.0	0.0	
Detector 2 Position(m)		28.7			28.7			28.7			28.7	
Detector 2 Size(m)		1.8			1.8			1.8			1.8	
Detector 2 Type		Cl+Ex			Cl+Ex			Cl+Ex			Cl+Ex	
Detector 2 Channel												
Detector 2 Extend (s)		0.0			0.0			0.0			0.0	
Turn Type		NA		pm+pt	NA		Perm	NA	Over	Perm	NA	
Protected Phases		2		1	6			8	1		4	
Permitted Phases				6			8			4		
Detector Phase		2		1	6		8	8	1	4	4	



Lane Group	EBL	EBT	EBR	WBL	WBT	WBR	NBL	NBT	NBR	SBL	SBT	SBR
Switch Phase												
Minimum Initial (s)		10.0		5.0	10.0		10.0	10.0	5.0	10.0	10.0	
Minimum Split (s)		25.4		11.8	25.4		27.4	27.4	11.8	27.4	27.4	
Total Split (s)		26.0		41.0	67.0		28.0	28.0	41.0	28.0	28.0	
Total Split (%)		27.4%		43.2%	70.5%		29.5%	29.5%	43.2%	29.5%	29.5%	
Maximum Green (s)		18.6		34.2	59.6		21.6	21.6	34.2	21.6	21.6	
Yellow Time (s)		3.0		3.0	3.0		3.3	3.3	3.0	3.3	3.3	
All-Red Time (s)		4.4		3.8	4.4		3.1	3.1	3.8	3.1	3.1	
Lost Time Adjust (s)		0.0		0.0	0.0			0.0	0.0		0.0	
Total Lost Time (s)		7.4		6.8	7.4			6.4	6.8		6.4	
Lead/Lag		Lag		Lead					Lead			
Lead-Lag Optimize?		Yes		Yes					Yes			
Vehicle Extension (s)		3.0		3.0	3.0		3.0	3.0	3.0	3.0	3.0	
Recall Mode		Max		Min	Max		None	None	Min	None	None	
Walk Time (s)		7.0			7.0		7.0	7.0		7.0	7.0	
Flash Dont Walk (s)		11.0			11.0		14.0	14.0		14.0	14.0	
Pedestrian Calls (#/hr)		40			40		40	40		40	40	
Act Effct Green (s)		23.5		60.3	59.7			19.3	29.4		19.3	
Actuated g/C Ratio		0.25		0.65	0.64			0.21	0.32		0.21	
v/c Ratio		0.07		0.33	0.03			0.35	0.87		0.84	
Control Delay		20.5		8.7	3.6			34.5	51.1		59.5	
Queue Delay		0.0		0.0	0.0			0.0	0.0		0.0	
Total Delay		20.5		8.7	3.6			34.5	51.1		59.5	
LOS		C		A	A			C	D		E	
Approach Delay		20.5			8.3			47.4			59.5	
Approach LOS		C			A			D			E	
Queue Length 50th (m)		1.3		16.5	0.2			15.7	58.6		40.7	
Queue Length 95th (m)		7.4		27.2	2.4			29.4	#96.7		#74.2	
Internal Link Dist (m)		53.3			59.9			291.3			249.6	
Turn Bay Length (m)									40.0			
Base Capacity (vph)		352		777	753			357	510		341	
Starvation Cap Reductn		0		0	0			0	0		0	
Spillback Cap Reductn		0		0	0			0	0		0	
Storage Cap Reductn		0		0	0			0	0		0	
Reduced v/c Ratio		0.07		0.32	0.03			0.31	0.75		0.75	

Intersection Summary

Area Type: CBD
 Cycle Length: 95
 Actuated Cycle Length: 92.8
 Natural Cycle: 90
 Control Type: Semi Act-Uncoord
 Maximum v/c Ratio: 0.87
 Intersection Signal Delay: 39.8
 Intersection LOS: D
 Intersection Capacity Utilization 78.9%
 ICU Level of Service D
 Analysis Period (min) 15
 # 95th percentile volume exceeds capacity, queue may be longer.
 Queue shown is maximum after two cycles.

Splits and Phases: 1: Churchill & Scott

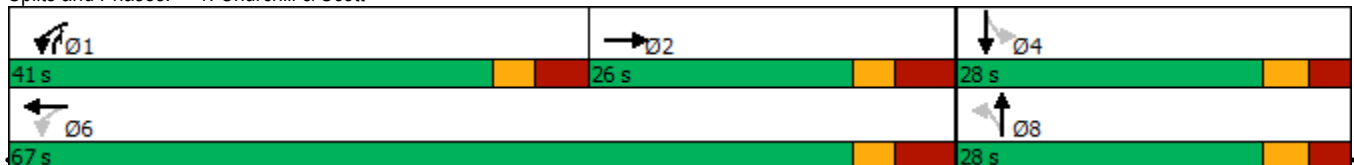

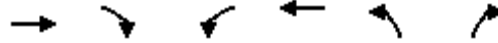

Lane Group	EBT	EBR	WBL	WBT	NBL	NBR
Lane Configurations						
Traffic Volume (vph)	431	20	21	244	15	45
Future Volume (vph)	431	20	21	244	15	45
Ideal Flow (vphpl)	1800	1800	1800	1800	1800	1800
Storage Length (m)		0.0	10.0		0.0	0.0
Storage Lanes		0	1		1	0
Taper Length (m)			30.0		10.0	
Lane Util. Factor	1.00	1.00	0.95	0.95	1.00	1.00
Ped Bike Factor						
Frt	0.994				0.899	
Flt Protected				0.996	0.988	
Satd. Flow (prot)	1614	0	0	2919	1488	0
Flt Permitted				0.996	0.988	
Satd. Flow (perm)	1614	0	0	2919	1488	0
Link Speed (k/h)	50			50	30	
Link Distance (m)	83.9			86.1	233.8	
Travel Time (s)	6.0			6.2	28.1	
Confl. Peds. (#/hr)		10	10			
Confl. Bikes (#/hr)		30				5
Peak Hour Factor	1.00	1.00	1.00	1.00	1.00	1.00
Heavy Vehicles (%)	4%	8%	6%	10%	1%	1%
Adj. Flow (vph)	431	20	21	244	15	45
Shared Lane Traffic (%)						
Lane Group Flow (vph)	451	0	0	265	60	0
Enter Blocked Intersection	No	No	No	No	No	No
Lane Alignment	Left	Right	Left	Left	Left	Right
Median Width(m)	0.0			0.0	4.0	
Link Offset(m)	0.0			0.0	0.0	
Crosswalk Width(m)	5.0			5.0	5.0	
Two way Left Turn Lane						
Headway Factor	1.16	1.16	1.16	1.16	1.16	1.16
Turning Speed (k/h)		14	24		24	14
Sign Control	Free			Free	Stop	
Intersection Summary						
Area Type:	CBD					
Control Type:	Unsignalized					
Intersection Capacity Utilization	39.0%			ICU Level of Service A		
Analysis Period (min)	15					

3: Athlone & Scott
AM Peak Hour

2026 Scott Street
2031 Total Traffic



Lane Group	EBL	EBT	EBR	WBL	WBT	WBR	NBL	NBT	NBR	SBL	SBT	SBR
Lane Configurations												
Traffic Volume (vph)	11	535	7	22	272	6	0	0	0	0	0	0
Future Volume (vph)	11	535	7	22	272	6	0	0	0	0	0	0
Ideal Flow (vphpl)	1800	1800	1800	1800	1800	1800	1800	1800	1800	1800	1800	1800
Lane Util. Factor	1.00	1.00	1.00	1.00	1.00	1.00	1.00	1.00	1.00	1.00	1.00	1.00
Ped Bike Factor	1.00		1.00		1.00		1.00		1.00		1.00	
Flt Protected	0.998		0.997		0.996		0.995		0.994		0.993	
Satd. Flow (prot)	0	1618	0	0	1545	0	0	0	0	0	0	0
Flt Permitted	0.993		0.952		0.911		0.870		0.829		0.788	
Satd. Flow (perm)	0	1606	0	0	1476	0	0	0	0	0	0	0
Right Turn on Red			Yes				Yes				Yes	
Satd. Flow (RTOR)	2				2				2			
Link Speed (k/h)	50				50		30				50	
Link Distance (m)	108.8				84.2		62.0				54.4	
Travel Time (s)	7.8				6.1		7.4				3.9	
Confl. Peds. (#/hr)	120		20	20		120	70		20	20		70
Confl. Bikes (#/hr)			15			10			5			
Peak Hour Factor	1.00	1.00	1.00	1.00	1.00	1.00	1.00	1.00	1.00	1.00	1.00	1.00
Heavy Vehicles (%)	100%	2%	20%	1%	7%	100%	1%	100%	1%	100%	100%	100%
Adj. Flow (vph)	11	535	7	22	272	6	0	0	0	0	0	0
Shared Lane Traffic (%)												
Lane Group Flow (vph)	0	553	0	0	300	0	0	0	0	0	0	0
Enter Blocked Intersection	No	No	No	No	No	No	No	No	No	No	No	No
Lane Alignment	Left	Left	Right	Left	Left	Right	Left	Left	Right	Left	Left	Right
Median Width(m)	0.0				0.0		0.0				0.0	
Link Offset(m)	0.0				0.0		0.0				0.0	
Crosswalk Width(m)	5.0				5.0		5.0				5.0	
Two way Left Turn Lane												
Headway Factor	1.16	1.16	1.16	1.16	1.16	1.16	1.16	1.16	1.16	1.16	1.16	1.16
Turning Speed (k/h)	24		14	24		14	24		14	24		14
Number of Detectors	1	2		1	2							
Detector Template	Left	Thru		Left	Thru							
Leading Detector (m)	6.1	30.5		6.1	30.5							
Trailing Detector (m)	0.0	0.0		0.0	0.0							
Detector 1 Position(m)	0.0	0.0		0.0	0.0							
Detector 1 Size(m)	6.1	1.8		6.1	1.8							
Detector 1 Type	CI+Ex	CI+Ex		CI+Ex	CI+Ex							
Detector 1 Channel												
Detector 1 Extend (s)	0.0	0.0		0.0	0.0							
Detector 1 Queue (s)	0.0	0.0		0.0	0.0							
Detector 1 Delay (s)	0.0	0.0		0.0	0.0							
Detector 2 Position(m)	28.7				28.7							
Detector 2 Size(m)	1.8				1.8							
Detector 2 Type	CI+Ex				CI+Ex							
Detector 2 Channel												
Detector 2 Extend (s)	0.0				0.0							
Turn Type	Perm	NA		Perm	NA							
Protected Phases	2				6							
Permitted Phases	2				6							
Detector Phase	2	2		6	6							
Switch Phase												
Minimum Initial (s)	10.0	10.0		10.0	10.0							
Minimum Split (s)	15.8	15.8		15.8	15.8							

Lane Group	Ø4
Lane Configurations	
Traffic Volume (vph)	
Future Volume (vph)	
Ideal Flow (vphpl)	
Lane Util. Factor	
Ped Bike Factor	
Frt	
Flt Protected	
Satd. Flow (prot)	
Flt Permitted	
Satd. Flow (perm)	
Right Turn on Red	
Satd. Flow (RTOR)	
Link Speed (k/h)	
Link Distance (m)	
Travel Time (s)	
Confl. Peds. (#/hr)	
Confl. Bikes (#/hr)	
Peak Hour Factor	
Heavy Vehicles (%)	
Adj. Flow (vph)	
Shared Lane Traffic (%)	
Lane Group Flow (vph)	
Enter Blocked Intersection	
Lane Alignment	
Median Width(m)	
Link Offset(m)	
Crosswalk Width(m)	
Two way Left Turn Lane	
Headway Factor	
Turning Speed (k/h)	
Number of Detectors	
Detector Template	
Leading Detector (m)	
Trailing Detector (m)	
Detector 1 Position(m)	
Detector 1 Size(m)	
Detector 1 Type	
Detector 1 Channel	
Detector 1 Extend (s)	
Detector 1 Queue (s)	
Detector 1 Delay (s)	
Detector 2 Position(m)	
Detector 2 Size(m)	
Detector 2 Type	
Detector 2 Channel	
Detector 2 Extend (s)	
Turn Type	
Protected Phases	4
Permitted Phases	
Detector Phase	
Switch Phase	
Minimum Initial (s)	20.0
Minimum Split (s)	24.0

3: Athlone & Scott
AM Peak Hour

2026 Scott Street
2031 Total Traffic



Lane Group	EBL	EBT	EBR	WBL	WBT	WBR	NBL	NBT	NBR	SBL	SBT	SBR
Total Split (s)	30.8	30.8		30.8	30.8							
Total Split (%)	56.2%	56.2%		56.2%	56.2%							
Maximum Green (s)	25.0	25.0		25.0	25.0							
Yellow Time (s)	3.3	3.3		3.3	3.3							
All-Red Time (s)	2.5	2.5		2.5	2.5							
Lost Time Adjust (s)		0.0			0.0							
Total Lost Time (s)		5.8			5.8							
Lead/Lag												
Lead-Lag Optimize?												
Vehicle Extension (s)	3.0	3.0		3.0	3.0							
Recall Mode	Max	Max		Max	Max							
Walk Time (s)												
Flash Dont Walk (s)												
Pedestrian Calls (#/hr)												
Act Effct Green (s)		44.8			44.8							
Actuated g/C Ratio		0.74			0.74							
v/c Ratio		0.46			0.27							
Control Delay		9.3			7.3							
Queue Delay		0.0			0.3							
Total Delay		9.3			7.5							
LOS		A			A							
Approach Delay		9.3			7.5							
Approach LOS		A			A							
Queue Length 50th (m)		38.9			17.3							
Queue Length 95th (m)		64.7			30.4							
Internal Link Dist (m)		84.8			60.2			38.0			30.4	
Turn Bay Length (m)												
Base Capacity (vph)		1195			1098							
Starvation Cap Reductn		0			330							
Spillback Cap Reductn		0			0							
Storage Cap Reductn		0			0							
Reduced v/c Ratio		0.46			0.39							

Intersection Summary

Area Type:	CBD
Cycle Length:	54.8
Actuated Cycle Length:	60.2
Natural Cycle:	60
Control Type:	Semi Act-Uncoord
Maximum v/c Ratio:	0.46
Intersection Signal Delay:	8.7
Intersection LOS:	A
Intersection Capacity Utilization:	41.7%
ICU Level of Service:	A
Analysis Period (min):	15

Splits and Phases: 3: Athlone & Scott

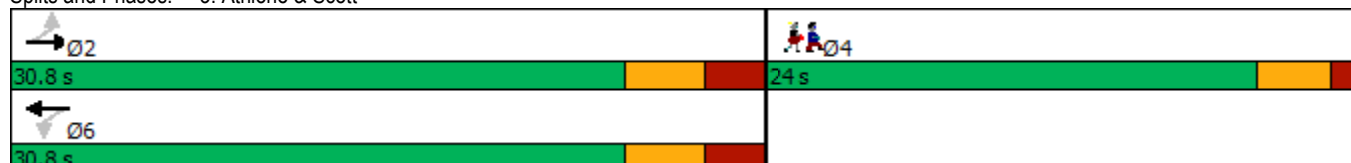

Lane Group	Ø4
Total Split (s)	24.0
Total Split (%)	44%
Maximum Green (s)	20.0
Yellow Time (s)	3.0
All-Red Time (s)	1.0
Lost Time Adjust (s)	
Total Lost Time (s)	
Lead/Lag	
Lead-Lag Optimize?	
Vehicle Extension (s)	3.0
Recall Mode	None
Walk Time (s)	7.0
Flash Dont Walk (s)	11.0
Pedestrian Calls (#/hr)	100
Act Effct Green (s)	
Actuated g/C Ratio	
v/c Ratio	
Control Delay	
Queue Delay	
Total Delay	
LOS	
Approach Delay	
Approach LOS	
Queue Length 50th (m)	
Queue Length 95th (m)	
Internal Link Dist (m)	
Turn Bay Length (m)	
Base Capacity (vph)	
Starvation Cap Reductn	
Spillback Cap Reductn	
Storage Cap Reductn	
Reduced v/c Ratio	
Intersection Summary	

4: Tweedsmuir & Scott
AM Peak Hour

2026 Scott Street
2031 Total Traffic



Lane Group	EBL	EBT	EBR	WBL	WBT	WBR	NBL	NBT	NBR	SBL	SBT	SBR
Lane Configurations												
Traffic Volume (vph)	0	542	3	10	274	5	0	0	0	0	0	0
Future Volume (vph)	0	542	3	10	274	5	0	0	0	0	0	0
Ideal Flow (vphpl)	1800	1800	1800	1800	1800	1800	1800	1800	1800	1800	1800	1800
Lane Util. Factor	1.00	1.00	1.00	1.00	1.00	1.00	1.00	1.00	1.00	1.00	1.00	1.00
Ped Bike Factor		1.00			1.00							
Flt		0.999			0.998							
Flt Protected					0.998							
Satd. Flow (prot)	0	1641	0	0	1563	0	0	0	0	0	0	0
Flt Permitted					0.982							
Satd. Flow (perm)	0	1641	0	0	1537	0	0	0	0	0	0	0
Right Turn on Red			Yes			Yes			Yes			Yes
Satd. Flow (RTOR)		1			2							
Link Speed (k/h)		50			50			50			50	
Link Distance (m)		84.2			67.4			275.0			51.7	
Travel Time (s)		6.1			4.9			19.8			3.7	
Confl. Peds. (#/hr)	160		20	20		160	10		130	130		10
Confl. Bikes (#/hr)			10			5						
Peak Hour Factor	1.00	1.00	1.00	1.00	1.00	1.00	1.00	1.00	1.00	1.00	1.00	1.00
Heavy Vehicles (%)	100%	3%	1%	1%	6%	100%	1%	1%	1%	100%	100%	100%
Adj. Flow (vph)	0	542	3	10	274	5	0	0	0	0	0	0
Shared Lane Traffic (%)												
Lane Group Flow (vph)	0	545	0	0	289	0	0	0	0	0	0	0
Enter Blocked Intersection	No	No	No	No	No	No	No	No	No	No	No	No
Lane Alignment	Left	Left	Right	Left	Left	Right	Left	Left	Right	Left	Left	Right
Median Width(m)		0.0			0.0			0.0			0.0	
Link Offset(m)		0.0			0.0			0.0			0.0	
Crosswalk Width(m)		5.0			5.0			5.0			5.0	
Two way Left Turn Lane												
Headway Factor	1.16	1.16	1.16	1.16	1.16	1.16	1.16	1.16	1.16	1.16	1.16	1.16
Turning Speed (k/h)	24		14	24		14	24		14	24		14
Number of Detectors	1	2		1	2							
Detector Template	Left	Thru		Left	Thru							
Leading Detector (m)	6.1	30.5		6.1	30.5							
Trailing Detector (m)	0.0	0.0		0.0	0.0							
Detector 1 Position(m)	0.0	0.0		0.0	0.0							
Detector 1 Size(m)	6.1	1.8		6.1	1.8							
Detector 1 Type	CI+Ex	CI+Ex		CI+Ex	CI+Ex							
Detector 1 Channel												
Detector 1 Extend (s)	0.0	0.0		0.0	0.0							
Detector 1 Queue (s)	0.0	0.0		0.0	0.0							
Detector 1 Delay (s)	0.0	0.0		0.0	0.0							
Detector 2 Position(m)		28.7			28.7							
Detector 2 Size(m)		1.8			1.8							
Detector 2 Type		CI+Ex			CI+Ex							
Detector 2 Channel												
Detector 2 Extend (s)		0.0			0.0							
Turn Type		NA		Perm	NA							
Protected Phases		2			6							
Permitted Phases	2			6								
Detector Phase	2	2		6	6							
Switch Phase												
Minimum Initial (s)	10.0	10.0		10.0	10.0							
Minimum Split (s)	15.8	15.8		15.8	15.8							

Lane Group	Ø4
Lane Configurations	
Traffic Volume (vph)	
Future Volume (vph)	
Ideal Flow (vphpl)	
Lane Util. Factor	
Ped Bike Factor	
Frt	
Flt Protected	
Satd. Flow (prot)	
Flt Permitted	
Satd. Flow (perm)	
Right Turn on Red	
Satd. Flow (RTOR)	
Link Speed (k/h)	
Link Distance (m)	
Travel Time (s)	
Confl. Peds. (#/hr)	
Confl. Bikes (#/hr)	
Peak Hour Factor	
Heavy Vehicles (%)	
Adj. Flow (vph)	
Shared Lane Traffic (%)	
Lane Group Flow (vph)	
Enter Blocked Intersection	
Lane Alignment	
Median Width(m)	
Link Offset(m)	
Crosswalk Width(m)	
Two way Left Turn Lane	
Headway Factor	
Turning Speed (k/h)	
Number of Detectors	
Detector Template	
Leading Detector (m)	
Trailing Detector (m)	
Detector 1 Position(m)	
Detector 1 Size(m)	
Detector 1 Type	
Detector 1 Channel	
Detector 1 Extend (s)	
Detector 1 Queue (s)	
Detector 1 Delay (s)	
Detector 2 Position(m)	
Detector 2 Size(m)	
Detector 2 Type	
Detector 2 Channel	
Detector 2 Extend (s)	
Turn Type	
Protected Phases	4
Permitted Phases	
Detector Phase	
Switch Phase	
Minimum Initial (s)	10.0
Minimum Split (s)	22.0

4: Tweedsmuir & Scott
AM Peak Hour

2026 Scott Street
2031 Total Traffic



Lane Group	EBL	EBT	EBR	WBL	WBT	WBR	NBL	NBT	NBR	SBL	SBT	SBR
Total Split (s)	28.0	28.0		28.0	28.0							
Total Split (%)	56.0%	56.0%		56.0%	56.0%							
Maximum Green (s)	22.2	22.2		22.2	22.2							
Yellow Time (s)	3.3	3.3		3.3	3.3							
All-Red Time (s)	2.5	2.5		2.5	2.5							
Lost Time Adjust (s)		0.0			0.0							
Total Lost Time (s)		5.8			5.8							
Lead/Lag												
Lead-Lag Optimize?												
Vehicle Extension (s)	3.0	3.0		3.0	3.0							
Recall Mode	Max	Max		Max	Max							
Walk Time (s)												
Flash Dont Walk (s)												
Pedestrian Calls (#/hr)												
Act Effct Green (s)		41.8			41.8							
Actuated g/C Ratio		0.74			0.74							
v/c Ratio		0.45			0.25							
Control Delay		8.6			6.7							
Queue Delay		0.5			0.0							
Total Delay		9.1			6.7							
LOS		A			A							
Approach Delay		9.1			6.7							
Approach LOS		A			A							
Queue Length 50th (m)		34.6			14.9							
Queue Length 95th (m)		58.2			26.6							
Internal Link Dist (m)		60.2			43.4			251.0			27.7	
Turn Bay Length (m)												
Base Capacity (vph)		1220			1143							
Starvation Cap Reductn		308			0							
Spillback Cap Reductn		0			0							
Storage Cap Reductn		0			0							
Reduced v/c Ratio		0.60			0.25							

Intersection Summary

Area Type:	CBD
Cycle Length:	50
Actuated Cycle Length:	56.2
Natural Cycle:	55
Control Type:	Semi Act-Uncoord
Maximum v/c Ratio:	0.45
Intersection Signal Delay:	8.2
Intersection LOS:	A
Intersection Capacity Utilization:	38.5%
ICU Level of Service:	A
Analysis Period (min):	15

Splits and Phases: 4: Tweedsmuir & Scott

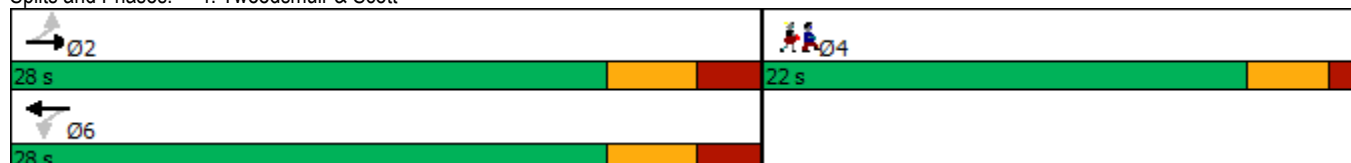

Lane Group	Ø4
Total Split (s)	22.0
Total Split (%)	44%
Maximum Green (s)	18.0
Yellow Time (s)	3.0
All-Red Time (s)	1.0
Lost Time Adjust (s)	
Total Lost Time (s)	
Lead/Lag	
Lead-Lag Optimize?	
Vehicle Extension (s)	3.0
Recall Mode	None
Walk Time (s)	7.0
Flash Dont Walk (s)	11.0
Pedestrian Calls (#/hr)	100
Act Effct Green (s)	
Actuated g/C Ratio	
v/c Ratio	
Control Delay	
Queue Delay	
Total Delay	
LOS	
Approach Delay	
Approach LOS	
Queue Length 50th (m)	
Queue Length 95th (m)	
Internal Link Dist (m)	
Turn Bay Length (m)	
Base Capacity (vph)	
Starvation Cap Reductn	
Spillback Cap Reductn	
Storage Cap Reductn	
Reduced v/c Ratio	
Intersection Summary	



Lane Group	EBT	EBR	WBL	WBT	NBL	NBR
Lane Configurations						
Traffic Volume (vph)	547	35	108	275	14	102
Future Volume (vph)	547	35	108	275	14	102
Ideal Flow (vphpl)	1800	1800	1800	1800	1800	1800
Lane Util. Factor	1.00	1.00	1.00	1.00	1.00	1.00
Ped Bike Factor						
Frt	0.992			0.881		
Flt Protected				0.986	0.994	
Satd. Flow (prot)	1631	0	0	1606	1467	0
Flt Permitted				0.986	0.994	
Satd. Flow (perm)	1631	0	0	1606	1467	0
Link Speed (k/h)	50			50	50	
Link Distance (m)	67.4			200.5	303.1	
Travel Time (s)	4.9			14.4	21.8	
Confl. Peds. (#/hr)	60		60			
Confl. Bikes (#/hr)	10				5	
Peak Hour Factor	1.00	1.00	1.00	1.00	1.00	1.00
Heavy Vehicles (%)	3%	1%	1%	5%	1%	1%
Adj. Flow (vph)	547	35	108	275	14	102
Shared Lane Traffic (%)						
Lane Group Flow (vph)	582	0	0	383	116	0
Enter Blocked Intersection	No	No	No	No	No	No
Lane Alignment	Left	Right	Left	Left	Left	Right
Median Width(m)	0.0			0.0	4.0	
Link Offset(m)	0.0			0.0	0.0	
Crosswalk Width(m)	5.0			5.0	5.0	
Two way Left Turn Lane						
Headway Factor	1.16	1.16	1.16	1.16	1.16	1.16
Turning Speed (k/h)	14		24		24	14
Sign Control	Free			Free	Stop	

Intersection Summary

Area Type:	CBD
Control Type:	Unsignalized
Intersection Capacity Utilization 78.8%	ICU Level of Service D
Analysis Period (min)	15

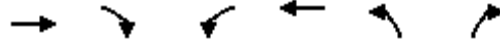

Lane Group	EBT	EBR	WBL	WBT	NBL	NBR
Lane Configurations						
Traffic Volume (vph)	530	6	11	278	12	23
Future Volume (vph)	530	6	11	278	12	23
Ideal Flow (vphpl)	1800	1800	1800	1800	1800	1800
Lane Util. Factor	1.00	1.00	1.00	1.00	1.00	1.00
Ped Bike Factor						
Frt	0.998			0.911		
Flt Protected				0.998	0.983	
Satd. Flow (prot)	1624	0	0	1540	1500	0
Flt Permitted				0.998	0.983	
Satd. Flow (perm)	1624	0	0	1540	1500	0
Link Speed (k/h)	50			50	30	
Link Distance (m)	86.1			108.8	89.0	
Travel Time (s)	6.2			7.8	10.7	
Confl. Peds. (#/hr)	20		20			
Confl. Bikes (#/hr)	30			5		
Peak Hour Factor	1.00	1.00	1.00	1.00	1.00	1.00
Heavy Vehicles (%)	4%	1%	1%	10%	1%	1%
Adj. Flow (vph)	530	6	11	278	12	23
Shared Lane Traffic (%)						
Lane Group Flow (vph)	536	0	0	289	35	0
Enter Blocked Intersection	No	No	No	No	No	No
Lane Alignment	Left	Right	Left	Left	Left	Right
Median Width(m)	4.0			4.0	4.0	
Link Offset(m)	0.0			0.0	0.0	
Crosswalk Width(m)	5.0			5.0	5.0	
Two way Left Turn Lane						
Headway Factor	1.16	1.16	1.16	1.16	1.16	1.16
Turning Speed (k/h)	14		24	24		14
Sign Control	Free			Free	Stop	

Intersection Summary

Area Type: CBD

Control Type: Unsignalized

Intersection Capacity Utilization 43.2% ICU Level of Service A

Analysis Period (min) 15



















Lane Group	EBL	EBR	NBL	NBT	SBT	SBR
Lane Configurations						
Traffic Volume (vph)	0	4	2	31	31	0
Future Volume (vph)	0	4	2	31	31	0
Ideal Flow (vphpl)	1800	1800	1800	1800	1800	1800
Lane Util. Factor	1.00	1.00	1.00	1.00	1.00	1.00
Ped Bike Factor						
Frt	0.865					
Flt Protected				0.997		
Satd. Flow (prot)	0	1449	0	1655	1659	0
Flt Permitted	0.997					
Satd. Flow (perm)	0	1449	0	1655	1659	0
Link Speed (k/h)	30			30		30
Link Distance (m)	66.2			194.5		62.0
Travel Time (s)	7.9			23.3		7.4
Confl. Peds. (#/hr)				20		20
Confl. Bikes (#/hr)	5			5		
Peak Hour Factor	1.00	1.00	1.00	1.00	1.00	1.00
Heavy Vehicles (%)	1%	1%	1%	2%	2%	1%
Adj. Flow (vph)	0	4	2	31	31	0
Shared Lane Traffic (%)						
Lane Group Flow (vph)	0	4	0	33	31	0
Enter Blocked Intersection	No	No	No	No	No	No
Lane Alignment	Left	Right	Left	Left	Left	Right
Median Width(m)	0.0			0.0		0.0
Link Offset(m)	0.0			0.0		0.0
Crosswalk Width(m)	5.0			5.0		5.0
Two way Left Turn Lane						
Headway Factor	1.16	1.16	1.16	1.16	1.16	1.16
Turning Speed (k/h)	24	14	24			14
Sign Control	Stop			Free		Free

Intersection Summary

Area Type:	CBD
Control Type:	Unsignalized
Intersection Capacity Utilization	18.2%
ICU Level of Service	A
Analysis Period (min)	15

















3: Athlone & Scott
AM Peak Hour

2026 Scott Street
2031 Total Traffic

												
Lane Group	EBL	EBT	EBR	WBL	WBT	WBR	NBL	NBT	NBR	SBL	SBT	SBR
Lane Configurations												
Traffic Volume (vph)	11	535	7	22	272	6	3	0	28	0	0	0
Future Volume (vph)	11	535	7	22	272	6	3	0	28	0	0	0
Ideal Flow (vphpl)	1800	1800	1800	1800	1800	1800	1800	1800	1800	1800	1800	1800
Lane Util. Factor	1.00	1.00	1.00	1.00	1.00	1.00	1.00	1.00	1.00	1.00	1.00	1.00
Ped Bike Factor												
Frt		0.998			0.997			0.878				
Flt Protected		0.999			0.996			0.995				
Satd. Flow (prot)	0	1619	0	0	1550	0	0	1464	0	0	846	0
Flt Permitted		0.999			0.996			0.995				
Satd. Flow (perm)	0	1619	0	0	1550	0	0	1464	0	0	846	0
Link Speed (k/h)		50			50			30			50	
Link Distance (m)		108.8			84.2			62.0			54.4	
Travel Time (s)		7.8			6.1			7.4			3.9	
Confl. Peds. (#/hr)	120		20	20		120	70		20	20		70
Confl. Bikes (#/hr)			15			10			5			
Peak Hour Factor	1.00	1.00	1.00	1.00	1.00	1.00	1.00	1.00	1.00	1.00	1.00	1.00
Heavy Vehicles (%)	100%	2%	20%	1%	7%	100%	1%	100%	1%	100%	100%	100%
Adj. Flow (vph)	11	535	7	22	272	6	3	0	28	0	0	0
Shared Lane Traffic (%)												
Lane Group Flow (vph)	0	553	0	0	300	0	0	31	0	0	0	0
Enter Blocked Intersection	No	No	No	No	No	No	No	No	No	No	No	No
Lane Alignment	Left	Left	Right	Left	Left	Right	Left	Left	Right	Left	Left	Right
Median Width(m)		0.0			0.0			0.0			0.0	
Link Offset(m)		0.0			0.0			0.0			0.0	
Crosswalk Width(m)		5.0			5.0			5.0			5.0	
Two way Left Turn Lane												
Headway Factor	1.16	1.16	1.16	1.16	1.16	1.16	1.16	1.16	1.16	1.16	1.16	1.16
Turning Speed (k/h)	24		14	24		14	24		14	24		14
Sign Control		Free			Free			Stop			Stop	
Intersection Summary												
Area Type:	CBD											
Control Type:	Unsignalized											
Intersection Capacity Utilization 55.9%	ICU Level of Service B											
Analysis Period (min) 15												

4: Tweedsmuir & Scott
AM Peak Hour

2026 Scott Street
2031 Total Traffic

												
Lane Group	EBL	EBT	EBR	WBL	WBT	WBR	NBL	NBT	NBR	SBL	SBT	SBR
Lane Configurations												
Traffic Volume (vph)	0	542	3	10	274	5	3	0	34	6	0	0
Future Volume (vph)	0	542	3	10	274	5	3	0	34	6	0	0
Ideal Flow (vphpl)	1800	1800	1800	1800	1800	1800	1800	1800	1800	1800	1800	1800
Lane Util. Factor	1.00	1.00	1.00	1.00	1.00	1.00	1.00	1.00	1.00	1.00	1.00	1.00
Ped Bike Factor												
Frt		0.999			0.998			0.876				
Flt Protected					0.998			0.996			0.950	
Satd. Flow (prot)	0	1641	0	0	1568	0	0	1462	0	0	804	0
Flt Permitted					0.998			0.996			0.950	
Satd. Flow (perm)	0	1641	0	0	1568	0	0	1462	0	0	804	0
Link Speed (k/h)		50			50			50			50	
Link Distance (m)		84.2			67.4			275.0			51.7	
Travel Time (s)		6.1			4.9			19.8			3.7	
Confl. Peds. (#/hr)	160			20		160	10		130	130		10
Confl. Bikes (#/hr)			10			5						
Peak Hour Factor	1.00	1.00	1.00	1.00	1.00	1.00	1.00	1.00	1.00	1.00	1.00	1.00
Heavy Vehicles (%)	100%	3%	1%	1%	6%	100%	1%	1%	1%	100%	100%	100%
Adj. Flow (vph)	0	542	3	10	274	5	3	0	34	6	0	0
Shared Lane Traffic (%)												
Lane Group Flow (vph)	0	545	0	0	289	0	0	37	0	0	6	0
Enter Blocked Intersection	No	No	No	No	No	No	No	No	No	No	No	No
Lane Alignment	Left	Left	Right	Left	Left	Right	Left	Left	Right	Left	Left	Right
Median Width(m)		0.0			0.0			0.0			0.0	
Link Offset(m)		0.0			0.0			0.0			0.0	
Crosswalk Width(m)		5.0			5.0			5.0			5.0	
Two way Left Turn Lane												
Headway Factor	1.16	1.16	1.16	1.16	1.16	1.16	1.16	1.16	1.16	1.16	1.16	1.16
Turning Speed (k/h)	24		14	24		14	24		14	24		14
Sign Control		Free			Free			Stop			Stop	
Intersection Summary												
Area Type:	CBD											
Control Type:	Unsignalized											
Intersection Capacity Utilization 53.6%	ICU Level of Service A											
Analysis Period (min) 15												

1: Churchill & Scott
PM Peak Hour

2026 Scott Street
2031 Total Traffic



Lane Group	EBL	EBT	EBR	WBL	WBT	WBR	NBL	NBT	NBR	SBL	SBT	SBR
Lane Configurations		↔		↔	↔			↔	↔		↔	
Traffic Volume (vph)	0	8	11	321	8	43	18	149	247	38	118	3
Future Volume (vph)	0	8	11	321	8	43	18	149	247	38	118	3
Ideal Flow (vphpl)	1800	1800	1800	1800	1800	1800	1800	1800	1800	1800	1800	1800
Storage Length (m)	0.0		0.0	0.0		0.0	0.0		40.0	0.0		0.0
Storage Lanes	0		0	1		0	0		1	0		0
Taper Length (m)	10.0			10.0			10.0			10.0		
Lane Util. Factor	1.00	1.00	1.00	1.00	1.00	1.00	1.00	1.00	1.00	1.00	1.00	1.00
Ped Bike Factor		0.95		0.96	0.84			0.99			0.99	
Frt		0.922			0.874				0.850		0.997	
Flt Protected				0.950				0.995			0.988	
Satd. Flow (prot)	0	1461	0	1576	1154	0	0	1660	1410	0	1619	0
Flt Permitted				0.603				0.956			0.876	
Satd. Flow (perm)	0	1461	0	959	1154	0	0	1583	1410	0	1423	0
Right Turn on Red			Yes			Yes			No			Yes
Satd. Flow (RTOR)		11			43							1
Link Speed (k/h)		50			50			50			50	
Link Distance (m)		77.3			83.9			315.3			273.6	
Travel Time (s)		5.6			6.0			22.7			19.7	
Confl. Peds. (#/hr)	50		20	20		50	40		20	20		40
Confl. Bikes (#/hr)			15			70			25			30
Peak Hour Factor	1.00	1.00	1.00	1.00	1.00	1.00	1.00	1.00	1.00	1.00	1.00	1.00
Heavy Vehicles (%)	1%	1%	1%	2%	1%	9%	5%	1%	2%	8%	1%	1%
Adj. Flow (vph)	0	8	11	321	8	43	18	149	247	38	118	3
Shared Lane Traffic (%)												
Lane Group Flow (vph)	0	19	0	321	51	0	0	167	247	0	159	0
Enter Blocked Intersection	No	No	No	No	No	No	No	No	No	No	No	No
Lane Alignment	Left	Left	Right	Left	Left	Right	Left	Left	Right	Left	Left	Right
Median Width(m)		4.0			4.0			0.0			0.0	
Link Offset(m)		0.0			0.0			0.0			0.0	
Crosswalk Width(m)		5.0			5.0			5.0			5.0	
Two way Left Turn Lane												
Headway Factor	1.16	1.16	1.16	1.16	1.16	1.16	1.16	1.16	1.16	1.16	1.16	1.16
Turning Speed (k/h)	24		14	24		14	24		14	24		14
Number of Detectors		2		1		2		1	2		1	2
Detector Template		Thru		Left	Thru		Left	Thru	Right	Left	Thru	
Leading Detector (m)		30.5		6.1	30.5		6.1	30.5	6.1	6.1	30.5	
Trailing Detector (m)		0.0		0.0	0.0		0.0	0.0	0.0	0.0	0.0	
Detector 1 Position(m)		0.0		0.0	0.0		0.0	0.0	0.0	0.0	0.0	
Detector 1 Size(m)		1.8		6.1	1.8		6.1	1.8	6.1	6.1	1.8	
Detector 1 Type		Cl+Ex		Cl+Ex	Cl+Ex		Cl+Ex	Cl+Ex	Cl+Ex	Cl+Ex	Cl+Ex	
Detector 1 Channel												
Detector 1 Extend (s)		0.0		0.0	0.0		0.0	0.0	0.0	0.0	0.0	
Detector 1 Queue (s)		0.0		0.0	0.0		0.0	0.0	0.0	0.0	0.0	
Detector 1 Delay (s)		0.0		0.0	0.0		0.0	0.0	0.0	0.0	0.0	
Detector 2 Position(m)		28.7			28.7			28.7			28.7	
Detector 2 Size(m)		1.8			1.8			1.8			1.8	
Detector 2 Type		Cl+Ex			Cl+Ex			Cl+Ex			Cl+Ex	
Detector 2 Channel												
Detector 2 Extend (s)		0.0			0.0			0.0			0.0	
Turn Type		NA		pm+pt	NA		Perm	NA	Over	Perm	NA	
Protected Phases		2		1	6			8	1		4	
Permitted Phases				6			8			4		
Detector Phase		2		1	6		8	8	1	4	4	

1: Churchill & Scott
PM Peak Hour

2026 Scott Street
2031 Total Traffic



Lane Group	EBL	EBT	EBR	WBL	WBT	WBR	NBL	NBT	NBR	SBL	SBT	SBR
Switch Phase												
Minimum Initial (s)		10.0		5.0	10.0		10.0	10.0	5.0	10.0	10.0	
Minimum Split (s)		25.4		11.8	25.4		27.4	27.4	11.8	27.4	27.4	
Total Split (s)		30.0		32.0	62.0		33.0	33.0	32.0	33.0	33.0	
Total Split (%)		31.6%		33.7%	65.3%		34.7%	34.7%	33.7%	34.7%	34.7%	
Maximum Green (s)		22.6		25.2	54.6		26.6	26.6	25.2	26.6	26.6	
Yellow Time (s)		3.0		3.0	3.0		3.3	3.3	3.0	3.3	3.3	
All-Red Time (s)		4.4		3.8	4.4		3.1	3.1	3.8	3.1	3.1	
Lost Time Adjust (s)		0.0		0.0	0.0			0.0	0.0		0.0	
Total Lost Time (s)		7.4		6.8	7.4			6.4	6.8		6.4	
Lead/Lag		Lag		Lead					Lead			
Lead-Lag Optimize?		Yes		Yes					Yes			
Vehicle Extension (s)		3.0		3.0	3.0		3.0	3.0	3.0	3.0	3.0	
Recall Mode		Max		Min	Max		None	None	Min	None	None	
Walk Time (s)		7.0			7.0		7.0	7.0		7.0	7.0	
Flash Dont Walk (s)		11.0			11.0		14.0	14.0		14.0	14.0	
Pedestrian Calls (#/hr)		40			40		40	40		40	40	
Act Effct Green (s)		28.7		55.4	54.8			16.7	19.2		16.7	
Actuated g/c Ratio		0.34		0.65	0.64			0.20	0.23		0.20	
v/c Ratio		0.04		0.42	0.07			0.54	0.78		0.57	
Control Delay		16.6		9.3	3.1			37.3	48.1		39.0	
Queue Delay		0.0		0.0	0.0			0.0	0.0		0.0	
Total Delay		16.6		9.3	3.1			37.3	48.1		39.0	
LOS		B		A	A			D	D		D	
Approach Delay		16.6			8.4			43.8			39.0	
Approach LOS		B			A			D			D	
Queue Length 50th (m)		0.9		22.1	0.5			22.6	36.6		21.6	
Queue Length 95th (m)		5.9		35.3	4.2			39.9	56.8		38.8	
Internal Link Dist (m)		53.3			59.9			291.3			249.6	
Turn Bay Length (m)									40.0			
Base Capacity (vph)		499		805	756			495	417		446	
Starvation Cap Reductn		0		0	0			0	0		0	
Spillback Cap Reductn		0		0	0			0	0		0	
Storage Cap Reductn		0		0	0			0	0		0	
Reduced v/c Ratio		0.04		0.40	0.07			0.34	0.59		0.36	

Intersection Summary

Area Type:	CBD
Cycle Length:	95
Actuated Cycle Length:	85.3
Natural Cycle:	75
Control Type:	Semi Act-Uncoord
Maximum v/c Ratio:	0.78
Intersection Signal Delay:	28.8
Intersection Capacity Utilization:	73.7%
Analysis Period (min):	15
Intersection LOS:	C
ICU Level of Service:	D

Splits and Phases: 1: Churchill & Scott

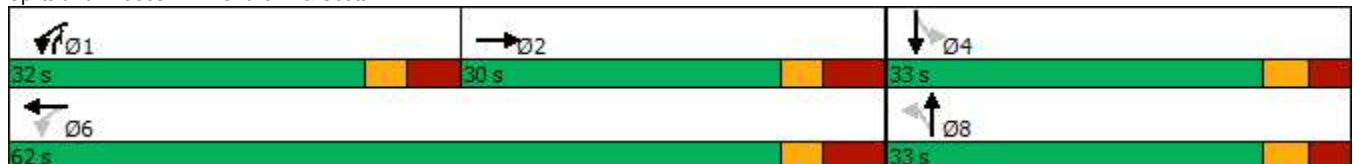



Lane Group	EBT	EBR	WBL	WBT	NBL	NBR
Lane Configurations						
Traffic Volume (vph)	364	16	49	454	10	46
Future Volume (vph)	364	16	49	454	10	46
Ideal Flow (vphpl)	1800	1800	1800	1800	1800	1800
Storage Length (m)		0.0	10.0		0.0	0.0
Storage Lanes		0	1		1	0
Taper Length (m)			30.0		10.0	
Lane Util. Factor	1.00	1.00	0.95	0.95	1.00	1.00
Ped Bike Factor						
Frt	0.994				0.889	
Flt Protected				0.995	0.991	
Satd. Flow (prot)	1634	0	0	3111	1476	0
Flt Permitted				0.995	0.991	
Satd. Flow (perm)	1634	0	0	3111	1476	0
Link Speed (k/h)	50			50	30	
Link Distance (m)	83.9			86.1	233.8	
Travel Time (s)	6.0			6.2	28.1	
Confl. Peds. (#/hr)		20	20			
Confl. Bikes (#/hr)		10				5
Peak Hour Factor	1.00	1.00	1.00	1.00	1.00	1.00
Heavy Vehicles (%)	3%	1%	1%	3%	1%	1%
Adj. Flow (vph)	364	16	49	454	10	46
Shared Lane Traffic (%)						
Lane Group Flow (vph)	380	0	0	503	56	0
Enter Blocked Intersection	No	No	No	No	No	No
Lane Alignment	Left	Right	Left	Left	Left	Right
Median Width(m)	0.0			0.0	4.0	
Link Offset(m)	0.0			0.0	0.0	
Crosswalk Width(m)	5.0			5.0	5.0	
Two way Left Turn Lane						
Headway Factor	1.16	1.16	1.16	1.16	1.16	1.16
Turning Speed (k/h)		14	24		24	14
Sign Control	Free			Free	Stop	

Intersection Summary

Area Type:	CBD
Control Type:	Unsignalized
Intersection Capacity Utilization	54.1%
ICU Level of Service	A
Analysis Period (min)	15

3: Athlone & Scott
PM Peak Hour

2026 Scott Street
2031 Total Traffic



Lane Group	EBL	EBT	EBR	WBL	WBT	WBR	NBL	NBT	NBR	SBL	SBT	SBR
Lane Configurations												
Traffic Volume (vph)	8	428	8	20	564	0	0	0	0	0	0	0
Future Volume (vph)	8	428	8	20	564	0	0	0	0	0	0	0
Ideal Flow (vphpl)	1800	1800	1800	1800	1800	1800	1800	1800	1800	1800	1800	1800
Lane Util. Factor	1.00	1.00	1.00	1.00	1.00	1.00	1.00	1.00	1.00	1.00	1.00	1.00
Ped Bike Factor	1.00		1.00		1.00		1.00		1.00		1.00	
Flt Protected	0.998		0.998		0.998		0.998		0.998		0.998	
Satd. Flow (prot)	0	1625	0	0	1656	0	0	0	0	0	0	0
Flt Permitted	0.991		0.981		0.981		0.981		0.981		0.981	
Satd. Flow (perm)	0	1610	0	0	1627	0	0	0	0	0	0	0
Right Turn on Red			Yes		Yes		Yes		Yes		Yes	
Satd. Flow (RTOR)	2		2		2		2		2		2	
Link Speed (k/h)	50		50		50		30		30		50	
Link Distance (m)	108.8		108.8		84.2		62.0		62.0		54.4	
Travel Time (s)	7.8		7.8		6.1		7.4		7.4		3.9	
Confl. Peds. (#/hr)	140		20	20		140	90		10	10		90
Confl. Bikes (#/hr)			5			25			5			
Peak Hour Factor	1.00	1.00	1.00	1.00	1.00	1.00	1.00	1.00	1.00	1.00	1.00	1.00
Heavy Vehicles (%)	100%	2%	1%	1%	2%	100%	1%	100%	1%	100%	100%	100%
Adj. Flow (vph)	8	428	8	20	564	0	0	0	0	0	0	0
Shared Lane Traffic (%)												
Lane Group Flow (vph)	0	444	0	0	584	0	0	0	0	0	0	0
Enter Blocked Intersection	No	No	No	No	No	No	No	No	No	No	No	No
Lane Alignment	Left	Left	Right	Left	Left	Right	Left	Left	Right	Left	Left	Right
Median Width(m)	0.0		0.0		0.0		0.0		0.0		0.0	
Link Offset(m)	0.0		0.0		0.0		0.0		0.0		0.0	
Crosswalk Width(m)	5.0		5.0		5.0		5.0		5.0		5.0	
Two way Left Turn Lane												
Headway Factor	1.16	1.16	1.16	1.16	1.16	1.16	1.16	1.16	1.16	1.16	1.16	1.16
Turning Speed (k/h)	24		14	24		14	24		14	24		14
Number of Detectors	1	2		1	2							
Detector Template	Left	Thru		Left	Thru							
Leading Detector (m)	6.1	30.5		6.1	30.5							
Trailing Detector (m)	0.0	0.0		0.0	0.0							
Detector 1 Position(m)	0.0	0.0		0.0	0.0							
Detector 1 Size(m)	6.1	1.8		6.1	1.8							
Detector 1 Type	CI+Ex	CI+Ex		CI+Ex	CI+Ex							
Detector 1 Channel												
Detector 1 Extend (s)	0.0	0.0		0.0	0.0							
Detector 1 Queue (s)	0.0	0.0		0.0	0.0							
Detector 1 Delay (s)	0.0	0.0		0.0	0.0							
Detector 2 Position(m)	28.7		28.7		28.7		28.7		28.7		28.7	
Detector 2 Size(m)	1.8		1.8		1.8		1.8		1.8		1.8	
Detector 2 Type	CI+Ex		CI+Ex		CI+Ex		CI+Ex		CI+Ex		CI+Ex	
Detector 2 Channel												
Detector 2 Extend (s)	0.0		0.0		0.0		0.0		0.0		0.0	
Turn Type	Perm	NA		Perm	NA							
Protected Phases	2		2		6		6		6		6	
Permitted Phases	2		2		6		6		6		6	
Detector Phase	2	2		6	6							
Switch Phase												
Minimum Initial (s)	10.0	10.0		10.0	10.0							
Minimum Split (s)	15.8	15.8		15.8	15.8							

Lane Group	Ø4
Lane Configurations	
Traffic Volume (vph)	
Future Volume (vph)	
Ideal Flow (vphpl)	
Lane Util. Factor	
Ped Bike Factor	
Frt	
Flt Protected	
Satd. Flow (prot)	
Flt Permitted	
Satd. Flow (perm)	
Right Turn on Red	
Satd. Flow (RTOR)	
Link Speed (k/h)	
Link Distance (m)	
Travel Time (s)	
Confl. Peds. (#/hr)	
Confl. Bikes (#/hr)	
Peak Hour Factor	
Heavy Vehicles (%)	
Adj. Flow (vph)	
Shared Lane Traffic (%)	
Lane Group Flow (vph)	
Enter Blocked Intersection	
Lane Alignment	
Median Width(m)	
Link Offset(m)	
Crosswalk Width(m)	
Two way Left Turn Lane	
Headway Factor	
Turning Speed (k/h)	
Number of Detectors	
Detector Template	
Leading Detector (m)	
Trailing Detector (m)	
Detector 1 Position(m)	
Detector 1 Size(m)	
Detector 1 Type	
Detector 1 Channel	
Detector 1 Extend (s)	
Detector 1 Queue (s)	
Detector 1 Delay (s)	
Detector 2 Position(m)	
Detector 2 Size(m)	
Detector 2 Type	
Detector 2 Channel	
Detector 2 Extend (s)	
Turn Type	
Protected Phases	4
Permitted Phases	
Detector Phase	
Switch Phase	
Minimum Initial (s)	20.0
Minimum Split (s)	24.0

3: Athlone & Scott
PM Peak Hour

2026 Scott Street
2031 Total Traffic



Lane Group	EBL	EBT	EBR	WBL	WBT	WBR	NBL	NBT	NBR	SBL	SBT	SBR
Total Split (s)	30.8	30.8		30.8	30.8							
Total Split (%)	56.2%	56.2%		56.2%	56.2%							
Maximum Green (s)	25.0	25.0		25.0	25.0							
Yellow Time (s)	3.3	3.3		3.3	3.3							
All-Red Time (s)	2.5	2.5		2.5	2.5							
Lost Time Adjust (s)		0.0			0.0							
Total Lost Time (s)		5.8			5.8							
Lead/Lag												
Lead-Lag Optimize?												
Vehicle Extension (s)	3.0	3.0		3.0	3.0							
Recall Mode	Max	Max		Max	Max							
Walk Time (s)												
Flash Dont Walk (s)												
Pedestrian Calls (#/hr)												
Act Effct Green (s)		44.8			44.8							
Actuated g/C Ratio		0.74			0.74							
v/c Ratio		0.37			0.48							
Control Delay		8.0			9.6							
Queue Delay		0.0			0.7							
Total Delay		8.0			10.2							
LOS		A			B							
Approach Delay		8.0			10.2							
Approach LOS		A			B							
Queue Length 50th (m)		28.2			42.2							
Queue Length 95th (m)		47.0			69.7							
Internal Link Dist (m)		84.8			60.2			38.0			30.4	
Turn Bay Length (m)												
Base Capacity (vph)		1198			1210							
Starvation Cap Reductn		0			309							
Spillback Cap Reductn		0			0							
Storage Cap Reductn		0			0							
Reduced v/c Ratio		0.37			0.65							

Intersection Summary

Area Type:	CBD
Cycle Length:	54.8
Actuated Cycle Length:	60.2
Natural Cycle:	60
Control Type:	Actuated-Uncoordinated
Maximum v/c Ratio:	0.48
Intersection Signal Delay:	9.3
Intersection LOS:	A
Intersection Capacity Utilization:	52.1%
ICU Level of Service:	A
Analysis Period (min):	15

Splits and Phases: 3: Athlone & Scott

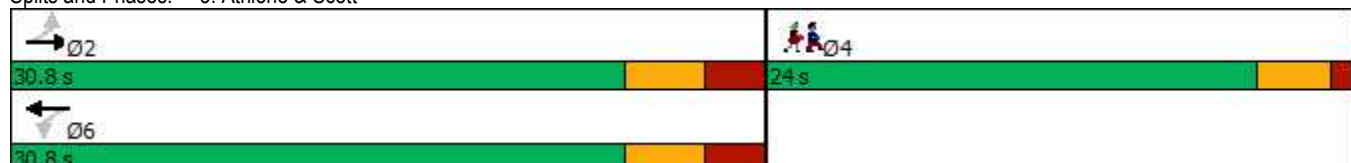

Lane Group	Ø4
Total Split (s)	24.0
Total Split (%)	44%
Maximum Green (s)	20.0
Yellow Time (s)	3.0
All-Red Time (s)	1.0
Lost Time Adjust (s)	
Total Lost Time (s)	
Lead/Lag	
Lead-Lag Optimize?	
Vehicle Extension (s)	3.0
Recall Mode	None
Walk Time (s)	7.0
Flash Dont Walk (s)	11.0
Pedestrian Calls (#/hr)	100
Act Effct Green (s)	
Actuated g/C Ratio	
v/c Ratio	
Control Delay	
Queue Delay	
Total Delay	
LOS	
Approach Delay	
Approach LOS	
Queue Length 50th (m)	
Queue Length 95th (m)	
Internal Link Dist (m)	
Turn Bay Length (m)	
Base Capacity (vph)	
Starvation Cap Reductn	
Spillback Cap Reductn	
Storage Cap Reductn	
Reduced v/c Ratio	
Intersection Summary	

4: Tweedsmuir & Scott
PM Peak Hour

2026 Scott Street
2031 Total Traffic



Lane Group	EBL	EBT	EBR	WBL	WBT	WBR	NBL	NBT	NBR	SBL	SBT	SBR
Lane Configurations												
Traffic Volume (vph)	0	433	7	14	484	5	0	0	0	0	0	0
Future Volume (vph)	0	433	7	14	484	5	0	0	0	0	0	0
Ideal Flow (vphpl)	1800	1800	1800	1800	1800	1800	1800	1800	1800	1800	1800	1800
Lane Util. Factor	1.00	1.00	1.00	1.00	1.00	1.00	1.00	1.00	1.00	1.00	1.00	1.00
Ped Bike Factor		1.00			1.00							
Flt		0.998			0.999							
Flt Protected					0.999							
Satd. Flow (prot)	0	1670	0	0	1620	0	0	0	0	0	0	0
Flt Permitted					0.986							
Satd. Flow (perm)	0	1670	0	0	1598	0	0	0	0	0	0	0
Right Turn on Red			Yes			Yes			Yes			Yes
Satd. Flow (RTOR)		2			1							
Link Speed (k/h)		50			50			50			50	
Link Distance (m)		84.2			67.4			275.0			51.7	
Travel Time (s)		6.1			4.9			19.8			3.7	
Confl. Peds. (#/hr)	240		30	30		240	10		200	200		10
Confl. Bikes (#/hr)			5			20			5			
Peak Hour Factor	1.00	1.00	1.00	1.00	1.00	1.00	1.00	1.00	1.00	1.00	1.00	1.00
Heavy Vehicles (%)	100%	1%	1%	1%	3%	100%	1%	1%	1%	100%	100%	100%
Adj. Flow (vph)	0	433	7	14	484	5	0	0	0	0	0	0
Shared Lane Traffic (%)												
Lane Group Flow (vph)	0	440	0	0	503	0	0	0	0	0	0	0
Enter Blocked Intersection	No	No	No	No	No	No	No	No	No	No	No	No
Lane Alignment	Left	Left	Right	Left	Left	Right	Left	Left	Right	Left	Left	Right
Median Width(m)		0.0			0.0			0.0			0.0	
Link Offset(m)		0.0			0.0			0.0			0.0	
Crosswalk Width(m)		5.0			5.0			5.0			5.0	
Two way Left Turn Lane												
Headway Factor	1.16	1.16	1.16	1.16	1.16	1.16	1.16	1.16	1.16	1.16	1.16	1.16
Turning Speed (k/h)	24		14	24		14	24		14	24		14
Number of Detectors	1	2		1	2							
Detector Template	Left	Thru		Left	Thru							
Leading Detector (m)	6.1	30.5		6.1	30.5							
Trailing Detector (m)	0.0	0.0		0.0	0.0							
Detector 1 Position(m)	0.0	0.0		0.0	0.0							
Detector 1 Size(m)	6.1	1.8		6.1	1.8							
Detector 1 Type	CI+Ex	CI+Ex		CI+Ex	CI+Ex							
Detector 1 Channel												
Detector 1 Extend (s)	0.0	0.0		0.0	0.0							
Detector 1 Queue (s)	0.0	0.0		0.0	0.0							
Detector 1 Delay (s)	0.0	0.0		0.0	0.0							
Detector 2 Position(m)		28.7			28.7							
Detector 2 Size(m)		1.8			1.8							
Detector 2 Type		CI+Ex			CI+Ex							
Detector 2 Channel												
Detector 2 Extend (s)		0.0			0.0							
Turn Type		NA		Perm	NA							
Protected Phases		2			6							
Permitted Phases	2			6								
Detector Phase	2	2		6	6							
Switch Phase												
Minimum Initial (s)	10.0	10.0		10.0	10.0							
Minimum Split (s)	15.8	15.8		15.8	15.8							

Lane Group	Ø4
Lane Configurations	
Traffic Volume (vph)	
Future Volume (vph)	
Ideal Flow (vphpl)	
Lane Util. Factor	
Ped Bike Factor	
Frt	
Flt Protected	
Satd. Flow (prot)	
Flt Permitted	
Satd. Flow (perm)	
Right Turn on Red	
Satd. Flow (RTOR)	
Link Speed (k/h)	
Link Distance (m)	
Travel Time (s)	
Confl. Peds. (#/hr)	
Confl. Bikes (#/hr)	
Peak Hour Factor	
Heavy Vehicles (%)	
Adj. Flow (vph)	
Shared Lane Traffic (%)	
Lane Group Flow (vph)	
Enter Blocked Intersection	
Lane Alignment	
Median Width(m)	
Link Offset(m)	
Crosswalk Width(m)	
Two way Left Turn Lane	
Headway Factor	
Turning Speed (k/h)	
Number of Detectors	
Detector Template	
Leading Detector (m)	
Trailing Detector (m)	
Detector 1 Position(m)	
Detector 1 Size(m)	
Detector 1 Type	
Detector 1 Channel	
Detector 1 Extend (s)	
Detector 1 Queue (s)	
Detector 1 Delay (s)	
Detector 2 Position(m)	
Detector 2 Size(m)	
Detector 2 Type	
Detector 2 Channel	
Detector 2 Extend (s)	
Turn Type	
Protected Phases	4
Permitted Phases	
Detector Phase	
Switch Phase	
Minimum Initial (s)	10.0
Minimum Split (s)	22.0

4: Tweedsmuir & Scott
PM Peak Hour

2026 Scott Street
2031 Total Traffic



Lane Group	EBL	EBT	EBR	WBL	WBT	WBR	NBL	NBT	NBR	SBL	SBT	SBR
Total Split (s)	28.0	28.0		28.0	28.0							
Total Split (%)	56.0%	56.0%		56.0%	56.0%							
Maximum Green (s)	22.2	22.2		22.2	22.2							
Yellow Time (s)	3.3	3.3		3.3	3.3							
All-Red Time (s)	2.5	2.5		2.5	2.5							
Lost Time Adjust (s)		0.0			0.0							
Total Lost Time (s)		5.8			5.8							
Lead/Lag												
Lead-Lag Optimize?												
Vehicle Extension (s)	3.0	3.0		3.0	3.0							
Recall Mode	Max	Max		Max	Max							
Walk Time (s)												
Flash Dont Walk (s)												
Pedestrian Calls (#/hr)												
Act Effct Green (s)		41.8			41.8							
Actuated g/C Ratio		0.74			0.74							
v/c Ratio		0.35			0.42							
Control Delay		7.4			8.3							
Queue Delay		0.4			0.0							
Total Delay		7.8			8.3							
LOS		A			A							
Approach Delay		7.8			8.3							
Approach LOS		A			A							
Queue Length 50th (m)		25.2			31.1							
Queue Length 95th (m)		42.4			52.8							
Internal Link Dist (m)		60.2			43.4			251.0			27.7	
Turn Bay Length (m)												
Base Capacity (vph)		1242			1188							
Starvation Cap Reductn		357			0							
Spillback Cap Reductn		0			0							
Storage Cap Reductn		0			0							
Reduced v/c Ratio		0.50			0.42							

Intersection Summary

Area Type:	CBD
Cycle Length:	50
Actuated Cycle Length:	56.2
Natural Cycle:	55
Control Type:	Actuated-Uncoordinated
Maximum v/c Ratio:	0.42
Intersection Signal Delay:	8.1
Intersection LOS:	A
Intersection Capacity Utilization:	48.4%
ICU Level of Service:	A
Analysis Period (min):	15

Splits and Phases: 4: Tweedsmuir & Scott

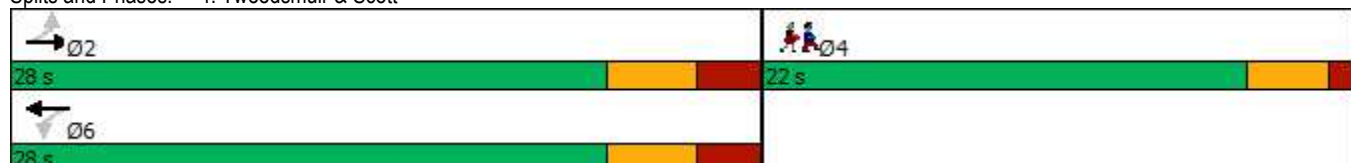

Lane Group	Ø4
Total Split (s)	22.0
Total Split (%)	44%
Maximum Green (s)	18.0
Yellow Time (s)	3.0
All-Red Time (s)	1.0
Lost Time Adjust (s)	
Total Lost Time (s)	
Lead/Lag	
Lead-Lag Optimize?	
Vehicle Extension (s)	3.0
Recall Mode	None
Walk Time (s)	7.0
Flash Dont Walk (s)	11.0
Pedestrian Calls (#/hr)	100
Act Effct Green (s)	
Actuated g/C Ratio	
v/c Ratio	
Control Delay	
Queue Delay	
Total Delay	
LOS	
Approach Delay	
Approach LOS	
Queue Length 50th (m)	
Queue Length 95th (m)	
Internal Link Dist (m)	
Turn Bay Length (m)	
Base Capacity (vph)	
Starvation Cap Reductn	
Spillback Cap Reductn	
Storage Cap Reductn	
Reduced v/c Ratio	
Intersection Summary	



Lane Group	EBT	EBR	WBL	WBT	NBL	NBR
Lane Configurations						
Traffic Volume (vph)	427	42	122	464	36	186
Future Volume (vph)	427	42	122	464	36	186
Ideal Flow (vphpl)	1800	1800	1800	1800	1800	1800
Lane Util. Factor	1.00	1.00	1.00	1.00	1.00	1.00
Ped Bike Factor						
Frt	0.988			0.887		
Flt Protected				0.990	0.992	
Satd. Flow (prot)	1640	0	0	1646	1474	0
Flt Permitted				0.990	0.992	
Satd. Flow (perm)	1640	0	0	1646	1474	0
Link Speed (k/h)	50			50	50	
Link Distance (m)	67.4			200.5	303.1	
Travel Time (s)	4.9			14.4	21.8	
Confl. Peds. (#/hr)	60		60			
Confl. Bikes (#/hr)	10			10		
Peak Hour Factor	1.00	1.00	1.00	1.00	1.00	1.00
Heavy Vehicles (%)	2%	1%	1%	2%	1%	1%
Adj. Flow (vph)	427	42	122	464	36	186
Shared Lane Traffic (%)						
Lane Group Flow (vph)	469	0	0	586	222	0
Enter Blocked Intersection	No	No	No	No	No	No
Lane Alignment	Left	Right	Left	Left	Left	Right
Median Width(m)	0.0			0.0	4.0	
Link Offset(m)	0.0			0.0	0.0	
Crosswalk Width(m)	5.0			5.0	5.0	
Two way Left Turn Lane						
Headway Factor	1.16	1.16	1.16	1.16	1.16	1.16
Turning Speed (k/h)	14		24	24		14
Sign Control	Free			Free	Stop	

Intersection Summary

Area Type: CBD

Control Type: Unsignalized

Intersection Capacity Utilization 92.1% ICU Level of Service F

Analysis Period (min) 15



Lane Group	EBT	EBR	WBL	WBT	NBL	NBR
Lane Configurations						
Traffic Volume (vph)	441	13	22	557	12	17
Future Volume (vph)	441	13	22	557	12	17
Ideal Flow (vphpl)	1800	1800	1800	1800	1800	1800
Lane Util. Factor	1.00	1.00	1.00	1.00	1.00	1.00
Ped Bike Factor						
Frt	0.996				0.921	
Flt Protected				0.998	0.980	
Satd. Flow (prot)	1637	0	0	1641	1512	0
Flt Permitted				0.998	0.980	
Satd. Flow (perm)	1637	0	0	1641	1512	0
Link Speed (k/h)	50				50	30
Link Distance (m)	86.1				108.8	89.0
Travel Time (s)	6.2				7.8	10.7
Confl. Peds. (#/hr)	20		20			
Confl. Bikes (#/hr)	10			5		
Peak Hour Factor	1.00	1.00	1.00	1.00	1.00	1.00
Heavy Vehicles (%)	3%	1%	1%	3%	1%	1%
Adj. Flow (vph)	441	13	22	557	12	17
Shared Lane Traffic (%)						
Lane Group Flow (vph)	454	0	0	579	29	0
Enter Blocked Intersection	No	No	No	No	No	No
Lane Alignment	Left	Right	Left	Left	Left	Right
Median Width(m)	4.0				4.0	4.0
Link Offset(m)	0.0				0.0	0.0
Crosswalk Width(m)	5.0				5.0	5.0
Two way Left Turn Lane						
Headway Factor	1.16	1.16	1.16	1.16	1.16	1.16
Turning Speed (k/h)	14		24	24		14
Sign Control	Free			Free	Stop	

Intersection Summary

Area Type: CBD

Control Type: Unsignalized

Intersection Capacity Utilization 65.3% ICU Level of Service C

Analysis Period (min) 15



Lane Group	EBL	EBR	NBL	NBT	SBT	SBR
Lane Configurations						
Traffic Volume (vph)	0	2	3	42	30	0
Future Volume (vph)	0	2	3	42	30	0
Ideal Flow (vphpl)	1800	1800	1800	1800	1800	1800
Lane Util. Factor	1.00	1.00	1.00	1.00	1.00	1.00
Ped Bike Factor						
Frt	0.865					
Flt Protected				0.997		
Satd. Flow (prot)	0	1449	0	1670	1675	0
Flt Permitted	0.997					
Satd. Flow (perm)	0	1449	0	1670	1675	0
Link Speed (k/h)	30			30		30
Link Distance (m)	66.2			190.5		62.0
Travel Time (s)	7.9			22.9		7.4
Confl. Peds. (#/hr)				20		20
Confl. Bikes (#/hr)	5			5		
Peak Hour Factor	1.00	1.00	1.00	1.00	1.00	1.00
Heavy Vehicles (%)	1%	1%	1%	1%	1%	1%
Adj. Flow (vph)	0	2	3	42	30	0
Shared Lane Traffic (%)						
Lane Group Flow (vph)	0	2	0	45	30	0
Enter Blocked Intersection	No	No	No	No	No	No
Lane Alignment	Left	Right	Left	Left	Left	Right
Median Width(m)	0.0			0.0		0.0
Link Offset(m)	0.0			0.0		0.0
Crosswalk Width(m)	5.0			5.0		5.0
Two way Left Turn Lane						
Headway Factor	1.16	1.16	1.16	1.16	1.16	1.16
Turning Speed (k/h)	24	14	24			14
Sign Control	Stop			Free		Free

Intersection Summary

Area Type: CBD

















Control Type: Unsignalized

Intersection Capacity Utilization 18.2% ICU Level of Service A

Analysis Period (min) 15

















3: Athlone & Scott
PM Peak Hour

2026 Scott Street
2031 Total Traffic

												
Lane Group	EBL	EBT	EBR	WBL	WBT	WBR	NBL	NBT	NBR	SBL	SBT	SBR
Lane Configurations												
Traffic Volume (vph)	8	428	8	20	564	0	1	0	38	0	0	0
Future Volume (vph)	8	428	8	20	564	0	1	0	38	0	0	0
Ideal Flow (vphpl)	1800	1800	1800	1800	1800	1800	1800	1800	1800	1800	1800	1800
Lane Util. Factor	1.00	1.00	1.00	1.00	1.00	1.00	1.00	1.00	1.00	1.00	1.00	1.00
Ped Bike Factor												
Frt		0.998						0.868				
Flt Protected		0.999			0.998			0.999				
Satd. Flow (prot)	0	1626	0	0	1656	0	0	1453	0	0	846	0
Flt Permitted		0.999			0.998			0.999				
Satd. Flow (perm)	0	1626	0	0	1656	0	0	1453	0	0	846	0
Link Speed (k/h)		50			50			30			50	
Link Distance (m)		108.8			84.2			62.0			54.4	
Travel Time (s)		7.8			6.1			7.4			3.9	
Confl. Peds. (#/hr)	140		20	20		140	90		10	10		90
Confl. Bikes (#/hr)			5			25			5			
Peak Hour Factor	1.00	1.00	1.00	1.00	1.00	1.00	1.00	1.00	1.00	1.00	1.00	1.00
Heavy Vehicles (%)	100%	2%	1%	1%	2%	100%	1%	100%	1%	100%	100%	100%
Adj. Flow (vph)	8	428	8	20	564	0	1	0	38	0	0	0
Shared Lane Traffic (%)												
Lane Group Flow (vph)	0	444	0	0	584	0	0	39	0	0	0	0
Enter Blocked Intersection	No	No	No	No	No	No	No	No	No	No	No	No
Lane Alignment	Left	Left	Right	Left	Left	Right	Left	Left	Right	Left	Left	Right
Median Width(m)		0.0			0.0			0.0			0.0	
Link Offset(m)		0.0			0.0			0.0			0.0	
Crosswalk Width(m)		5.0			5.0			5.0			5.0	
Two way Left Turn Lane												
Headway Factor	1.16	1.16	1.16	1.16	1.16	1.16	1.16	1.16	1.16	1.16	1.16	1.16
Turning Speed (k/h)	24		14	24		14	24		14	24		14
Sign Control		Free			Free			Stop			Stop	
Intersection Summary												
Area Type:	CBD											
Control Type:	Unsignalized											
Intersection Capacity Utilization 66.8%	ICU Level of Service C											
Analysis Period (min) 15												

4: Tweedsmuir & Scott
PM Peak Hour

2026 Scott Street
2031 Total Traffic

												
Lane Group	EBL	EBT	EBR	WBL	WBT	WBR	NBL	NBT	NBR	SBL	SBT	SBR
Lane Configurations												
Traffic Volume (vph)	0	433	7	14	484	5	10	0	30	5	0	1
Future Volume (vph)	0	433	7	14	484	5	10	0	30	5	0	1
Ideal Flow (vphpl)	1800	1800	1800	1800	1800	1800	1800	1800	1800	1800	1800	1800
Lane Util. Factor	1.00	1.00	1.00	1.00	1.00	1.00	1.00	1.00	1.00	1.00	1.00	1.00
Ped Bike Factor												
Frt		0.998			0.999			0.899			0.977	
Flt Protected					0.999			0.988			0.960	
Satd. Flow (prot)	0	1672	0	0	1625	0	0	1488	0	0	793	0
Flt Permitted					0.999			0.988			0.960	
Satd. Flow (perm)	0	1672	0	0	1625	0	0	1488	0	0	793	0
Link Speed (k/h)		50			50			50			50	
Link Distance (m)		84.2			67.4			275.0			51.7	
Travel Time (s)		6.1			4.9			19.8			3.7	
Confl. Peds. (#/hr)	240		30	30		240	10		200	200		10
Confl. Bikes (#/hr)			5			20			5			
Peak Hour Factor	1.00	1.00	1.00	1.00	1.00	1.00	1.00	1.00	1.00	1.00	1.00	1.00
Heavy Vehicles (%)	100%	1%	1%	1%	3%	100%	1%	1%	1%	100%	100%	100%
Adj. Flow (vph)	0	433	7	14	484	5	10	0	30	5	0	1
Shared Lane Traffic (%)												
Lane Group Flow (vph)	0	440	0	0	503	0	0	40	0	0	6	0
Enter Blocked Intersection	No	No	No	No	No	No	No	No	No	No	No	No
Lane Alignment	Left	Left	Right	Left	Left	Right	Left	Left	Right	Left	Left	Right
Median Width(m)		0.0			0.0			0.0			0.0	
Link Offset(m)		0.0			0.0			0.0			0.0	
Crosswalk Width(m)		5.0			5.0			5.0			5.0	
Two way Left Turn Lane												
Headway Factor	1.16	1.16	1.16	1.16	1.16	1.16	1.16	1.16	1.16	1.16	1.16	1.16
Turning Speed (k/h)	24		14	24		14	24		14	24		14
Sign Control		Free			Free			Stop			Stop	
Intersection Summary												
Area Type:	CBD											
Control Type:	Unsignalized											
Intersection Capacity Utilization 63.6%	ICU Level of Service B											
Analysis Period (min)	15											