

**Servicing and Stormwater
Management Brief –
Wellings of Stittsville Phase 2,
20 Cedarow Court**

Project # 160401511



Prepared for:
Nautical Lands Group

Prepared by:
Stantec Consulting Ltd.

September 1, 2023

Revision	Description	Author		Quality Check	
1	Issued for Review	2020-05-19	TR	2020-05-20	DT
2	Issued for Review	2021-08-30	TR	2021-08-31	DT
3	Issued for Review	2022-03-29	DT	2022-03-29	PM
4	Issued for Review	2022-07-14	DT	2022-07-14	PM
5	Revised Site Plan	2022-09-21	DT	2022-09-21	PM
6	Issued for Review	2023-06-28	DT	2023-06-30	PM
7	Final	2023-09-01	DT	2023-09-01	PM

Sign-off Sheet

This document entitled Servicing and Stormwater Management Brief – Wellings of Stittsville Phase 2, 20 Cedarow Court was prepared by Stantec Consulting Ltd. ("Stantec") for the account of Nautical Lands Group. (the "Client"). Any reliance on this document by any third party is strictly prohibited. The material in it reflects Stantec's professional judgment in light of the scope, schedule and other limitations stated in the document and in the contract between Stantec and the Client. The opinions in the document are based on conditions and information existing at the time the document was published and do not take into account any subsequent changes. In preparing the document, Stantec did not verify information supplied to it by others. Any use which a third party makes of this document is the responsibility of such third party. Such third party agrees that Stantec shall not be responsible for costs or damages of any kind, if any, suffered by it or any other third party as a result of decisions made or actions taken based on this document.

Prepared by  _____
(signature)

Dustin Thiffault, P.Eng.

Reviewed by  _____
(signature)

Peter Moroz, P.Eng.

**SERVICING AND STORMWATER MANAGEMENT BRIEF –
WELLINGS OF STITTSVILLE PHASE 2, 20 CEDAROW COURT**

September 1, 2023

Table of Contents

1.0 INTRODUCTION 1.4

2.0 BACKGROUND 2.1

3.0 WATER SUPPLY SERVICING 3.1

3.1 BACKGROUND 3.1

3.2 WATER DEMANDS 3.1

3.3 PROPOSED SERVICING 3.2

3.4 SUMMARY OF FINDINGS 3.2

4.0 WASTEWATER SERVICING 4.1

4.1 BACKGROUND 4.1

4.2 DESIGN CRITERIA 4.1

4.3 PROPOSED SERVICING 4.1

5.0 STORMWATER MANAGEMENT 5.1

5.1 OBJECTIVES 5.1

5.2 SWM CRITERIA AND CONSTRAINTS 5.1

5.2.1 Pre-Development Conditions 5.2

5.3 STORMWATER MANAGEMENT DESIGN 5.3

5.3.1 Design Methodology 5.3

5.3.2 Modeling Rationale 5.4

5.3.3 Input Parameters 5.6

5.3.4 Model Results 5.10

5.3.5 Water Quality Control 5.13

6.0 GRADING AND DRAINAGE 6.1

7.0 UTILITIES 7.1

8.0 APPROVALS 8.1

9.0 EROSION CONTROL DURING CONSTRUCTION 9.1

10.0 GEOTECHNICAL INVESTIGATION 10.1

11.0 CONCLUSIONS 11.1

11.1 WATER SERVICING 11.1

11.2 SANITARY SERVICING 11.1

11.3 STORMWATER SERVICING 11.1

11.4 GRADING 11.1

11.5 UTILITIES 11.1

11.6 APPROVALS/PERMITS 11.2

**SERVICING AND STORMWATER MANAGEMENT BRIEF –
WELLINGS OF STITTSVILLE PHASE 2, 20 CEDAROW COURT**

September 1, 2023

LIST OF TABLES

Table 1: General Subcatchment Parameters5.6
Table 2: Subcatchment Parameters.....5.7
Table 3: Storage Node Parameters5.8
Table 4: Outlet/Orifice Parameters.....5.9
Table 5: Site Peak Discharge Rates.....5.11
Table 6: Schedule of Roof Release Rates5.12
Table 7: Maximum Surface Water Depths5.12
Table 8: Recommended Pavement Structure – At-Grade Parking Areas 10.1
Table 9: Recommended Pavement Structure – Access Lanes and Heavy Truck Parking
Areas 10.2

LIST OF FIGURES

Figure 1 Location Plan..... 1.4
Figure 2: Schematic Representing Model Object Roles.....5.5

**SERVICING AND STORMWATER MANAGEMENT BRIEF –
WELLINGS OF STITTSVILLE PHASE 2, 20 CEDAROW COURT**

September 1, 2023

LIST OF APPENDICES

APPENDIX A	WATER SUPPLY SERVICING	A.1
A.1	Domestic Water Demand Estimate	A.1
A.2	Fire Flow Requirements Per FUS	A.2
A.3	Boundry Conditions	A.3
APPENDIX B	WASTEWATER SERVICING	B.1
B.1	Sanitary Sewer Design	B.1
B.2	Sanitary Excerpts from the KWMSS.....	B.1
APPENDIX C	STORMWATER MANAGEMENT	C.1
C.1	Storm Sewer Design Sheet And Roof Storage Calculations.....	C.1
C.2	SAMPLE PCSWMM Model Input (12HR 100YR SCS)	C.2
C.3	SAMPLE PCSWMM Model Output (12HR 100yr SCS).....	C.3
C.4	Oil/Grit Separator Sizing Calculations.....	C.4
C.5	Cedarow Court Storm Sewer Capacity	C.5
C.6	Excerpts from WOS Phase 1	C.6
C.7	Water Balance Calculations	C.7
APPENDIX D	GEOTECHNICAL INVESTIGATION	D.1
APPENDIX E	DRAWINGS.....	E.1

SERVICING AND STORMWATER MANAGEMENT BRIEF – WELLINGS OF STITTSVILLE PHASE 2, 20 CEDAROW COURT

Introduction
September 1, 2023

1.0 INTRODUCTION

Stantec Consulting Ltd. has been commissioned by Nautical Land Group to prepare the following servicing study in support of the development at 20 Cedarow Court located within the City of Ottawa. The subject property is located northwest of the intersection of Huntmar Road and Hazeldean Road. The property location is indicated in **Figure 1**. The proposed mixed use residential and commercial development comprises approximately 2.29ha of land and proposes construction of a 344 unit, six storey mixed use building (Phase 2 and 3), and one level of underground parking. The site will be constructed in two phases, beginning with building phase 2 along the eastern property line of the development. The intent of this report is to provide a servicing scenario for the site that is free of conflicts, provides on-site servicing in accordance with City of Ottawa design guidelines, and utilizes the existing local infrastructure in accordance with the guidelines outlined in background documents, and as per consultation with City of Ottawa.

Figure 1 Location Plan



SERVICING AND STORMWATER MANAGEMENT BRIEF – WELLINGS OF STITTSVILLE PHASE 2, 20 CEDAROW COURT

Background
September 1, 2023

2.0 BACKGROUND

Documents referenced in preparing the site design for the 20 Cedarow Court Development include:

- Kanata West Master Servicing Study, Stantec Consulting Ltd., Cumming Cockburn Limited / IBI, October 1, 2014.
- Carp River PCSWMM Model Documentation Draft Report, City of Ottawa, March 2016.
- Geotechnical Investigation, Proposed Mixed Use Development Wellings of Stittsville – Phase 2 20 Cedarow Court, Ottawa, Ontario, Paterson Group, March 7, 2019.
- Geotechnical Plan Review, Proposed Mixed Use Development Wellings of Stittsville – Phase 2 20 Cedarow Court, Ottawa, Ontario, Paterson Group, August 12, 2021.
- Servicing and Stormwater Management Brief-5731 Hazeldean Road, Stantec Consulting Ltd., March 22, 2017
- Tree Conservation Report – 5731 Hazeldean Road, IFS Associates, March 11, 2016.
- City of Ottawa Sewer Design Guidelines, City of Ottawa, October 2012.f
- City of Ottawa Design Guidelines – Water Distribution, City of Ottawa, July 2010.

SERVICING AND STORMWATER MANAGEMENT BRIEF – WELLINGS OF STITTSVILLE PHASE 2, 20 CEDAROW COURT

Water Supply Servicing
September 1, 2023

3.0 WATER SUPPLY SERVICING

3.1 BACKGROUND

The proposed development comprises one phased mixed-use residential apartment building with commercial space fronting Hazeldean Road, and complete with associated infrastructure and underground parking. The site is located west of Huntmar Drive, north of Hazeldean Road, and south of Poole Creek, and lies within the City's 3W pressure zone. The site will be serviced at two connection points via a proposed 200mm diameter tee connection to the existing 250mm main within the northern continuation of the Fringewood Avenue ROW at the eastern quadrant of the site, and a 300mm diameter connection to the existing 300mm diameter watermain within Cedarow Court along the western boundary of the site. Two building service connections for redundancy are proposed to the existing main and water stub at Fringewood Avenue, which in turn connects directly to the existing 762mm feedermain within Hazeldean Road immediately south of the site.

Site development additionally includes a proposed underground pedestrian connection between the adjacent property to the east to the 20 Cedarow Court building. The proposed tunnel location is in conflict with a portion of the existing 250mm main. It is proposed to deflect a portion of the 250mm main (approximately 13m in length) below the proposed underground link, and sleeve the watermain within a 400mm diameter steel casing as indicated on **Drawing SSP-1**. Any reduction in available capacity due to proposed minor watermain deflection is expected to be negligible.

3.2 WATER DEMANDS

Water demands for the development were estimated using the Ministry of Environment's Design Guidelines for Drinking Water Systems (2008) and the Ottawa Design Guidelines – Water Distribution (2010). A daily rate of 28,000 L/gross ha/day has been applied for commercial building space, whereas the residential facility demand was estimated at 280L/person/day with an estimated population of 1.4 persons/unit for bachelor or one bedroom apartments, and 2.1 persons/unit for two bedroom apartments. See **Appendix A.1** for detailed domestic water demand estimates.

The average day demand (AVDY) for the entire site was determined to be 1.7 L/s. The maximum daily demand (MXDY) is 1.5 times the AVDY for commercial property demand and 2.5 times the AVDY for residential demand, which equates to 4.3 L/s. The peak hour demand (PKHR) is 1.8 times the MXDY for commercial property and 2.2 times the MXDY for residential properties, totaling 9.4 L/s.

Non-combustible construction with 2-hour fire rated structural members were considered in the assessment of the fire flow requirements for the site according to the FUS Guidelines. The FUS

SERVICING AND STORMWATER MANAGEMENT BRIEF – WELLINGS OF STITTSVILLE PHASE 2, 20 CEDAROW COURT

Water Supply Servicing
September 1, 2023

Guidelines indicate that low hazard occupancies include apartments, dwellings, dormitories, hotels, and schools, and as such, a low hazard occupancy / limited combustible building contents credit was applied. A sprinkler system conforming to NFPA 13 was considered, and a credit applied per FUS Guidelines. Based on calculations per the FUS Guidelines (**Appendix A.2**), the maximum required fire flows for this development is 200 L/s (12,000 L/min). An additional hydrant located in proximity to the building siamese connection is proposed on the subject site. The existing hydrants along the northeastern boundary in addition to the proposed on-site hydrant will provide ample fire flow to support the development.

3.3 PROPOSED SERVICING

Per boundary conditions provided by the City of Ottawa and an approximate elevation on-site of 104.7m, adequate domestic water supply is available for the subject site with pressures ranging from 44.9m (75.4psi) to 56.4m (80.3psi). These values are within the normal operating pressure range as defined by the MECP and City of Ottawa design guidelines (desired 50-80 psi and not less than 40 psi). A pressure check once construction is completed is required to determine if pressure reducing valves are needed.

The boundary conditions for the proposed development under maximum day demands were initially provided under an assumed fire flow demand of 267L/s. As such, it can be confirmed that the system will maintain a residual pressure which is in excess of the required 140 kPa (20 psi) under the required fire flow demand of 200L/s. The above demonstrates that the existing watermain within Fringewood Avenue and Cedarow Court can provide adequate fire and domestic flows in excess of flow requirements for the subject site. An existing hydrant is located approximately 18m northeast of the subject site and at least one proposed hydrant is to be located within 45m of the building fire department connection (siamese) per OBC requirements.

3.4 SUMMARY OF FINDINGS

The proposed development is located in an area of the City's water distribution system that has sufficient capacity to provide both the required domestic and emergency fire flows. Based on the boundary conditions as provided by the City of Ottawa staff, fire flows are available for this development based on FUS guidelines and as per the City of Ottawa water distribution guidelines.

SERVICING AND STORMWATER MANAGEMENT BRIEF – WELLINGS OF STITTSVILLE PHASE 2, 20 CEDAROW COURT

Wastewater Servicing
September 1, 2023

4.0 WASTEWATER SERVICING

4.1 BACKGROUND

The site will be serviced via an existing 675mm dia. sanitary sewer located within the Hazeldean Road ROW south of the site and west of the intersection of Hazeldean Road and Huntmar Drive, which will ultimately outlet to the Kanata West Pump Station (see **Drawing SSP-1**).

4.2 DESIGN CRITERIA

As outlined in the City of Ottawa Sewer Design Guidelines and the MECP's Design Guidelines for Sewage Works, the following criteria were used to calculate estimated wastewater flow rates and to size the sanitary sewers:

- Minimum Velocity – 0.6 m/s (0.8 m/s for upstream sections)
- Maximum Velocity – 3.0 m/s
- Manning roughness coefficient for all smooth wall pipes – 0.013
- Minimum size – 250mm dia. for commercial areas
- Average Wastewater Generation (Commercial) – 28,000L/gross ha/day of building space
- Average Wastewater Generation (Residential) – 280L/cap/day
- Peak Factor (Commercial) – 1.5 (Max Day Demand per MOE Design Guidelines for Drinking Water Systems)
- Peak Factor (Residential) – 4.0 (Harmon's)
- Extraneous Flow Allowance – 0.33 l/s/ha (conservative value)
- Manhole Spacing – 120 m
- Minimum Cover – 2.5m
- Population density for single-bedroom and bachelor apartments – 1.4 pers./apartment
- Population density for two-bedroom apartments – 2.1 pers./apartment

4.3 PROPOSED SERVICING

The proposed site will be serviced by a gravity sewer which will direct the wastewater flows (approx. 7.5 L/s with allowance for infiltration) to the existing 675mm dia. Hazeldean Road sanitary sewer. A backflow preventer will be required for the on-site building in the event of surcharge of the sanitary sewer and will be coordinated with building mechanical engineers. A proposed excavation cross section of the Hazeldean Road connection to the existing 675mm diameter sanitary sewer has been included on **Drawing SSP-1**. Extra precaution should be taken to ensure no damages are made to the existing 762 backbone watermain located 2.9m south of the proposed sanitary connection. Additional construction details will be included by the contractor prior to construction.

SERVICING AND STORMWATER MANAGEMENT BRIEF – WELLINGS OF STITTSVILLE PHASE 2, 20 CEDAROW COURT

Wastewater Servicing
September 1, 2023

The proposed drainage pattern is in accordance with the Kanata West Master Servicing Study (KWMSS) for Hazeldean Road and is detailed on **Drawing SAN-1**. Sanitary flows will ultimately be discharging to the downstream Kanata West Pump Station. A Sanitary sewer design sheet is included in **Appendix B.1**. Excerpts of the overall sanitary system discharging to the Kanata West Pump Station based on the KWMSS are included in **Appendix B.2**. It is noted that peak ultimate sanitary discharge to the KWPS is likely to be far lower than that indicated within the KWMSS design sheet, as current operational parameters estimating peak flow from residential uses have decreased from 350L/person/day to 280L/person/day, and commercial lands contributions have decreased from 50,000L/ha/day to 28,000L/ha/day. As a result, it is assumed that there is ample capacity within the downstream conveyance network and KWPS to receive any additional flows from that originally assumed for the area ($50,000\text{L/ha/day} \times 2.29\text{ha} \times 1.5\text{ P.F.} =$ approximately 2.0L/s). Additional confirmation of the above has been provided by City of Ottawa staff and included within **Appendix B**.

SERVICING AND STORMWATER MANAGEMENT BRIEF – WELLINGS OF STITTSVILLE PHASE 2, 20 CEDAROW COURT

Stormwater Management
September 1, 2023

5.0 STORMWATER MANAGEMENT

5.1 OBJECTIVES

The objective of this stormwater management plan is to determine the measures necessary to control the quantity of stormwater released from the proposed development to established criteria, and to provide sufficient detail for approval and construction. The proposed development will discharge treated and controlled stormwater runoff to Poole Creek.

5.2 SWM CRITERIA AND CONSTRAINTS

Criteria were established by combining current design practices outlined by the City of Ottawa Design Guidelines (2012), Ministry of Environment Conservation and Parks (MECP) and Mississippi Valley Conservation Authority (MVCA). The following summarizes the criteria, with the source of each criterion indicated in italics:

General

- Use of the dual drainage principle (City of Ottawa)
- Assess impact of 100-year event outlined in the City of Ottawa Sewer Design Guidelines, and climate change scenarios with a 20% increase of rainfall intensity, on major & minor drainage system (City of Ottawa)
- Quality control to be provided for 80% TSS removal (City of Ottawa, MECP)
- Site discharge to be controlled to pre-development rates (City of Ottawa)

Storm Sewer & Inlet Controls

- Size storm sewers to convey the 2-year storm event under free-flow conditions using City of Ottawa I-D-F parameters (City of Ottawa)
- Minimum sewer inlet capture rates to be set such that no ponding occurs at the end of the 2-year event (City of Ottawa)
- Hydraulic Grade Line (HGL) analysis to be conducted using the 100 year 12 hour SCS storm distribution (City of Ottawa)
- 100-year Storm HGL to be a minimum of 0.30 m below building foundation footing otherwise foundation drains will be pumped (City of Ottawa)

SERVICING AND STORMWATER MANAGEMENT BRIEF – WELLINGS OF STITTSVILLE PHASE 2, 20 CEDAROW COURT

Stormwater Management
September 1, 2023

Surface Storage & Overland Flow

- Building openings to be a minimum of 0.30m above the 100-year water level (City of Ottawa)
- Maximum depth of flow under either static or dynamic conditions shall be less than 0.35m (City of Ottawa)
- Subdrains required in swales where longitudinal gradient is less than 1.5% (City of Ottawa)
- Provide adequate emergency overflow conveyance off-site (City of Ottawa)

5.2.1 Pre-Development Conditions

A background report for 20 Cedarow Court Commercial Development was completed on April 6, 2009 by Novatech Engineering for the proposed property. Currently, a large portion of the site is pervious, and sheet drains northwest towards Poole Creek. Based on topography, existing drainage is directed through the site from properties on Cedarow Court adjacent to the subject lands. The additional runoff will be returned to the Cedarow Court storm sewer and was not included in the overall area contributing to the pre-development rate. The sewers on Cedarow Court were analyzed based on 2K mapping data corroborated by field investigation, and the additional flows were determined not to impact the downstream 525mm diameter storm sewer. The design sheet and area map for the Cedarow Court sewer can be found in **Appendix C.5**.

The site discharge will be conveyed to the approved outlet located at the northwestern boundary of the subject site. The outlet was constructed as part of Wellings of Stittsville Inc. and Extendicare Inc. Phase 1 and was sized to convey flows from both sites. Excerpts from the Wellings of Stittsville Phase 1 servicing and stormwater management brief can be found in **Appendix C.6**.

A lumped catchment PCSWMM model was created for the subject site based on a site area of 2.3ha, and utilizing an existing SCS curve number of 82 per background documents (Carp River Full Restoration PCSWMM Model). Additional subcatchment parameters were defined based upon recent topographical survey of the property:

Area (ha)	Width (m)	Slope (%)	Imperv. (%)	Subarea Routing
2.29	143	1.0	0.0	Outlet

Based on the above, 2 through 100-year 12hr SCS event (MTO Distribution curves) peak pre-development outflow rates from the subject site were identified per the tables below:

SERVICING AND STORMWATER MANAGEMENT BRIEF – WELLINGS OF STITTSVILLE PHASE 2, 20 CEDAROW COURT

Stormwater Management
September 1, 2023

Storm Event	Peak Outflow Rate (L/s)
2-Year	17.9
5-Year	43.4
10-Year	69.8
25-Year	111.6
50-Year	142.4
100-Year	182.1

PCSWMM model input and output files for the predevelopment scenario are included within **Appendix C**.

5.3 STORMWATER MANAGEMENT DESIGN

5.3.1 Design Methodology

The intent of the stormwater management plan presented herein is to mitigate negative impacts that the proposed development might have on the receiving watercourse (Poole Creek), while providing adequate capacity to service the proposed buildings, underground parking and access areas. The proposed stormwater management plan is designed to detain runoff on available flat rooftops, surface storage within parking regions, and in a subsurface storage unit to ensure that peak flows after construction will not exceed the target discharge rates.

Runoff from the site is captured via catchbasins and roof drains and conveyed to a hydrodynamic separator for water quality treatment before entering an underground storage unit for quantity control. The storage unit is restricted by ICDs and a flow control weir at the downstream end while the roof runoff is controlled via roof drains discharging through the internal building plumbing. A StormTech system is proposed to provide subsurface storage in addition to meeting water balance requirements. The StormTech unit is required to store up to 485m³ of runoff above the clear stone bedding layer which is situated below the lowest connected ICD invert. The underground storage unit is sized assuming that roof areas are available to capture and store water up to 150mm in depth during the 100-year storm event.

In case of subsurface storage tank failure, overflows are managed via installed weir wall within STM 101 to address orifice blockage. Each cell of the StormTech unit is interconnected to prevent blockage of a cell from impacting the overall unit, and each cell is open to infiltration to soils below.

The proposed hydrodynamic separator maintains an internal overflow weir for large storm events for protection of building internal plumbing, and will not impede inflow to the downstream storage unit.

SERVICING AND STORMWATER MANAGEMENT BRIEF – WELLINGS OF STITTSVILLE PHASE 2, 20 CEDAROW COURT

Stormwater Management
September 1, 2023

The site discharge will be conveyed to the previously approved outlet location at the western boundary of the site which ultimately directs flow into Poole Creek. The existing outlet is designed to convey flows from the proposed site as well as the existing adjacent site to the northeast, Wellings of Stittsville Inc. and Extencicare Inc. Phase 1.

The site will be constructed in two phases, including build out of the underground parking structure. As the first phase is built, the entirety of the StormTech unit will be constructed.

Site development additionally includes a proposed underground pedestrian connection between the adjacent property to the east to the 20 Cedarow Court building. Two existing catch basins and one storm manhole lie near or within the required area for the pedestrian connection. The manhole is proposed to be relocated northwards approximately 3.7m to accommodate pathway construction. One catch basin (EX CB 500) along with its accompanying and previously installed ICD is proposed to be relocated north of the pedestrian connection. The capture area for CB 500 is proposed to be regraded to allow the catch basin to maintain identical top of grate and connected invert elevations, as well as maintain surface ponding regions as per the original design drawings for lands to the north. EX CB 502 on the western side of the access way is also proposed to be relocated, however, the catch basin does not currently have an ICD installed, and is anticipated to receive additional flows from uncontrolled runoff from areas immediately east of the 20 Cedarow building. A new ICD is proposed for the catch basin to limit inflows as described in sections below.

5.3.2 Modeling Rationale

A comprehensive hydrologic modeling exercise was completed with PCSWMM, accounting for the estimated major and minor systems to evaluate the storm sewer infrastructure. The use of PCSWMM for modeling of the site hydrology and hydraulics allowed for an analysis of the systems response during various storm events. Surface storage estimates were based on the final grading plan design (see **Drawing GP-1**). The following assumptions were applied to the detailed model:

- Hydrologic parameters as per Ottawa Sewer Design Guidelines, including Horton infiltration, Manning's 'n', and depression storage values
- 12-hour SCS Storm distribution for the 100-year analysis to model 'worst-case' scenario in regards to on-site storage volume.
- 12hr SCS distributions (2 and 100-year events) with free flowing boundary condition to model 'worst-case' scenario in regards to site discharge rates to meet target rate. It is of note that the 100-Year floodplain elevation of the Creek at the site discharge point will not affect upstream HGLs or storage volumes provided.
- To 'stress test' the system a 'climate change' scenario was created by adding 20% of the individual intensity values of the 100-year SCS storm event at their specified time step.

SERVICING AND STORMWATER MANAGEMENT BRIEF – WELLINGS OF STITTSVILLE PHASE 2, 20 CEDAROW COURT

Stormwater Management
September 1, 2023

- Percent imperviousness calculated based on actual soft and hard surfaces on each subcatchment, converted to equivalent Runoff Coefficient using the relationship $C = (\text{Imp.} \times 0.7) + 0.2$
- Subcatchment areas are defined from high-point to high-point where sags occur. Subcatchment width (average length of overland sheet flow) determined by dividing subcatchment area by subcatchment length (length of overland flow path measured from high-point to high-point).
- Number of catchbasins based on servicing plan (**Drawing SP-1**)

5.3.2.1 SWMM Dual Drainage Methodology

The proposed site is modeled in one modeling program as a dual conduit system (see **Figure 2**), with: 1) circular conduits representing the sewers & junction nodes representing manholes; 2) irregular conduits using street-shaped cross-sections to represent the sawtoothed overland road network from high-point to low-point and storage nodes representing catchbasins. The dual drainage systems are connected via outlet link objects (or orifices) from storage node (i.e. CB) to junction (i.e. MH), and represent inlet control devices (ICDs). Subcatchments are linked to the storage node on the surface so that generated hydrographs are directed there firstly.

Figure 2: Schematic Representing Model Object Roles

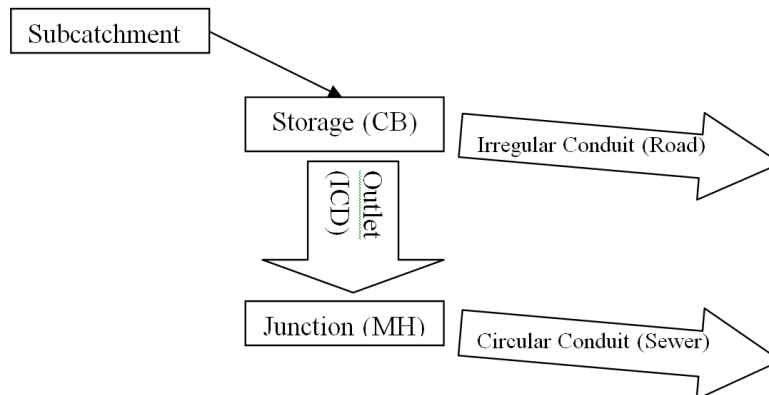

Storage nodes are used in the model to represent catchbasins as well as major system junctions. For storage nodes representing catchbasins (CBs), the invert of the storage node represents the invert of the CB and the rim of the storage node is the top of the CB plus the maximum above ground storage depth (all catch basins on top of the underground structure will not have any surface storage). An additional depth has been added to rim elevations to allow routing from one surface storage to the next and is unused where no spillage occurs between ponding areas.

Inlet control devices, as represented by orifice links, use a user-specified discharge coefficient to approximate manufacturer's specifications for the chosen ICD model. Discharge rates from the

SERVICING AND STORMWATER MANAGEMENT BRIEF – WELLINGS OF STITTSVILLE PHASE 2, 20 CEDAROW COURT

Stormwater Management
September 1, 2023

rooftops are based on the quantity of roof drains provided in the site plan per roof level. The roof drains are modelled using outlets with rating curves which specifies the outflows per roof level.

Subcatchment imperviousness was calculated via impervious area measured from **Drawing SSP-1**.

5.3.2.2 Boundary Conditions

The detailed PCSWMM hydrology and the proposed storm sewers were used to assess the peak inflows and hydraulic grade line (HGL) for the site. The elevation of the outlet sewer downstream of STM 100 immediately upstream of Poole Creek has been set conservatively to be above the 100-Year water elevation of the Creek per MVCA Flood Risk Mapping at an invert elevation of 99.83m to enable free-flowing model condition for the site outlet. The elevation of the water level within Cedarow Court was conservatively set to an obvert of the receiving sewer at 102.17m.

5.3.3 Input Parameters

Drawing SD-1 summarizes the discretized subcatchments used in the analysis of the proposed site, and outlines the major overland flow paths. The grading plans are also enclosed for review.

Appendices C2 and C3 summarize the modeling input parameters and results for the subject area; an example input and output file are provided for the 2-year and 100-year 12hr SCS storm. For all other input files and results of storm scenarios, please examine the electronic model files provided with this report. This analysis was performed using PCSWMM, which is a front-end GUI to the EPA-SWMM engine. Model files can be examined in any program which can read EPA-SWMM files version 5.1.015.

5.3.3.1 Hydrologic Parameters

Table 1 presents the general subcatchment parameters used:

Table 1: General Subcatchment Parameters

Parameter	Value
Infiltration Method	Horton
Max. Infil. Rate (mm/hr)	76.2
Min. Infil. Rate (mm/hr)	13.2
Decay Constant (1/hr)	4.14
N Impervious	0.013
N Pervious	0.25
Dstore Imperv. (mm)	1.57

**SERVICING AND STORMWATER MANAGEMENT BRIEF –
WELLINGS OF STITTSVILLE PHASE 2, 20 CEDAROW COURT**

Stormwater Management
September 1, 2023

Dstore perv. (mm)	4.67
Zero Imperv. (%)	0

Table 2 presents the individual parameters that vary for each of the proposed subcatchments. Subcatchment parameters for the existing catchment area for EX CB 502 (here identified as area L502A) have been sourced from the approved development plans for the Wellings development to the east.

Table 2: Subcatchment Parameters

Name	Outlet	Area (ha)	Width (m)	Slope (%)	Imperv. (%)
EXT-1	105	0.069	95	1.5	38.57
L102A	CB102A-1	0.061	19	2.5	82.86
L103A	CB103A-1	0.156	28	2.5	75.71
L103B	CB103B-1	0.059	29	2.5	80.00
L103C	CB103C-1	0.072	30	2.5	71.43
L103D	CB103D-1	0.239	32	2.5	65.71
L103E	CB103E-1	0.237	21	2.5	72.86
L104A	104	0.068	39	2.5	82.86
L104B	104	0.059	25	2.5	80.00
L106A	CB106A-1	0.142	27	2.5	77.14
L502A	EX502	0.037	88	0.8	100.00
L502B	EX502	0.084	95	25	41.43
RAMP	BLDG	0.022	8	15.0	100.00
ROOF2	ROOF2-S	0.220	50	1.5	100.00
ROOF1	ROOF1-S	0.020	5	1.5	100.00
ROOF3	ROOF3-S	0.185	42	1.5	100.00
ROOF4	ROOF4-S	0.020	5	1.5	100.00
UNC-2	POOLE	0.526	25	1.0	8.57
UNC-3	OF3	0.069	126	3.0	61.43
UNC-4	105	0.052	90	10.0	37.14

Table 3 summarizes the storage node parameters used in the model. Storage curves for each node have been created based on available volumes within each roof top or subsurface storage as applicable. Rim elevations for each node correspond to the rim elevation of the associated area's roof top drain or catch basin plus maximum depth of storage. No quantity

**SERVICING AND STORMWATER MANAGEMENT BRIEF –
WELLINGS OF STITTSVILLE PHASE 2, 20 CEDAROW COURT**

Stormwater Management
September 1, 2023

storage has been assumed for model conservatism for the subsurface storage clear stone bedding below pipe inverts being utilized as a water balance BMP described in **Section 5.3.6**.

Required storage volumes and release rates for the underground storage unit were obtained through PCSWMM hydrologic/hydraulic modeling:

Table 3: Storage Node Parameters

Name	Invert El. (m)	Rim Elev. (m)	Depth (m)	Curve Name	Storage Curve
100	99.90	103.70	3.80	*	FUNCTIONAL
101	101.39	104.14	2.74	*	FUNCTIONAL
102	101.90	104.33	2.43	*	FUNCTIONAL
103	102.13	104.07	1.94	*	FUNCTIONAL
104	102.61	104.10	1.49	CB104A-V	TABULAR
105	102.68	104.51	1.83	*	FUNCTIONAL
ADS	101.37	103.70	2.33	TANK-V	TABULAR
BLDG	102.78	104.69	1.91	*	FUNCTIONAL
CB102A-1	102.89	104.19	1.30	CB102A-V	TABULAR
CB103A-1	103.07	104.60	1.53	CB103A-V	TABULAR
CB103B-1	102.42	104.10	1.68	CB103B-V	TABULAR
CB103C-1	102.70	104.30	1.60	CB103C-V	TABULAR
CB103D-1	102.62	104.28	1.66	CB103D-V	TABULAR
CB103E-1	102.43	104.11	1.68	CB103E-V	TABULAR
CB106A-1	101.97	103.65	1.68	CB106A-V	TABULAR
EX	99.61	101.69	2.08	*	FUNCTIONAL
EX502	102.02	104.22	2.20	EX502-V	TABULAR
ROOF1-S	110.00	110.15	0.15	ROOF1-V	TABULAR
ROOF2-S	110.00	110.15	0.15	ROOF2-V	TABULAR
ROOF3-S	110.00	110.15	0.15	ROOF3-V	TABULAR
ROOF4-S	110.00	110.15	0.15	ROOF4-V	TABULAR

5.3.3.2 Hydraulic Parameters

As per the Ottawa Sewer Design Guidelines (OSDG 2012), Manning's roughness values of 0.013 were used for sewer modeling.

Storm sewers were modeled to confirm flow capacities and hydraulic grade lines (HGLs) in the proposed condition. The detailed storm sewer design sheet is included in **Appendix C**.

**SERVICING AND STORMWATER MANAGEMENT BRIEF –
WELLINGS OF STITTSVILLE PHASE 2, 20 CEDAROW COURT**

Stormwater Management
September 1, 2023

PCSWMM output hydrographs from Phase 1 for each storm event were applied at the downstream connecting manhole (EX) in the current PCSWMM model to accurately represent the total outflow from both properties at the headwall.

Table 4 below presents the parameters for the orifice and outlet link objects in the model, which represent ICDs and restricted roof release drains respectively. The 200mm circular orifice was assigned a discharge coefficient of 0.61, whereas ICDs representing IPEX Tempest HF controls were assigned a discharge coefficient of 0.572 to match manufacturer discharge curves. The subsurface storage unit is designed with an 83mm Tempest ICD to restrict flows during lesser storm event, as well as a higher elevation 200mm circular orifice and an overflow weir to allow additional flows to be directed towards the outlet during larger storm events. The weir is placed in manhole structure 100 and designed with a width of 0.4m (see **Table 4** for invert elevation).

The roof release discharge curves assume the use of standard Watts Model R1100 Accutrol controlled release roof drains as noted in the calculation sheets in **Appendix C**. The number of roof notches for each roof level was confirmed with the building mechanical engineer. Details for the IPEX ICDs and Watts drains are included as part of **Appendix C**.

Table 4: Outlet/Orifice Parameters

Name	Inlet	Outlet	Inlet Elev.	Type	Diameter (m)
100-O1	ADS	100	101.37	CIRCULAR	0.083
100-O2	ADS	100	102.25	CIRCULAR	0.200
100-W1	ADS	100	103.00	WEIR	0.4 (Width)
CB102A-O	CB102A-1	102	102.89	CIRCULAR	0.102
CB103A-O	CB103A-1	103	103.07	CIRCULAR	0.178
CB103B-O	CB103B-1	103	102.42	CIRCULAR	0.083
CB103C-O	CB103C-1	103	102.70	CIRCULAR	0.083
CB103D-O	CB103D-1	103	102.62	CIRCULAR	0.152
CB103E-O	CB103E-1	103	102.43	CIRCULAR	0.127
CB106A-O	CB106A-1	ADS	101.97	CIRCULAR	0.102
CBMH104A-O	104	103	102.61	CIRCULAR	0.102
EX502-O	EX502	OF1	102.02	CIRCULAR	0.083
105-OF4	105	OF4	102.68	CIRCULAR	0.083
W1	105	104	104.44	WEIR (ROADWAY)	6.0 (Width)
ROOF1-O	ROOF1-S	BLDG	110.00	ROOF CONTROL	*
ROOF2-O	ROOF2-S	BLDG	110.00	ROOF CONTROL	*

**SERVICING AND STORMWATER MANAGEMENT BRIEF –
WELLINGS OF STITTSVILLE PHASE 2, 20 CEDAROW COURT**

Stormwater Management
September 1, 2023

ROOF3-O	ROOF3-S	BLDG	110.00	ROOF CONTROL	*
ROOF4-O	ROOF4-S	BLDG	110.00	ROOF CONTROL	*

5.3.4 Model Results

The following section summarizes the key hydrologic and hydraulic model results. For detailed model results or inputs, please refer to the example input file in **Appendix C.2 and C.3** and the electronic model files provided.

5.3.4.1 Hydrologic Results

The following tables demonstrate the peak outflow from each modeled outfall during the design storm (12hr SCS 2-100yr) events. A free-flowing outfall condition has been modeled for these events to be conservative with respect to site peak release rates. Outfalls OF1 to OF4 denote uncontrolled flows from the perimeter of the site that, due to grading restrictions, are captured by the existing ROW on Fringewood Avenue at the eastern boundary, Poole Creek at the north boundaries of the site, Hazeldean Road to the south and Cedarow Court Row to the west.

The adjacent site on the eastern boundary (2500 Wellings Private) has sufficient capacity to capture minor uncontrolled flows from subcatchment UNC1.

Flows from area UNC3-OF will have a minimal contribution to the infrastructure within Hazeldean Road. The 450mm storm sewer that services the northerly lanes of Hazeldean Road maintains an upstream capture area of roughly 0.5ha as measured through aerial photography on GeoOttawa. Given a conservative runoff coefficient of 0.80, time of concentration of 10 minutes, and 10-year storm level of service, existing flows to the sewer are estimated at 135.7L/s. The 450mm sewer at a slope of 0.48 is expected to maintain a full flow capacity of 206.1L/s, which is more than sufficient to convey both existing flows in the sewer and runoff from area UNC3-OF, estimated at 32.8L/s during a 100-year storm event. As Hazeldean Road is equipped with numerous double catch basins to capture surface runoff, no capacity concerns are apparent based on the increase in uncontrolled runoff to the area.

Based on existing external and proposed grading, subcatchments EXT-1 and UNC-4 are proposed to drain to a swale and runoff is to be captured in the subdrain. Connection to the existing 300mm diameter storm sewer on Cedarow Court is proposed to direct the flows captured from the subdrain. The storm sewer along Cedarow Court ultimately discharges to Poole Creek upstream of the proposed site. A minimally sized ICD (83mm diameter) has been proposed to restrict minor system inflows to correspond to the 5-year storm runoff from areas EXT-1 and UNC-4 (equating to roughly 16.2L/s). Runoff from events beyond the 5-year storm is routed internally to the on-site storm sewers (specifically CB 104B-1) based on grading demonstrated on **Drawing GP-1**.

**SERVICING AND STORMWATER MANAGEMENT BRIEF –
WELLINGS OF STITTSVILLE PHASE 2, 20 CEDAROW COURT**

Stormwater Management
September 1, 2023

An 83mm orifice is proposed to be installed within existing CB 502 to limit inflows to the existing storm system. Per PCSWMM modeling of the 100yr 3hr Chicago storm event, the ICD is expected to permit peak capture rate of 18.3L/s. As the catch basin was previously uncontrolled with an assumed capture area of 0.042ha at a runoff coefficient of 0.90, existing condition capture rate for the equivalent 100-year event is 18.7L/s. As such, no additional concerns are identified for the existing storm collection system for capture of additional flows from area L502B.

Results of the PCSWMM model run have been provided in **Appendix C**. Peaks from the uncontrolled flows with the exception of UNC-2 are non-coincident with peaks from the subsurface storage unit/weir, and as such, flows from the conduit downstream of the subsurface storage unit (conduit C2) and UNC-2 have been considered in meeting the site pre-development release rate target. The required subsurface storage unit volume was determined through iteration of each event and sized to mirror the site release rate target.

Table 5: Site Peak Discharge Rates

Event	Location	Peak Discharge Rate (L/s)	Target (L/s)
2-Year 12 Hour SCS	Outlet Headwall	14.7	-
	Poole Creek	1.5	-
	Sum of Hydrographs	14.7	17.9
5-Year 12 Hour SCS	Outlet Headwall	37.8	-
	Poole Creek	6.7	-
	Sum of Hydrographs	41.5	43.4
10-Year 12 Hour SCS	Outlet Headwall	55.4	-
	Poole Creek	12.2	-
	Sum of Hydrographs	65.5	69.8
25-Year 12 Hour SCS	Outlet Headwall	77.1	-
	Poole Creek	20.1	-
	Sum of Hydrographs	92.7	111.6
50-Year 12 Hour SCS	Outlet Headwall	110.9	-
	Poole Creek	26.0	-
	Sum of Hydrographs	132.8	142.4
100-Year 12 Hour SCS	Outlet Headwall	154.9	-
	Poole Creek	32.3	-
	Sum of Hydrographs	183.9	182.1
100-Year 12 Hour SCS +20%	Outlet Headwall	193.7	-
	Poole Creek	47.5	-

**SERVICING AND STORMWATER MANAGEMENT BRIEF –
WELLINGS OF STITTSVILLE PHASE 2, 20 CEDAROW COURT**

Stormwater Management
September 1, 2023

	Sum of Hydrographs	239.1	-
--	--------------------	-------	---

*Post-development flows are a sum of the hydrographs from conduit C2 and outfall OF2

Table 6: Schedule of Roof Release Rates

Roof Area ID	Storage Depth (mm)	Discharge (L/s)	Required Volume (m3)	Available Volume (m3)
1	130	2.3	5.3	8.0
2	147	11.2	83.8	88.0
3	146	9.9	69.0	74.0
4	130	2.3	5.3	8.0

5.3.4.2 Hydraulic Results

The City of Ottawa requires that during major storm events, the maximum hydraulic grade line be kept at least 0.30 m below the underside-of-footing (USF) of any adjacent units connected to the storm sewer during design storm events. The USFs elevations have been considered at 0.5m below the lowest top of basement slab elevation of the proposed buildings. As the proposed building perimeter foundation drain will be disconnected from the storm sewer and pumped to the surface, the proposed building footings will not be hydraulically connected to the underground storage tank. The ramp drain is to be pumped to the storage unit. The maximum hydraulic grade line (HGL) of the underground storage unit reaches 103.20m and 103.26m during the 100 year and 100year +20% event. The HGL elevations in both scenarios remain below the proposed surface elevations as the lowest elevation of the connected catch basins within the aboveground parking structure are at 103.35m.

Table 7 presents the maximum total surface water depths (static ponding depth + dynamic flow) above the top-of-grate of catch basins for the worst case 100-year design storm (higher of the 3hr Chicago or 12hr SCS distribution) and climate change storm.

Table 7: Maximum Surface Water Depths

Storage node ID	Structure ID	T/G Elevation (m)	100 year		100 year +20%	
			Max HGL (m)	Total Surface Water Depth (m)	Max HGL (m)	Total Surface Water Depth (m)
CB102A-1	CB 102A-1	104.08	103.99	0.00	104.16	0.08
CB103A-1	CB 103A-1	104.45	103.86	0.00	104.28	0.00
CB103B-1	CB 103B-1	103.80	103.89	0.09	103.93	0.13

**SERVICING AND STORMWATER MANAGEMENT BRIEF –
WELLINGS OF STITTSVILLE PHASE 2, 20 CEDAROW COURT**

Stormwater Management
September 1, 2023

Storage node ID	Structure ID	T/G Elevation (m)	100 year		100 year +20%	
			Max HGL (m)	Total Surface Water Depth (m)	Max HGL (m)	Total Surface Water Depth (m)
CB103C-1	CB 103C-1	104.08	104.18	0.10	104.22	0.14
CB103D-1	CB 104D-1	104.00	104.18	0.18	104.26	0.26
CB103E-1	CB 103E-1	103.81	104.02	0.21	104.07	0.26
CB106A-1	CB 106A-1	103.35	103.51	0.16	103.55	0.20
104	CBMH 104A-1	103.80	104.05	0.25	104.1	0.30
105	CBMH 105	104.51	102.86	0.00	102.90	0.00
EX502	EX CB 502	103.96	104.17	0.21	104.22	0.26

5.3.5 Water Quality Control

On-site water quality control is required to provide 80% TSS removal prior to discharging to Poole Creek. A CDS oil/grit separator model 2025 is proposed upstream of the underground storage unit. Runoff from roof top areas are considered clean for calculation of the total treatment requirement of the contributing catchment area to the oil/grit separator. It is anticipated that control flow roof drains will provide peak flow reduction to match or exceed runoff from an equivalent pervious area (approx. 57.1L/s/ha per 100yr roof release schedule vs. 99.2L/s/ha for rational method runoff from an area with C=0.90 at Tc=10 minutes). Design calculations for the CDS unit indicate that the selected model will provide greater than 80% TSS removal on an annual basis. The CDS unit will be privately maintained. The location and general arrangement of the CDS unit is indicated on **Drawing SD-1**. Detailed sizing calculations for the CDS unit are included in **Appendix C.4**.

5.3.6 Water Balance

The KWMSS and Carp River Watershed Study report identify that the site is located within a low groundwater recharge area. The Watershed Study in particular recommends a minimum of 73mm per year of infiltration (or 1171m³/yr for the 2.29ha site) for water balance purposes and to support Poole Creek baseflow. As such, it is proposed that runoff from the development be directed to an infiltration BMP composed of clear stone be located directly underneath the proposed StormTech subsurface storage unit to provide baseflow to the creek during the inter-event period. The BMP is to tie in behind the orifice control for the subsurface storage to allow overflow via ICDs within the outlet manhole for larger storm events to be controlled prior to release to the creek. Inverts of the BMP have been set to avoid high groundwater elevations and provide a minimum offset of 1.0m from anticipated bedrock elevations. Sizing of the BMP has been provided within **Appendix C.8**, and demonstrates that sufficient storage exists below the perforated pipe drain to sequester 4mm of runoff from onsite impervious areas, and provide up to 3104m³ of annual infiltration.

SERVICING AND STORMWATER MANAGEMENT BRIEF – WELLINGS OF STITTSVILLE PHASE 2, 20 CEDAROW COURT

Grading and Drainage
September 1, 2023

6.0 GRADING AND DRAINAGE

The proposed development site measures approximately 2.29 ha in area. The topography across the site decreases from south to north, with a change in elevation of approximately 1.5 m to the top of bank of the existing Poole Creek. A detailed grading plan (see **Drawing GP-1**) has been provided to satisfy the stormwater management requirements, adhere to permissible grade raise restrictions (see **Section 10.0**) for the site, and provide for minimum cover requirements for storm and sanitary sewers where possible. Site grading has been established to provide emergency overland flow routes required for stormwater management in accordance with City of Ottawa requirements.

The subject site in its majority maintains emergency overland flow routes for flows deriving from storm events in excess of the maximum design event to Poole Creek as depicted in **Drawings GP-1, SD-1**.

SERVICING AND STORMWATER MANAGEMENT BRIEF – WELLINGS OF STITTSVILLE PHASE 2, 20 CEDAROW COURT

Utilities
September 1, 2023

7.0 UTILITIES

Utility infrastructure exists within the Hazeldean Road ROW at the south property boundary of the proposed site. Overhead utility poles are located along the south side of Hazeldean Road. It is anticipated that existing infrastructure will be sufficient to provide a means of distribution for the proposed site. Exact size, location and routing of utilities will be finalized after design circulation.

8.0 APPROVALS

As the site will be discharging to an existing storm sewer outlet, will remain under singular ownership, and will not drain industrial lands or industrial land uses, exemption from the Ontario Ministry of Environment, Conservation and Parks (MECP) Environmental Compliance Approval (ECA) process is expected for works within the subject site.

The outlet headwall has been previously approved under the neighboring property. The ECA application number is NUMBER 7185-ARZMHZ.

The Mississippi Valley Conservation Authority (MVCA) will need to be consulted in order to obtain municipal approval for site development, and permits acquired for any proposed fill within the Poole Creek regulatory limit.

Requirement for a MECP Permit to Take Water (PTTW) for sewer construction is unlikely for the site as the proposed works are above the groundwater elevations shown in the geotechnical report. Building excavation areas, however, will likely be within the groundwater table and may require a PTTW. The geotechnical consultant shall confirm at the time of application that a PTTW is not required.

SERVICING AND STORMWATER MANAGEMENT BRIEF – WELLINGS OF STITTSVILLE PHASE 2, 20 CEDAROW COURT

Erosion Control During Construction
September 1, 2023

9.0 EROSION CONTROL DURING CONSTRUCTION

Erosion and sediment controls must be in place during construction. The following recommendations to the contractor will be included in contract documents.

1. Implement best management practices to provide appropriate protection of the existing and proposed drainage system and the receiving water course(s).
2. Limit extent of exposed soils at any given time.
3. Re-vegetate exposed areas as soon as possible.
4. Minimize the area to be cleared and grubbed.
5. Protect exposed slopes with plastic or synthetic mulches.
6. Provide sediment traps and basins during dewatering.
7. Install sediment traps (such as SiltSack® by Terrafix) between catch basins and frames.
8. Plan construction at proper time to avoid flooding.
9. Installation of a mud matt to prevent mud and debris from being transported off site.
10. Installation of a silt fence to prevent sediment runoff.

The contractor will, at every rainfall, complete inspections and guarantee proper performance. The inspection is to include:

11. Verification that water is not flowing under silt barriers.
12. Clean and change silt traps at catch basins.

Refer to **Drawing EC/DS-1** for the proposed location of silt fences, straw bales, and other erosion control structures.

SERVICING AND STORMWATER MANAGEMENT BRIEF – WELLINGS OF STITTSVILLE PHASE 2, 20 CEDAROW COURT

Geotechnical Investigation
September 1, 2023

10.0 GEOTECHNICAL INVESTIGATION

A geotechnical investigation was completed by Paterson Group Ltd. in March of 2019. The report summarizes the existing soil conditions within the subject area and construction recommendations. For details which are not summarized below, please see the original Paterson report.

Subsurface soil conditions within the subject area were determined from 29 boreholes distributed across the proposed site. In general soil stratigraphy consisted of topsoil underlain by a hard to very stiff silty clay, followed by very stiff to stiff silty clay layer over a glacial till layer.

Groundwater Levels were measured on January 29, 2019 and vary in elevation from 1.7 to 3.2m below the original ground surface. It is expected that construction occur below the existing groundwater table and therefore a permit to take water may be required as well as requirements for damp proofing or foundation waterproofing may be required.

A permissible grade raise restriction of 2.0 m has been recommended within the Paterson Group report. The grade raise restrictions were accounted for in the grading design of the property.

The required pavement structure for the at-grade parking areas and access lanes are outlined in **Table 8** and **Table 9** below:

Table 8: Recommended Pavement Structure – At-Grade Parking Areas

Thickness (mm)	Material Description
50	Wear Course – HL-3 or Superpave 12.5 Asphaltic Concrete
150	Base – OPSS Granular A Crushed Stone
300	Subbase - OPSS Granular B Type II
-	Subgrade – In situ soil, or OPSS Granular B Type I or II material placed over in situ soil

**SERVICING AND STORMWATER MANAGEMENT BRIEF –
WELLINGS OF STITTSVILLE PHASE 2, 20 CEDAROW COURT**

Geotechnical Investigation
September 1, 2023

Table 9: Recommended Pavement Structure – Access Lanes and Heavy Truck Parking Areas

Thickness (mm)	Material Description
40	Wear Course – HL-3 or Superpave 12.5 Asphaltic Concrete
50	Binder Course – HL-8 or Superpave 19.0 Asphaltic Concrete
150	Base – OPSS Granular A Crushed Stone
450	Subbase - OPSS Granular B Type II
-	Subgrade – In situ soil, or OPSS Granular B Type I or II material placed over in situ soil.

SERVICING AND STORMWATER MANAGEMENT BRIEF – WELLINGS OF STITTSVILLE PHASE 2, 20 CEDAROW COURT

Conclusions
September 1, 2023

11.0 CONCLUSIONS

11.1 WATER SERVICING

Based on the supplied boundary conditions for existing watermains and estimated domestic and fire flow demands for the subject site, it is anticipated that the proposed servicing in this development will provide sufficient capacity to sustain both the required domestic demands and emergency fire flow demands of the proposed site. Fire flows greater than those required per the FUS Guidelines are available for this development.

11.2 SANITARY SERVICING

The proposed sanitary sewer network is sufficiently sized to provide gravity drainage of the site. The proposed site will be serviced by a gravity sewer which will direct the proposed wastewater flows to the existing 675mm dia. Hazeldean Road sanitary sewer. The proposed drainage pattern is in accordance with the Kanata West Master Servicing Report for the Hazeldean Road sewer.

11.3 STORMWATER SERVICING

The proposed stormwater management plan is in compliance with the criteria established for the site. Rooftop and subsurface storage have been designed to limit outflows from the subject site to calculated predevelopment levels. Poole Creek is located downstream of the site and has sufficient capacity to receive runoff volumes from the site based on anticipated peak flows and detention times for the subsurface storage unit servicing the development.

11.4 GRADING

Grading for the site has been designed to provide an emergency overland flow route as per City requirements and reflects the grade raise restrictions recommended in the Supplemental Geotechnical Investigation prepared by Paterson Group (March, 2019). Erosion and sediment control measures will be implemented during construction to reduce the impact on existing facilities.

11.5 UTILITIES

Utility infrastructure exists within the Hazeldean Road ROW at the south property boundary of the proposed site. Overhead poles are located along the south side of Hazeldean Road. It is anticipated that existing infrastructure will be sufficient to provide a means of distribution for the proposed site. Exact size, location and routing of utilities will be finalized after design circulation.

SERVICING AND STORMWATER MANAGEMENT BRIEF – WELLINGS OF STITTSVILLE PHASE 2, 20 CEDAROW COURT

Conclusions
September 1, 2023

11.6 APPROVALS/PERMITS

MECP Environmental Compliance Approval is not expected to be required for the proposed site works. A Permit to Take Water is not anticipated to be required for pumping requirements for sewer installation, however, will likely be a requirement for building excavation. The Mississippi Valley Conservation Authority will need to be consulted in order to obtain municipal approval for site development. No other approval requirements from other regulatory agencies are anticipated.

**SERVICING AND STORMWATER MANAGEMENT BRIEF –
WELLINGS OF STITTSVILLE PHASE 2, 20 CEDAROW COURT**

Appendix A Water Supply Servicing
September 1, 2023

Appendix A **WATER SUPPLY SERVICING**

A.1 **DOMESTIC WATER DEMAND ESTIMATE**

Wellings of Stittsville Phase 2 - 20 Cedarow Court - Domestic Water Demand Estimates

- Based on Wellings of Stittsville Site Phase 2 (160401511)

Building ID	Area (m ²)	Population	Daily Rate of Demand ¹	Avg Day Demand		Max Day Demand ^{2,3}		Peak Hour Demand ^{2,3}	
				(L/min)	(L/s)	(L/min)	(L/s)	(L/min)	(L/s)
Phase 2 and Phase 3									
Residential	-	522	280	101.5	1.69	253.8	4.23	558.5	9.31
Commercial and Communal Amenity Areas	950	-	28,000	1.8	0.03	2.8	0.05	5.0	0.08
Total Site :				103.4	1.72	256.6	4.28	563.5	9.39

1. 28,000 L/gross ha/day is used to calculate water demand for retail, restaurants and office space.
2. The City of Ottawa water demand criteria used to estimate peak demand rates for commercial space are as follows:
 maximum day demand rate = 1.5 x average day demand rate
 maximum hour demand rate = 1.8 x maximum day demand rate
3. The City of Ottawa water demand criteria used to estimate peak demand rates for residential areas are as follows:
 maximum day demand rate = 2.5 x average day demand rate
 maximum hour demand rate = 2.2 x maximum day demand rate

**SERVICING AND STORMWATER MANAGEMENT BRIEF –
WELLINGS OF STITTSVILLE PHASE 2, 20 CEDAROW COURT**

Appendix A Water Supply Servicing
September 1, 2023

A.2 FIRE FLOW REQUIREMENTS PER FUS



FUS Fire Flow Calculation Sheet - 2020 FUS Guidelines

Stantec Project #: 160401511
 Project Name: 20 Cedarow (Phases 2-3)
 Date: 9/26/2022
 Fire Flow Calculation #: 1
 Description: 6-Storey Mixed Use

Notes: Assumed no internal fire walls at Phase line

Step	Task	Notes	Value Used	Req'd Fire Flow (L/min)						
1	Determine Type of Construction	Type II - Noncombustible Construction / Type IV-A - Mass Timber Construction	0.8	-						
2	Determine Effective Floor Area	Sum of Two Largest Floors + 50% of Six Additional Floors	Vertical Openings Protected?	NO	-					
		6096 4081 4250 4188 4077 3987			18428	-				
3	Determine Required Fire Flow	(F = 220 x C x A ^{1/2}). Round to nearest 1000 L/min	-	24000						
4	Determine Occupancy Charge	Limited Combustible	-15%	20400						
5	Determine Sprinkler Reduction	Conforms to NFPA 13	-30%	-10200						
		Standard Water Supply	-10%							
		Fully Supervised	-10%							
		% Coverage of Sprinkler System	100%							
6	Determine Increase for Exposures (Max. 75%)	Direction	Exposure Distance (m)	Exposed Length (m)	Exposed Height (Stories)	Length-Height Factor (m x stories)	Construction of Adjacent Wall	Firewall / Sprinklered ?	-	-
		North	> 30	0	0	0-20	Type V	NO	0%	2040
		East	> 30	0	0	0-20	Type I-II - Unprotected Openings	YES	0%	
		South	> 30	0	0	0-20	Type V	NO	0%	
		West	10.1 to 20	12	1	0-20	Type V	NO	10%	
7	Determine Final Required Fire Flow	Total Required Fire Flow in L/min, Rounded to Nearest 1000L/min							12000	
		Total Required Fire Flow in L/s							200.0	
		Required Duration of Fire Flow (hrs)							2.50	
		Required Volume of Fire Flow (m ³)							1800	

**SERVICING AND STORMWATER MANAGEMENT BRIEF –
WELLINGS OF STITTSVILLE PHASE 2, 20 CEDAROW COURT**

Appendix A Water Supply Servicing
September 1, 2023

A.3 BOUNDARY CONDITIONS

Boundary Conditions - 20 Cedarow Court

Date Provided

October-19

Scenario	Demand	
	L/min	L/s
Average Daily Demand	156	2.60
Maximum Daily Demand	388	6.46
Peak Hour	850	14.17
Fire Flow Demand #1	16,020	267

of connections

2

Location:



Results:

Connection 1 - Cedarow Crescent

Demand Scenario	Head (m)	Pressure ¹ (psi)
Maximum HGL	161.1	80.3
Peak Hour	157.7	75.5
Max Day plus Fire 1	150.2	64.8

¹ Ground Elevation = 104.6m

Connection 2 - Wellings Pvt

Demand Scenario	Head (m)	Pressure ¹ (psi)
Maximum HGL	161.1	80.3
Peak Hour	157.7	75.4
Max Day plus Fire 1	149.6	63.9

¹ Ground Elevation = 104.7m

Notes:

1. Pressure reducing valve is required since the maximum pressure exceeds 80 psi.
2. Looping of the watermain is required to decrease vulnerability of the water system in case of breaks.
3. Confirm the ownership of the watermain on Wellings Private.

Disclaimer

The boundary condition information is based on current operation of the city water distribution system. The computer model simulation is based on the best information available at the time. The operation of the water distribution system can change on a regular basis, resulting in a variation in boundary conditions. The physical properties of watermains deteriorate over time, as such must be assumed in the absence of actual field test data. The variation in physical watermain properties can therefore alter the results of the computer model simulation. Fire Flow analysis is a reflection of available flow in the watermain; there may be additional restrictions that occur between the watermain and the hydrant that the model cannot take into account.

**SERVICING AND STORMWATER MANAGEMENT BRIEF –
WELLINGS OF STITTSVILLE PHASE 2, 20 CEDAROW COURT**

Appendix B Wastewater Servicing
September 1, 2023

Appendix B WASTEWATER SERVICING

B.1 SANITARY SEWER DESIGN

From: [Tousignant, Eric](#)
To: [Thiffault, Dustin](#)
Cc: [Moroz, Peter](#)
Subject: RE: Confirmation of Sanitary Capacity - 20 Cedarow Court
Date: Tuesday, July 12, 2022 10:03:53 AM

Hi Dustin

I don't see a problem with this additional flow, there is capacity in the sanitary sewer system.

Regards
Eric

Eric Tousignant, P.Eng.

Senior Water Resources Engineer/ Ingénieur principal en ressources hydriques

Infrastructure and Water Services / services d'infrastructure et d'eau

613-580-2424 ext 25129

Vacation Notice : Note that I will be away on vacation from July 25th to August 12, but will be checking emails periodically to forward them to appropriate staff.

From: Thiffault, Dustin <Dustin.Thiffault@stantec.com>
Sent: July 05, 2022 4:44 PM
To: Tousignant, Eric <Eric.Tousignant@ottawa.ca>
Cc: Moroz, Peter <peter.moroz@stantec.com>
Subject: Confirmation of Sanitary Capacity - 20 Cedarow Court

CAUTION: This email originated from an External Sender. Please do not click links or open attachments unless you recognize the source.

ATTENTION : Ce courriel provient d'un expéditeur externe. Ne cliquez sur aucun lien et n'ouvrez pas de pièce jointe, excepté si vous connaissez l'expéditeur.

Hi Eric,

We are working on a site plan control application for a residential development on 20 Cedarow Court set to have sanitary discharge to the 675mm trunk sewer within Hazeldean Road just west of Huntmar. The KWMSS had previously assumed the site to be entirely commercial, and so development review is asking for confirmation that the trunk can accept the increase in expected flows.

The KWMSS had estimated peak flows from the development at approx. 2.0L/s (under the older discharge parameters), whereas we are anticipating approximately 10.4L/s including allowance for infiltration. Would you be able to confirm that the 10.4L/s rate can be sufficiently accommodated within the Hazeldean sewer? I've attached a servicing drawing for your reference.

Thanks very much for your help!

Dustin Thiffault P.Eng.

Project Engineer

Mobile: 343-996-2211

dustin.thiffault@stantec.com

Stantec

300-1331 Clyde Avenue

Ottawa ON K2C 3G4



The content of this email is the confidential property of Stantec and should not be copied, modified, retransmitted, or used for any purpose except with Stantec's written authorization. If you are not the intended recipient, please delete all copies and notify us immediately.

This e-mail originates from the City of Ottawa e-mail system. Any distribution, use or copying of this e-mail or the information it contains by other than the intended recipient(s) is unauthorized. Thank you.

Le présent courriel a été expédié par le système de courriels de la Ville d'Ottawa. Toute distribution, utilisation ou reproduction du courriel ou des renseignements qui s'y trouvent par une personne autre que son destinataire prévu est interdite. Je vous remercie de votre collaboration.

SUBDIVISION		Nautical Lands Group - 20 Cedarow		SANITARY SEWER DESIGN SHEET (City of Ottawa)				DESIGN PARAMETERS																											
AREA ID NUMBER	LOCATION	FROM M.I.L.	TO M.I.L.	AREA (ha)	Stubs	Single Units	POP	RESIDENTIAL AREA AND POPULATION	PEAK FACT.	PEAK FLOW (L/s)	COMMERCIAL AREA (ha)	ACCUM. AREA (ha)	INDUSTRIAL (I) AREA (ha)	ACCUM. AREA (ha)	INDUSTRIAL (H) AREA (ha)	ACCUM. AREA (ha)	INSTITUTIONAL AREA (ha)	ACCUM. AREA (ha)	GREEN UNSEED AREA (ha)	ACCUM. AREA (ha)	CHH PEAK FLOW (L/s)	TOTAL PEAK FLOW (L/s)	INFILTRATION (ha)	ACCUM. AREA (ha)	INFILTRATION (L/s)	TOTAL FLOW (L/s)	LENGTH (m)	DA (mm)	MATERIAL CLASS	PIPE SLOPE (%)	CAP. (L/s)	CAP. FLOW (%)	VEL. (m/s)	VEL. (ft/s)	
Wellings of Stittsville Ph2	ENTIRE SITE	STUB	MAIN	2.20	34	252	58	522	3.96	6.7	0.10	0.10	0.00	0.00	0.00	0.00	0.00	0.00	0.00	0.00	0.00	0.0	2.29	2.29	0.8	7.5	23.0	300	PVC	SDR35	1.00	96.0	7.82%	1.36	0.68



**SERVICING AND STORMWATER MANAGEMENT BRIEF –
WELLINGS OF STITTSVILLE PHASE 2, 20 CEDAROW COURT**

Appendix B Wastewater Servicing
September 1, 2023

B.2 SANITARY EXCERPTS FROM THE KWMSS

4.0 SANITARY SEWER SERVICING

4.1 Introduction

This section outlines the evaluation criteria for wastewater servicing options, describes the alternative wastewater servicing alignments, summarizes the evaluation process, and compares the recommended alternatives to select the preferred option.

4.2 Evaluation Criteria and Weightings

The evaluation of alternatives is based, in part, on criteria previously developed for the Regional Master Plan for Water, Wastewater and Transportation, which can be found in Volume 2 of the "Planning and Environmental Assessment Summary Report" prepared by the former Region of Ottawa-Carleton.

The criteria are divided into four categories. The first three categories consider environmental, social, and economic impacts of the project on the Study area. The fourth category (Constructability/Functionality) considers project-specific criteria assessing the technical aspects and impacts of the project on the Study area. A list of each criteria and its respective category, as well as an explanation of their indicators, is provided in **Table 4.1-1**.

TABLE 4.1-1 Evaluation Criteria		
Category	Criteria	Indicator
Constructability/Functionality		
CO1.1	Geotechnical Issues and Construction Risks	Potential for encountering poor soils and/or elevated groundwater conditions.
CO1.2	Infrastructure Requirements	Extent of works required.
CO1.3	Operational Impacts	Amount of maintenance intensive infrastructure required.
CO1.4	Construction Scheduling	Impact of construction on development timing/phasing.
CO1.5	Property Acquisition	Ease of property acquisition. Depends on status of required and adjacent lands (i.e. vacant, leased or owner occupied).
CO1.6	System Reliability	Proximity of a storm sewer, SWM or other surface water for emergency overflow.
CO1.7	System Flexibility	Ease of accommodating potential changes in servicing plans.
Economy		
E1	Potential to Use Combined Service Corridor	Length and area of combined service corridor.
E2	Efficiency of use of existing infrastructure	Use of existing capacity.
E3	Energy consumption	Pumping requirements.
E5	Impact on Agriculture	Agricultural area likely to be affected by infrastructure.

E9	Construction Cost	Estimated construction cost.
Caring and Healthy Community		
C3	Displacement of Residents, Community/Recreation Features and Institutions	Affects on residential areas, institutions or businesses.
C4	Disruption to Existing Community	Extent of works affecting existing residences and businesses.
C9	Consistency with Planned Land Use and Infrastructure	Compatibility with City land use, design guidelines and infrastructure servicing corridor planning (Kanata West Transportation Master Plan Report and Storm Sewer and Watermain Needs).
Natural Environment		
N1	Impact on Significant Natural Features	Loss of natural areas due to installation of works.
N3	Impact on Aquatic Systems	Potential impact on fish habitat due to installation of works.
N4	Impact on Quality and Quantity of Surface Water and Groundwater	Potential impact on water quality in the Carp River resulting from rare emergency overflows to the SWM pond due to pumping station failure.
N5	Impact on Global Warming	Difference in carbon dioxide emissions resulting from occasional use of diesel generator.
N6	Effects on Urban Green Space, Open Space and Vegetation	Disruption to green space and trees.

4.2.1 Description of Evaluation Categories

Presented below is a description of the categories used to assess each of the three servicing alternatives. The four categories were selected to ensure that the various servicing alternatives were evaluated in a consistent and comprehensive manner. Further details on the criteria and weightings for each category are provided in Appendix 2.1.

Constructability/Functionality (C/F) – 36%

Wastewater infrastructure is required to facilitate the development of Kanata West. The infrastructure needs to provide a flexible servicing solution to accommodate the orderly development of the entire area in a series of phases. It is important that the construction of the wastewater servicing be coordinated with other major infrastructure projects such as storm sewers, watermain and transportation, to ensure all services are available when required. Various alignment alternatives, construction techniques and phasing options will be assessed.

Economy (E) – 25 %

The Kanata West area is recognized within the City of Ottawa Official Plan as a future growth area comprised of a mixture of residential, business, and commercial lands. The accelerated rate of development and design concerns within the Study area requires a cost-effective solution to providing municipal wastewater services.

Caring and Healthy Communities (CHC) – 25 %

Impact to the surrounding community is an important factor when determining the preferred servicing alternative. The selected alignment and construction techniques are evaluated to minimize disruption to surrounding communities. It is anticipated that impacts will be limited to the time of construction for the off-site servicing.

Natural Environment (NE) – 14%

The majority of the required wastewater infrastructure is aligned within existing or proposed public roads to limit the impacts to the natural environment. Servicing alignments selected outside of roadways were chosen to minimize impacts where possible. Construction of the wastewater services will be performed in conjunction with other servicing projects required as part of the overall development. Further information on the environmental impacts of the proposed road allowances are documented in the Kanata West Transportation Master Plan Report.

In the rare event that the pump station overflows, impacts to surface water quality are anticipated to be minimal. All discharges from the overflow will be directed to the stormwater management pond where they will be collected. Increases in CO₂ emissions from the emergency diesel generators during power failures or maintenance procedures will be negligible.

4.2.2 Outlet Alternatives

4.2.2.1 Description of Outlet Alternatives

To provide an adequate outlet for the KWCP wastewater system three servicing options were evaluated. Each of these options will ultimately discharge to the Tri Township Collector Sewer. The first servicing option utilizes a gravity sewer (tunnel), the remaining two options make use of a pumping station located at the intersection of Maple Grove Road and Silver Seven Road, with alternate forcemain alignments. **Figures 4.1-1, 4.1-2 and 4.1-3** illustrate the alternative outlet alignments, which are further described below:

- Alternative I (Gravity Outlet) – A gravity sewer (tunnel) along the Highway 417 corridor to the Tri Township Collector. The tunnel would be constructed within the existing road allowance, adjacent to the travel lanes. The alignment crosses Highway 417 east of Eagleson Road and parallels the Glen Cairn Collector. Refer to **Figure 4.1-1**.
- Alternative II (Forcemain Alignment 1) - A forcemain along the Highway 417 corridor from a proposed pumping station on Maple Grove Road, extending to the Glen Cairn Collector Sewer east of Eagleson Road. Refer to **Figure 4.1-2**.
- Alternative III (Forcemain Alignment 2) - A forcemain along Katimavik Road and Palladium Drive from a proposed Pumping Station on Maple Grove Road to the Glen Cairn Collector Sewer east of Eagleson Road. Refer to **Figure 4.1-3**.

4.2.2.2 Evaluation of Outlet Alternatives

Evaluation of the criteria was completed using the “standard pair-wise comparison” methodology. The weightings assigned to each of the criteria were selected based on the weightings applied for past similar projects, knowledge of environmental constraints, community concerns and professional judgment. The scores for each category and criterion were summed to determine the overall category weighting. Evaluation results are summarized in **Table 4.1-2**. An explanation of the category rankings and weightings are provided below.

Constructability/Functionality (C/F) (36%)

A review of the three proposed servicing options indicates that the forcemain alternatives present fewer issues with respect to the geotechnical constraints when compared to the gravity sewer alternative. The forcemain alternatives would require a relatively shallow excavation, reducing the conflict with the shallow bedrock formations that exist along each forcemain alignment. The shallow depth of the forcemains would also minimize the technical difficulties arising from earth to rock transitions along the trench. The effort required to install either of the forcemain alternatives would be much less than the gravity outlet alternative because the need to tunnel would be eliminated.

When comparing the two forcemain alternatives, an obvious benefit of Alternative II is its location along Katimavik Road as compared to the location of Alternative III, along Highway 417. Katimavik Road has a lower classification than Highway 417, reducing traffic management issues during construction and routine maintenance operations. The central location of the Alternative II forcemain alignment in relation to the area to be serviced also improves the flexibility for developing internal servicing options. The various alignments available for Alternative II, west of Terry Fox Drive (see **Figure 4.1-3**), are all located within existing road allowances and are considered equal when evaluated with the prescribed criteria. The Alternative II alignment along Silver Seven Road also allows the opportunity for the services to be installed in an easement located immediately adjacent to the east side of the right-of-way. Construction in this easement would eliminate the need to reconstruct this portion of the road. The use of easements for construction of the necessary services was not factored into the evaluation criteria and therefore the ranking was not affected.

Economy (E) (25%)

The costs of both forcemain alternatives are similar and much less expensive than the gravity sewer alternative. The increased costs of the gravity sewer are attributed to the need to tunnel through the existing bedrock. The forcemain alternatives allow for a relatively shallow excavation over the entire length of the alignment. The level of effort required to construct the gravity sewer would also be significantly greater than the effort required to install either of the forcemain alternatives.

Caring and Healthy Community (CHC) (25%)

Both the gravity outlet and the Alternative I forcemain would have minimal impact on the community given that the majority of the work would occur within the Highway 417 road allowance. The Alignment II forcemain alignment along Katimavik Road would require open cut excavation and would have a temporary impact on the residents during construction.

GRAVITY SANITARY OUTLET LOCATION



- Legend:**
- - - - - Gravity Outlet (Tunnel)
 - Existing Trunk Sewer

FIG. 4.1-1

MAY 2006



CCCL/IBI
CONSULTANTS

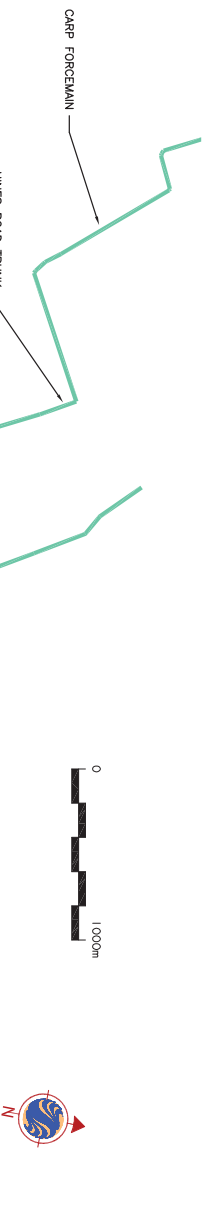

**SANITARY
FORCEMAIN OUTLET
ALIGNMENT 1
HWY 417**



FIG. 4.1-2

MAY 2006



**SANITARY
FORCEMAIN OUTLET
ALIGNMENT 2
KATIMAVIK RD.
(PREFERRED OPTION)**



- Legend:**
- - - - - Forcemain
 - - - - - Optional F.M. locations to accommodate internal servicing
 - Existing Trunk Sewer

FIG. 4.1-3

MAY 2006



The construction of both forcemain alternatives is compatible with existing City design standards and construction practices. However, only Alignment II can easily be integrated into other servicing or roadway improvements. The time required for the construction of the gravity outlet would be significantly longer than that of the forcemain alternatives.

Natural Environment (NE) (14%)

There are no significant differences on the impacts to the natural environment between the gravity outlet and forcemain Alternative II. The gravity outlet will be tunneled below ground for the majority of the alignment resulting in minimal impact to surface conditions. Forcemain Alternative II is located within the Katimavik Road allowance, which is already developed and has minimal environmental impact. Forcemain Alternative I has a greater impact on the natural areas located along the Highway 417 corridor than the gravity sewer.

4.2.2.3 Selection of Preferred Outlet Alternative

Based on the above evaluation Alternative II, the Katimavik Road alignment, is selected as the preferred outlet alternative. This alignment offers the greatest amount of flexibility for internal servicing design, uses a lower road classification corridor, which simplifies routine maintenance operations, and provides maximum separation from the sensitive natural areas located in the 417 corridor east of Terry Fox Drive.

While Forcemain Alignment II has a marginal cost increase over Alignment I, the benefits of improved internal servicing and phasing options more than offset this discrepancy.

4.2.3 Internal Servicing Alternatives

4.2.3.1 Description of Internal Servicing Alternatives

The preliminary servicing report prepared in support of the approved Community Design Plan identified the need for two pumping stations for the wastewater discharge from KWCP. The two stations identified are required to satisfy phasing needs for construction of the overall development area and to produce a cost effective initial phasing scheme. The new sanitary pumping station(s) south of Highway 417 will be required to provide internal wastewater service to that portion of KWCP south of Highway 417.

Three potential servicing alternatives were considered for the configuration and location for the pumping station(s) required to service these lands south of Hwy. 417. Internal servicing alternatives were chosen based on their proximity to the preferred outlet described in Section 4.2.3.3. above, and accessibility to the servicing areas as illustrated in **Figures 4.1-4, 4.1-5, 4.1-6 and 4.1-6A**. A brief description of the alternative pumping station locations are as follows:

- Alternative I - Two pumping stations connected with a combination of gravity sewer and forcemain. One pumping station will be located on Silver Seven Road at Highway 417. The second station will be located on Maple Grove Road at the Carp River. Refer to **Figure 4.1-4**.
- Alternative II - Two pumping stations connected with a gravity sewer. One station will be located on Maple Grove Road near the Carp River and will discharge to the main station located near the Carp River south of Highway 417. A diversion sewer will also be required to intercept the existing Silver Seven Road sanitary sewer. Refer to **Figure 4.1-5**.

Kanata West Wastewater - Outlet Alternatives



Criteria	Indicators	Weighting	Rationale for Relative Weights	Alternatives		
				Gravity Sewer Outlet	PS FM Alignment I	PS FM Alignment II
CONSTRUCTABILITY/FUNCTIONALITY						
COI.1	Geotechnical Issues and Construction Risks Potential for encountering poor soils and/or elevated groundwater conditions.	36%	Alt. I has potential for poor soils conditions due to depth and tunnelling in and out of rock.	16	20	22
COI.2	Infrastructure Requirements Extent of works required.	7%	Alt. I with tunnelling is a very large scale operation.	2	3	3
COI.3	Operational Impacts Amount of maintenance intensive infrastructure required.	7%		1	3	3
COI.4	Construction Scheduling Impact of construction on development timing.	6%	Alt. II and III require more extensive maintenance due to pumping.	3	2	2
COI.5	Property Acquisition Ease of property acquisition. (Depends on status of lands and adjacent lands, i.e. vacant, leased or owner occupied.)	4%	Alt. I with tunnelling is an extended construction schedule.	1	3	3
COI.6	System Reliability Proximity of a storm sewer, SWM or other surface water for emergency overflow	2%		4	4	4
COI.7	Serviceability Ease of accommodating potential changes in servicing plans.	6%	Alt. I and II have fixed alignments along the north limit of the servicing area. Alt. II has some flexibility to be realigned within the development area, but Alt. III due to its more central location has maximum flexibility within Kanata West.	3	3	3
COI.8	Serviceability Ease of accommodating potential changes in servicing plans.	6%	Alt. I and II have fixed alignments along the north limit of the servicing area. Alt. II has some flexibility to be realigned within the development area, but Alt. III due to its more central location has maximum flexibility within Kanata West.	2	2	4
ECONOMY						
E1	Potential to Use Combined Service Corridor Length and area of combined service corridor.	25%	Alt. I with the requirement for tunnelling does not offer any potential to use combined corridors.	9	13	15
E2	Efficiency of Use of Existing Infrastructure Use of existing capacity	6%	Alt. I requires reconstruction beyond the closest connection point to the Glen Cairn Collector sewer.	1	3	4
E3	Energy Consumption Pumping requirements	5%	Alt. II & III require pumping.	3	2	2
E4	Impact on Agriculture Agriculture area likely to be affected by infrastructure.	4%		3	3	3
E5	Capital Cost Estimated cost of construction.	2%	Alt. I is very expensive due to the tunnelling requirement.	3	3	3
E6	Capital Cost Estimated cost of construction.	8%		1	3	3
CARING AND HEALTHY COMMUNITIES						
C3	Displacement of Residents, Community/Recreation Features and Institutions. Affects areas of residence, institutions or businesses.	25%	Length of Construction for Alt. I will result in increased construction traffic, etc.	7	9	9
C4	Disruption to Existing Community Extent of works affecting existing residences and businesses and visibility of additional infrastructure.	6%		3	3	3
C9	Consistency with Planned Land Use and Infrastructure Compatibility with city land use, design guidelines and infrastructure servicing corridor planning (Kanata West Roadwork Environmental Study Report and Storm Sewer and Watermain Needs).	11%	Alt. I would provide service for larger area than the existing urban boundary due to size of pipe required to tunnel. Alt. II provides greater flexibility for internal servicing.	1	3	3
NATURAL ENVIRONMENT						
N1	Impact on Significant Natural Features Loss of natural area due to installation of works.	14%	Alt. I mostly tunnel therefore minimal impact. Alt. II in vicinity of ANSI in 417 corridor at Terry Fox.	16	12	14
N3	Impact on Aquatic Systems Potential impact on fish habitat due to installation of works.	3%		4	1	3
N4	Impact on Quality and Quantity of Surface Water and Groundwater Potential impact on water quality in the Carp River resulting from rare emergency overflows to the SWM pond due to pump station failure.	3%		3	3	3
N5	Impact on Global Warming Difference in carbon dioxide emissions resulting from occasional use of diesel generator.	1%	Alt. II and III require pumping in long term. Alt. I does not.	3	2	2
N6	Effects on Urban Greenspace, Open Space and Vegetation (i.e. trees, shrubs, etc.) Disruption to greenspace and trees.	5%		3	3	3
Total Score				2.17	2.75	3.01
Ranking				3	2	1
Estimated Capital Cost (in \$million)				30	8.8	9

Description of Alternatives
 Gravity Sewer Outlet
 Pump Station - Forcemain Alignment I - HWY 417
 Pump Station - Forcemain Alignment II - Katimavik Rd.

- Alternatives III and IIIA – Alternative III is a single pumping station with a gravity sewer intercepting the existing Silver Seven Road sanitary sewer. The gravity sewer alignment will be adjacent to the Carp River and connect to the pump station located at Maple Grove Road west of the Carp River. Alternative IIIA is a variation of this alternative utilizing a single pumping station and gravity sewer intercepting the existing Silver Seven Road sewer. The variation from Alternative III is that the gravity sewer will be located within a proposed road right-of-way, or an easement, north of Palladium Drive. Refer to **Figures 4.1-6 and 4.1-6A.**

4.2.3.2 Evaluation of Internal Servicing Alternatives

The alternative internal servicing alignments were evaluated as discussed in Section 4.2. The results of the evaluation are summarized in **Table 4.1-3**. An explanation of the category rankings and weightings are provided below.

Constructability/Functionality (C/F) (36%)

All proposed alternatives use pumping stations to provide internal wastewater servicing. The use of pumps allows the sewer system to be constructed at a relatively shallow depth. This reduces the potential for contact with poor subsurface conditions during construction. Deep Excavations will be confined to a limited area in the vicinity of the pumping station.

A benefit of Alternatives III and IIIA is that a single pumping station is required to provide the internal servicing. This is advantageous from a constructability and operational point of view when compared to Alternatives I and II which require two pumping stations to service the same area. A further benefit of Alternatives III and IIIA is that either servicing scenario will eliminate the need for the existing Palladium siphon under the Carp River. Removing the siphon will improve the overall reliability to the system.

A benefit of Alternative IIIA over Alternative III is that work in the Carp River corridor is reduced to a single crossing at Palladium Drive. Both Alternatives are close to a stormwater management pond which can be used as an emergency overflow in the rare event of flooding. (see **Figures 4.1-6 and 4.1-6A**)

All alternatives are capable of satisfying a phased development process.

Economy (E) (25%)

Alternatives I and II use two pumping stations and are significantly more expensive than Alternatives III and IIIA which use a single pump station. The additional pump stations in Alternatives I and II also increase the energy demand over the remaining options. Alternatives III and IIIA are able to service the entire KWCP with a single pump station resulting in equal or fewer economic impacts.

Caring and Healthy Community (CHC) (25%)

In terms of impact on the community, there are no differences between the alternatives. All options require construction in the vicinity of existing businesses. Impacts are anticipated to be relatively short in duration (less than two years).

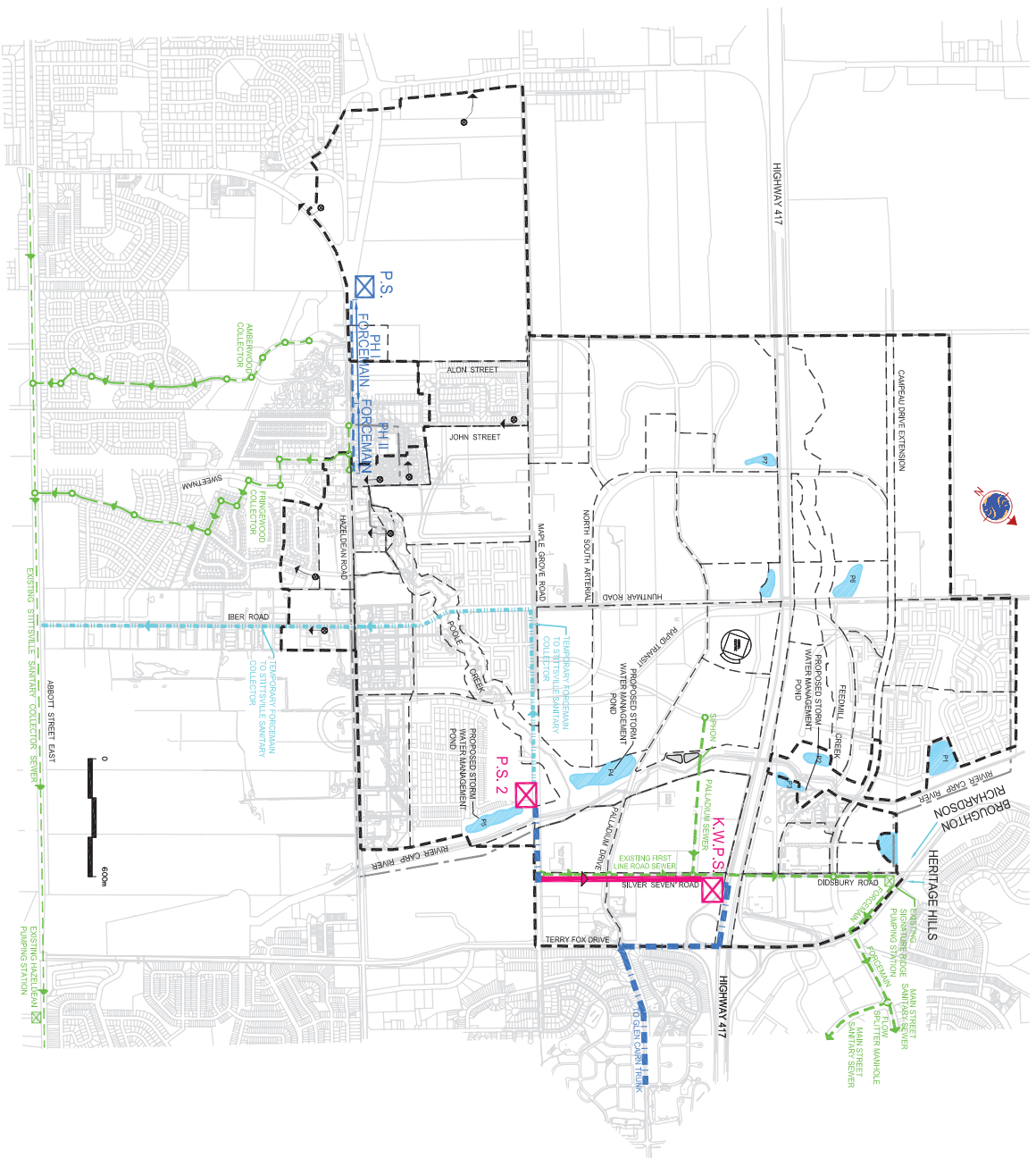

INTERNAL SANITARY SERVICING ALTERNATIVE I

- Ultimate Major Drainage Limit
- Proposed Trunk Sewer
- Forcemain
- - - Temporary Frocemain
- - - Existing Trunk Sewers
- Existing Pumping Station and Forcemain (To be Decommissioned)
- ⊠ Pump Station

MAY 2006

FIG. 4.1-4



CGCL/IBI
CONSULTING GROUP LIMITED

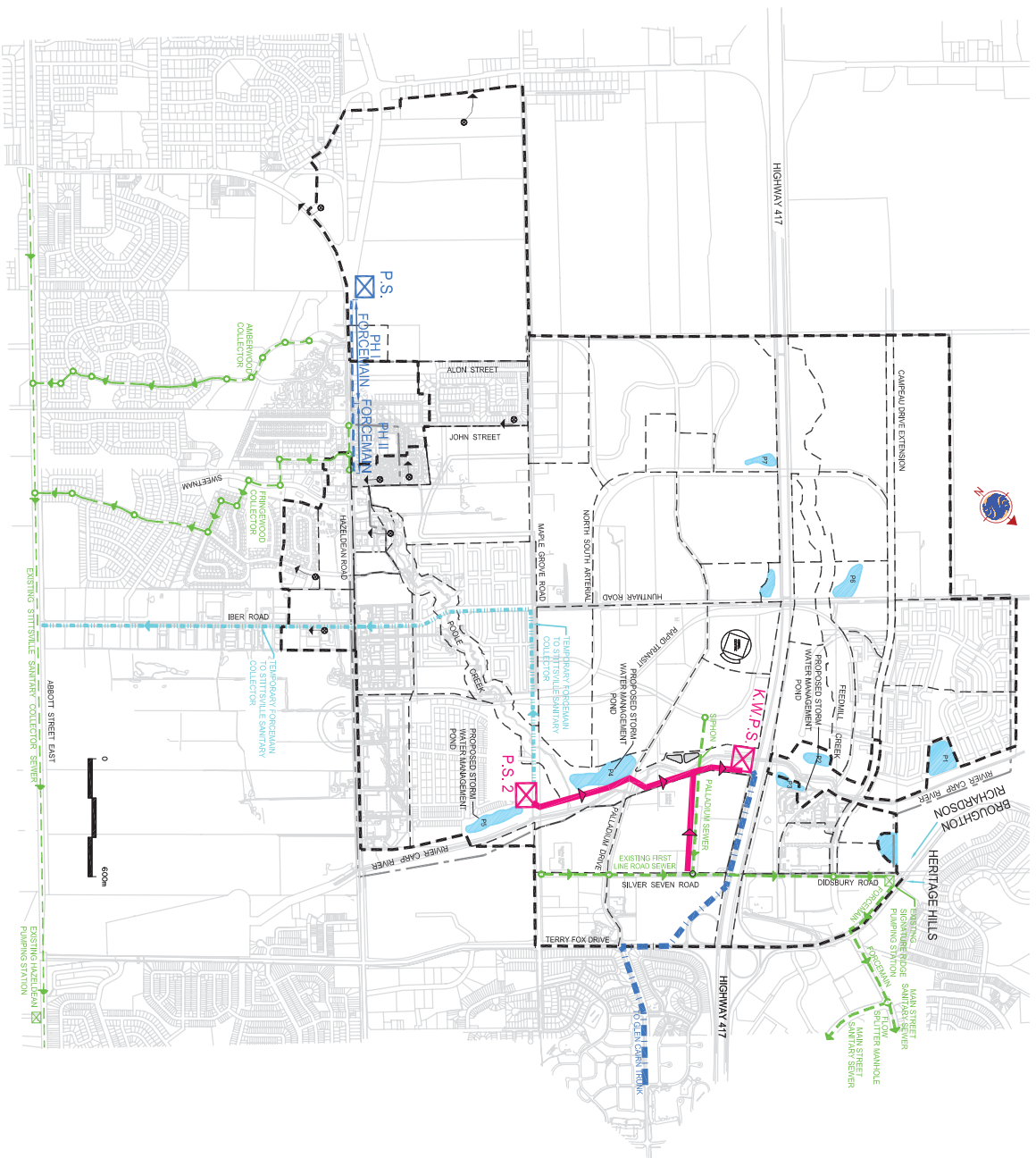

INTERNAL SANITARY SERVICING ALTERNATIVE II

- Ultimate Major Drainage Limit
- Proposed Trunk Sewer
- - - Forcemain
- - - Temporary Forcemain
- - - Existing Trunk Sewers
- Existing Pumping Station and Forcemain (To be Decommissioned)
- ⊠ Pump Station

FIG. 4.1-5

MAY 2006

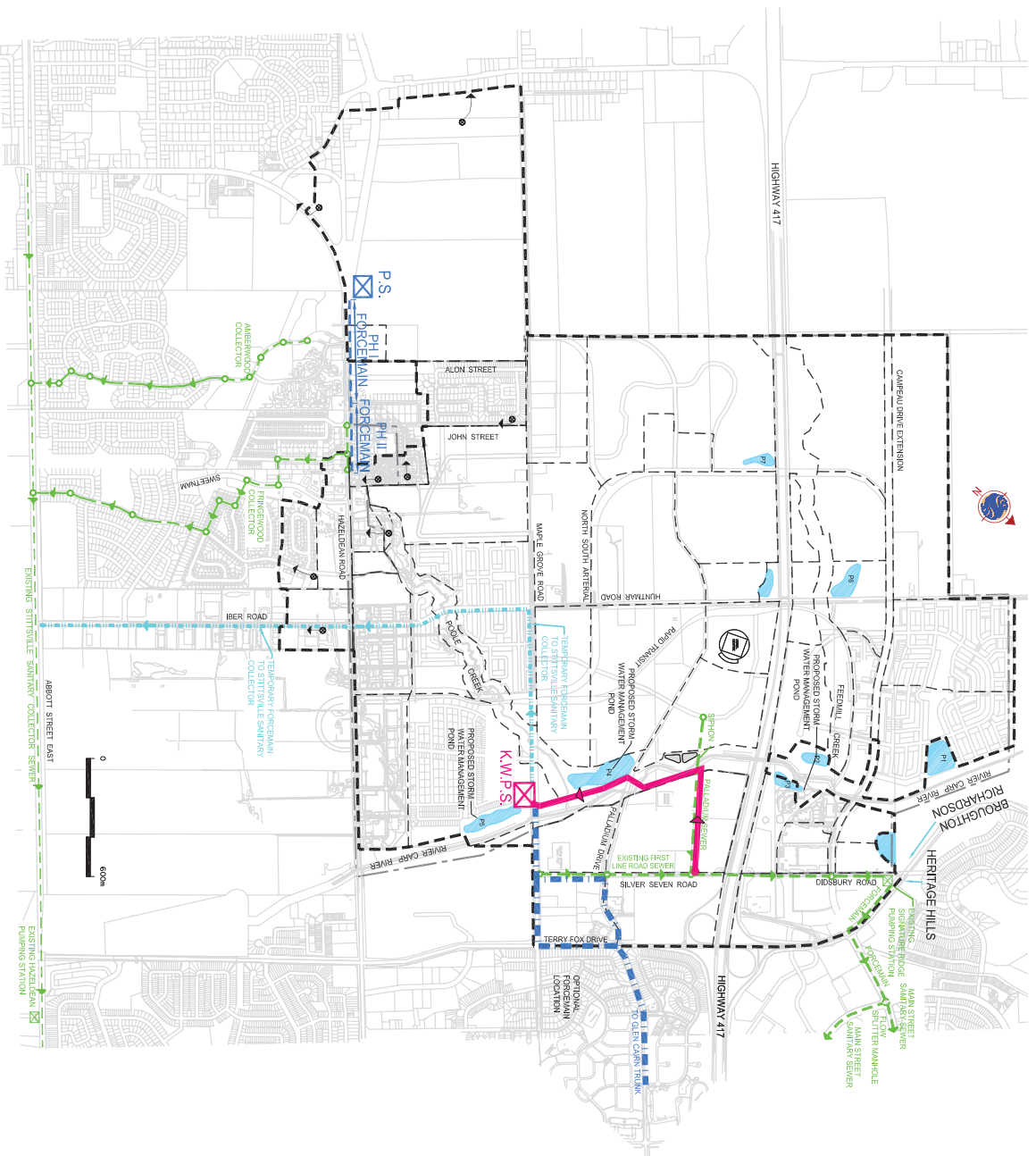

**INTERNAL SANITARY
SERVICING
ALTERNATIVE III**

- Ultimate Major Drainage Limit
- Proposed Trunk Sewer
- Forcemain
- Temporary Forcemain
- Existing Trunk Sewers
- Existing Pumping Station and Forcemain (To be Decommissioned)
- ⊠ Pump Station

FIG. 4.1-6

MAY 2006

INTERNAL SANITARY SERVICING ALTERNATIVE IIIA (PREFERRED OPTION)

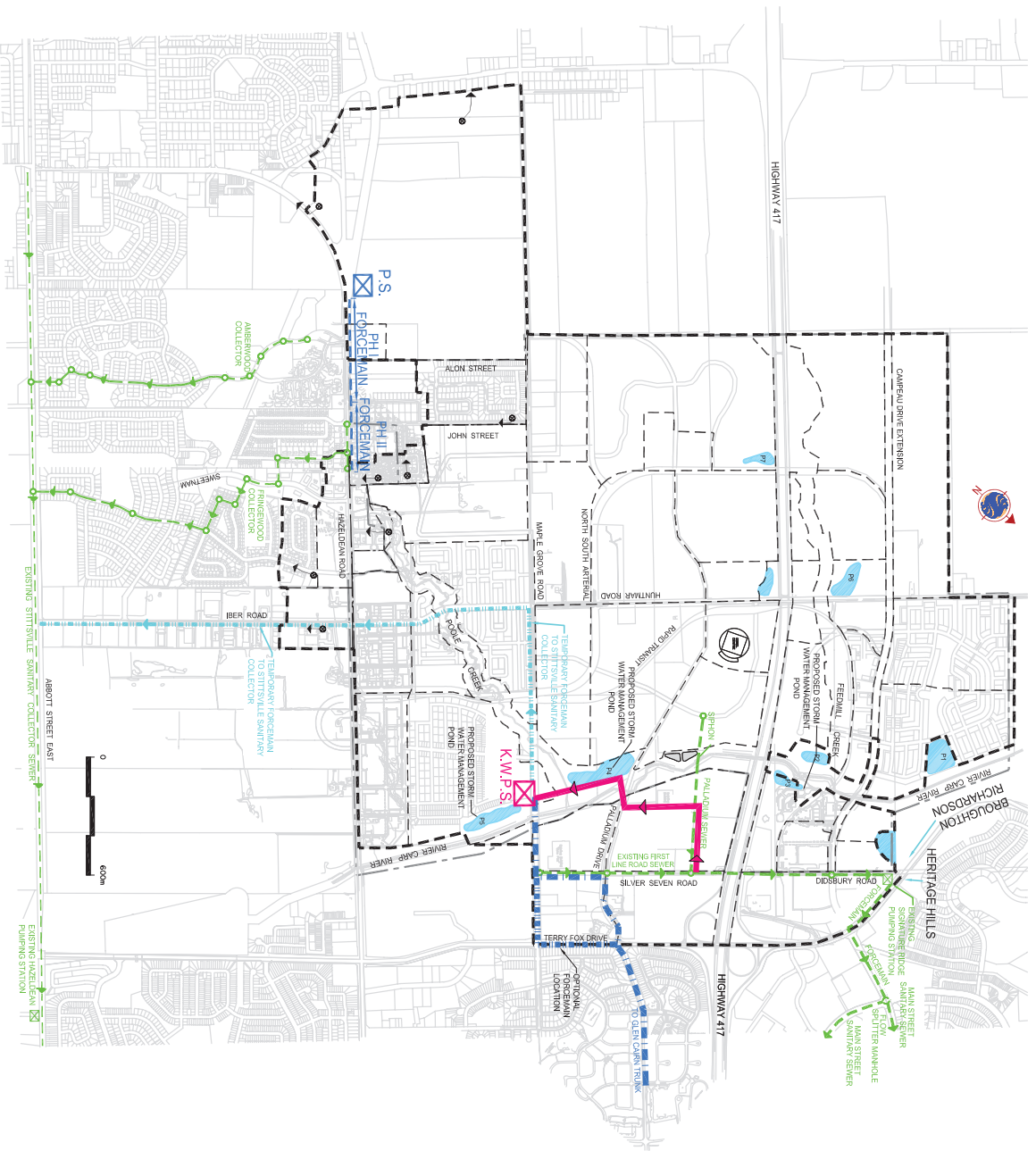

- Ultimate Major Drainage Limit
- Proposed Trunk Sewer
- - - Forcemain
- · · Temporary Forcemain
- - - Existing Trunk Sewers
- Existing Pumping Station and Forcemain (To be Decommissioned)
- ⊠ Pump Station

FIG. 4.1-6A

MAY 2006



Natural Environment (NE) (14%)

All four servicing options have a similar level of impact on the natural environment. Alternatives III and IIIA use a gravity sewer and a single pump station, thereby using less energy to discharge the sanitary flow from the KWCP. Alternatives II & III require the greatest amount of construction within the Carp River corridor.

Alternatives I and II both require two pumping stations. This increases the potential for impacts over the remaining options from the use of the emergency diesel generators and construction and construction.

4.2.3.3 Selection of Preferred Internal Servicing Alternative

Based on the above evaluation, Alternatives III and IIIA are considered to be the most viable options for the internal wastewater servicing for the KWCP. When comparing the two options, all of the evaluation criteria are similar. However, Alternative III requires the construction of the trunk sanitary sewer within the Carp River corridor. Alternative IIIA utilizes the proposed road allowances for the construction of a portion of the trunk sewer alignment, minimizing the potential for impacts to the Carp River. Based on the evaluation results, Alternative IIIA is selected as the preferred servicing alternative.

4.2.4 Temporary Forcemain Alternatives

4.2.4.1 Description of Temporary Forcemain Alternatives

A temporary forcemain will be required to service the initial phases of development within the KWCP. Three potential alignments were selected based on available corridors through the existing community. Each alignment begins at the preferred location of the Kanata West Pump Station, located on Maple Grove Road and west of the Carp River. All three servicing scenarios ultimately discharge to a temporary outlet, the Stittsville Collector Sewer. As illustrated on **Figure 4.1-7** the alternative forcemain alignments are:

- Alternative I – West along Maple Grove Road to Huntmar Road. South along Huntmar Road and Iber Road to the Stittsville Collector Sewer situated along Abbott Street East.
- Alternative II – South, parallel to the west side of the Carp River and through the proposed development lands to the Glen Cairn stormwater pond. East to Terry Fox Drive, then south along Terry Fox Drive to the Stittsville Collector Sewer.
- Alternative III – East on Maple Grove Road to Terry Fox Drive. South on Terry Fox Drive to the Stittsville Collector Sewer.

4.2.4.2 Evaluation of Temporary Forcemain Alternatives

The temporary forcemain alternatives were evaluated and ranked using the criteria discussed in Section 4.2. The results of the evaluation are summarized in **Table 4.1-4**. An explanation of the category rankings and weightings are provided below.

Kanata West Wastewater - Internal Servicing Alternatives



Criteria	Indicators	Weighting	Rationale for Relative Weights	Alternatives		
				I	II	III
CONSTRUCTABILITY/FUNCTIONALITY				14	14	23
CO1.1 Geotechnical Issues and Construction Risks	Potential for encountering poor soils and/or elevated groundwater conditions.	36%		3	3	3
CO1.2 Infrastructure Requirements	Extent of works required.	7%	Alt. I and II require two pumping stations. Alt. III and IIIA require one pumping station. All Alts. require the same amount of piping.	1	1	3
CO1.3 Operational Impacts	Amount of maintenance intensive infrastructure required.	7%	Alt. I and II (with two pumping stations) have more maintenance intensive infrastructure.	1	1	2
CO1.4 Construction Scheduling	Impact of construction on development timing.	6%		3	3	3
CO1.5 Property Acquisition	Ease of property acquisition. (Depends on status of lands and adjacent lands, i.e. vacant, leased or owner occupied.)	4%	Alt. III requires the least amount of property acquisition with only one pumping station located on active developers lands and using the Carp River corridor for sewer alignment.	2	2	4
CO1.6 System Reliability	Proximity of a storm sewer, SWM or other surface water for emergency overflow	2%	Alt. I and II have pumping stations remotely located relative to proposed storm ponds.	2	2	4
CO1.7 Servicing Flexibility	Ease of accommodating potential changes in servicing plans.	6%	The more central location of the main pumping station to the tributary area makes Alt. III and IIIA more flexible to change.	2	2	4
ECONOMY						
E1	Potential to Use Combined Service Corridor	25%	Alt. III and IIIA service the entire area south of Hwy 417 with one pumping station.	11	11	18
E2	Length and area of combined service corridor.	6%		2	2	4
E3	Efficiency of Use of Existing Infrastructure	5%		4	4	4
E4	Use of existing capacity	5%		1	1	3
E5	Pumping requirements	4%	Alt. I and II requires double pumping of a significant portion of the service area.	3	3	3
E6	Energy Consumption	4%		1	1	4
E7	Impact on Agriculture	2%	Alt. I and II are significantly more expensive primarily due to the cost of two pumping stations.	10	10	10
E8	Estimated cost of construction.	8%		4	4	4
CARING AND HEALTHY COMMUNITIES						
C3	Replacement of Residents, Community/Recreation Features and Institutions.	25%	Affects areas of residence, institutions or businesses.	3	3	3
C4	Disruption to Existing Community	6%	Extent of works affecting existing residences and businesses and visibility of additional infrastructure.	3	3	3
C9	Consistency with Planned Land Use and Infrastructure	11%	Compatibility with City land use, design guidelines and infrastructure servicing corridor planning (Kanata West Roadwork Environmental Study Report and Storm Sewer and Watermain Needs).	3	3	3
NATURAL ENVIRONMENT						
N1	Impact on Significant Natural Features	14%	Loss of natural area due to installation of works.	13	9	11
N3	Impact on Aquatic Systems	3%	Potential impact on fish habitat due to installation of works.	4	2	2
N4	Impact on Quality and Quantity of Surface Water and Groundwater	3%	Potential impact on water quality in the Carp River resulting from rare emergency overflows to the SWM pond due to pump station failure.	3	2	2
N5	Impact on Global Warming	1%	Difference in carbon dioxide emissions resulting from occasional use of diesel generator.	2	2	3
N6	Effects on Urban Greenspace, Open Space and Vegetation (i.e. trees shrubs, etc.)	5%	Disruption to greenspace and trees.	1	1	2
Total Score				2.39	2.26	3.21
Ranking				3	4	2
Estimated Capital Cost (in \$million)				8.5	8.5	5.5

Description of Alternatives
 Internal Servicing Alternative I - Silver Seven Road at HWY 417
 Internal Servicing Alternative II - HWY 417 East of Carp River
 Internal Servicing Alternative III - Maple Grove Road West of the Carp River
 Internal Servicing Alternative IIIA - Maple Grove Road West of the Carp River with an Alternative Sewer Alignment

Evaluation Ranking
 1 - 2 High or Negative Impact
 3 Moderate or No Impact
 4-5 Low or Positive Impact

Constructability/Functionality (C/F) –36%

All three alternatives require the construction of a shallow forcemain so geotechnical issues are not considered to be a concern along the selected alignments. However, an assessment of the subsurface conditions indicates that unlike Alternative III, Alternatives I and II will not require rock excavation.

Alternatives I and III are located entirely within existing or proposed road allowances eliminating the need for additional land or easements. A benefit of Alternative II is that the length of the require forcemain is moderately less than Alternatives I and III.

Alternative I is advantageous for routine maintenance operations as the alignment is located within a lower classification of roadway when compared to Alternative III.

Economy (E) – 25%

Approximately 50% of the Alternative I forcemain will be installed in conjunction with other development works minimizing the amount of reinstatement required. This reduces the overall cost of Alternative I relative to the other remaining options. A large portion of Alternative II would be constructed in open fields requiring fewer costs for reinstatement when compared to Alternative III.

Caring and Healthy Community (CHC) – 25%

All three alternatives present similar impacts to the community. These impacts are limited to the duration of construction and are therefore considered minimal. Alternative I creates the least amount of impact when compared to Alternatives II and III. This is due to the fact that approximately half of the construction of the temporary forcemain will be done with other development works. Alternative II requires construction along major arterials within existing communities east of the KWCP, resulting in the highest level of impact.

Natural Environment (NE) – 14%

Alternatives I and III are entirely contained within existing or proposed road allowances. However, Alternative III would require a crossing at the Carp River. Construction monitoring to detect any required mitigation measures for potential impacts to water quality would be required. A large portion of the Alternative II alignment is within the Carp River corridor and will have the highest impact on existing natural features.

4.2.4.3 Selection of Preferred Temporary Forcemain Alternative

Based on the above evaluation, temporary forcemain Alternative I, the Huntmar Road/Iber Road alignment, is selected as the preferred alternative. This alignment facilitates routine maintenance operations, as it is located within a roadway of lower classification when compared to the other alternatives (Terry Fox Drive). This alignment also results in the least amount of impact on the existing natural features. The Alternative I alignment is similar to Alternative II as the most economical options. Over half of the alignment will be constructed in conjunction with other works, unlike Alternative II.

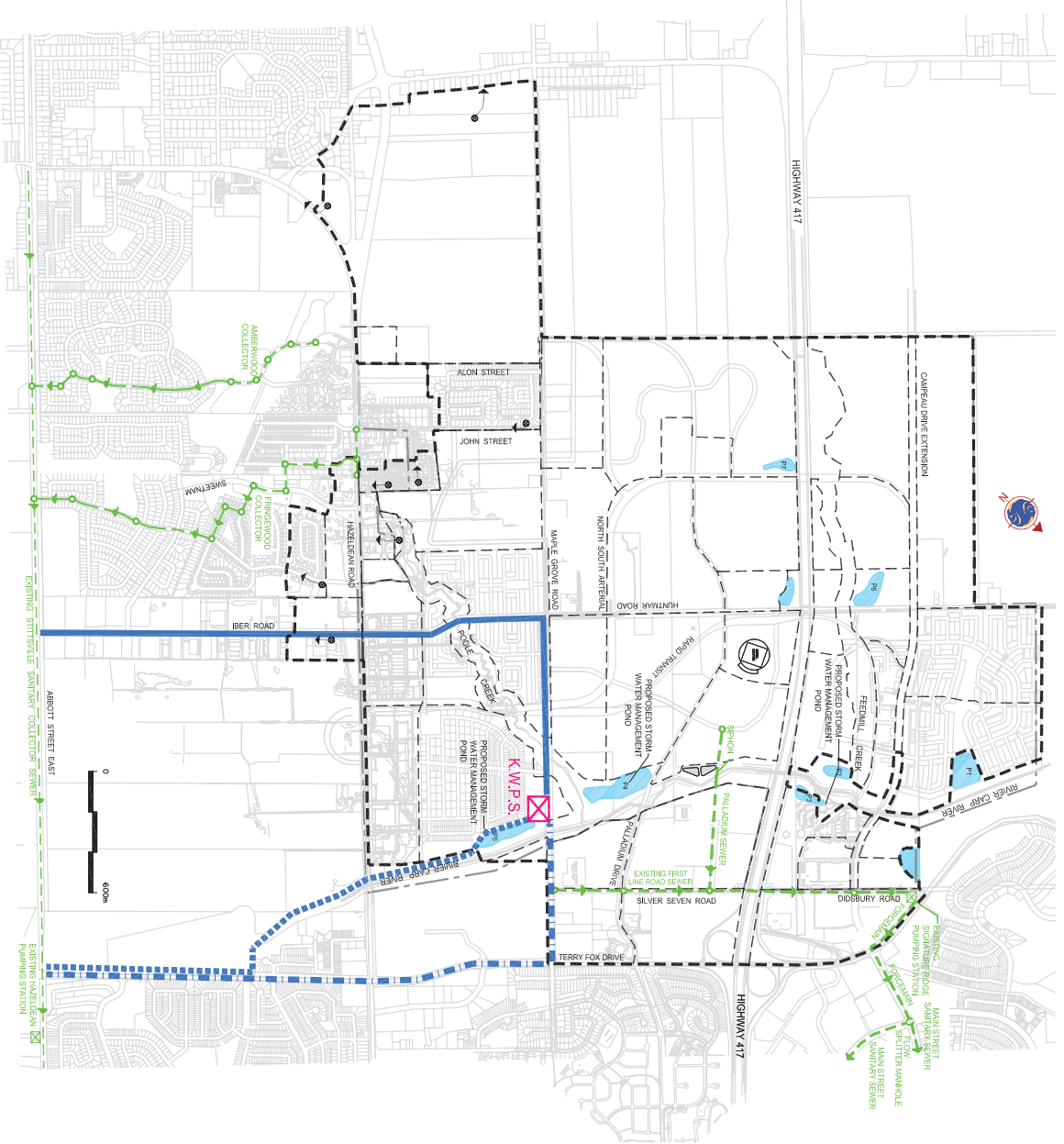

TEMPORARY SANITARY FORCEMAIN ALTERNATIVES

- Ultimate Major Drainage Limit
- Alternate I (Preferred Option)
- - - Alternate II
- · · Alternate III
- Existing Trunk Sewers
- Existing Pumping Station and Forcemain (To be Decommissioned)
- ⊠ Pump Station



CGCL/IBI
CONSULTING GROUP LIMITED

MAY 2006

FIG. 4.1-7

TABLE 4.1-4

Kanata West Wastewater - Temporary Foremain Alternatives



Criteria	Indicators	Weighting	Rationale for Relative Weights			Temporary Foremain Alternatives		
			I	II	III	I	II	III
CONSTRUCTABILITY/FUNCTIONALITY								
CO1.1	Potential for encountering poor soils and/or elevated groundwater conditions.	36%				21	18	20
						3	3	2
CO1.2	Extent of works required.	7%						
CO1.3	Amount of maintenance intensive infrastructure required.	7%						
CO1.4	Impact of construction on development timing.	6%						
CO1.5	Ease of property acquisition. (Depends on status of lands and adjacent lands, i.e. vacant, leased or owner occupied.)	4%						
CO1.6	Proximity of a storm sewer, SWM or other surface water for emergency overflow	2%						
CO1.7	Ease of accommodating potential changes in servicing plans.	6%						
		5%						
ECONOMY								
E1	Length and area of combined service corridor.	25%				16	14	13
						4	1	2
E2	Use of existing capacity	6%						
E3	Pumping requirements	5%						
E4	Agriculture area likely to be affected by infrastructure.	4%						
E5	Estimated cost of construction.	2%						
E9		8%						
CARING AND HEALTHY COMMUNITIES								
C3	Affects areas of residence, institutions or businesses.	25%				8	5	7
						3	2	3
C4	Extent of works affecting existing residences and businesses and visibility of additional infrastructure.	6%						
C9	Compatibility with City land use, design guidelines and infrastructure servicing corridor planning (Kanata West/Roadwork Environmental Study Report and Storm Sewer and Watermain Needs).	11%						
						2	2	2
NATURAL ENVIRONMENT								
N1	Loss of natural area due to installation of works.	8%						
		14%				15	9	14
N3	Potential impact on fish habitat due to installation of works.	3%						
		3%				3	2	3
N4	Potential impact on water quality in the Carp River resulting from rare emergency overflows to the SWM pond due to pump station failure.	3%						
		3%				3	2	3
N5	Difference in carbon dioxide emissions resulting from occasional use of diesel generator.	1%						
		1%				3	3	3
N6	Disruption to greenspace and trees.	5%						
		5%				3	1	3
Total Score								
		100%				2.93	2.29	2.52
Ranking								
						1	3	2
Estimated Capital Cost (in \$million)								
						1.5	1.5	2

Evaluation Ranking
 1 - 2 High or Negative Impact
 3 Moderate or No Impact
 4 - 5 Low or Positive Impact

Description of Alternatives
 Temporary Foremain Alternative I - Maple Grove/Hunter/ber Road to the Stittsville Collector
 Temporary Foremain Alternative II- Carp River/Terry Fox to the Stittsville Collector
 Temporary Foremain Alternative III- Maple Grove/Terry Fox to the Stittsville Collector

4.2.5 Trunk Sewer Alignment Alternatives

4.2.5.1 Description of Trunk Sewer Alignment Alternatives

Three potential alignments were considered for the gravity sewer that will service the un-serviced lands on Hazeldean Road. This sewer will also permit the decommissioning of several small existing pumping stations located along the north limit of the Village of Stittsville. As illustrated in **Figure 4.1-8** the alternative alignments considered for this sewer are:

- Alternative I - Maple Grove Road from the proposed pumping station to Huntmar Road, south on Huntmar Road to Hazeldean Road at Iber Road.
- Alternative II - Maple Grove Road to south of Poole Creek, southerly along Poole Creek to the transit corridor, southerly along the transitway to Hazeldean Road at Iber Road.
- Alternative III - South from the Maple Grove Road Pumping Station through the proposed development lands adjacent to the Carp River to Hazeldean Road, west on Hazeldean Road to Iber Road.

4.2.5.2 Evaluation of the Trunk Sewer Alignment Alternatives

The alternative sewer alignments were evaluated and ranked using the criteria discussed in Section 4.2. The results of the evaluation are summarized in **Table 4.1-5**. . An explanation of the category rankings and weightings are provided below.

Constructability/Functionality (C/F) – 36%

All three alternatives require approximately the same depth of excavation and present similar geotechnical issues. A benefit of Alternative I is that at least half of the works will be installed in conjunction with other infrastructure. In addition, the Alternative I alignment will be installed in a corridor that will be part of Phase One of construction providing flexibility in phasing works outside the KWCP area.

Alternatives I and II require the least amount of infrastructure to reach Iber Road.

Economy (E) – 25%

Alternatives I and II offer the opportunity to use combined service corridors along Maple Grove Road and Huntmar Road (Alternative I) and Hazeldean Road and the transitway (Alternative II). Alternative I would be part of Phase 1 of construction and will ensure that the timing of installation will coincide with other joint use utilities. This ensures that the economies of the combined corridor servicing will materialize for Alternative I.

Alternatives I and II are the least costly to install as they require the least amount of infrastructure.

Caring and Healthy Community (CHC) – 25%

There are no significant differences between the three alternatives in terms of the impact on the community. The alignment of all three alternatives is primarily confined to within the development area. Impacts will be confined to the period of construction in all cases.

Natural Environment (NE) – 14%

All three sewer alignment alternatives have a similar impact on the environment. Each alignment is confined to existing right-of-ways or in new right-of-ways proposed within the development area. Alternative I requires crossing Poole Creek that may impact water quality.

4.2.5.3 Selection of Preferred Huntmar Road Sewer Alignment Alternative

Based on the above evaluation, Huntmar Road sewer Alternative I is selected as the preferred alignment for the gravity sewer. This sewer will service Hazeldean Road and the southern portion of the KWCP. The alignment is preferred because it maximizes the flexibility for development within the KWCP without compromising the surrounding communities or natural environment.

4.2.6 Signature Ridge Pumping Station Alternatives

4.2.6.1 Description of Signature Ridge Pumping Station Alternatives

The Signature Ridge Pumping Station is a critical element for providing sanitary service to the KWCP. The present condition of the station is insufficient to provide the necessary level of service required to service the proposed area. To the capacity, two alternatives were considered for the Station. The station can be upgraded (Alternative II) or it can be completely rebuilt (Alternative I), including the construction of a new wet well, pumps and auxiliary power facility. Upgrade recommendations have been described in the "Signature Ridge Pumping Station Feasibility Study" by R.V. Anderson Assoc. Ltd., dated Sept. 2003.

These alternatives were considered because of the significant amount of infrastructure that is currently dependent on the Signature Ridge Pumping Station for an outlet. The station is also located in close proximity to the northeast portion of the KWCP. **Figure 4.1-9** illustrates the location of the Signature Ridge Pumping Station.

4.2.6.2 Evaluation of Signature Ridge Pumping Station Alternatives

The alternative pumping station alternatives were evaluated and ranked using the criteria discussed in Section 4.2. The results of the evaluation are summarized in **Table 4.1-6**. An explanation of the category rankings and weightings are provided below.

Constructability/Functionality (C/F) 36%

The Signature Ridge Pumping Station requires only mechanical upgrades to provide the necessary level of service, which can be accomplished through Alternative I (Station up-grade). This eliminates the need to perform deep excavations in soft clays for reconstruction of the wet well. A benefit of constructing a new pumping station would be the ability to increase the pumping capacity to more than that required for the KWCP, increasing the flexibility of the overall wastewater system.

Upgrading the existing station will not require any property acquisition and can be completed in stages to meet the needs of future development over time.

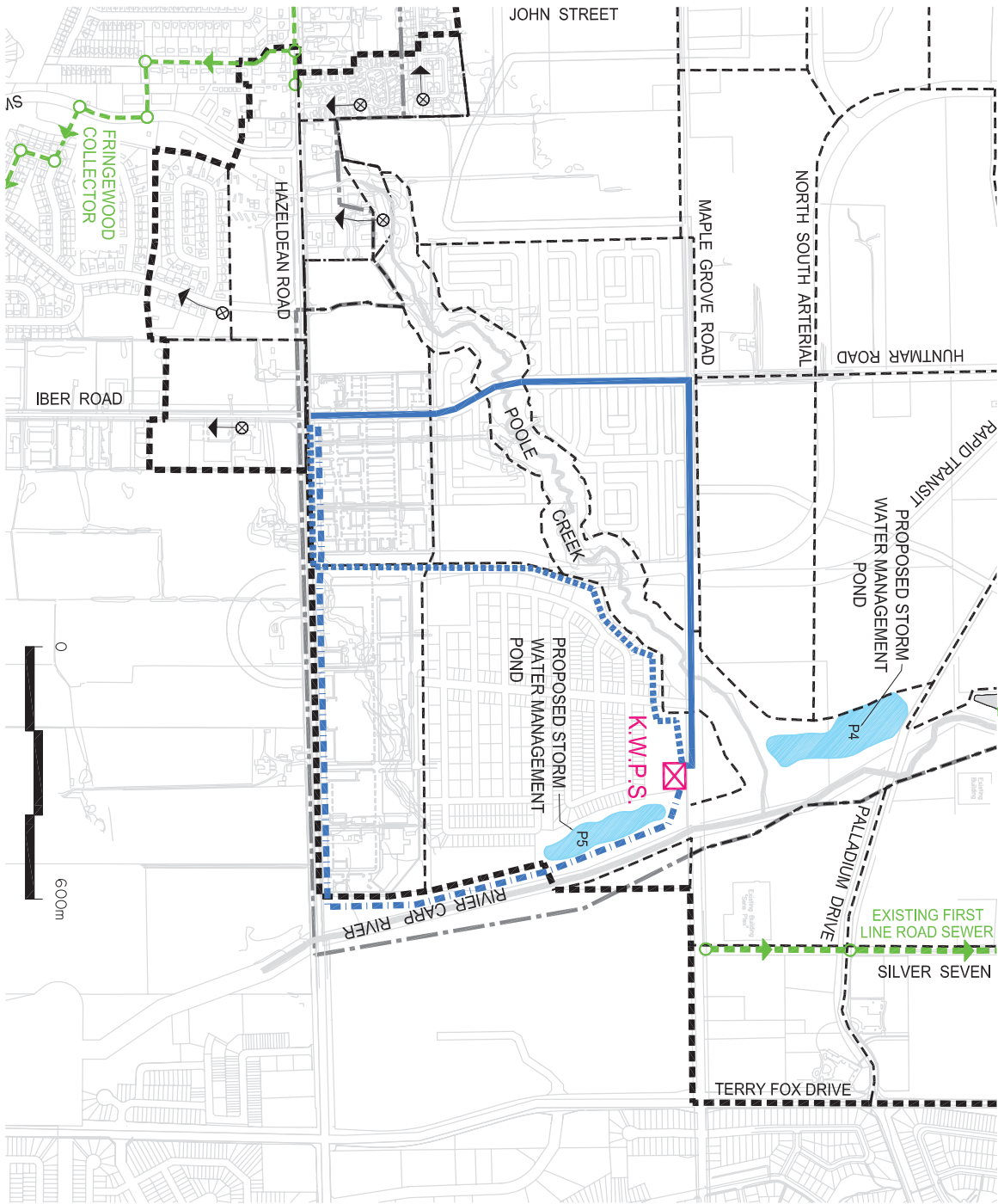

TRUNK SEWER ALIGNMENT ALTERNATIVES

- Ultimate Major Drainage Limit
- Alternate I (Preferred Option)
- ⋯ Alternate II
- ⋯ Alternate III
- Existing Trunk Sewers
- Existing Pumping Station and Forcemain (To be Decommissioned)
- ⊠ Pump Station

MAY 2006

FIG. 4.1-8



TCCL/IBI

TABLE 4.1-5

Kanata West Wastewater - Trunk Sewer Alternatives



Criteria	Indicators	Weighting	Rationale for Relative Weights		
			I	II	III
CONSTRUCTABILITY/FUNCTIONALITY		36%	27	17	19
CO1.1	Geotechnical Issue and Construction Risks Potential for encountering poor soils and/or elevated groundwater conditions.		3	3	3
CO1.2	Infrastructure Requirements Extent of works required.	7%			
CO1.3	Operational Impacts Amount of maintenance intensive infrastructure required.	7%			
CO1.4	Construction Scheduling Impact of construction on development/turning.	6%			
CO1.5	Property Acquisition Ease of property acquisition. (Depends on status of lands and adjacent lands, i.e. vacant, leased or owner occupied).	4%			
CO1.6	System Reliability Proximity of a storm sewer, SWM or other surface water for emergency overflow	2%			
CO1.7	Servicing Flexibility Ease of accommodating potential changes in servicing plans.	6%			
		5%			
ECONOMY		25%	17	15	12
E1	Potential to Use Combined Service Corridor Length and area of combined service corridor.		5	3	2
E2	Efficiency of Use of Existing Infrastructure Use of existing capacity	6%			
E3	Energy Consumption Pumping requirements	5%			
E4	Impact on Agriculture Agriculture area likely to be affected by infrastructure.	4%			
E5	Capital Cost Estimated cost of construction.	2%			
E9		8%			
CARINGS AND HEALTHY COMMUNITIES		25%	9	9	9
C3	Displacement of Residents/Community/Recreation Features and Institutions. Affects areas of residence, institutions or businesses.		3	3	3
C4	Disruption to Existing Community Extent of works affecting existing residences and businesses and visibility of additional infrastructure.	6%			
C9	Consistency with Planned Land Use and Infrastructure Compatibility with City land use, design guidelines and infrastructure servicing corridor planning (Kanata West Roadwork Environmental Study Report and Storm Sewer and Watermain Needs).	11%			
		8%			
NATURAL ENVIRONMENT		14%	13	15	15
N1	Impact on Significant Natural Features Loss of natural area due to installation of works.	3%	2	3	3
N3	Impact on Aquatic Systems Potential impact on fish habitat due to installation of works.	3%			
N4	Impact on Quality and Quantity of Surface Water and Groundwater Potential impact on water quality in the Carp River resulting from rare emergency overflows to the SWM pond due to pump station failure.	3%			
N5	Impact on Global Warming Difference in carbon dioxide emissions resulting from occasional use of diesel generator.	1%			
N6	Effects on Urban Greenspace, Open Space and Vegetation (i.e. trees, shrubs, etc.) Disruption to greenspace and trees.	5%			
Total Score		100%	3,29	2,84	2,61
Ranking			1	2	3
Estimated Capital Cost (in \$million)			1.5	1.5	2.5

Description of Alternatives
 Trunk Sewer Alternative I - Maple Grove/Hunter/Hazeldean Road
 Trunk Sewer Alternative II - Maple Grove/Pool Creek/Transitway/Hazeldean Road
 Trunk Sewer Alternative III - Maple Grove/Hazeldean Road

Evaluation Ranking
 1 - 2 High or Negative Impact
 3 Moderate or No Impact
 4-5 Low or Positive Impact

Economy (E) 25%

The reconstruction of the Signature Ridge Pumping Station is significantly more than the costs to upgrade the existing station.

Caring and Healthy Community (CHC) 25%

In terms of the impact on the Community, there are no significant differences between the two alternatives.

Natural Environment (NE) 14%

There are no significant differences between the two options with respect to impacts to the natural environment. Both alternatives require the construction of an emergency overflow to the Carp River. Impacts to surface water quality as a result of potential station overflows during an emergency situation are not expected to occur. Should an overflow occur for either alternative, the impacts would be mitigated by a SWM pond. Increases in CO₂ emissions as a result of the use of diesel generators during power failures or maintenance procedures will be negligible and are similar in both alternatives.

4.2.6.3 Selection of Preferred Signature Ridge Pumping Station Alternative

Based on the above evaluation, the Signature Ridge Pumping Station Alternative I, station upgrade, is selected as the preferred alternative. This alternative maximizes the use of existing infrastructure and offers the most flexibility in phasing of the works with the least amount of capital expenditure or impacts.

4.2.6.4 Summary

The preferred alternatives selected for the wastewater outlet, the internal servicing system, the temporary forcemain, the trunk sewer alignment, and the Signature Ridge Pumping Station have been used to develop a comprehensive wastewater servicing plan for the KWCP. This servicing plan is discussed in future detail in the following section of this report.

4.3 Preferred Sanitary Sewer Servicing Plan

Section 4.2 has detailed the selection of preferred alternatives for the major infrastructure required to provide sanitary sewer service to the KWCP. These preferred alternatives have been used to develop a Master Sanitary Servicing Plan for the area. This plan is illustrated on **Drawing S-1** (appended to this report). The major features of this plan are:

- (i.) An upgraded Signature Ridge Pumping Station (SRPS) to service all the KWCP lands north of the Queensway, the existing urban area north of the Queensway currently proposed to drain to the SRPS, and the Broughton/Richardson Interstitial lands. A spreadsheet detailing the exact areas and flows tributary to the SRPS is included in **Figure 4.2-1**.

The 400 l/sec peak flow capacity identified in **Figure 4.2-1** for the upgraded SRPS, is consistent with the findings of the R.V. Anderson Report titled "Signature Ridge Pumping Station Upgrades Feasibility Study".

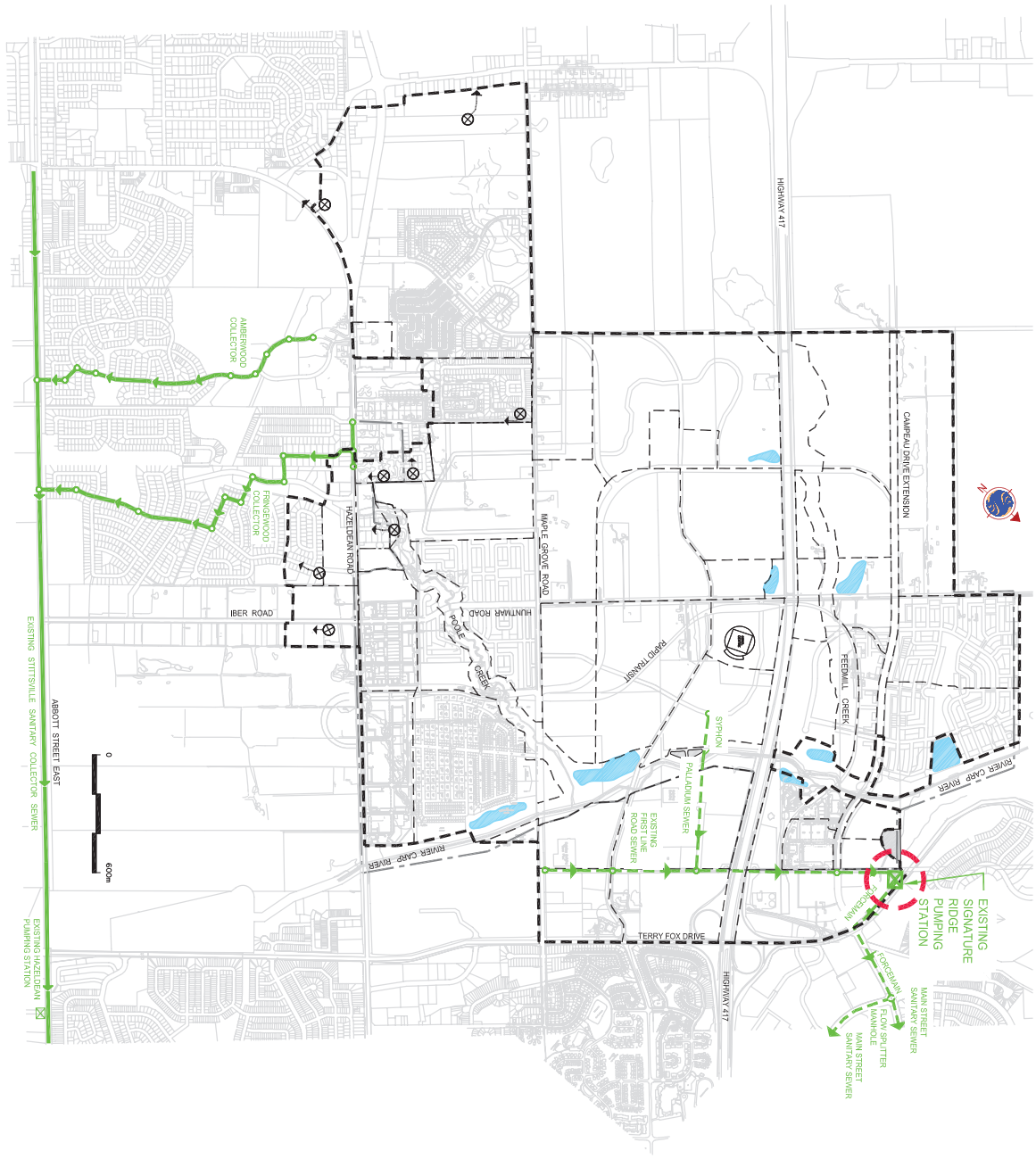

SIGNATURE RIDGE PUMPING STATION LOCATION

- Legend:**
- Ultimate Drainage Limit
 - Existing Sitsitsville Sewer
 - - - Existing Trunk Sewer
 - ⊗ Existing Pumping Station and Forcemain (To be Decommissioned)

FIG. 4.1-9

MAY 2006

TABLE 4.1-6



Kanata West Wastewater - Temporary Forcemain/Trunk Sewer/Signature Ridge Alternatives

Criteria	Indicators	Weighting	Rationale for Relative Weights	
			Upgrade	Rebuild
CONSTRUCTABILITY/FUNCTIONALITY				
CO1.1	Geotechnical Issues and Construction Risks	36%	24	16
	Potential for encountering poor soils and/or elevated groundwater conditions.		3	1
CO1.2	Infrastructure Requirements	7%		
	Extent of works required.		4	1
CO1.3	Operational Impacts	7%		
	Amount of maintenance intensive infrastructure required.		3	3
CO1.4	Construction Scheduling	6%		
	Impact of construction on development timing.		4	2
CO1.5	Property Acquisition	4%		
	Ease of property acquisition. (Depends on status of lands and adjacent lands, i.e. vacant, leased or owner occupied.)		5	2
CO1.6	System Reliability	2%		
	Proximity of a storm sewer, SWM or other surface water for emergency overflow		3	3
CO1.7	Servicing Flexibility	6%		
	Ease of accommodating potential changes in servicing plans.		2	4
		5%		
ECONOMY				
E1	Potential to Use Combined Service Corridor	25%	19	12
	Length and area of combined service corridor.		3	3
E2	Efficiency of Use of Existing Infrastructure	6%		
	Use of existing capacity		5	2
E3	Energy Consumption	5%		
	Pumping requirements		3	3
E5	Impact on Agriculture	4%		
	Agriculture area likely to be affected by infrastructure		3	3
E9	Capital Cost	2%		
	Estimated cost of construction.		5	1
		8%		
CARING AND HEALTHY COMMUNITIES				
C3	Displacement of Residents, Community/Recreation Features and Institutions.	25%	12	9
	Affects areas of residence, institutions or businesses.		4	4
C4	Disruption to Existing Community	6%		
	Extent of works affecting existing residences and businesses and visibility of additional infrastructure.		4	3
C9	Consistency with Planned Land Use and Infrastructure	11%		
	Compatibility with City land use, design guidelines and infrastructure servicing corridor planning (Kanata West Roadwork Environmental Study Report and Storm Sewer and Watermain Needs).		4	2
		8%		
NATURAL ENVIRONMENT				
N1	Impact on Significant Natural Features	14%	14	14
	Loss of natural area due to installation of works.		3	3
N3	Impact on Aquatic Systems	3%		
	Potential impact on fish habitat due to installation of works.		3	3
N4	Impact on Quality and Quantity of Surface Water and Groundwater	3%		
	Potential impact on water quality in the Carp River resulting from rare emergency overflows to the SWM pond due to pump station failure.		3	3
N5	Impact on Global Warming	1%		
	Difference in carbon dioxide emissions resulting from occasional use of diesel generator.		2	2
N6	Effects on Urban Greenspace, Open Space and Vegetation (i.e. trees, shrubs etc.)	5%		
	Disruption to greenspace and trees.		3	3
Total Score				
Ranking		100%	3.60	2.48
Estimated Capital Cost (in \$million)			1	4

Evaluation Ranking
 1-2 High or Negative Impact
 3 Moderate or No Impact
 4-5 Low or Positive Impact

Description of Alternatives
 Signature Ridge PS Alternative 1 - Rebuild
 Signature Ridge PS Alternative II - Upgrade

The Signature Ridge Pumping Station is currently not equipped with catastrophic failure protection in the form of a gravity overflow. A hydraulic analysis of the proposed sewer system was therefore completed to evaluate the potential for providing a gravity overflow. This analysis demonstrates that catastrophic protection can be provided by gravity. The analysis is included in **Appendix 4.2** and demonstrates that overflows to the existing stormwater management pond on First Line Road and to Pond I can provide the necessary level of protection.

- (ii.) A single new pumping station and forcemain located south of Maple Grove Road and west of the Carp River.

This new pumping station ultimately services all the KWCP south of Highway 417, the lands south of the 417 originally tributary to the SRPS, and the lands in the Village of Stittsville, along Hazeldean Road which are currently unserviceable by gravity to the Stittsville Sanitary Sewer System. This new pumping station has also been designed to accommodate the decommissioning of up to eight small public and private pumping stations along Hazeldean Road without deepening the Kanata West system. **Figure 4.2-1** details the exact areas and flows from Stittsville which will ultimately be tributary to the new pumping station. The areas are also illustrated on **Drawing S-1**.

Figures 4.2-3 and 4.2-4 illustrate a conceptual layout and cross-section for the new pumping station and **Appendix 4.3** details the conceptual design of the pumping station.

The new pumping station will temporarily outlet to the Stittsville Collector Sewer via a temporary forcemain in Huntmar Road and Iber Road. This temporary forcemain is designed to accommodate a flow of 190 l/sec (approximately 3,000 units). The temporary outlet will be located entirely within a public right-of-way. The single 405 mm diameter forcemain used for the initial outlet can be kept in service for long-term use as an emergency back up outlet. Rationale on the availability of capacity in the Stittsville Collector Sewer is attached as **Appendix 4.1**.

The permanent outlet for the new pumping station consists of a forcemain leading from the pumping station to the Glen Cairn Collector Sewer east of Eagleson Road. The preferred route for this forcemain is along Maple Grove Road to Silver Seven Road; along the east side of Silver Seven Road, in an easement, in the undeveloped lands between Maple Grove Road and Palladium Drive; easterly along Palladium Drive to Katimavik Road; and easterly along the north side of Katimavik Road, in the corridor for the unbuilt westbound lanes of Katimavik Road, to Eagleson Road and the Glen Cairn Collector Sewer. The location of the new pumping station is in close proximity to Stormwater Management Ponds 4 and 5. This provides catastrophic failure protection to the new pumping station in the form of a gravity overflow. The hydraulic analysis of this overflow system is attached as **Appendix 4.2**.

The preferred sanitary sewer system also includes a gravity sewer, which collects flow from several minor internal sanitary sewers and directs this flow to the new pumping station location. As illustrated on **Drawing S-1** this minor collector sewer runs parallel to the west side of the Carp River corridor between Maple Grove Road and Palladium Drive, crossing under the Carp River by boring beneath the river. The sewer extends northerly to intercept flows from Silver Seven Road and diverts them from the Signature Ridge Pumping Station. The inclusion of this north south sewer is a key element in eliminating the need for double pumping within Kanata

SANITARY SEWER DESIGN SHEET
 Sanitary Sewer Feasibility Study
 LOCATION : CITY OF OTTAWA

FILE: 3598LDrawings.XLS

STREET	LOCATION		PHASE I SIGNATURE RIDGE (population based criteria, CI small areas peaking)												TOTAL													
	FROM MH	TO MH	APPLIC AREA (Hd)	UNIT/Hd	TOTAL UNITS	INDV	POPULATION	PEAK FACTOR	PEAK FLOW (l/s)	APPLIC AREA (Hd)	ACCUM AREA (Hd)	TOTAL AREA (Hd)	FLOW RATE (l/s/Hd)	FLOW (l/s)	INDV	ACCUM	TOTAL	INfiltration AREA (Hd)	CUMUL	PEAK FLOW (l/s)	TOTAL FLOW (l/s)	CAPACITY (l/s)	VELOCITY (ft/s)	LOTH (m)	PIPE GRADE %	AVAIL CAP. (%)		
Campden Drive Trunk Sewer	1	2	0.00							0.00	0.00	0.00	0.00	0.00	0.00	0.00	0.00	0.00	0.00	0.00	0.00	0.00						
			0.00							0.00	0.00	0.00	0.00	0.00	0.00	0.00	0.00	0.00	0.00	0.00	0.00	0.00						
			0.00							0.00	0.00	0.00	0.00	0.00	0.00	0.00	0.00	0.00	0.00	0.00	0.00	0.00						
			0.00							0.00	0.00	0.00	0.00	0.00	0.00	0.00	0.00	0.00	0.00	0.00	0.00	0.00						
			29.19	19	555	1664	1664	3.65	2.438	0.00	0.00	0.00	0.00	0.00	0.00	0.00	0.00	0.00	0.00	0.00	0.00	283.79	1.27	3.000	3.52	0.40	100.00%	
			0.00							0.00	0.00	0.00	0.00	0.00	0.00	0.00	0.00	0.00	0.00	0.00	0.00	0.00						
			0.00							0.00	0.00	0.00	0.00	0.00	0.00	0.00	0.00	0.00	0.00	0.00	0.00	0.00						
			27.86	19	529	1588	1588	3.66	2.435	0.00	0.00	0.00	0.00	0.00	0.00	0.00	0.00	0.00	0.00	0.00	0.00	148.74	0.91	9.300	4.50	0.25	100.00%	
			4.0	4						0.00	0.00	0.00	0.00	0.00	0.00	0.00	0.00	0.00	0.00	0.00	0.00	200.67	0.90	7.500	4.50	0.25	83.68%	
			4.0	4						0.00	0.00	0.00	0.00	0.00	0.00	0.00	0.00	0.00	0.00	0.00	0.00	34.00	0.67	7.500	4.50	0.25	77.00%	
			4.13	50	88	263	3513	3.38	48.17	2.37	2.37	123.33	35000	1.44	1.44	1.44	1.44	4.13	4.13	61.18	66.26	20.60	0.90	600.0	7.50	0.20	66.74%	
			6.05							6.05	6.05	6.05	30000	3.15	3.15	3.15	3.15	6.05	6.05	30.00	45.52							
			20.15							20.15	26.20	26.20	14400	5.04	8.19	8.19	8.19	20.15	26.20	26.20	7.34	45.52						
			14.59							14.59	14.59	14.59	35000	8.87	8.87	8.87	8.87	14.59	14.59	14.59								
			11.97							11.97	26.56	26.56	35000	7.27	16.14	16.14	16.14	11.97	26.56	26.56								
			20.66							20.66	47.22	47.22	35000	12.35	28.69	28.69	28.69	20.66	47.22	47.22								
			28.89							28.89	76.11	76.11	55000	17.55	46.25	46.25	46.25	28.89	76.11	76.11								
			102.31							102.31	102.31	102.31	55000	6.35	54.44	54.44	54.44	102.31	102.31	58.66	67.56	100.27	0.88	664.0	3.73	0.30	37.59%	
			6.35							6.35	108.66	108.66	35000	3.86	58.29	58.29	58.29	6.35	6.35	6.35								
			11.80							11.80	115.45	115.45	35000	4.12	62.42	62.42	62.42	11.80	115.45	120.46	63.72	137.96	203.90	1.24	420.0	4.50	0.47	32.49%
			3.88							3.88	193.53	193.53	35000	2.36	64.77	64.77	64.77	3.88	124.34	80.10	330.33							
			468.84							468.84	144.83	268.20	30000	13.52	81.73	81.73	81.73	25.54	149.86	311.06	330.33							
			90.20							90.20	0.00	0.00	0.00	90.20	4.24	4.24	4.24	90.20	95.08	26.62	98.21							
			4.88							4.88	4.88	4.88	50000	4.24	4.24	4.24	4.24	4.88	95.08	26.62	65.00							
Total To SRPS	5A	SRPS	306.14							154.03	152.12	127.33		9409						313.6	85.97	625.68	1.37	30.0	7.50	0.29	37.03%	

Note: Sewer from node 5 to SRPS is existing and is to be replaced.

Average Daily Per capita Flow Rate = 350 l/cap/d
 Influent Allowance Flow Rate = 0.28 l/cap/d/s
 Residential Peaking Factor = 1.4 (4.04+0.30) l/cap/d in 1000's. Max of 4
 Population density per unit = 3.00
 Mixed User Assumes: 15% Community Retail, 42.5% Business Park and 42.5% Residential



FIG. 4.2-2

Revision No. 1: April 11, 2005

Revision No. 2: April 20, 2005

Revision No. 3: June 07, 2005

Revision No. 4: Oct. 14, 2005

Revision No. 5: Feb. 15, 2006

**SERVICING AND STORMWATER MANAGEMENT BRIEF –
WELLINGS OF STITTSVILLE PHASE 2, 20 CEDAROW COURT**

Appendix C Stormwater Management
September 1, 2023

Appendix C STORMWATER MANAGEMENT

**C.1 STORM SEWER DESIGN SHEET AND ROOF STORAGE
CALCULATIONS**

**Project #160401511, 20 Cedarow
Roof Drain Design Sheet, Area ROOF1**

Rating Curve				Volume Estimation			Drawdown Estimate				
Elevation (m)	Discharge Rate (cu.m/s)	Outlet Discharge (cu.m/s)	Storage (cu.m)	Elevation (m)	Area (sq.m)	Increment	Volume (cu.m)	Total Volume (cu.m)	Total Time (sec)	Vol (cu.m)	Detention Time (hr)
0.000	0.0000	0.0000	0	0.000	0	0	0	0.0	0.0	0.0	0
0.025	0.0003	0.0006	0	0.025	4	0	0	0.3	205.5	0.3	0.05707
0.050	0.0006	0.0013	0	0.050	18	0	0	1.0	446.2	0.7	0.18101
0.075	0.0008	0.0016	1	0.075	40	1	1	2.3	724.0	1.4	0.38213
0.100	0.0009	0.0019	2	0.100	71	1	2	4.6	1023.1	2.3	0.66633
0.125	0.0011	0.0022	5	0.125	111	2	5	8.0	1335.5	3.4	1.03731
0.150	0.0013	0.0025	8	0.150	160	3	8				

Roof Storage Summary

Total Building Area (sq.m) 200
 Assume Available Roof Area (sq. 80%
 Roof Imperviousness 160
 Roof Drain Requirement (sq.m/Notch) 0.99
 Number of Roof Notches* 232
 Max. Allowable Depth of Roof Ponding (m) 2
 Max. Allowable Storage (cu.m) 0.15 * As per Ontario Building Code section OBC 7.4.10.4.(2)(c).
 Estimated 100 Year Drawdown Time (h) 8
 0.7

From Watts Drain Catalogue

Head (m) L/s
 Open 0.75 0.5 0.25 Closed
 0.025 0.3155 0.3155 0.3155 0.3155 0.3155 0.3155
 0.05 0.6309 0.6309 0.6309 0.6309 0.6309 0.6309
 0.075 0.9464 0.8675 0.7886 0.7098 0.6309 0.6309
 0.1 1.2618 1.1041 0.9464 0.7886 0.6309 0.6309
 0.125 1.5773 1.3407 1.1041 0.8675 0.6309 0.6309
 0.15 1.8927 1.5773 1.2618 0.9464 0.6309 0.6309

Calculation Results

	5yr	100yr	Available
Qresult (cu.m/s)	0.002	0.002	-
Depth (m)	0.081	0.130	0.150
Volume (cu.m)	1.3	5.3	8.0
Draintime (hrs)	0.2	0.7	

* Note: Number of drains can be reduced if multiple-notch drain used.

**Project #160401511, 20 Cedarow
Roof Drain Design Sheet, Area ROOF2**

Rating Curve				Volume Estimation				Drawdown Estimate			
Elevation (m)	Discharge Rate (cu.m/s)	Outlet Discharge (cu.m/s)	Storage (cu.m)	Elevation (m)	Area (sq.m)	Increment	Volume (cu.m)	Total Volume (cu.m)	Total Time (sec)	Vol (cu.m)	Detention Time (hr)
0.000	0.0000	0.0000	0	0.000	0	0	0	0.0	0.0	0.0	0
0.025	0.0003	0.0028	0	0.025	49	0	0	2.9	502.3	2.9	0.13951
0.050	0.0006	0.0057	3	0.050	196	3	3	10.6	1090.6	7.7	0.44246
0.075	0.0008	0.0071	11	0.075	440	8	11	25.7	1769.8	15.1	0.93408
0.100	0.0009	0.0085	26	0.100	782	15	26	50.5	2501.0	24.9	1.62881
0.125	0.0011	0.0099	51	0.125	1222	25	51	87.6	3264.6	37.1	2.53566
0.150	0.0013	0.0114	88	0.150	1760	37	88				

Roof Storage Summary

Total Building Area (sq.m)	2200
Assume Available Roof Area (sq. m)	1760
Roof Imperviousness	80%
Roof Drain Requirement (sq.m/Notch)	232
Number of Roof Notches*	9
Max. Allowable Depth of Roof Ponding (m)	0.15
Max. Allowable Storage (cu.m)	88
Estimated 100 Year Drawdown Time (h)	2.4

* As per Ontario Building Code section OBC 7.4.10.4.(2)(c).

From Watts Drain Catalogue

Head (m) L/s	Open	0.75	0.5	0.25	Closed
0.025	0.3155	0.3155	0.3155	0.3155	0.3155
0.05	0.6309	0.6309	0.6309	0.6309	0.6309
0.075	0.9464	0.8675	0.7886	0.7098	0.6309
0.1	1.2618	1.1041	0.9464	0.7886	0.6309
0.125	1.5773	1.3407	1.1041	0.8675	0.6309
0.15	1.8927	1.5773	1.2618	0.9464	0.6309

* Note: Number of drains can be reduced if multiple-notch drain used.

Calculation Results

	5yr	100yr	Available
Qresult (cu.m/s)	0.008	0.011	-
Depth (m)	0.098	0.147	0.150
Volume (cu.m)	24.6	83.8	88.0
Draintime (hrs)	0.9	2.4	

**Project #160401511, 20 Cedarow
Roof Drain Design Sheet, Area ROOF3**

Rating Curve				Volume Estimation			Drawdown Estimate				
Elevation (m)	Discharge Rate (cu.m/s)	Outlet Discharge (cu.m/s)	Storage (cu.m)	Elevation (m)	Area (sq.m)	Increment	Volume (cu.m)	Total Volume (cu.m)	Total Time (sec)	Vol (cu.m)	Detention Time (hr)
0.000	0.0000	0.0000	0	0.000	0	0	0	0.0	0.0	0.0	0
0.025	0.0003	0.0025	0	0.025	41	0	0	2.4	475.1	2.4	0.13198
0.050	0.0006	0.0050	3	0.050	164	2	3	8.9	1031.7	6.5	0.41858
0.075	0.0008	0.0063	9	0.075	370	7	9	21.6	1674.3	12.7	0.88367
0.100	0.0009	0.0076	22	0.100	658	13	22	42.5	2366.0	20.9	1.54089
0.125	0.0011	0.0088	43	0.125	1028	21	43	73.7	3088.4	31.2	2.39879
0.150	0.0013	0.0101	74	0.150	1480	31	74				

Roof Storage Summary

Total Building Area (sq.m) 1850
 Assume Available Roof Area (sq. 80%
 Roof Imperviousness 0.99
 Roof Drain Requirement (sq.m/Notch) 232
 Number of Roof Notches* 8
 Max. Allowable Depth of Roof Ponding (m) 0.15 * As per Ontario Building Code section OBC 7.4.10.4.(2)(c).
 Max. Allowable Storage (cu.m) 74
 Estimated 100 Year Drawdown Time (h) 2.3

From Watts Drain Catalogue

Head (m) L/s
 Open 0.75 0.5 0.25 Closed
 0.025 0.3155 0.3155 0.3155 0.3155 0.3155 0.3155
 0.05 0.6309 0.6309 0.6309 0.6309 0.6309 0.6309
 0.075 0.9464 0.8675 0.7886 0.7098 0.6309 0.6309
 0.1 1.2618 1.1041 0.9464 0.7886 0.6309 0.6309
 0.125 1.5773 1.3407 1.1041 0.8675 0.6309 0.6309
 0.15 1.8927 1.5773 1.2618 0.9464 0.6309 0.6309

Calculation Results

	5yr	100yr	Available
Qresult (cu.m/s)	0.007	0.010	-
Depth (m)	0.096	0.146	0.150
Volume (cu.m)	20.1	69.0	74.0
Draintime (hrs)	0.8	2.3	

* Note: Number of drains can be reduced if multiple-notch drain used.

**Project #160401511, 20 Cedarow
Roof Drain Design Sheet, Area ROOF4**

Rating Curve				Volume Estimation				Drawdown Estimate			
Elevation (m)	Discharge Rate (cu.m/s)	Outlet Discharge (cu.m/s)	Storage (cu. m)	Elevation (m)	Area (sq. m)	Increment	Volume (cu. m)	Total Volume (cu.m)	Total Time (sec)	Vol (cu.m)	Detention Time (hr)
0.000	0.0000	0.0000	0	0.000	0	0	0	0.0	0.0	0.0	0
0.025	0.0003	0.0006	0	0.025	4	0	0	0.3	205.5	0.3	0.05707
0.050	0.0006	0.0013	0	0.050	18	0	0	1.0	446.2	0.7	0.18101
0.075	0.0008	0.0016	1	0.075	40	1	1	2.3	724.0	1.4	0.38213
0.100	0.0009	0.0019	2	0.100	71	1	2	4.6	1023.1	2.3	0.66633
0.125	0.0011	0.0022	5	0.125	111	2	5	8.0	1335.5	3.4	1.03731
0.150	0.0013	0.0025	8	0.150	160	3	8				

Roof Storage Summary

Total Building Area (sq.m)	200
Assume Available Roof Area (sq. m)	160
Roof Imperviousness	80%
Roof Drain Requirement (sq.m/Notch)	0.99
Number of Roof Notches*	232
Max. Allowable Depth of Roof Ponding (m)	2
Max. Allowable Storage (cu.m)	0.15
Estimated 100 Year Drawdown Time (h)	8
	0.7

* As per Ontario Building Code section OBC 7.4.10.4.(2)(c).

From Watts Drain Catalogue

Head (m) L/s	Open	0.75	0.5	0.25	Closed
0.025	0.3155	0.3155	0.3155	0.3155	0.3155
0.05	0.6309	0.6309	0.6309	0.6309	0.6309
0.075	0.9464	0.8675	0.7886	0.7098	0.6309
0.1	1.2618	1.1041	0.9464	0.7886	0.6309
0.125	1.5773	1.3407	1.1041	0.8675	0.6309
0.15	1.8927	1.5773	1.2618	0.9464	0.6309

* Note: Number of drains can be reduced if multiple-notch drain used.

Calculation Results

	5yr	100yr	Available
Qresult (cu.m/s)	0.002	0.002	-
Depth (m)	0.081	0.130	0.150
Volume (cu.m)	1.3	5.3	8.0
Draintime (hrs)	0.2	0.7	

Stormwater Management Calculations

Project #160401511, 20 Cedarow Modified Rational Method Calculators for Storage

2 yr Intensity City of Ottawa	$I = a/(t + b)^c$	a = 732.951	t (min)	I (mm/hr)
		b = 6.199		
		c = 0.81		
			10	76.81
			20	52.03
			30	40.04
			40	32.86
			50	28.04
			60	24.56
			70	21.91
			80	19.83
			90	18.14
			100	16.75
			110	15.57
			120	14.56

2 YEAR Modified Rational Method for Entire Site

Subdrainage Area: ROOF4
Area (ha): 0.02
C: 0.90

Roof
Maximum Storage Depth: 150 mm

tc (min)	I (5 yr) (mm/hr)	Qactual (L/s)	Qrelease (L/s)	Qstored (L/s)	Vstored (m³)	Depth (mm)
10	76.81	3.84	1.65	2.19	1.32	80.8
20	52.03	2.60	1.62	0.98	1.18	78.3
30	40.04	2.00	1.52	0.48	0.87	70.4
40	32.86	1.64	1.40	0.25	0.60	60.6
50	28.04	1.40	1.29	0.12	0.35	51.9
60	24.56	1.23	1.16	0.07	0.25	45.9
70	21.91	1.10	1.05	0.05	0.21	41.5
80	19.83	0.99	0.96	0.04	0.17	37.9
90	18.14	0.91	0.88	0.03	0.14	34.9
100	16.75	0.84	0.82	0.02	0.11	32.5
110	15.57	0.78	0.77	0.01	0.09	30.3
120	14.56	0.73	0.72	0.01	0.07	28.5

Storage: Roof Storage

Depth (mm)	Head (m)	Discharge (L/s)	Vreq (cu. m)	Vavail (cu. m)	Discharge Check	
2-year Water Level	80.76	0.08	1.65	1.32	8.00	0.00

Subdrainage Area: ROOF3
Area (ha): 0.19
C: 0.90

Roof
Maximum Storage Depth: 150 mm

tc (min)	I (5 yr) (mm/hr)	Qactual (L/s)	Qrelease (L/s)	Qstored (L/s)	Vstored (m³)	Depth (mm)
10	76.81	35.55	7.09	28.46	17.08	90.4
20	52.03	24.08	7.38	16.70	20.04	96.3
30	40.04	18.53	7.39	11.15	20.07	96.3
40	32.86	15.21	7.28	7.93	19.03	94.3
50	28.04	12.98	7.13	5.85	17.54	91.3
60	24.56	11.37	6.97	4.40	15.85	88.0
70	21.91	10.14	6.79	3.35	14.08	84.5
80	19.83	9.18	6.61	2.56	12.31	81.0
90	18.14	8.40	6.44	1.96	10.57	77.6
100	16.75	7.75	6.26	1.50	8.97	73.9
110	15.57	7.21	6.03	1.18	7.79	69.4
120	14.56	6.74	5.81	0.93	6.69	65.1

Storage: Roof Storage

Depth (mm)	Head (m)	Discharge (L/s)	Vreq (cu. m)	Vavail (cu. m)	Discharge Check	
2-year Water Level	96.34	0.10	7.39	20.07	74.00	0.00

Subdrainage Area: ROOF2
Area (ha): 0.22
C: 0.90

Roof
Maximum Storage Depth: 150 mm

tc (min)	I (5 yr) (mm/hr)	Qactual (L/s)	Qrelease (L/s)	Qstored (L/s)	Vstored (m³)	Depth (mm)
10	76.81	42.28	8.00	34.28	20.57	90.9
20	52.03	28.64	8.35	20.29	24.34	97.1
30	40.04	22.04	8.38	13.66	24.59	97.5
40	32.86	18.09	8.28	9.81	23.55	95.8
50	28.04	15.43	8.13	7.31	21.93	93.1
60	24.56	13.52	7.95	5.57	20.04	90.0
70	21.91	12.06	7.76	4.30	18.06	86.7
80	19.83	10.92	7.57	3.34	16.04	83.4
90	18.14	9.99	7.38	2.60	14.05	80.1
100	16.75	9.22	7.20	2.02	12.10	76.8
110	15.57	8.57	6.99	1.58	10.42	73.1
120	14.56	8.02	6.75	1.26	9.11	68.9

Storage: Roof Storage

Depth (mm)	Head (m)	Discharge (L/s)	Vreq (cu. m)	Vavail (cu. m)	Discharge Check	
2-year Water Level	97.55	0.10	8.38	24.59	88.00	0.00

Subdrainage Area: ROOF1
Area (ha): 0.02
C: 0.90

Roof
Maximum Storage Depth: 150 mm

tc (min)	I (5 yr) (mm/hr)	Qactual (L/s)	Qrelease (L/s)	Qstored (L/s)	Vstored (m³)	Depth (mm)
10	76.81	3.84	1.65	2.19	1.32	80.8
20	52.03	2.60	1.62	0.98	1.18	78.3
30	40.04	2.00	1.52	0.48	0.87	70.4
40	32.86	1.64	1.40	0.25	0.60	60.6
50	28.04	1.40	1.29	0.12	0.35	51.9
60	24.56	1.23	1.16	0.07	0.25	45.9

Project #160401511, 20 Cedarow Modified Rational Method Calculators for Storage

100 yr Intensity City of Ottawa	$I = a/(t + b)^c$	a = 1735.688	t (min)	I (mm/hr)
		b = 6.014		
		c = 0.820		
			10	178.56
			20	119.95
			30	91.87
			40	75.15
			50	63.95
			60	55.89
			70	49.79
			80	44.99
			90	41.11
			100	37.90
			110	35.20
			120	32.89

100 YEAR Modified Rational Method for Entire Site

Subdrainage Area: ROOF4
Area (ha): 0.02
C: 1.00

Roof
Maximum Storage Depth: 150 mm

tc (min)	I (100 yr) (mm/hr)	Qactual (L/s)	Qrelease (L/s)	Qstored (L/s)	Vstored (m³)	Depth (mm)
10	178.56	9.93	2.21	7.72	4.63	125.0
20	119.95	6.67	2.27	4.40	5.28	129.8
30	91.87	5.11	2.26	2.85	5.13	128.7
40	75.15	4.18	2.22	1.96	4.71	125.6
50	63.95	3.56	2.15	1.41	4.22	120.4
60	55.89	3.11	2.08	1.03	3.70	114.8
70	49.79	2.77	2.01	0.76	3.19	109.1
80	44.99	2.50	1.94	0.56	2.70	103.7
90	41.11	2.29	1.87	0.42	2.26	98.0
100	37.90	2.11	1.79	0.32	1.92	91.7
110	35.20	1.96	1.72	0.24	1.60	85.9
120	32.89	1.83	1.65	0.18	1.31	80.6

Storage: Roof Storage

Depth (mm)	Head (m)	Discharge (L/s)	Vreq (cu. m)	Vavail (cu. m)	Discharge Check	
100-year Water Level	129.83	0.13	2.27	5.28	8.00	0.00

Subdrainage Area: ROOF3
Area (ha): 0.19
C: 1.00

Roof
Maximum Storage Depth: 150 mm

tc (min)	I (100 yr) (mm/hr)	Qactual (L/s)	Qrelease (L/s)	Qstored (L/s)	Vstored (m³)	Depth (mm)
10	178.56	91.83	9.11	82.72	49.63	130.5
20	119.95	61.69	9.63	52.06	62.48	140.8
30	91.87	47.25	9.83	37.42	67.36	144.7
40	75.15	38.65	9.89	28.75	69.01	146.0
50	63.95	32.89	9.89	23.00	69.00	146.0
60	55.89	28.75	9.85	18.89	68.02	145.2
70	49.79	25.61	9.79	15.82	66.44	143.9
80	44.99	23.14	9.71	13.43	64.47	142.4
90	41.11	21.14	9.62	11.53	62.24	140.6
100	37.90	19.49	9.52	9.97	59.83	138.6
110	35.20	18.10	9.42	8.69	57.32	136.6
120	32.89	16.92	9.31	7.60	54.74	134.6

Storage: Roof Storage

Depth (mm)	Head (m)	Discharge (L/s)	Vreq (cu. m)	Vavail (cu. m)	Discharge Check	
100-year Water Level	146.00	0.15	9.89	69.01	74.00	0.00

Subdrainage Area: ROOF2
Area (ha): 0.22
C: 1.00

Roof
Maximum Storage Depth: 150 mm

tc (min)	I (100 yr) (mm/hr)	Qactual (L/s)	Qrelease (L/s)	Qstored (L/s)	Vstored (m³)	Depth (mm)
10	178.56	109.21	10.26	98.95	59.37	130.7
20	119.95	73.36	10.86	62.50	75.00	141.2
30	91.87	56.19	11.09	45.09	81.17	145.4
40	75.15	45.96	11.18	34.78	83.46	146.9
50	63.95	39.11	11.19	27.92	83.76	147.1
60	55.89	34.19	11.16	23.02	82.89	146.6
70	49.79	30.45	11.10	19.35	81.28	145.5
80	44.99	27.52	11.02	16.50	79.19	144.1
90	41.11	25.14	10.93	14.22	76.77	142.4
100	37.90	23.18	10.83	12.36	74.14	140.7
110	35.20	21.53	10.72	10.81	71.35	138.8
120	32.89	20.12	10.61	9.51	68.47	136.8

Storage: Roof Storage

Depth (mm)	Head (m)	Discharge (L/s)	Vreq (cu. m)	Vavail (cu. m)	Discharge Check	
100-year Water Level	147.14	0.15	11.19	83.76	88.00	0.00

Subdrainage Area: ROOF1
Area (ha): 0.02
C: 1.00

Roof
Maximum Storage Depth: 150 mm

tc (min)	I (100 yr) (mm/hr)	Qactual (L/s)	Qrelease (L/s)	Qstored (L/s)	Vstored (m³)	Depth (mm)
10	178.56	9.93	2.21	7.72	4.63	125.0
20	119.95	6.67	2.27	4.40	5.28	129.8
30	91.87	5.11	2.26	2.85	5.13	128.7
40	75.15	4.18	2.22	1.96	4.71	125.6
50	63.95	3.56	2.15	1.41	4.22	120.4
60	55.89	3.11	2.08	1.03	3.70	114.8

Stormwater Management Calculations

Project #160401511, 20 Cedarow

Modified Rational Method Calculatons for Storage

70	21.91	1.10	1.05	0.05	0.21	41.5	0.00
80	19.83	0.99	0.96	0.04	0.17	37.9	0.00
90	18.14	0.91	0.88	0.03	0.14	34.9	0.00
100	16.75	0.84	0.82	0.02	0.11	32.5	0.00
110	15.57	0.78	0.77	0.01	0.09	30.3	0.00
120	14.56	0.73	0.72	0.01	0.07	28.5	0.00

Storage: Roof Storage

	Depth (mm)	Head (m)	Discharge (L/s)	Vreq (cu. m)	Vavail (cu. m)	Discharge Check
2-year Water Level	80.76	0.08	1.65	1.32	8.00	0.00

SUMMARY TO OUTLET

		Vrequired	Vavailable*
Tributary Area	0.445 ha		
Total 2yr Flow to Sewer	24 L/s	0	0 m ³ Ok
Non-Tributary Area	0.000 ha		
Total 2yr Flow Uncontrolled	0 L/s		
Total Area	0.445 ha		
Total 2yr Flow	24 L/s		

Project #160401511, 20 Cedarow

Modified Rational Method Calculatons for Storage

70	49.79	2.77	2.01	0.76	3.19	109.1	0.00
80	44.99	2.50	1.94	0.56	2.70	103.7	0.00
90	41.11	2.29	1.87	0.42	2.26	98.0	0.00
100	37.90	2.11	1.79	0.32	1.92	91.7	0.00
110	35.20	1.96	1.72	0.24	1.60	85.9	0.00
120	32.89	1.83	1.65	0.18	1.31	80.6	0.00

Storage: Roof Storage

	Depth (mm)	Head (m)	Discharge (L/s)	Vreq (cu. m)	Vavail (cu. m)	Discharge Check
100-year Water Level	129.83	0.13	2.27	5.28	8.00	0.00

SUMMARY TO OUTLET

		Vrequired	Vavailable*
Tributary Area	0.445 ha		
Total 100yr Flow to Sewer	24 L/s	0	0 m ³ Ok
Non-Tributary Area	0.000 ha		
Total 100yr Flow Uncontrolled	0 L/s		
Total Area	0.445 ha		
Total 100yr Flow	24 L/s		



Adjustable Accutrol Weir
 Tag: _____

Adjustable Flow Control
 for Roof Drains

ADJUSTABLE ACCUTROL (for Large Sump Roof Drains only)

For more flexibility in controlling flow with heads deeper than 2", Watts Drainage offers the Adjustable Accutrol. The Adjustable Accutrol Weir is designed with a single parabolic opening that can be covered to restrict flow above 2" of head to less than 5 gpm per inch, up to 6" of head. To adjust the flow rate for depths over 2" of head, set the slot in the adjustable upper cone according to the flow rate required. Refer to Table 1 below.

Note: Flow rates are directly proportional to the amount of weir opening that is exposed.

EXAMPLE:

For example, if the adjustable upper cone is set to cover 1/2 of the weir opening, flow rates above 2" of head will be restricted to 2-1/2 gpm per inch of head.

Therefore, at 3" of head, the flow rate through the Accutrol Weir that has 1/2 the slot exposed will be:
 [5 gpm(per inch of head) x 2 inches of head] + 2-1/2 gpm(for the third inch of head) = 12-1/2 gpm.

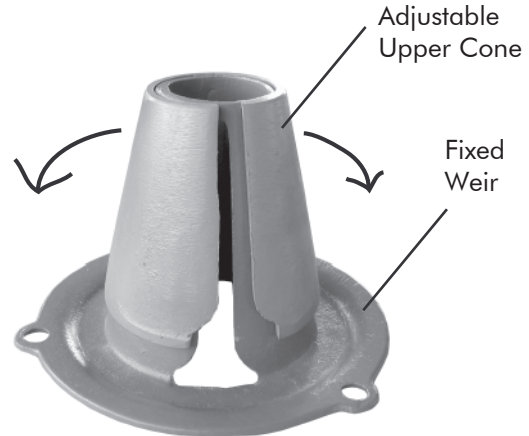
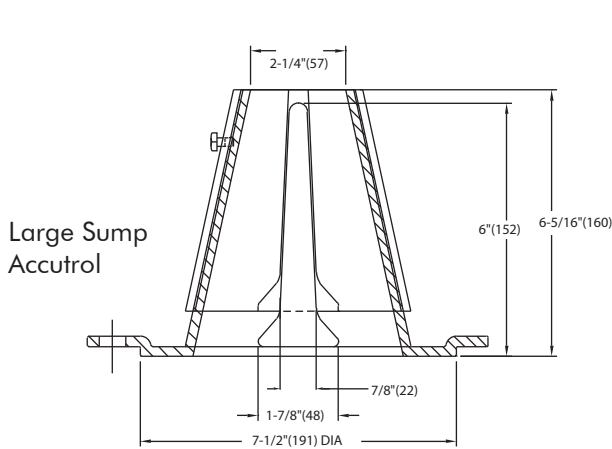

1/2 Weir Opening Exposed Shown Above

TABLE 1. Adjustable Accutrol Flow Rate Settings

Weir Opening Exposed	Head of Water					
	1"	2"	3"	4"	5"	6"
	Flow Rate (gallons per minute)					
Fully Exposed	5	10	15	20	25	30
3/4	5	10	13.75	17.5	21.25	25
1/2	5	10	12.5	15	17.5	20
1/4	5	10	11.25	12.5	13.75	15
Closed	5	10	10	10	10	10

Job Name _____ Contractor _____

Job Location _____ Contractor's P.O. No. _____

Engineer _____ Representative _____

WATTS Drainage reserves the right to modify or change product design or construction without prior notice and without incurring any obligation to make similar changes and modifications to products previously or subsequently sold. See your WATTS Drainage representative for any clarification. Dimensions are subject to manufacturing tolerances.



CANADA: 5435 North Service Road, Burlington, ON, L7L 5H7 TEL: 905-332-6718 TOLL-FREE: 1-888-208-8927 Website: www.wattsdrainage.ca



Volume III: TEMPEST™ INLET CONTROL DEVICES

Municipal Technical
Manual Series



FIRST EDITION

LMF (Low to Medium Flow) ICD

HF (High Flow) ICD

MHF (Medium to High Flow) ICD



IPEX

IPEX Tempest™ Inlet Control Devices

Municipal Technical Manual Series

Vol. I, 1st Edition

© 2011 by IPEX. All rights reserved. No part of this book may be used or reproduced in any manner whatsoever without prior written permission. For information contact: IPEX, Marketing, 2441 Royal Windsor Drive, Mississauga, Ontario, Canada, L5J 4C7.

The information contained here within is based on current information and product design at the time of publication and is subject to change without notification. IPEX does not guarantee or warranty the accuracy, suitability for particular applications, or results to be obtained therefrom.

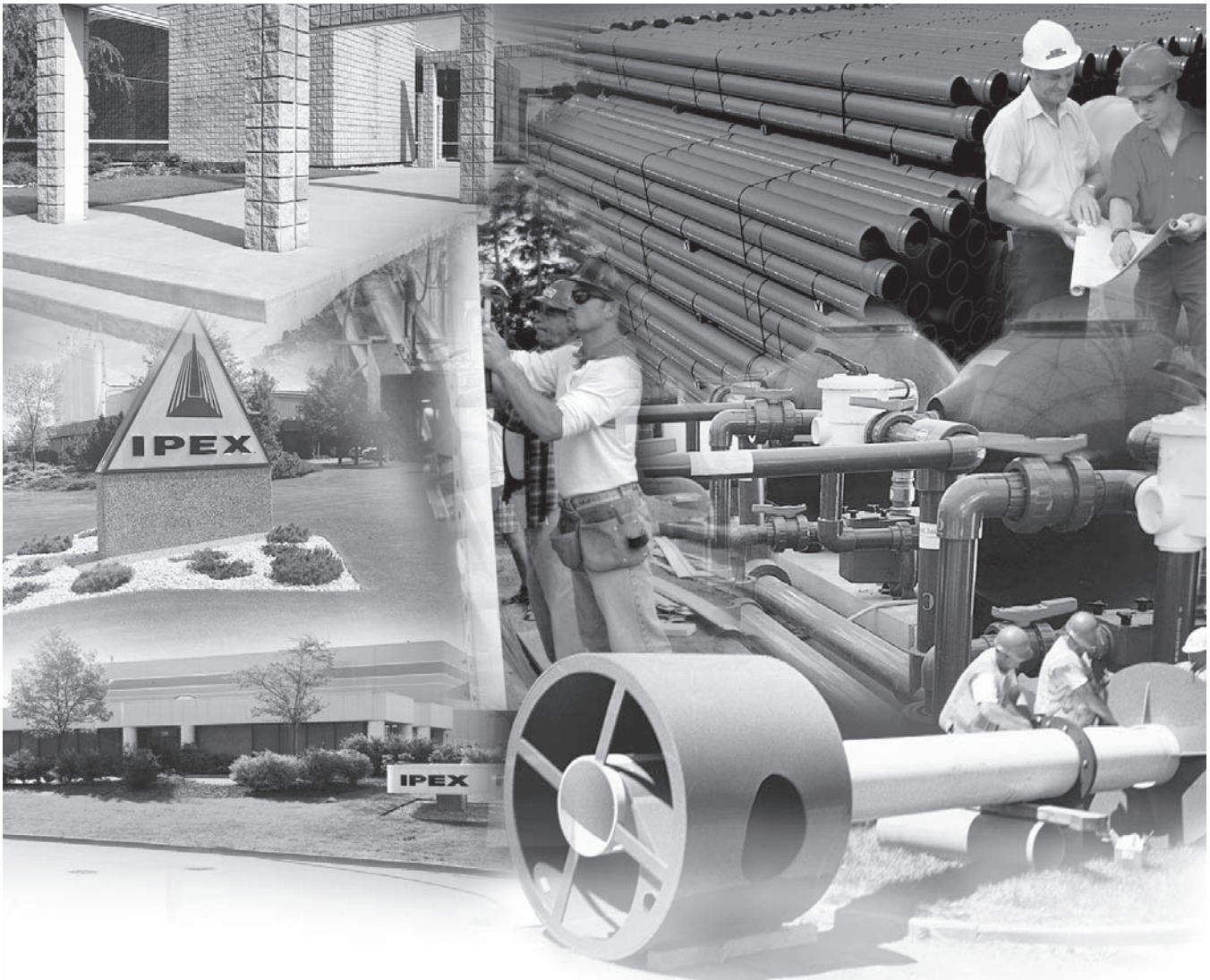

ABOUT IPEX

At IPEX, we have been manufacturing non-metallic pipe and fittings since 1951. We formulate our own compounds and maintain strict quality control during production. Our products are made available for customers thanks to a network of regional stocking locations throughout North America. We offer a wide variety of systems including complete lines of piping, fittings, valves and custom-fabricated items.

More importantly, we are committed to meeting our customers' needs. As a leader in the plastic piping industry, IPEX continually develops new products, modernizes manufacturing facilities and acquires innovative process technology. In addition, our staff take pride in their work, making available to customers their extensive thermoplastic knowledge and field experience. IPEX personnel are committed to improving the safety, reliability and performance of thermoplastic materials. We are involved in several standards committees and are members of and/or comply with the organizations listed on this page.

For specific details about any IPEX product, contact our customer service department.

CONTENTS

TEMPEST INLET CONTROL DEVICES Technical Manual

About IPEX

Section One:	Product Information: TEMPEST Low, Medium Flow (LMF) ICD	
	Purpose	5
	Product Description	5
	Product Function	5
	Product Construction	5
	Product Applications	5
	Product Installation	
	Instructions to assemble a TEMPEST LMF ICD into a square catch basin:	6
	Instructions to assemble a TEMPEST LMF ICD into a round catch basin:	6
	Product Technical Specification	
	General	7
	Materials	7
	Dimensioning	7
	Installation	7
Section Two:	Product Information: TEMPEST High Flow (HF) & Medium, High Flow (MHF) ICD	
	Product Description	9
	Product Function	9
	Product Construction	9
	Product Applications	9
	Product Installation	
	Instructions to assemble a TEMPEST HF or MHF ICD into a square catch basin:	10
	Instructions to assemble a TEMPEST HF or MHF ICD into a round catch basin:	10
	Instructions to assemble a TEMPEST HF Sump into a square or round catch basin:	11
	Product Technical Specification	
	General	11
	Materials	11
	Dimensioning	11
	Installation	11

PRODUCT INFORMATION: TEMPEST LOW, MEDIUM FLOW (LMF) ICD

Purpose

To control the amount of storm water runoff entering a sewer system by allowing a specified flow volume out of a catch basin or manhole at a specified head. This approach conserves pipe capacity so that catch basins downstream do not become uncontrollably surcharged, which can lead to basement floods, flash floods and combined sewer overflows.

Product Description

Our LMF ICD is designed to accommodate catch basins or manholes with sewer outlet pipes 6" in diameter and larger. Any storm sewer larger than 12" may require custom modification. However, IPEX can custom build a TEMPEST device to accommodate virtually any storm sewer size.

Available in 14 preset flow curves, the LMF ICD has the ability to provide flow rates: 2lps – 17lps (31gpm – 270gpm)

LMF 14 Preset Flow Curves

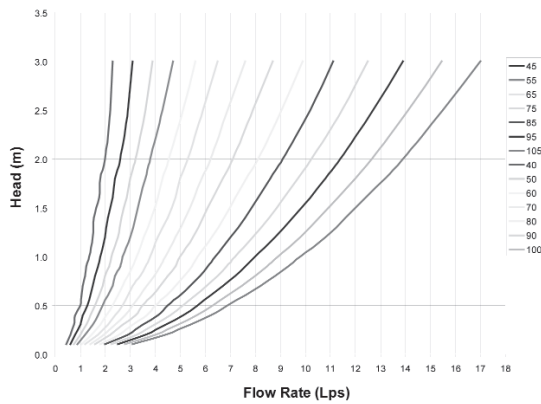

Product Function

The LMF ICD vortex flow action allows the LMF ICD to provide a narrower flow curve using a larger orifice than a conventional orifice plate ICD, making it less likely to clog. When comparing flows at the same head level, the LMF ICD has the ability to restrict more flow than a conventional ICD during a rain event, preserving greater sewer capacity.

LMF Flow vs. ICD Alternatives

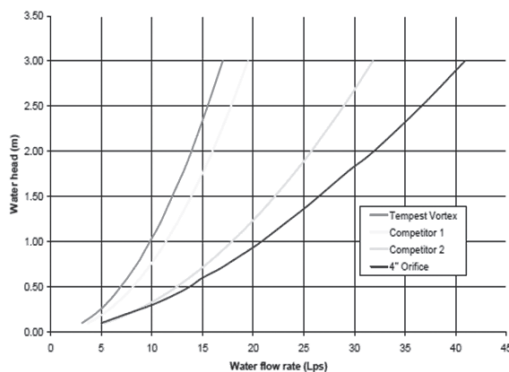

Product Construction

Constructed from durable PVC, the LMF ICD is light weight 8.95 Kg (19.7 lbs).

Product Applications

Will accommodate both square and round applications:

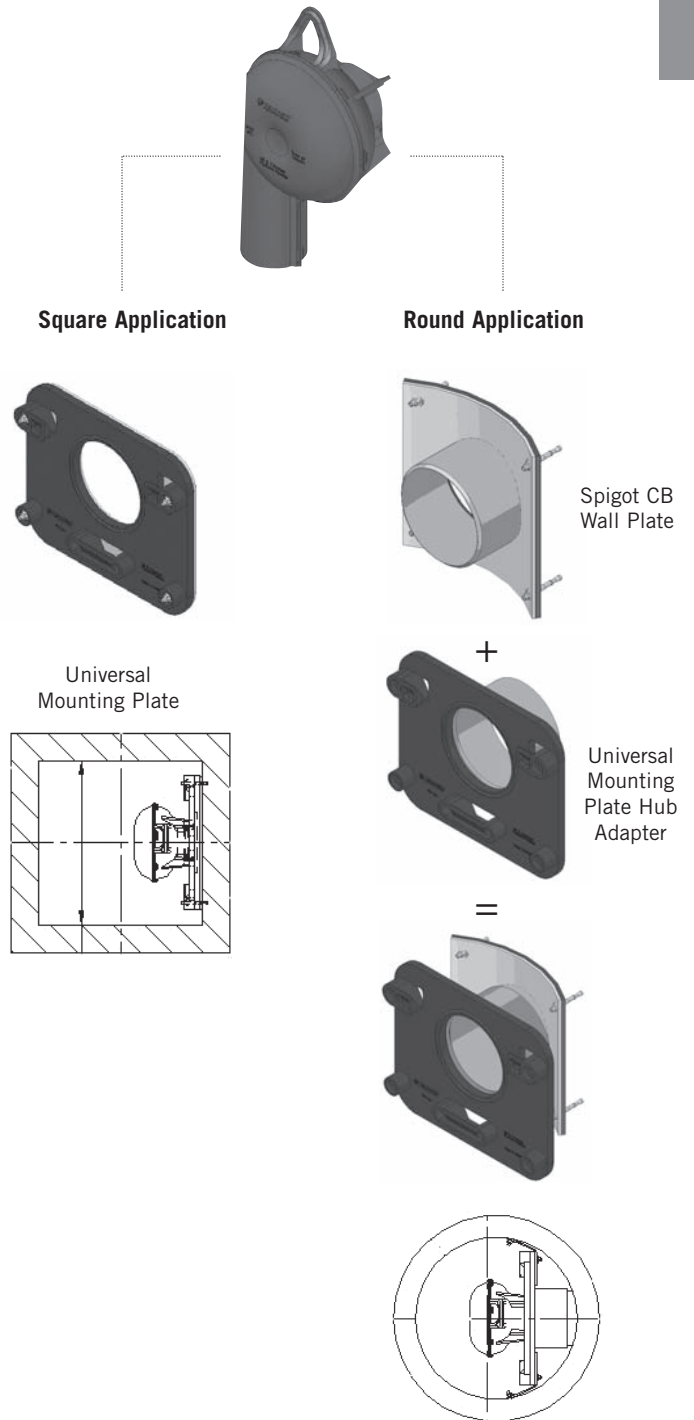

TEMPEST LMF ICD

PRODUCT INSTALLATION

Instructions to assemble a TEMPEST LMF ICD into a Square Catch Basin:

STEPS:

1. Materials and tooling verification:
 - Tooling: impact drill, 3/8" concrete bit, torque wrench for 9/16" nut, hand hammer, level, and marker.
 - Material: (4) concrete anchor 3/8 x 3-1/2, (4) washers, (4) nuts, universal mounting plate, ICD device.
2. Use the mounting wall plate to locate and mark the hole (4) pattern on the catch basin wall. You should use a level to ensure that the plate is at the horizontal.
3. Use an impact drill with a 3/8" concrete bit to make the four holes at a minimum of 1-1/2" depth up to 2-1/2". Clean the concrete dust from the holes.
4. Install the anchors (4) in the holes by using a hammer. Thread the nuts on the top of the anchors to protect the threads when you will hit the anchors with the hammer. Remove the nuts the ends of the anchors
5. Install the universal mounting plate on the anchors and screw the 4 nuts in place with a maximum torque of 40 N.m (30 lbf-ft). There should be no gap between the wall mounting plate and the catch basin wall.
6. From the ground above using a reach bar, lower the ICD device by hooking the end of the reach bar to the handle of the ICD device. Align the triangular plate portion into the mounting wall plate. Push down the device to be sure it has centered in to the universal mounting plate and has created a seal.



WARNING

- Verify that the outlet pipe doesn't protrude into the catch basin. If it does, cut down the pipe flush to the catch basin wall.
- Call your IPEX representative for more information or if you have any questions about our products.

Instructions to assemble a TEMPEST LMF ICD into a Round Catch Basin:

STEPS:

1. Materials and tooling verification.
 - Tooling: impact drill, 3/8" concrete bit, torque wrench for 9/16" nut, hand hammer, level and marker.
 - Material: (4) concrete anchor 3/8 x 3-1/2, (4) washers and (4) nuts, spigot CB wall plate, universal mounting plate hub adapter, ICD device.
2. Use the spigot catch basin wall plate to locate and mark the hole (4) pattern on the catch basin wall. You should use a level to sure that the plate is at the horizontal.
3. Use an impact drill with a 3/8" concrete bit to make the four holes at a depth between 1-1/2" to 2-1/2". Clean the concrete dust from the holes.
4. Install the anchors (4) in the holes by using a hammer. Thread the nuts on the top of the anchors to protect the threads when you will hit the anchors with the hammer. Remove the nuts from the ends of the anchors
5. Install the CB spigot wall plate on the anchors and screw the 4 nuts in place with a maximum torque of 40 N.m (30 lbf-ft). There should be no gap between CB the spigot wall plate and the catch basin wall.
6. Apply solvent cement on the hub of universal mounting plate, hub adapter and the spigot of spigot CB wall plate slide the hub over the spigot. Make sure the universal mounting plate is at the horizontal and its hub is completely inserted onto the spigot. Normally, the corners of the universal mounting plate hub adapter should touch the catch basin wall.
7. From ground above using a reach bar, lower the ICD device by hooking the end of the reach bar to the handle of the ICD device. Align the triangular plate portion into the mounting wall plate. Push down the device to be sure it has centered in to the mounting plate and has created a seal.



WARNING

- Verify that the outlet pipe doesn't protrude into the catch basin. If it does, cut back the pipe flush to the catch basin wall.
- The solvent cement which is used in this installation is to be approved for PVC.
- The solvent cement should not be used below 0°C (32°F) or in a high humidity environment. Refer to the IPEX solvent cement guide to confirm the required curing time or visit the IPEX Online Solvent Cement Training Course available at www.ipexinc.com.
- Call your IPEX representative for more information or if you have any questions about our products.

PRODUCT TECHNICAL SPECIFICATION

General

Inlet control devices (ICD's) are designed to provide flow control at a specified rate for a given water head level and also provide odour and floatable control. All ICD's will be IPEX Tempest or approved equal.

All devices shall be removable from a universal mounting plate. An operator from street level using only a T-bar with a hook will be able to retrieve the device while leaving the universal mounting plate secured to the catch basin wall face. The removal of the TEMPEST devices listed above must not require any unbolting or special manipulation or any special tools.

High Flow (HF) Sump devices will consist of a removable threaded cap which can be accessible from street level with out entry into the catchbasin (CB). The removal of the threaded cap shall not require any special tools other than the operator's hand.

ICD's must have no moving parts.

Materials

ICD's are to be manufactured from Polyvinyl Chloride (PVC) or Polyurethane material, designed to be durable enough to withstand multiple freeze-thaw cycles and exposure to harsh elements.

The inner ring seal will be manufactured using a Buna or Nitrile material with hardness between Duro 50 and Duro 70.

The wall seal is to be comprised of a 3/8" thick Neoprene Closed Cell Sponge gasket which is attached to the back of the wall plate.

All hardware will be made from 304 stainless steel.

Dimensioning

The Low Medium Flow (LMF), High Flow (HF) and the High Flow (HF) Sump shall allow for a minimum outlet pipe diameter of 200mm with a 600mm deep Catch Basin sump.

Installation

Contractor shall be responsible for securing, supporting and connecting the ICD's to the existing influent pipe and catchbasin/manhole structure as specified and designed by the Engineer.

PRODUCT INFORMATION: TEMPEST HF & MHF ICD

Product Description

Our HF, HF Sump and MHF ICD is designed to accommodate catch basins or manholes with sewer outlet pipes 6" in diameter or larger. Any storm sewer larger than 12" may require custom modification. However, IPEX can custom build a TEMPEST device virtually to accommodate any storm sewer size.

Available in 5 preset flow curves, these ICDs have the ability to provide constant flow rates: 9lps (143 gpm) and greater

HF & MHF Preset Flow Curves

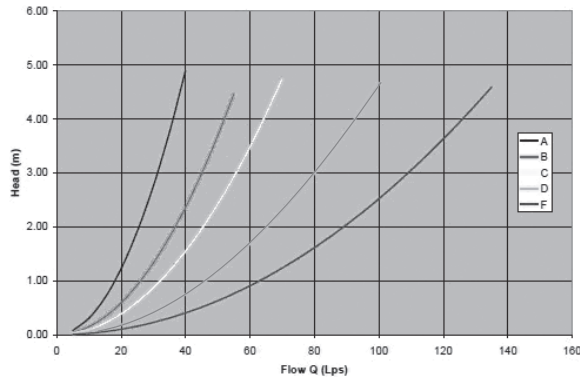

Product Function

TEMPEST HF (High Flow): designed to manage moderate to higher flows between 15 L/s (240 gpm) or greater and prevents the propagation of odour and floatables. With this device, the cross-sectional area of the device is larger than the orifice diameter and has been designed to limit head losses. The HF ICD can also be ordered without flow control when only odour and floatable control is required.



TEMPEST HF (High Flow) Sump: The height of a sewer outlet pipe in a catch basin is not always conveniently located. At times it may be located very close to the catch basin floor, not providing enough sump for one of the other TEMPEST ICDs with universal back plate to be installed. In these applications, a HF Sump is offered. The HF Sump offers the same features and benefits as the HF ICD; however, is designed to raise the outlet in a square or round catch basin structure. When installed, the HF sump is fixed in place and not easily removed. Any required service to the device is performed through a clean-out located in the top of the device which can be often accessed from ground level.

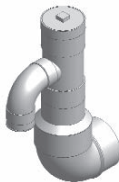

TEMPEST MHF (Medium to High Flow):

The MHF plate or plug is designed to control flow rates 9 L/s (143 gpm) or greater. It is not designed to prevent the propagation of odour and floatables.

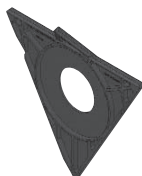

Product Construction

The HF, HF Sump and MHF ICDs are built to be light weight at a maximum weight of 6.82 Kg (14.6 lbs).

Product Applications

The HF and MHF ICD are available to accommodate both square and round applications:

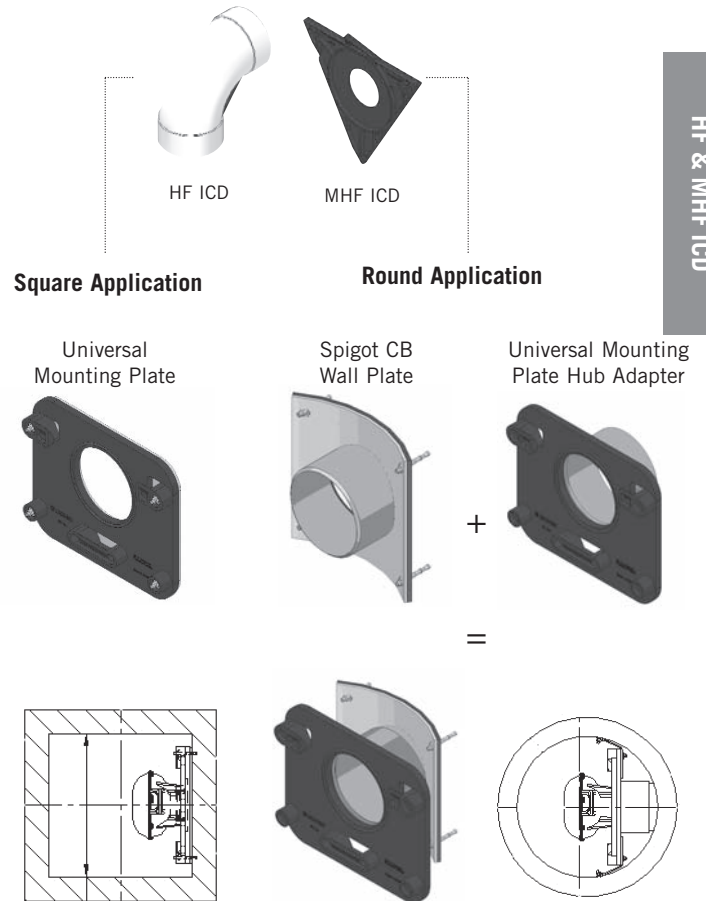

The HF Sump is available to accommodate low to no sump applications in both square and round catch basins:

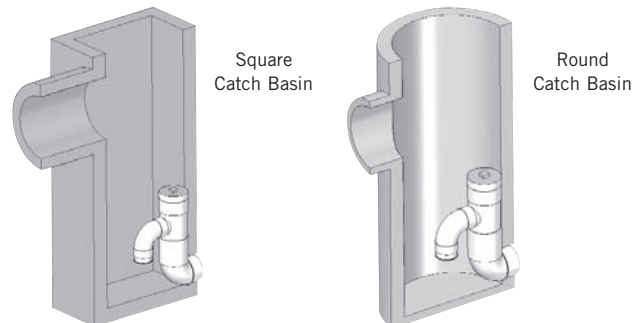

TEMPEST
HF & MHF ICD

PRODUCT INSTALLATION

Instructions to assemble a TEMPEST HF or MHF ICD into a Square Catch Basin:

1. Materials and tooling verification:
 - Tooling: impact drill, 3/8" concrete bit, torque wrench for 9/16" nut, hand hammer, level, and marker.
 - Material: (4) concrete anchor 3/8 x 3-1/2, (4) washers, (4) nuts, universal mounting plate, ICD device
2. Use the mounting wall plate to locate and mark the hole (4) pattern on the catch basin wall. You should use a level to ensure that the plate is at the horizontal.
3. Use an impact drill with a 3/8" concrete bit to make the four holes at a minimum of 1-1/2" depth up to 2-1/2". Clean the concrete dust from the holes.
4. Install the anchors (4) in the holes by using a hammer. Thread the nuts on the top of the anchors to protect the threads when you will hit the anchors with the hammer. Remove the nuts the ends of the anchors
5. Install the universal from wall mounting plate on the anchors and screw the 4 nuts in place with a maximum torque of 40 N.m (30 lbf-ft). There should be no gap between the wall mounting plate and the catch basin wall.
6. From the ground above using a reach bar, lower the device by hooking the end of the reach bar to the handle of the LMF device. Align the triangular plate portion into the mounting wall plate. Push down the device to be sure it has centered in to the universal wall mounting plate and has created a seal.



WARNING

- Verify that the outlet pipe doesn't protrude into the catch basin. If it does, cut down the pipe flush to the catch basin wall.
- Call your IPEX representative for more information or if you have any questions about our products.

Instructions to assemble a TEMPEST HF or MHF ICD into a Round Catch Basin:

STEPS:

1. Materials and tooling verification.
 - Tooling: impact drill, 3/8" concrete bit, torque wrench for 9/16" nut, hand hammer, level and marker.
 - Material: (4) concrete anchor 3/8 x 3-1/2, (4) washers and (4) nuts, spigot CB wall plate, universal mounting plate hub adaptor, ICD device.
2. Use the round catch basin spigot adaptor to locate and mark the hole (4) pattern on the catch basin wall. You should use a level to sure that the plate is at the horizontal.
3. Use an impact drill with a 3/8" concrete bit to make the four holes at a depth between 1-1/2" to 2-1/2". Clean the concrete dust from the holes.
4. Install the anchors (4) in the holes by using a hammer. Thread the nuts on the top of the anchors to protect the threads when you will hit the anchors with the hammer. Remove the nuts from the ends of the anchors
5. Install the spigot CB wall plate on the anchors and screw the 4 nuts in place with a maximum torque of 40 N.m (30 lbf-ft). There should be no gap between the spigot CB wall plate and the catch basin wall.
6. Put solvent cement on the hub of the universal mounting plate, hub adaptor and the spigot of spigot CB wall plate and slide the hub over the spigot. Make sure the universal mounting plate is at the horizontal and its hub is completely inserted onto the spigot. Normally, the corners of the hub adaptor should touch the catch basin wall.
7. From ground above using a reach bar, lower the ICD device by hooking the end of the reach bar to the handle of the ICD device. Align the triangular plate portion into the mounting wall plate. Push down the device to be sure it has centered in to the wall mounting plate and has created a seal.



WARNING

- Verify that the outlet pipe doesn't protrude into the catch basin. If it does, cut down the pipe flush to the catch basin wall.
- The solvent cement which is used in this installation is to be approved for PVC.
- The solvent cement should not be used below 0°C (32°F) or in a high humidity environment. Refer to the IPEX solvent cement guide to confirm the required curing time or visit the IPEX Online Solvent Cement Training Course available at www.ipexinc.com.
- Call your IPEX representative for more information or if you have any questions about our products.

Instructions to assemble a TEMPEST HF Sump into a Square or Round Catch Basin:

STEPS:

1. Materials and tooling verification:
 - Tooling: impact drill, 3/8" concrete bit, torque wrench for 9/16" nut, hand hammer, level, mastic tape and metal strapping
 - Material: (2) concrete anchor 3/8 x 3-1/2, (2) washers, (2) nuts, HF Sump pieces (2).
2. Apply solvent cement to the spigot end of the top half of the sump. Apply solvent cement to the hub of the bottom half of the sump. Insert the spigot of the top half of the sump into the hub of the bottom half of the sump.
3. Install the 8" spigot of the device into the outlet pipe. Use the mastic tape to seal the device spigot into the outlet pipe. You should use a level to be sure that the fitting is standing at the vertical.
4. Use an impact drill with a 3/8" concrete bit to make a series of 2 holes along each side of the body throat. The depth of the hole should be between 1-1/2" to 2-1/2". Clean the concrete dust from the 2 holes.
5. Install the anchors (2) in the holes by using a hammer. Put the nuts on the top of the anchors to protect the threads when you will hit the anchors. Remove the nuts on the anchors at the end.
6. Cut the metal strapping to length and connect each end of the strapping to the anchors. Screw the nuts in place with a maximum torque of 40 N.m (30 lbf-ft). The device should be completely flush with the catch basin wall.



WARNING

- Verify that the outlet pipe doesn't protrude into the catch basin. If it does, cut down the pipe flush to the catch basin wall.
- The solvent cement which is used in this installation is to be approved for PVC.
- The solvent cement should not be used below 0°C (32°F) or in a high humidity environment. Refer to the IPEX solvent cement guide to confirm the required curing time or visit the IPEX Online Solvent Cement Training Course available at www.ipexinc.com.
- Call your IPEX representative for more information or if you have any questions about our products.

PRODUCT TECHNICAL SPECIFICATION

General

Inlet control devices (ICD's) are designed to provide flow control at a specified rate for a given water head level and also provide odour and floatable control where specified. All ICD's will be IPEX Tempest or approved equal.

All devices shall be removable from a universal mounting plate. An operator from street level using only a T-bar with a hook will be able to retrieve the device while leaving the universal mounting plate secured to the catch basin wall face. The removal of the TEMPEST devices listed above must not require any unbolting or special manipulation or any special tools.

High Flow (HF) Sump devices will consist of a removable threaded cap which can be accessible from street level with out entry into the catchbasin (CB). The removal of the threaded cap shall not require any special tools other than the operator's hand.

ICD's must have no moving parts.

Materials

ICD's are to be manufactured from Polyvinyl Chloride (PVC) or Polyurethane material, designed to be durable enough to withstand multiple freeze-thaw cycles and exposure to harsh elements.

The inner ring seal will be manufactured using a Buna or Nitrile material with hardness between Duro 50 and Duro 70.

The wall seal is to be comprised of a 3/8" thick Neoprene Closed Cell Sponge gasket which is attached to the back of the wall plate.

All hardware will be made from 304 stainless steel.

Dimensioning

The Low Medium Flow (LMF), High Flow (HF) and the High Flow (HF) Sump shall allow for a minimum outlet pipe diameter of 200mm with a 600mm deep Catch Basin sump.

Installation

Contractor shall be responsible for securing, supporting and connecting the ICD's to the existing influent pipe and catchbasin/manhole structure as specified and designed by the Engineer.

SALES AND CUSTOMER SERVICE

Canadian Customers call IPEX Inc.

Toll free: (866) 473-9462

www.ipexinc.com

U.S. Customers call IPEX USA LLC

Toll free: (800) 463-9572

www.ipexamerica.com

About the IPEX Group of Companies

As leading suppliers of thermoplastic piping systems, the IPEX Group of Companies provides our customers with some of the largest and most comprehensive product lines. All IPEX products are backed by more than 50 years of experience. With state-of-the-art manufacturing facilities and distribution centers across North America, we have established a reputation for product innovation, quality, end-user focus and performance.

Markets served by IPEX group products are:

- Electrical systems
- Telecommunications and utility piping systems
- PVC, CPVC, PP, ABS, PEX, FR-PVDF and PE pipe and fittings (1/4" to 48")
- Industrial process piping systems
- Municipal pressure and gravity piping systems
- Plumbing and mechanical piping systems
- PE Electrofusion systems for gas and water
- Industrial, plumbing and electrical cements
- Irrigation systems

Products manufactured by IPEX Inc. and distributed in the United States by IPEX USA LLC.

Tempest™ is a trademark of IPEX Branding Inc.

This literature is published in good faith and is believed to be reliable. However it does not represent and/or warrant in any manner the information and suggestions contained in this brochure. Data presented is the result of laboratory tests and field experience.

A policy of ongoing product improvement is maintained. This may result in modifications of features and/or specifications without notice.

MNMNTPIP110817
© 2011 IPEX MN0038UC



**SERVICING AND STORMWATER MANAGEMENT BRIEF –
WELLINGS OF STITTSVILLE PHASE 2, 20 CEDAROW COURT**

Appendix C Stormwater Management
September 1, 2023

C.2 SAMPLE PCSWMM MODEL INPUT (12HR 100YR SCS)

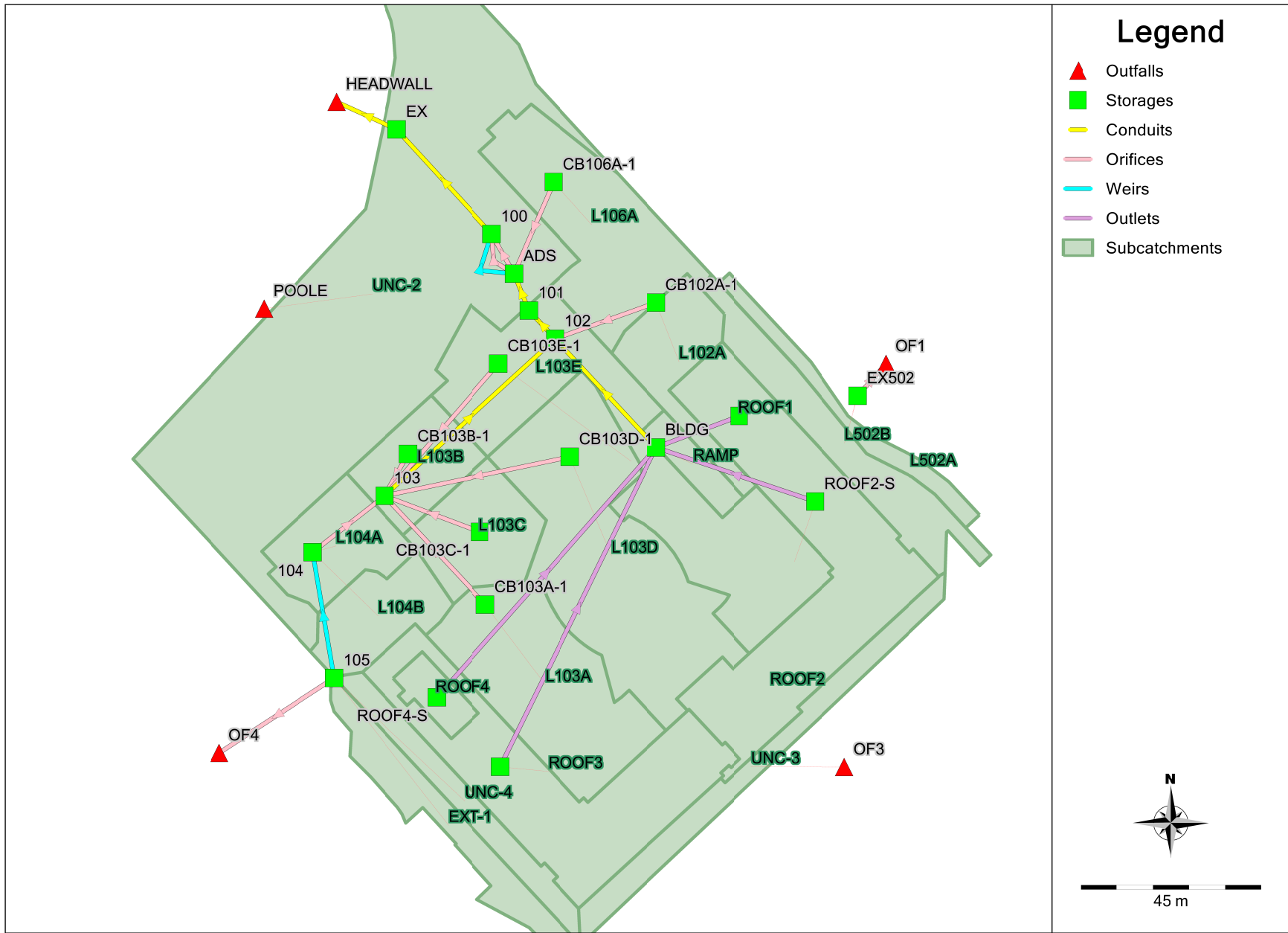

Legend

- ▲ Outfalls
- Storages
- Conduits
- Orifices
- Weirs
- Outlets
- Subcatchments



45 m

POST-DEVELOPMENT MODEL

```
[TITLE]
;;Project Title/Notes

[OPTIONS]
;;Option          Value
FLOW_UNITS        LPS
INFILTRATION      HORTON
FLOW_ROUTING      DYNWAVE
LINK_OFFSETS      ELEVATION
MIN_SLOPE          0
ALLOW_PONDING     YES
SKIP_STEADY_STATE NO

START_DATE        07/23/2009
START_TIME        00:00:00
REPORT_START_DATE 07/23/2009
REPORT_START_TIME 00:00:00
END_DATE          07/24/2009
END_TIME          00:00:00
SWEEP_START       01/01
SWEEP_END         12/31
DRY_DAYS          0
REPORT_STEP       00:05:00
WET_STEP          00:05:00
DRY_STEP          00:05:00
ROUTING_STEP      1
RULE_STEP         00:00:00

INERTIAL_DAMPING  PARTIAL
NORMAL_FLOW_LIMITED BOTH
FORCE_MAIN_EQUATION H-W
VARIABLE_STEP     0
LENGTHENING_STEP 0
MIN_SURFAREA      0
MAX_TRIALS        8
HEAD_TOLERANCE    0.0015
SYS_FLOW_TOL      5
LAT_FLOW_TOL      5
```

POST-DEVELOPMENT MODEL

```
MINIMUM_STEP      0.5
THREADS           4

[EVAPORATION]
;;Data Source     Parameters
;;-----
CONSTANT          0.0
DRY_ONLY          NO

[RAINGAGES]
;;Name           Format   Interval SCF   Source
;;-----
RG1              INTENSITY 0:15   1.0     TIMESERIES 100SCS

[SUBCATCHMENTS]
;;Name           Rain Gage   Outlet      Area   %Imperv  Width  %Slope  CurbLen  SnowPack
;;-----
;0.47
EXT-1           RG1        105         0.068859 38.571  95     1.5     0
;0.78
L102A          RG1        CB102A-1    0.061494 82.86   18.5   2.5     0
;0.73
L103A          RG1        CB103A-1    0.155713 75.71   28.2   2.5     0
;0.76
L103B          RG1        CB103B-1    0.059451 80       28.6   2.5     0
;0.70
L103C          RG1        CB103C-1    0.072415 71.43   29.9   2.5     0
;0.66
L103D          RG1        CB103D-1    0.239253 65.71   31.7   2.5     0
;0.71
```

POST-DEVELOPMENT MODEL							
L103E	RG1	CB103E-1	0.237258	72.86	21	2.5	0
;0.78							
L104A	RG1	104	0.068012	82.86	38.6	2.5	0
;0.76							
L104B	RG1	104	0.059101	80	24.6	2.5	0
;0.74							
L106A	RG1	CB106A-1	0.142402	77.14	26.5	2.5	0
;0.90							
L502A	RG1	EX502	0.037296	100	88	0.8	0
;0.49							
L502B	RG1	EX502	0.083714	41.43	95	25	0
;0.90							
RAMP	RG1	BLDG	0.021989	100	7.5	15	0
ROOF1	RG1	ROOF1-S	0.0203	100	4.568	1.5	0
;0.90							
ROOF2	RG1	ROOF2-S	0.220177	100	49.54	1.5	0
;0.90							
ROOF3	RG1	ROOF3-S	0.184975	100	41.619	1.5	0
;0.90							
ROOF4	RG1	ROOF4-S	0.020313	100	4.57	1.5	0
;0.26							
UNC-2	RG1	POOLE	0.526055	8.57	25	1	0
;0.63							
UNC-3	RG1	OF3	0.069306	61.43	126	3	0
;0.46							

POST-DEVELOPMENT MODEL							
UNC-4	RG1	105	0.051524	37.14	90	10	0

[SUBAREAS]							
;;Subcatchment	N-Imperv	N-Perv	S-Imperv	S-Perv	PctZero	RouteTo	PctRouted
;;-----							
EXT-1	0.013	0.25	1.57	4.67	0	PERVIOUS	100
L102A	0.013	0.25	1.57	4.67	0	OUTLET	
L103A	0.013	0.25	1.57	4.67	0	OUTLET	
L103B	0.013	0.25	1.57	4.67	0	OUTLET	
L103C	0.013	0.25	1.57	4.67	0	OUTLET	
L103D	0.013	0.25	1.57	4.67	0	OUTLET	
L103E	0.013	0.25	1.57	4.67	0	OUTLET	
L104A	0.013	0.25	1.57	4.67	0	OUTLET	
L104B	0.013	0.25	1.57	4.67	0	OUTLET	
L106A	0.013	0.25	1.57	4.67	0	OUTLET	
L502A	0.013	0.25	1.57	4.67	0	IMPERVIOUS	100
L502B	0.013	0.25	1.57	4.67	0	OUTLET	
RAMP	0.013	0.25	1.57	4.67	0	OUTLET	
ROOF1	0.013	0.25	1.57	4.67	0	OUTLET	
ROOF2	0.013	0.25	1.57	4.67	0	OUTLET	
ROOF3	0.013	0.25	1.57	4.67	0	OUTLET	
ROOF4	0.013	0.25	1.57	4.67	0	OUTLET	
UNC-2	0.013	0.25	1.57	4.67	0	PERVIOUS	100
UNC-3	0.013	0.25	1.57	4.67	0	PERVIOUS	100
UNC-4	0.013	0.25	1.57	4.67	0	PERVIOUS	100

[INFILTRATION]					
;;Subcatchment	Param1	Param2	Param3	Param4	Param5
;;-----					
EXT-1	76.2	13.2	4.14	7	0
L102A	76.2	13.2	4.14	7	0
L103A	76.2	13.2	4.14	7	0
L103B	76.2	13.2	4.14	7	0
L103C	76.2	13.2	4.14	7	0
L103D	76.2	13.2	4.14	7	0
L103E	76.2	13.2	4.14	7	0
L104A	76.2	13.2	4.14	7	0

POST-DEVELOPMENT MODEL

L104B	76.2	13.2	4.14	7	0
L106A	76.2	13.2	4.14	7	0
L502A	76.2	13.2	4.14	7	0
L502B	76.2	13.2	4.14	7	0
RAMP	76.2	13.2	4.14	7	0
ROOF1	76.2	13.2	4.14	7	0
ROOF2	76.2	13.2	4.14	7	0
ROOF3	76.2	13.2	4.14	7	0
ROOF4	76.2	13.2	4.14	7	0
UNC-2	76.2	13.2	4.14	7	0
UNC-3	76.2	13.2	4.14	7	0
UNC-4	76.2	13.2	4.14	7	0

[OUTFALLS]

;;Name	Elevation	Type	Stage Data	Gated	Route To
HEADWALL	99.48	FIXED	99.83	NO	
OF1	102.02	FREE		NO	
OF3	0	FREE		NO	
OF4	101.87	FIXED	102.17	NO	
POOLE	0	FREE		NO	

[STORAGE]

;;Name	Psi	Ksat	Elev. IMD	MaxDepth	InitDepth	Shape	Curve Name/Params	N/A	Fevap
100			99.903	3.797	0	FUNCTIONAL	0 0 0	0	0
101			101.393	2.743	0	FUNCTIONAL	0 0 0	0	0
102			101.9	2.43	0	FUNCTIONAL	0 0 0	0	0
103			102.131	1.936	0	FUNCTIONAL	0 0 0	0	0
104			102.61	1.49	0	TABULAR	CB104A-V	0	0
105			102.68	1.83	0	FUNCTIONAL	0 0 0	0	0
ADS			101.37	2.33	0	TABULAR	TANK-V	0	0
BLDG			102.78	1.91	0	FUNCTIONAL	0 0 0	0	0
CB102A-1			102.89	1.3	0	TABULAR	CB102A-V	0	0
CB103A-1			103.07	1.53	0	TABULAR	CB103A-V	0	0
CB103B-1			102.42	1.68	0	TABULAR	CB103B-V	0	0

POST-DEVELOPMENT MODEL

CB103C-1	102.7	1.6	0	TABULAR	CB103C-V	0	0
CB103D-1	102.62	1.66	0	TABULAR	CB103D-V	0	0
CB103E-1	102.43	1.68	0	TABULAR	CB103E-V	0	0
CB106A-1	101.97	1.68	0	TABULAR	CB106A-V	0	0
EX	99.608	2.082	0.222	FUNCTIONAL	0 0 0	0	0
EX502	102.02	2.2	0	TABULAR	EX502-V	0	0
ROOF1-S	110	0.15	0	TABULAR	ROOF1-V	0	0
ROOF2-S	110	0.15	0	TABULAR	ROOF2-V	0	0
ROOF3-S	110	0.15	0	TABULAR	ROOF3-V	0	0
ROOF4-S	110	0.15	0	TABULAR	ROOF4-V	0	0

[CONDUITS]

;;Name	From Node	To Node	Length	Roughness	InOffset	OutOffset	InitFlow
100--EX	100	EX	34.915	0.013	99.903	99.833	0 0
101--ADS	101	ADS	2.204	0.013	101.393	101.371	0 0
102--101	102	101	9.553	0.013	101.9	101.805	0 0
103--102	103	102	57.54	0.013	102.131	101.956	0 0
BLDG--102	BLDG	102	37.121	0.013	102.78	102.408	0 0
EX--HEADWALL	EX	HEADWALL	11.1	0.013	99.608	99.48	0 0

[ORIFICES]

;;Name	From Node	To Node	Type	Offset	Qcoeff	Gated	CloseTime
100-01	ADS	100	SIDE	101.37	0.572	NO	0
100-02	ADS	100	SIDE	102.25	0.61	NO	0
105--OF4	105	OF4	SIDE	102.68	0.572	NO	0
CB102A-0	CB102A-1	102	SIDE	102.89	0.572	NO	0
CB103A-0	CB103A-1	103	SIDE	103.07	0.572	NO	0
CB103B-0	CB103B-1	103	SIDE	102.42	0.572	NO	0

POST-DEVELOPMENT MODEL

CB103C-0	CB103C-1	103	SIDE	102.7	0.572	NO	0
CB103D-0	CB103D-1	103	SIDE	102.62	0.572	NO	0
CB103E-0	CB103E-1	103	SIDE	102.43	0.572	NO	0
CB106A-0	CB106A-1	ADS	SIDE	101.97	0.572	NO	0
CBMH104A-0	104	103	SIDE	102.61	0.572	NO	0
EX502-0	EX502	OF1	SIDE	102.02	0.572	NO	0

[WEIRS]

;;Name	From Node	To Node	Type	CrestHt	Qcoeff	Gated	EndCon
EndCoeff	Surcharge	RoadWidth	RoadSurf	Coeff.	Curve		
100-W1	ADS	100	TRANSVERSE	103	1.68	NO	0
YES							
W1	105	104	TRANSVERSE	104.44	1.67	NO	0
YES							

[OUTLETS]

;;Name	From Node	To Node	Offset	Type	QTable/Qcoeff	Qexpon
Gated						
ROOF1-0	ROOF1-S	BLDG	110	TABULAR/DEPTH	ROOF1-Q	
NO						
ROOF2-0	ROOF2-S	BLDG	110	TABULAR/DEPTH	ROOF2-Q	
NO						
ROOF3-0	ROOF3-S	BLDG	110	TABULAR/DEPTH	ROOF3-Q	
NO						
ROOF4-0	ROOF4-S	BLDG	110	TABULAR/DEPTH	ROOF4-Q	
NO						

[XSECTIONS]

;;Link	Shape	Geom1	Geom2	Geom3	Geom4	Barrels	Culvert
100--EX	CIRCULAR	0.525	0	0	0	1	
101--ADS	CIRCULAR	0.45	0	0	0	1	
102--101	CIRCULAR	0.45	0	0	0	1	
103--102	CIRCULAR	0.45	0	0	0	1	

POST-DEVELOPMENT MODEL

BLDG--102	CIRCULAR	0.45	0	0	0	1
EX--HEADWALL	CIRCULAR	0.675	0	0	0	1
100-01	CIRCULAR	0.083	0	0	0	
100-02	CIRCULAR	0.2	0	0	0	
105--OF4	CIRCULAR	0.083	0	0	0	
CB102A-0	CIRCULAR	0.102	0	0	0	
CB103A-0	CIRCULAR	0.178	0	0	0	
CB103B-0	CIRCULAR	0.083	0	0	0	
CB103C-0	CIRCULAR	0.083	0	0	0	
CB103D-0	CIRCULAR	0.152	0	0	0	
CB103E-0	CIRCULAR	0.127	0	0	0	
CB106A-0	CIRCULAR	0.102	0	0	0	
CBMH104A-0	CIRCULAR	0.102	0	0	0	
EX502-0	CIRCULAR	0.083	0	0	0	
100-W1	RECT_OPEN	0.3	0.4	0	0	
W1	RECT_OPEN	0.07	6	0	0	

[TRANSECTS]

```
;;Transect Data in HEC-2 format
;
NC 0.013 0.013 0.013
X1 Overland 5 0.15 6.85 0.0 0.0 0.0 0.0 0.0
GR 0.15 0 0 0.15 0 6.85 0.15 7 0.15 7
;
;[LE: 0][RE: 7]
NC 0.013 0.013 0.013
X1 Overland(orig) 4 0.15 6.85 0.0 0.0 0.0 0.0 0.0
GR 0.15 0 0 0.15 0 6.85 0.15 7
```

[LOSSES]

;;Link	Kentry	Kexit	Kavg	Flap Gate	Seepage
100--EX	0	0.157	0	NO	0
101--ADS	0	0.021	0	NO	0
102--101	0	0.141	0	NO	0
103--102	0	1.344	0	NO	0
BLDG--102	0	0.021	0	NO	0
EX--HEADWALL	0	0.021	0	NO	0

POST-DEVELOPMENT MODEL

[INFLOWS]						
;;Node	Constituent	Time Series	Type	Mfactor	Sfactor	Baseline Pattern

EX	FLOW	100yrHydrograph	FLOW	1.0	1	0
[CURVES]						
;;Name	Type	X-Value	Y-Value			

ROOF1-Q	Rating	0	0			
ROOF1-Q		0.025	0.6309			
ROOF1-Q		0.05	1.2618			
ROOF1-Q		0.075	1.5773			
ROOF1-Q		0.1	1.8927			
ROOF1-Q		0.125	2.2082			
ROOF1-Q		0.15	2.5236			
ROOF2-Q	Rating	0	0			
ROOF2-Q		0.025	2.8391			
ROOF2-Q		0.05	5.6781			
ROOF2-Q		0.075	7.0976			
ROOF2-Q		0.1	8.5172			
ROOF2-Q		0.125	9.9367			
ROOF2-Q		0.15	11.3562			
ROOF3-Q	Rating	0	0			
ROOF3-Q		0.025	2.5236			
ROOF3-Q		0.05	5.0472			
ROOF3-Q		0.075	6.309			
ROOF3-Q		0.1	7.5708			
ROOF3-Q		0.125	8.8326			
ROOF3-Q		0.15	10.0944			
ROOF4-Q	Rating	0	0			
ROOF4-Q		0.025	0.6309			
ROOF4-Q		0.05	1.2618			
ROOF4-Q		0.075	1.5773			
ROOF4-Q		0.1	1.8927			

POST-DEVELOPMENT MODEL

ROOF4-Q		0.125	2.2082			
ROOF4-Q		0.15	2.5236			
CB102A-V	Storage	0	0.36			
CB102A-V		1.19	0.36			
CB102A-V		1.3	65.4			
CB103A-V	Storage	0	0.36			
CB103A-V		1.38	0.36			
CB103A-V		1.53	51.1			
CB103B-V	Storage	0	0.36			
CB103B-V		1.38	0.36			
CB103B-V		1.68	350.5			
CB103C-V	Storage	0	0.36			
CB103C-V		1.38	0.36			
CB103C-V		1.6	247.3			
CB103D-V	Storage	0	0.36			
CB103D-V		1.38	0.36			
CB103D-V		1.66	265			
CB103E-V	Storage	0	0.36			
CB103E-V		1.38	0.36			
CB103E-V		1.68	447.9			
CB104A-V	Storage	0	0.36			
CB104A-V		1.19	0.36			
CB104A-V		1.49	333.3			
CB106A-V	Storage	0	0.36			
CB106A-V		1.38	0.36			
CB106A-V		1.68	523.3			
EX502-V	Storage	0	0.36			
EX502-V		1.94	0.36			
EX502-V		2.2	191.9			

POST-DEVELOPMENT MODEL

ROOF1-V	Storage	0	0
ROOF1-V		0.025	4
ROOF1-V		0.05	18
ROOF1-V		0.075	40
ROOF1-V		0.1	71
ROOF1-V		0.125	111
ROOF1-V		0.15	160
ROOF2-V	Storage	0	0
ROOF2-V		0.025	49
ROOF2-V		0.05	196
ROOF2-V		0.075	440
ROOF2-V		0.1	782
ROOF2-V		0.125	1222
ROOF2-V		0.15	1760
ROOF3-V	Storage	0	0
ROOF3-V		0.025	41
ROOF3-V		0.05	164
ROOF3-V		0.075	370
ROOF3-V		0.1	658
ROOF3-V		0.125	1028
ROOF3-V		0.15	1480
ROOF4-V	Storage	0	0
ROOF4-V		0.025	4
ROOF4-V		0.05	18
ROOF4-V		0.075	40
ROOF4-V		0.1	71
ROOF4-V		0.125	111
ROOF4-V		0.15	160
TANK-V	Storage	0	378.9370079
TANK-V		0.0254	378.9370079
TANK-V		0.051	378.94
TANK-V		0.076	378.94
TANK-V		0.102	378.94

POST-DEVELOPMENT MODEL

TANK-V	0.127	378.94
TANK-V	0.152	378.94
TANK-V	0.178	369.09
TANK-V	0.203	378.94
TANK-V	0.229	369.09
TANK-V	0.254	378.94
TANK-V	0.279	369.09
TANK-V	0.305	369.09
TANK-V	0.33	369.09
TANK-V	0.356	369.09
TANK-V	0.381	369.09
TANK-V	0.406	359.25
TANK-V	0.432	369.09
TANK-V	0.457	359.25
TANK-V	0.483	359.25
TANK-V	0.508	359.25
TANK-V	0.533	359.25
TANK-V	0.559	349.41
TANK-V	0.584	359.25
TANK-V	0.61	349.41
TANK-V	0.635	349.41
TANK-V	0.66	349.41
TANK-V	0.686	339.57
TANK-V	0.711	349.41
TANK-V	0.737	339.57
TANK-V	0.762	339.57
TANK-V	0.787	329.72
TANK-V	0.813	339.57
TANK-V	0.838	319.88
TANK-V	0.864	339.57
TANK-V	0.889	310.04
TANK-V	0.914	339.57
TANK-V	0.94	300.2
TANK-V	0.965	329.72
TANK-V	0.991	290.35
TANK-V	1.016	329.72
TANK-V	1.041	280.51
TANK-V	1.067	319.88

POST-DEVELOPMENT MODEL

TANK-V	1.092	280.51
TANK-V	1.118	300.2
TANK-V	1.143	280.51
TANK-V	1.168	290.35
TANK-V	1.194	260.83
TANK-V	1.219	290.35
TANK-V	1.245	241.14
TANK-V	1.27	280.51
TANK-V	1.295	231.3
TANK-V	1.321	260.83
TANK-V	1.346	211.61
TANK-V	1.372	231.3
TANK-V	1.397	191.93
TANK-V	1.422	191.93
TANK-V	1.448	182.09
TANK-V	1.473	182.09
TANK-V	1.499	182.09
TANK-V	1.524	162.4
TANK-V	1.525	0
TANK-V	3	0

[TIMESERIES]

;;Name	Date	Time	Value

;MTO Distribution, 15min intervals			
002SCS		0:00	0
002SCS		0:15	1.08
002SCS		0:30	1.08
002SCS		0:45	1.08
002SCS		1:00	1.08
002SCS		1:15	1.08
002SCS		1:30	1.08
002SCS		1:45	1.08
002SCS		2:00	1.296
002SCS		2:15	1.296
002SCS		2:30	1.296
002SCS		2:45	1.296
002SCS		3:00	1.728

POST-DEVELOPMENT MODEL

002SCS	3:15	1.728
002SCS	3:30	1.728
002SCS	3:45	1.728
002SCS	4:00	2.592
002SCS	4:15	2.592
002SCS	4:30	3.456
002SCS	4:45	3.456
002SCS	5:00	5.184
002SCS	5:15	5.184
002SCS	5:30	20.736
002SCS	5:45	57.024
002SCS	6:00	7.776
002SCS	6:15	7.776
002SCS	6:30	3.456
002SCS	6:45	3.456
002SCS	7:00	2.592
002SCS	7:15	2.592
002SCS	7:30	2.592
002SCS	7:45	2.592
002SCS	8:00	1.512
002SCS	8:15	1.512
002SCS	8:30	1.512
002SCS	8:45	1.512
002SCS	9:00	1.512
002SCS	9:15	1.512
002SCS	9:30	1.512
002SCS	9:45	1.512
002SCS	10:00	0.864
002SCS	10:15	0.864
002SCS	10:30	0.864
002SCS	10:45	0.864
002SCS	11:00	0.864
002SCS	11:15	0.864
002SCS	11:30	0.864
002SCS	11:45	0.864
002SCS	12:00	0
005SCS	0:00:00	0

POST-DEVELOPMENT MODEL

005SCS	0:15:00	1.44
005SCS	0:30:00	1.44
005SCS	0:45:00	1.44
005SCS	1:00:00	1.44
005SCS	1:15:00	1.44
005SCS	1:30:00	1.44
005SCS	1:45:00	1.44
005SCS	2:00:00	1.728
005SCS	2:15:00	1.728
005SCS	2:30:00	1.728
005SCS	2:45:00	1.728
005SCS	3:00:00	2.304
005SCS	3:15:00	2.304
005SCS	3:30:00	2.304
005SCS	3:45:00	2.304
005SCS	4:00:00	3.456
005SCS	4:15:00	3.456
005SCS	4:30:00	4.608
005SCS	4:45:00	4.608
005SCS	5:00:00	6.912
005SCS	5:15:00	6.912
005SCS	5:30:00	27.648
005SCS	5:45:00	76.032
005SCS	6:00:00	10.368
005SCS	6:15:00	10.368
005SCS	6:30:00	4.608
005SCS	6:45:00	4.608
005SCS	7:00:00	3.456
005SCS	7:15:00	3.456
005SCS	7:30:00	3.456
005SCS	7:45:00	3.456
005SCS	8:00:00	2.016
005SCS	8:15:00	2.016
005SCS	8:30:00	2.016
005SCS	8:45:00	2.016
005SCS	9:00:00	2.016
005SCS	9:15:00	2.016
005SCS	9:30:00	2.016

POST-DEVELOPMENT MODEL

005SCS	9:45:00	2.016
005SCS	10:00:00	1.152
005SCS	10:15:00	1.152
005SCS	10:30:00	1.152
005SCS	10:45:00	1.152
005SCS	11:00:00	1.152
005SCS	11:15:00	1.152
005SCS	11:30:00	1.152
005SCS	11:45:00	1.152
005SCS	12:00:00	0
010SCS	0:00:00	0
010SCS	0:15:00	1.68
010SCS	0:30:00	1.68
010SCS	0:45:00	1.68
010SCS	1:00:00	1.68
010SCS	1:15:00	1.68
010SCS	1:30:00	1.68
010SCS	1:45:00	1.68
010SCS	2:00:00	2.02
010SCS	2:15:00	2.02
010SCS	2:30:00	2.02
010SCS	2:45:00	2.02
010SCS	3:00:00	2.69
010SCS	3:15:00	2.69
010SCS	3:30:00	2.69
010SCS	3:45:00	2.69
010SCS	4:00:00	4.03
010SCS	4:15:00	4.03
010SCS	4:30:00	5.38
010SCS	4:45:00	5.38
010SCS	5:00:00	8.06
010SCS	5:15:00	8.06
010SCS	5:30:00	32.26
010SCS	5:45:00	88.7
010SCS	6:00:00	12.1
010SCS	6:15:00	12.1
010SCS	6:30:00	5.38

POST-DEVELOPMENT MODEL

010SCS	6:45:00	5.38
010SCS	7:00:00	4.03
010SCS	7:15:00	4.03
010SCS	7:30:00	4.03
010SCS	7:45:00	4.03
010SCS	8:00:00	2.35
010SCS	8:15:00	2.35
010SCS	8:30:00	2.35
010SCS	8:45:00	2.35
010SCS	9:00:00	2.35
010SCS	9:15:00	2.35
010SCS	9:30:00	2.35
010SCS	9:45:00	2.35
010SCS	10:00:00	1.34
010SCS	10:15:00	1.34
010SCS	10:30:00	1.34
010SCS	10:45:00	1.34
010SCS	11:00:00	1.34
010SCS	11:15:00	1.34
010SCS	11:30:00	1.34
010SCS	11:45:00	1.34
010SCS	12:00:00	0
025SCS	0:00:00	0
025SCS	0:15:00	1.98
025SCS	0:30:00	1.98
025SCS	0:45:00	1.98
025SCS	1:00:00	1.98
025SCS	1:15:00	1.98
025SCS	1:30:00	1.98
025SCS	1:45:00	1.98
025SCS	2:00:00	2.376
025SCS	2:15:00	2.376
025SCS	2:30:00	2.376
025SCS	2:45:00	2.376
025SCS	3:00:00	3.168
025SCS	3:15:00	3.168
025SCS	3:30:00	3.168

POST-DEVELOPMENT MODEL

025SCS	3:45:00	3.168
025SCS	4:00:00	4.752
025SCS	4:15:00	4.752
025SCS	4:30:00	6.336
025SCS	4:45:00	6.336
025SCS	5:00:00	9.504
025SCS	5:15:00	9.504
025SCS	5:30:00	38.016
025SCS	5:45:00	104.544
025SCS	6:00:00	14.256
025SCS	6:15:00	14.256
025SCS	6:30:00	6.336
025SCS	6:45:00	6.336
025SCS	7:00:00	4.752
025SCS	7:15:00	4.752
025SCS	7:30:00	4.752
025SCS	7:45:00	4.752
025SCS	8:00:00	2.772
025SCS	8:15:00	2.772
025SCS	8:30:00	2.772
025SCS	8:45:00	2.772
025SCS	9:00:00	2.772
025SCS	9:15:00	2.772
025SCS	9:30:00	2.772
025SCS	9:45:00	2.772
025SCS	10:00:00	1.584
025SCS	10:15:00	1.584
025SCS	10:30:00	1.584
025SCS	10:45:00	1.584
025SCS	11:00:00	1.584
025SCS	11:15:00	1.584
025SCS	11:30:00	1.584
025SCS	11:45:00	1.584
025SCS	12:00:00	0
050SCS	0:00:00	0
050SCS	0:15:00	2.19
050SCS	0:30:00	2.19

POST-DEVELOPMENT MODEL

050SCS	0:45:00	2.19
050SCS	1:00:00	2.19
050SCS	1:15:00	2.19
050SCS	1:30:00	2.19
050SCS	1:45:00	2.19
050SCS	2:00:00	2.628
050SCS	2:15:00	2.628
050SCS	2:30:00	2.628
050SCS	2:45:00	2.628
050SCS	3:00:00	3.504
050SCS	3:15:00	3.504
050SCS	3:30:00	3.504
050SCS	3:45:00	3.504
050SCS	4:00:00	5.256
050SCS	4:15:00	5.256
050SCS	4:30:00	7.008
050SCS	4:45:00	7.008
050SCS	5:00:00	10.512
050SCS	5:15:00	10.512
050SCS	5:30:00	42.048
050SCS	5:45:00	115.632
050SCS	6:00:00	15.768
050SCS	6:15:00	15.768
050SCS	6:30:00	7.008
050SCS	6:45:00	7.008
050SCS	7:00:00	5.256
050SCS	7:15:00	5.256
050SCS	7:30:00	5.256
050SCS	7:45:00	5.256
050SCS	8:00:00	3.066
050SCS	8:15:00	3.066
050SCS	8:30:00	3.066
050SCS	8:45:00	3.066
050SCS	9:00:00	3.066
050SCS	9:15:00	3.066
050SCS	9:30:00	3.066
050SCS	9:45:00	3.066
050SCS	10:00:00	1.752

POST-DEVELOPMENT MODEL

050SCS	10:15:00	1.752
050SCS	10:30:00	1.752
050SCS	10:45:00	1.752
050SCS	11:00:00	1.752
050SCS	11:15:00	1.752
050SCS	11:30:00	1.752
050SCS	11:45:00	1.752
050SCS	12:00:00	0

;MTO Distribution, 15min intervals

100SCS	0:00	0
100SCS	0:15	2.4
100SCS	0:30	2.4
100SCS	0:45	2.4
100SCS	1:00	2.4
100SCS	1:15	2.4
100SCS	1:30	2.4
100SCS	1:45	2.4
100SCS	2:00	2.4
100SCS	2:15	2.88
100SCS	2:30	2.88
100SCS	2:45	2.88
100SCS	3:00	2.88
100SCS	3:15	3.84
100SCS	3:30	3.84
100SCS	3:45	3.84
100SCS	4:00	3.84
100SCS	4:15	5.76
100SCS	4:30	5.76
100SCS	4:45	7.68
100SCS	5:00	7.68
100SCS	5:15	11.52
100SCS	5:30	11.52
100SCS	5:45	46.08
100SCS	6:00	126.72
100SCS	6:15	17.28
100SCS	6:30	17.28
100SCS	6:45	7.68

POST-DEVELOPMENT MODEL

100SCS	7:00	7.68
100SCS	7:15	5.76
100SCS	7:30	5.76
100SCS	7:45	5.76
100SCS	8:00	5.76
100SCS	8:15	3.36
100SCS	8:30	3.36
100SCS	8:45	3.36
100SCS	9:00	3.36
100SCS	9:15	3.36
100SCS	9:30	3.36
100SCS	9:45	3.36
100SCS	10:00	3.36
100SCS	10:15	1.92
100SCS	10:30	1.92
100SCS	10:45	1.92
100SCS	11:00	1.92
100SCS	11:15	1.92
100SCS	11:30	1.92
100SCS	11:45	1.92
100SCS	12:00	0

100yrHydrograph	0:05	0
100yrHydrograph	0:10	0
100yrHydrograph	0:15	0
100yrHydrograph	0:20	0
100yrHydrograph	0:25	0
100yrHydrograph	0:30	0
100yrHydrograph	0:35	0
100yrHydrograph	0:40	0
100yrHydrograph	0:45	0
100yrHydrograph	0:50	0
100yrHydrograph	0:55	0
100yrHydrograph	1:00	0
100yrHydrograph	1:05	0
100yrHydrograph	1:10	0
100yrHydrograph	1:15	0
100yrHydrograph	1:20	0

POST-DEVELOPMENT MODEL

100yrHydrograph	1:25	0
100yrHydrograph	1:30	0
100yrHydrograph	1:35	0
100yrHydrograph	1:40	0
100yrHydrograph	1:45	0
100yrHydrograph	1:50	0
100yrHydrograph	1:55	0
100yrHydrograph	2:00	0
100yrHydrograph	2:05	0.03368589
100yrHydrograph	2:10	0.400265
100yrHydrograph	2:15	0.6780789
100yrHydrograph	2:20	0.8096212
100yrHydrograph	2:25	0.9188437
100yrHydrograph	2:30	1.041047
100yrHydrograph	2:35	1.160273
100yrHydrograph	2:40	1.279933
100yrHydrograph	2:45	1.400491
100yrHydrograph	2:50	1.521803
100yrHydrograph	2:55	1.6431
100yrHydrograph	3:00	1.770213
100yrHydrograph	3:05	1.89238
100yrHydrograph	3:10	2.011746
100yrHydrograph	3:15	2.129715
100yrHydrograph	3:20	2.24681
100yrHydrograph	3:25	2.372673
100yrHydrograph	3:30	2.52147
100yrHydrograph	3:35	2.690327
100yrHydrograph	3:40	2.870473
100yrHydrograph	3:45	3.049115
100yrHydrograph	3:50	3.225464
100yrHydrograph	3:55	3.398892
100yrHydrograph	4:00	3.569112
100yrHydrograph	4:05	3.736014
100yrHydrograph	4:10	3.899172
100yrHydrograph	4:15	4.062318
100yrHydrograph	4:20	4.221156
100yrHydrograph	4:25	4.414243
100yrHydrograph	4:30	4.674353

POST-DEVELOPMENT MODEL

100yrHydrograph	4:35	4.971942
100yrHydrograph	4:40	5.279111
100yrHydrograph	4:45	6.154143
100yrHydrograph	4:50	6.507444
100yrHydrograph	4:55	6.698976
100yrHydrograph	5:00	6.914319
100yrHydrograph	5:05	7.139013
100yrHydrograph	5:10	7.358335
100yrHydrograph	5:15	7.568453
100yrHydrograph	5:20	7.776987
100yrHydrograph	5:25	8.043731
100yrHydrograph	5:30	8.375088
100yrHydrograph	5:35	8.720076
100yrHydrograph	5:40	9.065854
100yrHydrograph	5:45	9.411835
100yrHydrograph	5:50	9.817601
100yrHydrograph	5:55	10.7888
100yrHydrograph	6:00	12.18063
100yrHydrograph	6:05	13.55768
100yrHydrograph	6:10	15.79406
100yrHydrograph	6:15	18.70004
100yrHydrograph	6:20	42.87194
100yrHydrograph	6:25	89.41938
100yrHydrograph	6:30	110.0801
100yrHydrograph	6:35	120.6727
100yrHydrograph	6:40	126.8955
100yrHydrograph	6:45	131.1839
100yrHydrograph	6:50	135.1019
100yrHydrograph	6:55	136.1944
100yrHydrograph	7:00	134.3278
100yrHydrograph	7:05	133.2315
100yrHydrograph	7:10	131.9975
100yrHydrograph	7:15	130.5499
100yrHydrograph	7:20	128.9494
100yrHydrograph	7:25	127.0917
100yrHydrograph	7:30	124.968
100yrHydrograph	7:35	122.8077
100yrHydrograph	7:40	120.8129

POST-DEVELOPMENT MODEL

100yrHydrograph	7:45	118.6745
100yrHydrograph	7:50	116.2747
100yrHydrograph	7:55	113.7336
100yrHydrograph	8:00	111.03
100yrHydrograph	8:05	107.4665
100yrHydrograph	8:10	103.368
100yrHydrograph	8:15	99.26289
100yrHydrograph	8:20	95.15655
100yrHydrograph	8:25	90.6512
100yrHydrograph	8:30	85.96979
100yrHydrograph	8:35	81.40397
100yrHydrograph	8:40	77.20897
100yrHydrograph	8:45	73.056
100yrHydrograph	8:50	68.54881
100yrHydrograph	8:55	63.82666
100yrHydrograph	9:00	59.70413
100yrHydrograph	9:05	56.16789
100yrHydrograph	9:10	53.06845
100yrHydrograph	9:15	50.40911
100yrHydrograph	9:20	48.21593
100yrHydrograph	9:25	46.66951
100yrHydrograph	9:30	45.38166
100yrHydrograph	9:35	44.14623
100yrHydrograph	9:40	42.96396
100yrHydrograph	9:45	41.84916
100yrHydrograph	9:50	40.78232
100yrHydrograph	9:55	39.74205
100yrHydrograph	10:00	38.7661
100yrHydrograph	10:05	37.83093
100yrHydrograph	10:10	36.92952
100yrHydrograph	10:15	36.06311
100yrHydrograph	10:20	35.16625
100yrHydrograph	10:25	33.88804
100yrHydrograph	10:30	32.4535
100yrHydrograph	10:35	31.05881
100yrHydrograph	10:40	29.78304
100yrHydrograph	10:45	28.63077
100yrHydrograph	10:50	27.58944

POST-DEVELOPMENT MODEL

100yrHydrograph	10:55	26.653
100yrHydrograph	11:00	25.66802
100yrHydrograph	11:05	24.91771
100yrHydrograph	11:10	24.2445
100yrHydrograph	11:15	23.63535
100yrHydrograph	11:20	23.08379
100yrHydrograph	11:25	22.58303
100yrHydrograph	11:30	22.12786
100yrHydrograph	11:35	21.71402
100yrHydrograph	11:40	21.33782
100yrHydrograph	11:45	20.99621
100yrHydrograph	11:50	20.68643
100yrHydrograph	11:55	20.40586
100yrHydrograph	12:00	20.1529
100yrHydrograph	12:05	19.91762
100yrHydrograph	12:10	19.63007
100yrHydrograph	12:15	19.3239
100yrHydrograph	12:20	19.12781
100yrHydrograph	12:25	18.97093
100yrHydrograph	12:30	18.80998
100yrHydrograph	12:35	18.64461
100yrHydrograph	12:40	18.47622
100yrHydrograph	12:45	18.30533
100yrHydrograph	12:50	18.13219
100yrHydrograph	12:55	17.95722
100yrHydrograph	13:00	17.74718
100yrHydrograph	13:05	17.56915
100yrHydrograph	13:10	17.39227
100yrHydrograph	13:15	17.21504
100yrHydrograph	13:20	17.03772
100yrHydrograph	13:25	16.86038
100yrHydrograph	13:30	16.68295
100yrHydrograph	13:35	16.50546
100yrHydrograph	13:40	16.32839
100yrHydrograph	13:45	16.15076
100yrHydrograph	13:50	15.97309
100yrHydrograph	13:55	15.79539
100yrHydrograph	14:00	15.61763

POST-DEVELOPMENT MODEL

100yrHydrograph	14:05	15.44018
100yrHydrograph	14:10	15.26246
100yrHydrograph	14:15	15.08446
100yrHydrograph	14:20	14.90619
100yrHydrograph	14:25	14.72721
100yrHydrograph	14:30	14.54815
100yrHydrograph	14:35	14.36913
100yrHydrograph	14:40	14.19005
100yrHydrograph	14:45	14.011
100yrHydrograph	14:50	13.83076
100yrHydrograph	14:55	13.65002
100yrHydrograph	15:00	13.46919
100yrHydrograph	15:05	13.27224
100yrHydrograph	15:10	13.09266
100yrHydrograph	15:15	12.91431
100yrHydrograph	15:20	12.73593
100yrHydrograph	15:25	12.55792
100yrHydrograph	15:30	12.37996
100yrHydrograph	15:35	12.2021
100yrHydrograph	15:40	12.02427
100yrHydrograph	15:45	11.84651
100yrHydrograph	15:50	11.66898
100yrHydrograph	15:55	11.49166
100yrHydrograph	16:00	11.3145
100yrHydrograph	16:05	11.13787
100yrHydrograph	16:10	10.96224
100yrHydrograph	16:15	10.78573
100yrHydrograph	16:20	10.60909
100yrHydrograph	16:25	10.43269
100yrHydrograph	16:30	10.25677
100yrHydrograph	16:35	10.08101
100yrHydrograph	16:40	9.904943
100yrHydrograph	16:45	9.728643
100yrHydrograph	16:50	9.552533
100yrHydrograph	16:55	9.376752
100yrHydrograph	17:00	9.201365
100yrHydrograph	17:05	9.026419
100yrHydrograph	17:10	8.854236

POST-DEVELOPMENT MODEL

100yrHydrograph	17:15	8.68074
100yrHydrograph	17:20	8.507633
100yrHydrograph	17:25	8.335072
100yrHydrograph	17:30	8.163301
100yrHydrograph	17:35	7.992058
100yrHydrograph	17:40	7.821409
100yrHydrograph	17:45	7.651455
100yrHydrograph	17:50	7.482112
100yrHydrograph	17:55	7.313401
100yrHydrograph	18:00	7.145336
100yrHydrograph	18:05	6.979621
100yrHydrograph	18:10	6.813243
100yrHydrograph	18:15	6.647324
100yrHydrograph	18:20	6.482216
100yrHydrograph	18:25	5.824821
100yrHydrograph	18:30	5.295127
100yrHydrograph	18:35	5.060137
100yrHydrograph	18:40	4.84829
100yrHydrograph	18:45	4.645963
100yrHydrograph	18:50	4.453671
100yrHydrograph	18:55	4.270811
100yrHydrograph	19:00	4.09688
100yrHydrograph	19:05	3.932506
100yrHydrograph	19:10	3.778864
100yrHydrograph	19:15	3.629502
100yrHydrograph	19:20	3.486742
100yrHydrograph	19:25	3.350802
100yrHydrograph	19:30	3.221082
100yrHydrograph	19:35	3.097033
100yrHydrograph	19:40	2.978455
100yrHydrograph	19:45	2.864869
100yrHydrograph	19:50	2.756282
100yrHydrograph	19:55	2.654007
100yrHydrograph	20:00	2.556878
100yrHydrograph	20:05	2.461823
100yrHydrograph	20:10	2.370567
100yrHydrograph	20:15	2.283155
100yrHydrograph	20:20	2.199545

POST-DEVELOPMENT MODEL

100yrHydrograph	20:25	2.119371
100yrHydrograph	20:30	2.0424
100yrHydrograph	20:35	1.968455
100yrHydrograph	20:40	1.897445
100yrHydrograph	20:45	1.82913
100yrHydrograph	20:50	1.763424
100yrHydrograph	20:55	1.701357
100yrHydrograph	21:00	1.642923
100yrHydrograph	21:05	1.586518
100yrHydrograph	21:10	1.530593
100yrHydrograph	21:15	1.476459
100yrHydrograph	21:20	1.424285
100yrHydrograph	21:25	1.373979
100yrHydrograph	21:30	1.325569
100yrHydrograph	21:35	1.278883
100yrHydrograph	21:40	1.233917
100yrHydrograph	21:45	1.190506
100yrHydrograph	21:50	1.148588
100yrHydrograph	21:55	1.108119
100yrHydrograph	22:00	1.069048
100yrHydrograph	22:05	1.031321
100yrHydrograph	22:10	0.9948828
100yrHydrograph	22:15	0.9598325
100yrHydrograph	22:20	0.9265975
100yrHydrograph	22:25	0.895036
100yrHydrograph	22:30	0.8651206
100yrHydrograph	22:35	0.8349182
100yrHydrograph	22:40	0.8052853
100yrHydrograph	22:45	0.7765169
100yrHydrograph	22:50	0.7486013
100yrHydrograph	22:55	0.721274
100yrHydrograph	23:00	0.6946917
100yrHydrograph	23:05	0.6689637
100yrHydrograph	23:10	0.6440647
100yrHydrograph	23:15	0.619979
100yrHydrograph	23:20	0.5967006
100yrHydrograph	23:25	0.5741587
100yrHydrograph	23:30	0.5523183

POST-DEVELOPMENT MODEL

100yrHydrograph	23:35	0.5311568
100yrHydrograph	23:40	0.5106529
100yrHydrograph	23:45	0.4907854
100yrHydrograph	23:50	0.4715335
100yrHydrograph	23:55	0.4528767
10yrHydrograph	0:05	0
10yrHydrograph	0:10	0
10yrHydrograph	0:15	0
10yrHydrograph	0:20	0
10yrHydrograph	0:25	0
10yrHydrograph	0:30	0
10yrHydrograph	0:35	0
10yrHydrograph	0:40	0
10yrHydrograph	0:45	0
10yrHydrograph	0:50	0
10yrHydrograph	0:55	0
10yrHydrograph	1:00	0
10yrHydrograph	1:05	0
10yrHydrograph	1:10	0
10yrHydrograph	1:15	0
10yrHydrograph	1:20	0
10yrHydrograph	1:25	0
10yrHydrograph	1:30	0
10yrHydrograph	1:35	0
10yrHydrograph	1:40	0
10yrHydrograph	1:45	0
10yrHydrograph	1:50	0
10yrHydrograph	1:55	0
10yrHydrograph	2:00	0
10yrHydrograph	2:05	0
10yrHydrograph	2:10	0
10yrHydrograph	2:15	0
10yrHydrograph	2:20	0
10yrHydrograph	2:25	0
10yrHydrograph	2:30	0
10yrHydrograph	2:35	0
10yrHydrograph	2:40	0.2091637

POST-DEVELOPMENT MODEL

10yrHydrograph	2:45	0.4970559
10yrHydrograph	2:50	0.6621942
10yrHydrograph	2:55	0.7450011
10yrHydrograph	3:00	0.8098456
10yrHydrograph	3:05	0.8846287
10yrHydrograph	3:10	0.9675194
10yrHydrograph	3:15	1.05528
10yrHydrograph	3:20	1.151164
10yrHydrograph	3:25	1.254475
10yrHydrograph	3:30	1.361697
10yrHydrograph	3:35	1.470532
10yrHydrograph	3:40	1.579763
10yrHydrograph	3:45	1.69078
10yrHydrograph	3:50	1.803118
10yrHydrograph	3:55	1.911144
10yrHydrograph	4:00	2.017152
10yrHydrograph	4:05	2.122659
10yrHydrograph	4:10	2.240417
10yrHydrograph	4:15	2.389848
10yrHydrograph	4:20	2.566833
10yrHydrograph	4:25	2.760122
10yrHydrograph	4:30	2.955965
10yrHydrograph	4:35	3.15057
10yrHydrograph	4:40	3.364651
10yrHydrograph	4:45	3.620815
10yrHydrograph	4:50	3.904942
10yrHydrograph	4:55	4.202277
10yrHydrograph	5:00	4.49131
10yrHydrograph	5:05	4.779599
10yrHydrograph	5:10	5.130579
10yrHydrograph	5:15	6.106522
10yrHydrograph	5:20	6.627988
10yrHydrograph	5:25	6.905078
10yrHydrograph	5:30	7.156063
10yrHydrograph	5:35	7.436275
10yrHydrograph	5:40	8.155813
10yrHydrograph	5:45	9.272655
10yrHydrograph	5:50	10.49713

POST-DEVELOPMENT MODEL

10yrHydrograph	5:55	12.46128
10yrHydrograph	6:00	14.55868
10yrHydrograph	6:05	16.69105
10yrHydrograph	6:10	17.57468
10yrHydrograph	6:15	17.73389
10yrHydrograph	6:20	18.406
10yrHydrograph	6:25	20.56863
10yrHydrograph	6:30	26.55472
10yrHydrograph	6:35	34.31078
10yrHydrograph	6:40	39.67621
10yrHydrograph	6:45	44.02234
10yrHydrograph	6:50	47.93614
10yrHydrograph	6:55	53.37497
10yrHydrograph	7:00	58.61012
10yrHydrograph	7:05	62.00156
10yrHydrograph	7:10	63.79604
10yrHydrograph	7:15	64.48611
10yrHydrograph	7:20	64.4265
10yrHydrograph	7:25	63.8186
10yrHydrograph	7:30	62.8089
10yrHydrograph	7:35	61.51538
10yrHydrograph	7:40	60.02477
10yrHydrograph	7:45	58.40065
10yrHydrograph	7:50	56.68561
10yrHydrograph	7:55	54.9119
10yrHydrograph	8:00	53.13997
10yrHydrograph	8:05	51.36214
10yrHydrograph	8:10	49.42586
10yrHydrograph	8:15	47.58556
10yrHydrograph	8:20	46.1135
10yrHydrograph	8:25	44.63068
10yrHydrograph	8:30	43.10273
10yrHydrograph	8:35	41.60753
10yrHydrograph	8:40	40.13668
10yrHydrograph	8:45	38.70065
10yrHydrograph	8:50	37.30282
10yrHydrograph	8:55	35.92665
10yrHydrograph	9:00	34.34184

POST-DEVELOPMENT MODEL

10yrHydrograph	9:05	32.64213
10yrHydrograph	9:10	31.15942
10yrHydrograph	9:15	29.89203
10yrHydrograph	9:20	28.79363
10yrHydrograph	9:25	27.82757
10yrHydrograph	9:30	26.9729
10yrHydrograph	9:35	26.1101
10yrHydrograph	9:40	25.41559
10yrHydrograph	9:45	24.81808
10yrHydrograph	9:50	24.27901
10yrHydrograph	9:55	23.79137
10yrHydrograph	10:00	23.34904
10yrHydrograph	10:05	22.9389
10yrHydrograph	10:10	22.48323
10yrHydrograph	10:15	21.97798
10yrHydrograph	10:20	21.4708
10yrHydrograph	10:25	20.99098
10yrHydrograph	10:30	20.551
10yrHydrograph	10:35	20.15655
10yrHydrograph	10:40	19.81021
10yrHydrograph	10:45	19.51671
10yrHydrograph	10:50	19.28836
10yrHydrograph	10:55	19.15544
10yrHydrograph	11:00	19.05533
10yrHydrograph	11:05	18.95734
10yrHydrograph	11:10	18.85984
10yrHydrograph	11:15	18.76283
10yrHydrograph	11:20	18.66638
10yrHydrograph	11:25	18.57057
10yrHydrograph	11:30	18.47535
10yrHydrograph	11:35	18.38071
10yrHydrograph	11:40	18.28652
10yrHydrograph	11:45	18.19275
10yrHydrograph	11:50	18.09945
10yrHydrograph	11:55	17.99856
10yrHydrograph	12:00	17.8955
10yrHydrograph	12:05	17.80235
10yrHydrograph	12:10	17.68764

POST-DEVELOPMENT MODEL

10yrHydrograph	12:15	17.55217
10yrHydrograph	12:20	17.40501
10yrHydrograph	12:25	17.25057
10yrHydrograph	12:30	17.0913
10yrHydrograph	12:35	16.92862
10yrHydrograph	12:40	16.76336
10yrHydrograph	12:45	16.59601
10yrHydrograph	12:50	16.4273
10yrHydrograph	12:55	16.25765
10yrHydrograph	13:00	16.08657
10yrHydrograph	13:05	15.91465
10yrHydrograph	13:10	15.74201
10yrHydrograph	13:15	15.56869
10yrHydrograph	13:20	15.39524
10yrHydrograph	13:25	15.22079
10yrHydrograph	13:30	15.04575
10yrHydrograph	13:35	14.86994
10yrHydrograph	13:40	14.6931
10yrHydrograph	13:45	14.51619
10yrHydrograph	13:50	14.33899
10yrHydrograph	13:55	14.16153
10yrHydrograph	14:00	13.98371
10yrHydrograph	14:05	13.80437
10yrHydrograph	14:10	13.62443
10yrHydrograph	14:15	13.44434
10yrHydrograph	14:20	13.24739
10yrHydrograph	14:25	13.06937
10yrHydrograph	14:30	12.8914
10yrHydrograph	14:35	12.71344
10yrHydrograph	14:40	12.53581
10yrHydrograph	14:45	12.35817
10yrHydrograph	14:50	12.1806
10yrHydrograph	14:55	12.00298
10yrHydrograph	15:00	11.82543
10yrHydrograph	15:05	11.6481
10yrHydrograph	15:10	11.47097
10yrHydrograph	15:15	11.29398
10yrHydrograph	15:20	11.11775

POST-DEVELOPMENT MODEL

10yrHydrograph	15:25	10.94209
10yrHydrograph	15:30	10.76561
10yrHydrograph	15:35	10.58907
10yrHydrograph	15:40	10.41278
10yrHydrograph	15:45	10.23698
10yrHydrograph	15:50	10.06127
10yrHydrograph	15:55	9.885192
10yrHydrograph	16:00	9.708944
10yrHydrograph	16:05	9.532918
10yrHydrograph	16:10	9.357235
10yrHydrograph	16:15	9.181952
10yrHydrograph	16:20	9.007167
10yrHydrograph	16:25	8.835125
10yrHydrograph	16:30	8.6617
10yrHydrograph	16:35	8.488708
10yrHydrograph	16:40	8.316278
10yrHydrograph	16:45	8.144634
10yrHydrograph	16:50	7.973507
10yrHydrograph	16:55	7.802979
10yrHydrograph	17:00	7.63315
10yrHydrograph	17:05	7.463927
10yrHydrograph	17:10	7.295335
10yrHydrograph	17:15	7.12746
10yrHydrograph	17:20	6.961874
10yrHydrograph	17:25	6.795524
10yrHydrograph	17:30	6.62971
10yrHydrograph	17:35	6.464724
10yrHydrograph	17:40	5.728798
10yrHydrograph	17:45	5.266542
10yrHydrograph	17:50	5.03733
10yrHydrograph	17:55	4.826485
10yrHydrograph	18:00	4.625267
10yrHydrograph	18:05	4.434051
10yrHydrograph	18:10	4.252188
10yrHydrograph	18:15	4.079206
10yrHydrograph	18:20	3.915943
10yrHydrograph	18:25	3.763072
10yrHydrograph	18:30	3.614366

POST-DEVELOPMENT MODEL

10yrHydrograph	18:35	3.472344
10yrHydrograph	18:40	3.337124
10yrHydrograph	18:45	3.208032
10yrHydrograph	18:50	3.084581
10yrHydrograph	18:55	2.966579
10yrHydrograph	19:00	2.853495
10yrHydrograph	19:05	2.745559
10yrHydrograph	19:10	2.644138
10yrHydrograph	19:15	2.547041
10yrHydrograph	19:20	2.452365
10yrHydrograph	19:25	2.361523
10yrHydrograph	19:30	2.274521
10yrHydrograph	19:35	2.191282
10yrHydrograph	19:40	2.111462
10yrHydrograph	19:45	2.034816
10yrHydrograph	19:50	1.961183
10yrHydrograph	19:55	1.89047
10yrHydrograph	20:00	1.822429
10yrHydrograph	20:05	1.757003
10yrHydrograph	20:10	1.69533
10yrHydrograph	20:15	1.637367
10yrHydrograph	20:20	1.580895
10yrHydrograph	20:25	1.525128
10yrHydrograph	20:30	1.471199
10yrHydrograph	20:35	1.419219
10yrHydrograph	20:40	1.369106
10yrHydrograph	20:45	1.320877
10yrHydrograph	20:50	1.274369
10yrHydrograph	20:55	1.229568
10yrHydrograph	21:00	1.186311
10yrHydrograph	21:05	1.144543
10yrHydrograph	21:10	1.104219
10yrHydrograph	21:15	1.065286
10yrHydrograph	21:20	1.027691
10yrHydrograph	21:25	0.9913799
10yrHydrograph	21:30	0.9565145
10yrHydrograph	21:35	0.9234093
10yrHydrograph	21:40	0.8921673

POST-DEVELOPMENT MODEL

10yrHydrograph	21:45	0.8621652
10yrHydrograph	21:50	0.8319955
10yrHydrograph	21:55	0.802442
10yrHydrograph	22:00	0.7737648
10yrHydrograph	22:05	0.7459148
10yrHydrograph	22:10	0.7186539
10yrHydrograph	22:15	0.6921548
10yrHydrograph	22:20	0.6665107
10yrHydrograph	22:25	0.6416928
10yrHydrograph	22:30	0.6176897
10yrHydrograph	22:35	0.5944871
10yrHydrograph	22:40	0.5720161
10yrHydrograph	22:45	0.550244
10yrHydrograph	22:50	0.5291486
10yrHydrograph	22:55	0.5087084
10yrHydrograph	23:00	0.4889024
10yrHydrograph	23:05	0.4697101
10yrHydrograph	23:10	0.4511109
10yrHydrograph	23:15	0.4330854
10yrHydrograph	23:20	0.4156212
10yrHydrograph	23:25	0.3988013
10yrHydrograph	23:30	0.3825136
10yrHydrograph	23:35	0.3673834
10yrHydrograph	23:40	0.3523415
10yrHydrograph	23:45	0.3374563
10yrHydrograph	23:50	0.322884
10yrHydrograph	23:55	0.3086887
120SCS	0:00	0
120SCS	0:15	2.88
120SCS	0:30	2.88
120SCS	0:45	2.88
120SCS	1:00	2.88
120SCS	1:15	2.88
120SCS	1:30	2.88
120SCS	1:45	2.88
120SCS	2:00	2.88
120SCS	2:15	3.456

POST-DEVELOPMENT MODEL

120SCS	2:30	3.456
120SCS	2:45	3.456
120SCS	3:00	3.456
120SCS	3:15	4.608
120SCS	3:30	4.608
120SCS	3:45	4.608
120SCS	4:00	4.608
120SCS	4:15	6.912
120SCS	4:30	6.912
120SCS	4:45	9.216
120SCS	5:00	9.216
120SCS	5:15	13.824
120SCS	5:30	13.824
120SCS	5:45	55.296
120SCS	6:00	152.064
120SCS	6:15	20.736
120SCS	6:30	20.736
120SCS	6:45	9.216
120SCS	7:00	9.216
120SCS	7:15	6.912
120SCS	7:30	6.912
120SCS	7:45	6.912
120SCS	8:00	6.912
120SCS	8:15	4.032
120SCS	8:30	4.032
120SCS	8:45	4.032
120SCS	9:00	4.032
120SCS	9:15	4.032
120SCS	9:30	4.032
120SCS	9:45	4.032
120SCS	10:00	4.032
120SCS	10:15	2.304
120SCS	10:30	2.304
120SCS	10:45	2.304
120SCS	11:00	2.304
120SCS	11:15	2.304
120SCS	11:30	2.304
120SCS	11:45	2.304

POST-DEVELOPMENT MODEL

120SCS	12:00	0
120yrHydrograph	0:05	0
120yrHydrograph	0:10	0
120yrHydrograph	0:15	0
120yrHydrograph	0:20	0
120yrHydrograph	0:25	0
120yrHydrograph	0:30	0
120yrHydrograph	0:35	0
120yrHydrograph	0:40	0
120yrHydrograph	0:45	0
120yrHydrograph	0:50	0
120yrHydrograph	0:55	0
120yrHydrograph	1:00	0
120yrHydrograph	1:05	0
120yrHydrograph	1:10	0
120yrHydrograph	1:15	0
120yrHydrograph	1:20	0
120yrHydrograph	1:25	0
120yrHydrograph	1:30	0
120yrHydrograph	1:35	0
120yrHydrograph	1:40	0
120yrHydrograph	1:45	0
120yrHydrograph	1:50	0
120yrHydrograph	1:55	0.344241
120yrHydrograph	2:00	0.7189155
120yrHydrograph	2:05	0.9002669
120yrHydrograph	2:10	1.06309
120yrHydrograph	2:15	1.208622
120yrHydrograph	2:20	1.339344
120yrHydrograph	2:25	1.467497
120yrHydrograph	2:30	1.60491
120yrHydrograph	2:35	1.75987
120yrHydrograph	2:40	1.918853
120yrHydrograph	2:45	2.077065
120yrHydrograph	2:50	2.234614
120yrHydrograph	2:55	2.391056
120yrHydrograph	3:00	2.546204

POST-DEVELOPMENT MODEL

120yrHydrograph	3:05	2.700942
120yrHydrograph	3:10	2.855207
120yrHydrograph	3:15	3.004697
120yrHydrograph	3:20	3.152104
120yrHydrograph	3:25	3.314249
120yrHydrograph	3:30	3.509691
120yrHydrograph	3:35	3.728292
120yrHydrograph	3:40	3.955694
120yrHydrograph	3:45	4.183218
120yrHydrograph	3:50	4.403465
120yrHydrograph	3:55	4.618955
120yrHydrograph	4:00	4.829294
120yrHydrograph	4:05	5.0349
120yrHydrograph	4:10	5.235206
120yrHydrograph	4:15	5.540944
120yrHydrograph	4:20	6.294454
120yrHydrograph	4:25	6.504807
120yrHydrograph	4:30	6.683425
120yrHydrograph	4:35	6.874739
120yrHydrograph	4:40	7.064317
120yrHydrograph	4:45	7.249343
120yrHydrograph	4:50	7.429554
120yrHydrograph	4:55	7.642233
120yrHydrograph	5:00	7.89349
120yrHydrograph	5:05	8.152265
120yrHydrograph	5:10	8.405735
120yrHydrograph	5:15	8.653997
120yrHydrograph	5:20	8.908699
120yrHydrograph	5:25	9.24717
120yrHydrograph	5:30	9.663168
120yrHydrograph	5:35	10.09873
120yrHydrograph	5:40	10.52877
120yrHydrograph	5:45	10.95266
120yrHydrograph	5:50	11.4424
120yrHydrograph	5:55	12.55669
120yrHydrograph	6:00	13.91015
120yrHydrograph	6:05	15.48645
120yrHydrograph	6:10	18.21065

POST-DEVELOPMENT MODEL

120yrHydrograph	6:15	50.59299
120yrHydrograph	6:20	270.0371
120yrHydrograph	6:25	307.4776
120yrHydrograph	6:30	250.8829
120yrHydrograph	6:35	217.0673
120yrHydrograph	6:40	203.1162
120yrHydrograph	6:45	195.6699
120yrHydrograph	6:50	174.3307
120yrHydrograph	6:55	153.1465
120yrHydrograph	7:00	144.5096
120yrHydrograph	7:05	138.6253
120yrHydrograph	7:10	135.8059
120yrHydrograph	7:15	134.0851
120yrHydrograph	7:20	133.2594
120yrHydrograph	7:25	132.0687
120yrHydrograph	7:30	130.5854
120yrHydrograph	7:35	128.9982
120yrHydrograph	7:40	127.378
120yrHydrograph	7:45	125.6711
120yrHydrograph	7:50	123.9028
120yrHydrograph	7:55	122.2741
120yrHydrograph	8:00	120.7318
120yrHydrograph	8:05	119.0969
120yrHydrograph	8:10	117.2463
120yrHydrograph	8:15	115.2692
120yrHydrograph	8:20	113.1534
120yrHydrograph	8:25	110.5649
120yrHydrograph	8:30	107.6246
120yrHydrograph	8:35	104.5265
120yrHydrograph	8:40	101.2558
120yrHydrograph	8:45	97.00304
120yrHydrograph	8:50	91.96757
120yrHydrograph	8:55	86.90826
120yrHydrograph	9:00	82.11443
120yrHydrograph	9:05	77.84784
120yrHydrograph	9:10	73.76848
120yrHydrograph	9:15	69.56462
120yrHydrograph	9:20	65.01967

POST-DEVELOPMENT MODEL

120yrHydrograph	9:25	61.00045
120yrHydrograph	9:30	57.59517
120yrHydrograph	9:35	54.63307
120yrHydrograph	9:40	52.07724
120yrHydrograph	9:45	49.90475
120yrHydrograph	9:50	48.12168
120yrHydrograph	9:55	46.86055
120yrHydrograph	10:00	45.83988
120yrHydrograph	10:05	44.8803
120yrHydrograph	10:10	43.96325
120yrHydrograph	10:15	43.09737
120yrHydrograph	10:20	42.26453
120yrHydrograph	10:25	41.30003
120yrHydrograph	10:30	40.17061
120yrHydrograph	10:35	38.96439
120yrHydrograph	10:40	37.72797
120yrHydrograph	10:45	36.47209
120yrHydrograph	10:50	35.16019
120yrHydrograph	10:55	33.54345
120yrHydrograph	11:00	32.03094
120yrHydrograph	11:05	30.71702
120yrHydrograph	11:10	29.58024
120yrHydrograph	11:15	28.58254
120yrHydrograph	11:20	27.69443
120yrHydrograph	11:25	26.90261
120yrHydrograph	11:30	26.09016
120yrHydrograph	11:35	25.44282
120yrHydrograph	11:40	24.87686
120yrHydrograph	11:45	24.36362
120yrHydrograph	11:50	23.89707
120yrHydrograph	11:55	23.47196
120yrHydrograph	12:00	23.08405
120yrHydrograph	12:05	22.71103
120yrHydrograph	12:10	22.19095
120yrHydrograph	12:15	21.52439
120yrHydrograph	12:20	20.83647
120yrHydrograph	12:25	20.20144
120yrHydrograph	12:30	19.65854

POST-DEVELOPMENT MODEL

120yrHydrograph	12:35	19.26827
120yrHydrograph	12:40	19.0627
120yrHydrograph	12:45	18.88801
120yrHydrograph	12:50	18.71292
120yrHydrograph	12:55	18.53678
120yrHydrograph	13:00	18.35976
120yrHydrograph	13:05	18.18163
120yrHydrograph	13:10	18.00247
120yrHydrograph	13:15	17.79796
120yrHydrograph	13:20	17.60665
120yrHydrograph	13:25	17.42745
120yrHydrograph	13:30	17.24798
120yrHydrograph	13:35	17.06869
120yrHydrograph	13:40	16.88965
120yrHydrograph	13:45	16.71072
120yrHydrograph	13:50	16.53184
120yrHydrograph	13:55	16.35356
120yrHydrograph	14:00	16.17495
120yrHydrograph	14:05	15.9964
120yrHydrograph	14:10	15.81794
120yrHydrograph	14:15	15.63952
120yrHydrograph	14:20	15.46145
120yrHydrograph	14:25	15.28333
120yrHydrograph	14:30	15.10489
120yrHydrograph	14:35	14.92619
120yrHydrograph	14:40	14.74685
120yrHydrograph	14:45	14.56751
120yrHydrograph	14:50	14.38831
120yrHydrograph	14:55	14.20906
120yrHydrograph	15:00	14.03001
120yrHydrograph	15:05	13.8497
120yrHydrograph	15:10	13.6689
120yrHydrograph	15:15	13.488
120yrHydrograph	15:20	13.29222
120yrHydrograph	15:25	13.11104
120yrHydrograph	15:30	12.9327
120yrHydrograph	15:35	12.75426
120yrHydrograph	15:40	12.57617

POST-DEVELOPMENT MODEL

120yrHydrograph	15:45	12.39816
120yrHydrograph	15:50	12.22025
120yrHydrograph	15:55	12.04239
120yrHydrograph	16:00	11.86458
120yrHydrograph	16:05	11.687
120yrHydrograph	16:10	11.50963
120yrHydrograph	16:15	11.33242
120yrHydrograph	16:20	11.15543
120yrHydrograph	16:25	10.98002
120yrHydrograph	16:30	10.80355
120yrHydrograph	16:35	10.62688
120yrHydrograph	16:40	10.45045
120yrHydrograph	16:45	10.27446
120yrHydrograph	16:50	10.09868
120yrHydrograph	16:55	9.922655
120yrHydrograph	17:00	9.746346
120yrHydrograph	17:05	9.570194
120yrHydrograph	17:10	9.394366
120yrHydrograph	17:15	9.218925
120yrHydrograph	17:20	9.043921
120yrHydrograph	17:25	8.871584
120yrHydrograph	17:30	8.698081
120yrHydrograph	17:35	8.524907
120yrHydrograph	17:40	8.352276
120yrHydrograph	17:45	8.180416
120yrHydrograph	17:50	8.009106
120yrHydrograph	17:55	7.838382
120yrHydrograph	18:00	7.668346
120yrHydrograph	18:05	7.49893
120yrHydrograph	18:10	7.330142
120yrHydrograph	18:15	7.16198
120yrHydrograph	18:20	6.996102
120yrHydrograph	18:25	6.829738
120yrHydrograph	18:30	6.663744
120yrHydrograph	18:35	6.498552
120yrHydrograph	18:40	5.923402
120yrHydrograph	18:45	5.323525
120yrHydrograph	18:50	5.081725

POST-DEVELOPMENT MODEL

120yrHydrograph	18:55	4.868935
120yrHydrograph	19:00	4.66559
120yrHydrograph	19:05	4.472305
120yrHydrograph	19:10	4.288525
120yrHydrograph	19:15	4.11372
120yrHydrograph	19:20	3.948307
120yrHydrograph	19:25	3.79392
120yrHydrograph	19:30	3.643987
120yrHydrograph	19:35	3.500546
120yrHydrograph	19:40	3.363935
120yrHydrograph	19:45	3.233629
120yrHydrograph	19:50	3.109023
120yrHydrograph	19:55	2.989908
120yrHydrograph	20:00	2.875853
120yrHydrograph	20:05	2.766674
120yrHydrograph	20:10	2.663531
120yrHydrograph	20:15	2.566401
120yrHydrograph	20:20	2.471008
120yrHydrograph	20:25	2.379363
120yrHydrograph	20:30	2.291567
120yrHydrograph	20:35	2.207602
120yrHydrograph	20:40	2.127092
120yrHydrograph	20:45	2.049814
120yrHydrograph	20:50	1.975573
120yrHydrograph	20:55	1.904281
120yrHydrograph	21:00	1.835704
120yrHydrograph	21:05	1.769742
120yrHydrograph	21:10	1.707285
120yrHydrograph	21:15	1.648343
120yrHydrograph	21:20	1.59205
120yrHydrograph	21:25	1.535988
120yrHydrograph	21:30	1.481661
120yrHydrograph	21:35	1.429297
120yrHydrograph	21:40	1.378807
120yrHydrograph	21:45	1.330218
120yrHydrograph	21:50	1.283362
120yrHydrograph	21:55	1.238236
120yrHydrograph	22:00	1.194676

POST-DEVELOPMENT MODEL

120yrHydrograph	22:05	1.152613
120yrHydrograph	22:10	1.112003
120yrHydrograph	22:15	1.072797
120yrHydrograph	22:20	1.03494
120yrHydrograph	22:25	0.9983785
120yrHydrograph	22:30	0.963154
120yrHydrograph	22:35	0.929782
120yrHydrograph	22:40	0.8978769
120yrHydrograph	22:45	0.8680665
120yrHydrograph	22:50	0.8378413
120yrHydrograph	22:55	0.8081332
120yrHydrograph	23:00	0.7792751
120yrHydrograph	23:05	0.751291
120yrHydrograph	23:10	0.723901
120yrHydrograph	23:15	0.6972384
120yrHydrograph	23:20	0.6714275
120yrHydrograph	23:25	0.6464488
120yrHydrograph	23:30	0.6222823
120yrHydrograph	23:35	0.5989287
120yrHydrograph	23:40	0.5763167
120yrHydrograph	23:45	0.5544087
120yrHydrograph	23:50	0.5331817
120yrHydrograph	23:55	0.5126142

25yrHydrograph	0:05	0
25yrHydrograph	0:10	0
25yrHydrograph	0:15	0
25yrHydrograph	0:20	0
25yrHydrograph	0:25	0
25yrHydrograph	0:30	0
25yrHydrograph	0:35	0
25yrHydrograph	0:40	0
25yrHydrograph	0:45	0
25yrHydrograph	0:50	0
25yrHydrograph	0:55	0
25yrHydrograph	1:00	0
25yrHydrograph	1:05	0
25yrHydrograph	1:10	0

POST-DEVELOPMENT MODEL

25yrHydrograph	1:15	0
25yrHydrograph	1:20	0
25yrHydrograph	1:25	0
25yrHydrograph	1:30	0
25yrHydrograph	1:35	0
25yrHydrograph	1:40	0
25yrHydrograph	1:45	0
25yrHydrograph	1:50	0
25yrHydrograph	1:55	0
25yrHydrograph	2:00	0
25yrHydrograph	2:05	0
25yrHydrograph	2:10	0
25yrHydrograph	2:15	0
25yrHydrograph	2:20	0.001632289
25yrHydrograph	2:25	0.2622457
25yrHydrograph	2:30	0.5765883
25yrHydrograph	2:35	0.7342812
25yrHydrograph	2:40	0.8252636
25yrHydrograph	2:45	0.9269882
25yrHydrograph	2:50	1.032204
25yrHydrograph	2:55	1.12902
25yrHydrograph	3:00	1.221809
25yrHydrograph	3:05	1.313194
25yrHydrograph	3:10	1.408893
25yrHydrograph	3:15	1.518456
25yrHydrograph	3:20	1.642777
25yrHydrograph	3:25	1.783491
25yrHydrograph	3:30	1.923347
25yrHydrograph	3:35	2.061834
25yrHydrograph	3:40	2.199286
25yrHydrograph	3:45	2.335316
25yrHydrograph	3:50	2.470035
25yrHydrograph	3:55	2.602826
25yrHydrograph	4:00	2.736065
25yrHydrograph	4:05	2.867362
25yrHydrograph	4:10	3.017547
25yrHydrograph	4:15	3.213564
25yrHydrograph	4:20	3.443073

POST-DEVELOPMENT MODEL

25yrHydrograph	4:25	3.684345
25yrHydrograph	4:30	3.926774
25yrHydrograph	4:35	4.171638
25yrHydrograph	4:40	4.441309
25yrHydrograph	4:45	4.766339
25yrHydrograph	4:50	5.121798
25yrHydrograph	4:55	5.884091
25yrHydrograph	5:00	6.467876
25yrHydrograph	5:05	6.681189
25yrHydrograph	5:10	6.9106
25yrHydrograph	5:15	7.199862
25yrHydrograph	5:20	7.500936
25yrHydrograph	5:25	7.79267
25yrHydrograph	5:30	8.072257
25yrHydrograph	5:35	8.390318
25yrHydrograph	5:40	9.215314
25yrHydrograph	5:45	10.46289
25yrHydrograph	5:50	11.82743
25yrHydrograph	5:55	13.81016
25yrHydrograph	6:00	16.30336
25yrHydrograph	6:05	18.52387
25yrHydrograph	6:10	21.79064
25yrHydrograph	6:15	33.77943
25yrHydrograph	6:20	43.20488
25yrHydrograph	6:25	54.80698
25yrHydrograph	6:30	69.68421
25yrHydrograph	6:35	80.71678
25yrHydrograph	6:40	88.15202
25yrHydrograph	6:45	92.7329
25yrHydrograph	6:50	95.59068
25yrHydrograph	6:55	97.34319
25yrHydrograph	7:00	98.31504
25yrHydrograph	7:05	98.65141
25yrHydrograph	7:10	98.27661
25yrHydrograph	7:15	97.332
25yrHydrograph	7:20	95.19835
25yrHydrograph	7:25	92.09679
25yrHydrograph	7:30	88.82446

POST-DEVELOPMENT MODEL

25yrHydrograph	7:35	85.59274
25yrHydrograph	7:40	82.45365
25yrHydrograph	7:45	79.58022
25yrHydrograph	7:50	76.78926
25yrHydrograph	7:55	74.01968
25yrHydrograph	8:00	71.22165
25yrHydrograph	8:05	68.00592
25yrHydrograph	8:10	64.24236
25yrHydrograph	8:15	60.50372
25yrHydrograph	8:20	57.06802
25yrHydrograph	8:25	53.89598
25yrHydrograph	8:30	51.03894
25yrHydrograph	8:35	48.5897
25yrHydrograph	8:40	46.78022
25yrHydrograph	8:45	45.29158
25yrHydrograph	8:50	43.83835
25yrHydrograph	8:55	42.43797
25yrHydrograph	9:00	41.09942
25yrHydrograph	9:05	39.78819
25yrHydrograph	9:10	38.53657
25yrHydrograph	9:15	37.32283
25yrHydrograph	9:20	36.13959
25yrHydrograph	9:25	34.88116
25yrHydrograph	9:30	33.41477
25yrHydrograph	9:35	32.09751
25yrHydrograph	9:40	30.95746
25yrHydrograph	9:45	29.97478
25yrHydrograph	9:50	29.11481
25yrHydrograph	9:55	28.35425
25yrHydrograph	10:00	27.67503
25yrHydrograph	10:05	27.05764
25yrHydrograph	10:10	26.32501
25yrHydrograph	10:15	25.50807
25yrHydrograph	10:20	24.74522
25yrHydrograph	10:25	24.01871
25yrHydrograph	10:30	23.34307
25yrHydrograph	10:35	22.72353
25yrHydrograph	10:40	22.15742

POST-DEVELOPMENT MODEL

25yrHydrograph	10:45	21.64292
25yrHydrograph	10:50	21.17765
25yrHydrograph	10:55	20.75909
25yrHydrograph	11:00	20.38477
25yrHydrograph	11:05	20.05307
25yrHydrograph	11:10	19.76257
25yrHydrograph	11:15	19.51477
25yrHydrograph	11:20	19.3151
25yrHydrograph	11:25	19.18726
25yrHydrograph	11:30	19.10144
25yrHydrograph	11:35	19.01951
25yrHydrograph	11:40	18.93828
25yrHydrograph	11:45	18.85769
25yrHydrograph	11:50	18.77772
25yrHydrograph	11:55	18.69841
25yrHydrograph	12:00	18.6198
25yrHydrograph	12:05	18.54006
25yrHydrograph	12:10	18.43951
25yrHydrograph	12:15	18.31268
25yrHydrograph	12:20	18.16971
25yrHydrograph	12:25	18.01683
25yrHydrograph	12:30	17.83426
25yrHydrograph	12:35	17.66102
25yrHydrograph	12:40	17.49463
25yrHydrograph	12:45	17.3259
25yrHydrograph	12:50	17.15563
25yrHydrograph	12:55	16.98421
25yrHydrograph	13:00	16.81187
25yrHydrograph	13:05	16.63874
25yrHydrograph	13:10	16.46504
25yrHydrograph	13:15	16.29125
25yrHydrograph	13:20	16.11657
25yrHydrograph	13:25	15.94155
25yrHydrograph	13:30	15.76617
25yrHydrograph	13:35	15.5904
25yrHydrograph	13:40	15.41475
25yrHydrograph	13:45	15.23849
25yrHydrograph	13:50	15.06182

POST-DEVELOPMENT MODEL

25yrHydrograph	13:55	14.88464
25yrHydrograph	14:00	14.70663
25yrHydrograph	14:05	14.52861
25yrHydrograph	14:10	14.35047
25yrHydrograph	14:15	14.17213
25yrHydrograph	14:20	13.99351
25yrHydrograph	14:25	13.81356
25yrHydrograph	14:30	13.6331
25yrHydrograph	14:35	13.45256
25yrHydrograph	14:40	13.25532
25yrHydrograph	14:45	13.07675
25yrHydrograph	14:50	12.89854
25yrHydrograph	14:55	12.72034
25yrHydrograph	15:00	12.5425
25yrHydrograph	15:05	12.36468
25yrHydrograph	15:10	12.18695
25yrHydrograph	15:15	12.00922
25yrHydrograph	15:20	11.83156
25yrHydrograph	15:25	11.65413
25yrHydrograph	15:30	11.4769
25yrHydrograph	15:35	11.29981
25yrHydrograph	15:40	11.12345
25yrHydrograph	15:45	10.94775
25yrHydrograph	15:50	10.77124
25yrHydrograph	15:55	10.59464
25yrHydrograph	16:00	10.41831
25yrHydrograph	16:05	10.24246
25yrHydrograph	16:10	10.06672
25yrHydrograph	16:15	9.890636
25yrHydrograph	16:20	9.714363
25yrHydrograph	16:25	9.538301
25yrHydrograph	16:30	9.362578
25yrHydrograph	16:35	9.187253
25yrHydrograph	16:40	9.012401
25yrHydrograph	16:45	8.840317
25yrHydrograph	16:50	8.666858
25yrHydrograph	16:55	8.493819
25yrHydrograph	17:00	8.32134

POST-DEVELOPMENT MODEL

25yrHydrograph	17:05	8.14965
25yrHydrograph	17:10	7.978478
25yrHydrograph	17:15	7.807906
25yrHydrograph	17:20	7.638032
25yrHydrograph	17:25	7.468765
25yrHydrograph	17:30	7.30013
25yrHydrograph	17:35	7.13219
25yrHydrograph	17:40	6.966566
25yrHydrograph	17:45	6.800201
25yrHydrograph	17:50	6.634353
25yrHydrograph	17:55	6.469327
25yrHydrograph	18:00	5.751874
25yrHydrograph	18:05	5.273855
25yrHydrograph	18:10	5.043334
25yrHydrograph	18:15	4.832212
25yrHydrograph	18:20	4.630692
25yrHydrograph	18:25	4.439184
25yrHydrograph	18:30	4.257051
25yrHydrograph	18:35	4.083813
25yrHydrograph	18:40	3.920253
25yrHydrograph	18:45	3.767176
25yrHydrograph	18:50	3.618289
25yrHydrograph	18:55	3.476068
25yrHydrograph	19:00	3.340655
25yrHydrograph	19:05	3.211395
25yrHydrograph	19:10	3.087783
25yrHydrograph	19:15	2.969627
25yrHydrograph	19:20	2.856409
25yrHydrograph	19:25	2.7483
25yrHydrograph	19:30	2.646666
25yrHydrograph	19:35	2.54955
25yrHydrograph	19:40	2.454772
25yrHydrograph	19:45	2.363821
25yrHydrograph	19:50	2.276711
25yrHydrograph	19:55	2.193374
25yrHydrograph	20:00	2.113461
25yrHydrograph	20:05	2.03673
25yrHydrograph	20:10	1.963015

POST-DEVELOPMENT MODEL

25yrHydrograph	20:15	1.892225
25yrHydrograph	20:20	1.824112
25yrHydrograph	20:25	1.758609
25yrHydrograph	20:30	1.696838
25yrHydrograph	20:35	1.638761
25yrHydrograph	20:40	1.5823
25yrHydrograph	20:45	1.526491
25yrHydrograph	20:50	1.472508
25yrHydrograph	20:55	1.420478
25yrHydrograph	21:00	1.370315
25yrHydrograph	21:05	1.32204
25yrHydrograph	21:10	1.275487
25yrHydrograph	21:15	1.230644
25yrHydrograph	21:20	1.187347
25yrHydrograph	21:25	1.14554
25yrHydrograph	21:30	1.105179
25yrHydrograph	21:35	1.066211
25yrHydrograph	21:40	1.028582
25yrHydrograph	21:45	0.9922396
25yrHydrograph	21:50	0.9573277
25yrHydrograph	21:55	0.9241908
25yrHydrograph	22:00	0.892872
25yrHydrograph	22:05	0.8628887
25yrHydrograph	22:10	0.8327096
25yrHydrograph	22:15	0.8031358
25yrHydrograph	22:20	0.7744356
25yrHydrograph	22:25	0.7465697
25yrHydrograph	22:30	0.7192923
25yrHydrograph	22:35	0.6927726
25yrHydrograph	22:40	0.6671077
25yrHydrograph	22:45	0.6422694
25yrHydrograph	22:50	0.6182455
25yrHydrograph	22:55	0.595024
25yrHydrograph	23:00	0.5725354
25yrHydrograph	23:05	0.5507464
25yrHydrograph	23:10	0.5296347
25yrHydrograph	23:15	0.5091786
25yrHydrograph	23:20	0.4893577

POST-DEVELOPMENT MODEL

25yrHydrograph	23:25	0.4701509
25yrHydrograph	23:30	0.4515376
25yrHydrograph	23:35	0.4334984
25yrHydrograph	23:40	0.4160193
25yrHydrograph	23:45	0.3991844
25yrHydrograph	23:50	0.3828847
25yrHydrograph	23:55	0.3677303
2yrHydrograph	0:05	0
2yrHydrograph	0:10	0
2yrHydrograph	0:15	0
2yrHydrograph	0:20	0
2yrHydrograph	0:25	0
2yrHydrograph	0:30	0
2yrHydrograph	0:35	0
2yrHydrograph	0:40	0
2yrHydrograph	0:45	0
2yrHydrograph	0:50	0
2yrHydrograph	0:55	0
2yrHydrograph	1:00	0
2yrHydrograph	1:05	0
2yrHydrograph	1:10	0
2yrHydrograph	1:15	0
2yrHydrograph	1:20	0
2yrHydrograph	1:25	0
2yrHydrograph	1:30	0
2yrHydrograph	1:35	0
2yrHydrograph	1:40	0
2yrHydrograph	1:45	0
2yrHydrograph	1:50	0
2yrHydrograph	1:55	0
2yrHydrograph	2:00	0
2yrHydrograph	2:05	0
2yrHydrograph	2:10	0
2yrHydrograph	2:15	0
2yrHydrograph	2:20	0
2yrHydrograph	2:25	0
2yrHydrograph	2:30	0

POST-DEVELOPMENT MODEL

2yrHydrograph	2:35	0
2yrHydrograph	2:40	0
2yrHydrograph	2:45	0
2yrHydrograph	2:50	0
2yrHydrograph	2:55	0
2yrHydrograph	3:00	0
2yrHydrograph	3:05	0
2yrHydrograph	3:10	0
2yrHydrograph	3:15	0
2yrHydrograph	3:20	0
2yrHydrograph	3:25	0.003563957
2yrHydrograph	3:30	0.1682276
2yrHydrograph	3:35	0.3771983
2yrHydrograph	3:40	0.5159206
2yrHydrograph	3:45	0.6017497
2yrHydrograph	3:50	0.6697975
2yrHydrograph	3:55	0.7231919
2yrHydrograph	4:00	0.7669547
2yrHydrograph	4:05	0.820766
2yrHydrograph	4:10	0.880134
2yrHydrograph	4:15	0.9540438
2yrHydrograph	4:20	1.04035
2yrHydrograph	4:25	1.1353
2yrHydrograph	4:30	1.235741
2yrHydrograph	4:35	1.33869
2yrHydrograph	4:40	1.448107
2yrHydrograph	4:45	1.573878
2yrHydrograph	4:50	1.720981
2yrHydrograph	4:55	1.879236
2yrHydrograph	5:00	2.037325
2yrHydrograph	5:05	2.196208
2yrHydrograph	5:10	2.374235
2yrHydrograph	5:15	2.598158
2yrHydrograph	5:20	2.867055
2yrHydrograph	5:25	3.149988
2yrHydrograph	5:30	3.435339
2yrHydrograph	5:35	3.741842
2yrHydrograph	5:40	4.43628

POST-DEVELOPMENT MODEL

2yrHydrograph	5:45	6.246645
2yrHydrograph	5:50	7.538581
2yrHydrograph	5:55	9.078191
2yrHydrograph	6:00	10.93573
2yrHydrograph	6:05	12.56826
2yrHydrograph	6:10	13.39444
2yrHydrograph	6:15	13.77394
2yrHydrograph	6:20	14.07615
2yrHydrograph	6:25	14.32379
2yrHydrograph	6:30	14.47786
2yrHydrograph	6:35	14.56697
2yrHydrograph	6:40	14.58446
2yrHydrograph	6:45	14.54862
2yrHydrograph	6:50	14.4947
2yrHydrograph	6:55	14.4348
2yrHydrograph	7:00	14.37298
2yrHydrograph	7:05	14.31037
2yrHydrograph	7:10	14.25763
2yrHydrograph	7:15	14.47936
2yrHydrograph	7:20	14.7036
2yrHydrograph	7:25	14.87247
2yrHydrograph	7:30	14.99324
2yrHydrograph	7:35	15.07008
2yrHydrograph	7:40	15.11274
2yrHydrograph	7:45	15.13689
2yrHydrograph	7:50	15.15322
2yrHydrograph	7:55	15.16643
2yrHydrograph	8:00	15.17813
2yrHydrograph	8:05	15.18739
2yrHydrograph	8:10	15.17762
2yrHydrograph	8:15	15.14478
2yrHydrograph	8:20	15.09864
2yrHydrograph	8:25	15.04534
2yrHydrograph	8:30	14.98804
2yrHydrograph	8:35	14.92799
2yrHydrograph	8:40	14.86625
2yrHydrograph	8:45	14.80354
2yrHydrograph	8:50	14.74021

POST-DEVELOPMENT MODEL

2yrHydrograph	8:55	14.67653
2yrHydrograph	9:00	14.61272
2yrHydrograph	9:05	14.54884
2yrHydrograph	9:10	14.485
2yrHydrograph	9:15	14.42128
2yrHydrograph	9:20	14.35775
2yrHydrograph	9:25	14.29445
2yrHydrograph	9:30	14.23138
2yrHydrograph	9:35	14.16841
2yrHydrograph	9:40	14.10578
2yrHydrograph	9:45	14.04353
2yrHydrograph	9:50	13.98165
2yrHydrograph	9:55	13.92018
2yrHydrograph	10:00	13.85909
2yrHydrograph	10:05	13.79762
2yrHydrograph	10:10	13.72651
2yrHydrograph	10:15	13.64181
2yrHydrograph	10:20	13.54882
2yrHydrograph	10:25	13.45119
2yrHydrograph	10:30	13.34604
2yrHydrograph	10:35	13.23994
2yrHydrograph	10:40	13.13883
2yrHydrograph	10:45	13.03711
2yrHydrograph	10:50	12.93486
2yrHydrograph	10:55	12.83252
2yrHydrograph	11:00	12.73052
2yrHydrograph	11:05	12.6288
2yrHydrograph	11:10	12.52729
2yrHydrograph	11:15	12.42613
2yrHydrograph	11:20	12.32541
2yrHydrograph	11:25	12.22535
2yrHydrograph	11:30	12.12588
2yrHydrograph	11:35	12.02698
2yrHydrograph	11:40	11.92852
2yrHydrograph	11:45	11.83012
2yrHydrograph	11:50	11.73236
2yrHydrograph	11:55	11.63541
2yrHydrograph	12:00	11.53908

POST-DEVELOPMENT MODEL

2yrHydrograph	12:05	11.4425
2yrHydrograph	12:10	11.33366
2yrHydrograph	12:15	11.20708
2yrHydrograph	12:20	11.06886
2yrHydrograph	12:25	10.92265
2yrHydrograph	12:30	10.77066
2yrHydrograph	12:35	10.61468
2yrHydrograph	12:40	10.45481
2yrHydrograph	12:45	10.29258
2yrHydrograph	12:50	10.12861
2yrHydrograph	12:55	9.963152
2yrHydrograph	13:00	9.796572
2yrHydrograph	13:05	9.629131
2yrHydrograph	13:10	9.460951
2yrHydrograph	13:15	9.292142
2yrHydrograph	13:20	9.122916
2yrHydrograph	13:25	8.954589
2yrHydrograph	13:30	8.786025
2yrHydrograph	13:35	8.616723
2yrHydrograph	13:40	8.447497
2yrHydrograph	13:45	8.278463
2yrHydrograph	13:50	8.109735
2yrHydrograph	13:55	7.941167
2yrHydrograph	14:00	7.772891
2yrHydrograph	14:05	7.605002
2yrHydrograph	14:10	7.437465
2yrHydrograph	14:15	7.270429
2yrHydrograph	14:20	7.103953
2yrHydrograph	14:25	6.939199
2yrHydrograph	14:30	6.773605
2yrHydrograph	14:35	6.608643
2yrHydrograph	14:40	6.444577
2yrHydrograph	14:45	5.63632
2yrHydrograph	14:50	5.237718
2yrHydrograph	14:55	5.014342
2yrHydrograph	15:00	4.805491
2yrHydrograph	15:05	4.606251
2yrHydrograph	15:10	4.416846

POST-DEVELOPMENT MODEL

2yrHydrograph	15:15	4.236616
2yrHydrograph	15:20	4.06511
2yrHydrograph	15:25	3.903342
2yrHydrograph	15:30	3.751597
2yrHydrograph	15:35	3.603906
2yrHydrograph	15:40	3.462873
2yrHydrograph	15:45	3.328566
2yrHydrograph	15:50	3.200271
2yrHydrograph	15:55	3.077553
2yrHydrograph	16:00	2.960224
2yrHydrograph	16:05	2.847737
2yrHydrograph	16:10	2.740435
2yrHydrograph	16:15	2.639661
2yrHydrograph	16:20	2.542856
2yrHydrograph	16:25	2.448588
2yrHydrograph	16:30	2.358142
2yrHydrograph	16:35	2.271509
2yrHydrograph	16:40	2.1886
2yrHydrograph	16:45	2.109083
2yrHydrograph	16:50	2.03271
2yrHydrograph	16:55	1.959329
2yrHydrograph	17:00	1.888847
2yrHydrograph	17:05	1.821015
2yrHydrograph	17:10	1.755789
2yrHydrograph	17:15	1.69431
2yrHydrograph	17:20	1.636534
2yrHydrograph	17:25	1.580162
2yrHydrograph	17:30	1.524522
2yrHydrograph	17:35	1.470705
2yrHydrograph	17:40	1.418804
2yrHydrograph	17:45	1.368765
2yrHydrograph	17:50	1.320616
2yrHydrograph	17:55	1.274188
2yrHydrograph	18:00	1.229466
2yrHydrograph	18:05	1.186283
2yrHydrograph	18:10	1.144584
2yrHydrograph	18:15	1.104323
2yrHydrograph	18:20	1.065448

POST-DEVELOPMENT MODEL

2yrHydrograph	18:25	1.027906
2yrHydrograph	18:30	0.9916432
2yrHydrograph	18:35	0.9568146
2yrHydrograph	18:40	0.9237459
2yrHydrograph	18:45	0.8925131
2yrHydrograph	18:50	0.8625606
2yrHydrograph	18:55	0.8324248
2yrHydrograph	19:00	0.8028972
2yrHydrograph	19:05	0.7742414
2yrHydrograph	19:10	0.7464148
2yrHydrograph	19:15	0.7191743
2yrHydrograph	19:20	0.6926898
2yrHydrograph	19:25	0.6670574
2yrHydrograph	19:30	0.6422487
2yrHydrograph	19:35	0.6182515
2yrHydrograph	19:40	0.5950544
2yrHydrograph	19:45	0.5725881
2yrHydrograph	19:50	0.5508193
2yrHydrograph	19:55	0.5297256
2yrHydrograph	20:00	0.5092856
2yrHydrograph	20:05	0.4894789
2yrHydrograph	20:10	0.4702851
2yrHydrograph	20:15	0.4516833
2yrHydrograph	20:20	0.4336542
2yrHydrograph	20:25	0.4161834
2yrHydrograph	20:30	0.3993552
2yrHydrograph	20:35	0.3830626
2yrHydrograph	20:40	0.3679075
2yrHydrograph	20:45	0.352874
2yrHydrograph	20:50	0.3379888
2yrHydrograph	20:55	0.3234121
2yrHydrograph	21:00	0.3092104
2yrHydrograph	21:05	0.2954019
2yrHydrograph	21:10	0.2819829
2yrHydrograph	21:15	0.2689412
2yrHydrograph	21:20	0.2562622
2yrHydrograph	21:25	0.2439416
2yrHydrograph	21:30	0.2319621

POST-DEVELOPMENT MODEL

2yrHydrograph	21:35	0.2203049
2yrHydrograph	21:40	0.2092342
2yrHydrograph	21:45	0.1986824
2yrHydrograph	21:50	0.1884339
2yrHydrograph	21:55	0.1784449
2yrHydrograph	22:00	0.1687503
2yrHydrograph	22:05	0.1591294
2yrHydrograph	22:10	0.1495827
2yrHydrograph	22:15	0.1404474
2yrHydrograph	22:20	0.1318642
2yrHydrograph	22:25	0.1238625
2yrHydrograph	22:30	0.1164191
2yrHydrograph	22:35	0.1094914
2yrHydrograph	22:40	0.1030329
2yrHydrograph	22:45	0.09700606
2yrHydrograph	22:50	0.09149565
2yrHydrograph	22:55	0.08641619
2yrHydrograph	23:00	0.08192892
2yrHydrograph	23:05	0.07774525
2yrHydrograph	23:10	0.07367536
2yrHydrograph	23:15	0.0697474
2yrHydrograph	23:20	0.0659826
2yrHydrograph	23:25	0.0623938
2yrHydrograph	23:30	0.05898625
2yrHydrograph	23:35	0.05575913
2yrHydrograph	23:40	0.05270706
2yrHydrograph	23:45	0.049652
2yrHydrograph	23:50	0.04723772
2yrHydrograph	23:55	0.04519615
50yrHydrograph	0:05	0
50yrHydrograph	0:10	0
50yrHydrograph	0:15	0
50yrHydrograph	0:20	0
50yrHydrograph	0:25	0
50yrHydrograph	0:30	0
50yrHydrograph	0:35	0
50yrHydrograph	0:40	0

POST-DEVELOPMENT MODEL

50yrHydrograph	0:45	0
50yrHydrograph	0:50	0
50yrHydrograph	0:55	0
50yrHydrograph	1:00	0
50yrHydrograph	1:05	0
50yrHydrograph	1:10	0
50yrHydrograph	1:15	0
50yrHydrograph	1:20	0
50yrHydrograph	1:25	0
50yrHydrograph	1:30	0
50yrHydrograph	1:35	0
50yrHydrograph	1:40	0
50yrHydrograph	1:45	0
50yrHydrograph	1:50	0
50yrHydrograph	1:55	0
50yrHydrograph	2:00	0
50yrHydrograph	2:05	0
50yrHydrograph	2:10	0
50yrHydrograph	2:15	0.1896701
50yrHydrograph	2:20	0.5472082
50yrHydrograph	2:25	0.7396636
50yrHydrograph	2:30	0.8484906
50yrHydrograph	2:35	0.9710755
50yrHydrograph	2:40	1.091995
50yrHydrograph	2:45	1.204302
50yrHydrograph	2:50	1.312206
50yrHydrograph	2:55	1.418368
50yrHydrograph	3:00	1.524127
50yrHydrograph	3:05	1.62965
50yrHydrograph	3:10	1.746479
50yrHydrograph	3:15	1.878949
50yrHydrograph	3:20	2.026683
50yrHydrograph	3:25	2.183036
50yrHydrograph	3:30	2.341848
50yrHydrograph	3:35	2.500659
50yrHydrograph	3:40	2.657861
50yrHydrograph	3:45	2.817623
50yrHydrograph	3:50	2.971852

POST-DEVELOPMENT MODEL

50yrHydrograph	3:55	3.122654
50yrHydrograph	4:00	3.27065
50yrHydrograph	4:05	3.41763
50yrHydrograph	4:10	3.590356
50yrHydrograph	4:15	3.818011
50yrHydrograph	4:20	4.087829
50yrHydrograph	4:25	4.364322
50yrHydrograph	4:30	4.638282
50yrHydrograph	4:35	4.910603
50yrHydrograph	4:40	5.222383
50yrHydrograph	4:45	6.152192
50yrHydrograph	4:50	6.578424
50yrHydrograph	4:55	6.798974
50yrHydrograph	5:00	6.998712
50yrHydrograph	5:05	7.196966
50yrHydrograph	5:10	7.446401
50yrHydrograph	5:15	7.756927
50yrHydrograph	5:20	8.079263
50yrHydrograph	5:25	8.39279
50yrHydrograph	5:30	8.695212
50yrHydrograph	5:35	9.04722
50yrHydrograph	5:40	9.948486
50yrHydrograph	5:45	11.276
50yrHydrograph	5:50	12.71181
50yrHydrograph	5:55	14.74882
50yrHydrograph	6:00	17.45177
50yrHydrograph	6:05	22.92022
50yrHydrograph	6:10	42.51123
50yrHydrograph	6:15	65.40152
50yrHydrograph	6:20	83.9911
50yrHydrograph	6:25	96.50188
50yrHydrograph	6:30	105.2421
50yrHydrograph	6:35	111.2476
50yrHydrograph	6:40	114.2913
50yrHydrograph	6:45	115.6881
50yrHydrograph	6:50	116.1683
50yrHydrograph	6:55	116.0541
50yrHydrograph	7:00	115.5264

POST-DEVELOPMENT MODEL

50yrHydrograph	7:05	114.6432
50yrHydrograph	7:10	113.2731
50yrHydrograph	7:15	111.5772
50yrHydrograph	7:20	109.6637
50yrHydrograph	7:25	107.5958
50yrHydrograph	7:30	105.2636
50yrHydrograph	7:35	101.9584
50yrHydrograph	7:40	98.11825
50yrHydrograph	7:45	94.24832
50yrHydrograph	7:50	90.45274
50yrHydrograph	7:55	86.8265
50yrHydrograph	8:00	83.38847
50yrHydrograph	8:05	80.18378
50yrHydrograph	8:10	76.73662
50yrHydrograph	8:15	73.00931
50yrHydrograph	8:20	68.81713
50yrHydrograph	8:25	64.24008
50yrHydrograph	8:30	60.13707
50yrHydrograph	8:35	56.5633
50yrHydrograph	8:40	53.3765
50yrHydrograph	8:45	50.59797
50yrHydrograph	8:50	48.27942
50yrHydrograph	8:55	46.62717
50yrHydrograph	9:00	45.23665
50yrHydrograph	9:05	43.89004
50yrHydrograph	9:10	42.60054
50yrHydrograph	9:15	41.37586
50yrHydrograph	9:20	40.18433
50yrHydrograph	9:25	39.04485
50yrHydrograph	9:30	37.95589
50yrHydrograph	9:35	36.90046
50yrHydrograph	9:40	35.87971
50yrHydrograph	9:45	34.75984
50yrHydrograph	9:50	33.50101
50yrHydrograph	9:55	32.37787
50yrHydrograph	10:00	31.39983
50yrHydrograph	10:05	30.53877
50yrHydrograph	10:10	29.62945

POST-DEVELOPMENT MODEL

50yrHydrograph	10:15	28.63754
50yrHydrograph	10:20	27.63845
50yrHydrograph	10:25	26.68855
50yrHydrograph	10:30	25.6612
50yrHydrograph	10:35	24.86332
50yrHydrograph	10:40	24.14356
50yrHydrograph	10:45	23.48956
50yrHydrograph	10:50	22.89704
50yrHydrograph	10:55	22.35884
50yrHydrograph	11:00	21.87083
50yrHydrograph	11:05	21.42837
50yrHydrograph	11:10	21.02859
50yrHydrograph	11:15	20.66824
50yrHydrograph	11:20	20.34467
50yrHydrograph	11:25	20.05586
50yrHydrograph	11:30	19.80022
50yrHydrograph	11:35	19.57776
50yrHydrograph	11:40	19.39031
50yrHydrograph	11:45	19.24617
50yrHydrograph	11:50	19.16006
50yrHydrograph	11:55	19.08932
50yrHydrograph	12:00	19.01986
50yrHydrograph	12:05	18.94899
50yrHydrograph	12:10	18.85444
50yrHydrograph	12:15	18.73025
50yrHydrograph	12:20	18.58861
50yrHydrograph	12:25	18.43676
50yrHydrograph	12:30	18.27811
50yrHydrograph	12:35	18.11454
50yrHydrograph	12:40	17.9473
50yrHydrograph	12:45	17.7435
50yrHydrograph	12:50	17.57187
50yrHydrograph	12:55	17.39914
50yrHydrograph	13:00	17.2255
50yrHydrograph	13:05	17.05125
50yrHydrograph	13:10	16.87654
50yrHydrograph	13:15	16.7014
50yrHydrograph	13:20	16.52585

POST-DEVELOPMENT MODEL

50yrHydrograph	13:25	16.35056
50yrHydrograph	13:30	16.17458
50yrHydrograph	13:35	15.99831
50yrHydrograph	13:40	15.82184
50yrHydrograph	13:45	15.64514
50yrHydrograph	13:50	15.46854
50yrHydrograph	13:55	15.29174
50yrHydrograph	14:00	15.11445
50yrHydrograph	14:05	14.93687
50yrHydrograph	14:10	14.75854
50yrHydrograph	14:15	14.58004
50yrHydrograph	14:20	14.40156
50yrHydrograph	14:25	14.22281
50yrHydrograph	14:30	14.04426
50yrHydrograph	14:35	13.86423
50yrHydrograph	14:40	13.6837
50yrHydrograph	14:45	13.50301
50yrHydrograph	14:50	13.30914
50yrHydrograph	14:55	13.12618
50yrHydrograph	15:00	12.94802
50yrHydrograph	15:05	12.76969
50yrHydrograph	15:10	12.59169
50yrHydrograph	15:15	12.4138
50yrHydrograph	15:20	12.23598
50yrHydrograph	15:25	12.05821
50yrHydrograph	15:30	11.88046
50yrHydrograph	15:35	11.70293
50yrHydrograph	15:40	11.52561
50yrHydrograph	15:45	11.34845
50yrHydrograph	15:50	11.17146
50yrHydrograph	15:55	10.99606
50yrHydrograph	16:00	10.8197
50yrHydrograph	16:05	10.64304
50yrHydrograph	16:10	10.46662
50yrHydrograph	16:15	10.29062
50yrHydrograph	16:20	10.11486
50yrHydrograph	16:25	9.938902
50yrHydrograph	16:30	9.762617

POST-DEVELOPMENT MODEL

50yrHydrograph	16:35	9.586464
50yrHydrograph	16:40	9.410628
50yrHydrograph	16:45	9.235176
50yrHydrograph	16:50	9.060157
50yrHydrograph	16:55	8.8877
50yrHydrograph	17:00	8.714247
50yrHydrograph	17:05	8.541053
50yrHydrograph	17:10	8.368399
50yrHydrograph	17:15	8.196492
50yrHydrograph	17:20	8.02516
50yrHydrograph	17:25	7.854405
50yrHydrograph	17:30	7.68433
50yrHydrograph	17:35	7.514884
50yrHydrograph	17:40	7.346062
50yrHydrograph	17:45	7.177868
50yrHydrograph	17:50	7.011817
50yrHydrograph	17:55	6.845519
50yrHydrograph	18:00	6.679473
50yrHydrograph	18:05	6.514217
50yrHydrograph	18:10	6.030243
50yrHydrograph	18:15	5.35311
50yrHydrograph	18:20	5.102541
50yrHydrograph	18:25	4.888823
50yrHydrograph	18:30	4.684548
50yrHydrograph	18:35	4.490335
50yrHydrograph	18:40	4.305697
50yrHydrograph	18:45	4.130076
50yrHydrograph	18:50	3.963681
50yrHydrograph	18:55	3.808549
50yrHydrograph	19:00	3.658127
50yrHydrograph	19:05	3.514045
50yrHydrograph	19:10	3.376799
50yrHydrograph	19:15	3.245937
50yrHydrograph	19:20	3.120808
50yrHydrograph	19:25	3.001184
50yrHydrograph	19:30	2.886683
50yrHydrograph	19:35	2.776967
50yrHydrograph	19:40	2.67334

POST-DEVELOPMENT MODEL

50yrHydrograph	19:45	2.575817
50yrHydrograph	19:50	2.480122
50yrHydrograph	19:55	2.388107
50yrHydrograph	20:00	2.299947
50yrHydrograph	20:05	2.215632
50yrHydrograph	20:10	2.1348
50yrHydrograph	20:15	2.057227
50yrHydrograph	20:20	1.982703
50yrHydrograph	20:25	1.911137
50yrHydrograph	20:30	1.842309
50yrHydrograph	20:35	1.776098
50yrHydrograph	20:40	1.713254
50yrHydrograph	20:45	1.653753
50yrHydrograph	20:50	1.597621
50yrHydrograph	20:55	1.541439
50yrHydrograph	21:00	1.486925
50yrHydrograph	21:05	1.434374
50yrHydrograph	21:10	1.383702
50yrHydrograph	21:15	1.334931
50yrHydrograph	21:20	1.287907
50yrHydrograph	21:25	1.24262
50yrHydrograph	21:30	1.198912
50yrHydrograph	21:35	1.156705
50yrHydrograph	21:40	1.115956
50yrHydrograph	21:45	1.076615
50yrHydrograph	21:50	1.038629
50yrHydrograph	21:55	1.001943
50yrHydrograph	22:00	0.966554
50yrHydrograph	22:05	0.9330333
50yrHydrograph	22:10	0.9007493
50yrHydrograph	22:15	0.8710659
50yrHydrograph	22:20	0.8408281
50yrHydrograph	22:25	0.8110486
50yrHydrograph	22:30	0.7821017
50yrHydrograph	22:35	0.7540459
50yrHydrograph	22:40	0.7265956
50yrHydrograph	22:45	0.6998537
50yrHydrograph	22:50	0.6739593

POST-DEVELOPMENT MODEL

50yrHydrograph	22:55	0.6489003
50yrHydrograph	23:00	0.6246529
50yrHydrograph	23:05	0.6012228
50yrHydrograph	23:10	0.57854
50yrHydrograph	23:15	0.556564
50yrHydrograph	23:20	0.535271
50yrHydrograph	23:25	0.5146395
50yrHydrograph	23:30	0.4946485
50yrHydrograph	23:35	0.4752773
50yrHydrograph	23:40	0.4565056
50yrHydrograph	23:45	0.438313
50yrHydrograph	23:50	0.4206813
50yrHydrograph	23:55	0.4036704
5yrHydrograph	0:05	0
5yrHydrograph	0:10	0
5yrHydrograph	0:15	0
5yrHydrograph	0:20	0
5yrHydrograph	0:25	0
5yrHydrograph	0:30	0
5yrHydrograph	0:35	0
5yrHydrograph	0:40	0
5yrHydrograph	0:45	0
5yrHydrograph	0:50	0
5yrHydrograph	0:55	0
5yrHydrograph	1:00	0
5yrHydrograph	1:05	0
5yrHydrograph	1:10	0
5yrHydrograph	1:15	0
5yrHydrograph	1:20	0
5yrHydrograph	1:25	0
5yrHydrograph	1:30	0
5yrHydrograph	1:35	0
5yrHydrograph	1:40	0
5yrHydrograph	1:45	0
5yrHydrograph	1:50	0
5yrHydrograph	1:55	0
5yrHydrograph	2:00	0

POST-DEVELOPMENT MODEL

5yrHydrograph	2:05	0
5yrHydrograph	2:10	0
5yrHydrograph	2:15	0
5yrHydrograph	2:20	0
5yrHydrograph	2:25	0
5yrHydrograph	2:30	0
5yrHydrograph	2:35	0
5yrHydrograph	2:40	0
5yrHydrograph	2:45	0
5yrHydrograph	2:50	0
5yrHydrograph	2:55	0.1359298
5yrHydrograph	3:00	0.3930297
5yrHydrograph	3:05	0.5591156
5yrHydrograph	3:10	0.6563269
5yrHydrograph	3:15	0.7263873
5yrHydrograph	3:20	0.7832466
5yrHydrograph	3:25	0.8602272
5yrHydrograph	3:30	0.949561
5yrHydrograph	3:35	1.040848
5yrHydrograph	3:40	1.129301
5yrHydrograph	3:45	1.216549
5yrHydrograph	3:50	1.303134
5yrHydrograph	3:55	1.38916
5yrHydrograph	4:00	1.474818
5yrHydrograph	4:05	1.560286
5yrHydrograph	4:10	1.653159
5yrHydrograph	4:15	1.774101
5yrHydrograph	4:20	1.914395
5yrHydrograph	4:25	2.065953
5yrHydrograph	4:30	2.221644
5yrHydrograph	4:35	2.378466
5yrHydrograph	4:40	2.548352
5yrHydrograph	4:45	2.751761
5yrHydrograph	4:50	2.979939
5yrHydrograph	4:55	3.21575
5yrHydrograph	5:00	3.452507
5yrHydrograph	5:05	3.68941
5yrHydrograph	5:10	3.970027

POST-DEVELOPMENT MODEL

5yrHydrograph	5:15	4.336559
5yrHydrograph	5:20	4.746371
5yrHydrograph	5:25	5.167806
5yrHydrograph	5:30	6.125247
5yrHydrograph	5:35	6.60618
5yrHydrograph	5:40	7.26016
5yrHydrograph	5:45	8.276287
5yrHydrograph	5:50	9.40118
5yrHydrograph	5:55	11.18117
5yrHydrograph	6:00	13.27669
5yrHydrograph	6:05	15.05454
5yrHydrograph	6:10	16.05738
5yrHydrograph	6:15	16.35877
5yrHydrograph	6:20	16.5261
5yrHydrograph	6:25	16.64606
5yrHydrograph	6:30	16.8107
5yrHydrograph	6:35	17.73345
5yrHydrograph	6:40	18.56983
5yrHydrograph	6:45	19.41413
5yrHydrograph	6:50	21.27034
5yrHydrograph	6:55	23.88992
5yrHydrograph	7:00	26.86422
5yrHydrograph	7:05	29.48862
5yrHydrograph	7:10	32.33274
5yrHydrograph	7:15	34.75698
5yrHydrograph	7:20	36.25337
5yrHydrograph	7:25	37.2498
5yrHydrograph	7:30	37.93416
5yrHydrograph	7:35	38.35898
5yrHydrograph	7:40	38.55013
5yrHydrograph	7:45	38.52993
5yrHydrograph	7:50	38.31598
5yrHydrograph	7:55	37.92754
5yrHydrograph	8:00	37.38509
5yrHydrograph	8:05	36.69696
5yrHydrograph	8:10	35.77127
5yrHydrograph	8:15	34.42931
5yrHydrograph	8:20	32.79601

POST-DEVELOPMENT MODEL

5yrHydrograph	8:25	31.2692
5yrHydrograph	8:30	29.91289
5yrHydrograph	8:35	28.71217
5yrHydrograph	8:40	27.64098
5yrHydrograph	8:45	26.68515
5yrHydrograph	8:50	25.68662
5yrHydrograph	8:55	24.92772
5yrHydrograph	9:00	24.24983
5yrHydrograph	9:05	23.63789
5yrHydrograph	9:10	23.08488
5yrHydrograph	9:15	22.58359
5yrHydrograph	9:20	22.12847
5yrHydrograph	9:25	21.71508
5yrHydrograph	9:30	21.33958
5yrHydrograph	9:35	20.99883
5yrHydrograph	9:40	20.69
5yrHydrograph	9:45	20.41037
5yrHydrograph	9:50	20.15836
5yrHydrograph	9:55	19.93183
5yrHydrograph	10:00	19.7298
5yrHydrograph	10:05	19.54918
5yrHydrograph	10:10	19.36684
5yrHydrograph	10:15	19.2122
5yrHydrograph	10:20	19.10802
5yrHydrograph	10:25	19.00704
5yrHydrograph	10:30	18.90381
5yrHydrograph	10:35	18.7992
5yrHydrograph	10:40	18.69384
5yrHydrograph	10:45	18.58822
5yrHydrograph	10:50	18.48252
5yrHydrograph	10:55	18.37688
5yrHydrograph	11:00	18.27123
5yrHydrograph	11:05	18.16563
5yrHydrograph	11:10	18.06016
5yrHydrograph	11:15	17.93639
5yrHydrograph	11:20	17.82903
5yrHydrograph	11:25	17.72502
5yrHydrograph	11:30	17.62141

POST-DEVELOPMENT MODEL

5yrHydrograph	11:35	17.51838
5yrHydrograph	11:40	17.41596
5yrHydrograph	11:45	17.31414
5yrHydrograph	11:50	17.21291
5yrHydrograph	11:55	17.1123
5yrHydrograph	12:00	17.01231
5yrHydrograph	12:05	16.91126
5yrHydrograph	12:10	16.79244
5yrHydrograph	12:15	16.65569
5yrHydrograph	12:20	16.50852
5yrHydrograph	12:25	16.35518
5yrHydrograph	12:30	16.19693
5yrHydrograph	12:35	16.03533
5yrHydrograph	12:40	15.8712
5yrHydrograph	12:45	15.70505
5yrHydrograph	12:50	15.53723
5yrHydrograph	12:55	15.36853
5yrHydrograph	13:00	15.19821
5yrHydrograph	13:05	15.02684
5yrHydrograph	13:10	14.85402
5yrHydrograph	13:15	14.67999
5yrHydrograph	13:20	14.50557
5yrHydrograph	13:25	14.33055
5yrHydrograph	13:30	14.15497
5yrHydrograph	13:35	13.9786
5yrHydrograph	13:40	13.80049
5yrHydrograph	13:45	13.62188
5yrHydrograph	13:50	13.44306
5yrHydrograph	13:55	13.24735
5yrHydrograph	14:00	13.07019
5yrHydrograph	14:05	12.89289
5yrHydrograph	14:10	12.71552
5yrHydrograph	14:15	12.53842
5yrHydrograph	14:20	12.36123
5yrHydrograph	14:25	12.18404
5yrHydrograph	14:30	12.00669
5yrHydrograph	14:35	11.82936
5yrHydrograph	14:40	11.65223

POST-DEVELOPMENT MODEL

5yrHydrograph	14:45	11.47529
5yrHydrograph	14:50	11.29847
5yrHydrograph	14:55	11.12236
5yrHydrograph	15:00	10.94688
5yrHydrograph	15:05	10.77053
5yrHydrograph	15:10	10.59407
5yrHydrograph	15:15	10.41786
5yrHydrograph	15:20	10.24212
5yrHydrograph	15:25	10.06648
5yrHydrograph	15:30	9.890451
5yrHydrograph	15:35	9.714251
5yrHydrograph	15:40	9.538265
5yrHydrograph	15:45	9.362621
5yrHydrograph	15:50	9.187378
5yrHydrograph	15:55	9.012606
5yrHydrograph	16:00	8.840601
5yrHydrograph	16:05	8.66722
5yrHydrograph	16:10	8.494259
5yrHydrograph	16:15	8.321853
5yrHydrograph	16:20	8.150234
5yrHydrograph	16:25	7.979133
5yrHydrograph	16:30	7.808626
5yrHydrograph	16:35	7.638818
5yrHydrograph	16:40	7.469615
5yrHydrograph	16:45	7.301042
5yrHydrograph	16:50	7.133159
5yrHydrograph	16:55	6.967582
5yrHydrograph	17:00	6.80125
5yrHydrograph	17:05	6.635427
5yrHydrograph	17:10	6.470431
5yrHydrograph	17:15	5.757764
5yrHydrograph	17:20	5.275753
5yrHydrograph	17:25	5.044955
5yrHydrograph	17:30	4.833824
5yrHydrograph	17:35	4.632282
5yrHydrograph	17:40	4.44075
5yrHydrograph	17:45	4.258595
5yrHydrograph	17:50	4.08533

POST-DEVELOPMENT MODEL

5yrHydrograph	17:55	3.921725
5yrHydrograph	18:00	3.768626
5yrHydrograph	18:05	3.619721
5yrHydrograph	18:10	3.477474
5yrHydrograph	18:15	3.342031
5yrHydrograph	18:20	3.212744
5yrHydrograph	18:25	3.089107
5yrHydrograph	18:30	2.970923
5yrHydrograph	18:35	2.857682
5yrHydrograph	18:40	2.74953
5yrHydrograph	18:45	2.647825
5yrHydrograph	18:50	2.55073
5yrHydrograph	18:55	2.455931
5yrHydrograph	19:00	2.364952
5yrHydrograph	19:05	2.277812
5yrHydrograph	19:10	2.19445
5yrHydrograph	19:15	2.114511
5yrHydrograph	19:20	2.037755
5yrHydrograph	19:25	1.964015
5yrHydrograph	19:30	1.893201
5yrHydrograph	19:35	1.825066
5yrHydrograph	19:40	1.759538
5yrHydrograph	19:45	1.697725
5yrHydrograph	19:50	1.639592
5yrHydrograph	19:55	1.583153
5yrHydrograph	20:00	1.527332
5yrHydrograph	20:05	1.473329
5yrHydrograph	20:10	1.421277
5yrHydrograph	20:15	1.37109
5yrHydrograph	20:20	1.322793
5yrHydrograph	20:25	1.27622
5yrHydrograph	20:30	1.231358
5yrHydrograph	20:35	1.188044
5yrHydrograph	20:40	1.14622
5yrHydrograph	20:45	1.105842
5yrHydrograph	20:50	1.066858
5yrHydrograph	20:55	1.029213
5yrHydrograph	21:00	0.9928537

POST-DEVELOPMENT MODEL

5yrHydrograph	21:05	0.957914
5yrHydrograph	21:10	0.9247589
5yrHydrograph	21:15	0.8933879
5yrHydrograph	21:20	0.8634235
5yrHydrograph	21:25	0.8332421
5yrHydrograph	21:30	0.8036575
5yrHydrograph	21:35	0.7749439
5yrHydrograph	21:40	0.7470686
5yrHydrograph	21:45	0.7197814
5yrHydrograph	21:50	0.6932487
5yrHydrograph	21:55	0.6675706
5yrHydrograph	22:00	0.6427196
5yrHydrograph	22:05	0.6186827
5yrHydrograph	22:10	0.5954496
5yrHydrograph	22:15	0.5729498
5yrHydrograph	22:20	0.5511498
5yrHydrograph	22:25	0.5300273
5yrHydrograph	22:30	0.5095608
5yrHydrograph	22:35	0.4897293
5yrHydrograph	22:40	0.4705123
5yrHydrograph	22:45	0.4518893
5yrHydrograph	22:50	0.4338406
5yrHydrograph	22:55	0.4163517
5yrHydrograph	23:00	0.3995065
5yrHydrograph	23:05	0.383199
5yrHydrograph	23:10	0.3680256
5yrHydrograph	23:15	0.3529832
5yrHydrograph	23:20	0.338088
5yrHydrograph	23:25	0.3235011
5yrHydrograph	23:30	0.3092898
5yrHydrograph	23:35	0.2954722
5yrHydrograph	23:40	0.2820446
5yrHydrograph	23:45	0.2689951
5yrHydrograph	23:50	0.2563089
5yrHydrograph	23:55	0.2439816

[REPORT]
 ;;Reporting Options

POST-DEVELOPMENT MODEL

INPUT YES
 CONTROLS NO
 SUBCATCHMENTS ALL
 NODES ALL
 LINKS ALL

[TAGS]

[MAP]
 DIMENSIONS 350504.70725 5015809.991 350738.97975 5016090.183
 UNITS Meters

[COORDINATES]

```

;;Node X-Coord Y-Coord
;;-----
HEADWALL 350565.848 5016038.828
OF1 350702.274 5015973.798
OF3 350691.907 5015873.685
OF4 350536.617 5015877.154
POOLE 350547.792 5015987.469
100 350604.4 5016006
101 350613.6 5015987
102 350620.1 5015980
103 350577.8 5015941
104 350559.9 5015927
105 350565.233 5015895.797
ADS 350609.954 5015996.177
BLDG 350645.2 5015953
CB102A-1 350645.2 5015989
CB103A-1 350602.8 5015914
CB103B-1 350583.627 5015951.403
CB103C-1 350601.334 5015932.043
CB103D-1 350623.764 5015950.695
CB103E-1 350606.056 5015973.833
CB106A-1 350619.75 5016018.928
EX 350580.8 5016032
EX502 350695.235 5015965.852
ROOF1-S 350665.79 5015960.847
  
```

POST-DEVELOPMENT MODEL

ROOF2-S	350684.678	5015939.598
ROOF3-S	350606.529	5015873.726
ROOF4-S	350590.71	5015890.961

[VERTICES]

;;Link	X-Coord	Y-Coord
;;-----	-----	-----
100-02	350604.96	5015999.311
100-W1	350601.524	5015996.977

[POLYGONS]

;;Subcatchment	X-Coord	Y-Coord
;;-----	-----	-----
EXT-1	350626.393	5015829.475
EXT-1	350627.232	5015826.033
EXT-1	350627.232	5015826.033
EXT-1	350624.127	5015822.727
EXT-1	350624.127	5015822.727
EXT-1	350620.936	5015826.468
EXT-1	350620.936	5015826.468
EXT-1	350613.689	5015833.765
EXT-1	350613.689	5015833.765
EXT-1	350600.76	5015840.764
EXT-1	350600.76	5015840.764
EXT-1	350604.251	5015844.185
EXT-1	350604.251	5015844.185
EXT-1	350595.149	5015854.34
EXT-1	350595.149	5015854.34
EXT-1	350595.45	5015854.616
EXT-1	350595.45	5015854.616
EXT-1	350587.232	5015863.596
EXT-1	350587.232	5015863.596
EXT-1	350583.047	5015859.746
EXT-1	350583.047	5015859.746
EXT-1	350582.128	5015861.965
EXT-1	350582.128	5015861.965
EXT-1	350581.002	5015863.66
EXT-1	350581.002	5015863.66

POST-DEVELOPMENT MODEL

EXT-1	350574.449	5015871.047
EXT-1	350574.449	5015871.047
EXT-1	350569.16	5015876.374
EXT-1	350569.16	5015876.374
EXT-1	350569.521	5015882.427
EXT-1	350569.521	5015882.427
EXT-1	350565.233	5015887.407
EXT-1	350565.233	5015887.407
EXT-1	350564.373	5015890.234
EXT-1	350564.373	5015890.234
EXT-1	350564.403	5015893.181
EXT-1	350564.403	5015893.181
EXT-1	350565.137	5015896.048
EXT-1	350565.137	5015896.048
EXT-1	350569.544	5015891.262
EXT-1	350569.544	5015891.262
EXT-1	350626.393	5015829.475
L102A	350656.417	5015992.343
L102A	350662.013	5015986.146
L102A	350662.013	5015986.146
L102A	350661.506	5015979.248
L102A	350661.506	5015979.248
L102A	350656.004	5015974.225
L102A	350656.004	5015974.225
L102A	350648.407	5015967.196
L102A	350648.407	5015967.196
L102A	350670.181	5015943.531
L102A	350670.181	5015943.531
L102A	350667.053	5015940.653
L102A	350667.053	5015940.653
L102A	350647.202	5015962.229
L102A	350647.202	5015962.229
L102A	350636.422	5015973.945
L102A	350636.422	5015973.945
L102A	350634.153	5015976.411
L102A	350634.153	5015976.411
L102A	350637.369	5015981.883
L102A	350637.369	5015981.883

POST-DEVELOPMENT MODEL

L102A	350645.132	5015989.027
L102A	350645.132	5015989.027
L102A	350652.896	5015996.17
L102A	350652.896	5015996.17
L102A	350656.417	5015992.343
L103A	350587.998	5015906.399
L103A	350591.578	5015909.693
L103A	350591.578	5015909.693
L103A	350594.791	5015914.103
L103A	350594.791	5015914.103
L103A	350599.312	5015918.272
L103A	350599.312	5015918.272
L103A	350608.056	5015919.042
L103A	350608.056	5015919.042
L103A	350612.742	5015920.065
L103A	350612.742	5015920.065
L103A	350613.623	5015919.072
L103A	350613.623	5015919.072
L103A	350617.114	5015918.637
L103A	350617.114	5015918.637
L103A	350618.009	5015916.055
L103A	350618.009	5015916.055
L103A	350619.11	5015913.655
L103A	350619.11	5015913.655
L103A	350620.754	5015910.826
L103A	350620.754	5015910.826
L103A	350622.577	5015908.477
L103A	350622.577	5015908.477
L103A	350624.122	5015906.796
L103A	350624.122	5015906.796
L103A	350625.992	5015905.133
L103A	350625.992	5015905.133
L103A	350627.517	5015903.901
L103A	350627.517	5015903.901
L103A	350628.948	5015902.932
L103A	350628.948	5015902.932
L103A	350630.209	5015902.181
L103A	350630.209	5015902.181

POST-DEVELOPMENT MODEL

L103A	350631.694	5015901.401
L103A	350631.694	5015901.401
L103A	350634.83	5015889.695
L103A	350634.83	5015889.695
L103A	350636.618	5015891.012
L103A	350636.618	5015891.012
L103A	350638.49	5015892.726
L103A	350638.49	5015892.726
L103A	350643.944	5015886.798
L103A	350643.944	5015886.798
L103A	350647.671	5015882.748
L103A	350647.671	5015882.748
L103A	350628.262	5015864.89
L103A	350628.262	5015864.89
L103A	350627.229	5015866.013
L103A	350627.229	5015866.013
L103A	350626.107	5015864.98
L103A	350626.107	5015864.98
L103A	350621.695	5015869.775
L103A	350621.695	5015869.775
L103A	350587.998	5015906.399
L103B	350592.984	5015961.992
L103B	350603.421	5015950.649
L103B	350603.421	5015950.649
L103B	350601.691	5015949.057
L103B	350601.691	5015949.057
L103B	350594.884	5015942.794
L103B	350594.884	5015942.794
L103B	350588.077	5015936.531
L103B	350588.077	5015936.531
L103B	350582.337	5015931.25
L103B	350582.337	5015931.25
L103B	350568.36	5015946.662
L103B	350568.36	5015946.662
L103B	350589.334	5015965.959
L103B	350589.334	5015965.959
L103B	350592.984	5015961.992
L103C	350594.791	5015914.103

POST-DEVELOPMENT MODEL

L103C	350585.834	5015927.448
L103C	350585.834	5015927.448
L103C	350582.337	5015931.25
L103C	350582.337	5015931.25
L103C	350588.077	5015936.531
L103C	350588.077	5015936.531
L103C	350594.884	5015942.794
L103C	350594.884	5015942.794
L103C	350601.691	5015949.057
L103C	350601.691	5015949.057
L103C	350603.421	5015950.649
L103C	350603.421	5015950.649
L103C	350607.043	5015946.712
L103C	350607.043	5015946.712
L103C	350617.881	5015934.933
L103C	350617.881	5015934.933
L103C	350616.625	5015931.295
L103C	350616.625	5015931.295
L103C	350612.742	5015920.065
L103C	350612.742	5015920.065
L103C	350608.056	5015919.042
L103C	350608.056	5015919.042
L103C	350599.312	5015918.272
L103C	350599.312	5015918.272
L103C	350594.791	5015914.103
L103D	350641.315	5015948.69
L103D	350641.633	5015946.325
L103D	350641.633	5015946.325
L103D	350633.45	5015938.797
L103D	350633.45	5015938.797
L103D	350637.129	5015934.8
L103D	350637.129	5015934.8
L103D	350638.437	5015936.003
L103D	350638.437	5015936.003
L103D	350642.019	5015934.099
L103D	350642.019	5015934.099
L103D	350644.883	5015932.006
L103D	350644.883	5015932.006

POST-DEVELOPMENT MODEL

L103D	350647.556	5015929.428
L103D	350647.556	5015929.428
L103D	350649.614	5015926.84
L103D	350649.614	5015926.84
L103D	350651.337	5015924.017
L103D	350651.337	5015924.017
L103D	350652.503	5015921.504
L103D	350652.503	5015921.504
L103D	350653.159	5015919.682
L103D	350653.159	5015919.682
L103D	350663.248	5015916.348
L103D	350663.248	5015916.348
L103D	350662.404	5015914.954
L103D	350662.404	5015914.954
L103D	350661.17	5015913.603
L103D	350661.17	5015913.603
L103D	350659.227	5015911.815
L103D	350659.227	5015911.815
L103D	350668.411	5015901.832
L103D	350668.411	5015901.832
L103D	350664.259	5015898.011
L103D	350664.259	5015898.011
L103D	350661.571	5015900.974
L103D	350661.571	5015900.974
L103D	350655.925	5015895.778
L103D	350655.925	5015895.778
L103D	350650.28	5015890.585
L103D	350650.28	5015890.585
L103D	350652.989	5015887.641
L103D	350652.989	5015887.641
L103D	350647.671	5015882.748
L103D	350647.671	5015882.748
L103D	350643.944	5015886.798
L103D	350643.944	5015886.798
L103D	350638.49	5015892.726
L103D	350638.49	5015892.726
L103D	350636.618	5015891.012
L103D	350636.618	5015891.012

POST-DEVELOPMENT MODEL

L103D	350634.83	5015889.695
L103D	350634.83	5015889.695
L103D	350631.694	5015901.401
L103D	350631.694	5015901.401
L103D	350630.209	5015902.181
L103D	350630.209	5015902.181
L103D	350628.948	5015902.932
L103D	350628.948	5015902.932
L103D	350627.517	5015903.901
L103D	350627.517	5015903.901
L103D	350625.992	5015905.133
L103D	350625.992	5015905.133
L103D	350624.122	5015906.796
L103D	350624.122	5015906.796
L103D	350622.577	5015908.477
L103D	350622.577	5015908.477
L103D	350620.754	5015910.826
L103D	350620.754	5015910.826
L103D	350619.11	5015913.655
L103D	350619.11	5015913.655
L103D	350618.009	5015916.055
L103D	350618.009	5015916.055
L103D	350617.114	5015918.637
L103D	350617.114	5015918.637
L103D	350613.623	5015919.072
L103D	350613.623	5015919.072
L103D	350612.742	5015920.065
L103D	350612.742	5015920.065
L103D	350616.625	5015931.295
L103D	350616.625	5015931.295
L103D	350617.881	5015934.933
L103D	350617.881	5015934.933
L103D	350607.043	5015946.712
L103D	350607.043	5015946.712
L103D	350603.421	5015950.649
L103D	350603.421	5015950.649
L103D	350605.646	5015952.694
L103D	350605.646	5015952.694

POST-DEVELOPMENT MODEL

L103D	350607.357	5015954.271
L103D	350607.357	5015954.271
L103D	350626.712	5015972.078
L103D	350626.712	5015972.078
L103D	350630.209	5015968.277
L103D	350630.209	5015968.277
L103D	350641.315	5015948.69
L103E	350603.421	5015950.649
L103E	350592.984	5015961.992
L103E	350592.984	5015961.992
L103E	350589.334	5015965.959
L103E	350589.334	5015965.959
L103E	350593.271	5015969.581
L103E	350593.271	5015969.581
L103E	350590.44	5015972.299
L103E	350590.44	5015972.299
L103E	350599.149	5015988.382
L103E	350599.149	5015988.382
L103E	350606.733	5015981.967
L103E	350606.733	5015981.967
L103E	350612.514	5015987.287
L103E	350612.514	5015987.287
L103E	350618.814	5015993.083
L103E	350618.814	5015993.083
L103E	350628.464	5015982.595
L103E	350628.464	5015982.595
L103E	350634.153	5015976.411
L103E	350634.153	5015976.411
L103E	350636.422	5015973.945
L103E	350636.422	5015973.945
L103E	350647.202	5015962.229
L103E	350647.202	5015962.229
L103E	350641.682	5015957.151
L103E	350641.682	5015957.151
L103E	350645.73	5015952.752
L103E	350645.73	5015952.752
L103E	350661.534	5015935.575
L103E	350661.534	5015935.575

POST-DEVELOPMENT MODEL

L103E	350667.053	5015940.653
L103E	350667.053	5015940.653
L103E	350670.181	5015943.531
L103E	350670.181	5015943.531
L103E	350684.703	5015927.748
L103E	350684.703	5015927.748
L103E	350689.115	5015922.953
L103E	350689.115	5015922.953
L103E	350688.031	5015921.956
L103E	350688.031	5015921.956
L103E	350689.064	5015920.834
L103E	350689.064	5015920.834
L103E	350668.411	5015901.832
L103E	350668.411	5015901.832
L103E	350659.227	5015911.815
L103E	350659.227	5015911.815
L103E	350661.17	5015913.603
L103E	350661.17	5015913.603
L103E	350662.404	5015914.954
L103E	350662.404	5015914.954
L103E	350663.248	5015916.348
L103E	350663.248	5015916.348
L103E	350653.159	5015919.682
L103E	350653.159	5015919.682
L103E	350652.503	5015921.504
L103E	350652.503	5015921.504
L103E	350651.337	5015924.017
L103E	350651.337	5015924.017
L103E	350649.614	5015926.84
L103E	350649.614	5015926.84
L103E	350647.556	5015929.428
L103E	350647.556	5015929.428
L103E	350644.883	5015932.006
L103E	350644.883	5015932.006
L103E	350642.019	5015934.099
L103E	350642.019	5015934.099
L103E	350638.437	5015936.003
L103E	350638.437	5015936.003

POST-DEVELOPMENT MODEL

L103E	350637.129	5015934.8
L103E	350637.129	5015934.8
L103E	350633.45	5015938.797
L103E	350633.45	5015938.797
L103E	350641.633	5015946.325
L103E	350641.633	5015946.325
L103E	350641.315	5015948.69
L103E	350641.315	5015948.69
L103E	350630.209	5015968.277
L103E	350630.209	5015968.277
L103E	350626.712	5015972.078
L103E	350626.712	5015972.078
L103E	350607.357	5015954.271
L103E	350607.357	5015954.271
L103E	350605.646	5015952.694
L103E	350605.646	5015952.694
L103E	350603.421	5015950.649
L104A	350568.36	5015946.662
L104A	350582.337	5015931.25
L104A	350582.337	5015931.25
L104A	350585.834	5015927.448
L104A	350585.834	5015927.448
L104A	350578.409	5015920.366
L104A	350578.409	5015920.366
L104A	350575.912	5015922.142
L104A	350575.912	5015922.142
L104A	350572.984	5015922.644
L104A	350572.984	5015922.644
L104A	350567.133	5015917.261
L104A	350567.133	5015917.261
L104A	350561.283	5015911.878
L104A	350561.283	5015911.878
L104A	350558.977	5015914.384
L104A	350558.977	5015914.384
L104A	350553.55	5015916.457
L104A	350553.55	5015916.457
L104A	350548.811	5015921.608
L104A	350548.811	5015921.608

POST-DEVELOPMENT MODEL

L104A	350550.724	5015923.369
L104A	350550.724	5015923.369
L104A	350547.203	5015927.195
L104A	350547.203	5015927.195
L104A	350568.36	5015946.662
L104B	350587.998	5015906.399
L104B	350585.38	5015909.245
L104B	350585.38	5015909.245
L104B	350577.763	5015902.236
L104B	350577.763	5015902.236
L104B	350572.281	5015897.192
L104B	350572.281	5015897.192
L104B	350565.137	5015896.048
L104B	350565.137	5015896.048
L104B	350559.299	5015902.395
L104B	350559.299	5015902.395
L104B	350561.119	5015904.66
L104B	350561.119	5015904.66
L104B	350561.283	5015911.878
L104B	350561.283	5015911.878
L104B	350567.133	5015917.261
L104B	350567.133	5015917.261
L104B	350572.984	5015922.644
L104B	350572.984	5015922.644
L104B	350575.912	5015922.142
L104B	350575.912	5015922.142
L104B	350578.409	5015920.366
L104B	350578.409	5015920.366
L104B	350585.834	5015927.448
L104B	350585.834	5015927.448
L104B	350594.791	5015914.103
L104B	350594.791	5015914.103
L104B	350591.578	5015909.693
L104B	350591.578	5015909.693
L104B	350587.998	5015906.399
L106A	350614.163	5016038.267
L106A	350635.769	5016020.983
L106A	350635.769	5016020.983

POST-DEVELOPMENT MODEL

L106A	350658.795	5015995.921
L106A	350658.795	5015995.921
L106A	350656.417	5015992.343
L106A	350656.417	5015992.343
L106A	350652.896	5015996.17
L106A	350652.896	5015996.17
L106A	350645.132	5015989.027
L106A	350645.132	5015989.027
L106A	350637.369	5015981.883
L106A	350637.369	5015981.883
L106A	350634.153	5015976.411
L106A	350634.153	5015976.411
L106A	350628.464	5015982.595
L106A	350628.464	5015982.595
L106A	350618.814	5015993.083
L106A	350618.814	5015993.083
L106A	350624.105	5015997.951
L106A	350624.105	5015997.951
L106A	350626.208	5015999.478
L106A	350626.208	5015999.478
L106A	350601.359	5016026.486
L106A	350601.359	5016026.486
L106A	350605.185	5016030.007
L106A	350605.185	5016030.007
L106A	350603.425	5016031.92
L106A	350603.425	5016031.92
L106A	350608.576	5016036.66
L106A	350608.576	5016036.66
L106A	350610.336	5016034.746
L106A	350610.336	5016034.746
L106A	350614.163	5016038.267
L502A	350725.561	5015936.27
L502A	350722.136	5015933.059
L502A	350722.136	5015933.059
L502A	350717.196	5015938.434
L502A	350717.196	5015938.434
L502A	350714.443	5015941.425
L502A	350708.751	5015945.742

POST-DEVELOPMENT MODEL

L502A	350703.108	5015948.609
L502A	350703.108	5015948.609
L502A	350697.467	5015951.476
L502A	350683.135	5015967.951
L502A	350681.617	5015970.764
L502A	350679.655	5015973.289
L502A	350660.685	5015993.915
L502A	350660.685	5015993.915
L502A	350663.284	5015996.305
L502A	350663.284	5015996.305
L502A	350683.605	5015974.238
L502A	350683.605	5015974.238
L502A	350692.864	5015960.827
L502A	350692.864	5015960.827
L502A	350699.597	5015955.666
L502A	350699.597	5015955.666
L502A	350710.86	5015949.942
L502A	350710.86	5015949.942
L502A	350717.943	5015944.509
L502A	350717.943	5015944.509
L502A	350725.561	5015936.27
L502B	350662.013	5015986.146
L502B	350656.417	5015992.343
L502B	350656.417	5015992.343
L502B	350658.795	5015995.921
L502B	350658.795	5015995.921
L502B	350666.437	5015987.603
L502B	350666.437	5015987.603
L502B	350680.128	5015972.702
L502B	350697.467	5015951.476
L502B	350708.751	5015945.742
L502B	350714.443	5015941.425
L502B	350728.331	5015926.314
L502B	350728.331	5015926.314
L502B	350725.596	5015923.69
L502B	350725.596	5015923.69
L502B	350717.757	5015932.343
L502B	350717.757	5015932.343

POST-DEVELOPMENT MODEL

L502B	350717.387	5015932.007
L502B	350717.387	5015932.007
L502B	350717.01	5015921.94
L502B	350717.01	5015921.94
L502B	350715.379	5015921.027
L502B	350715.379	5015921.027
L502B	350709.118	5015927.832
L502B	350709.118	5015927.832
L502B	350708.066	5015926.864
L502B	350708.066	5015926.864
L502B	350704.949	5015930.251
L502B	350704.949	5015930.251
L502B	350705.836	5015931.068
L502B	350705.836	5015931.068
L502B	350697.802	5015939.8
L502B	350697.802	5015939.8
L502B	350661.506	5015979.248
L502B	350661.506	5015979.248
L502B	350662.013	5015986.146
RAMP	350667.053	5015940.653
RAMP	350661.534	5015935.575
RAMP	350661.534	5015935.575
RAMP	350645.73	5015952.752
RAMP	350645.73	5015952.752
RAMP	350641.682	5015957.151
RAMP	350641.682	5015957.151
RAMP	350647.202	5015962.229
RAMP	350647.202	5015962.229
RAMP	350667.053	5015940.653
ROOF1	350655.172	5015964.927
ROOF1	350669.21	5015949.669
ROOF1	350669.21	5015949.669
ROOF1	350676.087	5015955.997
ROOF1	350676.087	5015955.997
ROOF1	350666.993	5015965.881
ROOF1	350666.993	5015965.881
ROOF1	350668.776	5015967.522
ROOF1	350668.776	5015967.522

POST-DEVELOPMENT MODEL

ROOF1	350666.627	5015969.858
ROOF1	350666.627	5015969.858
ROOF1	350665.144	5015968.494
ROOF1	350665.144	5015968.494
ROOF1	350662.35	5015971.531
ROOF1	350662.35	5015971.531
ROOF1	350655.172	5015964.927
ROOF2	350684.703	5015927.748
ROOF2	350670.181	5015943.531
ROOF2	350670.181	5015943.531
ROOF2	350648.407	5015967.196
ROOF2	350648.407	5015967.196
ROOF2	350656.004	5015974.225
ROOF2	350656.004	5015974.225
ROOF2	350661.506	5015979.248
ROOF2	350661.506	5015979.248
ROOF2	350697.802	5015939.8
ROOF2	350697.802	5015939.8
ROOF2	350705.836	5015931.068
ROOF2	350705.836	5015931.068
ROOF2	350704.949	5015930.251
ROOF2	350704.949	5015930.251
ROOF2	350708.066	5015926.864
ROOF2	350708.066	5015926.864
ROOF2	350709.118	5015927.832
ROOF2	350709.118	5015927.832
ROOF2	350715.379	5015921.027
ROOF2	350715.379	5015921.027
ROOF2	350715.498	5015920.899
ROOF2	350715.498	5015920.899
ROOF2	350680.304	5015888.517
ROOF2	350680.304	5015888.517
ROOF2	350681.336	5015887.396
ROOF2	350681.336	5015887.396
ROOF2	350662.188	5015869.777
ROOF2	350662.188	5015869.777
ROOF2	350661.155	5015870.899
ROOF2	350661.155	5015870.899

POST-DEVELOPMENT MODEL

ROOF2	350661.818	5015871.509
ROOF2	350661.818	5015871.509
ROOF2	350661.164	5015872.22
ROOF2	350661.164	5015872.22
ROOF2	350663.178	5015874.074
ROOF2	350663.178	5015874.074
ROOF2	350663.698	5015873.512
ROOF2	350663.698	5015873.512
ROOF2	350666.032	5015875.66
ROOF2	350666.032	5015875.66
ROOF2	350662.217	5015879.806
ROOF2	350662.217	5015879.806
ROOF2	350661.499	5015879.145
ROOF2	350661.499	5015879.145
ROOF2	350653.364	5015887.987
ROOF2	350653.364	5015887.987
ROOF2	350652.989	5015887.641
ROOF2	350652.989	5015887.641
ROOF2	350650.28	5015890.585
ROOF2	350650.28	5015890.585
ROOF2	350655.925	5015895.778
ROOF2	350655.925	5015895.778
ROOF2	350661.571	5015900.974
ROOF2	350661.571	5015900.974
ROOF2	350664.259	5015898.011
ROOF2	350664.259	5015898.011
ROOF2	350668.411	5015901.832
ROOF2	350668.411	5015901.832
ROOF2	350689.064	5015920.834
ROOF2	350689.064	5015920.834
ROOF2	350688.031	5015921.956
ROOF2	350688.031	5015921.956
ROOF2	350689.115	5015922.953
ROOF2	350689.115	5015922.953
ROOF2	350684.703	5015927.748
ROOF3	350608.596	5015857.723
ROOF3	350572.281	5015897.192
ROOF3	350572.281	5015897.192

POST-DEVELOPMENT MODEL

ROOF3	350577.763	5015902.236
ROOF3	350577.763	5015902.236
ROOF3	350585.38	5015909.245
ROOF3	350585.38	5015909.245
ROOF3	350587.998	5015906.399
ROOF3	350587.998	5015906.399
ROOF3	350621.695	5015869.775
ROOF3	350621.695	5015869.775
ROOF3	350626.107	5015864.98
ROOF3	350626.107	5015864.98
ROOF3	350627.229	5015866.013
ROOF3	350627.229	5015866.013
ROOF3	350628.262	5015864.89
ROOF3	350628.262	5015864.89
ROOF3	350647.671	5015882.748
ROOF3	350647.671	5015882.748
ROOF3	350652.989	5015887.641
ROOF3	350652.989	5015887.641
ROOF3	350653.364	5015887.987
ROOF3	350653.364	5015887.987
ROOF3	350661.499	5015879.145
ROOF3	350661.499	5015879.145
ROOF3	350662.217	5015879.806
ROOF3	350662.217	5015879.806
ROOF3	350666.032	5015875.66
ROOF3	350666.032	5015875.66
ROOF3	350663.698	5015873.512
ROOF3	350663.698	5015873.512
ROOF3	350663.178	5015874.074
ROOF3	350663.178	5015874.074
ROOF3	350661.164	5015872.22
ROOF3	350661.164	5015872.22
ROOF3	350661.818	5015871.509
ROOF3	350661.818	5015871.509
ROOF3	350661.155	5015870.899
ROOF3	350661.155	5015870.899
ROOF3	350641.946	5015853.225
ROOF3	350641.946	5015853.225

POST-DEVELOPMENT MODEL

ROOF3	350631.461	5015843.578
ROOF3	350631.461	5015843.578
ROOF3	350625.961	5015838.518
ROOF3	350625.961	5015838.518
ROOF3	350619.582	5015845.452
ROOF3	350619.582	5015845.452
ROOF3	350620.634	5015846.42
ROOF3	350620.634	5015846.42
ROOF3	350617.479	5015849.849
ROOF3	350617.479	5015849.849
ROOF3	350616.591	5015849.033
ROOF3	350616.591	5015849.033
ROOF3	350608.596	5015857.723
ROOF4	350579.92	5015895.689
ROOF4	350587.098	5015902.293
ROOF4	350587.098	5015902.293
ROOF4	350601.137	5015887.036
ROOF4	350601.137	5015887.036
ROOF4	350594.26	5015880.708
ROOF4	350594.26	5015880.708
ROOF4	350585.165	5015890.593
ROOF4	350585.165	5015890.593
ROOF4	350583.382	5015888.952
ROOF4	350583.382	5015888.952
ROOF4	350581.233	5015891.288
ROOF4	350581.233	5015891.288
ROOF4	350582.715	5015892.652
ROOF4	350582.715	5015892.652
ROOF4	350579.92	5015895.689
UNC-2	350593.271	5015969.581
UNC-2	350589.334	5015965.959
UNC-2	350568.36	5015946.662
UNC-2	350547.203	5015927.195
UNC-2	350550.724	5015923.369
UNC-2	350548.811	5015921.608
UNC-2	350553.55	5015916.457
UNC-2	350558.977	5015914.384
UNC-2	350561.283	5015911.878

POST-DEVELOPMENT MODEL

UNC-2	350561.119	5015904.66
UNC-2	350559.299	5015902.395
UNC-2	350553.489	5015908.711
UNC-2	350515.356	5015950.141
UNC-2	350573.06	5016012.241
UNC-2	350574.15	5016017.199
UNC-2	350578.762	5016038.957
UNC-2	350580.464	5016049.762
UNC-2	350580.012	5016055.868
UNC-2	350579.4	5016059.051
UNC-2	350577.23	5016064.74
UNC-2	350581.761	5016069.817
UNC-2	350585.991	5016074.317
UNC-2	350587.836	5016075.223
UNC-2	350588.677	5016077.447
UNC-2	350604.978	5016059.728
UNC-2	350611.128	5016053.042
UNC-2	350615.294	5016043.268
UNC-2	350635.769	5016020.983
UNC-2	350614.163	5016038.267
UNC-2	350610.336	5016034.746
UNC-2	350608.576	5016036.66
UNC-2	350603.425	5016031.92
UNC-2	350605.185	5016030.007
UNC-2	350601.359	5016026.486
UNC-2	350626.208	5015999.478
UNC-2	350624.105	5015997.951
UNC-2	350618.814	5015993.083
UNC-2	350612.514	5015987.287
UNC-2	350606.733	5015981.967
UNC-2	350599.149	5015988.382
UNC-2	350590.44	5015972.299
UNC-2	350593.271	5015969.581
UNC-3	350641.946	5015853.225
UNC-3	350661.155	5015870.899
UNC-3	350661.155	5015870.899
UNC-3	350662.188	5015869.777
UNC-3	350662.188	5015869.777

POST-DEVELOPMENT MODEL

UNC-3	350681.336	5015887.396
UNC-3	350681.336	5015887.396
UNC-3	350680.304	5015888.517
UNC-3	350680.304	5015888.517
UNC-3	350715.498	5015920.899
UNC-3	350715.498	5015920.899
UNC-3	350715.379	5015921.027
UNC-3	350715.379	5015921.027
UNC-3	350717.01	5015921.94
UNC-3	350717.01	5015921.94
UNC-3	350716.764	5015915.35
UNC-3	350716.764	5015915.35
UNC-3	350634.018	5015836.721
UNC-3	350634.018	5015836.721
UNC-3	350626.393	5015829.475
UNC-3	350626.393	5015829.475
UNC-3	350625.961	5015838.518
UNC-3	350625.961	5015838.518
UNC-3	350631.461	5015843.578
UNC-3	350631.461	5015843.578
UNC-3	350641.946	5015853.225
UNC-4	350572.281	5015897.192
UNC-4	350608.596	5015857.723
UNC-4	350608.596	5015857.723
UNC-4	350616.591	5015849.033
UNC-4	350616.591	5015849.033
UNC-4	350617.479	5015849.849
UNC-4	350617.479	5015849.849
UNC-4	350620.634	5015846.42
UNC-4	350620.634	5015846.42
UNC-4	350619.582	5015845.452
UNC-4	350619.582	5015845.452
UNC-4	350625.961	5015838.518
UNC-4	350625.961	5015838.518
UNC-4	350626.393	5015829.475
UNC-4	350626.393	5015829.475
UNC-4	350569.544	5015891.262
UNC-4	350569.544	5015891.262

POST-DEVELOPMENT MODEL

UNC-4	350565.137	5015896.048
UNC-4	350565.137	5015896.048
UNC-4	350572.281	5015897.192

[SYMBOLS]

; ;Gage

X-Coord

Y-Coord

; ;-----

POST-DEVELOPMENT MODEL

```
[TITLE]
;;Project Title/Notes

[OPTIONS]
;;Option      Value
FLOW_UNITS    LPS
INFILTRATION  HORTON
FLOW_ROUTING  DYNWAVE
LINK_OFFSETS  ELEVATION
MIN_SLOPE     0
ALLOW_PONDING YES
SKIP_STEADY_STATE NO

START_DATE    07/23/2009
START_TIME    00:00:00
REPORT_START_DATE 07/23/2009
REPORT_START_TIME 00:00:00
END_DATE      07/24/2009
END_TIME      00:00:00
SWEEP_START   01/01
SWEEP_END     12/31
DRY_DAYS      0
REPORT_STEP   00:05:00
WET_STEP      00:05:00
DRY_STEP      00:05:00
ROUTING_STEP  1
RULE_STEP     00:00:00

INERTIAL_DAMPING PARTIAL
NORMAL_FLOW_LIMITED BOTH
FORCE_MAIN_EQUATION H-W
VARIABLE_STEP    0
LENGTHENING_STEP 0
MIN_SURFAREA     0
MAX_TRIALS       8
HEAD_TOLERANCE   0.0015
SYS_FLOW_TOL     5
LAT_FLOW_TOL     5
```

POST-DEVELOPMENT MODEL

```
MINIMUM_STEP    0.5
THREADS         4

[EVAPORATION]
;;Data Source   Parameters
;;-----
CONSTANT        0.0
DRY_ONLY        NO

[RAINGAGES]
;;Name          Format   Interval SCF   Source
;;-----
RG1             INTENSITY 0:10   1.0     TIMESERIES 002CHI

[SUBCATCHMENTS]
;;Name          Rain Gage      Outlet          Area   %Imperv  Width  %Slope  CurbLen  SnowPack
;;-----
;0.47
EXT-1          RG1           105             0.068859 38.571  95     1.5     0
;0.78
L102A         RG1           CB102A-1       0.061494 82.86   18.5   2.5     0
;0.73
L103A         RG1           CB103A-1       0.155713 75.71   28.2   2.5     0
;0.76
L103B         RG1           CB103B-1       0.059451 80       28.6   2.5     0
;0.70
L103C         RG1           CB103C-1       0.072415 71.43   29.9   2.5     0
;0.66
L103D         RG1           CB103D-1       0.239253 65.71   31.7   2.5     0
;0.71
```

POST-DEVELOPMENT MODEL							
L103E	RG1	CB103E-1	0.237258	72.86	21	2.5	0
;0.78							
L104A	RG1	104	0.068012	82.86	38.6	2.5	0
;0.76							
L104B	RG1	104	0.059101	80	24.6	2.5	0
;0.74							
L106A	RG1	CB106A-1	0.142402	77.14	26.5	2.5	0
;0.90							
L502A	RG1	EX502	0.037296	100	88	0.8	0
;0.49							
L502B	RG1	EX502	0.083714	41.43	95	25	0
;0.90							
RAMP	RG1	BLDG	0.021989	100	7.5	15	0
ROOF1	RG1	ROOF1-S	0.0203	100	4.568	1.5	0
;0.90							
ROOF2	RG1	ROOF2-S	0.220177	100	49.54	1.5	0
;0.90							
ROOF3	RG1	ROOF3-S	0.184975	100	41.619	1.5	0
;0.90							
ROOF4	RG1	ROOF4-S	0.020313	100	4.57	1.5	0
;0.26							
UNC-2	RG1	POOLE	0.526055	8.57	25	1	0
;0.63							
UNC-3	RG1	OF3	0.069306	61.43	126	3	0
;0.46							

POST-DEVELOPMENT MODEL							
UNC-4	RG1	105	0.051524	37.14	90	10	0

[SUBAREAS]							
;;Subcatchment	N-Imperv	N-Perv	S-Imperv	S-Perv	PctZero	RouteTo	PctRouted
;;-----							
EXT-1	0.013	0.25	1.57	4.67	0	PERVIOUS	100
L102A	0.013	0.25	1.57	4.67	0	OUTLET	
L103A	0.013	0.25	1.57	4.67	0	OUTLET	
L103B	0.013	0.25	1.57	4.67	0	OUTLET	
L103C	0.013	0.25	1.57	4.67	0	OUTLET	
L103D	0.013	0.25	1.57	4.67	0	OUTLET	
L103E	0.013	0.25	1.57	4.67	0	OUTLET	
L104A	0.013	0.25	1.57	4.67	0	OUTLET	
L104B	0.013	0.25	1.57	4.67	0	OUTLET	
L106A	0.013	0.25	1.57	4.67	0	OUTLET	
L502A	0.013	0.25	1.57	4.67	0	IMPERVIOUS	100
L502B	0.013	0.25	1.57	4.67	0	OUTLET	
RAMP	0.013	0.25	1.57	4.67	0	OUTLET	
ROOF1	0.013	0.25	1.57	4.67	0	OUTLET	
ROOF2	0.013	0.25	1.57	4.67	0	OUTLET	
ROOF3	0.013	0.25	1.57	4.67	0	OUTLET	
ROOF4	0.013	0.25	1.57	4.67	0	OUTLET	
UNC-2	0.013	0.25	1.57	4.67	0	PERVIOUS	100
UNC-3	0.013	0.25	1.57	4.67	0	PERVIOUS	100
UNC-4	0.013	0.25	1.57	4.67	0	PERVIOUS	100

[INFILTRATION]					
;;Subcatchment	Param1	Param2	Param3	Param4	Param5
;;-----					
EXT-1	76.2	13.2	4.14	7	0
L102A	76.2	13.2	4.14	7	0
L103A	76.2	13.2	4.14	7	0
L103B	76.2	13.2	4.14	7	0
L103C	76.2	13.2	4.14	7	0
L103D	76.2	13.2	4.14	7	0
L103E	76.2	13.2	4.14	7	0
L104A	76.2	13.2	4.14	7	0

POST-DEVELOPMENT MODEL

L104B	76.2	13.2	4.14	7	0
L106A	76.2	13.2	4.14	7	0
L502A	76.2	13.2	4.14	7	0
L502B	76.2	13.2	4.14	7	0
RAMP	76.2	13.2	4.14	7	0
ROOF1	76.2	13.2	4.14	7	0
ROOF2	76.2	13.2	4.14	7	0
ROOF3	76.2	13.2	4.14	7	0
ROOF4	76.2	13.2	4.14	7	0
UNC-2	76.2	13.2	4.14	7	0
UNC-3	76.2	13.2	4.14	7	0
UNC-4	76.2	13.2	4.14	7	0

[OUTFALLS]

;;Name	Elevation	Type	Stage Data	Gated	Route To
;;					
HEADWALL	99.48	FREE		NO	
OF1	102.02	FREE		NO	
OF3	0	FREE		NO	
OF4	101.87	FIXED	102.17	NO	
POOLE	0	FREE		NO	

[STORAGE]

;;Name	Psi	Ksat	Elev. IMD	MaxDepth	InitDepth	Shape	Curve Name/Params	N/A	Fevap
;;									
100			99.903	3.797	0	FUNCTIONAL	0 0 0	0	0
101			101.393	2.743	0	FUNCTIONAL	0 0 0	0	0
102			101.9	2.43	0	FUNCTIONAL	0 0 0	0	0
103			102.131	1.936	0	FUNCTIONAL	0 0 0	0	0
104			102.61	1.49	0	TABULAR	CB104A-V	0	0
105			102.68	1.83	0	FUNCTIONAL	0 0 0	0	0
ADS			101.37	2.33	0	TABULAR	TANK-V	0	0
BLDG			102.78	1.91	0	FUNCTIONAL	0 0 0	0	0
CB102A-1			102.89	1.3	0	TABULAR	CB102A-V	0	0
CB103A-1			103.07	1.53	0	TABULAR	CB103A-V	0	0
CB103B-1			102.42	1.68	0	TABULAR	CB103B-V	0	0

POST-DEVELOPMENT MODEL

CB103C-1	102.7	1.6	0	TABULAR	CB103C-V	0	0
CB103D-1	102.62	1.66	0	TABULAR	CB103D-V	0	0
CB103E-1	102.43	1.68	0	TABULAR	CB103E-V	0	0
CB106A-1	101.97	1.68	0	TABULAR	CB106A-V	0	0
EX	99.608	2.082	0	FUNCTIONAL	0 0 0	0	0
EX502	102.02	2.2	0	TABULAR	EX502-V	0	0
ROOF1-S	110	0.15	0	TABULAR	ROOF1-V	0	0
ROOF2-S	110	0.15	0	TABULAR	ROOF2-V	0	0
ROOF3-S	110	0.15	0	TABULAR	ROOF3-V	0	0
ROOF4-S	110	0.15	0	TABULAR	ROOF4-V	0	0

[CONDUITS]

;;Name	From Node	To Node	Length	Roughness	InOffset	OutOffset	InitFlow
;;							
MaxFlow							
;;							
100--EX	100	EX	34.915	0.013	99.903	99.833	0 0
101--ADS	101	ADS	2.204	0.013	101.393	101.371	0 0
102--101	102	101	9.553	0.013	101.9	101.805	0 0
103--102	103	102	57.54	0.013	102.131	101.956	0 0
BLDG--102	BLDG	102	37.121	0.013	102.78	102.408	0 0
EX--HEADWALL	EX	HEADWALL	11.1	0.013	99.608	99.48	0 0

[ORIFICES]

;;Name	From Node	To Node	Type	Offset	Qcoeff	Gated	CloseTime
;;							
100-01	ADS	100	SIDE	101.37	0.572	NO	0
100-02	ADS	100	SIDE	102.25	0.61	NO	0
105--OF4	105	OF4	SIDE	102.68	0.572	NO	0
CB102A-0	CB102A-1	102	SIDE	102.89	0.572	NO	0
CB103A-0	CB103A-1	103	SIDE	103.07	0.572	NO	0
CB103B-0	CB103B-1	103	SIDE	102.42	0.572	NO	0

POST-DEVELOPMENT MODEL

CB103C-0	CB103C-1	103	SIDE	102.7	0.572	NO	0
CB103D-0	CB103D-1	103	SIDE	102.62	0.572	NO	0
CB103E-0	CB103E-1	103	SIDE	102.43	0.572	NO	0
CB106A-0	CB106A-1	ADS	SIDE	101.97	0.572	NO	0
CBMH104A-0	104	103	SIDE	102.61	0.572	NO	0
EX502-0	EX502	OF1	SIDE	102.02	0.572	NO	0

[WEIRS]

;;Name	From Node	To Node	Type	CrestHt	Qcoeff	Gated	EndCon
EndCoeff	Surcharge	RoadWidth	RoadSurf	Coeff.	Curve		
100-W1	ADS	100	TRANSVERSE	103	1.68	NO	0 0
YES							
W1	105	104	TRANSVERSE	104.44	1.67	NO	0 0
YES							

[OUTLETS]

;;Name	From Node	To Node	Offset	Type	QTable/Qcoeff	Qexpon
Gated						
ROOF1-0	ROOF1-S	BLDG	110	TABULAR/DEPTH	ROOF1-Q	
NO						
ROOF2-0	ROOF2-S	BLDG	110	TABULAR/DEPTH	ROOF2-Q	
NO						
ROOF3-0	ROOF3-S	BLDG	110	TABULAR/DEPTH	ROOF3-Q	
NO						
ROOF4-0	ROOF4-S	BLDG	110	TABULAR/DEPTH	ROOF4-Q	
NO						

[XSECTIONS]

;;Link	Shape	Geom1	Geom2	Geom3	Geom4	Barrels	Culvert
100--EX	CIRCULAR	0.525	0	0	0	1	
101--ADS	CIRCULAR	0.45	0	0	0	1	
102--101	CIRCULAR	0.45	0	0	0	1	
103--102	CIRCULAR	0.45	0	0	0	1	

POST-DEVELOPMENT MODEL

BLDG--102	CIRCULAR	0.45	0	0	0	1
EX--HEADWALL	CIRCULAR	0.675	0	0	0	1
100-01	CIRCULAR	0.083	0	0	0	
100-02	CIRCULAR	0.2	0	0	0	
105--OF4	CIRCULAR	0.083	0	0	0	
CB102A-0	CIRCULAR	0.102	0	0	0	
CB103A-0	CIRCULAR	0.178	0	0	0	
CB103B-0	CIRCULAR	0.083	0	0	0	
CB103C-0	CIRCULAR	0.083	0	0	0	
CB103D-0	CIRCULAR	0.152	0	0	0	
CB103E-0	CIRCULAR	0.127	0	0	0	
CB106A-0	CIRCULAR	0.102	0	0	0	
CBMH104A-0	CIRCULAR	0.102	0	0	0	
EX502-0	CIRCULAR	0.083	0	0	0	
100-W1	RECT_OPEN	0.3	0.5	0	0	
W1	RECT_OPEN	0.07	6	0	0	

[TRANSECTS]

```
;;Transect Data in HEC-2 format
;
NC 0.013 0.013 0.013
X1 Overland 5 0.15 6.85 0.0 0.0 0.0 0.0 0.0
GR 0.15 0 0 0.15 0 6.85 0.15 7 0.15 7
;
;[LE: 0][RE: 7]
NC 0.013 0.013 0.013
X1 Overland(orig) 4 0.15 6.85 0.0 0.0 0.0 0.0 0.0
GR 0.15 0 0 0.15 0 6.85 0.15 7
```

[LOSSES]

;;Link	Kentry	Kexit	Kavg	Flap Gate	Seepage
100--EX	0	0.157	0	NO	0
101--ADS	0	0.021	0	NO	0
102--101	0	0.141	0	NO	0
103--102	0	1.344	0	NO	0
BLDG--102	0	0.021	0	NO	0
EX--HEADWALL	0	0.021	0	NO	0

POST-DEVELOPMENT MODEL

[INFLOWS]						
;;Node	Constituent	Time Series	Type	Mfactor	Sfactor	Baseline Pattern

EX	FLOW	2yrHydrograph	FLOW	1.0	1	0
[CURVES]						
;;Name	Type	X-Value	Y-Value	-----		

ROOF1-Q	Rating	0	0			
ROOF1-Q		0.025	0.6309			
ROOF1-Q		0.05	1.2618			
ROOF1-Q		0.075	1.5773			
ROOF1-Q		0.1	1.8927			
ROOF1-Q		0.125	2.2082			
ROOF1-Q		0.15	2.5236			
ROOF2-Q	Rating	0	0			
ROOF2-Q		0.025	2.8391			
ROOF2-Q		0.05	5.6781			
ROOF2-Q		0.075	7.0976			
ROOF2-Q		0.1	8.5172			
ROOF2-Q		0.125	9.9367			
ROOF2-Q		0.15	11.3562			
ROOF3-Q	Rating	0	0			
ROOF3-Q		0.025	2.5236			
ROOF3-Q		0.05	5.0472			
ROOF3-Q		0.075	6.309			
ROOF3-Q		0.1	7.5708			
ROOF3-Q		0.125	8.8326			
ROOF3-Q		0.15	10.0944			
ROOF4-Q	Rating	0	0			
ROOF4-Q		0.025	0.6309			
ROOF4-Q		0.05	1.2618			
ROOF4-Q		0.075	1.5773			
ROOF4-Q		0.1	1.8927			

POST-DEVELOPMENT MODEL

ROOF4-Q		0.125	2.2082			
ROOF4-Q		0.15	2.5236			
CB102A-V	Storage	0	0.36			
CB102A-V		1.19	0.36			
CB102A-V		1.3	65.4			
CB103A-V	Storage	0	0.36			
CB103A-V		1.38	0.36			
CB103A-V		1.53	51.1			
CB103B-V	Storage	0	0.36			
CB103B-V		1.38	0.36			
CB103B-V		1.68	350.5			
CB103C-V	Storage	0	0.36			
CB103C-V		1.38	0.36			
CB103C-V		1.6	247.3			
CB103D-V	Storage	0	0.36			
CB103D-V		1.38	0.36			
CB103D-V		1.66	265			
CB103E-V	Storage	0	0.36			
CB103E-V		1.38	0.36			
CB103E-V		1.68	447.9			
CB104A-V	Storage	0	0.36			
CB104A-V		1.19	0.36			
CB104A-V		1.49	333.3			
CB106A-V	Storage	0	0.36			
CB106A-V		1.38	0.36			
CB106A-V		1.68	523.3			
EX502-V	Storage	0	0.36			
EX502-V		1.94	0.36			
EX502-V		2.2	191.9			

POST-DEVELOPMENT MODEL

ROOF1-V	Storage	0	0
ROOF1-V		0.025	4
ROOF1-V		0.05	18
ROOF1-V		0.075	40
ROOF1-V		0.1	71
ROOF1-V		0.125	111
ROOF1-V		0.15	160
ROOF2-V	Storage	0	0
ROOF2-V		0.025	49
ROOF2-V		0.05	196
ROOF2-V		0.075	440
ROOF2-V		0.1	782
ROOF2-V		0.125	1222
ROOF2-V		0.15	1760
ROOF3-V	Storage	0	0
ROOF3-V		0.025	41
ROOF3-V		0.05	164
ROOF3-V		0.075	370
ROOF3-V		0.1	658
ROOF3-V		0.125	1028
ROOF3-V		0.15	1480
ROOF4-V	Storage	0	0
ROOF4-V		0.025	4
ROOF4-V		0.05	18
ROOF4-V		0.075	40
ROOF4-V		0.1	71
ROOF4-V		0.125	111
ROOF4-V		0.15	160
TANK-V	Storage	0	378.9370079
TANK-V		0.0254	378.9370079
TANK-V		0.051	378.94
TANK-V		0.076	378.94
TANK-V		0.102	378.94

POST-DEVELOPMENT MODEL

TANK-V	0.127	378.94
TANK-V	0.152	378.94
TANK-V	0.178	369.09
TANK-V	0.203	378.94
TANK-V	0.229	369.09
TANK-V	0.254	378.94
TANK-V	0.279	369.09
TANK-V	0.305	369.09
TANK-V	0.33	369.09
TANK-V	0.356	369.09
TANK-V	0.381	369.09
TANK-V	0.406	359.25
TANK-V	0.432	369.09
TANK-V	0.457	359.25
TANK-V	0.483	359.25
TANK-V	0.508	359.25
TANK-V	0.533	359.25
TANK-V	0.559	349.41
TANK-V	0.584	359.25
TANK-V	0.61	349.41
TANK-V	0.635	349.41
TANK-V	0.66	349.41
TANK-V	0.686	339.57
TANK-V	0.711	349.41
TANK-V	0.737	339.57
TANK-V	0.762	339.57
TANK-V	0.787	329.72
TANK-V	0.813	339.57
TANK-V	0.838	319.88
TANK-V	0.864	339.57
TANK-V	0.889	310.04
TANK-V	0.914	339.57
TANK-V	0.94	300.2
TANK-V	0.965	329.72
TANK-V	0.991	290.35
TANK-V	1.016	329.72
TANK-V	1.041	280.51
TANK-V	1.067	319.88

POST-DEVELOPMENT MODEL

TANK-V	1.092	280.51
TANK-V	1.118	300.2
TANK-V	1.143	280.51
TANK-V	1.168	290.35
TANK-V	1.194	260.83
TANK-V	1.219	290.35
TANK-V	1.245	241.14
TANK-V	1.27	280.51
TANK-V	1.295	231.3
TANK-V	1.321	260.83
TANK-V	1.346	211.61
TANK-V	1.372	231.3
TANK-V	1.397	191.93
TANK-V	1.422	191.93
TANK-V	1.448	182.09
TANK-V	1.473	182.09
TANK-V	1.499	182.09
TANK-V	1.524	162.4
TANK-V	1.525	0
TANK-V	3	0

[TIMESERIES]

**SERVICING AND STORMWATER MANAGEMENT BRIEF –
WELLINGS OF STITTSVILLE PHASE 2, 20 CEDAROW COURT**

Appendix C Stormwater Management
September 1, 2023

C.3 SAMPLE PCSWMM MODEL OUTPUT (12HR 100YR SCS)

POST-DEVELOPMENT MODEL

EPA STORM WATER MANAGEMENT MODEL - VERSION 5.1 (Build 5.1.015)

Element Count

Number of rain gages 1
 Number of subcatchments ... 20
 Number of nodes 26
 Number of links 24
 Number of pollutants 0
 Number of land uses 0

Raingage Summary

Name	Data Source	Data Type	Recording Interval
RG1	100SCS	INTENSITY	15 min.

Subcatchment Summary

Name	Area	Width	%Imperv	%Slope	Rain Gage	Outlet
EXT-1	0.07	95.00	38.57	1.5000	RG1	105
L102A	0.06	18.50	82.86	2.5000	RG1	CB102A-1
L103A	0.16	28.20	75.71	2.5000	RG1	CB103A-1
L103B	0.06	28.60	80.00	2.5000	RG1	CB103B-1
L103C	0.07	29.90	71.43	2.5000	RG1	CB103C-1
L103D	0.24	31.70	65.71	2.5000	RG1	CB103D-1
L103E	0.24	21.00	72.86	2.5000	RG1	CB103E-1

POST-DEVELOPMENT MODEL

L104A	0.07	38.60	82.86	2.5000	RG1	104
L104B	0.06	24.60	80.00	2.5000	RG1	104
L106A	0.14	26.50	77.14	2.5000	RG1	CB106A-1
L502A	0.04	88.00	100.00	0.8000	RG1	EX502
L502B	0.08	95.00	41.43	25.0000	RG1	EX502
RAMP	0.02	7.50	100.00	15.0000	RG1	BLDG
ROOF1	0.02	4.57	100.00	1.5000	RG1	ROOF1-S
ROOF2	0.22	49.54	100.00	1.5000	RG1	ROOF2-S
ROOF3	0.18	41.62	100.00	1.5000	RG1	ROOF3-S
ROOF4	0.02	4.57	100.00	1.5000	RG1	ROOF4-S
UNC-2	0.53	25.00	8.57	1.0000	RG1	POOLE
UNC-3	0.07	126.00	61.43	3.0000	RG1	OF3
UNC-4	0.05	90.00	37.14	10.0000	RG1	105

Node Summary

Name	Type	Invert Elev.	Max. Depth	Ponded Area	External Inflow
HEADWALL	OUTFALL	99.48	0.68	0.0	
OF1	OUTFALL	102.02	0.00	0.0	
OF3	OUTFALL	0.00	0.00	0.0	
OF4	OUTFALL	101.87	0.00	0.0	
POOLE	OUTFALL	0.00	0.00	0.0	
100	STORAGE	99.90	3.80	0.0	
101	STORAGE	101.39	2.74	0.0	
102	STORAGE	101.90	2.43	0.0	
103	STORAGE	102.13	1.94	0.0	
104	STORAGE	102.61	1.49	0.0	
105	STORAGE	102.68	1.83	0.0	
ADS	STORAGE	101.37	2.33	0.0	
BLDG	STORAGE	102.78	1.91	0.0	
CB102A-1	STORAGE	102.89	1.30	0.0	
CB103A-1	STORAGE	103.07	1.53	0.0	
CB103B-1	STORAGE	102.42	1.68	0.0	
CB103C-1	STORAGE	102.70	1.60	0.0	

POST-DEVELOPMENT MODEL

CB103D-1	STORAGE	102.62	1.66	0.0	
CB103E-1	STORAGE	102.43	1.68	0.0	
CB106A-1	STORAGE	101.97	1.68	0.0	
EX	STORAGE	99.61	2.08	0.0	Yes
EX502	STORAGE	102.02	2.20	0.0	
ROOF1-S	STORAGE	110.00	0.15	0.0	
ROOF2-S	STORAGE	110.00	0.15	0.0	
ROOF3-S	STORAGE	110.00	0.15	0.0	
ROOF4-S	STORAGE	110.00	0.15	0.0	

Link Summary

Name	From Node	To Node	Type	Length	%Slope	Roughness
100--EX	100	EX	CONDUIT	34.9	0.2005	0.0130
101--ADS	101	ADS	CONDUIT	2.2	0.9982	0.0130
102--101	102	101	CONDUIT	9.6	0.9945	0.0130
103--102	103	102	CONDUIT	57.5	0.3041	0.0130
BLDG--102	BLDG	102	CONDUIT	37.1	1.0022	0.0130
EX--HEADWALL	EX	HEADWALL	CONDUIT	11.1	1.1532	0.0130
100-01	ADS	100	ORIFICE			
100-02	ADS	100	ORIFICE			
105--OF4	105	OF4	ORIFICE			
CB102A-0	CB102A-1	102	ORIFICE			
CB103A-0	CB103A-1	103	ORIFICE			
CB103B-0	CB103B-1	103	ORIFICE			
CB103C-0	CB103C-1	103	ORIFICE			
CB103D-0	CB103D-1	103	ORIFICE			
CB103E-0	CB103E-1	103	ORIFICE			
CB106A-0	CB106A-1	ADS	ORIFICE			
CBMH104A-0	104	103	ORIFICE			
EX502-0	EX502	OF1	ORIFICE			
100-W1	ADS	100	WEIR			
W1	105	104	WEIR			
ROOF1-0	ROOF1-S	BLDG	OUTLET			
ROOF2-0	ROOF2-S	BLDG	OUTLET			

POST-DEVELOPMENT MODEL

ROOF3-0	ROOF3-S	BLDG	OUTLET
ROOF4-0	ROOF4-S	BLDG	OUTLET

Cross Section Summary

Conduit	Shape	Full Depth	Full Area	Hyd. Rad.	Max. Width	No. of Barrels	Full Flow
100--EX	CIRCULAR	0.53	0.22	0.13	0.53	1	192.58
101--ADS	CIRCULAR	0.45	0.16	0.11	0.45	1	284.87
102--101	CIRCULAR	0.45	0.16	0.11	0.45	1	284.34
103--102	CIRCULAR	0.45	0.16	0.11	0.45	1	157.24
BLDG--102	CIRCULAR	0.45	0.16	0.11	0.45	1	285.43
EX--HEADWALL	CIRCULAR	0.68	0.36	0.17	0.68	1	902.75

Transect Summary

Transect Overland
Area:

0.0196	0.0392	0.0588	0.0784	0.0980
0.1177	0.1374	0.1571	0.1768	0.1965
0.2162	0.2360	0.2558	0.2756	0.2954
0.3152	0.3351	0.3550	0.3748	0.3947
0.4147	0.4346	0.4546	0.4745	0.4945
0.5145	0.5346	0.5546	0.5747	0.5947
0.6148	0.6350	0.6551	0.6752	0.6954
0.7156	0.7358	0.7560	0.7762	0.7965
0.8168	0.8371	0.8574	0.8777	0.8980
0.9184	0.9388	0.9592	0.9796	1.0000

Hrad:

0.0208	0.0415	0.0622	0.0829	0.1036
0.1242	0.1448	0.1653	0.1858	0.2063

POST-DEVELOPMENT MODEL

	0.2268	0.2472	0.2676	0.2879	0.3083
	0.3285	0.3488	0.3690	0.3892	0.4094
	0.4295	0.4496	0.4697	0.4897	0.5097
	0.5297	0.5496	0.5695	0.5894	0.6093
	0.6291	0.6489	0.6686	0.6884	0.7081
	0.7277	0.7474	0.7670	0.7865	0.8061
	0.8256	0.8451	0.8646	0.8840	0.9034
	0.9228	0.9421	0.9614	0.9807	1.0000
Width:					
	0.9580	0.9589	0.9597	0.9606	0.9614
	0.9623	0.9631	0.9640	0.9649	0.9657
	0.9666	0.9674	0.9683	0.9691	0.9700
	0.9709	0.9717	0.9726	0.9734	0.9743
	0.9751	0.9760	0.9769	0.9777	0.9786
	0.9794	0.9803	0.9811	0.9820	0.9829
	0.9837	0.9846	0.9854	0.9863	0.9871
	0.9880	0.9889	0.9897	0.9906	0.9914
	0.9923	0.9931	0.9940	0.9949	0.9957
	0.9966	0.9974	0.9983	0.9991	1.0000

Transect Overland(orig)
Area:

	0.0196	0.0392	0.0588	0.0784	0.0980
	0.1177	0.1374	0.1571	0.1768	0.1965
	0.2162	0.2360	0.2558	0.2756	0.2954
	0.3152	0.3351	0.3550	0.3748	0.3947
	0.4147	0.4346	0.4546	0.4745	0.4945
	0.5145	0.5346	0.5546	0.5747	0.5947
	0.6148	0.6350	0.6551	0.6752	0.6954
	0.7156	0.7358	0.7560	0.7762	0.7965
	0.8168	0.8371	0.8574	0.8777	0.8980
	0.9184	0.9388	0.9592	0.9796	1.0000
Hrad:					
	0.0208	0.0415	0.0622	0.0829	0.1036
	0.1242	0.1448	0.1653	0.1858	0.2063
	0.2268	0.2472	0.2676	0.2879	0.3083
	0.3285	0.3488	0.3690	0.3892	0.4094
	0.4295	0.4496	0.4697	0.4897	0.5097

POST-DEVELOPMENT MODEL

	0.5297	0.5496	0.5695	0.5894	0.6093
	0.6291	0.6489	0.6686	0.6884	0.7081
	0.7277	0.7474	0.7670	0.7865	0.8061
	0.8256	0.8451	0.8646	0.8840	0.9034
	0.9228	0.9421	0.9614	0.9807	1.0000
Width:					
	0.9580	0.9589	0.9597	0.9606	0.9614
	0.9623	0.9631	0.9640	0.9649	0.9657
	0.9666	0.9674	0.9683	0.9691	0.9700
	0.9709	0.9717	0.9726	0.9734	0.9743
	0.9751	0.9760	0.9769	0.9777	0.9786
	0.9794	0.9803	0.9811	0.9820	0.9829
	0.9837	0.9846	0.9854	0.9863	0.9871
	0.9880	0.9889	0.9897	0.9906	0.9914
	0.9923	0.9931	0.9940	0.9949	0.9957
	0.9966	0.9974	0.9983	0.9991	1.0000

 NOTE: The summary statistics displayed in this report are based on results found at every computational time step, not just on results from each reporting time step.

Analysis Options

Flow Units LPS

Process Models:

Rainfall/Runoff YES

RDII NO

Snowmelt NO

Groundwater NO

Flow Routing YES

Ponding Allowed YES

Water Quality NO

Infiltration Method HORTON

Flow Routing Method DYNWAVE

POST-DEVELOPMENT MODEL

Surcharge Method EXTRAN
 Starting Date 07/23/2009 00:00:00
 Ending Date 07/24/2009 00:00:00
 Antecedent Dry Days 0.0
 Report Time Step 00:05:00
 Wet Time Step 00:05:00
 Dry Time Step 00:05:00
 Routing Time Step 1.00 sec
 Variable Time Step NO
 Maximum Trials 8
 Number of Threads 4
 Head Tolerance 0.001500 m

```

*****
Volume      Depth
Runoff Quantity Continuity  hectare-m      mm
*****
Total Precipitation ..... 0.229      95.520
Evaporation Loss ..... 0.000      0.000
Infiltration Loss ..... 0.070      28.998
Surface Runoff ..... 0.158      65.872
Final Storage ..... 0.002      0.972
Continuity Error (%) ..... -0.338
  
```

```

*****
Volume      Volume
Flow Routing Continuity  hectare-m      10^6 ltr
*****
Dry Weather Inflow ..... 0.000      0.000
Wet Weather Inflow ..... 0.158      1.581
Groundwater Inflow ..... 0.000      0.000
RDII Inflow ..... 0.000      0.000
External Inflow ..... 0.183      1.828
External Outflow ..... 0.339      3.387
Flooding Loss ..... 0.000      0.000
Evaporation Loss ..... 0.000      0.000
Exfiltration Loss ..... 0.000      0.000
Initial Stored Volume .... 0.000      0.002
  
```

POST-DEVELOPMENT MODEL

Final Stored Volume 0.002 0.023
 Continuity Error (%) 0.029

 Highest Flow Instability Indexes

 Link CB106A-0 (5)

 Routing Time Step Summary

 Minimum Time Step : 1.00 sec
 Average Time Step : 1.00 sec
 Maximum Time Step : 1.00 sec
 Percent in Steady State : 0.00
 Average Iterations per Step : 2.00
 Percent Not Converging : 0.00

 Subcatchment Runoff Summary

Total	Peak	Runoff	Total	Total	Total	Total	Imperv	Perv	Total
Runoff	Runoff	Coeff	Precip	Runon	Evap	Infil	Runoff	Runoff	Runoff
Subcatchment	Subcatchment		mm	mm	mm	mm	mm	mm	mm
ltr	LPS								10^6

EXT-1			95.52	0.00	0.00	52.88	36.25	42.54	42.54

POST-DEVELOPMENT MODEL

0.03	22.64	0.445							
L102A			95.52	0.00	0.00	10.83	78.08	5.67	83.75
0.05	21.23	0.877							
L103A			95.52	0.00	0.00	15.53	71.41	7.82	79.23
0.12	52.89	0.829							
L103B			95.52	0.00	0.00	12.60	75.29	6.65	81.94
0.05	20.46	0.858							
L103C			95.52	0.00	0.00	18.08	67.23	9.42	76.64
0.06	24.66	0.802							
L103D			95.52	0.00	0.00	22.32	62.00	10.59	72.59
0.17	77.30	0.760							
L103E			95.52	0.00	0.00	17.77	68.77	8.26	77.04
0.18	77.22	0.806							
L104A			95.52	0.00	0.00	10.77	77.96	5.72	83.68
0.06	23.49	0.876							
L104B			95.52	0.00	0.00	12.61	75.31	6.64	81.95
0.05	20.34	0.858							
L106A			95.52	0.00	0.00	14.59	72.76	7.39	80.14
0.11	48.55	0.839							
L502A			95.52	0.00	0.00	0.00	94.00	0.00	94.00
0.04	13.13	0.984							
L502B			95.52	0.00	0.00	36.71	38.95	19.60	58.55
0.05	27.60	0.613							
RAMP			95.52	0.00	0.00	0.00	94.06	0.00	94.06
0.02	7.74	0.985							
ROOF1			95.52	0.00	0.00	0.00	94.37	0.00	94.37
0.02	7.14	0.988							
ROOF2			95.52	0.00	0.00	0.00	94.37	0.00	94.37
0.21	77.50	0.988							
ROOF3			95.52	0.00	0.00	0.00	94.37	0.00	94.37
0.17	65.11	0.988							
ROOF4			95.52	0.00	0.00	0.00	94.37	0.00	94.37
0.02	7.15	0.988							
UNC-2			95.52	0.00	0.00	73.93	8.08	21.55	21.55
0.11	32.31	0.226							
UNC-3			95.52	0.00	0.00	43.06	57.72	51.73	51.73
0.04	23.41	0.542							
UNC-4			95.52	0.00	0.00	53.14	34.91	42.24	42.24

POST-DEVELOPMENT MODEL

0.02 16.95 0.442

Node Depth Summary

Node	Type	Average Depth Meters	Maximum Depth Meters	Maximum HGL Meters	Time of Max Occurrence days hr:min	Reported Max Depth Meters
HEADWALL	OUTFALL	0.35	0.35	99.83	0 00:00	0.35
OF1	OUTFALL	0.00	0.00	102.02	0 00:00	0.00
OF3	OUTFALL	0.00	0.00	0.00	0 00:00	0.00
OF4	OUTFALL	0.30	0.30	102.17	0 00:00	0.30
POOLE	OUTFALL	0.00	0.00	0.00	0 00:00	0.00
100	STORAGE	0.09	0.33	100.23	0 06:24	0.33
101	STORAGE	0.48	1.81	103.20	0 06:24	1.81
102	STORAGE	0.19	1.33	103.23	0 06:24	1.33
103	STORAGE	0.12	1.23	103.36	0 06:24	1.23
104	STORAGE	0.08	1.43	104.04	0 06:18	1.43
105	STORAGE	0.03	1.78	104.46	0 06:15	1.78
ADS	STORAGE	0.50	1.83	103.20	0 06:24	1.82
BLDG	STORAGE	0.03	0.46	103.24	0 06:23	0.46
CB102A-1	STORAGE	0.03	1.10	103.99	0 06:15	1.10
CB103A-1	STORAGE	0.03	0.79	103.86	0 06:15	0.79
CB103B-1	STORAGE	0.07	1.47	103.89	0 06:17	1.46
CB103C-1	STORAGE	0.05	1.48	104.18	0 06:17	1.48
CB103D-1	STORAGE	0.06	1.56	104.18	0 06:17	1.55
CB103E-1	STORAGE	0.09	1.59	104.02	0 06:19	1.59
CB106A-1	STORAGE	0.18	1.54	103.51	0 06:19	1.54
EX	STORAGE	0.22	0.29	99.90	0 06:29	0.29
EX502	STORAGE	0.07	2.15	104.17	0 06:17	2.14
ROOF1-S	STORAGE	0.01	0.13	110.13	0 06:19	0.13
ROOF2-S	STORAGE	0.03	0.15	110.15	0 06:28	0.15
ROOF3-S	STORAGE	0.03	0.15	110.15	0 06:25	0.15
ROOF4-S	STORAGE	0.01	0.13	110.13	0 06:19	0.13

POST-DEVELOPMENT MODEL

Node Inflow Summary

Node	Type	Maximum	Maximum	Time of Max Occurrence days hr:min	Lateral	Total	Flow Balance Error Percent
		Lateral Inflow LPS	Total Inflow LPS		Inflow Volume 10^6 ltr	Inflow Volume 10^6 ltr	
HEADWALL	OUTFALL	0.00	259.69	0 06:29	0	3.12	0.000
OF1	OUTFALL	0.00	19.91	0 06:17	0	0.0841	0.000
OF3	OUTFALL	23.41	23.41	0 06:15	0.0359	0.0359	0.000
OF4	OUTFALL	0.00	18.06	0 06:15	0	0.0364	0.000
POOLE	OUTFALL	32.31	32.31	0 06:15	0.113	0.113	0.000
100	STORAGE	0.00	155.39	0 06:24	0	1.29	0.016
101	STORAGE	0.00	232.81	0 06:06	0	1.2	-0.009
102	STORAGE	0.00	234.39	0 06:09	0	1.19	-0.300
103	STORAGE	0.00	189.58	0 06:06	0	0.704	0.643
104	STORAGE	43.84	65.36	0 06:15	0.105	0.12	0.005
105	STORAGE	39.58	39.58	0 06:15	0.0511	0.0511	0.000
ADS	STORAGE	0.00	254.20	0 06:06	0	1.31	-0.002
BLDG	STORAGE	7.74	54.09	0 06:21	0.0207	0.442	0.028
CB102A-1	STORAGE	21.23	21.23	0 06:15	0.0515	0.0515	0.000
CB103A-1	STORAGE	52.89	52.89	0 06:15	0.123	0.123	0.000
CB103B-1	STORAGE	20.46	20.46	0 06:15	0.0487	0.0487	0.002
CB103C-1	STORAGE	24.66	24.66	0 06:15	0.0555	0.0555	-0.000
CB103D-1	STORAGE	77.30	77.30	0 06:15	0.174	0.174	0.006
CB103E-1	STORAGE	77.22	77.22	0 06:15	0.183	0.183	0.001
CB106A-1	STORAGE	48.55	48.55	0 06:15	0.114	0.114	0.044
EX	STORAGE	136.19	259.65	0 06:29	1.83	3.12	0.000
EX502	STORAGE	40.73	40.73	0 06:15	0.0841	0.0841	0.009
ROOF1-S	STORAGE	7.14	7.14	0 06:15	0.0192	0.0192	-0.002
ROOF2-S	STORAGE	77.50	77.50	0 06:15	0.208	0.208	-0.001
ROOF3-S	STORAGE	65.11	65.11	0 06:15	0.175	0.175	-0.001
ROOF4-S	STORAGE	7.15	7.15	0 06:15	0.0192	0.0192	-0.002

POST-DEVELOPMENT MODEL

Node Surcharge Summary

No nodes were surcharged.

Node Flooding Summary

No nodes were flooded.

Storage Volume Summary

Storage Unit	Average Volume 1000 m3	Avg Pcnt Full	Evap Pcnt Loss	Exfil Pcnt Loss	Maximum Volume 1000 m3	Max Pcnt Full	Time of Max Occurrence days hr:min	Maximum Outflow LPS
100	0.000	0	0	0	0.000	0	0 00:00	154.85
101	0.000	0	0	0	0.000	0	0 00:00	232.23
102	0.000	0	0	0	0.000	0	0 00:00	232.81
103	0.000	0	0	0	0.000	0	0 00:00	186.16
104	0.001	1	0	0	0.032	64	0 06:18	22.75
105	0.000	0	0	0	0.000	0	0 00:00	39.58
ADS	0.175	36	0	0	0.485	100	0 06:20	155.39
BLDG	0.000	0	0	0	0.000	0	0 00:00	41.34
CB102A-1	0.000	0	0	0	0.000	10	0 06:15	21.18
CB103A-1	0.000	0	0	0	0.000	7	0 06:15	52.77
CB103B-1	0.000	0	0	0	0.005	9	0 06:17	14.60
CB103C-1	0.000	0	0	0	0.007	24	0 06:17	16.09
CB103D-1	0.000	0	0	0	0.016	41	0 06:17	53.41

POST-DEVELOPMENT MODEL

CB103E-1	0.001	1	0	0	0.032	48	0	06:19	36.63
CB106A-1	0.001	1	0	0	0.022	28	0	06:19	22.62
EX	0.000	0	0	0	0.000	0	0	00:00	259.69
EX502	0.000	1	0	0	0.017	66	0	06:17	19.91
ROOF1-S	0.000	2	0	0	0.006	68	0	06:19	2.29
ROOF2-S	0.009	10	0	0	0.084	94	0	06:28	11.19
ROOF3-S	0.007	9	0	0	0.069	93	0	06:25	9.90
ROOF4-S	0.000	2	0	0	0.006	68	0	06:19	2.29

 Outfall Loading Summary

Outfall Node	Flow Freq Pcnt	Avg Flow LPS	Max Flow LPS	Total Volume 10^6 ltr
HEADWALL	94.95	38.00	259.69	3.117
OF1	47.03	2.07	19.91	0.084
OF3	12.62	3.29	23.41	0.036
OF4	6.47	6.50	18.06	0.036
POOLE	12.30	10.66	32.31	0.113
System	34.67	60.52	313.12	3.387

 Link Flow Summary

Link	Type	Maximum Flow LPS	Time of Max Occurrence days hr:min	Maximum VLoc m/sec	Max/ Full Flow	Max/ Full Depth
100--EX	CONDUIT	154.85	0 06:24	1.23	0.80	0.56

POST-DEVELOPMENT MODEL

101--ADS	CONDUIT	232.23	0 06:06	1.46	0.82	1.00
102--101	CONDUIT	232.81	0 06:06	1.61	0.82	1.00
103--102	CONDUIT	186.16	0 06:05	1.21	1.18	1.00
BLDG--102	CONDUIT	41.34	0 06:21	1.16	0.14	1.00
EX--HEADWALL	CONDUIT	259.69	0 06:29	1.56	0.29	0.47
100-01	ORIFICE	18.32	0 06:24			1.00
100-02	ORIFICE	78.16	0 06:24			1.00
105--OF4	ORIFICE	18.06	0 06:15			1.00
CB102A-0	ORIFICE	21.18	0 06:15			1.00
CB103A-0	ORIFICE	52.77	0 06:15			1.00
CB103B-0	ORIFICE	14.60	0 06:05			1.00
CB103C-0	ORIFICE	16.09	0 06:06			1.00
CB103D-0	ORIFICE	53.41	0 06:06			1.00
CB103E-0	ORIFICE	36.63	0 06:02			1.00
CB106A-0	ORIFICE	22.62	0 06:03			1.00
CBMH104A-0	ORIFICE	22.75	0 06:05			1.00
EX502-0	ORIFICE	19.91	0 06:17			1.00
100-W1	WEIR	58.91	0 06:24			0.66
W1	WEIR	21.52	0 06:15			0.24
ROOF1-0	DUMMY	2.29	0 06:19			
ROOF2-0	DUMMY	11.19	0 06:28			
ROOF3-0	DUMMY	9.90	0 06:25			
ROOF4-0	DUMMY	2.29	0 06:19			

 Flow Classification Summary

Conduit	Adjusted /Actual Length	Fraction of Time in Flow Class								
		Dry	Up Dry	Down Dry	Sub Crit	Sup Crit	Up Crit	Down Crit	Norm Ltd	Inlet Ctrl
100--EX	1.00	0.04	0.00	0.00	0.00	0.00	0.00	0.96	0.00	0.00
101--ADS	1.00	0.04	0.00	0.00	0.92	0.01	0.00	0.04	0.00	0.00
102--101	1.00	0.04	0.00	0.00	0.42	0.00	0.00	0.54	0.05	0.00
103--102	1.00	0.04	0.00	0.00	0.35	0.00	0.00	0.61	0.07	0.00

POST-DEVELOPMENT MODEL

BLDG--102 1.00 0.04 0.00 0.00 0.08 0.01 0.00 0.88 0.06 0.00
 EX--HEADWALL 1.00 0.00 0.00 0.00 1.00 0.00 0.00 0.00 0.00 0.00

 Conduit Surcharge Summary

```

-----
Conduit                    ----- Hours Full -----            Hours            Hours
                          Both Ends    Upstream    Dnstream       Above Full       Capacity
                                                                                                                        
-----
101--ADS                    10.01       10.01       10.33            0.01            0.01
102--101                    4.05        4.05        5.33            0.01            0.01
103--102                    1.68        1.73        2.75            0.24            0.23
BLDG--102                    0.08        0.08        0.80            0.01            0.01
    
```

Analysis begun on: Fri Sep 1 13:36:53 2023
 Analysis ended on: Fri Sep 1 13:36:55 2023
 Total elapsed time: 00:00:02

POST-DEVELOPMENT MODEL

EPA STORM WATER MANAGEMENT MODEL - VERSION 5.1 (Build 5.1.015)

Element Count

Number of rain gages 1
 Number of subcatchments ... 20
 Number of nodes 26
 Number of links 24
 Number of pollutants 0
 Number of land uses 0

Raingage Summary

Name	Data Source	Data Type	Recording Interval
RG1	002CHI	INTENSITY	10 min.

Subcatchment Summary

Name	Area	Width	%Imperv	%Slope	Rain Gage	Outlet
EXT-1	0.07	95.00	38.57	1.5000	RG1	105
L102A	0.06	18.50	82.86	2.5000	RG1	CB102A-1
L103A	0.16	28.20	75.71	2.5000	RG1	CB103A-1
L103B	0.06	28.60	80.00	2.5000	RG1	CB103B-1
L103C	0.07	29.90	71.43	2.5000	RG1	CB103C-1
L103D	0.24	31.70	65.71	2.5000	RG1	CB103D-1
L103E	0.24	21.00	72.86	2.5000	RG1	CB103E-1

POST-DEVELOPMENT MODEL

L104A	0.07	38.60	82.86	2.5000	RG1	104
L104B	0.06	24.60	80.00	2.5000	RG1	104
L106A	0.14	26.50	77.14	2.5000	RG1	CB106A-1
L502A	0.04	88.00	100.00	0.8000	RG1	EX502
L502B	0.08	95.00	41.43	25.0000	RG1	EX502
RAMP	0.02	7.50	100.00	15.0000	RG1	BLDG
ROOF1	0.02	4.57	100.00	1.5000	RG1	ROOF1-S
ROOF2	0.22	49.54	100.00	1.5000	RG1	ROOF2-S
ROOF3	0.18	41.62	100.00	1.5000	RG1	ROOF3-S
ROOF4	0.02	4.57	100.00	1.5000	RG1	ROOF4-S
UNC-2	0.53	25.00	8.57	1.0000	RG1	POOLE
UNC-3	0.07	126.00	61.43	3.0000	RG1	OF3
UNC-4	0.05	90.00	37.14	10.0000	RG1	105

Node Summary

Name	Type	Invert Elev.	Max. Depth	Ponded Area	External Inflow
HEADWALL	OUTFALL	99.48	0.68	0.0	
OF1	OUTFALL	102.02	0.00	0.0	
OF3	OUTFALL	0.00	0.00	0.0	
OF4	OUTFALL	101.87	0.00	0.0	
POOLE	OUTFALL	0.00	0.00	0.0	
100	STORAGE	99.90	3.80	0.0	
101	STORAGE	101.39	2.74	0.0	
102	STORAGE	101.90	2.43	0.0	
103	STORAGE	102.13	1.94	0.0	
104	STORAGE	102.61	1.49	0.0	
105	STORAGE	102.68	1.83	0.0	
ADS	STORAGE	101.37	2.33	0.0	
BLDG	STORAGE	102.78	1.91	0.0	
CB102A-1	STORAGE	102.89	1.30	0.0	
CB103A-1	STORAGE	103.07	1.53	0.0	
CB103B-1	STORAGE	102.42	1.68	0.0	
CB103C-1	STORAGE	102.70	1.60	0.0	

POST-DEVELOPMENT MODEL

CB103D-1	STORAGE	102.62	1.66	0.0	
CB103E-1	STORAGE	102.43	1.68	0.0	
CB106A-1	STORAGE	101.97	1.68	0.0	
EX	STORAGE	99.61	2.08	0.0	Yes
EX502	STORAGE	102.02	2.20	0.0	
ROOF1-S	STORAGE	110.00	0.15	0.0	
ROOF2-S	STORAGE	110.00	0.15	0.0	
ROOF3-S	STORAGE	110.00	0.15	0.0	
ROOF4-S	STORAGE	110.00	0.15	0.0	

Link Summary

Name	From Node	To Node	Type	Length	%Slope	Roughness
100--EX	100	EX	CONDUIT	34.9	0.2005	0.0130
101--ADS	101	ADS	CONDUIT	2.2	0.9982	0.0130
102--101	102	101	CONDUIT	9.6	0.9945	0.0130
103--102	103	102	CONDUIT	57.5	0.3041	0.0130
BLDG--102	BLDG	102	CONDUIT	37.1	1.0022	0.0130
EX--HEADWALL	EX	HEADWALL	CONDUIT	11.1	1.1532	0.0130
100-01	ADS	100	ORIFICE			
100-02	ADS	100	ORIFICE			
105--OF4	105	OF4	ORIFICE			
CB102A-0	CB102A-1	102	ORIFICE			
CB103A-0	CB103A-1	103	ORIFICE			
CB103B-0	CB103B-1	103	ORIFICE			
CB103C-0	CB103C-1	103	ORIFICE			
CB103D-0	CB103D-1	103	ORIFICE			
CB103E-0	CB103E-1	103	ORIFICE			
CB106A-0	CB106A-1	ADS	ORIFICE			
CBMH104A-0	104	103	ORIFICE			
EX502-0	EX502	OF1	ORIFICE			
100-W1	ADS	100	WEIR			
W1	105	104	WEIR			
ROOF1-0	ROOF1-S	BLDG	OUTLET			
ROOF2-0	ROOF2-S	BLDG	OUTLET			

POST-DEVELOPMENT MODEL

ROOF3-0	ROOF3-S	BLDG	OUTLET
ROOF4-0	ROOF4-S	BLDG	OUTLET

Cross Section Summary

Conduit	Shape	Full Depth	Full Area	Hyd. Rad.	Max. Width	No. of Barrels	Full Flow
100--EX	CIRCULAR	0.53	0.22	0.13	0.53	1	192.58
101--ADS	CIRCULAR	0.45	0.16	0.11	0.45	1	284.87
102--101	CIRCULAR	0.45	0.16	0.11	0.45	1	284.34
103--102	CIRCULAR	0.45	0.16	0.11	0.45	1	157.24
BLDG--102	CIRCULAR	0.45	0.16	0.11	0.45	1	285.43
EX--HEADWALL	CIRCULAR	0.68	0.36	0.17	0.68	1	902.75

Transect Summary

Transect Overland
Area:

0.0196	0.0392	0.0588	0.0784	0.0980
0.1177	0.1374	0.1571	0.1768	0.1965
0.2162	0.2360	0.2558	0.2756	0.2954
0.3152	0.3351	0.3550	0.3748	0.3947
0.4147	0.4346	0.4546	0.4745	0.4945
0.5145	0.5346	0.5546	0.5747	0.5947
0.6148	0.6350	0.6551	0.6752	0.6954
0.7156	0.7358	0.7560	0.7762	0.7965
0.8168	0.8371	0.8574	0.8777	0.8980
0.9184	0.9388	0.9592	0.9796	1.0000

Hrad:

0.0208	0.0415	0.0622	0.0829	0.1036
0.1242	0.1448	0.1653	0.1858	0.2063

POST-DEVELOPMENT MODEL

	0.2268	0.2472	0.2676	0.2879	0.3083
	0.3285	0.3488	0.3690	0.3892	0.4094
	0.4295	0.4496	0.4697	0.4897	0.5097
	0.5297	0.5496	0.5695	0.5894	0.6093
	0.6291	0.6489	0.6686	0.6884	0.7081
	0.7277	0.7474	0.7670	0.7865	0.8061
	0.8256	0.8451	0.8646	0.8840	0.9034
	0.9228	0.9421	0.9614	0.9807	1.0000
Width:					
	0.9580	0.9589	0.9597	0.9606	0.9614
	0.9623	0.9631	0.9640	0.9649	0.9657
	0.9666	0.9674	0.9683	0.9691	0.9700
	0.9709	0.9717	0.9726	0.9734	0.9743
	0.9751	0.9760	0.9769	0.9777	0.9786
	0.9794	0.9803	0.9811	0.9820	0.9829
	0.9837	0.9846	0.9854	0.9863	0.9871
	0.9880	0.9889	0.9897	0.9906	0.9914
	0.9923	0.9931	0.9940	0.9949	0.9957
	0.9966	0.9974	0.9983	0.9991	1.0000

Transect Overland(orig)

Area:					
	0.0196	0.0392	0.0588	0.0784	0.0980
	0.1177	0.1374	0.1571	0.1768	0.1965
	0.2162	0.2360	0.2558	0.2756	0.2954
	0.3152	0.3351	0.3550	0.3748	0.3947
	0.4147	0.4346	0.4546	0.4745	0.4945
	0.5145	0.5346	0.5546	0.5747	0.5947
	0.6148	0.6350	0.6551	0.6752	0.6954
	0.7156	0.7358	0.7560	0.7762	0.7965
	0.8168	0.8371	0.8574	0.8777	0.8980
	0.9184	0.9388	0.9592	0.9796	1.0000
Hrad:					
	0.0208	0.0415	0.0622	0.0829	0.1036
	0.1242	0.1448	0.1653	0.1858	0.2063
	0.2268	0.2472	0.2676	0.2879	0.3083
	0.3285	0.3488	0.3690	0.3892	0.4094
	0.4295	0.4496	0.4697	0.4897	0.5097

POST-DEVELOPMENT MODEL

	0.5297	0.5496	0.5695	0.5894	0.6093
	0.6291	0.6489	0.6686	0.6884	0.7081
	0.7277	0.7474	0.7670	0.7865	0.8061
	0.8256	0.8451	0.8646	0.8840	0.9034
	0.9228	0.9421	0.9614	0.9807	1.0000
Width:					
	0.9580	0.9589	0.9597	0.9606	0.9614
	0.9623	0.9631	0.9640	0.9649	0.9657
	0.9666	0.9674	0.9683	0.9691	0.9700
	0.9709	0.9717	0.9726	0.9734	0.9743
	0.9751	0.9760	0.9769	0.9777	0.9786
	0.9794	0.9803	0.9811	0.9820	0.9829
	0.9837	0.9846	0.9854	0.9863	0.9871
	0.9880	0.9889	0.9897	0.9906	0.9914
	0.9923	0.9931	0.9940	0.9949	0.9957
	0.9966	0.9974	0.9983	0.9991	1.0000

 NOTE: The summary statistics displayed in this report are based on results found at every computational time step, not just on results from each reporting time step.

Analysis Options

Flow Units LPS

Process Models:

Rainfall/Runoff YES

RDII NO

Snowmelt NO

Groundwater NO

Flow Routing YES

Ponding Allowed YES

Water Quality NO

Infiltration Method HORTON

Flow Routing Method DYNWAVE

POST-DEVELOPMENT MODEL

Node	Area	Depth	31.86	0.00	0.00	24.40	11.73	7.49	7.49
EXT-1									
0.01	6.22	0.235							
L102A			31.86	0.00	0.00	5.44	25.27	0.04	25.31
0.02	10.94	0.794							
L103A			31.86	0.00	0.00	7.73	23.12	0.02	23.15
0.04	25.22	0.727							
L103B			31.86	0.00	0.00	6.35	24.36	0.06	24.41
0.01	10.26	0.766							
L103C			31.86	0.00	0.00	9.08	21.75	0.05	21.80
0.02	11.15	0.684							
L103D			31.86	0.00	0.00	10.92	20.08	0.02	20.10
0.05	33.55	0.631							
L103E			31.86	0.00	0.00	8.64	22.27	0.01	22.28
0.05	36.34	0.700							
L104A			31.86	0.00	0.00	5.43	25.22	0.06	25.28
0.02	12.17	0.794							
L104B			31.86	0.00	0.00	6.35	24.37	0.05	24.42
0.01	10.18	0.766							
L106A			31.86	0.00	0.00	7.27	23.56	0.02	23.58
0.03	23.50	0.740							
L502A			31.86	0.00	0.00	0.00	30.40	0.00	30.40
0.01	7.96	0.954							
L502B			31.86	0.00	0.00	18.52	12.61	0.38	12.99
0.01	8.47	0.408							
RAMP			31.86	0.00	0.00	0.00	30.42	0.00	30.42
0.01	4.69	0.955							
ROOF1			31.86	0.00	0.00	0.00	30.56	0.00	30.56
0.01	4.31	0.959							
ROOF2			31.86	0.00	0.00	0.00	30.56	0.00	30.56
0.07	46.70	0.959							
ROOF3			31.86	0.00	0.00	0.00	30.56	0.00	30.56
0.06	39.23	0.959							
ROOF4			31.86	0.00	0.00	0.00	30.56	0.00	30.56
0.01	4.31	0.959							
UNC-2			31.86	0.00	0.00	31.70	2.61	0.05	0.05
0.00	0.23	0.001							
UNC-3			31.86	0.00	0.00	17.67	18.69	13.69	13.69

POST-DEVELOPMENT MODEL

0.01	12.35	0.430							
UNC-4			31.86	0.00	0.00	24.47	11.30	7.78	7.78
0.00	7.02	0.244							

Node Depth Summary

Node	Type	Average Depth Meters	Maximum Depth Meters	Maximum HGL Meters	Time of Max Occurrence days hr:min	Reported Max Depth Meters
HEADWALL	OUTFALL	0.04	0.08	99.56	0 06:35	0.08
OF1	OUTFALL	0.00	0.00	102.02	0 00:00	0.00
OF3	OUTFALL	0.00	0.00	0.00	0 00:00	0.00
OF4	OUTFALL	0.30	0.30	102.17	0 00:00	0.30
POOLE	OUTFALL	0.00	0.00	0.00	0 00:00	0.00
100	STORAGE	0.05	0.09	100.00	0 03:13	0.09
101	STORAGE	0.21	0.81	102.21	0 02:59	0.81
102	STORAGE	0.04	0.28	102.18	0 03:11	0.28
103	STORAGE	0.01	0.39	102.52	0 01:10	0.38
104	STORAGE	0.01	1.17	103.78	0 01:10	1.17
105	STORAGE	0.01	0.71	103.39	0 01:12	0.62
ADS	STORAGE	0.23	0.81	102.18	0 03:13	0.81
BLDG	STORAGE	0.01	0.09	102.87	0 01:10	0.09
CB102A-1	STORAGE	0.01	0.33	103.22	0 01:10	0.33
CB103A-1	STORAGE	0.01	0.25	103.32	0 01:10	0.25
CB103B-1	STORAGE	0.01	0.62	103.04	0 01:10	0.61
CB103C-1	STORAGE	0.01	0.67	103.37	0 01:10	0.67
CB103D-1	STORAGE	0.01	0.60	103.22	0 01:10	0.60
CB103E-1	STORAGE	0.02	1.28	103.71	0 01:10	1.27
CB106A-1	STORAGE	0.03	1.26	103.23	0 01:10	1.26
EX	STORAGE	0.04	0.08	99.68	0 06:35	0.08
EX502	STORAGE	0.01	1.29	103.31	0 01:10	1.27
ROOF1-S	STORAGE	0.00	0.09	110.09	0 01:14	0.09
ROOF2-S	STORAGE	0.01	0.11	110.11	0 01:26	0.11

POST-DEVELOPMENT MODEL

ROOF3-S	STORAGE	0.01	0.10	110.10	0	01:25	0.10
ROOF4-S	STORAGE	0.00	0.09	110.09	0	01:14	0.09

Node Inflow Summary

Node	Type	Maximum Lateral Inflow LPS	Maximum Total Inflow LPS	Time of Max Occurrence days hr:min	Lateral Inflow Volume 10^6 ltr	Total Inflow Volume 10^6 ltr	Flow Balance Error Percent
HEADWALL	OUTFALL	0.00	23.63	0 06:35	0	0.839	0.000
OF1	OUTFALL	0.00	15.31	0 01:10	0	0.0222	0.000
OF3	OUTFALL	12.35	12.35	0 01:10	0.00949	0.00949	0.000
OF4	OUTFALL	0.00	11.23	0 01:12	0	0.00916	0.000
POOLE	OUTFALL	0.23	0.23	0 01:20	0.000238	0.000238	0.000
100	STORAGE	0.00	12.04	0 03:13	0	0.387	0.012
101	STORAGE	0.00	168.76	0 01:10	0	0.386	0.084
102	STORAGE	0.00	168.73	0 01:10	0	0.357	-0.126
103	STORAGE	0.00	136.24	0 01:10	0	0.199	0.228
104	STORAGE	22.35	22.35	0 01:10	0.0316	0.0316	0.000
105	STORAGE	13.24	13.24	0 01:10	0.00916	0.00916	0.000
ADS	STORAGE	0.00	191.05	0 01:10	0	0.419	-0.088
BLDG	STORAGE	4.69	23.08	0 01:10	0.00669	0.143	0.006
CB102A-1	STORAGE	10.94	10.94	0 01:10	0.0156	0.0156	0.000
CB103A-1	STORAGE	25.22	25.22	0 01:10	0.036	0.036	0.000
CB103B-1	STORAGE	10.26	10.26	0 01:10	0.0145	0.0145	0.000
CB103C-1	STORAGE	11.15	11.15	0 01:10	0.0158	0.0158	0.000
CB103D-1	STORAGE	33.55	33.55	0 01:10	0.0481	0.0481	0.000
CB103E-1	STORAGE	36.34	36.34	0 01:10	0.0529	0.0529	0.000
CB106A-1	STORAGE	23.50	23.50	0 01:10	0.0336	0.0336	0.113
EX	STORAGE	15.19	23.63	0 06:35	0.453	0.839	0.001
EX502	STORAGE	16.42	16.42	0 01:10	0.0222	0.0222	0.000
ROOF1-S	STORAGE	4.31	4.31	0 01:10	0.0062	0.0062	-0.008
ROOF2-S	STORAGE	46.70	46.70	0 01:10	0.0673	0.0673	-0.004

POST-DEVELOPMENT MODEL

ROOF3-S	STORAGE	39.23	39.23	0	01:10	0.0565	0.0565	-0.004
ROOF4-S	STORAGE	4.31	4.31	0	01:10	0.00621	0.00621	-0.008

Node Surcharge Summary

No nodes were surcharged.

Node Flooding Summary

No nodes were flooded.

Storage Volume Summary

Storage Unit	Average Volume 1000 m3	Avg Pcnt Full	Evap Pcnt Loss	Exfil Pcnt Loss	Maximum Volume 1000 m3	Max Pcnt Full	Time of Max Occurrence days hr:min	Maximum Outflow LPS
100	0.000	0	0	0	0.000	0	0 00:00	12.04
101	0.000	0	0	0	0.000	0	0 00:00	168.33
102	0.000	0	0	0	0.000	0	0 00:00	168.76
103	0.000	0	0	0	0.000	0	0 00:00	134.96
104	0.000	0	0	0	0.000	1	0 01:10	21.95
105	0.000	0	0	0	0.000	0	0 00:00	11.23
ADS	0.087	18	0	0	0.294	61	0 03:13	79.38
BLDG	0.000	0	0	0	0.000	0	0 00:00	23.02
CB102A-1	0.000	0	0	0	0.000	3	0 01:10	10.88
CB103A-1	0.000	0	0	0	0.000	2	0 01:10	25.16
CB103B-1	0.000	0	0	0	0.000	0	0 01:10	9.91

POST-DEVELOPMENT MODEL

Node	Flow	Flow	Flow	Flow	Time	Time
CB103C-1	0.000	0	0	0	0 01:10	10.88
CB103D-1	0.000	0	0	0	0 01:10	33.30
CB103E-1	0.000	0	0	0	0 01:10	35.13
CB106A-1	0.000	0	0	0	0 01:10	22.80
EX	0.000	0	0	0	0 00:00	23.63
EX502	0.000	0	0	0	0 01:10	15.31
ROOF1-S	0.000	0	0	0	0 01:14	1.74
ROOF2-S	0.002	2	0	0	0 01:26	8.82
ROOF3-S	0.001	2	0	0	0 01:25	7.79
ROOF4-S	0.000	0	0	0	0 01:14	1.74

 Outfall Loading Summary

Outfall Node	Flow Freq Pcmt	Avg Flow LPS	Max Flow LPS	Total Volume 10^6 ltr
HEADWALL	96.55	10.06	23.63	0.839
OF1	11.44	2.25	15.31	0.022
OF3	4.37	2.51	12.35	0.009
OF4	2.88	3.68	11.23	0.009
POOLE	1.73	0.16	0.23	0.000
System	23.39	18.66	44.49	0.881

 Link Flow Summary

Link	Type	Maximum Flow LPS	Time of Max Occurrence days hr:min	Maximum Veloc m/sec	Max/ Full Flow	Max/ Full Depth
------	------	--------------------	------------------------------------	-----------------------	----------------	-----------------

POST-DEVELOPMENT MODEL

100--EX	CONDUIT	12.04	0 03:13	0.56	0.06	0.15
101--ADS	CONDUIT	168.33	0 01:10	1.84	0.59	1.00
102--101	CONDUIT	168.76	0 01:10	1.81	0.59	0.75
103--102	CONDUIT	134.96	0 01:10	1.11	0.86	0.71
BLDG--102	CONDUIT	23.02	0 01:10	1.08	0.08	0.19
EX--HEADWALL	CONDUIT	23.63	0 06:35	1.08	0.03	0.11
100-01	ORIFICE	12.04	0 03:13			1.00
100-02	ORIFICE	0.00	0 00:00			0.00
105--OF4	ORIFICE	11.23	0 01:12			1.00
CB102A-0	ORIFICE	10.88	0 01:10			1.00
CB103A-0	ORIFICE	25.16	0 01:10			1.00
CB103B-0	ORIFICE	9.91	0 01:10			1.00
CB103C-0	ORIFICE	10.88	0 01:10			1.00
CB103D-0	ORIFICE	33.30	0 01:10			1.00
CB103E-0	ORIFICE	35.13	0 01:10			1.00
CB106A-0	ORIFICE	22.80	0 01:10			1.00
CBMH104A-0	ORIFICE	21.95	0 01:10			1.00
EX502-0	ORIFICE	15.31	0 01:10			1.00
100-W1	WEIR	0.00	0 00:00			0.00
W1	WEIR	0.00	0 00:00			0.00
ROOF1-0	DUMMY	1.74	0 01:14			
ROOF2-0	DUMMY	8.82	0 01:26			
ROOF3-0	DUMMY	7.79	0 01:25			
ROOF4-0	DUMMY	1.74	0 01:14			

 Flow Classification Summary

Conduit	Adjusted /Actual Length	Fraction of Time in Flow Class							
		Up Dry	Down Dry	Sub Dry	Sup Crit	Up Crit	Down Crit	Norm Ltd	Inlet Ctrl
100--EX	1.00	0.03	0.00	0.00	0.00	0.00	0.97	0.00	0.00
101--ADS	1.00	0.03	0.00	0.00	0.95	0.00	0.02	0.21	0.00

POST-DEVELOPMENT MODEL

102--101	1.00	0.02	0.00	0.00	0.23	0.00	0.00	0.74	0.05	0.00
103--102	1.00	0.02	0.00	0.00	0.15	0.00	0.00	0.83	0.13	0.00
BLDG--102	1.00	0.02	0.00	0.00	0.00	0.00	0.00	0.98	0.00	0.00
EX--HEADWALL	1.00	0.03	0.00	0.00	0.00	0.97	0.00	0.00	0.03	0.00

 Conduit Surcharge Summary

Conduit	Hours Full			Hours	Hours
	Both Ends	Upstream	Dnstream	Above Full Normal Flow	Capacity Limited
101--ADS	5.29	5.29	5.57	0.01	0.38

Analysis begun on: Fri Sep 1 13:31:29 2023
 Analysis ended on: Fri Sep 1 13:31:31 2023
 Total elapsed time: 00:00:02

**SERVICING AND STORMWATER MANAGEMENT BRIEF –
WELLINGS OF STITTSVILLE PHASE 2, 20 CEDAROW COURT**

Appendix C Stormwater Management
September 1, 2023

C.4 OIL/GRIT SEPARATOR SIZING CALCULATIONS



**CDS ESTIMATED NET ANNUAL SOLIDS LOAD REDUCTION
BASED ON THE RATIONAL RAINFALL METHOD
BASED ON A FINE PARTICLE SIZE DISTRIBUTION**



Project Name: Wellings of Stittsville
Location: Stittsville, ON
OGS #: OGS

Engineer: Stantec
Contact: Dustin Thiffault
Report Date: 10-Feb-23

Area 1.60 ha
Weighted C 0.56
CDS Model 2025

Rainfall Station # 215
Particle Size Distribution FINE
CDS Treatment Capacity 45 l/s

<u>Rainfall Intensity¹</u> <u>(mm/hr)</u>	<u>Percent Rainfall Volume¹</u>	<u>Cumulative Rainfall Volume</u>	<u>Total Flowrate (l/s)</u>	<u>Treated Flowrate (l/s)</u>	<u>Operating Rate (%)</u>	<u>Removal Efficiency (%)</u>	<u>Incremental Removal (%)</u>
0.5	9.2%	9.2%	1.2	1.2	2.7	98.1	9.0
1.0	10.6%	19.8%	2.5	2.5	5.5	97.3	10.3
1.5	9.9%	29.7%	3.7	3.7	8.2	96.5	9.6
2.0	8.4%	38.1%	5.0	5.0	11.0	95.7	8.0
2.5	7.7%	45.8%	6.2	6.2	13.7	94.9	7.3
3.0	5.9%	51.7%	7.5	7.5	16.5	94.1	5.6
3.5	4.4%	56.1%	8.7	8.7	19.2	93.3	4.1
4.0	4.7%	60.7%	10.0	10.0	22.0	92.6	4.3
4.5	3.3%	64.0%	11.2	11.2	24.7	91.8	3.0
5.0	3.0%	67.1%	12.5	12.5	27.5	91.0	2.7
6.0	5.4%	72.4%	14.9	14.9	33.0	89.4	4.8
7.0	4.4%	76.8%	17.4	17.4	38.5	87.8	3.8
8.0	3.5%	80.3%	19.9	19.9	44.0	86.3	3.1
9.0	2.8%	83.2%	22.4	22.4	49.5	84.7	2.4
10.0	2.2%	85.3%	24.9	24.9	55.0	83.1	1.8
15.0	7.0%	92.3%	37.4	37.4	82.5	75.2	5.3
20.0	4.5%	96.9%	49.8	45.3	100.0	63.8	2.9
25.0	1.4%	98.3%	62.3	45.3	100.0	51.1	0.7
30.0	0.7%	99.0%	74.7	45.3	100.0	42.6	0.3
35.0	0.5%	99.5%	87.2	45.3	100.0	36.5	0.2
40.0	0.5%	100.0%	99.6	45.3	100.0	31.9	0.2
45.0	0.0%	100.0%	112.1	45.3	100.0	28.4	0.0
50.0	0.0%	100.0%	124.5	45.3	100.0	25.5	0.0
							89.4

Removal Efficiency Adjustment² = 6.5%
Predicted Net Annual Load Removal Efficiency = 82.9%
Predicted Annual Rainfall Treated = 98.4%

1 - Based on 42 years of hourly rainfall data from Canadian Station 6105976, Ottawa ON

2 - Reduction due to use of 60-minute data for a site that has a time of concentration less than 30-minutes.

**SERVICING AND STORMWATER MANAGEMENT BRIEF –
WELLINGS OF STITTSVILLE PHASE 2, 20 CEDAROW COURT**

Appendix C Stormwater Management
September 1, 2023

C.5 CEDAROW COURT STORM SEWER CAPACITY

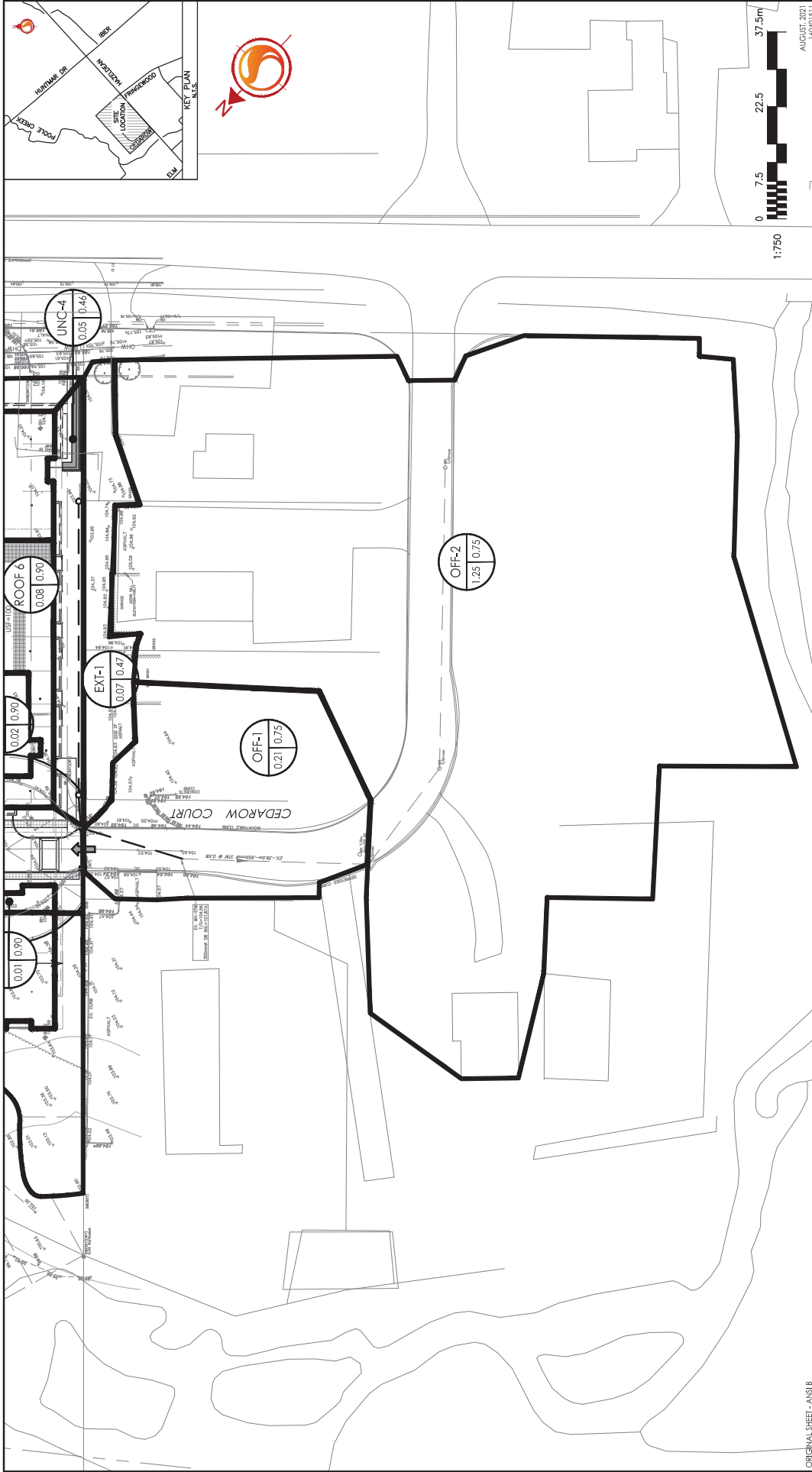

ORIGINAL SHEET - ANS1 B
 Client/Project: NAUTICAL LANDS GROUP
 WELLINGS OF STITTSVILLE PH 2
 20 CEDARROW COURT
 Figure No.: 1.0
 Title: CEDARROW COURT
 EXISTING STORM DRAINAGE PLAN
 AUGUST 2021
 160401511

Notes

- Legend
- OFF-1 (0.21 | 0.75) AREA ID
 - RUNOFF COEFFICIENT
 - STORM DRAINAGE AREA hg.
 - STORM DRAINAGE BOUNDARY
 - DIRECTION OF OVERLAND FLOW

Stantec
 Stantec Consulting Ltd.
 400 - 1331 Clyde Avenue
 Ottawa ON
 Tel. 613.722.4420
 www.stantec.com



DATE: 2024-09-01
 REVISION: 1
 DESIGNED BY: TR
 CHECKED BY:

Storm Sewer
 DESIGN SHEET
 (City of Ottawa)

DESIGN PARAMETERS
 (As per City of Ottawa Guidelines, 2012)

7.2 ft 1.5 ft 1.00 ft
 6.199 6.933 6.014 6.014 6.014
 0.212 0.214 0.214

11.00 ft 1.00 ft
 174.184 173.538
 6.014 6.014
 0.214

MANINGS n = 0.013
 MINIMUM COVER: 2.00 m
 BEDDING CLASS = B

AREA (SQ FT) TO MH

AREA ID NUMBER	LOCATION	FROM MH	TO MH	AREA (SQ FT)		C	C (5 YEAR)	C (10 YEAR)	C (25 YEAR)	A/C (5 YEAR)	A/C (10 YEAR)	A/C (25 YEAR)	A/C (100 YEAR)	A/C (100 YEAR) AC(100%)	T+G (mm)	S _{max} (mm)	S _{min} (mm)	S _{max} (mm)	S _{min} (mm)	S _{max} (mm)	S _{min} (mm)	Q _{max} (L/s)	Q _{min} (L/s)	Q _{max} (GAL/HR)	Q _{min} (GAL/HR)	ACUM. (L)	ACUM. (GAL)	LENGTH (mm)	PIPE ORDNATE (mm)	PIPE WIDTH (mm)	PIPE HIGHT (mm)	PIPE SHAPE	MATERIAL	CLASS	SLOPE (%)	Q ₁₀ (L/s)	Q ₁₀ (GAL)	% FILL (%)	VEL. (ACT) (m/s)	VEL. (FULL) (m/s)	TIME OF FLOW (min)				
				AREA (SQ FT)	AREA (SQ FT)																																					AREA (SQ FT)	AREA (SQ FT)	AREA (SQ FT)	AREA (SQ FT)
UNC-4 + EXT-1		CR507	EX1	0.00	0.12	0.00	0.00	0.00	0.00	0.00	0.00	0.00	0.00	0.00	0.00	104.19	122.14	174.96	0.0	0.0	0.0	0.0	0.0	0.0	0.0	0.0	0.0	0.0	213	250	250	CIRCULAR	CONCRETE	0.00	42.7	37.9%	0.86	0.86	0.82						
OFF-1		EX1	EX2	0.00	0.21	0.00	0.00	0.00	0.00	0.00	0.00	0.00	0.00	0.00	0.00	101.50	118.97	173.90	0.0	0.0	0.0	0.0	0.0	0.0	0.0	0.0	0.0	39.0	300	300	CIRCULAR	CONCRETE	0.00	68.0	87.02%	0.97	0.97	0.98							
OFF-2		EX2	POOLE CREEK	0.00	1.25	0.00	0.00	0.00	0.00	0.00	0.00	0.00	0.00	0.00	0.00	89.30	112.20	168.37	0.0	0.0	0.0	0.0	0.0	0.0	0.0	0.0	0.0	88.8	625	625	CIRCULAR	CONCRETE	0.00	353.3	88.82%	1.58	1.58	1.51							

**SERVICING AND STORMWATER MANAGEMENT BRIEF –
WELLINGS OF STITTSVILLE PHASE 2, 20 CEDAROW COURT**

Appendix C Stormwater Management
September 1, 2023

C.6 EXCERPTS FROM WOS PHASE 1

SERVICING AND STORMWATER MANAGEMENT BRIEF – 5731 HAZELDEAN ROAD

Stormwater Management
March 22, 2017

5.0 STORMWATER MANAGEMENT

5.1 OBJECTIVES

The objective of this stormwater management plan is to determine the measures necessary to control the quantity of stormwater released from the proposed development to established criteria, and to provide sufficient detail for approval and construction. The proposed development will discharge treated and controlled stormwater runoff to Poole Creek.

5.2 SWM CRITERIA AND CONSTRAINTS

Criteria were established by combining current design practices outlined by the City of Ottawa Design Guidelines (2012), Ministry of Environment and Climate Change (MOECC) and Mississippi Valley Conservation Authority (MVCA). The following summarizes the criteria, with the source of each criterion indicated in italics:

General

- Use of the dual drainage principle (City of Ottawa)
- Wherever feasible and practical, site-level measures should be used to reduce and control the volume and rate of runoff (City of Ottawa)
- Site-level infiltration measures to be implemented to meet infiltration criteria of minimum 50 mm/yr (MVCA)
- Assess impact of 100 year event outlined in the City of Ottawa Sewer Design Guidelines, and climate change scenarios with a 20% increase of rainfall intensity, on major & minor drainage system (City of Ottawa)
- Quality control to be provided for 80% TSS removal (MVCA, MOECC)
- Site discharge to be controlled to pre-development rates (MVCA, City of Ottawa)
- Site design to mitigate erosion impacts on Poole Creek (City of Ottawa)

Storm Sewer & Inlet Controls

- Size storm sewers to convey the 5 year storm event under free-flow conditions using City of Ottawa I-D-F parameters (City of Ottawa) with the exception of the outlet sewer from the proposed underground storage facility.
- Minimum sewer inlet capture rates to be set such that no ponding occurs at the end of the 5-year event (City of Ottawa)
- Hydraulic Grade Line (HGL) analysis to be conducted using the 100 year 12 hour SCS storm distribution (City of Ottawa).
- 100-year Storm HGL to be a minimum of 0.30 m below building foundation footing otherwise foundation drains will be pumped (City of Ottawa)

SERVICING AND STORMWATER MANAGEMENT BRIEF – 5731 HAZELDEAN ROAD

Stormwater Management
March 22, 2017

Surface Storage & Overland Flow

- Building openings to be a minimum of 0.30m above the 100-year water level (City of Ottawa)
- Maximum depth of flow under either static or dynamic conditions shall be less than 0.30m (City of Ottawa)
- Subdrains required in swales where longitudinal gradient is less than 1.5% (City of Ottawa)
- Provide adequate emergency overflow conveyance off-site (City of Ottawa)

5.2.1 Pre-Development Conditions

A lumped catchment PCSWMM model was created for the subject site based on a site area of 2.9ha, and utilizing an existing SCS curve number of 80 per background documents. Additional subcatchment parameters were defined based upon recent topographical survey of the property:

Area (ha)	Width (m)	Slope (%)	Imperv. (%)	Subarea Routing
2.90	161.1	1.0	0.0	Outlet

Based on the above and during the 2 through 100-year 12hr SCS events (MTO Distribution curves), peak pre-development outflow rates from the subject site were identified per the tables below:

Storm Event	2-Year	5-Year	10-Year
Peak Outflow Rate	17.7L/s	43.9L/s	66.2L/s

Storm Event	25-Year	50-Year	100-Year
Peak Outflow Rate	103.7L/s	136.5L/s	176.3L/s

PCSWMM model input and output files for the predevelopment scenario are included within **Appendix C**.

5.3 STORMWATER MANAGEMENT DESIGN

5.3.1 Rationale for Design and Servicing Deviations

5.3.1.1 Deviation from Kanata West MSS

Per the findings of the Kanata West MSS, stormwater outflows from the proposed site were intended to be directed to the storm sewer within Huntmar Drive, and in turn directed to the

SERVICING AND STORMWATER MANAGEMENT BRIEF – 5731 HAZELDEAN ROAD

Stormwater Management
March 22, 2017

downstream Fairwinds temporary pond 5. The MSS had assumed that the entire area of land west of Huntmar Drive and bound by Poole creek to the north and Hazeldean Road to the south was to be directed to the Huntmar Drive sewer, however, the proposed site forms only part of the tributary area, within lands owned by others blocking direct access to the storm sewer within Huntmar Drive. Rather than encumbering the adjacent property, and to avoid considerable connection fees associated with the outlet from the Kanata West Owners Group (KWOG), a separate outlet for the site to Poole Creek has been considered. As the downstream Pond 5 discharges to Poole Creek as well, by restricting flows to predevelopment levels, and assessing the erosive potential of such flows for the Poole Creek reach between the site outlet and that of the downstream Pond 5, no deleterious effects to the downstream watercourse are expected. Additionally, this option provides additional potential to supplement baseflows to Poole Creek in accordance with recommendations from the MVCA.

5.3.1.2 Deviation from Standard SWM Design

The proposed SWM design includes three LID measures to encourage on-site infiltration and water re-use for irrigation. It is recognized that these measures are not currently standard SWM controls and when they are used for water balance purposes are not traditionally included in SWM calculations due to concerns over longterm reliability. The proposed SWM design has included some of the storage and infiltration/reuse rates from these measures in the supporting analysis as discussed in the following sections. However the analysis has also included simulations assuming that these measures fail in order to assess the potential associated impacts. The benefit of including some of the storage and infiltration losses associated with the LID measures was that the end-of-pipe underground storage component of the infiltration gallery was able to be reduced by 30% as compared to previous design requirements when no credit was assigned for the LID measures. As discussed later in this report, a monitoring plan will be developed and implemented to ensure that constructed LID measures are performing as designed.

5.3.2 Design Methodology

The intent of the stormwater management plan presented herein is to mitigate negative impacts that the proposed development might have on the receiving watercourse (Poole Creek), while providing adequate capacity to service the proposed buildings, underground parking and access areas. The proposed stormwater management plan is designed to detain runoff on the rooftop, surface and in the subsurface (StormTech chamber) to ensure that peak flows after construction will not exceed the target discharge rates and erosion mitigation requirements.

Runoff from the site is captured via catchbasins, landscaping drains and roof drains and conveyed to a hydrodynamic separator for water quality treatment followed by an underground storage unit for quantity control. The storage unit is restricted by an ICD at the downstream end and is an open bottom unit designed to also promote infiltration. Roof runoff is controlled via roof drains discharging through the internal building plumbing to rainwater harvesting tanks. Two rainwater harvesting tanks are proposed for each building. Each rainwater

SERVICING AND STORMWATER MANAGEMENT BRIEF – 5731 HAZELDEAN ROAD

Stormwater Management
March 22, 2017

tank is capable of storing up to 91 m³ of runoff (approximately 32mm of rainfall) beyond which it will overflow into the storm sewer and be conveyed to the storage unit. The underground storage unit is sized assuming that the rainwater harvesting tanks are available at the start of the rainfall event.

Additional infiltration will be achieved on-site through the implementation of a bioswale along the east side of the site. The granular subbase of the swale is sized to store runoff from its tributary area. An overflow drain is also provided to convey excess water to the underground storage unit.

The site discharge will be conveyed to the approved outlet location for the adjacent CMHC lands to the west of the subject site. The outlet will be sized to convey flows from both sites. Utilizing this location addresses concerns regarding an additional outlet to Poole Creek and prevents disturbance of the natural area to the north of the site.

5.3.3 Modeling Rationale

A comprehensive hydrologic modeling exercise was completed with PCSWMM, accounting for the estimated major and minor systems to evaluate the storm sewer infrastructure. The use of PCSWMM for modeling of the site hydrology and hydraulics allowed for an analysis of the systems response during various storm events. Surface storage estimates were based on the final grading plan design (see **Drawing GP-1**). The following assumptions were applied to the detailed model:

- Hydrologic parameters as per Ottawa Sewer Design Guidelines, including Horton infiltration, Manning's 'n', and depression storage values
- 12-hour SCS Storm distribution for the 100-year analysis to model 'worst-case' scenario in regards to on-site HGLs.
- 12hr SCS distributions (2 and 100-year events) with free flowing boundary condition to model 'worst-case' scenario in regards to site discharge rates to meet target rate.
- To 'stress test' the system a 'climate change' scenario was created by adding 20% of the individual intensity values of the 100-year SCS storm event at their specified time step.
- All LID measures were designed outside of PCSWMM (as documented in the report and calculations included in **Appendix E**) in order to allow routing of LID overflows to the next downstream LID which cannot be done in PCSWMM where an LID is defined as part of a given subcatchment. Total design storage and calculated infiltration losses were then input into PCSWMM as storage nodes with separate outlets for infiltration losses.
- Percent imperviousness calculated based on actual soft and hard surfaces on each subcatchment, converted to equivalent Runoff Coefficient using the relationship $C = (\text{Imp.} \times 0.7) + 0.2$
- Subcatchment areas are defined from high-point to high-point where sags occur. Subcatchment width (average length of overland sheet flow) determined by dividing

SERVICING AND STORMWATER MANAGEMENT BRIEF – 5731 HAZELDEAN ROAD

Stormwater Management
March 22, 2017

subcatchment area by subcatchment length (length of overland flow path measured from high-point to high-point).

- Number of catchbasins based on servicing plan (**Drawing SP-1**)
- Catchbasin inflow restricted with inlet-control devices (ICDs) as necessary to maintain inflow target rate and maximize use of surface storage where possible.
- Surface ponding in sag storage calculated based on grading plans (**Drawing GP-1**).

5.3.3.1 SWMM Dual Drainage Methodology

The proposed site is modeled in one modeling program as a dual conduit system (see **Figure 3**), with: 1) circular conduits representing the sewers & junction nodes representing manholes; 2) irregular conduits using street-shaped cross-sections to represent the sawtoothed overland road network from high-point to low-point and storage nodes representing catchbasins. The dual drainage systems are connected via outlet link objects (or orifices) from storage node (i.e. CB) to junction (i.e. MH), and represent inlet control devices (ICDs). Subcatchments are linked to the storage node on the surface so that generated hydrographs are directed there firstly.

Figure 3: Schematic Representing Model Object Roles

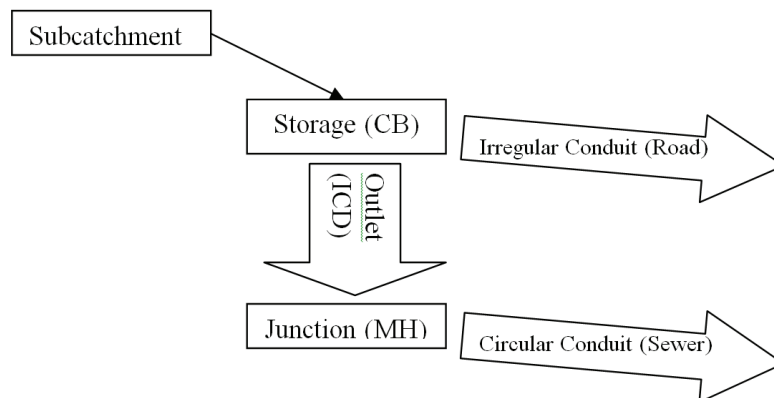

Storage nodes are used in the model to represent catchbasins as well as major system junctions. For storage nodes representing catchbasins (CBs), the invert of the storage node represents the invert of the CB and the rim of the storage node is the top of the CB plus the maximum above ground storage depth. An additional 0.3m has been added to rim elevations to allow routing from one surface storage to the next, and is unused where no spillage occurs between ponding areas. Ponding at low points is represented via storage area-depth curves for each individual storage node to match ponding volumes demonstrated on the grading plan **Drawing GP-1**. Storage volumes exceeding the sag storage available in the node will route through the connected irregular conduit to the next storage node and continue routing through the system until, ultimately, flows either re-enter the minor system or reach the outfall of the major system.

SERVICING AND STORMWATER MANAGEMENT BRIEF – 5731 HAZELDEAN ROAD

Stormwater Management
March 22, 2017

Inlet control devices, as represented by orifice links, use a user-specified discharge coefficient to approximate manufacturer's specifications for the chosen ICD model.

Subcatchment imperviousness was calculated via impervious area measured from **Drawing SSP-1**.

5.3.3.2 Boundary Conditions

The detailed PCSWMM hydrology and the proposed storm sewers were used to assess the peak inflows and hydraulic grade line (HGL) for the site. The elevation of the outlet sewer at MH100 immediately upstream of Poole Creek has been set conservatively to be above the 100-Year water elevation of the Creek per MVCA Flood Risk Mapping at an invert elevation of 99.7m to enable free-flowing model condition for the site outlet.

5.3.4 Input Parameters

Drawing SD-1 summarizes the discretized subcatchments used in the analysis of the proposed site, and outlines the major overland flow paths. The grading plans are also enclosed for review.

Appendices A1 to A3 summarize the modeling input parameters and results for the subject area; an example input and output file are provided for the 100-year 12hr SCS storm. For all other input files and results of storm scenarios, please examine the electronic model files located on the CD provided with this report. This analysis was performed using PCSWMM, which is a front-end GUI to the EPA-SWMM engine. Model files can be examined in any program which can read EPA-SWMM files version 5.1.010.

5.3.4.1 Hydrologic Parameters

Table 4 presents the general subcatchment parameters used:

Table 4: General Subcatchment Parameters

Parameter	Value
Infiltration Method	Curve Number
Drying Time (days)	7
Curve Number	80
N Impervious	0.013
N Pervious	0.2
Dstore Imperv. (mm)	1.57
Dstore perv. (mm)	4.67
Zero Imperv. (%)	0

**SERVICING AND STORMWATER MANAGEMENT BRIEF –
5731 HAZELDEAN ROAD**

Stormwater Management
March 22, 2017

Table 5 presents the individual parameters that vary for each of the proposed subcatchments.

Table 5: Subcatchment Parameters

Name	Outlet	Area (ha)	Width (m)	Slope (%)	Imperv. (%)
EXT1	EXT1-OF	0.07	15.1	33.3	0
EXT2	EXT2-OF	0.06	14.4	2	72.857
ST104A	ST104A-S	0.15	69	2	84.286
ST107A	ST107A-S	0.37	225.0	1.5	64.286
ST108A	ST108A-S	0.40	90.9	1.5	100
ST108B	ST108B-S	0.36	82.0	1.5	100
ST108C	ST108C-S	0.05	12.1	1.5	100
ST108D	ST108D-S	0.05	10.9	1.5	100
ST108E	ST108E-S	0.03	25.0	1.5	100
ST108F	108	0.38	86.0	1.2	44.286
ST109A	109	0.01	18.2	10	100
ST109C	ST109C-S	0.06	25.8	1	100
ST109B	ST109B-S	0.05	24.8	1	100
ST110A	110	0.07	16.8	0.8	7.143
ST110B	110	0.03	24.5	10	100
ST110C	110	0.03	26.6	10	100
ST110D	110	0.07	16.7	0.8	7.143
ST111A	ST111A-S	0.24	107.5	0.8	72.857
ST111B	ST111B-S	0.04	88.0	0.8	100
ST111C	ST111C-S	0.04	36.8	1.5	85.714
ST507A	ST507A-S	0.05	33.5	1.5	72.857
ST508A	508	0.34	189.2	1	7.143

Table 6 summarizes the storage node parameters used in the model. Storage curves for each node have been created based on volumes presented for each individual ponding area within **Drawing GP-1**. Rim elevations for each node correspond to the rim elevation of the associated area's catchbasin plus maximum depth of storage plus 0.30m to allow for demonstration of overland flow in the climate change event scenario. The 0.30m buffer is unused during other modeled events.

SERVICING AND STORMWATER MANAGEMENT BRIEF – 5731 HAZELDEAN ROAD

Stormwater Management
March 22, 2017

Storage volumes and release rates for the rainwater harvesting tank, bioswale/rain garden, and infiltration basin were obtained through iterations between design sizing calculations (final sizing attached in **Appendix E**) and PCSWMM hydrologic/hydraulic modeling.

Table 6: Storage Node Parameters

Name	Invert El. (m)	Rim Elev. (m)	Depth (m)	Coefficient	Exponent	Constant (m ²)	Curve Name	Storage Curve
108	99.27	104.37	5.10	0	0	0	RWhtank	TABULAR
508	101.06	102.85	1.79	0	0	0	ST508A-S	TABULAR
ST104A-S	101.52	103.62	2.1	1000	0	0	ST104A-S	TABULAR
ST107A-S	101.13	103.23	2.1	1000	0	0	ST107A-S	TABULAR
ST108A-S	118.6	118.75	0.15	1000	0	0	ST108A	TABULAR
ST108B-S	115.75	115.9	0.15	1000	0	0	ST108B	TABULAR
ST108C-S	110.4	110.55	0.15	1000	0	0	ST108C	TABULAR
ST108D-S	110.1	110.25	0.15	1000	0	0	ST108D	TABULAR
ST108E-S	107.2	107.35	0.15	1000	0	0	ST108E	TABULAR
ST109B-S	102.81	104.31	1.5	0	0	0	*	FUNCTIONAL
ST109C-S	102.81	104.31	1.5	0	0	0	*	FUNCTIONAL
ST111A-S	101.86	104.26	2.4	1000	0	0	ST111A-S	TABULAR
ST111C-S	101.95	104.05	2.1	0	0	0	*	FUNCTIONAL
ST507A-S	101.57	103.67	2.1	1000	0	0	ST504A-S	TABULAR
TANK	100.10	103.37	3.27	1000	0	0	TANK	TABULAR

5.3.4.2 Hydraulic Parameters

As per the Ottawa Sewer Design Guidelines (OSDG 2012), Manning's roughness values of 0.013 were used for sewer modeling and overland flow corridors representing roadways.

Storm sewers were modeled to confirm flow capacities and hydraulic grade lines (HGLs) in the proposed condition. The detailed storm sewer design sheet is included in **Appendix C**.

Table 7 below presents the parameters for the orifice and outlet link objects in the model, which represent ICDs and restricted roof release drains respectively. CB leads modeled as orifices were assigned a discharge coefficient of 0.65. The roof release discharge curves assume the use of standard Zurn model Z-105-5 controlled release roof drains as noted in the calculation sheet in **Appendix C**. The number of roof notches for each building area is to be confirmed with the

**SERVICING AND STORMWATER MANAGEMENT BRIEF –
5731 HAZELDEAN ROAD**

Stormwater Management
March 22, 2017

building mechanical engineer. Details for the IPEX ICDs and Zurn drains are included as part of **Appendix G**.

Table 7: Outlet/Orifice Parameters

Name	Inlet	Outlet	Inlet Elev.	Type	Diameter
OR1	TANK	102	100.10	CIRCULAR	0.11
OR2	TANK	102	100.70	CIRCULAR	0.15
OR3	TANK	102	101.00	CIRCULAR	0.15
ST104A-O	ST104A-S	104	101.52	IPEX HF	0.140
ST107A-O	ST107A-S	107	101.13	CIRCULAR	0.2
ST109B-O	ST109B-S	109	102.81	CIRCULAR	0.2
ST109C-O	ST109C-S	109	102.81	CIRCULAR	0.2
ST111A-O	ST111A-S	111	101.86	IPEX HF	0.076
ST111C-O	ST111C-S	111	101.95	CIRCULAR	0.2
ST111C-O1	ST111C-S	111	101.95	CIRCULAR	0.2
OL-1	TANK	P_OF1	100.10	0.66L/s	-
OL-2	508	P_OF2	101.06	0.3L/s	-
ST507A-O	ST507A-S	TANK	101.57	IPEX LMF 95	-
ST108A-O	ST108A-S	108	118.60	ROOF	-
ST108B-O	ST108B-S	108	115.75	ROOF	-
ST108C-O	ST108C-S	108	110.40	ROOF	-
ST108D-O	ST108D-S	108	110.10	ROOF	-
ST108E-O	ST108E-S	108	107.20	ROOF	-

5.3.5 Model Results

The following section summarizes the key hydrologic and hydraulic model results. For detailed model results or inputs please refer to the example input file in **Appendix C.2 and C.3** and the electronic model files on the enclosed CD.

5.3.5.1 Hydrologic Results

The following tables demonstrate the peak outflow from each modeled outfall during the design storm (12hr SCS 2-100yr) events. A free-flowing outfall condition has been modeled for these events to be conservative with respect to site peak release rates. Outfalls EXT1-OF and EXT2-OF denote uncontrolled flows from the perimeter of the site that, due to grading restrictions, are captured by the existing right-of-way/Poole Creek at the south and north boundaries of the site.

SERVICING AND STORMWATER MANAGEMENT BRIEF – 5731 HAZELDEAN ROAD

Stormwater Management
March 22, 2017

Flows from area EXT2 will have a minimal contribution to the infrastructure within Hazeldean Road. Peaks from these uncontrolled flows are non-coincident with peaks from the subsurface storage tank/weir, and as such, flows from the outlet headwall are the only values considered in meeting the release rate target. The required subsurface storage tank volume was determined through iteration of each event, and sized to mirror the site release rate target.

Table 8: Site Peak Discharge Rates

Event	Location	Discharge Rate (L/s)	Target (L/s)
2-Year 12 Hour SCS	Outlet Headwall	15.2	17.7
5-Year 12 Hour SCS	Outlet Headwall	38.6	43.9
10-Year 12 Hour SCS	Outlet Headwall	64.5	66.2
25-Year 12 Hour SCS	Outlet Headwall	98.7	103.7
50-Year 12 Hour SCS	Outlet Headwall	116.2	136.5
100-Year 12 Hour SCS	Outlet Headwall	136.3	176.3
100-Year 12 Hour SCS +20%	Outlet Headwall	317.0	-

5.3.5.2 Hydraulic Results

Table 9 summarizes the HGL results within the site for the 100 year storm events and the 'climate change' scenario storm required by the City of Ottawa Sewer Design Guidelines (2012), where intensities are increased by 20%. The City of Ottawa requires that during major storm events, the maximum hydraulic grade line be kept at least 0.30 m below the underside-of-footing (USF) of any adjacent units connected to the storm sewer during design storm events. As the proposed building perimeter drain and ramp drains will be disconnected from the storm sewer and pumped to the surface, USFs are considered at 0.3m below the lowest finished floor elevation of the building.

Table 9: Modeled Hydraulic Grade Line Results

STM MH	Proposed Ground Elev. (m)	100-year 12hr SCS		100-year 12hr SCS + 20%	
		HGL (m)	USF-HGL Clearance (m)	HGL (m)	USF-HGL Clearance (m)
103	104.20	101.97	2.23	102.78	1.42
104	104.20	101.98	2.22	102.80	1.40
105	104.20	101.99	2.21	102.86	1.34
106	104.20	101.99	2.21	102.87	1.33
107	104.20	102.00	2.20	102.89	1.31

SERVICING AND STORMWATER MANAGEMENT BRIEF – 5731 HAZELDEAN ROAD

Stormwater Management
March 22, 2017

STM MH	Proposed Ground Elev. (m)	100-year 12hr SCS		100-year 12hr SCS + 20%	
		HGL (m)	USF-HGL Clearance (m)	HGL (m)	USF-HGL Clearance (m)
108	104.20	102.04	2.16	103.04	1.16

As is demonstrated in the table above, the worst-case scenario results in HGL elevations remain at least 0.30 m below the proposed surface elevations, and HGL elevations remain below the proposed surface elevations during the 20% increased intensity 'climate change' scenario.

Table 10 presents the maximum total surface water depths (static ponding depth + dynamic flow) above the top-of-grate of catchbasins for the 100-year design storm and climate change storm. Based on the model results, the total ponding depth (static + dynamic) does not exceed the required 0.30m maximum during the 100-year event. Total ponding depths during the climate change scenario are below adjacent building openings and should not impact the proposed building.

Table 10: Maximum Surface Water Depths

Storage node ID	Structure ID	Rim Elevation (m)	100 year, 12hr SCS		100 year, 12hr SCS +20%	
			Max HGL (m)	Total Surface Water Depth (m)	Max HGL (m)	Total Surface Water Depth (m)
ST104A-S	CB 506	103.32	103.23	0.00	103.47	0.15
ST107A-S	CB 505	102.93	102.85	0.00	103.09	0.16
ST111A-S	CB 501	103.96	104.18	0.22	104.22	0.26
ST111C-S	CB 504	103.75	102.03	0.00	102.91	0.00
ST507A-S	CB 507	103.37	103.44	0.07	103.47	0.10
508	CB T 508	102.60	102.01	0.00	102.83	0.23

5.3.6 Water Quality Control

On-site water quality control is required to provide 80% TSS removal prior to discharging to Poole Creek. A Stormceptor unit STC300 is proposed upstream of the underground storage/infiltration basin. The Stormceptor will provide greater than 80% TSS removal in the 25mm event and will act as pre-treatment for the storage/ infiltration basin thereby reducing maintenance requirements of the facility and improving long-term performance. The Stormceptor unit will be privately maintained. The location and general arrangement of the Stormceptor unit is indicated on **Drawing SD-1**. Detailed sizing calculations for the Stormceptor unit are included in **Appendix C.5**

SERVICING AND STORMWATER MANAGEMENT BRIEF – 5731 HAZELDEAN ROAD

Stormwater Management
March 22, 2017

5.3.7 Infiltration Targets

The MVCA requires that BMP measures be implemented on-site to meet the minimum infiltration target rate of 50 mm/yr (as identified in the Kanata West Master Servicing Study, Stantec, 2006). For a site area of 2.9ha with an average imperviousness of 56% the total annual infiltration requirement is therefore 812m³/yr. The KWMSS also requires a 25% augmentation to site infiltration requirements to account for off-site road areas for which no infiltration measures were required. Therefore, the total site infiltration target is 1,015 m³/yr. Past correspondence with the MVCA indicated that the target infiltration rates were in fact “target hydrograph volume reduction rates”.

The LID bioswale and infiltration gallery proposed for the site will provide significant opportunity for stormwater infiltration. Infiltration calculations completed for the design and sizing of these LID measures were used to approximate an expected annual infiltration rate. Water balance calculations for a continuous rainfall scenario from August 2, 2009 to March 1, 2012 (see **Appendix E**) were used to determine an average daily infiltration rate over a one year period. The average rate was estimated to be 44m³/day. Note that this rate is averaged over 365 days per year and would underestimate summer months and overestimate winter. Nevertheless, the average annual infiltration that could be provided through the LID measures would be approximately 16,262 m³/yr. Therefore, only about 10% of the total possible infiltration is required to meet the infiltration target for the site.

The infiltration contribution from the bioswale and infiltration gallery is included in **Table 11** below. Note that this summary does not include infiltration resulting from the rainwater harvesting reuse for irrigation. The results in **Table 11** suggest that the infiltration target could be met with the bioswale infiltration only.

Table 11: Summary of Infiltration from LID Features

LID Feature	Estimated Total Annual Infiltration (m ³ /yr)
Bioswale	2,568
Infiltration Gallery	13,694
Total Infiltration	16,262

5.3.7.1 Potential Groundwater Mounding

Groundwater levels at the site were measured by Paterson Group during two separate site visits and are summarized in the attached Paterson memos in **Appendix F**. Based on the results of the

**SERVICING AND STORMWATER MANAGEMENT BRIEF –
5731 HAZELDEAN ROAD**

Stormwater Management
March 22, 2017

groundwater monitoring Paterson Group prepared a memo discussing the variation in groundwater level measurements and anticipated seasonally high and normal groundwater levels. The results for the boreholes near the LID features are summarized in **Table 12** below. The complete memo dated January 25, 2017 is included in **Appendix F**.

Table 12: Expected Seasonal Variation of Groundwater Levels

Borehole Number	Ground Elevation (m)	Long-term Groundwater Levels		Seasonally High Groundwater Level	
		Depth (m)	Elevation (m)	Depth (m)	Elevation (m)
BH 1	102.93	3.7	99.23	3.2	99.73
BH 2	103.02	3.7	99.32	3.2	99.82
BH 3	103.07	3.7	99.37	3.2	99.87
BH 4	103.15	3.7	99.45	3.2	99.95
BH 5	103.22	3.7	99.52	3.2	100.02
BH 6	103.25	3.7	99.55	3.2	100.05
BH 7	102.91	4.5	98.41	4.0	98.91

Since the clearance from the bottom of the infiltration tank to the groundwater table is less than 1.0m the potential for groundwater mounding was considered. Groundwater mounding calculations were completed for both the seasonally high groundwater condition and the normal groundwater condition. However, per the Paterson memo, the seasonally high level is expected to occur during March-April, as such historical rainfall data was used to establish the average rainfall event volume for March-April. The analysis indicated approximately a 10mm event. The duration of infiltration for the infiltration gallery was obtained from the PCSWMM hydraulic model based on the modeled time for the infiltration gallery to empty. No PCSWMM model was run for the 10mm event so the 2-year event was used as a conservative estimate. These durations were input into the groundwater mounding calculation spreadsheet in **Appendix E**. It is noted that the calculations are based on the Hantush (1967) equation for groundwater mounding and use the hydraulic conductivity (measured by Paterson and summarized in the attached memo from September 2016) as the recharge rate and typical specific yield for silty clay. It is also noted that spreadsheet inputs and results are in imperial units. **Table 13** below summarizes the results of the groundwater mounding calculations.

SERVICING AND STORMWATER MANAGEMENT BRIEF – 5731 HAZELDEAN ROAD

Stormwater Management
March 22, 2017

Table 13: Estimated Maximum Groundwater Mounding below Infiltration Gallery

Groundwater Condition	Mounding Height (m)	Mounding Elevation (m)	Distance to Bottom of Infiltration Gallery (m)
Long-term (99.23)	0.31	99.54	0.56
Seasonally High (99.73)	0.26	99.99	0.11

It is noted the above mounding depths are still below the bottom of the infiltration gallery. Should a larger rainfall even occur during the seasonally high groundwater condition there could be potential for the groundwater mound to extend into the infiltration gallery. However, there is a storm sewer outlet proposed at the bottom of the infiltration gallery (Invert =100.10m per attached **Drawing SSP-1**) which will limit the maximum groundwater height to the bottom of the infiltration gallery. Once the mounding reaches the bottom, the stored stormwater would discharge only through the controlled outlets and would not infiltrate. Since the groundwater mounding is caused only by infiltrating stormwater and not by external sources, there should be no loss of storage volume due to groundwater mounding.

5.3.8 Thermal Controls

The MVCA and MOECC confirmed that Poole Creek is designated as a “cool-water fish habitat”. As the proposed development will increase the amount of impervious area on the site and roof top detention will increase water temperatures, thermal mitigation measures are required for the site.

As the majority of heat transfer from paved surfaces occurs during the first flush (considered as the initial 10mm of each design event), storage of the 10mm event has been given priority. With exception of the rooftop areas, the site is designed with minimal surface storage. All runoff will be captured and detained in the underground storage unit which will allow for heat dumping into the surrounding ground and granular material. Similarly, runoff conveyed through the granular subbase of the bioswale will experience cooling. Roof discharge will be the most thermally impacted water as it will be retained on the rooftops for several hours. This water will be discharged to the underground rainwater harvesting tank and will inlet at the bottom of the tank such that if the tank is full, the cooler water will be discharged first through the overflow. With 167m³ of storage available in each of the rainwater harvesting tanks, the only occurrence where roof discharge would not experience any temperature mitigation via mixing or detention would be when total rainfall exceeds approximately a 2-year event. The reverse temperature mitigation effect (warming water during cold weather) would also occur with these measures as ground temperatures would warm the runoff.

SERVICING AND STORMWATER MANAGEMENT BRIEF – 5731 HAZELDEAN ROAD

Stormwater Management
March 22, 2017

5.3.9 Monitoring Plan

In addition to monitoring requirements to be identified by the MOECC in the Environmental Compliance Approval (ECA), the site will require regular monitoring of the LID measures installed on the site. A detailed monitoring program will be developed through consultation with the City of Ottawa and MVCA. In general, the monitoring plan will required pre-construction, during construction and post-construction monitoring and include the following:

- Installation of water level loggers in both the rainwater harvesting tank, infiltration gallery, and bioswale (monitoring “well” to be installed) to assess frequency of overflow and drawdown rates and compare with design values;
- Installation of temperature logger in the outlet manhole from the site to monitor temperature of the storm discharge. The temperature logger cannot be installed at the outlet to Poole Creek as this outlet will include discharge from the CMHC lands as well and would not be representative of the subject site;
- Collection of water quality samples upstream and downstream of the proposed OGS unit;
- Visual inspection of all LID systems at least once per month and following all large rainfall events. Including observations for:
 - o Debris accumulation on the surface
 - o Measurement of/inspection for sediment accumulation in rainwater harvesting tank and infiltration gallery
 - o Presence of ponded water on the surface of the bioswale beyond design duration
 - o Outlet/inlet blockages of tanks and OGS

A detailed monitoring plan is included in **Appendix H**.

5.3.10 Contingency Plan

It is recognized that the proposed stormwater management plan is considered a “pilot project” by the City of Ottawa and has allowed for credit from the LID measures toward the stormwater management design. As such the monitoring plan for the site will be critical in assessing the performance of the system. Should either the pre-construction monitoring result in findings that will impact the function of the system, then additional assessment of the design will be required to assess system performance and determine whether additional storage is required. Additional storage would be provided by expanding the size of the proposed infiltration gallery. This assessment would be required prior to constructing the facility. A memo will be issued to the City of Ottawa outlining the monitoring results and confirming whether there is any need for expansion of the infiltration system.

Similarly, post-construction monitoring will assess the performance of the system. Data analysis and reporting will be completed and review whether any retrofits to the system are required. The

SERVICING AND STORMWATER MANAGEMENT BRIEF – 5731 HAZELDEAN ROAD

Stormwater Management
March 22, 2017

greatest benefit to the SWM design is the storage available in the rainwater harvesting system. It is estimated that the greatest impact to the system storage requirements would be if this system does not operate as designed and this entire volume cannot be relied upon for the SWM system. This would result in the need for an additional 335m³ to be added to the infiltration gallery. While this extreme is assumed to be unlikely, it is recommended that the site MOECC ECA include this contingency volume of 335m³ to allow for the expansion if needed without requiring an amendment to the ECA before proceeding.

Post-construction monitoring will include groundwater level monitoring and water level monitoring within the infiltration gallery. Results will be monitored to ensure no storage volume is lost as a result of groundwater influences and storage volume would be adjusted as necessary. However, it is anticipated that since the infiltration gallery design includes an outlet at the bottom of the storage area, there should be no significant loss of volume caused by seasonal groundwater fluctuations or mounding.

5.4 SUMMARY OF FINDINGS

Based on the preceding, the following conclusions can be drawn:

- The proposed stormwater management plan is in compliance with the criteria established for the site and the 2012 City of Ottawa Sewer Guidelines.
- Inlet control devices are proposed to limit inflow from the site area into the minor system to maximize the use of surface storage.
- Subsurface storage has been provided to further limit site outflows to the peak site discharge rate determined via PCSWMM model (See **Table 14** below).
- The storm sewer hydraulic grade line is maintained at least 0.30 m below finished ground elevations during design storm events.
- All dynamic surface water depths are less than 0.30 m during all design storm events.
- Quality control is provided by a Stormceptor model STC3000 upstream of the underground storage facility to maintain water quality objectives outlined in the background reports.

Table 14: Site Peak Discharge Rates/Targets

Storm Event	Site Peak Discharge Rate (L/s)	Target Discharge Rate (L/s)
2-Year 12 Hour SCS	15.2	17.7
5-Year 12 Hour SCS	38.6	43.9
10-Year 12 Hour SCS	64.5	66.2
25-Year 12 Hour SCS	98.7	103.7
50-Year 12 Hour SCS	116.2	136.5
100-Year 12 Hour SCS	136.3	176.3
100-Year 12 Hour SCS +20%	317.0	-

**SERVICING AND STORMWATER MANAGEMENT BRIEF –
5731 HAZELDEAN ROAD**





Appendix C Stormwater Management
March 22, 2017

Appendix C STORMWATER MANAGEMENT

**C.1 STORM SEWER DESIGN SHEET AND ROOF STORAGE
CALCULATIONS**

FLOOD RISK MAP
POOLE CREEK
CARTE DU RISQUE D'INONDATION

LEGEND / LÉGENDE

-  Regulatory Floodplain / La Crue Régulatoire
-  Regulatory Limit / Limite Réglementaire
-  Contours / Courbes
-  Stream / Ruisseau
-  Cross Sections / La coupe traversale

Cross Section Number 1
Nombre de la coupe traversale 1

Regulatory Flood Elevation (m) 102.11
Niveau de la crue régulatoire (m) 102.11

INDEX À CONTOUR INTERVALS 2 METRES
WITH NORTH AMERICAN DATUM 1983
COURRES DE NIVEAU PRINCIPALES DE 2.0 MÈTRE
AVEC LE NIVEAU DE RÉFÉRENCE NORD AMÉRICAINE 1983
SYSTÈME DE RÉFÉRENCE GÉO-CENTRIQUE NORD AMÉRICAINE 1983

GENERAL INFORMATION

Vertical Datum: Mean sea level
Niveau de référence vertical: Niveau moyen de la mer
Horizontal Datum: North American 1983
Projetion: UTM
Map Projection: UTM
Projection: UTM
Projection: UTM
Projection: UTM



SHEET INDEX / TABLEAU D'ASSEMBLAGE

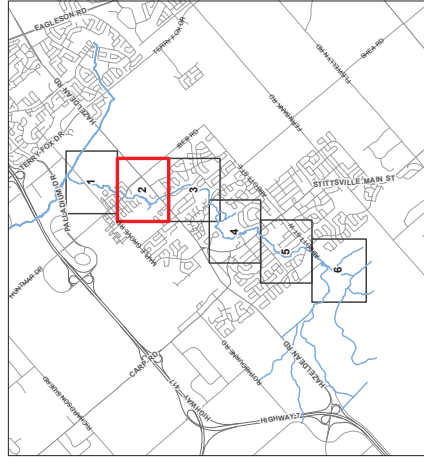

Revision #	Issue
1	Issue 1
2	Issue 2
3	Issue 3

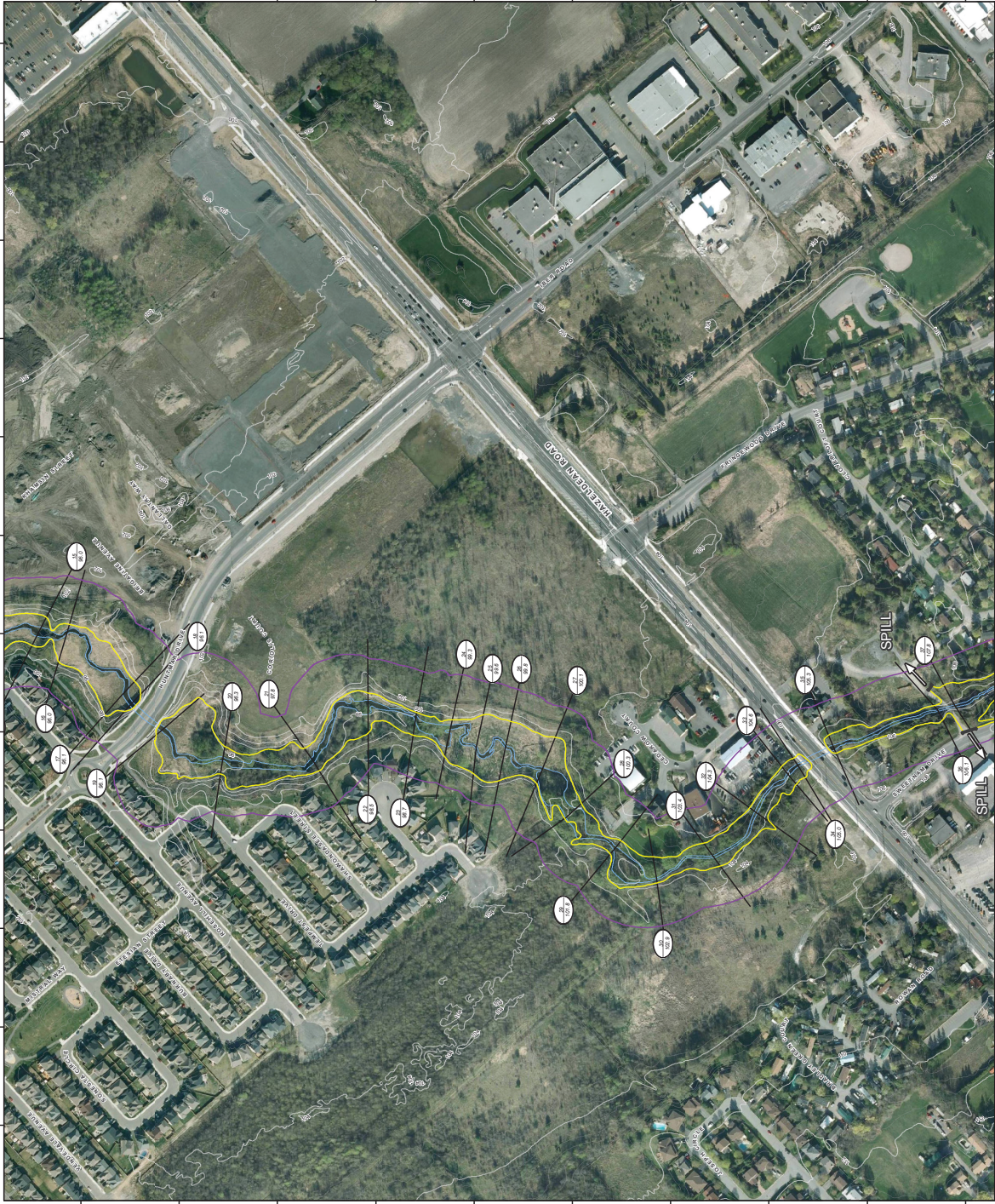

This map and the associated information displayed are to be used for general illustrative purposes only. Although best efforts have been made to ensure accuracy, due to the complex and extensive nature of the data, the user acknowledges that this map is not intended for true and accurate navigational purposes and hereby accepts and assumes all inherent risks associated with the use of this map.

The map is produced in part with data provided by the Ontario Geographic Data Exchange under Licence with the Province of Ontario and the City of Ottawa, 2011.

Images © City of Ottawa, 2011
Digital Elevation Information © GeoDigital International Inc. Spring 2008

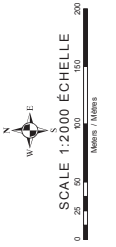

STORM SEWER DESIGN SHEET (City of Ottawa)		DESIGN PARAMETERS (As per City of Ottawa Guidelines, 2012)																									
5731 Hazeldean Road		[= a / (t*P)]																									
DATE: 23-Mar-2017		1:1.5 yr 1:100 yr																									
REVISION: 3		998071 1735.689																									
DESIGNED BY: DT		MANNINGS n = 0.013 BEDDING CLASS = B																									
CHECKED BY: AL		6.014 MINIMUM COVER: 2.00 m																									
FILE NUMBER: 1604-01195		0.820 TIME OF ENTRY 10 min																									
AREA ID NUMBER	LOCATION		DRAINAGE AREA										PIPE SELECTION														
	AREA (5-YEAR) (ha)	AREA (10-YEAR) (ha)	AREA (ROOF) (ha)	C	ACCUM. AREA (5-YEAR) (ha)	A x C	ACCUM. AREA (10-YEAR) (ha)	A x C	ACCUM. AREA (10-YEAR) (ha)	A x C	ACCUM. AREA (10-YEAR) (ha)	Q _{50YR} (L/s)	Q _{100YR} (L/s)	Q _{50YR} (FULL) (L/s)	SLOPE (%)	CLASS	MATERIAL	PIPE SHAPE	PIPE HEIGHT (mm)	PIPE WIDTH OR DIAMETER (mm)	LENGTH (m)	PIPE CLASS	% FULL (%)	VEL. (FULL) (m/s)	VEL. (ACT) (m/s)	TIME OF FLOW (min)	
			0.00	0.00	0.00	0.00	0.00	0.00	0.00	0.00	0.00	0.00	0.00	0.00	0.00	0.00	CONCRETE	CIRCULAR	450	450	2.8	0.20	33.76%	0.81	0.82	0.08	
			0.00	0.00	0.00	0.00	0.00	0.00	0.00	0.00	0.00	0.00	0.00	0.00	0.00	0.00	CONCRETE	CIRCULAR	450	450	3.0	1.00	0.00%	1.82	0.00	0.00	
			0.00	0.00	0.00	0.00	0.00	0.00	0.00	0.00	0.00	0.00	0.00	0.00	0.00	0.00	CONCRETE	CIRCULAR	450	450	70.7	0.20	33.76%	0.81	0.82	1.92	
			0.00	0.00	0.00	0.00	0.00	0.00	0.00	0.00	0.00	0.00	0.00	0.00	0.00	0.00	CONCRETE	CIRCULAR	450	450	101.6	0.20	33.76%	0.81	0.82	2.75	
			0.00	0.00	0.00	0.00	0.00	0.00	0.00	0.00	0.00	0.00	0.00	0.00	0.00	0.00	CONCRETE	CIRCULAR	675	675	11.1	1.40	10.34%	2.81	1.50	0.12	
ST109A-C			0.13	0.00	0.00	0.13	0.114	0.114	0.00	0.00	0.00	0.00	0.00	0.00	0.00	0.00	PVC	CIRCULAR	375	375	38.2	1.00	19.94%	1.56	1.01	0.63	
			0.21	0.00	0.00	0.44	0.21	0.093	0.00	0.00	0.00	0.00	0.00	0.00	0.00	0.00	PVC	CIRCULAR	375	375	12.5	1.00	16.24%	1.56	0.95	0.22	
ST110A-D			0.00	0.00	0.00	0.00	0.00	0.00	0.00	0.00	0.00	0.00	0.00	0.00	0.00	0.00	PVC	CIRCULAR	200	200	26.1	1.00	0.00%	1.05	0.00	0.00	
			0.00	0.00	0.00	0.00	0.00	0.00	0.00	0.00	0.00	0.00	0.00	0.00	0.00	0.00	PVC	CIRCULAR	200	200	4.0	1.00	0.00%	1.05	0.00	0.00	
			0.00	0.00	0.00	0.00	0.00	0.00	0.00	0.00	0.00	0.00	0.00	0.00	0.00	0.00	PVC	CIRCULAR	200	200	2.8	1.00	0.00%	1.05	0.00	0.00	
			0.32	0.00	0.00	0.68	0.32	0.221	0.00	0.00	0.00	0.00	0.00	0.00	0.00	0.00	PVC	CIRCULAR	375	375	110.4	0.70	46.41%	1.31	1.10	1.68	
ST111A-C			0.37	0.00	0.00	0.65	0.70	0.243	0.00	0.00	0.00	0.00	0.00	0.00	0.00	0.00	CONCRETE	CIRCULAR	450	450	63.3	0.50	58.87%	1.28	1.15	0.91	
ST107A			0.00	0.00	0.00	0.00	0.00	0.00	0.00	0.00	0.00	0.00	0.00	0.00	0.00	0.00	CONCRETE	CIRCULAR	525	525	17.6	0.20	71.05%	0.90	0.85	0.34	
ST108C-F			0.38	0.00	0.13	0.51	0.38	0.195	0.00	0.00	0.00	0.00	0.00	0.00	0.00	0.00	PVC	CIRCULAR	375	375	86.0	0.50	55.25%	1.11	0.87	1.46	
ST108A, B			0.00	0.00	0.77	0.25	0.38	0.00	0.195	0.00	0.00	0.00	0.00	0.00	0.00	0.00	CONCRETE	CIRCULAR	450	450	36.3	0.30	63.98%	0.99	0.82	0.66	
			0.00	0.00	0.00	0.00	0.00	0.00	0.00	0.00	0.00	0.00	0.00	0.00	0.00	0.00	CONCRETE	CIRCULAR	600	600	39.1	0.20	84.25%	0.98	0.88	0.66	
ST104A			0.15	0.00	0.00	0.79	1.57	0.118	0.883	0.00	0.00	0.00	0.00	0.00	0.00	0.00	CONCRETE	CIRCULAR	675	675	16.3	0.20	74.73%	1.06	1.03	0.26	
			0.00	0.00	0.00	0.00	0.00	0.00	0.00	0.00	0.00	0.00	0.00	0.00	0.00	0.00	CONCRETE	CIRCULAR	675	675	2.8	0.20	74.08%	1.06	1.02	0.05	
ST1507A			0.05	0.00	0.00	0.90	0.05	0.049	0.00	0.00	0.00	0.00	0.00	0.00	0.00	0.00	PVC	CIRCULAR	200	200	0.9	1.00	42.56%	1.05	0.85	0.02	
			0.00	0.00	0.00	0.00	0.00	0.00	0.00	0.00	0.00	0.00	0.00	0.00	0.00	0.00	CONCRETE	CIRCULAR	250	250	24.0	0.25	0.00%	0.61	0.00	0.00	
			0.00	0.00	0.00	0.00	0.00	0.00	0.00	0.00	0.00	0.00	0.00	0.00	0.00	0.00	CONCRETE	CIRCULAR	250	250	41.2	0.25	0.00%	0.61	0.00	0.00	
			0.00	0.00	0.00	0.00	0.00	0.00	0.00	0.00	0.00	0.00	0.00	0.00	0.00	0.00	CONCRETE	CIRCULAR	250	250	40.4	0.25	0.00%	0.61	0.00	0.00	
ST1508A			0.34	0.00	0.00	0.25	0.34	0.064	0.00	0.00	0.00	0.00	0.00	0.00	0.00	0.00	CONCRETE	CIRCULAR	250	250	8.7	0.25	30.4	0.61	0.60	0.24	

Stormwater Management Calculations

File No: 160401195
 Project: 5731 Hazeldean
 Date: 30-Jan-17

SWM Approach:
 Post-development to Pre-development flows

Post-Development Site Conditions:

Overall Runoff Coefficient for Site and Sub-Catchment Areas

Runoff Coefficient Table									
Catchment Type	Sub-catchment Area		Area (ha) "A"	Runoff Coefficient "C"		"A x C"	Overall Runoff Coefficient		
	ID / Description								
Roof	ST108D	Hard	0.05	0.9	0.047				
		Soft	0.00	0.2	0.000				
		Subtotal		0.052		0.047	0.900		
Roof	ST108E	Hard	0.03	0.9	0.024				
		Soft	0.00	0.2	0.000				
		Subtotal		0.027		0.024	0.900		
Roof	ST108B	Hard	0.36	0.9	0.328				
		Soft	0.00	0.2	0.000				
		Subtotal		0.364		0.328	0.900		
Roof	ST108A	Hard	0.40	0.9	0.363				
		Soft	0.00	0.2	0.000				
		Subtotal		0.404		0.363	0.900		
Roof	ST108C	Hard	0.05	0.9	0.042				
		Soft	0.00	0.2	0.000				
		Subtotal		0.047		0.042	0.900		
Total				0.894		0.805			
Overall Runoff Coefficient= C:									0.90

Total Roof Areas	0.894 ha
Total Tributary Surface Areas (Controlled and Uncontrolled)	0.000 ha
Total Tributary Area to Outlet	0.894 ha
 Total Uncontrolled Areas (Non-Tributary)	 0.000 ha
 Total Site	 0.894 ha

Stormwater Management Calculations

Project #160401195, 5731 Hazeldean
Modified Rational Method Calculators for Storage

5 yr Intensity City of Ottawa	$I = a/(t + b)^c$	a =	998.071	t (min)	I (mm/hr)
		b =	6.053	10	141.18
		c =	0.814	15	104.19
				20	83.56
			25	70.25	
			30	60.90	
			35	53.93	
			40	48.52	
			45	44.18	
			50	40.63	
			55	37.65	
			60	35.12	
			60	32.94	

5 YEAR Modified Rational Method for Entire Site

Subdrainage Area: ST108D
 Area (ha): 0.05
 C: 0.90
 Maximum Storage Depth: 150 mm

tc (min)	I (5 yr) (mm/hr)	Qactual (L/s)	Qrelease (L/s)	Qstored (L/s)	Vstored (m³)	Depth (mm)
5	141.18	18.26	2.75	15.51	4.65	89.6
10	104.19	13.48	3.09	10.39	6.24	100.5
15	83.56	10.81	3.17	7.64	6.88	103.2
20	70.25	9.09	3.20	5.89	7.07	104.0
25	60.90	7.88	3.19	4.69	7.03	103.9
30	53.93	6.98	3.17	3.81	6.86	103.1
35	48.52	6.28	3.13	3.14	6.60	102.0
40	44.18	5.72	3.09	2.62	6.29	100.7
45	40.63	5.26	3.04	2.22	5.98	99.0
50	37.65	4.87	2.98	1.90	5.69	96.9
55	35.12	4.54	2.91	1.63	5.39	94.8
60	32.94	4.26	2.85	1.41	5.09	92.7

Storage: Roof Storage

Depth (mm)	Head (m)	Discharge (L/s)	Vreq (cu. m)	Vavail (cu. m)	Discharge Check	
5-year Water Level	104.03	0.10	3.20	7.07	20.68	0.00

Subdrainage Area: ST108E
 Area (ha): 0.03
 C: 0.90
 Maximum Storage Depth: 150 mm

tc (min)	I (5 yr) (mm/hr)	Qactual (L/s)	Qrelease (L/s)	Qstored (L/s)	Vstored (m³)	Depth (mm)
5	141.18	9.61	1.38	8.23	2.47	89.9
10	104.19	7.09	1.55	5.54	3.32	100.8
15	83.56	5.68	1.59	4.09	3.68	103.7
20	70.25	4.78	1.61	3.17	3.81	104.7
25	60.90	4.14	1.61	2.53	3.80	104.7
30	53.93	3.67	1.60	2.07	3.73	104.1
35	48.52	3.30	1.58	1.72	3.61	103.1
40	44.18	3.01	1.57	1.44	3.46	101.9
45	40.63	2.76	1.54	1.22	3.29	100.6
50	37.65	2.56	1.52	1.04	3.13	98.8
55	35.12	2.39	1.49	0.90	2.98	96.8
60	32.94	2.24	1.46	0.79	2.83	94.7

Storage: Roof Storage

Depth (mm)	Head (m)	Discharge (L/s)	Vreq (cu. m)	Vavail (cu. m)	Discharge Check	
5-year Water Level	104.74	0.10	1.61	3.81	10.88	0.00

Subdrainage Area: ST108B
 Area (ha): 0.36
 C: 0.90
 Maximum Storage Depth: 150 mm

tc (min)	I (5 yr) (mm/hr)	Qactual (L/s)	Qrelease (L/s)	Qstored (L/s)	Vstored (m³)	Depth (mm)
5	141.18	128.71	17.98	110.73	33.22	90.0
10	104.19	94.99	20.17	74.81	44.89	101.0
15	83.56	76.18	20.78	55.40	49.86	104.1
20	70.25	64.04	21.00	43.05	51.66	105.1
25	60.90	55.52	21.01	34.51	51.76	105.2
30	53.93	49.16	20.90	28.26	50.87	104.7
35	48.52	44.23	20.72	23.51	49.38	103.8
40	44.18	40.28	20.49	19.79	47.50	102.6
45	40.63	37.04	20.23	16.81	45.38	101.3
50	37.65	34.33	19.95	14.37	43.12	99.9
55	35.12	32.02	19.56	12.46	41.13	97.9
60	32.94	30.03	19.16	10.87	39.14	96.0

Storage: Roof Storage

Depth (mm)	Head (m)	Discharge (L/s)	Vreq (cu. m)	Vavail (cu. m)	Discharge Check	
5-year Water Level	105.21	0.11	21.01	51.76	145.75	0.00

Subdrainage Area: ST108A
 Area (ha): 0.40
 C: 0.90
 Maximum Storage Depth: 150 mm

tc (min)	I (5 yr) (mm/hr)	Qactual (L/s)	Qrelease (L/s)	Qstored (L/s)	Vstored (m³)	Depth (mm)
5	141.18	142.64	19.39	123.25	36.97	90.2
10	104.19	105.27	21.77	83.50	50.10	101.2
15	83.56	84.42	22.44	61.98	55.78	104.3
20	70.25	70.98	22.69	48.28	57.94	105.5
25	60.90	61.53	22.72	38.80	58.20	105.7
30	53.93	54.48	22.62	31.86	57.35	105.2
35	48.52	49.02	22.44	26.58	55.81	104.4
40	44.18	44.64	22.21	22.43	53.84	103.3
45	40.63	41.05	21.94	19.11	51.58	102.0

Project #160401195, 5731 Hazeldean
Modified Rational Method Calculators for Storage

100 yr Intensity City of Ottawa	$I = a/(t + b)^c$	a =	1735.688	t (min)	I (mm/hr)
		b =	6.014	10	242.70
		c =	0.820	15	178.56
				20	142.89
			25	119.95	
			30	103.85	
			35	91.87	
			40	82.58	
			45	75.15	
			50	69.05	
			55	63.95	
			60	59.62	
			60	55.89	

100 YEAR Modified Rational Method for Entire Site

Subdrainage Area: ST108D
 Area (ha): 0.05
 C: 1.00
 Maximum Storage Depth: 150 mm

tc (min)	I (100 yr) (mm/hr)	Qactual (L/s)	Qrelease (L/s)	Qstored (L/s)	Vstored (m³)	Depth (mm)
10	178.56	25.67	3.93	21.73	13.04	128.1
20	119.95	17.24	4.17	13.07	15.69	135.7
30	91.87	13.21	4.21	8.99	16.19	137.1
40	75.15	10.80	4.18	6.62	15.88	136.2
50	63.95	9.19	4.13	5.07	15.20	134.3
60	55.89	8.03	4.05	3.98	14.35	131.8
70	49.79	7.16	3.97	3.19	13.40	129.1
80	44.99	6.47	3.88	2.59	12.42	126.3
90	41.11	5.91	3.78	2.13	11.50	123.0
100	37.90	5.45	3.67	1.78	10.67	119.5
110	35.20	5.06	3.56	1.50	9.87	116.0
120	32.89	4.73	3.46	1.26	9.11	112.7

Storage: Roof Storage

Depth (mm)	Head (m)	Discharge (L/s)	Vreq (cu. m)	Vavail (cu. m)	Discharge Check	
100-year Water Level	137.11	0.14	4.21	16.19	20.68	0.00

Subdrainage Area: ST108E
 Area (ha): 0.03
 C: 1.00
 Maximum Storage Depth: 150 mm

tc (min)	I (100 yr) (mm/hr)	Qactual (L/s)	Qrelease (L/s)	Qstored (L/s)	Vstored (m³)	Depth (mm)
10	178.56	13.50	1.97	11.53	6.92	128.4
20	119.95	9.07	2.09	6.97	8.37	136.3
30	91.87	6.94	2.12	4.82	8.68	139.0
40	75.15	5.68	2.11	3.57	8.57	137.4
50	63.95	4.83	2.08	2.75	8.25	135.7
60	55.89	4.23	2.05	2.18	7.83	133.4
70	49.79	3.76	2.01	1.75	7.37	130.9
80	44.99	3.40	1.97	1.43	6.88	128.2
90	41.11	3.11	1.93	1.18	6.38	125.4
100	37.90	2.87	1.88	0.99	5.94	122.1
110	35.20	2.66	1.82	0.84	5.53	118.8
120	32.89	2.49	1.77	0.71	5.13	115.5

Storage: Roof Storage

Depth (mm)	Head (m)	Discharge (L/s)	Vreq (cu. m)	Vavail (cu. m)	Discharge Check	
100-year Water Level	138.04	0.14	2.12	8.68	10.88	0.00

Subdrainage Area: ST108B
 Area (ha): 0.36
 C: 1.00
 Maximum Storage Depth: 150 mm

tc (min)	I (100 yr) (mm/hr)	Qactual (L/s)	Qrelease (L/s)	Qstored (L/s)	Vstored (m³)	Depth (mm)
10	178.56	180.87	25.67	155.20	93.12	128.6
20	119.95	121.50	27.29	94.21	113.05	136.7
30	91.87	93.06	27.67	65.39	117.70	138.6
40	75.15	76.12	27.57	48.54	116.51	138.1
50	63.95	64.78	27.26	37.53	112.58	136.5
60	55.89	56.62	26.82	29.80	107.26	134.3
70	49.79	50.43	26.33	24.10	101.23	131.9
80	44.99	45.57	25.81	19.76	94.85	129.3
90	41.11	41.64	25.28	16.36	88.34	126.6
100	37.90	38.39	24.70	13.70	82.18	123.7
110	35.20	35.66	24.03	11.62	76.72	120.4
120	32.89	33.33	23.40	9.92	71.45	117.2

Storage: Roof Storage

Depth (mm)	Head (m)	Discharge (L/s)	Vreq (cu. m)	Vavail (cu. m)	Discharge Check	
100-year Water Level	138.58	0.14	27.67	117.70	145.75	0.00

Subdrainage Area: ST108A
 Area (ha): 0.40
 C: 1.00
 Maximum Storage Depth: 150 mm

tc (min)	I (100 yr) (mm/hr)	Qactual (L/s)	Qrelease (L/s)	Qstored (L/s)	Vstored (m³)	Depth (mm)
10	178.56	200.45	27.68	172.76	103.66	128.7
20	119.95	134.66	29.47	105.19	126.23	137.0
30	91.87	103.13	29.91	73.22	131.80	139.1
40	75.15	84.36	29.83	54.52	130.66	138.7
50	63.95	71.79	29.52	42.28	128.84	137.3
60	55.89	62.75	29.07	33.67	121.23	135.2
70	49.79	55.89	28.56	27.33	114.78	132.8
80	44.99	50.51	28.02	22.48	107.93	130.3
90	41.11	46.15	27.47	18.68	100.90	127.7

Stormwater Management Calculations

Project #160401195, 5731 Hazeldean
Modified Rational Method Calculatons for Storage

50	37.65	38.04	21.66	16.39	49.16	100.7	0.00
55	35.12	35.49	21.30	14.19	46.81	99.1	0.00
60	32.94	33.28	20.88	12.40	44.65	97.1	0.00

Storage: Roof Storage

Depth (mm)	Head (m)	Discharge (L/s)	Vreq (cu. m)	Vavail (cu. m)	Discharge Check	
5-year Water Level	105.67	0.11	22.72	58.20	161.52	0.00

Subdrainage Area: ST108C
 Area (ha): 0.05
 C: 0.90
 Maximum Storage Depth: Roof 150 mm

tc (min)	I (5 yr) (mm/hr)	Qactual (L/s)	Qrelease (L/s)	Qstored (L/s)	Vstored (m³)	Depth (mm)
5	141.18	16.63	2.74	13.90	4.17	89.1
10	104.19	12.27	3.06	9.21	5.53	99.6
15	83.56	9.84	3.14	6.71	6.03	102.1
20	70.25	8.28	3.15	5.12	6.15	102.7
25	60.90	7.17	3.14	4.03	6.05	102.2
30	53.93	6.35	3.11	3.24	5.84	101.2
35	48.52	5.72	3.07	2.65	5.56	99.9
40	44.18	5.21	3.00	2.20	5.29	97.7
45	40.63	4.79	2.93	1.85	5.00	95.5
50	37.65	4.44	2.87	1.57	4.71	93.3
55	35.12	4.14	2.80	1.34	4.42	91.0
60	32.94	3.88	2.73	1.15	4.14	88.9

Storage: Roof Storage

Depth (mm)	Head (m)	Discharge (L/s)	Vreq (cu. m)	Vavail (cu. m)	Discharge Check	
5-year Water Level	102.66	0.10	3.15	6.15	18.83	0.00

Project #160401195, 5731 Hazeldean
Modified Rational Method Calculatons for Storage

100	37.90	42.55	26.91	15.64	93.84	125.1	0.00
110	35.20	39.52	26.21	13.31	87.81	121.9	0.00
120	32.89	36.93	25.53	11.39	82.04	118.7	0.00

Storage: Roof Storage

Depth (mm)	Head (m)	Discharge (L/s)	Vreq (cu. m)	Vavail (cu. m)	Discharge Check	
100-year Water Level	139.08	0.14	29.91	131.80	161.52	0.00

Subdrainage Area: ST108C
 Area (ha): 0.05
 C: 1.00
 Maximum Storage Depth: Roof 150 mm

tc (min)	I (100 yr) (mm/hr)	Qactual (L/s)	Qrelease (L/s)	Qstored (L/s)	Vstored (m³)	Depth (mm)
10	178.56	23.37	3.92	19.46	11.67	127.4
20	119.95	15.70	4.13	11.57	13.89	134.4
30	91.87	12.02	4.16	7.87	14.16	135.3
40	75.15	9.84	4.11	5.72	13.73	133.9
50	63.95	8.37	4.04	4.33	12.99	131.6
60	55.89	7.32	3.96	3.36	12.10	128.8
70	49.79	6.52	3.86	2.65	11.14	125.8
80	44.99	5.89	3.75	2.14	10.27	122.0
90	41.11	5.38	3.63	1.75	9.45	118.2
100	37.90	4.96	3.52	1.44	8.66	114.5
110	35.20	4.61	3.41	1.20	7.91	111.0
120	32.89	4.31	3.31	1.00	7.20	107.6

Storage: Roof Storage

Depth (mm)	Head (m)	Discharge (L/s)	Vreq (cu. m)	Vavail (cu. m)	Discharge Check	
100-year Water Level	135.29	0.14	4.16	14.16	18.83	0.00

**Project #160401195, 5731 Hazeldean
Roof Drain Design Sheet, Area ST108A
Standard Zurn Model Z-105-5 Control-Flo Single Notch Roof Drain**

Elevation (m)	Rating Curve		Storage (cu. m)	Elevation (m)	Volume Estimation			Water Depth (m)
	Discharge Rate (cu.m/s)	Outlet Discharge (cu.m/s)			Area (sq. m)	Increment	Volume (cu. m)	
0.000	0.0000	0.0000	0	0.000	0	0	0	0.000
0.025	0.0004	0.0054	1	0.025	90	1	1	0.025
0.050	0.0008	0.0108	6	0.050	359	5	6	0.050
0.075	0.0012	0.0161	20	0.075	808	14	20	0.075
0.100	0.0015	0.0215	48	0.100	1436	28	48	0.100
0.125	0.0019	0.0269	93	0.125	2243	46	93	0.125
0.150	0.0023	0.0323	162	0.150	3230	68	162	0.150

Drawdown Estimate			
Total Volume (cu.m)	Total Time (sec)	Vol (cu.m)	Detention Time (hr)
0.0	0.0	0.0	0
5.2	486.8	5.2	0.13523
19.4	881.0	14.2	0.37995
47.1	1286.7	27.7	0.73735
92.7	1697.0	45.6	1.20874
160.8	2109.7	68.0	1.79476

Roof Storage Summary

Total Building Area (sq.m) 4038
 Assume Available Roof Area (sq. 80% 3230
 Roof Imperviousness 0.99
 Roof Drain Requirement (sq.m/Notch) 232
 Number of Roof Notches* 14
 Max. Allowable Depth of Roof Ponding (m) 0.15 * As per Ontario Building Code section OBC 7.4.10.4.(2)(c).
 Max. Allowable Storage (cu.m) 162
 Estimated 100 Year Drawdown Time (h) 1.5

From Zurn Drain Catalogue
 Head (m) L/min L/s Notch Rating
 0.051 45.5 0.00076 232

* Note: Number of drains can be reduced if multiple-notch drain used.

Calculation Results

	5yr	100yr	Available
Qresult (cu.m/s)	0.023	0.030	-
Depth (m)	0.106	0.139	0.150
Volume (cu.m)	58.2	131.8	161.5
Draintime (hrs)	0.9	1.5	

**Project #160401195, 5731 Hazeldean
Roof Drain Design Sheet, Area ST108B
Standard Zurn Model Z-105-5 Control-Flo Single Notch Roof Drain**

Elevation (m)	Rating Curve		Storage (cu. m)	Elevation (m)	Volume Estimation			Water Depth (m)
	Discharge Rate (cu.m/s)	Outlet Discharge (cu.m/s)			Area (sq. m)	Increment	Volume (cu. m)	
0.000	0.0000	0.0000	0	0.000	0	0	0	0.000
0.025	0.0004	0.0050	1	0.025	81	1	1	0.025
0.050	0.0008	0.0100	5	0.050	324	5	5	0.050
0.075	0.0012	0.0150	18	0.075	729	13	18	0.075
0.100	0.0015	0.0200	43	0.100	1296	25	43	0.100
0.125	0.0019	0.0250	84	0.125	2024	41	84	0.125
0.150	0.0023	0.0300	146	0.150	2915	61	146	0.150

Drawdown Estimate			
Total Volume (cu.m)	Total Time (sec)	Vol (cu.m)	Detention Time (hr)
0.0	0.0	0.0	0
4.7	473.1	4.7	0.13141
17.5	856.1	12.8	0.36921
42.5	1250.3	25.0	0.71652
83.7	1649.1	41.2	1.17459
145.1	2050.0	61.4	1.74404

Roof Storage Summary

Total Building Area (sq.m) 3644
 Assume Available Roof Area (sq. 80%
 Roof Imperviousness 0.99
 Roof Drain Requirement (sq.m/Notch) 232
 Number of Roof Notches* 13
 Max. Allowable Depth of Roof Ponding (m) 0.15
 Max. Allowable Storage (cu.m) 146
 Estimated 100 Year Drawdown Time (h) 1.5

* As per Ontario Building Code section OBC 7.4.10.4.(2)(c).

* Note: Number of drains can be reduced if multiple-notch drain used.

Calculation Results	5yr	100yr	Available
Qresult (cu.m/s)	0.021	0.028	-
Depth (m)	0.105	0.139	0.150
Volume (cu.m)	51.8	117.7	145.7
Draintime (hrs)	0.8	1.5	

From Zurn Drain Catalogue
 Head (m) L/min L/s Notch Rating
 0.051 45.5 0.00076 232

**Project #160401195, 5731 Hazeldean
Roof Drain Design Sheet, Area ST108C
Standard Zurn Model Z-105-5 Control-Flo Single Notch Roof Drain**

Elevation (m)	Rating Curve		Storage (cu. m)	Elevation (m)	Volume Estimation			Water Depth (m)
	Discharge Rate (cu.m/s)	Outlet Discharge (cu.m/s)			Area (sq. m)	Increment	Volume (cu. m)	
0.000	0.0000	0.0000	0	0.000	0	0	0	0.000
0.025	0.0004	0.0008	0	0.025	10	0	0	0.025
0.050	0.0008	0.0015	1	0.050	42	1	1	0.050
0.075	0.0012	0.0023	2	0.075	94	2	2	0.075
0.100	0.0015	0.0031	6	0.100	167	3	6	0.100
0.125	0.0019	0.0038	11	0.125	262	5	11	0.125
0.150	0.0023	0.0046	19	0.150	377	8	19	0.150

Drawdown Estimate			
Total Volume (cu.m)	Total Time (sec)	Vol (cu.m)	Detention Time (hr)
0.0	0.0	0.0	0
0.6	397.4	0.6	0.11038
2.3	719.0	1.7	0.3101
5.5	1050.1	3.2	0.60181
10.8	1385.1	5.3	0.98655
18.7	1721.9	7.9	1.46485

Roof Storage Summary

Total Building Area (sq.m) 471
 Assume Available Roof Area (sq. 80%
 Roof Imperviousness 0.99
 Roof Drain Requirement (sq.m/Notch) 232
 Number of Roof Notches* 2
 Max. Allowable Depth of Roof Ponding (m) 0.15
 Max. Allowable Storage (cu.m) 19
 Estimated 100 Year Drawdown Time (h) 1.2

* Note: Number of drains can be reduced if multiple-notch drain used.

From Zurn Drain Catalogue
 Head (m) L/min L/s Notch Rating
 0.051 45.5 0.00076 232

* As per Ontario Building Code section OBC 7.4.10.4.(2)(c).

Calculation Results

	5yr	100yr	Available
Qresult (cu.m/s)	0.003	0.004	-
Depth (m)	0.103	0.135	0.150
Volume (cu.m)	6.1	14.2	18.8
Draintime (hrs)	0.6	1.2	

**Project #160401195, 5731 Hazeldean
Roof Drain Design Sheet, Area ST108D
Standard Zurn Model Z-105-5 Control-Flo Single Notch Roof Drain**

Elevation (m)	Rating Curve		Storage (cu. m)	Elevation (m)	Volume Estimation			Water Depth (m)
	Discharge Rate (cu.m/s)	Outlet Discharge (cu.m/s)			Area (sq. m)	Increment	Volume (cu. m)	
0.000	0.0000	0.0000	0	0.000	0	0	0	0.000
0.025	0.0004	0.0008	0	0.025	11	0	0	0.025
0.050	0.0008	0.0015	1	0.050	46	1	1	0.050
0.075	0.0012	0.0023	3	0.075	103	2	3	0.075
0.100	0.0015	0.0031	6	0.100	184	4	6	0.100
0.125	0.0019	0.0038	12	0.125	287	6	12	0.125
0.150	0.0023	0.0046	21	0.150	414	9	21	0.150

Drawdown Estimate			
Total Volume (cu.m)	Total Time (sec)	Vol (cu.m)	Detention Time (hr)
0.0	0.0	0.0	0
0.7	436.4	0.7	0.12121
2.5	789.6	1.8	0.34055
6.0	1153.3	3.5	0.6609
11.9	1521.1	5.8	1.08342
20.6	1890.9	8.7	1.60868

Roof Storage Summary

Total Building Area (sq.m) 517
 Assume Available Roof Area (sq. 80% 414
 Roof Imperviousness 0.99
 Roof Drain Requirement (sq.m/Notch) 232
 Number of Roof Notches* 2
 Max. Allowable Depth of Roof Ponding (m) 0.15 * As per Ontario Building Code section OBC 7.4.10.4.(2)(c).
 Max. Allowable Storage (cu.m) 21
 Estimated 100 Year Drawdown Time (h) 1.3

From Zurn Drain Catalogue
 Head (m) L/min L/s Notch Rating
 0.051 45.5 0.00076 232

* Note: Number of drains can be reduced if multiple-notch drain used.

Calculation Results	5yr	100yr	Available
Qresult (cu.m/s)	0.003	0.004	-
Depth (m)	0.104	0.137	0.150
Volume (cu.m)	7.1	16.2	20.7
Draintime (hrs)	0.7	1.3	

**Project #160401195, 5731 Hazeldean
Roof Drain Design Sheet, Area ST108E
Standard Zurn Model Z-105-5 Control-Flo Single Notch Roof Drain**

Elevation (m)	Rating Curve		Storage (cu. m)	Elevation (m)	Volume Estimation			Water Depth (m)
	Discharge Rate (cu.m/s)	Outlet Discharge (cu.m/s)			Area (sq. m)	Increment	Volume (cu. m)	
0.000	0.0000	0.0000	0	0.000	0	0	0	0.000
0.025	0.0004	0.0004	0	0.025	6	0	0	0.025
0.050	0.0008	0.0008	0	0.050	24	0	0	0.050
0.075	0.0012	0.0012	1	0.075	54	1	1	0.075
0.100	0.0015	0.0015	3	0.100	97	2	3	0.100
0.125	0.0019	0.0019	6	0.125	151	3	6	0.125
0.150	0.0023	0.0023	11	0.150	218	5	11	0.150

Drawdown Estimate			
Total Volume (cu.m)	Total Time (sec)	Vol (cu.m)	Detention Time (hr)
0.0	0.0	0.0	0
0.4	459.0	0.4	0.1275
1.3	830.5	1.0	0.3582
3.2	1213.0	1.9	0.69516
6.2	1599.9	3.1	1.13957
10.8	1988.9	4.6	1.69206

Roof Storage Summary

Total Building Area (sq.m) 272
 Assume Available Roof Area (sq. 80% 218
 Roof Imperviousness 0.99
 Roof Drain Requirement (sq.m/Notch) 232
 Number of Roof Notches* 1
 Max. Allowable Depth of Roof Ponding (m) 0.15 * As per Ontario Building Code section OBC 7.4.10.4.(2)(c).
 Max. Allowable Storage (cu.m) 11
 Estimated 100 Year Drawdown Time (h) 1.4

From Zurn Drain Catalogue
 Head (m) L/min L/s Notch Rating
 0.051 45.5 0.00076 232

* Note: Number of drains can be reduced if multiple-notch drain used.

Calculation Results

	5yr	100yr	Available
Qresult (cu.m/s)	0.002	0.002	-
Depth (m)	0.105	0.138	0.150
Volume (cu.m)	3.8	8.7	10.9
Draintime (hrs)	0.8	1.4	

Outlet Rip-Rap Sizing

US Army Corps of Engineers

1991 Procedure

EM1601

Common values

V	1.62	m/s
y	0.37125	m
Z	3.00	H:1V
phi	42	degrees
r	300	m
W	1	m
Ss	2.5	rock specific gravity
g	9.806	m/s ²
theta	18.4	degrees bank angle with horizontal

SF	1.1
Cs	0.3
Kl	1
Cv	0.79
Ct	1

D ₅₀ =	0.048	m
M ₅₀ =	0.147	kg

Selected D50	0.060	m
Min. thickness	0.120	m

**SERVICING AND STORMWATER MANAGEMENT BRIEF –
5731 HAZELDEAN ROAD**

Appendix C Stormwater Management
March 22, 2017

C.2 SAMPLE PCSWMM MODEL INPUT (12HR 100YR SCS)

[TITLE]

```

[OPTIONS]
;;Options      Value
-----
FLOW_UNITS    LPS
INFILTRATION  CURVE_NUMBER
FLOW_ROUTING  DYNWAVE
START_DATE    07/23/2009
START_TIME    00:00:00
REPORT_START_DATE 07/23/2009
REPORT_START_TIME 00:00:00
END_DATE      07/24/2009
END_TIME      00:00:00
SWEEP_START   01/01
SWEEP_END     12/31
DRY_DAYS      0
REPORT_STEP   00:05:00
WET_STEP      00:05:00
DRY_STEP      00:05:00
ROUTING_STEP  1
ALLOW_PONDING YES
INERTIAL_DAMPING PARTIAL
VARIABLE_STEP 0
LENGTHENING_STEP 0
MIN_SURFAREA  0
NORMAL_FLOW_LIMITED BOTH
SKIP_STEADY_STATE NO
FORCE_MAIN_EQUATION H-W
LINK_OFFSETS  ELEVATION
MIN_SLOPE     0
MAX_TRIALS    8
HEAD_TOLERANCE 0.0015
SYS_FLOW_TOL  5
LAT_FLOW_TOL  5
MINIMUM_STEP  0.5
THREADS       4
    
```

```

[EVAPORATION]
;;Type      Parameters
-----
CONSTANT    0.0
DRY_ONLY    NO
    
```

```

[RAINGAGES]
;;
;;Name      Rain      Time      Snow      Data
            Type      Intrvl    Catch    Source
    
```

```

-----
RG1          INTENSITY 0:15  1.0  TIMESERIES 100SCS
[SUBCATCHMENTS]
;;
;;Name      Raingage      Outlet      Total      Pcnt.      Width      Pcnt.      Curb      Snow
            Raingage      Outlet      Area      Imperv      Width      Slope      Length    Pack
-----
EXT1        RG1          EXT1-OF     0.067219  0          15.124    33.3      0
EXT2        RG1          EXT2-OF     0.063791  72.857    14.353    2          0
ST104A     RG1          ST104A-S   0.149935  84.286    69         2          0
ST107A     RG1          ST107A-S   0.373344  64.286    225        1.5        0
ST108A     RG1          ST108A-S   0.403809  100        90.857     1.5        0
ST108B     RG1          ST108B-S   0.36437   100        81.983     1.5        0
ST108C     RG1          ST108C-S   0.047083  100        12.1       1.5        0
ST108D     RG1          ST108D-S   0.051706  100        10.9       1.5        0
ST108E     RG1          ST108E-S   0.027193  100        25         1.5        0
ST108F     RG1          108        0.382042  44.286    85.96     1.2        0
ST109A     RG1          109        0.013537  100        18.2      10         0
ST109B     RG1          ST109B-S   0.054305  100        24.8       1          0
ST109C     RG1          ST109C-S   0.058618  100        25.8       1          0
ST110A     RG1          110        0.074661  7.143     16.799    0.8        0
ST110B     RG1          110        0.031906  100        24.5      10         0
ST110C     RG1          110        0.029561  100        26.6      10         0
ST110D     RG1          110        0.074098  7.143     16.672    0.8        0
ST111A     RG1          ST111A-S   0.242699  72.857    107.5     0.8        0
ST111B     RG1          111        0.037296  100        88         0.8        0
ST111C     RG1          ST111C-S   0.043507  85.714    36.8       1.5        0
ST507A     RG1          ST507A-S   0.054432  72.857    33.5       1.5        0
    
```

160401195_100SCS.inp

ST508A RG1 508 0.3356 7.143 189.2 1 0

[SUBAREAS]
 ;;Subcatchment N-Imperv N-Perv S-Imperv S-Perv PctZero RouteTo PctRouted

 EXT1 0.013 0.2 1.57 4.67 0 PERVIOUS 100
 EXT2 0.013 0.2 1.57 4.67 0 PERVIOUS 100
 ST104A 0.013 0.2 1.57 4.67 0 IMPERVIOUS 100
 ST107A 0.013 0.2 1.57 4.67 0 IMPERVIOUS 100
 ST108A 0.013 0.2 1.57 4.67 0 IMPERVIOUS 100
 ST108B 0.013 0.2 1.57 4.67 0 IMPERVIOUS 100
 ST108C 0.013 0.2 1.57 4.67 0 IMPERVIOUS 100
 ST108D 0.013 0.2 1.57 4.67 0 IMPERVIOUS 100
 ST108E 0.013 0.2 1.57 4.67 0 IMPERVIOUS 100
 ST108F 0.013 0.2 1.57 4.67 0 PERVIOUS 100
 ST109A 0.013 0.2 1.57 4.67 0 IMPERVIOUS 100
 ST109B 0.013 0.2 1.57 4.67 0 IMPERVIOUS 100
 ST109C 0.013 0.2 1.57 4.67 0 IMPERVIOUS 100
 ST110A 0.013 0.2 1.57 4.67 0 PERVIOUS 100
 ST110B 0.013 0.2 1.57 4.67 0 IMPERVIOUS 100
 ST110C 0.013 0.2 1.57 4.67 0 IMPERVIOUS 100
 ST110D 0.013 0.2 1.57 4.67 0 PERVIOUS 100
 ST111A 0.013 0.2 1.57 4.67 0 IMPERVIOUS 100
 ST111B 0.013 0.2 1.57 4.67 0 IMPERVIOUS 100
 ST111C 0.013 0.2 1.57 4.67 0 IMPERVIOUS 100
 ST507A 0.013 0.2 1.57 4.67 0 IMPERVIOUS 100
 ST508A 0.013 0.2 1.57 4.67 0 PERVIOUS 100

[INFILTRATION]
 ;;Subcatchment CurveNum HydCon DryTime

 EXT1 80 0 7
 EXT2 80 0 7
 ST104A 80 0 7
 ST107A 80 0 7
 ST108A 80 0 7
 ST108B 80 0 7
 ST108C 80 0 7
 ST108D 80 0 7
 ST108E 80 0 7
 ST108F 80 0 7
 ST109A 80 0 7
 ST109B 80 0 7
 ST109C 80 0 7
 ST110A 80 0 7
 ST110B 80 0 7

160401195_100SCS.inp

ST110C 80 0 7
 ST110D 80 0 7
 ST111A 80 0 7
 ST111B 80 0.5 7
 ST111C 80 0 7
 ST507A 80 0 7
 ST508A 80 0 7

[JUNCTIONS]
 ;;
 ;;Name Invert Elev. Max. Depth Init. Depth Surchage Depth Poned Area

 100 99.4 2.735 0 0 0
 101 99.60313 3.691 0 0 0
 102 99.7793 3.752 0 0 0
 103 100.035 3.526 0 0 0
 104 100.0785 3.492 0 0 0
 105 100.2317 3.406 0 0 0
 106 100.3418 2.976 0 0 0
 107 100.3418 2.976 0 0 0
 107 100.8033 2.417 0 0 0
 109 100.83 3.67 0 0 0
 110 100.686 3.814 0 0 0
 111 101.4225 2.65 0 0 0

[OUTFALLS]
 ;;
 ;;Name Invert Elev. Outfall Type Stage/Table Time Series Tide Gate Route To

 EXT1-OF 102.88 FREE NO
 EXT2-OF 104.2 FREE NO
 HEADWALL 98.7 FREE NO
 POOLE_OF1 100.1 FREE NO
 POOLE_OF2 101.059 FREE NO
 ST104A-OF 0 FREE NO
 ST107A-OF 0 FREE NO

[STORAGE]
 ;;
 ;;Name Invert Elev. Max. Depth Init. Depth Storage Curve Curve Params Poned Area Evap. Frac.

 Infiltration parameters

 108 97.239 7.127 0 TABULAR RWhtank 0 0
 508 101.06 1.79 0 TABULAR ST508A-S 0 0
 ST104A-S 101.52 2.1 0 TABULAR ST104A-S 0.01 0
 ST107A-S 101.13 2.1 0 TABULAR ST107A-S 0.01 0
 ST108A-S 118.6 0.15 0 TABULAR ST108A 0.01 0
 ST108B-S 115.75 0.15 0 TABULAR ST108B 0.01 0

160401195_100SCS.inp							
ST108C-S	110.4	0.15	0	TABULAR	ST108C	0.01	0
ST108D-S	110.1	0.15	0	TABULAR	ST108D	0.01	0
ST108E-S	107.2	0.15	0	TABULAR	ST108E	0.01	0
ST109B-S	102.81	1.5	0	FUNCTIONAL	0	0	0
ST109C-S	102.81	1.5	0	FUNCTIONAL	0	0	0
ST111A-S	101.86	2.4	0	TABULAR	ST111A-S	0.01	0
ST111C-S	101.95	2.1	0	FUNCTIONAL	0	0	0
ST507A-S	101.57	2.1	0	TABULAR	ST504A-S	0.01	0
TANK	100.1	3.27	0	TABULAR	TANK	0.01	0

[CONDUITS]							
;;	Inlet	Outlet		Manning	Inlet	Outlet	Init.
;;Max.							
;;Name	Node	Node	Length	N	Offset	Offset	Flow
;;Flow							
;;							
Pipe_13	100	HEADWALL	11.135	0.013	99.548	99.52	0 0
Pipe_14	106	105	17.55995	0.013	100.411	100.376	0 0
Pipe_14_(1)	105	104	39.10268	0.013	100.301	100.222	0 0
Pipe_15	109	104	38.24086	0.013	100.83	100.447	0 0
Pipe_16	110	106	12.50838	0.013	100.686	100.561	0 0
Pipe_17	111	107	110.3626	0.013	101.65	100.877	0 0
Pipe_21	104	103	16.284	0.013	100.143	100.11	0 0
Pipe_23	508	TANK	8.730414	0.013	101.6588	101.637	0 0
Pipe_26	101	100	101.5684	0.013	99.936	99.733	0 0
Pipe_27	108	105	36.34	0.013	100.441	100.332	0 0
Pipe_29	107	106	63.29649	0.013	100.802	100.486	0 0
Pipe_31	102	101	70.701	0.013	100.083	99.942	0 0
Pipe_34	103	TANK	2.81	0.013	100.106	100.1	0 0
ST104A-T	ST104A-S	ST104A-OF	2.5	0.025	103.47	102.88	0 0
ST107A-T	ST107A-S	ST107A-OF	2.5	0.025	103.08	103.04	0 0
ST111A-T	ST111A-S	ST111C-S	40.9	0.013	104.26	103.75	0 0

160401195_100SCS.inp							
ST111B-T	ST111C-S	ST107A-S	60	0.013	103.75	103.08	0 0
ST507A-T	ST507A-S	ST104A-S	14.9	0.013	103.5	103.47	0 0
W1	103	102	3	0.013	102	101.97	0 0

[ORIFICES]							
;;	Inlet	Outlet	Orifice	Crest	Disch.	Flap	Open/Close
;;Name	Node	Node	Type	Height	Coeff.	Gate	Time
;;							
OR1	TANK	102	SIDE	100.1	0.65	NO	0
OR2	TANK	102	SIDE	100.7	0.65	NO	0
OR3	TANK	102	SIDE	101	0.65	NO	0
ST104A-0	ST104A-S	104	SIDE	101.52	0.572	NO	0
ST107A-0	ST107A-S	107	SIDE	101.13	0.65	NO	0
ST109B-0	ST109B-S	109	SIDE	102.81	0.65	NO	0
ST109C-0	ST109C-S	109	SIDE	102.81	0.65	NO	0
ST111A-0	ST111A-S	111	SIDE	101.86	0.572	NO	0
ST111C-0	ST111C-S	111	SIDE	101.95	0.65	NO	0
ST111C-01	ST111C-S	111	SIDE	101.95	0.65	NO	0

[OUTLETS]							
;;	Inlet	Outlet	Outflow	Outlet	Qcoeff/		
;;Flap			Height	Type	QTable	Qexpon	
;;Name	Node	Node					
;;Gate							
;;							
OL1	TANK	POOLE_OF1	100.1	TABULAR/HEAD	TANK_BASEFLOW		
NO							
OL2	508	POOLE_OF2	101.06	TABULAR/HEAD	BIOSWALE_BASEFLOW		
NO							
ST108A-0	ST108A-S	108	118.6	TABULAR/HEAD	ST108A-0		
NO							
ST108B-0	ST108B-S	108	115.75	TABULAR/HEAD	ST108B-0		
NO							
ST108C-0	ST108C-S	108	110.4	TABULAR/HEAD	ST108C-0		
NO							
ST108D-0	ST108D-S	108	110.1	TABULAR/HEAD	ST108D-0		
NO							
ST108E-0	ST108E-S	108	107.2	TABULAR/HEAD	ST108E-0		
NO							
ST507A-0	ST507A-S	TANK	101.57	FUNCTIONAL/HEAD	7.996	0.499	
NO							

[XSECTIONS]

160401195_100SCS.inp						
;;Link	Shape	Geom1	Geom2	Geom3	Geom4	Barrels
Pipe_13	CIRCULAR	0.675	0	0	0	1
Pipe_14	CIRCULAR	0.525	0	0	0	1
Pipe_14_(1)	CIRCULAR	0.6	0	0	0	1
Pipe_15	CIRCULAR	0.375	0	0	0	1
Pipe_16	CIRCULAR	0.375	0	0	0	1
Pipe_17	CIRCULAR	0.375	0	0	0	1
Pipe_21	CIRCULAR	0.675	0	0	0	1
Pipe_23	CIRCULAR	0.25	0	0	0	1
Pipe_26	CIRCULAR	0.45	0	0	0	1
Pipe_27	CIRCULAR	0.45	0	0	0	1
Pipe_29	CIRCULAR	0.45	0	0	0	1
Pipe_31	CIRCULAR	0.45	0	0	0	1
Pipe_34	CIRCULAR	0.675	0	0	0	1
ST104A-T	IRREGULAR	overland	0	0	0	1
ST107A-T	IRREGULAR	overland	0	0	0	1
ST111A-T	IRREGULAR	overland	0	0	0	1
ST111B-T	IRREGULAR	overland	0	0	0	1
ST507A-T	IRREGULAR	overland	0	0	0	1
W1	CIRCULAR	0.45	0	0	0	1
OR1	CIRCULAR	0.11	0	0	0	
OR2	CIRCULAR	0.15	0	0	0	
OR3	CIRCULAR	0.15	0	0	0	
ST104A-O	CIRCULAR	0.14	0	0	0	
ST107A-O	CIRCULAR	0.2	0	0	0	
ST109B-O	CIRCULAR	0.2	0	0	0	
ST109C-O	CIRCULAR	0.2	0	0	0	
ST111A-O	CIRCULAR	0.076	0	0	0	
ST111C-O	CIRCULAR	0.2	0	0	0	
ST111C-O1	CIRCULAR	0.2	0	0	0	

[TRANSECTS]

NC 0.013	0.013	0.013								
X1 overland	5	0	0.15	6.85	0.0	0.0	0.0	0.0	0.0	0.0
GR 0.15	0	0	0.15	0	6.85	0.15	7	0.15	7	

;;[LE: 0][RE: 7]

NC 0.013	0.013	0.013								
X1 overland(orig)	4	0	0.15	6.85	0.0	0.0	0.0	0.0	0.0	0.0
GR 0.15	0	0	0.15	0	6.85	0.15	7			

[LOSSES]

;;Link	Inlet	Outlet	Average	Flap Gate	SeepageRate
Pipe_14	0	0.053	0	NO	0
Pipe_14_(1)	0	0.022	0	NO	0

Page 7

160401195_100SCS.inp					
Pipe_15	0	1.344	0	NO	0
Pipe_16	0	1.344	0	NO	0
Pipe_17	0	1.344	0	NO	0
Pipe_21	0	0.022	0	NO	0
Pipe_26	0	0.423	0	NO	0
Pipe_27	0	1.344	0	NO	0
Pipe_29	0	0.053	0	NO	0
Pipe_31	0	1.344	0	NO	0
W1	0	1.344	0	NO	0

[INFLOWS]

;;Node	Parameter	Time Series	Param Type	Units Factor	Scale Factor	Baseline Value	Baseline Pattern
100	FLOW	""	FLOW	1.0	1	175	

[CURVES]

;;Name	Type	X-Value	Y-Value
BIOSWALE_BASEFLOW	Rating	0.00	0
BIOSWALE_BASEFLOW		0.01	0.3
BIOSWALE_BASEFLOW		10.00	0.3
ST108A-O	Rating	0	0
ST108A-O		0.025	5.4
ST108A-O		0.050	10.8
ST108A-O		0.075	16.1
ST108A-O		0.100	21.5
ST108A-O		0.125	26.9
ST108A-O		0.150	32.3
ST108B-O	Rating	0	0
ST108B-O		0.025	5.0
ST108B-O		0.050	10.0
ST108B-O		0.075	15.0
ST108B-O		0.100	20.0
ST108B-O		0.125	25.0
ST108B-O		0.150	30.0
ST108C-O	Rating	0	0
ST108C-O		0.025	0.8
ST108C-O		0.050	1.5
ST108C-O		0.075	2.3
ST108C-O		0.100	3.1
ST108C-O		0.125	3.8
ST108C-O		0.150	4.6
ST108D-O	Rating	0	0

Page 8

160401195_100SCS.inp

ST108D-0		0.025	0.8
ST108D-0		0.050	1.5
ST108D-0		0.075	2.3
ST108D-0		0.100	3.1
ST108D-0		0.125	3.8
ST108D-0		0.150	4.6
ST108E-0	Rating	0	0
ST108E-0		0.025	0.4
ST108E-0		0.050	0.8
ST108E-0		0.075	1.2
ST108E-0		0.100	1.5
ST108E-0		0.125	1.9
ST108E-0		0.150	2.3
TANK_BASEFLOW	Rating	0.00	0
TANK_BASEFLOW		0.01	0.66
TANK_BASEFLOW		10.00	0.66
RWhtank	Storage	0	113.747
RWhtank		3.202	113.747
RWhtank		3.203	0
RWhtank		5	0
ST104A-S	Storage	0	0
ST104A-S		1.8	0
ST104A-S		1.95	32
ST107A-S	Storage	0	0
ST107A-S		1.8	0
ST107A-S		1.95	30.67
ST108A	Storage	0	0
ST108A		0.025	90
ST108A		0.050	359
ST108A		0.075	808
ST108A		0.100	1436
ST108A		0.125	2243
ST108A		0.150	3230
ST108B	Storage	0	0
ST108B		0.025	81
ST108B		0.050	324
ST108B		0.075	729
ST108B		0.100	1296
ST108B		0.125	2024
ST108B		0.150	2915

Page 9

160401195_100SCS.inp

ST108C	Storage	0	0
ST108C		0.025	10
ST108C		0.050	42
ST108C		0.075	94
ST108C		0.100	167
ST108C		0.125	262
ST108C		0.150	377
ST108D	Storage	0	0
ST108D		0.025	11
ST108D		0.050	46
ST108D		0.075	103
ST108D		0.100	184
ST108D		0.125	287
ST108D		0.150	414
ST108E	Storage	0	0
ST108E		0.025	6
ST108E		0.050	24
ST108E		0.075	54
ST108E		0.100	97
ST108E		0.125	151
ST108E		0.150	218
ST111A-S	Storage	0	0
ST111A-S		2.10	0
ST111A-S		2.40	724
ST504A-S	Storage	0	0
ST504A-S		1.8	0
ST504A-S		1.93	181.54
ST508A-S	Storage	0	0
ST508A-S		0.7	152
ST508A-S		0.701	0
ST508A-S		1.741	0
ST508A-S		1.991	114.4
TANK	Storage	0	560.7
TANK		0.026	560.7
TANK		0.051	560.7
TANK		0.077	560.7
TANK		0.102	559.44
TANK		0.127	559.44
TANK		0.153	558.18
TANK		0.178	556.92
TANK		0.204	555.66
TANK		0.229	554.4

Page 10

160401195_100SCS.inp

TANK	0.254	551.88
TANK	0.28	549.36
TANK	0.305	546.84
TANK	0.331	543.06
TANK	0.356	539.28
TANK	0.381	534.24
TANK	0.407	527.94
TANK	0.432	521.64
TANK	0.458	514.08
TANK	0.483	505.26
TANK	0.508	495.18
TANK	0.534	483.84
TANK	0.559	478.8
TANK	0.585	464.94
TANK	0.61	449.82
TANK	0.635	434.7
TANK	0.661	419.58
TANK	0.686	403.2
TANK	0.712	383.04
TANK	0.737	360.36
TANK	0.762	347.76
TANK	0.796	335.16
TANK	0.813	320.04
TANK	0.839	304.92
TANK	0.864	289.8
TANK	0.889	272.16
TANK	0.915	258.3
TANK	0.94	244.44
TANK	0.965	233.1
TANK	0.991	221.76
TANK	1.016	211.68
TANK	1.041	201.6
TANK	1.067	192.78
TANK	1.092	185.22
TANK	1.118	180.18
TANK	1.143	176.4
TANK	1.168	172.62
TANK	1.194	170.1
TANK	1.219	167.58
TANK	1.245	165.06
TANK	1.27	163.8
TANK	1.295	162.54
TANK	1.321	162.54
TANK	1.346	162.54
TANK	1.372	161.28
TANK	1.397	161.28
TANK	1.422	161.28
TANK	1.448	161.28

Page 11

160401195_100SCS.inp

TANK	1.473	161.28
TANK	1.499	161.28
TANK	1.524	161.28
TANK	1.549	161.28
TANK	1.575	161.28
TANK	1.6	161.28
TANK	1.626	161.28
TANK	1.651	161.28
TANK	1.676	161.28
TANK	1.702	161.28
TANK	1.727	161.28
TANK	1.753	161.28
TANK	1.778	161.28
TANK	1.803	161.28
TANK	1.829	161.28
TANK	1.83	0
TANK	5	0

Page 12

**SERVICING AND STORMWATER MANAGEMENT BRIEF –
5731 HAZELDEAN ROAD**

Appendix C Stormwater Management
March 22, 2017

C.3 SAMPLE PCSWMM MODEL OUTPUT (12HR 100YR SCS)

Legend

- Junctions
- Outfalls
- Storages
- Conduits
- Visible
- Major_Overland
- Orifices
- Outlets
- Subcatchments
- ACAD-160401195 SP

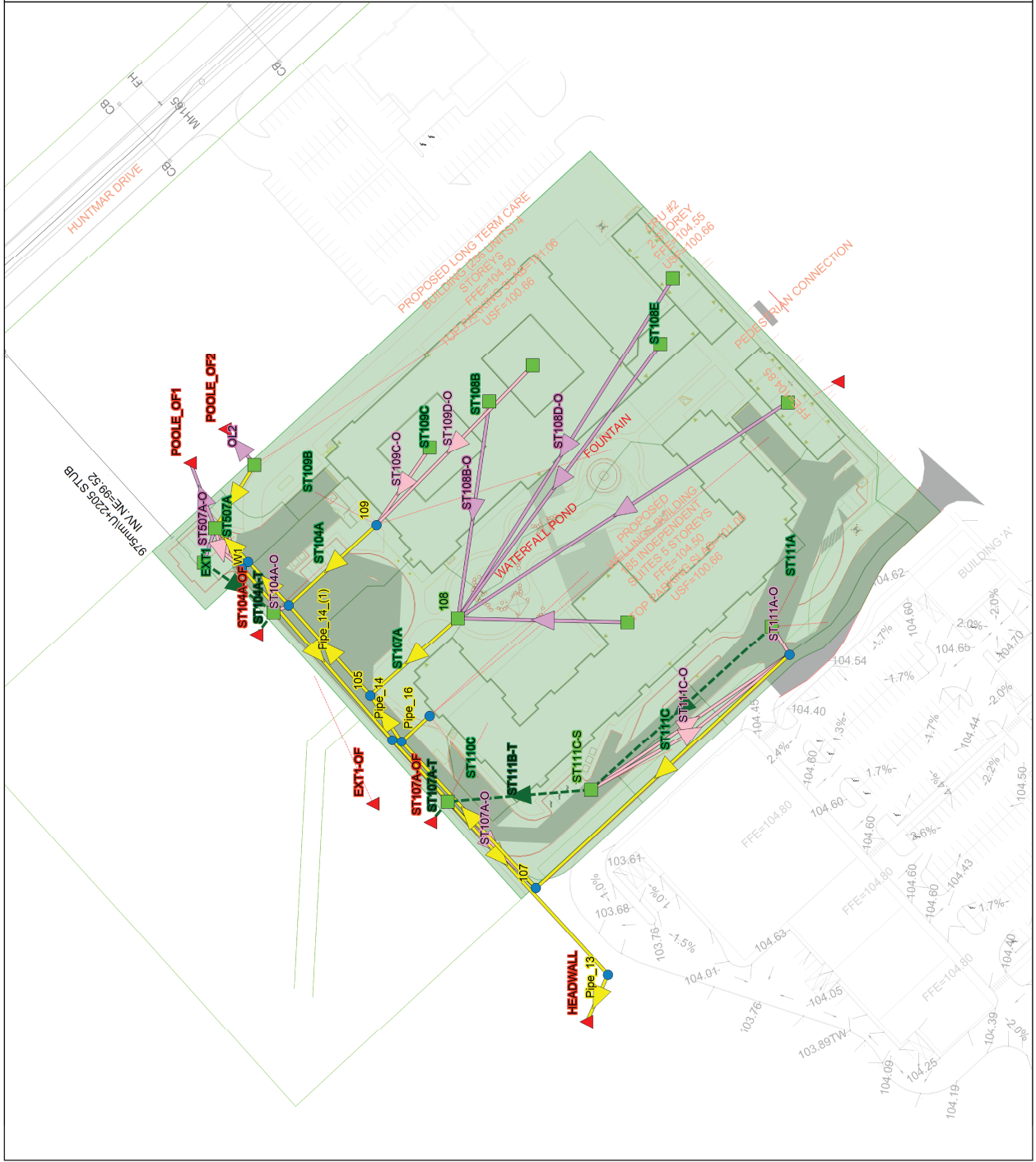

WARNING 03: negative offset ignored for Link Pipe_29

Element Count

Number of rain gages 1
 Number of subcatchments ... 22
 Number of nodes 33
 Number of links 37
 Number of pollutants 0
 Number of land uses 0

Raingage Summary

Name	Data Source	Data Type	Recording Interval
RG1	100SCS	INTENSITY	15 min.

Subcatchment Summary

Name	Area	Width	%Imperv	%Slope	Rain Gage	Outlet
EXT1	0.07	15.12	0.00	33.3000	RG1	EXT1-OF
EXT2	0.06	14.35	72.86	2.0000	RG1	EXT2-OF
ST104A	0.15	69.00	84.29	2.0000	RG1	ST104A-S
ST107A	0.37	225.00	64.29	1.5000	RG1	ST107A-S
ST108A	0.40	90.86	100.00	1.5000	RG1	ST108A-S
ST108B	0.36	81.98	100.00	1.5000	RG1	ST108B-S
ST108C	0.05	12.10	100.00	1.5000	RG1	ST108C-S
ST108D	0.05	10.90	100.00	1.5000	RG1	ST108D-S
ST108E	0.03	25.00	100.00	1.5000	RG1	ST108E-S
ST108F	0.38	85.96	44.29	1.2000	RG1	108
ST109A	0.01	18.20	100.00	10.0000	RG1	109
ST109B	0.05	24.80	100.00	1.0000	RG1	ST109B-S
ST109C	0.06	25.80	100.00	1.0000	RG1	ST109C-S
ST110A	0.07	16.80	7.14	0.8000	RG1	110
ST110B	0.03	24.50	100.00	10.0000	RG1	110
ST110C	0.03	26.60	100.00	10.0000	RG1	110

Name	Area	Width	%Imperv	%Slope	Rain Gage	Outlet
ST110D	0.07	16.67	7.14	0.8000	RG1	110
ST111A	0.24	107.50	72.86	0.8000	RG1	ST111A-S
ST111B	0.04	88.00	100.00	0.8000	RG1	111
ST111C	0.04	36.80	85.71	1.5000	RG1	ST111C-S
ST507A	0.05	33.50	72.86	1.5000	RG1	ST507A-S
ST508A	0.34	189.20	7.14	1.0000	RG1	508

Node Summary

Name	Type	Invert Elev.	Max. Depth	Ponded Area	External Inflow
100	JUNCTION	99.40	2.73	0.0	Yes
101	JUNCTION	99.60	3.69	0.0	
102	JUNCTION	99.78	3.75	0.0	
103	JUNCTION	100.04	3.53	0.0	
104	JUNCTION	100.08	3.49	0.0	
105	JUNCTION	100.23	3.41	0.0	
106	JUNCTION	100.34	2.98	0.0	
107	JUNCTION	100.80	2.42	0.0	
109	JUNCTION	100.83	3.67	0.0	
110	JUNCTION	100.69	3.81	0.0	
111	JUNCTION	101.42	2.65	0.0	
EXT1-OF	OUTFALL	102.88	0.00	0.0	
EXT2-OF	OUTFALL	104.20	0.00	0.0	
HEADWALL	OUTFALL	98.70	1.50	0.0	
POOLE_OF1	OUTFALL	100.10	0.00	0.0	
POOLE_OF2	OUTFALL	101.06	0.00	0.0	
ST104A-OF	OUTFALL	0.00	103.03	0.0	
ST107A-OF	OUTFALL	0.00	103.19	0.0	
108	STORAGE	97.24	7.13	0.0	
508	STORAGE	101.06	1.79	0.0	
ST104A-S	STORAGE	101.52	2.10	0.0	
ST107A-S	STORAGE	101.13	2.10	0.0	
ST108A-S	STORAGE	118.60	0.15	0.0	
ST108B-S	STORAGE	115.75	0.15	0.0	
ST108C-S	STORAGE	110.40	0.15	0.0	
ST108D-S	STORAGE	110.10	0.15	0.0	
ST108E-S	STORAGE	107.20	0.15	0.0	
ST109B-S	STORAGE	102.81	1.50	0.0	
ST109C-S	STORAGE	102.81	1.50	0.0	
ST111A-S	STORAGE	101.86	2.40	0.0	
ST111C-S	STORAGE	101.95	2.10	0.0	
ST507A-S	STORAGE	101.57	2.10	0.0	
TANK	STORAGE	100.10	3.27	0.0	

Link Summary

Name	From Node	To Node	Type	Length	%Slope	Roughness
Pipe_13	100	HEADWALL	CONDUIT	11.1	0.2515	0.0130
Pipe_14	106	105	CONDUIT	17.6	0.1993	0.0130
Pipe_14_(1)	105	104	CONDUIT	39.1	0.2020	0.0130
Pipe_15	109	104	CONDUIT	38.2	1.0016	0.0130
Pipe_16	110	106	CONDUIT	12.5	0.9994	0.0130
Pipe_17	111	107	CONDUIT	110.4	0.7004	0.0130
Pipe_21	104	103	CONDUIT	16.3	0.2027	0.0130
Pipe_23	508	TANK	CONDUIT	8.7	0.2497	0.0130
Pipe_26	101	100	CONDUIT	101.6	0.1999	0.0130
Pipe_27	108	105	CONDUIT	36.3	0.2999	0.0130
Pipe_29	107	106	CONDUIT	63.3	0.5013	0.0130
Pipe_31	102	101	CONDUIT	70.7	0.1994	0.0130
Pipe_34	103	TANK	CONDUIT	2.8	0.2135	0.0130
ST104A-T	ST104A-S	ST104A-OF	CONDUIT	2.5	24.2860	0.0130
ST107A-T	ST107A-S	ST107A-OF	CONDUIT	2.5	1.6002	0.0130
ST111A-T	ST111A-S	ST111C-S	CONDUIT	40.9	1.2470	0.0130
ST111B-T	ST111C-S	ST107A-S	CONDUIT	60.0	1.1167	0.0130
ST507A-T	ST507A-S	ST104A-S	CONDUIT	14.9	0.2013	0.0130
w1	103	102	CONDUIT	3.0	1.0001	0.0130
OR1	TANK	102	ORIFICE			
OR2	TANK	102	ORIFICE			
OR3	TANK	102	ORIFICE			
ST104A-O	ST104A-S	104	ORIFICE			
ST107A-O	ST107A-S	107	ORIFICE			
ST109B-O	ST109B-S	109	ORIFICE			
ST109C-O	ST109C-S	109	ORIFICE			
ST111A-O	ST111A-S	111	ORIFICE			
ST111C-O	ST111C-S	111	ORIFICE			
ST111C-01	ST111C-S	111	ORIFICE			
OL1	TANK	POOLE_OF1	OUTLET			
OL2	508	POOLE_OF2	OUTLET			
ST108A-O	ST108A-S	108	OUTLET			
ST108B-O	ST108B-S	108	OUTLET			
ST108C-O	ST108C-S	108	OUTLET			
ST108D-O	ST108D-S	108	OUTLET			
ST108E-O	ST108E-S	108	OUTLET			
ST507A-O	ST507A-S	TANK	OUTLET			

Cross Section Summary

Conduit	Shape	Full Depth	Full Area	Hyd. Rad.	Max. width	No. of Barrels	Full Flow
Pipe_13	CIRCULAR	0.68	0.36	0.17	0.68	1	421.55
Pipe_14	CIRCULAR	0.53	0.22	0.13	0.53	1	192.01
Pipe_14_(1)	CIRCULAR	0.60	0.28	0.15	0.60	1	276.00
Pipe_15	CIRCULAR	0.38	0.11	0.09	0.38	1	175.48
Pipe_16	CIRCULAR	0.38	0.11	0.09	0.38	1	175.29
Pipe_17	CIRCULAR	0.38	0.11	0.09	0.38	1	146.75
Pipe_21	CIRCULAR	0.68	0.36	0.17	0.68	1	378.43
Pipe_23	CIRCULAR	0.25	0.05	0.06	0.25	1	29.72
Pipe_26	CIRCULAR	0.45	0.16	0.11	0.45	1	127.47
Pipe_27	CIRCULAR	0.45	0.16	0.11	0.45	1	156.15
Pipe_29	CIRCULAR	0.45	0.16	0.11	0.45	1	201.87
Pipe_31	CIRCULAR	0.45	0.16	0.11	0.45	1	127.33
Pipe_34	CIRCULAR	0.68	0.36	0.17	0.68	1	388.45
ST104A-T	Overland	0.15	1.03	0.14	7.00	1	10684.06
ST107A-T	Overland	0.15	1.03	0.14	7.00	1	2742.50
ST111A-T	Overland	0.15	1.03	0.14	7.00	1	2421.02
ST111B-T	Overland	0.15	1.03	0.14	7.00	1	2291.05
ST507A-T	Overland	0.15	1.03	0.14	7.00	1	972.81
w1	CIRCULAR	0.45	0.16	0.11	0.45	1	285.13

Transect Summary

Transect Overland Area:

0.0196	0.0392	0.0588	0.0784	0.0980
0.1177	0.1374	0.1571	0.1768	0.1965
0.2162	0.2360	0.2558	0.2756	0.2954
0.3152	0.3351	0.3550	0.3748	0.3947
0.4147	0.4346	0.4546	0.4745	0.4945
0.5145	0.5346	0.5546	0.5747	0.5947
0.6148	0.6350	0.6551	0.6752	0.6954
0.7156	0.7358	0.7560	0.7762	0.7965
0.8168	0.8371	0.8574	0.8777	0.8980
0.9184	0.9388	0.9592	0.9796	1.0000
Hrad:				
0.0208	0.0415	0.0622	0.0829	0.1036
0.1242	0.1448	0.1653	0.1858	0.2063
0.2268	0.2472	0.2676	0.2879	0.3083
0.3285	0.3488	0.3690	0.3892	0.4094
0.4295	0.4496	0.4697	0.4897	0.5097
0.5297	0.5496	0.5695	0.5894	0.6093

	0.6291	0.6489	0.6686	0.6884	0.7081
	0.7277	0.7474	0.7670	0.7865	0.8061
	0.8256	0.8451	0.8646	0.8840	0.9034
	0.9228	0.9421	0.9614	0.9807	1.0000
width:	0.9580	0.9589	0.9597	0.9606	0.9614
	0.9623	0.9631	0.9640	0.9649	0.9657
	0.9666	0.9674	0.9683	0.9691	0.9700
	0.9709	0.9717	0.9726	0.9734	0.9743
	0.9751	0.9760	0.9769	0.9777	0.9786
	0.9794	0.9803	0.9811	0.9820	0.9829
	0.9837	0.9846	0.9854	0.9863	0.9871
	0.9880	0.9889	0.9897	0.9906	0.9914
	0.9923	0.9931	0.9940	0.9949	0.9957
	0.9966	0.9974	0.9983	0.9991	1.0000
Transect overland(orig)					
Area:	0.0196	0.0392	0.0588	0.0784	0.0980
	0.1177	0.1374	0.1571	0.1768	0.1965
	0.2162	0.2360	0.2558	0.2756	0.2954
	0.3152	0.3351	0.3550	0.3748	0.3947
	0.4147	0.4346	0.4546	0.4745	0.4945
	0.5145	0.5346	0.5546	0.5747	0.5947
	0.6148	0.6350	0.6551	0.6752	0.6954
	0.7156	0.7358	0.7560	0.7762	0.7965
	0.8168	0.8371	0.8574	0.8777	0.8980
	0.9184	0.9388	0.9592	0.9796	1.0000
Hrad:	0.0208	0.0415	0.0622	0.0829	0.1036
	0.1242	0.1448	0.1653	0.1858	0.2063
	0.2268	0.2472	0.2676	0.2879	0.3083
	0.3285	0.3488	0.3690	0.3892	0.4094
	0.4295	0.4496	0.4697	0.4897	0.5097
	0.5297	0.5496	0.5695	0.5894	0.6093
	0.6291	0.6489	0.6686	0.6884	0.7081
	0.7277	0.7474	0.7670	0.7865	0.8061
	0.8256	0.8451	0.8646	0.8840	0.9034
	0.9228	0.9421	0.9614	0.9807	1.0000
width:	0.9580	0.9589	0.9597	0.9606	0.9614
	0.9623	0.9631	0.9640	0.9649	0.9657
	0.9666	0.9674	0.9683	0.9691	0.9700
	0.9709	0.9717	0.9726	0.9734	0.9743
	0.9751	0.9760	0.9769	0.9777	0.9786
	0.9794	0.9803	0.9811	0.9820	0.9829
	0.9837	0.9846	0.9854	0.9863	0.9871
	0.9880	0.9889	0.9897	0.9906	0.9914

	0.9923	0.9931	0.9940	0.9949	0.9957
	0.9966	0.9974	0.9983	0.9991	1.0000

 NOTE: The summary statistics displayed in this report are based on results found at every computational time step, not just on results from each reporting time step.

 Analysis Options

Flow Units LPS
 Process Models:
 Rainfall/Runoff YES
 RDII NO
 Snowmelt NO
 Groundwater NO
 Flow Routing YES
 Ponding Allowed YES
 water Quality NO
 Infiltration Method CURVE_NUMBER
 Flow Routing Method DYNWAVE
 Starting Date 07/23/2009 00:00:00
 Ending Date 07/24/2009 00:00:00
 Antecedent Dry Days 0.0
 Report Time Step 00:05:00
 Wet Time Step 00:05:00
 Dry Time Step 00:05:00
 Routing Time Step 1.00 sec
 Variable Time Step NO
 Maximum Trials 8
 Number of Threads 4
 Head Tolerance 0.001500 m

	Volume hectare-m	Depth mm
Total Precipitation	0.285	95.520
Evaporation Loss	0.000	0.000
Infiltration Loss	0.041	13.902
Surface Runoff	0.239	80.308
Final Storage	0.005	1.589
Continuity Error (%)	-0.292	

160401195_100scs.rpt

Flow Routing Continuity	Volume hectare-m	Volume 10^6 ltr
Dry weather Inflow	0.000	0.000
Wet weather Inflow	0.239	2.394
Groundwater Inflow	0.000	0.000
RDII Inflow	0.000	0.000
External Inflow	1.512	15.120
External Outflow	1.711	17.108
Flooding Loss	0.000	0.000
Evaporation Loss	0.000	0.000
Exfiltration Loss	0.000	0.000
Initial Stored Volume	0.000	0.000
Final Stored Volume	0.041	0.409
Continuity Error (%)	-0.017	

Highest Flow Instability Indexes

Link Pipe_34 (3)

Routing Time Step Summary

Minimum Time Step	:	1.00 sec
Average Time Step	:	1.00 sec
Maximum Time Step	:	1.00 sec
Percent in Steady State	:	0.00
Average Iterations per Step	:	2.00
Percent Not Converging	:	0.05

Subcatchment Runoff Summary

Subcatchment	Total Precip mm	Total Runon mm	Total Evap mm	Total Infil mm	Total Runoff mm	Total Runoff 10^6 ltr	Peak Runoff LPS	Runoff Coeff
EXT1	95.52	0.00	0.00	41.82	52.63	0.04	16.91	0.551
EXT2	95.52	0.00	0.00	11.35	83.12	0.05	20.73	0.870
ST104A	95.52	0.00	0.00	6.56	87.63	0.13	50.18	0.917
ST107A	95.52	0.00	0.00	14.94	79.28	0.30	115.66	0.830
ST108A	95.52	0.00	0.00	0.00	94.37	0.38	142.13	0.988

Page 7

160401195_100scs.rpt

ST108B	95.52	0.00	0.00	0.00	94.37	0.34	128.25	0.988
ST108C	95.52	0.00	0.00	0.00	94.35	0.04	16.57	0.988
ST108D	95.52	0.00	0.00	0.00	94.37	0.05	18.20	0.988
ST108E	95.52	0.00	0.00	0.00	94.08	0.03	9.57	0.985
ST108F	95.52	0.00	0.00	23.30	70.82	0.27	102.04	0.741
ST109A	95.52	0.00	0.00	0.00	93.98	0.01	4.76	0.984
ST109B	95.52	0.00	0.00	0.00	94.28	0.05	19.11	0.987
ST109C	95.52	0.00	0.00	0.00	94.29	0.06	20.63	0.987
ST110A	95.52	0.00	0.00	38.83	54.74	0.04	12.92	0.573
ST110B	95.52	0.00	0.00	0.00	93.99	0.03	11.23	0.984
ST110C	95.52	0.00	0.00	0.00	93.99	0.03	10.41	0.984
ST110D	95.52	0.00	0.00	38.83	54.74	0.04	12.82	0.573
ST111A	95.52	0.00	0.00	11.35	82.89	0.20	77.09	0.868
ST111B	95.52	0.00	0.00	0.00	94.00	0.04	13.13	0.984
ST111C	95.52	0.00	0.00	5.96	88.16	0.04	14.64	0.923
ST507A	95.52	0.00	0.00	11.34	82.85	0.05	17.48	0.867
ST508A	95.52	0.00	0.00	38.83	55.31	0.19	79.58	0.579

Node Depth Summary

Node	Type	Average Depth Meters	Maximum Depth Meters	Maximum HGL Meters	Time of Max Occurrence days hr:min	Reported Max Depth Meters
100	JUNCTION	0.44	0.52	99.92	0 06:53	0.52
101	JUNCTION	0.41	0.74	100.34	0 06:53	0.74
102	JUNCTION	0.39	0.76	100.54	0 06:52	0.76
103	JUNCTION	0.45	1.94	101.97	0 06:52	1.93
104	JUNCTION	0.41	1.90	101.98	0 06:52	1.89
105	JUNCTION	0.34	1.76	101.99	0 06:52	1.75
106	JUNCTION	0.29	1.65	101.99	0 06:52	1.64
107	JUNCTION	0.12	1.20	102.00	0 06:52	1.19
109	JUNCTION	0.10	1.15	101.98	0 06:52	1.14
110	JUNCTION	0.13	1.31	101.99	0 06:52	1.30
111	JUNCTION	0.25	0.59	102.02	0 06:51	0.59
EXT1-OF	OUTFALL	0.00	0.00	102.88	0 00:00	0.00
EXT2-OF	OUTFALL	0.00	0.00	104.20	0 00:00	0.00
HEADWALL	OUTFALL	0.00	0.00	98.70	0 00:00	0.00
POOLE_OF1	OUTFALL	0.00	0.00	100.10	0 00:00	0.00
POOLE_OF2	OUTFALL	0.00	0.00	101.06	0 00:00	0.00
ST104A-OF	OUTFALL	0.00	0.00	0.00	0 00:00	0.00
ST107A-OF	OUTFALL	0.00	0.00	0.00	0 00:00	0.00
108	STORAGE	2.74	4.80	102.04	0 06:48	4.79
508	STORAGE	0.46	0.95	102.01	0 06:14	0.95

Page 8

160401195_100scs.rpt

ST104A-S	STORAGE	0.05	1.71	103.23	0	06:15	1.71
ST107A-S	STORAGE	0.09	1.72	102.85	0	06:15	1.71
ST108A-S	STORAGE	0.02	0.14	118.74	0	06:20	0.14
ST108B-S	STORAGE	0.02	0.14	115.89	0	06:20	0.14
ST108C-S	STORAGE	0.02	0.14	110.54	0	06:19	0.14
ST108D-S	STORAGE	0.02	0.14	110.24	0	06:19	0.14
ST108E-S	STORAGE	0.02	0.14	107.34	0	06:19	0.14
ST109B-S	STORAGE	0.01	0.15	102.96	0	06:10	0.15
ST109C-S	STORAGE	0.01	0.16	102.97	0	06:15	0.16
ST111A-S	STORAGE	0.23	2.32	104.18	0	06:24	2.32
ST111C-S	STORAGE	0.01	0.08	102.03	0	06:15	0.08
ST507A-S	STORAGE	0.06	1.87	103.44	0	06:17	1.87
TANK	STORAGE	0.38	1.87	101.97	0	06:52	1.86

Node Inflow Summary

Node	Type	Maximum Lateral Inflow LPS	Maximum Total Inflow LPS	Time of Max Occurrence days hr:min	Lateral Inflow Volume 10^6 ltr	Total Inflow Volume 10^6 ltr	Flow Balance Error Percent
100	JUNCTION	175.00	311.33	0 06:53	15.1	16.9	0.017
101	JUNCTION	0.00	136.63	0 06:52	0	1.83	-0.075
102	JUNCTION	0.00	136.71	0 06:52	0	1.83	0.036
103	JUNCTION	0.00	457.04	0 06:14	0	1.71	-0.003
104	JUNCTION	0.00	457.02	0 06:14	0	1.71	-0.145
105	JUNCTION	0.00	368.34	0 06:14	0	1.49	0.141
106	JUNCTION	0.00	206.19	0 06:14	0	0.707	-0.315
107	JUNCTION	0.00	159.99	0 06:15	0	0.569	0.194
109	JUNCTION	4.76	44.51	0 06:10	0.0127	0.119	0.473
110	JUNCTION	47.37	74.61	0 06:14	0.139	0.139	0.082
111	JUNCTION	13.13	45.04	0 06:15	0.0351	0.275	0.493
EXT1-OF	OUTFALL	16.91	16.91	0 06:15	0.0354	0.0354	0.000
EXT2-OF	OUTFALL	20.73	20.73	0 06:15	0.053	0.053	0.000
HEADWALL	OUTFALL	0.00	311.33	0 06:54	0	16.9	0.000
POOLE_OF1	OUTFALL	0.00	0.66	0 01:27	0	0.054	0.000
POOLE_OF2	OUTFALL	0.00	0.30	0 05:14	0	0.0203	0.000
ST104A-OF	OUTFALL	0.00	0.00	0 00:00	0	0	0.000
ST107A-OF	OUTFALL	0.00	0.00	0 00:00	0	0	0.000
108	STORAGE	102.04	240.16	0 06:13	0.271	1.14	-0.083
508	STORAGE	79.58	79.58	0 06:15	0.186	0.186	0.039
ST104A-S	STORAGE	50.18	50.18	0 06:15	0.131	0.131	0.004
ST107A-S	STORAGE	115.66	115.66	0 06:15	0.296	0.296	0.014
ST108A-S	STORAGE	142.13	142.13	0 06:15	0.381	0.381	-0.001

160401195_100scs.rpt

ST108B-S	STORAGE	128.25	128.25	0 06:15	0.344	0.344	-0.001
ST108C-S	STORAGE	16.57	16.57	0 06:15	0.0444	0.0444	-0.001
ST108D-S	STORAGE	18.20	18.20	0 06:15	0.0488	0.0488	-0.001
ST108E-S	STORAGE	9.57	9.57	0 06:10	0.0256	0.0256	-0.000
ST109B-S	STORAGE	19.11	19.11	0 06:10	0.0512	0.0512	-0.000
ST109C-S	STORAGE	20.63	20.63	0 06:15	0.0553	0.0553	-0.000
ST111A-S	STORAGE	77.09	77.09	0 06:15	0.201	0.201	-0.001
ST111C-S	STORAGE	14.64	14.64	0 06:15	0.0384	0.0384	0.078
ST507A-S	STORAGE	17.48	17.48	0 06:15	0.0451	0.0451	-0.002
TANK	STORAGE	0.00	548.41	0 06:15	0	1.89	-0.001

Node Surcharge Summary

Surcharging occurs when water rises above the top of the highest conduit.

Node	Type	Hours Surcharged	Max. Height Above Crown Meters	Min. Depth Below Rim Meters
104	JUNCTION	4.28	1.156	1.592
105	JUNCTION	3.62	1.092	1.645
106	JUNCTION	3.40	1.058	1.324
107	JUNCTION	2.19	0.747	1.220
109	JUNCTION	2.28	0.773	2.522
110	JUNCTION	2.81	0.933	2.506

Node Flooding Summary

No nodes were flooded.

Storage Volume Summary

Storage Unit	Average Volume 1000 m3	Avg Pcnt Full	Evap Pcnt Loss	Exfil Pcnt Loss	Maximum Volume 1000 m3	Max Pcnt Full	Time of Max Occurrence days hr:min	Maximum Outflow LPS
108	0.288	79	0	0	0.364	100	0 06:13	210.40
508	0.030	55	0	0	0.053	99	0 06:13	79.31

160401195_100scs.rpt

ST104A-S	0.000	0	0	0	0.000	0	0	00:00	49.96
ST107A-S	0.000	0	0	0	0.000	0	0	00:00	114.99
ST108A-S	0.010	6	0	0	0.141	86	0	06:20	30.68
ST108B-S	0.008	6	0	0	0.126	85	0	06:20	28.40
ST108C-S	0.001	4	0	0	0.015	80	0	06:19	4.26
ST108D-S	0.001	5	0	0	0.017	83	0	06:19	4.30
ST108E-S	0.001	5	0	0	0.009	85	0	06:19	2.17
ST109B-S	0.000	0	0	0	0.000	0	0	00:00	19.11
ST109C-S	0.000	0	0	0	0.000	0	0	00:00	20.63
ST111A-S	0.003	3	0	0	0.058	53	0	06:24	17.36
ST111C-S	0.000	0	0	0	0.000	0	0	00:00	14.64
ST507A-S	0.000	0	0	0	0.004	6	0	06:17	10.93
TANK	0.175	30	0	0	0.592	100	0	06:47	137.37

 Outfall Loading Summary

Outfall Node	Flow Freq Pcmt	Avg Flow LPS	Max Flow LPS	Total Volume 10 ⁶ ltr
EXT1-OF	30.18	1.36	16.91	0.035
EXT2-OF	45.84	1.34	20.73	0.053
HEADWALL	100.00	196.13	311.33	16.945
POOLE_OF1	95.39	0.65	0.66	0.054
POOLE_OF2	78.72	0.30	0.30	0.020
ST104A-OF	0.00	0.00	0.00	0.000
ST107A-OF	0.00	0.00	0.00	0.000
System	50.02	199.78	316.10	17.108

 Link Flow Summary

Link	Type	Maximum Flow LPS	Time of Max Occurrence days hr:min	Maximum Veloc m/sec	Max/ Full Flow	Max/ Full Depth
Pipe_13	CONDUIT	311.33	0 06:54	1.60	0.74	0.54
Pipe_14	CONDUIT	210.46	0 06:14	1.40	1.10	1.00
Pipe_14_(1)	CONDUIT	362.62	0 06:14	1.29	1.31	1.00
Pipe_15	CONDUIT	45.52	0 06:11	1.24	0.26	1.00

160401195_100scs.rpt

Pipe_16	CONDUIT	64.13	0 06:14	0.94	0.37	1.00
Pipe_17	CONDUIT	45.00	0 06:15	1.00	0.31	0.99
Pipe_21	CONDUIT	457.04	0 06:14	1.28	1.21	1.00
Pipe_23	CONDUIT	79.01	0 06:15	1.65	2.66	1.00
Pipe_26	CONDUIT	136.33	0 06:53	1.08	1.07	0.74
Pipe_27	CONDUIT	210.40	0 06:14	1.32	1.35	1.00
Pipe_29	CONDUIT	158.73	0 06:14	1.45	0.79	1.00
Pipe_31	CONDUIT	136.63	0 06:52	0.88	1.07	0.94
Pipe_34	CONDUIT	458.73	0 06:15	1.35	1.18	1.00
ST104A-T	CHANNEL	0.00	0 00:00	0.00	0.00	0.00
ST107A-T	CHANNEL	0.00	0 00:00	0.00	0.00	0.00
ST111A-T	CHANNEL	0.00	0 00:00	0.00	0.00	0.00
ST111B-T	CHANNEL	0.00	0 00:00	0.00	0.00	0.00
ST507A-T	CHANNEL	0.00	0 00:00	0.00	0.00	0.00
W1	CONDUIT	0.00	0 00:00	0.00	0.00	0.00
OR1	ORIFICE	32.79	0 06:48			1.00
OR2	ORIFICE	55.72	0 06:52			1.00
OR3	ORIFICE	48.25	0 06:52			1.00
ST104A-O	ORIFICE	49.96	0 06:15			1.00
ST107A-O	ORIFICE	114.99	0 06:15			1.00
ST109B-O	ORIFICE	19.11	0 06:10			0.76
ST109C-O	ORIFICE	20.63	0 06:15			0.80
ST111A-O	ORIFICE	17.36	0 06:24			1.00
ST111C-O	ORIFICE	7.32	0 06:15			0.40
ST111C-O1	ORIFICE	7.32	0 06:15			0.40
OL1	DUMMY	0.66	0 01:27			
OL2	DUMMY	0.30	0 05:14			
ST108A-O	DUMMY	30.68	0 06:20			
ST108B-O	DUMMY	28.40	0 06:20			
ST108C-O	DUMMY	4.26	0 06:19			
ST108D-O	DUMMY	4.30	0 06:19			
ST108E-O	DUMMY	2.17	0 06:19			
ST507A-O	DUMMY	10.93	0 06:17			

 Flow Classification Summary

Conduit	Adjusted /Actual Length	Fraction of Time in Flow Class								
		Dry	Up Dry	Down Dry	Sub Crit	Sup Crit	Up Crit	Down Crit	Norm Ltd	Inlet Ctrl
Pipe_13	1.00	0.00	0.00	0.00	0.00	0.00	0.00	1.00	0.00	0.00
Pipe_14	1.00	0.04	0.00	0.00	0.39	0.00	0.00	0.56	0.02	0.00
Pipe_14_(1)	1.00	0.04	0.00	0.00	0.51	0.00	0.00	0.45	0.06	0.00
Pipe_15	1.00	0.04	0.00	0.00	0.36	0.00	0.00	0.61	0.19	0.00

Pipe_16	1.00	0.04	0.00	0.00	0.31	0.00	0.00	0.65	0.05	0.00
Pipe_17	1.00	0.04	0.00	0.00	0.15	0.00	0.00	0.80	0.11	0.00
Pipe_21	1.00	0.04	0.00	0.00	0.94	0.00	0.00	0.02	0.14	0.00
Pipe_23	1.00	0.62	0.00	0.00	0.05	0.00	0.00	0.33	0.00	0.00
Pipe_26	1.00	0.00	0.09	0.00	0.72	0.00	0.00	0.19	0.54	0.00
Pipe_27	1.00	0.05	0.20	0.00	0.42	0.00	0.02	0.32	0.06	0.00
Pipe_29	1.00	0.04	0.00	0.00	0.34	0.00	0.00	0.63	0.17	0.00
Pipe_31	1.00	0.07	0.00	0.00	0.90	0.00	0.00	0.02	0.00	0.00
Pipe_34	1.00	0.04	0.00	0.00	0.89	0.07	0.00	0.00	0.01	0.00
ST104A-T	1.00	1.00	0.00	0.00	0.00	0.00	0.00	0.00	0.00	0.00
ST107A-T	1.00	1.00	0.00	0.00	0.00	0.00	0.00	0.00	0.00	0.00
ST111A-T	1.00	1.00	0.00	0.00	0.00	0.00	0.00	0.00	0.00	0.00
ST111B-T	1.00	1.00	0.00	0.00	0.00	0.00	0.00	0.00	0.00	0.00
ST507A-T	1.00	1.00	0.00	0.00	0.00	0.00	0.00	0.00	0.00	0.00
W1	1.00	1.00	0.00	0.00	0.00	0.00	0.00	0.00	0.00	0.00

 Conduit Surcharge Summary

Conduit	----- Both Ends	Hours Full Upstream	----- Dnstream	Hours Above Full Normal Flow	Hours Capacity Limited
Pipe_14	3.40	3.40	3.62	0.05	0.01
Pipe_14_(1)	3.61	3.62	4.28	0.07	0.05
Pipe_15	2.28	2.28	4.28	0.01	0.01
Pipe_16	2.81	2.81	3.40	0.01	0.01
Pipe_17	0.01	0.01	2.19	0.01	0.01
Pipe_21	4.31	4.31	4.63	0.05	0.03
Pipe_23	0.34	0.42	0.44	0.19	0.01
Pipe_26	0.01	0.01	0.01	0.72	0.01
Pipe_27	3.71	3.71	4.69	0.06	0.16
Pipe_29	2.19	2.19	3.40	0.01	0.01
Pipe_31	0.01	0.16	0.01	0.73	0.01
Pipe_34	4.68	4.68	4.75	0.04	0.02

Analysis begun on: Thu Mar 23 14:03:56 2017
 Analysis ended on: Thu Mar 23 14:03:58 2017
 Total elapsed time: 00:00:02

**SERVICING AND STORMWATER MANAGEMENT BRIEF –
5731 HAZELDEAN ROAD**

Appendix C Stormwater Management
March 22, 2017

C.4 OIL/GRIT SEPARATOR SIZING CALCULATIONS



Stormceptor Design Summary

PCSWMM for Stormceptor

Project Information

Date	11/4/2016
Project Name	5731 Hazeldean
Project Number	160401195
Location	Ottawa, ON

Designer Information

Company	Stantec Consulting Ltd.
Contact	N/A

Rainfall

Name	OTTAWA MACDONALD-CARTIER INT'L A
State	ON
ID	6000
Years of Records	1967 to 2003
Latitude	45°19'N
Longitude	75°40'W

Notes

N/A

Water Quality Objective

TSS Removal (%)	80
-----------------	----

Drainage Area

Total Area (ha)	2.72
Imperviousness (%)	70

Upstream Storage

Storage (ha-m)	Discharge (L/s)
0	0

The Stormceptor System model STC 3000 achieves the water quality objective removing 80% TSS for a CLOCA (clay, silt and sand) particle size distribution.

Stormceptor Sizing Summary

Stormceptor Model	TSS Removal %
STC 300	60
STC 750	73
STC 1000	73
STC 1500	74
STC 2000	79
STC 3000	80
STC 4000	84
STC 5000	84
STC 6000	87
STC 9000	90
STC 10000	90
STC 14000	92



Particle Size Distribution

Removing silt particles from runoff ensures that the majority of the pollutants, such as hydrocarbons and heavy metals that adhere to fine particles, are not discharged into our natural water courses. The table below lists the particle size distribution used to define the annual TSS removal.

CLOCA (clay, silt and sand)							
Particle Size µm	Distribution %	Specific Gravity	Settling Velocity m/s	Particle Size µm	Distribution %	Specific Gravity	Settling Velocity m/s
850	3.3	2.65	0.1465	50	3.9	2.65	0.0022
425	23.4	2.65	0.0698	36	2.6	2.65	0.0012
300	17.5	2.65	0.0439	22	1.3	2.65	0.0004
250	6.5	2.65	0.0335	12	1.9	2.65	0.0004
212	6.5	2.65	0.0259	9	0	2.65	0.0004
150	11.7	2.65	0.0145	6.5	1.3	2.65	0.0004
125	5.2	2.65	0.0105	3	1.3	2.65	0.0004
100	3.9	2.65	0.0070	1.5	1.3	2.65	0.0004
75	3.9	2.65	0.0040	1	4.5	2.65	0.0004

Stormceptor Design Notes

- Stormceptor performance estimates are based on simulations using PCSWMM for Stormceptor version 1.0
- Design estimates listed are only representative of specific project requirements based on total suspended solids (TSS) removal.
- Only the STC 300 is adaptable to function with a catch basin inlet and/or inline pipes.
- Only the Stormceptor models STC 750 to STC 6000 may accommodate multiple inlet pipes.
- Inlet and outlet invert elevation differences are as follows:

Inlet and Outlet Pipe Invert Elevations Differences

Inlet Pipe Configuration	STC 300	STC 750 to STC 6000	STC 9000 to STC 14000
Single inlet pipe	75 mm	25 mm	75 mm
Multiple inlet pipes	75 mm	75 mm	Only one inlet pipe.

- Design estimates are based on stable site conditions only, after construction is completed.
- Design estimates assume that the storm drain is not submerged during zero flows. For submerged applications, please contact your local Stormceptor representative.
- Design estimates may be modified for specific spills controls. Please contact your local Stormceptor representative for further assistance.
- For pricing inquiries or assistance, please contact Imbrium Systems Inc., 1-800-565-4801.



Stantec Consulting Ltd.
 1000 Lakeshore Blvd. West
 Suite 1000
 Oakville, ON L6L 7K9
 Tel: 905.709.9200
 www.stantec.com

Copyright Reserved

This drawing is the property of Stantec Consulting Ltd. and shall remain the property of Stantec Consulting Ltd. for the purposes of the project. It is not to be used for any other project without the written consent of Stantec Consulting Ltd.

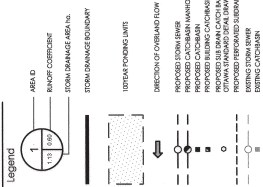

APPROVED REFUSED
 THIS PLAN OF WORK
 20.17
 Darick Woods, Manager
 Development Review West
 Development Department, City of Ottawa

NO.	DATE	BY	CHKD.	APPD.	REVISION
1	12/15/13	AW	AW	AW	ISSUED FOR PERMITS
2	03/25/14	AW	AW	AW	ISSUED FOR PERMITS
3	07/27/17	AW	AW	AW	REVISED AS PER CITY COMMENTS
4	08/14/17	AW	AW	AW	REVISED AS PER CITY COMMENTS
5	08/14/17	AW	AW	AW	REVISED AS PER CITY COMMENTS
6	08/14/17	AW	AW	AW	REVISED AS PER CITY COMMENTS



Client/Project
 WELLINGS OF STITTSVILLE INC. AND
 BIRCHDALE (CANADA) INC.
 AND 600 STITTSVILLE SENIORS LIVING
 AND 5731 HAZELDEAN ROAD
 STITTSVILLE
 OTTAWA, ON

Title
 STORM DRAINAGE PLAN

Project No. 160401195
 Scale 1:500
 Drawing No. Sheet
 Revision 6
 6 of 7
 SD-1
 9900-91-21-200

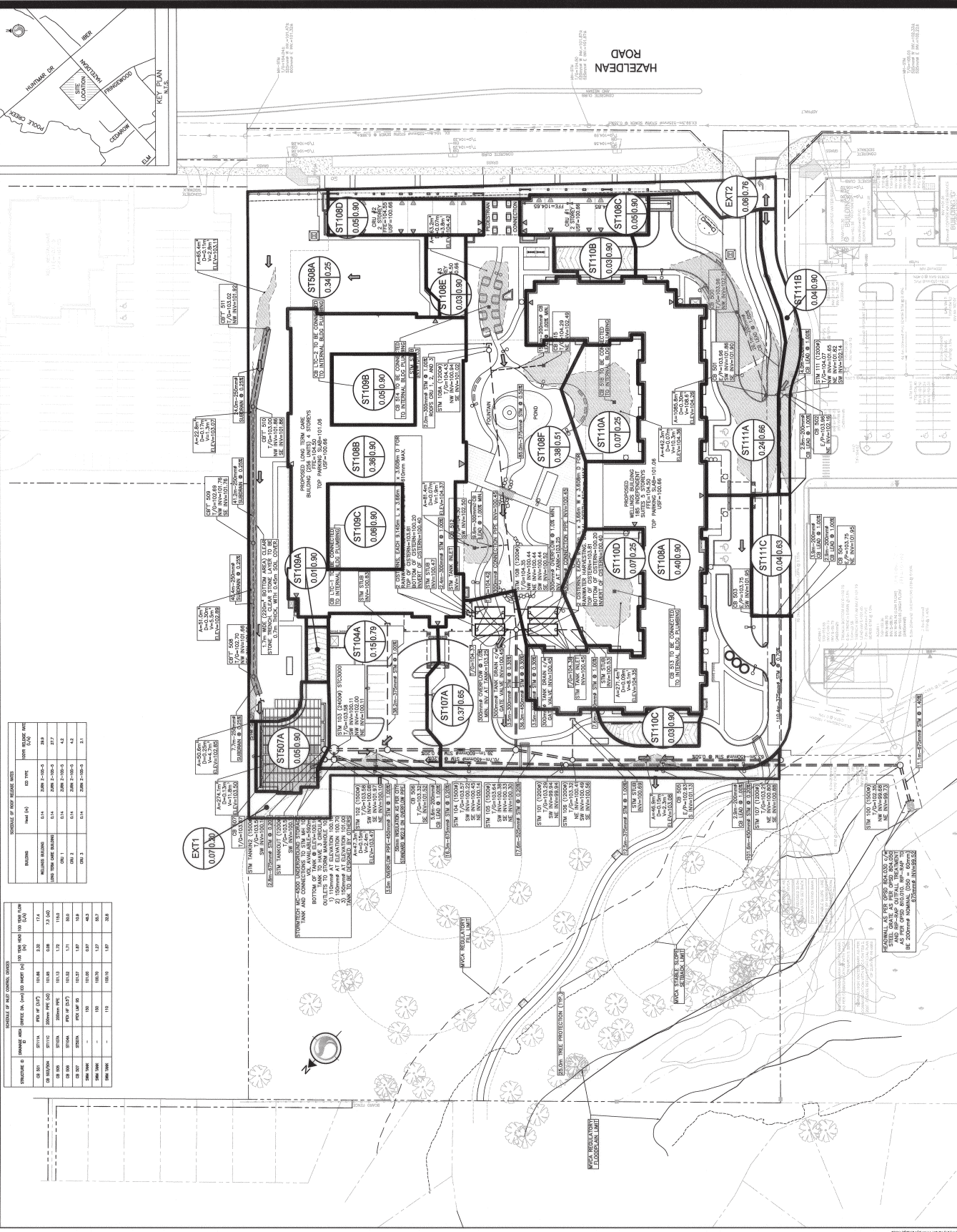

ROOM NO.	ROOM NAME	AREA (SQ. FT.)	DRY TYPE	STORM DRAINAGE
001	MECHANICAL ROOM	174	DRY	ST107A
002	MECHANICAL ROOM	217	DRY	ST108B
003	MECHANICAL ROOM	42	DRY	ST109C
004	MECHANICAL ROOM	42	DRY	ST110A
005	MECHANICAL ROOM	42	DRY	ST111B

STORM DRAINAGE	PIPE SIZE (IN.)	LENGTH (FT.)	PERCENTAGE OF PIPE COVERED
ST107A	18"	174	174
ST108B	18"	217	217
ST109C	18"	42	42
ST110A	18"	42	42
ST111B	18"	42	42

STORM DRAINAGE	PIPE SIZE (IN.)	LENGTH (FT.)	PERCENTAGE OF PIPE COVERED
ST107A	18"	174	174
ST108B	18"	217	217
ST109C	18"	42	42
ST110A	18"	42	42
ST111B	18"	42	42

4849

**SERVICING AND STORMWATER MANAGEMENT BRIEF –
WELLINGS OF STITTSVILLE PHASE 2, 20 CEDAROW COURT**

Appendix C Stormwater Management
September 1, 2023

C.7 WATER BALANCE CALCULATIONS

Project #160401511 - 20 Cedarrow Drive

Infiltration calculations

Required Infiltration Rate (KWMSS) 73 mm/yr
 Site Area 2.29 ha
 Pre-Development Imperviousness 0 %
 Pre-Development Infiltration 1674.5 m³/yr
 Post Development Imperviousness 61 %
 Post Development Pervious Area 0.89 ha
 Post Development Infiltration in Pervious Areas 653.0 m³/yr
Post Development Infiltration Volume Req. 1021.4 m³/yr

Determine Volume of Water to be Sequestered in Infiltration Trench (Assume storage up to 10mm event)

Area Tributary to Infiltration Trench 14200 m²
 Impervious Area to Infiltration Trench 11701 m²
 Total Depth of Annual Runoff to Infiltration Trench 760.5 mm/yr
 % of total precipitation of up to 4mm runoff from historical rainfall events > 2mm 35%
Volume of Runoff from Impervious Area to Infiltration Trench 3103.7 m³/yr
 (910.5mm/yr annual precipitation less urban ET of 150mm/yr)
 (Historical rainfall from MacDonald Cartier Airport 2009-2011)
 for all rainfall events with rainfall >2mm

In order to store up to 4mm from catchment area:

Max. Capacity Required (4mm)= 57 m³ volume of runoff
 Infiltration Area (m) 283.00 m
 Clear Stone Depth (m) 0.50 m
Volume Provided 57 m³
 40% Trench Porosity

Station Name OTTAWA MACDONALD-CARTIER INT'L A
 Province ONTARIO
 Latitude 45.32
 Longitude -75.67
 Elevation 114
 Climate Identifier 6106000
 WMO Identifier 71628
 TC Identifier YOW

Legend
 [Empty] No Data Available
 M Missing

E Estimated
 A Accumulated
 C Precipitation Occurred; Amount Uncertain
 L Precipitation May or May Not Have Occurred
 F Accumulated and Estimated
 N Temperature Missing but Known to be > 0
 Y Temperature Missing but Known to be < 0
 S More Than One Occurrence
 T Trace
 * Data for this day has undergone only preliminary quality checking
 ** Partner data that is not subject to review by the National Climate Archives

Date/Time	Year	Month	Day	Total Rain	Total Rain	Total Snow	Total Snow Flag	Total Precip (mm)
1/1/2009	2009	1	1	1	0	0		0
1/2/2009	2009	1	2	2	0	5.2		3.4
1/3/2009	2009	1	3	3	0	0	T	0
1/4/2009	2009	1	4	4	0	0	T	0
1/5/2009	2009	1	5	5	0	0.4		0.4
1/6/2009	2009	1	6	6	0	0	T	0
1/7/2009	2009	1	7	7	0	22.4		14.8
1/8/2009	2009	1	8	8	0	1.6		0.7
1/9/2009	2009	1	9	9	0	0		0
1/10/2009	2009	1	10	10	0	0		0
1/11/2009	2009	1	11	11	0	0		0
1/12/2009	2009	1	12	12	0	0	T	0
1/13/2009	2009	1	13	13	0	4.6		3
1/14/2009	2009	1	14	14	0	0		0
1/15/2009	2009	1	15	15	0	<--- should be from centreline o		0
1/16/2009	2009	1	16	16	0	water level		0.2
1/17/2009	2009	1	17	17	0	0.6		0.6
1/18/2009	2009	1	18	18	0	10.2		7.2
1/19/2009	2009	1	19	19	0	<-- use Goal Seek to quickly find		3.6
1/20/2009	2009	1	20	20	0	provides tT		
1/21/2009	2009	1	21	21	0	2.6		1.4
1/22/2009	2009	1	22	22	0	0.4		0.2
1/23/2009	2009	1	23	23	0	1.2		0.6
1/24/2009	2009	1	24	24	0	0		0
1/25/2009	2009	1	25	25	0	0		0
1/26/2009	2009	1	26	26	0	0.6		0
1/27/2009	2009	1	27	27	0	0	T	0
1/28/2009	2009	1	28	28	0	18		13
1/29/2009	2009	1	29	29	0	1.2		0.4
1/30/2009	2009	1	30	30	0	6.8		5
1/31/2009	2009	1	31	31	0	0	T	0
2/1/2009	2009	2	1	1	0 T	0.2		0.2
2/2/2009	2009	2	2	2	0	0	T	0
2/3/2009	2009	2	3	3	0	0		0
2/4/2009	2009	2	4	4	0	0		0
2/5/2009	2009	2	5	5	0	0		0
2/6/2009	2009	2	6	6	0	0.6		0
2/7/2009	2009	2	7	7	0	0		0
2/8/2009	2009	2	8	8	0 T	0.4		0.2
2/9/2009	2009	2	9	9	0	0.6		0.4
2/10/2009	2009	2	10	10	0 T	0		0
2/11/2009	2009	2	11	11	6.4	0		6.4
2/12/2009	2009	2	12	12	21.2	0	T	21.2
2/13/2009	2009	2	13	13	0	0		0
2/14/2009	2009	2	14	14	0	0		0

2/15/2009	2009	2	15	0	0	0
2/16/2009	2009	2	16	0	0	0
2/17/2009	2009	2	17	0	0	0
2/18/2009	2009	2	18	0	4.2	3.6
2/19/2009	2009	2	19	0	2.6	2.6
2/20/2009	2009	2	20	0	1.2	0.8
2/21/2009	2009	2	21	0	0 T	0
2/22/2009	2009	2	22	0	3.8	2.6
2/23/2009	2009	2	23	0	0.2	0.2
2/24/2009	2009	2	24	0	0 T	0
2/25/2009	2009	2	25	0	0 T	0
2/26/2009	2009	2	26	0	1.2	1.2
2/27/2009	2009	2	27	9.4	0.4	9.8
2/28/2009	2009	2	28	0	0	0
3/1/2009	2009	3	1	0	0	0
3/2/2009	2009	3	2	0	0	0
3/3/2009	2009	3	3	0	0	0
3/4/2009	2009	3	4	0	0	0
3/5/2009	2009	3	5	0 T	0 T	0
3/6/2009	2009	3	6	0.2	0	0.2
3/7/2009	2009	3	7	1.2	0	1.2
3/8/2009	2009	3	8	0	0	0
3/9/2009	2009	3	9	0.2	2.2	1.8
3/10/2009	2009	3	10	0.6	0.2	0.8
3/11/2009	2009	3	11	9	0 T	9
3/12/2009	2009	3	12	0	0	0
3/13/2009	2009	3	13	0	0	0
3/14/2009	2009	3	14	0	0	0
3/15/2009	2009	3	15	0	0	0
3/16/2009	2009	3	16	0	0	0
3/17/2009	2009	3	17	0	0	0
3/18/2009	2009	3	18	0.6	0	0.6
3/19/2009	2009	3	19	0	0	0
3/20/2009	2009	3	20	0	0	0
3/21/2009	2009	3	21	0	0.4	0
3/22/2009	2009	3	22	0	0.4	0
3/23/2009	2009	3	23	0	0	0
3/24/2009	2009	3	24	0	0	0
3/25/2009	2009	3	25	0	0	0
3/26/2009	2009	3	26	8.2	0	8.2
3/27/2009	2009	3	27	0.2	0	0.2
3/28/2009	2009	3	28	0	0	0
3/29/2009	2009	3	29	19.2	0	19.2
3/30/2009	2009	3	30	4	0 T	4
3/31/2009	2009	3	31	0	0	0
4/1/2009	2009	4	1	3	0	3
4/2/2009	2009	4	2	0	0	0
4/3/2009	2009	4	3	15.4	0	15.4
4/4/2009	2009	4	4	6	0 T	6
4/5/2009	2009	4	5	0	0 T	0
4/6/2009	2009	4	6	13	2	17.6
4/7/2009	2009	4	7	1.2	2.4	3.6
4/8/2009	2009	4	8	0 T	0 T	0
4/9/2009	2009	4	9	0	0	0
4/10/2009	2009	4	10	0	0	0
4/11/2009	2009	4	11	0	0	0
4/12/2009	2009	4	12	0	0	0
4/13/2009	2009	4	13	0	0	0
4/14/2009	2009	4	14	0	0	0
4/15/2009	2009	4	15	0	0	0
4/16/2009	2009	4	16	0	0	0
4/17/2009	2009	4	17	0	0	0
4/18/2009	2009	4	18	0.4	0	0.4
4/19/2009	2009	4	19	0	0	0
4/20/2009	2009	4	20	8.6	0	8.6
4/21/2009	2009	4	21	9.4	0	9.4
4/22/2009	2009	4	22	4.2	0	4.2
4/23/2009	2009	4	23	0.4	0	0.4
4/24/2009	2009	4	24	0.4	0	0.4
4/25/2009	2009	4	25	1.6	0	1.6
4/26/2009	2009	4	26	0 T	0	0
4/27/2009	2009	4	27	0	0	0

4/28/2009	2009	4	28	6.4	0	6.4
4/29/2009	2009	4	29	0	0	0
4/30/2009	2009	4	30	12	0	12
5/1/2009	2009	5	1	1	0	1
5/2/2009	2009	5	2	0.6	0	0.6
5/3/2009	2009	5	3	0	0	0
5/4/2009	2009	5	4	0	0	0
5/5/2009	2009	5	5	0 T	0	0
5/6/2009	2009	5	6	0 T	0	0
5/7/2009	2009	5	7	8	0	8
5/8/2009	2009	5	8	5	0	5
5/9/2009	2009	5	9	26	0	26
5/10/2009	2009	5	10	0	0	0
5/11/2009	2009	5	11	0	0	0
5/12/2009	2009	5	12	0	0	0
5/13/2009	2009	5	13	0	0	0
5/14/2009	2009	5	14	4.2	0	4.2
5/15/2009	2009	5	15	0	0	0
5/16/2009	2009	5	16	6.8	0	6.8
5/17/2009	2009	5	17	0	0	0
5/18/2009	2009	5	18	0	0	0
5/19/2009	2009	5	19	0 T	0	0
5/20/2009	2009	5	20	1	0	1
5/21/2009	2009	5	21	0	0	0
5/22/2009	2009	5	22	0 T	0	0
5/23/2009	2009	5	23	0	0	0
5/24/2009	2009	5	24	0 T	0	0
5/25/2009	2009	5	25	0	0	0
5/26/2009	2009	5	26	0	0	0
5/27/2009	2009	5	27	11.4	0	11.4
5/28/2009	2009	5	28	2.6	0	2.6
5/29/2009	2009	5	29	10.6	0	10.6
5/30/2009	2009	5	30	6	0	6
5/31/2009	2009	5	31	1	0	1
6/1/2009	2009	6	1	7.6	0	7.6
6/2/2009	2009	6	2	0	0	0
6/3/2009	2009	6	3	0 T	0	0
6/4/2009	2009	6	4	0	0	0
6/5/2009	2009	6	5	0	0	0
6/6/2009	2009	6	6	0	0	0
6/7/2009	2009	6	7	1.8	0	1.8
6/8/2009	2009	6	8	0.6	0	0.6
6/9/2009	2009	6	9	12.4	0	12.4
6/10/2009	2009	6	10	0	0	0
6/11/2009	2009	6	11	0 T	0	0
6/12/2009	2009	6	12	0 T	0	0
6/13/2009	2009	6	13	0	0	0
6/14/2009	2009	6	14	0.8	0	0.8
6/15/2009	2009	6	15	0.4	0	0.4
6/16/2009	2009	6	16	0	0	0
6/17/2009	2009	6	17	0	0	0
6/18/2009	2009	6	18	7.2	0	7.2
6/19/2009	2009	6	19	0.6	0	0.6
6/20/2009	2009	6	20	0	0	0
6/21/2009	2009	6	21	2.2	0	2.2
6/22/2009	2009	6	22	0	0	0
6/23/2009	2009	6	23	0	0	0
6/24/2009	2009	6	24	0	0	0
6/25/2009	2009	6	25	0	0	0
6/26/2009	2009	6	26	15.4	0	15.4
6/27/2009	2009	6	27	0	0	0
6/28/2009	2009	6	28	0.6	0	0.6
6/29/2009	2009	6	29	13.4	0	13.4
6/30/2009	2009	6	30	6.8	0	6.8
7/1/2009	2009	7	1	0 T	0	0
7/2/2009	2009	7	2	8.4	0	8.4
7/3/2009	2009	7	3	10.2	0	10.2
7/4/2009	2009	7	4	0	0	0
7/5/2009	2009	7	5	0	0	0
7/6/2009	2009	7	6	1.6	0	1.6
7/7/2009	2009	7	7	7	0	7
7/8/2009	2009	7	8	0 T	0	0

7/9/2009	2009	7	9	0	0	0
7/10/2009	2009	7	10	0	0	0
7/11/2009	2009	7	11	25.2	0	25.2
7/12/2009	2009	7	12	1.2	0	1.2
7/13/2009	2009	7	13	0 T	0	0
7/14/2009	2009	7	14	0.2	0	0.2
7/15/2009	2009	7	15	0 T	0	0
7/16/2009	2009	7	16	1	0	1
7/17/2009	2009	7	17	19.2	0	19.2
7/18/2009	2009	7	18	47.8	0	47.8
7/19/2009	2009	7	19	0 T	0	0
7/20/2009	2009	7	20	0	0	0
7/21/2009	2009	7	21	1.2	0	1.2
7/22/2009	2009	7	22	2.8	0	2.8
7/23/2009	2009	7	23	11.4	0	11.4
7/24/2009	2009	7	24	40.6	0	40.6
7/25/2009	2009	7	25	5.8	0	5.8
7/26/2009	2009	7	26	3.2	0	3.2
7/27/2009	2009	7	27	9.6	0	9.6
7/28/2009	2009	7	28	0	0	0
7/29/2009	2009	7	29	47	0	47
7/30/2009	2009	7	30	0	0	0
7/31/2009	2009	7	31	0.2	0	0.2
8/1/2009	2009	8	1	0	0	0
8/2/2009	2009	8	2	9	0	9
8/3/2009	2009	8	3	0.2	0	0.2
8/4/2009	2009	8	4	20.8	0	20.8
8/5/2009	2009	8	5	0	0	0
8/6/2009	2009	8	6	1.8	0	1.8
8/7/2009	2009	8	7	0	0	0
8/8/2009	2009	8	8	0	0	0
8/9/2009	2009	8	9	0	0	0
8/10/2009	2009	8	10	0.2	0	0.2
8/11/2009	2009	8	11	0.2	0	0.2
8/12/2009	2009	8	12	0	0	0
8/13/2009	2009	8	13	0	0	0
8/14/2009	2009	8	14	0	0	0
8/15/2009	2009	8	15	0	0	0
8/16/2009	2009	8	16	0	0	0
8/17/2009	2009	8	17	0.8	0	0.8
8/18/2009	2009	8	18	1.2	0	1.2
8/19/2009	2009	8	19	0	0	0
8/20/2009	2009	8	20	8.2	0	8.2
8/21/2009	2009	8	21	8.2	0	8.2
8/22/2009	2009	8	22	1.8	0	1.8
8/23/2009	2009	8	23	0	0	0
8/24/2009	2009	8	24	0	0	0
8/25/2009	2009	8	25	0	0	0
8/26/2009	2009	8	26	0	0	0
8/27/2009	2009	8	27	0	0	0
8/28/2009	2009	8	28	0 T	0	0
8/29/2009	2009	8	29	37.6	0	37.6
8/30/2009	2009	8	30	0.6	0	0.6
8/31/2009	2009	8	31	0	0	0
9/1/2009	2009	9	1	0	0	0
9/2/2009	2009	9	2	0	0	0
9/3/2009	2009	9	3	0	0	0
9/4/2009	2009	9	4	0	0	0
9/5/2009	2009	9	5	0	0	0
9/6/2009	2009	9	6	0	0	0
9/7/2009	2009	9	7	0	0	0
9/8/2009	2009	9	8	0	0	0
9/9/2009	2009	9	9	0	0	0
9/10/2009	2009	9	10	0	0	0
9/11/2009	2009	9	11	0	0	0
9/12/2009	2009	9	12	0	0	0
9/13/2009	2009	9	13	0	0	0
9/14/2009	2009	9	14	9.6	0	9.6
9/15/2009	2009	9	15	0	0	0
9/16/2009	2009	9	16	0	0	0
9/17/2009	2009	9	17	0	0	0

9/18/2009	2009	9	18	2.8	0	2.8
9/19/2009	2009	9	19	0	0	0
9/20/2009	2009	9	20	0	0	0
9/21/2009	2009	9	21	0.6	0	0.6
9/22/2009	2009	9	22	0.8	0	0.8
9/23/2009	2009	9	23	12.6	0	12.6
9/24/2009	2009	9	24	0 T	0	0
9/25/2009	2009	9	25	0	0	0
9/26/2009	2009	9	26	5.6	0	5.6
9/27/2009	2009	9	27	15.4	0	15.4
9/28/2009	2009	9	28	3.4	0	3.4
9/29/2009	2009	9	29	9.2	0	9.2
9/30/2009	2009	9	30	1	0	1
10/1/2009	2009	10	1	1.2	0	1.2
10/2/2009	2009	10	2	6.4	0	6.4
10/3/2009	2009	10	3	7.2	0	7.2
10/4/2009	2009	10	4	0.4	0	0.4
10/5/2009	2009	10	5	4.8	0	4.8
10/6/2009	2009	10	6	3.8	0	3.8
10/7/2009	2009	10	7	16.4	0	16.4
10/8/2009	2009	10	8	0.6	0	0.6
10/9/2009	2009	10	9	11.4	0	11.4
10/10/2009	2009	10	10	0.2	0	0.2
10/11/2009	2009	10	11	0 T	0	0
10/12/2009	2009	10	12	1	0	1
10/13/2009	2009	10	13	4.4	0	4.4
10/14/2009	2009	10	14	0	0	0
10/15/2009	2009	10	15	0	0	0
10/16/2009	2009	10	16	0	0	0
10/17/2009	2009	10	17	0	0	0
10/18/2009	2009	10	18	0	0	0
10/19/2009	2009	10	19	0	0	0
10/20/2009	2009	10	20	0	0	0
10/21/2009	2009	10	21	7	0	7
10/22/2009	2009	10	22	8.8	0 T	8.8
10/23/2009	2009	10	23	10	0	10
10/24/2009	2009	10	24	5.4	0	5.4
10/25/2009	2009	10	25	0	0	0
10/26/2009	2009	10	26	0 T	0	0
10/27/2009	2009	10	27	0.2	0	0.2
10/28/2009	2009	10	28	2.4	0	2.4
10/29/2009	2009	10	29	0.2	0	0.2
10/30/2009	2009	10	30	7	0	7
10/31/2009	2009	10	31	7.8	0	7.8
11/1/2009	2009	11	1	0	0	0
11/2/2009	2009	11	2	0.2	0	0.2
11/3/2009	2009	11	3	0.4	0	0.4
11/4/2009	2009	11	4	0	0	0
11/5/2009	2009	11	5	2.4	1.4	3.8
11/6/2009	2009	11	6	0	0 T	0
11/7/2009	2009	11	7	0	0	0
11/8/2009	2009	11	8	0	0	0
11/9/2009	2009	11	9	0	0	0
11/10/2009	2009	11	10	0	0	0
11/11/2009	2009	11	11	0	0	0
11/12/2009	2009	11	12	0	0	0
11/13/2009	2009	11	13	0	0	0
11/14/2009	2009	11	14	1.6	0	1.6
11/15/2009	2009	11	15	0.4	0	0.4
11/16/2009	2009	11	16	0	0	0
11/17/2009	2009	11	17	0	0	0
11/18/2009	2009	11	18	0	0	0
11/19/2009	2009	11	19	6	0	6
11/20/2009	2009	11	20	8.8	0	8.8
11/21/2009	2009	11	21	0	0	0
11/22/2009	2009	11	22	0	0	0
11/23/2009	2009	11	23	0	0	0
11/24/2009	2009	11	24	0.2	0	0.2
11/25/2009	2009	11	25	5.2	0	5.2
11/26/2009	2009	11	26	0.2	0	0.2
11/27/2009	2009	11	27	6.6	0	6.6

11/28/2009	2009	11	28	0	0	0
11/29/2009	2009	11	29	3.4	0.4	3.8
11/30/2009	2009	11	30	0	2	3.8
12/1/2009	2009	12	1	0	0.2	0.2
12/2/2009	2009	12	2	6.8	0	6.8
12/3/2009	2009	12	3	16	0	16
12/4/2009	2009	12	4	0	0	0
12/5/2009	2009	12	5	0	0	0
12/6/2009	2009	12	6	0	0.6	0.2
12/7/2009	2009	12	7	0	1.4	1.6
12/8/2009	2009	12	8	0	0 T	0
12/9/2009	2009	12	9	0	22.2	18.2
12/10/2009	2009	12	10	0	3.6	2.4
12/11/2009	2009	12	11	0	0 T	0
12/12/2009	2009	12	12	0	0 T	0
12/13/2009	2009	12	13	0	5	5
12/14/2009	2009	12	14	0 T	3	2.4
12/15/2009	2009	12	15	0	3.8	2.6
12/16/2009	2009	12	16	0	0.6	0.2
12/17/2009	2009	12	17	0	0	0
12/18/2009	2009	12	18	0	0	0
12/19/2009	2009	12	19	0	0	0
12/20/2009	2009	12	20	0	0	0
12/21/2009	2009	12	21	0	0	0
12/22/2009	2009	12	22	0	0.2	0
12/23/2009	2009	12	23	0	5.2	3.6
12/24/2009	2009	12	24	0	0	0
12/25/2009	2009	12	25	0	0	0
12/26/2009	2009	12	26	17.6	1.8	20.2
12/27/2009	2009	12	27	2.6	0 T	2.6
12/28/2009	2009	12	28	0	2.4	2
12/29/2009	2009	12	29	0	0.4	0.2
12/30/2009	2009	12	30	0	0 T	0
12/31/2009	2009	12	31	0	7	6.2
1/1/2010	2010	1	1	0	9.4	6.4
1/2/2010	2010	1	2	0	4	3
1/3/2010	2010	1	3	0	3.8	3.4
1/4/2010	2010	1	4	0	2	0.8
1/5/2010	2010	1	5	0 T	2	1.4
1/6/2010	2010	1	6	0	0 T	0
1/7/2010	2010	1	7	0	0 T	0
1/8/2010	2010	1	8	0	0.2	0.2
1/9/2010	2010	1	9	0	0	0
1/10/2010	2010	1	10	0	0	0
1/11/2010	2010	1	11	0	0 T	0
1/12/2010	2010	1	12	0	0 T	0
1/13/2010	2010	1	13	0.4	2.6	2
1/14/2010	2010	1	14	0 T	0 T	0
1/15/2010	2010	1	15	0.4	0	0.4
1/16/2010	2010	1	16	0	0	0
1/17/2010	2010	1	17	0	0	0
1/18/2010	2010	1	18	0 T	0 T	0
1/19/2010	2010	1	19	0	0.2	0
1/20/2010	2010	1	20	0	0.2	0
1/21/2010	2010	1	21	0	0	0
1/22/2010	2010	1	22	0	0	0
1/23/2010	2010	1	23	0	0	0
1/24/2010	2010	1	24	3	0 T	3
1/25/2010	2010	1	25	43.6	0	43.6
1/26/2010	2010	1	26	0.2	2.6	1.8
1/27/2010	2010	1	27	0	1.6	0.4
1/28/2010	2010	1	28	0	3.6	1.6
1/29/2010	2010	1	29	0	0	0
1/30/2010	2010	1	30	0	0 T	0
1/31/2010	2010	1	31	0	0.2	0.2
2/1/2010	2010	2	1	0	0 T	0
2/2/2010	2010	2	2	0	0 T	0
2/3/2010	2010	2	3	0	1.6	0.8
2/4/2010	2010	2	4	0	0	0
2/5/2010	2010	2	5	0	0	0
2/6/2010	2010	2	6	0	0	0

2/7/2010	2010	2	7	0	0 T	0
2/8/2010	2010	2	8	0	0.2	0.2
2/9/2010	2010	2	9	0	0	0
2/10/2010	2010	2	10	0	0 T	0
2/11/2010	2010	2	11	0	0	0
2/12/2010	2010	2	12	0	0 T	0
2/13/2010	2010	2	13	0	1	0.8
2/14/2010	2010	2	14	0	0 T	0
2/15/2010	2010	2	15	0	0	0
2/16/2010	2010	2	16	0	0 T	0
2/17/2010	2010	2	17	0	3.4	3.4
2/18/2010	2010	2	18	0	0.2	0.2
2/19/2010	2010	2	19	0	0.2	0.2
2/20/2010	2010	2	20	0	0.6	0.6
2/21/2010	2010	2	21	0	1	1
2/22/2010	2010	2	22	0	0 T	0
2/23/2010	2010	2	23	1.2	7	7
2/24/2010	2010	2	24	0	9.6	7.4
2/25/2010	2010	2	25	0.2	15.4	12.6
2/26/2010	2010	2	26	0	0 T	0
2/27/2010	2010	2	27	0 T	0.2	1.4
2/28/2010	2010	2	28	0.2	0	0.2
3/1/2010	2010	3	1	0	0	0
3/2/2010	2010	3	2	0	0	0
3/3/2010	2010	3	3	0	0	0
3/4/2010	2010	3	4	0	0	0
3/5/2010	2010	3	5	0	0	0
3/6/2010	2010	3	6	0	0	0
3/7/2010	2010	3	7	0	0	0
3/8/2010	2010	3	8	0	0	0
3/9/2010	2010	3	9	0	0	0
3/10/2010	2010	3	10	0	0	0
3/11/2010	2010	3	11	0	0	0
3/12/2010	2010	3	12	0	0	0
3/13/2010	2010	3	13	0.2	0	0.2
3/14/2010	2010	3	14	18.6	0	18.6
3/15/2010	2010	3	15	0	0	0
3/16/2010	2010	3	16	0	0	0
3/17/2010	2010	3	17	0	0	0
3/18/2010	2010	3	18	0	0	0
3/19/2010	2010	3	19	0	0	0
3/20/2010	2010	3	20	0 T	0	0
3/21/2010	2010	3	21	0	0	0
3/22/2010	2010	3	22	0.2	0	0.2
3/23/2010	2010	3	23	10.2	0	10.2
3/24/2010	2010	3	24	0	0	0
3/25/2010	2010	3	25	0	0	0
3/26/2010	2010	3	26	0	0	0
3/27/2010	2010	3	27	0	0	0
3/28/2010	2010	3	28	8	0	8
3/29/2010	2010	3	29	10.2	0	10.2
3/30/2010	2010	3	30	0	0	0
3/31/2010	2010	3	31	0	0	0
4/1/2010	2010	4	1	0	0	0
4/2/2010	2010	4	2	0	0	0
4/3/2010	2010	4	3	0	0	0
4/4/2010	2010	4	4	0	0	0
4/5/2010	2010	4	5	0.2	0	0.2
4/6/2010	2010	4	6	13.8	0	13.8
4/7/2010	2010	4	7	4.2	0	4.2
4/8/2010	2010	4	8	15	0	15
4/9/2010	2010	4	9	0 T	0 T	0
4/10/2010	2010	4	10	0 T	0 T	0
4/11/2010	2010	4	11	0.4	0	0.4
4/12/2010	2010	4	12	0	0	0
4/13/2010	2010	4	13	0	0	0
4/14/2010	2010	4	14	0	0	0
4/15/2010	2010	4	15	1.8	0	1.8
4/16/2010	2010	4	16	7.6	0	7.6
4/17/2010	2010	4	17	6.4	0	6.4
4/18/2010	2010	4	18	0 T	0	0
4/19/2010	2010	4	19	0	0	0

4/20/2010	2010	4	20	0	0	0
4/21/2010	2010	4	21	0	0	0
4/22/2010	2010	4	22	0 T	0	0
4/23/2010	2010	4	23	0	0	0
4/24/2010	2010	4	24	0	0	0
4/25/2010	2010	4	25	0	0	0
4/26/2010	2010	4	26	0	0	0
4/27/2010	2010	4	27	1.4	4.2	6
4/28/2010	2010	4	28	0 T	0	0
4/29/2010	2010	4	29	0	0	0
4/30/2010	2010	4	30	0 T	0	0
5/1/2010	2010	5	1	1.6	0	1.6
5/2/2010	2010	5	2	0	0	0
5/3/2010	2010	5	3	7.2	0	7.2
5/4/2010	2010	5	4	1.2	0	1.2
5/5/2010	2010	5	5	8.2	0	8.2
5/6/2010	2010	5	6	0.4	0	0.4
5/7/2010	2010	5	7	1	0	1
5/8/2010	2010	5	8	12.4	0 T	12.4
5/9/2010	2010	5	9	0	0 T	0
5/10/2010	2010	5	10	0	0	0
5/11/2010	2010	5	11	0	0	0
5/12/2010	2010	5	12	0	0	0
5/13/2010	2010	5	13	0.4	0	0.4
5/14/2010	2010	5	14	0	0	0
5/15/2010	2010	5	15	0 T	0	0
5/16/2010	2010	5	16	0	0	0
5/17/2010	2010	5	17	0	0	0
5/18/2010	2010	5	18	0	0	0
5/19/2010	2010	5	19	0	0	0
5/20/2010	2010	5	20	0	0	0
5/21/2010	2010	5	21	0	0	0
5/22/2010	2010	5	22	0.2	0	0.2
5/23/2010	2010	5	23	0	0	0
5/24/2010	2010	5	24	0	0	0
5/25/2010	2010	5	25	0	0	0
5/26/2010	2010	5	26	0	0	0
5/27/2010	2010	5	27	0	0	0
5/28/2010	2010	5	28	1	0	1
5/29/2010	2010	5	29	0.2	0	0.2
5/30/2010	2010	5	30	0	0	0
5/31/2010	2010	5	31	0	0	0
6/1/2010	2010	6	1	10	0	10
6/2/2010	2010	6	2	6.4	0	6.4
6/3/2010	2010	6	3	4.8	0	4.8
6/4/2010	2010	6	4	1.8	0	1.8
6/5/2010	2010	6	5	0.6	0	0.6
6/6/2010	2010	6	6	12	0	12
6/7/2010	2010	6	7	1.8	0	1.8
6/8/2010	2010	6	8	0	0	0
6/9/2010	2010	6	9	4.4	0	4.4
6/10/2010	2010	6	10	1.4	0	1.4
6/11/2010	2010	6	11	0	0	0
6/12/2010	2010	6	12	7.6	0	7.6
6/13/2010	2010	6	13	0	0	0
6/14/2010	2010	6	14	1.4	0	1.4
6/15/2010	2010	6	15	0	0	0
6/16/2010	2010	6	16	21.2	0	21.2
6/17/2010	2010	6	17	1.6	0	1.6
6/18/2010	2010	6	18	0	0	0
6/19/2010	2010	6	19	5.6	0	5.6
6/20/2010	2010	6	20	0	0	0
6/21/2010	2010	6	21	0	0	0
6/22/2010	2010	6	22	6	0	6
6/23/2010	2010	6	23	9.4	0	9.4
6/24/2010	2010	6	24	8.6	0	8.6
6/25/2010	2010	6	25	0	0	0
6/26/2010	2010	6	26	1.4	0	1.4
6/27/2010	2010	6	27	0.6	0	0.6
6/28/2010	2010	6	28	9.8	0	9.8
6/29/2010	2010	6	29	1.6	0	1.6
6/30/2010	2010	6	30	2.2	0	2.2

7/1/2010	2010	7	1	0 T	0	0
7/2/2010	2010	7	2	0	0	0
7/3/2010	2010	7	3	0	0	0
7/4/2010	2010	7	4	0	0	0
7/5/2010	2010	7	5	0	0	0
7/6/2010	2010	7	6	0	0	0
7/7/2010	2010	7	7	0	0	0
7/8/2010	2010	7	8	0.2	0	0.2
7/9/2010	2010	7	9	17.6	0	17.6
7/10/2010	2010	7	10	0	0	0
7/11/2010	2010	7	11	0	0	0
7/12/2010	2010	7	12	0.6	0	0.6
7/13/2010	2010	7	13	14.6	0	14.6
7/14/2010	2010	7	14	0	0	0
7/15/2010	2010	7	15	0	0	0
7/16/2010	2010	7	16	0.4	0	0.4
7/17/2010	2010	7	17	0.2	0	0.2
7/18/2010	2010	7	18	0.2	0	0.2
7/19/2010	2010	7	19	11.8	0	11.8
7/20/2010	2010	7	20	0	0	0
7/21/2010	2010	7	21	3.6	0	3.6
7/22/2010	2010	7	22	0	0	0
7/23/2010	2010	7	23	0.8	0	0.8
7/24/2010	2010	7	24	0 T	0	0
7/25/2010	2010	7	25	0	0	0
7/26/2010	2010	7	26	0	0	0
7/27/2010	2010	7	27	0	0	0
7/28/2010	2010	7	28	0 T	0	0
7/29/2010	2010	7	29	0	0	0
7/30/2010	2010	7	30	0	0	0
7/31/2010	2010	7	31	0	0	0
8/1/2010	2010	8	1	0	0	0
8/2/2010	2010	8	2	1.2	0	1.2
8/3/2010	2010	8	3	34.2	0	34.2
8/4/2010	2010	8	4	34	0	34
8/5/2010	2010	8	5	0	0	0
8/6/2010	2010	8	6	0	0	0
8/7/2010	2010	8	7	0	0	0
8/8/2010	2010	8	8	19.6	0	19.6
8/9/2010	2010	8	9	0	0	0
8/10/2010	2010	8	10	0.2	0	0.2
8/11/2010	2010	8	11	0	0	0
8/12/2010	2010	8	12	0	0	0
8/13/2010	2010	8	13	0	0	0
8/14/2010	2010	8	14	0	0	0
8/15/2010	2010	8	15	42.4	0	42.4
8/16/2010	2010	8	16	4.2	0	4.2
8/17/2010	2010	8	17	0	0	0
8/18/2010	2010	8	18	0	0	0
8/19/2010	2010	8	19	3.2	0	3.2
8/20/2010	2010	8	20	0	0	0
8/21/2010	2010	8	21	3.8	0	3.8
8/22/2010	2010	8	22	5.2	0	5.2
8/23/2010	2010	8	23	24.4	0	24.4
8/24/2010	2010	8	24	0	0	0
8/25/2010	2010	8	25	0.2	0	0.2
8/26/2010	2010	8	26	0.8	0	0.8
8/27/2010	2010	8	27	0	0	0
8/28/2010	2010	8	28	0	0	0
8/29/2010	2010	8	29	0	0	0
8/30/2010	2010	8	30	0	0	0
8/31/2010	2010	8	31	0	0	0
9/1/2010	2010	9	1	0	0	0
9/2/2010	2010	9	2	19.6	0	19.6
9/3/2010	2010	9	3	12	0	12
9/4/2010	2010	9	4	2.4	0	2.4
9/5/2010	2010	9	5	1	0	1
9/6/2010	2010	9	6	6.4	0	6.4
9/7/2010	2010	9	7	17	0	17
9/8/2010	2010	9	8	1	0	1
9/9/2010	2010	9	9	1	0	1
9/10/2010	2010	9	10	0	0	0

9/11/2010	2010	9	11	0	0	0
9/12/2010	2010	9	12	1.8	0	1.8
9/13/2010	2010	9	13	5.2	0	5.2
9/14/2010	2010	9	14	2	0	2
9/15/2010	2010	9	15	0	0	0
9/16/2010	2010	9	16	18.4	0	18.4
9/17/2010	2010	9	17	0	0	0
9/18/2010	2010	9	18	0 T	0	0
9/19/2010	2010	9	19	0	0	0
9/20/2010	2010	9	20	0	0	0
9/21/2010	2010	9	21	8	0	8
9/22/2010	2010	9	22	5.6	0	5.6
9/23/2010	2010	9	23	8.8	0	8.8
9/24/2010	2010	9	24	1.6	0	1.6
9/25/2010	2010	9	25	4.4	0	4.4
9/26/2010	2010	9	26	0.6	0	0.6
9/27/2010	2010	9	27	13	0	13
9/28/2010	2010	9	28	20	0	20
9/29/2010	2010	9	29	0.6	0	0.6
9/30/2010	2010	9	30	19.6	0	19.6
10/1/2010	2010	10	1	0	0	0
10/2/2010	2010	10	2	0.2	0	0.2
10/3/2010	2010	10	3	0	0	0
10/4/2010	2010	10	4	0	0	0
10/5/2010	2010	10	5	0	0	0
10/6/2010	2010	10	6	20.8	0	20.8
10/7/2010	2010	10	7	0.6	0	0.6
10/8/2010	2010	10	8	0	0	0
10/9/2010	2010	10	9	0	0	0
10/10/2010	2010	10	10	0	0	0
10/11/2010	2010	10	11	0	0	0
10/12/2010	2010	10	12	0	0	0
10/13/2010	2010	10	13	0	0	0
10/14/2010	2010	10	14	6.8	0	6.8
10/15/2010	2010	10	15	10.2	0	10.2
10/16/2010	2010	10	16	0	0	0
10/17/2010	2010	10	17	0	0	0
10/18/2010	2010	10	18	0	0	0
10/19/2010	2010	10	19	0 T	0	0
10/20/2010	2010	10	20	2.4	0	2.4
10/21/2010	2010	10	21	1	0	1
10/22/2010	2010	10	22	0	0 T	0
10/23/2010	2010	10	23	0	0	0
10/24/2010	2010	10	24	4.2	0	4.2
10/25/2010	2010	10	25	0.6	0	0.6
10/26/2010	2010	10	26	4.8	0	4.8
10/27/2010	2010	10	27	0.2	0	0.2
10/28/2010	2010	10	28	0	0	0
10/29/2010	2010	10	29	0 T	0 T	0
10/30/2010	2010	10	30	4.6	7.4	15.4
10/31/2010	2010	10	31	0	0 T	0
11/1/2010	2010	11	1	0	0	0
11/2/2010	2010	11	2	0	0	0
11/3/2010	2010	11	3	0	0	0
11/4/2010	2010	11	4	8.6	0	8.6
11/5/2010	2010	11	5	8.2	0 T	8.2
11/6/2010	2010	11	6	0	0	0
11/7/2010	2010	11	7	0	0	0
11/8/2010	2010	11	8	0	0	0
11/9/2010	2010	11	9	0	0	0
11/10/2010	2010	11	10	0	0	0
11/11/2010	2010	11	11	0	0	0
11/12/2010	2010	11	12	0	0	0
11/13/2010	2010	11	13	0	0	0
11/14/2010	2010	11	14	2.2	0	2.2
11/15/2010	2010	11	15	0	0	0
11/16/2010	2010	11	16	15.2	0	15.2
11/17/2010	2010	11	17	16.8	0	16.8
11/18/2010	2010	11	18	0	0 T	0
11/19/2010	2010	11	19	0 T	0 T	0
11/20/2010	2010	11	20	0.4	0	0.4
11/21/2010	2010	11	21	0 T	0 T	0

11/22/2010	2010	11	22	5.8	0	5.8
11/23/2010	2010	11	23	5.2	0 T	5.2
11/24/2010	2010	11	24	0	0	0
11/25/2010	2010	11	25	0 T	0	0
11/26/2010	2010	11	26	7	1	7.8
11/27/2010	2010	11	27	0	1	0.6
11/28/2010	2010	11	28	0	0	0
11/29/2010	2010	11	29	0	0	0
11/30/2010	2010	11	30	8.4	0	8.4
12/1/2010	2010	12	1	30	0.6	31
12/2/2010	2010	12	2	0	0 T	0
12/3/2010	2010	12	3	0	1.6	0.4
12/4/2010	2010	12	4	0	0 T	0
12/5/2010	2010	12	5	0	3.6	1.6
12/6/2010	2010	12	6	0	0 T	0
12/7/2010	2010	12	7	0	1	0.2
12/8/2010	2010	12	8	0	0.6	0.2
12/9/2010	2010	12	9	0	0 T	0
12/10/2010	2010	12	10	0	0.4	0.2
12/11/2010	2010	12	11	0	0 T	0
12/12/2010	2010	12	12	21.4	1	24.6
12/13/2010	2010	12	13	0 T	2.4	1.4
12/14/2010	2010	12	14	0	7.6	4
12/15/2010	2010	12	15	0	1	0.4
12/16/2010	2010	12	16	0	2.5	0.6
12/17/2010	2010	12	17	0	0.8	0.2
12/18/2010	2010	12	18	0	0.6	0.2
12/19/2010	2010	12	19	0	1	0.2
12/20/2010	2010	12	20	0	0 T	0
12/21/2010	2010	12	21	0	0 T	0
12/22/2010	2010	12	22	0	0 T	0
12/23/2010	2010	12	23	0	0	0
12/24/2010	2010	12	24	0	0	0
12/25/2010	2010	12	25	0	0	0
12/26/2010	2010	12	26	0	0	0
12/27/2010	2010	12	27	0	0	0
12/28/2010	2010	12	28	0.2	0 T	0.2
12/29/2010	2010	12	29	0	0 T	0
12/30/2010	2010	12	30	0 T	0	0
12/31/2010	2010	12	31	0.8	0	0.8
1/1/2011	2011	1	1	3.8	0	3.8
1/2/2011	2011	1	2	0 T	0 T	0
1/3/2011	2011	1	3	0	1	0.2
1/4/2011	2011	1	4	0	2.8	1.6
1/5/2011	2011	1	5	0	0 T	0
1/6/2011	2011	1	6	0	1.4	0.8
1/7/2011	2011	1	7	0	5.8	3.2
1/8/2011	2011	1	8	0	6.4	3.2
1/9/2011	2011	1	9	0	0 T	0
1/10/2011	2011	1	10	0	0	0
1/11/2011	2011	1	11	0	0 T	0
1/12/2011	2011	1	12	0	0.8	0.2
1/13/2011	2011	1	13	0	0.2	0
1/14/2011	2011	1	14	0	0.2	0
1/15/2011	2011	1	15	0	10.4	6
1/16/2011	2011	1	16	0	0 T	0
1/17/2011	2011	1	17	0	0	0
1/18/2011	2011	1	18	0	2.4	1.6
1/19/2011	2011	1	19	0	0 T	0
1/20/2011	2011	1	20	0	0.4	0.2
1/21/2011	2011	1	21	0	2.2	1.2
1/22/2011	2011	1	22	0	0.4	0
1/23/2011	2011	1	23	0	0 T	0
1/24/2011	2011	1	24	0	0 T	0
1/25/2011	2011	1	25	0	3	1.2
1/26/2011	2011	1	26	0	0.4	0.4
1/27/2011	2011	1	27	0	3	0.6
1/28/2011	2011	1	28	0	3.4	1.6
1/29/2011	2011	1	29	0	7.8	4
1/30/2011	2011	1	30	0	1	0.4
1/31/2011	2011	1	31	0	0	0
2/1/2011	2011	2	1	0	0 T	0

2/2/2011	2011	2	2	0	17.2	11
2/3/2011	2011	2	3	0	0	0
2/4/2011	2011	2	4	0	0	0
2/5/2011	2011	2	5	0	1.4	0.6
2/6/2011	2011	2	6	0	1	0.2
2/7/2011	2011	2	7	0	5.4	2.4
2/8/2011	2011	2	8	0	0 T	0
2/9/2011	2011	2	9	0	6	3.4
2/10/2011	2011	2	10	0	0	0
2/11/2011	2011	2	11	0	0 T	0
2/12/2011	2011	2	12	0	1.6	0.6
2/13/2011	2011	2	13	1.8	0.4	2
2/14/2011	2011	2	14	2.2	0.2	2.4
2/15/2011	2011	2	15	0	0	0
2/16/2011	2011	2	16	0	0	0
2/17/2011	2011	2	17	3	0	3
2/18/2011	2011	2	18	0.6	0.6	0.6
2/19/2011	2011	2	19	0	0.6	0.4
2/20/2011	2011	2	20	0	1.4	1
2/21/2011	2011	2	21	0	0 T	0
2/22/2011	2011	2	22	0	0	0
2/23/2011	2011	2	23	0	0	0
2/24/2011	2011	2	24	0	0 T	0
2/25/2011	2011	2	25	0	1.2	0.6
2/26/2011	2011	2	26	0	1	0.6
2/27/2011	2011	2	27	0	1.8	1.2
2/28/2011	2011	2	28	1	10.2	13.4
3/1/2011	2011	3	1	0	0	0
3/2/2011	2011	3	2	0	0 T	0
3/3/2011	2011	3	3	0	0	0
3/4/2011	2011	3	4	0	0 T	0
3/5/2011	2011	3	5	23.4	3.6	30
3/6/2011	2011	3	6	0	12.6	8.6
3/7/2011	2011	3	7	0	0	0
3/8/2011	2011	3	8	0	0	0
3/9/2011	2011	3	9	0	6	5.8
3/10/2011	2011	3	10	15.4	7.6	21.4
3/11/2011	2011	3	11	9.6	0	9.6
3/12/2011	2011	3	12	0	0.2	0.2
3/13/2011	2011	3	13	0	0.6	0.4
3/14/2011	2011	3	14	0	0	0
3/15/2011	2011	3	15	0	0	0
3/16/2011	2011	3	16	1.2	0	1.2
3/17/2011	2011	3	17	1.6	0	1.6
3/18/2011	2011	3	18	0 T	0 T	0
3/19/2011	2011	3	19	0	0	0
3/20/2011	2011	3	20	0	0	0
3/21/2011	2011	3	21	0	3.8	2.8
3/22/2011	2011	3	22	0	0	0
3/23/2011	2011	3	23	0	0	0
3/24/2011	2011	3	24	0	0	0
3/25/2011	2011	3	25	0	0	0
3/26/2011	2011	3	26	0	0	0
3/27/2011	2011	3	27	0	0	0
3/28/2011	2011	3	28	0	0	0
3/29/2011	2011	3	29	0	0 T	0
3/30/2011	2011	3	30	0	0	0
3/31/2011	2011	3	31	0 T	0	0
4/1/2011	2011	4	1	0.8	0 T	0.8
4/2/2011	2011	4	2	0	0	0
4/3/2011	2011	4	3	0	0	0
4/4/2011	2011	4	4	15.4	0.4	16
4/5/2011	2011	4	5	2.6	0 T	2.6
4/6/2011	2011	4	6	0	0 T	0
4/7/2011	2011	4	7	0	0	0
4/8/2011	2011	4	8	0	0	0
4/9/2011	2011	4	9	0	0	0
4/10/2011	2011	4	10	21	0	21
4/11/2011	2011	4	11	25.4	0	25.4
4/12/2011	2011	4	12	0	0	0
4/13/2011	2011	4	13	6.2	0	6.2
4/14/2011	2011	4	14	0	0	0

4/15/2011	2011	4	15	0	0	0
4/16/2011	2011	4	16	23.8	0	23.8
4/17/2011	2011	4	17	5.4	0 T	5.4
4/18/2011	2011	4	18	0	0	0
4/19/2011	2011	4	19	0	0	0
4/20/2011	2011	4	20	18.8	0 T	18.8
4/21/2011	2011	4	21	0	0.4	0.4
4/22/2011	2011	4	22	0	0	0
4/23/2011	2011	4	23	4.2	0	4.2
4/24/2011	2011	4	24	0	0	0
4/25/2011	2011	4	25	0	0	0
4/26/2011	2011	4	26	20.6	0	20.6
4/27/2011	2011	4	27	16.6	0	16.6
4/28/2011	2011	4	28	4.6	0	4.6
4/29/2011	2011	4	29	0.6	0	0.6
4/30/2011	2011	4	30	0	0	0
5/1/2011	2011	5	1	0	0	0
5/2/2011	2011	5	2	7.8	0	7.8
5/3/2011	2011	5	3	7.6	0	7.6
5/4/2011	2011	5	4	1.2	0	1.2
5/5/2011	2011	5	5	0	0	0
5/6/2011	2011	5	6	0.8	0	0.8
5/7/2011	2011	5	7	0	0	0
5/8/2011	2011	5	8	0	0	0
5/9/2011	2011	5	9	0	0	0
5/10/2011	2011	5	10	0	0	0
5/11/2011	2011	5	11	0	0	0
5/12/2011	2011	5	12	0	0	0
5/13/2011	2011	5	13	6	0	6
5/14/2011	2011	5	14	24.2	0	24.2
5/15/2011	2011	5	15	4.6	0	4.6
5/16/2011	2011	5	16	4.8	0	4.8
5/17/2011	2011	5	17	1.4	0	1.4
5/18/2011	2011	5	18	1.4	0	1.4
5/19/2011	2011	5	19	6	0	6
5/20/2011	2011	5	20	0 T	0	0
5/21/2011	2011	5	21	0	0	0
5/22/2011	2011	5	22	1.6	0	1.6
5/23/2011	2011	5	23	0.2	0	0.2
5/24/2011	2011	5	24	2.2	0	2.2
5/25/2011	2011	5	25	0.4	0	0.4
5/26/2011	2011	5	26	6	0	6
5/27/2011	2011	5	27	13.8	0	13.8
5/28/2011	2011	5	28	3	0	3
5/29/2011	2011	5	29	1.8	0	1.8
5/30/2011	2011	5	30	0	0	0
5/31/2011	2011	5	31	0	0	0
6/1/2011	2011	6	1	0	0	0
6/2/2011	2011	6	2	0	0	0
6/3/2011	2011	6	3	0	0	0
6/4/2011	2011	6	4	0	0	0
6/5/2011	2011	6	5	0	0	0
6/6/2011	2011	6	6	0	0	0
6/7/2011	2011	6	7	0 T	0	0
6/8/2011	2011	6	8	0.4	0	0.4
6/9/2011	2011	6	9	0	0	0
6/10/2011	2011	6	10	0	0	0
6/11/2011	2011	6	11	3.4	0	3.4
6/12/2011	2011	6	12	1	0	1
6/13/2011	2011	6	13	6.8	0	6.8
6/14/2011	2011	6	14	0	0	0
6/15/2011	2011	6	15	0	0	0
6/16/2011	2011	6	16	0	0	0
6/17/2011	2011	6	17	0.4	0	0.4
6/18/2011	2011	6	18	0	0	0
6/19/2011	2011	6	19	0	0	0
6/20/2011	2011	6	20	0	0	0
6/21/2011	2011	6	21	0	0	0
6/22/2011	2011	6	22	2.8	0	2.8
6/23/2011	2011	6	23	7	0	7
6/24/2011	2011	6	24	90.4	0	90.4
6/25/2011	2011	6	25	0.4	0	0.4

6/26/2011	2011	6	26	0	0	0
6/27/2011	2011	6	27	0	0	0
6/28/2011	2011	6	28	16	0	16
6/29/2011	2011	6	29	0.6	0	0.6
6/30/2011	2011	6	30	0.8	0	0.8
7/1/2011	2011	7	1	0	0	0
7/2/2011	2011	7	2	0	0	0
7/3/2011	2011	7	3	0	0	0
7/4/2011	2011	7	4	0	0	0
7/5/2011	2011	7	5	0	0	0
7/6/2011	2011	7	6	3.8	0	3.8
7/7/2011	2011	7	7	0	0	0
7/8/2011	2011	7	8	4.2	0	4.2
7/9/2011	2011	7	9	0	0	0
7/10/2011	2011	7	10	0	0	0
7/11/2011	2011	7	11	8.4	0	8.4
7/12/2011	2011	7	12	0	0	0
7/13/2011	2011	7	13	0.4	0	0.4
7/14/2011	2011	7	14	0	0	0
7/15/2011	2011	7	15	0	0	0
7/16/2011	2011	7	16	0	0	0
7/17/2011	2011	7	17	17.4	0	17.4
7/18/2011	2011	7	18	2.8	0	2.8
7/19/2011	2011	7	19	0	0	0
7/20/2011	2011	7	20	0	0	0
7/21/2011	2011	7	21	0	0	0
7/22/2011	2011	7	22	0	0	0
7/23/2011	2011	7	23	0	0	0
7/24/2011	2011	7	24	0	0	0
7/25/2011	2011	7	25	0.4	0	0.4
7/26/2011	2011	7	26	15.8	0	15.8
7/27/2011	2011	7	27	0	0	0
7/28/2011	2011	7	28	0	0	0
7/29/2011	2011	7	29	6.2	0	6.2
7/30/2011	2011	7	30	0	0	0
7/31/2011	2011	7	31	0	0	0
8/1/2011	2011	8	1	0	0	0
8/2/2011	2011	8	2	0	0	0
8/3/2011	2011	8	3	0	0	0
8/4/2011	2011	8	4	0	0	0
8/5/2011	2011	8	5	0	0	0
8/6/2011	2011	8	6	0	0	0
8/7/2011	2011	8	7	1.4	0	1.4
8/8/2011	2011	8	8	0	0	0
8/9/2011	2011	8	9	6.2	0	6.2
8/10/2011	2011	8	10	7.6	0	7.6
8/11/2011	2011	8	11	0 T	0	0
8/12/2011	2011	8	12	0	0	0
8/13/2011	2011	8	13	1	0	1
8/14/2011	2011	8	14	13.4	0	13.4
8/15/2011	2011	8	15	0.4	0	0.4
8/16/2011	2011	8	16	0	0	0
8/17/2011	2011	8	17	0	0	0
8/18/2011	2011	8	18	2.8	0	2.8
8/19/2011	2011	8	19	0	0	0
8/20/2011	2011	8	20	3	0	3
8/21/2011	2011	8	21	12	0	12
8/22/2011	2011	8	22	0.4	0	0.4
8/23/2011	2011	8	23	0 T	0	0
8/24/2011	2011	8	24	2.2	0	2.2
8/25/2011	2011	8	25	2.6	0	2.6
8/26/2011	2011	8	26	0	0	0
8/27/2011	2011	8	27	0	0	0
8/28/2011	2011	8	28	0	0	0
8/29/2011	2011	8	29	0	0	0
8/30/2011	2011	8	30	1.2	0	1.2
8/31/2011	2011	8	31	0	0	0
9/1/2011	2011	9	1	0.4	0	0.4
9/2/2011	2011	9	2	0	0	0
9/3/2011	2011	9	3	0 T	0	0
9/4/2011	2011	9	4	14	0	14
9/5/2011	2011	9	5	4	0	4

9/6/2011	2011	9	6	0	0	0
9/7/2011	2011	9	7	0.2	0	0.2
9/8/2011	2011	9	8	0	0	0
9/9/2011	2011	9	9	0	0	0
9/10/2011	2011	9	10	0	0	0
9/11/2011	2011	9	11	0	0	0
9/12/2011	2011	9	12	2.4	0	2.4
9/13/2011	2011	9	13	21.6	0	21.6
9/14/2011	2011	9	14	0.2	0	0.2
9/15/2011	2011	9	15	1.8	0	1.8
9/16/2011	2011	9	16	0	0	0
9/17/2011	2011	9	17	0	0	0
9/18/2011	2011	9	18	0	0	0
9/19/2011	2011	9	19	5	0	5
9/20/2011	2011	9	20	1.8	0	1.8
9/21/2011	2011	9	21	M	M	2.2
9/22/2011	2011	9	22	0 T	0	0
9/23/2011	2011	9	23	0 T	0	0
9/24/2011	2011	9	24	0	0	0
9/25/2011	2011	9	25	0	0	0
9/26/2011	2011	9	26	0	0	0
9/27/2011	2011	9	27	0.2	0	0.2
9/28/2011	2011	9	28	1.2	0	1.2
9/29/2011	2011	9	29	6.6	0	6.6
9/30/2011	2011	9	30	5.4	0	5.4
10/1/2011	2011	10	1	0.2	0	0.2
10/2/2011	2011	10	2	3.4	0	3.4
10/3/2011	2011	10	3	4.4	0	4.4
10/4/2011	2011	10	4	0 T	0	0
10/5/2011	2011	10	5	0	0	0
10/6/2011	2011	10	6	0	0	0
10/7/2011	2011	10	7	0	0	0
10/8/2011	2011	10	8	0	0	0
10/9/2011	2011	10	9	0	0	0
10/10/2011	2011	10	10	0	0	0
10/11/2011	2011	10	11	0	0	0
10/12/2011	2011	10	12	1	0	1
10/13/2011	2011	10	13	6.2	0	6.2
10/14/2011	2011	10	14	19.2	0	19.2
10/15/2011	2011	10	15	7	0	7
10/16/2011	2011	10	16	0.2	0	0.2
10/17/2011	2011	10	17	2.6	0	2.6
10/18/2011	2011	10	18	0	0	0
10/19/2011	2011	10	19	5	0	5
10/20/2011	2011	10	20	27	0	27
10/21/2011	2011	10	21	2	0	2
10/22/2011	2011	10	22	0	0	0
10/23/2011	2011	10	23	0	0	0
10/24/2011	2011	10	24	1.4	0	1.4
10/25/2011	2011	10	25	0.2	0	0.2
10/26/2011	2011	10	26	0	0	0
10/27/2011	2011	10	27	0	0	0
10/28/2011	2011	10	28	0	0	0
10/29/2011	2011	10	29	0	0	0
10/30/2011	2011	10	30	0	0	0
10/31/2011	2011	10	31	0	0	0
11/1/2011	2011	11	1	0	0	0
11/2/2011	2011	11	2	0	0	0
11/3/2011	2011	11	3	1.4	0	1.4
11/4/2011	2011	11	4	0	0	0
11/5/2011	2011	11	5	0	0	0
11/6/2011	2011	11	6	0	0	0
11/7/2011	2011	11	7	0	0	0
11/8/2011	2011	11	8	0	0	0
11/9/2011	2011	11	9	0.2	0	0.2
11/10/2011	2011	11	10	0 T	0	0
11/11/2011	2011	11	11	0	0	0
11/12/2011	2011	11	12	0	0	0
11/13/2011	2011	11	13	0.4	0	0.4
11/14/2011	2011	11	14	2.2	0	2.2
11/15/2011	2011	11	15	0 T	0	0
11/16/2011	2011	11	16	0	0	0

11/17/2011	2011	11	17	0	0 T	0
11/18/2011	2011	11	18	0	0	0
11/19/2011	2011	11	19	0 T	0	0
11/20/2011	2011	11	20	1.8	0	1.8
11/21/2011	2011	11	21	0	0	0
11/22/2011	2011	11	22	0	0 T	0
11/23/2011	2011	11	23	0	8.8	6.6
11/24/2011	2011	11	24	0	0	0
11/25/2011	2011	11	25	0	0	0
11/26/2011	2011	11	26	0	0	0
11/27/2011	2011	11	27	1	0	1
11/28/2011	2011	11	28	3	0	3
11/29/2011	2011	11	29	37.2	0	37.2
11/30/2011	2011	11	30	7.2	0	7.2
12/1/2011	2011	12	1	0	0 T	0
12/2/2011	2011	12	2	0.2	3.6	3.8
12/3/2011	2011	12	3	0	0	0
12/4/2011	2011	12	4	0.2	0	0.2
12/5/2011	2011	12	5	12.4	0.8	13.2
12/6/2011	2011	12	6	0	2.8	2.2
12/7/2011	2011	12	7	0	0.4	0.2
12/8/2011	2011	12	8	0	0.2	0
12/9/2011	2011	12	9	0	0.4	0.2
12/10/2011	2011	12	10	0	0.2	0
12/11/2011	2011	12	11	0	0	0
12/12/2011	2011	12	12	0	0	0
12/13/2011	2011	12	13	0.8	0	0.8
12/14/2011	2011	12	14	M	M	4.2
12/15/2011	2011	12	15			
12/16/2011	2011	12	16			
12/17/2011	2011	12	17			
12/18/2011	2011	12	18			
12/19/2011	2011	12	19			
12/20/2011	2011	12	20			
12/21/2011	2011	12	21			
12/22/2011	2011	12	22			
12/23/2011	2011	12	23			
12/24/2011	2011	12	24			
12/25/2011	2011	12	25			
12/26/2011	2011	12	26			
12/27/2011	2011	12	27			
12/28/2011	2011	12	28			
12/29/2011	2011	12	29			
12/30/2011	2011	12	30			
12/31/2011	2011	12	31			

**SERVICING AND STORMWATER MANAGEMENT BRIEF –
WELLINGS OF STITTSVILLE PHASE 2, 20 CEDAROW COURT**

Appendix D Geotechnical Investigation
September 1, 2023

Appendix D GEOTECHNICAL INVESTIGATION

Geotechnical
Engineering

Environmental
Engineering

Hydrogeology

Geological
Engineering

Materials Testing

Building Science

Archaeological Services

Geotechnical Investigation

Proposed Mixed-Use Development
Wellings of Stittsville - Phase 2
20 Cedarow Court
Ottawa, Ontario

Prepared For

Nautical Lands Group

Paterson Group Inc.

Consulting Engineers
154 Colonnade Road South
Ottawa (Nepean), Ontario
Canada K2E 7J5

Tel: (613) 226-7381
Fax: (613) 226-6344
www.patersongroup.ca

March 7, 2019

Report PG4772-1

Table of Contents

		Page
1.0	Introduction	1
2.0	Proposed Project	1
3.0	Method of Investigation	
	3.1 Field Investigation	2
	3.2 Field Survey	3
	3.3 Laboratory Testing	3
	3.4 Analytical Testing	3
4.0	Observations	
	4.1 Surface Conditions	4
	4.2 Subsurface Profile	4
	4.3 Groundwater	4
5.0	Discussion	
	5.1 Geotechnical Assessment	5
	5.2 Site Grading and Preparation	5
	5.3 Foundation Design	8
	5.4 Design for Earthquakes	10
	5.5 Basement Slab	11
	5.6 Basement Wall	11
	5.7 Pavement Structure	12
6.0	Design and Construction Precautions	
	6.1 Foundation Drainage and Backfill	14
	6.2 Protection of Footings Against Frost Action	15
	6.3 Excavation Side Slopes	15
	6.4 Pipe Bedding and Backfill	17
	6.5 Groundwater Control	18
	6.6 Winter Construction	18
	6.7 Corrosion Potential and Sulphate	19
	6.8 Limit of Hazard Lands	19
	6.9 Landscaping Considerations	22
7.0	Recommendations	23
8.0	Statement of Limitations	24

Appendices

- Appendix 1 Soil Profile and Test Data Sheets
 Symbols and Terms
 Analytical Testing Results
- Appendix 2 Figure 1 - Key Plan
 Figures 2 to 4 - Slope Stability Analysis Sections
 Drawing PG4772-1 - Test Hole Location Plan

1.0 Introduction

Paterson Group (Paterson) was commissioned by Nautical Lands Group to conduct a geotechnical investigation for the proposed mixed-use development to be located at 20 Cedarow Court in the City of Ottawa, Ontario (refer to Figure 1 - Key Plan in Appendix 2).

The objectives of the current investigation were to:

- Determine the subsurface conditions by means of boreholes.
- Provide geotechnical recommendations for the design of the proposed development including construction considerations which may affect the design.

The following report has been prepared specifically and solely for the aforementioned project. This report contains geotechnical findings and includes recommendations pertaining to the design and construction of the proposed development as understood at the time of writing this report.

2.0 Proposed Development

Based on the available drawings, it is our understanding that the proposed development will consist of four, five (5) storey mixed-use buildings with a shared underground parking level occupying the majority of the footprint of the subject site. The buildings are understood to include retail, office space and residential units. A one (1) storey restaurant building is also proposed within the centre of the site. At-grade parking areas, access lanes and landscaped areas are also anticipated a part of the development. It is anticipated that the proposed development will be municipally serviced.

3.0 Method of Investigation

3.1 Field Investigation

Field Program

The field program for the current investigation was carried out from January 14, 2019 to January 18, 2019. At that time, 29 boreholes were drilled to a maximum depth of 4 m below existing grade. The borehole locations were distributed in a manner to provide general coverage of the proposed development. The locations of the boreholes are shown on Drawing PG4772-1 - Test Hole Location Plan included in Appendix 2.

The boreholes were drilled using a track-mounted auger drill rig operated by a two-person crew. All fieldwork was conducted under the full-time supervision of Paterson personnel with the direction of a senior engineer. The drilling procedure consisted of augering to the required depths at the selected locations, sampling and testing the overburden.

Sampling and In Situ Testing

Soil samples were recovered from a 50 mm diameter split-spoon or the auger flights. The split-spoon and auger samples were classified on site and placed in sealed plastic bags. All samples were transported to our laboratory. The depths at which the split-spoon and auger samples were recovered from the boreholes are presented as SS and AU, respectively, on the Soil Profile and Test Data sheets.

Standard Penetration Tests (SPT) were conducted and recorded as “N” values on the Soil Profile and Test Data sheets. The “N” value is the number of blows required to drive the split-spoon sample 300 mm into the soil after the initial penetration of 150 mm using a 63.5 kg hammer falling from a height of 760 mm.

Undrained shear strength tests were conducted in cohesive soils with a field vane apparatus.

The subsurface conditions observed in the boreholes were recorded in detail in the field. The soil profiles are presented on the Soil Profile and Test Data sheets in Appendix 1.

Groundwater

Flexible polyethylene standpipes were installed in the majority of the boreholes to permit groundwater results subsequent to the sampling program completion. Monitoring wells were installed in BH 4, BH 9, BH 15, BH 22, and BH 27 to provide general site coverage as part of our hydrogeological study. The groundwater observations are discussed in Subsection 4.3 and presented in the Soil Profile and Test Data Sheets in Appendix 1.

Sample Storage

All samples will be stored in the laboratory for a period of one month after issuance of this report at which time the samples will be discarded unless otherwise directed.

3.2 Field Survey

The borehole locations were selected by Paterson taking in consideration site features. The ground surface at the test pit locations was located and surveyed by Annis, O'Sullivan, Vollebakk LTD. It is understood that the ground surface elevations at the borehole locations were referenced to a geodetic datum. The locations and ground surface elevation at the boreholes are presented on Drawing PG4772-1 - Test Hole Location Plan in Appendix 2.

3.3 Laboratory Testing

Soil samples recovered from the subject site were visually examined in our laboratory to review the field logs. All samples will be stored in the laboratory for a period of one month after the issuance of this report. They will then be discarded unless we are otherwise directed.

3.4 Analytical Testing

One (1) soil sample was submitted for analytical testing to assess the potential for exposed ferrous metals and the sulphate potential against subsurface concrete structures. The results are discussed further in Subsection 6.7.

4.0 Observations

4.1 Surface Conditions

The subject site is currently undeveloped and grass covered with a tree-line located along the west boundary line of Cedarow Court. The ground surface across the site is relatively flat and approximately 1 m lower than adjacent properties and Hazeldean Road. Poole Creek ravine runs along the western border of the subject site approximately 3 m below the subject site.

The subject site is bordered by an active construction site for Phase 1 of the Wellings of Stittsville development along the north, Hazeldean Road along the east, and commercial buildings at the edge of Cedarow Court along the south.

4.2 Subsurface Profile

Overburden

The subsurface profile at the borehole locations consists of topsoil overlying a hard to very stiff silty clay crust followed by a grey, very stiff to stiff silty clay layer. Glacial till was encountered below the silty clay layer consisting of compact silty sand to sandy silt with clay, gravel, cobbles and boulders. A deposit of very stiff to hard clayey silt was encountered below the topsoil in BH 17, BH 18, BH 24, BH 25, BH 26, and BH 27. Practical refusal to augering on inferred bedrock was encountered in all boreholes at depths ranging between 1.6 to 4.0 m. Specific details of the soil profile at each test hole location are presented on the Soil Profile and Test Data sheets provided in Appendix 1.

Bedrock

Based on available geological mapping, the subject site consists of interbedded dolostone and limestone of the Gull River formation and an approximate drift thickness of 2 to 15 m.

4.3 Groundwater

The measured groundwater levels at the borehole locations are presented in Table 1. Groundwater readings recorded in flexible piezometers could be influenced by surface water infiltrating the backfilled boreholes. The long-term groundwater level can also be estimated based on observations of the recovered soil samples, such as the moisture level, soil consistency and colouring. Based on these observations, the long-term groundwater level is anticipated at a depth ranging between 2.5 to 3.5 m below existing grade. Groundwater levels are subject to seasonal fluctuations and could vary at the time of construction.

Table 1 - Groundwater Readings Summary				
Test Hole Number	Ground Elevation (m)	Groundwater Levels (m)		Recording Date
		Depth	Elevation	
BH 1	104.37	DRY	n/a	January 29, 2019
BH 2	103.59	3.05	100.54	January 29, 2019
BH 3	103.55	1.81	101.74	January 29, 2019
BH 4	103.28	3.05	100.23	January 29, 2019
BH 5	103.45	3.05	100.40	January 29, 2019
BH 6	103.49	3.04	100.45	January 29, 2019
BH 7	103.41	DRY	n/a	January 29, 2019
BH 8	103.46	DRY	n/a	January 29, 2019
BH 9	103.42	3.17	100.25	January 29, 2019
BH 10	103.31	2.18	101.13	January 29, 2019
BH 11	103.44	DRY	n/a	January 29, 2019
BH 12	103.58	DRY	n/a	January 29, 2019
BH 13	103.55	DRY	n/a	January 29, 2019
BH 14	104.18	DRY	n/a	January 29, 2019
BH 15	103.65	2.92	100.73	January 29, 2019
BH 16	103.66	DRY	n/a	January 29, 2019
BH 17	104.19	DRY	n/a	January 29, 2019
BH 18	104.15	DRY	n/a	January 29, 2019
BH 19	103.78	DRY	n/a	January 29, 2019
BH 20	103.59	DRY	n/a	January 29, 2019
BH 21	103.58	DRY	n/a	January 29, 2019
BH 22	103.65	DRY	n/a	January 29, 2019
BH 23	103.87	2.62	101.25	January 29, 2019
BH 24	104.04	2.55	101.49	January 29, 2019
BH 25	104.07	1.68	102.39	January 29, 2019
BH 26	104.30	DRY	n/a	January 29, 2019
BH 27	103.97	DRY	n/a	January 29, 2019
BH 28	103.78	DRY	n/a	January 29, 2019
BH 29	103.71	DRY	n/a	January 29, 2019

Note: The ground surface elevation at the borehole locations was provided by Annis, O'Sullivan, Vollebakk Ltd.

5.0 Discussion

5.1 Geotechnical Assessment

From a geotechnical perspective, the subject site is suitable for the proposed development. The proposed structures will be founded on conventional shallow foundations placed on an undisturbed, hard to very stiff silty clay, compact to dense glacial till and/or clean, surface sounded bedrock bearing surface. Alternatively, conventional shallow footings can be placed over a near vertical, zero entry, concrete in-filled trenches extending to a clean, surface sounded bedrock bearing surface.

Permissible grade raise restriction areas are also required due to the silty clay deposit. A permissible grade raise restriction of **2 m** is recommended for areas where settlement sensitive structures are founded over the silty clay deposit.

Depending on the extent of the underground parking garage and potential grade raise, the bedrock may be encountered during excavation and construction. All contractors should be prepared for bedrock removal within the subject site.

Prior to considering blasting operations, if required, the blasting effects on the existing services, buildings and other structures should be addressed. A pre-blast or pre-construction survey of the existing structures located in proximity of the blasting operations should be carried out prior to commencing site activities. The extent of the survey should be determined by the blasting consultant and should be sufficient to respond to any inquiries/claims related to the blasting operations.

The blasting operations should be planned and conducted under the supervision of a licensed professional engineer who is also an experienced blasting consultant.

The above and other considerations are discussed in the following sections.

5.2 Site Grading and Preparation

Stripping Depth

Topsoil and deleterious fill, such as those containing organic materials, should be stripped from under any buildings, paved areas, pipe bedding, and other settlement sensitive structures.

Bedrock Removal

Bedrock removal can be accomplished by hoe ramming where only small quantity of the bedrock needs to be removed. Sound bedrock may be removed by line drilling and controlled blasting and/or hoe ramming.

Prior to considering blasting operations, the blasting effects on the existing services, buildings and other structures should be addressed. A pre-blast or pre-construction survey of the existing structures located in proximity of the blasting operations should be completed prior to commencing site activities. The extent of the survey should be determined by the blasting consultant and should be sufficient to respond to any inquiries/claims related to the blasting operations.

As a general guideline, peak particle velocities (measured at the structures) should not exceed 25 mm/s during the blasting program to reduce the risks of damage to the existing structures.

The blasting operations should be planned and conducted under the supervision of a licensed professional engineer who is also an experienced blasting consultant.

Excavation side slopes in sound bedrock can be excavated almost vertical side walls. A minimum 1 m horizontal ledge, should remain between the overburden excavation and the bedrock surface. The ledge will provide an area to allow for potential sloughing or a stable base for the overburden shoring system.

Vibration Considerations

Construction operations are the cause of vibrations, and possibly, sources of nuisance to the community. Therefore, means to reduce the vibration levels as much as possible should be incorporated in the construction operations to maintain, as much as possible, a cooperative environment with the residents.

The following construction equipments could be the source of vibrations: hoe ram, compactor, dozer, crane, truck traffic, etc. Vibrations, whether caused by blasting operations or by construction operations, could be the source of detrimental vibrations on the nearby buildings and structures. Therefore, all vibrations are recommended to be limited.

Two parameters are used to determine the permissible vibrations, namely, the maximum peak particle velocity and the frequency. For low frequency vibrations, the maximum allowable peak particle velocity is less than that for high frequency vibrations. As a guideline, the peak particle velocity should be less than 15 mm/s between frequencies of 4 to 12 Hz, and 50 mm/s above a frequency of 40 Hz (interpolate between 12 and 40 Hz). The guidelines are for current construction standards. Considering that these guidelines are above perceptible human level and, in some cases, could be very disturbing to some people, a pre-construction survey is recommended be completed to minimize the risks of claims during or following the construction of the proposed buildings.

Fill Placement

Fill placed for grading beneath the structure(s) or other settlement sensitive areas should consist, unless otherwise specified, of clean imported granular fill, such as Ontario Provincial Standard Specifications (OPSS) Granular A or Granular B Type II. This material should be tested and approved prior to delivery to the site. The engineered fill should be placed in maximum 300 mm thick lifts and compacted to 98% of the material's standard Proctor maximum dry density (SPMDD).

Non-specified existing fill along with site-excavated soil can be placed as general landscaping fill where surface settlement is a minor concern. The backfill materials should be spread in thin lifts and at a minimum compacted by the tracks of the spreading equipment to minimize voids. If the non-specified backfill is to be placed to increase the subgrade level for areas to be paved, the fill should be compacted in maximum 300 mm lifts and compacted to 95% of the material's SPMDD. Non-specified existing fill and site-excavated soils are not suitable for placement as backfill against foundation walls unless a composite drainage blanket connected to a perimeter drainage system is provided.

5.3 Foundation Design

Bearing Resistance Values (Shallow Foundation)

Footings for the proposed buildings can be designed with the following bearing resistance values presented in Table 2.

Table 2 - Bearing Resistance Values		
Bearing Surface	Bearing Resistance Value at SLS (kPa)	Factored Bearing Resistance Value at ULS (kPa)
Very stiff to hard silty clay	150	250
Compact to dense glacial till	200	300
Lean Concrete In-filled Trenches	-	1,500
Clean, Surface Sounded Limestone Bedrock	-	1,500
<p>Note: Strip footings, up to 3 m wide, and pad footings, up to 8 m wide, placed over an undisturbed, silty clay bearing surface can be designed using the abovenoted bearing resistance values. - A geotechnical resistance factor of 0.5 was applied to the above noted bearing resistance value at ULS.</p>		

The above-noted bearing resistance values at SLS for soil bearing surfaces will be subjected to potential post-construction total and differential settlements of 25 and 20 mm, respectively. Footings bearing on an acceptable bedrock bearing surface and designed for the bearing resistance values provided herein will be subjected to negligible potential post-construction total and differential settlements.

The bearing resistance values are provided on the assumption that the footings are placed on undisturbed soil bearing surfaces. An undisturbed soil bearing surface consists of one from which all topsoil and deleterious materials, such as loose, frozen or disturbed soil, whether in situ or not, have been removed, in the dry, prior to the placement of concrete for footings.

A clean, surface-sounded bedrock bearing surface should be free of loose materials, and have no near surface seams, voids, fissures or open joints which can be detected from surface sounding with a rock hammer.

Lean Concrete Filled Trenches

Where bedrock is encountered below the design underside of footing elevation, consideration should be given to excavating vertical trenches to expose the underlying bedrock surface and backfilling with lean concrete (**15 MPa** 28-day compressive strength). Typically, the excavation sidewalls will be used as the form to support the concrete. The additional width of the concrete poured against an undisturbed trench sidewall will suffice in providing a direct transfer of the footing load to the underlying bedrock.

The effectiveness of this operation will depend on the ability of maintaining vertical trenches until the lean concrete can be poured. It is suggested that once the bottom of the excavation is exposed, an assessment should be completed to determine the water infiltration and stability of the excavation sidewalls extending to the bedrock surface.

The trench excavation should be at least 300 mm wider than all sides of the footing at the base of the excavation. The excavation bottom should be relatively clean using the hydraulic shovel only (workers will not be permitted in the excavation below a 1.5 m depth). Once approved by the geotechnical engineer, lean concrete can be poured up to the proposed founding elevation.

Bedrock/Soil Transition

Where a building is founded partly on bedrock and partly on soil, it is recommended to decrease the soil bearing resistance value by 25% for the footings placed on soil bearing media to reduce the potential long term total and differential settlements. Also, at the soil/bedrock and bedrock/soil transitions, it is recommended that the upper 0.5 m of the bedrock be removed for a minimum length of 2 m (on the bedrock side) and replaced with nominally compacted OPSS Granular A or Granular B Type II material. The width of the sub-excavation should be at least the proposed footing width plus 0.5 m. Steel reinforcement, extending at least 3 m on both sides of the 2 m long transition, should be placed in the top part of the footings and foundation walls.

Lateral Support

The bearing medium under footing-supported structures is required to be provided with adequate lateral support with respect to excavations and different foundation levels. Adequate lateral support is provided to an engineered fill, stiff silty clay or glacial till above the groundwater table when a plane extending horizontally and vertically from the underside of the footing at a minimum of 1.5H:1V passing through in situ soil of the same or higher bearing capacity as the bearing medium soil.

Permissible Grade Raise Restriction

Based on the current borehole information, a **permissible grade raise restriction of 2 m** is recommended for the proposed buildings and settlement sensitive structures where founded over a silty clay deposit. A post-development groundwater lowering of 0.5 m was assumed for our calculations.

5.4 Design for Earthquakes

The site class for seismic site response can be taken as **Class C** for the foundations considered at this site. However, a higher site class, such as Class A or B can be provided if a site specific shear wave velocity test is completed to confirm the seismic site classification. The soils underlying the subject site are not susceptible to liquefaction. Refer to the latest revision of the Ontario Building Code for a full discussion of the earthquake design requirements.

5.5 Basement Slab

The basement area for the proposed project will be mostly parking and the recommended pavement structure noted in Subsection 5.7 will be applicable. However, if storage or other uses of the lower level where a concrete floor slab will be constructed, the upper 200 mm of sub-slab fill is recommended to consist of 19 mm clear crushed stone. The upper 200 mm of sub-slab fill is recommended to consist of OPSS Granular A crushed stone for slab on grade construction. All backfill material within the footprint of the proposed building(s) should be placed in maximum 300 mm thick loose layers and compacted to a minimum of 98% of the SPMDD.

Any soft areas should be removed and backfilled with appropriate backfill material prior to placing any fill. OPSS Granular A or Granular B Type II, with a maximum particle size of 50 mm, are recommended for backfilling below the floor slab. All backfill material within the footprint of the proposed building(s) should be placed in maximum 300 mm thick loose layers and compacted to a minimum of 98% of the SPMDD.

A subfloor drainage system, consisting of lines of perforated drainage pipe subdrains connected to a positive outlet, should be provided in the clear stone under the lower basement floor (discussed in Subsection 6.1).

5.6 Basement Wall

There are several combinations of backfill materials and retained soils that could be applicable for the proposed structure's basement walls. However, the conditions can be well-represented by assuming the retained soil consists of a material with an angle of internal friction of 30 degrees and a dry unit weight of 20 kN/m³.

The foundation wall is anticipated to be provided with a perimeter drainage system; therefore, the retained soils should be considered drained. For the undrained conditions, the applicable effective unit weight of the retained soil can be designed with 13 kN/m³. A hydrostatic pressure should be added to the total static earth pressure when calculating the effective unit weight. The total earth pressure (P_{AE}) includes both the static earth pressure component (P_o) and the seismic component (ΔP_{AE}).

Two distinct conditions, static and seismic, should be reviewed for design calculations. The parameters for design calculations for the two conditions are presented below.

Static Conditions

The static horizontal earth pressure (p_o) could be calculated with a triangular earth pressure distribution equal to $K_o \cdot \gamma \cdot H$ where:

- K_o = at-rest earth pressure coefficient of the applicable retained soil, 0.5
 γ = unit weight of fill of the applicable retained soil (kN/m³)
 H = height of the wall (m)

An additional pressure with a magnitude equal to $K_o \cdot q$ and acting on the entire height of the wall should be added to the above formula for any surcharge loading, q (kPa), that may be placed at ground surface adjacent to the wall. The surcharge pressure should only be applicable for static analyses and not be calculated in conjunction with the seismic loading case. Actual earth pressures could be higher than the “at-rest” case if care is not exercised during the compaction of the backfill materials to maintain a minimum separation of 0.3 m from the walls with the compaction equipment.

Seismic Conditions

The total seismic force (P_{AE}) includes both the earth force component (P_o) and the seismic component (ΔP_{AE}).

The seismic earth force (ΔP_{AE}) could be calculated using $0.375 \cdot a_c \cdot \gamma \cdot H^2/g$ where:

- $a_c = (1.45 - a_{max}/g) a_{max}$
 γ = unit weight of fill of the applicable retained soil (kN/m³)
 H = height of the wall (m)
 g = gravity, 9.81 m/s²

The peak ground acceleration, (a_{max}), for the Ottawa area is 0.32g according to OBC 2012. The vertical seismic coefficient is assumed to be zero. The earth force component (P_o) under seismic conditions could be calculated using $P_o = 0.5 K_o \gamma H^2$, where $K_o = 0.5$ for the soil conditions presented above.

The total earth force (P_{AE}) is considered to act at a height, h (m), from the base of the wall, where:

$$h = \{P_o \cdot (H/3) + \Delta P_{AE} \cdot (0.6 \cdot H)\} / P_{AE}$$

The earth forces calculated are unfactored. For the ULS case, the earth loads should be factored as live loads, as per OBC 2012.

5.7 Pavement Structure

For design purposes, the pavement structure presented in the following tables could be used for the design of car only parking areas and access lanes, if required.

Table 3 - Recommended Flexible Pavement Structure - At-Grade Parking Areas	
Thickness (mm)	Material Description
50	Wear Course - HL-3 or Superpave 12.5 Asphaltic Concrete
150	BASE - OPSS Granular A Crushed Stone
300	SUBBASE - OPSS Granular B Type II
	SUBGRADE - In situ soil, or OPSS Granular B Type I or II material placed over in situ soil

Table 4 - Recommended Flexible Pavement Structure - Access Lanes and Heavy Truck Parking Areas	
Thickness (mm)	Material Description
40	Wear Course - HL-3 or Superpave 12.5 Asphaltic Concrete
50	Binder Course - HL-8 or Superpave 19.0 Asphaltic Concrete
150	BASE - OPSS Granular A Crushed Stone
450	SUBBASE - OPSS Granular B Type II
	SUBGRADE - In situ soil, or OPSS Granular B Type I or II material placed over in situ soil

Minimum Performance Graded (PG) 58-34 asphalt cement should be used for this project.

If soft spots develop in the subgrade during compaction or due to construction traffic, the affected areas should be sub-excavated and replaced with OPSS Granular B Type II material.

The pavement granular base and subbase should be placed in maximum 300 mm thick lifts and compacted to a minimum of 98% of the SPMDD.

6.0 Design and Construction Precautions

6.1 Foundation Drainage and Backfill

Foundation Drainage

A perimeter foundation drainage system is recommended to be provided for the proposed structures. The composite drainage system (such as Miradrain G100N, Delta Drain 6000 or an approved equivalent) is recommended to extend to the footing level. Sleeves, 150 mm diameter, at 3 m centres are recommended to be placed in the footing or at the foundation wall/footing interface for blind sided pours to allow the infiltration of water to flow to the interior perimeter drainage pipe. The perimeter drainage pipe and underfloor drainage system should direct water to sump pit(s) within the lower basement area.

Underfloor Drainage

Underfloor drainage is recommend to control water infiltration for the proposed structures. For design purposes, Paterson recommends 150 mm diameter PVC, corrugated, perforated pipes be placed at 3 to 6 m centres. The spacing of the underfloor drainage system should be confirmed at the time of completing the excavation when water infiltration can be better assessed.

Adverse Effects of Dewatering on Adjacent Properties

Due to the low permeability of the subsoils profile, any minor dewatering will be considered relatively minor due to the proposed building. Therefore, adverse effects to the surrounding buildings or properties are not expected with respect to any groundwater lowering.

Foundation Backfill

Backfill against the exterior sides of the foundation walls should consist of free-draining non frost susceptible granular materials. The greater part of the site excavated materials will be frost susceptible and, as such, are not recommended for re-use as backfill against the foundation walls where frost heave sensitive structures, such as a concrete sidewalk, will be placed. Imported granular materials, such as clean sand or OPSS Granular B Type I granular material may be used for this purpose. A composite drainage system, such as Delta Drain 6000, Miradrain G100 or an approved equivalent, should be placed against the foundation wall to promote drainage toward the perimeter drainage pipe.

6.2 Protection of Footings Against Frost Action

Perimeter footings of heated structures are recommended to be protected against the deleterious effects of frost action. A minimum of 1.5 m of soil cover alone, or a combination of soil cover and foundation insulation should be provided.

Exterior unheated footings, such as isolated exterior piers, are more prone to deleterious movement associated with frost action than the exterior walls of the structure proper and require additional protection, such as soil cover of 2.1 m or a combination of soil cover and foundation insulation.

The parking garage should not require protection against frost action due to the founding depth. Unheated structures, such as the access ramp wall footings, may be required to be insulated against the deleterious effect of frost action. A minimum of 2.1 m of soil cover alone, or a minimum of 0.6 m of soil cover, in conjunction with foundation insulation, should be provided.

6.3 Excavation Side Slopes

Temporary Side Slopes

The temporary excavation side slopes should either be excavated to acceptable slopes or retained by shoring systems from the beginning of the excavation until the structure is backfilled.

The excavation side slopes above the groundwater level extending to a maximum depth of 3 m should be excavated at 1H:1V or shallower. The shallower slope is required for excavation below groundwater level. The subsurface soil is considered to be mainly Type 2 and 3 soil according to the Occupational Health and Safety Act and Regulations for Construction Projects.

Excavated soil should not be stockpiled directly at the top of excavations and heavy equipment should maintain safe working distance from the excavation sides.

Slopes in excess of 3 m in height should be periodically inspected by the geotechnical consultant in order to detect if the slopes are exhibiting signs of distress.

A trench box is recommended to be installed at all times to protect personnel working in trenches with steep or vertical sides. Services are expected to be installed by “cut and cover” methods and excavations should not remain exposed for extended periods of time.

Temporary Shoring

Temporary shoring may be required for the overburden soil to complete the required excavations where insufficient room is available for open cut methods. The shoring requirements designed by a structural engineer specializing in those works will depend on the excavation depths, the proximity of the adjacent structures and the elevation of the adjacent building foundations and underground services. The design and implementation of these temporary systems will be the responsibility of the excavation contractor and their design team. Inspections and approval of the temporary system will also be the responsibility of the designer. Geotechnical information provided below is to assist the designer in completing a suitable and safe shoring system. The designer should take into account the impact of a significant precipitation event and designate design measures to ensure that a precipitation will not negatively impact the shoring system or soils supported by the system. Any changes to the approved shoring design system should be reported immediately to the owner's structural designer prior to implementation.

The temporary system could consist of soldier pile and lagging system or interlocking steel sheet piling. Any additional loading due to street traffic, construction equipment, adjacent structures and facilities, etc., should be included to the earth pressures described below. These systems could be cantilevered, anchored or braced. Generally, it is expected that the shoring systems will be provided with tie-back rock anchors to ensure their stability. The shoring system is recommended to be adequately supported to resist toe failure and inspected to ensure that the sheet piles extend well below the excavation base. It should be noted if consideration is being given to utilizing a raker style support for the shoring system that lateral movements can occur and the structural engineer should ensure that the design selected minimizes these movements to tolerable levels.

The earth pressures acting on the shoring system may be calculated with the following parameters.

Table 6 - Soil Parameters	
Parameters	Values
Active Earth Pressure Coefficient (K_a)	0.33
Passive Earth Pressure Coefficient (K_p)	3
At-Rest Earth Pressure Coefficient (K_0)	0.5
Dry Unit Weight (γ), kN/m ³	20
Effective Unit Weight (γ), kN/m ³	13

The active earth pressure should be calculated where wall movements are permissible while the at-rest pressure should be calculated if no movement is permissible. The dry unit weight should be calculated above the groundwater level while the effective unit weight should be calculated below the groundwater level.

The hydrostatic groundwater pressure should be included to the earth pressure distribution wherever the effective unit weight are calculated for earth pressures. If the groundwater level is lowered, the dry unit weight for the soil/bedrock should be calculated full weight, with no hydrostatic groundwater pressure component.

For design purposes, the minimum factor of safety of 1.5 should be calculated.

6.4 Pipe Bedding and Backfill

Bedding and backfill materials should be in accordance with the most recent Material Specifications and Standard Detail Drawings from the Department of Public Works and Services, Infrastructure Services Branch of the City of Ottawa.

A minimum of a 150 mm layer of OPSS Granular A crushed stone should be placed for pipe bedding for sewer and water pipes for a soil subgrade. The bedding thickness should be increased to 300 mm for areas where the subgrade consists of bedrock. The bedding should extend to the spring line of the pipe. Cover material, from the spring line to at least 300 mm above the obvert of the pipe should consist of OPSS Granular A. The bedding and cover materials should be placed in maximum 300 mm thick lifts compacted to a minimum of 95% of the SPMDD.

The site excavated material may be placed above cover material if the excavation operations are completed in dry weather conditions and the site excavated material is approved by the geotechnical consultant. All cobbles greater than 200 mm in the longest dimension should be removed prior to the site materials being reused.

Where hard surface areas are considered above the trench backfill, the trench backfill material within the frost zone (about 1.8 m below finished grade) should match the soils exposed at the trench walls to reduce differential frost heaving. The trench backfill should be placed in maximum 225 mm thick loose lifts and compacted to a minimum of 95% of the SPMDD. Within the frost zone (1.8 m below finished grade), non frost susceptible materials should be used when backfilling trenches below the original bedrock level.

Clay seals are recommended for the subject site. The seals should be a minimum of 1.5 m long (in the trench direction) and should extend from trench wall to trench wall. Generally, the seals should extend from the frost line and fully penetrate the bedding, subbedding and cover material. The barriers should consist of relatively dry and compactable brown silty clay placed in maximum 225 mm thick loose layers and compacted to a minimum of 95% of the SPMDD. The clay seals should be placed at the site boundaries, roadway intersections and at a maximum distance of every 50 m in the service trenches.

6.5 Groundwater Control

Groundwater Control for Building Construction

It is anticipated that groundwater infiltration into the excavations should be low and controllable using open sumps. Pumping from open sumps should be sufficient to control the groundwater influx through the sides of shallow excavations. The contractor should be prepared to direct water away from all bearing surfaces and subgrades, regardless of the source, to prevent disturbance to the founding medium.

A temporary Ministry of the Environment, Conservation and Parks (MECP) permit to take water (PTTW) may be required for this project if more than 400,000 L/day of ground and/or surface water is to be pumped during the construction phase. A minimum 4 to 5 months should be allowed for completion of the PTTW application package and issuance of the permit by the MECP.

For typical ground or surface water volumes, being pumped during the construction phase, between 50,000 to 400,000 L/day, it is required to register on the Environmental Activity and Sector Registry (EASR). A minimum of two to four weeks should be allotted for completion of the EASR registration and the Water Taking and Discharge Plan to be prepared by a Qualified Person as stipulated under O.Reg. 63/16. If a project qualifies for a PTTW based upon anticipated conditions, an EASR will not be allowed as a temporary dewatering measure while awaiting the MECP review of the PTTW application.

6.6 Winter Construction

Precautions must be provided if winter construction is considered for this project. Where excavations are completed in proximity of existing structures which may be adversely affected due to the freezing conditions. In particular, where a shoring system is constructed, the soil behind the shoring system will be subjected to freezing conditions and could result in heaving of the structure(s) placed within or above frozen soil. Provisions in the contract documents should be provided to protect the excavation walls from freezing, if applicable.

In the event of construction during below zero temperatures, the founding stratum should be protected from freezing temperatures by the installation of straw, propane heaters and tarpaulins or other suitable means. The excavation base should be insulated from sub-zero temperatures immediately upon exposure and until such time as heat is adequately supplied to the building and the footings are protected with sufficient soil cover to prevent freezing at founding level.

Trench excavations and pavement construction are difficult activities to complete during freezing conditions without introducing frost in the subgrade or in the excavation walls and bottoms. Precautions should be considered if such activities are to be completed during freezing conditions. Additional information could be provided, if required.

6.7 Corrosion Potential and Sulphate

The results on analytical testing show that the sulphate content is less than 0.1%. The results are indicative that Type 10 Portland Cement (Type GU) would be appropriate for this site. The chloride content and the pH of the sample indicate that they are not significant factors in creating a corrosive environment for exposed ferrous metals at this site, whereas the resistivity is indicative of a low to moderate corrosive environment.

6.8 Limit of Hazard Lands

Field Observations

Paterson conducted a site visit on January 13, 2019 to review the slope located along the west boundary of the subject site, assess the current slope conditions and confirm the grades provided in the existing topographic mapping. A section of Poole Creek is located within the west portion of the site and shown in Drawing PG4772-1 - Test Hole Location Plan.

Three (3) slope cross-sections were reviewed in the field as the worst case scenarios. The cross section locations are presented on Drawing PG4772-1 - Test Hole Location Plan in Appendix 2. Generally, the riverbanks along both sides of Poole Creek are currently well vegetated and were observed in an acceptable condition. Poole Creek was observed within a 20 to 40 m wide flood plain. The slope along the east side of Poole Creek ranged in height between 3 and 5 m with an inclination ranging between 2.3H:1V and 3.3H:1V. The upper slope was observed to be well vegetated with little to no signs of active surficial erosion.

Slope Stability Analysis

Limit of Hazard Lands

The slope condition was reviewed based on available topographic mapping along the east side slopes of Poole Creek within the west portion of the subject development. A total of 3 slope cross-sections were assessed as the worst case scenarios. The cross section locations are presented on Drawing PG4772-1 - Test Hole Location Plan in Appendix 2.

A slope stability assessment was carried out to determine the required stable slope allowance setback from the top of slope based on a factor of safety of 1.5. A toe erosion and 6 m erosion access allowances were also included in the determination of limits of hazard lands and are discussed below. The proposed limit of hazard lands (as shown on Drawing PG4772-1 - Test Hole Location Plan) includes:

- a geotechnical slope stability allowance with a factor of safety of 1.5
- a toe erosion allowance
- a 6 m erosion access allowance and top of slope

Slope Stability Analysis

The analysis of the stability of the slope sections was carried out using SLIDE, a computer program which permits a two-dimensional slope stability analysis using several methods including the Bishop's method, which is a widely used and accepted analysis method. The program calculates a factor of safety, which represents the ratio of the forces resisting failure to those favoring failure. Theoretically, a factor of safety of 1.0 represents a condition where the slope is stable. However, due to intrinsic limitations of the calculation methods and the variability of the subsoil and groundwater conditions, a factor of safety greater than one is usually required to ascertain that the risks of failure are acceptable. A minimum factor of safety of 1.5 is generally recommended for conditions where the failure of the slope would endanger permanent structures.

An analysis considering seismic loading was also completed. A horizontal acceleration of 0.16G was considered for the sections for the seismic loading condition. A factor of safety of 1.1 is considered to be satisfactory for stability analyses including seismic loading.

The cross-sections were analysed taking into account a groundwater level at ground surface, which represents a worse-case scenario that can be reasonably expected to occur in cohesive soils. The stability analysis assumes full saturation of the soil with groundwater flow parallel to the slope face. Subsoil conditions at the cross-sections were inferred based on the findings at borehole locations along the top of slope and general knowledge of the area's geology.

Stable Slope Allowance

The results of the stability analysis for static conditions at Sections A through C are presented in Figures 2A to 4A in Appendix 2. All the reviewed slope sections along the subject creek were noted to be shaped to at least a 2.3H:1V. Based on the soil conditions observed and the results of the slope stability analysis, the slope stability factor of safety was calculated to be 1.5 or greater for all the slope sections which indicates that a stable slope allowance is not required for the subject slope.

The results of the analyses including seismic loading are shown in Figures 2B to 4B for the slope sections. The results indicate that the factor of safety for the sections are greater than 1.1.

It should be noted that the existing vegetation on the slope face should not be removed as it contributes to the stability of the slope and reduces erosion. If the existing vegetation needs to be removed, it is recommended that a 100 to 150 mm of topsoil mixed with a hardy seed and/or topped with an erosion control blanket be which can be placed across the exposed slope face.

Toe Erosion and Erosion Access Allowance

The toe erosion allowance for the valley corridor wall slope was based on the cohesive nature of the top layers of the subsoils, the observed current erosional activities and the width and location of the current watercourse. It should be noted that if the flood plain is measured to be greater than 20 m, no toe erosion will be required. Therefore, based on the above factors, no toe erosion allowance is considered for the subject slope.

An erosion access allowance of 6 m is required from the top of slope to ensure access is provided should future maintenance to the slope face is required. The limit of hazard lands, which includes these allowances, is indicated on Drawing PG4772-1 - Test Hole Location Plan in Appendix 2.

6.9 Landscaping Considerations

Tree Planting Restrictions

According to the City of Ottawa Guidelines for tree planting, where a sensitive silty clay deposit is present within the vicinity of the site, tree planting restrictions should be determined. However, for this site, based on the founding medium of the underground parking level which will occupy the majority of the site, tree planting restrictions are not required from a geotechnical perspective.

7.0 Recommendations

A materials testing and observation services program is a requirement for the provided foundation design data to be applicable. The following aspects of the program should be performed by the geotechnical consultant:

- Review detailed grading plan(s) from a geotechnical perspective.
- Review groundwater conditions at the time of construction to determine if waterproofing is required.
- Observation of all bearing surfaces prior to the placement of concrete.
- Sampling and testing of the concrete and fill materials used.
- Periodic observation of the condition of unsupported excavation side slopes in excess of 3 m in height, if applicable.
- Observation of all subgrades prior to backfilling.
- Field density tests to determine the level of compaction achieved.
- Sampling and testing of the bituminous concrete including mix design reviews.

A report confirming that the construction work has been conducted in general accordance with the above recommendations could be issued, upon request, following the completion of a satisfactory materials testing and observation program by the geotechnical consultant.

8.0 Statement of Limitations

The recommendations provided in the report are in accordance with Paterson's present understanding of the project. Paterson request permission to review the recommendations when the drawings and specifications are completed.

A geotechnical investigation is a limited sampling of a site. Should any conditions encountered during construction differ from the borehole locations, Paterson requests immediate notification to permit reassessment of the recommendations provided herein.

The recommendations provided should only be used by the design professionals associated with this project. The recommendations are not intended for contractors bidding on or constructing the project. The latter should evaluate the factual information provided in the report. The contractor should also determine the suitability and completeness for the intended construction schedule and methods. Additional testing may be required for the contractors purpose.

The present report applies only to the project described in this document. Use of this report for purposes other than those described herein or by person(s) other than Nautical Lands Group or their agent(s) is not authorized without review by Paterson for the applicability of our recommendations to the altered use of the report.

Paterson Group Inc.



Faisal I. Abou-Seido, P.Eng.



David J. Gilbert, P.Eng.

Report Distribution:

- Nautical Lands Group (3 copies)
- Paterson Group (1 copy)

APPENDIX 1

SOIL PROFILE AND TEST DATA SHEETS

SYMBOLS AND TERMS

ANALYTICAL TESTING RESULTS

DATUM Ground surface elevations provided by Annis, O'Sullivan, Vollebakk Ltd.

FILE NO. **PG4772**

REMARKS

HOLE NO. **BH 1**

BORINGS BY CME 55 Power Auger

DATE 2019 January 14

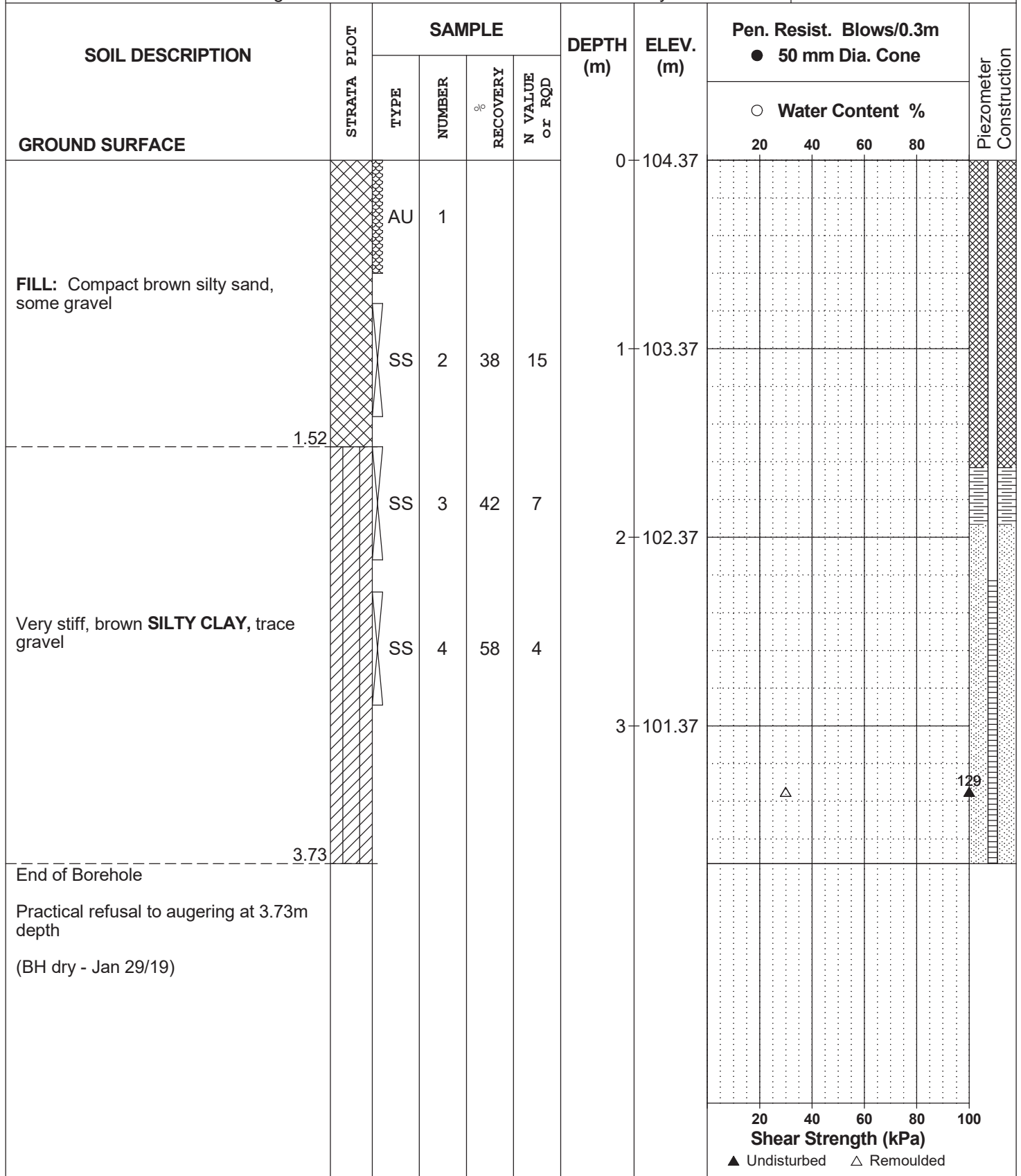

DATUM Ground surface elevations provided by Annis, O'Sullivan, Vollebakk Ltd.

FILE NO. **PG4772**

REMARKS

HOLE NO. **BH 2**

BORINGS BY CME 55 Power Auger

DATE 2019 January 14

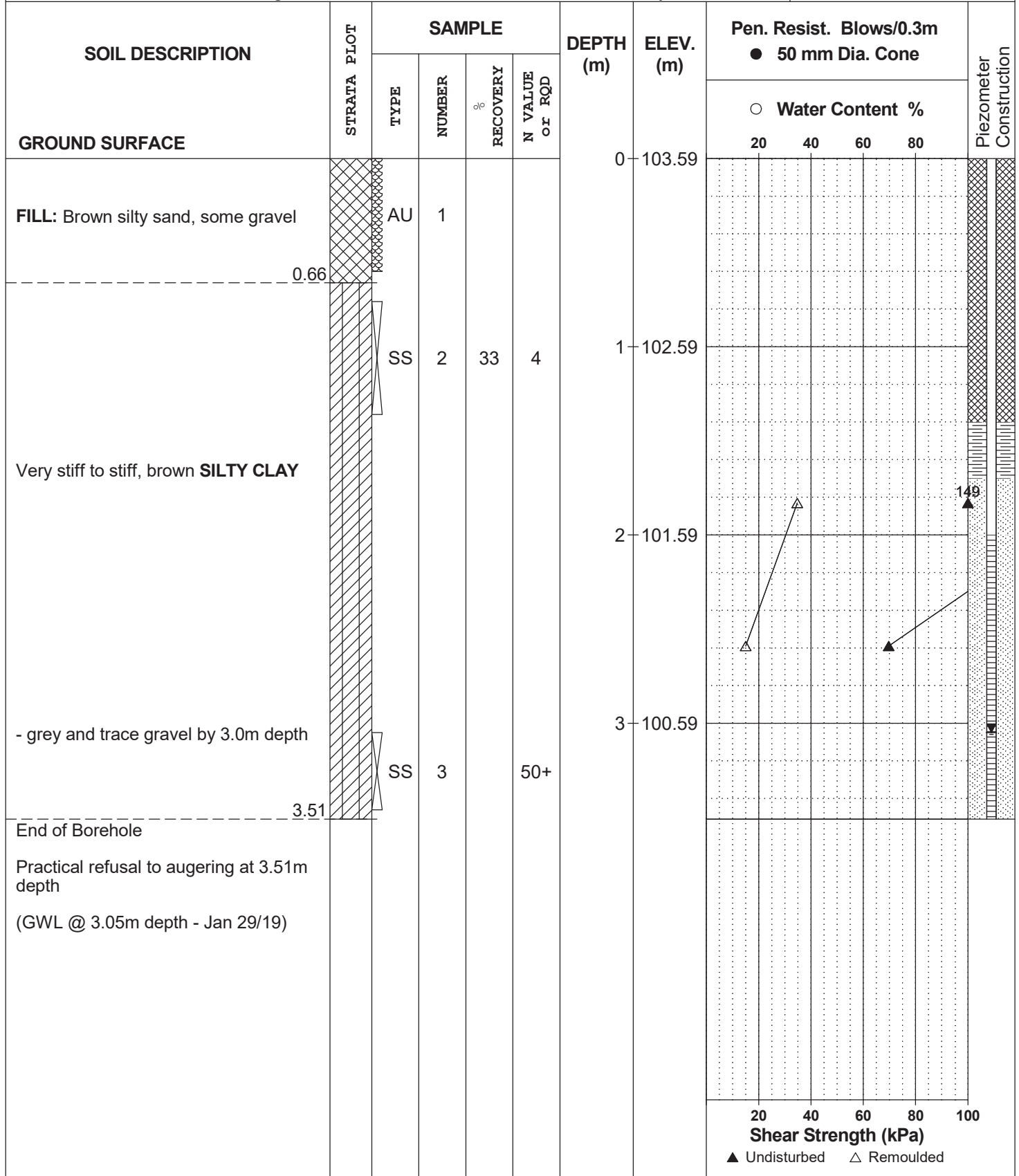

DATUM Ground surface elevations provided by Annis, O'Sullivan, Vollebakk Ltd.

FILE NO. **PG4772**

REMARKS

HOLE NO. **BH 3**

BORINGS BY CME 55 Power Auger

DATE 2019 January 14

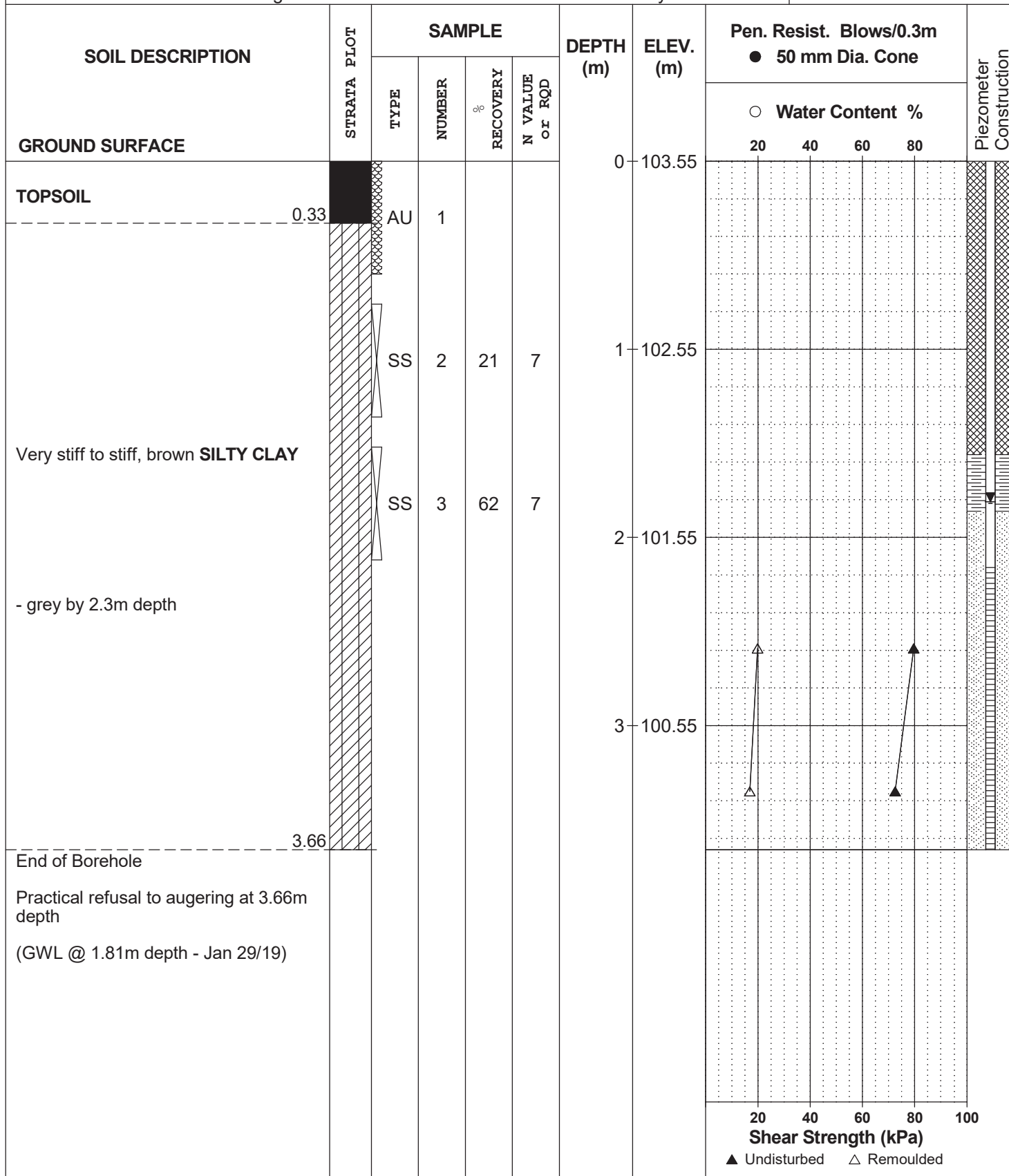

DATUM Ground surface elevations provided by Annis, O'Sullivan, Vollebakk Ltd.

FILE NO. **PG4772**

REMARKS

HOLE NO. **BH 4**

BORINGS BY CME 55 Power Auger

DATE 2019 January 14

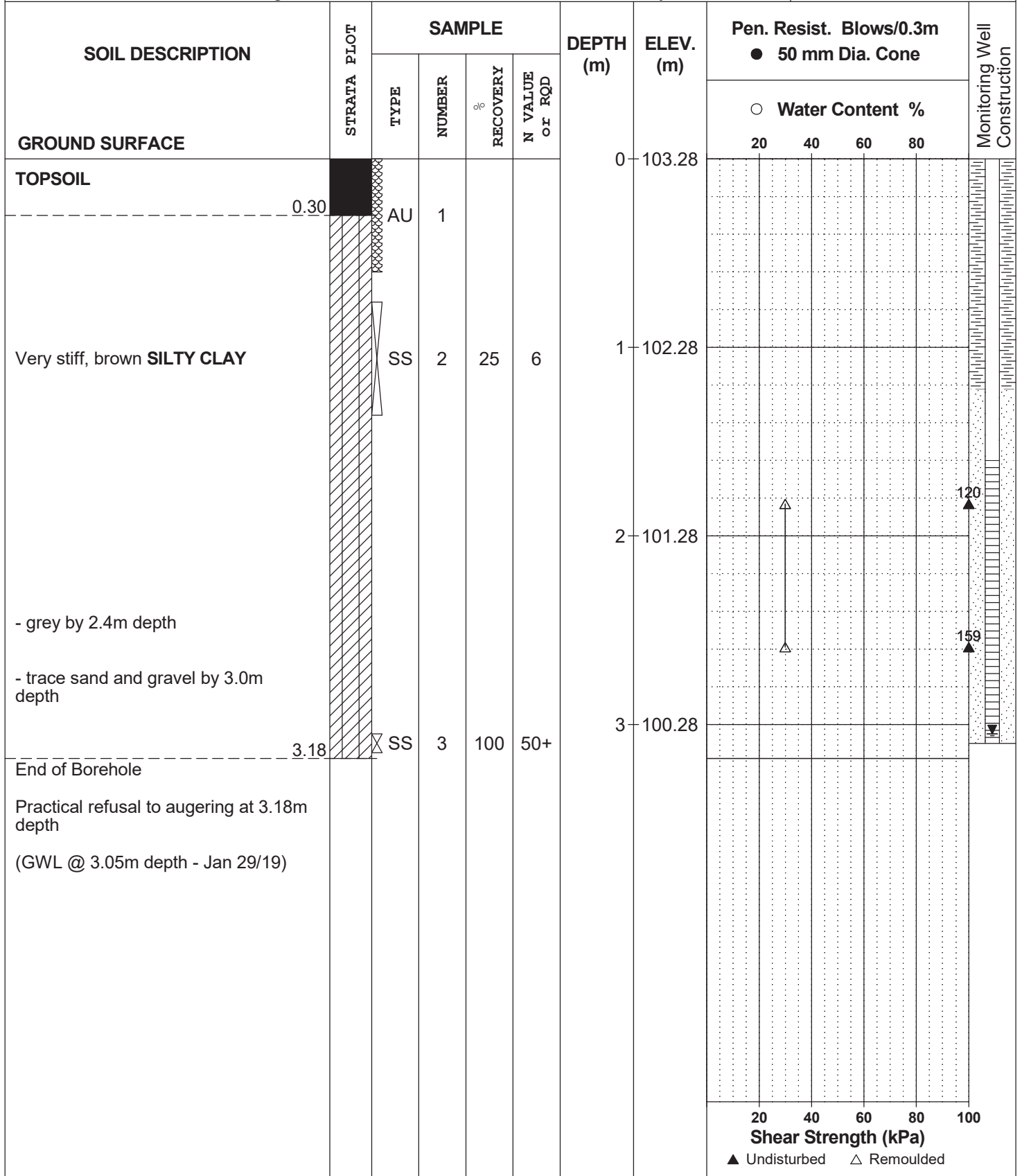

DATUM Ground surface elevations provided by Annis, O'Sullivan, Vollebakk Ltd.

FILE NO. **PG4772**

REMARKS

HOLE NO. **BH 5**

BORINGS BY CME 55 Power Auger

DATE 2019 January 14

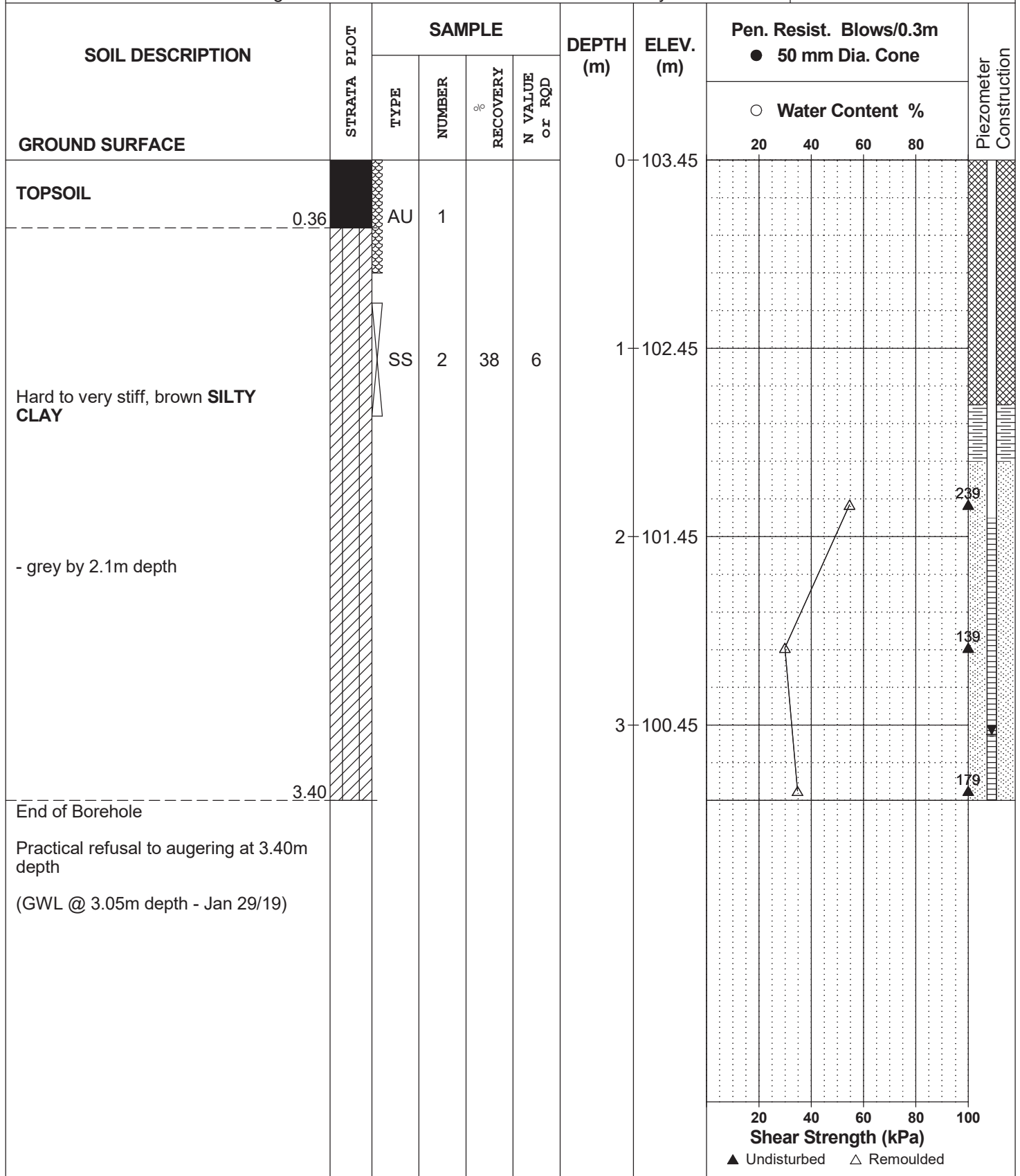

DATUM Ground surface elevations provided by Annis, O'Sullivan, Vollebakk Ltd.

FILE NO. **PG4772**

REMARKS

HOLE NO. **BH 6**

BORINGS BY CME 55 Power Auger

DATE 2019 January 14

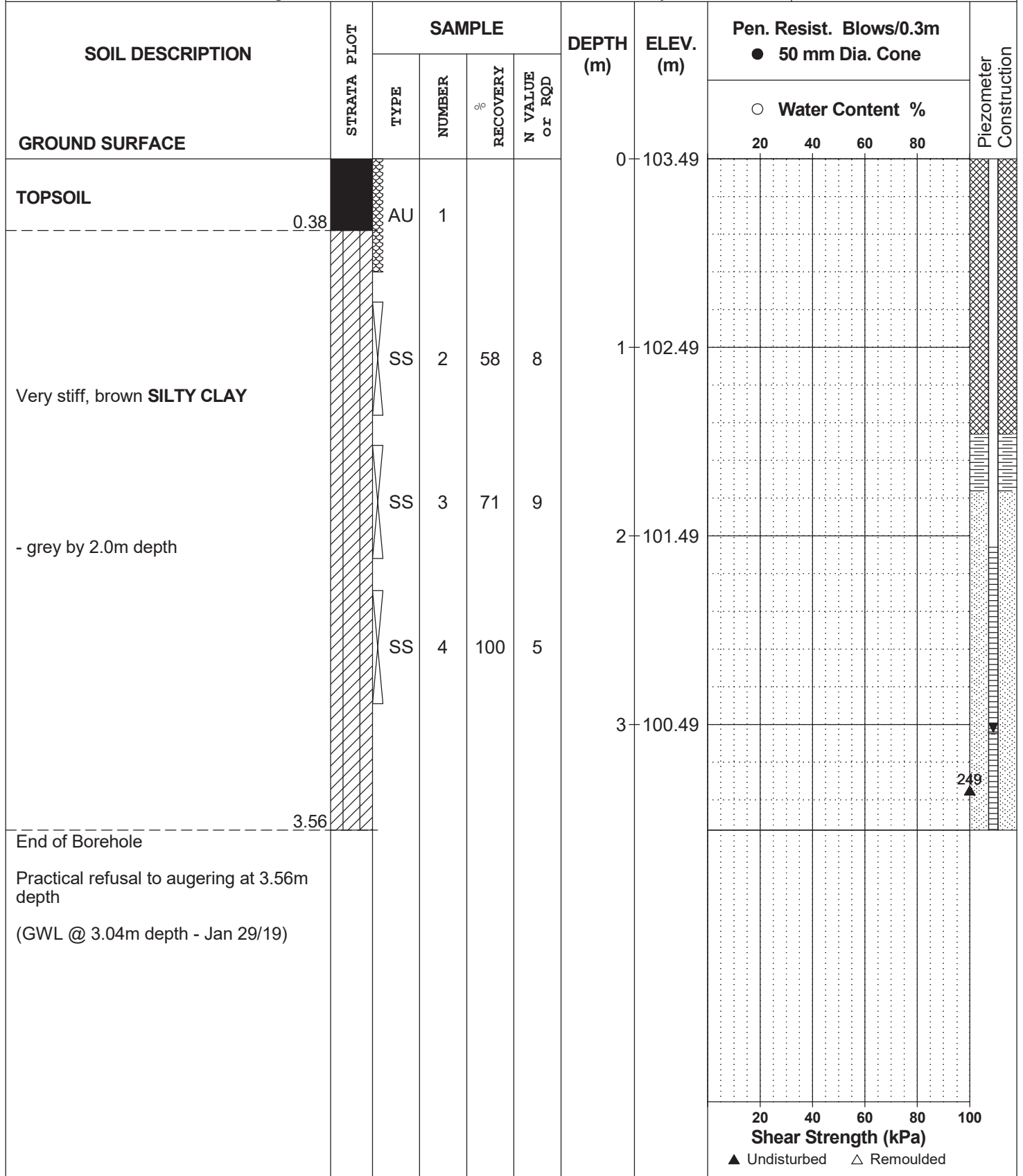

DATUM Ground surface elevations provided by Annis, O'Sullivan, Vollebakk Ltd.

FILE NO. **PG4772**

REMARKS

HOLE NO. **BH 7**

BORINGS BY CME 55 Power Auger

DATE 2019 January 14

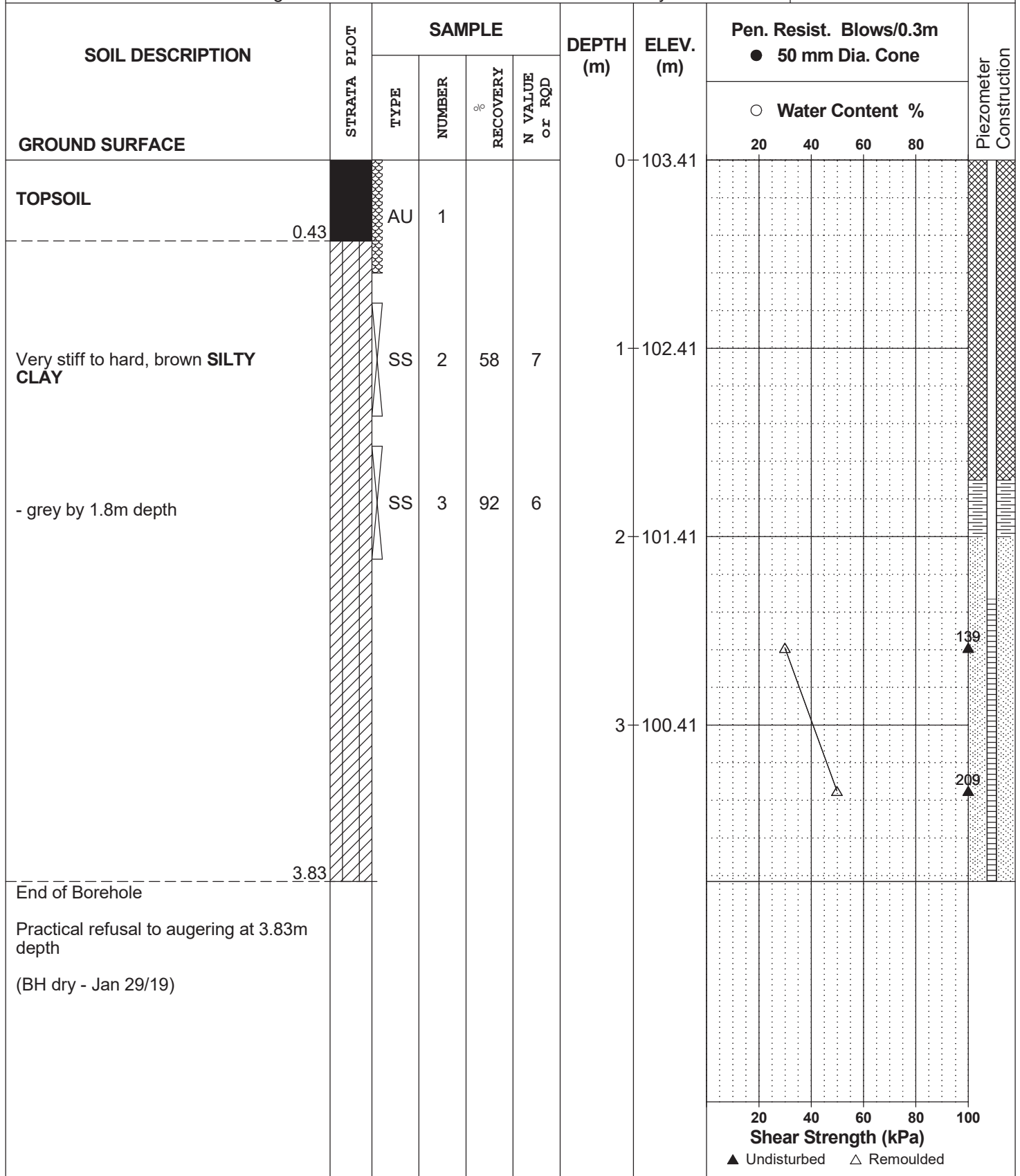

DATUM Ground surface elevations provided by Annis, O'Sullivan, Vollebakk Ltd.

FILE NO. **PG4772**

REMARKS

HOLE NO. **BH 8**

BORINGS BY CME 55 Power Auger

DATE 2019 January 14

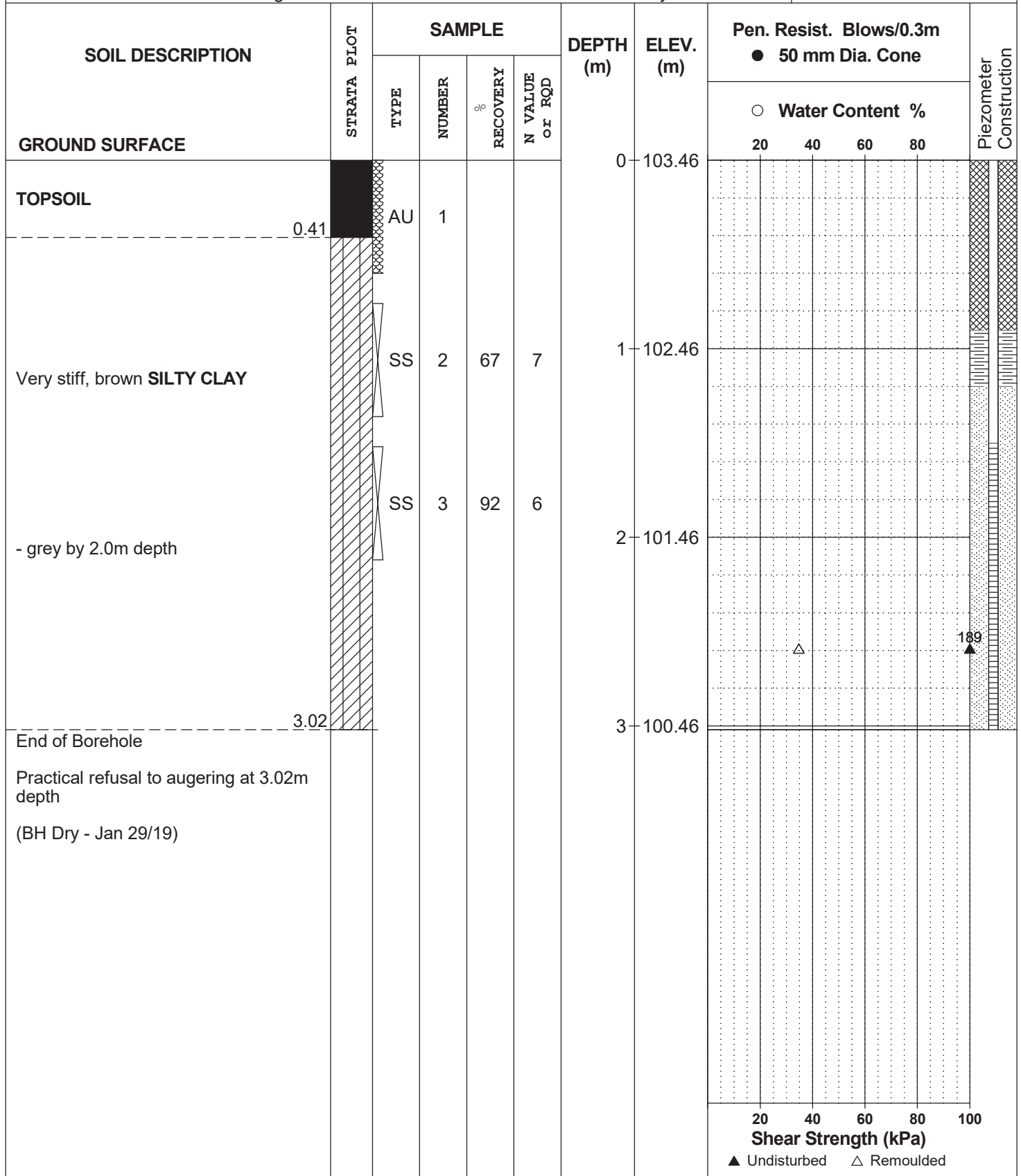

DATUM Ground surface elevations provided by Annis, O'Sullivan, Vollebakk Ltd.

FILE NO. **PG4772**

REMARKS

HOLE NO. **BH 9**

BORINGS BY CME 55 Power Auger

DATE 2019 January 15

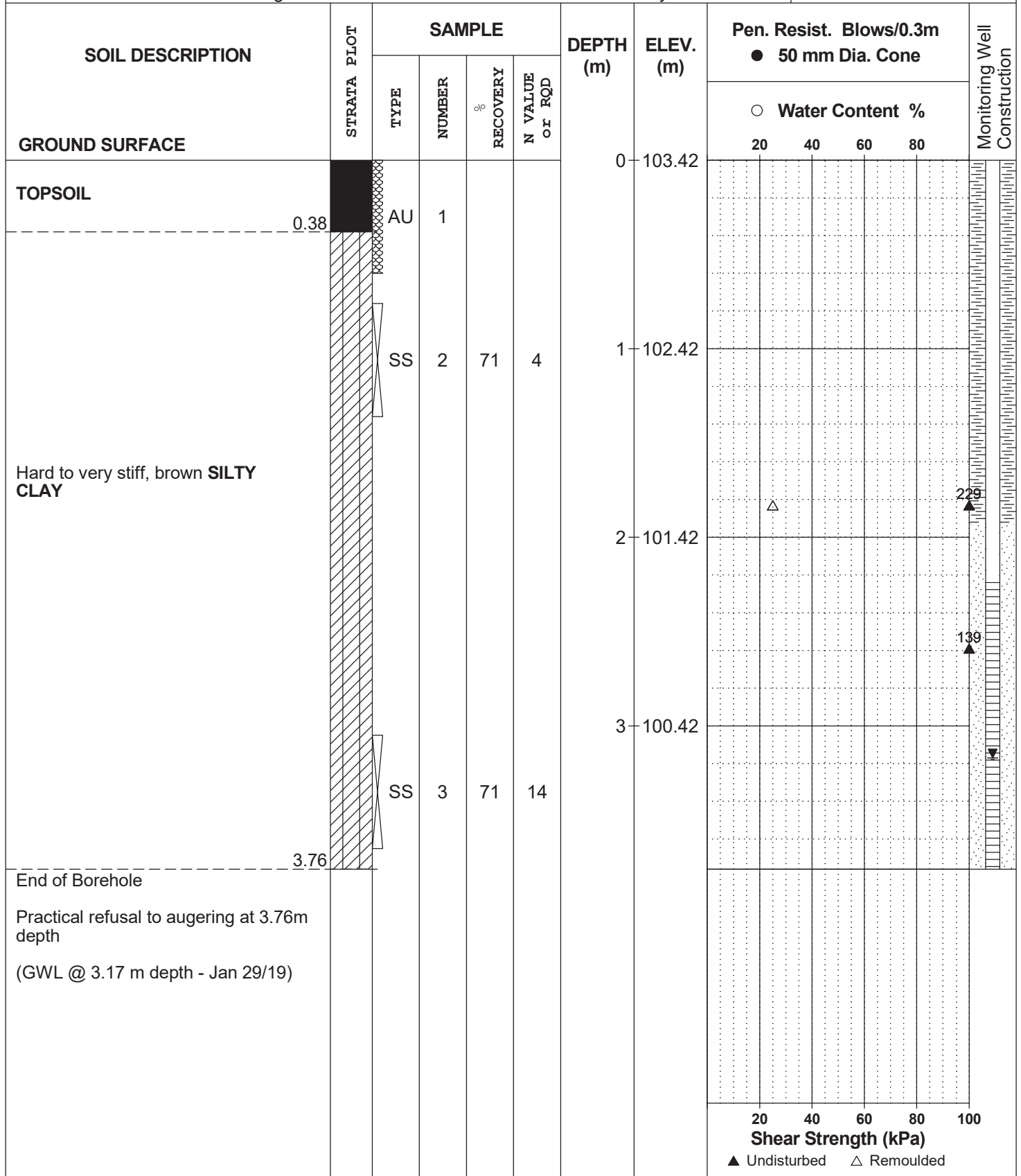

DATUM Ground surface elevations provided by Annis, O'Sullivan, Vollebekk Ltd.

FILE NO.
PG4772

REMARKS

HOLE NO.
BH10

BORINGS BY CME 55 Power Auger

DATE 2019 January 15

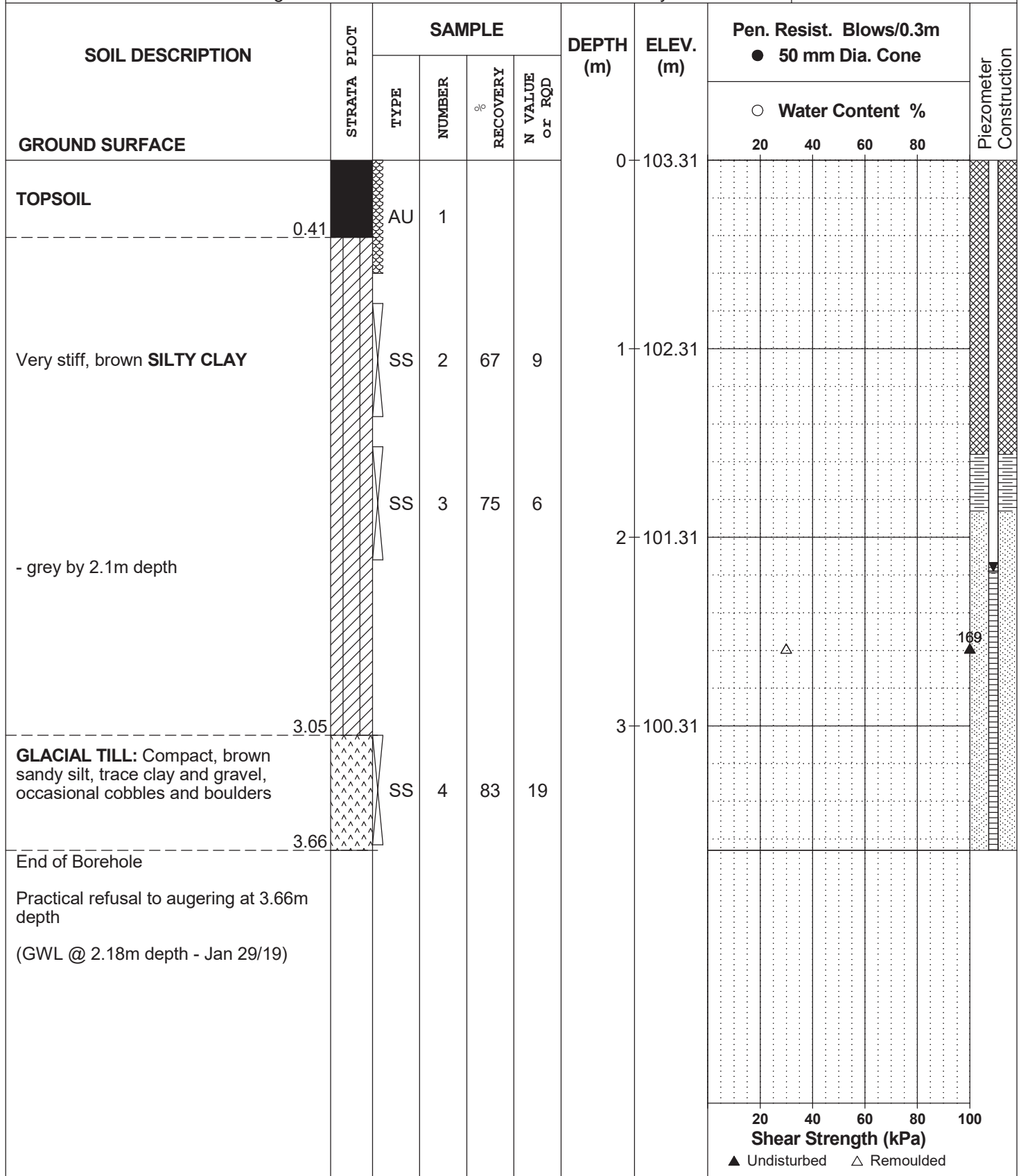

DATUM Ground surface elevations provided by Annis, O'Sullivan, Vollebakk Ltd.

FILE NO. **PG4772**

REMARKS

HOLE NO. **BH11**

BORINGS BY CME 55 Power Auger

DATE 2019 January 15

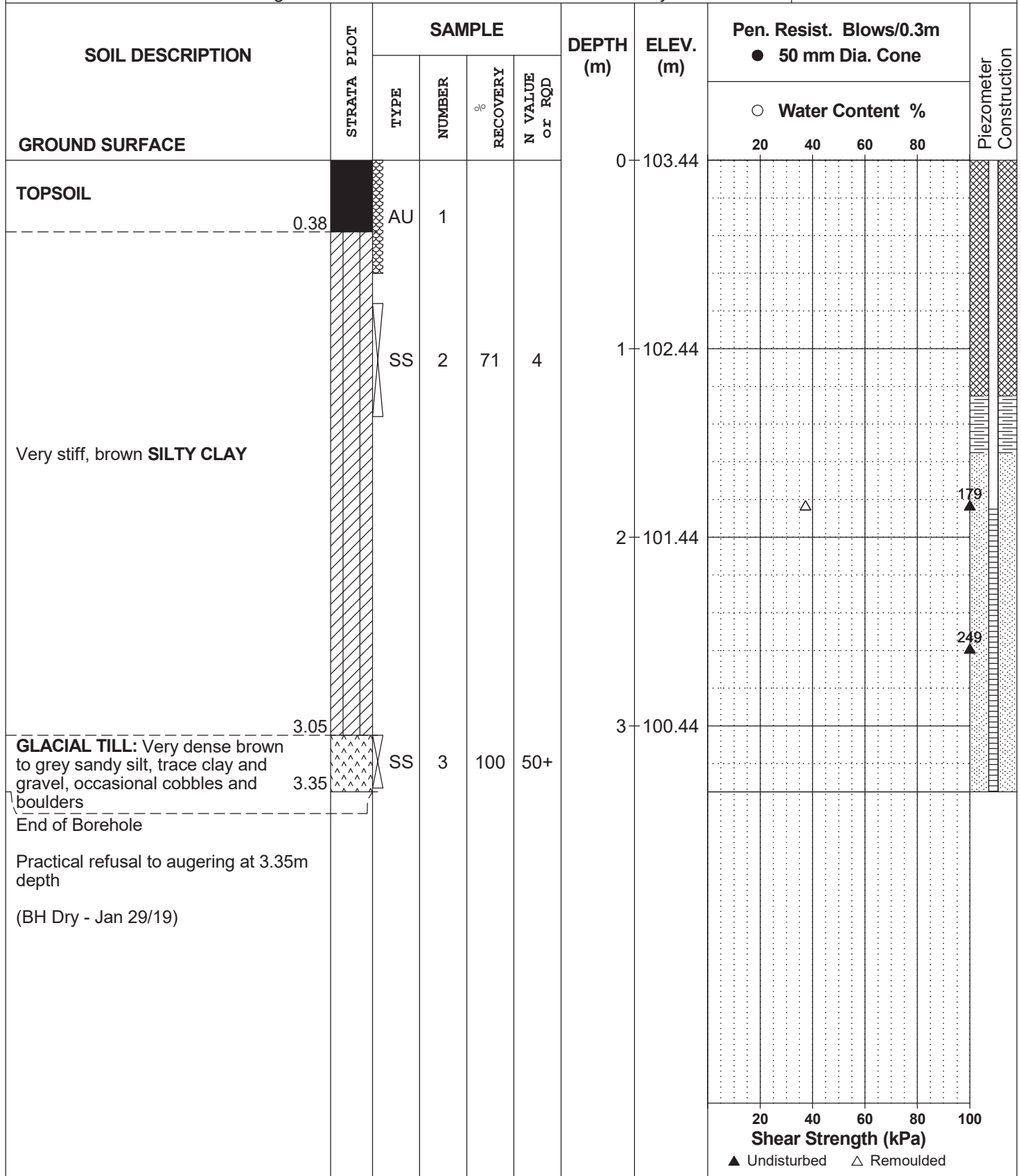

DATUM Ground surface elevations provided by Annis, O'Sullivan, Vollebakk Ltd.

FILE NO. **PG4772**

REMARKS

HOLE NO. **BH12**

BORINGS BY CME 55 Power Auger

DATE 2019 January 15

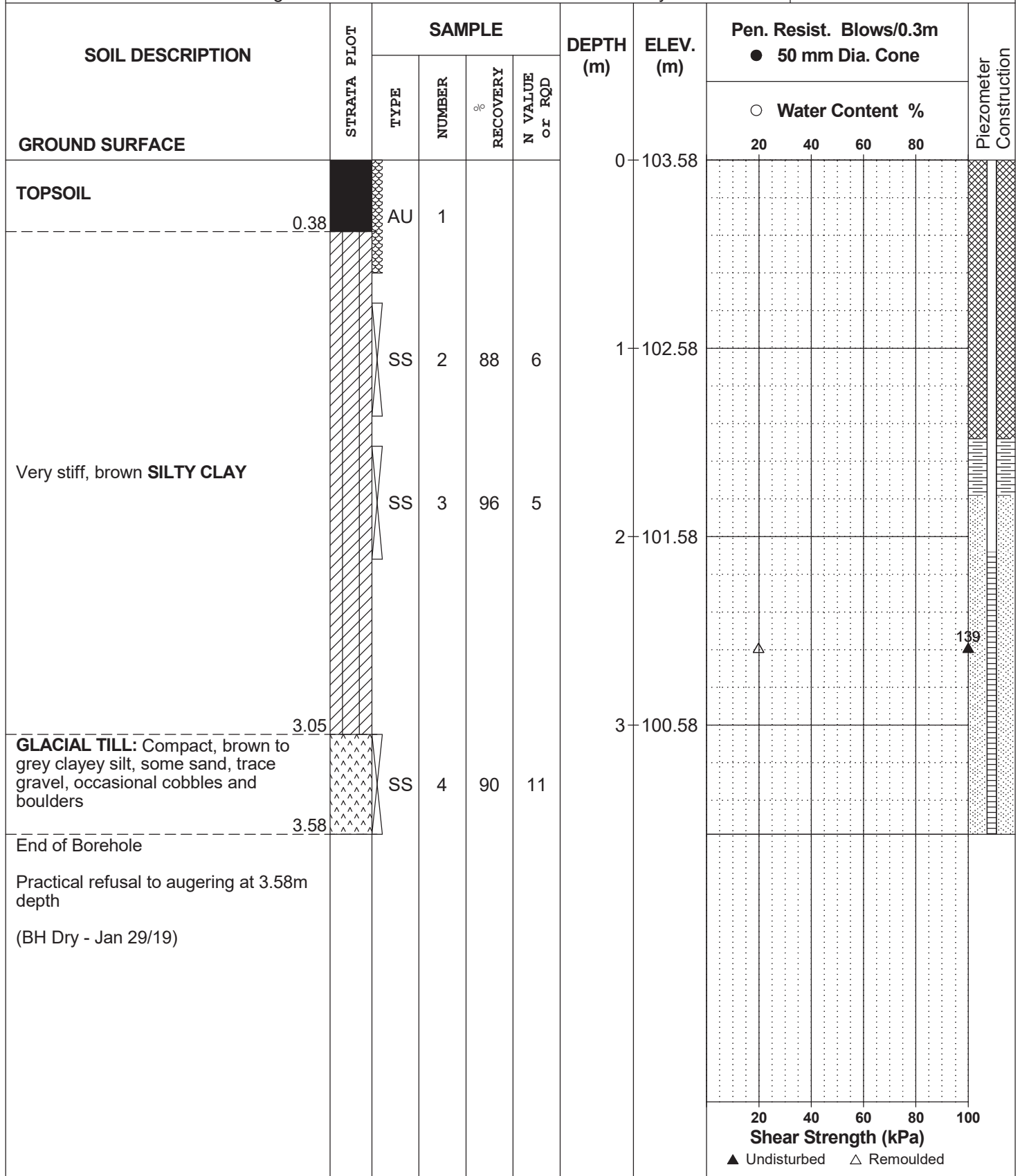

DATUM Ground surface elevations provided by Annis, O'Sullivan, Vollebakk Ltd.

FILE NO. **PG4772**

REMARKS

HOLE NO. **BH13**

BORINGS BY CME 55 Power Auger

DATE 2019 January 15

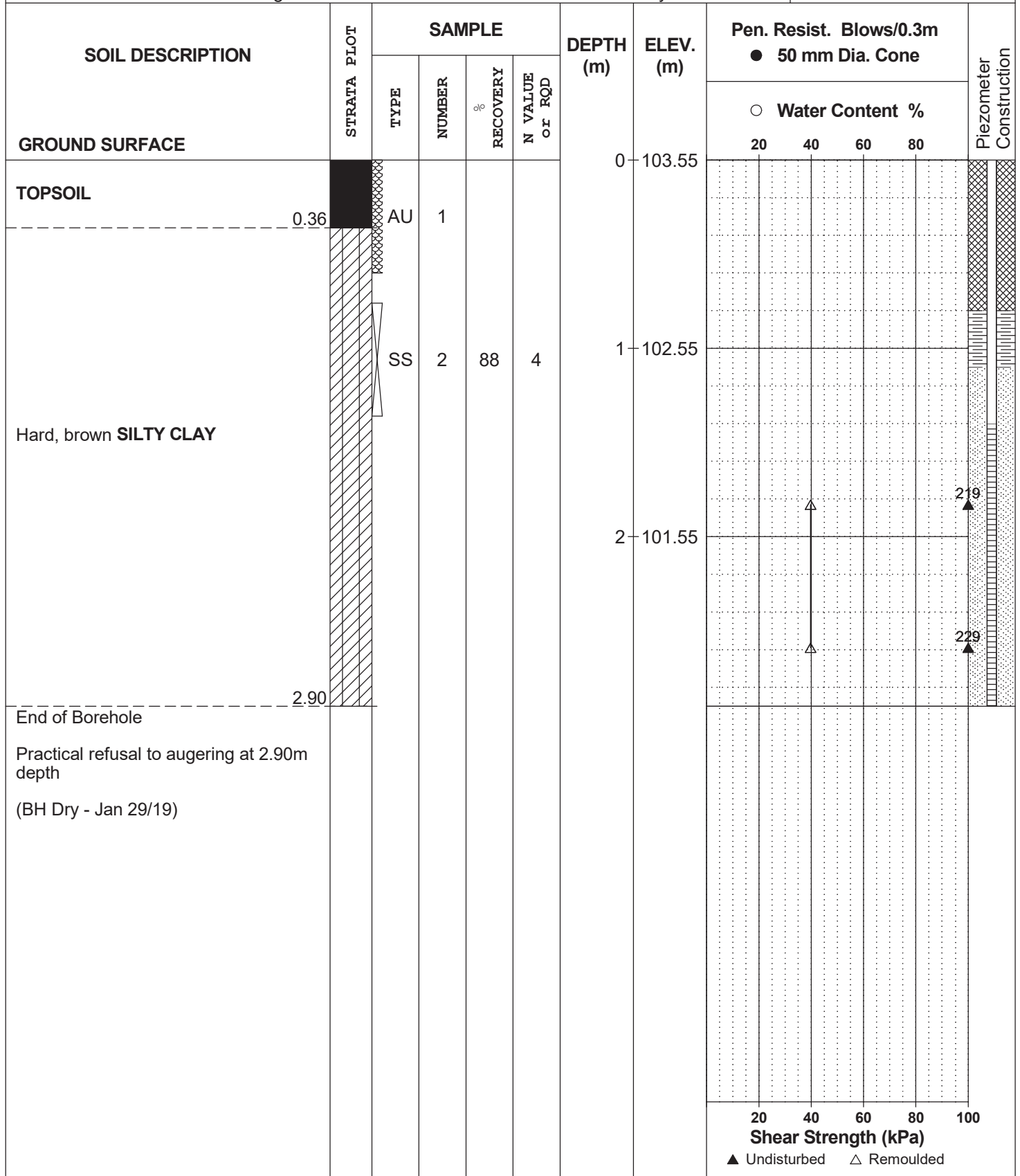

DATUM Ground surface elevations provided by Annis, O'Sullivan, Vollebekk Ltd.

FILE NO. **PG4772**

REMARKS

HOLE NO. **BH14**

BORINGS BY CME 55 Power Auger

DATE 2019 January 15

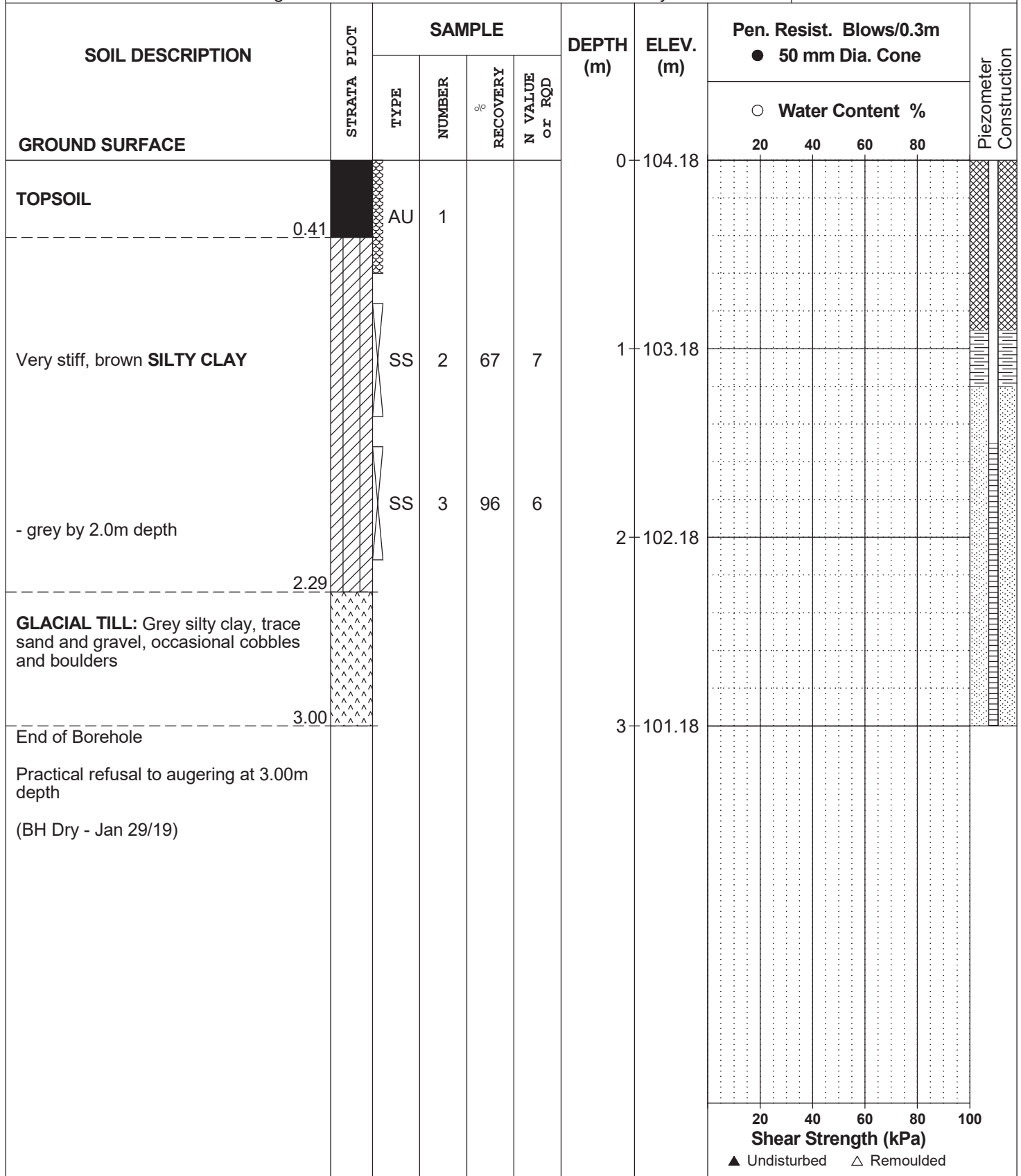

DATUM Ground surface elevations provided by Annis, O'Sullivan, Vollebakk Ltd.

FILE NO. **PG4772**

REMARKS

HOLE NO. **BH15**

BORINGS BY CME 55 Power Auger

DATE 2019 January 15

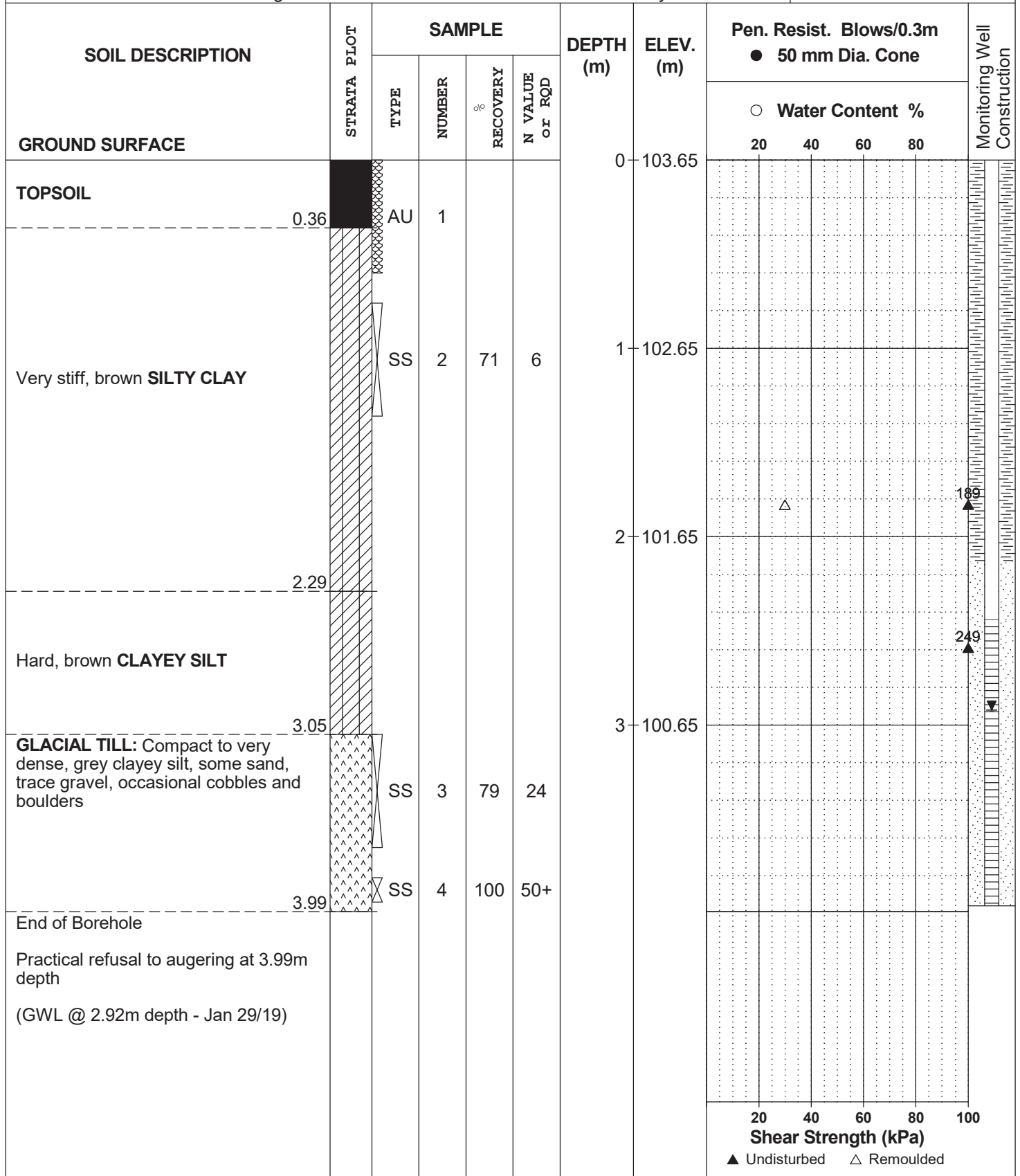

DATUM Ground surface elevations provided by Annis, O'Sullivan, Vollebakk Ltd.

FILE NO. **PG4772**

REMARKS

HOLE NO. **BH17**

BORINGS BY CME 55 Power Auger

DATE 2019 January 16

SOIL DESCRIPTION	STRATA PLOT	SAMPLE				DEPTH (m)	ELEV. (m)	Pen. Resist. Blows/0.3m ● 50 mm Dia. Cone				Piezometer Construction	
		TYPE	NUMBER	RECOVERY %	N VALUE or RQD			20	40	60	80		
GROUND SURFACE						0	104.19						
TOPSOIL		AU	1										
Very stiff to hard, brown CLAYEY SILT		SS	2	79	7	1	103.19						
- grey by 1.8m depth		SS	3	100	55	2	102.19						
End of Borehole Practical refusal to augering at 2.23m depth (BH Dry - Jan 29/19)													

20 40 60 80 100
Shear Strength (kPa)
▲ Undisturbed △ Remoulded

DATUM Ground surface elevations provided by Annis, O'Sullivan, Vollebakk Ltd.

FILE NO. **PG4772**

REMARKS

HOLE NO. **BH18**

BORINGS BY CME 55 Power Auger

DATE 2019 January 16

SOIL DESCRIPTION	STRATA PLOT	SAMPLE				DEPTH (m)	ELEV. (m)	Pen. Resist. Blows/0.3m ● 50 mm Dia. Cone				Piezometer Construction	
		TYPE	NUMBER	RECOVERY %	N VALUE or RQD			20	40	60	80		
GROUND SURFACE						0	104.15						
TOPSOIL	0.33	AU	1										
Hard, brown CLAYEY SILT	1.96	SS	2	88	11	1	103.15						
- grey by 1.8m depth		SS	3	88	50+								
End of Borehole													
Practical refusal to augering at 1.96m depth (BH Dry - Jan 29/19)													

20 40 60 80 100
Shear Strength (kPa)
▲ Undisturbed △ Remoulded

DATUM Ground surface elevations provided by Annis, O'Sullivan, Vollebakk Ltd.

FILE NO. **PG4772**

REMARKS

HOLE NO. **BH19**

BORINGS BY CME 55 Power Auger

DATE 2019 January 16

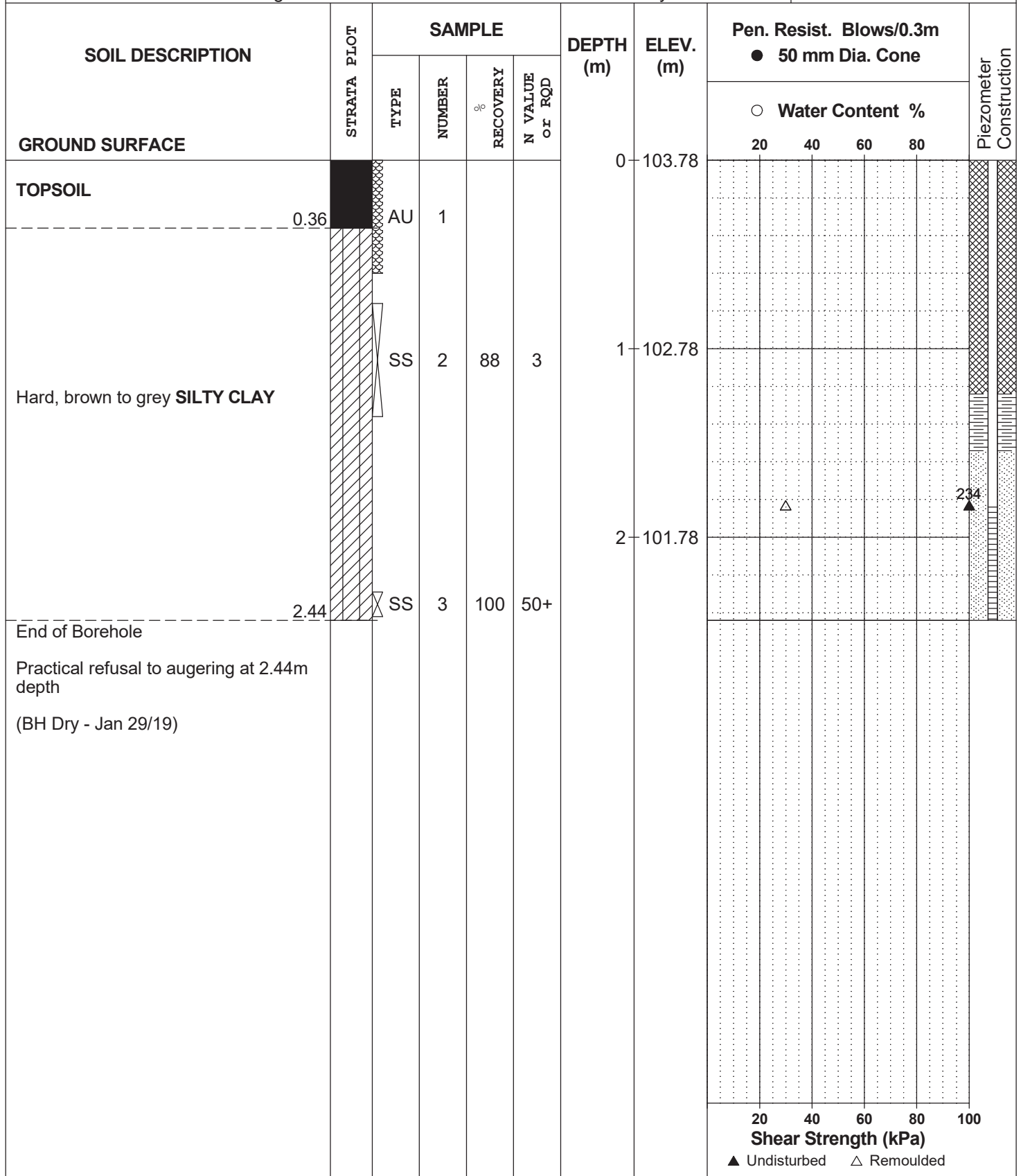

DATUM Ground surface elevations provided by Annis, O'Sullivan, Vollebakk Ltd.

FILE NO. **PG4772**

REMARKS

HOLE NO. **BH20**

BORINGS BY CME 55 Power Auger

DATE 2019 January 16

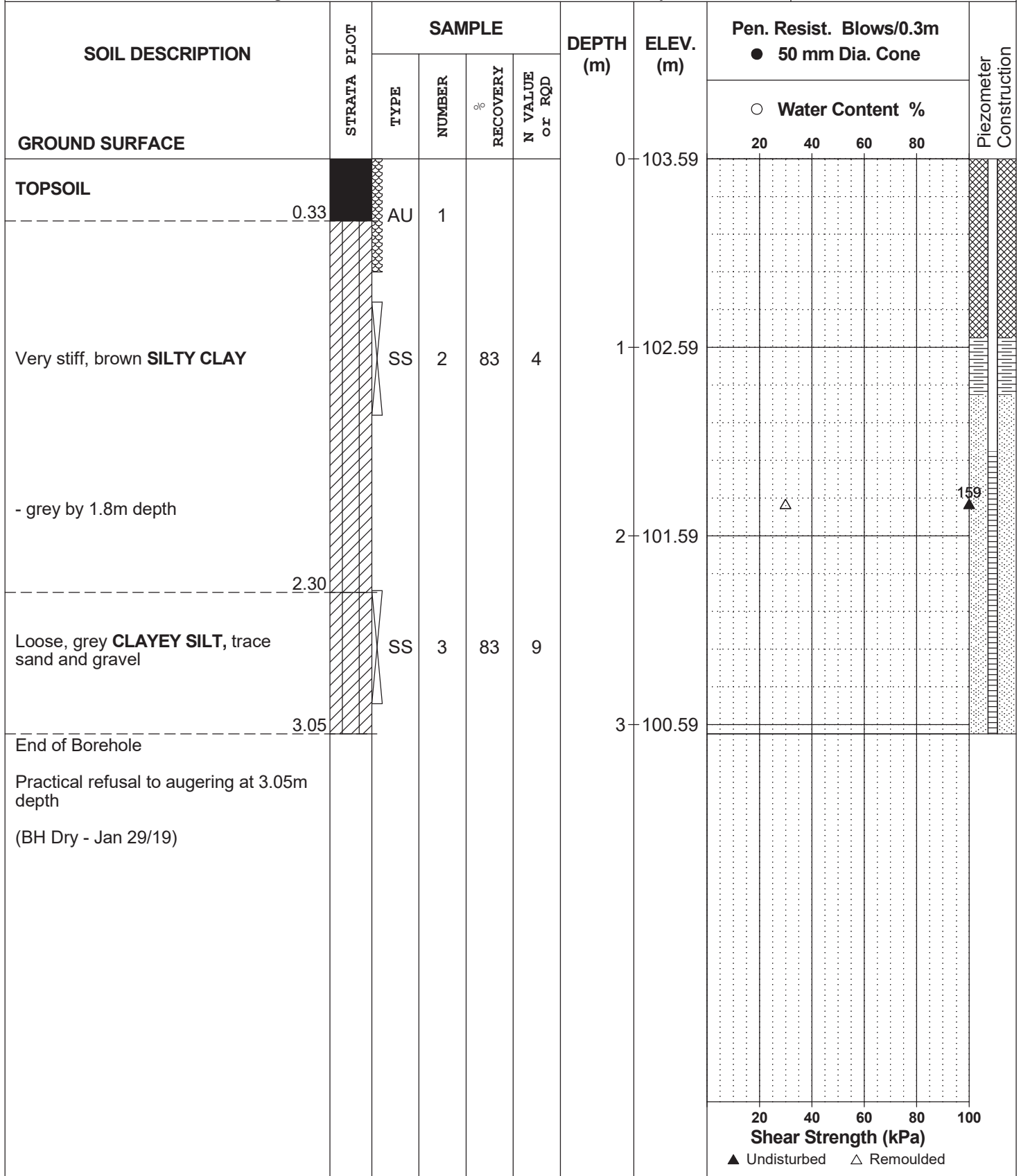

DATUM Ground surface elevations provided by Annis, O'Sullivan, Vollebakk Ltd.

FILE NO. **PG4772**

REMARKS

HOLE NO. **BH21**

BORINGS BY CME 55 Power Auger

DATE 2019 January 16

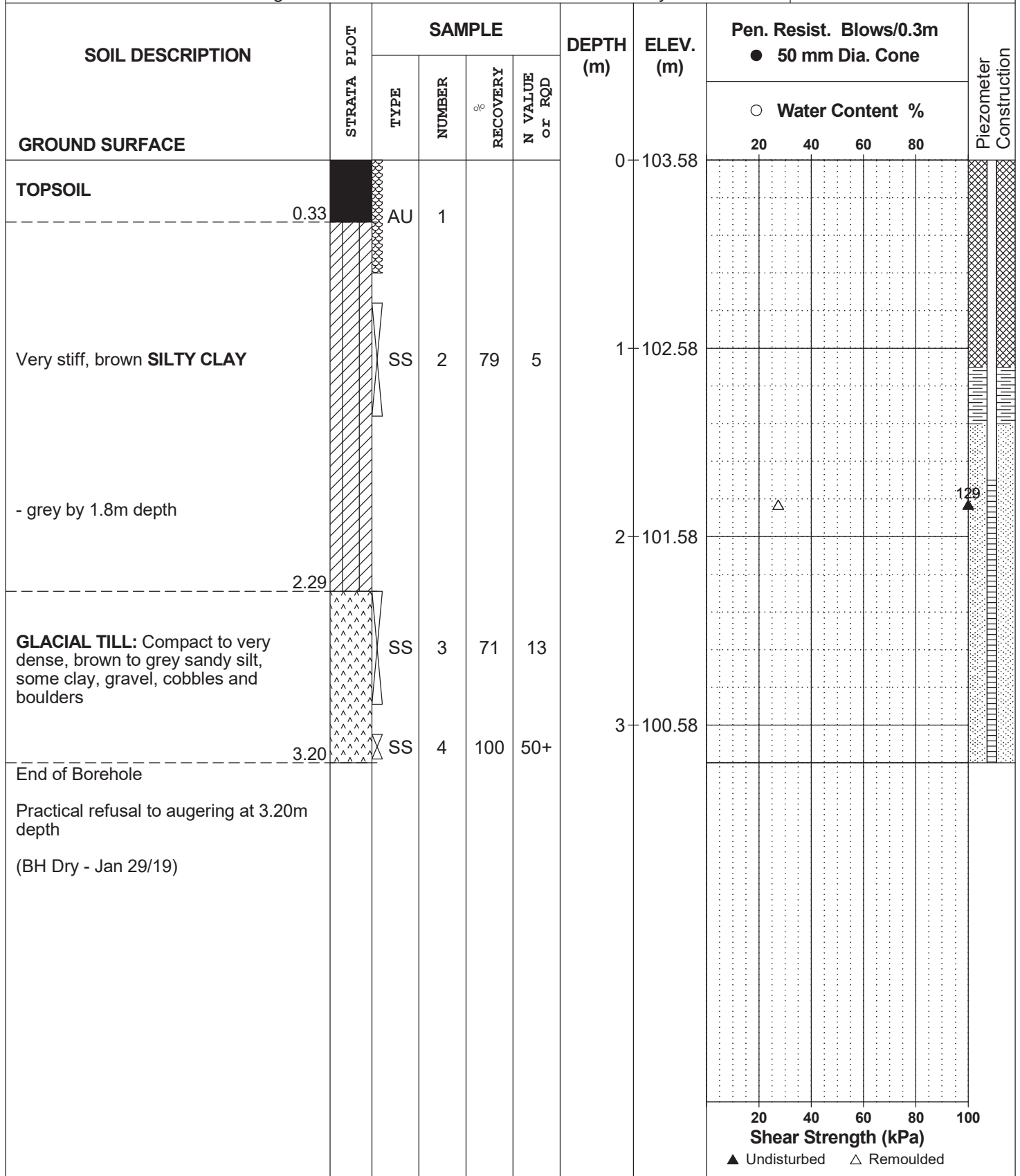

DATUM Ground surface elevations provided by Annis, O'Sullivan, Vollebakk Ltd.

FILE NO. **PG4772**

REMARKS

HOLE NO. **BH22**

BORINGS BY CME 55 Power Auger

DATE 2019 January 16

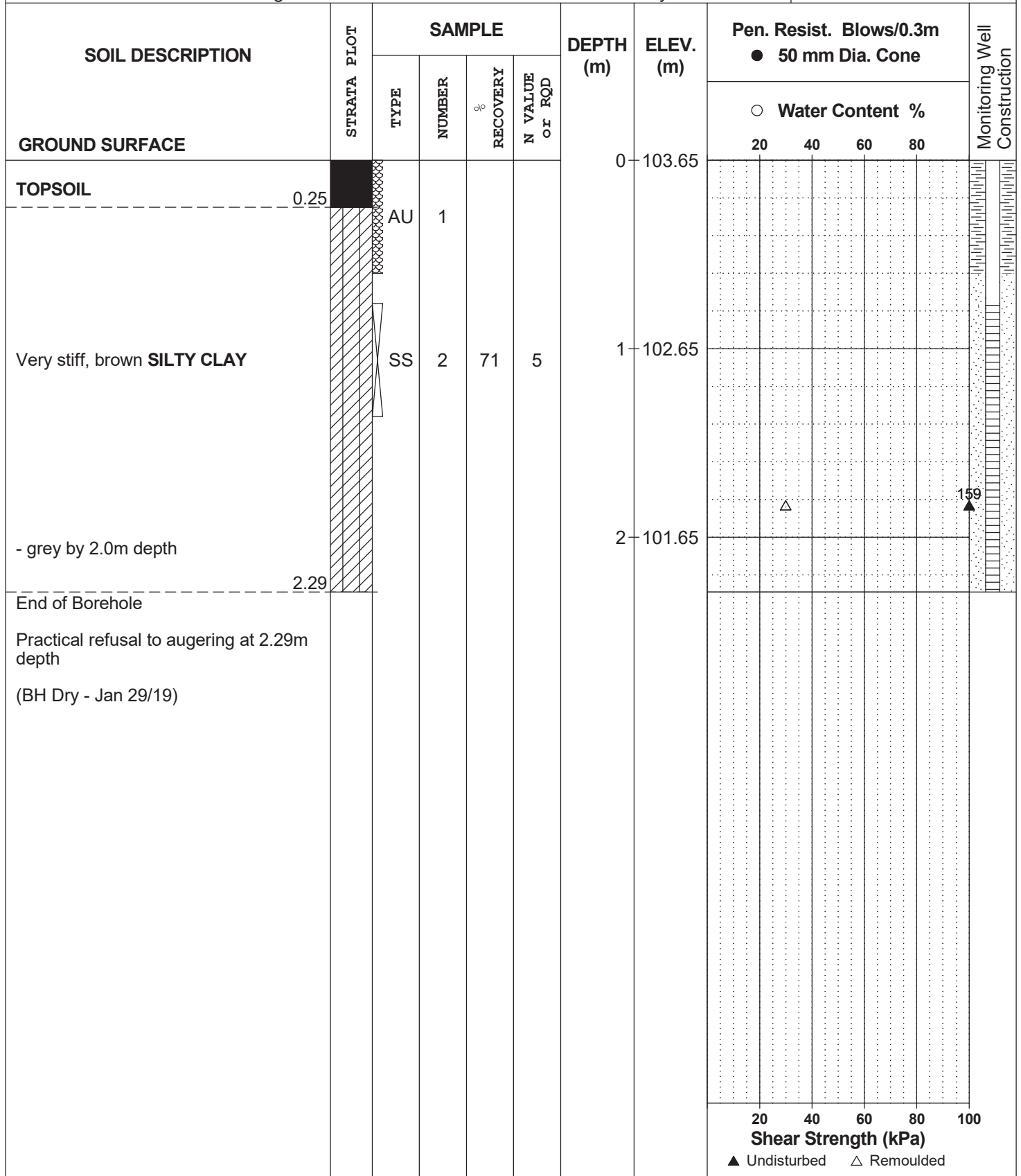

DATUM Ground surface elevations provided by Annis, O'Sullivan, Vollebakk Ltd.

FILE NO. PG4772

REMARKS

HOLE NO. BH23

BORINGS BY CME 55 Power Auger

DATE 2019 January 16

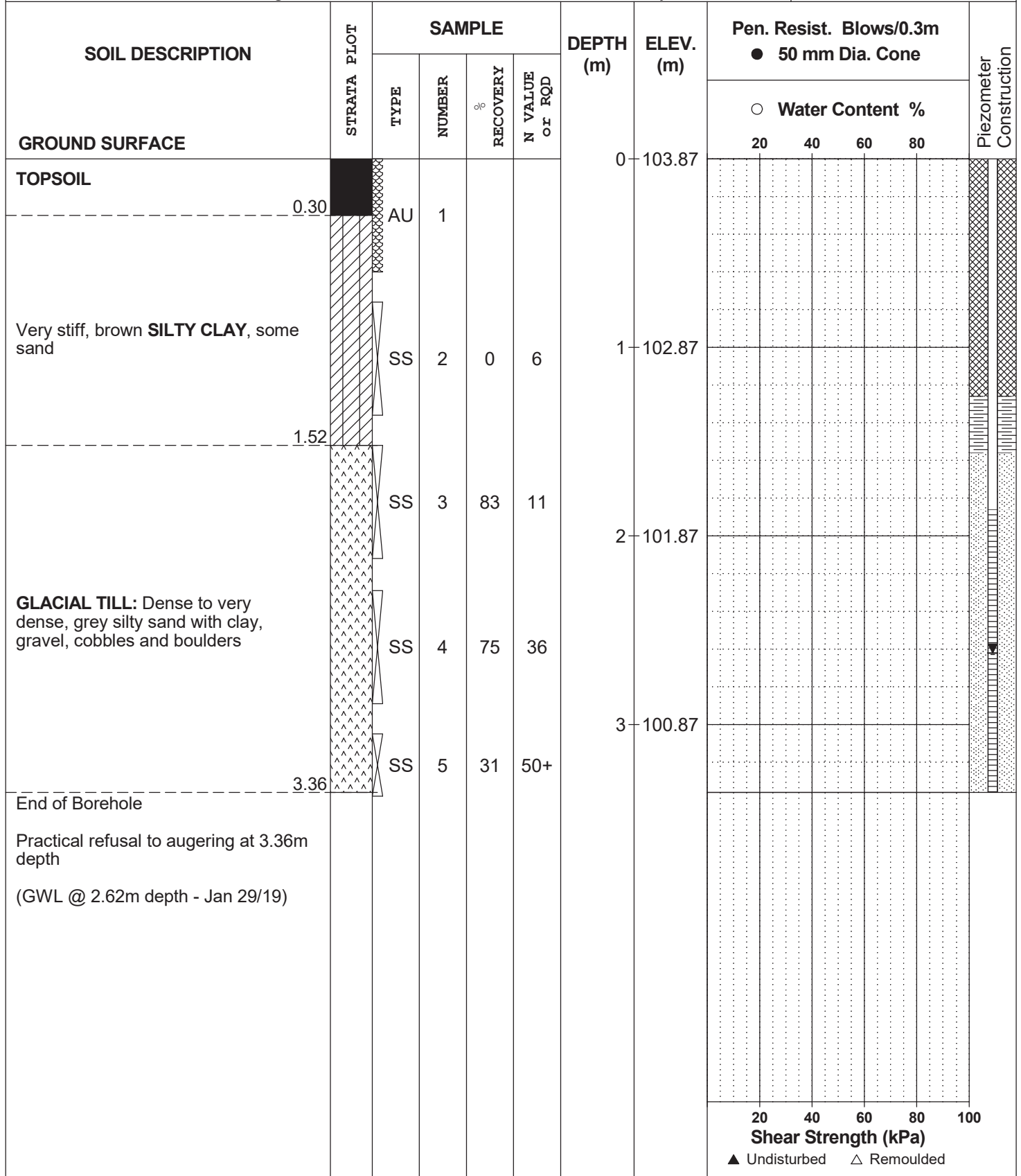

DATUM Ground surface elevations provided by Annis, O'Sullivan, Vollebakk Ltd.

FILE NO. **PG4772**

REMARKS

HOLE NO. **BH24**

BORINGS BY CME 55 Power Auger

DATE 2019 January 16

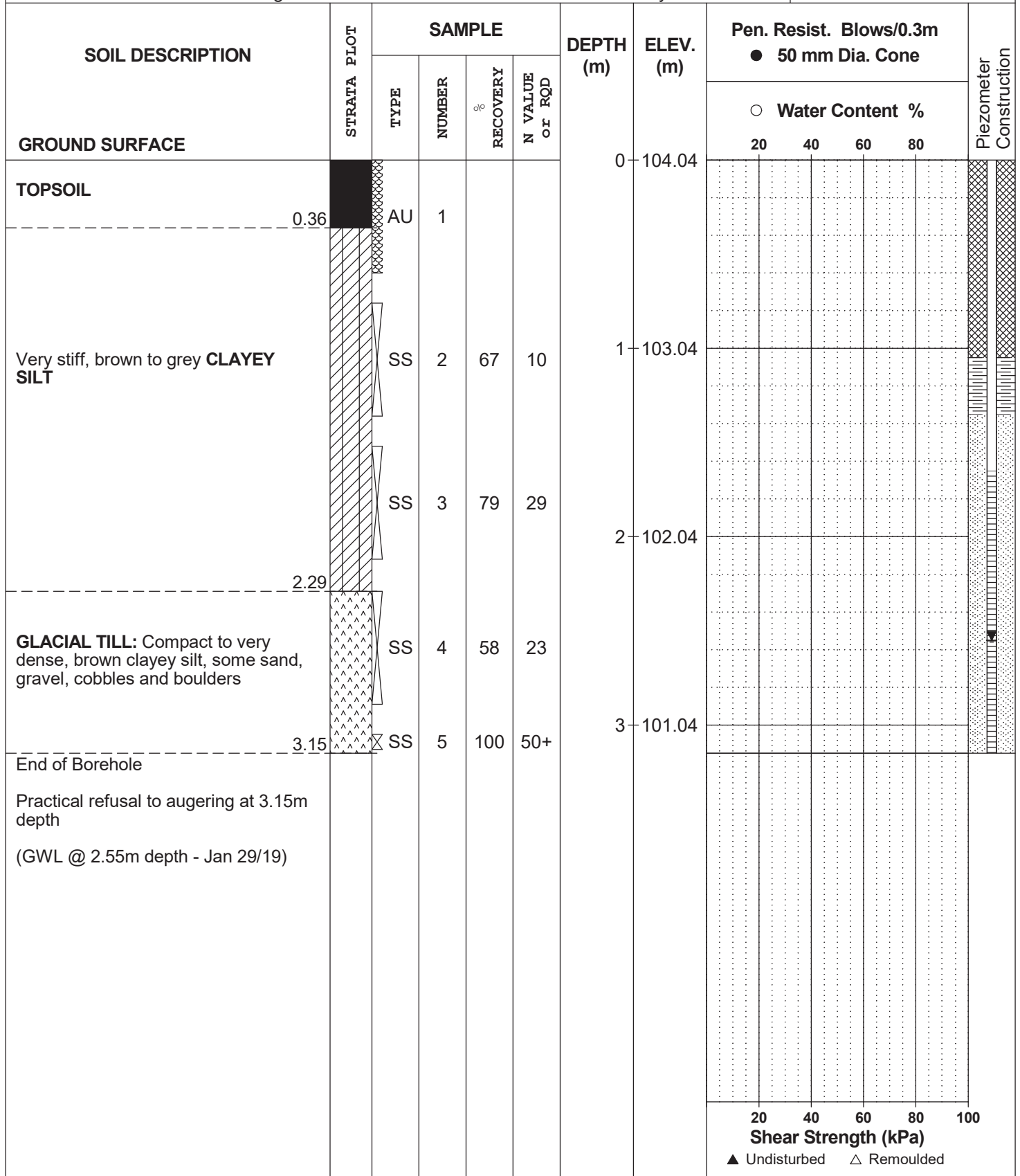

DATUM Ground surface elevations provided by Annis, O'Sullivan, Vollebakk Ltd.

FILE NO. **PG4772**

REMARKS

HOLE NO. **BH25**

BORINGS BY CME 55 Power Auger

DATE 2019 January 16

SOIL DESCRIPTION	STRATA PLOT	SAMPLE			DEPTH (m)	ELEV. (m)	Pen. Resist. Blows/0.3m ● 50 mm Dia. Cone				Piezometer Construction	
		TYPE	NUMBER	RECOVERY %			N VALUE or RQD	20	40	60		80
GROUND SURFACE					0	104.07						
TOPSOIL		AU	1									
Very stiff, brown CLAYEY SILT		SS	2	75	11	1	103.07					
GLACIAL TILL: Very dense, grey clayey silt with sand, gravel, cobbles, boulders		SS	3	75	50+							
End of Borehole												
Practical refusal to augering at 1.62m depth (GWL @ 1.68m depth - Jan 29/19)												

20 40 60 80 100
Shear Strength (kPa)
▲ Undisturbed △ Remoulded

SOIL PROFILE AND TEST DATA

Geotechnical Investigation
Proposed Mixed-Use Development - 20 Cedarow Ct.
Ottawa, Ontario

DATUM Ground surface elevations provided by Annis, O'Sullivan, Vollebakk Ltd.



FILE NO. **PG4772**

REMARKS

HOLE NO. **BH26**

BORINGS BY CME 55 Power Auger

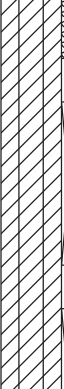
DATE 2019 January 17

SOIL DESCRIPTION	STRATA PLOT	SAMPLE				DEPTH (m)	ELEV. (m)	Pen. Resist. Blows/0.3m ● 50 mm Dia. Cone				Piezometer Construction	
		TYPE	NUMBER	RECOVERY %	N VALUE or RQD			20	40	60	80		
GROUND SURFACE						0	104.30						
TOPSOIL		AU	1										
Very stiff, brown CLAYEY SILT		SS	2	75	9	1	103.30						
GLACIAL TILL: Compact to dense, grey silty clay with gravel, cobbles and boulders		SS	3	50	19	2	102.30						
End of Borehole Practical refusal to augering at 2.87m depth (BH Dry - Jan 29/19)		SS	4	100	46								



DATUM Ground surface elevations provided by Annis, O'Sullivan, Vollebakk Ltd.

FILE NO. **PG4772**

REMARKS

HOLE NO. **BH27**

BORINGS BY CME 55 Power Auger

DATE 2019 January 17

SOIL DESCRIPTION	STRATA PLOT	SAMPLE				DEPTH (m)	ELEV. (m)	Pen. Resist. Blows/0.3m ● 50 mm Dia. Cone				Monitoring Well Construction	
		TYPE	NUMBER	RECOVERY %	N VALUE or RQD			20	40	60	80		
GROUND SURFACE						0	103.97						
TOPSOIL	0.33	AU	1										
Very stiff, brown CLAYEY SILT		SS	2	71	8	1	102.97						
- grey by 1.7m depth		SS	3	88	50+								
End of Borehole	1.93												
Practical refusal to augering at 1.93m depth (BH Dry - Jan 29/19)													

20 40 60 80 100
Shear Strength (kPa)
▲ Undisturbed △ Remoulded

DATUM Ground surface elevations provided by Annis, O'Sullivan, Vollebakk Ltd.

FILE NO. **PG4772**

REMARKS

HOLE NO. **BH28**

BORINGS BY CME 55 Power Auger

DATE 2019 January 17

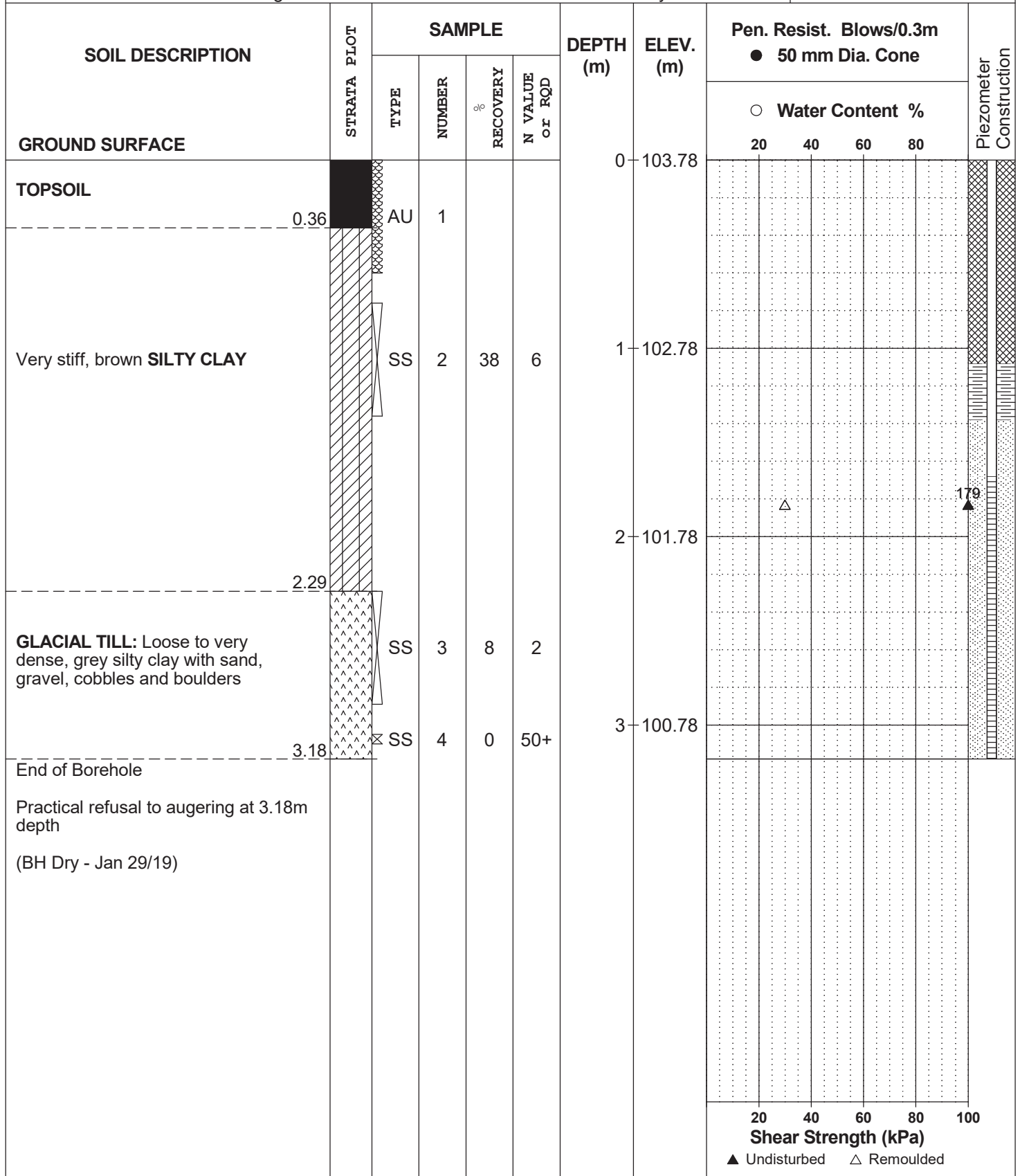

DATUM Ground surface elevations provided by Annis, O'Sullivan, Vollebakk Ltd.

FILE NO. **PG4772**

REMARKS

HOLE NO. **BH29**

BORINGS BY CME 55 Power Auger

DATE 2019 January 17

SOIL DESCRIPTION	STRATA PLOT	SAMPLE				DEPTH (m)	ELEV. (m)	Pen. Resist. Blows/0.3m ● 50 mm Dia. Cone				Piezometer Construction	
		TYPE	NUMBER	RECOVERY %	N VALUE or RQD			20	40	60	80		
GROUND SURFACE						0	103.71						
TOPSOIL		AU	1										
Very stiff, brown SILTY CLAY		SS	2	50	7	1	102.71						
		SS	3	71	4	2	101.71						
GLACIAL TILL: Loose, grey silty clay with sand, gravel, cobbles and boulders		SS	4	17	7								
End of Borehole													
Practical refusal to augering at 2.95m depth (BH Dry - Jan 29/19)													

20 40 60 80 100
Shear Strength (kPa)
▲ Undisturbed △ Remoulded

SYMBOLS AND TERMS

SOIL DESCRIPTION

Behavioural properties, such as structure and strength, take precedence over particle gradation in describing soils. Terminology describing soil structure are as follows:

Desiccated	-	having visible signs of weathering by oxidation of clay minerals, shrinkage cracks, etc.
Fissured	-	having cracks, and hence a blocky structure.
Varved	-	composed of regular alternating layers of silt and clay.
Stratified	-	composed of alternating layers of different soil types, e.g. silt and sand or silt and clay.
Well-Graded	-	Having wide range in grain sizes and substantial amounts of all intermediate particle sizes (see Grain Size Distribution).
Uniformly-Graded	-	Predominantly of one grain size (see Grain Size Distribution).

The standard terminology to describe the strength of cohesionless soils is the relative density, usually inferred from the results of the Standard Penetration Test (SPT) 'N' value. The SPT N value is the number of blows of a 63.5 kg hammer, falling 760 mm, required to drive a 51 mm O.D. split spoon sampler 300 mm into the soil after an initial penetration of 150 mm.

Relative Density	'N' Value	Relative Density %
Very Loose	<4	<15
Loose	4-10	15-35
Compact	10-30	35-65
Dense	30-50	65-85
Very Dense	>50	>85

The standard terminology to describe the strength of cohesive soils is the consistency, which is based on the undisturbed undrained shear strength as measured by the in situ or laboratory vane tests, penetrometer tests, unconfined compression tests, or occasionally by Standard Penetration Tests.

Consistency	Undrained Shear Strength (kPa)	'N' Value
Very Soft	<12	<2
Soft	12-25	2-4
Firm	25-50	4-8
Stiff	50-100	8-15
Very Stiff	100-200	15-30
Hard	>200	>30

SYMBOLS AND TERMS (continued)

SOIL DESCRIPTION (continued)

Cohesive soils can also be classified according to their "sensitivity". The sensitivity is the ratio between the undisturbed undrained shear strength and the remoulded undrained shear strength of the soil.

Terminology used for describing soil strata based upon texture, or the proportion of individual particle sizes present is provided on the Textural Soil Classification Chart at the end of this information package.

ROCK DESCRIPTION

The structural description of the bedrock mass is based on the Rock Quality Designation (RQD).

The RQD classification is based on a modified core recovery percentage in which all pieces of sound core over 100 mm long are counted as recovery. The smaller pieces are considered to be a result of closely-spaced discontinuities (resulting from shearing, jointing, faulting, or weathering) in the rock mass and are not counted. RQD is ideally determined from NXL size core. However, it can be used on smaller core sizes, such as BX, if the bulk of the fractures caused by drilling stresses (called "mechanical breaks") are easily distinguishable from the normal in situ fractures.

RQD %	ROCK QUALITY
90-100	Excellent, intact, very sound
75-90	Good, massive, moderately jointed or sound
50-75	Fair, blocky and seamy, fractured
25-50	Poor, shattered and very seamy or blocky, severely fractured
0-25	Very poor, crushed, very severely fractured

SAMPLE TYPES

SS	-	Split spoon sample (obtained in conjunction with the performing of the Standard Penetration Test (SPT))
TW	-	Thin wall tube or Shelby tube
PS	-	Piston sample
AU	-	Auger sample or bulk sample
WS	-	Wash sample
RC	-	Rock core sample (Core bit size AXT, BXL, etc.). Rock core samples are obtained with the use of standard diamond drilling bits.

SYMBOLS AND TERMS (continued)

GRAIN SIZE DISTRIBUTION

MC%	-	Natural moisture content or water content of sample, %
LL	-	Liquid Limit, % (water content above which soil behaves as a liquid)
PL	-	Plastic limit, % (water content above which soil behaves plastically)
PI	-	Plasticity index, % (difference between LL and PL)
Dxx	-	Grain size which xx% of the soil, by weight, is of finer grain sizes These grain size descriptions are not used below 0.075 mm grain size
D10	-	Grain size at which 10% of the soil is finer (effective grain size)
D60	-	Grain size at which 60% of the soil is finer
Cc	-	Concavity coefficient = $(D_{30})^2 / (D_{10} \times D_{60})$
Cu	-	Uniformity coefficient = D_{60} / D_{10}

Cc and Cu are used to assess the grading of sands and gravels:

Well-graded gravels have: $1 < Cc < 3$ and $Cu > 4$

Well-graded sands have: $1 < Cc < 3$ and $Cu > 6$

Sands and gravels not meeting the above requirements are poorly-graded or uniformly-graded.

Cc and Cu are not applicable for the description of soils with more than 10% silt and clay (more than 10% finer than 0.075 mm or the #200 sieve)

CONSOLIDATION TEST

p'_o	-	Present effective overburden pressure at sample depth
p'_c	-	Preconsolidation pressure of (maximum past pressure on) sample
Ccr	-	Recompression index (in effect at pressures below p'_c)
Cc	-	Compression index (in effect at pressures above p'_c)
OC Ratio		Overconsolidation ratio = p'_c / p'_o
Void Ratio		Initial sample void ratio = volume of voids / volume of solids
Wo	-	Initial water content (at start of consolidation test)

PERMEABILITY TEST

k	-	Coefficient of permeability or hydraulic conductivity is a measure of the ability of water to flow through the sample. The value of k is measured at a specified unit weight for (remoulded) cohesionless soil samples, because its value will vary with the unit weight or density of the sample during the test.
---	---	--------------------------------------------------------------------------------------------------------------------------------------------------------------------------------------------------------------------------------------------------------------------------------------------------------------------

SYMBOLS AND TERMS (continued)

STRATA PLOT



Topsoil



Asphalt

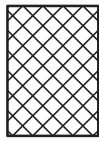

Fill



Peat

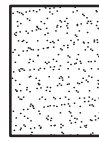

Sand

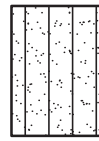

Silty Sand

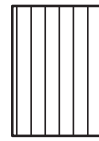

Silt

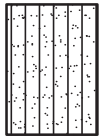

Sandy Silt

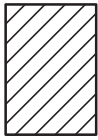

Clay

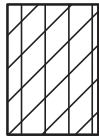

Silty Clay



Clayey Silty Sand



Glacial Till

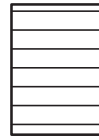

Shale

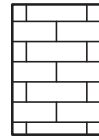

Bedrock

MONITORING WELL AND PIEZOMETER CONSTRUCTION

MONITORING WELL CONSTRUCTION

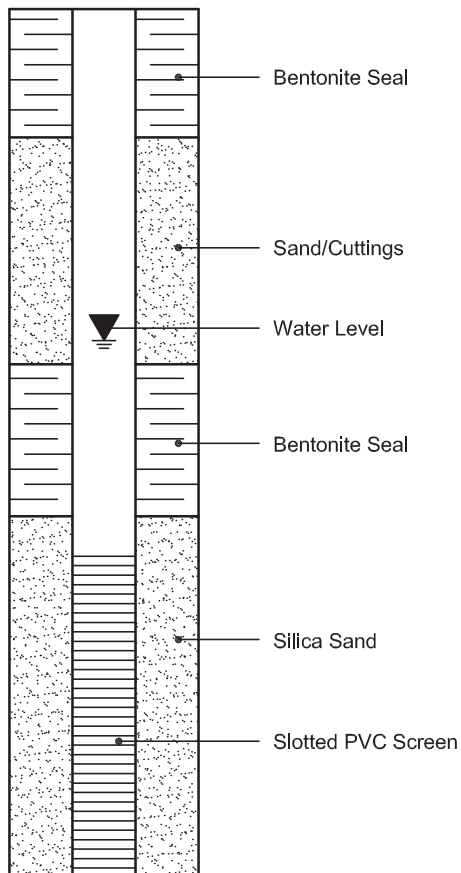

PIEZOMETER CONSTRUCTION

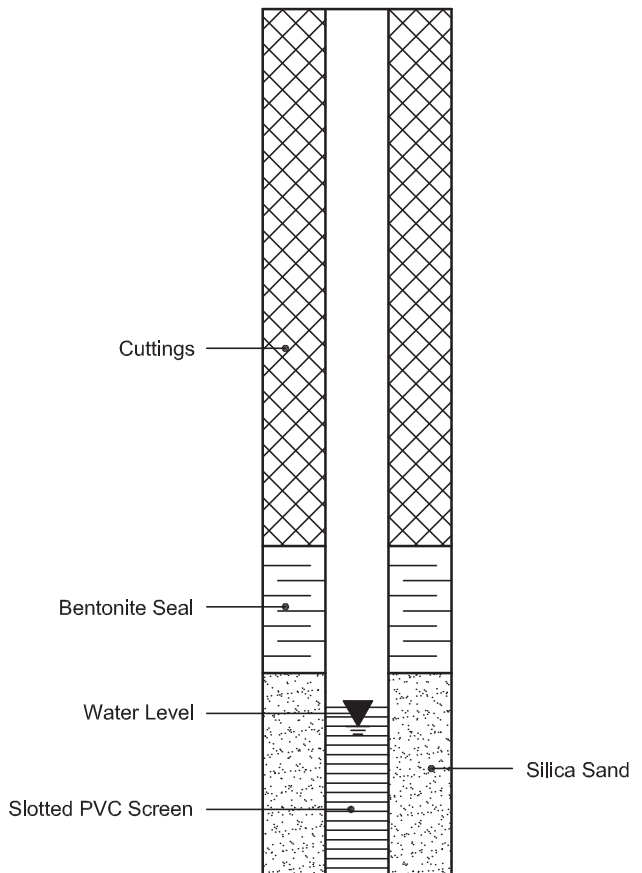

Certificate of Analysis
 Client: Paterson Group Consulting Engineers
 Client PO: 25648

Report Date: 22-Jan-2019

Order Date: 16-Jan-2019

Project Description: PG4772

Client ID:	BH#16-19 SS#3	-	-	-
Sample Date:	01/15/2019 09:00	-	-	-
Sample ID:	1903309-01	-	-	-
MDL/Units	Soil	-	-	-

Physical Characteristics

% Solids	0.1 % by Wt.	85.8	-	-	-
----------	--------------	------	---	---	---

General Inorganics

pH	0.05 pH Units	7.80	-	-	-
Resistivity	0.10 Ohm.m	76.2	-	-	-

Anions

Chloride	5 ug/g dry	6	-	-	-
Sulphate	5 ug/g dry	6	-	-	-

APPENDIX 2

FIGURE 1 - KEY PLAN

FIGURES 2 TO 4 - SLOPE STABILITY ANALYSIS SECTIONS

DRAWING PG4772-1 - TEST HOLE LOCATION PLAN

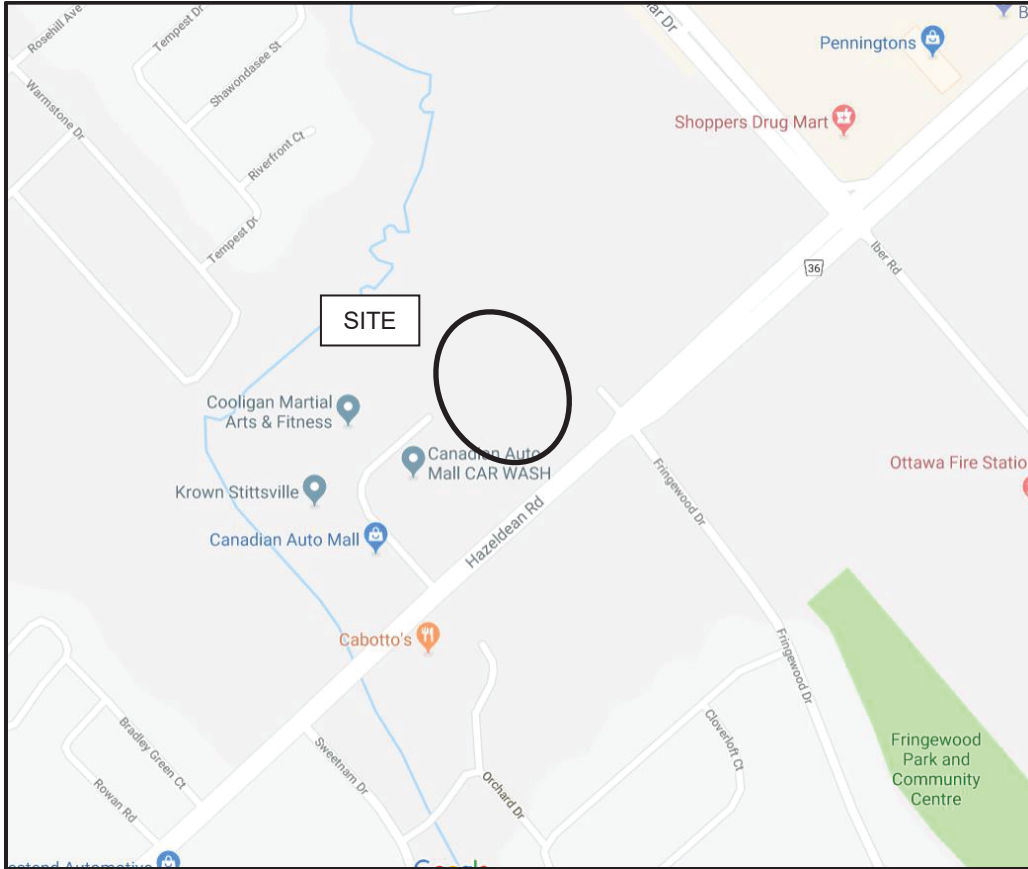
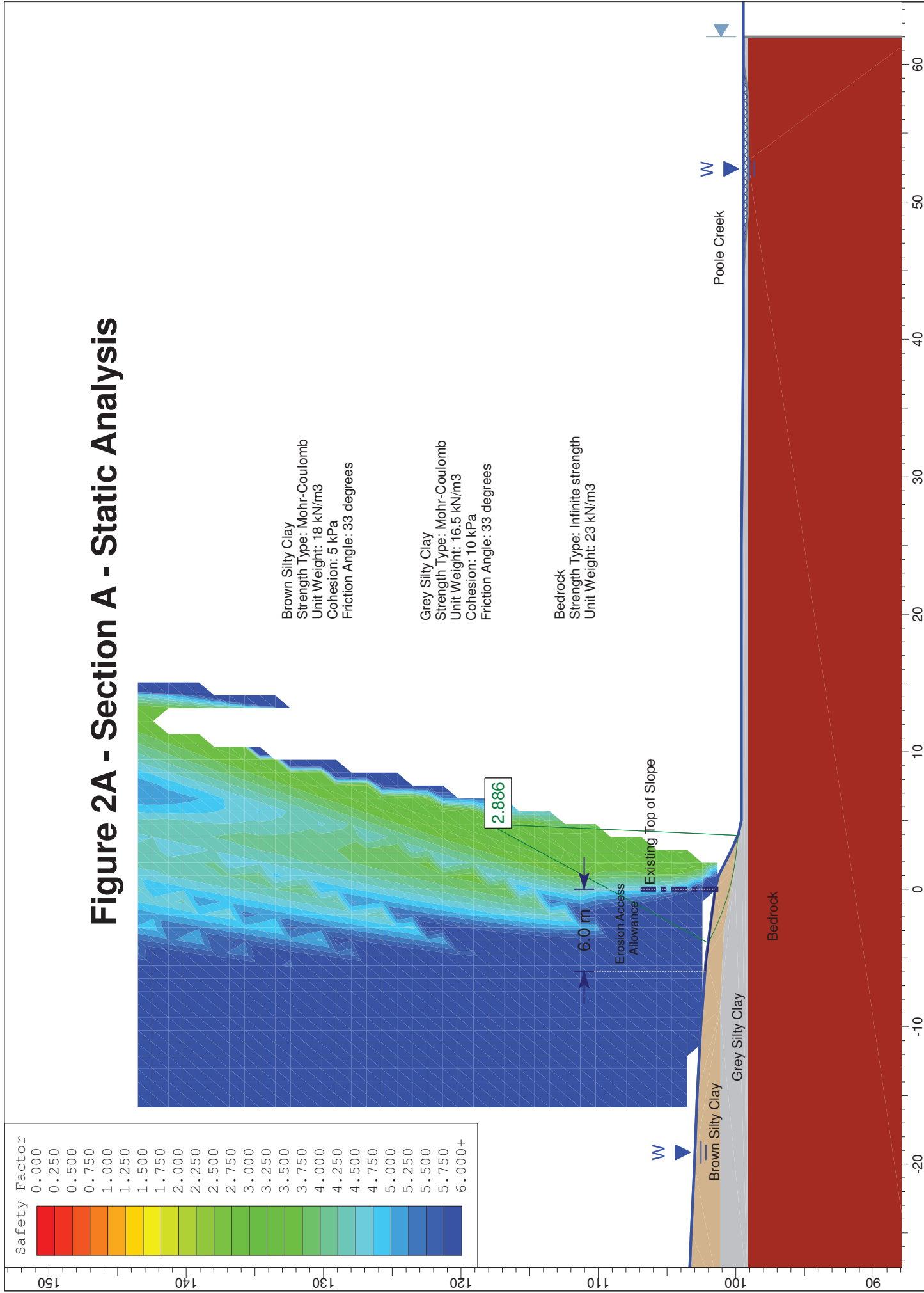

FIGURE 1

KEY PLAN

Figure 2A - Section A - Static Analysis



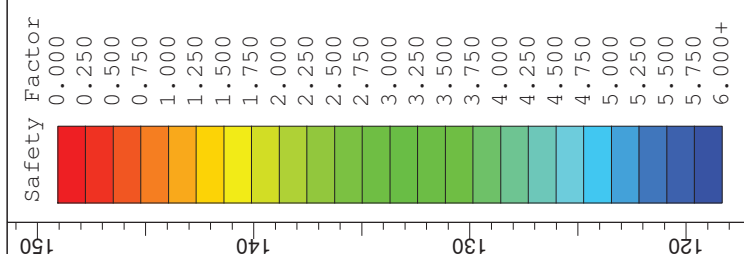

Figure 2B - Section A - Seismic Loading

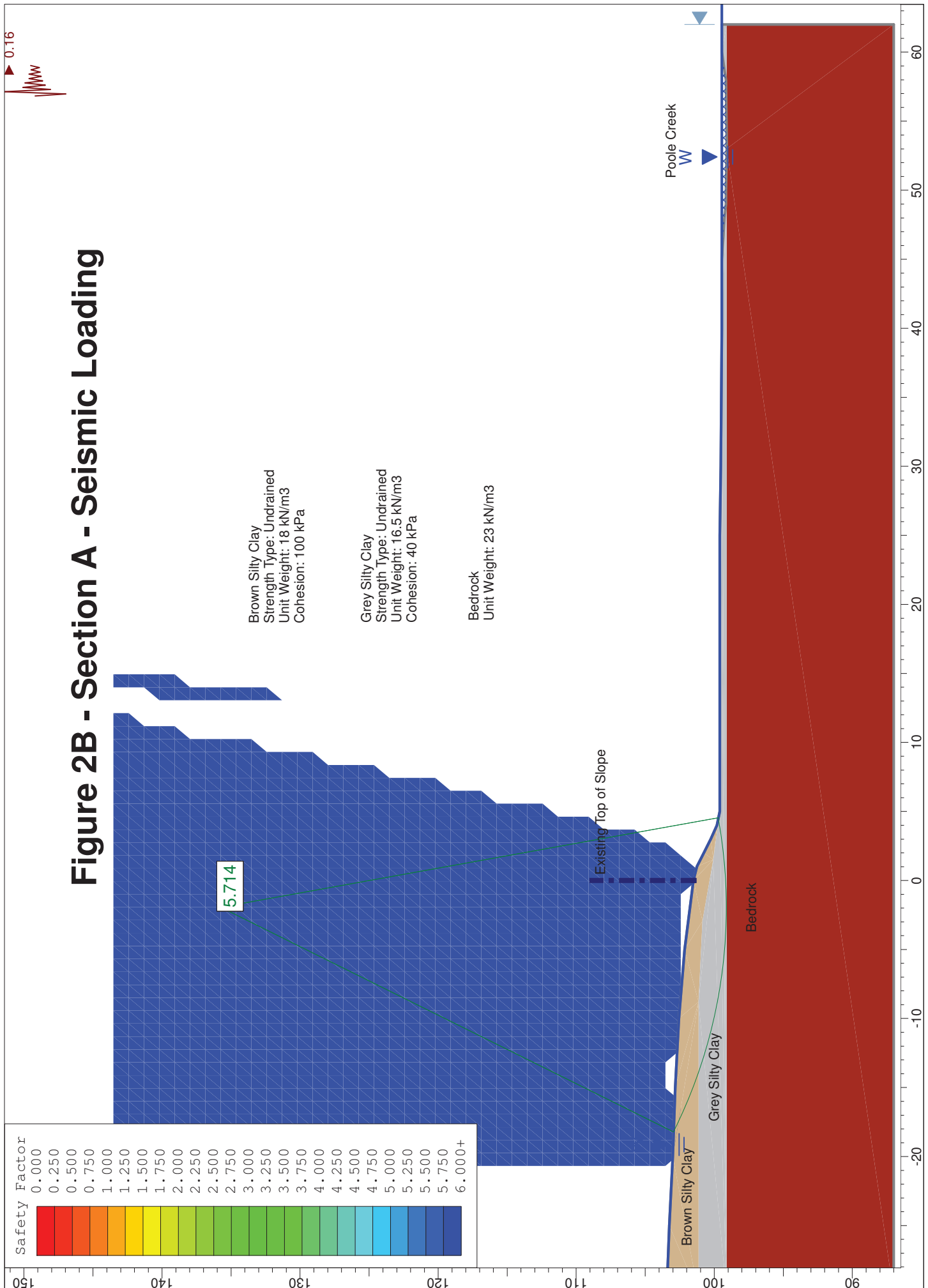
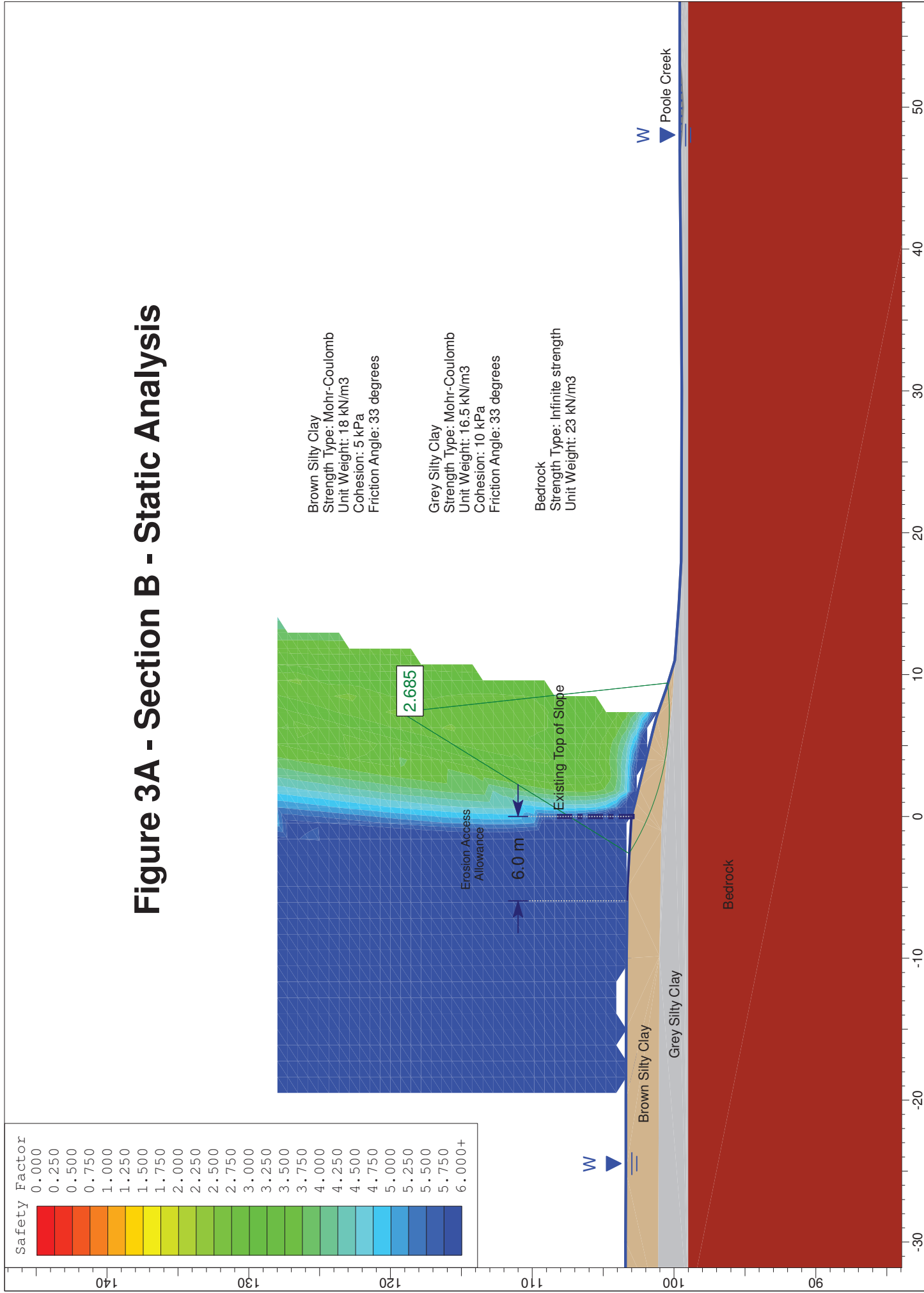

Figure 3A - Section B - Static Analysis



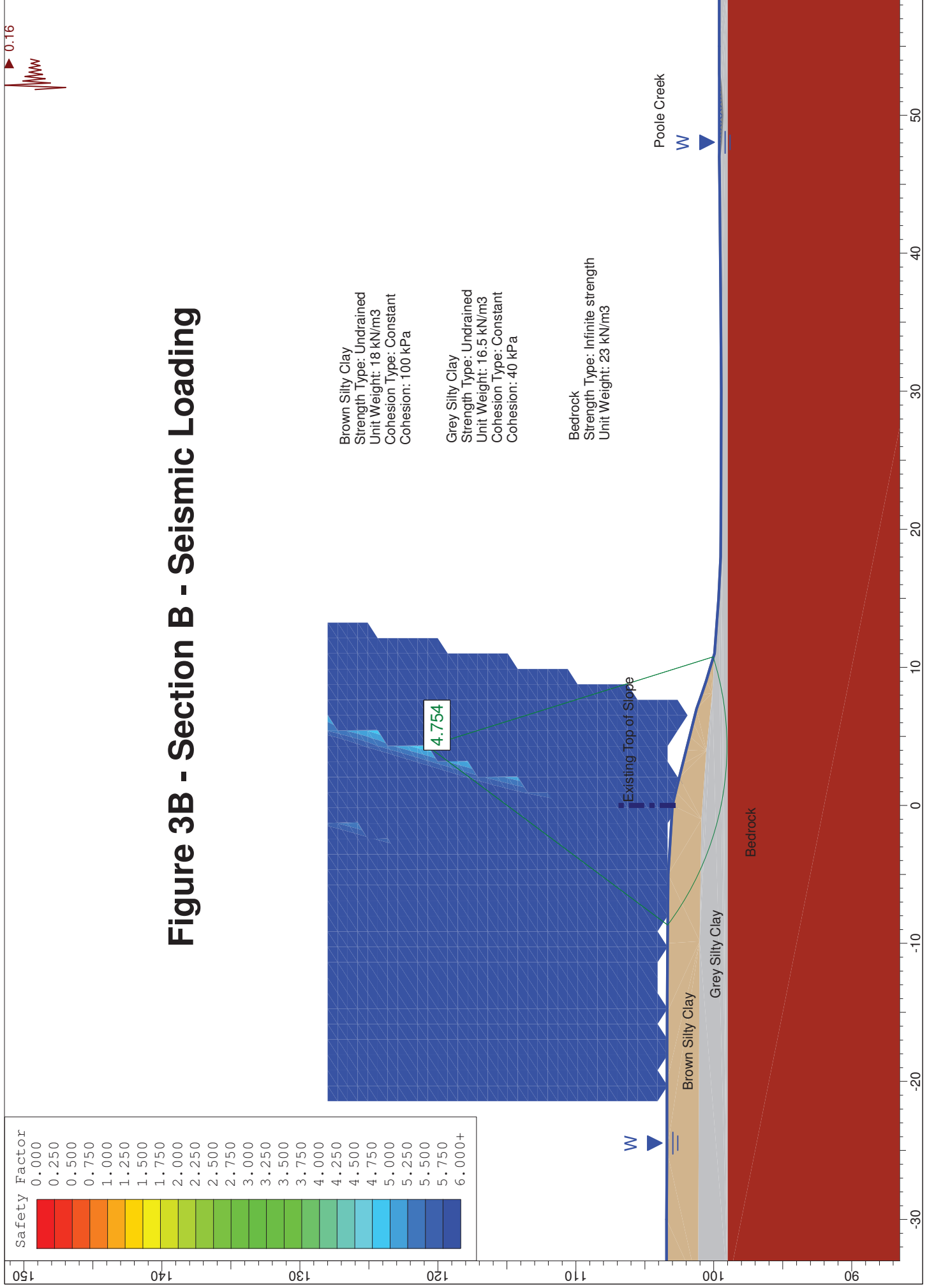

Figure 4A - Section C - Static Analysis

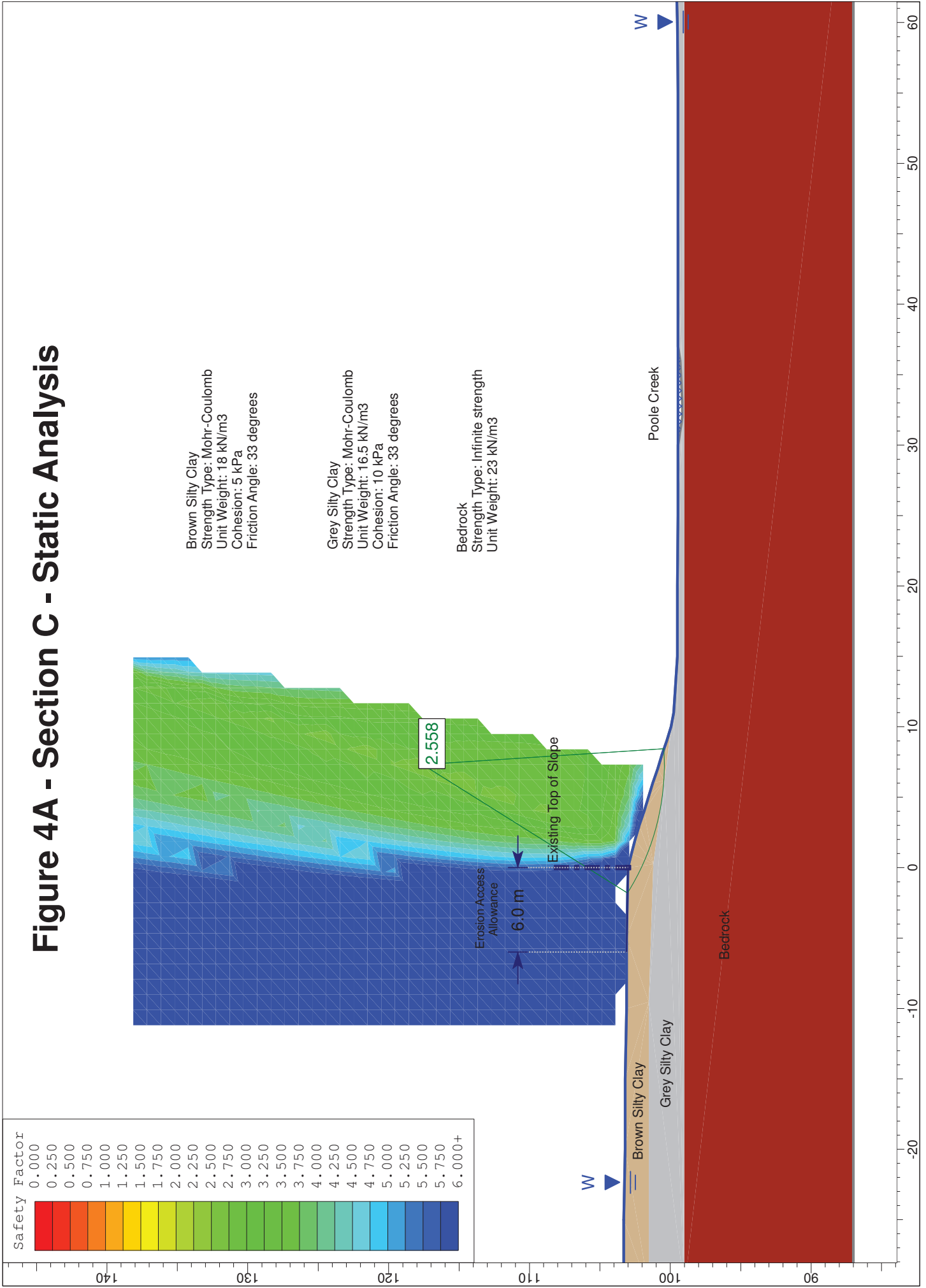
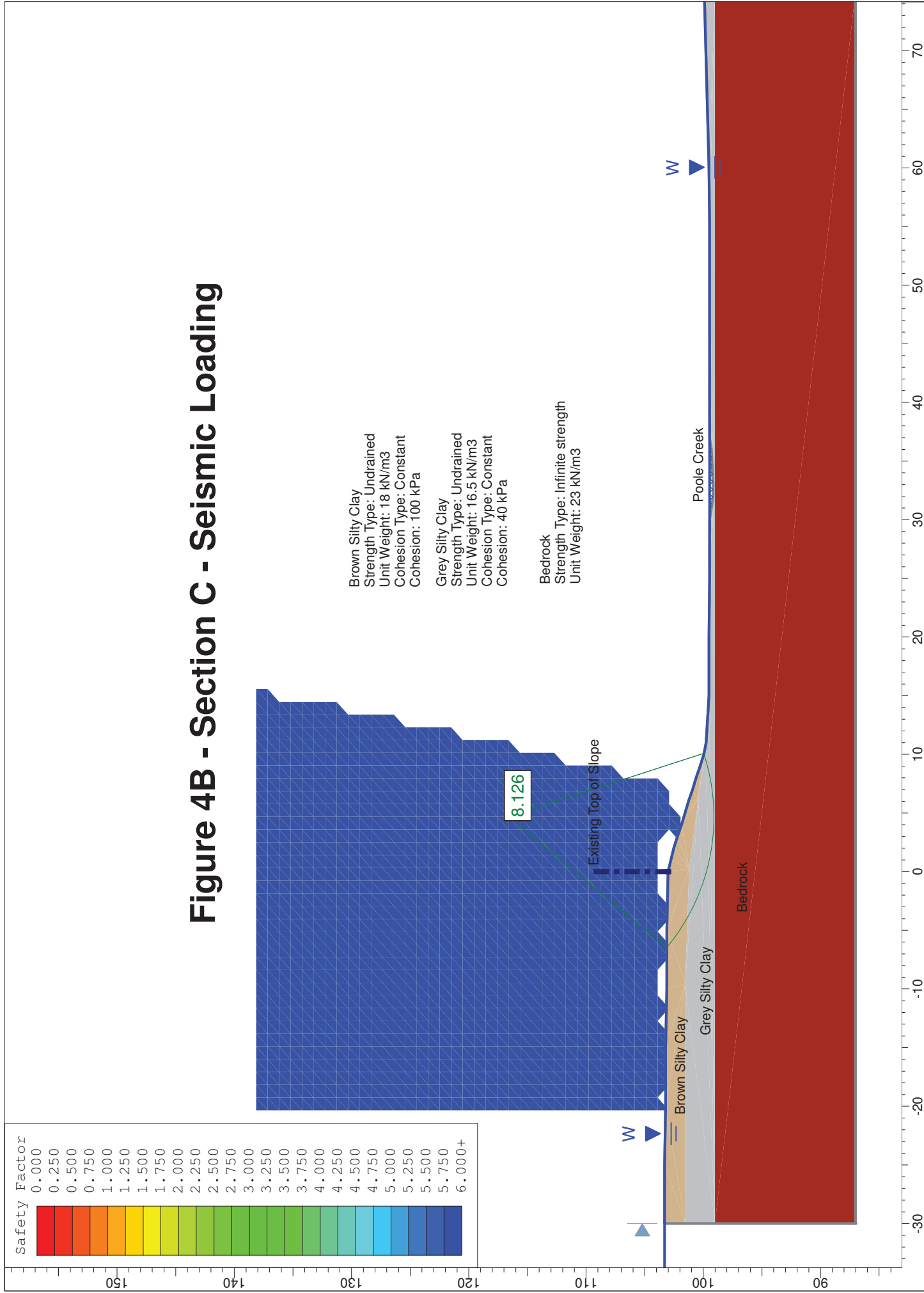
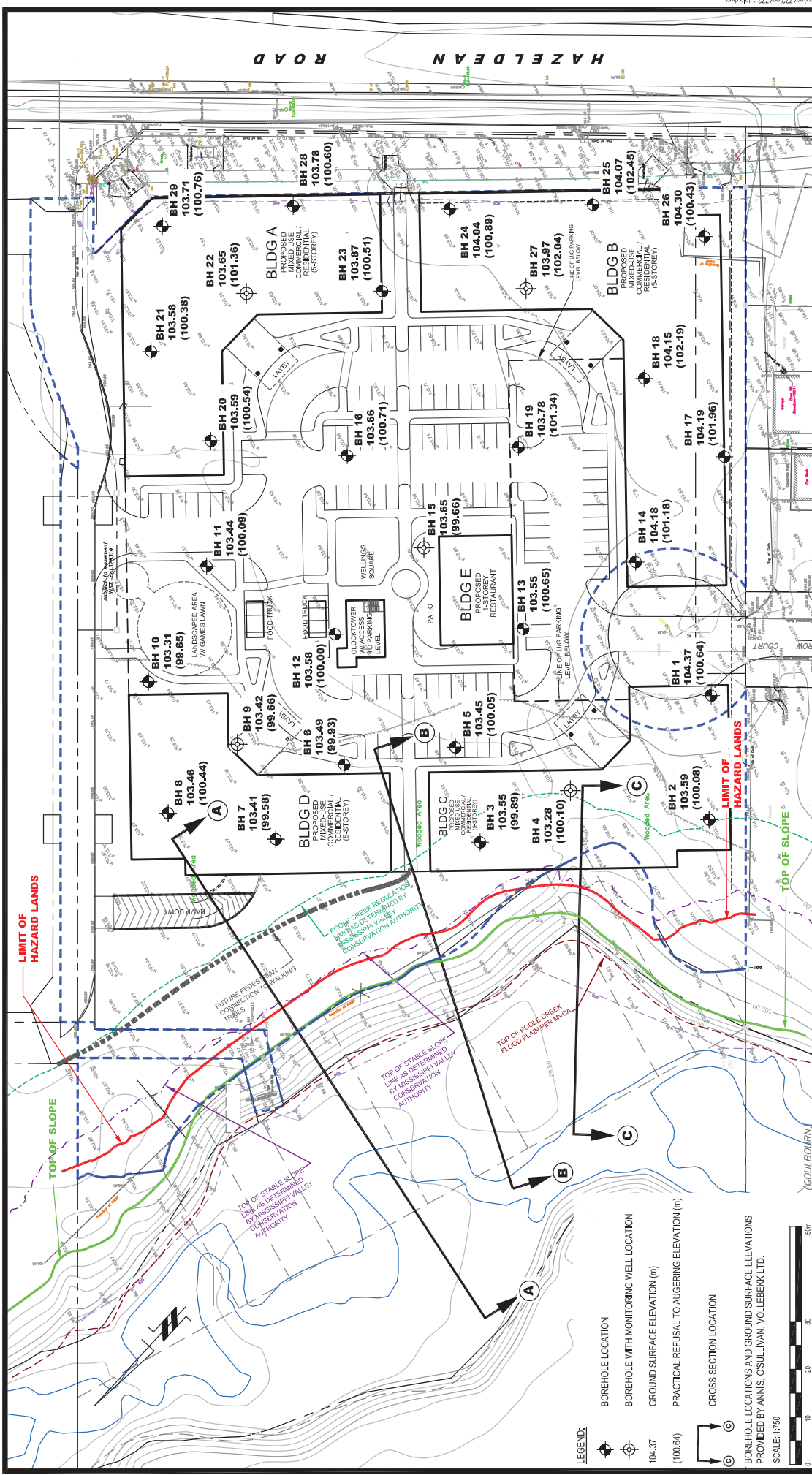

Figure 4B - Section C - Seismic Loading





Scale: 1:750		Date: 01/2019
Drawn by: MPG		Report No.: PG4772-1
Checked by: FA		Dwg. No.: PG4772-1
Approved by: DJG		Revision No.: 1
NAUTICAL LANDS GROUP GEOTECHNICAL INVESTIGATION PROP. MIXED-USE DEVELOPMENT - WELLINGS OF STITTSVILLE PHASE 2 - 20 CEDARROW CT. OTTAWA, ONTARIO		
Title: TEST HOLE LOCATION PLAN		
NO.	DATE	INITIAL
1	28/02/2019	FA
LIMIT OF HAZARD LANDS REVISED		

paterosngroup
consulting engineers

154 Colonnade Road South
Ottawa, Ontario K2E 7J5
Tel: (613) 226-7381 Fax: (613) 226-6344

planused dwg\p\g\geotech\blp\p4772\p4772-1.dwg

re: **Grading Plan Review**
Proposed Mixed-Use Development – Wellings of Stittsville Phase 2
20 Cedarow Court - Ottawa

to: Nautical Lands Group – **Mr. Mark Williams** – mwilliams@nauticallandsgroup.com

cc: Stantec – **Mr. Mike Sharp** – Mike.Sharp@stantec.com

date: August 12, 2021

file: PG4772-MEMO.03

Following your request and authorization, Paterson Group (Paterson) prepared the current memorandum to complete a grading plan review from a geotechnical perspective for Phase 2 of the mixed-use development to be constructed at the aforementioned site. The following memorandum should be read in conjunction with Paterson Group Report PG4772-1 Revision 1, dated September 29, 2020.

Grading Plan Review

Paterson reviewed the following grading plan prepared by Stantec regarding the aforementioned development:

- ☐ Grading Plan - Wellings of Stittsville Phase 2 - Project No. 160401511 - Drawing No. GP-1 - Sheet No. 4 of 7 - Revision 2 - dated August 3, 2021.

Based on our review of the above noted grading plan, the proposed grades within Phase 2 of the aforementioned development are within the permissible grade raise restriction of 2 m provided throughout the subject site in the aforementioned geotechnical investigation report. Therefore, the proposed grading is considered acceptable from a geotechnical perspective. No exceedances of the grade raise restriction were noted, therefore lightweight fill or other considerations to accommodate the proposed grades are not required at this time.

We trust that this information satisfies your immediate requirements.

Best Regards,

Paterson Group Inc.



Maha Saleh, Provisional P. Eng.

Paterson Group Inc.

Ottawa Head Office
154 Colonnade Road South
Ottawa – Ontario – K2E 7S8
Tel: (613) 226-7381



Faisal Abou-Seido, P. Eng.

Ottawa Laboratory
28 Concourse Gate
Ottawa – Ontario – K2E 7T7
Tel: (613) 226-7381

Northern Office and Laboratory
63 Gibson Street
North Bay – Ontario – P1B 8Z4
Tel: (705) 472-5331

**SERVICING AND STORMWATER MANAGEMENT BRIEF –
WELLINGS OF STITTSVILLE PHASE 2, 20 CEDAROW COURT**

Appendix E Drawings
September 1, 2023

Appendix E DRAWINGS

PROJECT INFORMATION	
ENGINEERED PRODUCT MANAGER:	HAIDER NASRULLAH 647-850-9417 HAIDER.NASRULLAH@ADS-PIPE.COM
ADS SALES REP:	HASSAN ELMI 416-985-9757 HASSAN.ELMI@ADS-PIPE.COM
PROJECT NO:	S302117
ADS SITE COORDINATOR:	RYAN RUBENSTEIN 519-710-3687 RYAN.RUBENSTEIN@ADS-PIPE.COM



20 CEDAROW COURT

OTTAWA, ON.

MC-7200 STORMTECH CHAMBER SPECIFICATIONS

- CHAMBERS SHALL BE STORMTECH MC-7200.
- CHAMBERS SHALL BE ARCH-SHAPED AND SHALL BE MANUFACTURED FROM VIRGIN, IMPACT-MODIFIED POLYPROPYLENE COPOLYMERS.
- CHAMBERS SHALL BE CERTIFIED TO CSA B184, "POLYMERIC SUB-SURFACE STORMWATER MANAGEMENT STRUCTURES", AND MEET THE REQUIREMENTS OF ASTM F2418, "STANDARD SPECIFICATION FOR POLYPROPYLENE (PP) CORRUGATED WALL STORMWATER COLLECTION CHAMBERS" CHAMBER CLASSIFICATION 60x101.
- CHAMBER ROWS SHALL PROVIDE CONTINUOUS, UNOBSTRUCTED INTERNAL SPACE WITH NO INTERNAL SUPPORTS THAT WOULD IMPEDE FLOW OR LIMIT ACCESS FOR INSPECTION.
- THE STRUCTURAL DESIGN OF THE CHAMBERS, THE STRUCTURAL BACKFILL, AND THE INSTALLATION REQUIREMENTS SHALL ENSURE THAT THE LOAD FACTORS SPECIFIED IN THE AASHTO LRFD BRIDGE DESIGN SPECIFICATIONS, SECTION 12.12, ARE MET FOR: 1) LONG-DURATION DEAD LOADS AND 2) SHORT-DURATION LIVE LOADS, BASED ON THE CSA S6 CL-625 TRUCK AND THE AASHTO DESIGN TRUCK WITH CONSIDERATION FOR IMPACT AND MULTIPLE VEHICLE PRESENCES.
- CHAMBERS SHALL BE DESIGNED, TESTED AND ALLOWABLE LOAD CONFIGURATIONS DETERMINED IN ACCORDANCE WITH ASTM F2787, "STANDARD PRACTICE FOR STRUCTURAL DESIGN OF THERMOPLASTIC CORRUGATED WALL STORMWATER COLLECTION CHAMBERS". LOAD CONFIGURATIONS SHALL INCLUDE: 1) INSTANTANEOUS (<1 MIN) AASHTO DESIGN TRUCK LIVE LOAD ON MINIMUM COVER 2) MAXIMUM PERMANENT (75-YR) COVER LOAD AND 3) ALLOWABLE COVER WITH PARKED (1-WEEK) AASHTO DESIGN TRUCK.
- REQUIREMENTS FOR HANDLING AND INSTALLATION:
 - TO MAINTAIN THE WIDTH OF CHAMBERS DURING SHIPPING AND HANDLING, CHAMBERS SHALL HAVE INTEGRAL, INTERLOCKING STACKING LUGS.
 - TO ENSURE A SECURE JOINT DURING INSTALLATION AND BACKFILL, THE HEIGHT OF THE CHAMBER JOINT SHALL NOT BE LESS THAN 75 mm (3").
 - TO ENSURE THE INTEGRITY OF THE ARCH SHAPE DURING INSTALLATION, a) THE ARCH STIFFNESS CONSTANT SHALL BE GREATER THAN OR EQUAL TO 450 LBS/FT/%. THE ASC IS DEFINED IN SECTION 6.2.8 OF ASTM F2418. AND b) TO RESIST CHAMBER DEFORMATION DURING INSTALLATION AT ELEVATED TEMPERATURES (ABOVE 23° C / 73° F), CHAMBERS SHALL BE PRODUCED FROM REFLECTIVE GOLD OR YELLOW COLORS.
- ONLY CHAMBERS THAT ARE APPROVED BY THE SITE DESIGN ENGINEER WILL BE ALLOWED. UPON REQUEST BY THE SITE DESIGN ENGINEER OR OWNER, THE CHAMBER MANUFACTURER SHALL SUBMIT A STRUCTURAL EVALUATION FOR APPROVAL BEFORE DELIVERING CHAMBERS TO THE PROJECT SITE AS FOLLOWS:
 - THE STRUCTURAL EVALUATION SHALL BE SEALED BY A REGISTERED PROFESSIONAL ENGINEER.
 - THE STRUCTURAL EVALUATION SHALL DEMONSTRATE THAT THE SAFETY FACTORS ARE GREATER THAN OR EQUAL TO 1.95 FOR DEAD LOAD AND 1.75 FOR LIVE LOAD, THE MINIMUM REQUIRED BY ASTM F2787 AND BY SECTIONS 3 AND 12.12 OF THE AASHTO LRFD BRIDGE DESIGN SPECIFICATIONS FOR THERMOPLASTIC PIPE.
 - THE TEST DERIVED CREEP MODULUS AS SPECIFIED IN ASTM F2418 SHALL BE USED FOR PERMANENT DEAD LOAD DESIGN EXCEPT THAT IT SHALL BE THE 75-YEAR MODULUS USED FOR DESIGN.
- CHAMBERS AND END CAPS SHALL BE PRODUCED AT AN ISO 9001 CERTIFIED MANUFACTURING FACILITY.

IMPORTANT - NOTES FOR THE BIDDING AND INSTALLATION OF MC-7200 CHAMBER SYSTEM

- STORMTECH MC-7200 CHAMBERS SHALL NOT BE INSTALLED UNTIL THE MANUFACTURER'S REPRESENTATIVE HAS COMPLETED A PRE-CONSTRUCTION MEETING WITH THE INSTALLERS.
- STORMTECH MC-7200 CHAMBERS SHALL BE INSTALLED IN ACCORDANCE WITH THE "STORMTECH MC-3500/MC-7200 CONSTRUCTION GUIDE".
- CHAMBERS ARE NOT TO BE BACKFILLED WITH A DOZER OR EXCAVATOR SITUATED OVER THE CHAMBERS. STORMTECH RECOMMENDS 3 BACKFILL METHODS:
 - STONESHOOTER LOCATED OFF THE CHAMBER BED.
 - BACKFILL AS ROWS ARE BUILT USING AN EXCAVATOR ON THE FOUNDATION STONE OR SUBGRADE.
 - BACKFILL FROM OUTSIDE THE EXCAVATION USING A LONG BOOM HOE OR EXCAVATOR.
- THE FOUNDATION STONE SHALL BE LEVELED AND COMPACTED PRIOR TO PLACING CHAMBERS.
- JOINTS BETWEEN CHAMBERS SHALL BE PROPERLY SEATED PRIOR TO PLACING STONE.
- MAINTAIN MINIMUM - 230 mm (9") SPACING BETWEEN THE CHAMBER ROWS.
- INLET AND OUTLET MANIFOLDS MUST BE INSERTED A MINIMUM OF 300 mm (12") INTO CHAMBER END CAPS.
- EMBEDMENT STONE SURROUNDING CHAMBERS MUST BE A CLEAN, CRUSHED, ANGULAR STONE WELL GRADED BETWEEN ¾" AND 2" (20-50 mm).
- STONE SHALL BE BROUGHT UP EVENLY AROUND CHAMBERS SO AS NOT TO DISTORT THE CHAMBER SHAPE. STONE DEPTHS SHOULD NEVER DIFFER BY MORE THAN 300 mm (12") BETWEEN ADJACENT CHAMBER ROWS.
- STONE MUST BE PLACED ON THE TOP CENTER OF THE CHAMBER TO ANCHOR THE CHAMBERS IN PLACE AND PRESERVE ROW SPACING.
- THE CONTRACTOR MUST REPORT ANY DISCREPANCIES WITH CHAMBER FOUNDATION MATERIAL BEARING CAPACITIES TO THE SITE DESIGN ENGINEER.
- ADS RECOMMENDS THE USE OF "FLEXSTORM CATCH IT" INSERTS DURING CONSTRUCTION FOR ALL INLETS TO PROTECT THE SUBSURFACE STORMWATER MANAGEMENT SYSTEM FROM CONSTRUCTION SITE RUNOFF.

NOTES FOR CONSTRUCTION EQUIPMENT

- STORMTECH MC-7200 CHAMBERS SHALL BE INSTALLED IN ACCORDANCE WITH THE "STORMTECH MC-7200 CONSTRUCTION GUIDE".
- THE USE OF EQUIPMENT OVER MC-7200 CHAMBERS IS LIMITED:
 - NO EQUIPMENT IS ALLOWED ON BARE CHAMBERS.
 - NO RUBBER TIRE LOADER, DUMP TRUCK, OR EXCAVATORS ARE ALLOWED UNTIL PROPER FILL DEPTHS ARE REACHED IN ACCORDANCE WITH THE "STORMTECH MC-7200 CONSTRUCTION GUIDE".
 - WEIGHT LIMITS FOR CONSTRUCTION EQUIPMENT CAN BE FOUND IN THE "STORMTECH MC-7200 CONSTRUCTION GUIDE".
- FULL 900 mm (36") OF STABILIZED COVER MATERIALS OVER THE CHAMBERS IS REQUIRED FOR DUMP TRUCK TRAVEL OR DUMPING.

USE OF A DOZER TO PUSH EMBEDMENT STONE BETWEEN THE ROWS OF CHAMBERS MAY CAUSE DAMAGE TO CHAMBERS AND IS NOT AN ACCEPTABLE BACKFILL METHOD. ANY CHAMBERS DAMAGED BY USING THE "DUMP AND PUSH" METHOD ARE NOT COVERED UNDER THE STORMTECH STANDARD WARRANTY.

CONTACT STORMTECH AT 1-888-892-2694 WITH ANY QUESTIONS ON INSTALLATION REQUIREMENTS OR WEIGHT LIMITS FOR CONSTRUCTION EQUIPMENT.

PROPOSED LAYOUT

61	STORMTECH MC-7200 CHAMBERS
12	STORMTECH MC-7200 END CAPS
305	STONE ABOVE (mm)
500	STONE BELOW (mm)
40	% STONE VOID
487.1	INSTALLED SYSTEM VOLUME (m³) ABOVE ELEVATION 101.37 (PERIMETER STONE INCLUDED)
426.1	SYSTEM AREA (m ²)
85.2	SYSTEM PERIMETER (m)

PROPOSED ELEVATIONS

104.970	MAXIMUM ALLOWABLE GRADE (TOP OF PAVEMENT/UNPAVED):
103.598	MINIMUM ALLOWABLE GRADE (UNPAVED WITH TRAFFIC):
103.446	MINIMUM ALLOWABLE GRADE (UNPAVED NO TRAFFIC):
103.446	MINIMUM ALLOWABLE GRADE (BASE OF FLEXIBLE PAVEMENT):
103.446	MINIMUM ALLOWABLE GRADE (TOP OF RIGID PAVEMENT):
103.141	TOP OF STONE:
102.836	TOP OF MC-7200 CHAMBER:
102.217	300 mm TOP MANIFOLD INVERT:
102.059	450 mm TOP MANIFOLD INVERT:
101.370	600 mm ISOLATOR ROW PLUS INVERT:
101.370	600 mm BOTTOM CONNECTION INVERT:
101.351	300 mm BOTTOM MANIFOLD INVERT:
101.312	BOTTOM OF MC-7200 CHAMBER:
100.812	BOTTOM OF STONE:

NOTES

- MANIFOLD SIZE TO BE DETERMINED BY SITE DESIGN ENGINEER. SEE TECHNICAL NOTE 6.32 FOR MANIFOLD SIZING GUIDANCE.
- DUE TO THE ADAPTATION OF THIS CHAMBER SYSTEM TO SPECIFIC SITE AND DESIGN CONSTRAINTS, IT MAY BE NECESSARY TO CUT AND COUPLE ADDITIONAL PIPE TO STANDARD MANIFOLD COMPONENTS IN THE FIELD.
- THIS CHAMBER SYSTEM WAS DESIGNED WITHOUT SITE-SPECIFIC INFORMATION ON SOIL CONDITIONS OR BEARING CAPACITY. THE SITE DESIGN ENGINEER IS RESPONSIBLE FOR DETERMINING THE SUITABILITY OF THE SOIL AND PROVIDING THE BEARING CAPACITY OF THE INSITU SOILS. THE BASE STONE DEPTH MAY BE INCREASED OR DECREASED ONCE THIS INFORMATION IS PROVIDED.

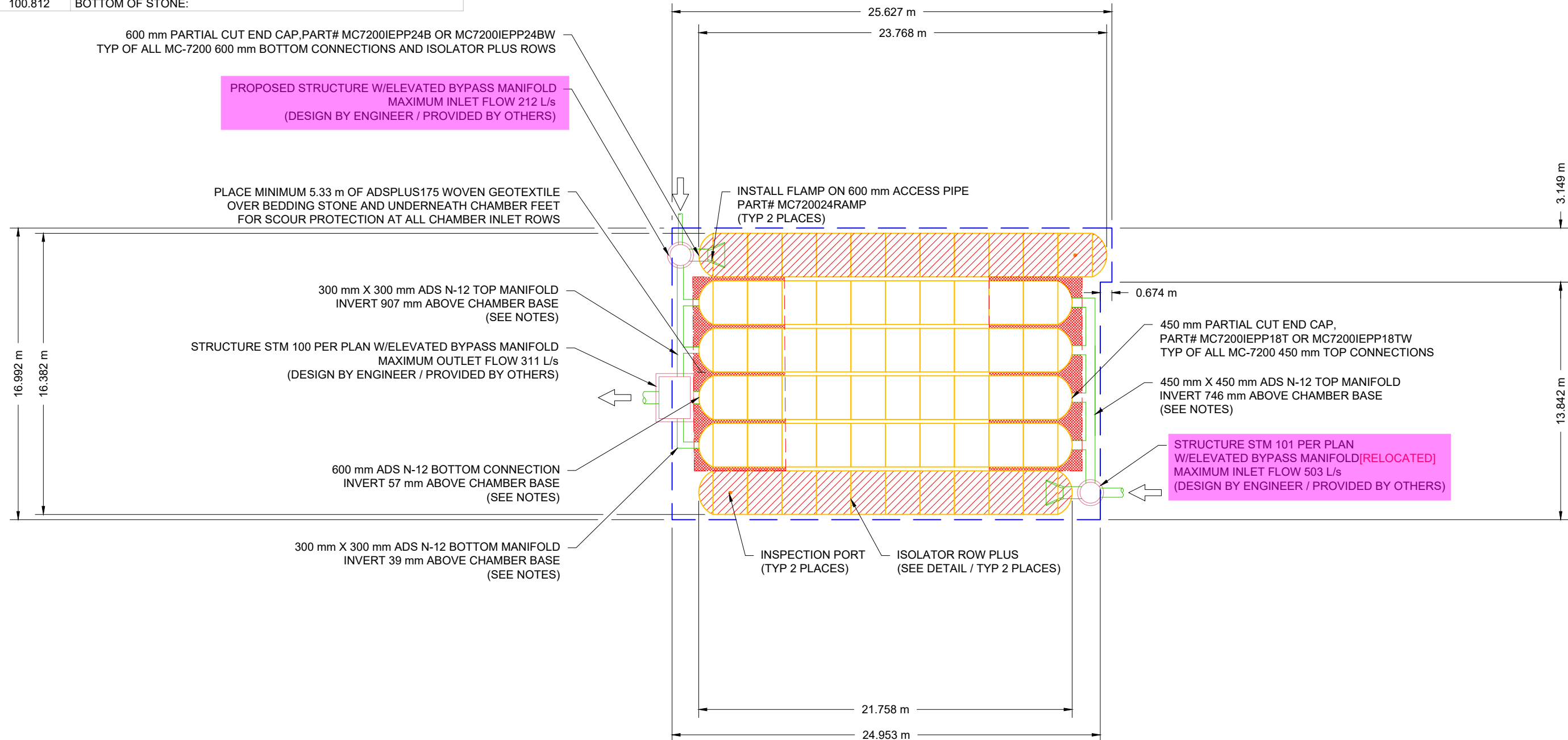

20 CEDAROW COURT

OTTAWA, ON.

DATE: 06/14/22 DRAWN: RCT

PROJECT #: S302117 CHECKED: RCT

DATE	DRWN	CHKD	DESCRIPTION
01/06/23	RCT	RCT	REVISED PER NEW PLAN
09/23/22	JMQ	JMQ	NEW PLAN, REDUCED VOLUME
8-10-22	BRE	RWD	REVISED PER NEW PLAN

StormTech®
Chamber System
888-892-2694 | WWW.STORMTECH.COM

4640 TRUEMAN BLVD
HILLIARD, OH 43026

SCALE = 1 : 250

2 SHEET
OF 5

THIS DRAWING HAS BEEN PREPARED BASED ON INFORMATION PROVIDED TO ADS UNDER THE DIRECTION OF THE SITE DESIGN ENGINEER OR OTHER PROJECT REPRESENTATIVE. THE SITE DESIGN ENGINEER SHALL REVIEW THIS DRAWING PRIOR TO CONSTRUCTION. IT IS THE ULTIMATE RESPONSIBILITY OF THE SITE DESIGN ENGINEER TO ENSURE THAT THE PRODUCT(S) DEPICTED AND ALL ASSOCIATED DETAILS MEET ALL APPLICABLE LAWS, REGULATIONS, AND PROJECT REQUIREMENTS.

ACCEPTABLE FILL MATERIALS: STORMTECH MC-7200 CHAMBER SYSTEMS

MATERIAL LOCATION	DESCRIPTION	AASHTO MATERIAL CLASSIFICATIONS	COMPACTION / DENSITY REQUIREMENT
D	FINAL FILL: FILL MATERIAL FOR LAYER 'D' STARTS FROM THE TOP OF THE 'C' LAYER TO THE BOTTOM OF FLEXIBLE PAVEMENT OR UNPAVED FINISHED GRADE ABOVE. NOTE THAT PAVEMENT SUBBASE MAY BE PART OF THE 'D' LAYER	N/A	PREPARE PER SITE DESIGN ENGINEER'S PLANS. PAVED INSTALLATIONS MAY HAVE STRINGENT MATERIAL AND PREPARATION REQUIREMENTS.
C	INITIAL FILL: FILL MATERIAL FOR LAYER 'C' STARTS FROM THE TOP OF THE EMBEDMENT STONE ('B' LAYER) TO 24" (600 mm) ABOVE THE TOP OF THE CHAMBER. NOTE THAT PAVEMENT SUBBASE MAY BE A PART OF THE 'C' LAYER.	AASHTO M145 ¹ A-1, A-2-4, A-3 OR AASHTO M43 ¹ 3, 357, 4, 467, 5, 56, 57, 6, 67, 68, 7, 78, 8, 89, 9, 10	BEGIN COMPACTIONS AFTER 24" (600 mm) OF MATERIAL OVER THE CHAMBERS IS REACHED. COMPACT ADDITIONAL LAYERS IN 12" (300 mm) MAX LIFTS TO A MIN. 95% PROCTOR DENSITY FOR WELL GRADED MATERIAL AND 95% RELATIVE DENSITY FOR PROCESSED AGGREGATE MATERIALS.
B	EMBEDMENT STONE: FILL SURROUNDING THE CHAMBERS FROM THE FOUNDATION STONE ('A' LAYER) TO THE 'C' LAYER ABOVE.	CLEAN, CRUSHED, ANGULAR STONE AASHTO M43 ¹ 3, 4	NO COMPACTION REQUIRED.
A	FOUNDATION STONE: FILL BELOW CHAMBERS FROM THE SUBGRADE UP TO THE FOOT (BOTTOM) OF THE CHAMBER.	CLEAN, CRUSHED, ANGULAR STONE AASHTO M43 ¹ 3, 4	PLATE COMPACT OR ROLL TO ACHIEVE A FLAT SURFACE. ^{2,3}

PLEASE NOTE:

- THE LISTED AASHTO DESIGNATIONS ARE FOR GRADATIONS ONLY. THE STONE MUST ALSO BE CLEAN, CRUSHED, ANGULAR. FOR EXAMPLE, A SPECIFICATION FOR #4 STONE WOULD STATE: "CLEAN, CRUSHED, ANGULAR NO. 4 (AASHTO M43) STONE".
- STORMTECH COMPACTION REQUIREMENTS ARE MET FOR 'A' LOCATION MATERIALS WHEN PLACED AND COMPACTED IN 9" (230 mm) (MAX) LIFTS USING TWO FULL COVERAGES WITH A VIBRATORY COMPACTOR.
- WHERE INFILTRATION SURFACES MAY BE COMPROMISED BY COMPACTION, FOR STANDARD DESIGN LOAD CONDITIONS, A FLAT SURFACE MAY BE ACHIEVED BY RAKING OR DRAGGING WITHOUT COMPACTION EQUIPMENT. FOR SPECIAL LOAD DESIGNS, CONTACT STORMTECH FOR COMPACTION REQUIREMENTS.
- ONCE LAYER 'C' IS PLACED, ANY SOIL/MATERIAL CAN BE PLACED IN LAYER 'D' UP TO THE FINISHED GRADE. MOST PAVEMENT SUBBASE SOILS CAN BE USED TO REPLACE THE MATERIAL REQUIREMENTS OF LAYER 'C' OR 'D' AT THE SITE DESIGN ENGINEER'S DISCRETION.

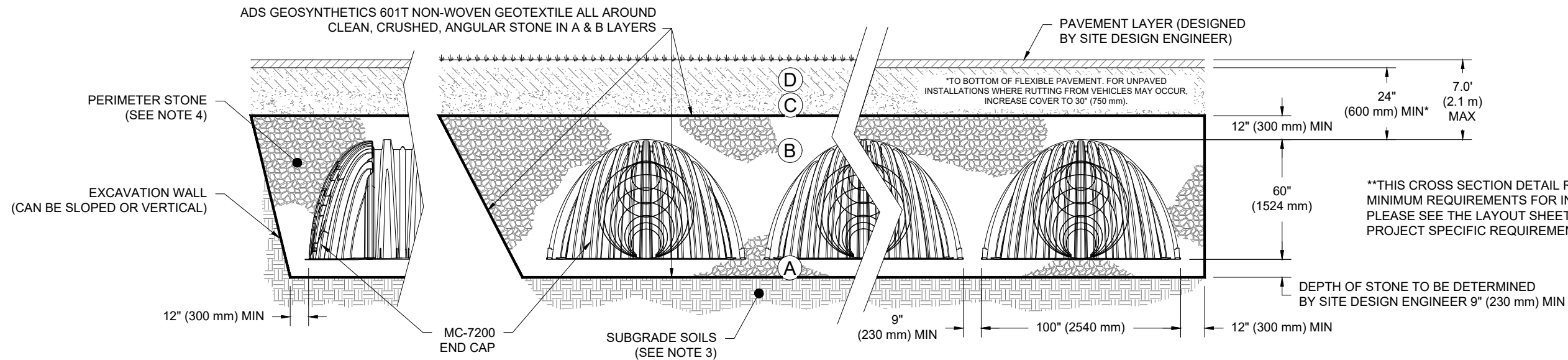

NOTES:

- CHAMBERS SHALL MEET THE REQUIREMENTS OF ASTM F2418, "STANDARD SPECIFICATION FOR POLYPROPYLENE (PP) CORRUGATED WALL STORMWATER COLLECTION CHAMBERS" CHAMBER CLASSIFICATION 60x101
- MC-7200 CHAMBERS SHALL BE DESIGNED IN ACCORDANCE WITH ASTM F2787 "STANDARD PRACTICE FOR STRUCTURAL DESIGN OF THERMOPLASTIC CORRUGATED WALL STORMWATER COLLECTION CHAMBERS".
- THE SITE DESIGN ENGINEER IS RESPONSIBLE FOR ASSESSING THE BEARING RESISTANCE (ALLOWABLE BEARING CAPACITY) OF THE SUBGRADE SOILS AND THE DEPTH OF FOUNDATION STONE WITH CONSIDERATION FOR THE RANGE OF EXPECTED SOIL MOISTURE CONDITIONS.
- PERIMETER STONE MUST BE EXTENDED HORIZONTALLY TO THE EXCAVATION WALL FOR BOTH VERTICAL AND SLOPED EXCAVATION WALLS.
- REQUIREMENTS FOR HANDLING AND INSTALLATION:
 - TO MAINTAIN THE WIDTH OF CHAMBERS DURING SHIPPING AND HANDLING, CHAMBERS SHALL HAVE INTEGRAL, INTERLOCKING STACKING LUGS.
 - TO ENSURE A SECURE JOINT DURING INSTALLATION AND BACKFILL, THE HEIGHT OF THE CHAMBER JOINT SHALL NOT BE LESS THAN 3".
 - TO ENSURE THE INTEGRITY OF THE ARCH SHAPE DURING INSTALLATION, a) THE ARCH STIFFNESS CONSTANT AS DEFINED IN SECTION 6.2.8 OF ASTM F2418 SHALL BE GREATER THAN OR EQUAL TO 500 LBS/FT.%. AND b) TO RESIST CHAMBER DEFORMATION DURING INSTALLATION AT ELEVATED TEMPERATURES (ABOVE 73° F / 23° C), CHAMBERS SHALL BE PRODUCED FROM REFLECTIVE GOLD OR YELLOW COLORS.

20 CEDAROW COURT

OTTAWA, ON.

DATE: 06/14/22
DRAWN: RCT
PROJECT #: S302117
CHECKED: RCT

DATE	DESCRIPTION
01/06/23	RCT REVISED PER NEW PLAN
09/23/22	JR NEW PLAN, REDUCED VOLUME
8-10-22	BRE REVISED PER NEW PLAN
	DRWN CHKD

StormTech®
Chamber System
888-892-2694 | WWW.STORMTECH.COM

4640 TRUEMAN BLVD
HILLIARD, OH 43026



THIS DRAWING HAS BEEN PREPARED BASED ON INFORMATION PROVIDED TO ADS UNDER THE DIRECTION OF THE SITE DESIGN ENGINEER OR OTHER PROJECT REPRESENTATIVE. THE SITE DESIGN ENGINEER SHALL REVIEW THIS DRAWING PRIOR TO CONSTRUCTION. IT IS THE ULTIMATE RESPONSIBILITY OF THE SITE DESIGN ENGINEER TO ENSURE THAT THE PRODUCT(S) DEPICTED AND ALL ASSOCIATED DETAILS MEET ALL APPLICABLE LAWS, REGULATIONS, AND PROJECT REQUIREMENTS.

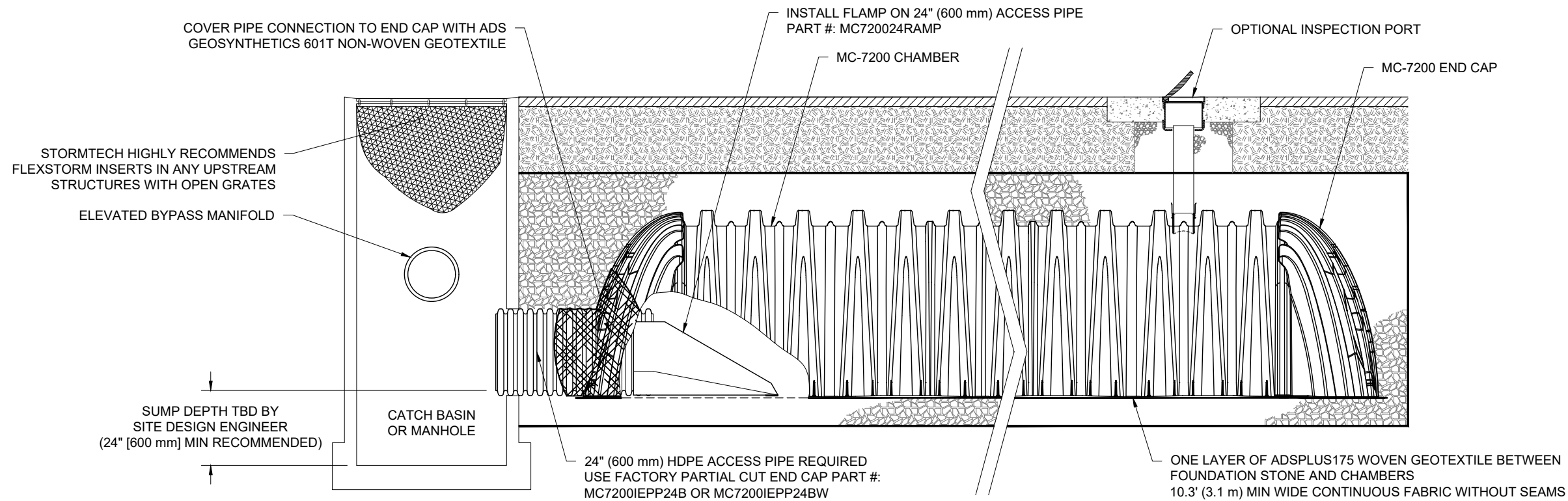

MC-7200 ISOLATOR ROW PLUS DETAIL

NTS

INSPECTION & MAINTENANCE

- STEP 1) INSPECT ISOLATOR ROW PLUS FOR SEDIMENT
- A. INSPECTION PORTS (IF PRESENT)
 - A.1. REMOVE/OPEN LID ON NYLOPLAST INLINE DRAIN
 - A.2. REMOVE AND CLEAN FLEXSTORM FILTER IF INSTALLED
 - A.3. USING A FLASHLIGHT AND STADIA ROD, MEASURE DEPTH OF SEDIMENT AND RECORD ON MAINTENANCE LOG
 - A.4. LOWER A CAMERA INTO ISOLATOR ROW PLUS FOR VISUAL INSPECTION OF SEDIMENT LEVELS (OPTIONAL)
 - A.5. IF SEDIMENT IS AT, OR ABOVE, 3" (80 mm) PROCEED TO STEP 2. IF NOT, PROCEED TO STEP 3.
 - B. ALL ISOLATOR PLUS ROWS
 - B.1. REMOVE COVER FROM STRUCTURE AT UPSTREAM END OF ISOLATOR ROW PLUS
 - B.2. USING A FLASHLIGHT, INSPECT DOWN THE ISOLATOR ROW PLUS THROUGH OUTLET PIPE
 - i) MIRRORS ON POLES OR CAMERAS MAY BE USED TO AVOID A CONFINED SPACE ENTRY
 - ii) FOLLOW OSHA REGULATIONS FOR CONFINED SPACE ENTRY IF ENTERING MANHOLE
 - B.3. IF SEDIMENT IS AT, OR ABOVE, 3" (80 mm) PROCEED TO STEP 2. IF NOT, PROCEED TO STEP 3.
- STEP 2) CLEAN OUT ISOLATOR ROW PLUS USING THE JETVAC PROCESS
- A. A FIXED CULVERT CLEANING NOZZLE WITH REAR FACING SPREAD OF 45" (1.1 m) OR MORE IS PREFERRED
 - B. APPLY MULTIPLE PASSES OF JETVAC UNTIL BACKFLUSH WATER IS CLEAN
 - C. VACUUM STRUCTURE SUMP AS REQUIRED
- STEP 3) REPLACE ALL COVERS, GRATES, FILTERS, AND LIDS; RECORD OBSERVATIONS AND ACTIONS.
- STEP 4) INSPECT AND CLEAN BASINS AND MANHOLES UPSTREAM OF THE STORMTECH SYSTEM.

NOTES

1. INSPECT EVERY 6 MONTHS DURING THE FIRST YEAR OF OPERATION. ADJUST THE INSPECTION INTERVAL BASED ON PREVIOUS OBSERVATIONS OF SEDIMENT ACCUMULATION AND HIGH WATER ELEVATIONS.
2. CONDUCT JETTING AND VACTORING ANNUALLY OR WHEN INSPECTION SHOWS THAT MAINTENANCE IS NECESSARY.

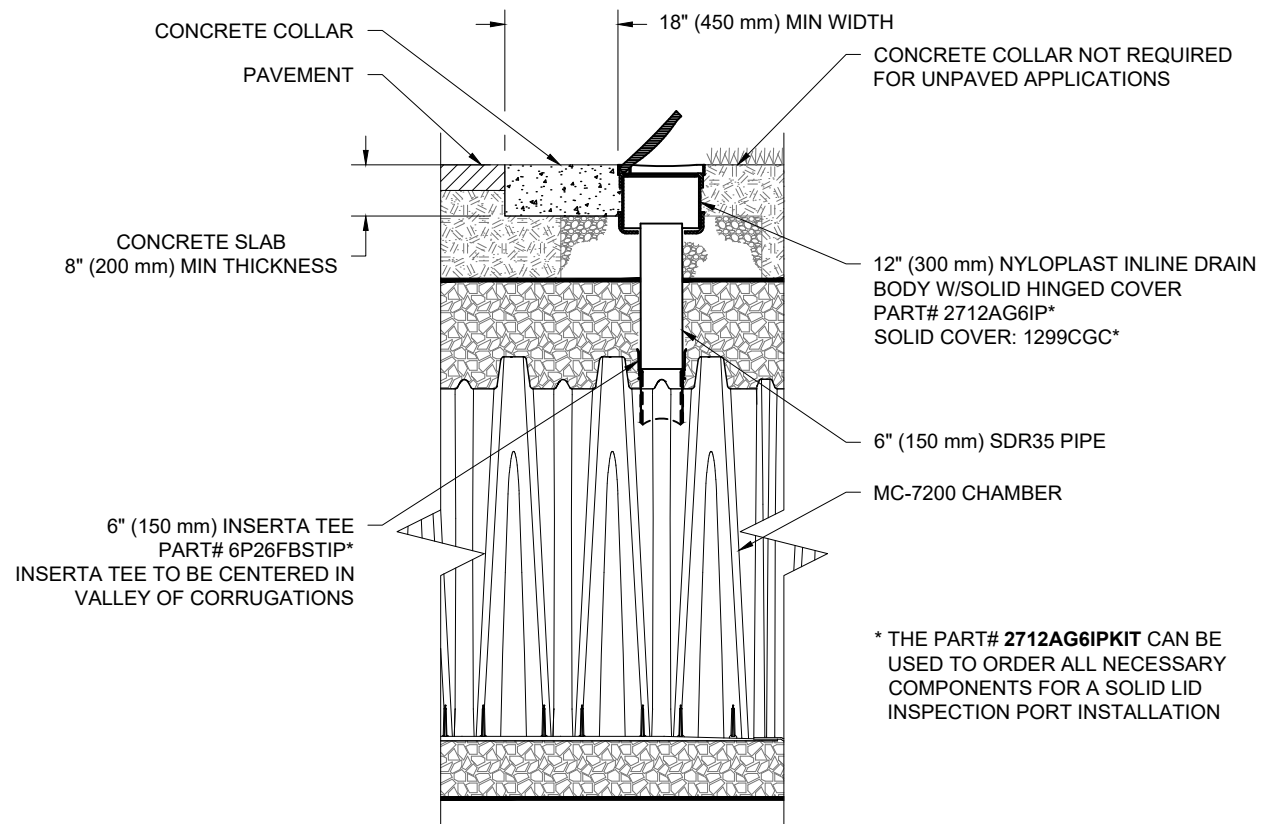

MC-7200 6" (150 mm) INSPECTION PORT DETAIL

NTS

20 CEDAROW COURT

OTTAWA, ON.

DATE: 06/14/22 DRAWN: RCT

PROJECT #: S302117 CHECKED: RCT

DATE	DRWN	CHKD	DESCRIPTION
01/06/23	RCT		REVISED PER NEW PLAN
09/23/22	JR	JMQ	NEW PLAN, REDUCED VOLUME
8-10-22	BRE	RWD	REVISED PER NEW PLAN

StormTech®
Chamber System

888-892-2694 | WWW.STORMTECH.COM

4640 TRUEMAN BLVD
HILLIARD, OH 43026

ADS

THIS DRAWING HAS BEEN PREPARED BASED ON INFORMATION PROVIDED TO ADS UNDER THE DIRECTION OF THE SITE DESIGN ENGINEER OR OTHER PROJECT REPRESENTATIVE. THE SITE DESIGN ENGINEER SHALL REVIEW THIS DRAWING PRIOR TO CONSTRUCTION. IT IS THE ULTIMATE RESPONSIBILITY OF THE SITE DESIGN ENGINEER TO ENSURE THAT THE PRODUCT(S) DEPICTED AND ALL ASSOCIATED DETAILS MEET ALL APPLICABLE LAWS, REGULATIONS, AND PROJECT REQUIREMENTS.

MC-7200 TECHNICAL SPECIFICATION

NTS

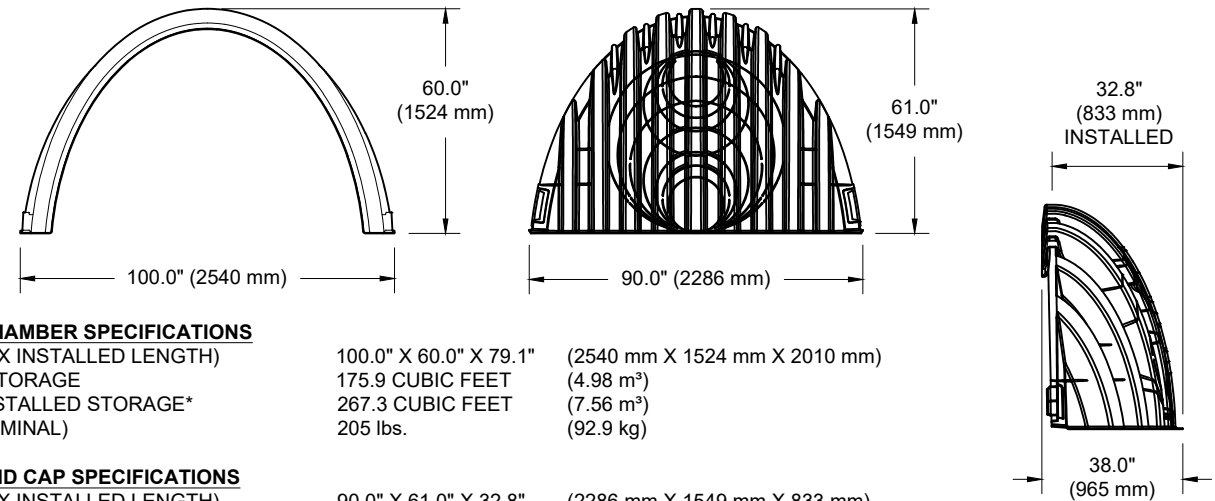
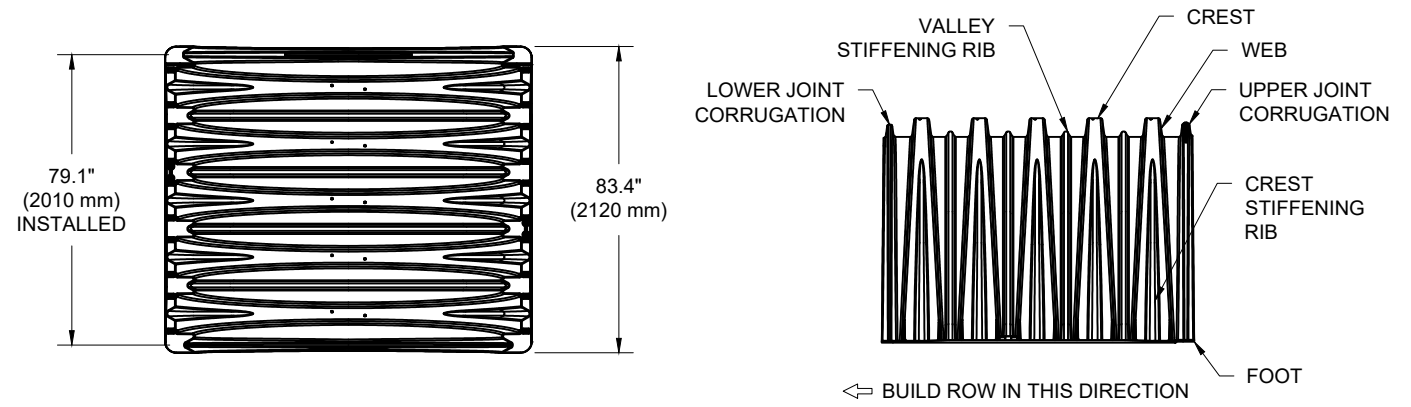

NOMINAL CHAMBER SPECIFICATIONS

SIZE (W X H X INSTALLED LENGTH)	100.0" X 60.0" X 79.1"	(2540 mm X 1524 mm X 2010 mm)
CHAMBER STORAGE	175.9 CUBIC FEET	(4.98 m ³)
MINIMUM INSTALLED STORAGE*	267.3 CUBIC FEET	(7.56 m ³)
WEIGHT (NOMINAL)	205 lbs.	(92.9 kg)

NOMINAL END CAP SPECIFICATIONS

SIZE (W X H X INSTALLED LENGTH)	90.0" X 61.0" X 32.8"	(2286 mm X 1549 mm X 833 mm)
END CAP STORAGE	39.5 CUBIC FEET	(1.12 m ³)
MINIMUM INSTALLED STORAGE*	115.3 CUBIC FEET	(3.26 m ³)
WEIGHT (NOMINAL)	90 lbs.	(40.8 kg)

*ASSUMES 12" (305 mm) STONE ABOVE, 9" (229 mm) STONE FOUNDATION AND BETWEEN CHAMBERS, 12" (305 mm) STONE PERIMETER IN FRONT OF END CAPS AND 40% STONE POROSITY.

PARTIAL CUT HOLES AT BOTTOM OF END CAP FOR PART NUMBERS ENDING WITH "B"
 PARTIAL CUT HOLES AT TOP OF END CAP FOR PART NUMBERS ENDING WITH "T"
 END CAPS WITH A PREFABRICATED WELDED STUB END WITH "W"

PART #	STUB	B	C
MC7200IEPP06T	6" (150 mm)	42.54" (1081 mm)	---
MC7200IEPP06B	---	---	0.86" (22 mm)
MC7200IEPP08T	8" (200 mm)	40.50" (1029 mm)	---
MC7200IEPP08B	---	---	1.01" (26 mm)
MC7200IEPP10T	10" (250 mm)	38.37" (975 mm)	---
MC7200IEPP10B	---	---	1.33" (34 mm)
MC7200IEPP12T	12" (300 mm)	35.69" (907 mm)	---
MC7200IEPP12B	---	---	1.55" (39 mm)
MC7200IEPP15T	15" (375 mm)	32.72" (831 mm)	---
MC7200IEPP15B	---	---	1.70" (43 mm)
MC7200IEPP18T	---	29.36" (746 mm)	---
MC7200IEPP18TW	18" (450 mm)	---	---
MC7200IEPP18B	---	---	1.97" (50 mm)
MC7200IEPP18BW	---	---	---
MC7200IEPP24T	---	23.05" (585 mm)	---
MC7200IEPP24TW	24" (600 mm)	---	---
MC7200IEPP24B	---	---	2.26" (57 mm)
MC7200IEPP24BW	---	---	---
MC7200IEPP30BW	30" (750 mm)	---	2.95" (75 mm)
MC7200IEPP36BW	36" (900 mm)	---	3.25" (83 mm)
MC7200IEPP42BW	42" (1050 mm)	---	3.55" (90 mm)

NOTE: ALL DIMENSIONS ARE NOMINAL

MC-SERIES END CAP INSERTION DETAIL

NTS

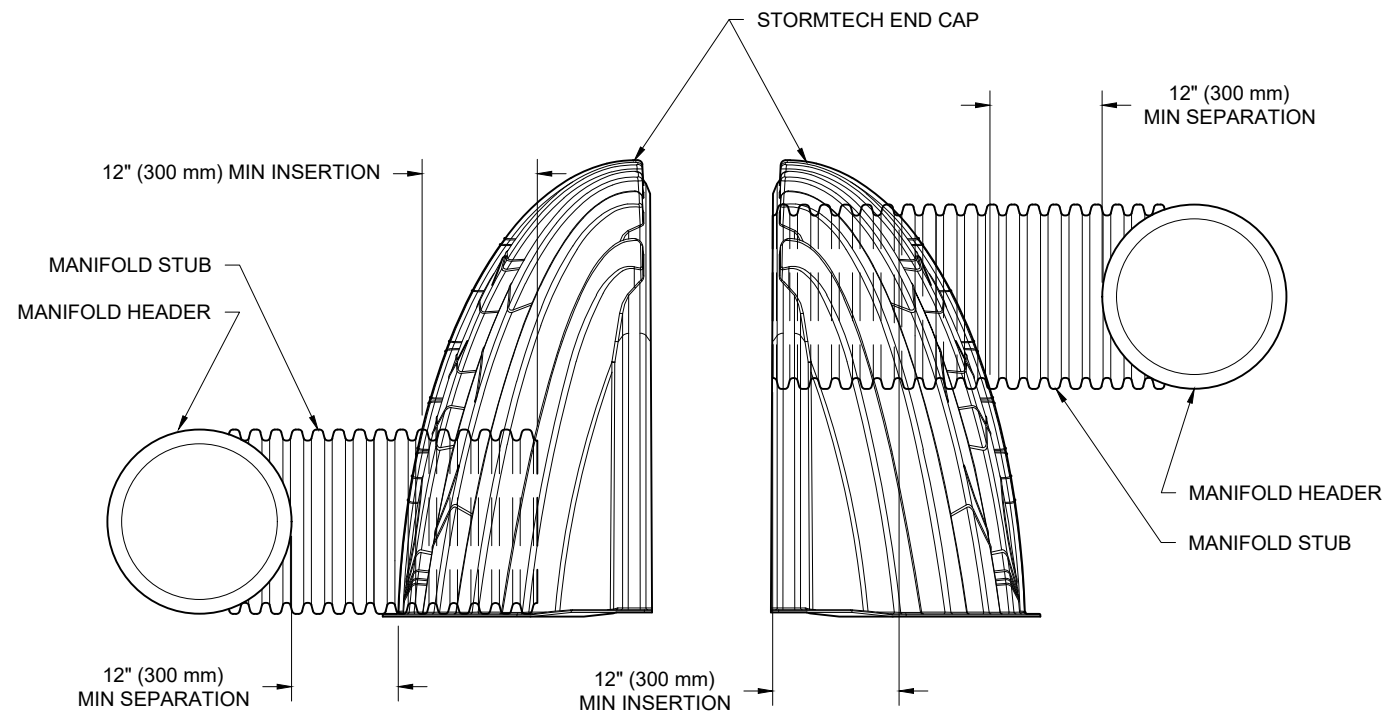

NOTE: MANIFOLD STUB MUST BE LAID HORIZONTAL FOR A PROPER FIT IN END CAP OPENING.

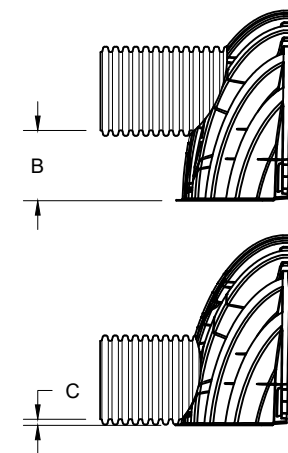

CUSTOM PREFABRICATED INVERTS ARE AVAILABLE UPON REQUEST. INVENTORIED MANIFOLDS INCLUDE 12-24" (300-600 mm) SIZE ON SIZE AND 15-48" (375-1200 mm) ECCENTRIC MANIFOLDS. CUSTOM INVERT LOCATIONS ON THE MC-7200 END CAP CUT IN THE FIELD ARE NOT RECOMMENDED FOR PIPE SIZES GREATER THAN 10" (250 mm). THE INVERT LOCATION IN COLUMN 'B' ARE THE HIGHEST POSSIBLE FOR THE PIPE SIZE.

20 CEDAROW COURT

OTTAWA, ON.

DATE: 06/14/22
 PROJECT #: S302117
 DRAWN: RCT
 CHECKED: RCT

DATE	DRWN	CHKD	DESCRIPTION
01/06/23	RCT	JR	REVISED PER NEW PLAN
09/23/22	JR	BRE	NEW PLAN, REDUCED VOLUME
8-10-22	BRE	RWD	REVISED PER NEW PLAN

StormTech[®]
 Chamber System

888-892-2694 | WWW.STORMTECH.COM

4640 TRUEMAN BLVD
 HILLIARD, OH 43026

ADS

THIS DRAWING HAS BEEN PREPARED BASED ON INFORMATION PROVIDED TO ADS UNDER THE DIRECTION OF THE SITE DESIGN ENGINEER OR OTHER PROJECT REPRESENTATIVE. THE SITE DESIGN ENGINEER SHALL REVIEW THIS DRAWING PRIOR TO CONSTRUCTION. IT IS THE ULTIMATE RESPONSIBILITY OF THE SITE DESIGN ENGINEER TO ENSURE THAT THE PRODUCT(S) DEPICTED AND ALL ASSOCIATED DETAILS MEET ALL APPLICABLE LAWS, REGULATIONS, AND PROJECT REQUIREMENTS.

EQUAL TO OR BETTER THAN EXISTING CONDITION.

ROAD CUT AS PER CITY STD R10. RE-INSTATE ROAD, CURB AND SIDEWALK TO EQUAL OR BETTER THAN ORIGINAL CONDITION. MATCH EXISTING ELEVATIONS AT TIE IN LOCATIONS.

ADS UNITS OR EQUIVALENT SHOP DRAWINGS TO BE PROVIDED.
100 YR REQUIRED STORAGE VOLUME = 485m³
100 YR HGL = 102.48m
TOP OF TANK = 102.89m
INVERT OF TANK = 101.37m
BOTTOM OF CLEAR STONE BEDDING = 100.87m
GWL (3.5m-2.5m BELOW OG)=99.8m TO 100.8m

TEE CONNECT TO EX. 250mmØ WATERMAIN WITH 250mm x 200mm TEE. EXCAVATION, CONNECTION AND BACKFILL BY CONTRACTOR, INSPECTION BY CITY FORCES. TOP OF EX. 250mmØ WATER = 101.81±

NEW 250mmØ VALVE AND BOX

EX. STM
T/G=103.09
NE INV= 100.82±
SE INV= 100.85±

EX. 101.6m-450mmØ STM @ 0.04%

CB 106A-1
T/G=103.35
SW INV=101.97

10.4m-200mmØ
CB LEAD @ 1.00%

ADS INLET 2
INV=101.87

ADS OUTLET
INV=101.37

2.1m-525mmØ STM @ 1.00%

CLAY SEAL AS PER GEOTECHNICAL RECOMMENDATIONS.

34.9m-525mmØ STM @ 0.20%

CONNECT TO 525mmØ STORM SEWER.
525mmØ INVERT=99.90
525mmØ SPRINGLINE=100.16
250mmØ INV CONNECTION=100.18

TAKE INTO AND CONNECT TO EX. STM MH INV=99.83

EX. STM
T/G=102.35
NE INV= 99.660
SE INV= 99.608

EX. STM
T/G=1.25%±

CONCRETE HEADWALL c/w HANDRAIL INV=99.48

TOP OF SLOPE
BOTTOM OF SLOPE

STM 100
1829mm x 2438mm
T/G=103.79
c/w ICDs IN WEIR WALL
83mmØ ICD INV=101.37
200mmØ ICD INV=102.30
INV OF WEIR=103.00
NW INV=99.90
SE INV=101.35

STM 10000 (1200Ø)
T/G=103.99
NE INV=100.30
SE INV=100.36

additional MH

slight deflection between MH's

CB 102A-1
T/G=104.08
SW INV=102.89

24.7m-200mmØ
CB LEAD @ 1.00%

STM 101 (1200Ø)
T/G=104.14
NE INV=101.80
SW INV=101.39

STM 102 (1200Ø)
STC 300
T/G=104.33
NW INV=101.90
SE INV=102.41
SW INV=101.96

11.9m-250mmØ STM @ 1.00%

9.5m-450mmØ STM @ 1.00%

69.2m-250mmØ STM @ 1.00%

2.2m-450mmØ STM @ 1.00%

ADS INLET 1
INV=101.37

CB 103E-1
T/G=103.81
SE INV=102.43

1.5m-200mmØ
CB LEAD @ 1.00%

CB 103D-1
T/G=104.00
NW INV=102.62

18.5m-200mmØ
CB LEAD @ 1.00%

SUBJECT TO ASEMENT INST. OC132331

LANDING
ELEV=105.70

SPEED HUMP AS PER CITY STD R19

LOADING AREA

EX. CB 502
E/P=103.96
W INV=102.02

BUILDING STORM
450mmØ INV=10

STM STUE
UNDERS
INV=101.
+
UNDERG
PARKING

200mm WATERMAIN A

2

3

PROJECT: 2510 WELLINGS PRIVATE
SHEMULE ON
2510 WELLINGS PRIVATE
SHEMULE ON
STORM DRAINAGE PLAN

DATE: 09/08/2021
DRAWN BY: [Name]
CHECKED BY: [Name]
DESIGNED BY: [Name]
PROJECT MANAGER: [Name]
PROJECT ENGINEER: [Name]
PROJECT ARCHITECT: [Name]
PROJECT CIVIL ENGINEER: [Name]
PROJECT ELECTRICAL ENGINEER: [Name]
PROJECT MECHANICAL ENGINEER: [Name]
PROJECT PLUMBING ENGINEER: [Name]
PROJECT SANITARY ENGINEER: [Name]
PROJECT STRUCTURAL ENGINEER: [Name]
PROJECT TRAFFIC ENGINEER: [Name]
PROJECT LANDSCAPE ARCHITECT: [Name]
PROJECT ENVIRONMENTAL ENGINEER: [Name]
PROJECT HISTORIC PRESERVATION ARCHITECT: [Name]
PROJECT INTERIOR ARCHITECT: [Name]
PROJECT LIGHTING DESIGNER: [Name]
PROJECT SOUND DESIGNER: [Name]
PROJECT VIDEO DESIGNER: [Name]
PROJECT AV DESIGNER: [Name]
PROJECT SECURITY DESIGNER: [Name]
PROJECT ACCESSIBILITY DESIGNER: [Name]
PROJECT ENERGY DESIGNER: [Name]
PROJECT SUSTAINABILITY DESIGNER: [Name]
PROJECT GREEN BUILDING DESIGNER: [Name]
PROJECT LEED DESIGNER: [Name]
PROJECT WELLNESS DESIGNER: [Name]
PROJECT USER EXPERIENCE DESIGNER: [Name]
PROJECT SERVICE DESIGNER: [Name]
PROJECT OPERATIONAL DESIGNER: [Name]
PROJECT MAINTENANCE DESIGNER: [Name]
PROJECT CONSTRUCTION DESIGNER: [Name]
PROJECT COMMUNITY DESIGNER: [Name]
PROJECT POLICY DESIGNER: [Name]
PROJECT STRATEGY DESIGNER: [Name]
PROJECT ANALYTICS DESIGNER: [Name]
PROJECT INNOVATION DESIGNER: [Name]
PROJECT RESEARCH DESIGNER: [Name]
PROJECT CONSULTING DESIGNER: [Name]
PROJECT ADVICE DESIGNER: [Name]
PROJECT SUPPORT DESIGNER: [Name]

NOTES:
1. SEE ALL NOTES ON ALL SHEETS.
2. ALL DIMENSIONS ARE IN METERS UNLESS OTHERWISE NOTED.
3. ALL DIMENSIONS ARE TO FACE UNLESS OTHERWISE NOTED.
4. ALL DIMENSIONS ARE TO CENTERLINE UNLESS OTHERWISE NOTED.
5. ALL DIMENSIONS ARE TO EDGE UNLESS OTHERWISE NOTED.
6. ALL DIMENSIONS ARE TO SURFACE UNLESS OTHERWISE NOTED.
7. ALL DIMENSIONS ARE TO CENTERLINE OF ROAD UNLESS OTHERWISE NOTED.
8. ALL DIMENSIONS ARE TO CENTERLINE OF RAILROAD UNLESS OTHERWISE NOTED.
9. ALL DIMENSIONS ARE TO CENTERLINE OF CANAL UNLESS OTHERWISE NOTED.
10. ALL DIMENSIONS ARE TO CENTERLINE OF DITCH UNLESS OTHERWISE NOTED.
11. ALL DIMENSIONS ARE TO CENTERLINE OF TRENCH UNLESS OTHERWISE NOTED.
12. ALL DIMENSIONS ARE TO CENTERLINE OF CUT UNLESS OTHERWISE NOTED.
13. ALL DIMENSIONS ARE TO CENTERLINE OF FILL UNLESS OTHERWISE NOTED.
14. ALL DIMENSIONS ARE TO CENTERLINE OF EMBANKMENT UNLESS OTHERWISE NOTED.
15. ALL DIMENSIONS ARE TO CENTERLINE OF DRAINAGE CHANNEL UNLESS OTHERWISE NOTED.
16. ALL DIMENSIONS ARE TO CENTERLINE OF DRAINAGE DITCH UNLESS OTHERWISE NOTED.
17. ALL DIMENSIONS ARE TO CENTERLINE OF DRAINAGE TRENCH UNLESS OTHERWISE NOTED.
18. ALL DIMENSIONS ARE TO CENTERLINE OF DRAINAGE CUT UNLESS OTHERWISE NOTED.
19. ALL DIMENSIONS ARE TO CENTERLINE OF DRAINAGE FILL UNLESS OTHERWISE NOTED.
20. ALL DIMENSIONS ARE TO CENTERLINE OF DRAINAGE EMBANKMENT UNLESS OTHERWISE NOTED.
21. ALL DIMENSIONS ARE TO CENTERLINE OF DRAINAGE CHANNEL UNLESS OTHERWISE NOTED.
22. ALL DIMENSIONS ARE TO CENTERLINE OF DRAINAGE DITCH UNLESS OTHERWISE NOTED.
23. ALL DIMENSIONS ARE TO CENTERLINE OF DRAINAGE TRENCH UNLESS OTHERWISE NOTED.
24. ALL DIMENSIONS ARE TO CENTERLINE OF DRAINAGE CUT UNLESS OTHERWISE NOTED.
25. ALL DIMENSIONS ARE TO CENTERLINE OF DRAINAGE FILL UNLESS OTHERWISE NOTED.
26. ALL DIMENSIONS ARE TO CENTERLINE OF DRAINAGE EMBANKMENT UNLESS OTHERWISE NOTED.
27. ALL DIMENSIONS ARE TO CENTERLINE OF DRAINAGE CHANNEL UNLESS OTHERWISE NOTED.
28. ALL DIMENSIONS ARE TO CENTERLINE OF DRAINAGE DITCH UNLESS OTHERWISE NOTED.
29. ALL DIMENSIONS ARE TO CENTERLINE OF DRAINAGE TRENCH UNLESS OTHERWISE NOTED.
30. ALL DIMENSIONS ARE TO CENTERLINE OF DRAINAGE CUT UNLESS OTHERWISE NOTED.
31. ALL DIMENSIONS ARE TO CENTERLINE OF DRAINAGE FILL UNLESS OTHERWISE NOTED.
32. ALL DIMENSIONS ARE TO CENTERLINE OF DRAINAGE EMBANKMENT UNLESS OTHERWISE NOTED.
33. ALL DIMENSIONS ARE TO CENTERLINE OF DRAINAGE CHANNEL UNLESS OTHERWISE NOTED.
34. ALL DIMENSIONS ARE TO CENTERLINE OF DRAINAGE DITCH UNLESS OTHERWISE NOTED.
35. ALL DIMENSIONS ARE TO CENTERLINE OF DRAINAGE TRENCH UNLESS OTHERWISE NOTED.
36. ALL DIMENSIONS ARE TO CENTERLINE OF DRAINAGE CUT UNLESS OTHERWISE NOTED.
37. ALL DIMENSIONS ARE TO CENTERLINE OF DRAINAGE FILL UNLESS OTHERWISE NOTED.
38. ALL DIMENSIONS ARE TO CENTERLINE OF DRAINAGE EMBANKMENT UNLESS OTHERWISE NOTED.
39. ALL DIMENSIONS ARE TO CENTERLINE OF DRAINAGE CHANNEL UNLESS OTHERWISE NOTED.
40. ALL DIMENSIONS ARE TO CENTERLINE OF DRAINAGE DITCH UNLESS OTHERWISE NOTED.
41. ALL DIMENSIONS ARE TO CENTERLINE OF DRAINAGE TRENCH UNLESS OTHERWISE NOTED.
42. ALL DIMENSIONS ARE TO CENTERLINE OF DRAINAGE CUT UNLESS OTHERWISE NOTED.
43. ALL DIMENSIONS ARE TO CENTERLINE OF DRAINAGE FILL UNLESS OTHERWISE NOTED.
44. ALL DIMENSIONS ARE TO CENTERLINE OF DRAINAGE EMBANKMENT UNLESS OTHERWISE NOTED.
45. ALL DIMENSIONS ARE TO CENTERLINE OF DRAINAGE CHANNEL UNLESS OTHERWISE NOTED.
46. ALL DIMENSIONS ARE TO CENTERLINE OF DRAINAGE DITCH UNLESS OTHERWISE NOTED.
47. ALL DIMENSIONS ARE TO CENTERLINE OF DRAINAGE TRENCH UNLESS OTHERWISE NOTED.
48. ALL DIMENSIONS ARE TO CENTERLINE OF DRAINAGE CUT UNLESS OTHERWISE NOTED.
49. ALL DIMENSIONS ARE TO CENTERLINE OF DRAINAGE FILL UNLESS OTHERWISE NOTED.
50. ALL DIMENSIONS ARE TO CENTERLINE OF DRAINAGE EMBANKMENT UNLESS OTHERWISE NOTED.

APPROVED: [Signature]
REFUSED: [Signature]
THIS IS A DAY OF September, 2021
ERIN O'CONNELL, M.C.P., R.P., P.M., M.A.S.T.P.
DEVELOPMENT REVIEW WEST
PLANNING DEPARTMENT CITY OF OTTAWA

PROJECT NO.: 0440191
DRAWING NO.: SD-1
SHEET: 6 OF 8
PLAN: 18203

CLIENT: 2510 WELLINGS PRIVATE
SHEMULE ON
STORM DRAINAGE PLAN

SCALE: 1:500
DATE: 09/08/2021

PROJECT: 2510 WELLINGS PRIVATE
SHEMULE ON
STORM DRAINAGE PLAN

DATE: 09/08/2021

PROJECT: 2510 WELLINGS PRIVATE
SHEMULE ON
STORM DRAINAGE PLAN

DATE: 09/08/2021

PROJECT: 2510 WELLINGS PRIVATE
SHEMULE ON
STORM DRAINAGE PLAN

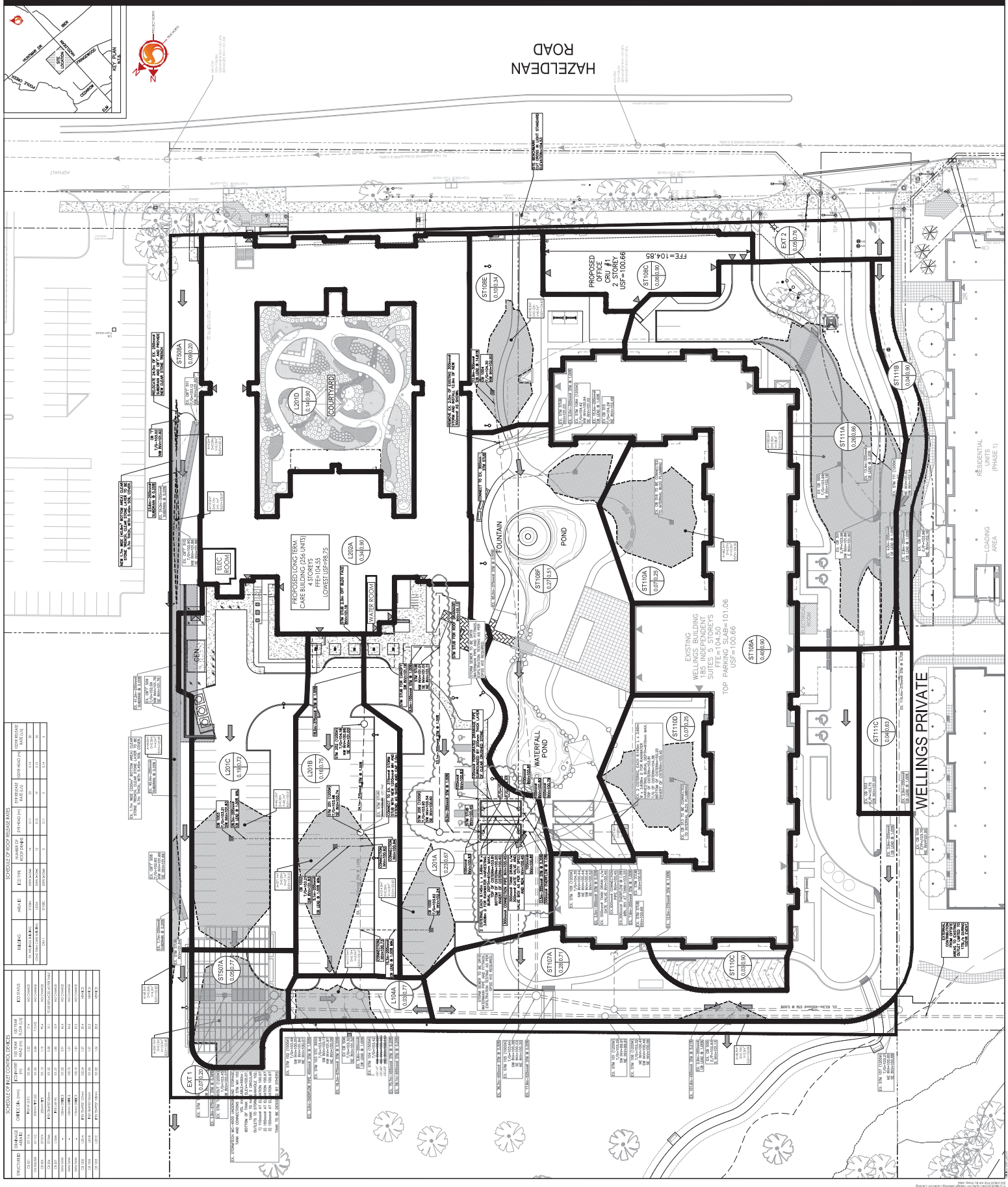

SCHEDULE OF ROOF RELEASE RATES

MEMBER	AREA	ROOF TYPE	HYETRAIN	ROOF AREA	HYETRAIN	RELEASE RATE
1	1000	ASPH/FLT	100	1000	100	100
2	2000	ASPH/FLT	200	2000	200	200
3	3000	ASPH/FLT	300	3000	300	300
4	4000	ASPH/FLT	400	4000	400	400
5	5000	ASPH/FLT	500	5000	500	500
6	6000	ASPH/FLT	600	6000	600	600
7	7000	ASPH/FLT	700	7000	700	700
8	8000	ASPH/FLT	800	8000	800	800
9	9000	ASPH/FLT	900	9000	900	900
10	10000	ASPH/FLT	1000	10000	1000	1000

SCHEDULE OF NET COVER RELEASES

MEMBER	AREA	NET COVER	RELEASE RATE
1	1000	1000	1000
2	2000	2000	2000
3	3000	3000	3000
4	4000	4000	4000
5	5000	5000	5000
6	6000	6000	6000
7	7000	7000	7000
8	8000	8000	8000
9	9000	9000	9000
10	10000	10000	10000