

1184-1196 Cummings Avenue Transportation Impact Assessment

Step 1 Screening Report

Step 2 Scoping Report

Step 3 Forecasting Report

Step 4 Strategy Report (Rev #1)

Prepared for:

TCU Development Corp.
1207-150 Isabella St.
Ottawa ON, K1S 5H3

Prepared by:



6 Plaza Court
Ottawa, ON K2H 7W1

September 2023

PN: 2022-168

Table of Contents

1	Screening.....	1
2	Existing and Planned Conditions.....	1
2.1	Proposed Development.....	1
2.2	Existing Conditions.....	3
2.2.1	Area Road Network.....	3
2.2.2	Existing Intersections.....	3
2.2.3	Existing Driveways.....	4
2.2.4	Cycling and Pedestrian Facilities.....	4
2.2.5	Existing Transit.....	7
2.2.6	Existing Area Traffic Management Measures.....	8
2.2.7	Existing Peak Hour Travel Demand.....	8
2.2.8	Collision Analysis.....	10
2.3	Planned Conditions.....	13
2.3.1	Changes to the Area Transportation Network.....	13
2.3.2	Other Study Area Developments.....	15
3	Study Area and Time Periods.....	15
3.1	Study Area.....	15
3.2	Time Periods.....	16
3.3	Horizon Years.....	16
4	Exemption Review.....	16
4.1	TIA Stepped Process.....	16
5	Development-Generated Travel Demand.....	16
5.1	Mode Shares.....	16
5.2	Trip Generation.....	17
5.3	Trip Distribution.....	18
5.4	Trip Assignment.....	18
6	Background Network Travel Demands.....	19
6.1	Transportation Network Plans.....	19
6.2	Background Growth.....	19
6.3	Other Developments.....	20
7	Demand Rationalization.....	21
7.1	2026 Future Background Operations.....	21
7.2	2031 Future Background Operations.....	23
7.3	2026 Future Total Operations.....	25
7.4	2031 Future Total Operations.....	27
7.5	Modal Share Sensitivity and Demand Rationalization Conclusions.....	29
8	Development Design.....	29
8.1	Design for Sustainable Modes.....	29
8.2	Circulation and Access.....	29
9	Parking.....	30
9.1	Parking Supply.....	30
10	Boundary Street Design.....	30

11 Access Intersections Design 31

 11.1 Location and Design of Access..... 31

 11.2 Intersection Control..... 31

 11.3 Access Intersection Design 31

 11.3.1 Future Access Intersection Operations 31

 11.3.2 Access Intersection MMLOS 31

 11.3.3 Recommended Design Elements..... 31

12 Transportation Demand Management 32

 12.1 Context for TDM 32

 12.2 Need and Opportunity..... 32

 12.3 TDM Program 32

13 Transit..... 32

 13.1 Route Capacity..... 32

 13.2 Transit Priority 33

14 Network Intersection Design..... 33

 14.1 Network Intersection Control..... 33

 14.2 Network Intersection Design..... 33

 14.2.1 2026 & 2031 Future Total Network Intersection Operations 33

 14.2.2 Network Intersection MMLOS..... 33

 14.2.3 Recommended Design Elements..... 34

15 Summary of Improvements Indicated and Modifications Options..... 34

16 Conclusion 37

List of Figures

Figure 1: Area Context Plan1

Figure 2: Concept Plan.....2

Figure 3: Existing Driveways4

Figure 4: Study Area Pedestrian Facilities5

Figure 5: Study Area Cycling Facilities5

Figure 6: Existing Pedestrian Volumes6

Figure 7: Existing Cyclist Volumes6

Figure 8: Existing Study Area Transit Service.....7

Figure 9: Existing Study Area Transit Stations and stops8

Figure 10: Existing Traffic Counts9

Figure 11: Study Area Collision Records..... 11

Figure 12: Cyrville TOD Pedestrian Network 13

Figure 13: Cyrville TOD Bicycle Network 14

Figure 14: Draft Transportation Master Plan (2024)..... 14

Figure 15: New Site Generation Auto Volumes..... 19

Figure 16: Background Development Volumes..... 21

Figure 17: 2026 Future Background Volumes 22

Figure 18: 2031 Future Background Volumes 24

Figure 19: 2026 Future Total Volumes 26

Figure 20: 2031 Future Total Volumes 28

Table of Tables

Table 1: Intersection Count Date.....8
 Table 2: Existing Intersection Operations.....9
 Table 3: Study Area Collision Summary, 2016-2020 10
 Table 4: Summary of Collision Locations, 2016-2020..... 11
 Table 5: Cummings Avenue at Ogilvie Road Collision Summary 12
 Table 6: Cummings Avenue at Donald Street Collision Summary 12
 Table 7: Exemption Review 16
 Table 8: TRANS Trip Generation Manual Recommended Mode Shares – Ottawa East..... 17
 Table 9: Proposed Development Mode Shares 17
 Table 10: Trip Generation Person Trip Rates 17
 Table 11: Total Person Trip Generation 17
 Table 12: Trip Generation by Mode 18
 Table 13: OD Survey Distribution – Ottawa East..... 18
 Table 14: Trip Assignment 18
 Table 15: TRANS Regional Model Projections – Study Area Growth Rates..... 20
 Table 16: Recommended Area Growth Rates 20
 Table 17: 2026 Future Background Intersection Operations 22
 Table 18: 2031 Future Background Intersection Operations 24
 Table 19: 2026 Future Total Intersection Operations 26
 Table 20: 2031 Future Total Intersection Operations 28
 Table 21: Boundary Street MMLOS Analysis 30
 Table 22: Trip Generation by Transit Mode 32
 Table 23: Forecasted Site-Generated Transit Ridership..... 32
 Table 24: Study Area Intersection MMLOS Analysis 33

List of Appendices

Appendix A – TIA Screening Form and Certification Form
 Appendix B – Turning Movement Count Data
 Appendix C – Synchro Intersection Worksheets – Existing Conditions
 Appendix D – Collision Data
 Appendix E – TRANS Plot
 Appendix F – Background Volumes
 Appendix G – Synchro Intersection Worksheets – 2026 Future Background Conditions
 Appendix H – Synchro Intersection Worksheets – 2031 Future Background Conditions
 Appendix I – Synchro Intersection Worksheets – 2026 Future Total Conditions
 Appendix J – Synchro Intersection Worksheets – 2031 Future Total Conditions
 Appendix K – TDM Checklist
 Appendix L – Turning Templates
 Appendix M – MMLOS Analysis

2.2 Existing Conditions

2.2.1 Area Road Network

Cummings Avenue: Cummings Avenue is a major collector road between Ogilvie Road and Donald Street, and north of Donald Street is a collector road, each with a two-lane urban cross-section. South of Ogilvie Road, Cummings Avenue is a City of Ottawa arterial road with a two-lane semi-urban cross section, curbed on its east side. North of Ogilvie Road, sidewalks are present on both sides of the road and south of Ogilvie Road, a sidewalk is present on the east side of the road and a 1.5-metre-wide gravel shoulder is on the west side. The posted speed limit is 50 km/h and the City-protected right of way is 26.0 metres between Ogilvie Road and Donald Street, 24.0 metres north of Donald Street, and 37.5 metres south of Ogilvie Road. Cummings Avenue south of Donald Street is a truck route.

Ogilvie Road: Ogilvie Road is a City of Ottawa arterial road with a four-lane, divided urban cross-section with curbside bike lanes and sidewalks on both sides of the road. The posted speed limit is 60 km/h and the City-protected right of way is 44.5 metres within the study area. Ogilvie Road is a truck route.

Cyrville Road: Cyrville Road is a City of Ottawa two-lane roadway, classified as an arterial south of Cummings Avenue/Labelle Street and a collector road to the north. Between St. Laurent Boulevard and Ogilvie Road, the cross-section includes a curb with a sidewalk on the east side and is uncurbed on the west side. Between Ogilvie Road and Cummings Avenue/Labelle Street, the cross-section is fully urban and includes a sidewalk and curb-side bike lane on each side of the road. South of Cummings Avenue/Labelle Street, the cross-section transitions to an uncurbed condition and includes a paved shoulder and sidewalk on the west side of the road and a mixed-use path on the east side of the road separated by a concrete rumble strip. The posted speed limit is 60 km/h. The City-protected right of way is 37.5 metres south of Cummings Avenue/Labelle Street and the existing right of way varies between 18.0 metres and 23.0 metres within the study area. Cyrville Road is a truck route.

Donald Street: Donald Street is a City of Ottawa major collector road with a two-lane urban cross-section, with sidewalks and curbside bike lanes on both sides of the road between Belgate Way and Alesther Street. The posted speed limit is 50 km/h and the existing right of way is 26.0 metres. Donald Street is a truck route within the study area.

2.2.2 Existing Intersections

The existing signalized area key intersections within 400 metres of the site have been summarized below:

Ogilvie Road at Cummings Avenue

The intersection of Ogilvie Road at Cummings Avenue is a signalized intersection. The northbound approach consists of an auxiliary left-turn lane and a shared through/channelized right-turn lane, and the southbound approach consists of an auxiliary left-turn lane and a shared through/right-turn lane. The eastbound and westbound approaches each consist of an auxiliary left-turn lane, a through lane, a shared through/right-turn lane, and a bike lane. No turn restrictions were noted.

Donald Street at Cummings Avenue

The intersection of Donald Street at Cummings Avenue is a signalized intersection. The northbound approach consists of an auxiliary left-turn lane and a through lane, and the southbound approach consists of a shared through/right-turn lane. The eastbound approach consists of an auxiliary left-turn lane, and a right-turn lane. No turn restrictions were noted.

Ogilvie Road at Cyrville Road

The intersection of Ogilvie Road at Cyrville Road is a signalized intersection. The northbound approach of Cyrville Road consists of an auxiliary left-turn lane, a shared through/right-turn lane, and a bike lane and the southbound consists of an auxiliary left-turn lane and a shared through/channelized right-turn lane. The eastbound approach consists of two through lanes, a bike lane, and an auxiliary right-turn lane and the westbound approach consists of an auxiliary left-turn lane, two through lanes, a bike lane, and an auxiliary right-turn lane. Eastbound left turns are restricted at this intersection.

2.2.3 Existing Driveways

Within 200 metres of the site accesses, driveways to gas stations, restaurant land uses, attached and detached residential land uses, a vacant lot, and a mid-rise residential land use exist on Cummings Avenue. Driveways to gas stations, a vacant lot, a community center, retail plazas, restaurant land uses, and a park exist on Ogilvie Road. Figure 3 illustrates the existing driveways.

Figure 3: Existing Driveways

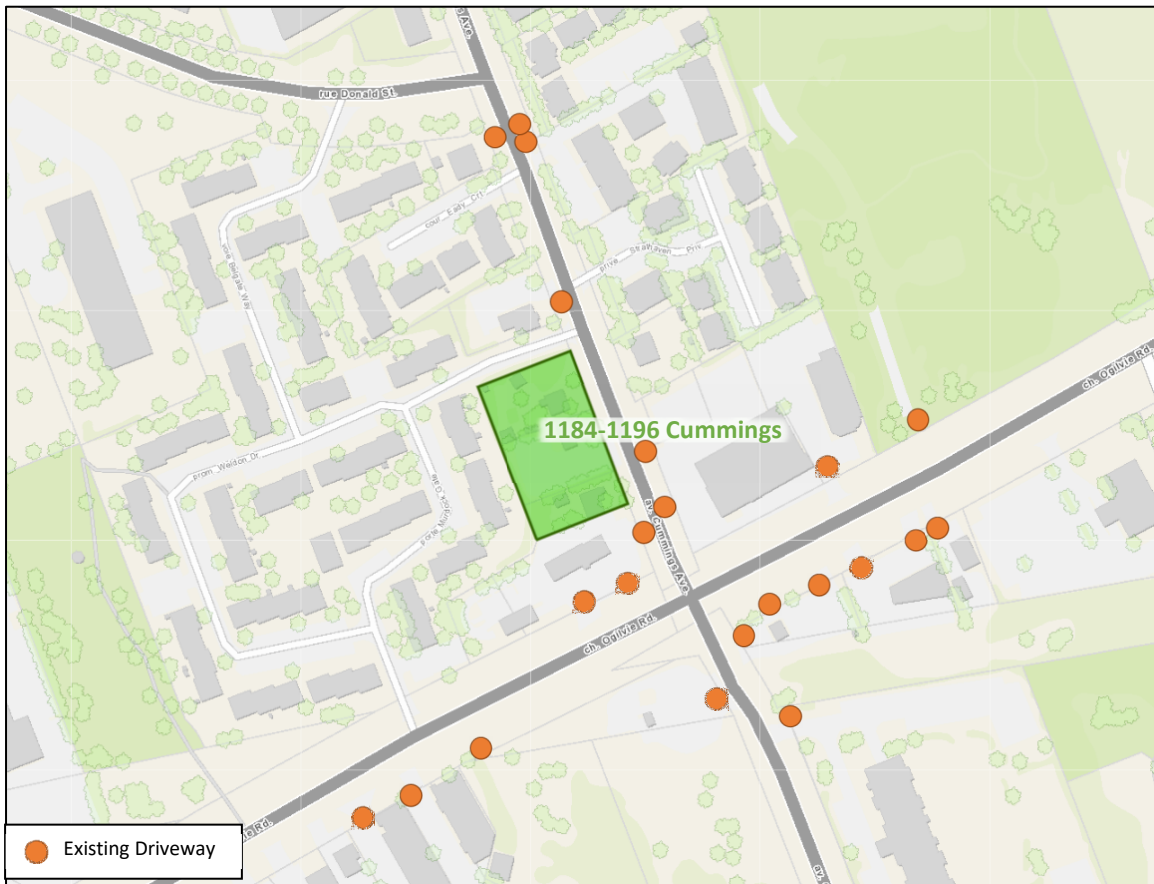

Source: <http://maps.ottawa.ca/geoOttawa/> Accessed: March 3, 2023

2.2.4 Cycling and Pedestrian Facilities

Figure 4 illustrates the pedestrian facilities in the study area and Figure 5 illustrates the cycling Facilities in the study area.

Sidewalks are provided along the east side of Cummings Avenue south of Ogilvie Road and both sides of Cyrville Road, Ogilvie Road, Donald Street, and Cummings Avenue north of Ogilvie Road.

Cycling facilities include bike lanes along Cyrville Road south of Ogilvie Road, Ogilvie Road, and Donald Street. Within the ultimate cycling network, Ogilvie Road and Cyrville Road are spine routes and Donald Street and Cummings Avenue are local routes. Cyrville Road south of Ogilvie Road and Ogilvie Road west of Cyrville Road form part of a crosstown bikeway.

Figure 4: Study Area Pedestrian Facilities

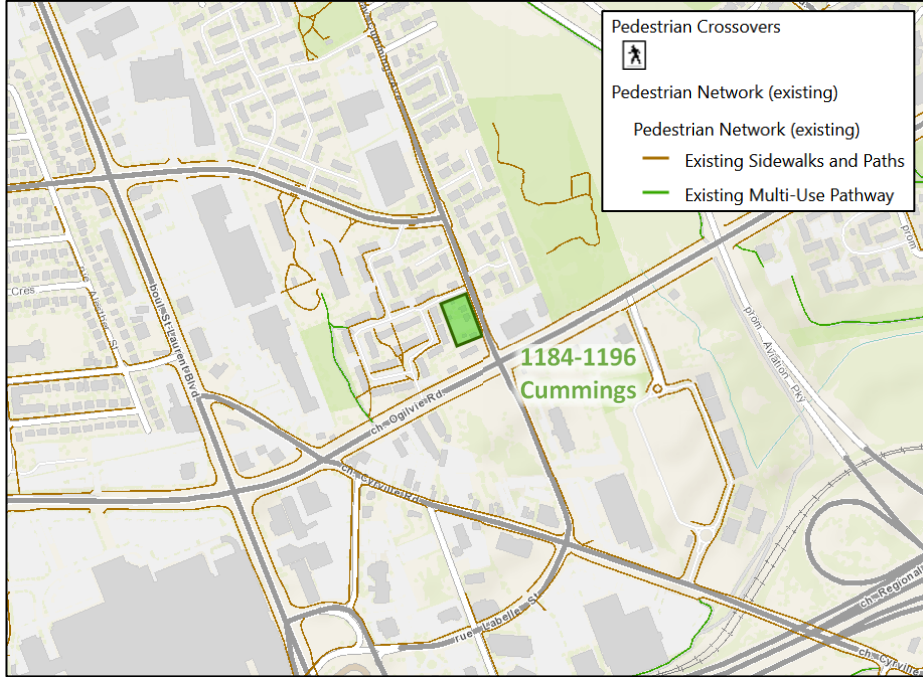

Source: <http://maps.ottawa.ca/geoOttawa/> Accessed: March 3, 2023

Figure 5: Study Area Cycling Facilities

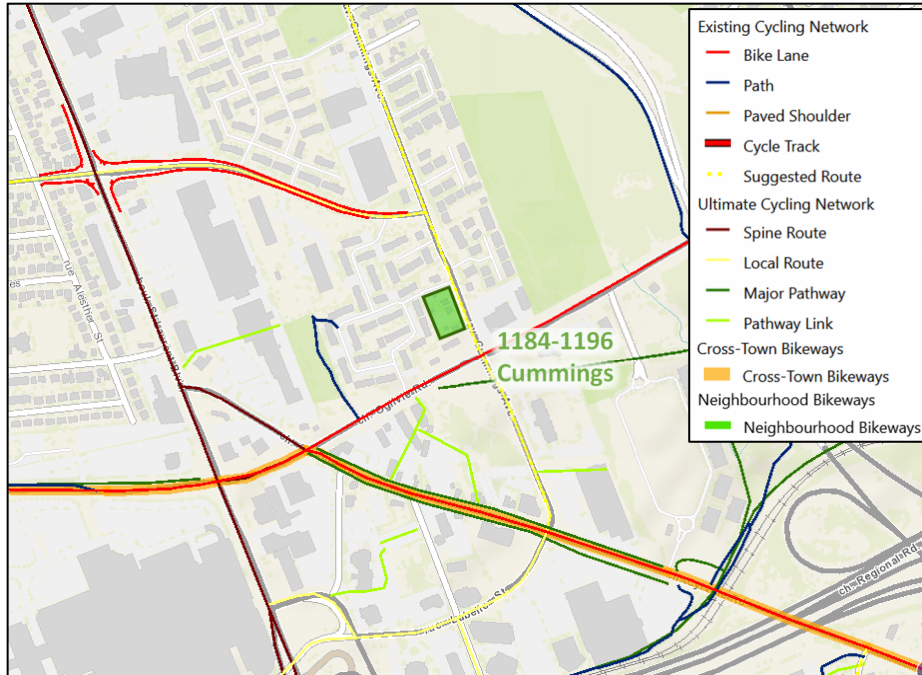

Source: <http://maps.ottawa.ca/geoOttawa/> Accessed: March 3, 2023

Pedestrian and cyclist volumes included in study area intersection counts, presented in Section 2.2.7, have been compiled and are illustrated in Figure 6 and Figure 7, respectively.

Figure 6: Existing Pedestrian Volumes

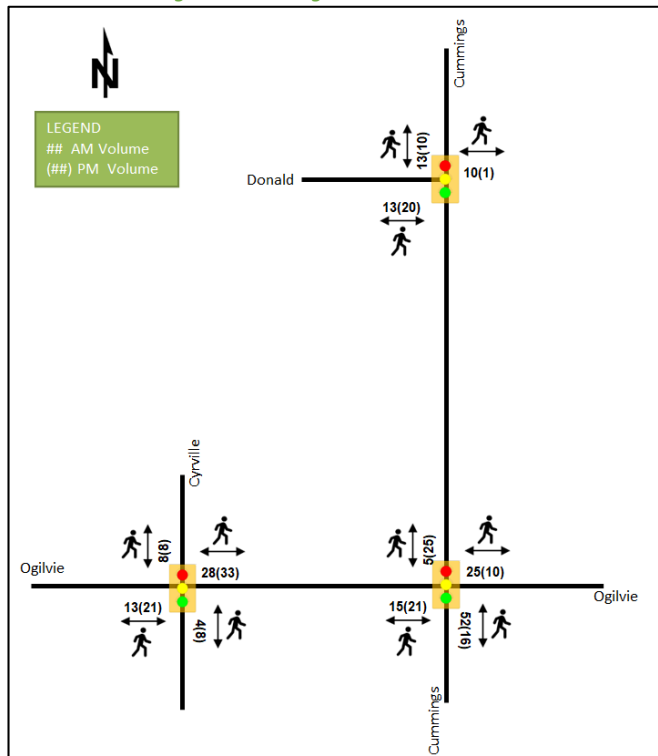
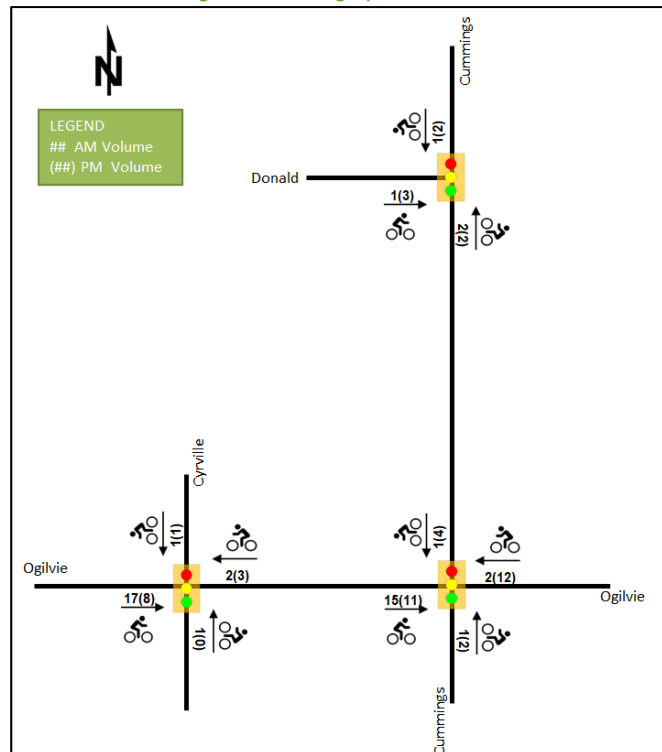

Figure 7: Existing Cyclist Volumes



2.2.5 Existing Transit

Figure 8 illustrates the transit system map in the study area and Figure 9 illustrates nearby transit stations and stops. All transit information is from March 3, 2023 and is included for general information purposes and context to the surrounding area.

Within the study area, routes #24 and #N39 travel along Ogilvie Road and routes #20 and #27 travel along Donald Street and Cummings Avenue to the north. The frequency of these routes within proximity of the proposed site based on March 3, 2023 service levels are:

- Route #20 – 30-minute service all day
- Route #24 – 15-minute service during peak hours, 30-minute service all day
- Route #27 – nine buses in each peak direction/period
- Route #N39 – seven-to-eight overnight buses per direction when the O-Train Line 1 does not run overnight

Additionally, the site is approximately one kilometre walking distance to Cyrville Station, on the Confederation LRT Line.

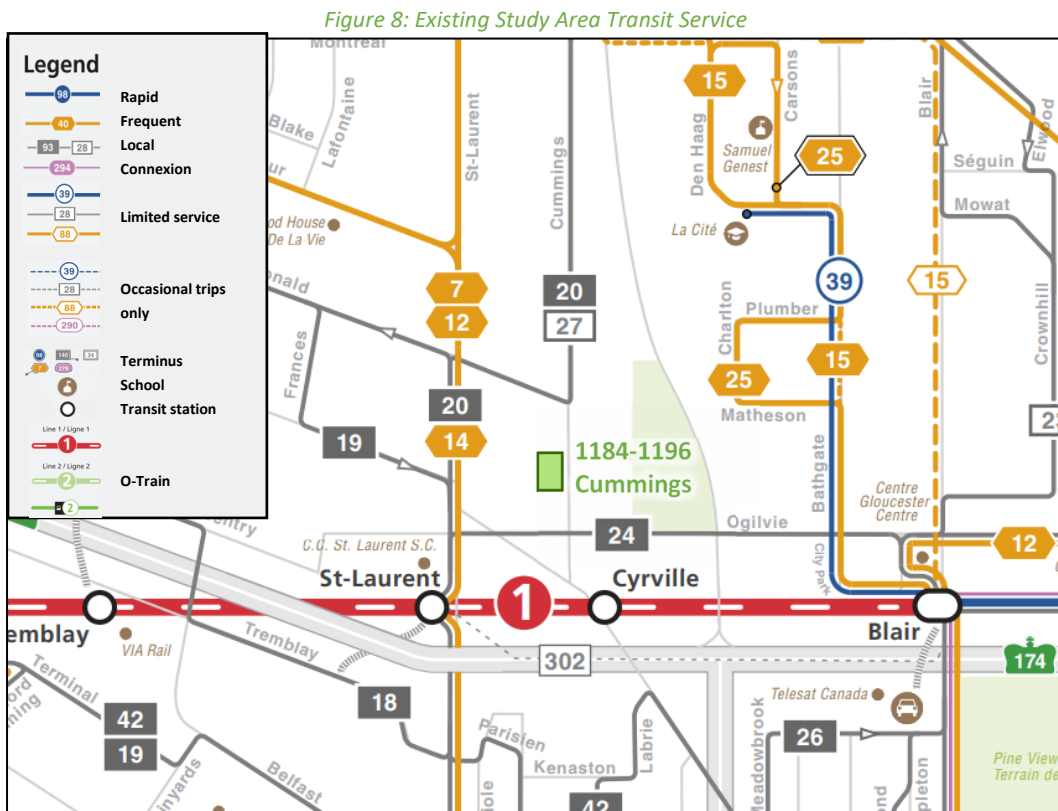

Source: <http://www.octranspo.com/> Accessed: March 3, 2023

Figure 9: Existing Study Area Transit Stations and stops



Source: <http://maps.ottawa.ca/geoOttawa/> Accessed: March 3, 2023

2.2.6 Existing Area Traffic Management Measures

There are no existing area traffic management measures within the study area.

2.2.7 Existing Peak Hour Travel Demand

Existing turning movement counts were acquired from the City of Ottawa for the existing study area key intersections. Table 1 summarizes the intersection count dates.

Table 1: Intersection Count Date

Intersection	Count Date
Ogilvie Road at Cyrville Road	Wednesday, April 11, 2018
Donald Street at Cummings Avenue	Wednesday, April 11, 2018
Ogilvie Road at Cummings Avenue	Wednesday, April 11, 2018

Figure 10 illustrates the existing traffic counts and Table 2 summarizes the existing intersection operations. The level of service for signalized intersections is based on volume to capacity ratio (v/c) calculations for individual lane movements and HCM 2000 v/c calculations for the overall intersection. Detailed turning movement count data is included in Appendix B and the Synchro worksheets are provided in Appendix C.

Figure 10: Existing Traffic Counts

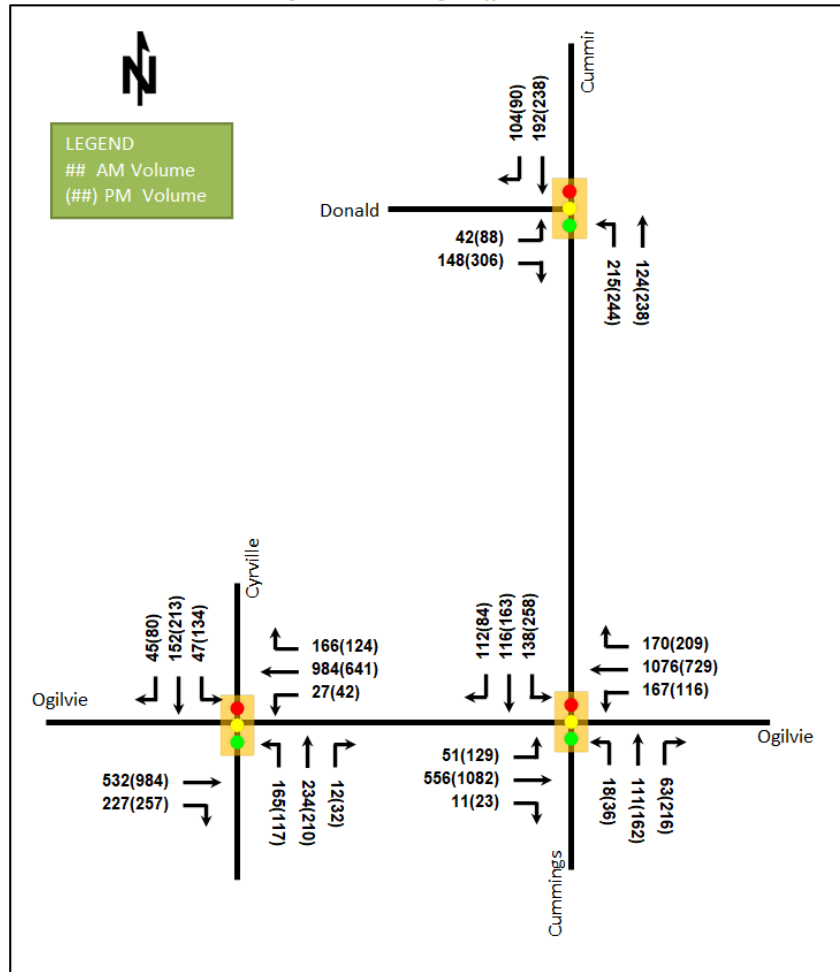

Table 2: Existing Intersection Operations

Intersection	Lane	AM Peak Hour				PM Peak Hour			
		LOS	V/C	Delay (s)	Q (95 th)	LOS	V/C	Delay (s)	Q (95 th)
Ogilvie Road at Cyrville Road <i>Signalized</i>	EBT	A	0.28	10.7	49.3	A	0.51	13.3	105.7
	EBR	A	0.27	2.2	11.3	A	0.29	2.2	11.7
	WBL	A	0.07	3.3	m0.9	A	0.20	22.6	m8.5
	WBT	A	0.51	3.5	14.7	A	0.33	18.8	m61.7
	WBR	A	0.20	0.3	m0.0	A	0.15	9.7	m11.3
	NBL	E	0.92	88.3	#65.1	F	1.05	138.2	#60.9
	NBT	B	0.65	46.8	75.8	B	0.65	46.0	73.6
	SBL	A	0.31	38.9	19.4	D	0.87	84.5	54.2
	SBT	A	0.55	40.9	59.0	C	0.80	54.1	89.9
Overall	B	0.62	17.6	-	B	0.66	29.1	-	
Donald Street at Cummings Avenue <i>Signalized</i>	EBL	A	0.12	14.8	11.0	A	0.25	17.3	19.4
	EBR	A	0.35	5.8	12.0	A	0.57	6.9	16.9
	NBL	A	0.57	15.5	31.8	B	0.67	18.8	38.4
	NBT	A	0.19	8.3	14.6	A	0.36	9.4	27.0
	SBT/R	A	0.45	8.9	29.3	A	0.50	10.2	35.9
	Overall	A	0.39	10.3	-	A	0.50	11.5	-

Intersection	Lane	AM Peak Hour				PM Peak Hour			
		LOS	V/C	Delay (s)	Q (95 th)	LOS	V/C	Delay (s)	Q (95 th)
Ogilvie Road at Cummings Avenue <i>Signalized</i>	EBL	A	0.37	30.2	20.5	C	0.73	49.5	#46.2
	EBT	A	0.39	18.2	50.6	F	1.06	76.8	#221.4
	WBL	A	0.48	18.4	33.1	B	0.69	42.3	#40.4
	WBT	D	0.84	33.2	#207.0	E	0.93	52.2	#170.7
	NBL	A	0.09	35.8	10.1	A	0.15	34.7	16.2
	NBT	A	0.56	41.8	57.2	E	0.93	66.1	#141.1
	SBL	A	0.52	35.3	41.4	E	0.94	65.4	#95.6
	SBT	A	0.48	29.3	60.8	A	0.38	22.2	58.4
Overall	C	0.75	29.3	-	F	1.01	60.4	-	

Notes: Saturation flow rate of 1800 veh/h/lane
 Queue is measured in metres
 Peak Hour Factor = 0.90
 Delay = average vehicle delay in seconds
 m = metered queue
 # = volume for the 95th %ile cycle exceeds capacity

During the PM peak hour, the study area intersections experience capacity issues on the northbound left at the intersections of Ogilvie Road at Cyrville Road and on the eastbound through at Ogilvie Road at Cummings Avenue.

At the intersection of Ogilvie Road and Cyrville Road, the northbound left-turn movement may be subject to high delays and extended queues during both peak hours, where during the PM peak hour this movement is over theoretical capacity, and the southbound left-turn movement may be subject to high delays.

The Ogilvie Road at Cummings Avenue intersection may be subject to extended queues on the westbound through movement during the AM peak hour and eastbound left, eastbound through, westbound left, westbound through, northbound through, and southbound left-turn movements during the PM peak hour. The overall intersection and the eastbound through movement are additionally over theoretical capacity where the eastbound through movement may also be subject to high delays during the PM peak hour.

2.2.8 Collision Analysis

Collision data have been acquired from the City of Ottawa open data website (data.ottawa.ca) for five years prior to the commencement of this TIA for the surrounding study area road network. Table 3 summarizes the collision types and conditions in the study area, Figure 11 illustrates the intersections and segments analyzed, and Table 4 summarizes the total collisions for each of these locations. Collision data are included in Appendix D.

Table 3: Study Area Collision Summary, 2016-2020

		Number	%
Total Collisions		110	100%
Classification	Fatality	0	0%
	Non-Fatal Injury	23	21%
	Property Damage Only	87	79%
Initial Impact Type	Angle	24	22%
	Rear end	34	31%
	Sideswipe	16	15%
	Turning Movement	29	26%
	SMV Other	5	4%
	Other	2	2%
Road Surface Condition	Dry	71	65%
	Wet	17	15%
	Loose Snow	6	5%
	Slush	2	2%
	Packed Snow	4	4%

		Number	%
Total Collisions		110	100%
	Ice	10	9%
Pedestrian Involved		2	2%
Cyclists Involved		6	5%

Figure 11: Study Area Collision Records



Table 4: Summary of Collision Locations, 2016-2020

Intersections / Segments	Number	%
Cummings Ave @ Ogilvie Rd	57	52%
Cummings Ave @ Donald St	17	15%
Cummings Ave btwn Weldon Dr & Ogilvie Rd	11	10%
Ogilvie Rd btwn Murdock Gt & Cummings Ave	10	9%
Ogilvie Rd btwn Cummings Ave & Beaulieu Pl	9	8%
Cummings Ave btwn Eady Cr & Strathaven Priv	4	4%
Cummings Ave btwn Donald St & Eady Cr	2	2%

Within the study area, the intersection of Cummings Avenue at Ogilvie Road and Cummings Avenue at Donald Street are noted to have experienced higher collisions than other locations. Table 5 and Table 6 summarize the collision types and conditions for each location.

Table 5: Cummings Avenue at Ogilvie Road Collision Summary

		Number	%
Total Collisions		57	100%
Classification	Fatality	0	0%
	Non-Fatal Injury	11	19%
	Property Damage Only	46	81%
Initial Impact Type	Angle	5	9%
	Rear end	23	40%
	Sideswipe	8	14%
	Turning Movement	18	32%
	SMV Other	1	2%
	Other	2	4%
Road Surface Condition	Dry	36	63%
	Wet	6	11%
	Loose Snow	5	9%
	Packed Snow	3	5%
	Ice	7	12%
Pedestrian Involved		1	2%
Cyclists Involved		4	7%

The Ogilvie Road at Cummings Avenue intersection had a total of 57 collisions during the 2016-2020 time period, with 46 involving property damage only and the remaining eleven having non-fatal injuries. The collision types are most represented by rear end with 23 collisions, followed by turning movement with 18, sideswipe with eight, angle with five, other with two and SMV (other) with one.

The City’s Cycling Safety Review of High-Volume Intersections (March 2020) completed a review of this intersection for pedestrian and cycling-related observations and movements. The report suggests improvements such as the removal of the northbound right-turn channel, the addition of a westbound right-turn lane, signal phasing changes, and ultimately a protected intersection configuration, which may help address a variety of collisions noted at this intersection. This report does not recommend any additional changes to those planned by the City. No further examination is required as part of this study.

Table 6: Cummings Avenue at Donald Street Collision Summary

		Number	%
Total Collisions		17	100%
Classification	Fatality	0	0%
	Non-Fatal Injury	4	24%
	Property Damage Only	13	76%
Initial Impact Type	Angle	3	18%
	Rear end	7	41%
	Sideswipe	1	6%
	Turning Movement	4	24%
	SMV Other	2	12%
Road Surface Condition	Dry	12	71%
	Wet	1	6%
	Loose Snow	1	6%
	Ice	3	18%
Pedestrian Involved		1	6%
Cyclists Involved		0	0%

The Cummings Avenue at Donald Street intersection had a total of 17 collisions during the 2016-2020 time period, with 13 involving property damage only and the remaining four having non-fatal injuries. The collision types are most represented by rear end with seven collisions, followed by turning movement with four, turning angle with three, SMV other with two, and sideswipe with one. The collision rates have been generally consistent through the years with 2017 and 2018 peaking with five and four collisions respectively. Weather conditions do not affect collisions at this location. No further examination is required as part of this study.

2.3 Planned Conditions

2.3.1 Changes to the Area Transportation Network

2.3.1.1 New Official Plan (2021)

Within the Transit and Network Ultimate diagram, transit priority corridor is identified along Ogilvie Road.

2.3.1.2 Cyrville TOD Plan area

The Cyrville TOD plan outlines a future sidewalk on the west side of Cummings Avenue south of Ogilvie Road and future shared-use lanes along Cummings Avenue. Figure 12 and Figure 13 illustrate the Cyrville pedestrian and cycling TOD plans.

Figure 12: Cyrville TOD Pedestrian Network

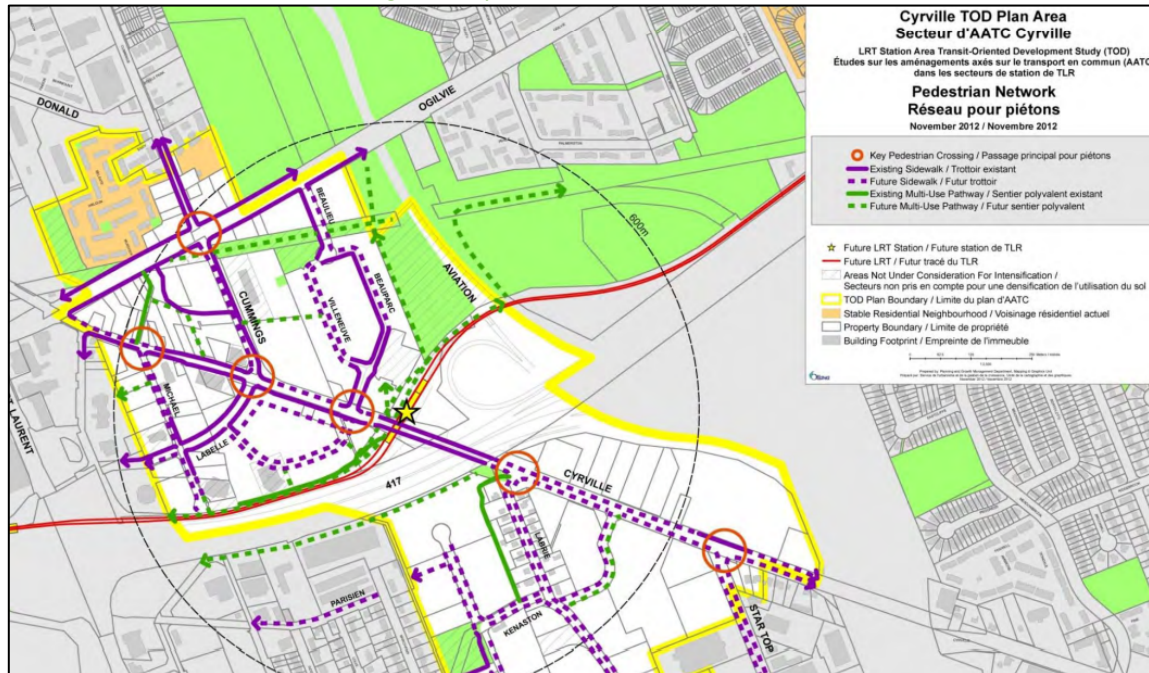

Source: <https://ottawa.ca/en/transit-oriented-development-tod-plans> Accessed: March 3, 2023

Figure 13: Cyrville TOD Bicycle Network

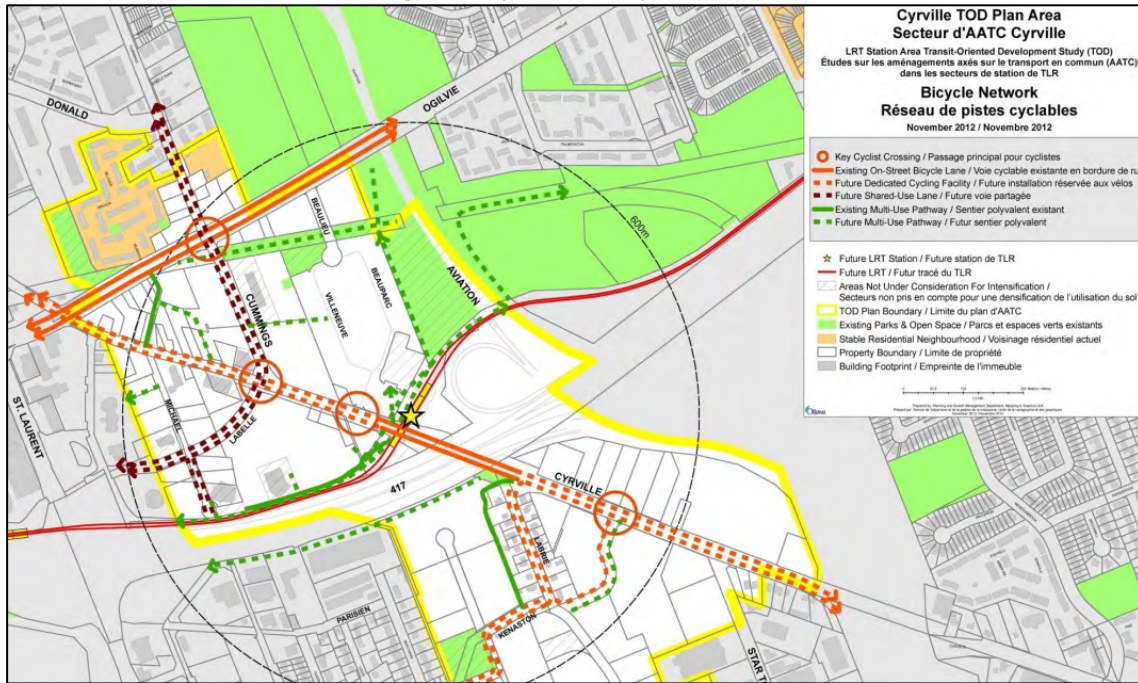

Source: <https://ottawa.ca/en/transit-oriented-development-tod-plans> Accessed: March 3, 2023

2.3.1.3 Draft Transportation Master Plan (2024)

In the Active Transportation project List (April 2022), cycling facilities are identified along Cummings Avenue between Donald Street and Cyrville Road. Based on the Cyrville TOD Plan area, it is assumed that this cycling facility would be a shared-use lane, however, due to the age of the Cyrville TOD, it is expected that the City will investigate alternative facilities for cycling, such as painted bike lanes or cycle tracks on each side of the road. Figure 14 illustrates the Draft Transportation Master Plan (2024).

Figure 14: Draft Transportation Master Plan (2024)

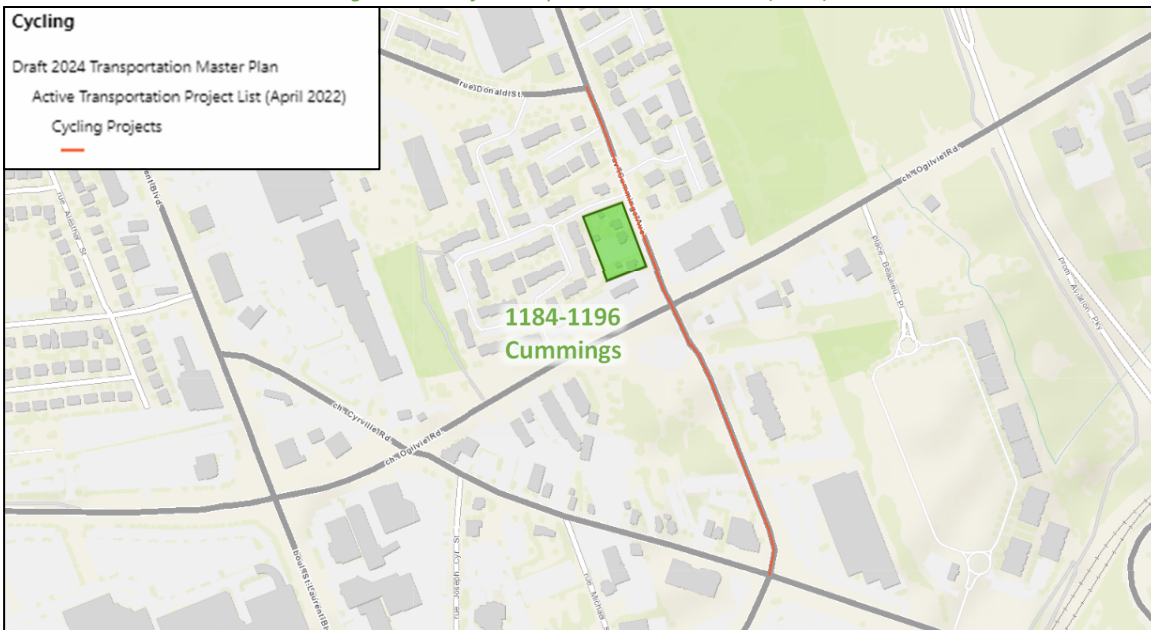

Source: <http://maps.ottawa.ca/geoOttawa/> Accessed: February 6, 2023

2.3.2 Other Study Area Developments

1098 Ogilvie Road, 1178 Cummings Avenue

The proposed development application includes a site plan for a two-phase development with occupancy horizons of 2022 and 2024, comprising three residential towers and one hotel for 850 residential dwelling units and 175 hotel rooms. The development is expected to generate 148 new AM peak hour two-way auto trips and 130 new PM peak hour two-way auto trips. (Parsons, 2020)

1298 Ogilvie Road

The proposed development application includes a site plan for seven townhome buildings comprising 78 residential units. The development is expected to generate 39 new AM peak hour two-way auto trips and 40 new PM peak hour two-way auto trips. The build-out horizon is assumed to be 2023 (Parsons, 2018)

1155 Joseph Cyr Street, 1082 Cyrville Road

The proposed development includes a Zoning by-law amendment and site plan application to construct a six-storey mixed-use building with 116 residential dwelling units and a 1425 sq. ft. ground floor commercial component to be built in a single phase by 2023. The development is predicted to generate eight new AM and nine new PM two-way peak-hour auto trips. (CGH Transportation, 2020)

1209 St Laurent Boulevard, 1200 Lemieux Street

The proposed development includes a site plan application to construct two 30-storey residential buildings including 644 units to be built by 2026. The development is expected to generate 35 new AM peak hour two-way auto trips and 38 new PM peak hour two-way auto trips. (CGH Transportation, 2022)

1209 St Laurent Boulevard, 1200 Lemieux Street

The proposed development includes a site plan application to construct two 30-storey residential buildings including 644 units to be built by 2026. The development is expected to generate 35 new AM peak hour two-way auto trips and 38 new PM peak hour two-way auto trips. (CGH Transportation, 2022)

1125 - 1149 Cyrville Road

The proposed development application includes a site plan to construct two residential buildings with a total of 354 units. The development is predicted to generate 22 new AM and 21 new PM two-way peak-hour auto trips. The anticipated build-out horizon is 2023. (Stantec, 2021)

3 Study Area and Time Periods

3.1 Study Area

The study area will include the intersections of:

- Donald Street at:
 - Cummings Avenue
- Ogilvie Road at:
 - Cyrville Road
 - Cummings Avenue
- Cummings Avenue at Site Access (future conditions)

The boundary roads will be Cummings Avenue and no screenlines are present within proximity to the site.

3.2 Time Periods

As the proposed development is composed entirely of residential units the AM and PM peak hours will be examined.

3.3 Horizon Years

The anticipated build-out year is 2026. As a result, the full build-out plus five years horizon year is 2031.

4 Exemption Review

Table 7 summarizes the exemptions for this TIA.

Table 7: Exemption Review

Module	Element	Explanation	Exempt/Required
Design Review Component			
4.1 Development Design	4.1.2 Circulation and Access	Only required for site plans	Required
	4.1.3 New Street Networks	Only required for plans of subdivision	Exempt
4.2 Parking	4.2.1 Parking Supply	Only required for site plans	Required
	4.2.2 Spillover Parking	Only required for site plans where parking supply is 15% below unconstrained demand	Exempt
Network Impact Component			
4.5 Transportation Demand Management	All Elements	Not required for site plans expected to have fewer than 60 employees and/or students on location at any given time	Required
4.6 Neighbourhood Traffic Management	4.6.1 Adjacent Neighbourhoods	Only required when the development relies on local or collector streets for access and total volumes exceed ATM capacity thresholds	Exempt
4.8 Network Concept		Only required when proposed development generates more than 200 person-trips during the peak hour in excess of equivalent volume permitted by established zoning	Exempt

4.1 TIA Stepped Process

Being located within the Cyrville TOD area and the site proposed small number of residential units, the expected new auto trips will be minimal to the study area. Given the existing conditions identified no barriers to the development of the proposed site, the remaining TIA stepped process has been included within the submission for a fulsome review by the City.

5 Development-Generated Travel Demand

5.1 Mode Shares

Examining the mode shares recommended in the TRANS Trip Generation Manual (2020) for the subject district, derived from the most recent National Capital Region Origin-Destination survey (OD Survey), the existing average district mode shares by land use for Ottawa East have been summarized in Table 8.

Table 8: TRANS Trip Generation Manual Recommended Mode Shares – Ottawa East

Travel Mode	Multi-Unit (High-Rise)	
	AM	PM
Auto Driver	40%	40%
Auto Passenger	8%	14%
Transit	38%	28%
Cycling	2%	3%
Walking	13%	15%
Total	100%	100%

Being within 600 metres of the Cyrville LRT station and within one kilometre of the St. Laurent LRT station, a higher transit mode is considered achievable at this location. A 17% shift to transit mode taken from the auto mode is proposed. The proposed modified mode share targets are summarized in Table 9.

Table 9: Proposed Development Mode Shares

Travel Mode	Multi-Unit (High-Rise)	
	AM	PM
Auto Driver	23%	23%
Auto Passenger	7%	14%
Transit	55%	45%
Cycling	2%	3%
Walking	13%	15%
Total	100%	100%

5.2 Trip Generation

This TIA has been prepared using the vehicle and person trip rates for the residential dwellings using the TRANS Trip Generation Manual (2020). Table 10 summarizes the person trip rates for the proposed residential land uses for each peak period.

Table 10: Trip Generation Person Trip Rates

Land Use	Land Use Code	Peak	Peak Period	
			Vehicle Trip Rate	Person Trip Rates
Multi-Unit (High-Rise)	221 & 222 (TRANS)	AM	-	0.80
		PM	-	0.90

Using the above person trip rates, the total person trip generation has been estimated. Table 11 summarizes the total person trip generation for the residential land uses.

Table 11: Total Person Trip Generation

Land Use	Units	AM Peak Period			PM Peak Period		
		In	Out	Total	In	Out	Total
Multi-Unit (High-Rise)	188	47	104	151	98	71	169

Using the above mode share targets for a LRT area, the person trips by mode have been projected. Trip generation by peak hour has been forecasted using the prescribed peak period conversion factors presented in the TRANS Trip Generation Manual (2020) for the residential component. Table 12 summarizes the residential trip generation by mode and peak hour.

Table 12: Trip Generation by Mode

Travel Mode		AM Peak Hour				PM Peak Hour			
		Mode Share	In	Out	Total	Mode Share	In	Out	Total
Multi-Unit (High-Rise)	Auto Driver	23%	5	12	17	23%	10	7	17
	Auto Passenger	7%	1	3	4	14%	6	4	10
	Transit	55%	14	31	45	45%	21	15	36
	Cycling	2%	1	1	2	3%	1	1	2
	Walking	13%	3	8	11	15%	8	6	14
	Total	100%	24	55	79	100%	46	33	79

As shown above, a total of 17 AM and 17 PM new peak hour two-way vehicle trips are projected as a result of the proposed development.

5.3 Trip Distribution

To understand the travel patterns of the subject development, the OD Survey has been reviewed to determine the travel for the residential component, and these patterns were applied based on the build-out of Ottawa East. Table 13 below summarizes the distributions.

Table 13: OD Survey Distribution – Ottawa East

To/From	Residential % of Trips
North	15%
South	20%
East	15%
West	50%
Total	100%

5.4 Trip Assignment

Using the distribution outlined above, turning movement splits, and access to major transportation infrastructure, the trips generated by the site have been assigned to the study area road network. Table 14 summarizes the proportional assignment to the study area roadways, and Figure 15 illustrates the new site generated volumes.

Table 14: Trip Assignment

To/From	Via
North	15% Cummings Ave (N)
South	5% Cummings Ave (N) 15% Ogilvie Rd (W)
East	15% Ogilvie Rd (E)
West	50% Ogilvie Rd (W)
Total	100%

Figure 15: New Site Generation Auto Volumes

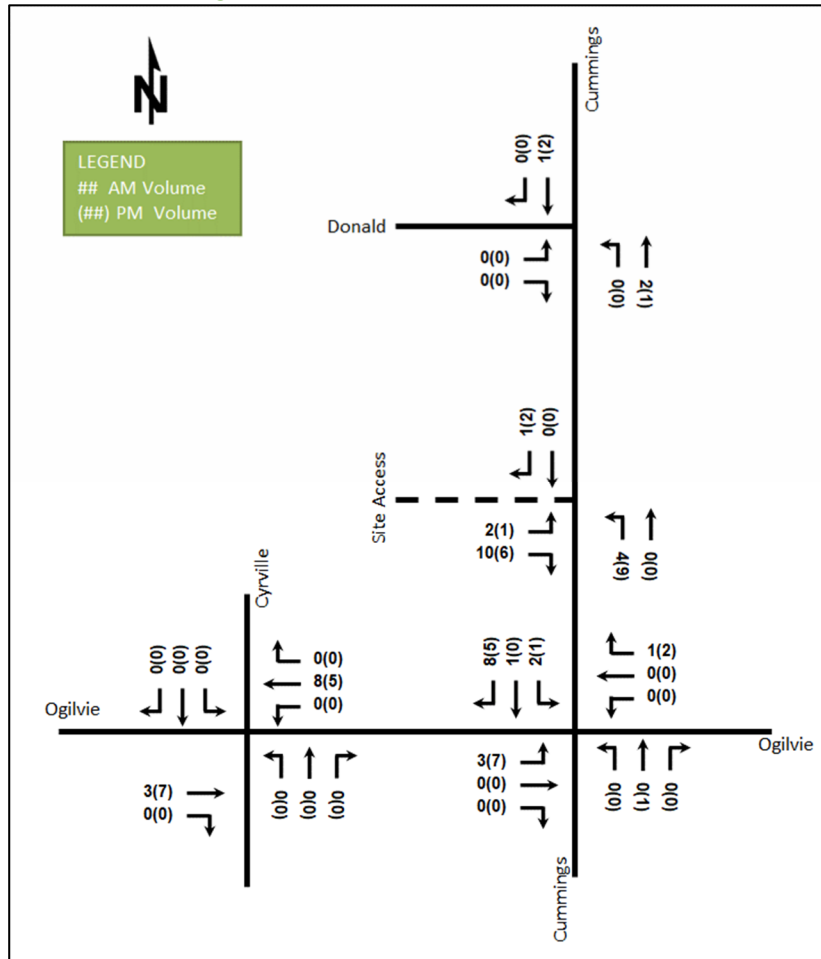

6 Background Network Travel Demands

6.1 Transportation Network Plans

The transportation network plans were discussed in Section 2.3 and will not have any notable impact on the study area traffic volumes and travel patterns.

6.2 Background Growth

A review of the background projections from the City’s TRANS Regional Model for the 2011 and 2031 horizons was completed to determine the background growth for each of the study area roadways. The volumes along Donald Street are significantly underestimated when compared to traffic counts and should not be considered for the area. The background TRANS model growth rates are summarized in Table 15 and the TRANS model plots are provided in Appendix E.

Table 15: TRANS Regional Model Projections – Study Area Growth Rates

Street	TRANS Rate		2011 to Existing		Existing to 2031	
	Eastbound	Westbound	Eastbound	Westbound	Eastbound	Westbound
Ogilvie Rd	0.29%	0.32%	-1.31%	0.81%	1.17%	0.05%
Donald St	-	-	-	-	-	-
	Northbound	Southbound	Northbound	Southbound	Northbound	Southbound
Cummings Ave	0.21%	1.02%	3.55%	4.46%	-1.55%	-0.79%
Cyrville Rd	0.36%	1.17%	0.70%	2.17%	-0.26%	0.96%

In general, the growth rates in the study area derived from the two TRANS model horizons are projected to be positive along all roadways. A conservative 1.00% growth will apply to Donald Street. A comparison of the 2011 to Existing volumes and the Existing to 2031 volumes illustrates a situation that development has not progressed linearly along Cummings Avenue. It is unlikely that the growth rates will decrease or become negative as the Existing to 2031 summary outlines, therefore it is expected that they will be lower than the 2011 to Existing rates that have been experienced. Table 16 summarizes the recommended growth rates to be considered within the study area.

Table 16: Recommended Area Growth Rates

Street	AM Peak Hour		PM Peak Hour	
	Eastbound	Westbound	Eastbound	Westbound
Ogilvie Rd	0.25%	0.25%	0.25%	0.25%
Donald St	1.00%	1.00%	1.00%	1.00%
	Northbound	Southbound	Northbound	Southbound
Cummings Ave	0.25%	1.00%	1.00%	0.25%
Cyrville Rd	0.25%	1.00%	1.00%	0.25%

6.3 Other Developments

The background developments explicitly considered in the background conditions (Section 6.2) include:

- 1098 Ogilvie Road, 1178 Cummings Avenue
- 1298 Ogilvie Road
- 1155 Joseph Cyr Street, 1082 Cyrville Road
- 1209 St Laurent Boulevard, 1200 Lemieux Street
- 1125 - 1149 Cyrville Road

Figure 16 illustrates the background development volumes, and the background development volumes within the study area have been provided in Appendix F.

Figure 16: Background Development Volumes

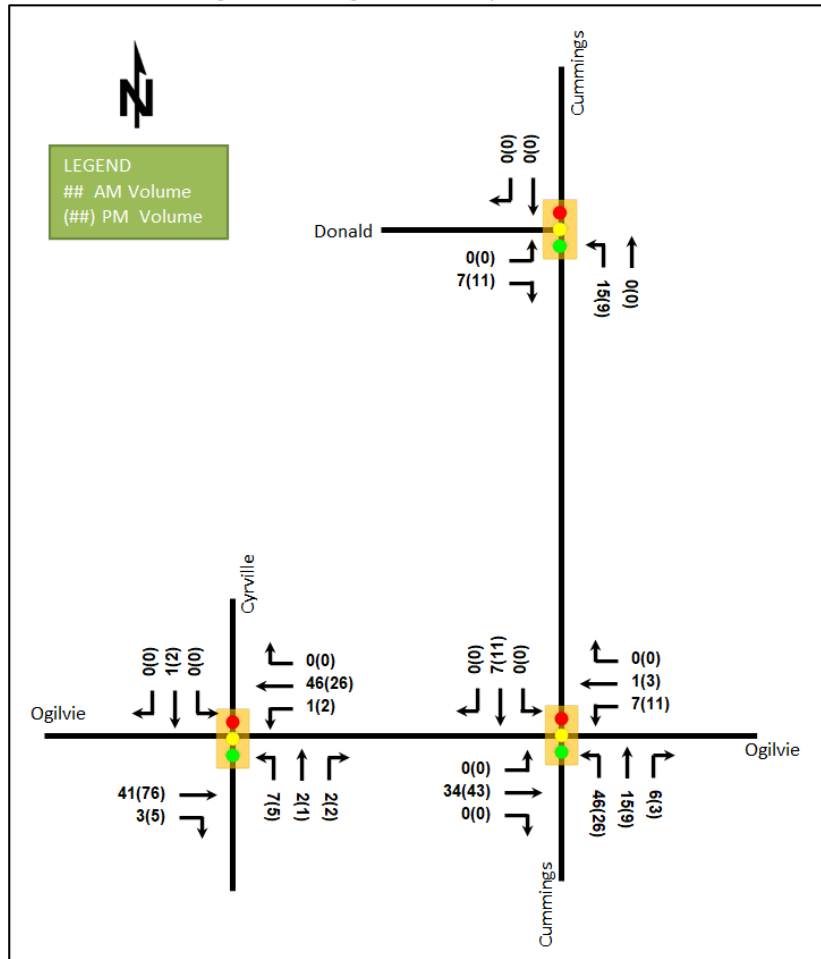

7 Demand Rationalization

7.1 2026 Future Background Operations

Figure 17 illustrates the 2026 background volumes and Table 17 summarizes the 2026 background intersection operations. The level of service for signalized intersections is based on v/c calculations for individual lane movements and HCM 2000 v/c calculations for the overall intersection. The synchro worksheets for the 2026 future background horizon are provided in Appendix G.

Figure 17: 2026 Future Background Volumes

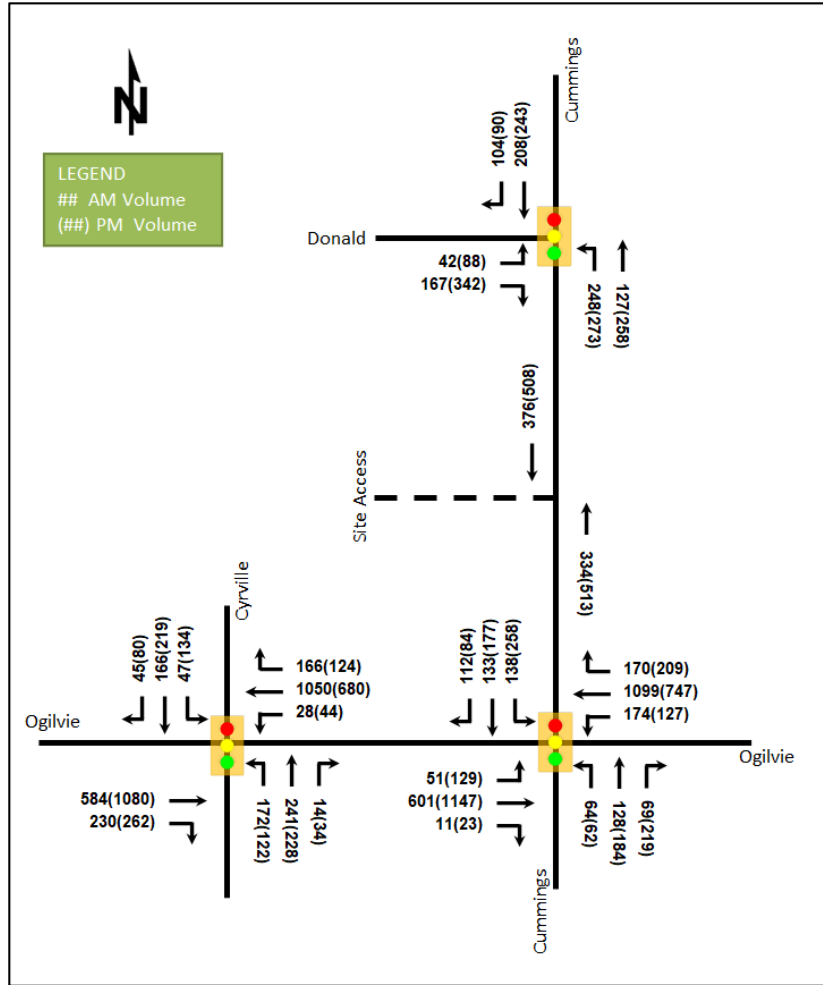

Table 17: 2026 Future Background Intersection Operations

Intersection	Lane	AM Peak Hour				PM Peak Hour			
		LOS	V/C	Delay (s)	Q (95 th)	LOS	V/C	Delay (s)	Q (95 th)
Ogilvie Road at Cyrville Road <i>Signalized</i>	EBT	A	0.27	10.1	48.6	A	0.49	12.4	103.7
	EBR	A	0.24	2.2	10.8	A	0.27	2.1	11.4
	WBL	A	0.06	4.3	m1.2	A	0.17	20.6	m9.0
	WBT	A	0.48	4.6	19.3	A	0.31	16.5	m65.9
	WBR	A	0.18	0.3	m0.1	A	0.14	8.7	m11.4
	NBL	D	0.90	85.9	59.6	E	0.95	113.5	#52.3
	NBT	B	0.64	47.1	70.3	B	0.66	48.1	71.5
	SBL	A	0.28	38.6	17.7	D	0.84	81.1	48.1
	SBT	A	0.56	42.2	57.1	C	0.77	53.5	81.7
Overall	A	0.59	17.8	-	B	0.61	26.8	-	

Intersection	Lane	AM Peak Hour				PM Peak Hour			
		LOS	V/C	Delay (s)	Q (95 th)	LOS	V/C	Delay (s)	Q (95 th)
Donald Street at Cummings Avenue Signalized	EBL	A	0.11	14.8	10.1	A	0.22	16.7	17.8
	EBR	A	0.35	5.9	12.0	A	0.57	6.8	17.0
	NBL	A	0.58	15.6	33.0	B	0.67	18.5	37.8
	NBT	A	0.17	8.1	13.6	A	0.35	9.4	26.4
	SBT/R	A	0.42	8.6	27.9	A	0.46	9.7	32.3
	Overall	A	0.40	10.3	-	A	0.50	11.2	-
Ogilvie Road at Cummings Avenue Signalized	EBL	A	0.28	22.1	17.0	B	0.61	33.5	29.4
	EBT	A	0.38	18.1	48.3	E	0.99	57.5	#205.4
	WBL	A	0.45	17.3	31.1	B	0.68	42.0	#40.2
	WBT	C	0.77	29.7	166.6	D	0.83	42.6	#147.8
	NBL	A	0.28	40.2	24.5	A	0.24	36.8	23.2
	NBT	A	0.56	42.4	58.7	E	0.92	64.7	#133.2
	SBL	A	0.47	33.7	37.8	D	0.83	46.1	#75.3
	SBT	A	0.46	29.5	59.6	A	0.37	22.3	55.7
Overall	B	0.69	27.5	-	E	0.92	48.6	-	

Notes: Saturation flow rate of 1800 veh/h/lane
 Queue is measured in metres
 Peak Hour Factor = 1.00
 Delay = average vehicle delay in seconds
 m = metered queue
 # = volume for the 95th %ile cycle exceeds capacity

Intersections within the study area will operate similarly to existing conditions with incremental improvement to the intersection operations. It is predominantly a result of the peak hour factor adjustment to 1.00 for forecasted conditions. No additional capacity issues are noted.

Similar to the existing condition, the northbound left-turn movement at the intersection of Ogilvie Road and Cyrville Road may be subject to high delays during both peak hours and extended queues during the PM peak hours. The Ogilvie Road at Cummings Avenue intersection may be subject to extended queues on the eastbound through, westbound left, westbound through, northbound through, and southbound left-turn movements during the PM peak hour.

7.2 2031 Future Background Operations

Figure 18 illustrates the 2031 background volumes and Table 18 summarizes the 2031 background intersection operations. The level of service for signalized intersections is based on v/c calculations for individual lane movements and HCM 2000 v/c calculations for the overall intersection. The synchro worksheets for the 2031 future background horizon are provided in Appendix H.

Figure 18: 2031 Future Background Volumes

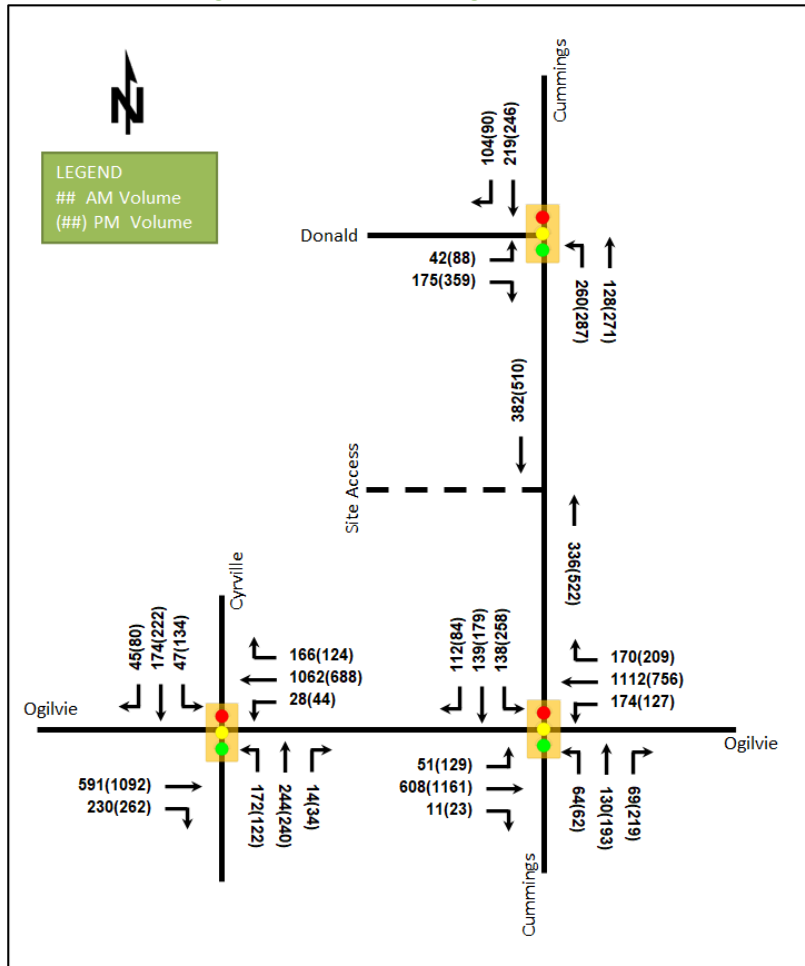

Table 18: 2031 Future Background Intersection Operations

Intersection	Lane	AM Peak Hour				PM Peak Hour			
		LOS	V/C	Delay (s)	Q (95 th)	LOS	V/C	Delay (s)	Q (95 th)
Ogilvie Road at Cyrville Road <i>Signalized</i>	EBT	A	0.28	10.3	49.3	A	0.50	12.6	105.5
	EBR	A	0.24	2.2	10.8	A	0.27	2.1	11.4
	WBL	A	0.06	4.3	m1.2	A	0.18	20.9	m8.6
	WBT	A	0.49	4.6	19.5	A	0.31	16.9	m65.2
	WBR	A	0.18	0.3	m0.1	A	0.14	8.9	m11.2
	NBL	E	0.91	88.8	60.3	E	0.96	114.7	#52.7
	NBT	B	0.64	46.9	71.3	B	0.69	49.3	75.1
	SBL	A	0.28	38.3	17.7	D	0.88	88.9	49.2
	SBT	A	0.57	42.5	59.2	C	0.78	53.7	82.4
	Overall	A	0.60	18.1	-	B	0.62	27.5	-
Donald Street at Cummings Avenue <i>Signalized</i>	EBL	A	0.11	15.0	10.1	A	0.23	17.3	18.1
	EBR	A	0.36	5.9	12.3	A	0.59	7.1	17.9
	NBL	B	0.61	16.5	35.5	B	0.69	19.1	40.6
	NBT	A	0.17	8.1	13.7	A	0.36	9.4	27.5
	SBT/R	A	0.43	8.8	29.2	A	0.46	9.5	32.5
	Overall	A	0.42	10.6	-	A	0.52	11.4	-

Intersection	Lane	AM Peak Hour				PM Peak Hour			
		LOS	V/C	Delay (s)	Q (95 th)	LOS	V/C	Delay (s)	Q (95 th)
Ogilvie Road at Cummings Avenue <i>Signalized</i>	EBL	A	0.29	22.8	17.3	B	0.62	35.8	30.6
	EBT	A	0.39	18.2	49.4	F	1.02	63.3	#209.4
	WBL	A	0.45	17.4	31.1	B	0.68	41.3	#39.6
	WBT	C	0.78	30.1	169.7	D	0.85	44.0	#150.2
	NBL	A	0.28	40.2	24.5	A	0.24	36.6	23.2
	NBT	A	0.57	42.9	59.5	E	0.93	66.1	#138.7
	SBL	A	0.47	33.7	37.8	D	0.84	47.0	#76.8
	SBT	A	0.47	30.1	61.9	A	0.37	22.2	56.2
Overall	B	0.70	27.8	-	E	0.93	51.4	-	

Notes: Saturation flow rate of 1800 veh/h/lane
 Queue is measured in metres
 Peak Hour Factor = 1.00
 Delay = average vehicle delay in seconds
 m = metered queue
 # = volume for the 95th %ile cycle exceeds capacity

Intersections within the study area will operate similar to existing condition during peak hours. No additional capacity issues are noted.

Similar to the existing condition, the northbound left-turn movement at the intersection of Ogilvie Road and Cyrville Road may be subject to high delays during both peak hours and extended queues during the PM peak hours.

Similar to the existing condition, the Ogilvie Road at Cummings Avenue intersection may be subject to extended queues on eastbound left, eastbound through, westbound left, westbound through, northbound through, and southbound left-turn movements during the PM peak hour. The eastbound through movement is additionally over theoretical capacity where the eastbound through movement may also be subject to high delays during the PM peak hour.

7.3 2026 Future Total Operations

Figure 19 illustrates the 2026 total volumes and Table 19 summarizes the 2026 total intersection operations. The level of service for signalized intersections is based on v/c calculations for individual lane movements and HCM 2000 v/c calculations for the overall intersection, and average delay for unsignalized intersections. The synchro worksheets for the 2026 total horizon are provided in Appendix I.

Figure 19: 2026 Future Total Volumes

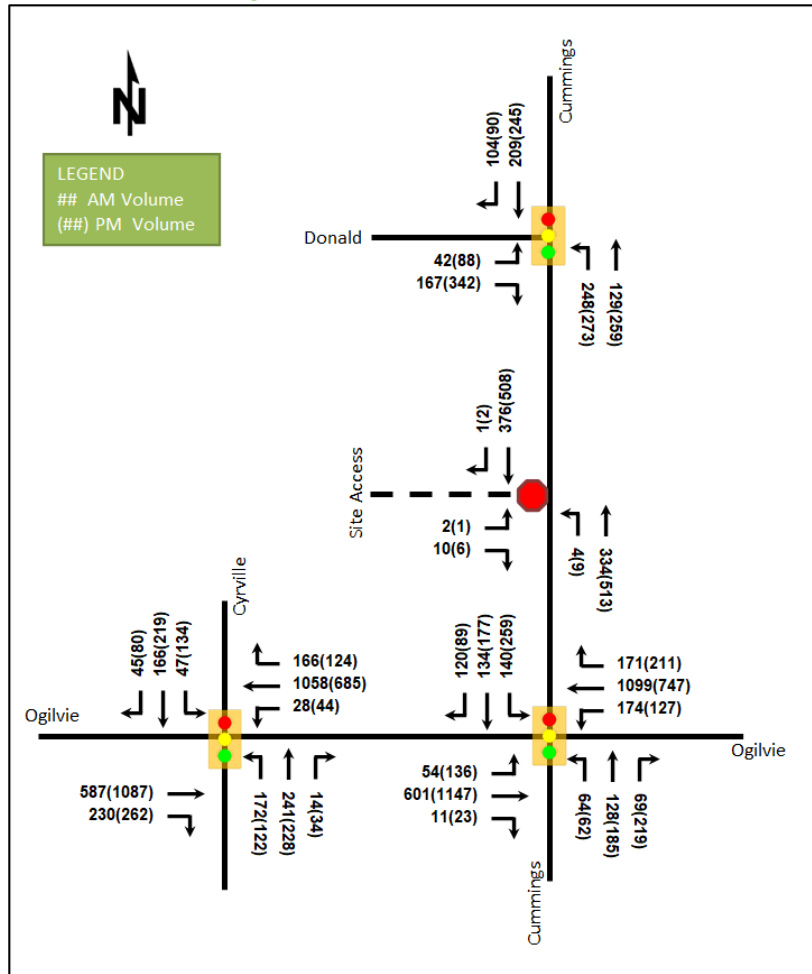

Table 19: 2026 Future Total Intersection Operations

Intersection	Lane	AM Peak Hour				PM Peak Hour			
		LOS	V/C	Delay (s)	Q (95 th)	LOS	V/C	Delay (s)	Q (95 th)
Ogilvie Road at Cyrville Road <i>Signalized</i>	EBT	A	0.27	10.1	48.9	A	0.50	12.5	104.8
	EBR	A	0.24	2.2	10.8	A	0.27	2.1	11.4
	WBL	A	0.06	4.5	m1.2	A	0.17	20.6	m8.8
	WBT	A	0.49	4.7	20.2	A	0.31	16.6	m66.1
	WBR	A	0.18	0.4	m0.2	A	0.14	8.7	m11.3
	NBL	D	0.90	85.9	59.6	E	0.95	113.5	#52.3
	NBT	B	0.64	47.1	70.3	B	0.66	48.1	71.5
	SBL	A	0.28	38.6	17.7	D	0.84	81.1	48.1
	SBT	A	0.56	42.2	57.1	C	0.77	53.5	81.7
Overall	A	0.59	17.9	-	B	0.61	26.8	-	
Donald Street at Cummings Avenue <i>Signalized</i>	EBL	A	0.11	14.8	10.1	A	0.22	16.7	17.8
	EBR	A	0.35	5.9	12.0	A	0.57	6.8	17.0
	NBL	A	0.58	15.7	33.1	B	0.67	18.6	37.9
	NBT	A	0.17	8.2	13.8	A	0.35	9.4	26.4
	SBT/R	A	0.42	8.6	27.9	A	0.47	9.8	32.5
	Overall	A	0.40	10.3	-	A	0.50	11.3	-

Intersection	Lane	AM Peak Hour				PM Peak Hour			
		LOS	V/C	Delay (s)	Q (95 th)	LOS	V/C	Delay (s)	Q (95 th)
Ogilvie Road at Cummings Avenue Signalized	EBL	A	0.30	22.9	17.9	B	0.64	36.3	#32.5
	EBT	A	0.38	18.1	48.6	E	1.00	57.7	#205.6
	WBL	A	0.45	17.3	31.1	B	0.68	41.6	#39.9
	WBT	C	0.78	29.7	166.8	D	0.84	43.1	#148.1
	NBL	A	0.28	40.2	24.5	A	0.24	36.8	23.2
	NBT	A	0.56	42.4	58.7	E	0.92	64.5	#133.6
	SBL	A	0.47	33.9	38.2	D	0.84	46.5	#75.8
	SBT	A	0.48	29.8	61.9	A	0.38	22.4	56.8
	Overall	B	0.69	27.6	-	E	0.92	48.9	-
Site Access at Cummings Avenue Signalized	EB	B	0.02	11.1	0.8	B	0.02	12.6	0.0
	NB	A	0.00	8.1	0.0	A	0.01	8.4	0.0
	SB	-	-	-	-	-	-	-	-
	Overall	A	-	0.2	-	A	-	0.1	-

Notes: Saturation flow rate of 1800 veh/h/lane
Queue is measured in metres
Peak Hour Factor = 1.00

Delay = average vehicle delay in seconds
m = metered queue
= volume for the 95th %ile cycle exceeds capacity

During both peak hours, the study area intersections operate similar to the 2026 future background conditions except for the eastbound left-turn movement during the PM peak hour at the intersection of Ogilvie Road at Cummings Avenue, which may be subject to extended queues, and it is similar to the existing condition.

7.4 2031 Future Total Operations

Figure 20 illustrates the 2031 total volumes and Table 20 summarizes the 2031 total intersection operations. The level of service for signalized intersections is based on v/c calculations for individual lane movements and HCM 2000 v/c calculations for the overall intersection, and average delay for unsignalized intersections. The synchro worksheets for the 2031 future total horizon are provided in Appendix J.

Figure 20: 2031 Future Total Volumes

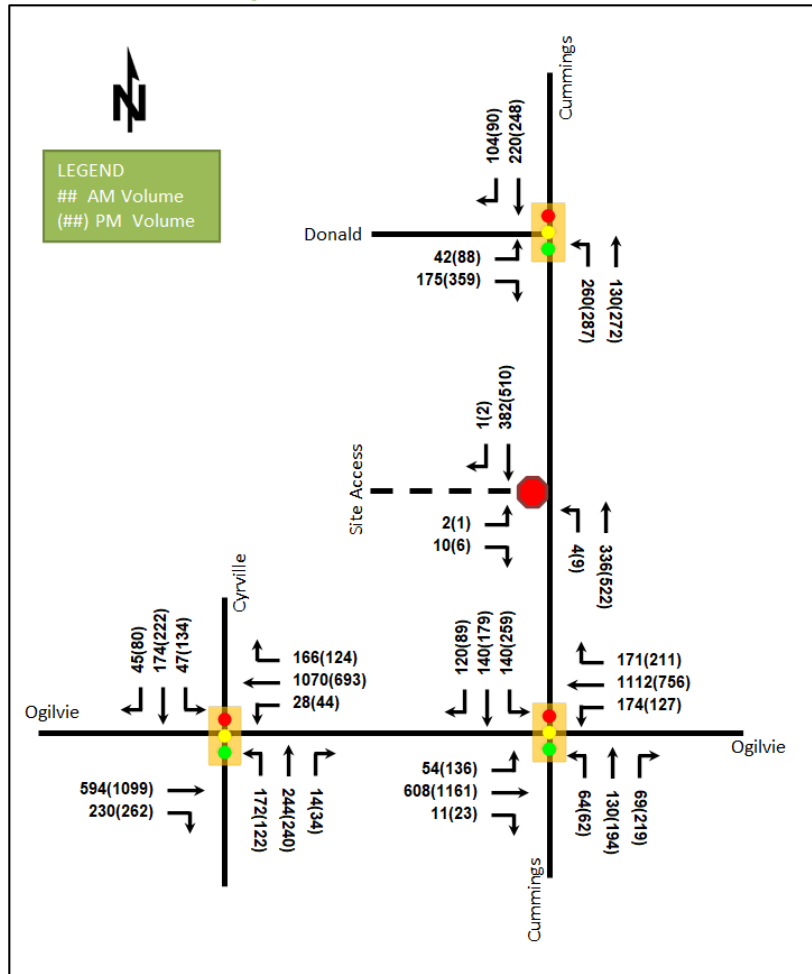

Table 20: 2031 Future Total Intersection Operations

Intersection	Lane	AM Peak Hour				PM Peak Hour			
		LOS	V/C	Delay (s)	Q (95 th)	LOS	V/C	Delay (s)	Q (95 th)
Ogilvie Road at Cyrville Road <i>Signalized</i>	EBT	A	0.28	10.3	49.6	A	0.50	12.6	106.5
	EBR	A	0.24	2.2	10.8	A	0.27	2.1	11.4
	WBL	A	0.06	4.5	m1.2	A	0.18	21.0	m8.6
	WBT	A	0.49	4.8	20.3	A	0.32	17.1	m65.6
	WBR	A	0.18	0.4	m0.2	A	0.14	8.9	m11.1
	NBL	E	0.91	88.8	60.3	E	0.96	114.7	#52.7
	NBT	B	0.64	46.9	71.3	B	0.69	49.3	75.1
	SBL	A	0.28	38.3	17.7	D	0.88	88.9	49.2
	SBT	A	0.57	42.5	59.2	C	0.78	53.7	82.4
Overall	A	0.60	18.1	-	B	0.62	27.5	-	
Donald Street at Cummings Avenue <i>Signalized</i>	EBL	A	0.11	15.0	10.1	A	0.23	17.3	18.1
	EBR	A	0.36	5.9	12.3	A	0.59	7.1	17.9
	NBL	B	0.61	16.5	35.5	B	0.69	19.2	40.6
	NBT	A	0.17	8.1	14.0	A	0.36	9.4	27.7
	SBT/R	A	0.43	8.8	29.4	A	0.46	9.6	32.7
	Overall	A	0.42	10.6	-	A	0.52	11.4	-

Intersection	Lane	AM Peak Hour				PM Peak Hour			
		LOS	V/C	Delay (s)	Q (95 th)	LOS	V/C	Delay (s)	Q (95 th)
Ogilvie Road at Cummings Avenue Signalized	EBL	A	0.31	23.7	18.2	B	0.65	38.6	#35.3
	EBT	A	0.39	18.3	49.5	F	1.02	63.7	#209.6
	WBL	A	0.45	17.4	31.1	B	0.68	41.5	#39.6
	WBT	C	0.78	30.1	169.7	D	0.86	44.6	#150.5
	NBL	A	0.28	40.3	24.5	A	0.24	36.6	23.2
	NBT	A	0.57	42.9	59.5	E	0.93	66.1	#138.7
	SBL	A	0.48	34.0	38.2	D	0.84	47.3	#77.3
	SBT	A	0.49	30.4	64.0	A	0.38	22.2	57.1
	Overall	B	0.70	27.9	-	E	0.93	51.8	-
Site Access at Cummings Avenue Signalized	EB	B	0.02	11.2	0.8	B	0.02	12.7	0.0
	NB	A	0.00	8.1	0.0	A	0.01	8.4	0.0
	SB	-	-	-	-	-	-	-	-
	Overall	A	-	0.2	-	A	-	0.1	-

Notes: Saturation flow rate of 1800 veh/h/lane
 Queue is measured in metres
 Peak Hour Factor = 1.00
 Delay = average vehicle delay in seconds
 m = metered queue
 # = volume for the 95th %ile cycle exceeds capacity

During both peak hours, the study area intersection operates similarly to the 2031 future background conditions except for the eastbound left-turn movement during the PM peak hour at the intersection of Ogilvie Road at Cummings Avenue may be subject to extended queues, which is similar to the existing condition. No additional capacity issues are noted.

7.5 Modal Share Sensitivity and Demand Rationalization Conclusions

The study area notes some minor capacity constraints along Ogilvie Road during the existing and forecasted horizons. These constraints are a result of the east-west traffic volumes and signal progression for the peak hours. It is also noted that the continued construction along Highway 417 and onto Highway 174 has likely inflated these volumes as drivers shift to alternate routes bypass delays only the highway system. These constraints should be monitored by the City as the construction activities wrap up and traffic may normalize back to the highway system. No further regional rationalization or trip demand is required.

The development is expected to generate less than 20 two-way vehicle trips, and the impact on the study area intersections is negligible. No site rationalization for adjusted mode shares or demand is required for this TIA.

8 Development Design

8.1 Design for Sustainable Modes

The proposed development includes a mid-rise building with a new two-way access on Cummings Avenue. A total of 90 bicycle parking spaces underground and a total of 94 bicycle parking spaces at grade in the bike room. Hard surface connections are provided between building entrances and the surrounding pedestrian facilities on Cummings Avenue. The closest bus stop is located less than 100 metres walking distance from the site, Cyrville LRT Station is located approximately one kilometre walking distance from the site access, and St-Laurent LRT Station is located approximately 1.3-kilometre walking distance from the site access.

The infrastructure TDM checklist is provided in Appendix K.

8.2 Circulation and Access

The proposed development will remove the existing site accesses on Cummings Avenue and propose a new access at the south end of the site. The site access is 6.7 metres wide, and the vehicle parking is proposed as accessing

the parking garage ramp with 6.5 metres width and a maximum of 7.5% slope. The garbage room is proposed on the south side of the building, and the garbage is expected to be collected on the internal aisle. The garbage collection vehicles are proposed to access the site via the site access on Cummings Avenue and reverse back to Cummings Avenue. The garbage collection vehicles were reviewed to confirm movements will be permitted on site, and the emergency services can access the site via the Cummings Avenue frontage. The turning templates are provided in Appendix L.

9 Parking

9.1 Parking Supply

The site provides a total of 56 vehicle parking spaces including 38 residential parking spaces and 18 visitor parking spaces. The site also provides a total of 184 bicycle parking spaces. A total of eleven vehicle parking spaces and 94 bicycle spaces will be provided at grade, and 45 vehicle parking spaces and 90 bicycle spaces will be provided underground.

Within 600 metres of a rapid transit station, the maximum vehicle parking provision is 329 spaces (1.75 ratio), including both residential and visitor parking. The minimum residential parking provision is 80 spaces (0.5 ratio after the first 12 units and a 10% reduction for underground parking), the minimum visitor parking provision is 18 spaces (0.1 ratio after the first 12 units), and the minimum bicycle parking provision is 94 spaces (0.5 ratio). The maximum parking requirement, minimum visitor parking and minimum bicycle parking requirements are satisfied. The minimum parking requirement does not meet the requirements.

Although the site proposes 42 less parking spaces than the minimum requirements, it proposes approximately one bike parking per unit on site. It is also noted that the site is approximately 100 metres from Area Z on schedule 1A, which does not have a minimum requirement for the residential parking, and the site is within 600 metres of the Cyrville LRT station and within one kilometre of the St. Laurent LRT station. Given the location of the site and the additional bike parking spaces provided, the proposed parking spaces is considered acceptable.

Based on the City of Ottawa Accessibility Design Standards (2015) and the total number of provided parking, the accessible parking required is one Type A and one Type B space. The site proposes one Type A space and will require a Type B to meet the accessible parking requirements.

10 Boundary Street Design

Table 21 summarizes the MMLOS analysis for the boundary street of Cummings Avenue. The MMLOS for Cummings Avenue are only assessed for the existing conditions, as the future conditions will be subject to the City's improvements to the cycling infrastructure (currently undefined). The boundary street analysis is based on the policy area of "Within 600 m of a rapid transit station" and the land-use designation of "Mixed Use Centre". The MMLOS worksheets have been provided in Appendix M.

Table 21: Boundary Street MMLOS Analysis

Segment	Pedestrian LOS		Bicycle LOS		Transit LOS		Truck LOS	
	PLOS	Target	BLOS	Target	TLOS	Target	TrLOS	Target
Cummings Avenue	E	A	D	B	N/A	N/A	C	D

The pedestrian LOS will not be met along the segment of Cummings Avenue. To meet the theoretical pedestrian LOS targets, the boulevards would need to be at least 0.5 metres along boundary streets and the operating speed would need to be lower than 30 km/h.

The bicycle LOS will not be met along the segment of Cummings Avenue. To meet the theoretical bicycle LOS targets, operating speeds would need to be decreased to less than 50 km/h. The City may look at reducing the speed limit to help improve the BLOS results (e.g. 40 km/h would become PLOS B).

No mitigation for the boundary street design is required as part of this application and require higher level City adjustments to the road operations, such as speed limits.

11 Access Intersections Design

11.1 Location and Design of Access

The proposed access width is approximately 6.7 metres, meeting the private approach width requirements. The access throat length is 12.2 metres and is below the suggested length from the TAC Geometric Design Guidelines requirement of 15.0 metres, as measured from the end of the corner radii. Given the site is within the Cyrville TOD area, and a total of 4 AM and 9 PM inbound northbound left-turns are expected at the access intersection, the throat length is considered acceptable.

Existing sidewalk is provided along the boundary road of Cumming Avenue, and the proposed access will be compliant with the City standard SC7.1.

The access is located within the southbound auxiliary left-turn lane for the Ogilvie Road at Cummins Avenue intersection. While this is not an ideal location for an access, given the entire length of Cummings Avenue has back-to-back left-turn lanes for northbound left-turns at Donald Street and southbound left-turns at Ogilvie Road, this cannot be avoided. Access should still be permitted within this section of roadway.

The site access is 1.5 metres from the adjacent property line, and it is closer to the required 3.0-metre offset from the private approach by-law. It is also noted that the adjacent gas station access is approximately 8.5 metres from the property line and the access separation would be greater than 9.0 metres. Therefore, the access location is considered acceptable and can be approved by the City as an exemption to the private approach bylaw.

11.2 Intersection Control

Based on the projected volumes, the site access will have stop-control on the minor approaches.

11.3 Access Intersection Design

11.3.1 Future Access Intersection Operations

The operations are noted in Section 7.4 and no mitigation is required for the development.

11.3.2 Access Intersection MMLOS

Based on the projected volumes, the site access will have stop-control on the minor approaches and don't require MMLOS.

11.3.3 Recommended Design Elements

The proposed access is provided via a depressed curb through the existing sidewalk at the roadway edge, and it will be compliant with the City standard SC7.1.

12 Transportation Demand Management

12.1 Context for TDM

The subject site is within the Cyrville TOD area, the mode shares used within the TIA represent a shift from auto mode to transit mode. Overall, the modal shares are likely to be achieved and supporting TDM measures should be provided.

Total bedrooms within the development are 212 bedrooms across both buildings with 164 studio/one-bedroom units and 24 two-bedroom units.

12.2 Need and Opportunity

The subject site has been assumed to rely predominantly on transit due to the proximity to the Cyrville LRT Station. The convenience of the transit station should provide the opportunity to reach the forecast transit mode share.

12.3 TDM Program

The “suite of post occupancy TDM measures” has been summarized in the TDM checklists for the residential land uses. The checklist is provided in Appendix K. The key TDM measures recommended include:

- Display local area maps with walking and cycling routes, and transit route information and schedules at major entrances
- Provide a multimodal travel option information package to new residents
- Inclusion of a 1-year Presto card for first time apartment rental, with a set time frame for this offer (e.g. 6-months) from the initial opening of the site
- Unbundle parking cost from rental costs

13 Transit

13.1 Route Capacity

In Section 5.1 the trip generation by mode was estimated, including an estimate of the number of transit trips that will be generated by the proposed development. Table 22 summarizes the transit trip generation.

Table 22: Trip Generation by Transit Mode

Travel Mode	Mode Share	AM Peak Hour			PM Peak Hour		
		In	Out	Total	In	Out	Total
Transit	55% (45%)	14	31	45	21	15	36

The proposed development is anticipated to generate an additional 45 AM and 36 PM peak hour two-way transit trips. From the trip distribution found in section 5.3, these values can be further broken down. Table 23 summarizes forecasted site-generated transit ridership trips by direction and the equivalent bus loads.

Table 23: Forecasted Site-Generated Transit Ridership

Direction	AM Peak Hour		PM Peak Hour		Service Type	Approximate Equivalent Peak Hour/Direction Bus Loads
	In	Out	In	Out		
North	2	5	3	2	Bus	Negligible
South	3	6	4	3	Bus	Negligible
East	2	5	3	2	Bus, LRT	Negligible
West	7	15	11	8	Bus, LRT	One-third of a standard bus

13.2 Transit Priority

Examining the study area intersection delays, negligible impacts are noted on the transit movements and no decrease in transit LOS at the study area intersections are noted as a result of forecasted site-generated traffic.

14 Network Intersection Design

14.1 Network Intersection Control

No change to the existing signalized control is recommended for the network intersections.

14.2 Network Intersection Design

14.2.1 2026 & 2031 Future Total Network Intersection Operations

The operations are noted in Section 7.4 and no mitigation of conditions is required for the subject site traffic.

14.2.2 Network Intersection MMLOS

Table 24 summarizes the MMLOS analysis for the network intersections of Ogilvie Road at Cyrville Road, Donald Street at Cummings Avenue, and Ogilvie Road at Cummings Avenue. The existing and future conditions for both intersections will be the same and are considered in one row. The intersection analysis is based on the policy area of “Within 600 m of a rapid transit station” and the land-use designation of “Mixed Use Centre”. The MMLOS worksheets have been provided in Appendix M.

Table 24: Study Area Intersection MMLOS Analysis

Intersection	Pedestrian LOS		Bicycle LOS		Transit LOS		Truck LOS		Auto LOS	
	PLOS	Target	BLOS	Target	TLOS	Target	TrLOS	Target	ALOS	Target
Ogilvie Road at Cyrville Road	F	A	F	B	C	C	C	D	B	D
Donald Street at Cummings Avenue	F	A	E	B	C	C	E	D	A	D
Ogilvie Road at Cummings Avenue	F	A	F	B	F	C	E	D	E	D

The pedestrian LOS targets will not be met at the study area intersections. As typical for arterial roads, the crossing distance does not permit the targets to be met. To meet pedestrian LOS targets, the maximum crossing distance on all pedestrian crossings would need to be reduced to two lane widths.

In addition to the geometric changes required to meet the PLOS targets for pedestrian exposure to traffic at signalized intersections (PETS), the pedestrian delay LOS would require all three intersections to have significant reductions in the cycle length and a balancing of phase times to reach an average delay of less than 10 seconds. These values are not likely to be able to be met with the required do not walk, amber, and all-red values. Generally, changes required to optimize pedestrian delay result in failure of auto and transit LOS and unnecessarily burden the pedestrian LOS. No signal timing changes are recommended on this basis.

The bicycle LOS targets will not be met at the study area intersections. To meet bicycle LOS targets, the left-turn configurations would need to be two-stage or include turn boxes.

The transit LOS will not be met at Ogilvie Road at Cummings Avenue intersection and the delay would need to be zero to meet the target of LOS A. This is not considered feasible and any target will be subject to the intersection operations maintained by the City of Ottawa.

The truck LOS will not be met at Donald Street at Cummings Avenue and Ogilvie Road at Cummings Avenue intersections, and the effective corner radius would need to be larger than 15 metres on the west approach at

Donald Street at Cummings Avenue intersection and on the east and west approaches at Ogilvie Road at Cummings Avenue intersection.

The development is expected to have negligible impact on the study area intersections, and the City will be responsible for exploring options to address the area PLOS, BLOS, TLOS, TrLOS, and ALOS deficiencies. An additional MMLOS analysis is suggested during the City's redesign and upgrades at the Ogilvie Road at Cummings Road intersection.

14.2.3 Recommended Design Elements

No study area intersection design elements are proposed as part of this study.

15 Summary of Improvements Indicated and Modifications Options

The following summarizes the analysis and results presented in this TIA report:

Proposed Site and Screening

- The proposed site includes an apartment building totaling 188 units with 38 residential parking spaces, 18 visitor parking spaces, and 184 bicycle parking spaces
- The existing site accesses on Cummings Avenue will be removed, and a new full-movement access is proposed on Cummings Avenue
- The development is proposed to be completed as a single phase by 2026
- The trip generation and safety triggers were met for the TIA Screening

Existing Conditions

- Cummings Avenue south of Ogilvie Road, Ogilvie Road, Cyrville Road south of Cummings Avenue/Labelle Street are arterial roads
- Cummings Avenue between Ogilvie Road and Donald Street, and Donald Street are major collector roads, and Cummings Avenue north of Donald Street, Cyrville Road north of Cummings Avenue/Labelle Street are collector roads in the study area
- Sidewalks are provided along the east side of Cummings Avenue south of Ogilvie Road and both sides of Cyrville Road, Ogilvie Road, Donald Street, and Cummings Avenue north of Ogilvie Road
- Bike lanes are provided along Cyrville Road south of Ogilvie Road, Ogilvie Road, and Donald Street
- Ogilvie Road and Cyrville Road are spine routes and Donald Street and Cummings Avenue are local routes. Cyrville Road south of Ogilvie Road and Ogilvie Road west of Cyrville Road form part of a crosstown bikeway
- During the PM peak hour, the study area intersections experience capacity issues on the northbound left at the intersections of Ogilvie Road at Cyrville Road and on the eastbound through at Ogilvie Road at Cummings Avenue
- Within the study area, the intersection of Cummings Avenue at Ogilvie Road and Cummings Avenue at Donald Street is noted to have experienced higher collisions than other locations
- The Ogilvie Road at Cummings Avenue intersection had a total of 57 collisions during the 2016-2020 time period, and collision types are most represented by rear end with 23 collisions
- The City's Cycling Safety Review of High-Volume Intersections (March 2020) completed a review of Ogilvie Road at Cummings Avenue intersection, and the report suggests improvements such as the removal of the northbound right-turn channel, the addition of a westbound right-turn lane, signal phasing changes, and ultimately a protected intersection configuration

- This report does not recommend any changes to those planned for implementation by the City based upon the Cycling Safety Review, and no further examination is required as part of this study

Development Generated Travel Demand

- The proposed development is forecasted produce 79 two-way people trips during the AM and PM peak hours
- Of the forecasted people trips, 17 two-way trips will be vehicle trips during the AM and PM peak hours based on a 23% modal share target
- Of the forecasted trips, 15% are anticipated to travel north and east, 20% to the south, and 50% to the west

Background Conditions

- The background developments were explicitly included in the background conditions, along with background growths along the mainline volumes along Ogilvie Road, Donald Street, Cummings Avenue, and Cyrville Road
- The study area intersections at future background conditions will operate similarly to the existing conditions
- No additional capacity issues are noted in the future conditions

Development Design

- There are 90 bicycle parking spaces underground and 94 bicycle parking spaces at grade in the bike room
- Hard surface connections are provided between building entrances and the surrounding pedestrian facilities on Cummings Avenue
- The closest bus stop is located less than 100 metres walking distance from the site, Cyrville LRT Station is located approximately one kilometre walking distance from the site access, and St-Laurent LRT Station is located approximately 1.3-kilometre walking distance from the site access
- The site access is 6.7 metres wide, and the vehicle parking is proposed as accessing the parking garage ramp with 6.5 metres width and a maximum of 7.5% slope
- The garbage collection vehicles are proposed to access the site via the site access on Cummings Avenue, collect garbage on the internal aisle, and reverse back to Cummings Avenue
- The garbage collection vehicles were reviewed to confirm movements will be permitted on site, and the emergency services can access the site via the Cummings Avenue frontage

Parking

- The site provides a total of 56 vehicle parking spaces including 38 residential parking spaces and 18 visitor parking spaces
- The site also provides a total of 184 bicycle parking spaces, or approximately a 1 per unit on site
- A total of eleven vehicle parking spaces and 94 bicycle spaces will be provided at grade, and 45 vehicle parking spaces and 90 bicycle spaces will be provided underground
- The minimum visitor parking and minimum bicycle parking requirements are satisfied
- The minimum parking requirement does not meet the requirements, provided at less than 42 spaces required by the zoning by-law
- Given the location of the site in close proximity to Cyrville LRT station and the adjacent Area Z zone, the reduced residential parking ratio is considered acceptable
- The site proposes one Type A, and would need an additional Type B accessible space to meet the accessible parking requirements

Boundary Street Design

- Cummings Avenue does not meet the pedestrian MMLOS targets, and at least 0.5 metres of boulevards and lower than 30 km/h operating speed would need to meet the targets
- The bicycle LOS will not be met along the segment of Cummings Avenue, and lower than 50 km/h operating speed would need to meet the targets
- The City may look at reducing the speed limit to help improve the BLOS results

Access Intersections Design

- The proposed access width is approximately 6.7 metres, meeting the private approach width requirements
- Given that the site is within the Cyrville TOD area, and a total of 4 AM and 9 PM inbound northbound left-turns are expected at the access intersection, the proposed access throat length of 12.2 metres is considered acceptable
- Existing sidewalk is provided along the boundary road of Cumming Avenue, and the proposed access will be compliant with the City standard SC7.1
- The site access is 1.5 metres from the adjacent property line, which is closer to the required 3.0-metre offset from the private approach by-law, and the adjacent gas station access is approximately 8.5 metres from the property line, therefore meeting the 9.0 metres offset between accesses
- The access location is considered acceptable, and the City can approve through an exemption to the private approach bylaw

TDM

- Supportive TDM measures to be included within the proposed development should include:
 - Display local area maps with walking and cycling routes, and transit route information and schedules at major entrances
 - Provide a multimodal travel option information package to new residents
 - Inclusion of a 1-year Presto card for first time apartment rental, with a set time frame for this offer (e.g. 6-months) from the initial opening of the site
 - Unbundle parking cost from rental costs

Transit

- The proposed development is anticipated to generate an additional 45 AM and 36 PM peak hour two-way transit trips
- Peak hour increases in transit ridership resulting from the site equate to one-third of a standard bus load westerly of the site, and negligible impact northerly, southerly, and easterly of the site
- Negligible impacts are noted on the transit movements

Network Intersection Design

- No change to the existing signalized control is recommended for the network intersections
- Generally, the network intersections will operate similarly to the existing condition, and no mitigation of conditions is required for the subject site traffic
- The pedestrian LOS targets will not be met at the study area intersections, and two lane-widths crossing distance on all pedestrian crossings would need
- Pedestrian delay LOS is not considered in the PLOS calculation

- The bicycle LOS targets will not be met at the study area intersections, and left-turn configurations would need to be two-stage or include turn boxes on all approaches
- The transit LOS will not be met at Ogilvie Road at Cummings Avenue intersection and the delay would need to be zero to meet the target of LOS A, and any target will be subject to the intersection operations maintained by the City of Ottawa
- The truck LOS will not be met at Donald Street at Cummings Avenue and Ogilvie Road at Cummings Avenue intersections, and the effective corner radius would need to be larger than 15 metres on the west approach at Donald Street at Cummings Avenue intersection and on the east and west approaches at Ogilvie Road at Cummings Avenue intersection
- The development is expected to have negligible impact on the study area intersections, and the City of Ottawa will be responsible for exploring options to address the area PLOS, BLOS, TLOS, TrLOS, and ALOS deficiencies

16 Conclusion

It is recommended that, from a transportation perspective, the proposed development applications proceed.

Prepared By:



Yu-Chu Chen, EIT
Transportation Engineering-Intern

Reviewed By:



Andrew Harte, P.Eng.
Senior Transportation Engineer

Appendix A

TIA Screening Form and PM Certification Form

City of Ottawa 2017 TIA Guidelines
Step 1 - Screening Form

Date: 21-Dec-22
Project Number: 2022-168
Project Reference: TCU 1184-96 Cummings

1.1 Description of Proposed Development	
Municipal Address	1184, 1188, 1196 Cummings Avenue
Description of Location	Three existing residential lots north of the Ogilvie-Cummings intersection
Land Use Classification	Residential Third Density (R3Y [708])
Development Size	188 residential units, approximately 56 parking stalls
Accesses	Single access
Phase of Development	Single
Buildout Year	2025
TIA Requirement	Full TIA Required

1.2 Trip Generation Trigger	
Land Use Type	Townhomes or apartments
Development Size	188 Units
Trip Generation Trigger	Yes

1.3 Location Triggers	
Does the development propose a new driveway to a boundary street that is designated as part of the City's Transit Priority, Rapid Transit or Spine Bicycle Networks?	No
Is the development in a Design Priority Area (DPA) or Transit-oriented Development (TOD) zone?	No
Location Trigger	No

1.4. Safety Triggers		
Are posted speed limits on a boundary street 80 km/hr or greater?	No	
Are there any horizontal/vertical curvatures on a boundary street limits sight lines at a proposed driveway?	No	
Is the proposed driveway within the area of influence of an adjacent traffic signal or roundabout (i.e. within 300 m of intersection in rural conditions, or within 150 m of intersection in urban/ suburban conditions)?	Yes	Site frontage is 32m north of Ogilvie to 108m north of Ogilvie
Is the proposed driveway within auxiliary lanes of an intersection?	Yes	Southbound left-turn on Cummings extends Donald, all accesses along Cummings are within an auxiliary lane
Does the proposed driveway make use of an existing median break that serves an existing site?	No	
Is there is a documented history of traffic operations or safety concerns on the boundary streets within 500 m of the development?	Yes	High collisions at Ogilvie and Cyrville
Does the development include a drive-thru facility?	No	
Safety Trigger	Yes	



TIA Plan Reports

On 14 June 2017, the Council of the City of Ottawa adopted new Transportation Impact Assessment (TIA) Guidelines. In adopting the guidelines, Council established a requirement for those preparing and delivering transportation impact assessments and reports to sign a letter of certification.

Individuals submitting TIA reports will be responsible for all aspects of development-related transportation assessment and reporting, and undertaking such work, in accordance and compliance with the City of Ottawa's Official Plan, the Transportation Master Plan and the Transportation Impact Assessment (2017) Guidelines.

By submitting the attached TIA report (and any associated documents) and signing this document, the individual acknowledges that s/he meets the four criteria listed below.

CERTIFICATION

1. I have reviewed and have a sound understanding of the objectives, needs and requirements of the City of Ottawa's Official Plan, Transportation Master Plan and the Transportation Impact Assessment (2017) Guidelines;
2. I have a sound knowledge of industry standard practice with respect to the preparation of transportation impact assessment reports, including multi modal level of service review;
3. I have substantial experience (more than 5 years) in undertaking and delivering transportation impact studies (analysis, reporting and geometric design) with strong background knowledge in transportation planning, engineering or traffic operations; and
4. I am either a licensed¹ or registered² professional in good standing, whose field of expertise [check appropriate field(s)] is either transportation engineering or transportation planning .

1,2 License of registration body that oversees the profession is required to have a code of conduct and ethics guidelines that will ensure appropriate conduct and representation for transportation planning and/or transportation engineering works.

City Of Ottawa
Infrastructure Services and Community
Sustainability
Planning and Growth Management
110 Laurier Avenue West, 4th fl.
Ottawa, ON K1P 1J1
Tel. : 613-580-2424
Fax: 613-560-6006

Ville d'Ottawa
Services d'infrastructure et Viabilité des
collectivités
Urbanisme et Gestion de la croissance
110, avenue Laurier Ouest
Ottawa (Ontario) K1P 1J1
Tél. : 613-580-2424
Télécopieur: 613-560-6006

Dated at Ottawa this 20 day of September, 2018.
(City)

Name: Andrew Harte
(Please Print)

Professional Title: Professional Engineer



Signature of Individual certifier that s/he meets the above four criteria

Office Contact Information (Please Print)
Address: 6 Plaza Court
City / Postal Code: Ottawa / K2H 7W1
Telephone / Extension: (613) 697-3797
E-Mail Address: Andrew.Harte@CGHTransportation.com



Appendix B

Turning Movement Counts



Transportation Services - Traffic Services

Turning Movement Count - Study Results

CYRVILLE RD @ OGILVIE RD

Survey Date: Wednesday, April 11, 2018

WO No: 37723

Start Time: 07:00

Device: Miovision

Full Study Diagram

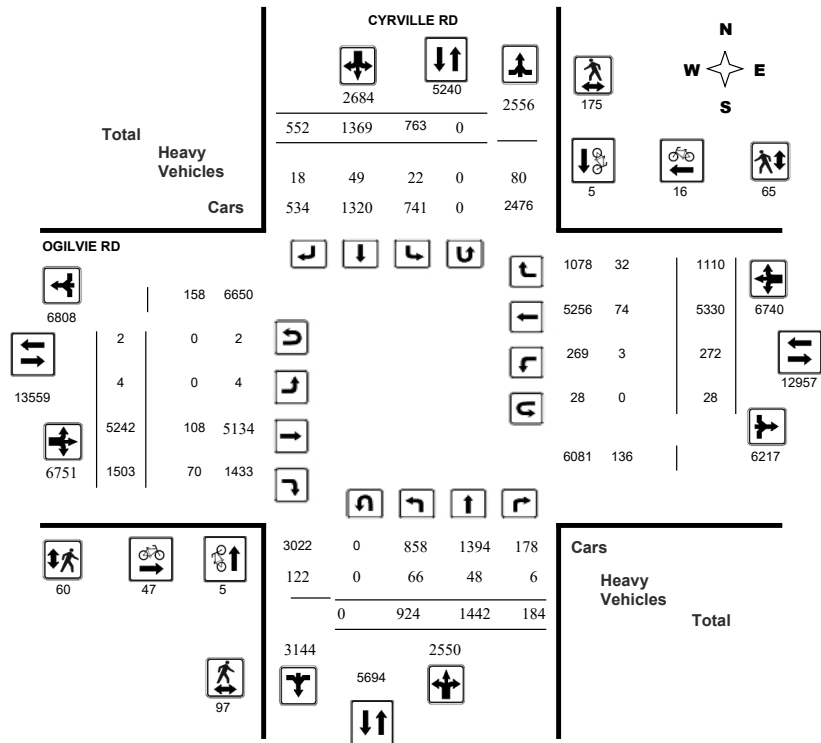

Transportation Services - Traffic Services

Turning Movement Count - Study Results

CYRVILLE RD @ OGILVIE RD

Survey Date: Wednesday, April 11, 2018

WO No: 37723

Start Time: 07:00

Device: Miovision

Full Study Peak Hour Diagram

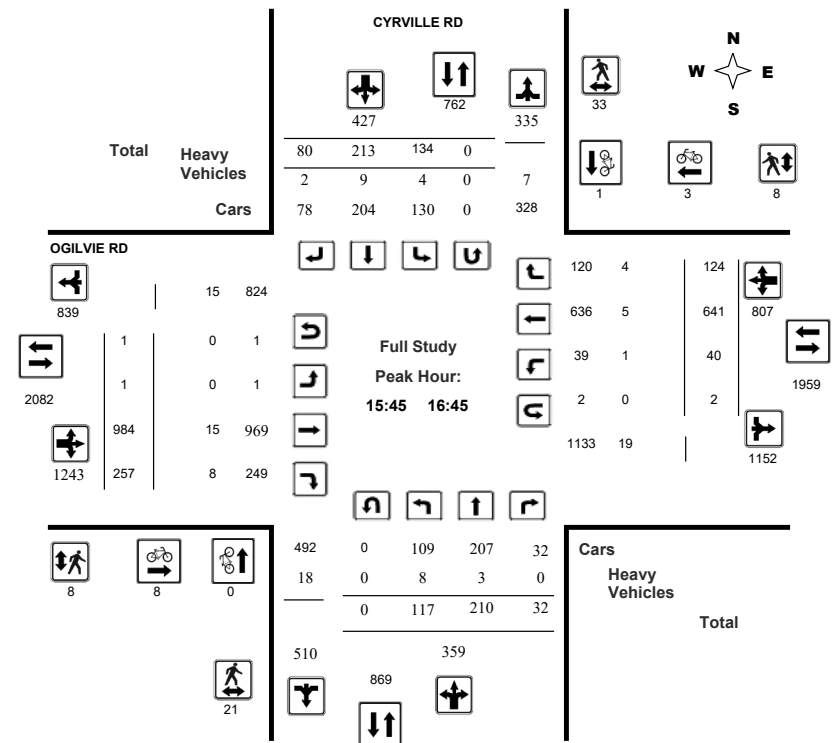



Transportation Services - Traffic Services
Turning Movement Count - Peak Hour Diagram
CYRVILLE RD @ OGILVIE RD

Survey Date: Wednesday, April 11, 2018
 Start Time: 07:00

WO No: 37723
 Device: Miovision

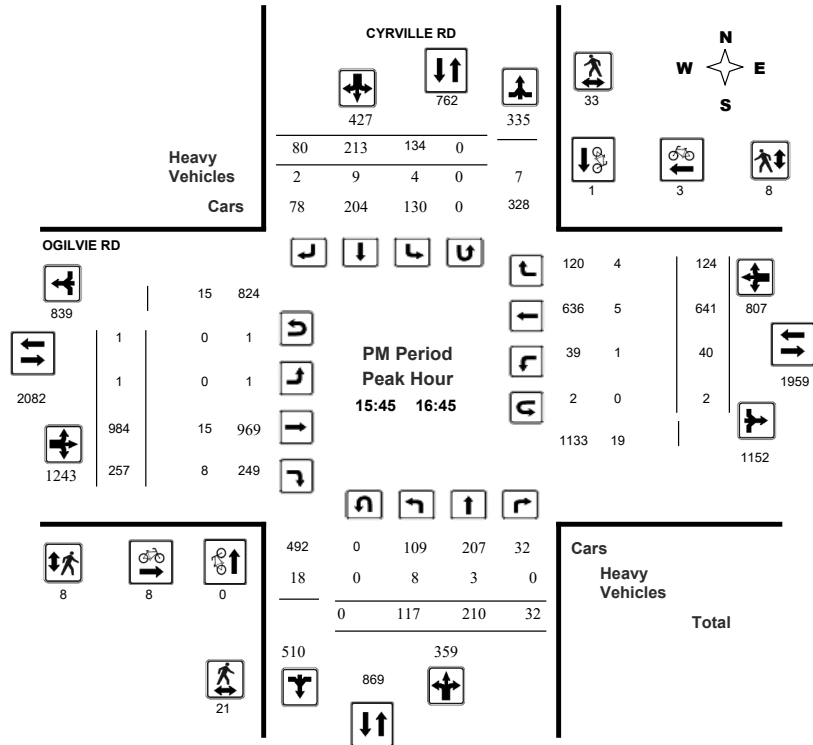

Comments



Transportation Services - Traffic Services
Turning Movement Count - Study Results
CYRVILLE RD @ OGILVIE RD

Survey Date: Wednesday, April 11, 2018
 Start Time: 07:00

WO No: 37723
 Device: Miovision

Full Study Summary (8 HR Standard)

Survey Date: Wednesday, April 11, 2018

Total Observed U-Turns
 Northbound: 0 Southbound: 0
 Eastbound: 2 Westbound: 28

AADT Factor .90

Period	CYRVILLE RD										OGILVIE RD										Grand Total
	Northbound					Southbound					Eastbound					Westbound					
	LT	ST	RT	NB TOT	LT	ST	RT	SB TOT	STR TOT	LT	ST	RT	EB TOT	LT	ST	RT	WB TOT	STR TOT			
07:00-08:00	144	156	10	310	27	172	35	234	544	0	556	185	741	24	838	146	1008	1749	2293		
08:00-09:00	157	230	13	400	64	144	49	257	657	0	545	201	746	31	921	172	1124	1870	2527		
09:00-10:00	86	133	12	231	74	144	52	270	501	1	475	145	621	38	576	126	740	1361	1862		
11:30-12:30	113	173	36	322	92	156	105	353	675	0	654	174	828	27	523	152	702	1530	2205		
12:30-13:30	113	151	35	299	146	179	90	415	714	0	563	188	751	44	535	138	717	1468	2182		
15:00-16:00	109	178	29	316	122	227	64	413	729	2	828	205	1035	33	632	143	808	1843	2572		
16:00-17:00	124	215	16	355	129	189	86	404	759	1	736	256	993	34	656	117	807	1800	2559		
17:00-18:00	78	206	33	317	109	158	71	338	655	0	885	149	1034	41	649	116	806	1840	2495		
Sub Total	924	1442	184	2550	763	1369	552	2684	5234	4	5242	1503	6749	272	5330	1110	6712	13461	18695		
U Turns	0					0					2					28					
Total	924	1442	184	2550	763	1369	552	2684	5234	4	5242	1503	6751	272	5330	1110	6740	13491	18725		
EQ 12Hr	1284	2004	256	3544	1061	1903	767	3731	7275	6	7286	2089	9384	378	7409	1543	9369	18752	26028		
Note: These values are calculated by multiplying the totals by the appropriate expansion factor.																			1.39		
AVG 12Hr	1089	1700	217	3006	900	1614	651	3164	6548	5	6180	1772	7959	321	6284	1309	7946	16877	23425		
Note: These volumes are calculated by multiplying the Equivalent 12 hr. totals by the AADT factor.																			0.9		
AVG 24Hr	1427	2227	284	3938	1178	2114	853	4145	8083	6	8096	2321	10427	420	8232	1714	10410	20837	28920		
Note: These volumes are calculated by multiplying the Average Daily 12 hr. totals by 12 to 24 expansion factor.																			1.31		
Note: U-Turns provided for approach totals. Refer to 'U-Turn' Report for specific breakdown.																					



Transportation Services - Traffic Services

Turning Movement Count - Study Results

CYRVILLE RD @ OGILVIE RD

Survey Date: Wednesday, April 11, 2018

WO No: 37723

Start Time: 07:00

Device: Miovision

Full Study 15 Minute Increments

		CYRVILLE RD								OGILVIE RD										
		Northbound				Southbound				Eastbound				Westbound						
Time Period		LT	ST	RT	N TOT	LT	ST	RT	S TOT	STR TOT	LT	ST	RT	E TOT	LT	ST	RT	W TOT	STR TOT	Grand Total
07:00	07:15	26	39	1	66	4	36	9	49	5	0	128	42	170	6	162	37	206	5	491
07:15	07:30	44	28	3	75	6	36	10	52	8	0	146	40	186	3	188	39	230	8	543
07:30	07:45	31	37	3	71	7	53	6	66	9	0	148	39	187	12	236	31	279	9	603
07:45	08:00	43	52	3	98	10	47	10	67	10	0	134	64	198	3	252	39	294	10	657
08:00	08:15	32	50	3	85	12	28	7	47	10	0	131	52	183	6	270	38	314	10	629
08:15	08:30	44	73	3	120	10	31	13	54	8	0	140	58	198	8	252	33	295	8	667
08:30	08:45	46	59	3	108	15	46	15	76	11	0	127	53	180	8	210	56	274	11	638
08:45	09:00	35	48	4	87	27	39	14	80	11	0	147	38	185	9	189	45	243	11	595
09:00	09:15	21	31	3	55	16	48	10	74	7	0	126	40	166	12	163	52	227	7	522
09:15	09:30	26	35	1	62	15	27	15	57	4	0	130	32	162	9	140	26	175	4	456
09:30	09:45	16	35	5	56	27	46	19	92	10	1	126	39	166	14	150	24	188	10	502
09:45	10:00	23	32	3	58	16	23	8	47	9	0	93	34	127	3	123	24	153	9	385
11:30	11:45	30	40	9	79	31	33	25	89	3	0	166	41	207	7	128	28	163	3	538
11:45	12:00	23	45	8	76	16	37	22	75	12	0	160	44	204	7	126	35	179	12	534
12:00	12:15	32	46	11	89	24	38	30	92	2	0	150	33	183	7	144	37	189	2	553
12:15	12:30	28	42	8	78	21	48	28	97	3	0	178	56	234	6	125	52	184	3	593
12:30	12:45	30	40	7	77	73	36	15	124	8	0	130	44	174	11	143	34	188	8	563
12:45	13:00	34	43	8	85	31	58	24	113	5	0	150	55	205	13	123	39	175	5	578
13:00	13:15	29	39	12	80	27	42	28	97	10	0	139	49	188	10	126	29	165	10	530
13:15	13:30	20	29	8	57	15	43	23	81	5	0	144	40	184	10	143	36	190	5	512
15:00	15:15	34	40	5	79	35	55	23	113	5	0	195	47	243	12	158	28	198	5	633
15:15	15:30	23	49	3	75	30	53	14	97	4	2	206	36	244	6	143	38	187	4	603
15:30	15:45	25	48	5	78	26	46	16	88	3	0	179	46	225	9	184	38	232	3	623
15:45	16:00	27	41	16	84	31	73	11	115	9	0	248	76	324	6	147	39	192	9	715
16:00	16:15	31	70	3	104	40	45	15	100	6	0	259	55	315	13	171	23	207	6	726
16:15	16:30	22	48	4	74	30	47	28	105	5	0	233	78	311	14	154	32	201	5	691
16:30	16:45	37	51	9	97	33	48	26	107	6	1	244	48	293	7	169	30	207	6	704
16:45	17:00	34	46	0	80	26	49	17	92	5	0	0	75	75	0	162	32	194	5	441
17:00	17:15	17	63	9	89	28	49	12	89	5	0	283	44	327	11	167	26	205	5	710
17:15	17:30	19	47	7	73	34	43	17	94	4	0	245	38	283	16	182	31	231	4	681
17:30	17:45	22	55	8	85	31	38	20	89	2	0	197	29	226	5	145	27	177	2	577
17:45	18:00	20	41	9	70	16	28	22	66	5	0	160	38	198	9	155	32	198	5	532
Total:		924	1442	184	2550	763	1369	552	2684	209	4	5242	1503	6751	272	5330	1110	6740	209	18,725

Note: U-Turns are included in Totals.



Transportation Services - Traffic Services

Turning Movement Count - Study Results

CYRVILLE RD @ OGILVIE RD

Survey Date: Wednesday, April 11, 2018

WO No: 37723

Start Time: 07:00

Device: Miovision

Full Study Cyclist Volume

		CYRVILLE RD			OGILVIE RD				
		Northbound	Southbound	Street Total	Eastbound	Westbound	Street Total	Grand Total	
07:00	07:15	0	0	0	1	0	1	1	
07:15	07:30	1	0	1	1	2	2	3	
07:30	07:45	0	1	1	1	2	3	4	
07:45	08:00	1	0	1	3	1	4	5	
08:00	08:15	0	0	0	8	0	8	8	
08:15	08:30	0	1	1	4	1	5	6	
08:30	08:45	0	0	0	2	0	2	2	
08:45	09:00	0	1	1	3	0	3	4	
09:00	09:15	1	0	1	1	0	1	2	
09:15	09:30	0	0	0	2	0	2	2	
09:30	09:45	0	0	0	1	1	2	2	
09:45	10:00	0	0	0	1	0	1	1	
11:30	11:45	1	0	1	0	0	0	1	
11:45	12:00	0	0	0	0	0	0	0	
12:00	12:15	0	0	0	0	0	0	0	
12:15	12:30	0	0	0	0	0	0	0	
12:30	12:45	0	0	0	1	0	1	1	
12:45	13:00	0	0	0	0	0	0	0	
13:00	13:15	0	0	0	0	0	0	0	
13:15	13:30	0	0	0	0	0	0	0	
15:00	15:15	0	0	0	1	1	2	2	
15:15	15:30	0	0	0	0	0	0	0	
15:30	15:45	0	0	0	2	0	2	2	
15:45	16:00	0	0	0	2	0	2	2	
16:00	16:15	0	0	0	0	0	0	0	
16:15	16:30	0	1	1	2	1	3	4	
16:30	16:45	0	0	0	4	2	6	6	
16:45	17:00	0	0	0	0	1	1	1	
17:00	17:15	0	0	0	4	2	6	6	
17:15	17:30	0	1	1	1	1	2	3	
17:30	17:45	1	0	1	1	2	3	4	
17:45	18:00	0	0	0	1	0	1	1	
Total		5	5	10	47	16	63	73	



Transportation Services - Traffic Services

Turning Movement Count - Study Results

CYRVILLE RD @ OGILVIE RD

Survey Date: Wednesday, April 11, 2018

WO No: 37723

Start Time: 07:00

Device: Miovision

Full Study Pedestrian Volume

CYRVILLE RD

OGILVIE RD

Table with 8 columns: Time Period, NB Approach, SB Approach, Total, EB Approach, WB Approach, Total, Grand Total. Rows show pedestrian counts for various time intervals from 07:00 to 18:00.



Transportation Services - Traffic Services

Turning Movement Count - Study Results

CYRVILLE RD @ OGILVIE RD

Survey Date: Wednesday, April 11, 2018

WO No: 37723

Start Time: 07:00

Device: Miovision

Full Study Heavy Vehicles

CYRVILLE RD

OGILVIE RD

Table with 22 columns: Time Period, Northbound (LT, ST, RT, N TOT, STR TOT), Southbound (LT, ST, RT, S TOT, STR TOT), Eastbound (LT, ST, RT, E TOT, W TOT), Westbound (LT, ST, RT, W TOT, STR TOT), Grand Total. Rows show heavy vehicle counts for various time intervals from 07:00 to 18:00.



Transportation Services - Traffic Services

Turning Movement Count - Study Results

CYRVILLE RD @ OGILVIE RD

Survey Date: Wednesday, April 11, 2018

WO No: 37723

Start Time: 07:00

Device: Miovision

Full Study 15 Minute U-Turn Total

CYRVILLE RD OGILVIE RD

Time Period	Northbound U-Turn Total	Southbound U-Turn Total	Eastbound U-Turn Total	Westbound U-Turn Total	Total
07:00 07:15	0	0	0	1	1
07:15 07:30	0	0	0	0	0
07:30 07:45	0	0	0	0	0
07:45 08:00	0	0	0	0	0
08:00 08:15	0	0	0	0	0
08:15 08:30	0	0	0	2	2
08:30 08:45	0	0	0	0	0
08:45 09:00	0	0	0	0	0
09:00 09:15	0	0	0	0	0
09:15 09:30	0	0	0	0	0
09:30 09:45	0	0	0	0	0
09:45 10:00	0	0	0	3	3
11:30 11:45	0	0	0	0	0
11:45 12:00	0	0	0	11	11
12:00 12:15	0	0	0	1	1
12:15 12:30	0	0	0	1	1
12:30 12:45	0	0	0	0	0
12:45 13:00	0	0	0	0	0
13:00 13:15	0	0	0	0	0
13:15 13:30	0	0	0	1	1
15:00 15:15	0	0	1	0	1
15:15 15:30	0	0	0	0	0
15:30 15:45	0	0	0	1	1
15:45 16:00	0	0	0	0	0
16:00 16:15	0	0	1	0	1
16:15 16:30	0	0	0	1	1
16:30 16:45	0	0	0	1	1
16:45 17:00	0	0	0	0	0
17:00 17:15	0	0	0	1	1
17:15 17:30	0	0	0	2	2
17:30 17:45	0	0	0	0	0
17:45 18:00	0	0	0	2	2
Total	0	0	2	28	30



Transportation Services - Traffic Services W.O. 37738

Turning Movement Count - 15 Minute Summary Report

CUMMINGS AVE @ OGILVIE RD

Survey Date: Wednesday, April 11, 2018

Total Observed U-Turns

Northbound: 2 Southbound: 0
 Eastbound: 76 Westbound: 20

Time Period	CUMMINGS AVE				OGILVIE RD				W TOT	STR TOT	Grand Total								
	Northbound		Southbound		Eastbound		Westbound												
	LT	ST	RT	N TOT	LT	ST	RT	S TOT	STR TOT	LT	ST	RT	E TOT	LT	ST	RT	W TOT	STR TOT	Grand Total
07:00 07:15	1	24	9	34	19	23	22	64	98	7	105	3	115	22	165	30	217	332	430
07:15 07:30	5	21	17	43	25	23	23	71	114	11	138	1	151	45	194	26	265	416	530
07:30 07:45	4	23	16	43	43	30	36	109	152	14	142	0	158	25	226	30	281	439	591
07:45 08:00	2	25	13	40	32	33	23	88	128	14	145	2	161	42	280	40	363	524	652
08:00 08:15	4	33	11	48	41	33	35	109	157	15	122	2	139	38	289	35	363	502	659
08:15 08:30	6	25	21	52	34	23	29	86	138	11	142	3	156	47	256	54	358	514	652
08:30 08:45	6	28	18	52	31	27	25	83	135	8	147	4	162	36	251	41	329	491	626
08:45 09:00	6	20	17	43	41	24	23	88	131	9	161	5	177	37	225	41	303	480	611
09:00 09:15	4	40	14	58	57	31	18	106	164	9	119	5	133	21	182	27	230	363	527
09:15 09:30	6	27	21	54	38	26	22	86	140	13	147	7	168	24	168	42	235	403	543
09:30 09:45	5	32	29	66	36	28	22	86	152	9	132	3	144	24	161	26	211	355	507
09:45 10:00	2	32	26	60	25	33	33	91	151	14	117	2	135	27	115	35	177	312	463
11:30 11:45	5	28	33	66	40	40	21	101	167	17	158	8	184	31	152	37	220	404	571
11:45 12:00	7	41	42	90	44	36	18	98	188	21	156	10	190	35	164	37	236	426	614
12:00 12:15	5	38	46	89	56	37	17	110	199	15	157	5	180	32	173	51	258	438	637
12:15 12:30	10	33	50	93	54	42	16	112	205	22	168	9	201	31	168	47	246	447	652
12:30 12:45	7	42	31	80	48	46	26	120	200	13	185	8	209	26	157	25	208	417	617
12:45 13:00	9	39	36	84	55	45	16	116	200	17	177	8	206	30	152	36	219	425	625
13:00 13:15	10	32	32	74	48	59	11	118	192	22	163	5	193	35	146	37	218	411	603
13:15 13:30	7	35	39	81	60	22	21	103	184	14	135	10	168	37	148	45	230	398	582
15:00 15:15	7	35	53	95	52	30	13	95	190	24	173	6	208	24	163	54	242	450	640
15:15 15:30	10	43	46	99	48	43	17	108	207	25	199	7	233	23	144	46	213	446	653
15:30 15:45	5	40	49	94	77	51	27	155	249	21	207	5	235	28	199	68	296	531	780
15:45 16:00	5	45	48	98	63	44	24	131	229	25	193	3	223	32	160	53	246	469	698
16:00 16:15	3	47	59	110	62	40	29	131	241	23	292	9	327	21	173	50	244	571	812
16:15 16:30	6	45	40	92	76	44	17	137	229	21	267	0	289	20	163	39	224	513	742
16:30 16:45	8	35	73	116	61	39	22	122	238	21	283	5	313	24	196	43	264	577	815
16:45 17:00	4	49	45	98	71	44	20	135	233	28	246	4	279	27	161	42	233	512	745
17:00 17:15	13	36	48	97	61	28	23	112	209	33	300	6	343	32	182	69	283	626	835
17:15 17:30	11	42	50	103	65	52	19	136	239	28	253	8	299	26	190	55	274	573	812
17:30 17:45	9	37	31	77	58	27	15	100	177	25	220	7	254	18	174	33	225	479	656
17:45 18:00	6	30	35	71	56	23	29	108	179	25	168	4	198	18	154	39	211	409	588
TOTAL:	198	1102	1098	2400	1577	1126	712	3415	5815	574	5717	164	6531	938	5831	1333	8122	14653	20468

Note: U-Turns are included in Totals.

Comment:



Transportation Services - Traffic Services
Turning Movement Count - Cyclist Volume Report

Work Order
 37738

CUMMINGS AVE @ OGILVIE RD

Count Date: Wednesday, April 11, 2018

Start Time: 07:00

Time Period	CUMMINGS AVE			OGILVIE RD			Grand Total
	Northbound	Southbound	Street Total	Eastbound	Westbound	Street Total	
07:00 08:00	0	1	1	8	6	14	15
08:00 09:00	3	1	4	13	1	14	18
09:00 10:00	0	0	0	5	1	6	6
11:30 12:30	0	1	1	0	2	2	3
12:30 13:30	0	0	0	1	2	3	3
15:00 16:00	3	4	7	5	8	13	20
16:00 17:00	1	5	6	6	7	13	19
17:00 18:00	3	2	5	7	8	15	20
Total	10	14	24	45	35	80	104

Comment:

Note: These volumes consists of bicycles only (no mopeds or motorcycles) and ARE NOT included in the Turning Movement Count Summary.



Transportation Services - Traffic Services
Turning Movement Count - Full Study Diagram

CUMMINGS AVE @ OGILVIE RD

Survey Date: Wednesday, April 11, 2018

WO#: 37738
 Device: Miovision

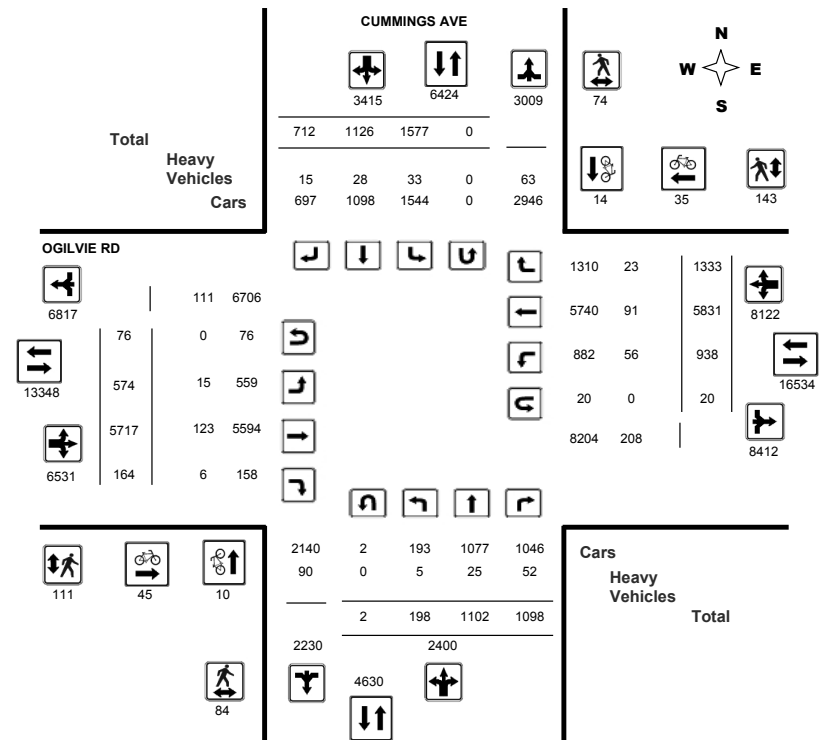

Comments



Transportation Services - Traffic Services

W.O. 37738

Turning Movement Count - Heavy Vehicle Report

CUMMINGS AVE @ OGILVIE RD

Survey Date: Wednesday, April 11, 2018

Table with columns for Time Period, CUMMINGS AVE (Northbound/Southbound), OGILVIE RD (Eastbound/Westbound), and Grand Total. Includes sub-totals for U-Turns and overall totals.

Heavy Vehicles include Buses, Single-Unit Trucks and Articulated Trucks. Further, they ARE included in the Turning Movement Count Summary.



Transportation Services - Traffic Services

Work Order 37738

Turning Movement Count - Pedestrian Volume Report

CUMMINGS AVE @ OGILVIE RD

Count Date: Wednesday, April 11, 2018

Start Time: 07:00

Table with columns for Time Period, NB Approach, SB Approach, Total, EB Approach, WB Approach, Grand Total. Shows pedestrian volume data for various time intervals.

Comment:



Transportation Services - Traffic Services

Work Order
37738

Turning Movement Count - Full Study Summary Report

CUMMINGS AVE @ OGILVIE RD

Survey Date: Wednesday, April 11, 2018

Total Observed U-Turns		AADT Factor .90
Northbound: 2	Southbound: 0	
Eastbound: 76	Westbound: 20	

Full Study

Period	CUMMINGS AVE								OGILVIE RD								WB TOT	STR TOT	Grand Total		
	Northbound				Southbound				Eastbound				Westbound								
	LT	ST	RT	NB TOT	LT	ST	RT	SB TOT	STR TOT	LT	ST	RT	EB TOT	LT	ST	RT				WB TOT	
07:00 08:00	12	93	55	160	119	109	104	332	492	46	530	6	582	134	865	126	1125	1707	2199		
08:00 09:00	22	106	67	195	147	107	112	366	561	43	572	14	629	158	1021	171	1350	1979	2540		
09:00 10:00	17	131	90	238	156	118	95	369	607	45	515	17	577	96	626	130	852	1429	2036		
11:30 12:30	27	140	171	338	194	155	72	421	759	75	639	32	746	129	657	172	958	1704	2463		
12:30 13:30	33	148	138	319	211	172	74	457	776	66	660	31	757	128	603	143	874	1631	2407		
15:00 16:00	27	163	196	386	240	168	81	489	875	95	772	21	888	107	666	221	994	1882	2757		
16:00 17:00	21	176	217	414	270	167	88	525	939	93	1088	18	1199	92	693	174	959	2158	3097		
17:00 18:00	39	145	164	348	240	130	86	456	804	111	941	25	1077	94	700	196	990	2067	2871		
Sub Total	198	1102	1098	2398	1577	1126	712	3415	5813	574	5717	164	6455	938	5831	1333	8102	14557	20370		
U Turns				2				0	2				76				20	96	98		
Total	198	1102	1098	2400	1577	1126	712	3415	5815	574	5717	164	6531	938	5831	1333	8122	14653	20468		
EQ 12Hr	275	1532	1526	3336	2192	1565	990	4747	8083	798	7947	228	9078	1304	8105	1853	11290	20368	28451		
Note: These values are calculated by multiplying the totals by the appropriate expansion factor.										1.39											
AVG 12Hr	248	1379	1374	3002	1973	1409	891	4272	7274	718	7152	205	8170	1173	7295	1668	10161	18331	25605		
Note: These volumes are calculated by multiplying the Equivalent 12 hr. totals by the AADT factor.										.90											
AVG 24Hr	324	1806	1799	3933	2584	1845	1167	5597	9530	941	9369	269	10703	1537	9556	2185	13310	24013	33543		
Note: These volumes are calculated by multiplying the Average Daily 12 hr. totals by 12 to 24 expansion factor.										1.31											

Comments:

Note: U-Turns provided for approach totals. Refer to 'U-Turn' Report for specific breakdown.



Transportation Services - Traffic Services

Turning Movement Count - Full Study Peak Hour Diagram

CUMMINGS AVE @ OGILVIE RD

Survey Date: Wednesday, April 11, 2018

Start Time: 07:00

WO No: 37738

Device: Miovision

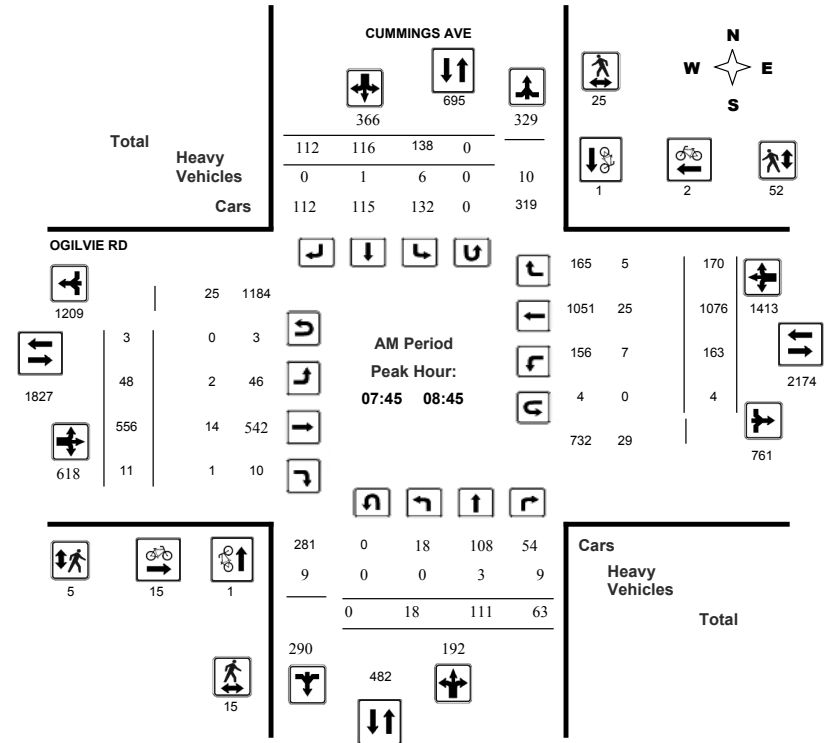



Transportation Services - Traffic Services

Turning Movement Count - Full Study Peak Hour Diagram

CUMMINGS AVE @ OGILVIE RD

Survey Date: Wednesday, April 11, 2018
Start Time: 07:00

WO No: 37738
Device: Miovision

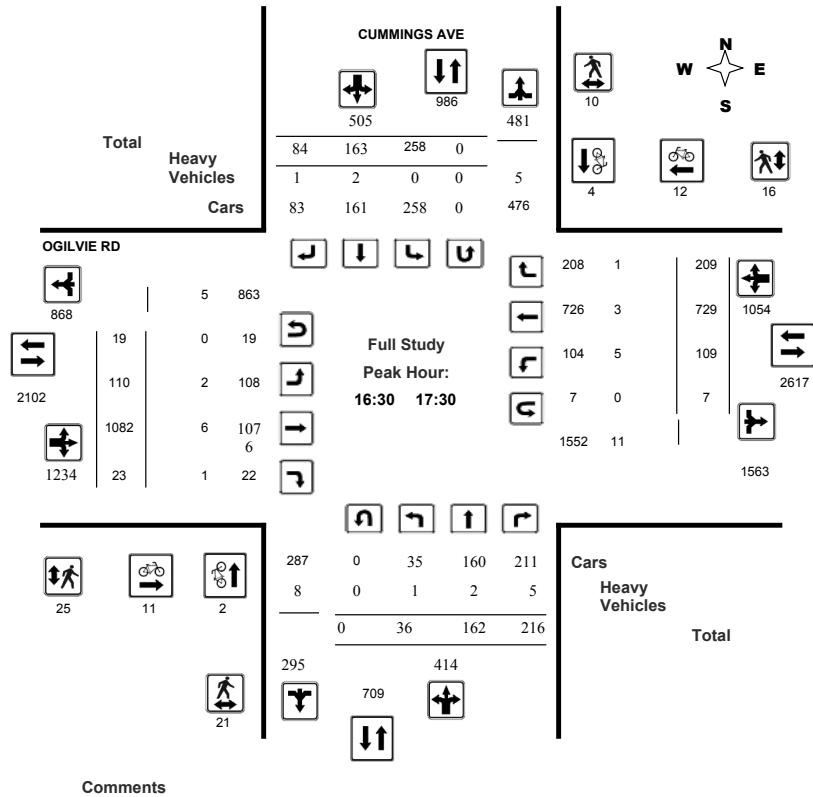

Transportation Services - Traffic Services

Turning Movement Count - Full Study Peak Hour Diagram

CUMMINGS AVE @ OGILVIE RD

Survey Date: Wednesday, April 11, 2018
Start Time: 07:00

WO No: 37738
Device: Miovision

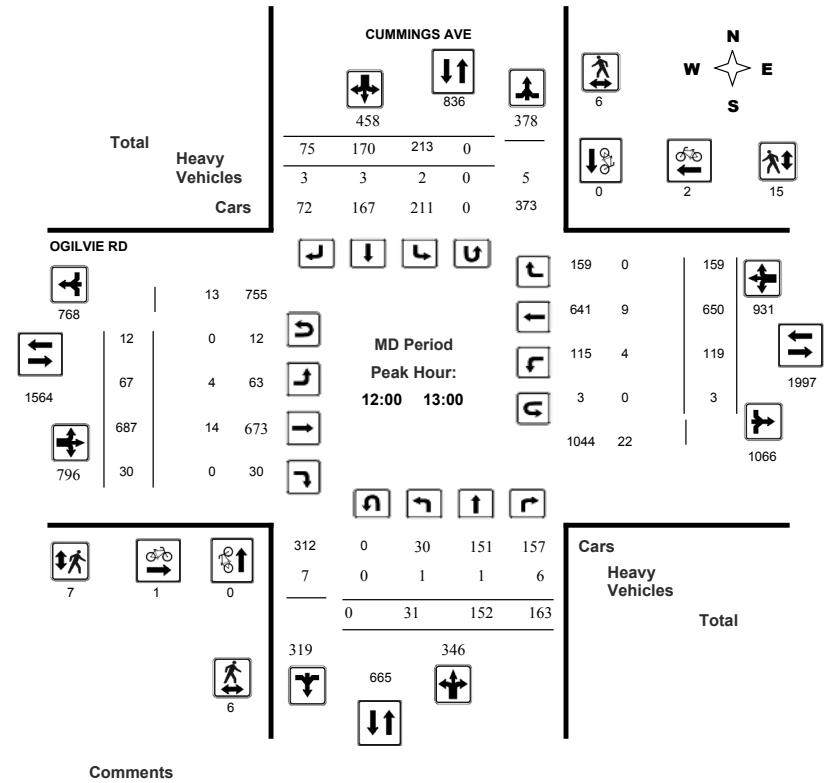



Transportation Services - Traffic Services

Turning Movement Count - Full Study Peak Hour Diagram

CUMMINGS AVE @ DONALD ST

Survey Date: Wednesday, April 11, 2018

Start Time: 07:00

WO No: 37720

Device: Miovision

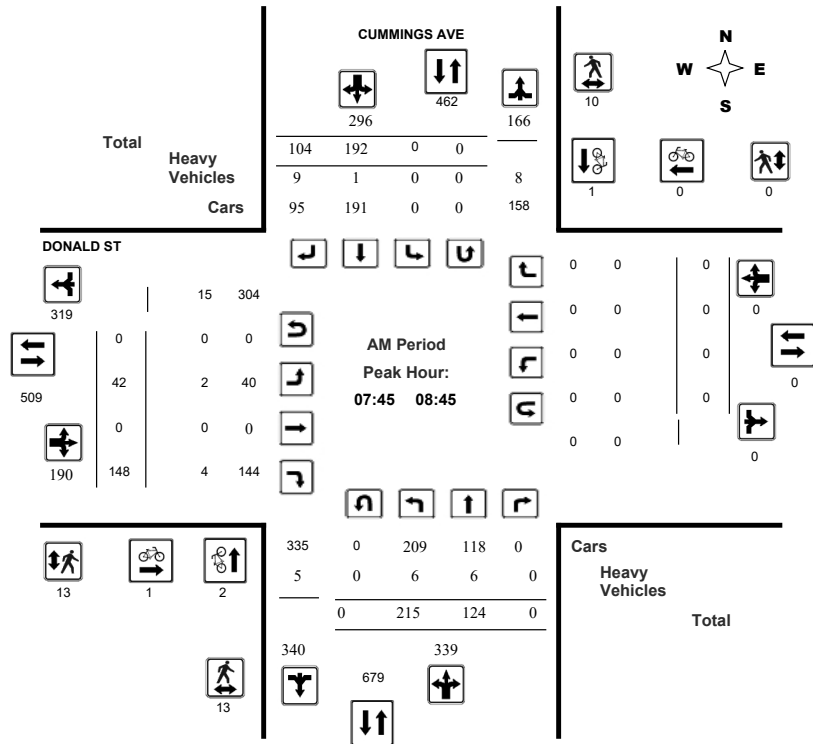

Comments



Transportation Services - Traffic Services

Turning Movement Count - Full Study Peak Hour Diagram

CUMMINGS AVE @ DONALD ST

Survey Date: Wednesday, April 11, 2018

Start Time: 07:00

WO No: 37720

Device: Miovision

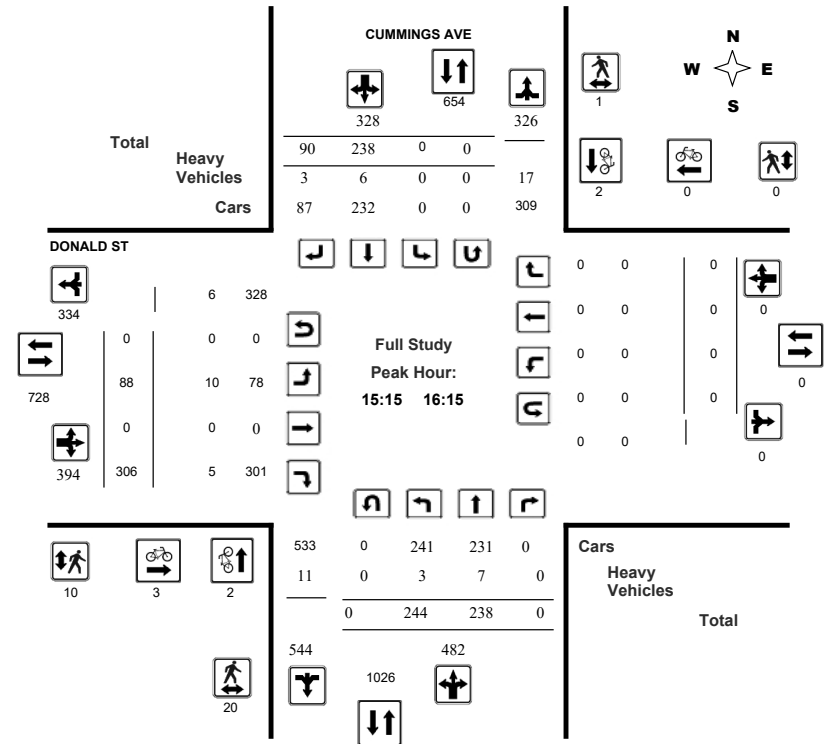

Comments



Transportation Services - Traffic Services

Turning Movement Count - Full Study Peak Hour Diagram

CUMMINGS AVE @ DONALD ST

Survey Date: Wednesday, April 11, 2018
Start Time: 07:00

WO No: 37720
Device: Miovision

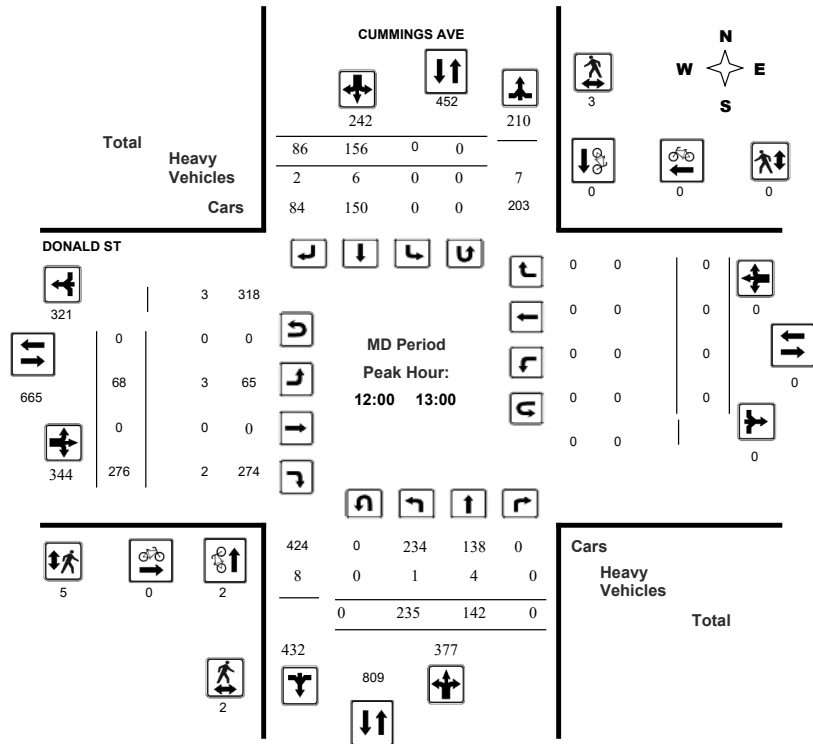

Comments



Transportation Services - Traffic Services

Turning Movement Count - Full Study Peak Hour Diagram

CUMMINGS AVE @ DONALD ST

Survey Date: Wednesday, April 11, 2018
Start Time: 07:00

WO No: 37720
Device: Miovision

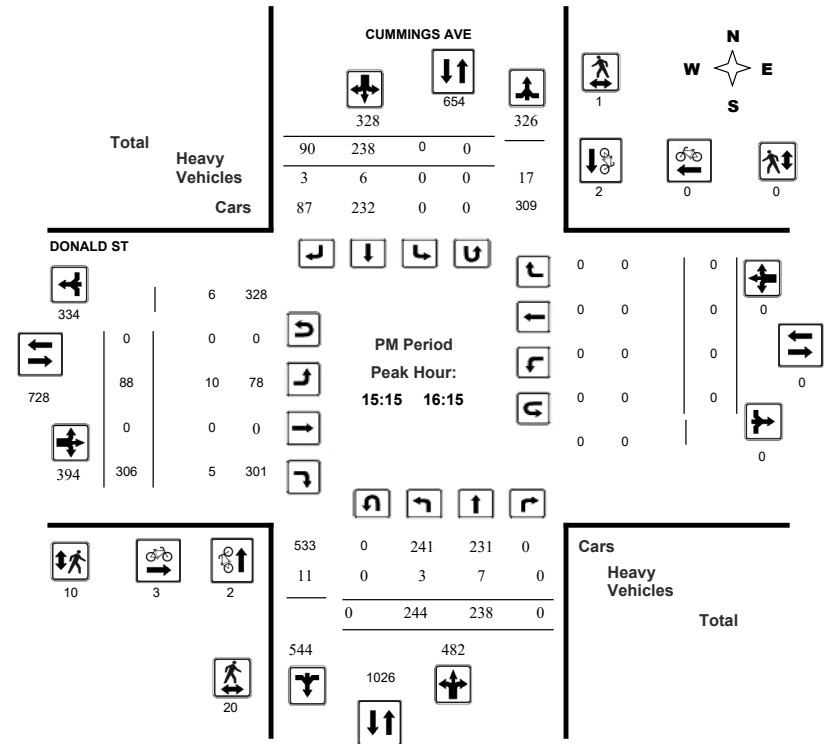

Comments



Transportation Services - Traffic Services
Turning Movement Count - Full Study Diagram

CUMMINGS AVE @ DONALD ST

Survey Date: Wednesday, April 11, 2018

WO#: 37720
Device: Miovision

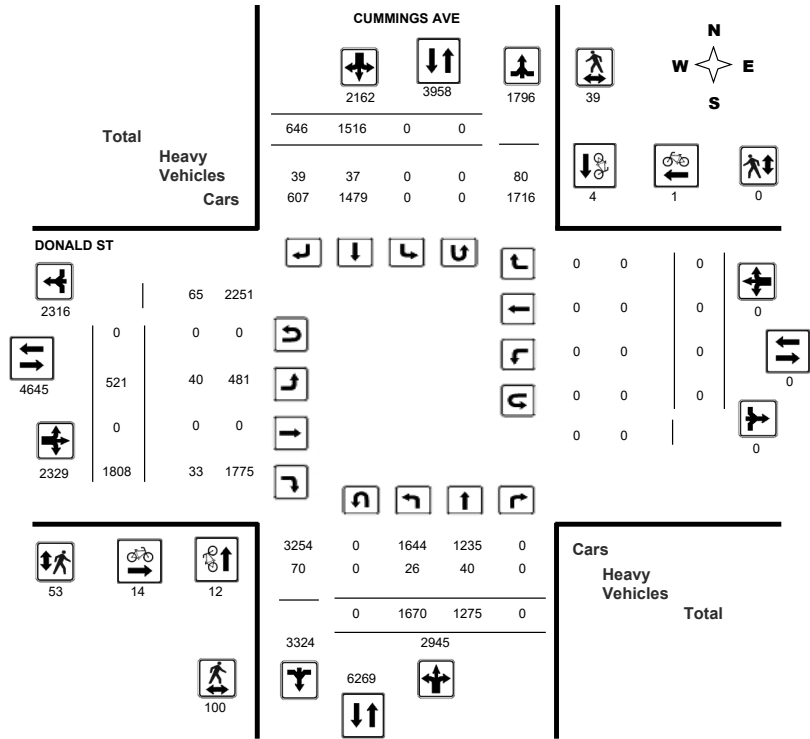

Comments



Transportation Services - Traffic Services

Work Order
37720

Turning Movement Count - Full Study Summary Report

CUMMINGS AVE @ DONALD ST

Survey Date: Wednesday, April 11, 2018

Total Observed U-Turns
Northbound: 0 Southbound: 0
Eastbound: 0 Westbound: 0
AADT Factor .90

Full Study

Period	CUMMINGS AVE								DONALD ST								WB TOT	STR TOT	Grand Total	
	Northbound				Southbound				Eastbound				Westbound							
	LT	ST	RT	NB TOT	LT	ST	RT	SB TOT	STR TOT	LT	ST	RT	EB TOT	LT	ST	RT				
07:00 08:00	156	106	0	262	0	189	56	245	507	39	0	128	167	0	0	0	0	167	674	
08:00 09:00	204	126	0	330	0	189	101	290	620	38	0	150	188	0	0	0	0	188	808	
09:00 10:00	185	121	0	306	0	177	74	251	557	45	0	182	227	0	0	0	0	227	784	
11:30 12:30	226	129	0	355	0	171	75	246	601	61	0	244	305	0	0	0	0	305	906	
12:30 13:30	218	142	0	360	0	151	75	226	586	67	0	272	339	0	0	0	0	339	925	
15:00 16:00	243	229	0	472	0	207	95	302	774	81	0	286	367	0	0	0	0	367	1141	
16:00 17:00	222	205	0	427	0	231	94	325	752	95	0	289	384	0	0	0	0	384	1136	
17:00 18:00	216	217	0	433	0	201	76	277	710	95	0	257	352	0	0	0	0	352	1062	
Sub Total	1670	1275	0	2945	0	1516	646	2162	5107	521	0	1808	2329	0	0	0	0	2329	7436	
U Turns	0				0				0				0				0		0	
Total	1670	1275	0	2945	0	1516	646	2162	5107	521	0	1808	2329	0	0	0	0	2329	7436	
EQ 12Hr	2321	1772	0	4094	0	2107	898	3005	7099	724	0	2513	3237	0	0	0	0	3237	10336	
Note: These values are calculated by multiplying the totals by the appropriate expansion factor.													1.39							
AVG 12Hr	2089	1595	0	3684	0	1897	808	2705	6389	652	0	2262	2914	0	0	0	0	2914	9303	
Note: These volumes are calculated by multiplying the Equivalent 12 hr. totals by the AADT factor.													.90							
AVG 24Hr	2737	2089	0	4826	0	2484	1059	3543	8369	854	0	2963	3817	0	0	0	0	3817	12186	
Note: These volumes are calculated by multiplying the Average Daily 12 hr. totals by 12 to 24 expansion factor.													1.31							

Comments:

Note: U-Turns provided for approach totals. Refer to 'U-Turn' Report for specific breakdown.



Transportation Services - Traffic Services W.O. 37720
Turning Movement Count - 15 Minute Summary Report

CUMMINGS AVE @ DONALD ST

Survey Date: Wednesday, April 11, 2018

Total Observed U-Turns

Northbound: 0 Southbound: 0
 Eastbound: 0 Westbound: 0

CUMMINGS AVE										DONALD ST										Grand Total
Northbound					Southbound					Eastbound					Westbound					
Time Period	LT	ST	RT	N TOT	LT	ST	RT	S TOT	STR TOT	LT	ST	RT	E TOT	LT	ST	RT	W TOT	STR TOT		
07:00 07:15	37	21	0	58	0	36	11	47	105	7	0	25	32	0	0	0	0	32	137	
07:15 07:30	35	30	0	65	0	41	11	52	117	12	0	36	48	0	0	0	0	48	165	
07:30 07:45	38	26	0	64	0	65	10	75	139	10	0	32	42	0	0	0	0	42	181	
07:45 08:00	46	29	0	75	0	47	24	71	146	10	0	35	45	0	0	0	0	45	191	
08:00 08:15	49	38	0	87	0	53	32	85	172	7	0	41	48	0	0	0	0	48	220	
08:15 08:30	60	33	0	93	0	48	25	73	166	11	0	32	43	0	0	0	0	43	209	
08:30 08:45	60	24	0	84	0	44	23	67	151	14	0	40	54	0	0	0	0	54	205	
08:45 09:00	35	31	0	66	0	44	21	65	131	6	0	37	43	0	0	0	0	43	174	
09:00 09:15	44	31	0	75	0	43	15	58	133	16	0	54	70	0	0	0	0	70	203	
09:15 09:30	58	27	0	85	0	44	25	69	154	9	0	40	49	0	0	0	0	49	203	
09:30 09:45	44	29	0	73	0	43	19	62	135	7	0	40	47	0	0	0	0	47	182	
09:45 10:00	39	34	0	73	0	47	15	62	135	13	0	48	61	0	0	0	0	61	196	
11:30 11:45	44	30	0	74	0	44	15	59	133	8	0	63	71	0	0	0	0	71	204	
11:45 12:00	57	28	0	85	0	47	14	61	146	17	0	45	62	0	0	0	0	62	208	
12:00 12:15	68	34	0	102	0	42	22	64	166	24	0	66	90	0	0	0	0	90	256	
12:15 12:30	57	37	0	94	0	38	24	62	156	12	0	70	82	0	0	0	0	82	238	
12:30 12:45	54	36	0	90	0	36	22	58	148	16	0	74	90	0	0	0	0	90	238	
12:45 13:00	56	35	0	91	0	40	18	58	149	16	0	66	82	0	0	0	0	82	231	
13:00 13:15	42	41	0	83	0	47	16	63	146	23	0	72	95	0	0	0	0	95	241	
13:15 13:30	66	30	0	96	0	28	19	47	143	12	0	60	72	0	0	0	0	72	215	
15:00 15:15	57	48	0	105	0	47	27	74	179	15	0	56	71	0	0	0	0	71	250	
15:15 15:30	59	52	0	111	0	45	24	69	180	20	0	69	89	0	0	0	0	89	269	
15:30 15:45	72	57	0	129	0	58	21	79	208	27	0	101	128	0	0	0	0	128	336	
15:45 16:00	55	72	0	127	0	57	23	80	207	19	0	60	79	0	0	0	0	79	286	
16:00 16:15	58	57	0	115	0	78	22	100	215	22	0	76	98	0	0	0	0	98	313	
16:15 16:30	55	50	0	105	0	56	19	75	180	22	0	57	79	0	0	0	0	79	259	
16:30 16:45	56	48	0	104	0	51	29	80	184	28	0	86	114	0	0	0	0	114	298	
16:45 17:00	53	50	0	103	0	46	24	70	173	23	0	70	93	0	0	0	0	93	266	
17:00 17:15	80	54	0	134	0	54	14	68	202	30	0	66	96	0	0	0	0	96	298	
17:15 17:30	45	69	0	114	0	58	17	75	189	25	0	71	96	0	0	0	0	96	285	
17:30 17:45	44	51	0	95	0	44	23	67	162	20	0	64	84	0	0	0	0	84	246	
17:45 18:00	47	43	0	90	0	45	22	67	157	20	0	56	76	0	0	0	0	76	233	
TOTAL:	1670	1275	0	2945	0	1516	646	2162	5107	521	0	1808	2329	0	0	0	0	2329	7436	

Note: U-Turns are included in Totals.

Comment:



Transportation Services - Traffic Services
Turning Movement Count - Cyclist Volume Report

Work Order
37720

CUMMINGS AVE @ DONALD ST

Count Date: Wednesday, April 11, 2018

Start Time: 07:00

Time Period	CUMMINGS AVE			DONALD ST			Grand Total
	Northbound	Southbound	Street Total	Eastbound	Westbound	Street Total	
07:00 08:00	0	0	0	4	1	5	5
08:00 09:00	2	1	3	0	0	0	3
09:00 10:00	0	0	0	0	0	0	0
11:30 12:30	2	1	3	0	0	0	3
12:30 13:30	3	0	3	0	0	0	3
15:00 16:00	1	1	2	3	0	3	5
16:00 17:00	3	1	4	5	0	5	9
17:00 18:00	1	0	1	2	0	2	3
Total	12	4	16	14	1	15	31

Comment:

Note: These volumes consists of bicycles only (no mopeds or motorcycles) and ARE NOT included in the Turning Movement Count Summary.



Transportation Services - Traffic Services
Turning Movement Count - Cyclist Volume Report

Work Order
37720

CUMMINGS AVE @ DONALD ST

Count Date: Wednesday, April 11, 2018

Start Time: 07:00

Time Period	CUMMINGS AVE			DONALD ST			Grand Total
	Northbound	Southbound	Street Total	Eastbound	Westbound	Street Total	
07:00 08:00	0	0	0	4	1	5	5
08:00 09:00	2	1	3	0	0	0	3
09:00 10:00	0	0	0	0	0	0	0
11:30 12:30	2	1	3	0	0	0	3
12:30 13:30	3	0	3	0	0	0	3
15:00 16:00	1	1	2	3	0	3	5
16:00 17:00	3	1	4	5	0	5	9
17:00 18:00	1	0	1	2	0	2	3
Total	12	4	16	14	1	15	31

Comment:



Transportation Services - Traffic Services
Turning Movement Count - Pedestrian Volume Report

Work Order
37720

CUMMINGS AVE @ DONALD ST

Count Date: Wednesday, April 11, 2018

Start Time: 07:00

Time Period	NB Approach (E or W Crossing)	SB Approach (E or W Crossing)	Total	EB Approach (N or S Crossing)	WB Approach (N or S Crossing)	Total	Grand Total
07:00 07:15	1	0	1	1	0	1	2
07:15 07:30	4	4	8	0	0	0	8
07:30 07:45	2	2	4	1	0	1	5
07:45 08:00	4	1	5	2	0	2	7
07:00 08:00	11	7	18	4	0	4	22
08:00 08:15	5	2	7	6	0	6	13
08:15 08:30	1	2	3	3	0	3	6
08:30 08:45	3	5	8	2	0	2	10
08:45 09:00	12	1	13	3	0	3	16
08:00 09:00	21	10	31	14	0	14	45
09:00 09:15	7	0	7	1	0	1	8
09:15 09:30	1	3	4	1	0	1	5
09:30 09:45	3	0	3	1	0	1	4
09:45 10:00	1	1	2	1	0	1	3
09:00 10:00	12	4	16	4	0	4	20
11:30 11:45	2	1	3	1	0	1	4
11:45 12:00	2	0	2	1	0	1	3
12:00 12:15	0	0	0	0	0	0	0
12:15 12:30	0	1	1	0	0	0	1
11:30 12:30	4	2	6	2	0	2	8
12:30 12:45	1	0	1	1	0	1	2
12:45 13:00	1	2	3	4	0	4	7
13:00 13:15	2	0	2	1	0	1	3
13:15 13:30	0	1	1	0	0	0	1
12:30 13:30	4	3	7	6	0	6	13
15:00 15:15	1	1	2	0	0	0	2
15:15 15:30	2	0	2	0	0	0	2
15:30 15:45	5	0	5	1	0	1	6
15:45 16:00	11	0	11	7	0	7	18
15:00 16:00	19	1	20	8	0	8	28
16:00 16:15	2	1	3	2	0	2	5
16:15 16:30	0	3	3	2	0	2	5
16:30 16:45	6	1	7	2	0	2	9
16:45 17:00	6	0	6	3	0	3	9
16:00 17:00	14	5	19	9	0	9	28
17:00 17:15	6	0	6	1	0	1	7
17:15 17:30	1	1	2	2	0	2	4
17:30 17:45	2	4	6	2	0	2	8
17:45 18:00	6	2	8	1	0	1	9
17:00 18:00	15	7	22	6	0	6	28
Total	100	39	139	53	0	53	192

Comment:

Note: These volumes consists of bicycles only (no mopeds or motorcycles) and ARE NOT included in the Turning Movement Count Summary.



Transportation Services - Traffic Services

Work Order
37720

Turning Movement Count - 15 Min U-Turn Total Report

CUMMINGS AVE @ DONALD ST

Survey Date: Wednesday, April 11, 2018

Time Period	Northbound U-Turn Total	Southbound U-Turn Total	Eastbound U-Turn Total	Westbound U-Turn Total	Total
07:00 07:15	0	0	0	0	0
07:15 07:30	0	0	0	0	0
07:30 07:45	0	0	0	0	0
07:45 08:00	0	0	0	0	0
08:00 08:15	0	0	0	0	0
08:15 08:30	0	0	0	0	0
08:30 08:45	0	0	0	0	0
08:45 09:00	0	0	0	0	0
09:00 09:15	0	0	0	0	0
09:15 09:30	0	0	0	0	0
09:30 09:45	0	0	0	0	0
09:45 10:00	0	0	0	0	0
11:30 11:45	0	0	0	0	0
11:45 12:00	0	0	0	0	0
12:00 12:15	0	0	0	0	0
12:15 12:30	0	0	0	0	0
12:30 12:45	0	0	0	0	0
12:45 13:00	0	0	0	0	0
13:00 13:15	0	0	0	0	0
13:15 13:30	0	0	0	0	0
15:00 15:15	0	0	0	0	0
15:15 15:30	0	0	0	0	0
15:30 15:45	0	0	0	0	0
15:45 16:00	0	0	0	0	0
16:00 16:15	0	0	0	0	0
16:15 16:30	0	0	0	0	0
16:30 16:45	0	0	0	0	0
16:45 17:00	0	0	0	0	0
17:00 17:15	0	0	0	0	0
17:15 17:30	0	0	0	0	0
17:30 17:45	0	0	0	0	0
17:45 18:00	0	0	0	0	0
Total	0	0	0	0	0

Appendix C

Synchro Intersection Worksheets – Existing Conditions

Lanes, Volumes, Timings
1: Cyrville Rd & Ogilvie Rd

Existing
AM Peak Hour

Lane Group	EBL	EBT	EBR	WBL	WBT	WBR	NBL	NBT	NBR	SBL	SBT	SBR
Lane Configurations		↑↑	↑	↑	↑↑	↑	↑	↑	↑	↑	↑	↑
Traffic Volume (vph)	0	532	227	27	984	166	165	234	12	47	152	45
Future Volume (vph)	0	532	227	27	984	166	165	234	12	47	152	45
Satd. Flow (prot)	0	3283	1414	1658	3316	1441	1551	1716	0	1626	1600	0
Fit Permitted				0.414			0.505			0.406		
Satd. Flow (perm)	0	3283	1329	714	3316	1319	821	1716	0	693	1600	0
Satd. Flow (RTOR)			252			184		2			13	
Lane Group Flow (vph)	0	591	252	30	1093	184	183	273	0	52	219	0
Turn Type		NA	Perm	Perm	NA	Perm	Perm	NA		Perm	NA	
Protected Phases		2			6			8				4
Permitted Phases			2	6		6	8			4		
Detector Phase		2	2	6	6	6	8	8		4	4	
Switch Phase												
Minimum Initial (s)		10.0	10.0	10.0	10.0	10.0	10.0	10.0		10.0	10.0	
Minimum Split (s)		32.2	32.2	32.2	32.2	32.2	47.1	47.1		47.1	47.1	
Total Split (s)		72.9	72.9	72.9	72.9	72.9	47.1	47.1		47.1	47.1	
Total Split (%)		60.8%	60.8%	60.8%	60.8%	60.8%	39.3%	39.3%		39.3%	39.3%	
Yellow Time (s)		3.7	3.7	3.7	3.7	3.7	3.7	3.7		3.7	3.7	
All-Red Time (s)		2.5	2.5	2.5	2.5	2.5	3.4	3.4		3.4	3.4	
Lost Time Adjust (s)		0.0	0.0	0.0	0.0	0.0	0.0	0.0		0.0	0.0	
Total Lost Time (s)		6.2	6.2	6.2	6.2	6.2	7.1	7.1		7.1	7.1	
Lead/Lag												
Lead-Lag Optimize?												
Recall Mode		C-Max	C-Max	C-Max	C-Max	C-Max	None	None		None	None	
Act Effct Green (s)		77.5	77.5	77.5	77.5	77.5	29.2	29.2		29.2	29.2	
Actuated g/C Ratio		0.65	0.65	0.65	0.65	0.65	0.24	0.24		0.24	0.24	
v/c Ratio		0.28	0.27	0.07	0.51	0.20	0.92	0.65		0.31	0.55	
Control Delay		10.7	2.2	3.3	3.5	0.3	88.3	46.8		38.9	40.9	
Queue Delay		0.0	0.0	0.0	0.0	0.0	0.0	0.0		0.0	0.0	
Total Delay		10.7	2.2	3.3	3.5	0.3	88.3	46.8		38.9	40.9	
LOS		B	A	A	A	A	F	D		D	D	
Approach Delay		8.2			3.0		63.4			40.5		
Approach LOS		A			A		E			D		
Queue Length 50th (m)		29.6	0.0	0.5	11.0	0.1	41.9	57.3		10.0	42.3	
Queue Length 95th (m)		49.3	11.3	m0.9	14.7	m0.0	#65.1	75.8		19.4	59.0	
Internal Link Dist (m)		113.5			313.9		191.2			190.6		
Turn Bay Length (m)				62.0		71.0	33.5			82.0		
Base Capacity (vph)		2119	947	461	2140	916	273	573		231	542	
Starvation Cap Reductn		0	0	0	0	0	0	0		0	0	
Spillback Cap Reductn		0	0	0	0	0	0	0		0	0	
Storage Cap Reductn		0	0	0	0	0	0	0		0	0	
Reduced v/c Ratio		0.28	0.27	0.07	0.51	0.20	0.67	0.48		0.23	0.40	

Intersection Summary

Cycle Length: 120

Actuated Cycle Length: 120

Offset: 10 (8%), Referenced to phase 2:EBT and 6:WBTL, Start of Green

Natural Cycle: 80

Control Type: Actuated-Coordinated

Scenario 1 1184 -1196 Cummings Avenue 12:49 am 04/13/2021 Existing

Synchro 11 Report
Page 1

Lanes, Volumes, Timings
1: Cyrville Rd & Ogilvie Rd

Existing
AM Peak Hour

Maximum v/c Ratio: 0.92	Intersection LOS: B
Intersection Signal Delay: 17.6	ICU Level of Service C
Intersection Capacity Utilization 72.0%	
Analysis Period (min) 15	
# 95th percentile volume exceeds capacity, queue may be longer.	
Queue shown is maximum after two cycles.	
m Volume for 95th percentile queue is metered by upstream signal.	

Splits and Phases: 1: Cyrville Rd & Ogilvie Rd

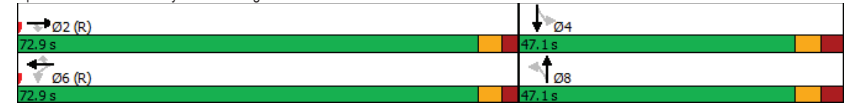

Scenario 1 1184 -1196 Cummings Avenue 12:49 am 04/13/2021 Existing

Synchro 11 Report
Page 2

Lanes, Volumes, Timings
2: Cummings Ave & Donald

Existing
AM Peak Hour

Lane Group	EBL	EBR	NBL	NBT	SBT	SBR
Lane Configurations						
Traffic Volume (vph)	42	148	215	124	192	104
Future Volume (vph)	42	148	215	124	192	104
Satd. Flow (prot)	1610	1469	1642	1695	1597	0
Fit Permitted	0.950		0.562			
Satd. Flow (perm)	1532	1382	957	1695	1597	0
Satd. Flow (RTOR)		164			68	
Lane Group Flow (vph)	47	164	239	138	329	0
Turn Type	Perm	Perm	Perm	NA	NA	
Protected Phases				2	6	
Permitted Phases	4	4	2			
Detector Phase	4	4	2	2	6	
Switch Phase						
Minimum Initial (s)	10.0	10.0	10.0	10.0	10.0	
Minimum Split (s)	22.0	22.0	39.9	39.9	39.9	
Total Split (s)	22.0	22.0	98.0	98.0	98.0	
Total Split (%)	18.3%	18.3%	81.7%	81.7%	81.7%	
Yellow Time (s)	3.3	3.3	3.3	3.3	3.3	
All-Red Time (s)	2.7	2.7	3.6	3.6	3.6	
Lost Time Adjust (s)	0.0	0.0	0.0	0.0	0.0	
Total Lost Time (s)	6.0	6.0	6.9	6.9	6.9	
Lead/Lag						
Lead-Lag Optimize?						
Recall Mode	None	None	Min	Min	Min	
Act Effct Green (s)	11.3	11.3	19.3	19.3	19.3	
Actuated g/C Ratio	0.26	0.26	0.44	0.44	0.44	
v/c Ratio	0.12	0.35	0.57	0.19	0.45	
Control Delay	14.8	5.8	15.5	8.3	8.9	
Queue Delay	0.0	0.0	0.0	0.0	0.0	
Total Delay	14.8	5.8	15.5	8.3	8.9	
LOS	B	A	B	A	A	
Approach Delay	7.8			12.9	8.9	
Approach LOS	A			B	A	
Queue Length 50th (m)	2.1	0.0	11.4	5.4	11.2	
Queue Length 95th (m)	11.0	12.0	31.8	14.6	29.3	
Internal Link Dist (m)	296.9			237.9	259.3	
Turn Bay Length (m)	60.0		60.0			
Base Capacity (vph)	580	625	957	1695	1597	
Starvation Cap Reductn	0	0	0	0	0	
Spillback Cap Reductn	0	0	0	0	0	
Storage Cap Reductn	0	0	0	0	0	
Reduced v/c Ratio	0.08	0.26	0.25	0.08	0.21	

Intersection Summary

Cycle Length: 120
Actuated Cycle Length: 44.1
Natural Cycle: 65
Control Type: Actuated-Uncoordinated
Maximum v/c Ratio: 0.57

Lanes, Volumes, Timings
2: Cummings Ave & Donald

Existing
AM Peak Hour

Intersection Signal Delay: 10.3
Intersection Capacity Utilization 60.0%
Analysis Period (min) 15

Intersection LOS: B
ICU Level of Service B

Splits and Phases: 2: Cummings Ave & Donald



Lanes, Volumes, Timings
3: Cummings Ave & Ogilvie Rd

Existing
AM Peak Hour

Lane Group	EBL	EBT	EBR	WBL	WBT	WBR	NBL	NBT	NBR	SBL	SBT	SBR
Lane Configurations	↔	↕	↔	↔	↕	↔	↔	↕	↔	↔	↕	↔
Traffic Volume (vph)	51	556	11	167	1076	170	18	111	63	138	116	112
Future Volume (vph)	51	556	11	167	1076	170	18	111	63	138	116	112
Satd. Flow (prot)	1626	3265	0	1626	3194	0	1658	1508	0	1626	1599	0
Fit Permitted	0.084			0.347			0.602			0.449		
Satd. Flow (perm)	144	3265	0	585	3194	0	1046	1508	0	737	1599	0
Satd. Flow (RTOR)		2			19			23			44	
Lane Group Flow (vph)	57	630	0	186	1385	0	20	193	0	153	253	0
Turn Type	pm+pt	NA		pm+pt	NA		Perm	NA		pm+pt	NA	
Protected Phases	5	2		1	6			8		7	4	
Permitted Phases	2			6			8			4		
Detector Phase	5	2		1	6		8	8		7	4	
Switch Phase												
Minimum Initial (s)	5.0	10.0		5.0	10.0		10.0	10.0		5.0	10.0	
Minimum Split (s)	9.7	24.7		9.7	24.7		36.6	36.6		9.3	36.6	
Total Split (s)	11.0	61.0		11.0	61.0		36.6	36.6		11.4	48.0	
Total Split (%)	9.2%	50.8%		9.2%	50.8%		30.5%	30.5%		9.5%	40.0%	
Yellow Time (s)	3.7	3.7		3.7	3.7		3.3	3.3		3.3	3.3	
All-Red Time (s)	1.0	2.0		1.0	2.0		3.3	3.3		1.0	3.3	
Lost Time Adjust (s)	0.0	0.0		0.0	0.0		0.0	0.0		0.0	0.0	
Total Lost Time (s)	4.7	5.7		4.7	5.7		6.6	6.6		4.3	6.6	
Lead/Lag	Lead	Lag		Lead	Lag		Lag	Lag		Lead		
Lead-Lag Optimize?	Yes	Yes		Yes	Yes		Yes	Yes		Yes		
Recall Mode	None	C-Max		None	C-Max		None	None		None	None	
Act Effct Green (s)	66.0	58.8		67.3	61.3		26.2	26.2		39.9	37.6	
Actuated g/C Ratio	0.55	0.49		0.56	0.51		0.22	0.22		0.33	0.31	
v/c Ratio	0.37	0.39		0.48	0.84		0.09	0.56		0.52	0.48	
Control Delay	30.2	18.2		18.4	33.2		35.8	41.8		35.3	29.3	
Queue Delay	0.0	0.0		0.0	0.0		0.0	0.0		0.0	0.0	
Total Delay	30.2	18.2		18.4	33.2		35.8	41.8		35.3	29.3	
LOS	C	B		B	C		D	D		D	C	
Approach Delay		19.2			31.5			41.3			31.6	
Approach LOS		B			C			D			C	
Queue Length 50th (m)	5.3	39.6		20.7	157.0		3.6	34.2		25.1	37.4	
Queue Length 95th (m)	20.5	50.6		33.1	#207.0		10.1	57.2		41.4	60.8	
Internal Link Dist (m)		313.9			184.8			136.9			237.9	
Turn Bay Length (m)	80.0			100.0			34.0			153.0		
Base Capacity (vph)	156	1601		384	1640		261	394		297	580	
Starvation Cap Reductn	0	0		0	0		0	0		0	0	
Spillback Cap Reductn	0	0		0	0		0	0		0	0	
Storage Cap Reductn	0	0		0	0		0	0		0	0	
Reduced v/c Ratio	0.37	0.39		0.48	0.84		0.08	0.49		0.52	0.44	

Intersection Summary

Cycle Length: 120
 Actuated Cycle Length: 120
 Offset: 110 (92%), Referenced to phase 2:EBTL and 6:WBTL, Start of Green
 Natural Cycle: 105
 Control Type: Actuated-Coordinated

Lanes, Volumes, Timings
3: Cummings Ave & Ogilvie Rd

Existing
AM Peak Hour

Maximum v/c Ratio: 0.84	Intersection LOS: C
Intersection Signal Delay: 29.3	ICU Level of Service E
Intersection Capacity Utilization 90.1%	
Analysis Period (min) 15	
# 95th percentile volume exceeds capacity, queue may be longer.	
Queue shown is maximum after two cycles.	

Splits and Phases: 3: Cummings Ave & Ogilvie Rd

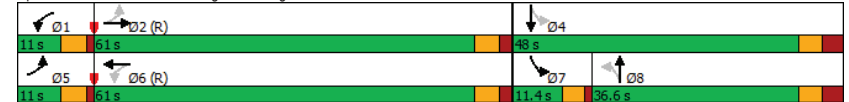

Lanes, Volumes, Timings
1: Cyrville Rd & Ogilvie Rd

Existing
PM Peak Hour

Lane Group	EBL	EBT	EBR	WBL	WBT	WBR	NBL	NBT	NBR	SBL	SBT	SBR
Lane Configurations		↑↑	↑	↑	↑↑	↑	↑	↑	↑	↑	↑	↑
Traffic Volume (vph)	0	984	257	42	641	124	117	210	32	134	213	80
Future Volume (vph)	0	984	257	42	641	124	117	210	32	134	213	80
Satd. Flow (prot)	0	3316	1469	1658	3316	1469	1580	1705	0	1642	1635	0
Fit Permitted				0.215			0.310			0.412		
Satd. Flow (perm)	0	3316	1353	373	3316	1303	514	1705	0	709	1635	0
Satd. Flow (RTOR)			286			138		7			18	
Lane Group Flow (vph)	0	1093	286	47	712	138	130	269	0	149	326	0
Turn Type	NA	Perm	Perm	NA	Perm	Perm	NA	Perm	NA	Perm	NA	
Protected Phases		2			6			8				4
Permitted Phases			2	6		6	8			4		
Detector Phase		2	2	6	6	6	8	8		4	4	
Switch Phase												
Minimum Initial (s)		10.0	10.0	10.0	10.0	10.0	10.0	10.0		10.0	10.0	
Minimum Split (s)		32.2	32.2	32.2	32.2	32.2	47.1	47.1		47.1	47.1	
Total Split (s)		70.0	70.0	70.0	70.0	70.0	50.0	50.0		50.0	50.0	
Total Split (%)		58.3%	58.3%	58.3%	58.3%	58.3%	41.7%	41.7%		41.7%	41.7%	
Yellow Time (s)		3.7	3.7	3.7	3.7	3.7	3.7	3.7		3.7	3.7	
All-Red Time (s)		2.5	2.5	2.5	2.5	2.5	3.4	3.4		3.4	3.4	
Lost Time Adjust (s)		0.0	0.0	0.0	0.0	0.0	0.0	0.0		0.0	0.0	
Total Lost Time (s)		6.2	6.2	6.2	6.2	6.2	7.1	7.1		7.1	7.1	
Lead/Lag												
Lead-Lag Optimize?												
Recall Mode		C-Max	C-Max	C-Max	C-Max	C-Max	None	None		None	None	
Act Effct Green (s)		77.7	77.7	77.7	77.7	77.7	29.0	29.0		29.0	29.0	
Actuated g/C Ratio		0.65	0.65	0.65	0.65	0.65	0.24	0.24		0.24	0.24	
v/c Ratio		0.51	0.29	0.20	0.33	0.15	1.05	0.65		0.87	0.80	
Control Delay		13.3	2.2	22.6	18.8	9.7	138.2	46.0		84.5	54.1	
Queue Delay		0.0	0.0	0.0	0.0	0.0	0.0	0.0		0.0	0.0	
Total Delay		13.3	2.2	22.6	18.8	9.7	138.2	46.0		84.5	54.1	
LOS		B	A	C	B	A	F	D		F	D	
Approach Delay		11.0			17.6			76.0			63.6	
Approach LOS		B			B			E			E	
Queue Length 50th (m)		65.1	0.0	6.3	53.5	8.5	~33.7	56.0		34.0	69.1	
Queue Length 95th (m)		105.7	11.7	m8.5	m61.7	m11.3	#60.9	73.6		54.2	89.9	
Internal Link Dist (m)		113.8			313.9			191.2			190.4	
Turn Bay Length (m)				62.0		71.0	33.5			82.0		
Base Capacity (vph)		2146	976	241	2146	892	183	614		253	596	
Starvation Cap Reductn		0	0	0	0	0	0	0		0	0	
Spillback Cap Reductn		0	0	0	0	0	0	0		0	0	
Storage Cap Reductn		0	0	0	0	0	0	0		0	0	
Reduced v/c Ratio		0.51	0.29	0.20	0.33	0.15	0.71	0.44		0.59	0.55	

Intersection Summary

Cycle Length: 120

Actuated Cycle Length: 120

Offset: 20 (17%), Referenced to phase 2:EBT and 6:WBTL, Start of Green

Natural Cycle: 80

Control Type: Actuated-Coordinated

Lanes, Volumes, Timings
1: Cyrville Rd & Ogilvie Rd

Existing
PM Peak Hour

Maximum v/c Ratio: 1.05	Intersection LOS: C
Intersection Signal Delay: 29.1	ICU Level of Service E
Intersection Capacity Utilization 83.2%	
Analysis Period (min) 15	
~ Volume exceeds capacity, queue is theoretically infinite.	
Queue shown is maximum after two cycles.	
# 95th percentile volume exceeds capacity, queue may be longer.	
Queue shown is maximum after two cycles.	
m Volume for 95th percentile queue is metered by upstream signal.	

Splits and Phases: 1: Cyrville Rd & Ogilvie Rd

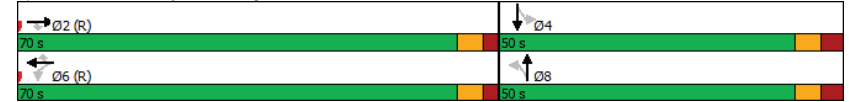

Lanes, Volumes, Timings
2: Cummings Ave & Donald

Existing
PM Peak Hour

Lane Group	EBL	EBR	NBL	NBT	SBT	SBR
Lane Configurations						
Traffic Volume (vph)	88	306	244	238	238	90
Future Volume (vph)	88	306	244	238	238	90
Satd. Flow (prot)	1523	1483	1658	1728	1647	0
Fit Permitted	0.950		0.544			
Satd. Flow (perm)	1518	1345	939	1728	1647	0
Satd. Flow (RTOR)		340			36	
Lane Group Flow (vph)	98	340	271	264	364	0
Turn Type	Perm	Perm	Perm	NA	NA	
Protected Phases				2	6	
Permitted Phases	4	4	2			
Detector Phase	4	4	2	2	6	
Switch Phase						
Minimum Initial (s)	10.0	10.0	10.0	10.0	10.0	
Minimum Split (s)	22.0	22.0	39.9	39.9	39.9	
Total Split (s)	31.0	31.0	89.0	89.0	89.0	
Total Split (%)	25.8%	25.8%	74.2%	74.2%	74.2%	
Yellow Time (s)	3.3	3.3	3.3	3.3	3.3	
All-Red Time (s)	2.7	2.7	3.6	3.6	3.6	
Lost Time Adjust (s)	0.0	0.0	0.0	0.0	0.0	
Total Lost Time (s)	6.0	6.0	6.9	6.9	6.9	
Lead/Lag						
Lead-Lag Optimize?						
Recall Mode	None	None	Min	Min	Min	
Act Effct Green (s)	11.3	11.3	18.7	18.7	18.7	
Actuated g/C Ratio	0.26	0.26	0.43	0.43	0.43	
v/c Ratio	0.25	0.57	0.67	0.36	0.50	
Control Delay	17.3	6.9	18.8	9.4	10.2	
Queue Delay	0.0	0.0	0.0	0.0	0.0	
Total Delay	17.3	6.9	18.8	9.4	10.2	
LOS	B	A	B	A	B	
Approach Delay	9.2			14.1	10.2	
Approach LOS	A			B	B	
Queue Length 50th (m)	5.3	0.0	13.6	11.1	14.7	
Queue Length 95th (m)	19.4	16.9	38.4	27.0	35.9	
Internal Link Dist (m)	296.3			237.9	259.3	
Turn Bay Length (m)	60.0		60.0			
Base Capacity (vph)	912	943	939	1728	1647	
Starvation Cap Reductn	0	0	0	0	0	
Spillback Cap Reductn	0	0	0	0	0	
Storage Cap Reductn	0	0	0	0	0	
Reduced v/c Ratio	0.11	0.36	0.29	0.15	0.22	

Intersection Summary

Cycle Length: 120
Actuated Cycle Length: 43.5
Natural Cycle: 65
Control Type: Semi Act-Uncoord
Maximum v/c Ratio: 0.67

Lanes, Volumes, Timings
2: Cummings Ave & Donald

Existing
PM Peak Hour

Intersection Signal Delay: 11.5
Intersection Capacity Utilization 63.2%
Analysis Period (min) 15

Intersection LOS: B
ICU Level of Service B

Splits and Phases: 2: Cummings Ave & Donald



Lanes, Volumes, Timings
3: Cummings Ave & Ogilvie Rd

Existing
PM Peak Hour

Lane Group	EBL	EBT	EBR	WBL	WBT	WBR	NBL	NBT	NBR	SBL	SBT	SBR
Lane Configurations	↖	↖↗	↗	↖	↖↗	↗	↖	↖↗	↗	↖	↖↗	↗
Traffic Volume (vph)	129	1082	23	116	729	209	36	162	216	258	163	84
Future Volume (vph)	129	1082	23	116	729	209	36	162	216	258	163	84
Satd. Flow (prot)	1658	3298	0	1626	3161	0	1642	1566	0	1658	1632	0
Fit Permitted	0.095			0.096			0.591			0.160		
Satd. Flow (perm)	166	3298	0	164	3161	0	1000	1566	0	277	1632	0
Satd. Flow (RTOR)		2			33			55			28	
Lane Group Flow (vph)	143	1228	0	129	1042	0	40	420	0	287	274	0
Turn Type	pm+pt	NA		pm+pt	NA		Perm	NA		pm+pt	NA	
Protected Phases	5	2		1	6			8		7	4	
Permitted Phases	2			6			8			4		
Detector Phase	5	2		1	6		8	8		7	4	
Switch Phase												
Minimum Initial (s)	5.0	10.0		5.0	10.0		10.0	10.0		5.0	10.0	
Minimum Split (s)	9.7	24.7		9.7	24.7		36.6	36.6		9.3	36.6	
Total Split (s)	15.0	45.0		15.0	45.0		40.0	40.0		20.0	60.0	
Total Split (%)	12.5%	37.5%		12.5%	37.5%		33.3%	33.3%		16.7%	50.0%	
Yellow Time (s)	3.7	3.7		3.7	3.7		3.3	3.3		3.3	3.3	
All-Red Time (s)	1.0	2.0		1.0	2.0		3.3	3.3		1.0	3.3	
Lost Time Adjust (s)	0.0	0.0		0.0	0.0		0.0	0.0		0.0	0.0	
Total Lost Time (s)	4.7	5.7		4.7	5.7		6.6	6.6		4.3	6.6	
Lead/Lag	Lead	Lag		Lead	Lag		Lag	Lag		Lead		
Lead-Lag Optimize?	Yes	Yes		Yes	Yes		Yes	Yes		Yes		
Recall Mode	None	C-Max		None	C-Max		None	None		None	None	
Act Effct Green (s)	52.8	42.0		52.3	41.7		31.4	31.4		53.7	51.4	
Actuated g/C Ratio	0.44	0.35		0.44	0.35		0.26	0.26		0.45	0.43	
v/c Ratio	0.73	1.06		0.69	0.93		0.15	0.93		0.94	0.38	
Control Delay	49.5	76.8		42.3	52.2		34.7	66.1		65.4	22.2	
Queue Delay	0.0	0.0		0.0	0.0		0.0	0.0		0.0	0.0	
Total Delay	49.5	76.8		42.3	52.2		34.7	66.1		65.4	22.2	
LOS	D	E		D	D		C	E		E	C	
Approach Delay		73.9			51.1			63.4			44.3	
Approach LOS		E			D			E			D	
Queue Length 50th (m)	12.7	~178.8		17.4	124.6		7.1	83.9		43.8	37.4	
Queue Length 95th (m)	#46.2	#221.4		#40.4	#170.7		16.2	#141.1		#95.6	58.4	
Internal Link Dist (m)		313.9			184.8			136.9			237.9	
Turn Bay Length (m)	80.0			100.0			34.0			153.0		
Base Capacity (vph)	202	1155		197	1120		278	475		304	741	
Starvation Cap Reductn	0	0		0	0		0	0		0	0	
Spillback Cap Reductn	0	0		0	0		0	0		0	0	
Storage Cap Reductn	0	0		0	0		0	0		0	0	
Reduced v/c Ratio	0.71	1.06		0.65	0.93		0.14	0.88		0.94	0.37	

Intersection Summary

Cycle Length: 120
 Actuated Cycle Length: 120
 Offset: 46 (38%), Referenced to phase 2:EBTL and 6:WBTL, Start of Green
 Natural Cycle: 125
 Control Type: Actuated-Coordinated

Lanes, Volumes, Timings
3: Cummings Ave & Ogilvie Rd

Existing
PM Peak Hour

Maximum v/c Ratio: 1.06	Intersection LOS: E
Intersection Signal Delay: 60.4	ICU Level of Service F
Intersection Capacity Utilization 96.3%	
Analysis Period (min) 15	
~ Volume exceeds capacity, queue is theoretically infinite.	
Queue shown is maximum after two cycles.	
# 95th percentile volume exceeds capacity, queue may be longer.	
Queue shown is maximum after two cycles.	

Splits and Phases: 3: Cummings Ave & Ogilvie Rd

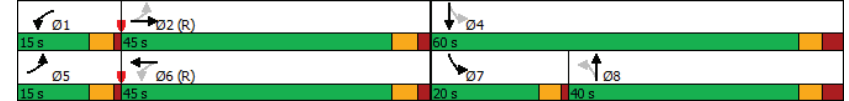

Appendix D

Collision Data

Accident Date	Accident Year	Accident Time	Location	Environment Condition	Light	Traffic Control	Traffic Control Condition	Classification Of Accident	Initial Impact Type	Road Surface Condition	# Vehicles	# Motorcycles	# Bicycles	# Pedestrians
3/24/2016	2016	11:12	CUMMINGS AVE @ DONALD ST (0009936)	03 - Snow	01 - Daylight	01 - Traffic signal	01 - Functioning	03 - P-D only	03 - Rear end	03 - Loose snow	2	0	0	0
5/24/2016	2016	8:39	CUMMINGS AVE @ DONALD ST (0009936)	01 - Clear	01 - Daylight	01 - Traffic signal	01 - Functioning	03 - P-D only	05 - Turning movement	01 - Dry	2	0	0	0
7/28/2016	2016	16:20	CUMMINGS AVE @ DONALD ST (0009936)	01 - Clear	01 - Daylight	01 - Traffic signal	01 - Functioning	03 - P-D only	03 - Rear end	01 - Dry	2	0	0	0
11/28/2017	2017	21:00	CUMMINGS AVE @ DONALD ST (0009936)	05 - Drifting Snow	07 - Dark	01 - Traffic signal	01 - Functioning	03 - P-D only	02 - Angle	06 - ice	2	0	0	0
1/9/2017	2017	19:20	CUMMINGS AVE @ DONALD ST (0009936)	01 - Clear	07 - Dark	01 - Traffic signal	01 - Functioning	03 - P-D only	05 - Turning movement	01 - Dry	2	0	0	0
4/20/2017	2017	13:05	CUMMINGS AVE @ DONALD ST (0009936)	01 - Clear	01 - Daylight	01 - Traffic signal	01 - Functioning	02 - Non-fatal injury	05 - Turning movement	01 - Dry	2	0	0	0
8/7/2017	2017	16:06	CUMMINGS AVE @ DONALD ST (0009936)	01 - Clear	01 - Daylight	01 - Traffic signal	01 - Functioning	02 - Non-fatal injury	03 - Rear end	01 - Dry	2	0	0	0
8/8/2017	2017	13:20	CUMMINGS AVE @ DONALD ST (0009936)	01 - Clear	01 - Daylight	01 - Traffic signal	00 - Unknown	03 - P-D only	03 - Rear end	01 - Dry	2	0	0	0
11/25/2018	2018	2:45	CUMMINGS AVE @ DONALD ST (0009936)	04 - Freezing Rain	07 - Dark	01 - Traffic signal	01 - Functioning	03 - P-D only	07 - SMV other	06 - ice	1	0	0	0
2/25/2018	2018	10:00	CUMMINGS AVE @ DONALD ST (0009936)	01 - Clear	01 - Daylight	01 - Traffic signal	01 - Functioning	03 - P-D only	03 - Rear end	01 - Dry	2	0	0	0
4/30/2018	2018	14:37	CUMMINGS AVE @ DONALD ST (0009936)	01 - Clear	01 - Daylight	01 - Traffic signal	01 - Functioning	03 - P-D only	03 - Rear end	01 - Dry	2	0	0	0
9/17/2018	2018	10:12	CUMMINGS AVE @ DONALD ST (0009936)	01 - Clear	01 - Daylight	01 - Traffic signal	01 - Functioning	02 - Non-fatal injury	05 - Turning movement	01 - Dry	2	0	0	0
7/13/2019	2019	10:30	CUMMINGS AVE @ DONALD ST (0009936)	01 - Clear	01 - Daylight	01 - Traffic signal	01 - Functioning	03 - P-D only	03 - Rear end	01 - Dry	2	0	0	0
7/22/2019	2019	15:16	CUMMINGS AVE @ DONALD ST (0009936)	01 - Clear	01 - Daylight	01 - Traffic signal	01 - Functioning	03 - P-D only	02 - Angle	01 - Dry	2	0	0	0
1/10/2020	2020	20:54	CUMMINGS AVE @ DONALD ST (0009936)	03 - Snow	07 - Dark	01 - Traffic signal	01 - Functioning	02 - Non-fatal injury	07 - SMV other	02 - Wet	2	0	0	0
1/11/2020	2020	14:44	CUMMINGS AVE @ DONALD ST (0009936)	01 - Clear	01 - Daylight	01 - Traffic signal	01 - Functioning	03 - P-D only	03 - Rear end	01 - Dry	2	0	0	0
6/12/2020	2020	21:14	CUMMINGS AVE @ DONALD ST (0009936)	01 - Clear	05 - Dusk	01 - Traffic signal	01 - Functioning	03 - P-D only	04 - Sideswipe	01 - Dry	3	0	0	0
2/9/2016	2016	16:07	CUMMINGS AVE btwn DONALD ST & EADY CRT (L_32B09T)	01 - Clear	01 - Daylight	10 - No control	0	03 - P-D only	05 - Turning movement	02 - Wet	2	0	0	0
9/16/2016	2016	17:44	CUMMINGS AVE btwn DONALD ST & EADY CRT (L_32B09T)	01 - Clear	01 - Daylight	10 - No control	0	02 - Non-fatal injury	02 - Angle	01 - Dry	2	0	0	0
5/24/2016	2016	10:00	CUMMINGS AVE btwn EADY CRT & STRATHAVEN PRIV (L_519TTH)	01 - Clear	01 - Daylight	10 - No control	0	03 - P-D only	03 - Rear end	01 - Dry	2	0	0	0
2/9/2018	2018	10:14	CUMMINGS AVE btwn EADY CRT & STRATHAVEN PRIV (L_519TTH)	01 - Clear	01 - Daylight	10 - No control	0	02 - Non-fatal injury	05 - Turning movement	04 - Slush	2	0	0	0
3/1/2019	2019	19:30	CUMMINGS AVE btwn EADY CRT & STRATHAVEN PRIV (L_519TTH)	01 - Clear	07 - Dark	10 - No control	0	03 - P-D only	04 - Sideswipe	02 - Wet	2	0	0	0
8/17/2019	2019	15:42	CUMMINGS AVE btwn EADY CRT & STRATHAVEN PRIV (L_519TTH)	01 - Clear	01 - Daylight	10 - No control	0	03 - P-D only	05 - Turning movement	01 - Dry	2	0	0	0
5/11/2016	2016	15:30	CUMMINGS AVE btwn WELDON DR & OGLIVIE RD (L_32A7UQ)	01 - Clear	07 - Dark	10 - No control	0	01 - Dry	05 - Turning movement	01 - Dry	2	0	0	0
5/22/2016	2016	10:36	CUMMINGS AVE btwn WELDON DR & OGLIVIE RD (L_32A7UQ)	01 - Clear	01 - Daylight	10 - No control	0	03 - P-D only	02 - Angle	01 - Dry	2	0	0	0
9/15/2016	2016	12:37	CUMMINGS AVE btwn WELDON DR & OGLIVIE RD (L_32A7UQ)	01 - Clear	01 - Daylight	10 - No control	0	02 - Non-fatal injury	02 - Angle	01 - Dry	2	0	0	0
3/8/2017	2017	9:19	CUMMINGS AVE btwn WELDON DR & OGLIVIE RD (L_32A7UQ)	01 - Clear	01 - Daylight	10 - No control	0	03 - P-D only	03 - Rear end	02 - Wet	3	0	0	0
16/12/2018	2018	16:40	CUMMINGS AVE btwn WELDON DR & OGLIVIE RD (L_32A7UQ)	01 - Clear	01 - Daylight	10 - No control	0	01 - Clear	02 - Angle	05 - Packed snow	2	0	0	0
6/16/2018	2018	14:44	CUMMINGS AVE btwn WELDON DR & OGLIVIE RD (L_32A7UQ)	01 - Clear	01 - Daylight	10 - No control	0	03 - P-D only	02 - Angle	01 - Dry	2	0	0	0
11/5/2019	2019	18:55	CUMMINGS AVE btwn WELDON DR & OGLIVIE RD (L_32A7UQ)	01 - Clear	07 - Dark	10 - No control	0	03 - P-D only	02 - Angle	01 - Dry	2	0	0	0
10/25/2019	2019	21:38	CUMMINGS AVE btwn WELDON DR & OGLIVIE RD (L_32A7UQ)	01 - Clear	07 - Dark	10 - No control	0	03 - P-D only	02 - Angle	01 - Dry	2	0	0	0
11/17/2019	2019	17:02	CUMMINGS AVE btwn WELDON DR & OGLIVIE RD (L_32A7UQ)	03 - Snow	07 - Dark	10 - No control	0	03 - P-D only	05 - Turning movement	02 - Wet	2	0	0	0
2/24/2020	2020	16:11	CUMMINGS AVE btwn WELDON DR & OGLIVIE RD (L_32A7UQ)	01 - Clear	01 - Daylight	10 - No control	0	03 - P-D only	02 - Angle	02 - Wet	3	0	0	0
7/7/2020	2020	15:00	CUMMINGS AVE btwn WELDON DR & OGLIVIE RD (L_32A7UQ)	01 - Clear	01 - Daylight	10 - No control	0	03 - P-D only	02 - Angle	01 - Dry	2	0	0	0
1/7/2016	2016	11:45	CUMMINGS AVE @ OGLIVIE RD (0009923)	01 - Clear	01 - Daylight	01 - Traffic signal	01 - Functioning	02 - Non-fatal injury	99 - Other	01 - Dry	2	0	0	0
2/17/2016	2016	22:17	CUMMINGS AVE @ OGLIVIE RD (0009923)	01 - Clear	07 - Dark	01 - Traffic signal	01 - Functioning	02 - Non-fatal injury	03 - Rear end	01 - Dry	2	0	0	0
2/17/2016	2016	20:50	CUMMINGS AVE @ OGLIVIE RD (0009923)	01 - Clear	07 - Dark	01 - Traffic signal	01 - Functioning	03 - P-D only	05 - Turning movement	06 - ice	2	0	0	0
2/17/2016	2016	21:02	CUMMINGS AVE @ OGLIVIE RD (0009923)	05 - Drifting Snow	07 - Dark	01 - Traffic signal	01 - Functioning	03 - P-D only	03 - Rear end	06 - ice	2	0	0	0
2/18/2016	2016	7:55	CUMMINGS AVE @ OGLIVIE RD (0009923)	03 - Snow	01 - Daylight	01 - Traffic signal	01 - Functioning	03 - P-D only	03 - Rear end	06 - ice	2	0	0	0
3/5/2016	2016	16:30	CUMMINGS AVE @ OGLIVIE RD (0009923)	01 - Clear	01 - Daylight	01 - Traffic signal	01 - Functioning	02 - Non-fatal injury	07 - SMV other	01 - Dry	1	0	0	1
7/15/2016	2016	16:14	CUMMINGS AVE @ OGLIVIE RD (0009923)	01 - Clear	01 - Daylight	01 - Traffic signal	01 - Functioning	02 - Non-fatal injury	03 - Rear end	01 - Dry	2	0	0	0
9/12/2016	2016	12:18	CUMMINGS AVE @ OGLIVIE RD (0009923)	01 - Clear	01 - Daylight	01 - Traffic signal	01 - Functioning	03 - P-D only	05 - Turning movement	01 - Dry	2	0	0	0
9/19/2016	2016	17:50	CUMMINGS AVE @ OGLIVIE RD (0009923)	01 - Clear	01 - Daylight	01 - Traffic signal	01 - Functioning	03 - P-D only	05 - Turning movement	01 - Dry	2	0	0	0
9/20/2016	2016	11:08	CUMMINGS AVE @ OGLIVIE RD (0009923)	01 - Clear	01 - Daylight	01 - Traffic signal	01 - Functioning	03 - P-D only	05 - Turning movement	01 - Dry	2	0	0	0
10/27/2017	2017	11:30	CUMMINGS AVE @ OGLIVIE RD (0009923)	01 - Clear	01 - Daylight	01 - Traffic signal	01 - Functioning	02 - Non-fatal injury	05 - Turning movement	01 - Dry	2	0	1	0
1/30/2017	2017	19:00	CUMMINGS AVE @ OGLIVIE RD (0009923)	01 - Clear	07 - Dark	01 - Traffic signal	01 - Functioning	03 - P-D only	03 - Rear end	01 - Dry	2	0	0	0
2/8/2017	2017	16:20	CUMMINGS AVE @ OGLIVIE RD (0009923)	01 - Clear	01 - Daylight	01 - Traffic signal	01 - Functioning	03 - P-D only	03 - Rear end	03 - Loose snow	3	0	0	0
2/15/2017	2017	8:17	CUMMINGS AVE @ OGLIVIE RD (0009923)	03 - Snow	01 - Daylight	01 - Traffic signal	01 - Functioning	03 - P-D only	05 - Turning movement	03 - Loose snow	2	0	0	0
3/9/2017	2017	10:45	CUMMINGS AVE @ OGLIVIE RD (0009923)	01 - Clear	01 - Daylight	01 - Traffic signal	01 - Functioning	02 - Non-fatal injury	03 - Rear end	01 - Dry	2	0	0	0
3/9/2017	2017	15:28	CUMMINGS AVE @ OGLIVIE RD (0009923)	01 - Clear	01 - Daylight	01 - Traffic signal	01 - Functioning	03 - P-D only	03 - Rear end	01 - Dry	2	0	0	0
8/2/2017	2017	12:40	CUMMINGS AVE @ OGLIVIE RD (0009923)	01 - Clear	01 - Daylight	01 - Traffic signal	01 - Functioning	03 - P-D only	05 - Turning movement	01 - Dry	2	0	0	0
8/3/2017	2017	7:50	CUMMINGS AVE @ OGLIVIE RD (0009923)	01 - Clear	01 - Daylight	01 - Traffic signal	01 - Functioning	02 - Non-fatal injury	05 - Turning movement	01 - Dry	2	0	1	0
8/27/2017	2017	0:11	CUMMINGS AVE @ OGLIVIE RD (0009923)	01 - Clear	07 - Dark	01 - Traffic signal	01 - Functioning	03 - P-D only	02 - Angle	01 - Dry	2	0	0	0
9/12/2017	2017	12:30	CUMMINGS AVE @ OGLIVIE RD (0009923)	01 - Clear	01 - Daylight	01 - Traffic signal	01 - Functioning	03 - P-D only	03 - Rear end	01 - Dry	2	0	0	0
9/8/2017	2017	8:37	CUMMINGS AVE @ OGLIVIE RD (0009923)	02 - Rain	01 - Daylight	01 - Traffic signal	01 - Functioning	03 - P-D only	03 - Rear end	02 - Wet	2	0	0	0
9/20/2017	2017	14:47	CUMMINGS AVE @ OGLIVIE RD (0009923)	01 - Clear	01 - Daylight	01 - Traffic signal	00 - Unknown	02 - Non-fatal injury	04 - Sideswipe	01 - Dry	2	1	0	0
10/10/2018	2018	15:15	CUMMINGS AVE @ OGLIVIE RD (0009923)	01 - Clear	01 - Daylight	01 - Traffic signal	01 - Functioning	03 - P-D only	05 - Turning movement	01 - Dry	2	0	0	0
11/21/2018	2018	16:10	CUMMINGS AVE @ OGLIVIE RD (0009923)	01 - Clear	01 - Daylight	01 - Traffic signal	01 - Functioning	03 - P-D only	05 - Turning movement	05 - Packed snow	2	0	0	0
12/8/2018	2018	18:00	CUMMINGS AVE @ OGLIVIE RD (0009923)	03 - Snow	07 - Dark	01 - Traffic signal	01 - Functioning	03 - P-D only	04 - Sideswipe	03 - Loose snow	2	0	0	0
3/24/2018	2018	18:25	CUMMINGS AVE @ OGLIVIE RD (0009923)	01 - Clear	05 - Dusk	01 - Traffic signal	01 - Functioning	02 - Non-fatal injury	03 - Rear end	01 - Dry	2	0	0	0
5/5/2018	2018	18:14	CUMMINGS AVE @ OGLIVIE RD (0009923)	01 - Clear	01 - Daylight	01 - Traffic signal	01 - Functioning	03 - P-D only	02 - Angle	01 - Dry	3	0	0	0
4/12/2018	2018	11:01	CUMMINGS AVE @ OGLIVIE RD (0009923)	01 - Clear	01 - Daylight	01 - Traffic signal	01 - Functioning	03 - P-D only	04 - Sideswipe	01 - Dry	2	0	0	0
5/29/2018	2018	15:00	CUMMINGS AVE @ OGLIVIE RD (0009923)	01 - Clear	01 - Daylight	01 - Traffic signal	01 - Functioning	03 - P-D only	04 - Sideswipe	01 - Dry	2	0	0	0
6/11/2018	2018	18:00	CUMMINGS AVE @ OGLIVIE RD (0009923)	01 - Clear	01 - Daylight	01 - Traffic signal	01 - Functioning	03 - P-D only	05 - Turning movement	01 - Dry	2	0	0	0
7/23/2018	2018	9:30	CUMMINGS AVE @ OGLIVIE RD (0009923)	01 - Clear	01 - Daylight	01 - Traffic signal	01 - Functioning	03 - P-D only	03 - Rear end	01 - Dry	2	0	0	0
8/20/2018	2018	17:00	CUMMINGS AVE @ OGLIVIE RD (0009923)	01 - Clear	01 - Daylight	01 - Traffic signal	01 - Functioning	02 - Non-fatal injury	05 - Turning movement	01 - Dry	2	0	1	0
9/19/2018	2018	17:07	CUMMINGS AVE @ OGLIVIE RD (0009923)	01 - Clear	01 - Daylight	01 - Traffic signal	01 - Functioning	03 - P-D only	05 - Turning movement	01 - Dry	2	0	0	0
1/23/2019	2019	12:30	CUMMINGS AVE @ OGLIVIE RD (0009923)	03 - Snow	01 - Daylight	01 - Traffic signal	01 - Functioning	03 - P-D only	04 - Sideswipe	05 - Packed snow	2	0	0	0
11/16/2019	2019	21:55	CUMMINGS AVE @ OGLIVIE RD (0009923)	01 - Clear	07 - Dark	01 - Traffic signal	01 - Functioning	03 - P-D only	03 - Rear end	06 - ice	3	0	0	0
11/25/2019	2019	9:53	CUMMINGS AVE @ OGLIVIE RD (0009923)	01 - Clear	01 - Daylight	01 - Traffic signal	01 - Functioning	03 - P-D only	03 - Rear end	01 - Dry	2	0	0	0
1/28/2019	2019	9:30	CUMMINGS AVE @ OGLIVIE RD (0009923)	01 - Clear	01 - Daylight	01 - Traffic signal	01 - Functioning	03 -						

1/10/2020	2020	18:00	OGILVIE RD btwn MURDOCK GT & CUMMINGS AVE (_3ZBN9A)	01 - Clear	07 - Dark	10 - No control	0	03 - P.D. only	04 - Sideswipe	01 - Dry	2	0	0	0
8/6/2020	2020	17:14	OGILVIE RD btwn MURDOCK GT & CUMMINGS AVE (_3ZBN9A)	01 - Clear	01 - Daylight	10 - No control	0	02 - Non-fatal injury	02 - Angle	01 - Dry	2	0	0	0

Appendix E

TRANS Plot

TRANS Regional Model

Version 2.15 - Assigned June 16, 2020

AM Peak Hour Total Traffic Volume

Cyrville - St. Laurent Area Growth

2011 Model - Basecase

N/A

User Initials: TIMW

Plot Prepared: August 10, 2020

EMME Scenario: 21711



Legend

AM Peak Hour Total Traffic Volume

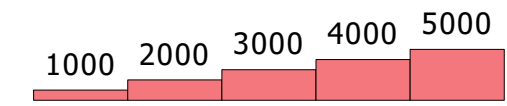

Distance (m)



The TRANS model is continuously refined & maintained, and all information is provided in good faith. However, model outputs are provided "as is", and no warranty or guarantee is provided as to the accuracy, reliability or reasonableness of the results. In using this data, you agree to accept any and all risks arising from any incorrect, incomplete, or misleading information.

Recipients are required to use caution and professional judgement in using and interpreting model outputs. In particular, caution should be used when focusing on a geographically limited area (such as a single road or intersection), as the model is primarily designed to simulate regional-scale phenomena and has been calibrated at a regional level.

As general good practice, it is recommended that the user confirm the network coding within the area of interest, and compare base year forecasts against traffic count data to assess the extent to which the model may be over- or under-estimating the travel demand.

TRANS Regional Model

Version 2.15 - Assigned June 16, 2020

AM Peak Hour Total Traffic Volume

Cyrville - St. Laurent Area Growth

2031 Model - Basecase

N/A

User Initials: TIMW

Plot Prepared: August 10, 2020

EMME Scenario: 21711



Legend

AM Peak Hour Total Traffic Volume

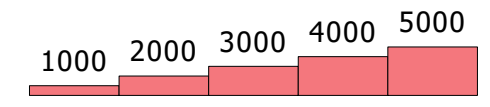

Distance (m)



The TRANS model is continuously refined & maintained, and all information is provided in good faith. However, model outputs are provided "as is", and no warranty or guarantee is provided as to the accuracy, reliability or reasonableness of the results. In using this data, you agree to accept any and all risks arising from any incorrect, incomplete, or misleading information.

Recipients are required to use caution and professional judgement in using and interpreting model outputs. In particular, caution should be used when focusing on a geographically limited area (such as a single road or intersection), as the model is primarily designed to simulate regional-scale phenomena and has been calibrated at a regional level.

As general good practice, it is recommended that the user confirm the network coding within the area of interest, and compare base year forecasts against traffic count data to assess the extent to which the model may be over- or under-estimating the travel demand.

Appendix F

Background Volumes

Figure 7: Total Phase 1 and 2 Site Generated Traffic

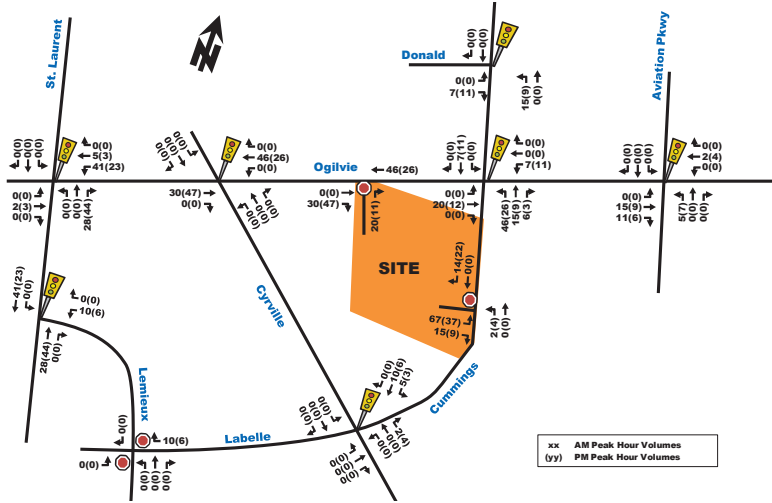

1125-1149 CYRVILLE ROAD TRANSPORTATION IMPACT ASSESSMENT
 Forecasting Report
 13 October 2021

Figure 10 - Site Traffic Assignment

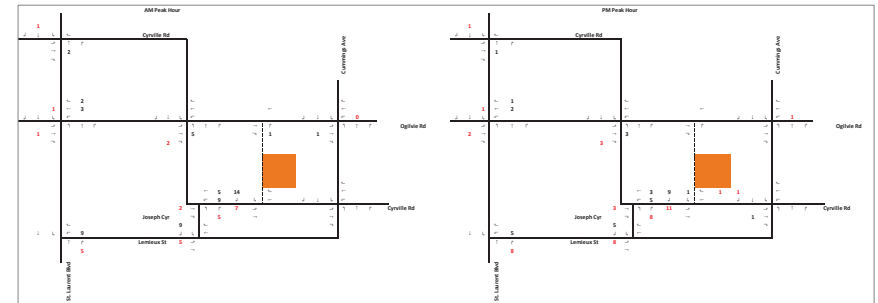

Figure 9: New Site Generation Auto Volumes

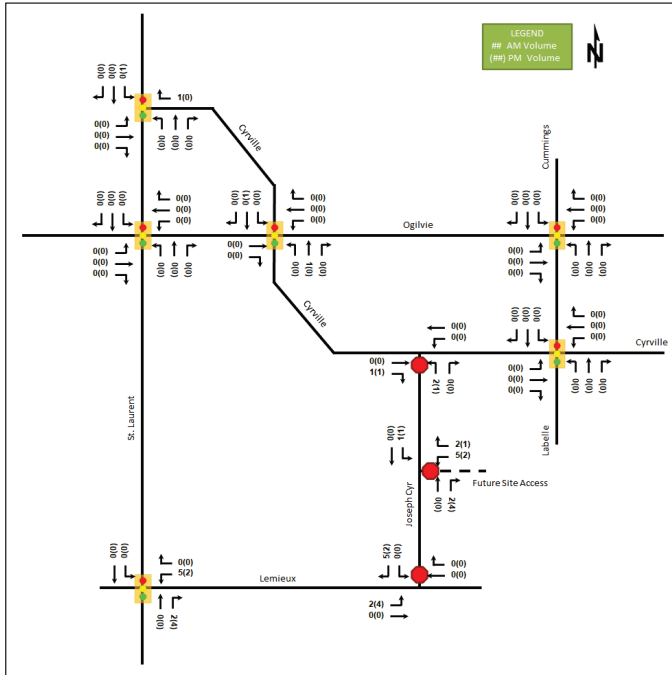
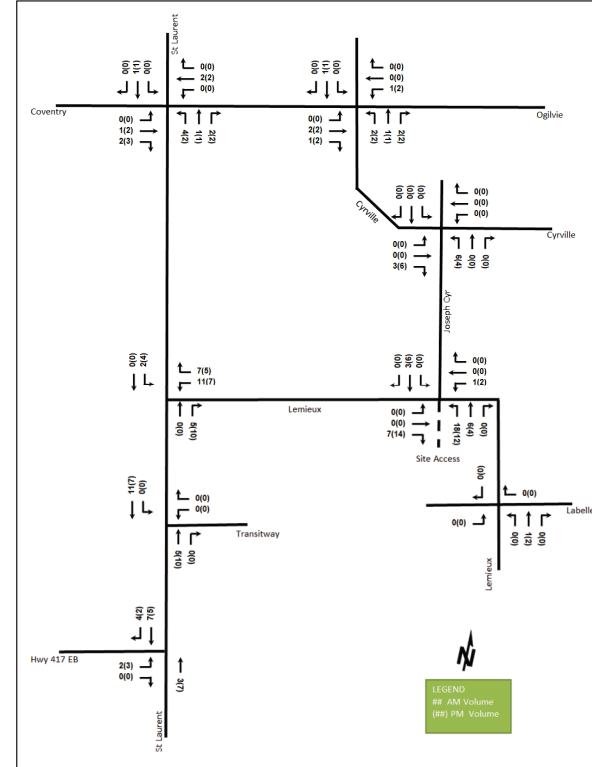

Figure 14: New Site Generation Auto Volumes



PARSONS

As shown in Table 5, a total of 39 and 40 veh/h are projected to travel to/from the proposed development during the weekday morning and afternoon peak hours.

9.1.2. MODE SHARES

Using the TRANS Auto Trips projected in Table 5 and the modal share percentages from the 2011 NCR Household Origin – Destination Survey and Table 3.13 of the TRANS Trip Generation Study, the modal share for the proposed development are summarized in Table 6.

Table 6: Total Site Trip Generation

Travel Mode	AM Mode Share	AM Peak (persons/h)			PM Mode Share	PM Peak (persons/h)		
		In	Out	Total		In	Out	Total
Auto Driver	50%	8	31	39	50%	24	16	40
Auto Passenger	10%	2	6	8	15%	8	4	12
Transit	25%	4	16	20	20%	9	7	16
Non-motorized	15%	2	10	12	15%	7	5	12
Total People Trips	100%	16	63	78	100%	48	32	80
Total 'New' Auto Trips		8	31	39		24	16	40

As shown in Table 6, based on the TRANS Trip Generation method, the proposed site is projected to generate approximately 78 to 80 two-way person-trips per hour during the weekday peak hours. The increase in two-way transit trips is estimated to be 16 to 20 persons per hour, and the increase in bike/walk trips is approximately 12 persons per hour.

Figure 6: Projected Site Access Volumes (2018)

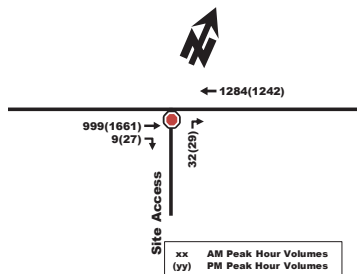

Appendix G

Synchro Intersection Worksheets – 2026 Future Background Conditions

Lanes, Volumes, Timings
1: Cyrville Rd & Ogilvie Rd

2026 Future Background
AM Peak Hour

Lane Group	EBL	EBT	EBR	WBL	WBT	WBR	NBL	NBT	NBR	SBL	SBT	SBR
Lane Configurations		↑↑	↑	↑	↑↑	↑	↑	↑	↑	↑	↑	↑
Traffic Volume (vph)	0	584	230	28	1050	166	172	241	14	47	166	45
Future Volume (vph)	0	584	230	28	1050	166	172	241	14	47	166	45
Satd. Flow (prot)	0	3283	1414	1658	3316	1441	1551	1714	0	1626	1604	0
Fit Permitted				0.419			0.510			0.426		
Satd. Flow (perm)	0	3283	1329	722	3316	1319	829	1714	0	727	1604	0
Satd. Flow (RTOR)			230			166		3			12	
Lane Group Flow (vph)	0	584	230	28	1050	166	172	255	0	47	211	0
Turn Type	NA	Perm	Perm	NA	Perm	Perm	NA	Perm	NA	Perm	NA	
Protected Phases		2		6		6	8		8		4	
Permitted Phases			2	6		6	8		8		4	
Detector Phase		2	2	6	6	6	8	8		4	4	
Switch Phase												
Minimum Initial (s)		10.0	10.0	10.0	10.0	10.0	10.0	10.0		10.0	10.0	
Minimum Split (s)		32.2	32.2	32.2	32.2	32.2	47.1	47.1		47.1	47.1	
Total Split (s)		72.9	72.9	72.9	72.9	72.9	47.1	47.1		47.1	47.1	
Total Split (%)		60.8%	60.8%	60.8%	60.8%	60.8%	39.3%	39.3%		39.3%	39.3%	
Yellow Time (s)		3.7	3.7	3.7	3.7	3.7	3.7	3.7		3.7	3.7	
All-Red Time (s)		2.5	2.5	2.5	2.5	2.5	3.4	3.4		3.4	3.4	
Lost Time Adjust (s)		0.0	0.0	0.0	0.0	0.0	0.0	0.0		0.0	0.0	
Total Lost Time (s)		6.2	6.2	6.2	6.2	6.2	7.1	7.1		7.1	7.1	
Lead/Lag												
Lead-Lag Optimize?												
Recall Mode		C-Max	C-Max	C-Max	C-Max	C-Max	None	None		None	None	
Act Effct Green (s)		78.9	78.9	78.9	78.9	78.9	27.8	27.8		27.8	27.8	
Actuated g/C Ratio		0.66	0.66	0.66	0.66	0.66	0.23	0.23		0.23	0.23	
v/c Ratio		0.27	0.24	0.06	0.48	0.18	0.90	0.64		0.28	0.56	
Control Delay		10.1	2.2	4.3	4.6	0.3	85.9	47.1		38.6	42.2	
Queue Delay		0.0	0.0	0.0	0.0	0.0	0.0	0.0		0.0	0.0	
Total Delay		10.1	2.2	4.3	4.6	0.3	85.9	47.1		38.6	42.2	
LOS		B	A	A	A	A	F	D		D	D	
Approach Delay		7.9			4.0		62.7			41.6		
Approach LOS		A			A		E			D		
Queue Length 50th (m)		27.6	0.0	0.7	15.2	0.1	39.5	53.9		9.2	41.5	
Queue Length 95th (m)		48.6	10.8	m1.2	19.3	m0.1	59.6	70.3		17.7	57.1	
Internal Link Dist (m)		113.5			313.9		191.2			190.6		
Turn Bay Length (m)				62.0		71.0	33.5			82.0		
Base Capacity (vph)		2158	952	474	2180	924	276	573		242	542	
Starvation Cap Reductn		0	0	0	0	0	0	0		0	0	
Spillback Cap Reductn		0	0	0	0	0	0	0		0	0	
Storage Cap Reductn		0	0	0	0	0	0	0		0	0	
Reduced v/c Ratio		0.27	0.24	0.06	0.48	0.18	0.62	0.45		0.19	0.39	

Intersection Summary

Cycle Length: 120
Actuated Cycle Length: 120
Offset: 10 (8%), Referenced to phase 2:EBT and 6:WBTL, Start of Green
Natural Cycle: 80
Control Type: Actuated-Coordinated

Lanes, Volumes, Timings
1: Cyrville Rd & Ogilvie Rd

2026 Future Background
AM Peak Hour

Maximum v/c Ratio: 0.90	Intersection Signal Delay: 17.8	Intersection LOS: B
Intersection Capacity Utilization 74.9%	ICU Level of Service D	
Analysis Period (min) 15		
m Volume for 95th percentile queue is metered by upstream signal.		

Splits and Phases: 1: Cyrville Rd & Ogilvie Rd



Lanes, Volumes, Timings
2: Cummings Ave & Donald

2026 Future Background
AM Peak Hour

Lane Group	EBL	EBR	NBL	NBT	SBT	SBR
Lane Configurations	↖	↗	↖	↗	↖	↗
Traffic Volume (vph)	42	167	248	127	208	104
Future Volume (vph)	42	167	248	127	208	104
Satd. Flow (prot)	1610	1469	1642	1695	1606	0
Fit Permitted	0.950		0.571			
Satd. Flow (perm)	1532	1382	972	1695	1606	0
Satd. Flow (RTOR)		167			62	
Lane Group Flow (vph)	42	167	248	127	312	0
Turn Type	Perm	Perm	Perm	NA	NA	
Protected Phases				2	6	
Permitted Phases	4	4	2			
Detector Phase	4	4	2	2	6	
Switch Phase						
Minimum Initial (s)	10.0	10.0	10.0	10.0	10.0	
Minimum Split (s)	22.0	22.0	39.9	39.9	39.9	
Total Split (s)	22.0	22.0	98.0	98.0	98.0	
Total Split (%)	18.3%	18.3%	81.7%	81.7%	81.7%	
Yellow Time (s)	3.3	3.3	3.3	3.3	3.3	
All-Red Time (s)	2.7	2.7	3.6	3.6	3.6	
Lost Time Adjust (s)	0.0	0.0	0.0	0.0	0.0	
Total Lost Time (s)	6.0	6.0	6.9	6.9	6.9	
Lead/Lag						
Lead-Lag Optimize?						
Recall Mode	None	None	Min	Min	Min	
Act Effct Green (s)	11.3	11.3	19.5	19.5	19.5	
Actuated g/C Ratio	0.26	0.26	0.44	0.44	0.44	
v/c Ratio	0.11	0.35	0.58	0.17	0.42	
Control Delay	14.8	5.9	15.6	8.1	8.6	
Queue Delay	0.0	0.0	0.0	0.0	0.0	
Total Delay	14.8	5.9	15.6	8.1	8.6	
LOS	B	A	B	A	A	
Approach Delay	7.6			13.1	8.6	
Approach LOS	A			B	A	
Queue Length 50th (m)	1.9	0.0	11.9	4.9	10.6	
Queue Length 95th (m)	10.1	12.0	33.0	13.6	27.9	
Internal Link Dist (m)	296.9			237.9	259.3	
Turn Bay Length (m)	60.0		60.0			
Base Capacity (vph)	577	625	972	1695	1606	
Starvation Cap Reductn	0	0	0	0	0	
Spillback Cap Reductn	0	0	0	0	0	
Storage Cap Reductn	0	0	0	0	0	
Reduced v/c Ratio	0.07	0.27	0.26	0.07	0.19	

Intersection Summary

Cycle Length: 120
Actuated Cycle Length: 44.3
Natural Cycle: 65
Control Type: Actuated-Uncoordinated
Maximum v/c Ratio: 0.58

Lanes, Volumes, Timings
2: Cummings Ave & Donald

2026 Future Background
AM Peak Hour

Intersection Signal Delay: 10.3
Intersection Capacity Utilization 62.5%
Analysis Period (min) 15

Intersection LOS: B
ICU Level of Service B

Splits and Phases: 2: Cummings Ave & Donald



Lanes, Volumes, Timings
3: Cummings Ave & Ogilvie Rd

2026 Future Background
AM Peak Hour

Lane Group	EBL	EBT	EBR	WBL	WBT	WBR	NBL	NBT	NBR	SBL	SBT	SBR
Lane Configurations	↔	↕	↔	↔	↕	↔	↔	↕	↔	↔	↕	↔
Traffic Volume (vph)	51	601	11	174	1099	170	64	128	69	138	133	112
Future Volume (vph)	51	601	11	174	1099	170	64	128	69	138	133	112
Satd. Flow (prot)	1626	3266	0	1626	3195	0	1658	1514	0	1626	1609	0
Fit Permitted	0.115			0.356			0.607			0.443		
Satd. Flow (perm)	197	3266	0	600	3195	0	1055	1514	0	727	1609	0
Satd. Flow (RTOR)		2			19			22			39	
Lane Group Flow (vph)	51	612	0	174	1269	0	64	197	0	138	245	0
Turn Type	pm+pt	NA		pm+pt	NA		Perm	NA		pm+pt	NA	
Protected Phases	5	2		1	6		8			7	4	
Permitted Phases	2			6			8			4		
Detector Phase	5	2		1	6		8	8		7	4	
Switch Phase												
Minimum Initial (s)	5.0	10.0		5.0	10.0		10.0	10.0		5.0	10.0	
Minimum Split (s)	9.7	24.7		9.7	24.7		36.6	36.6		9.3	36.6	
Total Split (s)	11.0	61.0		11.0	61.0		36.6	36.6		11.4	48.0	
Total Split (%)	9.2%	50.8%		9.2%	50.8%		30.5%	30.5%		9.5%	40.0%	
Yellow Time (s)	3.7	3.7		3.7	3.7		3.3	3.3		3.3	3.3	
All-Red Time (s)	1.0	2.0		1.0	2.0		3.3	3.3		1.0	3.3	
Lost Time Adjust (s)	0.0	0.0		0.0	0.0		0.0	0.0		0.0	0.0	
Total Lost Time (s)	4.7	5.7		4.7	5.7		6.6	6.6		4.3	6.6	
Lead/Lag	Lead	Lag		Lead	Lag		Lag	Lag		Lead		
Lead-Lag Optimize?	Yes	Yes		Yes	Yes		Yes	Yes		Yes		
Recall Mode	None	C-Max		None	C-Max		None	None		None	None	
Act Effct Green (s)	66.0	58.8		67.2	61.2		26.3	26.3		40.0	37.7	
Actuated g/C Ratio	0.55	0.49		0.56	0.51		0.22	0.22		0.33	0.31	
v/c Ratio	0.28	0.38		0.45	0.77		0.28	0.56		0.47	0.46	
Control Delay	22.1	18.1		17.3	29.7		40.2	42.4		33.7	29.5	
Queue Delay	0.0	0.0		0.0	0.0		0.0	0.0		0.0	0.0	
Total Delay	22.1	18.1		17.3	29.7		40.2	42.4		33.7	29.5	
LOS	C	B		B	C		D	D		C	C	
Approach Delay		18.4			28.2			41.9			31.0	
Approach LOS		B			C			D			C	
Queue Length 50th (m)	4.7	38.4		19.2	135.0		12.1	35.4		22.4	36.7	
Queue Length 95th (m)	17.0	48.3		31.1	166.6		24.5	58.7		37.8	59.6	
Internal Link Dist (m)		313.9			184.8			136.9			237.9	
Turn Bay Length (m)	80.0			100.0			34.0			153.0		
Base Capacity (vph)	183	1602		391	1638		263	395		295	580	
Starvation Cap Reductn	0	0		0	0		0	0		0	0	
Spillback Cap Reductn	0	0		0	0		0	0		0	0	
Storage Cap Reductn	0	0		0	0		0	0		0	0	
Reduced v/c Ratio	0.28	0.38		0.45	0.77		0.24	0.50		0.47	0.42	

Intersection Summary	
Cycle Length:	120
Actuated Cycle Length:	120
Offset:	110 (92%), Referenced to phase 2:EBTL and 6:WBTL, Start of Green
Natural Cycle:	95
Control Type:	Actuated-Coordinated

Lanes, Volumes, Timings
3: Cummings Ave & Ogilvie Rd

2026 Future Background
AM Peak Hour

Maximum v/c Ratio: 0.77	Intersection Signal Delay: 27.5	Intersection LOS: C
Intersection Capacity Utilization 91.0%	ICU Level of Service E	
Analysis Period (min) 15		

Splits and Phases: 3: Cummings Ave & Ogilvie Rd

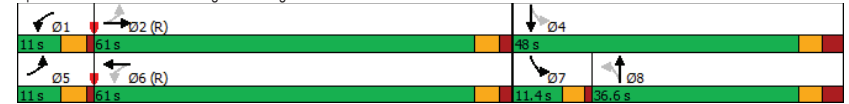

Lanes, Volumes, Timings
1: Cyrville Rd & Ogilvie Rd

2026 Future Background
PM Peak Hour

Lane Group	EBL	EBT	EBR	WBL	WBT	WBR	NBL	NBT	NBR	SBL	SBT	SBR
Lane Configurations		↑↑	↑	↑	↑↑	↑	↑	↑	↑	↑	↑	↑
Traffic Volume (vph)	0	1080	262	44	680	124	122	228	34	134	219	80
Future Volume (vph)	0	1080	262	44	680	124	122	228	34	134	219	80
Satd. Flow (prot)	0	3316	1469	1658	3316	1469	1580	1707	0	1642	1637	0
Fit Permitted				0.223			0.338			0.408		
Satd. Flow (perm)	0	3316	1353	387	3316	1303	560	1707	0	702	1637	0
Satd. Flow (RTOR)			262			124		7			17	
Lane Group Flow (vph)	0	1080	262	44	680	124	122	262	0	134	299	0
Turn Type		NA	Perm	Perm	NA	Perm	Perm	NA		Perm	NA	
Protected Phases		2			6			8				4
Permitted Phases			2	6		6	8			4		
Detector Phase		2	2	6	6	6	8	8		4	4	
Switch Phase												
Minimum Initial (s)		10.0	10.0	10.0	10.0	10.0	10.0	10.0		10.0	10.0	
Minimum Split (s)		32.2	32.2	32.2	32.2	32.2	47.1	47.1		47.1	47.1	
Total Split (s)		70.0	70.0	70.0	70.0	70.0	50.0	50.0		50.0	50.0	
Total Split (%)		58.3%	58.3%	58.3%	58.3%	58.3%	41.7%	41.7%		41.7%	41.7%	
Yellow Time (s)		3.7	3.7	3.7	3.7	3.7	3.7	3.7		3.7	3.7	
All-Red Time (s)		2.5	2.5	2.5	2.5	2.5	3.4	3.4		3.4	3.4	
Lost Time Adjust (s)		0.0	0.0	0.0	0.0	0.0	0.0	0.0		0.0	0.0	
Total Lost Time (s)		6.2	6.2	6.2	6.2	6.2	7.1	7.1		7.1	7.1	
Lead/Lag												
Lead-Lag Optimize?												
Recall Mode		C-Max	C-Max	C-Max	C-Max	C-Max	None	None		None	None	
Act Effct Green (s)		79.3	79.3	79.3	79.3	79.3	27.4	27.4		27.4	27.4	
Actuated g/C Ratio		0.66	0.66	0.66	0.66	0.66	0.23	0.23		0.23	0.23	
v/c Ratio		0.49	0.27	0.17	0.31	0.14	0.95	0.66		0.84	0.77	
Control Delay		12.4	2.1	20.6	16.5	8.7	113.5	48.1		81.1	53.5	
Queue Delay		0.0	0.0	0.0	0.0	0.0	0.0	0.0		0.0	0.0	
Total Delay		12.4	2.1	20.6	16.5	8.7	113.5	48.1		81.1	53.5	
LOS		B	A	C	B	A	F	D		F	D	
Approach Delay		10.4			15.6			68.8			62.1	
Approach LOS		B			B			E			E	
Queue Length 50th (m)		60.3	0.0	5.3	43.8	5.7	28.8	55.5		30.6	63.4	
Queue Length 95th (m)		103.7	11.4	m9.0	m65.9	m11.4	#52.3	71.5		48.1	81.7	
Internal Link Dist (m)		113.8			313.9			191.2			190.4	
Turn Bay Length (m)				62.0		71.0	33.5			82.0		
Base Capacity (vph)		2190	982	255	2190	902	200	614		250	596	
Starvation Cap Reductn		0	0	0	0	0	0	0		0	0	
Spillback Cap Reductn		0	0	0	0	0	0	0		0	0	
Storage Cap Reductn		0	0	0	0	0	0	0		0	0	
Reduced v/c Ratio		0.49	0.27	0.17	0.31	0.14	0.61	0.43		0.54	0.50	

Intersection Summary	
Cycle Length:	120
Actuated Cycle Length:	120
Offset:	20 (17%), Referenced to phase 2:EBT and 6:WBTL, Start of Green
Natural Cycle:	80
Control Type:	Actuated-Coordinated

Lanes, Volumes, Timings
1: Cyrville Rd & Ogilvie Rd

2026 Future Background
PM Peak Hour

Maximum v/c Ratio: 0.95	Intersection LOS: C
Intersection Signal Delay: 26.8	ICU Level of Service E
Intersection Capacity Utilization 85.2%	
Analysis Period (min) 15	
# 95th percentile volume exceeds capacity, queue may be longer.	
Queue shown is maximum after two cycles.	
m Volume for 95th percentile queue is metered by upstream signal.	

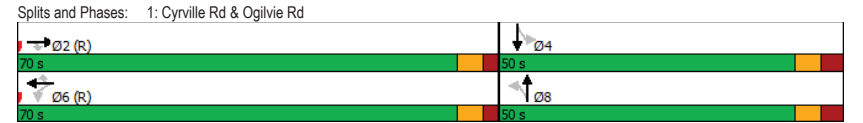

Lanes, Volumes, Timings
2: Cummings Ave & Donald

2026 Future Background
PM Peak Hour

	EBL	EBR	NBL	NBT	SBT	SBR
Lane Configurations	↖	↗	↖	↗	↖	↗
Traffic Volume (vph)	88	342	273	258	243	90
Future Volume (vph)	88	342	273	258	243	90
Satd. Flow (prot)	1523	1483	1658	1728	1649	0
Fit Permitted	0.950		0.560			
Satd. Flow (perm)	1518	1345	966	1728	1649	0
Satd. Flow (RTOR)		342			35	
Lane Group Flow (vph)	88	342	273	258	333	0
Turn Type	Perm	Perm	Perm	NA	NA	
Protected Phases				2	6	
Permitted Phases	4	4	2			
Detector Phase	4	4	2	2	6	
Switch Phase						
Minimum Initial (s)	10.0	10.0	10.0	10.0	10.0	
Minimum Split (s)	22.0	22.0	39.9	39.9	39.9	
Total Split (s)	31.0	31.0	89.0	89.0	89.0	
Total Split (%)	25.8%	25.8%	74.2%	74.2%	74.2%	
Yellow Time (s)	3.3	3.3	3.3	3.3	3.3	
All-Red Time (s)	2.7	2.7	3.6	3.6	3.6	
Lost Time Adjust (s)	0.0	0.0	0.0	0.0	0.0	
Total Lost Time (s)	6.0	6.0	6.9	6.9	6.9	
Lead/Lag						
Lead-Lag Optimize?						
Recall Mode	None	None	Min	Min	Min	
Act Effct Green (s)	11.3	11.3	18.3	18.3	18.3	
Actuated g/C Ratio	0.26	0.26	0.42	0.42	0.42	
v/c Ratio	0.22	0.57	0.67	0.35	0.46	
Control Delay	16.7	6.8	18.5	9.4	9.7	
Queue Delay	0.0	0.0	0.0	0.0	0.0	
Total Delay	16.7	6.8	18.5	9.4	9.7	
LOS	B	A	B	A	A	
Approach Delay	8.9			14.1	9.7	
Approach LOS	A			B	A	
Queue Length 50th (m)	4.6	0.0	13.6	10.9	13.0	
Queue Length 95th (m)	17.8	17.0	37.8	26.4	32.3	
Internal Link Dist (m)	296.3			237.9	259.3	
Turn Bay Length (m)	60.0		60.0			
Base Capacity (vph)	922	951	966	1728	1649	
Starvation Cap Reductn	0	0	0	0	0	
Spillback Cap Reductn	0	0	0	0	0	
Storage Cap Reductn	0	0	0	0	0	
Reduced v/c Ratio	0.10	0.36	0.28	0.15	0.20	

Intersection Summary

Cycle Length: 120
Actuated Cycle Length: 43.1
Natural Cycle: 65
Control Type: Semi Act-Uncoord
Maximum v/c Ratio: 0.67

Lanes, Volumes, Timings
2: Cummings Ave & Donald

2026 Future Background
PM Peak Hour

Intersection Signal Delay: 11.2
Intersection Capacity Utilization 65.0%
Analysis Period (min) 15

Intersection LOS: B
ICU Level of Service C

Splits and Phases: 2: Cummings Ave & Donald



Lanes, Volumes, Timings
3: Cummings Ave & Ogilvie Rd

2026 Future Background
PM Peak Hour

Lane Group	EBL	EBT	EBR	WBL	WBT	WBR	NBL	NBT	NBR	SBL	SBT	SBR
Lane Configurations	↖	↖↗	↗	↖	↖↗	↗	↖	↖↗	↗	↖	↖↗	↗
Traffic Volume (vph)	129	1147	23	127	747	209	62	184	219	258	177	84
Future Volume (vph)	129	1147	23	127	747	209	62	184	219	258	177	84
Satd. Flow (prot)	1658	3298	0	1626	3161	0	1642	1574	0	1658	1638	0
Fit Permitted	0.130			0.093			0.598			0.173		
Satd. Flow (perm)	227	3298	0	159	3161	0	1012	1574	0	300	1638	0
Satd. Flow (RTOR)		2			32			49			26	
Lane Group Flow (vph)	129	1170	0	127	956	0	62	403	0	258	261	0
Turn Type	pm+pt	NA		pm+pt	NA		Perm	NA		pm+pt	NA	
Protected Phases	5	2		1	6			8		7	4	
Permitted Phases	2			6			8			4		
Detector Phase	5	2		1	6		8	8		7	4	
Switch Phase												
Minimum Initial (s)	5.0	10.0		5.0	10.0		10.0	10.0		5.0	10.0	
Minimum Split (s)	9.7	24.7		9.7	24.7		36.6	36.6		9.3	36.6	
Total Split (s)	15.0	45.0		15.0	45.0		40.0	40.0		20.0	60.0	
Total Split (%)	12.5%	37.5%		12.5%	37.5%		33.3%	33.3%		16.7%	50.0%	
Yellow Time (s)	3.7	3.7		3.7	3.7		3.3	3.3		3.3	3.3	
All-Red Time (s)	1.0	2.0		1.0	2.0		3.3	3.3		1.0	3.3	
Lost Time Adjust (s)	0.0	0.0		0.0	0.0		0.0	0.0		0.0	0.0	
Total Lost Time (s)	4.7	5.7		4.7	5.7		6.6	6.6		4.3	6.6	
Lead/Lag	Lead	Lag		Lead	Lag		Lag	Lag		Lead		
Lead-Lag Optimize?	Yes	Yes		Yes	Yes		Yes	Yes		Yes		
Recall Mode	None	C-Max		None	C-Max		None	None		None	None	
Act Effct Green (s)	53.2	42.7		53.3	42.8		30.7	30.7		53.0	50.7	
Actuated g/C Ratio	0.44	0.36		0.44	0.36		0.26	0.26		0.44	0.42	
v/c Ratio	0.61	0.99		0.68	0.83		0.24	0.92		0.83	0.37	
Control Delay	33.5	57.5		42.0	42.6		36.8	64.7		46.1	22.3	
Queue Delay	0.0	0.0		0.0	0.0		0.0	0.0		0.0	0.0	
Total Delay	33.5	57.5		42.0	42.6		36.8	64.7		46.1	22.3	
LOS	C	E		D	D		D	E		D	C	
Approach Delay		55.1			42.6			61.0			34.1	
Approach LOS		E			D			E			C	
Queue Length 50th (m)	12.0	~163.6		17.1	109.6		11.2	80.2		37.6	35.4	
Queue Length 95th (m)	29.4	#205.4		#40.2	#147.8		23.2	#133.2		#75.3	55.7	
Internal Link Dist (m)		313.9			184.8			136.9			237.9	
Turn Bay Length (m)	80.0			100.0			34.0			153.0		
Base Capacity (vph)	224	1176		197	1147		281	473		310	743	
Starvation Cap Reductn	0	0		0	0		0	0		0	0	
Spillback Cap Reductn	0	0		0	0		0	0		0	0	
Storage Cap Reductn	0	0		0	0		0	0		0	0	
Reduced v/c Ratio	0.58	0.99		0.64	0.83		0.22	0.85		0.83	0.35	

Intersection Summary

Cycle Length: 120
 Actuated Cycle Length: 120
 Offset: 46 (38%), Referenced to phase 2:EBTL and 6:WBTL, Start of Green
 Natural Cycle: 105
 Control Type: Actuated-Coordinated

Lanes, Volumes, Timings
3: Cummings Ave & Ogilvie Rd

2026 Future Background
PM Peak Hour

Maximum v/c Ratio: 0.99	Intersection LOS: D
Intersection Signal Delay: 48.6	ICU Level of Service F
Intersection Capacity Utilization 99.8%	
Analysis Period (min) 15	
~ Volume exceeds capacity, queue is theoretically infinite.	
Queue shown is maximum after two cycles.	
# 95th percentile volume exceeds capacity, queue may be longer.	
Queue shown is maximum after two cycles.	

Splits and Phases: 3: Cummings Ave & Ogilvie Rd

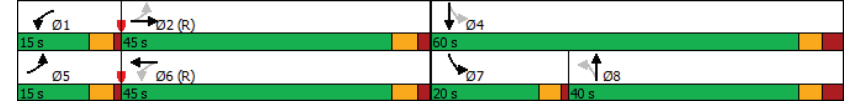

Appendix H

Synchro Intersection Worksheets – 2031 Future Background Conditions

Lanes, Volumes, Timings
1: Cyrville Rd & Ogilvie Rd

2031 Future Background
AM Peak Hour

Lane Group	EBL	EBT	EBR	WBL	WBT	WBR	NBL	NBT	NBR	SBL	SBT	SBR
Lane Configurations		↑↑	↑	↑	↑↑	↑	↑	↑	↑	↑	↑	↑
Traffic Volume (vph)	0	591	230	28	1062	166	172	244	14	47	174	45
Future Volume (vph)	0	591	230	28	1062	166	172	244	14	47	174	45
Satd. Flow (prot)	0	3283	1414	1658	3316	1441	1551	1714	0	1626	1605	0
Fit Permitted				0.416			0.497			0.423		
Satd. Flow (perm)	0	3283	1329	717	3316	1319	808	1714	0	722	1605	0
Satd. Flow (RTOR)			230			166		3			12	
Lane Group Flow (vph)	0	591	230	28	1062	166	172	258	0	47	219	0
Turn Type	NA	Perm	Perm	NA	Perm	Perm	NA	Perm	NA	Perm	NA	
Protected Phases		2		6		6	8		8		4	
Permitted Phases			2	6		6	8		8		4	
Detector Phase		2	2	6	6	6	8	8		4	4	
Switch Phase												
Minimum Initial (s)		10.0	10.0	10.0	10.0	10.0	10.0	10.0		10.0	10.0	
Minimum Split (s)		32.2	32.2	32.2	32.2	32.2	47.1	47.1		47.1	47.1	
Total Split (s)		72.9	72.9	72.9	72.9	72.9	47.1	47.1		47.1	47.1	
Total Split (%)		60.8%	60.8%	60.8%	60.8%	60.8%	39.3%	39.3%		39.3%	39.3%	
Yellow Time (s)		3.7	3.7	3.7	3.7	3.7	3.7	3.7		3.7	3.7	
All-Red Time (s)		2.5	2.5	2.5	2.5	2.5	3.4	3.4		3.4	3.4	
Lost Time Adjust (s)		0.0	0.0	0.0	0.0	0.0	0.0	0.0		0.0	0.0	
Total Lost Time (s)		6.2	6.2	6.2	6.2	6.2	7.1	7.1		7.1	7.1	
Lead/Lag												
Lead-Lag Optimize?												
Recall Mode		C-Max	C-Max	C-Max	C-Max	C-Max	None	None		None	None	
Act Effct Green (s)		78.6	78.6	78.6	78.6	78.6	28.1	28.1		28.1	28.1	
Actuated g/C Ratio		0.66	0.66	0.66	0.66	0.66	0.23	0.23		0.23	0.23	
v/c Ratio		0.28	0.24	0.06	0.49	0.18	0.91	0.64		0.28	0.57	
Control Delay		10.3	2.2	4.3	4.6	0.3	88.8	46.9		38.3	42.5	
Queue Delay		0.0	0.0	0.0	0.0	0.0	0.0	0.0		0.0	0.0	
Total Delay		10.3	2.2	4.3	4.6	0.3	88.8	46.9		38.3	42.5	
LOS		B	A	A	A	A	F	D		D	D	
Approach Delay		8.0			4.1		63.6			41.8		
Approach LOS		A			A		E			D		
Queue Length 50th (m)		28.5	0.0	0.7	15.3	0.1	39.5	54.3		9.1	43.2	
Queue Length 95th (m)		49.3	10.8	m1.2	19.5	m0.1	60.3	71.3		17.7	59.2	
Internal Link Dist (m)		113.5			313.9		191.2			190.6		
Turn Bay Length (m)				62.0		71.0	33.5			82.0		
Base Capacity (vph)		2149	949	469	2171	920	269	573		240	543	
Starvation Cap Reductn		0	0	0	0	0	0	0		0	0	
Spillback Cap Reductn		0	0	0	0	0	0	0		0	0	
Storage Cap Reductn		0	0	0	0	0	0	0		0	0	
Reduced v/c Ratio		0.28	0.24	0.06	0.49	0.18	0.64	0.45		0.20	0.40	

Intersection Summary

Cycle Length: 120
Actuated Cycle Length: 120
Offset: 10 (8%), Referenced to phase 2:EBT and 6:WBTL, Start of Green
Natural Cycle: 80
Control Type: Actuated-Coordinated

Lanes, Volumes, Timings
1: Cyrville Rd & Ogilvie Rd

2031 Future Background
AM Peak Hour

Maximum v/c Ratio: 0.91	Intersection Signal Delay: 18.1	Intersection LOS: B
Intersection Capacity Utilization 75.6%	ICU Level of Service D	
Analysis Period (min) 15		
m Volume for 95th percentile queue is metered by upstream signal.		

Splits and Phases: 1: Cyrville Rd & Ogilvie Rd

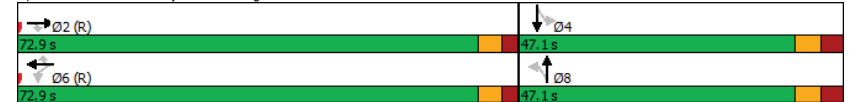

Lanes, Volumes, Timings
2: Cummings Ave & Donald

2031 Future Background
AM Peak Hour

Lane Group	EBL	EBR	NBL	NBT	SBT	SBR
Lane Configurations	↖	↗	↖	↗	↖	↗
Traffic Volume (vph)	42	175	260	128	219	104
Future Volume (vph)	42	175	260	128	219	104
Satd. Flow (prot)	1610	1469	1642	1695	1611	0
Fit Permitted	0.950		0.565			
Satd. Flow (perm)	1532	1382	962	1695	1611	0
Satd. Flow (RTOR)		175			59	
Lane Group Flow (vph)	42	175	260	128	323	0
Turn Type	Perm	Perm	Perm	NA	NA	
Protected Phases				2	6	
Permitted Phases	4	4	2			
Detector Phase	4	4	2	2	6	
Switch Phase						
Minimum Initial (s)	10.0	10.0	10.0	10.0	10.0	
Minimum Split (s)	22.0	22.0	39.9	39.9	39.9	
Total Split (s)	22.0	22.0	98.0	98.0	98.0	
Total Split (%)	18.3%	18.3%	81.7%	81.7%	81.7%	
Yellow Time (s)	3.3	3.3	3.3	3.3	3.3	
All-Red Time (s)	2.7	2.7	3.6	3.6	3.6	
Lost Time Adjust (s)	0.0	0.0	0.0	0.0	0.0	
Total Lost Time (s)	6.0	6.0	6.9	6.9	6.9	
Lead/Lag						
Lead-Lag Optimize?						
Recall Mode	None	None	Min	Min	Min	
Act Effct Green (s)	11.3	11.3	19.8	19.8	19.8	
Actuated g/C Ratio	0.25	0.25	0.44	0.44	0.44	
v/c Ratio	0.11	0.36	0.61	0.17	0.43	
Control Delay	15.0	5.9	16.5	8.1	8.8	
Queue Delay	0.0	0.0	0.0	0.0	0.0	
Total Delay	15.0	5.9	16.5	8.1	8.8	
LOS	B	A	B	A	A	
Approach Delay	7.7			13.7	8.8	
Approach LOS	A			B	A	
Queue Length 50th (m)	2.0	0.0	12.7	4.9	11.3	
Queue Length 95th (m)	10.1	12.3	35.5	13.7	29.2	
Internal Link Dist (m)	296.9			237.9	259.3	
Turn Bay Length (m)	60.0		60.0			
Base Capacity (vph)	572	626	962	1695	1611	
Starvation Cap Reductn	0	0	0	0	0	
Spillback Cap Reductn	0	0	0	0	0	
Storage Cap Reductn	0	0	0	0	0	
Reduced v/c Ratio	0.07	0.28	0.27	0.08	0.20	

Intersection Summary	
Cycle Length:	120
Actuated Cycle Length:	44.5
Natural Cycle:	65
Control Type:	Actuated-Uncoordinated
Maximum v/c Ratio:	0.61

Lanes, Volumes, Timings
2: Cummings Ave & Donald

2031 Future Background
AM Peak Hour

Intersection Signal Delay: 10.6	Intersection LOS: B
Intersection Capacity Utilization 63.6%	ICU Level of Service B
Analysis Period (min) 15	

Splits and Phases: 2: Cummings Ave & Donald



Lanes, Volumes, Timings
3: Cummings Ave & Ogilvie Rd

2031 Future Background
AM Peak Hour

Lane Group	EBL	EBT	EBR	WBL	WBT	WBR	NBL	NBT	NBR	SBL	SBT	SBR
Lane Configurations	↔	↕	↔	↔	↕	↔	↔	↕	↔	↔	↕	↔
Traffic Volume (vph)	51	608	11	174	1112	170	64	130	69	138	139	112
Future Volume (vph)	51	608	11	174	1112	170	64	130	69	138	139	112
Satd. Flow (prot)	1626	3266	0	1626	3195	0	1658	1517	0	1626	1613	0
Fit Permitted	0.111			0.353			0.603			0.439		
Satd. Flow (perm)	190	3266	0	595	3195	0	1048	1517	0	721	1613	0
Satd. Flow (RTOR)		2			19			21			37	
Lane Group Flow (vph)	51	619	0	174	1282	0	64	199	0	138	251	0
Turn Type	pm+pt	NA		pm+pt	NA		Perm	NA		pm+pt	NA	
Protected Phases	5	2		1	6		8			7	4	
Permitted Phases	2			6			8			4		
Detector Phase	5	2		1	6		8	8		7	4	
Switch Phase												
Minimum Initial (s)	5.0	10.0		5.0	10.0		10.0	10.0		5.0	10.0	
Minimum Split (s)	9.7	24.7		9.7	24.7		36.6	36.6		9.3	36.6	
Total Split (s)	11.0	61.0		11.0	61.0		36.6	36.6		11.4	48.0	
Total Split (%)	9.2%	50.8%		9.2%	50.8%		30.5%	30.5%		9.5%	40.0%	
Yellow Time (s)	3.7	3.7		3.7	3.7		3.3	3.3		3.3	3.3	
All-Red Time (s)	1.0	2.0		1.0	2.0		3.3	3.3		1.0	3.3	
Lost Time Adjust (s)	0.0	0.0		0.0	0.0		0.0	0.0		0.0	0.0	
Total Lost Time (s)	4.7	5.7		4.7	5.7		6.6	6.6		4.3	6.6	
Lead/Lag	Lead	Lag		Lead	Lag		Lag	Lag		Lead		
Lead-Lag Optimize?	Yes	Yes		Yes	Yes		Yes	Yes		Yes		
Recall Mode	None	C-Max		None	C-Max		None	None		None	None	
Act Effct Green (s)	65.9	58.8		67.2	61.2		26.3	26.3		40.0	37.7	
Actuated g/C Ratio	0.55	0.49		0.56	0.51		0.22	0.22		0.33	0.31	
v/c Ratio	0.29	0.39		0.45	0.78		0.28	0.57		0.47	0.47	
Control Delay	22.8	18.2		17.4	30.1		40.2	42.9		33.7	30.1	
Queue Delay	0.0	0.0		0.0	0.0		0.0	0.0		0.0	0.0	
Total Delay	22.8	18.2		17.4	30.1		40.2	42.9		33.7	30.1	
LOS	C	B		B	C		D	D		C	C	
Approach Delay		18.6			28.6			42.2			31.4	
Approach LOS		B			C			D			C	
Queue Length 50th (m)	4.7	38.7		19.2	137.4		12.1	36.0		22.4	38.3	
Queue Length 95th (m)	17.3	49.4		31.1	169.7		24.5	59.5		37.8	61.9	
Internal Link Dist (m)		313.9			184.8			136.9			237.9	
Turn Bay Length (m)	80.0			100.0			34.0			153.0		
Base Capacity (vph)	179	1600		389	1637		262	395		294	580	
Starvation Cap Reductn	0	0		0	0		0	0		0	0	
Spillback Cap Reductn	0	0		0	0		0	0		0	0	
Storage Cap Reductn	0	0		0	0		0	0		0	0	
Reduced v/c Ratio	0.28	0.39		0.45	0.78		0.24	0.50		0.47	0.43	

Intersection Summary

Cycle Length: 120
 Actuated Cycle Length: 120
 Offset: 110 (92%), Referenced to phase 2:EBTL and 6:WBTL, Start of Green
 Natural Cycle: 95
 Control Type: Actuated-Coordinated

Lanes, Volumes, Timings
3: Cummings Ave & Ogilvie Rd

2031 Future Background
AM Peak Hour

Maximum v/c Ratio: 0.78
 Intersection Signal Delay: 27.8
 Intersection Capacity Utilization 91.4%
 Analysis Period (min) 15
 Intersection LOS: C
 ICU Level of Service F

Splits and Phases: 3: Cummings Ave & Ogilvie Rd

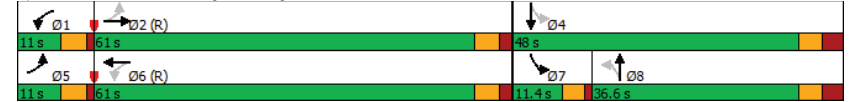

Lanes, Volumes, Timings
1: Cyrville Rd & Ogilvie Rd

2031 Future Background
PM Peak Hour

Lane Group	EBL	EBT	EBR	WBL	WBT	WBR	NBL	NBT	NBR	SBL	SBT	SBR
Lane Configurations		↑↑	↑	↑	↑↑	↑	↑	↑	↑	↑	↑	↑
Traffic Volume (vph)	0	1092	262	44	688	124	122	240	34	134	222	80
Future Volume (vph)	0	1092	262	44	688	124	122	240	34	134	222	80
Satd. Flow (prot)	0	3316	1469	1658	3316	1469	1580	1707	0	1642	1637	0
Fit Permitted				0.219			0.335			0.388		
Satd. Flow (perm)	0	3316	1353	380	3316	1303	555	1707	0	668	1637	0
Satd. Flow (RTOR)			262			124		7			17	
Lane Group Flow (vph)	0	1092	262	44	688	124	122	274	0	134	302	0
Turn Type		NA	Perm	Perm	NA	Perm	Perm	NA		Perm	NA	
Protected Phases		2			6			8			4	
Permitted Phases			2	6		6	8			4		
Detector Phase		2	2	6	6	6	8	8		4	4	
Switch Phase												
Minimum Initial (s)		10.0	10.0	10.0	10.0	10.0	10.0	10.0		10.0	10.0	
Minimum Split (s)		32.2	32.2	32.2	32.2	32.2	47.1	47.1		47.1	47.1	
Total Split (s)		70.0	70.0	70.0	70.0	70.0	50.0	50.0		50.0	50.0	
Total Split (%)		58.3%	58.3%	58.3%	58.3%	58.3%	41.7%	41.7%		41.7%	41.7%	
Yellow Time (s)		3.7	3.7	3.7	3.7	3.7	3.7	3.7		3.7	3.7	
All-Red Time (s)		2.5	2.5	2.5	2.5	2.5	3.4	3.4		3.4	3.4	
Lost Time Adjust (s)		0.0	0.0	0.0	0.0	0.0	0.0	0.0		0.0	0.0	
Total Lost Time (s)		6.2	6.2	6.2	6.2	6.2	7.1	7.1		7.1	7.1	
Lead/Lag												
Lead-Lag Optimize?												
Recall Mode		C-Max	C-Max	C-Max	C-Max	C-Max	None	None		None	None	
Act Effct Green (s)		79.1	79.1	79.1	79.1	79.1	27.6	27.6		27.6	27.6	
Actuated g/C Ratio		0.66	0.66	0.66	0.66	0.66	0.23	0.23		0.23	0.23	
v/c Ratio		0.50	0.27	0.18	0.31	0.14	0.96	0.69		0.88	0.78	
Control Delay		12.6	2.1	20.9	16.9	8.9	114.7	49.3		88.9	53.7	
Queue Delay		0.0	0.0	0.0	0.0	0.0	0.0	0.0		0.0	0.0	
Total Delay		12.6	2.1	20.9	16.9	8.9	114.7	49.3		88.9	53.7	
LOS		B	A	C	B	A	F	D		F	D	
Approach Delay		10.6			16.0			69.5			64.5	
Approach LOS		B			B			E			E	
Queue Length 50th (m)		61.6	0.0	5.4	44.7	6.0	28.8	58.5		30.9	64.1	
Queue Length 95th (m)		105.5	11.4	m8.6	m65.2	m11.2	#52.7	75.1		49.2	82.4	
Internal Link Dist (m)		113.8			313.9			191.2			190.4	
Turn Bay Length (m)				62.0		71.0	33.5			82.0		
Base Capacity (vph)		2186	981	250	2186	901	198	614		238	596	
Starvation Cap Reductn		0	0	0	0	0	0	0		0	0	
Spillback Cap Reductn		0	0	0	0	0	0	0		0	0	
Storage Cap Reductn		0	0	0	0	0	0	0		0	0	
Reduced v/c Ratio		0.50	0.27	0.18	0.31	0.14	0.62	0.45		0.56	0.51	

Intersection Summary	
Cycle Length:	120
Actuated Cycle Length:	120
Offset:	20 (17%), Referenced to phase 2:EBT and 6:WBTL, Start of Green
Natural Cycle:	80
Control Type:	Actuated-Coordinated

Lanes, Volumes, Timings
1: Cyrville Rd & Ogilvie Rd

2031 Future Background
PM Peak Hour

Maximum v/c Ratio: 0.96	Intersection LOS: C
Intersection Signal Delay: 27.5	ICU Level of Service E
Intersection Capacity Utilization 85.3%	
Analysis Period (min) 15	
# 95th percentile volume exceeds capacity, queue may be longer.	
Queue shown is maximum after two cycles.	
m Volume for 95th percentile queue is metered by upstream signal.	

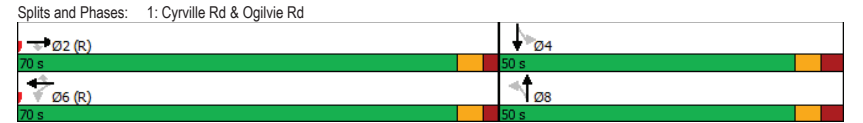

Lanes, Volumes, Timings
2: Cummings Ave & Donald

2031 Future Background
PM Peak Hour

Lane Group	EBL	EBR	NBL	NBT	SBT	SBR
Lane Configurations	↖	↗	↖	↗	↖	↗
Traffic Volume (vph)	88	359	287	271	246	90
Future Volume (vph)	88	359	287	271	246	90
Satd. Flow (prot)	1523	1483	1658	1728	1649	0
Fit Permitted	0.950		0.558			
Satd. Flow (perm)	1518	1345	963	1728	1649	0
Satd. Flow (RTOR)		359			35	
Lane Group Flow (vph)	88	359	287	271	336	0
Turn Type	Perm	Perm	Perm	NA	NA	
Protected Phases				2	6	
Permitted Phases	4	4	2			
Detector Phase	4	4	2	2	6	
Switch Phase						
Minimum Initial (s)	10.0	10.0	10.0	10.0	10.0	
Minimum Split (s)	22.0	22.0	39.9	39.9	39.9	
Total Split (s)	31.0	31.0	89.0	89.0	89.0	
Total Split (%)	25.8%	25.8%	74.2%	74.2%	74.2%	
Yellow Time (s)	3.3	3.3	3.3	3.3	3.3	
All-Red Time (s)	2.7	2.7	3.6	3.6	3.6	
Lost Time Adjust (s)	0.0	0.0	0.0	0.0	0.0	
Total Lost Time (s)	6.0	6.0	6.9	6.9	6.9	
Lead/Lag						
Lead-Lag Optimize?						
Recall Mode	None	None	Min	Min	Min	
Act Effct Green (s)	11.3	11.3	19.1	19.1	19.1	
Actuated g/C Ratio	0.26	0.26	0.44	0.44	0.44	
v/c Ratio	0.23	0.59	0.69	0.36	0.46	
Control Delay	17.3	7.1	19.1	9.4	9.5	
Queue Delay	0.0	0.0	0.0	0.0	0.0	
Total Delay	17.3	7.1	19.1	9.4	9.5	
LOS	B	A	B	A	A	
Approach Delay	9.1			14.4	9.5	
Approach LOS	A			B	A	
Queue Length 50th (m)	4.8	0.0	14.6	11.5	13.2	
Queue Length 95th (m)	18.1	17.9	40.6	27.5	32.5	
Internal Link Dist (m)	296.3			237.9	259.3	
Turn Bay Length (m)	60.0		60.0			
Base Capacity (vph)	905	947	963	1728	1649	
Starvation Cap Reductn	0	0	0	0	0	
Spillback Cap Reductn	0	0	0	0	0	
Storage Cap Reductn	0	0	0	0	0	
Reduced v/c Ratio	0.10	0.38	0.30	0.16	0.20	

Intersection Summary	
Cycle Length:	120
Actuated Cycle Length:	43.9
Natural Cycle:	65
Control Type:	Semi Act-Uncoord
Maximum v/c Ratio:	0.69

Lanes, Volumes, Timings
2: Cummings Ave & Donald

2031 Future Background
PM Peak Hour

Intersection Signal Delay: 11.4	Intersection LOS: B
Intersection Capacity Utilization 66.0%	ICU Level of Service C
Analysis Period (min) 15	

Splits and Phases: 2: Cummings Ave & Donald



Lanes, Volumes, Timings
3: Cummings Ave & Ogilvie Rd

2031 Future Background
PM Peak Hour

Lane Group	EBL	EBT	EBR	WBL	WBT	WBR	NBL	NBT	NBR	SBL	SBT	SBR
Lane Configurations	↔	↕	↔	↔	↕	↔	↔	↕	↔	↔	↕	↔
Traffic Volume (vph)	129	1161	23	127	756	209	62	193	219	258	179	84
Future Volume (vph)	129	1161	23	127	756	209	62	193	219	258	179	84
Satd. Flow (prot)	1658	3298	0	1626	3165	0	1642	1578	0	1658	1638	0
Fit Permitted	0.122			0.095			0.597			0.168		
Satd. Flow (perm)	213	3298	0	163	3165	0	1010	1578	0	291	1638	0
Satd. Flow (RTOR)		2			31			47			25	
Lane Group Flow (vph)	129	1184	0	127	965	0	62	412	0	258	263	0
Turn Type	pm+pt	NA		pm+pt	NA		Perm	NA		pm+pt	NA	
Protected Phases	5	2		1	6			8		7	4	
Permitted Phases	2			6			8			4		
Detector Phase	5	2		1	6		8	8		7	4	
Switch Phase												
Minimum Initial (s)	5.0	10.0		5.0	10.0		10.0	10.0		5.0	10.0	
Minimum Split (s)	9.7	24.7		9.7	24.7		36.6	36.6		9.3	36.6	
Total Split (s)	15.0	45.0		15.0	45.0		40.0	40.0		20.0	60.0	
Total Split (%)	12.5%	37.5%		12.5%	37.5%		33.3%	33.3%		16.7%	50.0%	
Yellow Time (s)	3.7	3.7		3.7	3.7		3.3	3.3		3.3	3.3	
All-Red Time (s)	1.0	2.0		1.0	2.0		3.3	3.3		1.0	3.3	
Lost Time Adjust (s)	0.0	0.0		0.0	0.0		0.0	0.0		0.0	0.0	
Total Lost Time (s)	4.7	5.7		4.7	5.7		6.6	6.6		4.3	6.6	
Lead/Lag	Lead	Lag		Lead	Lag		Lag	Lag		Lead		
Lead-Lag Optimize?	Yes	Yes		Yes	Yes		Yes	Yes		Yes		
Recall Mode	None	C-Max		None	C-Max		None	None		None	None	
Act Effct Green (s)	52.8	42.3		52.8	42.3		31.2	31.2		53.5	51.2	
Actuated g/C Ratio	0.44	0.35		0.44	0.35		0.26	0.26		0.45	0.43	
v/c Ratio	0.62	1.02		0.68	0.85		0.24	0.93		0.84	0.37	
Control Delay	35.8	63.3		41.3	44.0		36.6	66.1		47.0	22.2	
Queue Delay	0.0	0.0		0.0	0.0		0.0	0.0		0.0	0.0	
Total Delay	35.8	63.3		41.3	44.0		36.6	66.1		47.0	22.2	
LOS	D	E		D	D		D	E		D	C	
Approach Delay		60.6			43.7			62.2			34.5	
Approach LOS		E			D			E			C	
Queue Length 50th (m)	11.7	~167.2		17.1	111.2		11.2	83.3		37.6	35.9	
Queue Length 95th (m)	30.6	#209.4		#39.6	#150.2		23.2	#138.7		#76.8	56.2	
Internal Link Dist (m)		313.9			184.8			136.9			237.9	
Turn Bay Length (m)	80.0			100.0			34.0			153.0		
Base Capacity (vph)	218	1162		198	1135		281	473		308	742	
Starvation Cap Reductn	0	0		0	0		0	0		0	0	
Spillback Cap Reductn	0	0		0	0		0	0		0	0	
Storage Cap Reductn	0	0		0	0		0	0		0	0	
Reduced v/c Ratio	0.59	1.02		0.64	0.85		0.22	0.87		0.84	0.35	

Intersection Summary	
Cycle Length:	120
Actuated Cycle Length:	120
Offset:	46 (38%), Referenced to phase 2:EBTL and 6:WBTL, Start of Green
Natural Cycle:	105
Control Type:	Actuated-Coordinated

Lanes, Volumes, Timings
3: Cummings Ave & Ogilvie Rd

2031 Future Background
PM Peak Hour

Maximum v/c Ratio:	1.02
Intersection Signal Delay:	51.4
Intersection LOS:	D
Intersection Capacity Utilization:	100.7%
ICU Level of Service:	G
Analysis Period (min):	15
~ Volume exceeds capacity, queue is theoretically infinite.	
Queue shown is maximum after two cycles.	
# 95th percentile volume exceeds capacity, queue may be longer.	
Queue shown is maximum after two cycles.	

Splits and Phases: 3: Cummings Ave & Ogilvie Rd

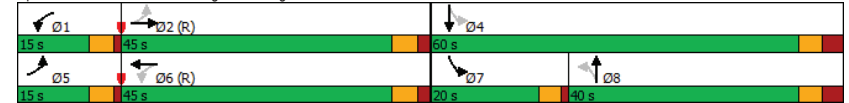

Appendix I

Synchro Intersection Worksheets – 2026 Future Total Conditions

Lanes, Volumes, Timings
1: Cyrville Rd & Ogilvie Rd

2026 Future Total
AM Peak Hour

Lane Group	EBL	EBT	EBR	WBL	WBT	WBR	NBL	NBT	NBR	SBL	SBT	SBR
Lane Configurations		↑↑	↑	↑	↑↑	↑	↑	↑	↑	↑	↑	↑
Traffic Volume (vph)	0	587	230	28	1058	166	172	241	14	47	166	45
Future Volume (vph)	0	587	230	28	1058	166	172	241	14	47	166	45
Satd. Flow (prot)	0	3283	1414	1658	3316	1441	1551	1714	0	1626	1604	0
Fit Permitted				0.418			0.510			0.426		
Satd. Flow (perm)	0	3283	1329	721	3316	1319	829	1714	0	727	1604	0
Satd. Flow (RTOR)			230			166		3			12	
Lane Group Flow (vph)	0	587	230	28	1058	166	172	255	0	47	211	0
Turn Type	NA	Perm	Perm	NA	Perm	Perm	NA	Perm	NA	Perm	NA	
Protected Phases		2		6		6	8		8		4	
Permitted Phases			2	6		6	8		8		4	
Detector Phase		2	2	6	6	6	8	8		4	4	
Switch Phase												
Minimum Initial (s)		10.0	10.0	10.0	10.0	10.0	10.0	10.0		10.0	10.0	
Minimum Split (s)		32.2	32.2	32.2	32.2	32.2	47.1	47.1		47.1	47.1	
Total Split (s)		72.9	72.9	72.9	72.9	72.9	47.1	47.1		47.1	47.1	
Total Split (%)		60.8%	60.8%	60.8%	60.8%	60.8%	39.3%	39.3%		39.3%	39.3%	
Yellow Time (s)		3.7	3.7	3.7	3.7	3.7	3.7	3.7		3.7	3.7	
All-Red Time (s)		2.5	2.5	2.5	2.5	2.5	3.4	3.4		3.4	3.4	
Lost Time Adjust (s)		0.0	0.0	0.0	0.0	0.0	0.0	0.0		0.0	0.0	
Total Lost Time (s)		6.2	6.2	6.2	6.2	6.2	7.1	7.1		7.1	7.1	
Lead/Lag												
Lead-Lag Optimize?												
Recall Mode		C-Max	C-Max	C-Max	C-Max	C-Max	None	None		None	None	
Act Effct Green (s)		78.9	78.9	78.9	78.9	78.9	27.8	27.8		27.8	27.8	
Actuated g/C Ratio		0.66	0.66	0.66	0.66	0.66	0.23	0.23		0.23	0.23	
v/c Ratio		0.27	0.24	0.06	0.49	0.18	0.90	0.64		0.28	0.56	
Control Delay		10.1	2.2	4.5	4.7	0.4	85.9	47.1		38.6	42.2	
Queue Delay		0.0	0.0	0.0	0.0	0.0	0.0	0.0		0.0	0.0	
Total Delay		10.1	2.2	4.5	4.7	0.4	85.9	47.1		38.6	42.2	
LOS		B	A	A	A	A	F	D		D	D	
Approach Delay		7.9			4.2		62.7			41.6		
Approach LOS		A			A		E			D		
Queue Length 50th (m)		27.8	0.0	0.8	15.8	0.1	39.5	53.9		9.2	41.5	
Queue Length 95th (m)		48.9	10.8	m1.2	20.2	m0.2	59.6	70.3		17.7	57.1	
Internal Link Dist (m)		113.5			313.9		191.2			190.6		
Turn Bay Length (m)				62.0		71.0	33.5			82.0		
Base Capacity (vph)		2158	952	474	2180	924	276	573		242	542	
Starvation Cap Reductn		0	0	0	0	0	0	0		0	0	
Spillback Cap Reductn		0	0	0	0	0	0	0		0	0	
Storage Cap Reductn		0	0	0	0	0	0	0		0	0	
Reduced v/c Ratio		0.27	0.24	0.06	0.49	0.18	0.62	0.45		0.19	0.39	

Intersection Summary

Cycle Length: 120
Actuated Cycle Length: 120
Offset: 10 (8%), Referenced to phase 2:EBT and 6:WBTL, Start of Green
Natural Cycle: 80
Control Type: Actuated-Coordinated

Lanes, Volumes, Timings
1: Cyrville Rd & Ogilvie Rd

2026 Future Total
AM Peak Hour

Maximum v/c Ratio: 0.90	Intersection Signal Delay: 17.9	Intersection LOS: B
Intersection Capacity Utilization 75.1%	ICU Level of Service D	
Analysis Period (min) 15		
m Volume for 95th percentile queue is metered by upstream signal.		

Splits and Phases: 1: Cyrville Rd & Ogilvie Rd



Lanes, Volumes, Timings
2: Cummings Ave & Donald

2026 Future Total
AM Peak Hour

Lane Group	EBL	EBR	NBL	NBT	SBT	SBR
Lane Configurations						
Traffic Volume (vph)	42	167	248	129	209	104
Future Volume (vph)	42	167	248	129	209	104
Satd. Flow (prot)	1610	1469	1642	1695	1606	0
Fit Permitted	0.950		0.570			
Satd. Flow (perm)	1532	1382	970	1695	1606	0
Satd. Flow (RTOR)		167			62	
Lane Group Flow (vph)	42	167	248	129	313	0
Turn Type	Perm	Perm	Perm	NA	NA	
Protected Phases				2	6	
Permitted Phases	4	4	2			
Detector Phase	4	4	2	2	6	
Switch Phase						
Minimum Initial (s)	10.0	10.0	10.0	10.0	10.0	
Minimum Split (s)	22.0	22.0	39.9	39.9	39.9	
Total Split (s)	22.0	22.0	98.0	98.0	98.0	
Total Split (%)	18.3%	18.3%	81.7%	81.7%	81.7%	
Yellow Time (s)	3.3	3.3	3.3	3.3	3.3	
All-Red Time (s)	2.7	2.7	3.6	3.6	3.6	
Lost Time Adjust (s)	0.0	0.0	0.0	0.0	0.0	
Total Lost Time (s)	6.0	6.0	6.9	6.9	6.9	
Lead/Lag						
Lead-Lag Optimize?						
Recall Mode	None	None	Min	Min	Min	
Act Effct Green (s)	11.3	11.3	19.5	19.5	19.5	
Actuated g/C Ratio	0.26	0.26	0.44	0.44	0.44	
v/c Ratio	0.11	0.35	0.58	0.17	0.42	
Control Delay	14.8	5.9	15.7	8.2	8.6	
Queue Delay	0.0	0.0	0.0	0.0	0.0	
Total Delay	14.8	5.9	15.7	8.2	8.6	
LOS	B	A	B	A	A	
Approach Delay	7.6			13.1	8.6	
Approach LOS	A			B	A	
Queue Length 50th (m)	1.9	0.0	11.9	5.0	10.6	
Queue Length 95th (m)	10.1	12.0	33.1	13.8	27.9	
Internal Link Dist (m)	296.9			132.3	259.3	
Turn Bay Length (m)	60.0		60.0			
Base Capacity (vph)	577	625	970	1695	1606	
Starvation Cap Reductn	0	0	0	0	0	
Spillback Cap Reductn	0	0	0	0	0	
Storage Cap Reductn	0	0	0	0	0	
Reduced v/c Ratio	0.07	0.27	0.26	0.08	0.19	

Intersection Summary

Cycle Length: 120
Actuated Cycle Length: 44.3
Natural Cycle: 65
Control Type: Actuated-Uncoordinated
Maximum v/c Ratio: 0.58

Lanes, Volumes, Timings
2: Cummings Ave & Donald

2026 Future Total
AM Peak Hour

Intersection Signal Delay: 10.3
Intersection Capacity Utilization 62.6%
Analysis Period (min) 15

Intersection LOS: B
ICU Level of Service B

Splits and Phases: 2: Cummings Ave & Donald

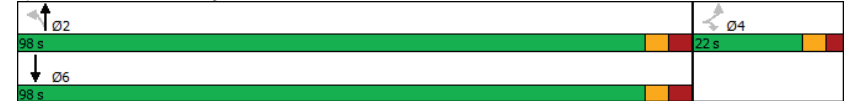

Lanes, Volumes, Timings
3: Cummings Ave & Ogilvie Rd

2026 Future Total
AM Peak Hour

Lane Group	EBL	EBT	EBR	WBL	WBT	WBR	NBL	NBT	NBR	SBL	SBT	SBR
Lane Configurations	↔	↕	↔	↔	↕	↔	↔	↕	↔	↔	↕	↔
Traffic Volume (vph)	54	601	11	174	1099	171	64	128	69	140	134	120
Future Volume (vph)	54	601	11	174	1099	171	64	128	69	140	134	120
Satd. Flow (prot)	1626	3266	0	1626	3194	0	1658	1514	0	1626	1605	0
Fit Permitted	0.114			0.356			0.602			0.443		
Satd. Flow (perm)	195	3266	0	600	3194	0	1046	1514	0	727	1605	0
Satd. Flow (RTOR)		2			19			22			41	
Lane Group Flow (vph)	54	612	0	174	1270	0	64	197	0	140	254	0
Turn Type	pm+pt	NA		pm+pt	NA		Perm	NA		pm+pt	NA	
Protected Phases	5	2		1	6		8			7	4	
Permitted Phases	2			6			8			4		
Detector Phase	5	2		1	6		8	8		7	4	
Switch Phase												
Minimum Initial (s)	5.0	10.0		5.0	10.0		10.0	10.0		5.0	10.0	
Minimum Split (s)	9.7	24.7		9.7	24.7		36.6	36.6		9.3	36.6	
Total Split (s)	11.0	61.0		11.0	61.0		36.6	36.6		11.4	48.0	
Total Split (%)	9.2%	50.8%		9.2%	50.8%		30.5%	30.5%		9.5%	40.0%	
Yellow Time (s)	3.7	3.7		3.7	3.7		3.3	3.3		3.3	3.3	
All-Red Time (s)	1.0	2.0		1.0	2.0		3.3	3.3		1.0	3.3	
Lost Time Adjust (s)	0.0	0.0		0.0	0.0		0.0	0.0		0.0	0.0	
Total Lost Time (s)	4.7	5.7		4.7	5.7		6.6	6.6		4.3	6.6	
Lead/Lag	Lead	Lag		Lead	Lag		Lag	Lag		Lead		
Lead-Lag Optimize?	Yes	Yes		Yes	Yes		Yes	Yes		Yes		
Recall Mode	None	C-Max		None	C-Max		None	None		None	None	
Act Effct Green (s)	66.0	58.8		67.2	61.2		26.3	26.3		40.0	37.7	
Actuated g/C Ratio	0.55	0.49		0.56	0.51		0.22	0.22		0.33	0.31	
v/c Ratio	0.30	0.38		0.45	0.78		0.28	0.56		0.47	0.48	
Control Delay	22.9	18.1		17.3	29.7		40.2	42.4		33.9	29.8	
Queue Delay	0.0	0.0		0.0	0.0		0.0	0.0		0.0	0.0	
Total Delay	22.9	18.1		17.3	29.7		40.2	42.4		33.9	29.8	
LOS	C	B		B	C		D	D		C	C	
Approach Delay		18.5			28.2			41.9			31.3	
Approach LOS		B			C			D			C	
Queue Length 50th (m)	5.0	38.3		19.2	135.3		12.1	35.4		22.7	38.2	
Queue Length 95th (m)	17.9	48.6		31.1	166.8		24.5	58.7		38.2	61.9	
Internal Link Dist (m)		313.9			184.8			136.9			81.8	
Turn Bay Length (m)	80.0			100.0			34.0			153.0		
Base Capacity (vph)	182	1602		391	1638		261	395		295	580	
Starvation Cap Reductn	0	0		0	0		0	0		0	0	
Spillback Cap Reductn	0	0		0	0		0	0		0	0	
Storage Cap Reductn	0	0		0	0		0	0		0	0	
Reduced v/c Ratio	0.30	0.38		0.45	0.78		0.25	0.50		0.47	0.44	

Intersection Summary

Cycle Length: 120
 Actuated Cycle Length: 120
 Offset: 110 (92%), Referenced to phase 2:EBTL and 6:WBTL, Start of Green
 Natural Cycle: 95
 Control Type: Actuated-Coordinated

Lanes, Volumes, Timings
3: Cummings Ave & Ogilvie Rd

2026 Future Total
AM Peak Hour

Maximum v/c Ratio: 0.78	Intersection LOS: C
Intersection Signal Delay: 27.6	ICU Level of Service F
Intersection Capacity Utilization 91.1%	
Analysis Period (min) 15	

Splits and Phases: 3: Cummings Ave & Ogilvie Rd

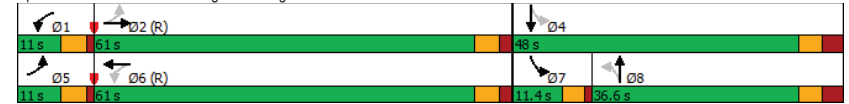

Lanes, Volumes, Timings
1: Cyrville Rd & Ogilvie Rd

2026 Future Total
PM Peak Hour

Maximum v/c Ratio: 0.95	Intersection LOS: C
Intersection Signal Delay: 26.8	ICU Level of Service E
Intersection Capacity Utilization 85.2%	
Analysis Period (min) 15	
# 95th percentile volume exceeds capacity, queue may be longer.	
Queue shown is maximum after two cycles.	
m Volume for 95th percentile queue is metered by upstream signal.	

Splits and Phases: 1: Cyrville Rd & Ogilvie Rd

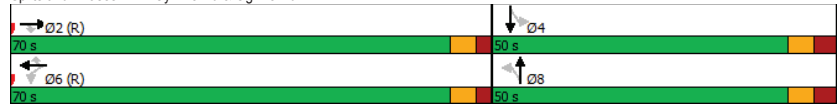

Lanes, Volumes, Timings
2: Cummings Ave & Donald

2026 Future Total
PM Peak Hour

Lane Group	EBL	EBR	NBL	NBT	SBT	SBR
Lane Configurations	↔	↔	↔	↔	↔	↔
Traffic Volume (vph)	88	342	273	259	245	90
Future Volume (vph)	88	342	273	259	245	90
Satd. Flow (prot)	1523	1483	1658	1728	1649	0
Fit Permitted	0.950		0.559			
Satd. Flow (perm)	1518	1345	965	1728	1649	0
Satd. Flow (RTOR)		342			35	
Lane Group Flow (vph)	88	342	273	259	335	0
Turn Type	Perm	Perm	Perm	NA	NA	
Protected Phases				2	6	
Permitted Phases	4	4	2			
Detector Phase	4	4	2	2	6	
Switch Phase						
Minimum Initial (s)	10.0	10.0	10.0	10.0	10.0	
Minimum Split (s)	22.0	22.0	39.9	39.9	39.9	
Total Split (s)	31.0	31.0	89.0	89.0	89.0	
Total Split (%)	25.8%	25.8%	74.2%	74.2%	74.2%	
Yellow Time (s)	3.3	3.3	3.3	3.3	3.3	
All-Red Time (s)	2.7	2.7	3.6	3.6	3.6	
Lost Time Adjust (s)	0.0	0.0	0.0	0.0	0.0	
Total Lost Time (s)	6.0	6.0	6.9	6.9	6.9	
Lead/Lag						
Lead-Lag Optimize?						
Recall Mode	None	None	Min	Min	Min	
Act Effct Green (s)	11.3	11.3	18.3	18.3	18.3	
Actuated g/C Ratio	0.26	0.26	0.42	0.42	0.42	
v/c Ratio	0.22	0.57	0.67	0.35	0.47	
Control Delay	16.7	6.8	18.6	9.4	9.8	
Queue Delay	0.0	0.0	0.0	0.0	0.0	
Total Delay	16.7	6.8	18.6	9.4	9.8	
LOS	B	A	B	A	A	
Approach Delay	8.9			14.1	9.8	
Approach LOS	A			B	A	
Queue Length 50th (m)	4.6	0.0	13.6	10.9	13.2	
Queue Length 95th (m)	17.8	17.0	37.9	26.4	32.5	
Internal Link Dist (m)	296.3			141.5	259.3	
Turn Bay Length (m)	60.0		60.0			
Base Capacity (vph)	922	951	965	1728	1649	
Starvation Cap Reductn	0	0	0	0	0	
Spillback Cap Reductn	0	0	0	0	0	
Storage Cap Reductn	0	0	0	0	0	
Reduced v/c Ratio	0.10	0.36	0.28	0.15	0.20	

Intersection Summary

Cycle Length: 120
Actuated Cycle Length: 43.1
Natural Cycle: 65
Control Type: Semi Act-Uncoord
Maximum v/c Ratio: 0.67

Lanes, Volumes, Timings
2: Cummings Ave & Donald

2026 Future Total
PM Peak Hour

Intersection Signal Delay: 11.3	Intersection LOS: B
Intersection Capacity Utilization 65.1%	ICU Level of Service C
Analysis Period (min) 15	

Splits and Phases: 2: Cummings Ave & Donald



Lanes, Volumes, Timings
3: Cummings Ave & Ogilvie Rd

2026 Future Total
PM Peak Hour

Lane Group	EBL	EBT	EBR	WBL	WBT	WBR	NBL	NBT	NBR	SBL	SBT	SBR
Lane Configurations	↖	↖↗	↗	↖	↖↗	↗	↖	↖↗	↗	↖	↖↗	↗
Traffic Volume (vph)	136	1147	23	127	747	211	62	185	219	259	177	89
Future Volume (vph)	136	1147	23	127	747	211	62	185	219	259	177	89
Satd. Flow (prot)	1658	3298	0	1626	3161	0	1642	1576	0	1658	1634	0
Fit Permitted	0.126			0.094			0.595			0.173		
Satd. Flow (perm)	220	3298	0	161	3161	0	1007	1576	0	300	1634	0
Satd. Flow (RTOR)		2			32			49			27	
Lane Group Flow (vph)	136	1170	0	127	958	0	62	404	0	259	266	0
Turn Type	pm+pt	NA		pm+pt	NA		Perm	NA		pm+pt	NA	
Protected Phases	5	2		1	6		8			7	4	
Permitted Phases	2			6			8			4		
Detector Phase	5	2		1	6		8	8		7	4	
Switch Phase												
Minimum Initial (s)	5.0	10.0		5.0	10.0		10.0	10.0		5.0	10.0	
Minimum Split (s)	9.7	24.7		9.7	24.7		36.6	36.6		9.3	36.6	
Total Split (s)	15.0	45.0		15.0	45.0		40.0	40.0		20.0	60.0	
Total Split (%)	12.5%	37.5%		12.5%	37.5%		33.3%	33.3%		16.7%	50.0%	
Yellow Time (s)	3.7	3.7		3.7	3.7		3.3	3.3		3.3	3.3	
All-Red Time (s)	1.0	2.0		1.0	2.0		3.3	3.3		1.0	3.3	
Lost Time Adjust (s)	0.0	0.0		0.0	0.0		0.0	0.0		0.0	0.0	
Total Lost Time (s)	4.7	5.7		4.7	5.7		6.6	6.6		4.3	6.6	
Lead/Lag	Lead	Lag		Lead	Lag		Lag	Lag		Lead		
Lead-Lag Optimize?	Yes	Yes		Yes	Yes		Yes	Yes		Yes		
Recall Mode	None	C-Max		None	C-Max		None	None		None	None	
Act Effct Green (s)	53.4	42.7		53.1	42.6		30.8	30.8		53.1	50.8	
Actuated g/C Ratio	0.44	0.36		0.44	0.36		0.26	0.26		0.44	0.42	
v/c Ratio	0.64	1.00		0.68	0.84		0.24	0.92		0.84	0.38	
Control Delay	36.3	57.7		41.6	43.1		36.8	64.5		46.5	22.4	
Queue Delay	0.0	0.0		0.0	0.0		0.0	0.0		0.0	0.0	
Total Delay	36.3	57.7		41.6	43.1		36.8	64.5		46.5	22.4	
LOS	D	E		D	D		D	E		D	C	
Approach Delay		55.5			42.9			60.8			34.3	
Approach LOS		E			D			E			C	
Queue Length 50th (m)	12.8	~163.7		17.1	110.0		11.2	80.4		37.8	36.1	
Queue Length 95th (m)	#32.5	#205.6		#39.9	#148.1		23.2	#133.6		#75.8	56.8	
Internal Link Dist (m)		313.9			184.8			136.9			72.5	
Turn Bay Length (m)	80.0			100.0			34.0			153.0		
Base Capacity (vph)	222	1174		197	1141		280	474		310	742	
Starvation Cap Reductn	0	0		0	0		0	0		0	0	
Spillback Cap Reductn	0	0		0	0		0	0		0	0	
Storage Cap Reductn	0	0		0	0		0	0		0	0	
Reduced v/c Ratio	0.61	1.00		0.64	0.84		0.22	0.85		0.84	0.36	

Intersection Summary

Cycle Length: 120
Actuated Cycle Length: 120
Offset: 46 (38%), Referenced to phase 2:EBTL and 6:WBTL, Start of Green
Natural Cycle: 105
Control Type: Actuated-Coordinated

Lanes, Volumes, Timings
3: Cummings Ave & Ogilvie Rd

2026 Future Total
PM Peak Hour

Maximum v/c Ratio: 1.00	Intersection LOS: D
Intersection Signal Delay: 48.9	ICU Level of Service F
Intersection Capacity Utilization 99.9%	
Analysis Period (min) 15	
~ Volume exceeds capacity, queue is theoretically infinite.	
Queue shown is maximum after two cycles.	
# 95th percentile volume exceeds capacity, queue may be longer.	
Queue shown is maximum after two cycles.	

Splits and Phases: 3: Cummings Ave & Ogilvie Rd

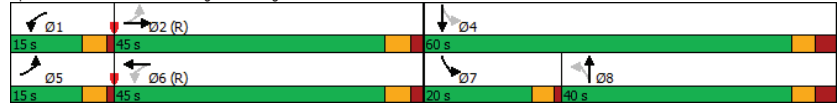

HCM 2010 TWSC
4: Cummings Ave & Site Access

2026 Future Total
PM Peak Hour

Intersection						
Int Delay, s/veh	0.1					
Movement	EBL	EBR	NBL	NBT	SBT	SBR
Lane Configurations	↔		↔		↔	
Traffic Vol, veh/h	1	6	9	513	508	2
Future Vol, veh/h	1	6	9	513	508	2
Conflicting Peds, #/hr	0	0	0	0	0	0
Sign Control	Stop	Stop	Free	Free	Free	Free
RT Channelized	-	None	-	None	-	None
Storage Length	0	-	-	-	-	-
Veh in Median Storage, #	0	-	-	0	0	-
Grade, %	0	-	-	0	0	-
Peak Hour Factor	100	100	100	100	100	100
Heavy Vehicles, %	2	2	2	2	2	2
Mvmt Flow	1	6	9	513	508	2

Major/Minor	Minor2	Major1	Major2		
Conflicting Flow All	1040	509	510	0	- 0
Stage 1	509	-	-	-	-
Stage 2	531	-	-	-	-
Critical Hdwy	6.42	6.22	4.12	-	-
Critical Hdwy Stg 1	5.42	-	-	-	-
Critical Hdwy Stg 2	5.42	-	-	-	-
Follow-up Hdwy	3.518	3.318	2.218	-	-
Pot Cap-1 Maneuver	255	564	1055	-	-
Stage 1	604	-	-	-	-
Stage 2	590	-	-	-	-
Platoon blocked, %	-	-	-	-	-
Mov Cap-1 Maneuver	252	564	1055	-	-
Mov Cap-2 Maneuver	252	-	-	-	-
Stage 1	597	-	-	-	-
Stage 2	590	-	-	-	-

Approach	EB	NB	SB
HCM Control Delay, s	12.6	0.1	0
HCM LOS	B		

Minor Lane/Major Mvmt	NBL	NBT EBLn1	SBT	SBR
Capacity (veh/h)	1055	- 479	-	-
HCM Lane V/C Ratio	0.009	- 0.015	-	-
HCM Control Delay (s)	8.4	0 12.6	-	-
HCM Lane LOS	A	A B	-	-
HCM 95th %tile Q(veh)	0	- 0	-	-

Appendix J

Synchro Intersection Worksheets – 2031 Future Total Conditions

Lanes, Volumes, Timings
1: Cyrville Rd & Ogilvie Rd

2031 Future Total
AM Peak Hour

Lane Group	EBL	EBT	EBR	WBL	WBT	WBR	NBL	NBT	NBR	SBL	SBT	SBR
Lane Configurations		↑↑	↑	↑	↑↑	↑	↑	↑	↑	↑	↑	↑
Traffic Volume (vph)	0	594	230	28	1070	166	172	244	14	47	174	45
Future Volume (vph)	0	594	230	28	1070	166	172	244	14	47	174	45
Satd. Flow (prot)	0	3283	1414	1658	3316	1441	1551	1714	0	1626	1605	0
Fit Permitted				0.414			0.497			0.423		
Satd. Flow (perm)	0	3283	1329	714	3316	1319	808	1714	0	722	1605	0
Satd. Flow (RTOR)			230			166		3			12	
Lane Group Flow (vph)	0	594	230	28	1070	166	172	258	0	47	219	0
Turn Type	NA	Perm	Perm	NA	Perm	Perm	NA	Perm	NA	Perm	NA	
Protected Phases		2			6			8				4
Permitted Phases			2	6		6	8			4		
Detector Phase		2	2	6	6	6	8	8		4	4	
Switch Phase												
Minimum Initial (s)		10.0	10.0	10.0	10.0	10.0	10.0	10.0		10.0	10.0	
Minimum Split (s)		32.2	32.2	32.2	32.2	32.2	47.1	47.1		47.1	47.1	
Total Split (s)		72.9	72.9	72.9	72.9	72.9	47.1	47.1		47.1	47.1	
Total Split (%)		60.8%	60.8%	60.8%	60.8%	60.8%	39.3%	39.3%		39.3%	39.3%	
Yellow Time (s)		3.7	3.7	3.7	3.7	3.7	3.7	3.7		3.7	3.7	
All-Red Time (s)		2.5	2.5	2.5	2.5	2.5	3.4	3.4		3.4	3.4	
Lost Time Adjust (s)		0.0	0.0	0.0	0.0	0.0	0.0	0.0		0.0	0.0	
Total Lost Time (s)		6.2	6.2	6.2	6.2	6.2	7.1	7.1		7.1	7.1	
Lead/Lag												
Lead-Lag Optimize?												
Recall Mode		C-Max	C-Max	C-Max	C-Max	C-Max	None	None		None	None	
Act Effct Green (s)		78.6	78.6	78.6	78.6	78.6	28.1	28.1		28.1	28.1	
Actuated g/C Ratio		0.66	0.66	0.66	0.66	0.66	0.23	0.23		0.23	0.23	
v/c Ratio		0.28	0.24	0.06	0.49	0.18	0.91	0.64		0.28	0.57	
Control Delay		10.3	2.2	4.5	4.8	0.4	88.8	46.9		38.3	42.5	
Queue Delay		0.0	0.0	0.0	0.0	0.0	0.0	0.0		0.0	0.0	
Total Delay		10.3	2.2	4.5	4.8	0.4	88.8	46.9		38.3	42.5	
LOS		B	A	A	A	A	F	D		D	D	
Approach Delay		8.0			4.2		63.6			41.8		
Approach LOS		A			A		E			D		
Queue Length 50th (m)		28.6	0.0	0.8	16.0	0.2	39.5	54.3		9.1	43.2	
Queue Length 95th (m)		49.6	10.8	m1.2	20.3	m0.2	60.3	71.3		17.7	59.2	
Internal Link Dist (m)		113.5			313.9		191.2			190.6		
Turn Bay Length (m)				62.0		71.0	33.5			82.0		
Base Capacity (vph)		2149	949	467	2171	920	269	573		240	543	
Starvation Cap Reductn		0	0	0	0	0	0	0		0	0	
Spillback Cap Reductn		0	0	0	0	0	0	0		0	0	
Storage Cap Reductn		0	0	0	0	0	0	0		0	0	
Reduced v/c Ratio		0.28	0.24	0.06	0.49	0.18	0.64	0.45		0.20	0.40	

Intersection Summary

Cycle Length: 120
 Actuated Cycle Length: 120
 Offset: 10 (8%), Referenced to phase 2:EBT and 6:WBTL, Start of Green
 Natural Cycle: 80
 Control Type: Actuated-Coordinated

Lanes, Volumes, Timings
1: Cyrville Rd & Ogilvie Rd

2031 Future Total
AM Peak Hour

Maximum v/c Ratio: 0.91
 Intersection Signal Delay: 18.1
 Intersection Capacity Utilization 75.8%
 Analysis Period (min) 15
 m Volume for 95th percentile queue is metered by upstream signal.

Splits and Phases: 1: Cyrville Rd & Ogilvie Rd

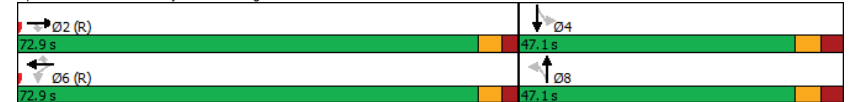

Lanes, Volumes, Timings
2: Cummings Ave & Donald

2031 Future Total
AM Peak Hour

Lane Group	EBL	EBR	NBL	NBT	SBT	SBR
Lane Configurations	↖	↗	↖	↗	↖	↗
Traffic Volume (vph)	42	175	260	130	220	104
Future Volume (vph)	42	175	260	130	220	104
Satd. Flow (prot)	1610	1469	1642	1695	1611	0
Fit Permitted	0.950		0.564			
Satd. Flow (perm)	1532	1382	960	1695	1611	0
Satd. Flow (RTOR)		175			59	
Lane Group Flow (vph)	42	175	260	130	324	0
Turn Type	Perm	Perm	Perm	NA	NA	
Protected Phases				2	6	
Permitted Phases	4	4	2			
Detector Phase	4	4	2	2	6	
Switch Phase						
Minimum Initial (s)	10.0	10.0	10.0	10.0	10.0	
Minimum Split (s)	22.0	22.0	39.9	39.9	39.9	
Total Split (s)	22.0	22.0	98.0	98.0	98.0	
Total Split (%)	18.3%	18.3%	81.7%	81.7%	81.7%	
Yellow Time (s)	3.3	3.3	3.3	3.3	3.3	
All-Red Time (s)	2.7	2.7	3.6	3.6	3.6	
Lost Time Adjust (s)	0.0	0.0	0.0	0.0	0.0	
Total Lost Time (s)	6.0	6.0	6.9	6.9	6.9	
Lead/Lag						
Lead-Lag Optimize?						
Recall Mode	None	None	Min	Min	Min	
Act Effct Green (s)	11.3	11.3	19.8	19.8	19.8	
Actuated g/C Ratio	0.25	0.25	0.44	0.44	0.44	
v/c Ratio	0.11	0.36	0.61	0.17	0.43	
Control Delay	15.0	5.9	16.5	8.1	8.8	
Queue Delay	0.0	0.0	0.0	0.0	0.0	
Total Delay	15.0	5.9	16.5	8.1	8.8	
LOS	B	A	B	A	A	
Approach Delay	7.7			13.7	8.8	
Approach LOS	A			B	A	
Queue Length 50th (m)	2.0	0.0	12.8	5.1	11.3	
Queue Length 95th (m)	10.1	12.3	35.5	14.0	29.4	
Internal Link Dist (m)	296.9			132.3	259.3	
Turn Bay Length (m)	60.0		60.0			
Base Capacity (vph)	572	626	960	1695	1611	
Starvation Cap Reductn	0	0	0	0	0	
Spillback Cap Reductn	0	0	0	0	0	
Storage Cap Reductn	0	0	0	0	0	
Reduced v/c Ratio	0.07	0.28	0.27	0.08	0.20	

Intersection Summary	
Cycle Length:	120
Actuated Cycle Length:	44.5
Natural Cycle:	65
Control Type:	Actuated-Uncoordinated
Maximum v/c Ratio:	0.61

Lanes, Volumes, Timings
2: Cummings Ave & Donald

2031 Future Total
AM Peak Hour

Intersection Signal Delay: 10.6	Intersection LOS: B
Intersection Capacity Utilization 63.7%	ICU Level of Service B
Analysis Period (min) 15	

Splits and Phases: 2: Cummings Ave & Donald



Lanes, Volumes, Timings
3: Cummings Ave & Ogilvie Rd

2031 Future Total
AM Peak Hour

Lane Group	EBL	EBT	EBR	WBL	WBT	WBR	NBL	NBT	NBR	SBL	SBT	SBR
Lane Configurations	↔	↕	↔	↔	↕	↔	↔	↕	↔	↔	↕	↔
Traffic Volume (vph)	54	608	11	174	1112	171	64	130	69	140	140	120
Future Volume (vph)	54	608	11	174	1112	171	64	130	69	140	140	120
Satd. Flow (prot)	1626	3266	0	1626	3195	0	1658	1517	0	1626	1609	0
Fit Permitted	0.111			0.353			0.599			0.439		
Satd. Flow (perm)	190	3266	0	595	3195	0	1041	1517	0	721	1609	0
Satd. Flow (RTOR)		2			19			21			39	
Lane Group Flow (vph)	54	619	0	174	1283	0	64	199	0	140	260	0
Turn Type	pm+pt	NA		pm+pt	NA		Perm	NA		pm+pt	NA	
Protected Phases	5	2		1	6		8			7	4	
Permitted Phases	2			6			8			4		
Detector Phase	5	2		1	6		8	8		7	4	
Switch Phase												
Minimum Initial (s)	5.0	10.0		5.0	10.0		10.0	10.0		5.0	10.0	
Minimum Split (s)	9.7	24.7		9.7	24.7		36.6	36.6		9.3	36.6	
Total Split (s)	11.0	61.0		11.0	61.0		36.6	36.6		11.4	48.0	
Total Split (%)	9.2%	50.8%		9.2%	50.8%		30.5%	30.5%		9.5%	40.0%	
Yellow Time (s)	3.7	3.7		3.7	3.7		3.3	3.3		3.3	3.3	
All-Red Time (s)	1.0	2.0		1.0	2.0		3.3	3.3		1.0	3.3	
Lost Time Adjust (s)	0.0	0.0		0.0	0.0		0.0	0.0		0.0	0.0	
Total Lost Time (s)	4.7	5.7		4.7	5.7		6.6	6.6		4.3	6.6	
Lead/Lag	Lead	Lag		Lead	Lag		Lag	Lag		Lead		
Lead-Lag Optimize?	Yes	Yes		Yes	Yes		Yes	Yes		Yes		
Recall Mode	None	C-Max		None	C-Max		None	None		None	None	
Act Effct Green (s)	65.9	58.8		67.2	61.2		26.3	26.3		40.0	37.7	
Actuated g/C Ratio	0.55	0.49		0.56	0.51		0.22	0.22		0.33	0.31	
v/c Ratio	0.31	0.39		0.45	0.78		0.28	0.57		0.48	0.49	
Control Delay	23.7	18.3		17.4	30.1		40.3	42.9		34.0	30.4	
Queue Delay	0.0	0.0		0.0	0.0		0.0	0.0		0.0	0.0	
Total Delay	23.7	18.3		17.4	30.1		40.3	42.9		34.0	30.4	
LOS	C	B		B	C		D	D		C	C	
Approach Delay		18.7			28.6			42.2			31.7	
Approach LOS		B			C			D			C	
Queue Length 50th (m)	5.0	38.8		19.2	137.5		12.1	36.0		22.7	39.8	
Queue Length 95th (m)	18.2	49.5		31.1	169.7		24.5	59.5		38.2	64.0	
Internal Link Dist (m)		313.9			184.8			136.9			81.8	
Turn Bay Length (m)	80.0			100.0			34.0			153.0		
Base Capacity (vph)	179	1600		389	1637		260	395		294	580	
Starvation Cap Reductn	0	0		0	0		0	0		0	0	
Spillback Cap Reductn	0	0		0	0		0	0		0	0	
Storage Cap Reductn	0	0		0	0		0	0		0	0	
Reduced v/c Ratio	0.30	0.39		0.45	0.78		0.25	0.50		0.48	0.45	

Intersection Summary	
Cycle Length:	120
Actuated Cycle Length:	120
Offset:	110 (92%), Referenced to phase 2:EBTL and 6:WBTL, Start of Green
Natural Cycle:	95
Control Type:	Actuated-Coordinated

Lanes, Volumes, Timings
3: Cummings Ave & Ogilvie Rd

2031 Future Total
AM Peak Hour

Maximum v/c Ratio: 0.78	Intersection Signal Delay: 27.9	Intersection LOS: C
Intersection Capacity Utilization 91.5%	ICU Level of Service F	
Analysis Period (min) 15		

Splits and Phases: 3: Cummings Ave & Ogilvie Rd

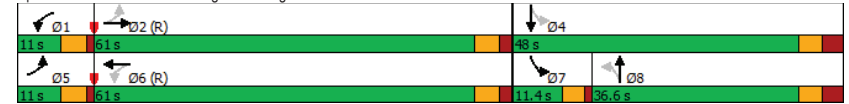

Lanes, Volumes, Timings
1: Cyrville Rd & Ogilvie Rd

2031 Future Total
PM Peak Hour

Maximum v/c Ratio: 0.96	Intersection LOS: C
Intersection Signal Delay: 27.5	ICU Level of Service E
Intersection Capacity Utilization 85.3%	
Analysis Period (min) 15	
# 95th percentile volume exceeds capacity, queue may be longer.	
Queue shown is maximum after two cycles.	
m Volume for 95th percentile queue is metered by upstream signal.	

Splits and Phases: 1: Cyrville Rd & Ogilvie Rd

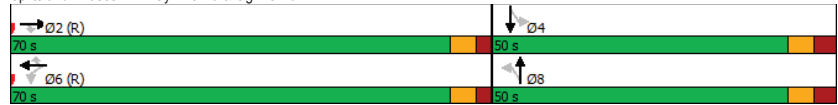

Lanes, Volumes, Timings
2: Cummings Ave & Donald

2031 Future Total
PM Peak Hour

Lane Group	EBL	EBR	NBL	NBT	SBT	SBR
Lane Configurations	↔	↔	↔	↔	↔	↔
Traffic Volume (vph)	88	359	287	272	248	90
Future Volume (vph)	88	359	287	272	248	90
Satd. Flow (prot)	1523	1483	1658	1728	1649	0
Fit Permitted	0.950		0.557			
Satd. Flow (perm)	1518	1345	961	1728	1649	0
Satd. Flow (RTOR)		359			34	
Lane Group Flow (vph)	88	359	287	272	338	0
Turn Type	Perm	Perm	Perm	NA	NA	
Protected Phases				2	6	
Permitted Phases	4	4	2			
Detector Phase	4	4	2	2	6	
Switch Phase						
Minimum Initial (s)	10.0	10.0	10.0	10.0	10.0	
Minimum Split (s)	22.0	22.0	39.9	39.9	39.9	
Total Split (s)	31.0	31.0	89.0	89.0	89.0	
Total Split (%)	25.8%	25.8%	74.2%	74.2%	74.2%	
Yellow Time (s)	3.3	3.3	3.3	3.3	3.3	
All-Red Time (s)	2.7	2.7	3.6	3.6	3.6	
Lost Time Adjust (s)	0.0	0.0	0.0	0.0	0.0	
Total Lost Time (s)	6.0	6.0	6.9	6.9	6.9	
Lead/Lag						
Lead-Lag Optimize?						
Recall Mode	None	None	Min	Min	Min	
Act Effct Green (s)	11.3	11.3	19.1	19.1	19.1	
Actuated g/C Ratio	0.26	0.26	0.44	0.44	0.44	
v/c Ratio	0.23	0.59	0.69	0.36	0.46	
Control Delay	17.3	7.1	19.2	9.4	9.6	
Queue Delay	0.0	0.0	0.0	0.0	0.0	
Total Delay	17.3	7.1	19.2	9.4	9.6	
LOS	B	A	B	A	A	
Approach Delay	9.1			14.4	9.6	
Approach LOS	A			B	A	
Queue Length 50th (m)	4.8	0.0	14.6	11.5	13.3	
Queue Length 95th (m)	18.1	17.9	40.6	27.7	32.7	
Internal Link Dist (m)	296.3			141.5	259.3	
Turn Bay Length (m)	60.0		60.0			
Base Capacity (vph)	905	947	961	1728	1649	
Starvation Cap Reductn	0	0	0	0	0	
Spillback Cap Reductn	0	0	0	0	0	
Storage Cap Reductn	0	0	0	0	0	
Reduced v/c Ratio	0.10	0.38	0.30	0.16	0.20	

Intersection Summary

Cycle Length: 120
Actuated Cycle Length: 43.9
Natural Cycle: 65
Control Type: Semi Act-Uncoord
Maximum v/c Ratio: 0.69

Lanes, Volumes, Timings
2: Cummings Ave & Donald

2031 Future Total
PM Peak Hour

Intersection Signal Delay: 11.4 Intersection LOS: B
Intersection Capacity Utilization 66.1% ICU Level of Service C
Analysis Period (min) 15

Splits and Phases: 2: Cummings Ave & Donald



Lanes, Volumes, Timings
3: Cummings Ave & Ogilvie Rd

2031 Future Total
PM Peak Hour

Lane Group	EBL	EBT	EBR	WBL	WBT	WBR	NBL	NBT	NBR	SBL	SBT	SBR
Lane Configurations	↔	↕	↔	↔	↕	↔	↔	↕	↔	↔	↕	↔
Traffic Volume (vph)	136	1161	23	127	756	211	62	194	219	259	179	89
Future Volume (vph)	136	1161	23	127	756	211	62	194	219	259	179	89
Satd. Flow (prot)	1658	3298	0	1626	3161	0	1642	1578	0	1658	1634	0
Fit Permitted	0.119			0.095			0.594			0.168		
Satd. Flow (perm)	208	3298	0	163	3161	0	1005	1578	0	291	1634	0
Satd. Flow (RTOR)		2			32			47			27	
Lane Group Flow (vph)	136	1184	0	127	967	0	62	413	0	259	268	0
Turn Type	pm+pt	NA		pm+pt	NA		Perm	NA		pm+pt	NA	
Protected Phases	5	2		1	6			8		7	4	
Permitted Phases	2			6			8			4		
Detector Phase	5	2		1	6		8	8		7	4	
Switch Phase												
Minimum Initial (s)	5.0	10.0		5.0	10.0		10.0	10.0		5.0	10.0	
Minimum Split (s)	9.7	24.7		9.7	24.7		36.6	36.6		9.3	36.6	
Total Split (s)	15.0	45.0		15.0	45.0		40.0	40.0		20.0	60.0	
Total Split (%)	12.5%	37.5%		12.5%	37.5%		33.3%	33.3%		16.7%	50.0%	
Yellow Time (s)	3.7	3.7		3.7	3.7		3.3	3.3		3.3	3.3	
All-Red Time (s)	1.0	2.0		1.0	2.0		3.3	3.3		1.0	3.3	
Lost Time Adjust (s)	0.0	0.0		0.0	0.0		0.0	0.0		0.0	0.0	
Total Lost Time (s)	4.7	5.7		4.7	5.7		6.6	6.6		4.3	6.6	
Lead/Lag	Lead	Lag		Lead	Lag		Lag	Lag		Lead		
Lead-Lag Optimize?	Yes	Yes		Yes	Yes		Yes	Yes		Yes		
Recall Mode	None	C-Max		None	C-Max		None	None		None	None	
Act Effct Green (s)	52.9	42.2		52.6	42.0		31.3	31.3		53.6	51.3	
Actuated g/C Ratio	0.44	0.35		0.44	0.35		0.26	0.26		0.45	0.43	
v/c Ratio	0.65	1.02		0.68	0.86		0.24	0.93		0.84	0.38	
Control Delay	38.6	63.7		41.5	44.6		36.6	66.1		47.3	22.2	
Queue Delay	0.0	0.0		0.0	0.0		0.0	0.0		0.0	0.0	
Total Delay	38.6	63.7		41.5	44.6		36.6	66.1		47.3	22.2	
LOS	D	E		D	D		D	E		D	C	
Approach Delay		61.1			44.3			62.2			34.5	
Approach LOS		E			D			E			C	
Queue Length 50th (m)	12.4	~167.2		17.1	111.5		11.2	83.6		37.8	36.5	
Queue Length 95th (m)	#35.3	#209.6		#39.6	#150.5		23.2	#138.7		#77.3	57.1	
Internal Link Dist (m)		313.9			184.8			136.9			72.5	
Turn Bay Length (m)	80.0			100.0			34.0			153.0		
Base Capacity (vph)	217	1160		198	1127		279	473		308	742	
Starvation Cap Reductn	0	0		0	0		0	0		0	0	
Spillback Cap Reductn	0	0		0	0		0	0		0	0	
Storage Cap Reductn	0	0		0	0		0	0		0	0	
Reduced v/c Ratio	0.63	1.02		0.64	0.86		0.22	0.87		0.84	0.36	

Intersection Summary

Cycle Length: 120
Actuated Cycle Length: 120
Offset: 46 (38%), Referenced to phase 2:EBTL and 6:WBTL, Start of Green
Natural Cycle: 105
Control Type: Actuated-Coordinated

Lanes, Volumes, Timings
3: Cummings Ave & Ogilvie Rd

2031 Future Total
PM Peak Hour

Maximum v/c Ratio: 1.02	Intersection LOS: D
Intersection Signal Delay: 51.8	ICU Level of Service G
Intersection Capacity Utilization 100.8%	
Analysis Period (min) 15	
~ Volume exceeds capacity, queue is theoretically infinite. Queue shown is maximum after two cycles.	
# 95th percentile volume exceeds capacity, queue may be longer. Queue shown is maximum after two cycles.	

Splits and Phases: 3: Cummings Ave & Ogilvie Rd

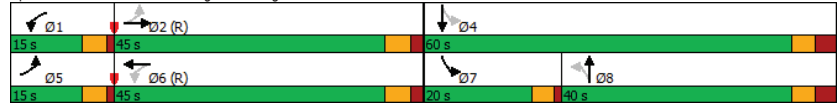

Lanes, Volumes, Timings
4: Cummings Ave & Site Access

2031 Future Total
PM Peak Hour

Lane Group	EBL	EBR	NBL	NBT	SBT	SBR
Lane Configurations	↔	↔	↔	↕	↕	↔
Traffic Volume (vph)	1	6	9	522	510	2
Future Volume (vph)	1	6	9	522	510	2
Satd. Flow (prot)	1532	0	0	1743	1743	0
Fit Permitted	0.993			0.999		
Satd. Flow (perm)	1532	0	0	1743	1743	0
Lane Group Flow (vph)	7	0	0	531	512	0
Sign Control	Stop			Free	Free	

Intersection Summary	
Control Type: Unsignalized	
Intersection Capacity Utilization 46.6%	ICU Level of Service A
Analysis Period (min) 15	

Intersection						
Int Delay, s/veh	0.1					
Movement	EBL	EBR	NBL	NBT	SBT	SBR
Lane Configurations	↔			↔	↔	
Traffic Vol, veh/h	1	6	9	522	510	2
Future Vol, veh/h	1	6	9	522	510	2
Conflicting Peds, #/hr	0	0	0	0	0	0
Sign Control	Stop	Stop	Free	Free	Free	Free
RT Channelized	-	None	-	None	-	None
Storage Length	0	-	-	-	-	-
Veh in Median Storage, #	0	-	-	0	0	-
Grade, %	0	-	-	0	0	-
Peak Hour Factor	100	100	100	100	100	100
Heavy Vehicles, %	2	2	2	2	2	2
Mvmt Flow	1	6	9	522	510	2
Major/Minor	Minor2	Major1	Major2			
Conflicting Flow All	1051	511	512	0	-	0
Stage 1	511	-	-	-	-	-
Stage 2	540	-	-	-	-	-
Critical Hdwy	6.42	6.22	4.12	-	-	-
Critical Hdwy Stg 1	5.42	-	-	-	-	-
Critical Hdwy Stg 2	5.42	-	-	-	-	-
Follow-up Hdwy	3.518	3.318	2.218	-	-	-
Pot Cap-1 Maneuver	251	563	1053	-	-	-
Stage 1	602	-	-	-	-	-
Stage 2	584	-	-	-	-	-
Platoon blocked, %	-	-	-	-	-	-
Mov Cap-1 Maneuver	248	563	1053	-	-	-
Mov Cap-2 Maneuver	248	-	-	-	-	-
Stage 1	595	-	-	-	-	-
Stage 2	584	-	-	-	-	-
Approach	EB	NB	SB			
HCM Control Delay, s	12.7	0.1	0			
HCM LOS	B					
Minor Lane/Major Mvmt	NBL	NBT	EBLn1	SBT	SBR	
Capacity (veh/h)	1053	-	477	-	-	
HCM Lane V/C Ratio	0.009	-	0.015	-	-	
HCM Control Delay (s)	8.4	0	12.7	-	-	
HCM Lane LOS	A	A	B	-	-	
HCM 95th %tile Q(veh)	0	-	0	-	-	

Appendix K

TDM Checklist

TDM Measures Checklist:
Residential Developments (multi-family, condominium or subdivision)

Legend	
BASIC	The measure is generally feasible and effective, and in most cases would benefit the development and its users
BETTER	The measure could maximize support for users of sustainable modes, and optimize development performance
★	The measure is one of the most dependably effective tools to encourage the use of sustainable modes

TDM measures: Residential developments		Check if proposed & add descriptions
1. TDM PROGRAM MANAGEMENT		
1.1 Program coordinator		
BASIC ★	1.1.1 Designate an internal coordinator, or contract with an external coordinator	<input type="checkbox"/>
1.2 Travel surveys		
BETTER	1.2.1 Conduct periodic surveys to identify travel-related behaviours, attitudes, challenges and solutions, and to track progress	<input type="checkbox"/>
2. WALKING AND CYCLING		
2.1 Information on walking/cycling routes & destinations		
BASIC	2.1.1 Display local area maps with walking/cycling access routes and key destinations at major entrances (<i>multi-family, condominium</i>)	<input checked="" type="checkbox"/>
2.2 Bicycle skills training		
BETTER	2.2.1 Offer on-site cycling courses for residents, or subsidize off-site courses	<input type="checkbox"/>

TDM measures: Residential developments		Check if proposed & add descriptions
3. TRANSIT		
3.1 Transit information		
BASIC	3.1.1 Display relevant transit schedules and route maps at entrances (<i>multi-family, condominium</i>)	<input checked="" type="checkbox"/>
BETTER	3.1.2 Provide real-time arrival information display at entrances (<i>multi-family, condominium</i>)	<input type="checkbox"/>
3.2 Transit fare incentives		
BASIC ★	3.2.1 Offer PRESTO cards preloaded with one monthly transit pass on residence purchase/move-in, to encourage residents to use transit	<input type="checkbox"/>
BETTER	3.2.2 Offer at least one year of free monthly transit passes on residence purchase/move-in	<input checked="" type="checkbox"/>
3.3 Enhanced public transit service		
BETTER ★	3.3.1 Contract with OC Transpo to provide early transit services until regular services are warranted by occupancy levels (<i>subdivision</i>)	<input type="checkbox"/>
3.4 Private transit service		
BETTER	3.4.1 Provide shuttle service for seniors homes or lifestyle communities (e.g. scheduled mall or supermarket runs)	<input type="checkbox"/>
4. CARSHARING & BIKESHARING		
4.1 Bikeshare stations & memberships		
BETTER	4.1.1 Contract with provider to install on-site bikeshare station (<i>multi-family</i>)	<input type="checkbox"/>
BETTER	4.1.2 Provide residents with bikeshare memberships, either free or subsidized (<i>multi-family</i>)	<input type="checkbox"/>
4.2 Carshare vehicles & memberships		
BETTER	4.2.1 Contract with provider to install on-site carshare vehicles and promote their use by residents	<input type="checkbox"/>
BETTER	4.2.2 Provide residents with carshare memberships, either free or subsidized	<input type="checkbox"/>
5. PARKING		
5.1 Priced parking		
BASIC ★	5.1.1 Unbundle parking cost from purchase price (<i>condominium</i>)	<input checked="" type="checkbox"/>
BASIC ★	5.1.2 Unbundle parking cost from monthly rent (<i>multi-family</i>)	<input checked="" type="checkbox"/>

TDM measures: Residential developments		Check if proposed & add descriptions
6. TDM MARKETING & COMMUNICATIONS		
6.1 Multimodal travel information		
BASIC ★	6.1.1 Provide a multimodal travel option information package to new residents	<input checked="" type="checkbox"/>
6.2 Personalized trip planning		
BETTER ★	6.2.1 Offer personalized trip planning to new residents	<input type="checkbox"/>

TDM-Supportive Development Design and Infrastructure Checklist:
Residential Developments (multi-family or condominium)

Legend	
REQUIRED	The Official Plan or Zoning By-law provides related guidance that must be followed
BASIC	The measure is generally feasible and effective, and in most cases would benefit the development and its users
BETTER	The measure could maximize support for users of sustainable modes, and optimize development performance

TDM-supportive design & infrastructure measures: Residential developments		Check if completed & add descriptions, explanations or plan/drawing references
1. WALKING & CYCLING: ROUTES		
1.1 Building location & access points		
BASIC	1.1.1 Locate building close to the street, and do not locate parking areas between the street and building entrances	<input checked="" type="checkbox"/>
BASIC	1.1.2 Locate building entrances in order to minimize walking distances to sidewalks and transit stops/stations	<input checked="" type="checkbox"/>
BASIC	1.1.3 Locate building doors and windows to ensure visibility of pedestrians from the building, for their security and comfort	<input checked="" type="checkbox"/>
1.2 Facilities for walking & cycling		
REQUIRED	1.2.1 Provide convenient, direct access to stations or major stops along rapid transit routes within 600 metres; minimize walking distances from buildings to rapid transit; provide pedestrian-friendly, weather-protected (where possible) environment between rapid transit accesses and building entrances; ensure quality linkages from sidewalks through building entrances to integrated stops/stations (see Official Plan policy 4.3.3)	<input checked="" type="checkbox"/>
REQUIRED	1.2.2 Provide safe, direct and attractive pedestrian access from public sidewalks to building entrances through such measures as: reducing distances between public sidewalks and major building entrances; providing walkways from public streets to major building entrances; within a site, providing walkways along the front of adjoining buildings, between adjacent buildings, and connecting areas where people may congregate, such as courtyards and transit stops; and providing weather protection through canopies, colonnades, and other design elements wherever possible (see Official Plan policy 4.3.12)	<input checked="" type="checkbox"/>

TDM-supportive design & infrastructure measures: <i>Residential developments</i>		Check if completed & add descriptions, explanations or plan/drawing references
REQUIRED	1.2.3 Provide sidewalks of smooth, well-drained walking surfaces of contrasting materials or treatments to differentiate pedestrian areas from vehicle areas, and provide marked pedestrian crosswalks at intersection sidewalks (see <i>Official Plan policy 4.3.10</i>)	<input checked="" type="checkbox"/>
REQUIRED	1.2.4 Make sidewalks and open space areas easily accessible through features such as gradual grade transition, depressed curbs at street corners and convenient access to extra-wide parking spaces and ramps (see <i>Official Plan policy 4.3.10</i>)	<input checked="" type="checkbox"/>
REQUIRED	1.2.5 Include adequately spaced inter-block/street cycling and pedestrian connections to facilitate travel by active transportation. Provide links to the existing or planned network of public sidewalks, multi-use pathways and on-road cycle routes. Where public sidewalks and multi-use pathways intersect with roads, consider providing traffic control devices to give priority to cyclists and pedestrians (see <i>Official Plan policy 4.3.11</i>)	<input checked="" type="checkbox"/>
BASIC	1.2.6 Provide safe, direct and attractive walking routes from building entrances to nearby transit stops	<input checked="" type="checkbox"/>
BASIC	1.2.7 Ensure that walking routes to transit stops are secure, visible, lighted, shaded and wind-protected wherever possible	<input checked="" type="checkbox"/>
BASIC	1.2.8 Design roads used for access or circulation by cyclists using a target operating speed of no more than 30 km/h, or provide a separated cycling facility	<input type="checkbox"/>
1.3 Amenities for walking & cycling		
BASIC	1.3.1 Provide lighting, landscaping and benches along walking and cycling routes between building entrances and streets, sidewalks and trails	<input type="checkbox"/>
BASIC	1.3.2 Provide wayfinding signage for site access (where required, e.g. when multiple buildings or entrances exist) and egress (where warranted, such as when directions to reach transit stops/stations, trails or other common destinations are not obvious)	<input type="checkbox"/>

TDM-supportive design & infrastructure measures: <i>Residential developments</i>		Check if completed & add descriptions, explanations or plan/drawing references
2. WALKING & CYCLING: END-OF-TRIP FACILITIES		
2.1 Bicycle parking		
REQUIRED	2.1.1 Provide bicycle parking in highly visible and lighted areas, sheltered from the weather wherever possible (see <i>Official Plan policy 4.3.6</i>)	<input checked="" type="checkbox"/>
REQUIRED	2.1.2 Provide the number of bicycle parking spaces specified for various land uses in different parts of Ottawa; provide convenient access to main entrances or well-used areas (see <i>Zoning By-law Section 111</i>)	<input checked="" type="checkbox"/>
REQUIRED	2.1.3 Ensure that bicycle parking spaces and access aisles meet minimum dimensions; that no more than 50% of spaces are vertical spaces; and that parking racks are securely anchored (see <i>Zoning By-law Section 111</i>)	<input checked="" type="checkbox"/>
BASIC	2.1.4 Provide bicycle parking spaces equivalent to the expected number of resident-owned bicycles, plus the expected peak number of visitor cyclists	<input type="checkbox"/>
2.2 Secure bicycle parking		
REQUIRED	2.2.1 Where more than 50 bicycle parking spaces are provided for a single residential building, locate at least 25% of spaces within a building/structure, a secure area (e.g. supervised parking lot or enclosure) or bicycle lockers (see <i>Zoning By-law Section 111</i>)	<input checked="" type="checkbox"/>
BETTER	2.2.2 Provide secure bicycle parking spaces equivalent to at least the number of units at condominiums or multi-family residential developments	<input checked="" type="checkbox"/>
2.3 Bicycle repair station		
BETTER	2.3.1 Provide a permanent bike repair station, with commonly used tools and an air pump, adjacent to the main bicycle parking area (or secure bicycle parking area, if provided)	<input type="checkbox"/>
3. TRANSIT		
3.1 Customer amenities		
BASIC	3.1.1 Provide shelters, lighting and benches at any on-site transit stops	<input type="checkbox"/>
BASIC	3.1.2 Where the site abuts an off-site transit stop and insufficient space exists for a transit shelter in the public right-of-way, protect land for a shelter and/or install a shelter	<input type="checkbox"/>
BETTER	3.1.3 Provide a secure and comfortable interior waiting area by integrating any on-site transit stops into the building	<input type="checkbox"/>

TDM-supportive design & infrastructure measures: <i>Residential developments</i>		Check if completed & add descriptions, explanations or plan/drawing references
4. RIDESHARING		
4.1 Pick-up & drop-off facilities		
BASIC	4.1.1 Provide a designated area for carpool drivers (plus taxis and ride-hailing services) to drop off or pick up passengers without using fire lanes or other no-stopping zones	<input type="checkbox"/>
5. CARSHARING & BIKESHARING		
5.1 Carshare parking spaces		
BETTER	5.1.1 Provide up to three carshare parking spaces in an R3, R4 or R5 Zone for specified residential uses (see <i>Zoning By-law Section 94</i>)	<input type="checkbox"/>
5.2 Bikeshare station location		
BETTER	5.2.1 Provide a designated bikeshare station area near a major building entrance, preferably lighted and sheltered with a direct walkway connection	<input type="checkbox"/>
6. PARKING		
6.1 Number of parking spaces		
REQUIRED	6.1.1 Do not provide more parking than permitted by zoning, nor less than required by zoning, unless a variance is being applied for	<input checked="" type="checkbox"/>
BASIC	6.1.2 Provide parking for long-term and short-term users that is consistent with mode share targets, considering the potential for visitors to use off-site public parking	<input type="checkbox"/>
BASIC	6.1.3 Where a site features more than one use, provide shared parking and reduce the cumulative number of parking spaces accordingly (see <i>Zoning By-law Section 104</i>)	<input type="checkbox"/>
BETTER	6.1.4 Reduce the minimum number of parking spaces required by zoning by one space for each 13 square metres of gross floor area provided as shower rooms, change rooms, locker rooms and other facilities for cyclists in conjunction with bicycle parking (see <i>Zoning By-law Section 111</i>)	<input type="checkbox"/>
6.2 Separate long-term & short-term parking areas		
BETTER	6.2.1 Provide separate areas for short-term and long-term parking (using signage or physical barriers) to permit access controls and simplify enforcement (i.e. to discourage residents from parking in visitor spaces, and vice versa)	<input type="checkbox"/>

Appendix L

Turning Templates

Garbage Inbound Turning Movement



Garbage Outbound Turning Movement

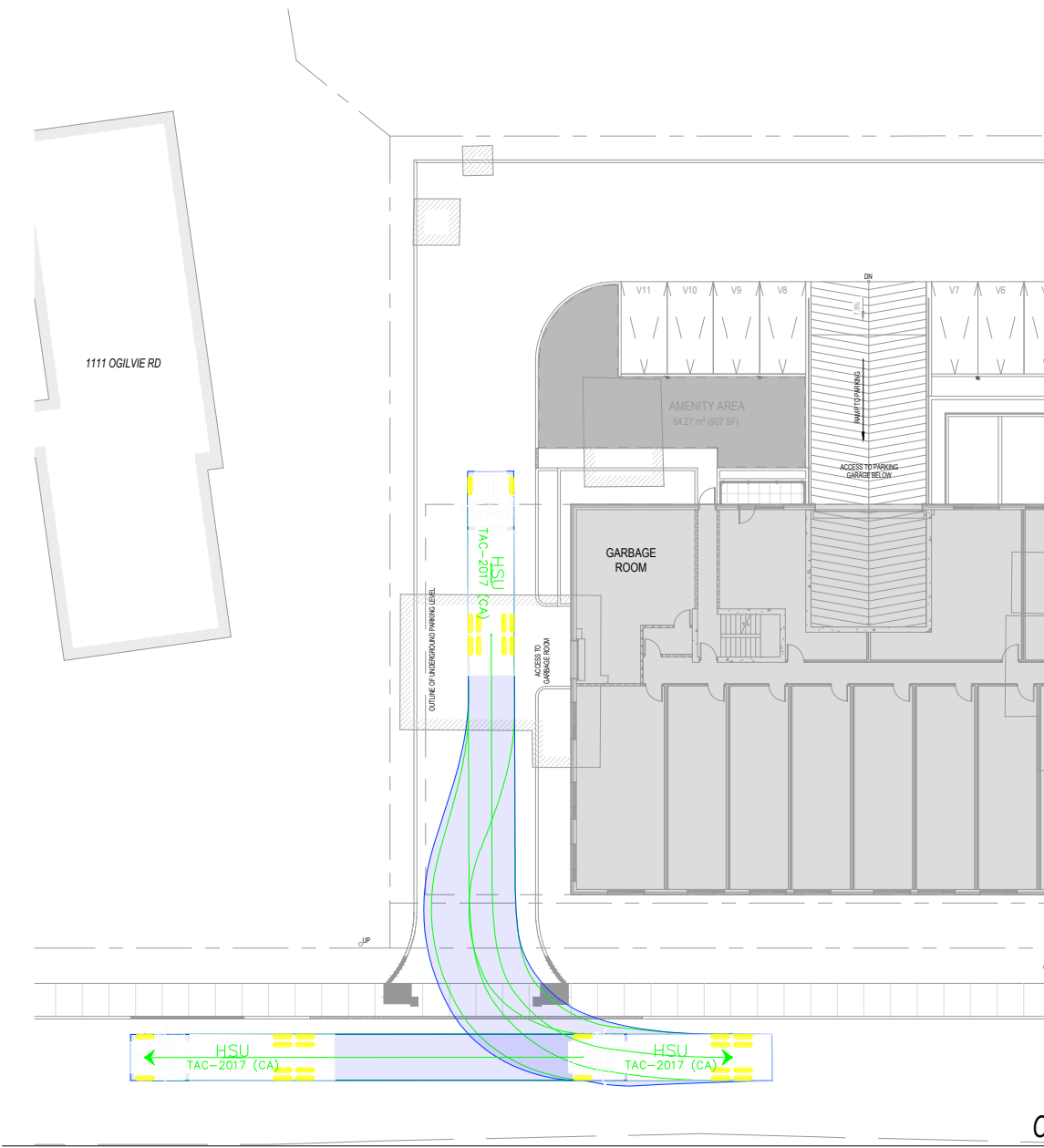

Notes:

Key Map:

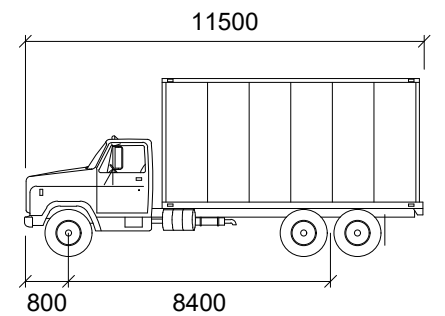

HSU

mm

Width : 2600
 Track : 2600
 Lock to Lock Time : 6.0
 Steering Angle : 40.0

02	Issued for Review	AN	2023-09-07
01	Issued for Review	AN	2023-03-30
REV:	DESCRIPTION:	BY:	DATE:
STATUS:			

CGH Transportation
 6 Plaza Court
 Ottawa, ON
 K2H 7W1
 (343) 999-9117

CLIENT: TCU Development Corp.

ARCHITECT:

SITE: 1184-1196 Cummings Avenue

TITLE: Turning Movement Analysis
 Garbage Turning Movements

SCALE AT A3: NTS	DATE: 2023-09-07	DRAWN: AN	CHECKED: JK
PROJECT NO: 2022-168	DRAWING NO: 001	REVISION: 02	

Appendix M

MMLOS Analysis

Multi-Modal Level of Service - Intersections Form

Consultant
Scenario
Comments

CGH Transportation Inc
Existing/Future

Project
Date

2022-168
9/7/2023

INTERSECTIONS													
Crossing Side		Ogilvie Road at Cyrville Road				Donald Street at Cummings Avenue				Ogilvie Road at Cummings Avenue			
		NORTH	SOUTH	EAST	WEST	NORTH	SOUTH	EAST	WEST	NORTH	SOUTH	EAST	WEST
Pedestrian	Lanes	9	6	10+	9	4	4		6	5	7	6	8
	Median	No Median - 2.4 m	No Median - 2.4 m	No Median - 2.4 m	No Median - 2.4 m	No Median - 2.4 m	No Median - 2.4 m		No Median - 2.4 m	No Median - 2.4 m	No Median - 2.4 m	No Median - 2.4 m	No Median - 2.4 m
	Conflicting Left Turns	No left turn / Prohib.	Permissive	Permissive	Permissive	Permissive	No left turn / Prohib.		Permissive	Protected/ Permissive	Protected/ Permissive	Protected/ Permissive	Permissive
	Conflicting Right Turns	Permissive or yield control	Permissive or yield control	Permissive or yield control	Permissive or yield control	No right turn	Permissive or yield control		Permissive or yield control	Permissive or yield control	Permissive or yield control	Permissive or yield control	Permissive or yield control
	Right Turns on Red (RTOR) ?	RTOR allowed	RTOR allowed	RTOR allowed	RTOR allowed	RTOR allowed	RTOR allowed		RTOR allowed	RTOR allowed	RTOR allowed	RTOR allowed	RTOR allowed
	Ped Signal Leading Interval?	No	No	No	No	No	No		No	No	No	No	No
	Right Turn Channel	Conventional with Receiving Lane	No Channel	No Channel	No Channel	No Channel	No Right Turn		No Channel	Conv'tl without Receiving Lane	No Channel	No Channel	No Channel
	Corner Radius	5-10m	5-10m	15-25m	15-25m	10-15m	No Right Turn		10-15m	15-25m	5-10m	5-10m	5-10m
	Crosswalk Type	Std transverse markings	Std transverse markings	Std transverse markings	Std transverse markings	Std transverse markings	Std transverse markings		Std transverse markings	Std transverse markings	Std transverse markings	Std transverse markings	Std transverse markings
	PETSI Score	-19	21	-47	-31	58	71		20	37	6	21	-11
	Ped. Exposure to Traffic LoS	F	F	F	F	D	C	-	F	E	F	F	F
	Cycle Length	60	120	120	120	120	120		120	120	120	120	120
	Effective Walk Time	19	7	47	47	63	82		7	18	6	27	27
	Average Pedestrian Delay	14	53	22	22	14	6		53	43	54	36	36
Pedestrian Delay LoS	B	E	C	C	B	A	-	E	E	E	D	D	
Level of Service	F	F	F	F	D	C	-	F	E	F	F	F	
		F				F				F			
Approach From		NORTH	SOUTH	EAST	WEST	NORTH	SOUTH	EAST	WEST	NORTH	SOUTH	EAST	WEST
Bicycle	Bicycle Lane Arrangement on Approach	Mixed Traffic	Curb Bike Lane, Cycletrack or MUP	Curb Bike Lane, Cycletrack or MUP	Curb Bike Lane, Cycletrack or MUP	Mixed Traffic	Mixed Traffic		Mixed Traffic	Mixed Traffic	Mixed Traffic	Curb Bike Lane, Cycletrack or MUP	Curb Bike Lane, Cycletrack or MUP
	Right Turn Lane Configuration												
	Right Turning Speed												
	Cyclist relative to RT motorists	#N/A	Not Applicable	Not Applicable	Not Applicable	#N/A	#N/A	-	#N/A	#N/A	#N/A	Not Applicable	Not Applicable
	Separated or Mixed Traffic	Mixed Traffic	Separated	Separated	Separated	Mixed Traffic	Mixed Traffic	-	Mixed Traffic	Mixed Traffic	Mixed Traffic	Separated	Separated
	Left Turn Approach	One lane crossed	1 lane crossed	1 lane crossed	≥ 2 lanes crossed		One lane crossed		One lane crossed	One lane crossed	One lane crossed	≥ 2 lanes crossed	≥ 2 lanes crossed
	Operating Speed	≥ 60 km/h	≥ 60 km/h	≥ 60 km/h	≥ 60 km/h		> 50 to < 60 km/h		> 50 to < 60 km/h	> 50 to < 60 km/h	> 50 to < 60 km/h	> 50 to < 60 km/h	> 50 to < 60 km/h
Left Turning Cyclist	F	E	E	F	-	E	-	E	E	E	F	F	
Level of Service	#N/A	E	E	F	#N/A	#N/A	-	#N/A	#N/A	#N/A	F	F	
		F				E				F			
Transit	Average Signal Delay			≤ 20 sec	≤ 20 sec	≤ 10 sec			≤ 20 sec			> 40 sec	> 40 sec
	Level of Service	-	-	C	C	B	-	-	C	-	-	F	F
		C				C				F			
Truck	Effective Corner Radius	10 - 15 m	10 - 15 m	> 15 m	> 15 m				10 - 15 m	> 15 m	> 15 m	10 - 15 m	10 - 15 m
	Number of Receiving Lanes on Departure from Intersection	≥ 2	≥ 2	1	1				1	≥ 2	≥ 2	1	1
	Level of Service	B	B	C	C	-	-	-	E	A	A	E	E
		C				E				E			
Auto	Volume to Capacity Ratio		0.61 - 0.70			0.0 - 0.60			0.91 - 1.00				
	Level of Service	B				A				E			

Multi-Modal Level of Service - Segments Form

Consultant	CGH Transportation Inc	Project	2022-168
Scenario	Existing	Date	9/7/2023
Comments			

SEGMENTS			Cummings Ave	Section	Section
			Existing	2	3
Pedestrian	Sidewalk Width	-	≥ 2 m		
	Boulevard Width		< 0.5		
	Avg Daily Curb Lane Traffic Volume		> 3000		
	Operating Speed		> 50 to 60 km/h		
	On-Street Parking		no		
	Exposure to Traffic PLoS		E	-	-
	Effective Sidewalk Width				
Pedestrian Volume					
Crowding PLoS	-	-	-		
Level of Service	-	-	-		
Bicycle	Type of Cycling Facility	D	Mixed Traffic		
	Number of Travel Lanes		≤ 2 (no centreline)		
	Operating Speed		≥ 50 to 60 km/h		
	# of Lanes & Operating Speed LoS		D	-	-
	Bike Lane (+ Parking Lane) Width				
	Bike Lane Width LoS		-	-	-
	Bike Lane Blockages				
	Blockage LoS		-	-	-
	Median Refuge Width (no median = < 1.8 m)		< 1.8 m refuge		
	No. of Lanes at Unsignalized Crossing		≤ 3 lanes		
Sidestreet Operating Speed	>50 to 60 km/h				
Unsignalized Crossing - Lowest LoS	C	-	-		
Level of Service	D	-	-		
Transit	Facility Type	D	Mixed Traffic		
	Friction or Ratio Transit:Posted Speed		Vt/Vp ≥ 0.8		
	Level of Service		D	-	-
Truck	Truck Lane Width	C	≤ 3.5 m		
	Travel Lanes per Direction		1		
	Level of Service		C	-	-