

Site Servicing Report – Canada Post Corporation

50 Leikin Drive, Ottawa ON



Site Servicing Report – Canada Post Corporation

50 Leikin Drive, Ottawa ON

Table of Contents

1.0	INTRODUCTION.....	1
1.1	Background.....	1
1.2	Site Description and Background	1
1.3	Existing Infrastructure	2
1.4	Proposed Servicing.....	3
1.5	Municipal Design Guidelines	3
1.6	Pre-Consultation, Permits and Approvals.....	4
2.0	WATER SERVICING	4
2.1	Water Supply and Design Criteria	4
2.2	Domestic Water Demands.....	5
2.3	Proposed Water Servicing	5
2.4	Required Fire Flow	6
2.5	Headloss Calculations	6
2.6	Summary and Conclusions.....	7
3.0	WASTEWATER SERVICING.....	8
3.1	Existing Conditions	8
3.2	Design Criteria	8
3.3	Theoretical Sanitary Peak Flow and Proposed Sanitary Servicing.....	8
3.4	Summary and Conclusions.....	9
4.0	STORM SERVICING AND STORMWATER MANAGEMENT	9
4.1	Storm Criteria.....	9
4.2	Allowable Release Rate.....	10
4.3	Proposed Storm Servicing	10
4.4	Proposed Stormwater Management Solution and Calculations	11
	4.4.1 Water Quantity	11
	4.4.2 Storage Chambers.....	13
	4.4.3 Water Quality	14
4.5	Summary and Conclusions.....	14
5.0	EROSION AND SEDIMENTATION CONTROL.....	14
6.0	SITE LIGHTING	15
7.0	OTHER UTILITIES SERVICING	15

List of Appendices

Appendix A – Background Documents
Appendix B – Water
Appendix C – Sanitary
Appendix D – Storm
Appendix E – Stormwater Management
Appendix F – Photometrics Plan

Site Servicing Report – Canada Post Corporation

50 Leikin Drive, Ottawa ON

1.0 INTRODUCTION

1.1 Background

J.L. Richards & Associates Limited (JLR) was retained by Colliers Project Leaders (Colliers), on behalf of Canada Post Corporation (CPC), to prepare civil drawings as well as a Site Servicing Report in support of a Processing Centre sited at 50 Leikin Drive, in the City of Ottawa.

As per the RFP requirements, email correspondence and a Teams meeting held on Tuesday June 7, 2022, JLR is to deliver the work for Phases 1 through 5 as described in the Collier's statement of requirements for the proposed 228,476 sq.ft. ($\pm 21,225 \text{ m}^2$) facility for CPC. Overall, the project includes approx. 226,700 sq.ft. ground floor footprint, 330 sq. ft. of hazardous storage, and 1,446 sq. ft. of admin block projection.

The existing Albert Jackson Processing Centre (AJPC) was referenced in preparing this design.

1.2 Site Description and Background

The subject property is located within the urban limits of the City of Ottawa, specifically in the Davidson Heights neighborhood, at the west side of Leikin Drive at the intersection of Bill Leathem Drive.

As illustrated in Figure 1 (below), the subject site currently consists of an unoccupied parcel at 50 Leikin Drive. The site currently consists of greenfield, which makes the subject site pervious as there are no existing buildings or asphalt.

Figure 1: Site Plan Location



The overall subject parcels amount to $\pm 89,700 \text{ m}^2$. Under the Zoning By-Law (ZBL) layer specified in GeoOttawa, the subject properties are zoned IL9 for light industrial uses.

The Site Plan (Appendix A) provides a breakdown of the type of spaces in the CPC Processing Centre.

Site Servicing Report – Canada Post Corporation

50 Leikin Drive, Ottawa ON

1.3 Existing Infrastructure

A review of existing civil drawings was carried out in the vicinity of the site. Available information has been included in Appendix A. Based on the review of the available information, the following infrastructure has been identified to exist within the Bill Leathem Drive and Leikin Drive Right-Of-Way (ROW):

Watermains:

- 305 mm diameter PVC watermain located within Bill Leathem Drive ROW
- 406 mm diameter high pressure concrete located within Leikin Drive ROW

Based on the review of “geoOttawa”, the following eight (8) hydrants are located within the prescribed distances noted in ISTB-2018-02, in proximity of the subject property:

- One (1) hydrant is located on the southeast corner of the property at the intersection of Bill Leathem Drive and Leikin Drive intersection.
- Two (2) hydrants are located at the edge of the property along Bill Leathem Drive.
- One (1) hydrant is located across the street from the property along Bill Leathem Drive.
- Four (4) hydrants are located across the street from the property along Leikin Drive.

Sanitary Sewers:

- 375 mm diameter sanitary sewer located within Bill Leathem Drive ROW (flowing east). This sanitary sewer eventually discharges into to the Leikin Drive’s 750 mm diameter trunk sanitary sewer, which in turn outlets into the Robert O. Pickard Environmental Centre (ROPEC) via a series of trunk sanitary sewers.
- 750 mm diameter sanitary sewer located within the Leikin Drive ROW. This sanitary sewer also outlets to ROPEC via a series of trunk sanitary sewers.

Storm Sewers:

- There is a single on-site catch basin (CB) at the edge of the property connected to the 1350 mm diameter concrete storm sewer within Bill Leathem Drive ROW.
- There are four (4) on-site catch basins (CBs) at the edge of the property connected to the 1050 mm diameter concrete storm sewer within Leikin Drive ROW.
- 1350 mm diameter concrete storm sewer located within Bill Leathem Drive ROW. This sewer discharges into the stormwater management pond located south of the site.
- 1050 mm diameter concrete storm sewer located within Leikin Drive ROW. This sewer also discharges into the stormwater management pond located south of the site.

Figure 2 below shows the existing infrastructure near the property parcel.

Figure 2: Existing Infrastructure

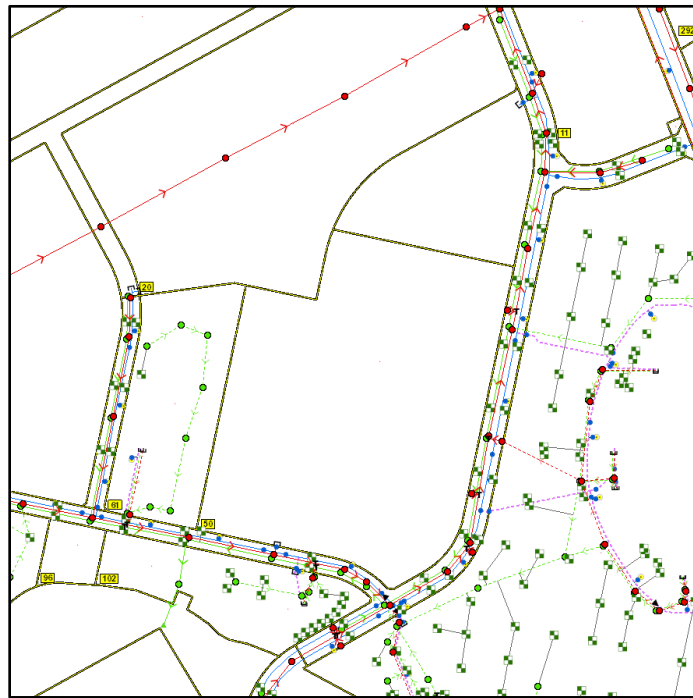

1.4 Proposed Servicing

The existing servicing and connections to off-site linear infrastructure is summarized in Section 1.3 and 1.4. Based on the above-noted connections with existing infrastructure, the following proposed servicing is envisioned:

Water Servicing: Proposed water service lateral for the building to connect to the existing Leikin Drive 406 mm diameter watermain.

Wastewater: Proposed 200 mm diameter sanitary lateral from the building to the existing Bill Leathem Drive 375 mm diameter sanitary sewer. The 200 mm diameter service lateral will originate from the building's mechanical room.

Storm: Runoff generated from site to be directed towards the existing 1350 mm diameter sewer on Bill Leathem Drive. On-site storage and controls to be implemented to respect the storm discharge design criteria.

1.5 Municipal Design Guidelines

The civil drawings were prepared in accordance with the following:

Ottawa Sewer Design Guidelines (October 2012) complete with the following Technical Bulletins:

- ISTB-2012-01
- ISTDB-2014-01

Site Servicing Report – Canada Post Corporation

50 Leikin Drive, Ottawa ON

- ISTDB-2016-01
- ISTDB-2018-01
- ISTDB-2019-01; and
- ISTDB-2019-02

City of Ottawa Water Distribution Guidelines complete with the following Technical Bulletins:

- ISTDB-2010-02
- ISTDB-2014-02
- ISTDB-2018-02; and
- ISTDB-2021-03

Detail Drawings as well as well as Sewer Material Specifications including:

- Sewer Connection (2003-513) and Sewer Use (2003-514) By-Laws
- Watermains/Services Material Specifications as well as Water and Road Standard Detail Drawings
- Water By-Law (2018-167)

1.6 Pre-Consultation, Permits and Approvals, Regulatory Requirements

A pre-consultation meeting was held between Colliers and JLR via a Teams Meeting on June 7, 2022 (refer to Appendix A for a copy of the pre-consultation meeting notes).

As the development is for an industrial site which may include oil drum storage, an application has been submitted to the Ministry of the Environment, Conservation and Parks (MECP) for Environmental Compliance Approval (ECA). A pre-consultation meeting was held between the MECP and JLR via a Teams Meeting on July 25, 2023 (refer to Appendix A for a copy of the pre-consultation meeting notes).

2.0 WATER SERVICING

2.1 Water Supply and Design Criteria

A Potable Water Assessment (PWA) was carried out to confirm that the existing watermain and proposed 150 mm diameter water service lateral can provide adequate supply while complying with both the Ottawa Design Guidelines for Water Distribution (July 2010) and Technical Bulletins ISDTB-2014-02 and ISTB-2018-02.

Section 4.2.2 of the Water Design Guidelines requires that all new development additions to the public water distribution system be designed such that the minimum and maximum water pressure, as well as the fire flow rates, conform to the following:

- Under maximum hourly demand conditions (peak hour), the pressures shall not be less than 276 kPa
- During periods of maximum day and fire flow demand, the residual pressure at any point in the distribution system shall not be less than 140 kPa (20 psi)

Site Servicing Report – Canada Post Corporation

50 Leikin Drive, Ottawa ON

- In accordance with the Ontario Building Code in areas that may be occupied, the static pressure at any fixture shall not exceed 552 kPa (80 psi)
- The maximum pressure at any point in the distribution system in unoccupied areas shall not exceed 689 kPa (100 psi); and
- Feeder mains, which have been provided primarily for the purpose of redundancy, shall meet, at a minimum, the basic day plus fire flow demand.

Table 2-1 summarizes the design criteria for water servicing, which will also serve as the basis of the detailed design for the site.

Table 2-1: Water Design Criteria

Design Criteria	Design Value
Light industrial average day demand	35,000 L/ha/day
Light industrial maximum demand	1.5 x Avg
Light industrial peak hour	1.8 x Max Day
Fire Flow Requirements	
Municipal ROW	FUS
Pressure/Flow	
Peak hour	>276 kPa (40 psi)
Maximum day plus fire flow	>140 kPa (20 psi)
Minimum hour (maximum HGL)	<552 kPa (80 psi)

2.2 Domestic Water Demands

The water demands were calculated to reflect the area outlined in the latest Site Plan (Appendix A) and the prescribed parameters included in the Ottawa Design Guidelines for Water Distribution which have been synthesized in Table 2-1. The calculations presented in Appendix D are based on the latest Site Plan.

Table 2-2 summarizes the water demands (Appendix D).

Table 2-2: Water Consumption Rates

Demand Scenario	Water Demand (L/s)
Average Day	3.63
Maximum Day	5.45
Peak Hour	9.81

2.3 Proposed Water Servicing

Water servicing will be provided by extending a 200 mm water service connection from the 400 mm diameter watermain on Leikin Drive to an on-site tee, which will then reduce to a 150 mm

Site Servicing Report – Canada Post Corporation

50 Leikin Drive, Ottawa ON

diameter service lateral into the building’s proposed sprinkler room near the southeast corner of the building. This service will provide water supply for both domestic and sprinkler uses. A private on-site hydrant with a 150 mm diameter hydrant lateral is also proposed within 45 m of the building’s siamese connection, in accordance with the Ontario Building Code (OBC).

As per City requirements, a redundant water service will be provided as the average day demand exceeds 50 m³/d. In addition, a 400 mm isolation valve chamber will be added to the watermain on Leikin Drive in between the two service connections.

2.4 Required Fire Flow

The required fire flow (RFF) was calculated based on the latest FUS Guidelines (2020). The FUS calculations reflect a sprinklered building, free-burning occupancy class building, and a non-combustible building classification. Based on these characteristics, the RFF calculated in accordance with the FUS was estimated at 267 L/s (Appendix D).

As shown in the table below, boundary conditions (BCs) were generated by the City for two (2) separate RFFs (refer to Appendix B). The city provided information at the Leikin Drive and Bill Leathem Drive connections. The provided BCs included existing and future conditions on Bill Leathem Drive. The future conditions were provided by the City as the serviced area from Bill Leathem is within an area that is planned to be reconfigured to Pressure Zone SUC in late 2024/2025. Unlike Bill Leathem Drive, Leikin Drive will not be impacted by the future pressure zone reconfiguration, so only existing conditions were provided by the City for the Leikin connection. The Leikin Drive connection is the proposed connection for the CPC Processing Centre.

Table 2-3: Hydraulic Boundary Conditions

Water Demand Scenario	Demand Building (L/s)	Head (m) on Bill Leathem Dr. Connection (Existing Condition)	Head (m) on Bill Leathem Dr. Connection (Future Condition)	Head (m) on Leikin Dr. Connection
Peak Hour	9.81	125.00	144.00	125.00
Maximum HGL	0.00	132.80	146.90	132.70
Max. Day + Fire Flow 1 (FUS)	267	123.80	139.10	124.80
Max. Day + Fire Flow 2 (FUS)	283	123.20	138.40	124.40

2.5 Headloss Calculations

Headloss calculations were carried out using the Hazen-Williams equation to confirm sizing of service lateral. The proposed servicing as presented on the Site Servicing Drawing (S1) was evaluated under the demand scenarios listed in Section 2.2 while the BCs along the ROW reflecting the RFFs calculated based on the FUS. The operating pressures along the proposed

Site Servicing Report – Canada Post Corporation

50 Leikin Drive, Ottawa ON

water service at the building's entry were calculated using the water demand scenarios listed in Table 2-2. The Headloss Calculation Spreadsheet summarizes the operating pressures at the building under peak hour, maximum pressure, and maximum day plus fire flow scenarios. Detailed calculations for each water demand scenario are included in Appendix B.

2.5.1 Peak Hour

The peak hour demand shown in Table 2-2 for the building was applied along the service lateral. Using the boundary conditions shown in Table 2-3, the anticipated pressure at the building was found to be 332 kPa (48.1 psi), exceeding the minimum pressure criterion of 276 kPa (40 psi).

2.5.2 Maximum Day Plus Fire Flow

Fire flow protection must be verified along the ROW per the FUS and onsite in accordance with the OBC. Along the ROW, the target FUS of 267 L/s is achieved by three (3) existing hydrants on Leikin Drive within the prescribed distances and by one (1) proposed on-site hydrant.

The headloss along the proposed water service lateral was evaluated to fulfill the maximum day demand (5.45 L/s), the sprinkler demand of 34.7 L/s and the hydrant flow of 95 L/s. The proposed water service lateral was assessed in three (3) different segments for the headloss analysis, with the domestic and sprinkler demand being supplied to the building and the 95 L/s hydrant flow being supplied simultaneously to the on-site hydrant.

The residual pressure at the building was calculated to be 236 kPa (34.3 psi) and the residual pressure at the on-site hydrant was calculated to be 178 kPa (25.8 psi), as shown in the headloss calculation sheet (Appendix B). The calculated operating pressure exceeds the minimum pressure requirement of 140 kPa (20 psi).

2.5.3 Maximum HGL

The Water Design Guidelines require that a high-pressure check (maximum hydraulic grade elevation) be performed to ensure that the maximum pressure constraint of 552 kPa (80 psi) is not exceeded. Based on a zero demand (0 L/s) and the maximum HGL boundary condition at Leikin Drive (refer to Table 2-3), the maximum pressure is 409 kPa (59.3 psi). This pressure is below the maximum pressure constraint of 552 kPa (80 psi). Consequently, a pressure reducing valve (PRV) is not warranted for the site.

2.6 Summary and Conclusions

Section 2.0 and the calculations presented in Appendix B demonstrate that the existing municipal water supply is adequate to service the proposed site.

Site Servicing Report – Canada Post Corporation

50 Leikin Drive, Ottawa ON

3.0 WASTEWATER SERVICING

3.1 Existing Conditions

Currently, the project Site does not include any hard surface nor an existing building. Therefore, there are no existing service laterals.

3.2 Design Criteria

The sanitary service for the building was designed based on the City of Ottawa Sewer Design Guidelines ((OSDG) - (October 2012)) and associated Technical Bulletins. Key design parameters have been summarized in Table 3-1.

Table 3-1: Wastewater Servicing Design Criteria

Design Criteria	Design Value	Reference
Average Day Light Industrial Flow	35,000 L/ha/day	ISTB-2018-01
Industrial peaking factor	4.3	ISTB-2018-01
Infiltration Allowance 0.05 L/s/ha (dry I/I) 0.28 L/s/ha (wet I/I)	0.33 L/s/ha	ISTB-2018-01
Minimum velocity	0.6 m/s	OSDG Section 6.1.2.2
Maximum velocity	3.0 m/s	OSDG Section 6.1.2.2
Manning Roughness Coefficient (for smooth wall pipes)	0.013	OSDG Section 6.1.8.2
Minimum allowable slopes	Varies	OSDG Table 6.2, Section 6.1.2.2

3.3 Theoretical Sanitary Peak Flow and Proposed Sanitary Servicing

Wastewater flows from the building will be accommodated by a dedicated sanitary service lateral. The building will be serviced via a 200 mm diameter sanitary connection to the existing 375 mm diameter sewer on Bill Leathem Drive. A 200 mm diameter sanitary sewer line is also proposed to service the gatehouse at the northwest corner of the site.

The average day light industrial flow allowance was used to calculate peak wastewater flow as recommended by ISTB-2018-01. The peak wastewater flow was calculated based on the peaking factor of 4.3. The peaking factor was determined by reading the curve of Peaking Factor for Industrial Areas of the ISTB-2018-01. Based on these parameters, the peak wastewater flow was calculated to be 22.7 L/s. This includes a conservative peak flow value of 4.0 L/s for the gatehouse. Appendix C includes the Sanitary Design Sheet.

Site Servicing Report – Canada Post Corporation

50 Leikin Drive, Ottawa ON

3.4 Summary and Conclusions

Section 3.0 and the calculations presented in Appendix C demonstrate that the site can be serviced using the existing infrastructure within the vicinity of the site.

4.0 STORM SERVICING AND STORMWATER MANAGEMENT

4.1 Storm Criteria

Storm servicing for the subject property has been designed in accordance with the City of Ottawa Sewer Design Guidelines (2012) and Technical Bulletins. The minor system has been designed to capture and convey runoff during frequent storm events up to the 1:5-year recurrence, while the major system has been designed to capture and retain runoff on-site for storm events up to the 1:100-year recurrence.

In addition to the general City of Ottawa design criteria, storm servicing for the proposed development has been designed to comply with the storm servicing requirements outlined in the pre-consultation meeting notes received November 16th, 2022 (Appendix 'A') as summarized below:

- The sites allowable release rate is based on a pre-development C-Factor of 0.24 being controlled to the 1:5-year design storm with a 15-minute time of concentration. For more details, please refer to the South Merivale Business Park Stormwater Management Report prepared by Novatech Engineering Consultants Ltd., dated November 1991 (equivalent of 54.5 L/s/ha).
- A calculated time of concentration for post-development flows with a minimum of 10 minutes.
- Flows to the storm sewer in excess of the allowable release rate must be detained on site for storms up to the 1:100-year return. No surface ponding is permitted for events up to and including the 1:5-year event.
- Ensure no overland flow for all storms up to and including the 1:100-year event.
- The 1:2-year storm or 1:5-year storm event using IDF information derived from the Meteorological Services of Canada rainfall data, taken from the MacDonald Cartier Airport, collected 1966 to 1997. Given that regressions for each recurrence is included in the OSDG, rainfall intensities for the 1:5-year and 1:100-year were extracted from the document to carry out sewer sizing and assess the effectiveness of the stormwater management system.
- Quality control requirements provided by Rideau Valley Conservation Authority (RVCA) are for “enhanced” target (80% TSS Removal). Quality control is provided by the existing Longfields/Davidson Stormwater Management Facility that is downstream of the site.
- Best Management Practices (BMPs) are recommended for this site.

Site Servicing Report – Canada Post Corporation

50 Leikin Drive, Ottawa ON

4.2 Allowable Release Rate

For the subject property, runoff will be collected by an on-site storm sewer system that outlets to the 1350 mm diameter Bill Leathem storm sewer which then outlets to the Longfields/Davidson Stormwater Management Facility that is downstream of the site. This section of pipe has been sized in the 1991 Novatech, City of Nepean South Merivale Business Park Stormwater Management Report.

The proposed development encompasses parts of Area 1 and Area 5 as divided in the 1991 Stormwater Management Report. In the 1991 Report, the overall inflow to the storm sewer system is restricted to 54.5 L/s/ha, however part of Area 1 contains the road network which is uncontrolled in up to the 1:10 year event and therefore has a higher capture rate in the 1:5-year event than the sites. The allowable release rate for the part of the site within the Area 1 catchment is restricted to 38.8 L/s/ha to accommodate the increased road drainage.

No road network is proposed within the Area 5 catchment identified in the 1991 Report and access can be achieved to sites via the existing road network in Area 1. Therefore, the allowable release rate from the parts of the development within the Area 5 drainage area is the full 54.5 L/s/ha.

The total release rate from the site is 425 L/s as shown in the calculations included in Appendix E.

4.3 Proposed Storm Servicing

The proposed storm servicing for the site is divided into three (3) different components: the controlled roof drainage, the controlled minor system capture, and the on-site major system storage.

Storm runoff from the ± 2.12 ha Processing Centre rooftop will be controlled on the roof via a series of rooftop restrictors (roof drains, e.g., Zurn or Watts). The controlled rooftop flows will then be conveyed by a series of internal piping to the southeast corner of the building before being outlet into the vernal pond, located near the Leikin Drive and Bill Leathem Drive intersection (southeast corner of the site). The vernal pond will have a perched outlet (ditch inlet catch basin) to the proposed storm sewers and will be configured to maintain a 300 mm depth of water for ecological purposes. As the water level in the vernal pond is intended to remain at 300 mm at all times, the restricted roof outflow will be conveyed through the vernal pond and then outlet into the minor system.

Storm runoff generated by the remaining controlled site areas will be collected by a series of surface catch basins (CBs). The captured flows will be controlled by independent inlet control devices (ICDs) and then conveyed via a minor system to the existing 1350 mm trunk storm sewer on Bill Leathem Drive, which eventually discharges into the existing Longfields/Davidson Stormwater Management Facility south of the proposed site (refer to Drawing S1).

Storm servicing for the site was developed into two (2) sewersheds, one system that services the eastern part of the site (referred to as the eastern system) and one system that services the western part of the site (referred to as the western system). The eastern system also includes the vernal pond discussed above and the storm service connection for the building roof. Both

Site Servicing Report – Canada Post Corporation

50 Leikin Drive, Ottawa ON

systems merge at a maintenance hole (MH19) immediately upstream of the connection to the Bill Leathem Drive 1350 mm diameter storm sewer (MH10A).

There is an uncontrolled site area of 0.59 ha which is designed to sheet flow to the existing road network off site.

The 1:100-year storm event from the controlled areas of the property will be detained on site and the aggregate sum of the controlled flows and uncontrolled flows will be restricted to the total allowable release rate of 425 L/s.

The 1:5 year storm event will be fully captured by the minor system and controlled using ICDs. The 1:5 year flow will be conveyed to one of two (2) underground storage facilities (one for each system – eastern and western) consisting of ADS StormTech chambers. These systems were designed to capture and detain the 1:5-year design storm while releasing the allowable flow to the Bill Leathem Drive 1350 mm diameter storm sewer outlet. An ICD will limit the outflows of each storage facility. The 1:100-year release rate from the storm chambers and the uncontrolled flows will be limited to the total allowable peak flow of 425 L/s (Appendix E). Thus, the proposed servicing solution will meet the constraints described in the South Merivale Business Park Stormwater Management Report.

4.4 Proposed Stormwater Management Solution and Calculations

4.4.1 Water Quantity

The storm and stormwater management solution were developed to limit the 1:100-year post-development flows to 425 L/s. To achieve this criterion, on-site restrictions are being proposed. The stormwater management strategy was developed as follows:

Major System (surface)

The 1:100-year post-development flows will be directed to the on-site catch basins (CBs). Flows exceeding the 1:5 year storm event will be controlled by inlet control devices (ICDs) and detained by parking lot depressions of various depths but limited to 300 mm (refer to Ponding Plan for details). The SWM calculations (Appendix E) show that grading was developed with sufficient storage at each of the CBs to accommodate the 1:100-year post-development flows while releasing the 1:5-year post-development flows. Hence, no surface ponding would occur during the 1:5-year storm. In the case of CB29, a small underground ADS StormTech chamber was designed to capture the 1:100 year storage volume of that catchment area due to the limited surface storage availability. An ICD in CB29 will allow the flow to the 1:100-year storm and another ICD will control the flow from the ADS StormTech chamber to the 1:5-year storm for that catchment area.

It is noted that the grading was constrained between the major overland spill point (89.85 m) and the north side of the building. Although the freeboard along the building's north side may appear minimal in some cases, the north and west sides of the building are loading dock areas which provide over 1.2 m of freeboard. Ponding depths in the vicinity of the loading zones will be minimal and will not impact the loading dock operation.

Site Servicing Report – Canada Post Corporation

50 Leikin Drive, Ottawa ON

To supplement the parking lot storage cells, runoff from the building will be controlled to 60 L/s by means of rooftop restrictors. The detailed design of the roof drains will be carried out by others. A technical data sheet for a potential roof drain is provided in Appendix E. The SWM calculations (Appendix E) show that there will be sufficient storage provided by the roof, as the calculations assume that only 40% of the roof area would be utilized as storage with a ponding depth of 150 mm.

Minor System (underground)

Given that the 1:5 year post-development flows will be transmitted by the proposed storm sewers, underground storage was incorporated into the site servicing to meet the maximum allowable flow of 335 L/s. When combined with the uncontrolled flow of 90 L/s, flows delivered to the off-site minor and major system will be limited to 425 L/s. As noted in Section 4.3, both underground storage facilities were designed to capture the 1:5-year post-development peak flows from the minor system while meeting the allowable peak flow of 335 L/s. Based on the Modified Rational Method (MRM) SWM calculations (Appendix E), a storage volume of 326 m³ and 973 m³ is required for the eastern and western chambers, respectively, based on a combined outflow of 335 L/s. It should be noted that outflow for the eastern and western chambers was reduced by 50% in the MRM calculations rather than using a dynamic model, to account for the lower release rate under increasing head.

Based on the storm and stormwater management strategy detailed in Appendix E, the storm discharge criteria will be met onsite.

Table 2 below provides a high-level summary given that detailed Modified Rational Method Calculations have been provided in Appendix E. The summary for the eastern and western systems has been totalled based on the serviced area.

Table 4-1: Summary of Controlled and Uncontrolled Areas

Component	Area	Q _{controlled} (L/s)	Q _{uncontrolled} (L/s)	Storage Volume req. (m ³)	Storage Volume provided (m ³)
Roof	2.12	60.0	N/A	985	1270
Western Storage cells (combined)	4.49	1,118 (5-yr)	N/A	526	859
Eastern Storage Cells (combined)	1.46	359 (5-yr)	N/A	287	478
Uncontrolled Areas	0.59	N/A	90.0	N/A	N/A
Western Chamber (minor system)	4.49	167.5	N/A	973	1000
Eastern Chamber (minor system)	1.46	167.5	N/A	326	351

The above Table shows the following (refer to Appendix E):

- Rooftop flows limited to 60 L/s will require 985 m³. The roof can provide ±1,270 m³ based on 150 mm ponding over 40% of the roof. Thus, the 1:100-year volume can be contained.

Site Servicing Report – Canada Post Corporation

50 Leikin Drive, Ottawa ON

- The individual MRM calculations for the Western storage cells indicate that sufficient storage is provided by the grading. When combined, a storage volume requirement of 526 m³ is required for the western parking cells while the grading can provide a combined storage of 859 m³ (refer to Ponding Plan).
- The individual MRM calculations for the Eastern storage cells indicate that sufficient storage is provided by the grading. When combined, a storage volume requirement of 287 m³ is required for the eastern parking cells while the grading can provide a combined storage of 478 m³ (refer to Ponding Plan).
- When combined, the uncontrolled areas will sheet flow 90.0 L/s under the 1:100-year storm.
- Based on the MRM calculation for the western chambers, a storage volume of 973 m³ is required under a release rate of 167.5 L/s. The design of the StormTech chambers will provide 1,000 m³.
- Based on the MRM calculation for the eastern chambers, a storage volume of 326 m³ is required under a release rate of 167.5 L/s. The design of the StormTech chambers will provide 351 m³.

4.4.2 Storage Chambers

To limit the capture flows to the allowable peak flow, two (2) underground storage units will be implemented. One of the storage units will be in the southeast of the site, under the employee parking lot. The second storage unit will be in the southwest of the site, under the 5-ton vehicle parking area. The available storage capacity for the underground storage system was calculated using the ADS StormTech Design Tool (refer to Appendix E) as summarized in Table 2. The chosen design chamber is a 7200-MC chamber.

The proposed underground storage unit located southeast of the site consists of 40 chambers and each chamber has a storage volume of 5 m³, which combined with the surrounding granular bed provides a total storage volume of 351 m³. The chambers are proposed to lay in a footprint of three (3) rows of six (6) chambers. The footprint has a length of approximately 31.7 m and a width of 8.9 m. The controlled release rate from the east storage chamber is 167.5 L/s.

The proposed underground storage unit located southwest of the site consists of 121 chambers and each chamber has a storage volume of 5 m³, which combined with the surrounding granular bed provides a total storage volume of 1,000 m³. The unit consists of six (6) rows of twelve (12) chambers. The proposed footprint has a length of approximately 45.8 m and a width of 17.2 m. The controlled release rate from the west chamber is 167.5 L/s.

The total storage capacity for both storage units combined is equal to 1434 m³, which exceeds the required 1,351 m³. The combined release rate from the two chambers is 335 L/s. Please refer to Appendix 'E' for further storage chamber specifications.

Site Servicing Report – Canada Post Corporation

50 Leikin Drive, Ottawa ON

Based on the Geotechnical Investigation (December 2022) by WSP E&I Canada Limited, there was no freestanding groundwater measured in the open boreholes on completion of drilling at the locations of the underground storage units.

4.4.3 Water Quality

Storm runoff generated by the proposed site will be collected and conveyed by an on-site storm sewer system into the Bill Leathem Drive storm sewer system that will outlet to the existing Longfields/Davidson Stormwater Management Facility (downstream of the site) to provide quality control, meeting an enhanced level of protection (80% TSS removal).

4.5 Summary and Conclusions

The storm servicing and stormwater management solution presented in this Site Servicing Report has been designed to satisfy the quantity and quality criteria specified by the City of Ottawa. The prescribed release rate of 425 L/s for the 1:100-year peak flow is met with the addition of underground storage while achieving an overall TSS removal in excess of 80%.

5.0 EROSION AND SEDIMENTATION CONTROL

Prior to initiating construction of the proposed development, erosion, and sedimentation control measures, as outlined in the Ontario Ministry of Natural Resources (MNR) Guidelines on Erosion and Sediment Control for Urban Construction Sites, are to be implemented to trap sediment on site.

The following erosion and sedimentation control measures are proposed, as shown on Drawing ESC:

- supply and installation of a silt fence barrier, as per OPSD 219.110;
- supply and installation of filter fabric between the frame and cover of existing catch basins adjacent to the proposed development, including regular inspection and maintenance as required;
- stockpiles of material during construction is to be located along flat areas away from drainage paths and are to be enclosed with additional silt fence;
- proposed catch basins are to be equipped with sumps, inspected frequently, and cleaned as required;
- sandbags are to be placed blocking part of the sewer pipe in the connecting storm maintenance holes to eliminate construction debris from entering the existing storm sewer system. The sandbags are to be removed after the proposed storm sewers have been fully cleaned.

The proposed erosion control measures shall conform to the following documents:

- “Guidelines on Erosion and Sediment Control for Urban Construction Sites” published by Ontario Ministries of Natural Resources, Environment, Municipal Affairs, and

Site Servicing Report – Canada Post Corporation

50 Leikin Drive, Ottawa ON

Transportation & Communication, Association of Construction Authorities of Ontario and Urban Development Institute, Ontario, May 1987.

- “MTO Drainage Manual”, Chapter F: “Erosion of Materials and Sediment Control”, Ministry of Transportation & Communications, 1985.
- “Erosion and Sediment Control” Training Manual by Ministry of Environment, Spring 1998.
- Applicable Regulations and Guidelines of the Ministry of Natural Resources.

6.0 SITE LIGHTING

Refer to the Photometrics Plan for the light levels measured in lux. Based on this Photometrics Plan, the light levels were determined to be adequate for the requirements of the site and meet the CPC standards.

7.0 OTHER UTILITIES SERVICING

Utilities (Hydro, Comms, Gas) will be consulted to provide their detailed designs to service the site.

Site Servicing Report – Canada Post Corporation

50 Leikin Drive, Ottawa ON

This report has been prepared by J.L. Richards & Associates Limited for Colliers Project Leaders' exclusive use. Its discussions and conclusions are summary in nature and cannot properly be used, interpreted or extended to other purposes without a detailed understanding and discussions with the client as to its mandated purpose, scope and limitations. This report is based on information, drawings, data, or reports provided by the named client, its agents, and certain other suppliers or third parties, as applicable, and relies upon the accuracy and completeness of such information. Any inaccuracy or omissions in information provided, or changes to applications, designs, or materials may have a significant impact on the accuracy, reliability, findings, or conclusions of this report.

This report was prepared for the sole benefit and use of the named client and may not be used or relied on by any other party without the express written consent of J.L. Richards & Associates Limited, and anyone intending to rely upon this report is advised to contact J.L. Richards & Associates Limited in order to obtain permission and to ensure that the report is suitable for their purpose.

J.L. RICHARDS & ASSOCIATES LIMITED

Prepared by:

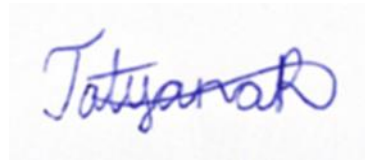

Tatyana Roumie, EIT
Civil Engineering Intern

Reviewed by:



Annie Williams, P.Eng.
Civil Engineer

Appendix A

Background Documents

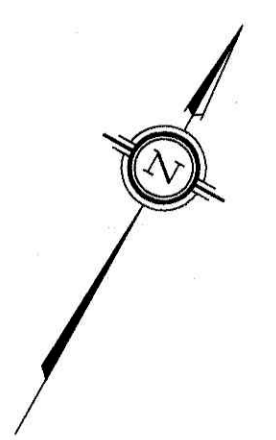

PLAN 4R-32287
 RECEIVED AND DEPOSITED
 DATE: Oct 2, 2019
 D. Bourdeau
 REPRESENTATIVE FOR
 LAND REGISTRAR FOR THE
 LAND TITLES DIVISION OF
 OTTAWA-CARLETON NO. 4.

SCHEDULE			
PART	BLOCK	PLAN	PIN
1	ALL OF 2	4M-1354	ALL OF 04733-6646
2			
3			

Part 3: Subject to easement, Inst. OC1093047.
 Parts 1, 2 and 3 together constitute all of PIN 04733-6646.

PLAN OF SURVEY OF
BLOCK 2
REGISTERED PLAN 4M-1354
CITY OF OTTAWA
 Surveyed by Annis, O'Sullivan, Vollebek Ltd.

Scale 1:1000

Metric
 DISTANCES AND COORDINATES SHOWN ON THIS PLAN
 ARE IN METRES AND CAN BE CONVERTED TO FEET BY
 DIVIDING BY 0.3048.

Surveyor's Certificate
 I CERTIFY THAT:
 1. This survey and plan are correct and in accordance with the Surveys
 Act, the Surveyors Act and the Land Titles Act and the regulations
 made under them.
 2. The survey was completed on the 18th day of September, 2019.

Sept 18/19
 Date

 Ontario Land Surveyor

- Notes & Legend
- Denotes Survey Monument Planted
 - Denotes Survey Monument Found
 - SIB = Standard Iron Bar
 - SSIB = Short Standard Iron Bar
 - IB = Iron Bar
 - W = Witness
 - (WIT) = Witness
 - (ADG) = Annis, O'Sullivan, Vollebek Ltd.
 - Meas = Measured
 - NT = Non Tangential
 - (P1) = Plan 4M-1354
 - (P2) = Plan 4R-9089
 - (P3) = Plan 4R-24338

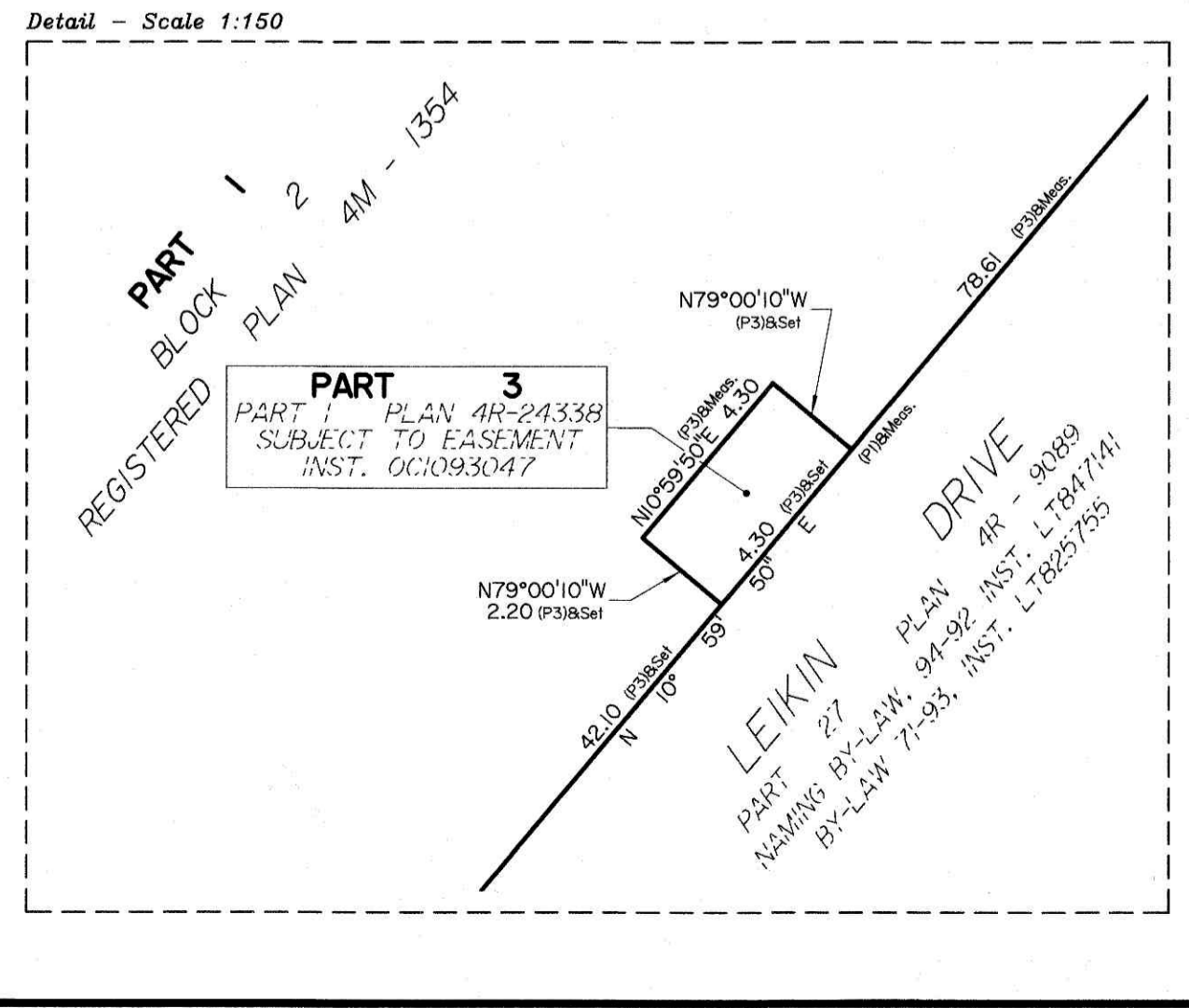
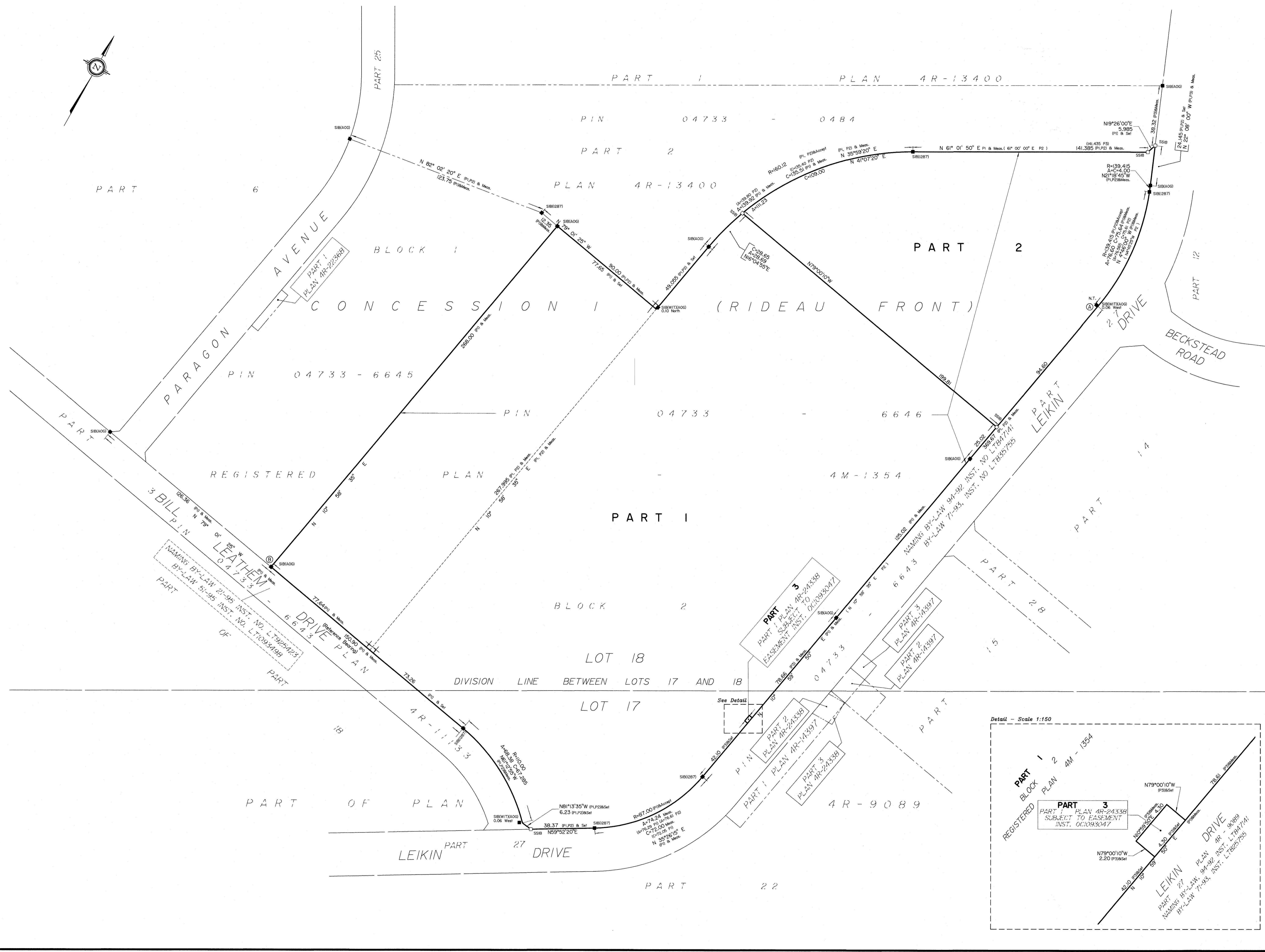

Distances shown on this plan are ground distances and can be converted to grid distances by multiplying by the combined scale factor of 0.999933.
 Bearings are grid, derived from the westerly limit of Leikin Drive, shown to be N 10°59'50" E on Registered Plan 4M-1354 and are referred to the Central Meridian of MTM Zone 9 (76°30' West Longitude) NAD-83 (original).
 Coordinates are derived from Can-Net 2016 Real Time Network GPS observations referenced to Specified Control Points 01919791338 and 01919871649, MTM Zone 9 (76°30' West Longitude) NAD-83 (original).
 Coordinate values are to urban accuracy in accordance with O. Reg. 216/10.

. 01919791338	Northing	5006055.96	Easting	346140.91
. 01919871649	Northing	5007189.87	Easting	372435.05
. Point A	Northing	5017899.36	Easting	367075.65
. Point B	Northing	5017520.64	Easting	366716.97

Caution: Coordinates cannot, in themselves, be used to re-establish corners or boundaries shown on this plan.

ANNIS, O'SULLIVAN, VOLLEBEK LTD.
 14 Concourse Gate, Suite 500
 Nepean, Ont. K2E 7S6
 Phone: (613) 727-0550 / Fax: (613) 727-1079
 Email: nepean@avol.com

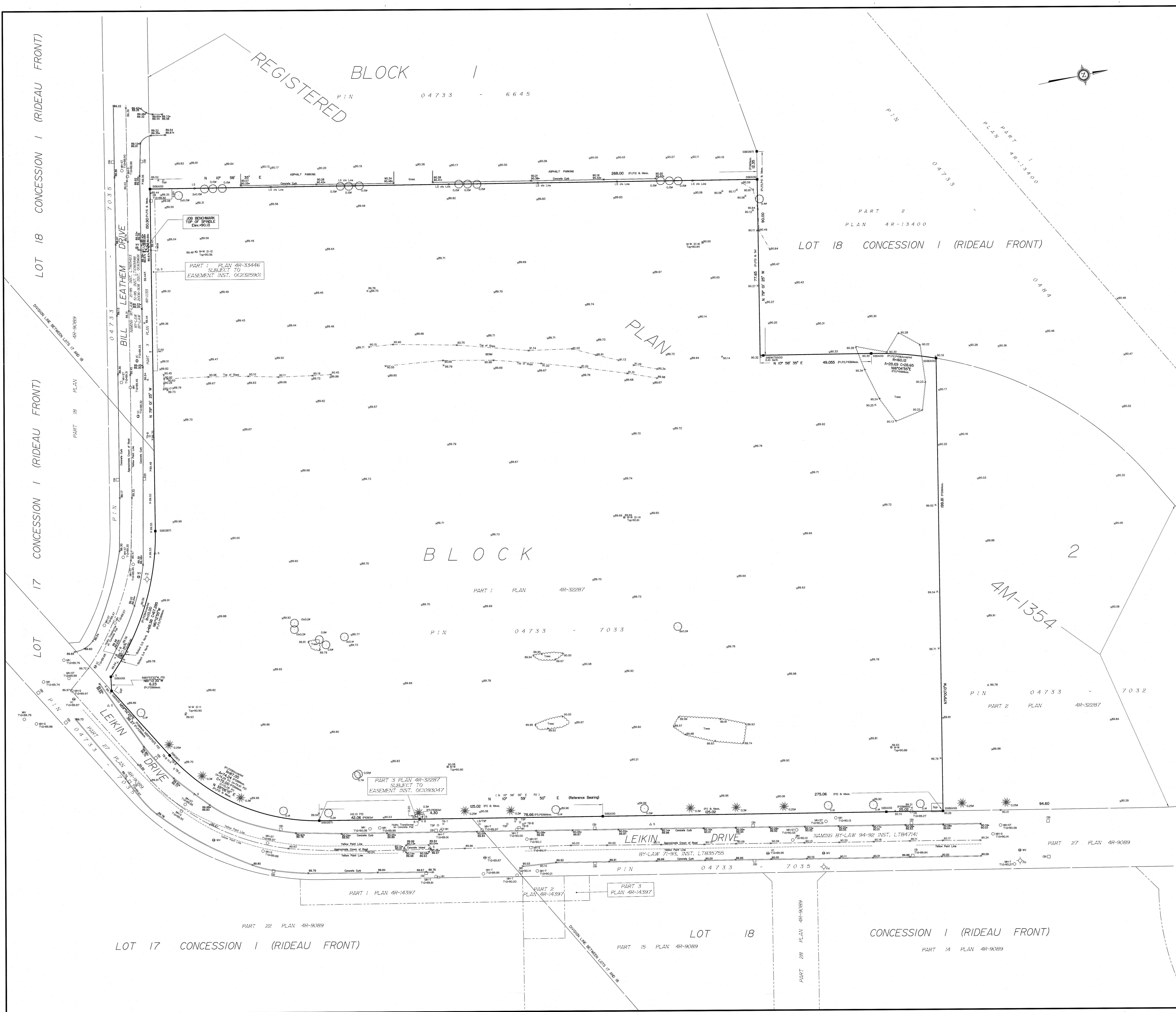

**TOPOGRAPHICAL PLAN OF SURVEY OF
PART OF BLOCK 2
REGISTERED PLAN 4M-1354
CITY OF OTTAWA**
Surveyed by Annis, O'Sullivan, Vollebek Ltd.

Scale 1: 500
Metric
DISTANCES SHOWN ON THIS PLAN ARE IN METRES AND
CAN BE CONVERTED TO FEET BY DIVIDING BY 0.3048

Surveyor's Certificate
I CERTIFY THAT:
1. This survey and plan are correct and in accordance with the Surveys Act, the Surveyors Act and the Land Titles Act and the regulations made under them.
2. The survey was completed on the 21st day of January, 2022.
Date: 21/01/2022
Annis, O'Sullivan, Vollebek Ltd.
Cedric Land Surveyor

Notes & Legend

Denotes	Description
—○—	Survey Monument Planted
—■—	Survey Monument Found
SIB	Standard Iron Bar
SSIB	Short Standard Iron Bar
IB	Iron Bar
(WIT)	Witness
Mec.	Measured
(AOS)	Annis, O'Sullivan, Vollebek Ltd.
(PI)	Registered Plan 4M-1354
(P2)	Plan 4R-8089
(P3)	Plan 4R-32287
(P4)	Plan 4R-13400
(P5)	Plan 4R-11133
○ MH-ST	Maintenance Hole (Storm Sewer)
○ MH-S	Maintenance Hole (Sanitary)
○ MH-T	Maintenance Hole (Traffic)
○ MH-U	Maintenance Hole (Unidentified)
○ VC	Valve Chamber (Watermain)
○ VC	Valve Chamber (Waterman)
○ FH	Fire Hydrant
○ WV	Water Valve
○ LS	Light Standard
□ CB	Catch Basin
□ CB	Catch Basin Inlet
T/G	Top of Grate
□ HI	Handhole
□ TB-S	Bolt Terminal Box
□ TB-C	Cable Terminal Box
□ TB-T	Traffic Terminal Box
□ TB-U	Unidentified Terminal Box
□ TP	Traffic Signal Post
○	Deciduous Tree
★	Coniferous Tree
✦	Bollard
△ S	Sign
○ M-W	Monitoring Well
○ W-C	Well Cap
○ D	Diameter
○	Location of Elevations
○	Top of Curb/ Wall Elevations
○	Centreline
—○—	Property Line
—WW—	Wooden Retaining Wall

ELEVATION NOTES
1. Elevations shown are geoid and are referred to the CGVD28 geoid datum.
2. It is the responsibility of the user of this information to verify that the job benchmark has not been altered or disturbed and that it's relative elevation and description agree with the information shown on this drawing.

UTILITY NOTES
1. This drawing cannot be accepted as acknowledging all of the utilities and it will be the responsibility of the user to contact the respective utility authorities for confirmation.
2. Only visible surface utilities were located.
3. A field location of underground plant by the pertinent utility authority is mandatory before any work involving breaking ground, probing, excavating etc.

Bearings are grid, derived from the westerly limit of Leikin Drive shown to be N10°56'52" E on Registered Plan 4M-1354 and are referred to the Central Meridian of MTM Zone 9 (76°30' West Longitude) NAD-83 (original).

Topographic data was collected under Winter Conditions. Snow cover and ice preclude determining location and elevation of some topographical data that is otherwise visible.

ASSOCIATION OF ONTARIO LAND SURVEYORS
PLAN SUBMISSION FORM
V-22632

THIS PLAN IS NOT VALID UNLESS IT IS AN UNRECORDED ORIGINAL COPY ISSUED BY THE SURVEYOR IN ACCORDANCE WITH REGULATION 1026, SECTION 29 (3).

© Annis, O'Sullivan, Vollebek Ltd. 2022. THIS PLAN IS PROTECTED BY COPYRIGHT.
ANNIS, O'SULLIVAN, VOLLEBEK LTD.
14 Concession Road, Suite 800
Newport, Ont. N5E 2S8
Phone: (519) 271-8800 / Fax: (519) 271-1079
www.annis-osullivan.com
Land Surveyors (Reg. No. 2662-29, 30, 31, 32, 33, 34, 35, 36, 37, 38, 39, 40, 41, 42, 43, 44, 45, 46, 47, 48, 49, 50, 51, 52, 53, 54, 55, 56, 57, 58, 59, 60, 61, 62, 63, 64, 65, 66, 67, 68, 69, 70, 71, 72, 73, 74, 75, 76, 77, 78, 79, 80, 81, 82, 83, 84, 85, 86, 87, 88, 89, 90, 91, 92, 93, 94, 95, 96, 97, 98, 99, 100)

Frechette, Luc

From: Gervais, Melanie <Melanie.Gervais@ottawa.ca>
Sent: December 1, 2022 9:18 AM
To: MacDonald, Nicole
Subject: Pre-con Follow-up - 50 Leikin Drive

Categories: CPC 821374

Hello Nicole,

Please refer to the below and attached notes regarding the Pre-Application Consultation (pre-con) Meeting held on November 16th 2022 for the property at 50 Leikin Drive for a Site Plan Control application in order to allow the development of parcel processing facility by Canada Post. I have also attached the required Plans & Study List for application submission.

Below are staff's preliminary comments based on the information available at the time of pre-con meeting:

Planning

- Official Plan:
 - The property is designated Mixed Industrial which permits light industrial uses such as warehousing, distribution and storage.
 - Section 10.2.2 Policy 2 requires a Noise study as this property is located within the airport's 25 Line (Composite of 25NEF/NEP), as shown on Schedule C14.
- Zoning By-law:
 - IL9 – Light Industrial Subzone 9, permits light industrial use. Please ensure the Site Plan includes a zoning chart that identifies all the required & proposed provisions in separate columns. Here's a [link](#) to the IL9 zone.
- Landscape requirements
 - The landscape plan must be signed by a landscape architect.
- I confirm that currently the main address for the property is 50 Leikin Drive. If you prefer a Bill Leathem address this request can be done through the Site Plan Control process.
- This will be a Complex Site Plan application with a fee of \$49,964.88 plus Engineering Design Review Fees (\$ varies) plus Conservation Authority fee (\$1065)
- New process: In 2023 the pre-consult process will become a 3-step process. If you submit in 2023 you will have to most likely come back for step 2 of the pre-con process. You can reach out in early 2023 and I should be able to provide you with the specifics at that time. If you submit by December 31st 2022, nothing changes.

Urban Design

- This proposal does not run along or does not meet the threshold in one of the City's Design Priority Areas and need not attend the City's UDRP. Staff will be responsible for evaluating the proposal and providing design direction.
- The concept plan is still very high level with minimal information and we have the following questions/comments about the proposal:
 - Building height: If a mezzanine is pursued we recommend it be incorporated into the proposed height of 30 feet (10 meters);
 - Landscape: We recommend vegetative buffers, street trees and screening be provided all around the site to soften the impact of the heavy use proposed on the surrounding lands;

- Amenity: If amenity is required for large number of employees we recommend this be located in a aggregated area that is screened from the drive aisles and connected to the office area with a safe and protected circulation path;
 - Light pollution - We recommend the site lighting be visually screened from the residential neighbourhood visible to the south;
 - Pedestrian movement and connectivity - We recommend a pedestrian movement plan be included in the site plan that identifies how pedestrians will access the site, move safely internally on the site with protected sidewalks, painted lanes, landscape buffers and how they can connect to future surrounding parcels;
 - Orientation & primary street frontage: We recommend some consideration for where the primary building facade is located and how it engages the street.
 - Land parcel to the north: How is this land parcel (currently left blank) envisioned and what opportunities does it present for some of the undetermined requirements for the site.
- A scoped Design Brief is a required submittal for all Site Plan/Re-zoning applications and can be combined with the Planning Rationale. Please see the Design Brief Terms of Reference provided.
 - Note. The Design Brief submittal should have a section which addresses these pre-consultation comments

Engineering

Please note the following information regarding the engineering design submissions for the above noted site:

1. The Servicing Study Guidelines for Development Applications are available at the following address: <https://ottawa.ca/en/city-hall/planning-and-development/how-develop-property/development-application-review-process-2/guide-preparing-studies-and-plans>
2. Servicing and site works shall be in accordance with the following documents:
 - Ottawa Sewer Design Guidelines (October 2012) and all the Technical Bulletins including, Technical Bulletin PIEDTB-2016-01 and ISTB-2018-01
 - Ottawa Design Guidelines – Water Distribution (2010) and Technical Bulletins ISD-2010-2, ISDTB-2014-02 and ISTB-2018-02
 - Geotechnical Investigation and Reporting Guidelines for Development Applications in the City of Ottawa (2007)
 - City of Ottawa Slope Stability Guidelines for Development Applications (revised 2012)
 - City of Ottawa Environmental Noise Control Guidelines (January, 2016)
 - City of Ottawa Park and Pathway Development Manual (2012)
 - City of Ottawa Accessibility Design Standards (2012)
 - Ottawa Standard Tender Documents (latest version)
 - Ontario Provincial Standards for Roads & Public Works (2013)
3. Record drawings and utility plans are also available for purchase from the City (Contact the City's Information Centre by email at GeoInformation@ottawa.ca or by phone at (613) 580-2424 x 44455
4. The Stormwater Management Criteria, for the subject site, is to be based on the following (as established in the **South Merivale Business Park Stormwater Management Report** prepared by Novatech Engineering Consultants Ltd., dated November 1991.
 - The sites allowable release rate is based on a pre-development C-Factor of 0.24 being controlled to the 5-year design storm with a 15-minute time of concentration. See the report listed above for more details (equivalent of 54.5 L/s/ha).
 - A calculated time of concentration for post-development flows (Cannot be less than 10 minutes).

- Flows to the storm sewer in excess of the allowable release rate must be detained on site for storms up to the 1:100 year return. No surface ponding is permitted for events up to and including the 5-year event.
- Ensure no overland flow for all storms up to and including the 100-year event.
- The 2-yr storm or 5-yr storm event using the IDF information derived from the Meteorological Services of Canada rainfall data, taken from the MacDonald Cartier Airport, collected 1966 to 1997.
- Quality control requirements provided by Rideau Valley Conservation Authority (RVCA) are for “enhanced” target (80% TSS Removal). Quality control is provided by the existing Longfields/Davidson Stormwater Management Facility that is downstream of the site.
- Best Management Practices (BMPs) are recommended for this site.

5. Deep Services:



- i. *A plan view of the approximate services may be seen above. Services should ideally be grouped in a common trench to minimize the number of road cuts. The sizing of available future services is:*
 - a. Connections:
 - i. 900 mm dia. STM Conc. Or 1050mm dia. STM Conc. Sewer on Leikin Drive.
 - ii. Existing Sanitary Maintenance hole MHSA19533 or MHSA19535 on Leikin Drive.
 - iii. 305 mm dia. WM PVC stub on Bill Leatham Drive.
- ii. *Provide existing servicing information and the recommended location for the proposed connections. Services should ideally be grouped in a common trench to minimize the number of road cuts.*

- iii. *Provide information on the monitoring manhole requirements – should be located in an accessible location on private property near the property line (ie. Not in a parking area).*
- iv. *Provide information on the type of connection permitted*

Sewer connections to be made above the springline of the sewermain as per:

- a. Std Dwg S11.1 for flexible main sewers – *connections made using approved tee or wye fittings.*
 - b. Std Dwg S11 (For rigid main sewers) – *lateral must be less than 50% the diameter of the sewermain,*
 - c. Std Dwg S11.2 (for rigid main sewers using bell end insert method) – *for larger diameter laterals where manufactured inserts are not available; lateral must be less than 50% the diameter of the sewermain,*
 - d. Connections to manholes permitted when the connection is to rigid main sewers where the lateral exceeds 50% the diameter of the sewermain. – Connect obvert to obvert with the outlet pipe unless pipes are a similar size.
 - e. *No submerged outlet connections.*
6. Civil consultant must request boundary conditions from the City's assigned Project Manager prior to first submission. Water Boundary condition requests must include the location of the service and the expected loads required by the proposed development. Please provide the following information:
- Location of service(s)
 - Type of development and the amount of fire flow required (as per FUS, 1999).
 - Average daily demand: ___ l/s.
 - Maximum daily demand: ___ l/s.
 - Maximum hourly daily demand: ___ l/s.
 - Hydrant location and spacing to meet City's Water Design guidelines.
 - Water supply redundancy will be required for more than 50 m³/day water demand.
7. Phase 1 ESAs and Phase 2 ESAs must conform to clause 4.8.4 of the Official Plan that requires that development applications conform to Ontario Regulation 153/04.
8. MECP ECA Requirements (Standard) –
All development applications should be considered for an Environmental Compliance Approval (ECA) by the Ministry of the Environment, Conservation, and Parks (MECP);
- Consultant determines if an approval for sewage works under Section 53 of OWRA is required. Consultant then determines what type of application is required and the City's project manager confirms. (If the consultant is not clear if an ECA is required, they will work with the City to determine what is required. If the consultant it is still unclear or there is a difference of opinion only then will the City PM approach the MECP.
 - The project will be either transfer of review (standard), transfer of review (additional), direct submission, or exempt as per O. Reg. 525/98.
 - Standard Works ToR Draft ECA's are sent to the local MECP office (moeccottawasewage@ontario.ca) for information only
 - Additional ToR draft ECAs require a project summary/design brief and require a response from the local MECP (10 business day window)

- Site plan Approval, or Draft Approval, is required before an application is sent to the MECP

9. General/ additional comments:

- Only one watermain connection per site. However, looping would be required if proposed demand is 50m³/day or greater.

Feel free to contact the Infrastructure Project Manager, Tyler Cassidy, at Tyler.Cassidy@ottawa.ca, for follow-up questions.

Transportation

- The submitted Transportation Review is not an acceptable Transportation Impact Assessment.
 - The TIA guidelines are available on the City website: <https://ottawa.ca/en/transportation-impact-assessment-guidelines>
 - The application will not be deemed complete until the submission of the draft step 2-4, including the functional draft RMA package (if applicable) and/or monitoring report (if applicable). Although a full review of the TIA Strategy report (Step 4) is not required prior to an application, it is strongly recommended.
 - Synchro files are required at Step 4.
- Corner sight triangle requirement is 5m x 5m.
- A Stationary Noise Impact Study is required if there is residential land use within 100m.
- Leikin and Bill Leathem both have a 26m right of way protection.

Feel free to contact the Transportation Project Manager, Mike Giampa, at Mike.Giampa@ottawa.ca, for follow-up questions.

Environmental

- The subject property appears to be a large parcel with undisturbed meadow and grasslands habitat. Given its proximity to the Rideau river and stormponds, and recent findings of nearby studies, I recommend completing a scoped Environmental Impact Study (EIS) that primarily focuses on significant habitat for threatened or endangered species. These surveys will need to be during the appropriate breeding season(s).
- Further details of the scoped EIS can be found in the EIS guidelines. https://documents.ottawa.ca/sites/documents/files/documents/eis_guidelines2015_en.pdf
- I understand that the applicant is obliged to complete an Impact Assessment (or an Environmental Effects Analysis) as part of their submission to the federal planning authority. While it is unclear if the objectives of the Impact Assessment align with and satisfy those of the City's policies, the EIS can be combined with the Impact Assessment (or EEA) to avoid duplications. However, the EIS must demonstrate that the proposed development will have no negative impacts on the natural features for which it was triggered, as outlined in the Provincial Policy Statement and the City's Official Plan.
- I would also encourage the applicant to seek opportunities to add more locally appropriate native trees, shrubs and vegetation to the proposed development. If implemented appropriately, this would not only contribute to the development design, but it would also contribute to the urban tree canopy, local biodiversity, improve the buildings' energy efficiency and reduce the urban heat island effect. Increased vegetation would be especially beneficial with the large parking lot proposed. Having more native trees and shrubs would also require providing sufficient space and soil for the trees and vegetation.
- Feel free to contact the Environmental Planner, Sami Rehman, at sami.rehman@ottawa.ca for follow-up questions.

TCR requirements:

1. a Tree Conservation Report (TCR) must be supplied for review along with the suite of other plans/reports required by the City

- a. an approved TCR is a requirement of Site Plan approval.
2. Any removal of privately-owned trees 10cm or larger in diameter, or city-owned trees of any diameter requires a tree permit issued under the Tree Protection Bylaw (Bylaw 2020 – 340); the permit will be based on an approved TCR and made available at or near plan approval.
3. The Planning Forester from Planning and Growth Management as well as foresters from Forestry Services will review the submitted TCR
 - a. If tree removal is required, both municipal and privately-owned trees will be addressed in a single permit issued through the Planning Forester
 - b. Compensation may be required for city owned trees – if so, it will need to be paid prior to the release of the tree permit
4. The TCR must contain 2 separate plans:
 - a. Plan/Map 1 - show existing conditions with tree cover information
 - b. Plan/Map 2 - show proposed development with tree cover information
 - c. Please ensure retained trees are shown on the landscape plan
5. the TCR must list all trees on site, as well as off-site trees if the CRZ extends into the developed area, by species, diameter and health condition
6. please identify trees by ownership – private onsite, private on adjoining site, city owned, co-owned (trees on a property line)
7. If trees are to be removed, the TCR must clearly show where they are, and document the reason they cannot be retained
8. All retained trees must be shown, and all retained trees within the area impacted by the development process must be protected as per City guidelines available at [Tree Protection Specification](#) or by searching Ottawa.ca
 - a. the location of tree protection fencing must be shown on the plan
 - b. show the critical root zone of the retained trees
9. the City encourages the retention of healthy trees; if possible, please seek opportunities for retention of trees that will contribute to the design/function of the site.
10. For more information on the process or help with tree retention options, contact Mark Richardson mark.richardson@ottawa.ca or on [City of Ottawa](#)

Landscape Plan tree planting requirements:

For additional information on the following please contact tracy.smith@Ottawa.ca

1. Minimum Setbacks
 - Maintain 1.5m from sidewalk or MUP/cycle track or water service laterals.
 - Maintain 2.5m from curb
 - Coniferous species require a minimum 4.5m setback from curb, sidewalk or MUP/cycle track/pathway.
 - Maintain 7.5m between large growing trees, and 4m between small growing trees. Park or open space planting should consider 10m spacing, except where otherwise approved in naturalization / afforestation areas. Adhere to Ottawa Hydro's planting guidelines (species and setbacks) when planting around overhead primary conductors.
2. Tree specifications
 - Minimum stock size: 50mm tree caliper for deciduous, 200cm height for coniferous.
 - Maximize the use of large deciduous species wherever possible to maximize future canopy coverage
 - Tree planting on city property shall be in accordance with the City of Ottawa's Tree Planting Specification; and include watering and warranty as described in the specification (can be provided by Forestry Services).
 - Plant native trees whenever possible
 - No root barriers, dead-man anchor systems, or planters are permitted.
 - No tree stakes unless necessary (and only 1 on the prevailing winds side of the tree)
3. Hard surface planting

- Curb style planter is highly recommended
 - No grates are to be used and if guards are required, City of Ottawa standard (which can be provided) shall be used.
 - Trees are to be planted at grade
4. Soil Volume
- Please document on the LP that adequate soil volumes can be met:

Tree Type/Size	Single Tree Soil Volume (m3)	Multiple Tree Soil Volume (m3/tree)
Ornamental	15	9
Columnar	15	9
Small	20	12
Medium	25	15
Large	30	18
Conifer	25	15

Please note that these soil volumes are not applicable in cases with Sensitive Marine Clay.

5. Sensitive Marine Clay
- Please follow the City's 2017 Tree Planting in Sensitive Marine Clay guidelines

Tree Canopy Cover:

1. The landscape plan shall show how the proposed tree planting will replace and increase canopy cover on the site over time, to support the City's 40% urban forest canopy cover target.
2. At a site level, efforts shall be made to provide as much canopy cover as possible, through tree planting and tree retention, with an aim of 40% canopy cover at 40 years, as appropriate.
3. Indicate on the plan the projected future canopy cover at 40 years for the site.

Parkland

- Parkland Dedication:
 - The amount of parkland dedication that is required is to be calculated as per the City of Ottawa Parkland Dedication By-law No. 2022-280.
 - Section 11(2)(g) of the by-law states that no conveyance of land or payment of money in-lieu is required for "a municipal or other government use".
 - The proposed development is being undertaken by Canada Post, a Crown corporation owned by the federal government, for the construction of a new Canada Post parcel processing facility.
 - Therefore, this proposal would be considered exempt from a parkland dedication requirement.
 - Please note that the park comments are preliminary and will be finalized, and subject to change, upon receipt of the development application. If the proposed development or land use changes, then the parkland dedication requirement will be re-evaluated accordingly.

City Surveyor

- The determination of property boundaries, minimum setbacks and other regulatory constraints are a critical component of development. An Ontario Land Surveyor (O.L.S.) needs to be consulted at the outset of a project to ensure properties are properly defined and can be used as the geospatial framework for the development.
- Topographic details may also be required for a project and should be either carried out by the O.L.S. that has provided the Legal Survey or done in consultation with the O.L.S. to ensure that the project is integrated to the appropriate control network.

Questions regarding the above requirements can be directed to the City's Surveyor, Bill Harper, at Bill.Harper@ottawa.ca

Conservation Authority

- Please reach out to Eric Lalande at the RVCA eric.lalande@rvca.ca

Other

- Plans are to be standard A1 size (594 mm x 841 mm) or Arch D size (609.6 mm x 914.4 mm) sheets, dimensioned in metric and utilizing an appropriate Metric scale (1:200, 1:250, 1:300, 1:400 or 1:500).
- All PDF submitted documents are to be unlocked and flattened.
- You are encouraged to contact the Ward Councillor, Councillor Wilson Lo, at wilson.lo@ottawa.ca about the proposal.

Please refer to the links to [Guide to preparing studies and plans](#) and [fees](#) for further information. Additional information is available related to [building permits](#), [development charges](#), and the [Accessibility Design Standards](#). Be aware that other fees and permits may be required, outside of the development review process. You may obtain background drawings by contacting geoinformation@ottawa.ca.

It is anticipated that, as a result of the *More Homes for Everyone Act, 2022*, for applications for site plan approval and zoning by-law amendments, new processes in respect of pre-application consultation will be in place as of January 1, 2023. The new processes are anticipated to require a multiple phase pre-application consultation approach before an application will be deemed complete. Applicants who have not filed a complete application by the effective date may be required to undertake further pre-application consultation(s) consistent with the provincial changes. The by-laws to be amended include By-law 2009-320, the Pre-Consultation By-law, By-law 2022-239, the planning fees by-law and By-law 2022-254, the Information and Materials for Planning Application By-law. The revisions are anticipated to be before Council in the period after the new Council takes office and the end of the year.

These pre-con comments are valid for one year. If you submit a development application(s) after this time, you may be required to meet for another pre-consultation meeting and/or the submission requirements may change. You are as well encouraged to contact us for a follow-up meeting if the plan/concept will be further refined.

Please do not hesitate to contact me if you have any questions.

Regards,

Mélanie Gervais MCIP, RPP
Planner III (A) / Urbaniste III (i)
Development Review - South /
Examen des demandes d'aménagement - sud
Planning, Real Estate and Economic Development Department /
Direction générale de la planification, des biens immobiliers et du développement économique

City of / Ville d'Ottawa
110, avenue Laurier Avenue West / Ouest,
4th Floor / 4ième étage
Ottawa, ON K1P 1J1
Tel. : 613-580-2424 ext. 24025
Cell. : 613-282-0508
E-mail / Courriel : Melanie.Gervais@ottawa.ca
Mail Code: 01-14

This e-mail originates from the City of Ottawa e-mail system. Any distribution, use or copying of this e-mail or the information it contains by other than the intended recipient(s) is unauthorized. Thank you.

Le présent courriel a été expédié par le système de courriels de la Ville d'Ottawa. Toute distribution, utilisation ou reproduction du courriel ou des renseignements qui s'y trouvent par une personne autre que son destinataire prévu est interdite. Je vous remercie de votre collaboration.

<<

image001.png (1.5MB)

image003.png (389.4KB)

Pre-con Applicant's Study and Plan Identification List 50 Leikin.pdf (195.8KB)

Leikin, 50_Design Brief.pdf (95.5KB)

(2.2MB)

>>

REMOVE EXISTING CAP & CONNECT TO NEW 400mm Ø WATERMANS CONNECTION BY R.M.O.C. EXCAVATION, BACKFILL REINSTATEMENT BY CONTRACTOR

REMOVE EXISTING WATERTIGHT PLUG AND CONNECT TO NEW MH 15A

CURVE DATA

Δ	= 07°29'41"
R	= 100.00m
T	= 6.55m
L	= 13.08m

CURVE DATA

Δ	= 48°55'16"
R	= 100.00m
T	= 45.49m
L	= 85.38m

SANITARY SERVICE DATA

MH No.	STATION	TYPE	T/G ELEV	INV
S1	1+055	1200* OPSPD 701.0M	90.18	87.96 85.91
S2	1+057.4	1200* OPSPD 701.0M	90.11	87.95 86.43
S3	1+200	1200* OPSPD 701.0M	90.14	87.86 86.19

STORM MANHOLE DATA

No.	STATION	TYPE	T.G ELEVATION
I2	1+235.4	1800* OPSPD 701.02M	89.97
I3	1+192.7	1800* OPSPD 701.04M	89.98
I4	1+193.3	1650* 12400* M6	89.88
I5	1+065.3	1200* OPSPD 701.0M	89.95

SANITARY MANHOLE DATA

No.	STATION	TYPE	T.G ELEVATION
I2	1+234.2	1500* OPSPD 701.04	89.90
I3	1+194.5	1500* OPSPD 701.04	89.97
I4	1+122.7	1200* 1200* M4	89.96
I5A	1+000	1500* OPSPD 701.04	89.90

CATCHBASIN DATA

No.	STATION	OUTLET INVERT ELEVATION	INLET INVERT ELEVATION	ICD ELEV	TYPE
1	1+070	88.58	-	-	-
2	1+070	88.41	88.44	88.51	B
3	1+114	88.46	88.47	88.56	B
4	1+132	88.57	-	-	-
5	1+170	88.53	-	-	-
6	1+170	88.35	88.38	88.45	B
7	1+240	88.58	-	-	-
8	1+240	88.40	88.43	88.50	B

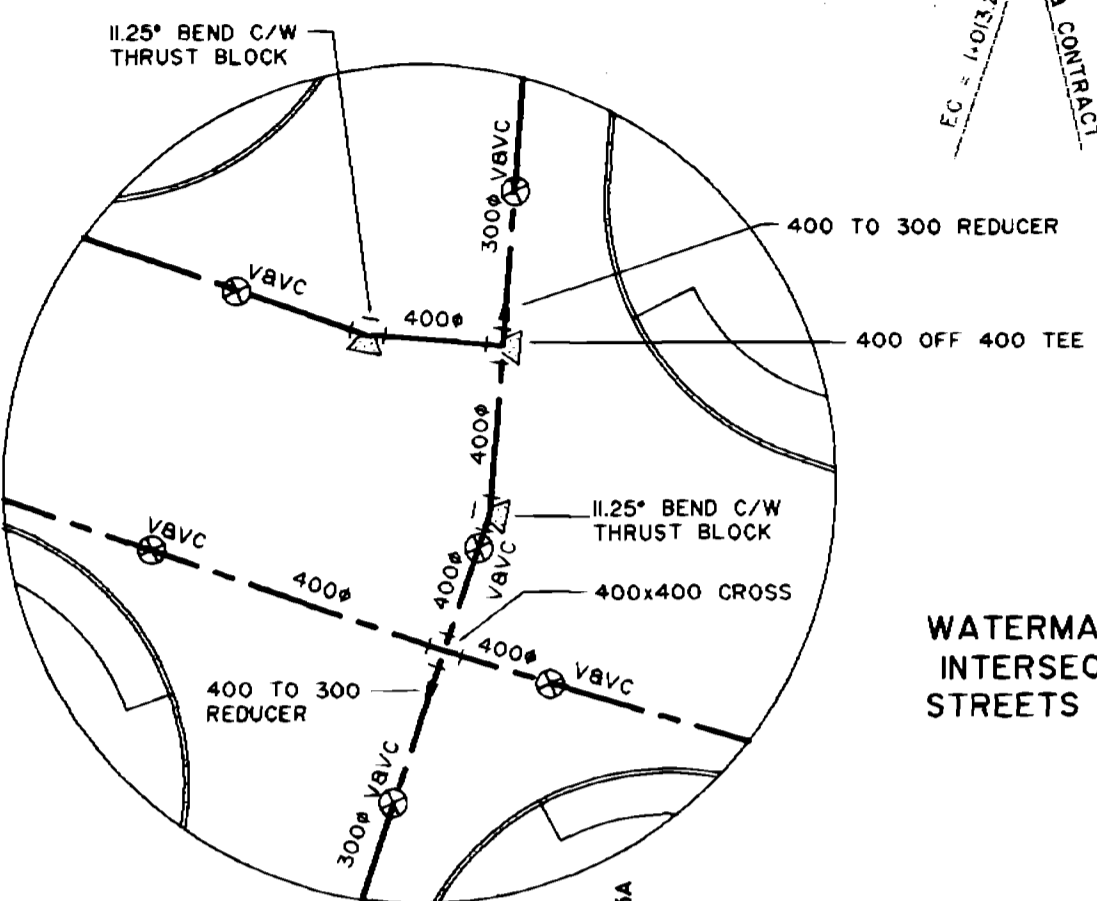

WATERMAIN DETAIL INTERSECTION OF STREETS A, B & F

LIMIT OF PHASE 1 STORM & SANITARY CONSTRUCTION PROVIDE WATERTIGHT PLUGS

PROVIDE CAP & THRUST BLOCK LIMIT OF PHASE 1 WATERMAIN CONSTRUCTION

AS-BUILTS LEGEND

80.90	AS BUILT INFO
80.91	ADDITIONAL AS-BUILT INFO

BOREHOLE LEGEND

[Symbol]	SILTY CLAY
[Symbol]	CLAYEY SILT
[Symbol]	GLACIAL TILL

BOREHOLE DATA FROM FONDEX LTD. REPORT NO. Q-A756-A, NOVEMBER, 1998

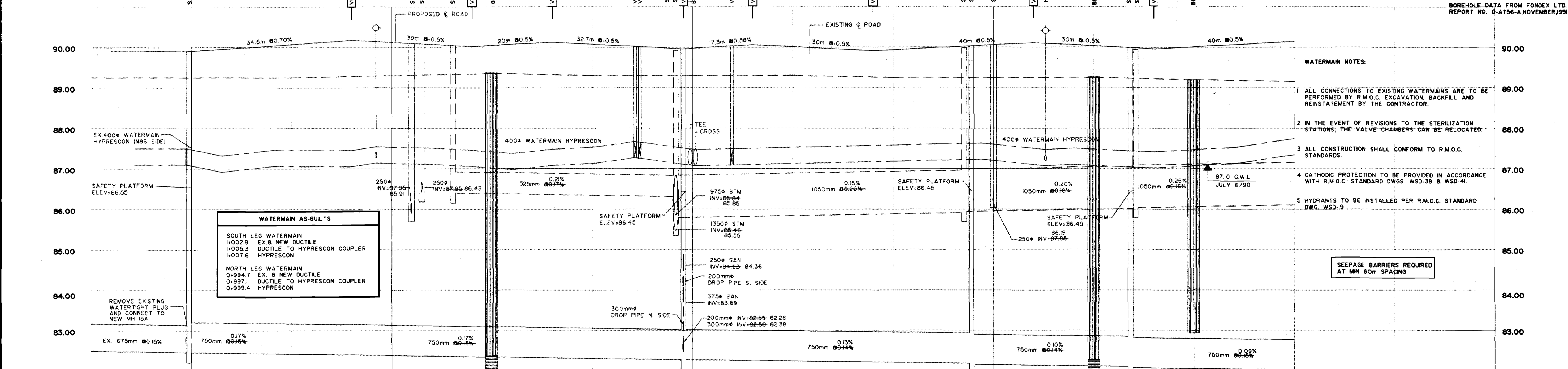

WATERMAIN AS-BUILTS

SOUTH LEG WATERMAIN	I-002.9 EX. B NEW DUCTILE
	I-005.3 DUCTILE TO HYPRESCON COUPLER
	I-007.6 HYPRESCON
NORTH LEG WATERMAIN	O-994.7 EX. B NEW DUCTILE
	O-997.1 DUCTILE TO HYPRESCON COUPLER
	O-999.4 HYPRESCON

- WATERMAIN NOTES:**
- ALL CONNECTIONS TO EXISTING WATERMANS ARE TO BE PERFORMED BY R.M.O.C. EXCAVATION, BACKFILL AND REINSTATEMENT BY THE CONTRACTOR.
 - IN THE EVENT OF REVISIONS TO THE STERILIZATION STATIONS, THE VALVE CHAMBERS CAN BE RELOCATED.
 - ALL CONSTRUCTION SHALL CONFORM TO R.M.O.C. STANDARDS.
 - CATHODIC PROTECTION TO BE PROVIDED IN ACCORDANCE WITH R.M.O.C. STANDARD DWGS. WSD-39 & WSD-41.
 - HYDRANTS TO BE INSTALLED PER R.M.O.C. STANDARD DWG. WSD-19.

SEEPAGE BARRIERS REQUIRED AT MIN 60m SPACING

ROAD ELEVATION	TOP OF WATERMAIN ELEVATION	STORM SEWER INVERT	SANITARY SEWER INVERT	EXISTING C.R.O.W. ELEVATION	CHAINAGE	ROAD ELEVATION
89.90	87.37 (N)	86.37	82.36	89.30	0+984.7 EX DUCTILE	89.90
89.93	87.39 (N)	86.37	82.36	89.30	0+989.4 HYPRESCON	89.93
90.07	87.40 (S)	86.37	82.36	89.30	I-000.9 EX DUCTILE	90.07
90.17	87.42 (S)	86.37	82.36	89.30	I-005.4 EX DUCTILE	90.17
90.12	87.43 (S)	86.37	82.36	89.30	I-007.6 HYPRESCON	90.12
90.02	87.45 (S)	86.37	82.36	89.30	O-046.8	90.02
90.05	87.46 (S)	86.37	82.36	89.30	I-040.0 VPI	90.05
90.12	87.48 (S)	86.37	82.36	89.30	I-046.8 VPI	90.12
90.07	87.51 (S)	86.37	82.36	89.30	I-050.0 VPI	90.07
89.96	87.53 (N)	86.37	82.36	89.30	I-055.0 MH	89.96
89.97	87.54 (S)	86.37	82.36	89.30	I-057.4 MH	89.97
90.06	87.55 (N)	86.37	82.36	89.30	I-065.3 MH	90.06
90.01	87.57 (N)	86.37	82.36	89.30	I-070.0 VPI	90.01
89.91	87.58 (N)	86.37	82.36	89.30	I-075.0 VPI	89.91
89.94	87.59 (N)	86.37	82.36	89.30	I-080.0 VPI	89.94
90.06	87.61 (N)	86.37	82.36	89.30	I-087.0 VPI	90.06
90.11	87.63 (S)	86.37	82.36	89.30	I-092.7 VPI	90.11
90.04	87.65 (S)	86.37	82.36	89.30	I-097.0 VPI	90.04
89.96	87.67 (S)	86.37	82.36	89.30	I-100.0 VPI	89.96
90.01	87.69 (S)	86.37	82.36	89.30	I-105.0 VPI	90.01
89.96	87.71 (S)	86.37	82.36	89.30	I-110.0 VPI	89.96
90.14	87.73 (S)	86.37	82.36	89.30	I-115.0 VPI	90.14

NOTE: THE POSITION OF ALL POLE LINES, CONDUITS, WATERMANS, SEWERS AND OTHER UNDERGROUND AND OVERGROUND UTILITIES AND STRUCTURES IS NOT NECESSARILY SHOWN ON THE CONTRACT DRAWINGS, AND WHERE SHOWN, THE ACCURACY OF THE POSITION OF SUCH UTILITIES AND STRUCTURES IS NOT GUARANTEED. BEFORE STARTING WORK, DETERMINE THE EXACT LOCATION OF ALL SUCH UTILITIES AND STRUCTURES AND ASSUME ALL LIABILITY FOR DAMAGE TO THEM.

No.	REVISION	DATE	BY	No.	REVISION	DATE	BY
10	ISSUED TO THE CITY OF NEPEAN	JAN. 30/96	JFB	3	ISSUED FOR TENDER	JAN.15/92	SG
9	AS-BUILTS AS PER NEPEAN COMMENTS	MAY 10/93	JFB	2	REVISED AS PER R.M.O.C. COMMENTS	DEC.9/91	SG
8	AS-BUILTS AS PER NEPEAN COMMENTS	MAR.26/93	JFB	1	REVISED AS PER NEPEAN COMMENTS	NOV.28/91	SG

APR.20/92 UB
FEB.14/92 SG
FEB.3/92 SG
JAN.17/92 SG
JAN.15/92 SG
DEC.9/91 SG
NOV.28/91 SG

Novatech
ENGINEERING CONSULTANTS LTD
OTTAWA, ONTARIO

SCALE: 1:500 HORIZONTAL, 1:50 VERTICAL

NEPEAN
SOUTH MERIVALE BUSINESS PARK AS-BUILTS
PLAN AND PROFILE (LEIKIN DRIVE)
STREET A - STATION 1+000 TO 1+275

PROJECT No. 94031
FIELD BOOK
DATE: JANUARY 1996
DRAWING No. 94031-P1

STREET 'A' (LEIKIN DRIVE)

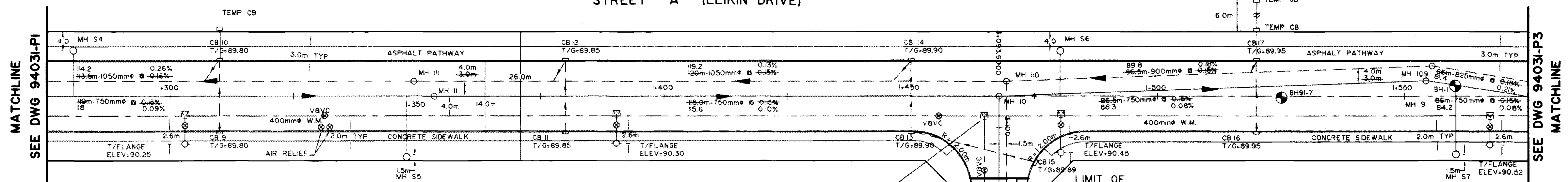

CATCHBASIN DATA

No.	STATION	OUTLET INVERT ELEVATION	INLET INVERT ELEVATION	ICD ELEV	TYPE
9	1+310	88.63			
10	1+310	88.45			
11	1+380	88.68	88.48	88.55	B
12	1+380	88.50	88.53	88.60	B
13	1+450	88.72	88.75		B
14	1+450	88.55	88.58	88.65	B
15	1+476	89.00			
16	1+520	88.78			
17	1+520	88.60	88.63	88.70	B

SANITARY SERVICE DATA

MH No.	STATION	TYPE	T/G ELEV	INV	
S4	1+280	1200# OPSD 70I.0M	90.18	87.90	85.51
S5	1+347.8	1200# OPSD 70I.0M	90.28	87.96	86.84
S6	1+480	1200# OPSD 70I.0M	90.29	88.05	86.09
S7	1+560	1200# OPSD 70I.0M	90.44	88.16	87.22

STREET 'F' NORTH DATA

SERVICE	STATION	TYPE	ELEVATION
VALVE & CHAMBER	3+108.6		87.80 87.87 T.W.M
WATERMAIN STUB	3+115	PVC CL.150 CONC CL.III	87.59 87.73 T.W.M
STORM STUB	3+116		86.96 86.99 INV
SANITARY STUB	3+117		86.24 86.44 INV
END OF ASPHALT	3+106.6	PVC SDR 35	90.09 & ROAD

STORM MANHOLE DATA

No.	STATION	TYPE	T.G ELEVATION
IO9	1+555.6	1800# OPSD 70I.0M	90.25
IO	1+469.3	1500x1800 MS	90.12
IO	1+349.3	1800# OPSD 70I.0M	90.12

SANITARY MANHOLE DATA

No.	STATION	TYPE	T.G ELEVATION
9	1+554.3	1500# OPSD 70I.0M	90.33
10	1+467.8	1800# OPSD 70I.05	90.20
11	1+352.8	1500# OPSD 70I.04	90.20
MH 10		DROP OPSD 1003.0M	

AS-BUILTS LEGEND

- 80.90 AS BUILT INFO
- 80.91 ADDITIONAL AS-BUILT INFO

BOREHOLE LEGEND

- SILTY CLAY
- CLAYEY SILT
- GLACIAL TILL

BOREHOLE DATA FROM FONDEX LTD. REPORT NO. 0-A756-A, NOVEMBER, 1991

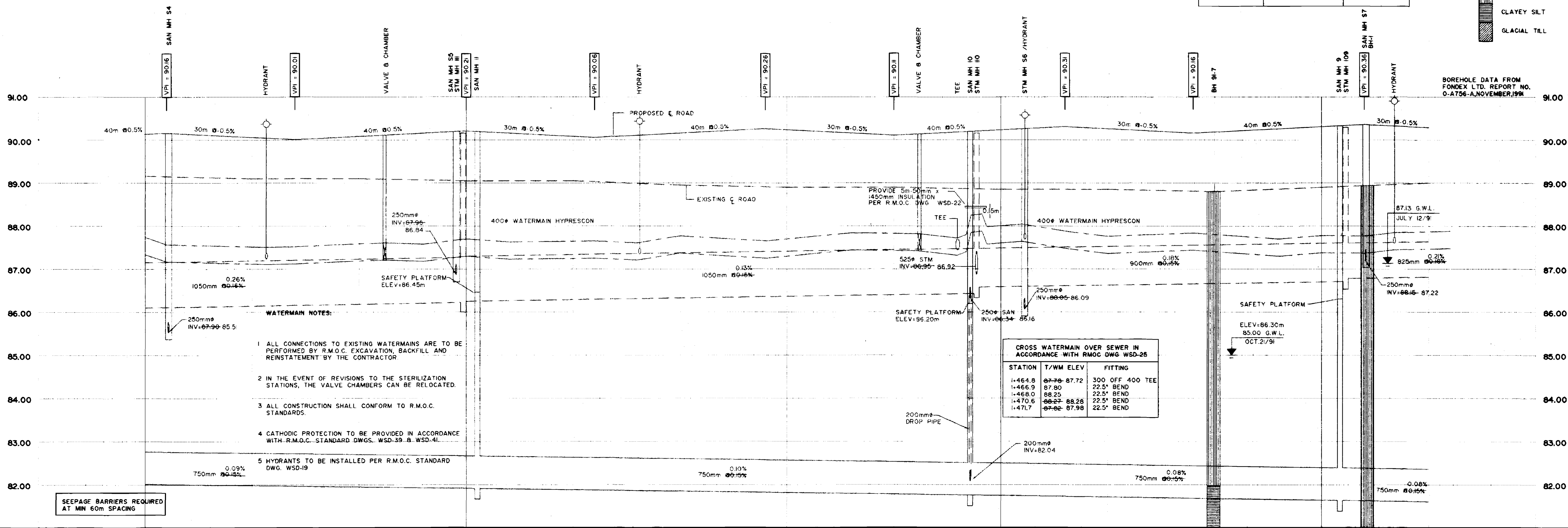

- WATERMAIN NOTES:**
- ALL CONNECTIONS TO EXISTING WATERMANS ARE TO BE PERFORMED BY R.M.O.C. EXCAVATION, BACKFILL AND REINSTATEMENT BY THE CONTRACTOR
 - IN THE EVENT OF REVISIONS TO THE STERILIZATION STATIONS, THE VALVE CHAMBERS CAN BE RELOCATED.
 - ALL CONSTRUCTION SHALL CONFORM TO R.M.O.C. STANDARDS.
 - CATHODIC PROTECTION TO BE PROVIDED IN ACCORDANCE WITH R.M.O.C. STANDARD DWGS. WSD-39 & WSD-41.
 - HYDRANTS TO BE INSTALLED PER R.M.O.C. STANDARD DWG. WSD-19

ROAD ELEVATION	TOP OF WATERMAIN ELEVATION	STORM SEWER INVERT	SANITARY SEWER INVERT	EXISTING C.R.O.W. ELEVATION	CHAINAGE	ROAD ELEVATION	TOP OF WATERMAIN ELEVATION	STORM SEWER INVERT	SANITARY SEWER INVERT	EXISTING C.R.O.W. ELEVATION	CHAINAGE
90.14	87.74	83.5m-1050# STM 0.26% CONC.CL.III	88.8m-750# SAN 0.09% CONC.CL.V	89.15	1+275	90.06	87.51	83.33	88.63	89.10	1+300
90.01	87.52			89.10	1+303	90.09	87.69	86.25	88.80	89.10	1+325
90.09	87.57	119.2 120m-1050# STM 0.13% CONC.CL.III	115.6 120m-750# SAN 0.10% CONC.CL.V	89.05	1+331	90.06	87.61	86.35	88.80	89.05	1+340
90.16	87.77			88.90	1+390	90.24	87.77	86.44	88.90	88.90	1+400
90.25	87.84			88.85	1+425	90.31	87.84	86.50	88.85	88.85	1+440
90.24	87.84			88.85	1+458.8	90.26	87.72	86.50	88.85	88.85	1+475
90.11	87.71			88.80	1+480	90.19	87.88	86.75	88.80	88.80	1+490
90.16	87.76			88.80	1+500	90.16	87.76	86.83	88.80	88.80	1+520
90.19	87.84			88.80	1+525	90.29	87.84	86.75	88.80	88.80	1+540
90.31	87.79			88.90	1+560	90.31	87.79	86.75	88.90	88.90	1+575
90.26	87.76			88.90	1+580	90.26	87.76	86.75	88.90	88.90	1+600
90.16	87.76			88.90	1+620	90.16	87.76	86.75	88.90	88.90	1+640
90.19	87.76			88.90	1+660	90.19	87.76	86.75	88.90	88.90	1+680
90.19	87.76			88.90	1+700	90.19	87.76	86.75	88.90	88.90	1+725
90.16	87.76			88.90	1+750	90.16	87.76	86.75	88.90	88.90	1+775
90.19	87.76			88.90	1+800	90.19	87.76	86.75	88.90	88.90	1+825
90.16	87.76			88.90	1+850	90.16	87.76	86.75	88.90	88.90	1+875
90.19	87.76			88.90	1+900	90.19	87.76	86.75	88.90	88.90	1+925
90.16	87.76			88.90	1+950	90.16	87.76	86.75	88.90	88.90	1+975
90.19	87.76			88.90	1+990	90.19	87.76	86.75	88.90	88.90	1+1000

NOTE: THE POSITION OF ALL POLE LINES, CONDUITS, WATERMANS, SEWERS AND OTHER UNDERGROUND AND OVERGROUND UTILITIES AND STRUCTURES IS NOT NECESSARILY SHOWN ON THE CONTRACT DRAWINGS, AND WHERE SHOWN, THE ACCURACY OF THE POSITION OF SUCH UTILITIES AND STRUCTURES IS NOT GUARANTEED. BEFORE STARTING WORK, DETERMINE THE EXACT LOCATION OF ALL SUCH UTILITIES AND STRUCTURES AND ASSUME ALL LIABILITY FOR DAMAGE TO THEM.

No.	REVISION	DATE	BY	No.	REVISION	DATE	BY
7	WATERMAIN OFFSET 4.0m	APR.20/92	UB	10	ISSUED TO THE CITY OF NEPEAN	JAN.30/96	JFB
6	REVISED AS PER NEPEAN COMMENTS	FEB.14/92	SG	9	AS-BUILTS AS PER NEPEAN COMMENTS	MAY.04/93	JFB
5	REVISED AS PER NEPEAN COMMENTS	FEB.3/92	SG	8	AS-BUILTS AS PER NEPEAN COMMENTS	MAR.26/93	JFB
4	REVISED AS PER R.M.O.C. COMMENTS	JAN.17/92	SG				
3	ISSUED FOR TENDER	JAN.15/92	SG				
2	REVISED AS PER R.M.O.C. COMMENTS	DEC.9/91	SG				
1	REVISED AS PER NEPEAN COMMENTS	NOV.28/91	SG				

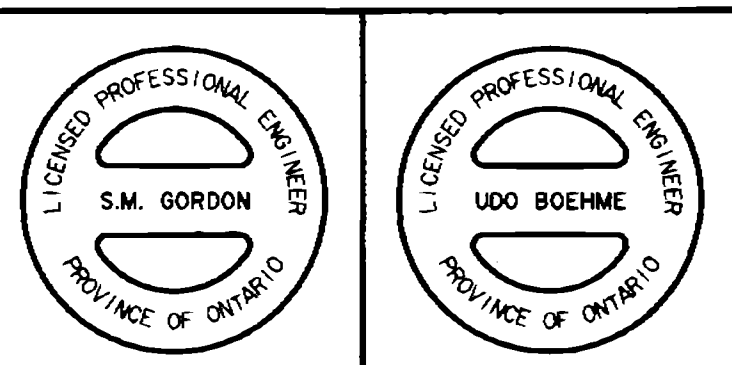

DESIGN	UB/JFB	SCALE
CHECKED	UB	0 5 10 15 20
DRAWN	JFB	HORIZONTAL
CHECKED	UB	0 0.5 1.0 1.5 2.0
APPROVED	JGR	VERTICAL

NEPEAN
SOUTH MERIVALE BUSINESS PARK
AS-BUILTS
PLAN AND PROFILE (LEIKIN DRIVE)
STREET A - STATION 1+275 TO 1+575
9403-P2

PROJECT No. 9403
FIELD BOOK
DATE JANUARY 1996
DRAWING No. 9403-P2

NOTE:
THE POSITION OF ALL POLE LINES, CONDUITS, WATERMAINS,
SEWERS AND OTHER UNDERGROUND AND OVERGROUND
UTILITIES AND STRUCTURES IS NOT NECESSARILY
SHOWN ON THE CONTRACT DRAWINGS, AND WHERE
SHOWN, THE ACCURACY OF THE POSITION OF SUCH
UTILITIES AND STRUCTURES IS NOT GUARANTEED.
BEFORE STARTING WORK, DETERMINE THE EXACT
LOCATION OF ALL SUCH UTILITIES AND STRUCTURES
AND ASSUME ALL LIABILITY FOR DAMAGE TO THEM.

EX. STORM MANHOLE DATA

No.	STATION	TYPE	EXISTING T.O. ELEVATION	PROPOSED T.O. ELEVATION
114	4+003.0	650x2400 M6	89.88	89.88
131	4+034.1	650x2400 M6	89.52	89.54
132	4+062.79	650x2400 M6	89.42	89.35
133	4+122.74	650x2400 M6	89.26	89.41
134	4+235.69	2400x2400 M8	89.27	89.94

EX. SANITARY MANHOLE DATA

No.	STATION	TYPE	EXISTING T.O. ELEVATION	PROPOSED T.O. ELEVATION
14	4+000	1200x200 M4	89.96	89.96
3	4+032.25	1200x OPSD 701.0	89.62	89.62
32	4+062.32	1200x OPSD 701.0	89.45	89.48
33	4+102.25	1200x OPSD 701.0	89.45	89.48
34	4+234.19	1200x OPSD 701.0	89.37	89.04
NH 4		300P OPSD 1003.0M		

CURVE DATA

Δ	44°08'47"
R	100.00m
T	40.50m
L	76.96m

STREET 'C' DATA

SERVICE	STATION	TYPE	ELEVATION
STORM STUB	4+066.02	CONC CL 65.0	85.20 NV
SANITARY STUB	4+066.02	PVC DR 35	84.32 NV
WATERMAIN STUB	4+066.02	PVC CL 150	86.69 T/WM
			86.94

CATCH BASIN DATA

No.	STATION	OUTLET INVERT ELEVATION	INLET INVERT ELEVATION	ICD ELEVATION	ICD TYPE
30	4+100	87.97			
31	4+100	87.83	87.86	87.93	B
32	4+240	87.55	87.58	87.65	B
122	4+240	87.70			

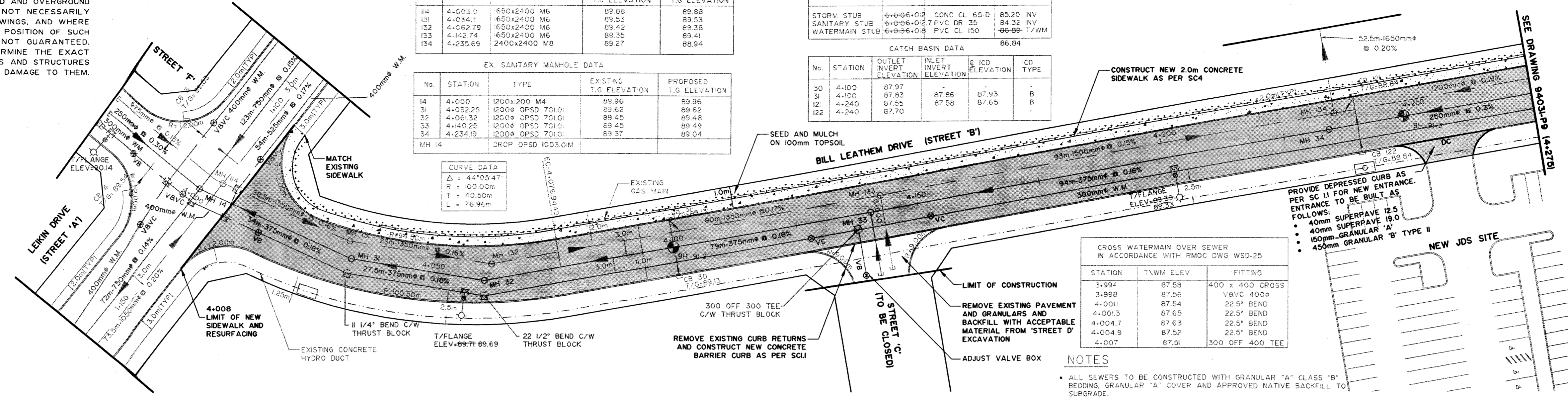

CROSS WATERMAIN OVER SEWER IN ACCORDANCE WITH R.M.O.C. DWG WSD-25

STATION	T.W.M. ELEV.	FITTING
3+994	87.58	400 x 400 CROSS
3+988	87.56	V8VC 400P
4+001	87.54	22.5" BEND
4+003	87.65	22.5" BEND
4+004.7	87.63	22.5" BEND
4+004.9	87.52	22.5" BEND
4+007	87.54	300 OFF 400 TEE

NOTES

- ALL SEWERS TO BE CONSTRUCTED WITH GRANULAR "A" CLASS "B" BEDDING, GRANULAR "A" COVER AND APPROVED NATIVE BACKFILL TO SUBGRADE.
- ROAD REINSTATEMENT TO BE AS FOLLOWS:
STREET A 40mm HL 4
45mm HL 8
150mm GRANULAR "A"
600mm GRANULAR "B"
- STREET B 50mm HL 4
150mm GRANULAR "A"
550mm GRANULAR "B"

- SURFACE TREATMENTS**
- ASPHALT
 - CONCRETE
 - SEED AND MULCH ON 100mm TOPSOIL
- BOREHOLE LEGEND**
- SILTY CLAY
 - CLAYEY SILT
 - GLACIAL TILL
- BOREHOLE DATA FROM FONDEX LTD. REPORT NO. 0-A756-A, NOVEMBER, 1991

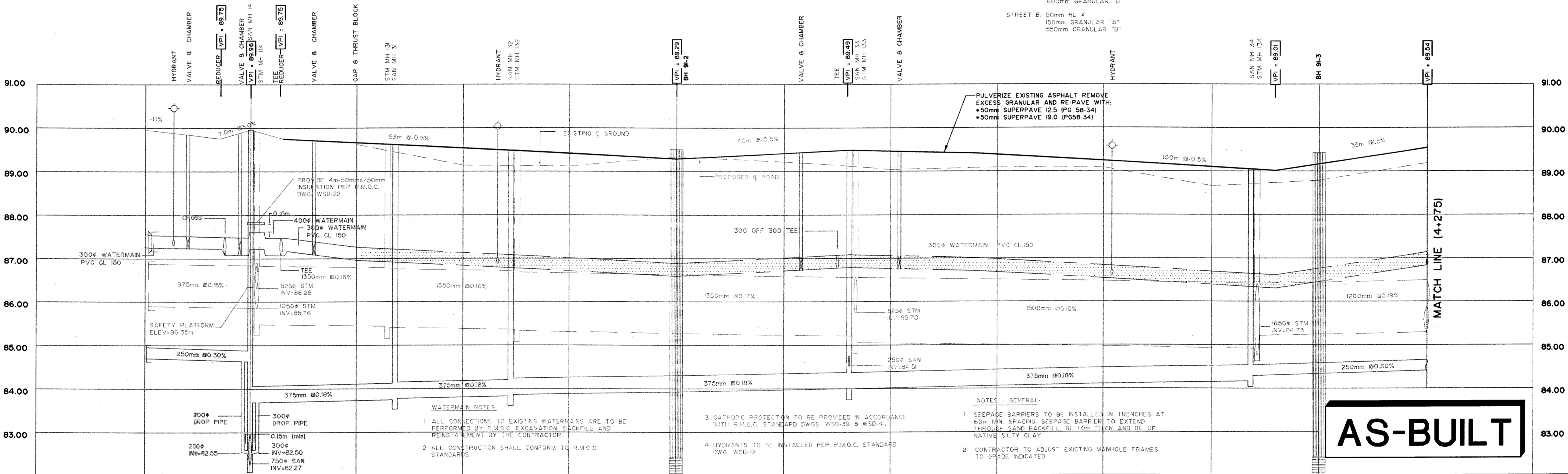

AS-BUILT

CH. ROAD ELEVATION	TOP OF WATERMAIN ELEVATION	STORM SEWER INVERT	SANITARY SEWER INVERT	EXISTING C.R.O.W. ELEVATION	CHAINAGE
89.54	87.53	85.88	84.44	89.95	3+975
89.66	87.50	85.86	84.35	89.76	3+976
89.65	87.44	85.85	84.36	89.75	3+978
89.75	87.44	85.85	84.36	89.75	3+981
89.75	87.44	85.85	84.36	89.75	3+985
89.75	87.44	85.85	84.36	89.75	3+994
89.75	87.44	85.85	84.36	89.75	3+994
89.75	87.44	85.85	84.36	89.75	3+994
89.75	87.44	85.85	84.36	89.75	4+003
89.75	87.44	85.85	84.36	89.75	4+007
89.66	87.25	85.85	84.36	89.62	4+025
89.54	87.12	85.85	84.36	89.42	4+032.25
89.41	87.03	85.85	84.36	89.12	4+034.1
89.41	87.03	85.85	84.36	89.12	4+062.79
89.29	86.97	85.85	84.36	89.34	4+100
89.41	86.97	85.85	84.36	89.34	4+122.74
89.41	86.97	85.85	84.36	89.34	4+185
89.41	86.97	85.85	84.36	89.34	4+175
89.41	86.97	85.85	84.36	89.34	4+180
89.41	86.97	85.85	84.36	89.34	4+185
89.41	86.97	85.85	84.36	89.34	4+200
89.41	86.97	85.85	84.36	89.34	4+202
89.41	86.97	85.85	84.36	89.34	4+220
89.41	86.97	85.85	84.36	89.34	4+225
89.41	86.97	85.85	84.36	89.34	4+235.69
89.41	86.97	85.85	84.36	89.34	4+240
89.41	86.97	85.85	84.36	89.34	4+245.2
89.41	86.97	85.85	84.36	89.34	4+250
89.41	86.97	85.85	84.36	89.34	4+255
89.54	87.17	85.85	84.36	89.19	4+275

23	AS-BUILT	FEB 6/08	DHI	No.	REVISION	DATE	BY	8	REVISED AS PER R.M.O.C. COMMENTS	JUNE 01/92	JFB
22	ISSUED FOR CONSTRUCTION SIDEWALK & NEW PAVEMENT	JUL 20/07	DHI	15	STREET NAMES ADDED	FEB 27/95	AR	7	WATERMAIN OFFSET 4.0m	APR 20/92	UB
21	ISSUED AS PART OF WATER PERMIT, ST. D	JUL 13/07	DHI	14	CB 30/31 - NOTES - AS BUILT	FEB 13/95	AR	6	REVISED AS PER NEPEAN COMMENTS	FEB 14/92	SG
20	ISSUED FOR TENDER	JUN 25/07	RSC	13	REVISIONS AS PER CITY OF NEPEAN	NOV 22/94	AR	5	REVISED AS PER NEPEAN COMMENTS	FEB 3/92	SG
19	GENERAL REVISIONS/ISSUED TO CITY OF OTTAWA	JUN 12/07	RSC	12	REVISIONS - CONTRACT 1994	AUG 10/94	AR	4	REVISED AS PER R.M.O.C. COMMENTS	JAN 17/92	SG
18	ISSUED TO THE CITY OF NEPEAN	JAN 10/96	JFB	11	ISSUED FOR APPROVAL	JULY 22/94	AR	3	ISSUED FOR TENDER	JAN 15/92	SG
17	AS-BUILT SEWERS AND WATERMAIN	JAN 10/96	JFB	10	REVISED AS PER R.M.O.C. COMMENTS	NOV 20/92	JFB	2	REVISED AS PER R.M.O.C. COMMENTS	DEC 9/91	SG
16	ISSUED FOR TENDER	03.04.95	AR	9	ISSUED FOR M.O.E. APPROVAL	SEPT.17/92	UB	1	REVISED AS PER NEPEAN COMMENTS	NOV 28/91	SG

NOVATECH
ENGINEERING CONSULTANTS LTD.
ENGINEERS & PLANNERS
Suite 200, 240 Michael Cowpland Drive
Ottawa, Ontario, Canada
K2M 1P6
Telephone: (613) 254-9643
Facsimile: (613) 254-5867
Email: novanfo@novatech-eng.com

UB/JFB
SCALE
1:500
HORIZONTAL
1:50
VERTICAL

NEPEAN
SOUTH MERIVALE BUSINESS PARK
PLAN AND PROFILE (BILL LEATHAM DRIVE)
STREET B - STATION 3+975 TO 4+275

PROJECT No. 94031
FIELD BOOK
DATE JANUARY 1996
DRAWING No. 94031-P8

NOTE: THE POSITION OF ALL POLE LINES, CONDUITS, WATERMAINS, SEWERS AND OTHER UNDERGROUND UTILITIES AND STRUCTURES IS NOT NECESSARILY SHOWN ON THE CONTRACT DRAWINGS, AND WHERE SHOWN, THE ACCURACY OF THE POSITION OF SUCH UTILITIES AND STRUCTURES IS NOT GUARANTEED. BEFORE STARTING WORK, DETERMINE THE EXACT LOCATION OF ALL SUCH UTILITIES AND STRUCTURES AND ASSUME ALL LIABILITY FOR DAMAGE TO THEM.

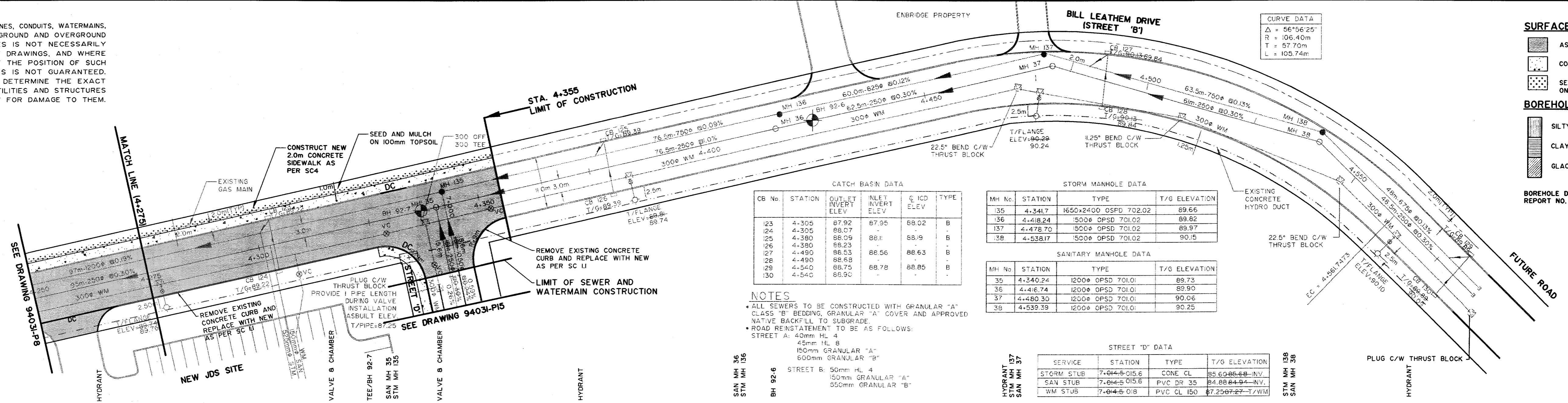

CURVE DATA

Δ	56°56'25"
R	106.40m
T	57.70m
L	105.74m

- SURFACE TREATMENTS**
- ASPHALT
 - CONCRETE
 - SEED AND MULCH ON 100mm TOPSOIL
- BOREHOLE LEGEND**
- SILTY CLAY
 - CLAYEY SILT
 - GLACIAL TILL
- BOREHOLE DATA FROM FONDEX LTD. REPORT NO. O-A756-A, NOVEMBER, 1991

CATCH BASIN DATA

CB No.	STATION	OUTLET INVERT ELEV.	INLET INVERT ELEV.	ICD ELEV.	TYPE
123	4-305	87.92	87.95	88.02	B
124	4-305	88.07	-	-	-
125	4-380	88.09	88.11	88.19	B
126	4-380	88.23	-	-	-
127	4-490	88.53	88.56	88.63	B
128	4-490	88.68	-	-	-
129	4-540	88.75	88.78	88.85	B
130	4-540	88.90	-	-	-

STORM MANHOLE DATA

MH No.	STATION	TYPE	T/G ELEVATION
135	4-341.7	1650x2400 OPSP 702.02	89.66
136	4-418.24	500# OPSP 701.02	89.82
137	4-478.70	500# OPSP 701.02	89.97
138	4-538.17	500# OPSP 701.02	90.15

SANITARY MANHOLE DATA

MH No.	STATION	TYPE	T/G ELEVATION
35	4-340.24	1200# OPSP 701.01	89.73
36	4-416.74	1200# OPSP 701.01	89.90
37	4-480.30	1200# OPSP 701.01	90.06
38	4-539.39	1200# OPSP 701.01	90.25

STREET 'D' DATA

SERVICE	STATION	TYPE	T/G ELEVATION
STORM STUB	7+044.8-015.6	CONE CL	85.000000-INV.
SAN STUB	7+044.5-015.6	PVC DR 35	84.888444-INV.
WM STUB	7+044.6-018	PVC CL 150	87.250727-T/W/M

NOTES

- ALL SEWERS TO BE CONSTRUCTED WITH GRANULAR "A" CLASS "B" BEDDING, GRANULAR "A" COVER AND APPROVED NATIVE BACKFILL TO SUBGRADE
- ROAD RESTATEMENT TO BE AS FOLLOWS:
STREET A: 40mm HL 4
45mm HL 8
150mm GRANULAR "A"
600mm GRANULAR "B"
- STREET B: 50mm HL 4
150mm GRANULAR "A"
550mm GRANULAR "B"

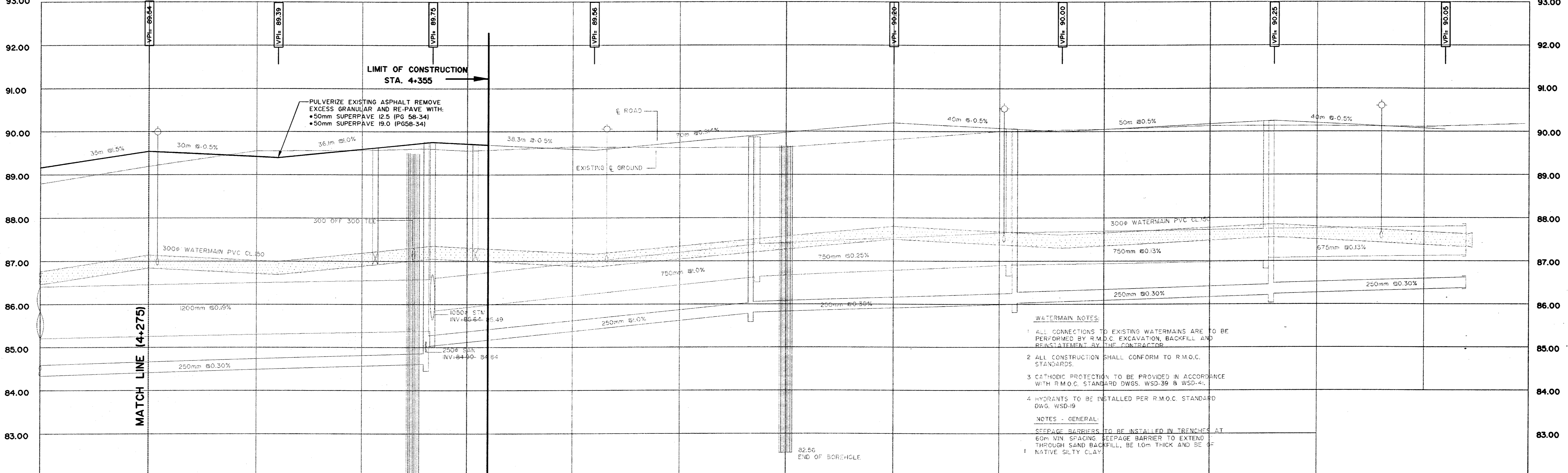

WATERMAIN NOTES

- ALL CONNECTIONS TO EXISTING WATERMAINS ARE TO BE PERFORMED BY R.M.O.C. EXCAVATION, BACKFILL AND RECONSTRUCTION BY THE CONTRACTOR.
- ALL CONSTRUCTION SHALL CONFORM TO R.M.O.C. STANDARDS.
- CATHODIC PROTECTION TO BE PROVIDED IN ACCORDANCE WITH R.M.O.C. STANDARD DWGS. WSD-39 & WSD-41.
- HYDRANTS TO BE INSTALLED PER R.M.O.C. STANDARD DWG. WSD-19.

NOTES - GENERAL

- SEEPAGE BARRIERS TO BE INSTALLED IN TRENCHES AT 60m MIN. SPACING. SEEPAGE BARRIER TO EXTEND THROUGH SAND BACKFILL, BE 1.0m THICK AND BE OF NATIVE SILTY CLAY.

Drawing: M:\AZ007\107045\CAD\design\asbuilt\94031P9.DWG Layout: PLOT_SETUP Updated: JUN 02, 2006 01:14:26m by: coram

ROAD ELEVATION	TOP OF WATERMAIN ELEVATION	STORM SEWER INVERT	SANITARY SEWER INVERT	EXISTING C.R.O.W. ELEVATION	CHAINAGE	C ROAD ELEVATION	TOP OF WATERMAIN ELEVATION	STORM SEWER INVERT	SANITARY SEWER INVERT	EXISTING C.R.O.W. ELEVATION	CHAINAGE
89.16	87.17	106.6m 97m-200# STM @ 0.15% CONC. CLASS 65 D	106.9m 95m-250# SAN @ 0.30% PVC DR 35	88.79	4+275 VPI 4+277 HYD	89.16	87.17	49.6m 66.6m-750# STM @ 0.13% CONC. CLASS 65 D	61.3m 46.6m-250# SAN @ 0.30% PVC DR 35	89.16	4+275 VPI
89.54	87.19			89.19	4+300 VPI	89.54	87.19			89.19	4+300 VPI
89.42	87.02			89.55	4+305 VPI	89.42	87.02			89.55	4+305 VPI
89.39	87.00			89.55	4+350 VPI	89.39	87.00			89.55	4+350 VPI
89.59	87.04			89.56	4+325 VPI	89.59	87.04			89.56	4+325 VPI
89.75	87.29			89.75	4+330.2 VBVC	89.75	87.29			89.75	4+330.2 VBVC
89.71	87.29			89.71	4+337.2 TEE/BH	89.71	87.29			89.71	4+337.2 TEE/BH
89.88	87.48			89.88	4+340.24 SAN	89.88	87.48			89.88	4+340.24 SAN
89.56	87.34			89.56	4+341.7 VPI/STM	89.56	87.34			89.56	4+341.7 VPI/STM
89.74	87.30			89.74	4+350 VPI	89.74	87.30			89.74	4+350 VPI
89.41	87.41			89.41	4+375 VPI	89.41	87.41			89.41	4+375 VPI
89.87	87.56			89.87	4+380 VPI	89.87	87.56			89.87	4+380 VPI
90.20	87.83			90.20	4+383 HYD	90.20	87.83			90.20	4+383 HYD
90.08	87.75			90.08	4+395	90.08	87.75			90.08	4+395
90.00	87.73			90.00	4+400	90.00	87.73			90.00	4+400
90.05	87.66			90.05	4+410	90.05	87.66			90.05	4+410
90.17	87.60			90.17	4+415.74 SAN	90.17	87.60			90.17	4+415.74 SAN
90.25	87.76			90.25	4+418.24 STM	90.25	87.76			90.25	4+418.24 STM
90.20	87.81			90.20	4+425 BH	90.20	87.81			90.20	4+425 BH
90.08	87.66			90.08	4+450 VPI	90.08	87.66			90.08	4+450 VPI
90.08	87.66			90.08	4+465	90.08	87.66			90.08	4+465
90.05	87.66			90.05	4+472 BEND	90.05	87.66			90.05	4+472 BEND
90.17	87.76			90.17	4+475 HYD	90.17	87.76			90.17	4+475 HYD
90.08	87.66			90.08	4+480 VPI	90.08	87.66			90.08	4+480 VPI
90.17	87.76			90.17	4+500 BEND 11.25°	90.17	87.76			90.17	4+500 BEND 11.25°
90.25	87.80			90.25	4+525	90.25	87.80			90.25	4+525
90.20	87.81			90.20	4+548 BEND	90.20	87.81			90.20	4+548 BEND
90.08	87.66			90.08	4+565 HYD	90.08	87.66			90.08	4+565 HYD
90.08	87.66			90.08	4+575	90.08	87.66			90.08	4+575
90.08	87.66			90.08	4+580 VPI	90.08	87.66			90.08	4+580 VPI
90.08	87.66			90.08	4+587.8 STM STUB	90.08	87.66			90.08	4+587.8 STM STUB
90.08	87.66			90.08	4+588 WM CL	90.08	87.66			90.08	4+588 WM CL

<p>NOVATECH ENGINEERING CONSULTANTS LTD. ENGINEERS & PLANNERS Suite 200, 240 Michael Cowpland Drive Ottawa, Ontario, Canada K2M 1P6 Telephone: (613) 254-9643 Facsimile: (613) 254-5867 Email: novainfo@novatech-eng.com</p>	DESIGN	UB/JFB	SCALE	PROJECT No.
	CHECKED	UB	1:500	94031
	DRAWN	JFB	0 5 10 15 20	FIELD BOOK
	CHECKED	UB	HORIZONTAL	DATE
APPROVED	JGR	0 0.5 1.0 1.5 2.0	VERTICAL	JANUARY 1996
<p>SOUTH MERIVALE BUSINESS PARK</p> <p>PLAN AND PROFILE (BILL LEATHAM DRIVE) STREET B - STATION 4+275 TO 4+600</p>				DRAWING No. 94031-P9

STORM MANHOLE DATA			
MH No.	STATION	TYPE	T/G ELEVATION
I35	6+997	1650x2400 M6	89.66
I58	7+108.52	1800# OPSD 701.010	90.02
I59	7+195.37	1800# OPSD 701.010	89.94
I60	7+242.52	1800# OPSD 701.010	89.98

SANITARY MANHOLE DATA			
MH No.	STATION	TYPE	T/G ELEVATION
35	7+000	1200# OPSD 701.010	89.73
58	7+110	1200# OPSD 701.010	89.97
59	7+196.96	1200# OPSD 701.010	89.98
60	7+241.20	1200# OPSD 701.010	90.02

CATCH BASIN DATA								
MH No.	STATION	OFFSET (m)	OUTLET INVERT ELEV	INLET INVERT ELEV	ICD ELEV	TYPE	STRUCTURE TYPE	COVER
I52	7+075	5.5 LT	88.25	88.35	88.35	B	OPSD-705.010	S22.S23
I53	7+075	5.5 RT	88.47	-	-	-	OPSD-705.010	S19
I54	7+145	5.5 LT	88.30	88.40	88.40	B	OPSD-705.010	S22.S23
I55	7+145	5.5 RT	88.52	-	-	-	OPSD-705.010	S22.S23
I56	7+215	5.5 LT	88.24	-	-	-	OPSD-705.010	S19
I57	7+215	5.5 RT	88.47	-	- </tr			

WATERMAIN DATA		
STATION	T/WM ELEV.	FITTING
7+019	87.28	COUPLING
7+041	87.51	HYDRANT
7+124	87.57	HYDRANT
7+188	87.56	VALVE & CHAMBER
7+196.96	87.61	11.25° HORIZONTAL BEND
7+206	87.58	HYDRANT
7+242	87.62	22.5° HORIZONTAL BEND
7+247.5	87.57	CAP

WATERMAIN NOTES:

- ALL CONNECTIONS TO EXISTING WATERMAINS ARE TO BE PERFORMED BY CITY OF OTTAWA FORCES. EXCAVATION, BACKFILL AND REINSTATEMENT BY THE CONTRACTOR.
- ALL CONSTRUCTION SHALL CONFORM TO CITY OF OTTAWA STANDARDS.
- CATHODIC PROTECTION TO BE PROVIDED IN ACCORDANCE WITH CITY OF OTTAWA STANDARD DWGS. W40 AND W42.
- HYDRANTS TO BE INSTALLED PER CITY OF OTTAWA STANDARD DWG. W19.
- SEEPAGE BARRIERS TO BE INSTALLED IN TRENCHES AT 60m MIN. SPACING. SEEPAGE BARRIER TO EXTEND THROUGH SAND BACKFILL, BE 10m THICK AND BE OF NATIVE SILTY CLAY.

SURFACE TREATMENTS

- ASPHALT
- GRANULAR
- SEED AND MULCH ON 100mm TOPSOIL
- CONCRETE

BOREHOLE LEGEND

- SILTY CLAY
- CLAYEY SILT
- GLACIAL TILL

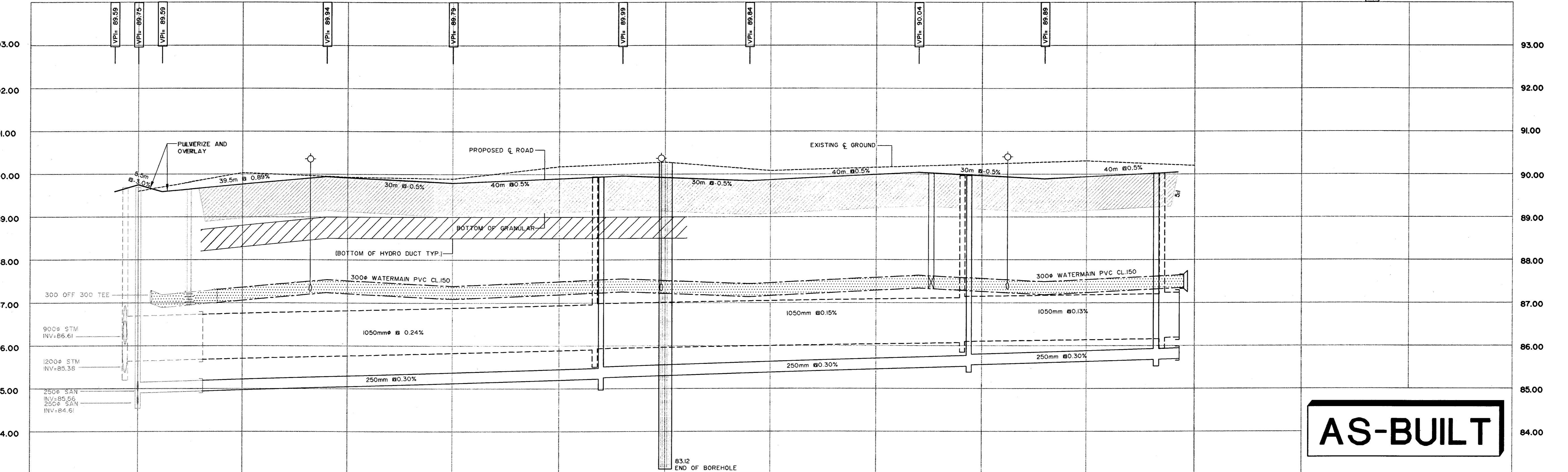
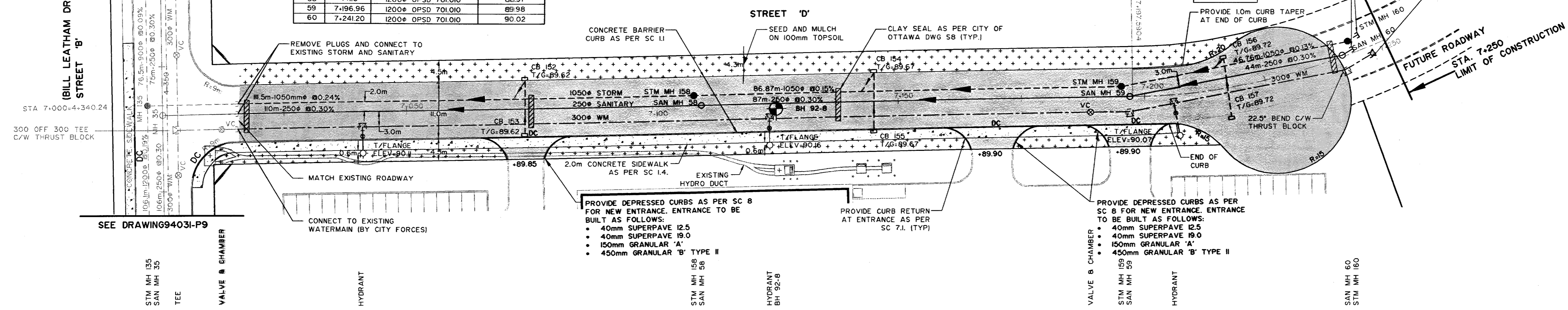

AS-BUILT

ROAD ELEVATION	TOP OF WATERMAIN ELEVATION	STORM SEWER INVERT	SANITARY SEWER INVERT	EXISTING C.R.O.W. ELEVATION	CHAINAGE
89.59					6+994.5 VPI
89.75	87.49	86.64	84.90	89.60	6+997 STM VPI/25M
89.59	87.19				7+000 VPI/25M
	87.25				7+005 VPI
	87.26				7+012 V8VC
89.71	87.37			90.03	7+019
		93.0-1200# STM @0.24% CONC. CLASS III	94-250# SAN @0.30% PVC SDR 35		7+025
	87.51				7+041 HYD VPI
	87.52				7+045
	87.52			89.93	7+050
89.79	87.30				7+075 VPI
					7+100
89.92	87.48			90.16	7+105 STM SAN
		86.75	85.15		7+110
	87.52				7+115 VPI
89.99	87.57			90.28	7+124 HYD BH
	87.57				7+125
		86.87m-1050# STM @0.15% CONC. CLASS III	87m-250# SAN @0.3% PVC SDR 35		7+145 VPI
	87.45				7+150
	87.47			90.08	7+175
					7+185 VPI
89.99	87.52			90.97	7+188 V8VC
	87.54				7+195.37 STM SAN/BEND
	87.56				7+200
	87.61	86.01	85.43	90.30	7+206 HYD
	87.57				7+215 VPI
	87.58				7+225
	87.54			90.31	7+242 SAN/BEND
	87.54				7+242.52 STM
		46.76m-1050# STM @0.13% CONC. CLASS III	44m-250# SAN @0.30% PVC SDR 35		7+247.5 CAP
	87.62	86.12	85.65	90.20	7+250
	87.57	86.20	85.72		
90.06	87.57				

NOTE: THE POSITION OF ALL POLE LINES, CONDUITS, WATERMAINS, SEWERS AND OTHER UNDERGROUND AND OVERGROUND UTILITIES AND STRUCTURES IS NOT NECESSARILY SHOWN ON THE CONTRACT DRAWINGS, AND WHERE SHOWN, THE ACCURACY OF THE POSITION OF SUCH UTILITIES AND STRUCTURES IS NOT GUARANTEED. BEFORE STARTING WORK, DETERMINE THE EXACT LOCATION OF ALL SUCH UTILITIES AND STRUCTURES AND ASSUME ALL LIABILITY FOR DAMAGE TO THEM.

No.	REVISION	DATE	BY	No.	REVISION	DATE	BY
7	ISSUED TO HYDRO OTTAWA			APR 20/07	RSC		
6	ISSUED TO HYDRO OTTAWA			FEB 27/07	RSC		
5	ISSUED TO THE CITY OF NEPEAN	FEB 6/08	DHI	JAN 10/96	JFB		
4	REVISIONS TO ROAD GRADES	JULY 20/07	DHI	13.7.94	AR		
3	REVISED AS PER R.M.O.C. COMMENTS	JULY 13/07	DHI	01.11.92	JFB		
2	ISSUED FOR M.O.E. APPROVAL	JUNE 25/07	RSC	17.09.92	UB		
1	REVISED AS PER R.M.O.C. COMMENTS	JUNE 12/07	RSC	01.06.92	JFB		

R.S. CEBRYK
PROVINCE OF ONTARIO

NOVATECH
ENGINEERING CONSULTANTS LTD.
ENGINEERS & PLANNERS
Suite 200, 240 Michael Cowpland Drive
Ottawa, Ontario, Canada
K2M 1P1
Telephone: (613) 254-9643
Facsimile: (613) 254-5867
Email: novinfo@novatech-eng.com

DESIGN: UB/JFB
CHECKED: UB
DRAWN: JFB
CHECKED: UB
APPROVED: JGR

SCALE: 1:500
HORIZONTAL: 1:50
VERTICAL: 1:20

PROJECT No. 94031
FIELD BOOK
DATE: JANUARY 1996
DRAWING No. 94031-P15

D:\107075\CAD\design\asbuilt\94031\5.DWG, PLOT SETUP: 6/22/2008 5:19:46 AM, coram_xerox EQ m\hr.pcs, A1, 11

14160

Canada Post Corporation - 50 Leikin Drive
DEVELOPMENT SERVICING STUDY CHECKLIST

REFERENCED STUDIES AND REPORTS	REFERENCE
Site Servicing Report for Canada Post Corporation, 50 Leikin Drive (J.L. Richards & Associates Limited, Revision 1 dated June 16, 2023)	SSR
Geotechnical Investigation Report, Proposed CPC Processing Centre, 50 Leikin Drive - Ottawa, Ontario Report Number (WSP) - OESA02132, dated December 2, 2022	GEO1
Geotechnical Investigation Factual Report – Revision 3, Proposed CPC Processing Centre, 50 Leikin Drive - Ottawa, Ontario Report Number (WSP) - OESA02132, dated June 13, 2023	GEO2
Stormwater Management Report, South Merivale Business Park – City of Nepean, Novatech Engineering Consultants, dated November 1, 1991 (Revised December 3, 1991)	NOV1
Services Design Report, South Merivale Business Park Phase II and III – City of Nepean, Novatech Engineering Consultants, dated June 23, 1992	NOV2

4.1	GENERAL CONTENT	REFERENCE
<input type="checkbox"/>	Executive Summary (for larger reports only).	N/A
<input checked="" type="checkbox"/>	Date and revision number of the report.	SSR (Title Page)
<input checked="" type="checkbox"/>	Location map and plan showing municipal address, boundary, and layout of proposed development.	SSR (Figure 1)
<input checked="" type="checkbox"/>	Plan showing the site and location of all existing services.	SSR (Figure 2, Appendix A)
<input checked="" type="checkbox"/>	Development statistics, land use, density, adherence to zoning and official plan, and reference to applicable subwatershed and watershed plans that provide context to which individual developments must adhere.	SSR (Sect. 1.2)
<input checked="" type="checkbox"/>	Summary of Pre-consultation Meetings with City and other approval agencies.	SSR (Appendix A)
<input checked="" type="checkbox"/>	Reference and confirm conformance to higher level studies and reports (Master Servicing Studies, Environmental Assessments, Community Design Plans), or in the case where it is not in conformance, the proponent must provide justification and develop a defensible design criteria.	SSR (4.0)
<input checked="" type="checkbox"/>	Statement of objectives and servicing criteria.	SSR (Sect. 2.1, 3.1, 3.2, 4.1, 4.2)

<input checked="" type="checkbox"/>	Identification of existing and proposed infrastructure available in the immediate area.	SSR (Sect. 1.3, 1.4)
<input type="checkbox"/>	Identification of Environmentally Significant Areas, watercourses and Municipal Drains potentially impacted by the proposed development (Reference can be made to the Natural Heritage Studies, if available).	N/A
<input checked="" type="checkbox"/>	Concept level master grading plan to confirm existing and proposed grades in the development. This is required to confirm the feasibility of proposed stormwater management and drainage, soil removal and fill constraints, and potential impacts to neighbouring properties. This is also required to confirm that the proposed grading will not impede existing major system flow paths.	Grading Plan (G1) Ponding Plans (SWM) Drainage Plan (DST)
<input type="checkbox"/>	Identification of potential impacts of proposed piped services on private services (such as wells and septic fields on adjacent lands) and mitigation required to address potential impacts.	N/A
<input type="checkbox"/>	Proposed phasing of the development, if applicable.	N/A
<input checked="" type="checkbox"/>	Reference to geotechnical studies and recommendations concerning servicing.	GEO1, GEO2
<input checked="" type="checkbox"/>	All preliminary and formal site plan submissions should have the following information: <ul style="list-style-type: none"> ▪ Metric scale ▪ North arrow (including construction North) ▪ Key plan ▪ Name and contact information of applicant and property owner ▪ Property limits, including bearings and dimensions ▪ Existing and proposed structures and parking areas ▪ Easements, road widening and rights-of-way ▪ Adjacent street names 	All Drawings

4.2	DEVELOPMENT SERVICING REPORT: WATER	REFERENCE
<input checked="" type="checkbox"/>	Confirm consistency with Master Servicing Study, if available.	NOV2
<input checked="" type="checkbox"/>	Availability of public infrastructure to service proposed development.	SSR (Sect. 1.4, 2.4) Site Servicing Plan (S1)
<input checked="" type="checkbox"/>	Identification of system constraints.	SSR (Sect. 2.0)
<input checked="" type="checkbox"/>	Identify boundary conditions.	SSR (Sect. 2.4)
<input checked="" type="checkbox"/>	Confirmation of adequate domestic supply and pressure.	SSR (Sect. 2.5, Appendix B)
<input checked="" type="checkbox"/>	Confirmation of adequate fire flow protection and confirmation that fire flow is calculated as per the Fire Underwriter's Survey. Output should show available fire flow at locations throughout the development.	SSR (Sect. 2.4, 2.5, Appendix B)
<input checked="" type="checkbox"/>	Provide a check of high pressures. If pressure is found to be high, an assessment is required to confirm the application of pressure reducing valves.	SSR (Sect. 2.5)

<input type="checkbox"/>	Definition of phasing constraints. Hydraulic modelling is required to confirm servicing for all defined phases of the project, including the ultimate design.	N/A
<input checked="" type="checkbox"/>	Address reliability requirements, such as appropriate location of shutoff valves.	Site Servicing Plan (S1)
<input checked="" type="checkbox"/>	Check on the necessity of a pressure zone boundary modification.	SSR (2.4)
<input checked="" type="checkbox"/>	Reference to water supply analysis to show that major infrastructure is capable of delivering sufficient water for the proposed land use. This includes data that shows that the expected demands under average day, peak hour and fire flow conditions provide water within the required pressure range.	SSR (Sect. 2.0)
<input checked="" type="checkbox"/>	Description of the proposed water distribution network, including locations of proposed connections to the existing system, provisions for necessary looping, and appurtenances (valves, pressure reducing valves, valve chambers, and fire hydrants), including special metering provisions.	SSR (Sect. 2.0) Site Servicing Plan (S1)
<input type="checkbox"/>	Description of off-site required feeder mains, booster pumping stations, and other water infrastructure that will be ultimately required to service proposed development, including financing, interim facilities, and timing of implementation.	N/A
<input checked="" type="checkbox"/>	Confirmation that water demands are calculated based on the City of Ottawa Design Guidelines.	SSR (Sect. 2.2)
<input checked="" type="checkbox"/>	Provision of a model schematic showing the boundary conditions locations, streets, parcels, and building locations for reference.	SSR (Appendix B Hazen-Williams Calculations)

4.3	DEVELOPMENT SERVICING REPORT: WASTEWATER	REFERENCE
<input checked="" type="checkbox"/>	Summary of proposed design criteria (Note: Wet weather flow criteria should not deviate from the City of Ottawa Sewer Design Guidelines. Monitored flow data from relatively new infrastructure cannot be used to justify capacity requirements for proposed infrastructure).	SSR (Sect. 3.2)
<input checked="" type="checkbox"/>	Confirm consistency with Master Servicing Study and/or justifications for deviations.	SSR (Sect. 3.0)
<input type="checkbox"/>	Consideration of local conditions that may contribute to extraneous flows that are higher than the recommended flows in the Guidelines. This includes groundwater and soil conditions, and age and condition of sewers.	N/A
<input checked="" type="checkbox"/>	Description of existing sanitary sewer available for discharge of wastewater from proposed development.	SSR (Sect. 1.4, 3.1, Appendix C)

<input checked="" type="checkbox"/>	Verify available capacity in downstream sanitary sewer and/or identification of upgrades necessary to service the proposed development. (Reference can be made to previously completed Master Servicing Study if applicable.)	SSR (Sect. 3.3)
<input checked="" type="checkbox"/>	Calculations related to dry weather and wet weather flow rates from the development in standard MOE sanitary sewer design table (Appendix 'C') format.	SSR (Appendix C)
<input checked="" type="checkbox"/>	Description of proposed sewer network, including sewers, pumping stations and forcemains.	SSR (Sect. 3.4, Appendix C)
<input checked="" type="checkbox"/>	Discussion of previously identified environmental constraints and impact on servicing (environmental constraints are related to limitations imposed on the development in order to preserve the physical condition of watercourses, vegetation, soil cover, as well as protecting against water quantity and quality).	NOV2
<input type="checkbox"/>	Pumping stations: impacts of proposed development on existing pumping stations or requirements for new pumping station to service development.	N/A
<input type="checkbox"/>	Forcemain capacity in terms of operational redundancy, surge pressure and maximum flow velocity.	N/A
<input type="checkbox"/>	Identification and implementation of the emergency overflow from sanitary pumping stations in relation to the hydraulic grade line to protect against basement flooding.	N/A
<input type="checkbox"/>	Special considerations, such as contamination, corrosive environment, etc.	N/A

4.4	DEVELOPMENT SERVICING REPORT: STORMWATER	REFERENCE
<input checked="" type="checkbox"/>	Description of drainage outlets and downstream constraints, including legality of outlets (i.e., municipal drain, right-of-way, watercourse, or private property).	SSR (Sect. 4.0)
<input checked="" type="checkbox"/>	Analysis of available capacity in existing public infrastructure.	SSR (Sect. 1.3)
<input checked="" type="checkbox"/>	A drawing showing the subject lands, its surroundings, the receiving watercourse, existing drainage patterns, and proposed drainage pattern.	Drainage Plan (DST)
<input checked="" type="checkbox"/>	Water quantity control objective (e.g. controlling post-development peak flows to pre-development level for storm events ranging from the 2 or 5 year event (dependent on the receiving sewer design) to 100 year return period); if other objectives are being applied, a rationale must be included with reference to hydrologic analyses of the potentially affected sub watersheds, taking into account long-term cumulative effects.	SSR (Sect. 4.2, 4.3)

<input checked="" type="checkbox"/>	Water Quality control objective (basic, normal or enhanced level of protection based on the sensitivities of the receiving watercourse) and storage requirements.	SSR (Sect. 4.4)
<input checked="" type="checkbox"/>	Description of the stormwater management concept with facility locations and descriptions with references and supporting information.	SSR (Sect. 4) S1, DST
<input type="checkbox"/>	Setback from private sewage disposal systems.	N/A
<input type="checkbox"/>	Watercourse and hazard lands setbacks.	N/A
<input checked="" type="checkbox"/>	Record of pre-consultation with the Ontario Ministry of Environment and the Conservation Authority that has jurisdiction on the affected watershed.	MECP Contacted Conservation Authority Not Required
<input checked="" type="checkbox"/>	Confirm consistency with subwatershed and Master Servicing Study, if applicable study exists.	NOV1
<input checked="" type="checkbox"/>	Storage requirements (complete with calculations) and conveyance capacity for minor events (1:2 year return period) and major events (1:100 year return period).	SSR (Sect. 4, Appendix E)
<input type="checkbox"/>	Identification of watercourses within the proposed development and how watercourses will be protected, or, if necessary, altered by the proposed development with applicable approvals.	N/A
<input checked="" type="checkbox"/>	Calculate pre- and post-development peak flow rates, including a description of existing site conditions and proposed impervious areas and drainage catchments in comparison to existing conditions.	SSR (Sect. 4, Appendix E)
<input type="checkbox"/>	Any proposed diversion of drainage catchment areas from one outlet to another.	N/A
<input checked="" type="checkbox"/>	Proposed minor and major systems, including locations and sizes of stormwater trunk sewers, and stormwater management facilities.	Site Servicing Plan (S1) Ponding Plans (SWM) Appendix E
<input type="checkbox"/>	If quantity control is not proposed, demonstration that downstream system has adequate capacity for the post-development flows up to and including the 100-year return period storm event.	N/A
<input checked="" type="checkbox"/>	Identification of potential impacts to receiving watercourses.	SSR (Sect 4.0)
<input type="checkbox"/>	Identification of municipal drains and related approval requirements.	N/A
<input checked="" type="checkbox"/>	Description of how the conveyance and storage capacity will be achieved for the development.	SSR (Sect. 4.3)
<input checked="" type="checkbox"/>	100 year flood levels and major flow routing to protect proposed development from flooding for establishing minimum building elevations (MBE) and overall grading.	SSR (Sect. 4.3) Site Servicing Plan (S1) Ponding Plans (SWM) Appendix E

<input checked="" type="checkbox"/>	Inclusion of hydraulic analysis, including hydraulic grade line elevations.	SSR (Sect. 4.3, Appendix E)
<input checked="" type="checkbox"/>	Description of approach to erosion and sediment control during construction for the protection of receiving watercourse or drainage corridors.	SSR (Sect. 5.0) Grading and Erosion & Sediment Control Plan (G1)
<input type="checkbox"/>	Identification of floodplains – proponent to obtain relevant floodplain information from the appropriate Conservation Authority. The proponent may be required to delineate floodplain elevations to the satisfaction of the Conservation Authority if such information is not available or if information does not match current conditions.	N/A
<input checked="" type="checkbox"/>	Identification of fill constraints related to floodplain and geotechnical investigation.	GEO1 and GEO2

4.5	APPROVAL AND PERMIT REQUIREMENTS	REFERENCE
The Servicing Study shall provide a list of applicable permits and regulatory approvals necessary for the proposed development, as well as the relevant issues affecting such approval. The approval and permitting shall include but not be limited to the following:		
<input type="checkbox"/>	Conservation Authority as the designated approval agency for modification of floodplain, potential impact on fish habitat, proposed works in or adjacent to a watercourse, cut/fill permits and Approval under Lakes and Rivers Improvement Act. The Conservation Authority is not the approval authority for the Lakes and Rivers Improvement Act. Where there are Conservation Authority regulations in place, approval under the Lakes and Rivers Improvement Act is not required, except in cases of dams, as defined in the Act.	N/A
<input type="checkbox"/>	Application for Environmental Compliance Approval (ECA) under the Ontario Water Resources Act.	N/A
<input type="checkbox"/>	Changes to Municipal Drains.	N/A
<input type="checkbox"/>	Other permits (National Capital Commission, Parks Canada, Public Works and Government Services Canada, Ministry of Transportation, etc.).	N/A

4.6	CONCLUSION CHECKLIST	REFERENCE
<input checked="" type="checkbox"/>	Clearly stated conclusions and recommendations.	SSR (Sect. 3.4, 4.5)
<input type="checkbox"/>	Comments received from review agencies, including the City of Ottawa and information on how the comments were addressed. Final sign-off from the responsible reviewing agency.	N/A
<input checked="" type="checkbox"/>	All draft and final reports shall be signed and stamped by a Professional Engineer registered in Ontario.	SSR, Drawings

Annie Williams

From: Diamond, Emily (MECP) <Emily.Diamond@ontario.ca>
Sent: July 26, 2023 2:05 PM
To: Annie Williams
Cc: Luc Frechette; Scheller, Ania; Allison Johns; Patrick Gehling; Lee Jablonski
Subject: RE: MECP Pre-Consult Meeting Notes for Canada Post Processing Centre

[CAUTION] This email originated from outside JLR. Do not click links or open attachments unless you recognize the sender and know the content is safe. Do not forward suspicious emails, if you are unsure, please send a separate message to Helpdesk.

Hi Annie,

Thank you for providing a summary of yesterday's meeting. I am in agreeance with what you have stated in your email.

The procedure for requesting expedited review is the following:

If you would like to request that your application be prioritized, please send an e-mail to enviropemissions@ontario.ca to make your request. To support your request, you should be prepared to provide by email/in writing:

- a) The reference number of the application
- b) The justification for prioritizing the application (e.g. environmental/health impacts, compliance related, infrastructure funding deadlines, etc.)
- c) The actual date by which you require the approval.

Every request to prioritize an application is given due consideration. The response to the request will come directly from the Client Services and Permissions Branch.

Please consider this a record of pre-consultation. If you have any further questions, please do not hesitate to reach out.

Thanks and have a great day,
Emily

Emily Diamond

Environmental Officer
Ministry of the Environment, Conservation and Parks
Ottawa District Office
2430 Don Reid Drive
Ottawa, Ontario, K1H 1E1
Cell: 613-866-0938
Fax: 613-521-5437
e-mail: emily.diamond@ontario.ca

From: Annie Williams <awilliams@jlrichards.ca>

Sent: July 26, 2023 12:20 PM

To: Diamond, Emily (MECP) <Emily.Diamond@ontario.ca>

Cc: Luc Frechette <Luc.Frechette@colliersprojectleaders.com>; Scheller, Ania <Ania.Scheller@colliersprojectleaders.com>; Allison Johns <ajohns@jlrichards.ca>; Patrick Gehling <pgehling@jlrichards.ca>; Lee Jablonski <ljablonski@jlrichards.ca>

Subject: MECP Pre-Consult Meeting Notes for Canada Post Processing Centre

CAUTION -- EXTERNAL E-MAIL - Do not click links or open attachments unless you recognize the sender.

Hi Emily,

This email is a summary of our pre-consult meeting with MECP on Tuesday July 25, 2023 in support of the proposed Canada Post Processing Centre in the City of Ottawa.

- An Environmental Compliance Approval (ECA) direct submission application is required for stormwater management (SWM) measures for this light industrial site
- The SWM measures include: minor system inlet control devices (ICDs), underground storage chambers, parking lot surface storage, rooftop storage, vernal pond, bioswales
- The City of Ottawa has approved discharging the site's stormwater to the existing Longfields/Davidson SWM Facility located just downstream of the site, which provides quality control
- The next step is to prepare and submit the ECA application and cheque
- Once submitted, it is expected to take approximately 1 week to receive the application reference number, at which time CPC can request expedited review from the Permissions Branch
- Emily will support CPC's request for expedited review
- Without expedited review, the approval could take 1 year
- Copy Emily with the ECA application submission
- Overall MECP has no concerns with this site and expects this will be a straight-forward application

Please confirm receipt of this email and advise of any errors or omissions.

Thank you,
Annie

Annie Williams, P.Eng.
Civil Engineer

J.L. Richards & Associates Limited
1000-343 Preston Street, Ottawa, ON K1S 1N4
Direct: 343-803-4523



Appendix B

Water

Water Demand Calculations
CPC Ottawa Processing Centre
(JLR 31940-000)

Light Industrial (Site Area)		
Area	8.97	ha
Average Day Consumption Rate	35000	L/ha/d
Average Day Demand	3.63	L/s
Maximum Day Peaking Factor	1.50	City of Ottawa
Maximum Day Demand	5.45	L/s
Peak Hour Peaking Factor	1.80	City of Ottawa
Peak Hour Demand	9.81	L/s

FUS Fire Flow Calculations

CPC Ottawa Processing Centre - Industrial Building (JLR 31940-000)

Step	Parameter	Value	Note
A	Type of Construction	Non-combustible	
	Coefficient (C)	0.8	
B	Ground Floor Area	23530	m ²
C	Height in storeys	1	storeys
	Total Floor Area	23530	m ²
D	Fire Flow Formula	F=220C√A	
	Fire Flow	26998	L/min
	Rounded Fire Flow	27000	L/min
E	Occupancy Class	Free Burning	Residential buildings have a limited combustible occupancy.
	Occupancy Charge	15%	
	Occupancy Increase or Decrease	4050	
	Fire Flow	31050	L/min
			No rounding applied.
F	Sprinkler Protection	Automatic Fully Supervised	
	Sprinkler Credit	-50%	
	Decrease for Sprinkler	-15525	L/min
G	<i>North Side Exposure</i>		
	Exposing Wall:	Wood Frame	
	Exposed Wall:	Wood Frame	
	Length of Exposed Wall:	0.0	m
	Height of Exposed Wall:	0	storeys
	Length-Height Factor	0.0	m-storeys
	Separation Distance	50	m
	North Side Exposure Charge	0%	
	<i>East Side Exposure</i>		
	Exposing Wall:	Wood Frame	
	Exposed Wall:	Wood Frame	
	Length of Exposed Wall:	0.0	m
	Height of Exposed Wall:	0	storeys
	Length-Height Factor	0.0	m-storeys
	Separation Distance	50	m
	East Side Exposure Charge	0%	
	<i>South Side Exposure</i>		
	Exposing Wall:	Wood Frame	
	Exposed Wall:	Wood Frame	
	Length of Exposed Wall:	0.0	m
	Height of Exposed Wall:	0	storeys
	Length-Height Factor	0.0	m-storeys
	Separation Distance	50	m
	South Side Exposure Charge	0%	
	<i>West Side Exposure</i>		
	Exposing Wall:	Wood Frame	
	Exposed Wall:	Wood Frame	
	Length of Exposed Wall:	0.0	m
Height of Exposed Wall:	0	storeys	
Length-Height Factor	0.0	m-storeys	
Separation Distance	50	m	
West Side Exposure Charge	0%		
Total Exposure Charge	0%		The total exposure charge is below the maximum value of 75%.
Increase for Exposures	0	L/min	
H	Fire Flow	15525	L/min
	Rounded Fire Flow	16000	L/min
City Cap	Required Fire Flow (RFF)	16000	L/min
		267	L/s

Fire Underwriters Survey (FUS) Fire Flow Calculations
 In accordance with City of Ottawa Technical Bulletin ISTB-2018-02 dated March 21, 2018

Boundary Conditions 50 Leikin Drive

Provided Information

Scenario	Demand	
	L/min	L/s
Average Daily Demand	218	3.63
Maximum Daily Demand	327	5.45
Peak Hour	589	9.81
Fire Flow Demand #1	16,020	267
Fire Flow Demand #2	16,980	283

Location



Results

Existing Condition (Pressure Zone 2W)

Connection 1 – Bill Leatham Dr.

Demand Scenario	Head (m)	Pressure ¹ (psi)
Maximum HGL	132.8	61.5
Peak Hour	125.0	50.5
Max Day plus Fire Flow #1	123.8	48.7
Max Day plus Fire Flow #2	123.2	47.9

¹ Ground Elevation = 89.5 m

Connection 2 - Leikin Dr. - Alternative Option for Connection

Demand Scenario	Head (m)	Pressure ¹ (psi)
Maximum HGL	132.7	60.3
Peak Hour	125.0	49.4
Max Day plus Fire Flow #1	124.8	49.1
Max Day plus Fire Flow #2	124.4	48.5

¹ Ground Elevation = 90.2 m

Future Condition (Pressure Zone SUC)

Connection 1 - Bill Leathem Dr.

Demand Scenario	Head (m)	Pressure ¹ (psi)
Maximum HGL	146.9	81.5
Peak Hour	144.0	77.5
Max Day plus Fire Flow #1	139.1	70.4
Max Day plus Fire Flow #2	138.4	69.5

¹ Ground Elevation = 89.5 m

Note Connection 1 on Bill Leathem Dr. will be converted to SUC zone for zone reconfiguration, this does not apply for connection 2.

Notes

1. As per the Ontario Building Code in areas that may be occupied, the static pressure at any fixture shall not exceed 552 kPa (80 psi.) Pressure control measures to be considered are as follows, in order of preference:
 - a. If possible, systems to be designed to residual pressures of 345 to 552 kPa (50 to 80 psi) in all occupied areas outside of the public right-of-way without special pressure control equipment.
 - b. Pressure reducing valves to be installed immediately downstream of the isolation valve in the home/ building, located downstream of the meter so it is owner maintained.

Disclaimer

The boundary condition information is based on current operation of the city water distribution system. The computer model simulation is based on the best information available at the time. The operation of the water distribution system can change on a regular basis, resulting in a variation in boundary conditions. The physical properties of watermains deteriorate over time, as such must be assumed in the absence of actual field test data. The variation in physical watermain properties can therefore alter the results of the computer model simulation. Fire Flow analysis is a reflection of available flow in the watermain; there may be additional restrictions that occur between the watermain and the hydrant that the model cannot take into account.

Demand Scenario (Calculated in April 2023)	Building
Average Day	3.63
Maximum Day	5.45
Required Fire Flow 1 (FUS)	267.00
Required Fire Flow 2 (FUS)	283.00
Peak Hour	9.81

Boundary Conditions (Email from City, May 3 2023):

Water Demand Scenario	Demand Building (L/s)	Head (m) on Bill Leatham Dr. Connection (Existing Condition)	Head (m) on Leikin Dr.
Peak Hour (per Apr. 2023 Demand Calculations)	9.81	125.00	125.00
Maximum HGL	0.00	132.80	132.70
Max Day + Fire Flow 1 (FUS) (per Apr. 2023 Demand Calculations)	267.00	123.80	124.80
Max Day + Fire Flow 2 (FUS) (per Apr. 2023 Demand Calculations)	283.00	123.20	124.40

Headloss Calculations (Hazen Williams Equation)

Hazen Williams equation (Mays, 1999; Streeter et al., 1998; Viessman and Hammer, 1993) where k=0.85 for meter and seconds units or 1.318 for feet and seconds units:

$$H = L \left[\frac{V}{kC} \left(\frac{A}{D} \right)^{0.63} \right]^{1/0.54} \quad V = \frac{Q}{A} \quad A = \frac{\pi}{4} D^2$$

Where,
 HL = Headloss (m)
 Q - Flow (m³/s)
 L - Length (m)
 C - Hazen Williams "C"
 D - Watermain Diameter (m)
 V - Velocity (m/s)
 A - Watermain Cross-Sectional Area (m²)

50 Leikin Dr. Headloss Calculations - Connection at Leikin Dr.

Water Demand Condition	Flow (Q) (L/s)	Flow (Q) (m ³ /s)	Length (m)	C	D (m)	V (m/s)	A (m ²)	Head Loss (m)	HGL (m)	Calculated HGL (m)	Elevation (m) of Building	Pressure @ Node			ODG 4.2.2 Requirement	Criteria Achieved?
												(m)	(kPa)	(psi)		
Peak Hour (400 mm Watermain Section)	9.81	0.010	130.84	100	0.393	0.081	0.121	0.005	125.000	124.995	91.00	33.995	333	48.4	276 kPa	Yes
Peak Hour (200 mm Service Lateral Section)	9.81	0.010	61.89	100	0.204	0.300	0.033	0.057	124.995	124.938	91.00	33.938	333	48.3	276 kPa	Yes
Peak Hour (150 mm Service Lateral Section)	9.81	0.010	35.31	100	0.155	0.520	0.019	0.125	124.938	124.813	91.00	33.813	332	48.1	276 kPa	Yes
Maximum HGL (400 mm Watermain Section)	0.00	0.000	130.84	100	0.393	0.000	0.121	0.000	132.700	132.700	91.00	41.700	409	59.3	552 kPa	Yes
Maximum HGL (200 mm Service Lateral Section)	0.00	0.000	61.89	100	0.204	0.000	0.033	0.000	132.700	132.700	91.00	41.700	409	59.3	552 kPa	Yes
Maximum HGL (150 mm Service Lateral)	0.00	0.000	35.31	100	0.155	0.000	0.019	0.000	132.700	132.700	91.00	41.700	409	59.3	552 kPa	Yes
Max Day + Sprinkler Flow + Hydrant (400 mm Watermain Section)	135.15	0.135	130.84	100	0.393	1.114	0.121	0.640	124.800	124.160	91.00	33.160	325	47.2	140 kPa	Yes
Max Day + Sprinkler Flow + Hydrant (200 mm Service Lateral, watermain to hydrant Tee)	135.15	0.135	61.89	100	0.204	4.135	0.033	7.380	124.160	116.780	91.00	25.780	253	36.7	140 kPa	Yes
Hydrant	95.00	0.095	32.47	100	0.155	5.035	0.019	7.681	116.780	109.099	91.00	18.099	178	25.8	140 kPa	Yes
Building	40.15	0.040	35.31	100	0.155	2.128	0.019	1.695	116.780	115.084	91.00	24.084	236	34.3	140 kPa	Yes

Appendix C

Sanitary



SANITARY DESIGN SHEET

Prepared By: TR
Checked By:

CANADA POST COROPORATION - OTTAWA PROCESSING CENTRE

JLR NO. 31940-000

Location			INDUSTRIAL			INFILTRATION			Plug Flow (L/s)	Total Peak Flow (L/s)	Sewer Data								Upstream Geometry				Downstream Geometry					
OUTLET	From MH	To MH	Total Area (ha)	Cum. Total Area (ha)	PEAK FLOW	Total Area (ha)	Cum. Total Area (ha)	PEAK FLOW			Type	Nominal Dia. (mm)	Actual Dia. (mm)	Slope	Length (m)	Q Full (L/s)	V Full (m/s)	Residual Capacity (L/s)	% Full	TG From	Obvert	Invert	Cover	TG To	Drop	Obvert	Invert	Cover
BILL LETHEM DRIVE	GATE HOUSE	MH20	3.30	3.30	5.75	3.30	3.30	1.09	4.00	10.84	PVC	200	203.20	1.00%	51.73	34.22	1.06	23.38	32%	90.33	88.66	88.46	1.67	89.65		88.14	87.94	1.51
BILL LETHEM DRIVE		MH20	0.52	3.82	6.65	0.52	3.82	1.26	4.00	11.91	PVC	200	203.20	0.32%	60.89	19.36	0.60	7.44	62%	89.65	88.14	87.94	1.51	89.61		87.95	87.74	1.66
BILL LETHEM DRIVE		MH40	0.78	4.60	8.01	0.78	4.60	1.52	4.00	13.53	PVC	200	203.20	0.32%	95.21	19.36	0.60	5.83	70%	89.61	87.95	87.74	1.66	89.70		87.64	87.44	2.06
BILL LETHEM DRIVE		MH21	0.36	4.96	8.64	0.36	4.96	1.64	4.00	14.28	PVC	200	203.20	0.57%	22.88	25.83	0.80	11.56	55%	89.70	87.64	87.44	2.06	89.87	0.600	87.51	87.31	2.36
BILL LETHEM DRIVE	BLDG	MH22	2.12	2.12	3.69	2.12	2.12	0.70		4.39	PVC	200	203.20	1.00%	2.20	34.22	1.06	29.82	13%	89.97	87.53	87.33	2.44	89.87	0.600	87.51	87.31	2.36
BILL LETHEM DRIVE		MH22	1.95	9.03	15.73	1.95	9.03	2.98	4.00	22.71	PVC	200	203.20	1.00%	48.91	34.22	1.06	11.51	66%	89.87	86.91	86.71	2.96	89.25	2.170	86.42	86.22	2.83

Design Parameters (Per OSDG)	
Manning's Coefficient =	0.013
Average Light Industrial Flow	35000 L/ha/day
Industrial Peaking Factor	4.3
Infiltration Rate	0.33 L/s/ha

Appendix D

Storm

Appendix E
Stormwater Management

50 Leikin Drive

Pre-development (Existing) Peak Flow Calculations

Guidance on Approach to Estimate Allowable Peak Flow and SWM Calculations:

- 1 Allowable peak flow shall be estimated based on a 1:2 year IDF and based on a C-Factor = 0.24.
- 2 Time of Concentration (Tc) of 15 minutes
- 3 Rooftop flows and Amenity Area Flows to be controlled and conveyed to the Bill Leathem Drive 1350 mm dia. Sewer
- 4 1:100 year post development flows to be limited to the allowable peak flow (1:2 year flow) by means of on-site retention measures
- 5 SWM calculations to be completed using the Modified Rational Method (MRM) for rooftop and at grade storage
- 6 MRM calculations to estimate cistern storage, to be estimated based on 50% of the peak flow rate per City requirement
- 7 All storm contributions to be released to storm sewers to be controlled by means of an inlet control device (ICD) or accounted as uncontrolled.

Total Area of Site: 90,708.88 m²

Allowable Release Rate Calculation

Area of site includes parts of Area 1 and Area 5

Total site area= 9.07 ha

Site in area 5= 4.57 ha

Site in area 1= 9.07 - 4.57 ha = 4.5 ha

The sites allowable release rate is based on a pre-development C-Factor of 0.24 being controlled to the 5-year design storm with a 15-minute time of concentration. See the report listed above for more details (equivalent of 54.5 L/s/ha).

Phase 1 site stormwater flows are limited to 38.8 L/s/ha

Allowable release rate for area 5= 4.57 ha * (54.8 L/s/ha) = 250 L/s

Allowable release rate for area 1= 4.5 ha * (38.8 L/s/ha) = 175 L/s

Allowable release rate for site = 250 + 175 L/s = 425 L/s

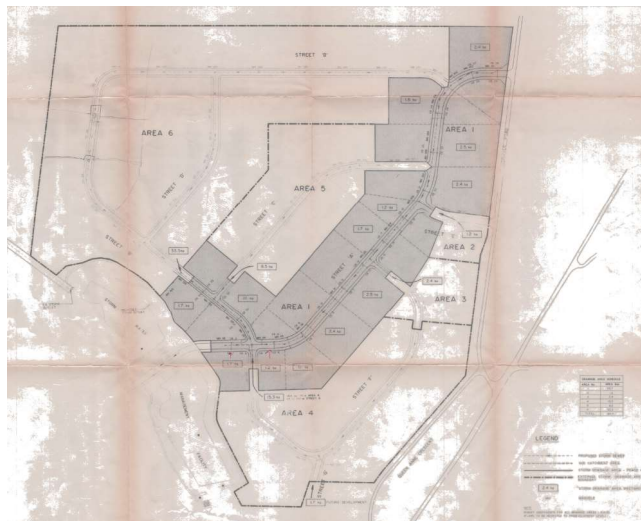

6.0 CONCLUSION

The following summarizes conclusions for the stormwater management for the SMBP.

1. An overall area release rate of 54.8 L/s/ha is permitted to the Longfield/Davidson Stormwater Management Facility.
2. Phase I stormwater flows are to be limited to 1293 L/s.
3. Phase I site stormwater flows are to be limited to 38.8 L/s/ha.
4. The minor stormwater system has been designed to transmit inlet flows equivalent to 54.8 L/s/ha.
5. Release rates in the road right-of-way can be limited to 30 L/s by utilizing a Scepter Type B inlet control device installed to a pair of catchbasins with 1.4 m of head.
6. Saw-tooth road grades have been set to contain the 1:100 year storm event on the road.
7. Sites can be provided with roof top and parking area storage to contain the 1:100 year storm event.

Source: City of Nepean South Merivale Business Park Stormwater Management Report - Novatech (Nepean_SWM Report (2))

50 Leikin Drive
SWM Calculations Major System East (Bill Leathem Storm Sewer)

CBMH03 - ICD 16 : **Ponding Area 12**

	100 YEAR
Area (imp) =	0.25
C-Factor =	1.00
Area (per) =	0.02
C-Factor =	0.25
(AxC)imp + (AxC)per =	0.26
Atotal =	0.27
C-Factor (overall) =	0.94
Storage Volume (m3)	

Time (min)	Intensity 1:100 Yr (mm/hr)	Qp 1:100 Yr (L/s)	Qp ICD (L/s)	Qp stored (L/s)	Max Volume Requirement (m ³)
10	178.56	126.58	66.48	60.10	36.06
15	142.89	101.30	66.48	34.82	31.34
20	119.95	85.03	66.48	18.56	22.27
25	103.85	73.62	66.48	7.14	10.71
30	91.87	65.13	66.48	N/A	N/A
35	82.58	58.54	66.48	N/A	N/A
40	75.15	53.27	66.48	N/A	N/A
45	69.05	48.95	66.48	N/A	N/A
50	63.95	45.34	66.48	N/A	N/A
55	59.62	42.27	66.48	N/A	N/A
60	55.89	39.62	66.48	N/A	N/A
65	52.65	37.32	66.48	N/A	N/A
70	49.79	35.30	66.48	N/A	N/A
75	47.26	33.50	66.48	N/A	N/A
80	44.99	31.89	66.48	N/A	N/A

Minimum storage volume requirement = 36.06 m³

Storage volume provided by design in summary below

*** No spill-over volume is expected for the 1:100 year storm.**

50 Leikin Drive
SWM Calculations Major System East (Bill Leathem Storm Sewer)

CB24 - ICD 17 :	Ponding Area 12
------------------------	------------------------

	100 YEAR
Area (imp) =	0.20
C-Factor =	1.00
Area (per) =	0.02
C-Factor =	0.25
(AxC)imp + (AxC)per =	0.21
Atotal =	0.22
C-Factor (overall) =	0.93
Storage Volume (m3)	

Time (min)	Intensity 1:100 Yr (mm/hr)	Qp 1:100 Yr (L/s)	Qp ICD (L/s)	Qp stored (L/s)	Max Volume Requirement (m ³)
10	178.56	101.76	53.53	48.23	28.94
15	142.89	81.44	53.53	27.91	25.12
20	119.95	68.36	53.53	14.83	17.80
25	103.85	59.18	53.53	5.65	8.48
30	91.87	52.36	53.53	N/A	N/A
35	82.58	47.06	53.53	N/A	N/A
40	75.15	42.83	53.53	N/A	N/A
45	69.05	39.35	53.53	N/A	N/A
50	63.95	36.45	53.53	N/A	N/A
55	59.62	33.98	53.53	N/A	N/A
60	55.89	31.85	53.53	N/A	N/A
65	52.65	30.00	53.53	N/A	N/A
70	49.79	28.38	53.53	N/A	N/A
75	47.26	26.93	53.53	N/A	N/A
80	44.99	25.64	53.53	N/A	N/A

Minimum storage volume requirement = 28.94 m³
Storage volume provided by design in summary below

*** No spill-over volume is expected for the 1:100 year storm.**

50 Leikin Drive
SWM Calculations Major System East (Bill Leathem Storm Sewer)

CB25 - ICD 18 :	Ponding Area 12
------------------------	------------------------

	100 YEAR
Area (imp) =	0.23
C-Factor =	1.00
Area (per) =	0.03
C-Factor =	0.25
(AxC)imp + (AxC)per =	0.24
Atotal =	0.26
C-Factor (overall) =	0.91
Storage Volume (m3)	

Time (min)	Intensity 1:100 Yr (mm/hr)	Qp 1:100 Yr (L/s)	Qp ICD (L/s)	Qp stored (L/s)	Max Volume Requirement (m ³)
10	178.56	117.89	61.75	56.14	33.68
15	142.89	94.35	61.75	32.59	29.33
20	119.95	79.20	61.75	17.44	20.93
25	103.85	68.57	61.75	6.81	10.22
30	91.87	60.66	61.75	N/A	N/A
35	82.58	54.52	61.75	N/A	N/A
40	75.15	49.61	61.75	N/A	N/A
45	69.05	45.59	61.75	N/A	N/A
50	63.95	42.23	61.75	N/A	N/A
55	59.62	39.37	61.75	N/A	N/A
60	55.89	36.90	61.75	N/A	N/A
65	52.65	34.76	61.75	N/A	N/A
70	49.79	32.87	61.75	N/A	N/A
75	47.26	31.20	61.75	N/A	N/A
80	44.99	29.71	61.75	N/A	N/A

Minimum storage volume requirement = 33.68 m³

Storage volume provided by design in summary below

*** No spill-over volume is expected for the 1:100 year storm.**

50 Leikin Drive
SWM Calculations Major System East (Bill Leathem Storm Sewer)

CB26 - ICD 19 :	Ponding Area 12
------------------------	------------------------

	100 YEAR
Area (imp) =	0.21
C-Factor =	1.00
Area (per) =	0.05
C-Factor =	0.25
(AxC)imp + (AxC)per =	0.22
Atotal =	0.26
C-Factor (overall) =	0.86
Storage Volume (m3)	

Time (min)	Intensity 1:100 Yr (mm/hr)	Qp 1:100 Yr (L/s)	Qp ICD (L/s)	Qp stored (L/s)	Max Volume Requirement (m ³)
10	178.56	110.45	57.99	52.46	31.48
15	142.89	88.39	57.99	30.40	27.36
20	119.95	74.20	57.99	16.21	19.45
25	103.85	64.23	57.99	6.25	9.37
30	91.87	56.83	57.99	N/A	N/A
35	82.58	51.08	57.99	N/A	N/A
40	75.15	46.48	57.99	N/A	N/A
45	69.05	42.71	57.99	N/A	N/A
50	63.95	39.56	57.99	N/A	N/A
55	59.62	36.88	57.99	N/A	N/A
60	55.89	34.57	57.99	N/A	N/A
65	52.65	32.56	57.99	N/A	N/A
70	49.79	30.80	57.99	N/A	N/A
75	47.26	29.23	57.99	N/A	N/A
80	44.99	27.83	57.99	N/A	N/A

Minimum storage volume requirement = 31.48 m³
Storage volume provided by design in summary below

*** No spill-over volume is expected for the 1:100 year storm.**

Summary of Storage volume provided by design

Minimum storage volume requirement = 130.16 m³
Storage volume provided by design = 382.46 m³

50 Leikin Drive
SWM Calculations Major System East (Bill Leathem Storm Sewer)

CB27 - ICD 20 :	Ponding Area 13
------------------------	------------------------

	100 YEAR
Area (imp) =	0.18
C-Factor =	1.00
Area (per) =	0.00
C-Factor =	0.25
(AxC)imp + (AxC)per =	0.18
Atotal =	0.18
C-Factor (overall) =	1.00
Storage Volume (m3)	

Time (min)	Intensity 1:100 Yr (mm/hr)	Qp 1:100 Yr (L/s)	Qp ICD (L/s)	Qp stored (L/s)	Max Volume Requirement (m ³)
10	178.56	89.35	46.92	42.43	25.46
15	142.89	71.50	46.92	24.58	22.12
20	119.95	60.02	46.92	13.10	15.72
25	103.85	51.97	46.92	5.04	7.56
30	91.87	45.97	46.92	N/A	N/A
35	82.58	41.32	46.92	N/A	N/A
40	75.15	37.60	46.92	N/A	N/A
45	69.05	34.55	46.92	N/A	N/A
50	63.95	32.00	46.92	N/A	N/A
55	59.62	29.84	46.92	N/A	N/A
60	55.89	27.97	46.92	N/A	N/A
65	52.65	26.34	46.92	N/A	N/A
70	49.79	24.91	46.92	N/A	N/A
75	47.26	23.65	46.92	N/A	N/A
80	44.99	22.51	46.92	N/A	N/A

Minimum storage volume requirement = 25.46 m³
 Storage volume provided by design = 21.95 m³ 3.51

*** 3.51 m3 is expected to spill-over for the 1:100 year storm**

50 Leikin Drive
SWM Calculations Major System East (Bill Leathem Storm Sewer)

CB28 - ICD 21 :	Ponding Area 14
------------------------	------------------------

	100 YEAR
Area (imp) =	0.14
C-Factor =	1.00
Area (per) =	0.00
C-Factor =	0.25
(AxC)imp + (AxC)per =	0.14
Atotal =	0.14
C-Factor (overall) =	1.00
Storage Volume (m3)	

Time (min)	Intensity 1:100 Yr (mm/hr)	Qp 1:100 Yr (L/s)	Qp ICD (L/s)	Qp stored (L/s)	Max Volume Requirement (m ³)
10	178.56	69.50	36.50	33.00	19.80
15	142.89	55.61	36.50	19.12	17.21
20	119.95	46.68	36.50	10.19	12.23
25	103.85	40.42	36.50	3.92	5.88
30	91.87	35.76	36.50	N/A	N/A
35	82.58	32.14	36.50	N/A	N/A
40	75.15	29.25	36.50	N/A	N/A
45	69.05	26.87	36.50	N/A	N/A
50	63.95	24.89	36.50	N/A	N/A
55	59.62	23.21	36.50	N/A	N/A
60	55.89	21.75	36.50	N/A	N/A
65	52.65	20.49	36.50	N/A	N/A
70	49.79	19.38	36.50	N/A	N/A
75	47.26	18.39	36.50	N/A	N/A
80	44.99	17.51	36.50	N/A	N/A

Minimum storage volume requirement = 23.30 m³
 Storage volume provided by design = 13.01 m³ 10.29

*** 10.29 m3 is expected to spill-over for the 1:100 year storm**

50 Leikin Drive
SWM Calculations Major System East (Bill Leathem Storm Sewer)

CB29 - ICD 22 :	Ponding Area 15
------------------------	------------------------

	100 YEAR
Area (imp) =	0.14
C-Factor =	1.00
Area (per) =	0.00
C-Factor =	0.25
(AxC)imp + (AxC)per =	0.14
Atotal =	0.14
C-Factor (overall) =	1.00
Storage Volume (m3)	

Time (min)	Intensity 1:100 Yr (mm/hr)	Qp 1:100 Yr (L/s)	Qp ICD (L/s)	Qp stored (L/s)	Max Volume Requirement (m ³)
10	178.56	69.50	20.28	49.22	29.53
15	142.89	55.61	20.28	35.34	31.80
20	119.95	46.68	20.28	26.41	31.69
25	103.85	40.42	20.28	20.14	30.21
30	91.87	35.76	20.28	15.48	27.86
35	82.58	32.14	20.28	11.86	24.91
40	75.15	29.25	20.28	8.97	21.53
45	69.05	26.87	20.28	6.60	17.82
50	63.95	24.89	20.28	4.61	13.84
55	59.62	23.21	20.28	2.93	9.67
60	55.89	21.75	20.28	1.48	5.32
65	52.65	20.49	20.28	0.21	0.83
70	49.79	19.38	20.28	N/A	N/A
75	47.26	18.39	20.28	N/A	N/A
80	44.99	17.51	20.28	N/A	N/A

Minimum storage volume requirement = 42.10 m³
 Storage volume provided by design = 8.78 m³ 33.32

*** 33.32 m3 will be conveyed to Underground Storage Chamber 3 sized for the 1:100 year storm.**

50 Leikin Drive
SWM Calculations Major System East (Bill Leathem Storm Sewer)

BUILDING ROOF :

	100 YEAR
Area (imp) =	2.12
C-Factor =	1.00
Area (per) =	0.00
C-Factor =	0.25
(AxC)imp + (AxC)per =	2.12
Atotal =	2.12
C-Factor (overall) =	1.00
Storage Volume (m3)	

Time (min)	Intensity 1:100 Yr (mm/hr)	Qp 1:100 Yr (L/s)	Qp ICD (L/s)	Qp stored (L/s)	Max Volume Requirement (m ³)
10	178.56	1052.36	60.00	992.36	595.41
15	142.89	842.16	60.00	782.16	703.94
20	119.95	706.94	60.00	646.94	776.33
25	103.85	612.03	60.00	552.03	828.05
30	91.87	541.43	60.00	481.43	866.58
35	82.58	486.69	60.00	426.69	896.04
40	75.15	442.88	60.00	382.88	918.90
45	69.05	406.96	60.00	346.96	936.78
50	63.95	376.92	60.00	316.92	950.76
55	59.62	351.40	60.00	291.40	961.62
60	55.89	329.42	60.00	269.42	969.91
65	52.65	310.28	60.00	250.28	976.08
70	49.79	293.44	60.00	233.44	980.45
75	47.26	278.51	60.00	218.51	983.27
80	44.99	265.16	60.00	205.16	984.76
81	44.57	262.66	60.00	202.66	984.91
82	44.15	260.21	60.00	200.21	985.02
83	43.74	257.81	60.00	197.81	985.08
84	43.34	255.46	60.00	195.46	985.10
85	42.95	253.15	60.00	193.15	985.08
86	42.57	250.90	60.00	190.90	985.02
87	42.20	248.68	60.00	188.68	984.92
88	41.83	246.51	60.00	186.51	984.77
89	41.47	244.38	60.00	184.38	984.59
90	41.11	242.29	60.00	182.29	984.37
91	40.76	240.24	60.00	180.24	984.12

Minimum storage volume requirement = 985.10 m³
 Storage volume provided by design = 1272.00 m³ 40% of roof assumed

*** No spill-over volume is expected for the 1:100 year storm.**

50 Leikin Drive

SWM Calculations Major System West (Bill Leathem Storm Sewer)

Allowable Release Rate= 425 L/s

Uncontrolled Areas (4)

Area (ha)	C-Factor	Intensity (mm/hr)	Peak Flow (L/s)
0.39	0.25	178.56	48.40
0.03	0.25	178.56	3.72
0.03	0.25	178.56	3.72
0.05	0.25	178.56	6.20
0.04	0.69	178.56	13.70
0.03	0.29	178.56	4.32
0.02	1.00	178.56	9.93
SUM=			90.00

Controlled Flow= 335.00 L/s

CBMH01 - ICD 1 :	Ponding Area 25
-------------------------	------------------------

	100 YEAR
Area (imp) =	0.10
C-Factor =	1.00
Area (per) =	0.30
C-Factor =	0.25
(AxC)imp + (AxC)per =	0.18
Atotal =	0.40
C-Factor (overall) =	0.44
Storage Volume (m3)	

Time (min)	Intensity 1:100 Yr (mm/hr)	Qp 1:100 Yr (L/s)	Qp ICD (L/s)	Qp stored (L/s)	Max Volume Requirement (m ³)
10	178.56	86.87	44.03	42.84	25.70
15	142.89	69.52	44.03	25.49	22.94
20	119.95	58.36	44.03	14.33	17.19
25	103.85	50.52	44.03	6.49	9.74
30	91.87	44.69	44.03	0.67	1.20
35	82.58	40.17	44.03	N/A	N/A
40	75.15	36.56	44.03	N/A	N/A
45	69.05	33.59	44.03	N/A	N/A
50	63.95	31.11	44.03	N/A	N/A
55	59.62	29.01	44.03	N/A	N/A
60	55.89	27.19	44.03	N/A	N/A
65	52.65	25.61	44.03	N/A	N/A
70	49.79	24.22	44.03	N/A	N/A
75	47.26	22.99	44.03	N/A	N/A
80	44.99	21.89	44.03	N/A	N/A

Minimum storage volume requirement = 25.70 m³
 Storage volume provided by design = 37.28 m³

*** No spill-over volume is expected for the 1:100 year storm.**

50 Leikin Drive
SWM Calculations Major System West (Bill Leathem Storm Sewer)

CB03 - ICD 2 :	Ponding Areas 23 & 24
-----------------------	----------------------------------

	100 YEAR
Area (imp) =	0.12
C-Factor =	1.00
Area (per) =	0.38
C-Factor =	0.25
(AxC)imp + (AxC)per =	0.22
Atotal =	0.50
C-Factor (overall) =	0.43
Storage Volume (m3)	

Time (min)	Intensity 1:100 Yr (mm/hr)	Qp 1:100 Yr (L/s)	Qp ICD (L/s)	Qp stored (L/s)	Max Volume Requirement (m ³)
10	178.56	106.72	53.59	53.14	31.88
15	142.89	85.41	53.59	31.82	28.64
20	119.95	71.69	53.59	18.11	21.73
25	103.85	62.07	53.59	8.48	12.72
30	91.87	54.91	53.59	1.32	2.38
35	82.58	49.36	53.59	N/A	N/A
40	75.15	44.91	53.59	N/A	N/A
45	69.05	41.27	53.59	N/A	N/A
50	63.95	38.23	53.59	N/A	N/A
55	59.62	35.64	53.59	N/A	N/A
60	55.89	33.41	53.59	N/A	N/A
65	52.65	31.47	53.59	N/A	N/A
70	49.79	29.76	53.59	N/A	N/A
75	47.26	28.24	53.59	N/A	N/A
80	44.99	26.89	53.59	N/A	N/A

Minimum storage volume requirement =	31.88 m ³	
Storage volume provided by design =	16.21 m ³	15.67

* 15.67 m3 is expected to spill-over for the 1:100 year storm.

50 Leikin Drive
SWM Calculations Major System West (Bill Leathem Storm Sewer)

CBO5 - ICD 3 :	Ponding Areas 21 & 22
-----------------------	----------------------------------

	100 YEAR
Area (imp) =	0.13
C-Factor =	1.00
Area (per) =	0.00
C-Factor =	0.25
(AxC)imp + (AxC)per =	0.13
Atotal =	0.13
C-Factor (overall) =	1.00
Storage Volume (m3)	

Time (min)	Intensity 1:100 Yr (mm/hr)	Qp 1:100 Yr (L/s)	Qp ICD (L/s)	Qp stored (L/s)	Max Volume Requirement (m ³)
10	178.56	64.53	33.89	30.64	18.38
15	142.89	51.64	33.89	17.75	15.98
20	119.95	43.35	33.89	9.46	11.35
25	103.85	37.53	33.89	3.64	5.46
30	91.87	33.20	33.89	N/A	N/A
35	82.58	29.84	33.89	N/A	N/A
40	75.15	27.16	33.89	N/A	N/A
45	69.05	24.95	33.89	N/A	N/A
50	63.95	23.11	33.89	N/A	N/A
55	59.62	21.55	33.89	N/A	N/A
60	55.89	20.20	33.89	N/A	N/A
65	52.65	19.03	33.89	N/A	N/A
70	49.79	17.99	33.89	N/A	N/A
75	47.26	17.08	33.89	N/A	N/A
80	44.99	16.26	33.89	N/A	N/A

Minimum storage volume requirement =	34.06 m ³	
Storage volume provided by design =	3.10 m ³	30.96

*** 30.96 m3 is expected to spill-over for the 1:100 year storm.**

50 Leikin Drive
SWM Calculations Major System West (Bill Leathem Storm Sewer)

CBMH02 - ICD 4 :	Ponding Area 11
-------------------------	------------------------

	100 YEAR
Area (imp) =	0.36
C-Factor =	1.00
Area (per) =	0.00
C-Factor =	0.25
(AxC)imp + (AxC)per =	0.36
Atotal =	0.36
C-Factor (overall) =	1.00
Storage Volume (m3)	

Time (min)	Intensity 1:100 Yr (mm/hr)	Qp 1:100 Yr (L/s)	Qp ICD (L/s)	Qp stored (L/s)	Max Volume Requirement (m ³)
10	178.56	178.70	93.85	84.85	50.91
15	142.89	143.01	93.85	49.16	44.24
20	119.95	120.05	93.85	26.20	31.44
25	103.85	103.93	93.85	10.08	15.12
30	91.87	91.94	93.85	N/A	N/A
35	82.58	82.64	93.85	N/A	N/A
40	75.15	75.21	93.85	N/A	N/A
45	69.05	69.11	93.85	N/A	N/A
50	63.95	64.01	93.85	N/A	N/A
55	59.62	59.67	93.85	N/A	N/A
60	55.89	55.94	93.85	N/A	N/A
65	52.65	52.69	93.85	N/A	N/A
70	49.79	49.83	93.85	N/A	N/A
75	47.26	47.29	93.85	N/A	N/A
80	44.99	45.03	93.85	N/A	N/A

Minimum storage volume requirement = 50.91 m³
 Storage volume provided by design = 147.49 m³

*** No spill-over volume is expected for the 1:100 year storm.**

50 Leikin Drive
SWM Calculations Major System West (Bill Leathem Storm Sewer)

CB06 - ICD 5 :	Ponding Area 10
-----------------------	------------------------

	100 YEAR
Area (imp) =	0.33
C-Factor =	1.00
Area (per) =	0.00
C-Factor =	0.25
(AxC)imp + (AxC)per =	0.33
Atotal =	0.33
C-Factor (overall) =	1.00
Storage Volume (m3)	

Time (min)	Intensity 1:100 Yr (mm/hr)	Qp 1:100 Yr (L/s)	Qp ICD (L/s)	Qp stored (L/s)	Max Volume Requirement (m ³)
10	178.56	163.81	86.03	77.78	46.67
15	142.89	131.09	86.03	45.06	40.56
20	119.95	110.04	86.03	24.01	28.82
25	103.85	95.27	86.03	9.24	13.86
30	91.87	84.28	86.03	N/A	N/A
35	82.58	75.76	86.03	N/A	N/A
40	75.15	68.94	86.03	N/A	N/A
45	69.05	63.35	86.03	N/A	N/A
50	63.95	58.67	86.03	N/A	N/A
55	59.62	54.70	86.03	N/A	N/A
60	55.89	51.28	86.03	N/A	N/A
65	52.65	48.30	86.03	N/A	N/A
70	49.79	45.68	86.03	N/A	N/A
75	47.26	43.35	86.03	N/A	N/A
80	44.99	41.27	86.03	N/A	N/A

Minimum storage volume requirement = 46.67 m³
 Storage volume provided by design = 176.10 m³

*** No spill-over volume is expected for the 1:100 year storm.**

50 Leikin Drive
SWM Calculations Major System West (Bill Leathem Storm Sewer)

CB07 - ICD 6 :	Ponding Area 9
-----------------------	-----------------------

	100 YEAR
Area (imp) =	0.32
C-Factor =	1.00
Area (per) =	0.00
C-Factor =	0.25
(AxC)imp + (AxC)per =	0.32
Atotal =	0.32
C-Factor (overall) =	1.00
Storage Volume (m3)	

Time (min)	Intensity 1:100 Yr (mm/hr)	Qp 1:100 Yr (L/s)	Qp ICD (L/s)	Qp stored (L/s)	Max Volume Requirement (m ³)
10	178.56	158.85	83.42	75.42	45.25
15	142.89	127.12	83.42	43.70	39.33
20	119.95	106.71	83.42	23.29	27.94
25	103.85	92.38	83.42	8.96	13.44
30	91.87	81.73	83.42	N/A	N/A
35	82.58	73.46	83.42	N/A	N/A
40	75.15	66.85	83.42	N/A	N/A
45	69.05	61.43	83.42	N/A	N/A
50	63.95	56.89	83.42	N/A	N/A
55	59.62	53.04	83.42	N/A	N/A
60	55.89	49.72	83.42	N/A	N/A
65	52.65	46.83	83.42	N/A	N/A
70	49.79	44.29	83.42	N/A	N/A
75	47.26	42.04	83.42	N/A	N/A
80	44.99	40.02	83.42	N/A	N/A

Minimum storage volume requirement = 45.25 m³
 Storage volume provided by design = 110.79 m³

***No spill-over volume is expected for the 1:100 year storm.**

50 Leikin Drive
SWM Calculations Major System West (Bill Leathem Storm Sewer)

CB08 - ICD 7 :	Ponding Area 8
-----------------------	-----------------------

	100 YEAR
Area (imp) =	0.33
C-Factor =	1.00
Area (per) =	0.00
C-Factor =	0.25
(AxC)imp + (AxC)per =	0.33
Atotal =	0.33
C-Factor (overall) =	1.00
Storage Volume (m3)	

Time (min)	Intensity 1:100 Yr (mm/hr)	Qp 1:100 Yr (L/s)	Qp ICD (L/s)	Qp stored (L/s)	Max Volume Requirement (m ³)
10	178.56	163.81	86.03	77.78	46.67
15	142.89	131.09	86.03	45.06	40.56
20	119.95	110.04	86.03	24.01	28.82
25	103.85	95.27	86.03	9.24	13.86
30	91.87	84.28	86.03	N/A	N/A
35	82.58	75.76	86.03	N/A	N/A
40	75.15	68.94	86.03	N/A	N/A
45	69.05	63.35	86.03	N/A	N/A
50	63.95	58.67	86.03	N/A	N/A
55	59.62	54.70	86.03	N/A	N/A
60	55.89	51.28	86.03	N/A	N/A
65	52.65	48.30	86.03	N/A	N/A
70	49.79	45.68	86.03	N/A	N/A
75	47.26	43.35	86.03	N/A	N/A
80	44.99	41.27	86.03	N/A	N/A

Minimum storage volume requirement = 77.63 m³
 Storage volume provided by design = 134.65 m³

*** No spill-over volume is expected for the 1:100 year storm.**

50 Leikin Drive
SWM Calculations Major System West (Bill Leathem Storm Sewer)

CB19 - ICD 8 :	Ponding Area 6
-----------------------	-----------------------

	100 YEAR
Area (imp) =	0.68
C-Factor =	1.00
Area (per) =	0.03
C-Factor =	0.25
(AxC)imp + (AxC)per =	0.69
Atotal =	0.71
C-Factor (overall) =	0.97
Storage Volume (m3)	

Time (min)	Intensity 1:100 Yr (mm/hr)	Qp 1:100 Yr (L/s)	Qp ICD (L/s)	Qp stored (L/s)	Max Volume Requirement (m ³)
10	178.56	341.27	178.92	162.35	97.41
15	142.89	273.11	178.92	94.19	84.77
20	119.95	229.26	178.92	50.33	60.40
25	103.85	198.48	178.92	19.56	29.34
30	91.87	175.58	178.92	N/A	N/A
35	82.58	157.83	178.92	N/A	N/A
40	75.15	143.62	178.92	N/A	N/A
45	69.05	131.97	178.92	N/A	N/A
50	63.95	122.23	178.92	N/A	N/A
55	59.62	113.96	178.92	N/A	N/A
60	55.89	106.83	178.92	N/A	N/A
65	52.65	100.62	178.92	N/A	N/A
70	49.79	95.16	178.92	N/A	N/A
75	47.26	90.32	178.92	N/A	N/A
80	44.99	85.99	178.92	N/A	N/A

Minimum storage volume requirement = 97.41 m³
Storage volume provided by design in summary below

*** No spill-over volume is expected for the 1:100 year storm.**

50 Leikin Drive
SWM Calculations Major System West (Bill Leathem Storm Sewer)

CB20 - ICD 9 :	Ponding Area 6
-----------------------	-----------------------

	100 YEAR
Area (imp) =	0.33
C-Factor =	1.00
Area (per) =	0.01
C-Factor =	0.25
(AxC)imp + (AxC)per =	0.33
Atotal =	0.34
C-Factor (overall) =	0.98
Storage Volume (m3)	

Time (min)	Intensity 1:100 Yr (mm/hr)	Qp 1:100 Yr (L/s)	Qp ICD (L/s)	Qp stored (L/s)	Max Volume Requirement (m ³)
10	178.56	165.05	86.67	78.39	47.03
15	142.89	132.08	86.67	45.42	40.88
20	119.95	110.88	86.67	24.21	29.05
25	103.85	95.99	86.67	9.33	13.99
30	91.87	84.92	86.67	N/A	N/A
35	82.58	76.33	86.67	N/A	N/A
40	75.15	69.46	86.67	N/A	N/A
45	69.05	63.83	86.67	N/A	N/A
50	63.95	59.12	86.67	N/A	N/A
55	59.62	55.11	86.67	N/A	N/A
60	55.89	51.67	86.67	N/A	N/A
65	52.65	48.66	86.67	N/A	N/A
70	49.79	46.02	86.67	N/A	N/A
75	47.26	43.68	86.67	N/A	N/A
80	44.99	41.59	86.67	N/A	N/A

Minimum storage volume requirement = 47.03 m³
 Storage volume provided by design in summary below

*** No spill-over volume is expected for the 1:100 year storm.**

Summary of Storage volume provided by design

Minimum storage volume requirement = 144.44 m³
 Storage volume provided by design = 157.85 m³

***No spill-over volume is expected for the 1:100 year storm.**

50 Leikin Drive
SWM Calculations Major System West (Bill Leathem Storm Sewer)

CB21 - ICD 10 :	Ponding Area 5
------------------------	-----------------------

	100 YEAR
Area (imp) =	0.33
C-Factor =	1.00
Area (per) =	0.01
C-Factor =	0.25
(AxC)imp + (AxC)per =	0.33
Atotal =	0.34
C-Factor (overall) =	0.98
Storage Volume (m3)	

Time (min)	Intensity 1:100 Yr (mm/hr)	Qp 1:100 Yr (L/s)	Qp ICD (L/s)	Qp stored (L/s)	Max Volume Requirement (m ³)
10	178.56	165.05	86.67	78.39	47.03
15	142.89	132.08	86.67	45.42	40.88
20	119.95	110.88	86.67	24.21	29.05
25	103.85	95.99	86.67	9.33	13.99
30	91.87	84.92	86.67	N/A	N/A
35	82.58	76.33	86.67	N/A	N/A
40	75.15	69.46	86.67	N/A	N/A
45	69.05	63.83	86.67	N/A	N/A
50	63.95	59.12	86.67	N/A	N/A
55	59.62	55.11	86.67	N/A	N/A
60	55.89	51.67	86.67	N/A	N/A
65	52.65	48.66	86.67	N/A	N/A
70	49.79	46.02	86.67	N/A	N/A
75	47.26	43.68	86.67	N/A	N/A
80	44.99	41.59	86.67	N/A	N/A

Minimum storage volume requirement = 47.03 m³
 Storage volume provided by design = 87.70 m³

*** No spill-over volume is expected for the 1:100 year storm.**

50 Leikin Drive
SWM Calculations Major System West (Bill Leathem Storm Sewer)

CB22 - ICD 11 :	Ponding Area 4
------------------------	-----------------------

	100 YEAR
Area (imp) =	0.38
C-Factor =	1.00
Area (per) =	0.02
C-Factor =	0.25
(AxC)imp + (AxC)per =	0.39
Atotal =	0.40
C-Factor (overall) =	0.96
Storage Volume (m3)	

Time (min)	Intensity 1:100 Yr (mm/hr)	Qp 1:100 Yr (L/s)	Qp ICD (L/s)	Qp stored (L/s)	Max Volume Requirement (m ³)
10	178.56	191.11	100.80	90.31	54.19
15	142.89	152.94	100.80	52.14	46.93
20	119.95	128.38	100.80	27.58	33.10
25	103.85	111.15	100.80	10.35	15.52
30	91.87	98.33	100.80	N/A	N/A
35	82.58	88.38	100.80	N/A	N/A
40	75.15	80.43	100.80	N/A	N/A
45	69.05	73.90	100.80	N/A	N/A
50	63.95	68.45	100.80	N/A	N/A
55	59.62	63.82	100.80	N/A	N/A
60	55.89	59.82	100.80	N/A	N/A
65	52.65	56.35	100.80	N/A	N/A
70	49.79	53.29	100.80	N/A	N/A
75	47.26	50.58	100.80	N/A	N/A
80	44.99	48.15	100.80	N/A	N/A

Minimum storage volume requirement =	54.19 m ³
Storage volume provided by design =	82.97 m ³

*** No spill-over volume is expected for the 1:100 year storm.**

50 Leikin Drive
SWM Calculations Major System West (Bill Leathem Storm Sewer)

CB01A - ICD 12 :	Ponding Area 3
-------------------------	-----------------------

	100 YEAR
Area (imp) =	0.19
C-Factor =	1.00
Area (per) =	0.00
C-Factor =	0.25
(AxC)imp + (AxC)per =	0.19
Atotal =	0.19
C-Factor (overall) =	1.00
Storage Volume (m3)	

Time (min)	Intensity 1:100 Yr (mm/hr)	Qp 1:100 Yr (L/s)	Qp ICD (L/s)	Qp stored (L/s)	Max Volume Requirement (m ³)
10	178.56	94.31	49.53	44.78	26.87
15	142.89	75.48	49.53	25.95	23.35
20	119.95	63.36	49.53	13.83	16.59
25	103.85	54.85	49.53	5.32	7.98
30	91.87	48.52	49.53	N/A	N/A
35	82.58	43.62	49.53	N/A	N/A
40	75.15	39.69	49.53	N/A	N/A
45	69.05	36.47	49.53	N/A	N/A
50	63.95	33.78	49.53	N/A	N/A
55	59.62	31.49	49.53	N/A	N/A
60	55.89	29.52	49.53	N/A	N/A
65	52.65	27.81	49.53	N/A	N/A
70	49.79	26.30	49.53	N/A	N/A
75	47.26	24.96	49.53	N/A	N/A
80	44.99	23.76	49.53	N/A	N/A

Minimum storage volume requirement = 26.87 m³
 Storage volume provided by design = 45.84 m³

*** No spill-over volume is expected for the 1:100 year storm.**

50 Leikin Drive
SWM Calculations Major System West (Bill Leathem Storm Sewer)

CB18 - ICD 13 :	Ponding Area 20
------------------------	------------------------

	100 YEAR
Area (imp) =	0.07
C-Factor =	1.00
Area (per) =	0.02
C-Factor =	0.25
(AxC)imp + (AxC)per =	0.08
Atotal =	0.09
C-Factor (overall) =	0.83
Storage Volume (m3)	

Time (min)	Intensity 1:100 Yr (mm/hr)	Qp 1:100 Yr (L/s)	Qp ICD (L/s)	Qp stored (L/s)	Max Volume Requirement (m ³)
10	178.56	37.23	19.29	17.94	10.76
15	142.89	29.79	19.29	10.50	9.45
20	119.95	25.01	19.29	5.72	6.86
25	103.85	21.65	19.29	2.36	3.54
30	91.87	19.15	19.29	N/A	N/A
35	82.58	17.22	19.29	N/A	N/A
40	75.15	15.67	19.29	N/A	N/A
45	69.05	14.40	19.29	N/A	N/A
50	63.95	13.33	19.29	N/A	N/A
55	59.62	12.43	19.29	N/A	N/A
60	55.89	11.65	19.29	N/A	N/A
65	52.65	10.98	19.29	N/A	N/A
70	49.79	10.38	19.29	N/A	N/A
75	47.26	9.85	19.29	N/A	N/A
80	44.99	9.38	19.29	N/A	N/A

Minimum storage volume requirement = 10.76 m³
 Storage volume provided by design = 98.00 m³

*** No spill-over volume is expected for the 1:100 year storm.**

50 Leikin Drive
SWM Calculations Major System West (Bill Leathem Storm Sewer)

CB02A - ICD 14 :	Ponding Area 1
-------------------------	-----------------------

	100 YEAR
Area (imp) =	0.16
C-Factor =	1.00
Area (per) =	0.00
C-Factor =	0.25
(AxC)imp + (AxC)per =	0.16
Atotal =	0.16
C-Factor (overall) =	1.00
Storage Volume (m3)	

Time (min)	Intensity 1:100 Yr (mm/hr)	Qp 1:100 Yr (L/s)	Qp ICD (L/s)	Qp stored (L/s)	Max Volume Requirement (m ³)
10	178.56	79.42	41.71	37.71	22.63
15	142.89	63.56	41.71	21.85	19.66
20	119.95	53.35	41.71	11.64	13.97
25	103.85	46.19	41.71	4.48	6.72
30	91.87	40.86	41.71	N/A	N/A
35	82.58	36.73	41.71	N/A	N/A
40	75.15	33.42	41.71	N/A	N/A
45	69.05	30.71	41.71	N/A	N/A
50	63.95	28.45	41.71	N/A	N/A
55	59.62	26.52	41.71	N/A	N/A
60	55.89	24.86	41.71	N/A	N/A
65	52.65	23.42	41.71	N/A	N/A
70	49.79	22.15	41.71	N/A	N/A
75	47.26	21.02	41.71	N/A	N/A
80	44.99	20.01	41.71	N/A	N/A

Minimum storage volume requirement =	22.63 m ³
Storage volume provided by design =	72.81 m ³

*** No spill-over volume is expected for the 1:100 year storm.**

50 Leikin Drive
SWM Calculations Major System West (Bill Leathem Storm Sewer)

CB03A - ICD 15 :	Ponding Area 2
-------------------------	-----------------------

	100 YEAR
Area (imp) =	0.14
C-Factor =	1.00
Area (per) =	0.01
C-Factor =	0.25
(AxC)imp + (AxC)per =	0.14
Atotal =	0.15
C-Factor (overall) =	0.95
Storage Volume (m3)	

Time (min)	Intensity 1:100 Yr (mm/hr)	Qp 1:100 Yr (L/s)	Qp ICD (L/s)	Qp stored (L/s)	Max Volume Requirement (m ³)
10	178.56	70.74	36.50	34.24	20.54
15	142.89	56.61	36.50	20.11	18.10
20	119.95	47.52	36.50	11.02	13.23
25	103.85	41.14	36.50	4.64	6.96
30	91.87	36.39	36.50	N/A	N/A
35	82.58	32.71	36.50	N/A	N/A
40	75.15	29.77	36.50	N/A	N/A
45	69.05	27.35	36.50	N/A	N/A
50	63.95	25.34	36.50	N/A	N/A
55	59.62	23.62	36.50	N/A	N/A
60	55.89	22.14	36.50	N/A	N/A
65	52.65	20.86	36.50	N/A	N/A
70	49.79	19.72	36.50	N/A	N/A
75	47.26	18.72	36.50	N/A	N/A
80	44.99	17.82	36.50	N/A	N/A

Minimum storage volume requirement = 20.54 m³
 Storage volume provided by design = 33.73 m³

*** No spill-over volume is expected for the 1:100 year storm.**

EAST STORMTECH (STORAGE 1) :

100 YEAR	
Area (imp) =	
C-Factor =	
Area (per) =	
C-Factor =	
(AxC)imp + (AxC)per =	
Atotal =	1.46
C-Factor (ove	0.85
Storage Volume (m3)	

*Excluding Roof Area

Time (min)	Intensity 1:5 Yr (mm/hr)	Qp 1:5 Yr (L/s)	Qp ICD (L/s)	Qp stored (L/s)	Max Volume Requirement (m ³)
10	104.19	359.46	83.75	275.71	165.43
15	83.56	348.27	83.75	264.52	238.07
20	70.25	302.36	83.75	218.61	262.34
25	60.90	270.09	83.75	186.34	279.51
30	53.93	246.05	83.75	162.30	292.14
35	48.52	227.38	83.75	143.63	301.63
40	44.18	212.44	83.75	128.69	308.85
45	40.63	200.17	83.75	116.42	314.33
50	37.65	189.90	83.75	106.15	318.46
55	35.12	181.17	83.75	97.42	321.50
60	32.94	173.65	83.75	89.90	323.66
65	31.04	167.10	83.75	83.35	325.07
70	29.37	161.33	83.75	77.58	325.85
75	27.89	156.21	83.75	72.46	326.09
80	26.56	151.64	83.75	67.89	325.87

Minimum storage volume requiremen **326 m³**
Storage volume provided by design = **351 m³**

WEST STORMTECH (STORAGE 2) :

100 YEAR	
Area (imp) =	
C-Factor =	
Area (per) =	
C-Factor =	
(AxC)imp + (AxC)per =	
Atotal =	4.49
C-Factor (ove	0.86
Storage Volume (m3)	

Time (min)	Intensity 1:5 Yr (mm/hr)	Qp 1:5 Yr (L/s)	Qp ICD (L/s)	Qp stored (L/s)	Max Volume Requirement (m ³)
10	104.19	1118.48	83.75	1034.73	620.84
15	83.56	896.96	83.75	813.21	731.89
20	70.25	754.12	83.75	670.37	804.45
25	60.90	653.70	83.75	569.95	854.93
30	53.93	578.90	83.75	495.15	891.26
35	48.52	520.82	83.75	437.07	917.85
40	44.18	474.31	83.75	390.56	937.34
45	40.63	436.14	83.75	352.39	951.44
50	37.65	404.20	83.75	320.45	961.34
55	35.12	377.04	83.75	293.29	967.85
60	32.94	353.64	83.75	269.89	971.60
65	31.04	333.24	83.75	249.49	973.03
70	29.37	315.30	83.75	231.55	972.50
75	27.89	299.37	83.75	215.62	970.30
80	26.56	285.14	83.75	201.39	966.65

Minimum storage volume requiremen 973 m³
Storage volume provided by design = 1000 m³

User Inputs

Chamber Model:	MC-7200
Outlet Control Structure:	Yes
Project Name:	CPC 50 Leikin EAST Storage
Engineer:	N/A
Project Location:	
Measurement Type:	Metric
Required Storage Volume:	975.01 cubic meters.
Stone Porosity:	40%
Stone Foundation Depth:	229 mm.
Stone Above Chambers:	305 mm.
Average Cover Over Chambers:	2401 mm.
Design Constraint Dimensions:	(25.00 m. x 50.00 m.)

Results

System Volume and Bed Size

Installed Storage Volume:	999.55 cubic meters.
Storage Volume Per Chamber:	4.99 cubic meters.
Number Of Chambers Required:	121
Number Of End Caps Required:	12
Chamber Rows:	6
Maximum Length:	45.84 m.
Maximum Width:	17.18 m.
Approx. Bed Size Required:	765.39 square me- ters.

System Components

Amount Of Stone Required:	959 cubic meters
Volume Of Excavation (Not Including Fill):	1575 cubic meters
Total Non-woven Geotextile Required:	2155 square meters
Woven Geotextile Required (excluding Isolator Row):	89 square meters
Woven Geotextile Required (Isolator Row):	281 square meters
Total Woven Geotextile Required:	370 square meters
Impervious Liner Required:	0 square meters

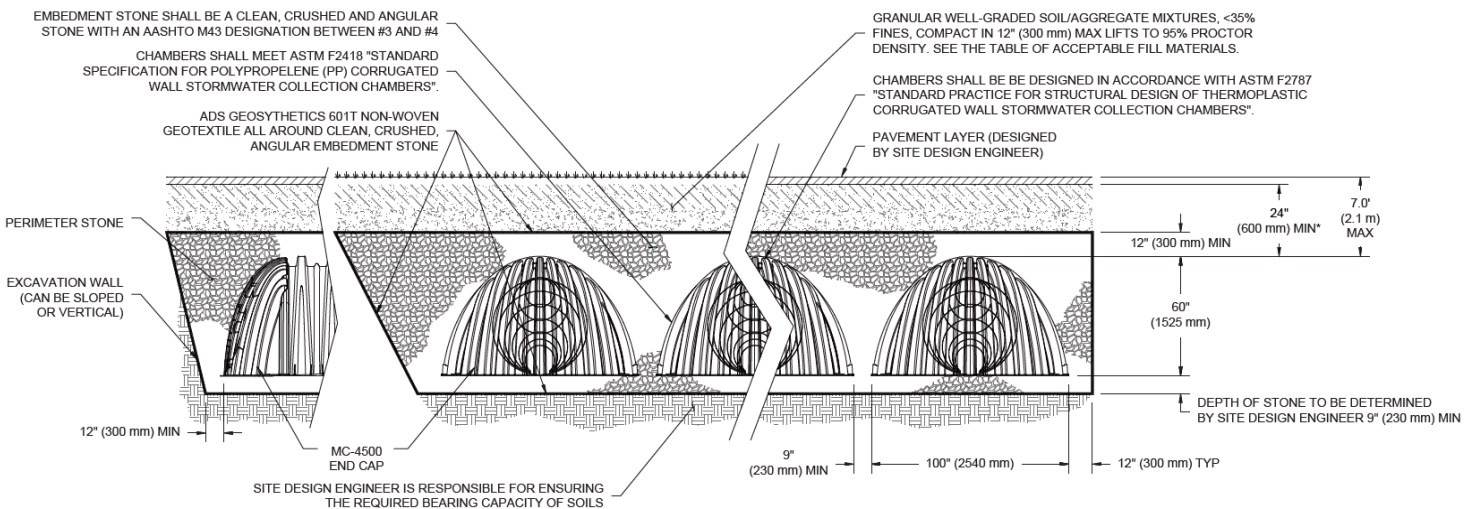

*MINIMUM COVER TO BOTTOM OF FLEXIBLE PAVEMENT. FOR UNPAVED INSTALLATIONS WHERE RUTTING FROM VEHICLES MAY OCCUR, INCREASE COVER TO 30" (750 mm).

User Inputs

Chamber Model:	MC-7200
Outlet Control Structure:	Yes
Project Name:	CPC 50 Leikin EAST Storage
Engineer:	N/A
Project Location:	
Measurement Type:	Metric
Required Storage Volume:	328.00 cubic meters.
Stone Porosity:	40%
Stone Foundation Depth:	229 mm.
Stone Above Chambers:	305 mm.
Average Cover Over Chambers:	2401 mm.
Design Constraint Dimensions:	(10.01 m. x 40.00 m.)

Results

System Volume and Bed Size

Installed Storage Volume:	351.17 cubic meters.
Storage Volume Per Chamber:	4.99 cubic meters.
Number Of Chambers Required:	40
Number Of End Caps Required:	6
Chamber Rows:	3
Maximum Length:	31.67 m.
Maximum Width:	8.87 m.
Approx. Bed Size Required:	276.56 square me- ters.

System Components

Amount Of Stone Required:	364 cubic meters
Volume Of Excavation (Not Including Fill):	569 cubic meters
Total Non-woven Geotextile Required:	864 square meters
Woven Geotextile Required (excluding Isolator Row):	36 square meters
Woven Geotextile Required (Isolator Row):	191 square meters
Total Woven Geotextile Required:	227 square meters
Impervious Liner Required:	0 square meters

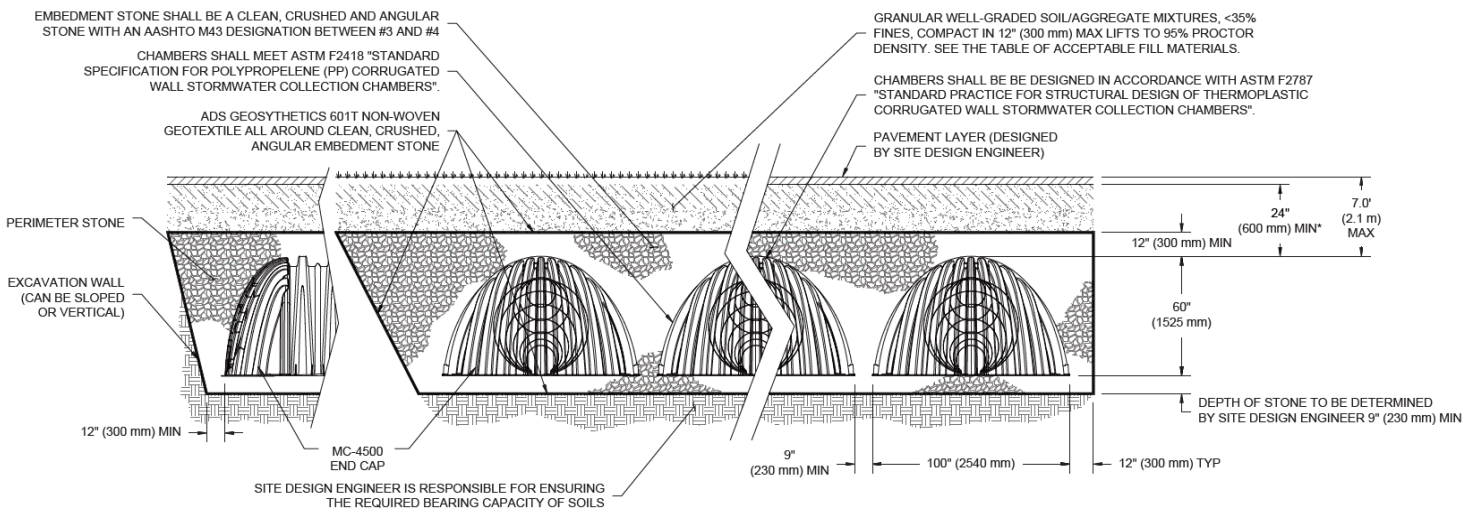

*MINIMUM COVER TO BOTTOM OF FLEXIBLE PAVEMENT. FOR UNPAVED INSTALLATIONS WHERE RUTTING FROM VEHICLES MAY OCCUR, INCREASE COVER TO 30" (750 mm).

User Inputs

Chamber Model:	MC-3500
Outlet Control Structure:	No
Project Name:	CPC 50 Leikin EAST Storage
Engineer:	N/A
Project Location:	
Measurement Type:	Metric
Required Storage Volume:	38.10 cubic meters.
Stone Porosity:	40%
Stone Foundation Depth:	229 mm.
Stone Above Chambers:	305 mm.
Average Cover Over Chambers:	2000 mm.
Design Constraint Dimensions:	(8.01 m. x 25.00 m.)

Results

System Volume and Bed Size

Installed Storage Volume:	42.90 cubic meters.
Storage Volume Per Chamber:	3.12 cubic meters.
Number Of Chambers Required:	7
Number Of End Caps Required:	2
Chamber Rows:	1
Maximum Length:	17.05 m.
Maximum Width:	2.57 m.
Approx. Bed Size Required:	43.73 square meters.

System Components

Amount Of Stone Required:	51 cubic meters
Volume Of Excavation (Not Including Fill):	74 cubic meters
Total Non-woven Geotextile Required:	184 square meters
Woven Geotextile Required (excluding Isolator Row):	0 square meters
Woven Geotextile Required (Isolator Row):	53 square meters
Total Woven Geotextile Required:	53 square meters
Impervious Liner Required:	0 square meters

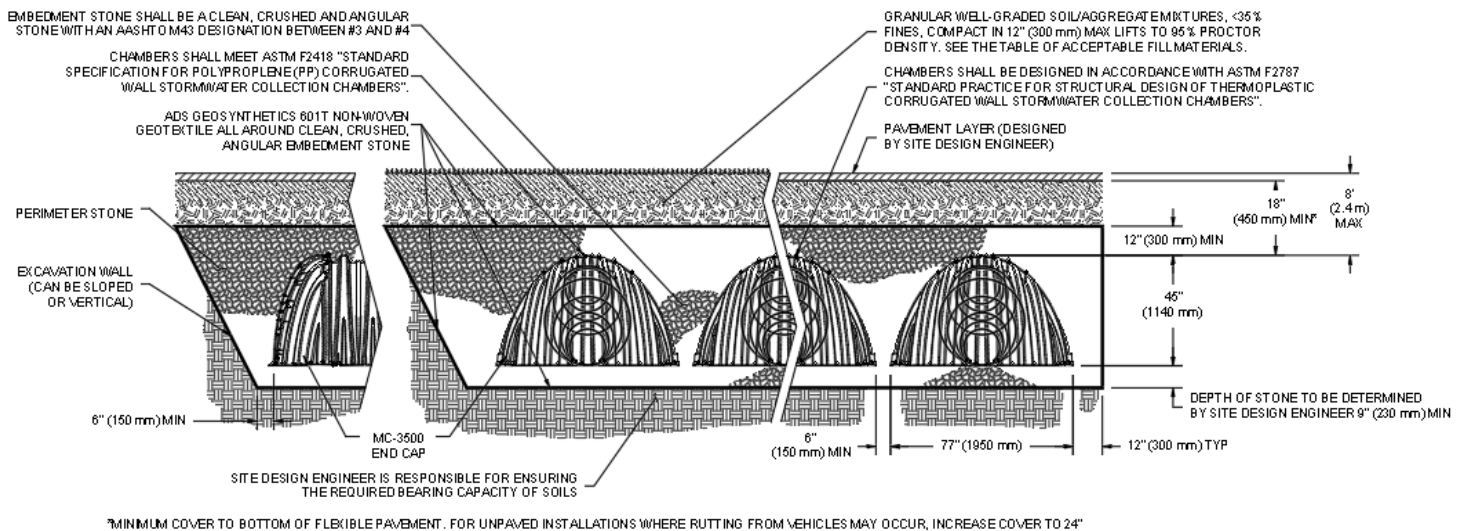

ZURN CONTROL-FLO

ROOF DRAINAGE SYSTEM

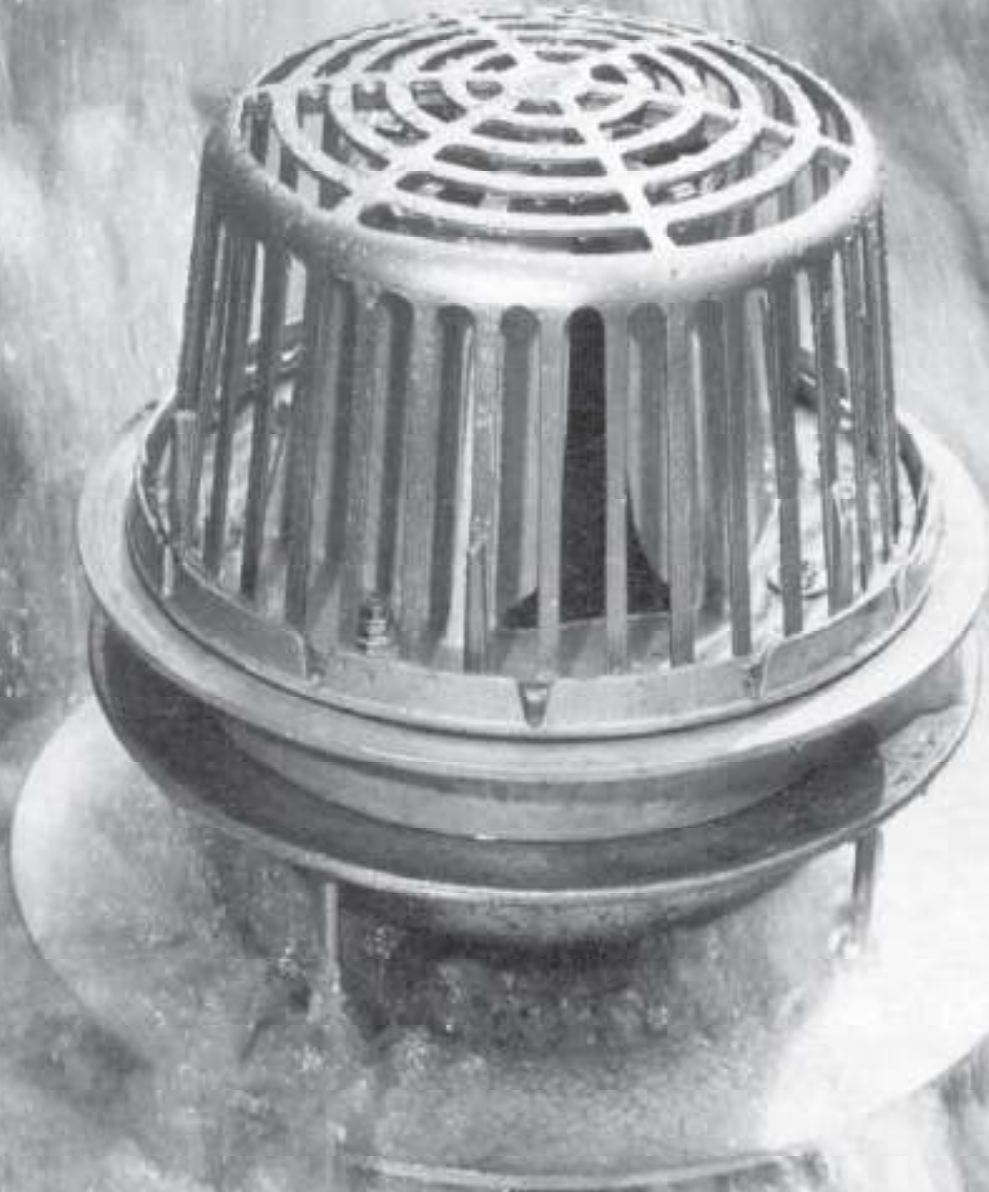

⚠️ WARNING: Cancer and Reproductive Harm - www.P65Warnings.ca.gov
⚠️ ADVERTENCIA: Cáncer y daño reproductivo - www.P65Warnings.ca.gov
⚠️ AVERTISSEMENT: Cancer et effets néfastes sur la reproduction - www.P65Warnings.ca.gov

Zurn Industries, LLC | Specification Drainage Operation
1801 Pittsburgh Avenue, Erie, PA U.S.A. 16502 · Ph. 855-663-9876, Fax 814-454-7929
In Canada | Zurn Industries Limited
3544 Nashua Drive, Mississauga, Ontario L4V 1L2 · Ph. 905-405-8272, Fax 905-405-1292

www.zurn.com

Rev. A
Date: 05/14/2018
C.N. No. 139851
Form No. RD72

Page 1 of 1



Control-Flo . . . Today's Successful Answer to More

THE ZURN "CONTROL-FLO CONCEPT"

Originally, Zurn introduced the scientifically- advanced "Control-Flo" drainage principle for dead-level roofs. Today, after thousands of successful applications in modern, large dead-level roof areas, Zurn engineers have adapted the comprehensive "Control-Flo" data to **sloped roof** areas.

WHAT IS "CONTROL-FLO"?

It is an advanced method of removing rain water off dead-level or sloped roofs. As contrasted with conventional drainage practices, which attempt to drain off storm water as quickly as it falls on the roof's surface, "Control-Flo" drains the roof at a controlled rate. Excess water accumulates on the roof under controlled conditions... then drains off at a lower rate after a storm abates.

CUTS DRAINAGE COSTS

Fewer roof drains, smaller diameter piping, smaller sewer sizes, and lower installation costs are possible with a "Control-Flo" drainage system because roof areas are utilized as temporary storage reservoirs.

REDUCES PROBABILITY OF STORM DAMAGE

Lightens load on combination sewers by reducing rate of water drain from roof tops during severe storms thereby reducing probability of flooded sewers, and consequent backflow into basements and other low areas.

THANKS TO EXCLUSIVE ZURN

"AQUA-WEIR" ACTION

Key to successful "Control-Flo" drainage is a unique, scientifically-designed weir containing accurately calibrated notches with sides formed by parabolic curves which provide flow rates directly proportional to the head. Shape and size of notches are based on pre- determined flow rates, and all factors involved in roof drainage to assure permanent regulation of drainage flow rates for specific geographic locations and rainfall intensities.

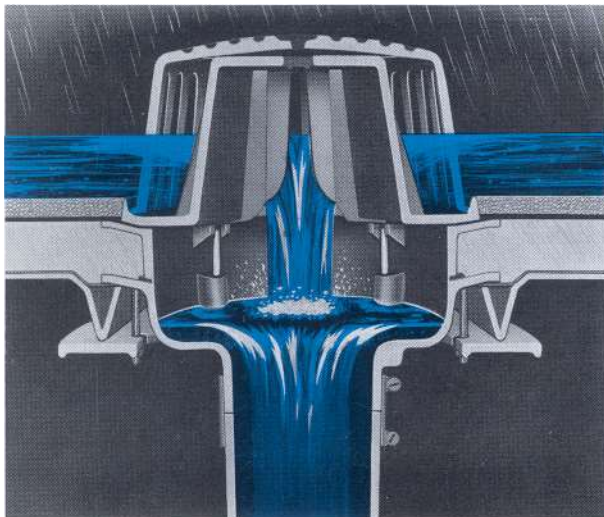

DEFINITION

DEAD LEVEL ROOFS

A dead-level roof for purposes of applying the Zurn "Control-Flo" drainage principle is one which has been designed for zero slope across its entire surface.

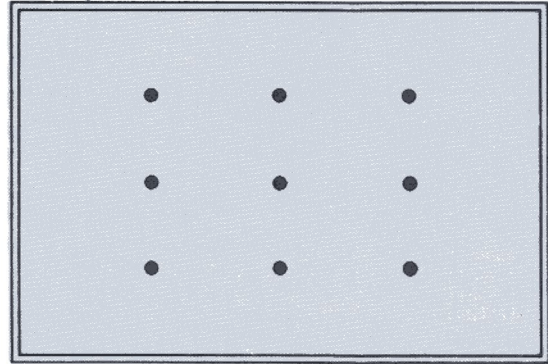

(Plan View)

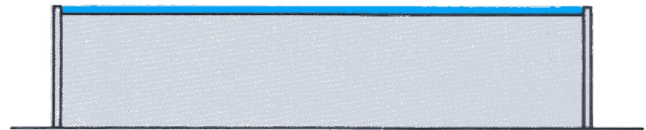

(Section View)

SLOPED ROOFS

A sloped roof is one designed commonly with a shallow slope. The Zurn "Control-Flo" drainage system can be applied to any slope which results in a total rise up to 6"... and data can be calculated for rises exceeding 6".

The total rise of a roof as calculated for "Control-Flo" application is defined as the vertical increase in height in inches, from the low point or valley of a sloping roof (A) to the top of the sloping section (B). (Example: a roof that slopes 1/8" per foot having a 24-foot span would have a rise of 24 x 1/8 or 3")

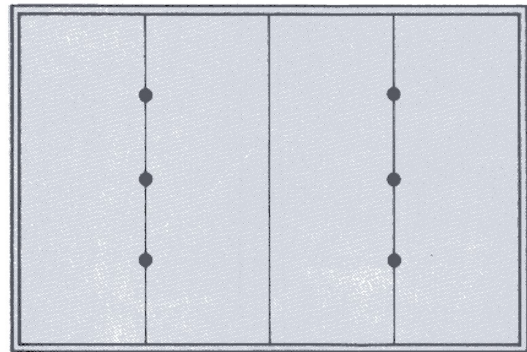

(Plan View)

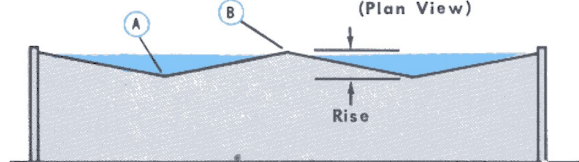

(Section View)

Economical Roof Drainage Installation

SPECIFICATION DATA

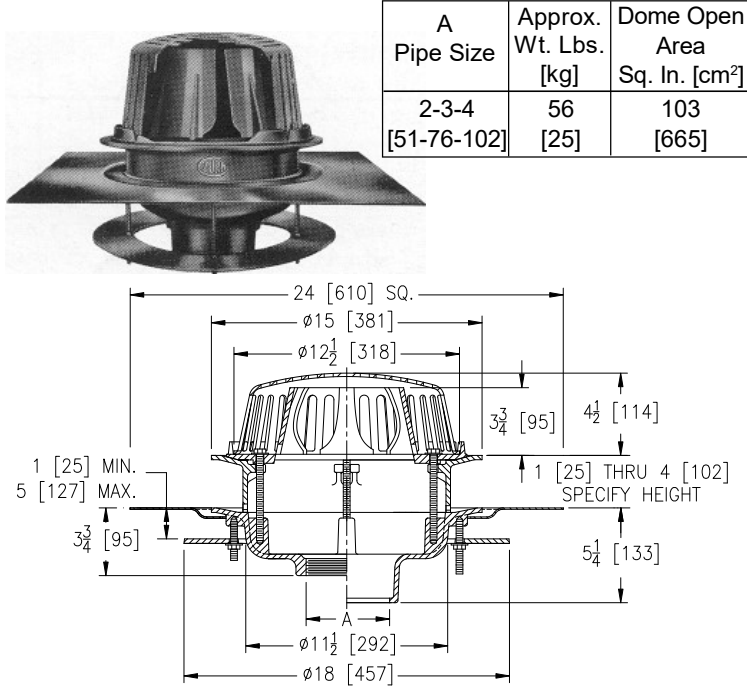

ROOF DESIGN RECOMMENDATIONS

Basic roofing design should incorporate protection that will prevent roof overloading by installing adequate overflow scuppers in parapet walls.

GENERAL RECOMMENDATIONS

On dead-level roofs, our general recommendations are to design for a 3" depth for the 10-year storm. In this case, even the 100-year storm will not result in a maximum depth of 6". A 6" depth represents a roof load of 31.2 pounds per square foot which approximates the 30 pound per square foot factor commonly used in roof design.

NOTE: A more conservative practice used by a few engineers in the past, depending upon other design considerations, has been to design for the 3" depth with the 25, 50, or even 100-year storm . . . and to also lower scuppers to 5" or 4" above roof level. In either case, the final determination rests with the engineering personnel responsible for this phase of the design.

ENGINEERING SPECIFICATION: ZURN Z105-C-E-R 15" Diameter "Control-Flo" roof drain for dead-level roof construction, Dura-Coated cast iron body, "Control-Flo" weir shall be linear functioning with integral membrane flashing clamp/gravel guard, static extension, secondary clamping collar with O-ring, Poly-Dome, roof sump receiver and underdeck clamp. All data shall be verified proportional to flow rates.

GENERAL RECOMMENDATIONS

On sloping roofs, we again recommend a 3" design depth for the 10-year storm, but by 3" we refer to an equivalent depth of 3". An equivalent depth is the depth of water attained at the drains that results in the same roof stresses as those realized on a dead-level roof. In all cases this equivalent depth is almost equal to that attained by using the same notch area rating for the different rises to 6". With the same depth of water at the drain the roof stresses will decrease with increasing total rise. Therefore, it would be possible to have a depth in excess of 6" at the drain on a sloping roof without exceeding stresses normally encountered in a 6" depth on a dead-level roof. However, it is recommended that scuppers be placed to limit the maximum water depth on any roof to 6" to prevent the over flow of the weirs on the drains and consequent overloading of drain piping.

NOTE: An equivalent depth is that depth of water attained at the drains at the lowest line or valley of the roof with all other conditions such as notch area and rainfall intensity being equal. For Galveston, Texas a notch area of 1800 square feet results in a 3" depth on a **dead-level** roof for a 10-year storm. For the same notch area and a 10-year storm, equivalent depths for a 2", 4", and 6" rise respectively on a **sloped roof** would be 3.4", 3.8", and 4.6". Roof stresses will be approximately equal in all cases.

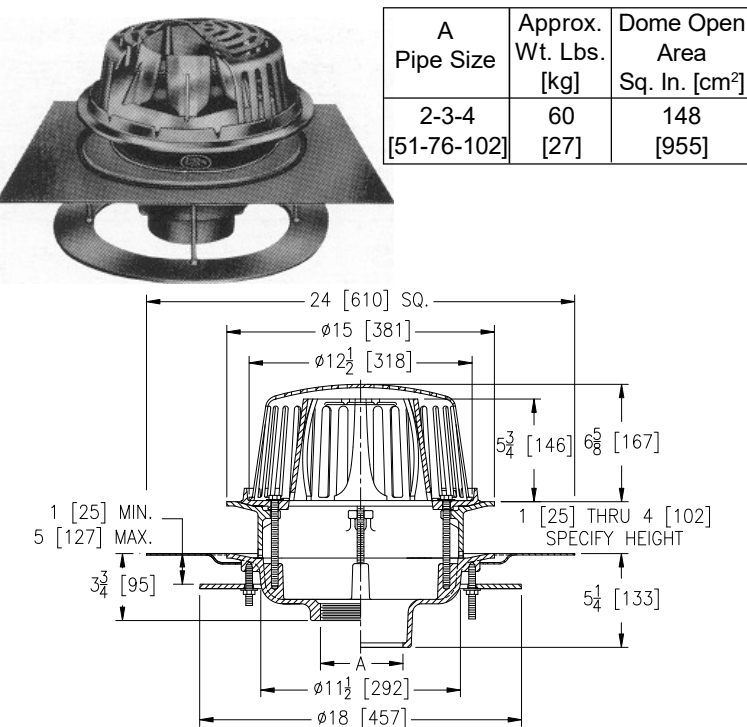

ENGINEERING SPECIFICATION: ZURN Z105-C-E-R-10 "Control-Flo" roof drain for Sloped Roof construction, Dura-Coated cast iron body, "Control-Flo" weir shall be linear functioning with integral membrane flashing clamp/gravel guard and 6 5/8 [168] high Aluminum dome. All data shall be verified proportional to flow rates.



Control-Flo Drain Selection is Quick and Easy . . .

The exclusive Zurn "Selecta-Drain". Chart (pages 6, 7, 8, 9) tabulates recommended selection data for several hundred localities in the United States. It constitutes your best assurance of sure, safe, economical additional data for your Zurn "Control-Flo" systems for your specific geographical area.

If the "Selecta-Drain" Chart doesn't not suit your specific design criteria, write directly to Zurn Industries, Inc. Field Service Engineering, Specification Drainage Operations, Erie, Pa for additional data for your locality. Listed below is additional information pertinent to proper engineering of the "Control-Flo" system.

ROOF USED AS TEMPORARY RETENTION

The key to economical "Control-Flo" drainage is the utilization of large roof areas to temporarily store the maximum amount of water without overloading average roofs or creating excessive drain down time during periods of heavy rainfall.

The data shown in the "Selecta-Drain" Chart, which takes all these factors into consideration, represents only one point on a series of curves prepared for each locality and was determined after careful study and research as imparting optimum economy in design.

ROOF LOADING AND RUN-OFF RATES

The values for notch areas selected from the design curves were based on a 3" head on a dead-level roof for the 10-year storm. In low rainfall localities the area per notch was limited to 25,000 square feet to keep the drain down time within reasonable limits. The same area for each respective locality was used for the various roof rises for sloping roofs.

Extensive studies show that stresses due to water load on a sloping roof for any fixed set of conditions are very nearly the same as those on a dead-level roof. A sloping roof tends to concentrate more water in the valleys and increase the water depth at this point. The greater depth around the drain leads to a faster run-off rate, particularly a faster early run-off rate. As a result, the total volume of water stored on the roof is less, and the total load on the sloping roof is less. By using the same area on the sloping roof as on the dead-level roof the increase in roof stresses due to increased water depth in the valleys is offset by the decrease in the total load due to less water stored. The net result is the maximum roof stresses are approximately the same for single span, rise and fixed set of conditions. A fixed set of conditions would be the same notch area, the same frequency storm, and the same locality.

NOTCH FLOW AND WATER DEPTH

The flow through each notch of the "Control-Flo" weir is 10 GPM per inch of head. To compute the depth of water in inches at the drain, obtain the total flow for any fixed set of conditions and locale from the "Selecta-Drain" Chart and divide by 10. For example, for Anniston, Alabama the discharge rates are 30, 35, 39 and 43 GPM for the 10, 25, 50 and 100-year storms respectively on a dead-level roof.

Since the possibility of exceeding 4.3" of water exists only once every 100 years, the drains can be sized to carry 43 GPM per notch and scuppers can be set at a height of 4.3" above the roof to prevent overloading the drains if a worse than 100-year storm occurs. On a similar basis, drain pipe sizes and scupper heights can be selected for various roof slopes and storm frequencies.

ADDITIONAL NOTCH RATINGS

The "Selecta-Drain" Chart along with Tables I and II enables the engineer to select "Control-Flo" Drains and drain pipe sizes for most applications. The "Selecta-Drain" Chart and Tables I and II are computed for a proportional flow weir that is sized to give a flow of 10 GPM per inch of head. However, this data can be applied to other sizes of proportional flow weirs by simple multiplication or division. For example, if a similar weir that is sized to give a flow of 5 GPM per inch is substituted for the 10 GPM per inch weir, the notch area and discharge in GPM would be divided by two, and this opening would be given a 7'2 notch area rating.

PROPER DRAIN LOCATION

The following good design practice is recommended for selecting the proper number of "Control-Flo" drains for a given area.

On dead-level roofs, drains should be located no further than 50 feet from each edge of the roof to assure good run-off regardless of wind direction. Weir should be flush with roof surface, not recessed.

On sloping roofs, drains should be located in the valleys at a distance no greater than 50 feet from each end of the valleys. Weir should be flush with the valley roof surface, not recessed.

On large roof areas, drains should not be spaced at a distance greater than 200 feet.

Saves Specification Time, Assures Proper Application

QUICK EASY SELECTION

Using the "Selecta-Drain" Chart (pages 6, 7, 8, 9) in combination with the steps and examples appearing below, should save you countless hours in engineering specification time. This vast compilation of data is related to the proper selection of drains for over 200 cities. If a specific city does not appear in this tabulation, choose the city, nearest your area and select the proper drain using these factors.

3 EASY STEPS

AND 3 TYPICAL EXAMPLES FOR APPLICATION OF SURE, SCIENTIFIC CONTROL OF DRAINAGE FROM DEAD-LEVEL AND SLOPING ROOFS WITH THE ZURN CONCEPT

WASHINGTON, D. C.	DEAD-LEVEL ROOF	4 INCH RISE	6 INCH RISE
<p>1 Determine total roof area or individual areas when roof is divided by expansion joints or peaks in the case of sloping roof.</p>	<p>Roof Area: 192 ft. x 500 ft. = 96,000 sq. ft.</p>	<p>3 Individual Roof Areas: 64 ft. x 500 ft. = 32,000 sq. ft. Valleys 500 ft. long 3 x 32,000 = 96,000 sq. ft.</p>	<p>2 Individual Roof Areas: 98 ft. x 500 ft. = 48,000 sq. ft. Valleys 500 ft. long 2 x 48,000 = 96,000 sq. ft.</p>
<p>2 Divide roof area or individual areas by Zurn Notch Area Rating to obtain the total number of notches required.</p>	<p>Zurn Notch Area Rating for Washington, D. C. = 13,300 "Selecta-Drain" Chart</p> <p>Total Notches Required = 96,000 sq. ft</p> <p>13,300 sq. ft. notch area = 7.2 notches-USE 8 PER AREA</p>	<p>Zurn Notch Area Rating for Washington, D.C. = 13,000 from "Selecta-Drain" Chart</p> <p>Total Notches Required = 32,000 sq. ft.</p> <p>13,300 sq. ft. notch area = 2.4 notches - USE 8 PER AREA</p>	<p>Zurn Notch Area Rating for Washington, D.C. = 13,000 from "Selecta-Drain" Chart</p> <p>Total Notches Required = 48,000 sq. ft.</p> <p>13,300 sq. ft. notch area = 3.6 notches - USE 4 PER AREA</p>
<p>3 Determine total number of drains required by not exceeding maximum spacing dimensions in the preceding instructions.</p> <p>Divide total number of notches required to determine the number of notches per drain.</p> <p>Note flow rate for the 100-year storm and divide by 10 to determine maximum water depth at drain and use this dimension to determine scupper height. Maximum scupper height to be used is 6". Use this flowrate to size leaders and drain lines.</p>	<p>6 drains required. 3 along each side within 50 ft. of the side with a spacing of 50 ft. - 200 ft. 200 ft. - 50 ft. Two drains must have two notches for a total of eight notches. Located at diagonally opposite corners.</p> <p>Flow rate for the 100-year storm is 44 GPM. Maximum water depth and scupper height equals 4.4". Size leaders from single notch drains for 44 GPM and leaders from double notch drains for 88 GPM.</p>	<p>3 drains per area required in the valleys 50 ft. from each end with one in the middle. All drains will have one notch.</p> <p>Flow rate for the 100-year storm is 59 GPM maximum. Water depth and scupper height equals 5.9". Size leaders for 59 GPM.</p>	<p>3 drains per area required in the valleys 50 ft. from each end with one in the middle. 4 notches are required there fore one drain must have two notches. Locate this one in the middle. Flow rate for the 100-year storm is 64 GPM. Locate scuppers at 6" and use 60 GPM as maximum flow rate and 6" maximum depth. The probability of water flowing out scuppers is now less than once every 50 years instead of every 100 years. Size leaders for 60 GPM</p>

SPECIAL CONSIDERATIONS

The 3" design water level for the 10-year storm represents a roof load of approximately 15 lbs. per sq. ft. This is only half the usual minimum design roof load rating of 30 lbs. per sq. ft. and so presents no problem from that aspect. However, since it is desirable to contain the design depth of water on the roof and to prevent spillage over the roof in high wind condition, it is recommended that any roof construction, parapets, flashing and curves should be high enough to prevent flooding over them.

Another special case applies to water cooled roofs and here the "Control-Flo" principle can still be used. An adjustable collar on the drain body will retain a pool of water 0 to 3" deep on the roof and a 3" high "Control-Flo" Weir on top of the adjustable collar will control storm water falling on this pool. This restricts maximum depth on the roof to 6" and scuppers should be located at this height. Since the weirs are only 3" high on this drain, they should be selected for a 3" head based on the 100-year frequency storm.



Selecta-Drain Chart

LOCATION	Notch Area Rating	DEAD-LEVEL				2-INCH RISE				4-INCH RISE				6-INCH RISE			
		Discharge GPM Draindown Time Hrs.				Discharge GPM Draindown Time Hrs.				Discharge GPM Draindown Time Hrs.				Discharge GPM Draindown Time Hrs.			
		10 Yrs.	25 Yrs.	50 Yrs.	100 Yrs.	10 Yrs.	25 Yrs.	50 Yrs.	100 Yrs.	10 Yrs.	25 Yrs.	50 Yrs.	100 Yrs.	10 Yrs.	25 Yrs.	50 Yrs.	100 Yrs.
Anniston, AL	13,300	30 26	35 28	39 29	43 30	37 22	43 24	47 26	50 27	45 16	51 18	55 19	59 21	53 12	59 14	63 15	67 16
Birmingham, AL	10,200	30 20	36 22	40 23	44 24	36 17	41 19	46 20	50 21	44 12	49 13	53 14	57 15	52 9	57 10	61 11	64 12
Mobile, AL	4,000	30 7.8	36 8.5	40 9	44 9.8	36 6.4	40 7	45 7.5	50 8	44 4.5	48 5.1	52 5.5	57 6	52 3.6	56 3.9	59 4	62 4.3
Montgomery, AL	5,330	30 9.5	36 10.5	40 11	44 11.5	35 8	39 9	43 9.5	48 10	43 5.5	47 6	51 6.6	55 7.1	50 4.2	55 4.8	58 5.2	61 5.5
Fairbanks, AK	25,000	14 26	16 30	18 32	19 33	18 22	20 23	22 25	25 28	24 15	27 16	30 18	33 21	30 12	33 14	37 15	39 16
Juneau, AK	25,000	27 41	30 44	31 45	34 48	30 34	33 37	35 38	38 41	37 23	39 24	41 25	44 27	42 17	44 18	47 19	51 21
Phoenix, AZ	25,000	19 33	23 37	26 40	29 43	26 30	30 34	33 37	36 39	33 21	37 23	40 25	44 27	39 16	45 19	48 20	52 22
Bentonville, AR	22,000	30 40	36 44	40 46	43 48	38 38	44 40	47 42	50 44	44 24	50 28	54 30	58 33	52 20	57 22	61 23	64 24
Fort Smith, AR	16,000	30 31	36 34	40 36	45 38	37 28	43 30	46 31	51 32	45 19	50 21	54 23	59 25	52 15	57 16	61 18	65 19
Little Rock, AR	9,500	30 18	36 20	40 21	44 22	36 16	40 17	45 19	50 20	43 11	48 12	51 13	56 14	51 8.5	56 9.5	59 10.5	62 11.5
Eureka, CA	25,000	28 42	33 47	37 50	43 54	32 36	36 39	41 44	45 46	39 24	44 27	48 30	53 32	44 18	49 20	53 22	56 24
Fresno, CA	25,000	15 29	17 32	19 33	21 35	21 24	24 27	26 30	28 32	28 17	32 20	34 21	36 23	33 14	37 15	40 16	43 18
Los Angeles, CA	20,000	30 38	38 44	44 46	49 47	33 30	40 36	46 38	52 42	37 19	44 21	49 26	55 29	42 15	50 18	55 20	60 21
Mt. Tamalpias, CA	25,000	22 36	24 38	26 40	27 41	25 28	28 32	30 34	31 35	32 20	357 22	37 23	39 24	37 15	40 16	42 17	44 18
Port Reyes, CA	25,000	19 33	22 36	25 39	27 41	23 26	27 31	29 33	31 35	31 19	35 22	37 23	39 24	36 15	40 16	43 18	46 19
Red Bluff, CA	25,000	27 41	31 45	36 49	41 52	33 37	38 41	43 45	46 47	40 25	46 28	51 32	56 35	47 19	53 22	57 24	61 26
Sacramento, CA	25,000	22 36	25 39	28 42	31 45	25 28	28 32	30 34	33 37	32 20	36 23	38 24	41 25	37 15	42 17	45 19	48 20
San Diego, CA	25,000	19 33	23 37	26 40	29 43	24 27	27 31	29 33	31 35	32 20	35 22	37 23	39 24	37 15	40 16	43 18	46 19
San Francisco, CA	25,000	22 36	25 39	28 42	30 44	25 28	28 32	30 34	33 38	33 21	36 23	38 24	40 25	37 15	41 17	45 19	47 19
San Luis Obispo CA	17,000	30 33	37 36	43 39	47 41	33 27	38 30	44 32	48 33	38 17	44 19	48 21	53 23	43 12	49 15	54 16	58 17
Denver, CO	25,000	17 32	20 34	23 37	25 39	25 28	28 32	31 35	34 38	33 21	37 23	39 24	42 26	39 16	45 19	48 20	52 22
Grand Junction CO	25,000	12 22	14 26	16 30	18 32	16 20	18 22	20 23	22 25	23 14	25 15	278 16	29 18	27 11	30 12	32 13	34 14
Pueblo, CO	25,000	12 32	21 35	24 38	26 40	26 30	30 34	33 37	37 40	34 21	38 24	41 25	45 28	42 17	46 19	51 21	54 23
Wagon Wheel Gap CO	25,000	14 26	16 30	18 32	19 33	18 22	21 24	23 26	25 28	25 15	29 18	31 19	33 21	30 12	34 14	36 15	38 16
Hartford, CT	25,000	29 43	34 48	38 50	42 53	35 38	39 42	42 45	46 47	41 25	46 28	50 31	54 33	48 20	54 23	57 24	60 25
New Haven, CT	19,000	30 36	36 40	40 42	45 44	36 31	41 34	45 36	49 38	43 21	49 24	53 27	57 29	48 16	53 18	57 19	60 20
Washington, DC	13,300	30 25	27 27	40 28	44 30	38 22	44 24	48 26	51 27	46 16	52 17	56 19	59 20	54 12	59 14	62 15	64 16
Apalachicola, FL	2,670	30 5.1	37 5.8	41 6	46 6.2	35 4.5	40 5	44 5.2	49 5.5	43 3.2	47 3.5	50 3.7	55 4	48 2.2	53 2.4	57 2.6	60 2.8
Jacksonville, FL	4,670	30 8.5	36 9.5	40 10	45 11	36 7.5	40 8	45 9	50 9.5	43 5	48 5.6	52 6	56 6.6	51 4	56 4.5	59 4.8	63 5
Key West, FL	3,300	30 6.2	37 7	42 7.5	47 7.8	35 5.5	41 6	46 6.3	51 6.8	43 3.7	48 4	53 4.7	58 5.2	50 2.8	55 2.9	58 3.3	63 3.7
Miami, FL	2,100	30 4	37 4.5	42 4.8	47 5	35 3.6	41 3.9	46 4.2	50 4.5	43 2.5	48 2.8	52 3.1	56 3.3	50 1.8	54 1.9	57 2.1	61 2.2
Pensacola, FL	1,900	30 3.6	37 4	43 4.5	47 4.7	35 3.2	41 3.6	46 3.8	50 4	43 2	48 2.5	53 2.8	57 3.1	50 1.7	55 1.8	59 2	62 2.1

LOCATION	Notch Area Rating	DEAD-LEVEL				2-INCH RISE				4-INCH RISE				6-INCH RISE			
		Discharge GPM Draindown Time Hrs.				Discharge GPM Draindown Time Hrs.				Discharge GPM Draindown Time Hrs.				Discharge GPM Draindown Time Hrs.			
		10 Yrs.	25 Yrs.	50 Yrs.	100 Yrs.	10 Yrs.	25 Yrs.	50 Yrs.	100 Yrs.	10 Yrs.	25 Yrs.	50 Yrs.	100 Yrs.	10 Yrs.	25 Yrs.	50 Yrs.	100 Yrs.
Tampa, FL	3,600	30 7	36 7.5	39 7.9	42 8	35 5.9	40 6.3	44 6.9	48 7.2	43 4	48 4.5	52 5	56 5.4	51 3.2	56 3.5	58 3.6	62 3.8
Atlanta, GA	12,100	30 24	35 25	37 26	41 28	36 21	40 22	44 23	48 24	44 14	47 15	50 16	54 17	52 11	55 12	58 12	62 13
Augusta, GA	6,700	30 32	36 36	40 38	45 40	37 29	43 31	47 33	51 36	45 20	51 23	55 25	59 27	53 16	58 17	62 19	66 21
Macon, GA	8,000	30 16	37 18	42 19	48 20	37 14	44 15	49 16	56 17	45 10	51 11	56 12	60 13	53 7.5	59 8.2	63 9	67 10
Savannah, GA	3,800	30 7.2	36 8	40 8.4	43 8.9	35 6.1	39 6.8	43 7.1	48 7.6	42 4.1	47 4.8	51 5.1	54 5.4	51 3.3	55 3.6	58 3.8	61 3.9
Thomasville, GA	4,600	30 8.5	36 9.5	39 10	42 10.5	36 7.2	40 8	44 8.5	47 9	43 5	47 5.5	51 6	54 6.4	51 4	55 4.3	58 4.5	61 4.9
Honolulu, HI	7,300	30 14	37 16	42 17	47 18	36 12	42 13	47 14	52 15	43 8	49 9.5	54 10.5	58 11.5	50 6.5	56 7.2	60 7.8	63 8.1
Boise, ID	25,000	12 22	14 26	15 28	16 30	17 21	19 23	20 23	22 25	23 14	26 16	28 17	29 18	27 11	30 12	32 13	34 14
Lewiston, ID	25,000	13 24	15 28	16 30	17 32	17 31	19 23	20 23	22 25	23 14	25 15	27 17	29 18	27 11	30 12	32 13	34 14
Pocatello, ID	25,000	12 22	14 26	16 30	17 32	18 22	21 24	23 26	25 28	26 16	29 18	31 19	33 21	31 13	35 14	37 15	39 16
Cairo, IL	15,300	30 29	37 32	40 33	45 36	37 26	43 28	47 29	50 30	45 18	51 20	55 22	59 23	53 14	58 15	62 16	66 18
Chicago, IL	25,000	28 42	33 47	37 50	41 52	36 39	41 44	45 46	49 49	44 27	49 31	53 32	57 35	52 22	57 24	61 26	65 27
Peoria, IL	25,000	30 44	35 48	39 51	43 54	37 40	42 45	46 47	49 49	45 28	50 31	54 33	58 36	53 22	57 24	61 26	64 27
Springfield, IL	25,000	30 44	36 49	40 52	44 54	37 40	42 45	46 47	50 50	44 27	50 31	55 34	58 36	52 22	58 24	61 26	65 27
Evansville, IN	25,000	30 44	36 49	40 52	44 54	37 40	42 45	46 47	49 49	45 28	50 31	53 32	57 35	53 22	57 24	60 25	64 27
Fort Wayne, IN	25,000	27 41	30 44	34 48	38 50	34 38	38 41	41 44	44 46	40 25	44 27	48 30	51 32	49 20	53 22	56 24	59 25
Indianapolis, IN	25,000	30 44	37 48	41 51	45 54	38 40	45 44	49 46	53 48	46 28	53 32	57 36	62 39	54 22	60 24	63 26	66 27
Terre Haute, IN	17,000	30 33	36 36	39 38	44 40	37 29	42 31	46 32	50 34	45 20	50 23	54 24	57 26	53 16	57 17	60 18	64 20
Charles City, IA	25,000	30 44	36 49	41 52	45 55	37 40	43 45	47 47	50 50	45 28	50 31	55 34	59 37	53 22	57 24	61 26	65 27
Davenport, IA	25,000	30 44	36 49	41 52	45 55	38 41	44 46	48 48	52 52	46 28	52 32	56 35	60 38	54 23	59 25	63 27	66 28
Des Moines, IA	16,700	30 32	37 37	41 39	46 41	38 30	44 32	48 33	53 36	46 21	53 24	56 25	60 27	54 1	59 18	63 19	66 21
Dubuque, IA	16,700	32 32	36 36	38 38	40 40	29 29	31 31	33 33	36 36	21 21	23 23	26 26	27 27	16 16	17 17	19 19	20 20
Keokuk, IA	20,000	30 38	36 42	40 44	44 46	38 34	43 37	47 40	51 42	46 24	51 27	56 29	60 31	54 19	58 20	62 22	66 23
Sioux City, IA	25,000	27 41	31 45	38 50	42 53	35 38	40 43	45 46	49 49	43 26	49 31	54 33	59 37	53 22	58 24	61 26	64 27
Concordia, KS	14,100	30 27	36 29	41 31	46 32	38 22	45 25	49 26	54 27	46 15	53 19	57 21	61 23	54 13	57 14	61 15	66 19
Dodge City, KS	15,800	30 30	36 33	40 36	46 38	38 28	45 30	40 32	54 33	46 19	53 22	57 24	62 26	54 15	61 17	63 18	68 20
Iola, KS	10,000	30 19	36 21	39 22	42 23	37 17	41 19	45 20	49 21	44 11.5	48 12.5	52 13.5	56 14.5	52 9	56 10	59 10.5	63 11.3
Topeka, KS	8,000	30 15	35 17	40 18	44 19	37 14	42 15	46 16	50 16.5	45 9.5	50 10.5	54 11.5	58 12	53 7.5	58 8	62 9	67 10
Wichita, KS	10,300	30 30	36 36	40 40	44 44	37 37	42 42	47 47	51 51	46 46	50 50	55 55	59 59	55 55	58 58	62 62	66 66
Lexington, KY	16,000	30 31	36 34	41 37	46 39	37 28	43 30	48 31	53 33	45 19	51 21	56 23	60 25	53 16	58 17	62 18	65 19
Louisville, KY	23,000	30 42	36 46	40 49	45 52	34 36	38 39	41 41	43 42	40 24	46 27	50 30	53 31	47 18	53 21	56 22	58 23
New Orleans, LA	3,000	30 6	36 6.2	40 6.8	44 7.2	35 5	40 5.5	44 5.8	47 6	42 3.4	46 3.7	50 4	54 4.3	49 2.6	53 2.8	57 3	60 3.2



Selecta-Drain Chart

LOCATION	Notch Area Rating	DEAD-LEVEL				2-INCH RISE				4-INCH RISE				6-INCH RISE			
		Discharge GPM Draindown Time Hrs.				Discharge GPM Draindown Time Hrs.				Discharge GPM Draindown Time Hrs.				Discharge GPM Draindown Time Hrs.			
		10 Yrs.	25 Yrs.	50 Yrs.	100 Yrs.	10 Yrs.	25 Yrs.	50 Yrs.	100 Yrs.	10 Yrs.	25 Yrs.	50 Yrs.	100 Yrs.	10 Yrs.	25 Yrs.	50 Yrs.	100 Yrs.
Shreveport, LA	5,100	30 9.5	36 10.5	41 10.9	45 11.6	36 8.2	40 9	45 9.7	50 10.2	43 5.5	48 6	52 6.7	57 7.5	51 4.5	55 4.9	59 5.2	62 5.5
Eastport, ME	25,000	24 38	27 41	30 44	32 46	30 34	34 38	37 40	40 43	37 23	42 26	44 27	48 30	44 18	50 21	53 22	56 24
Portland, ME	25,000	27 41	31 45	34 48	38 50	31 35	35 38	38 41	41 44	38 24	44 27	47 29	50 31	46 19	50 21	53 22	56 24
Baltimore, MD	16,700	30 32	36 36	40 38	45 40	37 27	42 30	46 32	50 34	46 20	51 22	55 24	59 26	52 15	57 17	62 20	66 22
Boston, MA	25,000	28 42	33 47	37 50	41 52	35 38	40 43	43 45	47 47	42 26	46 28	50 31	54 33	50 21	54 23	57 24	61 26
Nantucket, MA	25,000	27 41	32 46	37 50	41 52	35 38	39 42	42 45	46 47	42 26	46 28	50 31	54 33	51 21	55 23	58 24	61 26
Alpena, MI	25,000	20 34	23 37	26 40	28 42	28 32	32 36	36 39	39 42	36 23	40 25	43 26	47 29	44 18	49 20	53 22	56 24
Detroit, MI	25,000	25 39	30 44	34 48	38 50	34 38	39 42	43 45	47 47	42 26	47 29	51 32	55 34	51 21	55 24	60 25	63 27
East Lansing, MI	25,000	21 35	25 39	27 41	29 43	28 32	33 37	36 39	38 41	37 23	40 25	43 26	46 28	44 18	49 20	53 22	56 24
Escanaba, MI	25,000	23 37	27 41	30 44	33 47	30 34	35 38	38 41	41 44	38 24	43 26	46 28	50 31	47 19	51 21	55 23	58 24
Grand Haven, MI	25,000	24 38	28 42	33 47	37 50	32 36	36 39	41 44	45 46	40 25	45 28	49 31	53 32	48 20	53 22	57 24	60 25
Grand Rapids, MI	25,000	24 38	37 41	30 44	34 48	32 36	36 39	39 42	42 45	39 24	43 26	46 28	49 31	46 19	52 22	55 23	57 24
Houghton, MI	25,000	22 36	24 38	27 41	30 44	28 32	31 35	35 38	38 41	36 23	38 24	41 25	44 27	42 17	46 19	49 20	52 22
Marquette, MI	25,000	24 38	28 42	32 46	34 48	32 36	36 39	40 43	43 45	40 25	44 27	48 30	52 32	48 20	53 22	57 24	60 25
Port Huron, MI	25,000	23 37	27 41	29 43	32 46	30 34	35 38	37 40	40 43	37 23	42 26	45 28	48 30	45 19	50 21	54 23	56 24
Sault Ste. Marie, MI	25,000	17 32	21 35	24 38	28 42	25 28	29 33	32 36	35 38	32 20	37 23	40 25	43 26	39 16	44 18	47 19	50 21
Duluth, MN	25,000	24 38	27 41	30 44	34 48	32 36	35 38	38 41	42 45	39 24	43 26	47 29	50 31	47 19	52 22	55 23	59 25
Minneapolis, MN	25,000	27 41	33 47	37 50	41 52	36 39	41 44	45 46	49 48	44 27	50 31	54 33	58 38	52 22	58 24	62 26	66 28
Moorehead, MN	25,000	27 27	33 33	37 37	43 43	34 36	41 41	45 45	51 51	44 44	50 50	54 54	59 59	52 52	58 58	62 62	67 67
St. Paul, MN	25,000	27 41	31 45	35 48	40 42	36 39	39 42	43 45	48 47	44 27	48 30	52 32	56 35	52 22	56 24	60 25	64 27
Meridian, MS	7,800	30 15	36 16	41 18	44 19	38 14	45 14.7	49 15.5	52 16	47 9.5	53 11	57 11.8	61 12.3	56 7.5	61 8	65 9	69 10
Vicksburg, MS	7,300	30 14	35 15	39 16	42 17	37 12	40 13	43 14	48 15	44 8	47 9	50 9.5	55 10.5	51 6.5	54 6.9	57 7.2	62 8
Columbia, MO	21,000	30 39	36 44	40 46	44 47	37 36	41 38	46 40	48 42	45 24	49 27	53 29	57 31	53 19	57 21	60 22	64 24
Hannibal, MO	16,700	30 32	37 36	42 38	49 42	38 28	45 31	50 34	59 38	46 20	53 23	58 25	65 30	54 16	60 19	65 21	72 22
Kansas City, MO	6,700	30 13	36 14.5	41 15.5	46 16	37 12	42 13	47 14	51 14.5	44 8	49 9	54 10	58 11	52 6.2	57 7	61 7.5	65 8
St. Joseph, MO	13,300	30 26	36 28	40 30	45 31	37 23	43 25	47 26	50 27	45 16	50 18	55 20	58 21	53 12	58 14	62 15	65 16
St. Louis, MO	8,300	30 16	36 18	41 20	46 21	37 15	42 16	47 17	51 18	45 10	50 11	55 12	9 13	53 7.5	57 8.5	61 9	65 10
Springfield, MO	17,000	30 33	36 35	40 38	44 40	37 27	42 30	46 32	50 34	44 19	50 22	54 24	58 25	52 15	56 16	60 19	64 21
Havre, MO	25,000	17 32	19 33	21 35	23 37	22 24	25 28	27 31	29 33	30 18	33 21	35 22	37 23	36 14	39 16	42 17	45 19
Helena, MO	25,000	15 28	18 32	20 34	22 36	18 22	20 23	22 25	24 27	24 15	28 17	30 18	32 20	29 12	33 13	35 14	37 15
Kalispell, MO	25,000	14 26	16 30	18 32	20 34	18 22	20 23	22 25	24 27	25 15	28 17	30 18	32 20	30 12	33 13	35 14	37 15
Miles City, MO	25,000	16 30	19 33	21 35	23 37	22 25	25 28	27 31	29 33	30 18	33 21	35 22	37 23	35 15	38 16	42 17	44 18

LOCATION	Notch Area Rating	DEAD-LEVEL				2-INCH RISE				4-INCH RISE				6-INCH RISE			
		Discharge GPM Draindown Time Hrs.				Discharge GPM Draindown Time Hrs.				Discharge GPM Draindown Time Hrs.				Discharge GPM Draindown Time Hrs.			
		10 Yrs.	25 Yrs.	50 Yrs.	100 Yrs.	10 Yrs.	25 Yrs.	50 Yrs.	100 Yrs.	10 Yrs.	25 Yrs.	50 Yrs.	100 Yrs.	10 Yrs.	25 Yrs.	50 Yrs.	100 Yrs.
Missoula, MO	25,000	13 23	15 28	17 32	19 33	17 21	20 23	22 25	24 27	24 15	27 16	29 18	31 19	29 12	32 13	34 14	36 15
Lincoln, NE	18,000	30 34	37 38	42 41	46 43	36 30	41 32	45 34	49 36	44 21	51 24	56 27	60 29	53 16	59 18	62 20	65 22
North Platte, NE	25,000	27 41	33 47	39 51	43 54	36 39	43 45	47 47	51 51	44 27	51 32	56 35	60 38	52 22	59 25	63 27	66 28
Omaha, NE	22,000	30 40	38 46	43 48	48 52	39 38	44 40	49 43	54 45	46 26	52 29	57 32	62 36	54 21	60 23	64 24	67 26
Valentine, NE	25,000	26 40	31 45	36 49	41 52	35 38	40 43	44 46	49 48	43 26	49 13	54 33	59 37	52 22	58 24	62 26	66 28
Reno, NV	25,000	14 26	16 30	17 32	18 32	17 21	19 23	21 24	22 25	24 15	26 13	28 17	30 18	29 12	32 13	34 14	36 15
Tonopah, NV	25,000	13 23	15 28	17 32	19 33	16 20	18 22	19 23	21 24	20 13	2 14	26 16	28 17	25 10.5	27 11.5	29 12	32 13
Winnemucca, NV	25,000	10 20	12 27	13 23	15 28	16 20	18 22	19 23	20 23	22 14	25 15	27 16	28 17	29 11	32 12	34 13	36 14
Concord, NH	25,000	27 41	32 46	37 50	41 52	32 36	37 40	40 43	44 46	40 25	45 28	49 31	51 32	46 19	51 21	55 23	58 24
Atlantic City, NJ	7,800	30 44	38 50	43 54	48 58	37 40	43 45	48 48	54 52	44 27	50 31	55 34	60 38	51 21	57 24	62 26	66 28
Sandy Hook, NJ	17,000	30 33	36 36	40 38	44 40	37 27	43 30	47 32	50 34	45 20	50 22	54 24	58 25	53 19	58 17	62 20	65 21
Trenton, NJ	25,000	28 42	33 47	38 50	42 53	36 39	40 43	44 46	47 47	43 26	48 30	52 32	56 35	51 21	56 24	59 25	63 27
Albuquerque, NM	25,000	15 28	18 32	20 34	22 36	23 26	26 39	29 33	31 35	31 19	34 21	37 23	39 24	37 15	41 17	44 18	47 19
Roswell, NM	25,000	23 37	27 41	30 44	33 47	31 35	36 39	39 42	43 45	39 24	43 26	47 29	51 32	47 19	52 22	56 24	59 25
Sante Fe, NM	25,000	16 30	18 32	20 34	22 36	23 26	26 30	28 32	30 34	31 19	34 21	36 23	38 24	37 15	40 16	43 18	46 19
Albany, NY	25,000	23 37	26 40	29 43	32 46	28 32	32 36	35 38	37 40	36 23	39 24	42 26	45 28	43 18	47 19	50 21	53 22
Binghamton, NY	25,000	23 37	27 41	30 44	33 47	30 34	34 38	37 40	40 43	38 24	42 26	46 28	49 31	46 19	51 21	55 23	58 24
Buffalo, NY	25,000	23 37	26 40	29 43	32 46	31 35	36 39	39 42	42 45	39 24	43 26	47 29	50 31	47 19	52 22	56 24	59 25
Canton, NY	25,000	25 39	30 44	35 48	39 51	33 37	39 42	43 45	47 47	40 25	46 28	51 32	56 35	48 20	55 23	59 25	63 27
Ithaca, NY	20,000	30 38	35 41	39 44	43 45	35 42	40 36	48 38	48 40	40 21	48 24	51 27	56 30	47 16	54 19	58 21	62 22
New York, NY	15,800	30 31	36 34	41 37	46 38	38 28	43 30	48 31	52 32	46 19	51 22	56 23	60 24	54 15	59 17	64 18	68 19
Oswego, NY	25,000	19 53	22 36	24 38	26 40	25 28	38 32	30 34	32 36	33 21	36 23	38 24	40 25	38 16	42 17.5	45 19	48 20
Rochester, NY	25,000	22 36	26 40	29 43	31 45	30 34	35 38	37 40	41 44	38 24	42 26	45 28	49 31	45 19	51 21	54 23	56 23.7
Syracuse, NY	25,000	26 40	32 46	36 49	41 52	34 38	40 43	45 46	49 49	42 26	48 30	53 32	57 37	50 21	56 23.7	61 26	68 27
Asheville, NC	21,000	30 39	37 44	47 47	47 50	37 36	43 39	47 42	51 43	45 24	51 28	55 30	58 32	52 19	57 21	61 22	65 24
Charlotte, NC	17,000	30 33	35 35	39 38	42 39	35 26	40 29	45 31	50 34	43 19	48 22	52 23	55 24	51 15	55 16	59 18	62 19
Greensboro, NC	16,700	30 32	36 35	41 38	46 40	35 26	38 28	42 30	46 31	41 18	45 20	49 22	52 23	49 15	54 16	57 17	60 18
Hatteras, NC	2,500	30 4.6	38 505	43 5.8	48 6.2	34 4	41 4.7	46 5	51 5.2	40 2.7	46 3	50 3.4	56 3.6	46 1.9	52 2.2	57 2.5	62 2.7
Raleigh, NC	9,000	30 17	36 18	40 20	44 21	37 15	42 17	46 17.5	50 18	45 11	50 12	55 13	59 14	53 8	59 9	61 10	64 11
Wilmington, NC	6,800	30 13	36 14	40 15	45 16	36 11	41 12	46 13	50 14	43 7.5	48 9	52 9.8	56 10	51 6	56 6.8	59 7.2	62 7.5
Bismarck, ND	25,000	22 36	26 40	29 43	33 47	30 34	35 38	38 41	41 44	38 24	43 26	47 29	50 31	46 19	52 22	55 23.3	58 24
Devils Lake, ND	25,000	23 37	27 41	30 44	34 48	30 34	35 38	38 41	41 44	38 24	43 26	47 29	50 31	46 19	52 22	55 23.3	58 24



Selecta-Drain Chart

LOCATION	Notch Area Rating	DEAD-LEVEL				2-INCH RISE				4-INCH RISE				6-INCH RISE			
		Discharge GPM Draindown Time Hrs.				Discharge GPM Draindown Time Hrs.				Discharge GPM Draindown Time Hrs.				Discharge GPM Draindown Time Hrs.			
		10 Yrs.	25 Yrs.	50 Yrs.	100 Yrs.	10 Yrs.	25 Yrs.	50 Yrs.	100 Yrs.	10 Yrs.	25 Yrs.	50 Yrs.	100 Yrs.	10 Yrs.	25 Yrs.	50 Yrs.	100 Yrs.
Williston, ND	25,000	21 35	25 39	28 42	31 45	29 33	34 38	38 41	41 41	37 23	42 26	46 28	50 31	45 19	52 22	55 23.3	59 25
Cincinnati, OH	25,000	27 41	31 45	38 48	39 51	34 38	32 42	42 45	45 46	42 26	47 29	50 31	53 32	50 21	54 23	57 24	60 25
Cleveland, OH	25,000	23 37	26 40	29 43	32 46	30 34	34 38	37 40	40 43	38 24	42 26	45 28	48 30	46 19	50 21	53 22	56 23.7
Columbus, OH	25,000	22 36	26 40	28 42	30 44	30 34	34 38	37 40	40 43	38 24	42 26	45 28	48 50	46 19	50 21	53 22	56 23.7
Dayton, OH	25,000	24 38	28 42	31 45	34 48	32 36	36 39	39 42	41 44	39 24	43 26	47 29	50 31	47 19	52 22	56 23.7	59 25
Sandusky, OH	25,000	28 42	34 38	39 51	43 54	36 39	42 45	47 47	51 51	44 27	50 31	55 34	59 37	52 22	58 24	63 27	66 28
Toledo, OH	25,000	26 40	30 44	35 48	39 51	34 38	38 41	43 45	46 47	42 26	46 28	51 32	54 33	50 21	54 23	58 24	62 26
Oklahoma City, OK	7,500	30 14	36 16	40 17	44 18	36 12	42 14	46 15	50 16	44 8.5	50 10	54 10.5	58 11.5	52 6.6	57 7.5	60 7.9	64 8.5
Baker, OR	25,000	10 20	12 22	13 24	14 26	17 21	19 23	20 23	21 24	26 14	25 15.5	27 16	29 18	26 11	30 12	32 13	34 14
Portland, OR	25,000	22 36	25 39	29 43	32 46	26 30	30 34	33 37	36 39	34 21	38 21	41 25	44 27	38 16	42 17.5	45 19	48 20
Roseburg, OR	25,000	22 36	25 39	29 43	32 46	26 30	30 34	33 37	36 39	34 21	38 24	41 25	44 27	37 15	42 17.5	49 19	47 19
Erie, PA	21,000	30 39	38 44	44 47	48 50	38 36	45 40	49 42	54 44	45 24	52 29	57 31	62 33	53 19	58 21	63 23	67 25
Harrisburg, PA	25,000	28 42	33 47	47 50	41 52	35 38	40 43	44 46	48 48	43 26	48 30	52 32	56 35	31 21	56 24	60 25	64 27
Philadelphia, PA	25,000	29 43	34 48	38 50	41 52	36 39	40 43	43 45	47 47	43 26	48 30	52 32	56 35	51 21	56 24	59 25	62 26
Pittsburgh, PA	25,000	22 36	25 39	37 41	20 43	29 33	33 36	35 38	37 40	37 23	40 25	43 26	45 28	45 19	49 20	51 21	54 23
Reading, PA	25,000	30 44	37 50	42 53	46 56	38 41	45 36	49 49	52 52	45 28	52 32	57 35	60 38	53 22	59 25	63 27	67 28
Scranton, PA	25,000	26 40	30 44	34 48	38 50	34 38	38 41	41 44	44 46	41 28	46 28	49 31	52 32	49 20	54 23	57 24	60 25
Block Island, RI	25,000	26 40	30 44	34 48	38 50	34 38	38 41	41 44	44 46	41 25	46 28	49 31	52 32	48 20	54 23	57 24	59 25
Providence, RI	25,000	30 44	37 60	42 53	47 57	38 41	44 46	48 48	53 53	46 28	51 32	56 35	61 38.5	54 23	58 24	62 26	66 28
Charleston, SC	3,800	30 7.2	37 8	41 8.5	46 9	36 6.2	40 6.8	46 7.2	51 7.8	44 4.2	48 4.8	54 5.4	59 5.9	51 3.4	56 3.6	60 3.8	63 4
Columbia, SC	16,700	30 32	36 35	40 38	44 39.2	37 27.5	43 30.5	46 32	49 33.5	44 19.4	50 22.2	54 23.8	57 24.6	52 15.5	58 17.5	61 19.5	64 21
Greenville, SC	11,700	30 24	36 25.5	39 26.5	43 28	36 20	41 21.5	45 22.5	49 23	44 13	48 14	52 15.5	56 17	52 11	56 12	60 13	64 14
Huron, SD	25,000	28 38	27 41	30 44	34 48	32 36	36 39	39 42	43 45	39 24	44 27	48 30	52 32	47 19	53 22	56 23.7	59 25
Pierre, SD	25,000	23 37	26 40	28 42	31 45	31 35	35 38	37 40	40 43	38 24	43 26	46 28	49 31	46 19	51 21	54 23	57 24
Rapid City, SD	25,000	25 39	31 45	35 48	39 51	32 36	37 40	40 43	44 46	39 24	45 28	49 31	52 32	46 19	52 22	56 23.7	59 25
Yankton, SD	25,000	27 41	31 45	36 49	41 52	36 39	40 43	45 46	49 49	44 27	49 31	54 33	58 36	53 22	58 24	62 26	66 28
Chattanooga, TN	17,000	30 33	35 35	38 37	41 38	36 27	40 29	43 30.5	46 32	43 19	47 20.7	51 22.7	55 24.3	51 14.8	55 16.7	58 17.5	61 19.5
Knoxville, TN	25,000	29 53	35 49	40 52	44 54	37 40	43 45	47 37	51 51	45 28	51 32	55 34	59 37	53 22	59 25	63 27	66 28
Memphis, TN	9,000	30 17	36 18	40 20	45 21	36 15	41 17	45 17.5	49 18	43 10	48 11	52 12	56 13	51 8	55 9	59 9.5	62 10.2
Nashville, TN	25,000	29 43	35 48	39 51	42 53	37 40	43 45	46 47	49 48	45 28	50 31	55 34	58 36	53 22	58 24	62 26	65 27
Abilene, TX	8,500	30 16	37 17.5	41 18.5	46 20	37 14.5	43 16	47 17	51 18	44 10	50 11	55 12	59 13	52 7.8	58 8.5	61 9	64 9.5
Amarillo, TX	25,000	30 44	37 50	42 53	46 56	38 41	43 45	48 48	52 52	46 28	51 32	56 35	60 38	54 23	59 25	63 27	67 28

LOCATION	Notch Area Rating	DEAD-LEVEL				2-INCH RISE				4-INCH RISE				6-INCH RISE			
		Discharge GPM Draindown Time Hrs.				Discharge GPM Draindown Time Hrs.				Discharge GPM Draindown Time Hrs.				Discharge GPM Draindown Time Hrs.			
		10 Yrs.	25 Yrs.	50 Yrs.	100 Yrs.	10 Yrs.	25 Yrs.	50 Yrs.	100 Yrs.	10 Yrs.	25 Yrs.	50 Yrs.	100 Yrs.	10 Yrs.	25 Yrs.	50 Yrs.	100 Yrs.
Austin, TX	4,300	30 8.8	36 9.5	41 10	46 10.5	36 7.2	40 7.8	46 8.5	51 9	44 5	49 5.7	54 6.2	59 6.8	52 3.8	57 4.2	61 4.7	65 5
Brownsville, TX	3,500	30 6.8	36 7.2	41 7.8	46 8	36 5.8	40 6.2	45 6.8	50 7.2	44 4	49 4.5	54 5	58 5.5	52 3.1	56 3.3	60 3.5	64 4
Corpus Christi, TX	7,000	30 13.5	35 14	39 15	43 16	36 11.5	41 12.5	45 13.5	49 14	44 8	48 9	52 9.8	56 10.6	51 6	56 6.4	59 7	62 7.5
Dallas, TX	4,500	30 8.5	36 9.5	40 10	44 10.4	36 7.2	40 7.8	45 8.4	50 8.9	43 4.9	48 5.7	52 6	56 6.5	50 3.5	56 4	59 4.4	62 4.7
Del Rio, TX	4,200	30 8.5	38 9.5	43 10.3	48 11	36 7.2	41 8	48 8.8	53 9.2	43 4.9	49 5.7	55 6.2	60 7	50 3.8	56 4.2	61 4.7	66 5
El Paso, TX	25,000	16 29	18 32	20 34	22 36	24 27	27 31	29 33	31 35	32 20	36 23	38 24	40 25	38 16	43 18	46 19	49 20
Fort Worth, TX	6,500	30 12.4	36 13	40 13.5	44 14.8	37 11	41 11.9	45 12.2	49 13	44 7.2	49 8	52 8.8	56 9.5	51 5.7	56 6.2	59 6.5	62 7
Galveston, TX	1,800	30 3.5	38 3.9	45 4.2	49 4.5	36 3.1	43 3.5	49 3.7	53 3.9	44 2.1	49 2.5	54 2.8	59 3	50 1.6	56 1.8	61 2	66 2.2
Houston, TX	2,450	36 4.6	37 5.2	41 5.5	45 5.7	35 4	40 4.3	44 3.7	48 5	43 2.9	47 3.1	51 3.5	54 3.8	50 2.1	54 2.3	57 2.5	60 2.6
Palestine, TX	5,800	30 11	36 12	40 13	44 13.8	37 10	41 10.5	45 11	49 11.5	44 6.5	49 7.5	53 8	57 9	52 5.4	57 5.9	60 6.2	64 6.6
Port Arthur, TX	2,600	30 4.6	38 5.5	43 5.8	47 6	36 4.2	41 4.7	45 5	49 5.3	44 3	49 3.3	53 3.7	57 4	49 2	54 2.3	58 2.7	62 2.8
San Antonio, TX	8,150	30 15	37 17	41 18	46 19	37 14	42 15.2	47 16	52 17	45 9.5	50 10.5	55 11.5	60 13	53 7.2	57 8	60 8.5	64 9.5
Taylor, TX	2,100	30 4	40 4.7	47 5	53 5.3	37 3.7	44 4	51 4.3	57 4.6	44 2.5	50 3	56 3.2	62 3.6	49 1.8	56 2	62 2.3	67 2.7
Modena, UT	25,000	16 29	18 32	20 34	22 36	24 27	27 31	30 34	32 36	32 20	36 23	38 24	40 25	38 16	42 17.5	46 19	50 21
Salt Lake City, UT	25,000	13 23	15 38	16 30	17 32	18 22	20 23	22 35	24 27	25 15	28 17	30 18	32 20	31 13	34 14	36 14	38 16
Burlington, VT	25,000	22 36	25 39	28 42	32 46	26 30	29 33	32 36	35 38	34 21	38 24	40 25	42 26	40 17	44 18	46 19	49 20
Northfield, VT	25,000	26 40	31 45	36 49	41 52	31 35	36 39	40 43	45 46	38 24	43 26	47 29	51 32	45 19	50 21	54 23	57 24
Cape Henry, VA	15,300	30 30	36 32	40 34	45 37	38 27	45 29	49 31	54 32	47 19	53 21	58 24	62 26	56 15	61 17	66 19	70 20
Lynchburg, VA	18,000	30 34	36 38	41 41	45 43	38 30	44 33	48 36	52 38	45 21	51 24	55 26	60 29	52 16	58 19	62 20	66 22
Norfolk, VA	8,300	30 16	35 18	40 19	44 20	36 14	41 15	48 16	49 17	44 9.5	49 10.5	53 12	57 13	52 7.5	56 8	60 9	63 9.5
Richmond, VA	8,000	30 16	37 18	42 19	47 20	37 14	44 15	49 16	54 17	45 9.5	51 10.5	56 12	61 13	53 7.5	58 8	63 9	68 10.5
Wytheville, VA	25,000	29 40	30 44	34 48	38 50	34 38	38 41	42 45	45 46	41 25	46 28	50 31	54 33	49 20	54 23	57 24	61 26
North Head, WA	25,000	22 36	24 38	29 40	28 42	26 30	28 32	29 33	31 35	33 21	36 23	38 24	40 25	37 15	41 17	43 18	45 19
Port Angeles, WA	25,000	15 28	18 32	20 34	22 36	19 23	22 25	23 36	25 28	26 16	29 18	31 19	34 21	29 12	33 13	35 14	37 15
Seattle, WA	25,000	16 30	19 33	21 35	23 37	21 24	24 27	26 30	28 32	27 16	31 19	33 21	36 23	32 13	36 15	38 16	40 17
Spokane, WA	25,000	12 22	14 26	15 28	16 30	17 21	19 23	20 23	22 25	21 13	24 15	26 16	29 18	27 12	30 12	32 13	34 14
Tacoma, WA	25,000	17 32	20 34	22 36	28 38	23 26	26 30	28 32	30 34	30 18	33 21	37 23	39 24	35 14	38 16	41 17	44 18
Tatoosh, WA	25,000	27 41	32 46	33 47	39 51	32 36	36 39	39 42	42 45	40 25	44 27	47 29	50 31	46 19	49 20	52 22	56 24
Walla Walla, WA	25,000	13 23	15 28	16 30	18 32	16 20	18 22	19 23	20 23	22 14	24 15	26 16	27 17	26 11	28 12	30 12	31 13
Yakima, WA	25,000	7 17	9 19	10 20	11 21	16 20	18 22	19 23	20 23	21 16	24 15	27 16	29 18	26 11	29 12	32 13	334 14
Elkins, WV	25,000	27 41	32 46	37 50	41 52	34 38	40 43	44 45	48 48	42 26	48 30	52 32	56 35	50 21	56 24	59 25	62 26
Parkersburg, WV	25,000	23 39	26 42	31 45	34 48	32 36	36 39	39 42	42 45	40 23	44 27	47 29	50 31	43 20	53 22	56 24	59 23



Selecta-Drain Chart

LOCATION	Notch Area Rating	DEAD-LEVEL				2-INCH RISE				4-INCH RISE				6-INCH RISE			
		Discharge GPM Draindown Time Hrs.				Discharge GPM Draindown Time Hrs.				Discharge GPM Draindown Time Hrs.				Discharge GPM Draindown Time Hrs.			
		10 Yrs.	25 Yrs.	50 Yrs.	100 Yrs.	10 Yrs.	25 Yrs.	50 Yrs.	100 Yrs.	10 Yrs.	25 Yrs.	50 Yrs.	100 Yrs.	10 Yrs.	25 Yrs.	50 Yrs.	100 Yrs.
Green Bay, WI	25,000	24 38	28 42	31 45	35 48	32 36	36 39	39 42	43 45	39 24	44 27	47 29	51 32	47 19	53 22	36 23	59 25
La Crosse, WI	25,000	23 42	31 45	35 48	39 51	35 38	40 43	48 45	46 47	43 26	48 30	32 32	56 35	51 21	56 24	39 25	62 26
Madison, WI	25,000	29 43	36 49	40 52	44 54	37 40	43 45	47 47	50 50	46 28	51 32	55 34	60 38	54 23	60 25	62 26	65 28
Milwaukee, WI	25,000	25 40	30 44	35 48	39 51	34 38	38 41	42 45	45 46	41 25	45 28	49 31	53 32	49 20	54 23	57 24	60 25
Cheyenne, WY	25,000	17 32	19 33	21 35	23 37	24 27	27 31	30 34	33 37	32 20	36 23	38 24	40 25	39 16	44 18	47 19	50 21
Lander, WY	25,000	15 28	19 33	21 35	23 37	21 24	25 28	27 31	29 33	28 17	32 20	35 22	37 23	33 13	36 14	39 16	42 17
Sheridan, WY	25,000	19 33	24 38	27 41	30 44	2 30	30 34	33 37	39 39	34 21	38 24	41 25	44 27	39 16	44 18	18 20	52 22
Yellowstone Park WY	25,000	12 22	14 26	15 28	16 30	16 20	17 21	18 22	19 23	22 14	24 15	25 15	26 16	26 11	28 12	29 12	30 12
San Juan, PR	3,000	30 5.9	38 6.6	44 7	48 7.3	37 5.3	43 5.7	44 5.8	52 6	45 3.6	50 4	54 4.3	58 4.8	51 2.7	55 2.9	60 3.2	64 3.5

Select Proper Vertical Storm Drain Piping

Roof Drainage Data

While the flow rate for any design condition can be easily computed from the data contained on the preceding pages, the tabulations shown below (and on page 14) can be used to simplify selection of drain line sizes.

TABLE I - Suggested Relation of Drain Outlet and Vertical Leader Size to of the six Z105-10 Zum Control-Flo Roof Drains (Based on National Plumbing Code ASA-A40.8 Data on Vertical Leaders).

No. of Notches in Drain	Max. Flow per Notch in GPM			
	Pipe Size			
	2	3	4	5
1	30	60*	-	-
2	15	45	60*	-
3	-	31	60*	-
4	-	23	48	60*
5	-	18	38	60*
6	-	15	32	60*

* Maximum flow obtainable from 1 notch.

Table I illustrates gallons per minute from each notch of the six Z105-10 drains that can be carried off by various leader sizes. Once the drains are selected for a given roof per this manual, simply read the GPM flow per notch from the chart, refer to **Table I** and select the smallest drain line that will accommodate that flow. Drain pipes should be sized for the 100-year storm unless scuppers are located at a height that will not permit a depth of water to accumulate on the roof that is predicted for the 100-year storm. For example, if your installation is Anniston, Alabama, on a dead-level roof the data for the 100-year storm shows a discharge of 43 GPM per notch. For this application scuppers would be located at a 4.3" height. Using Table I a 3" drain pipe or vertical leader would be used for a drain with 1- or 2- notches. A 4" leader would be used with a 3- or 4-notch drain and a 5" leader with a 5- or 6-notch drain. For Anniston, Alabama, and a roof with a 2" rise, the 100-year storm shows a flow rate of 50 GPM. In this case scuppers should be located at a height of 5.0". A 3" leader would be used with a single notch drain, a 4" leader with a 2- and 3-notch drain, and a 5" leader with a 4-, 5- or 6-notch drain. The same type of selection would be made for a roof with a 4" rise. For Anniston, Alabama, the flow rate for the 100-year storm would be located at a height of 5.9".

For the roof with a 6" rise, the data for Anniston, Alabama, as well as several other localities, for the 100-year storm, shows a flow rate greater than 60 GPM. In these cases the scuppers will be located at the maximum recommended height of 6" and the vertical leaders will be sized for a maximum flow rate of 60 GPM per notch.

In the few cases where the data shows a flow rate in excess of 60 GPM for the 100-year storm, and if all drains and drain lines are sized according to recommendations, the only consequence will be a brief flow through the scuppers more often than once every 100 years.

EXAMPLE

LOCATION	Notch Area Rating	DEAD-LEVEL				2-INCH RISE				4-INCH RISE				6-INCH RISE			
		Discharge GPM				Discharge GPM				Discharge GPM				Discharge GPM			
		10 Yrs.	25 Yrs.	50 Yrs.	100 Yrs.	10 Yrs.	25 Yrs.	50 Yrs.	100 Yrs.	10 Yrs.	25 Yrs.	50 Yrs.	100 Yrs.	10 Yrs.	25 Yrs.	50 Yrs.	100 Yrs.
La Crosse, WI	25,000	23	31	35	39	35	40	48	46	43	48	32	56	51	56	39	62
		42	45	48	51	38	43	45	47	26	30	32	35	21	24	25	26
Madison, WI	25,000	29	36	40	44	37	43	47	50	46	51	55	60	54	60	62	65
		43	49	52	54	40	45	47	50	28	32	34	38	23	25	26	28
Milwaukee, WI	25,000	25	30	35	39	34	38	42	45	41	45	49	53	49	54	57	60
		40	44	48	51	38	41	45	46	25	28	31	32	20	23	24	25
Cheyenne, WY	25,000	17	19	21	23	24	27	30	33	32	36	38	40	39	44	47	50
		32	33	35	37	27	31	34	37	20	23	24	25	16	18	19	21

Select Proper Horizontal Storm Drain Piping

Table II is similar to **Table I** but is used in determining the size of the building storm drain. Use the same flow rate established for sizing the vertical leaders to size the storm drain. Count the total number of notches feeding any one drain or branch to the drain. Enter the Table at the total number of notches and under the proper storm drain slope select the column that gives a flow rate equal to or larger than the established notch flow rate. Read the storm drain size required at the top of this column.

TABLE II - Suggested Relation of Horizontal Storm Drain Size to Zurn Control-Flo Roof Drainage (Based on National Plumbing Code ASA-A40.8 Data on Horizontal Storm Drains w/ 1/8", 1/4" and 1/2" per foot slope).

Total No. of Notches Discharging to Storm Drain	MAX. FLOW PER NOTCH IN GPM							MAX. FLOW PER NOTCH IN GPM							MAX. FLOW PER NOTCH IN GPM								
	Storm Drain Size 1/8" per ft. slope							Storm Drain Size 1/4" per ft. slope							Storm Drain Size 1/2" per ft. slope								
	3	4	5	6	8	10	12	13	3	4	5	6	8	10	12	15	3	4	5	6	8	10	12
1	34	60*	—	—	—	—	—	48	60*	—	—	—	—	—	—	60*	—	—	—	—	—	—	—
2	17	39	60*	—	—	—	—	24	55*	60*	—	—	—	—	—	34	60*	—	—	—	—	—	—
3	11	26	46	60*	—	—	—	16	37	60*	—	—	—	—	—	22	52*	60*	—	—	—	—	—
4	8	19	34	53	60*	—	—	12	28	48	60*	—	—	—	—	17	39	60*	—	—	—	—	—
5	—	15	28	44	60*	—	—	—	22	39	60*	—	—	—	—	13	31	60*	—	—	—	—	—
6	—	13	23	37	60*	—	—	—	18	33	52*	60*	—	—	—	11	26	46	60*	—	—	—	—
7	—	11	20	32	60*	—	—	—	16	28	45	60*	—	—	—	—	22	39	60*	—	—	—	—
8	—	—	17	28	60*	—	—	—	14	25	39	60*	—	—	—	—	19	36	55*	60*	—	—	—
9	—	—	15	25	53	60*	—	—	—	12	22	35	60*	—	—	—	17	30	49	60*	—	—	—
10	—	—	14	22	48	60*	—	—	—	—	20	31	60*	—	—	—	15	27	44	60*	—	—	—
11	—	—	12	20	43	60*	—	—	—	—	18	29	60*	—	—	—	14	25	40	60*	—	—	—
12	—	—	—	18	40	60*	—	—	—	—	16	26	56	60*	—	—	—	13	23	37	60*	—	—
13	—	—	—	17	37	60*	—	—	—	—	15	24	52*	60*	—	—	—	12	21	34	60*	—	—
14	—	—	—	15	34	60*	—	—	—	—	14	22	48	60*	—	—	—	10	31	60*	—	—	—
15	—	—	—	15	32	57	60*	—	—	—	13	21	45	60*	—	—	—	18	29	60*	—	—	—
16	—	—	—	14	30	54	60*	—	—	—	—	20	42	60*	—	—	—	17	27	60*	—	—	—
17	—	—	—	13	28	51	60*	—	—	—	—	18	40	60*	—	—	—	—	16	26	56	60*	—
18	—	—	—	12	26	48	60*	—	—	—	—	17	37	60*	—	—	—	—	15	24	53	60*	—
19	—	—	—	—	25	45	60*	—	—	—	—	16	35	60*	—	—	—	—	14	23	50	60*	—
20	—	—	—	—	24	43	60*	—	—	—	—	16	34	60*	—	—	—	—	13	22	47	60*	—
23	—	—	—	—	20	37	60*	—	—	—	—	14	29	53*	60*	—	—	—	12	19	41	60*	—
25	—	—	—	—	19	34	55*	60*	—	—	—	13	27	49	60*	—	—	—	17	38	60*	—	—
30	—	—	—	—	16	28	46	60*	—	—	—	—	22	49	60*	—	—	—	14	31	57	60*	—
35	—	—	—	—	13	24	39	60*	—	—	—	—	19	35	56	60*	—	—	12	27	49	60*	—
40	—	—	—	—	12	21	34	60*	—	—	—	—	17	30	49	60*	—	—	—	23	43	60*	—
45	—	—	—	—	—	19	31	55*	—	—	—	—	15	27	44	60*	—	—	—	21	38	60*	—
50	—	—	—	—	—	17	27	49*	—	—	—	—	13	24	39	60*	—	—	—	19	34	55	60*
55	—	—	—	—	—	15	25	45*	—	—	—	—	—	22	35	60*	—	—	—	17	31	50	60*
60	—	—	—	—	—	14	23	41*	—	—	—	—	—	20	32	58*	—	—	—	15	28	46	60*
65	—	—	—	—	—	13	21	38*	—	—	—	—	—	18	30	54*	—	—	—	14	26	42	60*
70	—	—	—	—	—	12	20	35*	—	—	—	—	—	17	28	50*	—	—	—	13	24	39	60*

* Maximum flow obtainable from 1 notch.

Special Considerations for Structural Safety Rigid Roof Design

Normal Practice of Roof Design is Based on 30-lbs. Per Sq. Ft. ... therefore this factor should definitely be kept in mind as a prime requirement for assuring a structurally sound roof. Otherwise, roof deflection may minimize the advantages of a well-designed roof drainage system.

Failure to recognize the adverse effects of roof deflection, even with conventional roof drainage, may lead to roof failure. With the new concept of "Control-Flo" Roof Drainage, the design condition of deflection is equally important. If severe deflection is permitted, rain water will simply seek low areas, thus intensifying the degree of deflection. Thus it is extremely important that flat roofs are designed in accordance with normal load factors so that deflection will be slight enough in any bay to prevent progressive deflection which could cause water depths to load the roof beyond its design limits.

SCUPPERS AND OVERFLOW DRAINS

Roofing members and understructures, weakened by seepage and rot resulting from improper drainage and roof construction can give away under the weight of rapidly accumulated water during flash storms. Thus, it is recommended, and often required by building codes, to install scuppers and overflow drains in parapet-type roofs. Properly selected and sized scuppers and overflow drains are vital to a well-engineered drainage system to prevent excessive loading, erosion, seepage and rotting.



Control-Flo Roof Drains

the most advanced drainage control available,
lets you design roof drainage systems with confidence

Check These Years Ahead Engineered Features

Large 148 Square-Inch Open Area Dome permits unobstructed flow. Dome is made of lightweight, shock-resistant aluminum and is bayonet-locked to gravel guard on weir.

Multi-Weir Barrier provides flow rates directly proportional to the head. Available with 1 to 6 inverted parabolic notches to meet varying requirements.

Gravel Insulation

Waterproofing Membrane

Metal Roof Deck

Extension Sleeve Accommodates the Addition of Insulation to a roof deck. Height as required by thickness of insulation.

Integral Clamping Collar at bottom of weir provides positive clamping action without puncturing roof or flashing. Also provides integral gravel guard.

Bayonet-type Locking Device on dome holds dome firmly in place with weir yet allows dome to be easily removed.

Broad Plane Surface combines with clamping collar to hold flashing and roofing felts in tight vise-like grip.

Roof Sump Receiver Distributes Weight of drain over 4 square feet. Supports the drain body and assures flush, roof-level placement.

Underdeck Clamp For Rigid Mounting stabilizes the entire assembly and renders it an integral part of the roof structure.

Threaded, caulk or No-Hub outlet connections available.
(Z105-C-E-R-10 Illustrated)

ORIFICE SIZING FOR CUSTOM ICD

JLR No.: 31940-000 Project: Canada Post Ottawa Processing Centre Date: August 22, 2023 Revised: n/a Designed by: TR Checked by: BP						Notes: Values in blue are user variables Values in Green are changed to achieve Qall during temp condition orifice Values in red are calculated User Notes: Typical Custom ICD used to control flow															
CBMH02																					
Q _{all} (L/s)	Outlet Pipe Dia. (mm)	Invert (m)	T/G (m)	Orifice Radius (m)	Head (m)																
104.28	250	87.490	89.59	0.094	2.006																
Solving for 'Q'						Solving for 'r' (radius of orifice)															
$Q = CA \sqrt{2gh}$						$r = \sqrt{\frac{Q}{C\pi\sqrt{2gh}}}$															
h= 2.006 Head (m) (input value calculated above) C= 0.60 Coefficient of Discharge D= 0.188 Diameter (m) g= 9.8 Gravity (9.81 m/s ²)						<table border="1" style="width: 100%; border-collapse: collapse;"> <tr> <td style="text-align: center; padding: 5px;">Circular Orifice</td> <td style="text-align: center; padding: 5px;">Square Orifice</td> </tr> <tr> <td style="padding: 5px;">Radius = 0.094 m</td> <td style="padding: 5px;">One side = 0.166 m</td> </tr> <tr> <td style="padding: 5px;">Diameter = 0.188 m</td> <td style="padding: 5px;">= 166 mm</td> </tr> <tr> <td style="padding: 5px;">= 188 mm</td> <td style="padding: 5px;"></td> </tr> <tr> <td style="padding: 5px;">= 7.40 in</td> <td style="padding: 5px;"></td> </tr> </table>						Circular Orifice	Square Orifice	Radius = 0.094 m	One side = 0.166 m	Diameter = 0.188 m	= 166 mm	= 188 mm		= 7.40 in	
Circular Orifice	Square Orifice																				
Radius = 0.094 m	One side = 0.166 m																				
Diameter = 0.188 m	= 166 mm																				
= 188 mm																					
= 7.40 in																					
A= 0.02772 Area of Flow (m ²) Q= 0.104 Discharge (m ³ /s) 104.28 Discharge (L/s)																					

Appendix F

Photometrics Plan



Statistics						
Description	Symbol	Avg	Min	Max/Min	Avg/Min	Max
Building Perimeter	+	38.1 lux	3.2 lux	36.5:1	11.9:1	116.7 lux
E Pedestrian Crossing		47.4 lux	24.6 lux	3.3:1	1.9:1	81.9 lux
East Parking	+	24.6 lux	4.0 lux	24.3:1	6.2:1	97.3 lux
East Pedestrian Walkway	+	50.3 lux	2.3 lux	35.7:1	21.9:1	82.2 lux
North Parking	+	20.4 lux	2.7 lux	32.6:1	7.6:1	87.9 lux
North Security Gate		30.7 lux	10.6 lux	5.0:1	2.9:1	52.7 lux
NW Pedestrian Crossing	+	51.9 lux	16.8 lux	7.5:1	3.1:1	126.0 lux
South Parking	+	26.6 lux	2.5 lux	38.7:1	10.6:1	96.8 lux
South Pedestrian Walkway	+	50.8 lux	15.2 lux	7.5:1	3.3:1	113.5 lux
West Parking	+	23.9 lux	0.4 lux	328.0:1	59.8:1	131.2 lux
West Security Gate		35.3 lux	29.9 lux	1.4:1	1.2:1	40.8 lux

Schedule							
Label	Manufacturer	Catalog Number	Description	Quantity	Lumens Per Lamp	Light Loss Factor	Wattage
C1	Lithonia Lighting	KACM LED 60C 700 40K R5 MVOLT	KACM LED WITH 60-LEDS, @700mA, 4000K, AND TYPE R5 OPTICS	3	16962	1	137
P1	Lithonia Lighting	DSX2 LED P4 40K 70CRI BLC4	D-Series Size 2 Area Luminaire P4 Performance Package 4000K CCT 70 CRI Type 4 Extreme Backlight Control	5	26324	1	272.65
P2	Lithonia Lighting	DSX2 LED P6 40K 70CRI BLC4	D-Series Size 2 Area Luminaire P6 Performance Package 4000K CCT 70 CRI Type 4 Extreme Backlight Control	7	33726	1	341.66
P3	Lithonia Lighting	DSX2 LED P8 40K 70CRI BLC4	D-Series Size 2 Area Luminaire P8 Performance Package 4000K CCT 70 CRI Type 4 Extreme Backlight Control	2	42306	1	462.45
P4	Lithonia Lighting	DSX0 LED P7 40K 70CRI BLC4	D-Series Size 0 Area Luminaire P7 Performance Package 4000K CCT 70 CRI Type 4 Extreme Backlight Control	4	15265	0.9	170.81
P5	Lithonia Lighting	DSX1 LED P9 40K 70CRI BLC3	D-Series Size 1 Area Luminaire P9 Performance Package 4000K CCT 70 CRI Type 3 Extreme Backlight Control	2	24735	1	277.07
P6	Lithonia Lighting	DSX0 LED P4 40K 70CRI BLC3	D-Series Size 0 Area Luminaire P4 Performance Package 4000K CCT 70 CRI Type 3 Extreme Backlight Control	6	8096	0.9	93.04
P7	Lithonia Lighting	DSX0 LED P7 40K 70CRI BLC3	D-Series Size 0 Area Luminaire P7 Performance Package 4000K CCT 70 CRI Type 3 Extreme Backlight Control	2	14780	0.9	170.81
P8	Lithonia Lighting	DSX2 LED P6 40K 70CRI T2M HS	D-Series Size 2 Area Luminaire P6 Performance Package 4000K CCT 70 CRI Type 5 Medium HouseShield	2	34071	1	341.6643
P9	Lithonia Lighting	DSX2 LED P5 40K 70CRI T2M HS	D-Series Size 2 Area Luminaire P5 Performance Package 4000K CCT 70 CRI Type 2 Medium HouseShield	1	34469	1	326.5841
P10	Lithonia Lighting	DSX0 LED P4 40K 70CRI T2M HS	D-Series Size 0 Area Luminaire P4 Performance Package 4000K CCT 70 CRI Type 2 Medium HouseShield	1	9547	1	93.04
P11	Lithonia Lighting	DSX2 LED P6 40K 70CRI T4M	D-Series Size 2 Area Luminaire P6 Performance Package 4000K CCT 70 CRI Type 4 Medium	1	45563	1	341.66
P12	Lithonia Lighting	DSX0 LED P7 40K 70CRI T2M	D-Series Size 0 Area Luminaire P7 Performance Package 4000K CCT 70 CRI Type 2 Medium	1	20086	0.9	170.81
P13	Lithonia Lighting	DSX0 LED P4 40K 70CRI RCCO	D-Series Size 0 Area Luminaire P4 Performance Package 4000K CCT 70 CRI Right Corner Cutoff Extreme Backlight Control	1	8169	0.9	93.04
P14	Lithonia Lighting	DSX0 LED P4 40K 70CRI LCCO	D-Series Size 0 Area Luminaire P4 Performance Package 4000K CCT 70 CRI Left Corner Cutoff Extreme Backlight Control	2	8169	0.9	93.04
W1	Lithonia Lighting	WDGE2 LED P2 4000K 80CRI VW	WDGE2 LED WITH P2 - PERFORMANCE PACKAGE, 4000K, 80CRI, VISUAL COMFORT WIDE OPTIC	34	2075	0.9	14.53
W2	Lithonia Lighting	WDGE4 LED P3 4000K, 70CRI, R2 40K	WDGE4 LED WITH P3 - PERFORMANCE PACKAGE, 4000K, 70CRI, TYPE 2 OPTIC	5	18440	1	124.86
W3	Lithonia Lighting	WDGE4 LED P3 4000K, 70CRI, R3 40K	WDGE4 LED WITH P3 - PERFORMANCE PACKAGE, 4000K, 70CRI, TYPE 3 OPTIC	3	18073	1	124.86
W4	Lithonia Lighting	WDGE4 LED P6 4000K, 70CRI, R2 40K	WDGE4 LED WITH P6 - PERFORMANCE PACKAGE, 4000K, 70CRI, TYPE 2 OPTIC	1	25745	1	185.23
W5	Lithonia Lighting	WDGE4 LED P6 4000K, 70CRI, R4 40K	WDGE4 LED WITH P6 - PERFORMANCE PACKAGE, 4000K, 70CRI, TYPE 4 OPTIC	5	25861	1	185.23
W6	Lithonia Lighting	WDGE4 LED P6 4000K, 70CRI, RFT 40K	WDGE4 LED WITH P6 - PERFORMANCE PACKAGE, 4000K, 70CRI, FORWARD THROW OPTIC	5	25586	1	185.23

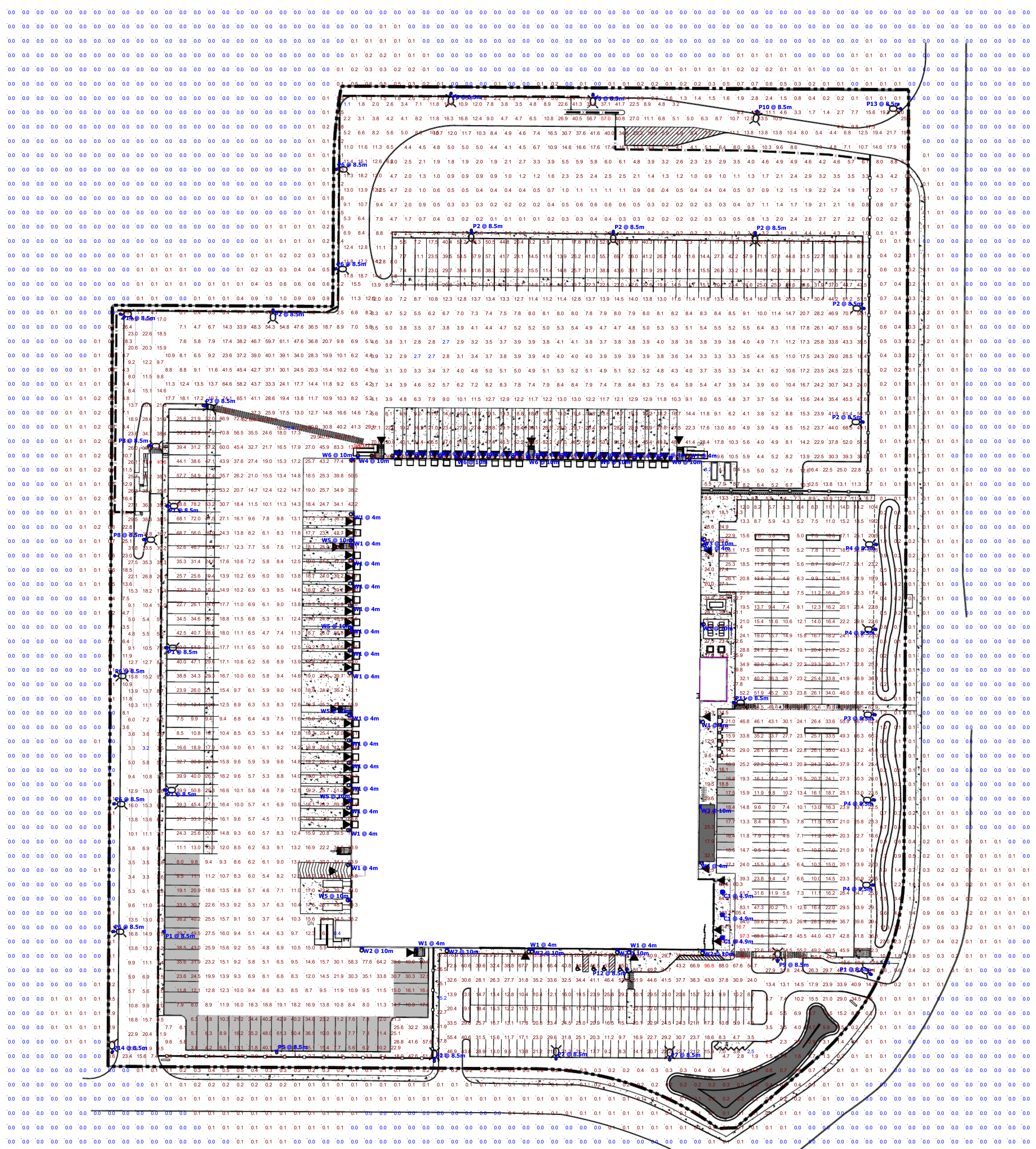

Plan View
Scale - 1 : 775



Platinum
member

www.jlrichards.ca

Ottawa

343 Preston Street
Tower II, Suite 1000
Ottawa ON Canada
K1S 1N4
Tel: 613 728-3571
ottawa@jlrichards.ca

Kingston

203-863 Princess Street
Kingston ON Canada
K7L 5N4
Tel: 613 544-1424
kingston@jlrichards.ca

Sudbury

314 Countryside Drive
Sudbury ON Canada
P3E 6G2
Tel: 705 522-8174
sudbury@jlrichards.ca

Timmins

834 Mountjoy Street S
Timmins ON Canada
P4N 7C5
Tel: 705 360-1899
timmins@jlrichards.ca

North Bay

501-555 Oak Street E
North Bay ON Canada
P1B 8E3
Tel: 705 495-7597

northbay@jlrichards.ca

Hawkesbury

326 Bertha Street
Hawkesbury ON Canada
K6A 2A8
Tel: 613 632-0287

hawkesbury@jlrichards.ca

Guelph

107-450 Speedvale Ave. West
Guelph ON Canada
N1H 7Y6
Tel: 519 763-0713

guelph@jlrichards.ca

