

# CBSERVICING & STORMWATER MANAGEMENT REPORT SCHLEGEL VILLAGES – 1919 RIVERSIDE DRIVE

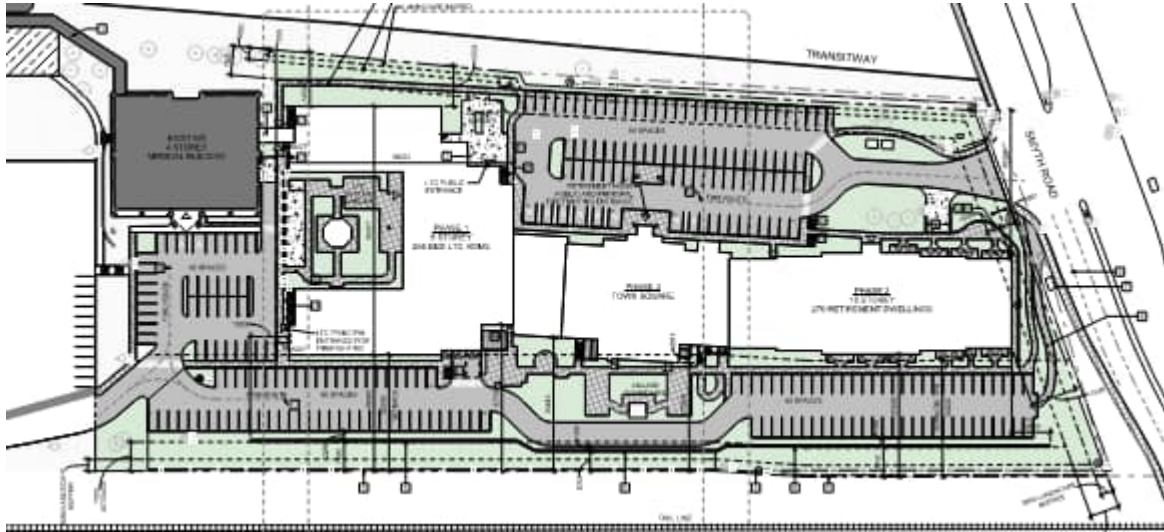

Project No.: CCO-21-2955

City File No.: D07-12-21-0170

Prepared for:

RBJ Schlegel Holdings  
325 Max Becker Drive, Suite 201  
Kitchener, ON N2E 4H5

Prepared by:

McIntosh Perry Consulting Engineers Ltd.  
115 Walgreen Road  
Carp, ON K0A 1L0

Rev 5: July 19, 2023

TABLE OF CONTENTS

1.0	PROJECT DESCRIPTION .....	1
1.1	<i>Purpose</i> .....	1
1.2	<i>Site Description</i> .....	1
1.3	<i>Proposed Development and Statistics</i> .....	2
1.4	<i>Existing Conditions and Infrastructures</i> .....	2
1.5	<i>Approvals</i> .....	3
2.0	BACKGROUND STUDIES, STANDARDS, AND REFERENCES .....	4
2.1	<i>Background Reports / Reference Information</i> .....	4
2.2	<i>Applicable Guidelines and Standards</i> .....	4
3.0	PRE-CONSULTATION SUMMARY .....	5
4.0	WATERMAIN .....	6
4.1	<i>Existing Watermain</i> .....	6
4.2	<i>Proposed Watermain</i> .....	6
4.3	<i>Water Model Results</i> .....	8
5.0	SANITARY DESIGN .....	9
5.1	<i>Existing Sanitary Sewer</i> .....	9
5.2	<i>Proposed Sanitary Sewer</i> .....	9
5.3	<i>Sanitary Sewer Realignment</i> .....	10
5.3.1	Pipe Capacity .....	10
5.3.2	Construction Staging and Sewer Flow Management .....	10
6.0	STORM SEWER DESIGN .....	11
6.1	<i>Existing Storm Sewers</i> .....	11
6.2	<i>Proposed Storm Sewers</i> .....	11
7.0	PROPOSED STORMWATER MANAGEMENT .....	13
7.1	<i>Design Criteria and Methodology</i> .....	13
7.2	<i>Runoff Calculations</i> .....	13
7.3	<i>Pre-Development Drainage</i> .....	14
7.4	<i>Post-Development Drainage</i> .....	14
8.0	EROSION AND SEDIMENT CONTROL .....	16
8.1	<i>Temporary Measures</i> .....	16
8.2	<i>Permanent Measures</i> .....	16
9.0	SUMMARY .....	17
10.0	RECOMMENDATION .....	18
11.0	STATEMENT OF LIMITATIONS .....	19

## LIST OF TABLES

Table 1: Water Supply Design Criteria and Water Demands .....	7
Table 2: Boundary Conditions Results .....	7
Table 3: Hydrant Coverage Confirmation.....	8
Table 4: Water Pressure at Junctions.....	8
Table 5: Sanitary Design Criteria.....	9
Table 6: Summary of Estimated Sanitary Flow .....	10
Table 7: Pre-Development Runoff Summary.....	14
Table 8: Post-Development Runoff Summary .....	14

## APPENDICES

Appendix A: Site Location Plan

Appendix B: Background Documents

Appendix C: Watermain Calculations

Appendix D: Sanitary Calculations

Appendix E: Pre-Development Drainage Plan

Appendix F: Post-Development Drainage Plan

Appendix G: Stormwater Management Calculations

Appendix H: City of Ottawa Design Checklist

## 1.0 PROJECT DESCRIPTION

### 1.1 Purpose

McIntosh Perry (MP) has been retained by RBJ Schlegel Holdings to prepare this Servicing and Stormwater Management Report in support of the Site Plan Control process for the proposed development located at 1919 Riverside Drive within the City of Ottawa.

The main purpose of this report is to present a servicing and stormwater management design for the development in accordance with the recommendations and guidelines provided by the City of Ottawa (City), the Rideau Valley Conservation Authority (RVCA), and the Ministry of the Environment, Conservation and Parks (MECP). This report will address the water, sanitary and storm sewer servicing for the development, ensuring that existing and available services will adequately service the proposed development.

This report should be read in conjunction with the following drawings:

- CCO-21-2955, C101 – Site Grading and Drainage Plan
- CCO-21-2955, C102 – Site Servicing Plan
- CCO-21-2955, C103 – Sediment and Erosion Control Plan
- CCO-21-2955, PRE – Pre-Development Drainage Area Plan (*Appendix 'E'*)
- CCO-21-2955, POST – Post Development Drainage Area Plan (*Appendix 'F'*)

### 1.2 Site Description



Figure 1: Site Map

The subject property, herein referred to as the site, is located at 1919 Riverside Drive within the Alta Vista Ward. The site covers approximately *8.48 ha* and is located at the intersection of Smyth Road and Riverside Drive. The site is zoned for Major Institutional use (I2). See Site Location Plan in *Appendix 'A'* for more details.

### 1.3 Proposed Development and Statistics

The proposed development consists of a long-term care facility and retirement residence. The long-term care facility proposes to contain *256 beds* with *85 staff* and the retirement residence proposes to contain *270 units* with *60 staff*. Drive aisles will be provided throughout the site with access from the Smyth Road and from the existing parking lot. Parking will be provided via underground and aboveground parking lots. Development is proposed within *2.13 ha* of the site. Refer to *Site Plan* prepared by CSV Architects and included in *Appendix 'B'* for further details.

### 1.4 Existing Conditions and Infrastructures

The site is currently developed containing several parking lots and two medical buildings. Sanitary, water, and storm services exist within the parking area and will be removed or relocated to accommodate the proposed development.

Sewer and watermain mapping collected from the City of Ottawa indicate that the following services exist across the property frontages within the adjacent municipal rights-of-way(s) and within the subject site:

- ❖ Smyth Road
  - 1050 mm diameter concrete storm sewer tributary to the Rideau River approximately 310 m downstream.
- ❖ Subject Site (98m south of Smyth Road)
  - 254 mm diameter unlined cast iron watermain, and a
  - 675 mm diameter concrete sanitary sewer tributary to the Rideau River collector.
- ❖ Transitway
  - 203 mm diameter watermain,
  - 1350-1500 mm diameter Rideau River collector sanitary trunk sewer, and a
  - 375 mm diameter concrete storm sewer tributary to the Rideau River approximately 520 m downstream.

## 1.5 Approvals

The proposed development is subject to the City of Ottawa site plan control approval process. Site plan control requires the City to review, provide concurrence and approve the engineering design package. Permits to construct can be requested once the City has issued a site plan agreement.

An Environmental Compliance Approval (*ECA*) through the Ministry of Environment, Conservation and Parks (*MECP*) is anticipated to be required for the sanitary sewer realignment under the Transfer of Review process. Requirement to be confirmed by City of Ottawa staff.

## 2.0 BACKGROUND STUDIES, STANDARDS, AND REFERENCES

### 2.1 Background Reports / Reference Information

As-built drawings of existing services, provided by the City of Ottawa Information centre, within the vicinity of the proposed site were reviewed in order to identify infrastructure available to service the proposed development.

A topographic survey (21319-20) of the site was completed by Annis, O’Sullivan, Vollebekk Ltd and dated December 18<sup>th</sup>, 2020.

The Site Plan (A1.02) was prepared by CSV Architects and dated November 22, 2022 (*Site Plan*).

A Geotechnical Investigation was conducted by Patterson Group and dated July 18, 2022.

### 2.2 Applicable Guidelines and Standards

City of Ottawa:

- ◆ Ottawa Sewer Design Guidelines, City of Ottawa, SDG002, October 2012. (*Ottawa Sewer Guidelines*)
  - Technical Bulletin ISTB-2014-01 City of Ottawa, February 2014. (*ISTB-2014-01*)
  - Technical Bulletin PIEDTB-2016-01 City of Ottawa, September 2016. (*PIEDTB-2016-01*)
  - Technical Bulletin ISTB-2018-01 City of Ottawa, January 2018. (*ISTB-2018-01*)
  - Technical Bulletin ISTB-2018-03 City of Ottawa, March 2018. (*ISTB-2018-03*)
  - Technical Bulletin ISTB-2019-01 City of Ottawa, January 2019. (*ISTB-2019-01*)
  - Technical Bulletin ISTB-2019-02 City of Ottawa, February 2019. (*ISTB-2019-02*)
- ◆ Ottawa Design Guidelines – Water Distribution City of Ottawa, July 2010. (*Ottawa Water Guidelines*)
  - Technical Bulletin ISD-2010-2 City of Ottawa, December 15, 2010. (*ISD-2010-2*)
  - Technical Bulletin ISDTB-2014-02 City of Ottawa, May 2014. (*ISDTB-2014-02*)
  - Technical Bulletin ISTB-2018-02 City of Ottawa, March 2018. (*ISTB-2018-02*)

Ministry of Environment, Conservation and Parks:

- ◆ Stormwater Planning and Design Manual, Ministry of the Environment, March 2003. (*MECP Stormwater Design Manual*)
- ◆ Design Guidelines for Sewage Works, Ministry of the Environment, 2008. (*MECP Sewer Design Guidelines*)

### 3.0 PRE-CONSULTATION SUMMARY

A pre-consultation email was provided by City staff on April 29<sup>th</sup>, 2021 regarding the proposed development and site servicing. Specific design parameters to be incorporated within this design include the following:

- Pre-development and post-development flows shall be calculated using a time of concentration (T<sub>c</sub>) greater than 10 minutes.
- Control 5 through 100-year post-development flows to the 5-year storm event, based on a rational method coefficient of 0.5 and calculated time of concentration.
- Quality control are to be confirmed by the RVCA.



## 4.0 WATERMAIN

### 4.1 Existing Watermain

The site is located within the 1E pressure zone, as per the Water Distribution System figure included in *Appendix C*. There is an existing 254 mm diameter unlined cast iron watermain running within the development area through the existing parking lot.

### 4.2 Proposed Watermain

In accordance with Section 4.3.1 of the *Ottawa Water Guidelines*, service areas with a basic day demand greater than 50 m<sup>3</sup>/day require a dual connection to the municipal system. A dual connection to the 254 mm diameter watermain at the east of the site and to the existing 200 mm watermain west of the site is proposed to service the development.

It is proposed to connect a 200mm diameter water service to the 200 mm watermain west of the site with water valves at the property line. The existing 250 mm watermain is proposed to be relocated around the subject site, connecting to the existing 200 mm watermain within Smyth Road. Three private hydrants have been proposed within the site. The watermain is designed to have a minimum of 2.4 m cover. Refer to drawing *C102* for a detailed servicing layout.

The 203 mm diameter watermain network servicing the existing medical buildings will remain as part of this development. In addition, existing fire hydrants within the site will be retained therefore there is no anticipated impact to the fire servicing for the existing development.

The Fire Underwriters Survey 2020 (FUS) method was utilized to estimate the required fire flow for the site. Fire flow requirements were calculated per City of Ottawa Technical Bulletin *ISTB-2018-02*. The following parameters were coordinated with the architect.

- ❖ Type of construction – Non-Combustible Construction
- ❖ Occupancy Type – Limited Combustibility
- ❖ Sprinkler Protection – Supervised Sprinkler System

The results of the calculations yielded a required fire flow of 6,000 L/min (100.00 L/s). The detailed calculations for the FUS can be found in *Appendix C*.

The water demands for the proposed building have been calculated to adhere to the *Ottawa Water Guidelines* and can be found in *Appendix C*. The results have been summarized below:

Table 1: Water Supply Design Criteria and Water Demands

Site Area	2.13 ha
Nursing Homes & Rest Homes	450 L/bed/day
Medical Office – Doctors, Nurses & Medical Staff	275 L/person/day
Maximum Daily Peaking Factor	1.5 x avg day
Maximum Hour Peaking Factor	1.8 x max day
Average Day Demand (L/s)	3.20
Maximum Daily Demand (L/s)	4.80
Peak Hourly Demand (L/s)	8.64
FUS Fire Flow Requirement (L/s)	100.00 L/s (6,000 L/min)

The City provided the estimated water pressures at both for the average day scenario, peak hour scenario and the max day plus fire flow scenario for the demands indicated by the correspondence in *Appendix C*. The resulting pressures for the boundary conditions results are shown in *Table 2*, below.

Table 2: Boundary Conditions Results

Scenario	Proposed Demands (L/S)	Connection 1 HGL (m H <sub>2</sub> O)* /kPa	Connection 2 HGL (m H <sub>2</sub> O)* /kPa
Average Day Demand	3.20	56.5 / 554.3	49.6 / 486.6
Maximum Daily + Fire Flow Demand	104.80	33.0 / 323.7	26.1 / 256.0
Peak Hourly Demand	8.64	45.2 / 443.4	38.3 / 375.7

*\*Adjusted for an estimated ground elevation of 62.4 m at Connection 1 and 69.3 m at Connection 69.3m above the connection point for connection. Based on boundary conditions provided by the City of Ottawa on June 13, 2023.*

To confirm the adequacy of the hydrant coverage to protect the proposed development, public and private fire hydrants within 150 m of the proposed building were analysed per City of Ottawa *ISTB 2018-02 Appendix I Table 1*. The results are summarized below.

Table 3: Hydrant Coverage Confirmation

Building	Fire Flow* Demand (L/min.)	Fire Hydrant(s) within 75m	Fire Hydrant(s) within 150m
1919 Riverside	6,000	1 private (existing) 2 private (proposed) 1 public (proposed)	1 private (existing)
* Based on the 2020 revision to the Fire Underwriter's Survey guidelines, 6,000 L/min is required for fire protection			

Assuming 5,700 L/min fire flow for hydrants within 75m and 3,800 L/min fire flow for hydrants within 150m based on City guidelines (*ISTB-2018-02*), the existing and proposed hydrants can provide adequate hydrant coverage to the proposed development.

### 4.3 Water Model Results

A water model was completed using the EPANet modelling software and the boundary condition results provided and noted above. The results determined that the relocated 250 mm watermain can adequately service the proposed development and provide sufficient fire flow. The model determined pressures during average day, maximum day plus fire flow, and peak hour demands. The model results identify the estimated pressures at the building finished floors and at fire hydrants during fire flow conditions. For the purposes of determining pressures during the fire flow scenario, a demand of 100.00 L/s (6,000 L/min) was assumed at hydrant six (*FH6*).

Table 4: Water Pressure at Junctions

Junction	Average Day (kPa)	Max. Day + Fire Flow (kPa)	Peak Hourly (kPa)
J1	544.13	276.48	409.62
J2	545.50	291.97	434.42
J3	548.44	298.44	437.36
J4	567.66	337.16	456.87
J5	507.85	277.06	397.07
PROP	543.84	290.20	432.56
FH3	522.56	272.56	411.48
FH5	564.23	333.73	453.44
FH6	520.60	147.36	409.62

The normal operating pressure range is anticipated to be 409 kPa to 564 kPa and will not be less than 275 kPa (40 psi) or exceed 689 kPa (100 psi). The proposed watermain will meet the minimum required 20 psi (140 kPa) at the ground level under maximum day demand and fire flow conditions.

## 5.0 SANITARY DESIGN

### 5.1 Existing Sanitary Sewer

There is an existing 1350-1500 mm diameter concrete sanitary trunk sewer (the Rideau River Collector sewer) within the transitway, fronting the west edge of the site. In addition, there is an existing 675 mm diameter sanitary sewer running through the subject site. The site currently contributes wastewater to the Rideau River collector sewer via the existing 675 mm diameter sanitary sewer.

### 5.2 Proposed Sanitary Sewer

An internal sanitary sewer network is proposed to service the development. As shown by drawing C102, the development will be serviced via the existing 675 mm diameter sanitary sewer within the western parking lot and by the realigned 675 mm diameter sanitary sewer within the eastern parking lot.

Table 5, below, summarizes the wastewater design criteria identified by the *Ottawa Sewer Guidelines*.

Table 5: Sanitary Design Criteria

Design Parameter	Value
Site Area	2.13 ha
Nursing Homes & Rest Homes	450 L/bed/day
Medical Office – Doctors, Nurses & Medical Staff	275 L/person/day
Institutional Peaking Factor	1.5

Table 6, below, summarizes the estimated wastewater flow from the proposed development. Refer to *Appendix 'D'* for detailed calculations.

Table 6: Summary of Estimated Sanitary Flow

Design Parameter	Total Flow (L/s)
Total Estimated Average Dry Weather Flow	3.31
Total Estimated Peak Dry Weather Flow	4.91
Total Estimated Peak Wet Weather Flow	5.50

As noted above, the development is proposed to be serviced via the existing sanitary sewers, directly connected to the Rideau River Collector sewer. Due to the complexity of the downstream network the City will need to advise of any downstream constraints.

### 5.3 Sanitary Sewer Realignment

The existing 675 mm diameter sanitary sewer crossing through the site within the former Balmoral Place Right-of-way needs to be relocated to allow for construction of the Phase II building.

#### 5.3.1 Pipe Capacity

Based on Balmoral Place as-builts (Contact No. 89-17, Plan No. 2185), the 675 mm sanitary sewer with a 0.36-0.90% slope has an estimated capacity of 526 L/s within the constraining leg of sanitary sewer.

As shown by drawing C102, a 675 mm diameter sanitary sewer is proposed to be realigned at a minimum 0.67% slope. Therefore, it is estimated that the future capacity of the sewer is 725 L/s, which exceeds the required design flow of 682 L/s provided by the City Asset Management Group while respecting scouring velocities.

#### 5.3.2 Construction Staging and Sewer Flow Management

In order to maintain continued service to the existing upstream area it is proposed to construct the new sewer with the exception of the final connections prior to taking the existing sewer offline. The sanitary flow from the existing structure directly upstream of trunk sewer connection will be bypassed and pumped to the trunk sewer maintenance structure, allowing for interception of the existing sewer at proposed SAN MH4. At the upstream end of the relocation, the existing structure will be pumped into SAN MH5A to allow for the installation of the connecting sewer between SAN MH5A and the existing structure. The existing sanitary pipe between the relocation will then be removed, allowing for the construction of the phase II building.

The contractor will be required to submit a formal construction phasing and flow management plan to both MP and the City inspector for approval prior to commencement of construction.

## 6.0 STORM SEWER DESIGN

### 6.1 Existing Storm Sewers

Stormwater runoff from the site is currently tributary to the Rideau River within the Ottawa Central sub-watershed. There are three existing stormwater outlets for the subject site:

- The first collects drainage within the western parking lot via a catch basin system. Drainage is collected and directed to the 1050 mm diameter storm sewer within Smyth Road via a 200 mm service. Stormwater drainage is conveyed to the Rideau River (outlet OUT04494) approximately 210 m downstream, herein referred to as Outlet 1.
- The second collects drainage east of the existing medical buildings and within the central drive aisles via a catch basin system. Drainage is collected and directed to the existing 675 mm diameter storm sewer within the Transitway via a 375 mm diameter storm sewer. Stormwater drainage is conveyed to the Rideau River (outlet OUT04495) approximately 240 m downstream, herein referred to as Outlet 2.
- The third collects drainage within the southern parking lot via a catch basin system. Drainage is collected and directed to the 1200 mm diameter storm sewer at the south end of the site. Stormwater drainage is conveyed to the Rideau River (outlet OUT04345) approximately 234 m downstream, herein referred to as Outlet 3. No changes to Outlet 3 and the existing storm system will be proposed as part of this development.

### 6.2 Proposed Storm Sewers

The existing 200 mm diameter storm sewer network in the western parking area is proposed to be realigned and increased in diameter. The sewer system will provide flow attenuation for the parking lot and landscaped areas via storm maintenance structure CBMH3. This storm sewer system is tributary to Outlet 1, noted in Section 6.1 above.

The existing 375 mm diameter storm sewer network in the eastern parking area is proposed to be realigned. The storm sewer system will provide flow attenuation for the parking lots, courtyard, and garden via storm maintenance structure MH6 and CB11. This storm sewer system is tributary to Outlet 2, noted in Section 6.1 above, and will contain an OGS unit.

Runoff collected on the roof of the proposed Phase I building will be stored and controlled internally using nine roof drains. Roof drains will be used to limit the flow from the roof to the specified allowable release rate. For calculation purposes a Watts Accutrol roof drain was used to estimate a reasonable roof flow. Other products maybe specified at detailed building design so long as release rates and storage volumes are respected. Drainage from the roof will be directed towards Outlet 1 via a storm maintenance structure OGS.

Runoff collected on the roof of the proposed Phase II building will be stored and controlled internally using eighteen roof drains. Roof drains will be used to limit the flow from the roof to the specified allowable release rate. For calculation purposes a Watts Accutrol roof drain was used to estimate a reasonable roof flow. Other products maybe specified at detailed building design so long as release rates and storage volumes are respected. Drainage from the roof will be directed towards Outlet 1 via storm maintenance structure OGS.

Foundation drainage is proposed to be conveyed to the Smyth Road outlet via the 300 mm storm services connected at the west end of the building. No flow controls are proposed downstream of the foundation drainage.

See CCO-21-2955 - *POST* include in *Appendix F* of this report for more details. The Stormwater Management design for the subject property will be outlined in *Section 7.0* of this report.

## 7.0 PROPOSED STORMWATER MANAGEMENT

### 7.1 Design Criteria and Methodology

Stormwater management for the proposed site will be maintained through two methods. The first will store and control runoff collected on the roof of the proposed buildings. It is estimated that twenty-four Watts Accutrol Weirs will be used to control the release rate of the stormwater. The second will control stormwater via an underground sewer system and will collect runoff from the at-grade areas within the site.

In summary, the following design criteria have been employed in developing the stormwater management design for the site as directed by the City:

#### Quality Control

- The site has been designed to achieve an 80% total suspended solids removal (enhanced level).

#### Quantity Control

- Pre-development and post-development flows shall be calculated using a time of concentration ( $T_c$ ) greater than 10 minutes.
- Control 5 through 100-year post-development flows to the 5-year storm event, based on a rational method coefficient of 0.5 and calculated time of concentration. Refer to *Section 7.2* for further details.

### 7.2 Runoff Calculations

Runoff calculations presented in this report are derived using the Rational Method, given as:

$$Q = 2.78CIA \text{ (L/s)}$$

Where:

- C = Runoff coefficient
- I = Rainfall intensity in mm/hr (City of Ottawa IDF curves)
- A = Drainage area in hectares

It is recognized that the Rational Method tends to overestimate runoff rates. As a result, the conservative calculation of runoff ensures that any SWM facility sized using this method is expected to function as intended. The following coefficients were used to develop an average C for each area:

Roofs/Concrete/Asphalt	0.90
Undeveloped and Grass	0.20

As per the *City of Ottawa - Sewer Design Guidelines*, the 5-year balanced 'C' value must be increased by 25% for a 100-year storm event to a maximum of 1.0.



### 7.3 Pre-Development Drainage

It has been assumed that the existing development contained no stormwater management controls for flow attenuation. The estimated pre-development peak flows for the 5, and 100-year events are summarized below in *Table 7*. See CCO-21-2955 - *PRE* in *Appendix E* and *Appendix G* for calculations.

Table 7: Pre-Development Runoff Summary

Drainage Area	Area (ha)	Q (L/s)	
		5-Year	100-Year
A1	2.126	434.08	834.72

### 7.4 Post-Development Drainage

To meet the stormwater objectives the development will contain a combination of flow attenuation with rooftop controls and surface storage.

Based on the criteria listed in *Section 7.1*, the development will be required to restrict flow to the 5-year storm event. It is estimated that the target release rate will be *307.9 L/s*. See *Appendix G* for calculations.

The proposed site drainage limits are demonstrated on the Post-Development Drainage Area Plan. See CCO-21-2955 - *POST* in *Appendix F* of this report for more details. A summary of the post-development runoff calculations can be found below.

Table 8: Post-Development Runoff Summary

Drainage Area	Area (ha)	5-year Peak Flow (L/s)	100-year Peak Flow (L/s)	100-year Storage Required (m <sup>3</sup> )	100-year Storage Available (m <sup>3</sup> )
B1	0.229	2.84	2.84	134.20	135.89
B2	0.326	5.68	5.68	174.24	181.18
B3	0.335	77.03	124.39	22.38	29.18
B4	0.090	14.69	28.57	-	-
B5	0.188	20.74	21.24	45.61	47.32
B6	0.181	35.40	35.84	104.51	104.87
B7	0.132				
B8	0.080				
B9	0.167				
B10	0.398	43.25	86.46	-	-
Total	2.126	199.63	305.02	480.95	498.44

Runoff for area B1 will be stored on the roof of the retirement residence (B1) and restricted using nine fully closed Watts Accutrol roof drains (or equivalent product) to a maximum release rate of 2.84 L/s and will provide up to 135.9 m<sup>3</sup> of storage. Stormwater drainage will be directed to Outlet 1.

Runoff for area B2 will be stored on the roof of the long-term care facility (B2) and restricted using eighteen fully closed Watts Accutrol roof drains (or equivalent product) to a maximum release rate of 5.68 L/s and will provide up to 181.2 m<sup>3</sup> of storage. Stormwater drainage will be directed to Outlet 1.

Runoff for area B3 will be restricted before discharging to the existing storm system within Smyth Road. The flow will be controlled within a catch basin maintenance structure (CBMH3) installed with a 195 mm plug style ICD. Drainage from Area B3 will be controlled to a maximum release rate of 124.39 L/s and will provide up to 29.2 m<sup>3</sup> of surface storage. Stormwater drainage will be directed to Outlet 1.

Runoff for area B4 will be collected before discharging without attenuation to the existing 375 mm diameter storm sewer system. Runoff will be compensated for in areas with attenuation. Stormwater drainage will be directed to Outlet 2.

Runoff for area B5 will be restricted before discharging to the existing 375 mm diameter storm system. The flow will be controlled within a catch basin (CB11) installed with a 88 mm plug style ICD. Drainage from Area B5 will be controlled to a maximum release rate of 21.24 L/s and will provide up to 47.3 m<sup>3</sup> of surface storage. Stormwater drainage will be directed to Outlet 2.

Runoff for area B6-B9 will be restricted before discharging to the existing 375 mm diameter storm system. The flow will be controlled within a maintenance structure (MH6) installed with a 101 mm plug style ICD. Drainage from Area B6-B9 will be controlled to a maximum release rate of 35.84 L/s and will provide up to 104.9 m<sup>3</sup> of surface storage. Stormwater drainage will be directed to Outlet 2.

The flow from Area B10 will be directed to the City's right of ways (Smyth Road) without restriction and will be compensated or in areas with attenuation.

As per drawing C102, a Stormceptor EF06 OGS unit or an approved equivalent is proposed to be installed at the downstream end of the Smyth Road storm sewer system (to Outlet 1). The oil & grit separator structure will provide an enhanced level of treatment (80% TSS removal) for the rooftop, foundation, and parking lot drainage.

As per drawing C102, a Stormceptor EF04 OGS unit or an approved equivalent is proposed to be installed at the downstream end of the eastern/southern storm sewer system (to Outlet 2). The oil & grit separator structure will provide an enhanced level of treatment (80% TSS removal) for the parking lot drainage.

## 8.0 EROSION AND SEDIMENT CONTROL

### 8.1 Temporary Measures

Before construction begins, temporary silt fence, straw bale or rock flow check dams will be installed at all-natural runoff outlets from the property. It is crucial that these controls be maintained throughout construction and inspection of sediment and erosion control will be facilitated by the Contractor or Contract Administration staff throughout the construction period.

Silt fences will be installed where shown on the final engineering plans, specifically along the downstream property limits. The Contractor, at their discretion or at the instruction of the City, Conservation Authority or the Contract Administrator shall increase the quantity of sediment and erosion controls on-site to ensure that the site is operating as intended and no additional sediment finds its way off site. The rock flow, straw bale & silt fence check dams and barriers shall be inspected weekly and after rainfall events. Care shall be taken to properly remove sediment from the fences and check dams as required. Fibre roll barriers are to be installed at all existing curb inlet catch basins and filter fabric is to be placed under the grates of all existing catch basins and manholes along the frontage of the site and any new structures immediately upon installation. The measures for the existing/proposed structures is to be removed only after all areas have been paved. Care shall be taken at the removal stage to ensure that any silt that has accumulated is properly handled and disposed of. Removal of silt fences without prior removal of the sediments shall not be permitted.

Although not anticipated, work through winter months shall be closely monitored for erosion along sloped areas. Should erosion be noted, the Contractor shall be alerted and shall take all necessary steps to rectify the situation. Should the Contractor's efforts fail at remediating the eroded areas, the Contractor shall contact the City and/or Conservation Authority to review the site conditions and determine the appropriate course of action. As the ground begins to thaw, the Contractor shall place silt fencing at all required locations as soon as ground conditions warrant. Please see the *Site Grading, Drainage and Sediment & Erosion Control Plan* for additional details regarding the temporary measures to be installed and their appropriate OPSD references.

### 8.2 Permanent Measures

It is expected that the Contractor will promptly ensure that all disturbed areas receive topsoil and seed/sod and that grass be established as soon as possible. Any areas of excess fill shall be removed or levelled as soon as possible and must be located a sufficient distance from any watercourse to ensure that no sediment is washed out into the watercourse. As the vegetation growth within the site provides a key component to the control of sediment for the site, it must be properly maintained once established. Once the construction is complete, it will be up to the landowner to maintain the vegetation and ensure that the vegetation is not overgrown or impeded by foreign objects.

## 9.0 SUMMARY

- A new 256-bed long-term care facility and a 270-bed retirement residence is proposed within the northern portion of 1919 Riverside Drive. Development is proposed within 2.13 ha of the site.
- New 200 mm diameter water services will be installed to service the site, connecting to the existing 250 mm diameter watermain east of the site and the 200 mm diameter watermain west of the site.
- The existing 250 mm diameter watermain crossing through the development area is proposed to be re-aligned, as per drawing C102.
- A new sanitary sewer network will be installed within the north-west portion of the site in order to service the development and existing 4-storey medical office building.
- The existing 675 mm diameter sanitary sewer crossing through the development area is proposed to be re-aligned, as per drawing C102.
- The proposed storm sewer, ranging in diameter from 200 mm to 450 mm, will be installed throughout the site and drain to the existing storm sewer outlets.
- Storage for the 5- through 100-year storm events will be provided within the parking lot areas above the proposed storm structures and on the proposed flat roof.
- As per drawing C102, an oil & grit separator is proposed to be installed at the downstream end of the Smyth Road storm sewer system (to Outlet 1) and at the downstream end of the eastern/southern storm sewer system (to Outlet 2). The oil & grit separator structures will provide an enhanced level of treatment (80% TSS removal) for the rooftop, foundation, and parking lot drainage.

## 10.0 RECOMMENDATION

Based on the information presented in this report, we recommend that City of Ottawa approve this Servicing and Stormwater Management report in support of the proposed development at 1919 Riverside Drive.

This report is respectfully being submitted for approval.

Regards,

McIntosh Perry Consulting Engineers Ltd.



Robert D. Freel, P.Eng.  
Senior Project Manager, Land  
Development  
T: 613.714.6174  
E: r.freel@mcintoshperry.com

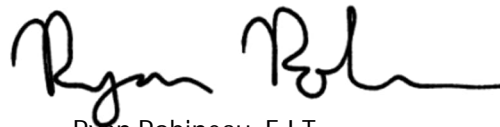

Ryan Robineau, E.I.T  
Civil Engineer in Training, Land  
Development  
T: 613.714.6611  
E: r.robineau@mcintoshperry.com

## 11.0 STATEMENT OF LIMITATIONS

This report was produced for the exclusive use of RBJ Schlegel Holdings. The purpose of the report is to assess the existing stormwater management system and provide recommendations and designs for the post-construction scenario that are in compliance with the guidelines and standards from the Ministry of the Environment, Parks and Climate Change, City of Ottawa and local approval agencies. McIntosh Perry reviewed the site information and background documents listed in Section 2.0 of this report. While the previous data was reviewed by McIntosh Perry and site visits were performed, no field verification/measures of any information were conducted.





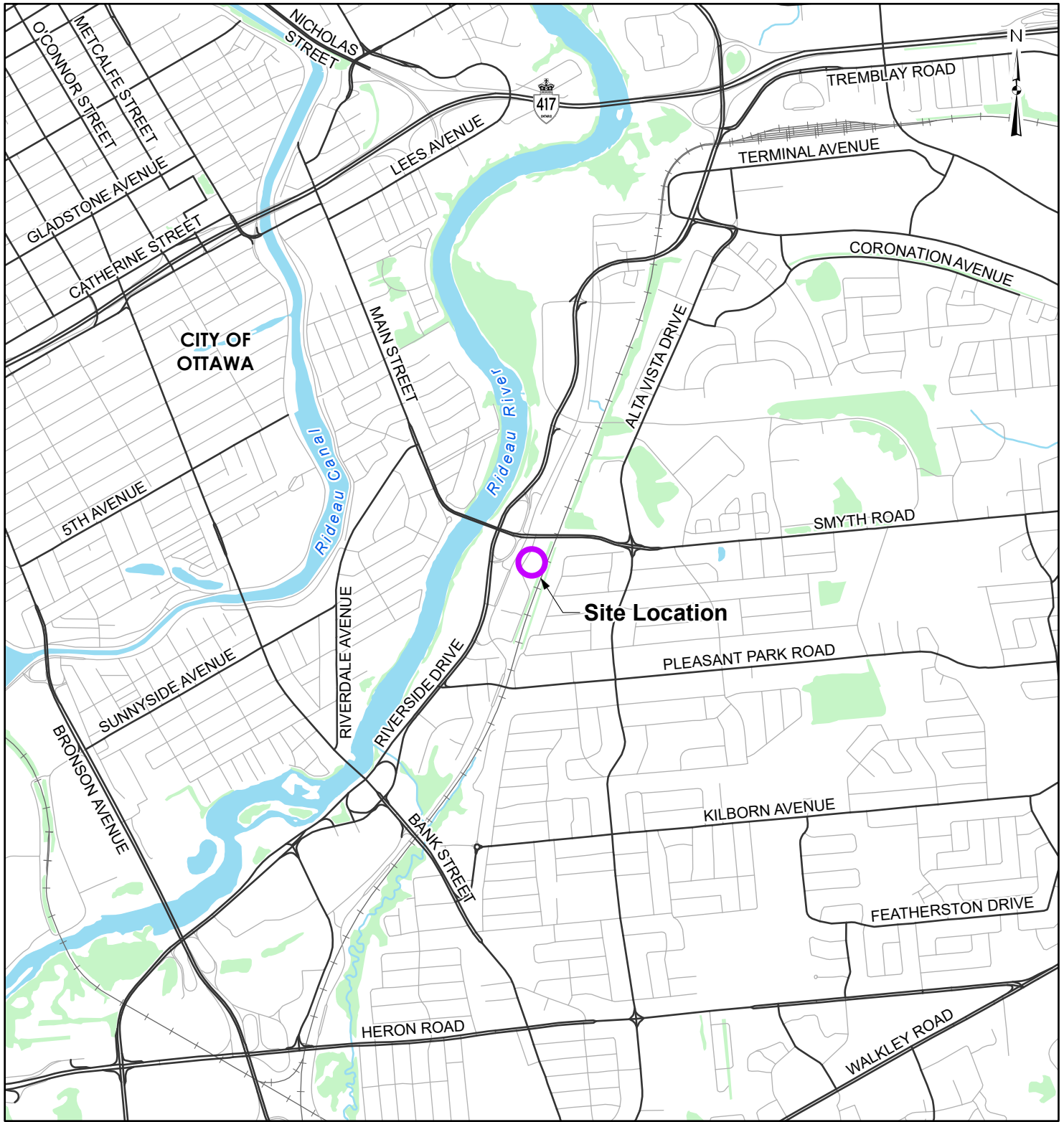

Any use of this review by a third party, or any reliance on decisions made based on it, without a reliance report is the responsibility of such third parties. McIntosh Perry accepts no responsibility for damages, if any, suffered by any third party as a result of decisions or actions made based on this review.

The findings, conclusions and/or recommendations of this report are only valid as of the date of this report. No assurance is made regarding any changes in conditions subsequent to this date. If additional information is discovered or becomes available at a future date, McIntosh Perry should be requested to re-evaluate the conclusions presented in this report, and provide amendments, if required.

**APPENDIX A  
KEY PLAN**



**LEGEND**

-  Site Location
-  Local Road
-  Major Road
-  Railroad
-  Watercourse
-  Waterbody
-  Wooded Area



**REFERENCE**

GIS data provided by the Ontario Ministry of Natural Resources and Forestry, 2021.

CLIENT:		SCHLEGEL VILLAGES OTTAWA	
PROJECT:		1919 RIVERSIDE DRIVE, OTTAWA, ON	
TITLE:		KEY MAP	
PROJECT NO: CCO-21-2955		FIGURE:	
Date	Oct., 19, 2021	<b>1</b>	
GIS	EU		
Checked By	AG		

**McINTOSH PERRY**  
 115 Walgreen Road, RR3, Carp, ON K0A1L0  
 Tel: 613-836-2184 Fax: 613-836-3742  
 www.mcintoshperry.com



**APPENDIX B**  
**BACKGROUND DOCUMENTS**

## Alison Gosling

---

**From:** Moore, Sean <Sean.Moore@ottawa.ca>  
**Sent:** April 29, 2021 12:00 PM  
**To:** Brian Casagrande; Bria Aird; Brad Schlegel  
**Cc:** Moise, Christopher; Hayley, Matthew; Krabicka, Jeannette; Harrold, Eric; Richardson, Mark; Gervais, Josiane; Xu, Lily  
**Subject:** 1919 Riverside Drive / Schlegel Villages site plan  
**Attachments:** Riverside, 1919\_UD Comments PRE1.docx; Riverside, 1919\_Design Brief.pdf; 210428\_1919 Riverside\_pre-app consult mtg\_PFP comments.pdf

Brian, Bria and Brad,

In regards to our April 22, 2021 preconsultation meeting for a Site Plan Control and Zoning By-law amendment at 1919 Riverside Drive please find our comments and submission requirements below. Myself and our team would be happy to discuss these comments if you have any questions moving forward.

**Site Plan Control (complex site plan category):**

[https://app06.ottawa.ca/online\\_services/forms/ds/site\\_plan\\_control\\_en.pdf](https://app06.ottawa.ca/online_services/forms/ds/site_plan_control_en.pdf)

**Zoning By-law Amendment (minor or major, depending upon request):**

[https://app06.ottawa.ca/online\\_services/forms/ds/zoning\\_amendment\\_en.pdf](https://app06.ottawa.ca/online_services/forms/ds/zoning_amendment_en.pdf)

**List of Reports and Plans:**

- The following reports and plans are required (all in digital format from an FTP site) in order to support the proposed Site Plan Control and Minor Zoning By-law amendment applications:
  1. Site Plan
  2. Concept Plan for both phases and interim conditions plan if Phase 2 will be a number of years after Phase 1
  3. Landscape Plan
  4. Tree Conservation Report
  5. Elevation Drawings
  6. Planning Rationale with Design Brief
  7. Sun Shadow Analysis / Wind analysis
  8. Noise and Vibration Study for proximity to Rail and the Transitway.
  9. Transportation Impact Assessment
  10. Archeological Assessment
  11. Phase 1 Environmental Site Assessment / Phase 2 if required. (Ontario Regulation 153/04 Ontario Regulation 153/04)
  12. Site Servicing Plan
  13. Grade Control and Drainage Plan
  14. Erosion and Sediment Control Plan
  15. Stormwater Management Report

16. Site Servicing Study
17. Geotechnical Study
18. A Sewer Flow Management Plan (Standard F1007) will be required, to be reviewed following first submission. The sewer flow management plan details how the Contractor intends to manage the sewer flow through and around the work zone.

**Planning Comments:**

1. Within the Planning Rationale please illustrate what the FSI of 1.0 restricts the built form to; to illustrate an as of right zoning vs. the proposed. Please provide design and planning rationale for the requested FSI.
2. Please advise if you will be seeking a 'restaurant' use or if the restaurant will be ancillary to the retirement home. This will impact the type of zoning (major vs. minor).
3. We would seek opportunities to connect to the BRT station from an outdoor sidewalk / pathway connection (if possible)
4. Are there opportunities to lower the grade at Smyth Road, such that the Phase 2 building is more at 'street level'
5. We are aware of the 'restrictive covenant' on title, and will provide more information with this as we explore this matter
6. Coupled with the attached Design Comments please refer to the High-Rise Design Guidelines and reference these in your Planning Rationale when you speak to your design considerations
7. Please ensure the Wind and Shadow study are used to inform the design of the buildings
8. Please ensure you understand VIA's requirements upfront ([Paul.Charbach@viarail.ca](mailto:Paul.Charbach@viarail.ca)) I will forward you information about VIA's review.

**Parks Comments:**

- See parks comments attached
- Keep in mind the 30m setback to VIA cannot count towards parkland dedication

**Urban Design Comments**

- See attached word document
- See attached pdf of the Urban Design Brief terms of reference

**Environmental Comments**

- Landscaping - OP Section 4.9 - shading for outdoor space to combat the urban heat island
- Bird safe design - [https://documents.ottawa.ca/sites/documents/files/birdsafedesign\\_guidelines\\_en.pdf](https://documents.ottawa.ca/sites/documents/files/birdsafedesign_guidelines_en.pdf)

**Transportation Comments**

- Follow Traffic Impact Assessment Guidelines
  - A TIA is required. Submit Screening Form and Scoping Report at your earliest convenience to [Josiane.Gervais@ottawa.ca](mailto:Josiane.Gervais@ottawa.ca).
  - Start this process asap. The application will not be deemed complete until the submission of the draft step 1-4, including the functional draft RMA package (if applicable) and/or monitoring report (if applicable).
  - Request base mapping asap if RMA is required. Contact Engineering Services (<https://ottawa.ca/en/city-hall/planning-and-development/engineering-services>)
  - An update to the *TRANS Trip Generation Manual* has been completed (October 2020). This manual is to be utilized for this TIA. A copy of this document can be provided upon request.
  - The presentation noted the Village offers community services and amenities, ensure the TIA trip generation accounts for trips associated with these services.
- Concept as shown results in a closure of one access to the Hospital, the TIA must show how this can be accommodated:
  - Implications to vehicle access and emergency vehicles;
  - Can the single access accommodate all vehicle traffic?

- Are existing turning lanes at Riverside intersection adequate lengths or will they need to be extended? RMA will be required if there are impacts to the intersection.
- Ensure the site plan clearly shows how pedestrians/cyclists from Smyth Road reach the Riverside Campus, the Transit Station and the proposed site.
- Consultation with City Emergency Services is encouraged early in the process to ensure emergency vehicles destined to/from the Riverside Campus and proposed site can be accommodated.
- Specifically for the Smyth Road access:
  - Clear throat requirements for apartments >200 units on an arterial is 40m. This distance must be provided and shown on the Site Plan. Traffic must adequately clear Smyth Road during green time.
  - Stacking must be accommodated on private property for vehicles egressing the site.
  - In addition, the TIA must show if the WB-LT lane at Smyth Road intersection into the site sufficient or will it need to be extended? RMA will be required if there are impacts to the intersection.
- Existing parking that is associated with the existing Riverside Campus will be impacted by this proposal, how are the impacted parking stalls going to be accommodated?
- Show pedestrian pathways on site. Ensure all crosswalks located internally on the site provide a TWSI at the depressed curb, per requirements of the Integrated Accessibility Standards Regulation under the AODA.
- On site plan:
  - Show all details of the roads abutting the site up to and including the opposite curb; include such items as pavement markings, accesses and/or sidewalks.
  - Turning movement diagrams required for all accesses showing the largest vehicle to access/egress the site.
  - Turning movement diagrams required for internal movements (loading areas, garbage).
  - Show all curb radii measurements; ensure that all curb radii are reduced as much as possible
  - Show lane/aisle widths.
  - Sidewalk is not to be continuous across access as per City Specification 7.1.
  - Grey out any area that will not be impacted by this application.
  - Show slope of garage ramp on site plan. Note that underground ramps should be limited to a 12% grade and must contain a subsurface melting device when exceeding 6%. Ramp grades greater than 15% can be psychological barriers to some drivers.
- As the proposed site is institutional and for general public use, AODA legislation applies.
- Consider using the City's Accessibility Design Standards.
- Noise Impact Studies required for the following:
  - Road
  - Rail
  - Stationary, due to the proximity to neighboring exposed mechanical equipment, and/or if there will be any exposed mechanical equipment due to the proximity to neighboring noise sensitive land uses.

## Engineering Comments

Please note the following information regarding the engineering design submissions for the above noted site:

1. The Servicing Study Guidelines for Development Applications are available at the following address:
 

<https://ottawa.ca/en/city-hall/planning-and-development/how-develop-property/development-application-review-process-2/guide-preparing-studies-and-plans>
2. Servicing and site works shall be in accordance with the following documents:
  - Ottawa Sewer Design Guidelines (October 2012) and all the Technical Bulletins including, Technical Bulletin PIEDTB-2016-01 and ISTB-2018-01
  - Ottawa Design Guidelines – Water Distribution (2010) and Technical Bulletins ISD-2010-2, ISDTB-2014-02 and ISTB-2018-02

- Geotechnical Investigation and Reporting Guidelines for Development Applications in the City of Ottawa (2007)
  - City of Ottawa Slope Stability Guidelines for Development Applications (revised 2012)
  - City of Ottawa Environmental Noise Control Guidelines (January, 2016)
  - City of Ottawa Park and Pathway Development Manual (2012)
  - City of Ottawa Accessibility Design Standards (2012)
  - Ottawa Standard Tender Documents (latest version)
  - Ontario Provincial Standards for Roads & Public Works (2013)
3. Record drawings and utility plans are also available for purchase from the City (Contact the City's Information Centre by email at [InformationCentre@ottawa.ca](mailto:InformationCentre@ottawa.ca) or by phone at (613) 580-2424 x 44455
4. The Stormwater Management Criteria, for the subject site, is to be based on the following:
- Stormwater flows controlled to the 5 year event using Allowable Runoff Coefficient (C) = 0.5
  - Due to location of the storm outlet to the Rideau River, surcharging is a possibility and should be considered.
  - The 2-yr storm or 5-yr storm event using the IDF information derived from the Meteorological Services of Canada rainfall data, taken from the MacDonald Cartier Airport, collected 1966 to 1997.
  - A calculated time of concentration (Cannot be less than 10 minutes).
  - Flows to the storm sewer in excess of the 5-year storm release rate, up to and including the 100-year storm event, must be detained on site.
  - Please contact RVCA for specific water quality requirement (discharge to Rideau River).
  - Note that there are known drainage issues near the railroad abutting the property, and that the Rideau River is prone to surcharge.
  - Note: There may be area specific SWM Criteria that may apply. Check for any related SWM &/or Sub-watershed studies that may have been completed.

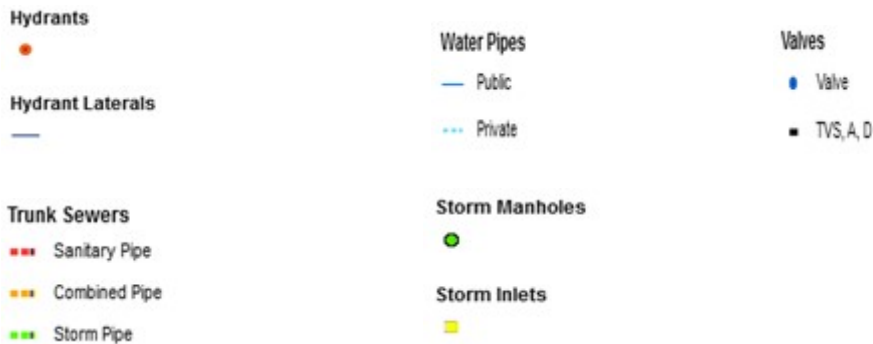
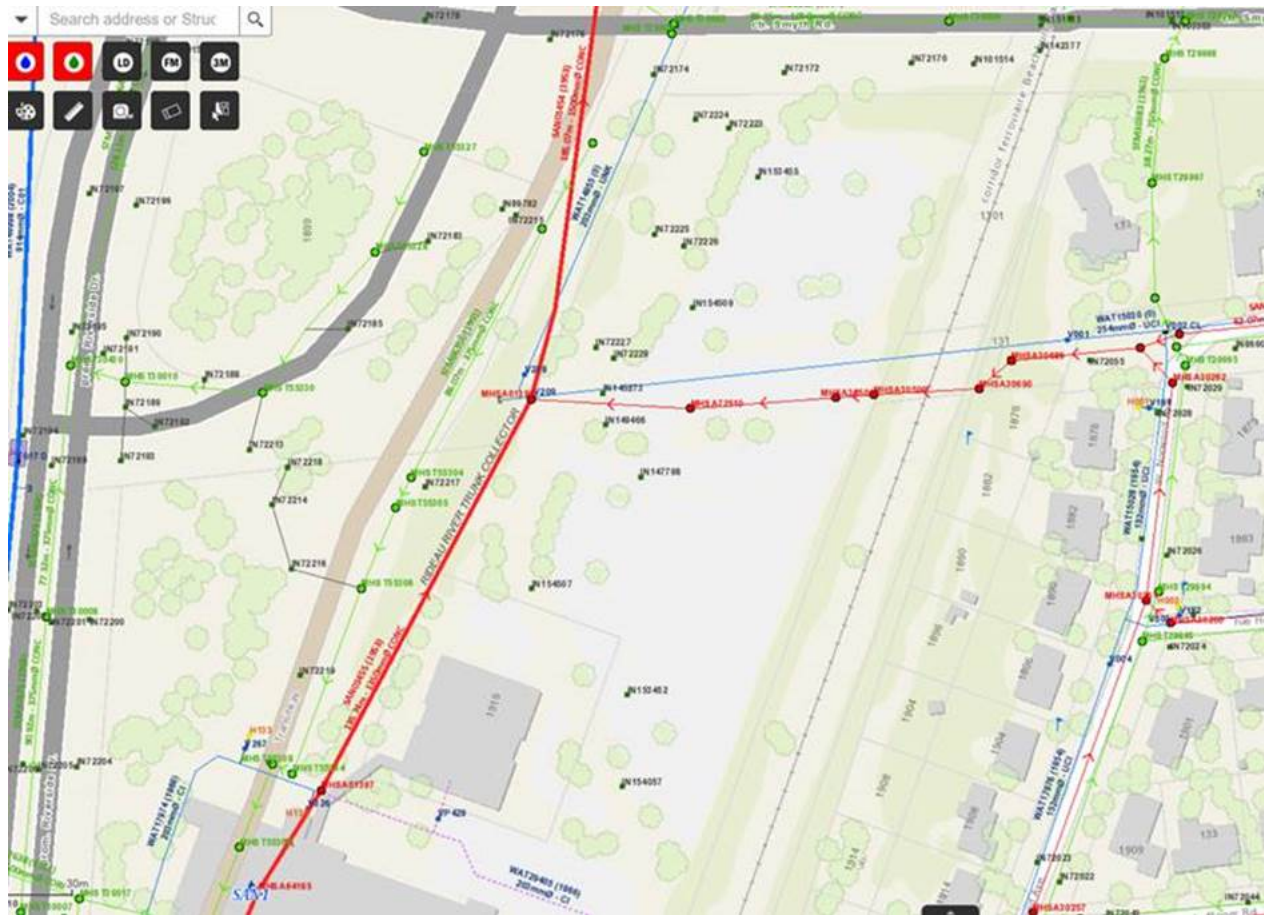

5. Services (Storm, Sanitary & Water Supply):

- i. A plan view of the approximate services is shown above. Services should ideally be grouped in a common trench to minimize the number of road cuts. The sizing of available future services is:
  - a. Connections (Sewers on Riverside Drive - Preferred):
    - i. 450 mm dia. STM (Conc.). Note that there is existing stormwater management infrastructure beneath the northern portion of the parking area.
    - ii. 203 mm private dia. Watermain (UNK). This private watermain currently services the Riverside campus, and has a redundant connection to the watermains located along Riverside Drive and Rodney Crescent.
    - iii. 254 mm dia. Watermain (UCI). This watermain must be relocated, as it underlies the Phase II building footprint. The watermain should be relocated to the north. The un-used

portion of pipe will need to be abandoned. A Form 1 from the MECP will be required prior to issuance of the Commence Work Notification. Due to the relocation of existing services in this area, the City's Asset Management group will be circulated on technical submissions for comment. The City's Asset Management group indicated this this watermain must be relocated, and not terminated.

- iv. 675 mm dia. SAN (Conc.). A portion of this sewer must be relocated, as it underlies the Phase II building footprint. The sewer should be relocated to the north, wrapping around the proposed building, and returning towards the south so that the existing connection to the 1350 mm trunk sewer can be re-used. The City does not support a new connection to the 1350 mm trunk sewer.
- ii. *Provide existing servicing information and the recommended location for the proposed connections. Services should ideally be grouped in a common trench to minimize the number of road cuts.*
- iii. *Connections to trunk sewers and easement sewers are typically not permitted. Connection to the trunk storm on Riverside is permitted for this site plan*
- iv. *Provide information on the monitoring manhole requirements – should be located in an accessible location on private property near the property line (ie. Not in a parking area).*
- v. *Review provision of a high-level sewer.*
- vi. *Provide information on the type of connection permitted*

Sewer connections to be made above the springline of the sewermain as per:

- a. Std Dwg S11.1 for flexible main sewers – *connections made using approved tee or wye fittings.*
  - b. Std Dwg S11 (For rigid main sewers) – *lateral must be less than 50% the diameter of the sewermain,*
  - c. Std Dwg S11.2 (for rigid main sewers using bell end insert method) – *for larger diameter laterals where manufactured inserts are not available; lateral must be less than 50% the diameter of the sewermain,*
  - d. *Connections to manholes permitted when the connection is to rigid main sewers where the lateral exceeds 50% the diameter of the sewermain. – Connect obvert to obvert with the outlet pipe unless pipes are a similar size.*
  - e. *No submerged outlet connections.*
6. Water Boundary condition requests must include the location of the service and the expected loads required by the proposed development. Please provide the following information:
- i. Location of service
  - ii. Type of development and the amount of fire flow required (as per FUS, 1999).
  - iii. Average daily demand: \_\_\_ l/s.
  - iv. Maximum daily demand: \_\_\_ l/s.
  - v. Maximum hourly daily demand: \_\_\_ l/s.
  - vi. Hydrant location and spacing to meet City's Water Design guidelines.

- vii. Water supply redundancy will be required for more than 50 m<sup>3</sup>/day water demand. Note that this is a supply sensitive user, and as such the facility will require two separate water services. The existing private watermain servicing the Riverside campus has an existing redundant connection to the watermain on Rodney Crescent.
- 7. Phase 1 Environmental Site Assessment (ESA) and Phase 2 ESAs must conform to clause 4.8.4 of the Official Plan that requires that development applications conform to Ontario Regulation 153/04. The ESA may provide recommendations where site contamination may be present. The recommendations from the ESA need to be coordinated with the servicing report to ensure compliance with the Sewer Use By-Law.
- 8. MECP ECA Requirements – All development applications should be considered for an Environmental Compliance Approval (ECA) by the Ministry of the Environment, Conservation, and Parks (MECP);
  - a. The consultants determine if an approval for sewage works under Section 53 of OWRA is required and determines what type of application. The City’s project manager may help confirm and coordinate with the MECP as required.
  - b. The project will be either transfer of review (standard), transfer of review (additional), direct submission, or exempt as per O. Reg. 525/98.
  - c. Pre-consultation is not required if applying for standard or additional works (Schedule A of the Agreement) under Transfer Review.
  - d. Pre-consultation with local District office of MECP is recommended for direct submission.
  - e. Consultant completes an MECP request form for a pre-consultation. Sends request to [moeccottawasewage@ontario.ca](mailto:moeccottawasewage@ontario.ca)
  - f. ECA applications are required to be submitted online through the MECP portal. A business account required to submit ECA application. For more information visit <https://www.ontario.ca/page/environmental-compliance-approval>
  - g. A Transfer of Review (TOR) ECA will likely be required for the sanitary sewer relocation.
  - h. Water supply redundancy will be required for more than 50 m<sup>3</sup>/day water demand. Provide watermain looped connection or with isolation valve to meet this requirement.

NOTE: Site Plan Approval, or Draft Approval, is required before an application is sent to the MECP.

- 9. Please contact RVCA for specific water quality requirements (discharge to Rideau River).
- 10. General Engineering Submission requirements:
  - a. As per section 53 of the Professional Engineers Act, O. Reg 941/40, R.S.O. 1990, all documents prepared by engineers must be signed and dated on the seal.
  - b. All required plans are to be submitted on standard A1 size sheets (594mm x 841mm) sheets, utilizing a reasonable and appropriate metric scale as per City of Ottawa Servicing and Grading Plan Requirements: title blocks are to be placed on the right of the sheets and not along the bottom. Engineering plans may be combined, but the Site Plans must be provided separately. Plans shall include the survey monument used to confirm datum. Information shall be provided to enable a non-surveyor to locate the survey monument presented by the consultant.
  - c. All required plans & reports are to be provided in \*.pdf format (at application submission and for any, and all, re-submissions).
  - d. Engineering Reports and Drawings can be requested from the ISD Information Centre by emailing [informationcentre@ottawa.ca](mailto:informationcentre@ottawa.ca).



Should you have any questions or require additional information, please contact me directly at (613) 580-2424, ext. 21447 or by email at [eric.harrold@ottawa.ca](mailto:eric.harrold@ottawa.ca).

#### **TCR requirements:**

1. a Tree Conservation Report (TCR) must be supplied for review along with the suite of other plans/reports required by the City
  - a. an approved TCR is a requirement of Site Plan approval.
2. As of January 1 2021, any removal of privately-owned trees 10cm or larger in diameter, or publicly (City) owned trees of any diameter requires a tree permit issued under the Tree Protection Bylaw (Bylaw 2020 – 340); the permit will be based on an approved TCR and made available at or near plan approval.
3. The Planning Forester from Planning and Growth Management as well as foresters from Forestry Services will review the submitted TCR
  - a. If tree removal is required, both municipal and privately-owned trees will be addressed in a single permit issued through the Planning Forester
  - b. Compensation may be required for city owned trees – if so, it will need to be paid prior to the release of the tree permit
4. the TCR must list all trees on site by species, diameter and health condition
5. please identify trees by ownership – private onsite, private on adjoining site, city owned, co-owned (trees on a property line)
6. the TCR must list all trees on adjacent sites if they have a critical root zone that extends onto the development site
7. If trees are to be removed, the TCR must clearly show where they are, and document the reason they cannot be retained
8. All retained trees must be shown and all retained trees within the area impacted by the development process must be protected as per City guidelines available at [Tree Protection Specification](#) or by searching Ottawa.ca
  - a. the location of tree protection fencing must be shown on a plan
  - b. show the critical root zone of the retained trees
  - c. if excavation will occur within the critical root zone, please show the limits of excavation
9. the City encourages the retention of healthy trees; if possible, please seek opportunities for retention of trees that will contribute to the design/function of the site.
10. For more information on the process or help with tree retention options, contact Mark Richardson [mark.richardson@ottawa.ca](mailto:mark.richardson@ottawa.ca) or on [City of Ottawa](#)

#### **Landscape Plan and tree planting requirements:**

For additional information on the following please contact [tracy.smith@Ottawa.ca](mailto:tracy.smith@Ottawa.ca)

##### Minimum Setbacks

- Maintain 1.5m from sidewalk or MUP/cycle track.
- Maintain 2.5m from curb
- Coniferous species require a minimum 4.5m setback from curb, sidewalk or MUP/cycle track/pathway.
- Maintain 7.5m between large growing trees, and 4m between small growing trees. Park or open space planting should consider 10m spacing.
- Adhere to Ottawa Hydro's planting guidelines (species and setbacks) when planting around overhead primary conductors.

##### Tree specifications

- Minimum stock size: 50mm tree caliper for deciduous, 200cm height for coniferous.
- Maximize the use of large deciduous species wherever possible to maximize future canopy coverage
- Tree planting on city property shall be in accordance with the City of Ottawa’s Tree Planting Specification; and include watering and warranty as described in the specification (can be provided by Forestry Services).
- Plant native trees whenever possible
- No root barriers, dead-man anchor systems, or planters are permitted.
- No tree stakes unless necessary (and only 1 on the prevailing winds side of the tree)

Hard surface planting

- Curb style planter is highly recommended
- No grates are to be used and if guards are required, City of Ottawa standard (which can be provided) shall be used.
- Trees are to be planted at grade

Soil Volume

- Please ensure adequate soil volumes are met:

Tree Type/Size	Single Tree Soil Volume (m3)	Multiple Tree Soil Volume (m3/tree)
Ornamental	15	9
Columnar	15	9
Small	20	12
Medium	25	15
Large	30	18
Conifer	25	15

Please note that these soil volumes are not applicable in cases with Sensitive Marine Clay.

Sensitive Marine Clay

- Please follow the City’s 2017 Tree Planting in Sensitive Marine Clay guidelines

**APPLICATION SUBMISSION:**

- Planning Operations has created a detailed process for the receipt and handling of applications sent to the Planning Circulations inbox. [PlanningCirculations@ottawa.ca](mailto:PlanningCirculations@ottawa.ca) All applications are to be sent to this inbox so that the MAP files can be created, and materials uploaded to both SharePoint and MAP.

**1. THINGS TO NOTE**

- Payment Initiation:** Once the digital files have been sent to [PlanningCirculations@ottawa.ca](mailto:PlanningCirculations@ottawa.ca) a submissions email will be forwarded to the applicant in order to initiate payment for the application.
- Payments:** Application payments will now be handled by the Client Service Centre. Details on how to make such payments are included within the email to the applicants. Please note, EFT and Wire Transfers are no longer being accepted as payment methods.

Regards,

Sean Moore, RPP/MCIP  
 Senior Planner  
 Development Review South Unit  
 Planning, Infrastructure and Economic Development Dept.  
 City of Ottawa

Cell: 613-805-9804

- Please note I am working from home during this crisis until further notice

'

This e-mail originates from the City of Ottawa e-mail system. Any distribution, use or copying of this e-mail or the information it contains by other than the intended recipient(s) is unauthorized. Thank you.

Le présent courriel a été expédié par le système de courriels de la Ville d'Ottawa. Toute distribution, utilisation ou reproduction du courriel ou des renseignements qui s'y trouvent par une personne autre que son destinataire prévu est interdite. Je vous remercie de votre collaboration.

'

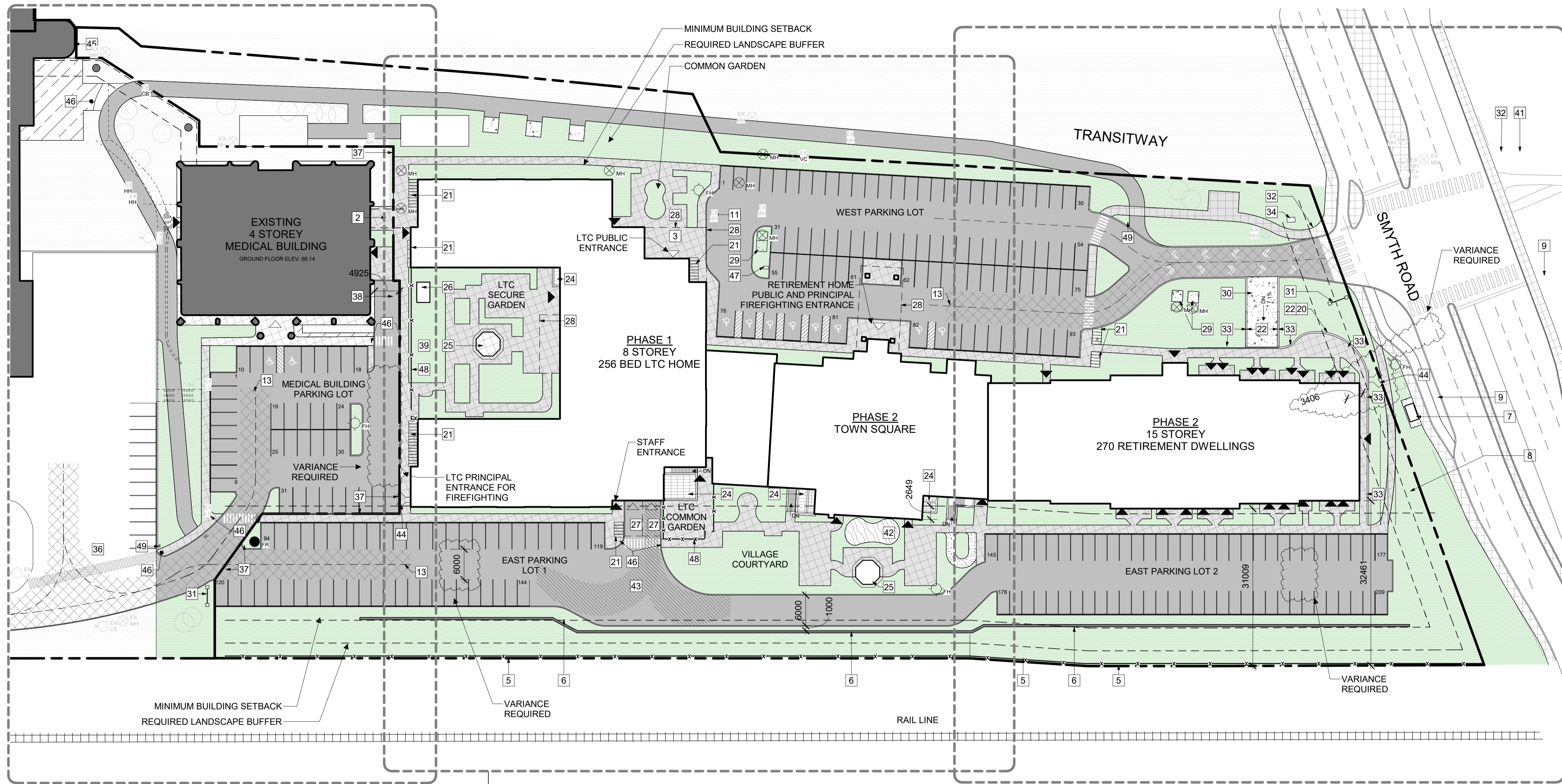

- SITE PLAN GENERAL NOTES:**
1. ALL GENERAL SITE INFORMATION AND CONDITIONS COMPILED FROM EXISTING PLANS AND SURVEYS
  2. DO NOT SCALE THIS DRAWING
  3. REPORT ANY DISCREPANCIES PRIOR TO COMMENCING WORK. NO RESPONSIBILITY IS BORN BY THE CONSULTANT FOR UNKNOWN SUBSURFACE CONDITIONS
  4. CONTRACTOR TO CHECK AND VERIFY ALL DIMENSIONS ON SITE AND REPORT ANY ERRORS AND/OR OMISSIONS TO THE CONSULTANT
  5. REINSTATE ALL AREAS AND ITEMS DAMAGED AS A RESULT OF CONSTRUCTION ACTIVITIES TO THE SATISFACTION OF THE CONSULTANT
  6. CONTRACTOR TO LAYOUT PLANTING BEDS, PATHWAYS ETC. TO APPROVAL OF CONSULTANT PRIOR TO ANY JOB EXCAVATION
  7. THE ACCURACY OF THE POSITION OF UTILITIES IS NOT GUARANTEED - CONTRACTOR TO VERIFY PRIOR TO EXCAVATION
  8. INDIVIDUAL UTILITY COMPANY MUST BE CONTACTED FOR CONFIRMATION OF UTILITY EXISTENCE AND LOCATION PRIOR TO DIGGING
  9. ALL DISTURBED AREAS TO BE RESTORED TO ORIGINAL CONDITION OR BETTER UNLESS OTHERWISE NOTED

- SITE PLAN LEGEND:**
- EXISTING BUILDING
  - EXISTING GRASS/SOFT LANDSCAPE - REFER TO LANDSCAPE DRAWINGS
  - EXISTING SIDEWALK
  - NEW ASPHALT PAVING
  - NEW GRASS / SOFT LANDSCAPE - REFER TO LANDSCAPE DRAWINGS
  - CONCRETE SIDEWALK
  - CONCRETE PAD
  - STONE DUST/SAND
  - PEDESTRIAN CROSSWALK
  - EXISTING PAVERS
  - FIRE ROUTE
  - FIRE ROUTE
  - OTHER ENTRANCE / EXIT
  - SERVICE DOORS
  - BUILDING MAIN ENTRANCE
  - PROPERTY LINE
  - FENCE - REFER TO LANDSCAPE PLANS
  - RELOCATED UNDERGROUND SERVICES - REFER TO CIVIL FOR DETAILS
  - LIMIT OF WORK
  - EXISTING LIGHT STANDARD
  - EXISTING MANHOLE
  - EXISTING UTILITY POLE
  - EXISTING TRAFFIC LIGHT POLE
  - FIRE ROUTE SIGN
  - SIAMESE CONNECTION
  - FIRE HYDRANT

**1 SITE PLAN - MASTER PLAN**  
A1.02 | 1 : 500 (WHEN PLOTTED ON A1 SIZED SHEET)

**SITE PLAN LEGEND:**

- 1 EXISTING RAISED PEDESTRIAN LINK
- 2 POTENTIAL PEDESTRIAN LINK
- 3 LTC PORCH
- 4 NEW FENCE AND GATE
- 5 NEW 1829mm HIGH CHAIN LINK FENCE
- 6 NEW 450mm THICK, 2135mm HIGH CONCRETE CRASH WALL
- 7 EXISTING BUS SHELTER (RELOCATED)
- 8 NEW BIKE PATH
- 9 END OF FUTURE BIKE LANE
- 11 LAY-BY
- 13 END OF FIRE ROUTE
- 20 LOOKOUT
- 21 BICYCLE PARKING
- 22 RETAINING WALL
- 24 AREAWAY
- 25 GAZEBO
- 26 SHED
- 27 LOADING ZONE
- 28 OVERHANG ABOVE
- 29 HYDRO BOX
- 30 HEATED RAMP
- 31 SIGNAGE
- 32 EXISTING ROAD BARRIER
- 33 1100 mm HIGH GUARD
- 34 EXISTING UTILITY COVER AT SURFACE
- 35 ACCESS AISLE
- 36 FIRE TRUCK TURNAROUND FACILITY
- 37 PROPOSED PROPERTY LINE
- 38 EXISTING LOADING / GARBAGE AREA
- 39 SOD
- 40 EXISTING BUS SHELTER
- 41 EXISTING MULTI-USE PATHWAY
- 42 POND
- 43 DELIVERY TRUCK TURNAROUND FACILITY
- 44 SIAMESE CONNECTION
- 45 EXISTING ACCESS TO TRANSIT STATION
- 46 TACTILE WALKING SURFACE INDICATOR (TWSI) C/W DEPRESSED CURB
- 47 COMMUNICATIONS PULLBOX
- 48 1.6m HT FENCE WITH LOCKING GATE
- 49 STOP SIGN
- 50 MULTI-USE PATHWAY SIGNAGE (MUP)
- 51 NO BIKES SIGNAGE



**2 PARKING LAYOUT**  
A1.02 | 1 : 500 (WHEN PLOTTED ON A1 SIZED SHEET)

43R (4-3 R.F. 1987 Riverside Drive, Ottawa, Ontario) S 946 897 1441 z z z 2023

**CSV ARCHITECTS**  
sustainable design - conception écologique

ISSUED FOR REVIEW: 2022-04-08  
ISSUED FOR SITE PLAN CONTROL, RE-SUBMISSION: 2022-04-08  
ISSUED FOR SITE PLAN CONTROL, RE-SUBMISSION: 2022-04-31  
REVISED MUP LAYOUT: 2022-04-31  
MINISTRY OF LONG TERM CARE COORDINATION

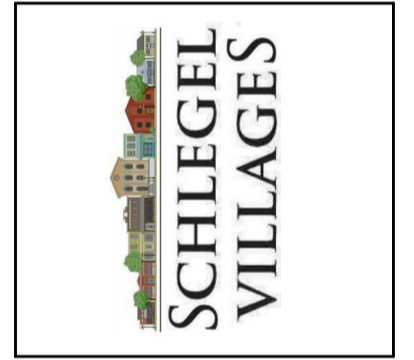

**SCHLEGEL VILLAGES OTTAWA**  
1915, 1987 RIVERSIDE DRIVE, OTTAWA, ONTARIO

**MASTER PLAN**

Project No.: 202090  
Drawn By: MM  
Plot Date: 2022-11-23  
2022-11-01

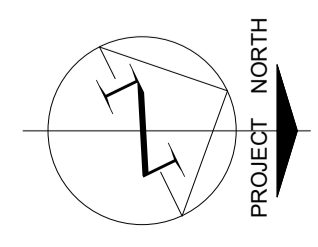
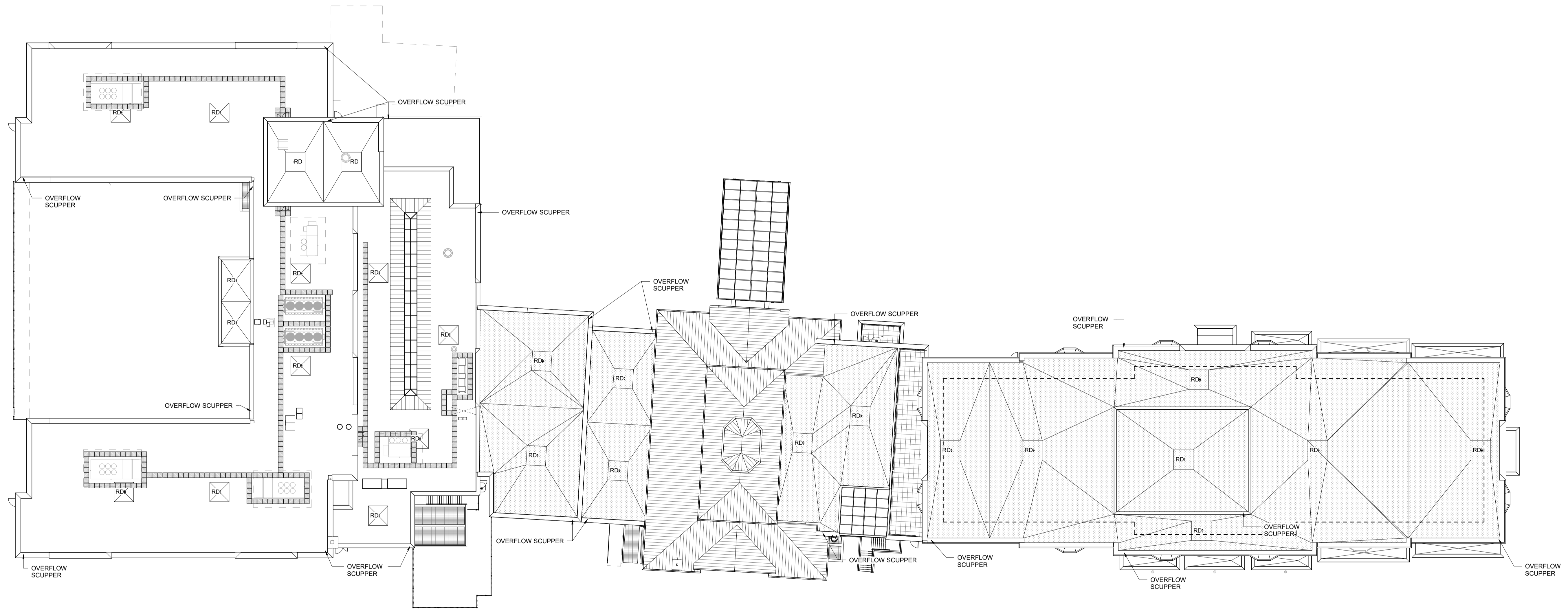





**ROOF CONSTRUCTION ASSEMBLIES**

**TPO ROOF ON PRECAST**  
 FULLY ADHERED TPO ROOF MEMBRANE  
 TAPERED POLYISO INSULATION  
 2 LAYERS 75mm (RSI = 7.3) POLYISO INSULATION  
 (STAGGERED JOINTS) ON  
 2 PLY 15LB ROOF FELT AIR & VAPOUR BARRIER MEMBRANE  
 ON STRUCTURE (SEE STRUCT. DWG.)

**TPO ROOF ON METAL DECK**  
 FULLY ADHERED TPO ROOF MEMBRANE  
 TAPERED POLYISO INSULATION  
 2 LAYERS 75mm (RSI = 7.3) POLYISO INSULATION  
 (STAGGERED JOINTS) ON  
 2 PLY 15LB ROOF FELT AIR & VAPOUR BARRIER MEMBRANE ON  
 12.7mm FIBER BOARD ON  
 STRUCTURE (SEE STRUCT. DWG.)

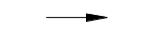
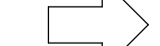
**TYPICAL TERRACE**  
 DURADEK ON  
 SLOPED POURED CONC. TOPPING (SEE STRUCT. FOR DEPTH)  
 ON STRUCTURE (SEE STRUCT. FOR DEPTH)  
 \* LV1 - LV6 TERRACE SOFFITS ARE METAL STUD FRAMED  
 VENTED ALUMINUM SOFFIT (REFER TO SECTIONS & SPEC.)

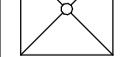
**ROOF PLAN SYMBOL LEGEND**  
 APPLICABLE TO ALL DRAWINGS

-  SLOPED INSULATION
-  SLOPED STRUCTURE - REFER TO STRUCT DWGS
-  SLOPED INSULATION - TAPERED FIBREBOARD (AT 2% MINIMUM)
-  SUMP & ROOF DRAIN
-  ROOF DRAIN - REFER TO MECH DWGS
-  ROOF ANCHOR - REFER TO STRUCTURAL DWG.

610mm X 610mm PATIO STONE ON SACRIFICIAL EPDM LAYER BETWEEN PATIO STONES AND ROOFING MEMBRANE. LOCATE AT THE TOP & BOTTOM OF ACCESS LADDERS & WHERE INDICATED ON ROOF PLAN.

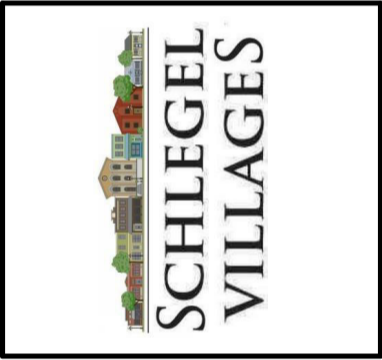

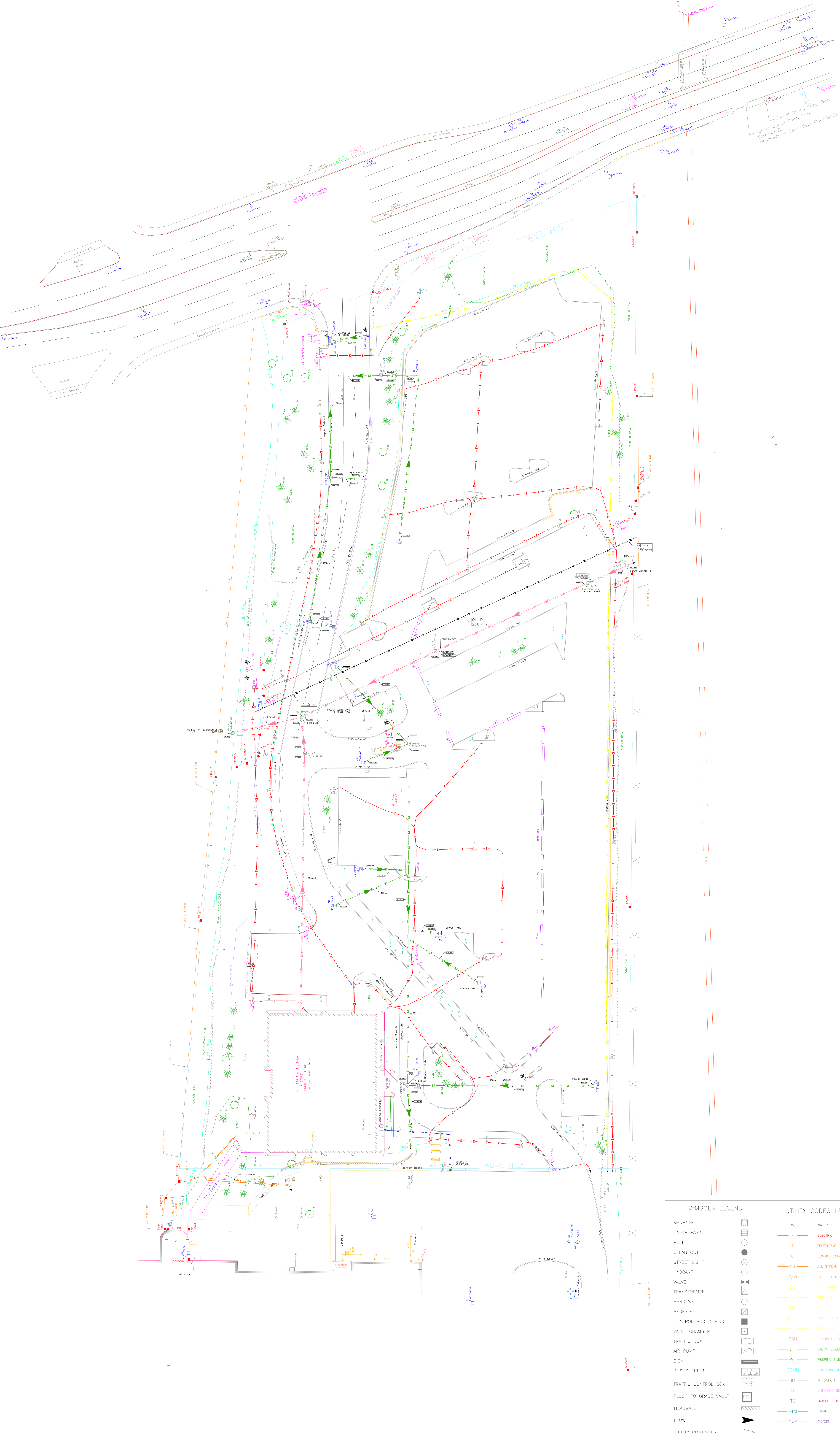

Utility Mapping Quality Levels  
as per ASCE C-1 38-02

QL-A - Locating exact vertical and horizontal position of underground utilities using appropriate safe excavation techniques and recording these data.

QL-B - Designating the horizontal position of underground utilities by the application of appropriate surface geophysical methods.  
- Limited in scope to verification of provided level D information.  
- Utilities may escape detection. (See Notes)

QL-C - Survey of surface features.

QL-D - Records and plans research including record collection and review.

Notes:

- This information is provided for design purposes only.
- This information is not a substitute for sanctioned locates as provided by the utility owner.
- Prior to any excavation, all utility owners must be contacted to obtain sanctioned locates, as stipulated by the Occupational Health & Safety Act.
- Inferred utility depths indicated on this drawing are only estimates and should be verified by direct physical exposure.
- Underground infrastructure shown on this drawing was obtained on a best-effort, best-practices basis, within the technical limitations of the instrumentation.
- The spatial accuracy of the plotted information is dependent on the accuracy of the base map information as provided by others.
- This information is provided on a best effort basis within the limitations of the technology. Consequently some utilities may escape detection (i.e. non-conductive, inaccessible, incomplete level D information provided by the Client and/or physical expression not reasonably identifiable at the time of the survey, etc.)
- The information herein documents the position of suspected or known utilities existing at this site as of the drawing date.
- Quality Level 'D' information was obtained by MARK IT Locates Inc. during the course of this investigation.

SYMBOLS LEGEND	
MANHOLE	[Symbol]
CATCH BASIN	[Symbol]
POLE	[Symbol]
CLEAN OUT	[Symbol]
STREET LIGHT	[Symbol]
HYDRANT	[Symbol]
VALVE	[Symbol]
TRANSFORMER	[Symbol]
HAND WELL	[Symbol]
PEDESTAL	[Symbol]
CONTROL BOX / PLUG	[Symbol]
VALVE CHAMBER	[Symbol]
TRAFFIC BOX	[Symbol]
AIR PUMP	[Symbol]
SIGN	[Symbol]
BUS SHELTER	[Symbol]
TRAFFIC CONTROL BOX	[Symbol]
FLUSH TO GRADE VAULT	[Symbol]
HEADWALL	[Symbol]
FLOW	[Symbol]
UTILITY CONTIGUES	[Symbol]
TEST PIT	[Symbol]

UTILITY CODES LEGEND	
W	WATER
E	ELECTRIC
T	TELEPHONE
C	COMMUNICATION CABLES/DUCT
ALL	ALL STREAM
F/O	FIBER OPTIC
CS	GAS SERVICE
GM	GAS MAIN
DZL	DIESEL
TNPL	TRANS NORTHERN PIPELINE
FL	FUEL LINE
SAN	SANITARY SEWER
ST	STORM SEWER
WT	WEeping TILE
COMB	COMBINATION SEWER
IR	IRRIGATION
U	UNKNOWN SERVICE
TC	TRAFFIC CONTROL
STM	STEAM
OXY	OXYGEN

TOPOGRAPHICAL PLAN OF PART OF NORTHERLY  
EASTERLY AND WESTERLY BOUNDARY OF  
PIN 04201 - 0191 AND PIN 04201 - 0147 BEING

PART OF LOTS 15 and 16  
JUNCTION GORE  
and  
PART OF ROAD ALLOWANCE BETWEEN  
LOTS 15 and 16  
JUNCTION GORE  
(closed by By-Law 174-88, Inst. N451929)  
Geographic Township of Gloucester  
CITY OF OTTAWA

Surveyed by Annis, O'Sullivan, Vollebek Ltd.

Scale 1:300

Metric  
DISTANCES SHOWN ON THIS PLAN ARE IN METRES AND  
CAN BE CONVERTED TO FEET BY DIVIDING BY 0.3048

Surveyor's Certificate

1. This survey and plan are correct and in accordance with the Survey Act and the Surveyors Act and the regulations made under them.  
2. The survey was completed on the 18th day of December, 2020.

Date: \_\_\_\_\_  
E. H. Henoyer  
Ontario Land Surveyor

Notes & Legend

- |   |   |
|---|---|
| — | Denotes   |
| — | Survey Monument Planted                         |
| — | Survey Monument Found                           |
| — | Standard Iron Bar                               |
| — | Short Standard Iron Bar                         |
| — | Iron Bar  |
| — | Cut Cross                                       |
| — | Concrete Pin                                    |
| — | Rock Pin  |
| — | Witness   |
| — | Measured  |
| — | Annis, O'Sullivan, Vollebek Ltd.                |
| — | Plan 48-19213                                   |
| — | Deciduous Tree                                  |
| — | Coniferous Tree                                 |
| — | Fire Hydrant                                    |
| — | Water Valve                                     |
| — | Water Stand Post                                |
| — | Maintenance Hole (Storm Sewer)                  |
| — | Maintenance Hole (Sanitary)                     |
| — | Maintenance Hole (Bell Telephone)               |
| — | Maintenance Hole (Traffic)                      |
| — | Maintenance Hole (Hydro)                        |
| — | Maintenance Hole (Gas)                          |
| — | Maintenance Hole (Undersized)                   |
| — | Valve Chamber (Waterman)                        |
| — | Catch Basin                                     |
| — | Catch Basin Inlet                               |
| — | Handhole  |
| — | Belt Terminal Box                               |
| — | Cable Terminal Box                              |
| — | Traffic Terminal Box                            |
| — | Undersized Terminal Box                         |
| — | Traffic Signal Post                             |
| — | Wood Pole                                       |
| — | Metal Pole                                      |
| — | Concrete Pole                                   |
| — | Traffic Light                                   |
| — | Utility Pole                                    |
| — | Light Stand                                     |
| — | Location of Elevations                          |
| — | Top of Concrete Curb Elevation                  |
| — | Location of Elevations at Top of Retaining Wall |
| — | Carline   |
| — | Top of Grade                                    |
| — | Stone Retaining Wall                            |
| — | Concrete Retaining Wall                         |
| — | Bolted  |
| — | Sign  |
| — | Parking Meter                                   |
| — | Diameter  |
| — | Chain Link Fence                                |
| — | Arched Barrier                                  |
| — | Compugated Plastic Pipe                         |
| — | Top of Pipe                                     |

**ELEVATION NOTES**  
1. Elevations shown are geodetic and are referred to the CGVD2011 geodetic datum.  
2. It is the responsibility of the user of this information to verify that the job benchmark has not been altered or disturbed and that its relative elevation and description agrees with the information shown on this drawing.

**UTILITY NOTES**  
1. This drawing cannot be accepted as acknowledging all of the utilities and it will be the responsibility of the user to contact the respective utility authorities for confirmation.  
2. Only visible surface utilities were located.  
3. A field location of underground plans by the pertinent utility authority is mandatory before any work involving breaking ground, probing, excavating, etc.

Bearings are gtd. derived from the easterly limit of Part 31 Plan 48-19213 shown to be N19°57'30"E Bearing, MTM Zone 8 (78°30' West Longitude) NAD-83 (original).

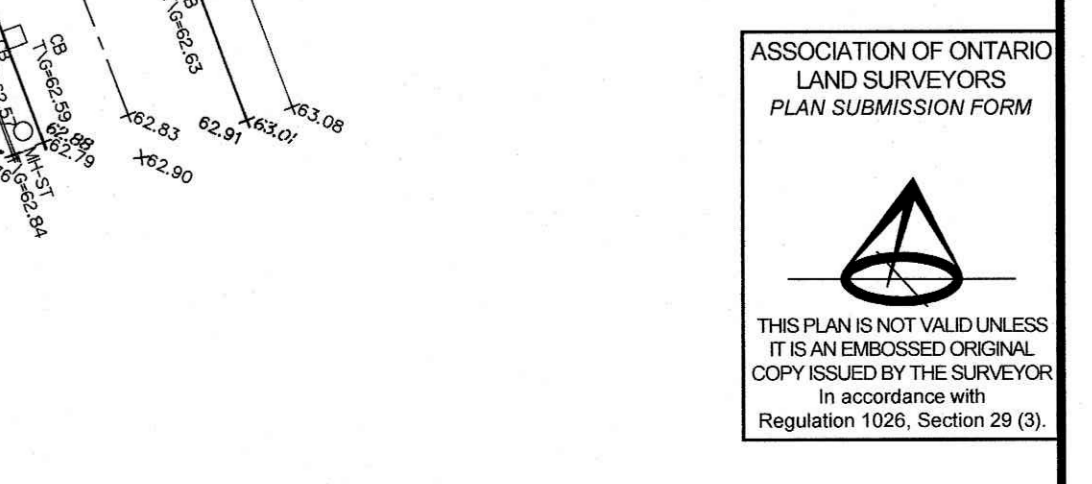

© Annis, O'Sullivan, Vollebek Ltd. 2020. THIS PLAN IS PROTECTED BY COPYRIGHT.  
ANIS, O'SULLIVAN, VOLLEBEK LTD.  
14 Corporate Drive, Suite 300  
Nepean, Ont. K2E 7S8  
Phone: (613) 739-6899 / Fax: (613) 727-1979  
Email: info@aosvl.com  
Regulation 1005, Section 29 (2)







**APPENDIX C**  
**WATERMAIN CALCULATIONS**

# McINTOSH PERRY

## CCO-21-2955 - 1919 Riverside Dr - Ultimate - Water Demands

Project:	1919 Riverside Dr - Ultimate
Project No.:	CCO-21-2955
Designed By:	AJG
Checked By:	RDF
Date:	June 14, 2023

LTC Home	256 beds
LTC Home Staff	85 persons
Retirement Home	270 beds
Retirement Home Staff	60 persons

### AVERAGE DAILY DEMAND

DEMAND TYPE	AMOUNT	UNITS
Residential	280	L/c/d
Industrial - Light	35,000	L/gross ha/d
Industrial - Heavy	55,000	L/gross ha/d
<i>Nursing Homes &amp; Rest Homes</i>	<i>450</i>	<i>L/bed/d</i>
<i>Medical Office - Doctors, Nurses &amp; Medical Staff</i>	<i>275</i>	<i>L/person/day</i>
Tourist Commercial	28,000	L/gross ha/d
Other Commercial	28,000	L/gross ha/d
<b>AVERAGE DAILY DEMAND</b>	<b>3.20</b>	<b>L/s</b>
	<b>192.07</b>	<b>L/min</b>

### MAXIMUM DAILY DEMAND

DEMAND TYPE	AMOUNT	UNITS
Residential	2.2	x avg. day L/c/d
Industrial	1.5	x avg. day L/gross ha/d
Commercial	1.5	x avg. day L/gross ha/d
<i>Institutional</i>	<i>1.5</i>	<i>x avg. day</i> <i>L/gross ha/d</i>
<b>MAXIMUM DAILY DEMAND</b>	<b>4.80</b>	<b>L/s</b>
	<b>288.10</b>	<b>L/min</b>

### MAXIMUM HOUR DEMAND

DEMAND TYPE	AMOUNT	UNITS
Residential	5.5	x avg. day L/c/d
Industrial	1.8	x max. day L/gross ha/d
Commercial	1.8	x max. day L/gross ha/d
<i>Institutional</i>	<i>1.8</i>	<i>x max. day</i> <i>L/gross ha/d</i>
<b>MAXIMUM HOUR DEMAND</b>	<b>8.64</b>	<b>L/s</b>
	<b>1,584.54</b>	<b>L/min</b>

WATER DEMAND DESIGN FLOWS PER UNIT COUNT  
CITY OF OTTAWA - WATER DISTRIBUTION GUIDELINES, JULY 2010

AVERAGE DAILY DEMAND	3.20	L/s
MAXIMUM DAILY DEMAND	4.80	L/s
MAXIMUM HOUR DEMAND	8.64	L/s

# McINTOSH PERRY

## CCO-21-2955 - 1919 Riverside Dr - Phase 1 - Fire Underwriters Survey

Project: 1919 Riverside Dr - Phase 1  
 Project No.: CCO-21-2955  
 Designed By: AJG  
 Checked By: RDF  
 Date: June 14, 2023

### From the Fire Underwriters Survey (2020)

From Part II – Guide for Determination of Required Fire Flow Copyright I.S.O.:  
 City of Ottawa Technical Bulletin ISTB-2018-02 Applied Where Applicable

#### A. BASE REQUIREMENT (Rounded to the nearest 1000 L/min)

F = 220 x C x √A Where: F = Required fire flow in liters per minute  
 C = Coefficient related to the type of construction.  
 A = The total effective floor area in square meters per the 2020 FUS Page 22

Construction Type Non-Combustible Construction

C	0.8	Gross Floor Area	15,319.0 m <sup>2</sup>	
A	Total Floor Area (per the 2020 FUS Page 22 - Total Effective Area)	3,467.8 m <sup>2</sup>		*Protected Vertical Openings

Calculated Fire Flow	10,364.3 L/min
	10,000.0 L/min

#### B. REDUCTION FOR OCCUPANCY TYPE (No Rounding)

From Page 24 of the Fire Underwriters Survey:  
 Limited Combustible -15%

Fire Flow	8,500.0 L/min
-----------	---------------

#### C. REDUCTION FOR SPRINKLER TYPE (No Rounding)

Fully Supervised Sprinklered -50%

Reduction	-4,250.0 L/min
-----------	----------------

#### D. INCREASE FOR EXPOSURE (No Rounding)

	Separation Distance (m)	Cons.of Exposed Wall	Length Exposed Adjacent Wall (m)	Height (Stories)	Length-Height Factor	
Exposure 1	Over 30 m	Ordinary - Mass Timber (Unprotected)	20	2	40.0	0%
Exposure 2	Over 30 m	Ordinary - Mass Timber (Unprotected)	20	12	240.0	0%
Exposure 3	Over 30 m	Wood frame	33	2	66.0	0%
Exposure 4	3.1 to 10	Fire Resistive - Non Combustible (Unprotected Openings)	29.6	4	118.4	11%
					% Increase*	11%

Increase*	935.0 L/min
-----------	-------------

#### E. Total Fire Flow (Rounded to the Nearest 1000 L/min)

Fire Flow	5,185.0 L/min
Fire Flow Required**	5,000.0 L/min

\*In accordance with Part II, Section 4, the Increase for separation distance is not to exceed 75%

\*\*In accordance with Section 4 the Fire flow is not to exceed 45,000 L/min or be less than 2,000 L/min

# McINTOSH PERRY

## CCO-21-2955 - 1919 Riverside Dr - Phase 2 - Fire Underwriters Survey

Project: 1919 Riverside Dr - Phase 2  
 Project No.: CCO-21-2955  
 Designed By: AJG  
 Checked By: RDF  
 Date: June 14, 2023

### From the Fire Underwriters Survey (2020)

From Part II – Guide for Determination of Required Fire Flow Copyright I.S.O.:  
 City of Ottawa Technical Bulletin ISTB-2018-02 Applied Where Applicable

#### A. BASE REQUIREMENT (Rounded to the nearest 1000 L/min)

F = 220 x C x √A Where: F = Required fire flow in liters per minute  
 C = Coefficient related to the type of construction.  
 A = The total effective floor area in square meters per the 2020 FUS Page 22

Construction Type Non-Combustible Construction

C	0.8	Gross Floor Area	57,277.0 m <sup>2</sup>	
A	Total Floor Area (per the 2020 FUS Page 22 - Total Effective Area)	4,751.0 m <sup>2</sup>		*Protected Vertical Openings

Calculated Fire Flow	12,131.2 L/min
	12,000.0 L/min

#### B. REDUCTION FOR OCCUPANCY TYPE (No Rounding)

From Page 24 of the Fire Underwriters Survey:  
 Limited Combustible -15%

Fire Flow	10,200.0 L/min
-----------	----------------

#### C. REDUCTION FOR SPRINKLER TYPE (No Rounding)

Fully Supervised Sprinklered -50%

Reduction	-5,100.0 L/min
-----------	----------------

#### D. INCREASE FOR EXPOSURE (No Rounding)

	Separation Distance (m)	Cons.of Exposed Wall	Length Exposed Adjacent Wall (m)	Height (Stories)	Length-Height Factor	
Exposure 1	Over 30 m	Ordinary - Mass Timber (Unprotected)	20	2	40.0	0%
Exposure 2	Over 30 m	Ordinary - Mass Timber (Unprotected)	20	12	240.0	0%
Exposure 3	Over 30 m	Wood frame	33	2	66.0	0%
Exposure 4	3.1 to 10	Fire Resistive - Non Combustible (Unprotected Openings)	29.6	4	118.4	11%
					% Increase*	11%

Increase*	1,122.0 L/min
-----------	---------------

#### E. Total Fire Flow (Rounded to the Nearest 1000 L/min)

Fire Flow	6,222.0 L/min
Fire Flow Required**	6,000.0 L/min

\*In accordance with Part II, Section 4, the Increase for separation distance is not to exceed 75%

\*\*In accordance with Section 4 the Fire flow is not to exceed 45,000 L/min or be less than 2,000 L/min

# McINTOSH PERRY

## CCO-21-2955 - 1919 Riverside Dr - Boundary Condition Unit Conversion

---

Project: 1919 Riverside Dr  
Project No.: CCO-21-2955  
Designed By: AJG  
Checked By: RDF  
Date: June 14, 2023

---

### Boundary Conditions Unit Conversion

---

#### Connection 1 (Smyth Road - North West)

Scenario	Height (m)	Elevation (m)	m H <sub>2</sub> O	PSI	kPa
Avg. DD	118.9	62.4	56.5	80.4	554.3
Fire Flow (100 L/s or 6,000 L/min)	95.4	62.4	33.0	47.0	323.7
Peak Hour	107.6	62.4	45.2	64.3	443.4

#### Connection 2 (Balmoral Place - North East)

Scenario	Height (m)	Elevation (m)	m H <sub>2</sub> O	PSI	kPa
Avg. DD	118.9	69.3	49.6	70.6	486.6
Fire Flow (100 L/s or 6,000 L/min)	95.4	69.3	26.1	37.1	256.0
Peak Hour	107.6	69.3	38.3	54.5	375.7

## CCO-21-2955 - 1919 Riverside Drive - Model Output

Project:	1919 Riverside Drive
Project No.:	CCO-21-2955
Designed By:	A.J.G.
Checked By:	R.D.F.
Date:	June 14, 2023

### MODEL INPUTS

Flow Units	L/s
Headloss Formula	H-W
Specific Gravity	1.0
Accuracy	0.001
Demand Multiplier	1.0
Maximum Fire Flow (L/s)	100.0

### MODEL LOSSES

Standard Tee - Flow through run	0.6
Standard Tee - Flow through branch	1.8
45 Degree Elbow	0.4
Long Radius Elbow	0.6
Short Radius Elbow	0.9
Gate valve, fully open	0.2
Swing check valve, fully open	2.5

### MODEL RESULTS

Junctions	Average Daily Demand (kPa)	Maximum Daily Demand + Fire Flow (kPa)	Peak Hourly Demand (kPa)
J1	544.13	276.48	409.62
J2	545.50	291.97	434.42
J3	548.44	298.44	437.36
J4	567.66	337.16	456.87
J5	507.85	277.06	397.07
PROP	543.84	290.20	432.56
FH3	522.56	272.56	411.48
FH5	564.23	333.73	453.44
FH6	520.60	147.36	409.62

Junctions	Average Daily Demand (m)	Maximum Daily Demand + Fire Flow (m)	Peak Hourly Demand (m)
J1	55.50	28.20	41.78
J2	55.64	29.78	44.31
J3	55.94	30.44	44.61
J4	57.90	34.39	46.60
J5	51.80	28.26	40.50
PROP	55.47	29.60	44.12
FH3	53.30	27.80	41.97
FH5	57.55	34.04	46.25
FH6	53.10	15.03	41.78

EPANET WATER MODEL  
AVERAGE DAY SCENARIO

# AVERAGE DAY SCENARIO

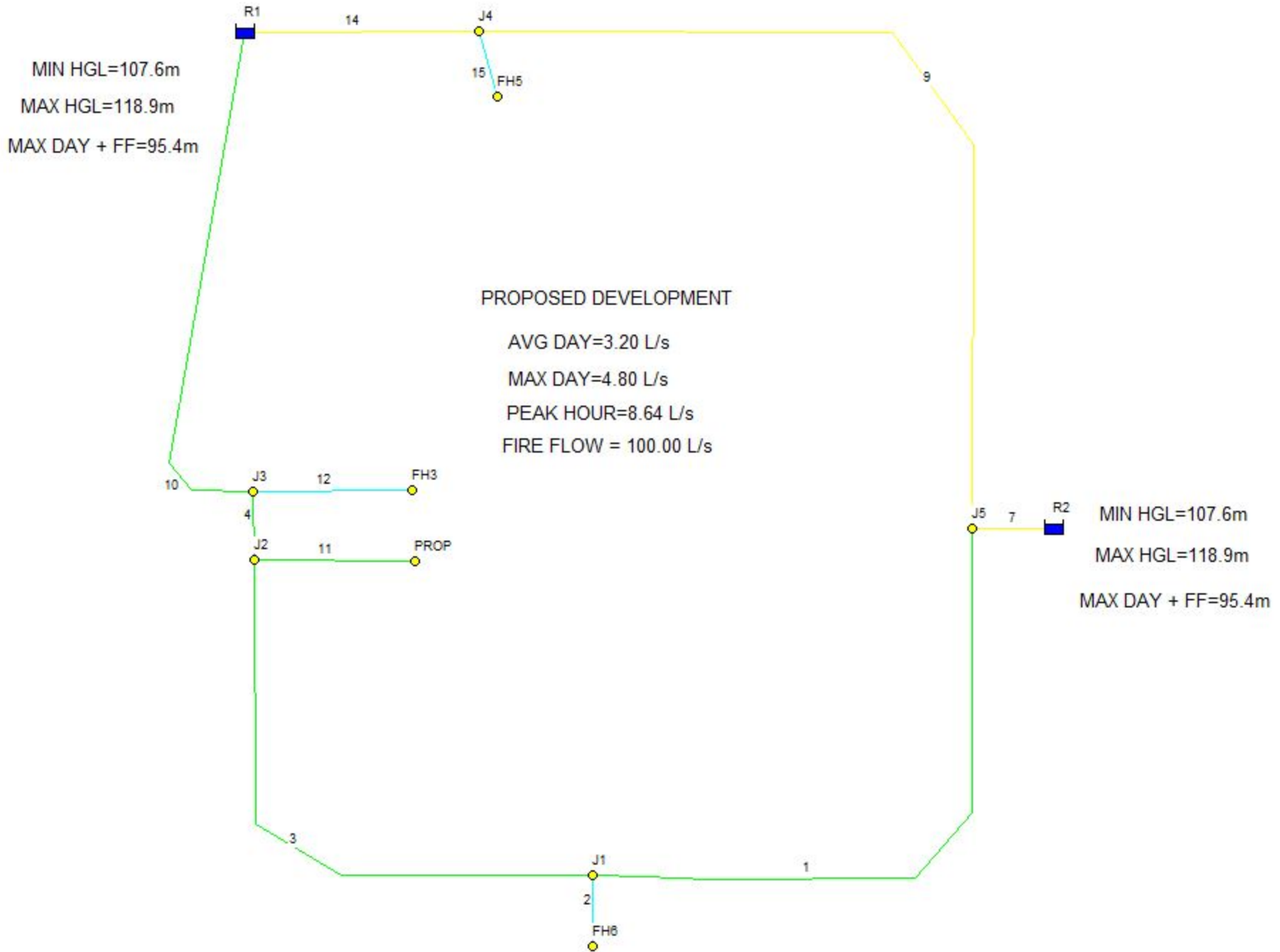
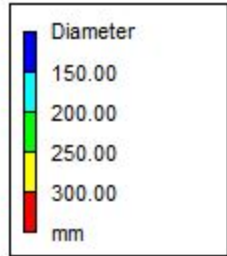
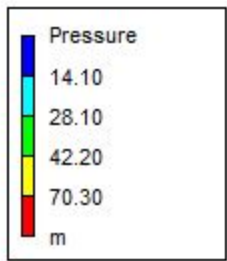



```
*****
*                               E P A N E T                               *
*                               Hydraulic and Water Quality              *
*                               Analysis for Pipe Networks                *
*                               Versi on 2.2                            *
*****
```

Input File: 2023-06-013\_avgday.net

Link - Node Table:

Link ID	Start Node	End Node	Length m	Diameter mm
7	J5	R2	1	254
9	J5	J4	135.4	254
10	R1	J3	124.07	203
11	PROP	J2	11.9	203
12	FH3	J3	4.59	152
14	J4	R1	37	254
15	J4	FH5	5.8	152
1	J1	J5	159.62	203
2	FH6	J1	4.47	150
3	J1	J2	102.45	203
4	J2	J3	13.2	203

Node Results:

Node ID	Demand LPS	Head m	Pressure m	Quality
J5	0.00	118.90	51.80	0.00
J3	0.00	118.90	55.94	0.00
PROP	3.20	118.89	55.47	0.00
FH5	0.00	118.90	57.55	0.00
FH3	0.00	118.90	53.30	0.00
J4	0.00	118.90	57.90	0.00
FH6	0.00	118.90	53.10	0.00
J1	0.00	118.90	55.50	0.00
J2	0.00	118.89	55.64	0.00
R2	-1.19	118.90	0.00	0.00 Reservoir
R1	-2.01	118.90	0.00	0.00 Reservoir



Link Results:

Link	Flow	Velocity	Unit	Headloss	Status
------	------	----------	------	----------	--------

ID	LPS	m/s	m/km	
7	-1.19	0.02	0.02	Open
9	-0.15	0.00	0.00	Open
10	1.87	0.06	0.04	Open
11	-3.20	0.10	0.35	Open
12	0.00	0.00	0.00	Open
14	-0.15	0.00	0.00	Open
15	0.00	0.00	0.00	Open
1	-1.33	0.04	0.02	Open
2	0.00	0.00	0.00	Open
3	1.33	0.04	0.02	Open
4	-1.87	0.06	0.06	Open

EPANET WATER MODEL  
MAX DAY + FIRE FLOW SCENARIO

# MAX DAY + FIRE FLOW SCENARIO

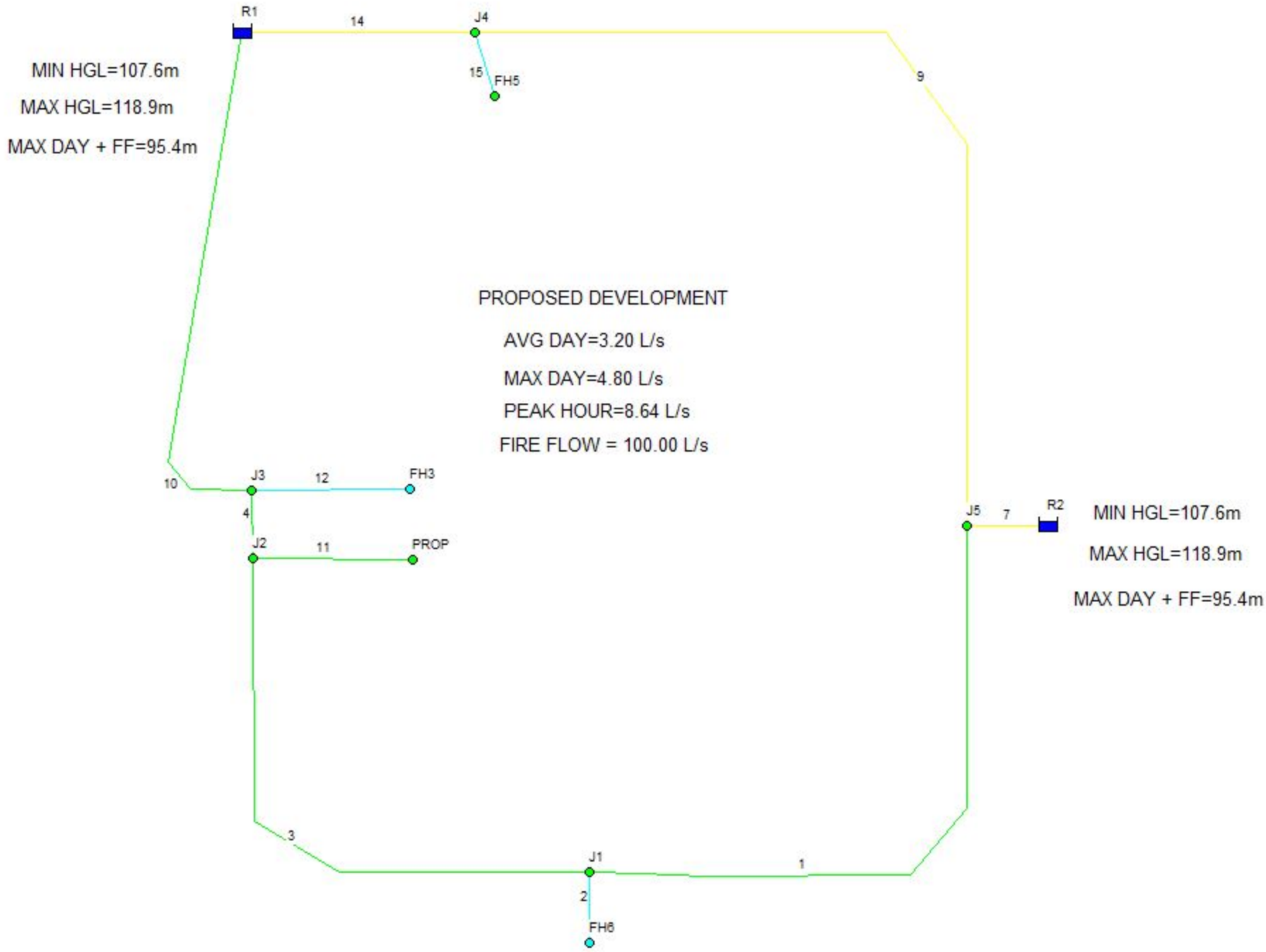
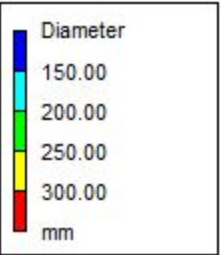
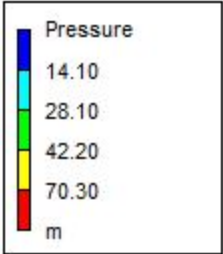

```

*****
*                               E P A N E T                               *
*                               Hydraulic and Water Quality                 *
*                               Analysis for Pipe Networks                   *
*                               Version 2.2                                *
*****
    
```

Input File: 2023-06-013\_maxdayfi reflow.net

Link - Node Table:

Link ID	Start Node	End Node	Length m	Diameter mm
7	J5	R2	1	254
9	J5	J4	135.4	254
10	R1	J3	124.07	203
11	PROP	J2	11.9	203
12	FH3	J3	4.59	152
14	J4	R1	37	254
15	J4	FH5	5.8	152
1	J1	J5	159.62	203
2	FH6	J1	4.47	150
3	J1	J2	102.45	203
4	J2	J3	13.2	203

Node Results:

Node ID	Demand LPS	Head m	Pressure m	Quality
J5	0.00	95.36	28.26	0.00
J3	0.00	93.40	30.44	0.00
PROP	4.80	93.02	29.60	0.00
FH5	0.00	95.39	34.04	0.00
FH3	0.00	93.40	27.80	0.00
J4	0.00	95.39	34.39	0.00
FH6	100.00	80.83	15.03	0.00
J1	0.00	91.60	28.20	0.00
J2	0.00	93.03	29.78	0.00
R2	-50.00	95.40	0.00	0.00 Reservoir
R1	-54.80	95.40	0.00	0.00 Reservoir



Link Results:

Link	Flow	Velocity	Unit	Headloss	Status
------	------	----------	------	----------	--------

ID	LPS	m/s	m/km	
7	-50.00	0.99	35.21	Open
9	-7.66	0.15	0.20	Open
10	47.14	1.46	16.15	Open
11	-4.80	0.15	0.77	Open
12	0.00	0.00	0.00	Open
14	-7.66	0.15	0.21	Open
15	0.00	0.00	0.00	Open
1	-57.66	1.78	23.60	Open
2	-100.00	5.66	2409.23	Open
3	-42.34	1.31	13.99	Open
4	-47.14	1.46	27.68	Open

EPANET WATER MODEL  
PEAK HOUR SCENARIO

# PEAK HOUR SCENARIO

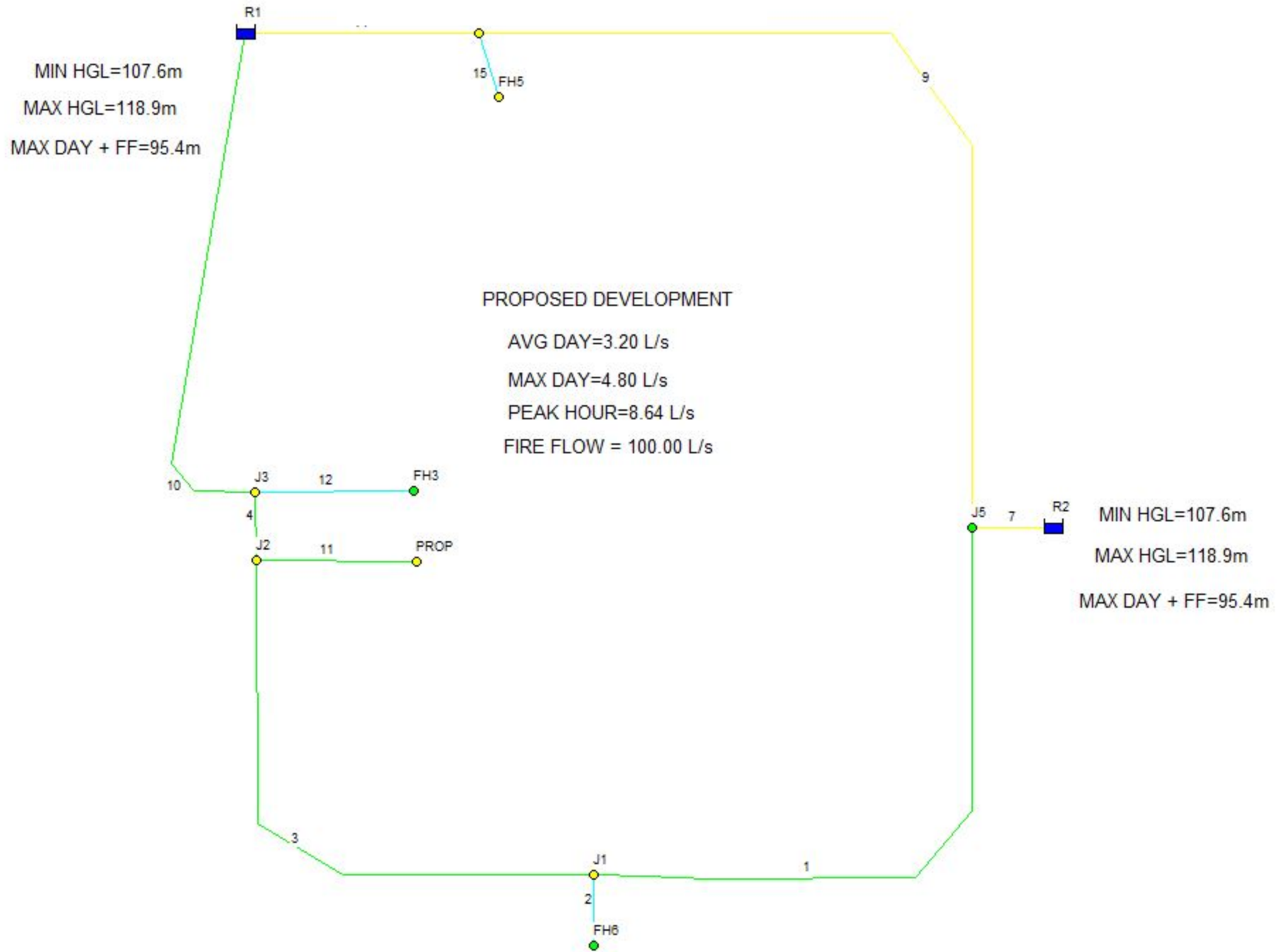
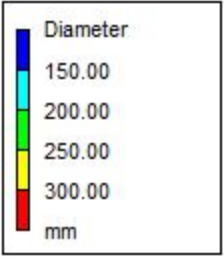
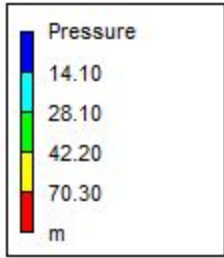



```

*****
*                               E P A N E T                               *
*                               Hydraulic and Water Quality                *
*                               Analysis for Pipe Networks                  *
*                               Version 2.2                               *
*****
    
```

Input File: 2023-06-013\_peakhour.net

Link - Node Table:

Link ID	Start Node	End Node	Length m	Diameter mm
7	J5	R2	1	254
9	J5	J4	135.4	254
10	R1	J3	124.07	203
11	PROP	J2	11.9	203
12	FH3	J3	4.59	152
14	J4	R1	37	254
15	J4	FH5	5.8	152
1	J1	J5	159.62	203
2	FH6	J1	4.47	150
3	J1	J2	102.45	203
4	J2	J3	13.2	203

Node Results:

Node ID	Demand LPS	Head m	Pressure m	Quality
J5	0.00	107.60	40.50	0.00
J3	0.00	107.57	44.61	0.00
PROP	8.64	107.54	44.12	0.00
FH5	0.00	107.60	46.25	0.00
FH3	0.00	107.57	41.97	0.00
J4	0.00	107.60	46.60	0.00
FH6	0.00	107.58	41.78	0.00
J1	0.00	107.58	44.18	0.00
J2	0.00	107.56	44.31	0.00
R2	-3.19	107.60	0.00	0.00 Reservoir
R1	-5.45	107.60	0.00	0.00 Reservoir



Link Results:

Link	Flow	Velocity	Unit	Headloss	Status
------	------	----------	------	----------	--------

ID	LPS	m/s	m/km	
7	-3.19	0.06	0.16	Open
9	-0.42	0.01	0.00	Open
10	5.03	0.16	0.25	Open
11	-8.64	0.27	2.43	Open
12	0.00	0.00	0.00	Open
14	-0.42	0.01	0.00	Open
15	0.00	0.00	0.00	Open
1	-3.61	0.11	0.13	Open
2	0.00	0.00	0.00	Open
3	3.61	0.11	0.14	Open
4	-5.03	0.16	0.38	Open

Ryan Robineau

---

From: Sevigny, John <John.Sevigny@ottawa.ca>  
Sent: June 13, 2023 2:54 PM  
To: Ryan Robineau  
Cc: Robert Freel  
Subject: RE: 1919 Riverside Boundary Conditions & Utility Relocation ECA  
Attachments: 1919 Riverside Drive May 2023.pdf

Hi Ryan,  
Here's the boundary conditions. The prompt worked 😊

The following are boundary conditions, HGL, for hydraulic analysis at 1919 Riverside Drive (zone 1E) assumed to be connected to the 203 mm and 254 mm at Smyth Road and Balmoral Place (see attached PDF for location).

Both Connections:

Minimum HGL: 107.6 m

Maximum HGL: 118.9 m

Max Day + FF (100 L/s): 95.4 m

These are for current conditions and are based on computer model simulation.

*Disclaimer: The boundary condition information is based on current operation of the city water distribution system. The computer model simulation is based on the best information available at the time. The operation of the water distribution system can change on a regular basis, resulting in a variation in boundary conditions. The physical properties of watermains deteriorate over time, as such must be assumed in the absence of actual field test data. The variation in physical watermain properties can therefore alter the results of the computer model simulation.*

Regards,

**John Sevigny, C.E.T.**

Senior Project Manager

Development Review, Suburban Services | *Examen des projets d'aménagement, Services suburbains*

Planning, Real Estate and Economic Development Department | Direction générale de la planification, des biens immobiliers et du développement économique

City of Ottawa | Ville d'Ottawa

110 Laurier Avenue West, Ottawa, ON | 110, avenue, Laurier Ouest, Ottawa (Ontario) K1P 1J1

613.580.2424 ext./poste 14388, fax/télé: 613-580-2576, [john.sevigny@ottawa.ca](mailto:john.sevigny@ottawa.ca)

---

From: Ryan Robineau <r.robineau@mcintoshperry.com>

Sent: June 13, 2023 11:11 AM



To: Sevigny, John <John.Sevigny@ottawa.ca>

Cc: Robert Freel <r.freel@mcintoshperry.com>

Subject: RE: 1919 Riverside Boundary Conditions & Utility Relocation ECA

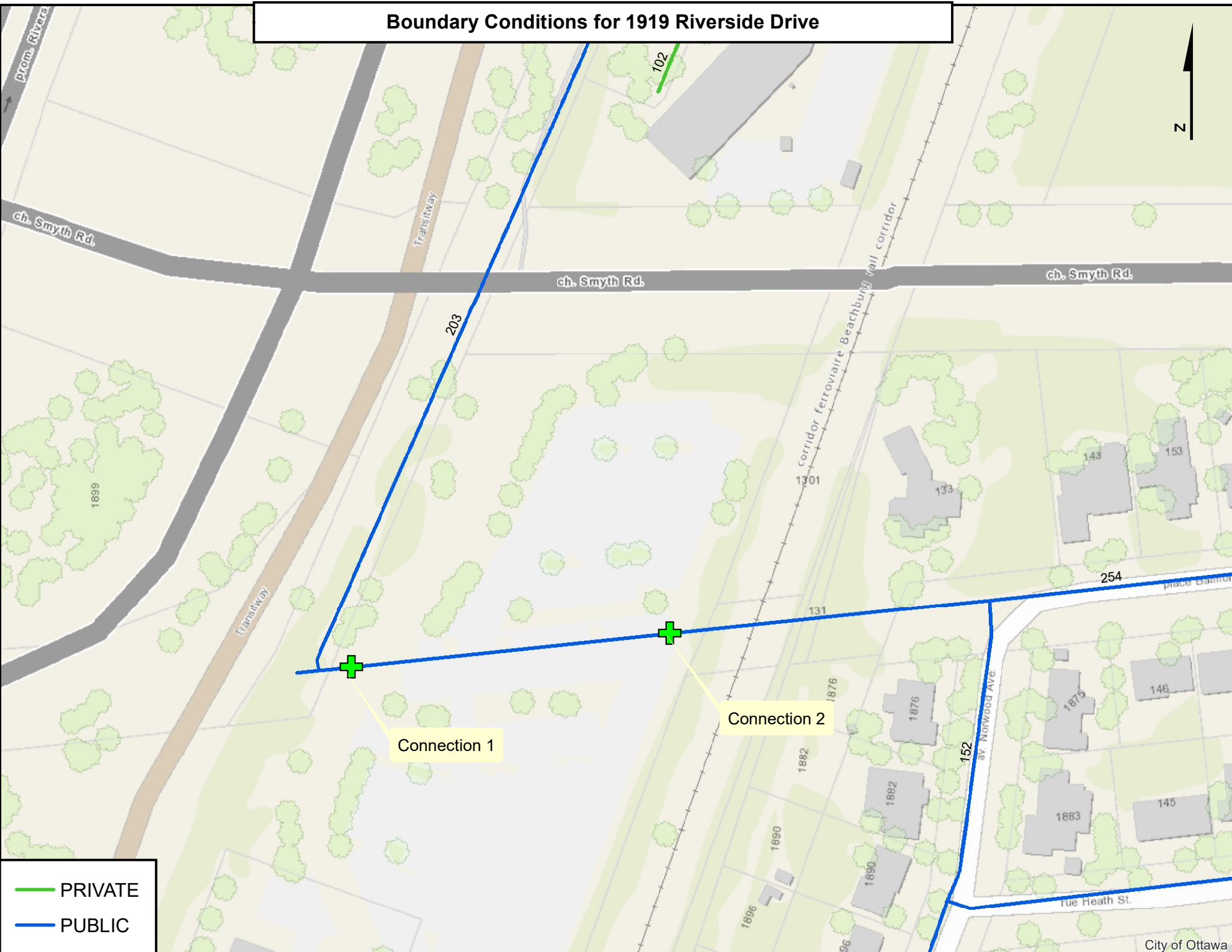
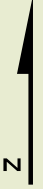
# Boundary Conditions for 1919 Riverside Drive



-  PRIVATE
-  PUBLIC

# City of Ottawa - Water Distribution System Facilities & Feeder mains

**ET STREET P.S.**

**HURDMAN P.S.**

**BILLINGS BRIDGE P.S.**

**CARLINGTON HEIGHTS P.S. & RES.**

**CONROY RD ELEVATED TANK**

**SUBJECT SITE**

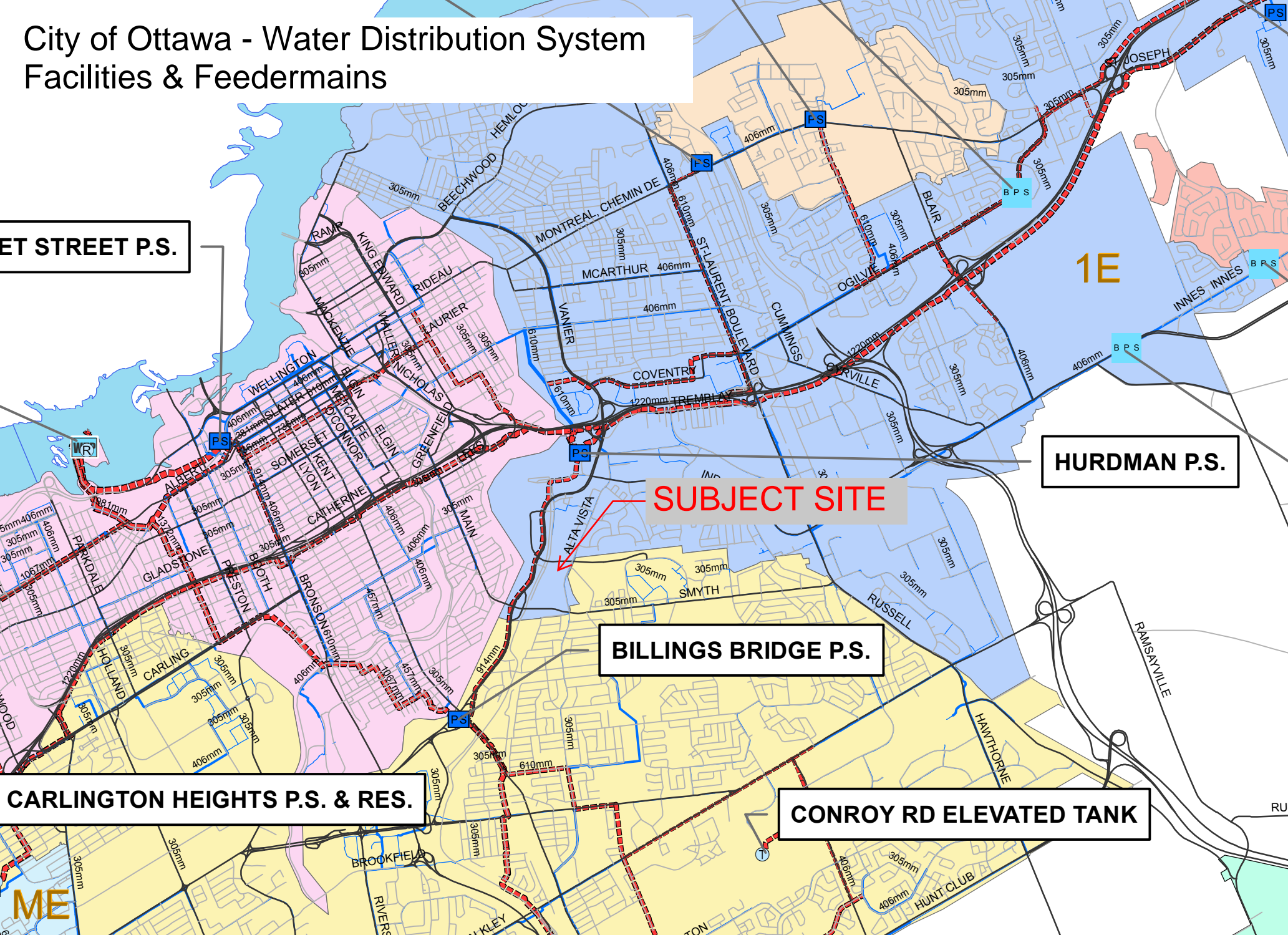



**APPENDIX D**  
**SANITARY CALCULATIONS**

# McINTOSH PERRY

## CCO-21-2955 - 1919 Riverside Dr - Ultimate Site - Sanitary Demands

Project:	1919 Riverside Dr - Ultimate Site
Project No.:	CCO-21-2955
Designed By:	AJG
Checked By:	RDF
Date:	Apr-23
Site Area	2.13 Gross ha
LTC Home	256 beds
LTC Home Staff	85 persons
Retirement Home	270 beds
Retirement Home Staff	60 persons
Commercial Area	0.00 m <sup>2</sup>
Amenity Space	0.00 m <sup>2</sup>

### DESIGN PARAMETERS

Institutional/Commercial Peaking Factor	1.5	
Residential Peaking Factor	3.80	* Using Harmon Formula = $1+(14/(4+P^{0.5}))\cdot 0.8$ where P = population in thousands, Harmon's Correction Factor = 0.8
Mannings coefficient (n)	0.013	
Demand (per capita)	280	L/day
Infiltration allowance	0.33	L/s/Ha

### EXTRANEOUS FLOW ALLOWANCES

Infiltration / Inflow	Flow (L/s)
Dry	0.11
Wet	0.60
Total	0.70

### AVERAGE DAILY DEMAND

DEMAND TYPE	AMOUNT	UNITS	POPULATION / AREA	Flow (L/s)
Residential	280	L/c/d		0
Industrial - Light**	35,000	L/gross ha/d		0
Industrial - Heavy**	55,000	L/gross ha/d		0
Commercial / Amenity	2,800	L/(1000m <sup>2</sup> /d )		0
<i>Nursing Homes &amp; Rest Homes</i>	<i>450</i>	<i>L/(bed/d)</i>	<i>526</i>	<i>2.74</i>
<i>Medical Office - Doctors, Nurses &amp; Medical Staff</i>	<i>275</i>	<i>L/(Person/d)</i>	<i>145</i>	<i>0.46</i>
Tourist Commercial	28,000	L/gross ha/d		0
Other Commercial	28,000	L/gross ha/d		0

AVERAGE FLOW	3.20	L/s
PEAK FLOW	4.80	L/s
PEAK INDUSTRIAL FLOW	0.00	L/s
TOTAL PEAK ICI FLOW	4.80	L/s

### TOTAL SANITARY DEMAND

TOTAL ESTIMATED AVERAGE DRY WEATHER FLOW	3.31	L/s
TOTAL ESTIMATED PEAK DRY WEATHER FLOW	4.91	L/s
TOTAL ESTIMATED PEAK WET WEATHER FLOW	5.50	L/s



SANITARY SEWER DESIGN SHEET

PROJECT: CCO-21-2955  
 LOCATION: 1919 Riverside



LOCATION				RESIDENTIAL								ICI AREAS								INFILTRATION ALLOWANCE			FLOW		SEWER DATA							
1	2	3	4	5	6	7	8	9	10	11	12	13	14	15	16	17	18	19	20	21	22	23	24	25	26	27	28	29	30	31		
STREET	AREA ID	FROM MH	TO MH	UNIT TYPES				AREA (ha)	POPULATION		PEAK FACTOR	PEAK FLOW (L/s)	POPULATION				AREA (Ha)		PEAK FLOW (L/s)	AREA (ha)		FLOW (L/s)	DESIGN FLOW (L/s)	CAPACITY (L/s)	LENGTH (m)	DIA (mm)	SLOPE (%)	VELOCITY (full) (m/s)	AVAILABLE CAPACITY			
				SF	SD	TH	APT		IND	CUM			IND	CUM	IND	CUM	IND	CUM		IND	CUM								IND	CUM	L/s	(%)
		EX BLDG	MH1A					0.00	0.0	0.0	3.80	0.00							0.44	0.44	0.82	2.13	2.13	0.70	1.52	15.89	5.17	150	1.00	0.871	14.37	90
		MH1A	MH2A					0.00	0.0	0.0	3.80	0.00							0.00	0.44	0.82	0.00	2.13	0.70	1.52	30.39	7.56	250	0.24	0.600	28.87	95
		MH2A	MH4A					0.00	0.0	0.0	3.80	0.00							0.00	0.44	0.82	0.00	2.13	0.70	1.52	41.08	41.08	250	0.24	0.600	39.56	96
		MH4A	MH3A					0.00	0.0	0.0	3.80	0.00		0.00		0.00	0.00	0.44	0.82	0.00	0.00	0.00	0.82	30.39	25.61	250	0.24	0.600	29.58	97		
		PHASE 1/2	MH3A					0.00	0.0	0.0	3.80	0.00	526	526	145	145	0.00	0.00	4.80	2.13	2.13	0.70	5.50	62.04	17.12	250	1.00	1.224	56.53	91		
		MH3A	MH9A					0.00	0.0	0.0	3.80	0.00	0	526	0	145	0.00	0.44	5.62	0.00	2.13	0.70	6.32	31.63	7.05	250	0.26	0.624	25.31	80		
Design Parameters:				Notes:								Designed: RRR								No.			Revision						Date			
Residential				1. Mannings coefficient (n) = 0.013								Checked: AJG								1.												
SF 3.4 p/p/u				2. Demand (per capita): 280 L/day								Project No.: CCO-21-2955																				
TH/SD 2.7 p/p/u				3. Infiltration allowance: 0.33 L/s/Ha																												
APT 2.3 p/p/u				4. Residential Peaking Factor:																												
Other 60 p/p/Ha				Harmon Formula = $1+(14/(4+P^{0.5})*0.8)$																												
				where P = population in thousands																												
																													Sheet No: 1 of 1			

SANITARY SEWER DESIGN SHEET - EX. San Sewer Capacity v. Proposed Relocation Capacity

PROJECT: CCO-21-2955  
 LOCATION: 1919 RIVERSIDE

# McINTOSH PERRY

LOCATION				RESIDENTIAL									ICI AREAS						INFILTRATION ALLOWANCE			FLOW	SEWER DATA										
1	2	3	4	5	6	7	8	9	10	11	12	13	14	15	16	17	18	19	20	21	22	23	24	25	26	27	28	29	30	31			
STREET	AREA ID	FROM MH	TO MH	UNIT TYPES				AREA (ha)	POPULATION		PEAK FACTOR	PEAK FLOW (L/s)	AREA (ha)						PEAK FLOW (L/s)	AREA (ha)		DESIGN FLOW (L/s)	CAPACITY (L/s)	LENGTH (m)	DIA (mm)	SLOPE (%)	VELOCITY (full) (m/s)	AVAILABLE CAPACITY					
				SF	SD	TH	APT		IND	CUM			INSTITUTIONAL		COMMERCIAL		INDUSTRIAL			IND	CUM							IND	CUM	L/s	(%)	L/s	(%)
													IND	CUM	IND	CUM	IND	CUM		IND	CUM							IND	CUM				
*EX. San SewerSite		MHSA78510	MHSA30501																					526.16	44.16	675	0.36	1.424					
Relocated San Sewer		EX SAN MH1	MH5A																					547.64	2.69	675	0.39	1.483					
		MH5A	MH6A																					620.09	13.19	675	0.50	1.679					
		MH6A	MH7A																					960.63	70.35	675	1.20	2.601					
		MH7A	MH8A																					1,074.02	18.65	675	1.50	2.908					
		MH8A	MH9A																					526.16	69.63	675	0.36	1.424					
		MH9A	MH10A																					526.16	109.13	675	0.36	1.424					
		MH10A	EX SAN MH2																														
Design Parameters:				Notes:									Designed: RRR						No. Revision			Date											
Residential				1. Mannings coefficient (n) = 0.013									Checked: RDF						1.														
ICI Areas				2. Demand (per capita): 280 L/day									Project No.: CCO-21-2955																				
SF	3.4	p/p/u		3. Infiltration allowance: 0.33 L/s/Ha																													
TH/SD	2.7	p/p/u	INST	28,000	L/Ha/day	4. Residential Peaking Factor:																											
APT	2.3	p/p/u	COM	28,000	L/Ha/day	Harmon Formula = 1+(14/(4+P^0.5))*0.8																											
Other	60	p/p/Ha	IND	35,000	L/Ha/day	where P = population in thousands																											
				MOE Chart																													
																						Sheet No:											
																						1 of 1											

\*Constraining leg of existing 675mm sewer analysed for determining existing capacity

**APPENDIX E**  
**PRE-DEVELOPMENT DRAINAGE PLAN**

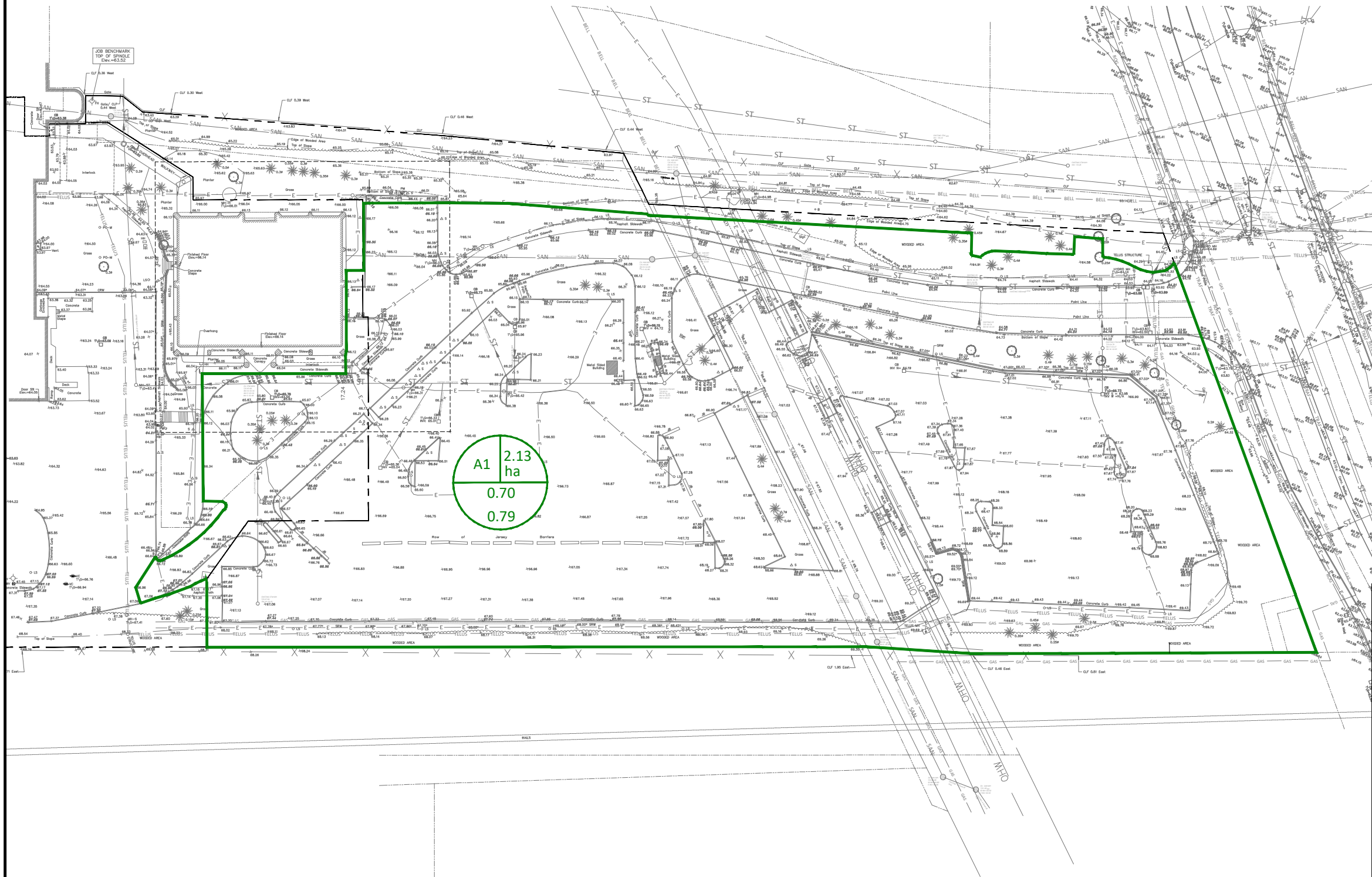

**Legend:**

The legend diagram shows a circle divided into three sections. The top section is labeled 'B3' and '0.07 ha'. The bottom-left section is labeled '0.79'. The bottom-right section is labeled '0.88'. Arrows point from the text labels to the corresponding sections of the circle.

- DRAINAGE AREA
- AREA
- 5-YEAR RUNOFF COEFFICIENT
- 100-YEAR RUNOFF COEFFICIENT

FILENAME: U:\Ottawa\01 Project - Proposal\2021 Jobs\CCO\CCO-21-2955 Cornerstone\_Schlegel Villages\_1919 Riverside DR\Civil\12 - Drawings\CCO-21-2955 - Presentations.dwg  
 LAST PLOTTED: Monday, June 26, 2023 3:28:10 PM  
 CTR FILE USED:

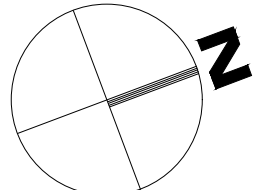
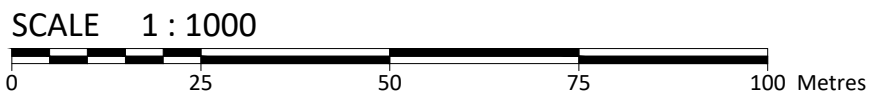

**McINTOSH PERRY**  
 115 Walgreen Road, RR3, Carp, ON K0A 1L0  
 Tel: 613-836-2184 Fax: 613-836-3742  
 www.mcintoshperry.com

Client:	<b>RBJ SCHLEGEL HOLDINGS</b> 325 MAX BECKER DRIVE SUITE 201 KITCHENER, ON N2E 4H5	
Project:	<b>SCHLEGEL VILLAGES OTTAWA</b> 1919 RIVERSIDE DRIVE	
Drawing Title:	<b>PRE-DEVELOPMENT DRAINAGE AREA PLAN</b>	
Drawn by:	R.R.R.	Checked By: A.J.G.
Scale:	1:1000	Project Number: CCO-21-2955
No.	Revisions	Date
		<b>PRE</b>

**APPENDIX F**  
**POST-DEVELOPMENT DRAINAGE PLAN**

FILENAME: U:\Ottawa\01 Project - Proposal\2021 Jobs\CCO\CCO-21-2955 Cornerstone\_Schlegel Villages\_1919 Riverside Dr\Civil\12 - Drawings\CCO-21-2955 - Presentations.dwg  
 LAST PLOTTED: Monday, June 26, 2023 3:18:42 PM  
 LAST USER: A.J.G.

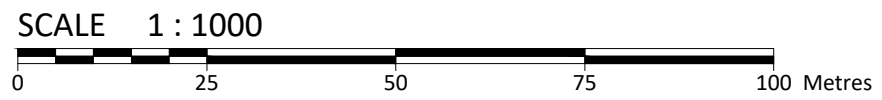
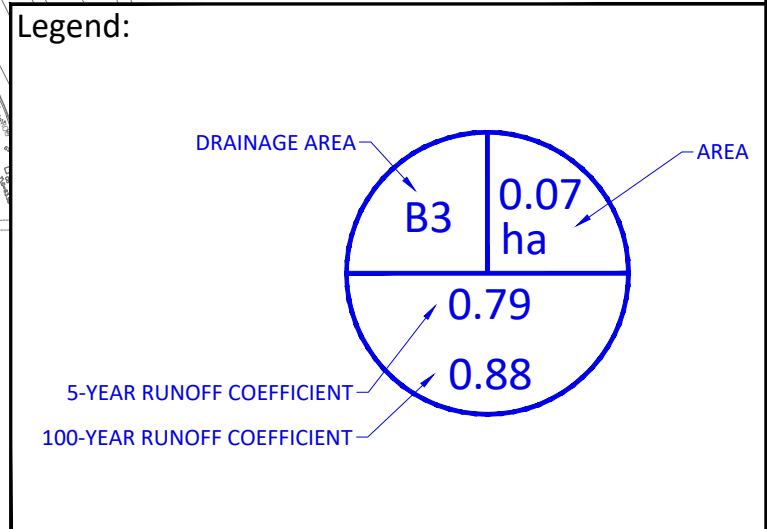
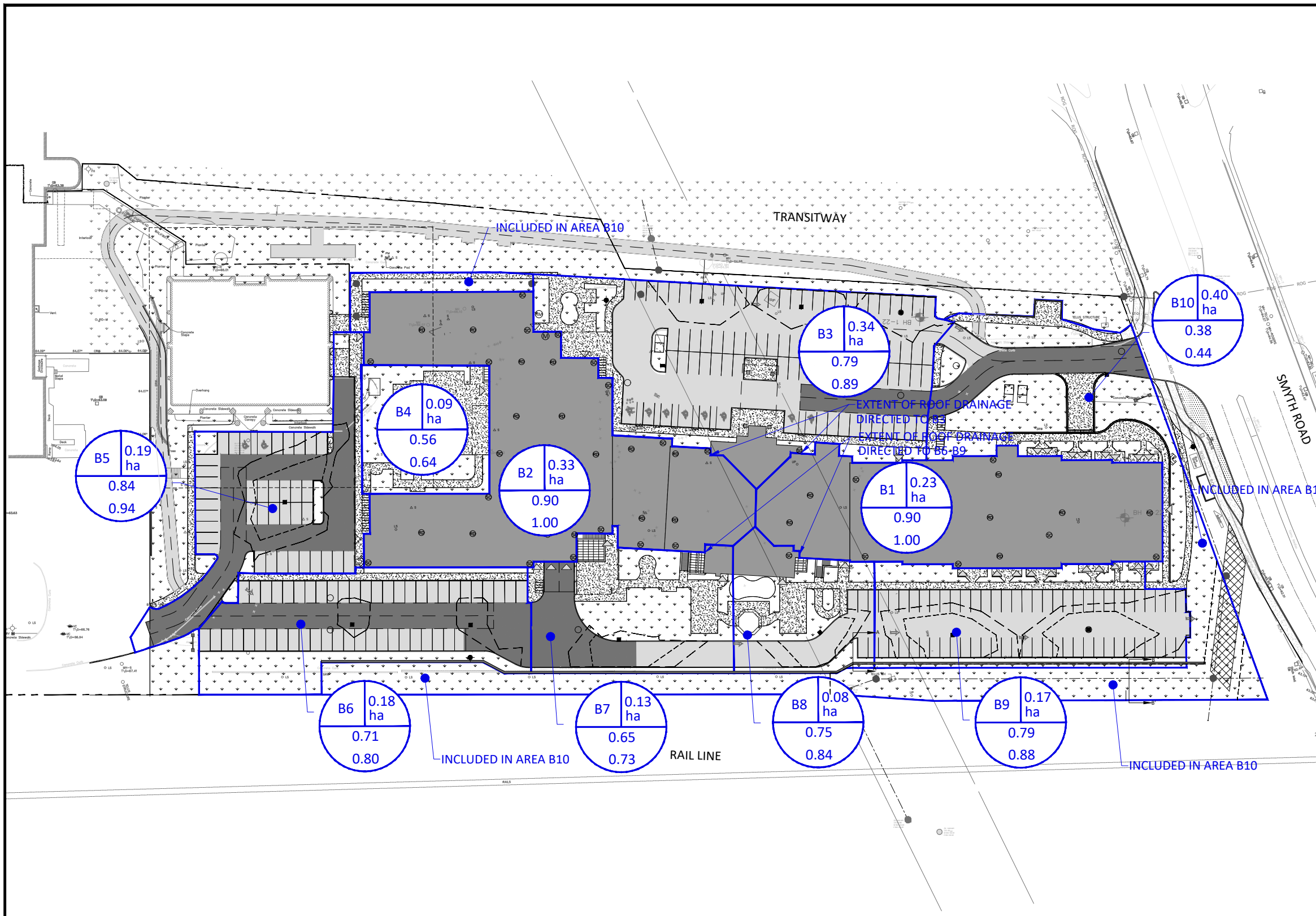

	<h2>McINTOSH PERRY</h2> <p>115 Walgreen Road, RR3, Carp, ON K0A 1L0          Tel: 613-836-2184 Fax: 613-836-3742          www.mcintoshperry.com</p>		Client: <b>RBJ SCHLEGEL HOLDINGS</b> 325 MAX BECKER DRIVE SUITE 201 KITCHENER, ON N2E 4H5	
	Project: <b>SCHLEGEL VILLAGES OTTAWA</b> 1919 RIVERSIDE DRIVE		Drawing Title: <b>POST-DEVELOPMENT DRAINAGE AREA PLAN</b>	
Drawn by: <b>R.R.R.</b>	Checked By: <b>A.J.G.</b>	Drawing Number: <b>POST</b>		
Scale: <b>1:1000</b>	Project Number: <b>CCO-21-2955</b>	No.	Revisions	Date

**APPENDIX G**  
**STORMWATER MANAGEMENT CALCULATIONS**

# McINTOSH PERRY

CCO-21-2955 - 1919 Riverside Drive - Runoff Calculations

1 of 13

## Pre-Development Runoff Coefficient

Drainage Area	Area (ha)	Impervious Area (m <sup>2</sup> )	C	Gravel Area (m <sup>2</sup> )	C	Pervious Area (m <sup>2</sup> )	C	C <sub>AVG</sub> 5-Year	C <sub>AVG</sub> 100-Year
A1	2.126	15,334.70	0.90	0.00	0.60	5,923.50	0.20	0.70	0.79

## Pre-Development Runoff Calculations

Drainage Area	Area (ha)	C 5-Year	C 100-Year	Tc (min)	I (mm/hr)		Q (L/s)	
					5-Year	100-Year	5-Year	100-Year
A1	2.126	0.70	0.79	10	104.2	178.6	434.08	834.72
Total	2.126						434.08	834.72

## Post-Development Runoff Coefficient

Drainage Area	Area (ha)	Impervious Area (m <sup>2</sup> )	C	Gravel Area (m <sup>2</sup> )	C	Pervious Area (m <sup>2</sup> )	C	C <sub>AVG</sub> 5-Year	C <sub>AVG</sub> 100-Year
B1	0.229	2,294.61	0.90	0.00	0.60	0.00	0.20	0.90	1.00
B2	0.326	3,260.30	0.90	0.00	0.60	0.00	0.20	0.90	1.00
B3	0.335	2,840.95	0.90	0.00	0.60	512.80	0.20	0.79	0.89
B4	0.090	467.03	0.90	0.00	0.60	434.27	0.20	0.56	0.64
B5	0.188	1,718.85	0.90	0.00	0.60	162.76	0.20	0.84	0.94
B6	0.181	1,318.60	0.90	0.00	0.60	488.99	0.20	0.71	0.80
B7	0.132	840.40	0.90	0.00	0.60	477.48	0.20	0.65	0.73
B8	0.080	624.54	0.90	0.00	0.60	170.60	0.20	0.75	0.84
B9	0.167	1,397.89	0.90	0.00	0.60	271.69	0.20	0.79	0.88
B10	0.398	996.93	0.90	0.00	0.60	2,979.51	0.20	0.38	0.44

## Post-Development Runoff Calculations

Drainage Area	Area (ha)	C 5-Year	C 100-Year	Tc (min)	I (mm/hr)		Q (L/s)	
					5-Year	100-Year	5-Year	100-Year
B1	0.229	0.90	1.00	10	104.2	178.6	59.82	113.90
B2	0.326	0.90	1.00	10	104.2	178.6	84.99	161.84
B3	0.335	0.79	0.89	10	104.2	178.6	77.03	147.39
B4	0.090	0.56	0.64	10	104.2	178.6	14.69	28.57
B5	0.188	0.84	0.94	10	104.2	178.6	45.75	87.34
B6	0.181	0.71	0.80	10	104.2	178.6	37.21	71.52
B7	0.132	0.65	0.73	10	104.2	178.6	24.67	47.64
B8	0.080	0.75	0.84	10	104.2	178.6	17.27	33.12
B9	0.167	0.79	0.88	10	104.2	178.6	38.02	72.76
B10	0.398	0.38	0.44	10	104.2	178.6	43.25	86.46
Total	2.126						442.70	850.55



# McINTOSH PERRY

## CCO-21-2955 - 1919 Riverside Drive - Runoff Calculations

### Required Restricted Flow

Drainage Area	Area (ha)	C 5-Year	Tc (min)	I (mm/hr)	Q (L/s)
				5-Year	5-Year
A1	2.126	0.50	10	104.2	307.88

### Post-Development Restricted Runoff Calculations

Drainage Area	Unrestricted Flow (L/s)		Restricted Flow (L/s)		Storage Required (m <sup>3</sup> )		Storage Provided (m <sup>3</sup> )		
	5-Year	100-Year	5-Year	100-Year	5-Year	100-Year	5-Year	100-Year	
B1	59.82	113.90	2.84	2.84	60.16	134.20	61.77	135.89	Restricted
B2	84.99	161.84	5.68	5.68	76.78	174.24	80.52	181.18	Restricted
B3	77.03	147.39	77.03	124.39	0.00	22.38		29.18	Restricted
B4	14.69	28.57	14.69	28.57					Unrestricted
B5	45.75	87.34	20.74	21.24	15.01	44.93	17.68	47.32	Restricted
B6	37.21	71.52	35.40	35.84	35.07	104.51	41.08	104.87	Restricted
B7	24.67	47.64							
B8	17.27	33.12							
B9	38.02	72.76							
B10	43.25	86.46	43.25	86.46					Unrestricted
Total	344.17	658.21	199.63	305.02	187.01	480.26	201.05	498.44	

# McINTOSH PERRY

Storage Requirements for Area B1

5-Year Storm Event

Tc (min)	I (mm/hr)	B1 Runoff (L/s)	Allowable Outflow (L/s)	Runoff to be Stored (L/s)	Storage Required (m <sup>3</sup> )
50	37.7	21.62	2.84	18.78	56.33
60	32.9	18.91	2.84	16.07	57.87
70	29.4	16.86	2.84	14.02	58.90
80	26.6	15.25	2.84	12.41	59.57
90	24.3	13.94	2.84	11.10	59.97
100	22.4	12.86	2.84	10.02	60.15
110	20.8	11.95	2.84	9.11	60.16
120	19.5	11.18	2.84	8.34	60.03
130	18.3	10.50	2.84	7.66	59.78
140	17.3	9.91	2.84	7.07	59.43

Maximum Storage Required 5-Year (m<sup>3</sup>) = 60.16

100-Year Storm Event

Tc (min)	I (mm/hr)	B1 Runoff (L/s)	Allowable Outflow (L/s)	Runoff to be Stored (L/s)	Storage Required (m <sup>3</sup> )
160	26.2	16.74	2.84	13.90	133.43
170	25.0	15.95	2.84	13.11	133.77
180	23.9	15.25	2.84	12.41	134.01
190	22.9	14.61	2.84	11.77	134.15
200	22.0	14.02	2.84	11.18	134.20
210	21.1	13.49	2.84	10.65	134.17
220	20.4	13.00	2.84	10.16	134.08
230	19.7	12.54	2.84	9.70	133.91

Maximum Storage Required 100-Year (m<sup>3</sup>) = 134.20

Storage Occupied In Area B1

5-Year Storm Event

Roof Storage			
Location	Area*	Depth	Volume (m <sup>3</sup> )
Roof	1235.39	0.050	61.77
		<b>Total</b>	<b>61.77</b>

Storage Available (m<sup>3</sup>) = 61.77  
Storage Required (m<sup>3</sup>) = 60.16

100-Year Storm Event

Roof Storage			
Location	Area*	Depth	Volume (m <sup>3</sup> )
Roof	1235.39	0.110	135.89
		<b>Total</b>	<b>135.89</b>

Storage Available (m<sup>3</sup>) = 135.89  
Storage Required (m<sup>3</sup>) = 134.20

\*Storage area is 75% of the total roof area. Peaked section of roof excluded as storage area.

# McINTOSH PERRY

Roof Drain Flow (B1)

Roof Drains Summary		
Type of Control Device	Watts Drainage - Accutrol Weir	
Number of Roof Drains	9	
	5-Year	100-Year
Rooftop Storage (m <sup>3</sup> )	61.77	135.89
Storage Depth (m)	0.050	0.110
Flow (Per Roof Drain) (L/s)	0.32	0.32
Total Flow (L/s)	2.84	2.84

Flow Rate Vs. Build-Up (One Weir, Fully Closed)	
Depth (mm)	Flow (L/s)
15	0.18
20	0.24
25	0.30
30	0.32
35	0.32
40	0.32
45	0.32
50	0.32
55	0.32

\*Roof Drain model to be Accutrol Weirs, See attached sheets

\*Roof Drain Flow information taken from Watts Drainage website. Roof drains assumed to be in fully closed position and locked to prevent tamper.

CALCULATING ROOF FLOW EXAMPLES

2 roof drains during a 5 year storm  
 elevation of water = 30mm  
 Flow leaving 2 roof drains = (2 x 0.32 L/s) = 0.64 L/s

2 roof drains during a 100 year storm  
 elevation of water = 45mm  
 Flow leaving 2 roof drains = (2 x 0.32 L/s) = 0.64 L/s

Roof Drain Flow		
Flow (l/s)	Storage Depth (mm)	Drains Flow (l/s)
0.18	15	1.62
0.24	20	2.16
0.32	25	2.88
0.32	30	2.84
0.32	35	2.84
0.32	40	2.84
0.32	45	2.84
0.32	50	2.84
0.32	55	2.84
0.32	60	2.84
0.32	65	2.84
0.32	70	2.84
0.32	75	2.84
0.32	80	2.84
0.32	85	2.84
0.32	90	2.84
0.32	95	2.84
0.32	100	2.84
0.32	105	2.84
0.32	110	2.84
0.32	115	2.84
0.32	120	2.84
0.32	125	2.84
0.32	130	2.84
0.32	135	2.84
0.32	140	2.84
0.32	145	2.84
0.32	150	2.84

5-Year

100-Year

Note: The flow leaving through a restricted roof drain is based on flow vs. head information

# McINTOSH PERRY

Storage Requirements for Area B2

5-Year Storm Event

Tc (min)	I (mm/hr)	B2 Runoff (L/s)	Allowable Outflow (L/s)	Runoff to be Stored (L/s)	Storage Required (m <sup>3</sup> )
50	37.7	30.71	5.68	25.04	75.11
60	32.9	26.87	5.68	21.19	76.30
70	29.4	23.96	5.68	18.28	76.78
80	26.6	21.67	5.68	15.99	76.74
90	24.3	19.81	5.68	14.13	76.32
100	22.4	18.28	5.68	12.60	75.59
110	20.8	16.99	5.68	11.31	74.62
120	19.5	15.88	5.68	10.20	73.45
130	18.3	14.92	5.68	9.24	72.11
140	17.3	14.09	5.68	8.41	70.62

Maximum Storage Required 5-Year (m<sup>3</sup>) = 76.78

100-Year Storm Event

Tc (min)	I (mm/hr)	B2 Runoff (L/s)	Allowable Outflow (L/s)	Runoff to be Stored (L/s)	Storage Required (m <sup>3</sup> )
110	35.2	31.91	5.68	26.23	173.10
120	32.9	29.81	5.68	24.14	173.78
130	30.9	28.01	5.68	22.33	174.14
140	29.2	26.42	5.68	20.74	174.24
150	27.6	25.03	5.68	19.35	174.12
160	26.2	23.78	5.68	18.10	173.79
170	25.0	22.67	5.68	16.99	173.29
180	23.9	21.66	5.68	15.99	172.64

Maximum Storage Required 100-Year (m<sup>3</sup>) = 174.24

Storage Occupied In Area B2

5-Year Storm Event

Roof Storage			
Location	Area*	Depth	Volume (m <sup>3</sup> )
Roof	2013.11	0.040	80.52
Total			80.52

Storage Available (m<sup>3</sup>) = 80.52  
Storage Required (m<sup>3</sup>) = 76.78

100-Year Storm Event

Roof Storage			
Location	Area*	Depth	Volume (m <sup>3</sup> )
Roof	2013.11	0.090	181.18
Total			181.18

Storage Available (m<sup>3</sup>) = 181.18  
Storage Required (m<sup>3</sup>) = 174.24

\*Storage area is 75% of the total roof area. Peaked section of roof excluded as storage area.

# McINTOSH PERRY

Roof Drain Flow (B2)

Roof Drains Summary		
Type of Control Device	Watts Drainage - Accutrol Weir	
Number of Roof Drains	18	
	5-Year	100-Year
Rooftop Storage (m <sup>3</sup> )	61.77	135.89
Storage Depth (m)	0.040	0.090
Flow (Per Roof Drain) (L/s)	0.32	0.32
Total Flow (L/s)	5.68	5.68

Flow Rate Vs. Build-Up (One Weir, Fully Closed)	
Depth (mm)	Flow (L/s)
15	0.18
20	0.24
25	0.32
30	0.32
35	0.32
40	0.32
45	0.32
50	0.32
55	0.32

\*Roof Drain model to be Accutrol Weirs, See attached sheets

\*Roof Drain Flow information taken from Watts Drainage website. Roof drains assumed to be in fully closed position and locked to prevent tamper.

CALCULATING ROOF FLOW EXAMPLES

2 roof drains during a 5 year storm  
 elevation of water = 30mm  
 Flow leaving 2 roof drains = (2 x 0.32 L/s) = 0.64 L/s

2 roof drains during a 100 year storm  
 elevation of water = 45mm  
 Flow leaving 2 roof drains = (2 x 0.32 L/s) = 0.64 L/s

Roof Drain Flow			
	Flow (l/s)	Storage Depth (mm)	Drains Flow (l/s)
	0.18	15	3.24
	0.24	20	4.32
	0.32	25	5.76
	0.32	30	5.68
	0.32	35	5.68
5-Year	0.32	40	5.68
	0.32	45	5.68
	0.32	50	5.68
	0.32	55	5.68
	0.32	60	5.68
	0.32	65	5.68
	0.32	70	5.68
	0.32	75	5.68
	0.32	80	5.68
	0.32	85	5.68
100-Year	0.32	90	5.68
	0.32	95	5.68
	0.32	100	5.68
	0.32	105	5.68
	0.32	110	5.68
	0.32	115	5.68
	0.32	120	5.68
	0.32	125	5.68
	0.32	130	5.68
	0.32	135	5.68
	0.32	140	5.68
	0.32	145	5.68
	0.32	150	5.68

Note: The flow leaving through a restricted roof drain is based on flow vs. head information

# McINTOSH PERRY

Storage Requirements for Area B3

5-Year Storm Event

Tc (min)	I (mm/hr)	B3 Runoff (L/s)	Allowable Outflow (L/s)	Runoff to be Stored (L/s)	Storage Required (m <sup>3</sup> )
10	104.2	77.03	122.11	0.00	0.00
15	83.6	61.78	122.11	0.00	0.00
20	70.3	51.94	122.11	0.00	0.00
25	60.9	45.02	122.11	0.00	0.00
30	53.9	39.87	122.11	0.00	0.00
35	48.5	35.87	122.11	0.00	0.00
40	44.2	32.67	122.11	0.00	0.00

Maximum Storage Required 5-Year (m<sup>3</sup>) = 0.00

100-Year Storm Event

Tc (min)	I (mm/hr)	B3 Runoff (L/s)	Allowable Outflow (L/s)	Runoff to be Stored (L/s)	Storage Required (m <sup>3</sup> )
4	262.4	216.60	124.39	92.21	22.13
6	226.0	186.55	124.39	62.16	22.38
8	199.2	164.42	124.39	40.03	19.22
10	178.6	147.39	124.39	23.00	13.80
12	162.1	133.83	124.39	9.44	6.80
14	148.7	122.76	124.39	0.00	0.00
16	137.5	113.54	124.39	0.00	0.00

Maximum Storage Required 100-Year (m<sup>3</sup>) = 22.38

100-Year Storm Event Storage Summary

Water Elev. (m) =		65.32			
Structure	T/G	Inv (m)	Head (m)	Depth (m)	Storage
CB1	65.15	62.45	2.64	0.17	11.64
CB2	65.15	62.72	2.37	0.17	8.05
CBMH3	65.15	62.85	2.24	0.17	9.49
Total					29.18

100 Year Storage Summary

Storage Available (m <sup>3</sup> ) =	29.2
Storage Required (m <sup>3</sup> ) =	22.4

# McINTOSH PERRY

For Orifice Flow, C= 0.6  
 For Weir Flow, C= 3.33

	Orifice 1	Orifice 2	Weir 1	Weir 2
invert elevation	62.78			
center of crest elevation	62.87			
orifice width / weir length	195 mm			
orifice height				
orifice area (m <sup>2</sup> )	0.030	0.000		

Elevation Discharge Table - Storm Routing

Elevation (m)	Orifice 1		Orifice 2		Weir 1		Weir 2		Total Q [l/s]
	H [m]	Q [m <sup>3</sup> ]	H [m]	Q [m <sup>3</sup> ]	H [m]	Q [m <sup>3</sup> ]	H [m]	Q [m <sup>3</sup> ]	
62.78	x	x							0.00
62.80	x	x							0.00
62.81	x	x							0.00
62.82	x	x							0.00
62.83	x	x							0.00
62.84	x	x							0.00
62.85	x	x							0.00
65.14	2.27	0.120							119.72
65.15	2.28	0.120							119.99
65.16	2.29	0.120							120.25
65.17	2.30	0.121							120.51
65.18	2.31	0.121							120.78
65.19	2.32	0.121							121.04
65.20	2.33	0.121							121.30
65.21	2.34	0.122							121.56
65.22	2.35	0.122							121.82
65.23	2.36	0.122							122.08
65.24	2.37	0.122							122.34
65.25	2.38	0.123							122.59
65.26	2.39	0.123							122.85
65.27	2.40	0.123							123.11
65.28	2.41	0.123							123.37
65.29	2.42	0.124							123.62
65.30	2.43	0.124							123.88
65.31	2.44	0.124							124.13
<b>65.32</b>	<b>2.45</b>	<b>0.124</b>							<b>124.39</b>
65.33	2.46	0.125							124.64
65.34	2.47	0.125							124.89

- Notes:
1. For Orifice Flow, User is to Input an Elevation Higher than Crown of Orifice.
  2. Orifice Equation:  $Q = cA(2gh)^{1/2}$
  3. Weir flow calculated in Bentley's FlowMaster - Trapezoidal Channel at 0.1%, 3:1 side slopes, roughness coeff. Of 0.035
  4. These Computations Do Not Account for Submergence Effects Within the Pond Riser.
  5. H for orifice equations is depth of water above the centroid of the orifice.
  6. H for weir equations is depth of water above the weir crest.

# McINTOSH PERRY

Storage Requirements for Area B5

5-Year Storm Event

Tc (min)	I (mm/hr)	B5 Runoff (L/s)	Allowable Outflow (L/s)	Runoff to be Stored (L/s)	Storage Required (m <sup>3</sup> )
10	104.2	45.75	20.74	25.01	15.01
12	94.7	41.58	20.74	20.84	15.01
14	86.9	38.17	20.74	17.43	14.65
16	80.5	35.33	20.74	14.59	14.01
18	75.0	32.92	20.74	12.18	13.16
20	70.3	30.85	20.74	10.11	12.13
22	66.1	29.05	20.74	8.31	10.97

Maximum Storage Required 5-Year (m<sup>3</sup>) = 15.01

100-Year Storm Event

Tc (min)	I (mm/hr)	B5 Runoff (L/s)	Allowable Outflow (L/s)	Runoff to be Stored (L/s)	Storage Required (m <sup>3</sup> )
14	148.7	72.75	21.24	51.51	43.27
16	137.5	67.28	21.24	46.05	44.20
18	128.1	62.65	21.24	41.42	44.73
20	120.0	58.67	21.24	37.44	44.93
22	112.9	55.22	21.24	33.98	44.85
24	106.7	52.18	21.24	30.94	44.56
26	101.2	49.49	21.24	28.26	44.08

Maximum Storage Required 100-Year (m<sup>3</sup>) = 44.93

5 Year Storage Summary

Water Elev. (m) =	65.69				
Structure	T/G	INV. (out)	Head (m)	Depth (m)	Storage Volume
CB11	65.50	62.60	2.94	3.09	17.68

Storage Available (m<sup>3</sup>) = 17.7  
Storage Required (m<sup>3</sup>) = 15.0

100 Year Storage Summary

Water Elev. (m) =	65.77				
Structure	T/G	INV. (out)	Head (m)	Depth (m)	Storage Volume
CB11	65.50	62.60	3.02	3.17	47.32
<b>Total</b>					<b>47.32</b>

Storage Available (m<sup>3</sup>) = 47.3  
Storage Required (m<sup>3</sup>) = 44.9



# McINTOSH PERRY

CCO-21-2955 - 1919 Riverside Drive - Runoff Calculations

10 of 13

For Orifice Flow, C= 0.6  
 For Weir Flow, C= 3.33

	Orifice 1	Orifice 2	Weir 1	Weir 2
invert elevation	64.00			
center of crest elevation	64.04			
orifice width / weir length	88 mm			
orifice height				
orifice area (m <sup>2</sup> )	0.006	0.000		

Elevation Discharge Table - Storm Routing

Elevation (m)	Orifice 1		Orifice 2		Weir 1		Weir 2		Total Q [l/s]
	H [m]	Q [m <sup>3</sup> ]	H [m]	Q [m <sup>3</sup> ]	H [m]	Q [m <sup>3</sup> ]	H [m]	Q [m <sup>3</sup> ]	
64.00	x	x							0.00
64.02	x	x							0.00
64.03	x	x							0.00
65.50	1.46	0.020							19.50
65.51	1.47	0.020							19.57
65.52	1.48	0.020							19.64
65.53	1.49	0.020							19.70
65.54	1.50	0.020							19.77
65.55	1.51	0.020							19.84
65.56	1.52	0.020							19.90
65.57	1.53	0.020							19.97
65.58	1.54	0.020							20.03
65.59	1.55	0.020							20.10
65.60	1.56	0.020							20.16
65.61	1.57	0.020							20.23
65.62	1.58	0.020							20.29
65.63	1.59	0.020							20.36
65.64	1.60	0.020							20.42
65.65	1.61	0.020							20.48
65.66	1.62	0.021							20.55
65.67	1.63	0.021							20.61
65.68	1.64	0.021							20.68
65.69	1.65	0.021							20.74
65.70	1.66	0.021							20.80
65.71	1.67	0.021							20.86
65.72	1.68	0.021							20.93
65.73	1.69	0.021							20.99
65.74	1.70	0.021							21.05
65.75	1.71	0.021							21.11
65.76	1.72	0.021							21.17
65.77	1.73	0.021							21.24
65.78	1.74	0.021							21.30
65.79	1.75	0.021							21.36
65.80	1.76	0.021							21.42

- Notes: 1. For Orifice Flow, User is to Input an Elevation Higher than Crown of Orifice.  
 2. Orifice Equation:  $Q = cA(2gh)^{1/2}$   
 3. Weir flow calculated in Bentley's FlowMaster - Trapezoidal Channel at 0.1%, 3:1 side slopes, roughness coeff. Of 0.035  
 4. These Computations Do Not Account for Submergence Effects Within the Pond Riser.  
 5. H for orifice equations is depth of water above the centroide of the orifice.  
 6. H for weir equations is depth of water above the weir crest.

# McINTOSH PERRY

CCO-21-2955 - 1919 Riverside Drive - Runoff Calculations

11 of 13

## Storage Requirements for Area B6, B7, B8 & B9

### 5-Year Storm Event

Tc (min)	I (mm/hr)	B6 Runoff (L/s)	B7 Runoff (L/s)	B8 Runoff (L/s)	B9 Runoff (L/s)	Allowable Outflow (L/s)	Runoff to be Stored (L/s)	Storage Required (m <sup>3</sup> )
10	104.2	37.21	24.67	17.27	13.58	35.40	57.33	34.40
15	83.6	29.84	19.79	13.85	10.89	35.40	38.96	35.07
20	70.3	25.09	16.64	11.64	9.15	35.40	27.12	32.54
25	60.9	21.75	14.42	10.09	7.93	35.40	18.79	28.19
30	53.9	19.26	12.77	8.94	7.03	35.40	12.59	22.67
35	48.5	17.33	11.49	8.04	6.32	35.40	7.78	16.33
40	44.2	15.78	10.46	7.32	5.76	35.40	3.92	9.41

Maximum Storage Required 5-Year (m<sup>3</sup>) = 35.07

### 100-Year Storm Event

Tc (min)	I (mm/hr)	B6 Runoff (L/s)	B7 Runoff (L/s)	B8 Runoff (L/s)	B9 Runoff (L/s)	Allowable Outflow (L/s)	Runoff to be Stored (L/s)	Storage Required (m <sup>3</sup> )
10	178.6	71.52	47.64	33.12	29.15	35.84	145.59	87.35
15	142.9	57.24	38.13	26.50	23.32	35.84	109.35	98.42
20	120.0	48.05	32.00	22.25	19.58	35.84	86.04	103.25
25	103.8	41.60	27.71	19.26	16.95	35.84	69.68	104.51
30	91.9	36.80	24.51	17.04	15.00	35.84	57.50	103.51
35	82.6	33.08	22.03	15.32	13.48	35.84	48.07	100.94
40	75.1	30.10	20.05	13.94	12.27	35.84	40.51	97.23

Maximum Storage Required 100-Year (m<sup>3</sup>) = 104.51

### 5 Year Storage Summary

Water Elev. (m) =		65.58			
Structure	T/G	INV. (out)	Head (m)	Depth (m)	Storage Volume
CICB8	65.40	63.30	2.13	2.28	6.61
CICB9	65.40	63.56	1.87	2.02	7.39
CB10	65.40	64.43	1.00	1.15	10.88
CBMH4	65.40	64.43	1.00	1.15	16.20
<b>Total</b>					<b>41.08</b>

Storage Available (m<sup>3</sup>) = 41.1  
Storage Required (m<sup>3</sup>) = 35.1

### 100 Year Storage Summary

Water Elev. (m) =		65.65			
Structure	T/G	INV. (out)	Head (m)	Depth (m)	Storage Volume
CICB8	65.40	63.30	2.20	2.35	17.94
CICB9	65.40	63.56	1.94	2.09	17.03
CB10	65.40	64.43	1.07	1.22	31.34
CB11	65.40	64.43	1.07	1.22	38.56
<b>Total</b>					<b>104.87</b>

Storage Available (m<sup>3</sup>) = 104.9  
Storage Required (m<sup>3</sup>) = 104.5

# McINTOSH PERRY

CCO-21-2955 - 1919 Riverside Drive - Runoff Calculations

12 of 13

For Orifice Flow, C= 0.6  
 For Weir Flow, C= 3.33

	Orifice 1	Orifice 2	Weir 1	Weir 2
invert elevation	62.71			
center of crest elevation	62.76			
orifice width / weir length	101 mm			
orifice height				
orifice area (m <sup>2</sup> )	0.008	0.000		

Elevation Discharge Table - Storm Routing

Elevation (m)	Orifice 1		Orifice 2		Weir 1		Weir 2		Total Q [l/s]
	H [m]	Q [m <sup>3</sup> ]	H [m]	Q [m <sup>3</sup> ]	H [m]	Q [m <sup>3</sup> ]	H [m]	Q [m <sup>3</sup> ]	
62.71	x	x							0.00
62.73	x	x							0.00
62.74	x	x							0.00
62.75	x	x							0.00
62.76	x	x							0.00
62.77	0.01	0.002							2.08
62.78	0.02	0.003							2.96
62.79	0.03	0.004							3.64
62.80	0.04	0.004							4.20
62.81	0.05	0.005							4.70
62.82	0.06	0.005							5.15
62.83	0.07	0.006							5.57
62.84	0.08	0.006							5.95
62.85	0.09	0.006							6.32
62.86	0.10	0.007							6.66
62.87	0.11	0.007							6.98
62.88	0.12	0.007							7.30
62.89	0.13	0.008							7.59
62.90	0.14	0.008							7.88
62.91	0.15	0.008							8.16
62.92	0.16	0.008							8.43
62.93	0.17	0.009							8.69
62.94	0.18	0.009							8.94
62.95	0.19	0.009							9.18
62.96	0.20	0.009							9.42
62.97	0.21	0.010							9.66
62.98	0.22	0.010							9.88
65.42	2.66	0.034							34.38
65.43	2.67	0.034							34.45
65.44	2.68	0.035							34.51
65.45	2.69	0.035							34.58
65.46	2.70	0.035							34.64
65.47	2.71	0.035							34.70
65.48	2.72	0.035							34.77
65.49	2.73	0.035							34.83
65.50	2.74	0.035							34.90
65.51	2.75	0.035							34.96
65.52	2.76	0.035							35.02
65.53	2.77	0.035							35.09
65.54	2.78	0.035							35.15
65.55	2.79	0.035							35.21
65.56	2.80	0.035							35.28
65.57	2.81	0.035							35.34
65.58	2.82	0.035							35.40
65.59	2.83	0.035							35.46
65.60	2.84	0.036							35.53
65.61	2.85	0.036							35.59
65.62	2.86	0.036							35.65
65.63	2.87	0.036							35.71
65.64	2.88	0.036							35.78
65.65	2.89	0.036							35.84

- Notes: 1. For Orifice Flow, User is to Input an Elevation Higher than Crown of Orifice.  
 2. Orifice Equation:  $Q = cA(2gh)^{1/2}$   
 3. Weir flow calculated in Bentley's FlowMaster - Trapezoidal Channel at 0.1%, 3:1 side slopes, roughness coeff. Of 0.035  
 4. These Computations Do Not Account for Submergence Effects Within the Pond Riser.  
 5. H for orifice equations is depth of water above the centre of the orifice.  
 6. H for weir equations is depth of water above the weir crest.

# McINTOSH PERRY

CCO-21-2955 - 1919 Riverside Drive - Runoff Calculations

13 of 13

## Time of Concentration Pre-Development

Drainage Area ID	Sheet Flow Distance (m)	Slope of Land (%)	Tc (min) (5-Year)	Tc (min) (100-Year)
A1	102	2.29	10	5

*\*Therefore, a Tc of 10 can be used*

$$Tc = (3.26(1.1-c)L^{0.5}/S^{0.33})$$

c= Balanced Runoff Coefficient

L= Length of Drainage Area

S= Average Slope of Watershed

Stormceptor® EF Sizing Report

**STORMCEPTOR®**

**ESTIMATED NET ANNUAL SEDIMENT (TSS) LOAD REDUCTION**

06/22/2023

Province:	Ontario
City:	Ottawa
Nearest Rainfall Station:	OTTAWA CDA RCS
Climate Station Id:	6105978
Years of Rainfall Data:	20

Site Name:	1919 Riverside OGS1
------------	---------------------

Drainage Area (ha):	0.94
---------------------	------

Runoff Coefficient 'c':	0.87
-------------------------	------

Particle Size Distribution:	Fine
-----------------------------	------

Target TSS Removal (%):	80.0
-------------------------	------

Required Water Quality Runoff Volume Capture (%):	90.00
---	-------

Estimated Water Quality Flow Rate (L/s):	26.39
--	-------

Oil / Fuel Spill Risk Site?	Yes
-----------------------------	-----

Upstream Flow Control?	Yes
------------------------	-----

Upstream Orifice Control Flow Rate to Stormceptor (L/s):	132.90
--	--------

Peak Conveyance (maximum) Flow Rate (L/s):	132.90
--	--------

Site Sediment Transport Rate (kg/ha/yr):	480.00
--	--------

Estimated Average Annual Sediment Load (kg/yr):	392.54
---	--------

Project Name:	Schlegel Villages Ottawa ogs1
---------------	-------------------------------

Project Number:	CCO-21-2955
-----------------	-------------

Designer Name:	Ryan Robineau
----------------	---------------

Designer Company:	McIntosh Perry
-------------------	----------------

Designer Email:	r.robineau@mcintoshperry.com
-----------------	------------------------------

Designer Phone:	613-714-6611
-----------------	--------------

EOR Name:	
-----------	--

EOR Company:	
--------------	--

EOR Email:	
------------	--

EOR Phone:	
------------	--

**Net Annual Sediment (TSS) Load Reduction Sizing Summary**

Stormceptor Model	TSS Removal Provided (%)
EFO4	76
<b>EFO6</b>	<b>87</b>
EFO8	93
EFO10	96
EFO12	98

**Recommended Stormceptor EFO Model: EFO6**

**Estimated Net Annual Sediment (TSS) Load Reduction (%): 87**

**Water Quality Runoff Volume Capture (%): > 90**



## Stormceptor® EF Sizing Report

### THIRD-PARTY TESTING AND VERIFICATION

► **Stormceptor® EF and Stormceptor® EFO** are the latest evolutions in the Stormceptor® oil-grit separator (OGS) technology series, and are designed to remove a wide variety of pollutants from stormwater and snowmelt runoff. These technologies have been third-party tested in accordance with the Canadian ETV **Procedure for Laboratory Testing of Oil-Grit Separators** and performance has been third-party verified in accordance with the **ISO 14034 Environmental Technology Verification (ETV)** protocol.

### PERFORMANCE

► **Stormceptor® EF and EFO** remove stormwater pollutants through gravity separation and floatation, and feature a patent-pending design that generates positive removal of total suspended solids (TSS) throughout each storm event, including high-intensity storms. Captured pollutants include sediment, free oils, and sediment-bound pollutants such as nutrients, heavy metals, and petroleum hydrocarbons. Stormceptor is sized to remove a high level of TSS from the frequent rainfall events that contribute the vast majority of annual runoff volume and pollutant load. The technology incorporates an internal bypass to convey excessive stormwater flows from high-intensity storms through the device without resuspension and washout (scour) of previously captured pollutants. Proper routine maintenance ensures high pollutant removal performance and protection of downstream waterways.

### PARTICLE SIZE DISTRIBUTION (PSD)

► The **Canadian ETV PSD** shown in the table below was used, or in part, for this sizing. This is the identical PSD that is referenced in the Canadian ETV **Procedure for Laboratory Testing of Oil-Grit Separators** for both sediment removal testing and scour testing. The Canadian ETV PSD contains a wide range of particle sizes in the sand and silt fractions, and is considered reasonably representative of the particle size fractions found in typical urban stormwater runoff.

Particle Size (µm)	Percent Less Than	Particle Size Fraction (µm)	Percent
1000	100	500-1000	5
500	95	250-500	5
250	90	150-250	15
150	75	100-150	15
100	60	75-100	10
75	50	50-75	5
50	45	20-50	10
20	35	8-20	15
8	20	5-8	10
5	10	2-5	5
2	5	<2	5

Stormceptor®EF Sizing Report

Upstream Flow Controlled Results

Rainfall Intensity (mm / hr)	Percent Rainfall Volume (%)	Cumulative Rainfall Volume (%)	Flow Rate (L/s)	Flow Rate (L/min)	Surface Loading Rate (L/min/m <sup>2</sup> )	Removal Efficiency (%)	Incremental Removal (%)	Cumulative Removal (%)
0.5	8.6	8.6	1.14	68.0	26.0	100	8.6	8.6
1	20.3	29.0	2.27	136.0	52.0	100	20.3	29.0
2	16.2	45.2	4.55	273.0	104.0	96	15.6	44.5
3	12.0	57.2	6.82	409.0	156.0	89	10.7	55.3
4	8.4	65.6	9.09	546.0	207.0	83	7.0	62.3
5	5.9	71.6	11.37	682.0	259.0	80	4.8	67.0
6	4.6	76.2	13.64	818.0	311.0	78	3.6	70.7
7	3.1	79.3	15.91	955.0	363.0	76	2.3	73.0
8	2.7	82.0	18.19	1091.0	415.0	73	2.0	75.0
9	3.3	85.3	20.46	1228.0	467.0	71	2.4	77.4
10	2.3	87.6	22.73	1364.0	519.0	69	1.6	78.9
11	1.6	89.2	25.01	1500.0	571.0	66	1.0	80.0
12	1.3	90.5	27.28	1637.0	622.0	64	0.9	80.8
13	1.7	92.2	29.56	1773.0	674.0	64	1.1	81.9
14	1.2	93.5	31.83	1910.0	726.0	64	0.8	82.7
15	1.2	94.6	34.10	2046.0	778.0	63	0.7	83.4
16	0.7	95.3	36.38	2183.0	830.0	63	0.4	83.9
17	0.7	96.1	38.65	2319.0	882.0	62	0.5	84.3
18	0.4	96.5	40.92	2455.0	934.0	62	0.2	84.6
19	0.4	96.9	43.20	2592.0	985.0	62	0.3	84.8
20	0.2	97.1	45.47	2728.0	1037.0	61	0.1	85.0
21	0.5	97.5	47.74	2865.0	1089.0	59	0.3	85.2
22	0.2	97.8	50.02	3001.0	1141.0	58	0.1	85.4
23	1.0	98.8	52.29	3137.0	1193.0	57	0.6	86.0
24	0.3	99.1	54.56	3274.0	1245.0	56	0.2	86.1
25	0.9	100.0	56.84	3410.0	1297.0	55	0.5	86.6
30	0.9	100.9	68.20	4092.0	1556.0	47	0.4	87.1
35	-0.9	100.0	79.57	4774.0	1815.0	40	N/A	86.7
40	0.0	100.0	90.94	5456.0	2075.0	35	0.0	86.7
45	0.0	100.0	102.31	6138.0	2334.0	31	0.0	86.7
<b>Estimated Net Annual Sediment (TSS) Load Reduction =</b>								<b>87 %</b>

Climate Station ID: 6105978 Years of Rainfall Data: 20



Stormceptor® **EF** Sizing Report

**RAINFALL DATA FROM OTTAWA CDA RCS RAINFALL STATION**

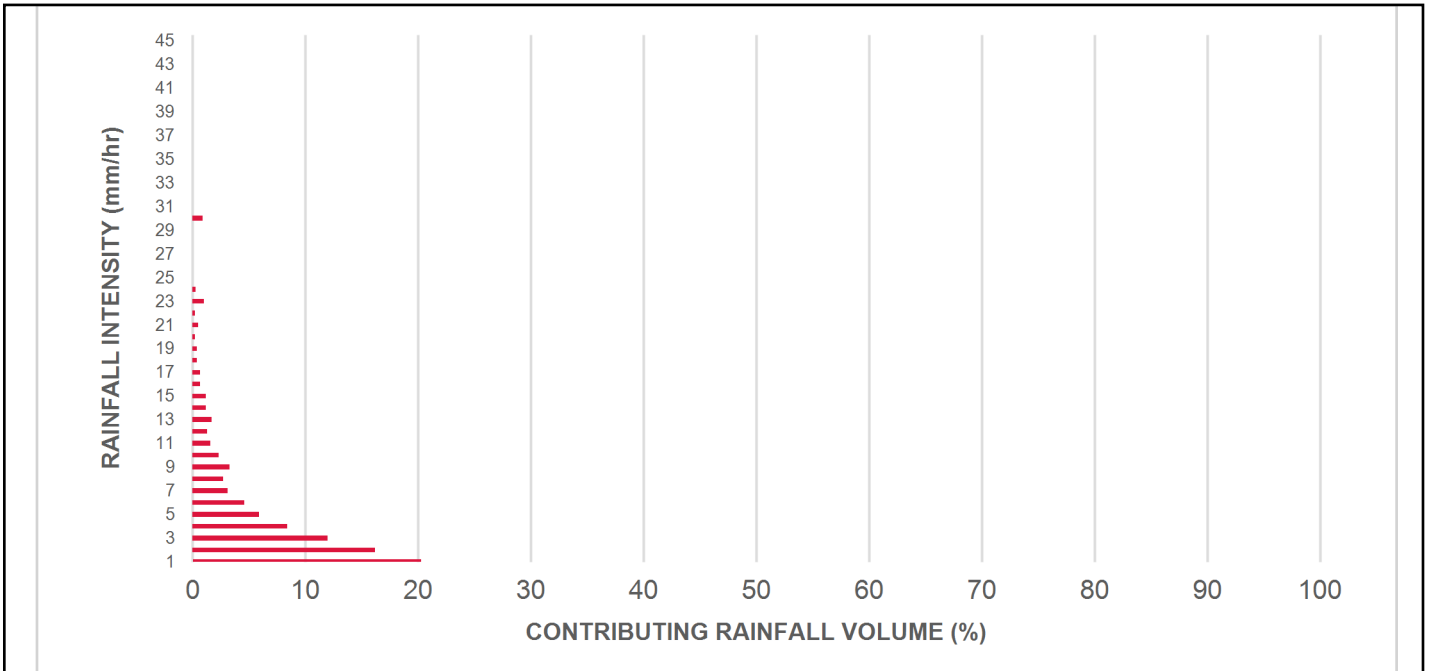

**INCREMENTAL AND CUMULATIVE TSS REMOVAL FOR THE RECOMMENDED STORMCEPTOR® MODEL**

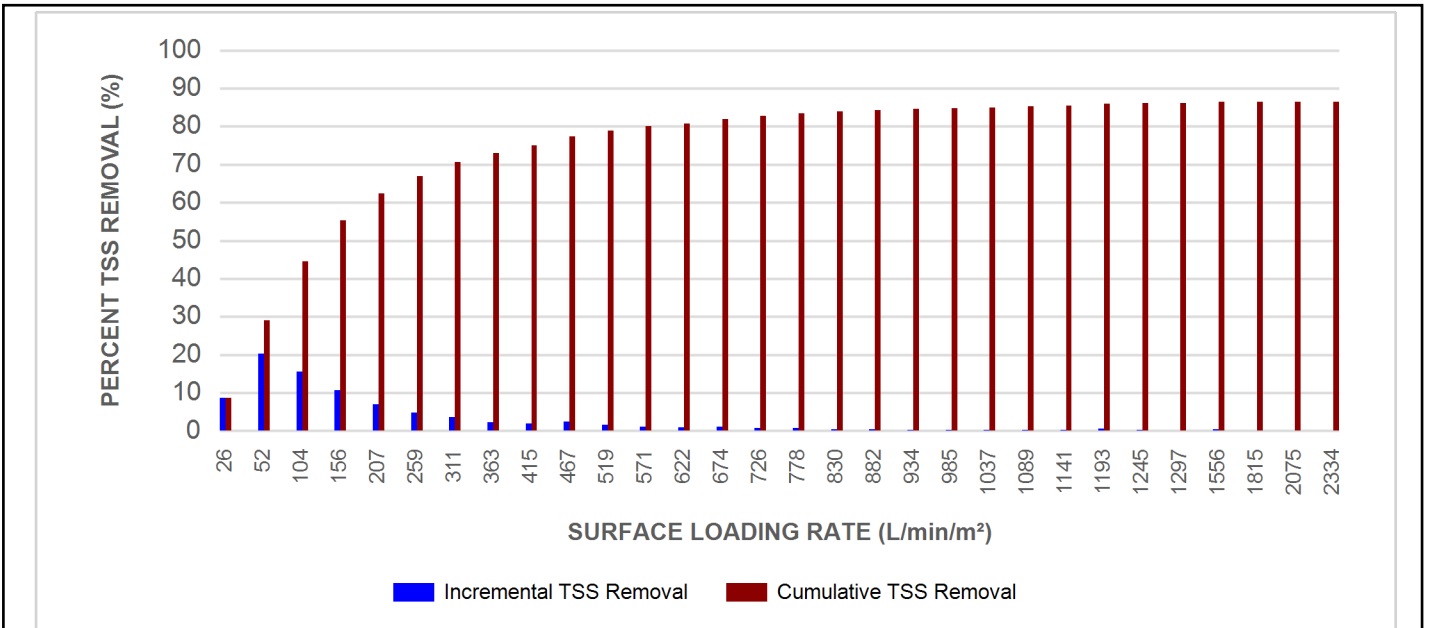



Stormceptor® **EF** Sizing Report

Maximum Pipe Diameter / Peak Conveyance

Stormceptor EF / EFO	Model Diameter		Min Angle Inlet / Outlet Pipes	Max Inlet Pipe Diameter		Max Outlet Pipe Diameter		Peak Conveyance Flow Rate	
	(m)	(ft)		(mm)	(in)	(mm)	(in)	(L/s)	(cfs)
EF4 / EFO4	1.2	4	90	609	24	609	24	425	15
EF6 / EFO6	1.8	6	90	914	36	914	36	990	35
EF8 / EFO8	2.4	8	90	1219	48	1219	48	1700	60
EF10 / EFO10	3.0	10	90	1828	72	1828	72	2830	100
EF12 / EFO12	3.6	12	90	1828	72	1828	72	2830	100

**SCOUR PREVENTION AND ONLINE CONFIGURATION**

► Stormceptor® EF and EFO feature an internal bypass and superior scour prevention technology that have been demonstrated in third-party testing according to the scour testing provisions of the Canadian ETV **Procedure for Laboratory Testing of Oil-Grit Separators**, and the exceptional scour test performance has been third-party verified in accordance with the ISO 14034 ETV protocol. As a result, Stormceptor EF and EFO are approved for online installation, eliminating the need for costly additional bypass structures, piping, and installation expense.

**DESIGN FLEXIBILITY**

► Stormceptor® EF and EFO offers design flexibility in one simplified platform, accepting stormwater flow from a single inlet pipe or multiple inlet pipes, and/or surface runoff through an inlet grate. The device can also serve as a junction structure, accommodate a 90-degree inlet-to-outlet bend angle, and can be modified to ensure performance in submerged conditions.

**OIL CAPTURE AND RETENTION**

► While Stormceptor® EF will capture and retain oil from dry weather spills and low intensity runoff, Stormceptor® EFO has demonstrated superior oil capture and greater than 99% oil retention in third-party testing according to the light liquid re-entrainment testing provisions of the Canadian ETV **Procedure for Laboratory Testing of Oil-Grit Separators**. Stormceptor EFO is recommended for sites where oil capture and retention is a requirement.

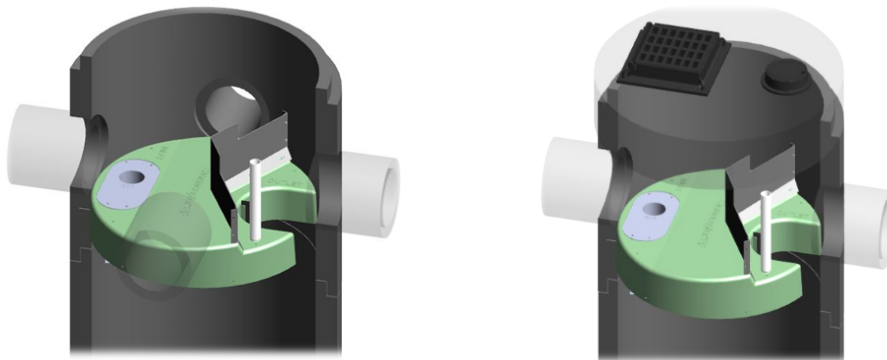

## Stormceptor® EF Sizing Report

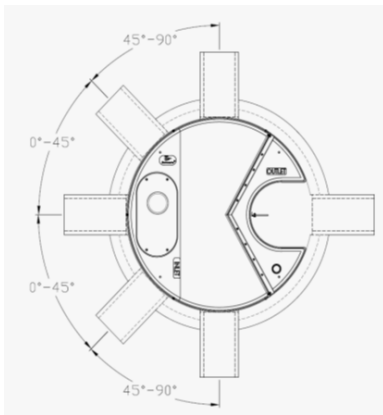

### INLET-TO-OUTLET DROP

Elevation differential between inlet and outlet pipe inverts is dictated by the angle at which the inlet pipe(s) enters the unit.

0° - 45° : The inlet pipe is 1-inch (25mm) higher than the outlet pipe.

45° - 90° : The inlet pipe is 2-inches (50mm) higher than the outlet pipe.

### HEAD LOSS

The head loss through Stormceptor EF is similar to that of a 60-degree bend structure. The applicable K value for calculating minor losses through the unit is 1.1.

For submerged conditions the applicable K value is 3.0.

### Pollutant Capacity

Stormceptor EF / EFO	Model Diameter		Depth (Outlet Pipe Invert to Sump Floor)		Oil Volume		Recommended Sediment Maintenance Depth *		Maximum Sediment Volume *		Maximum Sediment Mass **	
	(m)	(ft)	(m)	(ft)	(L)	(Gal)	(mm)	(in)	(L)	(ft³)	(kg)	(lb)
EF4 / EFO4	1.2	4	1.52	5.0	265	70	203	8	1190	42	1904	5250
EF6 / EFO6	1.8	6	1.93	6.3	610	160	305	12	3470	123	5552	15375
EF8 / EFO8	2.4	8	2.59	8.5	1070	280	610	24	8780	310	14048	38750
EF10 / EFO10	3.0	10	3.25	10.7	1670	440	610	24	17790	628	28464	78500
EF12 / EFO12	3.6	12	3.89	12.8	2475	655	610	24	31220	1103	49952	137875

\*Increased sump depth may be added to increase sediment storage capacity

\*\* Average density of wet packed sediment in sump = 1.6 kg/L (100 lb/ft³ )

Feature	Benefit	Feature Appeals To
Patent-pending enhanced flow treatment and scour prevention technology	Superior, verified third-party performance	Regulator, Specifying & Design Engineer
Third-party verified light liquid capture and retention for EFO version	Proven performance for fuel/oil hotspot locations	Regulator, Specifying & Design Engineer, Site Owner
Functions as bend, junction or inlet structure	Design flexibility	Specifying & Design Engineer
Minimal drop between inlet and outlet	Site installation ease	Contractor
Large diameter outlet riser for inspection and maintenance	Easy maintenance access from grade	Maintenance Contractor & Site Owner

### STANDARD STORMCEPTOR EF/EFO DRAWINGS

For standard details, please visit <http://www.imbriumsystems.com/stormwater-treatment-solutions/stormceptor-ef>

### STANDARD STORMCEPTOR EF/EFO SPECIFICATION

For specifications, please visit <http://www.imbriumsystems.com/stormwater-treatment-solutions/stormceptor-ef>

Stormceptor® **EF** Sizing Report

**STANDARD PERFORMANCE SPECIFICATION FOR  
“OIL GRIT SEPARATOR” (OGS) STORMWATER QUALITY TREATMENT DEVICE**

**PART 1 – GENERAL**

1.1 WORK INCLUDED

This section specifies requirements for selecting, sizing, and designing an underground Oil Grit Separator (OGS) device for stormwater quality treatment, with third-party testing results and a Statement of Verification in accordance with ISO 14034 Environmental Management – Environmental Technology Verification (ETV).

1.2 REFERENCE STANDARDS & PROCEDURES

ISO 14034:2016 Environmental management – Environmental technology verification (ETV)

Canadian Environmental Technology Verification (ETV) Program’s **Procedure for Laboratory Testing of Oil-Grit Separators**

1.3 SUBMITTALS

1.3.1 All submittals, including sizing reports & shop drawings, shall be submitted upon request with each order to the contractor then forwarded to the Engineer of Record for review and acceptance. Shop drawings shall detail all OGS components, elevations, and sequence of construction.

1.3.2 Alternative devices shall have features identical to or greater than the specified device, including: treatment chamber diameter, treatment chamber wet volume, sediment storage volume, and oil storage volume.

1.3.3 Unless directed otherwise by the Engineer of Record, OGS stormwater quality treatment product substitutions or alternatives submitted within ten days prior to project bid shall not be accepted. All alternatives or substitutions submitted shall be signed and sealed by a local registered Professional Engineer, based on the exact same criteria detailed in Section 3, in entirety, subject to review and approval by the Engineer of Record.

**PART 2 – PRODUCTS**

2.1 OGS POLLUTANT STORAGE

The OGS device shall include a sump for sediment storage, and a protected volume for the capture and storage of petroleum hydrocarbons and buoyant gross pollutants. The minimum sediment & petroleum hydrocarbon storage capacity shall be as follows:

2.1.1	4 ft (1219 mm) Diameter OGS Units:	1.19 m <sup>3</sup> sediment / 265 L oil
	6 ft (1829 mm) Diameter OGS Units:	3.48 m <sup>3</sup> sediment / 609 L oil
	8 ft (2438 mm) Diameter OGS Units:	8.78 m <sup>3</sup> sediment / 1,071 L oil
	10 ft (3048 mm) Diameter OGS Units:	17.78 m <sup>3</sup> sediment / 1,673 L oil
	12 ft (3657 mm) Diameter OGS Units:	31.23 m <sup>3</sup> sediment / 2,476 L oil

**PART 3 – PERFORMANCE & DESIGN**

3.1 GENERAL

The OGS stormwater quality treatment device shall be verified in accordance with ISO 14034:2016 Environmental management – Environmental technology verification (ETV). The OGS stormwater quality treatment device shall



## Stormceptor® EF Sizing Report

remove oil, sediment and gross pollutants from stormwater runoff during frequent wet weather events, and retain these pollutants during less frequent high flow wet weather events below the insert within the OGS for later removal during maintenance. The Manufacturer shall have at least ten (10) years of local experience, history and success in engineering design, manufacturing and production and supply of OGS stormwater quality treatment device systems, acceptable to the Engineer of Record.

### 3.2 SIZING METHODOLOGY

The OGS device shall be engineered, designed and sized to provide stormwater quality treatment based on treating a minimum of 90 percent of the average annual runoff volume and a minimum removal of an annual average 60% of the sediment (TSS) load based on the Particle Size Distribution (PSD) specified in the sizing report for the specified device. Sizing of the OGS shall be determined by use of a minimum ten (10) years of local historical rainfall data provided by Environment Canada. Sizing shall also be determined by use of the sediment removal performance data derived from the ISO 14034 ETV third-party verified laboratory testing data from testing conducted in accordance with the Canadian ETV protocol Procedure for Laboratory Testing of Oil-Grit Separators, as follows:

3.2.1 Sediment removal efficiency for a given surface loading rate and its associated flow rate shall be based on sediment removal efficiency demonstrated at the seven (7) tested surface loading rates specified in the protocol, ranging 40 L/min/m<sup>2</sup> to 1400 L/min/m<sup>2</sup>, and as stated in the ISO 14034 ETV Verification Statement for the OGS device.

3.2.2 Sediment removal efficiency for surface loading rates between 40 L/min/m<sup>2</sup> and 1400 L/min/m<sup>2</sup> shall be based on linear interpolation of data between consecutive tested surface loading rates.

3.2.3 Sediment removal efficiency for surface loading rates less than the lowest tested surface loading rate of 40 L/min/m<sup>2</sup> shall be assumed to be identical to the sediment removal efficiency at 40 L/min/m<sup>2</sup>. No extrapolation shall be allowed that results in a sediment removal efficiency that is greater than that demonstrated at 40 L/min/m<sup>2</sup>.

3.2.4 Sediment removal efficiency for surface loading rates greater than the highest tested surface loading rate of 1400 L/min/m<sup>2</sup> shall assume zero sediment removal for the portion of flow that exceeds 1400 L/min/m<sup>2</sup>, and shall be calculated using a simple proportioning formula, with 1400 L/min/m<sup>2</sup> in the numerator and the higher surface loading rate in the denominator, and multiplying the resulting fraction times the sediment removal efficiency at 1400 L/min/m<sup>2</sup>.

The OGS device shall also have sufficient annual sediment storage capacity as specified and calculated in Section 2.1.

### 3.3 CANADIAN ETV or ISO 14034 ETV VERIFICATION OF SCOUR TESTING

The OGS device shall have Canadian ETV or ISO 14034 ETV Verification of third-party scour testing conducted in accordance with the Canadian ETV Program's **Procedure for Laboratory Testing of Oil-Grit Separators**.

3.3.1 To be acceptable for on-line installation, the OGS device must demonstrate an average scour test effluent concentration less than 10 mg/L at each surface loading rate tested, up to and including 2600 L/min/m<sup>2</sup>.

### 3.4 LIGHT LIQUID RE-ENTRAINMENT SIMULATION TESTING

The OGS device shall have Canadian ETV or ISO 14034 ETV Verification of completed third-party Light Liquid Re-entrainment Simulation Testing in accordance with the Canadian ETV **Program's Procedure for Laboratory Testing of Oil-Grit Separators**, with results reported within the Canadian ETV or ISO 14034 ETV verification. This re-entrainment testing is conducted with the device pre-loaded with low density polyethylene (LDPE) plastic beads as a surrogate for light liquids such as oil and fuel. Testing is conducted on the same OGS unit tested for sediment removal to

## Stormceptor® EF Sizing Report

assess whether light liquids captured after a spill are effectively retained at high flow rates.

3.4.1 For an OGS device to be an acceptable stormwater treatment device on a site where vehicular traffic occurs and the potential for an oil or fuel spill exists, the OGS device must have reported verified performance results of greater than 99% cumulative retention of LDPE plastic beads for the five specified surface loading rates (ranging 200 L/min/m<sup>2</sup> to 2600 L/min/m<sup>2</sup>) in accordance with the Light Liquid Re-entrainment Simulation Testing within the Canadian ETV Program's **Procedure for Laboratory Testing of Oil-Grit Separators**. However, an OGS device shall not be allowed if the Light Liquid Re-entrainment Simulation Testing was performed with screening components within the OGS device that are effective at retaining the LDPE plastic beads, but would not be expected to retain light liquids such as oil and fuel.

Stormceptor® EF Sizing Report

**STORMCEPTOR®**

**ESTIMATED NET ANNUAL SEDIMENT (TSS) LOAD REDUCTION**

06/22/2023

Province:	Ontario
City:	Ottawa
Nearest Rainfall Station:	OTTAWA CDA RCS
Climate Station Id:	6105978
Years of Rainfall Data:	20

Site Name:	1919Riverside OGS2
------------	--------------------

Drainage Area (ha):	0.56
---------------------	------

Runoff Coefficient 'c':	0.75
-------------------------	------

Particle Size Distribution:	Fine
-----------------------------	------

Target TSS Removal (%):	80.0
-------------------------	------

Required Water Quality Runoff Volume Capture (%):	90.00
---	-------

Estimated Water Quality Flow Rate (L/s):	13.56
--	-------

Oil / Fuel Spill Risk Site?	Yes
-----------------------------	-----

Upstream Flow Control?	Yes
------------------------	-----

Upstream Orifice Control Flow Rate to Stormceptor (L/s):	35.84
--	-------

Peak Conveyance (maximum) Flow Rate (L/s):	35.84
--	-------

Site Sediment Transport Rate (kg/ha/yr):	480.00
--	--------

Estimated Average Annual Sediment Load (kg/yr):	201.60
---	--------

Project Name:	Schlegel Villages Ottawa OGS2
---------------	-------------------------------

Project Number:	CCO-21-2955
-----------------	-------------

Designer Name:	Ryan Robineau
----------------	---------------

Designer Company:	McIntosh Perry
-------------------	----------------

Designer Email:	r.robineau@mcintoshperry.com
-----------------	------------------------------

Designer Phone:	613-714-6611
-----------------	--------------

EOR Name:	
-----------	--

EOR Company:	
--------------	--

EOR Email:	
------------	--

EOR Phone:	
------------	--

**Net Annual Sediment (TSS) Load Reduction Sizing Summary**

Stormceptor Model	TSS Removal Provided (%)
EFO4	85
EFO6	93
EFO8	97
EFO10	99
EFO12	100

**Recommended Stormceptor EFO Model: EFO4**

**Estimated Net Annual Sediment (TSS) Load Reduction (%): 85**

**Water Quality Runoff Volume Capture (%): > 90**



## Stormceptor® EF Sizing Report

### THIRD-PARTY TESTING AND VERIFICATION

► **Stormceptor® EF and Stormceptor® EFO** are the latest evolutions in the Stormceptor® oil-grit separator (OGS) technology series, and are designed to remove a wide variety of pollutants from stormwater and snowmelt runoff. These technologies have been third-party tested in accordance with the Canadian ETV **Procedure for Laboratory Testing of Oil-Grit Separators** and performance has been third-party verified in accordance with the **ISO 14034 Environmental Technology Verification (ETV)** protocol.

### PERFORMANCE

► **Stormceptor® EF and EFO** remove stormwater pollutants through gravity separation and floatation, and feature a patent-pending design that generates positive removal of total suspended solids (TSS) throughout each storm event, including high-intensity storms. Captured pollutants include sediment, free oils, and sediment-bound pollutants such as nutrients, heavy metals, and petroleum hydrocarbons. Stormceptor is sized to remove a high level of TSS from the frequent rainfall events that contribute the vast majority of annual runoff volume and pollutant load. The technology incorporates an internal bypass to convey excessive stormwater flows from high-intensity storms through the device without resuspension and washout (scour) of previously captured pollutants. Proper routine maintenance ensures high pollutant removal performance and protection of downstream waterways.

### PARTICLE SIZE DISTRIBUTION (PSD)

► The **Canadian ETV PSD** shown in the table below was used, or in part, for this sizing. This is the identical PSD that is referenced in the Canadian ETV **Procedure for Laboratory Testing of Oil-Grit Separators** for both sediment removal testing and scour testing. The Canadian ETV PSD contains a wide range of particle sizes in the sand and silt fractions, and is considered reasonably representative of the particle size fractions found in typical urban stormwater runoff.

Particle Size (µm)	Percent Less Than	Particle Size Fraction (µm)	Percent
1000	100	500-1000	5
500	95	250-500	5
250	90	150-250	15
150	75	100-150	15
100	60	75-100	10
75	50	50-75	5
50	45	20-50	10
20	35	8-20	15
8	20	5-8	10
5	10	2-5	5
2	5	<2	5

Stormceptor®EF Sizing Report

Upstream Flow Controlled Results

Rainfall Intensity (mm / hr)	Percent Rainfall Volume (%)	Cumulative Rainfall Volume (%)	Flow Rate (L/s)	Flow Rate (L/min)	Surface Loading Rate (L/min/m <sup>2</sup> )	Removal Efficiency (%)	Incremental Removal (%)	Cumulative Removal (%)
0.5	8.6	8.6	0.58	35.0	29.0	100	8.6	8.6
1	20.3	29.0	1.17	70.0	58.0	100	20.3	29.0
2	16.2	45.2	2.34	140.0	117.0	95	15.3	44.3
3	12.0	57.2	3.50	210.0	175.0	87	10.4	54.7
4	8.4	65.6	4.67	280.0	234.0	82	6.9	61.6
5	5.9	71.6	5.84	350.0	292.0	79	4.7	66.3
6	4.6	76.2	7.01	420.0	350.0	76	3.5	69.9
7	3.1	79.3	8.17	490.0	409.0	74	2.3	72.1
8	2.7	82.0	9.34	560.0	467.0	71	1.9	74.1
9	3.3	85.3	10.51	631.0	525.0	68	2.3	76.3
10	2.3	87.6	11.68	701.0	584.0	66	1.5	77.8
11	1.6	89.2	12.84	771.0	642.0	64	1.0	78.9
12	1.3	90.5	14.01	841.0	701.0	64	0.8	79.7
13	1.7	92.2	15.18	911.0	759.0	63	1.1	80.8
14	1.2	93.5	16.35	981.0	817.0	63	0.8	81.6
15	1.2	94.6	17.51	1051.0	876.0	63	0.7	82.3
16	0.7	95.3	18.68	1121.0	934.0	62	0.4	82.7
17	0.7	96.1	19.85	1191.0	992.0	62	0.5	83.2
18	0.4	96.5	21.02	1261.0	1051.0	60	0.2	83.4
19	0.4	96.9	22.18	1331.0	1109.0	59	0.2	83.7
20	0.2	97.1	23.35	1401.0	1168.0	58	0.1	83.8
21	0.5	97.5	24.52	1471.0	1226.0	56	0.3	84.0
22	0.2	97.8	25.69	1541.0	1284.0	55	0.1	84.2
23	1.0	98.8	26.85	1611.0	1343.0	54	0.5	84.7
24	0.3	99.1	28.02	1681.0	1401.0	52	0.1	84.9
25	0.0	99.1	29.19	1751.0	1460.0	50	0.0	84.9
30	0.9	100.0	35.03	2102.0	1751.0	42	0.4	85.2
35	0.0	100.0	36.00	2160.0	1800.0	41	0.0	85.2
40	0.0	100.0	36.00	2160.0	1800.0	41	0.0	85.2
45	0.0	100.0	36.00	2160.0	1800.0	41	0.0	85.2
<b>Estimated Net Annual Sediment (TSS) Load Reduction =</b>								<b>85 %</b>

Climate Station ID: 6105978 Years of Rainfall Data: 20





Stormceptor® **EF** Sizing Report

**RAINFALL DATA FROM OTTAWA CDA RCS RAINFALL STATION**

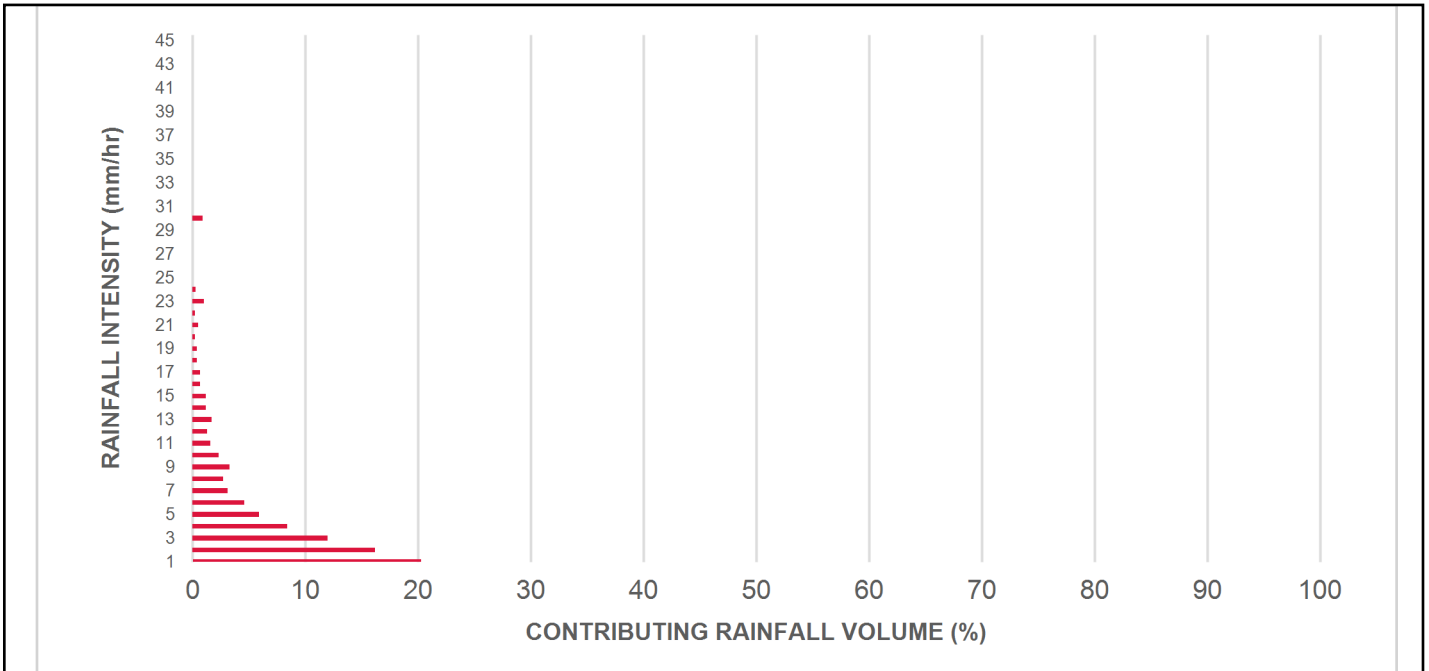

**INCREMENTAL AND CUMULATIVE TSS REMOVAL FOR THE RECOMMENDED STORMCEPTOR® MODEL**

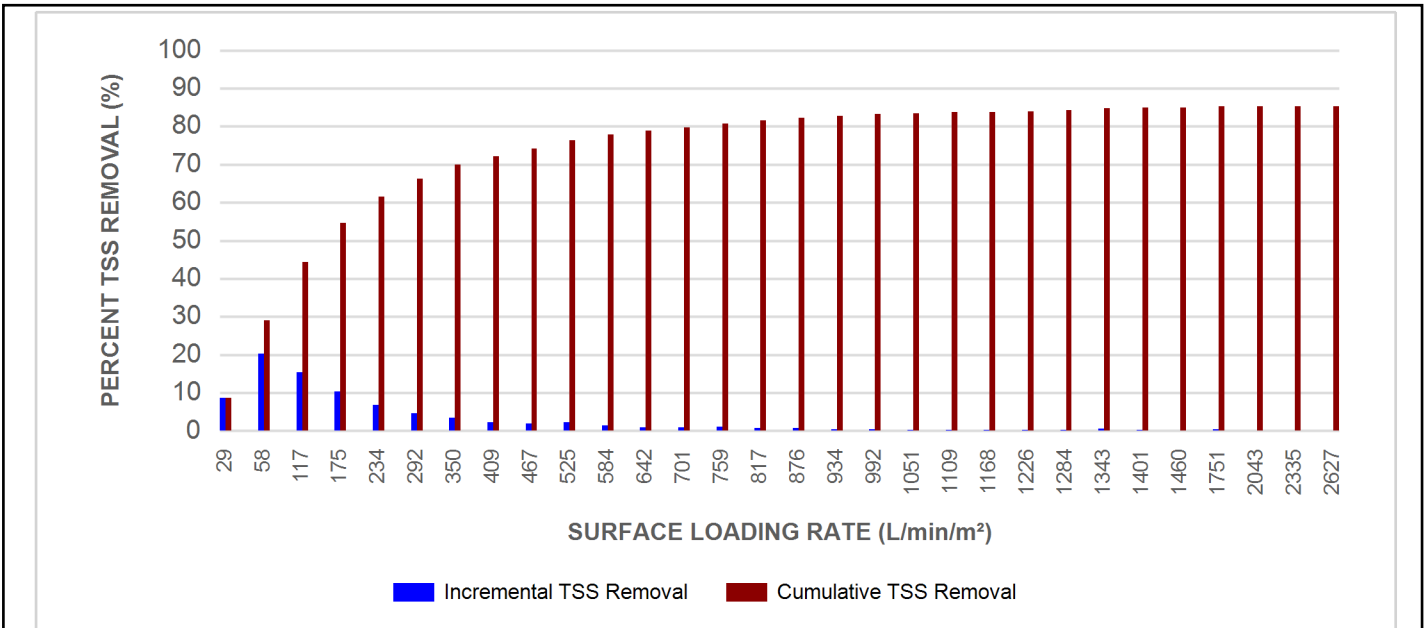

Stormceptor® **EF** Sizing Report

Maximum Pipe Diameter / Peak Conveyance

Stormceptor EF / EFO	Model Diameter		Min Angle Inlet / Outlet Pipes	Max Inlet Pipe Diameter		Max Outlet Pipe Diameter		Peak Conveyance Flow Rate	
	(m)	(ft)		(mm)	(in)	(mm)	(in)	(L/s)	(cfs)
EF4 / EFO4	1.2	4	90	609	24	609	24	425	15
EF6 / EFO6	1.8	6	90	914	36	914	36	990	35
EF8 / EFO8	2.4	8	90	1219	48	1219	48	1700	60
EF10 / EFO10	3.0	10	90	1828	72	1828	72	2830	100
EF12 / EFO12	3.6	12	90	1828	72	1828	72	2830	100

**SCOUR PREVENTION AND ONLINE CONFIGURATION**

► Stormceptor® EF and EFO feature an internal bypass and superior scour prevention technology that have been demonstrated in third-party testing according to the scour testing provisions of the Canadian ETV **Procedure for Laboratory Testing of Oil-Grit Separators**, and the exceptional scour test performance has been third-party verified in accordance with the ISO 14034 ETV protocol. As a result, Stormceptor EF and EFO are approved for online installation, eliminating the need for costly additional bypass structures, piping, and installation expense.

**DESIGN FLEXIBILITY**

► Stormceptor® EF and EFO offers design flexibility in one simplified platform, accepting stormwater flow from a single inlet pipe or multiple inlet pipes, and/or surface runoff through an inlet grate. The device can also serve as a junction structure, accommodate a 90-degree inlet-to-outlet bend angle, and can be modified to ensure performance in submerged conditions.

**OIL CAPTURE AND RETENTION**

► While Stormceptor® EF will capture and retain oil from dry weather spills and low intensity runoff, Stormceptor® EFO has demonstrated superior oil capture and greater than 99% oil retention in third-party testing according to the light liquid re-entrainment testing provisions of the Canadian ETV **Procedure for Laboratory Testing of Oil-Grit Separators**. Stormceptor EFO is recommended for sites where oil capture and retention is a requirement.

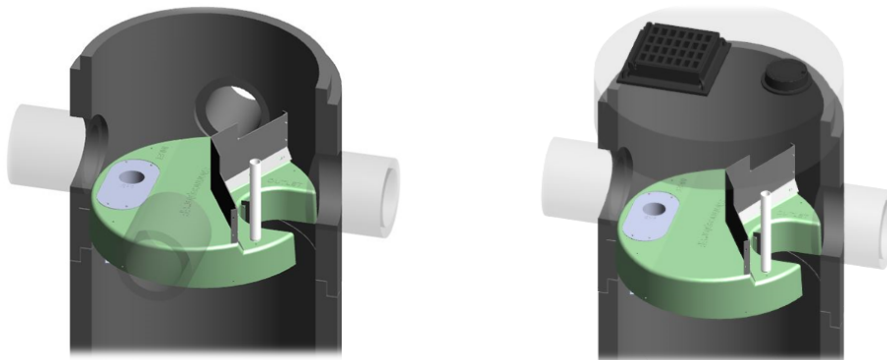

## Stormceptor® EF Sizing Report

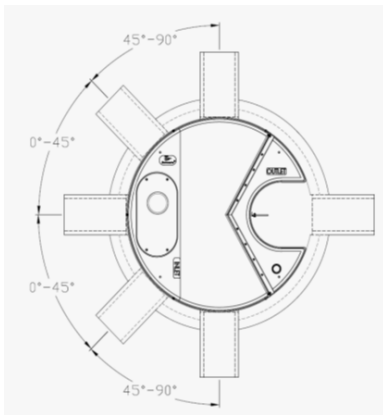

### INLET-TO-OUTLET DROP

Elevation differential between inlet and outlet pipe inverts is dictated by the angle at which the inlet pipe(s) enters the unit.

0° - 45° : The inlet pipe is 1-inch (25mm) higher than the outlet pipe.

45° - 90° : The inlet pipe is 2-inches (50mm) higher than the outlet pipe.

### HEAD LOSS

The head loss through Stormceptor EF is similar to that of a 60-degree bend structure. The applicable K value for calculating minor losses through the unit is 1.1.

For submerged conditions the applicable K value is 3.0.

### Pollutant Capacity

Stormceptor EF / EFO	Model Diameter		Depth (Outlet Pipe Invert to Sump Floor)		Oil Volume		Recommended Sediment Maintenance Depth *		Maximum Sediment Volume *		Maximum Sediment Mass **	
	(m)	(ft)	(m)	(ft)	(L)	(Gal)	(mm)	(in)	(L)	(ft³)	(kg)	(lb)
EF4 / EFO4	1.2	4	1.52	5.0	265	70	203	8	1190	42	1904	5250
EF6 / EFO6	1.8	6	1.93	6.3	610	160	305	12	3470	123	5552	15375
EF8 / EFO8	2.4	8	2.59	8.5	1070	280	610	24	8780	310	14048	38750
EF10 / EFO10	3.0	10	3.25	10.7	1670	440	610	24	17790	628	28464	78500
EF12 / EFO12	3.6	12	3.89	12.8	2475	655	610	24	31220	1103	49952	137875

\*Increased sump depth may be added to increase sediment storage capacity

\*\* Average density of wet packed sediment in sump = 1.6 kg/L (100 lb/ft³ )

Feature	Benefit	Feature Appeals To
Patent-pending enhanced flow treatment and scour prevention technology	Superior, verified third-party performance	Regulator, Specifying & Design Engineer
Third-party verified light liquid capture and retention for EFO version	Proven performance for fuel/oil hotspot locations	Regulator, Specifying & Design Engineer, Site Owner
Functions as bend, junction or inlet structure	Design flexibility	Specifying & Design Engineer
Minimal drop between inlet and outlet	Site installation ease	Contractor
Large diameter outlet riser for inspection and maintenance	Easy maintenance access from grade	Maintenance Contractor & Site Owner

### STANDARD STORMCEPTOR EF/EFO DRAWINGS

For standard details, please visit <http://www.imbriumsystems.com/stormwater-treatment-solutions/stormceptor-ef>

### STANDARD STORMCEPTOR EF/EFO SPECIFICATION

For specifications, please visit <http://www.imbriumsystems.com/stormwater-treatment-solutions/stormceptor-ef>

Stormceptor® **EF** Sizing Report

**STANDARD PERFORMANCE SPECIFICATION FOR  
“OIL GRIT SEPARATOR” (OGS) STORMWATER QUALITY TREATMENT DEVICE**

**PART 1 – GENERAL**

1.1 WORK INCLUDED

This section specifies requirements for selecting, sizing, and designing an underground Oil Grit Separator (OGS) device for stormwater quality treatment, with third-party testing results and a Statement of Verification in accordance with ISO 14034 Environmental Management – Environmental Technology Verification (ETV).

1.2 REFERENCE STANDARDS & PROCEDURES

ISO 14034:2016 Environmental management – Environmental technology verification (ETV)

Canadian Environmental Technology Verification (ETV) Program’s **Procedure for Laboratory Testing of Oil-Grit Separators**

1.3 SUBMITTALS

1.3.1 All submittals, including sizing reports & shop drawings, shall be submitted upon request with each order to the contractor then forwarded to the Engineer of Record for review and acceptance. Shop drawings shall detail all OGS components, elevations, and sequence of construction.

1.3.2 Alternative devices shall have features identical to or greater than the specified device, including: treatment chamber diameter, treatment chamber wet volume, sediment storage volume, and oil storage volume.

1.3.3 Unless directed otherwise by the Engineer of Record, OGS stormwater quality treatment product substitutions or alternatives submitted within ten days prior to project bid shall not be accepted. All alternatives or substitutions submitted shall be signed and sealed by a local registered Professional Engineer, based on the exact same criteria detailed in Section 3, in entirety, subject to review and approval by the Engineer of Record.

**PART 2 – PRODUCTS**

2.1 OGS POLLUTANT STORAGE

The OGS device shall include a sump for sediment storage, and a protected volume for the capture and storage of petroleum hydrocarbons and buoyant gross pollutants. The minimum sediment & petroleum hydrocarbon storage capacity shall be as follows:

2.1.1	4 ft (1219 mm) Diameter OGS Units:	1.19 m <sup>3</sup> sediment / 265 L oil
	6 ft (1829 mm) Diameter OGS Units:	3.48 m <sup>3</sup> sediment / 609 L oil
	8 ft (2438 mm) Diameter OGS Units:	8.78 m <sup>3</sup> sediment / 1,071 L oil
	10 ft (3048 mm) Diameter OGS Units:	17.78 m <sup>3</sup> sediment / 1,673 L oil
	12 ft (3657 mm) Diameter OGS Units:	31.23 m <sup>3</sup> sediment / 2,476 L oil

**PART 3 – PERFORMANCE & DESIGN**

3.1 GENERAL

The OGS stormwater quality treatment device shall be verified in accordance with ISO 14034:2016 Environmental management – Environmental technology verification (ETV). The OGS stormwater quality treatment device shall



## Stormceptor® EF Sizing Report

remove oil, sediment and gross pollutants from stormwater runoff during frequent wet weather events, and retain these pollutants during less frequent high flow wet weather events below the insert within the OGS for later removal during maintenance. The Manufacturer shall have at least ten (10) years of local experience, history and success in engineering design, manufacturing and production and supply of OGS stormwater quality treatment device systems, acceptable to the Engineer of Record.

### 3.2 SIZING METHODOLOGY

The OGS device shall be engineered, designed and sized to provide stormwater quality treatment based on treating a minimum of 90 percent of the average annual runoff volume and a minimum removal of an annual average 60% of the sediment (TSS) load based on the Particle Size Distribution (PSD) specified in the sizing report for the specified device. Sizing of the OGS shall be determined by use of a minimum ten (10) years of local historical rainfall data provided by Environment Canada. Sizing shall also be determined by use of the sediment removal performance data derived from the ISO 14034 ETV third-party verified laboratory testing data from testing conducted in accordance with the Canadian ETV protocol Procedure for Laboratory Testing of Oil-Grit Separators, as follows:

3.2.1 Sediment removal efficiency for a given surface loading rate and its associated flow rate shall be based on sediment removal efficiency demonstrated at the seven (7) tested surface loading rates specified in the protocol, ranging 40 L/min/m<sup>2</sup> to 1400 L/min/m<sup>2</sup>, and as stated in the ISO 14034 ETV Verification Statement for the OGS device.

3.2.2 Sediment removal efficiency for surface loading rates between 40 L/min/m<sup>2</sup> and 1400 L/min/m<sup>2</sup> shall be based on linear interpolation of data between consecutive tested surface loading rates.

3.2.3 Sediment removal efficiency for surface loading rates less than the lowest tested surface loading rate of 40 L/min/m<sup>2</sup> shall be assumed to be identical to the sediment removal efficiency at 40 L/min/m<sup>2</sup>. No extrapolation shall be allowed that results in a sediment removal efficiency that is greater than that demonstrated at 40 L/min/m<sup>2</sup>.

3.2.4 Sediment removal efficiency for surface loading rates greater than the highest tested surface loading rate of 1400 L/min/m<sup>2</sup> shall assume zero sediment removal for the portion of flow that exceeds 1400 L/min/m<sup>2</sup>, and shall be calculated using a simple proportioning formula, with 1400 L/min/m<sup>2</sup> in the numerator and the higher surface loading rate in the denominator, and multiplying the resulting fraction times the sediment removal efficiency at 1400 L/min/m<sup>2</sup>.

The OGS device shall also have sufficient annual sediment storage capacity as specified and calculated in Section 2.1.

### 3.3 CANADIAN ETV or ISO 14034 ETV VERIFICATION OF SCOUR TESTING

The OGS device shall have Canadian ETV or ISO 14034 ETV Verification of third-party scour testing conducted in accordance with the Canadian ETV Program's **Procedure for Laboratory Testing of Oil-Grit Separators**.

3.3.1 To be acceptable for on-line installation, the OGS device must demonstrate an average scour test effluent concentration less than 10 mg/L at each surface loading rate tested, up to and including 2600 L/min/m<sup>2</sup>.

### 3.4 LIGHT LIQUID RE-ENTRAINMENT SIMULATION TESTING

The OGS device shall have Canadian ETV or ISO 14034 ETV Verification of completed third-party Light Liquid Re-entrainment Simulation Testing in accordance with the Canadian ETV **Program's Procedure for Laboratory Testing of Oil-Grit Separators**, with results reported within the Canadian ETV or ISO 14034 ETV verification. This re-entrainment testing is conducted with the device pre-loaded with low density polyethylene (LDPE) plastic beads as a surrogate for light liquids such as oil and fuel. Testing is conducted on the same OGS unit tested for sediment removal to

## Stormceptor® EF Sizing Report

assess whether light liquids captured after a spill are effectively retained at high flow rates.

3.4.1 For an OGS device to be an acceptable stormwater treatment device on a site where vehicular traffic occurs and the potential for an oil or fuel spill exists, the OGS device must have reported verified performance results of greater than 99% cumulative retention of LDPE plastic beads for the five specified surface loading rates (ranging 200 L/min/m<sup>2</sup> to 2600 L/min/m<sup>2</sup>) in accordance with the Light Liquid Re-entrainment Simulation Testing within the Canadian ETV Program's **Procedure for Laboratory Testing of Oil-Grit Separators**. However, an OGS device shall not be allowed if the Light Liquid Re-entrainment Simulation Testing was performed with screening components within the OGS device that are effective at retaining the LDPE plastic beads, but would not be expected to retain light liquids such as oil and fuel.



# Adjustable Accutrol Weir

Tag: \_\_\_\_\_

## Adjustable Flow Control for Roof Drains

### ADJUSTABLE ACCUTROL (for Large Sump Roof Drains only)

For more flexibility in controlling flow with heads deeper than 2", Watts Drainage offers the Adjustable Accutrol. The Adjustable Accutrol Weir is designed with a single parabolic opening that can be covered to restrict flow above 2" of head to less than 5 gpm per inch, up to 6" of head. To adjust the flow rate for depths over 2" of head, set the slot in the adjustable upper cone according to the flow rate required. Refer to Table 1 below.  
 Note: Flow rates are directly proportional to the amount of weir opening that is exposed.

#### EXAMPLE:

For example, if the adjustable upper cone is set to cover 1/2 of the weir opening, flow rates above 2" of head will be restricted to 2-1/2 gpm per inch of head.

Therefore, at 3" of head, the flow rate through the Accutrol Weir that has 1/2 the slot exposed will be:  
 [5 gpm (per inch of head) x 2 inches of head ] + 2-1/2 gpm (for the third inch of head) = 12-1/2 gpm.

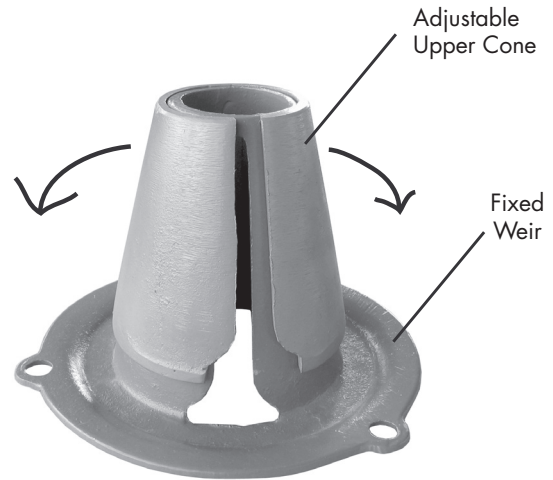
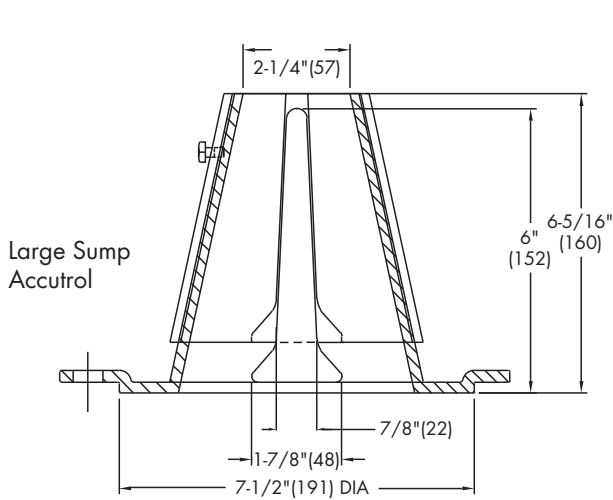

1/2 Weir Opening Exposed Shown Above

TABLE 1. Adjustable Accutrol Flow Rate Settings

Weir Opening Exposed	1"	2"	3"	4"	5"	6"
	Flow Rate (gallons per minute)					
Fully Exposed	5	10	15	20	25	30
3/4	5	10	13.75	17.5	21.25	25
1/2	5	10	12.5	15	17.5	20
1/4	5	10	11.25	12.5	13.75	15
Closed	5	5	5	5	5	5

Job Name \_\_\_\_\_  
 Job Location \_\_\_\_\_  
 Engineer \_\_\_\_\_

Contractor \_\_\_\_\_  
 Contractor's P.O. No. \_\_\_\_\_  
 Representative \_\_\_\_\_

Watts product specifications in U.S. customary units and metric are approximate and are provided for reference only. For precise measurements, please contact Watts Technical Service. Watts reserves the right to change or modify product design, construction, specifications, or materials without prior notice and without incurring any obligation to make such changes and modifications on Watts products previously or subsequently sold.

USA: Tel: (800) 338-2581 • Fax: (828) 248-3929 • Watts.com  
 Canada: Tel: (905) 332-4090 • Fax: (905) 332-7068 • Watts.ca  
 Latin America: Tel: (52) 81-1001-8600 • Fax: (52) 81-8000-7091 • Watts.com



A Watts Water Technologies Company





**APPENDIX H  
CITY OF OTTAWA DESIGN CHECKLIST**

# City of Ottawa

## 4. Development Servicing Study Checklist

The following section describes the checklist of the required content of servicing studies. It is expected that the proponent will address each one of the following items for the study to be deemed complete and ready for review by City of Ottawa Infrastructure Approvals staff.

The level of required detail in the Servicing Study will increase depending on the type of application. For example, for Official Plan amendments and re-zoning applications, the main issues will be to determine the capacity requirements for the proposed change in land use and confirm this against the existing capacity constraint, and to define the solutions, phasing of works and the financing of works to address the capacity constraint. For subdivisions and site plans, the above will be required with additional detailed information supporting the servicing within the development boundary.

### 4.1 General Content

Criteria	Location (if applicable)
<input type="checkbox"/> Executive Summary (for larger reports only).	N/A
<input type="checkbox"/> Date and revision number of the report.	On Cover
<input type="checkbox"/> Location map and plan showing municipal address, boundary, and layout of proposed development.	Appendix A
<input type="checkbox"/> Plan showing the site and location of all existing services.	Site Servicing Plan (C102)
<input type="checkbox"/> Development statistics, land use, density, adherence to zoning and official plan, and reference to applicable subwatershed and watershed plans that provide context to which individual developments must adhere.	1.1 Purpose 1.2 Site Description 6.0 Stormwater Management
<input type="checkbox"/> Summary of pre-consultation meetings with City and other approval agencies.	Appendix B
<input type="checkbox"/> Reference and confirm conformance to higher level studies and reports (Master Servicing Studies, Environmental Assessments, Community Design Plans), or in the case where it is not in conformance, the proponent must provide justification and develop a defensible design criteria.	1.1 Purpose 1.2 Site Description 6.0 Stormwater Management
<input type="checkbox"/> Statement of objectives and servicing criteria.	3.0 Pre-Consultation Summary

<input type="checkbox"/> Identification of existing and proposed infrastructure available in the immediate area.	N/A
<input type="checkbox"/> Identification of Environmentally Significant Areas, watercourses and Municipal Drains potentially impacted by the proposed development (Reference can be made to the Natural Heritage Studies, if available).	Site Grading Plan (C101)
<input type="checkbox"/> Concept level master grading plan to confirm existing and proposed grades in the development. This is required to confirm the feasibility of proposed stormwater management and drainage, soil removal and fill constraints, and potential impacts to neighbouring properties. This is also required to confirm that the proposed grading will not impede existing major system flow paths.	Site Grading Plan (C101)
<input type="checkbox"/> Identification of potential impacts of proposed piped services on private services (such as wells and septic fields on adjacent lands) and mitigation required to address potential impacts.	N/A
<input type="checkbox"/> Proposed phasing of the development, if applicable.	N/A
<input type="checkbox"/> Reference to geotechnical studies and recommendations concerning servicing.	Section 2.0 Background Studies, Standards and References
<input type="checkbox"/> All preliminary and formal site plan submissions should have the following information: <ul style="list-style-type: none"> <li>○ Metric scale</li> <li>○ North arrow (including construction North)</li> <li>○ Key plan</li> <li>○ Name and contact information of applicant and property owner</li> <li>○ Property limits including bearings and dimensions</li> <li>○ Existing and proposed structures and parking areas</li> <li>○ Easements, road widening and rights-of-way</li> <li>○ Adjacent street names</li> </ul>	Site Grading Plan (C101)

## 4.2 Development Servicing Report: Water

Criteria	Location (if applicable)
<input type="checkbox"/> Confirm consistency with Master Servicing Study, if available	N/A
<input type="checkbox"/> Availability of public infrastructure to service proposed development	N/A
<input type="checkbox"/> Identification of system constraints	N/A
<input type="checkbox"/> Identify boundary conditions	Appendix C
<input type="checkbox"/> Confirmation of adequate domestic supply and pressure	N/A
<input type="checkbox"/> Confirmation of adequate fire flow protection and confirmation that fire flow is calculated as per the Fire Underwriter’s Survey. Output should show available fire flow at locations throughout the development.	Appendix C
<input type="checkbox"/> Provide a check of high pressures. If pressure is found to be high, an assessment is required to confirm the application of pressure reducing valves.	N/A
<input type="checkbox"/> Definition of phasing constraints. Hydraulic modeling is required to confirm servicing for all defined phases of the project including the ultimate design	N/A
<input type="checkbox"/> Address reliability requirements such as appropriate location of shut-off valves	N/A
<input type="checkbox"/> Check on the necessity of a pressure zone boundary modification.	N/A
<input type="checkbox"/> Reference to water supply analysis to show that major infrastructure is capable of delivering sufficient water for the proposed land use. This includes data that shows that the expected demands under average day, peak hour and fire flow conditions provide water within the required pressure range	Appendix C, Section 4.2

<input type="checkbox"/> Description of the proposed water distribution network, including locations of proposed connections to the existing system, provisions for necessary looping, and appurtenances (valves, pressure reducing valves, valve chambers, and fire hydrants) including special metering provisions.	Site Servicing Plan (C101)
<input type="checkbox"/> Description of off-site required feeder mains, booster pumping stations, and other water infrastructure that will be ultimately required to service proposed development, including financing, interim facilities, and timing of implementation.	N/A
<input type="checkbox"/> Confirmation that water demands are calculated based on the City of Ottawa Design Guidelines.	Appendix C
<input type="checkbox"/> Provision of a model schematic showing the boundary conditions locations, streets, parcels, and building locations for reference.	N/A

#### 4.3 Development Servicing Report: Wastewater

Criteria	Location (if applicable)
<input type="checkbox"/> Summary of proposed design criteria (Note: Wet-weather flow criteria should not deviate from the City of Ottawa Sewer Design Guidelines. Monitored flow data from relatively new infrastructure cannot be used to justify capacity requirements for proposed infrastructure).	N/A
<input type="checkbox"/> Confirm consistency with Master Servicing Study and/or justifications for deviations.	N/A
<input type="checkbox"/> Consideration of local conditions that may contribute to extraneous flows that are higher than the recommended flows in the guidelines. This includes groundwater and soil conditions, and age and condition of sewers.	N/A
<input type="checkbox"/> Description of existing sanitary sewer available for discharge of wastewater from proposed development.	Section 5.2 Proposed Sanitary Sewer

<input type="checkbox"/> Verify available capacity in downstream sanitary sewer and/or identification of upgrades necessary to service the proposed development. (Reference can be made to previously completed Master Servicing Study if applicable)	Section 5.3 Proposed Sanitary Design
<input type="checkbox"/> Calculations related to dry-weather and wet-weather flow rates from the development in standard MOE sanitary sewer design table (Appendix 'C') format.	N/A
<input type="checkbox"/> Description of proposed sewer network including sewers, pumping stations, and forcemains.	Section 5.2 Proposed Sanitary Sewer
<input type="checkbox"/> Discussion of previously identified environmental constraints and impact on servicing (environmental constraints are related to limitations imposed on the development in order to preserve the physical condition of watercourses, vegetation, soil cover, as well as protecting against water quantity and quality).	N/A
<input type="checkbox"/> Pumping stations: impacts of proposed development on existing pumping stations or requirements for new pumping station to service development.	N/A
<input type="checkbox"/> Forcemain capacity in terms of operational redundancy, surge pressure and maximum flow velocity.	N/A
<input type="checkbox"/> Identification and implementation of the emergency overflow from sanitary pumping stations in relation to the hydraulic grade line to protect against basement flooding.	N/A
<input type="checkbox"/> Special considerations such as contamination, corrosive environment etc.	N/A

#### 4.4 Development Servicing Report: Stormwater Checklist

Criteria	Location (if applicable)
<input type="checkbox"/> Description of drainage outlets and downstream constraints including legality of outlets (i.e. municipal drain, right-of-way, watercourse, or private property)	Section 6.0 Stormwater Sewer Design & Section 7.0 Proposed Stormwater Management
<input type="checkbox"/> Analysis of available capacity in existing public infrastructure.	N/A
<input type="checkbox"/> A drawing showing the subject lands, its surroundings, the receiving watercourse, existing drainage patterns, and proposed drainage pattern.	Pre & Post-Development Plans
<input type="checkbox"/> Water quantity control objective (e.g. controlling post-development peak flows to pre-development level for storm events ranging from the 2 or 5-year event (dependent on the receiving sewer design) to 100-year return period); if other objectives are being applied, a rationale must be included with reference to hydrologic analyses of the potentially affected subwatersheds, taking into account long-term cumulative effects.	Section 6.0 Stormwater Sewer Design & Section 7.0 Proposed Stormwater Management
<input type="checkbox"/> Water Quality control objective (basic, normal or enhanced level of protection based on the sensitivities of the receiving watercourse) and storage requirements.	Section 6.0 Stormwater Sewer Design & Section 7.0 Proposed Stormwater Management
<input type="checkbox"/> Description of the stormwater management concept with facility locations and descriptions with references and supporting information.	Section 6.0 Stormwater Sewer Design & Section 7.0 Proposed Stormwater Management
<input type="checkbox"/> Set-back from private sewage disposal systems.	N/A
<input type="checkbox"/> Watercourse and hazard lands setbacks.	N/A
<input type="checkbox"/> Record of pre-consultation with the Ontario Ministry of Environment and the Conservation Authority that has jurisdiction on the affected watershed.	N/A
<input type="checkbox"/> Confirm consistency with sub-watershed and Master Servicing Study, if applicable study exists.	N/A
<input type="checkbox"/> Storage requirements (complete with calculations) and conveyance capacity for minor events (1:5-year return period) and major events (1:100-year return period).	Appendix G

<input type="checkbox"/> Identification of watercourses within the proposed development and how watercourses will be protected, or, if necessary, altered by the proposed development with applicable approvals.	Site Grading Plan
<input type="checkbox"/> Calculate pre-and post development peak flow rates including a description of existing site conditions and proposed impervious areas and drainage catchments in comparison to existing conditions.	Section 7.0 Proposed Stormwater Management Appendix G
<input type="checkbox"/> Any proposed diversion of drainage catchment areas from one outlet to another.	Section 6.0 Stormwater Sewer Design & Section 7.0 Proposed Stormwater Management
<input type="checkbox"/> Proposed minor and major systems including locations and sizes of stormwater trunk sewers, and stormwater management facilities.	Section 6.0 Stormwater Sewer Design & Section 7.0 Proposed Stormwater Management
<input type="checkbox"/> If quantity control is not proposed, demonstration that downstream system has adequate capacity for the post-development flows up to and including the 100-year return period storm event.	N/A
<input type="checkbox"/> Identification of potential impacts to receiving watercourses	N/A
<input type="checkbox"/> Identification of municipal drains and related approval requirements.	N/A
<input type="checkbox"/> Descriptions of how the conveyance and storage capacity will be achieved for the development.	Section 6.0 Stormwater Sewer Design & Section 7.0 Proposed Stormwater Management
<input type="checkbox"/> 100-year flood levels and major flow routing to protect proposed development from flooding for establishing minimum building elevations (MBE) and overall grading.	Site Grading Plan (C101)
<input type="checkbox"/> Inclusion of hydraulic analysis including hydraulic grade line elevations.	N/A



<input type="checkbox"/> Description of approach to erosion and sediment control during construction for the protection of receiving watercourse or drainage corridors.	Section 8.0 Sediment & Erosion Control, Erosion and Sediment Control Plan C103
<input type="checkbox"/> Identification of floodplains – proponent to obtain relevant floodplain information from the appropriate Conservation Authority. The proponent may be required to delineate floodplain elevations to the satisfaction of the Conservation Authority if such information is not available or if information does not match current conditions.	N/A
<input type="checkbox"/> Identification of fill constraints related to floodplain and geotechnical investigation.	N/A

#### 4.5 Approval and Permit Requirements: Checklist

The Servicing Study shall provide a list of applicable permits and regulatory approvals necessary for the proposed development as well as the relevant issues affecting each approval. The approval and permitting shall include but not be limited to the following:

Criteria	Location (if applicable)
<input type="checkbox"/> Conservation Authority as the designated approval agency for modification of floodplain, potential impact on fish habitat, proposed works in or adjacent to a watercourse, cut/fill permits and Approval under Lakes and Rivers Improvement Act. The Conservation Authority is not the approval authority for the Lakes and Rivers Improvement Act. Where there are Conservation Authority regulations in place, approval under the Lakes and Rivers Improvement Act is not required, except in cases of dams as defined in the Act.	N/A
<input type="checkbox"/> Application for Certificate of Approval (CofA) under the Ontario Water Resources Act.	N/A
<input type="checkbox"/> Changes to Municipal Drains.	N/A
<input type="checkbox"/> Other permits (National Capital Commission, Parks Canada, Public Works and Government Services Canada, Ministry of Transportation etc.)	N/A

## 4.6 Conclusion Checklist

Criteria	Location (if applicable)
<input type="checkbox"/> Clearly stated conclusions and recommendations	Section 9.0 Summary  Section 10.0 Recommendations
<input type="checkbox"/> Comments received from review agencies including the City of Ottawa and information on how the comments were addressed. Final sign-off from the responsible reviewing agency.	All are stamped
<input type="checkbox"/> All draft and final reports shall be signed and stamped by a professional Engineer registered in Ontario	All are stamped