

SERVICING & STORMWATER MANAGEMENT REPORT

56 CAPILANO DRIVE



Project No.: CCO-23-3325

City File No.: D07-12-23-0028

Prepared for:

CSV Architects
190 O'Connor Street
Ottawa, Ontario
K2P 2R3

Prepared by:

McIntosh Perry Consulting Engineers Ltd.
115 Walgreen Road
Carp, ON K0A 1L0

March 3, 2023

Rev02: June 30, 2023

TABLE OF CONTENTS

1.0	PROJECT DESCRIPTION	1
1.1	<i>Purpose</i>	1
1.2	<i>Site Description</i>	1
1.3	<i>Proposed Development and Statistics</i>	2
1.4	<i>Existing Conditions and Infrastructures</i>	2
1.5	<i>Approvals</i>	2
2.0	BACKGROUND STUDIES, STANDARDS, AND REFERENCES.....	3
2.1	<i>Background Reports / Reference Information</i>	3
2.2	<i>Applicable Guidelines and Standards</i>	3
3.0	PRE-CONSULTATION SUMMARY	4
4.0	WATERMAIN	5
4.1	<i>Existing Watermain</i>	5
4.2	<i>Proposed Watermain</i>	5
5.0	SANITARY DESIGN	7
5.1	<i>Existing Sanitary Sewer</i>	7
5.2	<i>Proposed Sanitary Sewer</i>	7
6.0	STORM SEWER DESIGN	9
6.1	<i>Existing Storm Sewers</i>	9
6.2	<i>Proposed Storm Sewers</i>	9
7.0	PROPOSED STORMWATER MANAGEMENT	10
7.1	<i>Design Criteria and Methodology</i>	10
7.2	<i>Runoff Calculations</i>	10
7.3	<i>Pre-Development Drainage</i>	11
7.4	<i>Post-Development Drainage</i>	11
7.4.1	<i>Post-Development Drainage Areas</i>	12
7.5	<i>Quality Control</i>	12
8.0	EROSION AND SEDIMENT CONTROL.....	13
8.1	<i>Temporary Measures</i>	13
8.2	<i>Permanent Measures</i>	13

9.0	SUMMARY	14
10.0	RECOMMENDATION	15
11.0	STATEMENT OF LIMITATIONS	16

LIST OF TABLES

Table 1: Water Supply Design Criteria	5
Table 2: Summary of Estimated Water Demand	6
Table 3: Available Fire Flow Based on Hydrant Spacing	7
Table 4: Sanitary Design Criteria	7
Table 5: Summary of Estimated Sanitary Flow	8
Table 6: Pre-Development Runoff Summary	11
Table 7: Required Restricted Flow	11
Table 8: Post-Development Controlled Runoff Summary	11
Table 9: Roof Drainage Summary	12

APPENDICES

Appendix A: Site Location Plan

Appendix B: Background Documents

Appendix C: Watermain Calculations

Appendix D: Sanitary Calculations

Appendix E: Pre-Development Drainage Plan

Appendix F: Post-Development Drainage Plan

Appendix G: Stormwater Management Calculations

Appendix H: City of Ottawa Design Checklist

1.0 PROJECT DESCRIPTION

1.1 Purpose

McIntosh Perry (MP) has been retained by CSV Architects to prepare this Servicing and Stormwater Management Report in support of the Site Plan Control process for the proposed development located at 56 Capilano Drive within the City of Ottawa.

The main purpose of this report is to present a servicing and stormwater management design for the development in accordance with the recommendations and guidelines provided by the City of Ottawa (City), the Rideau Valley Conservation Authority (RVCA), and the Ministry of the Environment, Conservation and Parks (MECP). This report will address the water, sanitary and storm sewer servicing for the development, ensuring that existing and available services will adequately service the proposed development.

This report should be read in conjunction with the following drawings:

- CCO-23-3325, C101 – Lot Grading, Drainage, Servicing, Erosion & Sediment Control Plan
- CCO-23-3325, PRE – Pre-Development Drainage Plan (*Appendix E*)
- CCO-23-3325, POST – Post-Development Drainage Plan (*Appendix F*)

1.2 Site Description

Figure 1: Site Map



The subject property, herein referred to as “the site”, is located at 56 Capilano Drive within the Knoxdale-Merivale Ward. The site covers approximately 0.28 ha and is located along Capilano Drive between Kerry Crescent and Gilbey Drive. The site is zoned for Residential Fourth Density (R4Z). See Site Location Plan in *Appendix ‘A’* for more details.

1.3 Proposed Development and Statistics

The proposed development consists of the addition of a 4-unit townhouse block and a 4-storey 54-unit apartment building, complete with surface parking and street access from Capilano Drive. The development is proposed within 0.28 ha of the site. Refer to *Site Plan* prepared by CSV Architects and included in *Appendix B* for further details.

1.4 Existing Conditions and Infrastructures

The site previously contained a two-storey building and attached curling rink, which have since been demolished. Presently, the site is undeveloped.

Sewer and watermain mapping collected from the City of Ottawa indicate that the following services exist across the property frontages within the adjacent municipal rights-of-way(s):

- ❖ Capilano Drive
 - 152 mm diameter CI watermain, a
 - 200 mm diameter AC sanitary sewer, and a
 - 375 mm diameter concrete storm sewer, tributary to the Rideau Waterway approximately 3.7km downstream.

1.5 Approvals

The proposed development is subject to the City of Ottawa site plan control approval process. Site plan control requires the City to review, provide concurrence and approve the engineering design package. Permits to construct can be requested once the City has issued a site plan agreement.

An Environmental Compliance Approval (ECA) through the Ministry of Environment, Conservation and Parks (MECP) is not anticipated to be required since the proposed storm sewer system services one parcel of land and industrial use is not proposed.

2.0 BACKGROUND STUDIES, STANDARDS, AND REFERENCES

2.1 Background Reports / Reference Information

As-built drawings of existing services, provided by the City of Ottawa Information centre, within the vicinity of the proposed site were reviewed in order to identify infrastructure available to service the proposed development.

A topographic survey (V22200) of the site was completed by Fairhall, Moffat & Woodland and dated July 21st, 2016.

The Site Plan (A100) was prepared by CSV Architects (*Site Plan*).

2.2 Applicable Guidelines and Standards

City of Ottawa:

- ◆ Ottawa Sewer Design Guidelines, City of Ottawa, SDG002, October 2012. (*Ottawa Sewer Guidelines*)
 - Technical Bulletin ISTB-2014-01 City of Ottawa, February 2014. (*ISTB-2014-01*)
 - Technical Bulletin PIEDTB-2016-01 City of Ottawa, September 2016. (*PIEDTB-2016-01*)
 - Technical Bulletin ISTB-2018-01 City of Ottawa, January 2018. (*ISTB-2018-01*)
 - Technical Bulletin ISTB-2018-04 City of Ottawa, March 2018. (*ISTB-2018-04*)
 - Technical Bulletin ISTB-2019-02 City of Ottawa, February 2019. (*ISTB-2019-02*)
- ◆ Ottawa Design Guidelines – Water Distribution City of Ottawa, July 2010. (*Ottawa Water Guidelines*)
 - Technical Bulletin ISD-2010-2 City of Ottawa, December 15, 2010. (*ISD-2010-2*)
 - Technical Bulletin ISDTB-2014-02 City of Ottawa, May 2014. (*ISDTB-2014-02*)
 - Technical Bulletin ISTB-2018-02 City of Ottawa, March 2018. (*ISTB-2018-02*)
 - Technical Bulletin ISTB-2021-03 City of Ottawa, August 2021. (*ISTB-2021-03*)

Ministry of Environment, Conservation and Parks:

- ◆ Stormwater Planning and Design Manual, Ministry of the Environment, March 2003. (*MECP Stormwater Design Manual*)
- ◆ Design Guidelines for Sewage Works, Ministry of the Environment, 2008. (*MECP Sewer Design Guidelines*)

Other:

- ◆ Water Supply for Public Fire Protection, Fire Underwriters Survey, 2020. (*FUS Guidelines*)

3.0 PRE-CONSULTATION SUMMARY

A pre-consultation meeting was held with City staff on December 16th, 2021 regarding the proposed site servicing. Specific design parameters to be incorporated within this design include the following:

- Pre-development and post-development flows shall be calculated using a time of concentration (T_c) no less than 10 minutes.
- Control 100-year post-development flows to the 2-year pre-development flow with a combined C value to a maximum of 0.50.

Based on further discussion with City staff included in *Appendix B*, the pre-development C value can be based on the previously developed condition, up to a maximum of 0.5.

4.0 WATERMAIN

4.1 Existing Watermain

The site is located within the ME pressure zone, as per the Water Distribution System mapping included in *Appendix C*. There are two municipal fire hydrants available to service the proposed development, located at the corner of Capilano Drive and Kerry Crescent, and at the corner of Capilano Drive and Gilbey Drive.

4.2 Proposed Watermain

It is proposed to service the property with a dual 150 mm diameter water service connected to the existing 152 mm diameter watermain within Capilano Drive. The townhouse block will be serviced by a 50 mm diameter water lateral connected to the new 150 mm diameter water service within the site limits. A dual 150 mm diameter water service connection is proposed to provide redundancy due to the number of units on the site.

Table 1, below, summarizes the water supply design criteria obtained from the *Ottawa Water Guidelines* and utilized for the water analysis.

Table 1: Water Supply Design Criteria

Site Area	0.28 ha
Townhouse Block	4 Units
Apartment Building	54 Studio Apartments
Residential	280 L/day/person
Residential Apartment – 1 Bedroom/Studio	1.4 person/unit
Townhouse	2.7 person/unit
Max Day Peaking Factor - Residential	7.3 x avg. day
Peak Hour Peaking Factor - Residential	11.0 x avg. day
Average Day Demand	0.28 L/s
Max Day Demand	2.06 L/s
Peak Hour Demand	3.11 L/s

The OBC and Fire Underwriters Survey 2020 (FUS) methods were utilized to estimate the required fire flow for the proposed building and townhouse block. Fire flow requirements were calculated per City of Ottawa Technical Bulletin *ISTB-2018-02*. The following parameters were utilized for the calculations:

FUS:

- ❖ Type of construction – Non-Combustible Construction (Apartment), Wood Frame (Townhouse Block)
- ❖ Occupancy Type – Limited Combustible (Apartment and Townhouse Block)

- ❖ Sprinkler Protection – Standard Sprinkler System (Apartment), Non-Sprinklered (Townhouse Block)

OBC:

- ❖ Type of construction – Non-Combustible Construction (Apartment), Combustible Construction (Townhouse Block)
- ❖ Occupancy Type: Group C
- ❖ Water Supply Coefficient (K): 16 (Apartment), 23 (Townhouse Block)

The results of the FUS calculations yielded a maximum required fire flow of 7,000 L/min (116.67 L/s), and the results of the OBC calculations yielded a maximum required fire flow of 9,000 L/min (150.0 L/s). The detailed calculations for the FUS and OBC can be found in *Appendix C*.

The City provided the estimated water pressures at both the average day scenario, peak hour scenario, and the max day plus fire flow scenario for the demands indicated by the correspondence in *Appendix C*. The resulting pressures for the boundary conditions results are shown in *Table 2*, below.

Table 2: Summary of Estimated Water Demand

Scenario	Proposed Demands (L/S)	Connection 1 HGL (m H ₂ O)* /kPa
Average Day Demand	0.28	65.1 / 638.6
Maximum Daily + Fire Flow Demand (FUS)	118.73	51.3 / 503.3
Peak Hourly Demand	3.11	53.7 / 526.8
<i>*Adjusted for an estimated top of watermain elevation of 93.2m</i>		

The normal operating pressure range is anticipated to be 526.8 kPa to 638.6 kPa and will not be less than 275 kPa (40 psi) or exceed 689 kPa (100 psi). The proposed watermains will meet the minimum required 20 psi (140 kPa) from the *Ottawa Water Guidelines* at the ground level under maximum day demand and fire flow conditions. Further coordination with the mechanical designer may be required to determine if a pressure reducing valve is required, as the pressure is expected to exceed 80 psi (551 kpa) during the average day scenario.

To confirm the adequacy of fire flow to protect the proposed development, existing hydrants within 150 m of the proposed building were analysed per City of Ottawa *ISTB 2018-02 Appendix I Table 1*. The results are summarized below. A hydrant coverage figure can be found in *Appendix C*.

Table 3: Available Fire Flow Based on Hydrant Spacing

Building Location	Fire Flow Demand (L/min.)	Fire Hydrant(s) within 75m (5,700 L/min)	Fire Hydrant(s) within 150m (3,800 L/min)	Fire Flow Contribution (L/min)
56 Capilano Drive	9,000 (OBC) 7,000 (FUS)	1 Public 1 Private (Proposed)	1 Public	15,200

5.0 SANITARY DESIGN

5.1 Existing Sanitary Sewer

There is an existing 200 mm diameter asbestos cement sanitary sewer located within Capilano Drive available to service the proposed development.

5.2 Proposed Sanitary Sewer

A new 150 mm diameter PVC gravity sanitary service will be extended from the 200 mm diameter sanitary main within Capilano Drive to service the proposed apartment building. The townhouse block will be serviced via a 135 mm diameter service connection to the new 150 mm diameter sanitary service within the site limits. Refer to drawing C102 for a detailed servicing layout.

Table 4, below, summarizes the wastewater design criteria identified by the *Ottawa Sewer Guidelines*.

Table 4: Sanitary Design Criteria

Design Parameter	Value
Site Area	0.28 ha
Residential	280 L/person/day
1 Bedroom Apartment	1.4 persons/unit
Townhouse	2.7 persons/unit
Residential Peaking Factor	3.61
Extraneous Flow Allowance	0.33 L/s/ha
Estimated Population	87 persons

Table 5, below, summarizes the estimated wastewater flow from the proposed development. Refer to *Appendix D* for detailed calculations.

Table 5: Summary of Estimated Sanitary Flow

Design Parameter	Total Flow (L/s)
Total Estimated Average Dry Weather Flow	0.31
Total Estimated Peak Dry Weather Flow	1.05
Total Estimated Peak Wet Weather Flow	1.13

As noted above, the development is proposed to be serviced via a proposed 150 mm sanitary service connection to the 200 mm asbestos cement sanitary sewer within Capilano Drive.

The full flowing capacity of a 150 mm diameter service at 1.0% slope is estimated to be 15.89 L/s. Per *Table 5*, a peak wet weather flow of 1.13 L/s will be conveyed within the 150 mm diameter service, therefore the proposed system is sufficiently sized for the development.

The full flowing capacity of the existing 200 mm diameter sanitary sewer at 0.42% slope is estimated to be 22.17 L/s. Per *Table 5*, the proposed development will only occupy 5.1% of the sewer capacity, therefore capacity issues are not anticipated. Due to the complexity of the downstream network the City will need to advise of any downstream constraints.

6.0 STORM SEWER DESIGN

6.1 Existing Storm Sewers

Stormwater runoff from the existing site flows overland towards the Capilano Drive ROW. Runoff is then collected by municipal infrastructure, and travels approximately 3.7km downstream before discharging into the Rideau Waterway.

6.2 Proposed Storm Sewers

The proposed development will be serviced through a new 300 mm storm service connection to the existing 375 mm diameter concrete storm sewer within Capilano Drive.

Runoff collected on the roof of the proposed apartment building will be stored and controlled internally using 2 roof drains. The roof drains will be used to limit the flow from the roof to the specified allowable release rate. Roof drainage will be directed to the proposed maintenance hole MH2. For calculation purposes a Watts Accutrol roof drain in the $\frac{3}{4}$ open position was used to estimate a reasonable roof flow. Other products may be specified at detailed building design provided that the proposed release rates and storage volumes are achieved.

Runoff from the townhouse block and surface parking lot will be restricted by Tempest inlet control devices (ICD) located within structures CB1 and CB3. The restricted flow will discharge through the proposed 300 mm diameter storm service to the 375 mm diameter storm sewer within Capilano Drive.

Foundation drainage for the townhouse block is proposed to be conveyed via a 150 mm diameter storm lateral connected to the new 300 mm diameter storm service.

Foundation drainage for the apartment building is proposed to be conveyed via a 200 mm storm lateral connected to the proposed maintenance hole MH2, complete with a backwater valve.

See CCO-23-3325 - *POST* include in *Appendix F* of this report for more details. The Stormwater Management design for the subject property will be outlined in *Section 7.0* of this report.

7.0 PROPOSED STORMWATER MANAGEMENT

7.1 Design Criteria and Methodology

As per *Section 6.2*, stormwater management for the proposed development will be provided by surface and roof storage. The controlled stormwater flow will be directed to the existing 375 mm diameter storm sewer within Capilano Drive.

In summary, the following design criteria have been employed in developing the stormwater management design for the site as directed by the RVCA and City:

Quality Control

- Based on coordination with City Staff included in *Appendix B*, quality controls are not required based on the distance to the outlet.

Quantity Control

- Any storm events greater than the 2-year, up to, and including the 100-year storm event must be detained on site.
- Post-development flow to be restricted to the 2-year storm event, based on a calculated time of concentration of at least 10 minutes and a combined maximum rational method coefficient of 0.50. Refer to *Section 7.2* for further details.
- Based on coordination with City Staff included in *Appendix B*, the runoff coefficient can be based upon the previously developed site condition, up to a maximum of 0.5.

7.2 Runoff Calculations

Runoff calculations presented in this report are derived using the Rational Method, given as:

$$Q = 2.78CIA \text{ (L/s)}$$

Where:	C	= Runoff coefficient
	I	= Rainfall intensity in mm/hr (City of Ottawa IDF curves)
	A	= Drainage area in hectares

It is recognized that the Rational Method tends to overestimate runoff rates. As a result, the conservative calculation of runoff ensures that any SWM facility sized using this method is expected to function as intended. The following coefficients were used to develop an average C for each area:

Roofs/Concrete/Asphalt	0.90
Undeveloped and Grass	0.20

As per the *City of Ottawa - Sewer Design Guidelines*, the 5-year balanced 'C' value must be increased by 25% for a 100-year storm event to a maximum of 1.0.

7.3 Pre-Development Drainage

It has been assumed that the pre-development area contains no stormwater management controls for flow attenuation. The estimated pre-development peak flows for the 2-, 5-, and 100-year events are summarized below in *Table 6*. See CCO-23-3325 - *PRE* in *Appendix E* and *Appendix G* for calculations.

Table 6: Pre-Development Runoff Summary

Drainage Area	Area (ha)	C 2/5 & 100- Year	Q (L/s)		
			2-Year	5-Year	100-Year
A1	0.28	0.64 / 0.72	37.93	51.45	99.39
Total	0.28	-	37.93	51.45	99.39

7.4 Post-Development Drainage

To meet the stormwater objectives, the development will contain flow attenuation via rooftop and surface storage. *Table 7*, below, summarizes the required restricted flow for the site.

Table 7: Required Restricted Flow

Drainage Area	Area (ha)	C (2-Year)	Q (L/s) 2-Year
A1	0.28	0.50	29.62

Based on the criteria listed in *Section 7.1*, the development will be required to restrict flow to the 2-year storm event with a maximum runoff coefficient of 0.50. It is estimated that the target release rate during the 100-year event will be 29.62 L/s. See *Appendix G* for calculations.

The proposed site drainage limits are demonstrated on the Post-Development Drainage Area Plan. See CCO-23-3325 - *POST* in *Appendix F* of this report for more details. A summary of the post-development runoff calculations can be found below.

Table 8: Post-Development Controlled Runoff Summary

Drainage Area	Unrestricted Flow (L/S)		Restricted Flow (L/S)		Storage Required (m ³)		Storage Provided (m ³)	
	5-year	100-Year	5-Year	100-Year	5-Year	100-Year	5-Year	100-Year
B1	20.21	38.49	1.83	3.15	16.45	32.01	17.57	32.95
B2	20.64	39.71	7.30	7.44	8.33	23.47	9.16	24.66
B3	11.06	21.24	5.78	5.91	3.17	10.04	3.59	11.30
B4	6.53	13.05	6.53	13.05				
Total	58.45	112.49	21.44	29.56	27.95	65.52	30.32	68.91

7.4.1 Post-Development Drainage Areas

Runoff from area B1 will be controlled and stored on the roof of the proposed building (B1) using two (2) roof drains. The roof drains will be used to limit the flow from the roof to the specified allowable release rate. For calculation purposes a Watts Accutrol roof drain in the ¾ open position was used to estimate a reasonable roof flow. Other products may be specified at detailed building design provided release rates and storage volumes are respected.

Runoff for areas B2 and B3 is comprised of surface runoff from the parking and landscaped areas, and roof runoff from the townhouse block.

Runoff for area B2 will be directed towards the proposed catch basin CB1. Flow will be restricted by a Tempest LMF80 ICD in the outlet of CB1 to a maximum release rate of 7.44 L/s, allowing for a proposed 24.66 m³ of storage.

Runoff for area B3 will be directed towards the proposed catch basin CB3. Flow will be restricted by a Tempest LMF75 ICD in the outlet of CB3 to a maximum release rate of 5.91 L/s, allowing for a proposed 11.30 m³ of storage.

Runoff for area B4 will be unrestricted and compensated for in areas with flow restriction.

As seen in *Table 9* below, roof runoff will be restricted to a maximum release rate of 3.15 L/s, allowing for a proposed roof storage volume of 32.95 m³, resulting in a maximum drawdown time of 169 minutes. Emergency roof scuppers have been proposed to ensure roof ponding does not exceed 150 mm.

Table 9: Roof Drainage Summary

Drainage Area	Area (ha)	# of Roof Drains	Storage Volume (m ³)		Total Flow Rate (L/s)		Drawdown Time (min)	
			5-Year	100-Year	5-Year	100-Year	5-Year	100-Year
B1	0.08	2	16.45	32.01	1.83	3.15	150	169
Total	0.08	2	16.45	32.01	1.83	3.15	150	169

7.5 Quality Control

As noted in *Section 7.1*, quality controls are required based on coordination with City Staff. Correspondence can be found in *Appendix B*.

8.0 EROSION AND SEDIMENT CONTROL

8.1 Temporary Measures

Before construction begins, temporary silt fence, straw bale or rock flow check dams will be installed at all-natural runoff outlets from the property. It is crucial that these controls be maintained throughout construction and inspection of sediment and erosion control will be facilitated by the Contractor or Contract Administration staff throughout the construction period.

Silt fences will be installed where shown on the final engineering plans, specifically along the downstream property limits. The Contractor, at their discretion or at the instruction of the City, Conservation Authority or the Contract Administrator shall increase the quantity of sediment and erosion controls on-site to ensure that the site is operating as intended and no additional sediment finds its way off site. The rock flow, straw bale & silt fence check dams and barriers shall be inspected weekly and after rainfall events. Care shall be taken to properly remove sediment from the fences and check dams as required. Fibre roll barriers are to be installed at all existing curb inlet catch basins and filter fabric is to be placed under the grates of all existing catch basins and manholes along the frontage of the site and any new structures immediately upon installation. The measures for the existing/proposed structures are to be removed only after all areas have been paved. Care shall be taken at the removal stage to ensure that any silt that has accumulated is properly handled and disposed of. Removal of silt fences without prior removal of the sediments shall not be permitted.

Although not anticipated, work through winter months shall be closely monitored for erosion along sloped areas. Should erosion be noted, the Contractor shall be alerted and shall take all necessary steps to rectify the situation. Should the Contractor's efforts fail at remediating the eroded areas, the Contractor shall contact the City and/or Conservation Authority to review the site conditions and determine the appropriate course of action. As the ground begins to thaw, the Contractor shall place silt fencing at all required locations as soon as ground conditions warrant. Please see the *Site Grading, Drainage and Sediment & Erosion Control Plan* for additional details regarding the temporary measures to be installed and their appropriate OPSD references.

8.2 Permanent Measures

It is expected that the Contractor will promptly ensure that all disturbed areas receive topsoil and seed/sod and that grass be established as soon as possible. Any areas of excess fill shall be removed or levelled as soon as possible and must be located a sufficient distance from any watercourse to ensure that no sediment is washed out into the watercourse. As the vegetation growth within the site provides a key component to the control of sediment for the site, it must be properly maintained once established. Once the construction is complete, it will be up to the landowner to maintain the vegetation and ensure that the vegetation is not overgrown or impeded by foreign objects.

9.0 SUMMARY

- A new 4-storey 775 m² apartment building and 4-unit townhouse block are proposed to be constructed at 56 Capilano Drive. The development is proposed within 0.28 ha of the site.
- It is proposed to service the new building through a new dual 150 mm diameter water service and 150 mm diameter sanitary service. A new 300 mm diameter storm service is proposed to collect and control drainage within the development area.
- It is proposed to service the townhouse block with a new 50 mm diameter water service, 135 mm diameter sanitary service, and 150 mm diameter storm service. Services for the townhouse block will be connected to the proposed 150 mm diameter water, 150 mm diameter sanitary, and 300 mm diameter storm services.
- It is proposed to manage stormwater for the development area via surface and roof storage. The storm system will connect to the existing 375 mm diameter concrete storm sewer located within Capilano Drive.
- Storage for the 5- through 100-year storm events will be provided on the roof and in the parking area.
- Quality controls are not required based on coordination with City staff.

10.0 RECOMMENDATION

Based on the information presented in this report, we recommend that City of Ottawa approve this Servicing and Stormwater Management report in support of the proposed development at 56 Capilano Drive.

This report is respectfully being submitted for approval.

Regards,

McIntosh Perry Consulting Engineers Ltd.



Francis Valenti, EIT.
Engineering Intern, Land Development
E: f.valenti@mcintoshperry.com



James Hewson, P.Eng.
Project Engineer, Land Development
E: j.hewson@mcintoshperry.com

11.0 STATEMENT OF LIMITATIONS

This report was produced for the exclusive use of CSV Architects. The purpose of the report is to assess the existing stormwater management system and provide recommendations and designs for the post-construction scenario that are in compliance with the guidelines and standards from the Ministry of the Environment, Parks and Climate Change, City of Ottawa and local approval agencies. McIntosh Perry reviewed the site information and background documents listed in Section 2.0 of this report. While the previous data was reviewed by McIntosh Perry and site visits were performed, no field verification/measures of any information were conducted.





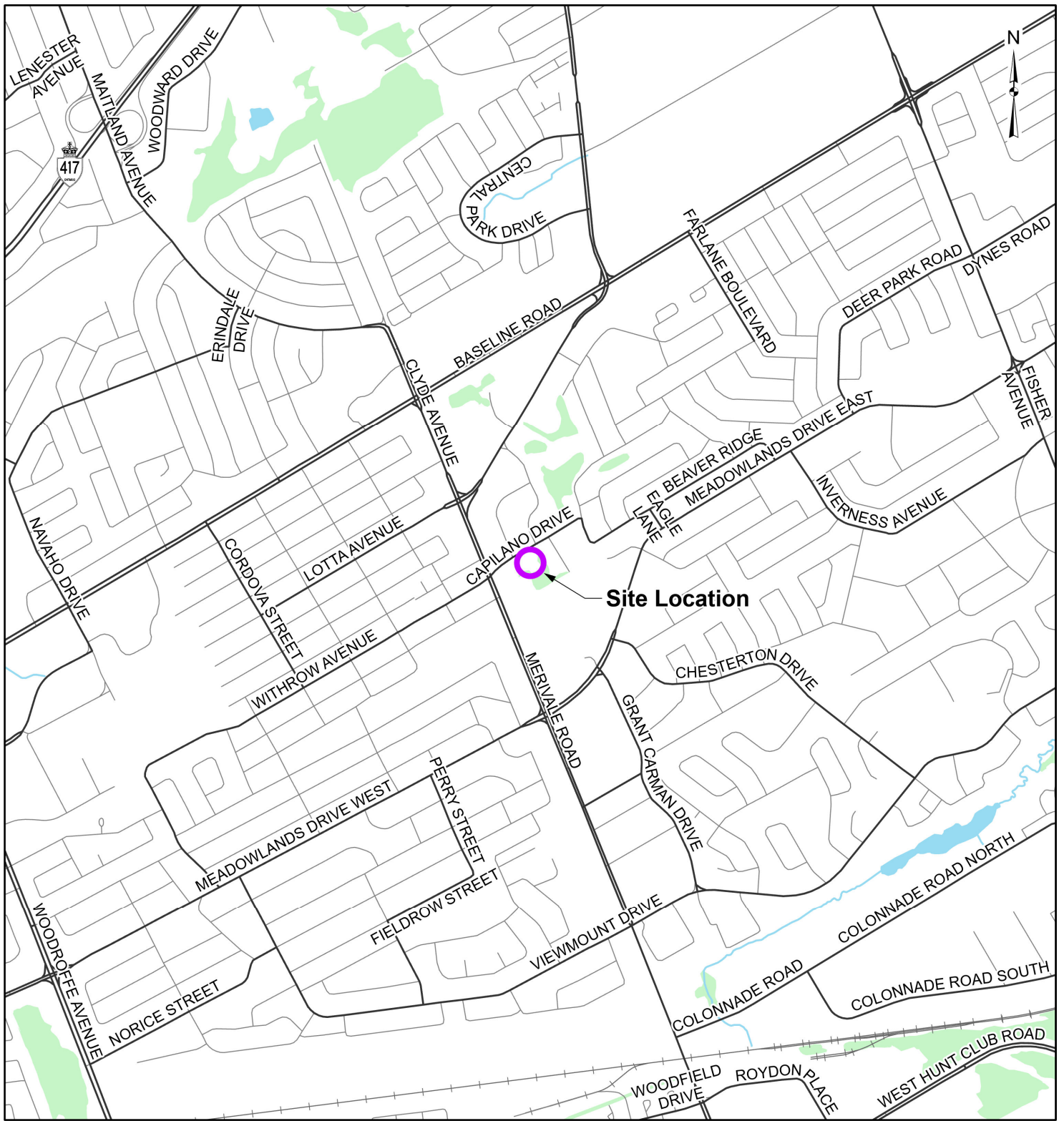

Any use of this review by a third party, or any reliance on decisions made based on it, without a reliance report is the responsibility of such third parties. McIntosh Perry accepts no responsibility for damages, if any, suffered by any third party as a result of decisions or actions made based on this review.

The findings, conclusions and/or recommendations of this report are only valid as of the date of this report. No assurance is made regarding any changes in conditions subsequent to this date. If additional information is discovered or becomes available at a future date, McIntosh Perry should be requested to re-evaluate the conclusions presented in this report, and provide amendments, if required.

APPENDIX A
KEY PLAN



LEGEND

-  Site Location
-  Local Road
-  Major Road
-  Railroad
-  Watercourse
-  Waterbody
-  Wooded Area

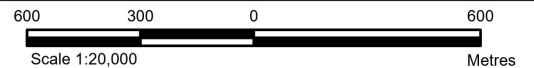

REFERENCE

GIS data provided by the Ontario Ministry of Natural Resources and Forestry, 2023.

CLIENT:	CSV ARCHITECTS	
PROJECT:	RESIDENTIAL DEVELOPMENT - 56 CAPILANO DRIVE	
TITLE:	SITE LOCATION	
McINTOSH PERRY <small>115 Walgreen Road, RR3, Carp, ON K0A1L0 Tel: 613-836-2184 Fax: 613-836-3742 www.mcintoshperry.com</small>	PROJECT NO: CCO-23-3325	FIGURE:
	Date	Feb., 28, 2023
	Checked By	FV
		1

APPENDIX B
BACKGROUND DOCUMENTS

Pre-Application Consultation Meeting Notes

Property Address: 56 Capilano Drive
PC2021-0425
December 16th, 2021

Attendees:

Applicant Team –

Bria Aird (Fotenn)
Haris Khan (Fotenn)
Brian Casagrande (Fotenn)
Daryl Hood (CSV Architecture)
Patrick McDonald (McDonald Brothers Construction)
Alessandro Guarna (McDonald Brothers Construction)

City Staff –

Molly Smith (Planning)
Abi Dieme (Infrastructure)
Pat McMahon (Transportation)
Louise Cerveny (Parks)
Adrian van Wyk (Urban Design)

Subject: 56 Capilano Drive

Meeting notes:

Overview of proposal

- A rezoning to facilitate future development, either a low-rise or low-mid-rise apartment building. Access will be shared from Capilano Drive with the existing driveway serving the City View Curling facility.
- Formerly there was a curling facility, was demolished and building moved, lot severed (flag lot).
- Considering a range of options and interested in flexibility for a range of uses.
- Looking into the possibility of working with OCH, seeking to reduce the parking rate and pursue a AM zone with height restriction.

Preliminary comments and questions from staff and agencies:

- Planning
 - Applicant seeking to rezone (Major Rezoning) the property from L1 to AM or R4.
 - Subject to public consultation – provide notice to all property owners within 120m of the site. Application goes to Council and is subject to an appeal process.
 - Under the old Official Plan, the designation is General Urban Area.
 - Under the new Official Plan, the site is designated Outer Urban Transect – Evolving Neighbourhood Overlay.
 - When preparing the planning rationale, both OP's need to be reviewed. If the application is submitted before Ministry adoption, whichever provisions are more restrictive between the old and new OP will apply.
 - In the new OP, sections and policies that are relevant to the proposal are:
 - Section 5.3.1 – speaks to low to mid-density development

- Lot must be able to provide suitable transition to abutting low-rise areas, in which case only low-rise development shall be permitted.
 - Section 5.3.3(3) – speaks to building heights
 - Section 5.6.1.1 – 150m from the boundary of a Mainstreet (evolving overlay for intensification)
 - Table 3A for minimum density requirements (page 131/138)
 - ROW protection – 24m
 - Size zoned as L1 – Community Leisure Facility Zone
 - Seeking a rezoning to either R4 or AM
 - R4 – permits low-rise apartment building
 - AM – would need to be along Merivale Road or provide other policies that would justify AM zoning
 - R4 is more appropriate based on local context and OP policies.
 - Parking Area C
 - Low-rise, mid-rise apartment: 1.2 per dwelling unit
 - Visitor parking: 0.2 per dwelling unit
 - Bicycle parking: 0.5 per dwelling unit, more is encouraged especially if a parking reduction is sought.
 - Great to see possible partnership with OCH.
 - The main building entrance should be along Capilano Drive.
 - Continue the pathway to the parking lot from Capilano, ensure pathways are well thought of and connected.
 - Include trees and increased landscaping along Capilano.
 - It would be great to see shared parking with the Curling Club.
 - Keeping in mind that the adjacent property on Merivale could change in the future, the building should be flipped to be along the east side.
 - It is recommended to reach out the Councillor Egli to discuss the proposal.
- Urban Design
 - A scoped Urban Design Brief will be required as part of a complete application. Please see the attached Terms of Reference for requirements.
 - The applicant is encouraged to consider shared parking arrangements with the neighbouring curling club, as well as to provide a space for car sharing.
 - The building should have a street-fronting main entrance off Capilano Drive.
 - The proposal should consider and respond to the possible future redevelopment of the neighbouring property to the west. The applicant should consider flipping the building so that its long side is along the east elevation and an amenity area can be created on the west side. Please see the illustration attached for reference.
 - The planting of street trees along Capilano Drive is strongly encouraged.
 - Please consider the [Urban Design Guidelines for Low-rise Infill](#).
- Engineering
 - Infrastructure Information – All existing and proposed utilities (municipal pipes) must be shown on the servicing plans
 - **Water:**
 - District Plan No. ME
 - Verify with ROW Approvals Unit if frontage charges apply (\$190.00 per metre) **Yes**
 No
 - Connection point: 152mm CI watermain on Capilano Drive



- Submission documents must include:
 - Boundary conditions (civil consultant to request boundary conditions from the City's assigned Project Manager, Development Review). Water boundary conditions request must include the location of the service and the expected loads required by the proposed development. Please provide all the following information:
 - Location of service (show on a plan or map)
 - Type of development and the amount of fire flow required.
 - Average daily demand: ___ l/s.
 - Maximum daily demand: ___ l/s.
 - Maximum hourly daily demand: ___ l/s.
 - Supporting Calculations for all demands listed above and required fire flow per Ontario Building Code (OBC) method or Fire Underwriter Surveys if the OBC method yields a fire flow of 9000 L/min.
- Watermain system analysis demonstrating adequate pressure per section 4.2.2 of the Water Distribution Guidelines.
- Fire protection (Fire demand, Hydrant Locations). A hydrant coverage table and map demonstrating adequate fire protection shall be included. Please review Technical Bulletin ISTB-2018-02, Appendix I table 1 – maximum flow to be considered from a given hydrant

Further note that:

- Residential buildings with a basic day demand greater than 50 m³/day shall be connected with a minimum of two water services, separated by an isolation valve, to avoid the creation of a vulnerable service area

Sanitary:

- Connection Point: 200mm AC sanitary main on Capilano Drive

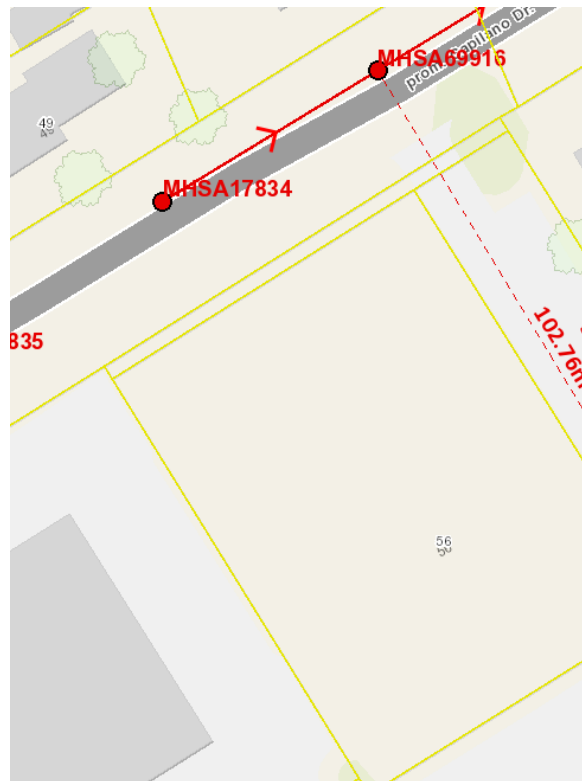

Is a monitoring manhole required on private property? Yes No

- Provide an analysis to demonstrate that there is adequate residual capacity in the receiving and downstream wastewater system to accommodate the proposed development
- Please apply the wastewater design flow parameters in Technical Bulletin PIEDTB-2018-01.

Storm:

Connection Point: 375mm Conc storm sewer on Capilano Drive.

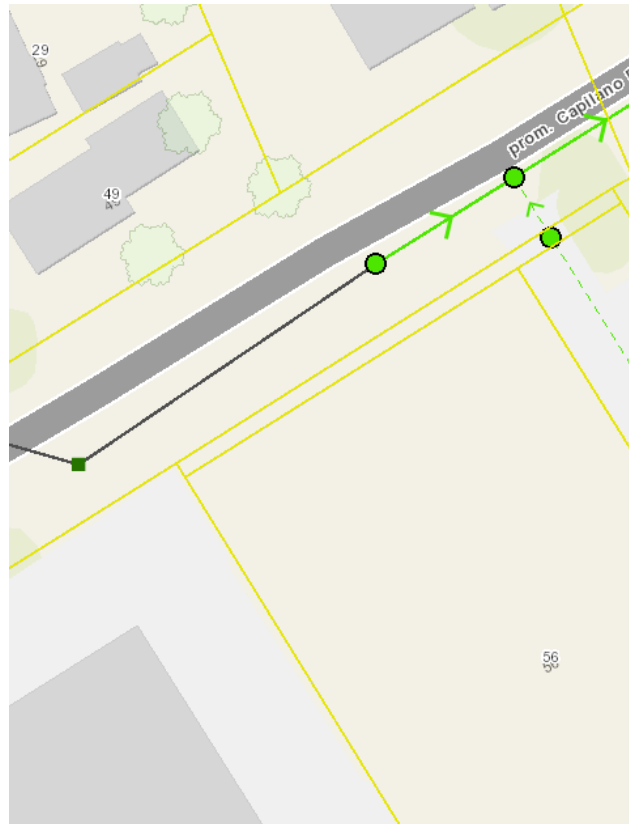

Stormwater Management:

- Quality Control:
 - Rideau Valley Conservation Authority to provide criteria.
- Quantity Control:
 - Design storm for receiving sewer: 2-year design storm
 - Runoff coefficient (C): $C=0.5$ or $C=\text{pre-development}$, whichever is less
 - Time of concentration (T_c): To be calculated, min $T_c=10\text{mins}$
 - Allowable flow rate: Control the 100-year event to the 2-year event

Please note that SWM calculations using the modified rational method is acceptable, however, if a combination of surface ponding and underground storage is used, the consultant is reminded to either: (a) use a dynamic computer model or (b) use the modified rational method assuming an average release rate of 50% of the area-specific peak flow rate where above and below ground storage is provided.

Additional Notes:

- No Capital Works Projects that would impact the application has been identified.
- No moratorium that would impact the applications has been identified.
- Any easement identified should be on all plans.

○ Transportation

- Review the TIA Screening Form. If the property is deemed not part of the Design Priority Area, no TIA will be required. However, the applicant is encouraged to complete both Transportation Demand Management Checklists and include measures to help rationalize the need for less parking.
- Noise Impact Study may be required if exposed mechanical equipment is present due to the proximity to noise-sensitive land uses.
- As the site proposed is residential, AODA legislation applies for all areas accessible to the public (i.e. outdoor pathways, parking, etc.).
- Consider using the City's Accessibility Design Standards.
- Capilano has a protected right of way of 24m. Show this on the plan, a widening is likely required.
- Providing at least one bicycle space per unit is encouraged particularly if a reduction in parking is sought to encourage sustainable transportation.

For future site plan:

- Clear throat required for an apartment of less than 100 units on a collector road is 8m.
- On future site plan:
 - Show all details of the roads abutting the site up to and including the opposite curb; include such items as pavement markings, accesses and/or sidewalks.
 - Turning templates will be required for all accesses showing the largest vehicle to access the site; required for internal movements and at all access (entering and exiting and going in both directions).
 - Show all curb radii measurements; ensure that all curb radii are reduced as much as possible
 - Show lane/aisle widths.

○ Environmental

TCR requirements:

- A Tree Conservation Report (TCR) must be supplied for review along with the suite of other plans/reports required by the City
 - an approved TCR is a requirement of Site Plan approval.
 - The TCR may be combined with the LP provided all information is supplied
- As of January 1 2021, any removal of privately-owned trees 10cm or larger in diameter, or publicly (City) owned trees of any diameter requires a tree permit issued under the Tree Protection Bylaw (Bylaw 2020 – 340); the permit will be based on an approved TCR and made available at or near plan approval.
- The Planning Forester from Planning and Growth Management as well as foresters from Forestry Services will review the submitted TCR
 - If tree removal is required, both municipal and privately-owned trees will be addressed in a single permit issued through the Planning Forester
 - Compensation may be required for city owned trees – if so, it will need to be paid prior to the release of the tree permit
- The TCR must list all trees on site, as well as off-site trees if the CRZ extends into the developed area, by species, diameter and health condition
- Please identify trees by ownership – private onsite, private on adjoining site, city owned, co-owned (trees on a property line)
- The TCR must list all trees on adjacent sites if they have a critical root zone that extends onto the development site

- If trees are to be removed, the TCR must clearly show where they are, and document the reason they cannot be retained
- All retained trees must be shown and all retained trees within the area impacted by the development process must be protected as per City guidelines available at [Tree Protection Specification](#) or by searching Ottawa.ca
- The location of tree protection fencing must be shown on a plan
- Show the critical root zone of the retained trees
- If excavation will occur within the critical root zone, please show the limits of excavation
- The City encourages the retention of healthy trees; if possible, please seek opportunities for retention of trees that will contribute to the design/function of the site.
- For more information on the process or help with tree retention options, contact Mark Richardson mark.richardson@ottawa.ca or on [City of Ottawa](#)

LP tree planting requirements:

For additional information on the following please contact tracy.smith@Ottawa.ca

Minimum Setbacks

- Maintain 1.5m from sidewalk or MUP/cycle track.
- Maintain 2.5m from curb
- Coniferous species require a minimum 4.5m setback from curb, sidewalk or MUP/cycle track/pathway.
- Maintain 7.5m between large growing trees, and 4m between small growing trees. Park or open space planting should consider 10m spacing.
- Adhere to Ottawa Hydro’s planting guidelines (species and setbacks) when planting around overhead primary conductors.

Tree specifications

- Minimum stock size: 50mm tree caliper for deciduous, 200cm height for coniferous.
- Maximize the use of large deciduous species wherever possible to maximize future canopy coverage
- Tree planting on city property shall be in accordance with the City of Ottawa’s Tree Planting Specification; and include watering and warranty as described in the specification (can be provided by Forestry Services).
- Plant native trees whenever possible
- No root barriers, dead-man anchor systems, or planters are permitted.
- No tree stakes unless necessary (and only 1 on the prevailing winds side of the tree)

Hard surface planting

- Curb style planter is highly recommended
- No grates are to be used and if guards are required, City of Ottawa standard (which can be provided) shall be used.
- Trees are to be planted at grade

Soil Volume

- Please ensure adequate soil volumes are met:

Tree Type/Size	Single Tree Soil Volume (m3)	Multiple Tree Soil Volume (m3/tree)
----------------	------------------------------	-------------------------------------

Ornamental	15	9
Columnar	15	9
Small	20	12
Medium	25	15
Large	30	18
Conifer	25	15

Sensitive Marine Clay

- Please follow the City’s 2017 Tree Planting in Sensitive Marine Clay guidelines
- Parks
 - Parks and Facilities Planning will require 10% cash-in-lieu of Parkland based on the total developable area for this project.
 - Will a parking agreement be in place for the shared use of the parking lot at the Curling Club?
 - The proposed L- shape building would benefit from reorientation towards Capilano. This would provide a welcoming presence in the neighborhood, a sense of openness toward the street and parking area and the opportunity to plant trees in the front yard, along Capilano and the driveway entrance.
- City Surveyor
 - The determination of property boundaries, minimum setbacks and other regulatory constraints are a critical component of development. An Ontario Land Surveyor (O.L.S.) needs to be consulted at the outset of a project to ensure properties are properly defined and can be used as the geospatial framework for the development.
 - Topographic details may also be required for a project and should be either carried out by the O.L.S. that has provided the Legal Survey or done in consultation with the O.L.S. to ensure that the project is integrated to the appropriate control network.

Questions regarding the above requirements can be directed to the City’s Surveyor, Bill Harper, at Bill.Harper@ottawa.ca

Other

- Plans are to be standard A1 size (594 mm x 841 mm) sheets, utilizing an appropriate Metric scale (1:200, 1:250, 1:300, 1:400 or 1:500).
- All PDF submitted documents are to be unlocked and flattened.
- Please refer to the links to the [guide to preparing studies and plans](#) and [development application fees](#) for general information. Additional information is available related to [building permits](#), [development charges](#), and [the Accessibility Design Standards](#). Be aware that other fees and

permits may be required, outside of the development review process. You may obtain background drawings by contacting informationcentre@ottawa.ca.

- These pre-consultation comments are valid for one year. If you submit a development application(s) after this time, you may be required to meet for another pre-consultation meeting and/or the submission requirements may change. You are as well encouraged to contact us for a follow-up meeting if the plan/concept will be further refined.

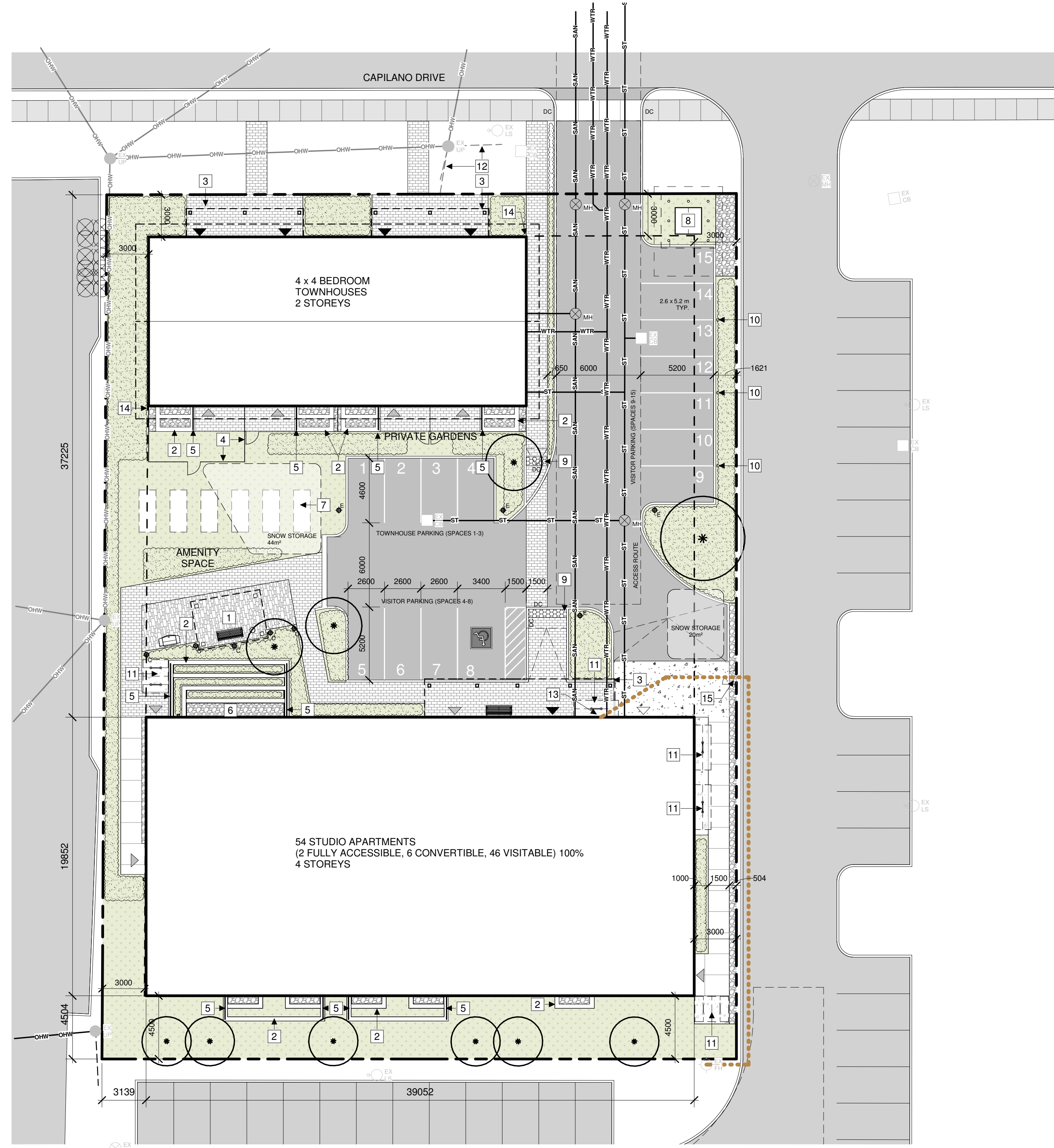

1 OVERALL SITE NEW
A100 1:200

ZONING PROVISION	REQUIRED	PROVIDED
MIN. LOT WIDTH	18m	44.86m
MIN. LOT AREA	1,400 m ²	2,774.84 m ²
MIN. FRONT YARD SETBACK	Avg. of nearest lots to max of 3 m	3 m
MIN. REAR YARD SETBACK	4.5 m	4.5 m
MIN. INTERIOR YARD SETBACK	West Lot Line: 3m East Lot Line: To Be Confirmed by City Staff	3 m 3 m
MAX. HEIGHT	Low-rise apartment: 14.5 m Townhouse: 11 m	Low-rise apartment: 13.09 m Townhouse: 6.79 m
AMENITY AREA	Low-rise apartment: 15m ² /unit for first 8 units + 6m ² /unit thereafter = 396 m ² Minimum 120 m ² communal, 80% soft landscaped May not be located in front yard	245m ² exterior amenity space (labelled on site plan). + 285m ² interior amenities (Tenant Resource Centre, & Multi-purpose Rm.)
LANDSCAPED AREA	Min 30% lot area = 832.5 m ²	41.32% - 1146m ²

PARKING QUEUING + LOADING	REQUIRED	PROVIDED
RESIDENTIAL SPACES	0	0
VISITOR SPACES	12	15
ACCESSIBLE PARKING	0	1
BICYCLE PARKING	27	14 Exterior Spaces + 13 Interior Spaces (Located in appartment basement)
GARBAGE COLLECTION	1 x 6 Yard bin	2 x 4 Yard bin
GMP COLLECTION	1 x Yard bin	3 x 240L Bins
FIBRE COLLECTION	2 x Yard bin	8 x 240L Bins
ORGANICS COLLECTION	1 x 240L Bin	1 x 240L Bin

LEGAL DESCRIPTION
Part 2, 4R-27938 PIN 04678-0068

REFERENCE SURVEY
Fairhall, Moffatt & Woodland Ltd V22200

MUNICIPAL ADDRESS
56 Capilano Drive

SITE AREA 2,775 m²

APARTMENT BUILDING AREA 775 m²
TOWNHOUSE BUILDING AREA 324 m²

APARTMENT GROSS FLOOR AREA 3101 m²
TOWNHOUSE GROSS FLOOR AREA 648.5 m²

APARTMENT BUILDING HEIGHT 13.09 m 4 STOREYS
TOWNHOUSE BUILDING HEIGHT 6.79 m 2 STOREYS

ZONE R4Z(2840)-h

SCHEDULE 1: AREA C
SCHEDULE 1A: AREA C

SITE PLAN GENERAL NOTES:

- ALL GENERAL SITE INFORMATION AND CONDITIONS COMPILED FROM EXISTING PLANS AND SURVEYS
- DO NOT SCALE THIS DRAWING
- REPORT ANY DISCREPANCIES PRIOR TO COMMENCING WORK. NO RESPONSIBILITY IS BORN BY THE CONSULTANT FOR UNKNOWN SUBSURFACE CONDITIONS
- CONTRACTOR TO CHECK AND VERIFY ALL DIMENSIONS ON SITE AND REPORT ANY ERRORS AND/OR OMISSIONS TO THE CONSULTANT
- REINSTATE ALL AREAS AND ITEMS DAMAGED AS A RESULT OF CONSTRUCTION ACTIVITIES TO THE SATISFACTION OF THE CONSULTANT
- CONTRACTOR TO LAYOUT PLANTING BEDS, PATHWAYS ETC. TO APPROVAL OF CONSULTANT PRIOR TO ANY JOB EXCAVATION
- THE ACCURACY OF THE POSITION OF UTILITIES IS NOT GUARANTEED - CONTRACTOR TO VERIFY PRIOR TO EXCAVATION
- INDIVIDUAL UTILITY COMPANY MUST BE CONTACTED FOR CONFIRMATION OF UTILITY EXISTENCE AND LOCATION PRIOR TO DIGGING
- ALL DISTURBED AREAS TO BE RESTORED TO ORIGINAL CONDITION OR BETTER UNLESS OTHERWISE NOTED

SITE PLAN KEYNOTES:

- SHADE STRUCTURE
- TANDEM NEXT CONCRETE BLOCK RETAINING WALL
- CANOPY STRUCTURE
- CEDAR FENCE 1800mm HIGH. GATES AS SHOWN
- 1070mm HIGH STAINLESS STEEL GUARD ANCHORED TO CONCRETE BLOCK RETAINING WALL
- WINDOW WELL
- GARDEN PLOTS
- HYDRO TRANSFORMER
- 600mm DEEP TACTILE INDICATION SURFACE CAST INTO CONCRETE WALKWAY
- TYPE 2 ELECTRIC CAR CHARGING STATION WITH DUAL CHARGERS
- 1800x600mm BICYCLE PARKING SPACE c/w PARKING RACK/RING CENTERED BETWEEN EVERY TWO PARKING SPACES.
- EXISTING GUY WIRE TO REMAIN
- SIAMESE CONNECTION
- DOWNSPOUT
- GATE

SITE PLAN LEGEND:

	NEW BUILDING
	EXISTING ASPHALT PAVING
	NEW ASPHALT PAVING
	EXISTING GRASS
	NEW GRASS AND SOFT LANDSCAPING
	EXISTING CONCRETE SIDEWALK
	NEW CONCRETE SIDEWALK
	CRUSHED STONE
	NEW CONCRETE PAD
	BUILDING MAIN ENTRANCE
	SECONDARY ENTRANCE / EMERGENCY EXIT
	SERVICE ENTRANCE
	PROPERTY LINE
	FENCE PER LANDSCAPE
	NEW DOMESTIC WATER
	NEW SANITARY
	NEW STORM
	NEW ELECTRICAL SERVICE (BELOW GRADE)
	EXISTING OVERHEAD WIRE
	DC DROPPED CURB
	NEW CATCH BASIN PER CIVIL
	NEW MANHOLE PER CIVIL
	EXISTING CATCH BASIN - TO REMAIN
	EXISTING MANHOLE - TO REMAIN
	EXISTING LIGHT STANDARD - TO REMAIN
	EXISTING FIRE HYDRANT - TO REMAIN
	EXISTING UTILITY POLE - TO REMAIN
	NEW TREE



STRUCTURAL ENGINEER
Cleland Jardine Engineering Ltd
580 Terry Fox Drive, Suite 200
Ottawa, ON
613-591-1533
mail@clelandjardine.com



MECHANICAL & ELECTRICAL ENGINEER
Chorley + Bisset Consulting Engineers
250 City Centre Ave.,
Ottawa, ON
613-241-0030
email@chorley.com



CIVIL ENGINEER
McIntosh Perry
115 Walgreen Road
RR3 Carp, ON
613-836-2184
info@mcintoshperry.com



LANDSCAPE ARCHITECT
Fotenn
396 Cooper St, Suite 300
Ottawa, ON
613-730-5709
info@fotenn.com

STAMP

2 2023.03.08 ISSUED FOR SITE PLAN CONTROL
1 2023.02.03 ISSUED FOR RHI 3 APPLICATION
REV DATE ISSUE

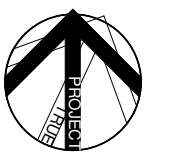

NOTES

- OWNERSHIP OF THE COPYRIGHT OF THE DESIGN AND THE WORKS EXECUTED FROM THE DESIGN REMAINS WITH CSV ARCHITECTS, AND MAY NOT BE REPRODUCED IN ANY FORM WITHOUT THE WRITTEN CONSENT OF CSV ARCHITECTS.
- THE DRAWINGS, PRESENTATIONS AND SPECIFICATIONS AS INSTRUMENTS OF SERVICE ARE AND SHALL REMAIN THE PROPERTY OF CSV ARCHITECTS. THEY ARE NOT TO BE USED BY THE CLIENT ON OTHER PROJECTS OR ON EXTENSIONS TO THIS PROJECT WITHOUT THE WRITTEN CONSENT OF CSV ARCHITECTS.
- THIS DRAWING IS TO BE READ IN CONJUNCTION WITH ALL OTHER PROJECT DRAWINGS AND SPECIFICATIONS.
- DO NOT SCALE DRAWINGS. CONTRACTOR SHALL BE RESPONSIBLE TO VERIFY DIMENSIONS ON SITE.
- ALL WORK SHALL BE IN ACCORDANCE WITH THE ONTARIO BUILDING CODE AND ALL SUPPLEMENTS AND APPLICABLE MUNICIPAL REGULATIONS.

CLIENT

OTTAWA SALUS
200 Scott Street
Ottawa Ontario
K1Z 6T2
Salusottawa.org

PROJECT

SALUS 56 CAPILANO
56 Capilano Drive, Ottawa, ON

TITLE

SITE PLAN

PROJECT NO: 2019-0291
DRAWN: AS, KV
APPROVED: DH
SCALE: 1 : 200

REV DRAWING NO.

2 A100
#18926

D07-12-23-0028

Francis Valenti

Subject: FW: 56 Capilano - Servicing

From: Dieme, Abi <Abibatou.Dieme@ottawa.ca>
Sent: February 23, 2023 12:14 PM
To: Curtis Melanson <c.melanson@mcintoshperry.com>
Cc: Nicholas Vachon <n.vachon@mcintoshperry.com>
Subject: RE: 56 Capilano - Servicing

Hi Curtis and Nicholas,

The City agrees that the predevelopment C value can be based on the 2015 hardscape up to a maximum of 0.5 however we will need the system to be controlled to the 2-year pre-development release rate.

Regards,
Abi

From: Curtis Melanson <c.melanson@mcintoshperry.com>
Sent: February 23, 2023 10:47 AM
To: Dieme, Abi <Abibatou.Dieme@ottawa.ca>
Cc: Nicholas Vachon <n.vachon@mcintoshperry.com>
Subject: RE: 56 Capilano - Servicing

CAUTION: This email originated from an External Sender. Please do not click links or open attachments unless you recognize the source.

ATTENTION : Ce courriel provient d'un expéditeur externe. Ne cliquez sur aucun lien et n'ouvrez pas de pièce jointe, excepté si vous connaissez l'expéditeur.

Hi Abi,
I'm just checking in on this one to see if you've reviewed the storm calculations/servicing layout?

We'd like to finalize and have it ready for site plan submission ASAP since there is also funding tied to timing of documents.

Can you give us an update whenever you get a moment?

Thanks,

Curtis Melanson, C.E.T.

Practice Area Lead, Land Development

T. 613.714.4621 | C. 613.857.0784

c.melanson@mcintoshperry.com | www.mcintoshperry.com

McINTOSH PERRY

Turning Possibilities Into Reality



Platinum member

From: Dieme, Abi <Abibatou.Dieme@ottawa.ca>
Sent: Tuesday, February 14, 2023 2:34 PM
To: Curtis Melanson <c.melanson@mcintoshperry.com>
Cc: Nicholas Vachon <n.vachon@mcintoshperry.com>
Subject: RE: 56 Capilano - Servicing

Hi Curtis,

I am available tomorrow afternoon or Thursday afternoon. Please let me know which time works best for you and I will set up a quick meeting.

Regards,
Abi

From: Curtis Melanson <c.melanson@mcintoshperry.com>
Sent: February 14, 2023 2:02 PM
To: Dieme, Abi <Abibatou.Dieme@ottawa.ca>
Cc: Nicholas Vachon <n.vachon@mcintoshperry.com>
Subject: 56 Capilano - Servicing

CAUTION: This email originated from an External Sender. Please do not click links or open attachments unless you recognize the source.

ATTENTION : Ce courriel provient d'un expéditeur externe. Ne cliquez sur aucun lien et n'ouvrez pas de pièce jointe, excepté si vous connaissez l'expéditeur.

Hi Abi,
We are working on this site and providing the civil engineering documents for a site plan control submission.

Would you be available to discuss the servicing on this site?

See attached preliminary concept for servicing. Let me know when you are available to discuss.

Thanks,

Curtis Melanson, C.E.T.

Practice Area Lead, Land Development

T. 613.714.4621 | C. 613.857.0784

c.melanson@mcintoshperry.com | www.mcintoshperry.com

McINTOSH PERRY

Turning Possibilities Into Reality



.

This e-mail originates from the City of Ottawa e-mail system. Any distribution, use or copying of this e-mail or the information it contains by other than the intended recipient(s) is unauthorized. Thank you.

Le présent courriel a été expédié par le système de courriels de la Ville d'Ottawa. Toute distribution, utilisation ou reproduction du courriel ou des renseignements qui s'y trouvent par une personne autre que son destinataire prévu est interdite. Je vous remercie de votre collaboration.

.

This e-mail originates from the City of Ottawa e-mail system. Any distribution, use or copying of this e-mail or the information it contains by other than the intended recipient(s) is unauthorized. Thank you.

Le présent courriel a été expédié par le système de courriels de la Ville d'Ottawa. Toute distribution, utilisation ou reproduction du courriel ou des renseignements qui s'y trouvent par une personne autre que son destinataire prévu est interdite. Je vous remercie de votre collaboration.

.

Francis Valenti

Subject: RE: 23-3325 - Quality Control Requirement - 56 Capilano Drive

From: Dieme, Abi <Abibatou.Dieme@ottawa.ca>
Sent: June 19, 2023 2:01 PM
To: Curtis Melanson <c.melanson@mcintoshperry.com>
Subject: RE: 23-3325 - Quality Control Requirement - 56 Capilano Drive

Hi Curtis,

I apologize for the delay. I have discussed internally and agreed with the City's Infrastructure and Water Services Department that we will not require quality control for this site. Please let me know if you need anything else.

Regards,
Abi

From: Curtis Melanson <c.melanson@mcintoshperry.com>
Sent: May 31, 2023 2:25 PM
To: Dieme, Abi <Abibatou.Dieme@ottawa.ca>
Subject: RE: 23-3325 - Quality Control Requirement - 56 Capilano Drive

CAUTION: This email originated from an External Sender. Please do not click links or open attachments unless you recognize the source.

ATTENTION : Ce courriel provient d'un expéditeur externe. Ne cliquez sur aucun lien et n'ouvrez pas de pièce jointe, excepté si vous connaissez l'expéditeur.

Hi Abi,
I followed the pipe network and I believe our site bypasses Gilbey pond/park.

See below sketch, the 750 from Gilbey turns into a 1050 from MHST18464 to MHST1843, continues west and bypasses OUT12225 into Gilbey pond.

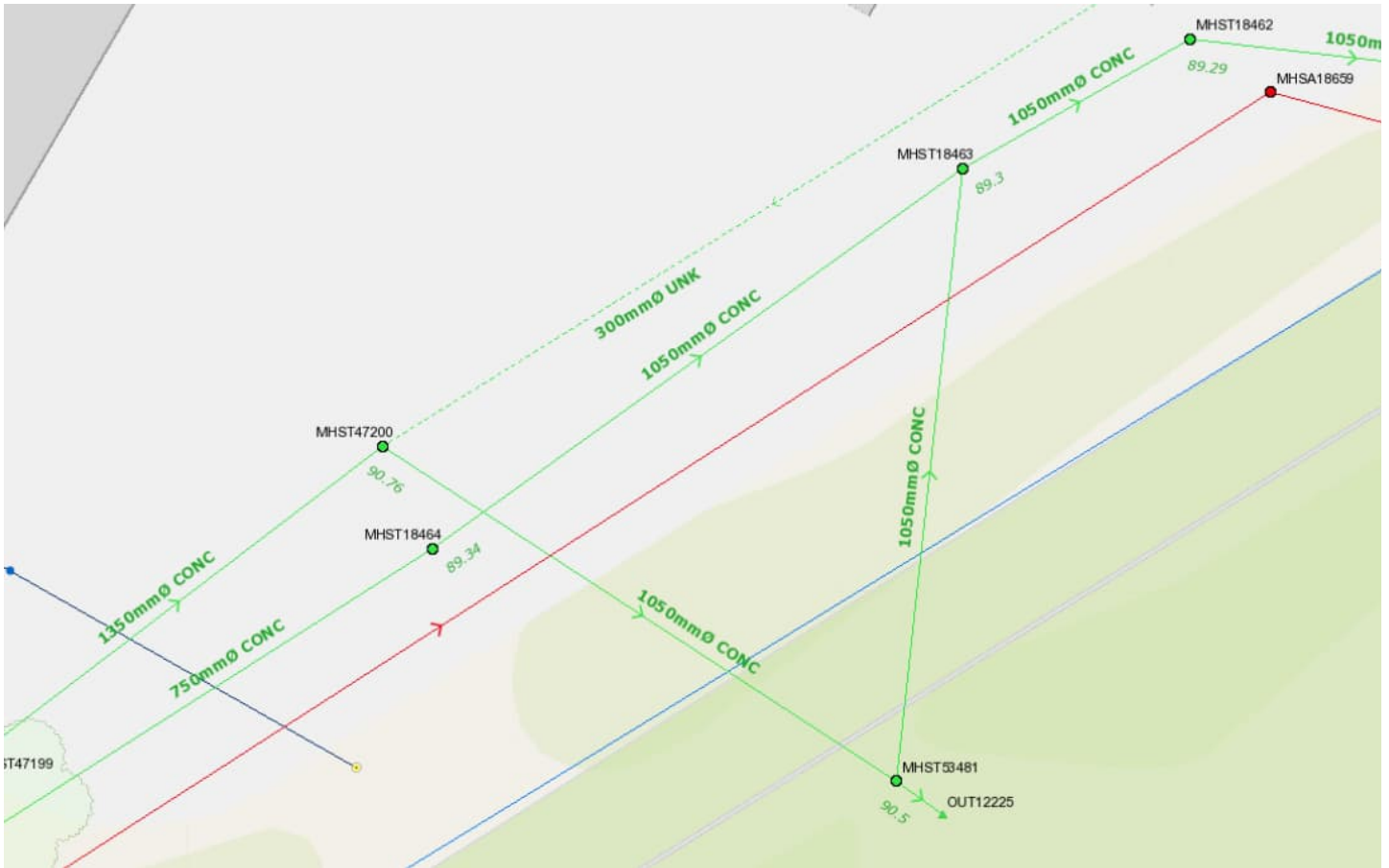

Therefore, I don't think quality control should be required. Can you please have a quick look and let me know if this changes the requirement.

Thanks,

Curtis Melanson, C.E.T.

Practice Area Lead, Land Development

T. 613.714.4621 | C. 613.857.0784

c.melanson@mcintoshperry.com | www.mcintoshperry.com

McINTOSH PERRY

Turning Possibilities Into Reality

Confidentiality Notice – If this email wasn't intended for you, please return or delete it. Click [here](#) to read all of the legal language around this concept.



Platinum member

From: Dieme, Abi <Abibatou.Dieme@ottawa.ca>

Sent: May 31, 2023 1:43 PM

To: Curtis Melanson <c.melanson@mcintoshperry.com>

Subject: RE: 23-3325 - Quality Control Requirement - 56 Capilano Drive

Hi Curtis,

As discussed, quality control requirements are no longer within the CA's purview for projects that do not have hazard lands. This site is tributary to the Gilbey pond which is not a treatment pond but rather a stormwater attenuation pond for peak flow control, and therefore quality control is required. Since it is within the City's purview now, 80% TSS removal will be our requirement going forward.

Regards,
Abi

From: Curtis Melanson <c.melanson@mcintoshperry.com>
Sent: May 31, 2023 12:40 PM
To: Dieme, Abi <Abibatou.Dieme@ottawa.ca>
Subject: FW: 23-3325 - Quality Control Requirement - 56 Capilano Drive

CAUTION: This email originated from an External Sender. Please do not click links or open attachments unless you recognize the source.

ATTENTION : Ce courriel provient d'un expéditeur externe. Ne cliquez sur aucun lien et n'ouvrez pas de pièce jointe, excepté si vous connaissez l'expéditeur.

As discussed,
See below from RVCA.

Thanks,

Curtis Melanson, C.E.T.

Practice Area Lead, Land Development

T. 613.714.4621 | C. 613.857.0784

c.melanson@mcintoshperry.com | www.mcintoshperry.com

McINTOSH PERRY

Turning Possibilities Into Reality

Confidentiality Notice – If this email wasn't intended for you, please return or delete it. Click [here](#) to read all of the legal language around this concept.



Platinum
member

From: Eric Lalande <eric.lalande@rvca.ca>
Sent: March 3, 2023 3:00 PM
To: Francis Valenti <F.Valenti@McIntoshPerry.com>
Cc: Nicholas Vachon <n.vachon@mcintoshperry.com>
Subject: RE: 23-3325 - Quality Control Requirement - 56 Capilano Drive

Hi Francis,

I would concur that based on the information provided, the RVCA would not require Water Quality Control measures for the project and site design. However please note, that water quality review is now ultimately subject to the municipality.

Thank you,

Eric Lalande, MCIP, RPP
Planner, RVCA
613-692-3571 x1137

From: Francis Valenti <F.Valenti@McIntoshPerry.com>
Sent: Friday, March 3, 2023 12:11 PM
To: Eric Lalande <eric.lalande@rvca.ca>
Cc: Nicholas Vachon <n.vachon@mcintoshperry.com>
Subject: 23-3325 - Quality Control Requirement - 56 Capilano Drive

Hi Eric,

See attached site plan for a project that we're working on at 56 Capilano Drive. The site was previously developed with a commercial building but is currently undeveloped. The proposed development consists of a 4-storey apartment building and a 4-unit townhouse block, complete with surface parking with street access from Capilano Drive. Fifteen Parking spaces are proposed.

Surface runoff will be collected by two catch basins, each restricted by an ICD. Flows in excess of the allowable release rate will be stored in the parking area. Runoff from the roof of the proposed building will be stored and controlled using roof drains. As seen in the attached Drainage Path figure, runoff from the site will be conveyed to the 300mm diameter storm sewer within Capilano Drive before discharging to the Rideau Waterway approximately 3.7km downstream.

Based on the distance to the outlet quality controls are not anticipated to be required, but can you please review and confirm?

Thanks,

Francis Valenti, EIT
Engineering Intern, Land Development
T. 613.714.6895 | C. 613.808.2123
F.Valenti@McIntoshPerry.com | www.mcintoshperry.com

McINTOSH PERRY

Turning Possibilities Into Reality

Confidentiality Notice – If this email wasn't intended for you, please return or delete it. Click [here](#) to read all of the legal language around this concept.



Platinum
member

This e-mail originates from the City of Ottawa e-mail system. Any distribution, use or copying of this e-mail or the information it contains by other than the intended recipient(s) is unauthorized. Thank you.

Le présent courriel a été expédié par le système de courriels de la Ville d'Ottawa. Toute distribution, utilisation ou reproduction du courriel ou des renseignements qui s'y trouvent par une personne autre que son destinataire prévu est interdite. Je vous remercie de votre collaboration.

·
·

This e-mail originates from the City of Ottawa e-mail system. Any distribution, use or copying of this e-mail or the information it contains by other than the intended recipient(s) is unauthorized. Thank you.

Le présent courriel a été expédié par le système de courriels de la Ville d'Ottawa. Toute distribution, utilisation ou reproduction du courriel ou des renseignements qui s'y trouvent par une personne autre que son destinataire prévu est interdite. Je vous remercie de votre collaboration.

·

APPENDIX C
WATERMAIN CALCULATIONS

McINTOSH PERRY

CCO-23-3325 - 56 Capilano Drive - Water Demands

Project:	56 Capilano Drive
Project No.:	CCO-23-3325
Designed By:	FV
Checked By:	NV
Date:	June 13, 2023
Site Area:	0.28 gross ha

Residential	NUMBER OF UNITS	UNIT RATE	
Townhouse	4 homes	2.7	persons/unit
Studio	54 units	1.4	persons/unit
Total Population	87 persons		

AVERAGE DAILY DEMAND

DEMAND TYPE	AMOUNT	UNITS	
Residential	280	L/c/d	
Industrial - Light	35,000	L/gross ha/d	
Industrial - Heavy	55,000	L/gross ha/d	
Shopping Centres	2,500	L/(1000m ² /d)	
Hospital	900	L/(bed/day)	
Schools	70	L/(Student/d)	
Trailer Park with no Hook-Ups	340	L/(space/d)	
Trailer Park with Hook-Ups	800	L/(space/d)	
Campgrounds	225	L/(campsite/d)	
Mobile Home Parks	1,000	L/(Space/d)	
Motels	150	L/(bed-space/d)	
Hotels	225	L/(bed-space/d)	
Tourist Commercial	28,000	L/gross ha/d	
Other Commercial	28,000	L/gross ha/d	
AVERAGE DAILY DEMAND	Residential	0.28	L/s
	Commercial/Industrial /Institutional	0.00	L/s

MAXIMUM DAILY DEMAND

DEMAND TYPE	AMOUNT	UNITS	
Residential	7.3	x avg. day	L/c/d
Industrial	1.5	x avg. day	L/gross ha/d
Commercial	1.5	x avg. day	L/gross ha/d
Institutional	1.5	x avg. day	L/gross ha/d
MAXIMUM DAILY DEMAND	Residential	2.06	L/s
	Commercial/Industrial /Institutional	0.00	L/s

MAXIMUM HOUR DEMAND

DEMAND TYPE	AMOUNT	UNITS	
Residential	11.0	x avg. day	L/c/d
Industrial	1.8	x max. day	L/gross ha/d
Commercial	1.8	x max. day	L/gross ha/d
Institutional	1.8	x max. day	L/gross ha/d
MAXIMUM HOUR DEMAND	Residential	3.11	L/s
	Commercial/Industrial /Institutional	0.00	L/s

WATER DEMAND DESIGN FLOWS PER UNIT COUNT
CITY OF OTTAWA - WATER DISTRIBUTION GUIDELINES, JULY 2010

AVERAGE DAILY DEMAND	0.28	L/s
MAXIMUM DAILY DEMAND	2.06	L/s
MAXIMUM HOUR DEMAND	3.11	L/s

McINTOSH PERRY

CCO-23-3325 - 56 Capilano Drive - OBC Fire Calculations - Apartment Building

Project:	56 Capilano Drive
Project No.:	CCO-23-3325
Designed By:	FV
Checked By:	NV
Date:	June 13, 2023

Ontario 2006 Building Code Compendium (Div. B - Part 3)

Water Supply for Fire-Fighting - Apartment Building

Building is classified as Group : C - Residential Occupancies

Building is of noncombustible construction or of heavy timber construction conforming to Article 3.1.4.6. Floor assemblies are fire separations but with no fire-resistance rating. Roof assemblies, mezzanines, loadbearing walls, columns and arches do not have a

From Div. B A-3.2.5.7. of the Ontario Building Code - 3. Building On-Site Water Supply:

(a) $Q = K \times V \times Stot$

where:

Q = minimum supply of water in litres

K = water supply coefficient from Table 1

V = total building volume in cubic metres

Stot = total of spatial coefficient values from the property line exposures on all sides as obtained from the formula:

$Stot = 1.0 + [S_{side1} + S_{side2} + S_{side3} + \dots \text{etc.}]$

K	16	
V	10,148	(Total building volume in m ³ .)
Stot	2.0	(From figure 1 pg A-32)
Q =	324,745.10 L	

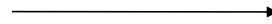

			From Figure
			1 (A-32)
Snorth	37.31	m	0.0
Seast	3	m	0.5
Ssouth	4.5	m	0.5
Swest	3	m	0.5

*approximate distances

From Table 2: Required Minimum Water Supply Flow Rate (L/s)

9000 L/min if Q > 270,000 L
2378 gpm

McINTOSH PERRY

CCO-23-3325 - 56 Capilano Drive - OBC Fire Calculations - Townhouse Block

Project:	56 Capilano Drive
Project No.:	CCO-23-3325
Designed By:	FV
Checked By:	NV
Date:	June 13, 2023

Ontario 2006 Building Code Compendium (Div. B - Part 3)

Water Supply for Fire-Fighting - Townhouse Block

Building is classified as Group : C - Residential Occupancies

Building is of combustible construction. Floor assemblies are fire separations but with no fire-resistance ratings. Roof assemblies, mezzanias, loadbearing walls, columns and arches do not have a fire-resistance rating.

From Div. B A-3.2.5.7. of the Ontario Building Code - 3. Building On-Site Water Supply:

(a) $Q = K \times V \times Stot$

where:

Q = minimum supply of water in litres

K = water supply coefficient from Table 1

V = total building volume in cubic metres

Stot = total of spatial coefficient values from the property line exposures on all sides as obtained from the formula:

$Stot = 1.0 + [S_{side1} + S_{side2} + S_{side3} + \dots \text{etc.}]$

K	23	
V	2,202	(Total building volume in m ³ .)
Stot	2.0	(From figure 1 pg A-32)
Q =	101,270.00 L	

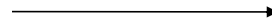

From Figure 1 (A-32)

Snorth	3 m	0.5
Seast	15 m	0.0
Ssouth	46.5 m	0.0
Swest	3 m	0.5

*approximate distances

From Table 2: Required Minimum Water Supply Flow Rate (L/s)

2700 L/min if Q < 108,000 L
713 gpm

McINTOSH PERRY

CCO-23-3325 - 56 Capilano Drive - Fire Underwriters Survey - Apartment Building

Project: 56 Capilano Drive
 Project No.: CCO-23-3325
 Designed By: FV
 Checked By: NV
 Date: June 13, 2023

From the Fire Underwriters Survey (2020)

From Part II – Guide for Determination of Required Fire Flow Copyright I.S.O.:
 City of Ottawa Technical Bulletin ISTB-2018-02 Applied Where Applicable

A. BASE REQUIREMENT (Rounded to the nearest 1000 L/min)

F = 220 x C x √A Where: F = Required fire flow in liters per minute
 C = Coefficient related to the type of construction.
 A = The total floor area in square meters (including all storey's, but excluding basements at least 50 percent below grade) in the building being considered.

Construction Type **Non-Combustible Construction**

C 0.8 A 3,101.0 m²
 Total Floor Area (per the 2020 FUS Page 20 - Total Effective Area) 2,325.0 m²

Calculated Fire Flow 8,486.4 L/min
 8,000.0 L/min

B. REDUCTION FOR OCCUPANCY TYPE (No Rounding)

From Page 24 of the Fire Underwriters Survey:
 Limited Combustible -15%

Fire Flow 6,800.0 L/min

C. REDUCTION FOR SPRINKLER TYPE (No Rounding)

Standard Water Supply Sprinklered -40%

Reduction -2,720.0 L/min

D. INCREASE FOR EXPOSURE (No Rounding)

	Separation Distance (m)	Cons.of Exposed Wall	Length Exposed Adjacent Wall (m)	Height (Stories)	Length-Height Factor	
Exposure 1	20.1 to 30	Wood frame	26.89	2	53.8	4%
Exposure 2	Over 30 m	Wood frame	8.35	1	8.4	0%
Exposure 3	10.1 to 20	Ordinary - Mass Timber (Unprotected)	19.97	1	20.0	5%
Exposure 4	10.1 to 20	Fire Resistive - Non Combustible (Unprotected Openings)	94	1	94.0	7%
						% Increase*
						16%

Increase* 1,088.0 L/min

E. Total Fire Flow (Rounded to the Nearest 1000 L/min)

Fire Flow 5,168.0 L/min
 Fire Flow Required** 5,000.0 L/min

*In accordance with Part II, Section 4, the Increase for separation distance is not to exceed 75%

**In accordance with Section 4 the Fire flow is not to exceed 45,000 L/min or be less than 2,000 L/min

McINTOSH PERRY

CCO-23-3325 - 56 Capilano Drive - Fire Underwriters Survey - Townhouse Block

Project: 56 Capilano Drive
 Project No.: CCO-23-3325
 Designed By: FV
 Checked By: NV
 Date: June 13, 2023

From the Fire Underwriters Survey (2020)

From Part II – Guide for Determination of Required Fire Flow Copyright I.S.O.:
 City of Ottawa Technical Bulletin ISTB-2018-02 Applied Where Applicable

A. BASE REQUIREMENT (Rounded to the nearest 1000 L/min)

F = 220 x C x vA Where: F = Required fire flow in liters per minute
 C = Coefficient related to the type of construction.
 A = The total floor area in square meters (including all storey's, but excluding basements at least 50 percent below grade) in the building being considered.

Construction Type Wood Frame

C 1.5 A 648.5 m²
 Total Floor Area (per the 2020 FUS Page 20 - Total Effective Area) 648.5 m²

Calculated Fire Flow 8,403.7 L/min
 8,000.0 L/min

B. REDUCTION FOR OCCUPANCY TYPE (No Rounding)

From Page 24 of the Fire Underwriters Survey:
 Limited Combustible -15%

Fire Flow 6,800.0 L/min

C. REDUCTION FOR SPRINKLER TYPE (No Rounding)

Non-Sprinklered 0%

Reduction 0.0 L/min

D. INCREASE FOR EXPOSURE (No Rounding)

	Separation Distance (m)	Cons.of Exposed Wall	Length Exposed Adjacent Wall (m)	Height (Stories)	Length-Height Factor	
Exposure 1	Over 30 m	Wood frame	23.8	1	23.8	0%
Exposure 2	Over 30 m	Wood frame	8.35	1	8.4	0%
Exposure 3	20.1 to 30	Fire Resistive - Non Combustible (Unprotected Openings)	19.97	1	39.1	0%
Exposure 4	10.1 to 20	Fire Resistive - Non Combustible (Unprotected Openings)	94	1	94.0	7%
					% Increase*	7%

Increase* 476.0 L/min

E. Total Fire Flow (Rounded to the Nearest 1000 L/min)

Fire Flow 7,276.0 L/min
 Fire Flow Required** 7,000.0 L/min

*In accordance with Part II, Section 4, the Increase for separation distance is not to exceed 75%

**In accordance with Section 4 the Fire flow is not to exceed 45,000 L/min or be less than 2,000 L/min

McINTOSH PERRY

CCO-23-3325 - 56 Capilano Drive - Boundary Condition Unit Conversion

Project: 56 Capilano Drive

Project No.: CCO-23-3325

Designed By: FV

Checked By: BC

Date: June 13, 2023

Boundary Conditions Unit Conversion

Capilano Drive

Scenario	Height (m)	Elevation (m)	m H ₂ O	PSI	kPa
Avg. DD	158.3	93.2	65.1	92.6	638.6
Fire Flow (116.7 L/s or 7,000 L/min)	144.5	93.2	51.3	73.0	503.3
Peak Hour	146.9	93.2	53.7	76.4	526.8

56 Capilano Drive Hydrant Coverage Figure

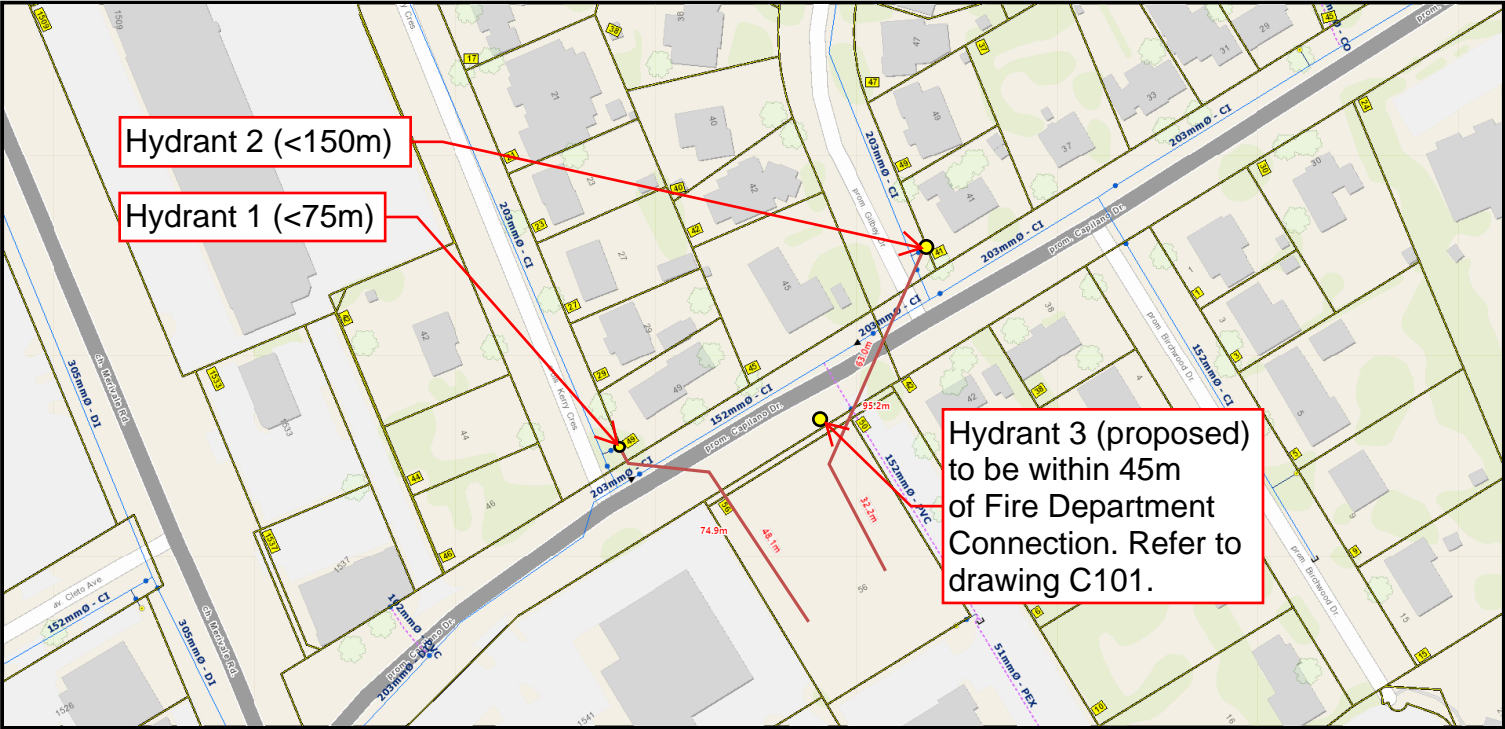

56 Capilano Drive Pressure Zone Figure

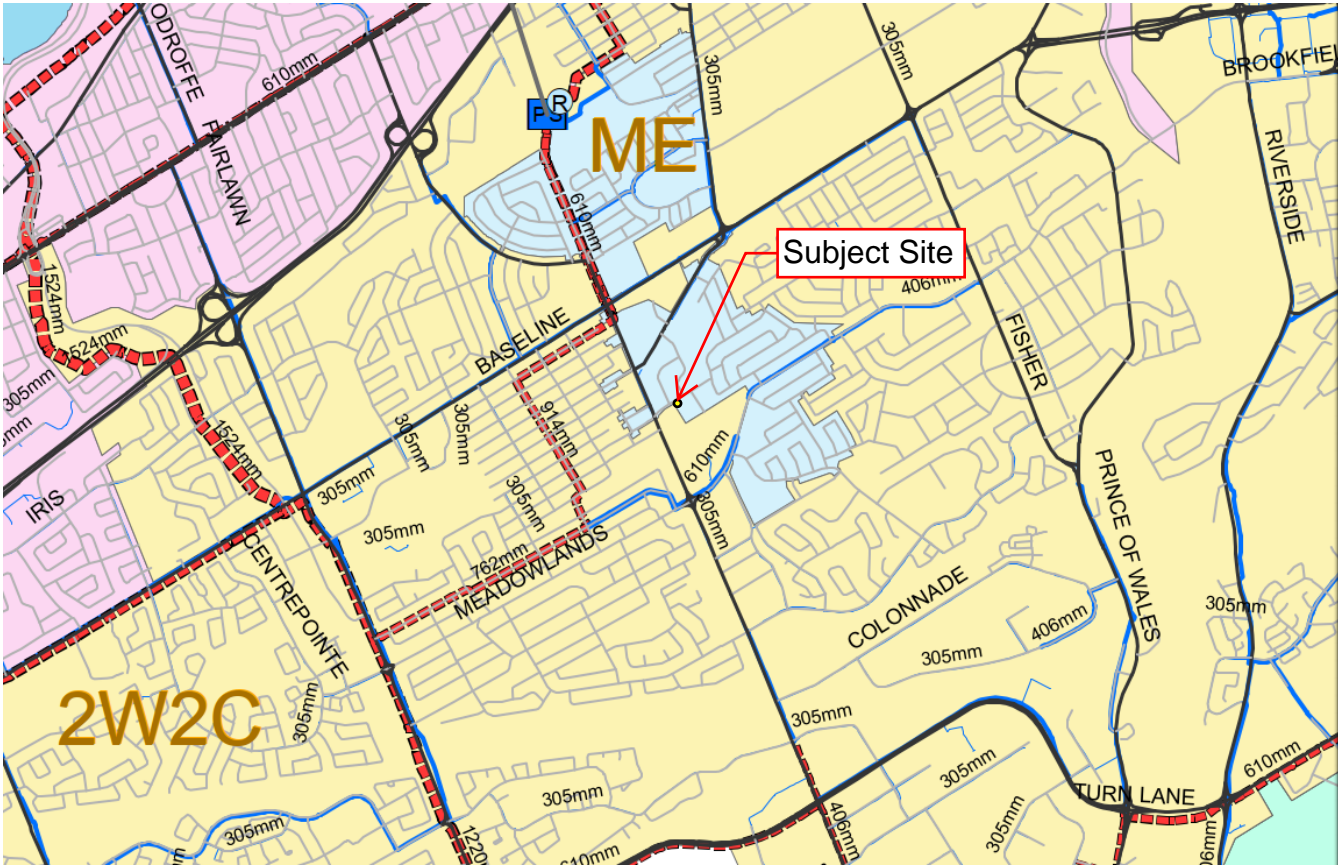

APPENDIX D
SANITARY CALCULATIONS

McINTOSH PERRY

CCO-23-3325 - 56 Capilano Drive - Sanitary Demands

Project:	56 Capilano Drive		
Project No.:	CCO-23-3325		
Designed By:	FV		
Checked By:	NV		
Date:	Feb-23		
Site Area	0.28	Gross ha	
Townhouse	4	2.70	Persons per unit
1 Bedroom	54	1.40	Persons per unit
Total Population	87	Persons	
Amenity Space	396.00	m ²	

DESIGN PARAMETERS

Institutional/Commercial Peaking Factor	1.5	
Residential Peaking Factor	3.61	* Using Harmon Formula = $1+(14/(4+P^{0.5}))^{*0.8}$ where P = population in thousands, Harmon's Correction Factor = 0.8
Mannings coefficient (n)	0.013	
Demand (per capita)	280	L/day
Infiltration allowance	0.33	L/s/Ha

EXTRANEIOUS FLOW ALLOWANCES

Infiltration / Inflow	Flow (L/s)
Dry	0.01
Wet	0.08
Total	0.09

AVERAGE DAILY DEMAND

DEMAND TYPE	AMOUNT	UNITS	POPULATION / AREA	Flow (L/s)
Residential	280	L/c/d	87	0.28
Industrial - Light**	35,000	L/gross ha/d		0
Industrial - Heavy**	55,000	L/gross ha/d		0
Commercial / Amenity	2,800	L/(1000m ² /d)	396.00	0.01
Hospital	900	L/(bed/day)		0
Schools	70	L/(Student/d)		0
Trailer Parks no Hook-Ups	340	L/(space/d)		0
Trailer Park with Hook-Ups	800	L/(space/d)		0
Campgrounds	225	L/(campsite/d)		0
Mobile Home Parks	1,000	L/(Space/d)		0
Motels	150	L/(bed-space/d)		0
Hotels	225	L/(bed-space/d)		0
Office	75	L/7.0m ² /d		0
Tourist Commercial	28,000	L/gross ha/d		0
Other Commercial	28,000	L/gross ha/d		0

AVERAGE RESIDENTIAL FLOW	0.28	L/s
PEAK RESIDENTIAL FLOW	1.02	L/s
AVERAGE ICI FLOW	0.01	L/s
PEAK INSTITUTIONAL/COMMERCIAL FLOW	0.02	L/s
PEAK INDUSTRIAL FLOW	0.00	L/s
TOTAL PEAK ICI FLOW	0.02	L/s

TOTAL SANITARY DEMAND

TOTAL ESTIMATED AVERAGE DRY WEATHER FLOW	0.31	L/s
TOTAL ESTIMATED PEAK DRY WEATHER FLOW	1.05	L/s
TOTAL ESTIMATED PEAK WET WEATHER FLOW	1.13	L/s

SANITARY SEWER DESIGN SHEET

PROJECT: Residential Development
 LOCATION: 56 Capilano Drive
 CLIENT: CSV Architects



LOCATION				RESIDENTIAL								ICI AREAS								INFILTRATION ALLOWANCE		FLOW	SEWER DATA														
1	2	3	4	5	6	7	8	9	10	11	12	13	14	15	16	17	18	19	20	21	22	23	24	25	26	27	28	29	30	31							
STREET	AREA ID	FROM MH	TO MH	UNIT TYPES				AREA (ha)	POPULATION		PEAK FACTOR	PEAK FLOW (L/s)	AREA (ha)						PEAK FLOW (L/s)	AREA (ha)		FLOW (L/s)	DESIGN FLOW (L/s)	CAPACITY (L/s)	LENGTH (m)	DIA (mm)	SLOPE (%)	VELOCITY (full) (m/s)	AVAILABLE CAPACITY								
				SF	SD	TH	1-Bed		IND	CUM			INSTITUTIONAL	COMMERCIAL	INDUSTRIAL	IND	CUM	IND		CUM	IND								CUM	IND	CUM	L/s	(%)	L/s	(%)		
Capilano Drive		BLDG	MH1A				54	0.28	75.6	75.6	3.62	0.89				0.00			0.00				0.00				0.28	0.28	0.09	0.98	15.89	27.79	150	1.00	0.871	14.91	93.84
		TH Block	MH1A			4		0.28	10.8	10.8	3.73	0.13				0.00			0.00				0.28	0.09	0.22	16.97	2.78	135	2.00	1.148	16.74	98.69					
		MH1A	MH2A							86.4	3.61	1.01				0.00			0.00			0.28	0.09	1.10	15.89	7.79	150	1.00	0.871	14.79	93.06						
		MH2A	EX. 200							86.4	3.61	1.01				0.00			0.00			0.28	0.09	1.10	15.89	16.22	150	1.00	0.871	14.79	93.06						
Design Parameters:				Notes: 1. Mannings coefficient (n) = 0.013 2. Demand (per capita): 280 L/day 3. Infiltration allowance: 0.33 L/s/Ha 4. Residential Peaking Factor: Harmon Formula = $1 + (14 / (4 + P^{0.5})) * 0.8$ where P = population in thousands									Designed: FV			No.:		Revision			Date																
Residential ICI Areas SF 3.4 p/p/u TH/SD 2.7 p/p/u 1-Bed 1.4 p/p/u Other 60 p/p/Ha INST 28,000 L/Ha/day COM 28,000 L/Ha/day IND 35,000 L/Ha/day				Peak Factor 1.5 MOE Chart									Checked: JH			1.		Issued For Review			2023.06.30																
													Project No.: CCO-23-3325								Sheet No: 1 of 1																

APPENDIX E
PRE-DEVELOPMENT DRAINAGE PLAN

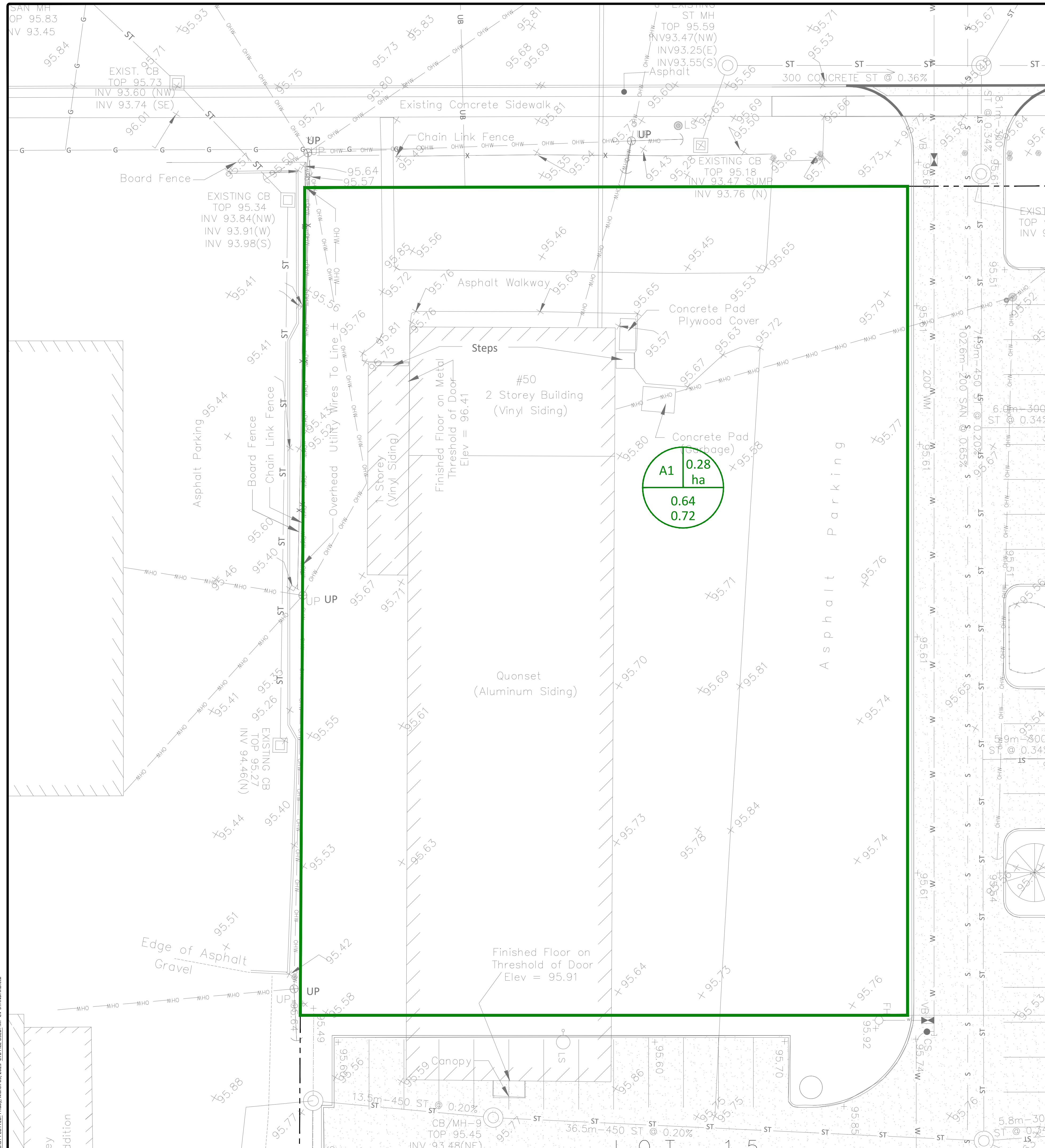

GENERAL NOTES

1. THE ORIGINAL TOPOGRAPHY, GROUND ELEVATION AND SURVEY DATA SHOWN ARE SUPPLIED FOR INFORMATION PURPOSES ONLY. THE CONTRACTOR SHALL BE RESPONSIBLE FOR ALL TRAFFIC CONTROL AND SAFETY MEASURES DURING CONSTRUCTION PERIOD, INCLUDING THE SUPPLY, INSTALLATION, AND REMOVAL OF ALL NECESSARY SIGNAGE, DELINEATORS, MARKERS AND BARRIERS.
2. THIS PLAN IS NOT A CADASTRAL SURVEY SHOWING LEGAL PROPERTY BOUNDARIES AND EASEMENTS. THE PROPERTY BOUNDARIES SHOWN HEREON HAVE BEEN DERIVED FROM INFORMATION SUPPLIED BY (OR SHOWN ON) FAIRHALL, MOFFAT & WOODLAND DRAWING 22200 AND CANNOT BE RELIED UPON TO BE ACCURATE OR COMPLETE. THE PRECISE LOCATION OF THE CURRENT PROPERTY BOUNDARIES AND EASEMENTS CAN ONLY BE DETERMINED BY AN UP-TO-DATE LAND TITLES SEARCH AND A SUBSEQUENT CADASTRAL SURVEY PERFORMED AND CERTIFIED BY AN ONTARIO LAND SURVEYOR.
3. THE CONTRACTOR IS TO OBTAIN AND PAY FOR ALL NECESSARY PERMITS AND APPROVALS FROM THE CITY BEFORE COMMENCING CONSTRUCTION.
4. THE CONTRACTOR IS RESPONSIBLE FOR ALL LAYOUT.
5. THE CONTRACTOR IS TO DETERMINE THE EXACT LOCATION, SIZE, MATERIAL AND ELEVATION OF ALL EXISTING UTILITIES PRIOR TO COMMENCING CONSTRUCTION. PROTECT AND ASSUME ALL RESPONSIBILITY FOR EXISTING UTILITIES WHETHER OR NOT SHOWN ON THESE DRAWINGS. IF THERE IS ANY DISCREPANCY THE CONTRACTOR IS TO NOTIFY THE ENGINEER PROMPTLY.
6. RESTORE ALL TRENCHES AND SURFACES OF PUBLIC ROAD ALLOWANCES TO CONDITION EQUAL OR BETTER THAN ORIGINAL CONDITION AND TO THE SATISFACTION OF THE CITY AUTHORITIES.
7. EXCAVATE AND DISPOSE OF ALL EXCESS EXCAVATED MATERIAL, SUCH AS ASPHALT, CURBING AND DEBRIS, OFF SITE AS DIRECTED BY THE ENGINEER AND THE CITY.
8. TOPSOIL TO BE STRIPPED AND STOCKPILED FOR REHABILITATION. CLEAN FILL TO BE PLACED IN FILL AREAS AND COMPACTED TO 95% STANDARD PROCTOR DENSITY.
9. ALL DISTURBED AREAS TO BE RESTORED TO ORIGINAL CONDITION OR BETTER UNLESS OTHERWISE SPECIFIED.
10. THE CONTRACTOR SHALL BE RESPONSIBLE FOR ALL TRAFFIC CONTROL AND SAFETY MEASURES DURING CONSTRUCTION PERIOD, INCLUDING THE SUPPLY, INSTALLATION, AND REMOVAL OF ALL NECESSARY SIGNAGE, DELINEATORS, MARKERS AND BARRIERS.
11. DO NOT ALTER GRADING OF THE SITE WITHOUT PRIOR APPROVAL OF THE ENGINEER/CITY.
12. ALL ROADWAY, PARKING LOT, AND GRADING WORKS TO BE UNDERTAKEN IN ACCORDANCE WITH CITY STANDARDS AND SPECIFICATIONS. THE CONTRACTOR IS TO PROVIDE POSITIVE DRAINAGE AWAY FROM THE BUILDING.
13. CONTACT THE CITY FOR INSPECTION OF ROUGH GRADING OF PARKING LOTS, ROADWAYS AND LANDSCAPED AREAS PRIOR TO PLACEMENT OF ASPHALT AND TOPSOIL. ALL DEFICIENCIES NOTED SHALL BE RECTIFIED TO THE CITY'S SATISFACTION PRIOR TO PLACEMENT OF ANY ASPHALT, TOPSOIL, SEED & MULCH AND/OR SOO.
14. ALL DIMENSIONS AND INVERTS MUST BE VERIFIED PRIOR TO CONSTRUCTION. IF THERE IS ANY DISCREPANCY THE CONTRACTOR IS TO NOTIFY THE ENGINEER PROMPTLY.
15. ELECTRICAL, GAS, TELEPHONE AND TELEVISION SERVICE LOCATIONS ARE SUBJECT TO THE INDIVIDUAL AGENCY:
 - ELECTRICAL SERVICE - HYDRO ONE.
 - GAS SERVICE - ENBRIDGE.
 - TELEPHONE SERVICE - BELL CANADA.
 - TELEVISION SERVICE - ROGERS.
16. INSTALLATION TO BE IN ACCORDANCE WITH CURRENT CODES AND STANDARDS OF APPROVAL AGENCIES HYDRO ONE, BELL AND THE CITY.
17. CONTRACTOR TO ENSURE ALL APPLICABLE OPS SPECIFICATIONS ARE FOLLOWED DURING CONSTRUCTION.
18. ALL PROPOSED CURB TO BE CONCRETE BARRIER CURB UNLESS OTHERWISE SPECIFIED.

LEGEND:

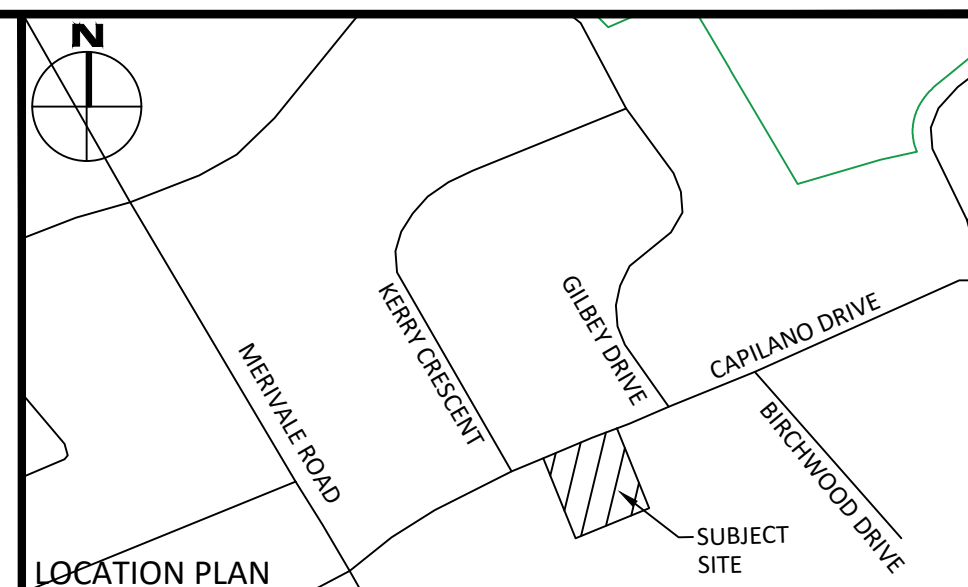
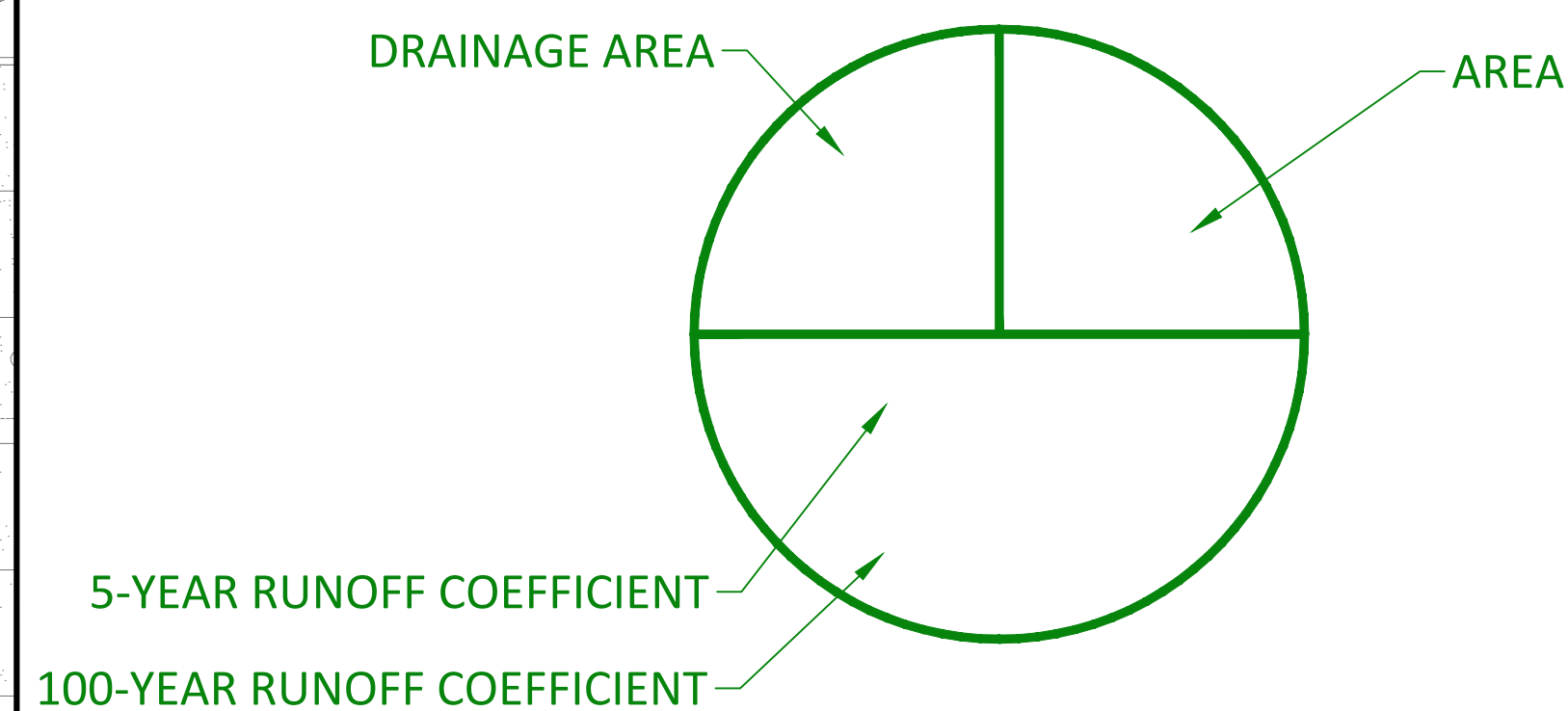

LEGEND

FOR REVIEW ONLY
NOT FOR CONSTRUCTION

1	ISSUED FOR REVIEW	MAR. 03, 2023
	Revisions	Date

Check and verify all dimensions before proceeding with the work Do not scale drawings

SCALE 1 : 250

McINTOSH PERRY
115 Walgreen Road, RR3, Carp, ON K0A 1L0
Tel: 613-836-2184 Fax: 613-836-3742
www.mcintoshperry.com

Client: **CSV ARCHITECTS**
190 O'CONNOR STREET, SUITE 100
OTTAWA, ON K2P 2R3

Project: **RESIDENTIAL DEVELOPMENT**
56 CAPILANO DRIVE

Drawing Title: **PRE-DEVELOPMENT DRAINAGE AREA PLAN**

Scale:	1:250	Project Number:	CCO-23-3325
Drawn By:	NV	Checked By:	CJM
Designed By:	NV	Drawing Number:	PRE

FILENAME: U:\C:\Users\j1\OneDrive - Project - Proj\2023\2023\03\03\CCO-23-3325\03-3325 PRESENTATION.dwg
 DATE SAVED: Thursday, February 16, 2023 10:58 AM
 LAST SAVED BY: j1
 LAST PLOTTED: Friday, March 03, 2023 10:58 AM
 PLOT FILE USED: PLOT_STANDARD.dwg

D07-12-XX-XXXX

#XXXX

APPENDIX F
POST-DEVELOPMENT DRAINAGE PLAN

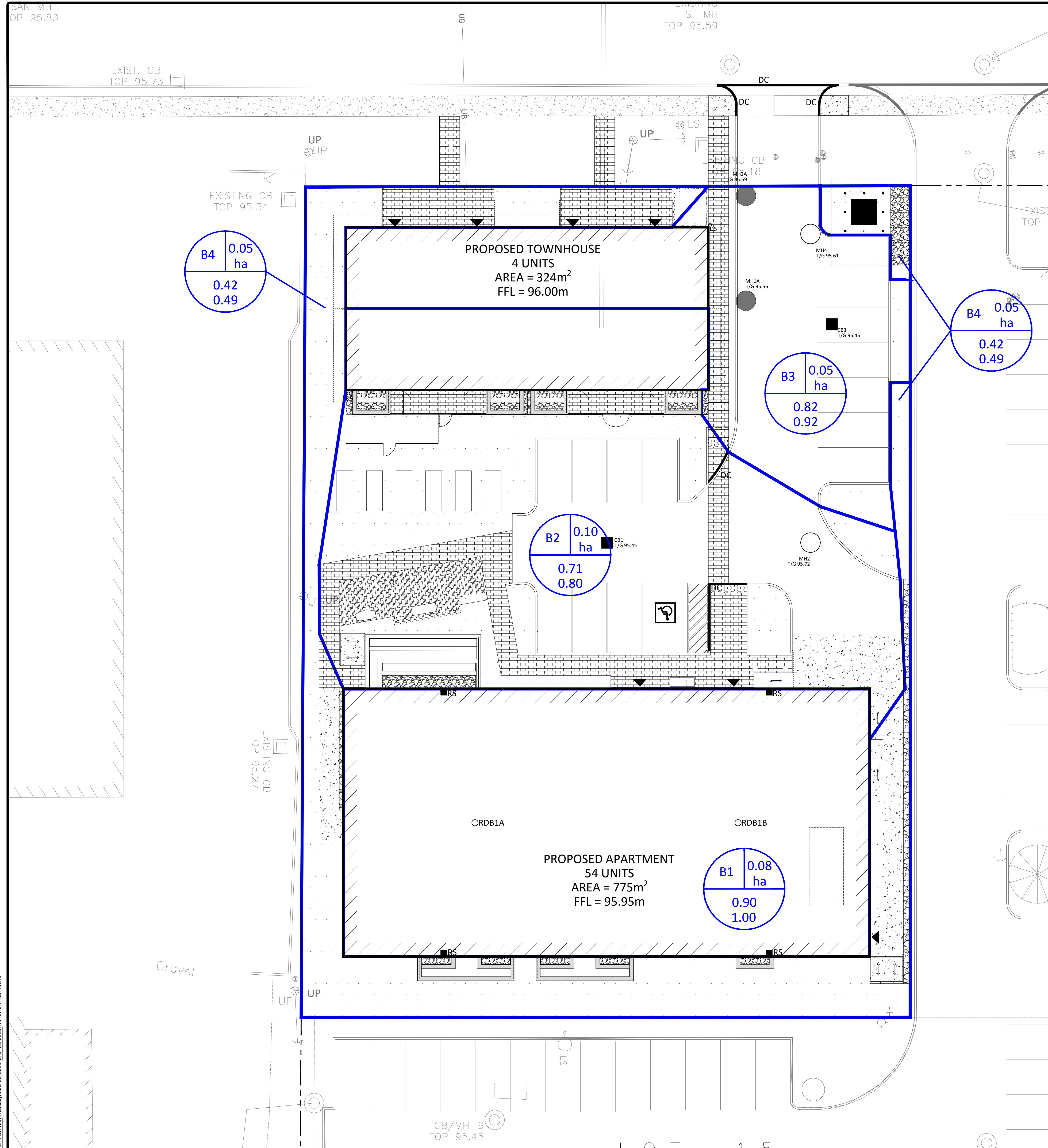

GENERAL NOTES

- THE ORIGINAL TOPOGRAPHY, GROUND ELEVATION AND SURVEY DATA SHOWN ARE SUPPLIED FOR INFORMATION PURPOSES ONLY, AND IMPLY NO GUARANTEE OF ACCURACY. IT SHALL BE THE RESPONSIBILITY OF THE CONTRACTOR TO VERIFY ALL INFORMATION SHOWN.
- THIS PLAN IS NOT A CADASTRAL SURVEY SHOWING LEGAL PROPERTY BOUNDARIES AND EASEMENTS. THE PROPERTY BOUNDARIES SHOWN HEREON HAVE BEEN DERIVED FROM INFORMATION SUPPLIED BY (OR SHOWN ON) FAIRHALL, MOFFAT & WOODLAND DRAWING 22200 AND CANNOT BE RELIED UPON TO BE ACCURATE OR COMPLETE. THE PRECISE LOCATION OF THE CURRENT PROPERTY BOUNDARIES AND EASEMENTS CAN ONLY BE DETERMINED BY AN UP-TO-DATE LAND TITLES SEARCH AND A SUBSEQUENT CADASTRAL SURVEY PERFORMED AND CERTIFIED BY AN ONTARIO LAND SURVEYOR.
- THE CONTRACTOR IS TO OBTAIN AND PAY FOR ALL NECESSARY PERMITS AND APPROVALS FROM THE CITY BEFORE COMMENCING CONSTRUCTION.
- THE CONTRACTOR IS RESPONSIBLE FOR ALL LAYOUT.
- THE CONTRACTOR IS TO DETERMINE THE EXACT LOCATION, SIZE, MATERIAL AND ELEVATION OF ALL EXISTING UTILITIES PRIOR TO COMMENCING CONSTRUCTION. PROTECT AND ASSUME ALL RESPONSIBILITY FOR EXISTING UTILITIES WHETHER OR NOT SHOWN ON THESE DRAWINGS. IF THERE IS ANY DISCREPANCY THE CONTRACTOR IS TO NOTIFY THE ENGINEER PROMPTLY.
- RESTORE ALL TRENCHES AND SURFACES OF PUBLIC ROAD ALLOWANCES TO CONDITION EQUAL OR BETTER THAN ORIGINAL CONDITION AND TO THE SATISFACTION OF THE CITY AUTHORITIES.
- EXCAVATE AND DISPOSE OF ALL EXCESS EXCAVATED MATERIAL, SUCH AS ASPHALT, CURBING AND DEBRIS, OFF SITE AS DIRECTED BY THE ENGINEER AND THE CITY.
- TOPSOIL TO BE STRIPPED AND STOCKPILED FOR REHABILITATION. CLEAN FILL TO BE PLACED IN FILL AREAS AND COMPACTED TO 95% STANDARD PROCTOR DENSITY.
- ALL DISTURBED AREAS TO BE RESTORED TO ORIGINAL CONDITION OR BETTER UNLESS OTHERWISE SPECIFIED. THE CONTRACTOR SHALL BE RESPONSIBLE FOR ALL TRAFFIC CONTROL AND SAFETY MEASURES DURING THE CONSTRUCTION PERIOD, INCLUDING THE SUPPLY, INSTALLATION, AND REMOVAL OF ALL NECESSARY SIGNAGE, DELINEATORS, MARKERS AND BARRIERS.
- DO NOT ALTER GRADING OF THE SITE WITHOUT PRIOR APPROVAL OF THE ENGINEER/CITY.
- ALL ROADWAY, PARKING LOT, AND GRADING WORKS TO BE UNDERTAKEN IN ACCORDANCE WITH CITY STANDARDS AND SPECIFICATIONS. THE CONTRACTOR IS TO PROVIDE POSITIVE DRAINAGE AWAY FROM THE BUILDING.
- CONTACT THE CITY FOR INSPECTION OF ROUGH GRADING OF PARKING LOTS, ROADWAYS AND LANDSCAPED AREAS PRIOR TO PLACEMENT OF ASPHALT AND TOPSOIL. ALL DEFICIENCIES NOTED SHALL BE RECTIFIED TO THE CITY'S SATISFACTION PRIOR TO PLACEMENT OF ANY ASPHALT, TOPSOIL, SEED & MULCH AND/OR SOO.
- ALL DIMENSIONS AND INVERTS MUST BE VERIFIED PRIOR TO CONSTRUCTION. IF THERE IS ANY DISCREPANCY THE CONTRACTOR IS TO NOTIFY THE ENGINEER PROMPTLY.
- ELECTRICAL, GAS, TELEPHONE AND TELEVISION SERVICE LOCATIONS ARE SUBJECT TO THE INDIVIDUAL AGENCY:
 - ELECTRICAL SERVICE - HYDRO ONE.
 - GAS SERVICE - ENBRIDGE.
 - TELEPHONE SERVICE - BELL CANADA.
 - TELEVISION SERVICE - ROGERS.
- INSTALLATION TO BE IN ACCORDANCE WITH CURRENT CODES AND STANDARDS OF APPROVAL AGENCIES HYDRO ONE, BELL AND THE CITY.
- CONTRACTOR TO ENSURE ALL APPLICABLE OPS SPECIFICATIONS ARE FOLLOWED DURING CONSTRUCTION.
- ALL PROPOSED CURB TO BE CONCRETE BARRIER CURB UNLESS OTHERWISE SPECIFIED.

LEGEND:

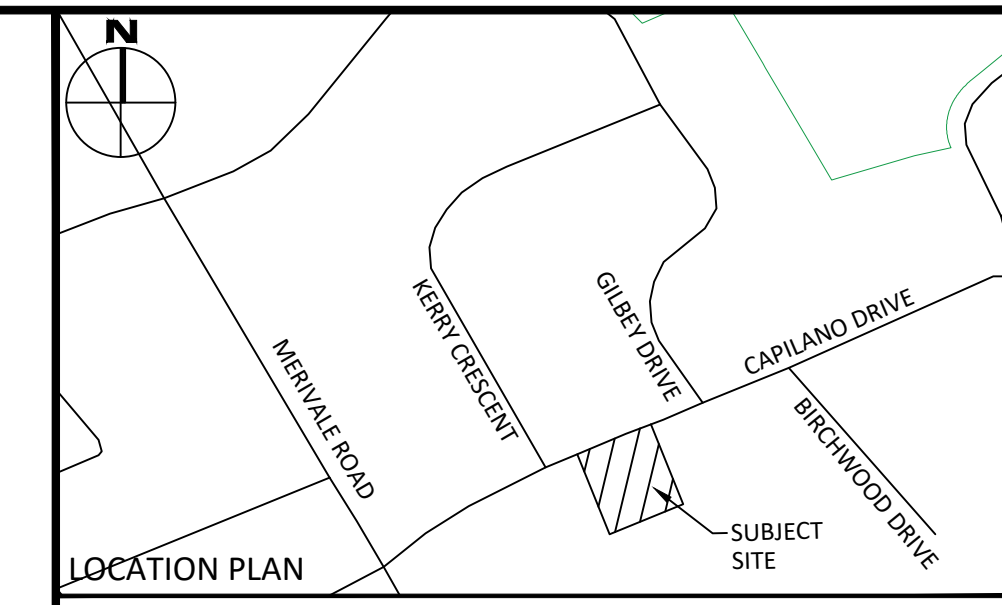
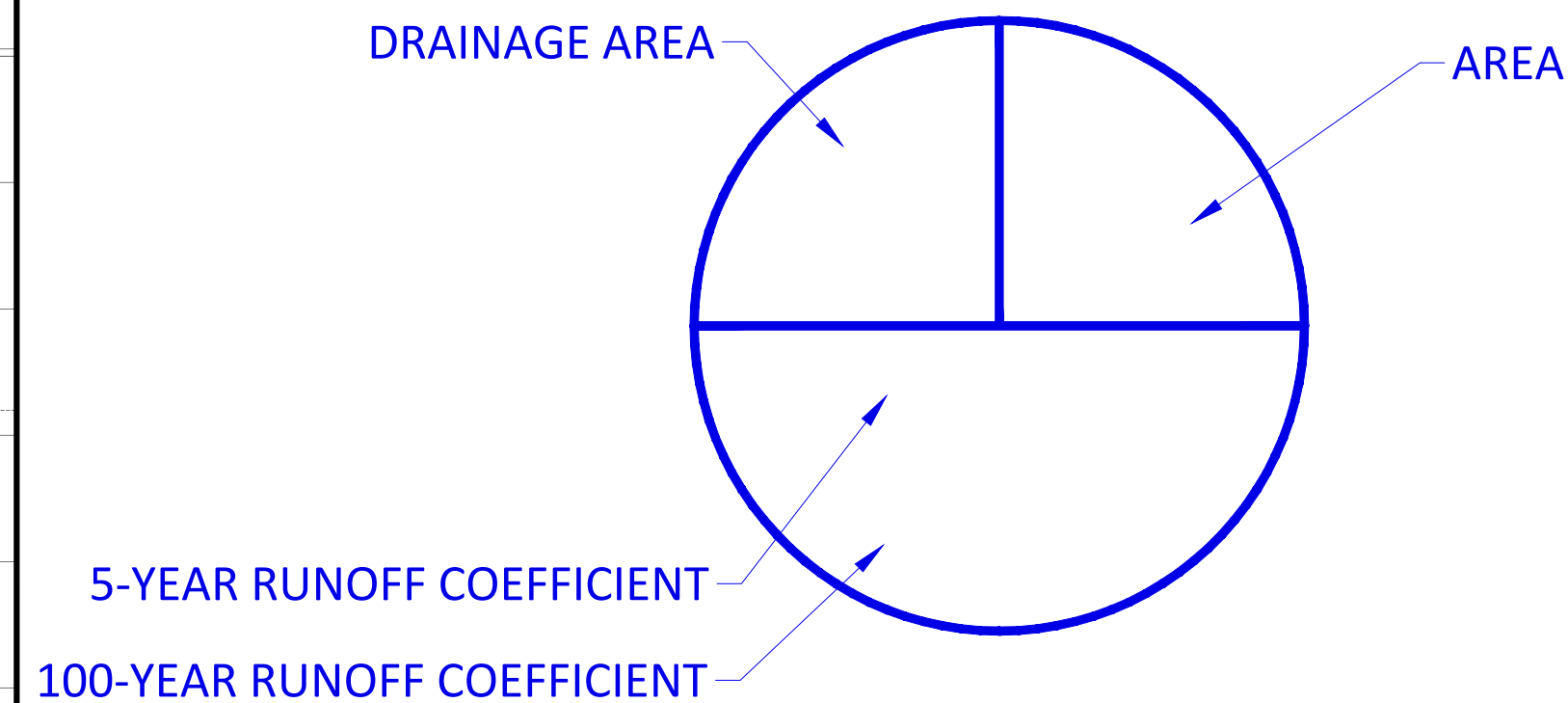

FOR REVIEW ONLY
NOT FOR CONSTRUCTION

No.	Revisions	Date
2	REVISED PER CITY COMMENTS	JUNE 13, 2023
1	ISSUED FOR REVIEW	MAR. 03, 2023

Check and verify all dimensions before proceeding with the work. Do not scale drawings.

SCALE 1 : 150

McINTOSH PERRY
115 Walgreen Road, RR3, Carp, ON K0A 1L0
Tel: 613-836-2184 Fax: 613-836-3742
www.mcintoshperry.com

Stamp:

Client: **CSV ARCHITECTS**
190 O'CONNOR STREET, SUITE 100
OTTAWA, ON K2P 2R3

Project: **RESIDENTIAL DEVELOPMENT**
56 CAPILANO DRIVE

Drawing Title: **POST-DEVELOPMENT DRAINAGE AREA PLAN**

Scale: 1:150	Project Number: CCO-23-3325
Drawn By: NV	Checked By: CIM
Designed By: NV	Drawing Number: POST

FILENAME: \\Ottawa\01\Projects - Proposed\2023\hki\CCO-23-3325\01 - Drawing\CCO-23-3325 PRESENTATION.dwg
 DATE SAVED: Thursday, June 22, 2023 1:51:54 PM
 LAST PLOTTED: Thursday, June 22, 2023 1:51:54 PM
 PLOTTER: HP DesignJet T1100

D07-12-23-0028

APPENDIX G
STORMWATER MANAGEMENT CALCULATIONS

McINTOSH PERRY

CCO-23-3325 - 56 Capilano Drive

1 of 5

Tc (min)	Intensity (mm/hr)		
	2-Year	5-Year	100-Year
20	51.79	70.3	120.0
10	76.81	104.2	178.6

C-Values	
Impervious	0.90
Gravel	0.60
Pervious	0.20

Pre-Development Runoff Coefficient

Drainage Area	Impervious Area (m ²)	Gravel (m ²)	Pervious Area (m ²)	Average C (5-year)	Average C (100-year)
A1	1,745	0	1,030	0.64	0.72

Pre-Development Runoff Calculations

Drainage Area	Area (ha)	C 5-Year	C 100-Year	Tc (min)	Q (L/s)	
					5-Year	100-Year
A1	0.28	0.64	0.72	10	51.45	99.39
Total	0.28				51.45	99.39

Post-Development Runoff Coefficient

Drainage Area	Impervious Area (m ²)	Gravel (m ²)	Pervious Area (m ²)	Average C (5-year)	Average C (100-year)	
B1	775	0	0	0.90	1.00	Restricted Roof
B2	725	12	261	0.71	0.80	Restricted Parking
B3	396	30	37	0.82	0.92	Restricted Parking/Entry
B4	152	29	356	0.42	0.49	Unrestricted

Post-Development Runoff Calculations

Drainage Area	Area (ha)	C 5-Year	C 100-Year	Tc (min)	Q (L/s)		
					5-Year	100-Year	
B1	0.08	0.90	1.00	10	20.21	38.49	Restricted Roof
B2	0.10	0.71	0.80	10	20.64	39.71	Restricted Parking
B3	0.05	0.82	0.92	10	11.06	21.24	Restricted Parking/Entry
B4	0.05	0.42	0.49	10	6.53	13.05	Unrestricted
Total	0.28				58.45	112.49	

Required Restricted Flow

Drainage Area	Area (ha)	C 2/5-Year	Tc (min)	Q (L/s)
				2-Year
A1	0.28	0.50	10	29.62

Post-Development Restricted Runoff Calculations

Drainage Area	Unrestricted Flow (L/S)		Restricted Flow (L/S)		Storage Required (m ³)		Storage Provided (m ³)	
	5-year	100-Year	5-Year	100-Year	5-Year	100-Year	5-Year	100-Year
B1	20.21	38.49	1.83	3.15	16.45	32.01	17.57	32.95
B2	20.64	39.71	7.30	7.44	8.33	23.47	9.16	24.66
B3	11.06	21.24	5.78	5.91	3.17	10.04	3.59	11.30
B4	6.53	13.05	6.53	13.05				
Total	58.45	112.49	21.44	29.56	27.95	65.52	30.32	68.91

McINTOSH PERRY

CCO-23-3325 - 56 Capilano Drive - Roof Storage

2 of 5

5-Year Storm Event

Tc (min)	I (mm/hr)	B1 Runoff (L/s)	Allowable	Runoff to	Storage
			Outflow (L/s)	be Stored (L/s)	Required (m ³)
10	104.2	20.21	1.83	18.38	11.03
20	70.3	13.64	1.83	11.81	14.17
30	53.9	10.46	1.83	8.63	15.53
40	44.2	8.57	1.83	6.74	16.19
50	37.7	7.31	1.83	5.48	16.45
60	32.9	6.38	1.83	4.55	16.39
70	29.4	5.70	1.83	3.87	16.27
80	26.6	5.16	1.83	3.33	15.99

Maximum Storage Required 5-Year (m³) = 16.45

100-Year Storm Event

Tc (min)	I (mm/hr)	B1 Runoff (L/s)	Allowable	Runoff to	Storage
			Outflow (L/s)	be Stored (L/s)	Required (m ³)
10	178.6	38.49	3.15	35.33	21.20
20	120.0	25.85	3.15	22.70	27.24
30	91.9	19.80	3.15	16.65	29.96
40	75.1	16.20	3.15	13.04	31.30
50	64.0	13.78	3.15	10.63	31.89
60	55.9	12.05	3.15	8.89	32.01
70	49.8	10.73	3.15	7.58	31.82
80	45.0	9.70	3.15	6.54	31.40

Maximum Storage Required 100-Year (m³) = 32.01

Storage Parameters	
Roof Area (m ²)	775.30
Usable Roof Area (%)	85%
Usable Roof Area (m ²)	659.01

5-Year Storage Summary	
Max. Storage Available (m ³) at Specified Ponding Depth	17.57
Storage Required (m ³)	16.45
Ponding Depth (m)	0.08

100-Year Storage Summary	
Max. Storage Available (m ³) at Specified Ponding Depth	32.95
100-Year Storage Required (m ³)	32.01
Ponding Depth (m)	0.150

McINTOSH PERRY

CCO-23-3325 - 56 Capilano Drive - Roof Storage

Roof Drain Flow (B1)

3 of 5

Roof Drains Summary		
Type of Control Device	Watts Drainage - Accutrol Weir	
Number of Roof Drains	2	
Roof Drain Position	3/4 Open	
	5-Year	100-Year
Rooftop Storage Available (m ³)	17.57	32.95
Rooftop Storage Required (m ³)	16.45	32.01
Storage Depth (m)	0.080	0.150
Flow (Per Roof Drain) (L/s)	0.91	1.58
Total Flow (L/s)	1.83	3.15

Flow Rate Vs. Build-Up (Individual Drain)	
Depth (mm)	Flow (L/s)
0	0.00
5	0.06
10	0.13
15	0.19
20	0.25
25	0.32
30	0.38
35	0.44
40	0.50
45	0.57
50	0.63
55	0.68
60	0.73
65	0.77
70	0.82
75	0.87
80	0.91
85	0.96
90	1.01
95	1.06
100	1.10
105	1.15
110	1.20
115	1.25
120	1.29
125	1.34
130	1.39
135	1.44
140	1.48
145	1.53
150	1.58

Roof Drain Flow		
Individual Flow (l/s)	Storage Depth (mm)	Cumulative Flow (l/s)
0.00	0	0.00
0.06	5	0.13
0.13	10	0.25
0.19	15	0.38
0.25	20	0.50
0.32	25	0.63
0.38	30	0.76
0.44	35	0.88
0.50	40	1.01
0.57	45	1.14
0.63	50	1.26
0.68	55	1.36
0.73	60	1.45
0.77	65	1.55
0.82	70	1.64
0.87	75	1.73
0.91	80	1.83
0.96	85	1.92
1.01	90	2.02
1.06	95	2.11
1.10	100	2.21
1.15	105	2.30
1.20	110	2.40
1.25	115	2.49
1.29	120	2.59
1.34	125	2.68
1.39	130	2.78
1.44	135	2.87
1.48	140	2.97
1.53	145	3.06
1.58	150	3.15

5-Year

100-Year

*Roof Drain model to be Accutrol Weirs, See attached sheets
 *Roof Drain Flow information taken from Watts Drainage website

Note: The flow leaving through a restricted roof drain is based on flow vs. head information

McINTOSH PERRY

CCO-23-3325 - 56 Capilano Drive

4 of 5

Storage Requirements for Area B2

5-Year Storm Event

Tc (min)	I (mm/hr)	Runoff (L/s) B2	Allowable Outflow (L/s)	Runoff to be Stored (L/s)	Storage Required (m ³)
10	104.2	20.64	7.30	13.34	8.00
15	83.6	16.56	7.30	9.26	8.33
20	70.3	13.93	7.30	6.63	7.95
25	60.9	12.06	7.30	4.76	7.15
30	53.9	10.68	7.30	3.38	6.08
35	48.5	9.61	7.30	2.31	4.85
40	44.2	8.76	7.30	1.46	3.49
45	40.6	8.04	7.30	0.74	2.00
50	37.7	7.47	7.30	0.17	0.50

Maximum Storage Required 5-year = 8.33 m³

100-Year Storm Event

Tc (min)	I (mm/hr)	Runoff (L/s) B2	Allowable Outflow (L/s)	Runoff to be Stored (L/s)	Storage Required (m ³)
10	178.6	39.72	7.44	32.28	19.37
15	142.9	31.78	7.44	24.34	21.91
20	120.0	26.69	7.44	19.25	23.10
25	103.8	23.09	7.44	15.65	23.47
30	91.9	20.44	7.44	13.00	23.40
35	82.6	18.37	7.44	10.93	22.95
40	75.1	16.70	7.44	9.26	22.23
45	69.1	15.37	7.44	7.93	21.41
50	64.0	14.23	7.44	6.79	20.38

Maximum Storage Required 100-year = 23.47 m³

5-Year Storm Event Storage Summary

Water Elev. (m) = 95.61						
Location	T/G	INV. (out)	Area (m ²)	Depth (m)	Head (m)	Volume (m ³)
CB1	95.45	93.86	154.1	0.16	1.65	9.2

Storage Available (m³) = 9.2
Storage Required (m³) = 8.3

*Available Storage calculated from AutoCAD

100-Year Storm Event Storage Summary

Water Elev. (m) = 95.69						
Location	T/G	INV. (out)	Area (m ²)	Depth (m)	Head (m)	Volume (m ³)
CB1	95.45	93.86	243.7	0.24	1.73	24.7

Storage Available (m³) = 24.7
Storage Required (m³) = 23.5

*Available Storage calculated from AutoCAD

McINTOSH PERRY

CCO-23-3325 - 56 Capilano Drive

5 of 5

Storage Requirements for Area B3

5-Year Storm Event

Tc (min)	I (mm/hr)	Runoff (L/s) B3	Allowable Outflow (L/s)	Runoff to be Stored (L/s)	Storage Required (m ³)
10	104.2	11.06	5.78	5.28	3.17
15	83.6	8.88	5.78	3.10	2.79
20	70.3	7.46	5.78	1.68	2.02
25	60.9	6.47	5.78	0.69	1.03

Maximum Storage Required 5-year = 3.17 m³

100-Year Storm Event

Tc (min)	I (mm/hr)	Runoff (L/s) B3	Allowable Outflow (L/s)	Runoff to be Stored (L/s)	Storage Required (m ³)
10	178.6	21.25	5.91	15.34	9.20
15	142.9	17.00	5.91	11.09	9.98
20	120.0	14.28	5.91	8.37	10.04
25	103.8	12.35	5.91	6.44	9.66
30	91.9	10.93	5.91	5.02	9.04
35	82.6	9.83	5.91	3.92	8.22

Maximum Storage Required 100-year = 10.04 m³

5-Year Storm Event Storage Summary

		Water Elev. (m) = 95.57				
Location	T/G	INV. (out)	Area (m ²)	Depth (m)	Head (m)	Volume (m ³)
CB2	95.45	94.14	89.5	0.12	1.35	3.6

Storage Available (m³) = 3.6
Storage Required (m³) = 3.2

*Available Storage calculated from AutoCAD

100-Year Storm Event Storage Summary

		Water Elev. (m) = 95.63				
Location	T/G	INV. (out)	Area (m ²)	Depth (m)	Head (m)	Volume (m ³)
CB2	95.45	94.14	166.9	0.18	1.41	11.3

Storage Available (m³) = 11.3
Storage Required (m³) = 10.0

*Available Storage calculated from AutoCAD

STORM SEWER DESIGN SHEET



PROJECT: Residential Development
 LOCATION: 56 Capilano Drive
 CLIENT: CSV Architects

LOCATION				CONTRIBUTING AREA (ha)								RATIONAL DESIGN FLOW										SEWER DATA																
1	2	3	4	5	6	7	8	9	10	11	12	13	14	15	16	17	18	19	20	21	22	23	24	25	26	27	28	29	30	31	32							
STREET	AREA ID	FROM MH	TO MH	C-VALUE						INDIV AC	CUMUL AC	INLET (min)	TIME IN PIPE	TOTAL (min)	i (2) (mm/hr)	i (10) (mm/hr)	i (100) (mm/hr)	2yr PEAK FLOW (L/s)	10yr PEAK FLOW (L/s)	100yr PEAK FLOW (L/s)	FIXED FLOW (L/s)	DESIGN FLOW (L/s)	CAPACITY (L/s)	LENGTH (m)	PIPE SIZE (mm)			SLOPE (%)	VELOCITY (m/s)	AVAIL CAP (2yr)								
				0.20	0.60	0.42	0.71	0.82	0.90																DIA	W	H			(L/s)	(%)							
	B1	BLDG	MH2						0.078	0.07	0.07	10.00	0.17	10.17	76.81	167.22	178.56	14.90				14.90	34.22	10.85	200			1.00	1.055	19.32	56.46%							
	B2	CB1	MH2				0.10			0.07	0.07	10.00	0.24	10.24	76.81	122.14	178.56	15.21				15.21	34.22	15.08	200			1.00	1.055	19.00	55.54%							
	B3	CB3	TEE					0.05		0.04	0.04	10.00	0.02	10.02	76.81	122.14	178.56	8.11				8.11	22.47	1.57	150			2.00	1.232	14.36	63.92%							
	B1-B3	MH2	MH4							0.00	0.18	10.24	0.28	10.51	75.90	120.68	176.41	37.77				37.77	100.88	22.89	300			1.00	1.383	63.11	62.56%							
	B1-B3	MH4	EX. 375							0.00	0.18	10.51	0.15	10.67	74.89	119.03	173.99	37.27				37.27	100.88	12.59	300			1.00	1.383	63.62	63.06%							
Definitions: Q = 2.78CIA, where: Q = Peak Flow in Litres per Second (L/s) A = Area in Hectares (ha) i = Rainfall intensity in millimeters per hour (mm/hr) [i = 732.951 / (TC+6.199)^0.81] 2 YEAR [i = 998.071 / (TC+6.053)^0.814] 5 YEAR [i = 1174.184 / (TC+6.014)^0.816] 10 YEAR [i = 1735.688 / (TC+6.014)^0.820] 100 YEAR				Notes: 1. Mannings coefficient (n) = 0.013								Designed: N.B.V. Checked: N.B.V. Project No.: CCO-23-3325										<table border="1"> <thead> <tr> <th>No.</th> <th>Revision</th> <th>Date</th> </tr> </thead> <tbody> <tr> <td>1.</td> <td>Issued for review</td> <td>2023-03-03</td> </tr> <tr> <td>2</td> <td>Revised Per City Comments</td> <td>2023-06-30</td> </tr> </tbody> </table>								No.	Revision	Date	1.	Issued for review	2023-03-03	2	Revised Per City Comments	2023-06-30
No.	Revision	Date																																				
1.	Issued for review	2023-03-03																																				
2	Revised Per City Comments	2023-06-30																																				
Sheet No: 1 of 1																																						

TEMPEST LMF flow curves ICD - CB3

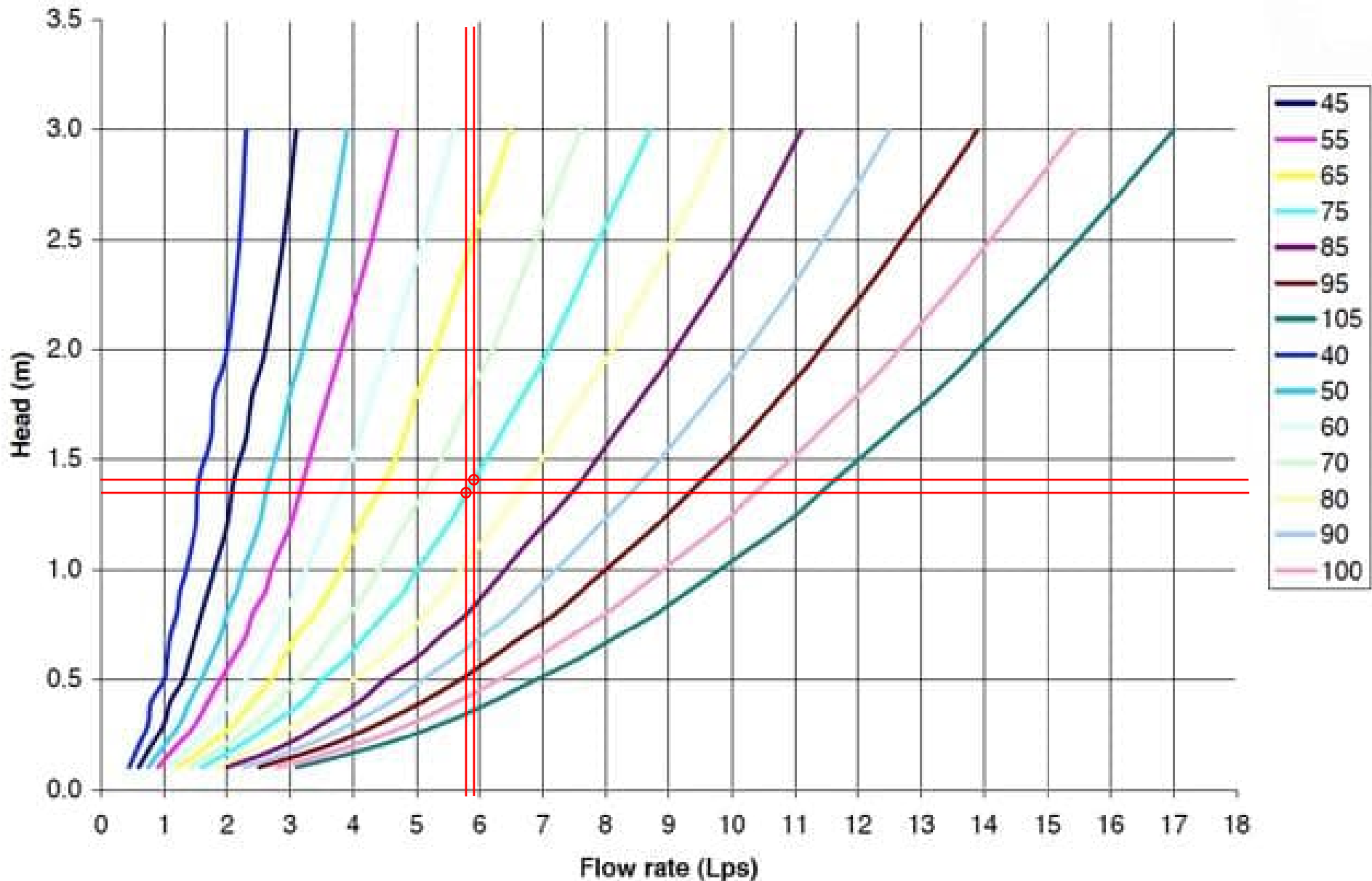



Adjustable Accutrol Weir

Tag: _____

Adjustable Flow Control for Roof Drains

ADJUSTABLE ACCUTROL (for Large Sump Roof Drains only)

For more flexibility in controlling flow with heads deeper than 2", Watts Drainage offers the Adjustable Accutrol. The Adjustable Accutrol Weir is designed with a single parabolic opening that can be covered to restrict flow above 2" of head to less than 5 gpm per inch, up to 6" of head. To adjust the flow rate for depths over 2" of head, set the slot in the adjustable upper cone according to the flow rate required. Refer to Table 1 below.
 Note: Flow rates are directly proportional to the amount of weir opening that is exposed.

EXAMPLE:

For example, if the adjustable upper cone is set to cover 1/2 of the weir opening, flow rates above 2" of head will be restricted to 2-1/2 gpm per inch of head.

Therefore, at 3" of head, the flow rate through the Accutrol Weir that has 1/2 the slot exposed will be:
 [5 gpm (per inch of head) x 2 inches of head] + 2-1/2 gpm (for the third inch of head) = 12-1/2 gpm.

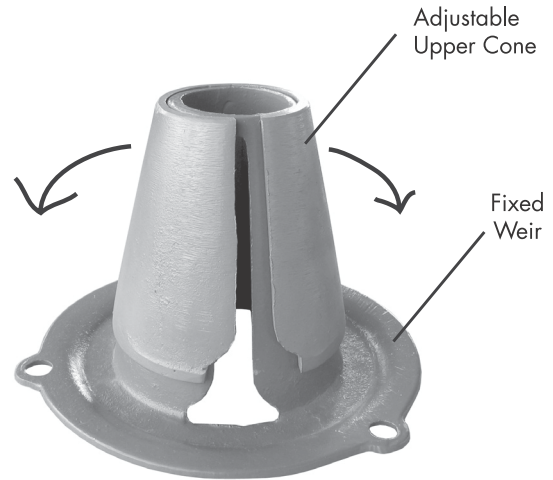
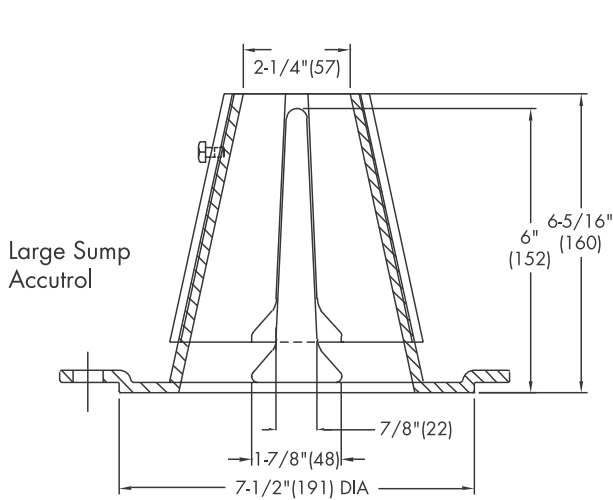

1/2 Weir Opening Exposed Shown Above

TABLE 1. Adjustable Accutrol Flow Rate Settings

Weir Opening Exposed	1"	2"	3"	4"	5"	6"
	Flow Rate (gallons per minute)					
Fully Exposed	5	10	15	20	25	30
3/4	5	10	13.75	17.5	21.25	25
1/2	5	10	12.5	15	17.5	20
1/4	5	10	11.25	12.5	13.75	15
Closed	5	5	5	5	5	5

Job Name _____
 Job Location _____
 Engineer _____

Contractor _____
 Contractor's P.O. No. _____
 Representative _____

Watts product specifications in U.S. customary units and metric are approximate and are provided for reference only. For precise measurements, please contact Watts Technical Service. Watts reserves the right to change or modify product design, construction, specifications, or materials without prior notice and without incurring any obligation to make such changes and modifications on Watts products previously or subsequently sold.

USA: Tel: (800) 338-2581 • Fax: (828) 248-3929 • Watts.com
 Canada: Tel: (905) 332-4090 • Fax: (905) 332-7068 • Watts.ca
 Latin America: Tel: (52) 81-1001-8600 • Fax: (52) 81-8000-7091 • Watts.com



APPENDIX H
CITY OF OTTAWA DESIGN CHECKLIST

City of Ottawa

4. Development Servicing Study Checklist

The following section describes the checklist of the required content of servicing studies. It is expected that the proponent will address each one of the following items for the study to be deemed complete and ready for review by City of Ottawa Infrastructure Approvals staff.

The level of required detail in the Servicing Study will increase depending on the type of application. For example, for Official Plan amendments and re-zoning applications, the main issues will be to determine the capacity requirements for the proposed change in land use and confirm this against the existing capacity constraint, and to define the solutions, phasing of works and the financing of works to address the capacity constraint. For subdivisions and site plans, the above will be required with additional detailed information supporting the servicing within the development boundary.

4.1 General Content

Criteria	Location (if applicable)
<input type="checkbox"/> Executive Summary (for larger reports only).	N/A
<input type="checkbox"/> Date and revision number of the report.	On Cover
<input type="checkbox"/> Location map and plan showing municipal address, boundary, and layout of proposed development.	Appendix A
<input type="checkbox"/> Plan showing the site and location of all existing services.	Site Servicing Plan (C102)
<input type="checkbox"/> Development statistics, land use, density, adherence to zoning and official plan, and reference to applicable subwatershed and watershed plans that provide context to which individual developments must adhere.	1.1 Purpose 1.2 Site Description 6.0 Stormwater Management
<input type="checkbox"/> Summary of pre-consultation meetings with City and other approval agencies.	Appendix B
<input type="checkbox"/> Reference and confirm conformance to higher level studies and reports (Master Servicing Studies, Environmental Assessments, Community Design Plans), or in the case where it is not in conformance, the proponent must provide justification and develop a defensible design criteria.	1.1 Purpose 1.2 Site Description 6.0 Stormwater Management
<input type="checkbox"/> Statement of objectives and servicing criteria.	3.0 Pre-Consultation Summary

<input type="checkbox"/> Identification of existing and proposed infrastructure available in the immediate area.	N/A
<input type="checkbox"/> Identification of Environmentally Significant Areas, watercourses and Municipal Drains potentially impacted by the proposed development (Reference can be made to the Natural Heritage Studies, if available).	Site Grading Plan (C101)
<input type="checkbox"/> Concept level master grading plan to confirm existing and proposed grades in the development. This is required to confirm the feasibility of proposed stormwater management and drainage, soil removal and fill constraints, and potential impacts to neighbouring properties. This is also required to confirm that the proposed grading will not impede existing major system flow paths.	Site Grading Plan (C101)
<input type="checkbox"/> Identification of potential impacts of proposed piped services on private services (such as wells and septic fields on adjacent lands) and mitigation required to address potential impacts.	N/A
<input type="checkbox"/> Proposed phasing of the development, if applicable.	N/A
<input type="checkbox"/> Reference to geotechnical studies and recommendations concerning servicing.	Section 2.0 Background Studies, Standards and References
<input type="checkbox"/> All preliminary and formal site plan submissions should have the following information: <ul style="list-style-type: none"> ○ Metric scale ○ North arrow (including construction North) ○ Key plan ○ Name and contact information of applicant and property owner ○ Property limits including bearings and dimensions ○ Existing and proposed structures and parking areas ○ Easements, road widening and rights-of-way ○ Adjacent street names 	Site Grading Plan (C101)

4.2 Development Servicing Report: Water

Criteria	Location (if applicable)
<input type="checkbox"/> Confirm consistency with Master Servicing Study, if available	N/A
<input type="checkbox"/> Availability of public infrastructure to service proposed development	N/A
<input type="checkbox"/> Identification of system constraints	N/A
<input type="checkbox"/> Identify boundary conditions	Appendix C
<input type="checkbox"/> Confirmation of adequate domestic supply and pressure	N/A
<input type="checkbox"/> Confirmation of adequate fire flow protection and confirmation that fire flow is calculated as per the Fire Underwriter's Survey. Output should show available fire flow at locations throughout the development.	Appendix C
<input type="checkbox"/> Provide a check of high pressures. If pressure is found to be high, an assessment is required to confirm the application of pressure reducing valves.	N/A
<input type="checkbox"/> Definition of phasing constraints. Hydraulic modeling is required to confirm servicing for all defined phases of the project including the ultimate design	N/A
<input type="checkbox"/> Address reliability requirements such as appropriate location of shut-off valves	N/A
<input type="checkbox"/> Check on the necessity of a pressure zone boundary modification.	N/A
<input type="checkbox"/> Reference to water supply analysis to show that major infrastructure is capable of delivering sufficient water for the proposed land use. This includes data that shows that the expected demands under average day, peak hour and fire flow conditions provide water within the required pressure range	Appendix C, Section 4.2

<input type="checkbox"/> Description of the proposed water distribution network, including locations of proposed connections to the existing system, provisions for necessary looping, and appurtenances (valves, pressure reducing valves, valve chambers, and fire hydrants) including special metering provisions.	Site Servicing Plan (C101)
<input type="checkbox"/> Description of off-site required feeder mains, booster pumping stations, and other water infrastructure that will be ultimately required to service proposed development, including financing, interim facilities, and timing of implementation.	N/A
<input type="checkbox"/> Confirmation that water demands are calculated based on the City of Ottawa Design Guidelines.	Appendix C
<input type="checkbox"/> Provision of a model schematic showing the boundary conditions locations, streets, parcels, and building locations for reference.	N/A

4.3 Development Servicing Report: Wastewater

Criteria	Location (if applicable)
<input type="checkbox"/> Summary of proposed design criteria (Note: Wet-weather flow criteria should not deviate from the City of Ottawa Sewer Design Guidelines. Monitored flow data from relatively new infrastructure cannot be used to justify capacity requirements for proposed infrastructure).	N/A
<input type="checkbox"/> Confirm consistency with Master Servicing Study and/or justifications for deviations.	N/A
<input type="checkbox"/> Consideration of local conditions that may contribute to extraneous flows that are higher than the recommended flows in the guidelines. This includes groundwater and soil conditions, and age and condition of sewers.	N/A
<input type="checkbox"/> Description of existing sanitary sewer available for discharge of wastewater from proposed development.	Section 5.2 Proposed Sanitary Sewer

<input type="checkbox"/> Verify available capacity in downstream sanitary sewer and/or identification of upgrades necessary to service the proposed development. (Reference can be made to previously completed Master Servicing Study if applicable)	Section 5.3 Proposed Sanitary Design
<input type="checkbox"/> Calculations related to dry-weather and wet-weather flow rates from the development in standard MOE sanitary sewer design table (Appendix 'C') format.	N/A
<input type="checkbox"/> Description of proposed sewer network including sewers, pumping stations, and forcemains.	Section 5.2 Proposed Sanitary Sewer
<input type="checkbox"/> Discussion of previously identified environmental constraints and impact on servicing (environmental constraints are related to limitations imposed on the development in order to preserve the physical condition of watercourses, vegetation, soil cover, as well as protecting against water quantity and quality).	N/A
<input type="checkbox"/> Pumping stations: impacts of proposed development on existing pumping stations or requirements for new pumping station to service development.	N/A
<input type="checkbox"/> Forcemain capacity in terms of operational redundancy, surge pressure and maximum flow velocity.	N/A
<input type="checkbox"/> Identification and implementation of the emergency overflow from sanitary pumping stations in relation to the hydraulic grade line to protect against basement flooding.	N/A
<input type="checkbox"/> Special considerations such as contamination, corrosive environment etc.	N/A

4.4 Development Servicing Report: Stormwater Checklist

Criteria	Location (if applicable)
<input type="checkbox"/> Description of drainage outlets and downstream constraints including legality of outlets (i.e. municipal drain, right-of-way, watercourse, or private property)	Section 6.0 Stormwater Sewer Design & Section 7.0 Proposed Stormwater Management
<input type="checkbox"/> Analysis of available capacity in existing public infrastructure.	N/A
<input type="checkbox"/> A drawing showing the subject lands, its surroundings, the receiving watercourse, existing drainage patterns, and proposed drainage pattern.	Pre & Post-Development Plans
<input type="checkbox"/> Water quantity control objective (e.g. controlling post-development peak flows to pre-development level for storm events ranging from the 2 or 5-year event (dependent on the receiving sewer design) to 100-year return period); if other objectives are being applied, a rationale must be included with reference to hydrologic analyses of the potentially affected subwatersheds, taking into account long-term cumulative effects.	Section 6.0 Stormwater Sewer Design & Section 7.0 Proposed Stormwater Management
<input type="checkbox"/> Water Quality control objective (basic, normal or enhanced level of protection based on the sensitivities of the receiving watercourse) and storage requirements.	Section 6.0 Stormwater Sewer Design & Section 7.0 Proposed Stormwater Management
<input type="checkbox"/> Description of the stormwater management concept with facility locations and descriptions with references and supporting information.	Section 6.0 Stormwater Sewer Design & Section 7.0 Proposed Stormwater Management
<input type="checkbox"/> Set-back from private sewage disposal systems.	N/A
<input type="checkbox"/> Watercourse and hazard lands setbacks.	N/A
<input type="checkbox"/> Record of pre-consultation with the Ontario Ministry of Environment and the Conservation Authority that has jurisdiction on the affected watershed.	N/A
<input type="checkbox"/> Confirm consistency with sub-watershed and Master Servicing Study, if applicable study exists.	N/A
<input type="checkbox"/> Storage requirements (complete with calculations) and conveyance capacity for minor events (1:5-year return period) and major events (1:100-year return period).	Appendix G

<input type="checkbox"/> Identification of watercourses within the proposed development and how watercourses will be protected, or, if necessary, altered by the proposed development with applicable approvals.	Site Grading Plan
<input type="checkbox"/> Calculate pre-and post development peak flow rates including a description of existing site conditions and proposed impervious areas and drainage catchments in comparison to existing conditions.	Section 7.0 Proposed Stormwater Management Appendix G
<input type="checkbox"/> Any proposed diversion of drainage catchment areas from one outlet to another.	Section 6.0 Stormwater Sewer Design & Section 7.0 Proposed Stormwater Management
<input type="checkbox"/> Proposed minor and major systems including locations and sizes of stormwater trunk sewers, and stormwater management facilities.	Section 6.0 Stormwater Sewer Design & Section 7.0 Proposed Stormwater Management
<input type="checkbox"/> If quantity control is not proposed, demonstration that downstream system has adequate capacity for the post-development flows up to and including the 100-year return period storm event.	N/A
<input type="checkbox"/> Identification of potential impacts to receiving watercourses	N/A
<input type="checkbox"/> Identification of municipal drains and related approval requirements.	N/A
<input type="checkbox"/> Descriptions of how the conveyance and storage capacity will be achieved for the development.	Section 6.0 Stormwater Sewer Design & Section 7.0 Proposed Stormwater Management
<input type="checkbox"/> 100-year flood levels and major flow routing to protect proposed development from flooding for establishing minimum building elevations (MBE) and overall grading.	Site Grading Plan (C101)
<input type="checkbox"/> Inclusion of hydraulic analysis including hydraulic grade line elevations.	N/A

<input type="checkbox"/> Description of approach to erosion and sediment control during construction for the protection of receiving watercourse or drainage corridors.	Section 8.0 Sediment & Erosion Control
<input type="checkbox"/> Identification of floodplains – proponent to obtain relevant floodplain information from the appropriate Conservation Authority. The proponent may be required to delineate floodplain elevations to the satisfaction of the Conservation Authority if such information is not available or if information does not match current conditions.	N/A
<input type="checkbox"/> Identification of fill constraints related to floodplain and geotechnical investigation.	N/A

4.5 Approval and Permit Requirements: Checklist

The Servicing Study shall provide a list of applicable permits and regulatory approvals necessary for the proposed development as well as the relevant issues affecting each approval. The approval and permitting shall include but not be limited to the following:

Criteria	Location (if applicable)
<input type="checkbox"/> Conservation Authority as the designated approval agency for modification of floodplain, potential impact on fish habitat, proposed works in or adjacent to a watercourse, cut/fill permits and Approval under Lakes and Rivers Improvement Act. The Conservation Authority is not the approval authority for the Lakes and Rivers Improvement Act. Where there are Conservation Authority regulations in place, approval under the Lakes and Rivers Improvement Act is not required, except in cases of dams as defined in the Act.	N/A
<input type="checkbox"/> Application for Certificate of Approval (CofA) under the Ontario Water Resources Act.	N/A
<input type="checkbox"/> Changes to Municipal Drains.	N/A
<input type="checkbox"/> Other permits (National Capital Commission, Parks Canada, Public Works and Government Services Canada, Ministry of Transportation etc.)	N/A

4.6 Conclusion Checklist

Criteria	Location (if applicable)
<input type="checkbox"/> Clearly stated conclusions and recommendations	Section 9.0 Summary Section 10.0 Recommendations
<input type="checkbox"/> Comments received from review agencies including the City of Ottawa and information on how the comments were addressed. Final sign-off from the responsible reviewing agency.	All are stamped
<input type="checkbox"/> All draft and final reports shall be signed and stamped by a professional Engineer registered in Ontario	All are stamped