

ACCESS PROPERTY DEVELOPMENT INC

864 LADY ELLEN PLACE STORMWATER MANAGEMENT REPORT

JUNE 16, 2023





864 LADY ELLEN PLACE STORMWATER MANAGEMENT REPORT

ACCESS PROPERTY DEVELOPMENT INC

3RD SUBMISSION

PROJECT NO.: 221-04646-00

CLIENT REF:

DATE: JUNE 16, 2023

WSP
SUITE 300
2611 QUEENSVIEW DRIVE
OTTAWA, ON, CANADA K2B 8K2

T: +1 613 829-2800

F: +1 613 829-8299

WSP.COM

REVISION HISTORY

FIRST ISSUE

December 16 th , 2022	SWM Report			
Prepared by	Reviewed by	Approved By		
AJ	CF	CF		
SECOND ISSUE				
April 17 th , 2023	SWM Report			
Prepared by	Reviewed by	Approved By		
KK	BO	BO		
THIRD ISSUE				
June 16 th , 2023	SWM Report			
Prepared by	Reviewed by	Approved By		
KK	BO	BO		

SIGNATURES

PREPARED BY



Kathryn Kerker, M.A.Sc., EIT.
Designer, Water Resources

June 16th, 2023

Date

APPROVED¹ BY

June 16th, 2023

Bryan Orendorff, M.A.Sc., P.Eng.
Manager, Water Resources

Date

WSP Canada Inc. ("WSP") prepared this report solely for the use of the intended recipient, ACCESS PROPERTY DEVELOPMENT INC, in accordance with the professional services agreement. The intended recipient is solely responsible for the disclosure of any information contained in this report. The content and opinions contained in the present report are based on the observations and/or information available to WSP at the time of preparation. If a third party makes use of, relies on, or makes decisions in accordance with this report, said third party is solely responsible for such use, reliance or decisions. WSP does not accept responsibility for damages, if any, suffered by any third party as a result of decisions made or actions taken by said third party based on this report. This limitations statement is considered an integral part of this report.

The original of this digital file will be conserved by WSP for a period of not less than 10 years. As the digital file transmitted to the intended recipient is no longer under the control of WSP, its integrity cannot be assured. As such, WSP does not guarantee any modifications made to this digital file subsequent to its transmission to the intended recipient.

¹ Approval of this document is an administrative function indicating readiness for release and does not impart legal liability on to the Approver for any technical content contained herein. Technical accuracy and fit-for-purpose of this content is obtained through the review process. The Approver shall ensure the applicable review process has occurred prior to signing the document.

CONTRIBUTORS

CLIENT

Access Property Development Inc. Frank Abrantes

100 Canadian Road,
Toronto, ON
M1R 4Z5

WSP

Water Resources, Designer Kathryn Kerker

Water Resources, Manager Bryan Orendorff

Municipal, Project Engineer Alex Sereda

Water Resources, Project Engineer Ayham Jadallah

Civil, Senior Project Engineer Winston Yang



TABLE OF CONTENTS

1	INTRODUCTION.....	1
1.1	Scope.....	1
1.2	Site Location.....	1
1.3	Stormwater Management Plan Objectives.....	2
1.4	Design Criteria.....	2
2	METHODOLOGY.....	3
2.1	Existing Conditions Calculations.....	3
2.2	Proposed Conditions PCSWMM Model.....	3
3	PRE-DEVELOPMENT CONDITIONS.....	5
3.1	General.....	5
3.2	Allowable Flow Rates.....	5
4	POST-DEVELOPMENT CONDITIONS.....	6
4.1	General.....	6
4.2	Water Quantity.....	6
4.3	Water Quality.....	8
4.4	Major Overland Flow Route.....	8
4.5	Tailwater Conditions.....	8
4.6	MTO Drainage Assessment.....	9
4.7	External Drainage Areas.....	9
5	CONCLUSIONS.....	11

TABLES

TABLE 2-1: PCSWMM ATTRIBUTES	3
TABLE 2-2: PCSWMM CATCHMENT PARAMETERS ..	4
TABLE 4-1: ICD LOCATIONS.....	7
TABLE 4-2: PCSWMM MODELING PEAK FLOW RESULTS	7
TABLE 4-3: PCSWMM MODELLING RESULTS – SURFACE PONDING DEPTH	7
TABLE 4-4: PCSWMM RESULTS - PONDING VOLUME	8

FIGURES

FIGURE 1-1. SITE LOCATION	1
FIGURE 4-1: EXTERNAL DRAINAGE AREA – 24 HA.	10
FIGURE 4-2: EXTERNAL DRAINAGE AREA - 2.8 HA	10

APPENDICES

A	PRE-CONSULTATION MEETING MINUTES AND TECHNICAL COMMENTS
B	EXHIBITS
C	CALCULATIONS & PCSWMM OUTPUT
C-1	Existing Conditions
C-2	Proposed Conditions
C-3	100-year Tailwater
D	SUPPORTING DOCUMENTS

1 INTRODUCTION

1.1 SCOPE

WSP Canada Inc. was retained by Access Property Development Inc. to prepare a Stormwater Management (SWM) report for the proposed development at 864 Lady Ellen Place in Ottawa, Ontario. This SWM report examines the potential water quality and quantity impacts of the proposed commercial development and summarizes how each will be addressed in accordance with applicable guidelines.

1.2 SITE LOCATION

The site of the proposed commercial development is located at 864 Lady Ellen Place, Ottawa, Ontario. The subject site is bounded by Highway 417 to the north, other commercial properties to the east and west and south. The site is accessed via Lady Ellen Place.

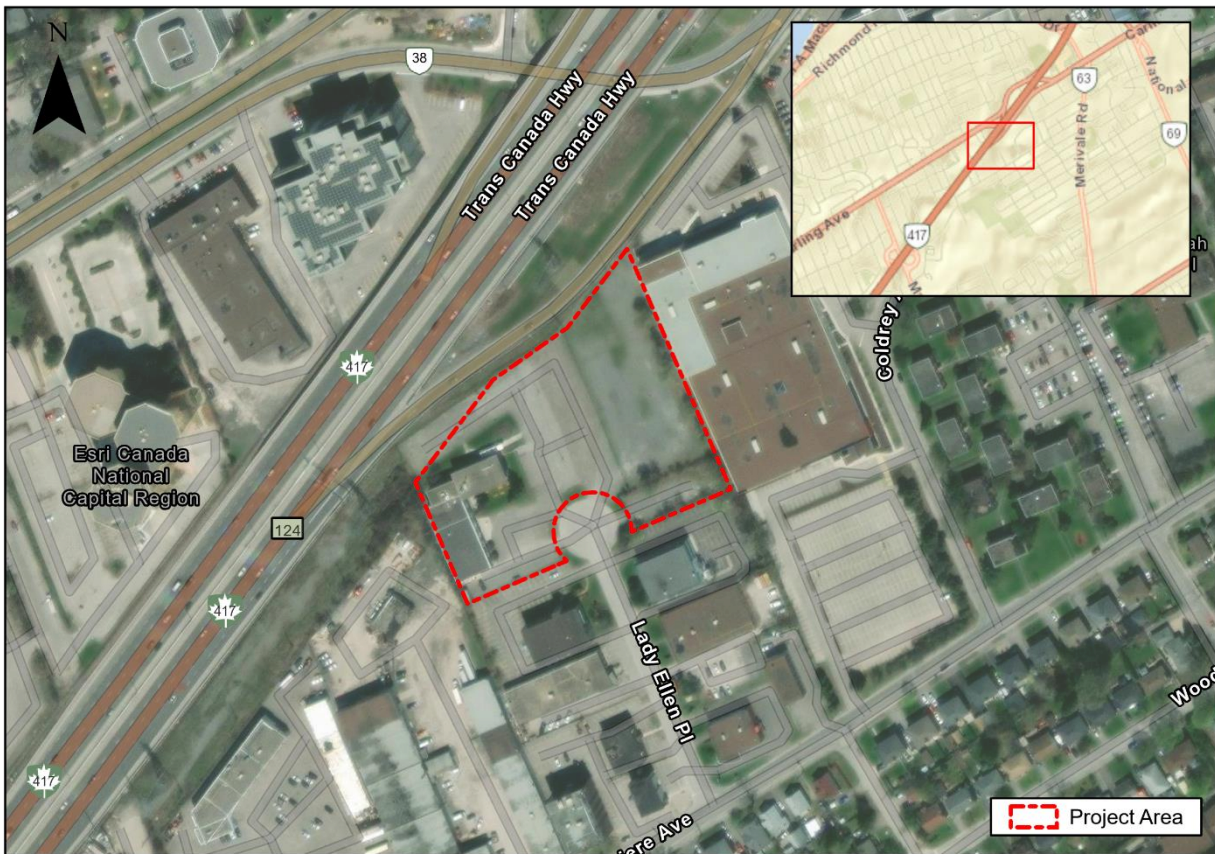

Figure 1-1. Site Location

1.3 STORMWATER MANAGEMENT PLAN OBJECTIVES

The objectives of the stormwater management plan are as follows:

- Collect and review background information
- Determine the site-specific stormwater management requirements to ensure that the proposals are in conformance with the applicable Provincial, Municipal and Conservation Authority stormwater management and development guidelines.
- Evaluate various stormwater management practices that meet the applicable SWM and development requirements and recommend a preferred strategy.
- Prepare a stormwater management report documenting the strategy along with the technical information necessary for the justification and sizing of the proposed stormwater management facilities.

1.4 DESIGN CRITERIA

Design criteria were obtained through pre-consultation with the City of Ottawa held on September 27th, 2021 (meeting minutes included in **Appendix A**). Criteria for 864 Lady Ellen are as follows:

- **Stormwater Quantity** – control post-development flows up to the 100-year return period to the 2-year pre-development level with a runoff coefficient (C) of 0.5. The existing drainage patterns for the site should be maintained.
- **Storm Quality** – The City has requested that 80% TSS removal be provided. Correspondence is included in **Appendix A**.

2 METHODOLOGY

2.1 EXISTING CONDITIONS CALCULATIONS

Existing conditions peak flows were calculated using the Rational Method with a runoff coefficient of 0.5 and a time of concentration of 10 minutes. A runoff coefficient of 0.5 was used as per Ottawa Sewer Design Guidelines section 8.3.7.3.

$$Q = 2.78CiA$$

Where:

- Q = peak flow rate (L/s)
- C = runoff coefficient
- i = rainfall intensity (mm/hour)
- A = catchment area (hectares)

The rainfall intensity is calculated in accordance with Section 5.4.2 of the Ottawa Sewer Design Guidelines (October, 2012):

Where;

$$i = \left[\frac{A}{(Td + C)^B} \right]$$

- A, B, C = regression constants for each return period (defined in section 5.4.2)
- i = rainfall intensity (mm/hour)
- Td = storm duration (minutes)

The IDF parameters/regression constants are per the Ottawa Sewer Design Guidelines (October, 2012).

2.2 PROPOSED CONDITIONS PCSWMM MODEL

Modelling for proposed conditions was performed in PCSWMM. Modelling includes catchment areas, storage, outlet control, existing and proposed storm sewers, ditches, and the outfall. The following describes the modelling methodology for the proposed condition model.

Catchment areas: Subcatchments were delineated based on the proposed discharge locations, which largely follow the existing conditions drainage patterns. Subcatchment imperviousness was calculated based on spatial weighting of the proposed land-use. The standard City of Ottawa values were used for infiltration, depression storage, and roughness coefficient values as described in Table 2-1. Catchment area, flow length, slope, and imperviousness for each subcatchment in the proposed model are shown in Table 2-2.

Table 2-1: PCSWMM Attributes

PCSWMM PARAMETER	VALUE
N Imperv	0.013
N Perv	0.25
Dstore Imperv (mm)	1.57
Dstore Perv (mm)	4.67
Max. Infil. Rate (mm/hr)	76.2

PCSWMM PARAMETER	VALUE
Min. Infil. Rate (mm/hr)	13.2
Decay Constant (1/hr)	4.14
Drying Time (days)	7

Table 2-2: PCSWMM Catchment Parameters

CATCHMENT ID	AREA (HA)	FLOW LENGTH (M)	SLOPE (%)	IMPERVIOUSNESS (%)
S-101	0.090	25	1.2	87
S-102	0.050	24	2.2	100
S-103	0.050	25	3.8	100
S-104	0.130	46	3.1	100
S-105	0.040	16	3.2	100
S-106	0.040	13	3.0	100
S-107	0.080	26	1.2	77
S-108_1	0.025	130	1.0	5
S-108_2	0.002	24	4.0	5
S-109_1	0.030	7	3.1	6
S-109_2	0.050	30	2.8	6
S-109_3	0.080	14	4.1	6
S-109_5	0.040	9	2.8	6
S-110	0.004	44	3.5	5
S-111	0.080	18	1.3	53
S-Bldg-A	0.400	10	1.0	100
S-Bldg-B	0.180	10	1.0	100

Storage: Parking lot surface storage was modelled using a storage node with a storage curve representing the available depth and area of ponding. Flow from surface storage is controlled using outlets with a stage-discharge curve representative of the proposed ICD. Weirs were added to simulate flow between storage areas if ponding exceeds the spill point. Roof storage was modelled in a similar way, with a storage node and outlet. The outlet stage discharge curves were assigned based on the number of roof drains and the proposed open fraction.

Ditches: Ditches were modelled as conduits with a trapezoidal cross-section and roughness coefficient of 0.035.

Boundary Conditions: Existing storm sewer manhole MHST65789, located northeast of the site, was set as the model outfall. The tailwater condition at the outfall was set as a free outfall for evaluating quantity control for the site. See Section 4.5 for further details.

3 PRE-DEVELOPMENT CONDITIONS

3.1 GENERAL

The subject site is a 1.36 ha parcel of land comprised of a paved parking area and an approximately 1300 m² commercial building. Vehicular access to the site is via entrance on Lady Ellen Place. Under pre-development conditions the subject site consists of primarily impervious building and parking area. Existing drainage patterns for the site were determined based on topographic survey information and found that existing drainage is towards the existing municipal storm sewer which crosses the site from south to north via Lady Ellen Place and continues along the Highway 417 Exit to Carling Avenue. The existing major overland flow route is to the north of the site and flows to the adjacent parking lot. The existing runoff coefficient for the site is estimated as 0.9. Per the City of Ottawa Sewer Design Guidelines section 8.3.7.3, a pre-development runoff coefficient of 0.5 was used to analyze the pre-development conditions. The pre-development catchment characteristics are illustrated in **Exhibit 1 (Appendix B)**.

3.2 ALLOWABLE FLOW RATES

As noted in section 1.4, relevant policies from the OSDG for a re-development and the pre-consultation meeting require the post-development peak discharge from the site for the 2 through 100-year events match pre-development 2-year peak flows where pre-development conditions are analyzed using the lesser of the actual runoff coefficient and a runoff coefficient of 0.5.

The Rational Method was used to analyze the existing conditions for the 1.36 ha site and determine the allowable peak flow rates from the site into the existing storm sewer (as discussed in meeting with the City on March 23rd 2023). Using a C value of 0.5 and a time of concentration of 10 minutes, the 2-year flow is **0.145 m³/s**. Rational Method calculations are provided in **Appendix C1**.

4 POST-DEVELOPMENT CONDITIONS

4.1 GENERAL

The proposed Lady Ellen project is a commercial development in Ottawa. Post development condition catchment characteristics are shown in **Exhibit 2 (Appendix B)**. The proposed development mainly includes the construction of two commercial buildings and parking areas. Vehicular access to the site will continue to be via the existing Lady Ellen Place. Similar to existing conditions, the site runoff will be towards the existing 450 mm municipal storm sewer.

To meet stormwater management objectives, as defined by the design criteria outlined in Section 1.4, the following components have been proposed:

- Roof storage
- Parking lot surface storage
- Oversized pipes
- Grassed ditches

The application and sizing of these proposed stormwater management facilities is outlined in the following sections.

4.2 WATER QUANTITY

As noted previously, it is required that the post-development discharge rate from the site for the 2-year through 100-year events match pre-development levels for the 2-year storm event.

Proposed features to achieve these targets include:

- Roof storage on the two proposed buildings, controlled by WATTS Adjustable Flow Control Roof Drains (or equivalent)
- Surface storage with inlet control devices (ICDs) (HYDROVEX or equivalent)
- Oversized pipes
- Grass ditches

PCSWMM software has been used to model the behaviour of the proposed SWM system and determine its response under various storm events. The model was developed and tested in an iterative manner to determine the necessary storage volumes and flow control rates to meet the target peak flow.

The model was developed assuming that 80% and 77% of the building roofs A and B respectively is available for stormwater storage. Based on the roof plans, 19 WATTS Adjustable Flow Control Roof Drains (or equivalent) set to the closed position are proposed for Building A. Similarly, for Building B 10 WATTS Adjustable Flow Control Roof Drains (or equivalent) set to the closed position are proposed. Manufacturer information is provided in **Appendix D**.

Parking lot surface storage controlled with ICDs is also proposed. The grading was designed such that ponding will always remain below 0.3 m depth and have greater than 0.3 m freeboard to the building finished floor elevations. Oversized pipes are proposed in some locations to ensure there is no surface ponding during the 2-year event. Hydrovex vortex flow control devices are proposed in four locations within catch basins and maintenance holes on the site. Table 4-1 shows the proposed ICD locations, type, and relevant parameters.

An additional ICD was added at CBMH114 to limit the external flow entering the storm sewer (as discussed in meeting with the City on March 23rd 2023). The ICD was sized based on the peak 100-year uncontrolled flow from subcatchment S-109.

Table 4-1: ICD Locations

CATCH BASIN	ICD	MAX HEAD (M)	MAX FLOW (L/S)
CBMH100	Hydrovex 75VHV-1	1.70	7
CBMH111	Hydrovex 75VHV-1	2.63	7
CBMH108	Hydrovex 125VHV-2	1.90	17
CB04	Hydrovex 75VHV-1	2.62	8
CBMH114	0.18 m Orifice	0.74	63

A summary of the target versus the proposed modelled peak flows is provided in Table 4-2, with detailed PCSWMM modeling results are provided in **Appendix C2**.

Table 4-2: PCSWMM Modeling Peak Flow Results

RETURN PERIOD (YEARS)	TARGET RELEASE RATE (M ³ /SEC)	POST DEVELOPMENT PEAK FLOW (M ³ /SEC)
2	0.145	0.052
5		0.075
10		0.093
25		0.113
50		0.127
100		0.136

As shown, the 100-year post-development peak flow of 0.136 m³/s meets the 2-year pre-development target flow of 0.145 m³/s. Table 4-3 shows the peak surface ponding depth and Table 4-4 shows the peak ponding volume at each storage zone during the 100-year event. As shown, ponding remains below 0.30 m depth at all surface locations and below 0.15 m depth on the rooftops.

Table 4-3: PCSWMM Modelling Results – Surface Ponding Depth

LOCATION	PONDING DEPTH (M)					
	2 YEAR	5 YEAR	10 YEAR	25 YEAR	50 YEAR	100 YEAR
CBMH112	0.00	0.09	0.12	0.14	0.16	0.17
CB03	0.00	0.10	0.13	0.15	0.17	0.18
CB04	0.00	0.05	0.07	0.09	0.11	0.12
CBMH113	0.00	0.12	0.14	0.17	0.18	0.20
CB02	0.00	0.11	0.13	0.16	0.17	0.19
CBMH108	0.00	0.12	0.14	0.17	0.18	0.20
CBMH109	0.00	0.12	0.14	0.17	0.18	0.20
SU1 (Building B)	0.09	0.10	0.12	0.13	0.14	0.15
SU2 (Building A)	0.09	0.10	0.11	0.13	0.14	0.14

Table 4-4: PCSWMM Results - Ponding Volume

Location	Ponding Volume (m ³)					
	2 Year	5 Year	10 Year	25 Year	50 Year	100 Year
CBMH112	1	5	7	12	15	18
CB03	3	6	9	12	14	17
CB04	1	3	4	6	8	9
CBMH113	2	3	5	7	8	10
CB02	2	7	11	16	21	25
CBMH108	2	8	13	19	24	29
CBMH109	2	5	8	11	14	16
SU1 (Building B)	34	50	61	75	85	97
SU2 (Building A)	80	116	141	173	197	223

4.3 WATER QUALITY

The City of Ottawa has requested 80% TSS removal as indicated in comments received on February 27, 2023.

It is assumed that runoff from the proposed rooftop areas will be free of typical sediment-generating activities and therefore runoff will leave them effectively unchanged and can be considered clean for the purposes of water quality assessment. It should be noted that the typical sediment-generating activities are in areas with vehicular access, such as loading areas and parking areas. In the case of this development, the overall parking area is reduced and replaced with the roof areas of the proposed buildings. Therefore, the overall water quality leaving the site is considered to be improved upon existing conditions.

Two OGS units (Stormceptor EFO 4 or equivalent) are proposed to provide water treatment. OGS sizing is provided in **Appendix D**.

4.4 MAJOR OVERLAND FLOW ROUTE

The major overland flow outlet for the site is at the north corner. The proposed grading of the site is designed to direct flow along the north and west site boundaries to the major overland flow outlet. Due to grading constraints, water will pond at the low point of the swale to a depth of 0.15 m before it spills to the adjacent parking area. Ponded water in the swale will gradually infiltrate or enter the minor system through a controlled inlet. **Exhibit 3** shows the proposed major overland flow route.

4.5 TAILWATER CONDITIONS

The peak hydraulic grade line (HGL) for the receiving sewer was provided by the City on February 27th, 2023. The peak HGL at MHST65789 for the 100-year event is 76.46 m. It is important to note that it is very unlikely that the timing of the 100-year peak flow from the site will correspond to the timing of the 100-year peak HGL in the receiving storm sewer. Under these conditions, the upstream maintenance hole (MH) on the study site is surcharging which does not allow minor system drainage from the site (i.e. the downstream system is blocked). Given this condition, we have assumed that it only applies to a special 100-year flow scenario. Under proposed conditions, overflow from the surcharging MH is directed toward the swale and to the major flow outlet.

The PCSWMM model results presented in Section 4.2 use a free outfall. The special 100-year flow scenario uses a fixed tailwater condition of 76.46 m at the model outlet. Under these extreme conditions, excess runoff is directed toward the major flow route and ponding on site remains well below the finished floor elevations of the buildings. PCSWMM model results are included in **Appendix C3**.

4.6 MTO DRAINAGE ASSESSMENT

MTO comments 11.2, 11.3, and 11.4 (included in **Appendix A**) request that the system be assessed under the scenario where quantity control systems fail, which would mean that no flow is entering the minor system and all runoff is directed toward the major flow outlet. As shown in **Exhibit 3**, major flow would continue northeast within the parking lot of the adjacent property before entering the Carling Ave. right-of-way (ROW). At no point will flow enter the MTO ROW up to the 100-year storm event.

A strip of pervious land within the MTO ROW that forms the embankment of the superelevated Carling Ave. exit drains onto the private property. This runoff will be captured in the northern site boundary swale and will be directed to the major flow outlet.

4.7 EXTERNAL DRAINAGE AREAS

The City of Ottawa has advised that two external drainage areas generate runoff that flow through the site. The first drainage area is located to the west of the site with an estimated area (per City correspondence) is 24 ha (Figure 4-1). The second area is 2.8 ha located to the south of the site as advised by the City (Figure 4-2).

For the 24 ha external area, it is anticipated that the City's storm system will drain part of the generated runoff through the existing roadway minor systems and catch basins along the hydro corridor. Part of the runoff will also be infiltrated through pervious areas. To account for the external runoff that may enter the site from this area, the proposed storm drainage system includes a grass swale that extends along the western and northern boundary.

Runoff generated from the 2.8 ha external area to the south of the site will be drained through the City's storm system, and the excess overflow will cross the parking area as detailed in the proposed grading (as it does in existing conditions). Flows are directed toward the major overland flow outlet at the north end of the site once the capacity of the minor system is exceeded or the spill elevation is reached.

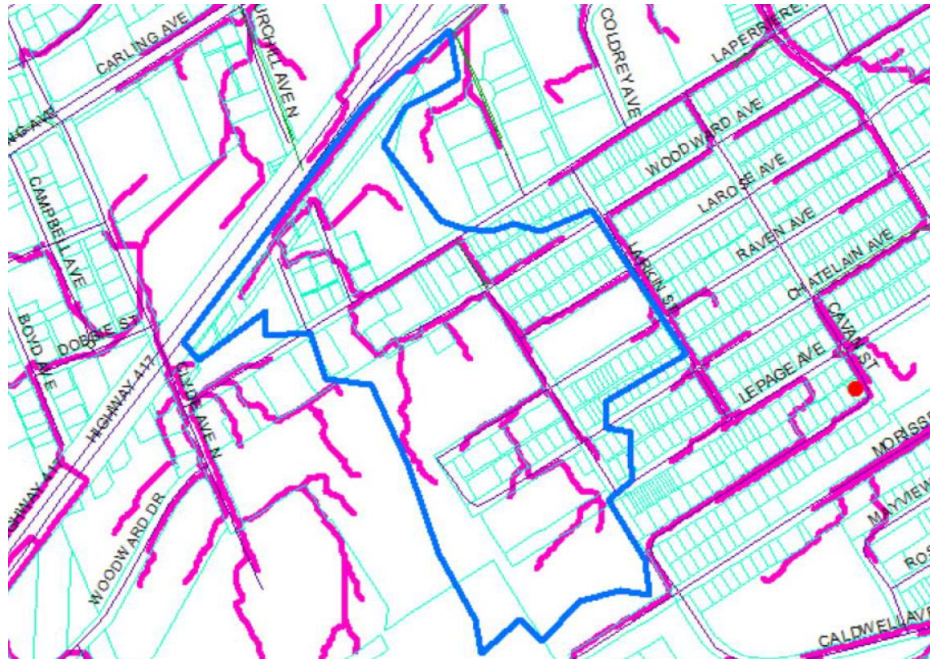

Figure 4-1: External drainage area – 24 ha

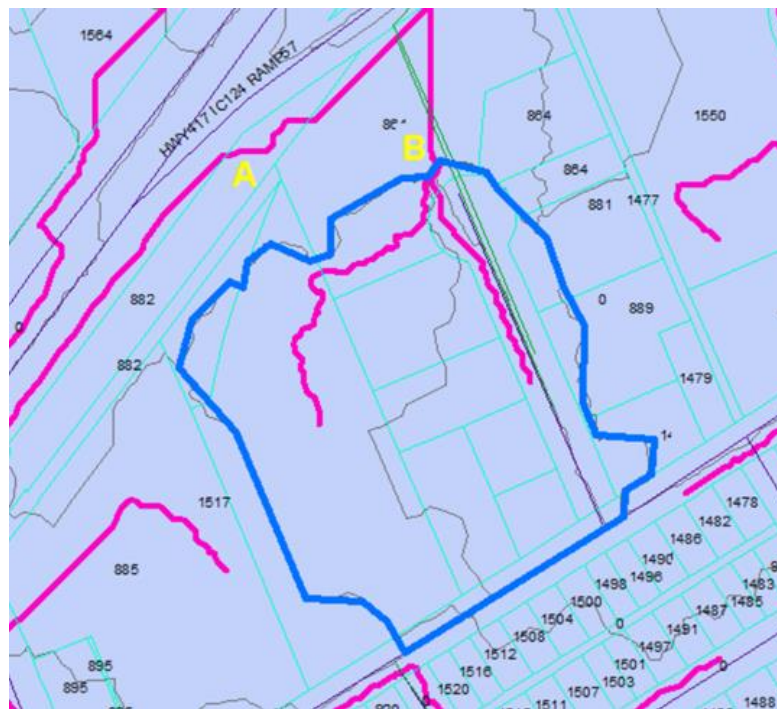

Figure 4-2: External drainage area - 2.8 ha

5 CONCLUSIONS

A stormwater management report has been prepared to support the feasibility study for the proposed development at 864 Lady Ellen Place in the City of Ottawa. The key points are summarized below.

WATER QUANTITY

Quantity control will be provided via roof storage on the two proposed buildings and surface storage on parking areas to control the 100-year post-development flow rate to the 2-year pre-development target.

WATER QUALITY

Two OGS units are proposed to treat runoff from parking areas. It is assumed that runoff from the proposed rooftop areas will be free of typical sediment-generating activities and therefore runoff will leave them effectively unchanged and can be considered clean for the purposes of water quality assessment.

APPENDIX

A

PRE-CONSULTATION
MEETING MINUTES
AND TECHNICAL
COMMENTS

MEMO

Date:

To /
Destinataire Craig Hamilton, Planner

From /
Expéditeur Bruce Bramah, Project Manager, Infrastructure
Approvals

Pre-Application Consultation
864 Lady Ellen Place, Ward #16

File No. PC2022-0240

Subject /
Objet _____,
*Two new storage warehouses are proposed to
be constructed that are one-storey and 4-
storeys in height.*

Please note the following information regarding the engineering design submission for the above noted site:

- The original storm sewer within the easement was installed in 1959; no design sheet can be found for this. When the sewer was rehabilitated in 2012, there was no design sheet prepared..
- 1. The Servicing Study Guidelines for Development Applications are available at the following address: <https://ottawa.ca/en/planning-development-and-construction/developing-property/development-application-review-process/development-application-submission/guide-preparing-studies-and-plans#servicing-study-guidelines-development-applications>
- 2. Servicing and site works shall be in accordance with the following documents:
 - ⇒ Ottawa Sewer Design Guidelines (October 2012)
 - ⇒ Ottawa Design Guidelines – Water Distribution (2010)
 - ⇒ Geotechnical Investigation and Reporting Guidelines for Development Applications in the City of Ottawa (2007)
 - ⇒ City of Ottawa Slope Stability Guidelines for Development Applications (revised 2012)
 - ⇒ City of Ottawa Environmental Noise Control Guidelines (January, 2016)

- ⇒ City of Ottawa Park and Pathway Development Manual (2012)
 - ⇒ City of Ottawa Accessibility Design Standards (2012)
 - ⇒ Ottawa Standard Tender Documents (latest version)
 - ⇒ Ontario Provincial Standards for Roads & Public Works (2013)
3. Record drawings and utility plans are also available for purchase from the City (Contact the City's Information Centre by email at InformationCentre@ottawa.ca or by phone at (613) 580-2424 x.44455).
4. The Stormwater Management Criteria, for the subject site, is to be based on the following:
- TSS requirements from the RVCA are pending at this time. Please contact the RVCA and provide the correspondence in the design brief.
 - i. The 2-yr storm event using the IDF information derived from the Meteorological Services of Canada rainfall data, taken from the MacDonald Cartier Airport, collected 1966 to 1997.
 - ii. The pre-development runoff coefficient or a maximum equivalent 'C' of 0.5, whichever is less (§ 8.3.7.3).
 - iii. A calculated time of concentration (Cannot be less than 10 minutes).
 - iv. Flows to the storm sewer in excess of the 2-year pre development storm release rate, up to and including the 100-year post development storm event, must be detained on site.
- Note: There may be area specific SWM Criteria that may apply. Check for any related SWM &/or Sub-watershed studies that may have been completed.
5. Deep Services (Storm, Sanitary & Water Supply)
- i. *Provide information on the monitoring manhole requirements – should be located in an accessible location on private property and outside of the easement (ie. Not in a parking area).*
 - ii. *Review provision of a high-level sewer.*
 - iii. *Provide information on the type of connection permitted*

Sewer connections to be made above the springline of the sewermain as per:

- a. Std Dwg S11.1 for flexible main sewers – *connections made using approved tee or wye fittings.*
 - b. Std Dwg S11 (For rigid main sewers) – *lateral must be less than 50% the diameter of the sewermain,*
 - c. Std Dwg S11.2 (for rigid main sewers using bell end insert method) – *for larger diameter laterals where manufactured inserts are not available; lateral must be less than 50% the diameter of the sewermain,*
 - d. Connections to manholes permitted when the connection is to rigid main sewers where the lateral exceeds 50% the diameter of the sewermain. – Connect obvert to obvert with the outlet pipe unless pipes are a similar size.
 - e. *No submerged outlet connections.*
6. Water Boundary condition requests must include the location of the service and the expected loads required by the proposed development. Please provide the following information:
- i. Location of service
 - ii. Type of development and the amount of fire flow required (as per FUS, 2020).
 - iii. Average daily demand: ___ l/s.
 - iv. Maximum daily demand: ___ l/s.
 - v. Maximum hourly daily demand: ___ l/s.
7. MECP ECA Requirements

An MECP Environmental Compliance Approval (Input Application Type - Industrial Sewage Works or Municipal/Private Sewage Works) may be required for the proposed development based on the industrial zoning and multiple parcels of land. Please contact Ontario Ministry of the Environment and Climate Change, Ottawa District Office to arrange a pre-submission consultation:

For I/C/I applications: Emily Diamond
 (613) 521-3450, ext. 238

Emily.Diamond@ontario.ca

8. Phase 1 ESAs and Phase 2 ESAs must conform to clause 4.8.4 of the Official Plan that requires that development applications conform to Ontario Regulation 153/04.

9. Submission Requirements

– **SITE PLAN APPLICATION – Municipal servicing**

Legend:

The letter S indicates that the study or plan is required with application submission.

The letter M indicates that the study or plan may be required with application submission.

For information on preparing required studies and plans refer to:

<http://ottawa.ca/en/development-application-review-process-0/guide-preparing-studies-and-plans>

S/A	Number of copies	ENGINEERING		S/A	Number of copies
S	1	1. Site Servicing Plan	2. Assessment of Adequacy of Public Services / Site Servicing Study / Brief	S	1
S	1	3. Grade Control and Drainage Plan	4. Geotechnical Study / Slope Stability Study	S	1
	1	5. Composite Utility Plan	6. Groundwater Impact Study		1
	1	7. Servicing Options Report	8. Wellhead Protection Study		1
	1	9. Community Transportation Study and/or Transportation Impact Study / Brief	10. Erosion and Sediment Control Plan / Brief	S	1
S	1	11. Storm water Management Report / Brief	12. Hydro-geological and Terrain Analysis		1
M	1	13. Water main Analysis	14. Noise / Vibration Study		1
	1	15. Roadway Modification Design Plan	16. Confederation Line Proximity Study		1

Should you have any questions or require additional information, please contact me directly at (613) 580-2424, ext. 29686 or by email at Bruce.Bramah@ottawa.ca.

February 27, 2023

Jill MacDonald
Access Properties c/o WSP Canada Inc.
Via email: Jill.macdonald@wsp.com

Subject: Site Plan Control Application – 864 Lady Ellen place - 1st Review Comments

Please find below the consolidated comments from the 1st review of the above noted application.

1. Engineering

List of Drawing(s) reviewed:

- **Notes and Details**, C01, prepared by WSP, Project # 221-04646-00, dated November 2022, revision 0, dated 2022-12-16
- **Removal Plan**, C02, prepared by WSP, Project # 221-04646-00, dated November 2022, revision 0, dated 2022-12-16
- **Grading Plan**, C03, prepared by WSP, Project # 221-04646-00, dated November 2022, revision 0, dated 2022-12-16
- **Servicing Plan**, C04, prepared by WSP, Project # 221-04646-00, dated November 2022, revision 0, dated 2022-12-16
- **Storm Drainage Area Plan**, C05, prepared by WSP, Project # 221-04646-00, dated November 2022, revision 0, dated 2022-12-16
- **Erosion and Sediment Control Plan**, C06, prepared by WSP, Project # 221-04646-00, dated November 2022, revision 0, dated 2022-12-16

List of Report(s) reviewed:

- **Stormwater Management Report**, prepared by WSP, Project # 221-04646-00, dated December 16, 2022.
- **Servicing Report**, prepared by WSP, Project # 221-04646-00, dated December 2022.
- **Geotechnical Investigation – Access Property Developments**, prepared by WSP Golder, Project #22524317, dated December 15, 2022

Comments:

- 1.1. Please refer to the following link for marked up plans and reports:  [1st Review](#)

Additional Comments:

1. The plan and development number for this application shall be incorporated into the bottom right hand corner of the plans, Plan #18904 and D07-12-22-0175. **ADDED**



2. Please provide confirmation from all easement holders for the proposed works within the existing easements.

Feel free to contact Bruce Bramah (bruce.bramah@ottawa.ca), Infrastructure Project Manager, for follow-up questions.

2. Transportation

List of Drawing(s) reviewed:

- **Site Plan**, A100, prepared by Architecture 49, dated November 29, 2022, revision 0 dated November 29, 2022.

Comments:

- 2.1. No comments.

Feel free to contact Neeti Paudel (Neeti.paudel@ottawa.ca), Transportation Project Manager, for follow-up questions.

3. Noise

List of Report(s) reviewed:

- **Noise Impact Assessment**, prepared by WSP, Project #221-04646-00, dated December 20, 2022.

Comments:

- 3.1. Within the introduction of the report, please correct "commercial" to "industrial" development.
- 3.2. Contour figures are not included within the study. Please provide.
- 3.3. Include a figure showing the source and POR locations.

Feel free to contact Neeti Paudel (Neeti.paudel@Ottawa.ca), Transportation Project Manager, for follow-up questions.

4. Conservation Authority

Comments:

- 4.1. No comment at this time.

5. Environmental and Trees

List of Report(s) reviewed:

- **Building A Floor Plan**, prepared by Architecture 49, dated June 17, 2022, revision 0.
- **Landscape Plan L100**, prepared by Architecture 49, dated November 29, 2022, revision 0

- **Tree Conservation Report**, prepared by WSP, Project #221-04646-00, dated December 19, 2022
- **Landscape Detail, L300** prepared by Architecture 49, dated November 2, 2022, revision 0.

Comments:

- 5.1. A permit is required prior to any tree removal on site. The tree permit will be released upon site plan approval. Please contact the planner associated with the file or the Planning Forester, Hayley Murray (hayley.murray@ottawa.ca) for information on obtaining the tree permit.
- 5.2. Removal or injury of a boundary or adjacently owned tree would require written consent from the neighboring landowner.
- 5.3. The TCR does not show the location of tree protection fencing; please include on plans.
- 5.4. Tree 3 is a red maple in good condition. Can a retention solution be considered for this tree?
- 5.5. The required number of parking spaces is 71 and 74 are proposed. Explore the option of reducing the number of parking spaces and adjusting the layout to allow for additional retention of healthy trees and/or tree planting.
- 5.6. Will grade be maintained at the property line where the drainage swale runs?
- 5.7. It appears that there is an existing asphalt parking lot on the east side of the property. Why do Tree #s 21 and 23 need to be removed?
- 5.8. There are no plans for planting along the southern property boundary east of the entrance where trees # 21,23-25 are planned for removal. Is there space available for additional planting here?
- 5.9. Trees listed for retention on the TCR do not align with what is shown on the LP. Please update.
- 5.10. Consider additional tree planting in the rear northeast corner which is shown as sod. If tree plantings are not feasible, other heat mitigation measures may also be considered to help reduce the urban heat island effect.
- 5.11. The large amount of glazing on the west and (to a lesser degree) the south facades of Building A may pose a hazard to bird health. The glass will be required to be made bird-safe as specified in the [Bird Safe Design Guidelines](#). The Bird Safe Design guidelines apply to Building A of this development.
- 5.12. If interior hallways are proposed to be visible (i.e., clear glass) then visual markers should be used. In particular, the all-glass corner on the northwestern point of the building should incorporate non-transparent glazing in order to reduce the likelihood of birdstrikes
- 5.13. Other than *Acer rubrum* and the birch trees there are few larger growing trees proposed. To help increase the city's forest canopy, larger growing trees should to be considered and added to the planting list.

- 5.14. The southwestern boundary of the subject property proposes coniferous trees; please indicate the species and ensure there is adequate space for future growth on the Landscape Plan. Conifers require a 4.5m setback so as not to impede on future hardsurface/infrastructure.

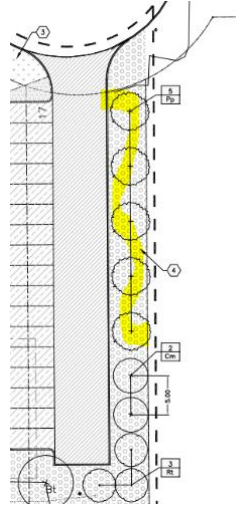

- 5.15. On the Landscape Detail, please revise: Trees are to be planted at grade (not above as indicated on the detail)
- 5.16. On the Landscape Detail, please revise: The top 2/3 of the basket and wire are to be removed (and not 1/3 as indicated on the detail)
- 5.17. On the Landscape Detail, please note: Stakes are not required unless the trees require it (on the prevailing winds side of the tree)
- 5.18. On the Landscape Detail, please note that Soil Volume should be indicated for those trees proposed within the parking islands.

6. Environmental Remediations Unit

List of Reports reviewed:

- **Phase One Environmental Site Assessment**, prepared by Pinchin, File Number 301925 dated January 20, 2022.
- **Phase Two Environmental Site Assessment**, prepared by Pinchin, File Number 301925.001, dated March 3, 2022

- 6.1. The phase two ESAs (Pinchin, March 2022 & Golder, Dec 2022) have reported the presence of VOCs impacted groundwater within the southeast area of the site due to offsite sources. Although Golder's phase two ESA (Dec 2022) has conducted a limited risk evaluation through one round of soil vapour sampling, it has recommended a second round of sampling to account for seasonal variations.
- 6.2. Staff are requesting a due diligence human health risk assessment that utilizes the existing data as well as the recommended 2nd round of soil vapour sampling to ensure the future site users (indoor and outdoor construction workers, employees, etc.) will not be adversely exposed to the existing contaminations.



Please contact Vahid Arasteh (vahid.arasteh@ottawa.ca), Specialist (environmental remediation) should you have any questions on the above.

7. Planning

List of Drawing(s) reviewed:

- **Site Plan**, A100, prepared by Architecture 49, dated November 29, 2022, revision 0 dated November 29, 2022.

Comments:

- 7.1. A minimum of 12 bicycle parking spaces are required; please ensure that adequate bicycle parking spaces are shown on the Site Plan.
- 7.2. Please dimension the rear yard setback at the narrowest point along the northern lot line, as the minimum required rear yard setback is 7.5m.
- 7.3. The parking area surrounding the loading spaces is a large, asphalted parking lot. Please consider reducing any unnecessary asphalted areas which do not serve the loading spaces and/or garbage collection area.

List of Report(s) reviewed:

- **Planning Rationale and Design Brief**, prepared by WSP, dated December 2022, revision 0.

Comments:

- 7.4. No comments at this time.

8. Parkland

- 8.1. The applicant is proposing to develop a 4-storey building with a GFA of 15,913 m² and a 1-storey building with a GFA of 1,750 m². The total GFA proposed is 17,663 m². The buildings are proposed to be used as self-storage/warehouse buildings. The existing office building has a GFA of 3,529 m², according to the site statistics on the Site Plan, and will be demolished. The site has a lot area of 13,576.785 m².
- 8.2. Cash-in-lieu of parkland dedication will be required as a condition of site plan approval because there is a net increase in GFA of a commercial use.
- 8.3. Please included the following condition of approval in the delegated authority report:
- 8.4. Cash-in-Lieu of Parkland Dedication:

The Owner agrees to provide cash-in-lieu of parkland dedication on the subject lands within Ward 16 in accordance with the Planning Act and the City of Ottawa Parkland Dedication By-law No. 2022-280, to the satisfaction of the General Manager, Recreation, Cultural and Facility Services. If there is a change in the proposed gross floor area prior to the registration of the site plan agreement, the parkland dedication requirement will also change. A land area of 217 m² has been calculated for the cash-in-lieu of parkland dedication requirement as follows.

Proposed Use	Gross Land Area	Cash-in-lieu of Parkland Dedication Rate	Parkland Dedication Area
Commercial	13,576.785 m ²	2%	(Proposed GFA – Existing GFA) / Proposed GFA x Gross Land Area x 2% = (17,663 m ² – 3,529 m ²) / 17,663 m ² x 13,576.785 m ² x 2% = 217 m ²

- 8.5. The valuation of the cash-in-lieu of parkland dedication requirement shall be determined in accordance with Section 10, Valuation of Cash-in-Lieu, and Section 14, Transition, of Parkland Dedication By-law No. 2022-280. The Owner further agrees to pay for the cost of the appraisal inclusive of HST.
- 8.6. The cash-in-lieu of parkland dedication shall be directed 60% towards the Ward 16 cash-in-lieu of parkland reserve (Account 830305) and 40% towards the City-wide cash-in-lieu of parkland reserve (Account 830015).

9. Transportation Services

- 9.1. Construction approach – Please contact the Transportation Services Department (TMconstruction@ottawa.ca) early in the site plan process to determine the ability to construct the site and copy me on this request.

10. Councillor and Community issues

- 10.1. No comments raised by the Ward Councillor.
- 10.2. No comments raised by the community

11. Ministry of Transportation

- 11.1. Building A will need to be located 14 m from the Ministry of Transportation property line. The Storm Water Management Report has been sent to the Planning and Design group for review. Since the proposed development is located within our area of control; therefore the owner/consultant will need to submit a Building and Land Use and a Sign Permit for any signs that are visible from Highway 417. All these permits can be submitted on-line at www.hcms.mto.gov.on.ca if you have any questions, please do not hesitate to contact our office at 613-720-2802. Thank you. Alain Nadeau Planner, Ministry of Transportation Ottawa Area Office 613-720-280

List of Report(s) reviewed

- **Stormwater Management Report**, prepared by WSP, Project # 221-04646-00, dated December 16, 2022.

Comments:

- 11.2. Please note that rooftop storage is not considered to be a permanent SWM control due to the ability to tamper with and therefore, continuous effectiveness of the rooftop storage devices cannot be guaranteed. Where roof top storage is considered, the

SWM report needs to demonstrate that tempering or removal of the rooftop storage devices will not have an adverse impact on the highway drainage system.

- 11.3. It is noted that inlet control device is proposed to provide quantity control. Please note that MTO does not recognise any benefit from the attenuation of stormwater runoff using inlet control devices. MTO's concern is that as the continued functioning of such a control device cannot be guaranteed. To avoid future adverse impacts, the proponent shall confirm that will be no negative impact on the highway infrastructure where the inlet control device doesn't work the way it has been claimed.
- 11.4. It is understood that the receiving minor system is the existing City storm sewer system. However, we were not able to find information about the receiving major system. Please identify the major flow system and provide supporting calculations showing that receiving major system will have adequate capacity to receive flows from the proposed development. Please review and resubmit for our review.
- 11.5. For further questions, please contact Alain Nadeau Planner, Ministry of Transportation Ottawa Area Office 613-720-2802 alain.nadeau@Ontario.ca

12. Enbridge Gas Limited

- 12.1. This response does not constitute a pipe locate, clearance for construction or availability of gas.
- 12.2. The applicant shall contact Enbridge Gas Inc.'s Customer Connections department by emailing SalesArea60@Enbridge.com to determine gas availability, service and meter installation details and to ensure all gas piping is installed prior to the commencement of site landscaping (including, but not limited to: tree planting, silva cells, and/or soil trenches) and/or asphalt paving.
- 12.3. If the gas main needs to be relocated as a result of changes in the alignment or grade of the future road allowances or for temporary gas pipe installations pertaining to phased construction, all costs are the responsibility of the applicant.
- 12.4. In the event that easement(s) are required to service this development, and any future adjacent developments, the applicant will provide the easement(s) to Enbridge Gas Inc. at no cost. The inhibiting order will not be lifted until the application has met all of Enbridge Gas Inc.'s requirements.
- 12.5. The applicant will contact Enbridge Gas Inc.'s Customer Connections department by emailing SalesArea60@Enbridge.com prior to any site construction activities to determine if existing piping facilities need to be relocated or abandoned.
- 12.6. Blasting and pile driving activities in the vicinity of Enbridge Gas Distribution and Storage (GDS) facilities require prior approval by GDS. The Blasting and Pile Driving Form, referenced in Enbridge's Third Party Requirements in the Vicinity of Natural Gas Facilities Standard, must be provided to mark-ups@enbridge.com by the Owner of the proposed work for all blasting and pile driving operations. In addition, a licensed blasting consultant's stamped validation report must be submitted to GDS for review if blasting is to occur within thirty (30) metres of GDS facilities. The request must be submitted a minimum of four (4) weeks prior to the beginning of work to allow sufficient time for review.

13. Hydro One Networks Inc.

13.1. The transmission lines abutting the subject lands operate at either 500,000, 230,000 or 115,000 volts. Section 188 of Regulation 213/91 pursuant to the Occupational Health and Safety Act, require that no object be brought closer than 6 metres (20 feet) to an energized 500 kV conductor. The distance for 230 kV conductors is 4.5 metres (15 feet), and for 115 kV conductors it is 3 metres (10 feet). It is the developer's responsibility to be aware, and to make all personnel on site aware, that all equipment and personnel must come no closer than the distance specified in the Act. They should also be aware that the conductors can raise and lower without warning, depending on the electrical demand placed on the line

14. Hydro Ottawa Limited

14.1. The Owner is advised that there are medium voltage overhead lines along the west and north side of the property.

14.1.1. a. The Applicant is advised that permanent structures located within the "restricted zone" surrounding overhead lines are prohibited. This zone is defined by Hydro Ottawa's standard OLS0002 "Overhead High Voltage Clearances to Adjacent Building", which can be found at <https://hydroottawa.com/accounts-services/accounts/contractors-developers/clearances>. This standard complies with the requirements of the Ministry of Labour's Occupational Health & Safety Act, the Ontario Building Code, and the Ontario Electrical Safety Code. Permanent structures include buildings, signs (even lit signs when open for maintenance), antennas, pools, and fences.

14.1.2. b. The Applicant shall ensure that any landscaping or surface finishing does not encroach into existing or proposed Hydro Ottawa overhead or underground assets or easement. When proposing to plant trees in proximity of existing power lines, the Owner shall refer to Hydro Ottawa's free publication "Tree Planting Advice" which can be found at <https://hydroottawa.com/outages-safety/safety-home/outside-home/planting-trees>. The shrub or tree location and expected growth must be considered. If any Hydro Ottawa related activity requires the trimming, cutting or removal of vegetation, or removal of other landscaping or surface finishing, the activity and the re-instatement shall be at the owner's expense.

14.1.3. c. Should any activity, such as tree trimming or working on the sides of a building, be anticipated within three meters (3m) of Hydro Ottawa's overhead lines, contact Hydro Ottawa to discuss arrangements before any activity is undertaken. In line with the Ministry of Labour's Occupational Health & Safety Act, only a Hydro Ottawa employee or Hydro Ottawa approved contractor can work in proximity of these lines.

14.1.4. d. If the change in grade is more than three tenths of a meter (0.3m) in the vicinity of proposed or existing electric utility equipment. Hydro Ottawa requests to be consulted to prevent damages to its equipment.

14.2. The Owner shall contact Hydro Ottawa and expose existing duct banks and/or cable chambers. Hydro Ottawa will have the existing duct bank and manholes inspected to record existing conditions. Once piling and shoring is completed, Hydro Ottawa will re-inspect the underground plant for any damages. The Owner shall inform Hydro Ottawa of any acute shock construction process or rubblization to be used during construction, and apply Hydro Ottawa's work procedure UDS0022 ""Protecting



Electrical Distribution Plant & Support Structures from Vibrations Caused by Construction Activity"" which can be found at <https://hydroottawa.com/accounts-services/accounts/contractors-developers/miscellaneous>.

- 14.3. The Owner shall enter an Installation and Service agreement with Hydro Ottawa.
- 14.4. The Owner is to contact Hydro Ottawa if the electrical servicing of the site is to change in location or in size. A load summary will be needed for the technical evaluation.
- 14.5. The Applicant may be responsible for a Capital Contribution payment(s) towards a distribution system expansion if the proposed development requires electrical servicing greater than can be provided by the existing distribution system in the vicinity, either in capacity or in extension limit. This amount shall be in accordance with Hydro Ottawa's Contributed Capital Policy and Conditions of Service.
- 14.6. The Owner shall be responsible for servicing the buildings within the property. Only one service entrance per property shall be permitted.
- 14.7. The Owner shall be responsible for all costs for feasible relocations, protection or encasement of any existing Hydro Ottawa plant.
- 14.8. The Owner shall ensure the proposed building modifications do not hinder Hydro Ottawa's ability to access the electricity meters or other distribution assets.
- 14.9. The Owner shall convey, at their cost, all required easements as determined by Hydro Ottawa.
- 14.10. The Applicant shall comply with Hydro Ottawa's Conditions of Service and thus should be consulted for the servicing terms. The document, including referenced standards, guidelines and drawings, may be found at <https://hydroottawa.com/about-us/policies/conditions-service>. The Owner should consult Hydro Ottawa prior to commencing engineering designs to ensure compliance with these documents.
- 14.11. Hydro Ottawa reserves the right to raise conditions throughout the development of this proposal should the revisions contain non-conformances with, for example, Hydro Ottawa's Conditions of Service or Standards. To ensure the best outcome, Hydro Ottawa welcomes an early discussion on the proposal. For more information on electrical servicing, the following link outlines Hydro Ottawa's services for Commercial, Overhead and Underground, and Residential projects, together with contact information for Hydro Ottawa representatives:
<https://hydroottawa.com/accounts-services/accounts/contractors-developers/distribution-system-design>

15. Bell Canada

- 15.1. Upon receipt of this comment letter, the Owner is to provide Bell Canada with servicing plans/CUP at their earliest convenience to planninganddevelopment@bell.ca to confirm the provision of communication/telecommunication infrastructure needed to service the development.
- 15.2. It shall be noted that it is the responsibility of the Owner to provide entrance/service duct(s) from Bell Canada's existing network infrastructure to service this development. In the event that no such network infrastructure exists, in accordance with the Bell Canada Act, the Owner may be required to pay for the extension of such network infrastructure.



15.3. If the Owner elects not to pay for the above noted connection, Bell Canada may decide not to provide service to this development.

16. For the next submission

- The next submission should address all of the comments or issues, to ensure the effectiveness and consistency of the next review.
- A cover letter must be included that states how each comment was addressed in the resubmission. Please co-ordinate the numbering of each resubmission comment, or issue, with the above noted comment number.
- Please ensure the File Number D07-12-22-0175 and Plan Number **#18904** are incorporated in the bottom right hand corner of all plans.
- Plans are to be standard A1 size (594 mm x 841 mm) or Arch D size (609.6 mm x 914.4 mm) sheets, utilizing an appropriate Metric scale (1:200, 1:250, 1:300, 1:400 or 1:500).
- All addenda or revisions to any studies or plans must be provided in PDF. All PDF documents are to be unlocked and flattened.
- In order to achieve the target review and approval timeline, please provide the next submission in 5 weeks, by April 3, 2023 Otherwise, the application will be placed on-hold.

The development review team will be happy to meet you to discuss comments and resolve issues. We highly recommend holding the comments review meeting within one week from the date of this letter. Please contact me at your earliest convenience to confirm the meeting date, time, format and location.

Should there be any other questions, please do not hesitate to contact me.

Yours Truly,
Craig Hamilton

cc.

Craig Hamilton
PM, Bruce Bramah
TPM, Neeti Paudel

City of Ottawa Comments

Stormwater Management Report

1. Please ensure final reports are sealed by a P.Eng.
WSP: Report has been sealed
2. Please include the owners information (Name, full address, phone number). This will be used for issuing permits
WSP: Has been added
3. There is currently not enough detail in the report on what was done within the model. Please clearly detail the setup and findings of the model in a clear and concise manner in the report. The SWM report shall provide a complete summary of the PCSWMM model including tables for that summarize the storm sewer design parameters, pre and post development flow calculations, pre and post development subcatchment parameters, required and available storage per catchment area, boundary conditions, model inputs, ICD sizes and flowrates.
WSP: The SWM report has been updated with modelling methodology and more detailed modelling results.
4. SWM quantity criteria is to control the post development flows to the pre-development 2 year event. Please see the pre-consultation engineering comments and provide a revised SWM submission.
WSP: Report has been revised
5. The introduction of Bill 23 has prohibited the Conservation Authority's from providing services outside of Natural Hazards on Planning Applications. The City of Ottawa will require on site 80% TSS removal. Please provide an update SWM report and manufacturer product specifications upon your next submission.
WSP: Noted. Quality control has been incorporated in the revised design.
6. Please see the comment letter for the receiving sewers boundary conditions.
WSP: A discussion and modelling with provided boundary conditions has been provided in the revised report.
7. The total development area shall be used in the pre-development flow rate calculations.
WSP: Report has been updated accordingly, with pre-development calculations performed using the entire area with the Rational Method.
8. Please provide a completed table for each ICD selection.
WSP: ICD table has been provided.
9. Please provide a summary table for the number of drains, max depth, flow rate.
WSP: Report has been updated with ponding depths.

HGL

Conduit STM78702
Flow = 0.637 m³/s

Conduit STM78701
Flow = 0.517 m³/s

Conduit STM78685
Flow = 0.302 m³/s

Conduit STM80131
Flow = 0.322 m³/s

Conduit STM80130
Flow = 0.161 m³/s

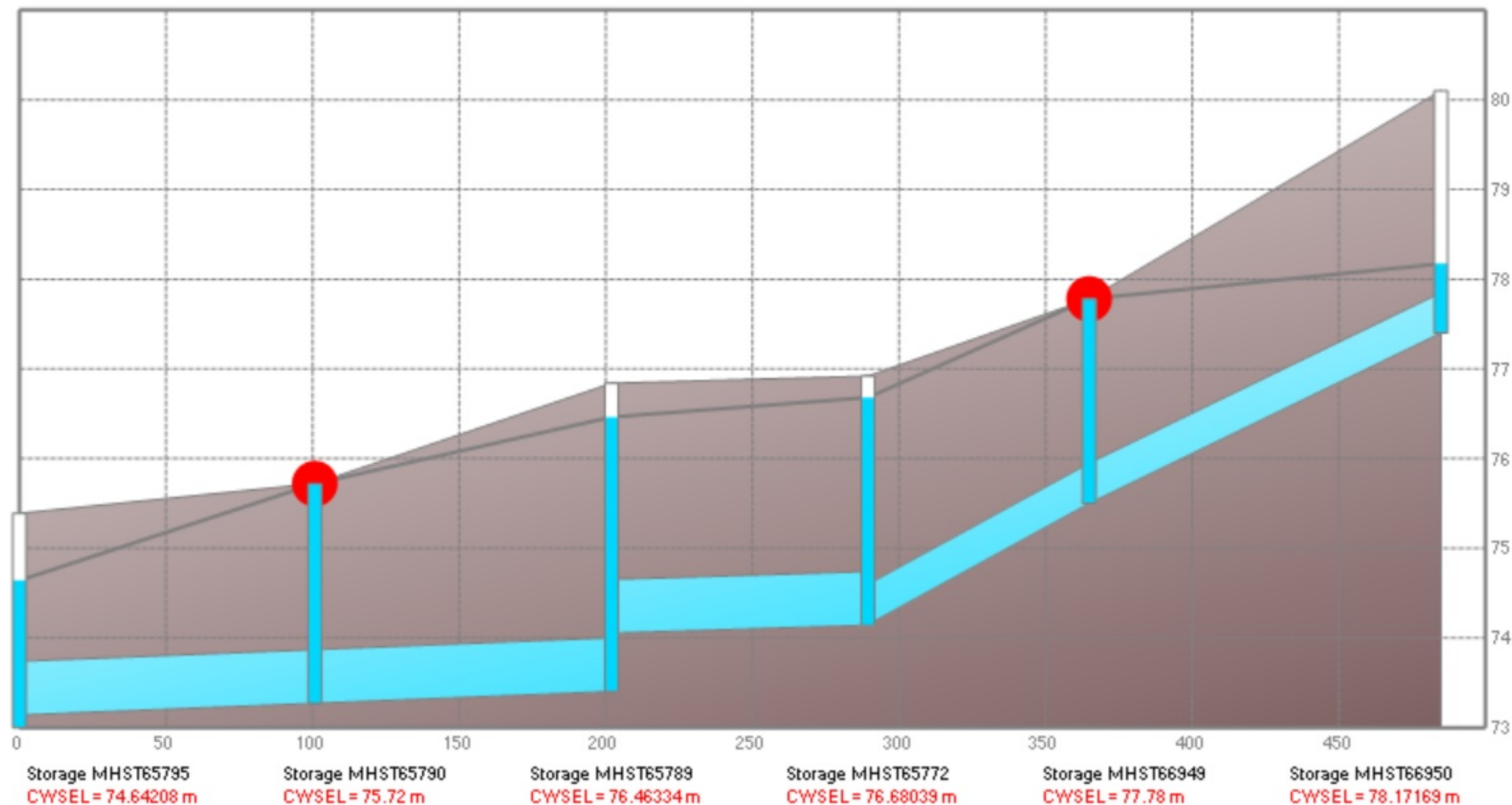

APPENDIX

B EXHIBITS





CLIENT
ACCESS PROPERTY DEVELOPMENT
INC.

PROJECT
864 LADY ELLEN PLACE

TITLE
**EXHIBIT 1
EXISTING CONDITIONS
DRAINAGE MOSAIC**

Map showing the location of the site relative to St. Lawrence St. and Madoc, near Moira Lake.

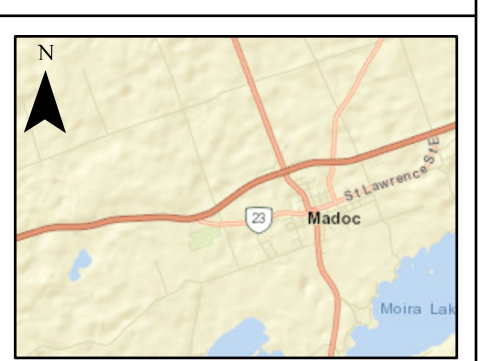

- LEGEND**
- Subcatchment
 - Existing Storm Sewers
 - ➔ Major Flow Direction

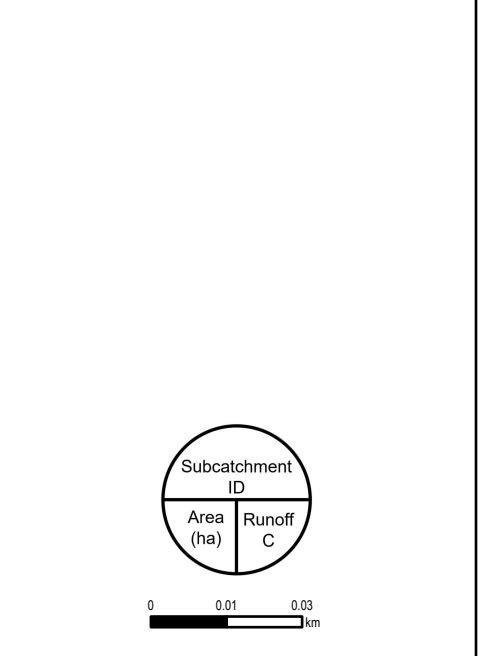

DRAWN BY	KK	CHECKED BY	BO
	April 2023		
	NAD 1983 MTM 9		
	1:1,250		

Document Path: C:\Users\CAK\72000\Documents\221-04646-00 864 Lady Ellen Place\GIS\864-Lady-Ellen.aprx

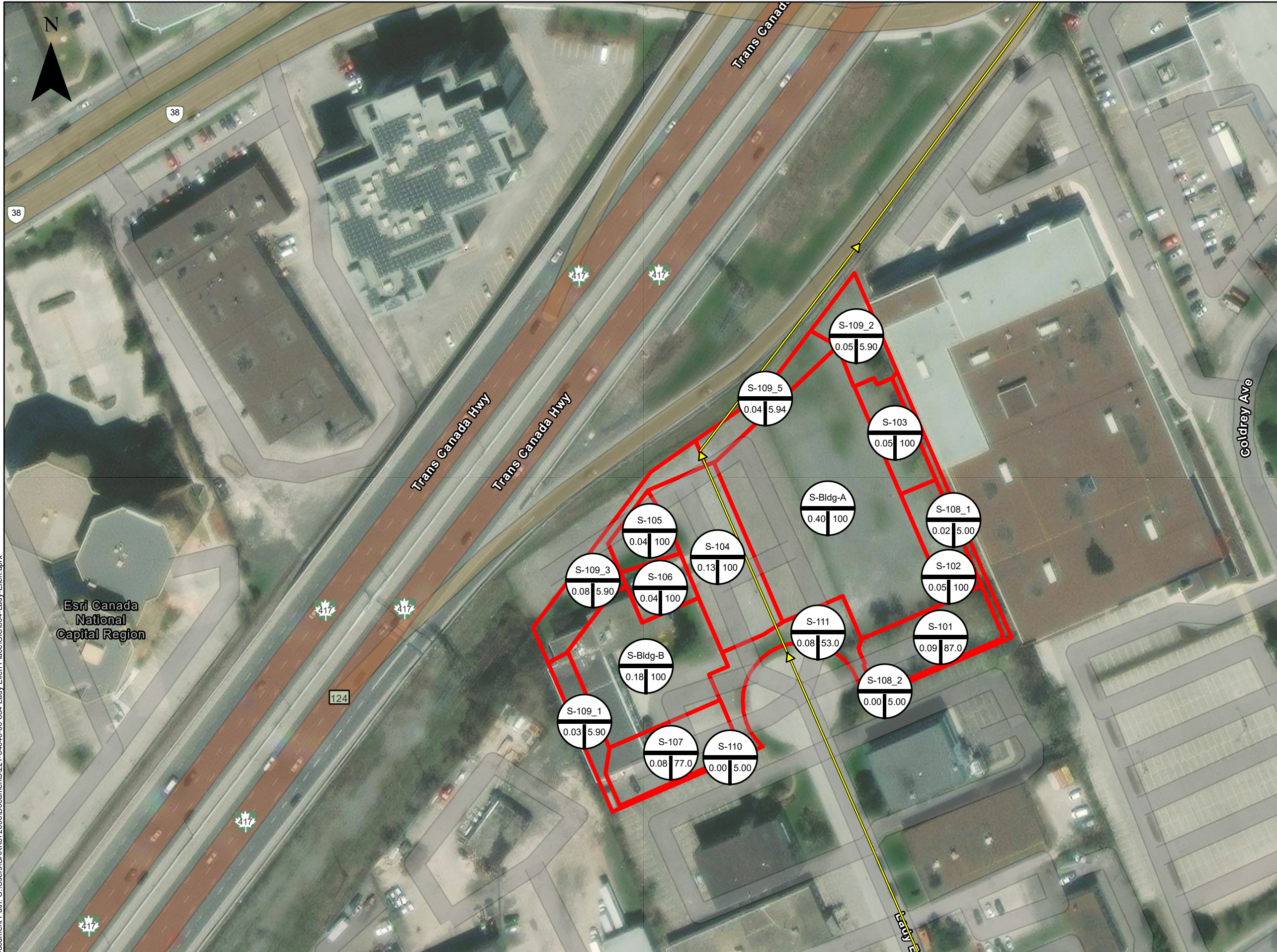

CLIENT
ACCESS PROPERTY DEVELOPMENT INC.

PROJECT
864 LADY ELLEN PLACE

TITLE
**EXHIBIT 2
PROPOSED CONDITIONS
DRAINAGE AREA PLAN**

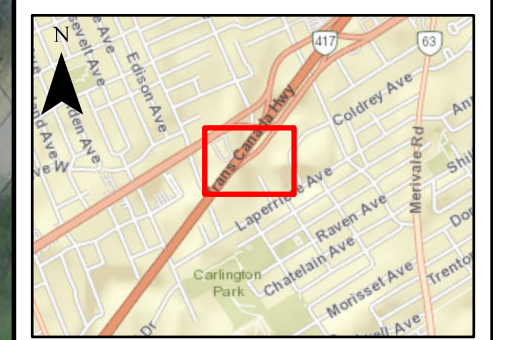

LEGEND
 Subcatchments
➤ Existing Storm Sewers

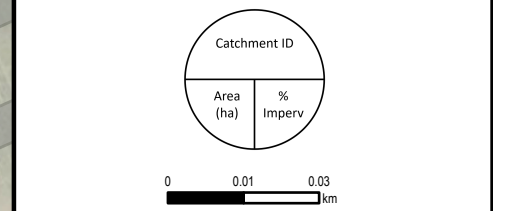

DRAWN BY KK CHECKED BY BO
 April 2023
 NAD 1983 MTM 9
 1:1,250



Document Path: C:\Users\CAK\72000\Documents\221-04646-00 864 Lady Ellen Place\GIS\864-Lady-Allen.aprx

Esri Canada
National
Capital Region

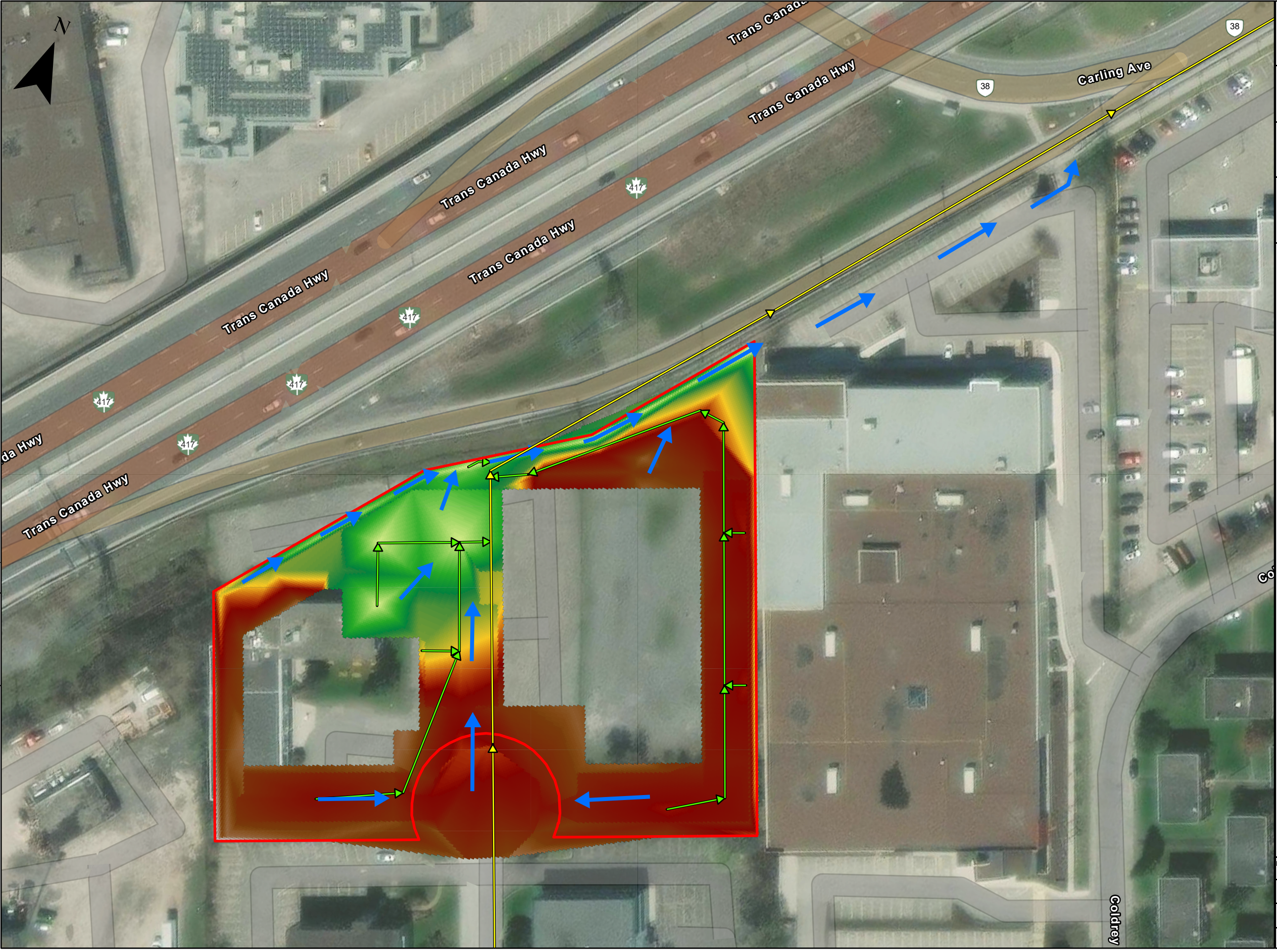

Document Path: C:\Users\CAK\72000\Documents\221-04646-00-864-Lady Ellen Place\GIS\864-Lady Ellen.aprx

CLIENT
ACCESS PROPERTY DEVELOPMENT
INC.

PROJECT
864 LADY ELLEN PLACE

TITLE
**EXHIBIT 3
PROPOSED CONDITIONS
MAJOR FLOW**

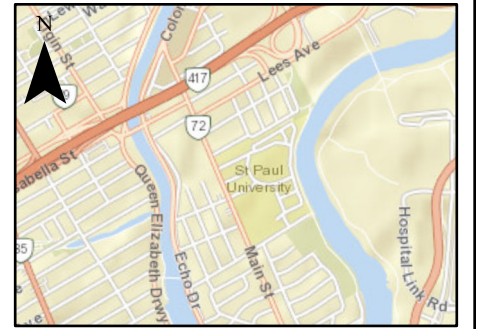

LEGEND

- ➔ Major Flow
- Site Boundary
- ➔ Proposed Storm Sewer
- ➔ Existing Storm Sewers

Elevation (m)

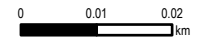

DRAWN BY
KK
April 2023
NAD 1983 MTM 9
1:1,000

CHECKED BY
BO

APPENDIX

C CALCULATIONS & PCSWMM OUTPUT

APPENDIX

C-1 *EXISTING CONDITIONS*



Project:	864 Lady Ellen	No.:	221-04646-00	Page:	1
By:	KK	Date:	2023-04-14		
Checked:	BO	Checked:	2023-04-14		

Subject: **SWM CALCULATIONS- Pre-Development Peak Flow**

Calculation of existing runoff rate is undertaken using the Rational Method:

$$Q = 2.78CiA$$

Where: Q = peak flow rate (litres/second)

C = runoff coefficient

i = rainfall intensity (mm/hour)

A = catchment area (hectares)

Site Area, A	13,600	m ²
Site Area, A	1.36	hectares
Runoff Coefficient, C	0.50	

Rainfall intensity calculated in accordance with City of Ottawa Sewer Design Guidelines (section 5.4.2):

$$i = \left[\frac{A}{(Td + C)^B} \right]$$

Where: A, B, C = regression constants for each return period (defined in section 5.4.2)

i = rainfall intensity (mm/hour)

Td = storm duration (minutes)

10 minutes

Return Period (Years)	2	5	10	25	50	100
A	733.0	998.1	1,174.2	1,402.9	1,569.6	1,735.7
B	0.810	0.814	0.816	0.819	0.820	0.820
C	6.199	6.053	6.014	6.018	6.014	6.014
T (mins)	10	10	10	10	10	10
I (mm/hr)	76.8	104.2	122.1	144.7	161.5	178.6
Multiplier	1.0	1.0	1.0	1.1	1.2	1.25
Q (litres/sec)	145	197	231	301	366	422
Q (m3/sec)	0.15	0.20	0.23	0.30	0.37	0.42

APPENDIX

C-2 *PROPOSED
CONDITIONS*

APPENDIX

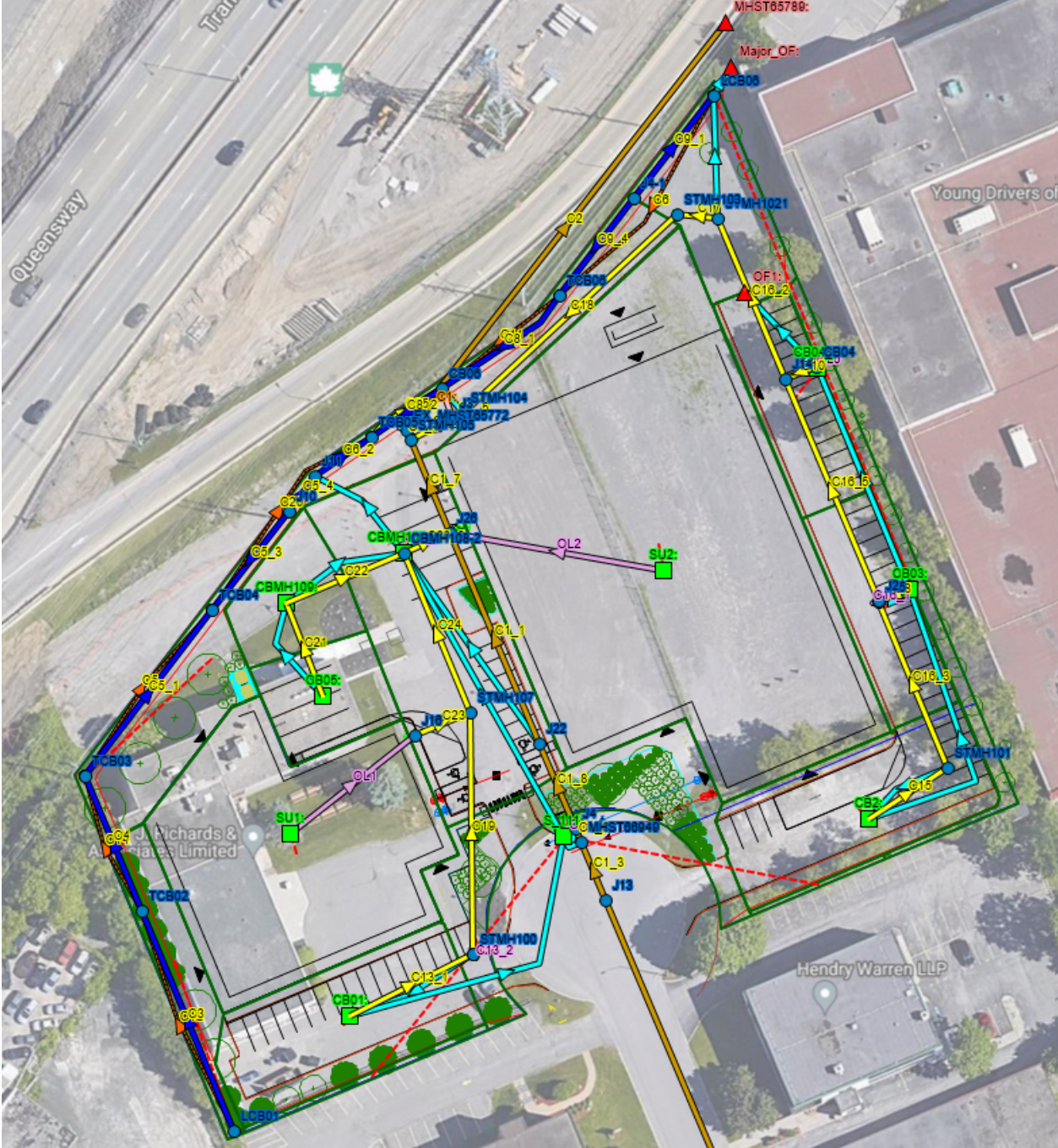

Element Count

Number of rain gages 18
 Number of subcatchments ... 17
 Number of nodes 46
 Number of links 71
 Number of pollutants 0
 Number of land uses 0

Raingage Summary

Name	Data Source	Data Type	Recording Interval
100yr	100yr	INTENSITY	10 min.
100yr_3hr_Chicago	100yr_3hr_Chicago	INTENSITY	10 min.
100yr_3hr_Chicago_Climate_Change	100yr_3hr_Chicago_Increase_20percent	INTENSITY	10 min.
100yr_6hr_Chicago	100yr_6hr_Chicago	INTENSITY	10 min.
100yr_6hr_Chicago_Climate_Change	100yr_6hr_Chicago_Increase_20percent	INTENSITY	10 min.
10yr_3hr_Chicago	10yr_3hr_Chicago	INTENSITY	10 min.
10yr_6hr_Chicago	10yr_6hr_Chicago	INTENSITY	10 min.
25mm_3hr_Chicago	25mm_3hr_Chicago	INTENSITY	10 min.
25mm_4hr_Chicago	25mm_4hr_Chicago	INTENSITY	10 min.
25yr_3hr_Chicago	25yr_3hr_Chicago	INTENSITY	10 min.
25yr_6hr_Chicago	25yr_6hr_Chicago	INTENSITY	10 min.
2yr	2yr	INTENSITY	10 min.
2yr_3hr_Chicago	2yr_3hr_Chicago	INTENSITY	10 min.
2yr_6hr_Chicago	2yr_6hr_Chicago	INTENSITY	10 min.
50yr_3hr_Chicago	50yr_3hr_Chicago	INTENSITY	10 min.
50yr_6hr_Chicago	50yr_6hr_Chicago	INTENSITY	10 min.
5yr_3hr_Chicago	5yr_3hr_Chicago	INTENSITY	10 min.
5yr_6hr_Chicago	5yr_6hr_Chicago	INTENSITY	10 min.

Subcatchment Summary

Name	Area	Width	%Imperv	%Slope	Rain Gage	Outlet
S-101	0.09	35.60	86.59	1.2000	100yr	CB2
S-102	0.05	20.58	100.00	2.2000	100yr	CB03
S-103	0.05	19.68	100.00	3.8000	100yr	CB04_1
S-104	0.13	28.57	100.00	3.1000	100yr	CBMH108-1
S-105	0.04	24.69	100.00	3.2000	100yr	CBMH109
S-106	0.04	31.50	100.00	3.0000	100yr	CB05
S-107	0.08	30.65	76.83	1.2000	100yr	CB01
S-108_1	0.02	1.91	5.00	1.0000	100yr	LCB06
S-108_2	0.00	0.96	5.00	4.0000	100yr	S_111
S-109_1	0.03	43.48	5.94	3.1000	100yr	LCB01
S-109_2	0.05	16.56	5.94	2.8000	100yr	LCB06
S-109_3	0.08	55.94	5.94	4.1000	100yr	TCB03
S-109_5	0.04	42.55	5.94	2.8000	100yr	J4-1
S-110	0.00	1.00	5.00	3.5000	100yr	S_111
S-111	0.08	45.00	52.50	1.3000	100yr	S_111
S-Bldg-A	0.40	400.00	100.00	1.0000	100yr	SU2
S-Bldg-B	0.18	180.00	100.00	1.0000	100yr	SU1

Node Summary

Name	Type	Invert Elev.	Max. Depth	Ponded Area	External Inflow
CB04	JUNCTION	75.15	3.50	0.0	
CB06	JUNCTION	74.17	3.83	0.0	
CBMH108-2	JUNCTION	74.79	2.74	0.0	
EX_MHST65772	JUNCTION	74.15	3.18	0.0	
J1	JUNCTION	76.28	2.58	0.0	
J10	JUNCTION	76.65	1.68	0.0	
J11	JUNCTION	76.58	1.64	0.0	
J13	JUNCTION	75.76	1.75	0.0	
J14	JUNCTION	75.00	2.51	0.0	
J15	JUNCTION	75.20	3.45	0.0	
J16	JUNCTION	75.64	1.72	0.0	
J2	JUNCTION	75.20	2.48	0.0	
J22	JUNCTION	75.25	2.93	0.0	
J26	JUNCTION	74.55	3.15	0.0	
J3	JUNCTION	74.41	2.80	0.0	
J4	JUNCTION	75.54	3.02	0.0	
J4-1	JUNCTION	76.40	1.50	0.0	

LCB01	JUNCTION	77.16	2.34	0.0
LCB06	JUNCTION	75.50	2.15	0.0
MHST66949	JUNCTION	75.58	2.97	0.0
MHST66950	JUNCTION	77.40	2.50	0.0
STMH100	JUNCTION	76.20	1.66	0.0
STMH101	JUNCTION	75.35	3.45	0.0
STMH1021	JUNCTION	74.72	3.66	0.0
STMH103	JUNCTION	74.62	2.90	0.0
STMH104	JUNCTION	74.35	3.96	0.0
STMH105	JUNCTION	74.22	2.58	0.0
STMH107	JUNCTION	75.52	1.84	0.0
TCB02	JUNCTION	76.87	1.90	0.0
TCB03	JUNCTION	76.20	2.92	0.0
TCB04	JUNCTION	75.54	3.08	0.0
TCB05	JUNCTION	75.00	3.23	0.0
TCB06	JUNCTION	75.25	2.89	0.0
Major_OF	OUTFALL	0.00	0.00	0.0
MHST65789	OUTFALL	73.10	0.60	0.0
OF1	OUTFALL	0.00	0.00	0.0
CB01	STORAGE	76.51	1.63	0.0
CB03	STORAGE	75.35	2.49	0.0
CB04_1	STORAGE	75.15	3.64	0.0
CB05	STORAGE	75.18	2.59	0.0
CB2	STORAGE	75.61	2.37	0.0
CBMH108-1	STORAGE	74.70	3.01	0.0
CBMH109	STORAGE	74.87	2.81	0.0
S_111	STORAGE	77.55	0.39	0.0
SU1	STORAGE	100.00	0.15	0.0
SU2	STORAGE	100.00	0.15	0.0

Link Summary

Name	From Node	To Node	Type	Length	%Slope	Roughness
C1_1	J22	J26	CONDUIT	38.6	1.8157	0.0130
C1_2	MHST66950	J13	CONDUIT	109.5	1.4984	0.0130
C1_3	J13	MHST66949	CONDUIT	10.6	1.5158	0.0130
C1_4	STMH105	EX_MHST65772	CONDUIT	1.8	3.4014	0.0130
C1_5	STMH104	J3	CONDUIT	2.1	0.3852	0.0130
C1_6	MHST66949	J4	CONDUIT	2.4	1.8278	0.0130
C1_7	J26	STMH105	CONDUIT	17.2	1.9222	0.0130
C1_8	J4	J22	CONDUIT	15.6	1.8410	0.0130
C1_9	J3	STMH105	CONDUIT	8.1	0.4938	0.0130
C10	CB04	J14	CONDUIT	5.6	1.0751	0.0130
C11	TCB06	CB06	CONDUIT	25.4	0.9833	0.0130
C12	LCB01	TCB02	CONDUIT	40.2	0.7219	0.0130
C13_1	CB01	J1	CONDUIT	23.3	0.9825	0.0130
C14	TCB02	TCB03	CONDUIT	25.0	2.6824	0.0130
C15	CB2	STMH101	CONDUIT	15.8	1.0129	0.0130
C16_2	J14	STMH1021	CONDUIT	29.4	0.5094	0.0130
C16_3	STMH101	J15	CONDUIT	30.1	0.4986	0.0130
C16_5	J2	J14	CONDUIT	40.5	0.4964	0.0130
C17	STMH1021	STMH103	CONDUIT	7.0	0.5697	0.0130
C18	STMH103	STMH104	CONDUIT	49.0	0.4897	0.0130
C19	STMH100	STMH107	CONDUIT	40.7	0.5893	0.0130
C2	EX_MHST65772	MHST65789	CONDUIT	87.3	1.2022	0.0130
C20	TCB04	TCB05	CONDUIT	40.7	1.3255	0.0130
C21	CB05	CBMH109	CONDUIT	16.8	1.0601	0.0130
C22	CBMH109	CBMH108-1	CONDUIT	21.8	0.2298	0.0130
C23	J16	STMH107	CONDUIT	10.0	0.9977	0.0130
C23_2	CBMH108-2	J26	CONDUIT	8.4	1.1911	0.0130
C24	STMH107	CBMH108-2	CONDUIT	29.1	0.4127	0.0130
C25	TCB05	CB06	CONDUIT	14.5	1.0167	0.0130
C3	LCB01	TCB02	CONDUIT	40.0	0.7242	0.0350
C4	TCB02	TCB03	CONDUIT	24.8	2.7049	0.0350
C5	TCB03	TCB04	CONDUIT	35.5	1.8619	0.0130
C5_1	TCB03	TCB04	CONDUIT	35.4	1.8633	0.0350
C5_3	J10	TCB04	CONDUIT	21.1	0.5678	0.0350
C5_4	J10	J11	CONDUIT	7.3	1.0951	0.0350
C6	LCB06	TCB06	CONDUIT	42.0	0.5952	0.0130
C6_2	J11	TCB05	CONDUIT	11.6	0.7766	0.0350
C8	CB03	J15	CONDUIT	5.7	1.0490	0.0130
C8_1	TCB06	CB06	CONDUIT	25.7	-0.3118	0.0350
C8_2	CB06	TCB05	CONDUIT	14.3	0.2792	0.0350
C9_1	J4-1	LCB06	CONDUIT	22.0	0.8181	0.0350
C9_4	J4-1	TCB06	CONDUIT	20.7	-0.1210	0.0350
C1	CB06	J3	ORIFICE			
W1	CB05	CBMH109	WEIR			
W10	J4	S_111	WEIR			
W11	MHST66949	S_111	WEIR			
W12	LCB06	Major_OF	WEIR			
W13	J22	CBMH108-1	WEIR			
W14	J26	CBMH108-1	WEIR			
W15	J15	CB03	WEIR			
W16	STMH101	CB2	WEIR			
W18	CB04	CB04_1	WEIR			

W19	STMH1021	LCB06	WEIR
W2	CBMH109	CBMH108-1	WEIR
W20	STMH104	CB06	WEIR
W21	CBMH108-2	CBMH108-1	WEIR
W22	J1	CB01	WEIR
W3	EX_MHST65772	CB06	WEIR
W4	S_111	CBMH108-1	WEIR
W5	CB01	S_111	WEIR
W6	CB2	CB03	WEIR
W7	CBMH108-1	J11	WEIR
W8	CB03	CB04_1	WEIR
W9	CB04_1	OF1	WEIR
C13_2	J1	STMH100	OUTLET
C16_1	J15	J2	OUTLET
C23_1	CBMH108-1	CBMH108-2	OUTLET
C9	S_111	J4	OUTLET
OL1	SU1	J16	OUTLET
OL2	SU2	J26	OUTLET
OL5	CB04_1	CB04	OUTLET

Cross Section Summary

Conduit	Shape	Full Depth	Full Area	Hyd. Rad.	Max. Width	No. of Barrels	Full Flow
C1_1	CIRCULAR	0.45	0.16	0.11	0.45	1	0.38
C1_2	CIRCULAR	0.45	0.16	0.11	0.45	1	0.35
C1_3	CIRCULAR	0.45	0.16	0.11	0.45	1	0.35
C1_4	CIRCULAR	0.45	0.16	0.11	0.45	1	0.53
C1_5	CIRCULAR	0.30	0.07	0.07	0.30	1	0.06
C1_6	CIRCULAR	0.45	0.16	0.11	0.45	1	0.39
C1_7	CIRCULAR	0.45	0.16	0.11	0.45	1	0.40
C1_8	CIRCULAR	0.45	0.16	0.11	0.45	1	0.39
C1_9	CIRCULAR	0.30	0.07	0.07	0.30	1	0.07
C10	CIRCULAR	0.20	0.03	0.05	0.20	1	0.03
C11	CIRCULAR	0.25	0.05	0.06	0.25	1	0.06
C12	CIRCULAR	0.25	0.05	0.06	0.25	1	0.05
C13_1	CIRCULAR	0.30	0.07	0.07	0.30	1	0.10
C14	CIRCULAR	0.25	0.05	0.06	0.25	1	0.10
C15	CIRCULAR	0.20	0.03	0.05	0.20	1	0.03
C16_2	CIRCULAR	0.30	0.07	0.07	0.30	1	0.07
C16_3	CIRCULAR	0.30	0.07	0.07	0.30	1	0.07
C16_5	CIRCULAR	0.30	0.07	0.07	0.30	1	0.07
C17	CIRCULAR	0.30	0.07	0.07	0.30	1	0.07
C18	CIRCULAR	0.30	0.07	0.07	0.30	1	0.07
C19	CIRCULAR	0.20	0.03	0.05	0.20	1	0.03
C2	CIRCULAR	0.60	0.28	0.15	0.60	1	0.67
C20	CIRCULAR	0.25	0.05	0.06	0.25	1	0.07
C21	CIRCULAR	0.53	0.22	0.13	0.53	1	0.44
C22	CIRCULAR	0.68	0.36	0.17	0.68	1	0.40
C23	CIRCULAR	0.25	0.05	0.06	0.25	1	0.06
C23_2	CIRCULAR	0.38	0.11	0.09	0.38	1	0.19
C24	CIRCULAR	0.30	0.07	0.07	0.30	1	0.06
C25	CIRCULAR	0.25	0.05	0.06	0.25	1	0.06
C3	TRAPEZOIDAL	0.50	0.75	0.24	3.00	1	0.70
C4	TRAPEZOIDAL	0.50	0.75	0.24	3.00	1	1.35
C5	CIRCULAR	0.25	0.05	0.06	0.25	1	0.08
C5_1	TRAPEZOIDAL	0.50	0.75	0.24	3.00	1	1.12
C5_3	TRAPEZOIDAL	0.50	0.75	0.24	3.00	1	0.62
C5_4	TRAPEZOIDAL	0.50	0.75	0.24	3.00	1	0.86
C6	CIRCULAR	0.25	0.05	0.06	0.25	1	0.05
C6_2	TRAPEZOIDAL	0.50	0.75	0.24	3.00	1	0.72
C8	CIRCULAR	0.20	0.03	0.05	0.20	1	0.03
C8_1	TRAPEZOIDAL	0.50	0.75	0.24	3.00	1	0.46
C8_2	TRAPEZOIDAL	0.50	0.75	0.24	3.00	1	0.43
C9_1	TRAPEZOIDAL	0.50	0.75	0.24	3.00	1	0.74
C9_4	TRAPEZOIDAL	0.50	0.75	0.24	3.00	1	0.29

NOTE: The summary statistics displayed in this report are based on results found at every computational time step, not just on results from each reporting time step.

Analysis Options

Flow Units CMS
Process Models:
 Rainfall/Runoff YES
 RDII NO
 Snowmelt NO
 Groundwater NO
 Flow Routing YES

Ponding Allowed YES
 Water Quality NO
 Infiltration Method HORTON
 Flow Routing Method DYNWAVE
 Surcharge Method EXTRAN
 Starting Date 11/10/2013 00:10:00
 Ending Date 11/10/2013 15:00:00
 Antecedent Dry Days 0.0
 Report Time Step 00:05:00
 Wet Time Step 00:05:00
 Dry Time Step 00:05:00
 Routing Time Step 1.00 sec
 Variable Time Step YES
 Maximum Trials 20
 Number of Threads 2
 Head Tolerance 0.001500 m

	Volume	Depth
Runoff Quantity Continuity	hectare-m	mm
Total Precipitation	0.098	71.677
Evaporation Loss	0.000	0.000
Infiltration Loss	0.013	9.552
Surface Runoff	0.084	61.364
Final Storage	0.002	1.242
Continuity Error (%)	-0.673	

	Volume	Volume
Flow Routing Continuity	hectare-m	10 ⁶ ltr
Dry Weather Inflow	0.000	0.000
Wet Weather Inflow	0.084	0.842
Groundwater Inflow	0.000	0.000
RDII Inflow	0.000	0.000
External Inflow	0.000	0.000
External Outflow	0.084	0.840
Flooding Loss	0.000	0.000
Evaporation Loss	0.000	0.000
Exfiltration Loss	0.000	0.000
Initial Stored Volume	0.000	0.000
Final Stored Volume	0.000	0.000
Continuity Error (%)	0.162	

 Highest Continuity Errors

 Node CB03 (30.86%)
 Node J15 (-13.16%)
 Node J1 (-1.40%)
 Node CB01 (1.38%)

 Time-Step Critical Elements

 Link C1_4 (91.45%)

 Highest Flow Instability Indexes

 Link W15 (29)
 Link W22 (9)
 Link C9 (8)
 Link C16_1 (8)

 Routing Time Step Summary

Minimum Time Step	:	0.50 sec
Average Time Step	:	0.71 sec
Maximum Time Step	:	1.00 sec
Percent in Steady State	:	-0.00
Average Iterations per Step	:	2.00
Percent Not Converging	:	0.00
Time Step Frequencies	:	
1.000 - 0.871 sec	:	10.09 %
0.871 - 0.758 sec	:	10.47 %
0.758 - 0.660 sec	:	47.32 %
0.660 - 0.574 sec	:	8.52 %
0.574 - 0.500 sec	:	23.60 %

Subcatchment Runoff Summary

Subcatchment	Total Precip mm	Total Runon mm	Total Evap mm	Total Infil mm	Imperv Runoff mm	Perv Runoff mm	Total Runoff mm	Total Runoff 10 ⁶ ltr	Peak Runoff CMS	Runoff Coeff
S-101	71.68	0.00	0.00	5.87	60.97	4.10	65.08	0.06	0.04	0.908
S-102	71.68	0.00	0.00	0.00	70.36	0.00	70.36	0.04	0.02	0.982
S-103	71.68	0.00	0.00	0.00	70.30	0.00	70.30	0.04	0.02	0.981
S-104	71.68	0.00	0.00	0.00	70.50	0.00	70.50	0.09	0.06	0.984
S-105	71.68	0.00	0.00	0.00	70.23	0.00	70.23	0.03	0.02	0.980
S-106	71.68	0.00	0.00	0.00	70.21	0.00	70.21	0.03	0.02	0.980
S-107	71.68	0.00	0.00	10.21	54.08	6.83	60.91	0.05	0.04	0.850
S-108_1	71.68	0.00	0.00	51.23	3.51	20.52	20.52	0.01	0.00	0.286
S-108_2	71.68	0.00	0.00	43.19	3.52	29.53	29.53	0.00	0.00	0.412
S-109_1	71.68	0.00	0.00	41.98	4.19	31.94	31.94	0.01	0.01	0.446
S-109_2	71.68	0.00	0.00	43.48	4.17	28.93	28.93	0.01	0.01	0.404
S-109_3	71.68	0.00	0.00	42.34	4.18	30.87	30.87	0.02	0.03	0.431
S-109_5	71.68	0.00	0.00	42.17	4.19	31.29	31.29	0.01	0.02	0.437
S-110	71.68	0.00	0.00	44.36	3.51	27.90	27.90	0.00	0.00	0.389
S-111	71.68	0.00	0.00	21.05	36.87	13.72	50.58	0.04	0.03	0.706
S-Bldg-A	71.68	0.00	0.00	0.00	70.25	0.00	70.25	0.28	0.20	0.980
S-Bldg-B	71.68	0.00	0.00	0.00	70.25	0.00	70.25	0.13	0.09	0.980

Node Depth Summary

Node	Type	Average Depth Meters	Maximum Depth Meters	Maximum HGL Meters	Time of Max Occurrence days hr:min	Reported Max Depth Meters
CB04	JUNCTION	0.01	0.07	75.22	0 01:04	0.07
CB06	JUNCTION	0.35	1.09	75.26	0 01:02	0.99
CBMH108-2	JUNCTION	0.04	0.10	74.89	0 01:15	0.10
EX_MHST65772	JUNCTION	0.06	0.18	74.33	0 01:01	0.18
J1	JUNCTION	0.29	1.67	77.95	0 01:14	1.67
J10	JUNCTION	0.00	0.00	76.65	0 00:00	0.00
J11	JUNCTION	0.00	0.00	76.58	0 00:00	0.00
J13	JUNCTION	0.00	0.00	75.76	0 00:00	0.00
J14	JUNCTION	0.03	0.10	75.10	0 01:13	0.10
J15	JUNCTION	0.78	2.63	77.83	0 01:25	2.63
J16	JUNCTION	0.45	0.46	76.10	0 00:35	0.46
J2	JUNCTION	0.03	0.07	75.27	0 01:25	0.07
J22	JUNCTION	0.01	0.09	75.34	0 01:00	0.09
J26	JUNCTION	0.05	0.13	74.68	0 01:00	0.12
J3	JUNCTION	0.03	0.23	74.64	0 01:02	0.22
J4	JUNCTION	0.01	0.09	75.63	0 01:00	0.09
J4-1	JUNCTION	0.06	0.20	76.60	0 01:00	0.20
LCB01	JUNCTION	0.00	0.09	77.25	0 01:00	0.09
LCB06	JUNCTION	0.01	0.09	75.59	0 01:00	0.09
MHST66949	JUNCTION	0.00	0.05	75.63	0 01:00	0.05
MHST66950	JUNCTION	0.00	0.00	77.40	0 00:00	0.00
STMH100	JUNCTION	0.07	0.12	76.32	0 01:14	0.12
STMH101	JUNCTION	0.73	2.48	77.83	0 01:24	2.48
STMH1021	JUNCTION	0.10	0.16	74.88	0 01:13	0.16
STMH103	JUNCTION	0.10	0.17	74.79	0 01:26	0.17
STMH104	JUNCTION	0.12	0.29	74.64	0 01:02	0.28
STMH105	JUNCTION	0.05	0.16	74.38	0 01:01	0.16
STMH107	JUNCTION	0.43	0.47	75.99	0 01:15	0.47
TCB02	JUNCTION	0.00	0.06	76.93	0 01:00	0.06
TCB03	JUNCTION	0.01	0.12	76.32	0 01:00	0.12
TCB04	JUNCTION	0.01	0.14	75.68	0 01:00	0.13
TCB05	JUNCTION	0.01	0.31	75.31	0 01:02	0.19
TCB06	JUNCTION	0.01	0.12	75.37	0 01:01	0.11
Major_OF	OUTFALL	0.00	0.00	0.00	0 00:00	0.00
MHST65789	OUTFALL	0.06	0.18	73.28	0 01:01	0.18
OF1	OUTFALL	0.00	0.00	0.00	0 00:00	0.00
CB01	STORAGE	0.23	1.44	77.95	0 01:14	1.44
CB03	STORAGE	0.71	2.48	77.83	0 01:25	2.48
CB04_1	STORAGE	0.27	2.62	77.77	0 01:04	2.62
CB05	STORAGE	0.29	1.52	76.70	0 01:14	1.52
CB2	STORAGE	0.63	2.23	77.84	0 01:24	2.23
CBMH108-1	STORAGE	0.59	2.00	76.70	0 01:15	2.00
CBMH109	STORAGE	0.42	1.83	76.70	0 01:15	1.83
S_111	STORAGE	0.00	0.06	77.62	0 01:00	0.06
SU1	STORAGE	0.09	0.15	100.15	0 02:30	0.15
SU2	STORAGE	0.10	0.14	100.14	0 02:44	0.14

Node Inflow Summary

Node	Type	Maximum Lateral Inflow CMS	Maximum Total Inflow CMS	Time of Max Occurrence days hr:min	Lateral Inflow Volume 10^6 ltr	Total Inflow Volume 10^6 ltr	Flow Balance Error Percent
CB04	JUNCTION	0.000	0.008	0 01:04	0	0.0351	0.003
CB06	JUNCTION	0.000	0.060	0 01:01	0	0.0662	0.534
CBMH108-2	JUNCTION	0.000	0.027	0 01:15	0	0.322	0.001
EX_MHST65772	JUNCTION	0.000	0.136	0 01:01	0	0.84	0.001
J1	JUNCTION	0.000	0.015	0 00:54	0	0.0481	-1.384
J10	JUNCTION	0.000	0.000	0 00:00	0	0	0.000 ltr
J11	JUNCTION	0.000	0.000	0 00:00	0	0	0.000 ltr
J13	JUNCTION	0.000	0.000	0 00:00	0	0	0.000 ltr
J14	JUNCTION	0.000	0.015	0 01:12	0	0.129	-0.005
J15	JUNCTION	0.000	0.022	0 00:55	0	0.0832	-11.629
J16	JUNCTION	0.000	0.003	0 00:34	0	0.126	0.390
J2	JUNCTION	0.000	0.007	0 01:25	0	0.0938	0.012
J22	JUNCTION	0.000	0.034	0 01:00	0	0.0427	-0.063
J26	JUNCTION	0.000	0.067	0 01:00	0	0.645	0.004
J3	JUNCTION	0.000	0.073	0 01:02	0	0.194	-0.038
J4	JUNCTION	0.000	0.034	0 01:00	0	0.0426	-0.191
J4-1	JUNCTION	0.015	0.015	0 01:00	0.0125	0.0125	0.436
LCB01	JUNCTION	0.012	0.012	0 01:00	0.00958	0.00958	-0.084
LCB06	JUNCTION	0.013	0.013	0 01:00	0.0196	0.0196	-0.044
MHST66949	JUNCTION	0.000	0.001	0 00:54	0	5.67e-05	0.068
MHST66950	JUNCTION	0.000	0.000	0 00:00	0	0	0.000 ltr
STMH100	JUNCTION	0.000	0.007	0 01:14	0	0.0487	0.121
STMH101	JUNCTION	0.000	0.026	0 00:54	0	0.0585	-0.033
STMH1021	JUNCTION	0.000	0.015	0 01:13	0	0.129	0.064
STMH103	JUNCTION	0.000	0.015	0 01:13	0	0.129	0.025
STMH104	JUNCTION	0.000	0.015	0 01:13	0	0.129	0.112
STMH105	JUNCTION	0.000	0.136	0 01:01	0	0.84	0.001
STMH107	JUNCTION	0.000	0.010	0 01:15	0	0.175	0.259
TCB02	JUNCTION	0.000	0.012	0 01:00	0	0.00959	0.107
TCB03	JUNCTION	0.029	0.040	0 01:00	0.0247	0.0343	-0.033
TCB04	JUNCTION	0.000	0.040	0 01:00	0	0.0343	0.013
TCB05	JUNCTION	0.000	0.039	0 01:00	0	0.0343	0.136
TCB06	JUNCTION	0.000	0.026	0 01:00	0	0.032	0.128
Major_OF	OUTFALL	0.000	0.000	0 00:00	0	0	0.000 ltr
MHST65789	OUTFALL	0.000	0.136	0 01:01	0	0.84	0.000
OF1	OUTFALL	0.000	0.000	0 00:00	0	0	0.000 ltr
CB01	STORAGE	0.037	0.037	0 01:00	0.0487	0.0488	1.399
CB03	STORAGE	0.025	0.031	0 00:55	0.0352	0.0355	44.637
CB04_1	STORAGE	0.025	0.025	0 01:00	0.0351	0.0351	0.003
CB05	STORAGE	0.020	0.020	0 01:00	0.0281	0.0281	-0.022
CB2	STORAGE	0.044	0.044	0 01:00	0.0586	0.0586	0.034
CBMH108-1	STORAGE	0.064	0.069	0 00:57	0.0916	0.152	0.063
CBMH109	STORAGE	0.020	0.036	0 00:54	0.0281	0.0606	0.002
S_111	STORAGE	0.035	0.035	0 01:00	0.0424	0.0424	-0.481
SU1	STORAGE	0.089	0.089	0 01:00	0.126	0.126	-0.000
SU2	STORAGE	0.198	0.198	0 01:00	0.281	0.281	0.000

Node Surcharge Summary

No nodes were surcharged.

Node Flooding Summary

No nodes were flooded.

Storage Volume Summary

Storage Unit	Average Volume 1000 m3	Avg Pcnt Full	Evap Pcnt Loss	Exfil Pcnt Loss	Maximum Volume 1000 m3	Max Pcnt Full	Time of Max Occurrence days hr:min	Maximum Outflow CMS
CB01	0.002	2	0	0	0.018	21	0 01:14	0.015
CB03	0.003	17	0	0	0.017	92	0 01:25	0.015
CB04_1	0.000	0	0	0	0.009	1	0 01:04	0.008
CB05	0.001	0	0	0	0.010	3	0 01:14	0.010
CB2	0.004	6	0	0	0.025	35	0 01:24	0.026
CBMH108-1	0.003	1	0	0	0.029	7	0 01:15	0.034
CBMH109	0.002	1	0	0	0.016	7	0 01:15	0.011
S_111	0.000	0	0	0	0.001	1	0 01:00	0.034
SU1	0.046	45	0	0	0.097	95	0 02:30	0.003
SU2	0.120	50	0	0	0.223	92	0 02:44	0.006

 Outfall Loading Summary

Outfall Node	Flow Freq Pent	Avg Flow CMS	Max Flow CMS	Total Volume 10^6 ltr
Major_OF	0.00	0.000	0.000	0.000
MHST65789	94.59	0.020	0.136	0.840
OF1	0.00	0.000	0.000	0.000
System	31.53	0.020	0.136	0.840

 Link Flow Summary

Link	Type	Maximum Flow CMS	Time of Max Occurrence days hr:min	Maximum Veloc m/sec	Max/ Full Flow	Max/ Full Depth
C1_1	CONDUIT	0.034	0 01:00	1.17	0.09	0.24
C1_2	CONDUIT	0.000	0 00:00	0.00	0.00	0.00
C1_3	CONDUIT	0.000	0 00:00	0.00	0.00	0.03
C1_4	CONDUIT	0.136	0 01:01	2.52	0.26	0.37
C1_5	CONDUIT	0.018	0 01:06	0.80	0.30	0.68
C1_6	CONDUIT	0.001	0 00:54	0.07	0.00	0.15
C1_7	CONDUIT	0.067	0 01:00	1.67	0.17	0.32
C1_8	CONDUIT	0.034	0 01:00	1.50	0.09	0.20
C1_9	CONDUIT	0.073	0 01:02	1.32	1.07	0.73
C10	CONDUIT	0.008	0 01:05	0.88	0.23	0.33
C11	CONDUIT	0.026	0 01:01	1.10	0.44	0.73
C12	CONDUIT	0.012	0 01:00	1.02	0.24	0.29
C13_1	CONDUIT	0.015	0 00:54	0.32	0.15	1.00
C14	CONDUIT	0.012	0 01:00	0.73	0.12	0.36
C15	CONDUIT	0.026	0 00:54	0.82	0.78	1.00
C16_2	CONDUIT	0.015	0 01:13	0.80	0.22	0.31
C16_3	CONDUIT	0.009	0 00:55	0.18	0.14	1.00
C16_5	CONDUIT	0.007	0 01:25	0.62	0.11	0.27
C17	CONDUIT	0.015	0 01:13	0.81	0.21	0.31
C18	CONDUIT	0.015	0 01:13	0.79	0.22	0.47
C19	CONDUIT	0.007	0 01:15	0.69	0.27	0.35
C2	CONDUIT	0.136	0 01:01	1.86	0.20	0.30
C20	CONDUIT	0.039	0 01:00	1.32	0.57	0.77
C21	CONDUIT	0.010	0 00:55	0.43	0.02	1.00
C22	CONDUIT	0.018	0 00:54	0.31	0.04	1.00
C23	CONDUIT	0.003	0 00:35	0.64	0.05	0.16
C23_2	CONDUIT	0.027	0 01:15	1.22	0.14	0.25
C24	CONDUIT	0.010	0 01:15	0.68	0.16	0.26
C25	CONDUIT	0.034	0 01:01	1.21	0.56	1.00
C3	CONDUIT	0.000	0 00:00	0.00	0.00	0.00
C4	CONDUIT	0.000	0 00:00	0.00	0.00	0.00
C5	CONDUIT	0.040	0 01:00	1.56	0.49	0.52
C5_1	CONDUIT	0.000	0 00:00	0.00	0.00	0.00
C5_3	CONDUIT	0.000	0 00:00	0.00	0.00	0.00
C5_4	CONDUIT	0.000	0 00:00	0.00	0.00	0.00
C6	CONDUIT	0.013	0 01:00	0.68	0.28	0.41
C6_2	CONDUIT	0.000	0 00:00	0.00	0.00	0.00
C8	CONDUIT	0.014	0 00:54	0.46	0.42	1.00
C8_1	CONDUIT	0.000	0 00:00	0.00	0.00	0.00
C8_2	CONDUIT	0.000	0 00:00	0.00	0.00	0.00
C9_1	CONDUIT	0.000	0 01:00	0.11	0.00	0.04
C9_4	CONDUIT	0.014	0 01:01	0.26	0.05	0.26
C1	ORIFICE	0.058	0 01:02			1.00
W1	WEIR	0.000	0 00:00			0.00
W10	WEIR	0.000	0 00:00			0.00
W11	WEIR	0.000	0 00:00			0.00
W12	WEIR	0.000	0 00:00			0.00
W13	WEIR	0.000	0 00:00			0.00
W14	WEIR	0.000	0 00:00			0.00
W15	WEIR	0.009	0 03:19			0.18
W16	WEIR	0.000	0 00:00			0.00
W18	WEIR	0.000	0 00:00			0.00
W19	WEIR	0.000	0 00:00			0.00
W2	WEIR	0.002	0 01:15			0.02
W20	WEIR	0.000	0 00:00			0.00
W21	WEIR	0.000	0 00:00			0.00
W22	WEIR	0.011	0 01:08			0.09
W3	WEIR	0.000	0 00:00			0.00
W4	WEIR	0.000	0 00:00			0.00
W5	WEIR	0.000	0 00:00			0.00
W6	WEIR	0.000	0 00:00			0.00
W7	WEIR	0.000	0 00:00			0.00

W8	WEIR	0.000	0	00:00	0.00
W9	WEIR	0.000	0	00:00	0.00
C13_2	DUMMY	0.007	0	01:14	
C16_1	DUMMY	0.007	0	01:25	
C23_1	DUMMY	0.017	0	01:15	
C9	DUMMY	0.034	0	01:00	
OL1	DUMMY	0.003	0	00:34	
OL2	DUMMY	0.006	0	00:34	
OL5	DUMMY	0.008	0	01:04	

Flow Classification Summary

Conduit	Adjusted /Actual Length	Fraction of Time in Flow Class								
		Up Dry	Down Dry	Sub Dry	Sup Crit	Up Crit	Down Crit	Norm Ltd	Inlet Ctrl	
C1_1	1.00	0.01	0.33	0.00	0.64	0.02	0.00	0.00	0.99	0.00
C1_2	1.00	1.00	0.00	0.00	0.00	0.00	0.00	0.00	0.00	0.00
C1_3	1.00	0.98	0.02	0.00	0.00	0.00	0.00	0.00	0.00	0.00
C1_4	1.00	0.01	0.00	0.00	0.00	0.30	0.00	0.69	0.01	0.00
C1_5	1.00	0.03	0.00	0.00	0.07	0.00	0.00	0.91	0.00	0.00
C1_6	1.00	0.01	0.93	0.00	0.06	0.00	0.00	0.00	0.92	0.00
C1_7	1.00	0.01	0.00	0.00	0.00	0.99	0.00	0.00	0.20	0.00
C1_8	1.00	0.01	0.00	0.00	0.69	0.30	0.00	0.00	0.30	0.00
C1_9	1.00	0.03	0.00	0.00	0.00	0.00	0.00	0.97	0.00	0.00
C10	1.00	0.01	0.00	0.00	0.00	0.00	0.00	0.99	0.00	0.00
C11	1.00	0.05	0.00	0.00	0.01	0.00	0.00	0.94	0.01	0.00
C12	1.00	0.05	0.00	0.00	0.85	0.09	0.00	0.00	0.87	0.00
C13_1	1.00	0.01	0.00	0.00	0.99	0.00	0.00	0.00	0.20	0.00
C14	1.00	0.05	0.00	0.00	0.95	0.00	0.00	0.00	0.94	0.00
C15	1.00	0.01	0.00	0.00	0.36	0.00	0.00	0.62	0.03	0.00
C16_2	1.00	0.01	0.00	0.00	0.00	0.00	0.00	0.99	0.00	0.00
C16_3	1.00	0.01	0.00	0.00	0.47	0.00	0.00	0.52	0.06	0.00
C16_5	1.00	0.01	0.02	0.00	0.96	0.00	0.00	0.00	0.98	0.00
C17	1.00	0.02	0.00	0.00	0.00	0.00	0.00	0.98	0.00	0.00
C18	1.00	0.02	0.00	0.00	0.05	0.00	0.00	0.93	0.03	0.00
C19	1.00	0.02	0.00	0.00	0.00	0.00	0.00	0.98	0.00	0.00
C2	1.00	0.01	0.00	0.00	0.00	0.99	0.00	0.00	0.25	0.00
C20	1.00	0.05	0.00	0.00	0.85	0.10	0.00	0.00	0.93	0.00
C21	1.00	0.01	0.00	0.00	0.33	0.00	0.00	0.66	0.08	0.00
C22	1.00	0.01	0.00	0.00	0.99	0.00	0.00	0.01	0.03	0.00
C23	1.00	0.02	0.00	0.00	0.00	0.00	0.00	0.98	0.00	0.00
C23_2	1.00	0.01	0.00	0.00	0.00	0.00	0.00	0.99	0.00	0.00
C24	1.00	0.02	0.00	0.00	0.00	0.00	0.00	0.98	0.00	0.00
C25	1.00	0.05	0.00	0.00	0.01	0.00	0.00	0.93	0.00	0.00
C3	1.00	1.00	0.00	0.00	0.00	0.00	0.00	0.00	0.00	0.00
C4	1.00	1.00	0.00	0.00	0.00	0.00	0.00	0.00	0.00	0.00
C5	1.00	0.05	0.00	0.00	0.84	0.11	0.00	0.00	0.94	0.00
C5_1	1.00	1.00	0.00	0.00	0.00	0.00	0.00	0.00	0.00	0.00
C5_3	1.00	1.00	0.00	0.00	0.00	0.00	0.00	0.00	0.00	0.00
C5_4	1.00	1.00	0.00	0.00	0.00	0.00	0.00	0.00	0.00	0.00
C6	1.00	0.05	0.63	0.00	0.31	0.01	0.00	0.00	0.86	0.00
C6_2	1.00	1.00	0.00	0.00	0.00	0.00	0.00	0.00	0.00	0.00
C8	1.00	0.01	0.00	0.00	0.44	0.00	0.00	0.55	0.02	0.00
C8_1	1.00	1.00	0.00	0.00	0.00	0.00	0.00	0.00	0.00	0.00
C8_2	1.00	1.00	0.00	0.00	0.00	0.00	0.00	0.00	0.00	0.00
C9_1	1.00	0.99	0.00	0.00	0.00	0.00	0.00	0.01	0.00	0.00
C9_4	1.00	0.05	0.00	0.00	0.00	0.00	0.95	0.00	0.00	0.00

Conduit Surcharge Summary

Conduit	Hours				
	Both Ends	Full Upstream	Full Dnstream	Above Full Normal Flow	Full Capacity Limited
C1_9	0.01	0.01	0.01	0.08	0.01
C11	0.01	0.01	0.02	0.01	0.01
C13_1	1.84	1.84	2.26	0.01	0.01
C15	3.65	3.65	3.83	0.01	0.01
C16_3	3.83	3.83	4.11	0.01	0.01
C20	0.01	0.01	0.05	0.01	0.01
C21	2.09	2.09	2.21	0.01	0.01
C22	2.19	2.19	2.23	0.01	0.01
C25	0.05	0.05	0.10	0.01	0.01
C8	4.05	4.05	4.21	0.01	0.01

Analysis begun on: Fri Jun 16 09:05:40 2023
Analysis ended on: Fri Jun 16 09:05:48 2023
Total elapsed time: 00:00:08

APPENDIX

C-3 *100-YEAR TAILWATER*

 Element Count

Number of rain gages 18
 Number of subcatchments ... 17
 Number of nodes 46
 Number of links 72
 Number of pollutants 0
 Number of land uses 0

 Raingage Summary

Name	Data Source	Data Type	Recording Interval
100yr	100yr	INTENSITY	10 min.
100yr_3hr_Chicago	100yr_3hr_Chicago	INTENSITY	10 min.
100yr_3hr_Chicago_Climate_Change	100yr_3hr_Chicago_Increase_20percent	INTENSITY	10 min.
100yr_6hr_Chicago	100yr_6hr_Chicago	INTENSITY	10 min.
100yr_6hr_Chicago_Climate_Change	100yr_6hr_Chicago_Increase_20percent	INTENSITY	10 min.
10yr_3hr_Chicago	10yr_3hr_Chicago	INTENSITY	10 min.
10yr_6hr_Chicago	10yr_6hr_Chicago	INTENSITY	10 min.
25mm_3hr_Chicago	25mm_3hr_Chicago	INTENSITY	10 min.
25mm_4hr_Chicago	25mm_4hr_Chicago	INTENSITY	10 min.
25yr_3hr_Chicago	25yr_3hr_Chicago	INTENSITY	10 min.
25yr_6hr_Chicago	25yr_6hr_Chicago	INTENSITY	10 min.
2yr	2yr	INTENSITY	10 min.
2yr_3hr_Chicago	2yr_3hr_Chicago	INTENSITY	10 min.
2yr_6hr_Chicago	2yr_6hr_Chicago	INTENSITY	10 min.
50yr_3hr_Chicago	50yr_3hr_Chicago	INTENSITY	10 min.
50yr_6hr_Chicago	50yr_6hr_Chicago	INTENSITY	10 min.
5yr_3hr_Chicago	5yr_3hr_Chicago	INTENSITY	10 min.
5yr_6hr_Chicago	5yr_6hr_Chicago	INTENSITY	10 min.

 Subcatchment Summary

Name	Area	Width	%Imperv	%Slope	Rain Gage	Outlet
S-101	0.09	35.60	86.59	1.2000	100yr	CB2
S-102	0.05	20.58	100.00	2.2000	100yr	CB03
S-103	0.05	19.68	100.00	3.8000	100yr	CB04_1
S-104	0.13	28.57	100.00	3.1000	100yr	CBMH108-1
S-105	0.04	24.69	100.00	3.2000	100yr	CBMH109
S-106	0.04	31.50	100.00	3.0000	100yr	CB05
S-107	0.08	30.65	76.83	1.2000	100yr	CB01
S-108_1	0.02	1.91	5.00	1.0000	100yr	LCB06
S-108_2	0.00	0.96	5.00	4.0000	100yr	S_111
S-109_1	0.03	43.48	5.94	3.1000	100yr	LCB01
S-109_2	0.05	16.56	5.94	2.8000	100yr	LCB06
S-109_3	0.08	55.94	5.94	4.1000	100yr	TCB03
S-109_5	0.04	42.55	5.94	2.8000	100yr	J4-1
S-110	0.00	1.00	5.00	3.5000	100yr	S_111
S-111	0.08	45.00	52.50	1.3000	100yr	S_111
S-Bldg-A	0.40	400.00	100.00	1.0000	100yr	SU2
S-Bldg-B	0.18	180.00	100.00	1.0000	100yr	SU1

 Node Summary

Name	Type	Invert Elev.	Max. Depth	Ponded Area	External Inflow
CB04	JUNCTION	75.15	3.50	0.0	
CB06	JUNCTION	74.17	3.83	0.0	
CBMH108-2	JUNCTION	74.79	2.74	0.0	
EX_MHST65772	JUNCTION	74.15	3.18	0.0	
J1	JUNCTION	76.28	2.58	0.0	
J10	JUNCTION	76.65	1.68	0.0	
J11	JUNCTION	76.58	1.64	0.0	
J13	JUNCTION	75.76	1.75	0.0	
J14	JUNCTION	75.00	2.51	0.0	
J15	JUNCTION	75.20	3.45	0.0	
J16	JUNCTION	75.64	1.72	0.0	
J2	JUNCTION	75.20	3.45	0.0	
J22	JUNCTION	75.25	2.93	0.0	
J26	JUNCTION	74.55	3.15	0.0	
J3	JUNCTION	74.41	2.80	0.0	
J4	JUNCTION	75.54	3.02	0.0	
J4-1	JUNCTION	76.40	1.50	0.0	

LCB01	JUNCTION	77.16	2.34	0.0
LCB06	JUNCTION	75.50	2.15	0.0
MHST66949	JUNCTION	75.58	2.97	0.0
MHST66950	JUNCTION	77.40	2.50	0.0
STMH100	JUNCTION	76.20	1.66	0.0
STMH101	JUNCTION	75.35	3.45	0.0
STMH1021	JUNCTION	74.72	3.66	0.0
STMH103	JUNCTION	74.62	2.90	0.0
STMH104	JUNCTION	74.35	3.96	0.0
STMH105	JUNCTION	74.22	2.58	0.0
STMH107	JUNCTION	75.52	1.84	0.0
TCB02	JUNCTION	76.87	1.90	0.0
TCB03	JUNCTION	76.20	2.92	0.0
TCB04	JUNCTION	75.54	3.08	0.0
TCB05	JUNCTION	75.00	3.23	0.0
TCB06	JUNCTION	75.25	2.89	0.0
Major_OF	OUTFALL	0.00	0.00	0.0
MHST65789	OUTFALL	73.10	0.60	0.0
OF1	OUTFALL	0.00	0.00	0.0
CB01	STORAGE	76.51	1.63	0.0
CB03	STORAGE	75.35	3.49	0.0
CB04_1	STORAGE	75.15	3.64	0.0
CB05	STORAGE	75.18	2.59	0.0
CB2	STORAGE	75.61	2.37	0.0
CBMH108-1	STORAGE	74.70	3.01	0.0
CBMH109	STORAGE	74.87	2.81	0.0
S_111	STORAGE	77.55	0.39	0.0
SU1	STORAGE	100.00	0.15	0.0
SU2	STORAGE	100.00	0.15	0.0

Link Summary

Name	From Node	To Node	Type	Length	%Slope	Roughness
C1_1	J22	J26	CONDUIT	38.6	1.8157	0.0130
C1_2	MHST66950	J13	CONDUIT	109.5	1.4984	0.0130
C1_3	J13	MHST66949	CONDUIT	10.6	1.5158	0.0130
C1_4	STMH105	EX_MHST65772	CONDUIT	1.8	3.4014	0.0130
C1_5	STMH104	J3	CONDUIT	2.1	0.3852	0.0130
C1_6	MHST66949	J4	CONDUIT	2.4	1.8278	0.0130
C1_7	J26	STMH105	CONDUIT	17.2	1.9222	0.0130
C1_8	J4	J22	CONDUIT	15.6	1.8410	0.0130
C1_9	J3	STMH105	CONDUIT	8.1	0.4938	0.0130
C10	CB04	J14	CONDUIT	5.6	1.0751	0.0130
C11	TCB06	CB06	CONDUIT	25.4	0.9833	0.0130
C12	LCB01	TCB02	CONDUIT	40.2	0.7219	0.0130
C13_1	CB01	J1	CONDUIT	23.3	0.9825	0.0130
C14	TCB02	TCB03	CONDUIT	25.0	2.6824	0.0130
C15	CB2	STMH101	CONDUIT	15.8	1.0129	0.0130
C16_2	J14	STMH1021	CONDUIT	29.4	0.5094	0.0130
C16_3	STMH101	J15	CONDUIT	30.1	0.4986	0.0130
C16_5	J2	J14	CONDUIT	40.5	0.4964	0.0130
C17	STMH1021	STMH103	CONDUIT	7.0	0.5697	0.0130
C18	STMH103	STMH104	CONDUIT	49.0	0.4897	0.0130
C19	STMH100	STMH107	CONDUIT	40.7	0.5893	0.0130
C2	EX_MHST65772	MHST65789	CONDUIT	87.3	1.2022	0.0130
C20	TCB04	TCB05	CONDUIT	40.7	1.3255	0.0130
C21	CB05	CBMH109	CONDUIT	16.8	1.0601	0.0130
C22	CBMH109	CBMH108-1	CONDUIT	21.8	0.2298	0.0130
C23	J16	STMH107	CONDUIT	10.0	0.9977	0.0130
C23_2	CBMH108-2	J26	CONDUIT	8.4	1.1911	0.0130
C24	STMH107	CBMH108-2	CONDUIT	29.1	0.4127	0.0130
C25	TCB05	CB06	CONDUIT	14.5	1.0167	0.0130
C3	LCB01	TCB02	CONDUIT	40.0	0.7242	0.0350
C4	TCB02	TCB03	CONDUIT	24.8	2.7049	0.0350
C5	TCB03	TCB04	CONDUIT	35.5	1.8619	0.0130
C5_1	TCB03	TCB04	CONDUIT	35.4	1.8633	0.0350
C5_3	J10	TCB04	CONDUIT	21.1	0.5678	0.0350
C5_4	J10	J11	CONDUIT	7.3	1.0951	0.0350
C6	LCB06	TCB06	CONDUIT	42.0	0.5952	0.0130
C6_2	J11	TCB05	CONDUIT	11.6	0.7766	0.0350
C8	CB03	J15	CONDUIT	5.7	1.0490	0.0130
C8_1	TCB06	CB06	CONDUIT	25.7	-0.3118	0.0350
C8_2	CB06	TCB05	CONDUIT	14.3	0.2792	0.0350
C9_1	J4-1	LCB06	CONDUIT	22.0	0.8181	0.0350
C9_4	J4-1	TCB06	CONDUIT	20.7	-0.1210	0.0350
C1	CB06	J3	ORIFICE			
W1	CB05	CBMH109	WEIR			
W10	J4	S_111	WEIR			
W11	MHST66949	S_111	WEIR			
W12	LCB06	Major_OF	WEIR			
W13	J22	CBMH108-1	WEIR			
W14	J26	CBMH108-1	WEIR			
W15	J15	CB03	WEIR			
W16	STMH101	CB2	WEIR			
W17	J2	CB03	WEIR			

W18	CB04	CB04_1	WEIR
W19	STMH1021	LCB06	WEIR
W2	CBMH109	CBMH108-1	WEIR
W20	STMH104	CB06	WEIR
W21	CBMH108-2	CBMH108-1	WEIR
W22	J1	CB01	WEIR
W3	EX_MHST65772	CB06	WEIR
W4	S_111	CBMH108-1	WEIR
W5	CB01	S_111	WEIR
W6	CB2	CB03	WEIR
W7	CBMH108-1	J11	WEIR
W8	CB03	CB04_1	WEIR
W9	CB04_1	OF1	WEIR
C13_2	J1	STMH100	OUTLET
C16_1	J15	J2	OUTLET
C23_1	CBMH108-1	CBMH108-2	OUTLET
C9	S_111	J4	OUTLET
OL1	SU1	J16	OUTLET
OL2	SU2	J26	OUTLET
OL5	CB04_1	CB04	OUTLET

Cross Section Summary

Conduit	Shape	Full Depth	Full Area	Hyd. Rad.	Max. Width	No. of Barrels	Full Flow
C1_1	CIRCULAR	0.45	0.16	0.11	0.45	1	0.38
C1_2	CIRCULAR	0.45	0.16	0.11	0.45	1	0.35
C1_3	CIRCULAR	0.45	0.16	0.11	0.45	1	0.35
C1_4	CIRCULAR	0.45	0.16	0.11	0.45	1	0.53
C1_5	CIRCULAR	0.30	0.07	0.07	0.30	1	0.06
C1_6	CIRCULAR	0.45	0.16	0.11	0.45	1	0.39
C1_7	CIRCULAR	0.45	0.16	0.11	0.45	1	0.40
C1_8	CIRCULAR	0.45	0.16	0.11	0.45	1	0.39
C1_9	CIRCULAR	0.30	0.07	0.07	0.30	1	0.07
C10	CIRCULAR	0.20	0.03	0.05	0.20	1	0.03
C11	CIRCULAR	0.25	0.05	0.06	0.25	1	0.06
C12	CIRCULAR	0.25	0.05	0.06	0.25	1	0.05
C13_1	CIRCULAR	0.30	0.07	0.07	0.30	1	0.10
C14	CIRCULAR	0.25	0.05	0.06	0.25	1	0.10
C15	CIRCULAR	0.20	0.03	0.05	0.20	1	0.03
C16_2	CIRCULAR	0.30	0.07	0.07	0.30	1	0.07
C16_3	CIRCULAR	0.30	0.07	0.07	0.30	1	0.07
C16_5	CIRCULAR	0.30	0.07	0.07	0.30	1	0.07
C17	CIRCULAR	0.30	0.07	0.07	0.30	1	0.07
C18	CIRCULAR	0.30	0.07	0.07	0.30	1	0.07
C19	CIRCULAR	0.20	0.03	0.05	0.20	1	0.03
C2	CIRCULAR	0.60	0.28	0.15	0.60	1	0.67
C20	CIRCULAR	0.25	0.05	0.06	0.25	1	0.07
C21	CIRCULAR	0.53	0.22	0.13	0.53	1	0.44
C22	CIRCULAR	0.68	0.36	0.17	0.68	1	0.40
C23	CIRCULAR	0.25	0.05	0.06	0.25	1	0.06
C23_2	CIRCULAR	0.38	0.11	0.09	0.38	1	0.19
C24	CIRCULAR	0.30	0.07	0.07	0.30	1	0.06
C25	CIRCULAR	0.25	0.05	0.06	0.25	1	0.06
C3	TRAPEZOIDAL	0.50	0.75	0.24	3.00	1	0.70
C4	TRAPEZOIDAL	0.50	0.75	0.24	3.00	1	1.35
C5	CIRCULAR	0.25	0.05	0.06	0.25	1	0.08
C5_1	TRAPEZOIDAL	0.50	0.75	0.24	3.00	1	1.12
C5_3	TRAPEZOIDAL	0.50	0.75	0.24	3.00	1	0.62
C5_4	TRAPEZOIDAL	0.50	0.75	0.24	3.00	1	0.86
C6	CIRCULAR	0.25	0.05	0.06	0.25	1	0.05
C6_2	TRAPEZOIDAL	0.50	0.75	0.24	3.00	1	0.72
C8	CIRCULAR	0.20	0.03	0.05	0.20	1	0.03
C8_1	TRAPEZOIDAL	0.50	0.75	0.24	3.00	1	0.46
C8_2	TRAPEZOIDAL	0.50	0.75	0.24	3.00	1	0.43
C9_1	TRAPEZOIDAL	0.50	0.75	0.24	3.00	1	0.74
C9_4	TRAPEZOIDAL	0.50	0.75	0.24	3.00	1	0.29

NOTE: The summary statistics displayed in this report are based on results found at every computational time step, not just on results from each reporting time step.

Analysis Options

Flow Units CMS
Process Models:
 Rainfall/Runoff YES
 RDII NO
 Snowmelt NO
 Groundwater NO

```

Flow Routing ..... YES
Ponding Allowed ..... YES
Water Quality ..... NO
Infiltration Method ..... HORTON
Flow Routing Method ..... DYNWAVE
Surcharge Method ..... EXTRAN
Starting Date ..... 11/10/2013 00:10:00
Ending Date ..... 11/10/2013 15:00:00
Antecedent Dry Days ..... 0.0
Report Time Step ..... 00:05:00
Wet Time Step ..... 00:05:00
Dry Time Step ..... 00:05:00
Routing Time Step ..... 1.00 sec
Variable Time Step ..... YES
Maximum Trials ..... 20
Number of Threads ..... 2
Head Tolerance ..... 0.001500 m

```

```

*****
Volume      Depth
Runoff Quantity Continuity  hectare-m      mm
*****
Total Precipitation .....      0.098      71.677
Outfall Runon .....      0.000      0.031
Evaporation Loss .....      0.000      0.000
Infiltration Loss .....      0.013      9.554
Surface Runoff .....      0.084      61.394
Final Storage .....      0.002      1.242
Continuity Error (%) .....      -0.673

```

```

*****
Volume      Volume
Flow Routing Continuity  hectare-m      10^6 ltr
*****
Dry Weather Inflow .....      0.000      0.000
Wet Weather Inflow .....      0.084      0.842
Groundwater Inflow .....      0.000      0.000
RDI Inflow .....      0.000      0.000
External Inflow .....      0.016      0.157
External Outflow .....      0.083      0.832
Flooding Loss .....      0.000      0.000
Evaporation Loss .....      0.000      0.000
Exfiltration Loss .....      0.000      0.000
Initial Stored Volume ....      0.001      0.012
Final Stored Volume .....      0.009      0.093
Continuity Error (%) .....      8.516

```

```

*****
Highest Continuity Errors
*****
Node J13 (96.26%)
Node CBMH109 (12.74%)
Node TCB06 (12.38%)
Node TCB04 (11.12%)
Node J22 (10.91%)

```

```

*****
Time-Step Critical Elements
*****
None

```

```

*****
Highest Flow Instability Indexes
*****
Link C23 (109)
Link C1_3 (43)
Link C24 (37)
Link C13_2 (34)
Link C23_1 (24)

```

```

*****
Routing Time Step Summary
*****
Minimum Time Step      :      0.32 sec
Average Time Step      :      1.00 sec
Maximum Time Step      :      1.00 sec
Percent in Steady State :      0.00
Average Iterations per Step :      3.96
Percent Not Converging  :      0.04
Time Step Frequencies  :
  1.000 - 0.871 sec    :      99.74 %
  0.871 - 0.758 sec    :      0.01 %
  0.758 - 0.660 sec    :      0.04 %
  0.660 - 0.574 sec    :      0.04 %

```

0.574 - 0.500 sec : 0.17 %

 Subcatchment Runoff Summary

Subcatchment	Total Precip mm	Total Runon mm	Total Evap mm	Total Infil mm	Imperv Runoff mm	Perv Runoff mm	Total Runoff mm	Total Runoff 10 ⁶ ltr	Peak Runoff CMS	Runoff Coeff
S-101	71.68	0.00	0.00	5.87	60.97	4.10	65.08	0.06	0.04	0.908
S-102	71.68	0.00	0.00	0.00	70.36	0.00	70.36	0.04	0.02	0.982
S-103	71.68	0.00	0.00	0.00	70.30	0.00	70.30	0.04	0.02	0.981
S-104	71.68	0.00	0.00	0.00	70.50	0.00	70.50	0.09	0.06	0.984
S-105	71.68	0.00	0.00	0.00	70.23	0.00	70.23	0.03	0.02	0.980
S-106	71.68	0.00	0.00	0.00	70.21	0.00	70.21	0.03	0.02	0.980
S-107	71.68	0.00	0.00	10.21	54.08	6.83	60.91	0.05	0.04	0.850
S-108_1	71.68	0.00	0.00	51.23	3.51	20.52	20.52	0.01	0.00	0.286
S-108_2	71.68	0.00	0.00	43.19	3.52	29.53	29.53	0.00	0.00	0.412
S-109_1	71.68	0.00	0.00	41.98	4.19	31.94	31.94	0.01	0.01	0.446
S-109_2	71.68	0.85	0.00	43.53	4.22	29.73	29.73	0.01	0.01	0.410
S-109_3	71.68	0.00	0.00	42.34	4.18	30.87	30.87	0.02	0.03	0.431
S-109_5	71.68	0.00	0.00	42.17	4.19	31.29	31.29	0.01	0.02	0.437
S-110	71.68	0.00	0.00	44.36	3.51	27.90	27.90	0.00	0.00	0.389
S-111	71.68	0.00	0.00	21.05	36.87	13.72	50.58	0.04	0.03	0.706
S-Bldg-A	71.68	0.00	0.00	0.00	70.25	0.00	70.25	0.28	0.20	0.980
S-Bldg-B	71.68	0.00	0.00	0.00	70.25	0.00	70.25	0.13	0.09	0.980

 Node Depth Summary

Node	Type	Average Depth Meters	Maximum Depth Meters	Maximum HGL Meters	Time of Max Occurrence days hr:min	Reported Max Depth Meters
CB04	JUNCTION	1.31	1.60	76.75	0 01:01	1.59
CB06	JUNCTION	2.28	2.36	76.53	0 01:01	2.36
CBMH108-2	JUNCTION	1.67	1.75	76.54	0 01:00	1.74
EX_MHST65772	JUNCTION	2.31	2.37	76.52	0 01:00	2.37
J1	JUNCTION	0.35	1.67	77.95	0 01:10	1.67
J10	JUNCTION	0.01	0.04	76.69	0 01:03	0.03
J11	JUNCTION	0.00	0.05	76.63	0 01:16	0.05
J13	JUNCTION	0.70	1.02	76.78	0 00:03	0.78
J14	JUNCTION	1.46	1.97	76.97	0 00:02	1.74
J15	JUNCTION	1.34	2.52	77.72	0 01:00	2.52
J16	JUNCTION	0.82	2.09	77.73	0 00:03	0.90
J2	JUNCTION	1.26	1.63	76.83	0 01:01	1.62
J22	JUNCTION	1.21	1.29	76.54	0 01:00	1.29
J26	JUNCTION	1.91	1.98	76.53	0 01:00	1.98
J3	JUNCTION	2.05	2.13	76.54	0 01:01	2.13
J4	JUNCTION	0.92	1.01	76.54	0 01:00	1.00
J4-1	JUNCTION	0.06	0.20	76.60	0 01:00	0.20
LCB01	JUNCTION	0.00	0.09	77.25	0 01:00	0.09
LCB06	JUNCTION	0.96	1.06	76.56	0 01:01	1.05
MHST66949	JUNCTION	0.88	0.96	76.54	0 01:00	0.96
MHST66950	JUNCTION	0.00	0.00	77.40	0 00:00	0.00
STMH100	JUNCTION	0.26	1.11	77.31	0 00:04	0.35
STMH101	JUNCTION	1.19	2.39	77.74	0 01:00	2.39
STMH1021	JUNCTION	1.74	1.96	76.68	0 01:01	1.95
STMH103	JUNCTION	1.84	2.04	76.66	0 01:01	2.04
STMH104	JUNCTION	2.11	2.20	76.55	0 01:01	2.19
STMH105	JUNCTION	2.24	2.31	76.53	0 01:00	2.30
STMH107	JUNCTION	0.94	1.63	77.15	0 00:03	1.02
TCB02	JUNCTION	0.00	0.06	76.93	0 01:00	0.06
TCB03	JUNCTION	0.26	0.62	76.82	0 01:00	0.59
TCB04	JUNCTION	0.92	1.15	76.69	0 01:02	1.12
TCB05	JUNCTION	1.46	1.57	76.57	0 01:01	1.56
TCB06	JUNCTION	1.21	1.31	76.56	0 01:01	1.30
Major_OF	OUTFALL	0.00	0.00	0.00	0 00:00	0.00
MHST65789	OUTFALL	3.36	3.36	76.46	0 00:00	3.36
OF1	OUTFALL	0.00	0.00	0.00	0 00:00	0.00
CB01	STORAGE	0.16	1.44	77.95	0 01:14	1.44
CB03	STORAGE	1.19	2.37	77.72	0 01:00	2.37
CB04_1	STORAGE	1.45	2.65	77.80	0 01:11	2.65
CB05	STORAGE	1.28	1.54	76.72	0 01:15	1.54
CB2	STORAGE	0.93	2.19	77.80	0 01:03	2.19
CBMH108-1	STORAGE	1.76	2.02	76.72	0 01:14	2.02
CBMH109	STORAGE	1.59	1.85	76.72	0 01:14	1.85
S_111	STORAGE	0.00	0.06	77.62	0 01:00	0.06
SU1	STORAGE	0.08	0.15	100.15	0 02:30	0.15
SU2	STORAGE	0.09	0.14	100.14	0 02:44	0.14

Node Inflow Summary

Node	Type	Maximum		Time of Max Occurrence days hr:min	Lateral Inflow Volume 10^6 ltr	Total Inflow Volume 10^6 ltr	Flow Balance Error Percent
		Lateral Inflow CMS	Total Inflow CMS				
CB04	JUNCTION	0.000	0.055	0 00:02	0	0.0388	4.109
CB06	JUNCTION	0.000	0.120	0 00:04	0	0.114	2.730
CBMH108-2	JUNCTION	0.000	0.120	0 00:01	0	0.398	1.082
EX_MHST65772	JUNCTION	0.000	0.814	0 00:00	0	0.984	2.596
J1	JUNCTION	0.000	0.015	0 00:54	0	0.0513	0.741
J10	JUNCTION	0.000	0.001	0 01:02	0	5.44e-05	-14.770
J11	JUNCTION	0.000	0.001	0 01:14	0	0.000738	0.125
J13	JUNCTION	0.000	0.134	0 00:02	0	0.00994	2570.411
J14	JUNCTION	0.000	0.094	0 00:02	0	0.147	2.153
J15	JUNCTION	0.000	0.023	0 01:05	0	0.093	4.032
J16	JUNCTION	0.000	0.028	0 00:03	0	0.127	0.559
J2	JUNCTION	0.000	0.057	0 00:03	0	0.105	2.877
J22	JUNCTION	0.000	0.194	0 00:01	0	0.0746	12.244
J26	JUNCTION	0.000	0.415	0 00:00	0	0.713	2.095
J3	JUNCTION	0.000	0.249	0 00:00	0	0.179	2.293
J4	JUNCTION	0.000	0.158	0 00:02	0	0.0661	3.377
J4-1	JUNCTION	0.015	0.015	0 01:00	0.0125	0.0127	-0.052
LCB01	JUNCTION	0.012	0.012	0 01:00	0.00958	0.00958	-0.091
LCB06	JUNCTION	0.013	0.019	0 00:04	0.02	0.0253	11.457
MHST66949	JUNCTION	0.000	0.148	0 00:02	0	0.0152	11.563
MHST66950	JUNCTION	0.000	0.000	0 00:00	0	0	0.000 ltr
STMH100	JUNCTION	0.000	0.012	0 00:04	0	0.0523	-0.213
STMH101	JUNCTION	0.000	0.023	0 01:05	0	0.0639	5.384
STMH1021	JUNCTION	0.000	0.101	0 00:01	0	0.149	3.135
STMH103	JUNCTION	0.000	0.101	0 00:01	0	0.15	1.056
STMH104	JUNCTION	0.000	0.220	0 00:00	0	0.161	6.869
STMH105	JUNCTION	0.000	0.663	0 00:00	0	0.872	1.083
STMH107	JUNCTION	0.000	0.035	0 00:02	0	0.18	1.125
TCB02	JUNCTION	0.000	0.012	0 01:00	0	0.00959	0.109
TCB03	JUNCTION	0.029	0.040	0 01:00	0.0247	0.0388	4.096
TCB04	JUNCTION	0.000	0.042	0 00:04	0	0.0479	12.512
TCB05	JUNCTION	0.000	0.059	0 00:04	0	0.0554	12.102
TCB06	JUNCTION	0.000	0.049	0 00:04	0	0.0448	14.135
Major_OF	OUTFALL	0.000	0.008	0 01:01	0	0.00206	0.000
MHST65789	OUTFALL	0.000	0.814	0 00:00	0	0.986	0.000
OF1	OUTFALL	0.000	0.001	0 01:11	0	0.000425	0.000
CB01	STORAGE	0.037	0.037	0 01:00	0.0487	0.0489	0.590
CB03	STORAGE	0.025	0.037	0 01:00	0.0352	0.0701	0.424
CB04_1	STORAGE	0.025	0.025	0 01:00	0.0351	0.0366	2.878
CB05	STORAGE	0.020	0.020	0 01:00	0.0281	0.0354	9.770
CB2	STORAGE	0.044	0.044	0 01:00	0.0586	0.06	1.051
CBMH108-1	STORAGE	0.064	0.065	0 00:59	0.0916	0.219	3.471
CBMH109	STORAGE	0.020	0.027	0 00:58	0.0281	0.0771	14.601
S_111	STORAGE	0.035	0.035	0 01:00	0.0424	0.0424	-0.877
SU1	STORAGE	0.089	0.089	0 01:00	0.126	0.126	0.012
SU2	STORAGE	0.198	0.198	0 01:00	0.281	0.281	0.011

Node Surcharge Summary

Surcharging occurs when water rises above the top of the highest conduit.

Node	Type	Hours Surcharged	Max. Height	Min. Depth
			Above Crown Meters	Below Rim Meters
J13	JUNCTION	14.77	0.568	0.734
J14	JUNCTION	14.79	1.672	0.538
J16	JUNCTION	14.77	1.424	0.000
J3	JUNCTION	14.82	1.599	0.666
STMH100	JUNCTION	14.70	0.865	0.545
STMH103	JUNCTION	14.81	1.614	0.856
STMH105	JUNCTION	14.82	1.856	0.274
STMH107	JUNCTION	14.77	0.944	0.206

Node Flooding Summary

No nodes were flooded.

Storage Volume Summary

Storage Unit	Average Volume 1000 m3	Avg Pcnt Full	Evap Pcnt Loss	Exfil Pcnt Loss	Maximum Volume 1000 m3	Max Pcnt Full	Time of Max Occurrence days hr:min	Maximum Outflow CMS
CB01	0.001	1	0	0	0.018	21	0 01:14	0.015
CB03	0.001	0	0	0	0.004	0	0 01:00	0.036
CB04_1	0.001	0	0	0	0.014	2	0 01:11	0.006
CB05	0.002	1	0	0	0.012	3	0 01:15	0.006
CB2	0.001	2	0	0	0.016	22	0 01:03	0.023
CBMH108-1	0.005	1	0	0	0.036	9	0 01:14	0.019
CBMH109	0.003	1	0	0	0.020	9	0 01:14	0.011
S_111	0.000	0	0	0	0.001	1	0 01:00	0.034
SU1	0.041	40	0	0	0.097	95	0 02:30	0.003
SU2	0.108	45	0	0	0.223	92	0 02:44	0.006

 Outfall Loading Summary

Outfall Node	Flow Freq Pcnt	Avg Flow CMS	Max Flow CMS	Total Volume 10^6 ltr
Major_OF	0.81	0.005	0.008	0.002
MHST65789	97.57	0.019	0.814	0.986
OF1	1.84	0.000	0.001	0.000
System	33.41	0.025	0.814	0.988

 Link Flow Summary

Link	Type	Maximum Flow CMS	Time of Max Occurrence days hr:min	Maximum Veloc m/sec	Max/ Full Flow	Max/ Full Depth
C1_1	CONDUIT	0.194	0 00:01	1.30	0.50	1.00
C1_2	CONDUIT	0.000	0 00:00	0.00	0.00	0.50
C1_3	CONDUIT	0.134	0 00:02	1.73	0.38	1.00
C1_4	CONDUIT	0.663	0 00:00	4.17	1.26	1.00
C1_5	CONDUIT	0.220	0 00:00	3.12	3.67	1.00
C1_6	CONDUIT	0.148	0 00:02	1.29	0.38	1.00
C1_7	CONDUIT	0.415	0 00:00	2.64	1.05	1.00
C1_8	CONDUIT	0.158	0 00:02	1.08	0.41	1.00
C1_9	CONDUIT	0.249	0 00:00	3.52	3.66	1.00
C10	CONDUIT	0.055	0 00:02	1.92	1.60	1.00
C11	CONDUIT	0.049	0 00:04	1.00	0.83	1.00
C12	CONDUIT	0.012	0 01:00	1.02	0.24	0.29
C13_1	CONDUIT	0.015	0 00:54	0.21	0.15	1.00
C14	CONDUIT	0.012	0 01:00	0.37	0.12	0.62
C15	CONDUIT	0.023	0 01:05	0.72	0.68	1.00
C16_2	CONDUIT	0.094	0 00:02	1.46	1.36	1.00
C16_3	CONDUIT	0.023	0 01:05	0.32	0.33	1.00
C16_5	CONDUIT	0.057	0 00:03	0.82	0.84	1.00
C17	CONDUIT	0.101	0 00:01	1.48	1.39	1.00
C18	CONDUIT	0.101	0 00:01	1.43	1.50	1.00
C19	CONDUIT	0.012	0 00:04	0.46	0.47	1.00
C2	CONDUIT	0.814	0 00:00	2.92	1.21	1.00
C20	CONDUIT	0.042	0 00:04	0.86	0.62	1.00
C21	CONDUIT	0.007	0 00:15	0.12	0.02	1.00
C22	CONDUIT	0.015	0 00:15	0.37	0.04	1.00
C23	CONDUIT	0.028	0 00:03	0.66	0.47	1.00
C23_2	CONDUIT	0.120	0 00:01	1.09	0.63	1.00
C24	CONDUIT	0.035	0 00:02	0.61	0.56	1.00
C25	CONDUIT	0.059	0 00:04	1.20	0.98	1.00
C3	CONDUIT	0.000	0 00:00	0.00	0.00	0.00
C4	CONDUIT	0.000	0 00:00	0.00	0.00	0.00
C5	CONDUIT	0.038	0 01:00	0.78	0.47	1.00
C5_1	CONDUIT	0.000	0 00:00	0.00	0.00	0.15
C5_3	CONDUIT	0.001	0 01:02	0.06	0.00	0.17
C5_4	CONDUIT	0.000	0 01:03	0.13	0.00	0.05
C6	CONDUIT	0.019	0 00:04	0.50	0.42	1.00
C6_2	CONDUIT	0.001	0 01:16	0.19	0.00	0.08
C8	CONDUIT	0.011	0 00:53	0.34	0.31	1.00
C8_1	CONDUIT	0.000	0 01:01	0.04	0.00	0.13
C8_2	CONDUIT	0.001	0 01:02	0.08	0.00	0.10
C9_1	CONDUIT	0.000	0 01:00	0.01	0.00	0.18
C9_4	CONDUIT	0.014	0 01:00	0.23	0.05	0.28
C1	ORIFICE	0.056	0 00:02			1.00
W1	WEIR	0.000	0 00:00			0.00
W10	WEIR	0.000	0 00:00			0.00

W11	WEIR	0.000	0	00:00	0.00
W12	WEIR	0.008	0	01:01	0.01
W13	WEIR	0.000	0	00:00	0.00
W14	WEIR	0.000	0	00:00	0.00
W15	WEIR	0.009	0	01:03	0.07
W16	WEIR	0.000	0	00:00	0.00
W17	WEIR	0.036	0	01:00	0.07
W18	WEIR	0.000	0	00:00	0.00
W19	WEIR	0.000	0	00:00	0.00
W2	WEIR	0.004	0	01:13	0.04
W20	WEIR	0.000	0	00:00	0.00
W21	WEIR	0.000	0	00:00	0.00
W22	WEIR	0.011	0	01:40	0.09
W3	WEIR	0.078	0	00:05	0.20
W4	WEIR	0.000	0	00:00	0.00
W5	WEIR	0.000	0	00:00	0.00
W6	WEIR	0.000	0	00:00	0.00
W7	WEIR	0.001	0	01:14	0.01
W8	WEIR	0.000	0	00:00	0.00
W9	WEIR	0.001	0	01:11	0.01
C13_2	DUMMY	0.007	0	01:14	
C16_1	DUMMY	0.007	0	01:00	
C23_1	DUMMY	0.017	0	01:14	
C9	DUMMY	0.034	0	01:00	
OL1	DUMMY	0.003	0	00:34	
OL2	DUMMY	0.006	0	00:34	
OL5	DUMMY	0.006	0	01:28	

Flow Classification Summary

Conduit	Adjusted /Actual Length	----- Fraction of Time in Flow Class -----								
		Dry	Up Dry	Down Dry	Sub Crit	Sup Crit	Up Crit	Down Crit	Norm Ltd	Inlet Ctrl
C1_1	1.00	0.00	0.00	0.00	1.00	0.00	0.00	0.00	0.00	0.00
C1_2	1.00	0.00	1.00	0.00	0.00	0.00	0.00	0.00	0.00	0.00
C1_3	1.00	0.00	0.00	0.00	1.00	0.00	0.00	0.00	0.00	0.00
C1_4	1.00	0.00	0.00	0.00	1.00	0.00	0.00	0.00	0.00	0.00
C1_5	1.00	0.00	0.00	0.00	1.00	0.00	0.00	0.00	0.00	0.00
C1_6	1.00	0.00	0.00	0.00	1.00	0.00	0.00	0.00	0.00	0.00
C1_7	1.00	0.00	0.00	0.00	1.00	0.00	0.00	0.00	0.00	0.00
C1_8	1.00	0.00	0.00	0.00	1.00	0.00	0.00	0.00	0.00	0.00
C1_9	1.00	0.00	0.00	0.00	1.00	0.00	0.00	0.00	0.00	0.00
C10	1.00	0.00	0.00	0.00	1.00	0.00	0.00	0.00	0.00	0.00
C11	1.00	0.00	0.00	0.00	1.00	0.00	0.00	0.00	0.00	0.00
C12	1.00	0.06	0.00	0.00	0.88	0.07	0.00	0.00	0.87	0.00
C13_1	1.00	0.01	0.15	0.00	0.84	0.00	0.00	0.00	0.81	0.00
C14	1.00	0.01	0.86	0.00	0.13	0.00	0.00	0.00	0.94	0.00
C15	1.00	0.01	0.01	0.00	0.98	0.00	0.00	0.00	0.00	0.00
C16_2	1.00	0.00	0.00	0.00	1.00	0.00	0.00	0.00	0.00	0.00
C16_3	1.00	0.00	0.00	0.00	0.99	0.00	0.00	0.00	0.00	0.00
C16_5	1.00	0.00	0.00	0.00	1.00	0.00	0.00	0.00	0.00	0.00
C17	1.00	0.00	0.00	0.00	1.00	0.00	0.00	0.00	0.00	0.00
C18	1.00	0.00	0.00	0.00	1.00	0.00	0.00	0.00	0.00	0.00
C19	1.00	0.00	0.00	0.00	0.99	0.00	0.00	0.00	0.00	0.00
C2	1.00	0.00	0.00	0.00	1.00	0.00	0.00	0.00	0.00	0.00
C20	1.00	0.00	0.00	0.00	1.00	0.00	0.00	0.00	0.00	0.00
C21	1.00	0.01	0.00	0.00	0.99	0.00	0.00	0.00	0.00	0.00
C22	1.00	0.00	0.00	0.00	1.00	0.00	0.00	0.00	0.00	0.00
C23	1.00	0.00	0.00	0.00	0.99	0.00	0.00	0.00	0.00	0.00
C23_2	1.00	0.00	0.00	0.00	1.00	0.00	0.00	0.00	0.00	0.00
C24	1.00	0.00	0.00	0.00	1.00	0.00	0.00	0.00	0.00	0.00
C25	1.00	0.00	0.00	0.00	1.00	0.00	0.00	0.00	0.00	0.00
C3	1.00	1.00	0.00	0.00	0.00	0.00	0.00	0.00	0.00	0.00
C4	1.00	1.00	0.00	0.00	0.00	0.00	0.00	0.00	0.00	0.00
C5	1.00	0.00	0.00	0.00	0.99	0.00	0.00	0.00	0.00	0.00
C5_1	1.00	0.98	0.02	0.00	0.00	0.00	0.00	0.00	0.00	0.00
C5_3	1.00	0.06	0.01	0.00	0.01	0.00	0.00	0.92	0.01	0.00
C5_4	1.00	0.07	0.00	0.00	0.93	0.00	0.00	0.00	0.92	0.00
C6	1.00	0.00	0.00	0.00	1.00	0.00	0.00	0.00	0.00	0.00
C6_2	1.00	0.06	0.01	0.00	0.01	0.00	0.00	0.92	0.01	0.00
C8	1.00	0.01	0.00	0.00	0.99	0.00	0.00	0.00	0.00	0.00
C8_1	1.00	0.01	0.98	0.00	0.00	0.00	0.01	0.00	0.00	0.00
C8_2	1.00	0.98	0.01	0.00	0.00	0.00	0.01	0.00	0.00	0.00
C9_1	1.00	0.01	0.98	0.00	0.01	0.00	0.00	0.00	0.94	0.00
C9_4	1.00	0.01	0.00	0.00	0.89	0.00	0.05	0.05	0.02	0.00

Conduit Surchage Summary

Hours Hours

Conduit	----- Hours Full -----			Above Full	Capacity
	Both Ends	Upstream	Dnstream	Normal Flow	Limited
C1_1	14.80	14.80	14.82	0.01	0.01
C1_3	14.77	14.77	14.79	0.01	0.01
C1_4	14.82	14.82	14.83	0.01	0.01
C1_5	14.82	14.82	14.82	0.05	0.01
C1_6	14.79	14.79	14.79	0.01	0.01
C1_7	14.82	14.82	14.82	0.01	0.01
C1_8	14.79	14.79	14.80	0.01	0.01
C1_9	14.82	14.82	14.82	0.07	0.01
C10	14.79	14.79	14.79	0.01	0.01
C11	14.78	14.78	14.80	0.01	0.01
C13_1	1.84	1.84	2.29	0.01	0.01
C14	0.01	0.01	13.99	0.01	0.01
C15	14.51	14.51	14.57	0.01	0.01
C16_2	14.79	14.79	14.80	0.01	0.01
C16_3	14.57	14.57	14.65	0.01	0.01
C16_5	14.78	14.78	14.79	0.01	0.01
C17	14.80	14.80	14.81	0.02	0.01
C18	14.81	14.81	14.82	0.03	0.01
C19	14.70	14.70	14.77	0.01	0.01
C2	14.82	14.82	14.83	0.01	0.01
C20	14.75	14.75	14.78	0.01	0.01
C21	14.53	14.53	14.58	0.01	0.01
C22	14.57	14.57	14.59	0.01	0.01
C23	14.77	14.77	14.77	0.01	0.01
C23_2	14.82	14.82	14.82	0.01	0.01
C24	14.77	14.77	14.79	0.01	0.01
C25	14.80	14.80	14.81	0.01	0.01
C5	14.62	14.62	14.74	0.01	0.01
C6	14.76	14.76	14.78	0.01	0.01
C8	14.63	14.63	14.67	0.01	0.01

Analysis begun on: Fri Jun 16 09:52:36 2023
Analysis ended on: Fri Jun 16 09:52:38 2023
Total elapsed time: 00:00:02

APPENDIX

D SUPPORTING DOCUMENTS





VHV Vertical Vortex Flow Regulator

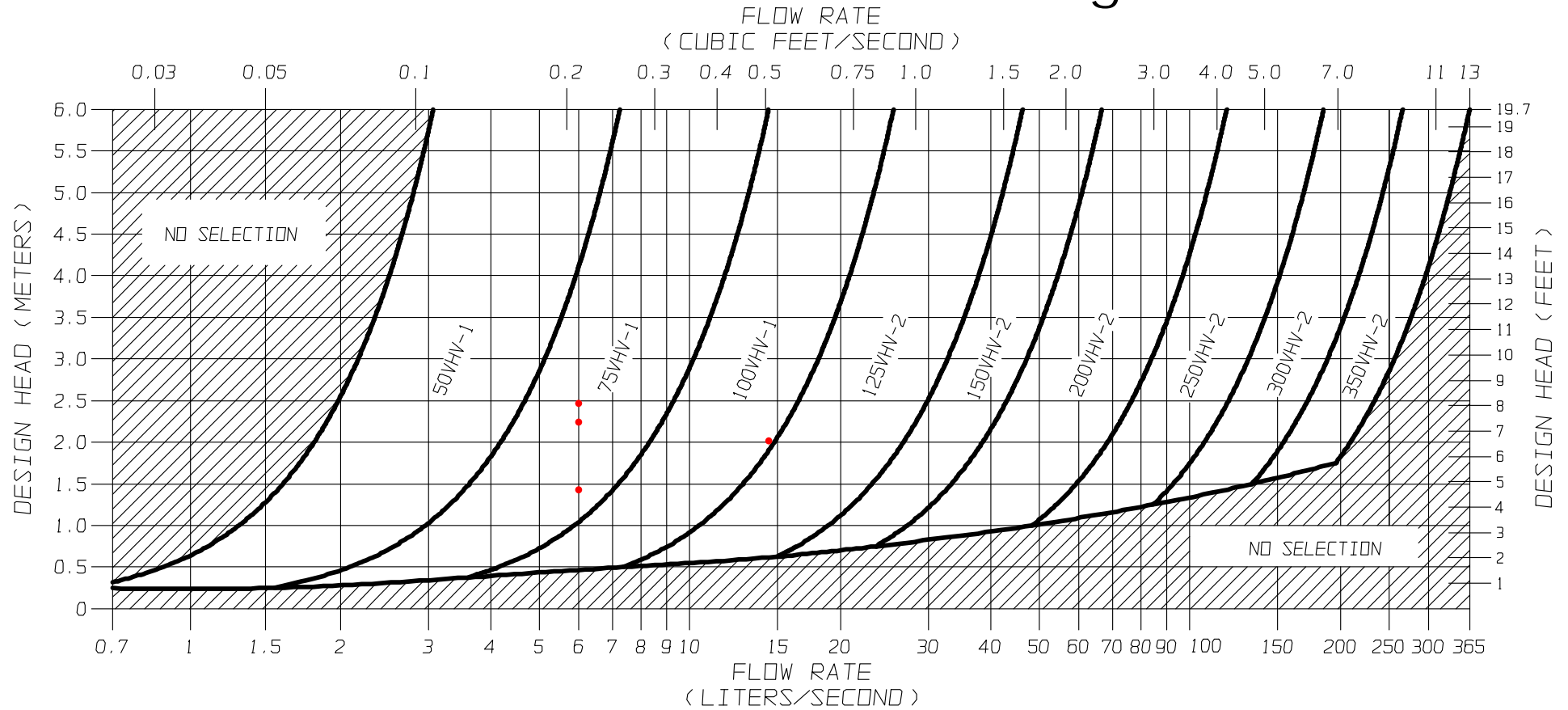

FIGURE 3 - VHV

JOHN MEUNIER



Adjustable Accutrol Weir

Tag: _____

Adjustable Flow Control for Roof Drains

ADJUSTABLE ACCUTROL (for Large Sump Roof Drains only)

For more flexibility in controlling flow with heads deeper than 2", Watts Drainage offers the Adjustable Accutrol. The Adjustable Accutrol Weir is designed with a single parabolic opening that can be covered to restrict flow above 2" of head to less than 5 gpm per inch, up to 6" of head. To adjust the flow rate for depths over 2" of head, set the slot in the adjustable upper cone according to the flow rate required. Refer to Table 1 below.
 Note: Flow rates are directly proportional to the amount of weir opening that is exposed.

EXAMPLE:

For example, if the adjustable upper cone is set to cover 1/2 of the weir opening, flow rates above 2" of head will be restricted to 2-1/2 gpm per inch of head.

Therefore, at 3" of head, the flow rate through the Accutrol Weir that has 1/2 the slot exposed will be:
 [5 gpm (per inch of head) x 2 inches of head] + 2-1/2 gpm (for the third inch of head) = 12-1/2 gpm.

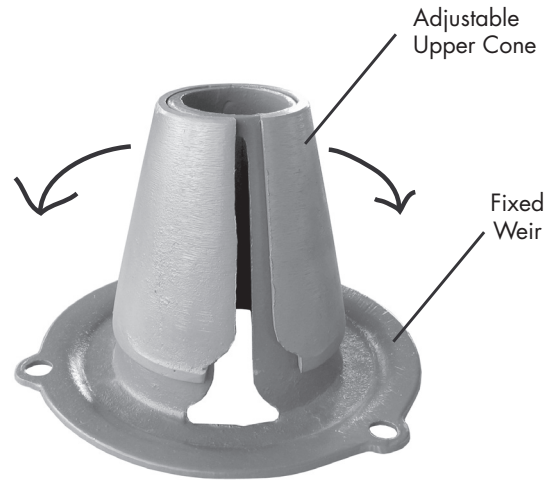
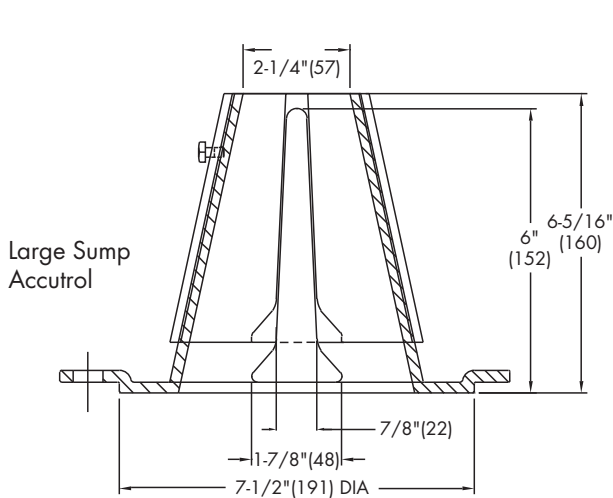

1/2 Weir Opening Exposed Shown Above

TABLE 1. Adjustable Accutrol Flow Rate Settings

Weir Opening Exposed	1"	2"	3"	4"	5"	6"
	Flow Rate (gallons per minute)					
Fully Exposed	5	10	15	20	25	30
3/4	5	10	13.75	17.5	21.25	25
1/2	5	10	12.5	15	17.5	20
1/4	5	10	11.25	12.5	13.75	15
Closed	5	5	5	5	5	5

Job Name _____
 Job Location _____
 Engineer _____

Contractor _____
 Contractor's P.O. No. _____
 Representative _____

Watts product specifications in U.S. customary units and metric are approximate and are provided for reference only. For precise measurements, please contact Watts Technical Service. Watts reserves the right to change or modify product design, construction, specifications, or materials without prior notice and without incurring any obligation to make such changes and modifications on Watts products previously or subsequently sold.

USA: Tel: (800) 338-2581 • Fax: (828) 248-3929 • Watts.com
 Canada: Tel: (905) 332-4090 • Fax: (905) 332-7068 • Watts.ca
 Latin America: Tel: (52) 81-1001-8600 • Fax: (52) 81-8000-7091 • Watts.com



Stormceptor® EF Sizing Report

STORMCEPTOR®

ESTIMATED NET ANNUAL SEDIMENT (TSS) LOAD REDUCTION

04/14/2023

Province:	Ontario
City:	Ottawa
Nearest Rainfall Station:	OTTAWA CDA RCS
Climate Station Id:	6105978
Years of Rainfall Data:	20

Project Name:	864 Lady Ellen Place
Project Number:	221-04646-00
Designer Name:	Kathryn Kerker
Designer Company:	WSP
Designer Email:	kathryn.kerker@wsp.com
Designer Phone:	613-690-1206
EOR Name:	
EOR Company:	
EOR Email:	
EOR Phone:	

Site Name:	STMH104
------------	---------

Drainage Area (ha):	0.18
% Imperviousness:	98.00

Runoff Coefficient 'c': 0.88

Particle Size Distribution:	Fine
Target TSS Removal (%):	80.0

Required Water Quality Runoff Volume Capture (%):	90.00
Estimated Water Quality Flow Rate (L/s):	5.16
Oil / Fuel Spill Risk Site?	Yes
Upstream Flow Control?	Yes
Upstream Orifice Control Flow Rate to Stormceptor (L/s):	18.00
Peak Conveyance (maximum) Flow Rate (L/s):	
Site Sediment Transport Rate (kg/ha/yr):	

Net Annual Sediment (TSS) Load Reduction Sizing Summary	
Stormceptor Model	TSS Removal Provided (%)
EFO4	95
EFO6	98
EFO8	100
EFO10	100
EFO12	100

Recommended Stormceptor EFO Model: EFO4
Estimated Net Annual Sediment (TSS) Load Reduction (%): 95
Water Quality Runoff Volume Capture (%): > 90



Stormceptor® EF Sizing Report

THIRD-PARTY TESTING AND VERIFICATION

► **Stormceptor® EF and Stormceptor® EFO** are the latest evolutions in the Stormceptor® oil-grit separator (OGS) technology series, and are designed to remove a wide variety of pollutants from stormwater and snowmelt runoff. These technologies have been third-party tested in accordance with the Canadian ETV **Procedure for Laboratory Testing of Oil-Grit Separators** and performance has been third-party verified in accordance with the **ISO 14034 Environmental Technology Verification (ETV)** protocol.

PERFORMANCE

► **Stormceptor® EF and EFO** remove stormwater pollutants through gravity separation and floatation, and feature a patent-pending design that generates positive removal of total suspended solids (TSS) throughout each storm event, including high-intensity storms. Captured pollutants include sediment, free oils, and sediment-bound pollutants such as nutrients, heavy metals, and petroleum hydrocarbons. Stormceptor is sized to remove a high level of TSS from the frequent rainfall events that contribute the vast majority of annual runoff volume and pollutant load. The technology incorporates an internal bypass to convey excessive stormwater flows from high-intensity storms through the device without resuspension and washout (scour) of previously captured pollutants. Proper routine maintenance ensures high pollutant removal performance and protection of downstream waterways.

PARTICLE SIZE DISTRIBUTION (PSD)

► The **Canadian ETV PSD** shown in the table below was used, or in part, for this sizing. This is the identical PSD that is referenced in the Canadian ETV **Procedure for Laboratory Testing of Oil-Grit Separators** for both sediment removal testing and scour testing. The Canadian ETV PSD contains a wide range of particle sizes in the sand and silt fractions, and is considered reasonably representative of the particle size fractions found in typical urban stormwater runoff.

Particle Size (µm)	Percent Less Than	Particle Size Fraction (µm)	Percent
1000	100	500-1000	5
500	95	250-500	5
250	90	150-250	15
150	75	100-150	15
100	60	75-100	10
75	50	50-75	5
50	45	20-50	10
20	35	8-20	15
8	20	5-8	10
5	10	2-5	5
2	5	<2	5

Stormceptor®EF Sizing Report

Upstream Flow Controlled Results

Rainfall Intensity (mm / hr)	Percent Rainfall Volume (%)	Cumulative Rainfall Volume (%)	Flow Rate (L/s)	Flow Rate (L/min)	Surface Loading Rate (L/min/m ²)	Removal Efficiency (%)	Incremental Removal (%)	Cumulative Removal (%)
0.5	8.6	8.6	0.22	13.0	11.0	100	8.6	8.6
1	20.3	29.0	0.44	27.0	22.0	100	20.3	29.0
2	16.2	45.2	0.89	53.0	44.0	100	16.2	45.2
3	12.0	57.2	1.33	80.0	67.0	100	12.0	57.2
4	8.4	65.6	1.78	107.0	89.0	98	8.3	65.5
5	5.9	71.6	2.22	133.0	111.0	95	5.6	71.1
6	4.6	76.2	2.67	160.0	133.0	92	4.3	75.4
7	3.1	79.3	3.11	187.0	156.0	89	2.7	78.1
8	2.7	82.0	3.55	213.0	178.0	87	2.4	80.5
9	3.3	85.3	4.00	240.0	200.0	83	2.8	83.3
10	2.3	87.6	4.44	267.0	222.0	82	1.9	85.2
11	1.6	89.2	4.89	293.0	244.0	81	1.3	86.4
12	1.3	90.5	5.33	320.0	267.0	80	1.1	87.5
13	1.7	92.2	5.78	347.0	289.0	79	1.4	88.9
14	1.2	93.5	6.22	373.0	311.0	78	1.0	89.8
15	1.2	94.6	6.67	400.0	333.0	77	0.9	90.7
16	0.7	95.3	7.11	427.0	355.0	76	0.5	91.2
17	0.7	96.1	7.55	453.0	378.0	75	0.6	91.8
18	0.4	96.5	8.00	480.0	400.0	74	0.3	92.1
19	0.4	96.9	8.44	507.0	422.0	73	0.3	92.4
20	0.2	97.1	8.89	533.0	444.0	72	0.2	92.5
21	0.5	97.5	9.33	560.0	467.0	71	0.3	92.9
22	0.2	97.8	9.78	587.0	489.0	70	0.2	93.0
23	1.0	98.8	10.22	613.0	511.0	69	0.7	93.7
24	0.3	99.1	10.66	640.0	533.0	68	0.2	93.9
25	0.9	100.0	11.11	667.0	555.0	67	0.6	94.5
30	0.9	100.9	13.33	800.0	667.0	64	0.6	95.1
35	-0.9	100.0	15.55	933.0	778.0	63	N/A	94.6
40	0.0	100.0	17.77	1066.0	889.0	62	0.0	94.6
45	0.0	100.0	18.00	1080.0	900.0	62	0.0	94.6
Estimated Net Annual Sediment (TSS) Load Reduction =								95 %

Climate Station ID: 6105978 Years of Rainfall Data: 20



Stormceptor® EF Sizing Report

RAINFALL DATA FROM OTTAWA CDA RCS RAINFALL STATION

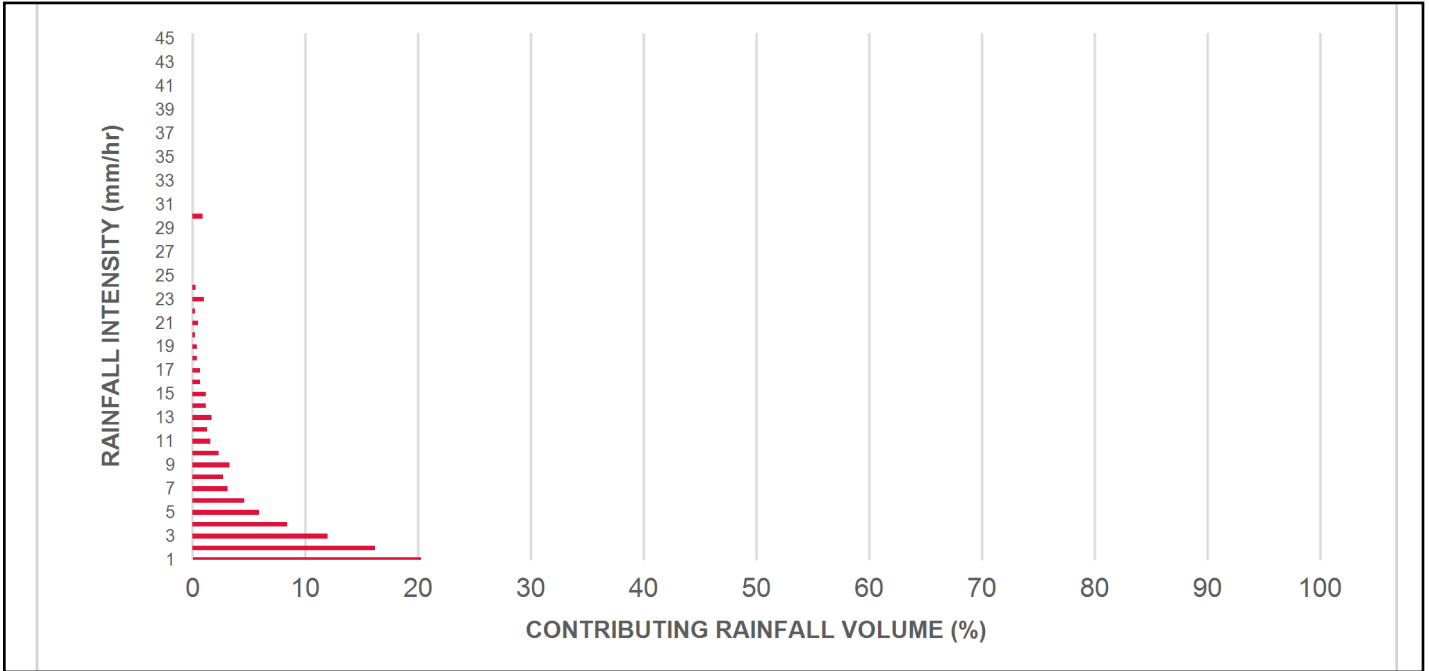

INCREMENTAL AND CUMULATIVE TSS REMOVAL FOR THE RECOMMENDED STORMCEPTOR® MODEL

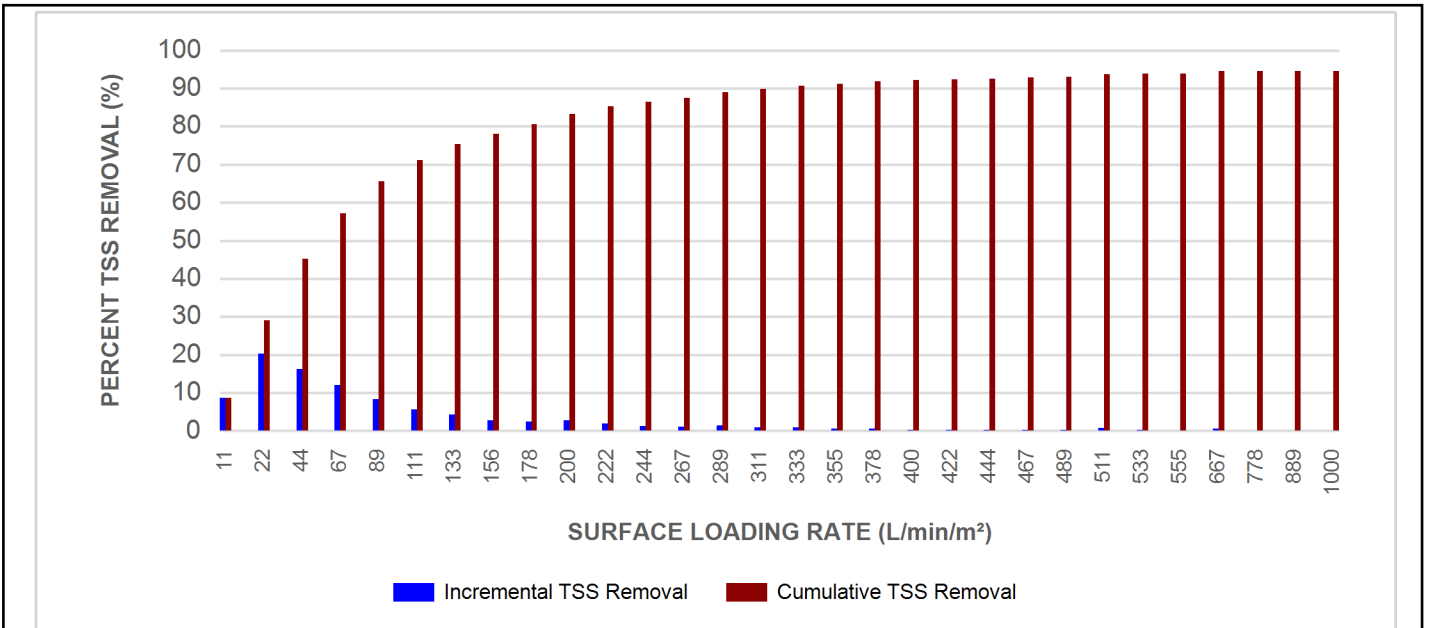

Stormceptor® **EF** Sizing Report

Maximum Pipe Diameter / Peak Conveyance

Stormceptor EF / EFO	Model Diameter		Min Angle Inlet / Outlet Pipes	Max Inlet Pipe Diameter		Max Outlet Pipe Diameter		Peak Conveyance Flow Rate	
	(m)	(ft)		(mm)	(in)	(mm)	(in)	(L/s)	(cfs)
EF4 / EFO4	1.2	4	90	609	24	609	24	425	15
EF6 / EFO6	1.8	6	90	914	36	914	36	990	35
EF8 / EFO8	2.4	8	90	1219	48	1219	48	1700	60
EF10 / EFO10	3.0	10	90	1828	72	1828	72	2830	100
EF12 / EFO12	3.6	12	90	1828	72	1828	72	2830	100

SCOUR PREVENTION AND ONLINE CONFIGURATION

► Stormceptor® EF and EFO feature an internal bypass and superior scour prevention technology that have been demonstrated in third-party testing according to the scour testing provisions of the Canadian ETV **Procedure for Laboratory Testing of Oil-Grit Separators**, and the exceptional scour test performance has been third-party verified in accordance with the ISO 14034 ETV protocol. As a result, Stormceptor EF and EFO are approved for online installation, eliminating the need for costly additional bypass structures, piping, and installation expense.

DESIGN FLEXIBILITY

► Stormceptor® EF and EFO offers design flexibility in one simplified platform, accepting stormwater flow from a single inlet pipe or multiple inlet pipes, and/or surface runoff through an inlet grate. The device can also serve as a junction structure, accommodate a 90-degree inlet-to-outlet bend angle, and can be modified to ensure performance in submerged conditions.

OIL CAPTURE AND RETENTION

► While Stormceptor® EF will capture and retain oil from dry weather spills and low intensity runoff, Stormceptor® EFO has demonstrated superior oil capture and greater than 99% oil retention in third-party testing according to the light liquid re-entrainment testing provisions of the Canadian ETV **Procedure for Laboratory Testing of Oil-Grit Separators**. Stormceptor EFO is recommended for sites where oil capture and retention is a requirement.

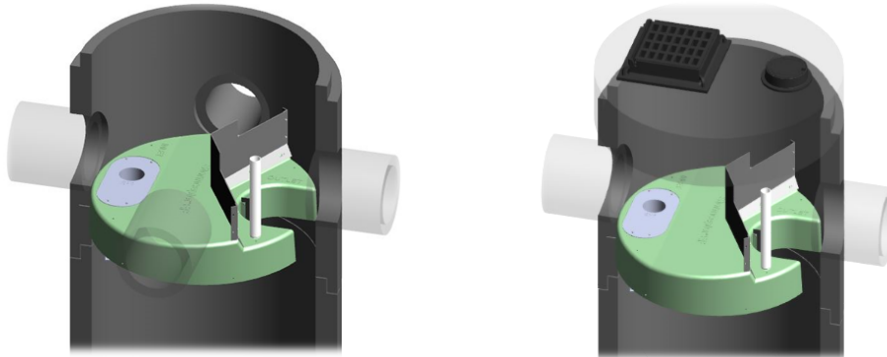

Stormceptor® EF Sizing Report

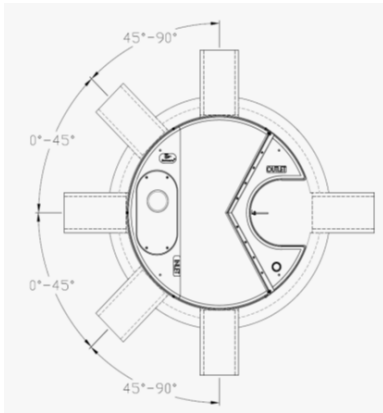

INLET-TO-OUTLET DROP

Elevation differential between inlet and outlet pipe inverts is dictated by the angle at which the inlet pipe(s) enters the unit.

0° - 45° : The inlet pipe is 1-inch (25mm) higher than the outlet pipe.

45° - 90° : The inlet pipe is 2-inches (50mm) higher than the outlet pipe.

HEAD LOSS

The head loss through Stormceptor EF is similar to that of a 60-degree bend structure. The applicable K value for calculating minor losses through the unit is 1.1.

For submerged conditions the applicable K value is 3.0.

Pollutant Capacity

Stormceptor EF / EFO	Model Diameter		Depth (Outlet Pipe Invert to Sump Floor)		Oil Volume		Recommended Sediment Maintenance Depth *		Maximum Sediment Volume *		Maximum Sediment Mass **	
	(m)	(ft)	(m)	(ft)	(L)	(Gal)	(mm)	(in)	(L)	(ft³)	(kg)	(lb)
EF4 / EFO4	1.2	4	1.52	5.0	265	70	203	8	1190	42	1904	5250
EF6 / EFO6	1.8	6	1.93	6.3	610	160	305	12	3470	123	5552	15375
EF8 / EFO8	2.4	8	2.59	8.5	1070	280	610	24	8780	310	14048	38750
EF10 / EFO10	3.0	10	3.25	10.7	1670	440	610	24	17790	628	28464	78500
EF12 / EFO12	3.6	12	3.89	12.8	2475	655	610	24	31220	1103	49952	137875

*Increased sump depth may be added to increase sediment storage capacity

** Average density of wet packed sediment in sump = 1.6 kg/L (100 lb/ft³)

Feature	Benefit	Feature Appeals To
Patent-pending enhanced flow treatment and scour prevention technology	Superior, verified third-party performance	Regulator, Specifying & Design Engineer
Third-party verified light liquid capture and retention for EFO version	Proven performance for fuel/oil hotspot locations	Regulator, Specifying & Design Engineer, Site Owner
Functions as bend, junction or inlet structure	Design flexibility	Specifying & Design Engineer
Minimal drop between inlet and outlet	Site installation ease	Contractor
Large diameter outlet riser for inspection and maintenance	Easy maintenance access from grade	Maintenance Contractor & Site Owner

STANDARD STORMCEPTOR EF/EFO DRAWINGS

For standard details, please visit <http://www.imbriumsystems.com/stormwater-treatment-solutions/stormceptor-ef>

STANDARD STORMCEPTOR EF/EFO SPECIFICATION

For specifications, please visit <http://www.imbriumsystems.com/stormwater-treatment-solutions/stormceptor-ef>

Stormceptor® **EF** Sizing Report

**STANDARD PERFORMANCE SPECIFICATION FOR
“OIL GRIT SEPARATOR” (OGS) STORMWATER QUALITY TREATMENT DEVICE**

PART 1 – GENERAL

1.1 WORK INCLUDED

This section specifies requirements for selecting, sizing, and designing an underground Oil Grit Separator (OGS) device for stormwater quality treatment, with third-party testing results and a Statement of Verification in accordance with ISO 14034 Environmental Management – Environmental Technology Verification (ETV).

1.2 REFERENCE STANDARDS & PROCEDURES

ISO 14034:2016 Environmental management – Environmental technology verification (ETV)

Canadian Environmental Technology Verification (ETV) Program’s **Procedure for Laboratory Testing of Oil-Grit Separators**

1.3 SUBMITTALS

1.3.1 All submittals, including sizing reports & shop drawings, shall be submitted upon request with each order to the contractor then forwarded to the Engineer of Record for review and acceptance. Shop drawings shall detail all OGS components, elevations, and sequence of construction.

1.3.2 Alternative devices shall have features identical to or greater than the specified device, including: treatment chamber diameter, treatment chamber wet volume, sediment storage volume, and oil storage volume.

1.3.3 Unless directed otherwise by the Engineer of Record, OGS stormwater quality treatment product substitutions or alternatives submitted within ten days prior to project bid shall not be accepted. All alternatives or substitutions submitted shall be signed and sealed by a local registered Professional Engineer, based on the exact same criteria detailed in Section 3, in entirety, subject to review and approval by the Engineer of Record.

PART 2 – PRODUCTS

2.1 OGS POLLUTANT STORAGE

The OGS device shall include a sump for sediment storage, and a protected volume for the capture and storage of petroleum hydrocarbons and buoyant gross pollutants. The minimum sediment & petroleum hydrocarbon storage capacity shall be as follows:

2.1.1	4 ft (1219 mm) Diameter OGS Units:	1.19 m ³ sediment / 265 L oil
	6 ft (1829 mm) Diameter OGS Units:	3.48 m ³ sediment / 609 L oil
	8 ft (2438 mm) Diameter OGS Units:	8.78 m ³ sediment / 1,071 L oil
	10 ft (3048 mm) Diameter OGS Units:	17.78 m ³ sediment / 1,673 L oil
	12 ft (3657 mm) Diameter OGS Units:	31.23 m ³ sediment / 2,476 L oil

PART 3 – PERFORMANCE & DESIGN

3.1 GENERAL

The OGS stormwater quality treatment device shall be verified in accordance with ISO 14034:2016 Environmental management – Environmental technology verification (ETV). The OGS stormwater quality treatment device shall



Stormceptor® EF Sizing Report

remove oil, sediment and gross pollutants from stormwater runoff during frequent wet weather events, and retain these pollutants during less frequent high flow wet weather events below the insert within the OGS for later removal during maintenance. The Manufacturer shall have at least ten (10) years of local experience, history and success in engineering design, manufacturing and production and supply of OGS stormwater quality treatment device systems, acceptable to the Engineer of Record.

3.2 SIZING METHODOLOGY

The OGS device shall be engineered, designed and sized to provide stormwater quality treatment based on treating a minimum of 90 percent of the average annual runoff volume and a minimum removal of an annual average 60% of the sediment (TSS) load based on the Particle Size Distribution (PSD) specified in the sizing report for the specified device. Sizing of the OGS shall be determined by use of a minimum ten (10) years of local historical rainfall data provided by Environment Canada. Sizing shall also be determined by use of the sediment removal performance data derived from the ISO 14034 ETV third-party verified laboratory testing data from testing conducted in accordance with the Canadian ETV protocol Procedure for Laboratory Testing of Oil-Grit Separators, as follows:

3.2.1 Sediment removal efficiency for a given surface loading rate and its associated flow rate shall be based on sediment removal efficiency demonstrated at the seven (7) tested surface loading rates specified in the protocol, ranging 40 L/min/m² to 1400 L/min/m², and as stated in the ISO 14034 ETV Verification Statement for the OGS device.

3.2.2 Sediment removal efficiency for surface loading rates between 40 L/min/m² and 1400 L/min/m² shall be based on linear interpolation of data between consecutive tested surface loading rates.

3.2.3 Sediment removal efficiency for surface loading rates less than the lowest tested surface loading rate of 40 L/min/m² shall be assumed to be identical to the sediment removal efficiency at 40 L/min/m². No extrapolation shall be allowed that results in a sediment removal efficiency that is greater than that demonstrated at 40 L/min/m².

3.2.4 Sediment removal efficiency for surface loading rates greater than the highest tested surface loading rate of 1400 L/min/m² shall assume zero sediment removal for the portion of flow that exceeds 1400 L/min/m², and shall be calculated using a simple proportioning formula, with 1400 L/min/m² in the numerator and the higher surface loading rate in the denominator, and multiplying the resulting fraction times the sediment removal efficiency at 1400 L/min/m².

The OGS device shall also have sufficient annual sediment storage capacity as specified and calculated in Section 2.1.

3.3 CANADIAN ETV or ISO 14034 ETV VERIFICATION OF SCOUR TESTING

The OGS device shall have Canadian ETV or ISO 14034 ETV Verification of third-party scour testing conducted in accordance with the Canadian ETV Program's **Procedure for Laboratory Testing of Oil-Grit Separators**.

3.3.1 To be acceptable for on-line installation, the OGS device must demonstrate an average scour test effluent concentration less than 10 mg/L at each surface loading rate tested, up to and including 2600 L/min/m².

3.4 LIGHT LIQUID RE-ENTRAINMENT SIMULATION TESTING

The OGS device shall have Canadian ETV or ISO 14034 ETV Verification of completed third-party Light Liquid Re-entrainment Simulation Testing in accordance with the Canadian ETV **Program's Procedure for Laboratory Testing of Oil-Grit Separators**, with results reported within the Canadian ETV or ISO 14034 ETV verification. This re-entrainment testing is conducted with the device pre-loaded with low density polyethylene (LDPE) plastic beads as a surrogate for light liquids such as oil and fuel. Testing is conducted on the same OGS unit tested for sediment removal to

Stormceptor® EF Sizing Report

assess whether light liquids captured after a spill are effectively retained at high flow rates.

3.4.1 For an OGS device to be an acceptable stormwater treatment device on a site where vehicular traffic occurs and the potential for an oil or fuel spill exists, the OGS device must have reported verified performance results of greater than 99% cumulative retention of LDPE plastic beads for the five specified surface loading rates (ranging 200 L/min/m² to 2600 L/min/m²) in accordance with the Light Liquid Re-entrainment Simulation Testing within the Canadian ETV Program's **Procedure for Laboratory Testing of Oil-Grit Separators**. However, an OGS device shall not be allowed if the Light Liquid Re-entrainment Simulation Testing was performed with screening components within the OGS device that are effective at retaining the LDPE plastic beads, but would not be expected to retain light liquids such as oil and fuel.

Stormceptor® EF Sizing Report

STORMCEPTOR®

ESTIMATED NET ANNUAL SEDIMENT (TSS) LOAD REDUCTION

04/14/2023

Province:	Ontario
City:	Ottawa
Nearest Rainfall Station:	OTTAWA CDA RCS
Climate Station Id:	6105978
Years of Rainfall Data:	20

Project Name:	864 Lady Ellen Place
Project Number:	221-04646-00
Designer Name:	Kathryn Kerker
Designer Company:	WSP
Designer Email:	kathryn.kerker@wsp.com
Designer Phone:	613-690-1206
EOR Name:	
EOR Company:	
EOR Email:	
EOR Phone:	

Site Name:	STMH106
------------	---------

Drainage Area (ha):	0.54
---------------------	------

% Imperviousness:	91.00
-------------------	-------

Runoff Coefficient 'c': 0.84

Particle Size Distribution:	Fine
-----------------------------	------

Target TSS Removal (%):	80.0
-------------------------	------

Required Water Quality Runoff Volume Capture (%):	90.00
---	-------

Estimated Water Quality Flow Rate (L/s):	14.74
--	-------

Oil / Fuel Spill Risk Site?	Yes
-----------------------------	-----

Upstream Flow Control?	Yes
------------------------	-----

Upstream Orifice Control Flow Rate to Stormceptor (L/s):	23.00
--	-------

Peak Conveyance (maximum) Flow Rate (L/s):	
--	--

Site Sediment Transport Rate (kg/ha/yr):	
--	--

Net Annual Sediment (TSS) Load Reduction Sizing Summary	
Stormceptor Model	TSS Removal Provided (%)
EFO4	84
EFO6	93
EFO8	97
EFO10	98
EFO12	100

Recommended Stormceptor EFO Model: EFO4

Estimated Net Annual Sediment (TSS) Load Reduction (%): 84

Water Quality Runoff Volume Capture (%): > 90



Stormceptor® EF Sizing Report

THIRD-PARTY TESTING AND VERIFICATION

► **Stormceptor® EF and Stormceptor® EFO** are the latest evolutions in the Stormceptor® oil-grit separator (OGS) technology series, and are designed to remove a wide variety of pollutants from stormwater and snowmelt runoff. These technologies have been third-party tested in accordance with the Canadian ETV **Procedure for Laboratory Testing of Oil-Grit Separators** and performance has been third-party verified in accordance with the **ISO 14034 Environmental Technology Verification (ETV)** protocol.

PERFORMANCE

► **Stormceptor® EF and EFO** remove stormwater pollutants through gravity separation and floatation, and feature a patent-pending design that generates positive removal of total suspended solids (TSS) throughout each storm event, including high-intensity storms. Captured pollutants include sediment, free oils, and sediment-bound pollutants such as nutrients, heavy metals, and petroleum hydrocarbons. Stormceptor is sized to remove a high level of TSS from the frequent rainfall events that contribute the vast majority of annual runoff volume and pollutant load. The technology incorporates an internal bypass to convey excessive stormwater flows from high-intensity storms through the device without resuspension and washout (scour) of previously captured pollutants. Proper routine maintenance ensures high pollutant removal performance and protection of downstream waterways.

PARTICLE SIZE DISTRIBUTION (PSD)

► The **Canadian ETV PSD** shown in the table below was used, or in part, for this sizing. This is the identical PSD that is referenced in the Canadian ETV **Procedure for Laboratory Testing of Oil-Grit Separators** for both sediment removal testing and scour testing. The Canadian ETV PSD contains a wide range of particle sizes in the sand and silt fractions, and is considered reasonably representative of the particle size fractions found in typical urban stormwater runoff.

Particle Size (µm)	Percent Less Than	Particle Size Fraction (µm)	Percent
1000	100	500-1000	5
500	95	250-500	5
250	90	150-250	15
150	75	100-150	15
100	60	75-100	10
75	50	50-75	5
50	45	20-50	10
20	35	8-20	15
8	20	5-8	10
5	10	2-5	5
2	5	<2	5

Stormceptor®EF Sizing Report

Upstream Flow Controlled Results

Rainfall Intensity (mm / hr)	Percent Rainfall Volume (%)	Cumulative Rainfall Volume (%)	Flow Rate (L/s)	Flow Rate (L/min)	Surface Loading Rate (L/min/m ²)	Removal Efficiency (%)	Incremental Removal (%)	Cumulative Removal (%)
0.5	8.6	8.6	0.64	38.0	32.0	100	8.6	8.6
1	20.3	29.0	1.27	76.0	64.0	100	20.3	29.0
2	16.2	45.2	2.54	152.0	127.0	93	15.1	44.1
3	12.0	57.2	3.81	229.0	191.0	84	10.1	54.2
4	8.4	65.6	5.08	305.0	254.0	81	6.8	61.0
5	5.9	71.6	6.35	381.0	318.0	78	4.6	65.7
6	4.6	76.2	7.62	457.0	381.0	75	3.5	69.1
7	3.1	79.3	8.89	533.0	445.0	72	2.2	71.3
8	2.7	82.0	10.16	610.0	508.0	69	1.9	73.2
9	3.3	85.3	11.43	686.0	572.0	66	2.2	75.4
10	2.3	87.6	12.70	762.0	635.0	64	1.5	76.9
11	1.6	89.2	13.97	838.0	699.0	64	1.0	77.9
12	1.3	90.5	15.24	914.0	762.0	63	0.8	78.8
13	1.7	92.2	16.51	991.0	826.0	63	1.1	79.8
14	1.2	93.5	17.78	1067.0	889.0	62	0.8	80.6
15	1.2	94.6	19.05	1143.0	953.0	62	0.7	81.3
16	0.7	95.3	20.32	1219.0	1016.0	61	0.4	81.7
17	0.7	96.1	21.59	1295.0	1080.0	60	0.4	82.2
18	3.9	100.0	22.86	1372.0	1143.0	58	2.3	84.5
19	0.0	100.0	23.00	1380.0	1150.0	58	0.0	84.5
20	0.0	100.0	23.00	1380.0	1150.0	58	0.0	84.5
21	0.0	100.0	23.00	1380.0	1150.0	58	0.0	84.5
22	0.0	100.0	23.00	1380.0	1150.0	58	0.0	84.5
23	0.0	100.0	23.00	1380.0	1150.0	58	0.0	84.5
24	0.0	100.0	23.00	1380.0	1150.0	58	0.0	84.5
25	0.0	100.0	23.00	1380.0	1150.0	58	0.0	84.5
30	0.0	100.0	23.00	1380.0	1150.0	58	0.0	84.5
35	0.0	100.0	23.00	1380.0	1150.0	58	0.0	84.5
40	0.0	100.0	23.00	1380.0	1150.0	58	0.0	84.5
45	0.0	100.0	23.00	1380.0	1150.0	58	0.0	84.5
Estimated Net Annual Sediment (TSS) Load Reduction =								84 %

Climate Station ID: 6105978 Years of Rainfall Data: 20



Stormceptor® EF Sizing Report

RAINFALL DATA FROM OTTAWA CDA RCS RAINFALL STATION

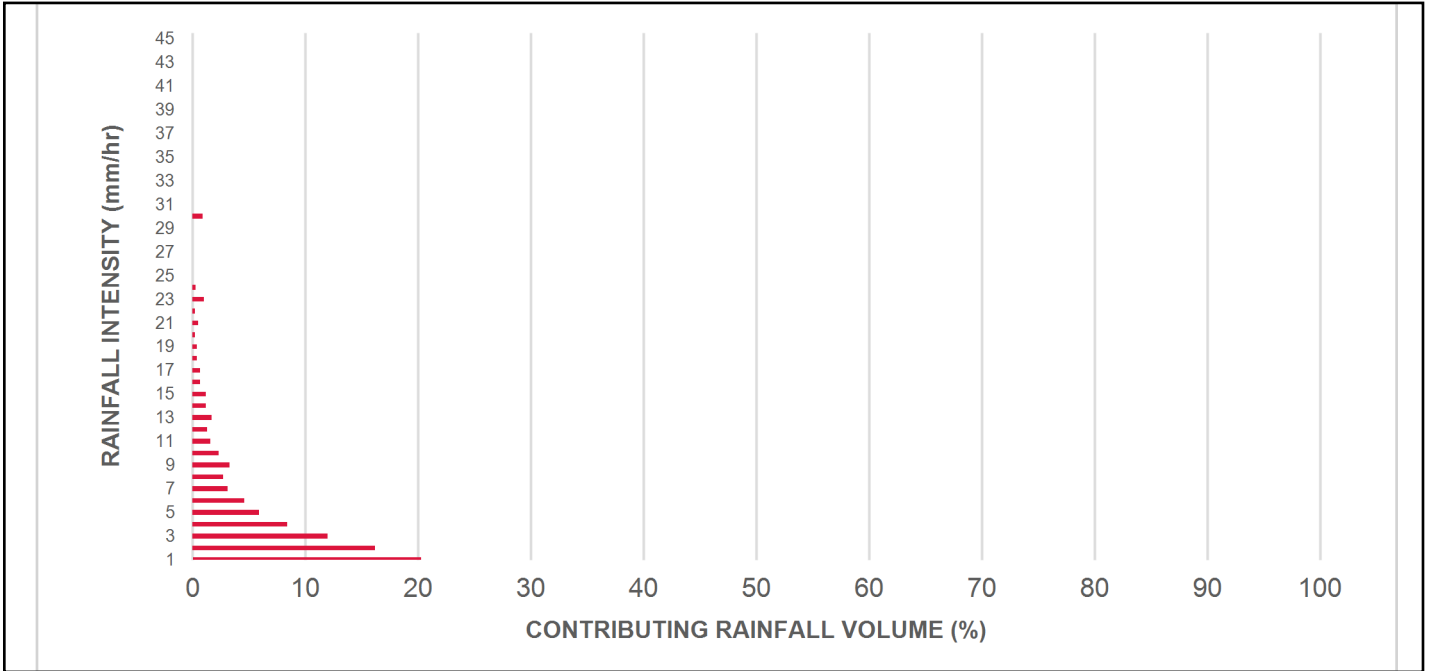

INCREMENTAL AND CUMULATIVE TSS REMOVAL FOR THE RECOMMENDED STORMCEPTOR® MODEL

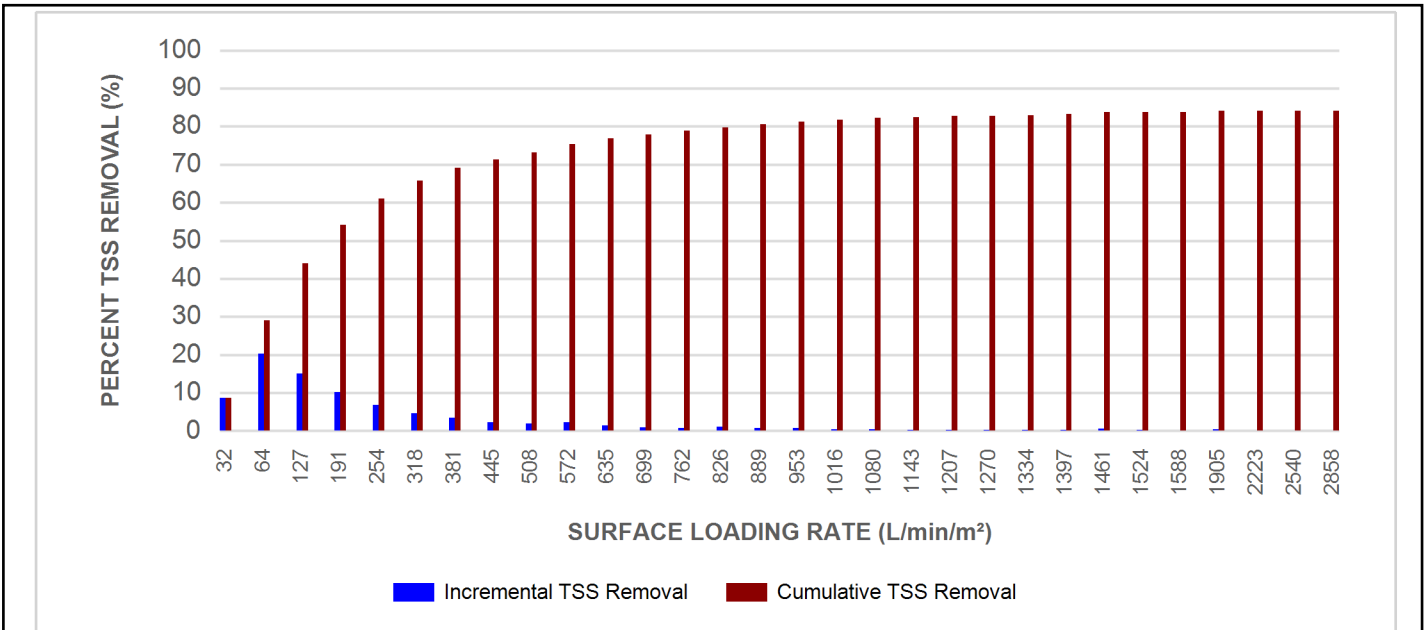

Stormceptor® **EF** Sizing Report

Maximum Pipe Diameter / Peak Conveyance

Stormceptor EF / EFO	Model Diameter		Min Angle Inlet / Outlet Pipes	Max Inlet Pipe Diameter		Max Outlet Pipe Diameter		Peak Conveyance Flow Rate	
	(m)	(ft)		(mm)	(in)	(mm)	(in)	(L/s)	(cfs)
EF4 / EFO4	1.2	4	90	609	24	609	24	425	15
EF6 / EFO6	1.8	6	90	914	36	914	36	990	35
EF8 / EFO8	2.4	8	90	1219	48	1219	48	1700	60
EF10 / EFO10	3.0	10	90	1828	72	1828	72	2830	100
EF12 / EFO12	3.6	12	90	1828	72	1828	72	2830	100

SCOUR PREVENTION AND ONLINE CONFIGURATION

► Stormceptor® EF and EFO feature an internal bypass and superior scour prevention technology that have been demonstrated in third-party testing according to the scour testing provisions of the Canadian ETV **Procedure for Laboratory Testing of Oil-Grit Separators**, and the exceptional scour test performance has been third-party verified in accordance with the ISO 14034 ETV protocol. As a result, Stormceptor EF and EFO are approved for online installation, eliminating the need for costly additional bypass structures, piping, and installation expense.

DESIGN FLEXIBILITY

► Stormceptor® EF and EFO offers design flexibility in one simplified platform, accepting stormwater flow from a single inlet pipe or multiple inlet pipes, and/or surface runoff through an inlet grate. The device can also serve as a junction structure, accommodate a 90-degree inlet-to-outlet bend angle, and can be modified to ensure performance in submerged conditions.

OIL CAPTURE AND RETENTION

► While Stormceptor® EF will capture and retain oil from dry weather spills and low intensity runoff, Stormceptor® EFO has demonstrated superior oil capture and greater than 99% oil retention in third-party testing according to the light liquid re-entrainment testing provisions of the Canadian ETV **Procedure for Laboratory Testing of Oil-Grit Separators**. Stormceptor EFO is recommended for sites where oil capture and retention is a requirement.

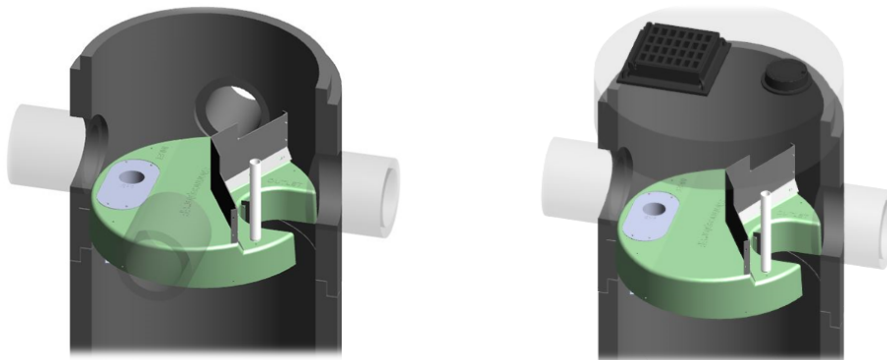

Stormceptor® EF Sizing Report

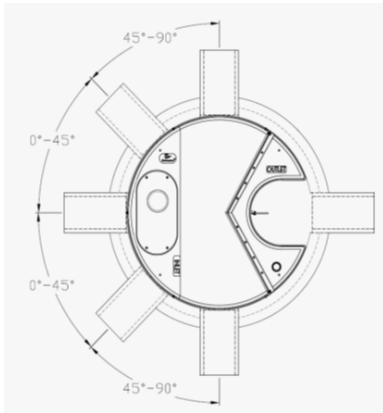

INLET-TO-OUTLET DROP

Elevation differential between inlet and outlet pipe inverts is dictated by the angle at which the inlet pipe(s) enters the unit.

0° - 45° : The inlet pipe is 1-inch (25mm) higher than the outlet pipe.

45° - 90° : The inlet pipe is 2-inches (50mm) higher than the outlet pipe.

HEAD LOSS

The head loss through Stormceptor EF is similar to that of a 60-degree bend structure. The applicable K value for calculating minor losses through the unit is 1.1.

For submerged conditions the applicable K value is 3.0.

Pollutant Capacity

Stormceptor EF / EFO	Model Diameter		Depth (Outlet Pipe Invert to Sump Floor)		Oil Volume		Recommended Sediment Maintenance Depth *		Maximum Sediment Volume *		Maximum Sediment Mass **	
	(m)	(ft)	(m)	(ft)	(L)	(Gal)	(mm)	(in)	(L)	(ft³)	(kg)	(lb)
EF4 / EFO4	1.2	4	1.52	5.0	265	70	203	8	1190	42	1904	5250
EF6 / EFO6	1.8	6	1.93	6.3	610	160	305	12	3470	123	5552	15375
EF8 / EFO8	2.4	8	2.59	8.5	1070	280	610	24	8780	310	14048	38750
EF10 / EFO10	3.0	10	3.25	10.7	1670	440	610	24	17790	628	28464	78500
EF12 / EFO12	3.6	12	3.89	12.8	2475	655	610	24	31220	1103	49952	137875

*Increased sump depth may be added to increase sediment storage capacity

** Average density of wet packed sediment in sump = 1.6 kg/L (100 lb/ft³)

Feature	Benefit	Feature Appeals To
Patent-pending enhanced flow treatment and scour prevention technology	Superior, verified third-party performance	Regulator, Specifying & Design Engineer
Third-party verified light liquid capture and retention for EFO version	Proven performance for fuel/oil hotspot locations	Regulator, Specifying & Design Engineer, Site Owner
Functions as bend, junction or inlet structure	Design flexibility	Specifying & Design Engineer
Minimal drop between inlet and outlet	Site installation ease	Contractor
Large diameter outlet riser for inspection and maintenance	Easy maintenance access from grade	Maintenance Contractor & Site Owner

STANDARD STORMCEPTOR EF/EFO DRAWINGS

For standard details, please visit <http://www.imbriumsystems.com/stormwater-treatment-solutions/stormceptor-ef>

STANDARD STORMCEPTOR EF/EFO SPECIFICATION

For specifications, please visit <http://www.imbriumsystems.com/stormwater-treatment-solutions/stormceptor-ef>

Stormceptor® **EF** Sizing Report

**STANDARD PERFORMANCE SPECIFICATION FOR
“OIL GRIT SEPARATOR” (OGS) STORMWATER QUALITY TREATMENT DEVICE**

PART 1 – GENERAL

1.1 WORK INCLUDED

This section specifies requirements for selecting, sizing, and designing an underground Oil Grit Separator (OGS) device for stormwater quality treatment, with third-party testing results and a Statement of Verification in accordance with ISO 14034 Environmental Management – Environmental Technology Verification (ETV).

1.2 REFERENCE STANDARDS & PROCEDURES

ISO 14034:2016 Environmental management – Environmental technology verification (ETV)

Canadian Environmental Technology Verification (ETV) Program’s **Procedure for Laboratory Testing of Oil-Grit Separators**

1.3 SUBMITTALS

1.3.1 All submittals, including sizing reports & shop drawings, shall be submitted upon request with each order to the contractor then forwarded to the Engineer of Record for review and acceptance. Shop drawings shall detail all OGS components, elevations, and sequence of construction.

1.3.2 Alternative devices shall have features identical to or greater than the specified device, including: treatment chamber diameter, treatment chamber wet volume, sediment storage volume, and oil storage volume.

1.3.3 Unless directed otherwise by the Engineer of Record, OGS stormwater quality treatment product substitutions or alternatives submitted within ten days prior to project bid shall not be accepted. All alternatives or substitutions submitted shall be signed and sealed by a local registered Professional Engineer, based on the exact same criteria detailed in Section 3, in entirety, subject to review and approval by the Engineer of Record.

PART 2 – PRODUCTS

2.1 OGS POLLUTANT STORAGE

The OGS device shall include a sump for sediment storage, and a protected volume for the capture and storage of petroleum hydrocarbons and buoyant gross pollutants. The minimum sediment & petroleum hydrocarbon storage capacity shall be as follows:

2.1.1	4 ft (1219 mm) Diameter OGS Units:	1.19 m ³ sediment / 265 L oil
	6 ft (1829 mm) Diameter OGS Units:	3.48 m ³ sediment / 609 L oil
	8 ft (2438 mm) Diameter OGS Units:	8.78 m ³ sediment / 1,071 L oil
	10 ft (3048 mm) Diameter OGS Units:	17.78 m ³ sediment / 1,673 L oil
	12 ft (3657 mm) Diameter OGS Units:	31.23 m ³ sediment / 2,476 L oil

PART 3 – PERFORMANCE & DESIGN

3.1 GENERAL

The OGS stormwater quality treatment device shall be verified in accordance with ISO 14034:2016 Environmental management – Environmental technology verification (ETV). The OGS stormwater quality treatment device shall



Stormceptor® EF Sizing Report

remove oil, sediment and gross pollutants from stormwater runoff during frequent wet weather events, and retain these pollutants during less frequent high flow wet weather events below the insert within the OGS for later removal during maintenance. The Manufacturer shall have at least ten (10) years of local experience, history and success in engineering design, manufacturing and production and supply of OGS stormwater quality treatment device systems, acceptable to the Engineer of Record.

3.2 SIZING METHODOLOGY

The OGS device shall be engineered, designed and sized to provide stormwater quality treatment based on treating a minimum of 90 percent of the average annual runoff volume and a minimum removal of an annual average 60% of the sediment (TSS) load based on the Particle Size Distribution (PSD) specified in the sizing report for the specified device. Sizing of the OGS shall be determined by use of a minimum ten (10) years of local historical rainfall data provided by Environment Canada. Sizing shall also be determined by use of the sediment removal performance data derived from the ISO 14034 ETV third-party verified laboratory testing data from testing conducted in accordance with the Canadian ETV protocol Procedure for Laboratory Testing of Oil-Grit Separators, as follows:

3.2.1 Sediment removal efficiency for a given surface loading rate and its associated flow rate shall be based on sediment removal efficiency demonstrated at the seven (7) tested surface loading rates specified in the protocol, ranging 40 L/min/m² to 1400 L/min/m², and as stated in the ISO 14034 ETV Verification Statement for the OGS device.

3.2.2 Sediment removal efficiency for surface loading rates between 40 L/min/m² and 1400 L/min/m² shall be based on linear interpolation of data between consecutive tested surface loading rates.

3.2.3 Sediment removal efficiency for surface loading rates less than the lowest tested surface loading rate of 40 L/min/m² shall be assumed to be identical to the sediment removal efficiency at 40 L/min/m². No extrapolation shall be allowed that results in a sediment removal efficiency that is greater than that demonstrated at 40 L/min/m².

3.2.4 Sediment removal efficiency for surface loading rates greater than the highest tested surface loading rate of 1400 L/min/m² shall assume zero sediment removal for the portion of flow that exceeds 1400 L/min/m², and shall be calculated using a simple proportioning formula, with 1400 L/min/m² in the numerator and the higher surface loading rate in the denominator, and multiplying the resulting fraction times the sediment removal efficiency at 1400 L/min/m².

The OGS device shall also have sufficient annual sediment storage capacity as specified and calculated in Section 2.1.

3.3 CANADIAN ETV or ISO 14034 ETV VERIFICATION OF SCOUR TESTING

The OGS device shall have Canadian ETV or ISO 14034 ETV Verification of third-party scour testing conducted in accordance with the Canadian ETV Program's **Procedure for Laboratory Testing of Oil-Grit Separators**.

3.3.1 To be acceptable for on-line installation, the OGS device must demonstrate an average scour test effluent concentration less than 10 mg/L at each surface loading rate tested, up to and including 2600 L/min/m².

3.4 LIGHT LIQUID RE-ENTRAINMENT SIMULATION TESTING

The OGS device shall have Canadian ETV or ISO 14034 ETV Verification of completed third-party Light Liquid Re-entrainment Simulation Testing in accordance with the Canadian ETV **Program's Procedure for Laboratory Testing of Oil-Grit Separators**, with results reported within the Canadian ETV or ISO 14034 ETV verification. This re-entrainment testing is conducted with the device pre-loaded with low density polyethylene (LDPE) plastic beads as a surrogate for light liquids such as oil and fuel. Testing is conducted on the same OGS unit tested for sediment removal to

Stormceptor® EF Sizing Report

assess whether light liquids captured after a spill are effectively retained at high flow rates.

3.4.1 For an OGS device to be an acceptable stormwater treatment device on a site where vehicular traffic occurs and the potential for an oil or fuel spill exists, the OGS device must have reported verified performance results of greater than 99% cumulative retention of LDPE plastic beads for the five specified surface loading rates (ranging 200 L/min/m² to 2600 L/min/m²) in accordance with the Light Liquid Re-entrainment Simulation Testing within the Canadian ETV Program's **Procedure for Laboratory Testing of Oil-Grit Separators**. However, an OGS device shall not be allowed if the Light Liquid Re-entrainment Simulation Testing was performed with screening components within the OGS device that are effective at retaining the LDPE plastic beads, but would not be expected to retain light liquids such as oil and fuel.