

## Engineering

- Land/Site Development
- Municipal Infrastructure
- Environmental/Water Resources
- Traffic/Transportation
- Recreational

## Planning

- Land/Site Development
- Planning Application Management
- Municipal Planning
- Urban Design
- Expert Witness (LPAT)
- Wireless Industry

## Landscape Architecture

- Streetscapes & Public Amenities
- Open Space, Parks & Recreation
- Community & Residential
- Commercial & Institutional
- Environmental Restoration

# 1185 Beaverwood Road Development Servicing Study and Stormwater Management Report



**PROPOSED RESIDENTIAL DEVELOPMENT  
1185 BEAVERWOOD ROAD**

**DEVELOPMENT SERVICING STUDY AND  
STORMWATER MANAGEMENT REPORT**

Prepared by:

**NOVATECH**

Suite 200, 240 Michael Cowpland Drive  
Kanata, Ontario  
K2M 1P6

July 15, 2022

Revised December 22, 2022

**Revised March 16, 2023**

Ref: R-2022-013

Novatech File No. 121184

March 16, 2023

NIVO Developments Inc.  
255 Michael Cowpland Drive  
Ottawa, ON  
K2M 0M5

**Attention: Mr. Anthony Nicolini**

Dear Sir:

**Re: Development Servicing Study and Stormwater Management Report  
Proposed Residential Development  
1185 Beaverwood Road, Ottawa, ON  
Novatech File No.: 121184**

---

Enclosed is a copy of the revised 'Development Servicing Study and Stormwater Management Report' for the proposed residential development located at 1185 Beaverwood Road, in the City of Ottawa. This report addresses the approach to site servicing and stormwater management and is submitted in support of both Zoning By-Law Amendment and Site Plan Control applications.

Please contact the undersigned, should you have any questions or require additional information.

Yours truly,

**NOVATECH**



François Thauvette, P. Eng.  
Senior Project Manager

cc: Christine Reist (City of Ottawa)  
Ryan Koolwine (Project 1 Studio)

## TABLE OF CONTENTS

<b>1.0</b>	<b>INTRODUCTION</b> .....	<b>1</b>
1.1	Site Description and Location .....	1
1.2	Pre-Consultation Information .....	1
1.3	Proposed Development.....	2
1.4	Reference Material.....	2
<b>2.0</b>	<b>SITE SERVICING</b> .....	<b>2</b>
2.1	Sanitary Sewage .....	2
2.2	Water Supply for Domestic Use and Firefighting .....	3
2.2.1	Water Demands and Watermain Analysis .....	3
2.3	Storm Drainage and Stormwater Management.....	6
2.3.1	Stormwater Management Criteria and Objectives .....	6
2.3.2	Pre-Development Conditions and Allowable Release Rate .....	6
2.3.3	Post-Development Conditions .....	7
2.3.3.1	Area OS-1: Uncontrolled Flows from Off-Site Areas .....	7
2.3.3.2	Area OS-2: Uncontrolled Flows from Off-Site Areas .....	7
2.3.3.3	Area A-1: Direct Runoff from Subject Site to Roadside Ditches.....	8
2.3.3.4	Area A-2: Controlled Site Flow Re-Directed to Storm Sewer .....	8
2.3.3.5	Area R-1: Controlled Building Roof Flow Re-Directed to Storm Sewer .....	8
2.3.3.6	Stormwater Flow Summary .....	9
2.3.3.7	Rationale for Connecting into the Existing 250mm dia. Storm Sewer .....	10
2.3.4	Stormwater Quality Control.....	11
<b>3.0</b>	<b>SITE GRADING</b> .....	<b>11</b>
<b>4.0</b>	<b>GEOTECHNICAL INVESTIGATIONS</b> .....	<b>11</b>
<b>5.0</b>	<b>EROSION AND SEDIMENT CONTROL</b> .....	<b>11</b>
<b>6.0</b>	<b>CONCLUSION</b> .....	<b>13</b>

## **LIST OF FIGURES**

Figure 1 Aerial Plan

## **LIST OF APPENDICES**

Appendix A: Project Correspondence

Appendix B: Development Servicing Study Checklist

Appendix C: Sanitary Sewage Calculations

Appendix D: Water Demands, OBC Fire Flow Calculations, City of Ottawa Boundary Conditions and Hydrant Location Sketch

Appendix E: IDF Curves and SWM Calculations, By-Pass Swale Flow Capacities and Excerpts from The Village Walk Subdivision – Stormwater Management Report

Appendix F: Inlet Control Device (ICD) Information

Appendix G: Control Flow Roof Drain Information

## **LIST OF PLANS**

General Plan of Services (121184-GP)

Grading and Erosion & Sediment Control Plan (121184-GR)

Pre-Development Stormwater Management Plan (121184-SWM1)

Post-Development Stormwater Management Plan (121184-SWM2)

## 1.0 INTRODUCTION

NIVO Developments Inc. is proposing to develop a new residential building and has retained Novatech to complete the site servicing, grading, and stormwater management design for this project. This report is being submitted in support of both Zoning By-Law Amendment and Site Plan Control applications.

### 1.1 Site Description and Location

The subject site is located on the northwest corner of Beaverwood Road and Scharfield Road in the Village of Manotick. The property covers an area of approximately 0.236 hectares. The legal description of the subject site as indicated on the Topographical Plan of Survey prepared by Annis, O’Sullivan, Vollbekk Ltd. is designated as Part of Block C, Registered Plan 771, City of Ottawa.

**Figure 1: Aerial View of the Subject Site**



### 1.2 Pre-Consultation Information

A pre-consultation meeting was held with the City of Ottawa on December 13, 2021, at which time the client was advised of the general submission requirements. The Rideau Valley Conservation Authority (RVCA) was also consulted regarding the proposed development. Based on a review of **O. Reg. 525/98: Approval Exemptions**, a Ministry of the Environment, Conservation and Parks (MECP) Environmental Compliance Approval (ECA) will not be required for the proposed development. Refer to **Appendix A** for a summary of the correspondence related to the proposed development.

### 1.3 Proposed Development

The proposed development will include a 3-storey, 27-unit residential building, outdoor (landscaped) amenity space, an underground parking garage along with five (5) surface parking spots for visitors. The site entrance and access to the underground parking garage will be off Scharfield Road. The proposed building will be serviced by extending new laterals to the municipal sanitary sewer, storm sewer and watermain in Beaverwood Road. Stormwater from the adjacent properties will flow along the north and west property lines and will continue to be directed to the existing roadside ditches along Beaverwood Road and Scharfield Road.

### 1.4 Reference Material

The following reports and studies were prepared and/or reviewed as part of the design process:

- <sup>1</sup> The Village Walk Subdivision – Stormwater Management Report (Ref. R-2002-158), prepared by Novatech Engineering Consultants Ltd. on October 22, 2002, which references the following:
  - 1.1 Conceptual Stormwater Drainage Plan – Crossings in Manotick – Doctor Leach Drive and John Street Former Township of Rideau (Ref. R-2001-201), prepared by Novatech Engineering Consultants Ltd. in December 2001.
  - 1.2 The Stormwater Management Report, Village Court Development Stormwater Management Report (September 1997), prepared by Connelly McManus.
  - 1.3 The Manotick Master Drainage Plan Phase II, dated February 1996, prepared by Robinson Consultants Inc. for the City of Ottawa (formerly Township of Rideau).
- <sup>2</sup> The Geotechnical Investigation Report (Ref. No. PG6160-1, rev. 3), prepared by Paterson Group Inc. on March 21, 2023.

## 2.0 SITE SERVICING

The objective of the site servicing design is to provide proper sewage outlets, a suitable domestic water supply and to ensure that appropriate fire protection is provided for the proposed development. The servicing criteria, the expected sewage flows and the water demands are to conform to the requirements of the City of Ottawa municipal design guidelines for sewer and water distribution systems. The City of Ottawa Servicing Study Guidelines for Development Applications requires that a Development Servicing Study Checklist be included to confirm that each applicable item is deemed complete and ready for review by City of Ottawa Infrastructure Approvals. A completed checklist is enclosed in **Appendix B** of the report.

### 2.1 Sanitary Sewage

The existing residential dwelling is currently being serviced by the existing 200mm dia. sanitary sewer in Beaverwood Road. Under post-development conditions, the proposed development will continue to be serviced by the municipal sanitary sewer in Beaverwood Road. The sanitary service lateral will enter the mechanical room near the southwest building corner and will be equipped with a backflow preventer.

The City of Ottawa design criteria were used to calculate the theoretical sanitary flows for the proposed development. The following design criteria were taken from Section 4 – ‘Sanitary Sewer Systems’ of the City of Ottawa Sewer Design Guidelines:

## Residential Use

- Residential Units (1-Bedroom or Studio): 1.4 people per unit
- Residential Units (2-Bedroom): 2.1 people per unit
- Average Daily Residential Sewage Flow: 280 L/person/day (ISTB-2018-01)
- Residential Peaking Factor = 3.78 (Harmon Equation)
- Infiltration Allowance: 0.33 L/s/ha x 0.236 ha site = 0.08 L/s

Given the size of the proposed development, contributing floor drain flow generated by rain or snow melting off cars parked in the UG parking garage are deemed negligible and were therefore not included in the calculations. **Table 1** identifies the theoretical sanitary flows for the proposed development based on the above design criteria and information provided by the architect.

**Table 1: Theoretical Post-Development Sanitary Flows**

Residential Use	Unit Count	Design Population	Average Flow (L/s)	Peaking Factor	Peak Flow (L/s)	Total Flow (L/s)
1-Bedroom / Studio	10	14	0.05	3.78	0.17	0.17
2-Bedroom	17	36	0.12		0.44	0.44
Infiltration Allowance	-	-	-	-	-	0.08
<b>Total for Site</b>	<b>27</b>	<b>50</b>	0.17	3.78	0.61	<b>0.69</b>

A 200mm dia. sanitary service at a minimum slope of 1.0% has a full flow conveyance capacity of 34.2 L/s and should have enough capacity to convey the theoretical sanitary flows from the proposed development. Refer to **Appendix C** for detailed sanitary sewage calculations.

## **2.2 Water Supply for Domestic Use and Firefighting**

The subject site is located within the City of Ottawa 3SW watermain pressure zone. The existing residential dwelling is currently being serviced by the existing 300mm dia. watermain in Beaverwood Road. Under post-development conditions, the proposed development will continue to be serviced by the municipal watermain network in Beaverwood Road. The building will be non-sprinklered and the water meter will be located within the water entry room, with a remote meter on the exterior face of the building.

### **2.2.1 Water Demands and Watermain Analysis**

The theoretical water demand and fire flow calculations are based on criteria in the City of Ottawa Design Guidelines. The fire flow requirements were calculated per the Ontario Building Code (OBC), based on information provided by the architect. The following design criteria were taken from Section 4 – ‘Water Distribution Systems’ of the Ottawa Design Guidelines – Water Distribution:



- Residential Units (1-Bedroom or Studio): 1.4 people per unit
- Residential Units (2-Bedroom): 2.1 people per unit
- Average Daily Residential Water Demand: 280 L/person/day (ISTB-2021-03)
- Maximum Day Demand Peaking Factor = 2.5 x Avg. Day Demand (City Water Table 4.2)
- Peak Hour Demand Peaking Factor = 2.2 x Max. Day Demand (City Water Table 4.2)

**Table 2** identifies the theoretical domestic water demands and fire flow requirements for the development based on the above design criteria. Refer to **Appendix D** for detailed calculations.

**Table 2: Theoretical Water Demand for Proposed Development**

Residential Use	Unit Count / Floor Area	Design Population	Avg. Day Demand (L/s)	Max. Day Demand (L/s)	Peak Hour Demand (L/s)	Fire Flow (L/s)
1-Bdrm/Studio	10	14	0.05	0.11	0.25	90
2-Bdrm	17	36	0.12	0.29	0.64	
<b>Total for Site</b>	<b>27</b>	<b>50</b>	<b>0.17*</b>	<b>0.40*</b>	<b>0.89*</b>	<b>90</b>

\*Represents rounded values

The following design criteria were taken from Section 4.2.2 – ‘Watermain Pressure and Demand Objectives’ of the City of Ottawa Design Guidelines for Water Distribution:

- Normal operating pressures are to range between 345 kPa (50 psi) and 483 kPa (70 psi) under Max Day demands.
- Minimum system pressures are to be 276 kPa (40 psi) under Peak Hour demands.
- Minimum system pressures are to be 140 kPa (20 psi) under Max Day + Fire Flow demands.

Preliminary domestic water demands, and fire flow requirements were provided to the City of Ottawa to generate the municipal watermain network boundary conditions. **Table 2.1** and **Table 2.2** summarize the City’s municipal watermain boundary conditions and the preliminary hydraulic analysis results based on the following scenarios: Existing Conditions and SUC Zone Reconfiguration.

**Table 2.1: Hydraulic Boundary Conditions Provided by the City (Existing Conditions)**

Municipal Watermain Boundary Condition	Boundary Condition	Normal Operating Pressure Range (psi)	Anticipated WM Pressure (psi)*
<b>Water Service Connection off Municipal Watermain in Beaverwood Road</b>			
Minimum HGL (Peak Hour Demand)	140.2 m	40 psi (min.)	~ 68 psi
Maximum HGL (Max Day Demand)	156.9 m	50 - 70 psi	~ 92 psi
HGL (Max Day + Fire Flow)	139.2 m	20 psi (min.)	~ 67 psi

\*Based on an approximate roadway elevation of 92.3m at the service connections.

\*\*Based on an approximate roadway elevation of 92.3m in Beaverwood Road at the service connection.  
Design pressure = (HGL – watermain elevation) x 1.42197 PSI/m.

**Table 2.2: Hydraulic Boundary Conditions Provided by City (SUC Zone Reconfiguration)**

Municipal Watermain Boundary Condition	Boundary Condition	Normal Operating Pressure Range (psi)	Anticipated WM Pressure (psi)*
<b>Water Service Connection off Municipal Watermain in Beaverwood Road</b>			
Minimum HGL (Peak Hour Demand)	142.5 m	40 psi (min.)	~ 71 psi
Maximum HGL (Max Day Demand)	148.2 m	50 - 70 psi	~ 80 psi
HGL (Max Day + Fire Flow)	133.7 m	20 psi (min.)	~ 59 psi

\*Based on an approximate roadway elevation of 92.3m at the service connections.

\*\*Based on an approximate roadway elevation of 92.3m in Beaverwood Road at the service connection.  
Design pressure = (HGL – watermain elevation) x 1.42197 PSI/m.

There are currently four (4) Class AA (blue bonnet) hydrants within 150m of the proposed site. Based on the City of Ottawa Technical Bulletin ISTB-2018-02, Class AA (blue bonnet) hydrants within 75m have a maximum capacity of 95 L/s while hydrants between 75m and 150m have a maximum capacity of 63 L/s (at a pressure of 20 PSI). **Table 2.3** compares the theoretical fire flow available from the nearby municipal fire hydrants to the fire flow demands based on the OBC calculations.

**Table 2.3: Theoretical Fire Protection Summary Table**

Building	(OBC) Fire Flow Demand (L/s)	Fire Hydrant(s) within 75m (~ 95 L/s each)	Fire Hydrant(s) within 150m (~ 63 L/s each)	Available Fire Flow (L/s)
Residential Building	90	3	1	>90

\*Theoretical values exceed the (OBC) Fire Flow requirements and were therefore not confirmed by hydraulic analysis.

The flow available from the nearby municipal hydrants will exceed the Max Day + Fire Flow requirement of the proposed development.

Based on the preliminary calculations, adequate water and system pressures will exist throughout the watermain network under the specified 'Max Day + Fire Flow' and 'Peak Hour' conditions. Pressure reducing valves (PRV) may not be required for the proposed building, depending on timing of the SUC re-configuration. However, booster pump(s) may also be required to provide adequate water pressure to the upper floors. Refer to **Appendix D** for detailed calculations, correspondence from the City of Ottawa, a sketch showing the existing fire hydrant locations and the dimensions confirming the appropriate site coverage.

## 2.3 Storm Drainage and Stormwater Management

Under post-development conditions, on-site stormwater management (SWM) will be required to mitigate the impacts of the increased imperviousness of the site. Storm flows will include both uncontrolled direct runoff and controlled site flows. The proposed storm drainage and stormwater management design for the site is discussed in the following sections of the report.

### 2.3.1 Stormwater Management Criteria and Objectives

The stormwater management (SWM) criteria have been provided during a pre-consultation meeting with the City of Ottawa. The SWM (quantity control) criteria and objectives are as follows:

- Provide a dual drainage system (i.e., minor, and major system flows).
- Control post-development storm flows, up to an including the 100-year design event, to the maximum allowable release rate calculated using the Rational Method, with a runoff coefficient equivalent to existing conditions, but in no case greater than  $C=0.5$ , a time of concentration no less than 10 minutes and a 5-year rainfall intensity from City of Ottawa IDF curves.
- Implement Low Impact Development (LID), where applicable.
- Provide guidelines to ensure that site preparation and construction is in accordance with the current Best Management Practices for Erosion and Sediment Control.

The subject site is located within the jurisdiction of the Rideau Valley Conservation Authority (RVCA). Based on preliminary feedback from the RVCA, on-site stormwater quality control measures will not be required. Refer to **Appendix A** for the correspondence.

### 2.3.2 Pre-Development Conditions and Allowable Release Rate

Under pre-development conditions, stormwater runoff from the subject site and from the abutting properties to the north and west currently sheet drains uncontrolled through the subject site towards the roadside ditches along Beaverwood and Scharfield Roads. Off-site flows from the neighbouring properties (identified as areas OS-1 and OS-2) will need to be maintained. In other words, these flows cannot be impeded by the proposed development. Stormwater within the existing roadside ditches flows east along Beaverwood Road and drains into the existing 900mm dia. trunk sewer, located east of Village Walk subdivision (located south of the subject site). Refer to Village Walk subdivision plan 101159-STM in **Appendix E**. The uncontrolled pre-development runoff from the subject site, excluding off-site flows, was calculated using the Rational Method to be 20.4 L/s during the 5-year design event and 42.7 L/s during the 100-year design event. Refer to the Pre-Development Stormwater Management Plan (121184-SWM 1) and to **Appendix E** for detailed calculations.

As specified by the City of Ottawa, the maximum allowable release rate from the subject site is to be calculated using the Rational Method, with a runoff coefficient equivalent to existing conditions, but in no case greater than  $C=0.5$ , a time of concentration of 10 minutes and a 5-year rainfall intensity from City of Ottawa IDF curves. The maximum allowable release rate was calculated as follows:

$$\begin{aligned}
 T_c &= 10 \text{ min} & C &= 0.30 \\
 I_{5\text{yr}} &= 104.2 \text{ mm/hr} & A &= 0.236 \text{ ha} \\
 Q_{\text{allow}} &= 2.78 \text{ CIA} \\
 &= 2.78 (0.30) (104.2) (0.236) \\
 &= 20.4 \text{ L/s}
 \end{aligned}$$

### 2.3.3 Post-Development Conditions

Post-development conditions will include both uncontrolled direct runoff and controlled site flows. Due to the proposed grading design, the landscaped (grassed) area around the perimeter of the building will sheet drain uncontrolled towards the existing roadside ditches, as there is no practical way to capture this drainage. Uncontrolled runoff from the abutting properties to the north and west, will continue to sheet drain towards the roadside ditches along Scharfield Road and Beaverwood Road, via the by-pass swales along the north and west property lines, thus maintaining existing drainage patterns. The by-pass drainage swales will be sized to adequately convey tributary flows in excess of the 100-year design event. Since it is not feasible to direct (pipelined) flows to the shallow ditches, controlled flows from the remainder of the site (i.e., including the building roof, rear yard outdoor amenity space, paved entrance, and visitor parking area) will be directed into the municipal storm sewer on the south side of Beaverwood Road. On-site stormwater management (SWM) will be required to mitigate the impacts of the increased imperviousness of the site.

As discussed with City staff, Low Impact Development (LID) measures are limited on this site due to the existing topography, existing soils, and the size of the building itself. However, depressions have been provided within the flatter swale sections along the north and west property lines as a Low Impact Development (LID) measure to promote infiltration.

#### 2.3.3.1 Area OS-1: Uncontrolled Flows from Off-Site Areas

The uncontrolled post-development flows from sub-catchment area **OS-1** were calculated using the Rational Method to be approximately 10.6 L/s during the 5-year design event and 21.8 L/s during the 100-year design event. The proposed swale along the north property line has a conveyance capacity exceeding the anticipated 100-year + 20% design event. Refer to the Post-Development Stormwater Management Plan (121184-SWM 2) and to **Appendix E** for detailed flow and ditch capacity calculations.

#### 2.3.3.2 Area OS-2: Uncontrolled Flows from Off-Site Areas

The uncontrolled post-development flows from sub-catchment area **OS-2** were calculated using the Rational Method to be approximately 10.3 L/s during the 5-year design event and 21.2 L/s during the 100-year design event. The proposed swale along the west property line has a conveyance capacity exceeding the anticipated 100-year + 20% design event. Refer to the Post-Development Stormwater Management Plan (121184-SWM 2) and to **Appendix E** for detailed flow and ditch capacity calculations.

### 2.3.3.3 Area A-1: Direct Runoff from Subject Site to Roadside Ditches

The uncontrolled post-development flow from this sub-catchment area was calculated using the Rational Method to be approximately 5.9 L/s during the 5-year design event and 12.2 L/s during the 100-year design event. Refer to the Post-Development Stormwater Management Plan (121184-SWM 2) and to **Appendix E** for detailed SWM calculations.

### 2.3.3.4 Area A-2: Controlled Site Flow Re-Directed to Storm Sewer

The post-development flow from this sub-catchment area, including the rear yard amenity space, paved entrance and visitor parking area will be attenuated by an ICD installed in the outlet pipe of STM MH 101. Stormwater runoff from this sub-catchment area will be temporarily stored underground within the storm sewer system prior to being discharged into the downstream municipal storm sewer system.

**Table 3** summarizes the post-development design flow from this sub-catchment area as well as the ICD specifications, the anticipated ponding elevations, storage volumes required and storage volume provided for the 2-year, 5-year and the 100-year design events.

**Table 3: Stormwater Flows, ICD Information & Storage Requirements**

Design Event	Controlled Site Flows from Area A-2					
	ICD Type	Peak Flow	Water Elevation	50% of Qpeak	Storage Vol. Required*	Max Storage Provided
2-Year	IPEX Tempest Vortex LMF Model 75	1.2 L/s	89.50 m	0.6 L/s	14.4 m <sup>3</sup>	38.7 m <sup>3</sup>
5-Year		1.4 L/s	89.68 m	0.7 L/s	20.0 m <sup>3</sup>	
100-Year		2.5 L/s	90.89 m	1.3 L/s	38.6 m <sup>3</sup>	
100-Year (+20%)		2.5 L/s	90.89 m	1.3 L/s	48.5 m <sup>3</sup>	

\*Storage Volume requirements are based on Average Flow (50% Peak Flow)

As indicated in the table above, this sub-catchment area will provide sufficient storage for the 2-year, 5-year and 100-year design events. The site has been designed to ensure that no stormwater will pond on the paved entrance during the 2-year storm event. Furthermore, the site grading design will ensure that surface ponding depths will not touch the building envelope or lowest building openings (91.30m) during the 100-year+20% stress test, as flows will overflow towards the roadside ditch via the grate of CBMH 101 (T/G=90.90m), which has been set 0.4m below the lowest building floor elevation. Refer to the Post-Development Stormwater Management Plan (121184-SWM2) and to **Appendix E** for detailed SWM calculations and to **Appendix F** for ICD information.

### 2.3.3.5 Area R-1: Controlled Building Roof Flow Re-Directed to Storm Sewer

The post-development flow from this sub-catchment area will be attenuated using Watts adjustable 'Accutrol' control flow roof drains (model number RD-100-A-ADJ: one set to have fully exposed weirs and four set to a closed weir setting). Even with a closed weir setting, the control flow roof drain allows a constant flow rate of 0.32 L/s. Refer to **Appendix G** for varying flow rates based on the different weir settings.

**Table 3.1** summarizes the post-development design flows from this sub-catchment area as well as the type of roof drains, the maximum anticipated ponding depths, storage volumes required and storage volumes provided for both the 5-year and the 100-year design events.

**Table 3.1: Controlled Flow Building Roof Drains**

Roof Drain ID & Drainage Area (ha)	Number of Roof Drains	Watts Roof Drain Model ID (Weir Opening)	Controlled Flow per Drain (L/s)		Approximate Ponding Depth Above Drains (m)		Storage Volume Required (m <sup>3</sup> )		Max. Storage Available (m <sup>3</sup> )
			1:5 Year	1:100 Year	1:5 Year	1:100 Year	1:5 Year	1:100 Year	
RD 1 (0.018 ha)	1	RD-100-A-ADJ (Closed)	0.32	0.32	0.08	0.12	4.2	9.5	14.9
RD 2 (0.018 ha)	1	RD-100-A-ADJ (Closed)	0.32	0.32	0.08	0.12	4.1	9.3	14.6
RD 3 (0.005 ha)	1	RD-100-A-ADJ (Closed)	0.32	0.32	0.07	0.10	0.6	1.7	3.9
RD 4 (0.013 ha)	1	RD-100-A-ADJ (Fully Exposed)	1.26	1.73	0.10	0.14	1.3	3.1	3.3
RD 5 (0.017 ha)	1	RD-100-A-ADJ (Closed)	0.32	0.32	0.08	0.12	3.9	8.9	13.8
<b>Total Roof (0.071 ha)</b>	<b>5</b>	<b>-</b>	<b>2.5</b>	<b>3.0</b>	<b>-</b>	<b>-</b>	<b>14.1</b>	<b>32.5</b>	<b>50.5</b>

\*Table represents rounded values

In addition to the controlled roof drain flow, weeping tile flows will be pumped to the building service. Based on the City of Ottawa Sewer Design Guidelines, a foundation drain allowance of approximately 2.7 L/s (equivalent to 6 houses at 0.45 L/s/house) has been included in the calculations.

Refer to the Post-Development Stormwater Management Plan (121184-SWM 2), to **Appendix E** for detailed SWM calculations and to **Appendix G** for detailed roof drain information. As indicated in the table above, the building roof will provide sufficient storage for both the 5-year and 100-year design events.

### 2.3.3.6 Stormwater Flow Summary

**Table 3.2** provides a summary of the total post-development flows from the site and compares them to the uncontrolled pre-development flows and allowable release rate specified by the City of Ottawa.

**Table 3.2: Stormwater Flows Comparison Table**

Design Event	Pre-Development Conditions		Post-Development Conditions					
	Uncontrolled Flow (L/s)	Allowable Release Rate (L/s)	A-1 Flow (L/s)*	A-2 Flow (L/s)**	R-1 Flow (L/s)**	W.T. Flow (L/s)**	Total Flow (L/s)	Reduction in Flow (L/s or %)**
5-Yr	20.4	20.4	5.9	1.4	2.5	2.7	12.5	7.9 or 39%
100-Yr	42.7		12.2	2.5	3.0	2.7	20.4	22.3 or 52%

\*Represents flows tributary to existing roadside ditches, excluding OS-1 and OS-2.

\*\*Represents flows being re-directed to municipal storm sewer in Beaverwood Road, including controlled roof and weeping tile flows.

\*\*\*Reduced flow compared to uncontrolled pre-development conditions from subject site, excl. off-site flows.

As indicated in the table above, the post-development flows from the subject site have been controlled to meet the SWM (quantity control) design criteria established by the City of Ottawa. It is therefore assumed that the downstream (trunk sewer) has adequate capacity for the proposed flows, whether directed to the municipal storm sewer in Beaverwood Road or flowing uncontrolled into the municipal roadside ditches. Furthermore, this represents significant reductions in total site flow rate when compared to the uncontrolled pre-development conditions.

### **2.3.3.7 Rationale for Connecting into the Existing 250mm dia. Storm Sewer**

As previously discussed with the City of Ottawa, there is very little (if any) stormwater runoff currently entering the existing 250mm dia. storm sewer in Beaverwood Road. This is based on field observations during a recent rainfall event and due to the following factors:

- The STM MH at the upstream end of the system is not located within a sag, thus does not capture surface runoff.
- Due to the longitudinal slope of the roadway (~4.4%) very little runoff is intercepted by the curb inlet catch basin (CICB) near the downstream end of the system, as it is not located within a sag.

Although there doesn't appear to be any surface flows currently being directed to the municipal storm sewer, based on the City of Ottawa Sewer Design Guidelines, a foundation drain allowance of approximately 2.3 L/s (equivalent to 5 houses at 0.45 L/s/house) has been included in the calculations. Based on a review of the Storm Drainage Area Plan (101159-STM) and 5-Year Storm Design Sheet (revised October 16<sup>th</sup>, 2002) included in The Village Walk Subdivision – Stormwater Management Report<sup>1,1</sup>, the 250mm dia. storm sewer in Beaverwood Road, upstream of the 900mm dia. trunk sewer to the east, was originally designed to have a conveyance capacity of approximately 66.2 L/s. Upon review of the as-built plans, the 250mm dia. storm sewer in Beaverwood Road was installed with a much flatter slope (~0.25%), which reduces the full-flow conveyance capacity to approximately 31 L/s. Considering the existing foundation drain allowance of 2.3 L/s, the remaining capacity of the sewer is therefore approximately 28.7 L/s (31.0 L/s - 2.3 L/s). As indicated above, the combined controlled 5-year flow from areas A-2 and R-1 being re-directed to the municipal storm sewer in Beaverwood Road will be approximately 6.6 L/s (1.4 + 2.5 + 2.7), while the combined controlled 100-year flow will be approximately 8.2 L/s (2.5 + 3.0 + 2.7), both well below the remaining capacity of the storm sewer in Beaverwood Road. Consequently, re-directing a portion of the site flows to the existing 250mm dia. storm sewer, rather than directing flow to the roadside ditch, which also drains into the 900mm dia. trunk sewer approximately 93m further east, should not negatively impact the municipal storm sewer system. Refer to **Appendix E** for excerpts from report<sup>1</sup>.

### **2.3.4 Stormwater Quality Control**

As stated above, the subject site is located within the jurisdiction of the Rideau Valley Conservation Authority (RVCA). Based on preliminary feedback from the RVCA, landscaped areas and roof tops are considered clean for the purposes of water quality and aquatic habitat protection. In this case, since most of the parking will be provided underground and surface parking areas will be minimal, on-site stormwater quality control will not be required. Refer to **Appendix A** for correspondence from the RVCA.

## **3.0 SITE GRADING**

The elevation of the subject site varies significantly. The existing site generally slopes in a south-easterly direction from the northwest corner (~95.7m) down to the southeast corner (~90.5m). Due to the existing topography, stormwater runoff from a portion of the adjacent properties to the north and west currently sheet drains onto the subject site and makes its way to the roadside ditches along Beaverwood and Scharfield Roads.

Under post-development conditions, the proposed building footprint and buried underground parking level will occupy most of the site with landscaped areas of varying widths on all sides of the building. The Level 00 (lower) floor elevation has been set at 91.30m to accommodate walkout units, while the Level 01 (main floor) elevation has been set at an elevation of 94.40m. The lowest building openings have been set at 0.4m above the 100-year spill elevation from the lid of CBMH 101. The emergency overland flow route (i.e., back of proposed sidewalk elevation at the intersection of Beaverwood and Scharfield Roads) has also been shown on the plan. The existing grades along the north and west property lines will be maintained to ensure that stormwater runoff from the adjacent properties can by-pass the on-site storm sewer system and landscaped area drains and flow towards the roadside ditches. Depressions have been provided within the flatter swale sections along the north and west property lines as a Low Impact Development (LID) measure to promote infiltration. The major overland flow route is shown on the design drawings. Refer to the enclosed Grading and Erosion & Sediment Control Plans for details.

## **4.0 GEOTECHNICAL INVESTIGATIONS**

A Geotechnical Investigation Report has been prepared by Paterson Group Inc. for the proposed project. Refer to the Geotechnical Report<sup>2</sup> for subsurface conditions, construction recommendations and geotechnical inspection requirements.

## **5.0 EROSION AND SEDIMENT CONTROL**

To mitigate erosion and to prevent sediment from entering the storm drainage system, temporary erosion and sediment control measures will be implemented on-site during construction in accordance with Best Management Practices for Erosion and Sediment Control. Details are provided on the Grading and Erosion and Sediment Control Plan. This includes the following measures:

- Filter bags / catchbasin inserts (sediment sacks) will be placed under the grates of nearby catchbasins and manholes and they will remain in place until vegetation has been established and construction is completed.
- Silt fencing will be placed per OPSS 577 and OPSD 219.110 along the surrounding construction limits.



- Mud mats will be installed at the site entrances.
- Street sweeping and cleaning will be performed, as required, to suppress dust and to provide safe and clean roadways adjacent to the construction site.
- On-site dewatering is to be directed to a sediment trap and/or gravel splash pad and discharged safely to an approved outlet as directed by the engineer.
- Any stockpiled material will be properly managed to prevent those materials from entering the sewer system and/or the downstream ditch or watercourse.

The temporary erosion and sediment control measures will be implemented prior to construction and will remain in place during all phases of construction. Regular inspection and maintenance of the erosion control measures will be undertaken.

## 6.0 CONCLUSION

This report has been prepared in support of both Zoning By-Law Amendment and Site Plan Control applications for the proposed residential development located at 1185 Beaverwood Road. The conclusions are as follows:

- The proposed development will be serviced by the municipal infrastructure in Beaverwood Road.
  - Sanitary flows will continue to be directed to the municipal sanitary sewer in Beaverwood Road.
  - Storm flows (from the subject site) currently draining to the existing roadside ditches along Beaverwood, and Scharfield Roads will be significantly reduced when compared to current conditions. The proposed design also re-directs the controlled stormwater flows to the municipal storm sewer in Beaverwood Road.
  - The proposed development will continue to be serviced by the municipal watermain network. Adequate water and system pressures will exist throughout the watermain network under the specified 'Max Day + Fire Flow' and 'Peak Hour' conditions.
- The proposed building will be non-sprinklered however the nearby municipal fire hydrants will provide the necessary water for fire protection.
- The total post-development flow directed to the downstream storm sewer system will be approximately 12.5 L/s during the 5-year design event and 20.4 L/s during the 100-year event, including both direct runoff from the subject site and the controlled flow being re-directed to the municipal storm sewer in Beaverwood Road. Total site flow rates are being reduced by 7.9 L/s (or 39%) during the 5-year event and by 22.3 L/s (or 52%) during the 100-year design event, when compared to the respective current conditions.
- Regular inspection and maintenance of the building services, roof drains and inlet control device (ICD) is recommended to ensure that the storm drainage system is clean and operational.
- Erosion and sediment controls are to be provided during construction.

It is recommended that the proposed site servicing and stormwater management design be approved for implementation.

### NOVATECH

Revised by:



Chris Visser  
Project Coordinator

Reviewed by:



François Thauvette, P. Eng.  
Senior Project Manager

**APPENDIX A**  
**Project Correspondence**

## **Pre-Application Consultation Meeting Notes**

**Property Address:** 185 Beaverwood Road  
PC2021-0404  
December 13, 2021

### **Attendees:**

**Sarah McCormick**, Planner II, City of Ottawa  
**Damien Whittaker**, Senior Engineer, City of Ottawa  
**Christine Reist**, Project Manager, City of Ottawa  
**Tessa Dilorio**, Risk Official and Hydrogeologist, City of Ottawa  
**Matthew Hayley**, Environmental Planner II, City of Ottawa  
**Andrian van Wyck**, Urban Design Planner, City of Ottawa  
**Samantha Willock**, Planning Student, City of Ottawa

**Murray Chown**, Director – Planning & Development, Novatech  
**Taylor West**, Planner, Novatech  
**Ryan Koolwine**, Architect, Project1 Studio  
**Anthony Nicollini**, Owner, Ark Construction

### **Regrets:**

**Neeti Paudel**, Transportation Engineer, City of Ottawa  
**Kersten Nitsche**, Parks Planner, City of Ottawa  
**Eric Lalande**, Rideau Valley Conservation Authority

**Subject: 1185 Beaverwood Road**

### **Meeting notes:**

#### Development Proposal

- 0.24 hectare corner lot
- Existing single detached dwelling located on site – identified for demolition.
- 3-storey low-rise apartment with 27 units.
- 34 parking spaces are proposed, with 29 below grade, and 5 above grade.
- Zoning required to rezone the property to a V3 zone.
- Specific site exceptions will be required.
- Performance standards are consistent (generally) with the existing zoning
  - Example: 28% lot coverage (meets V3, and just over the existing permitted lot coverage)

#### Architectural overview:

- Mindful of the Manotick context
- Towns across Beaverwood and Commercial across from Scharfield
- Climb in grade as you move west (diagonal climb)
- Wanted to keep some of the existing vegetation
- Draw from historic building materials; stone, red brick (2 main elements played with), as well as wood.
  - Used red brick, with stone masonry.
  - Masonry at base of building.

- Wood siding on upper portions of the building.
- Cuts in finish, to break up the massing of the building.
- Banding breaks down the height of the building.
- 3 storey apartment; underground parking drive aisle is flat and burrowed into the topography. And limited surface parking.
- Heavy landscaping and outdoor amenity area on the north/west side of the site
- Terraces towards both Beaverwood and Scharfield Roads.
- If sidewalks required, looking to connect to those public realm features.
- 5 outdoor parking spaces and 29 below grade spaces; meets minimum requirements
- Indoor bicycle parking.
- 3 lower level units ('at grade'), 8 units per floor for upper 3.
- Therefore along Scharfield Road, 4 storeys and to west, 3 storeys. 92.54 average grade.
- Building further from Beaverwood to ensure maintenance of existing trees.
- Retaining walls along the north property line to manage the grade on site

Preliminary comments and questions from staff and agencies, including follow-up actions:

### Planning

#### *Official Plan (new)*

- Property is located within the Rural Transect on Schedule A of the newly adopted Official Plan
- Property is designated Village on Schedule B9 of the newly adopted Official Plan.
- Beaverwood and Scharfield Roads are identified as local roads on Schedule C10 of the newly adopted Official Plan; the protected right-of-way widths for both roads is 20 metres.

#### *Manotick Secondary Plan (Volume 2B – Rural Secondary Plans)*

- The property is identified as Village Core in Schedule A the Manotick Secondary Plan.
- The property is identified as Gaps in Schedule B the Manotick Secondary Plan.
- Sidewalks are required as per Annex 9 (Village Connectivity) of the Manotick Secondary Plan.
- Village Core Designation
  - Development in the Village Core will contribute to a lively pedestrian-oriented environment.
  - Development should be designed with respect to the Built Form and Landscape/Streetscape Design policies in Section 2.2 of the Manotick Secondary Plan, particularly the following should be addressed:
    - New buildings will be designed to be pedestrian oriented, which includes providing entrances and clear windows that face the street.
    - Rooftop mechanical equipment should be screened from public view, where possible.
    - Longer buildings should have articulated facades that break up the mass of the building.
    - New development will use soft landscaping to screen parking areas and define property limits.
- Gaps
  - The designations contemplates a low-rise apartment for the subject property.

### *Zoning*

- The property is currently zoned (V1P); A low-rise apartment building is not a permitted use within the current zone.

- A Major ZBLA application will be required to add a low-rise apartment as a permitted use.
- The development proposal identifies modifying the zoning of the property to a V3 zone, which includes a low-rise apartment as a permitted use. The proposal also states that *site specific exceptions will be required once the V3 subzone is chosen*. As changes to the performance standards were not included in the pre-consultation application request, staff cannot provide comments in this regard. If the developer would like feedback relating to any proposed modifications to the performance standards, staff are open to reviewing them prior to the filing of the applications, and once a more detailed concept plan has been prepared.

### *Discussion*

- The existing building is located on the heritage register, but is not designated. Additional details are provided below.
- The main entrance should face Scharfield Road with pedestrian connection provided to a new sidewalk.
- One (1) accessible parking space is required for parking lots between 20 and 99 spaces.
- Please note that the visitor parking rate for this site is 0.2 spaces/unit not 0.1spaces per unit over 12 units. Staff note that the required 5 spaces is correctly identified, but the rate is incorrect.
- Staff is not opposed to indoor bicycle parking, however some at-grade, outdoor bicycle parking is encouraged.
- Staff's preliminary calculations identify a minimum required amenity space 192m<sup>2</sup>. Please revisit the calculation and provide the rate and required total in the zoning chart for the site plan submission.
- Access to the amenity space should be identified on the Site Plan; additional landscaping is encouraged within the amenity area.
- The site plan application must demonstrate how the refuse collection will be accessed; will the waste storage bins be winched out?
- While a full height treed streetscape is desired along Beaverwood Road, it is understood that there are overhead hydro lines at this location. The developer is encouraged to provide landscaping of varying height along Beaverwood to provide the impression of a treed frontage.
- Landscaping is encouraged along the frontage of Scharfield Road, and along the perimeter of the property.
- The parking plan shows some reduced width parking spaces:
  - The Site Plan must identify the standard and reduced widths proposed.
  - The zoning chart must demonstrate compliance with the reduced parking space width requirements of Section 106 of the Zoning By-law.
- Aisle width should be calculated from the narrowest portion of the aisle, not from the parking spaces. Staff note that the 6.7m identified on the concept plan relates to the maximum permitted in the Zoning By-law. Please ensure that the site plan demonstrate the minimum aisle width of 6m from the supporting posts in the parking garage.
- The site design must have respect to the policies of Energy and Climate Change – Section 2.2.3 of the Official Plan
  - As per policy 2, sustainable and resilient design measures will be applied as part of site planning and exterior building design.

- As per policy 5, the site design should mitigate the impacts of heat by providing adequate shade in both the public and private realms.
  - Please refer to the [City's High Performance Development Standard](#) for additional information.
- A Major Zoning By-law amendment application will be required to add a low-rise apartment as a permitted use on the property.
  - A Complex Site Plan Control application, subject to public consultation, will be required.
  - The developer is encouraged to reach out to the Councillor, local community association(s) and neighbours regarding the proposed development.
  - Noted retaining walls; any required on Beaverwood Road, or will the building take care of the slope stability.

## Urban Design

### *Design*

- A Design Brief will be required as part of a complete application. Please see the attached Terms of Reference for details.
- Please review the [Urban Design Guidelines for Low-rise Infill Housing](#).
- A front entrance must be provided at grade with access to a public street. The main entrance proposed on the north elevation is appropriate as a secondary entrance but not as a main entrance to the building. You may wish to consider swapping the Entrance Lobby and Unit 3.
- Sidewalks should be provided as part of this development.
- Street trees of appropriate size and species should be provided along Beaverwood and Scharfield Roads.
- Please carefully consider sustainable design features and how these can be integrated into the proposal.
- Please limit hard surfaces to an absolute minimum. Permeable paving may be an appropriate alternative to asphalt.
- Please pay careful attention to the amenity area located in the rear. This area should be functional and have multiple points of access. Consider strategic tree planting, shade structures and other landscape elements to ensure four-season comfort.
- Consider opportunities to leverage the street corner as a design feature.

### *Heritage*

- This property is listed on the City's Heritage Register. If a property owner wishes to demolish a listed building, the City must receive a [Notice of Intention to Demolish](#) in accordance with Section 27 of the *Ontario Heritage Act*. The Notice must include the following:
  - a. [Completed Form for Buildings Listed on the Heritage Register](#)
  - b. Rationale for demolition and supporting studies. A Cultural Heritage Evaluation Report (CHER) will be requested (to be completed by a heritage professional).
  - c. Full colour photographs of each elevation of the building(s) you want to demolish. One set of original colour photographs is required and all photographs shall be labeled with address, orientation and date. All photographs must be high quality (focused, well lit, clear).

The following information may also be required at the request of Heritage Staff:

- Copy of Fire Insurance Plans (if available);
- City Directory information;
- Architect or builder;
- Additional biographical information regarding significant owners; and
- Historic photo or building plans (if available).

If historic information is requested as part of the Notice of Intention to Demolish, property owners are expected to make reasonable efforts to provide this information. Information can be found online, at the City of Ottawa Archives, the Ottawa Public Library (Ottawa Room, Kanata Room etc.) and Library and Archives Canada. If some information is not found, property owners should provide a list of resources that were consulted during their research.

## Engineering

### *Existing Municipal Services:*

- An existing municipal 305 mm dia. watermain exists in both Beaverwood Rd and Scharfield Rd. City records indicate that the site has an existing municipal water service connection from Beaverwood Rd. There is an existing fire hydrant located on the south side of Beaverwood Rd at the intersection of Beaverwood and Scharfield. There is also an existing hydrant located on the east side of Scharfield Rd, north of the property.
- An existing municipal 200 mm dia. Sanitary sewer existing in both Beaverwood Rd and Scharfield Rd.
- There is an existing 250 mm dia storm sewer south of Beaverwood Rd along the eastern portion of the site. However, it appears that the site currently drains to the roadside ditches along Beaverwood Rd and Scharfield Rd.
- There are [Manotick Water Supply and Sanitary Sewer Area-Specific Development Charges](#) that will apply to this site.

### *Site Servicing Design:*

- Watermain boundary conditions will need to be requested by the applicant with a list of the demand values, the fire flow demand calculations, and a plan indicating the approximate location of any proposed water service connection.
- A Water Card will need to be completed for the water meter sizing.
- The Site Servicing Study must include an assessment of adequacy of public services to support the development, including discussion of the servicing capacity of the connecting systems and anticipated performance.
- A culvert will be required under the site entrance.
- Note that as per Ottawa Sewer Design Guidelines (SDG) 6.1.10, drainage for covered parking garages is to be directed to the sanitary sewer.
- Also, note that there needs to be a vertical clearance of at least 0.15m between the storm water spill elevation and the ground elevation at the building envelope. Refer to SDG Technical Bulletin PIEDTB-2016-01, section 8.3.9.9. This requirement is applicable to the entrance of the proposed underground parking garage.



#### *Stormwater Management:*

- It will need to be demonstrated that there is legal and sufficient stormwater outlet from the site. If it is proposed to discharge storm water to the existing ditches in the ROW, the ditches will need to be shown to provide continuous flow to an outlet.
- Stormwater management quality criteria shall be set by Rideau Valley Conservation Authority (RVCA).
- The stormwater management quantity criteria for the development is that the 100-year post-development stormwater runoff must be controlled to the 5-year pre-development runoff as per section 8.3.7.3 of the Ottawa Sewer Design Guidelines (SDG). As per SDG 8.3.7.3, the pre-development condition is to be determined using the smaller of a runoff coefficient of 0.5 (0.4 in combined areas) or the actual existing site runoff coefficient.
- SWM calculations using the modified rational method is acceptable, however, if underground storage is used, the consultant is reminded to either: use a dynamic computer model or use the modified rational method assuming an average release rate of 50% of the area-specific peak flow rate where below ground storage is provided.
- The preliminary plans included with the pre-consultation application don't indicate areas for stormwater management. Note that space is going to be required on the property for the stormwater management systems.
- Any existing stormwater runoff from adjacent site(s) that crosses the property must be accommodated by the proposed stormwater management design.
- If an oil/grit separator is proposed, a direct submission Environmental Compliance Approval (ECA) application to the Ministry of the Environment Conservation and Parks (MECP) will be required. Oil/grit separators require Environmental Technology Verification (ETV) protocol for ECA approval. The turnaround time for an ECA from the MECP can be up to one year.

#### *Geotechnical:*

- Please note that there is potential for sensitive marine clays in the area of the proposal and, if so, enhanced geotechnical investigation and analysis will be necessary. Investigation of clays should be undertaken with vane shear, Atterberg limits, shrinkage, grain size, grade raise restriction, consolidation, sensitivity, and liquefaction analysis- amongst others.
- In sensitive marine clays, trees in proximity to foundations can cause foundation damage. Refer to the [City's Tree Planting in Sensitive Marine Clay Soils – 2017 Guidelines](#) for additional information.

#### *Slope Stability:*

- Based on the preliminary plans provided, it appears that a Slope Stability Assessment Report will be required. A Slope Stability Assessment Report is required for:
  - Retaining walls over 1m in height; and,
  - Slopes steeper than 5 horizontal to 1 vertical with a grade difference of more than 2 m across.
- Refer to the City document, "Slope Stability Guidelines for Development Applications in the City of Ottawa" and its Appendix A, "Minimum Requirements for Slope Stability Assessment Reports".

#### *Environmental Site Assessment:*

- A Phase 1 Environmental Site Assessment (ESA) completed in accordance with Ontario Regulation (O.Reg.) 153/04 is required.
- A Phase 2 ESA may be required, depending on the outcome of the Phase 1 ESA.

*Grading:*

- The ramp into the underground parking needs to be heated if the slope is greater than 6%. The maximum slope is 12%.
- In grassed areas, grades steeper than 7% require terracing at a max of 3:1. Terracing isn't permitted in access easements.

*Parking / Access / Fire Route:*

- A Traffic Movement Plan is required for the above-ground and below-ground parking areas.
- It will need to be demonstrated that the access to the Waste Storage area provides adequate space for waste collection.
- Fire routes are to be designated by By-law for Fire Services to establish them as a legal fire route. If applicable, an 'Application for a Fire Route Designation' form will need to be completed and submitted to the City to add the fire route to the By-law. The form must be filled out by the applicant/agent of the property as well as the property owner. This form will be provided after the application is received or can be provided in advance upon request.

*Exterior Site Lighting:*

- Any exterior lighting proposed for the site requires certification by a qualified Professional Engineer confirming the design complies with the following criteria:
  - Lighting must be designed using only fixtures that meet the criteria for Full-Cut-Off (Sharp cut-off) Classification, as recognized by the Illuminating Engineering Society of North America (IESNA or IES).
  - It must result in minimal light spillage onto adjacent properties. As a guide, 0.5 foot-candle is normally the maximum allowable spillage.
  - The location of the fixtures, fixture types (make, model, and part number), and the mounting heights must be shown on one of the approved plans.

*Snow Storage:*

- Any portion of the subject property which is intended to be used for permanent or temporary snow storage shall be as shown on the approved Site Plan and Grade Control and Drainage Plan. Snow storage shall not interfere with approved grading and drainage patterns. Snow storage areas shall be setback from the property lines, foundations, fencing or landscaping a minimum of 1.5m. Snow storage areas shall not occupy driveways, aisles, required parking spaces, or any portion of a road allowance.

*Private Utilities:*

- The applicant must determine the locations of any existing or proposed private utilities and confirm they don't conflict with the proposed development. A Composite Utility Plan is required.

*City's Planned Construction:*

- Please note that the following City construction projects are planned within the vicinity of the subject site:

- Renewal of the culvert under Scharfield Rd, north of the intersection with Beaverwood Rd is targeted within the next 1 to 2 years.

*Permits and Approvals:*

- Please contact RVCA, amongst other federal and provincial departments/agencies, to identify all the necessary permits and approvals required to facilitate the development. Responsibility rests with the developer and their consultant for obtaining all external agency approvals. The address shall be in good standing with all approval agencies. Copies of confirmation of correspondence will be required by the City of Ottawa from all approval agencies that a form of assent is given.
- If an MECP ECA is required, the ECA application is not submitted until after City of Ottawa Engineering is satisfied that components directly or indirectly aligned with the ECA process concur with standards, directives, and guidelines of the MECP. No construction shall commence until after a commence work notification is given by Development Review Engineering staff.

*Plan Submission Requirements for Engineering:*

- Site Servicing Plan
- Grade Control and Drainage Plan
- Erosion and Sediment Control Plan
- Composite Utility Plan
- Traffic Movement Plan

All identified required plans are to be submitted on standard A1 size sheets and use an appropriate metric scale as per [City of Ottawa Servicing and Grading Plan Requirements](#).

*Report Submission Requirements for Engineering*

- Site Servicing Study
- Geotechnical Investigation Report
- Slope Stability Assessment Report, if required based on proposed grades or retaining walls (refer to Slope Stability comment above)
- Stormwater Management Report
- Phase 1 Environmental Site Assessment (ESA)
- Phase 2 Environmental Site Assessment (ESA), if required based on outcome of Phase 1 (refer to Environmental Site Assessment comment above)

Guide to preparing City of Ottawa Studies and Plans: <http://ottawa.ca/en/development-application-review-process-0/guide-preparing-studies-and-plans>

To request City of Ottawa plan(s) or report information please contact the [JSD Information Centre](#): (613) 580-2424 ext. 44455

Please contact Christine Reist at [Christine.Reist@ottawa.ca](mailto:Christine.Reist@ottawa.ca), for follow-up questions.

*Hydrogeology:*

- it is understood that the proposed development is a low-rise apartment complex with underground parking. The development will be serviced with municipal water and sewer.
- A Groundwater Impact Assessment Report is required (to be completed prior to zoning) to identify the potential impact of the development on adjacent groundwater users (i.e. well

users); both water quantity and quality impact should be assessed for conditions during and after construction/

- All private well users within 500m of the site should be considered in the groundwater impact assessment; the assessment should take into account the groundwater flow direction, depth and type of overburden material, depth of excavation, and method of excavation.
- It is noted that there are over 100 properties that rely on private wells within 500m of the site; including those directly adjacent to the site on Beaverwood Road (west of the site) and Maple Avenue. A map can be provided to identify the locations of privately serviced lots within 500m.
- The overburden geology and depth to bedrock must be discussed in term of the potential impact on adjacent well users; local well records indicate “hardpan” as shallow as 10ft below ground surface and bedrock potentially as shallow as 13ft. If blasting will be needed for excavation, then vibrations may cause water quality issues in local wells – this information should be considered in terms of distance to include properties in a baseline water quality sampling program.
- The Groundwater Impact Assessment Report should identify all lots that will be included in the baseline water quality sampling program as well as outline the program methodology; i.e. how will homeowners be invited to participate, how will the sampling be conducted, what parameters will be sampled, etc. The City recommends the sampling program to include the “subdivision suite” parameter as well as VOC to account for potential local contamination, at a minimum.
- The Baseline Water Quality Sampling Program is required (to be completed prior to the commence work order) for private wells that may be impacted, or for private wells in close proximity that may perceive impact by the adjacent construction. The purpose of the program is to obtain baseline water quality information that can be referenced in case of a complaint. The lots to be included in the baseline water quality sampling program must be mutually agreed with City staff before commencing the sampling program.
- Requirements for the Groundwater Impact Assessment Report and the Baseline Water Quality Sampling Program can be discussed through technical consultation with the hydrogeological report reviewer: Tessa Di Iorio ([Tessa.diiorio@ottawa.ca](mailto:Tessa.diiorio@ottawa.ca)).

### Transportation

- a TIA will not be required.
- Site triangles at the following locations on the final plan will be required:
  - Local to local road: 5 metre x 5 metre
- Stationary Noise Impact Study required **if** there will be any exposed mechanical equipment due to the proximity to neighbouring noise sensitive land uses.
- An upgrade to the existing bus stop on Scharfield may be required (OC Transpo to confirm).
- Consider adding a sidewalk along Scharfield Road to connect to the bus stop.
- As the site proposed is residential, AODA legislation applies for all areas accessible to the public (i.e outdoor pathways, parking, etc.). Please refer to the City’s Accessibility Design Standards.

### Environmental

- Bird Safe Design Guidelines is not required, but should be considered.
  - Bird safe glass could be used
- Tree preservation
  - Look into the CRZ of the existing trees to ensure they . Root pruning ahead of construction would be beneficial, as well as root fertilization.

- Boundary trees must be identified and any with CRZ into development zone are identified and protected.

### Parks

- Pursuant to section 3 and Section 10(1) Parkland Dedication By-law 2009-05, as amended, cash-in-lieu of parkland shall be paid by the Owner as follows:
  - Uplift of units on the site, not to exceed 10% of the land area of the site being developed.
  - As calculated by PFP, the amount required based on the uplift is as follows:  
[(27-1) x 10,000] / 500 = 520 sq. m.
  - As the site is 2,353m<sup>2</sup>, the required CIL shall be 235.3 sq. m.
- The value of the land will be determined as of the day before Site Plan approval.

### Rideau Valley Conservation Authority

- the area of the surface parking lot and drive aisle for subgrade parking is on the threshold for triggering water quality control requirements.
- The RVCA recommends to minimize the surface parking area to avoid needing on-site water quality control requirements.
- Any changes in the design should be sent to the RVCA for review to determine whether on-site control will be required.

### **Submission requirements and fees**

- The development proposal triggers the requirement of a Complex (manager approval, public consultation) Site Plan Control application.
- The submission requirements for this application can be found on the accompanying required Plans and Studies list. Please note that these requirements apply to the Site Plan Control application, additional studies and/or plans may be requested if it is determined that a Zoning By-law Amendment is necessary.

### **Next steps**

- It is encourage that you discuss the proposal with the Ward Councillor, local community groups and neighbours

**– SITE PLAN APPLICATION – Municipal servicing**

Legend:

The letter **S** indicates that the study or plan is required with application submission.  
The letter **M** indicates that the study or plan may be required with application submission.

For information on preparing required studies and plans refer to:

<http://ottawa.ca/en/development-application-review-process-0/guide-preparing-studies-and-plans>

S/M	Number of copies	ENGINEERING		S/M	Number of copies
S		1. Site Servicing Plan	2. Site Servicing Study	S	
S		3. Grade Control and Drainage Plan	4. Geotechnical Investigation Report / Slope Stability Assessment Report	S / S	
S		5. Composite Utility Plan	6. Groundwater Impact Assessment Report	S	
		7. Servicing Options Report	8. Wellhead Protection Study		
		9. Community Transportation Study and/or Transportation Impact Study / Brief	10. Erosion and Sediment Control Plan	S	
S		11. Stormwater Management Report	12. Hydro-geological and Terrain Analysis		
		13. Water main Analysis	14. Stationary Noise Impact Study (required if there are exposed mechanical equipment)	M	
		15. Roadway Modification Design Plan	16. Confederation Line Proximity Study		

S/M	Number of copies	PLANNING / DESIGN / SURVEY		S/M	Number of copies
		17. Draft Plan of Subdivision	18. Plan Showing Layout of Parking Garage	S	
		19. Draft Plan of Condominium	20. Planning Rationale	S	
S		21. Site Plan	22. Minimum Distance Separation (MDS)		
		23. Concept Plan Showing Proposed Land Uses and Landscaping	24. Agrology and Soil Capability Study		
		25. Concept Plan Showing Ultimate Use of Land	26. Cultural Heritage Impact Statement		
S		27. Landscape Plan incl. Tree Conservation Report	28. Archaeological Resource Assessment Requirements: S (site plan) A (subdivision, condo)		
S		29. Survey Plan	30. Shadow Analysis		
S		31. Architectural Building Elevation Drawings (dimensioned)	32. Design Brief (can be included in planning rationale)	S	
		33. Wind Analysis			

S/M	Number of copies	ENVIRONMENTAL		S/M	Number of copies
S		34. Phase 1 Environmental Site Assessment	35. Impact Assessment of adjacent Waste Disposal/Former Landfill Site		
M		36. Phase 2 Environmental Site Assessment (depends on the outcome of Phase 1)	37. Assessment of Landform Features		
		38. Record of Site Condition	39. Mineral Resource Impact Assessment		
M		40. Tree Conservation Report (can be provided on Landscape Plan)	41. Environmental Impact Statement / Impact Assessment of Endangered Species		
		42. Mine Hazard Study / Abandoned Pit or Quarry Study			

S/M	Number of copies	ADDITIONAL REQUIREMENTS		S/M	Number of copies
S		43. Traffic Movement Plan	44. Public Consultation Details	S	
M		45. Notice of Intention to Demolish (will be required prior to or as a condition of Site Plan approval)	46. Baseline Water Quality Sampling Program (required prior to commence work order)	M	

Meeting Date: **December 13, 2021**

Application Type: **Site Plan Control**

File Lead: Sarah McCormick

Engineer/Project Manager: Chris Reist

Site Address: 1185 Beaverwood Road

\*Preliminary Assessment: 1  2  3  4  5

\*One (1) indicates that considerable revisions are required before a planning application is submitted, while five (5) suggest that proposal appears to meet the City's key land use policies and guidelines. This assessment is purely advisory and does not consider technical aspects of the proposal, or in any way guarantee application approval.

*It is important to note that the need for additional studies and plans may result during application review. If following the submission of your application, it is determined that material that is not identified in this checklist is required to achieve complete application status, in accordance with the Planning Act and Official Plan requirements, City Planning will notify you of outstanding material required within the required 30-day period. Mandatory pre-application consultation will not shorten the City's standard processing timelines or guarantee that an application will be approved. It is intended to help educate and inform the applicant about submission requirements as well as municipal processes, policies, and key issues in advance of submitting a formal development application. This list is valid for one year following the meeting date. If the application is not submitted within this timeframe the applicant must again pre-consult with the City.*

## Steve Matthews

---

**From:** Eric Lalande <eric.lalande@rvca.ca>  
**Sent:** Tuesday, April 5, 2022 11:05 AM  
**To:** Francois Thauvette  
**Cc:** Steve Matthews  
**Subject:** RE: 1185 Beaverwood - Residential Development - RVCA Pre-Consultation

Hi Francois,

Based on the submitted site plan the RVCA will not require water quality control based on the site plan, however, strongly encourage that the site include best management practices such as minimizing the number of at grade visitor spaces, covering surface parking and reducing total amount of surface drive aisles and parking areas, where feasible.

Thanks,

**Eric Lalande, MCIP, RPP**  
Planner, RVCA  
613-692-3571 x1137

---

**From:** Francois Thauvette <f.thauvette@novatech-eng.com>  
**Sent:** Monday, April 4, 2022 12:05 PM  
**To:** Eric Lalande <eric.lalande@rvca.ca>  
**Cc:** Steve Matthews <S.Matthews@novatech-eng.com>  
**Subject:** 1185 Beaverwood - Residential Development - RVCA Pre-Consultation

Hi Eric,

We are working on a proposed 27-unit residential development at 1185 Beaverwood Road in the City of Ottawa (Manotick). The site will include a 3-storey building, outdoor (landscaped) amenity space and underground parking. Please note however that the development will include five (5) exterior visitor parking stalls. See attached preliminary Site Plan for details. Please review and advise if on-site storm water quality control measures will be required for the driveway and the five (5) exterior parking stalls.

Regards,

**François Thauvette**, P. Eng., Senior Project Manager | Land Development & Public Sector Engineering  
**NOVATECH** Engineers, Planners & Landscape Architects

Please note that I am working from home. Email or MS Teams are the best ways to contact me.

240 Michael Cowpland Drive, Suite 200, Ottawa, ON, K2M 1P6 | Tel: 613.254.9643 Ext: 219 | Cell: 613.276.0310 | Fax: 613.254.5867  
The information contained in this email message is confidential and is for exclusive use of the addressee.

## **APPENDIX B**

### **Development Servicing Study Checklist**



## Servicing study guidelines for development applications

### 4. Development Servicing Study Checklist

The following section describes the checklist of the required content of servicing studies. It is expected that the proponent will address each one of the following items for the study to be deemed complete and ready for review by City of Ottawa Infrastructure Approvals staff.

The level of required detail in the Servicing Study will increase depending on the type of application. For example, for Official Plan amendments and re-zoning applications, the main issues will be to determine the capacity requirements for the proposed change in land use and confirm this against the existing capacity constraint, and to define the solutions, phasing of works and the financing of works to address the capacity constraint. For subdivisions and site plans, the above will be required with additional detailed information supporting the servicing within the development boundary.

#### 4.1 General Content

- Executive Summary (for larger reports only).
- Date and revision number of the report.
- Location map and plan showing municipal address, boundary, and layout of proposed development.
- Plan showing the site and location of all existing services.
- Development statistics, land use, density, adherence to zoning and official plan, and reference to applicable subwatershed and watershed plans that provide context to which individual developments must adhere.
- Summary of Pre-consultation Meetings with City and other approval agencies.
- Reference and confirm conformance to higher level studies and reports (Master Servicing Studies, Environmental Assessments, Community Design Plans), or in the case where it is not in conformance, the proponent must provide justification and develop a defensible design criteria.
- Statement of objectives and servicing criteria.
- Identification of existing and proposed infrastructure available in the immediate area.
- Identification of Environmentally Significant Areas, watercourses and Municipal Drains potentially impacted by the proposed development (Reference can be made to the Natural Heritage Studies, if available).
- Concept level master grading plan to confirm existing and proposed grades in the development. This is required to confirm the feasibility of proposed stormwater management and drainage, soil removal and fill constraints, and potential impacts to neighbouring properties. This is also required to confirm that the proposed grading will not impede existing major system flow paths.
- Identification of potential impacts of proposed piped services on private services (such as wells and septic fields on adjacent lands) and mitigation required to address potential impacts.
- Proposed phasing of the development, if applicable.

- Reference to geotechnical studies and recommendations concerning servicing.
  
- All preliminary and formal site plan submissions should have the following information:
  - Metric scale
  
  - North arrow (including construction North)
  
  - Key plan
  
  - Name and contact information of applicant and property owner
  
  - Property limits including bearings and dimensions
  
  - Existing and proposed structures and parking areas
  
  - Easements, road widening and rights-of-way
  
  - Adjacent street names

#### **4.2 Development Servicing Report: Water**

- Confirm consistency with Master Servicing Study, if available
- Availability of public infrastructure to service proposed development
- Identification of system constraints
- Identify boundary conditions
- Confirmation of adequate domestic supply and pressure
- Confirmation of adequate fire flow protection and confirmation that fire flow is calculated as per the Fire Underwriter's Survey. Output should show available fire flow at locations throughout the development.
- Provide a check of high pressures. If pressure is found to be high, an assessment is required to confirm the application of pressure reducing valves.
- Definition of phasing constraints. Hydraulic modeling is required to confirm servicing for all defined phases of the project including the ultimate design
- Address reliability requirements such as appropriate location of shut-off valves
- Check on the necessity of a pressure zone boundary modification.
- Reference to water supply analysis to show that major infrastructure is capable of delivering sufficient water for the proposed land use. This includes data that shows that the expected demands under average day, peak hour and fire flow conditions provide water within the required pressure range

- Description of the proposed water distribution network, including locations of proposed connections to the existing system, provisions for necessary looping, and appurtenances (valves, pressure reducing valves, valve chambers, and fire hydrants) including special metering provisions.
- Description of off-site required feeder mains, booster pumping stations, and other water infrastructure that will be ultimately required to service proposed development, including financing, interim facilities, and timing of implementation.
- Confirmation that water demands are calculated based on the City of Ottawa Design Guidelines.
- Provision of a model schematic showing the boundary conditions locations, streets, parcels, and building locations for reference.

### 4.3 Development Servicing Report: Wastewater

- Summary of proposed design criteria (Note: Wet-weather flow criteria should not deviate from the City of Ottawa Sewer Design Guidelines. Monitored flow data from relatively new infrastructure cannot be used to justify capacity requirements for proposed infrastructure).
- Confirm consistency with Master Servicing Study and/or justifications for deviations.
- Consideration of local conditions that may contribute to extraneous flows that are higher than the recommended flows in the guidelines. This includes groundwater and soil conditions, and age and condition of sewers.
- Description of existing sanitary sewer available for discharge of wastewater from proposed development.
- Verify available capacity in downstream sanitary sewer and/or identification of upgrades necessary to service the proposed development. (Reference can be made to previously completed Master Servicing Study if applicable)
- Calculations related to dry-weather and wet-weather flow rates from the development in standard MOE sanitary sewer design table (Appendix 'C') format.
- Description of proposed sewer network including sewers, pumping stations, and forcemains.
- Discussion of previously identified environmental constraints and impact on servicing (environmental constraints are related to limitations imposed on the development in order to preserve the physical condition of watercourses, vegetation, soil cover, as well as protecting against water quantity and quality).
- Pumping stations: impacts of proposed development on existing pumping stations or requirements for new pumping station to service development.
- Forcemain capacity in terms of operational redundancy, surge pressure and maximum flow velocity.
- Identification and implementation of the emergency overflow from sanitary pumping stations in relation to the hydraulic grade line to protect against basement flooding.
- Special considerations such as contamination, corrosive environment etc.

#### 4.4 Development Servicing Report: Stormwater Checklist

- Description of drainage outlets and downstream constraints including legality of outlets (i.e. municipal drain, right-of-way, watercourse, or private property)
- Analysis of available capacity in existing public infrastructure.
- A drawing showing the subject lands, its surroundings, the receiving watercourse, existing drainage patterns, and proposed drainage pattern.
- Water quantity control objective (e.g. controlling post-development peak flows to pre-development level for storm events ranging from the 2 or 5 year event (dependent on the receiving sewer design) to 100 year return period); if other objectives are being applied, a rationale must be included with reference to hydrologic analyses of the potentially affected subwatersheds, taking into account long-term cumulative effects.
- Water Quality control objective (basic, normal or enhanced level of protection based on the sensitivities of the receiving watercourse) and storage requirements.
- Description of the stormwater management concept with facility locations and descriptions with references and supporting information.
- Set-back from private sewage disposal systems.
- Watercourse and hazard lands setbacks.
- Record of pre-consultation with the Ontario Ministry of Environment and the Conservation Authority that has jurisdiction on the affected watershed.
- Confirm consistency with sub-watershed and Master Servicing Study, if applicable study exists.
- Storage requirements (complete with calculations) and conveyance capacity for minor events (1:5 year return period) and major events (1:100 year return period).
- Identification of watercourses within the proposed development and how watercourses will be protected, or, if necessary, altered by the proposed development with applicable approvals.
- Calculate pre and post development peak flow rates including a description of existing site conditions and proposed impervious areas and drainage catchments in comparison to existing conditions.
- Any proposed diversion of drainage catchment areas from one outlet to another.
- Proposed minor and major systems including locations and sizes of stormwater trunk sewers, and stormwater management facilities.
- If quantity control is not proposed, demonstration that downstream system has adequate capacity for the post-development flows up to and including the 100 year return period storm event.
- Identification of potential impacts to receiving watercourses
- Identification of municipal drains and related approval requirements.
- Descriptions of how the conveyance and storage capacity will be achieved for the development.
- 100 year flood levels and major flow routing to protect proposed development from flooding for establishing minimum building elevations (MBE) and overall grading.

- Inclusion of hydraulic analysis including hydraulic grade line elevations.
- Description of approach to erosion and sediment control during construction for the protection of receiving watercourse or drainage corridors.
- Identification of floodplains – proponent to obtain relevant floodplain information from the appropriate Conservation Authority. The proponent may be required to delineate floodplain elevations to the satisfaction of the Conservation Authority if such information is not available or if information does not match current conditions.
- Identification of fill constraints related to floodplain and geotechnical investigation.

#### **4.5 Approval and Permit Requirements: Checklist**

The Servicing Study shall provide a list of applicable permits and regulatory approvals necessary for the proposed development as well as the relevant issues affecting each approval. The approval and permitting shall include but not be limited to the following:

- Conservation Authority as the designated approval agency for modification of floodplain, potential impact on fish habitat, proposed works in or adjacent to a watercourse, cut/fill permits and Approval under Lakes and Rivers Improvement Act. The Conservation Authority is not the approval authority for the Lakes and Rivers Improvement Act. Where there are Conservation Authority regulations in place, approval under the Lakes and Rivers Improvement Act is not required, except in cases of dams as defined in the Act.
- Application for Certificate of Approval (CofA) under the Ontario Water Resources Act.
- Changes to Municipal Drains.
- Other permits (National Capital Commission, Parks Canada, Public Works and Government Services Canada, Ministry of Transportation etc.)

#### **4.6 Conclusion Checklist**

- Clearly stated conclusions and recommendations
- Comments received from review agencies including the City of Ottawa and information on how the comments were addressed. Final sign-off from the responsible reviewing agency.
- All draft and final reports shall be signed and stamped by a professional Engineer registered in Ontario

**APPENDIX C**  
**Sanitary Sewage Calculations**

## 1185 Beaverwood Rd - Proposed Residential Building SANITARY SEWAGE ANALYSIS

<b>Residential</b>	<b>Post-Development</b>	
Number of 1-Bedroom Apartments	10	
Number of Persons per 1-Bdrm Apartment	1.4	
Number of 2-Bedroom Apartments	17	
Number of Persons per 2-Bdrm Apartment	2.1	
Design Population	50	
Average Daily Flow per resident	280	L/c/day
Peak Factor (Harmon Formula)	3.78	
Peak Residential Flow	0.61	L/s
<b>Extraneous Flow</b>		
Site Area	0.236	ha
Infiltration Allowance	0.33	L/s/ha
<b>Peak Extraneous Flows</b>	0.08	L/s
<b>Total Peak Sanitary Flow</b>	<b>0.69</b>	<b>L/s</b>

## **APPENDIX D**

### **Water Demands, OBC Fire Flow Calculations, City of Ottawa Boundary Conditions and Hydrant Location Sketch**



## **Francois Thauvette**

---

**From:** Reist, Christine <christine.reist@ottawa.ca>  
**Sent:** Wednesday, May 4, 2022 3:33 PM  
**To:** Francois Thauvette  
**Cc:** Steve Matthews  
**Subject:** Re: 1185 Beaverwood Road (Manotick)- Watermain Boundary Conditions Request - Fire Flow Using OBC Method  
**Attachments:** 1185 Beaverwood Road\_03May2022.docx

Hi François,

Please see attached boundary conditions for 1185 Beaverwood. There are two different fire flow demands included (5,400 L/min & 10,000 L/min). The City's water modelling department included the 10,000L/min fire flow demand because they noticed that the 5,400 L/min seemed low, even for the OBC fire flow calculation method.

When the site plan application is submitted, please include information to confirm that the proposed building will be the type of construction used to select the Water Supply Coefficient from OBC A-3.2.5.7. Table 1 in the fire flow calculations. You can disregard the 10,000L/min fire flow demand. If the proposed building construction type changes, please send an updated boundary condition request.

You'll also see that there are two sets of boundary conditions provided in the attached document: one for the existing water distribution system and one for the future SUC Zone Reconfiguration. Please note that the water servicing design will need to account for both the existing and future water distribution system configurations.

Please let me know if you have any questions.

Thanks,  
Chris

**Chris Reist, P.Eng.**

**Project Manager**

Development Review, Rural Services Unit | Examen des projets d'aménagement, Unité des services ruraux

Planning, Real Estate & Economic Development | Direction générale de la planification, des biens immobiliers et du développement économique

City of Ottawa | Ville d'Ottawa

110 Laurier Avenue W. | 110 avenue Laurier O.

**From:** Francois Thauvette <f.thauvette@novatech-eng.com>

**Sent:** Tuesday, April 12, 2022 11:08 AM

**To:** Reist, Christine <christine.reist@ottawa.ca>

**Cc:** Steve Matthews <S.Matthews@novatech-eng.com>

**Subject:** FW: 1185 Beaverwood Road (Manotick)- Watermain Boundary Conditions Request - Fire Flow Using OBC Method

**CAUTION: This email originated from an External Sender. Please do not click links or open attachments unless you recognize the source.**

**ATTENTION : Ce courriel provient d'un expéditeur externe. Ne cliquez sur aucun lien et n'ouvrez pas de pièce jointe, excepté si vous connaissez l'expéditeur.**

Hi Christine,

The domestic water demands have not changed since the previous e-mail; however, we have updated the fire flow requirements per OBC. Please provide the municipal watermain boundary conditions based on the information summarized below:

- Average Day Demand = 0.2 L/s
- Maximum Day Demand = 0.4 L/s
- Peak Hour Demand = 0.9 L/s
- Maximum Fire Flow Demand = 90 L/s (per OBC)

See preliminary calculation sheets and hydrant location sketch for details.

Regards,

**François Thauvette**, P. Eng., Senior Project Manager | Land Development & Public Sector Engineering

**NOVATECH** Engineers, Planners & Landscape Architects

Please note that I am working from home. Email or MS Teams are the best ways to contact me.

240 Michael Cowpland Drive, Suite 200, Ottawa, ON, K2M 1P6 | Tel: 613.254.9643 Ext: 219 | Cell: 613.276.0310 | Fax: 613.254.5867

The information contained in this email message is confidential and is for exclusive use of the addressee.

---

**From:** Steve Matthews <S.Matthews@novatech-eng.com>

**Sent:** Tuesday, April 12, 2022 10:44 AM

**To:** Francois Thauvette <f.thauvette@novatech-eng.com>

**Subject:** RE: 1185 Beaverwood Road (Manotick)- Watermain Boundary Conditions Request - Fire Flow Using OBC Method

François,

The OBC Water Supply calculations for the site and Table 2 for the Minimum Water Supply Flow Rates (see second attachment), the proposed 3-storey development would only require **90 L/s** (5400 L/min) based on the volume requirement of 176,000 L calculated in first attachment. This is significantly less than the 200 L/s that the FUS calculation yields for the site as previously calculated.

Regards,  
Steve

**Stephen Matthews**, B.A.(Env), Senior Design Technologist

**NOVATECH** Engineers, Planners & Landscape Architects

240 Michael Cowpland Drive, Suite 200, Ottawa, ON, K2M 1P6 | Tel: 613.254.9643 x 223 | Fax: 613.254.5867

The information contained in this email message is confidential and is for exclusive use of the addressee.

---

**From:** Reist, Christine <[christine.reist@ottawa.ca](mailto:christine.reist@ottawa.ca)>

**Sent:** Monday, April 11, 2022 10:51 AM

**To:** Francois Thauvette <[f.thauvette@novatech-eng.com](mailto:f.thauvette@novatech-eng.com)>

**Cc:** Steve Matthews <[S.Matthews@novatech-eng.com](mailto:S.Matthews@novatech-eng.com)>

**Subject:** RE: 1185 Beaverwood Road (Manotick)- Watermain Boundary Conditions Request

Hi François,

Please use the OBC method for calculating the fire flow instead of FUS (unless the OBC calc yields a fire flow greater than 9,000 L/min, then FUS should be used).

Thanks,  
Chris

**Chris Reist, P.Eng.**

**Project Manager**

Development Review, Rural Services Unit | Examen des projets d'aménagement, Unité des services ruraux

Planning, Real Estate & Economic Development | Direction générale de la planification, des biens immobiliers et du développement économique

City of Ottawa | Ville d'Ottawa

110 Laurier Avenue W. | 110 avenue Laurier O.

---

**From:** Francois Thauvette <[f.thauvette@novatech-eng.com](mailto:f.thauvette@novatech-eng.com)>

**Sent:** April 06, 2022 3:40 PM

**To:** Reist, Christine <[christine.reist@ottawa.ca](mailto:christine.reist@ottawa.ca)>

**Cc:** Steve Matthews <[S.Matthews@novatech-eng.com](mailto:S.Matthews@novatech-eng.com)>

**Subject:** FW: 1185 Beaverwood Road (Manotick)- Watermain Boundary Conditions Request

**CAUTION: This email originated from an External Sender. Please do not click links or open attachments unless you recognize the source.**

**ATTENTION : Ce courriel provient d'un expéditeur externe. Ne cliquez sur aucun lien et n'ouvrez pas de pièce jointe, excepté si vous connaissez l'expéditeur.**

We are sending this e-mail to request watermain boundary conditions for the proposed re-development of the 1185 Beaverwood Road property. Please see e-mail below and attachments for details.

Regards,

**François Thauvette**, P. Eng., Senior Project Manager | Land Development & Public Sector Engineering

**NOVATECH** Engineers, Planners & Landscape Architects

Please note that I am working from home. Email or MS Teams are the best ways to contact me.

**From:** Steve Matthews <[S.Matthews@novatech-eng.com](mailto:S.Matthews@novatech-eng.com)>  
**Sent:** Wednesday, April 6, 2022 2:14 PM  
**To:** Francois Thauvette <[f.thauvette@novatech-eng.com](mailto:f.thauvette@novatech-eng.com)>  
**Subject:** 1185 Beaverwood Road (Manotick)- Watermain Boundary Conditions Request

Hi François,

Please forward this information to the City of Ottawa as our request for municipal watermain boundary conditions in relation to the proposed residential development at 1185 Beaverwood Road (in the Manotick area). The site development will include a 27-unit residential building with a common underground parking garage and five (5) surface parking spots for visitor parking with the main entrance driveway off Scharfield Road. Refer to the attached Site Plan for details.

Please request watermain boundary conditions from the City of Ottawa for the existing 300mm dia. PVC municipal watermain in Beaverwood Road (as shown on geoOttawa). A multi-hydrant approach will be required (and will be provided by the nearby municipal hydrants), as the building will be non-sprinklered. As indicated on the geoOttawa website, there are multiple blue bonnet municipal hydrants within 150m of the subject site that could be used for firefighting purposes. See attached Hydrant location Sketch for details.

The proposed water service will be located in the south-west corner of the building, off the 300mm dia. municipal watermain in Beaverwood Road. The anticipated water demands for the proposed development are as follows:

- Average Day Demand = 0.2 L/s
- Maximum Day Demand = 0.4 L/s
- Peak Hour Demand = 0.9 L/s
- Maximum Fire Flow Demand = 200 L/s

See preliminary calculation sheets and hydrant location sketch for details.

Regards,  
Steve

**Stephen Matthews**, B.A.(Env), Senior Design Technologist

**NOVATECH** Engineers, Planners & Landscape Architects

240 Michael Cowpland Drive, Suite 200, Ottawa, ON, K2M 1P6 | Tel: 613.254.9643 x 223 | Fax: 613.254.5867

The information contained in this email message is confidential and is for exclusive use of the addressee.

'  
This e-mail originates from the City of Ottawa e-mail system. Any distribution, use or copying of this e-mail or the information it contains by other than the intended recipient(s) is unauthorized. Thank you.

Le présent courriel a été expédié par le système de courriels de la Ville d'Ottawa. Toute distribution, utilisation ou reproduction du courriel ou des renseignements qui s'y trouvent par une personne autre que son destinataire prévu est interdite. Je vous remercie de votre collaboration.

'  
This e-mail originates from the City of Ottawa e-mail system. Any distribution, use or copying of this e-mail or the information it contains by other than the intended recipient(s) is unauthorized. Thank you.

Le présent courriel a été expédié par le système de courriels de la Ville d'Ottawa. Toute distribution, utilisation ou reproduction du courriel ou des renseignements qui s'y trouvent par une personne autre que son destinataire prévu est interdite. Je vous remercie de votre collaboration.

## 1185 Beaverwood Road - Proposed Residential Building WATER ANALYSIS

### DOMESTIC WATER DEMANDS

<b>Residential</b>	<b>Post-Development</b>	
Number of 1-Bedroom Apartments	10	
Number of Persons per 1-Bdrm Apartment	1.4	
Number of 2-Bedroom Apartments	17	
Number of Persons per 2-Bdrm Apartment	2.1	
Design Population	50	
Average Daily Flow per resident	280	L/c/day
<b>Average Day Demand</b>	<b>0.16</b>	<b>L/s</b>
<b>Maximum Day Demand (2.5 x avg. day)</b>	<b>0.41</b>	<b>L/s</b>
<b>Peak Hour Demand (2.2 x max. day)</b>	<b>0.89</b>	<b>L/s</b>
<b>TOTAL</b>		
<b>Average Day Demand</b>	<b>0.16</b>	<b>L/s</b>
<b>Maximum Day Demand</b>	<b>0.41</b>	<b>L/s</b>
<b>Peak Hour Demand</b>	<b>0.89</b>	<b>L/s</b>

### 6.3 Buildings Requiring On-Site Fire Protection Water Supply

- (a) Except for sprinklered buildings and as required by Sections 6.3 (c) and 6.3 (d), new buildings shall be provided with a supply of water available for fire fighting purposes not less than the quantity derived from the following formula:

$$Q = KVS_{Tot}$$

where

- Q = minimum supply of water in litres (L)
- K = water supply coefficient from Table 1
- V = total building volume in cubic metres
- S<sub>Tot</sub> = total of spatial coefficient values from property line exposures on all sides, as obtained from the formula:

$$S_{Tot} = 1.0 + [(S_{Side1}) + (S_{Side2}) + (S_{Side3}) + \dots \text{etc.}]$$

where

- S<sub>Side</sub> values are obtained from Figure 1, as modified by Sections 6.3 (e) and 6.3 (f) of this guideline, and
- S<sub>Tot</sub> need not exceed 2.0

(see also Section 7.0 of this guideline)

- (b) Except as provided in Section 6.3 (d), water supply flow rates shall not be less than that specified in Table 2. Where the water supply is from a municipal or industrial water supply system, then the required flow rate shall be available at a minimum pressure of 140 kPa.
- (c) Except as provided in Section 6.3 (d), the minimum fire protection water supply “Q” required in Section 6.3 (a) shall not be less than what is needed to provide the minimum flow rate specified in Table 2 for a duration of 30 minutes.
- (d) In elementary and secondary schools, the water supply determined in accordance with Sections 6.3 (a) and 6.3 (b) may be reduced. The level of reduction to be applied should be at the discretion of the local jurisdictional authority and should not exceed 30%. Factors to consider should include fire department response time, fire department resources and the size and complexity of the school building (see Section 9.10 of this guideline for additional information).

**TABLE 1**  
**WATER SUPPLY COEFFICIENT -- K**

TYPE OF CONSTRUCTION	Classification by Group or Division in Accordance with Table 3.1.2.1 of the Ontario Building Code				
	A-2 B-1 B-2 B-3 C D	A-4 F-3	A-1 A-3	E F-2	F-1
Building is of noncombustible construction with fire separations and fire-resistance ratings provided in accordance with Subsection 3.2.2. of the OBC, including loadbearing walls, columns and arches.	10	12	14	17	23
Building is of noncombustible construction or of heavy timber construction conforming to Article 3.1.4.6. of the OBC. Floor assemblies are fire separations but with no fire-resistance rating. Roof assemblies, mezzanines, loadbearing walls, columns and arches do not have a fire-resistance rating.	16	19	22	27	37
Building is of combustible construction with fire separations and fire-resistance ratings provided in accordance with Subsection 3.2.2. of the OBC, including loadbearing walls, columns and arches. Noncombustible construction may be used in lieu of fire-resistance rating where permitted in Subsection 3.2.2. of the OBC.	18	22	25	31	41
Building is of combustible construction. Floor assemblies are fire separations but with no fire-resistance rating. Roof assemblies, mezzanines, loadbearing walls, columns and arches do not have a fire-resistance rating.	23	28	32	39	53
<b>Column 1</b>	<b>2</b>	<b>3</b>	<b>4</b>	<b>5</b>	<b>6</b>

**TABLE 2**  
**MINIMUM WATER SUPPLY FLOW RATES**

Building Code, Part 3 Buildings	Required Minimum Water Supply Flow Rate (L/min.)
One-storey building with building area not exceeding 600m <sup>2</sup> (excluding F-1 occupancies)	1800
All other buildings	2700 (If $Q \leq 108,000L$ ) <sup>(1)</sup> 3600 (If $Q > 108,000L$ and $\leq 135,000L$ ) <sup>(1)</sup> 4500 (If $Q > 135,000L$ and $\leq 162,000L$ ) <sup>(1)</sup> 5400 (If $Q > 162,000L$ and $\leq 190,000L$ ) <sup>(1)</sup> 6300 (If $Q > 190,000L$ and $\leq 270,000L$ ) <sup>(1)</sup> 9000 (If $Q > 270,000L$ ) <sup>(1)</sup>

Note: <sup>(1)</sup>  $Q = KVS_{Tot}$  as referenced in Section 3 (a)



**FIGURE 1**

**SPATIAL COEFFICIENT VS EXPOSURE DISTANCE**

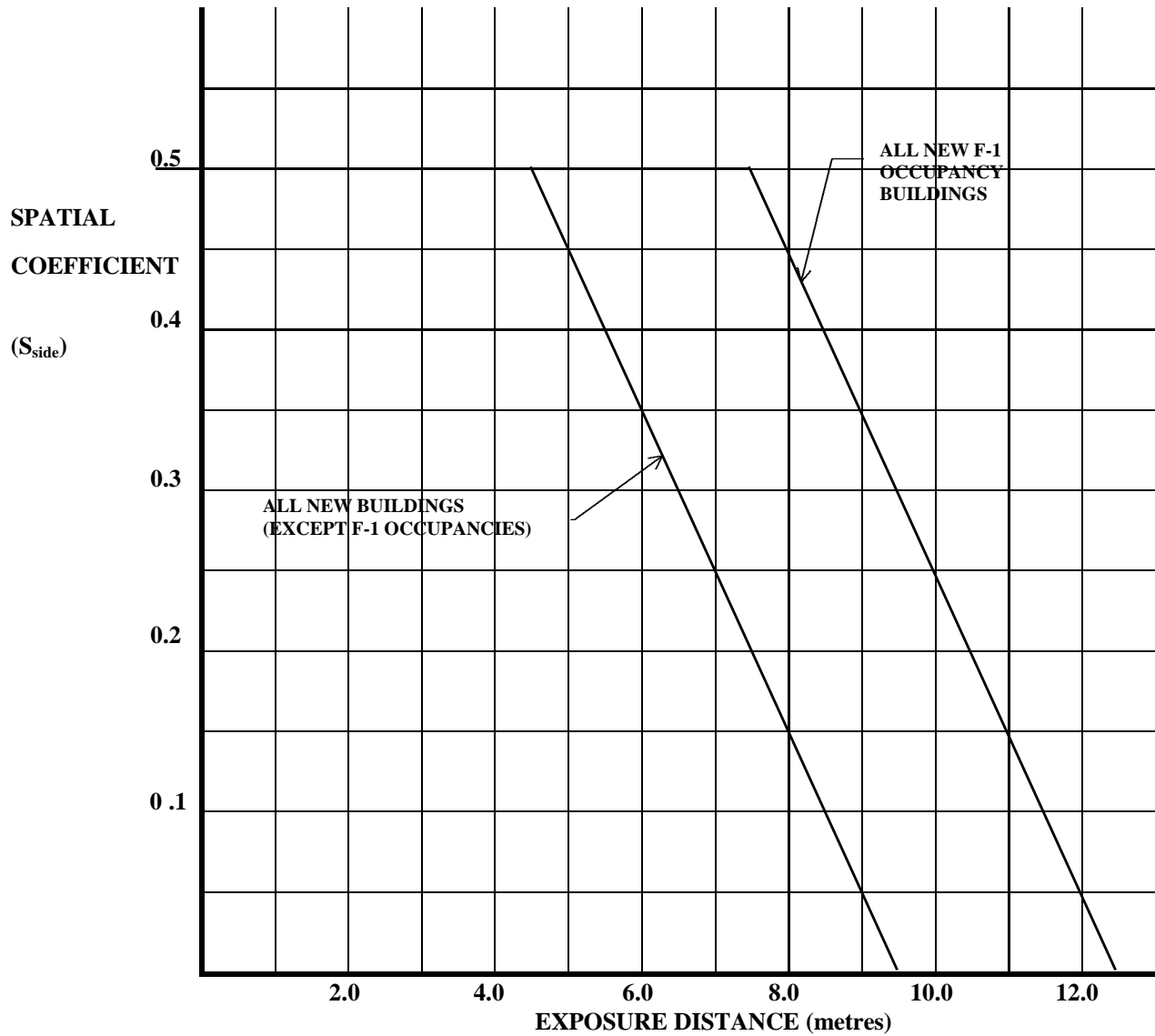

- (e) Where a masonry wall with a minimum fire-resistance rating of 2 hours and no unprotected openings is provided as an exterior wall, the spatial coefficient “ $S_{Side}$ ” for this side of the new building may be considered equal to 0. This exterior masonry wall shall be provided with a minimum 150 mm parapet.

Firewalls that divide a structure into two or more buildings may be given similar consideration when evaluating the exposure of the buildings to each other.

- (f) The spatial coefficient “ $S_{Side}$ ” may be considered equal to 0 when the exposed building is on the same property and is less than 10 m<sup>2</sup> in building area.

#### **6.4 Additions to Existing Buildings**

- (a) Except as permitted in Sections 6.4 (b) and 6.4 (c), additions to existing buildings shall be provided with a fire protection water supply as required in Sections 6.3 (a) to 6.3 (f) (see Section 8.2 of this guideline for additional information).
- (b) Buildings with new additions falling into any one of the following criteria do not require an additional water supply for fire fighting:
  - (i) the expanded building complies with all the requirements of Section 6.1 (a),
  - (ii) the new addition does not exceed 100 m<sup>2</sup> in building area, or
  - (iii) the new addition exceeds 100 m<sup>2</sup> but does not exceed 400 m<sup>2</sup> in building area, contains an assembly, business and personal services, mercantile or low hazard industrial occupancy, is of noncombustible construction, does not result in a significant increase in exposure to other existing buildings, has no combustible storage or process, and is separated from the existing building by a minimum 1 hr fire-rated separation.
- (c) Where a firewall is provided between the new addition and the existing building, the fire protection water supply may be determined in accordance with Sections 6.1 (a) and 6.3 (a), using only the building volume of the new addition.

***NOTE:** Consideration should be given to designing the water supply to the more stringent requirements of the two separated buildings.*

## Fire-Fighting Water Supply - OBC 2006 (A-3.2.5.7.)

Project: **1185 Beaverwood**

Proj. No.: **121184**

Date: **Apr 11/22**

Reference: [Ontario Fire Marshal - OBC Fire Fighting Water Supply](#)

Building Classification:	<b>C</b>	OBC 3.1.2.1.
Water Supply Coefficient K:	<b>10</b>	A-3.2.5.7. Table 1
Building Dimensions:	W (ft) <b>58</b> 17.7 m	A = <b>761</b> m <sup>2</sup>
	L (ft) <b>141.3</b> 43.1 m	V = <b>9622</b> m <sup>3</sup>
use avg interior height	H (ft) <b>9</b> 2.7 m	Total Volume (above & below grade) of Building to underside of roof deck

Exterior Wall Exposure = Distance between exterior face and:  
(Limiting Distance)

OBC 3.2.3.1.(3)

Property Line  
or Centreline of Street  
or Line at mid-distance to another building on same lot

North:	<b>16.6</b> m	S <sub>side 1</sub> = <b>0.00</b>
East:	<b>6.2</b> m	S <sub>side 2</sub> = <b>0.38</b>
South:	<b>6.0</b> m	S <sub>side 3</sub> = <b>0.40</b>
West:	<b>9.5</b> m	S <sub>side 4</sub> = <b>0.05</b>

A-3.2.5.7.  
Figure 1

*If LD > 10 m (> 13 m for F-1), S = 0, thus an accurate measure of LD is not required.*

*Can enter LD = >10 or >13*

*If a building is separated by a firewall, S = 0 for that side (see A-3.2.5.7.3(d)). Enter LD = firewall*

Spatial Coefficient: S<sub>Tot</sub> =  
1.0 + (S<sub>side 1</sub> + S<sub>side 2</sub> + S<sub>side 3</sub> + S<sub>side 4</sub>) = **1.83**

Fire Water Supply Volume Required: Q =	K V S <sub>Tot</sub>	=	<b>176000</b> L
	Q <sub>min</sub> from A-3.2.5.7. Table 2	=	<b>162000</b> L
	Q <sub>REQ</sub>	=	<b>176000</b> L
	Q <sub>REQ</sub>	=	<b>176</b> m <sup>3</sup>

## Boundary Conditions 1185 Beaverwood Road

### Provided Information

Scenario	Demand	
	L/min	L/s
Average Daily Demand	12	0.20
Maximum Daily Demand	24	0.40
Peak Hour	54	0.90
Fire Flow Demand #1	5,400	90.00
Fire Flow Demand #2	10,000	166.67

### Location



### Results – Existing Conditions

#### Connection 1 – Beaverwood Rd.

Demand Scenario	Head (m)	Pressure <sup>1</sup> (psi)
Maximum HGL	156.9	91.8
Peak Hour	140.2	68.2
Max Day plus Fire 1	139.2	66.6
Max Day plus Fire 2	119.3	38.3

Ground Elevation = 92.3 m

## **Results – SUC Zone Reconfiguration**

### **Connection 1 – Beaverwood Rd.**

<b>Demand Scenario</b>	<b>Head (m)</b>	<b>Pressure<sup>1</sup> (psi)</b>
Maximum HGL	148.2	79.5
Peak Hour	142.5	71.4
Max Day plus Fire 1	133.7	58.9
Max Day plus Fire 2	114.7	31.9

Ground Elevation = 92.3 m

### **Notes**

1. As per the Ontario Building Code in areas that may be occupied, the static pressure at any fixture shall not exceed 552 kPa (80 psi.) Pressure control measures to be considered are as follows, in order of preference:
  - a. If possible, systems to be designed to residual pressures of 345 to 552 kPa (50 to 80 psi) in all occupied areas outside of the public right-of-way without special pressure control equipment.
  - b. Pressure reducing valves to be installed immediately downstream of the isolation valve in the home/ building, located downstream of the meter so it is owner maintained.

### **Disclaimer**

*The boundary condition information is based on current operation of the city water distribution system. The computer model simulation is based on the best information available at the time. The operation of the water distribution system can change on a regular basis, resulting in a variation in boundary conditions. The physical properties of watermains deteriorate over time, as such must be assumed in the absence of actual field test data. The variation in physical watermain properties can therefore alter the results of the computer model simulation. Fire Flow analysis is a reflection of available flow in the watermain; there may be additional restrictions that occur between the watermain and the hydrant that the model cannot take into account.*

1185 BEAVERWOOD RD X

Show search results for 1185 Beaverw...



# Watermain Boundary Conditions Request 1185 Beaverwood Road

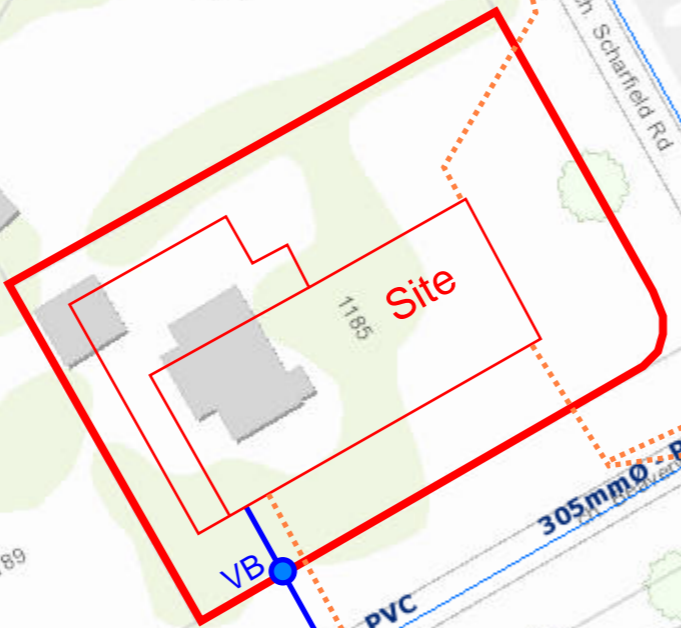

City Fire Hydrant ID:  
**368009H006** approximately  
63m from Proposed Building

City Fire Hydrant ID:  
**368009H003** approximately  
115m from Proposed Building

City Fire Hydrant ID:  
**368009H004** approximately  
37m from Proposed Building

Proposed Water Service  
Connection to existing 300mm dia.  
watermain in Beaverwood Road

City Fire Hydrant ID:  
**368009H005** approximately  
57m from Proposed Building

20m

-8425620.845 5656691.776 Meters

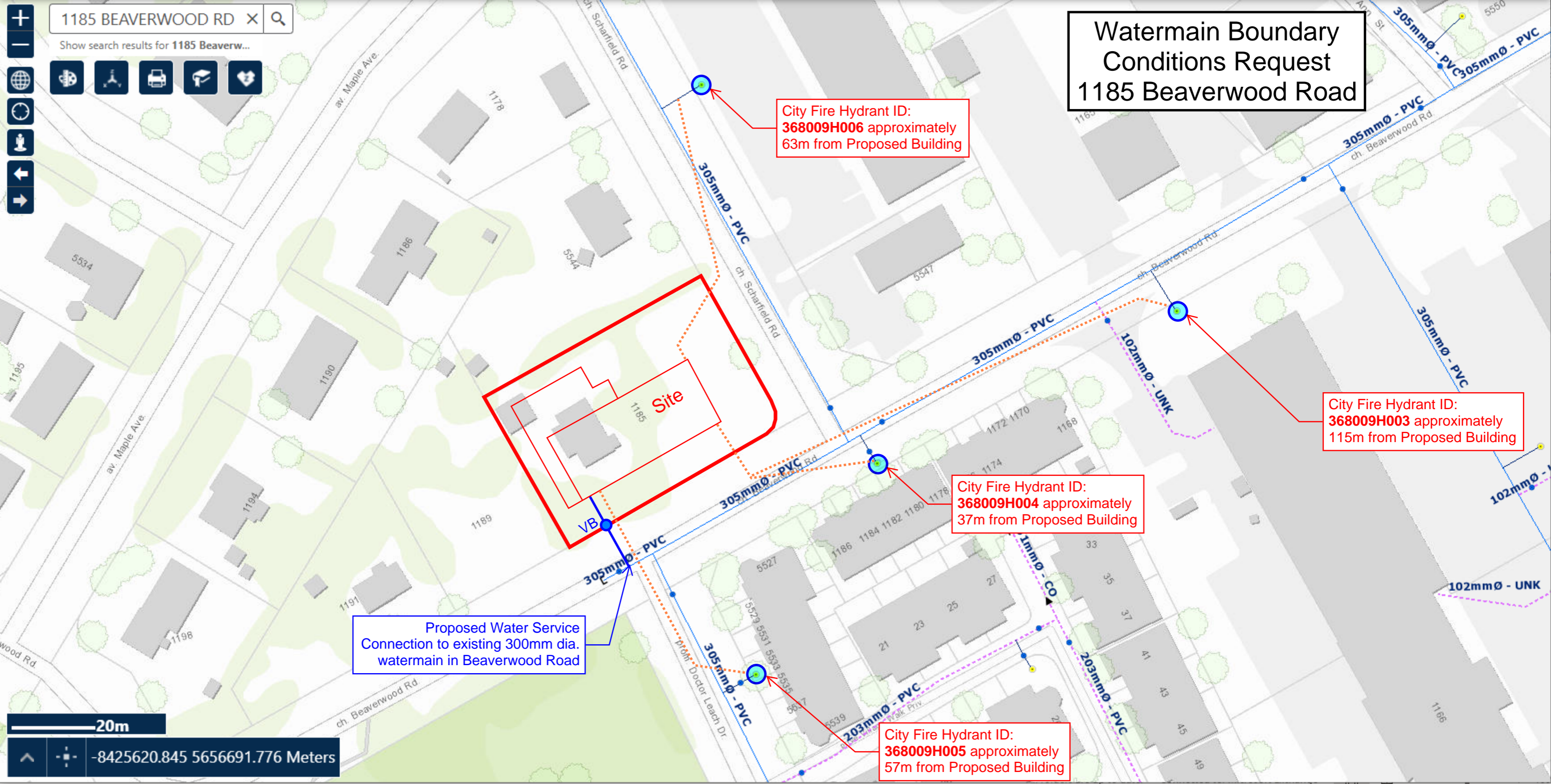

## **APPENDIX E**

### **IDF Curves and SWM Calculations, By-Pass Swale Flow Capacities and Excerpts from The Village Walk Subdivision Stormwater Management Report**

APPENDIX 5-A

OTTAWA INTENSITY DURATION FREQUENCY (IDF) CURVE

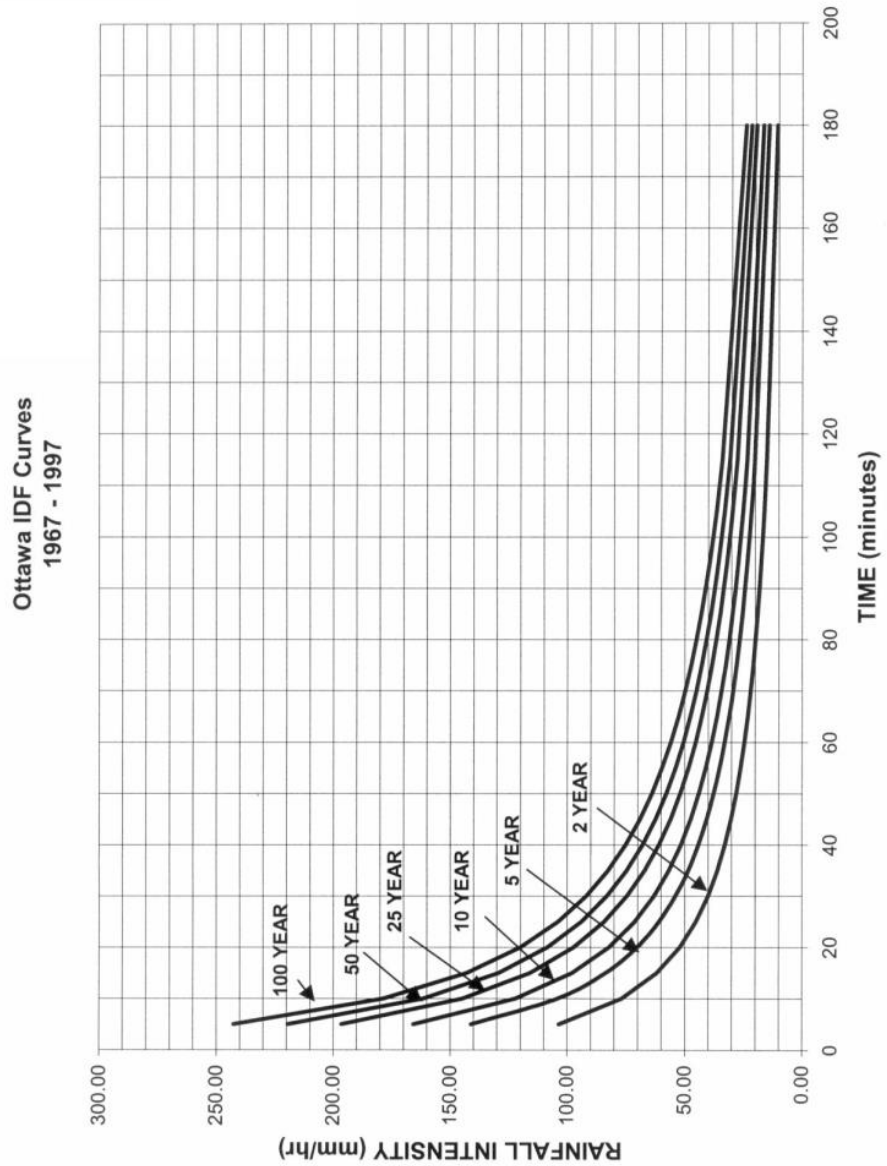



## Proposed Residential Development 1185 Beaverwood Road

Pre - Development Stormwater Flows											
Description	Area (ha)	A <sub>imperv</sub> (ha) C=0.9	A <sub>gravel</sub> (ha) C=0.7	A <sub>pervious</sub> (ha) C=0.2	Weighted C <sub>w5</sub>	Weighted C <sub>w100</sub>	1:2 Year Flow (L/s)	1:5 Year Flow (L/s)	1:100 Year Flow (L/s)	Allowable C <sub>w</sub>	Allowable Flows
											5-year (L/s)
Off-Site Tributary Area OS-1	0.130	0.015	0.000	0.115	0.28	0.34	7.8	10.6	21.8	0.28	---
Off-Site Tributary Area OS-2	0.129	0.014	0.000	0.115	0.28	0.33	7.6	10.3	21.2	0.28	---
Subject Site to be Developed	0.236	0.017	0.023	0.196	0.30	0.36	15.0	20.4	42.7	0.30	<b>20.4</b>

Target 100-yr Q<sub>cap</sub> in North by-pass swale = 25 L/s  
 Target 100-yr Q<sub>cap</sub> in West by-pass swale = 25 L/s

T<sub>c</sub> = 10mins

Post - Development Stormwater Flows																
Area	Description	Area (ha)	A <sub>imp</sub> (ha) C=0.9	A <sub>perv</sub> (ha) C=0.2	C <sub>s</sub>	C <sub>100</sub>	Uncontrolled Flow (L/s)			Controlled Flow (L/s)			Storage Required (m <sup>3</sup> )			Storage Provided (m <sup>3</sup> )
							2-year	5-year	100-year	2-year	5-year	100-year	2-year	5-year	100-year	
OS-1	OS-1 Conveyed through Site via. East Ditch	0.130	0.015	0.115	0.28	0.34	7.8	10.6	21.8	-	-	-	-	-	-	-
OS-2	OS-2 Conveyed through Site via. South Ditch	0.129	0.014	0.115	0.28	0.33	7.6	10.3	21.2	-	-	-	-	-	-	-
A-1	Direct Runoff to Roadside Ditches	0.071	0.009	0.062	0.29	0.35	4.4	5.9	12.2	-	-	-	-	-	-	-
A-2	Controlled Super-Pipe Flows	0.094	0.065	0.029	0.68	0.77	-	-	-	1.2	1.4	2.5	14.4	20.0	38.6	38.7
R-1	Controlled Flow Roof Drains	0.071	0.071	0.000	0.90	1.00	-	-	-	2.2	2.5	3.0	9.5	14.1	32.5	50.5
<b>Totals :</b>		0.495	-	-	-	-	4.4	5.9	12.2	3.4	3.9	5.5	9.5	14.1	32.5	50.5

**Total On-Site Stormwater Flows :** 7.8 9.8 17.7

T<sub>c</sub> = 10mins

2.7 Weeping Tile Flow  
 20.4

**Proposed Residential Development**  
**Novatech Project No. 121184**  
**Uncontrolled Runoff - 1:2 YEAR EVENT**  
**AREA OS-1 Un-Controlled Runoff to East Ditch**

OTTAWA IDF CURVE

Area = 0.130 ha      Qallow = 7.8 L/s  
C = 0.28                Vol(max) = 0.0 m3

Time (min)	Intensity (mm/hr)	Q (L/s)	Qnet (L/s)	Vol (m3)
5	103.57	10.53	2.72	0.82
10	76.81	7.81	0.00	0.00
15	61.77	6.28	-1.53	-1.38
20	52.03	5.29	-2.52	-3.02
25	45.17	4.59	-3.22	-4.82
30	40.04	4.07	-3.74	-6.73
35	36.06	3.67	-4.14	-8.70
40	32.86	3.34	-4.47	-10.72
45	30.24	3.07	-4.73	-12.78
50	28.04	2.85	-4.96	-14.87
55	26.17	2.66	-5.15	-16.99
60	24.56	2.50	-5.31	-19.12
65	23.15	2.35	-5.45	-21.27
70	21.91	2.23	-5.58	-23.44
75	20.81	2.12	-5.69	-25.62
90	18.14	1.84	-5.96	-32.20
105	16.13	1.64	-6.17	-38.86
120	14.56	1.48	-6.33	-45.56
135	13.30	1.35	-6.46	-52.30
150	12.25	1.25	-6.56	-59.07

**Proposed Residential Development**  
**Novatech Project No. 121184**  
**Uncontrolled Runoff - 1:5 YEAR EVENT**  
**AREA OS-1 Un-Controlled Runoff to East Ditch**

OTTAWA IDF CURVE

Area = 0.130 ha      Qallow = 10.6 L/s  
C = 0.28                Vol(max) = 0.0 m3

Time (min)	Intensity (mm/hr)	Q (L/s)	Qnet (L/s)	Vol (m3)
5	141.18	14.35	3.76	1.13
10	104.19	10.59	0.00	0.00
15	83.56	8.49	-2.10	-1.89
20	70.25	7.14	-3.45	-4.14
25	60.90	6.19	-4.40	-6.60
30	53.93	5.48	-5.11	-9.20
35	48.52	4.93	-5.66	-11.89
40	44.18	4.49	-6.10	-14.64
45	40.63	4.13	-6.46	-17.45
50	37.65	3.83	-6.76	-20.29
55	35.12	3.57	-7.02	-23.17
60	32.94	3.35	-7.24	-26.08
65	31.04	3.16	-7.44	-29.00
70	29.37	2.99	-7.61	-31.95
75	27.89	2.84	-7.76	-34.91
90	24.29	2.47	-8.12	-43.87
105	21.58	2.19	-8.40	-52.91
120	19.47	1.98	-8.61	-62.02
135	17.76	1.81	-8.79	-71.17
150	16.36	1.66	-8.93	-80.36

**Proposed Residential Development**  
**Novatech Project No. 121184**  
**Uncontrolled Runoff - 1:100 YEAR EVENT**  
**AREA OS-1 Un-Controlled Runoff to East Ditch**

OTTAWA IDF CURVE

Area = 0.130 ha      Qallow = 21.9 L/s  
C = 0.34                Vol(max) = 0.0 m3

Time (min)	Intensity (mm/hr)	Q (L/s)	Qnet (L/s)	Vol (m3)
5	242.70	29.82	7.88	2.36
10	178.56	21.94	0.00	0.00
15	142.89	17.56	-4.38	-3.94
20	119.95	14.74	-7.20	-8.64
25	103.85	12.76	-9.18	-13.77
30	91.87	11.29	-10.65	-19.17
35	82.58	10.15	-11.79	-24.77
40	75.15	9.23	-12.71	-30.50
45	69.05	8.48	-13.46	-36.33
50	63.95	7.86	-14.08	-42.25
55	59.62	7.33	-14.61	-48.23
60	55.89	6.87	-15.07	-54.26
65	52.65	6.47	-15.47	-60.34
70	49.79	6.12	-15.82	-66.46
75	47.26	5.81	-16.13	-72.60
90	41.11	5.05	-16.89	-91.20
105	36.50	4.48	-17.46	-109.97
120	32.89	4.04	-17.90	-128.87
135	30.00	3.69	-18.25	-147.86
150	27.61	3.39	-18.55	-166.93

**Proposed Residential Development**  
**Novatech Project No. 121184**  
**Uncontrolled Runoff - 1:100 YR + 20% IDF Increase**  
**AREA OS-1 Un-Controlled Runoff to East Ditch**

OTTAWA IDF CURVE

Area = 0.130 ha      Qallow = 26.3 L/s  
C = 0.34                Vol(max) = 0.0 m3

Time (min)	Intensity (mm/hr)	Q (L/s)	Qnet (L/s)	Vol (m3)
5	291.24	35.79	9.46	2.84
10	214.27	26.33	0.00	0.00
15	171.47	21.07	-5.26	-4.73
20	143.94	17.69	-8.64	-10.37
25	124.62	15.31	-11.02	-16.52
30	110.24	13.55	-12.78	-23.01
35	99.09	12.18	-14.15	-29.72
40	90.17	11.08	-15.25	-36.60
45	82.86	10.18	-16.15	-43.60
50	76.74	9.43	-16.90	-50.70
55	71.55	8.79	-17.54	-57.87
60	67.07	8.24	-18.09	-65.11
65	63.18	7.76	-18.57	-72.41
70	59.75	7.34	-18.99	-79.75
75	56.71	6.97	-19.36	-87.12
90	49.33	6.06	-20.27	-109.44
105	43.80	5.38	-20.95	-131.97
120	39.47	4.85	-21.48	-154.64
135	36.00	4.42	-21.91	-177.44
150	33.13	4.07	-22.26	-200.32

**Proposed Residential Development**  
**Novatech Project No. 121184**  
**Uncontrolled Runoff - 1:2 YEAR EVENT**  
**AREA OS-2 Un-Controlled Runoff to South Ditch**

OTTAWA IDF CURVE

Area = 0.129 ha      Qallow = 7.6 L/s  
C = 0.28              Vol(max) = 0.0 m3

Time (min)	Intensity (mm/hr)	Q (L/s)	Qnet (L/s)	Vol (m3)
5	103.57	10.25	2.65	0.79
10	76.81	7.60	0.00	0.00
15	61.77	6.11	-1.49	-1.34
20	52.03	5.15	-2.45	-2.94
25	45.17	4.47	-3.13	-4.70
30	40.04	3.96	-3.64	-6.55
35	36.06	3.57	-4.03	-8.47
40	32.86	3.25	-4.35	-10.44
45	30.24	2.99	-4.61	-12.44
50	28.04	2.78	-4.83	-14.48
55	26.17	2.59	-5.01	-16.54
60	24.56	2.43	-5.17	-18.61
65	23.15	2.29	-5.31	-20.71
70	21.91	2.17	-5.43	-22.82
75	20.81	2.06	-5.54	-24.94
90	18.14	1.80	-5.81	-31.35
105	16.13	1.60	-6.00	-37.83
120	14.56	1.44	-6.16	-44.35
135	13.30	1.32	-6.29	-50.91
150	12.25	1.21	-6.39	-57.50

**Proposed Residential Development**  
**Novatech Project No. 121184**  
**Uncontrolled Runoff - 1:5 YEAR EVENT**  
**AREA OS-2 Un-Controlled Runoff to South Ditch**

OTTAWA IDF CURVE

Area = 0.129 ha      Qallow = 10.3 L/s  
C = 0.28              Vol(max) = 0.0 m3

Time (min)	Intensity (mm/hr)	Q (L/s)	Qnet (L/s)	Vol (m3)
5	141.18	13.97	3.66	1.10
10	104.19	10.31	0.00	0.00
15	83.56	8.27	-2.04	-1.84
20	70.25	6.95	-3.36	-4.03
25	60.90	6.03	-4.29	-6.43
30	53.93	5.34	-4.97	-8.95
35	48.52	4.80	-5.51	-11.57
40	44.18	4.37	-5.94	-14.25
45	40.63	4.02	-6.29	-16.99
50	37.65	3.73	-6.59	-19.76
55	35.12	3.48	-6.84	-22.56
60	32.94	3.26	-7.05	-25.39
65	31.04	3.07	-7.24	-28.23
70	29.37	2.91	-7.40	-31.10
75	27.89	2.76	-7.55	-33.98
90	24.29	2.40	-7.91	-42.70
105	21.58	2.14	-8.18	-51.51
120	19.47	1.93	-8.39	-60.37
135	17.76	1.76	-8.55	-69.28
150	16.36	1.62	-8.69	-78.23

**Proposed Residential Development**  
**Novatech Project No. 121184**  
**Uncontrolled Runoff - 1:100 YEAR EVENT**  
**AREA OS-2 Un-Controlled Runoff to South Ditch**

OTTAWA IDF CURVE

Area = 0.129 ha      Qallow = 21.1 L/s  
C = 0.33              Vol(max) = 0.0 m3

Time (min)	Intensity (mm/hr)	Q (L/s)	Qnet (L/s)	Vol (m3)
5	242.70	28.72	7.59	2.28
10	178.56	21.13	0.00	0.00
15	142.89	16.91	-4.22	-3.80
20	119.95	14.20	-6.94	-8.32
25	103.85	12.29	-8.84	-13.26
30	91.87	10.87	-10.26	-18.47
35	82.58	9.77	-11.36	-23.85
40	75.15	8.89	-12.24	-29.37
45	69.05	8.17	-12.96	-34.99
50	63.95	7.57	-13.56	-40.69
55	59.62	7.06	-14.08	-46.45
60	55.89	6.61	-14.52	-52.26
65	52.65	6.23	-14.90	-58.11
70	49.79	5.89	-15.24	-64.00
75	47.26	5.59	-15.54	-69.93
90	41.11	4.87	-16.27	-87.84
105	36.50	4.32	-16.81	-105.92
120	32.89	3.89	-17.24	-124.12
135	30.00	3.55	-17.58	-142.41
150	27.61	3.27	-17.86	-160.78

**Proposed Residential Development**  
**Novatech Project No. 121184**  
**Uncontrolled Runoff - 1:100 YR + 20% IDF Increase**  
**AREA OS-2 Un-Controlled Runoff to South Ditch**

OTTAWA IDF CURVE

Area = 0.129 ha      Qallow = 25.4 L/s  
C = 0.33              Vol(max) = 0.0 m3

Time (min)	Intensity (mm/hr)	Q (L/s)	Qnet (L/s)	Vol (m3)
5	291.24	34.47	9.11	2.73
10	214.27	25.36	0.00	0.00
15	171.47	20.29	-5.06	-4.56
20	143.94	17.03	-8.32	-9.99
25	124.62	14.75	-10.61	-15.92
30	110.24	13.05	-12.31	-22.16
35	99.09	11.73	-13.63	-28.62
40	90.17	10.67	-14.69	-35.25
45	82.86	9.81	-15.55	-41.99
50	76.74	9.08	-16.28	-48.83
55	71.55	8.47	-16.89	-55.74
60	67.07	7.94	-17.42	-62.71
65	63.18	7.48	-17.88	-69.74
70	59.75	7.07	-18.29	-76.81
75	56.71	6.71	-18.65	-83.91
90	49.33	5.84	-19.52	-105.41
105	43.80	5.18	-20.17	-127.10
120	39.47	4.67	-20.69	-148.94
135	36.00	4.26	-21.10	-170.89
150	33.13	3.92	-21.44	-192.93

**Proposed Residential Development**  
**Novatech Project No. 121184**  
**Uncontrolled Runoff - 1:2 YEAR EVENT**  
**AREA A-1 Un-Controlled Runoff to Beaverwood**

OTTAWA IDF CURVE

Area = 0.071 ha      Qallow = 4.4 L/s  
C = 0.29      Vol(max) = 0.0 m3

Time (min)	Intensity (mm/hr)	Q (L/s)	Qnet (L/s)	Vol (m3)
5	103.57	5.90	1.53	0.46
10	76.81	4.38	0.00	0.00
15	61.77	3.52	-0.86	-0.77
20	52.03	2.97	-1.41	-1.69
25	45.17	2.57	-1.80	-2.70
30	40.04	2.28	-2.10	-3.77
35	36.06	2.06	-2.32	-4.88
40	32.86	1.87	-2.50	-6.01
45	30.24	1.72	-2.65	-7.17
50	28.04	1.60	-2.78	-8.34
55	26.17	1.49	-2.89	-9.52
60	24.56	1.40	-2.98	-10.72
65	23.15	1.32	-3.06	-11.93
70	21.91	1.25	-3.13	-13.14
75	20.81	1.19	-3.19	-14.36
90	18.14	1.03	-3.34	-18.05
105	16.13	0.92	-3.46	-21.78
120	14.56	0.83	-3.55	-25.54
135	13.30	0.76	-3.62	-29.32
150	12.25	0.70	-3.68	-33.11

**Proposed Residential Development**  
**Novatech Project No. 121184**  
**Uncontrolled Runoff - 1:5 YEAR EVENT**  
**AREA A-1 Un-Controlled Runoff to Beaverwood**

OTTAWA IDF CURVE

Area = 0.071 ha      Qallow = 5.9 L/s  
C = 0.29      Vol(max) = 0.0 m3

Time (min)	Intensity (mm/hr)	Q (L/s)	Qnet (L/s)	Vol (m3)
5	141.18	8.05	2.11	0.63
10	104.19	5.94	0.00	0.00
15	83.56	4.76	-1.18	-1.06
20	70.25	4.00	-1.93	-2.32
25	60.90	3.47	-2.47	-3.70
30	53.93	3.07	-2.86	-5.16
35	48.52	2.77	-3.17	-6.66
40	44.18	2.52	-3.42	-8.21
45	40.63	2.32	-3.62	-9.78
50	37.65	2.15	-3.79	-11.38
55	35.12	2.00	-3.94	-12.99
60	32.94	1.88	-4.06	-14.62
65	31.04	1.77	-4.17	-16.26
70	29.37	1.67	-4.26	-17.91
75	27.89	1.59	-4.35	-19.57
90	24.29	1.38	-4.55	-24.59
105	21.58	1.23	-4.71	-29.66
120	19.47	1.11	-4.83	-34.77
135	17.76	1.01	-4.93	-39.90
150	16.36	0.93	-5.01	-45.05

**Proposed Residential Development**  
**Novatech Project No. 121184**  
**Uncontrolled Runoff - 1:100 YEAR EVENT**  
**AREA A-1 Un-Controlled Runoff to Beaverwood**

OTTAWA IDF CURVE

Area = 0.071 ha      Qallow = 12.2 L/s  
C = 0.35      Vol(max) = 0.0 m3

Time (min)	Intensity (mm/hr)	Q (L/s)	Qnet (L/s)	Vol (m3)
5	242.70	16.53	4.37	1.31
10	178.56	12.16	0.00	0.00
15	142.89	9.73	-2.43	-2.19
20	119.95	8.17	-3.99	-4.79
25	103.85	7.07	-5.09	-7.63
30	91.87	6.26	-5.90	-10.63
35	82.58	5.62	-6.54	-13.73
40	75.15	5.12	-7.04	-16.90
45	69.05	4.70	-7.46	-20.14
50	63.95	4.36	-7.81	-23.42
55	59.62	4.06	-8.10	-26.73
60	55.89	3.81	-8.35	-30.08
65	52.65	3.59	-8.58	-33.45
70	49.79	3.39	-8.77	-36.84
75	47.26	3.22	-8.94	-40.24
90	41.11	2.80	-9.36	-50.55
105	36.50	2.49	-9.68	-60.96
120	32.89	2.24	-9.92	-71.43
135	30.00	2.04	-10.12	-81.96
150	27.61	1.88	-10.28	-92.53

**Proposed Residential Development**  
**Novatech Project No. 121184**  
**Uncontrolled Runoff - 1:100 YR + 20% IDF Increase**  
**AREA A-1 Un-Controlled Runoff to Beaverwood**

OTTAWA IDF CURVE

Area = 0.071 ha      Qallow = 14.6 L/s  
C = 0.35      Vol(max) = 0.0 m3

Time (min)	Intensity (mm/hr)	Q (L/s)	Qnet (L/s)	Vol (m3)
5	291.24	19.84	5.24	1.57
10	214.27	14.59	0.00	0.00
15	171.47	11.68	-2.91	-2.62
20	143.94	9.80	-4.79	-5.75
25	124.62	8.49	-6.11	-9.16
30	110.24	7.51	-7.09	-12.75
35	99.09	6.75	-7.84	-16.47
40	90.17	6.14	-8.45	-20.29
45	82.86	5.64	-8.95	-24.17
50	76.74	5.23	-9.37	-28.10
55	71.55	4.87	-9.72	-32.08
60	67.07	4.57	-10.03	-36.09
65	63.18	4.30	-10.29	-40.14
70	59.75	4.07	-10.52	-44.20
75	56.71	3.86	-10.73	-48.29
90	49.33	3.36	-11.23	-60.66
105	43.80	2.98	-11.61	-73.15
120	39.47	2.69	-11.91	-85.72
135	36.00	2.45	-12.14	-98.35
150	33.13	2.26	-12.34	-111.04

**Proposed Residential Development Storage Calculations Using Average**  
 Novatech Project No. 121184 Release Rate Equal to 50% of the Qpeak  
**REQUIRED STORAGE - 1:2 YEAR EVENT**

**AREA A-2 Controlled Site Flows + Underground Storage**

OTTAWA IDF CURVE  
 Area = 0.094 ha Qpeak = 1.2 L/s  
 C = 0.68 Qavg = 0.6 L/s  
 Vol(max) = 14.4 m3  
 (Vol calculated for Qallow-avg)

Time (min)	Intensity (mm/hr)	Q (L/s)	Qnet (L/s)	Vol (m3)
5	103.57	18.46	17.86	5.36
10	76.81	13.69	13.09	7.86
15	61.77	11.01	10.41	9.37
20	52.03	9.28	8.68	10.41
25	45.17	8.05	7.45	11.18
30	40.04	7.14	6.54	11.77
35	36.06	6.43	5.83	12.24
40	32.86	5.86	5.26	12.62
45	30.24	5.39	4.79	12.94
50	28.04	5.00	4.40	13.20
55	26.17	4.67	4.07	13.42
60	24.56	4.38	3.78	13.60
65	23.15	4.13	3.53	13.76
70	21.91	3.91	3.31	13.89
75	20.81	3.71	3.11	14.00
90	18.14	3.23	2.63	14.23
105	16.13	2.88	2.28	14.34
120	14.56	2.60	2.00	14.37
135	13.30	2.37	1.77	14.34
150	12.25	2.18	1.58	14.26

**Proposed Residential Development Storage Calculations Using Average**  
 Novatech Project No. 121184 Release Rate Equal to 50% of the Qpeak  
**REQUIRED STORAGE - 1:5 YEAR EVENT**

**AREA A-2 Controlled Site Flows + Underground Storage**

OTTAWA IDF CURVE  
 Area = 0.094 ha Qpeak = 1.4 L/s  
 C = 0.68 Qavg = 0.7 L/s  
 Vol(max) = 20.0 m3  
 (Vol calculated for Qallow-avg)

Time (min)	Intensity (mm/hr)	Q (L/s)	Qnet (L/s)	Vol (m3)
5	141.18	25.17	24.47	7.34
10	104.19	18.58	17.88	10.73
15	83.56	14.90	14.20	12.78
20	70.25	12.52	11.82	14.19
25	60.90	10.86	10.16	15.23
30	53.93	9.61	8.91	16.05
35	48.52	8.65	7.95	16.69
40	44.18	7.88	7.18	17.22
45	40.63	7.24	6.54	17.67
50	37.65	6.71	6.01	18.04
55	35.12	6.26	5.56	18.35
60	32.94	5.87	5.17	18.62
65	31.04	5.53	4.83	18.85
70	29.37	5.24	4.54	19.05
75	27.89	4.97	4.27	19.22
90	24.29	4.33	3.63	19.60
105	21.58	3.85	3.15	19.83
120	19.47	3.47	2.77	19.95
135	17.76	3.17	2.47	19.98
150	16.36	2.92	2.22	19.95

**Proposed Residential Development Storage Calculations Using Average**  
 Novatech Project No. 121184 Release Rate Equal to 50% of the Qpeak  
**REQUIRED STORAGE - 1:100 YEAR EVENT**

**AREA A-2 Controlled Site Flows + Underground Storage**

OTTAWA IDF CURVE  
 Area = 0.094 ha Qpeak = 2.5 L/s  
 C = 0.77 Qavg = 1.3 L/s  
 Vol(max) = 38.6 m3  
 (Vol calculated for Qallow-avg)

Time (min)	Intensity (mm/hr)	Q (L/s)	Qnet (L/s)	Vol (m3)
5	242.70	48.62	47.37	14.21
10	178.56	35.77	34.52	20.71
15	142.89	28.63	27.38	24.64
20	119.95	24.03	22.78	27.34
25	103.85	20.81	19.56	29.33
30	91.87	18.41	17.16	30.88
35	82.58	16.54	15.29	32.12
40	75.15	15.05	13.80	33.13
45	69.05	13.83	12.58	33.98
50	63.95	12.81	11.56	34.69
55	59.62	11.95	10.70	35.29
60	55.89	11.20	9.95	35.81
65	52.65	10.55	9.30	36.26
70	49.79	9.98	8.73	36.65
75	47.26	9.47	8.22	36.98
90	41.11	8.24	6.99	37.73
105	36.50	7.31	6.06	38.19
120	32.89	6.59	5.34	38.45
135	30.00	6.01	4.76	38.55
150	27.61	5.53	4.28	38.53

**Proposed Residential Development Storage Calculations Using Average**  
 Novatech Project No. 121184 Release Rate Equal to 50% of the Qpeak  
**REQUIRED STORAGE - 1:100 YR + 20% IDF Increase**

**AREA A-2 Controlled Site Flows + Underground Storage**

OTTAWA IDF CURVE  
 Area = 0.094 ha Qpeak = 2.5 L/s  
 C = 0.77 Qavg = 1.3 L/s  
 Vol(max) = 48.5 m3  
 (Vol calculated for Qallow-avg)

Time (min)	Intensity (mm/hr)	Q (L/s)	Qnet (L/s)	Vol (m3)
5	291.24	58.35	57.10	17.13
10	214.27	42.93	41.68	25.01
15	171.47	34.35	33.10	29.79
20	143.94	28.84	27.59	33.11
25	124.62	24.97	23.72	35.57
30	110.24	22.09	20.84	37.51
35	99.09	19.85	18.60	39.07
40	90.17	18.07	16.82	40.36
45	82.86	16.60	15.35	41.45
50	76.74	15.38	14.13	42.38
55	71.55	14.33	13.08	43.18
60	67.07	13.44	12.19	43.88
65	63.18	12.66	11.41	44.49
70	59.75	11.97	10.72	45.02
75	56.71	11.36	10.11	45.50
90	49.33	9.88	8.63	46.62
105	43.80	8.77	7.52	47.40
120	39.47	7.91	6.66	47.94
135	36.00	7.21	5.96	48.29
150	33.13	6.64	5.39	48.49

Structures	Size (mm)	Area (m²)	T/G	Inv IN	Inv OUT
CBMH 102	1829	2.63	91.04	89.65	89.15
CBMH 101	1829	2.63	90.90	89.08	88.98

**Area A-2: Storage Table**

Elevation (m)	System Depth (m)	CBMH 102 Volume (m³)	Volume (m³)	CBMH 101 Volume (m³)	Combined Volume (m³)	Surface Storage				Total Storage	
						CBMH 102		CBMH 101		Ponding Volume (m³)	Total Volume (m³)
						Area (m²)	Volume (m³)	Area (m²)	Volume (m³)		
88.98	-	-	0.00	0.00	0.00	-	-	-	-	-	0
89.15	0.00	0.00	0.00	0.45	2.34	-	-	-	-	-	2.3
89.35	0.20	0.53	0.00	0.97	8.76	-	-	-	-	-	8.8
89.60	0.45	1.18	0.00	1.63	17.34	-	-	-	-	-	17.3
89.80	0.65	1.71	0.00	2.15	23.33	-	-	-	-	-	23.3
90.15	1.00	2.63	0.00	3.07	34.76	-	-	-	-	-	34.8
90.25	1.10	2.89	0.00	3.34	35.29	-	-	-	-	-	35.3
90.35	1.20	3.15	0.00	3.60	35.81	-	-	0.0	0.0	0.0	35.8
90.60	1.45	3.81	0.00	4.26	37.13	-	-	0.00	0.00	0.0	37.1
90.75	1.60	4.20	1.00	4.65	37.91	-	-	0.00	0.00	0.0	37.9
90.90	1.75	4.60	2.00	5.04	38.70	-	-	0.00	0.00	0.0	38.7

PI = 3.141592654  
 PIPE I.D.= 1067 (Concrete Pipe) 991 1067 1220  
**U/G Storage Pipe Volume**  
 End Area 0.894 (m²)  
 Total Length 32.5 (m)  
 Pipe Volume 29.1 (m³)

U/G Pipe Size	975mm dia.
Pipe Segment	CBMH 102 - CBMH 101
Centre-Centre Length	33.8
Inside Structure	1.3
U/G Storage Length	32.5

**Design Head**

Maximum Ponding Depths (cm)	(cm)
1:100 Yr	-1
1:5 Yr	-122
1:2 Yr	-140

**Tempest Vortex LMF Model 75 ICD**

**1:100 Yr**  
 Flow (L/s) = 2.5  
 Head (m) = 1.81  
 Elevation (m) = 90.89  
 Outlet Pipe Dia.(mm) = 203  
 Volume (m³) = 38.6

**1:5 Yr**  
 Flow (L/s) = 1.4  
 Head (m) = 0.60  
 Elevation (m) = 89.68  
 Outlet Pipe Dia.(mm) = 203  
 Volume (m³) = 20.0

**1:2 Yr**  
 Flow (L/s) = 1.2  
 Head (m) = 0.42  
 Elevation (m) = 89.50  
 Outlet Pipe Dia.(mm) = 203  
 Volume (m³) = 14.4

**Orifice Size - 1:100 yr Flow Check**  
 $Q = 0.62 \times A \times \sqrt{2gh} \times 0.5$

1:100 yr	Flow Check
Q (m³/s) = 0.0025	<b>0.0024</b>
g (m/s²) = 9.81	9.81
h (m) = 1.81	1.81
A (m²) = 0.000676923	<b>0.00066</b>
D (m) = 0.02935789	<b>0.02900</b>
D (mm) = 29	29.0

**1:5 yr Flow Check**

1:5 yr
Q (m³/s) = 0.0014
g (m/s²) = 9.81
h (m) = 0.60
A (m²) = 0.00066
D (m) = 0.029
D (mm) = 29

**1:2 yr Flow Check**

1:2 yr
Q (m³/s) = 0.0012
g (m/s²) = 9.81
h (m) = 0.42
A (m²) = 0.00066
D (m) = 0.029
D (mm) = 29

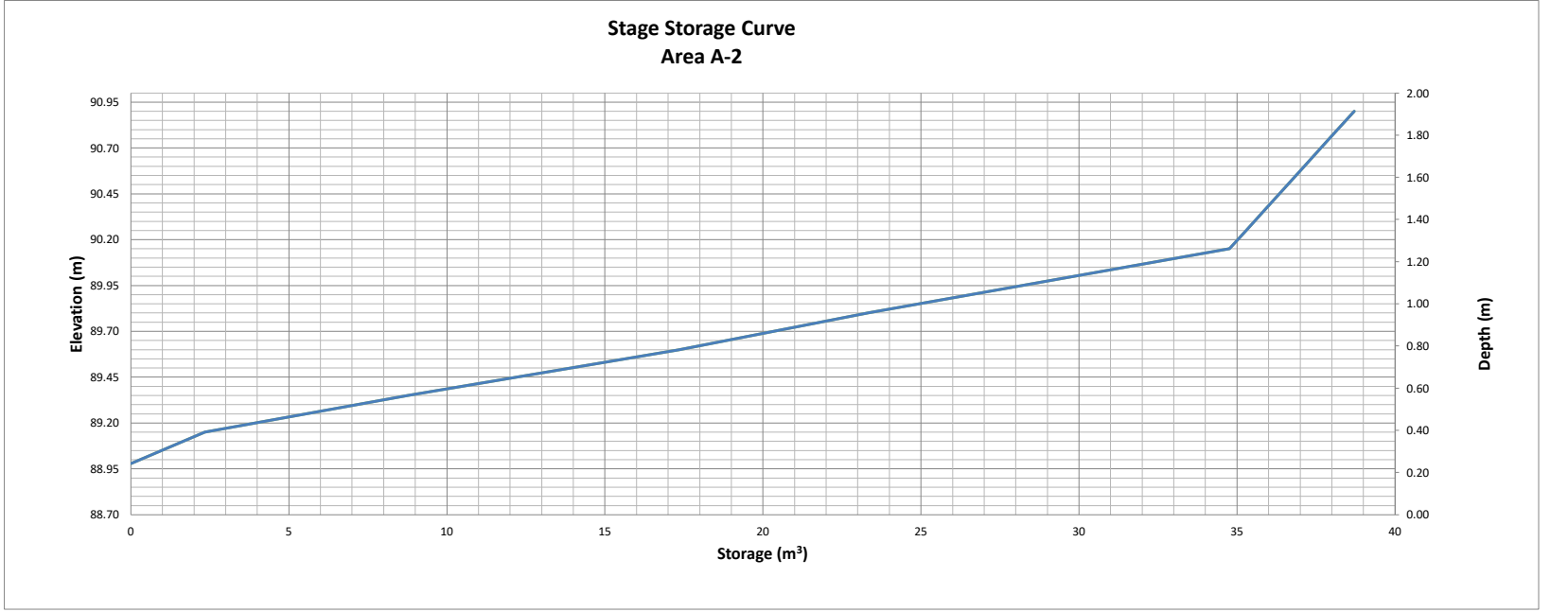

Proposed Residential Development					
Novatech Project No. 121184					
REQUIRED STORAGE - 1:2 YEAR EVENT					
AREA R-1		Controlled Roof Drain #1			
OTTAWA IDF CURVE					
Area =	0.018	ha	Qallow =	0.32	L/s
C =	0.90		Vol(max) =	2.8	m3
Time (min)	Intensity (mm/hr)	Q (L/s)	Qnet (L/s)	Vol (m3)	
5	103.57	4.66	4.34	1.30	
10	76.81	3.46	3.14	1.88	
15	61.77	2.78	2.46	2.22	
20	52.03	2.34	2.02	2.43	
25	45.17	2.03	1.71	2.57	
30	40.04	1.80	1.48	2.67	
35	36.06	1.62	1.30	2.74	
40	32.86	1.48	1.16	2.78	
45	30.24	1.36	1.04	2.81	
50	28.04	1.26	0.94	2.83	
55	26.17	1.18	0.86	2.83	
60	24.56	1.11	0.79	2.83	
65	23.15	1.04	0.72	2.82	
70	21.91	0.99	0.67	2.80	
75	20.81	0.94	0.62	2.78	
90	18.14	0.82	0.50	2.68	
105	16.13	0.73	0.41	2.56	
120	14.56	0.66	0.34	2.42	

Proposed Residential Development					
Novatech Project No. 121184					
REQUIRED STORAGE - 1:5 YEAR EVENT					
AREA R-1		Controlled Roof Drain #1			
OTTAWA IDF CURVE					
Area =	0.018	ha	Qallow =	0.32	L/s
C =	0.90		Vol(max) =	4.2	m3
Time (min)	Intensity (mm/hr)	Q (L/s)	Qnet (L/s)	Vol (m3)	
5	141.18	6.36	6.04	1.81	
10	104.19	4.69	4.37	2.62	
15	83.56	3.76	3.44	3.10	
20	70.25	3.16	2.84	3.41	
25	60.90	2.74	2.42	3.63	
30	53.93	2.43	2.11	3.80	
35	48.52	2.19	1.87	3.92	
40	44.18	1.99	1.67	4.01	
45	40.63	1.83	1.51	4.08	
50	37.65	1.70	1.38	4.13	
55	35.12	1.58	1.26	4.16	
60	32.94	1.48	1.16	4.19	
65	31.04	1.40	1.08	4.20	
70	29.37	1.32	1.00	4.21	
75	27.89	1.26	0.94	4.21	
90	24.29	1.09	0.77	4.18	
105	21.58	0.97	0.65	4.11	
120	19.47	0.88	0.56	4.01	

Watts Accutrol Flow Control Roof Drains: RD-100-A-ADJ set to Closed					
Design Event	Flow/Drain (L/s)	Total Flow (L/s)	Ponding (cm)	Storage (m <sup>3</sup> )	
				Required	Provided
1:2 Year	0.32	0.32	7	2.8	
1:5 Year	0.32	0.32	8	4.2	14.9
1:100 Year	0.32	0.32	12	9.5	

Roof Drain Storage Table for Area RD 1		
Elevation	Area RD 1	Total Volume
m	m <sup>2</sup>	m <sup>3</sup>
0.00	0	0
0.05	41.94	1.0
0.10	170.383	6.4
0.15	170.383	14.9

Proposed Residential Development					
Novatech Project No. 121184					
REQUIRED STORAGE - 1:100 YEAR EVENT					
AREA R-1		Controlled Roof Drain #1			
OTTAWA IDF CURVE					
Area =	0.018	ha	Qallow =	0.32	L/s
C =	1.00		Vol(max) =	9.5	m3
Time (min)	Intensity (mm/hr)	Q (L/s)	Qnet (L/s)	Vol (m3)	
5	242.70	12.14	11.82	3.55	
10	178.56	8.94	8.62	5.17	
15	142.89	7.15	6.83	6.15	
20	119.95	6.00	5.68	6.82	
25	103.85	5.20	4.88	7.31	
30	91.87	4.60	4.28	7.70	
35	82.58	4.13	3.81	8.01	
40	75.15	3.76	3.44	8.26	
45	69.05	3.46	3.14	8.47	
50	63.95	3.20	2.88	8.64	
55	59.62	2.98	2.66	8.79	
60	55.89	2.80	2.48	8.92	
65	52.65	2.63	2.31	9.03	
70	49.79	2.49	2.17	9.12	
75	47.26	2.36	2.04	9.20	
90	41.11	2.06	1.74	9.38	
105	36.50	1.83	1.51	9.49	
120	32.89	1.65	1.33	9.55	

Proposed Residential Development					
Novatech Project No. 121184					
REQUIRED STORAGE - 1:100 YEAR + 20%					
AREA R-1		Controlled Roof Drain #1			
OTTAWA IDF CURVE					
Area =	0.018	ha	Qallow =	0.32	L/s
C =	1.00		Vol(max) =	11.9	m3
Time (min)	Intensity (mm/hr)	Q (L/s)	Qnet (L/s)	Vol (m3)	
5	291.24	14.57	14.25	4.28	
10	214.27	10.72	10.40	6.24	
15	171.47	8.58	8.26	7.43	
20	143.94	7.20	6.88	8.26	
25	124.62	6.24	5.92	8.87	
30	110.24	5.52	5.20	9.35	
35	99.09	4.96	4.64	9.74	
40	90.17	4.51	4.19	10.06	
45	82.86	4.15	3.83	10.33	
50	76.74	3.84	3.52	10.56	
55	71.55	3.58	3.26	10.76	
60	67.07	3.36	3.04	10.93	
65	63.18	3.16	2.84	11.08	
70	59.75	2.99	2.67	11.21	
75	56.71	2.84	2.52	11.33	
90	49.33	2.47	2.15	11.60	
105	43.80	2.19	1.87	11.79	
120	39.47	1.98	1.66	11.92	

Stage Storage Curve: Area R-1  
Controlled Roof Drain #1

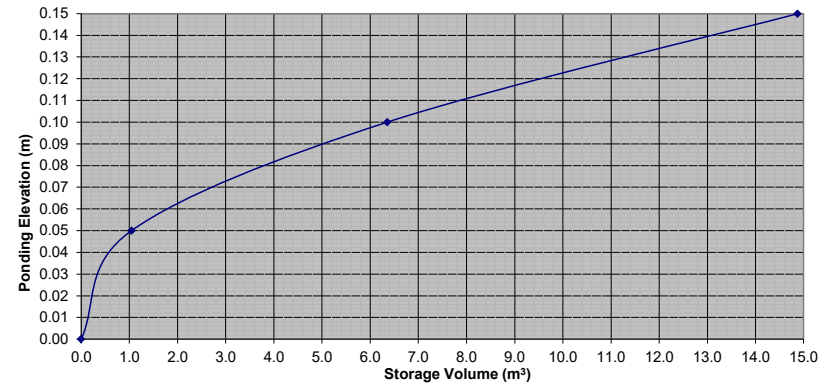

Proposed Residential Development					
Novatech Project No. 121184					
REQUIRED STORAGE - 1:2 YEAR EVENT					
AREA R-1			Controlled Roof Drain #2		
OTTAWA IDF CURVE					
Area = 0.018 ha		Qallow = 0.32 L/s			
C = 0.90		Vol(max) = 2.7 m3			
Time (min)	Intensity (mm/hr)	Q (L/s)	Qnet (L/s)	Vol (m3)	
5	103.57	4.56	4.24	1.27	
10	76.81	3.38	3.06	1.84	
15	61.77	2.72	2.40	2.16	
20	52.03	2.29	1.97	2.37	
25	45.17	1.99	1.67	2.50	
30	40.04	1.76	1.44	2.60	
35	36.06	1.59	1.27	2.66	
40	32.86	1.45	1.13	2.71	
45	30.24	1.33	1.01	2.73	
50	28.04	1.23	0.91	2.74	
55	26.17	1.15	0.83	2.75	
60	24.56	1.08	0.76	2.74	
65	23.15	1.02	0.70	2.73	
70	21.91	0.96	0.64	2.71	
75	20.81	0.92	0.60	2.68	
90	18.14	0.80	0.48	2.59	
105	16.13	0.71	0.39	2.46	
120	14.56	0.64	0.32	2.31	

Proposed Residential Development					
Novatech Project No. 121184					
REQUIRED STORAGE - 1:5 YEAR EVENT					
AREA R-1			Controlled Roof Drain #2		
OTTAWA IDF CURVE					
Area = 0.018 ha		Qallow = 0.32 L/s			
C = 0.90		Vol(max) = 4.1 m3			
Time (min)	Intensity (mm/hr)	Q (L/s)	Qnet (L/s)	Vol (m3)	
5	141.18	6.22	5.90	1.77	
10	104.19	4.59	4.27	2.56	
15	83.56	3.68	3.36	3.02	
20	70.25	3.09	2.77	3.33	
25	60.90	2.68	2.36	3.54	
30	53.93	2.37	2.05	3.70	
35	48.52	2.14	1.82	3.81	
40	44.18	1.95	1.63	3.90	
45	40.63	1.79	1.47	3.97	
50	37.65	1.66	1.34	4.01	
55	35.12	1.55	1.23	4.05	
60	32.94	1.45	1.13	4.07	
65	31.04	1.37	1.05	4.08	
70	29.37	1.29	0.97	4.09	
75	27.89	1.23	0.91	4.09	
90	24.29	1.07	0.75	4.05	
105	21.58	0.95	0.63	3.97	
120	19.47	0.86	0.54	3.87	

Watts Accutrol Flow Control Roof Drains: RD-100-A-ADJ set to Closed					
Design Event	Flow/Drain (L/s)	Total Flow (L/s)	Ponding (cm)	Storage (m <sup>3</sup> )	
				Required	Provided
1:2 Year	0.32	0.32	7	2.7	
1:5 Year	0.32	0.32	8	4.1	14.6
1:100 Year	0.32	0.32	12	9.3	

Roof Drain Storage Table for Area RD 2		
Elevation	Area RD 1	Total Volume
m	m <sup>2</sup>	m <sup>3</sup>
0.00	0	0
0.05	41	1.0
0.10	167.27	6.2
0.15	167.27	14.6

Proposed Residential Development					
Novatech Project No. 121184					
REQUIRED STORAGE - 1:100 YEAR EVENT					
AREA R-1			Controlled Roof Drain #2		
OTTAWA IDF CURVE					
Area = 0.018 ha		Qallow = 0.32 L/s			
C = 1.00		Vol(max) = 9.3 m3			
Time (min)	Intensity (mm/hr)	Q (L/s)	Qnet (L/s)	Vol (m3)	
5	242.70	11.88	11.56	3.47	
10	178.56	8.74	8.42	5.05	
15	142.89	6.99	6.67	6.00	
20	119.95	5.87	5.55	6.66	
25	103.85	5.08	4.76	7.14	
30	91.87	4.49	4.17	7.51	
35	82.58	4.04	3.72	7.81	
40	75.15	3.68	3.36	8.06	
45	69.05	3.38	3.06	8.26	
50	63.95	3.13	2.81	8.43	
55	59.62	2.92	2.60	8.57	
60	55.89	2.73	2.41	8.69	
65	52.65	2.58	2.26	8.80	
70	49.79	2.44	2.12	8.89	
75	47.26	2.31	1.99	8.96	
90	41.11	2.01	1.69	9.13	
105	36.50	1.79	1.47	9.23	
120	32.89	1.61	1.29	9.28	

Proposed Residential Development					
Novatech Project No. 121184					
REQUIRED STORAGE - 1:100 YEAR + 20%					
AREA R-1			Controlled Roof Drain #2		
OTTAWA IDF CURVE					
Area = 0.018 ha		Qallow = 0.32 L/s			
C = 1.00		Vol(max) = 11.6 m3			
Time (min)	Intensity (mm/hr)	Q (L/s)	Qnet (L/s)	Vol (m3)	
5	291.24	14.25	13.93	4.18	
10	214.27	10.48	10.16	6.10	
15	171.47	8.39	8.07	7.26	
20	143.94	7.04	6.72	8.07	
25	124.62	6.10	5.78	8.67	
30	110.24	5.39	5.07	9.13	
35	99.09	4.85	4.53	9.51	
40	90.17	4.41	4.09	9.82	
45	82.86	4.05	3.73	10.08	
50	76.74	3.75	3.43	10.30	
55	71.55	3.50	3.18	10.50	
60	67.07	3.28	2.96	10.66	
65	63.18	3.09	2.77	10.81	
70	59.75	2.92	2.60	10.93	
75	56.71	2.77	2.45	11.05	
90	49.33	2.41	2.09	11.31	
105	43.80	2.14	1.82	11.48	
120	39.47	1.93	1.61	11.60	

Stage Storage Curve: Area R-1  
Controlled Roof Drain #2

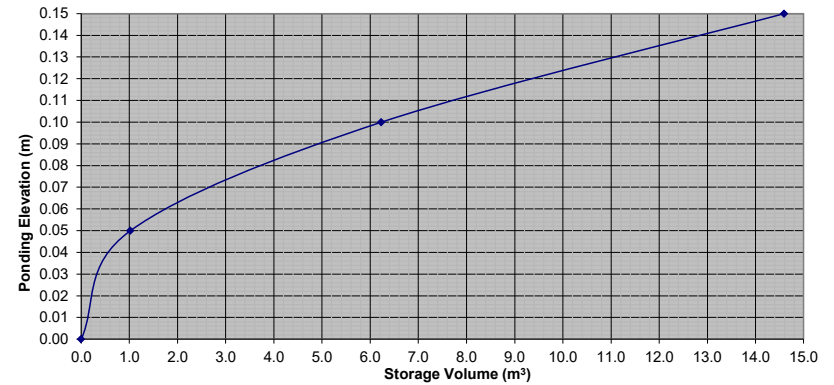

Proposed Residential Development					
Novatech Project No. 121184					
REQUIRED STORAGE - 1:2 YEAR EVENT					
AREA R-1		Controlled Roof Drain #3			
OTTAWA IDF CURVE					
Area =	0.005	ha	Qallow =	0.32	L/s
C =	0.90		Vol(max) =	0.4	m3
Time (min)	Intensity (mm/hr)	Q (L/s)	Qnet (L/s)	Vol (m3)	
5	103.57	1.27	0.95	0.28	
10	76.81	0.94	0.62	0.37	
15	61.77	0.76	0.44	0.39	
20	52.03	0.64	0.32	0.38	
25	45.17	0.55	0.23	0.35	
30	40.04	0.49	0.17	0.31	
35	36.06	0.44	0.12	0.26	
40	32.86	0.40	0.08	0.20	
45	30.24	0.37	0.05	0.14	
50	28.04	0.34	0.02	0.07	
55	26.17	0.32	0.00	0.00	
60	24.56	0.30	-0.02	-0.07	
65	23.15	0.28	-0.04	-0.14	
70	21.91	0.27	-0.05	-0.22	
75	20.81	0.26	-0.06	-0.29	
90	18.14	0.22	-0.10	-0.53	
105	16.13	0.20	-0.12	-0.77	
120	14.56	0.18	-0.14	-1.02	

Proposed Residential Development					
Novatech Project No. 121184					
REQUIRED STORAGE - 1:5 YEAR EVENT					
AREA R-1		Controlled Roof Drain #3			
OTTAWA IDF CURVE					
Area =	0.005	ha	Qallow =	0.32	L/s
C =	0.90		Vol(max) =	0.6	m3
Time (min)	Intensity (mm/hr)	Q (L/s)	Qnet (L/s)	Vol (m3)	
5	141.18	1.73	1.41	0.42	
10	104.19	1.28	0.96	0.57	
15	83.56	1.02	0.70	0.63	
20	70.25	0.86	0.54	0.65	
25	60.90	0.75	0.43	0.64	
30	53.93	0.66	0.34	0.61	
35	48.52	0.59	0.27	0.58	
40	44.18	0.54	0.22	0.53	
45	40.63	0.50	0.18	0.48	
50	37.65	0.46	0.14	0.42	
55	35.12	0.43	0.11	0.36	
60	32.94	0.40	0.08	0.30	
65	31.04	0.38	0.06	0.24	
70	29.37	0.36	0.04	0.17	
75	27.89	0.34	0.02	0.10	
90	24.29	0.30	-0.02	-0.12	
105	21.58	0.26	-0.06	-0.35	
120	19.47	0.24	-0.08	-0.59	

Watts Accutrol Flow Control Roof Drains: RD-100-A-ADJ set to Closed					
Design Event	Flow/Drain (L/s)	Total Flow (L/s)	Ponding (cm)	Storage (m <sup>3</sup> )	
				Required	Provided
1:2 Year	0.32	0.32	6	0.4	
1:5 Year	0.32	0.32	7	0.6	3.9
1:100 Year	0.32	0.32	10	1.7	

Roof Drain Storage Table for Area RD 3		
Elevation	Area RD 1	Total Volume
m	m <sup>2</sup>	m <sup>3</sup>
0.00	0	0
0.05	11.3	0.3
0.10	44.41	1.7
0.15	44.41	3.9

Proposed Residential Development					
Novatech Project No. 121184					
REQUIRED STORAGE - 1:100 YEAR EVENT					
AREA R-1		Controlled Roof Drain #3			
OTTAWA IDF CURVE					
Area =	0.005	ha	Qallow =	0.32	L/s
C =	1.00		Vol(max) =	1.7	m3
Time (min)	Intensity (mm/hr)	Q (L/s)	Qnet (L/s)	Vol (m3)	
5	242.70	3.31	2.99	0.90	
10	178.56	2.43	2.11	1.27	
15	142.89	1.95	1.63	1.46	
20	119.95	1.63	1.31	1.58	
25	103.85	1.41	1.09	1.64	
30	91.87	1.25	0.93	1.68	
35	82.58	1.12	0.80	1.69	
40	75.15	1.02	0.70	1.69	
45	69.05	0.94	0.62	1.68	
50	63.95	0.87	0.55	1.65	
55	59.62	0.81	0.49	1.62	
60	55.89	0.76	0.44	1.59	
65	52.65	0.72	0.40	1.55	
70	49.79	0.68	0.36	1.50	
75	47.26	0.64	0.32	1.46	
90	41.11	0.56	0.24	1.30	
105	36.50	0.50	0.18	1.12	
120	32.89	0.45	0.13	0.92	

Proposed Residential Development					
Novatech Project No. 121184					
REQUIRED STORAGE - 1:100 YEAR + 20%					
AREA R-1		Controlled Roof Drain #3			
OTTAWA IDF CURVE					
Area =	0.005	ha	Qallow =	0.32	L/s
C =	1.00		Vol(max) =	2.2	m3
Time (min)	Intensity (mm/hr)	Q (L/s)	Qnet (L/s)	Vol (m3)	
5	291.24	3.97	3.65	1.09	
10	214.27	2.92	2.60	1.56	
15	171.47	2.34	2.02	1.81	
20	143.94	1.96	1.64	1.97	
25	124.62	1.70	1.38	2.07	
30	110.24	1.50	1.18	2.13	
35	99.09	1.35	1.03	2.16	
40	90.17	1.23	0.91	2.18	
45	82.86	1.13	0.81	2.18	
50	76.74	1.05	0.73	2.18	
55	71.55	0.97	0.65	2.16	
60	67.07	0.91	0.59	2.14	
65	63.18	0.86	0.54	2.11	
70	59.75	0.81	0.49	2.07	
75	56.71	0.77	0.45	2.04	
90	49.33	0.67	0.35	1.90	
105	43.80	0.60	0.28	1.74	
120	39.47	0.54	0.22	1.57	

Stage Storage Curve: Area R-1  
Controlled Roof Drain #3

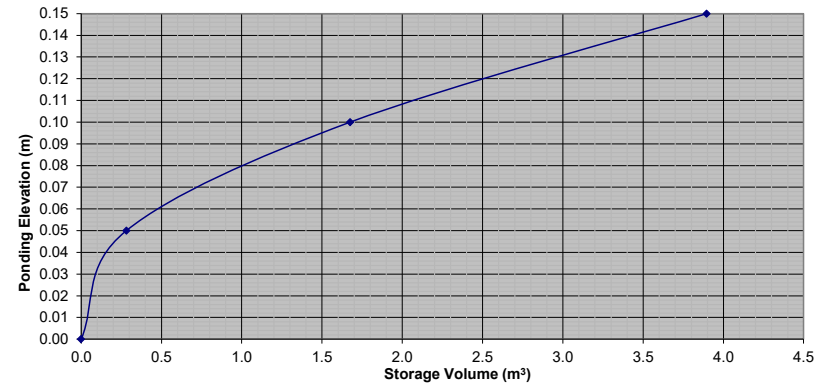



Proposed Residential Development					
Novatech Project No. 121184					
REQUIRED STORAGE - 1:2 YEAR EVENT					
AREA R-1		Controlled Roof Drain #4			
OTTAWA IDF CURVE					
Area =	0.013	ha	Qallow =	0.95	L/s
C =	0.90		Vol(max) =	0.9	m3
Time (min)	Intensity (mm/hr)	Q (L/s)	Qnet (L/s)	Vol (m3)	
5	103.57	3.34	2.39	0.72	
10	76.81	2.48	1.53	0.92	
15	61.77	1.99	1.04	0.94	
20	52.03	1.68	0.73	0.88	
25	45.17	1.46	0.51	0.76	
30	40.04	1.29	0.34	0.62	
35	36.06	1.16	0.21	0.45	
40	32.86	1.06	0.11	0.27	
45	30.24	0.98	0.03	0.07	
50	28.04	0.91	-0.04	-0.13	
55	26.17	0.84	-0.11	-0.35	
60	24.56	0.79	-0.16	-0.57	
65	23.15	0.75	-0.20	-0.79	
70	21.91	0.71	-0.24	-1.02	
75	20.81	0.67	-0.28	-1.25	
90	18.14	0.59	-0.36	-1.97	
105	16.13	0.52	-0.43	-2.70	
120	14.56	0.47	-0.48	-3.46	

Proposed Residential Development					
Novatech Project No. 121184					
REQUIRED STORAGE - 1:5 YEAR EVENT					
AREA R-1		Controlled Roof Drain #4			
OTTAWA IDF CURVE					
Area =	0.013	ha	Qallow =	1.26	L/s
C =	0.90		Vol(max) =	1.3	m3
Time (min)	Intensity (mm/hr)	Q (L/s)	Qnet (L/s)	Vol (m3)	
5	141.18	4.56	3.30	0.99	
10	104.19	3.36	2.10	1.26	
15	83.56	2.70	1.44	1.29	
20	70.25	2.27	1.01	1.21	
25	60.90	1.97	0.71	1.06	
30	53.93	1.74	0.48	0.87	
35	48.52	1.57	0.31	0.64	
40	44.18	1.43	0.17	0.40	
45	40.63	1.31	0.05	0.14	
50	37.65	1.22	-0.04	-0.13	
55	35.12	1.13	-0.13	-0.42	
60	32.94	1.06	-0.20	-0.71	
65	31.04	1.00	-0.26	-1.01	
70	29.37	0.95	-0.31	-1.31	
75	27.89	0.90	-0.36	-1.62	
90	24.29	0.78	-0.48	-2.57	
105	21.58	0.70	-0.56	-3.55	
120	19.47	0.63	-0.63	-4.55	

Watts Accutrol Flow Control Roof Drains: RD-100-A-ADJ set to Fully Exposed					
Design Event	Flow/Drain (L/s)	Total Flow (L/s)	Ponding (cm)	Storage (m <sup>3</sup> )	
				Required	Provided
1:2 Year	0.95	0.95	8	0.9	
1:5 Year	1.26	1.26	10	1.3	3.3
1:100 Year	1.73	1.73	14	3.1	

Roof Drain Storage Table for Area RD 4		
Elevation	Area RD 1	Total Volume
m	m <sup>2</sup>	m <sup>3</sup>
0.00	0	0
0.05	11.07	0.3
0.10	36.99	1.5
0.15	36.99	3.3

Proposed Residential Development					
Novatech Project No. 121184					
REQUIRED STORAGE - 1:100 YEAR EVENT					
AREA R-1		Controlled Roof Drain #4			
OTTAWA IDF CURVE					
Area =	0.013	ha	Qallow =	1.73	L/s
C =	1.00		Vol(max) =	3.1	m3
Time (min)	Intensity (mm/hr)	Q (L/s)	Qnet (L/s)	Vol (m3)	
5	242.70	8.70	6.97	2.09	
10	178.56	6.40	4.67	2.80	
15	142.89	5.12	3.39	3.06	
20	119.95	4.30	2.57	3.09	
25	103.85	3.72	1.99	2.99	
30	91.87	3.29	1.56	2.82	
35	82.58	2.96	1.23	2.59	
40	75.15	2.69	0.96	2.32	
45	69.05	2.48	0.75	2.01	
50	63.95	2.29	0.56	1.69	
55	59.62	2.14	0.41	1.35	
60	55.89	2.00	0.27	0.99	
65	52.65	1.89	0.16	0.62	
70	49.79	1.79	0.06	0.23	
75	47.26	1.69	-0.04	-0.16	
90	41.11	1.47	-0.26	-1.38	
105	36.50	1.31	-0.42	-2.65	
120	32.89	1.18	-0.55	-3.96	

Proposed Residential Development					
Novatech Project No. 121184					
REQUIRED STORAGE - 1:100 YEAR + 20%					
AREA R-1		Controlled Roof Drain #4			
OTTAWA IDF CURVE					
Area =	0.013	ha	Qallow =	1.73	L/s
C =	1.00		Vol(max) =	4.1	m3
Time (min)	Intensity (mm/hr)	Q (L/s)	Qnet (L/s)	Vol (m3)	
5	291.24	10.44	8.71	2.61	
10	214.27	7.68	5.95	3.57	
15	171.47	6.15	4.42	3.98	
20	143.94	5.16	3.43	4.12	
25	124.62	4.47	2.74	4.11	
30	110.24	3.95	2.22	4.00	
35	99.09	3.55	1.82	3.83	
40	90.17	3.23	1.50	3.61	
45	82.86	2.97	1.24	3.35	
50	76.74	2.75	1.02	3.07	
55	71.55	2.57	0.84	2.76	
60	67.07	2.41	0.68	2.43	
65	63.18	2.27	0.54	2.09	
70	59.75	2.14	0.41	1.73	
75	56.71	2.03	0.30	1.37	
90	49.33	1.77	0.04	0.21	
105	43.80	1.57	-0.16	-1.00	
120	39.47	1.42	-0.31	-2.26	

Stage Storage Curve: Area R-1  
Controlled Roof Drain #4

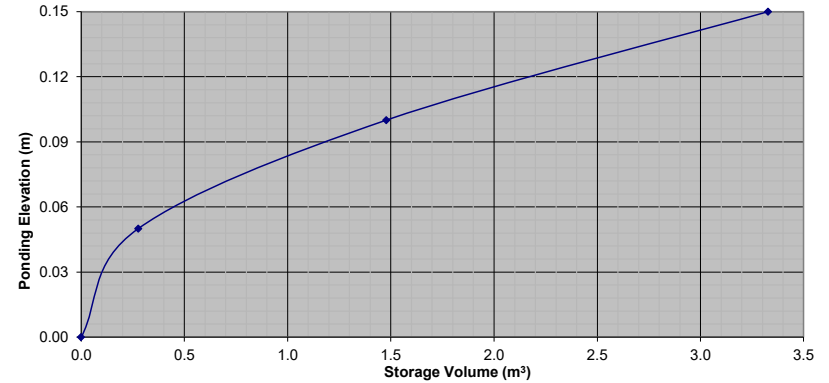

Proposed Residential Development					
Novatech Project No. 121184					
REQUIRED STORAGE - 1:2 YEAR EVENT					
AREA R-1 Controlled Roof Drain #5					
OTTAWA IDF CURVE					
Area =	0.017	ha	Qallow =	0.32	L/s
C =	0.90		Vol(max) =	2.6	m3
Time (min)	Intensity (mm/hr)	Q (L/s)	Qnet (L/s)	Vol (m3)	
5	103.57	4.41	4.09	1.23	
10	76.81	3.27	2.95	1.77	
15	61.77	2.63	2.31	2.08	
20	52.03	2.21	1.89	2.27	
25	45.17	1.92	1.60	2.40	
30	40.04	1.70	1.38	2.49	
35	36.06	1.53	1.21	2.55	
40	32.86	1.40	1.08	2.59	
45	30.24	1.29	0.97	2.61	
50	28.04	1.19	0.87	2.62	
55	26.17	1.11	0.79	2.62	
60	24.56	1.04	0.72	2.61	
65	23.15	0.98	0.66	2.59	
70	21.91	0.93	0.61	2.57	
75	20.81	0.89	0.57	2.54	
90	18.14	0.77	0.45	2.44	
105	16.13	0.69	0.37	2.31	
120	14.56	0.62	0.30	2.16	

Proposed Residential Development					
Novatech Project No. 121184					
REQUIRED STORAGE - 1:5 YEAR EVENT					
AREA R-1 Controlled Roof Drain #5					
OTTAWA IDF CURVE					
Area =	0.017	ha	Qallow =	0.32	L/s
C =	0.90		Vol(max) =	3.9	m3
Time (min)	Intensity (mm/hr)	Q (L/s)	Qnet (L/s)	Vol (m3)	
5	141.18	6.00	5.68	1.71	
10	104.19	4.43	4.11	2.47	
15	83.56	3.55	3.23	2.91	
20	70.25	2.99	2.67	3.20	
25	60.90	2.59	2.27	3.41	
30	53.93	2.29	1.97	3.55	
35	48.52	2.06	1.74	3.66	
40	44.18	1.88	1.56	3.74	
45	40.63	1.73	1.41	3.80	
50	37.65	1.60	1.28	3.84	
55	35.12	1.49	1.17	3.87	
60	32.94	1.40	1.08	3.89	
65	31.04	1.32	1.00	3.90	
70	29.37	1.25	0.93	3.90	
75	27.89	1.19	0.87	3.90	
90	24.29	1.03	0.71	3.85	
105	21.58	0.92	0.60	3.77	
120	19.47	0.83	0.51	3.66	

Watts Accutrol Flow Control Roof Drains: RD-100-A-ADJ set to Closed					
Design Event	Flow/Drain (L/s)	Total Flow (L/s)	Ponding (cm)	Storage (m <sup>3</sup> )	
				Required	Provided
1:2 Year	0.32	0.32	7	2.6	
1:5 Year	0.32	0.32	8	3.9	13.8
1:100 Year	0.32	0.32	12	8.9	

Roof Drain Storage Table for Area RD 5		
Elevation	Area RD 1	Total Volume
m	m <sup>2</sup>	m <sup>3</sup>
0.00	0	0
0.05	39.36	1.0
0.10	157.73	5.9
0.15	157.73	13.8

Proposed Residential Development					
Novatech Project No. 121184					
REQUIRED STORAGE - 1:100 YEAR EVENT					
AREA R-1 Controlled Roof Drain #5					
OTTAWA IDF CURVE					
Area =	0.017	ha	Qallow =	0.32	L/s
C =	1.00		Vol(max) =	8.9	m3
Time (min)	Intensity (mm/hr)	Q (L/s)	Qnet (L/s)	Vol (m3)	
5	242.70	11.47	11.15	3.35	
10	178.56	8.44	8.12	4.87	
15	142.89	6.75	6.43	5.79	
20	119.95	5.67	5.35	6.42	
25	103.85	4.91	4.59	6.88	
30	91.87	4.34	4.02	7.24	
35	82.58	3.90	3.58	7.52	
40	75.15	3.55	3.23	7.76	
45	69.05	3.26	2.94	7.95	
50	63.95	3.02	2.70	8.11	
55	59.62	2.82	2.50	8.24	
60	55.89	2.64	2.32	8.36	
65	52.65	2.49	2.17	8.46	
70	49.79	2.35	2.03	8.54	
75	47.26	2.23	1.91	8.61	
90	41.11	1.94	1.62	8.76	
105	36.50	1.72	1.40	8.85	
120	32.89	1.55	1.23	8.89	

Proposed Residential Development					
Novatech Project No. 121184					
REQUIRED STORAGE - 1:100 YEAR + 20%					
AREA R-1 Controlled Roof Drain #5					
OTTAWA IDF CURVE					
Area =	0.017	ha	Qallow =	0.32	L/s
C =	1.00		Vol(max) =	11.1	m3
Time (min)	Intensity (mm/hr)	Q (L/s)	Qnet (L/s)	Vol (m3)	
5	291.24	13.76	13.44	4.03	
10	214.27	10.13	9.81	5.88	
15	171.47	8.10	7.78	7.01	
20	143.94	6.80	6.48	7.78	
25	124.62	5.89	5.57	8.35	
30	110.24	5.21	4.89	8.80	
35	99.09	4.68	4.36	9.16	
40	90.17	4.26	3.94	9.46	
45	82.86	3.92	3.60	9.71	
50	76.74	3.63	3.31	9.92	
55	71.55	3.38	3.06	10.10	
60	67.07	3.17	2.85	10.26	
65	63.18	2.99	2.67	10.40	
70	59.75	2.82	2.50	10.52	
75	56.71	2.68	2.36	10.62	
90	49.33	2.33	2.01	10.86	
105	43.80	2.07	1.75	11.02	
120	39.47	1.87	1.55	11.13	

Stage Storage Curve: Area R-1  
Controlled Roof Drain #5

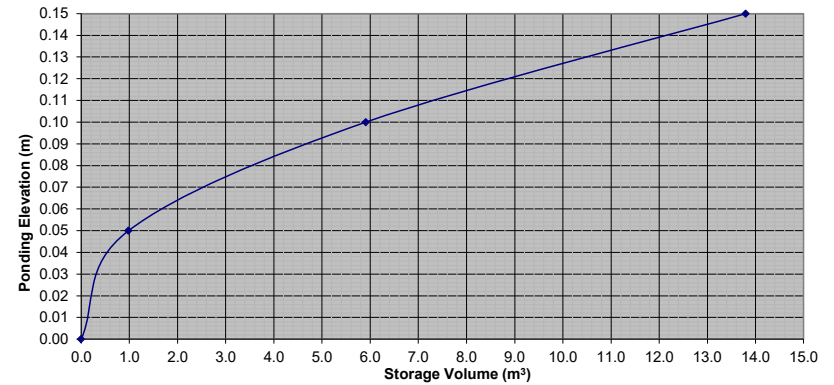

**Location :** 1185 Beaverwood Road

**Description:** North Property Line Rip-Rap Lined By-pass Ditch

**Dimensions:** Bottom width = 0.00 m  
 Right Side slopes = 3.0 :1  
 Left Side slopes = 3.0 :1

Average Slope = 8.30%  
 Mannings n = 0.033  
 Average depth = 0.15 m

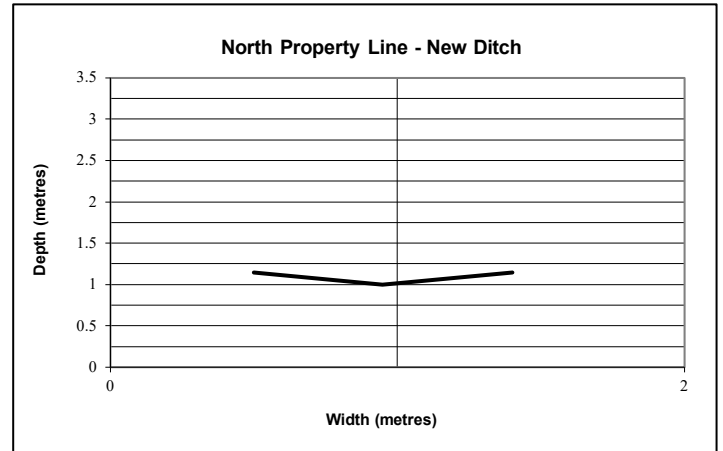

Depth (m)	Area (m <sup>2</sup> )	Hydraulic Radius (m)	Velocity (m/s)	Flow (m <sup>3</sup> /s)
0.00	0.00	0.00	0.00	0.00
0.02	0.00	0.01	0.32	0.00
0.03	0.00	0.01	0.51	0.00
0.05	0.01	0.02	0.67	0.00
0.06	0.01	0.03	0.82	0.01
0.08	0.02	0.04	0.95	0.02
0.09	0.02	0.04	1.07	0.03
0.11	0.03	0.05	1.18	0.04
0.12	0.04	0.06	1.29	0.06
0.14	0.05	0.06	1.40	0.08
0.15	0.07	0.07	1.50	0.10
0.17	0.08	0.08	1.60	0.13

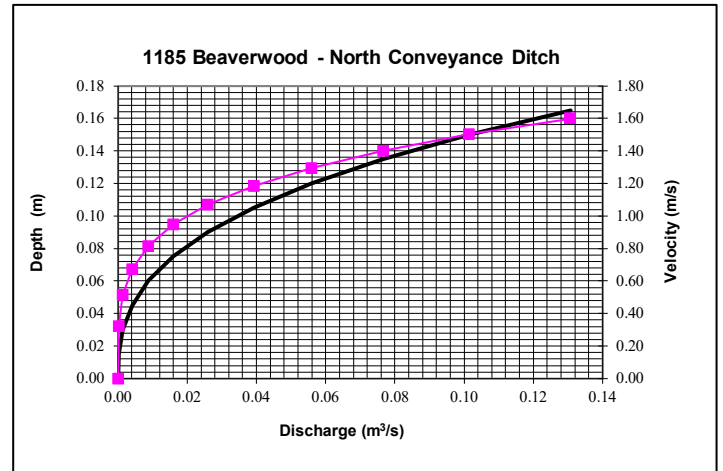

— Discharge (Flow) vs Velocity  
 — Discharge (Flow) vs. Depth

**Location :** 1185 Beaverwood Road

**Description:** West Property Line Rip-Rap Lined By-pass Ditch

**Dimensions:** Bottom width = 0.00 m  
 Right Side slopes = 3.0 :1  
 Left Side slopes = 3.0 :1

Average Slope = 5.20%  
 Mannings n = 0.033  
 Average depth = 0.15 m

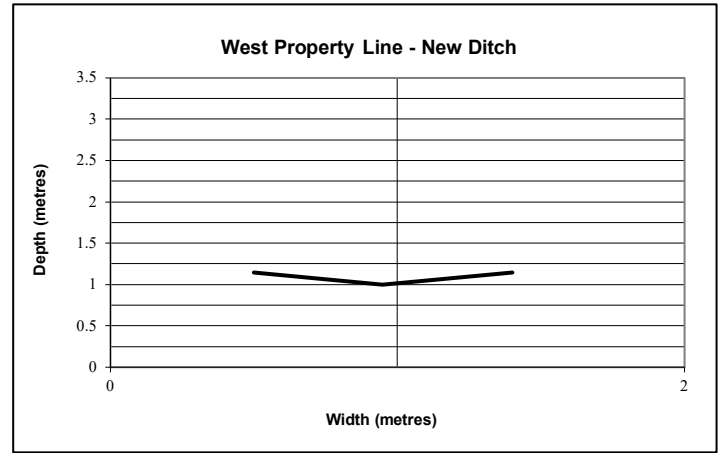

Depth (m)	Area (m <sup>2</sup> )	Hydraulic Radius (m)	Velocity (m/s)	Flow (m <sup>3</sup> /s)
0.00	0.00	0.00	0.00	0.00
0.02	0.00	0.01	0.26	0.00
0.03	0.00	0.01	0.41	0.00
0.05	0.01	0.02	0.53	0.00
0.06	0.01	0.03	0.65	0.01
0.08	0.02	0.04	0.75	0.01
0.09	0.02	0.04	0.85	0.02
0.11	0.03	0.05	0.94	0.03
0.12	0.04	0.06	1.02	0.04
0.14	0.05	0.06	1.11	0.06
0.15	0.07	0.07	1.19	0.08
0.17	0.08	0.08	1.27	0.10

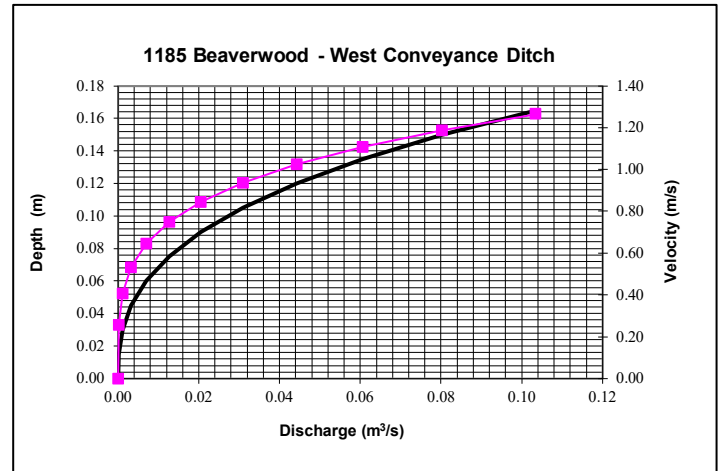

— Discharge (Flow) vs Velocity  
 — Discharge (Flow) vs. Depth

# Excerpt from Village Walk Subdivision - Stormwater Management Report

## STORM DESIGN SHEET

DESIGNED BY : MER  
CHECKED BY : JGR

PROJECT: VILLAGE WALK  
DEVELOPER: VILLAGE WALK INC. c/o REGIONAL

AREA	LOCATION			AREA (ha)			INDIV 2.78 AR	ACCUM 2.78 AR	TIME OF CONC (min)	RAINFALL INTENSITY (mm/hr)	PEAK FLOW Q (l/s)	PROPOSED SEWER								
	STREET	FROM M.H.	TO M.H.	R= 0.95	R= 0.35	R= 0.2						TYPE OF PIPE	PIPE SIZE (mm)	PIPE ID (mm)	GRADE %	LENGTH (m)	CAPACITY (L/s)	FULL FLOW VELOCITY	TIME OF FLOW (min)	Percentage of Capacity
1	Beaverwood Road	102	EX11	0.13		0.07	0.37	0.37	20.00	68.5	25.3	DR 35	250	251	1.20	66.0	66.2	1.33	0.83	38.27%
11	Beaverwood Road	104	106	0.09		0.02	0.24	0.24	20.00	68.5	16.4	DR 35	250	251	0.55	109.0	44.8	0.90	2.01	36.51%
8	Beaverwood Road	106	108	0.36		0.14	1.03	1.27	22.01	64.6	81.8	DR 35	375	366	0.50	75.5	116.6	1.11	1.14	70.15%
A	from Arena		108			3.12	1.73	1.73	20.00	68.5	118.7									
B	From Senior Residence	CBMH4	CBMH3			1.92	1.87	1.87	20.00	68.5	127.9									
16	Easement	108	CBMH4	0.02		0.03	0.06	3.07	22.01	64.6	198.0	CONC	600	610	0.66	28.5	521.3	1.78	0.27	37.97%
7	Easement	CBMH4	CBMH3	0.02		0.03	0.06	5.00	22.28	64.1	320.4	CONC	600	610	0.66	54.8	521.3	1.78	0.51	61.46%
10	Village Walk Private	110	112	0.17		0.06	0.47	0.47	20.00	68.5	32.4	DR 35	250	251	0.37	40.7	36.7	0.74	0.92	88.16%
2	Rear yard	CBMH1	CBMH2	0.07		0.07	0.22	0.22	20.00	68.5	15.4									
14	Rear yard	CBMH1	CBMH2	0.03		0.04	0.10	0.33	20.00	68.5	22.3	DR 35	250	251	0.50	5.0	42.7	0.86	0.10	52.20%
3	Village Walk Private	CBMH2	112	0.01		0.02	0.04	0.36	20.10	68.3	24.8	DR 35	250	251	0.50	21.1	42.7	0.86	0.41	58.12%
4	Village Walk Private	112	114	0.09		0.05	0.26	0.26	20.00	68.5	18.1									
9	Village Walk Private	112	114	0.07		0.07	0.23	0.23	20.00	68.5	15.5									
15	Village Walk Private	112	114	0.02		0.02	0.06	1.38	20.51	67.4	93.2	DR 35	450	448	0.25	74.0	140.8	0.89	1.38	66.21%
5	Village Walk Private	114	116	0.02		0.02	0.06	0.06	20.00	68.5	4.3									
13	Village Walk Private	114	116	0.14		0.07	0.41	0.41	20.00	68.5	27.9									
12	Village Walk Private	114	116	0.04		0.04	0.13	1.99	21.89	64.8	128.8	DR 35	450	448	0.25	29.8	140.8	0.89	0.56	91.53%
	Access Road	116	120					1.99	22.44	63.8	126.9	DR 35	450	448	0.30	19.0	154.2	0.98	0.32	82.28%
		120	CBMH3					1.99	22.77	63.3	125.8	DR 35	450	448	0.30	26.4	154.2	0.98	0.45	81.56%
	CMS Treatment Facility										1.7									
6	Easement	CBMH3	EX13	0.02		0.06	0.09	7.07	23.22	62.5	443.7	CONC	600	610	0.50	20.4	453.7	1.55	0.22	97.79%

Prepared: August 8, 2002  
Revised: Sept 27, 2002  
Revised: October 7, 2002  
Revised: October 16, 2002

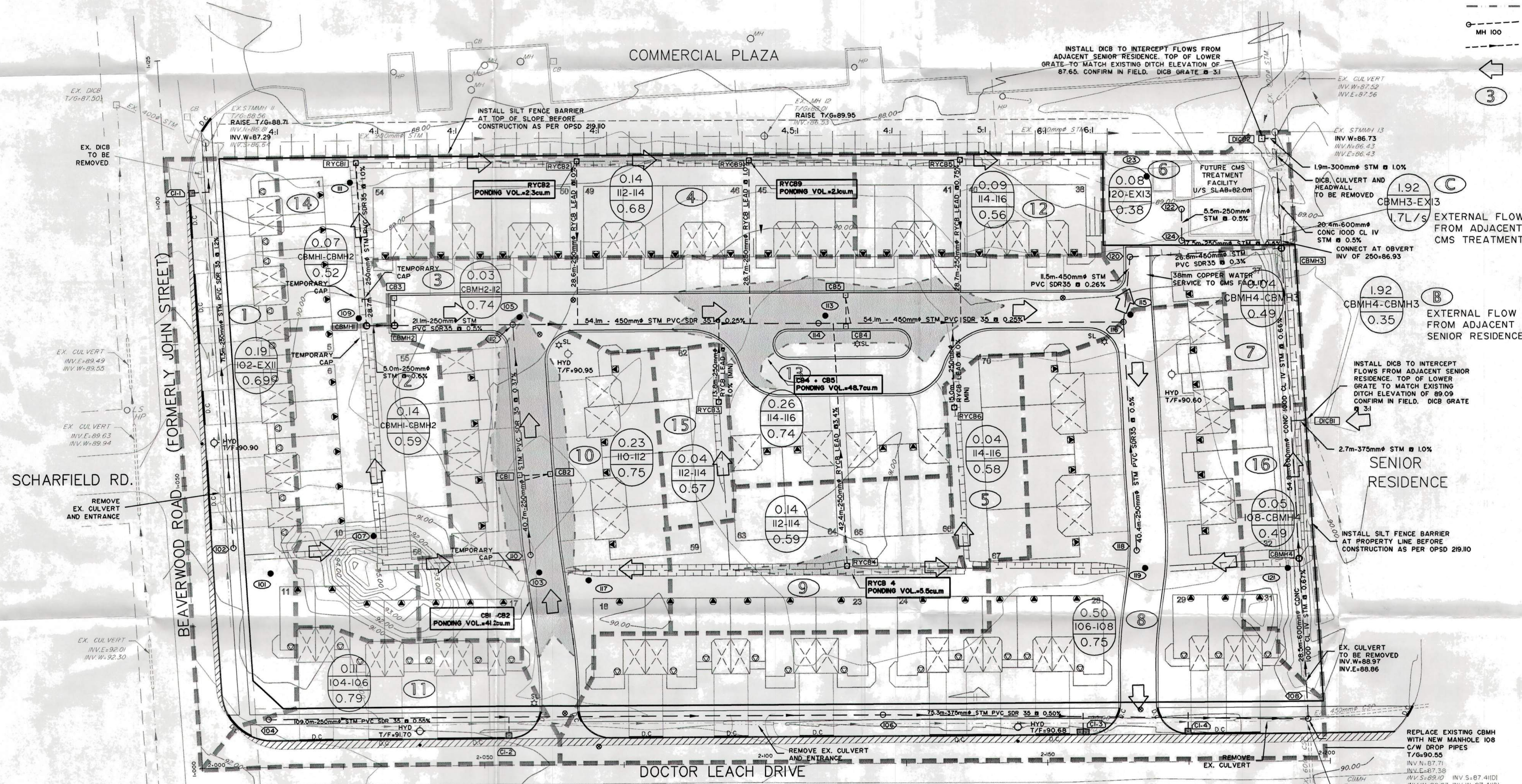
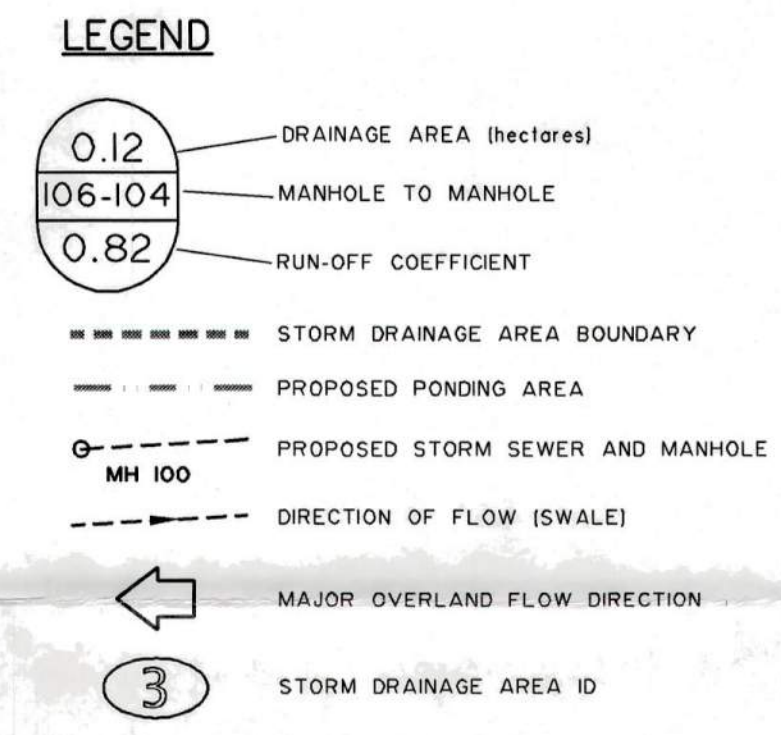

C:\22\_2002\_150321 DWG Name: K:\2001\0150321\0150321.dwg Updated: B... C:\Users\...

NOTE:  
 THE POSITION OF ALL POLE LINES, CONDUITS, WATERMANS,  
 SEWERS AND OTHER UNDERGROUND AND OVERGROUND  
 UTILITIES AND STRUCTURES IS NOT NECESSARILY  
 SHOWN ON THE CONTRACT DRAWINGS, AND WHERE  
 SHOWN, THE ACCURACY OF THE POSITION OF SUCH  
 UTILITIES AND STRUCTURES IS NOT GUARANTEED.  
 BEFORE STARTING WORK, DETERMINE THE EXACT  
 LOCATION OF ALL SUCH UTILITIES AND STRUCTURES  
 AND ASSUME ALL LIABILITY FOR DAMAGE TO THEM.

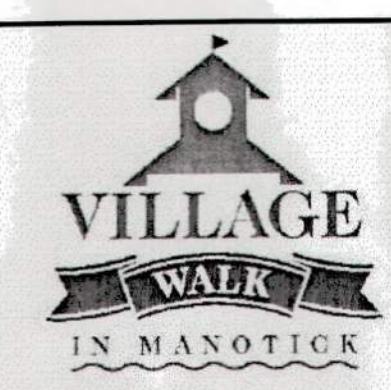

No.	REVISION	DATE	BY
6.	REVISED PER SWM REPORT & CITY COMMENTS	OCT. 22/02	MER
5.	REVISED LOTTING/ISSUED FOR APPROVAL	OCT. 17/02	MER
4.	REVISED PER CITY COMMENTS	OCT. 08/02	MER
3.	ISSUED FOR MOEE APPROVAL	SEPT.26/02	MER
2.	ISSUED FOR SITE PLAN APPROVAL	AUG 9/02	MER
1.	ISSUED FOR APPROVAL	DEC. 14/01	CJS

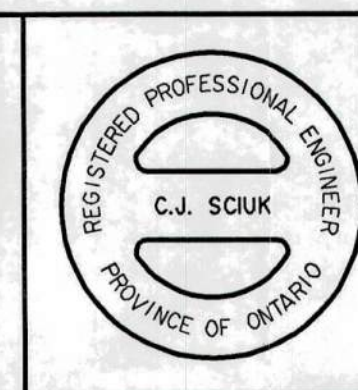
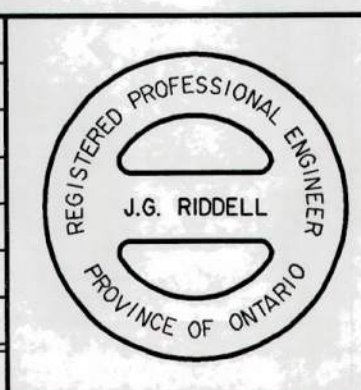

**NOVATECH**  
**ENGINEERING**  
**CONSULTANTS LTD.**  
 ENGINEERS & PLANNERS  
 Suite 200, 240 Michael Cowpland Drive  
 Kanata, Ontario, Canada  
 K2M 1P6  
 Telephone (613) 254-9643  
 Facsimile (613) 254-5867  
 Email: novainfo@novatech-eng.com

DESIGN	CJS	SCALE
CHECKED	JGR	1 : 400
DRAWN	SM	
CHECKED	CJS	
APPROVED	JGR	

CITY OF OTTAWA  
**VILLAGE WALK**  
**STORM DRAINAGE AREA PLAN**

PROJECT No.	10159-0
DATE	OCT 22 2002
DATE	DECEMBER 13, 2001
DRAWING No.	10159-STM

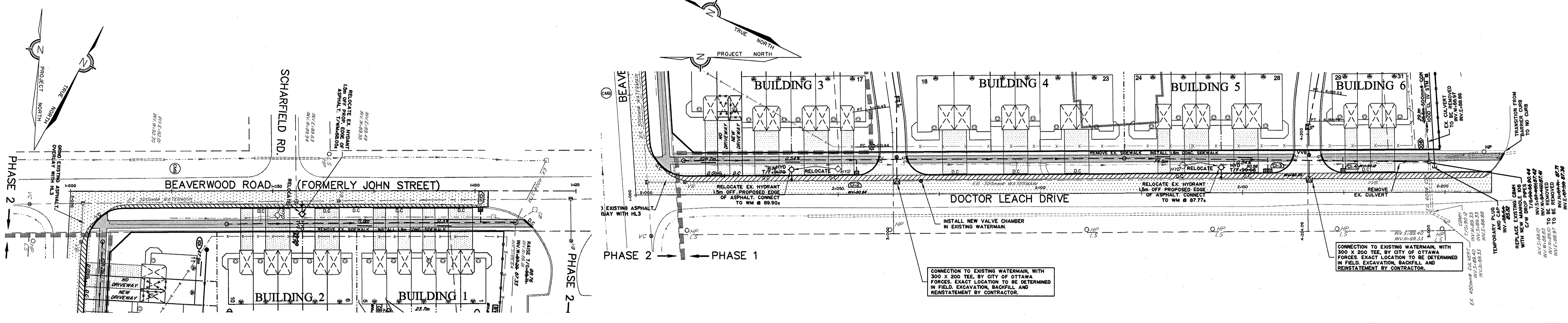

# AS-BUILT

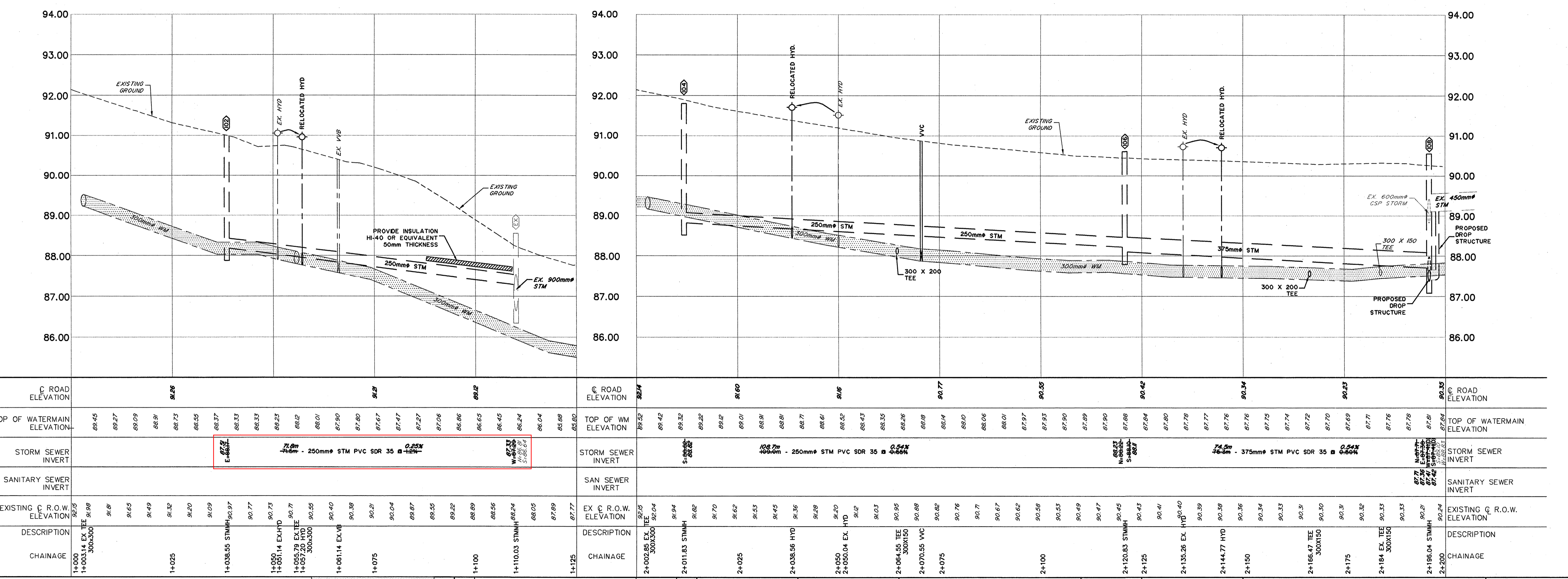

DWG Name: M:\2001\0109\CAD\Design\As-Built\0109-Dr.dwg Updated By: mzurawski  
 Feb 21, 2005 1:32:03

NOTE:  
 THE POSITION OF ALL POLE LINES, CONDUITS, WATERMANS,  
 SEWERS AND OTHER UNDERGROUND AND OVERGROUND  
 UTILITIES AND STRUCTURES IS NOT NECESSARILY  
 SHOWN ON THE CONTRACT DRAWINGS, AND WHERE  
 SHOWN, THE ACCURACY OF THE POSITION OF SUCH  
 UTILITIES AND STRUCTURES IS NOT GUARANTEED.  
 BEFORE STARTING WORK, DETERMINE THE EXACT  
 LOCATION OF ALL SUCH UTILITIES AND STRUCTURES  
 AND ASSUME ALL LIABILITY FOR DAMAGE TO THEM.

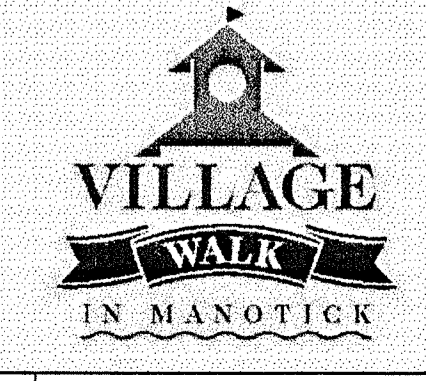

7.	AS-BUILTS	NOV. 16/04	SAB
6.	ISSUED FOR WATER PERMIT	NOV. 14/02	MER
5.	REVISED PER SWM REPORT & CITY COMMENTS	OCT. 22/02	MER
4.	REVISED LOTTING / ISSUED FOR APPROVAL	OCT. 17/02	MER
3.	REVISED PER CITY COMMENTS	OCT. 08/02	MER
2.	REVISED PER CITY COMMENTS	SEPT. 25/02	MER
1.	ISSUED FOR TENDER	SEPT. 23/02	MER
No.	REVISION	DATE	BY

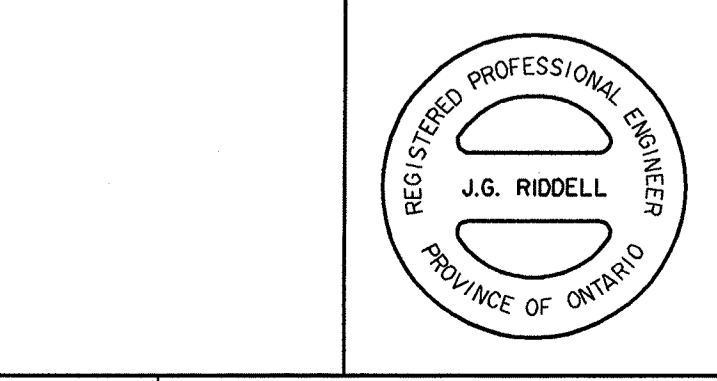

**NOVATECH**  
**ENGINEERING**  
**CONSULTANTS LTD.**  
 ENGINEERS & PLANNERS  
 Suite 200, 240 Michael Cowpland Drive  
 Kanata, Ontario, Canada  
 K2M 1P6  
 Telephone (613) 254-9643  
 Facsimile (613) 254-5567  
 Email: novainfo@novatech-eng.com

DESIGN	MER	SCALE	1:500
CHECKED	JGR	0 5 10 15 20	
DRAWN	CAH	HORIZONTAL	
CHECKED	MER	0 0.5 1.0 1.5 2.0	
APPROVED	JGR	VERTICAL	

CITY OF OTTAWA  
 (FORMERLY RIDEAU TOWNSHIP)  
**VILLAGE WALK**  
 PLAN AND PROFILE  
 BEAVERWOOD ROAD  
 STATION 1+000 TO 1+125  
 DOCTOR LEACH DRIVE  
 STATION 2+000 TO 2+200

PROJECT No.	101159-0
DATE	SEPTEMBER 2002
DRAWING No.	101159-PI

PLANA109 - 64mmx59mm

## **APPENDIX F**

### **Inlet Control Device (ICD) Information**



# IPEX Tempest™ Inlet Control Devices

Municipal Technical Manual Series

Vol. I, 2nd Edition

© 2012 by IPEX. All rights reserved. No part of this book may be used or reproduced in any manner whatsoever without prior written permission. For information contact: IPEX, Marketing, 2441 Royal Windsor Drive, Mississauga, Ontario, Canada, L5J 4C7.

The information contained here within is based on current information and product design at the time of publication and is subject to change without notification. IPEX does not guarantee or warranty the accuracy, suitability for particular applications, or results to be obtained therefrom.

## PRODUCT INFORMATION: TEMPEST LOW, MEDIUM FLOW (LMF) ICD

### Purpose

To control the amount of storm water runoff entering a sewer system by allowing a specified flow volume out of a catch basin or manhole at a specified head. This approach conserves pipe capacity so that catch basins downstream do not become uncontrollably surcharged, which can lead to basement floods, flash floods and combined sewer overflows.

### Product Description

Our LMF ICD is designed to accommodate catch basins or manholes with sewer outlet pipes 6" in diameter and larger. Any storm sewer larger than 12" may require custom modification. However, IPEX can custom build a TEMPEST device to accommodate virtually any storm sewer size.

Available in 14 preset flow curves, the LMF ICD has the ability to provide flow rates: 2lps – 17lps (31gpm – 270gpm)

### Product Function

The LMF ICD vortex flow action allows the LMF ICD to provide a narrower flow curve using a larger orifice than a conventional orifice plate ICD, making it less likely to clog. When comparing flows at the same head level, the LMF ICD has the ability to restrict more flow than a conventional ICD during a rain event, preserving greater sewer capacity.

### Product Construction

Constructed from durable PVC, the LMF ICD is light weight 8.9 Kg (19.7 lbs).

### Product Applications

Will accommodate both square and round applications:

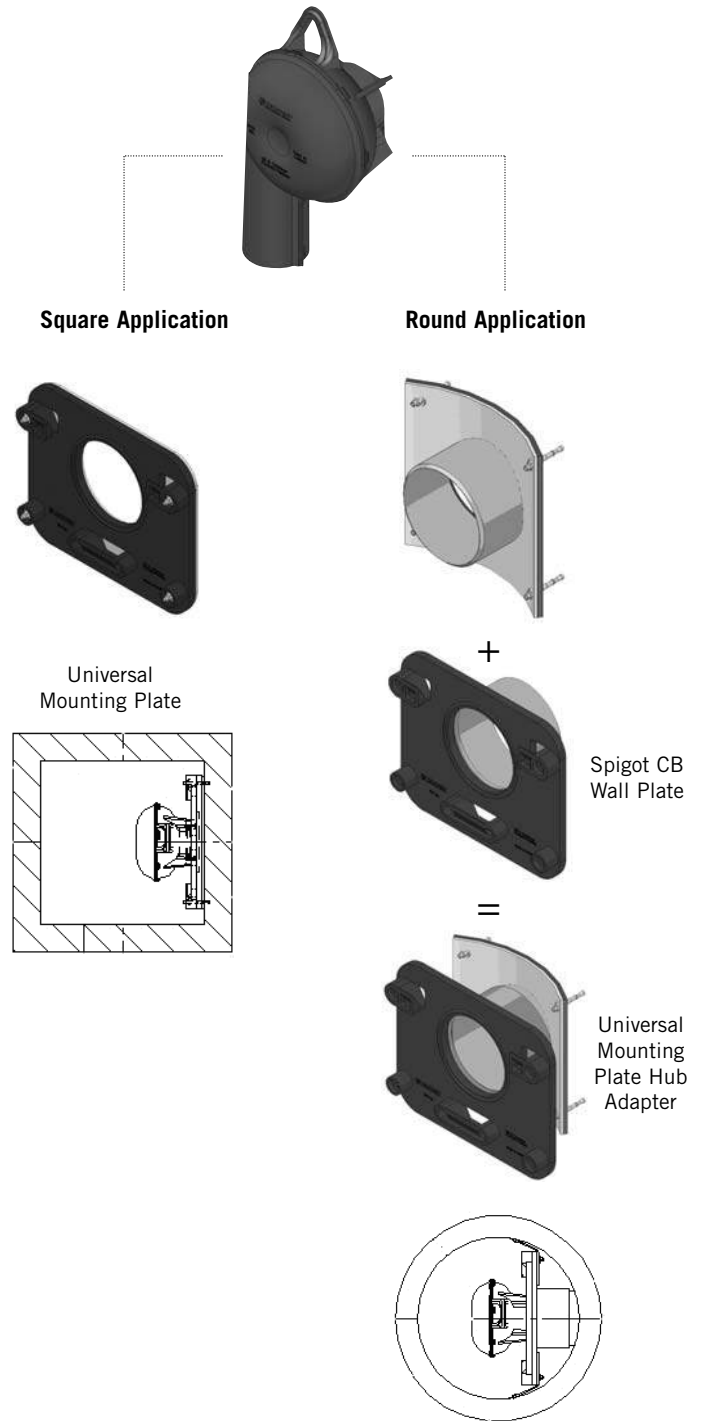

**Chart 1: LMF 14 Preset Flow Curves**

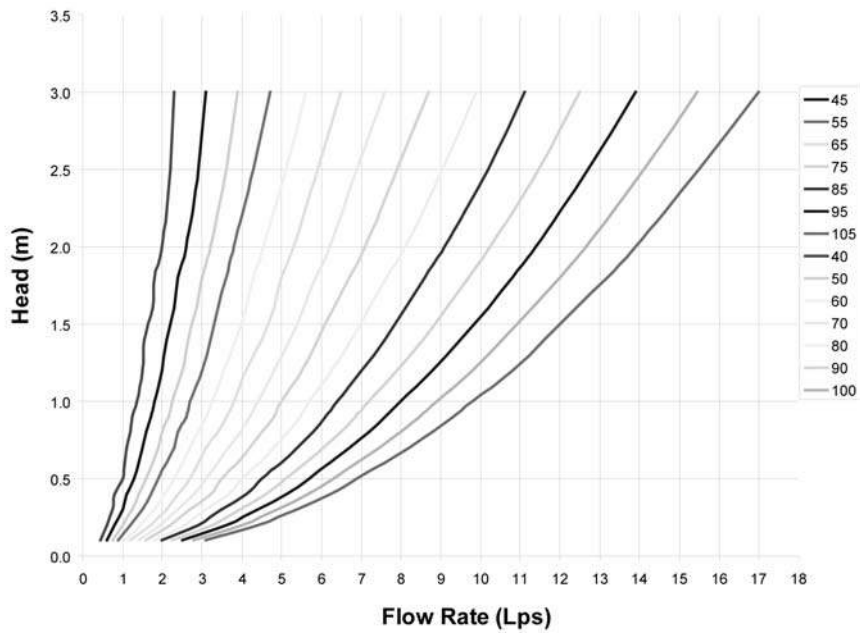

**Chart 2: LMF Flow vs. ICD Alternatives**

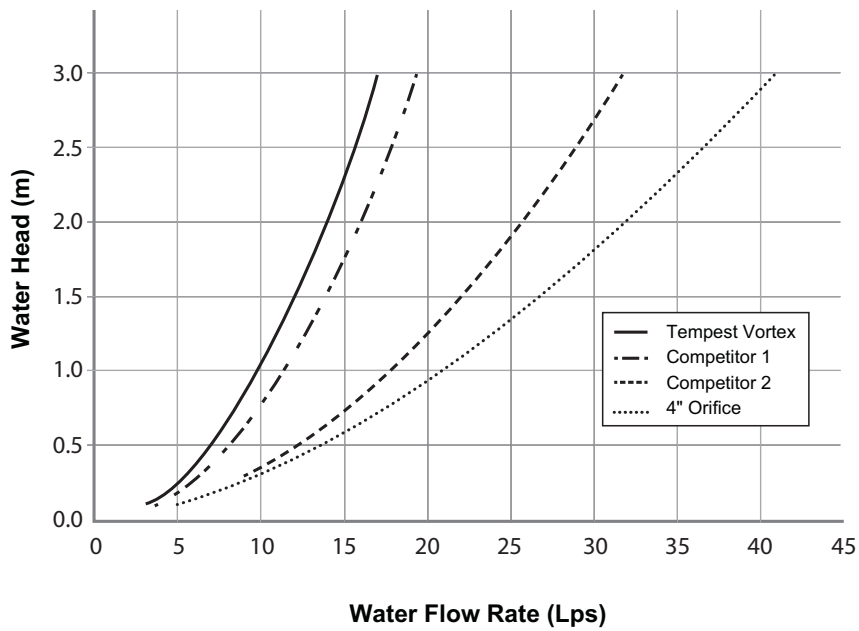

## PRODUCT INSTALLATION

### Instructions to assemble a TEMPEST LMF ICD into a Square Catch Basin:

#### STEPS:

1. Materials and tooling verification:
  - Tooling: impact drill, 3/8" concrete bit, torque wrench for 9/16" nut, hand hammer, level, and marker.
  - Material: (4) concrete anchor 3/8 x 3-1/2, (4) washers, (4) nuts, universal mounting plate, ICD device.
2. Use the mounting wall plate to locate and mark the hole (4) pattern on the catch basin wall. You should use a level to ensure that the plate is at the horizontal.
3. Use an impact drill with a 3/8" concrete bit to make the four holes at a minimum of 1-1/2" depth up to 2-1/2". Clean the concrete dust from the holes.
4. Install the anchors (4) in the holes by using a hammer. Thread the nuts on the top of the anchors to protect the threads when you hit the anchors with the hammer. Remove the nuts from the ends of the anchors.
5. Install the universal mounting plate on the anchors and screw the 4 nuts in place with a maximum torque of 40 N.m (30 lbf-ft). There should be no gap between the wall mounting plate and the catch basin wall.
6. From the ground above using a reach bar, lower the ICD device by hooking the end of the reach bar to the handle of the ICD device. Align the triangular plate portion into the mounting wall plate. Push down the device to be sure it has centered in to the universal mounting plate and has created a seal.



#### WARNING

- Verify that the outlet pipe doesn't protrude into the catch basin. If it does, cut down the pipe flush to the catch basin wall.
- Call your IPEX representative for more information or if you have any questions about our products.

### Instructions to assemble a TEMPEST LMF ICD into a Round Catch Basin:

#### STEPS:

1. Materials and tooling verification.
  - Tooling: impact drill, 3/8" concrete bit, torque wrench for 9/16" nut, hand hammer, level and marker.
  - Material: (4) concrete anchor 3/8 x 3-1/2, (4) washers and (4) nuts, spigot CB wall plate, universal mounting plate hub adapter, ICD device.
2. Use the spigot catch basin wall plate to locate and mark the hole (4) pattern on the catch basin wall. You should use a level to ensure that the plate is at the horizontal.
3. Use an impact drill with a 3/8" concrete bit to make the four holes at a depth between 1-1/2" to 2-1/2". Clean the concrete dust from the holes.
4. Install the anchors (4) in the holes by using a hammer. Thread the nuts on the top of the anchors to protect the threads when you hit the anchors with the hammer. Remove the nuts from the ends of the anchors.
5. Install the CB spigot wall plate on the anchors and screw the 4 nuts in place with a maximum torque of 40 N.m (30 lbf-ft). There should be no gap between the spigot wall plate and the catch basin wall.
6. Apply solvent cement on the hub of the universal mounting plate, hub adapter and the spigot of the CB wall plate, then slide the hub over the spigot. Make sure the universal mounting plate is at the horizontal and its hub is completely inserted onto the spigot. Normally, the corners of the universal mounting plate hub adapter should touch the catch basin wall.
7. From ground above using a reach bar, lower the ICD device by hooking the end of the reach bar to the handle of the ICD device. Align the triangular plate portion into the mounting wall plate. Push down the device to be sure it has centered in to the mounting plate and has created a seal.



#### WARNING

- Verify that the outlet pipe doesn't protrude into the catch basin. If it does, cut back the pipe flush to the catch basin wall.
- The solvent cement which is used in this installation is to be approved for PVC.
- The solvent cement should not be used below 0°C (32°F) or in a high humidity environment. Refer to the IPEX solvent cement guide to confirm the required curing time or visit the IPEX Online Solvent Cement Training Course available at [www.ipexinc.com](http://www.ipexinc.com).
- Call your IPEX representative for more information or if you have any questions about our products.

## PRODUCT TECHNICAL SPECIFICATION

### General

Inlet control devices (ICD's) are designed to provide flow control at a specified rate for a given water head level and also provide odour and floatable control. All ICD's will be IPEX Tempest or approved equal.

All devices shall be removable from a universal mounting plate. An operator from street level using only a T-bar with a hook will be able to retrieve the device while leaving the universal mounting plate secured to the catch basin wall face. The removal of the TEMPEST devices listed above must not require any unbolting or special manipulation or any special tools.

High Flow (HF) Sump devices will consist of a removable threaded cap which can be accessible from street level with out entry into the catchbasin (CB). The removal of the threaded cap shall not require any special tools other than the operator's hand.

ICD's shall have no moving parts.

### Materials

ICD's are to be manufactured from Polyvinyl Chloride (PVC) or Polyurethane material, designed to be durable enough to withstand multiple freeze-thaw cycles and exposure to harsh elements.

The inner ring seal will be manufactured using a Buna or Nitrile material with hardness between Duro 50 and Duro 70.

The wall seal is to be comprised of a 3/8" thick Neoprene Closed Cell Sponge gasket which is attached to the back of the wall plate.

All hardware will be made from 304 stainless steel.

### Dimensioning

The Low Medium Flow (LMF), High Flow (HF) and the High Flow (HF) Sump shall allow for a minimum outlet pipe diameter of 200mm with a 600mm deep Catch Basin sump.

### Installation

Contractor shall be responsible for securing, supporting and connecting the ICD's to the existing influent pipe and catchbasin/manhole structure as specified and designed by the Engineer.

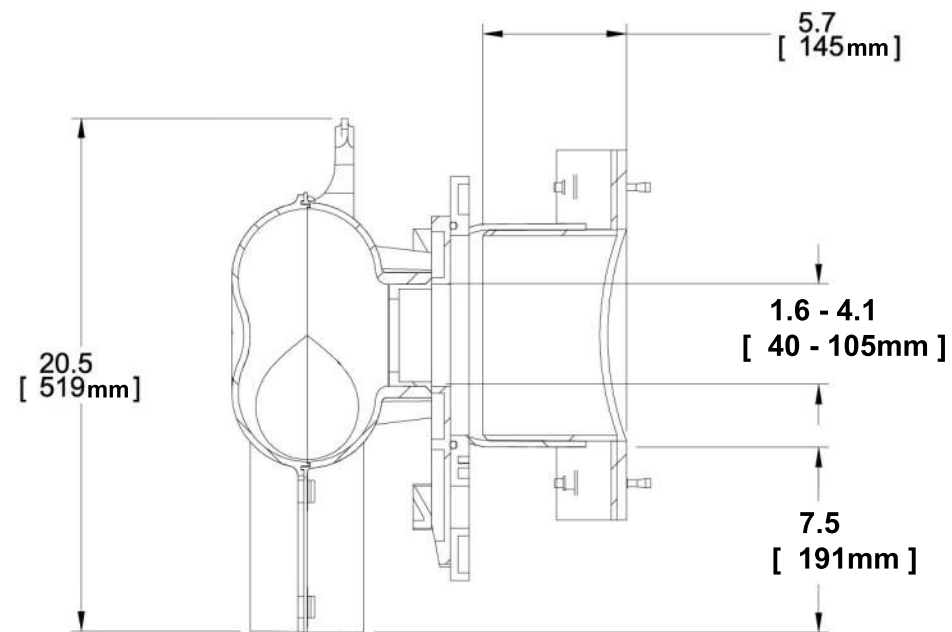
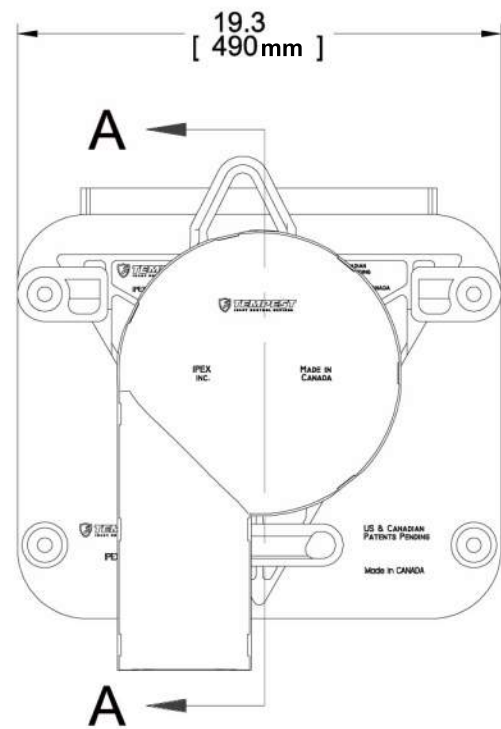
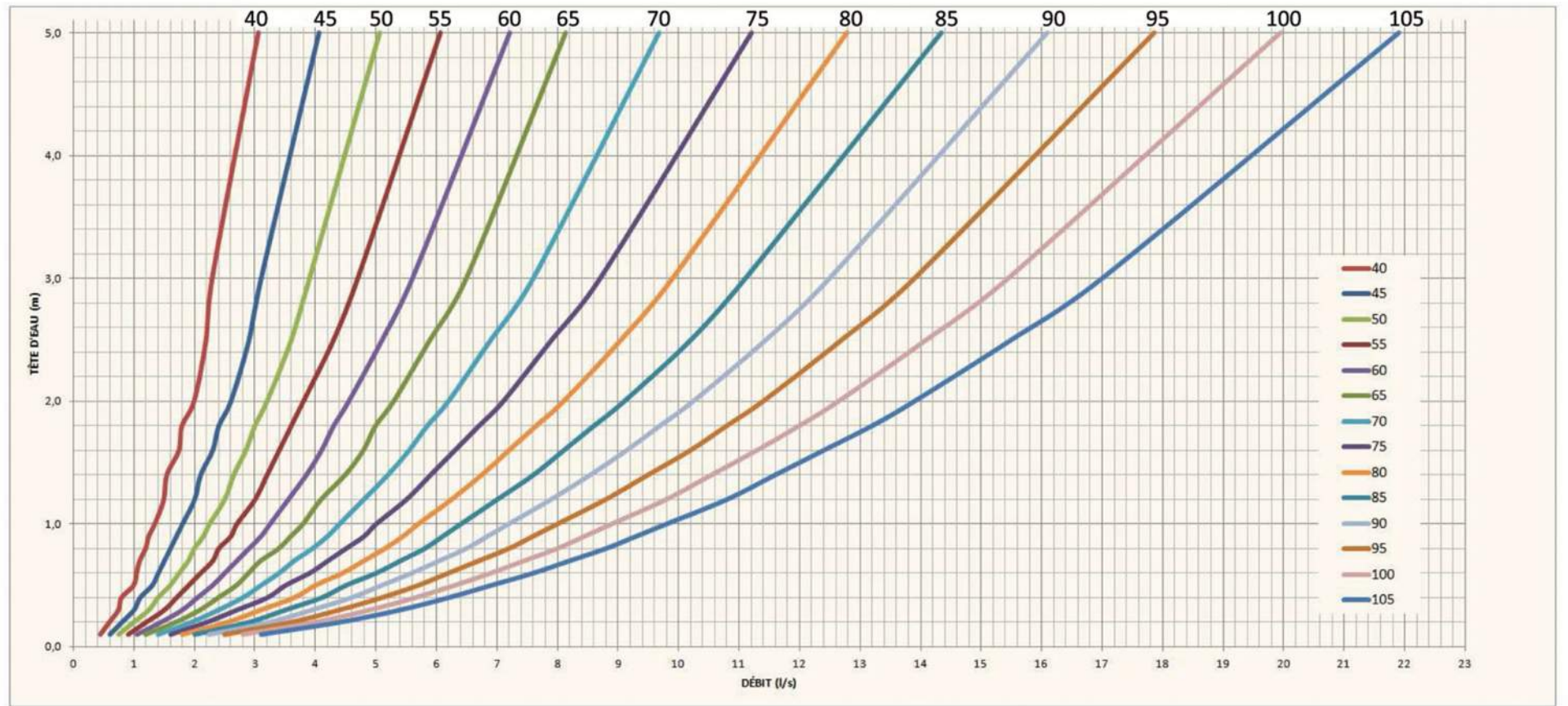
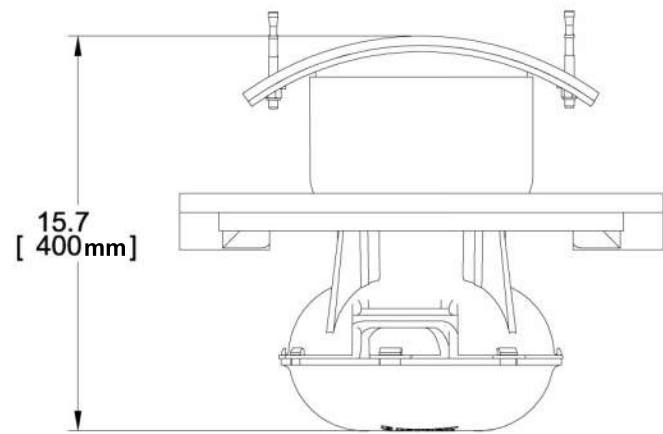

SECTION A-A

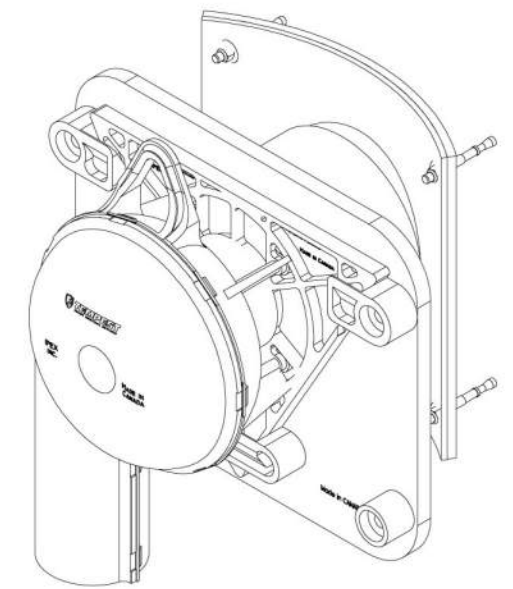

## **APPENDIX G**

### **Control Flow Roof Drain Information**



**Adjustable Accutrol Weir**  
 Tag: RD-100-A-ADJ

**Adjustable Flow Control  
 for Roof Drains**

**ADJUSTABLE ACCUTROL (for Large Sump Roof Drains only)**

For more flexibility in controlling flow with heads deeper than 2", Watts Drainage offers the Adjustable Accutrol. The Adjustable Accutrol Weir is designed with a single parabolic opening that can be covered to restrict flow above 2" of head to less than 5 gpm per inch, up to 6" of head. To adjust the flow rate for depths over 2" of head, set the slot in the adjustable upper cone according to the flow rate required. Refer to Table 1 below.  
 Note: Flow rates are directly proportional to the amount of weir opening that is exposed.

**EXAMPLE:**

For example, if the adjustable upper cone is set to cover 1/2 of the weir opening, flow rates above 2" of head will be restricted to 2-1/2 gpm per inch of head.

Therefore, at 3" of head, the flow rate through the Accutrol Weir that has 1/2 the slot exposed will be:  
 [5 gpm (per inch of head) x 2 inches of head ] + 2-1/2 gpm (for the third inch of head) = 12-1/2 gpm.

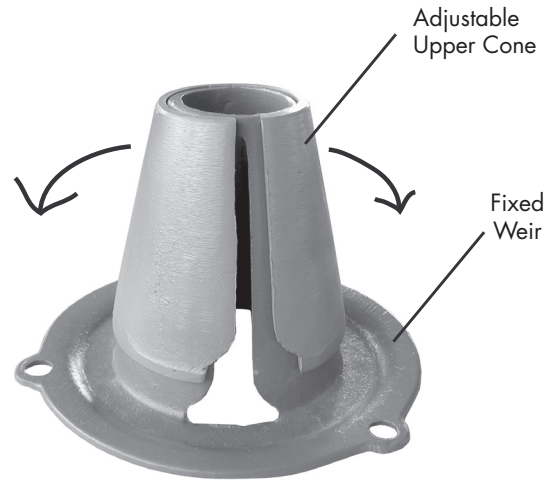
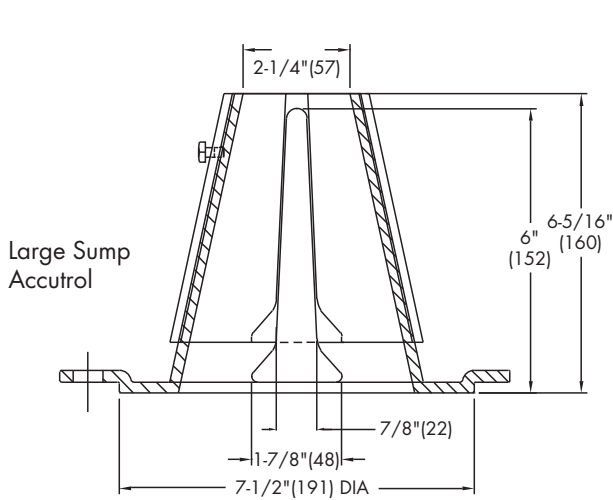

1/2 Weir Opening Exposed Shown Above

TABLE 1. Adjustable Accutrol Flow Rate Settings

Weir Opening Exposed	1"	2"	3"	4"	5"	6"
	Flow Rate (gallons per minute)					
Fully Exposed	5	10	15	20	25	30
3/4	5	10	13.75	17.5	21.25	25
1/2	5	10	12.5	15	17.5	20
1/4	5	10	11.25	12.5	13.75	15
Closed	5	5	5	5	5	5

Job Name \_\_\_\_\_  
 Job Location \_\_\_\_\_  
 Engineer \_\_\_\_\_

Contractor \_\_\_\_\_  
 Contractor's P.O. No. \_\_\_\_\_  
 Representative \_\_\_\_\_

Watts product specifications in U.S. customary units and metric are approximate and are provided for reference only. For precise measurements, please contact Watts Technical Service. Watts reserves the right to change or modify product design, construction, specifications, or materials without prior notice and without incurring any obligation to make such changes and modifications on Watts products previously or subsequently sold.

**USA:** Tel: (800) 338-2581 • Fax: (828) 248-3929 • Watts.com  
**Canada:** Tel: (905) 332-4090 • Fax: (905) 332-7068 • Watts.ca  
**Latin America:** Tel: (52) 81-1001-8600 • Fax: (52) 81-8000-7091 • Watts.com



A Watts Water Technologies Company



LEGEND

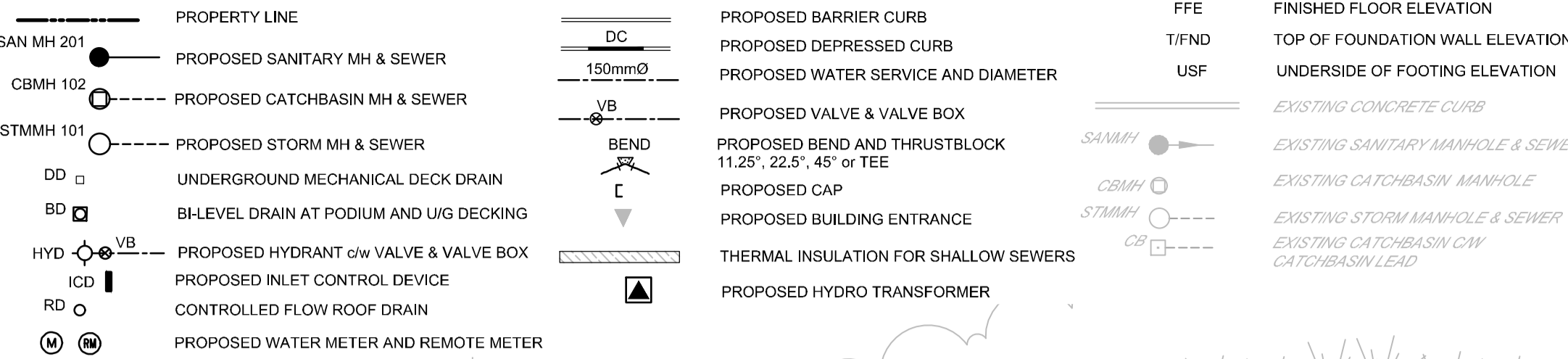

BENCHMARK NOTES:

- 1. ELEVATIONS SHOWN ARE GEODETIC AND ARE REFERRED TO THE 2011 GEODETIC DATUM. ELEVATIONS ARE RELATED TO VERTICAL CONTROL MONUMENT 011948U553G HAVING AN ELEVATION OF 96.03m.
2. IT IS THE RESPONSIBILITY OF THE USER OF THIS INFORMATION TO VERIFY THAT THE JOB BENCHMARK HAS NOT BEEN ALTERED OR DISTURBED AND THAT ITS RELATIVE ELEVATION AND DESCRIPTION AGREES WITH THE INFORMATION SHOWN ON THIS DRAWING.
3. BENCHMARK WAS PROVIDED ON TOPOGRAPHICAL PLAN OF SURVEY, PART OF BLOCK C, REGISTERED PLAN 771, CITY OF OTTAWA, PREPARED BY ANNIS, OSULLIVAN, VOLLEBEKK LTD.
4. TEMPORARY JOB BENCHMARK DESCRIPTION IS LOCATED ON WALL IN EAST FACE OF UTILITY POLE LOCATED APPROXIMATELY 24.7m WEST OF THE SOUTHWEST PROPERTY BOUNDARY ALONG BEAVERWOOD ROAD. SEE TOPOGRAPHICAL PLAN OF SURVEY MENTIONED ABOVE FOR DETAILS.

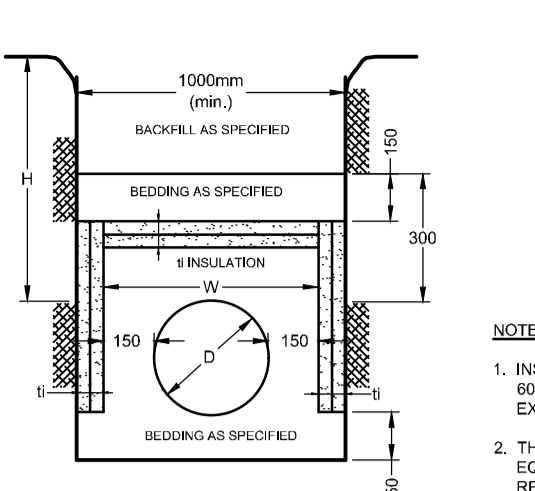
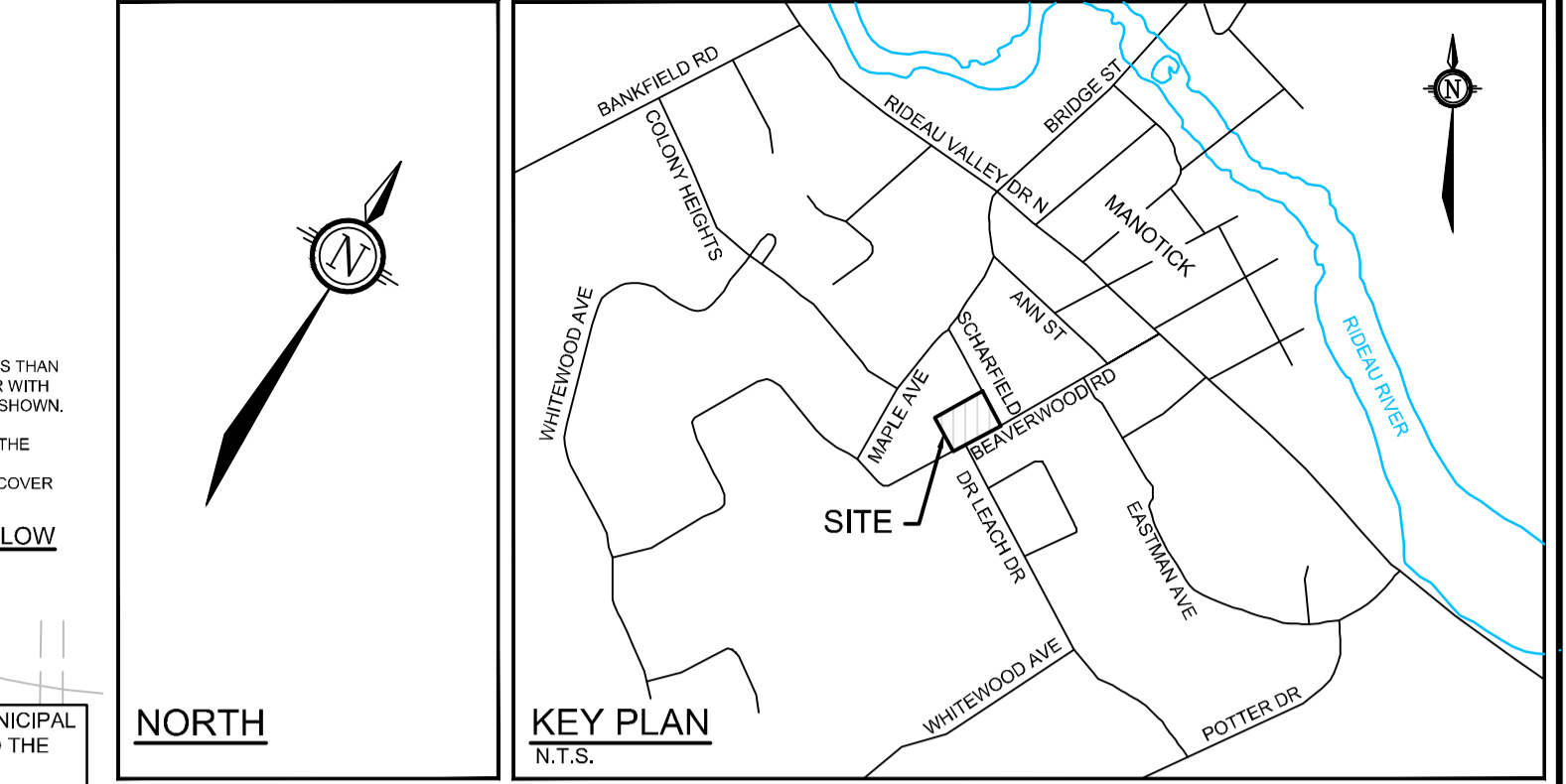

Table with 2 columns: COVER (mm) and THICKNESS (mm). Rows include 1800-1500, 1500-1200, 1200-900, 900-600, 600-300. Includes notes on insulation thickness and bedding.

INSULATION DETAIL FOR SHALLOW SEWERS ONLY NOT TO SCALE



GENERAL NOTES:

- 1. COORDINATE AND SCHEDULE ALL WORK WITH OTHER TRADES AND CONTRACTORS.
2. DETERMINE THE EXACT LOCATION, SIZE, MATERIAL AND ELEVATION OF ALL EXISTING UTILITIES PRIOR TO COMMENCING CONSTRUCTION. PROTECT AND ASSUME RESPONSIBILITY FOR ALL EXISTING UTILITIES WHETHER OR NOT SHOWN ON THIS DRAWING.
3. OBTAIN ALL NECESSARY PERMITS AND APPROVALS FROM THE CITY OF OTTAWA BEFORE COMMENCING CONSTRUCTION.
4. BEFORE COMMENCING CONSTRUCTION OBTAIN AND PROVIDE PROOF OF COMPREHENSIVE, ALL RISK AND OPERATIONAL LIABILITY INSURANCE FOR \$5,000,000.00. INSURANCE POLICY TO NAME OWNERS, ENGINEERS AND ARCHITECTS AS CO-INSURED.
5. COMPLETE ALL WORKS IN ACCORDANCE WITH THE MOST CURRENT CITY OF OTTAWA STANDARDS AND SPECIFICATIONS USING THE CURRENT GUIDELINES, BYLAWS AND STANDARDS INCLUDING MATERIALS OF CONSTRUCTION, INSPECTION AND ALL RELEVANT REFERENCES TO OPSS, OPSS & AWWA GUIDELINES - ALL CURRENT VERSIONS AND AS AMENDED.
6. RESTORE ALL DISTURBED AREAS ON-SITE AND OFF-SITE, INCLUDING TRENCHES AND SURFACES ON PUBLIC ROAD ALLOWANCES TO EXISTING CONDITIONS OR BETTER TO THE SATISFACTION OF MUNICIPAL AUTHORITIES.
7. REMOVE FROM SITE ALL EXCESS EXCAVATED MATERIAL, ORGANIC MATERIAL AND DEBRIS UNLESS OTHERWISE INSTRUCTED BY ENGINEER. EXCAVATE AND REMOVE FROM SITE ANY CONTAMINATED MATERIAL. ALL CONTAMINATED MATERIAL SHALL BE DISPOSED OF AT A LICENSED LANDFILL FACILITY.
8. ALL ELEVATIONS ARE GEODETIC.
9. REFER TO GEOTECHNICAL INVESTIGATION REPORT (PG6160-1, REVISION 3, DATED MARCH 21, 2023), FOR SUBSURFACE CONDITIONS, CONSTRUCTION RECOMMENDATIONS AND GEOTECHNICAL INSPECTION REQUIREMENTS. THE GEOTECHNICAL CONSULTANT IS TO REVIEW ON-SITE CONDITIONS AFTER EXCAVATION PRIOR TO PLACEMENT OF THE GRANULAR MATERIAL.
10. REFER TO ARCHITECTS AND LANDSCAPE ARCHITECTS DRAWINGS FOR BUILDING AND HARD SURFACED AREAS AND DIMENSIONS.
11. REFER TO THE 'DEVELOPMENT' SERVICING STUDY AND STORMWATER MANAGEMENT REPORT (R-2022-013) PREPARED BY NOVATECH.
12. SAW CUT AND GRIND ASPHALT AT ALL ROAD CUTS AND ASPHALT TIE-IN POINTS AS PER CITY OF OTTAWA STANDARDS (R10).

SEWER NOTES:

- 1. SUPPLY AND CONSTRUCT ALL SEWERS AND APPURTENANCES IN ACCORDANCE WITH THE MOST CURRENT CITY OF OTTAWA STANDARDS AND SPECIFICATIONS - ALL CURRENT VERSIONS AND AS AMENDED.
2. SPECIFICATIONS: ITEM, SPEC. No., REFERENCE.
ITEM: STORM / SANITARY MANHOLE (1000) SPEC. No. 701.010 REFERENCE: OPSS
SANITARY MANHOLE FRAME AND COVER 401.010 - TYPE 'A' OPSS
STORMWATER FRAME AND COVER 401.010 - TYPE 'B' OPSS
WATERTIGHT MANHOLE FRAME AND COVER 401.033 OPSS
CATCHBASIN (600x600) 705.010 OPSS
CATCHBASIN FRAME & COVER 519 CITY OF OTTAWA
SEWER TRENCH 58 CITY OF OTTAWA
STORM SEWER PVC DR 35 (450mm PIPE AND SMALLER) PVC DR 35 (450mm PIPE AND LARGER) CITY OF OTTAWA
SANITARY SEWER PVC DR 35 (450mm PIPE AND SMALLER) PVC DR 35 (450mm PIPE AND LARGER) CITY OF OTTAWA
3. THE SANITARY SERVICE LATERAL SHALL BE EQUIPPED WITH BACKFLOW PREVENTERS WITHIN THE BUILDING FOOTPRINT AS PER CITY OF OTTAWA STANDARD DETAILS S14.1. REFER TO MECHANICAL PLANS FOR DETAILS.
4. THE STORM SERVICE LATERAL SHALL BE EQUIPPED WITH A BACKFLOW PREVENTER WITHIN THE BUILDING FOOTPRINT AS PER CITY OF OTTAWA STANDARD DETAILS S14. REFER TO MECHANICAL PLANS FOR DETAILS.
5. SERVICES ARE TO BE CONSTRUCTED TO 1.5m FROM FACE OF BUILDING AT A MINIMUM SLOPE OF 1.0%.
6. PIPE BEDDING, COVER AND BACKFILL ARE TO BE COMPACTED TO AT LEAST 95% OF THE STANDARD PROCTOR MAXIMUM DRY DENSITY. THE USE OF CLEAR CRUSHED STONE AS A BEDDING LAYER SHALL NOT BE PERMITTED.
7. INSULATE ALL PIPES (SAN / STM) THAT HAVE LESS THAN 150mm COVER WITH HD-40 INSULATION PER INSULATION DETAIL FOR SHALLOW SEWERS. PROVIDE 150mm CLEARANCE BETWEEN PIPE AND INSULATION.
8. CONCRETE MANHOLES ARE TO BE 1200mm STRUCTURES UNLESS OTHERWISE NOTED ON THE DRAWING. FLEXIBLE CONNECTIONS ARE REQUIRED FOR CONNECTING PIPES TO MANHOLES (FOR EXAMPLE KOR-SEAL, PSX, POSITIVE SEAL AND DURASEAL). THE CONCRETE CRADLE FOR THE PIPE CAN BE ELIMINATED.
9. TYPICAL STORM MANHOLES AND CATCHBASIN MANHOLES ARE TO HAVE 300mm SUMPS UNLESS OTHERWISE INDICATED.
10. THE CONTRACTOR IS TO TELETYPE (CCTV) ALL PROPOSED SEWERS, 200mm OR GREATER PRIOR TO BASE COURSE ASPHALT. UPON COMPLETION OF CONTRACT, THE CONTRACTOR IS RESPONSIBLE TO FLUSH ALL SEWERS & APPURTENANCES. PROVIDE A COPY OF ALL CCTV INSPECTION REPORTS TO THE ENGINEER FOR REVIEW.
11. CONTRACTOR TO PROVIDE THE CONSULTANT WITH A GENERAL PLAN OF SERVICES INDICATING ALL APPLICABLE SERVICES AS-BUILT INFORMATION SHOWN ON THIS PLAN AS-BUILT INFORMATION MUST INCLUDE: PIPE MATERIAL, SIZES, LENGTHS, SLOPES, INVERT AND TIG ELEVATIONS, STRUCTURE LOCATIONS AND ANY ALIGNMENT CHANGES, ETC.
12. THE OWNER SHALL REQUIRE THAT THE SITE SERVICING CONTRACTOR PERFORM FIELD TESTS FOR QUALITY CONTROL OF ALL SANITARY SEWERS. LEAKAGE TESTING SHALL BE COMPLETED IN ACCORDANCE WITH OPSS 410.07, 16, 410.07, 16.04 AND 407.07.24. DYE TESTING IS TO BE COMPLETED ON ALL SANITARY SEWERS TO CONFIRM PROPER CONNECTION TO THE SANITARY SEWER MAIN. THE FIELD TESTS SHALL BE PERFORMED IN THE PRESENCE OF A CERTIFIED PROFESSIONAL ENGINEER WHO SHALL SUBMIT A CERTIFIED COPY OF THE TEST RESULTS.

WATERMAIN NOTES:

- 1. SUPPLY AND CONSTRUCT ALL WATERMANS AND APPURTENANCES IN ACCORDANCE WITH THE CITY OF OTTAWA STANDARDS AND SPECIFICATIONS - ALL CURRENT VERSIONS AND AS AMENDED.
2. SPECIFICATIONS: ITEM, SPEC. No., REFERENCE.
ITEM: WATERMAIN TRENCHING W17 CITY OF OTTAWA
HYDRANT INSTALLATION W19 CITY OF OTTAWA
THERMAL INSULATION IN SHALLOW TRENCHES W22 CITY OF OTTAWA
THERMAL INSULATION BY OPEN STRUCTURES W23 CITY OF OTTAWA
VALVE BOX ASSEMBLY W24 CITY OF OTTAWA
WATERMAIN CROSSING BELOW SEWERS W25 CITY OF OTTAWA
CATHODIC PROTECTION FOR PVC WATERMANS W40 CITY OF OTTAWA
WATERMAIN MATERIAL PVC DR 18 (100mm AND LARGER)
3. EXCAVATION, INSTALLATION, BACKFILL AND RESTORATION OF ALL WATERMANS BY THE CONTRACTOR. CONNECTIONS AND SHUT-OFFS AT THE MAN AND CROCKING IN OF THE WATER SYSTEM SHALL BE PERFORMED BY CITY OFFICIALS.
4. WATERMAIN SHALL BE MINIMUM 2.4m DEPTH BELOW GRADE UNLESS OTHERWISE INDICATED.
5. PROVIDE MINIMUM 0.5m CLEARANCE BETWEEN OUTSIDE OF PIPES AT ALL CROSSINGS, UNLESS OTHERWISE INDICATED.
6. WATER SERVICE IS TO BE CONSTRUCTED TO WITHIN 1.0m OF FOUNDATION WALL AND CAPPED, UNLESS OTHERWISE INDICATED.

INLET CONTROL DEVICE DATA TABLE: AREA A-2. Table with columns: DESIGN EVENT, ICD TYPE (PLUG TYPE), OUTLET STRUCTURE, DIAMETER OF OUTLET PIPE (mm), PEAK FLOW (L/s), DESIGN HEAD (m), WATER ELEVATION (m), VOLUME (m³), AVAILABLE STORAGE.

PROPOSED ROOF DRAIN TABLE: AREA R-1 (RD 1 TO RD 5). Table with columns: AREA ID, ROOF DRAIN NO. (WATTS MODEL), ROOF DRAIN OPENING SETTING, 1.5 YEAR RELEASE RATE, APPROX. 5-YR PONDING DEPTH, 1.00 YEAR RELEASE RATE, APPROX. 100-YR PONDING DEPTH.

PROPOSED 100mmØ WATER SERVICE TABLE. Table with columns: STATION, SURFACE ELEVATION, T&M ELEVATION, COMMENTS.

ALL REAR PATIO DECK / BI-LEVEL PODIUM DRAINS ARE TO BE CONNECTED TO THE INTERNAL PLUMBING SYSTEM AND OUTLET TO THE BUILDING STORM SERVICE UPSTREAM OF STM MH 102. REFER TO MECHANICAL PLANS FOR DETAILS.

CONCRETE RETAINING WALL RAISED BOCCO COURT. DD T/G=94.10, T/G=94.10. 17.0m PERFORATED SUBDRAIN BELOW RAISED BOCCO COURT.

PROPOSED STORM SERVICE TO BE SLEEVED THROUGH FOUNDATION WALL. REFER TO MECHANICAL PLANS FOR DETAILS. INSULATE SHALLOW STORM SERVICE WHERE COVER IS LESS THAN 2.0m (TYPICAL).

THE INTERNAL PLUMBING SYSTEM FOR THE REAR PATIO DECKS AND PODIUM DRAINS IS TO BE CONSTRUCTED WITH PRESSURE PIPE AND FITTINGS. REFER TO MECHANICAL PLANS FOR DETAILS.

THE PROPOSED WEEPING TILE SYSTEM AND UNDERSLAB DRAINAGE SYSTEMS ARE TO BE CONNECTED TO THE INTERNAL MECHANICAL PLUMBING AND OUTLET TO THE BUILDING STORM SERVICE UPSTREAM OF STM MH 103 (BYPASSING THE CONTROLLED SWM SYSTEM). REFER TO MECHANICAL PLANS FOR DETAILS.

PROPOSED 3-STOREY APARTMENT. LEVEL 01 = 94.40, T/FND = 94.40, LEVEL 00 = 91.30, HIGH USF = 90.30, LOW USF = 89.05. ALL UPPER ROOF DRAINS (RD 1 - 5) ARE TO BE CONTROLLED FLOW DRAINS CONNECTED TO THE INTERNAL PLUMBING SYSTEM AND OUTLET TO THE BUILDING STORM SERVICE UPSTREAM OF STM MH 103 (BYPASSING THE CONTROLLED SWM SYSTEM). REFER TO MECHANICAL PLANS FOR DETAILS.

PROPOSED STORM SERVICE TO BE SLEEVED THROUGH FOUNDATION WALL. REFER TO MECHANICAL PLANS FOR DETAILS.

STORM TO CROSS BELOW EX. BELL CLEARANCE=0.6m.

PROVIDE RIP-RAP PER OPSS 810.010 (TYP). MAINTAIN AND PROTECT EXISTING GAS MAIN AND EXISTING UTILITIES WITHIN THE MUNICIPAL R.O.W.

RELOCATE EXISTING GUY WIRE (BY HYDRO FORCES).

OUTLET HEADWALL PER OPSS 804.030. PIPE INVERT=90.55.

OUTLET HEADWALL PER OPSS 804.030. PIPE INVERT=90.39.

CULVERT #3 1.5m-600mmØ CSP. CULVERT EXTENSION INV.W=89.86.

STORM TO CROSS BELOW EX. GAS. CLEARANCE=0.6m.

APPROXIMATE LIMITS OF ROADWAY REINSTATEMENT (PER CITY STANDARD R10).

PROPOSED STORM SEWER SERVICE TO CROSS ABOVE EXISTING 300mmØ SANITARY. EXISTING T/SAN=87.82m. CLEARANCE=1.0m.

CONNECT TO EXISTING 250mmØ PVC STORM SEWER FROM ABOVE PER CITY DETAIL S11.1 WITH ROLLED TEE AND TWO (2) 22.5" RADIUS BENDS. MAINTAIN AND PROTECT EXISTING FLOWS FROM THE WEST. EXCAVATION, BACKFILL AND REINSTATEMENT BY CONTRACTOR. EXISTING 250mmØ INVERT=87.50m.

PROPOSED 200mmØ INVERT (AT CONNECTION)=87.61m. PROPOSED 200mmØ INVERT (AT VERTICAL BEND)=89.79m.

STORM TO CROSS BELOW EX. GAS. CLEARANCE=1.3m.

PIPE CROSSING TABLE. Table with columns: CROSSING, LOWER PIPE, HIGHER PIPE, CLEARANCE.

NOTE: THE POSITION OF ALL POLE LINES, CONDUITS, WATERMANS, SEWERS AND OTHER UNDERGROUND AND OVERGROUND UTILITIES AND STRUCTURES IS NOT NECESSARILY SHOWN ON THE CONTRACT DRAWINGS, AND WHERE SHOWN, THE ACCURACY OF THE POSITION OF SUCH UTILITIES AND STRUCTURES IS NOT GUARANTEED. BEFORE STARTING WORK, DETERMINE THE EXACT LOCATION OF ALL SUCH UTILITIES AND STRUCTURES AND ASSUME ALL LIABILITY FOR DAMAGE TO THEM.

OWNER INFORMATION: NIVO DEVELOPMENTS INC. 255 MICHAEL COWPLAND DRIVE, OTTAWA, ONTARIO, K2M 0M5. CONTACT: ANTHONY NICOLINI. PHONE: (613) 880-2274. EMAIL: anthony@arkconstruction.ca

Revision table with columns: No., REVISION, DATE, BY.

FOR REVIEW ONLY. Includes design, checked, drawn, approved stamps and a professional engineer seal for F.S. THAUVETTE, dated MAR 16, 2023.

NOVATECH logo and contact information. Location: CITY OF OTTAWA, 1185 BEAVERWOOD ROAD. DRAWING NAME: GENERAL PLAN OF SERVICES. PROJECT No. 121184. REV # 3. DRAWING No. 121184-GP.

M:\2021\121184\CAD\DWG\121184-GP.dwg, GP, Mar 17, 2023, 10:14am, zll

D07-12-22-0114

**LEGEND**

	PROPOSED ELEVATION		PROPOSED SANITARY MANHOLE		EXISTING SERVICE POST
	PROPOSED TOP OF CURB ELEVATION		PROPOSED STORM MANHOLE		EXISTING HYDRANT
	PROPOSED SWALE ELEVATION		PROPOSED CATCHBASIN MANHOLE		EXISTING CONCRETE CURB
	MATCH INTO EXISTING GRADES		UNDERGROUND MECHANICAL DECK DRAIN		EXISTING CATCHBASIN
	EXISTING ELEVATION		BI-LEVEL DRAIN AT PODIUM AND U/G DECKING		EXISTING CATCHBASIN MH
	GRADE AND DIRECTION		PROPOSED FILTER BAG		EXISTING UTILITY POLE
	MAXIMUM 3:1 SIDESLOPE		EMERGENCY OVERLAND FLOW ROUTE		EXISTING FENCE
	PROPOSED TERRACE ELEVATION		BUILDING ENTRANCE / EXIT		EXISTING OVERHEAD WIRES
	PROPOSED SILT FENCING (OPSD 219.110)		TRANSFORMER		
	PROPERTY LINE		PROPOSED WATER METER AND REMOTE METER		
	FINISHED FLOOR ELEVATION		TWSI		
	TOP OF FOUNDATION WALL ELEVATION				
	UNDERSIDE OF FOOTING ELEVATION				

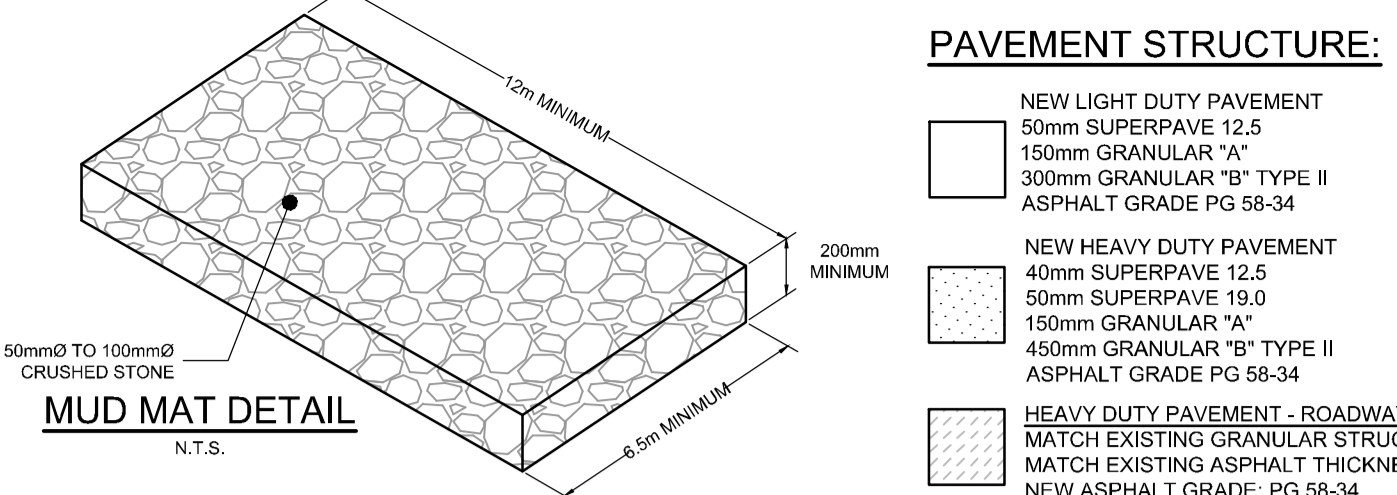
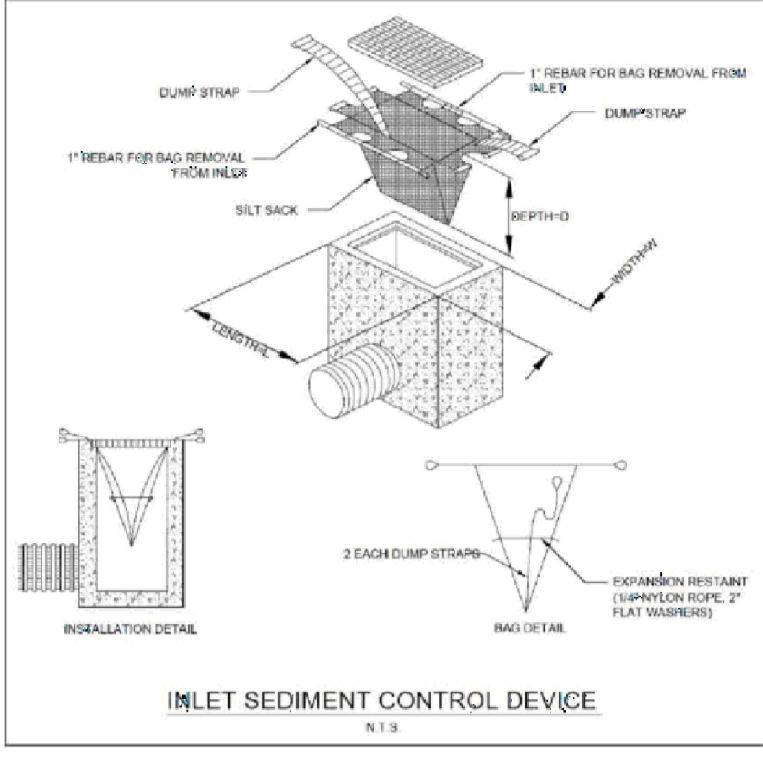

**BENCHMARK NOTES:**

- ELEVATIONS SHOWN ARE GEODETIC AND ARE REFERRED TO THE CGVD28 GEODETIC DATUM. ELEVATIONS ARE RELATED TO VERTICAL CONTROL MONUMENT 011948583G HAVING AN ELEVATION OF 96.03m.
- IT IS THE RESPONSIBILITY OF THE USER OF THIS INFORMATION TO VERIFY THAT THE JOB BENCHMARK HAS NOT BEEN ALTERED OR DISTURBED AND THAT ITS RELATIVE ELEVATION AND DESCRIPTION AGREES WITH THE INFORMATION SHOWN ON THIS DRAWING.
- BENCHMARK WAS PROVIDED ON TOPOGRAPHICAL PLAN OF SURVEY, PART OF BLOCK C, REGISTERED PLAN 771, CITY OF OTTAWA, WEST OF THE SOUTHWEST PROPERTY BOUNDARY ALONG BEAVERWOOD ROAD. SEE TOPOGRAPHICAL PLAN OF SURVEY MENTIONED ABOVE FOR DETAILS.
- TEMPORARY JOB BENCHMARK DESCRIPTION IS LOCATED ON NAIL IN EAST FACE OF UTILITY POLE, LOCATED APPROXIMATED 24.7m WEST OF THE SOUTHWEST PROPERTY BOUNDARY ALONG BEAVERWOOD ROAD. SEE TOPOGRAPHICAL PLAN OF SURVEY MENTIONED ABOVE FOR DETAILS.

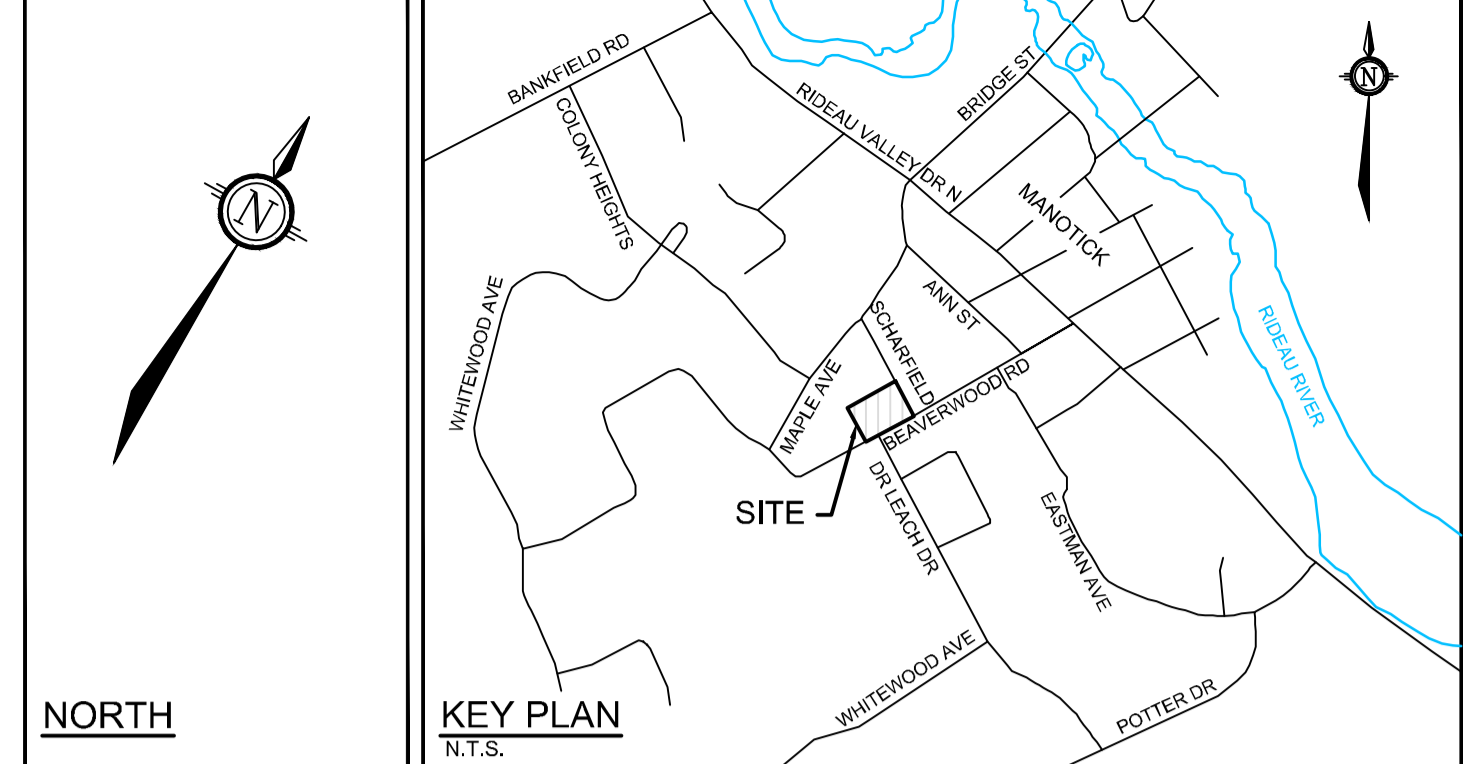

**GENERAL NOTES:**

- COORDINATE AND SCHEDULE ALL WORK WITH OTHER TRADES AND CONTRACTORS.
- DETERMINE THE EXACT LOCATION, SIZE, MATERIAL AND ELEVATION OF ALL EXISTING UTILITIES PRIOR TO COMMENCING CONSTRUCTION. PROTECT AND ASSUME RESPONSIBILITY FOR ALL EXISTING UTILITIES WHETHER OR NOT SHOWN ON THIS DRAWING.
- OBTAIN ALL NECESSARY PERMITS AND APPROVALS FROM THE CITY OF OTTAWA BEFORE COMMENCING CONSTRUCTION.
- BEFORE COMMENCING CONSTRUCTION OBTAIN AND PROVIDE PROOF OF COMPREHENSIVE, ALL RISK AND OPERATIONAL LIABILITY INSURANCE FOR \$5,000,000.00, INSURANCE POLICY TO NAME OWNERS, ENGINEERS AND ARCHITECTS AS CO-INSURED.
- COMPLETE ALL WORKS IN ACCORDANCE WITH THE MOST CURRENT CITY OF OTTAWA STANDARDS AND SPECIFICATIONS USING THE CURRENT GUIDELINES, BYLAWS AND STANDARDS INCLUDING MATERIALS OF CONSTRUCTION, DISINFECTION AND ALL RELEVANT REFERENCES TO OPSS, OPSS & AWWA GUIDELINES - ALL CURRENT VERSIONS AND AS AMENDED.
- RESTORE ALL DISTURBED AREAS ON-SITE AND OFF-SITE, INCLUDING TRENCHES AND SURFACES ON PUBLIC ROAD ALLOWANCES TO EXISTING CONDITIONS OR BETTER TO THE SATISFACTION OF THE CITY OF OTTAWA AND ENGINEER.
- ALL ELEVATIONS ARE GEODETIC.
- REFER TO GEOTECHNICAL INVESTIGATION REPORT (PG#160-1, REVISION 3, DATED MARCH 21, 2023), PREPARED BY PATERSON GROUP INC. FOR SUBSURFACE CONDITIONS, CONSTRUCTION RECOMMENDATIONS, AND GEOTECHNICAL INSPECTION REQUIREMENTS. THE GEOTECHNICAL CONSULTANT IS TO REVIEW ON-SITE CONDITIONS AFTER EXCAVATION PRIOR TO PLACEMENT OF THE GRANULAR MATERIAL.
- REFER TO ARCHITECTS' AND LANDSCAPE ARCHITECTS' DRAWINGS FOR BUILDING AND HARDWARE SURFACES AND DIMENSIONS.
- REFER TO THE DEVELOPMENT SERVICING STUDY AND STORMWATER MANAGEMENT REPORT (R-2022-013) PREPARED BY NOVATECH.
- SAW CUT AND KEY GRIND ASPHALT AT ALL ROAD CUTS AND ASPHALT TIE IN POINTS AS PER CITY OF OTTAWA STANDARDS (R10).

**GRADING NOTES:**

- ALL TOPSOIL, ORGANIC OR DELETERIOUS MATERIAL MUST BE ENTIRELY REMOVED FROM BENEATH THE PROPOSED PAVED AREAS AS DIRECTED BY THE SITE ENGINEER OR GEOTECHNICAL ENGINEER.
- EXPOSED SUBGRADES IN PROPOSED PAVED AREAS SHOULD BE PROOF ROLLED WITH A LARGE STEEL DRUM ROLLER AND INSPECTED BY THE GEOTECHNICAL ENGINEER PRIOR TO THE PLACEMENT OF GRANULARS.
- ANY SOFT AREAS EVIDENT FROM THE PROOF ROLLING SHOULD BE SUB-EXCAVATED AND REPLACED WITH SUITABLE MATERIAL THAT IS FROST COMPATIBLE WITH THE EXISTING SOILS AS RECOMMENDED BY THE GEOTECHNICAL ENGINEER.
- THE GRANULAR BASE SHOULD BE COMPACTED TO AT LEAST 99% OF THE STANDARD PROCTOR MAXIMUM DRY DENSITY VALUE. ANY ADDITIONAL GRANULAR FILL USED BELOW THE PROPOSED PAVEMENT SHOULD BE COMPACTED TO AT LEAST 95% OF THE STANDARD PROCTOR MAXIMUM DRY DENSITY VALUE.
- MINIMUM OF 2% GRADE FOR ALL GRASS AREAS UNLESS OTHERWISE NOTED.
- MAXIMUM TERRACING GRADE TO BE 3:1 UNLESS OTHERWISE NOTED.
- ALL GRADES BY CURBS ARE EDGE OF PAVEMENT GRADES UNLESS OTHERWISE INDICATED.
- ALL CURBS SHALL BE BARRIER CURB (150mm) UNLESS OTHERWISE NOTED AND CONSTRUCTED AS PER CITY OF OTTAWA STANDARDS (SC1.1).
- REFER TO LANDSCAPE PLAN FOR PLANTING AND OTHER LANDSCAPE FEATURE DETAILS.
- CONTRACTOR TO PROVIDE THE CONSULTANT WITH A GRADING PLAN INDICATING THE AS-BUILT ELEVATIONS OF ALL DESIGN GRADES SHOWN ON THIS PLAN.

**EROSION AND SEDIMENT CONTROL NOTES:**

- ALL EROSION AND SEDIMENT CONTROLS ARE TO BE INSTALLED TO THE SATISFACTION OF THE ENGINEER AND THE CITY OF OTTAWA. THEY ARE TO BE APPROPRIATE TO THE SITE CONDITIONS, PRIOR TO UNDERTAKING ANY SITE ALTERATIONS (FILLING, GRADING, REMOVAL OF VEGETATION, ETC.) AND DURING ALL PHASES OF SITE PREPARATION AND CONSTRUCTION. THESE PRACTICES ARE TO BE IMPLEMENTED IN ACCORDANCE WITH THE CURRENT BEST MANAGEMENT PRACTICES FOR EROSION AND SEDIMENT CONTROL AND SHOULD INCLUDE AS A MINIMUM THOSE MEASURES INDICATED ON THE PLAN.
- A LIGHT DUTY SILT FENCE BARRIER WILL ALSO BE INSTALLED AROUND THE CONSTRUCTION AREA. THESE CONTROL MEASURES WILL REMAIN IN PLACE UNTIL CONSTRUCTION IS COMPLETE.
- TO PREVENT SURFACE EROSION FROM ENTERING ANY STORM SEWER SYSTEM DURING CONSTRUCTION, FILTER BAGS WILL BE PLACED UNDER GRATES OF NEARBY SURFACE CATCHBASINS AND MANHOLE STRUCTURES. TERRAFIX 8" ULTRA SILT SOCK (FILTER SOCK) IS TO BE USED AT THE OPENING OF ALL CURB INLET CATCHBASINS. A LIGHT DUTY SILT FENCE BARRIER WILL ALSO BE INSTALLED (PER OPSD 219.110) AROUND THE CONSTRUCTION AREA (WHERE APPLICABLE). IN AREAS WHERE SILT FENCING CANNOT BE INSTALLED PER OPSD 219.110 (i.e. HARD SURFACES), A FILTER SOCK SHALL BE SUBSTITUTED. THESE CONTROL MEASURES WILL REMAIN IN PLACE UNTIL CONSTRUCTION IS COMPLETE.
- THE SEDIMENT CONTROL MEASURES SHALL ONLY BE REMOVED WHEN, IN THE OPINION OF THE ENGINEER, THE MEASURES ARE NO LONGER REQUIRED. NO CONTROL MEASURES MAY BE PERMANENTLY REMOVED WITHOUT PRIOR AUTHORIZATION FROM THE ENGINEER.
- THE CONTRACTOR SHALL IMMEDIATELY REPORT TO THE ENGINEER ANY ACCIDENTAL DISCHARGES OF SEDIMENT MATERIAL INTO ANY STORM SEWER SYSTEM. APPROPRIATE RESPONSE MEASURES, INCLUDING ANY REPAIRS TO EXISTING CONTROL MEASURES OR THE IMPLEMENTATION OF ADDITIONAL CONTROL MEASURES, SHALL BE CARRIED OUT BY THE CONTRACTOR WITHOUT DELAY.
- THE CONTRACTOR ACKNOWLEDGES THAT FAILURE TO IMPLEMENT EROSION AND SEDIMENT CONTROL MEASURES MAY BE SUBJECT TO PENALTIES IMPOSED BY ANY APPLICABLE REGULATORY AGENCY.
- ROADWAYS ARE TO BE SWEEPED AS REQUIRED OR AS DIRECTED BY THE ENGINEER AND/OR MUNICIPALITY.
- THE CONTRACTOR SHALL ENSURE PROPER DUST CONTROL IS PROVIDED WITH THE APPLICATION OF WATER (AND IF REQUIRED, CALCIUM CHLORIDE) DURING DRY PERIODS.
- ON-SITE DEWATERING IS TO BE DIRECTED TO A SEDIMENT TRAP AND/OR GRAVEL SPLASH PAD AND DISCHARGED SAFELY TO AN APPROVED OUTLET AS DIRECTED BY THE ENGINEER.

**Erosion and Sediment Control Responsibilities:**

ESC Measure	Symbol	Specification	During Construction		After Construction Prior to Final Acceptance		After Final Acceptance	
			Inspection/Maintenance Responsibility	Frequency	Approval to Remove	Removal Responsibility	Inspection/Maintenance Responsibility	Frequency
Silt Fence		OPSD 219.110	Developer's Contractor	Weekly (as a minimum)	Consultant	Developer's Contractor	N/A	
Filter Bags/Socks		Location as Indicated in ESC Note #3	Developer's Contractor	Weekly (as a minimum)	Consultant	Developer's Contractor	N/A	
Mud Mat		Drawing Details	Developer's Contractor	Weekly (as a minimum)	Developer's Contractor	Developer's Contractor	N/A	
Dust Control		Location as Required Around Site	Developer's Contractor	Weekly (as a minimum)	Consultant	Developer's Contractor	N/A	
Stabilized Material Stockpiling		Location as Required by Contractor	Developer's Contractor	Weekly (as a minimum)	Developer's Contractor	Developer's Contractor	N/A	
Sediment Basin (or Rows being pumped out of excavations)		Location as Required by Contractor	Developer's Contractor	Developer's Contractor	After Every Rainstorm	Developer's Contractor	Developer's Contractor	N/A

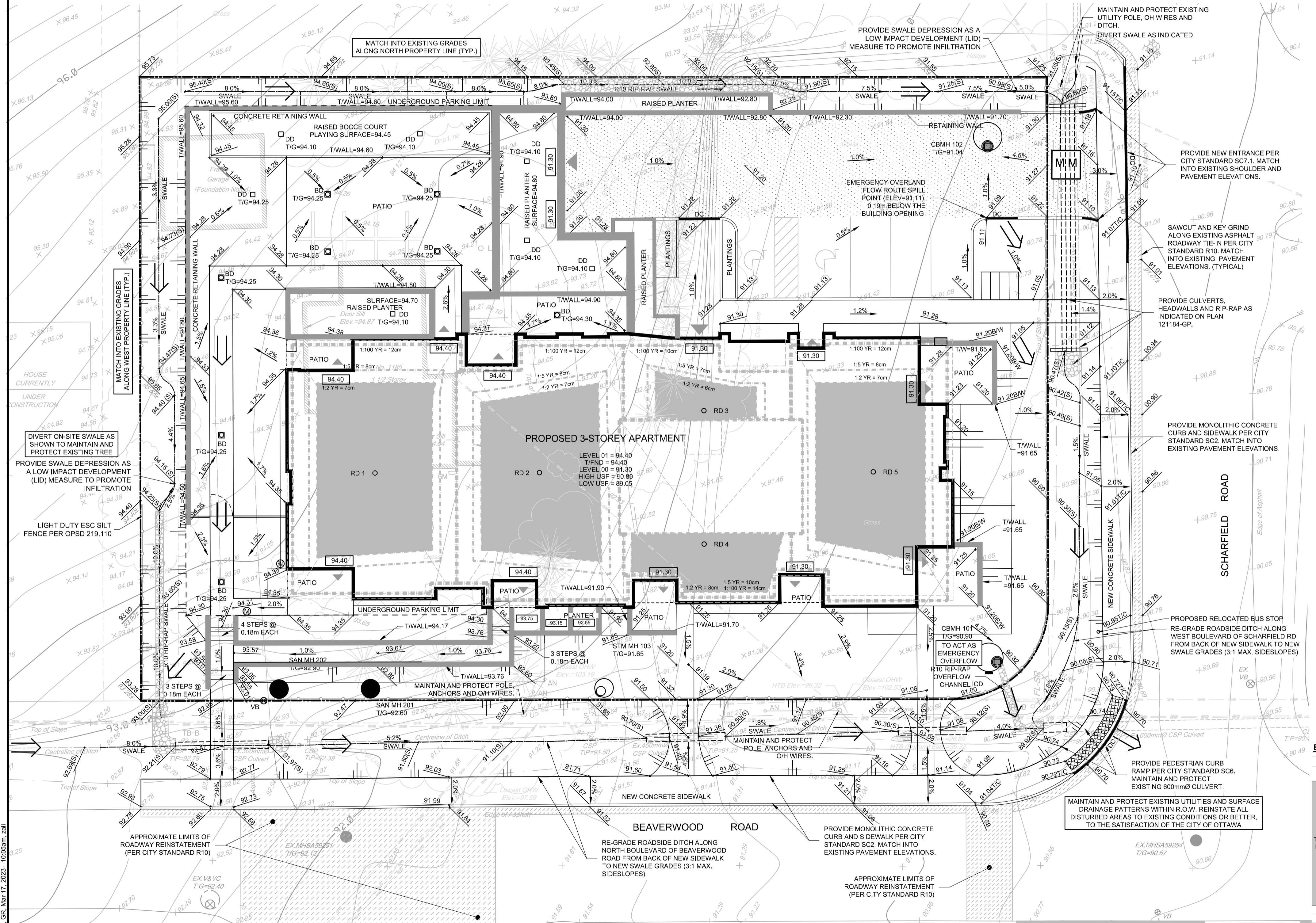

**NOTE:** THE POSITION OF ALL POLE LINES, CONDUITS, WATERMANS, SEWERS AND OTHER UNDERGROUND AND OVERGROUND UTILITIES AND STRUCTURES IS NOT NECESSARILY SHOWN ON THE CONTRACT DRAWINGS, AND WHERE SHOWN, THE ACCURACY OF THE POSITION OF SUCH UTILITIES AND STRUCTURES IS NOT GUARANTEED. BEFORE STARTING WORK, DETERMINE THE EXACT LOCATION OF ALL SUCH UTILITIES AND STRUCTURES AND ASSUME ALL LIABILITY FOR DAMAGE TO THEM.

**OWNER INFORMATION**  
 NIVO DEVELOPMENTS INC.  
 255 MICHAEL COWPLAND DRIVE,  
 OTTAWA, ONTARIO, K2M 0M5  
 CONTACT: ANTHONY NICOLINI  
 PHONE: (613) 880-2274  
 EMAIL: anthony@arkconstruction.ca

No.	REVISION	DATE	BY
3	REVISED PER CITY COMMENTS	MAR 16/23	FST
2	REVISED PER CITY COMMENTS	DEC 22/22	FST
1	ISSUED FOR SITE PLAN APPROVAL	JUL 15/22	FST

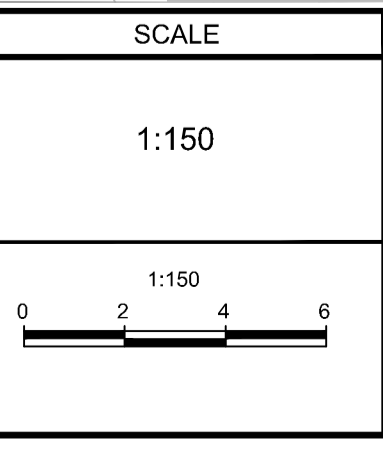

**FOR REVIEW ONLY**

**NOVATECH**  
 Engineers, Planners & Landscape Architects  
 Suite 200, 240 Michael Cowpland Drive  
 Ottawa, Ontario, Canada K2M 1P6  
 Telephone: (613) 254-9643  
 Facsimile: (613) 254-5867  
 Website: www.novatech-eng.com

**LOCATION**  
 CITY OF OTTAWA  
 1185 BEAVERWOOD ROAD

**DRAWING NAME**  
 GRADING AND EROSION & SEDIMENT CONTROL PLAN

PROJECT No. 121184  
 REV # 3  
 DRAWING No. 121184-GR

M:\2021\121184\CAD\Drawings\121184-GR.dwg, GR, Mar 17, 2023 - 10:05am, zll

D07-12-22-0114

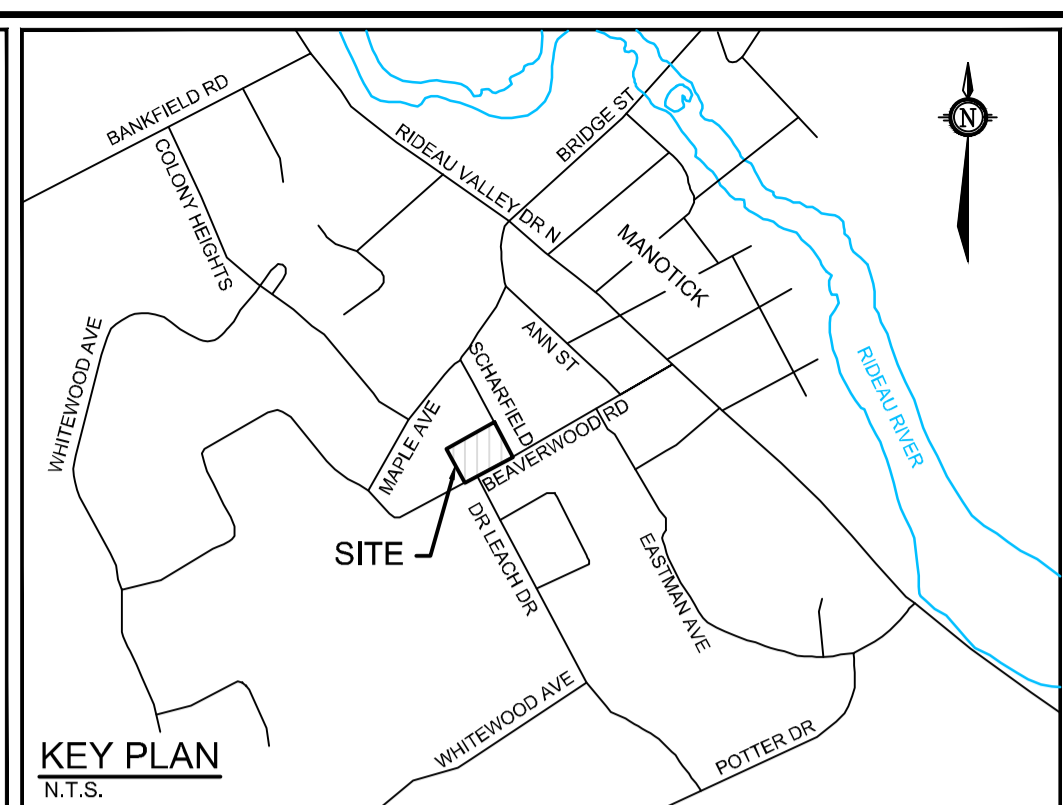
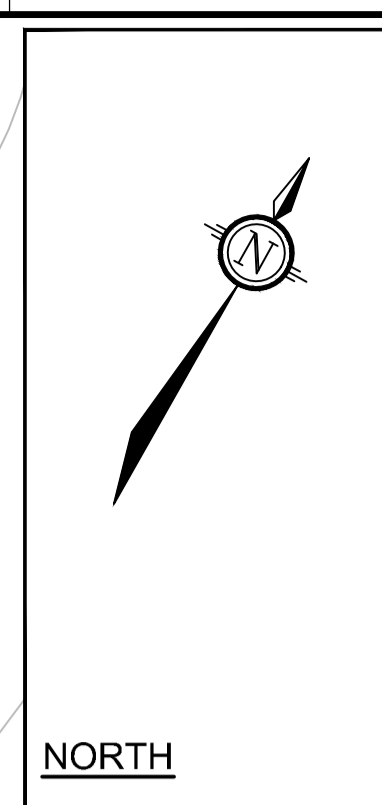

**LEGEND**

	PROPOSED BARRIER CURB
	PROPOSED DEPRESSED CURB
	DRAINAGE AREA LIMITS
	PRE-DEVELOPMENT AREA ID
	PRE-DEVELOPMENT DRAINAGE AREA (ha)
	1.5 YEAR WEIGHTED RUNOFF COEFFICIENT
	MAXIMUM 3:1 SIDESLOPE
	OFF-SITE AREA ID
	OFF-SITE DRAINAGE AREA (ha)
	1.5 YEAR WEIGHTED RUNOFF COEFFICIENT
	EXISTING CONCRETE CURB
	EXISTING VALVE & VALVE BOX
	EXISTING SERVICE POST
	EXISTING HYDRANT
	EXISTING CATCHBASIN
	EXISTING CATCHBASIN MH
	EXISTING UTILITY POLE
	C/W GUY WIRES

- GENERAL NOTES:**
- COORDINATE AND SCHEDULE ALL WORK WITH OTHER TRADES AND CONTRACTORS.
  - DETERMINE THE EXACT LOCATION, SIZE, MATERIAL, AND ELEVATION OF ALL EXISTING UTILITIES PRIOR TO COMMENCING CONSTRUCTION. PROTECT AND ASSUME RESPONSIBILITY FOR ALL EXISTING UTILITIES WHETHER OR NOT SHOWN ON THIS DRAWING.
  - ALL ELEVATIONS ARE GEODETIC.
  - REFER TO GEOTECHNICAL INVESTIGATION REPORT (PG6160-1, REVISION 3, DATED MARCH 21, 2023), PREPARED BY PATERSON GROUP INC., FOR SUBSURFACE CONDITIONS, CONSTRUCTION RECOMMENDATIONS, AND GEOTECHNICAL INSPECTION REQUIREMENTS. THE GEOTECHNICAL CONSULTANT IS TO REVIEW ON-SITE CONDITIONS AFTER EXCAVATION PRIOR TO PLACEMENT OF THE GRANULAR MATERIAL.
  - REFER TO THE DEVELOPMENT SERVICING STUDY AND STORMWATER MANAGEMENT REPORT (R-2022-013) PREPARED BY NOVATECH.

- BENCHMARK NOTES:**
- ELEVATIONS SHOWN ARE GEODETIC AND ARE REFERRED TO THE CGVD28 GEODETIC DATUM. ELEVATIONS ARE RELATED TO VERTICAL CONTROL MONUMENT 011948U83G HAVING AN ELEVATION OF 96.03m.
  - IT IS THE RESPONSIBILITY OF THE USER OF THIS INFORMATION TO VERIFY THAT THE JOB BENCHMARK HAS NOT BEEN ALTERED OR DISTURBED AND THAT ITS RELATIVE ELEVATION AND DESCRIPTION AGREES WITH THE INFORMATION SHOWN ON THIS DRAWING.
  - BENCHMARK WAS PROVIDED ON TOPOGRAPHICAL PLAN OF SURVEY, PART OF BLOCK C, REGISTERED PLAN 771, CITY OF OTTAWA, PREPARED BY ANNIS, O'SULLIVAN, VOLLEBECK LTD.
  - TEMPORARY JOB BENCHMARK DESCRIPTION IS LOCATED ON NAIL IN EAST FACE OF UTILITY POLE. LOCATED APPROXIMATED 24.7m WEST OF THE SOUTHWEST PROPERTY BOUNDARY ALONG BEAVERWOOD ROAD. SEE TOPOGRAPHICAL PLAN OF SURVEY MENTIONED ABOVE FOR DETAILS.

**NOTE:**  
THE POSITION OF ALL POLE LINES, CONDUITS, WATERMANS, SEWERS AND OTHER UNDERGROUND AND OVERGROUND UTILITIES AND STRUCTURES IS NOT NECESSARILY SHOWN ON THE CONTRACT DRAWINGS, AND WHERE SHOWN, THE ACCURACY OF THE POSITION OF SUCH UTILITIES AND STRUCTURES IS NOT GUARANTEED. BEFORE STARTING WORK, DETERMINE THE EXACT LOCATION OF ALL SUCH UTILITIES AND STRUCTURES AND ASSUME ALL LIABILITY FOR DAMAGE TO THEM.

**OWNER INFORMATION**  
NIVO DEVELOPMENTS INC.  
255 MICHAEL COWPLAND DRIVE,  
OTTAWA, ONTARIO, K2M 0M5  
CONTACT: ANTHONY NICOLINI  
PHONE: (613) 880-2274  
EMAIL: anthony@arkconstruction.ca

No.	REVISION	DATE	BY
3	REVISED PER CITY COMMENTS	MAR 16/23	FST
2	REVISED PER CITY COMMENTS	DEC 22/22	FST
1	ISSUED FOR SITE PLAN APPROVAL	JUL 15/22	FST

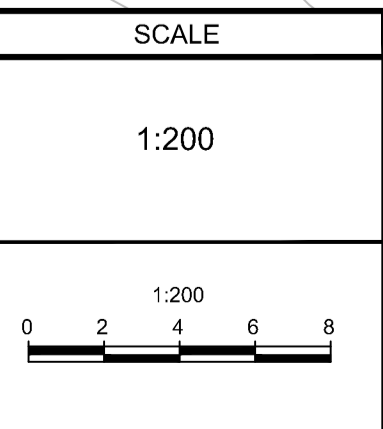

DESIGN	SM
CHECKED	FST
DRAWN	SM
CHECKED	FST
APPROVED	FST



<b>LOCATION</b> CITY OF OTTAWA 1185 BEAVERWOOD ROAD	
<b>DRAWING NAME</b> PRE-DEVELOPMENT STORMWATER MANAGEMENT PLAN	
PROJECT No.	121184
REV	REV # 3
DRAWING No.	121184-SWM1

M:\2021\121184\CADD\design\121184-SWM1.dwg, SWM1, Mar 17, 2023, 10:05am, zell

D07-12-22-0114

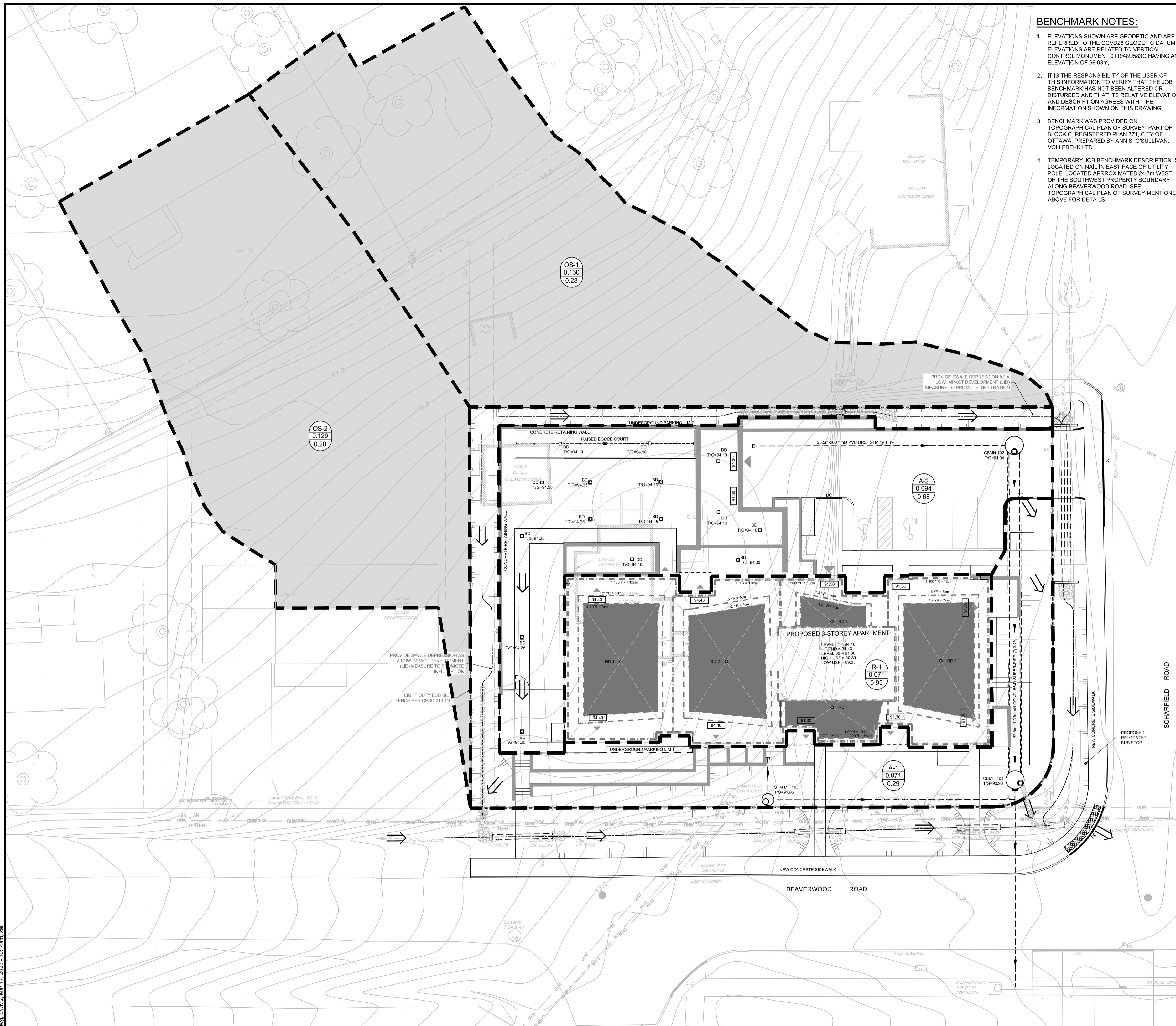

**BENCHMARK NOTES:**

- ELEVATIONS SHOWN ARE GEODETIC AND ARE REFERRED TO THE CGVD28 GEODETIC DATUM. ELEVATIONS ARE RELATED TO VERTICAL CONTROL MONUMENT 011948US83G HAVING AN ELEVATION OF 96.03m.
- IT IS THE RESPONSIBILITY OF THE USER OF THIS INFORMATION TO VERIFY THAT THE JOB BENCHMARK HAS NOT BEEN ALTERED OR DISTURBED AND THAT ITS RELATIVE ELEVATION AND DESCRIPTION AGREES WITH THE INFORMATION SHOWN ON THIS DRAWING.
- BENCHMARK WAS PROVIDED ON TOPOGRAPHICAL PLAN OF SURVEY, PART OF BLOCK C, REGISTERED PLAN 771, CITY OF OTTAWA, PREPARED BY ANNIS, O'SULLIVAN, VOLLEBEKK LTD.
- TEMPORARY JOB BENCHMARK DESCRIPTION IS LOCATED ON NAIL IN EAST FACE OF UTILITY POLE, LOCATED APPROXIMATED 24.7m WEST OF THE SOUTHWEST PROPERTY BOUNDARY ALONG BEAVERWOOD ROAD. SEE TOPOGRAPHICAL PLAN OF SURVEY MENTIONED ABOVE FOR DETAILS.

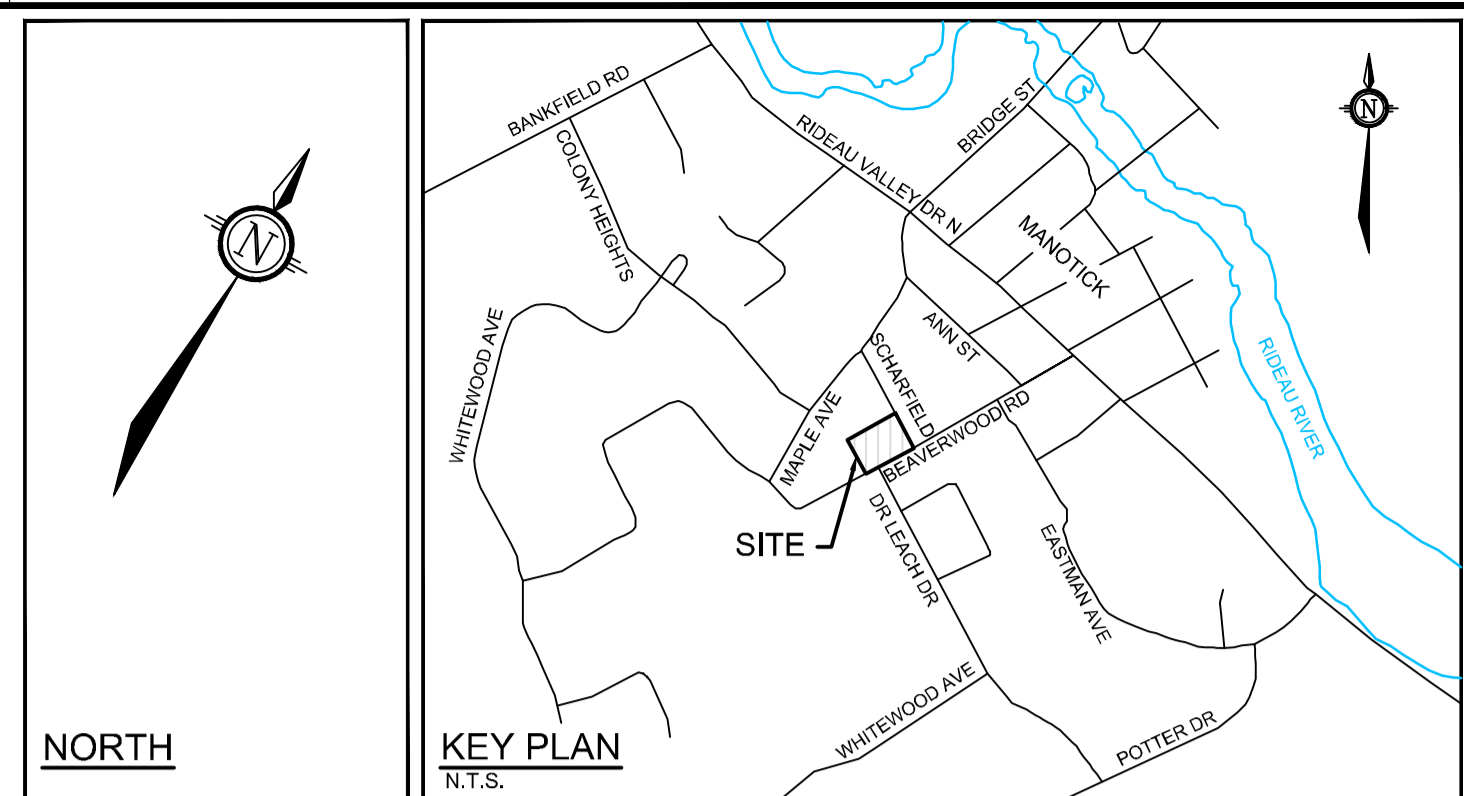

**GENERAL NOTES:**

- COORDINATE AND SCHEDULE ALL WORK WITH OTHER TRADES AND CONTRACTORS.
- DETERMINE THE EXACT LOCATION, SIZE, MATERIAL AND ELEVATION OF ALL EXISTING UTILITIES PRIOR TO COMMENCING CONSTRUCTION. PROTECT AND ASSUME RESPONSIBILITY FOR ALL EXISTING UTILITIES WHETHER OR NOT SHOWN ON THIS DRAWING.
- OBTAIN ALL NECESSARY PERMITS AND APPROVALS FROM THE CITY OF OTTAWA BEFORE COMMENCING CONSTRUCTION.
- BEFORE COMMENCING CONSTRUCTION OBTAIN AND PROVIDE PROOF OF COMPREHENSIVE, ALL RISK AND OPERATIONAL LIABILITY INSURANCE FOR \$5,000,000.00. INSURANCE POLICY TO NAME OWNERS, ENGINEERS AND ARCHITECTS AS CO-INSURED.
- COMPLETE ALL WORKS IN ACCORDANCE WITH THE MOST CURRENT CITY OF OTTAWA STANDARDS AND SPECIFICATIONS USING THE CURRENT GUIDELINES, BYLAWS AND STANDARDS INCLUDING MATERIALS OF CONSTRUCTION, DISINFECTION AND ALL RELEVANT REFERENCES TO CPSS, OPSD & AWWA GUIDELINES - ALL CURRENT VERSIONS AND AS AMENDED.
- RESTORE ALL DISTURBED AREAS ON-SITE AND OFF-SITE, INCLUDING TRENCHES AND SURFACES ON PUBLIC ROAD ALLOWANCES TO EXISTING CONDITIONS OR BETTER TO THE SATISFACTION OF THE CITY OF OTTAWA AND ENGINEER.
- REMOVE FROM SITE ALL EXCESS EXCAVATED MATERIAL, ORGANIC MATERIAL AND DEBRIS UNLESS OTHERWISE INSTRUCTED BY ENGINEER. EXCAVATE AND REMOVE FROM SITE ANY CONTAMINATED MATERIAL. ALL CONTAMINATED MATERIAL SHALL BE DISPOSED OF AT A LICENSED LANDFILL FACILITY.
- ALL ELEVATIONS ARE GEODETIC.
- REFER TO GEOTECHNICAL INVESTIGATION REPORT (PG6160-1, REVISION 3, DATED MARCH 21, 2023), PREPARED BY PATERSON GROUP INC., FOR SUBSURFACE CONDITIONS, CONSTRUCTION RECOMMENDATIONS, AND GEOTECHNICAL INSPECTION REQUIREMENTS. THE GEOTECHNICAL CONSULTANT IS TO REVIEW ON-SITE CONDITIONS AFTER EXCAVATION PRIOR TO PLACEMENT OF THE GRANULAR MATERIAL.
- REFER TO ARCHITECTS' AND LANDSCAPE ARCHITECTS' DRAWINGS FOR BUILDING AND HARDSURFACE AREAS AND DIMENSIONS.
- REFER TO THE DEVELOPMENT SERVICING STUDY AND STORMWATER MANAGEMENT REPORT (R-2022-013) PREPARED BY NOVATECH.
- SAW CUT AND KEY GRIND ASPHALT AT ALL ROAD CUTS AND ASPHALT TIE IN POINTS AS PER CITY OF OTTAWA STANDARDS (R10).

**INLET CONTROL DEVICE DATA TABLE: AREA A-2**

DESIGN EVENT	ICD TYPE (PLUG TYPE)	OUTLET STRUCTURE	DIAMETER OF OUTLET PIPE (mm)	PEAK DESIGN FLOW (L/s)	DESIGN HEAD (m)	WATER ELEVATION (m)	VOLUME (m³)	AVAILABLE STORAGE
1:2 YR	IPEX	CBMH 101	200mm Ø PVC	1.2	0.42	89.50	14.4	38.7 m³
1:5 YR	VORTEX LMF 75	CBMH 101	200mm Ø PVC	1.4	0.60	89.88	20.0	
1:100 YR				2.5	1.81	90.89	38.6	

**PROPOSED ROOF DRAIN TABLE: AREA R-1 (RD 1 to RD 5)**

AREA ID	ROOF DRAIN No. (WATTS MODEL)	ROOF DRAIN OPENING RATE	1.5 YEAR RELEASE RATE	APPROX. 5-YR PONDING DEPTH	1:100 YEAR PONDING DEPTH	APPROX. 100-YR PONDING DEPTH
R-1	RD 1 (RD-100-A-ADJ)	CLOSED	0.32 L/s	8 cm	0.32 L/s	12 cm
R-1	RD 2 (RD-100-A-ADJ)	CLOSED	0.32 L/s	8 cm	0.32 L/s	12 cm
R-1	RD 3 (RD-100-A-ADJ)	CLOSED	0.32 L/s	7 cm	0.32 L/s	10 cm
R-1	RD 4 (RD-100-A-ADJ)	FULLY EXPOSED	1.28 L/s	10 cm	1.73 L/s	14 cm
R-1	RD 5 (RD-100-A-ADJ)	CLOSED	0.32 L/s	8 cm	0.32 L/s	12 cm

\* REFER TO THE 'DEVELOPMENT SERVICING STUDY AND STORMWATER MANAGEMENT REPORT' (R-2022-013) PREPARED BY NOVATECH FOR DRAINAGE AREA IDENTIFIERS AND STORMWATER MANAGEMENT DETAILS.

**LEGEND**

- PROPOSED BARRIER CURB
- DC PROPOSED DEPRESSED CURB
- DRAINAGE AREA LIMITS
- POST-DEVELOPMENT AREA ID
- POST-DEVELOPMENT DRAINAGE AREA (ha)
- 1.5 YEAR WEIGHTED RUNOFF COEFFICIENT
- MAXIMUM 3:1 SIDESLOPE
- PROPOSED TERRACE ELEVATION
- PROPOSED SANITARY MANHOLE
- PROPOSED STORM MANHOLE
- PROPOSED HYDRANT AND VALVE
- PROPOSED CATCHBASIN MANHOLE
- PROPOSED CATCHBASIN
- EMERGENCY OVERLAND FLOW ROUTE
- PROPOSED HYDRO TRANSFORMER
- FINISHED FLOOR ELEVATION
- APPROXIMATE PONDING LIMITS
- BUILDING ENTRANCE / EXIT
- EXISTING CONCRETE CURB
- EXISTING VALVE & VALVE BOX
- EXISTING SERVICE POST
- EXISTING HYDRANT
- EXISTING CATCHBASIN
- EXISTING CATCHBASIN MH
- EXISTING UTILITY POLE
- EXISTING GUY WIRES

**NOTE:** THE POSITION OF ALL POLE LINES, CONDUITS, WATERMANS, SEWERS AND OTHER UNDERGROUND AND OVERGROUND UTILITIES AND STRUCTURES IS NOT NECESSARILY SHOWN ON THE CONTRACT DRAWINGS, AND WHERE SHOWN, THE ACCURACY OF THE POSITION OF SUCH UTILITIES AND STRUCTURES IS NOT GUARANTEED. BEFORE STARTING WORK, DETERMINE THE EXACT LOCATION OF ALL SUCH UTILITIES AND STRUCTURES AND ASSUME ALL LIABILITY FOR DAMAGE TO THEM.

**OWNER INFORMATION**  
 NIVO DEVELOPMENTS INC.  
 255 MICHAEL COWPLAND DRIVE,  
 OTTAWA, ONTARIO, K2M 0M5  
 CONTACT: ANTHONY NICOLINI  
 PHONE: (613) 880-2274  
 EMAIL: anthony@arkconstruction.ca

No.	REVISION	DATE	BY
3	REVISED PER CITY COMMENTS	MAR 16/23	FST
2	REVISED PER CITY COMMENTS	DEC 22/22	FST
1	ISSUED FOR SITE PLAN APPROVAL	JUL 15/22	FST

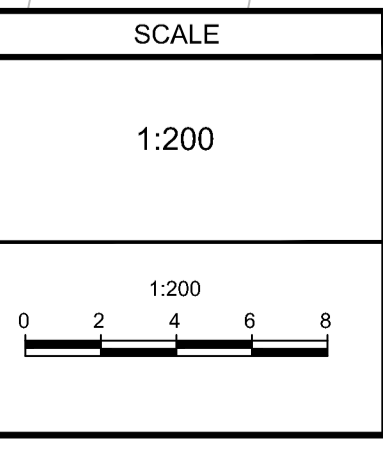

DESIGN	SM
CHECKED	FST
DRAWN	SM
CHECKED	FST
APPROVED	FST



**NOVATECH**  
 Engineers, Planners & Landscape Architects  
 Suite 200, 240 Michael Cowpland Drive  
 Ottawa, Ontario, Canada K2M 1P6  
 Telephone: (613) 254-9643  
 Facsimile: (613) 254-5867  
 Website: www.novatech-eng.com

LOCATION	CITY OF OTTAWA 1185 BEAVERWOOD ROAD
DRAWING NAME	POST-DEVELOPMENT STORMWATER MANAGEMENT PLAN
PROJECT No.	121184
REV	REV # 3
DRAWING No.	121184-SWM2

M:\2021\121184\CADD\Design\121184-SWM2.dwg, SWM2, Mar 17, 2023, 10:14am, zali

D07-12-22-0114