

SERVICING & STORMWATER MANAGEMENT REPORT FIX AUTO ORLEANS – 1400 & 1410 YOVILLE DRIVE



Project No.: CCO-23-0480

City File No.: D07-12-22-0130

Prepared for:

BBS Construction (Ontario) LTD.
1805 Woodward Drive
Ottawa, ON. K2C 0P9

Prepared by:

McIntosh Perry Consulting Engineers Ltd.
115 Walgreen Road
Carp, ON K0A 1L0

May 01, 2023

TABLE OF CONTENTS

1.0	PROJECT DESCRIPTION.....	1
1.1	<i>Purpose</i>	1
1.2	<i>Site Description</i>	2
1.3	<i>Proposed Development and Statistics</i>	2
1.4	<i>Existing Conditions and Infrastructures</i>	2
1.5	<i>Approvals</i>	3
2.0	BACKGROUND STUDIES.....	4
2.1	<i>Applicable Guidelines and Standards</i>	4
3.0	PRE-CONSULTATION SUMMARY.....	5
4.0	WATERMAIN.....	6
4.1	<i>Existing Watermain</i>	6
4.2	<i>Proposed Watermain</i>	6
5.0	SANITARY DESIGN.....	8
5.1	<i>Existing Sanitary Sewer</i>	8
5.2	<i>Proposed Sanitary Sewer</i>	8
6.0	STORM SEWER DESIGN.....	10
6.1	<i>Existing Storm Sewers</i>	10
6.2	<i>Proposed Storm Sewers</i>	10
7.0	PROPOSED STORMWATER MANAGEMENT.....	11
7.1	<i>Design Criteria and Methodology</i>	11
7.2	<i>Runoff Calculations</i>	11
7.3	<i>Pre-Development Drainage</i>	12
7.4	<i>Post-Development Drainage</i>	12
7.5	<i>Quality Control</i>	13
8.0	EROSION AND SEDIMENT CONTROL.....	14
8.1	<i>Temporary Measures</i>	14
8.2	<i>Permanent Measures</i>	14
9.0	SUMMARY.....	15
10.0	RECOMMENDATION.....	16
11.0	STATEMENT OF LIMITATIONS.....	17

LIST OF TABLES

Table 1: Water Demands.....	6
Table 2: Boundary Conditions Results	7
Table 3: Fire Protection Confirmation.....	7
Table 4: Sanitary Design Criteria.....	8
Table 5: Summary of Estimated Sanitary Flow	9
Table 6: Pre-Development Runoff Summary.....	12
Table 7: Post-Development Runoff Summary	12

APPENDICES

Appendix A: Site Location Plan

Appendix B: City of Ottawa Pre-Consultation Notes

Appendix C: Watermain Calculations

Appendix D: Sanitary Calculations

Appendix E: Pre-Development Drainage Plan

Appendix F: Post-Development Drainage Plan

Appendix G: Stormwater Management Calculations

Appendix H: City of Ottawa Design Checklist

1.0 PROJECT DESCRIPTION

1.1 Purpose

McIntosh Perry (MP) has been retained by BBS Construction (Ontario) LTD. to prepare this Servicing and Stormwater Management Report in support of the Site Plan Control process for the proposed automobile body shop, located at 1400 & 1410 Youville Drive within the City of Ottawa (City File No. D07-12-22-0130).

The main purpose of this report is to present a servicing design for the development in accordance with the recommendations and guidelines provided by the City of Ottawa (City), the Rideau Valley Conservation Authority (RVCA), and the Ministry of the Environment, Conservation and Parks (MECP). This report will address the water, sanitary and storm sewer servicing for the development, ensuring that existing and available services will adequately service the proposed development.

This report should be read in conjunction with the following drawings:

- CCO-23-0480, C101 – Site Grading, Drainage & Sediment and Erosion Control Plan, and
- CCO-23-0480, C102 – Site Servicing Plan,
- CCO-23-0480, PRE – Pre-Development Drainage Area Plan (*Appendix E*)
- CCO-23-0480, POST – Post-Development Drainage Area Plan (*Appendix F*)

1.2 Site Description



Figure 1: Site Map

The subject property, herein referred to as the site, is located at 1400 & 1410 Youville Drive within the Orleans ward in the City of Ottawa. It is described as Parts 1 and 3 on Plan 4R-6509. The land in question covers approximately 0.92 ha and is located north of the Youville Drive and St-Joseph Blvd intersection. The site is zoned for light industrial use (IL2). See Site Location Plan in *Appendix A* for more details.

1.3 Proposed Development and Statistics

The proposed development consists of a 2,115 m², one storey automobile body shop and service station complete with office space. Parking and drive aisles will be provided throughout the site along with access from Youville Drive. See *Appendix B* for further details.

1.4 Existing Conditions and Infrastructures

The existing site is currently developed with a car wash and Jim Keay Ford gravel parking areas. The existing car wash is serviced by a 50 mm diameter water service, a 150 mm diameter sanitary service, and a 250 mm diameter storm service all of which are serviced by the municipal infrastructure within Youville Drive.

Sewer and watermain mapping collected from the City of Ottawa indicate that the following services exist across the property frontages within the adjacent municipal rights-of-way(s):

- Youville Drive
 - 762 mm diameter concrete backbone watermain,
 - 305 mm diameter ductile iron watermain,
 - 50 mm concrete sanitary sewer tributary to the Orleans Collector, and a
 - 675 mm concrete storm sewer tributary to the West Bilberry Creek and ultimately tributary to the Ottawa River approximately 1.7 km downstream.

1.5 Approvals

The proposed development is subject to the City of Ottawa site plan control approval process. Site plan control requires the City to review, provide concurrence and approve the engineering design package. Permits to construct can be requested once the City has issued a site plan agreement.

An Environmental Compliance Approval (ECA) Amendment through the Ministry of Environment, Conservation and Parks (MECP) may be required due to the light industrial zoning. Requirements to be further discussed with City staff.

2.0 BACKGROUND STUDIES

As-built drawings of existing services, provided by the City of Ottawa Information centre, within the vicinity of the proposed site were reviewed in order to identify infrastructure available to service the proposed development.

A topographic survey of the site was completed by Stantec Geomatics Ltd (Contract No. 161614550-111) dated March 29th, 2022.

The Site Plan (A010) was prepared by KWC Architects Inc and dated January 25, 2023 (*Site Plan*).

2.1 Applicable Guidelines and Standards

City of Ottawa:

- ◆ Ottawa Sewer Design Guidelines, City of Ottawa, SDG002, October 2012. (*Ottawa Sewer Guidelines*)
 - Technical Bulletin ISTB-2014-01 City of Ottawa, February 2014. (*ISTB-2014-01*)
 - Technical Bulletin PIEDTB-2016-01 City of Ottawa, September 2016. (*PIEDTB-2016-01*)
 - Technical Bulletin ISTB-2018-01 City of Ottawa, January 2018. (*ISTB-2018-01*)
 - Technical Bulletin ISTB-2018-03 City of Ottawa, March 2018. (*ISTB-2018-03*)
 - Technical Bulletin ISTB-2019-01 City of Ottawa, January 2019. (*ISTB-2019-01*)
 - Technical Bulletin ISTB-2019-02 City of Ottawa, February 2019. (*ISTB-2019-02*)
- ◆ Ottawa Design Guidelines – Water Distribution City of Ottawa, July 2010. (*Ottawa Water Guidelines*)
 - Technical Bulletin ISD-2010-2 City of Ottawa, December 15, 2010. (*ISD-2010-2*)
 - Technical Bulletin ISDTB-2014-02 City of Ottawa, May 2014. (*ISDTB-2014-02*)
 - Technical Bulletin ISTB-2018-02 City of Ottawa, March 2018. (*ISTB-2018-02*)

Ministry of Environment, Conservation and Parks:

- ◆ Stormwater Planning and Design Manual, Ministry of the Environment, March 2003. (*MECP Stormwater Design Manual*)
- ◆ Design Guidelines for Sewage Works, Ministry of the Environment, 2008. (*MECP Sewer Design Guidelines*)

Other:

- ◆ Water Supply for Public Fire Protection, Fire Underwriters Survey, 2020. (*FUS Guidelines*)

3.0 PRE-CONSULTATION SUMMARY

A pre-consultation meeting was conducted on September 29, 2021, regarding the proposed site. Specific design parameters to be incorporated within this design include the following:

- Pre-development and post-development flows shall be calculated using a maximum time of concentration (Tc) of 10 minutes.
- Control 5 through 100-year post-development flows to the 5-year flows with a combined C value of 0.50.
- Quality control is required to be provided for this site (80% TSS Removal) as per RVCA requirements.

The notes from the City of Ottawa can be found in *Appendix B*.

4.0 WATERMAIN

4.1 Existing Watermain

The site is located within the 1E pressure zone, as per the Water Distribution System Mapping included in *Appendix C*. There are existing 762 mm diameter C01 and 305 mm diameter DI watermains within Youville Drive. The 305 mm diameter watermain services the existing car wash as well as the fire hydrants along the east side of Youville Drive. There are three municipal hydrants along Youville drive available to service the development.

4.2 Proposed Watermain

A new 150 mm diameter PVC water service will service the proposed building complete with a water valve located at the property line. The service will extend from the existing 305 mm diameter watermain within Youville Drive. Refer to drawing *C102* for a detailed servicing layout.

The Fire Underwriters Survey 2020 (FUS) method was utilized to determine the required fire flow for the site. The 'C' factor (type of construction) for the FUS calculation was determined to be 0.8 (non-combustible type construction). The total floor area ('A' value) for the FUS calculation was determined to be 2,113.1 m². The results of the calculations yielded a required fire flow of 7,000 L/min. A fire flow of 9,000 L/min was calculated using the Ontario Building Code (OBC) requirements. The detailed calculations for the FUS and OBC can be found in *Appendix C*.

The water demands for the proposed building have been calculated to adhere to the *Ottawa Design Guidelines – Water Distribution* manual and can be found in *Appendix C*. The results have been summarized below:

Table 1: Water Demands

Site Area	0.92 ha
Industrial - Light	35,000 L/ha/day
Average Day Demand (L/s)	0.37
Maximum Daily Demand (L/s)	0.56
Peak Hourly Demand (L/s)	1.00
OBC Fire Flow Requirement (L/s)	150.00
FUS Fire Flow Requirement (L/s)	116.67

The City provided the estimated water pressures at both for the average day scenario, peak hour scenario and the max day plus fire flow scenario for the demands indicated by the correspondence in *Appendix C*. The resulting pressures for the boundary conditions results are shown in *Table 2*, below.

Table 2: Boundary Conditions Results

Scenario	Proposed Demands (L/s)	Connection HGL (m H ₂ O)*/kPa
Average Day Demand	0.37	53.1 / 520.9
Maximum Daily + Fire Flow Demand	150.56	49.6 / 486.6
Peak Hourly Demand	1.00	50.3 / 493.4
<i>*Adjusted for an estimated ground elevation of 61.50m above the connection point.</i>		

The normal operating pressure range is anticipated to be 487 kPa to 530 kPa and will not be less than 275 kPa (40 psi) or exceed 689 kPa (100 psi).

To confirm the adequacy of fire flow to protect the proposed development, public fire hydrants within 150 m of the proposed building were analysed per City of Ottawa *ISTB 2018-02* Appendix I Table 1. Based on City guidelines (*ISTB-2018-02*), the existing hydrants can provide adequate fire protection to the proposed development. The results are summarized below.

Table 3: Fire Protection Confirmation

Building	Fire Flow Demand (L/min.)	Fire Hydrant(s) within 75m	Fire Hydrant(s) within 150m	Combined Fire Flow (L/min.)
1400-1410 Youville Drive	7,000 (FUS) 9,000 (OBC)	2	1	15,200

5.0 SANITARY DESIGN

5.1 Existing Sanitary Sewer

There is a 450 mm diameter concrete sanitary sewer within Youville Drive. Sanitary flow from the sewer is tributary to the Orleans Collector Sewer per the City of Ottawa Trunk Sewer Map figure available in *Appendix 'D'*.

5.2 Proposed Sanitary Sewer

It is proposed to repurpose the existing 150 mm diameter sanitary service currently connected to the existing car wash. The existing sanitary service is currently complete with a maintenance structure which is located just inside the property line as per the *City of Ottawa – Sewer Design Guidelines*, October 2012, Clause 4.4.4.7 and City of Ottawa Sewer-Use By-Law 2003-514 (14). The service connects to the existing 450 mm diameter sanitary sewer within Youville Drive. The existing 150 mm diameter gravity service has undergone CCTV inspection, however, the true condition of the existing service was not able to be determined. Per the recommendation of the CCTV report attached in *Appendix 'D'*, the service is to be flushed and re-examined prior to construction. Refer to drawing *C102* for a detailed servicing layout.

The proposed development consists of an automobile body shop and service station complete with office space. The peak design flows for the proposed buildings were calculated using criteria from the *Ottawa Sewer Guidelines* and are summarized in *Table 3*, below. Based on the unit occupancy statistics provided by the architect, the proposed site development will generate a flow of 1.79 L/s. See *Appendix 'D'* of this report for more details.

Table 4: Sanitary Design Criteria

Design Parameter	Value
Site Area	0.92 ha
Industrial Demand (Light)	35,000 L/gross ha/d
Industrial Peaking Factor	6.80
Extraneous Flow Allowance	0.33 L/s/ha

Table 5 below, summarizes the estimated wastewater flow from the proposed development. Refer to *Appendix D* for detailed calculations.

Table 5: Summary of Estimated Sanitary Flow

Design Parameter	Total Flow (L/s)
Total Estimated Average Dry Weather Flow	0.42
Total Estimated Peak Dry Weather Flow	2.58
Total Estimated Peak Wet Weather Flow	2.84

It is anticipated that the existing service has a minimum full flow target velocity (cleansing velocity) of 0.6 m/s and a full flow velocity of not more than 3.0 m/s. The estimated capacity of the service lateral is 15.89 L/s based on an assumed slope of 1.0%. Due to the complexity of the downstream network, the City will need to advise of any downstream constraints.

6.0 STORM SEWER DESIGN

6.1 Existing Storm Sewers

The site is located within the Ottawa River East subwatershed. There is an existing 675 mm diameter concrete storm sewer within Youville Drive that outlets 0.3 Km downstream to Voyageur Creek. The site is currently serviced by a 250 mm diameter storm sewer network, which outlets to the existing 675 mm diameter storm sewer within Youville Drive.

6.2 Proposed Storm Sewers

A new 250-525 mm storm sewer network is proposed to extend from the existing 675mm sewer within Youville Drive in order to support the proposed development.

Runoff from the parking lot areas and drive aisles will be collected by existing and proposed catch basins. Based on architectural plans, drainage from the roof of the proposed building will be directed to the proposed sewer network within the parking lot area. Runoff collected from the site will be attenuated via an ICD on the outlet side of CBMH1.

Runoff collected by the storm sewer network will be treated by a proposed Hydro International Downstream Defender DD8 OGS unit or approved equivalent before stormwater is discharged to the existing storm outlet, as per drawing C102.

Foundation drainage for the proposed building will be conveyed via a 250 mm diameter storm service downstream of the on-site controls.

A maintenance structure (MH2) is proposed just inside the property line of the development to provide monitoring as per the *City of Ottawa – Sewer Design Guidelines*, October 2012, Clause 4.4.4.7 and City of Ottawa Sewer-Use By-Law 2003-514 (14). Refer to drawing C102.

See CCO-23-0480 - POST included in *Appendix F* of this report for more details. The Stormwater Management design for the subject property will be outlined in Section 7.0 of this report.

7.0 PROPOSED STORMWATER MANAGEMENT

7.1 Design Criteria and Methodology

Stormwater management for the proposed site will be maintained through positive drainage away from the proposed building and parking lot surface attenuation. Drainage from the roof of the building, the parking lot, and a landscaped external drainage area from the adjacent site will be collected by a series of catch basins. The collected parking lot flow will be restricted by a 200 mm diameter orifice before discharging towards a proposed OGS unit and finally an existing storm manhole within the site. Flow from the existing manhole will continue to convey stormwater to the 675 mm diameter storm sewer within Youville Drive. The quantitative and qualitative properties of the storm runoff for both the pre & post development flows are further detailed below.

In summary, the following design criteria have been employed in developing the stormwater management design for the site as directed by the RVCA and City:

Quality Control

- The site has been designed to achieve an 80% total suspended solids removal (*enhanced level*) using a proposed oil/grit separator.

Quantity Control

- Post-development flow 5/100-year is be restricted to match the 5-year pre-development flow with a maximum C value of 0.50.

7.2 Runoff Calculations

Runoff calculations presented in this report are derived using the Rational Method, given as:

$$Q = 2.78CIA \text{ (L/s)}$$

Where:

C	=	Runoff coefficient
I	=	Rainfall intensity in mm/hr (City of Ottawa IDF curves)
A	=	Drainage area in hectares

It is recognized that the Rational Method tends to overestimate runoff rates. As a result, the conservative calculation of runoff ensures that any SWM facility sized using this method is expected to function as intended.

The following coefficients were used to develop an average C for each area:

Roofs/Concrete/Asphalt	0.90
Gravel	0.60
Undeveloped and Grass	0.20

As per the *City of Ottawa - Sewer Design Guidelines*, the 5-year balanced 'C' value must be increased by 25% for a 100-year storm event to a maximum of 1.0.

As per the pre-consultation meeting with the City of Ottawa the time of concentration (Tc) used for pre-development shall be determined using a calculated Tc of no less than 10 minutes and post-development flows shall be calculated using a Tc of 10 minutes.

7.3 Pre-Development Drainage

It has been assumed that the site contains no stormwater management controls for flow attenuation. The estimated pre-development peak flows for the 5, and 100-year events are summarized below in *Table 5*. See CCO-23-0480 - *PRE* in *Appendix E* and *Appendix G* for calculations.

Table 6: Pre-Development Runoff Summary

Drainage Area	Area (ha)	Q (L/s)	
		5-Year	100-Year
A1	0.92	188.01	376.59
A2 (External Drainage)	0.005	0.31	0.66
Total	0.92	188.31	377.25

7.4 Post-Development Drainage

The proposed site drainage limits are demonstrated on the Post-Development Drainage Area Plan. See CCO-23-0480 - *POST* in *Appendix 'F'* of this report for more details. A summary of the Post-Development Runoff Calculations can be found below.

Table 7: Post-Development Runoff Summary

Drainage Area	Area (ha)	5-Year Peak Flow (L/s)	100-Year Peak Flow (L/s)	100-Year Storage Requirement (m ³)	100-Year Storage Available (m ³)
B1	0.82	114.91	116.68	172.8	189.3
B2	0.10	5.99	12.82	-	-
Total	0.92	120.90	129.50	172.8	189.3

Post development drainage will be restricted to a maximum release rate of 129.50 L/s based on a maximum release rate requirement of 133.38 L/s.

Runoff within Area B1 will be collected by the proposed catchbasin system and restricted by a 185 mm orifice installed on the outlet side of CBMH3. The flow will be restricted to a maximum release

rate of 116.68 L/S with 189.3 m³ of storage to be provided via surface ponding within the parking lot.

Runoff within Area B2 will sheet drain without flow attenuation towards the golf course to the west of the site and towards Youville Drive to the east of the site. Gravel drainage within the 1410 Youville Drive parcel of land currently drains towards the golf course. As per drawing C101, the drainage area is proposed to be significantly reduced and will only direct landscaping runoff towards the neighbouring property. As a result, the development proposes to improve the existing condition.

7.5 Quality Control

Based on coordination with the RVCA an enhanced water quality target (80% TSS removal) is required for the site. This will be achieved by treating runoff collected from area B1 with a Hydro International Downstream Defender DD8 OGS unit or approved equivalent. Runoff within Area B2 is proposed to flow off-site without quality treatment.

8.0 EROSION AND SEDIMENT CONTROL

8.1 Temporary Measures

Before construction begins, temporary silt fence, straw bale or rock flow check dams will be installed at all natural runoff outlets from the property. It is crucial that these controls be maintained throughout construction and inspection of sediment and erosion control will be facilitated by the Contractor or Contract Administration staff throughout the construction period.

Silt fences will be installed where shown on the final engineering plans, specifically along the downstream property limits. The Contractor, at their discretion or at the instruction of the City, Conservation Authority or the Contract Administrator shall increase the quantity of sediment and erosion controls on-site to ensure that the site is operating as intended and no additional sediment finds its way off site. The rock flow, straw bale & silt fence check dams and barriers shall be inspected weekly and after rainfall events. Care shall be taken to properly remove sediment from the fences and check dams as required. Fibre roll barriers are to be installed at all existing curb inlet catchbasins and filter fabric is to be placed under the grates of all existing catchbasins and manholes along the frontage of the site and any new structures immediately upon installation. The measures for the existing/proposed structures is to be removed only after all areas have been paved. Care shall be taken at the removal stage to ensure that any silt that has accumulated is properly handled and disposed of. Removal of silt fences without prior removal of the sediments shall not be permitted.

Although not anticipated, work through winter months shall be closely monitored for erosion along sloped areas. Should erosion be noted, the Contractor shall be alerted and shall take all necessary steps to rectify the situation. Should the Contractor's efforts fail at remediating the eroded areas, the Contractor shall contact the City and/or Conservation Authority to review the site conditions and determine the appropriate course of action. As the ground begins to thaw, the Contractor shall place silt fencing at all required locations as soon as ground conditions warrant. Please see the *Site Grading, Drainage and Sediment & Erosion Control Plan* for additional details regarding the temporary measures to be installed and their appropriate OPSD references.

8.2 Permanent Measures

It is expected that the Contractor will promptly ensure that all disturbed areas receive topsoil and seed/sod and that grass be established as soon as possible. Any areas of excess fill shall be removed or levelled as soon as possible and must be located a sufficient distance from any watercourse to ensure that no sediment is washed out into the watercourse. As the vegetation growth within the site provides a key component to the control of sediment for the site, it must be properly maintained once established. Once the construction is complete, it will be up to the landowner to maintain the vegetation and ensure that the vegetation is not overgrown or impeded by foreign objects.

9.0 SUMMARY

- A new automobile body shop, service station, and office is proposed at 1400 & 1410 Youville Drive.
- A 150 mm diameter water service is proposed to service the development, extending from the existing 300 mm diameter watermain with Youville Drive.
- It is proposed to repurpose the existing 150 mm diameter sanitary service to service to the proposed building.
- The proposed storm sewer system, ranging in diameter from 250 mm to 525 mm, will service the site. The storm service will discharge stormwater into the 675 mm sewer within Youville drive.
- Storage for the 5- through 100-year storm events will be provided within the parking lot areas above the proposed storm structures via surface storage.
- Quality Control will be provided via an OGS unit.

10.0 RECOMMENDATION

Based on the information presented in this report, we recommend that City of Ottawa approve this Servicing and Stormwater Management Report in support of the proposed automobile body shop 1400 & 1410 Youville Drive

This report is respectfully being submitted for approval.

Regards,

McIntosh Perry Consulting Engineers Ltd.



Charissa Hampel, P.Eng.
Project Engineer, Land Development
T: 613.714.4625
E: c.hampel@mcintoshperry.com

A handwritten signature in black ink that reads "Ryan Robineau".

Ryan R. Robineau, E.I.T.
Civil Engineering Technologist, Land Development
T: 613.714.6611
E: r.robineau@mcintoshperry.com

11.0 STATEMENT OF LIMITATIONS

This report was produced for the exclusive use of BBS Construction LTD. The purpose of the report is to assess the existing stormwater management system and provide recommendations and designs for the post-construction scenario that are in compliance with the guidelines and standards from the Ministry of the Environment, Conservation and Parks, City of Ottawa and local approval agencies. McIntosh Perry reviewed the site information and background documents listed in Section 2.0 of this report. While the previous data was reviewed by McIntosh Perry and site visits were performed, no field verification/measures of any information were conducted.

Any use of this review by a third party, or any reliance on decisions made based on it, without a reliance report is the responsibility of such third parties. McIntosh Perry accepts no responsibility for damages, if any, suffered by any third party as a result of decisions or actions made based on this review.

The findings, conclusions and/or recommendations of this report are only valid as of the date of this report. No assurance is made regarding any changes in conditions subsequent to this date. If additional information is discovered or becomes available at a future date, McIntosh Perry should be requested to re-evaluate the conclusions presented in this report, and provide amendments, if required.

APPENDIX A
KEY PLAN

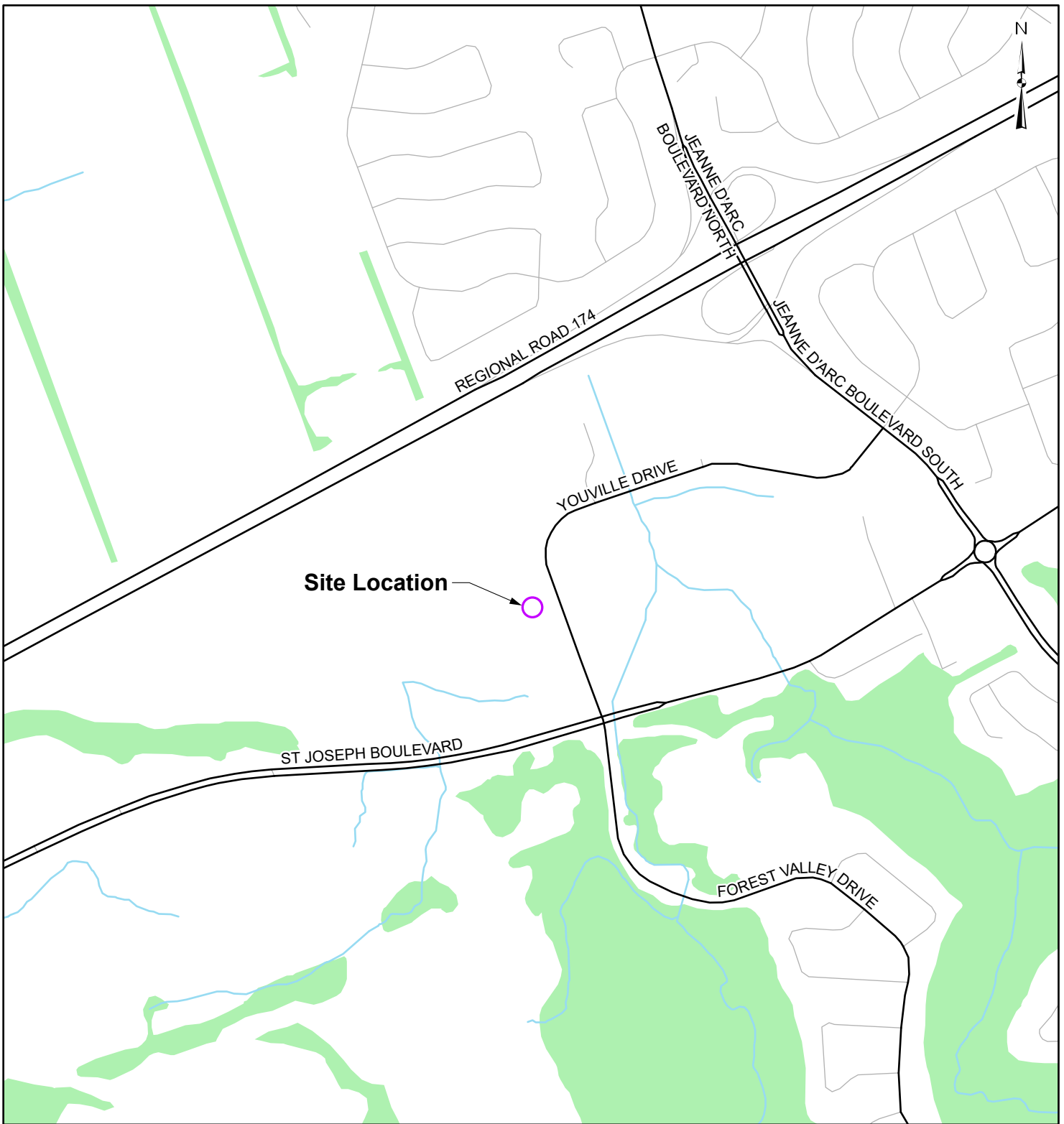

LEGEND

- Approximate Site Location
- Local Road
- Major Road
- Watercourse
- Wooded Area

REFERENCE

GIS data provided by the Ontario Ministry of Northern Development, Mines, Natural Resources and Forestry, 2022.

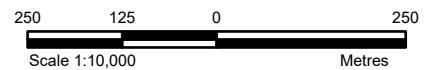

CLIENT:	JIM KEAY FORD		
PROJECT:	1400-1410 YOUVILLE		
TITLE:	SITE LOCATION PLAN		
McINTOSH PERRY <small>115 Walgreen Road, RR3, Carp, ON K0A1L0 Tel: 613-836-2184 Fax: 613-836-3742 www.mcintoshperry.com</small>	PROJECT NO:	CCO-23-0480	FIGURE:
	Date	Aug., 22, 2022	1
	GIS	MG	
Checked By	AG		

APPENDIX B
BACKGROUND DOCUMENTS

Pre- Application Consultation 1410 (1438) Youville Drive (PC2021-0330) – City of Ottawa Internal Department Comments

Transportation:

- Follow Transportation Impact Assessment Guidelines
 - Submit a Screening form to start, a full Transportation Impact Assessment if any of the triggers on the screening form are satisfied. The Screening Form can be sent directly to Josiane.Gervais@ottawa.ca
 - Start this process asap. The application will not be deemed complete until the submission of the draft step 1-4, including the functional draft RMA package (if applicable) and/or monitoring report (if applicable).
 - Request base mapping asap if RMA is required. Contact Engineering Services (<https://ottawa.ca/en/city-hall/planning-and-development/engineering-services>)
- Clear throat requirement on a collector is 8m.
- Ensure site access meets the City's Private Approach Bylaw.
- Ensure drive aisle meets the City's Part 4 - Parking, Queuing and Loading Provisions (Sections 100 to 114) Bylaw, i.e. minimum 6.7m width.
- The site falls just outside of the 600m radius from the existing Jeanne d'Arc transit station (and future Jeanne d'Arc LRT station).
- Include a new bus pad, as per City Standards.
- On site plan:
 - Show all details of the roads abutting the site up to and including the opposite curb; include such items as pavement markings, accesses and/or sidewalks.
 - Turning movement diagrams required for all accesses showing the largest vehicle to access/egress the site.
 - Turning movement diagrams required for internal movements (loading areas, garbage).
 - Show all curb radii measurements; ensure that all curb radii are reduced as much as possible and meet TAC Figure 8.5.1.
 - Show dimensions for site elements (i.e. lane/aisle widths, access width and throat length, parking stalls, sidewalks, pedestrian pathways, etc.)
- As the proposed site is for general public use, AODA legislation applies. Consider using the City's Accessibility Design Standards.
 - Access aisles are required next to the accessible parking spaces.
 - Ensure all crosswalks located internally on the site provide a TWSI at the depressed curb, per requirements of the Integrated Accessibility Standards Regulation under the AODA.

Environmental:

Tree Conservation Report Requirements:

- If there are trees within the area impacted, contact Mark Richardson mark.richardson@ottawa.ca for information on the City's TCR requirements

Urban Design:

- A Design Brief is required as part of the submission. The Terms of Reference is attached for convenience.
- With respect to the proposed design:
 - Please consult OC-Transpo to explore opportunities to improve the bus stop. Considerations should be given to improvements such as a concrete pad for people to stand, a seat for people to sit, or a glass bus shelter.
 - Please provide a pedestrian walkway from the building main entrance to the bus stop.
 - Provide large canopy trees along the front to the extent possible . Given the location of the hydro lines, such trees will likely have to set back from the property line substantially and be located approximately at where the parking spaces are. Considerations should be given to relocate and reduce some front yard parking to create room for tree planting. (see attached diagram)
 - Provide a landscape buffer at the back of the site, approximately minimum 3m to allow for some landscaping. (also see attached diagram)
 - The preliminary design shows a 7.5m area on the north side of the site for landscaping. Would it be beneficial to flip the site design so that the landscape area can be located on the sunny side of the site?

Policy Planning:

- The existing Official Plan designation is *General Urban Area*, which allows flexibility to permit the proposed use.
- The proposed New Official Plan designation is *Neighbourhood*, which allows flexibility to permit the proposed use.
- Advancing present and new Official Plans, the preliminary directions for the present Jeanne D'Arc Station Area study, part of the broader Orleans Corridor Secondary Plan study, envisions this south-west quadrant (south and west of Highway 174 and Jeanne D'Arc Boulevard, to St. Joseph Blvd.) as transitioning away from the largely light-industrial land use character to a character that is more transit-supportive based on primarily residential and commercial uses.
- While the envisioned vision will take many years to achieve, with the directions of the existing and future Official Plans in mind, the present proposal should advance site planning and design measures that will support and advance the transition to a more urban structure with more urban elements. A future application here should implement, for example, urban elements such as:
 - Building that is close to the street, with frontage that relates to people on the sidewalk, e.g. entrance that faces the street vs. a side parking lot
 - Items that support comfortable and inviting active transportation (walking or cycling), e.g. inclusion of medium to large street trees; support for transit infrastructure

- Site planning and design should anticipate the implementation of a municipal sidewalk in the future within the City right-of-way.
- Minimum and/or reduce large areas of asphalt (e.g. to transition from auto-oriented visual character of area to active transportation character; to reduce heat island effect; increase tree canopy)
- Refer to DRS Urban Design recommendations and for future ideas on how to best address these items.

Planning:

- **Official Plan:** The City's Official Plan (OP), Schedule B, designates the subject site "General Urban Area" for the entire depth of the property. General Urban Area designation permits many types and densities of housing, as well as employment, retail uses, service, industrial, cultural, leisure, greenspace, entertainment, and institutional uses. The General Urban Area permits uses that may generate traffic, noise or other impacts that have the potential to create conflicts with the surrounding residential community. More information can be found at: [Section 3 - Designations and Land Use | City of Ottawa](#).
- **Zoning By-law 2008-250:** The site is zoned Light Industrial Zone (IL2 H(14)). It is understood that the lands will be rezoned. The details of the proposed zoning can be discussed.
- **Comments:**
 - It is recommended to relocate the proposed building closer to Youville Drive and remove front yard parking to create an enhanced street presence.
 - Consider increasing the landscape buffer along the rear yard property line.
 - Consider moving the location of the proposed loading zone further back from its current proposed location to reduce its visibility from the street.
 - It is encouraged to not have any vehicles displayed for sale at the front of the property.
 - Given the existing auto dominated nature of the Youville Drive Business Park, the proposed automotive related land use does not pose as a concern at this time.
 - There are no concerns of the proposed zoning change currently.

Engineering:

- Please find attached the engineering comments for the proposed development.

Application Type and Fees:

- The Application Fees (2021 Rates) for the applications are as follows:

Application Type	Planning/ Legal Fee	Initial Engineering Design Review & Inspection Fee	Conservation Authority Fee (Initial)	Total
Zoning By-law Amendment (Major)	21,722.94	n/a	390	22,112.94
Site Plan Control Approval (New – Complex)	48,298.80	\$10,000 (incl. HST) services >\$300,000	1,040	59,338.80

Submission Requirements:

- Documents required in support of this application are highlighted in the attached Study and Plan Identification List

Links to Design Guidelines And Relevant Policy:

As part of Planning staff's review, we will evaluate your proposal against the relevant Official Plan policies and applicable Council-approved design guidelines. I have provided links to some of the more critical ones for your information.

- City Official Plan: <https://ottawa.ca/en/planning-development-and-construction/official-plan-and-master-plans/official-plan>
- Guidelines: For the following design guidelines, reference the following link: <https://ottawa.ca/en/planning-development-and-construction/community-design/design-and-planning-guidelines/completed-guidelines>

Please refer to the links to [Guide to preparing studies and plans](#) and [fees](#) for further information. Additional information is available related to [building permits](#), [development charges](#), and the [Accessibility Design Standards](#). Be aware that other fees and permits may be required, outside of the development review process. You may obtain background drawings by contacting informationcentre@ottawa.ca.

These pre-application consultation comments are valid for one year. If you submit a development application(s) after this time, you may be required to meet for another pre-consultation meeting and/or the submission requirements may change. You are as well encouraged to contact us for a follow-up meeting if the plan/concept will be further refined.

Alison Gosling

From: Jamie Batchelor <jamie.batchelor@rvca.ca>
Sent: August 15, 2022 11:23 AM
To: Ryan Robineau
Cc: Alison Gosling
Subject: RE: 1410 Youville Drive RVCA Requirement

Good Morning Ryan,

The water quality target would be enhanced (80% TSS removal). Given the erosive nature of Voyageur Creek, the stormwater from the site should demonstrate how the hydrology of the site is being maintained through the a water budget/balance. I will inquire further with our technical staff in this regard.

Jamie Batchelor, MCIP, RPP
Planner, ext. 1191
[Jamie.batchelor@rvca.ca](mailto:jamie.batchelor@rvca.ca)



3889 Rideau Valley Drive
PO Box 599, Manotick ON K4M 1A5
T 613-692-3571 | 1-800-267-3504 F 613-692-0831 | www.rvca.ca

This message may contain information that is privileged or confidential and is intended to be for the use of the individual(s) or entity n may contain confidential or personal information which may be subject to the provisions of the Municipal *Freedom of Information & P* you are not the intended recipient of this e-mail, any use, review, revision, retransmission, distribution, dissemination, copying, printing, taking of any action in reliance upon this e-mail, is strictly prohibited. If you have received this e-mail in error, please contact the send and any copy of the e-mail and any printout thereof, immediately. Your cooperation is appreciated.

From: Ryan Robineau <r.robineau@mcintoshperry.com>
Sent: Monday, August 15, 2022 10:43 AM
To: Jamie Batchelor <jamie.batchelor@rvca.ca>
Cc: Alison Gosling <a.gosling@mcintoshperry.com>
Subject: 1410 Youville Drive RVCA Requirement

Good morning Jamie,

We wanted to touch base with you regarding a proposed development at 1410 Youville Drive.

The development involves the construction of a 1-storey automobile body shop and service station with surface parking. Drainage will be collected and conveyed to the 675mm dia storm sewer within Youville Drive. As shown by the attached figure, water travels approximately 0.30km to the Bilberry Creek (Outlet ID #09116). It is anticipated that drainage will be collected by catch basins.

We would like to know what SWM requirements the RVCA would have for the site.

Please let me know if you have any questions.



1 LOCATION PLAN
A010 N.T.S.

LEGAL DESCRIPTION:

PARCELS WW-8 AND WW-11 ON SEC 4M-152
 PART OF BLOCK WW ON REGISTERED PLAN 4M-152
 PARTS 1 AND 3 ON PLAN 4R-8609, FORMER CITY OF GLOUCESTER, NOW IN CITY OF OTTAWA
 AS PREPARED BY STANTEC GEOMATICS LTD., 29 MARCH 2022

Project Zoning Review/Statistics

Municipality: City of Ottawa
Municipal Address: 1400-1410 Youville Drive
Registered Owner: Jim Keay
Lot Area: 9,188 sq.m. (98,894 sq.ft. (2.27 acres))
Zoning By-law: 2008-250
Zone: IL2 H(14) - Light Industrial
Proposed Use: Automobile Body Shop & Automobile Service Station

Building Areas	Gross (out-to-out)	
	Sq.m.	Sq.ft
Proposed Development		
Ground Floor, Offices	291	3,130
Ground Floor, Body & Service Shop	1,596	17,177
Ground Floor, Parts	228	2,457
Total	2,115	22,764

Development Standards	Required	Provided
	Minimum Lot Area	2,000 sq.m.
Minimum Lot Width	No min.	91.3m
Minimum Required Yard		
Front Yard (min.)	7.5m	7.5m
Interior Side Yard (min.)	7.5m	20.39m
Rear Yard (min.)	7.5m	38.32m
Maximum Building Height	14m	8.01m
Maximum Lot Coverage	65%	22%
Maximum Floor Space Index	2	±0.2
Minimum Width of Landscaped Area		
Abutting a street	3m	6.95m
All other cases	No min.	3m

Parking, Loading, Queuing

Existing Parking	
Parking Spaces (Minimum 2.6m x 5.2m)	
Offices (2.4 spaces / 100 sq.m.)	Required: 8 Area C of Schedule 1A Provided: 30
Body Shop & Service Station (3 spaces per Service Bay @ 13 Service Bays)	Required: 39 Provided: 56
Accessible Parking	Required: 2
Section 111 of By-law 2017-301	Provided: 2 1x Type A & 1x Type B
Loading Spaces (3.5m x 9m)	Required: 1 Provided: 1
Bicycle Parking (Offices: 1 space / 250 sq.m. ; All other: 1 space / 1,500 sq.m.)	Required: 2 1x for Offices; 1x for Body Shop/Service Station Provided: 4 3x for Offices; 1x for Body Shop/Service Station

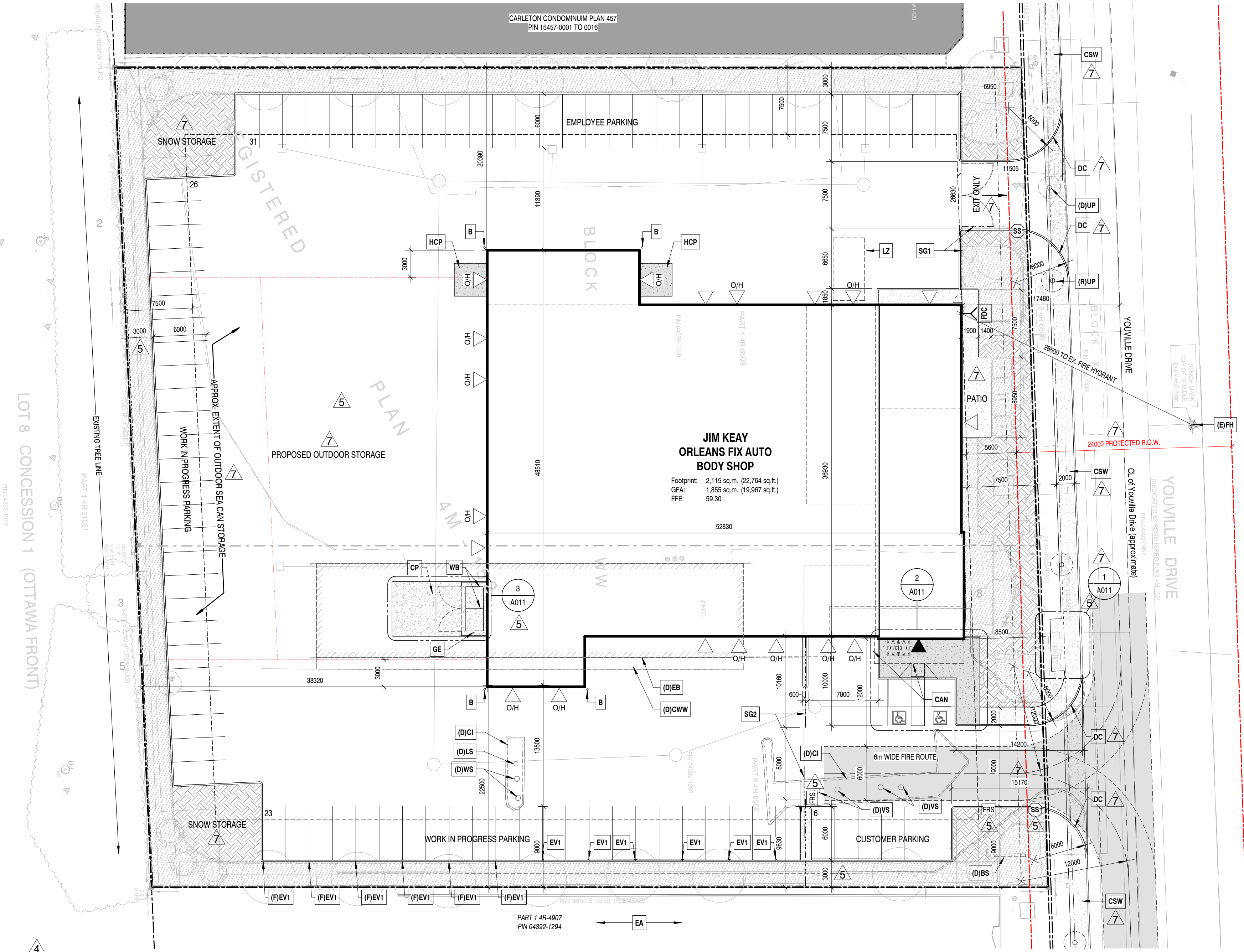

2 SITE PLAN
A010 1 : 300

GENERAL NOTES:
 1. ALL ARCHITECTURAL SITE PLAN DRAWINGS TO BE READ IN CONJUNCTION WITH THE LANDSCAPE, CIVIL AND ELECTRICAL SITE PLAN DRAWINGS.

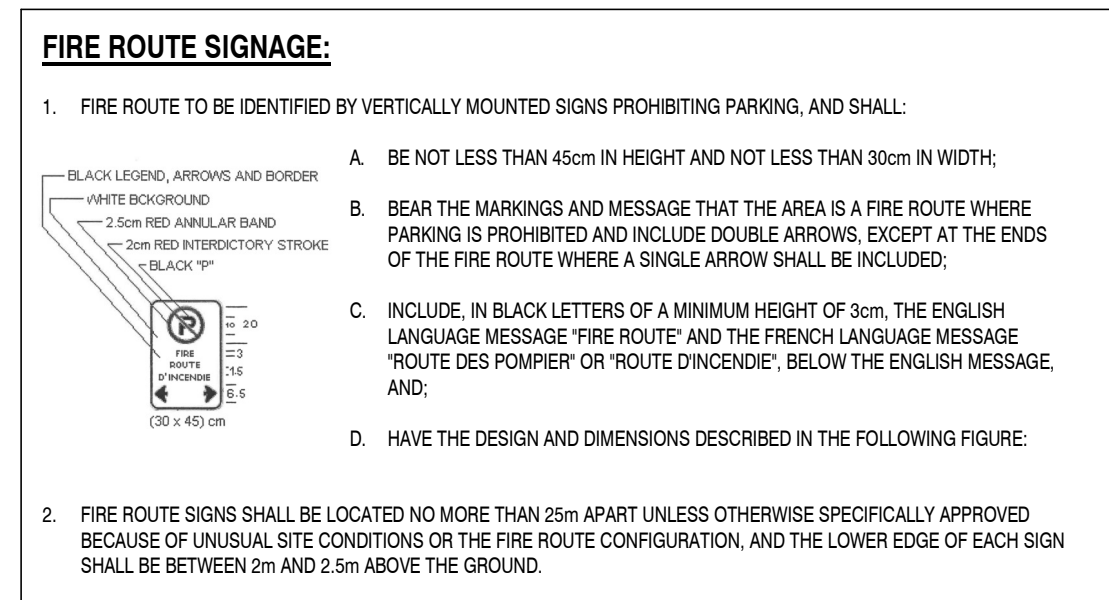

SITE PLAN SYMBOLS

ICON	DESCRIPTION
[Symbol]	Existing Buildings
[Symbol]	Existing Buildings to be Demolished
[Symbol]	Proposed Buildings
[Symbol]	Property Lines
[Symbol]	Shared Property Lines
[Symbol]	Setback Lines
[Symbol]	Landscape Buffer
[Symbol]	Overhead Wires
[Symbol]	Fence
[Symbol]	Existing Concrete Curb
[Symbol]	Existing Concrete Curb to be Demolished
[Symbol]	Proposed Concrete Curb
[Symbol]	Depressed Concrete Curb
[Symbol]	Proposed Concrete Sidewalk
[Symbol]	Proposed Landscape Area
[Symbol]	Stop Sign
[Symbol]	Barrier Free Parking Space
[Symbol]	Principal Entrance Door
[Symbol]	Exterior Door (O/H indicates Overhead Door)
[Symbol]	Exterior 6m Wide Fire Route (12m centerline radius on all turns, TYP.)

SITE PLAN NOTES

NOTE#	NOTE
(D)BS	Existing Signage to be Demolished - Project/Construction Manager to coordinate.
(D)CI	Existing Concrete Island to be Demolished
(D)CWW	Existing Concrete Walkway to be Demolished
(D)EB	Existing Building to be Demolished
(D)LS	Existing Light Standard to be Demolished
(D)UP	Existing Utility Pole, to be relocated. Refer also to Civil.
(D)VS	Existing Vacuum Station to be Demolished - refer to Electrical
(D)WS	Existing Windshield Wash Station to be Demolished - refer to Electrical
(E)FH	Existing Fire Hydrant to remain.
(F)EV1	Future Electric Vehicle Charging Station
(R)UP	Proposed relocation of Existing Utility Pole. Refer also to Civil.
B	Bollard
CAN	Outline of Carport/Canopy above
CP	Concrete Pad - refer to Structural
CSW	Concrete Sidewalk
DC	Depressed Curb
EA	Existing Asphalt
EV1	Electric Vehicle Charging Station: post-mounted level 2 dual-charging station by Owner
GE	Prefinished Metal Panel on Galvanized Steel framing
HCP	12'-0" x 12'-0" Concrete Pad c/w In-slab Heating - refer to Mechanical & Structural
LZ	Loading Zone, 3.5m W x 7.0m L
SG1	Steel post & chain linked swinging gate, c/w locking mechanism
SG2	Steel post & chain linked sliding gate, c/w locking mechanism
WB	Waste Bins, by Owner

REVISIONS

No.	DATE	DESCRIPTION
0	05 July 2022	Issued for Coordination
1	12 August 2022	Issued for Coordination
2	16 August 2022	Issued for Site Plan Control
3	15 September 2022	Issued for PCA/Consultant Coordination
4	23 December 2022	Issued for Coordination
5	25 January 2023	Response to Planning Comments
6	20 March 2023	Issued for Permit
7	20 April 2023	Response to Planning Comments

It is the responsibility of the appropriate contractor to check and verify all dimensions on site and report all errors and / or omissions to the Architect. All contractors must comply with all permit codes and by-laws. Do not scale drawings. This drawing may not be used for construction until signed by KWC Architects Inc. and shall not be used without the Architect's consent.

North arrow and architect's seal area.

KWC ARCHITECTS INC.
 383 Parkdale Avenue, Suite 201
 Ottawa, Ontario, Canada, K1Y 4R4
 Phone: 613 238-2217
 Fax: 613 238-6595
 E-Mail: kwc@kwc-arch.com

BBS
 BUILDING A REPUTATION ON EXCELLENCE
 BBS CONSTRUCTION (ONTARIO) LTD.
 1805 WOODWARD DRIVE,
 OTTAWA, ON. K2C 0P9 CANADA
 TEL: (613) 226-8830 FAX: (613) 226-7709
 www.bbsconstruction.ca

owner: **JIM KEAY**

project: **'FIX AUTO' ORLEANS - AUTOMOBILE BODY SHOP**

drawing title: **SITE PLAN**

project no. **2255** drawing no.
 scale **As indicated**
 drawn by **TC**
 date **2023 JAN 31**
A010

March 29, 2022
16164550-111.dwg

ASSOCIATION OF ONTARIO
LAND SURVEYORS
PLAN SUBMISSION FORM
V-21216

THIS PLAN IS NOT VALID
UNLESS IT IS AN EMBOSSED
ORIGINAL COPY
ISSUED BY THE SURVEYOR

BENCH MARK
TOP OF SPINDLE
ELEV=59.91m

YOUVILLE DRIVE
(DEDICATED BY REGISTERED PLAN 4M-152)
PIN 04392-0952

Copyright 2022 Stantec Geomatics Ltd. The reproduction, alteration or use of this
REPORT in whole or in part without the express permission of Stantec Geomatics Ltd.
IS STRICTLY PROHIBITED.

PLAN OF SURVEY
**PART OF BLOCK WW
REGISTERED PLAN 4M-152
CITY OF OTTAWA**

Scale 1:250
5 0 5 10 15 METRES

METRIC CONVERSION

DISTANCES AND COORDINATES SHOWN ON THIS PLAN ARE IN METRES
AND CAN BE CONVERTED TO FEET BY DIVIDING BY 0.3048

BEARING NOTE

BEARINGS ARE GRID, DERIVED FROM CAN-NET VRS NETWORK GPS OBSERVATIONS ON NCC
HORIZONTAL CONTROL MONUMENTS 19773035 AND 19680191, CENTRAL MERIDIAN, 76° 30'
WEST LONGITUDE MTM ZONE 9, NAD83 (ORIGINAL).

19773035 N:5006060.42 E:324888.04
19680191 N:5033564.26 E:388064.94

ELEVATION NOTE

ELEVATIONS SHOWN HEREON ARE GEODETIC (CGVD-1928) AND ARE DERIVED FROM
VERTICAL CONTROL MONUMENT NO. 0011985055 HAVING AN ELEVATION OF 59.525m.

LEGEND

■	DENOTES	FOUND MONUMENTS
□		SET MONUMENTS
▣		IRON BAR
⊕		ROUND IRON BAR
⊖		STANDARD IRON BAR
⊗		SHORT STANDARD IRON BAR
⊘		CUT CROSS
⊙		CONCRETE PIN
⊚		WITNESS
⊛		PROPERTY IDENTIFICATION NUMBER
⊜		MEASURED
⊝		INSTRUMENT
⊞		PROPORTIONED
⊟		ORIGIN UNKNOWN
⊠		STANTEC GEOMATICS LTD.
⊡		PLAN 4R-4509
⊢		PLAN 4R-21021
⊣		
⊤		
⊥		
⊦		
⊧		
⊨		
⊩		
⊪		
⊫		
⊬		
⊭		
⊮		
⊯		
⊰		
⊱		
⊲		
⊳		
⊴		
⊵		
⊶		
⊷		
⊸		
⊹		
⊺		
⊻		
⊼		
⊽		
⊾		
⊿		
⊀		
⊁		
⊂		
⊃		
⊄		
⊅		
⊆		
⊇		
⊈		
⊉		
⊊		
⊋		
⊌		
⊍		
⊎		
⊏		
⊐		
⊑		
⊒		
⊓		
⊔		
⊕		
⊖		
⊗		
⊘		
⊙		
⊚		
⊛		
⊜		
⊝		
⊞		
⊟		
⊠		
⊡		
⊢		
⊣		
⊤		
⊥		
⊦		
⊧		
⊨		
⊩		
⊪		
⊫		
⊬		
⊭		
⊮		
⊯		
⊰		
⊱		
⊲		
⊳		
⊴		
⊵		
⊶		
⊷		
⊸		
⊹		
⊺		
⊻		
⊼		
⊽		
⊾		
⊿		
⊀		
⊁		
⊂		
⊃		
⊄		
⊅		
⊆		
⊇		
⊈		
⊉		
⊊		
⊋		
⊌		
⊍		
⊎		
⊏		
⊐		
⊑		
⊒		
⊓		
⊔		
⊕		
⊖		
⊗		
⊘		
⊙		
⊚		
⊛		
⊜		
⊝		
⊞		
⊟		
⊠		
⊡		
⊢		
⊣		
⊤		
⊥		
⊦		
⊧		
⊨		
⊩		
⊪		
⊫		
⊬		
⊭		
⊮		
⊯		
⊰		
⊱		
⊲		
⊳		
⊴		
⊵		
⊶		
⊷		
⊸		
⊹		
⊺		
⊻		
⊼		
⊽		
⊾		
⊿		
⊀		
⊁		
⊂		
⊃		
⊄		
⊅		
⊆		
⊇		
⊈		
⊉		
⊊		
⊋		
⊌		
⊍		
⊎		
⊏		
⊐		
⊑		
⊒		
⊓		
⊔		
⊕		
⊖		
⊗		
⊘		
⊙		
⊚		
⊛		
⊜		
⊝		
⊞		
⊟		
⊠		
⊡		
⊢		
⊣		
⊤		
⊥		
⊦		
⊧		
⊨		
⊩		
⊪		
⊫		
⊬		
⊭		
⊮		
⊯		
⊰		
⊱		
⊲		
⊳		
⊴		
⊵		
⊶		
⊷		
⊸		
⊹		
⊺		
⊻		
⊼		
⊽		
⊾		
⊿		
⊀		
⊁		
⊂		
⊃		
⊄		
⊅		
⊆		
⊇		
⊈		
⊉		
⊊		
⊋		
⊌		
⊍		
⊎		
⊏		
⊐		
⊑		
⊒		
⊓		
⊔		
⊕		
⊖		
⊗		
⊘		
⊙		
⊚		
⊛		
⊜		
⊝		
⊞		
⊟		
⊠		
⊡		
⊢		
⊣		
⊤		
⊥		
⊦		
⊧		
⊨		
⊩		
⊪		
⊫		
⊬		
⊭		
⊮		
⊯		
⊰		
⊱		
⊲		
⊳		
⊴		
⊵		
⊶		
⊷		
⊸		
⊹		
⊺		
⊻		
⊼		
⊽		
⊾		
⊿		
⊀		
⊁		
⊂		
⊃		
⊄		
⊅		
⊆		
⊇		
⊈		
⊉		
⊊		
⊋		
⊌		
⊍		
⊎		
⊏		
⊐		
⊑		
⊒		
⊓		
⊔		
⊕		
⊖		
⊗		
⊘		
⊙		
⊚		
⊛		
⊜		
⊝		
⊞		
⊟		
⊠		
⊡		
⊢		
⊣		
⊤		
⊥		
⊦		
⊧		
⊨		
⊩		
⊪		
⊫		
⊬		
⊭		
⊮		
⊯		
⊰		
⊱		
⊲		
⊳		
⊴		
⊵		
⊶		
⊷		
⊸		
⊹		
⊺		
⊻		
⊼		
⊽		
⊾		
⊿		
⊀		
⊁		
⊂		
⊃		
⊄		
⊅		
⊆		
⊇		
⊈		
⊉		
⊊		
⊋		
⊌		
⊍		
⊎		
⊏		
⊐		
⊑		
⊒		
⊓		
⊔		
⊕		
⊖		
⊗		
⊘		
⊙		
⊚		
⊛		
⊜		
⊝		
⊞		
⊟		
⊠		
⊡		
⊢		
⊣		
⊤		
⊥		
⊦		
⊧		
⊨		
⊩		
⊪		
⊫		
⊬		
⊭		
⊮		
⊯		
⊰		
⊱		
⊲		
⊳		
⊴		
⊵		
⊶		
⊷		
⊸		
⊹		
⊺		
⊻		
⊼		
⊽		
⊾		
⊿		
⊀		
⊁		
⊂		
⊃		
⊄		
⊅		
⊆		
⊇		
⊈		
⊉		
⊊		
⊋		
⊌		
⊍		
⊎		
⊏		
⊐		
⊑		
⊒		
⊓		
⊔		
⊕		
⊖		
⊗		
⊘		
⊙		
⊚		
⊛		
⊜		
⊝		
⊞		
⊟		
⊠		
⊡		
⊢		
⊣		
⊤		
⊥		
⊦		
⊧		
⊨		
⊩		
⊪		
⊫		
⊬		
⊭		
⊮		
⊯		
⊰		
⊱		
⊲		
⊳		
⊴		
⊵		
⊶		
⊷		
⊸		
⊹		
⊺		
⊻		
⊼		
⊽		
⊾		
⊿		
⊀		
⊁		
⊂		
⊃		
⊄		
⊅		
⊆		
⊇		
⊈		
⊉		
⊊		
⊋		
⊌		
⊍		

APPENDIX C
WATERMAIN CALCULATIONS

McINTOSH PERRY

CCO-22-0480 - Youville Drive - Water Demands

Project:	Youville Drive
Project No.:	CCO-22-0480
Designed By:	RRR
Checked By:	AJG
Date:	April 28, 2023
Site Area:	0.92 gross ha

Commercial	m2
Industrial - Light	9188 m2
Industrial - Heavy	m2

AVERAGE DAILY DEMAND

DEMAND TYPE	AMOUNT	UNITS	
Residential	280	L/c/d	
Industrial - Light	35,000	L/gross ha/d	
Industrial - Heavy	55,000	L/gross ha/d	
Shopping Centres	2,500	L/(1000m ² /d	
Hospital	900	L/(bed/day)	
Schools	70	L/(Student/d)	
Trailer Park with no Hook-Ups	340	L/(space/d)	
Trailer Park with Hook-Ups	800	L/(space/d)	
Campgrounds	225	L/(campsite/d)	
Mobile Home Parks	1,000	L/(Space/d)	
Motels	150	L/(bed-space/d)	
Hotels	225	L/(bed-space/d)	
Tourist Commercial	28,000	L/gross ha/d	
Other Commercial	28,000	L/gross ha/d	
AVERAGE DAILY DEMAND	Residential	0.00	L/s
	Commercial/Industrial/ Institutional	0.37	L/s

McINTOSH PERRY

MAXIMUM DAILY DEMAND

DEMAND TYPE	AMOUNT		UNITS
Residential	9.5	x avg. day	L/c/d
Industrial	1.5	x avg. day	L/gross ha/d
Commercial	1.5	x avg. day	L/gross ha/d
Institutional	1.5	x avg. day	L/gross ha/d
MAXIMUM DAILY DEMAND	Residential	0.00	L/s
	Commercial/Industrial/ Institutional	0.56	L/s

MAXIMUM HOUR DEMAND

DEMAND TYPE	AMOUNT		UNITS
Residential	14.3	x avg. day	L/c/d
Industrial	1.8	x max. day	L/gross ha/d
Commercial	1.8	x max. day	L/gross ha/d
Institutional	1.8	x max. day	L/gross ha/d
MAXIMUM HOUR DEMAND	Residential	0.00	L/s
	Commercial/Industrial/ Institutional	1.00	L/s

WATER DEMAND DESIGN FLOWS PER UNIT COUNT

CITY OF OTTAWA - WATER DISTRIBUTION GUIDELINES, JULY 2010

AVERAGE DAILY DEMAND	0.37	L/s
MAXIMUM DAILY DEMAND	0.56	L/s
MAXIMUM HOUR DEMAND	1.00	L/s

McINTOSH PERRY

CCO-22-0480 - Youville Drive - Fire Underwriters Survey

Project: Youville Drive
 Project No.: CCO-22-0480
 Designed By: RRR
 Checked By: AJG
 Date: April 28, 2023

From the Fire Underwriters Survey (2020)

From Part II – Guide for Determination of Required Fire Flow Copyright I.S.O.:
 City of Ottawa Technical Bulletin ISTB-2018-02 Applied Where Applicable

A. BASE REQUIREMENT (Rounded to the nearest 1000 L/min)

$F = 220 \times C \times \sqrt{A}$ Where:
 F = Required fire flow in liters per minute
 C = Coefficient related to the type of construction.
 A = The total floor area in square meters (including all storey's, but excluding basements at least 50 percent below grade) in the building being considered.

Construction Type **Non-Combustible Construction**

C	0.8	A	2,115.0 m ²
Total Floor Area (per the 2020 FUS Page 20 - Total Effective Area)			2,115.0 m ² <i>*Unprotected Vertical Openings</i>

Calculated Fire Flow	8,094.1 L/min
	8,000.0 L/min

B. REDUCTION FOR OCCUPANCY TYPE (No Rounding)

From Page 24 of the Fire Underwriters Survey:
 Limited Combustible -15%

Fire Flow	6,800.0 L/min
-----------	---------------

C. REDUCTION FOR SPRINKLER TYPE (No Rounding)

Non-Sprinklered 0%

Reduction	0.0 L/min
-----------	-----------

D. INCREASE FOR EXPOSURE (No Rounding)

	Separation Distance (m)	Cons. of Exposed Wall	Length Exposed Adjacent Wall (m)	Height (Stories)	Length-Height Factor	
Exposure 1	20.1 to 30	Ordinary - Mass Timber (Unprotected)	93	2	186.0	5%
Exposure 2	Over 30 m	Ordinary - Mass Timber (Unprotected)	20	1	20.0	0%
Exposure 3	Over 30 m	Ordinary - Mass Timber (Unprotected)	50	2	100.0	0%
Exposure 4	Over 30 m	Ordinary - Mass Timber (Unprotected)	20	1	20.0	0%
% Increase*						5%

Increase*	340.0 L/min
-----------	-------------

E. Total Fire Flow (Rounded to the Nearest 1000 L/min)

Fire Flow	7,140.0 L/min
Fire Flow Required**	7,000.0 L/min

*In accordance with Part II, Section 4, the Increase for separation distance is not to exceed 75%

**In accordance with Section 4 the Fire flow is not to exceed 45,000 L/min or be less than 2,000 L/min

McINTOSH PERRY

CCO-22-0480 - Youville Drive - Boundary Condition Unit Conversion

Project: Youville Drive

Project No.: CCO-22-0480

Designed By: RRR

Checked By: AJG

Date: April 28, 2023

Boundary Conditions Unit Conversion

Youville Drive

Scenario	Height (m)	Elevation (m)	m H ₂ O	PSI	kPa
Avg. DD	114.6	61.5	53.1	75.6	520.9
Fire Flow (150L/s or 9,000 L/min)	111.1	61.5	49.6	70.6	486.6
Peak Hour	111.8	61.5	50.3	71.6	493.4

City of Ottawa Water Distribution System Figure

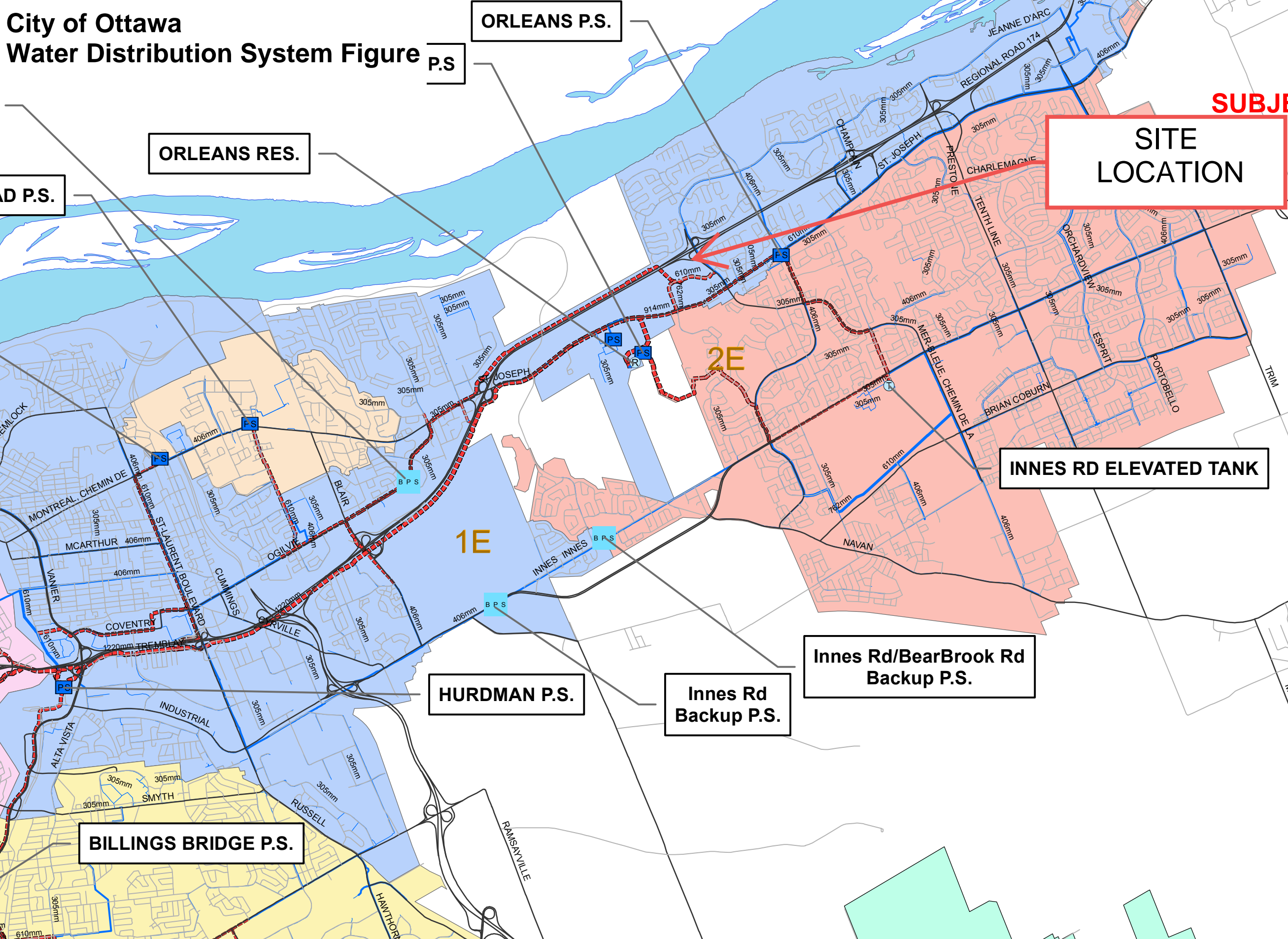

ORLEANS P.S.

ORLEANS RES.

SUBJ...
**SITE
LOCATION**

D P.S.

INNES RD ELEVATED TANK

HURDMAN P.S.

**Innes Rd
Backup P.S.**

**Innes Rd/BearBrook Rd
Backup P.S.**

BILLINGS BRIDGE P.S.

1E

2E

1400-1410 Youville Drive Hydrant Coverage Figure



Municipal Hydrants within 75m: 2

Municipal Hydrants within 150m: 1

Boundary Conditions 1400 & 1410 Youville Drive

Provided Information

Scenario	Demand	
	L/min	L/s
Average Daily Demand	22	0.37
Maximum Daily Demand	34	0.56
Peak Hour	60	1.00
Fire Flow Demand #1	9,000	150.00

Location

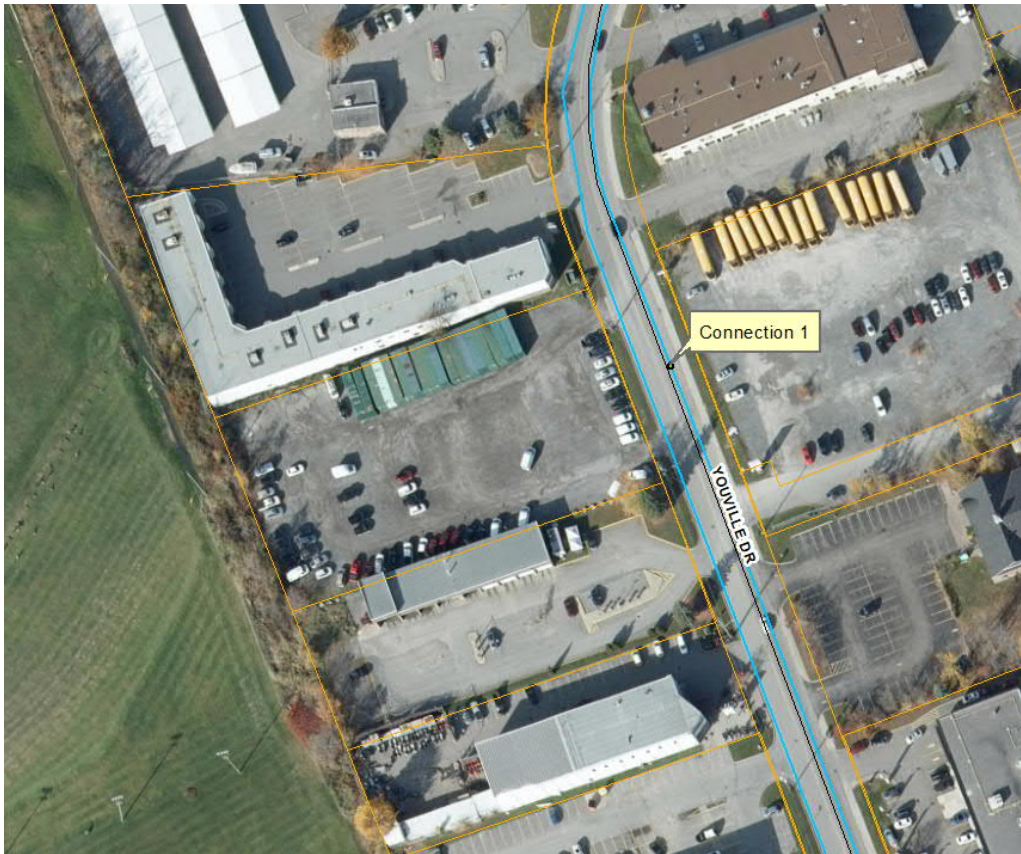

Results

Connection 1 – Youville Dr.

Demand Scenario	Head (m)	Pressure ¹ (psi)
Maximum HGL	114.6	75.5
Peak Hour	111.1	70.6
Max Day plus Fire 1	111.8	71.5

Ground Elevation = 61.5 m

APPENDIX D
SANITARY CALCULATIONS

McINTOSH PERRY

CCO-23-0480 - 1410 Youville Drive - Sanitary Demands

Project:	1410 Youville Drive
Project No.:	CCO-23-0480
Designed By:	RRR
Checked By:	AJG
Date:	August 26, 2022
Site Area	0.92 Gross ha

DESIGN PARAMETERS

Institutional/Commercial Peaking Factor	1.5
Industrial Peaking Factor	6.8
Residential Peaking Factor	3.80 * Using Harmon Formula = $1 + (14 / (4 + P^{0.5})) * 0.8$ where P = population in thousands, Harmon's Correction Factor = 0.8
Mannings coefficient (n)	0.013
Demand (per capita)	280 L/day
Infiltration allowance	0.33 L/s/Ha

EXTRANEOUS FLOW ALLOWANCES

Infiltration / Inflow	Flow (L/s)
Dry	0.05
Wet	0.26
Total	0.30

AVERAGE DAILY DEMAND

DEMAND TYPE	AMOUNT	UNITS	POPULATION / AREA	Flow (L/s)
Residential	280	L/c/d	0	0.00
Industrial - Light**	35,000	L/gross ha/d	0.92	0.37
Industrial - Heavy**	55,000	L/gross ha/d		0
Commercial / Amenity	2,800	L/(1000m ² /d)	0.00	0.00
Hospital	900	L/(bed/day)		0
Schools	70	L/(Student/d)		0
Trailer Parks no Hook-Ups	340	L/(space/d)		0
Trailer Park with Hook-Ups	800	L/(space/d)		0
Campgrounds	225	L/(campsite/d)		0
Mobile Home Parks	1,000	L/(Space/d)		0
Motels	150	L/(bed-space/d)		0
Hotels	225	L/(bed-space/d)		0
Office	75	L/7.0m ² /d		0
Tourist Commercial	28,000	L/gross ha/d		0
Other Commercial	28,000	L/gross ha/d		0

McINTOSH PERRY

AVERAGE RESIDENTIAL FLOW	0.00	L/s
PEAK RESIDENTIAL FLOW	0.00	L/s
AVERAGE ICI FLOW	0.00	L/s
PEAK INSTITUTIONAL/COMMERCIAL FLOW	0.00	L/s
PEAK INDUSTRIAL FLOW	2.53	L/s
TOTAL PEAK ICI FLOW	2.53	L/s

TOTAL SANITARY DEMAND

TOTAL ESTIMATED AVERAGE DRY WEATHER FLOW	0.42	L/s
TOTAL ESTIMATED PEAK DRY WEATHER FLOW	2.58	L/s
TOTAL ESTIMATED PEAK WET WEATHER FLOW	2.84	L/s

** PEAK INDUSTRIAL FLOW PER CITY OF OTTAWA SEWER DESIGN GUIDELINES APPENDIX 4B

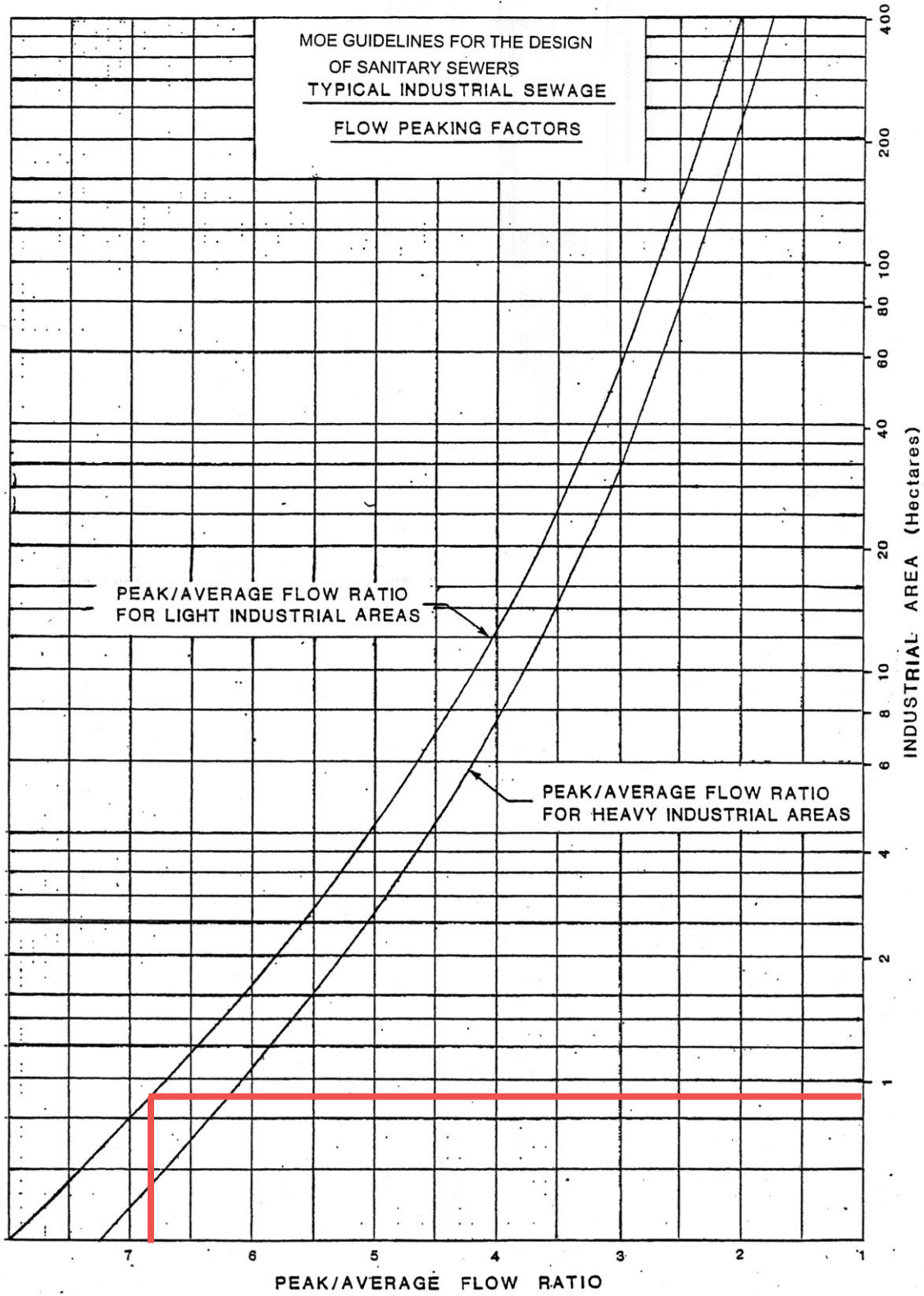

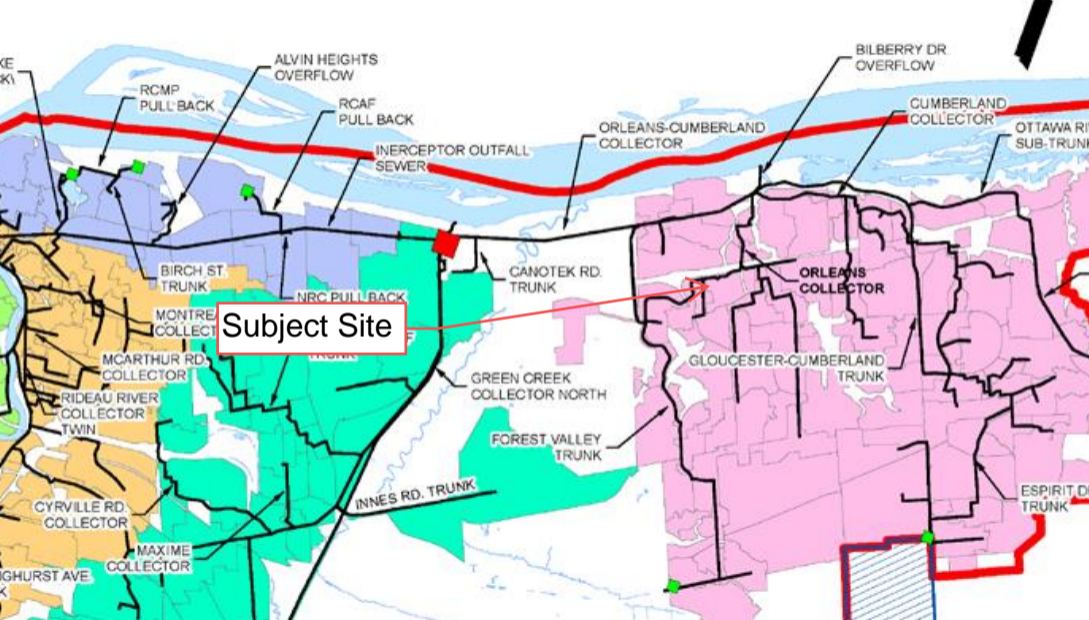

Subject Site

Sewerteks Inc.



McINTOSH PERRY

SANITARY SEWER LATERAL CCTV CONDITION ASSESSMENT

JOB LOCATION:

**140 YOUVILLE STREET
OTTAWA, ONTARIO**

JOB DATE:

Monday, April 24, 2023

Sewerteks Inc.



TABLE OF CONTENT

Cover Page.....pages 1-1

Table of contents.....pages 2-2

Project summary.....pages 3-4

Sanitary Detail Inspections.....pages 5-14

Map.....pages 15-15

WRC Code Descriptions.....pages 16-18

PROJECT SUMMARY

The following is the result from the camera inspections of the sanitary sewer located at 140 Youville Street Ottawa, Ontario.

COMBINE SYSTEM

The sewer system is combine in the building. The first access point was a Roof Drain stack CO. The line was labeled COMB1. When the camera was at 2.2 meters into the line, one of the washroom toilets was flushed and found out that the connection at 2.2 meters from the stack CO, connected to the toilet line. A reversal inspection was done because of the excessive debris sediment in the line.

CLEANING

The lines were not cleaned prior to the CCTV condition assessment.

PLR

Each inspected pipe segment has a unique identification ID. This unique ID is the Pipe Line Reference ID or PLR. All the IDs are labeled in the map.

REPORT NAVIGATION

The PLR is used to navigate this report online. It's a link to the video inspection and video file. You can jump from the Summary to the actual inspection details by clicking the PLR link. The report also has a table of contents that are also link to each section of the report. In addition, the report has a link to re-direct you to the table of contents in every page.

DVD/USB DRIVE

The DVD or USB drive contains the digital report and videos.

STRUCTURAL AND OPERATIONAL DEFECTS

The following table#1 below describes the structural and operational defects of each individual pipe segment inspected identified by its unique ID or PipeLine Reference ID. The comments depict any additional information about each segment inspected.

Table#1 below describes the structural and operational defects of each individual sanitary pipe segment inspected identified by its unique ID or PipeLine Reference ID.

PIPELINE REF. ID (PLR)	STRUCTURAL DEFECTS	OPERATIONAL DEFECTS	COMMENTS
COMB1	*TBD	DE	The sewer line has excessive amounts of debris sediment. The wye connection at 2.2 meters is the connection to the washroom toilet line. At the same time. It also picks up at least one roof drain. The inspection was abandoned at 21.2 meters due to debris sediment and multiple line deviations. However, by the line tracing technique, it was traced to a manhole in the property as shown in the map of this report. The reversal inspection is this line starts from the manhole.
COMB1-R	*TBD	*TBD	The camera was under water throughout the survey. However, the camera was pushed and traced up to the 18.2 meter mark where line SAN1 from the stack CO inside the building ended. The sewer line needs to be flushed and re-camera in order to determine the true condition of the pipe.
COMB2	*TBD	DE	The camera was under water a few pipe segments. And excessive pockets of debris sediment were found. The inspection ended at the city sewer main line at 12.6 meters from manhole MHSA. The sewer line needs to be flushed and re-camera in order to determine the true condition of the pipe.

*TBD: To Be Determined

Sewerteks Inc.



Date	4/24/2023	Sewer Type	COMBINE	Pipe Size (mm)	100MM
Client	McINTOSH PERRY	Work order	531		
Contact	CURTIS MELANSON	Pipe Material	ABS/PVC		
Start	STACKCO (RD1)	Camera Direction	With Flow		
End	21.2 METERS TO MHSA1	DVD#/USB#	1		
Further Location Details	THE ACCESS STACK CO (RD1) IS LOCATED IN THE BUILDING AS SHOWN IN THE MAP OF THIS REPORT.	Video name (PLR)	COMB1.mpg		
		Report No	1		
Job Address	140 YOUVILLE STREET OTTAWA, ONTARIO	Operator	Saul Cerna		
Comments	The sewer line has excessive amounts of debris sediment. The wye connection at 2.2 meters is the connection to the washroom toilet line. At the same time. It alsopicks up atleast one roof drain. The inspection was abandoned at 21.2 meters due to debris sediment and multiple line deviations. However, by the line tracing technique, it				

DISTANCE (m)	CODE DESCRIPTION	%	SIZE (mm)	LENGTH (m)	CLOCK FROM	CLOCK TO	REMARKS
0.0	Start of inspection						Start at access point STACKCO (RD1).
0.0	Line deviates down			0.6			Drop into the line.
0.6	Water Level	0					
0.6	Line deviates down			2.6			
0.6	Dimesion of Sewer Changes		150				
1.6	Connection		100		12		At the drop
2.2	Connection		75		1		Washroom toilet line
3.0	Water Level	40					Camera under murky water
3.8	Camera Under Water						Murky
4.0	Debris	50		1.0			Sediment
5.0	Debris	60					Sediment
5.6	Line Deviates Right						
6.0	Water Level	5					
11.6	Water Level	10					
12.8	Water Level	30					

Sewerteks Inc.



Sewerteks Inc.



Date	4/24/2023	Sewer Type	COMBINE	Pipe Size (mm)	100MM
Client	McINTOSH PERRY	Work order	531		
Contact	CURTIS MELANSON	Pipe Material	ABS/PVC		
Start	STACKCO (RD1)	Camera Direction	With Flow		
End	21.2 METERS TO MHSA1	DVD#/USB#	1		
Further Location Details	THE ACCESS STACK CO (RD1) IS LOCATED IN THE BUILDING AS SHOWN IN THE MAP OF THIS REPORT.	Video name (PLR)	COMB1.mpg		
		Report No	1		
Job Address	140 YOUVILLE STREET OTTAWA, ONTARIO	Operator	Saul Cerna		
Comments	The sewer line has excessive amounts of debris sediment. The wye connection at 2.2 meters is the connection to the washroom toilet line. At the same time. It alsopicks up atleast one roof drain. The inspection was abandoned at 21.2 meters due to debris sediment and multiple line deviations. However, by the line tracing technique, it				

DISTANCE (m)	CODE DESCRIPTION	%	SIZE (mm)	LENGTH (m)	CLOCK FROM	CLOCK TO	REMARKS
13.0	Camera Under Water						
15.8	General observation						camera under murky water
21.2	Survey Abandoned						

Sewerteks Inc.



PROJECT NAME

SANITARY SEWER LATERAL CCTV CONDITION ASSESSMENT

VIDEO NAME

SAN1

Figure#1: Start of inspection at access point STACKCO (RD1)

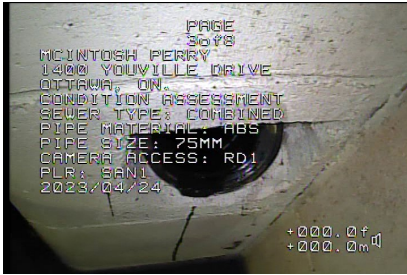

0.0 m

Figure#2: A view to the line deviation downwards at 0.0 meters from the top of STACKCO (RD1).

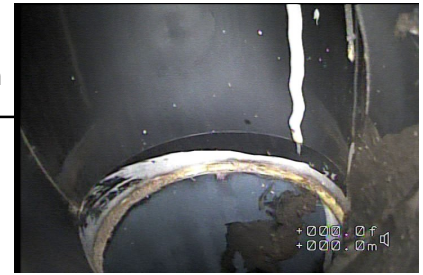

0.0 m

Figure#3: A view to the 0% water level and downward deviation at 0.6 meters from the top of STACKCO (RD1).

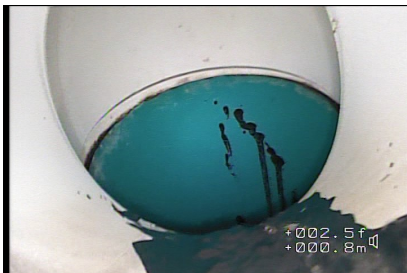

0.6 m

Figure#4: A view to the 100mm 12 o'clock connection at 1.4 meters from the top STACKCO (RD1).



1.4 m

Figure#5: A view to the 75mm 1 o'clock connection to the washroom toilet line at 2.0 meters from the top STACKCO



2.0 m

Figure#6: A view to the 40% water level at 2.8 meters from the top of STACKCO (RD1).



2.8 m

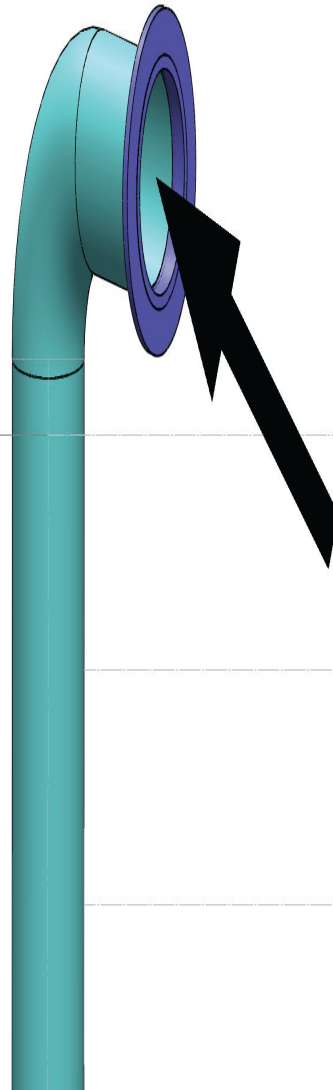

PROJECT NAME

SANITARY SEWER LATERAL CCTV CONDITION ASSESSMENT

VIDEO NAME

SAN1

Figure#7: A view to the camera under murky water at 3.8 meters from the top of STACKCO (RD1).



3.8 m

Figure#8: A view to the 50 % Debris sediment at 4.8 meters from the top of STACKCO (RD1).

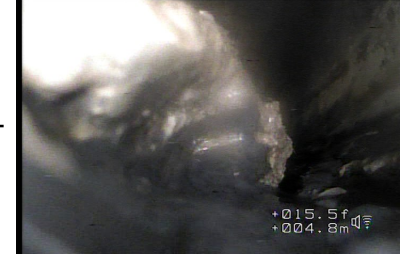

4.8 m

Figure#9: A view to the 60 % Debris sediment at 5.0 meters from the top of STACKCO (RD1).



5.0 m

Figure#10: A view to the right line deviation at 5.6 meters from the top of STACKCO (RD1).

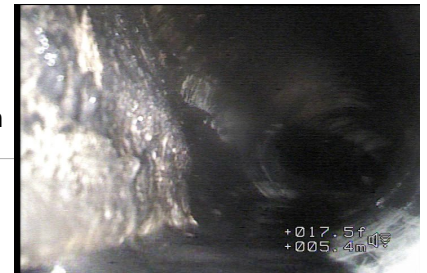

5.6 m

Figure#11: A view to the 5% water level at 6.6 meters from the top of STACKCO (RD1).

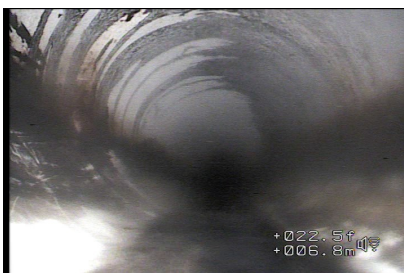

6.0 m

Figure#12: A view to the 10% water level at 11.6 meters from the top of STACKCO (RD1).



11.6 m





PROJECT NAME

SANITARY SEWER LATERAL CCTV CONDITION ASSESSMENT

VIDEO NAME

SAN1

Figure#13: A view to the 30% water level at 12.8 meters from the top of STACKCO (RD1).



12.8 m

Figure#14: A view to the camera under murky water at 15.8 meters from the top of STACKCO (RD1).



15.8 m

Figure#15: Abandoned due to debris under the murky water and debris sediment at 21.2 meters from the stack

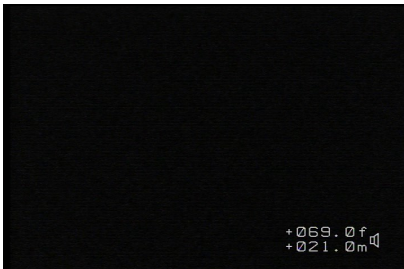

21.2 m



m

m

m



Sewerteks Inc.



Date	4/24/2023	Sewer Type	COMBINE	Pipe Size (mm)	100/150MM
Client	McINTOSH PERRY	Work order	531		
Contact	CURTIS MELANSON	Pipe Material	ABS/PVC		
Start	MHSA1	Camera Direction	Against Flow		
End	18.2 METERS TO STACKCO (RD1)	DVD#/USB#	1		
Further Location Details	THE ACCESS MANHOLE MHSA1 IS LOCATED IN THE BUILDING AS SHOWN IN THE MAP OF THIS REPORT.	Video name (PLR)	COMB1-R.mpg		
		Report No	1		
Job Address	140 YOUVILLE STREET OTTAWA, ONTARIO	Operator	Saul Cerna		
Comments	The camera was under water throughout the survey. However, the camera was pushed and traced up to the 18.2 meter mark where line SAN1 from the stack CO inside the building ended. The sewer line needs to be flushed and re-camera in order to determine the true condition of the pipe.				

DISTANCE (m)	CODE DESCRIPTION	%	SIZE (mm)	LENGTH (m)	CLOCK FROM	CLOCK TO	REMARKS
0.0	Start of inspection						Start at access point STACKCO (RD1).
0.0	Water Level	40					
0.4	Camera Under Water						Murky water
10.6	General observation						camera under murky water
18.2	Finish Survey						End atline SAN1

Sewerteks Inc.





PROJECT NAME

SANITARY SEWER LATERAL CCTV CONDITION ASSESSMENT

VIDEO NAME

SAN1-R

Figure#1: Start of inspection at access point STACKCO (RD1)



Figure#3: A view to the camera under murky water at 10.6 meters from the top of STACKCO (RD1).

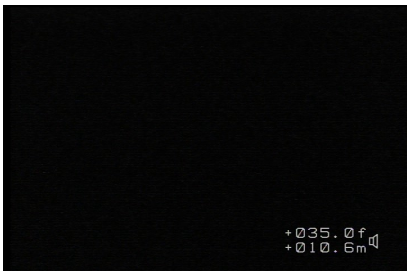

Figure#2: A view to the 40% water level at 0.4 meters from the top of STACKCO (RD1).

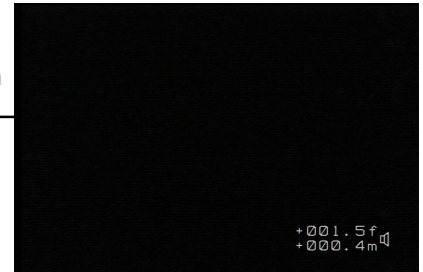

Figure#4: End of inspection at 18.2 meters from manhole MHSA1. Note traced to the same end point of line

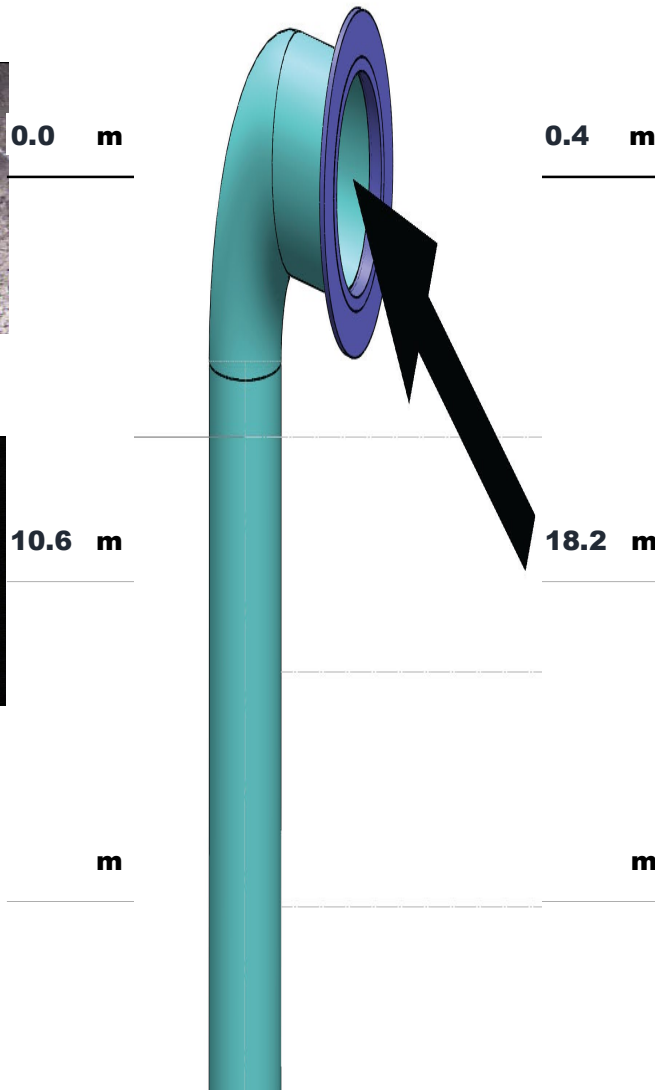

Sewerteks Inc.



Date	4/24/2023	Sewer Type	COMBINE	Pipe Size (mm)	150MM
Client	McINTOSH PERRY	Work order	531		
Contact	CURTIS MELANSON	Pipe Material	ABS/PVC		
Start	MHSA1	Camera Direction	With Flow		
End	CITY MAIN LINE	DVD#/USB#	1		
Further Location Details	THE ACCESS MANHOLE MHSA1 IS LOCATED IN THE BUILDING AS SHOWN IN THE MAP OF THIS REPORT.	Video name (PLR)	COMB2.mpg		
		Report No	1		
Job Address	140 YOUVILLE STREET OTTAWA, ONTARIO	Operator	Saul Cerna		
Comments	The camera was under water a few pipe segments. And excessive pockets of debris sediment were found. The inspection ended at the city sewer main line at 12.6 meters from manhole MHSA. The sewer line needs to be flushed and re-camera in order to determine the true condition of the pipe.				

DISTANCE (m)	CODE DESCRIPTION	%	SIZE (mm)	LENGTH (m)	CLOCK FROM	CLOCK TO	REMARKS
0.0	Start of inspection						Start at access point MHSA1.
0.0	Water Level	40					
0.0	Camera Under Water						
4.6	Debris	50					Sediment
5.0	General observation						Camera lens blocked by sediment
11.0	Camera Above Water						
11.4	Line deviates down						To the city main line
11.8	Line deviates down						To the city main line
12.6	Finish Survey						End at CITY MAIN LINE.

Sewerteks Inc.





PROJECT NAME

SANITARY SEWER LATERAL CCTV CONDITION ASSESSMENT

VIDEO NAME

SAN2

Figure#1: Start of inspection at access point MHSA1

Figure#2: A view to the 40% water level at 0.0 meters from the top of MHSA1.



0.0 m



0.0 m

Figure#3: A view to the camera under the murky water at 0.0 meters from the top of MHSA1.

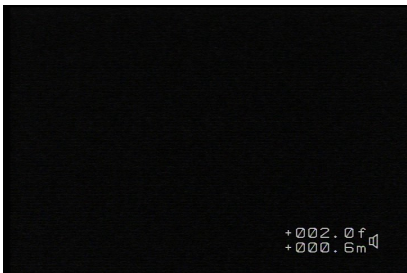

0.0 m

Figure#4: A view to the 40% Debris sediment at 4.6 meters from the top of MHSA1.



4.6 m

Figure#5: A view to the Camera lens blocked by sediment at 5.4 meters from the top of MHSA1.



5.4 m

Figure#6: A view to the camera above water at 11.0 meters from the top of MHSA1.



11.0 m

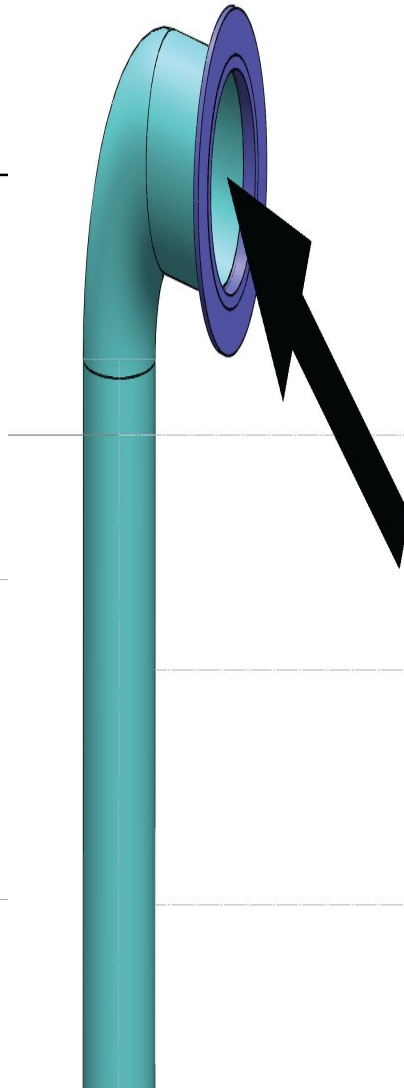



PROJECT NAME

SANITARY SEWER LATERAL CCTV CONDITION ASSESSMENT

VIDEO NAME

SAN2

Figure#7: A view to the line deviation downwards at 11.4 meters from the top of MHSA1.



11.4 m

Figure#8: A view to the line deviation downwards at 11.8 meters from the top of MHSA1.



11.8 m

Figure#9: A view to the end point CITY MAIN LINE at 12.4 meters from the top of MHSA1.



12.6 m

m

m

m





Depth: 6'0"

6'5"

7'0"

7'4"

8'0"

9'0"

9'2"

10'0"

RD1

COMB1

COMB1-R

MHSA1

COMB2

CITY SANITARY MAIN

Observations

Problem

Structural Condition - Brickwork

DB – Displaced Bricks
DI – Dropped Invert
MB – Missing Bricks

Structural Condition – Mortar Missing

MM - Mortar missing medium
MS – Mortar missing slight
MT – Mortar missing total

Structural Condition – Surface damage

SSL - Spalling large
SSM - Spalling medium
SSS – Spalling slight
SWL – Wear large
SWM – Wear medium
SWS – Wear slight

Structural Condition – Joint Displaced

JDL – Joint Displaced Large
JDM – Joint Displaced Medium

Structural Condition – Open Joint

OJL – Open Joint Large
OJM – Open Joint Medium

Structural Condition – Cracked

CC – Crack Circumferential
CL – Crack Longitudinal
CM – Crack multiple

Structural Condition – Fractured

FC – Fracture Circumferential
FL – Fracture Longitudinal
FM – Fracture Multiple

Structural Condition – Broken (pipe sewers)

B- Broken
H – Hole

Structural Condition – Deformed

D – Deformed Sewer

Structural Condition – Collapsed

X – Collapsed

Construction Features – Connection

CN – Connection
CNI – Connection intruding
CX – Connection defective
CXI – Connection defective intruding
WYE - End point connection / End of a line

Construction Features – Junction

JN – Junction
JX – Junction Defective

Construction Features – Lining defect

LN – Lining defect

Construction Features – Major branch

BR – Branch major

Construction Features – Manhole/node

MH – Manhole/Node

Miscellaneous Features

CU – Camera underwater
DC – Dimension of sewers changes
GO – General Observation
GP – General Photograph
LC – Lining Change
MC – Material change
PC – Pipe length change
SC – Shape change
V – Vermin (rats and/or mice)
WL – Water Level

Service Defects – Roots

RF – Roots fine
RFJ – Roots fine at joint
RM – Roots mass
RMJ – roots mass at joint
RT – Roots tap
RJ – Roots tap at joint

Service Defects – Infiltration

ID – Infiltration dripper
IDJ – Infiltration dripper at joint
IG – Infiltration gusher
IGJ – Infiltration gusher at joint
IR – Infiltration runner
IRJ – Infiltration runner at joint
IS – Infiltration seep
ISJ – Infiltration seep at joint

Service Defects – Encrustation

EH – Encrustation heavy
EHJ – Encrustation heavy at joint
EL – Encrustation light
ELJ – Encrustation light at joint
EM – Encrustation medium
EMJ – Encrustation medium at joint

Service Defects – Debris

DE – Debris
DEG – Debris grease
DES – Debris silt

Service Defects – Line

LD – Line deviates down
LL – Line deviates left
LR – Line deviates right
LU – Line deviates up

Service Defects – Obstruction

OB – Debris grease

Other Codes

Inspections

CID – Continue inspection downstream
CIU – Continue inspection upstream
FH – Finish Survey
SA – Survey abandoned
ST – Start of Survey

Weather

- 1- Dry
- 2- Heavy Rain
- 3- Light Rain
- 4- Showers
- 5- Snow

Reasons & Purpose

- A- Structural or service condition defects
- B- Infiltration
- C- Assessment of complete remedial or renovation works
- D- Pre-adoption
- E- Pre-acceptance
- F- Sample survey to determine asset condition
- G- Associated with future capital scheme including drainage area planning
- H- Resurvey for any reason
- X- Other
- Z- Not known

Surface Type & Location

- A- Main road (urban)
- B- Main road (suburban/rural)
- C- Light road
- D- Footpath or verge (within the highway boundary)
- E- Fields (farmland and public open space)
- F- Gardens (within private property)
- G- Woodland
- X- Difficult access (motorway, railway, watercourse, inside building)

Pipe Type

AC – Alkathene
AK – Alkathene
BR – Brick
CC – Concrete box culvert
CI – Cast Iron
CO – Concrete
CSB – Concrete segments (bolted)
CSU – Concrete segments (unbolted)
DI – Ductile Iron
GRC – Glass reinforced cement
GRP – Glass reinforced plastic
MAC – Masonry (in regular courses)
MAR – Masonry (randomly coursed)
PE – Polyethylene
PF – Pitch fibre
PP – Polypropylene
PSC – Plastic/steel composite
PVC – Polyvinyl chloride
RPM – Reinforced plastic matrix
SI – Spun (grey) iron
ST – Steel
TRA - Transite
VC – Vitrified clay
XXX – Other
ZZZ – Not known

Pipe Shape

A- Arched (with flat bottom)
B- Barrel
C- Circular
E- Egg shaped
H- Horseshoe
O- Oval
R- Rectangular
S- Square
T- Trapezoidal
U- U-shaped with flat top
X- Other

Use of Sewer

A- Combined
F- Foul
S- Surface water
T- Trade effluent
W- Watercourse (culverted)
X- Other
Z- Not known

Lining Method

BL – Bitumen
CL – Cement
CPP – Cured in place
IS – Soft inversion type liner
PL – Plastic
RL – Resin
XXX – Other
ZZ – Not known

Pre-Cleaning

N- No pre-cleaning
Y- Pre-cleaning was carried out
Z- Not known

APPENDIX E
PRE-DEVELOPMENT DRAINAGE PLAN



GENERAL NOTES

1. THE ORIGINAL TOPOGRAPHY, GROUND ELEVATION AND SURVEY DATA SHOWN ARE SUPPLIED FOR INFORMATION PURPOSES ONLY, AND IMPLY NO GUARANTEE OF ACCURACY. IT SHALL BE THE RESPONSIBILITY OF THE CONTRACTOR TO VERIFY ALL INFORMATION SHOWN.
2. THIS PLAN IS NOT A CADASTRAL SURVEY SHOWING LEGAL PROPERTY BOUNDARIES AND EASEMENTS. THE PROPERTY BOUNDARIES SHOWN HEREON HAVE BEEN DERIVED FROM INFORMATION SUPPLIED BY STANTEC GEOMATICS LTD. (PROJ. NO. 161614550-111) AND CANNOT BE RELIED UPON TO BE ACCURATE OR COMPLETE. THE PRECISE LOCATION OF THE CURRENT PROPERTY BOUNDARIES AND EASEMENTS CAN ONLY BE DETERMINED BY AN UP-TO-DATE LAND TITLES SEARCH AND A SUBSEQUENT CADASTRAL SURVEY PERFORMED AND CERTIFIED BY AN ONTARIO LAND SURVEYOR.
3. THE CONTRACTOR IS TO OBTAIN AND PAY FOR ALL NECESSARY PERMITS AND APPROVALS FROM THE CITY BEFORE COMMENCING CONSTRUCTION.
4. THE CONTRACTOR IS RESPONSIBLE FOR ALL LAYOUT.
5. THE CONTRACTOR IS TO DETERMINE THE EXACT LOCATION, SIZE, MATERIAL AND ELEVATION OF ALL EXISTING UTILITIES PRIOR TO COMMENCING CONSTRUCTION. PROTECT AND ASSUME ALL RESPONSIBILITY FOR EXISTING UTILITIES WHETHER OR NOT SHOWN ON THESE DRAWINGS. IF THERE IS ANY DISCREPANCY THE CONTRACTOR IS TO NOTIFY THE ENGINEER PROMPTLY.
6. RESTORE ALL TRENCHES AND SURFACES OF PUBLIC ROAD ALLOWANCES TO CONDITION EQUAL OR BETTER THAN ORIGINAL CONDITION AND TO THE SATISFACTION OF THE CITY AUTHORITIES.
7. EXCAVATE AND DISPOSE OF ALL EXCESS EXCAVATED MATERIAL, SUCH AS ASPHALT, CURBING AND DEBRIS, OFF SITE AS DIRECTED BY THE ENGINEER AND THE CITY.
8. TOPSOIL TO BE STRIPPED AND STOCKPILED FOR REHABILITATION. CLEAN FILL TO BE PLACED IN FILL AREAS AND COMPACTED TO 95% STANDARD PROCTOR DENSITY.
9. ALL DISTURBED AREAS TO BE RESTORED TO ORIGINAL CONDITION OR BETTER UNLESS OTHERWISE SPECIFIED.
10. THE CONTRACTOR SHALL BE RESPONSIBLE FOR ALL TRAFFIC CONTROL AND SAFETY MEASURES DURING THE CONSTRUCTION PERIOD, INCLUDING THE SUPPLY, INSTALLATION, AND REMOVAL OF ALL NECESSARY SIGNAGE, DELINEATORS, MARKERS AND BARRIERS.
11. DO NOT ALTER GRADING OF THE SITE WITHOUT PRIOR APPROVAL OF THE ENGINEER/CITY.
12. ALL ROADWAY, PARKING LOT, AND GRADING WORKS TO BE UNDERTAKEN IN ACCORDANCE WITH CITY STANDARDS AND SPECIFICATIONS. THE CONTRACTOR IS TO PROVIDE POSITIVE DRAINAGE AWAY FROM THE BUILDING.
13. CONTACT THE CITY FOR INSPECTION OF ROUGH GRADING OF PARKING LOTS, ROADWAYS AND LANDSCAPED AREAS PRIOR TO PLACEMENT OF ASPHALT AND TOPSOIL. ALL DEFICIENCIES NOTED SHALL BE RECTIFIED TO THE CITY'S SATISFACTION PRIOR TO PLACEMENT OF ANY ASPHALT, TOPSOIL, SEED & MULCH AND/OR SOD.
14. ALL DIMENSIONS AND INVERTS MUST BE VERIFIED PRIOR TO CONSTRUCTION, IF THERE IS ANY DISCREPANCY THE CONTRACTOR IS TO NOTIFY THE ENGINEER PROMPTLY.
15. ELECTRICAL, GAS, TELEPHONE AND TELEVISION SERVICE LOCATIONS ARE SUBJECT TO THE INDIVIDUAL AGENCY:
 - ELECTRICAL SERVICE - HYDRO ONE,
 - GAS SERVICE - ENBRIDGE,
 - TELEPHONE SERVICE - BELL CANADA,
 - TELEVISION SERVICE - ROGERS.
16. INSTALLATION TO BE IN ACCORDANCE WITH CURRENT CODES AND STANDARDS OF APPROVAL AGENCIES HYDRO ONE, BELL AND THE CITY.
17. CONTRACTOR TO ENSURE ALL APPLICABLE OPS SPECIFICATIONS ARE FOLLOWED DURING CONSTRUCTION
18. ALL PROPOSED CURB TO BE CONCRETE BARRIER CURB UNLESS OTHERWISE SPECIFIED.
19. THIS PLAN MUST BE READ IN CONJUNCTION WITH THE GEOTECHNICAL INVESTIGATION COMPLETED BY PINCHN, DATED AUGUST 2022.

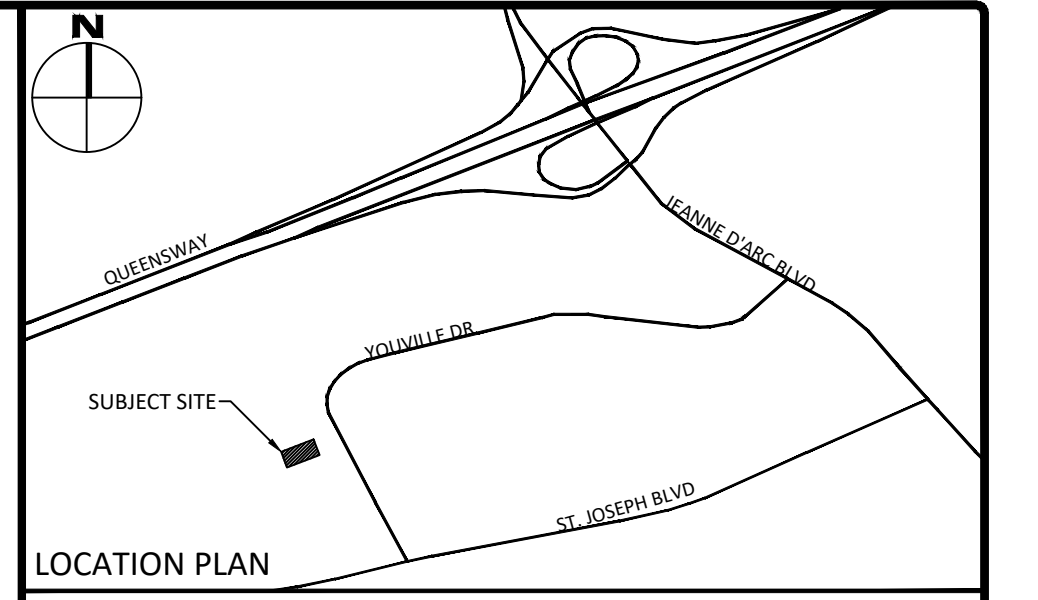

LEGEND

	BARRIER CURB & CURB DEPRESSION		CENTRELINE OF SWALE
	PROPOSED DRIVEWAY ASPHALT AREA		CENTRELINE OF DITCH
	PROPOSED CONCRETE WALKWAY		SLOPING AT 3:1 UNLESS SPECIFIED
	STORM MANHOLE		PROPOSED ELEVATION
	CATCHBASIN, CURB INLET OR DITCH INLET		EXISTING ELEVATION
	SANITARY MANHOLE		SWALE ELEVATION
	PERFORATED PIPE		TOP/BOTTOM WALL FACE ELEVATIONS
	WATER VALVE/CHAMBER		EMERGENCY OVERLAND FLOW ROUTE
	FIRE HYDRANT		SILT FENCE BARRIER PER OPSD 219.110
	PROPOSED WALL		BUILDING ENTRANCE OVERHEAD DOOR REDUCER
	SEDIMENT CONTROL DEVICE PER DETAIL		DOWNSPOUT LOCATION
	ROADCUT AND REINSTATEMENT PER CITY R10		SERVICE CROSSING
	5-YEAR PONDING ELEV.		100-YEAR PONDING ELEV.

FOR REVIEW ONLY
NOT FOR CONSTRUCTION

3	ISSUED FOR REVIEW	MAY 01, 2023
2	ISSUED FOR REVIEW	FEB 02, 2023
1	ISSUED FOR REVIEW	AUG 26, 2022
No.	Revisions	Date

Check and verify all dimensions before proceeding with the work. Do not scale drawings.

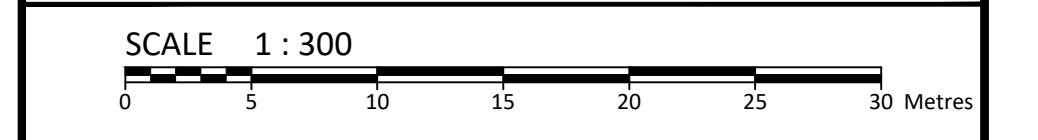

McINTOSH PERRY
115 Walgreen Road, RR3, Carp, ON K0A 1L0
Tel: 613-836-2184 Fax: 613-836-3742
www.mcintoshperry.com

Client: **BBS CONSTRUCTION LTD**
1805 WOODWARD DRIVE
OTTAWA, ON K2C 0P9

Project: **JIM KEAY FORD**
1410 YOUVILLE DRIVE

OTTAWA ON

Drawing Title: **PRE-DEVELOPMENT DRAINAGE PLAN**

Scale: 1:300	Project Number: CCO-23-0480
Drawn By: R.R.R.	Checked By: A.J.G.
Designed By: A.J.G.	Project Number: CCO-23-0480
	Project Number: CCO-23-0480

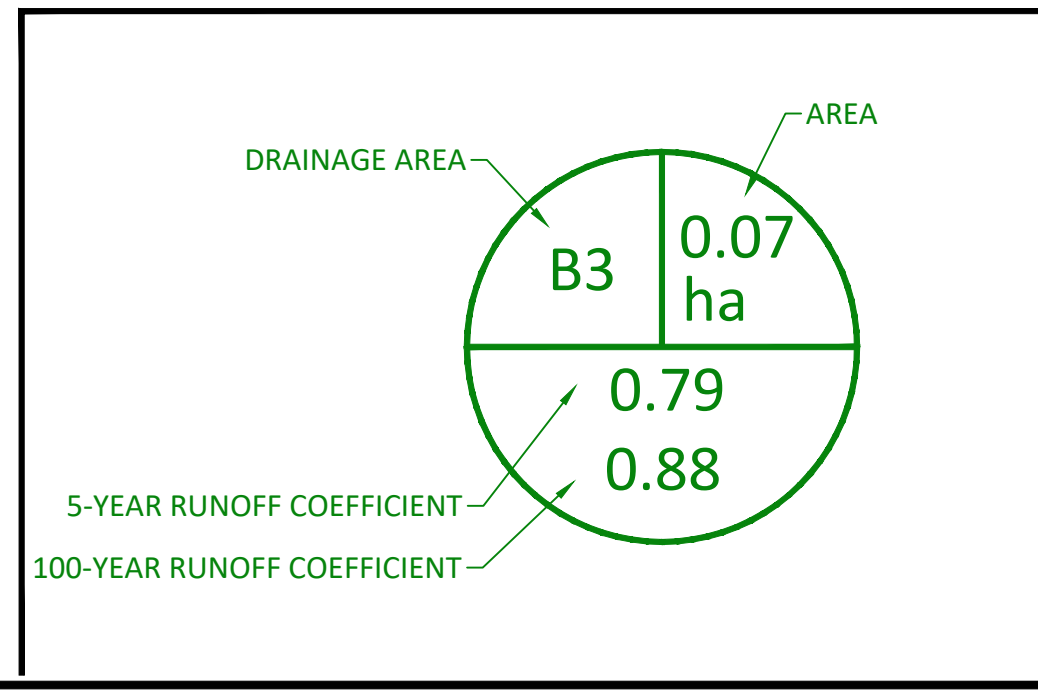

FILENAME: I:\Cityworks\01 Project - Proposed\2023\0480\CCO-23-0480_BBS_1410 Youville Drive_L1 - Drawing\CCO-23-0480_P01-01.dwg
 DATE PLOTTED: Friday, April 28, 2023 10:58:11 AM
 LAST SAVED BY: r.robinson
 LAST PLOTTED: Friday, April 28, 2023 10:58:11 AM

D07-12-22-0130

APPENDIX F
POST-DEVELOPMENT DRAINAGE PLAN

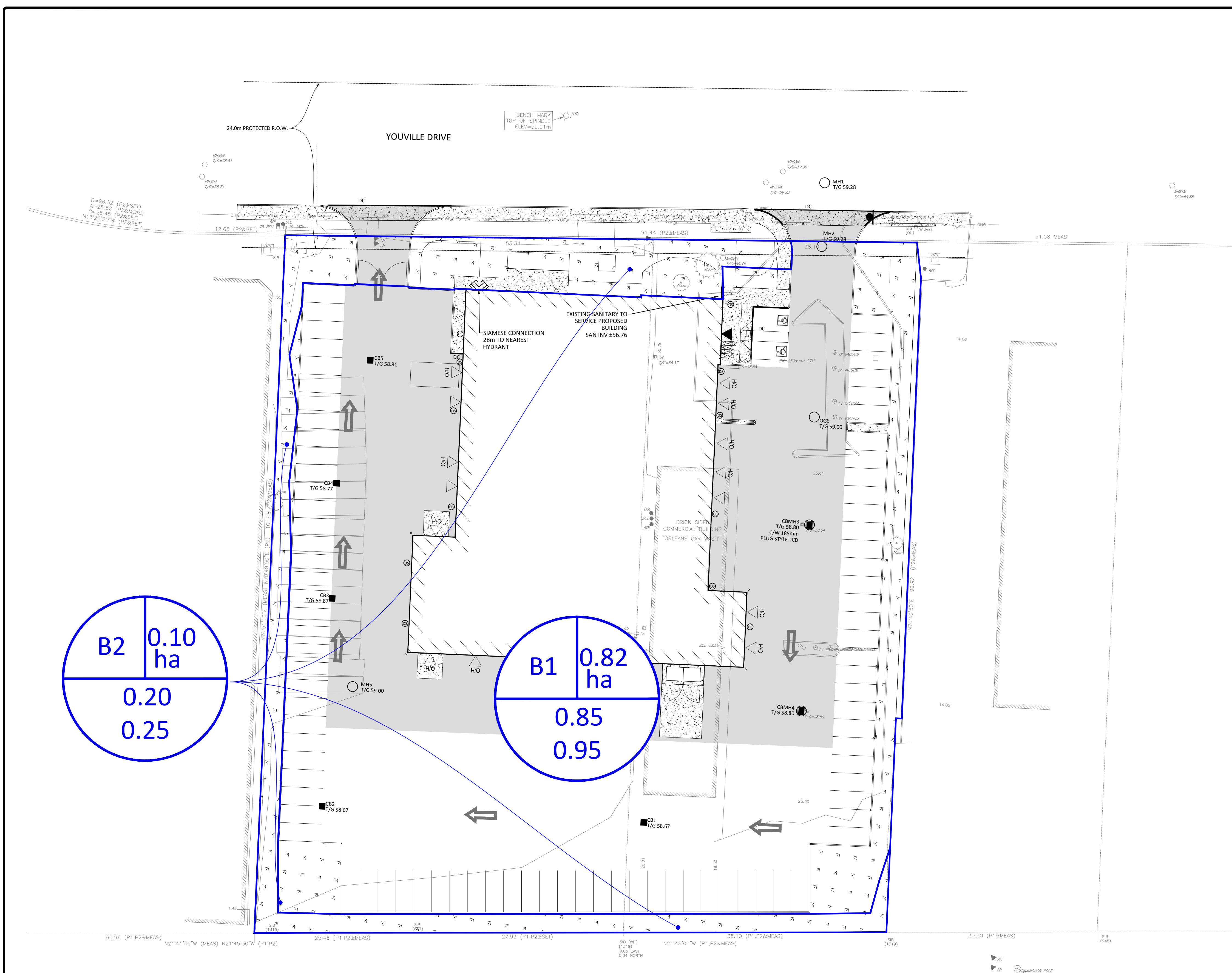

GENERAL NOTES

- THE ORIGINAL TOPOGRAPHY, GROUND ELEVATION AND SURVEY DATA SHOWN ARE SUPPLIED FOR INFORMATION PURPOSES ONLY, AND IMPLY NO GUARANTEE OF ACCURACY. IT SHALL BE THE RESPONSIBILITY OF THE CONTRACTOR TO VERIFY ALL INFORMATION SHOWN.
- THIS PLAN IS NOT A CADASTRAL SURVEY SHOWING LEGAL PROPERTY BOUNDARIES AND EASEMENTS. THE PROPERTY BOUNDARIES SHOWN HEREON HAVE BEEN DERIVED FROM INFORMATION SUPPLIED BY STANTEC GEOMATICS LTD. (PROJ. NO. 161614550-111) AND CANNOT BE RELIED UPON TO BE ACCURATE OR COMPLETE. THE PRECISE LOCATION OF THE CURRENT PROPERTY BOUNDARIES AND EASEMENTS CAN ONLY BE DETERMINED BY AN UP-TO-DATE LAND TITLES SEARCH AND A SUBSEQUENT CADASTRAL SURVEY PERFORMED AND CERTIFIED BY AN ONTARIO LAND SURVEYOR.
- THE CONTRACTOR IS TO OBTAIN AND PAY FOR ALL NECESSARY PERMITS AND APPROVALS FROM THE CITY BEFORE COMMENCING CONSTRUCTION.
- THE CONTRACTOR IS RESPONSIBLE FOR ALL LAYOUT.
- THE CONTRACTOR IS TO DETERMINE THE EXACT LOCATION, SIZE, MATERIAL AND ELEVATION OF ALL EXISTING UTILITIES PRIOR TO COMMENCING CONSTRUCTION. PROTECT AND ASSUME ALL RESPONSIBILITY FOR EXISTING UTILITIES WHETHER OR NOT SHOWN ON THESE DRAWINGS. IF THERE IS ANY DISCREPANCY THE CONTRACTOR IS TO NOTIFY THE ENGINEER PROMPTLY.
- RESTORE ALL TRENCHES AND SURFACES OF PUBLIC ROAD ALLOWANCES TO CONDITION EQUAL OR BETTER THAN ORIGINAL CONDITION AND TO THE SATISFACTION OF THE CITY AUTHORITIES.
- EXCAVATE AND DISPOSE OF ALL EXCESS EXCAVATED MATERIAL, SUCH AS ASPHALT, CURBING AND DEBRIS, OFF SITE AS DIRECTED BY THE ENGINEER AND THE CITY.
- TOPSOIL TO BE STRIPPED AND STOCKPILED FOR REHABILITATION. CLEAN FILL TO BE PLACED IN FILL AREAS AND COMPACTED TO 95% STANDARD PROCTOR DENSITY.
- ALL DISTURBED AREAS TO BE RESTORED TO ORIGINAL CONDITION OR BETTER UNLESS OTHERWISE SPECIFIED.
- THE CONTRACTOR SHALL BE RESPONSIBLE FOR ALL TRAFFIC CONTROL AND SAFETY MEASURES DURING THE CONSTRUCTION PERIOD, INCLUDING THE SUPPLY, INSTALLATION, AND REMOVAL OF ALL NECESSARY SIGNAGE, DELINEATORS, MARKERS AND BARRIERS.
- DO NOT ALTER GRADING OF THE SITE WITHOUT PRIOR APPROVAL OF THE ENGINEER/CITY.
- ALL ROADWAY, PARKING LOT, AND GRADING WORKS TO BE UNDERTAKEN IN ACCORDANCE WITH CITY STANDARDS AND SPECIFICATIONS. THE CONTRACTOR IS TO PROVIDE POSITIVE DRAINAGE AWAY FROM THE BUILDING.
- CONTACT THE CITY FOR INSPECTION OF ROUGH GRADING OF PARKING LOTS, ROADWAYS AND LANDSCAPED AREAS PRIOR TO PLACEMENT OF ASPHALT AND TOPSOIL. ALL DEFICIENCIES NOTED SHALL BE RECTIFIED TO THE CITY'S SATISFACTION PRIOR TO PLACEMENT OF ANY ASPHALT, TOPSOIL, SEED & MULCH AND/OR SOD.
- ALL DIMENSIONS AND INVERTS MUST BE VERIFIED PRIOR TO CONSTRUCTION, IF THERE IS ANY DISCREPANCY THE CONTRACTOR IS TO NOTIFY THE ENGINEER PROMPTLY.
- ELECTRICAL, GAS, TELEPHONE AND TELEVISION SERVICE LOCATIONS ARE SUBJECT TO THE INDIVIDUAL AGENCY:
 - ELECTRICAL SERVICE - HYDRO ONE,
 - GAS SERVICE - ENBRIDGE,
 - TELEPHONE SERVICE - BELL CANADA,
 - TELEVISION SERVICE - ROGERS.
- INSTALLATION TO BE IN ACCORDANCE WITH CURRENT CODES AND STANDARDS OF APPROVAL AGENCIES HYDRO ONE, BELL AND THE CITY.
- CONTRACTOR TO ENSURE ALL APPLICABLE OPS SPECIFICATIONS ARE FOLLOWED DURING CONSTRUCTION
- ALL PROPOSED CURB TO BE CONCRETE BARRIER CURB UNLESS OTHERWISE SPECIFIED.
- THIS PLAN MUST BE READ IN CONJUNCTION WITH THE GEOTECHNICAL INVESTIGATION COMPLETED BY PINCHN, DATED AUGUST 2022.

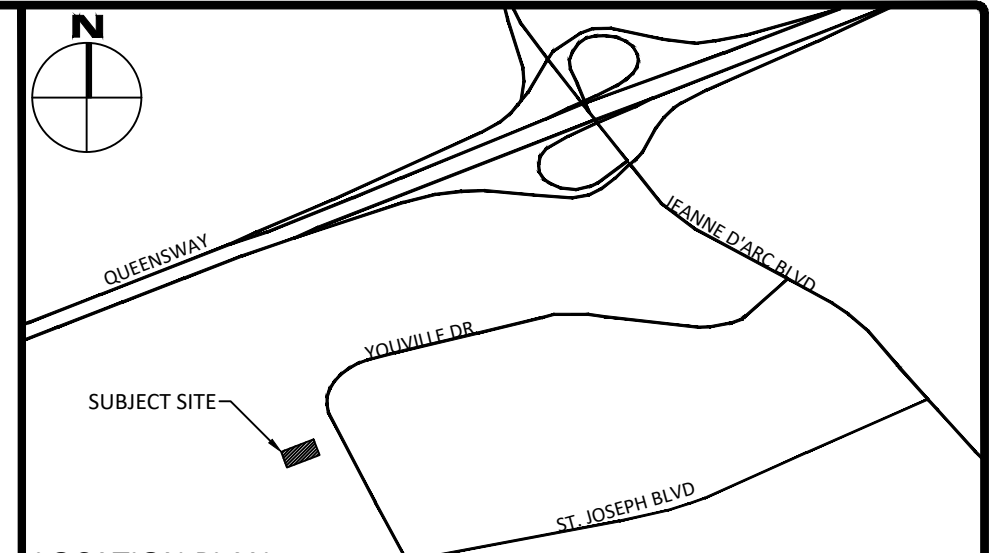

LEGEND

- Barrier curb & curb depression
- Proposed driveway asphalt area
- Proposed concrete walkway
- Storm manhole
- Catchbasin, curb inlet or ditch inlet
- Sanitary manhole
- Perforated pipe
- Water valve/chamber
- Fire hydrant
- Proposed wall
- Sediment control device per detail
- Roadcut and reinstatement per city R10
- Service crossing
- 5-year ponding elev.
- 100-year ponding elev.
- Centreline of swale
- Centreline of ditch
- Sloping at 3:1 unless specified
- Proposed elevation existing elevation
- Swale elevation
- Top/bottom wall face elevations
- Emergency overland flow route
- Silt fence barrier per OPS 219.110
- Building entrance overhead door reducer
- Downspout location refer to architectural plans

FOR REVIEW ONLY
NOT FOR CONSTRUCTION

No.	Revisions	Date
3	ISSUED FOR REVIEW	MAY 01, 2023
2	ISSUED FOR REVIEW	FEB 02, 2023
1	ISSUED FOR REVIEW	AUG 26, 2022

Check and verify all dimensions before proceeding with the work. Do not scale drawings.



McINTOSH PERRY
115 Walgreen Road, RR3, Carp, ON K0A 1L0
Tel: 613-836-2184 Fax: 613-836-3742
www.mcintoshperry.com

Stamp:

Client: **BBS CONSTRUCTION LTD**
1805 WOODWARD DRIVE
OTTAWA, ON K2C 0P9

Project: **JIM KEAY FORD**
1410 YOUVILLE DRIVE

OTTAWA ON

Drawing Title: **POST-DEVELOPMENT DRAINAGE PLAN**

Scale: 1:300	Project Number: CCO-23-0480
Drawn By: R.R.R.	
Checked By: A.J.G.	Drawing Number: POST
Designed By: A.J.G.	

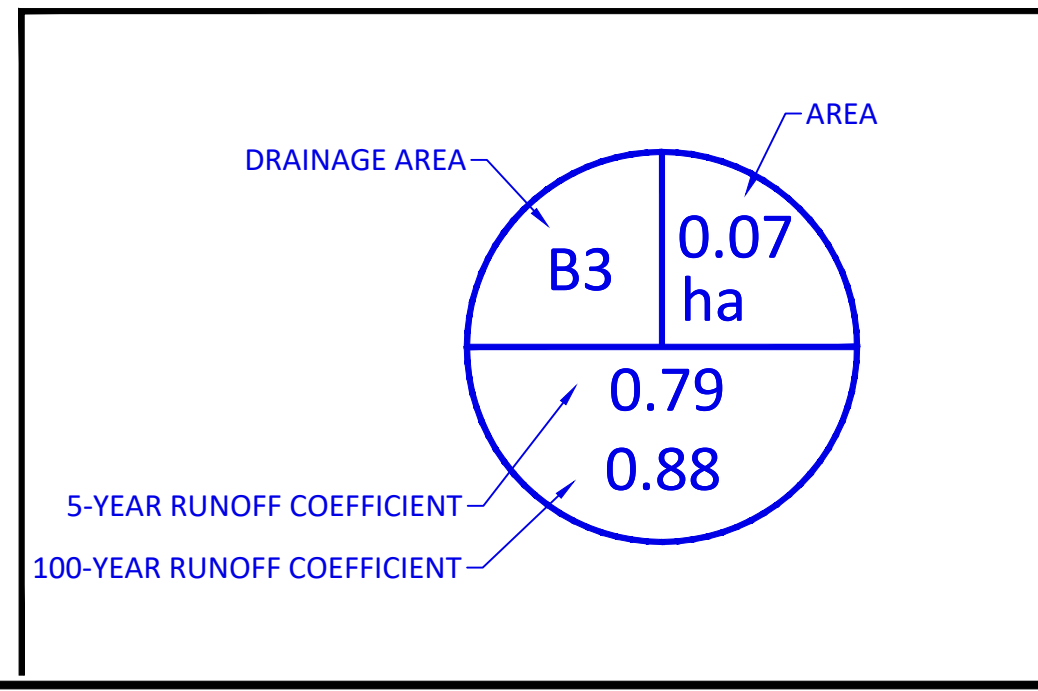

FILENAME: I:\Other\01\Project - Proposed\2023\hmk\CCO-23-0480\BBS - Jim Keay Ford_1410 Youville Drive_L1 - Drainage\CCO-23-0480 - PRESENTATION.dwg
 LAST SAVED: Wednesday, May 03, 2023 1:51:34 PM
 LAST PLOTTED: Wednesday, May 03, 2023 1:51:34 PM

D07-12-22-0130

#XXXXX

APPENDIX G
STORMWATER MANAGEMENT CALCULATIONS

McINTOSH PERRY

CO-22-0480 - Youville Drive - SWM Calculations

1 of 4

Tc (min)	Intensity (mm/hr)		
	5-Year	100-Year	
10	104.2	178.6	PRE-DEVELOPMENT
10	104.2	178.6	POST-DEVELOPMENT

C-Values	
Impervious	0.90
Gravel	0.60
Pervious	0.20

Pre-Development Runoff Coefficient

Drainage Area	Impervious Area (m ²)	Gravel (m ²)	Pervious Area (m ²)	Average C (5-year)	Average C (100-year)
A1	4,214	4,258	716	0.71	0.83
A2	0	0	54	0.20	0.25

Pre-Development Runoff Calculations

Drainage Area	Area (ha)	C 5-Year	C 100-Year	Tc (min)	Q (L/s)	
					5-Year	100-Year
A1	0.92	0.71	0.83	10	188.01	376.59
A2	0.005	0.20	0.25	10	0.31	0.66
Total	0.92				188.31	377.25

*External drainage

Post-Development Runoff Coefficient

Drainage Area	Impervious Area (m ²)	Gravel (m ²)	Pervious Area (m ²)	Average C (5-year)	Average C (100-year)
B1	7,610	0	598	0.85	0.95
B2	0	0	1,033	0.20	0.25

Post-Development Runoff Calculations

Drainage Area	Area (ha)	C 5-Year	C 100-Year	Tc (min)	Q (L/s)	
					5-Year	100-Year
B1	0.82	0.85	0.95	10	201.86	385.20
B2	0.10	0.20	0.25	10	5.99	12.82
Total	0.92				207.85	398.03

Restricted
Unrestricted

Required Restricted Flow

Drainage Area	Area (ha)	C 5-Year	Tc (min)	Q (L/s)
				5-Year
A1	0.92	0.50	10	133.07
A2	0.005	0.20	10	0.31
Total				133.38

*External Drainage area added to target flow rate

Post-Development Restricted Runoff Calculations

Drainage Area	Unrestricted Flow (L/S)		Restricted Flow (L/S)		Storage Required (m ³)		Storage Provided (m ³)	
	5-year	100-Year	5-Year	100-Year	5-Year	100-Year	5-Year	100-Year
B1	201.86	385.20	114.91	116.68	51.0	172.8	60.1	189.3
B2	5.99	12.82	5.99	12.82	-	-	-	-
Total	207.85	398.03	120.90	129.50				

McINTOSH PERRY

CO-22-0480 - Youville Drive - SWM Calculations

2 of 4

Storage Requirements for Area B1

5-Year Storm Event

Tc (min)	I (mm/hr)	Runoff (L/s) B1	Allowable Outflow (L/s)	Runoff to be Stored (L/s)	Storage Required (m ³)
1	203.5	394.26	114.91	279.35	16.76
6	131.6	254.96	114.91	140.05	50.42
11	99.2	192.19	114.91	77.28	51.01
16	80.5	155.96	114.91	41.05	39.41
21	68.1	131.94	114.91	17.03	21.45

Maximum Storage Required 5-year = 51 m³

100-Year Storm Event

Tc (min)	I (mm/hr)	Runoff (L/s) B1	Allowable Outflow (L/s)	Runoff to be Stored (L/s)	Storage Required (m ³)
1	351.4	758.07	116.68	641.39	38.48
6	226.0	487.55	116.68	370.87	133.51
11	169.9	366.52	116.68	249.84	164.90
16	137.5	296.63	116.68	179.95	172.75
21	116.3	250.89	116.68	134.21	169.11
26	101.2	218.32	116.68	101.64	158.56
31	89.8	193.73	116.68	77.05	143.30
36	81.0	174.74	116.68	58.06	125.41
41	73.8	159.21	116.68	42.53	104.62
46	68.0	146.70	116.68	30.02	82.84

Maximum Storage Required 100-year = 173 m³

5-Year Storm Event Storage Summary

		Water Elev. (m) =		58.89	
Location	T/G	INV. (out)	Depth (m)	Head (m)	Volume (m ³)
CBMH3	58.80	56.21	0.09	2.59	60.1

Storage Available (m³) = 60.1 *
Storage Required (m³) = 51.0

100-Year Storm Event Storage Summary

		Water Elev. (m) =		58.97	
Location	T/G	INV. (out)	Depth (m)	Head (m)	Volume (m ³)
CBMH3	58.80	56.21	0.17	2.67	189.3

Storage Available (m³) = 189.3 *
Storage Required (m³) = 172.8

*Available Storage calculated from AutoCAD

McINTOSH PERRY

CO-22-0480 - Youville Drive - SWM Calculations

For Orifice Flow, C= 0.60
 For Weir Flow, C= 1.84

3 of 4

	Orifice 1	Orifice 2	Weir 1	Weir 2
invert elevation	56.21	X	X	X
center of crest elevation	56.30	X		X
orifice width / weir length	185 mm	X	X	X
weir height				X
orifice area (m ²)	0.027	X	x	X

Elevation Discharge Table - Storm Routing

Elevation	Orifice 1		Orifice 2		Weir 1		Weir 2		Total Q [L/s]
	H [m]	Q [m ³ /s]	H [m]	Q [m ³ /s]	H [m]	Q [m ³ /s]	H [m]	Q [m ³ /s]	
56.21	x	x	x	x	x	x	x	x	0.00
56.22	x	x	x	x	x	x	x	x	0.00
56.23	x	x	x	x	x	x	x	x	0.00
56.24	x	x	x	x	x	x	x	x	0.00
56.25	x	x	x	x	x	x	x	x	0.00
56.26	x	x	x	x	x	x	x	x	0.00
56.27	x	x	x	x	x	x	x	x	0.00
56.28	x	x	x	x	x	x	x	x	0.00
58.64	2.34	0.11	x	x	x	x	x	x	109.22
58.65	2.35	0.11	x	x	x	x	x	x	109.46
58.66	2.36	0.11	x	x	x	x	x	x	109.69
58.67	2.37	0.11	x	x	x	x	x	x	109.92
58.68	2.38	0.11	x	x	x	x	x	x	110.15
58.69	2.39	0.11	x	x	x	x	x	x	110.38
58.70	2.40	0.11	x	x	x	x	x	x	110.62
58.71	2.41	0.11	x	x	x	x	x	x	110.85
58.72	2.42	0.11	x	x	x	x	x	x	111.08
58.73	2.43	0.11	x	x	x	x	x	x	111.31
58.74	2.44	0.11	x	x	x	x	x	x	111.53
58.75	2.45	0.11	x	x	x	x	x	x	111.76
58.76	2.46	0.11	x	x	x	x	x	x	111.99
58.77	2.47	0.11	x	x	x	x	x	x	112.22
58.78	2.48	0.11	x	x	x	x	x	x	112.45
58.79	2.49	0.11	x	x	x	x	x	x	112.67
58.80	2.50	0.11	x	x	x	x	x	x	112.90
58.81	2.51	0.11	x	x	x	x	x	x	113.12
58.82	2.52	0.11	x	x	x	x	x	x	113.35
58.83	2.53	0.11	x	x	x	x	x	x	113.57
58.84	2.54	0.11	x	x	x	x	x	x	113.80
58.85	2.55	0.11	x	x	x	x	x	x	114.02
58.86	2.56	0.11	x	x	x	x	x	x	114.25
58.87	2.57	0.11	x	x	x	x	x	x	114.47
58.88	2.58	0.11	x	x	x	x	x	x	114.69
58.89	2.59	0.11	x	x	x	x	x	x	114.91
58.90	2.60	0.12	x	x	x	x	x	x	115.14
58.91	2.61	0.12	x	x	x	x	x	x	115.36
58.92	2.62	0.12	x	x	x	x	x	x	115.58
58.93	2.63	0.12	x	x	x	x	x	x	115.80
58.94	2.64	0.12	x	x	x	x	x	x	116.02
58.95	2.65	0.12	x	x	x	x	x	x	116.24
58.96	2.66	0.12	x	x	x	x	x	x	116.46
58.97	2.67	0.12	x	x	x	x	x	x	116.68

5-Year

100-Year

- Notes:
1. For Orifice Flow, User is to Input an Elevation Higher than Crown of Orifice.
 2. Orifice Equation: $Q = cA(2gh)^{1/2}$
 3. Weir Equation: $Q = CLH^{3/2}$
 4. These Computations Do Not Account for Submergence Effects Within the Pond Riser.
 5. H for orifice equations is depth of water above the centroid of the orifice.
 6. H for weir equations is depth of water above the weir crest.

McINTOSH PERRY

CO-22-0480 - Youville Drive - SWM Calculations

4 of 4

Time of Concentration Pre-Development

Drainage Area ID	Sheet Flow Distance (m)	Slope of Land (%)	Tc (min) (5-Year)	Tc (min) (100-Year)
A1	51	1.54	8	6

Therefore, a Tc of 10 can be used

$$T_c = (3.26(1.1-c)L^{0.5}/S^{0.33})$$

c = Balanced Runoff Coefficient

L = Length of drainage area

S = Average slope of watershed

STORM SEWER DESIGN SHEET

PROJECT: Jim Keay Ford
 LOCATION: 1400-1410 Youville Drive
 CLIENT: BBS Construction



LOCATION				CONTRIBUTING AREA (ha)				RATIONAL DESIGN FLOW											SEWER DATA									
1	2	3	4	5	6	7	8	9	10	11	12	13	14	15	16	17	18	19	20	21	22	23	24	25	26	27	28	
STREET	AREA ID	FROM MH	TO MH	C-VALUE	AREA	INDIV AC	CUMUL AC	INLET (min)	TIME IN PIPE	TOTAL (min)	i (5) (mm/hr)	i (10) (mm/hr)	i (100) (mm/hr)	5yr PEAK FLOW (L/s)	10yr PEAK FLOW (L/s)	100yr PEAK FLOW (L/s)	FIXED FLOW (L/s)	DESIGN FLOW (L/s)	CAPACITY (L/s)	LENGTH (m)	PIPE SIZE (mm)			SLOPE (%)	VELOCITY (m/s)	AVAIL CAP (5yr)		
																					DIA	W	H			(L/s)	(%)	
	B1	CB5	MH5	0.85	0.45	0.38	0.38	10.00	0.99	10.99	104.19	122.14	178.56	110.70					110.70	131.34	47.31	450			0.20	0.800	20.65	15.72%
		MH5	CBMH4	0.85	0.21	0.18	0.56	10.99	1.09	12.08	99.26	116.33	170.02	155.25					155.25	162.91	65.07	450			0.30	0.992	7.67	4.71%
		CBMH4	CBMH3	0.85	0.16	0.14	1.08	12.08	0.33	12.41	94.36	110.56	161.56	283.51					283.51	300.97	26.97	525			0.45	1.347	17.46	5.80%
		CBMH3	OGS	-	-	-	1.08	12.41	0.19	12.61	92.97	108.93	159.15	279.33					279.33	300.97	15.62	525			0.45	1.347	21.64	7.19%
		OGS	MH2	-	-	-	1.08	12.61	0.30	12.91	92.19	108.00	157.80	276.98					276.98	300.97	24.27	525			0.45	1.347	23.99	7.97%
		MH2	MH1	-	-	-	1.08	12.91	0.11	13.02	91.00	106.60	155.74	273.40					273.40	300.97	9.22	525			0.45	1.347	27.57	9.16%
Definitions: O = 2.78CIA, where: O = Peak Flow in Litres per Second (L/s) A = Area in Hectares (ha) i = Rainfall intensity in millimeters per hour (mm/hr) [i = 998.071 / (TC+6.053)^0.814] 5 YEAR [i = 1174.184 / (TC+6.014)^0.816] 10 YEAR [i = 1735.688 / (TC+6.014)^0.820] 100 YEAR				Notes: 1. Mannings coefficient (n) = 0.013				Designed: RRR				No.				Revision				Date								
								Checked: AJG																				
								Project No.: CCO-23-0480																				
																Date: 2023-01-31				Sheet No: 1 of 1								

Hydro Downstream Defender®

Net Annual Water Quality Worksheet

Rev. 11.1



Project Name: **1400-1410 Youville Drive** Report Date: Paste

Street: City: **Ottawa**

Province: **Ontario** Country: **Canada**

Designer: email:

Net Annual Removal Model: DD8

Intensity ⁽¹⁾	Fraction of Rainfall ⁽¹⁾	DD8 Removal Efficiency ⁽²⁾	Weighted Net Annual Efficiency ⁽⁴⁾
(mm/hr)	(%)	(%)	(%)
0.50	0.1%	100.0%	0.09%
1.00	14.1%	100.0%	14.11%
1.50	14.2%	100.0%	14.20%
2.00	14.1%	100.0%	14.12%
2.50	4.2%	100.0%	4.16%
3.00	1.5%	97.3%	1.45%
3.50	8.5%	94.9%	8.11%
4.00	5.4%	92.9%	5.04%
4.50	1.2%	91.1%	1.06%
5.00	5.5%	89.5%	4.95%
6.00	4.3%	86.9%	3.76%
7.00	4.5%	84.8%	3.83%
8.00	3.1%	82.9%	2.56%
9.00	2.3%	81.4%	1.90%
10.00	2.6%	80.0%	2.05%
20.00	9.2%	71.4%	6.60%
30.00	2.6%	66.9%	1.75%
40.00	1.2%	63.9%	0.74%
50.00	0.5%	63.9%	0.34%
100.00	0.7%	63.9%	0.46%
150.00	0.1%	63.9%	0.04%
200.00	0.0%	63.9%	0.00%

Treatment Parameters

Structure ID:

TSS Goal: **80 % Removal**

TSS Particle Size: **Fine**

Area: **0.82 ha**

Percent Impervious: **93%**

Rational C value: **0.95**

Rainfall Station: **Ottawa, ONT**

Peak Storm Flow: **116.68 L/s**

Peak Storm Return: **100 yrs**

RESULTS SUMMARY

Model	TSS	Volume
DD4	76.0%	97.5%
DD6	86.0%	99.5%
DD8	91.0%	99.9%
DD10	94.0%	100.0%
DD12	96.0%	99.9%

Model Specification

Select Model: **DD8**

Diameter: **2400 mm**

Peak Flow Capacity: **425.00 L/s** OK

Sediment Storage: **3.56 m³**

Oil Storage: **2044.00 L**

Installation Configuration

Placement: **Online**

Outlet Pipe Size: **525 mm** 600 to 525 matched invert coupler required

Inlet Pipe 1 Size: **525 mm** OK

Inlet Pipe 2 Size: mm OK

Rim Level: **59.000 m**

Outlet Pipe Invert: **56.120 m** OK

Invert Pipe 1: **56.140 m** OK

Invert Pipe 2: m

Total Net Annual Removal Efficiency: 91.0%

Total Annual Runoff Volume Treated: 99.9%

1. Rainfall Data: 1960:2007, HLY03, Ottawa, ONT, 6105976 & 6105978.

2. Based on third party verified data and approximating the removal of a PSD similar to the STC Fine distribution.

3. Rainfall adjusted to 5 min peak intensity based on hourly average.

4. Factored to account for bypass flow.

Designer Notes:

Hydro Downstream Defender[®]

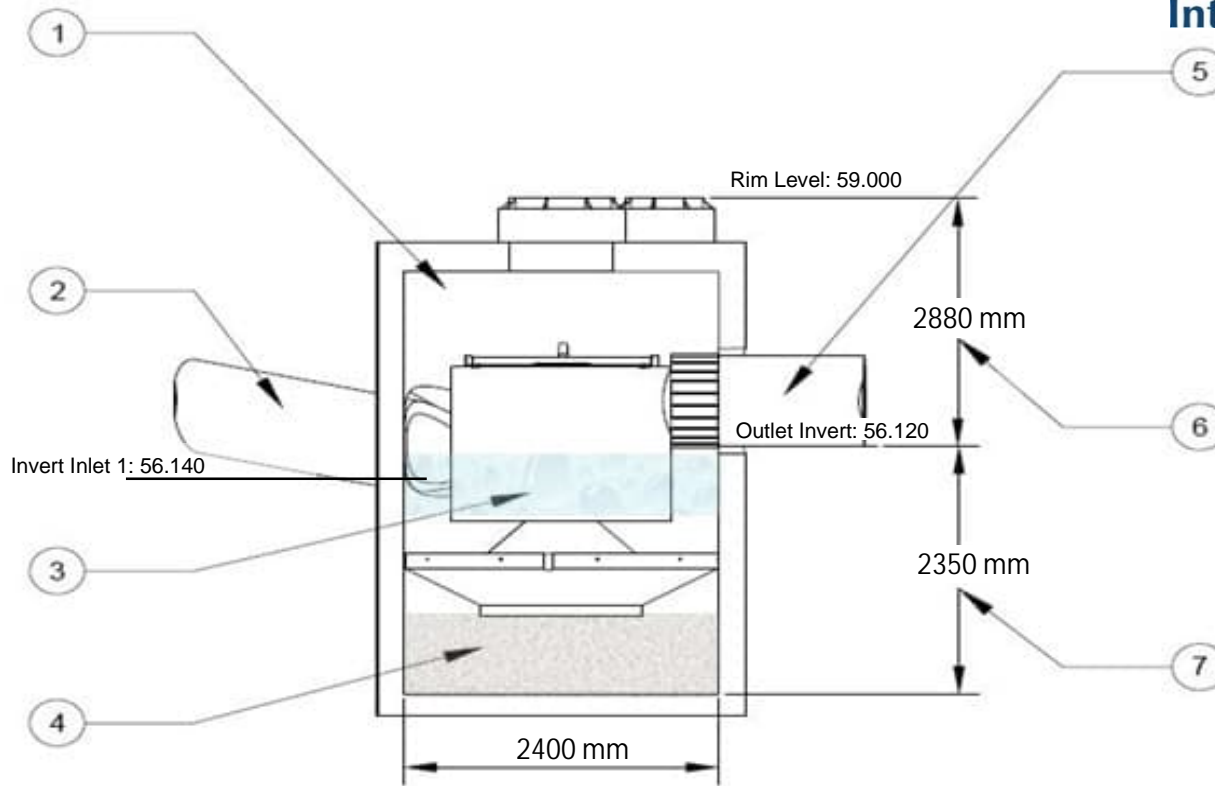

All drawing elevations are metres.

DD8 Specification

1	Vortex Chamber Diameter	2400 mm
2	Inlet Pipe Diameter	525 mm
3	Oil Storage Capacity	2044 L
4	Min. Provided Sediment Storage Capacity	3.56 m ³
5	Outlet Pipe Diameter	525 mm
6	Rim to Outlet Invert	2880 mm
7	Outlet Invert to Sump	2350 m
Total Depth		5230 mm

Notes:

The Downstream Defender is certified by Canada ETV

APPENDIX H
CITY OF OTTAWA DESIGN CHECKLIST

City of Ottawa

4. Development Servicing Study Checklist

The following section describes the checklist of the required content of servicing studies. It is expected that the proponent will address each one of the following items for the study to be deemed complete and ready for review by City of Ottawa Infrastructure Approvals staff.

The level of required detail in the Servicing Study will increase depending on the type of application. For example, for Official Plan amendments and re-zoning applications, the main issues will be to determine the capacity requirements for the proposed change in land use and confirm this against the existing capacity constraint, and to define the solutions, phasing of works and the financing of works to address the capacity constraint. For subdivisions and site plans, the above will be required with additional detailed information supporting the servicing within the development boundary.

4.1 General Content

Criteria	Location (if applicable)
<input type="checkbox"/> Executive Summary (for larger reports only).	N/A
<input type="checkbox"/> Date and revision number of the report.	On Cover
<input type="checkbox"/> Location map and plan showing municipal address, boundary, and layout of proposed development.	Appendix A
<input type="checkbox"/> Plan showing the site and location of all existing services.	Site Servicing Plan (C102)
<input type="checkbox"/> Development statistics, land use, density, adherence to zoning and official plan, and reference to applicable subwatershed and watershed plans that provide context to which individual developments must adhere.	1.1 Purpose 1.2 Site Description 6.0 Stormwater Management
<input type="checkbox"/> Summary of pre-consultation meetings with City and other approval agencies.	Appendix B
<input type="checkbox"/> Reference and confirm conformance to higher level studies and reports (Master Servicing Studies, Environmental Assessments, Community Design Plans), or in the case where it is not in conformance, the proponent must provide justification and develop a defensible design criteria.	1.1 Purpose 1.2 Site Description 6.0 Stormwater Management
<input type="checkbox"/> Statement of objectives and servicing criteria.	3.0 Pre-Consultation Summary

<input type="checkbox"/> Identification of existing and proposed infrastructure available in the immediate area.	N/A
<input type="checkbox"/> Identification of Environmentally Significant Areas, watercourses and Municipal Drains potentially impacted by the proposed development (Reference can be made to the Natural Heritage Studies, if available).	Site Grading Plan (C101)
<input type="checkbox"/> Concept level master grading plan to confirm existing and proposed grades in the development. This is required to confirm the feasibility of proposed stormwater management and drainage, soil removal and fill constraints, and potential impacts to neighbouring properties. This is also required to confirm that the proposed grading will not impede existing major system flow paths.	Site Grading Plan (C101)
<input type="checkbox"/> Identification of potential impacts of proposed piped services on private services (such as wells and septic fields on adjacent lands) and mitigation required to address potential impacts.	N/A
<input type="checkbox"/> Proposed phasing of the development, if applicable.	N/A
<input type="checkbox"/> Reference to geotechnical studies and recommendations concerning servicing.	Section 2.0 Background Studies, Standards and References
<input type="checkbox"/> All preliminary and formal site plan submissions should have the following information: <ul style="list-style-type: none"> ○ Metric scale ○ North arrow (including construction North) ○ Key plan ○ Name and contact information of applicant and property owner ○ Property limits including bearings and dimensions ○ Existing and proposed structures and parking areas ○ Easements, road widening and rights-of-way ○ Adjacent street names 	Site Grading Plan (C101)

4.2 Development Servicing Report: Water

Criteria	Location (if applicable)
<input type="checkbox"/> Confirm consistency with Master Servicing Study, if available	N/A
<input type="checkbox"/> Availability of public infrastructure to service proposed development	N/A
<input type="checkbox"/> Identification of system constraints	N/A
<input type="checkbox"/> Identify boundary conditions	Appendix C
<input type="checkbox"/> Confirmation of adequate domestic supply and pressure	N/A
<input type="checkbox"/> Confirmation of adequate fire flow protection and confirmation that fire flow is calculated as per the Fire Underwriter's Survey. Output should show available fire flow at locations throughout the development.	Appendix C
<input type="checkbox"/> Provide a check of high pressures. If pressure is found to be high, an assessment is required to confirm the application of pressure reducing valves.	N/A
<input type="checkbox"/> Definition of phasing constraints. Hydraulic modeling is required to confirm servicing for all defined phases of the project including the ultimate design	N/A
<input type="checkbox"/> Address reliability requirements such as appropriate location of shut-off valves	N/A
<input type="checkbox"/> Check on the necessity of a pressure zone boundary modification.	N/A
<input type="checkbox"/> Reference to water supply analysis to show that major infrastructure is capable of delivering sufficient water for the proposed land use. This includes data that shows that the expected demands under average day, peak hour and fire flow conditions provide water within the required pressure range	Appendix C, Section 4.2

<input type="checkbox"/> Description of the proposed water distribution network, including locations of proposed connections to the existing system, provisions for necessary looping, and appurtenances (valves, pressure reducing valves, valve chambers, and fire hydrants) including special metering provisions.	Site Servicing Plan (C101)
<input type="checkbox"/> Description of off-site required feeder mains, booster pumping stations, and other water infrastructure that will be ultimately required to service proposed development, including financing, interim facilities, and timing of implementation.	N/A
<input type="checkbox"/> Confirmation that water demands are calculated based on the City of Ottawa Design Guidelines.	Appendix C
<input type="checkbox"/> Provision of a model schematic showing the boundary conditions locations, streets, parcels, and building locations for reference.	N/A

4.3 Development Servicing Report: Wastewater

Criteria	Location (if applicable)
<input type="checkbox"/> Summary of proposed design criteria (Note: Wet-weather flow criteria should not deviate from the City of Ottawa Sewer Design Guidelines. Monitored flow data from relatively new infrastructure cannot be used to justify capacity requirements for proposed infrastructure).	N/A
<input type="checkbox"/> Confirm consistency with Master Servicing Study and/or justifications for deviations.	N/A
<input type="checkbox"/> Consideration of local conditions that may contribute to extraneous flows that are higher than the recommended flows in the guidelines. This includes groundwater and soil conditions, and age and condition of sewers.	N/A
<input type="checkbox"/> Description of existing sanitary sewer available for discharge of wastewater from proposed development.	Section 5.2 Proposed Sanitary Sewer

<input type="checkbox"/> Verify available capacity in downstream sanitary sewer and/or identification of upgrades necessary to service the proposed development. (Reference can be made to previously completed Master Servicing Study if applicable)	Section 5.3 Proposed Sanitary Design
<input type="checkbox"/> Calculations related to dry-weather and wet-weather flow rates from the development in standard MOE sanitary sewer design table (Appendix 'C') format.	N/A
<input type="checkbox"/> Description of proposed sewer network including sewers, pumping stations, and forcemains.	Section 5.2 Proposed Sanitary Sewer
<input type="checkbox"/> Discussion of previously identified environmental constraints and impact on servicing (environmental constraints are related to limitations imposed on the development in order to preserve the physical condition of watercourses, vegetation, soil cover, as well as protecting against water quantity and quality).	N/A
<input type="checkbox"/> Pumping stations: impacts of proposed development on existing pumping stations or requirements for new pumping station to service development.	N/A
<input type="checkbox"/> Forcemain capacity in terms of operational redundancy, surge pressure and maximum flow velocity.	N/A
<input type="checkbox"/> Identification and implementation of the emergency overflow from sanitary pumping stations in relation to the hydraulic grade line to protect against basement flooding.	N/A
<input type="checkbox"/> Special considerations such as contamination, corrosive environment etc.	N/A

4.4 Development Servicing Report: Stormwater Checklist

Criteria	Location (if applicable)
<input type="checkbox"/> Description of drainage outlets and downstream constraints including legality of outlets (i.e. municipal drain, right-of-way, watercourse, or private property)	Section 6.0 Stormwater Sewer Design & Section 7.0 Proposed Stormwater Management
<input type="checkbox"/> Analysis of available capacity in existing public infrastructure.	N/A
<input type="checkbox"/> A drawing showing the subject lands, its surroundings, the receiving watercourse, existing drainage patterns, and proposed drainage pattern.	Pre & Post-Development Plans
<input type="checkbox"/> Water quantity control objective (e.g. controlling post-development peak flows to pre-development level for storm events ranging from the 2 or 5-year event (dependent on the receiving sewer design) to 100-year return period); if other objectives are being applied, a rationale must be included with reference to hydrologic analyses of the potentially affected subwatersheds, taking into account long-term cumulative effects.	Section 6.0 Stormwater Sewer Design & Section 7.0 Proposed Stormwater Management
<input type="checkbox"/> Water Quality control objective (basic, normal or enhanced level of protection based on the sensitivities of the receiving watercourse) and storage requirements.	Section 6.0 Stormwater Sewer Design & Section 7.0 Proposed Stormwater Management
<input type="checkbox"/> Description of the stormwater management concept with facility locations and descriptions with references and supporting information.	Section 6.0 Stormwater Sewer Design & Section 7.0 Proposed Stormwater Management
<input type="checkbox"/> Set-back from private sewage disposal systems.	N/A
<input type="checkbox"/> Watercourse and hazard lands setbacks.	N/A
<input type="checkbox"/> Record of pre-consultation with the Ontario Ministry of Environment and the Conservation Authority that has jurisdiction on the affected watershed.	N/A
<input type="checkbox"/> Confirm consistency with sub-watershed and Master Servicing Study, if applicable study exists.	N/A
<input type="checkbox"/> Storage requirements (complete with calculations) and conveyance capacity for minor events (1:5-year return period) and major events (1:100-year return period).	Appendix G

<input type="checkbox"/> Identification of watercourses within the proposed development and how watercourses will be protected, or, if necessary, altered by the proposed development with applicable approvals.	Site Grading Plan
<input type="checkbox"/> Calculate pre-and post development peak flow rates including a description of existing site conditions and proposed impervious areas and drainage catchments in comparison to existing conditions.	Section 7.0 Proposed Stormwater Management Appendix G
<input type="checkbox"/> Any proposed diversion of drainage catchment areas from one outlet to another.	Section 6.0 Stormwater Sewer Design & Section 7.0 Proposed Stormwater Management
<input type="checkbox"/> Proposed minor and major systems including locations and sizes of stormwater trunk sewers, and stormwater management facilities.	Section 6.0 Stormwater Sewer Design & Section 7.0 Proposed Stormwater Management
<input type="checkbox"/> If quantity control is not proposed, demonstration that downstream system has adequate capacity for the post-development flows up to and including the 100-year return period storm event.	N/A
<input type="checkbox"/> Identification of potential impacts to receiving watercourses	N/A
<input type="checkbox"/> Identification of municipal drains and related approval requirements.	N/A
<input type="checkbox"/> Descriptions of how the conveyance and storage capacity will be achieved for the development.	Section 6.0 Stormwater Sewer Design & Section 7.0 Proposed Stormwater Management
<input type="checkbox"/> 100-year flood levels and major flow routing to protect proposed development from flooding for establishing minimum building elevations (MBE) and overall grading.	Site Grading Plan (C101)
<input type="checkbox"/> Inclusion of hydraulic analysis including hydraulic grade line elevations.	N/A

<input type="checkbox"/> Description of approach to erosion and sediment control during construction for the protection of receiving watercourse or drainage corridors.	Section 8.0 Sediment & Erosion Control
<input type="checkbox"/> Identification of floodplains – proponent to obtain relevant floodplain information from the appropriate Conservation Authority. The proponent may be required to delineate floodplain elevations to the satisfaction of the Conservation Authority if such information is not available or if information does not match current conditions.	N/A
<input type="checkbox"/> Identification of fill constraints related to floodplain and geotechnical investigation.	N/A

4.5 Approval and Permit Requirements: Checklist

The Servicing Study shall provide a list of applicable permits and regulatory approvals necessary for the proposed development as well as the relevant issues affecting each approval. The approval and permitting shall include but not be limited to the following:

Criteria	Location (if applicable)
<input type="checkbox"/> Conservation Authority as the designated approval agency for modification of floodplain, potential impact on fish habitat, proposed works in or adjacent to a watercourse, cut/fill permits and Approval under Lakes and Rivers Improvement Act. The Conservation Authority is not the approval authority for the Lakes and Rivers Improvement Act. Where there are Conservation Authority regulations in place, approval under the Lakes and Rivers Improvement Act is not required, except in cases of dams as defined in the Act.	N/A
<input type="checkbox"/> Application for Certificate of Approval (CofA) under the Ontario Water Resources Act.	N/A
<input type="checkbox"/> Changes to Municipal Drains.	N/A
<input type="checkbox"/> Other permits (National Capital Commission, Parks Canada, Public Works and Government Services Canada, Ministry of Transportation etc.)	N/A

4.6 Conclusion Checklist

Criteria	Location (if applicable)
<input type="checkbox"/> Clearly stated conclusions and recommendations	Section 9.0 Summary Section 10.0 Recommendations
<input type="checkbox"/> Comments received from review agencies including the City of Ottawa and information on how the comments were addressed. Final sign-off from the responsible reviewing agency.	All are stamped
<input type="checkbox"/> All draft and final reports shall be signed and stamped by a professional Engineer registered in Ontario	All are stamped