

112 Montreal Road

Transportation Impact Assessment

Step 1 Screening Report

Step 2 Scoping Report

Step 3 Forecasting Report

Step 4 Strategy Report

(Revised)

Prepared for:

2705460 Ontario Inc.

Prepared by:



6 Plaza Court
Ottawa, ON K2H 7W1

March 2023

PN: 2022-109

Table of Contents

1	Screening	1
2	Existing and Planned Conditions.....	1
2.1	Proposed Development.....	1
2.2	Existing Conditions.....	3
2.2.1	Area Road Network.....	3
2.2.2	Existing Intersections.....	4
2.2.3	Existing Driveways	6
2.2.4	Cycling and Pedestrian Facilities.....	6
2.2.5	Existing Transit.....	10
2.2.6	Existing Area Traffic Management Measures.....	11
2.2.7	Existing Peak Hour Travel Demand.....	11
2.2.8	Collision Analysis.....	15
2.3	Planned Conditions.....	20
2.3.1	Changes to the Area Transportation Network.....	20
2.3.2	Other Study Area Developments	20
3	Study Area and Time Periods.....	21
3.1	Study Area	21
3.2	Time Periods	22
3.3	Horizon Years.....	22
4	Exemption Review	22
5	Development-Generated Travel Demand	22
5.1	Mode Shares.....	22
5.2	Trip Generation.....	23
5.3	Trip Distribution.....	24
5.4	Trip Assignment.....	25
6	Background Network Travel Demands	28
6.1	Transportation Network Plans.....	28
6.2	Background Growth.....	28
6.3	Other Developments	28
7	Demand Rationalization	29
7.1	2024 Future Background Operations.....	29
7.2	2029 Future Background Operations.....	32
7.3	Modal Share Sensitivity and Demand Rationalization Conclusions.....	35
8	Development Design	36
8.1	Design for Sustainable Modes	36
8.2	Circulation and Access	36
9	Parking.....	36
9.1	Parking Supply	36
10	Boundary Street Design.....	36
11	Access Intersections Design.....	37
11.1	Location and Design of Access.....	37
11.2	Intersection Control.....	37

11.3 Access Intersection Design37

 11.3.1 2024 Future Total Access Intersection Operations37

 11.3.2 2029 Future Total Access Intersection Operations37

 11.3.3 Access Intersection MMLOS40

 11.3.4 Recommended Design Elements40

12 Transportation Demand Management40

 12.1 Context for TDM40

 12.2 Need and Opportunity40

 12.3 TDM Program40

13 Neighbourhood Traffic Management40

14 Transit41

 14.1 Route Capacity41

 14.2 Transit Priority41

15 Network Intersection Design41

 15.1 Network Intersection Control41

 15.2 Network Intersection Design42

 15.2.1 2024 Future Total Network Intersection Operations42

 15.2.2 2029 Future Total Network Intersection Operations43

 15.2.3 Network Intersection MMLOS45

 15.2.4 Recommended Design Elements46

16 Summary of Improvements Indicated and Modifications Options46

17 Conclusion49

List of Figures

Figure 1: Area Context Plan1

Figure 2: Concept Plan2

Figure 3: Study Area Pedestrian Facilities7

Figure 4: Study Area Cycling Facilities7

Figure 5: Existing Pedestrian Volumes8

Figure 6: Existing Cyclist Volumes9

Figure 7: Existing Study Area Transit Service10

Figure 8: Existing Study Area Transit Stops11

Figure 9: Existing Traffic Counts12

Figure 10: Representation of Study Area Collision Records16

Figure 11: Montreal Road Revitalization20

Figure 12: New Site-Generated Auto Volumes26

Figure 13: Pass-By Auto Volumes27

Figure 14: 2024 Future Background Volumes30

Figure 15: 2029 Future Background Volumes33

Figure 16: 2024 Future Total Volumes38

Figure 17: 2029 Future Total Volumes39

Table of Tables

Table 1: Intersection Count Date.....	11
Table 2: Existing Intersection Operations.....	13
Table 3: Study Area Collision Summary, 2016-2020.....	15
Table 4: Summary of Collision Locations, 2016-2020.....	16
Table 5: Montreal Road at Vanier Parkway Collision Summary.....	16
Table 6: Montreal Road between Palace Street and Vanier Parkway Collision Summary.....	17
Table 7: Montreal Road between Montgomery Street and Palace Street Collision Summary.....	18
Table 8: Montreal Road at Palace Street Collision Summary.....	18
Table 9: McArthur Avenue at Mayfield Street Collision Summary.....	19
Table 10: Exemption Review.....	22
Table 11: TRANS Trip Generation Manual Recommended Mode Shares – Ottawa East.....	23
Table 12: Proposed Development Mode Shares.....	23
Table 13: Trip Generation Person Trip Rates by Peak Period.....	23
Table 14: Total Residential Person Trip Generation by Peak Period.....	23
Table 15: Internal Capture Rates.....	24
Table 16: Trip Generation by Mode.....	24
Table 17: OD Survey Distribution – Ottawa East.....	25
Table 18: Trip Assignment.....	25
Table 19: TRANS Regional Model Projections – Study Area Growth Rates.....	28
Table 20: TRANS Regional Model Projections – Study Area Growth Rates.....	28
Table 21: 2024 Future Background Intersection Operations.....	31
Table 22: 2029 Future Background Intersection Operations.....	34
Table 23: Boundary Street Segment MMLOS Analysis.....	36
Table 24: 2024 NTM Review.....	41
Table 25: Trip Generation by Transit Mode.....	41
Table 26: Forecasted Site-Generated Transit Ridership.....	41
Table 27: 2024 Future Total Intersection Operations.....	42
Table 28: 2029 Future Total Intersection Operations.....	43
Table 29: Study Area Intersection MMLOS.....	45

List of Appendices

Appendix A – TIA Screening Form and Certification Form
Appendix B – Turning Movement Count Data
Appendix C – Synchro Intersection Worksheets – Existing Conditions
Appendix D – Collision Data
Appendix E – TRANS Model Plots
Appendix F – Background Development Traffic Volumes
Appendix G – Synchro Intersection Worksheets – 2024 Future Background Conditions
Appendix H – Synchro Intersection Worksheets – 2029 Future Background Conditions
Appendix I – Site Turning Templates
Appendix J – MMLOS Analysis
Appendix K – Synchro Intersection Worksheets – 2024Future Total Conditions

Appendix L –Synchro Intersection Worksheets – 2029 Future Total Conditions
Appendix M – TDM Checklist

1 Screening

Guidelines. Accordingly, a Step 1 Screening Form has been prepared and is included as Appendix A, along with the Certification Form for TIA Study PM. As shown in the Screening Form, the trip generation, location, and safety triggers were met, and a TIA is required including the Design Review component and the Network Impact Component. This TIA is in support of a site plan application.

2 Existing and Planned Conditions

2.1 Proposed Development

The proposed development, located at 112 Montreal Road, is currently zoned as Traditional Mainstreet (TM[2363] S365-h). The site plan application is for the first phase of redevelopment on the north end of the parcel, which is planned to include an eight-storey mixed-use building fronting Montreal Road comprising 36 dwelling units and 2,525 sq. ft. of ground floor commercial space, and a 37-storey residential building fronting Vanier Parkway comprising 394 dwelling units. The anticipated build-out for phase one is 2024. The development is proposed as including 390 vehicle parking spaces. Access is proposed one left-in/left-out access on the one-way Palace Street. The site is located within the Montreal Road District Secondary Plan area and intersects the Montreal Arterial Mainstreet design priority area. Figure 1 illustrates the study area context and Figure 2 illustrates the proposed concept plan.

Figure 1: Area Context Plan

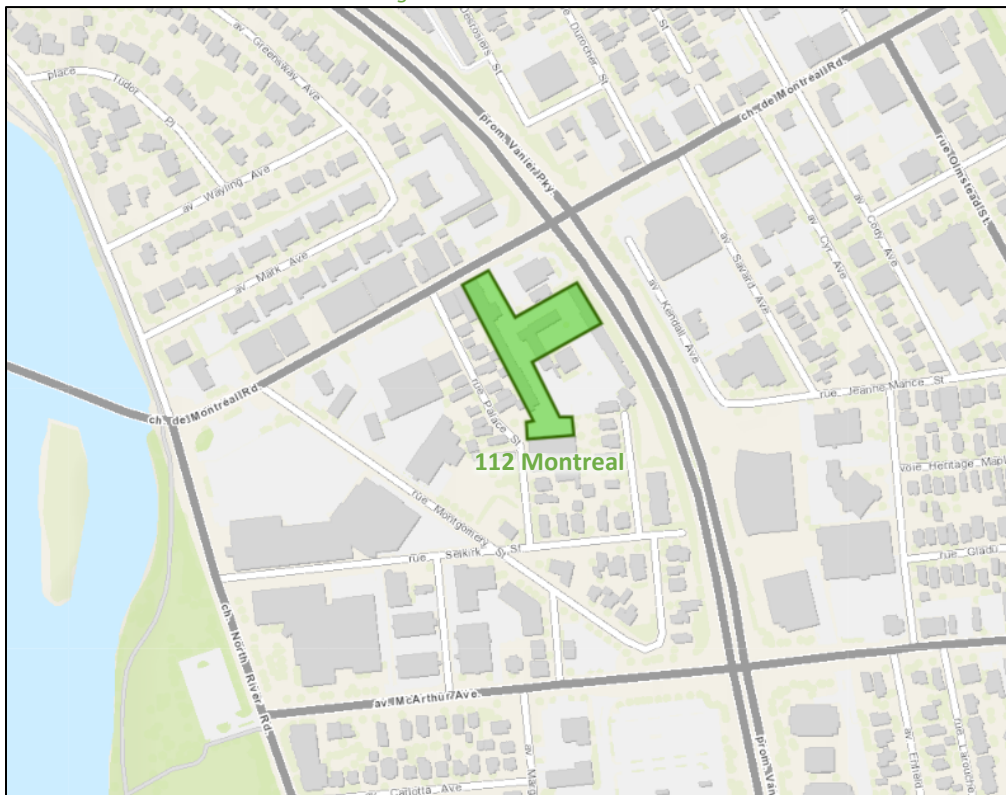

Source: <http://maps.ottawa.ca/geoOttawa/> Accessed: August 25, 2022

PROJECT INFORMATION		NOTATION SYMBOLS:	
ZONING: 112-0-0-001	PHASE 1 AREA: 112-0-0-001	① EXISTING CONCRETE FOUNDATION	② EXISTING CONCRETE FOUNDATION
PHASE 2 AREA: 112-0-0-002	REQUIRED: 112-0-0-001	③ EXISTING CONCRETE FOUNDATION	④ EXISTING CONCRETE FOUNDATION
PROJECT STATISTICS - PHASE 1		PROJECT STATISTICS - PHASE 2	
TOTAL AREA: 2,734.00 M ²		TOTAL AREA: 2,734.00 M ²	
TOTAL FLOOR AREA: 2,734.00 M ²		TOTAL FLOOR AREA: 2,734.00 M ²	
TOTAL GARAGE: 2,734.00 M ²		TOTAL GARAGE: 2,734.00 M ²	
TOTAL GARAGE: 2,734.00 M ²		TOTAL GARAGE: 2,734.00 M ²	
TOTAL GARAGE: 2,734.00 M ²		TOTAL GARAGE: 2,734.00 M ²	
TOTAL GARAGE: 2,734.00 M ²		TOTAL GARAGE: 2,734.00 M ²	

PROJECT INFORMATION		NOTATION SYMBOLS:	
ZONING: 112-0-0-001	PHASE 1 AREA: 112-0-0-001	① EXISTING CONCRETE FOUNDATION	② EXISTING CONCRETE FOUNDATION
PHASE 2 AREA: 112-0-0-002	REQUIRED: 112-0-0-001	③ EXISTING CONCRETE FOUNDATION	④ EXISTING CONCRETE FOUNDATION
PROJECT STATISTICS - PHASE 1		PROJECT STATISTICS - PHASE 2	
TOTAL AREA: 2,734.00 M ²		TOTAL AREA: 2,734.00 M ²	
TOTAL FLOOR AREA: 2,734.00 M ²		TOTAL FLOOR AREA: 2,734.00 M ²	
TOTAL GARAGE: 2,734.00 M ²		TOTAL GARAGE: 2,734.00 M ²	
TOTAL GARAGE: 2,734.00 M ²		TOTAL GARAGE: 2,734.00 M ²	
TOTAL GARAGE: 2,734.00 M ²		TOTAL GARAGE: 2,734.00 M ²	
TOTAL GARAGE: 2,734.00 M ²		TOTAL GARAGE: 2,734.00 M ²	



PROJECT DEVELOPER		LEGAL DESCRIPTION	
Minor Park Management 231 Belfry Drive, Suite D Ottawa, ON K2L 1Y3 E-Mail: k.park@minorpark.com		TOPOGRAPHIC SURVEY OF LOT 5 AND PART OF LOTS 6 AND 7 BLOCK 2 REDEVELOPMENT PLAN LOT 68 AND PART OF LOTS 40 & 41 REGISTERED PLAN 49 CITY OF OTTAWA	
SURVEYOR		URBAN PLANNER	
FARHALL, MOFFATT & WOODLAND 100-650 TERRY FOX DRIVE 9-Place Court, Suite 701 Tel: (613) 953-2500 Fax: (613) 953-1456 E-Mail: f.moffatt@fmw.com		FoTerra Consultants Inc. 396 Cooper Street, Unit 300 Ottawa, ON Canada K2P 2H7 Tel: (613) 734-1136 Fax: (613) 734-1136 E-Mail: pose@foterra.com	
CIVIL ENGINEER		LANDSCAPE DESIGNER	
WSP 300-2911 Cochrane Drive 9-Place Court, Suite 701 Tel: (613) 953-2500 Fax: (613) 953-1456 E-Mail: h.bagshaw@wsp.com		LEVSTEK CONSULTANTS 5871 High Crescent Ottawa, ON Canada K2G 2M0 Tel: (613) 826-0518 E-Mail: levstek@levstek.com	
TRANSPORTATION ENGINEER		PROJECT MANAGER	
CGH Transportation Inc. 5-Place Court, Suite 701 Tel: (613) 953-2500 Fax: (613) 953-1456 E-Mail: andrew.burke@cght.com		Minor Park Management 231 Belfry Drive, Suite D Ottawa, ON K2L 1Y3 E-Mail: k.park@minorpark.com	

2.2 Existing Conditions

2.2.1 Area Road Network

Vanier Parkway: Vanier Parkway is a City of Ottawa arterial road with a divided, four-lane urban cross-section, sidewalks on both sides of the road, and a posted speed limit of 60 km/h within the study area. A cycle track and shared bike lanes are provided in the northbound direction between McArthur Avenue and Montreal Road. The existing right of way throughout the study area varies along adjacent properties.

Montreal Road: Montreal Road is a City of Ottawa arterial road with a four-lane urban cross-section with sidewalks on both sides of the road. The curbside lanes serve as peak hour bus/taxi lanes in the westbound direction during the AM peak and the eastbound direction during the PM peak. On-street parking restricted on the north side of the road between 7-9 AM and on the south side between 3:30-5:30 PM. The posted speed limit is 40 km/h, and the city-protected right of way is 23.0 metres east of North River Road. Cycletracks are present on both sides of the road east of Vanier Parkway. Montreal Road is designated a truck route.

McArthur Avenue: McArthur Avenue is a City of Ottawa arterial road with a two-lane urban cross-section west of Vanier Parkway and a two-lane urban cross-section east of Vanier Parkway. Sidewalks and bike lanes are on both sides of the road, the posted speed limit is 50 km/h, and the existing right of way provided is 20.0 metres west of Vanier Parkway and 23.5 metres east of Vanier Parkway. McArthur Avenue is designated a truck route east of Vanier Parkway.

North River Road: North River Road is a City of Ottawa local road north of Montreal Road, an arterial road between Montreal Road and McArthur Avenue, and a collector road south of McArthur Avenue, each with a two-lane urban cross-section. A MUP and sidewalk are provided north of Montreal Road on the west and east sides of the road respectively, sidewalks on both sides of the road are provided between Montreal Road and McArthur Avenue and a single sidewalk on the east side of the road is provide south of McArthur Avenue. On-street parking is permitted on the east side of the road south of McArthur Avenue. The unposted speed limit is assumed to be 50 km/h, and the existing right-of-way provided is 13.0 metres north of Montreal Road, varies from 19.0 metres to 27.0 metres between Montreal Road and McArthur Avenue, and 17.5 metres south of McArthur Avenue.

Montgomery Street: Montgomery Street is a City of Ottawa local road with a two-lane urban cross-section. A sidewalk is provided on the east side of the road and a sidewalk is provided on the west side of the road between Selkirk Street and Mayfield Street. Parking is permitted on both sides of the road with restrictions at the school for loading and bus zones. The posted speed limit is 30 km/h, and a school zone is signed between Montreal Road and Selkirk Street. The existing right-of-way provided is 18.5 metres.

Palace Street: Palace Street is a one-way southbound City of Ottawa local road with a posted speed limit of 30 km/h. The existing right of way is 8.0 metres to the north of the s-bend and 11.5 metres south of that point. The Official Plan reserves an additional 2.0 metres from each side from Montreal Road to Lot 85.

Selkirk Street: Selkirk Street is a City of Ottawa local road with a two-lane urban cross section. West of Dundas Street, Selkirk Street is one-way westbound and has a sidewalk, permits on-street parking for 60 metres, and has a taxi stand for 60 metres each on the south side of the road. East of Gardner Street, Selkirk Street is no-exit. The posted speed limit is 30 km/h, and the existing right-of-way provided is 13.5 metres.

Dundas Street: Dundas Street is a City of Ottawa local road with a two-lane urban cross-section and a sidewalk on the west side of the road. The posted speed limit is 30 km/h, and the existing right of way provided is 12.0 metres. No on-street parking is permitted.

Mayfield Street: Mayfield Street is a one-way southbound City of Ottawa local road with a sidewalk of the west side of the road. The posted speed limit is 30 km/h, and the existing right of way provided is 12.0 metres. No on-street parking is permitted.

Marguerite Avenue: Marguerite Avenue is a City of Ottawa local road with a two-lane urban cross-section, a sidewalk on the west side of the road and on-street parking permitted on the east side of the road. The posted speed limit is 40 km/h, and the existing right of way within the study area provided is 15.0 metres.

Gardner Street: Gardner Street is a City of Ottawa local road with a two-lane urban cross-section, on-street parking permitted on the east side of the road between 6:00 pm and 7:00 am, and a sidewalk on the east side of the road south of the site. The road alignment sits approximately 10 metres east on the south side of Selkirk Street. The posted speed limit is 30 km/h, and the existing right of way provided is 12.0 metres. Gardner Street terminates south of the site property line.

2.2.2 Existing Intersections

The existing area intersections adjacent to the proposed site and signalized intersections confirmed with City staff have been summarized below:

Montreal Road & North River Road

The intersection of Montreal Road and North River Road is a signalized intersection. The northbound approach consists of an auxiliary left-turn lane and a shared through/right-turn lane, and the southbound approach consists of a shared all-movements lane. The eastbound approach consists of a shared left-turn/through lane and a shared through/right-turn lane, and the westbound approach consists of a through lane and a shared through/right-turn lane. Eastbound left turns are prohibited weekdays during peak periods, eastbound right turns on red are prohibited, and westbound left turns are prohibited. Trucks are restricted from turning onto south leg.

Montreal Road & Montgomery Street

The intersection of Montreal Road and Montgomery Street is signalized intersection. The northbound approach consists of a left-turn lane and a right-turn lane. The eastbound approach consists of a through lane and a shared through/right-turn lane and the westbound approach consists of a shared left-turn/through lane and a through lane. No turn restrictions are noted.

Montreal Road & Palace Street

The intersection Montreal Road and Palace Street is an uncontrolled intersection. The eastbound approach consists of a through lane and a shared-right-turn lane, the westbound approach consists of a shared left-turn/through lane and a through lane, and the south leg is inbound only. No turn restrictions are noted.

Montreal Road & Vanier Parkway

The intersection of Montreal Road & Vanier Parkway is a signalized intersection. The northbound and southbound approaches each consist of an auxiliary left-turn lane, two through lanes, and an auxiliary shared through/right-turn lane. The eastbound approach consists of an auxiliary left-turn lane, a through lane, and a right-turn lane and the westbound approach consists of an auxiliary left-turn lane, a through lane, and a shared through/right-turn lane. Trucks are restricted from turning onto Vanier Parkway.

Selkirk Street & North River Road

The intersection of Selkirk Street and North River Road is a stop-controlled T-intersection on the minor approach of Selkirk Street. The northbound and southbound approaches consist of a single through lane each. The westbound approach consists of a left-turn lane and a right-turn lane. No turn restrictions are noted.

Selkirk Street & Dundas Street

The intersection of Selkirk Street and Dundas Street is a stop-controlled T-intersection on the minor approach of Dundas Street. The northbound approach consists of a shared left-turn/right-turn lane. The westbound approach consists of a shared left-turn/through lane, and the one-way west leg of the intersection is inbound only. No turn restrictions are noted.

Selkirk Street & Montgomery Street

The intersection of Selkirk Street and Montgomery Street is a stop-controlled intersection on the minor approaches of Selkirk Street. The northbound and southbound approaches of Montgomery Street each consist of a shared all-movements lane, as do the eastbound and westbound approaches. No turn restrictions are noted.

McArthur Avenue & North River Road

The intersection of McArthur Avenue and North River Road is a signalized intersection. The northbound and eastbound approaches each consist of shared all-movements lane. The southbound approach consists of an auxiliary left-turn lane and a shared through/right-turn lane. The westbound approach consists of a shared left-turn/through lane and an auxiliary right-turn lane. The eastbound and westbound approaches each additionally include a bike lane. No turn restrictions are noted.

McArthur Avenue & Dundas Street

The intersection of McArthur Avenue and Dundas Street is a stop-controlled intersection on the minor approach of Dundas Street. The southbound approach consists of a shared left-turn/right-turn lane. The eastbound approach consists of a shared left-turn/through lane, and the westbound approach consists of a shared through/right-turn lane. No turn restrictions are noted.

McArthur Avenue & Marguerite Avenue

The intersection of McArthur Avenue and Marguerite Avenue is a signalized intersection. The northbound approach consists of an auxiliary left-turn lane and a right-turn lane. The eastbound approach consists of a shared through/right-turn lane and the westbound approach consists of a shared left-turn/through lane. No turn restrictions are noted.

McArthur Avenue & Mayfield Street

The intersection of McArthur Avenue and Mayfield Street is a stop-controlled intersection on the minor approach of Mayfield Street. The southbound approach consists of a left-turn lane and a right-turn lane and the eastbound and westbound approaches each consist of a through lane. No turn restrictions are noted.

McArthur Avenue & Vanier Parkway

The intersection of McArthur Avenue and Vanier Parkway is a signalized intersection. The northbound and southbound approaches each consist of an auxiliary left-turn lane, two through lanes and an auxiliary, channelized right turn lane. The eastbound approach consists of an auxiliary left-turn lane, a through lane, a floating bike lane, and an auxiliary channelized right turn lane. The westbound approach consists of two auxiliary left-turn lanes, a through lane, a bike lane, and a right-turn lane channel. All U-turn movements are prohibited at this intersection.

2.2.3 Existing Driveways

Within 200 metres, private accesses to small commercial lots, and low-rise residential land uses exist on both sides of the road in each direction from the site access on Palace Street. None of the driveways within the area of consideration are significant traffic generators.

2.2.4 Cycling and Pedestrian Facilities

Sidewalks are provided along both sides on North River Road, Vanier Parkway, Montreal Road, and McArthur Avenue. Sidewalks are provided on both sides of Selkirk Street between Montgomery Street and Gardner Street, along the east side of Montgomery Street and on the west side of Montgomery Street between Mayfield Street and Selkirk Street. Sidewalks are also provided on the east side of Gardner Street, and along the west side of Dundas Street, Mayfield Street and Marguerite Avenue.

Cycletracks are present on both sides of Montreal Road east of Vanier Parkway. Bike lanes are provided along both sides of McArthur Avenue and on the north side of Montreal Road west of North River Road. A shared use lane is on the south side of Montreal Road west of North River Road. Along the west side of North River Road is the Rideau River Eastern Pathway. MUP connections to the communities north of Montreal Road are provided to the intersection of Montreal Road at Vanier Parkway. North River Road, Vanier Parkway, and Montreal Road are spine routes.

Figure 3 illustrates the pedestrian facilities in the study area and Figure 4 illustrates the cycling facilities.

Pedestrian and cyclist volumes included in study area intersection counts, presented in Section 2.2.7, have been compiled and are illustrated in Figure 6 and Figure 7, respectively.

Figure 3: Study Area Pedestrian Facilities

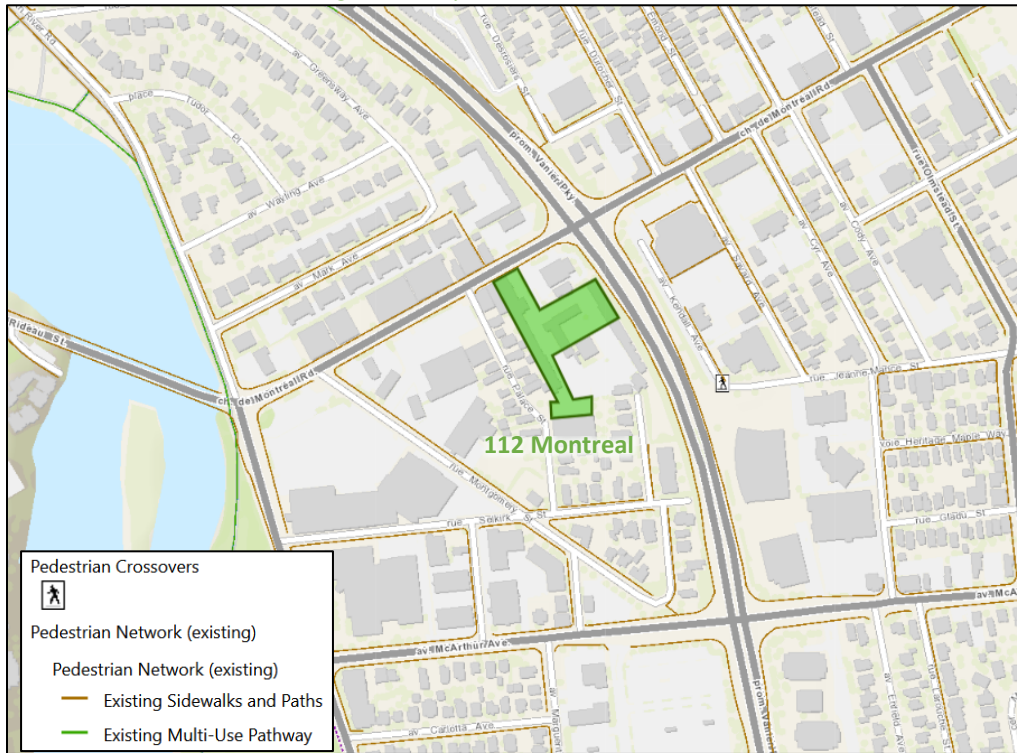

Source: <http://maps.ottawa.ca/geoOttawa/> Accessed: August 25, 2022

Figure 4: Study Area Cycling Facilities

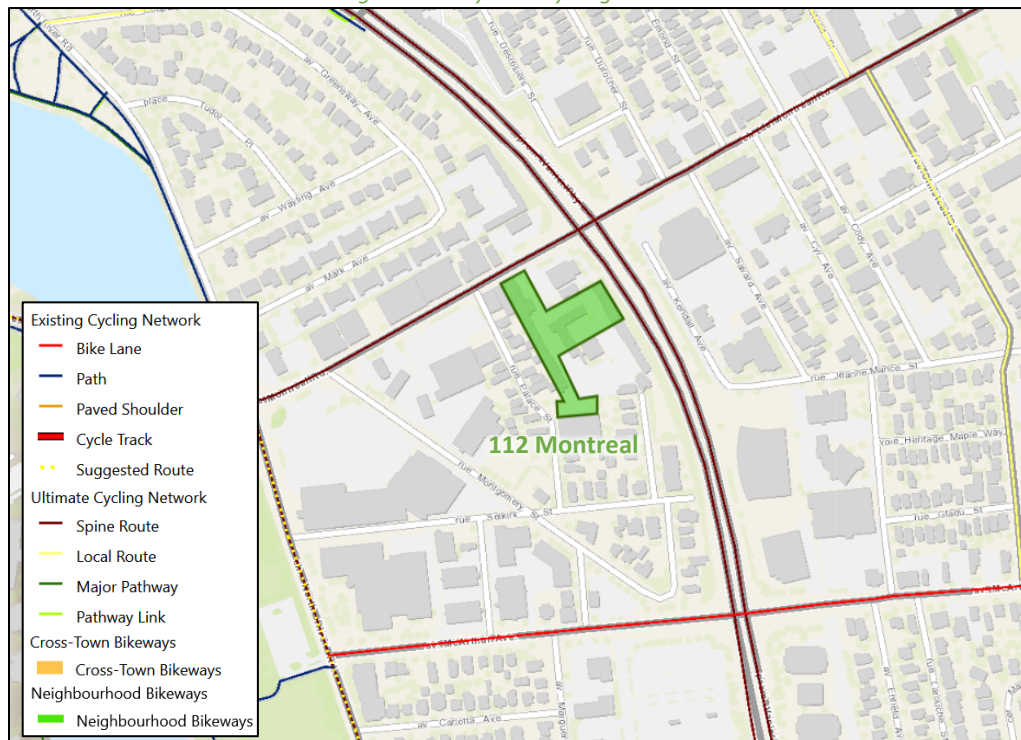

Source: <http://maps.ottawa.ca/geoOttawa/> Accessed: August 25, 2022

Figure 5: Existing Pedestrian Volumes

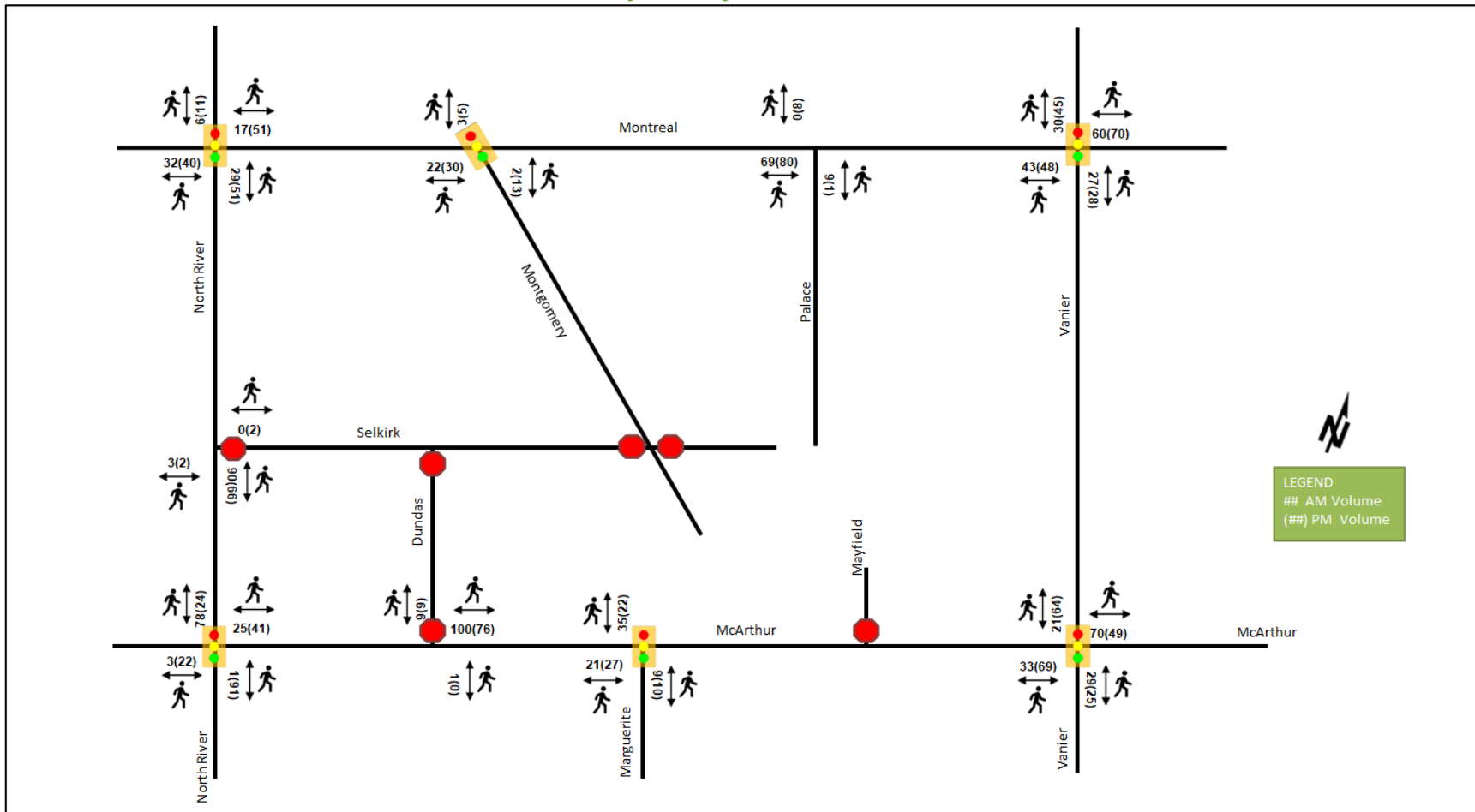
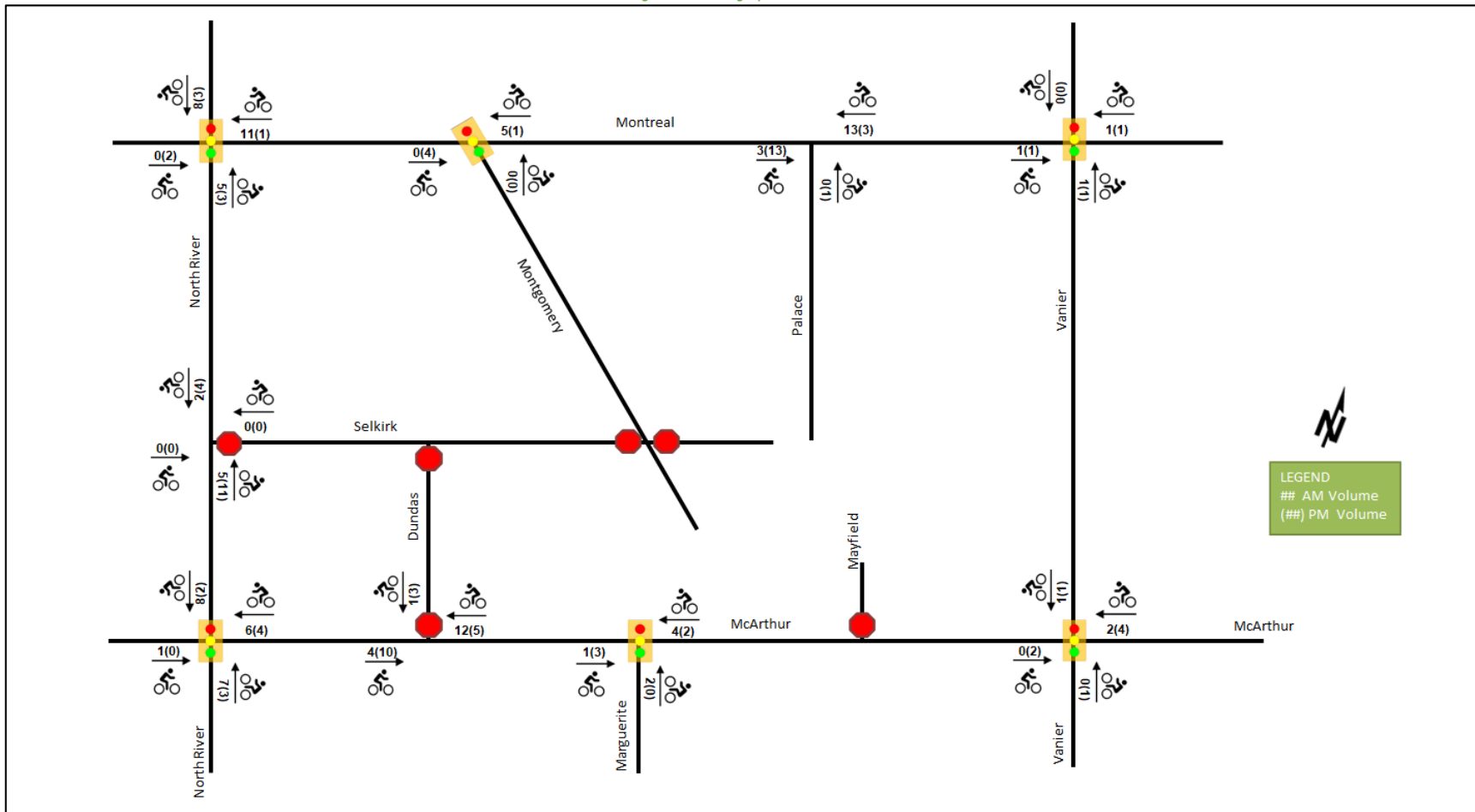

Figure 6: Existing Cyclist Volumes



2.2.5 Existing Transit

At the time of this report, temporary transit detours due to construction on Montreal Road and the existing service is not reflective of typical conditions. Within the study area, the route #18 travels along North River Road, the routes #9 and #19 travel along Vanier Parkway, the route #14 travels along McArthur Avenue, and the route #15 (and typically the route #12) travels along Montreal Road. Stops are located at Montreal Road and North River Road, Montreal Road and Montgomery Street, Montreal Road and Vanier Parkway, Selkirk Street and North River Road, and McArthur Avenue and Vanier Parkway. The frequency of these routes within proximity of the proposed site are currently:

- Route #9 – 15-minute service in peak direction/period, 30-minute service all day
- Route #14 – 15-minute service all day, 30-minute service after 7:00PM
- Route #15 – 10-minute service all day, 30-minute service before 7:00AM after 8:00PM
- Route #18 – 30-minute service all day
- Route #19 – 30-minute service all day

Figure 7 illustrates the transit system map in the study area and Figure 8 illustrates nearby transit stops.

Figure 7: Existing Study Area Transit Service

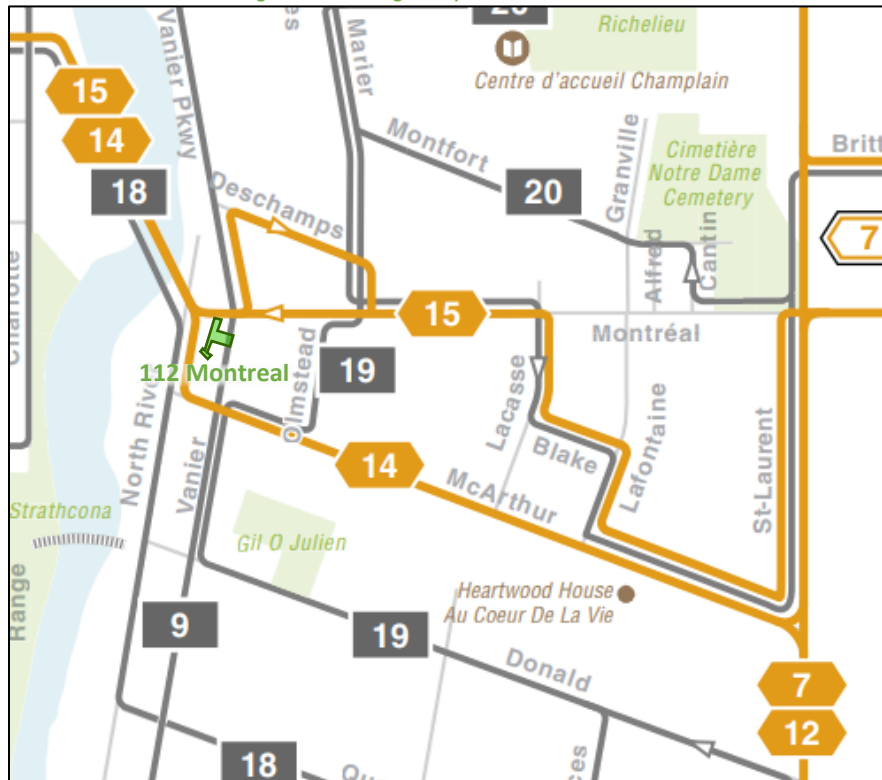

Source: <http://www.octranspo.com/> Accessed: August 25, 2022

Figure 8: Existing Study Area Transit Stops

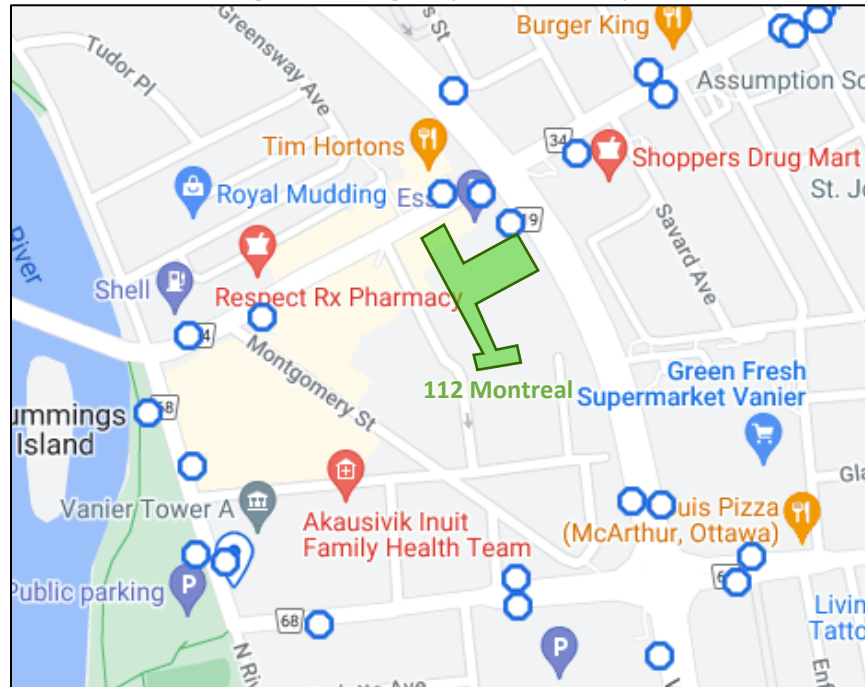

Source: <http://www.octranspo.com/> Accessed: August 25, 2022

2.2.6 Existing Area Traffic Management Measures

Signage indicating a “Traffic Calmed Neighbourhood” and flexible bollards are present on Montgomery Street. No further traffic management measures are present in the study area.

2.2.7 Existing Peak Hour Travel Demand

Existing turning movement counts were acquired from the City of Ottawa and The Traffic Specialist for the existing study area intersections. Table 1 summarizes the intersection count dates and sources.

Table 1: Intersection Count Date

Intersection	Count Date	Source
Montreal Road & North River Road	Tuesday, March 10, 2020	City of Ottawa
Montreal Road & Montgomery Street	Wednesday, February 19, 2020	City of Ottawa
Montreal Road & Palace Street	Tuesday, November 26, 2019	The Traffic Specialist
Montreal Road & Vanier Parkway	Tuesday, March 26, 2019	City of Ottawa
Selkirk Street & North River Road	Tuesday, November 26, 2019	The Traffic Specialist
McArthur Avenue & North River Road	Tuesday, March 19, 2019	City of Ottawa
McArthur Avenue & Dundas Street	Tuesday, November 26, 2019	The Traffic Specialist
McArthur Avenue & Marguerite Avenue	Tuesday, March 26, 2019	City of Ottawa
McArthur Avenue & Vanier Parkway	Tuesday, March 26, 2019	City of Ottawa

Figure 9 illustrates the existing traffic counts balanced along Montreal Road and North River Road and Table 2 summarizes the existing intersection operations. The internal intersections of Selkirk Street at Dundas Street, Selkirk Street at Montgomery Street, and McArthur Avenue at Mayfield Street have been interpolated from existing area traffic work. The level of service for signalized intersections is based on volume-to-capacity (v/c) calculations for individual lane movements and HCM 2000 v/c calculations for the overall intersection, and HCM 2010 average delay for unsignalized intersections. Detailed turning movement count data is included in Appendix B and the Synchro worksheets are provided in Appendix C.

Figure 9: Existing Traffic Counts

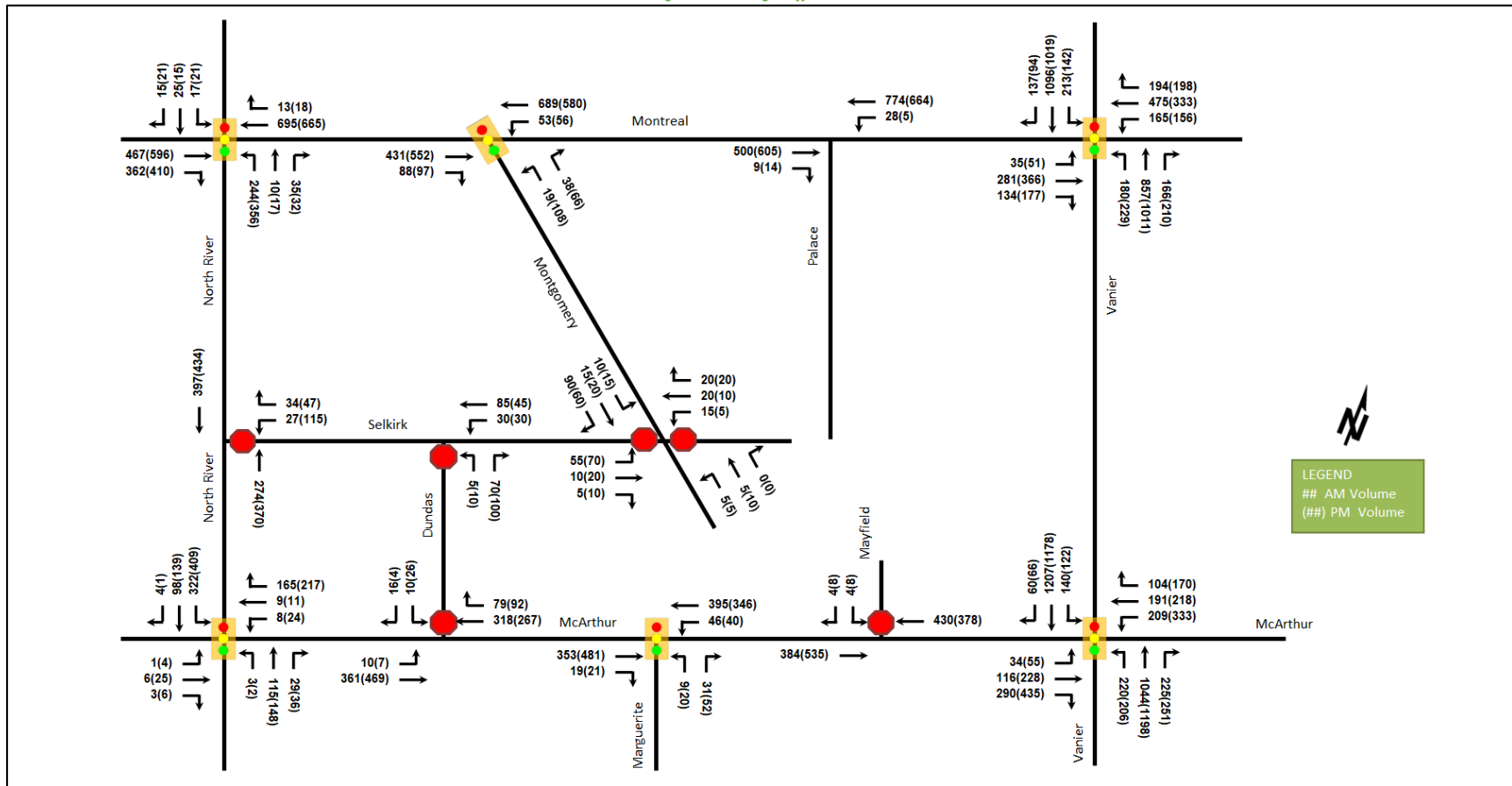

Table 2: Existing Intersection Operations

Intersection	Lane	AM Peak Hour				PM Peak Hour			
		LOS	V/C	Delay(s)	Q (95 th)	LOS	V/C	Delay(s)	Q (95 th)
Montreal Road & North River Road <i>Signalized</i>	EBT/R	D	0.87	39.9	#130.0	D	0.89	40.6	#175.6
	WBT/R	B	0.69	81.7	90.7	A	0.59	83.8	101.3
	NBL	B	0.70	43.0	68.3	D	0.84	55.6	116.4
	NBT/R	A	0.10	9.3	8.6	A	0.09	11.3	10.8
	SB	A	0.37	38.2	20.8	A	0.43	47.9	24.2
	Overall	B	0.66	55.2	-	C	0.75	56.3	-
Montreal Road & Montgomery Street <i>Signalized</i>	EBT/R	A	0.22	3.3	20.0	A	0.30	5.6	28.5
	WBT/L	A	0.36	4.1	36.1	A	0.35	4.8	32.2
	NBL	A	0.09	30.6	8.6	A	0.56	50.4	37.9
	NBR	A	0.19	12.2	8.1	A	0.31	12.7	11.6
	Overall	A	0.36	4.4	-	A	0.38	8.9	-
Montreal Road & Vanier Parkway <i>Signalized</i>	EBL	A	0.38	72.8	22.2	A	0.48	74.7	29.2
	EBT	C	0.76	62.5	#116.4	D	0.89	71.7	#179.7
	EBR	A	0.33	8.3	17.2	A	0.39	10.0	24.3
	WBL	F	1.20	190.0	#108.9	C	0.77	80.2	70.7
	WBT/R	D	0.82	53.2	#142.2	A	0.54	34.5	84.2
	NBL	D	0.82	88.6	m73.5	E	0.92	89.2	m79.2
	NBT/R	C	0.77	48.6	87.2	F	1.06	95.6	m#168.3
	SBL	D	0.89	90.2	#108.5	C	0.73	77.3	64.3
	SBT/R	D	0.89	52.5	#165.2	F	1.09	103.5	#172.6
Overall	E	0.96	60.5	-	E	0.96	81.8	-	
Selkirk Street & North River Road <i>Unsignalized</i>	WB	B	0.11	11.8	3.0	C	0.39	17.7	13.5
	NB	-	-	-	-	-	-	-	-
	SB	-	-	-	-	-	-	-	-
	Overall	A	-	1.0	-	A	-	3.0	-
Selkirk Street & Dundas Street <i>Unsignalized</i>	Low volumes at intersection return LOS A and zero second delay for intersection								
Selkirk Street & Montgomery Street <i>Unsignalized</i>	EB	A	0.10	9.9	2.3	B	0.14	10.1	3.8
	WB	A	0.07	9.5	1.5	A	0.04	9.1	0.8
	NB	A	0.00	7.5	0.0	A	0.00	7.4	0.0
	SB	A	0.01	7.2	0.0	A	0.01	7.3	0.0
	Overall	A	-	5.3	-	A	-	6.0	-
McArthur Avenue & North River Road <i>Signalized</i>	EB	A	0.02	14.6	3.8	A	0.09	18.3	10.0
	WBT/L	A	0.04	11.3	m5.3	A	0.11	21.2	12.4
	WBR	A	0.33	8.1	25.6	A	0.45	13.2	35.6
	NB	A	0.19	8.4	18.2	A	0.22	7.5	20.8
	SBL	B	0.67	20.4	62.5	D	0.81	27.5	#104.4
	SBT/R	A	0.13	9.1	14.2	A	0.16	8.0	17.4
	Overall	A	0.46	13.6	-	B	0.61	17.6	-
McArthur Avenue & Dundas Street <i>Unsignalized</i>	EB	A	0.01	9.0	0.0	A	0.01	8.5	0.0
	WB	-	-	-	-	-	-	-	-
	SB	C	0.08	15.6	2.3	C	0.13	20.7	3.0
	Overall	A	-	0.6	-	A	-	0.8	-

Intersection	Lane	AM Peak Hour				PM Peak Hour			
		LOS	V/C	Delay(s)	Q (95 th)	LOS	V/C	Delay(s)	Q (95 th)
McArthur Avenue & Mayfield Street <i>Unsignalized</i>	EB	-	-	-	-	-	-	-	-
	WB	-	-	-	-	-	-	-	-
	SBL	C	0.01	16.9	0.0	C	0.03	19.1	0.8
	SBR	B	0.01	11.2	0.0	B	0.01	10.8	0.0
	Overall	A	-	0.1	-	-	A	-	0.3
McArthur Avenue & Marguerite Street <i>Signalized</i>	EBT/R	A	0.31	4.5	28.4	A	0.43	5.9	m38.4
	WBT/L	A	0.39	8.1	m50.4	A	0.36	6.6	48.5
	NBL	A	0.04	20.7	4.1	A	0.09	24.4	7.5
	NBR	A	0.13	8.8	5.9	A	0.22	8.9	8.1
	Overall	A	0.37	6.7	-	-	A	0.39	6.8
McArthur Avenue & Vanier Parkway <i>Signalized</i>	EBL	A	0.29	65.1	22.8	A	0.42	68.7	30.8
	EBT	A	0.41	46.1	44.2	B	0.69	61.7	95.6
	EBR	B	0.70	21.8	42.4	F	1.03	75.9	#154.8
	WBL	C	0.77	79.1	#48.7	F	1.19	166.5	#95.2
	WBT	A	0.59	57.5	80.0	A	0.58	55.2	91.5
	WBR	A	0.28	3.1	3.8	A	0.40	8.7	20.4
	NBL	F	1.22	185.4	#136.1	F	1.15	161.3	#126.3
	NBT	D	0.82	42.9	#200.7	E	1.00	66.6	#252.7
	NBR	A	0.34	6.8	24.4	A	0.40	9.7	34.1
	SBL	C	0.80	82.7	m51.9	C	0.75	80.4	m42.9
	SBT	E	0.95	77.9	m#236.8	F	1.01	94.5	m187.5
	SBR	A	0.10	17.2	m6.6	A	0.13	21.3	m8.4
Overall	E	0.91	61.3	-	-	F	1.07	80.2	-

Notes: Saturation flow rate of 1800 veh/h/lane
Queue is measured in metres
Peak Hour Factor = 0.90

Delay = average vehicle delay in seconds
m = metered queue
= volume for the 95th %ile cycle exceeds capacity

A number of capacity issues may be noted at the study area intersections in the existing conditions. It is noted that the volumes modelled at the study area intersections are associated with pre-construction geometry. Given restriction in lanes on Montreal Road east of Vanier Parkway and the reduction of lanes on Vanier Parkway at its intersection with Montreal Road, it is anticipated that volumes will change post construction.

At the intersection of Montreal Road and North River Road, high delays are noted on the westbound through/right movement, and extended queues are noted on the eastbound through/right movement during both peak hours.

During the AM peak hour at the intersection of Montreal Road and Vanier Parkway the southbound left-turn movement may be subject to high delays and extended queues, the northbound left-turn movement may experience high delays, and the eastbound through, westbound through/right, and the southbound through/right movement may exhibit extended queues. During the PM peak hour, the northbound through/right and southbound through/right movements are over theoretical capacity, the westbound left, northbound left, and overall intersection may experience high delays, and the eastbound through movement may exhibit extended queues.

The southbound left movement at the intersection of McArthur Avenue and North River Road may exhibit extended queues during the PM peak hour.

During the AM peak hour, the intersection of McArthur Avenue and Vanier Parkway’s northbound left movement is over theoretical capacity and may exhibit be subject to high delays and extended queues, the westbound left, northbound through, and southbound through movements may exhibit extended queues. During the PM peak

hour, westbound left and northbound left movements are over theoretical capacity and may be subject to high delays and extended queues, the eastbound right movement is over theoretical capacity and may exhibit extended queues, the southbound through movement and overall intersection are over theoretical capacity and may be subject to high delays, the northbound through movement is at capacity and may exhibit extended queues, and the southbound left movement may experience high delays.

Given the recent Montreal Road Revitalization project, no further improvements are recommended to address the existing conditions. Post-construction volumes will be modeled within the future traffic studies and condition should be monitored by the City for it to determine the impacts of the improvements and to apply any necessary mitigations.

2.2.8 Collision Analysis

Collision data have been acquired from the City of Ottawa open data website (data.ottawa.ca) for five years prior to the commencement of this TIA for the surrounding study area road network. Table 3 summarizes the collision types and conditions in the study area, Figure 10 illustrates the intersections and segments analyzed, and Table 4 summarizes the total collisions for each of these locations. Collision data are included in Appendix D.

Table 3: Study Area Collision Summary, 2016-2020

Total Collisions		Number	%
		206	100%
Classification	Fatality	0	0%
	Non-Fatal Injury	41	20%
	Property Damage Only	165	80%
Initial Impact Type	Approaching	2	1%
	Angle	30	15%
	Rear end	65	32%
	Sideswipe	49	24%
	Turning Movement	36	17%
	SMV Unattended	4	2%
	SMV Other	15	7%
	Other	5	2%
Road Surface Condition	Dry	144	70%
	Wet	33	16%
	Loose Snow	12	6%
	Slush	8	4%
	Packed Snow	3	1%
	Ice	6	3%
Pedestrian Involved		15	7%
Cyclists Involved		8	4%

Figure 10: Representation of Study Area Collision Records

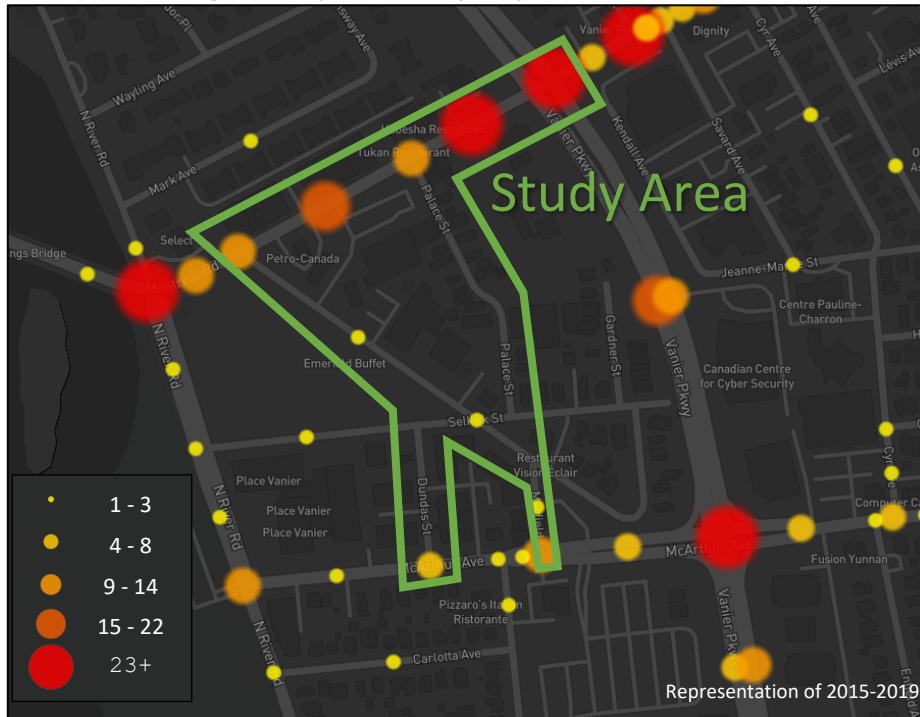

Table 4: Summary of Collision Locations, 2016-2020

Intersections / Segments	Number	%
Intersections / Segments	206	100%
Montreal Rd @ Vanier Pkwy	118	57%
Montreal Rd btwn Palace St & Vanier Pkwy	35	17%
Montreal Rd btwn Montgomery St & Palace St	16	8%
Mayfield St @ McArthur Ave	11	5%
Montgomery St @ Montreal Rd	9	4%
Montreal Rd @ Palace St	9	4%
Dundas St @ McArthur Ave	4	2%
Montgomery St btwn Montreal Rd & Selkirk St	2	1%
Montgomery St @ Selkirk St	1	0%
Mayfield St btwn Montgomery St & McArthur Ave	1	0%

Within the study area, the intersections of Montreal Road at Vanier Parkway and McArthur Avenue at Mayfield Street, and segments of Montreal Road between Palace Street and Vanier Parkway, and between Montgomery Street and Palace Street are noted to have experienced higher collisions than other intersections. Furthermore, the City has requested an analysis of collisions at Montreal Road and Palace Street. Table 5, Table 6, Table 7, Table 8, and Table 9 summarize the collision types and conditions for each location.

Table 5: Montreal Road at Vanier Parkway Collision Summary

Total Collisions		Number	%
Total Collisions		118	100%
Classification	Fatality	0	0%
	Non-Fatal Injury	23	19%
	Property Damage Only	95	81%
Initial Impact Type	Angle	9	8%
	Rear end	54	46%

		Number	%
Total Collisions		118	100%
	Sideswipe	32	27%
	Turning Movement	13	11%
	SMV Other	8	7%
	Other	2	2%
Road Surface Condition	Dry	81	69%
	Wet	19	16%
	Loose Snow	6	5%
	Slush	8	7%
	Packed Snow	1	1%
	Ice	3	3%
Pedestrian Involved		9	8%
Cyclists Involved		2	2%

The Montreal Road at Vanier Parkway intersection had a total of 118 collisions during the 2016-2020 time period, with 95 involving property damage only, and the remaining 23 collisions having non-fatal injuries. The collision types are most represented by rear end with 54 collisions followed by 32 sideswipe, 13 turning movement, and ten or less each of angle, SMV other and other. The rear end collisions are typical of congested areas as are sideswipe collisions where multiple lanes and/or auxiliary lanes are present. The turning movement and angle collisions may be influenced by the turn channels that were present within the collision study period and have since been removed. Six of the pedestrian collisions occurred in 2016 and it is unknown why this year was a significant spike in collisions. Weather conditions are not considered to have influenced collisions at this location. Future studies will document how collisions change beyond the 2022 horizon that have resulted from the corridor revitalization improvements along Montreal Road. No further analysis is required as part of this study.

Table 6: Montreal Road between Palace Street and Vanier Parkway Collision Summary

		Number	%
Total Collisions		35	100%
Classification	Fatality	0	0%
	Non-Fatal Injury	4	11%
	Property Damage Only	31	89%
Initial Impact Type	Approaching	1	3%
	Angle	7	20%
	Rear end	3	9%
	Sideswipe	8	23%
	Turning Movement	11	31%
	SMV Unattended	2	6%
	SMV Other	3	9%
Road Surface Condition	Dry	23	66%
	Wet	8	23%
	Loose Snow	2	6%
	Packed Snow	1	3%
	Ice	1	3%
Pedestrian Involved		3	9%
Cyclists Involved		0	0%

The Montreal Road segments between Palace Street and Vanier Parkway had a total of 35 collisions during the 2016-2020 time period including 31 property damage only collisions and four non-fatal injuries collisions. Turning movement comprised the majority of collision types at this intersection with eleven collisions, followed by eight sideswipe and seven angle collisions, with the remaining collision types represented by approaching, rear end, SMV unattended other and SMV other. Turning movement collisions may be associated with multiple accesses along Montreal Road. Weather conditions are not considered to have influenced collisions at this location. It is noted that no changes to access driveways were made by the City during the Montreal Revitalization project. Collision reductions at this intersection may be experienced in the future as a result of the Revitalization project. No further analysis is required as part of this study.

Table 7: Montreal Road between Montgomery Street and Palace Street Collision Summary

Total Collisions		Number	%
		16	100%
Classification	Fatality	0	0%
	Non-Fatal Injury	4	25%
	Property Damage Only	12	75%
Initial Impact Type	Approaching	1	6%
	Angle	3	19%
	Rear end	2	13%
	Sideswipe	2	13%
	Turning Movement	3	19%
	SMV Unattended	2	13%
	SMV Other	2	13%
	Other	1	6%
	Road Surface Condition	Dry	13
Wet		1	6%
Loose Snow		1	6%
Ice		1	6%
Pedestrian Involved		1	6%
Cyclists Involved		2	13%

The Montreal Road segments between Montgomery Street and Palace Street had a total of 16 collisions during the 2016-2020 time period. Twelve collisions had property damage only and the remaining four collisions had non-fatal injuries. Three collisions each for the turning movement and angle, followed by two collisions each for the rear end, sideswipe, SMV unattended, and SMV other, and the remaining split between approaching and other. Weather conditions do not affect collisions at this location. It is noted that no changes to access driveways were made by the City during the Montreal Revitalization project. No collision pattern is noted for this segment and no further collision review is required within the scope of the subject development.

Table 8: Montreal Road at Palace Street Collision Summary

Total Collisions		Number	%
		9	100%
Classification	Fatality	0	0%
	Non-Fatal Injury	3	33%
	Property Damage Only	6	67%
Initial Impact Type	Sideswipe	2	22%
	Turning Movement	6	67%
	SMV Other	1	11%

		Number	%
Total Collisions		9	100%
Road Surface Condition	Dry	8	89%
	Wet	1	11%
Pedestrian Involved		1	11%
Cyclists Involved		1	11%

The intersection of Montreal Road at Palace Street had a total of nine collisions during the 2016-2020 time period including six property damage only collisions and three non-fatal injuries collisions. Turning movement collisions comprised the majority of collision types at this intersection with six collisions, followed by two sideswipe collisions and one collision as SMV (other). While absolute values of collisions are low and it may be impossible to make normative statements about the data, it is noted that five of six turning movement collisions involved property damage only, where four of six turning movement collisions occurred during the PM peak period and one occurred during the AM peak period. Two of these collisions involved a pedestrian or cyclist. While no identifiable issues are present, if the City was concerned about the collisions at this location, and as part of its review, a solution to possible collision issues at this location was possible, it is assumed that this treatment would have been part of the design of the Montreal Road Revitalization. No further analysis is required as part of this study.

Table 9: McArthur Avenue at Mayfield Street Collision Summary

		Number	%
Total Collisions		11	100%
Classification	Fatality	0	0%
	Non-Fatal Injury	3	27%
	Property Damage Only	8	73%
Initial Impact Type	Angle	8	73%
	Rear end	2	18%
	Other	1	9%
Road Surface Condition	Dry	8	73%
	Wet	1	9%
	Loose Snow	1	9%
	Ice	1	9%
Pedestrian Involved		0	0%
Cyclists Involved		0	0%

The intersection of McArthur Avenue at Mayfield Street had a total of 11 collisions during the 2016-2020 time period including eight property damage only collisions and three non-fatal injuries collisions. Angle collisions comprised the majority of collision types at this intersection with eight collisions, followed by two rear end collisions and one collision as other. Seven out of eight angle collisions occurred in the three-year period of 2016-2018, where the McArthur Avenue included four travel lanes through the intersection. Only one further angle collision was noted in 2019 around the time of the curb lanes being repainted to buffered bike lanes reducing the vehicle travel lanes by two. As such, no additional mitigation beyond this previous treatment is considered necessary to address angle collisions at this intersection. No further analysis is required as part of this study.

2.3 Planned Conditions

2.3.1 Changes to the Area Transportation Network

The Transportation Master Plan identifies continuous transit priority along Montreal Road within the Affordable and Ultimate Network Concepts. In the Ultimate Network Concept, isolated transit priority measures are identified as along North River Road between Montreal Road and McArthur Avenue, and along McArthur Avenue.

The Montreal Road Revitalization is a project that is currently underway and is scheduled to be completed by autumn of 2022. Major transportation-related changes contained in this plan include changes to the cross-section of Montreal Road, east of Vanier Parkway as well as a review of transit stops and the addition of shelters along the arterial. The newly planned cross-section east of Vanier Parkway includes two westbound lanes, one eastbound lane and cycling tacks/lanes in both directions. Figure 9 illustrates examples of the new study area conditions on Montreal Road.

Figure 11: Montreal Road Revitalization



2.3.2 Other Study Area Developments

337-345 Montgomery Street and 94 Selkirk Street

The application includes an Official Plan amendment/zoning by-law amendment for the construction of a 20-storey high-rise apartment building. The anticipated full build-out and occupancy horizon is 2026 and the development is anticipated to generate 31 new AM and 33 new PM peak hour two-way auto trips (CGH, 2021).

263 Greensway Avenue

The application includes a site plan proposing the construction of a six-storey apartment building with 77 residential units on the site. The anticipated full build-out and occupancy horizon is assumed to be 2023. The development is anticipated to generate 21 new AM two-way peak-hour auto trips and 24 new PM two-way peak-hour auto trips (Parsons, 2019).

18 McArthur Avenue

The application includes a site plane proposing the replacement of a surface parking lot with a three-storey, ten residential unit building. No TIA is available for this application.

353-357 Gardner Street

The application includes a zoning by-law amendment and site plan for the construction of a nine-storey building comprising 61 dwelling units. No TIA is available for this application.

2 Montreal Road, 3 Selkirk Street, 280 & 300 Montgomery Street

The application includes a site plan application for a multi-phase mixed-use development. Phase 1 is comprised of 294 residential units and a 16,143 ft² grocery store, Phase 2 is comprised of 433 residential units and 5,132 ft² of retail space, and Phase 3 is comprised of 364 residential units. Phase 1 of development is anticipated to be built-out by 2023 and to generate 106 new AM and 154 new PM peak hour two-way auto trips. Phase 2 and Phase 3 are anticipated to be built-out by 2025 and to generate 234 new AM and 249 new PM peak hour two-way auto trips (Parsons, 2022).

26 McArthur Avenue

The application includes a site plan application for the construction of a four-storey residential building with 12 units. The initially anticipated full build-out and occupancy horizon was 2021. Based on the TIA screening form, no TIA is required for the development.

216 McArthur Avenue

The application includes a site plan application for a three-storey, low-rise, mixed-use building with a retail unit on ground floor and twelve dwelling units. No TIA is available for this application.

641 Rideau Street

The application includes a zoning by-law amendment and official plan amendment 25-storey residential building comprising 292 dwelling units. The anticipated full build-out and occupancy horizon is 2024. The development is anticipated to generate 24 new AM two-way peak-hour auto trips and 23 new PM two-way peak-hour auto trips (CGH, 2021).

3 Study Area and Time Periods

3.1 Study Area

The study area will include the intersections of:

- Montreal Road at:
 - North River Road
 - Montgomery Street
 - Palace Street
 - Vanier Parkway
- Selkirk Street at North River Road
- McArthur Avenue at:
 - Dundas Street
 - Marguerite Avenue
 - Vanier Parkway
 - North River Road
- The newly proposed site access at Palace Street

The intersections of Montreal Road at Olmstead Street, Montreal Road at Hannah Street/Cody Avenue, and Deschamps Avenue at Vanier Parkway have been excluded from the analysis prescribed within the TIA Guidelines. While they are within 400 metres of the site, the traffic impacts from the proposed development will be captured by the upstream intersections examined and/or will only be impacted by through traffic from the proposed site.

The boundary roads are Montreal Road, Vanier Parkway, and Palace Street. TRANS Screenline 33 is present within proximity to the site, though will not be analyzed as part of this study.

3.2 Time Periods

As the proposed development is composed primarily of residential units the AM and PM peak hours will be examined.

3.3 Horizon Years

The anticipated build-out year is 2024. As a result, the full build-out plus five years horizon year is 2029.

4 Exemption Review

Table 10 summarizes the exemptions for this TIA.

Table 10: Exemption Review

Module	Element	Explanation	Exempt/Required
Design Review Component			
4.1 Development Design	4.1.2 Circulation and Access	Only required for site plans	Required
	4.1.3 New Street Networks	Only required for plans of subdivision	Exempt
4.2 Parking	4.2.1 Parking Supply	Only required for site plans	Required
	4.2.2 Spillover Parking	Only required for site plans where parking supply is 15% below unconstrained demand	Exempt
Network Impact Component			
4.5 Transportation Demand Management	All Elements	Not required for site plans expected to have fewer than 60 employees and/or students on location at any given time	Required
4.6 Neighbourhood Traffic Management	4.6.1 Adjacent Neighbourhoods	Only required when the development relies on local or collector streets for access and total volumes exceed ATM capacity thresholds	Required
4.8 Network Concept		Only required when proposed development generates more than 200 person-trips during the peak hour in excess of equivalent volume permitted by established zoning	Exempt

5 Development-Generated Travel Demand

5.1 Mode Shares

Examining the mode shares recommended in the TRANS Trip Generation Manual (2020) for the subject district, derived from the most recent National Capital Region Origin-Destination survey (OD Survey), the recommended district mode shares by land use for Ottawa East have been summarized in Table 11.

Table 11: TRANS Trip Generation Manual Recommended Mode Shares – Ottawa East

Travel Mode	Multi-Unit (High-Rise)		Commercial Generator	
	AM	PM	AM	PM
Auto Driver	39%	40%	57%	55%
Auto Passenger	7%	14%	10%	18%
Transit	38%	28%	15%	11%
Cycling	2%	3%	1%	1%
Walking	14%	15%	17%	15%
Total	100%	100%	100%	100%

Based upon the site’s context of being within 400 metres’ walk of the Montreal Road arterial mainstreet and transit priority corridor, modified mode share targets with a 5% shift from auto travel to transit are proposed for all development land uses and are summarized in Table 12.

Table 12: Proposed Development Mode Shares

Travel Mode	Multi-Unit (High-Rise)		Commercial Generator	
	AM	PM	AM	PM
Auto Driver	34%	35%	52%	50%
Auto Passenger	7%	14%	10%	18%
Transit	43%	33%	20%	16%
Cycling	2%	3%	1%	1%
Walking	14%	15%	17%	15%
Total	100%	100%	100%	100%

5.2 Trip Generation

This TIA has been prepared using the vehicle and person trip rates for the residential dwellings using the TRANS Trip Generation Manual (2020) and the vehicle trip rates and derived person trip rates for commercial component from the ITE Trip Generation Manual 11h Edition (2021) using the City-prescribed conversion factor of 1.28. Table 13 summarizes the person trip rates for the proposed residential land use for each peak period and the person trip rates for the commercial land use by peak hour.

Table 13: Trip Generation Person Trip Rates by Peak Period

Land Use	Land Use Code	Peak Period	Vehicle Trip Rate	Person Trip Rates
Multi-Unit High-Rise	221 & 222 (TRANS)	AM	-	0.80
		PM	-	0.90
Land Use	Land Use Code	Peak Hour	Vehicle Trip Rate	Person Trip Rates
Retail (<40k sq. ft.)	822 (ITE)	AM	2.36	3.02
		PM	6.59	8.44

Using the above person trip rates, the total person trip generation has been estimated. Table 14 summarizes the total person trip generation for the residential land use by peak period and for the commercial land use by peak hour.

Table 14: Total Residential Person Trip Generation by Peak Period

Land Use	Units	AM Peak Period			PM Peak Period		
		In	Out	Total	In	Out	Total
Multi-Unit High-Rise	430	107	237	344	224	163	387
Land Use	GFA (sq. ft.)	AM Peak Hour			PM Peak Hour		
		In	Out	Total	In	Out	Total
Retail (<40k sq. ft.)	2,525	5	3	8	11	11	21

Internal capture rates from the ITE Trip Generation Handbook 3rd Edition have been assigned to the development’s retail component for mixed-use developments. The rates summarized in Table 15 represent the percentage of trips to/from the retail use based on the residential component.

Table 15: Internal Capture Rates

Land Use	AM		PM	
	In	Out	In	Out
Residential to/from Retail	17%	14%	10%	26%

Pass-by reductions applied to the retail trip generation at a rate of 40% have been included using the recommended value presented in the ITE Trip Generation Manual 11th Edition (2021) for the most similar land use with a recommended rate, “Retail (40k – 150k sq. ft.)”.

Using the proposed site mode share targets and the person trip rates, the person trips by mode have been projected. Trip generation by peak hour has been forecasted using the prescribed peak period conversion factors presented in the TRANS Trip Generation Manual (2020) for the residential component. Table 16 summarizes the residential trip generation and the commercial trip generation by mode and peak hour.

Table 16: Trip Generation by Mode

Travel Mode		AM Peak Hour				PM Peak Hour			
		Mode Share	In	Out	Total	Mode Share	In	Out	Total
Multi-Unit (High-Rise)	Auto Driver	34%	17	38	56	35%	34	25	59
	Auto Passenger	7%	3	8	12	14%	14	10	24
	Transit	43%	25	56	81	33%	35	25	60
	Cycling	2%	1	3	4	3%	3	2	6
	Walking	14%	9	19	28	15%	17	12	30
	Total	100%	55	124	181	100%	103	74	179
Retail (<40k sq. ft.)	Auto Driver	52%	1	1	2	50%	3	3	5
	Auto Passenger	10%	0	0	0	18%	1	1	2
	Transit	20%	0	0	1	16%	1	1	2
	Cycling	1%	0	0	0	1%	0	0	0
	Walking	17%	0	0	1	15%	1	1	2
	Pass-by	40%	-2	-1	-3	40%	-4	-4	-8
	Internal Capture	<i>varies</i>	-1	0	-1	<i>varies</i>	-1	-2	-3
Total	100%	1	1	2	100%	6	5	10	
Total	Auto Driver	-	18	40	58	-	37	28	64
	Auto Passenger	-	3	8	12	-	15	11	26
	Transit	-	25	56	82	-	36	26	62
	Cycling	-	1	3	4	-	3	2	6
	Walking	-	9	19	29	-	19	13	32
	Total	-	57	127	185	-	110	79	189

As shown above, a total of 58 new AM and 64 new PM peak hour two-way vehicle trips are projected as a result of the proposed development.

5.3 Trip Distribution

To understand the travel patterns of the subject development, the OD Survey has been reviewed to determine the travel for the residential component, and these patterns were applied based on the build-out of Ottawa East. Table 17 below summarizes the distribution.

Table 17: OD Survey Distribution – Ottawa East

To/From	% of Trips
North	5%
South	30%
East	25%
West	40%
Total	100%

5.4 Trip Assignment

Using the distribution outlined above, turning movement splits, and access to major transportation infrastructure, the trips generated by the site have been assigned to the study area road network. Table 18 summarizes the proportional assignment to the study area roadways, and Figure 12 and Figure 13 illustrate the new site generated volumes and pass-by volumes.

Table 18: Trip Assignment

To/From	Inbound Via	Outbound Via
North	5% Vanier Pkwy (N)	5% Vanier Pkwy (N)
South	20% North River Rd (S), 10% Vanier Pkwy (S)	20% Vanier Pkwy (S) 10% North River Rd (S)
East	10% Montreal Rd (E) 10% McArthur Ave (E) 5% Vanier Pkwy (S)	10% McArthur Ave (E), 10% Montreal Rd (E), 5% Vanier Pkwy (S)
West	20% Montreal Rd (W), 10% North River Rd (S), 10% Vanier Pkwy (S)	20% Montreal Rd (W), 10% Vanier Pkwy (S) 10% North River Rd (S)
Total	100%	100%

Figure 12: New Site-Generated Auto Volumes

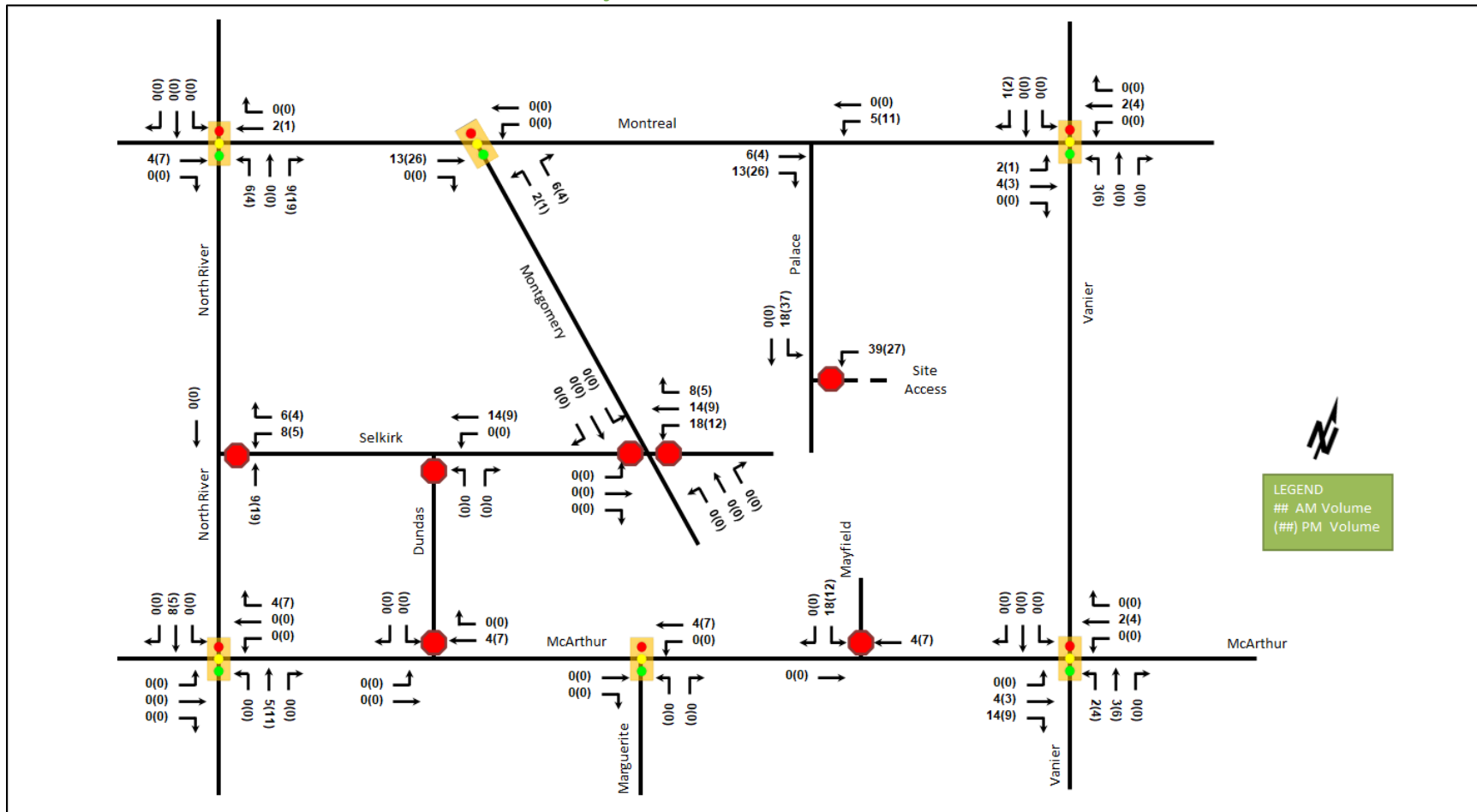
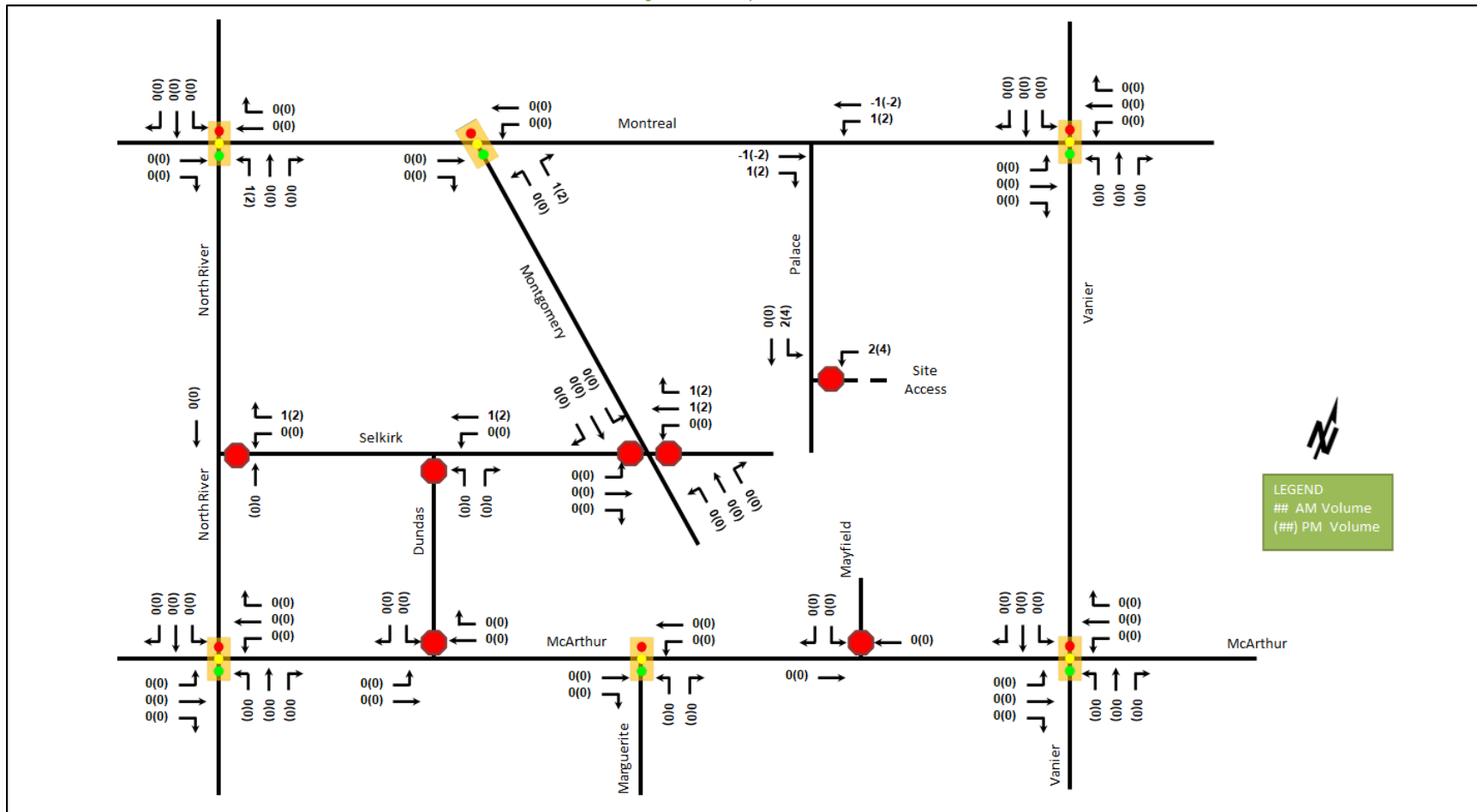

Figure 13: Pass-By Auto Volumes



6 Background Network Travel Demands

6.1 Transportation Network Plans

The transportation network plans were discussed in Section 2.3.1. Construction activities associated with the Montreal Road Revitalization are concluding at the time of this report and the improvements have been included in the existing conditions. No other plans for the study area were noted.

6.2 Background Growth

A review of the background projections from the City’s TRANS Regional Model for the 2011 and 2031 horizons was completed to determine the background growth for the arterial network. Table 19 summarizes the results of the model and the projections are provided in Appendix E.

Table 19: TRANS Regional Model Projections – Study Area Growth Rates

Street	Direction Growth Percentage	
	Eastbound	Westbound
Montreal Rd	0.66%	-0.30%
McArthur Ave	1.15%	0.02%
	Northbound	Southbound
North River Rd	-2.05%	1.80%
Vanier Pkwy	0.37%	0.68%

In general, the TRANS projections forecast growth rates within the range of -2.0% to 1.8% in the study area. Historically, it is shown that rates of contraction of -4% to -2% for volumes at the intersection of Montreal Road at North River Road and of -2% to -0.2% at the intersection of Montreal Road at Vanier Parkway have been observed between 2000 and 2016 in both the AM and PM peak hours. Additionally, with the reduction in lanes on McArthur Avenue and on Montreal Road east of Vanier Parkway, it is not anticipated that these roadways can accommodate future growth. Therefore, a growth rate of 0.5% will be applied to the mainline volumes on Vanier Parkway. Table 20 summarizes the growth rates applied within the study area.

Table 20: TRANS Regional Model Projections – Study Area Growth Rates

Street	AM Peak Hour		PM Peak Hour	
	Eastbound	Westbound	Eastbound	Westbound
Montreal Rd	-	-	-	-
McArthur Ave	-	-	-	-
	Northbound	Southbound	Northbound	Southbound
North River Rd	-	-	-	-
Vanier Pkwy	0.50%	0.50%	0.50%	0.50%

6.3 Other Developments

As the only developments with non-negligible traffic generation in the study area, the background developments explicitly considered in the background conditions (Section 6.2) include:

- 337-345 Montgomery Street and 94 Selkirk Street
- 641 Rideau Street
- 2 Montreal Road, 3 Selkirk Street, 280 & 300 Montgomery Street

The background development volumes within the study area have been provided in Appendix F.

7 Demand Rationalization

7.1 2024 Future Background Operations

Figure 14 illustrates the 2024 background volumes and Table 21 summarizes the 2024 background intersection operations. The level of service for signalized intersections is based on v/c calculations for individual lane movements and HCM 2000 v/c calculations for the overall intersection, and average delay for unsignalized intersections. The synchro worksheets for the 2024 future background horizon are provided in Appendix G

Figure 14: 2024 Future Background Volumes

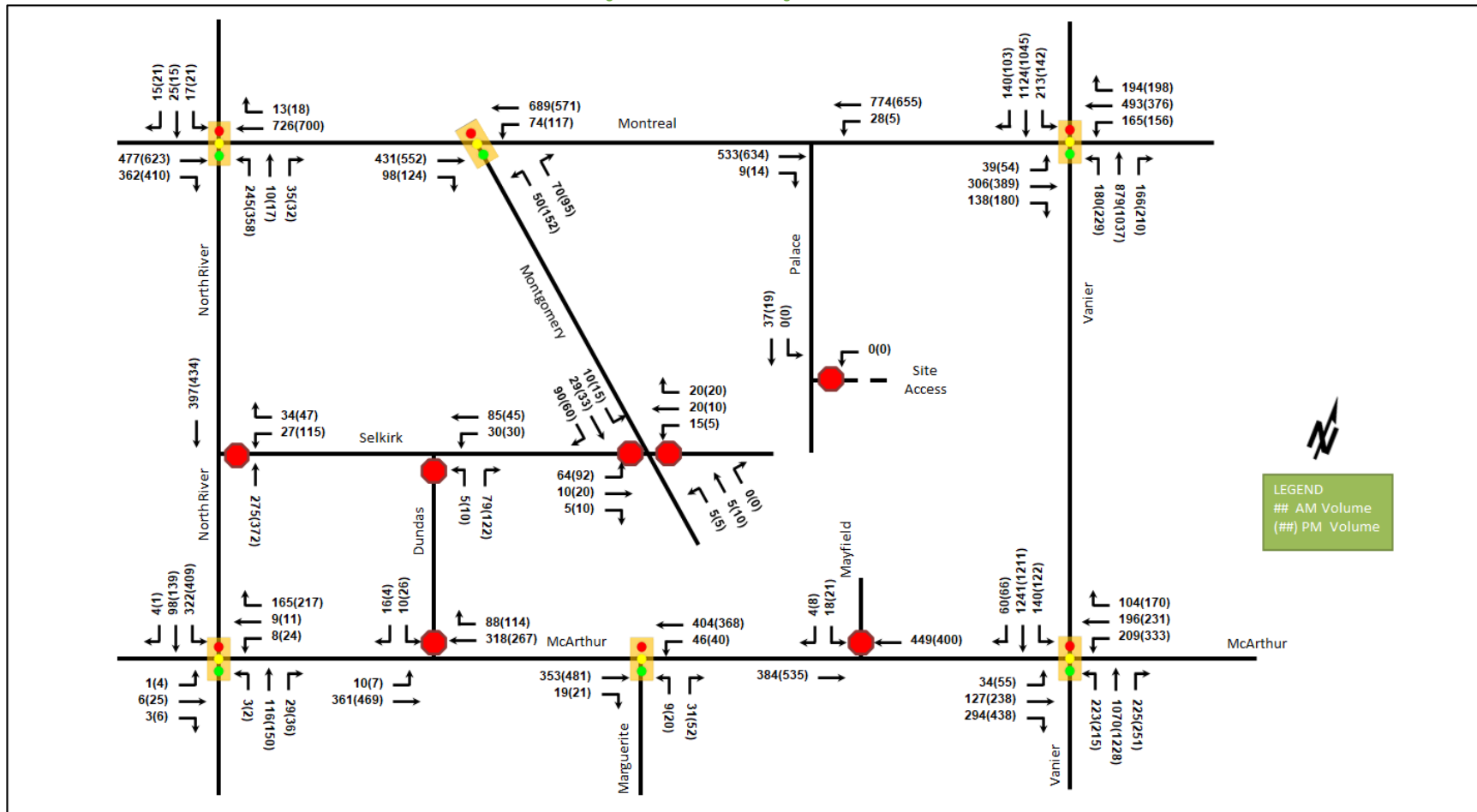

Table 21: 2024 Future Background Intersection Operations

Intersection	Lane	AM Peak Hour				PM Peak Hour			
		LOS	V/C	Delay	Q (95 th)	LOS	V/C	Delay	Q (95 th)
Montreal Road & North River Road <i>Signalized</i>	EBT/R	C	0.74	31.1	#108.2	C	0.76	30.3	#133.8
	WBT/R	A	0.60	60.4	82.1	A	0.49	59.8	86.5
	NBL	C	0.71	45.9	62.8	D	0.83	58.7	105.3
	NBT/R	A	0.10	10.1	8.3	A	0.09	12.5	10.4
	SB	A	0.33	36.4	18.7	A	0.40	45.7	21.9
	Overall	A	0.60	43.9	-	B	0.67	44.3	-
Montreal Road & Montgomery Street <i>Signalized</i>	EBT/R	A	0.22	3.9	17.8	A	0.26	5.1	24.1
	WBT/L	A	0.37	4.8	33.1	A	0.30	4.3	26.9
	NBL	A	0.23	33.0	15.7	A	0.52	49.8	35.1
	NBR	A	0.28	11.3	10.2	A	0.30	13.3	11.2
	Overall	A	0.37	5.8	-	A	0.33	8.4	-
Montreal Road & Vanier Parkway <i>Signalized</i>	EBL	A	0.38	72.8	22.2	A	0.45	74.0	27.1
	EBT	C	0.75	61.6	113.2	C	0.78	60.0	#153.8
	EBR	A	0.31	8.4	16.5	A	0.35	7.7	18.6
	WBL	F	1.09	155.2	#96.9	C	0.74	78.3	63.9
	WBT/R	C	0.76	50.0	#124.2	A	0.48	32.3	73.0
	NBL	C	0.78	88.8	m71.9	D	0.87	89.0	m79.3
	NBT/R	B	0.70	44.4	80.4	E	0.93	70.1	#162.9
	SBL	D	0.84	84.5	#93.0	B	0.70	76.2	58.2
	SBT/R	C	0.80	46.7	139.7	E	0.95	68.7	#146.1
Overall	D	0.87	55.0	-	D	0.86	62.6	-	
Selkirk Street & North River Road <i>Unsignalized</i>	WB	B	0.10	11.3	2.3	C	0.32	15.6	10.5
	NB	-	-	-	-	-	-	-	-
	SB	-	-	-	-	-	-	-	-
	Overall	A	-	0.9	-	A	-	2.6	-
Selkirk Street & Dundas Street <i>Unsignalized</i>	Low volumes at intersection return LOS A and zero second delay for intersection								
Selkirk Street & Montgomery Street <i>Unsignalized</i>	EB	A	0.10	9.9	2.3	A	0.12	9.9	3.0
	WB	A	0.06	9.5	1.5	A	0.04	9.1	0.8
	NB	A	0.00	7.5	0.0	A	0.00	7.4	0.0
	SB	A	0.01	7.2	0.0	A	0.01	7.3	0.0
	Overall	A	-	5.2	-	A	-	5.9	-
McArthur Avenue & North River Road <i>Signalized</i>	EB	A	0.02	14.4	3.5	A	0.08	18.4	9.4
	WBT/L	A	0.03	11.5	5.4	A	0.10	21.1	11.5
	WBR	A	0.30	8.2	22.1	A	0.42	12.6	32.3
	NB	A	0.18	8.1	16.5	A	0.20	7.2	18.6
	SBL	A	0.60	17.7	52.6	C	0.72	21.2	#78.8
	SBT/R	A	0.12	9.0	13.1	A	0.14	7.9	15.9
	Overall	A	0.41	12.5	-	A	0.54	14.9	-
McArthur Avenue & Dundas Street <i>Unsignalized</i>	EB	A	0.01	8.9	0.0	A	0.01	8.4	0.0
	WB	-	-	-	-	-	-	-	-
	SB	B	0.07	14.7	1.5	C	0.10	18.5	2.3
	Overall	A	-	0.6	-	A	-	0.7	-

Intersection	Lane	AM Peak Hour				PM Peak Hour			
		LOS	V/C	Delay	Q (95 th)	LOS	V/C	Delay	Q (95 th)
McArthur Avenue & Mayfield Street <i>Unsignalized</i>	EB	-	-	-	-	-	-	-	-
	WB	-	-	-	-	-	-	-	-
	SBL	C	0.05	16.2	1.5	C	0.03	17.2	0.8
	SBR	B	0.01	10.9	0.0	B	0.01	10.4	0.0
	Overall	A	-	0.4	-	-	A	-	0.2
McArthur Avenue & Marguerite Street <i>Signalized</i>	EBT/R	A	0.28	4.0	21.0	A	0.37	4.9	37.5
	WBT/L	A	0.35	7.2	m47.8	A	0.30	5.8	42.3
	NBL	A	0.03	20.6	3.9	A	0.08	24.2	7.0
	NBR	A	0.12	8.9	5.5	A	0.20	9.0	7.7
	Overall	A	0.33	6.0	-	-	A	0.35	5.9
McArthur Avenue & Vanier Parkway <i>Signalized</i>	EBL	A	0.29	66.1	21.5	A	0.38	67.2	28.5
	EBT	A	0.40	45.8	42.3	B	0.68	62.2	86.0
	EBR	B	0.63	17.4	31.8	E	0.96	57.4	#123.6
	WBL	C	0.71	75.0	42.8	E	0.94	94.6	#83.3
	WBT	A	0.49	51.7	74.3	A	0.53	53.5	82.2
	WBR	A	0.24	1.4	0.5	A	0.37	8.8	19.2
	NBL	F	1.11	152.4	#122.3	F	1.03	130.6	#110.8
	NBT	C	0.74	39.1	169.8	D	0.89	48.1	#212.2
	NBR	A	0.31	5.4	18.6	A	0.36	7.4	26.1
	SBL	C	0.76	84.4	m51.7	B	0.70	83.1	m42.1
	SBT	D	0.88	72.2	m#211.4	D	0.90	81.4	m186.4
	SBR	A	0.09	14.9	m6.2	A	0.12	19.3	m8.6
Overall	D	0.82	55.7	-	-	E	0.94	63.1	-

Notes: Saturation flow rate of 1800 veh/h/lane
Queue is measured in metres
Peak Hour Factor = 1.00

Delay = average vehicle delay in seconds
m = metered queue
= volume for the 95th %ile cycle exceeds capacity

At the 2024 future background horizon, the study area intersections are noted to have minor operational improvements above the existing conditions with the peak hour factor changing from 0.90 to 1.00. No new capacity issues are noted.

7.2 2029 Future Background Operations

Figure 15 illustrates the 2029 background volumes and Table 22 summarizes the 2029 background intersection operations. The level of service for signalized intersections is based on v/c calculations for individual lane movements and HCM 2000 v/c calculations for the overall intersection, and average delay for unsignalized intersections. The synchro worksheets for the 2029 future background horizon are provided in Appendix H.

Figure 15: 2029 Future Background Volumes

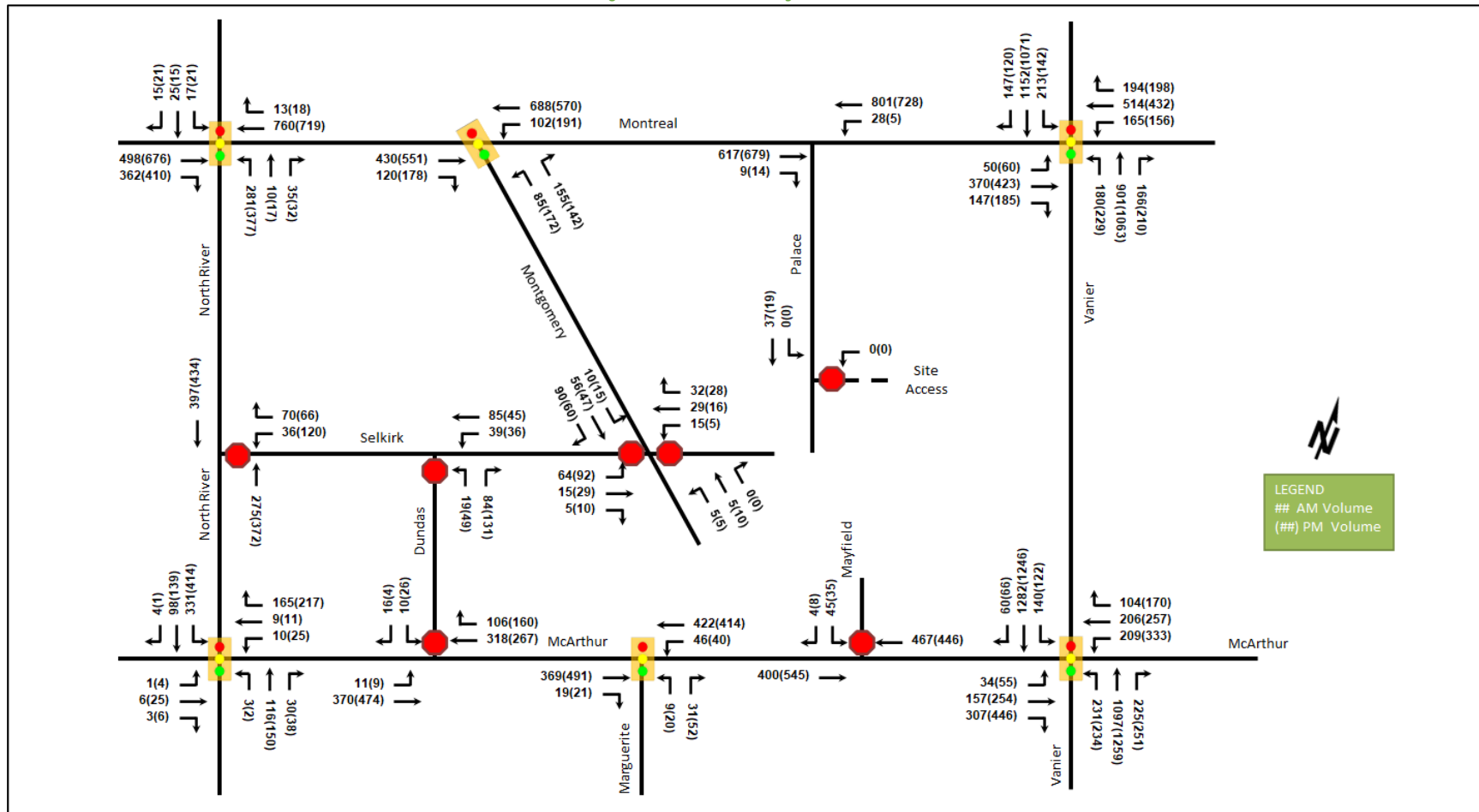

Table 22: 2029 Future Background Intersection Operations

Intersection	Lane	AM Peak Hour				PM Peak Hour			
		LOS	V/C	Delay	Q (95 th)	LOS	V/C	Delay	Q (95 th)
Montreal Road & North River Road <i>Signalized</i>	EBT/R	D	0.84	38.0	#118.3	D	0.85	37.2	#169.7
	WBT/R	B	0.70	82.8	89.7	A	0.55	81.9	96.6
	NBL	B	0.70	41.7	70.4	D	0.84	57.5	111.3
	NBT/R	A	0.09	9.3	8.0	A	0.09	12.0	10.2
	SB	A	0.33	36.4	18.7	A	0.40	45.7	21.9
	Overall	B	0.63	55.0	-	C	0.72	54.5	-
Montreal Road & Montgomery Street <i>Signalized</i>	EBT/R	A	0.25	4.6	18.0	A	0.31	5.9	28.0
	WBT/L	A	0.44	5.9	35.8	A	0.50	7.2	44.5
	NBL	A	0.38	36.0	23.7	B	0.69	54.6	51.6
	NBR	A	0.48	10.9	14.8	A	0.45	11.0	15.8
	Overall	A	0.43	7.5	-	A	0.53	11.5	-
Montreal Road & Vanier Parkway <i>Signalized</i>	EBL	A	0.45	74.6	26.6	A	0.49	74.9	30.6
	EBT	D	0.90	77.3	#156.1	D	0.90	72.2	#190.0
	EBR	A	0.33	8.4	17.0	A	0.37	10.8	25.0
	WBL	F	1.09	155.2	#96.9	C	0.74	78.3	63.9
	WBT/R	C	0.80	52.5	#133.8	A	0.59	38.1	96.1
	NBL	C	0.78	88.1	m70.1	D	0.87	86.7	m75.0
	NBT/R	C	0.71	45.0	81.8	E	0.97	74.8	m#164.4
	SBL	D	0.84	84.5	#93.0	B	0.70	76.2	58.2
	SBT/R	D	0.82	47.7	144.7	F	1.02	82.7	#163.0
Overall	E	0.91	57.2	-	E	0.92	69.4	-	
Selkirk Street & North River Road <i>Unsignalized</i>	WB	B	0.16	11.5	4.5	C	0.36	16.0	12.0
	NB	-	-	-	-	-	-	-	-
	SB	-	-	-	-	-	-	-	-
	Overall	A	-	1.6	-	A	-	3.0	-
Selkirk Street & Dundas Street <i>Unsignalized</i>	Low volumes at intersection return LOS A and zero second delay for intersection								
Selkirk Street & Montgomery Street <i>Unsignalized</i>	EB	B	0.11	10.4	3.0	B	0.17	10.5	4.5
	WB	A	0.09	9.7	2.3	A	0.06	9.2	1.5
	NB	A	0.00	7.5	0.0	A	0.00	7.4	0.0
	SB	A	0.01	7.2	0.0	A	0.01	7.3	0.0
	Overall	A	-	5.3	-	A	-	6.2	-
McArthur Avenue & North River Road <i>Signalized</i>	EB	A	0.02	14.4	3.5	A	0.08	18.4	9.4
	WBT/L	A	0.04	11.5	5.8	A	0.10	20.9	11.8
	WBR	A	0.30	8.1	22.8	A	0.42	12.4	32.9
	NB	A	0.18	8.1	16.5	A	0.20	7.2	19.0
	SBL	B	0.61	18.2	54.6	C	0.73	21.8	#89.6
	SBT/R	A	0.12	9.0	13.1	A	0.14	7.9	15.9
	Overall	A	0.42	12.7	-	A	0.55	15.1	-
McArthur Avenue & Dundas Street <i>Unsignalized</i>	EB	A	0.01	8.9	0.0	A	0.01	8.6	0.0
	WB	-	-	-	-	-	-	-	-
	SB	B	0.07	14.9	1.5	C	0.11	19.5	3.0
	Overall	A	-	0.6	-	A	-	0.7	-

Intersection	Lane	AM Peak Hour				PM Peak Hour			
		LOS	V/C	Delay	Q (95 th)	LOS	V/C	Delay	Q (95 th)
McArthur Avenue & Mayfield Street <i>Unsignalized</i>	EB	-	-	-	-	-	-	-	-
	WB	-	-	-	-	-	-	-	-
	SBL	C	0.14	17.9	3.8	C	0.13	20.1	3.0
	SBR	B	0.01	11.1	0.0	B	0.01	11.0	0.0
	Overall	A	-	0.9	-	A	-	0.8	-
McArthur Avenue & Marguerite Street <i>Signalized</i>	EBT/R	A	0.29	4.1	23.0	A	0.37	5.0	38.2
	WBT/L	A	0.37	7.7	m50.0	A	0.35	6.2	51.8
	NBL	A	0.03	20.6	3.9	A	0.08	24.2	7.0
	NBR	A	0.12	8.9	5.5	A	0.20	9.0	7.7
	Overall	A	0.35	6.3	-	A	0.36	6.1	-
McArthur Avenue & Vanier Parkway <i>Signalized</i>	EBL	A	0.29	65.9	21.7	A	0.38	67.2	28.5
	EBT	A	0.49	48.1	51.3	C	0.73	65.4	95.9
	EBR	B	0.66	18.4	35.3	E	0.97	60.7	#131.1
	WBL	C	0.71	75.0	42.8	E	0.96	100.1	#83.3
	WBT	A	0.51	52.2	77.8	B	0.62	56.6	97.3
	WBR	A	0.24	1.4	0.5	A	0.37	8.8	19.2
	NBL	F	1.16	164.3	#127.5	F	1.17	169.0	#129.8
	NBT	C	0.77	40.1	175.7	E	0.94	53.8	#231.0
	NBR	A	0.31	5.8	19.8	A	0.36	8.3	28.6
	SBL	C	0.76	83.7	m50.0	B	0.70	81.0	m40.3
	SBT	E	0.91	74.0	m#224.2	E	0.96	85.9	m187.0
	SBR	A	0.09	14.7	m5.7	A	0.12	18.9	m7.7
Overall	D	0.85	57.4	-	E	0.99	69.1	-	

Notes: Saturation flow rate of 1800 veh/h/lane
Queue is measured in metres
Peak Hour Factor = 1.00

Delay = average vehicle delay in seconds
m = metered queue
= volume for the 95th %ile cycle exceeds capacity

During both the AM and PM peak hours, the study area intersections operate similarly to the 2024 future background conditions. As in the existing conditions, at the intersection of Montreal Road and North River Road, high delays are anticipated on the westbound through/right movement during both peak hours. Similarly, as in the existing conditions, at the intersection of Montreal Road at Vanier Parkway, the eastbound through movement may exhibit extended queues during the AM peak hour and the southbound through/right movement is forecast to be over theoretical capacity and may be subject to high delays during the PM peak hour at this horizon.

7.3 Modal Share Sensitivity and Demand Rationalization Conclusions

With respect to background conditions, no rationalization for the forecasted traffic contributing to capacity issues is required. The Montreal Revitalization is expected to change the background volumes within the study area. Any residual demand requiring rationalization will be discussed in future study area TIAs.

The TIA supporting the zoning by-law amendment for both phases of the subject development was previously approved, and traffic volumes forecasted with the first phase of development of the subject parcel are consistent with those from the approved TIA. Therefore, travel demand for the subject development does not require rationalization.

8 Development Design

8.1 Design for Sustainable Modes

The proposed development is a residential site plan with underground parking for both automobiles and bicycles via an 11% grade for the ramps. Hard surface connections to existing area pedestrian facilities along the site's Montreal Road and Vanier Parkway frontages are proposed connecting to all site building entrances.

Stops for route #15 are within 200 metres' walk from the site, for route #9 within 300 metres' walk, for routes #14 and #18 within 400 metres' walk, and for route #19 within 500 metres' walk.

8.2 Circulation and Access

Access for vehicles and cyclists is provided via a left-in/left-out access on Palace Street on the west side of the site. Garbage collection is to take place on the internal site drive aisles and a fire route is designated along the internal site drive aisles serving both site buildings. Aisle widths and radii permit the intended site operations and turning template for site design vehicles are provided in Appendix I.

9 Parking

9.1 Parking Supply

The site provides 436 bicycle parking spaces for the first phase of development, with 410 parking spaces provided below ground on the first parking level and 26 spaces are provided in surface racks near building entrances. Also within the first underground parking level as part of phase one, 465 bicycle parking spaces will be reserved for the second phase of development. A total of 390 vehicle parking spaces are proposed, with 358 for residents and 32 for visitors, with 376 spaces across three parking levels and 14 spaces in surface lots. The minimum parking provision from the zoning by-law is 203 resident vehicle parking spaces, 32 visitor vehicle parking spaces, and 215 bicycle parking spaces. Therefore, the minimum parking requirements from the zoning by-law are satisfied.

10 Boundary Street Design

Table 23 summarizes the MMLOS analysis for the site boundary roads of Montreal Road, Vanier Parkway, and Palace Street. Where the existing and future conditions will be the same, they are considered in one row. In the case of Vanier Parkway, the Phase 2 conditions will be considered for the future analysis. The analysis is based on the policy area "Within 300m of a school", Mauril-Belanger Elementary School. The MMLOS worksheets are provided in Appendix J.

Table 23: Boundary Street Segment MMLOS Analysis

Segment		Pedestrian LOS		Bicycle LOS		Transit LOS		Truck LOS	
		PLOS	Target	BLOS	Target	TLOS	Target	TkLOS	Target
Vanier Pkwy	Ex.	F	A	F	C	D	D	A	D
	Fut.	D	A	A	C	D	D	A	D
Montreal Rd	Ex./Fut.	C	A	E	C	D	C	C	D
Palace St	Ex./Fut.	F	A	B	B	-	-	-	-

The site boundary streets do not meet the MMLOS targets for pedestrian LOS Montreal Road and for Vanier Parkway in the existing conditions and Montreal Road does not meet the bicycle LOS targets.

The pedestrian LOS target of A will not be met on Montreal Road and Vanier Parkway, typical of arterial roads. On Palace Street, no sidewalks are present and a 1.8-metre-wide sidewalk with a two-metre-wide boulevard, or a two-metre-wide sidewalk with a 0.5-metre-wide boulevard would be required to meet targets.

Bicycle LOS on Montreal Road is limited by the mixed traffic conditions and would require physically separated facilities to meet targets.

Overall, no recommended improvements along the boundary streets are proposed as part of this Phase 1 site plan. During Phase 2, improvements will be undertaken along Vanier Parkway in conjunction with the new access. Montreal Road has recently been studied and redesigned by the City, and therefore are assumed to meet City MMLOS objectives for this corridor.

11 Access Intersections Design

11.1 Location and Design of Access

The site accesses consist of a left-in/left-out connection onto Palace Street via a 6.7-metre-wide driveway with an approximately 15-metre-long clear throat. The curb radius on the north side of the access is 18.0 metres constituting a gradual return given the access location on the bend of Palace Street, and the curb radius on the south side of the access is 5.0 metres, each permitting ingress and egress for emergency services and garbage collection vehicles. The site access is approximately 4.5 metres from the adjacent property line to the north on Palace Street and approximately 2.5 metres from the adjacent property to the south.

The existing site access on Montreal Road is to be removed as part of development. The construction interim access is proposed on the Vanier Parkway frontage to avoid community impacts of vehicles entering and exiting the site. The proposed interim access width is anticipated to be a typical width to permit contractor vehicles to turn right, both inbound and outbound, and will be controlled per Ontario Traffic Manual (OTM) Book 7. Similarly, the truck entrance signage will need to be compliant with OTM Book 7. The contractor will be responsible for submitting the interim access size and signage prior to opening of the access. It is noted that pedestrian movements along Vanier Parkway must be maintained throughout the construction timeframe and have priority at the interim access crossing.

11.2 Intersection Control

Based on the projected volumes, site access will have a stop-control on the minor access approach. No further traffic control is necessary to address operational issues.

11.3 Access Intersection Design

11.3.1 2024 Future Total Access Intersection Operations

The 2024 future total future traffic volumes have been illustrated in Figure 16. The level of service is based on average delay for unsignalized intersections. The synchro worksheets have been provided in Appendix K.

It is noted that given the low volumes at the site access, negligible delay and no level of service value result from the Synchro analysis and the intersection is anticipated to operate well.

11.3.2 2029 Future Total Access Intersection Operations

The 2029 future total intersection volumes are illustrated in Figure 17. The level of service is based on average delay for unsignalized intersections. The synchro worksheets have been provided in Appendix L.

It is again noted that given the low volumes at the site access, negligible delay and no level of service value result from the Synchro analysis and the intersection is anticipated to operate well.

Figure 16: 2024 Future Total Volumes

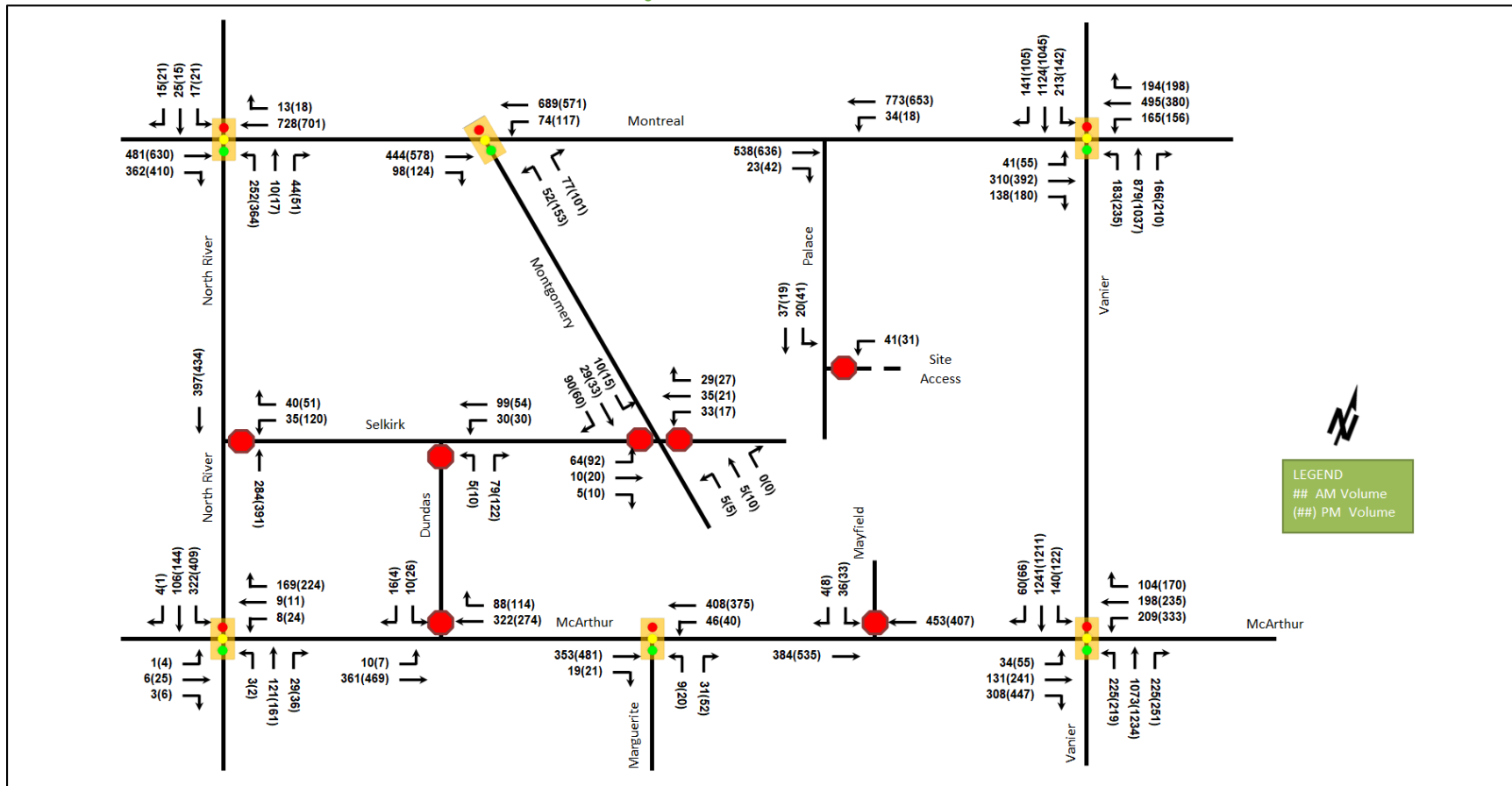
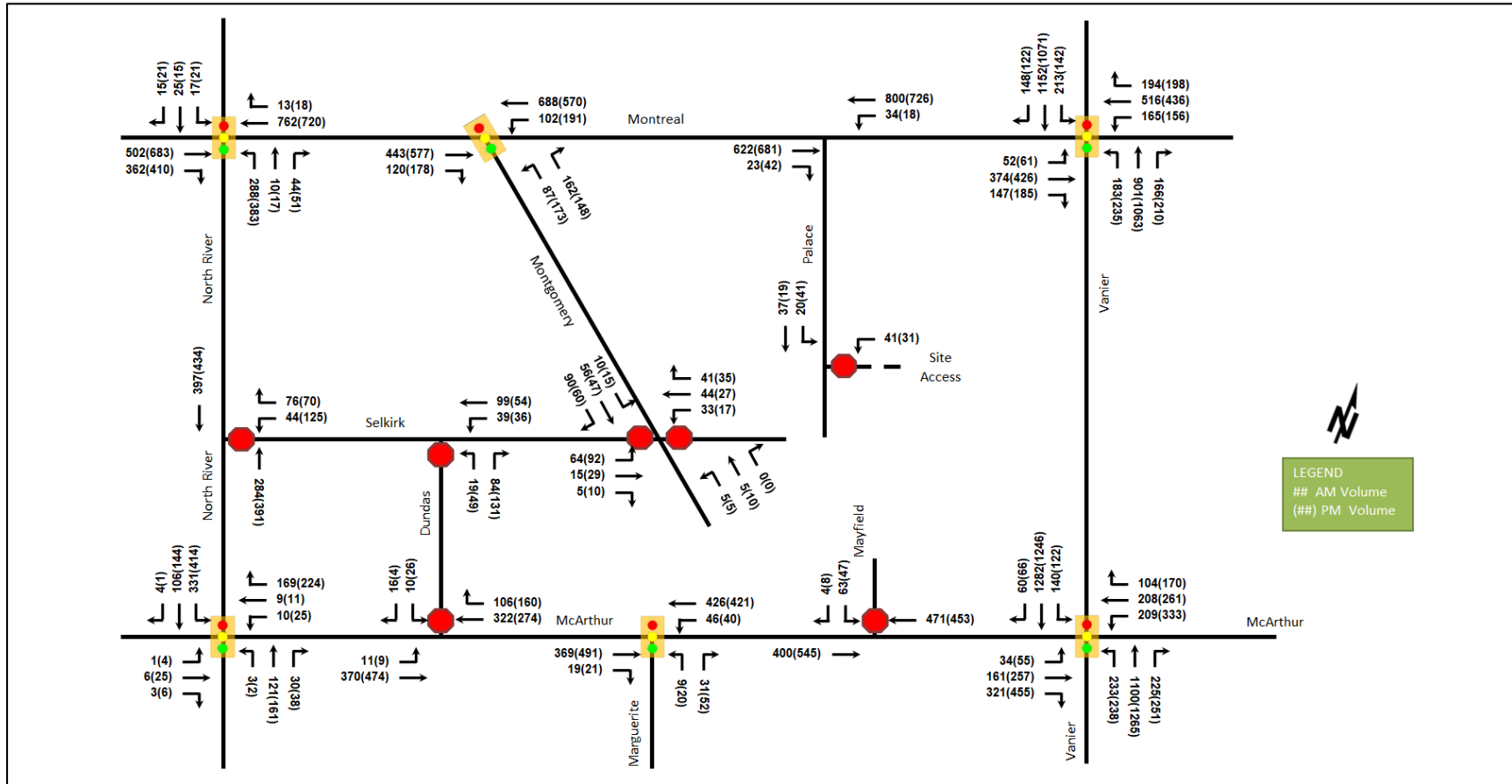

Figure 17: 2029 Future Total Volumes



11.3.3 Access Intersection MMLoS

As the access intersection is unsignalized, no access intersection MMLoS analysis is required.

11.3.4 Recommended Design Elements

As noted above, the site access is 2.5 metres from the adjacent property line to the south, which is under the three metres recommended by the private approach by-law. The location of the access is constrained by property for the provision of a sidewalk on the north side of the driveway. Furthermore, no impacts to the adjacent property are noted as a building on that site is 0.5 metres from the subject property line. Site plan approval in exemption to the private approach by-law will be required.

12 Transportation Demand Management

12.1 Context for TDM

The mode shares used within the TIA represent a slight shift to in transit from the typical district shares and these assumptions have been carried through the analysis. Given the presence of the transit priority corridor, the increase in transit modal share of 5% in each peak hour are likely to be achieved.

The site intersects the Montreal Arterial Mainstreet design priority area. A unit breakdown of 291 one-bedroom units, 107 two-bedroom units, and 32 three-bedroom units is proposed for a total of 601 bedrooms within the development. No age restrictions are noted.

12.2 Need and Opportunity

The mode shares used within the TIA represent a minor change from the typical recommended district mode shares. Risks associated with failing to meet mode share targets would result in a negligible increase in traffic on the overcapacity northbound left movement at the intersection of McArthur Avenue at Vanier Parkway. Supportive TDM measures should be included to achieve these and potential further shifts towards transit.

12.3 TDM Program

The “suite of post occupancy TDM measures” has been summarized in the TDM checklists for both the residential and non-residential land uses. The checklist is provided in Appendix M.

The key TDM measures recommended include:

- Posting of pedestrian, cycling, and transit information and maps at primary entrances/exits
- Inclusion of a 1-year Presto card for first time new residential and retail tenants, along with a set time frame for this offer (e.g., 6-months) from the ‘opening’ of the buildings/towers
- Contract with provider to install on-site micromobility (e.g., scooter or bike share) station
- Contract with provider to install on-site carshare vehicles and promote their use by residents
- Provide a permanent bicycle repair station with common tools for the use of residents
- Unbundle parking from rental costs

13 Neighbourhood Traffic Management

The proposed development will connect to the arterial network via Palace Street (a local road) and is additionally forecasted to make use of Selkirk Street (a local road) and Montgomery Street (a local road). The TIA guidelines have outlined neighbourhood traffic management thresholds of 120 two-way vehicles on local roads. City Staff have noted that these NTM thresholds are too low for the purposes of the analysis, and they under review and

will be updated in the future. The volumes at the 2024 future background horizon and the site volumes each by peak hour are summarized for each road in the NTM analysis in Table 24.

Table 24: 2024 NTM Review

Segment	AM Peak Hour				PM Peak Hour			
	NB	SB	Two-Way	Site Vols	NB	SB	Two-Way	Site Vols
Palace Street	-	37	37	21	-	19	19	41
Montgomery Street	120	172	292	9	247	241	488	7
Segment	AM Peak Hour				PM Peak Hour			
	EB	WB	Two-Way	Site Vols	EB	WB	Two-Way	Site Vols
Selkirk Street	-	61	61	15	-	162	162	9

As noted above, Montgomery Street and Selkirk Street are above NTM thresholds in the background conditions. The site is forecast to contribute 15 vehicles or less to each road. Thus, no impact to the roads functions or classifications are forecast to result from the proposed development.

14 Transit

14.1 Route Capacity

In section 5.1 the trip generation by mode was estimated, including an estimate of the number of transit trips that will be generated by the proposed development. Table 25 summarizes the transit trip generation.

Table 25: Trip Generation by Transit Mode

Travel Mode	Residential Mode Share	AM Peak Hour			PM Peak Hour		
		In	Out	Total	In	Out	Total
Transit	33%-43%	26	57	83	35	26	61

The proposed development is anticipated to generate an additional 83 AM and 61 PM peak hour two-way transit trips. From the trip distribution found in section 5.2, these values can be further broken down. Table 26 summarizes forecasted site-generated transit ridership trips by direction, the routes that are impacted, and the equivalent bus loads.

Table 26: Forecasted Site-Generated Transit Ridership

Direction	AM Peak Hour		PM Peak Hour		Routes Serving	Approximate Equivalent Peak Hour/Direction Bus Loads
	In	Out	In	Out		
North	1	3	2	1	#9	Negligible
South	8	17	11	8	#9, #12, #18, #19	One third of a standard bus
East	7	14	9	7	#12, #14, #15	One quarter of a standard bus
West	10	23	14	10	#14, #15, #18, #19	Half of a standard bus

14.2 Transit Priority

No impacts to the Montreal Road transit priority result from the site access location on Palace Street. As summarized in Section 10.2.3, no change in transit LOS is noted throughout the study area.

15 Network Intersection Design

15.1 Network Intersection Control

No change in control is recommended for the network intersections as part of this study.

15.2 Network Intersection Design

15.2.1 2024 Future Total Network Intersection Operations

Figure 14 illustrates the 2024 total volumes and Table 21 summarizes the 2024 total intersection operations. The level of service for signalized intersections is based on v/c calculations for individual lane movements and HCM 2000 v/c calculations for the overall intersection, and average delay for unsignalized intersections. The synchro worksheets for the 2024 future background horizon are provided in Appendix K.

Table 27: 2024 Future Total Intersection Operations

Intersection	Lane	AM Peak Hour				PM Peak Hour			
		LOS	V/C	Delay	Q (95 th)	LOS	V/C	Delay	Q (95 th)
Montreal Road & North River Road <i>Signalized</i>	EBT/R	C	0.75	32.0	#110.2	C	0.80	32.9	#152.6
	WBT/R	B	0.61	64.2	83.0	A	0.52	77.3	92.7
	NBL	C	0.71	45.2	64.2	D	0.83	58.1	107.5
	NBT/R	A	0.11	9.1	8.8	A	0.12	10.1	11.6
	SB	A	0.33	36.4	18.7	A	0.40	45.7	21.9
	Overall	A	0.60	45.5	-	B	0.69	50.8	-
Montreal Road & Montgomery Street <i>Signalized</i>	EBT/R	A	0.22	3.9	18.4	A	0.29	5.9	28.5
	WBT/L	A	0.37	4.8	33.1	A	0.40	5.8	35.3
	NBL	A	0.23	33.2	16.3	B	0.65	52.6	46.5
	NBR	A	0.31	11.3	10.8	A	0.37	11.4	13.4
	Overall	A	0.37	5.8	-	A	0.44	10.5	-
Montreal Road & Vanier Parkway <i>Signalized</i>	EBL	A	0.39	73.0	23.0	A	0.47	74.5	28.4
	EBT	C	0.76	62.2	#114.9	D	0.83	64.5	#169.9
	EBR	A	0.31	8.4	16.5	A	0.36	9.0	21.4
	WBL	F	1.09	155.2	#96.9	C	0.74	78.3	63.9
	WBT/R	C	0.77	50.4	#125.7	A	0.53	35.4	84.3
	NBL	C	0.79	89.2	m73.1	D	0.88	88.8	m78.8
	NBT/R	B	0.70	44.4	80.4	E	0.95	72.3	m#163.3
	SBL	D	0.84	84.5	#93.0	B	0.70	76.2	58.2
	SBT/R	C	0.80	47.0	140.0	E	0.99	77.0	#154.3
Overall	D	0.88	55.3	-	D	0.89	66.3	-	
Selkirk Street & North River Road <i>Unsignalized</i>	WB	B	0.15	13.3	3.8	C	0.41	19.2	14.3
	NB	-	-	-	-	-	-	-	-
	SB	-	-	-	-	-	-	-	-
	Overall	A	-	1.3	-	A	-	3.3	-
Selkirk Street & Dundas Street <i>Unsignalized</i>	Low volumes at intersection return LOS A and zero second delay for intersection								
Selkirk Street & Montgomery Street <i>Unsignalized</i>	EB	B	0.10	10.1	2.3	B	0.15	10.3	3.8
	WB	A	0.11	9.8	3.0	A	0.08	9.5	1.5
	NB	A	0.00	7.5	0.0	A	0.00	7.4	0.0
	SB	A	0.01	7.2	0.0	A	0.01	7.3	0.0
	Overall	A	-	5.9	-	A	-	6.5	-
McArthur Avenue & North River Road <i>Signalized</i>	EB	A	0.02	14.4	3.5	A	0.08	18.4	9.4
	WBT/L	A	0.03	11.6	5.4	A	0.10	21.0	11.6
	WBR	A	0.31	8.2	22.6	A	0.43	12.6	33.6
	NB	A	0.18	8.3	17.0	A	0.21	7.4	20.2
	SBL	A	0.60	17.8	52.8	C	0.73	21.6	#81.4
	SBT/R	A	0.13	9.1	14.0	A	0.15	8.0	16.4
Overall	A	0.42	12.5	-	A	0.55	15.0	-	

Intersection	Lane	AM Peak Hour				PM Peak Hour			
		LOS	V/C	Delay	Q (95 th)	LOS	V/C	Delay	Q (95 th)
McArthur Avenue & Dundas Street <i>Unsignalized</i>	EB	A	0.01	8.9	0.0	A	0.01	8.5	0.0
	WB	-	-	-	-	-	-	-	-
	SB	B	0.07	14.7	1.5	C	0.10	18.8	2.3
	Overall	A	-	0.6	-	A	-	0.7	-
McArthur Avenue & Mayfield Street <i>Unsignalized</i>	EB	-	-	-	-	-	-	-	-
	WB	-	-	-	-	-	-	-	-
	SBL	C	0.11	17.0	3.0	C	0.11	18.9	3.0
	SBR	B	0.01	11.0	0.0	B	0.01	10.7	0.0
	Overall	A	-	0.7	-	A	-	0.7	-
McArthur Avenue & Marguerite Street <i>Signalized</i>	EBT/R	A	0.28	4.0	21.2	A	0.37	4.9	37.4
	WBT/L	A	0.36	7.3	m48.1	A	0.32	6.0	46.1
	NBL	A	0.03	20.6	3.9	A	0.08	24.2	7.0
	NBR	A	0.12	8.9	5.5	A	0.20	9.0	7.7
	Overall	A	0.34	6.1	-	A	0.35	6.0	-
McArthur Avenue & Vanier Parkway <i>Signalized</i>	EBL	A	0.29	66.0	21.3	A	0.38	67.2	28.5
	EBT	A	0.42	46.4	43.3	B	0.69	62.9	90.8
	EBR	B	0.67	18.8	34.9	E	0.97	60.9	#131.7
	WBL	C	0.71	75.0	42.8	E	0.96	100.9	#83.3
	WBT	A	0.49	51.8	74.9	A	0.57	54.6	88.7
	WBR	A	0.24	1.4	0.5	A	0.37	8.8	19.2
	NBL	F	1.12	155.3	#123.5	F	1.09	146.8	#119.4
	NBT	C	0.75	39.2	170.2	E	0.92	51.4	#223.1
	NBR	A	0.31	5.5	18.8	A	0.36	8.0	27.6
	SBL	C	0.76	84.0	m51.3	B	0.70	82.0	m41.3
	SBT	D	0.88	72.5	m#211.4	E	0.94	84.0	m185.6
	SBR	A	0.09	14.9	m5.9	A	0.12	19.2	m8.4
Overall	D	0.82	56.0	-	E	0.97	66.2	-	

Notes: Saturation flow rate of 1800 veh/h/lane
Queue is measured in metres
Peak Hour Factor = 1.00

Delay = average vehicle delay in seconds
m = metered queue
= volume for the 95th %ile cycle exceeds capacity

The network intersections at the 2024 future total horizon are forecast to operate similarly to the 2024 future background conditions. No new capacity issues are noted.

15.2.2 2029 Future Total Network Intersection Operations

Figure 15 illustrates the 2029 total volumes and Table 22 summarizes the 2029 total intersection operations. The level of service for signalized intersections is based on v/c calculations for individual lane movements and HCM 2000 v/c calculations for the overall intersection, and average delay for unsignalized intersections. The synchro worksheets for the 2029 future background horizon are provided in Appendix L.

Table 28: 2029 Future Total Intersection Operations

Intersection	Lane	AM Peak Hour				PM Peak Hour			
		LOS	V/C	Delay	Q (95 th)	LOS	V/C	Delay	Q (95 th)
Montreal Road & North River Road <i>Signalized</i>	EBT/R	D	0.86	40.7	#120.6	D	0.86	38.6	#172.6
	WBT/R	C	0.72	84.1	90.5	A	0.56	82.4	97.1
	NBL	B	0.69	40.5	71.8	D	0.84	56.9	112.6
	NBT/R	A	0.10	8.4	8.4	A	0.12	9.7	11.4
	SB	A	0.33	36.4	18.7	A	0.40	45.7	21.9
	Overall	B	0.64	56.2	-	C	0.73	54.7	-

Intersection	Lane	AM Peak Hour				PM Peak Hour			
		LOS	V/C	Delay	Q (95 th)	LOS	V/C	Delay	Q (95 th)
Montreal Road & Montgomery Street <i>Signalized</i>	EBT/R	A	0.25	4.7	18.6	A	0.32	6.1	29.7
	WBT/L	A	0.44	5.9	36.0	A	0.51	7.3	44.8
	NBL	A	0.38	36.2	24.2	B	0.69	54.7	52.1
	NBR	A	0.49	10.9	15.2	A	0.46	11.0	16.0
	Overall	A	0.43	7.6	-	A	0.54	11.6	-
Montreal Road & Vanier Parkway <i>Signalized</i>	EBL	A	0.46	75.0	27.5	A	0.50	74.9	30.6
	EBT	E	0.91	78.8	#159.0	E	0.91	73.1	#191.2
	EBR	A	0.33	8.4	17.0	A	0.37	11.0	25.3
	WBL	F	1.09	155.2	#96.9	C	0.74	78.3	63.9
	WBT/R	C	0.80	52.8	#134.4	A	0.59	38.4	97.3
	NBL	C	0.79	88.4	m71.0	D	0.88	87.6	m76.8
	NBT/R	C	0.71	45.1	81.8	E	0.97	74.8	m#163.3
	SBL	D	0.84	84.5	#93.0	B	0.70	76.2	58.2
	SBT/R	D	0.83	48.0	144.9	F	1.03	85.6	#163.4
Overall	E	0.91	57.6	-	E	0.93	70.4	-	
Selkirk Street & North River Road <i>Unsignalized</i>	WB	B	0.23	13.8	6.8	C	0.45	20.0	17.3
	NB	-	-	-	-	-	-	-	-
	SB	-	-	-	-	-	-	-	-
	Overall	A	-	2.1	-	A	-	3.8	-
Selkirk Street & Dundas Street <i>Unsignalized</i>	Low volumes at intersection return LOS A and zero second delay for intersection								
Selkirk Street & Montgomery Street <i>Unsignalized</i>	EB	B	0.12	10.6	3.0	B	0.17	10.7	4.5
	WB	B	0.14	10.0	3.8	A	0.09	9.6	2.3
	NB	A	0.00	7.5	0.0	A	0.00	7.4	0.0
	SB	A	0.01	7.2	0.0	A	0.01	7.3	0.0
	Overall	A	-	5.9	-	A	-	6.6	-
McArthur Avenue & North River Road <i>Signalized</i>	EB	A	0.02	14.4	3.5	A	0.08	18.4	9.4
	WBT/L	A	0.04	11.5	5.7	A	0.10	20.8	11.8
	WBR	A	0.31	8.1	23.2	A	0.43	12.4	33.9
	NB	A	0.18	8.2	17.0	A	0.21	7.4	20.3
	SBL	B	0.62	18.4	54.9	C	0.74	22.3	#90.3
	SBT/R	A	0.13	9.1	14.0	A	0.15	8.0	16.4
	Overall	A	0.43	12.7	-	A	0.56	15.2	-
McArthur Avenue & Dundas Street <i>Unsignalized</i>	EB	A	0.01	9.0	0.0	A	0.01	8.7	0.0
	WB	-	-	-	-	-	-	-	-
	SB	B	0.07	14.9	1.5	C	0.11	19.6	3.0
	Overall	A	-	0.6	-	A	-	0.7	-
McArthur Avenue & Mayfield Street <i>Unsignalized</i>	EB	-	-	-	-	-	-	-	-
	WB	-	-	-	-	-	-	-	-
	SBL	C	0.20	18.9	5.3	C	0.17	21.1	4.5
	SBR	B	0.01	11.1	0.0	B	0.01	11.0	0.0
	Overall	A	-	1.3	-	A	-	1.0	-
McArthur Avenue & Marguerite Street <i>Signalized</i>	EBT/R	A	0.29	4.2	23.3	A	0.37	5.0	38.2
	WBT/L	A	0.37	7.8	m50.4	A	0.36	6.3	52.9
	NBL	A	0.03	20.6	3.9	A	0.08	24.2	7.0
	NBR	A	0.12	8.9	5.5	A	0.20	9.0	7.7
	Overall	A	0.35	6.4	-	A	0.36	6.1	-

Intersection	Lane	AM Peak Hour				PM Peak Hour			
		LOS	V/C	Delay	Q (95 th)	LOS	V/C	Delay	Q (95 th)
McArthur Avenue & Vanier Parkway <i>Signalized</i>	EBL	A	0.29	65.9	21.7	A	0.38	67.2	28.5
	EBT	A	0.50	48.6	53.1	C	0.73	64.7	97.3
	EBR	B	0.69	19.8	38.5	E	0.98	63.3	#136.9
	WBL	C	0.71	75.0	42.8	E	0.99	109.4	#83.3
	WBT	A	0.51	52.2	78.5	B	0.63	57.0	98.7
	WBR	A	0.23	1.4	0.5	A	0.37	8.8	19.2
	NBL	F	1.17	167.4	#128.6	F	1.19	175.4	#132.1
	NBT	C	0.77	40.2	176.4	E	0.94	54.4	#232.7
	NBR	A	0.31	5.9	20.0	A	0.37	8.4	28.8
	SBL	C	0.76	83.5	m50.0	B	0.70	80.6	m40.1
	SBT	E	0.91	74.4	m#224.2	E	0.96	86.2	m185.8
	SBR	A	0.09	14.8	m5.5	A	0.12	18.9	m7.7
Overall	D	0.85	57.8	-	E	1.00	70.6	-	

Notes: Saturation flow rate of 1800 veh/h/lane
Queue is measured in metres
Peak Hour Factor = 1.00

Delay = average vehicle delay in seconds
m = metered queue
= volume for the 95th %ile cycle exceeds capacity

The network intersection operations for the 2029 future total horizon operate similarly to the 2029 future background conditions. No new capacity issues are noted.

15.2.3 Network Intersection MMLOS

Table 25 summarizes the MMLOS analysis for the network intersections in the study area. The existing and future conditions will be the same and are considered in one row. The analysis is based on the policy area “Within 300m of a school,” with the study area intersections falling within 300m of Mauril-Belanger Elementary School. The MMLOS worksheets have been provided in Appendix J.

Table 29: Study Area Intersection MMLOS

Intersection	Pedestrian LOS		Bicycle LOS		Transit LOS		Truck LOS		Auto LOS	
	PLOS	Target	BLOS	Target	TLOS	Target	TkLOS	Target	ALOS	Target
Montreal Road & North River Road	E	A	E	C	F	C	-	-	D	E
Montreal Road & Montgomery Street	E	A	E	C	B	C	-	-	A	E
Montreal Road & Vanier Parkway	F	A	F	C	F	C	D	E	E	E
McArthur Avenue & North River Road	F	A	E	C	D	D	-	-	A	E
McArthur Avenue & Marguerite Street	D	A	E	B	B	D	-	-	A	E
McArthur Avenue & Vanier Parkway	F	A	F	C	F	D	A	E	D	E

Throughout the study area, pedestrian and cycling LOS targets will not be met at all intersections and transit LOS targets will not be met at the arterial-arterial intersections of Montreal Road at North River Road, Montreal Road at Vanier Parkway, and McArthur Road at Vanier Parkway.

To meet pedestrian LOS at all intersections, the maximum crossing distances would need to be no more than two lane widths at all crossings. To meet cycling LOS targets, protected crossings on the eastbound approach of the

intersection of Montreal Road at Vanier Parkway, and on the northbound and southbound approaches of the intersection of McArthur Avenue at Vanier Parkway, and left-turn boxes/two-stage left-turns on all multi-lane approaches. To meet transit LOS, the delay would need to be reduced to below 30 seconds on all transit approach movements.

As the Montreal Road was recently reconstructed, and McArthur Avenue has been improved within the past five years, it is assumed the City's desired balance of MMLOS objectives has been achieved at all signalized study area intersections.

15.2.4 Recommended Design Elements

No design elements are proposed for the network intersections as part of this study.

16 Summary of Improvements Indicated and Modifications Options

The following summarizes the analysis and results presented in this TIA report:

Proposed Site and Screening

- The proposed site includes an eight-storey mixed use building and a 37-storey residential building comprising a total of 430 apartment units and 2,525 ft² of commercial space
- Accesses to the site are proposed as one left-in/left-out access on Palace Street
- The site proposes the inclusion of 390 vehicle parking spaces
- The development is proposed as the first phase of the redevelopment of the site and is anticipated to be built-out by 2024
- The Trip Generation, Location, and Safety triggers were all met through the TIA Screening
- The application for the proposed site is for a site plan

Existing Conditions

- Montreal Road, Vanier Parkway, McArthur Avenue, and a portion of North River Road are the study area arterial roads
- Sidewalks are provided along both sides on North River Road, Vanier Parkway, Montreal Road, and McArthur Avenue, on both sides of Selkirk Street between Montgomery Street and Gardner Street, along the east side of Montgomery Street and on the west side of Montgomery Street between Mayfield Street and Selkirk Street, and on the east side of Gardner Street, and along the west side of Dundas Street, Mayfield Street and Marguerite Avenue
- Cycletracks are present on both sides of Montreal Road east of Vanier Parkway, bike lanes are provided along both sides of McArthur Avenue and on the north side of Montreal Road west of North River Road, a shared use lane is on the south side of Montreal Road west of North River Road, along the west side of North River Road is the Rideau River Eastern Pathway and MUP connections to the communities north of Montreal Road are provided to the intersection of Montreal Road at Vanier Parkway; North River Road, Vanier Parkway, and Montreal Road are spine routes
- The existing transit routes #9, 14, 15, 18, and 19 stop on the within walking distance of the proposed site
- The Montreal Road at Vanier Parkway and McArthur Avenue at Vanier Parkway intersections are noted to have capacity issues during both the AM and PM peak hours
- Given the recent Montreal Road Revitalization project, no further improvements are recommended to address the existing conditions

- Post-construction volumes will be modeled within the future traffic studies and condition should be monitored by the City for it to determine the impacts of the improvements and to apply any necessary mitigations.
- A number of collisions are noted along Montreal Road, of which the majority are rear end and sideswipe indicating that they are generally lower speed and a result of congestion

Development Generated Travel Demand

- The proposed development is forecasted to generate 185 two-way people trips during the AM peak hour and 189 two-way people trips during the PM peak hour
- Based on a 5% increase in transit mode share target from typical district shares due to the transit priority corridor along Montreal Road/Rideau Street, a total of 58 two-way vehicle trips will be generated during the AM peak hour and 64 two-way vehicle trips during the PM peak
- The distribution of the site trips is estimated to be 5% to the north, 30% to the south, 25% to the east, and 40% to the west

Background Conditions

- Area background development traffic was explicitly included on the network at the future horizons
- The background growth applied is an annual 0.5% growth on existing Vanier Parkway mainline volumes
- The future background intersection operations are anticipated to operate similarly to the existing conditions

Development Design

- Underground parking for bicycles and autos is proposed via a ramp with an 11% grade
- Pedestrian connections will be made between site building entrances and the surrounding sidewalks on Montreal Road and Vanier Parkway
- All area bus routes are within 500 metres' walk of the site buildings, with all but the route #19 being within 400 metres' walk
- Emergency services and garbage collection vehicles are able to circulate the site drive aisles

Parking

- The development is proposed as including 436 bicycle parking spaces for the first phase of development, reserving 465 bicycle spaces for later phases, and 390 vehicle parking spaces of which 358 are for residents and 32 are for visitors
- The zoning by-law prescribes a minimum of 225 bicycle spaces, 208 resident vehicles spaces, and 32 visitor parking spaces
- Minimum vehicle and bicycle parking provisions from the zoning by-law are being met

Boundary Street Design

- The site boundary streets do not meet the MMLoS targets for pedestrian LOS Montreal Road and for Vanier Parkway in the existing conditions and Montreal Road does not meet the bicycle LOS targets
- Pedestrian LOS targets will not typically be met on arterial roads, and Montreal Road would require separated bicycle facilities to meet Bicycle LOS targets
- No improvements are recommended as part of the Phase 1 site plan, as part of the Phase 2 site plan, improvements will be undertaken along Vanier Parkway in conjunction with the new access

- Montreal Road was recently redesigned and is assumed to meet City MMLOS objectives for the corridor

Access Intersections Design

- A 6.7-metre-wide left-in/left-out access on Place Street is proposed with an 18.0-metre curb return on the north side and a 5.0-metre curb return on the south side of the access
- The clear throat of the access is approximately 15 metres in length, and the access is proposed as being 4.5 metres from the north property line and 2.5 metres from the south property line on Palace Street
- The existing site access on Montreal is to be removed as part of the redevelopment
- The access intersection is anticipated to operate well at both future horizons
- The site access will be minor stop-controlled, and will require approval exempting it from the minimum three metres offset from an adjacent property line from the private approach by-law

TDM

- Supportive TDM measures include:
 - Posting of pedestrian, cycling, and transit information and maps at primary entrances/exits
 - Inclusion of a 1-year Presto card for first time new residential and retail tenants, along with a set time frame for this offer (e.g. 6-months) from the 'opening' of the buildings/towers
 - Contract with provider to install on-site bikeshare or scootershare station (multi-family)
 - Contract with provider to install on-site carshare vehicles and promote their use by residents
 - Provide a permanent bicycle repair station with common tools for the use of residents
 - Unbundle parking from rental costs

NTM

- Palace Street will be under local road thresholds, and Selkirk Street and Montgomery Street will be above local road thresholds in both the background and total conditions
- Site traffic is forecasted to be a marginal increase to the background traffic and is not anticipated to impact any of the roadway classifications

Transit

- The forecasted transit trips will include 83 two-way trips during the AM peak and 61 two-way trips during the PM peak
- Peak hour increases in transit ridership resulting from the site equate to a half bus load west of the site, a quarter of a standard bus load east of the site, a third of a standard bus load south of the site and a negligible increase in traffic north of the site
- No impact on transit priority are anticipated as a result of development based on access location or and no increase in transit LOS is anticipated to result from the addition of site traffic to the network

Network Intersection Design

- The network intersections at the future total horizons are forecast to operate similarly to the future background conditions
- The MMLOS targets for pedestrians will be met at all study area intersections, and bicycle and transit LOS will not be met at the arterial-arterial intersections of Montreal Road at North River Road, Montreal Road at Vanier Parkway, and McArthur Road at Vanier Parkway
- To meet pedestrian LOS targets, crossings would need to be no wider than three lane-widths

- To meet bicycle LOS, protected crossings on the eastbound approach of the intersection of Montreal Road at Vanier Parkway, and on the northbound and southbound approaches of the intersection of McArthur Avenue at Vanier Parkway, and all approaches would require two-stage left turn or left-turn boxes on all multi-lane approaches
- As the Montreal Road intersections and McArthur Avenue have been improved in the last five years, signalized intersections are assumed to meet the City's balance of MMLOS objectives

17 Conclusion

It is recommended that, from a transportation perspective, the proposed development applications proceed.

Prepared By:



John Kingsley, EIT
Transportation Engineering-Intern

Reviewed By:



Andrew Harte, P.Eng.
Senior Transportation Engineer

Appendix A

TIA Screening Form and PM Certification Form

City of Ottawa 2017 TIA Guidelines
Step 1 - Screening Form

Date: 09-Sep-22
Project Number: 2022-109
Project Reference: 112 Montreal Rd

1.1 Description of Proposed Development	
Municipal Address	112 Montreal Road
Description of Location	Ward 12 - PIN: 042370019 PLAN 29 LOT 5 PT LOT 6-7 BLK;2 LOT 88 & PT LOT 40 41 PLAN;49 RP4R-6112 PT 1 TOG WIT;ROW
Land Use Classification	Tradditional Mainstreet (TM(2363) F(3.5) S365-h
Development Size	484 apartment units, 2,200 sq. ft. commercial
Accesses	One left-in/left-out on Palace Street
Phase of Development	First phase
Buildout Year	2024
TIA Requirement	Full TIA Required

1.2 Trip Generation Trigger	
Land Use Type	Townhomes or apartments
Development Size	484 Units
Trip Generation Trigger	Yes

1.3 Location Triggers	
Does the development propose a new driveway to a boundary street that is designated as part of the City's Transit Priority, Rapid Transit or Spine Bicycle Networks?	No
Is the development in a Design Priority Area (DPA) or Transit-oriented Development (TOD) zone?	Yes
Location Trigger	Yes

1.4. Safety Triggers	
Are posted speed limits on a boundary street 80 km/hr or greater?	No
Are there any horizontal/vertical curvatures on a boundary street limits sight lines at a proposed driveway?	No
Is the proposed driveway within the area of influence of an adjacent traffic signal or roundabout (i.e. within 300 m of intersection in rural conditions, or within 150 m of intersection in urban/ suburban conditions)?	No
Is the proposed driveway within auxiliary lanes of an intersection?	No
Does the proposed driveway make use of an existing median break that serves an existing site?	No
Is there is a documented history of traffic operations or safety concerns on the boundary streets within 500 m of the development?	Yes
Does the development include a drive-thru facility?	No
Safety Trigger	Yes

Appendix B

Turning Movement Counts



Transportation Services - Traffic Services

Turning Movement Count - Full Study Peak Hour Diagram

MONTREAL RD @ NORTH RIVER RD

Survey Date: Tuesday, January 19, 2016
Start Time: 07:00

WO No: 35162
Device: Miovision

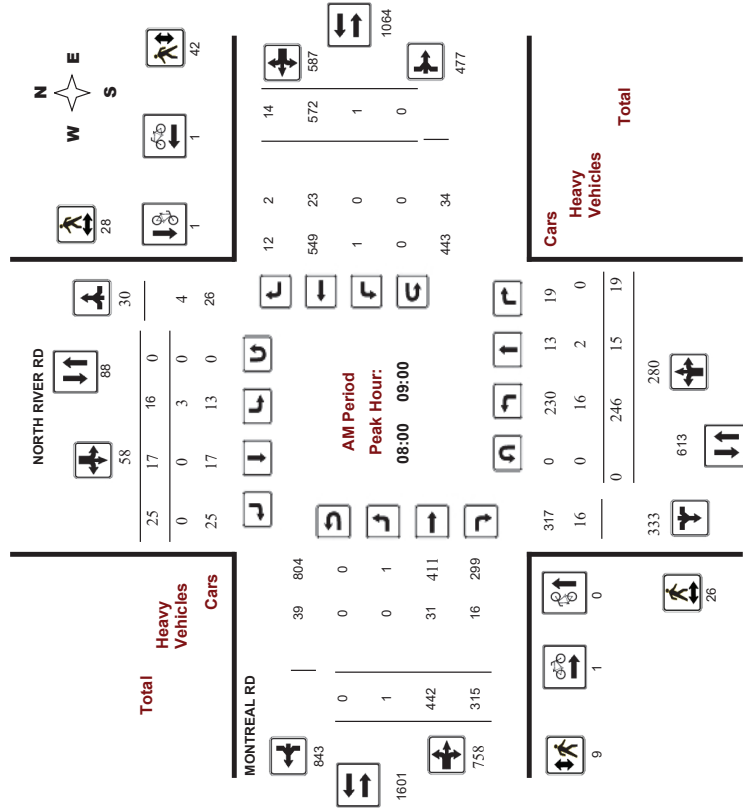

Comments



Transportation Services - Traffic Services

Turning Movement Count - Full Study Peak Hour Diagram

MONTREAL RD @ NORTH RIVER RD

Survey Date: Tuesday, January 19, 2016
Start Time: 07:00

WO No: 35162
Device: Miovision

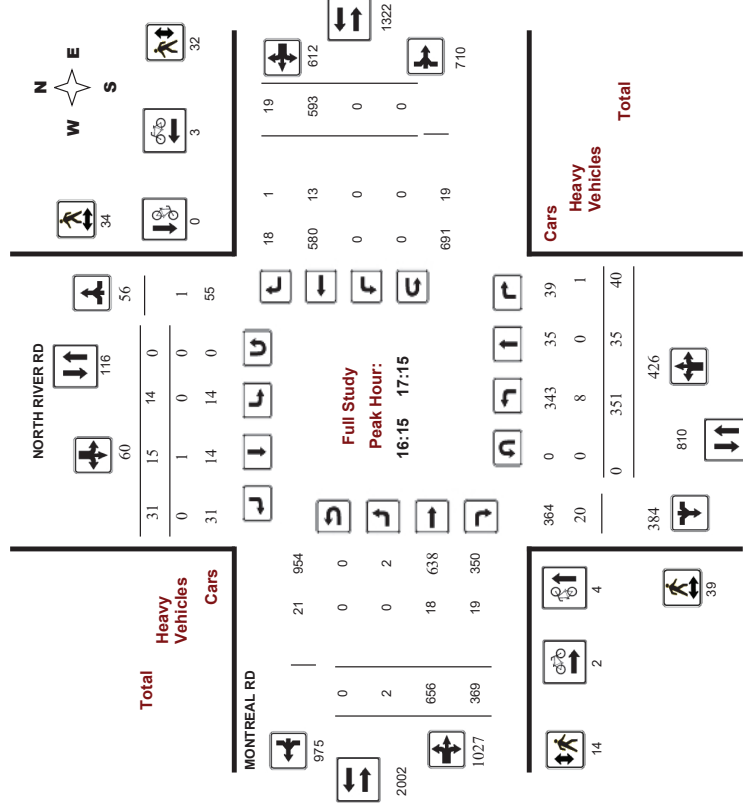

Comments



Transportation Services - Traffic Services
Turning Movement Count - Full Study Peak Hour Diagram
MONTREAL RD @ NORTH RIVER RD

Survey Date: Tuesday, January 19, 2016
 Start Time: 07:00

WO No: 35162
 Device: Miivision

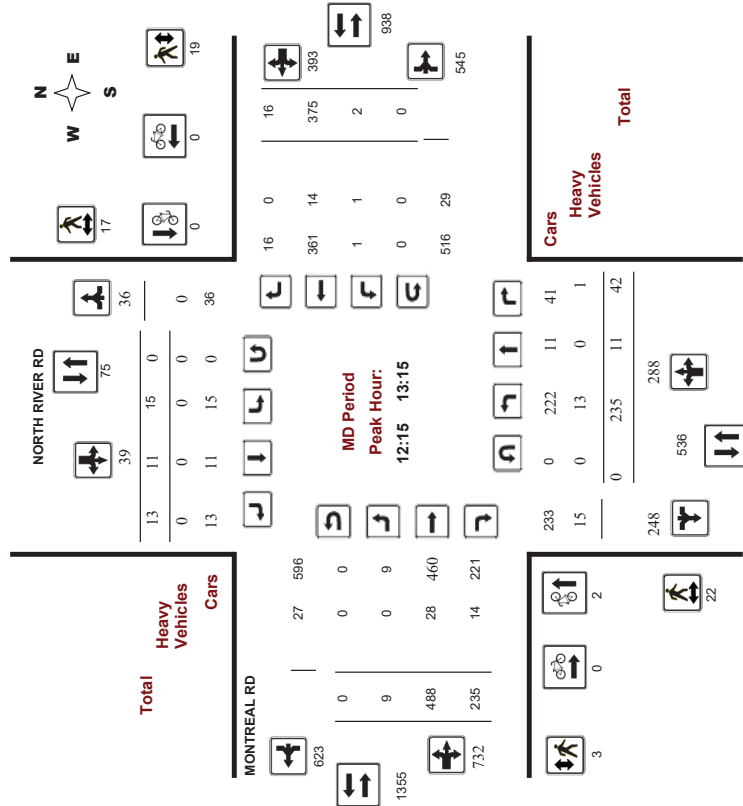

Comments



Transportation Services - Traffic Services
Turning Movement Count - Full Study Peak Hour Diagram
MONTREAL RD @ NORTH RIVER RD

Survey Date: Tuesday, January 19, 2016
 Start Time: 07:00

WO No: 35162
 Device: Miivision

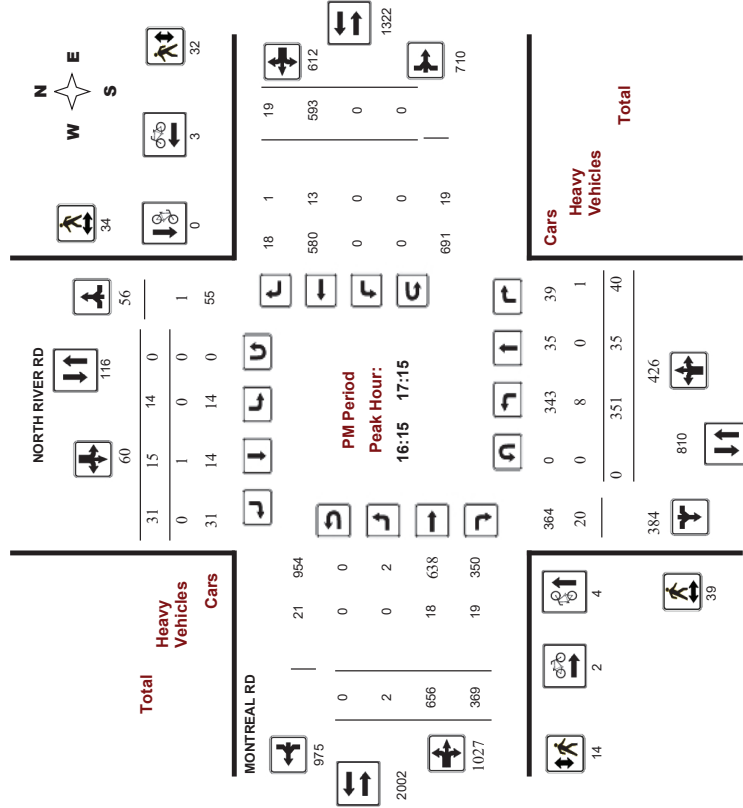

Comments



Transportation Services - Traffic Services
Turning Movement Count - Study Results
MONTREAL RD @ NORTH RIVER RD

Survey Date: Tuesday, January 19, 2016
Start Time: 07:00

WO No: 35162
Device: Miovision

Full Study Diagram

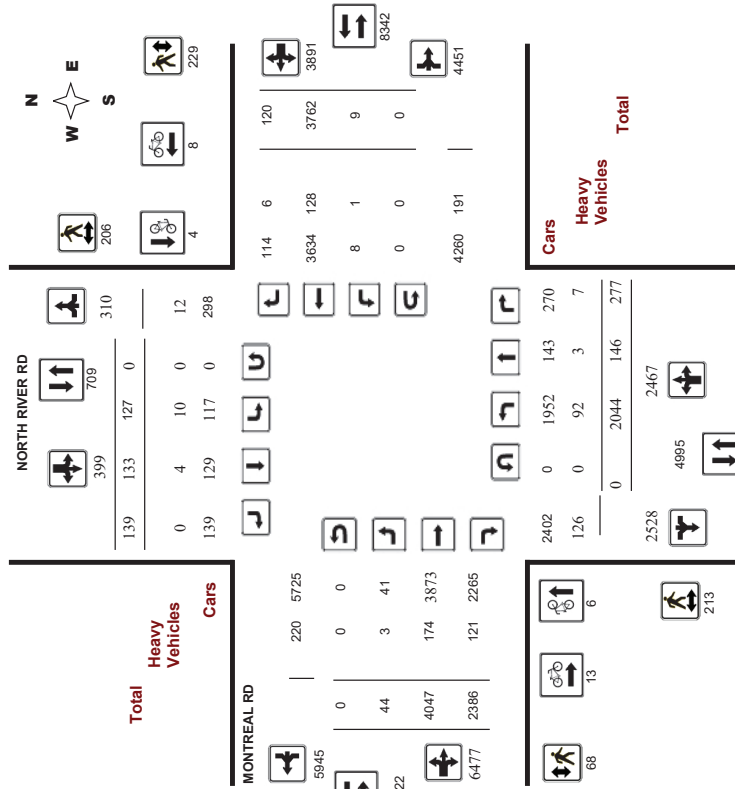

Transportation Services - Traffic Services
Turning Movement Count - Study Results
MONTREAL RD @ NORTH RIVER RD

Survey Date: Tuesday, January 19, 2016
Start Time: 07:00

WO No: 35162
Device: Miovision

Full Study Peak Hour Diagram

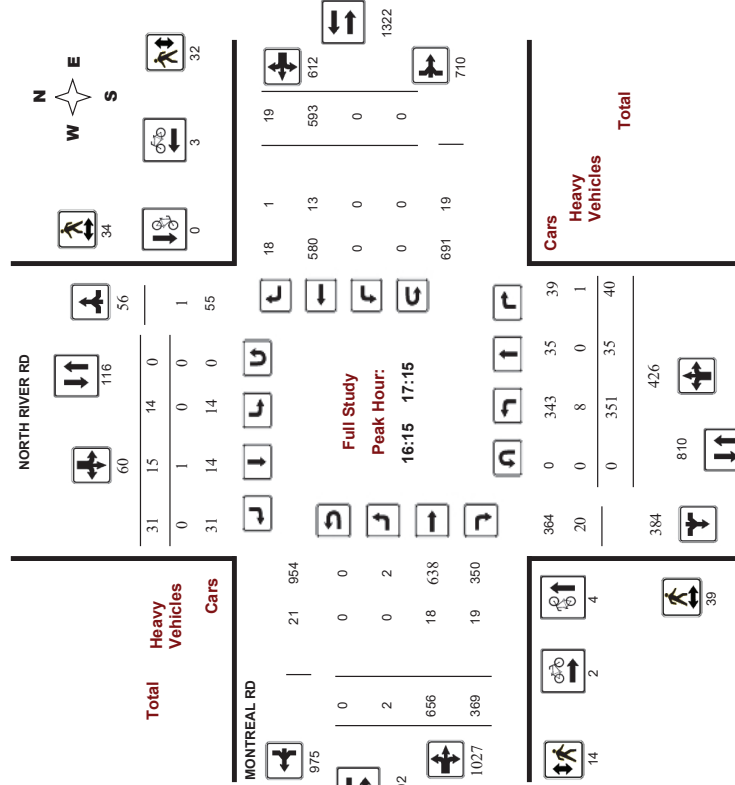



Transportation Services - Traffic Services

Turning Movement Count - Study Results

MONTREAL RD @ NORTH RIVER RD

Survey Date: Tuesday, January 19, 2016
 Start Time: 07:00

WO No: 35162
 Device: Miovision

Full Study Summary (8 HR Standard)

Total Observed U-Turns
 Northbound: 0 Southbound: 0 AADT Factor 1.53
 Eastbound: 0 Westbound: 0

Period	Northbound						Southbound						Eastbound			Westbound			WB TOT	STR TOT	Grand Total	
	Northbound			Southbound			Northbound			Southbound			EB TOT	LT	ST	RT	WB TOT	STR TOT				Grand Total
	LT	ST	RT	NB TOT	LT	ST	RT	SB TOT	LT	ST	RT	EB TOT										
07:00-08:00	158	4	25	187	17	9	6	32	219	2	408	284	684	1	412	6	419	1113	1332			
08:00-09:00	246	15	19	280	16	17	25	58	338	1	442	315	758	1	572	14	587	1345	1683			
09:00-10:00	188	12	26	226	12	18	2	32	258	5	419	245	669	2	361	10	373	1042	1300			
11:30-12:30	227	11	40	278	16	22	10	48	326	7	455	246	708	3	380	15	398	1106	1432			
12:30-13:30	225	12	42	279	14	14	13	41	320	10	494	238	742	0	368	13	381	1123	1443			
15:00-16:00	341	28	35	404	21	24	23	68	472	10	567	374	951	2	570	24	596	1547	2019			
16:00-17:00	358	39	47	444	16	13	34	63	507	2	637	350	989	0	607	16	623	1612	2119			
17:00-18:00	301	25	43	369	15	16	26	57	426	7	625	334	966	0	492	22	514	1480	1906			
Sub Total	2044	146	277	2467	127	133	139	399	2866	44	4047	2386	6477	9	3762	120	3891	10368	13234			
U-Turns	0	0	0	0	0	0	0	0	0	0	0	0	0	0	0	0	0	0	0			
Total	2044	146	277	2467	127	133	139	399	2866	44	4047	2386	6477	9	3762	120	3891	10368	13234			
EQ 12hr	2841	203	385	3429	177	185	193	555	3884	61	5625	3317	9003	13	5229	167	5408	14412	18395			
Note: These values are calculated by multiplying the totals by the appropriate expansion factor.																						
AVG 12hr	3125	223	424	3772	194	203	213	610	4382	67	6188	3648	9903	14	5752	183	5949	15853	20234			
Note: These values are calculated by multiplying the Equivalent 12 hr. totals by the AADT factor.																						
AVG 24hr	4084	292	555	4941	254	266	278	799	5740	88	8106	4779	12973	18	7535	240	7794	20767	26507			
Note: These volumes are calculated by multiplying the Average Daily 12 hr. totals by 12 to 24 expansion factor.																						
Note: U-Turns provided for approach totals. Refer to 'U-Turn' Report for specific breakdown.																						



Transportation Services - Traffic Services

Turning Movement Count - Study Results

MONTREAL RD @ NORTH RIVER RD

Survey Date: Tuesday, January 19, 2016
 Start Time: 07:00

WO No: 35162
 Device: Miovision

Full Study 15 Minute Increments

Total Observed U-Turns
 Northbound: 0 Southbound: 0 AADT Factor 1.53
 Eastbound: 0 Westbound: 0

Time Period	Northbound			Southbound			Eastbound			Westbound			W TOT	STR TOT	Grand Total							
	Northbound			Southbound			Northbound			Southbound						EB TOT	LT	ST	RT	WB TOT	STR TOT	Grand Total
	LT	ST	RT	NB TOT	LT	ST	RT	SB TOT	LT	ST	RT	EB TOT										
07:00	07:15	30	2	7	39	5	4	0	9	125	0	98	68	166	0	81	3	84	125	298		
07:15	07:30	38	0	3	41	2	2	4	8	129	1	79	76	156	0	75	1	76	129	281		
07:30	07:45	45	2	9	56	6	3	2	11	146	1	109	71	181	1	115	1	117	146	365		
07:45	08:00	45	0	6	51	4	0	0	4	125	0	122	69	191	0	141	1	142	125	368		
08:00	08:15	59	4	8	71	5	6	4	15	189	0	115	70	185	1	126	2	128	189	400		
08:15	08:30	64	3	3	70	4	5	8	17	181	0	84	80	164	0	149	6	155	181	406		
08:30	08:45	62	5	4	71	2	5	11	18	186	0	117	83	200	0	161	4	165	186	454		
08:45	09:00	61	3	4	68	5	1	2	8	165	1	128	82	209	0	136	2	138	165	423		
09:00	09:15	43	4	7	54	4	5	0	9	139	1	102	62	165	0	112	4	116	139	344		
09:15	09:30	47	0	7	54	1	4	1	6	130	1	94	64	159	1	79	0	80	130	299		
09:30	09:45	48	4	3	53	4	3	0	7	124	1	110	49	160	1	90	6	97	124	317		
09:45	10:00	52	4	9	65	3	6	2	10	157	2	113	70	185	0	80	0	80	157	340		
11:30	11:45	61	0	8	69	2	6	2	10	155	1	98	68	167	0	106	1	107	155	353		
11:45	12:00	45	3	12	60	6	7	4	17	150	2	128	54	184	0	98	7	105	150	366		
12:00	12:15	59	6	10	75	5	8	2	15	182	3	116	72	191	1	87	2	90	182	371		
12:15	12:30	62	2	10	74	3	1	2	6	143	1	113	52	166	2	89	5	96	143	342		
12:30	12:45	55	2	9	66	6	3	2	11	140	3	117	51	171	0	94	4	98	140	346		
12:45	13:00	66	4	9	79	4	4	5	13	171	4	128	65	197	0	100	2	102	171	381		
13:00	13:15	52	3	10	65	2	3	4	8	139	2	119	55	176	0	82	2	84	139	333		
13:15	13:30	52	3	10	65	2	3	4	8	139	2	119	55	176	0	82	2	84	139	333		
15:00	15:15	88	4	11	103	6	7	6	19	222	6	125	80	211	0	118	3	121	222	484		
15:15	15:30	77	11	4	92	5	5	5	15	230	4	171	100	275	1	141	2	144	230	526		
15:30	15:45	76	6	9	91	5	8	4	17	224	0	154	94	248	1	178	7	186	224	542		
15:45	16:00	100	7	11	118	5	4	8	17	258	0	177	100	217	0	133	12	145	258	497		
16:00	16:15	82	10	17	109	6	2	8	16	218	0	170	78	248	0	149	3	152	218	525		
16:15	16:30	93	14	7	114	5	5	12	22	247	2	142	83	227	0	162	7	169	247	532		
16:30	16:45	99	6	12	117	2	0	5	7	231	0	140	99	239	0	168	2	170	231	553		
16:45	17:00	84	9	11	104	3	6	9	18	231	0	185	90	275	0	128	4	132	231	529		
17:00	17:15	75	6	10	91	4	4	5	13	217	0	189	97	286	0	135	6	141	217	531		
17:15	17:30	68	6	14	88	4	2	7	13	196	0	167	80	247	0	145	7	152	196	500		
17:30	17:45	84	5	11	100	2	6	7	15	197	0	120	68	188	0	114	3	117	197	420		
17:45	18:00	74	8	8	90	5	4	7	16	220	7	149	89	245	0	98	6	104	220	455		
Total:		2044	146	277	2467	127	133	139	399	2866	44	4047	2386	6477	9	3762	120	3891	10368	13234		

Note: U-Turns are included in Totals.



Transportation Services - Traffic Services
Turning Movement Count - Study Results
MONTREAL RD @ NORTH RIVER RD

Survey Date: Tuesday, January 19, 2016
Start Time: 07:00

WO No: 35162
Device: Miovision

Full Study Cyclist Volume
NORTH RIVER RD
MONTREAL RD

Time Period	Northbound		Street Total	Eastbound		Street Total	Grand Total
	Southbound	Westbound		Westbound	Eastbound		
07:00 07:15	0	0	0	0	0	0	0
07:15 07:30	0	2	2	0	0	0	2
07:30 07:45	0	1	1	0	0	0	1
07:45 08:00	0	0	0	0	0	0	0
08:00 08:15	0	0	0	0	0	0	0
08:15 08:30	0	1	1	0	1	1	2
08:30 08:45	0	0	0	0	0	0	0
08:45 09:00	0	0	0	1	0	1	1
09:00 09:15	0	0	0	1	1	2	2
09:15 09:30	0	0	0	0	0	0	0
09:30 09:45	0	0	0	0	0	0	0
09:45 10:00	0	0	0	2	2	2	2
10:00 10:15	0	0	0	0	0	0	0
10:15 10:30	0	0	0	1	1	1	1
10:30 10:45	0	0	0	0	0	0	0
10:45 11:00	0	0	0	0	0	0	0
11:00 11:15	0	0	0	0	0	0	0
11:15 11:30	0	0	0	0	0	0	0
11:30 11:45	0	0	0	0	0	0	0
11:45 12:00	0	0	0	0	0	0	0
12:00 12:15	0	0	0	0	0	0	0
12:15 12:30	2	0	2	0	0	0	2
12:30 12:45	0	0	0	0	0	0	0
12:45 13:00	0	0	0	0	0	0	0
13:00 13:15	0	0	0	0	0	0	0
13:15 13:30	0	0	0	1	0	1	1
13:30 13:45	0	0	0	0	0	0	0
13:45 14:00	0	0	0	2	0	2	2
14:00 14:15	0	0	0	0	0	0	0
14:15 14:30	0	0	0	1	0	1	1
14:30 14:45	0	0	0	0	0	0	0
14:45 15:00	0	0	0	1	0	1	1
15:00 15:15	0	0	0	0	0	0	0
15:15 15:30	0	0	0	2	0	2	2
15:30 15:45	0	0	0	1	0	1	1
15:45 16:00	0	0	0	0	0	0	0
16:00 16:15	0	0	0	2	0	2	2
16:15 16:30	0	0	0	1	0	1	1
16:30 16:45	0	0	0	1	0	1	1
16:45 17:00	3	0	3	0	2	2	5
17:00 17:15	1	0	1	0	1	1	2
17:15 17:30	0	0	0	0	1	1	1
17:30 17:45	0	0	0	1	0	1	1
17:45 18:00	0	0	0	0	0	0	0
Total	6	4	10	13	8	21	31



Transportation Services - Traffic Services
Turning Movement Count - Study Results
MONTREAL RD @ NORTH RIVER RD

Survey Date: Tuesday, January 19, 2016
Start Time: 07:00

WO No: 35162
Device: Miovision

Full Study Pedestrian Volume
NORTH RIVER RD
MONTREAL RD

Time Period	NB Approach (E or W Crossing)		Total	SB Approach (E or W Crossing)		Total	EB Approach (N or S Crossing)		WB Approach (N or S Crossing)	Total	Grand Total
	E or W	E or W		E or W	E or W		N or S	N or S			
07:00 07:15	5	4	9	0	0	0	3	3	0	3	12
07:15 07:30	3	6	9	0	0	0	0	0	0	0	9
07:30 07:45	6	4	10	2	2	4	3	5	0	15	15
07:45 08:00	8	5	13	0	0	0	11	11	0	24	24
08:00 08:15	8	6	14	1	1	2	16	17	0	31	31
08:15 08:30	9	9	18	5	5	10	11	16	0	34	34
08:30 08:45	5	6	11	2	2	4	7	9	0	20	20
08:45 09:00	4	7	11	1	1	2	8	9	0	20	20
09:00 09:15	3	5	8	2	2	4	6	8	0	16	16
09:15 09:30	4	4	8	1	1	2	4	5	0	13	13
09:30 09:45	5	3	8	1	1	2	5	6	0	14	14
09:45 10:00	6	2	8	1	1	2	2	3	0	11	11
10:00 10:15	1	7	8	3	3	6	11	14	0	22	22
10:15 10:30	4	6	10	1	1	2	12	13	0	23	23
10:30 10:45	4	5	9	0	0	0	5	5	0	14	14
10:45 11:00	4	5	9	0	0	0	5	5	0	14	14
11:00 11:15	10	3	13	0	0	0	5	5	0	18	18
11:15 11:30	6	4	10	2	2	4	4	6	0	16	16
11:30 11:45	2	5	7	1	1	2	5	6	0	13	13
11:45 12:00	3	2	5	2	2	4	5	7	0	12	12
12:00 12:15	6	10	16	3	3	6	5	8	0	24	24
12:15 12:30	6	10	16	3	3	6	5	8	0	24	24
12:30 12:45	10	6	16	10	10	20	3	3	0	31	31
12:45 13:00	6	4	10	4	4	8	4	6	0	16	16
13:00 13:15	2	5	7	2	2	4	5	6	0	13	13
13:15 13:30	3	2	5	2	2	4	5	7	0	12	12
13:30 13:45	6	10	16	3	3	6	5	8	0	24	24
13:45 14:00	9	9	18	3	3	6	10	13	0	31	31
14:00 14:15	12	7	19	7	7	14	11	12	0	31	31
14:15 14:30	13	4	17	4	4	8	7	8	0	25	25
14:30 14:45	4	9	13	5	5	10	11	16	0	29	29
14:45 15:00	5	9	14	3	3	6	7	10	0	24	24
15:00 15:15	9	10	19	3	3	6	9	12	0	31	31
15:15 15:30	8	8	16	7	7	14	9	16	0	38	38
15:30 15:45	11	7	18	1	1	2	7	8	0	26	26
15:45 16:00	8	16	24	5	5	10	8	13	0	37	37
16:00 16:15	12	8	20	5	5	10	8	13	0	33	33
16:15 16:30	10	10	20	5	5	10	7	12	0	32	32
16:30 16:45	213	206	419	68	68	136	229	287	0	716	716



Transportation Services - Traffic Services
 Turning Movement Count - Study Results
 MONTREAL RD @ NORTH RIVER RD

Survey Date: Tuesday, January 19, 2016
 Start Time: 07:00

WO No: 35162
 Device: Miovision

Full Study 15 Minute U-Turn Total
 NORTH RIVER RD

Time Period	Northbound		Southbound		Eastbound		Westbound		Total
	U-Turn	Total	U-Turn	Total	U-Turn	Total	U-Turn	Total	
07:00	0	0	0	0	0	0	0	0	0
07:15	0	0	0	0	0	0	0	0	0
07:30	0	0	0	0	0	0	0	0	0
07:45	0	0	0	0	0	0	0	0	0
08:00	0	0	0	0	0	0	0	0	0
08:15	0	0	0	0	0	0	0	0	0
08:30	0	0	0	0	0	0	0	0	0
08:45	0	0	0	0	0	0	0	0	0
09:00	0	0	0	0	0	0	0	0	0
09:15	0	0	0	0	0	0	0	0	0
09:30	0	0	0	0	0	0	0	0	0
09:45	0	0	0	0	0	0	0	0	0
10:00	0	0	0	0	0	0	0	0	0
11:30	0	0	0	0	0	0	0	0	0
11:45	0	0	0	0	0	0	0	0	0
12:00	0	0	0	0	0	0	0	0	0
12:15	0	0	0	0	0	0	0	0	0
12:30	0	0	0	0	0	0	0	0	0
12:45	0	0	0	0	0	0	0	0	0
13:00	0	0	0	0	0	0	0	0	0
13:15	0	0	0	0	0	0	0	0	0
13:30	0	0	0	0	0	0	0	0	0
15:00	0	0	0	0	0	0	0	0	0
15:15	0	0	0	0	0	0	0	0	0
15:30	0	0	0	0	0	0	0	0	0
15:45	0	0	0	0	0	0	0	0	0
16:00	0	0	0	0	0	0	0	0	0
16:15	0	0	0	0	0	0	0	0	0
16:30	0	0	0	0	0	0	0	0	0
16:45	0	0	0	0	0	0	0	0	0
17:00	0	0	0	0	0	0	0	0	0
17:15	0	0	0	0	0	0	0	0	0
17:30	0	0	0	0	0	0	0	0	0
17:45	0	0	0	0	0	0	0	0	0
18:00	0	0	0	0	0	0	0	0	0
Total	0	0	0	0	0	0	0	0	0



Transportation Services - Traffic Services
 Turning Movement Count - Study Results
 MONTREAL RD @ NORTH RIVER RD

Survey Date: Tuesday, January 19, 2016
 Start Time: 07:00

WO No: 35162
 Device: Miovision

Full Study Heavy Vehicles
 NORTH RIVER RD

Time Period	Northbound				Southbound				Eastbound				Westbound				W	STR	Grand
	LT	ST	RT	TOT	LT	ST	RT	TOT	LT	ST	RT	TOT	LT	ST	RT	TOT			
07:00	3	0	0	3	0	0	0	0	0	0	0	0	0	0	0	0	0	26	
07:15	3	0	0	3	0	0	0	0	0	0	0	0	0	0	0	0	0	22	
07:30	4	0	0	4	0	0	0	0	0	0	0	0	0	0	0	0	18		
07:45	2	0	0	2	0	0	0	0	0	0	0	0	0	0	0	0	34		
08:00	2	0	0	2	0	0	0	0	0	0	0	0	0	0	0	0	23		
08:15	5	0	0	5	0	0	0	0	0	0	0	0	0	0	0	0	16		
08:30	2	0	0	2	0	0	0	0	0	0	0	0	0	0	0	0	27		
08:45	6	1	0	7	0	0	0	0	0	0	0	0	0	0	0	0	26		
09:00	3	1	0	4	0	0	0	0	0	0	0	0	0	0	0	0	16		
09:15	1	0	0	1	0	0	0	0	0	0	0	0	0	0	0	0	29		
09:30	4	0	0	4	0	0	0	0	0	0	0	0	0	0	0	0	29		
09:45	5	1	0	6	0	0	0	0	0	0	0	0	0	0	0	0	22		
10:00	3	0	0	3	0	0	0	0	0	0	0	0	0	0	0	0	33		
11:30	4	0	0	4	0	0	0	0	0	0	0	0	0	0	0	0	19		
11:45	1	0	0	1	0	0	0	0	0	0	0	0	0	0	0	0	18		
12:00	1	0	0	1	0	0	0	0	0	0	0	0	0	0	0	0	21		
12:15	1	0	0	1	0	0	0	0	0	0	0	0	0	0	0	0	22		
12:30	3	0	0	3	0	0	0	0	0	0	0	0	0	0	0	0	14		
12:45	2	0	0	2	0	0	0	0	0	0	0	0	0	0	0	0	16		
13:00	5	0	0	5	0	0	0	0	0	0	0	0	0	0	0	0	25		
13:15	3	0	0	3	0	0	0	0	0	0	0	0	0	0	0	0	16		
13:30	2	0	0	2	0	0	0	0	0	0	0	0	0	0	0	0	21		
15:00	4	0	0	4	0	0	0	0	0	0	0	0	0	0	0	0	17		
15:15	1	0	0	1	0	0	0	0	0	0	0	0	0	0	0	0	19		
15:30	3	0	0	3	0	0	0	0	0	0	0	0	0	0	0	0	14		
15:45	1	0	0	1	0	0	0	0	0	0	0	0	0	0	0	0	21		
16:00	1	0	0	1	0	0	0	0	0	0	0	0	0	0	0	0	30		
16:15	4	0	0	4	0	0	0	0	0	0	0	0	0	0	0	0	21		
16:30	3	0	0	3	0	0	0	0	0	0	0	0	0	0	0	0	21		
16:45	3	0	0	3	0	0	0	0	0	0	0	0	0	0	0	0	17		
17:00	1	0	0	1	0	0	0	0	0	0	0	0	0	0	0	0	26		
17:15	1	0	0	1	0	0	0	0	0	0	0	0	0	0	0	0	11		
17:30	2	0	0	2	0	0	0	0	0	0	0	0	0	0	0	0	9		
17:45	2	0	0	2	0	0	0	0	0	0	0	0	0	0	0	0	12		
18:00	2	0	0	2	0	0	0	0	0	0	0	0	0	0	0	0	10		
Total	92	3	7	102	4	0	0	26	254	3	174	121	518	1	128	6	844	549	



Transportation Services - Traffic Services
Turning Movement Count - Full Study Peak Hour Diagram
MONTGOMERY ST @ MONTREAL RD

Survey Date: Wednesday, January 13, 2016
 Start Time: 07:00

WO No: 35640
 Device: Miovision

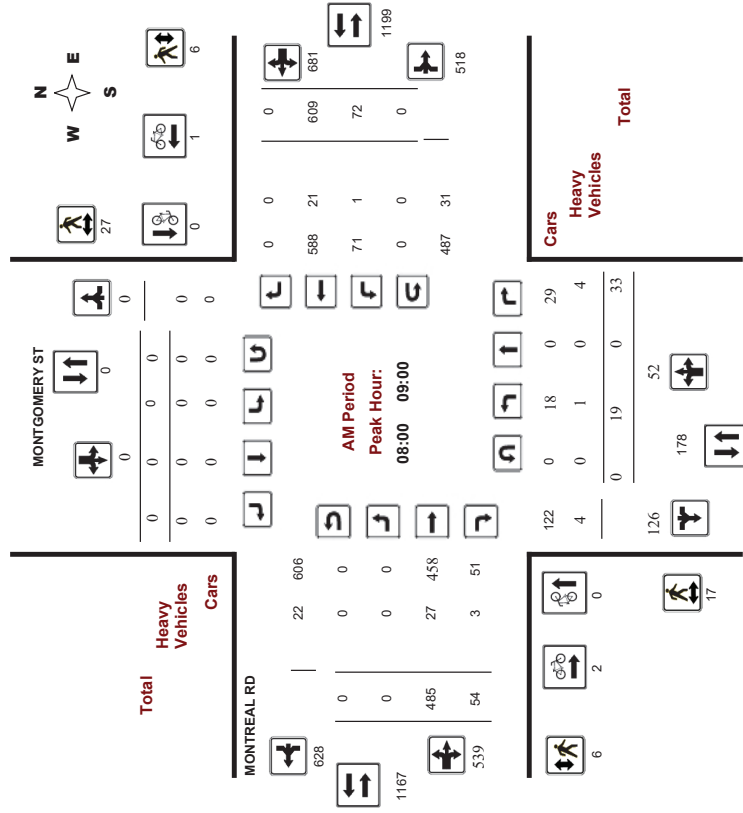

Comments



Transportation Services - Traffic Services
Turning Movement Count - Full Study Peak Hour Diagram
MONTGOMERY ST @ MONTREAL RD

Survey Date: Wednesday, January 13, 2016
 Start Time: 07:00

WO No: 35640
 Device: Miovision

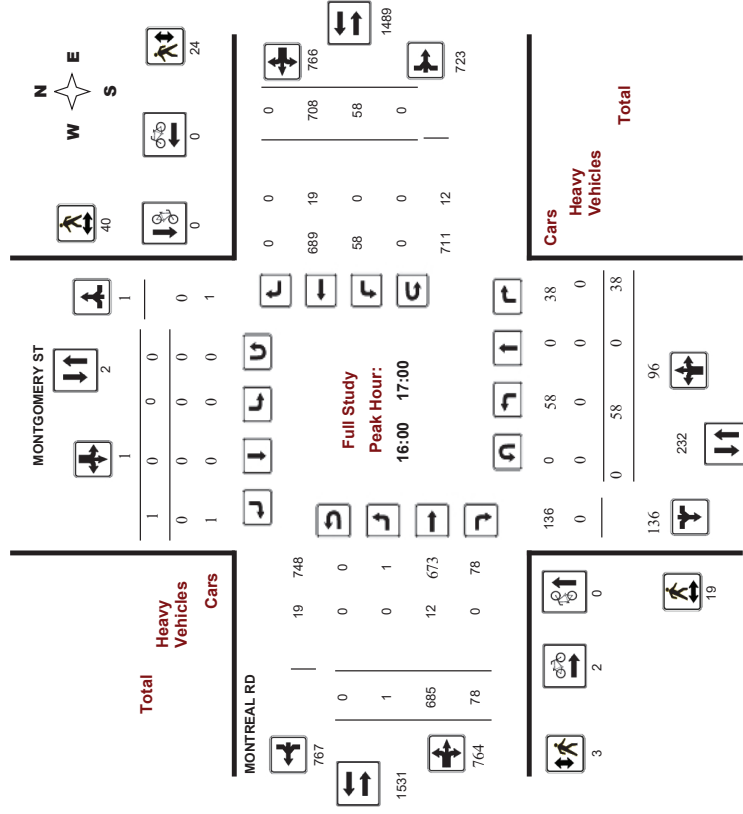

Comments



Transportation Services - Traffic Services
Turning Movement Count - Full Study Peak Hour Diagram
MONTGOMERY ST @ MONTREAL RD

Survey Date: Wednesday, January 13, 2016
 Start Time: 07:00

WO No: 35640
 Device: Miovision

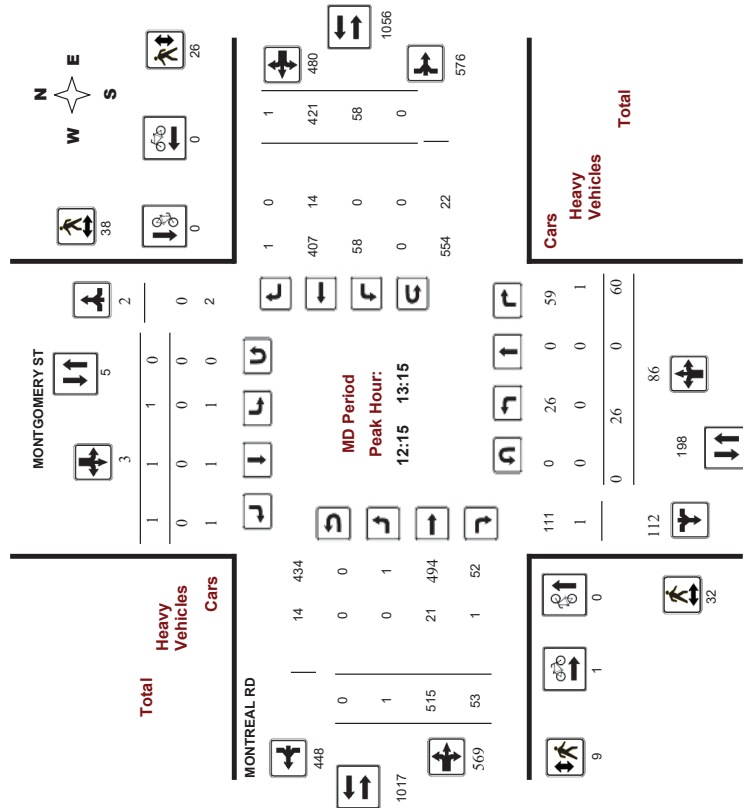

Transportation Services - Traffic Services
Turning Movement Count - Full Study Peak Hour Diagram
MONTGOMERY ST @ MONTREAL RD

Survey Date: Wednesday, January 13, 2016
 Start Time: 07:00

WO No: 35640
 Device: Miovision

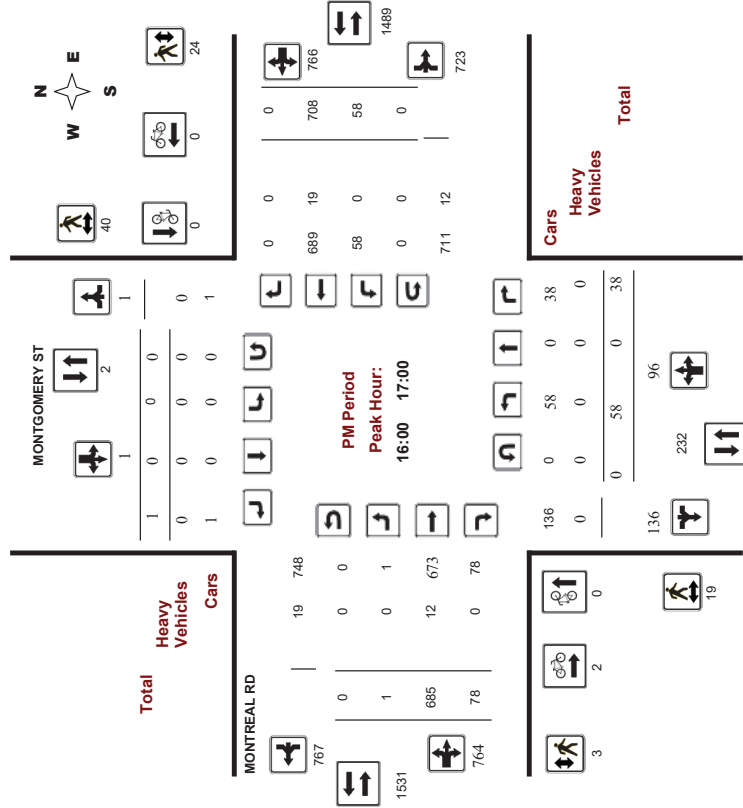



Transportation Services - Traffic Services

Turning Movement Count - Study Results

MONTGOMERY ST @ MONTREAL RD

Survey Date: Wednesday, January 13, 2016
Start Time: 07:00

WO No: 35640
Device: Miovision

Full Study Diagram

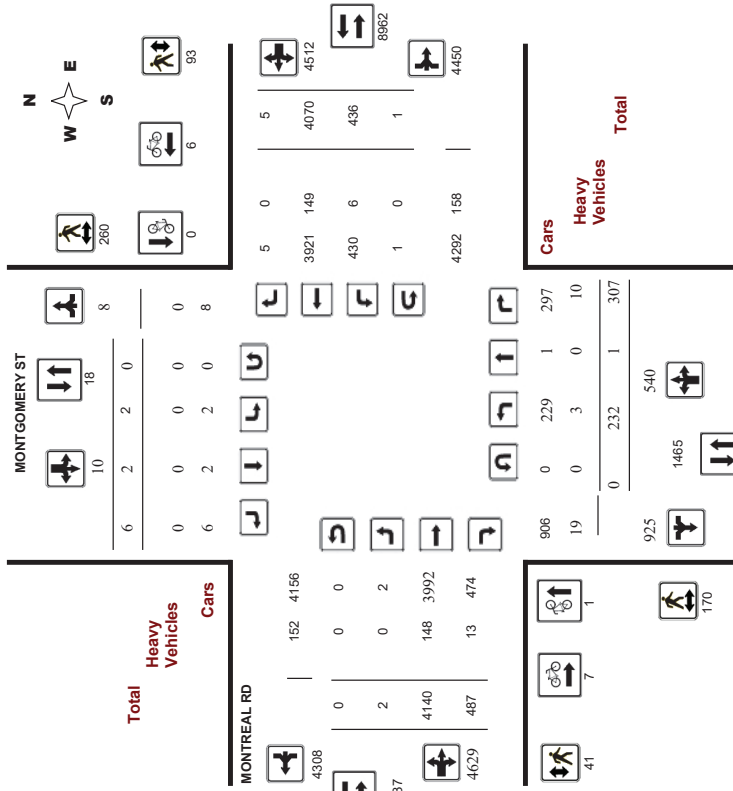

Transportation Services - Traffic Services

Turning Movement Count - Study Results

MONTGOMERY ST @ MONTREAL RD

Survey Date: Wednesday, January 13, 2016
Start Time: 07:00

WO No: 35640
Device: Miovision

Full Study Peak Hour Diagram

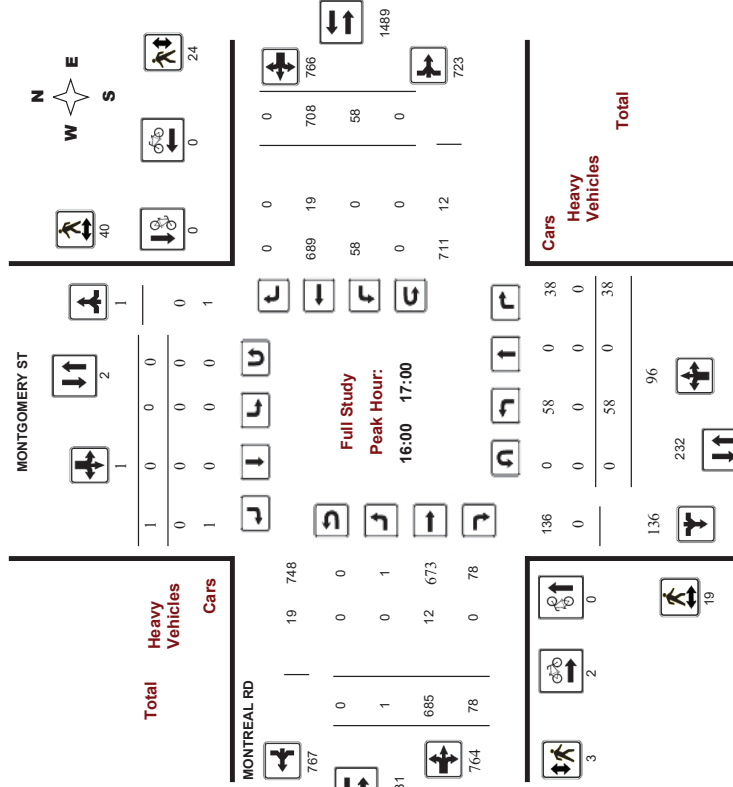



Transportation Services - Traffic Services Turning Movement Count - Study Results MONTGOMERY ST @ MONTREAL RD

Survey Date: Wednesday, January 13, 2016 **WO No:** 35640
Start Time: 07:00 **Device:** Miovision

Full Study Summary (8 HR Standard)

Survey Date: Wednesday, January 13, 2016 **Total Observed U-Turns** **AAADT Factor**
Northbound: 0 Southbound: 0 1.39
Eastbound: 0 Westbound: 1

Period	Northbound				Southbound				Eastbound				Westbound			
	LT	ST	RT	TOT	LT	ST	RT	TOT	LT	ST	RT	TOT	LT	ST	RT	TOT
07:00-08:00	7	0	20	27	0	0	0	0	402	37	439	844	418	0	489	926
08:00-09:00	19	0	33	52	0	0	0	0	485	54	539	1078	609	0	681	1220
09:00-10:00	10	0	22	32	0	0	0	0	403	55	458	914	440	1	486	944
11:30-12:30	20	0	44	64	0	1	0	1	488	86	574	1041	419	1	467	1041
12:30-13:30	24	0	57	81	1	2	4	7	488	53	542	1083	380	1	445	1072
15:00-16:00	51	0	65	116	0	0	2	2	578	71	649	1382	561	1	615	1382
16:00-17:00	58	0	38	96	0	0	1	1	685	76	764	1506	708	0	766	1506
17:00-18:00	43	1	28	72	1	0	1	2	611	53	664	1329	535	1	591	1255
Sub Total	232	1	307	540	2	2	6	10	4140	487	4629	9256	436	5	4511	9690
U-Turns	0	0	0	0	0	0	0	0	0	0	0	0	0	0	0	0
Total	232	1	307	540	2	2	6	10	4140	487	4629	9256	436	5	4512	9691
EQ 12hr	322	1	427	751	3	3	8	14	5755	677	6434	12776	606	7	6272	13470

Note: These values are calculated by multiplying the totals by the appropriate expansion factor.

Period	LT	ST	RT	TOT	SB	TOT	WB	TOT
07:00-08:00	7	0	20	27	0	0	480	480
08:00-09:00	19	0	33	52	0	0	681	681
09:00-10:00	10	0	22	32	0	0	486	486
11:30-12:30	20	0	44	64	0	1	467	1041
12:30-13:30	24	0	57	81	1	2	445	1072
15:00-16:00	51	0	65	116	0	2	615	1382
16:00-17:00	58	0	38	96	0	1	766	1506
17:00-18:00	43	1	28	72	1	2	591	1255
Sub Total	232	1	307	540	2	6	4511	9690
U-Turns	0	0	0	0	0	0	0	0
Total	232	1	307	540	2	6	4512	9691
EQ 12hr	322	1	427	751	3	8	6272	13470

Note: These values are calculated by multiplying the totals by the appropriate expansion factor.

Note: These volumes are calculated by multiplying the Average Daily 12 hr. totals by 12 to 24 expansion factor.
 Note: U-Turns provided for approach totals. Refer to 'U-Turn' Report for specific breakdown.

Period	LT	ST	RT	TOT	SB	TOT	WB	TOT
07:00-08:00	7	0	20	27	0	0	480	480
08:00-09:00	19	0	33	52	0	0	681	681
09:00-10:00	10	0	22	32	0	0	486	486
11:30-12:30	20	0	44	64	0	1	467	1041
12:30-13:30	24	0	57	81	1	2	445	1072
15:00-16:00	51	0	65	116	0	2	615	1382
16:00-17:00	58	0	38	96	0	1	766	1506
17:00-18:00	43	1	28	72	1	2	591	1255
Sub Total	232	1	307	540	2	6	4511	9690
U-Turns	0	0	0	0	0	0	0	0
Total	232	1	307	540	2	6	4512	9691
EQ 12hr	322	1	427	751	3	8	6272	13470



Transportation Services - Traffic Services Turning Movement Count - Study Results MONTGOMERY ST @ MONTREAL RD

Survey Date: Wednesday, January 13, 2016 **WO No:** 35640
Start Time: 07:00 **Device:** Miovision

Full Study 15 Minute Increments

Time Period	Northbound				Southbound				Eastbound				Westbound			
	LT	ST	RT	TOT	LT	ST	RT	TOT	LT	ST	RT	TOT	LT	ST	RT	TOT
07:00	1	0	2	3	0	0	0	0	90	6	96	192	88	0	97	186
07:15	0	0	7	7	0	0	0	0	93	7	100	201	85	0	93	201
07:30	0	0	6	6	0	0	0	0	105	8	113	228	118	0	129	251
07:45	0	0	5	5	0	0	0	0	114	16	130	279	127	0	142	279
08:00	0	0	7	7	0	0	0	0	122	13	135	284	133	0	147	284
08:15	0	0	10	10	0	0	0	0	123	9	132	307	153	0	162	307
08:30	0	0	8	8	0	0	0	0	115	13	128	327	164	0	188	327
08:45	0	0	8	8	0	0	0	0	125	19	144	344	159	0	184	344
09:00	0	0	8	8	0	0	0	0	65	0	65	263	117	0	140	263
09:15	0	0	4	4	0	0	0	0	109	13	122	263	123	0	133	263
09:30	0	0	10	10	0	0	0	0	100	13	113	244	107	1	120	244
09:45	0	0	5	5	0	0	0	0	93	15	108	206	83	0	93	206
11:30	0	0	8	8	0	0	0	0	113	35	148	263	92	1	101	263
11:45	0	0	11	11	0	0	0	0	115	23	138	277	112	0	126	277
12:00	0	0	10	10	0	0	0	0	128	16	144	270	144	0	110	270
12:15	0	0	15	15	0	0	0	0	132	12	144	296	122	0	130	296
12:30	0	0	12	12	0	0	0	0	126	15	141	285	105	0	124	285
12:45	0	0	21	21	0	0	0	0	118	16	134	284	105	0	119	284
13:00	0	0	12	12	0	0	0	0	139	10	149	273	147	89	107	45
13:15	0	0	19	19	0	0	0	0	130	13	143	286	110	0	124	286
15:00	0	0	19	19	0	0	0	0	147	24	171	373	141	1	157	373
15:15	0	0	16	16	0	0	0	0	135	22	157	357	157	0	168	357
15:30	0	0	4	4	0	0	0	0	166	12	178	356	153	0	166	356
16:00	0	0	8	8	0	0	0	0	161	16	177	389	169	0	184	389
16:30	0	0	11	11	0	0	0	0	172	17	189	400	176	0	191	400
16:45	0	0	9	9	0	0	0	0	173	25	198	420	166	0	202	420
17:00	0	0	8	8	0	0	0	0	168	14	182	361	132	0	149	361
17:15	0	0	6	6	0	0	0	0	154	12	166	348	151	1	164	348
17:30	0	0	6	6	0	0	0	0	127	19	146	302	126	0	141	302
17:45	0	0	8	8	0	0	0	0	162	8	170	318	177	0	137	318
18:00	0	0	16	16	0	0	0	0	179	20	199	418	111	12	189	62
Total:	232	1	307	540	2	6	10	1483	4140	487	4629	9183	4070	5	4512	9183

Note: U-Turns are included in Totals.



Transportation Services - Traffic Services
Turning Movement Count - Study Results
MONTGOMERY ST @ MONTREAL RD

Survey Date: Wednesday, January 13, 2016
Start Time: 07:00

WO No: 35640
Device: Miovision

Full Study Cyclist Volume

Time Period	MONTGOMERY ST		MONTREAL RD		Grand Total
	Northbound	Southbound	Street Total	Westbound	
07:00 07:15	1	0	1	0	3
07:15 07:30	0	0	0	0	0
07:30 07:45	0	0	0	0	0
07:45 08:00	0	0	0	0	0
08:00 08:15	0	0	0	0	0
08:15 08:30	0	0	0	0	0
08:30 08:45	0	0	0	0	0
08:45 09:00	0	0	0	0	0
09:00 09:15	0	0	0	0	0
09:15 09:30	0	0	0	0	0
09:30 09:45	0	0	0	0	0
09:45 10:00	0	0	0	0	0
10:00 10:15	0	0	0	0	0
10:15 10:30	0	0	0	0	0
10:30 10:45	0	0	0	0	0
10:45 11:00	0	0	0	0	0
11:00 11:15	0	0	0	0	0
11:15 11:30	0	0	0	0	0
11:30 11:45	0	0	0	0	0
11:45 12:00	0	0	0	0	0
12:00 12:15	0	0	0	0	0
12:15 12:30	0	0	0	0	0
12:30 12:45	0	0	0	0	0
12:45 13:00	0	0	0	0	0
13:00 13:15	0	0	0	0	0
13:15 13:30	0	0	0	0	0
13:30 13:45	0	0	0	0	0
13:45 14:00	0	0	0	0	0
14:00 14:15	0	0	0	0	0
14:15 14:30	0	0	0	0	0
14:30 14:45	0	0	0	0	0
14:45 15:00	0	0	0	0	0
15:00 15:15	0	0	0	0	0
15:15 15:30	0	0	0	0	0
15:30 15:45	0	0	0	0	0
15:45 16:00	0	0	0	0	0
16:00 16:15	0	0	0	0	0
16:15 16:30	0	0	0	0	0
16:30 16:45	0	0	0	0	0
16:45 17:00	0	0	0	0	0
17:00 17:15	0	0	0	0	0
17:15 17:30	0	0	0	0	0
17:30 17:45	0	0	0	0	0
17:45 18:00	0	0	0	0	0
18:00 18:15	0	0	0	0	0
18:15 18:30	0	0	0	0	0
Total	1	0	1	0	1



Transportation Services - Traffic Services
Turning Movement Count - Study Results
MONTGOMERY ST @ MONTREAL RD

Survey Date: Wednesday, January 13, 2016
Start Time: 07:00

WO No: 35640
Device: Miovision

Full Study Pedestrian Volume

Time Period	MONTGOMERY ST		MONTREAL RD		Grand Total
	NB Approach (E or W Crossing)	SB Approach (E or W Crossing)	EB Approach (N or S Crossing)	WB Approach (N or S Crossing)	
07:00 07:15	2	4	1	0	7
07:15 07:30	7	4	2	0	13
07:30 07:45	8	5	0	2	15
07:45 08:00	1	8	0	0	9
08:00 08:15	6	3	0	1	10
08:15 08:30	5	10	2	2	19
08:30 08:45	3	10	3	3	19
08:45 09:00	3	4	1	0	8
09:00 09:15	6	6	0	4	16
09:15 09:30	4	2	0	1	7
09:30 09:45	2	5	0	1	8
09:45 10:00	1	6	1	2	10
10:00 10:15	0	9	0	1	10
10:15 10:30	4	4	1	1	10
10:30 10:45	2	10	0	1	13
10:45 11:00	12	9	4	10	35
11:00 11:15	5	8	1	5	19
11:15 11:30	2	11	0	7	20
11:30 11:45	13	10	4	4	31
11:45 12:00	4	5	2	6	17
12:00 12:15	6	14	2	2	24
12:15 12:30	6	7	1	1	15
12:30 12:45	3	8	1	2	14
12:45 13:00	11	13	0	7	31
13:00 13:15	10	10	4	4	28
13:15 13:30	4	5	2	6	17
13:30 13:45	6	14	2	2	24
13:45 14:00	6	7	1	1	15
14:00 14:15	8	8	1	2	19
14:15 14:30	11	8	1	1	21
14:30 14:45	4	9	0	2	15
14:45 15:00	4	10	1	10	25
15:00 15:15	4	13	1	6	24
15:15 15:30	12	13	3	3	31
15:30 15:45	9	9	3	2	23
15:45 16:00	5	17	3	5	30
16:00 16:15	9	11	2	2	24
16:15 16:30	7	8	1	6	22
Total	170	260	41	93	564



Turning Movement Count Summary, AM and PM Peak Hour Flow Diagrams

Automobiles, Taxis, Light Trucks, Vans, SUV's, Motorcycles, Heavy Trucks, Buses, and School Buses

Turning Movement Count Heavy Vehicle Summary

Construction Vehicles, Heavy Trucks, Buses & School Buses, Heavy vehicles **ARE** included in the all vehicles summary and flow diagrams.

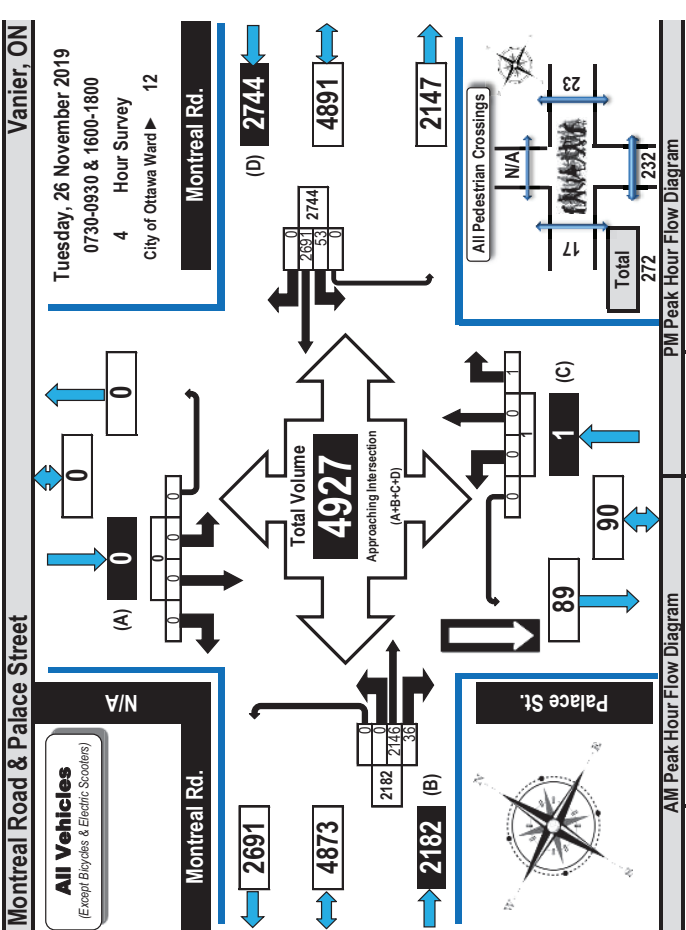
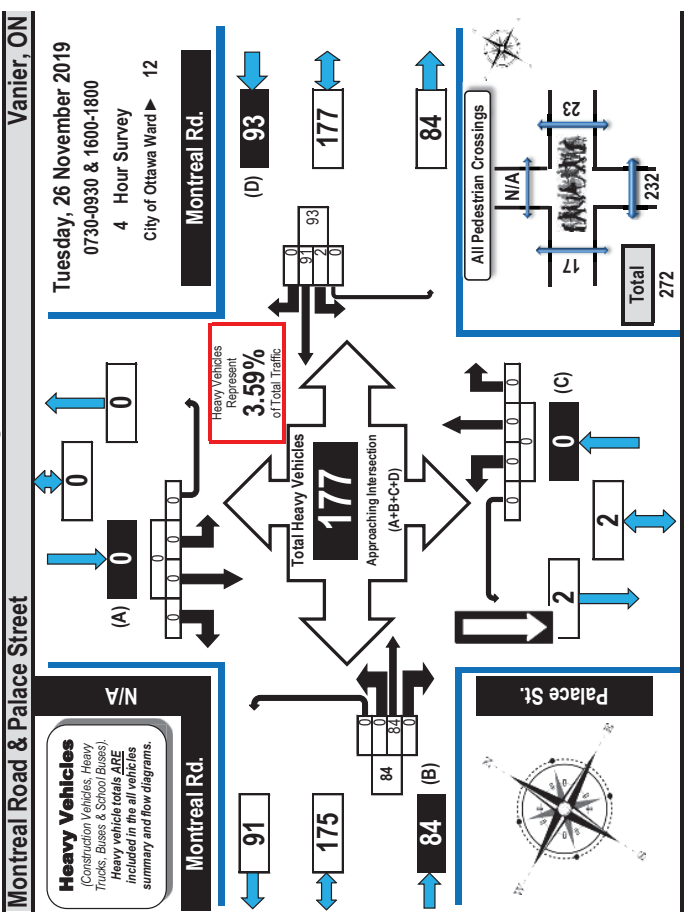

Time Period	Montreal Rd. Eastbound				Montreal Rd. Westbound				Palace St. Northbound				Palace St. Southbound				s. Tot	RT	UT	s. Tot	G. Tot
	LT	ST	RT	UT	LT	ST	RT	UT	LT	ST	RT	UT	LT	ST	RT	UT					
0730-0800	0	9	0	0	9	0	16	0	0	0	0	0	0	0	0	0	0	0	0	25	
0800-0900	0	30	0	0	30	0	35	0	0	0	0	0	0	0	0	0	0	0	0	67	
0900-0930	0	17	0	0	17	0	14	0	0	0	0	0	0	0	0	0	0	0	0	31	
1600-1700	0	14	0	0	14	0	18	0	0	0	0	0	0	0	0	0	0	0	0	32	
1700-1800	0	14	0	0	14	0	8	0	0	0	0	0	0	0	0	0	0	0	0	22	
Totals	0	84	0	0	84	0	91	0	0	0	0	0	0	0	0	0	0	0	0	177	

Time Period	Montreal Rd. Eastbound				Montreal Rd. Westbound				Palace St. Northbound				Palace St. Southbound				s. Tot	RT	UT	s. Tot	G. Tot
	LT	ST	RT	UT	LT	ST	RT	UT	LT	ST	RT	UT	LT	ST	RT	UT					
0730-0800	0	9	0	0	9	0	16	0	0	0	0	0	0	0	0	0	0	0	0	25	
0800-0900	0	30	0	0	30	0	35	0	0	0	0	0	0	0	0	0	0	0	0	67	
0900-0930	0	17	0	0	17	0	14	0	0	0	0	0	0	0	0	0	0	0	0	31	
1600-1700	0	14	0	0	14	0	18	0	0	0	0	0	0	0	0	0	0	0	0	32	
1700-1800	0	14	0	0	14	0	8	0	0	0	0	0	0	0	0	0	0	0	0	22	
Totals	0	84	0	0	84	0	91	0	0	0	0	0	0	0	0	0	0	0	0	177	

Comments:
Palace Street is one way southbound and there was 1 northbound right turn to Montreal Road. During the evening portion of the traffic count and occasionally in the morning eastbound traffic backs up from the Vanier Parkway.

Comments:
Palace Street is one way southbound and there was 1 northbound right turn to Montreal Road. During the evening portion of the traffic count and occasionally in the morning eastbound traffic backs up from the Vanier Parkway.



Turning Movement Count Bicycle Summary Flow Diagram



Montreal Rd & Palace Street Vanier, ON
 Tuesday, 26 November 2019
 0730-0930 & 1600-1800
 4 Hour Survey
 City of Ottawa Ward 12

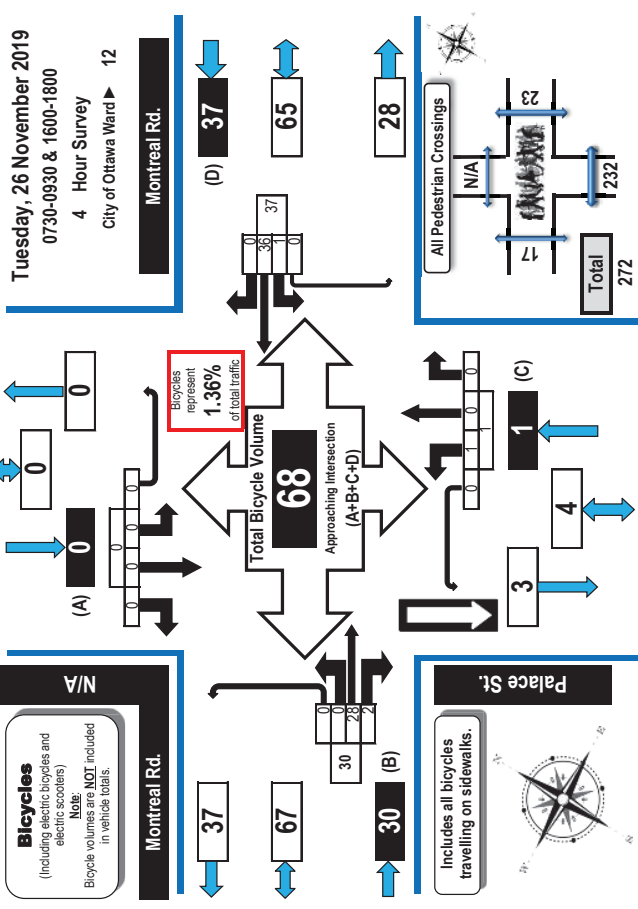

Time Period	Montreal Rd. Eastbound						Montreal Rd. Westbound						Palace St. Northbound						Palace St. Southbound					
	LT	ST	RT	UT	s.Tot	G.Tot	LT	ST	RT	UT	s.Tot	G.Tot	LT	ST	RT	UT	s.Tot	G.Tot	LT	ST	RT	UT	s.Tot	G.Tot
0730-0800	0	0	0	0	0	0	0	0	0	0	0	0	0	0	0	0	0	0	0	0	0	0	0	0
0800-0900	0	3	0	0	13	0	0	0	0	0	0	0	0	0	0	0	0	0	0	0	0	0	0	0
0900-0930	0	2	0	0	5	0	0	0	0	0	0	0	0	0	0	0	0	0	0	0	0	0	0	0
1600-1700	0	11	2	0	13	0	0	3	0	0	3	1	0	0	0	0	0	0	0	0	0	0	0	0
1700-1800	0	12	0	0	12	0	1	10	0	0	11	0	0	0	0	0	0	0	0	0	0	0	0	0
Totals	0	28	2	0	30	0	1	36	0	0	37	1	0	0	0	0	0	0	0	0	0	0	0	0

Comments:
 Palace Street is one way southbound and there was 1 northbound right turn to Montreal Road. During the evening portion of the traffic count and occasionally in the morning eastbound traffic backs up from the Vanier Parkway.



Turning Movement Count Pedestrian Crossings Summary and Flow Diagram



Montreal Rd & Palace Street Vanier, ON
 Tuesday, 26 November 2019
 0730-0930 & 1600-1800
 4 Hour Survey
 City of Ottawa Ward 12

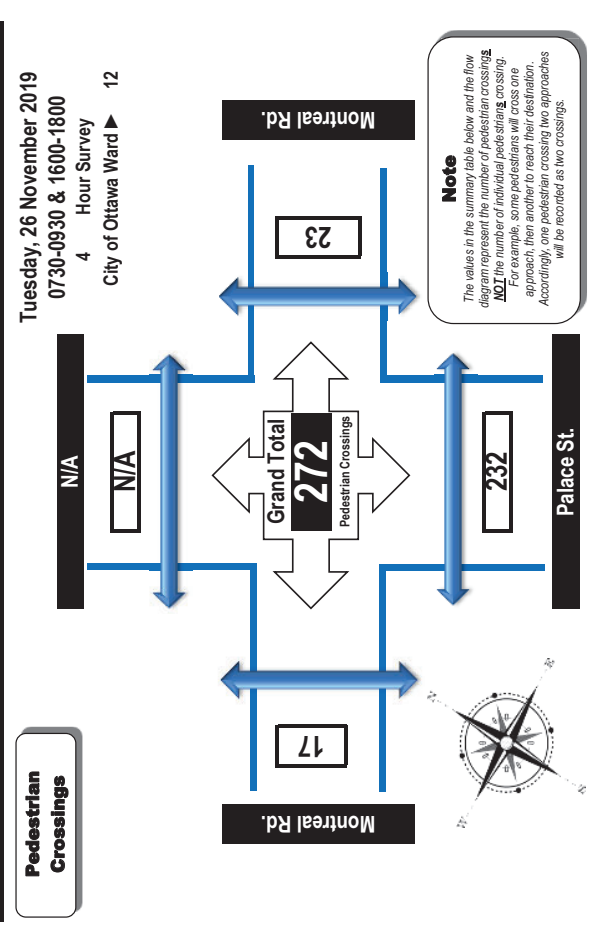

Note
 The values in the summary table below and the flow diagram represent the number of pedestrian crossings. The number of northbound right turn crossings, eastbound left turn crossings, and southbound left turn crossings will be recorded as two crossings. Accordingly, one pedestrian crossing two approaches will be recorded as two crossings.

Time Period	West Side Crossing Montreal Rd.		East Side Crossing Montreal Rd.		South Side Crossing Palace St.		North Side Crossing		Street Total	Grand Total
	Montreal Rd.	Palace St.	Montreal Rd.	Palace St.	Palace St.	Palace St.	N/A	Total		
0730-0800	5	0	6	0	23	0	0	0	11	23
0800-0900	0	0	9	2	69	8	0	0	9	69
0900-0930	0	0	2	1	8	80	0	0	2	8
1600-1700	8	4	1	5	80	52	0	0	9	80
1700-1800	4	17	5	23	52	232	0	0	9	52
Totals	17	23	23	40	232	232	0	0	40	232

Comments:
 Palace Street is one way southbound and there was 1 northbound right turn to Montreal Road. During the evening portion of the traffic count and occasionally in the morning eastbound traffic backs up from the Vanier Parkway.



Turning Movement Count Summary Report AADT and Expansion Factors

Automobiles, Taxis,
Light Trucks, Vans,
SUVs, Motorcycles,
Heavy Trucks, Buses,
and School Buses

Montreal Road & Palace Street

Survey Date: Tuesday, 26 November 2019 Start Time: 0730 AADT Factor: 1.0
 Weather AM: Overcast +5°C Survey Duration: 4 Hrs. Survey Hours: 0730-0930 & 1600-1800
 Weather PM: Overcast +10°C Surveyor(s): Carmody

Time Period	Montreal Rd. Eastbound						Palace St. Northbound						Montreal Rd. Westbound						Palace St. Southbound							
	LT	ST	RT	UT	EB Tot	Street Tot	LT	ST	RT	UT	N/B Tot	Street Tot	LT	ST	RT	UT	W/B Tot	Street Tot	LT	ST	RT	UT	S/B Tot	Street Tot		
0730-0800	0	189	4	0	193	6	288	0	0	0	0	0	0	0	0	0	0	0	0	0	0	0	0	0	0	487
0800-0900	0	365	9	0	394	27	735	0	0	0	0	0	0	0	0	0	0	0	0	0	0	0	0	0	0	1156
0900-0930	0	224	2	0	226	7	285	0	0	1	0	1	0	0	0	0	0	0	0	0	0	0	0	0	0	519
1600-1700	0	670	14	0	684	6	773	0	0	0	0	0	0	0	0	0	0	0	0	0	0	0	0	0	0	1463
1700-1800	0	678	7	0	685	7	610	0	0	0	0	0	0	0	0	0	0	0	0	0	0	0	0	0	0	1302
Totals	0	2146	36	0	2182	53	2691	0	0	1	0	1	0	0	0	0	0	0	0	0	0	0	0	0	0	4927

Equivalent 12 & 24-hour Vehicle Volumes Including the Annual Average Daily Traffic (AADT) Factor
 Applicable to the Day and Month of the Turning Movement Count

Expansion factors are applied exclusively to standard weekday 8-hour turning movement counts conducted during the hours of 0700h - 1000h, 1130h - 1330h and 1500h - 1800h

Equ. 12-Hr	n/a	n/a	n/a	n/a	n/a	n/a	n/a	n/a	n/a	n/a	n/a	n/a	n/a	n/a	n/a	n/a	n/a	n/a	n/a	n/a	n/a	n/a	n/a	n/a	n/a	n/a	
Equivalent 12-hour vehicle volumes. These volumes are calculated by multiplying the 8-hour totals by the 8 → 12 expansion factor of 1.39																											
Equivalent 24-hour vehicle volumes. These volumes are calculated by multiplying the equivalent 12-hour totals by the AADT factor of 1.0																											
Average daily 12-hour vehicle volumes. These volumes are calculated by multiplying the equivalent 12-hour totals by the AADT factor of 1.0																											
24-hour AADT. These volumes are calculated by multiplying the average daily 12-hour vehicle volumes by the 12 → 24 expansion factor of 1.51																											

AADT and expansion factors provided by the City of Ottawa

AM Peak Hour Factor → 0.91													Highest Hourly Vehicle Volume Between 0700h & 1000h														
AM Peak Hr	LT	ST	RT	UT	TOT	LT	ST	RT	UT	TOT	S.TOT	G.TOT	AM Peak Hr	LT	ST	RT	UT	TOT	LT	ST	RT	UT	TOT	S.TOT	G.TOT		
0800-0900	0	365	9	0	394	27	735	0	0	0	0	0	0	0	0	0	0	0	0	0	0	0	0	0	0	0	1156

PM Peak Hour Factor → 0.91

Highest Hourly Vehicle Volume Between 1500h & 1800h																										
PM Peak Hr	LT	ST	RT	UT	TOT	LT	ST	RT	UT	TOT	S.TOT	G.TOT														
1600-1700	0	670	14	0	684	6	773	0	0	0	0	0	0	0	0	0	0	0	0	0	0	0	0	0	0	1463

Comments:
 Palace Street is one way southbound and there was 1 northbound right turn to Montreal Road. During the evening portion of the traffic count and occasionally in the morning eastbound traffic backs up from the Vanier Parkway.

Notes:
 1. Includes all vehicle types except bicycles, electric bicycles, and electric scooters.
 2. When expansion and AADT factors are applied, the results will differ slightly due to rounding.

Transportation Services - Traffic Services Turning Movement Count - Full Study Peak Hour Diagram MONTREAL RD @ VANIER PKWY

Survey Date: Tuesday, March 26, 2019 WO No: 38462
 Start Time: 07:00 Device: Miovision

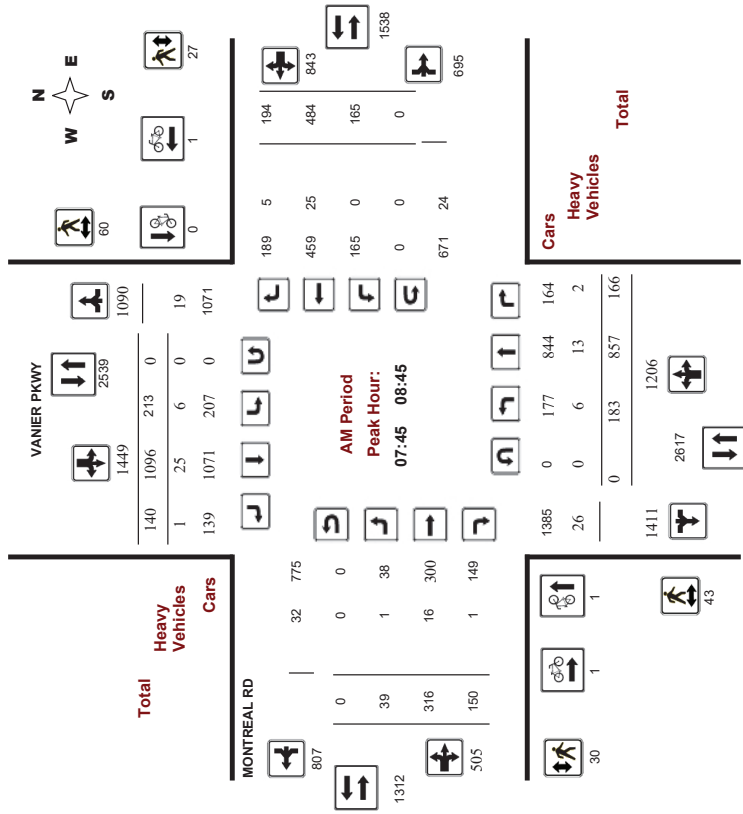

Comments



Transportation Services - Traffic Services

Turning Movement Count - Full Study Peak Hour Diagram

MONTREAL RD @ VANIER PKWY

Survey Date: Tuesday, March 26, 2019

WO No: 38462

Start Time: 07:00

Device: Miovision

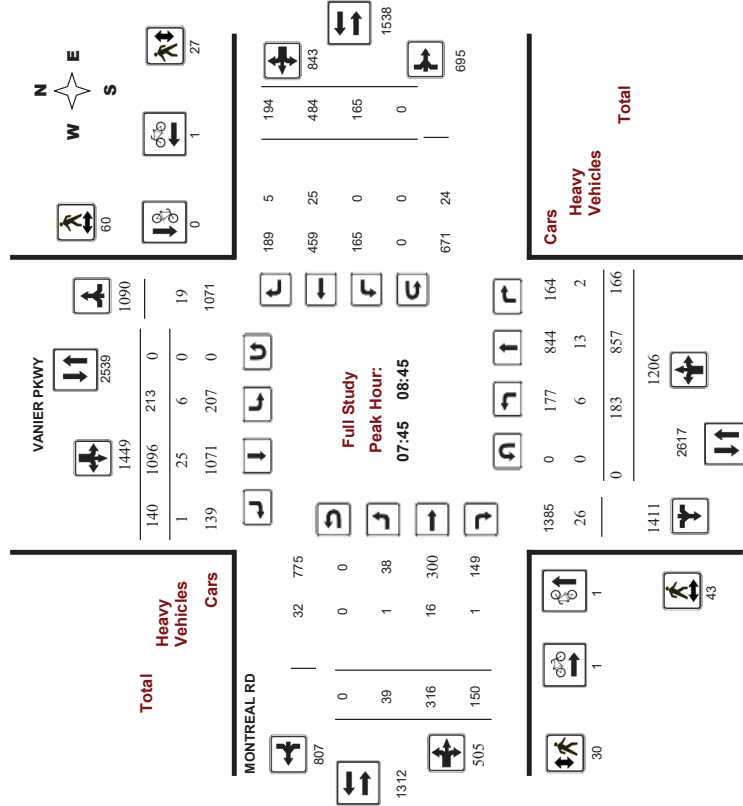

Transportation Services - Traffic Services

Turning Movement Count - Full Study Peak Hour Diagram

MONTREAL RD @ VANIER PKWY

Survey Date: Tuesday, March 26, 2019

WO No: 38462

Start Time: 07:00

Device: Miovision

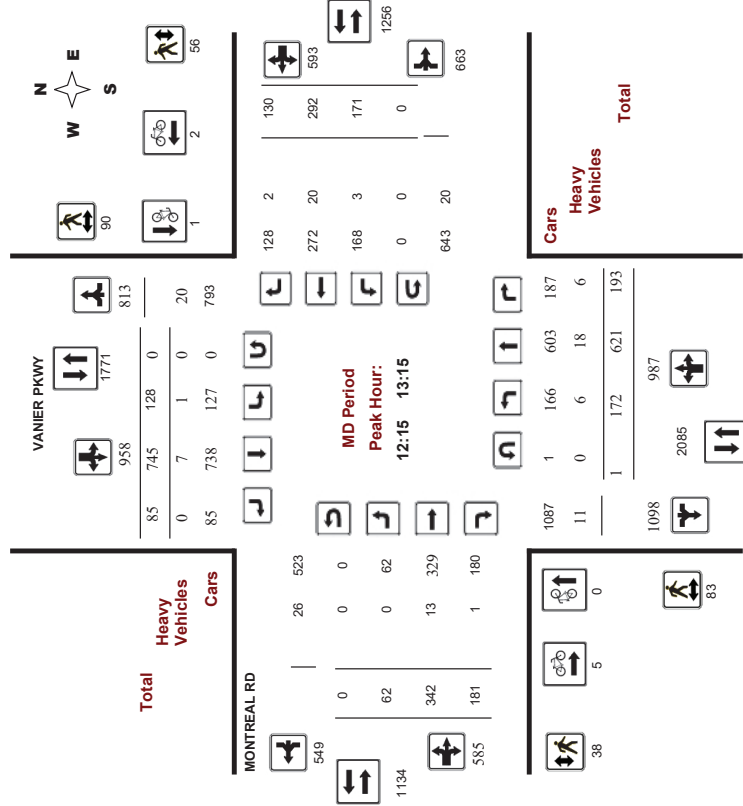

Transportation Services - Traffic Services

Turning Movement Count - Full Study Peak Hour Diagram

MONTREAL RD @ VANIER PKWY

Survey Date: Tuesday, March 26, 2019

Start Time: 07:00

WO No: 38462

Device: Miovision

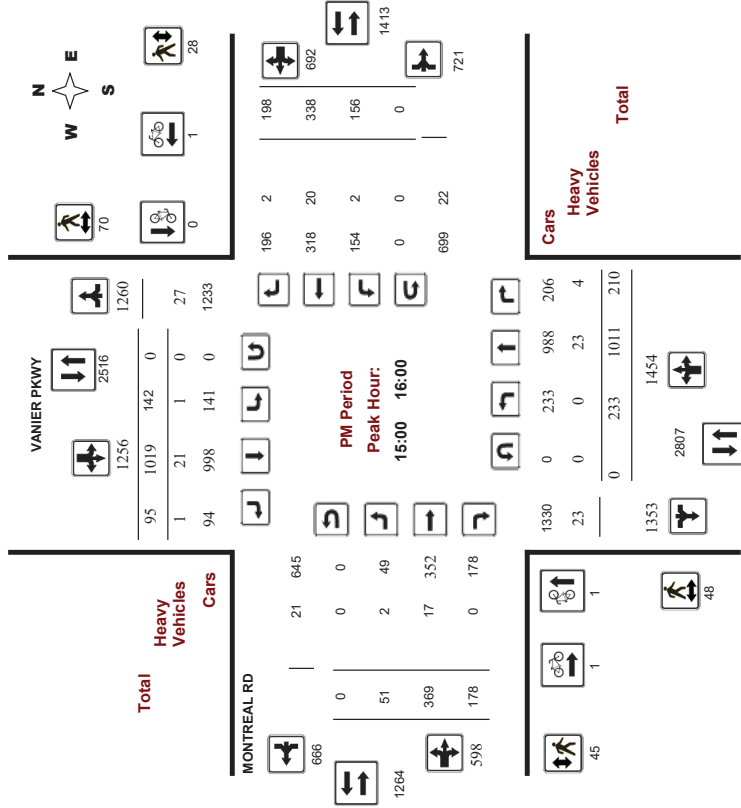

Comments

Transportation Services - Traffic Services

Turning Movement Count - Full Study Diagram

MONTREAL RD @ VANIER PKWY

Survey Date: Tuesday, March 26, 2019

WO#: 38462

Device: Miovision

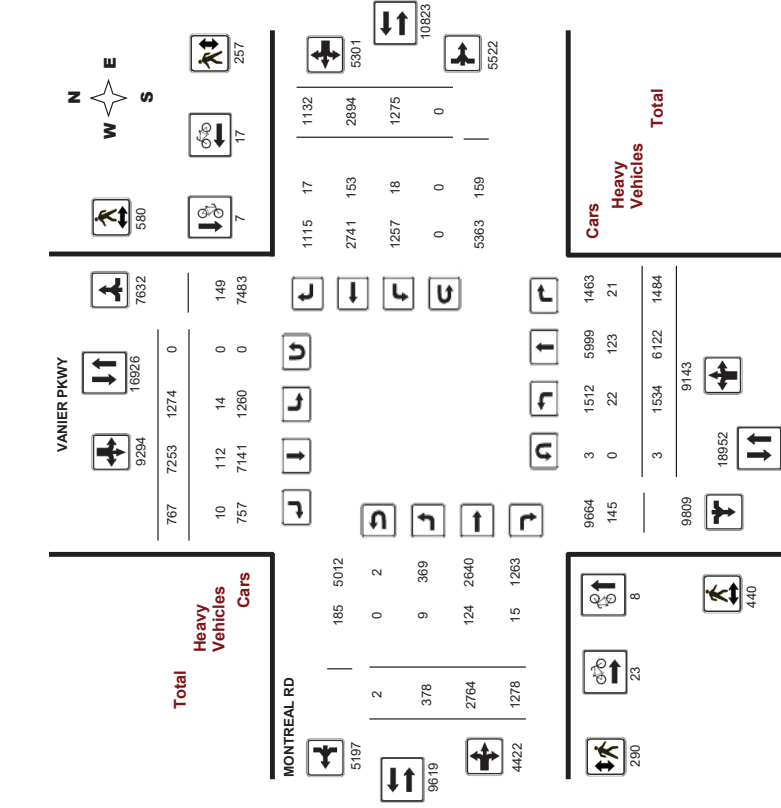

Comments

Transportation Services - Traffic Services
Turning Movement Count - 15 Minute Summary Report**Turning Movement Count - Full Study Summary Report****MONTREAL RD @ VANIER PKWY**

Survey Date: Tuesday, March 26, 2019

Total Observed U-Turns
 Northbound: 3 Southbound: 0
 Eastbound: 2 Westbound: 0

AADT Factor
1.00

Survey Date: Tuesday, March 26, 2019

Total Observed U-Turns
 Northbound: 3 Southbound: 0
 Eastbound: 2 Westbound: 0

Period	VANIER PKWY												MONTREAL RD												Grand Total
	Northbound						Southbound						Eastbound						Westbound						
	LT	ST	RT	TOT	SB	STR	LT	ST	RT	TOT	EB	STR	LT	ST	RT	TOT	WB	STR	LT	ST	RT	TOT	WB	STR	
07:00-08:00	128	674	122	924	218	999	89	1306	2230	38	270	140	448	162	329	162	653	1101	3331						
08:00-09:00	185	806	165	1156	185	1132	128	1445	2801	39	318	144	501	164	506	178	848	1349	3950						
09:00-10:00	196	677	195	1068	155	879	97	1131	2199	42	247	151	440	160	306	109	575	1015	3214						
11:30-12:30	163	588	181	932	138	703	86	927	1859	55	331	173	559	165	271	119	555	1114	2973						
12:30-13:30	158	624	187	969	135	731	69	935	1904	58	351	176	585	170	314	145	629	1214	3118						
15:00-16:00	233	1011	210	1454	142	1019	95	1256	2710	51	369	178	588	156	338	198	692	1290	4000						
16:00-17:00	256	907	196	1359	133	863	103	1099	2458	51	440	177	668	140	439	123	702	1370	3828						
17:00-18:00	215	835	228	1278	168	927	100	1195	2473	44	438	139	621	158	391	98	647	1268	3741						
Sub Total	1534	6122	1484	9140	1274	7253	767	9294	18434	378	2764	1278	4420	1275	2884	1132	5301	9721	28155						
U Turns	3			3	0			3	2			2	0			2	5								
Total	1534	6122	1484	9143	1274	7253	767	9294	18437	378	2764	1278	4422	1275	2884	1132	5301	9723	28160						
EQ 12hr	2132	8510	2063	12709	1771	10082	1066	12919	25628	525	3842	1776	6147	1772	4023	1573	7368	13515	39143						
Note: These values are calculated by multiplying the totals by the appropriate expansion factor.																									
AVG 12hr	2132	8510	2063	12709	1771	10082	1066	12919	25628	525	3842	1776	6147	1772	4023	1573	7368	13515	39143						
Note: These values are calculated by multiplying the Equivalent 12 hr. totals by the AADT factor.																									
AVG 24hr	2793	11148	2702	16648	2320	13207	1397	16923	33571	688	5033	2327	8032	2322	5270	2061	9653	17705	51276						
Note: These volumes are calculated by multiplying the Average Daily 12 hr. totals by 12 to 24 expansion factor.																									

Comments:
 Note: U-Turns provided for approach totals. Refer to 'U-Turn' Report for specific breakdown.

TOTAL: 1534 6122 1484 9143 1274 7253 767 9294 18437 378 2764 1278 4422 1275 2884 1132 5301 9723 28160

Note: U-Turns are included in Totals. **Comment:**



Transportation Services - Traffic Services
Turning Movement Count - Cyclist Volume Report

Work Order
38462



Transportation Services - Traffic Services

W.O.
38462

Turning Movement Count - Heavy Vehicle Report

MONTREAL RD @ VANIER PKWY

Count Date: Tuesday, March 26, 2019 **Start Time:** 07:00

Time Period	VANIER PKWY			MONTREAL RD			Grand Total
	Northbound	Southbound	Street Total	Eastbound	Westbound	Street Total	
07:00 08:00	0	1	1	0	3	3	4
08:00 09:00	1	0	1	1	0	1	2
09:00 10:00	0	0	0	1	3	4	4
11:30 12:30	0	1	1	3	1	4	5
12:30 13:30	0	0	0	9	3	12	12
15:00 16:00	1	0	1	1	1	2	3
16:00 17:00	2	1	3	1	1	2	5
17:00 18:00	4	4	8	7	5	12	20
Total	8	7	15	23	17	40	55

Comment:

Survey Date: Tuesday, March 26, 2019

Time Period	VANIER PKWY						MONTREAL RD						Grand Total							
	Northbound			Southbound			Eastbound			Westbound										
	LT	ST	RT	N	LT	ST	RT	S	STR	LT	ST	RT		E	LT	ST	RT	W	STR	TOT
07:00 08:00	3	17	1	21	4	8	1	13	34	0	24	4	28	3	16	1	20	48	82	
08:00 09:00	5	15	3	23	2	24	2	28	51	2	20	3	25	1	30	5	36	61	112	
09:00 10:00	4	14	4	22	1	15	3	19	41	2	12	2	16	1	25	1	27	43	84	
11:30 12:30	2	15	2	19	2	15	1	18	37	2	13	0	15	4	12	2	18	33	70	
12:30 13:30	5	15	5	25	1	7	0	8	33	1	14	3	18	3	20	2	25	43	76	
15:00 16:00	0	23	4	27	1	21	1	23	50	2	17	0	19	2	20	2	24	43	93	
16:00 17:00	2	12	1	15	2	13	2	17	32	0	16	3	19	1	17	2	20	39	71	
17:00 18:00	1	12	1	14	1	9	0	10	24	0	8	0	8	0	3	13	2	18	26	50
Sub Total	22	123	21	166	14	112	10	136	302	9	124	15	148	18	153	17	188	336	638	
U-Turns (Heavy Vehicles)	0	0	0	0	0	0	0	0	0	0	0	0	0	0	0	0	0	0	0	0
Total	22	123	21	166	14	112	10	136	302	9	124	15	148	18	153	17	188	336	638	

Heavy Vehicles include Buses, Single-Unit Trucks and Articulated Trucks. Further, they ARE included in the Turning Movement Count Summary.



Transportation Services - Traffic Services
Turning Movement Count - 15 Min U-Turn Total Report

Work Order
38462

MONTREAL RD @ VANIER PKWY

Survey Date: Tuesday, March 26, 2019

Time Period	Northbound		Southbound		Eastbound		Westbound		Total
	U-Turn	Total	U-Turn	Total	U-Turn	Total	U-Turn	Total	
07:00	0	0	0	0	0	0	0	0	0
07:15	0	0	0	0	0	0	0	0	0
07:30	0	0	0	0	0	0	0	0	0
07:45	0	0	0	0	0	0	0	0	0
08:00	0	0	0	0	0	0	0	0	0
08:15	0	0	0	0	0	0	0	0	0
08:30	0	0	0	0	0	0	0	0	0
08:45	0	0	0	0	0	0	0	0	0
09:00	0	0	0	0	0	0	0	0	0
09:15	0	0	0	0	0	0	0	0	0
09:30	0	0	0	0	0	0	0	0	0
09:45	0	0	0	0	0	0	0	0	0
10:00	0	0	0	0	0	0	0	0	0
11:30	0	0	0	0	0	0	0	0	0
11:45	0	0	0	0	0	0	0	0	0
12:00	0	0	0	0	0	0	0	0	0
12:15	0	0	0	0	0	0	0	0	0
12:30	0	0	0	0	0	0	0	0	0
12:45	0	0	0	0	0	0	0	0	0
13:00	1	0	0	0	0	0	0	0	1
13:15	0	0	0	0	0	0	0	0	0
15:00	0	0	0	0	0	0	0	0	0
15:15	0	0	0	0	0	0	0	0	0
15:30	0	0	0	0	0	0	0	0	0
15:45	0	0	0	0	0	0	0	0	0
16:00	0	0	0	0	0	0	0	0	0
16:15	0	0	0	0	0	0	0	0	0
16:30	0	0	0	0	0	0	0	0	0
16:45	0	0	0	0	1	0	0	0	1
17:00	1	0	0	0	0	0	0	0	1
17:15	0	0	0	0	0	0	0	0	0
17:30	1	0	0	0	1	0	0	0	2
17:45	0	0	0	0	0	0	0	0	0
Total	3	0	0	0	2	0	0	0	5



Transportation Services - Traffic Services
Turning Movement Count - Pedestrian Volume Report

Work Order
39462

MONTREAL RD @ VANIER PKWY

Count Date: Tuesday, March 26, 2019 Start Time: 07:00

Time Period	NB Approach (E or W Crossing)		SB Approach (E or W Crossing)		EB Approach (N or S Crossing)		WB Approach (N or S Crossing)		Total	Grand Total
	E	W	E	W	E	W	E	W		
07:00	4	10	10	2	10	2	10	2	12	26
07:15	10	11	5	8	21	13	21	13	34	34
07:30	14	7	4	7	21	11	21	11	32	32
07:45	8	9	9	7	17	16	17	16	33	33
08:00	36	37	28	24	73	52	73	52	125	125
08:15	13	18	6	4	31	10	31	10	41	41
08:30	13	17	4	11	30	15	30	15	45	45
08:45	9	16	11	5	25	16	25	16	41	41
08:55	12	18	11	6	30	17	30	17	47	47
09:00	47	69	32	26	116	58	116	58	174	174
09:05	12	12	3	13	28	16	28	16	44	44
09:10	8	18	6	4	26	10	26	10	36	36
09:15	9	13	11	9	22	20	22	20	42	42
09:20	12	12	3	9	20	12	20	12	32	32
09:25	41	55	23	35	96	58	96	58	154	154
10:00	17	17	14	8	24	22	24	22	46	46
11:30	19	16	4	9	35	13	35	13	48	48
12:00	12	18	17	3	30	20	30	20	50	50
12:15	16	16	10	6	33	16	33	16	49	49
12:30	55	67	45	26	122	71	122	71	193	193
12:45	31	22	15	22	53	37	53	37	90	90
13:00	26	24	6	10	50	16	50	16	66	66
13:15	9	28	7	18	37	25	37	25	62	62
13:30	31	26	7	15	57	22	57	22	79	79
13:45	97	100	35	65	197	100	197	100	297	297
15:00	10	16	2	2	18	5	18	5	23	23
15:15	5	17	20	8	22	28	22	28	50	50
15:30	19	20	8	11	39	19	39	19	58	58
15:45	14	17	14	7	31	21	31	21	52	52
16:00	48	70	45	28	118	73	118	73	191	191
16:05	21	26	16	6	47	22	47	22	69	69
16:10	18	16	13	14	34	27	34	27	61	61
16:15	12	25	11	4	37	15	37	15	52	52
16:20	17	20	37	9	54	26	54	26	80	80
16:25	68	87	48	25	155	73	155	73	228	228
16:30	14	18	10	5	32	15	32	15	47	47
16:35	11	19	15	3	30	18	30	18	48	48
16:40	7	29	5	5	36	10	36	10	46	46
16:45	16	29	45	15	64	19	64	19	83	83
17:00	48	95	34	28	143	62	143	62	205	205
Total	440	580	290	257	1020	547	1020	547	1567	1567

Comment:



Turning Movement Count Summary, AM and PM Peak Hour Flow Diagrams

Automobiles, Taxis, Light Trucks, Vans, SUV's, Motorcycles, Heavy Trucks, Buses, and School Buses

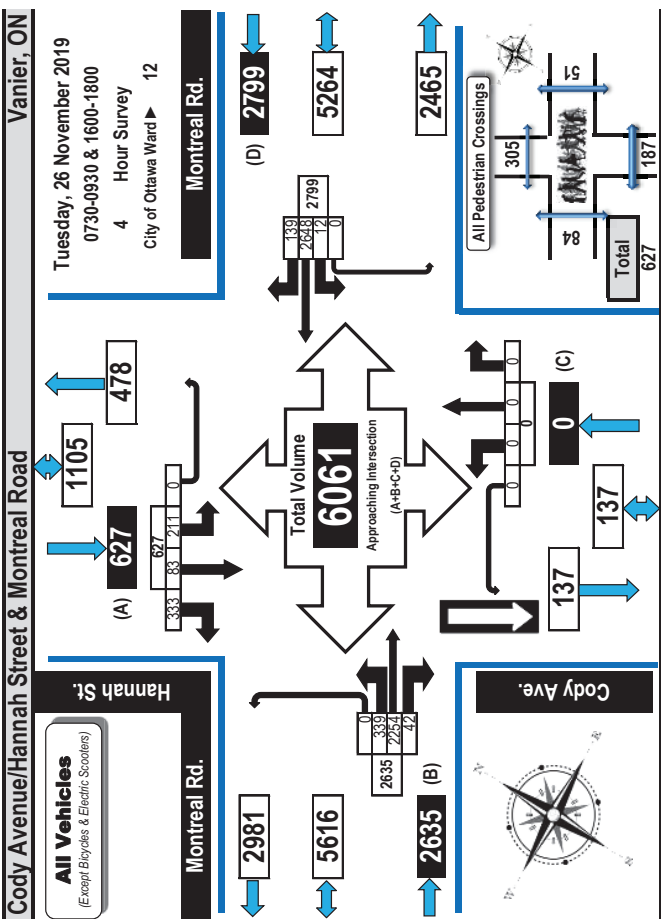

Turning Movement Count Bicycle Summary Flow Diagram

Tuesday, 26 November 2019
0730-0930 & 1600-1800
4 Hour Survey
City of Ottawa Ward 12

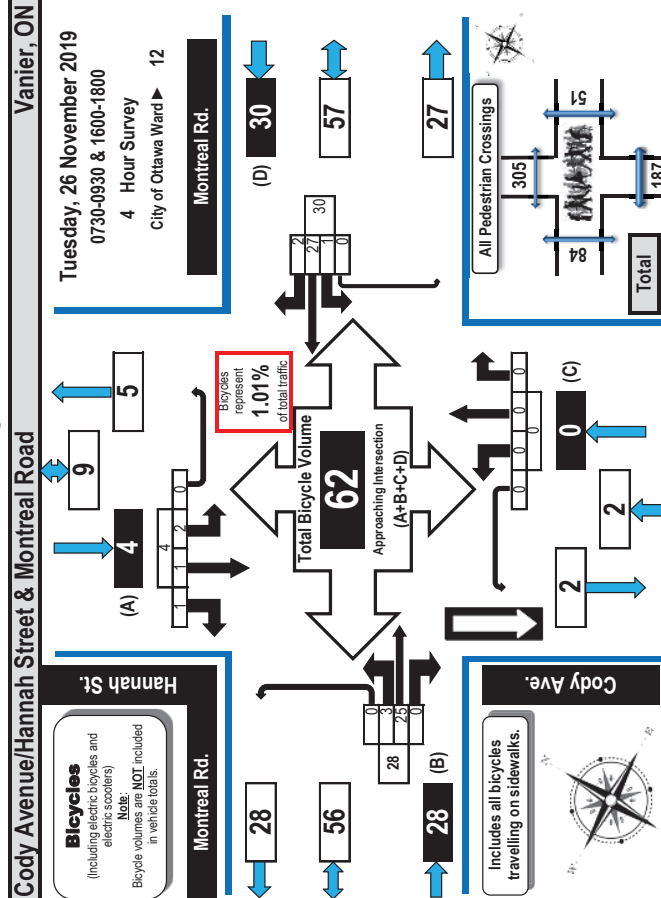

AM Peak Hour Flow Diagram

Time Period	Hannah St. Eastbound			Hannah St. Westbound			Cody Ave. Northbound			Cody Ave. Southbound			Montreal Rd. Eastbound			Montreal Rd. Westbound			Hannah St. Southbound		
	LT	ST	RT	LT	ST	RT	LT	ST	RT	LT	ST	RT	LT	ST	RT	LT	ST	RT	LT	ST	RT
0730-0800	0	1	0	0	0	0	0	0	0	0	0	0	0	0	0	0	0	0	0	0	0
0800-0900	0	1	0	0	0	0	0	0	0	0	0	0	0	0	0	0	0	0	0	0	0
0900-0930	0	2	0	0	0	0	0	0	0	0	0	0	0	0	0	0	0	0	0	0	0
1600-1700	1	11	0	0	0	0	0	0	0	0	0	0	0	0	0	0	0	0	0	0	0
1700-1800	2	10	0	0	0	0	0	0	0	0	0	0	0	0	0	0	0	0	0	0	0
Totals	3	25	0	0	0	0	0	0	0	0	0	0	0	0	0	0	0	0	0	0	0

PM Peak Hour Flow Diagram

Time Period	Hannah St. Eastbound			Hannah St. Westbound			Cody Ave. Northbound			Cody Ave. Southbound			Montreal Rd. Eastbound			Montreal Rd. Westbound			Hannah St. Southbound		
	LT	ST	RT	LT	ST	RT	LT	ST	RT	LT	ST	RT	LT	ST	RT	LT	ST	RT	LT	ST	RT
0730-0800	0	1	0	0	0	0	0	0	0	0	0	0	0	0	0	0	0	0	0	0	0
0800-0900	0	1	0	0	0	0	0	0	0	0	0	0	0	0	0	0	0	0	0	0	0
0900-0930	0	2	0	0	0	0	0	0	0	0	0	0	0	0	0	0	0	0	0	0	0
1600-1700	1	11	0	0	0	0	0	0	0	0	0	0	0	0	0	0	0	0	0	0	0
1700-1800	2	10	0	0	0	0	0	0	0	0	0	0	0	0	0	0	0	0	0	0	0
Totals	3	25	0	0	0	0	0	0	0	0	0	0	0	0	0	0	0	0	0	0	0

Comments:
Cody Avenue is one way southbound.



Turning Movement Count Pedestrian Crossings Summary and Flow Diagram



Cody Avenue/Hannah Street & Montreal Road Vanier, ON

Pedestrian Crossings

Tuesday, 26 November 2019
0730-0930 & 1600-1800
4 Hour Survey
City of Ottawa Ward 12

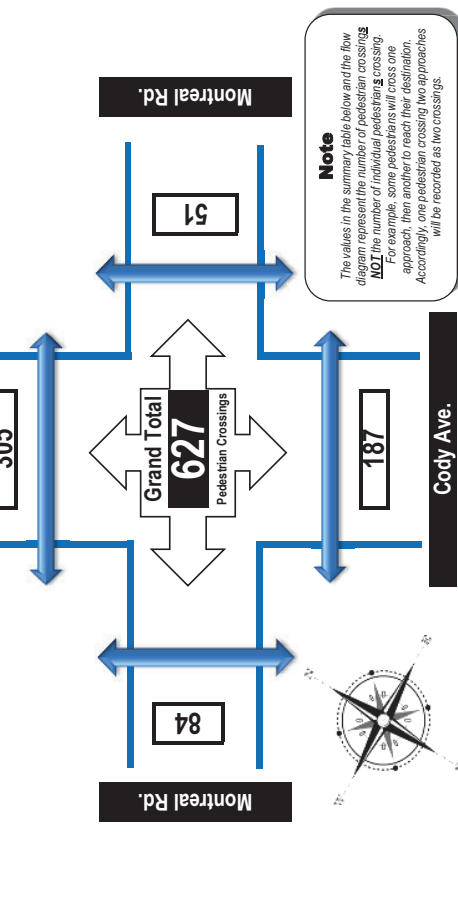

Note
The values in the summary table below and the flow diagram represent the number of pedestrian crossings. **NOT** the number of pedestrians crossing. For each approach, there are two pedestrian crossings. Accordingly, one pedestrian crossing two approaches will be recorded as two crossings.



Time Period	West Side Crossing		East Side Crossing		North Side Crossing		South Side Crossing		Grand Total
	Montreal Rd.	Hannah St.	Montreal Rd.	Hannah St.	Montreal Rd.	Cody Ave.	Cody Ave.	Total	
0730-0800	3	4	1	13	24	11	11	24	28
0800-0900	11	19	8	58	95	37	12	95	114
0900-0930	6	17	11	41	53	12	12	53	70
1600-1700	36	49	13	102	165	63	102	165	214
1700-1800	28	46	18	91	155	64	91	155	201
Totals	84	135	51	305	492	187	187	492	627

Comments:
Cody Avenue is one way southbound.



Turning Movement Count Heavy Vehicle Summary Flow Diagram



Cody Avenue/Hannah Street & Montreal Road Vanier, ON

Heavy Vehicles
(Construction Vehicles, Heavy Trucks, Buses & School Buses). Heavy vehicles are **ALSO** included in the all vehicles summary and flow diagrams.

Tuesday, 26 November 2019
0730-0930 & 1600-1800
4 Hour Survey
City of Ottawa Ward 12

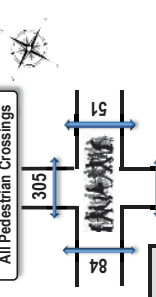
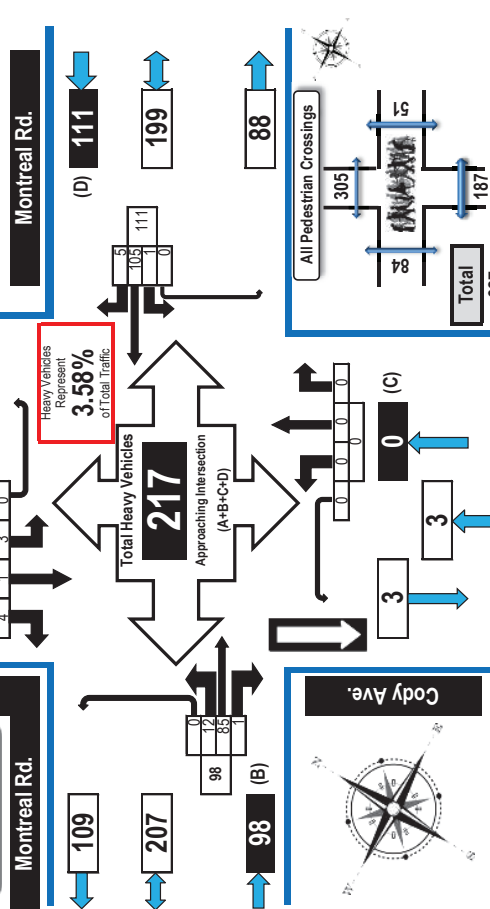

Time Period	Montreal Rd. Eastbound				Montreal Rd. Westbound				Cody Ave. Northbound				Hannah St. Southbound				s. Tot	RT	UT	s. Tot	G. Tot
	LT	ST	RT	UT	LT	ST	RT	UT	LT	ST	RT	UT	LT	ST	RT	UT					
0730-0800	1	12	0	0	13	0	18	1	0	19	0	0	0	0	0	0	0	0	0	32	
0800-0900	5	24	0	0	29	0	36	1	0	37	0	0	0	0	1	1	2	0	4	70	
0900-0930	3	15	0	0	18	1	15	1	0	17	0	0	0	0	1	0	0	0	1	36	
1600-1700	0	19	1	0	20	0	20	2	0	22	0	0	0	0	0	0	0	0	0	42	
1700-1800	3	15	0	0	18	0	16	0	0	16	0	0	0	0	1	0	2	0	3	37	
Totals	12	85	1	0	98	1	105	5	0	111	0	0	0	0	3	1	4	0	8	217	

Comments:
Cody Avenue is one way southbound.



Turning Movement Count Summary Report AADT and Expansion Factors

Automobiles, Taxis, Light Trucks, Vans, SUVs, Motorcycles, Heavy Trucks, Buses, and School Buses

Cody Avenue/Hannah Street & Montreal Road Vanier, ON

Survey Date: Tuesday, 26 November 2019 Start Time: 0730 AADT Factor: 1.0
 Weather: AM: Overcast +5°C Survey Duration: 4 Hrs. Survey Hours: 0730-0930 & 1600-1800
 Weather: PM: Overcast +10°C Surveyor(s): Carmody

Time Period	Eastbound				Westbound				Northbound				Southbound				
	LT	ST	RT	UT	LT	ST	RT	UT	LT	ST	RT	UT	LT	ST	RT	UT	
0730-0800	20	224	3	0	247	2	364	13	0	379	626	0	0	0	23	10	50
0800-0900	70	458	10	0	538	1	780	15	0	796	1334	0	0	50	35	112	0
0900-0930	36	257	8	0	301	5	274	13	0	292	593	0	0	15	8	47	0
1600-1700	97	658	13	0	768	2	641	48	0	691	1459	0	0	54	14	55	0
1700-1800	116	657	8	0	781	2	589	50	0	641	1422	0	0	69	16	69	0
Totals	339	2254	42	0	2635	12	2648	139	0	2799	5434	0	0	211	83	333	0

Equivalent 12 & 24-hour Vehicle Volumes Including the Annual Average Daily Traffic (AADT) Factor
 Applicable to the Day and Month of the Turning Movement Count

Expansion factors are applied exclusively to standard weekday 8-hour turning movement counts conducted during the hours of 0700h - 1000h, 1130h - 1330h and 1500h - 1800h

Equ. 12-Hr	n/a	n/a	n/a	n/a	n/a	n/a	n/a	n/a	n/a	n/a	n/a	n/a	n/a	n/a	n/a	n/a	n/a	n/a	n/a
Average daily 12-hour vehicle volumes. These volumes are calculated by multiplying the 8-hour totals by the 8 → 12 expansion factor of 1.39																			
Equivalent 12-hour vehicle volumes. These volumes are calculated by multiplying the equivalent 12-hour totals by the AADT factor of: 1.0																			
Average daily 24-hour vehicle volumes. These volumes are calculated by multiplying the average daily 12-hour vehicle volumes by the 12 → 24 expansion factor of 1.31																			
Equivalent 24-hour vehicle volumes. These volumes are calculated by multiplying the equivalent 24-hour totals by the AADT factor of: 1.0																			

AADT and expansion factors provided by the City of Ottawa

AM Peak Hour Factor	0.91
AM Peak Hr	LT ST RT UT TOT
0800-0900	70 458 10 0 538
PM Peak Hour Factor <th>0.95</th>	0.95
PM Peak Hr	LT ST RT UT TOT
1645-1745	114 661 7 0 782

Comments: Cody Avenue is one way southbound.

- Notes:
- Includes all vehicle types except bicycles, electric bicycles, and electric scooters.
 - When expansion and AADT factors are applied, the results will differ slightly due to rounding.



Turning Movement Count Summary, AM and PM Peak Hour Flow Diagrams

Automobiles, Taxis, Light Trucks, Vans, SUVs, Motorcycles, Heavy Trucks, Buses, and School Buses

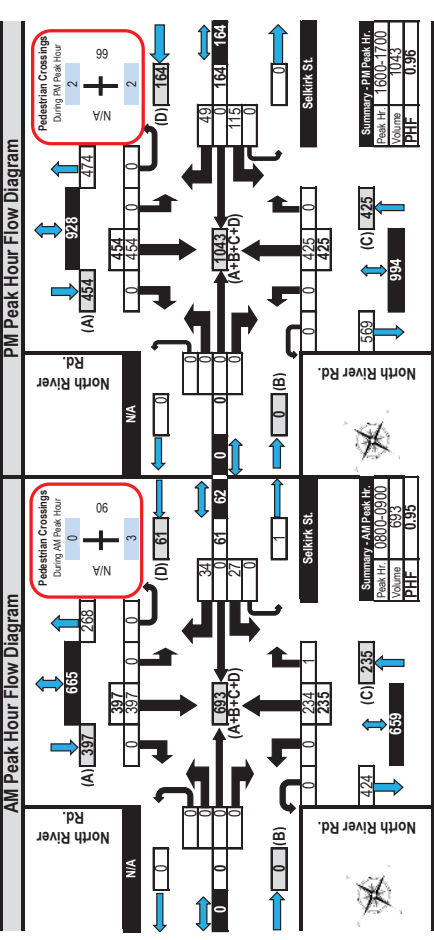
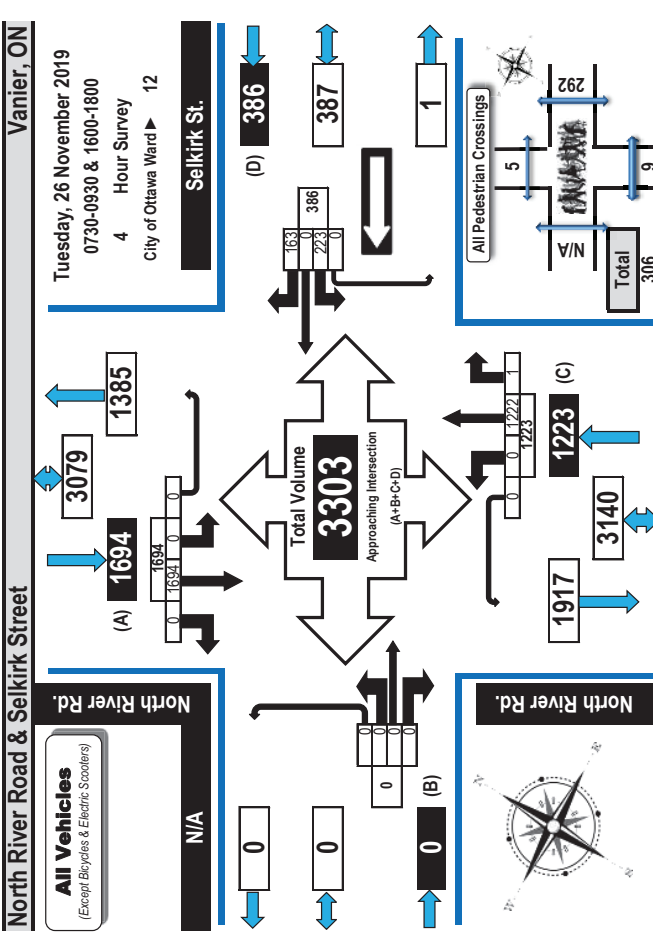



Turning Movement Count Pedestrian Crossings Summary and Flow Diagram



North River Road & Selkirk Street Vanier, ON

Pedestrian Crossings
Tuesday, 26 November 2019
0730-0930 & 1600-1800
4 Hour Survey
City of Ottawa Ward 12

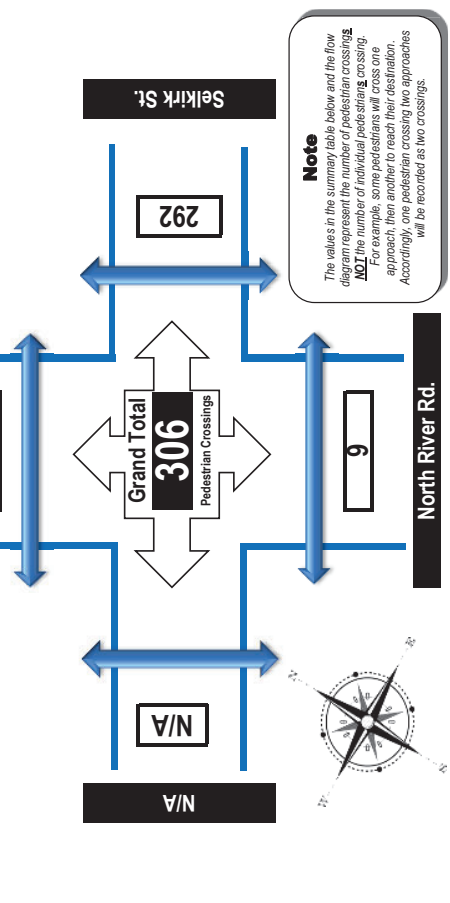

Note
The values in the summary table below and the flow diagram represent the number of pedestrian crossings. This is the number of approaches to a crossing. For example, a crossing with two approaches, one to each direction, will be recorded as two crossings. Accordingly, one pedestrian crossing two approaches will be recorded as two crossings.

Time Period	West Side Crossing		East Side Crossing		South Side Crossing		North Side Crossing		Grand Total
	NA	NA	Selkirk St.	North River Rd.	North River Rd.	North River Rd.	North River Rd.		
0730-0800	0	0	48	1	0	0	1	49	
0800-0900	0	0	90	3	0	0	3	93	
0900-0930	0	0	28	2	0	0	4	32	
1600-1700	0	0	66	2	0	0	2	70	
1700-1800	0	0	60	1	0	0	2	62	
Totals	0	0	292	9	0	0	14	306	

Comments:
Selkirk Street is one way westbound. One northbound heavy vehicle turned right from North River Road. Southbound traffic backs up from McArthur Avenue, primarily during the evening portion of the survey to Selkirk Street and occasionally to Montreal Road. Some westbound left turns from Selkirk Street force their way into traffic to complete their turn.



Turning Movement Count Bicycle Summary Flow Diagram



North River Road & Selkirk Street Vanier, ON

Bicycles
(Including electric bicycles and electric scooters)
NOTE:
Bicycle volumes are NOT included in vehicle totals.

Tuesday, 26 November 2019
0730-0930 & 1600-1800
4 Hour Survey
City of Ottawa Ward 12

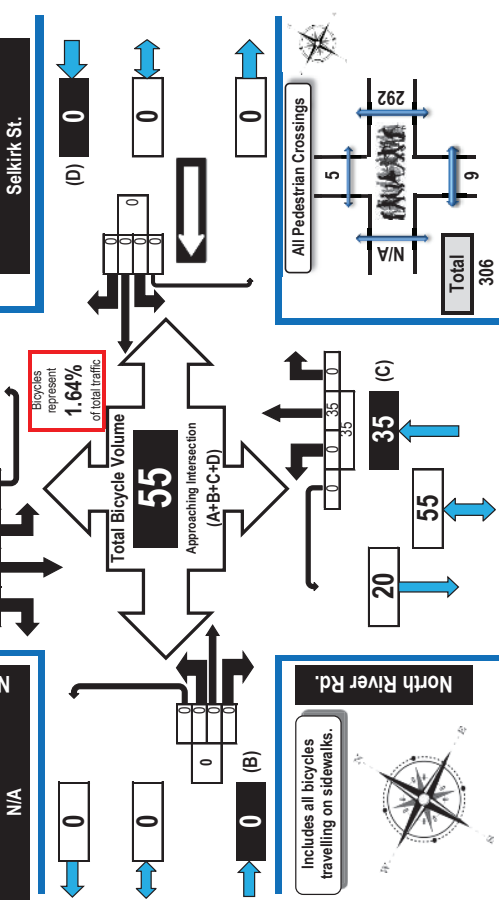

Note
Bicycles represent 1.64% of total traffic.

Time Period	Eastbound				North River Rd. Northbound				North River Rd. Southbound				G.Total	
	LT	ST	RT	UT	LT	ST	RT	UT	LT	ST	RT	UT		
0730-0800	0	0	0	0	0	0	0	0	0	0	0	0	0	4
0800-0900	0	0	0	0	0	0	0	0	0	0	0	0	0	2
0900-0930	0	0	0	0	0	0	0	0	0	0	0	0	0	1
1600-1700	0	0	0	0	0	0	0	0	0	0	0	0	0	4
1700-1800	0	0	0	0	0	0	0	0	0	0	0	0	0	9
Totals	0	0	0	0	0	0	0	0	0	0	0	0	0	20

Comments:
Selkirk Street is one way westbound. One northbound heavy vehicle turned right from North River Road. Southbound traffic backs up from McArthur Avenue, primarily during the evening portion of the survey to Selkirk Street and occasionally to Montreal Road. Some westbound left turns from Selkirk Street force their way into traffic to complete their turn.



Turning Movement Count Heavy Vehicle Summary



North River Road & Selkirk Street

Vanier, ON

Tuesday, 26 November 2019
0730-0930 & 1600-1800
4 Hour Survey
City of Ottawa Ward 12

Heavy Vehicles
(Construction Vehicles, Heavy Trucks, Buses & School Buses). Heavy vehicle totals ARE included in the all vehicles summary and flow diagrams.

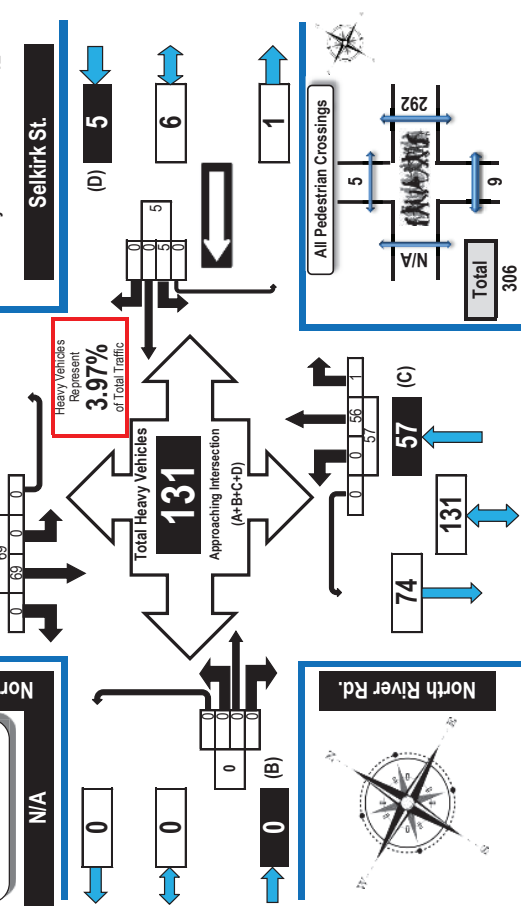

Time Period	Selkirk St. Westbound				Selkirk St. Northbound				North River Rd. Eastbound				North River Rd. Westbound				s.Tot	RT	UT	s.Tot	G.Tot
	LT	ST	RT	UT	LT	ST	RT	UT	LT	ST	RT	UT	LT	ST	RT	UT					
0730-0900	0	0	0	0	0	0	0	0	0	0	0	0	0	0	0	0	0	0	0	8	18
0800-0900	0	0	0	0	0	0	0	0	0	0	0	0	0	0	0	0	0	0	0	9	30
0900-0930	0	0	0	0	0	0	0	0	0	0	0	0	0	0	0	0	0	0	0	20	30
1600-1700	0	0	0	0	0	0	0	0	0	0	0	0	0	0	0	0	0	0	0	19	33
1700-1800	0	0	0	0	0	0	0	0	0	0	0	0	0	0	0	0	0	0	0	13	20
Totals	0	0	0	0	0	0	0	0	0	0	0	0	0	0	0	0	0	0	57	69	131

Comments:
Selkirk Street is one way westbound. One northbound heavy vehicle turned right from North River Road. Southbound traffic backs up from McArthur Avenue, primarily during the evening portion of the survey to Selkirk Street and occasionally to Montreal Road. Some westbound left turns from Selkirk Street force their way into traffic to complete their turn.



Turning Movement Count Summary Report AADT and Expansion Factors

Automobiles, Taxis,
Light Trucks, Vans,
SUV's, Motorcycles,
Heavy Trucks, Buses,
and School Buses

North River Road & Selkirk Street

Vanier, ON

Survey Date: Tuesday, 26 November 2019 Start Time: 0730 AADT Factor: 1.0
Weather AM: Overcast +5°C Survey Duration: 4 Hrs. Survey Hours: 0730-0930 & 1600-1800
Weather PM: Overcast +10°C Surveyor(s): Carmody

Time Period	Eastbound				Westbound				Northbound				Southbound				Grand Total		
	LT	ST	RT	UT	LT	ST	RT	UT	LT	ST	RT	UT	LT	ST	RT	UT			
0730-0800	0	0	0	0	0	12	0	16	0	28	28	0	121	0	182	0	182	303	331
0800-0900	0	0	0	0	0	27	0	34	0	61	61	0	234	0	235	0	397	0	397
0900-0930	0	0	0	0	0	11	0	19	0	30	30	0	106	0	106	0	177	0	177
1600-1700	0	0	0	0	0	115	0	49	0	164	164	0	425	0	425	0	454	0	454
1700-1800	0	0	0	0	0	58	0	45	0	103	103	0	336	0	336	0	484	0	484
Totals	0	0	0	0	0	223	0	163	0	386	386	0	1222	0	1223	0	1694	0	1694

Equivalent 12 & 24-hour Vehicle Volumes Including the Annual Average Daily Traffic (AADT) Factor
Applicable to the Day and Month of the Turning Movement Count

Expansion factors are applied exclusively to standard weekday 8-hour turning movement counts conducted during the hours of 0700h - 1000h, 1130h - 1330h and 1500h - 1800h

Equivalent 12-hour vehicle volumes. These volumes are calculated by multiplying the 8-hour totals by the 8 → 12 expansion factor of 1.39

Equivalent 24-hour vehicle volumes. These volumes are calculated by multiplying the equivalent 12-hour totals by the AADT factor of: 1.0

24-hour AADT these volumes are calculated by multiplying the average daily 24-hour vehicle volumes by the 12 → 24 expansion factor of 1.31

AADT and expansion factors provided by the City of Ottawa

AM Peak Hour Factor	0.95				Highest Hourly Vehicle Volume Between 0700h & 1000h															
	LT	ST	RT	UT	LT	ST	RT	UT												
0800-0900	0	0	0	0	0	27	0	34	0	61	0	234	0	235	0	397	0	397	632	693

PM Peak Hour Factor	0.96				Highest Hourly Vehicle Volume Between 1500h & 1800h														
	LT	ST	RT	UT	LT	ST	RT	UT											
1600-1700	0	0	0	0	0	115	0	49	0	164	164	0	425	0	425	0	454	0	454

Comments:
Selkirk Street is one way westbound. One northbound heavy vehicle turned right from North River Road. Southbound traffic backs up from McArthur Avenue, primarily during the evening portion of the survey to Selkirk Street and occasionally to Montreal Road. Some westbound left turns from Selkirk Street force their way into traffic to complete their turn.

Notes:
1. Includes all vehicle types except bicycles, electric bicycles, and electric scooters.
2. When expansion and AADT factors are applied, the results will differ slightly due to rounding.



Turning Movement Count Summary, AM and PM Peak Hour Flow Diagrams

Automobiles, Taxis, Light Trucks, Vans, SUV's, Motorcycles, Heavy Trucks, Buses, and School Buses

Dundas Street & McArthur Avenue Vanier, ON

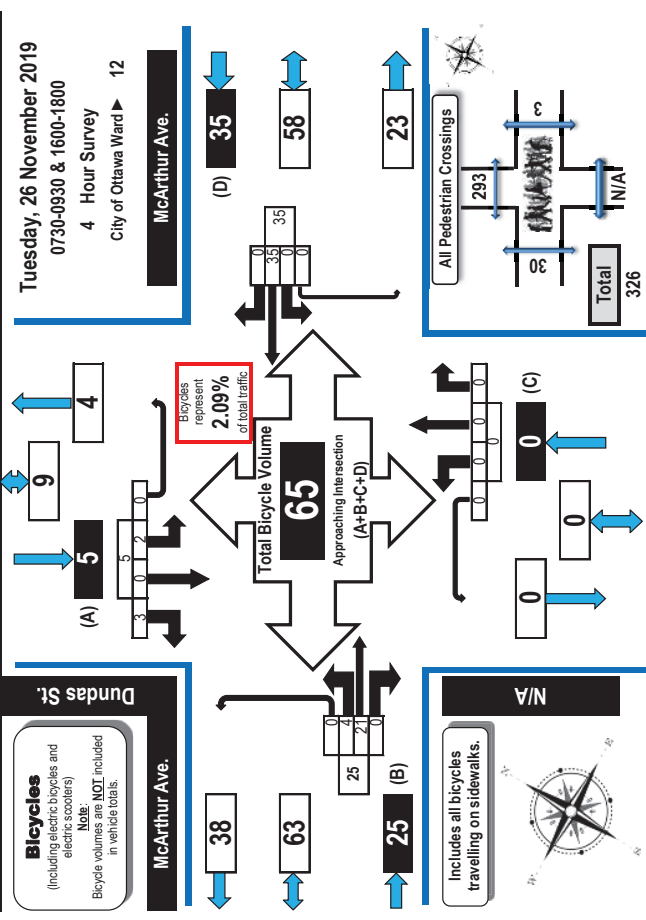

Time Period	McArthur Ave. Eastbound			McArthur Ave. Westbound			Northbound			Southbound			G.Tot.
	LT	ST	RT	LT	ST	RT	LT	ST	RT	LT	ST	RT	
0730-0800	0	1	0	0	0	0	0	0	0	0	0	0	0
0800-0900	2	2	0	4	0	0	0	0	0	0	0	0	1
0900-0930	0	0	0	0	0	0	0	0	0	0	0	0	0
1600-1700	1	9	0	10	0	0	5	0	0	0	0	0	3
1700-1800	1	9	0	10	0	0	7	0	0	0	0	0	1
Totals	4	21	0	25	0	0	35	0	0	2	0	0	5

Comments:
There were no traffic issues observed.



Turning Movement Count Summary, AM and PM Peak Hour Flow Diagrams

Automobiles, Taxis, Light Trucks, Vans, SUV's, Motorcycles, Heavy Trucks, Buses, and School Buses

Dundas Street & McArthur Avenue Vanier, ON

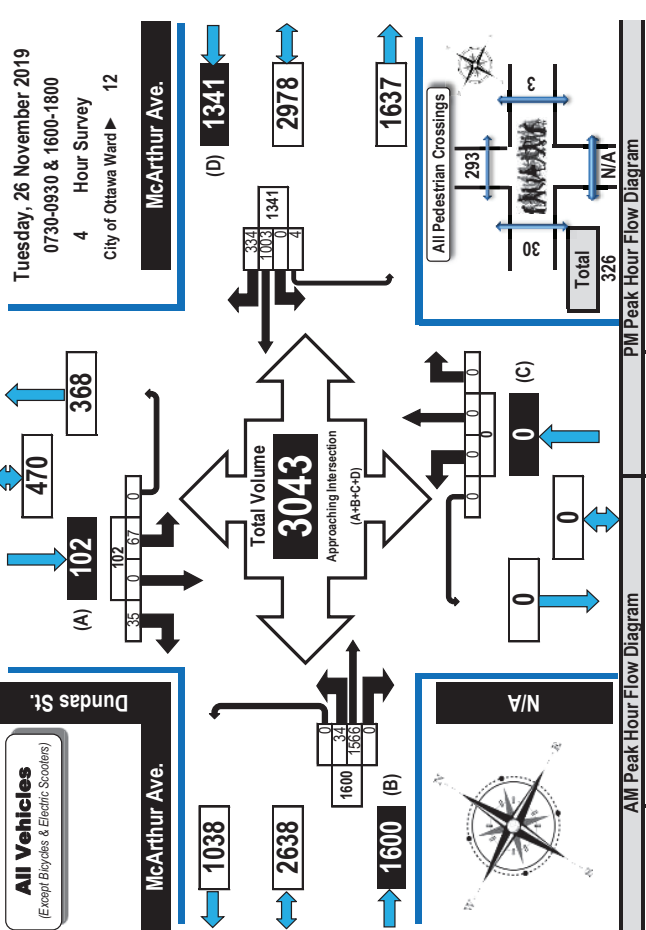

Time Period	McArthur Ave. Eastbound			McArthur Ave. Westbound			Northbound			Southbound			G.Tot.
	LT	ST	RT	LT	ST	RT	LT	ST	RT	LT	ST	RT	
0730-0800	0	1	0	0	0	0	0	0	0	0	0	0	0
0800-0900	2	2	0	4	0	0	0	0	0	0	0	0	1
0900-0930	0	0	0	0	0	0	0	0	0	0	0	0	0
1600-1700	1	9	0	10	0	0	5	0	0	0	0	0	3
1700-1800	1	9	0	10	0	0	7	0	0	0	0	0	1
Totals	4	21	0	25	0	0	35	0	0	2	0	0	5

Comments:
There were no traffic issues observed.



Turning Movement Count Summary, AM and PM Peak Hour Flow Diagrams

Automobiles, Taxis, Light Trucks, Vans, SUV's, Motorcycles, Heavy Trucks, Buses, and School Buses

Dundas Street & McArthur Avenue Vanier, ON

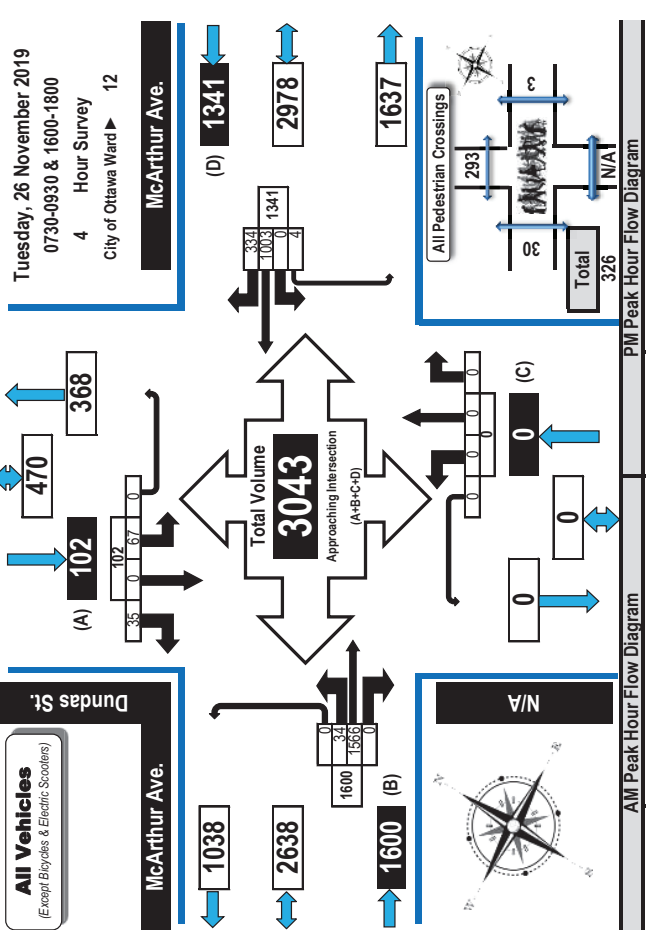

Time Period	McArthur Ave. Eastbound			McArthur Ave. Westbound			Northbound			Southbound			G.Tot.
	LT	ST	RT	LT	ST	RT	LT	ST	RT	LT	ST	RT	
0730-0800	0	1	0	0	0	0	0	0	0	0	0	0	0
0800-0900	2	2	0	4	0	0	0	0	0	0	0	0	1
0900-0930	0	0	0	0	0	0	0	0	0	0	0	0	0
1600-1700	1	9	0	10	0	0	5	0	0	0	0	0	3
1700-1800	1	9	0	10	0	0	7	0	0	0	0	0	1
Totals	4	21	0	25	0	0	35	0	0	2	0	0	5

Comments:
There were no traffic issues observed.



Turning Movement Count Pedestrian Crossings Summary and Flow Diagram



Dundas Street & McArthur Avenue Vanier, ON

Tuesday, 26 November 2019
0730-0930 & 1600-1800
4 Hour Survey
City of Ottawa Ward 12

Pedestrian Crossings

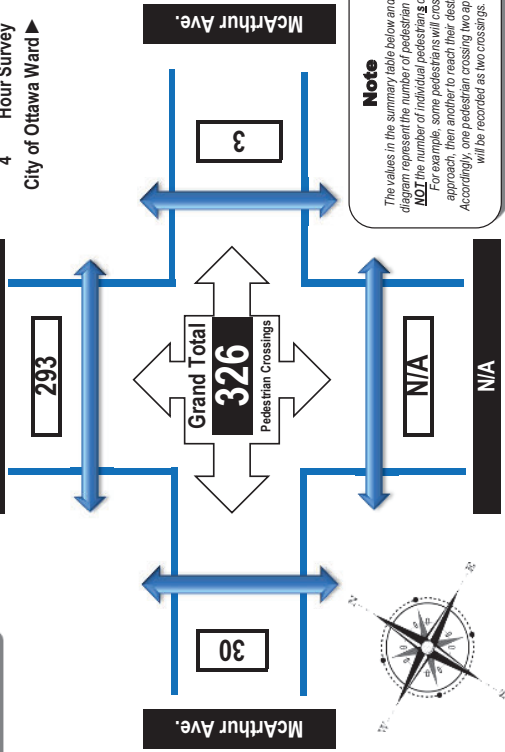

Note
The values in the summary table below and the flow diagram represent the number of pedestrian crossings. **NOT** the number of pedestrians crossing. For each approach, these are recorded as two approaches. Accordingly, one pedestrian crossing two approaches will be recorded as two crossings.



Time Period	West Side Crossing McArthur Ave.		East Side Crossing McArthur Ave.		South Side Crossing N/A		North Side Crossing Dundas St.		Street Total		Grand Total
	LT	RT	LT	RT	LT	RT	LT	RT	LT	RT	
0730-0800	4	0	0	0	0	0	50	0	4	50	54
0800-0900	11	1	1	0	0	0	91	0	12	91	103
0900-0930	5	0	0	0	0	0	32	0	5	32	37
1600-1700	9	0	0	0	0	0	76	0	9	76	85
1700-1800	1	2	2	0	0	0	44	0	3	44	47
Totals	30	3	3	0	0	0	293	0	33	293	326

Comments:
There were no traffic issues observed.



Turning Movement Count Heavy Vehicle Summary Flow Diagram



Dundas Street & McArthur Avenue Vanier, ON

Tuesday, 26 November 2019
0730-0930 & 1600-1800
4 Hour Survey
City of Ottawa Ward 12

Heavy Vehicles
(Construction Vehicles, Heavy Trucks, Buses & School Buses). Heavy vehicles are **NOT** included in the all vehicles summary and flow diagrams.

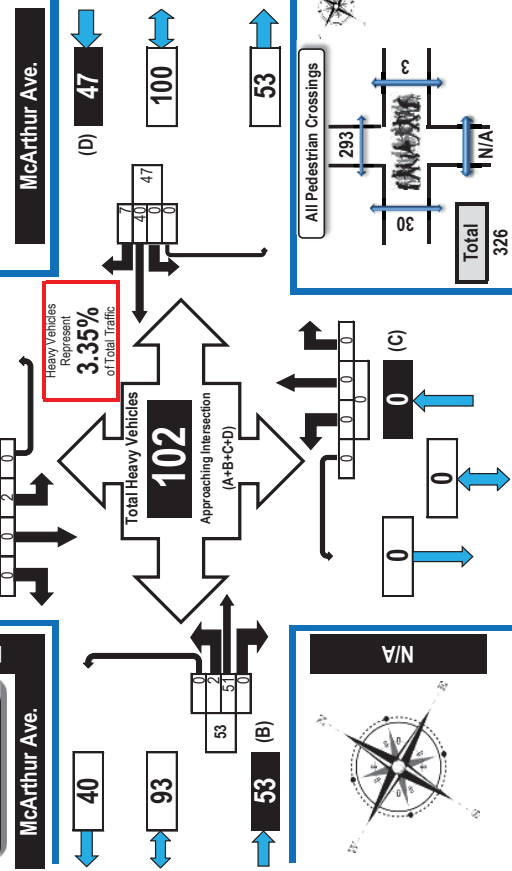

Time Period	West Side Crossing McArthur Ave.		East Side Crossing McArthur Ave.		South Side Crossing N/A		North Side Crossing Dundas St.		Street Total		Grand Total
	LT	RT	LT	RT	LT	RT	LT	RT	LT	RT	
0730-0800	1	7	0	0	0	0	8	0	1	7	13
0800-0900	1	9	0	0	0	0	10	0	14	2	16
0900-0930	0	13	0	0	0	0	7	0	4	11	24
1600-1700	0	14	0	0	0	0	10	0	10	0	20
1700-1800	0	8	0	0	0	0	5	0	5	0	13
Totals	2	51	0	0	0	0	53	0	40	7	102

Comments:
There were no traffic issues observed.



Turning Movement Count Summary Report AADT and Expansion Factors

Automobiles, Taxis,
Light Trucks, Vans,
SUVs, Motorcycles,
Heavy Trucks, Buses,
and School Buses

Dundas Street & McArthur Avenue

Survey Date: Tuesday, 26 November 2019 Start Time: 07:30 AADT Factor: 1.0
 Weather AM: Overcast +5°C Survey Duration: 4 Hrs. Survey Hours: 07:30-09:30 & 16:00-18:00
 Weather PM: Overcast +10°C Surveyor(s): Merrett/Mousseau

Time Period	McArthur Ave. Eastbound				McArthur Ave. Westbound				Dundas St. Southbound				Grand Total	
	LT	ST	RT	UT	WB	ST	RT	UT	LT	ST	RT	UT		
0730-0800	4	181	0	0	139	32	0	0	0	0	0	0	17	373
0800-0900	15	354	0	0	353	92	3	353	722	0	0	0	24	746
0900-0930	5	133	0	0	138	0	105	49	1	155	293	0	4	297
1600-1700	7	474	0	0	481	0	292	92	0	384	865	0	30	895
1700-1800	3	424	0	0	427	0	209	69	0	278	705	0	27	732
Totals	34	1566	0	0	1600	0	1003	334	4	1341	2941	0	102	3043

Equivalent 12 & 24-hour Vehicle Volumes Including the Annual Average Daily Traffic (AADT) Factor
 Applicable to the Day and Month of the Turning Movement Count

Expansion factors are applied exclusively to standard weekday 8-hour turning movement counts conducted during the hours of 0700h - 1000h, 1130h - 1330h and 1500h - 1800h

Equ. 12 Hr	n/a	n/a	n/a	n/a	n/a	n/a	n/a	n/a	n/a	n/a	n/a	n/a	n/a	n/a
Equivalent 12-hour vehicle volumes. These volumes are calculated by multiplying the 8-hour totals by the 8 → 12 expansion factor of 1.39														
Average daily 12-hour vehicle volumes. These volumes are calculated by multiplying the equivalent 12-hour totals by the AADT factor of: 1.0														
AADT 12-hr	n/a	n/a	n/a	n/a	n/a	n/a	n/a	n/a	n/a	n/a	n/a	n/a	n/a	n/a
24-hour AADT: these volumes are calculated by multiplying the average daily 12-hour vehicle volumes by the 12 → 24 expansion factor of 1.1														
AADT 24-hr	n/a	n/a	n/a	n/a	n/a	n/a	n/a	n/a	n/a	n/a	n/a	n/a	n/a	n/a

AADT and expansion factors provided by the City of Ottawa

AM Peak Hour Factor	0.97				Highest Hourly Vehicle Volume Between 0700h & 1000h														
	LT	ST	RT	UT	LT	ST	RT	UT											
0745-0845	10	371	0	0	381	0	258	79	3	340	721	0	0	10	0	16	0	26	747
PM Peak Hour Factor	0.83				Highest Hourly Vehicle Volume Between 1500h & 1800h														
	LT	ST	RT	UT	LT	ST	RT	UT											
1600-1700	7	474	0	0	481	0	292	92	0	384	865	0	0	26	0	4	0	30	895

Comments:

There were no traffic issues observed.

Notes:

1. Includes all vehicle types except bicycles, electric bicycles, and electric scooters.
2. When expansion and AADT factors are applied, the results will differ slightly due to rounding.



Transportation Services - Traffic Services Turning Movement Count - Full Study Peak Hour Diagram MARGUERITE AVE @ MCARTHUR AVE

Survey Date: Tuesday, March 26, 2019 WO No: 38444
 Start Time: 07:00 Device: Miovision

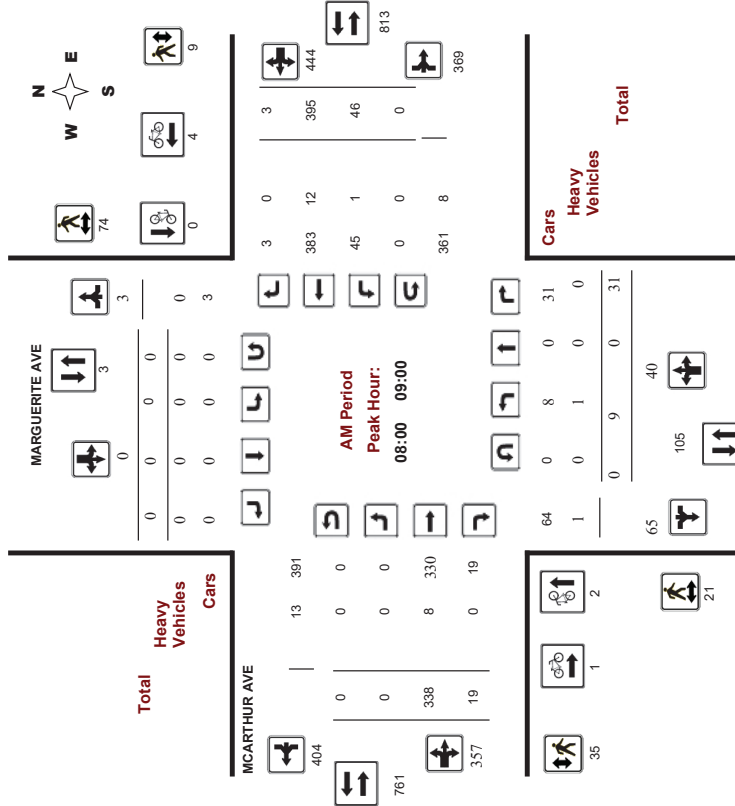

Comments



Transportation Services - Traffic Services
Turning Movement Count - Full Study Peak Hour Diagram
MARGUERITE AVE @ MCARTHUR AVE

Survey Date: Tuesday, March 26, 2019
 Start Time: 07:00

WO No: 38444
 Device: Miovision

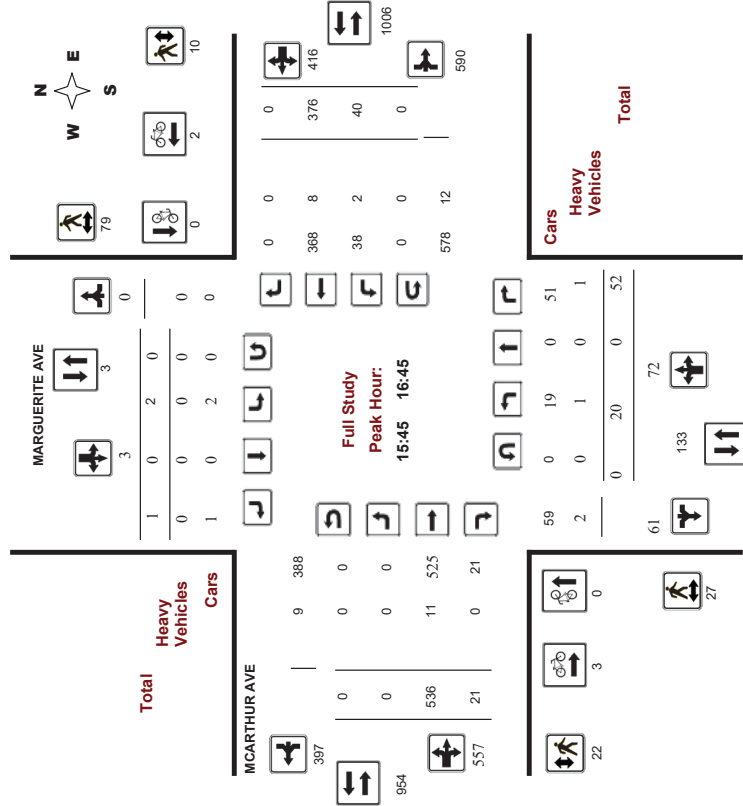

Comments



Transportation Services - Traffic Services
Turning Movement Count - Full Study Peak Hour Diagram
MARGUERITE AVE @ MCARTHUR AVE

Survey Date: Tuesday, March 26, 2019
 Start Time: 07:00

WO No: 38444
 Device: Miovision

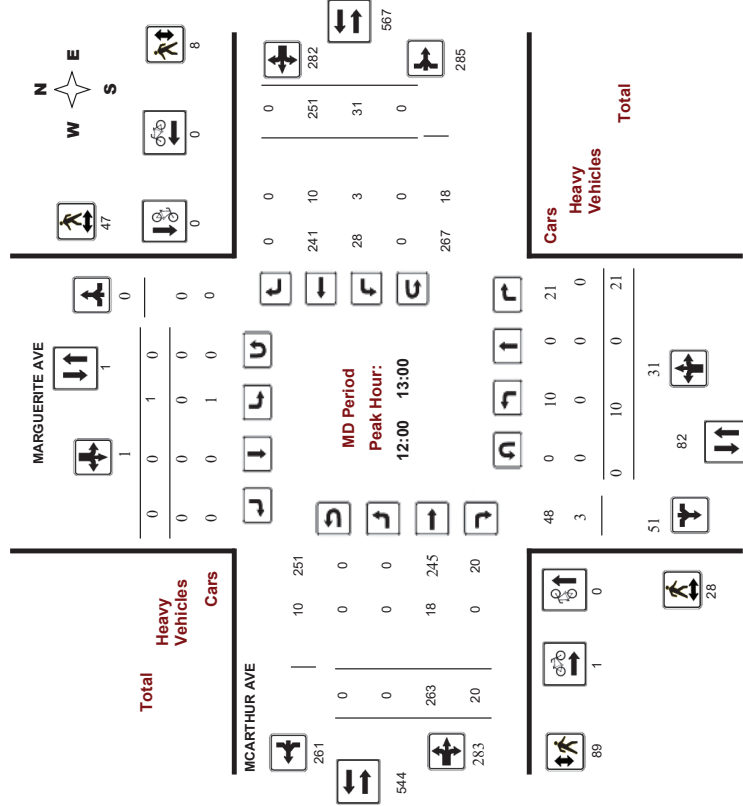

Comments



Transportation Services - Traffic Services

Turning Movement Count - Full Study Peak Hour Diagram

MARGUERITE AVE @ MCARTHUR AVE

Survey Date: Tuesday, March 26, 2019

WO No: 38444

Start Time: 07:00

Device: Miovision

MCARTHUR AVE	MARGUERITE AVE	Total	Heavy Vehicles	Cars
↔	↔	954	0	954
↔	↔	536	11	525
↔	↔	397	0	388
↔	↔	557	21	526

MCARTHUR AVE	MARGUERITE AVE	PM Peak Period	PM Peak Hour
↔	↔	9	15:45
↔	↔	0	16:45
↔	↔	0	
↔	↔	0	
↔	↔	536	
↔	↔	21	
↔	↔	557	

MCARTHUR AVE	MARGUERITE AVE	Total	Heavy Vehicles	Cars
↔	↔	954	0	954
↔	↔	536	11	525
↔	↔	397	0	388
↔	↔	557	21	526

Comments



Transportation Services - Traffic Services

Turning Movement Count - Study Results

MARGUERITE AVE @ MCARTHUR AVE

Survey Date: Tuesday, March 26, 2019

WO No: 38444

Start Time: 07:00

Device: Miovision

Full Study Diagram

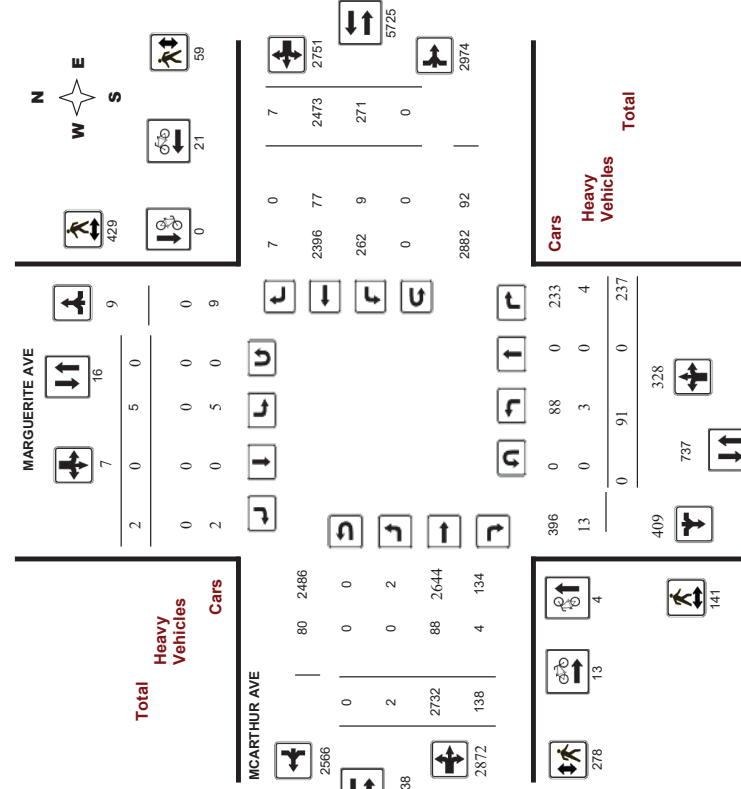



Transportation Services - Traffic Services
Turning Movement Count - Study Results
MARGUERITE AVE @ MCARTHUR AVE

Survey Date: Tuesday, March 26, 2019
Start Time: 07:00

WO No: 38444
Device: Miovision

Full Study Peak Hour Diagram

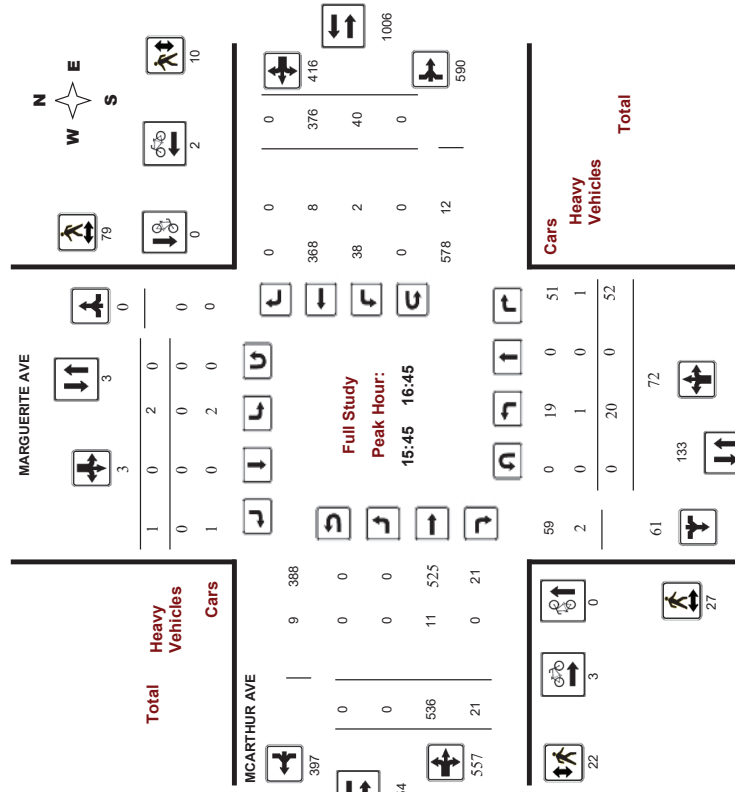

Transportation Services - Traffic Services
Turning Movement Count - Study Results
MARGUERITE AVE @ MCARTHUR AVE

Survey Date: Tuesday, March 26, 2019
Start Time: 07:00

WO No: 38444
Device: Miovision

Full Study Summary (8 HR Standard)

Survey Date: Tuesday, March 26, 2019
Total Observed U-Turns: 1.39
 Northbound: 0
 Southbound: 0
 Eastbound: 0
 Westbound: 0

Period	MARGUERITE AVE						MARGUERITE AVE						MCARTHUR AVE						Grand Total						
	Northbound			Southbound			Eastbound			Westbound			Northbound			Southbound				Eastbound			Westbound		
	LT	ST	RT	NB	LT	RT	SB	LT	RT	EB	LT	RT	WB	LT	RT	ST	LT	RT		ST	LT	RT	ST	LT	RT
07:00-08:00	6	0	14	20	0	0	0	0	0	0	20	1	265	9	275	46	358	2	406	681	701				
08:00-09:00	9	0	31	40	0	0	0	0	0	40	0	338	19	357	46	395	3	444	801	841					
09:00-10:00	5	0	14	19	0	0	0	0	0	19	1	234	17	252	22	283	1	306	558	577					
11:30-12:30	7	0	15	22	1	0	0	0	0	23	0	253	20	273	27	214	0	241	514	537					
12:30-13:30	13	0	24	37	0	0	0	0	0	37	0	237	19	256	27	259	1	287	543	580					
15:00-16:00	12	0	55	67	0	0	1	1	68	0	472	11	483	32	327	0	359	842	910						
16:00-17:00	21	0	51	72	4	0	1	5	77	0	530	26	556	36	360	0	396	952	1029						
17:00-18:00	18	0	33	51	0	0	0	0	51	0	403	17	420	35	277	0	312	732	783						
Sub Total	91	0	237	328	5	0	2	7	335	2	2732	138	2872	271	2473	7	2751	5623	5958						
U-Turns	0	0	0	0	0	0	0	0	0	0	0	0	0	0	0	0	0	0	0	0					
Total	91	0	237	328	5	0	2	7	335	2	2732	138	2872	271	2473	7	2751	5623	5958						
EQ 12hr	126	0	329	456	7	0	3	10	466	3	3797	192	3992	377	3437	10	3824	7616	8282						
AVG 12hr	126	0	329	456	7	0	3	10	466	3	3797	192	3992	377	3437	10	3824	7616	8282						
AVG 24hr	166	0	432	597	9	0	4	13	610	4	4975	251	5230	493	4503	13	5009	10239	10849						

Note: These volumes are calculated by multiplying the Average Daily 12 hr. totals by 12 to 24 expansion factor. 1.31
 Note: U-Turns provided for approach totals. Refer to 'U-Turn' Report for specific breakdown.



Transportation Services - Traffic Services
Turning Movement Count - Study Results
MARGUERITE AVE @ MCARTHUR AVE

Survey Date: Tuesday, March 26, 2019 **WO No:** 38444
Start Time: 07:00 **Device:** Miovision

Full Study 15 Minute Increments
MARGUERITE AVE **MCARTHUR AVE**

Time Period	Northbound				Southbound				Eastbound				Westbound				Grand Total					
	LT	ST	RT	TOT	LT	ST	RT	TOT	LT	ST	RT	TOT	LT	ST	RT	TOT						
07:00	3	0	2	5	0	0	0	0	0	43	4	47	11	59	1	71	21	123				
07:15	07:30	1	0	4	5	0	0	0	0	60	2	62	14	95	0	109	21	176				
07:30	07:45	0	0	3	3	0	0	0	0	92	3	96	9	96	0	105	16	204				
07:45	08:00	2	0	5	7	0	0	0	0	70	0	70	12	108	1	121	20	188				
08:00	08:15	3	0	10	13	0	0	0	0	94	4	98	13	88	2	103	32	214				
08:15	08:30	5	0	5	10	0	0	0	0	24	0	24	0	86	3	89	11	94	0	105	24	204
08:30	08:45	1	0	10	11	0	0	0	0	82	7	89	10	114	1	125	29	225				
08:45	09:00	1	0	6	6	0	0	0	0	76	5	81	12	99	0	111	23	188				
09:00	09:15	1	0	7	8	0	0	0	0	63	7	71	9	94	1	104	26	183				
09:15	09:30	1	0	0	1	0	0	0	0	55	2	57	4	71	0	75	7	133				
09:30	09:45	2	0	1	3	0	0	0	0	82	0	82	4	87	0	71	7	136				
09:45	10:00	1	0	6	7	0	0	0	0	54	8	62	5	51	0	56	20	125				
11:30	11:45	1	0	5	6	0	0	0	0	64	3	67	0	64	0	64	9	137				
11:45	12:00	0	0	2	2	0	0	0	0	50	7	57	8	41	0	49	17	108				
12:00	12:15	2	0	5	7	1	0	0	1	72	7	79	12	57	0	69	27	156				
12:15	12:30	4	0	3	7	0	0	0	0	67	3	70	7	52	0	59	17	136				
12:30	12:45	3	0	5	8	0	0	0	0	56	6	62	9	75	0	84	23	154				
12:45	13:00	1	0	8	9	0	0	0	0	68	4	72	3	67	0	70	16	151				
13:00	13:15	5	0	6	10	0	0	0	0	66	6	72	11	48	1	60	28	142				
13:15	13:30	4	0	5	10	0	0	0	0	47	3	50	4	69	0	73	17	133				
15:00	15:15	5	0	13	18	0	0	1	1	117	3	120	9	71	0	80	31	219				
15:15	15:30	1	0	8	9	0	0	0	0	99	4	103	6	76	0	82	19	194				
15:30	15:45	2	0	23	25	0	0	0	0	123	3	126	9	84	0	83	37	244				
15:45	16:00	4	0	11	15	0	0	0	0	133	1	134	8	96	0	104	24	253				
16:00	16:15	7	0	16	23	1	0	1	2	40	0	124	5	129	10	104	40	258				
16:15	16:30	4	0	18	22	1	0	0	1	45	0	140	7	147	15	106	0	121	45	291		
16:30	16:45	5	0	7	12	0	0	0	0	139	8	147	7	80	0	87	27	246				
16:45	17:00	5	0	10	15	2	0	0	2	127	6	133	4	80	0	84	27	234				
17:00	17:15	8	0	9	17	0	0	0	0	125	6	131	11	77	0	88	34	236				
17:15	17:30	6	0	8	14	0	0	0	0	108	7	115	14	69	0	83	35	212				
17:30	17:45	3	0	10	13	0	0	0	0	84	3	87	5	78	0	81	21	181				
17:45	18:00	1	0	6	7	0	0	0	0	86	1	87	5	55	0	60	13	154				
Total:		91	0	237	328	5	0	2	7	2732	138	2872	271	2473	7	2751	753	5,958				

Note: U-Turns are included in Totals.



Transportation Services - Traffic Services
Turning Movement Count - Study Results
MARGUERITE AVE @ MCARTHUR AVE

Survey Date: Tuesday, March 26, 2019 **WO No:** 38444
Start Time: 07:00 **Device:** Miovision

Full Study Cyclist Volume
MARGUERITE AVE **MCARTHUR AVE**

Time Period	Northbound	Southbound	Street Total	Eastbound		Westbound		Street Total	Grand Total
				Street	Total	Street	Total		
07:00	0	0	0	0	0	0	0	1	1
07:15	07:30	0	0	0	0	0	0	0	0
07:30	07:45	0	0	0	0	0	0	1	1
07:45	08:00	0	0	0	0	0	0	1	1
08:00	08:15	0	0	0	0	0	0	2	2
08:15	08:30	1	0	1	1	1	2	2	3
08:30	08:45	1	0	1	0	1	1	1	2
08:45	09:00	0	0	0	0	0	0	0	0
09:00	09:15	0	0	0	0	0	0	1	1
09:15	09:30	0	0	0	0	0	0	0	0
09:30	09:45	0	0	0	0	0	0	1	1
09:45	10:00	0	0	0	0	0	0	2	2
11:30	11:45	0	0	0	0	0	0	1	1
11:45	12:00	0	0	0	0	0	0	1	1
12:00	12:15	0	0	0	1	0	0	1	1
12:15	12:30	0	0	0	0	0	0	0	0
12:30	12:45	0	0	0	0	0	0	0	0
12:45	13:00	0	0	0	0	0	0	0	0
13:00	13:15	1	0	0	1	0	0	1	1
13:15	13:30	0	0	0	0	0	0	0	0
15:00	15:15	0	0	0	0	0	0	1	1
15:15	15:30	0	0	0	0	0	0	0	0
15:30	15:45	0	0	0	0	0	0	1	1
15:45	16:00	0	0	0	0	0	0	0	0
16:00	16:15	0	0	0	0	0	0	2	2
16:15	16:30	0	0	0	0	0	0	2	2
16:30	16:45	0	0	0	0	1	0	1	1
16:45	17:00	0	0	0	0	2	0	2	2
17:00	17:15	0	0	0	0	3	0	3	3
17:15	17:30	0	0	0	0	0	0	1	1
17:30	17:45	0	0	0	0	2	0	2	2
17:45	18:00	1	0	0	0	1	0	1	2
Total:		4	0	0	4	13	21	34	38



Transportation Services - Traffic Services
Turning Movement Count - Study Results
MARGUERITE AVE @ MCARTHUR AVE

Survey Date: Tuesday, March 26, 2019
Start Time: 07:00

WO No: 38444
Device: Miovision

Full Study Pedestrian Volume
MARGUERITE AVE **MCARTHUR AVE**

Time Period	SB Approach (E or W Crossing)		EB Approach (N or S Crossing)		Total	Grand Total
	NB	WB	NB	WB		
07:00-07:15	3	20	9	2	11	34
07:15-07:30	1	12	8	2	10	23
07:30-07:45	0	12	6	1	7	19
07:45-08:00	6	18	4	1	24	29
08:00-08:15	5	14	6	2	8	27
08:15-08:30	6	19	10	2	12	37
08:30-08:45	7	19	12	4	16	42
08:45-09:00	3	22	7	1	8	33
09:00-09:15	4	13	10	2	12	29
09:15-09:30	1	9	8	1	9	19
09:30-09:45	1	5	4	3	7	13
09:45-10:00	1	5	4	0	4	10
11:30-11:45	0	4	3	1	4	8
11:45-12:00	0	9	7	0	7	16
12:00-12:15	5	18	23	1	29	52
12:15-12:30	9	4	13	3	28	41
12:30-12:45	10	7	17	3	24	41
12:45-13:00	4	18	22	1	16	38
13:00-13:15	4	11	15	3	16	31
13:15-13:30	3	10	13	1	7	20
15:00-15:15	9	24	33	9	9	42
15:15-15:30	2	11	13	7	7	20
15:30-15:45	7	21	28	6	11	39
15:45-16:00	9	19	28	4	3	35
16:00-16:15	6	26	32	3	5	37
16:15-16:30	8	10	18	8	2	28
16:30-16:45	4	10	24	7	3	38
16:45-17:00	8	10	18	8	3	29
17:00-17:15	3	15	18	7	1	26
17:15-17:30	6	11	17	6	4	28
17:30-17:45	3	5	8	5	5	13
17:45-18:00	3	4	7	1	2	10
Total	141	429	570	278	59	907



Transportation Services - Traffic Services
Turning Movement Count - Study Results
MARGUERITE AVE @ MCARTHUR AVE

Survey Date: Tuesday, March 26, 2019
Start Time: 07:00

WO No: 38444
Device: Miovision

Full Study Heavy Vehicles
MARGUERITE AVE **MCARTHUR AVE**

Time Period	Northbound			Southbound			Eastbound			Westbound			W STR TOT	STR TOT	Grand Total												
	LT	ST	RT	LT	ST	RT	LT	ST	RT	LT	ST	RT															
07:00-07:15	0	0	0	0	0	0	0	0	0	0	0	0	0	0	0	3											
07:15-07:30	0	0	2	3	0	0	0	0	0	0	0	0	0	0	0	3	1	2	0	6	9	6					
07:30-07:45	0	0	0	0	0	0	0	0	0	0	0	0	0	0	0	0	6	0	5	0	6	12	6				
07:45-08:00	0	0	0	1	0	0	0	0	0	0	0	0	0	0	0	0	4	1	2	0	5	9	5				
08:00-08:15	0	0	0	0	0	0	0	0	0	0	0	0	0	0	0	0	4	0	3	0	4	8	4				
08:15-08:30	0	0	0	0	0	0	0	0	0	0	0	0	0	0	0	0	3	0	1	0	3	6	3				
08:30-08:45	1	0	0	2	0	0	0	0	0	0	0	0	0	0	0	0	6	1	4	0	6	12	7				
08:45-09:00	0	0	0	0	0	0	0	0	0	0	0	0	0	0	0	0	4	0	4	0	8	16	8				
09:00-09:15	0	0	0	0	0	0	0	0	0	0	0	0	0	0	0	0	0	0	0	0	0	0	0	10			
09:15-09:30	0	0	0	1	0	0	0	0	0	0	0	0	0	0	0	0	1	5	0	2	0	4	9	5			
09:30-09:45	0	0	0	0	0	0	0	0	0	0	0	0	0	0	0	0	2	0	0	0	5	10	5				
09:45-10:00	0	0	0	2	0	0	0	0	0	0	0	0	0	0	0	0	2	6	0	0	4	10	6				
11:30-11:45	0	0	0	0	0	0	0	0	0	0	0	0	0	0	0	0	6	0	0	0	11	22	11				
11:45-12:00	0	0	0	0	0	0	0	0	0	0	0	0	0	0	0	0	1	0	0	0	1	2	1				
12:00-12:15	0	0	0	1	0	0	0	0	0	0	0	0	0	0	0	0	3	0	5	1	2	0	6	11	6		
12:15-12:30	0	0	0	0	0	0	0	0	0	0	0	0	0	0	0	0	3	0	0	0	3	6	3	3			
12:30-12:45	0	0	0	2	0	0	0	0	0	0	0	0	0	0	0	0	4	0	10	2	6	0	12	22	12		
12:45-13:00	0	0	0	0	0	0	0	0	0	0	0	0	0	0	0	0	8	0	10	0	2	0	10	20	10		
13:00-13:15	0	0	0	0	0	0	0	0	0	0	0	0	0	0	0	0	3	0	5	0	2	0	5	10	5		
13:15-13:30	0	0	0	0	0	0	0	0	0	0	0	0	0	0	0	0	3	0	7	0	4	0	7	14	7		
15:00-15:15	0	0	1	1	0	0	0	0	0	0	0	0	0	0	0	0	4	0	6	0	2	0	7	13	7		
15:15-15:30	0	0	0	0	0	0	0	0	0	0	0	0	0	0	0	0	1	0	4	0	3	0	4	8	4		
15:30-15:45	0	0	0	0	0	0	0	0	0	0	0	0	0	0	0	0	3	0	7	0	4	0	7	14	7		
15:45-16:00	0	0	1	2	0	0	0	0	0	0	0	0	0	0	0	0	3	0	5	1	2	0	7	12	7		
16:00-16:15	1	0	0	1	0	0	0	0	0	0	0	0	0	0	0	0	3	0	6	0	2	0	5	11	6		
16:15-16:30	0	0	0	1	0	0	0	0	0	0	0	0	0	0	0	0	2	0	5	1	3	0	6	11	6		
16:30-16:45	0	0	0	0	0	0	0	0	0	0	0	0	0	0	0	0	3	0	4	0	1	0	4	8	4		
16:45-17:00	1	0	0	2	0	0	0	0	0	0	0	0	0	0	0	0	4	1	7	0	1	0	5	12	7		
17:00-17:15	0	0	0	0	0	0	0	0	0	0	0	0	0	0	0	0	2	0	2	0	0	0	2	4	2		
17:15-17:30	0	0	0	0	0	0	0	0	0	0	0	0	0	0	0	0	2	0	4	0	2	0	4	8	4		
17:30-17:45	0	0	0	0	0	0	0	0	0	0	0	0	0	0	0	0	2	0	3	0	1	0	3	6	3		
17:45-18:00	0	0	0	1	0	0	0	0	0	0	0	0	0	0	0	0	3	0	4	1	1	0	5	9	5		
Total	3	0	4	20	0	0	0	0	0	0	0	0	0	0	0	0	20	0	88	4	172	9	77	0	178	350	185



Transportation Services - Traffic Services
Turning Movement Count - Study Results
MARGUERITE AVE @ MCARTHUR AVE

Survey Date: Tuesday, March 26, 2019
 Start Time: 07:00

WO No: 38444
 Device: Miovision

Full Study 15 Minute U-Turn Total

Time Period	MARGUERITE AVE		MCARTHUR AVE		Total
	Northbound U-Turn Total	Southbound U-Turn Total	Eastbound U-Turn Total	Westbound U-Turn Total	
07:00	0	0	0	0	0
07:15	0	0	0	0	0
07:30	0	0	0	0	0
07:45	0	0	0	0	0
08:00	0	0	0	0	0
08:15	0	0	0	0	0
08:30	0	0	0	0	0
08:45	0	0	0	0	0
09:00	0	0	0	0	0
09:15	0	0	0	0	0
09:30	0	0	0	0	0
09:45	0	0	0	0	0
10:00	0	0	0	0	0
11:30	0	0	0	0	0
11:45	0	0	0	0	0
12:00	0	0	0	0	0
12:15	0	0	0	0	0
12:30	0	0	0	0	0
12:45	0	0	0	0	0
13:00	0	0	0	0	0
13:15	0	0	0	0	0
13:30	0	0	0	0	0
15:00	0	0	0	0	0
15:15	0	0	0	0	0
15:30	0	0	0	0	0
15:45	0	0	0	0	0
16:00	0	0	0	0	0
16:15	0	0	0	0	0
16:30	0	0	0	0	0
16:45	0	0	0	0	0
17:00	0	0	0	0	0
17:15	0	0	0	0	0
17:30	0	0	0	0	0
17:45	0	0	0	0	0
18:00	0	0	0	0	0
Total	0	0	0	0	0



Transportation Services - Traffic Services
Turning Movement Count - Full Study Peak Hour Diagram
MCARTHUR AVE @ VANIER PKWY

Survey Date: Tuesday, March 26, 2019
 Start Time: 07:00

WO No: 38463
 Device: Miovision

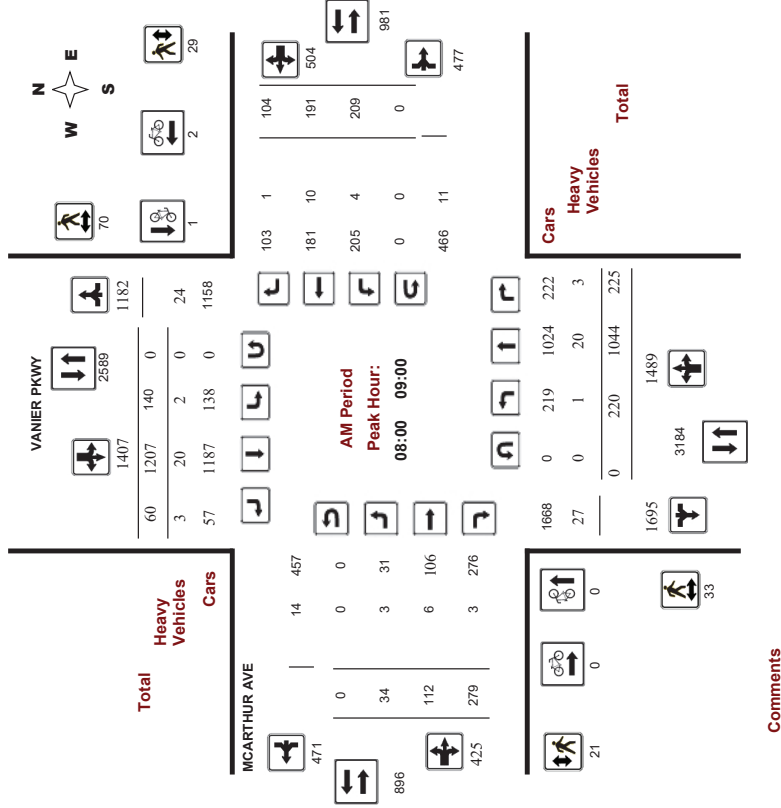



Transportation Services - Traffic Services

Turning Movement Count - Full Study Peak Hour Diagram

MCARTHUR AVE @ VANIER PKWY

Survey Date: Tuesday, March 26, 2019

WO No: 38463

Start Time: 07:00

Device: Miovision

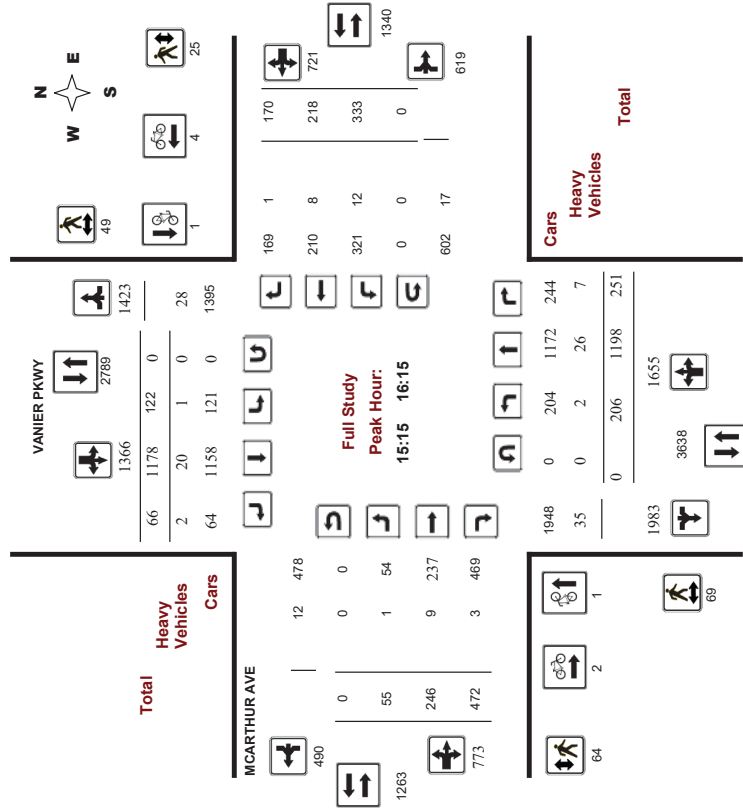

Transportation Services - Traffic Services

Turning Movement Count - Full Study Peak Hour Diagram

MCARTHUR AVE @ VANIER PKWY

Survey Date: Tuesday, March 26, 2019

WO No: 38463

Start Time: 07:00

Device: Miovision

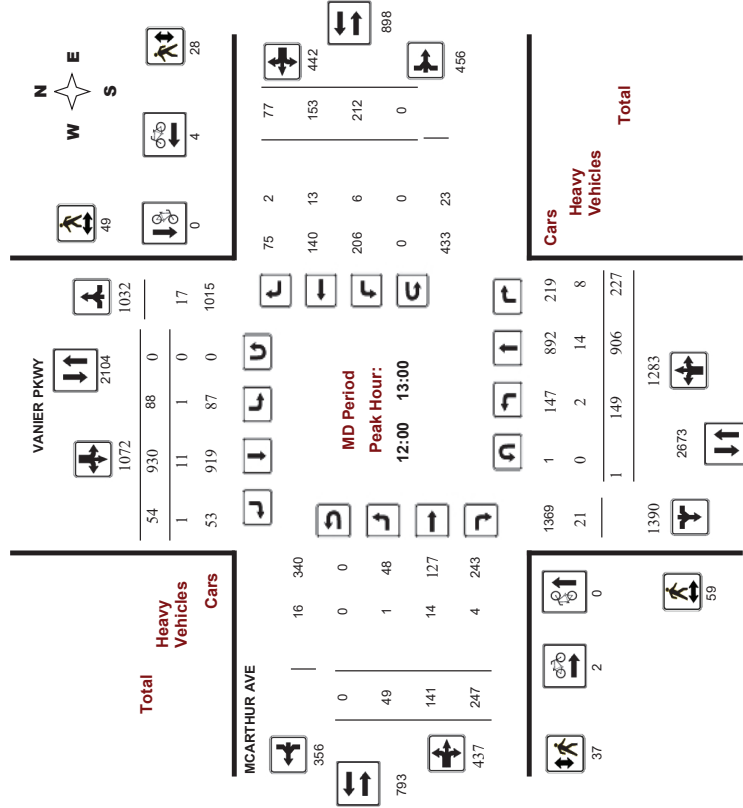



Transportation Services - Traffic Services

Turning Movement Count - Full Study Peak Hour Diagram

MCARTHUR AVE @ VANIER PKWY

Survey Date: Tuesday, March 26, 2019
Start Time: 07:00

WO No: 38463
Device: Miovision

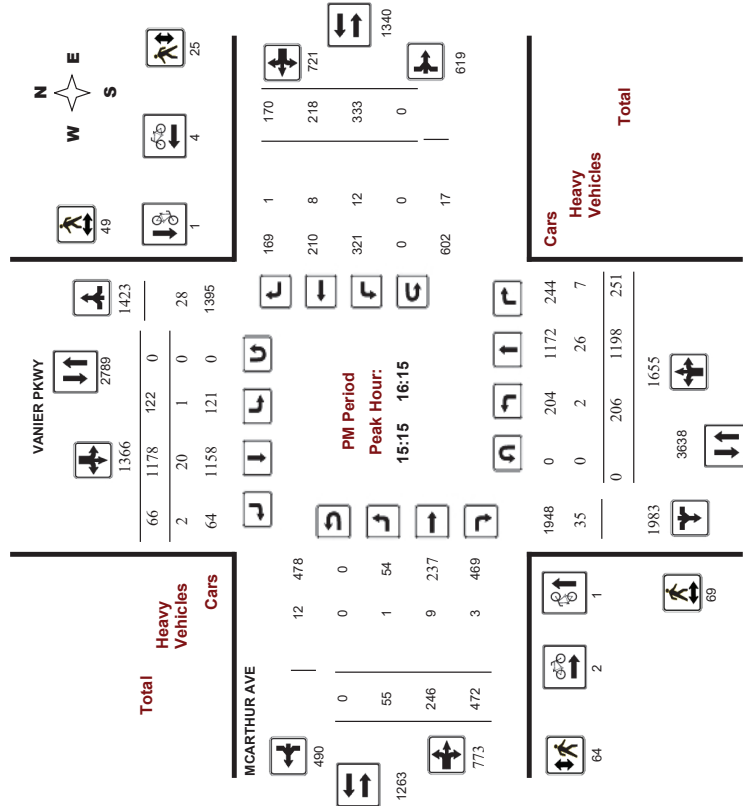

Comments



Transportation Services - Traffic Services

Turning Movement Count - Study Results

MCARTHUR AVE @ VANIER PKWY

Survey Date: Tuesday, March 26, 2019
Start Time: 07:00

WO No: 38463
Device: Miovision

Full Study Diagram

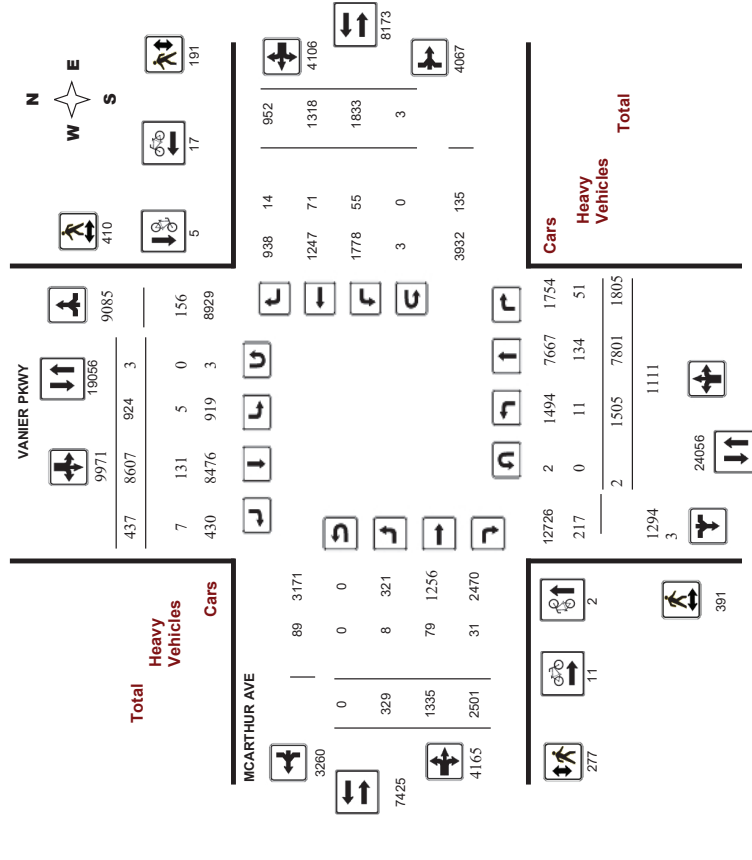

Survey Date: Tuesday, March 26, 2019
Start Time: 07:00

WO No: 38463
Device: Miovision

Full Study Peak Hour Diagram

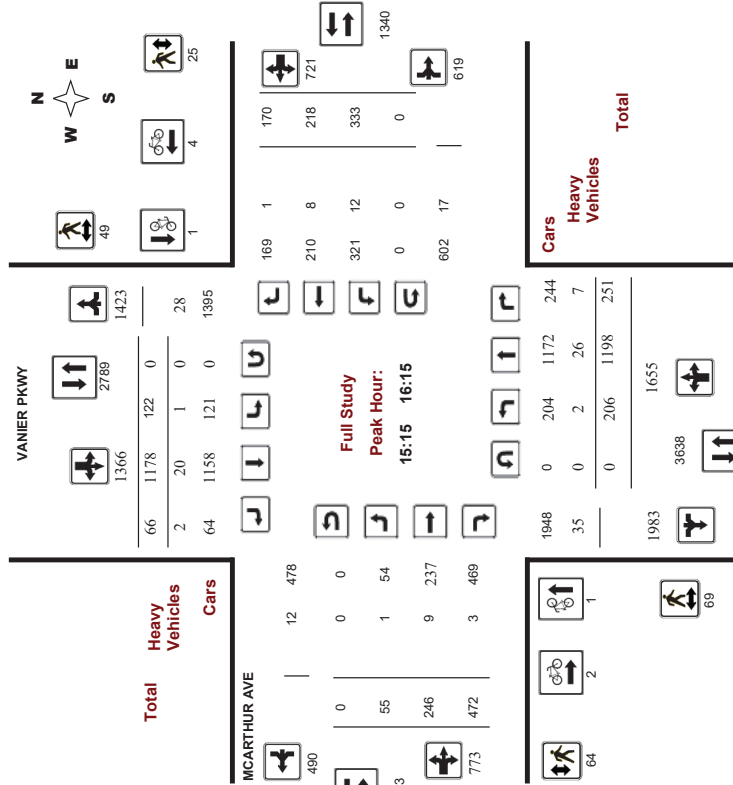

Survey Date: Tuesday, March 26, 2019
Start Time: 07:00

WO No: 38463
Device: Miovision

Full Study Summary (8 HR Standard)

Survey Date: Tuesday, March 26, 2019
Total Observed U-Turns: 1.39
 Northbound: 2
 Southbound: 3
 Eastbound: 0
 Westbound: 3

Period	Northbound				Southbound				Eastbound				Westbound				Grand Total				
	LT	ST	RT	TOT	NB	LT	ST	RT	TOT	SB	STR	LT	ST	RT	TOT	WB		STR	LT	ST	RT
07:00-08:00	200	794	163	1157	175	1027	45	1247	2404	19	106	186	311	201	162	96	459	770	3174		
08:00-09:00	220	1044	225	1489	140	1207	60	1407	2896	34	112	279	425	209	191	104	504	929	3825		
09:00-10:00	202	923	195	1320	80	1142	49	1271	2591	35	107	196	338	194	108	114	416	754	3345		
11:30-12:30	135	867	199	1201	87	941	50	1078	2279	31	129	240	400	204	129	82	415	815	3094		
12:30-13:30	151	769	214	1134	78	979	56	1113	2247	46	129	250	425	224	141	71	436	861	3108		
15:00-16:00	200	1196	255	1651	119	1148	65	1332	2983	54	231	477	762	349	209	195	753	1515	4498		
16:00-17:00	207	1144	271	1622	103	1066	54	1223	2845	55	286	492	833	245	216	140	601	1434	4279		
17:00-18:00	190	1064	283	1537	142	1097	58	1297	2854	55	235	381	671	207	162	150	519	1190	4024		
Sub Total	1505	7801	1805	11111	924	8607	437	9968	21079	329	1335	2501	4165	1833	1318	952	4103	8268	29347		
U-Turns	2				3				5				0				3				8
Total	1505	7801	1805	11113	924	8607	437	9971	21084	329	1335	2501	4165	1833	1318	952	4106	8271	29355		
EQ 12hr	2092	10843	2509	15447	1284	11964	607	13860	29307	457	1856	3476	5789	2548	1832	1323	5707	11497	40803		

Note: These values are calculated by multiplying the totals by the appropriate expansion factor.

AVG 12hr: 2092, 10843, 2509, 15447, 1284, 11964, 607, 13860, 29307, 457, 1856, 3476, 5789, 2548, 1832, 1323, 5707, 11497, 40803

AVG 24hr: 2740, 14205, 3287, 20236, 1683, 15672, 796, 18156, 38392, 599, 2431, 4554, 7584, 3338, 2400, 1733, 7477, 15061, 53453

Note: These volumes are calculated by multiplying the Average Daily 12 hr. totals by 12 to 24 expansion factor.

Note: These volumes are calculated by multiplying the Equivalent 12 hr. totals by the AADT factor.

AVG 12hr: 2092, 10843, 2509, 15447, 1284, 11964, 607, 13860, 29307, 457, 1856, 3476, 5789, 2548, 1832, 1323, 5707, 11497, 40803

AVG 24hr: 2740, 14205, 3287, 20236, 1683, 15672, 796, 18156, 38392, 599, 2431, 4554, 7584, 3338, 2400, 1733, 7477, 15061, 53453

Note: These volumes are calculated by multiplying the Average Daily 12 hr. totals by 12 to 24 expansion factor.

Note: These volumes are calculated by multiplying the Equivalent 12 hr. totals by the AADT factor.

AVG 12hr: 2092, 10843, 2509, 15447, 1284, 11964, 607, 13860, 29307, 457, 1856, 3476, 5789, 2548, 1832, 1323, 5707, 11497, 40803

AVG 24hr: 2740, 14205, 3287, 20236, 1683, 15672, 796, 18156, 38392, 599, 2431, 4554, 7584, 3338, 2400, 1733, 7477, 15061, 53453

Note: These volumes are calculated by multiplying the Average Daily 12 hr. totals by 12 to 24 expansion factor.

Note: These volumes are calculated by multiplying the Equivalent 12 hr. totals by the AADT factor.



Transportation Services - Traffic Services

Turning Movement Count - Study Results

MCARTHUR AVE @ VANIER PKWY

Survey Date: Tuesday, March 26, 2019
Start Time: 07:00

WO No: 38463
Device: Miovision

Full Study 15 Minute Increments

VANIER PKWY

Table with columns for Time Period, Northbound, Southbound, Eastbound, Westbound, and Grand Total. Rows represent 15-minute intervals from 07:00 to 17:45, plus a Total row.

Note: U-Turns are included in Totals.

Transportation Services - Traffic Services

Turning Movement Count - Study Results

MCARTHUR AVE @ VANIER PKWY

Survey Date: Tuesday, March 26, 2019
Start Time: 07:00

WO No: 38463
Device: Miovision

Full Study Cyclist Volume

VANIER PKWY

Table with columns for Time Period, Northbound, Southbound, Eastbound, Westbound, Street Total, and Grand Total. Rows represent 15-minute intervals from 07:00 to 17:45, plus a Total row.



Transportation Services - Traffic Services
Turning Movement Count - Study Results
MCARTHUR AVE @ VANIER PKWY

Survey Date: Tuesday, March 26, 2019
Start Time: 07:00

WO No: 38463
Device: Miovision

Full Study Pedestrian Volume
MCARTHUR AVE

VANIER PKWY

Time Period	SB Approach (E or W Crossing)		EB Approach (N or S Crossing)		Total	Grand Total
	E or W	S or N	N or S	E or W		
07:00 07:15	5	22	2	6	8	35
07:15 07:30	2	15	1	6	7	24
07:30 07:45	6	15	0	6	6	27
07:45 08:00	12	18	2	15	17	47
08:00 08:15	11	11	2	9	15	37
08:15 08:30	9	20	3	9	12	41
08:30 08:45	6	14	2	5	7	27
08:45 09:00	7	25	10	6	16	48
09:00 09:15	1	8	0	2	2	11
09:15 09:30	0	8	4	2	6	14
09:30 09:45	0	2	4	4	8	10
09:45 10:00	4	5	3	4	7	16
11:30 11:45	14	7	10	5	15	36
11:45 12:00	10	17	9	3	12	39
12:00 12:15	21	11	32	8	17	49
12:15 12:30	15	9	13	9	22	46
12:30 12:45	12	10	4	7	11	33
12:45 13:00	11	19	11	4	15	45
13:00 13:15	13	9	8	5	13	35
13:15 13:30	13	9	5	4	9	31
15:00 15:15	15	25	13	8	21	61
15:15 15:30	9	8	8	5	13	30
15:30 15:45	13	14	12	8	20	47
15:45 16:00	23	6	22	6	28	57
16:00 16:15	24	21	22	6	28	73
16:15 16:30	22	13	17	6	23	58
16:30 16:45	21	15	18	5	23	59
16:45 17:00	17	19	9	11	20	56
17:00 17:15	14	14	14	1	15	43
17:15 17:30	24	11	13	4	17	52
17:30 17:45	18	8	13	4	17	43
17:45 18:00	19	2	10	8	18	39
Total	391	410	277	191	468	1269



Transportation Services - Traffic Services
Turning Movement Count - Study Results
MCARTHUR AVE @ VANIER PKWY

Survey Date: Tuesday, March 26, 2019
Start Time: 07:00

WO No: 38463
Device: Miovision

Full Study Heavy Vehicles
MCARTHUR AVE

VANIER PKWY

Time Period	Northbound			Southbound			Eastbound			Westbound			W STR TOT	R STR TOT	Grand Total	
	L	S	T	L	S	T	L	S	T	L	S	T				
07:00 07:15	0	5	1	15	0	5	0	12	27	0	3	0	6	4	3	23
07:15 07:30	1	5	1	12	1	2	0	8	20	0	1	0	4	3	2	16
07:30 07:45	1	4	2	12	0	3	0	8	20	0	3	1	8	1	3	19
07:45 08:00	0	5	0	9	0	2	0	7	16	0	2	1	6	1	3	14
08:00 08:15	0	7	2	14	0	3	0	11	25	1	1	1	6	1	3	19
08:15 08:30	0	1	0	6	0	4	1	6	12	0	1	0	2	1	0	8
08:30 08:45	0	7	0	17	1	8	2	20	37	1	0	1	7	1	3	25
08:45 09:00	1	5	1	14	1	5	0	12	26	1	4	1	11	1	4	24
09:00 09:15	1	5	3	22	0	7	0	14	36	1	3	3	13	3	5	32
09:15 09:30	0	5	4	21	0	10	1	16	37	0	3	0	6	2	0	27
09:30 09:45	1	5	2	14	0	4	0	9	23	0	3	0	6	2	0	19
09:45 10:00	0	6	1	12	0	2	0	10	22	1	2	1	5	2	1	17
11:30 11:45	0	2	1	11	0	5	0	7	18	0	4	2	11	1	5	20
11:45 12:00	0	3	4	14	0	5	0	9	23	0	1	2	3	0	0	16
12:00 12:15	0	1	1	11	0	6	0	7	18	0	3	0	6	3	0	17
12:15 12:30	0	3	0	5	0	2	0	6	11	0	1	0	2	0	1	8
12:30 12:45	1	8	3	16	0	1	1	11	27	1	2	1	13	2	7	27
12:45 13:00	1	2	4	13	1	2	0	6	19	0	8	3	14	1	2	25
13:00 13:15	0	6	2	16	0	3	0	10	26	1	4	2	9	3	0	23
13:15 13:30	1	1	8	0	3	0	5	13	0	1	1	5	1	2	0	12
15:00 15:15	0	2	2	12	0	3	0	6	18	0	4	1	6	4	1	18
15:15 15:30	1	9	1	19	1	3	0	14	33	1	1	0	5	2	0	24
15:30 15:45	1	6	2	24	0	9	0	15	39	0	2	2	7	4	0	28
15:45 16:00	0	2	1	13	0	7	2	11	24	0	1	1	5	2	1	17
16:00 16:15	0	9	3	14	0	1	0	11	25	0	5	0	8	1	3	23
16:15 16:30	1	5	1	15	0	5	0	10	25	0	3	3	10	0	7	21
16:30 16:45	0	4	0	9	0	3	0	7	16	0	3	1	5	1	0	13
16:45 17:00	0	2	2	11	0	5	0	8	19	0	2	1	4	1	1	15
17:00 17:15	0	3	1	7	0	2	0	5	12	0	1	1	2	0	0	8
17:15 17:30	0	3	1	9	0	3	0	7	16	0	2	0	4	2	1	14
17:30 17:45	0	2	3	11	0	4	0	6	17	0	2	1	4	1	0	11
17:45 18:00	0	1	1	7	0	4	0	5	12	0	3	0	4	1	1	14
Total	11	134	51	413	5	131	7	299	712	8	79	31	207	55	71	482



Transportation Services - Traffic Services
Turning Movement Count - Study Results
MCARTHUR AVE @ VANIER PKWY

Survey Date: Tuesday, March 26, 2019
Start Time: 07:00

WO No: 38463
Device: Miovision

Full Study 15 Minute U-Turn Total
VANIER PKWY **MCARTHUR AVE**

Time Period	Northbound U-Turn Total		Southbound U-Turn Total		Eastbound U-Turn Total		Westbound U-Turn Total		Total
	U-Turn	Total	U-Turn	Total	U-Turn	Total	U-Turn	Total	
07:00	0	0	0	0	0	0	0	0	0
07:15	0	0	0	0	0	0	0	0	0
07:30	0	0	0	0	0	0	1	1	1
07:45	0	0	3	0	0	0	2	2	5
08:00	0	0	0	0	0	0	0	0	0
08:15	0	0	0	0	0	0	0	0	0
08:30	0	0	0	0	0	0	0	0	0
08:45	0	0	0	0	0	0	0	0	0
09:00	0	0	0	0	0	0	0	0	0
09:15	0	0	0	0	0	0	0	0	0
09:30	0	0	0	0	0	0	0	0	0
09:45	0	0	0	0	0	0	0	0	0
10:00	0	0	0	0	0	0	0	0	0
11:30	0	0	0	0	0	0	0	0	0
11:45	0	0	0	0	0	0	0	0	0
12:00	0	0	0	0	0	0	0	0	0
12:15	0	0	0	0	0	0	0	0	0
12:30	0	0	0	0	0	0	0	0	0
12:45	0	0	0	0	0	0	0	0	0
13:00	1	1	0	0	0	0	0	0	1
13:15	0	0	0	0	0	0	0	0	0
13:30	0	0	0	0	0	0	0	0	0
15:00	0	0	0	0	0	0	0	0	0
15:15	0	0	0	0	0	0	0	0	0
15:30	0	0	0	0	0	0	0	0	0
15:45	0	0	0	0	0	0	0	0	0
16:00	0	0	0	0	0	0	0	0	0
16:15	0	0	0	0	0	0	0	0	0
16:30	0	0	0	0	0	0	0	0	0
16:45	0	0	0	0	0	0	0	0	0
17:00	0	0	0	0	0	0	0	0	0
17:15	1	1	0	0	0	0	0	0	1
17:30	0	0	0	0	0	0	0	0	0
17:45	0	0	0	0	0	0	0	0	0
Total	2	2	3	3	0	0	3	3	8

Transportation Services - Traffic Services

Turning Movement Count - Study Results

MCARTHUR AVE @ NORTH RIVER RD

Survey Date: Tuesday, March 19, 2019
Start Time: 07:00

WO No: 38447
Device: Miovision

Full Study Summary (8 HR Standard)

Survey Date: Tuesday, March 19, 2019

Total Observed U-Turns
 Northbound: 0
 Southbound: 1
 Eastbound: 0
 Westbound: 0

AAADT Factor
 1.00

Period	Northbound				Southbound				Eastbound				Westbound				WB TOT	STR TOT	Grand Total
	LT	ST	RT	TOT	NB	LT	ST	RT	SB	STR	LT	ST	RT	TOT	EB	LT			
07:00-08:00	2	67	20	89	287	56	5	348	437	1	5	0	6	12	11	110	133	139	576
08:00-09:00	3	125	29	157	332	102	4	438	595	1	6	3	10	8	9	165	182	192	787
09:00-10:00	6	125	18	149	201	107	2	310	459	0	4	2	6	11	5	103	119	125	584
11:30-12:30	5	122	22	149	228	119	4	351	500	1	5	3	9	10	3	131	144	153	653
12:30-13:30	4	112	28	144	241	109	5	355	499	4	6	1	11	14	2	138	154	165	664
15:00-16:00	2	148	36	186	409	139	1	549	735	4	25	6	35	24	11	217	252	287	1022
16:00-17:00	2	147	26	175	437	108	0	545	720	3	15	0	18	13	5	216	234	252	972
17:00-18:00	0	186	28	214	359	157	4	520	734	5	5	3	13	23	1	211	235	248	982
Sub Total	24	1032	207	1263	2494	897	25	3416	4679	19	71	18	108	115	47	1291	1453	1561	6240
U-Turns	0	0	0	0	1	1	1	1	0	0	0	0	0	0	0	0	0	0	1
Total	24	1032	207	1263	2494	897	25	3417	4680	19	71	18	108	115	47	1291	1453	1561	6241
EQ 12hr	33	1434	288	1756	3467	1247	35	4750	6505	26	99	25	150	160	65	1794	2020	2170	8675

Note: These values are calculated by multiplying the totals by the appropriate expansion factor.
 Note: These volumes are calculated by multiplying the Equivalent 12 hr. totals by the AADT factor.
 Note: These volumes are calculated by multiplying the Average Daily 12 hr. totals by 12 to 24 expansion factor.
 Note: U-Turns provided for approach totals. Refer to "U-Turn" Report for specific breakdown.

Transportation Services - Traffic Services

Turning Movement Count - Peak Hour Diagram

MCARTHUR AVE @ NORTH RIVER RD

Survey Date: Tuesday, March 19, 2019
Start Time: 07:00

WO No: 38447
Device: Miovision

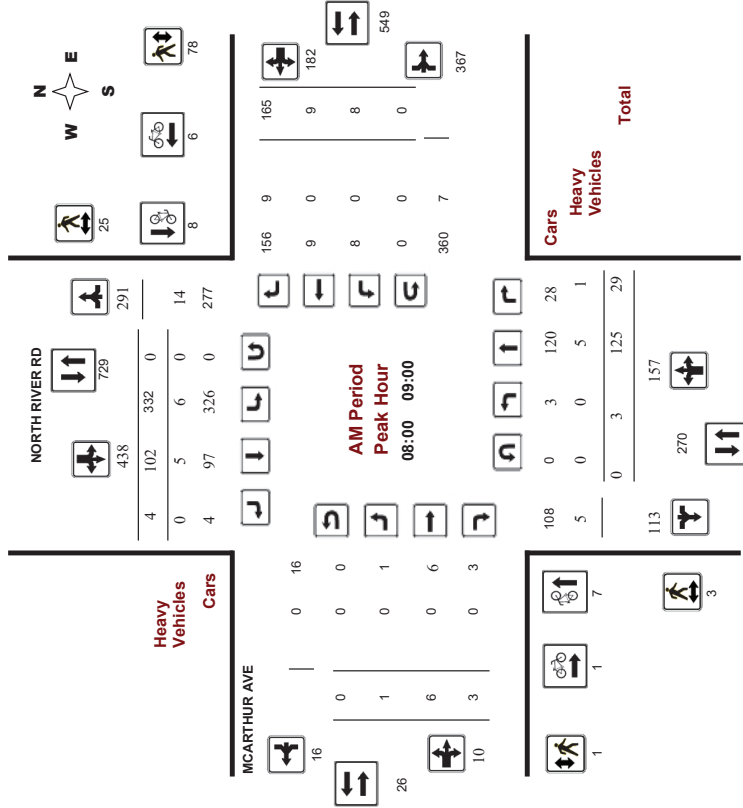



Transportation Services - Traffic Services

Turning Movement Count - Peak Hour Diagram

MCARTHUR AVE @ NORTH RIVER RD

Survey Date: Tuesday, March 19, 2019

Start Time: 07:00

WO No: 38447

Device: Miovision

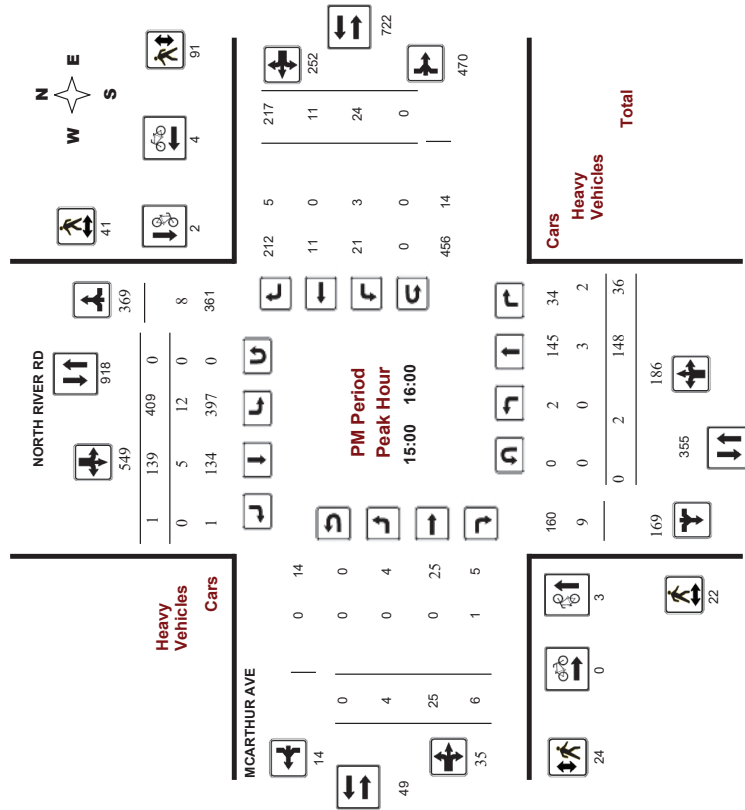

Comments

Appendix C

Synchro Intersection Worksheets – Existing Conditions

Lanes, Volumes, Timings
1: North River & Montreal

Existing
AM Peak Hour

Lane Group	EBL	EBT	EBR	WBL	WBT	WBR	NBL	NBT	NBR	SBL	SBT	SBR
Lane Configurations		↑↑			↑↑		↑	↑			↑↓	
Traffic Volume (vph)	0	467	362	0	695	13	244	10	35	17	25	15
Future Volume (vph)	0	467	362	0	695	13	244	10	35	17	25	15
Satd. Flow (prot)	0	2927	0	0	3167	0	1595	1336	0	0	1519	0
Fit Permitted							0.950				0.985	
Satd. Flow (perm)	0	2927	0	0	3167	0	1581	1336	0	0	1499	0
Satd. Flow (RTOR)								39			15	
Lane Group Flow (vph)	0	921	0	0	786	0	271	50	0	0	64	0
Turn Type		NA			NA		Prot	NA		Split	NA	
Protected Phases		2			6		3!	8		7	7!	
Permitted Phases												
Detector Phase		2			6		3	8		7	7	
Switch Phase												
Minimum Initial (s)		10.0			10.0		5.0	10.0		10.0	10.0	
Minimum Split (s)		21.7			21.7		11.5	24.5		16.5	16.5	
Total Split (s)		29.0			29.0		24.0	49.0		17.0	17.0	
Total Split (%)		30.5%			30.5%		25.3%	51.6%		17.9%	17.9%	
Yellow Time (s)		3.0			3.0		3.3	3.3		3.3	3.3	
All-Red Time (s)		3.7			3.7		3.2	3.2		3.2	3.2	
Lost Time Adjust (s)		0.0			0.0		0.0	0.0		0.0	0.0	
Total Lost Time (s)		6.7			6.7		6.5	6.5		6.5	6.5	
Lead/Lag							Lag	Lag		Lead	Lead	
Lead-Lag Optimize?												
Recall Mode		C-Max			C-Max		None	Ped		None	None	
Act Effct Green (s)		34.4			34.4		22.9	34.1		10.1	10.1	
Actuated g/C Ratio		0.36			0.36		0.24	0.36		0.11	0.11	
v/c Ratio		0.87			0.69		0.70	0.10		0.37	0.37	
Control Delay		39.9			30.3		43.0	9.3		38.2	38.2	
Queue Delay		0.0			51.4		0.0	0.0		0.0	0.0	
Total Delay		39.9			81.7		43.0	9.3		38.2	38.2	
LOS		D			F		D	A		D	D	
Approach Delay		39.9			81.7			37.7		38.2	38.2	
Approach LOS		D			F			D		D	D	
Queue Length 50th (m)		82.6			64.2		45.1	1.4		8.5	8.5	
Queue Length 95th (m)		#130.0			90.7		68.3	8.6		20.8	20.8	
Internal Link Dist (m)		194.5			52.8			112.9		59.0	59.0	
Turn Bay Length (m)							90.0					
Base Capacity (vph)		1059			1146		386	619		181	181	
Starvation Cap Reductn		0			460		0	0		0	0	
Spillback Cap Reductn		0			0		0	0		0	0	
Storage Cap Reductn		0			0		0	0		0	0	
Reduced v/c Ratio		0.87			1.15		0.70	0.08		0.35	0.35	

Intersection Summary	
Cycle Length: 95	
Actuated Cycle Length: 95	
Offset: 0 (0%), Referenced to phase 2:EBT and 6:WBT, Start of Green	
Natural Cycle: 90	
Control Type: Actuated-Coordinated	

Lanes, Volumes, Timings
1: North River & Montreal

Existing
AM Peak Hour

Lane Group	Ø4
Lane Configurations	
Traffic Volume (vph)	
Future Volume (vph)	
Satd. Flow (prot)	
Fit Permitted	
Satd. Flow (perm)	
Satd. Flow (RTOR)	
Lane Group Flow (vph)	
Turn Type	
Protected Phases	4
Permitted Phases	
Detector Phase	
Switch Phase	
Minimum Initial (s)	5.0
Minimum Split (s)	24.5
Total Split (s)	42.0
Total Split (%)	44%
Yellow Time (s)	3.3
All-Red Time (s)	3.2
Lost Time Adjust (s)	
Total Lost Time (s)	
Lead/Lag	Lead
Lead-Lag Optimize?	
Recall Mode	Ped
Act Effct Green (s)	
Actuated g/C Ratio	
v/c Ratio	
Control Delay	
Queue Delay	
Total Delay	
LOS	
Approach Delay	
Approach LOS	
Queue Length 50th (m)	
Queue Length 95th (m)	
Internal Link Dist (m)	
Turn Bay Length (m)	
Base Capacity (vph)	
Starvation Cap Reductn	
Spillback Cap Reductn	
Storage Cap Reductn	
Reduced v/c Ratio	

Intersection Summary	
Cycle Length: 95	
Actuated Cycle Length: 95	
Offset: 0 (0%), Referenced to phase 2:EBT and 6:WBT, Start of Green	
Natural Cycle: 90	
Control Type: Actuated-Coordinated	

Lanes, Volumes, Timings
1: North River & Montreal

Existing
AM Peak Hour

Maximum v/c Ratio: 0.87	Intersection LOS: E
Intersection Signal Delay: 55.2	ICU Level of Service B
Intersection Capacity Utilization 59.1%	
Analysis Period (min) 15	
# 95th percentile volume exceeds capacity, queue may be longer.	
Queue shown is maximum after two cycles.	
! Phase conflict between lane groups.	

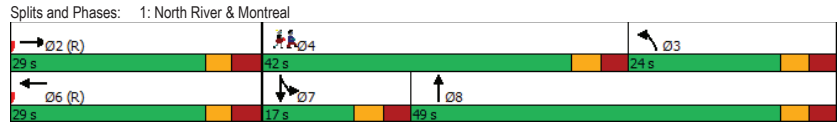

Lanes, Volumes, Timings
2: Montgomery & Montreal

Existing
AM Peak Hour

Lane Group	EBT	EBR	WBL	WBT	NBL	NBR
Lane Configurations	↕↕			↕↕	↕	↕
Traffic Volume (vph)	431	88	53	689	19	38
Future Volume (vph)	431	88	53	689	19	38
Satd. Flow (prot)	3131	0	0	3182	1658	1401
Fit Permitted				0.868	0.950	
Satd. Flow (perm)	3131	0	0	2771	1649	1379
Satd. Flow (RTOR)	56				42	
Lane Group Flow (vph)	577	0	0	825	21	42
Turn Type	NA		Perm	NA	Perm	Perm
Protected Phases	2			6		
Permitted Phases			6		8	8
Detector Phase	2		6	6	8	8
Switch Phase						
Minimum Initial (s)	10.0		10.0	10.0	10.0	10.0
Minimum Split (s)	40.4		16.4	16.4	19.5	19.5
Total Split (s)	56.0		56.0	56.0	24.0	24.0
Total Split (%)	70.0%		70.0%	70.0%	30.0%	30.0%
Yellow Time (s)	3.0		3.0	3.0	3.3	3.3
All-Red Time (s)	3.4		3.4	3.4	2.2	2.2
Lost Time Adjust (s)	0.0		0.0	0.0	0.0	0.0
Total Lost Time (s)	6.4		6.4	6.4	5.5	5.5
Lead/Lag						
Lead-Lag Optimize?						
Recall Mode	C-Max		C-Max	C-Max	None	None
Act Effct Green (s)	66.1		66.1	66.1	10.8	10.8
Actuated g/C Ratio	0.83		0.83	0.83	0.14	0.14
v/c Ratio	0.22		0.36	0.36	0.09	0.19
Control Delay	3.0		4.1	4.1	30.6	12.2
Queue Delay	0.3		0.0	0.0	0.0	0.0
Total Delay	3.3		4.1	4.1	30.6	12.2
LOS	A		A	A	C	B
Approach Delay	3.3		4.1	4.1	18.3	
Approach LOS	A		A	A	B	
Queue Length 50th (m)	11.0		20.7	20.7	2.9	0.0
Queue Length 95th (m)	20.0		36.1	36.1	8.6	8.1
Internal Link Dist (m)	52.8		138.9	138.9	214.6	
Turn Bay Length (m)					35.0	
Base Capacity (vph)	2595		2288	2288	381	351
Starvation Cap Reductn	1337		0	0	0	0
Spillback Cap Reductn	0		0	0	0	0
Storage Cap Reductn	0		0	0	0	0
Reduced v/c Ratio	0.46		0.36	0.36	0.06	0.12

Intersection Summary						
Cycle Length:	80					
Actuated Cycle Length:	80					
Offset:	0 (0%), Referenced to phase 2:EBT and 6:WBTL, Start of Green					
Natural Cycle:	60					
Control Type:	Actuated-Coordinated					

Lanes, Volumes, Timings
2: Montgomery & Montreal

Existing
AM Peak Hour

Maximum v/c Ratio: 0.36	Intersection LOS: A
Intersection Signal Delay: 4.4	ICU Level of Service C
Intersection Capacity Utilization 72.2%	
Analysis Period (min) 15	

Splits and Phases: 2: Montgomery & Montreal

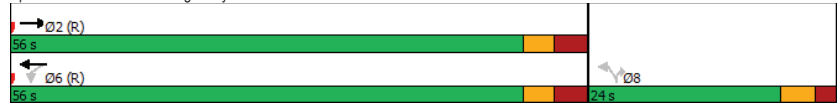

Lanes, Volumes, Timings
4: Vanier & Montreal

Existing
AM Peak Hour

Lane Group	EBL	EBT	EBR	WBL	WBT	WBR	NBL	NBT	NBR	SBL	SBT	SBR
Lane Configurations	↔	↕	↔	↔	↕	↔	↔	↕	↔	↔	↕	↔
Traffic Volume (vph)	35	281	134	165	475	194	180	857	166	213	1096	137
Future Volume (vph)	35	281	134	165	475	194	180	857	166	213	1096	137
Satd. Flow (prot)	1642	1695	1483	1658	3018	0	1642	4573	0	1642	4649	0
Fit Permitted	0.950			0.950			0.950			0.950		
Satd. Flow (perm)	1597	1695	1385	1599	3018	0	1628	4573	0	1614	4649	0
Satd. Flow (RTOR)			149		42			29			16	
Lane Group Flow (vph)	39	312	149	183	744	0	200	1136	0	237	1370	0
Turn Type	Prot	NA	Perm	Prot	NA		Prot	NA		Prot	NA	
Protected Phases	7	4		3	8		5	2		1	6	
Permitted Phases			4									
Detector Phase	7	4	4	3	8		5	2		1	6	
Switch Phase												
Minimum Initial (s)	5.0	10.0	10.0	5.0	10.0		5.0	10.0		5.0	10.0	
Minimum Split (s)	12.1	40.1	40.1	12.1	40.1		11.1	28.9		11.1	28.9	
Total Split (s)	20.0	41.0	41.0	20.0	41.0		30.0	49.0		30.0	49.0	
Total Split (%)	14.3%	29.3%	29.3%	14.3%	29.3%		21.4%	35.0%		21.4%	35.0%	
Yellow Time (s)	3.0	3.0	3.0	3.0	3.0		3.7	3.7		3.7	3.7	
All-Red Time (s)	4.1	4.1	4.1	4.1	4.1		2.4	2.2		2.4	2.2	
Lost Time Adjust (s)	0.0	0.0	0.0	0.0	0.0		0.0	0.0		0.0	0.0	
Total Lost Time (s)	7.1	7.1	7.1	7.1	7.1		6.1	5.9		6.1	5.9	
Lead/Lag	Lead	Lag	Lag	Lead	Lag		Lead	Lag		Lead	Lag	
Lead-Lag Optimize?	Yes	Yes	Yes	Yes	Yes		Yes	Yes		Yes	Yes	
Recall Mode	None	Max	Max	None	Max		None	C-Max		None	C-Max	
Act Effct Green (s)	8.7	33.9	33.9	12.9	40.6		20.9	44.3		22.7	46.1	
Actuated g/C Ratio	0.06	0.24	0.24	0.09	0.29		0.15	0.32		0.16	0.33	
v/c Ratio	0.38	0.76	0.33	1.20	0.82		0.82	0.77		0.89	0.89	
Control Delay	72.8	62.5	8.3	190.0	53.2		88.6	48.6		90.2	52.5	
Queue Delay	0.0	0.0	0.0	0.0	0.0		0.0	0.0		0.0	0.0	
Total Delay	72.8	62.5	8.3	190.0	53.2		88.6	48.6		90.2	52.5	
LOS	E	E	A	F	D		F	D		F	D	
Approach Delay		47.2			80.2			54.6			58.0	
Approach LOS		D			F			D			E	
Queue Length 50th (m)	10.6	80.9	0.0	-61.2	98.9		58.0	72.9		64.4	132.5	
Queue Length 95th (m)	22.2	#116.4	17.2	#108.9	#142.2		m73.5	87.2		#108.5	#165.2	
Internal Link Dist (m)		99.5			262.7			154.6			239.2	
Turn Bay Length (m)	30.0			35.0			94.5			90.0		
Base Capacity (vph)	151	410	448	152	904		280	1466		280	1542	
Starvation Cap Reductn	0	0	0	0	0		0	0		0	0	
Spillback Cap Reductn	0	0	0	0	0		0	0		0	0	
Storage Cap Reductn	0	0	0	0	0		0	0		0	0	
Reduced v/c Ratio	0.26	0.76	0.33	1.20	0.82		0.71	0.77		0.85	0.89	

Intersection Summary

Cycle Length: 140
 Actuated Cycle Length: 140
 Offset: 102 (73%), Referenced to phase 2:NBT and 6:SBT, Start of Green
 Natural Cycle: 125
 Control Type: Actuated-Coordinated

Lanes, Volumes, Timings
4: Vanier & Montreal

Existing
AM Peak Hour

Maximum v/c Ratio: 1.20	Intersection LOS: E
Intersection Signal Delay: 60.5	ICU Level of Service F
Intersection Capacity Utilization 95.4%	
Analysis Period (min) 15	
~ Volume exceeds capacity, queue is theoretically infinite. Queue shown is maximum after two cycles.	
# 95th percentile volume exceeds capacity, queue may be longer. Queue shown is maximum after two cycles.	
m Volume for 95th percentile queue is metered by upstream signal.	

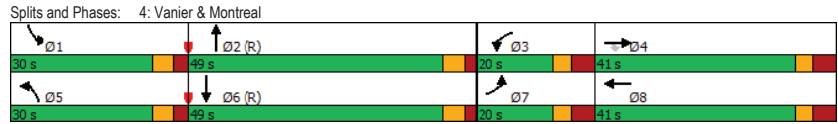

HCM 2010 TWSC
6: North River & Selkirk

Existing
AM Peak Hour

Intersection						
Int Delay, s/veh	1					
Movement	WBL	WBR	NBT	NBR	SBL	SBT
Lane Configurations	↔	↔	↑	↔	↔	↔
Traffic Vol, veh/h	27	34	274	0	0	397
Future Vol, veh/h	27	34	274	0	0	397
Conflicting Peds, #/hr	3	0	0	90	90	0
Sign Control	Stop	Stop	Free	Free	Free	Free
RT Channelized	-	None	-	None	-	None
Storage Length	0	-	-	-	-	-
Veh in Median Storage, #	0	-	0	-	-	0
Grade, %	0	-	0	-	-	0
Peak Hour Factor	90	90	90	90	90	90
Heavy Vehicles, %	7	2	8	2	2	2
Mvmt Flow	30	38	304	0	0	441

Major/Minor	Minor1	Major1	Major2
Conflicting Flow All	528	304	0
Stage 1	304	-	-
Stage 2	224	-	-
Critical Hdwy	6.705	6.23	-
Critical Hdwy Stg 1	5.505	-	-
Critical Hdwy Stg 2	5.905	-	-
Follow-up Hdwy	3.5665	3.319	-
Pot Cap-1 Maneuver	485	735	0
Stage 1	734	-	0
Stage 2	779	-	0
Platoon blocked, %	-	-	-
Mov Cap-1 Maneuver	484	735	-
Mov Cap-2 Maneuver	484	-	-
Stage 1	734	-	-
Stage 2	777	-	-

Approach	WB	NB	SB
HCM Control Delay, s	11.8	0	0
HCM LOS	B		

Minor Lane/Major Mvmt	NBTWBLn1	SBT
Capacity (veh/h)	- 598	-
HCM Lane V/C Ratio	- 0.113	-
HCM Control Delay (s)	- 11.8	-
HCM Lane LOS	- B	-
HCM 95th %tile Q(veh)	- 0.4	-

HCM 2010 TWSC
7: Dundas & Selkirk

Existing
AM Peak Hour

Intersection						
Int Delay, s/veh	0					
Movement	EBT	EBR	WBL	WBT	NBL	NBR
Lane Configurations				↕	↕	
Traffic Vol, veh/h	0	0	30	85	5	70
Future Vol, veh/h	0	0	30	85	5	70
Conflicting Peds, #/hr	0	0	0	0	0	0
Sign Control	Free	Free	Free	Free	Stop	Stop
RT Channelized	-	None	-	None	-	None
Storage Length	-	-	-	-	0	-
Veh in Median Storage, #	-	-	-	-	0	-
Grade, %	0	-	-	0	0	-
Peak Hour Factor	90	90	90	90	90	90
Heavy Vehicles, %	2	2	2	2	2	2
Mvmt Flow	0	0	33	94	6	78

Major/Minor	Major2	Minor1
Conflicting Flow All	0	160
Stage 1	-	0
Stage 2	-	160
Critical Hdwy	4.12	6.42
Critical Hdwy Stg 1	-	-
Critical Hdwy Stg 2	-	5.42
Follow-up Hdwy	2.218	3.518
Pot Cap-1 Maneuver	-	831
Stage 1	-	-
Stage 2	-	869
Platoon blocked, %	-	-
Mov Cap-1 Maneuver	-	831
Mov Cap-2 Maneuver	-	831
Stage 1	-	-
Stage 2	-	869

Approach	WB	NB
HCM Control Delay, s		
HCM LOS		

Minor Lane/Major Mvmt	NBLn1	WBL	WBT
Capacity (veh/h)	-	-	-
HCM Lane V/C Ratio	-	-	-
HCM Control Delay (s)	-	-	-
HCM Lane LOS	-	-	-
HCM 95th %tile Q(veh)	-	-	-

HCM 2010 TWSC
8: Montgomery & Selkirk

Existing
AM Peak Hour

Intersection												
Int Delay, s/veh	5.3											
Movement	EBL	EBT	EBR	WBL	WBT	WBR	NBL	NBT	NBR	SBL	SBT	SBR
Lane Configurations		↕			↕			↕			↕	
Traffic Vol, veh/h	55	10	5	15	20	20	5	5	0	10	15	90
Future Vol, veh/h	55	10	5	15	20	20	5	5	0	10	15	90
Conflicting Peds, #/hr	0	0	0	0	0	0	0	0	0	0	0	0
Sign Control	Stop	Stop	Stop	Stop	Stop	Stop	Free	Free	Free	Free	Free	Free
RT Channelized	-	-	None	-	-	None	-	-	None	-	-	None
Storage Length	-	-	-	-	-	-	-	-	-	-	-	-
Veh in Median Storage, #	-	0	-	-	0	-	-	0	-	-	0	-
Grade, %	-	0	-	-	0	-	-	0	-	-	0	-
Peak Hour Factor	90	90	90	90	90	90	90	90	90	90	90	90
Heavy Vehicles, %	2	2	2	2	2	2	2	2	2	2	2	2
Mvmt Flow	61	11	6	17	22	22	6	6	0	11	17	100

Major/Minor	Minor2	Minor1	Major1	Major2
Conflicting Flow All	129	107	67	116
Stage 1	89	89	-	18
Stage 2	40	18	-	98
Critical Hdwy	7.12	6.52	6.22	7.12
Critical Hdwy Stg 1	6.12	5.52	-	6.12
Critical Hdwy Stg 2	6.12	5.52	-	6.12
Follow-up Hdwy	3.518	4.018	3.318	3.518
Pot Cap-1 Maneuver	844	783	997	861
Stage 1	918	821	-	1001
Stage 2	975	880	-	908
Platoon blocked, %	-	-	-	-
Mov Cap-1 Maneuver	801	774	997	839
Mov Cap-2 Maneuver	801	774	-	839
Stage 1	914	815	-	997
Stage 2	927	876	-	884

Approach	EB	WB	NB	SB
HCM Control Delay, s	9.9	9.5	3.7	0.6
HCM LOS	A	A		

Minor Lane/Major Mvmt	NBL	NBT	NBR	EBLn1	WBLn1	SBL	SBT	SBR
Capacity (veh/h)	1471	-	-	808	860	1615	-	-
HCM Lane V/C Ratio	0.004	-	-	0.096	0.071	0.007	-	-
HCM Control Delay (s)	7.5	0	-	9.9	9.5	7.2	0	-
HCM Lane LOS	A	A	-	A	A	A	A	-
HCM 95th %tile Q(veh)	0	-	-	0.3	0.2	0	-	-

Lanes, Volumes, Timings
9: North River & McArthur

Existing
AM Peak Hour

Lane Group	EBL	EBT	EBR	WBL	WBT	WBR	NBL	NBT	NBR	SBL	SBT	SBR
Lane Configurations		↔			↔	↔		↔		↔	↔	
Traffic Volume (vph)	1	6	3	8	9	165	3	115	29	322	98	4
Future Volume (vph)	1	6	3	8	9	165	3	115	29	322	98	4
Satd. Flow (prot)	0	1660	0	0	1705	1441	0	1624	0	1658	1687	0
Fit Permitted		0.989			0.922			0.997		0.654		
Satd. Flow (perm)	0	1644	0	0	1605	1341	0	1621	0	1042	1687	0
Satd. Flow (RTOR)		3			183			26		4		
Lane Group Flow (vph)	0	11	0	0	19	183	0	163	0	358	113	0
Turn Type	Perm	NA		Perm	NA	Perm	Perm	NA		Perm	NA	
Protected Phases		4			8			2			6	
Permitted Phases	4			8		8	2			6		
Detector Phase	4	4		8	8	8	2	2		6	6	
Switch Phase												
Minimum Initial (s)	10.0	10.0		10.0	10.0	10.0	10.0	10.0		10.0	10.0	
Minimum Split (s)	25.6	25.6		25.6	25.6	25.6	31.1	31.1		31.1	31.1	
Total Split (s)	28.0	28.0		28.0	28.0	28.0	42.0	42.0		42.0	42.0	
Total Split (%)	40.0%	40.0%		40.0%	40.0%	40.0%	60.0%	60.0%		60.0%	60.0%	
Yellow Time (s)	3.3	3.3		3.3	3.3	3.3	3.3	3.3		3.3	3.3	
All-Red Time (s)	2.3	2.3		2.3	2.3	2.3	2.8	2.8		2.8	2.8	
Lost Time Adjust (s)		0.0			0.0	0.0		0.0		0.0	0.0	
Total Lost Time (s)		5.6			5.6	5.6		6.1		6.1	6.1	
Lead/Lag												
Lead-Lag Optimize?												
Recall Mode	Max	Max		Max	Max	Max	C-Max	C-Max		C-Max	C-Max	
Act Effct Green (s)		22.4			22.4	22.4		35.9		35.9	35.9	
Actuated g/C Ratio		0.32			0.32	0.32		0.51		0.51	0.51	
v/c Ratio		0.02			0.04	0.33		0.19		0.67	0.13	
Control Delay		14.6			11.3	8.1		8.4		20.4	9.1	
Queue Delay		0.0			0.0	0.0		0.0		0.0	0.0	
Total Delay		14.6			11.3	8.1		8.4		20.4	9.1	
LOS		B			B	A		A		C	A	
Approach Delay		14.6			8.4			8.4			17.7	
Approach LOS		B			A			A			B	
Queue Length 50th (m)		0.7			1.7	12.8		8.9		32.4	6.9	
Queue Length 95th (m)		3.8			m5.3	25.6		18.2		62.5	14.2	
Internal Link Dist (m)		22.5			128.8			367.7			94.3	
Turn Bay Length (m)						60.0				55.0		
Base Capacity (vph)		528			513	553		844		534	867	
Starvation Cap Reductn		0			0	0		0		0	0	
Spillback Cap Reductn		0			0	0		0		0	0	
Storage Cap Reductn		0			0	0		0		0	0	
Reduced v/c Ratio		0.02			0.04	0.33		0.19		0.67	0.13	

Intersection Summary	
Cycle Length:	70
Actuated Cycle Length:	70
Offset:	0 (0%), Referenced to phase 2:NBTL and 6:SBTL, Start of Green
Natural Cycle:	60
Control Type:	Actuated-Coordinated

Lanes, Volumes, Timings
9: North River & McArthur

Existing
AM Peak Hour

Maximum v/c Ratio: 0.67	Intersection Signal Delay: 13.6	Intersection LOS: B
Intersection Capacity Utilization 73.2%	ICU Level of Service D	
Analysis Period (min) 15		
m Volume for 95th percentile queue is metered by upstream signal.		

Splits and Phases: 9: North River & McArthur

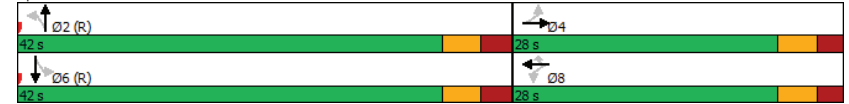

Intersection						
Int Delay, s/veh	0.6					
Movement	EBL	EBT	WBT	WBR	SBL	SBR
Lane Configurations		↖	↖		↗	↗
Traffic Vol, veh/h	10	361	318	79	10	16
Future Vol, veh/h	10	361	318	79	10	16
Conflicting Peds, #/hr	100	0	0	100	1	9
Sign Control	Free	Free	Free	Free	Stop	Stop
RT Channelized	-	None	-	None	-	None
Storage Length	-	-	-	-	0	-
Veh in Median Storage, #	-	0	0	-	0	-
Grade, %	-	0	0	-	0	-
Peak Hour Factor	90	90	90	90	90	90
Heavy Vehicles, %	10	2	5	3	2	2
Mvmt Flow	11	401	353	88	11	18
Major/Minor	Major1	Major2	Minor2			
Conflicting Flow All	541	0	0	921	506	
Stage 1	-	-	-	497	-	
Stage 2	-	-	-	424	-	
Critical Hdwy	4.2	-	-	6.42	6.22	
Critical Hdwy Stg 1	-	-	-	5.42	-	
Critical Hdwy Stg 2	-	-	-	5.42	-	
Follow-up Hdwy	2.29	-	-	3.518	3.318	
Pot Cap-1 Maneuver	988	-	-	300	566	
Stage 1	-	-	-	611	-	
Stage 2	-	-	-	660	-	
Platoon blocked, %	-	-	-	-	-	
Mov Cap-1 Maneuver	911	-	-	251	518	
Mov Cap-2 Maneuver	-	-	-	251	-	
Stage 1	-	-	-	554	-	
Stage 2	-	-	-	609	-	
Approach	EB	WB	SB			
HCM Control Delay, s	0.2	0	15.6			
HCM LOS			C			
Minor Lane/Major Mvmt	EBL	EBT	WBT	WBR	SBLn1	
Capacity (veh/h)	911	-	-	-	368	
HCM Lane V/C Ratio	0.012	-	-	-	0.079	
HCM Control Delay (s)	9	0	-	-	15.6	
HCM Lane LOS	A	A	-	-	C	
HCM 95th %tile Q(veh)	0	-	-	-	0.3	

Lane Group	EBT	EBR	WBL	WBT	NBL	NBR
Lane Configurations	↖			↖	↖	↖
Traffic Volume (vph)	353	19	46	395	9	31
Future Volume (vph)	353	19	46	395	9	31
Satd. Flow (prot)	1728	0	0	1736	1658	1483
Fit Permitted				0.929	0.950	
Satd. Flow (perm)	1728	0	0	1618	1551	1426
Satd. Flow (RTOR)	6					34
Lane Group Flow (vph)	413	0	0	490	10	34
Turn Type	NA		Perm	NA	Prot	Perm
Protected Phases	2			6	8	
Permitted Phases			6			8
Detector Phase	2		6	6	8	8
Switch Phase						
Minimum Initial (s)	10.0		10.0	10.0	5.0	5.0
Minimum Split (s)	27.5		15.5	15.5	24.5	24.5
Total Split (s)	45.0		45.0	45.0	25.0	25.0
Total Split (%)	64.3%		64.3%	64.3%	35.7%	35.7%
Yellow Time (s)	3.3		3.3	3.3	3.3	3.3
All-Red Time (s)	2.2		2.2	2.2	2.2	2.2
Lost Time Adjust (s)	0.0		0.0	0.0	0.0	0.0
Total Lost Time (s)	5.5		5.5	5.5	5.5	5.5
Lead/Lag						
Lead-Lag Optimize?						
Recall Mode	C-Max		C-Max	C-Max	None	None
Act Effct Green (s)	54.6		54.6	11.1	11.1	
Actuated g/C Ratio	0.78		0.78	0.16	0.16	
v/c Ratio	0.31		0.39	0.04	0.13	
Control Delay	4.5		8.1	20.7	8.8	
Queue Delay	0.0		0.0	0.0	0.0	
Total Delay	4.5		8.1	20.7	8.8	
LOS	A		A	C	A	
Approach Delay	4.5		8.1	11.5		
Approach LOS	A		A	B		
Queue Length 50th (m)	10.1		42.1	1.2	0.0	
Queue Length 95th (m)	28.4		m50.4	4.1	5.9	
Internal Link Dist (m)	36.3		7.3	144.2		
Turn Bay Length (m)				20.0		
Base Capacity (vph)	1349		1261	461	421	
Starvation Cap Reductn	0		0	0	0	
Spillback Cap Reductn	0		0	0	0	
Storage Cap Reductn	0		0	0	0	
Reduced v/c Ratio	0.31		0.39	0.02	0.08	

Intersection Summary	
Cycle Length:	70
Actuated Cycle Length:	70
Offset:	0 (0%), Referenced to phase 2:EBT and 6:WBTL, Start of Green
Natural Cycle:	55
Control Type:	Actuated-Coordinated

Lanes, Volumes, Timings
11: Marguerite & McArthur

Existing
AM Peak Hour

Maximum v/c Ratio: 0.39	Intersection Signal Delay: 6.7	Intersection LOS: A
Intersection Capacity Utilization 66.5%	ICU Level of Service C	
Analysis Period (min) 15		
m Volume for 95th percentile queue is metered by upstream signal.		

Splits and Phases: 11: Marguerite & McArthur



Lanes, Volumes, Timings
12: Vanier & McArthur

Existing
AM Peak Hour

Lane Group	EBL	EBT	EBR	WBL	WBT	WBR	NBL	NBT	NBR	SBL	SBT	SBR
Lane Configurations	↔	↕	↔	↔	↕	↔	↔	↕	↔	↕	↔	↔
Traffic Volume (vph)	34	116	290	209	191	104	220	1044	225	140	1207	60
Future Volume (vph)	34	116	290	209	191	104	220	1044	225	140	1207	60
Satd. Flow (prot)	1551	1695	1483	3216	1695	1483	1658	3316	1483	1658	3316	1441
Fit Permitted	0.950			0.950			0.950			0.950		
Satd. Flow (perm)	1438	1695	1398	3092	1695	1320	1645	3316	1407	1644	3316	1342
Satd. Flow (RTOR)			246			168			219			121
Lane Group Flow (vph)	38	129	322	232	212	116	244	1160	250	156	1341	67
Turn Type	Prot	NA	Perm	Prot	NA	Perm	Prot	NA	Perm	Prot	NA	Perm
Protected Phases	7	4		3	8		5	2		1	6	
Permitted Phases			4			8			2			6
Detector Phase	7	4	4	3	8	8	5	2	2	1	6	6
Switch Phase												
Minimum Initial (s)	5.0	10.0	10.0	5.0	10.0	10.0	5.0	10.0	10.0	5.0	10.0	10.0
Minimum Split (s)	11.2	36.2	36.2	11.2	36.2	36.2	11.1	36.1	36.1	11.1	36.1	36.1
Total Split (s)	20.0	36.2	36.2	20.0	36.2	36.2	23.0	59.8	59.8	24.0	60.8	60.8
Total Split (%)	14.3%	25.9%	25.9%	14.3%	25.9%	25.9%	16.4%	42.7%	42.7%	17.1%	43.4%	43.4%
Yellow Time (s)	3.3	3.3	3.3	3.3	3.3	3.3	3.7	3.7	3.7	3.7	3.7	3.7
All-Red Time (s)	2.9	2.9	2.9	2.9	2.9	2.9	2.4	2.4	2.4	2.4	2.4	2.4
Lost Time Adjust (s)	0.0	0.0	0.0	0.0	0.0	0.0	0.0	0.0	0.0	0.0	0.0	0.0
Total Lost Time (s)	6.2	6.2	6.2	6.2	6.2	6.2	6.1	6.1	6.1	6.1	6.1	6.1
Lead/Lag	Lag	Lead	Lead	Lag	Lead	Lead	Lag	Lag	Lag	Lead	Lead	Lead
Lead-Lag Optimize?	Yes	Yes	Yes	Yes	Yes	Yes	Yes	Yes	Yes	Yes	Yes	Yes
Recall Mode	None	None	None	None	None	None	C-Max	C-Max	None	C-Max	C-Max	C-Max
Act Effct Green (s)	12.0	26.0	26.0	13.1	29.5	29.5	16.9	59.8	59.8	16.4	59.4	59.4
Actuated g/C Ratio	0.09	0.19	0.19	0.09	0.21	0.21	0.12	0.43	0.43	0.12	0.42	0.42
v/c Ratio	0.29	0.41	0.70	0.77	0.59	0.28	1.22	0.82	0.34	0.80	0.95	0.10
Control Delay	65.1	46.1	21.8	79.1	57.5	3.1	185.4	42.9	6.8	82.7	77.9	17.2
Queue Delay	0.0	0.0	0.0	0.0	0.0	0.0	0.0	0.0	0.0	0.0	0.0	0.0
Total Delay	65.1	46.1	21.8	79.1	57.5	3.1	185.4	42.9	6.8	82.7	77.9	17.2
LOS	E	D	C	E	E	A	F	D	A	F	E	B
Approach Delay	31.6			55.2			58.5			75.8		
Approach LOS	C			E			E			E		
Queue Length 50th (m)	11.0	25.2	20.8	32.7	53.2	0.0	~82.7	159.2	5.4	45.6	~200.4	4.1
Queue Length 95th (m)	22.8	44.2	42.4	#48.7	80.0	3.8	#136.1	#200.7	24.4	m51.9 m#236.8	m6.6	
Internal Link Dist (m)	122.9			141.8			130.7			202.5		
Turn Bay Length (m)	30.0		50.0	120.0		115.0	90.0		90.0	90.0		90.0
Base Capacity (vph)	152	363	492	317	363	414	200	1417	726	211	1405	639
Starvation Cap Reductn	0	0	0	0	0	0	0	0	0	0	0	0
Spillback Cap Reductn	0	0	0	0	0	0	0	0	0	0	0	0
Storage Cap Reductn	0	0	0	0	0	0	0	0	0	0	0	0
Reduced v/c Ratio	0.25	0.36	0.65	0.73	0.58	0.28	1.22	0.82	0.34	0.74	0.95	0.10

Intersection Summary

Cycle Length: 140
Actuated Cycle Length: 140
Offset: 100 (71%), Referenced to phase 2:NBT and 6:SBT, Start of Green
Natural Cycle: 145
Control Type: Actuated-Coordinated

Lanes, Volumes, Timings
12: Vanier & McArthur

Existing
AM Peak Hour

Maximum v/c Ratio: 1.22	
Intersection Signal Delay: 61.3	Intersection LOS: E
Intersection Capacity Utilization 93.2%	ICU Level of Service F
Analysis Period (min) 15	
~ Volume exceeds capacity, queue is theoretically infinite.	
Queue shown is maximum after two cycles.	
# 95th percentile volume exceeds capacity, queue may be longer.	
Queue shown is maximum after two cycles.	
m Volume for 95th percentile queue is metered by upstream signal.	

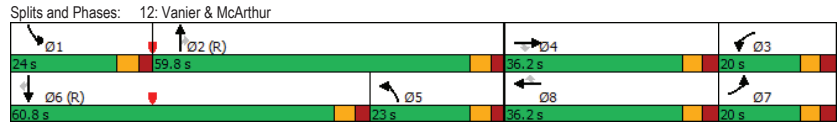

HCM 2010 TWSC
15: McArthur & Mayfield

Existing
AM Peak Hour

Intersection						
Int Delay, s/veh	0.1					
Movement	EBL	EBT	WBT	WBR	SBL	SBR
Lane Configurations		↑	↑		↓	↓
Traffic Vol, veh/h	0	384	430	0	4	4
Future Vol, veh/h	0	384	430	0	4	4
Conflicting Peds, #/hr	0	0	0	0	0	0
Sign Control	Free	Free	Free	Free	Stop	Stop
RT Channelized	-	None	-	None	-	None
Storage Length	-	-	-	-	0	0
Veh in Median Storage, #	-	0	0	-	0	-
Grade, %	-	0	0	-	0	-
Peak Hour Factor	90	90	90	90	90	90
Heavy Vehicles, %	2	2	2	2	2	2
Mvmt Flow	0	427	478	0	4	4

Major/Minor	Major1	Major2	Minor2
Conflicting Flow All	-	0	0
Stage 1	-	-	-
Stage 2	-	-	-
Critical Hdwy	-	-	-
Critical Hdwy Stg 1	-	-	-
Critical Hdwy Stg 2	-	-	-
Follow-up Hdwy	-	-	-
Pot Cap-1 Maneuver	0	-	0
Stage 1	0	-	0
Stage 2	0	-	0
Platoon blocked, %	-	-	-
Mov Cap-1 Maneuver	-	-	-
Mov Cap-2 Maneuver	-	-	-
Stage 1	-	-	-
Stage 2	-	-	-

Approach	EB	WB	SB
HCM Control Delay, s	0	0	14.1
HCM LOS			B

Minor Lane/Major Mvmt	EBT	WBT	SBLn1	SBLn2
Capacity (veh/h)	-	-	307	587
HCM Lane V/C Ratio	-	-	0.014	0.008
HCM Control Delay (s)	-	-	16.9	11.2
HCM Lane LOS	-	-	C	B
HCM 95th %tile Q(veh)	-	-	0	0

Lanes, Volumes, Timings
1: North River & Montreal

Existing
PM Peak Hour



Lane Group	EBL	EBT	EBR	WBL	WBT	WBR	NBL	NBT	NBR	SBL	SBT	SBR
Lane Configurations		↑↓			↑↓		↑	↓			↑↓	
Traffic Volume (vph)	0	596	410	0	665	18	356	17	32	21	15	21
Future Volume (vph)	0	596	410	0	665	18	356	17	32	21	15	21
Satd. Flow (prot)	0	2916	0	0	3241	0	1658	1486	0	0	1508	0
Fit Permitted							0.950				0.982	
Satd. Flow (perm)	0	2916	0	0	3241	0	1634	1486	0	0	1475	0
Satd. Flow (RTOR)		142						36			19	
Lane Group Flow (vph)	0	1118	0	0	759	0	396	55	0	0	63	0
Turn Type		NA			NA		Prot	NA		Split	NA	
Protected Phases		2			6		3!	8		7	7!	
Permitted Phases												
Detector Phase		2			6		3	8		7	7	
Switch Phase												
Minimum Initial (s)		10.0			10.0		5.0	10.0		10.0	10.0	
Minimum Split (s)		21.7			21.7		11.5	24.5		16.5	16.5	
Total Split (s)		39.0			39.0		39.0	64.0		17.0	17.0	
Total Split (%)		32.5%			32.5%		32.5%	53.3%		14.2%	14.2%	
Yellow Time (s)		3.0			3.0		3.3	3.3		3.3	3.3	
All-Red Time (s)		3.7			3.7		3.2	3.2		3.2	3.2	
Lost Time Adjust (s)		0.0			0.0		0.0	0.0		0.0	0.0	
Total Lost Time (s)		6.7			6.7		6.5	6.5		6.5	6.5	
Lead/Lag							Lag	Lag		Lead	Lead	
Lead-Lag Optimize?							Yes	Yes		Yes	Yes	
Recall Mode		C-Max			C-Max		None	Ped		None	None	
Act Effct Green (s)		48.0			48.0		34.3	45.4		10.2	10.2	
Actuated g/C Ratio		0.40			0.40		0.29	0.38		0.08	0.08	
v/c Ratio		0.89			0.59		0.84	0.09		0.43	0.43	
Control Delay		40.6			31.6		55.6	11.3		47.9	47.9	
Queue Delay		0.0			52.2		0.0	0.0		0.0	0.0	
Total Delay		40.6			83.8		55.6	11.3		47.9	47.9	
LOS		D			F		E	B		D	D	
Approach Delay		40.6			83.8		50.2	47.9		47.9	47.9	
Approach LOS		D			F		D	D		D	D	
Queue Length 50th (m)		116.3			73.8		86.4	2.9		10.0	10.0	
Queue Length 95th (m)		#175.6			101.3		116.4	10.8		24.2	24.2	
Internal Link Dist (m)		179.1			52.8		112.9	59.0		59.0	59.0	
Turn Bay Length (m)							90.0					
Base Capacity (vph)		1250			1295		495	730		149	149	
Starvation Cap Reductn		0			644		0	0		0	0	
Spillback Cap Reductn		0			0		0	0		0	0	
Storage Cap Reductn		0			0		0	0		0	0	
Reduced v/c Ratio		0.89			1.17		0.80	0.08		0.42	0.42	

Intersection Summary
 Cycle Length: 120
 Actuated Cycle Length: 120
 Offset: 0 (0%), Referenced to phase 2:EBT and 6:WBT, Start of Green
 Natural Cycle: 100
 Control Type: Actuated-Coordinated

Lanes, Volumes, Timings
1: North River & Montreal

Existing
PM Peak Hour

Lane Group	Ø4
Lane Configurations	
Traffic Volume (vph)	
Future Volume (vph)	
Satd. Flow (prot)	
Fit Permitted	
Satd. Flow (perm)	
Satd. Flow (RTOR)	
Lane Group Flow (vph)	
Turn Type	
Protected Phases	4
Permitted Phases	
Detector Phase	
Switch Phase	
Minimum Initial (s)	5.0
Minimum Split (s)	27.5
Total Split (s)	42.0
Total Split (%)	35%
Yellow Time (s)	3.3
All-Red Time (s)	3.2
Lost Time Adjust (s)	
Total Lost Time (s)	
Lead/Lag	Lead
Lead-Lag Optimize?	Yes
Recall Mode	Ped
Act Effct Green (s)	
Actuated g/C Ratio	
v/c Ratio	
Control Delay	
Queue Delay	
Total Delay	
LOS	
Approach Delay	
Approach LOS	
Queue Length 50th (m)	
Queue Length 95th (m)	
Internal Link Dist (m)	
Turn Bay Length (m)	
Base Capacity (vph)	
Starvation Cap Reductn	
Spillback Cap Reductn	
Storage Cap Reductn	
Reduced v/c Ratio	

Intersection Summary

Lanes, Volumes, Timings
1: North River & Montreal

Existing
PM Peak Hour

Maximum v/c Ratio: 0.89	Intersection LOS: E
Intersection Signal Delay: 56.3	ICU Level of Service C
Intersection Capacity Utilization 71.1%	
Analysis Period (min) 15	
# 95th percentile volume exceeds capacity, queue may be longer.	
Queue shown is maximum after two cycles.	
! Phase conflict between lane groups.	

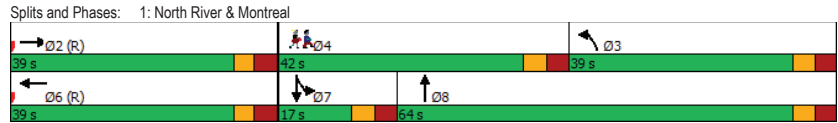

Lanes, Volumes, Timings
2: Montgomery & Montreal

Existing
PM Peak Hour

Lane Group	EBT	EBR	WBL	WBT	NBL	NBR
Lane Configurations	↔↔			↔↔	↔↔	↔↔
Traffic Volume (vph)	552	97	56	580	108	66
Future Volume (vph)	552	97	56	580	108	66
Satd. Flow (prot)	3192	0	0	3268	1658	1401
Fit Permitted				0.821	0.950	
Satd. Flow (perm)	3192	0	0	2691	1647	1314
Satd. Flow (RTOR)	48					73
Lane Group Flow (vph)	721	0	0	706	120	73
Turn Type	NA		Perm	NA	Prot	Perm
Protected Phases	2			6	8	
Permitted Phases			6			8
Detector Phase	2		6	6	8	8
Switch Phase						
Minimum Initial (s)	10.0		10.0	10.0	10.0	10.0
Minimum Split (s)	39.9		15.9	15.9	19.5	19.5
Total Split (s)	76.0		76.0	76.0	24.0	24.0
Total Split (%)	76.0%		76.0%	76.0%	24.0%	24.0%
Yellow Time (s)	3.0		3.0	3.0	3.3	3.3
All-Red Time (s)	2.6		2.6	2.6	2.2	2.2
Lost Time Adjust (s)	0.0		0.0	0.0	0.0	0.0
Total Lost Time (s)	5.6		5.6	5.6	5.5	5.5
Lead/Lag						
Lead-Lag Optimize?						
Recall Mode	C-Max		C-Max	C-Max	None	None
Act Effct Green (s)	75.9		75.9	13.0	13.0	13.0
Actuated g/C Ratio	0.76		0.76	0.13	0.13	0.13
v/c Ratio	0.30		0.35	0.56	0.31	0.31
Control Delay	4.1		4.8	50.4	12.7	12.7
Queue Delay	1.6		0.0	0.0	0.0	0.0
Total Delay	5.6		4.8	50.4	12.7	12.7
LOS	A		A	D	B	B
Approach Delay	5.6		4.8	36.2		
Approach LOS	A		A	D		
Queue Length 50th (m)	16.7		18.7	22.3	0.0	0.0
Queue Length 95th (m)	28.5		32.2	37.9	11.6	11.6
Internal Link Dist (m)	52.8		138.9	214.6		
Turn Bay Length (m)				35.0		
Base Capacity (vph)	2434		2043	306	302	302
Starvation Cap Reductn	1474		0	0	0	0
Spillback Cap Reductn	0		0	0	0	0
Storage Cap Reductn	0		0	0	0	0
Reduced v/c Ratio	0.75		0.35	0.39	0.24	0.24

Intersection Summary						
Cycle Length:	100					
Actuated Cycle Length:	100					
Offset:	0 (0%), Referenced to phase 2:EBT and 6:WBTL, Start of Green					
Natural Cycle:	60					
Control Type:	Actuated-Coordinated					

Lanes, Volumes, Timings
2: Montgomery & Montreal

Existing
PM Peak Hour

Maximum v/c Ratio: 0.56	Intersection LOS: A
Intersection Signal Delay: 8.9	ICU Level of Service C
Intersection Capacity Utilization 69.4%	
Analysis Period (min) 15	

Splits and Phases: 2: Montgomery & Montreal

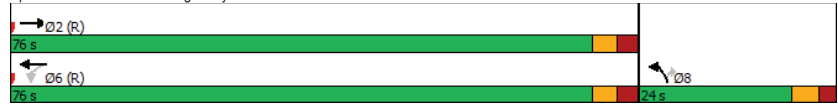

Lanes, Volumes, Timings
4: Vanier & Montreal

Existing
PM Peak Hour

Lane Group	EBL	EBT	EBR	WBL	WBT	WBR	NBL	NBT	NBR	SBL	SBT	SBR
Lane Configurations	[Diagrammatic Lane Configurations]											
Traffic Volume (vph)	51	366	177	156	333	198	229	1011	210	142	1019	94
Future Volume (vph)	51	366	177	156	333	198	229	1011	210	142	1019	94
Satd. Flow (prot)	1626	1695	1483	1658	2941	0	1658	4557	0	1658	4666	0
Fit Permitted	0.950			0.950			0.950			0.950		
Satd. Flow (perm)	1562	1695	1376	1600	2941	0	1633	4557	0	1636	4666	0
Satd. Flow (RTOR)			181		82			30			10	
Lane Group Flow (vph)	57	407	197	173	590	0	254	1356	0	158	1236	0
Turn Type	Prot	NA	Perm	Prot	NA		Prot	NA		Prot	NA	
Protected Phases	7	4		3	8		5	2		1	6	
Permitted Phases			4									
Detector Phase	7	4	4	3	8		5	2		1	6	
Switch Phase												
Minimum Initial (s)	5.0	10.0	10.0	5.0	10.0		5.0	10.0		5.0	10.0	
Minimum Split (s)	12.1	40.1	40.1	12.1	40.1		11.1	28.9		11.1	28.9	
Total Split (s)	30.0	41.0	41.0	30.0	41.0		30.0	39.0		30.0	39.0	
Total Split (%)	21.4%	29.3%	29.3%	21.4%	29.3%		21.4%	27.9%		21.4%	27.9%	
Yellow Time (s)	3.0	3.0	3.0	3.0	3.0		3.7	3.7		3.7	3.7	
All-Red Time (s)	4.1	4.1	4.1	4.1	4.1		2.4	2.2		2.4	2.2	
Lost Time Adjust (s)	0.0	0.0	0.0	0.0	0.0		0.0	0.0		0.0	0.0	
Total Lost Time (s)	7.1	7.1	7.1	7.1	7.1		6.1	5.9		6.1	5.9	
Lead/Lag	Lead	Lag	Lag	Lead	Lag		Lead	Lag		Lead	Lag	
Lead-Lag Optimize?	Yes	Yes	Yes	Yes	Yes		Yes	Yes		Yes	Yes	
Recall Mode	None	Max	Max	None	Max		None	C-Max		None	C-Max	
Act Effct Green (s)	10.3	37.8	37.8	19.0	49.2		23.2	38.7		18.3	33.8	
Actuated g/C Ratio	0.07	0.27	0.27	0.14	0.35		0.17	0.28		0.13	0.24	
v/c Ratio	0.48	0.89	0.39	0.77	0.54		0.92	1.06		0.73	1.09	
Control Delay	74.7	71.7	10.0	80.2	34.5		89.2	95.6		77.3	103.5	
Queue Delay	0.0	0.0	0.0	0.0	0.0		0.0	0.0		0.0	0.0	
Total Delay	74.7	71.7	10.0	80.2	34.5		89.2	95.6		77.3	103.5	
LOS	E	E	A	F	C		F	F		E	F	
Approach Delay		53.6			44.9			94.6			100.5	
Approach LOS		D			D			F			F	
Queue Length 50th (m)	15.4	109.7	3.3	46.6	61.1		74.5	~144.4		42.6	~142.7	
Queue Length 95th (m)	29.2	#179.7	24.3	70.7	84.2		m79.2	m#168.3		64.3	#172.6	
Internal Link Dist (m)		99.5			237.5			154.5			139.4	
Turn Bay Length (m)	30.0			35.0			94.5			90.0		
Base Capacity (vph)	265	457	503	271	1085		283	1282		283	1133	
Starvation Cap Reductn	0	0	0	0	0		0	0		0	0	
Spillback Cap Reductn	0	0	0	0	0		0	0		0	0	
Storage Cap Reductn	0	0	0	0	0		0	0		0	0	
Reduced v/c Ratio	0.22	0.89	0.39	0.64	0.54		0.90	1.06		0.56	1.09	

Intersection Summary

Cycle Length: 140
 Actuated Cycle Length: 140
 Offset: 56 (40%), Referenced to phase 2:NBT and 6:SBT, Start of Green
 Natural Cycle: 125
 Control Type: Actuated-Coordinated

Lanes, Volumes, Timings
4: Vanier & Montreal

Existing
PM Peak Hour

Maximum v/c Ratio: 1.09	Intersection LOS: F
Intersection Signal Delay: 81.8	ICU Level of Service F
Intersection Capacity Utilization 95.1%	
Analysis Period (min) 15	
~ Volume exceeds capacity, queue is theoretically infinite. Queue shown is maximum after two cycles.	
# 95th percentile volume exceeds capacity, queue may be longer. Queue shown is maximum after two cycles.	
m Volume for 95th percentile queue is metered by upstream signal.	

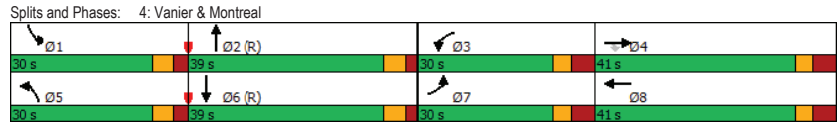

HCM 2010 TWSC
6: North River & Selkirk

Existing
PM Peak Hour

Intersection						
Int Delay, s/veh	3					
Movement	WBL	WBR	NBT	NBR	SBL	SBT
Lane Configurations	↔	↔	↑	↔	↔	↔
Traffic Vol, veh/h	115	47	370	0	0	434
Future Vol, veh/h	115	47	370	0	0	434
Conflicting Peds, #/hr	2	2	0	66	66	0
Sign Control	Stop	Stop	Free	Free	Free	Free
RT Channelized	-	None	-	None	-	None
Storage Length	0	-	-	-	-	-
Veh in Median Storage, #	0	-	0	-	-	0
Grade, %	0	-	0	-	-	0
Peak Hour Factor	90	90	90	90	90	90
Heavy Vehicles, %	2	2	3	2	2	4
Mvmt Flow	128	52	411	0	0	482

Major/Minor	Minor1	Major1	Major2
Conflicting Flow All	654	413	0
Stage 1	411	-	-
Stage 2	243	-	-
Critical Hdwy	6.63	6.23	-
Critical Hdwy Stg 1	5.43	-	-
Critical Hdwy Stg 2	5.83	-	-
Follow-up Hdwy	3,519	3,319	-
Pot Cap-1 Maneuver	415	638	-
Stage 1	668	-	0
Stage 2	775	-	0
Platoon blocked, %	-	-	-
Mov Cap-1 Maneuver	414	637	-
Mov Cap-2 Maneuver	414	-	-
Stage 1	668	-	-
Stage 2	773	-	-

Approach	WB	NB	SB
HCM Control Delay, s	17.7	0	0
HCM LOS	C		

Minor Lane/Major Mvmt	NBTWBLn1	SBT
Capacity (veh/h)	- 461	-
HCM Lane V/C Ratio	- 0.39	-
HCM Control Delay (s)	- 17.7	-
HCM Lane LOS	- C	-
HCM 95th %tile Q(veh)	- 1.8	-

HCM 2010 TWSC
7: Dundas & Selkirk

Existing
PM Peak Hour

Intersection						
Int Delay, s/veh	0					
Movement	EBT	EBR	WBL	WBT	NBL	NBR
Lane Configurations				↕	↕	
Traffic Vol, veh/h	0	0	30	45	10	100
Future Vol, veh/h	0	0	30	45	10	100
Conflicting Peds, #/hr	0	0	0	0	0	0
Sign Control	Free	Free	Free	Free	Stop	Stop
RT Channelized	-	None	-	None	-	None
Storage Length	-	-	-	-	0	-
Veh in Median Storage, #	-	-	-	-	0	-
Grade, %	0	-	-	0	0	-
Peak Hour Factor	90	90	90	90	90	90
Heavy Vehicles, %	2	2	2	2	2	2
Mvmt Flow	0	0	33	50	11	111

Major/Minor	Major2	Minor1
Conflicting Flow All	0	116
Stage 1	-	0
Stage 2	-	116
Critical Hdwy	4.12	6.42
Critical Hdwy Stg 1	-	-
Critical Hdwy Stg 2	-	5.42
Follow-up Hdwy	2.218	3.518
Pot Cap-1 Maneuver	-	880
Stage 1	-	-
Stage 2	-	909
Platoon blocked, %	-	-
Mov Cap-1 Maneuver	-	880
Mov Cap-2 Maneuver	-	880
Stage 1	-	-
Stage 2	-	909

Approach	WB	NB
HCM Control Delay, s		
HCM LOS		

Minor Lane/Major Mvmt	NBLn1	WBL	WBT
Capacity (veh/h)	-	-	-
HCM Lane V/C Ratio	-	-	-
HCM Control Delay (s)	-	-	-
HCM Lane LOS	-	-	-
HCM 95th %tile Q(veh)	-	-	-

HCM 2010 TWSC
8: Montgomery & Selkirk

Existing
PM Peak Hour

Intersection												
Int Delay, s/veh	6											
Movement	EBL	EBT	EBR	WBL	WBT	WBR	NBL	NBT	NBR	SBL	SBT	SBR
Lane Configurations		↕			↕			↕			↕	
Traffic Vol, veh/h	70	20	10	5	10	20	5	10	0	15	20	60
Future Vol, veh/h	70	20	10	5	10	20	5	10	0	15	20	60
Conflicting Peds, #/hr	0	0	0	0	0	0	0	0	0	0	0	0
Sign Control	Stop	Stop	Stop	Stop	Stop	Stop	Free	Free	Free	Free	Free	Free
RT Channelized	-	-	None	-	-	None	-	-	None	-	-	None
Storage Length	-	-	-	-	-	-	-	-	-	-	-	-
Veh in Median Storage, #	-	0	-	-	0	-	-	0	-	-	0	-
Grade, %	-	0	-	-	0	-	-	0	-	-	0	-
Peak Hour Factor	90	90	90	90	90	90	90	90	90	90	90	90
Heavy Vehicles, %	2	2	2	2	2	2	2	2	2	2	2	2
Mvmt Flow	78	22	11	6	11	22	6	11	0	17	22	67

Major/Minor	Minor2	Minor1	Major1	Major2
Conflicting Flow All	130	113	56	129
Stage 1	90	90	-	23
Stage 2	40	23	-	106
Critical Hdwy	7.12	6.52	6.22	7.12
Critical Hdwy Stg 1	6.12	5.52	-	6.12
Critical Hdwy Stg 2	6.12	5.52	-	6.12
Follow-up Hdwy	3.518	4.018	3.318	3.518
Pot Cap-1 Maneuver	843	777	1011	844
Stage 1	917	820	-	995
Stage 2	975	876	-	900
Platoon blocked, %	-	-	-	-
Mov Cap-1 Maneuver	807	765	1011	807
Mov Cap-2 Maneuver	807	765	-	807
Stage 1	913	811	-	991
Stage 2	939	872	-	856

Approach	EB	WB	NB	SB
HCM Control Delay, s	10.1	9.1	2.5	1.1
HCM LOS	B	A		

Minor Lane/Major Mvmt	NBL	NBT	NBR	EBLn1	WBLn1	SBL	SBT	SBR
Capacity (veh/h)	1506	-	-	814	909	1608	-	-
HCM Lane V/C Ratio	0.004	-	-	0.137	0.043	0.01	-	-
HCM Control Delay (s)	7.4	0	-	10.1	9.1	7.3	0	-
HCM Lane LOS	A	A	-	B	A	A	A	-
HCM 95th %tile Q(veh)	0	-	-	0.5	0.1	0	-	-

Lanes, Volumes, Timings
9: North River & McArthur

Existing
PM Peak Hour

Lane Group	EBL	EBT	EBR	WBL	WBT	WBR	NBL	NBT	NBR	SBL	SBT	SBR
Lane Configurations		↔			↔	↔		↔		↔	↔	
Traffic Volume (vph)	4	25	6	24	11	217	2	148	36	409	139	1
Future Volume (vph)	4	25	6	24	11	217	2	148	36	409	139	1
Satd. Flow (prot)	0	1633	0	0	1570	1483	0	1636	0	1642	1709	0
Fit Permitted		0.981			0.833			0.998		0.629		
Satd. Flow (perm)	0	1598	0	0	1316	1334	0	1632	0	976	1709	0
Satd. Flow (RTOR)		7			241			27		1		
Lane Group Flow (vph)	0	39	0	0	39	241	0	206	0	454	155	0
Turn Type	Perm	NA		Perm	NA	Perm	Perm	NA		Perm	NA	
Protected Phases		4			8			2			6	
Permitted Phases	4			8		8	2			6		
Detector Phase	4	4		8	8	8	2	2		6	6	
Switch Phase												
Minimum Initial (s)	10.0	10.0		10.0	10.0	10.0	10.0	10.0		10.0	10.0	
Minimum Split (s)	25.6	25.6		25.6	25.6	25.6	31.1	31.1		31.1	31.1	
Total Split (s)	26.0	26.0		26.0	26.0	26.0	49.0	49.0		49.0	49.0	
Total Split (%)	34.7%	34.7%		34.7%	34.7%	34.7%	65.3%	65.3%		65.3%	65.3%	
Yellow Time (s)	3.3	3.3		3.3	3.3	3.3	3.3	3.3		3.3	3.3	
All-Red Time (s)	2.3	2.3		2.3	2.3	2.3	2.8	2.8		2.8	2.8	
Lost Time Adjust (s)		0.0			0.0	0.0		0.0			0.0	
Total Lost Time (s)		5.6			5.6	5.6		6.1			6.1	
Lead/Lag												
Lead-Lag Optimize?												
Recall Mode	Max	Max		Max	Max	Max	C-Max	C-Max		C-Max	C-Max	
Act Effct Green (s)		20.4			20.4	20.4		42.9		42.9	42.9	
Actuated g/C Ratio		0.27			0.27	0.27		0.57		0.57	0.57	
v/c Ratio		0.09			0.11	0.45		0.22		0.81	0.16	
Control Delay		18.3			21.2	13.2		7.5		27.5	8.0	
Queue Delay		0.0			0.0	0.0		0.0		0.0	0.0	
Total Delay		18.3			21.2	13.2		7.5		27.5	8.0	
LOS		B			C	B		A		C	A	
Approach Delay		18.3			14.3			7.5		22.6		
Approach LOS		B			B			A		C		
Queue Length 50th (m)		3.4			4.7	1.1		11.1		46.8	9.3	
Queue Length 95th (m)		10.0			12.4	35.6		20.8		#104.4	17.4	
Internal Link Dist (m)		22.5			128.8			119.0			94.3	
Turn Bay Length (m)						60.0				55.0		
Base Capacity (vph)		439			357	538		945		558	977	
Starvation Cap Reductn		0			0	0		0		0	0	
Spillback Cap Reductn		0			0	0		0		0	0	
Storage Cap Reductn		0			0	0		0		0	0	
Reduced v/c Ratio		0.09			0.11	0.45		0.22		0.81	0.16	

Intersection Summary	
Cycle Length:	75
Actuated Cycle Length:	75
Offset:	0 (0%), Referenced to phase 2:NBTL and 6:SBTL, Start of Green
Natural Cycle:	65
Control Type:	Actuated-Coordinated

Lanes, Volumes, Timings
9: North River & McArthur

Existing
PM Peak Hour

Maximum v/c Ratio: 0.81	Intersection LOS: B
Intersection Signal Delay: 17.6	ICU Level of Service D
Intersection Capacity Utilization 76.3%	
Analysis Period (min) 15	
# 95th percentile volume exceeds capacity, queue may be longer.	
Queue shown is maximum after two cycles.	



HCM 2010 TWSC
10: McArthur & Dundas

Existing
PM Peak Hour

Intersection						
Int Delay, s/veh	0.8					
Movement	EBL	EBT	WBT	WBR	SBL	SBR
Lane Configurations		↖	↖		↗	↗
Traffic Vol, veh/h	7	469	267	92	26	4
Future Vol, veh/h	7	469	267	92	26	4
Conflicting Peds, #/hr	76	0	0	76	0	9
Sign Control	Free	Free	Free	Free	Stop	Stop
RT Channelized	-	None	-	None	-	None
Storage Length	-	-	-	-	0	-
Veh in Median Storage, #	-	0	0	-	0	-
Grade, %	-	0	0	-	0	-
Peak Hour Factor	90	90	90	90	90	90
Heavy Vehicles, %	2	3	3	2	8	2
Mvmt Flow	8	521	297	102	29	4
Major/Minor	Major1	Major2	Minor2			
Conflicting Flow All	475	0	0	961	433	
Stage 1	-	-	-	424	-	
Stage 2	-	-	-	537	-	
Critical Hdwy	4.12	-	-	6.48	6.22	
Critical Hdwy Stg 1	-	-	-	5.48	-	
Critical Hdwy Stg 2	-	-	-	5.48	-	
Follow-up Hdwy	2.218	-	-	3.572	3.318	
Pot Cap-1 Maneuver	1087	-	-	277	623	
Stage 1	-	-	-	648	-	
Stage 2	-	-	-	574	-	
Platoon blocked, %	-	-	-	-	-	
Mov Cap-1 Maneuver	1023	-	-	243	582	
Mov Cap-2 Maneuver	-	-	-	243	-	
Stage 1	-	-	-	603	-	
Stage 2	-	-	-	540	-	
Approach	EB	WB	SB			
HCM Control Delay, s	0.1	0	20.7			
HCM LOS			C			
Minor Lane/Major Mvmt	EBL	EBT	WBT	WBR	SBLn1	
Capacity (veh/h)	1023	-	-	-	263	
HCM Lane V/C Ratio	0.008	-	-	-	0.127	
HCM Control Delay (s)	8.5	0	-	-	20.7	
HCM Lane LOS	A	A	-	-	C	
HCM 95th %tile Q(veh)	0	-	-	-	0.4	

Lanes, Volumes, Timings
11: Marguerite & McArthur

Existing
PM Peak Hour

Lane Group	EBT	EBR	WBL	WBT	NBL	NBR
Lane Configurations	↖			↖	↖	↖
Traffic Volume (vph)	481	21	40	346	20	52
Future Volume (vph)	481	21	40	346	20	52
Satd. Flow (prot)	1730	0	0	1736	1658	1483
Fit Permitted				0.915	0.950	
Satd. Flow (perm)	1730	0	0	1594	1586	1425
Satd. Flow (RTOR)	5					58
Lane Group Flow (vph)	557	0	0	428	22	58
Turn Type	NA		Perm	NA	Prot	Perm
Protected Phases	2			6	8	
Permitted Phases			6			8
Detector Phase	2		6	6	8	8
Switch Phase						
Minimum Initial (s)	10.0		10.0	10.0	5.0	5.0
Minimum Split (s)	27.5		15.5	15.5	24.5	24.5
Total Split (s)	50.0		50.0	50.0	25.0	25.0
Total Split (%)	66.7%		66.7%	66.7%	33.3%	33.3%
Yellow Time (s)	3.3		3.3	3.3	3.3	3.3
All-Red Time (s)	2.2		2.2	2.2	2.2	2.2
Lost Time Adjust (s)	0.0		0.0	0.0	0.0	0.0
Total Lost Time (s)	5.5		5.5	5.5	5.5	5.5
Lead/Lag						
Lead-Lag Optimize?						
Recall Mode	C-Max		C-Max	C-Max	None	None
Act Effct Green (s)	56.1		56.1	11.2	11.2	11.2
Actuated g/C Ratio	0.75		0.75	0.15	0.15	0.15
v/c Ratio	0.43		0.36	0.09	0.22	0.22
Control Delay	5.9		6.6	24.4	8.9	8.9
Queue Delay	0.0		0.0	0.0	0.0	0.0
Total Delay	5.9		6.6	24.4	8.9	8.9
LOS	A		A	C	A	A
Approach Delay	5.9		6.6	13.2		
Approach LOS	A		A	B		
Queue Length 50th (m)	15.6		14.4	2.9	0.0	0.0
Queue Length 95th (m)	38.4		48.5	7.5	8.1	8.1
Internal Link Dist (m)	36.3		7.3	144.2		
Turn Bay Length (m)				30.0		
Base Capacity (vph)	1295		1192	431	413	
Starvation Cap Reductn	0		0	0	0	
Spillback Cap Reductn	0		0	0	0	
Storage Cap Reductn	0		0	0	0	
Reduced v/c Ratio	0.43		0.36	0.05	0.14	

Intersection Summary	
Cycle Length: 75	
Actuated Cycle Length: 75	
Offset: 0 (0%), Referenced to phase 2:EBT and 6:WBTL, Start of Green	
Natural Cycle: 55	
Control Type: Actuated-Coordinated	

Lanes, Volumes, Timings
11: Marguerite & McArthur

Existing
PM Peak Hour

Maximum v/c Ratio: 0.43	Intersection LOS: A
Intersection Signal Delay: 6.8	ICU Level of Service C
Intersection Capacity Utilization 70.9%	
Analysis Period (min) 15	

m Volume for 95th percentile queue is metered by upstream signal.

Splits and Phases: 11: Marguerite & McArthur



Lanes, Volumes, Timings
12: Vanier & McArthur

Existing
PM Peak Hour

Lane Group	EBL	EBT	EBR	WBL	WBT	WBR	NBL	NBT	NBR	SBL	SBT	SBR
Lane Configurations	↔	↗	↘	↔	↗	↘	↔	↗	↘	↔	↗	↘
Traffic Volume (vph)	55	228	435	333	218	170	206	1198	251	122	1178	66
Future Volume (vph)	55	228	435	333	218	170	206	1198	251	122	1178	66
Satd. Flow (prot)	1658	1712	1483	3154	1712	1483	1658	3316	1469	1658	3316	1469
Fit Permitted	0.950			0.950			0.950			0.950		
Satd. Flow (perm)	1577	1712	1323	2940	1712	1360	1618	3316	1400	1649	3316	1223
Satd. Flow (RTOR)			238			189			213			121
Lane Group Flow (vph)	61	253	483	370	242	189	229	1331	279	136	1309	73
Turn Type	Prot	NA	Perm	Prot	NA	Perm	Prot	NA	Perm	Prot	NA	Perm
Protected Phases	7	4		3	8		5	2		1	6	
Permitted Phases			4			8			2			6
Detector Phase	7	4	4	3	8	8	5	2	2	1	6	6
Switch Phase												
Minimum Initial (s)	5.0	10.0	10.0	5.0	10.0	10.0	5.0	10.0	10.0	5.0	10.0	10.0
Minimum Split (s)	11.2	36.2	36.2	11.2	36.2	36.2	11.1	36.1	36.1	11.1	36.1	36.1
Total Split (s)	20.0	36.2	36.2	20.0	36.2	36.2	23.0	59.8	59.8	24.0	60.8	60.8
Total Split (%)	14.3%	25.9%	25.9%	14.3%	25.9%	25.9%	16.4%	42.7%	42.7%	17.1%	43.4%	43.4%
Yellow Time (s)	3.3	3.3	3.3	3.3	3.3	3.3	3.7	3.7	3.7	3.7	3.7	3.7
All-Red Time (s)	2.9	2.9	2.9	2.9	2.9	2.9	2.4	2.4	2.4	2.4	2.4	2.4
Lost Time Adjust (s)	0.0	0.0	0.0	0.0	0.0	0.0	0.0	0.0	0.0	0.0	0.0	0.0
Total Lost Time (s)	6.2	6.2	6.2	6.2	6.2	6.2	6.1	6.1	6.1	6.1	6.1	6.1
Lead/Lag	Lag	Lead	Lead	Lag	Lead	Lead	Lag	Lag	Lag	Lead	Lead	Lead
Lead-Lag Optimize?	Yes	Yes	Yes	Yes	Yes	Yes	Yes	Yes	Yes	Yes	Yes	Yes
Recall Mode	None	None	None	None	None	None	C-Max	C-Max	None	C-Max	C-Max	C-Max
Act Effct Green (s)	12.3	30.0	30.0	13.8	34.0	34.0	16.9	56.2	56.2	15.4	54.7	54.7
Actuated g/C Ratio	0.09	0.21	0.21	0.10	0.24	0.24	0.12	0.40	0.40	0.11	0.39	0.39
v/c Ratio	0.42	0.69	1.03	1.19	0.58	0.40	1.15	1.00	0.40	0.75	1.01	0.13
Control Delay	68.7	61.7	75.9	166.5	55.2	8.7	161.3	66.6	9.7	80.4	94.5	21.3
Queue Delay	0.0	0.0	0.0	0.0	0.0	0.0	0.0	0.0	0.0	0.0	0.0	0.0
Total Delay	68.7	61.7	75.9	166.5	55.2	8.7	161.3	66.6	9.7	80.4	94.5	21.3
LOS	E	E	E	F	E	A	F	E	A	F	F	C
Approach Delay		70.8			95.6			69.8			89.7	
Approach LOS		E			F			E			F	
Queue Length 50th (m)	16.1	65.2	~87.2	~63.5	61.9	0.0	~74.1	~205.8	11.6	39.6	~194.7	6.9
Queue Length 95th (m)	30.8	95.6	#154.8	#95.2	91.5	20.4	#126.3	#252.7	34.1	m42.9	m187.5	m8.4
Internal Link Dist (m)		122.9			146.0			119.5			202.0	
Turn Bay Length (m)	30.0		50.0	120.0		115.0	90.0		90.0	90.0		90.0
Base Capacity (vph)	163	366	470	310	415	473	200	1330	689	211	1295	551
Starvation Cap Reductn	0	0	0	0	0	0	0	0	0	0	0	0
Spillback Cap Reductn	0	0	0	0	0	0	0	0	0	0	0	0
Storage Cap Reductn	0	0	0	0	0	0	0	0	0	0	0	0
Reduced v/c Ratio	0.37	0.69	1.03	1.19	0.58	0.40	1.15	1.00	0.40	0.64	1.01	0.13

Intersection Summary

Cycle Length: 140
Actuated Cycle Length: 140
Offset: 54 (39%), Referenced to phase 2:NBT and 6:SBT, Start of Green
Natural Cycle: 145
Control Type: Actuated-Coordinated

Lanes, Volumes, Timings
12: Vanier & McArthur

Existing
PM Peak Hour

Maximum v/c Ratio: 1.19	Intersection LOS: F
Intersection Signal Delay: 80.2	ICU Level of Service G
Intersection Capacity Utilization 100.7%	
Analysis Period (min) 15	
~ Volume exceeds capacity, queue is theoretically infinite. Queue shown is maximum after two cycles.	
# 95th percentile volume exceeds capacity, queue may be longer. Queue shown is maximum after two cycles.	
m Volume for 95th percentile queue is metered by upstream signal.	

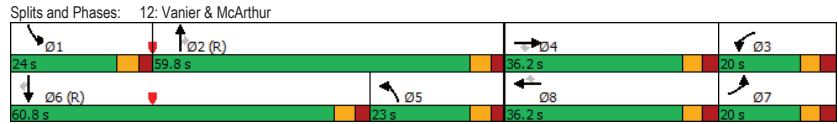

HCM 2010 TWSC
15: McArthur & Mayfield

Existing
PM Peak Hour

Intersection						
Int Delay, s/veh	0.3					
Movement	EBL	EBT	WBT	WBR	SBL	SBR
Lane Configurations		↑	↑		↓	↓
Traffic Vol, veh/h	0	535	378	0	8	8
Future Vol, veh/h	0	535	378	0	8	8
Conflicting Peds, #/hr	0	0	0	0	0	0
Sign Control	Free	Free	Free	Free	Stop	Stop
RT Channelized	-	None	-	None	-	None
Storage Length	-	-	-	-	0	0
Veh in Median Storage, #	-	0	0	-	0	-
Grade, %	-	0	0	-	0	-
Peak Hour Factor	90	90	90	90	90	90
Heavy Vehicles, %	2	2	2	2	2	2
Mvmt Flow	0	594	420	0	9	9

Major/Minor	Major1	Major2	Minor2
Conflicting Flow All	-	0	0 1014 420
Stage 1	-	-	- 420 -
Stage 2	-	-	- 594 -
Critical Hdwy	-	-	- 6.42 6.22
Critical Hdwy Stg 1	-	-	- 5.42 -
Critical Hdwy Stg 2	-	-	- 5.42 -
Follow-up Hdwy	-	-	- 3.518 3.318
Pot Cap-1 Maneuver	0	-	0 264 633
Stage 1	0	-	0 663 -
Stage 2	0	-	0 552 -
Platoon blocked, %	-	-	- -
Mov Cap-1 Maneuver	-	-	- 264 633
Mov Cap-2 Maneuver	-	-	- 264 -
Stage 1	-	-	- 663 -
Stage 2	-	-	- 552 -

Approach	EB	WB	SB
HCM Control Delay, s	0	0	15
HCM LOS			C

Minor Lane/Major Mvmt	EBT	WBT	SBLn1	SBLn2
Capacity (veh/h)	-	-	264	633
HCM Lane V/C Ratio	-	-	0.034	0.014
HCM Control Delay (s)	-	-	19.1	10.8
HCM Lane LOS	-	-	C	B
HCM 95th %tile Q(veh)	-	-	0.1	0

Appendix D

Collision Data

Appendix E

TRANS Model Plots

TRANS Regional Model

Version 2.13 - Assigned February 07, 2019

AM Peak Hour Total Traffic Volume

112 Montreal Rd

2011 Model - Base Scenario

No Modifications from Base Version

User Initials: MM

Plot Prepared: November 21, 2019

EMME Scenario: 21311



Legend

AM Peak Hour Total Traffic Volume



Distance (m)

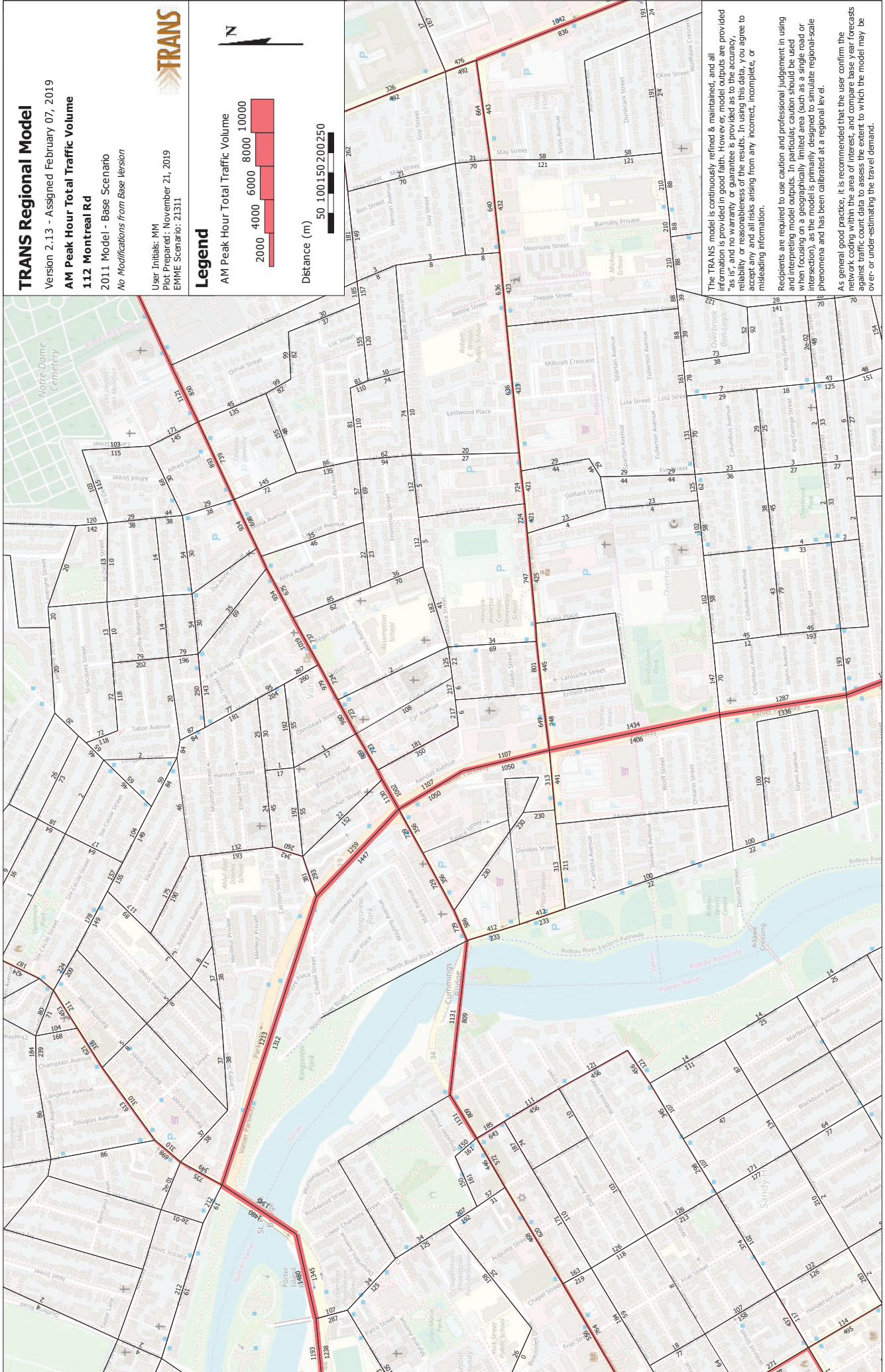

The TRANS model is continuously refined & maintained, and all information is provided in good faith. However, model outputs are provided "as is", and no warranty or guarantee is provided as to the accuracy, reliability, or reasonableness of the results. In using this data, you agree to accept any and all risks arising from any incorrect, incomplete, or misleading information.

Recipients are required to use caution and professional judgement in using and interpreting model outputs. In particular, caution should be used when focusing on a geographically limited area (such as a single road or intersection), as the model is primarily designed to simulate regional-scale phenomena and has been calibrated at a regional level.

As a general good practice, it is recommended that the user confirm the network coding within the area of interest, and compare base year forecasts against traffic count data to assess the extent to which the model may be over- or under-estimating the travel demand.

TRANS Regional Model

Version 2.11 - Assigned October 31, 2019

AM Peak Hour Total Traffic Volume

112 Montreal Rd

2031 Model - Affordable Road & Transit Network

No Modifications from Base Version

User Initials: MM

Plot Prepared: November 21, 2019

EMME Scenario: 21131



Legend

AM Peak Hour Total Traffic Volume

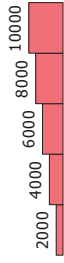

Distance (m)

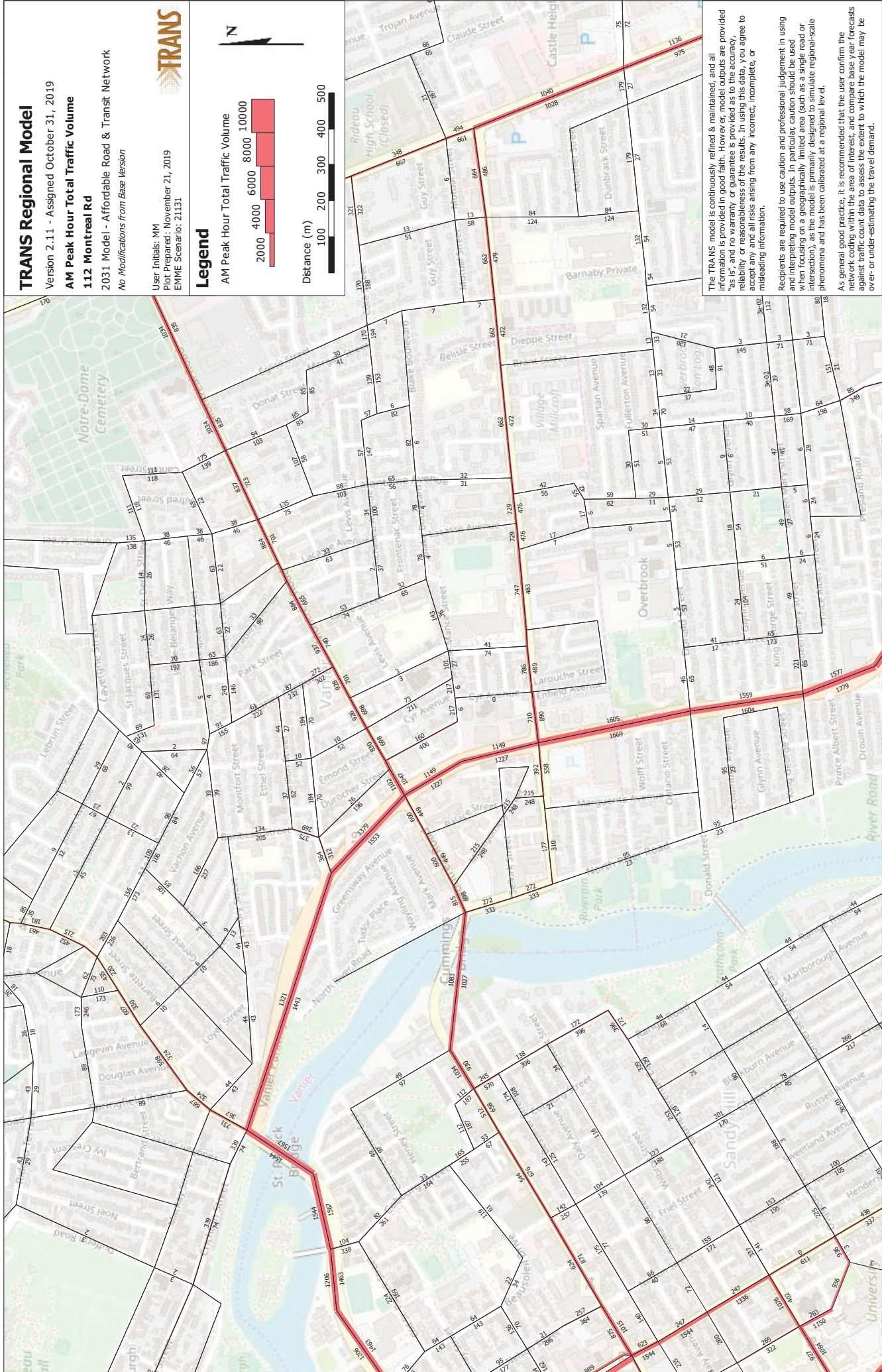

The TRANS model is continuously refined & maintained, and all information is provided in good faith. However, model outputs are provided "as is", and no warranty or guarantee is provided as to the accuracy, reliability or reasonableness of the results. In using this data, you agree to accept any and all risks arising from any incorrect, incomplete, or misleading information.

Recipients are required to use caution and professional judgement in using and interpreting model outputs. In particular, caution should be used when focusing on a geographically limited area (such as a single road or intersection), as the model is primarily designed to simulate regional-scale phenomena and has been calibrated at a regional level.

As a general good practice, it is recommended that the user confirm the network coding within the area of interest, and compare base year forecasts against traffic count data to assess the extent to which the model may be over- or under-estimating the travel demand.

Appendix F

Background Development Traffic Volumes

Figure 10: New Site Generation Auto Volumes

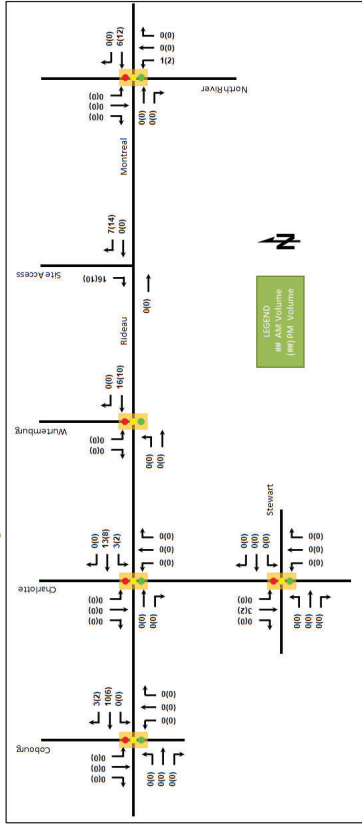

Figure 13: Phase 1 'New' and 'Pass-by' Site-Generated Traffic

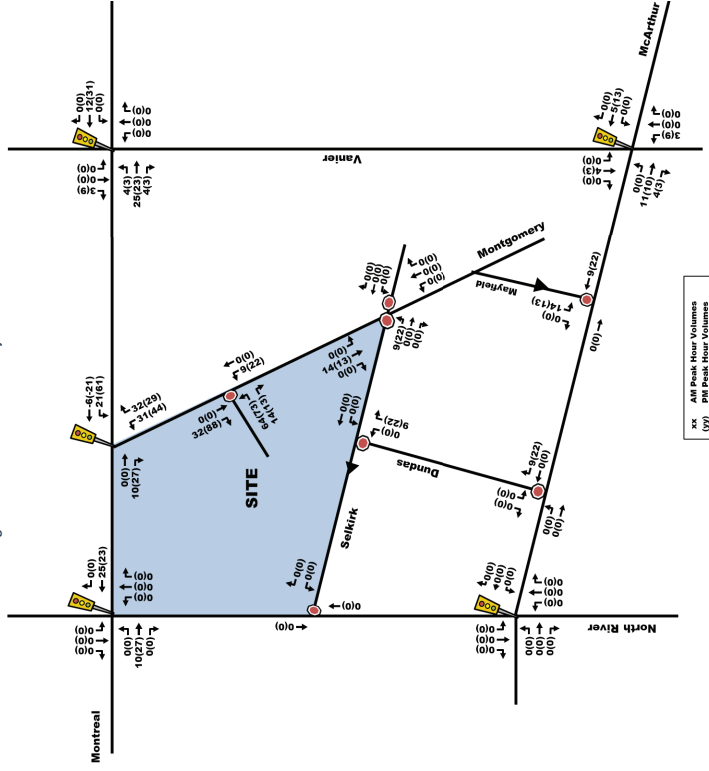

Figure 14: Phase 2 and 3 'New and 'Pass-By' Site-Generated Traffic

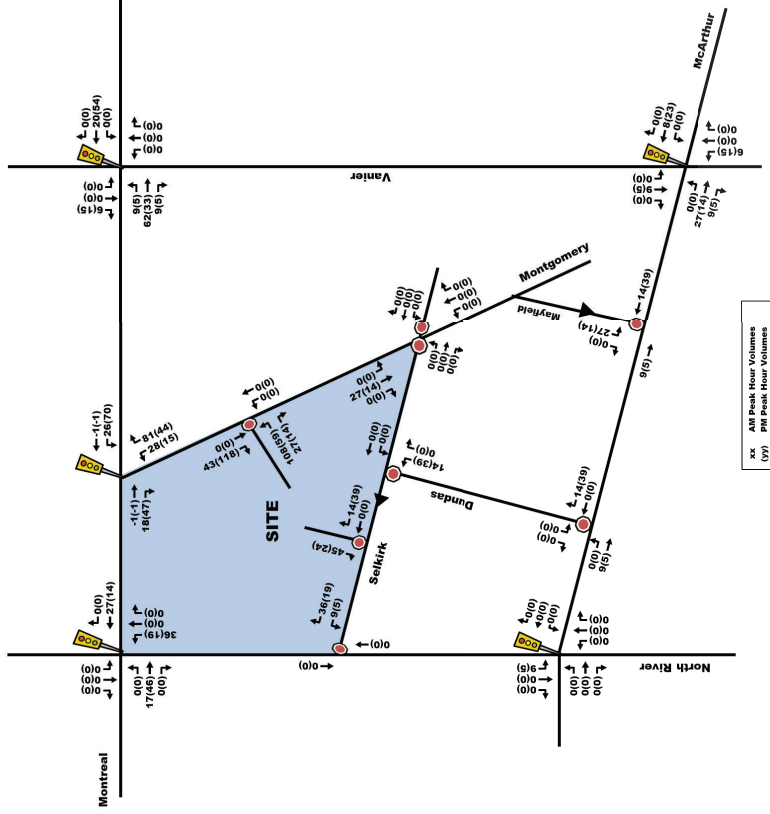
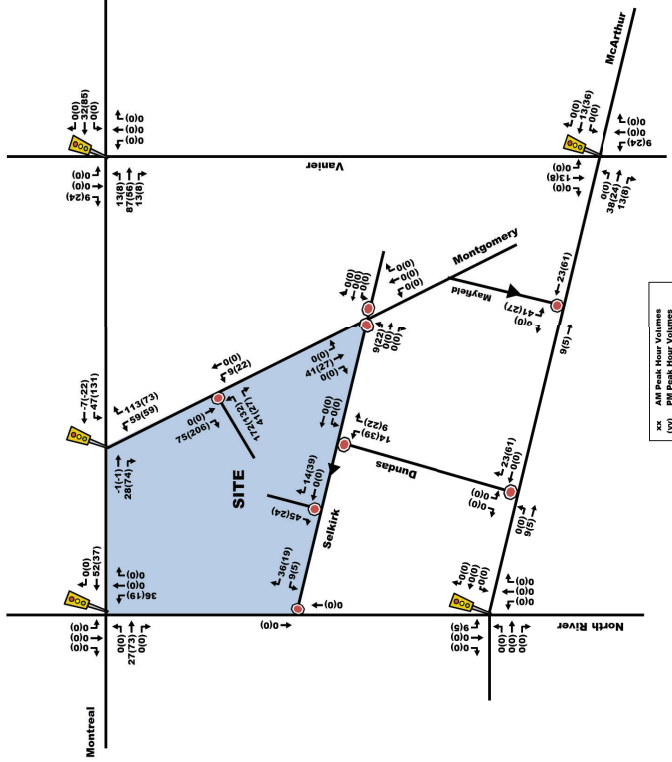

Figure 15: Total Site Trip Generation



3.2. BACKGROUND NETWORK TRAFFIC

3.2.1. TRANSPORTATION NETWORK PLANS

Refer to Section 2.1.3.

3.2.2. BACKGROUND GROWTH

The following background traffic growth (summarized in Table 20) was calculated based on historical traffic count data (years 2010, 2016 and 2020) provided by the City of Ottawa at the North River/Montreal intersection. Detailed background traffic growth analysis is included as Appendix D.

Table 20: North River/Montreal Historical Background Growth (2010-2020)

Time Period	Percent Annual Change			Overall
	North Leg	South Leg	West Leg	
8 hrs	-1.31%	-0.79%	-1.06%	-1.08%
AM Peak	-0.65%	-0.97%	-0.38%	-0.65%
PM Peak	-5.20%	-2.46%	-1.40%	-1.53%

Figure 13: New Site Generation Auto Volumes

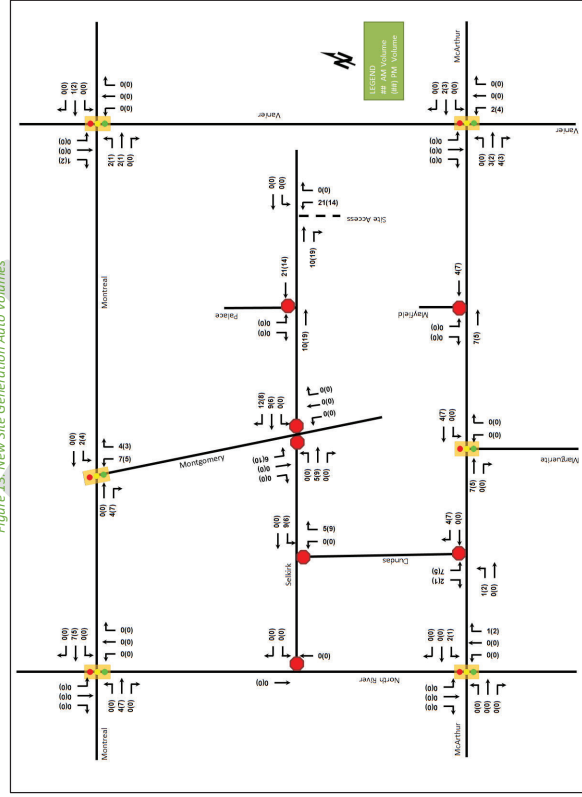

Appendix G

Synchro Intersection Worksheets – 2024 Future Background Conditions

Lanes, Volumes, Timings
1: North River & Montreal

2024 Future Background
AM Peak Hour

Lane Group	EBL	EBT	EBR	WBL	WBT	WBR	NBL	NBT	NBR	SBL	SBT	SBR
Lane Configurations		↑↑			↑↑		↑	↑			↑↓	
Traffic Volume (vph)	0	477	362	0	726	13	245	10	35	17	25	15
Future Volume (vph)	0	477	362	0	726	13	245	10	35	17	25	15
Satd. Flow (prot)	0	2928	0	0	3167	0	1595	1336	0	0	1518	0
Fit Permitted							0.950				0.985	
Satd. Flow (perm)	0	2928	0	0	3167	0	1581	1336	0	0	1499	0
Satd. Flow (RTOR)								35			15	
Lane Group Flow (vph)	0	839	0	0	739	0	245	45	0	0	57	0
Turn Type		NA			NA		Prot	NA		Split	NA	
Protected Phases		2			6		3!	8		7	7!	
Permitted Phases												
Detector Phase		2			6		3	8		7	7	
Switch Phase												
Minimum Initial (s)		10.0			10.0		5.0	10.0		10.0	10.0	
Minimum Split (s)		21.7			21.7		11.5	24.5		16.5	16.5	
Total Split (s)		29.0			29.0		24.0	49.0		17.0	17.0	
Total Split (%)		30.5%			30.5%		25.3%	51.6%		17.9%	17.9%	
Yellow Time (s)		3.0			3.0		3.3	3.3		3.3	3.3	
All-Red Time (s)		3.7			3.7		3.2	3.2		3.2	3.2	
Lost Time Adjust (s)		0.0			0.0		0.0	0.0		0.0	0.0	
Total Lost Time (s)		6.7			6.7		6.5	6.5		6.5	6.5	
Lead/Lag							Lag	Lag		Lead	Lead	
Lead-Lag Optimize?							Yes	Yes		Yes	Yes	
Recall Mode		C-Max			C-Max		None	Ped		None	None	
Act Effct Green (s)		36.8			36.8		20.5	31.7		10.1	10.1	
Actuated g/C Ratio		0.39			0.39		0.22	0.33		0.11	0.11	
v/c Ratio		0.74			0.60		0.71	0.10		0.33	0.33	
Control Delay		31.1			26.7		45.9	10.1		36.4	36.4	
Queue Delay		0.0			33.7		0.0	0.0		0.0	0.0	
Total Delay		31.1			60.4		45.9	10.1		36.4	36.4	
LOS		C			E		D	B		D	D	
Approach Delay		31.1			60.4			40.3		36.4	36.4	
Approach LOS		C			E			D		D	D	
Queue Length 50th (m)		68.8			56.4		41.6	1.3		7.2	7.2	
Queue Length 95th (m)		#108.2			82.1		62.8	8.3		18.7	18.7	
Internal Link Dist (m)		194.5			52.8			112.9		59.0	59.0	
Turn Bay Length (m)							90.0					
Base Capacity (vph)		1134			1227		355	617		181	181	
Starvation Cap Reductn		0			525		0	0		0	0	
Spillback Cap Reductn		0			0		0	0		0	0	
Storage Cap Reductn		0			0		0	0		0	0	
Reduced v/c Ratio		0.74			1.05		0.69	0.07		0.31	0.31	

Intersection Summary	
Cycle Length: 95	
Actuated Cycle Length: 95	
Offset: 0 (0%), Referenced to phase 2:EBT and 6:WBT, Start of Green	
Natural Cycle: 80	
Control Type: Actuated-Coordinated	

Lanes, Volumes, Timings
1: North River & Montreal

2024 Future Background
AM Peak Hour

Lane Group	Ø4
Lane Configurations	
Traffic Volume (vph)	
Future Volume (vph)	
Satd. Flow (prot)	
Fit Permitted	
Satd. Flow (perm)	
Satd. Flow (RTOR)	
Lane Group Flow (vph)	
Turn Type	
Protected Phases	4
Permitted Phases	
Detector Phase	
Switch Phase	
Minimum Initial (s)	5.0
Minimum Split (s)	24.5
Total Split (s)	42.0
Total Split (%)	44%
Yellow Time (s)	3.3
All-Red Time (s)	3.2
Lost Time Adjust (s)	
Total Lost Time (s)	
Lead/Lag	Lead
Lead-Lag Optimize?	Yes
Recall Mode	Ped
Act Effct Green (s)	
Actuated g/C Ratio	
v/c Ratio	
Control Delay	
Queue Delay	
Total Delay	
LOS	
Approach Delay	
Approach LOS	
Queue Length 50th (m)	
Queue Length 95th (m)	
Internal Link Dist (m)	
Turn Bay Length (m)	
Base Capacity (vph)	
Starvation Cap Reductn	
Spillback Cap Reductn	
Storage Cap Reductn	
Reduced v/c Ratio	

Intersection Summary	
Cycle Length: 95	
Actuated Cycle Length: 95	
Offset: 0 (0%), Referenced to phase 2:EBT and 6:WBT, Start of Green	
Natural Cycle: 80	
Control Type: Actuated-Coordinated	

Lanes, Volumes, Timings
1: North River & Montreal

2024 Future Background
AM Peak Hour

Maximum v/c Ratio: 0.74	Intersection LOS: D
Intersection Signal Delay: 43.9	ICU Level of Service B
Intersection Capacity Utilization 59.4%	
Analysis Period (min) 15	
# 95th percentile volume exceeds capacity, queue may be longer.	
Queue shown is maximum after two cycles.	
! Phase conflict between lane groups.	

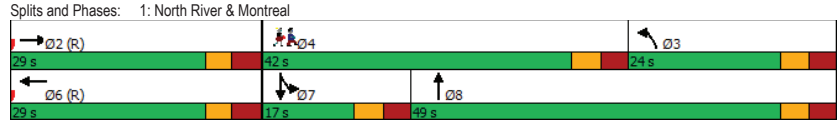

Lanes, Volumes, Timings
2: Montgomery & Montreal

2024 Future Background
AM Peak Hour

Lane Group	EBT	EBR	WBL	WBT	NBL	NBR
Lane Configurations	↕↕			↕↕	↕	↕
Traffic Volume (vph)	431	98	74	689	50	70
Future Volume (vph)	431	98	74	689	50	70
Satd. Flow (prot)	3120	0	0	3180	1658	1401
Fit Permitted				0.842	0.950	
Satd. Flow (perm)	3120	0	0	2688	1649	1379
Satd. Flow (RTOR)	64					70
Lane Group Flow (vph)	529	0	0	763	50	70
Turn Type	NA		Perm	NA	Perm	Perm
Protected Phases	2			6		
Permitted Phases			6		8	8
Detector Phase	2		6	6	8	8
Switch Phase						
Minimum Initial (s)	10.0		10.0	10.0	10.0	10.0
Minimum Split (s)	40.4		16.4	16.4	19.5	19.5
Total Split (s)	56.0		56.0	56.0	24.0	24.0
Total Split (%)	70.0%		70.0%	70.0%	30.0%	30.0%
Yellow Time (s)	3.0		3.0	3.0	3.3	3.3
All-Red Time (s)	3.4		3.4	3.4	2.2	2.2
Lost Time Adjust (s)	0.0		0.0	0.0	0.0	0.0
Total Lost Time (s)	6.4		6.4	6.4	5.5	5.5
Lead/Lag						
Lead-Lag Optimize?						
Recall Mode	C-Max		C-Max	C-Max	None	None
Act Effct Green (s)	61.7		61.7	61.7	10.8	10.8
Actuated g/C Ratio	0.77		0.77	0.77	0.14	0.14
v/c Ratio	0.22		0.37	0.37	0.23	0.28
Control Delay	3.4		4.8	4.8	33.0	11.3
Queue Delay	0.4		0.0	0.0	0.0	0.0
Total Delay	3.9		4.8	4.8	33.0	11.3
LOS	A		A	A	C	B
Approach Delay	3.9		4.8	4.8	20.4	
Approach LOS	A		A	A	C	
Queue Length 50th (m)	9.6		18.8	18.8	7.0	0.0
Queue Length 95th (m)	17.8		33.1	33.1	15.7	10.2
Internal Link Dist (m)	52.8		138.9	138.9	214.6	
Turn Bay Length (m)					35.0	
Base Capacity (vph)	2420		2072	2072	381	372
Starvation Cap Reductn	1358		0	0	0	0
Spillback Cap Reductn	0		0	0	0	0
Storage Cap Reductn	0		0	0	0	0
Reduced v/c Ratio	0.50		0.37	0.37	0.13	0.19

Intersection Summary						
Cycle Length:	80					
Actuated Cycle Length:	80					
Offset:	0 (0%), Referenced to phase 2:EBT and 6:WBTL, Start of Green					
Natural Cycle:	60					
Control Type:	Actuated-Coordinated					

Lanes, Volumes, Timings
2: Montgomery & Montreal

2024 Future Background
AM Peak Hour

Maximum v/c Ratio: 0.37	Intersection LOS: A
Intersection Signal Delay: 5.8	ICU Level of Service C
Intersection Capacity Utilization 72.8%	
Analysis Period (min) 15	

Splits and Phases: 2: Montgomery & Montreal

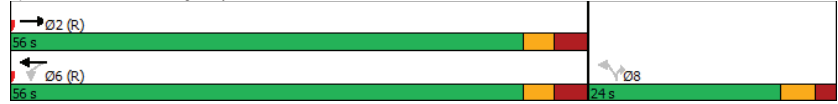

Lanes, Volumes, Timings
4: Vanier & Montreal

2024 Future Background
AM Peak Hour

Lane Group	EBL	EBT	EBR	WBL	WBT	WBR	NBL	NBT	NBR	SBL	SBT	SBR
Lane Configurations	↔	↕	↔	↔	↕	↔	↕	↕	↔	↕	↕	↔
Traffic Volume (vph)	39	306	138	165	493	194	180	879	166	213	1124	140
Future Volume (vph)	39	306	138	165	493	194	180	879	166	213	1124	140
Satd. Flow (prot)	1642	1695	1483	1658	3026	0	1642	4575	0	1642	4649	0
Fit Permitted	0.950			0.950			0.950			0.950		
Satd. Flow (perm)	1593	1695	1385	1599	3026	0	1626	4575	0	1610	4649	0
Satd. Flow (RTOR)			138		39			28			16	
Lane Group Flow (vph)	39	306	138	165	687	0	180	1045	0	213	1264	0
Turn Type	Prot	NA	Perm	Prot	NA		Prot	NA		Prot	NA	
Protected Phases	7	4	4	3	8		5	2		1	6	
Permitted Phases				4								
Detector Phase	7	4	4	3	8		5	2		1	6	
Switch Phase												
Minimum Initial (s)	5.0	10.0	10.0	5.0	10.0		5.0	10.0		5.0	10.0	
Minimum Split (s)	12.1	40.1	40.1	12.1	40.1		11.1	28.9		11.1	28.9	
Total Split (s)	20.0	41.0	41.0	20.0	41.0		30.0	49.0		30.0	49.0	
Total Split (%)	14.3%	29.3%	29.3%	14.3%	29.3%		21.4%	35.0%		21.4%	35.0%	
Yellow Time (s)	3.0	3.0	3.0	3.0	3.0		3.7	3.7		3.7	3.7	
All-Red Time (s)	4.1	4.1	4.1	4.1	4.1		2.4	2.2		2.4	2.2	
Lost Time Adjust (s)	0.0	0.0	0.0	0.0	0.0		0.0	0.0		0.0	0.0	
Total Lost Time (s)	7.1	7.1	7.1	7.1	7.1		6.1	5.9		6.1	5.9	
Lead/Lag	Lead	Lag	Lag	Lead	Lag		Lead	Lag		Lead	Lag	
Lead-Lag Optimize?	Yes	Yes	Yes	Yes	Yes		Yes	Yes		Yes	Yes	
Recall Mode	None	Max	Max	None	Max		None	C-Max		None	C-Max	
Act Effct Green (s)	8.7	33.9	33.9	12.9	40.6		19.7	45.4		21.6	47.3	
Actuated g/C Ratio	0.06	0.24	0.24	0.09	0.29		0.14	0.32		0.15	0.34	
v/c Ratio	0.38	0.75	0.31	1.09	0.76		0.78	0.70		0.84	0.80	
Control Delay	72.8	61.6	8.4	155.2	50.0		88.8	44.4		84.5	46.7	
Queue Delay	0.0	0.0	0.0	0.0	0.0		0.0	0.0		0.0	0.0	
Total Delay	72.8	61.6	8.4	155.2	50.0		88.8	44.4		84.5	46.7	
LOS	E	E	A	F	D		F	D		F	D	
Approach Delay		47.3			70.4			50.9			52.2	
Approach LOS		D			E			D			D	
Queue Length 50th (m)	10.6	78.9	0.0	-50.9	89.0		51.7	61.5		57.0	115.8	
Queue Length 95th (m)	22.2	113.2	16.5	#96.9	#124.2		m71.9	80.4		#93.0	139.7	
Internal Link Dist (m)		99.5			262.7			154.6			239.2	
Turn Bay Length (m)	30.0			35.0			94.5			90.0		
Base Capacity (vph)	151	410	439	152	904		280	1501		280	1580	
Starvation Cap Reductn	0	0	0	0	0		0	0		0	0	
Spillback Cap Reductn	0	0	0	0	0		0	0		0	0	
Storage Cap Reductn	0	0	0	0	0		0	0		0	0	
Reduced v/c Ratio	0.26	0.75	0.31	1.09	0.76		0.64	0.70		0.76	0.80	

Intersection Summary

Cycle Length: 140
Actuated Cycle Length: 140
Offset: 102 (73%), Referenced to phase 2:NBT and 6:SBT, Start of Green
Natural Cycle: 115
Control Type: Actuated-Coordinated

Lanes, Volumes, Timings
4: Vanier & Montreal

2024 Future Background
AM Peak Hour

Maximum v/c Ratio: 1.09	Intersection LOS: E
Intersection Signal Delay: 55.0	ICU Level of Service F
Intersection Capacity Utilization 96.0%	
Analysis Period (min) 15	
~ Volume exceeds capacity, queue is theoretically infinite. Queue shown is maximum after two cycles.	
# 95th percentile volume exceeds capacity, queue may be longer. Queue shown is maximum after two cycles.	
m Volume for 95th percentile queue is metered by upstream signal.	

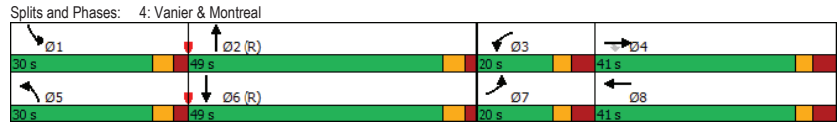

HCM 2010 TWSC
6: North River & Selkirk

2024 Future Background
AM Peak Hour

Intersection						
Int Delay, s/veh	0.9					
Movement	WBL	WBR	NBT	NBR	SBL	SBT
Lane Configurations	↔	↔	↑	↔	↔	↔
Traffic Vol, veh/h	27	34	275	0	0	397
Future Vol, veh/h	27	34	275	0	0	397
Conflicting Peds, #/hr	3	0	0	90	90	0
Sign Control	Stop	Stop	Free	Free	Free	Free
RT Channelized	-	None	-	None	-	None
Storage Length	0	-	-	-	-	-
Veh in Median Storage, #	0	-	0	-	-	0
Grade, %	0	-	0	-	-	0
Peak Hour Factor	100	100	100	100	100	100
Heavy Vehicles, %	7	2	8	2	2	2
Mvmt Flow	27	34	275	0	0	397

Major/Minor	Minor1	Major1	Major2
Conflicting Flow All	477	275	0
Stage 1	275	-	-
Stage 2	202	-	-
Critical Hdwy	6.705	6.23	-
Critical Hdwy Stg 1	5.505	-	-
Critical Hdwy Stg 2	5.905	-	-
Follow-up Hdwy	3.5665	3.319	-
Pot Cap-1 Maneuver	521	763	0
Stage 1	757	-	0
Stage 2	800	-	0
Platoon blocked, %	-	-	-
Mov Cap-1 Maneuver	520	763	-
Mov Cap-2 Maneuver	520	-	-
Stage 1	757	-	-
Stage 2	798	-	-

Approach	WB	NB	SB
HCM Control Delay, s	11.3	0	0
HCM LOS	B		

Minor Lane/Major Mvmt	NBTWBLn1	SBT
Capacity (veh/h)	- 632	-
HCM Lane V/C Ratio	- 0.097	-
HCM Control Delay (s)	- 11.3	-
HCM Lane LOS	- B	-
HCM 95th %tile Q(veh)	- 0.3	-

HCM 2010 TWSC
7: Dundas & Selkirk

2024 Future Background
AM Peak Hour

Intersection						
Int Delay, s/veh	0					
Movement	EBT	EBR	WBL	WBT	NBL	NBR
Lane Configurations				↕	↕	
Traffic Vol, veh/h	0	0	30	85	5	79
Future Vol, veh/h	0	0	30	85	5	79
Conflicting Peds, #/hr	0	0	0	0	0	0
Sign Control	Free	Free	Free	Free	Stop	Stop
RT Channelized	-	None	-	None	-	None
Storage Length	-	-	-	-	0	-
Veh in Median Storage, #	-	-	-	-	0	-
Grade, %	0	-	-	0	0	-
Peak Hour Factor	100	100	100	100	100	100
Heavy Vehicles, %	2	2	2	2	2	2
Mvmt Flow	0	0	30	85	5	79

Major/Minor	Major2	Minor1
Conflicting Flow All	0	145
Stage 1	-	0
Stage 2	-	145
Critical Hdwy	4.12	6.42
Critical Hdwy Stg 1	-	-
Critical Hdwy Stg 2	-	5.42
Follow-up Hdwy	2.218	3.518
Pot Cap-1 Maneuver	-	847
Stage 1	-	-
Stage 2	-	882
Platoon blocked, %	-	-
Mov Cap-1 Maneuver	-	847
Mov Cap-2 Maneuver	-	847
Stage 1	-	-
Stage 2	-	882

Approach	WB	NB
HCM Control Delay, s		
HCM LOS		

Minor Lane/Major Mvmt	NBLn1	WBL	WBT
Capacity (veh/h)	-	-	-
HCM Lane V/C Ratio	-	-	-
HCM Control Delay (s)	-	-	-
HCM Lane LOS	-	-	-
HCM 95th %tile Q(veh)	-	-	-

HCM 2010 TWSC
8: Montgomery & Selkirk

2024 Future Background
AM Peak Hour

Intersection												
Int Delay, s/veh	5.2											
Movement	EBL	EBT	EBR	WBL	WBT	WBR	NBL	NBT	NBR	SBL	SBT	SBR
Lane Configurations		↕			↕			↕			↕	
Traffic Vol, veh/h	64	10	5	15	20	20	5	5	0	10	29	90
Future Vol, veh/h	64	10	5	15	20	20	5	5	0	10	29	90
Conflicting Peds, #/hr	0	0	0	0	0	0	0	0	0	0	0	0
Sign Control	Stop	Stop	Stop	Stop	Stop	Stop	Free	Free	Free	Free	Free	Free
RT Channelized	-	-	None	-	-	None	-	-	None	-	-	None
Storage Length	-	-	-	-	-	-	-	-	-	-	-	-
Veh in Median Storage, #	-	0	-	-	0	-	-	0	-	-	0	-
Grade, %	-	0	-	-	0	-	-	0	-	-	0	-
Peak Hour Factor	100	100	100	100	100	100	100	100	100	100	100	100
Heavy Vehicles, %	2	2	2	2	2	2	2	2	2	2	2	2
Mvmt Flow	64	10	5	15	20	20	5	5	0	10	29	90

Major/Minor	Minor2	Minor1	Major1	Major2
Conflicting Flow All	129	109	74	117
Stage 1	94	94	-	15
Stage 2	35	15	-	102
Critical Hdwy	7.12	6.52	6.22	7.12
Critical Hdwy Stg 1	6.12	5.52	-	6.12
Critical Hdwy Stg 2	6.12	5.52	-	6.12
Follow-up Hdwy	3.518	4.018	3.318	3.518
Pot Cap-1 Maneuver	844	781	988	859
Stage 1	913	817	-	1005
Stage 2	981	883	-	904
Platoon blocked, %	-	-	-	-
Mov Cap-1 Maneuver	805	773	988	840
Mov Cap-2 Maneuver	805	773	-	840
Stage 1	910	811	-	1002
Stage 2	938	880	-	882

Approach	EB	WB	NB	SB
HCM Control Delay, s	9.9	9.5	3.7	0.6
HCM LOS	A	A		

Minor Lane/Major Mvmt	NBL	NBT	NBR	EBLn1	WBLn1	SBL	SBT	SBR
Capacity (veh/h)	1469	-	-	810	862	1616	-	-
HCM Lane V/C Ratio	0.003	-	-	0.098	0.064	0.006	-	-
HCM Control Delay (s)	7.5	0	-	9.9	9.5	7.2	0	-
HCM Lane LOS	A	A	-	A	A	A	A	-
HCM 95th %tile Q(veh)	0	-	-	0.3	0.2	0	-	-

Lanes, Volumes, Timings
9: North River & McArthur

2024 Future Background
AM Peak Hour

Lane Group	EBL	EBT	EBR	WBL	WBT	WBR	NBL	NBT	NBR	SBL	SBT	SBR
Lane Configurations		↔			↔	↔		↔		↔	↔	
Traffic Volume (vph)	1	6	3	8	9	165	3	116	29	322	98	4
Future Volume (vph)	1	6	3	8	9	165	3	116	29	322	98	4
Satd. Flow (prot)	0	1652	0	0	1705	1441	0	1626	0	1658	1685	0
Fit Permitted		0.988			0.925			0.997		0.663		
Satd. Flow (perm)	0	1633	0	0	1610	1341	0	1623	0	1054	1685	0
Satd. Flow (RTOR)		3			165			26		4		
Lane Group Flow (vph)	0	10	0	0	17	165	0	148	0	322	102	0
Turn Type	Perm	NA		Perm	NA	Perm	Perm	NA		Perm	NA	
Protected Phases		4			8			2			6	
Permitted Phases	4			8		8	2			6		
Detector Phase	4	4		8	8	8	2	2		6	6	
Switch Phase												
Minimum Initial (s)	10.0	10.0		10.0	10.0	10.0	10.0	10.0		10.0	10.0	
Minimum Split (s)	25.6	25.6		25.6	25.6	25.6	31.1	31.1		31.1	31.1	
Total Split (s)	28.0	28.0		28.0	28.0	28.0	42.0	42.0		42.0	42.0	
Total Split (%)	40.0%	40.0%		40.0%	40.0%	40.0%	60.0%	60.0%		60.0%	60.0%	
Yellow Time (s)	3.3	3.3		3.3	3.3	3.3	3.3	3.3		3.3	3.3	
All-Red Time (s)	2.3	2.3		2.3	2.3	2.3	2.8	2.8		2.8	2.8	
Lost Time Adjust (s)		0.0			0.0	0.0		0.0		0.0	0.0	
Total Lost Time (s)		5.6			5.6	5.6		6.1		6.1	6.1	
Lead/Lag												
Lead-Lag Optimize?												
Recall Mode	Max	Max		Max	Max	Max	C-Max	C-Max		C-Max	C-Max	
Act Effct Green (s)		22.4			22.4	22.4		35.9		35.9	35.9	
Actuated g/C Ratio		0.32			0.32	0.32		0.51		0.51	0.51	
v/c Ratio		0.02			0.03	0.30		0.18		0.60	0.12	
Control Delay		14.4			11.5	8.2		8.1		17.7	9.0	
Queue Delay		0.0			0.0	0.0		0.0		0.0	0.0	
Total Delay		14.4			11.5	8.2		8.1		17.7	9.0	
LOS		B			B	A		A		B	A	
Approach Delay		14.4			8.5			8.1		15.6		
Approach LOS		B			A			A		B		
Queue Length 50th (m)		0.6			1.6	13.4		7.9		27.6	6.2	
Queue Length 95th (m)		3.5			5.4	22.1		16.5		52.6	13.1	
Internal Link Dist (m)		22.5			128.8			367.7			94.3	
Turn Bay Length (m)						60.0				55.0		
Base Capacity (vph)		524			515	541		845		540	866	
Starvation Cap Reductn		0			0	0		0		0	0	
Spillback Cap Reductn		0			0	0		0		0	0	
Storage Cap Reductn		0			0	0		0		0	0	
Reduced v/c Ratio		0.02			0.03	0.30		0.18		0.60	0.12	

Intersection Summary	
Cycle Length:	70
Actuated Cycle Length:	70
Offset:	0 (0%), Referenced to phase 2:NBTL and 6:SBTL, Start of Green
Natural Cycle:	60
Control Type:	Actuated-Coordinated

Lanes, Volumes, Timings
9: North River & McArthur

2024 Future Background
AM Peak Hour

Maximum v/c Ratio: 0.60	Intersection LOS: B
Intersection Signal Delay: 12.5	ICU Level of Service D
Intersection Capacity Utilization 73.2%	
Analysis Period (min) 15	

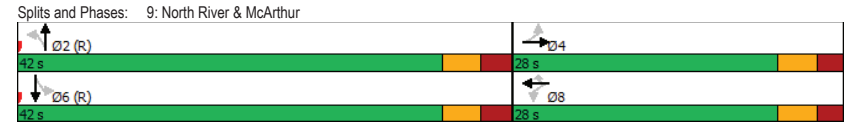

Intersection						
Int Delay, s/veh	0.6					
Movement	EBL	EBT	WBT	WBR	SBL	SBR
Lane Configurations		↖	↖		↗	↗
Traffic Vol, veh/h	10	361	318	88	10	16
Future Vol, veh/h	10	361	318	88	10	16
Conflicting Peds, #/hr	100	0	0	100	1	9
Sign Control	Free	Free	Free	Free	Stop	Stop
RT Channelized	-	None	-	None	-	None
Storage Length	-	-	-	-	0	-
Veh in Median Storage, #	-	0	0	-	0	-
Grade, %	-	0	0	-	0	-
Peak Hour Factor	100	100	100	100	100	100
Heavy Vehicles, %	10	2	5	3	2	2
Mvmt Flow	10	361	318	88	10	16
Major/Minor	Major1	Major2	Minor2			
Conflicting Flow All	506	0	0	844	471	
Stage 1	-	-	-	462	-	
Stage 2	-	-	-	382	-	
Critical Hdwy	4.2	-	-	6.42	6.22	
Critical Hdwy Stg 1	-	-	-	5.42	-	
Critical Hdwy Stg 2	-	-	-	5.42	-	
Follow-up Hdwy	2.29	-	-	3.518	3.318	
Pot Cap-1 Maneuver	1019	-	-	334	593	
Stage 1	-	-	-	634	-	
Stage 2	-	-	-	690	-	
Platoon blocked, %	-	-	-	-	-	
Mov Cap-1 Maneuver	940	-	-	280	543	
Mov Cap-2 Maneuver	-	-	-	280	-	
Stage 1	-	-	-	577	-	
Stage 2	-	-	-	636	-	
Approach	EB	WB	SB			
HCM Control Delay, s	0.2	0	14.7			
HCM LOS			B			
Minor Lane/Major Mvmt	EBL	EBT	WBT	WBR	SBLn1	
Capacity (veh/h)	940	-	-	-	399	
HCM Lane V/C Ratio	0.011	-	-	-	0.065	
HCM Control Delay (s)	8.9	0	-	-	14.7	
HCM Lane LOS	A	A	-	-	B	
HCM 95th %tile Q(veh)	0	-	-	-	0.2	

Lane Group	EBT	EBR	WBL	WBT	NBL	NBR
Lane Configurations	↖			↖	↖	↖
Traffic Volume (vph)	353	19	46	404	9	31
Future Volume (vph)	353	19	46	404	9	31
Satd. Flow (prot)	1728	0	0	1736	1658	1483
Fit Permitted				0.937	0.950	
Satd. Flow (perm)	1728	0	0	1632	1551	1426
Satd. Flow (RTOR)	6					31
Lane Group Flow (vph)	372	0	0	450	9	31
Turn Type	NA		Perm	NA	Prot	Perm
Protected Phases	2			6	8	
Permitted Phases			6			8
Detector Phase	2		6	6	8	8
Switch Phase						
Minimum Initial (s)	10.0		10.0	10.0	5.0	5.0
Minimum Split (s)	27.5		15.5	15.5	24.5	24.5
Total Split (s)	45.0		45.0	45.0	25.0	25.0
Total Split (%)	64.3%		64.3%	64.3%	35.7%	35.7%
Yellow Time (s)	3.3		3.3	3.3	3.3	3.3
All-Red Time (s)	2.2		2.2	2.2	2.2	2.2
Lost Time Adjust (s)	0.0		0.0	0.0	0.0	0.0
Total Lost Time (s)	5.5		5.5	5.5	5.5	5.5
Lead/Lag						
Lead-Lag Optimize?						
Recall Mode	C-Max		C-Max	C-Max	None	None
Act Effct Green (s)	54.6		54.6	11.1	11.1	11.1
Actuated g/C Ratio	0.78		0.78	0.16	0.16	0.16
v/c Ratio	0.28		0.35	0.03	0.12	0.12
Control Delay	4.0		7.2	20.6	8.9	8.9
Queue Delay	0.0		0.0	0.0	0.0	0.0
Total Delay	4.0		7.2	20.6	8.9	8.9
LOS	A		A	C	A	A
Approach Delay	4.0		7.2	11.5		
Approach LOS	A		A	B		
Queue Length 50th (m)	9.1		36.5	1.1	0.0	0.0
Queue Length 95th (m)	21.0		m47.8	3.9	5.5	5.5
Internal Link Dist (m)	36.3		7.3	144.2		
Turn Bay Length (m)				20.0		
Base Capacity (vph)	1349		1273	461	419	
Starvation Cap Reductn	0		0	0	0	
Spillback Cap Reductn	0		0	0	0	
Storage Cap Reductn	0		0	0	0	
Reduced v/c Ratio	0.28		0.35	0.02	0.07	

Intersection Summary	
Cycle Length:	70
Actuated Cycle Length:	70
Offset:	0 (0%), Referenced to phase 2:EBT and 6:WBTL, Start of Green
Natural Cycle:	55
Control Type:	Actuated-Coordinated

Lanes, Volumes, Timings
11: Marguerite & McArthur

2024 Future Background
AM Peak Hour

Maximum v/c Ratio: 0.35	Intersection LOS: A
Intersection Signal Delay: 6.0	ICU Level of Service C
Intersection Capacity Utilization 67.0%	
Analysis Period (min) 15	

m Volume for 95th percentile queue is metered by upstream signal.

Splits and Phases: 11: Marguerite & McArthur



Lanes, Volumes, Timings
12: Vanier & McArthur

2024 Future Background
AM Peak Hour

Lane Group	EBL	EBT	EBR	WBL	WBT	WBR	NBL	NBT	NBR	SBL	SBT	SBR
Lane Configurations	↔	↕	↔	↔	↕	↔	↔	↕	↔	↕	↔	↔
Traffic Volume (vph)	34	127	294	209	196	104	223	1070	225	140	1241	60
Future Volume (vph)	34	127	294	209	196	104	223	1070	225	140	1241	60
Satd. Flow (prot)	1551	1695	1483	3216	1695	1483	1658	3316	1483	1658	3316	1441
Fit Permitted	0.950			0.950			0.950			0.950		
Satd. Flow (perm)	1436	1695	1398	3092	1695	1320	1643	3316	1407	1643	3316	1342
Satd. Flow (RTOR)			251			168			214			121
Lane Group Flow (vph)	34	127	294	209	196	104	223	1070	225	140	1241	60
Turn Type	Prot	NA	Perm	Prot	NA	Perm	Prot	NA	Perm	Prot	NA	Perm
Protected Phases	7	4		3	8		5	2		1	6	
Permitted Phases			4			8			2			6
Detector Phase	7	4	4	3	8	8	5	2	2	1	6	6
Switch Phase												
Minimum Initial (s)	5.0	10.0	10.0	5.0	10.0	10.0	5.0	10.0	10.0	5.0	10.0	10.0
Minimum Split (s)	11.2	36.2	36.2	11.2	36.2	36.2	11.1	36.1	36.1	11.1	36.1	36.1
Total Split (s)	20.0	36.2	36.2	20.0	36.2	36.2	23.0	59.8	59.8	24.0	60.8	60.8
Total Split (%)	14.3%	25.9%	25.9%	14.3%	25.9%	25.9%	16.4%	42.7%	42.7%	17.1%	43.4%	43.4%
Yellow Time (s)	3.3	3.3	3.3	3.3	3.3	3.3	3.7	3.7	3.7	3.7	3.7	3.7
All-Red Time (s)	2.9	2.9	2.9	2.9	2.9	2.9	2.4	2.4	2.4	2.4	2.4	2.4
Lost Time Adjust (s)	0.0	0.0	0.0	0.0	0.0	0.0	0.0	0.0	0.0	0.0	0.0	0.0
Total Lost Time (s)	6.2	6.2	6.2	6.2	6.2	6.2	6.1	6.1	6.1	6.1	6.1	6.1
Lead/Lag	Lag	Lead	Lead	Lag	Lead	Lead	Lag	Lag	Lag	Lead	Lead	Lead
Lead-Lag Optimize?	Yes	Yes	Yes	Yes	Yes	Yes	Yes	Yes	Yes	Yes	Yes	Yes
Recall Mode	None	None	None	None	None	None	C-Max	C-Max	C-Max	C-Max	C-Max	C-Max
Act Effct Green (s)	10.8	26.0	26.0	12.9	33.1	33.1	16.9	60.8	60.8	15.7	59.6	59.6
Actuated g/C Ratio	0.08	0.19	0.19	0.09	0.24	0.24	0.12	0.43	0.43	0.11	0.43	0.43
v/c Ratio	0.29	0.40	0.63	0.71	0.49	0.24	1.11	0.74	0.31	0.76	0.88	0.09
Control Delay	66.1	45.8	17.4	75.0	51.7	1.4	152.4	39.1	5.4	84.4	72.2	14.9
Queue Delay	0.0	0.0	0.0	0.0	0.0	0.0	0.0	0.0	0.0	0.0	0.0	0.0
Total Delay	66.1	45.8	17.4	75.0	51.7	1.4	152.4	39.1	5.4	84.4	72.2	14.9
LOS	E	D	B	E	D	A	F	D	A	F	E	B
Approach Delay		28.9			51.0			50.8			71.0	
Approach LOS		C			D			D			E	
Queue Length 50th (m)	9.5	25.0	16.9	29.2	48.6	0.0	~70.6	139.7	1.9	40.7	171.1	2.9
Queue Length 95th (m)	21.5	42.3	31.8	42.8	74.3	0.5	#122.3	169.8	18.6	m51.7 m#211.4	m6.2	
Internal Link Dist (m)		122.9			141.8			130.7		202.5		
Turn Bay Length (m)	30.0		50.0	120.0		115.0	90.0		90.0	90.0		90.0
Base Capacity (vph)	152	363	496	317	409	445	200	1440	732	211	1411	641
Starvation Cap Reductn	0	0	0	0	0	0	0	0	0	0	0	0
Spillback Cap Reductn	0	0	0	0	0	0	0	0	0	0	0	0
Storage Cap Reductn	0	0	0	0	0	0	0	0	0	0	0	0
Reduced v/c Ratio	0.22	0.35	0.59	0.66	0.48	0.23	1.11	0.74	0.31	0.66	0.88	0.09

Intersection Summary

Cycle Length: 140
Actuated Cycle Length: 140
Offset: 100 (71%), Referenced to phase 2:NBT and 6:SBT, Start of Green
Natural Cycle: 135
Control Type: Actuated-Coordinated

Lanes, Volumes, Timings
12: Vanier & McArthur

2024 Future Background
AM Peak Hour

Maximum v/c Ratio: 1.11	Intersection LOS: E
Intersection Signal Delay: 55.7	ICU Level of Service F
Intersection Capacity Utilization 97.5%	
Analysis Period (min) 15	
~ Volume exceeds capacity, queue is theoretically infinite. Queue shown is maximum after two cycles.	
# 95th percentile volume exceeds capacity, queue may be longer. Queue shown is maximum after two cycles.	
m Volume for 95th percentile queue is metered by upstream signal.	

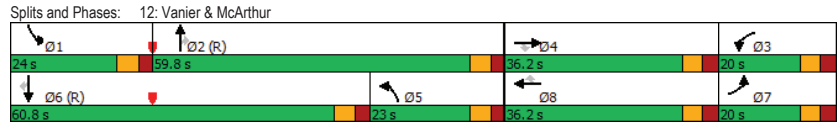

HCM 2010 TWSC
15: McArthur & Mayfield

2024 Future Background
AM Peak Hour

Intersection						
Int Delay, s/veh	0.4					
Movement	EBL	EBT	WBT	WBR	SBL	SBR
Lane Configurations		↑	↑		↓	↓
Traffic Vol, veh/h	0	384	449	0	18	4
Future Vol, veh/h	0	384	449	0	18	4
Conflicting Peds, #/hr	0	0	0	0	0	0
Sign Control	Free	Free	Free	Free	Stop	Stop
RT Channelized	-	None	-	None	-	None
Storage Length	-	-	-	-	0	0
Veh in Median Storage, #	-	0	0	-	0	-
Grade, %	-	0	0	-	0	-
Peak Hour Factor	100	100	100	100	100	100
Heavy Vehicles, %	2	2	2	2	2	2
Mvmt Flow	0	384	449	0	18	4

Major/Minor	Major1	Major2	Minor2			
Conflicting Flow All	-	0	-	833	449	
Stage 1	-	-	-	449	-	
Stage 2	-	-	-	384	-	
Critical Hdwy	-	-	-	6.42	6.22	
Critical Hdwy Stg 1	-	-	-	5.42	-	
Critical Hdwy Stg 2	-	-	-	5.42	-	
Follow-up Hdwy	-	-	-	3.518	3.318	
Pot Cap-1 Maneuver	0	-	-	0	339	610
Stage 1	0	-	-	0	643	-
Stage 2	0	-	-	0	688	-
Platoon blocked, %	-	-	-	-	-	-
Mov Cap-1 Maneuver	-	-	-	-	339	610
Mov Cap-2 Maneuver	-	-	-	-	339	-
Stage 1	-	-	-	-	643	-
Stage 2	-	-	-	-	688	-

Approach	EB	WB	SB
HCM Control Delay, s	0	0	15.2
HCM LOS			C

Minor Lane/Major Mvmt	EBT	WBT	SBLn1	SBLn2
Capacity (veh/h)	-	-	339	610
HCM Lane V/C Ratio	-	-	0.053	0.007
HCM Control Delay (s)	-	-	16.2	10.9
HCM Lane LOS	-	-	C	B
HCM 95th %tile Q(veh)	-	-	0.2	0

Lanes, Volumes, Timings
1: North River & Montreal

2024 Future Background
PM Peak Hour

Lane Group	EBL	EBT	EBR	WBL	WBT	WBR	NBL	NBT	NBR	SBL	SBT	SBR
Lane Configurations		↑↑			↑↑		↑	↑			↑↓	
Traffic Volume (vph)	0	596	410	0	665	18	356	17	32	21	15	21
Future Volume (vph)	0	596	410	0	665	18	356	17	32	21	15	21
Satd. Flow (prot)	0	2916	0	0	3241	0	1658	1486	0	0	1506	0
Fit Permitted							0.950				0.982	
Satd. Flow (perm)	0	2916	0	0	3241	0	1634	1486	0	0	1473	0
Satd. Flow (RTOR)		141						32			19	
Lane Group Flow (vph)	0	1006	0	0	683	0	356	49	0	0	57	0
Turn Type		NA			NA		Prot	NA		Split	NA	
Protected Phases		2			6		3!	8		7	7!	
Permitted Phases												
Detector Phase		2			6		3	8		7	7	
Switch Phase												
Minimum Initial (s)		10.0			10.0		5.0	10.0		10.0	10.0	
Minimum Split (s)		21.7			21.7		11.5	24.5		16.5	16.5	
Total Split (s)		39.0			39.0		39.0	64.0		17.0	17.0	
Total Split (%)		32.5%			32.5%		32.5%	53.3%		14.2%	14.2%	
Yellow Time (s)		3.0			3.0		3.3	3.3		3.3	3.3	
All-Red Time (s)		3.7			3.7		3.2	3.2		3.2	3.2	
Lost Time Adjust (s)		0.0			0.0		0.0	0.0		0.0	0.0	
Total Lost Time (s)		6.7			6.7		6.5	6.5		6.5	6.5	
Lead/Lag							Lag	Lag		Lead	Lead	
Lead-Lag Optimize?							Yes	Yes		Yes	Yes	
Recall Mode		C-Max			C-Max		None	Ped		None	None	
Act Effct Green (s)		51.4			51.4		30.9	42.1		10.1	10.1	
Actuated g/C Ratio		0.43			0.43		0.26	0.35		0.08	0.08	
v/c Ratio		0.76			0.49		0.83	0.09		0.40	0.40	
Control Delay		30.3			27.5		58.7	12.5		45.7	45.7	
Queue Delay		0.0			32.2		0.0	0.0		0.0	0.0	
Total Delay		30.3			59.8		58.7	12.5		45.7	45.7	
LOS		C			E		E	B		D	D	
Approach Delay		30.3			59.8		53.1			45.7		
Approach LOS		C			E		D			D		
Queue Length 50th (m)		91.1			60.6		79.1	2.7		8.6	8.6	
Queue Length 95th (m)		#133.8			86.5		105.3	10.4		21.9	21.9	
Internal Link Dist (m)		179.1			52.8			112.9		59.0	59.0	
Turn Bay Length (m)							90.0					
Base Capacity (vph)		1328			1387		472	728		149	149	
Starvation Cap Reductn		0			734		0	0		0	0	
Spillback Cap Reductn		0			0		0	0		0	0	
Storage Cap Reductn		0			0		0	0		0	0	
Reduced v/c Ratio		0.76			1.05		0.75	0.07		0.38	0.38	

Intersection Summary	
Cycle Length:	120
Actuated Cycle Length:	120
Offset:	0 (0%), Referenced to phase 2:EBT and 6:WBT, Start of Green
Natural Cycle:	90
Control Type:	Actuated-Coordinated

Lanes, Volumes, Timings
1: North River & Montreal

2024 Future Background
PM Peak Hour

Lane Group	Ø4
Lane Configurations	
Traffic Volume (vph)	
Future Volume (vph)	
Satd. Flow (prot)	
Fit Permitted	
Satd. Flow (perm)	
Satd. Flow (RTOR)	
Lane Group Flow (vph)	
Turn Type	
Protected Phases	4
Permitted Phases	
Detector Phase	
Switch Phase	
Minimum Initial (s)	5.0
Minimum Split (s)	24.5
Total Split (s)	42.0
Total Split (%)	35%
Yellow Time (s)	3.3
All-Red Time (s)	3.2
Lost Time Adjust (s)	
Total Lost Time (s)	
Lead/Lag	Lead
Lead-Lag Optimize?	Yes
Recall Mode	Ped
Act Effct Green (s)	
Actuated g/C Ratio	
v/c Ratio	
Control Delay	
Queue Delay	
Total Delay	
LOS	
Approach Delay	
Approach LOS	
Queue Length 50th (m)	
Queue Length 95th (m)	
Internal Link Dist (m)	
Turn Bay Length (m)	
Base Capacity (vph)	
Starvation Cap Reductn	
Spillback Cap Reductn	
Storage Cap Reductn	
Reduced v/c Ratio	

Intersection Summary	
----------------------	--

Lanes, Volumes, Timings
1: North River & Montreal

2024 Future Background
PM Peak Hour

Maximum v/c Ratio: 0.83
 Intersection Signal Delay: 44.3 Intersection LOS: D
 Intersection Capacity Utilization 71.1% ICU Level of Service C
 Analysis Period (min) 15
 # 95th percentile volume exceeds capacity, queue may be longer.
 Queue shown is maximum after two cycles.
 ! Phase conflict between lane groups.

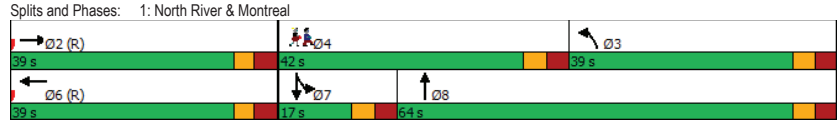

Lanes, Volumes, Timings
2: Montgomery & Montreal

2024 Future Background
PM Peak Hour

Lane Group	EBT	EBR	WBL	WBT	NBL	NBR
Lane Configurations	↔↔			↔↔	↔↔	↔↔
Traffic Volume (vph)	552	97	56	580	108	66
Future Volume (vph)	552	97	56	580	108	66
Satd. Flow (prot)	3192	0	0	3268	1658	1401
Fit Permitted				0.839	0.950	
Satd. Flow (perm)	3192	0	0	2750	1647	1314
Satd. Flow (RTOR)	48					66
Lane Group Flow (vph)	649	0	0	636	108	66
Turn Type	NA		Perm	NA	Prot	Perm
Protected Phases	2			6	8	
Permitted Phases			6			8
Detector Phase	2		6	6	8	8
Switch Phase						
Minimum Initial (s)	10.0		10.0	10.0	10.0	10.0
Minimum Split (s)	39.9		15.9	15.9	19.5	19.5
Total Split (s)	76.0		76.0	76.0	24.0	24.0
Total Split (%)	76.0%		76.0%	76.0%	24.0%	24.0%
Yellow Time (s)	3.0		3.0	3.0	3.3	3.3
All-Red Time (s)	2.6		2.6	2.6	2.2	2.2
Lost Time Adjust (s)	0.0		0.0	0.0	0.0	0.0
Total Lost Time (s)	5.6		5.6	5.6	5.5	5.5
Lead/Lag						
Lead-Lag Optimize?						
Recall Mode	C-Max		C-Max	C-Max	None	None
Act Effct Green (s)	76.4		76.4	12.5	12.5	
Actuated g/C Ratio	0.76		0.76	0.12	0.12	
v/c Ratio	0.26		0.30	0.52	0.30	
Control Delay	3.7		4.3	49.8	13.3	
Queue Delay	1.4		0.0	0.0	0.0	
Total Delay	5.1		4.3	49.8	13.3	
LOS	A		A	D	B	
Approach Delay	5.1		4.3	35.9		
Approach LOS	A		A	D		
Queue Length 50th (m)	13.9		15.5	20.1	0.0	
Queue Length 95th (m)	24.1		26.9	35.1	11.2	
Internal Link Dist (m)	52.8		138.9	214.6		
Turn Bay Length (m)				35.0		
Base Capacity (vph)	2451		2102	306	296	
Starvation Cap Reductn	1539		0	0	0	
Spillback Cap Reductn	0		0	0	0	
Storage Cap Reductn	0		0	0	0	
Reduced v/c Ratio	0.71		0.30	0.35	0.22	

Intersection Summary
 Cycle Length: 100
 Actuated Cycle Length: 100
 Offset: 0 (0%), Referenced to phase 2:EBT and 6:WBT, Start of Green
 Natural Cycle: 60
 Control Type: Actuated-Coordinated

Lanes, Volumes, Timings
2: Montgomery & Montreal

2024 Future Background
PM Peak Hour

Maximum v/c Ratio: 0.52	Intersection LOS: A
Intersection Signal Delay: 8.4	ICU Level of Service C
Intersection Capacity Utilization 69.4%	
Analysis Period (min) 15	

Splits and Phases: 2: Montgomery & Montreal

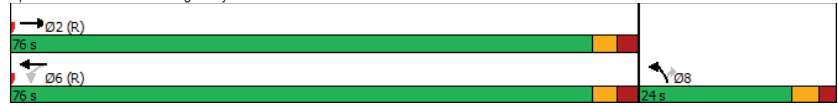

Lanes, Volumes, Timings
4: Vanier & Montreal

2024 Future Background
PM Peak Hour

Lane Group	EBL	EBT	EBR	WBL	WBT	WBR	NBL	NBT	NBR	SBL	SBT	SBR
Lane Configurations	↔	↕	↔	↔	↕	↔	↔	↕	↔	↔	↕	↔
Traffic Volume (vph)	51	366	177	156	333	198	229	1011	210	142	1019	94
Future Volume (vph)	51	366	177	156	333	198	229	1011	210	142	1019	94
Satd. Flow (prot)	1626	1695	1483	1658	2941	0	1658	4556	0	1658	4665	0
Fit Permitted	0.950			0.950			0.950			0.950		
Satd. Flow (perm)	1557	1695	1376	1597	2941	0	1629	4556	0	1632	4665	0
Satd. Flow (RTOR)			177		83			30			10	
Lane Group Flow (vph)	51	366	177	156	531	0	229	1221	0	142	1113	0
Turn Type	Prot	NA	Perm	Prot	NA		Prot	NA		Prot	NA	
Protected Phases	7	4		3	8		5	2		1	6	
Permitted Phases			4									
Detector Phase	7	4	4	3	8		5	2		1	6	
Switch Phase												
Minimum Initial (s)	5.0	10.0	10.0	5.0	10.0		5.0	10.0		5.0	10.0	
Minimum Split (s)	12.1	40.1	40.1	12.1	40.1		11.1	28.9		11.1	28.9	
Total Split (s)	30.0	41.0	41.0	30.0	41.0		30.0	39.0		30.0	39.0	
Total Split (%)	21.4%	29.3%	29.3%	21.4%	29.3%		21.4%	27.9%		21.4%	27.9%	
Yellow Time (s)	3.0	3.0	3.0	3.0	3.0		3.7	3.7		3.7	3.7	
All-Red Time (s)	4.1	4.1	4.1	4.1	4.1		2.4	2.2		2.4	2.2	
Lost Time Adjust (s)	0.0	0.0	0.0	0.0	0.0		0.0	0.0		0.0	0.0	
Total Lost Time (s)	7.1	7.1	7.1	7.1	7.1		6.1	5.9		6.1	5.9	
Lead/Lag	Lead	Lag	Lag	Lead	Lag		Lead	Lag		Lead	Lag	
Lead-Lag Optimize?	Yes	Yes	Yes	Yes	Yes		Yes	Yes		Yes	Yes	
Recall Mode	None	Max	Max	None	Max		None	C-Max		None	C-Max	
Act Effct Green (s)	9.8	38.8	38.8	18.0	49.6		22.2	39.8		17.2	34.8	
Actuated g/C Ratio	0.07	0.28	0.28	0.13	0.35		0.16	0.28		0.12	0.25	
v/c Ratio	0.45	0.78	0.35	0.74	0.48		0.87	0.93		0.70	0.95	
Control Delay	74.0	60.0	7.7	78.3	32.3		89.0	70.1		76.2	68.7	
Queue Delay	0.0	0.0	0.0	0.0	0.0		0.0	0.0		0.0	0.0	
Total Delay	74.0	60.0	7.7	78.3	32.3		89.0	70.1		76.2	68.7	
LOS	E	E	A	E	C		F	E		E	E	
Approach Delay		45.6			42.8			73.1			69.5	
Approach LOS		D			D			E			E	
Queue Length 50th (m)	13.8	94.2	0.0	42.0	52.1		66.8	99.4		38.3	~113.3	
Queue Length 95th (m)	27.1	#153.8	18.6	63.9	73.0		m79.3	#162.9		58.2	#146.1	
Internal Link Dist (m)		99.5			237.5			154.5			139.4	
Turn Bay Length (m)	30.0			35.0			94.5			90.0		
Base Capacity (vph)	265	470	509	271	1095		283	1315		283	1167	
Starvation Cap Reductn	0	0	0	0	0		0	0		0	0	
Spillback Cap Reductn	0	0	0	0	0		0	0		0	0	
Storage Cap Reductn	0	0	0	0	0		0	0		0	0	
Reduced v/c Ratio	0.19	0.78	0.35	0.58	0.48		0.81	0.93		0.50	0.95	

Intersection Summary

Cycle Length: 140
Actuated Cycle Length: 140
Offset: 56 (40%), Referenced to phase 2:NBT and 6:SBT, Start of Green
Natural Cycle: 115
Control Type: Actuated-Coordinated

Lanes, Volumes, Timings
4: Vanier & Montreal

2024 Future Background
PM Peak Hour

Maximum v/c Ratio: 0.95	Intersection LOS: E
Intersection Signal Delay: 62.6	ICU Level of Service F
Intersection Capacity Utilization 95.1%	
Analysis Period (min) 15	
~ Volume exceeds capacity, queue is theoretically infinite.	
Queue shown is maximum after two cycles.	
# 95th percentile volume exceeds capacity, queue may be longer.	
Queue shown is maximum after two cycles.	
m Volume for 95th percentile queue is metered by upstream signal.	

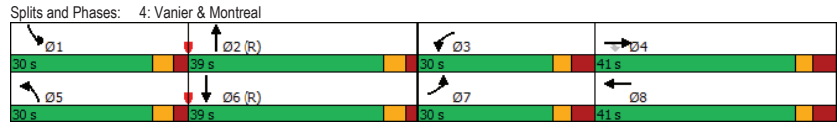

HCM 2010 TWSC
6: North River & Selkirk

2024 Future Background
PM Peak Hour

Intersection						
Int Delay, s/veh	2.6					
Movement	WBL	WBR	NBT	NBR	SBL	SBT
Lane Configurations	↔	↔	↑	↑	↔	↔
Traffic Vol, veh/h	115	47	370	0	0	434
Future Vol, veh/h	115	47	370	0	0	434
Conflicting Peds, #/hr	2	2	0	66	66	0
Sign Control	Stop	Stop	Free	Free	Free	Free
RT Channelized	-	None	-	None	-	None
Storage Length	0	-	-	-	-	-
Veh in Median Storage, #	0	-	0	-	-	0
Grade, %	0	-	0	-	-	0
Peak Hour Factor	100	100	100	100	100	100
Heavy Vehicles, %	2	2	3	2	2	4
Mvmt Flow	115	47	370	0	0	434

Major/Minor	Minor1	Major1	Major2
Conflicting Flow All	589	372	0
Stage 1	370	-	-
Stage 2	219	-	-
Critical Hdwy	6.63	6.23	-
Critical Hdwy Stg 1	5.43	-	-
Critical Hdwy Stg 2	5.83	-	-
Follow-up Hdwy	3,519	3,319	-
Pot Cap-1 Maneuver	455	673	-
Stage 1	698	-	0
Stage 2	797	-	0
Platoon blocked, %	-	-	-
Mov Cap-1 Maneuver	454	672	-
Mov Cap-2 Maneuver	454	-	-
Stage 1	698	-	-
Stage 2	795	-	-

Approach	WB	NB	SB
HCM Control Delay, s	15.6	0	0
HCM LOS	C		

Minor Lane/Major Mvmt	NBTWBLn1	SBT
Capacity (veh/h)	- 501	-
HCM Lane V/C Ratio	- 0.323	-
HCM Control Delay (s)	- 15.6	-
HCM Lane LOS	- C	-
HCM 95th %tile Q(veh)	- 1.4	-

HCM 2010 TWSC
7: Dundas & Selkirk

2024 Future Background
PM Peak Hour

Intersection						
Int Delay, s/veh	0					
Movement	EBT	EBR	WBL	WBT	NBL	NBR
Lane Configurations				↕	↕	
Traffic Vol, veh/h	0	0	30	45	10	100
Future Vol, veh/h	0	0	30	45	10	100
Conflicting Peds, #/hr	0	0	0	0	0	0
Sign Control	Free	Free	Free	Free	Stop	Stop
RT Channelized	-	None	-	None	-	None
Storage Length	-	-	-	-	0	-
Veh in Median Storage, #	-	-	-	-	0	-
Grade, %	0	-	-	0	0	-
Peak Hour Factor	100	100	100	100	100	100
Heavy Vehicles, %	2	2	2	2	2	2
Mvmt Flow	0	0	30	45	10	100

Major/Minor	Major2	Minor1
Conflicting Flow All	0	105
Stage 1	-	0
Stage 2	-	105
Critical Hdwy	4.12	6.42
Critical Hdwy Stg 1	-	-
Critical Hdwy Stg 2	-	5.42
Follow-up Hdwy	2.218	3.318
Pot Cap-1 Maneuver	-	893
Stage 1	-	-
Stage 2	-	919
Platoon blocked, %	-	-
Mov Cap-1 Maneuver	-	893
Mov Cap-2 Maneuver	-	893
Stage 1	-	-
Stage 2	-	919

Approach	WB	NB
HCM Control Delay, s		
HCM LOS		

Minor Lane/Major Mvmt	NBLn1	WBL	WBT
Capacity (veh/h)	-	-	-
HCM Lane V/C Ratio	-	-	-
HCM Control Delay (s)	-	-	-
HCM Lane LOS	-	-	-
HCM 95th %tile Q(veh)	-	-	-

HCM 2010 TWSC
8: Montgomery & Selkirk

2024 Future Background
PM Peak Hour

Intersection												
Int Delay, s/veh	5.9											
Movement	EBL	EBT	EBR	WBL	WBT	WBR	NBL	NBT	NBR	SBL	SBT	SBR
Lane Configurations		↕			↕			↕			↕	
Traffic Vol, veh/h	70	20	10	5	10	20	5	10	0	15	20	60
Future Vol, veh/h	70	20	10	5	10	20	5	10	0	15	20	60
Conflicting Peds, #/hr	0	0	0	0	0	0	0	0	0	0	0	0
Sign Control	Stop	Stop	Stop	Stop	Stop	Stop	Free	Free	Free	Free	Free	Free
RT Channelized	-	-	None	-	-	None	-	-	None	-	-	None
Storage Length	-	-	-	-	-	-	-	-	-	-	-	-
Veh in Median Storage, #	-	0	-	-	0	-	-	0	-	-	0	-
Grade, %	-	0	-	-	0	-	-	0	-	-	0	-
Peak Hour Factor	100	100	100	100	100	100	100	100	100	100	100	100
Heavy Vehicles, %	2	2	2	2	2	2	2	2	2	2	2	2
Mvmt Flow	70	20	10	5	10	20	5	10	0	15	20	60

Major/Minor	Minor2	Minor1	Major1	Major2
Conflicting Flow All	115	100	50	115
Stage 1	80	80	-	20
Stage 2	35	20	-	95
Critical Hdwy	7.12	6.52	6.22	7.12
Critical Hdwy Stg 1	6.12	5.52	-	6.12
Critical Hdwy Stg 2	6.12	5.52	-	6.12
Follow-up Hdwy	3.518	4.018	3.318	3.518
Pot Cap-1 Maneuver	862	790	1018	862
Stage 1	929	828	-	999
Stage 2	981	879	-	912
Platoon blocked, %	-	-	-	-
Mov Cap-1 Maneuver	829	780	1018	828
Mov Cap-2 Maneuver	829	780	-	828
Stage 1	926	820	-	996
Stage 2	949	876	-	872

Approach	EB	WB	NB	SB
HCM Control Delay, s	9.9	9.1	2.5	1.1
HCM LOS	A	A		

Minor Lane/Major Mvmt	NBL	NBT	NBR	EBLn1	WBLn1	SBL	SBT	SBR
Capacity (veh/h)	1518	-	-	834	920	1610	-	-
HCM Lane V/C Ratio	0.003	-	-	0.12	0.038	0.009	-	-
HCM Control Delay (s)	7.4	0	-	9.9	9.1	7.3	0	-
HCM Lane LOS	A	A	-	A	A	A	A	-
HCM 95th %tile Q(veh)	0	-	-	0.4	0.1	0	-	-

Lanes, Volumes, Timings
9: North River & McArthur

2024 Future Background
PM Peak Hour

Lane Group	EBL	EBT	EBR	WBL	WBT	WBR	NBL	NBT	NBR	SBL	SBT	SBR
Lane Configurations		↔			↔	↔		↔		↔	↔	
Traffic Volume (vph)	4	25	6	24	11	217	2	148	36	409	139	1
Future Volume (vph)	4	25	6	24	11	217	2	148	36	409	139	1
Satd. Flow (prot)	0	1636	0	0	1571	1483	0	1635	0	1642	1709	0
Fit Permitted		0.980			0.841			0.998		0.640		
Satd. Flow (perm)	0	1599	0	0	1330	1334	0	1632	0	989	1709	0
Satd. Flow (RTOR)		6			217			27		1		
Lane Group Flow (vph)	0	35	0	0	35	217	0	186	0	409	140	0
Turn Type	Perm	NA		Perm	NA	Perm	Perm	NA		Perm	NA	
Protected Phases		4			8			2			6	
Permitted Phases	4			8		8	2			6		
Detector Phase	4	4		8	8	8	2	2		6	6	
Switch Phase												
Minimum Initial (s)	10.0	10.0		10.0	10.0	10.0	10.0	10.0		10.0	10.0	
Minimum Split (s)	25.6	25.6		25.6	25.6	25.6	31.1	31.1		31.1	31.1	
Total Split (s)	26.0	26.0		26.0	26.0	26.0	49.0	49.0		49.0	49.0	
Total Split (%)	34.7%	34.7%		34.7%	34.7%	34.7%	65.3%	65.3%		65.3%	65.3%	
Yellow Time (s)	3.3	3.3		3.3	3.3	3.3	3.3	3.3		3.3	3.3	
All-Red Time (s)	2.3	2.3		2.3	2.3	2.3	2.8	2.8		2.8	2.8	
Lost Time Adjust (s)		0.0			0.0	0.0		0.0			0.0	
Total Lost Time (s)		5.6			5.6	5.6		6.1			6.1	
Lead/Lag												
Lead-Lag Optimize?												
Recall Mode	Max	Max		Max	Max	Max	C-Max	C-Max		C-Max	C-Max	
Act Effct Green (s)		20.4			20.4	20.4		42.9		42.9	42.9	
Actuated g/C Ratio		0.27			0.27	0.27		0.57		0.57	0.57	
v/c Ratio		0.08			0.10	0.42		0.20		0.72	0.14	
Control Delay		18.4			21.1	12.6		7.2		21.2	7.9	
Queue Delay		0.0			0.0	0.0		0.0		0.0	0.0	
Total Delay		18.4			21.1	12.6		7.2		21.2	7.9	
LOS		B			C	B		A		C	A	
Approach Delay		18.4			13.8			7.2		17.8		
Approach LOS		B			B			A		B		
Queue Length 50th (m)		3.0			4.3	0.0		9.7		38.5	8.4	
Queue Length 95th (m)		9.4			11.5	32.3		18.6		#78.8	15.9	
Internal Link Dist (m)		22.5			128.8			119.0			94.3	
Turn Bay Length (m)						60.0				55.0		
Base Capacity (vph)		439			361	520		945		565	977	
Starvation Cap Reductn		0			0	0		0		0	0	
Spillback Cap Reductn		0			0	0		0		0	0	
Storage Cap Reductn		0			0	0		0		0	0	
Reduced v/c Ratio		0.08			0.10	0.42		0.20		0.72	0.14	

Intersection Summary	
Cycle Length:	75
Actuated Cycle Length:	75
Offset:	0 (0%), Referenced to phase 2:NBTL and 6:SBTL, Start of Green
Natural Cycle:	60
Control Type:	Actuated-Coordinated

Lanes, Volumes, Timings
9: North River & McArthur

2024 Future Background
PM Peak Hour

Maximum v/c Ratio: 0.72	Intersection Signal Delay: 14.9	Intersection LOS: B
Intersection Capacity Utilization 76.3%	ICU Level of Service D	
Analysis Period (min) 15		
# 95th percentile volume exceeds capacity, queue may be longer.		
Queue shown is maximum after two cycles.		

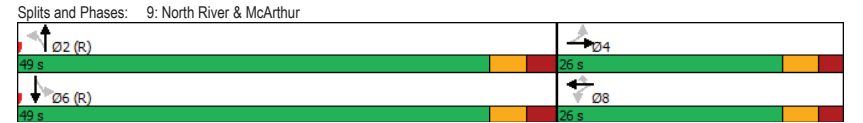

Intersection						
Int Delay, s/veh	0.7					
Movement	EBL	EBT	WBT	WBR	SBL	SBR
Lane Configurations		↗	↗		↘	↘
Traffic Vol, veh/h	7	469	267	92	26	4
Future Vol, veh/h	7	469	267	92	26	4
Conflicting Peds, #/hr	76	0	0	76	0	9
Sign Control	Free	Free	Free	Free	Stop	Stop
RT Channelized	-	None	-	None	-	None
Storage Length	-	-	-	-	0	-
Veh in Median Storage, #	-	0	0	-	0	-
Grade, %	-	0	0	-	0	-
Peak Hour Factor	100	100	100	100	100	100
Heavy Vehicles, %	2	3	3	2	8	2
Mvmt Flow	7	469	267	92	26	4
Major/Minor	Major1	Major2	Minor2			
Conflicting Flow All	435	0	0	872	398	
Stage 1	-	-	-	389	-	
Stage 2	-	-	-	483	-	
Critical Hdwy	4.12	-	-	6.48	6.22	
Critical Hdwy Stg 1	-	-	-	5.48	-	
Critical Hdwy Stg 2	-	-	-	5.48	-	
Follow-up Hdwy	2.218	-	-	3.572	3.318	
Pot Cap-1 Maneuver	1125	-	-	313	652	
Stage 1	-	-	-	672	-	
Stage 2	-	-	-	608	-	
Platoon blocked, %	-	-	-	-	-	
Mov Cap-1 Maneuver	1059	-	-	275	609	
Mov Cap-2 Maneuver	-	-	-	275	-	
Stage 1	-	-	-	627	-	
Stage 2	-	-	-	572	-	
Approach	EB	WB	SB			
HCM Control Delay, s	0.1	0	18.5			
HCM LOS			C			
Minor Lane/Major Mvmt	EBL	EBT	WBT	WBR	SBLn1	
Capacity (veh/h)	1059	-	-	-	297	
HCM Lane V/C Ratio	0.007	-	-	-	0.101	
HCM Control Delay (s)	8.4	0	-	-	18.5	
HCM Lane LOS	A	A	-	-	C	
HCM 95th %tile Q(veh)	0	-	-	-	0.3	

Lane Group	EBT	EBR	WBL	WBT	NBL	NBR
Lane Configurations	↗	↗	↗	↖	↖	↖
Traffic Volume (vph)	481	21	40	346	20	52
Future Volume (vph)	481	21	40	346	20	52
Satd. Flow (prot)	1730	0	0	1736	1658	1483
Fit Permitted				0.924	0.950	
Satd. Flow (perm)	1730	0	0	1609	1586	1425
Satd. Flow (RTOR)	5					52
Lane Group Flow (vph)	502	0	0	386	20	52
Turn Type	NA		Perm	NA	Prot	Perm
Protected Phases	2			6	8	
Permitted Phases			6			8
Detector Phase	2		6	6	8	8
Switch Phase						
Minimum Initial (s)	10.0		10.0	10.0	5.0	5.0
Minimum Split (s)	27.5		15.5	15.5	24.5	24.5
Total Split (s)	50.0		50.0	50.0	25.0	25.0
Total Split (%)	66.7%		66.7%	66.7%	33.3%	33.3%
Yellow Time (s)	3.3		3.3	3.3	3.3	3.3
All-Red Time (s)	2.2		2.2	2.2	2.2	2.2
Lost Time Adjust (s)	0.0		0.0	0.0	0.0	0.0
Total Lost Time (s)	5.5		5.5	5.5	5.5	5.5
Lead/Lag						
Lead-Lag Optimize?						
Recall Mode	C-Max		C-Max	C-Max	None	None
Act Effct Green (s)	59.5		59.5	11.2	11.2	11.2
Actuated g/C Ratio	0.79		0.79	0.15	0.15	0.15
v/c Ratio	0.37		0.30	0.08	0.20	0.20
Control Delay	4.9		5.8	24.2	9.0	9.0
Queue Delay	0.0		0.0	0.0	0.0	0.0
Total Delay	4.9		5.8	24.2	9.0	9.0
LOS	A		A	C	A	A
Approach Delay	4.9		5.8	13.2		
Approach LOS	A		A	B		
Queue Length 50th (m)	14.0		12.3	2.7	0.0	0.0
Queue Length 95th (m)	37.5		42.3	7.0	7.7	7.7
Internal Link Dist (m)	36.3		7.3	144.2		
Turn Bay Length (m)				30.0		
Base Capacity (vph)	1373		1276	431	408	
Starvation Cap Reductn	0		0	0	0	
Spillback Cap Reductn	0		0	0	0	
Storage Cap Reductn	0		0	0	0	
Reduced v/c Ratio	0.37		0.30	0.05	0.13	

Intersection Summary	
Cycle Length: 75	
Actuated Cycle Length: 75	
Offset: 0 (0%), Referenced to phase 2:EBT and 6:WBT, Start of Green	
Natural Cycle: 55	
Control Type: Actuated-Coordinated	

Lanes, Volumes, Timings
11: Marguerite & McArthur

2024 Future Background
PM Peak Hour

Maximum v/c Ratio: 0.37	Intersection LOS: A
Intersection Signal Delay: 5.9	ICU Level of Service C
Intersection Capacity Utilization 70.9%	
Analysis Period (min) 15	

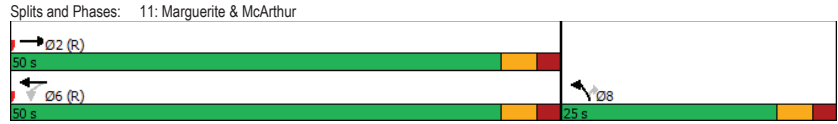

Lanes, Volumes, Timings
12: Vanier & McArthur

2024 Future Background
PM Peak Hour

Lane Group	EBL	EBT	EBR	WBL	WBT	WBR	NBL	NBT	NBR	SBL	SBT	SBR	
Lane Configurations	↔	↗	↘	↔	↗	↘	↔	↗	↘	↔	↗	↘	
Traffic Volume (vph)	55	228	435	333	218	170	206	1198	251	122	1178	66	
Future Volume (vph)	55	228	435	333	218	170	206	1198	251	122	1178	66	
Satd. Flow (prot)	1658	1712	1483	3154	1712	1483	1658	3316	1469	1658	3316	1469	
Fit Permitted	0.950			0.950			0.950			0.950			
Satd. Flow (perm)	1574	1712	1323	2932	1712	1360	1610	3316	1400	1647	3316	1223	
Satd. Flow (RTOR)			241			170			213			121	
Lane Group Flow (vph)	55	228	435	333	218	170	206	1198	251	122	1178	66	
Turn Type	Prot	NA	Perm	Prot	NA	Perm	Prot	NA	Perm	Prot	NA	Perm	
Protected Phases	7	4		3	8		5	2		1	6		
Permitted Phases			4			8			2			6	
Detector Phase	7	4	4	3	8	8	5	2	2	1	6	6	
Switch Phase													
Minimum Initial (s)	5.0	10.0	10.0	5.0	10.0	10.0	5.0	10.0	10.0	5.0	10.0	10.0	
Minimum Split (s)	11.2	36.2	36.2	11.2	36.2	36.2	11.1	36.1	36.1	11.1	36.1	36.1	
Total Split (s)	20.0	36.2	36.2	20.0	36.2	36.2	23.0	59.8	59.8	24.0	60.8	60.8	
Total Split (%)	14.3%	25.9%	25.9%	14.3%	25.9%	25.9%	16.4%	42.7%	42.7%	17.1%	43.4%	43.4%	
Yellow Time (s)	3.3	3.3	3.3	3.3	3.3	3.3	3.7	3.7	3.7	3.7	3.7	3.7	
All-Red Time (s)	2.9	2.9	2.9	2.9	2.9	2.9	2.4	2.4	2.4	2.4	2.4	2.4	
Lost Time Adjust (s)	0.0	0.0	0.0	0.0	0.0	0.0	0.0	0.0	0.0	0.0	0.0	0.0	
Total Lost Time (s)	6.2	6.2	6.2	6.2	6.2	6.2	6.1	6.1	6.1	6.1	6.1	6.1	
Lead/Lag	Lag	Lead	Lead	Lag	Lead	Lead	Lag	Lag	Lag	Lead	Lead	Lead	
Lead-Lag Optimize?	Yes	Yes	Yes	Yes	Yes	Yes	Yes	Yes	Yes	Yes	Yes	Yes	
Recall Mode	None	None	None	None	None	None	C-Max	C-Max	C-Max	C-Max	C-Max	C-Max	
Act Effct Green (s)	12.2	27.6	27.6	15.9	33.7	33.7	16.9	57.1	57.1	14.8	55.0	55.0	
Actuated g/C Ratio	0.09	0.20	0.20	0.11	0.24	0.24	0.12	0.41	0.41	0.11	0.39	0.39	
v/c Ratio	0.38	0.68	0.96	0.94	0.53	0.37	1.03	0.89	0.36	0.70	0.90	0.12	
Control Delay	67.2	62.2	57.4	94.6	53.5	8.8	130.6	48.1	7.4	83.1	81.4	19.3	
Queue Delay	0.0	0.0	0.0	0.0	0.0	0.0	0.0	0.0	0.0	0.0	0.0	0.0	
Total Delay	67.2	62.2	57.4	94.6	53.5	8.8	130.6	48.1	7.4	83.1	81.4	19.3	
LOS	E	E	E	F	D	A	F	D	A	F	F	B	
Approach Delay	59.7				62.0				52.2				78.6
Approach LOS	E				E				D				E
Queue Length 50th (m)	14.5	57.8	59.0	~52.5	54.8	0.0	~60.9	162.5	6.4	35.7	173.1	5.5	
Queue Length 95th (m)	28.5	86.0	#123.6	#83.3	82.2	19.2	#110.8	#212.2	26.1	m42.1	m186.4	m8.6	
Internal Link Dist (m)	122.9				146.0		119.5				202.0		
Turn Bay Length (m)	30.0		50.0		120.0		115.0		90.0		90.0		
Base Capacity (vph)	163		366		472		411		456		200		
Starvation Cap Reductn	0		0		0		0		0		0		
Spillback Cap Reductn	0		0		0		0		0		0		
Storage Cap Reductn	0		0		0		0		0		0		
Reduced v/c Ratio	0.34	0.62	0.92	0.94	0.53	0.37	1.03	0.89	0.36	0.58	0.90	0.12	

Intersection Summary												
Cycle Length: 140												
Actuated Cycle Length: 140												
Offset: 54 (39%), Referenced to phase 2:NBT and 6:SBT, Start of Green												
Natural Cycle: 135												
Control Type: Actuated-Coordinated												

Lanes, Volumes, Timings
12: Vanier & McArthur

2024 Future Background
PM Peak Hour

Maximum v/c Ratio: 1.03	Intersection LOS: E
Intersection Signal Delay: 63.1	ICU Level of Service G
Intersection Capacity Utilization 100.7%	
Analysis Period (min) 15	
~ Volume exceeds capacity, queue is theoretically infinite. Queue shown is maximum after two cycles.	
# 95th percentile volume exceeds capacity, queue may be longer. Queue shown is maximum after two cycles.	
m Volume for 95th percentile queue is metered by upstream signal.	

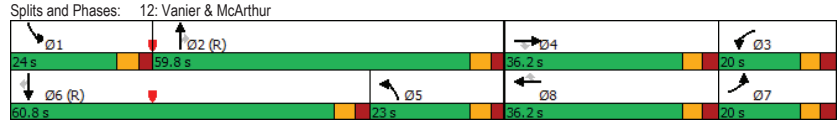

HCM 2010 TWSC
15: McArthur & Mayfield

2024 Future Background
PM Peak Hour

Intersection						
Int Delay, s/veh	0.2					
Movement	EBL	EBT	WBT	WBR	SBL	SBR
Lane Configurations		↑	↑		↓	↓
Traffic Vol, veh/h	0	535	378	0	8	8
Future Vol, veh/h	0	535	378	0	8	8
Conflicting Peds, #/hr	0	0	0	0	0	0
Sign Control	Free	Free	Free	Free	Stop	Stop
RT Channelized	-	None	-	None	-	None
Storage Length	-	-	-	-	0	0
Veh in Median Storage, #	-	0	0	-	0	-
Grade, %	-	0	0	-	0	-
Peak Hour Factor	100	100	100	100	100	100
Heavy Vehicles, %	2	2	2	2	2	2
Mvmt Flow	0	535	378	0	8	8

Major/Minor	Major1	Major2	Minor2			
Conflicting Flow All	-	0	-	913	378	
Stage 1	-	-	-	378	-	
Stage 2	-	-	-	535	-	
Critical Hdwy	-	-	-	6.42	6.22	
Critical Hdwy Stg 1	-	-	-	5.42	-	
Critical Hdwy Stg 2	-	-	-	5.42	-	
Follow-up Hdwy	-	-	-	3.518	3.318	
Pot Cap-1 Maneuver	0	-	-	0	304	669
Stage 1	0	-	-	0	693	-
Stage 2	0	-	-	0	587	-
Platoon blocked, %	-	-	-	-	-	-
Mov Cap-1 Maneuver	-	-	-	-	304	669
Mov Cap-2 Maneuver	-	-	-	-	304	-
Stage 1	-	-	-	-	693	-
Stage 2	-	-	-	-	587	-

Approach	EB	WB	SB
HCM Control Delay, s	0	0	13.8
HCM LOS			B

Minor Lane/Major Mvmt	EBT	WBT	SBLn1	SBLn2
Capacity (veh/h)	-	-	304	669
HCM Lane V/C Ratio	-	-	0.026	0.012
HCM Control Delay (s)	-	-	17.2	10.4
HCM Lane LOS	-	-	C	B
HCM 95th %tile Q(veh)	-	-	0.1	0

Appendix H

Synchro Intersection Worksheets – 2029 Future Background Conditions

Lanes, Volumes, Timings
1: North River & Montreal

2029 Future Background
AM Peak Hour

Lane Group	EBL	EBT	EBR	WBL	WBT	WBR	NBL	NBT	NBR	SBL	SBT	SBR
Lane Configurations		↑↑			↑↑		↑	↑			↑↓	
Traffic Volume (vph)	0	498	362	0	760	13	281	10	35	17	25	15
Future Volume (vph)	0	498	362	0	760	13	281	10	35	17	25	15
Satd. Flow (prot)	0	2937	0	0	3168	0	1595	1336	0	0	1518	0
Fit Permitted							0.950				0.985	
Satd. Flow (perm)	0	2937	0	0	3168	0	1581	1336	0	0	1499	0
Satd. Flow (RTOR)								35			15	
Lane Group Flow (vph)	0	860	0	0	773	0	281	45	0	0	57	0
Turn Type		NA			NA		Prot	NA		Split	NA	
Protected Phases		2			6		3!	8		7	7!	
Permitted Phases												
Detector Phase		2			6		3	8		7	7	
Switch Phase												
Minimum Initial (s)		10.0			10.0		5.0	10.0		10.0	10.0	
Minimum Split (s)		21.7			21.7		11.5	24.5		16.5	16.5	
Total Split (s)		29.0			29.0		24.0	49.0		17.0	17.0	
Total Split (%)		30.5%			30.5%		25.3%	51.6%		17.9%	17.9%	
Yellow Time (s)		3.0			3.0		3.3	3.3		3.3	3.3	
All-Red Time (s)		3.7			3.7		3.2	3.2		3.2	3.2	
Lost Time Adjust (s)		0.0			0.0		0.0	0.0		0.0	0.0	
Total Lost Time (s)		6.7			6.7		6.5	6.5		6.5	6.5	
Lead/Lag							Lag	Lag		Lead	Lead	
Lead-Lag Optimize?							Yes	Yes		Yes	Yes	
Recall Mode		C-Max			C-Max		None	Ped		None	None	
Act Effct Green (s)		33.3			33.3		24.0	35.2		10.1	10.1	
Actuated g/C Ratio		0.35			0.35		0.25	0.37		0.11	0.11	
v/c Ratio		0.84			0.70		0.70	0.09		0.33	0.33	
Control Delay		38.0			31.3		41.7	9.3		36.4	36.4	
Queue Delay		0.0			51.5		0.0	0.0		0.0	0.0	
Total Delay		38.0			82.8		41.7	9.3		36.4	36.4	
LOS		D			F		D	A		D	D	
Approach Delay		38.0			82.8			37.2		36.4	36.4	
Approach LOS		D			F			D		D	D	
Queue Length 50th (m)		76.0			63.8		46.4	1.2		7.2	7.2	
Queue Length 95th (m)		#118.3			89.7		70.4	8.0		18.7	18.7	
Internal Link Dist (m)		194.5			52.8			112.9		59.0	59.0	
Turn Bay Length (m)							90.0					
Base Capacity (vph)		1029			1109		403	620		181	181	
Starvation Cap Reductn		0			444		0	0		0	0	
Spillback Cap Reductn		0			0		0	0		0	0	
Storage Cap Reductn		0			0		0	0		0	0	
Reduced v/c Ratio		0.84			1.16		0.70	0.07		0.31	0.31	

Intersection Summary
 Cycle Length: 95
 Actuated Cycle Length: 95
 Offset: 0 (0%), Referenced to phase 2:EBT and 6:WBT, Start of Green
 Natural Cycle: 80
 Control Type: Actuated-Coordinated

Lanes, Volumes, Timings
1: North River & Montreal

2029 Future Background
AM Peak Hour

Lane Group	Ø4
Lane Configurations	
Traffic Volume (vph)	
Future Volume (vph)	
Satd. Flow (prot)	
Fit Permitted	
Satd. Flow (perm)	
Satd. Flow (RTOR)	
Lane Group Flow (vph)	
Turn Type	
Protected Phases	4
Permitted Phases	
Detector Phase	
Switch Phase	
Minimum Initial (s)	5.0
Minimum Split (s)	24.5
Total Split (s)	42.0
Total Split (%)	44%
Yellow Time (s)	3.3
All-Red Time (s)	3.2
Lost Time Adjust (s)	
Total Lost Time (s)	
Lead/Lag	Lead
Lead-Lag Optimize?	Yes
Recall Mode	Ped
Act Effct Green (s)	
Actuated g/C Ratio	
v/c Ratio	
Control Delay	
Queue Delay	
Total Delay	
LOS	
Approach Delay	
Approach LOS	
Queue Length 50th (m)	
Queue Length 95th (m)	
Internal Link Dist (m)	
Turn Bay Length (m)	
Base Capacity (vph)	
Starvation Cap Reductn	
Spillback Cap Reductn	
Storage Cap Reductn	
Reduced v/c Ratio	

Intersection Summary

Lanes, Volumes, Timings
1: North River & Montreal

2029 Future Background
AM Peak Hour

Maximum v/c Ratio: 0.84	Intersection LOS: E
Intersection Signal Delay: 55.0	ICU Level of Service B
Intersection Capacity Utilization 62.1%	
Analysis Period (min) 15	
# 95th percentile volume exceeds capacity, queue may be longer.	
Queue shown is maximum after two cycles.	
! Phase conflict between lane groups.	

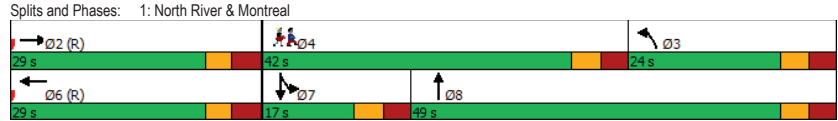

Lanes, Volumes, Timings
2: Montgomery & Montreal

2029 Future Background
AM Peak Hour

Lane Group	EBT	EBR	WBL	WBT	NBL	NBR
Lane Configurations	↔↔			↔↔	↔↔	↔↔
Traffic Volume (vph)	430	120	102	688	85	155
Future Volume (vph)	430	120	102	688	85	155
Satd. Flow (prot)	3102	0	0	3179	1658	1401
Fit Permitted				0.794	0.950	
Satd. Flow (perm)	3102	0	0	2535	1649	1379
Satd. Flow (RTOR)	84					155
Lane Group Flow (vph)	550	0	0	790	85	155
Turn Type	NA		Perm	NA	Perm	Perm
Protected Phases	2			6		
Permitted Phases			6		8	8
Detector Phase	2		6	6	8	8
Switch Phase						
Minimum Initial (s)	10.0		10.0	10.0	10.0	10.0
Minimum Split (s)	40.4		16.4	16.4	19.5	19.5
Total Split (s)	56.0		56.0	56.0	24.0	24.0
Total Split (%)	70.0%		70.0%	70.0%	30.0%	30.0%
Yellow Time (s)	3.0		3.0	3.0	3.3	3.3
All-Red Time (s)	3.4		3.4	3.4	2.2	2.2
Lost Time Adjust (s)	0.0		0.0	0.0	0.0	0.0
Total Lost Time (s)	6.4		6.4	6.4	5.5	5.5
Lead/Lag						
Lead-Lag Optimize?						
Recall Mode	C-Max		C-Max	C-Max	None	None
Act Effct Green (s)	57.1		57.1	11.0	11.0	11.0
Actuated g/C Ratio	0.71		0.71	0.14	0.14	0.14
v/c Ratio	0.25		0.44	0.38	0.48	0.48
Control Delay	3.8		5.9	36.0	10.9	10.9
Queue Delay	0.8		0.0	0.0	0.0	0.0
Total Delay	4.6		5.9	36.0	10.9	10.9
LOS	A		A	D	B	B
Approach Delay	4.6		5.9	19.8		
Approach LOS	A		A	B		
Queue Length 50th (m)	9.6		20.3	12.1	0.0	0.0
Queue Length 95th (m)	18.0		35.8	23.7	14.8	14.8
Internal Link Dist (m)	52.8		138.9	214.6		
Turn Bay Length (m)				35.0		
Base Capacity (vph)	2237		1809	381	438	438
Starvation Cap Reductn	1333		0	0	0	0
Spillback Cap Reductn	0		0	0	0	0
Storage Cap Reductn	0		0	0	0	0
Reduced v/c Ratio	0.61		0.44	0.22	0.35	0.35

Intersection Summary	
Cycle Length: 80	
Actuated Cycle Length: 80	
Offset: 0 (0%), Referenced to phase 2:EBT and 6:WBTL, Start of Green	
Natural Cycle: 60	
Control Type: Actuated-Coordinated	

Lanes, Volumes, Timings
2: Montgomery & Montreal

2029 Future Background
AM Peak Hour

Maximum v/c Ratio: 0.48	Intersection LOS: A
Intersection Signal Delay: 7.5	ICU Level of Service D
Intersection Capacity Utilization 73.7%	
Analysis Period (min) 15	

Splits and Phases: 2: Montgomery & Montreal

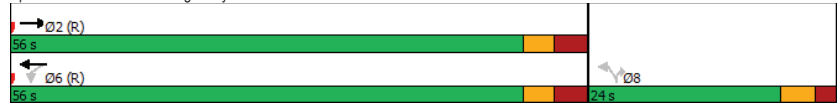

Lanes, Volumes, Timings
4: Vanier & Montreal

2029 Future Background
AM Peak Hour

Lane Group	EBL	EBT	EBR	WBL	WBT	WBR	NBL	NBT	NBR	SBL	SBT	SBR
Lane Configurations	↔	↕	↔	↔	↕	↔	↔	↕	↔	↔	↕	↔
Traffic Volume (vph)	50	370	147	165	514	194	180	901	166	213	1152	147
Future Volume (vph)	50	370	147	165	514	194	180	901	166	213	1152	147
Satd. Flow (prot)	1642	1695	1483	1658	3031	0	1642	4581	0	1642	4648	0
Fit Permitted	0.950			0.950			0.950			0.950		
Satd. Flow (perm)	1595	1695	1385	1604	3031	0	1627	4581	0	1611	4648	0
Satd. Flow (RTOR)			147		37			27			17	
Lane Group Flow (vph)	50	370	147	165	708	0	180	1067	0	213	1299	0
Turn Type	Prot	NA	Perm	Prot	NA		Prot	NA		Prot	NA	
Protected Phases	7	4		3	8		5	2		1	6	
Permitted Phases			4									
Detector Phase	7	4	4	3	8		5	2		1	6	
Switch Phase												
Minimum Initial (s)	5.0	10.0	10.0	5.0	10.0		5.0	10.0		5.0	10.0	
Minimum Split (s)	12.1	40.1	40.1	12.1	40.1		11.1	28.9		11.1	28.9	
Total Split (s)	20.0	41.0	41.0	20.0	41.0		30.0	49.0		30.0	49.0	
Total Split (%)	14.3%	29.3%	29.3%	14.3%	29.3%		21.4%	35.0%		21.4%	35.0%	
Yellow Time (s)	3.0	3.0	3.0	3.0	3.0		3.7	3.7		3.7	3.7	
All-Red Time (s)	4.1	4.1	4.1	4.1	4.1		2.4	2.2		2.4	2.2	
Lost Time Adjust (s)	0.0	0.0	0.0	0.0	0.0		0.0	0.0		0.0	0.0	
Total Lost Time (s)	7.1	7.1	7.1	7.1	7.1		6.1	5.9		6.1	5.9	
Lead/Lag	Lead	Lag	Lag	Lead	Lag		Lead	Lag		Lead	Lag	
Lead-Lag Optimize?	Yes	Yes	Yes	Yes	Yes		Yes	Yes		Yes	Yes	
Recall Mode	None	Max	Max	None	Max		None	C-Max		None	C-Max	
Act Effct Green (s)	9.5	33.9	33.9	12.9	39.9		19.7	45.4		21.6	47.3	
Actuated g/C Ratio	0.07	0.24	0.24	0.09	0.28		0.14	0.32		0.15	0.34	
v/c Ratio	0.45	0.90	0.33	1.09	0.80		0.78	0.71		0.84	0.82	
Control Delay	74.6	77.3	8.4	155.2	52.5		88.1	45.0		84.5	47.7	
Queue Delay	0.0	0.0	0.0	0.0	0.0		0.0	0.0		0.0	0.0	
Total Delay	74.6	77.3	8.4	155.2	52.5		88.1	45.0		84.5	47.7	
LOS	E	E	A	F	D		F	D		F	D	
Approach Delay		59.2			71.9			51.3			52.9	
Approach LOS		E			E			D			D	
Queue Length 50th (m)	13.6	100.0	0.0	-50.9	93.8		51.8	63.9		57.0	120.2	
Queue Length 95th (m)	26.6	#156.1	17.0	#96.9	#133.8		m70.1	81.8		#93.0	144.7	
Internal Link Dist (m)		99.5			262.7			154.6			239.2	
Turn Bay Length (m)	30.0			35.0			94.5			90.0		
Base Capacity (vph)	151	410	446	152	889		280	1503		280	1580	
Starvation Cap Reductn	0	0	0	0	0		0	0		0	0	
Spillback Cap Reductn	0	0	0	0	0		0	0		0	0	
Storage Cap Reductn	0	0	0	0	0		0	0		0	0	
Reduced v/c Ratio	0.33	0.90	0.33	1.09	0.80		0.64	0.71		0.76	0.82	

Intersection Summary

Cycle Length: 140
Actuated Cycle Length: 140
Offset: 102 (73%), Referenced to phase 2:NBT and 6:SBT, Start of Green
Natural Cycle: 115
Control Type: Actuated-Coordinated

Lanes, Volumes, Timings
4: Vanier & Montreal

2029 Future Background
AM Peak Hour

Maximum v/c Ratio: 1.09	Intersection LOS: E
Intersection Signal Delay: 57.2	ICU Level of Service F
Intersection Capacity Utilization 96.8%	
Analysis Period (min) 15	
~ Volume exceeds capacity, queue is theoretically infinite. Queue shown is maximum after two cycles.	
# 95th percentile volume exceeds capacity, queue may be longer. Queue shown is maximum after two cycles.	
m Volume for 95th percentile queue is metered by upstream signal.	

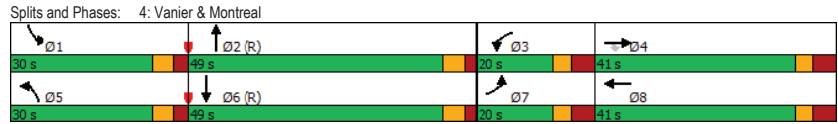

HCM 2010 TWSC
6: North River & Selkirk

2029 Future Background
AM Peak Hour

Intersection						
Int Delay, s/veh	1.6					
Movement	WBL	WBR	NBT	NBR	SBL	SBT
Lane Configurations	↔	↔	↑	↔	↔	↔
Traffic Vol, veh/h	36	70	275	0	0	397
Future Vol, veh/h	36	70	275	0	0	397
Conflicting Peds, #/hr	3	0	0	90	90	0
Sign Control	Stop	Stop	Free	Free	Free	Free
RT Channelized	-	None	-	None	-	None
Storage Length	0	-	-	-	-	-
Veh in Median Storage, #	0	-	0	-	-	0
Grade, %	0	-	0	-	-	0
Peak Hour Factor	100	100	100	100	100	100
Heavy Vehicles, %	7	2	8	2	2	2
Mvmt Flow	36	70	275	0	0	397
Major/Minor	Minor1	Major1	Major2			
Conflicting Flow All	477	275	0	-	-	-
Stage 1	275	-	-	-	-	-
Stage 2	202	-	-	-	-	-
Critical Hdwy	6.705	6.23	-	-	-	-
Critical Hdwy Stg 1	5.505	-	-	-	-	-
Critical Hdwy Stg 2	5.905	-	-	-	-	-
Follow-up Hdwy	3.5665	3.319	-	-	-	-
Pot Cap-1 Maneuver	521	763	-	0	0	-
Stage 1	757	-	-	0	0	-
Stage 2	800	-	-	0	0	-
Platoon blocked, %	-	-	-	-	-	-
Mov Cap-1 Maneuver	520	763	-	-	-	-
Mov Cap-2 Maneuver	520	-	-	-	-	-
Stage 1	757	-	-	-	-	-
Stage 2	798	-	-	-	-	-
Approach	WB	NB	SB			
HCM Control Delay, s	11.5	0	0			
HCM LOS	B					
Minor Lane/Major Mvmt	NBTWBLn1	SBT				
Capacity (veh/h)	-	658	-			
HCM Lane V/C Ratio	-	0.161	-			
HCM Control Delay (s)	-	11.5	-			
HCM Lane LOS	-	B	-			
HCM 95th %tile Q(veh)	-	0.6	-			

HCM 2010 TWSC
7: Dundas & Selkirk

2029 Future Background
AM Peak Hour

Intersection						
Int Delay, s/veh	0					
Movement	EBT	EBR	WBL	WBT	NBL	NBR
Lane Configurations				↕	↕	
Traffic Vol, veh/h	0	0	39	85	19	84
Future Vol, veh/h	0	0	39	85	19	84
Conflicting Peds, #/hr	0	0	0	0	0	0
Sign Control	Free	Free	Free	Free	Stop	Stop
RT Channelized	-	None	-	None	-	None
Storage Length	-	-	-	-	0	-
Veh in Median Storage, #	-	-	-	-	0	-
Grade, %	0	-	-	0	0	-
Peak Hour Factor	100	100	100	100	100	100
Heavy Vehicles, %	2	2	2	2	2	2
Mvmt Flow	0	0	39	85	19	84

Major/Minor	Major2	Minor1	
Conflicting Flow All	0	163	0
Stage 1	-	0	-
Stage 2	-	163	-
Critical Hdwy	4.12	6.42	6.22
Critical Hdwy Stg 1	-	-	-
Critical Hdwy Stg 2	-	5.42	-
Follow-up Hdwy	2.218	3.518	3.318
Pot Cap-1 Maneuver	-	828	-
Stage 1	-	-	-
Stage 2	-	866	-
Platoon blocked, %	-	-	-
Mov Cap-1 Maneuver	-	828	-
Mov Cap-2 Maneuver	-	828	-
Stage 1	-	-	-
Stage 2	-	866	-

Approach	WB	NB
HCM Control Delay, s		
HCM LOS		

Minor Lane/Major Mvmt	NBLn1	WBL	WBT
Capacity (veh/h)	-	-	-
HCM Lane V/C Ratio	-	-	-
HCM Control Delay (s)	-	-	-
HCM Lane LOS	-	-	-
HCM 95th %tile Q(veh)	-	-	-

HCM 2010 TWSC
8: Montgomery & Selkirk

2029 Future Background
AM Peak Hour

Intersection												
Int Delay, s/veh	5.3											
Movement	EBL	EBT	EBR	WBL	WBT	WBR	NBL	NBT	NBR	SBL	SBT	SBR
Lane Configurations		↕			↕			↕			↕	
Traffic Vol, veh/h	64	15	5	15	29	32	5	5	0	10	56	90
Future Vol, veh/h	64	15	5	15	29	32	5	5	0	10	56	90
Conflicting Peds, #/hr	0	0	0	0	0	0	0	0	0	0	0	0
Sign Control	Stop	Stop	Stop	Stop	Stop	Stop	Free	Free	Free	Free	Free	Free
RT Channelized	-	-	None	-	-	None	-	-	None	-	-	None
Storage Length	-	-	-	-	-	-	-	-	-	-	-	-
Veh in Median Storage, #	-	0	-	-	0	-	-	0	-	-	0	-
Grade, %	-	0	-	-	0	-	-	0	-	-	0	-
Peak Hour Factor	100	100	100	100	100	100	100	100	100	100	100	100
Heavy Vehicles, %	2	2	2	2	2	2	2	2	2	2	2	2
Mvmt Flow	64	15	5	15	29	32	5	5	0	10	56	90

Major/Minor	Minor2	Minor1	Major1	Major2								
Conflicting Flow All	167	136	101	146	181	5	146	0	0	5	0	0
Stage 1	121	121	-	15	15	-	-	-	-	-	-	-
Stage 2	46	15	-	131	166	-	-	-	-	-	-	-
Critical Hdwy	7.12	6.52	6.22	7.12	6.52	6.22	4.12	-	-	4.12	-	-
Critical Hdwy Stg 1	6.12	5.52	-	6.12	5.52	-	-	-	-	-	-	-
Critical Hdwy Stg 2	6.12	5.52	-	6.12	5.52	-	-	-	-	-	-	-
Follow-up Hdwy	3.518	4.018	3.318	3.518	4.018	3.318	2.218	-	-	2.218	-	-
Pot Cap-1 Maneuver	797	755	954	823	713	1078	1436	-	-	1616	-	-
Stage 1	883	796	-	1005	883	-	-	-	-	-	-	-
Stage 2	968	883	-	873	761	-	-	-	-	-	-	-
Platoon blocked, %	-	-	-	-	-	-	-	-	-	-	-	-
Mov Cap-1 Maneuver	744	747	954	800	706	1078	1436	-	-	1616	-	-
Mov Cap-2 Maneuver	744	747	-	800	706	-	-	-	-	-	-	-
Stage 1	880	790	-	1002	880	-	-	-	-	-	-	-
Stage 2	906	880	-	846	756	-	-	-	-	-	-	-

Approach	EB	WB	NB	SB
HCM Control Delay, s	10.4	9.7	3.8	0.5
HCM LOS	B	A		

Minor Lane/Major Mvmt	NBL	NBT	NBR	EBLn1	WBLn1	SBL	SBT	SBR
Capacity (veh/h)	1436	-	-	754	849	1616	-	-
HCM Lane V/C Ratio	0.003	-	-	0.111	0.09	0.006	-	-
HCM Control Delay (s)	7.5	0	-	10.4	9.7	7.2	0	-
HCM Lane LOS	A	A	-	B	A	A	A	-
HCM 95th %tile Q(veh)	0	-	-	0.4	0.3	0	-	-

Lanes, Volumes, Timings
9: North River & McArthur

2029 Future Background
AM Peak Hour

Lane Group	EBL	EBT	EBR	WBL	WBT	WBR	NBL	NBT	NBR	SBL	SBT	SBR
Lane Configurations		↔			↔	↔		↔		↔	↔	
Traffic Volume (vph)	1	6	3	10	9	165	3	116	30	331	98	4
Future Volume (vph)	1	6	3	10	9	165	3	116	30	331	98	4
Satd. Flow (prot)	0	1652	0	0	1700	1441	0	1623	0	1658	1685	0
Fit Permitted		0.988			0.912			0.997		0.662		
Satd. Flow (perm)	0	1633	0	0	1587	1341	0	1620	0	1053	1685	0
Satd. Flow (RTOR)		3			165			27		4		
Lane Group Flow (vph)	0	10	0	0	19	165	0	149	0	331	102	0
Turn Type	Perm	NA		Perm	NA	Perm	Perm	NA		Perm	NA	
Protected Phases		4			8			2			6	
Permitted Phases	4			8		8	2			6		
Detector Phase	4	4		8	8	8	2	2		6	6	
Switch Phase												
Minimum Initial (s)	10.0	10.0		10.0	10.0	10.0	10.0	10.0		10.0	10.0	
Minimum Split (s)	25.6	25.6		25.6	25.6	25.6	31.1	31.1		31.1	31.1	
Total Split (s)	28.0	28.0		28.0	28.0	28.0	42.0	42.0		42.0	42.0	
Total Split (%)	40.0%	40.0%		40.0%	40.0%	40.0%	60.0%	60.0%		60.0%	60.0%	
Yellow Time (s)	3.3	3.3		3.3	3.3	3.3	3.3	3.3		3.3	3.3	
All-Red Time (s)	2.3	2.3		2.3	2.3	2.3	2.8	2.8		2.8	2.8	
Lost Time Adjust (s)		0.0			0.0	0.0		0.0		0.0	0.0	
Total Lost Time (s)		5.6			5.6	5.6		6.1		6.1	6.1	
Lead/Lag												
Lead-Lag Optimize?												
Recall Mode	Max	Max		Max	Max	Max	C-Max	C-Max		C-Max	C-Max	
Act Effct Green (s)		22.4			22.4	22.4		35.9		35.9	35.9	
Actuated g/C Ratio		0.32			0.32	0.32		0.51		0.51	0.51	
v/c Ratio		0.02			0.04	0.30		0.18		0.61	0.12	
Control Delay		14.4			11.5	8.1		8.1		18.2	9.0	
Queue Delay		0.0			0.0	0.0		0.0		0.0	0.0	
Total Delay		14.4			11.5	8.1		8.1		18.2	9.0	
LOS		B			B	A		A		B	A	
Approach Delay		14.4			8.4			8.1			16.1	
Approach LOS		B			A			A			B	
Queue Length 50th (m)		0.6			1.7	12.4		7.8		28.7	6.2	
Queue Length 95th (m)		3.5			5.8	22.8		16.5		54.6	13.1	
Internal Link Dist (m)		22.5			128.8			367.7			94.3	
Turn Bay Length (m)						60.0				55.0		
Base Capacity (vph)		524			507	541		843		540	866	
Starvation Cap Reductn		0			0	0		0		0	0	
Spillback Cap Reductn		0			0	0		0		0	0	
Storage Cap Reductn		0			0	0		0		0	0	
Reduced v/c Ratio		0.02			0.04	0.30		0.18		0.61	0.12	

Intersection Summary	
Cycle Length:	70
Actuated Cycle Length:	70
Offset:	0 (0%), Referenced to phase 2:NBTL and 6:SBTL, Start of Green
Natural Cycle:	60
Control Type:	Actuated-Coordinated

Lanes, Volumes, Timings
9: North River & McArthur

2029 Future Background
AM Peak Hour

Maximum v/c Ratio: 0.61	Intersection LOS: B
Intersection Signal Delay: 12.7	ICU Level of Service D
Intersection Capacity Utilization 73.2%	
Analysis Period (min) 15	

Splits and Phases: 9: North River & McArthur

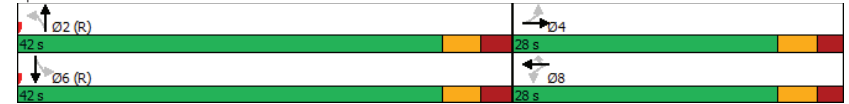

Intersection						
Int Delay, s/veh	0.6					
Movement	EBL	EBT	WBT	WBR	SBL	SBR
Lane Configurations		↗	↗		↘	↘
Traffic Vol, veh/h	11	370	318	106	10	16
Future Vol, veh/h	11	370	318	106	10	16
Conflicting Peds, #/hr	100	0	0	100	1	9
Sign Control	Free	Free	Free	Free	Stop	Stop
RT Channelized	-	None	-	None	-	None
Storage Length	-	-	-	-	0	-
Veh in Median Storage, #	-	0	0	-	0	-
Grade, %	-	0	0	-	0	-
Peak Hour Factor	100	100	100	100	100	100
Heavy Vehicles, %	10	2	5	3	2	2
Mvmt Flow	11	370	318	106	10	16
Major/Minor	Major1	Major2	Minor2			
Conflicting Flow All	524	0	0	864	480	
Stage 1	-	-	-	471	-	
Stage 2	-	-	-	393	-	
Critical Hdwy	4.2	-	-	6.42	6.22	
Critical Hdwy Stg 1	-	-	-	5.42	-	
Critical Hdwy Stg 2	-	-	-	5.42	-	
Follow-up Hdwy	2.29	-	-	3.518	3.318	
Pot Cap-1 Maneuver	1003	-	-	325	586	
Stage 1	-	-	-	628	-	
Stage 2	-	-	-	682	-	
Platoon blocked, %	-	-	-	-	-	
Mov Cap-1 Maneuver	925	-	-	272	537	
Mov Cap-2 Maneuver	-	-	-	272	-	
Stage 1	-	-	-	570	-	
Stage 2	-	-	-	629	-	
Approach	EB	WB	SB			
HCM Control Delay, s	0.3	0	14.9			
HCM LOS			B			
Minor Lane/Major Mvmt	EBL	EBT	WBT	WBR	SBLn1	
Capacity (veh/h)	925	-	-	-	391	
HCM Lane V/C Ratio	0.012	-	-	-	0.066	
HCM Control Delay (s)	8.9	0	-	-	14.9	
HCM Lane LOS	A	A	-	-	B	
HCM 95th %tile Q(veh)	0	-	-	-	0.2	

Lane Group	EBT	EBR	WBL	WBT	NBL	NBR
Lane Configurations	↗			↗	↘	↘
Traffic Volume (vph)	369	19	46	422	9	31
Future Volume (vph)	369	19	46	422	9	31
Satd. Flow (prot)	1728	0	0	1736	1658	1483
Fit Permitted				0.938	0.950	
Satd. Flow (perm)	1728	0	0	1634	1551	1426
Satd. Flow (RTOR)	6					31
Lane Group Flow (vph)	388	0	0	468	9	31
Turn Type	NA		Perm	NA	Prot	Perm
Protected Phases	2			6	8	
Permitted Phases			6			8
Detector Phase	2		6	6	8	8
Switch Phase						
Minimum Initial (s)	10.0		10.0	10.0	5.0	5.0
Minimum Split (s)	27.5		15.5	15.5	24.5	24.5
Total Split (s)	45.0		45.0	45.0	25.0	25.0
Total Split (%)	64.3%		64.3%	64.3%	35.7%	35.7%
Yellow Time (s)	3.3		3.3	3.3	3.3	3.3
All-Red Time (s)	2.2		2.2	2.2	2.2	2.2
Lost Time Adjust (s)	0.0		0.0	0.0	0.0	0.0
Total Lost Time (s)	5.5		5.5	5.5	5.5	5.5
Lead/Lag						
Lead-Lag Optimize?						
Recall Mode	C-Max		C-Max	C-Max	None	None
Act Effct Green (s)	54.6		54.6	11.1	11.1	11.1
Actuated g/C Ratio	0.78		0.78	0.16	0.16	0.16
v/c Ratio	0.29		0.37	0.03	0.12	0.12
Control Delay	4.1		7.7	20.6	8.9	8.9
Queue Delay	0.0		0.0	0.0	0.0	0.0
Total Delay	4.1		7.7	20.6	8.9	8.9
LOS	A		A	C	A	A
Approach Delay	4.1		7.7	11.5		
Approach LOS	A		A	B		
Queue Length 50th (m)	9.5		40.1	1.1	0.0	0.0
Queue Length 95th (m)	23.0		m50.0	3.9	5.5	5.5
Internal Link Dist (m)	36.3		7.3	144.2		
Turn Bay Length (m)				20.0		
Base Capacity (vph)	1349		1274	461	419	
Starvation Cap Reductn	0		0	0	0	
Spillback Cap Reductn	0		0	0	0	
Storage Cap Reductn	0		0	0	0	
Reduced v/c Ratio	0.29		0.37	0.02	0.07	

Intersection Summary	
Cycle Length:	70
Actuated Cycle Length:	70
Offset:	0 (0%), Referenced to phase 2:EBT and 6:WBTL, Start of Green
Natural Cycle:	55
Control Type:	Actuated-Coordinated

Lanes, Volumes, Timings
11: Marguerite & McArthur

2029 Future Background
AM Peak Hour

Maximum v/c Ratio: 0.37	Intersection LOS: A
Intersection Signal Delay: 6.3	ICU Level of Service C
Intersection Capacity Utilization 68.9%	
Analysis Period (min) 15	

m Volume for 95th percentile queue is metered by upstream signal.

Splits and Phases: 11: Marguerite & McArthur



Lanes, Volumes, Timings
12: Vanier & McArthur

2029 Future Background
AM Peak Hour

Lane Group	EBL	EBT	EBR	WBL	WBT	WBR	NBL	NBT	NBR	SBL	SBT	SBR
Lane Configurations	↔	↕	↔	↔	↕	↔	↔	↕	↔	↕	↔	↔
Traffic Volume (vph)	34	157	307	209	206	104	231	1097	225	140	1282	60
Future Volume (vph)	34	157	307	209	206	104	231	1097	225	140	1282	60
Satd. Flow (prot)	1551	1695	1483	3216	1695	1483	1658	3316	1483	1658	3316	1441
Fit Permitted	0.950			0.950			0.950			0.950		
Satd. Flow (perm)	1437	1695	1398	3097	1695	1320	1644	3316	1407	1643	3316	1342
Satd. Flow (RTOR)			250			168			209			121
Lane Group Flow (vph)	34	157	307	209	206	104	231	1097	225	140	1282	60
Turn Type	Prot	NA	Perm	Prot	NA	Perm	Prot	NA	Perm	Prot	NA	Perm
Protected Phases	7	4		3	8		5	2		1	6	
Permitted Phases			4			8			2			6
Detector Phase	7	4	4	3	8	8	5	2	2	1	6	6
Switch Phase												
Minimum Initial (s)	5.0	10.0	10.0	5.0	10.0	10.0	5.0	10.0	10.0	5.0	10.0	10.0
Minimum Split (s)	11.2	36.2	36.2	11.2	36.2	36.2	11.1	36.1	36.1	11.1	36.1	36.1
Total Split (s)	20.0	36.2	36.2	20.0	36.2	36.2	23.0	59.8	59.8	24.0	60.8	60.8
Total Split (%)	14.3%	25.9%	25.9%	14.3%	25.9%	25.9%	16.4%	42.7%	42.7%	17.1%	43.4%	43.4%
Yellow Time (s)	3.3	3.3	3.3	3.3	3.3	3.3	3.7	3.7	3.7	3.7	3.7	3.7
All-Red Time (s)	2.9	2.9	2.9	2.9	2.9	2.9	2.4	2.4	2.4	2.4	2.4	2.4
Lost Time Adjust (s)	0.0	0.0	0.0	0.0	0.0	0.0	0.0	0.0	0.0	0.0	0.0	0.0
Total Lost Time (s)	6.2	6.2	6.2	6.2	6.2	6.2	6.1	6.1	6.1	6.1	6.1	6.1
Lead/Lag	Lag	Lead	Lead	Lag	Lead	Lead	Lag	Lag	Lag	Lead	Lead	Lead
Lead-Lag Optimize?	Yes	Yes	Yes	Yes	Yes	Yes	Yes	Yes	Yes	Yes	Yes	Yes
Recall Mode	None	None	None	None	None	None	C-Max	C-Max	None	C-Max	C-Max	C-Max
Act Effct Green (s)	10.8	26.3	26.3	12.9	33.4	33.4	16.9	60.5	60.5	15.7	59.3	59.3
Actuated g/C Ratio	0.08	0.19	0.19	0.09	0.24	0.24	0.12	0.43	0.43	0.11	0.42	0.42
v/c Ratio	0.29	0.49	0.66	0.71	0.51	0.24	1.16	0.77	0.31	0.76	0.91	0.09
Control Delay	65.9	48.1	18.4	75.0	52.2	1.4	164.3	40.1	5.8	83.7	74.0	14.7
Queue Delay	0.0	0.0	0.0	0.0	0.0	0.0	0.0	0.0	0.0	0.0	0.0	0.0
Total Delay	65.9	48.1	18.4	75.0	52.2	1.4	164.3	40.1	5.8	83.7	74.0	14.7
LOS	E	D	B	E	D	A	F	D	A	F	E	B
Approach Delay		31.0			51.2			53.6			72.5	
Approach LOS		C			D			D			E	
Queue Length 50th (m)	9.7	31.3	17.4	29.2	51.5	0.0	~75.2	145.0	2.7	41.0	177.8	2.8
Queue Length 95th (m)	21.7	51.3	35.3	42.8	77.8	0.5	#127.5	175.7	19.8	m50.0 m#224.2	m5.7	
Internal Link Dist (m)		122.9			141.8			130.7		202.5		
Turn Bay Length (m)	30.0		50.0	120.0		115.0	90.0		90.0	90.0		90.0
Base Capacity (vph)	152	363	496	317	409	445	200	1432	726	211	1403	638
Starvation Cap Reductn	0	0	0	0	0	0	0	0	0	0	0	0
Spillback Cap Reductn	0	0	0	0	0	0	0	0	0	0	0	0
Storage Cap Reductn	0	0	0	0	0	0	0	0	0	0	0	0
Reduced v/c Ratio	0.22	0.43	0.62	0.66	0.50	0.23	1.16	0.77	0.31	0.66	0.91	0.09

Intersection Summary

Cycle Length: 140
Actuated Cycle Length: 140
Offset: 100 (71%), Referenced to phase 2:NBT and 6:SBT, Start of Green
Natural Cycle: 135
Control Type: Actuated-Coordinated

Lanes, Volumes, Timings
12: Vanier & McArthur

2029 Future Background
AM Peak Hour

Maximum v/c Ratio: 1.16	Intersection LOS: E
Intersection Signal Delay: 57.4	ICU Level of Service F
Intersection Capacity Utilization 99.3%	
Analysis Period (min) 15	
~ Volume exceeds capacity, queue is theoretically infinite. Queue shown is maximum after two cycles.	
# 95th percentile volume exceeds capacity, queue may be longer. Queue shown is maximum after two cycles.	
m Volume for 95th percentile queue is metered by upstream signal.	

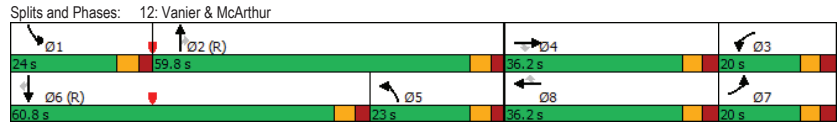

HCM 2010 TWSC
15: McArthur & Mayfield

2029 Future Background
AM Peak Hour

Intersection						
Int Delay, s/veh	0.9					
Movement	EBL	EBT	WBT	WBR	SBL	SBR
Lane Configurations		↑	↑		↓	↓
Traffic Vol, veh/h	0	400	467	0	45	4
Future Vol, veh/h	0	400	467	0	45	4
Conflicting Peds, #/hr	0	0	0	0	0	0
Sign Control	Free	Free	Free	Free	Stop	Stop
RT Channelized	-	None	-	None	-	None
Storage Length	-	-	-	-	0	0
Veh in Median Storage, #	-	0	0	-	0	-
Grade, %	-	0	0	-	0	-
Peak Hour Factor	100	100	100	100	100	100
Heavy Vehicles, %	2	2	2	2	2	2
Mvmt Flow	0	400	467	0	45	4

Major/Minor	Major1	Major2	Minor2
Conflicting Flow All	-	0	867
Stage 1	-	-	467
Stage 2	-	-	400
Critical Hdwy	-	-	6.42
Critical Hdwy Stg 1	-	-	5.42
Critical Hdwy Stg 2	-	-	5.42
Follow-up Hdwy	-	-	3.518
Pot Cap-1 Maneuver	0	-	323
Stage 1	0	-	631
Stage 2	0	-	677
Platoon blocked, %	-	-	-
Mov Cap-1 Maneuver	-	-	323
Mov Cap-2 Maneuver	-	-	323
Stage 1	-	-	631
Stage 2	-	-	677

Approach	EB	WB	SB
HCM Control Delay, s	0	0	17.3
HCM LOS			C

Minor Lane/Major Mvmt	EBT	WBT	SBLn1	SBLn2
Capacity (veh/h)	-	-	323	596
HCM Lane V/C Ratio	-	-	0.139	0.007
HCM Control Delay (s)	-	-	17.9	11.1
HCM Lane LOS	-	-	C	B
HCM 95th %tile Q(veh)	-	-	0.5	0

Lanes, Volumes, Timings
1: North River & Montreal

2029 Future Background
PM Peak Hour

Lane Group	EBL	EBT	EBR	WBL	WBT	WBR	NBL	NBT	NBR	SBL	SBT	SBR
Lane Configurations		↑↑			↑↑		↑	↑			↑↓	
Traffic Volume (vph)	0	676	410	0	719	18	377	17	32	21	15	21
Future Volume (vph)	0	676	410	0	719	18	377	17	32	21	15	21
Satd. Flow (prot)	0	2941	0	0	3243	0	1658	1486	0	0	1506	0
Fit Permitted							0.950				0.982	
Satd. Flow (perm)	0	2941	0	0	3243	0	1634	1486	0	0	1473	0
Satd. Flow (RTOR)		104						32			19	
Lane Group Flow (vph)	0	1086	0	0	737	0	377	49	0	0	57	0
Turn Type		NA			NA		Prot	NA		Split	NA	
Protected Phases		2			6		3!	8		7	7!	
Permitted Phases												
Detector Phase		2			6		3	8		7	7	
Switch Phase												
Minimum Initial (s)		10.0			10.0		5.0	10.0		10.0	10.0	
Minimum Split (s)		21.7			21.7		11.5	24.5		16.5	16.5	
Total Split (s)		39.0			39.0		39.0	64.0		17.0	17.0	
Total Split (%)		32.5%			32.5%		32.5%	53.3%		14.2%	14.2%	
Yellow Time (s)		3.0			3.0		3.3	3.3		3.3	3.3	
All-Red Time (s)		3.7			3.7		3.2	3.2		3.2	3.2	
Lost Time Adjust (s)		0.0			0.0		0.0	0.0		0.0	0.0	
Total Lost Time (s)		6.7			6.7		6.5	6.5		6.5	6.5	
Lead/Lag							Lag	Lag		Lead	Lead	
Lead-Lag Optimize?							Yes	Yes		Yes	Yes	
Recall Mode		C-Max			C-Max		None	Ped		None	None	
Act Effct Green (s)		49.7			49.7		32.6	43.8		10.1	10.1	
Actuated g/C Ratio		0.41			0.41		0.27	0.36		0.08	0.08	
v/c Ratio		0.85			0.55		0.84	0.09		0.40	0.40	
Control Delay		37.2			29.7		57.5	12.0		45.7	45.7	
Queue Delay		0.0			52.2		0.0	0.0		0.0	0.0	
Total Delay		37.2			81.9		57.5	12.0		45.7	45.7	
LOS		D			F		E	B		D	D	
Approach Delay		37.2			81.9		52.2	12.0		45.7	45.7	
Approach LOS		D			F		D	D		D	D	
Queue Length 50th (m)		111.2			68.8		83.3	2.6		8.6	8.6	
Queue Length 95th (m)		#169.7			96.6		111.3	10.2		21.9	21.9	
Internal Link Dist (m)		179.1			52.8			112.9		59.0	59.0	
Turn Bay Length (m)							90.0					
Base Capacity (vph)		1278			1343		482	728		149	149	
Starvation Cap Reductn		0			686		0	0		0	0	
Spillback Cap Reductn		0			0		0	0		0	0	
Storage Cap Reductn		0			0		0	0		0	0	
Reduced v/c Ratio		0.85			1.12		0.78	0.07		0.38	0.38	

Intersection Summary	
Cycle Length:	120
Actuated Cycle Length:	120
Offset:	0 (0%), Referenced to phase 2:EBT and 6:WBT, Start of Green
Natural Cycle:	90
Control Type:	Actuated-Coordinated

Lanes, Volumes, Timings
1: North River & Montreal

2029 Future Background
PM Peak Hour

Lane Group	Ø4
Lane Configurations	
Traffic Volume (vph)	
Future Volume (vph)	
Satd. Flow (prot)	
Fit Permitted	
Satd. Flow (perm)	
Satd. Flow (RTOR)	
Lane Group Flow (vph)	
Turn Type	
Protected Phases	4
Permitted Phases	
Detector Phase	
Switch Phase	
Minimum Initial (s)	5.0
Minimum Split (s)	24.5
Total Split (s)	42.0
Total Split (%)	35%
Yellow Time (s)	3.3
All-Red Time (s)	3.2
Lost Time Adjust (s)	
Total Lost Time (s)	
Lead/Lag	Lead
Lead-Lag Optimize?	Yes
Recall Mode	Ped
Act Effct Green (s)	10.1
Actuated g/C Ratio	
v/c Ratio	
Control Delay	
Queue Delay	
Total Delay	
LOS	
Approach Delay	
Approach LOS	
Queue Length 50th (m)	
Queue Length 95th (m)	
Internal Link Dist (m)	
Turn Bay Length (m)	
Base Capacity (vph)	
Starvation Cap Reductn	
Spillback Cap Reductn	
Storage Cap Reductn	
Reduced v/c Ratio	

Intersection Summary	
Cycle Length:	
Actuated Cycle Length:	
Offset:	
Natural Cycle:	
Control Type:	

Lanes, Volumes, Timings
1: North River & Montreal

2029 Future Background
PM Peak Hour

Maximum v/c Ratio: 0.85
 Intersection Signal Delay: 54.5 Intersection LOS: D
 Intersection Capacity Utilization 74.6% ICU Level of Service D
 Analysis Period (min) 15
 # 95th percentile volume exceeds capacity, queue may be longer.
 Queue shown is maximum after two cycles.
 ! Phase conflict between lane groups.

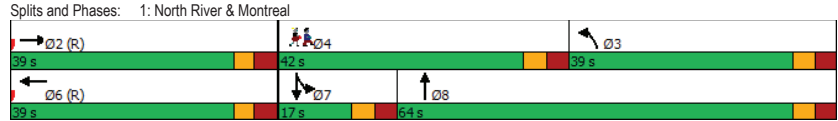

Lanes, Volumes, Timings
2: Montgomery & Montreal

2029 Future Background
PM Peak Hour

Lane Group	EBT	EBR	WBL	WBT	NBL	NBR
Lane Configurations	↕↕			↕↕	↕	↕
Traffic Volume (vph)	551	178	191	570	172	142
Future Volume (vph)	551	178	191	570	172	142
Satd. Flow (prot)	3132	0	0	3236	1658	1401
Fit Permitted				0.631	0.950	
Satd. Flow (perm)	3132	0	0	2061	1647	1314
Satd. Flow (RTOR)	105					142
Lane Group Flow (vph)	729	0	0	761	172	142
Turn Type	NA		Perm	NA	Prot	Perm
Protected Phases	2			6	8	
Permitted Phases			6			8
Detector Phase	2		6	6	8	8
Switch Phase						
Minimum Initial (s)	10.0		10.0	10.0	10.0	10.0
Minimum Split (s)	39.9		15.9	15.9	19.5	19.5
Total Split (s)	76.0		76.0	76.0	24.0	24.0
Total Split (%)	76.0%		76.0%	76.0%	24.0%	24.0%
Yellow Time (s)	3.0		3.0	3.0	3.3	3.3
All-Red Time (s)	2.6		2.6	2.6	2.2	2.2
Lost Time Adjust (s)	0.0		0.0	0.0	0.0	0.0
Total Lost Time (s)	5.6		5.6	5.6	5.5	5.5
Lead/Lag						
Lead-Lag Optimize?						
Recall Mode	C-Max		C-Max	C-Max	None	None
Act Effct Green (s)	73.9		73.9	15.0	15.0	15.0
Actuated g/C Ratio	0.74		0.74	0.15	0.15	0.15
v/c Ratio	0.31		0.50	0.69	0.45	0.45
Control Delay	4.4		7.2	54.6	11.0	11.0
Queue Delay	1.5		0.0	0.0	0.0	0.0
Total Delay	5.9		7.2	54.6	11.0	11.0
LOS	A		A	D	B	B
Approach Delay	5.9		7.2	34.9		
Approach LOS	A		A	C		
Queue Length 50th (m)	18.0		27.7	31.8	0.0	0.0
Queue Length 95th (m)	28.0		44.5	51.6	15.8	15.8
Internal Link Dist (m)	52.8		138.9	214.6		
Turn Bay Length (m)				35.0		
Base Capacity (vph)	2340		1522	306	358	358
Starvation Cap Reductn	1367		0	0	0	0
Spillback Cap Reductn	0		0	0	0	0
Storage Cap Reductn	0		0	0	0	0
Reduced v/c Ratio	0.75		0.50	0.56	0.40	0.40

Intersection Summary
 Cycle Length: 100
 Actuated Cycle Length: 100
 Offset: 0 (0%), Referenced to phase 2:EBT and 6:WBT, Start of Green
 Natural Cycle: 60
 Control Type: Actuated-Coordinated

Lanes, Volumes, Timings
2: Montgomery & Montreal

2029 Future Background
PM Peak Hour

Maximum v/c Ratio: 0.69	Intersection LOS: B
Intersection Signal Delay: 11.5	ICU Level of Service D
Intersection Capacity Utilization 74.0%	
Analysis Period (min) 15	

Splits and Phases: 2: Montgomery & Montreal

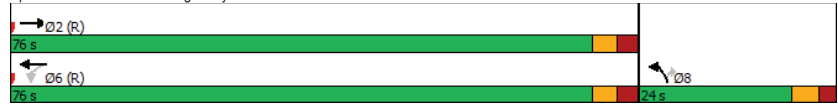

Lanes, Volumes, Timings
4: Vanier & Montreal

2029 Future Background
PM Peak Hour

Lane Group	EBL	EBT	EBR	WBL	WBT	WBR	NBL	NBT	NBR	SBL	SBT	SBR
Lane Configurations	↔	↕	↔	↔	↕	↔	↕	↕	↔	↕	↕	↔
Traffic Volume (vph)	60	423	185	156	432	198	229	1063	210	142	1071	120
Future Volume (vph)	60	423	185	156	432	198	229	1063	210	142	1071	120
Satd. Flow (prot)	1626	1695	1483	1658	2980	0	1658	4565	0	1658	4649	0
Fit Permitted	0.950			0.950			0.950			0.950		
Satd. Flow (perm)	1566	1695	1376	1602	2980	0	1632	4565	0	1634	4649	0
Satd. Flow (RTOR)			163		50			28			13	
Lane Group Flow (vph)	60	423	185	156	630	0	229	1273	0	142	1191	0
Turn Type	Prot	NA	Perm	Prot	NA		Prot	NA		Prot	NA	
Protected Phases	7	4		3	8		5	2		1	6	
Permitted Phases			4									
Detector Phase	7	4	4	3	8		5	2		1	6	
Switch Phase												
Minimum Initial (s)	5.0	10.0	10.0	5.0	10.0		5.0	10.0		5.0	10.0	
Minimum Split (s)	12.1	40.1	40.1	12.1	40.1		11.1	28.9		11.1	28.9	
Total Split (s)	30.0	41.0	41.0	30.0	41.0		30.0	39.0		30.0	39.0	
Total Split (%)	21.4%	29.3%	29.3%	21.4%	29.3%		21.4%	27.9%		21.4%	27.9%	
Yellow Time (s)	3.0	3.0	3.0	3.0	3.0		3.7	3.7		3.7	3.7	
All-Red Time (s)	4.1	4.1	4.1	4.1	4.1		2.4	2.2		2.4	2.2	
Lost Time Adjust (s)	0.0	0.0	0.0	0.0	0.0		0.0	0.0		0.0	0.0	
Total Lost Time (s)	7.1	7.1	7.1	7.1	7.1		6.1	5.9		6.1	5.9	
Lead/Lag	Lead	Lag	Lag	Lead	Lag		Lead	Lag		Lead	Lag	
Lead-Lag Optimize?	Yes	Yes	Yes	Yes	Yes		Yes	Yes		Yes	Yes	
Recall Mode	None	Max	Max	None	Max		None	C-Max		None	C-Max	
Act Effct Green (s)	10.5	38.8	38.8	18.0	49.0		22.2	39.8		17.2	34.8	
Actuated g/C Ratio	0.08	0.28	0.28	0.13	0.35		0.16	0.28		0.12	0.25	
v/c Ratio	0.49	0.90	0.37	0.74	0.59		0.87	0.97		0.70	1.02	
Control Delay	74.9	72.2	10.8	78.3	38.1		86.7	74.8		76.2	82.7	
Queue Delay	0.0	0.0	0.0	0.0	0.0		0.0	0.0		0.0	0.0	
Total Delay	74.9	72.2	10.8	78.3	38.1		86.7	74.8		76.2	82.7	
LOS	E	E	B	E	D		F	E		E	F	
Approach Delay		55.4			46.1			76.6			82.1	
Approach LOS		E			D			E			F	
Queue Length 50th (m)	16.3	113.7	4.5	42.0	71.2		67.0	105.3		38.3	~133.1	
Queue Length 95th (m)	30.6	#190.0	25.0	63.9	96.1		m75.0 m#164.4			58.2	#163.0	
Internal Link Dist (m)		99.5			237.5			154.5			139.4	
Turn Bay Length (m)	30.0			35.0			94.5			90.0		
Base Capacity (vph)	265	470	499	271	1074		283	1317		283	1165	
Starvation Cap Reductn	0	0	0	0	0		0	0		0	0	
Spillback Cap Reductn	0	0	0	0	0		0	0		0	0	
Storage Cap Reductn	0	0	0	0	0		0	0		0	0	
Reduced v/c Ratio	0.23	0.90	0.37	0.58	0.59		0.81	0.97		0.50	1.02	

Intersection Summary

Cycle Length: 140
Actuated Cycle Length: 140
Offset: 56 (40%), Referenced to phase 2:NBT and 6:SBT, Start of Green
Natural Cycle: 115
Control Type: Actuated-Coordinated

Lanes, Volumes, Timings
4: Vanier & Montreal

2029 Future Background
PM Peak Hour

Maximum v/c Ratio: 1.02	Intersection LOS: E
Intersection Signal Delay: 69.4	ICU Level of Service F
Intersection Capacity Utilization 96.9%	
Analysis Period (min) 15	
~ Volume exceeds capacity, queue is theoretically infinite. Queue shown is maximum after two cycles.	
# 95th percentile volume exceeds capacity, queue may be longer. Queue shown is maximum after two cycles.	
m Volume for 95th percentile queue is metered by upstream signal.	

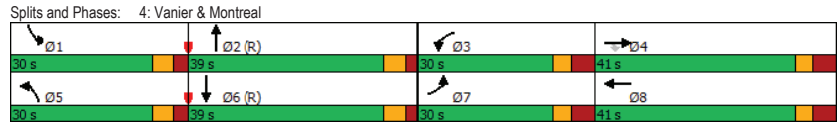

HCM 2010 TWSC
6: North River & Selkirk

2029 Future Background
PM Peak Hour

Intersection						
Int Delay, s/veh	3					
Movement	WBL	WBR	NBT	NBR	SBL	SBT
Lane Configurations	↔	↔	↑	↑	↔	↔
Traffic Vol, veh/h	120	66	372	0	0	434
Future Vol, veh/h	120	66	372	0	0	434
Conflicting Peds, #/hr	2	2	0	66	66	0
Sign Control	Stop	Stop	Free	Free	Free	Free
RT Channelized	-	None	-	None	-	None
Storage Length	0	-	-	-	-	-
Veh in Median Storage, #	0	-	0	-	-	0
Grade, %	0	-	0	-	-	0
Peak Hour Factor	100	100	100	100	100	100
Heavy Vehicles, %	2	2	3	2	2	4
Mvmt Flow	120	66	372	0	0	434

Major/Minor	Minor1	Major1	Major2
Conflicting Flow All	591	374	0
Stage 1	372	-	-
Stage 2	219	-	-
Critical Hdwy	6.63	6.23	-
Critical Hdwy Stg 1	5.43	-	-
Critical Hdwy Stg 2	5.83	-	-
Follow-up Hdwy	3,519	3,319	-
Pot Cap-1 Maneuver	454	671	0
Stage 1	696	-	0
Stage 2	797	-	0
Platoon blocked, %	-	-	-
Mov Cap-1 Maneuver	453	670	-
Mov Cap-2 Maneuver	453	-	-
Stage 1	696	-	-
Stage 2	795	-	-

Approach	WB	NB	SB
HCM Control Delay, s	16	0	0
HCM LOS	C		

Minor Lane/Major Mvmt	NBTWBLn1	SBT
Capacity (veh/h)	- 512	-
HCM Lane V/C Ratio	- 0.363	-
HCM Control Delay (s)	- 16	-
HCM Lane LOS	- C	-
HCM 95th %tile Q(veh)	- 1.6	-

HCM 2010 TWSC
7: Dundas & Selkirk

2029 Future Background
PM Peak Hour

Intersection						
Int Delay, s/veh	0					
Movement	EBT	EBR	WBL	WBT	NBL	NBR
Lane Configurations				↕	↕	
Traffic Vol, veh/h	0	0	36	45	49	131
Future Vol, veh/h	0	0	36	45	49	131
Conflicting Peds, #/hr	0	0	0	0	0	0
Sign Control	Free	Free	Free	Free	Stop	Stop
RT Channelized	-	None	-	None	-	None
Storage Length	-	-	-	-	0	-
Veh in Median Storage, #	-	-	-	-	0	-
Grade, %	0	-	-	0	0	-
Peak Hour Factor	100	100	100	100	100	100
Heavy Vehicles, %	2	2	2	2	2	2
Mvmt Flow	0	0	36	45	49	131

Major/Minor	Major2	Minor1
Conflicting Flow All	0	117
Stage 1	-	0
Stage 2	-	117
Critical Hdwy	4.12	6.42
Critical Hdwy Stg 1	-	-
Critical Hdwy Stg 2	-	5.42
Follow-up Hdwy	2.218	3.518
Pot Cap-1 Maneuver	-	879
Stage 1	-	-
Stage 2	-	908
Platoon blocked, %	-	-
Mov Cap-1 Maneuver	-	879
Mov Cap-2 Maneuver	-	879
Stage 1	-	-
Stage 2	-	908

Approach	WB	NB
HCM Control Delay, s		
HCM LOS		

Minor Lane/Major Mvmt	NBLn1	WBL	WBT
Capacity (veh/h)	-	-	-
HCM Lane V/C Ratio	-	-	-
HCM Control Delay (s)	-	-	-
HCM Lane LOS	-	-	-
HCM 95th %tile Q(veh)	-	-	-

HCM 2010 TWSC
8: Montgomery & Selkirk

2029 Future Background
PM Peak Hour

Intersection												
Int Delay, s/veh	6.2											
Movement	EBL	EBT	EBR	WBL	WBT	WBR	NBL	NBT	NBR	SBL	SBT	SBR
Lane Configurations		↕			↕			↕			↕	
Traffic Vol, veh/h	92	29	10	5	16	28	5	10	0	15	47	60
Future Vol, veh/h	92	29	10	5	16	28	5	10	0	15	47	60
Conflicting Peds, #/hr	0	0	0	0	0	0	0	0	0	0	0	0
Sign Control	Stop	Stop	Stop	Stop	Stop	Stop	Free	Free	Free	Free	Free	Free
RT Channelized	-	-	None	-	-	None	-	-	None	-	-	None
Storage Length	-	-	-	-	-	-	-	-	-	-	-	-
Veh in Median Storage, #	-	0	-	-	0	-	-	0	-	-	0	-
Grade, %	-	0	-	-	0	-	-	0	-	-	0	-
Peak Hour Factor	100	100	100	100	100	100	100	100	100	100	100	100
Heavy Vehicles, %	2	2	2	2	2	2	2	2	2	2	2	2
Mvmt Flow	92	29	10	5	16	28	5	10	0	15	47	60

Major/Minor	Minor2	Minor1	Major1	Major2
Conflicting Flow All	149	127	77	147
Stage 1	107	107	-	20
Stage 2	42	20	-	127
Critical Hdwy	7.12	6.52	6.22	7.12
Critical Hdwy Stg 1	6.12	5.52	-	6.12
Critical Hdwy Stg 2	6.12	5.52	-	6.12
Follow-up Hdwy	3.518	4.018	3.318	3.518
Pot Cap-1 Maneuver	819	764	984	821
Stage 1	898	807	-	999
Stage 2	972	879	-	877
Platoon blocked, %	-	-	-	-
Mov Cap-1 Maneuver	776	754	984	781
Mov Cap-2 Maneuver	776	754	-	781
Stage 1	895	799	-	996
Stage 2	927	876	-	828

Approach	EB	WB	NB	SB
HCM Control Delay, s	10.5	9.2	2.5	0.9
HCM LOS	B	A		

Minor Lane/Major Mvmt	NBL	NBT	NBR	EBLn1	WBLn1	SBL	SBT	SBR
Capacity (veh/h)	1484	-	-	784	897	1610	-	-
HCM Lane V/C Ratio	0.003	-	-	0.167	0.055	0.009	-	-
HCM Control Delay (s)	7.4	0	-	10.5	9.2	7.3	0	-
HCM Lane LOS	A	A	-	B	A	A	A	-
HCM 95th %tile Q(veh)	0	-	-	0.6	0.2	0	-	-

Lanes, Volumes, Timings
9: North River & McArthur

2029 Future Background
PM Peak Hour

Lane Group	EBL	EBT	EBR	WBL	WBT	WBR	NBL	NBT	NBR	SBL	SBT	SBR
Lane Configurations		↔			↔	↔		↔		↔	↔	
Traffic Volume (vph)	4	25	6	25	11	217	2	150	38	414	139	1
Future Volume (vph)	4	25	6	25	11	217	2	150	38	414	139	1
Satd. Flow (prot)	0	1636	0	0	1568	1483	0	1631	0	1642	1709	0
Fit Permitted		0.979			0.838			0.998		0.638		
Satd. Flow (perm)	0	1598	0	0	1323	1334	0	1629	0	987	1709	0
Satd. Flow (RTOR)		6			217			28		1		
Lane Group Flow (vph)	0	35	0	0	36	217	0	190	0	414	140	0
Turn Type	Perm	NA		Perm	NA	Perm	Perm	NA		Perm	NA	
Protected Phases		4			8			2			6	
Permitted Phases	4			8		8	2			6		
Detector Phase	4	4		8	8	8	2	2		6	6	
Switch Phase												
Minimum Initial (s)	10.0	10.0		10.0	10.0	10.0	10.0	10.0		10.0	10.0	
Minimum Split (s)	25.6	25.6		25.6	25.6	25.6	31.1	31.1		31.1	31.1	
Total Split (s)	26.0	26.0		26.0	26.0	26.0	49.0	49.0		49.0	49.0	
Total Split (%)	34.7%	34.7%		34.7%	34.7%	34.7%	65.3%	65.3%		65.3%	65.3%	
Yellow Time (s)	3.3	3.3		3.3	3.3	3.3	3.3	3.3		3.3	3.3	
All-Red Time (s)	2.3	2.3		2.3	2.3	2.3	2.8	2.8		2.8	2.8	
Lost Time Adjust (s)		0.0			0.0	0.0		0.0			0.0	
Total Lost Time (s)		5.6			5.6	5.6		6.1			6.1	
Lead/Lag												
Lead-Lag Optimize?												
Recall Mode	Max	Max		Max	Max	Max	C-Max	C-Max		C-Max	C-Max	
Act Effct Green (s)		20.4			20.4	20.4		42.9		42.9	42.9	
Actuated g/C Ratio		0.27			0.27	0.27		0.57		0.57	0.57	
v/c Ratio		0.08			0.10	0.42		0.20		0.73	0.14	
Control Delay		18.4			20.9	12.4		7.2		21.8	7.9	
Queue Delay		0.0			0.0	0.0		0.0		0.0	0.0	
Total Delay		18.4			20.9	12.4		7.2		21.8	7.9	
LOS		B			C	B		A		C	A	
Approach Delay		18.4			13.6			7.2			18.3	
Approach LOS		B			B			A			B	
Queue Length 50th (m)		3.0			4.4	1.3		10.0		39.3	8.4	
Queue Length 95th (m)		9.4			11.8	32.9		19.0		#89.6	15.9	
Internal Link Dist (m)		22.5			128.8			119.0			94.3	
Turn Bay Length (m)						60.0				55.0		
Base Capacity (vph)		439			359	520		943		564	977	
Starvation Cap Reductn		0			0	0		0		0	0	
Spillback Cap Reductn		0			0	0		0		0	0	
Storage Cap Reductn		0			0	0		0		0	0	
Reduced v/c Ratio		0.08			0.10	0.42		0.20		0.73	0.14	

Intersection Summary	
Cycle Length:	75
Actuated Cycle Length:	75
Offset:	0 (0%), Referenced to phase 2:NBTL and 6:SBTL, Start of Green
Natural Cycle:	60
Control Type:	Actuated-Coordinated

Lanes, Volumes, Timings
9: North River & McArthur

2029 Future Background
PM Peak Hour

Maximum v/c Ratio: 0.73	Intersection LOS: B
Intersection Signal Delay: 15.1	ICU Level of Service D
Intersection Capacity Utilization 76.5%	
Analysis Period (min) 15	
# 95th percentile volume exceeds capacity, queue may be longer.	
Queue shown is maximum after two cycles.	

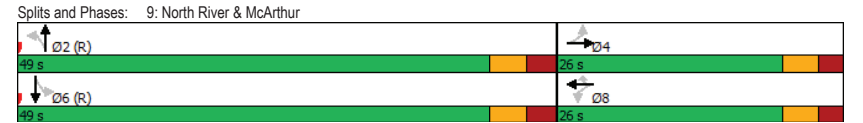

Intersection						
Int Delay, s/veh	0.7					
Movement	EBL	EBT	WBT	WBR	SBL	SBR
Lane Configurations		↖	↖		↗	↗
Traffic Vol, veh/h	9	474	267	160	26	4
Future Vol, veh/h	9	474	267	160	26	4
Conflicting Peds, #/hr	76	0	0	76	0	9
Sign Control	Free	Free	Free	Free	Stop	Stop
RT Channelized	-	None	-	None	-	None
Storage Length	-	-	-	-	0	-
Veh in Median Storage, #	-	0	0	-	0	-
Grade, %	-	0	0	-	0	-
Peak Hour Factor	100	100	100	100	100	100
Heavy Vehicles, %	2	3	3	2	8	2
Mvmt Flow	9	474	267	160	26	4
Major/Minor	Major1	Major2	Minor2			
Conflicting Flow All	503	0	0	915	432	
Stage 1	-	-	-	423	-	
Stage 2	-	-	-	492	-	
Critical Hdwy	4.12	-	-	6.48	6.22	
Critical Hdwy Stg 1	-	-	-	5.48	-	
Critical Hdwy Stg 2	-	-	-	5.48	-	
Follow-up Hdwy	2.218	-	-	3.572	3.318	
Pot Cap-1 Maneuver	1061	-	-	295	624	
Stage 1	-	-	-	648	-	
Stage 2	-	-	-	602	-	
Platoon blocked, %	-	-	-	-	-	
Mov Cap-1 Maneuver	998	-	-	258	583	
Mov Cap-2 Maneuver	-	-	-	258	-	
Stage 1	-	-	-	603	-	
Stage 2	-	-	-	566	-	
Approach	EB	WB	SB			
HCM Control Delay, s	0.2	0	19.5			
HCM LOS			C			
Minor Lane/Major Mvmt	EBL	EBT	WBT	WBR	SBLn1	
Capacity (veh/h)	998	-	-	-	279	
HCM Lane V/C Ratio	0.009	-	-	-	0.108	
HCM Control Delay (s)	8.6	0	-	-	19.5	
HCM Lane LOS	A	A	-	-	C	
HCM 95th %tile Q(veh)	0	-	-	-	0.4	

Lane Group	EBT	EBR	WBL	WBT	NBL	NBR
Lane Configurations	↖			↖	↖	↖
Traffic Volume (vph)	491	21	40	414	20	52
Future Volume (vph)	491	21	40	414	20	52
Satd. Flow (prot)	1730	0	0	1738	1658	1483
Fit Permitted				0.934	0.950	
Satd. Flow (perm)	1730	0	0	1627	1586	1425
Satd. Flow (RTOR)	5					52
Lane Group Flow (vph)	512	0	0	454	20	52
Turn Type	NA		Perm	NA	Prot	Perm
Protected Phases	2			6	8	
Permitted Phases			6			8
Detector Phase	2		6	6	8	8
Switch Phase						
Minimum Initial (s)	10.0		10.0	10.0	5.0	5.0
Minimum Split (s)	27.5		15.5	15.5	24.5	24.5
Total Split (s)	50.0		50.0	50.0	25.0	25.0
Total Split (%)	66.7%		66.7%	66.7%	33.3%	33.3%
Yellow Time (s)	3.3		3.3	3.3	3.3	3.3
All-Red Time (s)	2.2		2.2	2.2	2.2	2.2
Lost Time Adjust (s)	0.0		0.0	0.0	0.0	0.0
Total Lost Time (s)	5.5		5.5	5.5	5.5	5.5
Lead/Lag						
Lead-Lag Optimize?						
Recall Mode	C-Max		C-Max	C-Max	None	None
Act Effct Green (s)	59.5		59.5	11.2	11.2	
Actuated g/C Ratio	0.79		0.79	0.15	0.15	
v/c Ratio	0.37		0.35	0.08	0.20	
Control Delay	5.0		6.2	24.2	9.0	
Queue Delay	0.0		0.0	0.0	0.0	
Total Delay	5.0		6.2	24.2	9.0	
LOS	A		A	C	A	
Approach Delay	5.0		6.2	13.2		
Approach LOS	A		A	B		
Queue Length 50th (m)	14.3		15.3	2.7	0.0	
Queue Length 95th (m)	38.2		51.8	7.0	7.7	
Internal Link Dist (m)	36.3		7.3	144.2		
Turn Bay Length (m)				30.0		
Base Capacity (vph)	1373		1291	431	408	
Starvation Cap Reductn	0		0	0	0	
Spillback Cap Reductn	0		0	0	0	
Storage Cap Reductn	0		0	0	0	
Reduced v/c Ratio	0.37		0.35	0.05	0.13	

Intersection Summary	
Cycle Length:	75
Actuated Cycle Length:	75
Offset:	0 (0%), Referenced to phase 2:EBT and 6:WBTL, Start of Green
Natural Cycle:	55
Control Type:	Actuated-Coordinated

Lanes, Volumes, Timings
11: Marguerite & McArthur

2029 Future Background
PM Peak Hour

Maximum v/c Ratio: 0.37	Intersection LOS: A
Intersection Signal Delay: 6.1	ICU Level of Service D
Intersection Capacity Utilization 74.7%	
Analysis Period (min) 15	

Splits and Phases: 11: Marguerite & McArthur

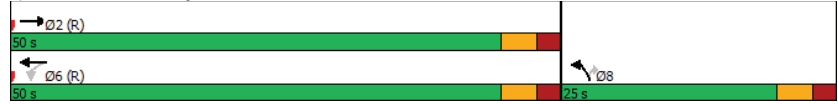

Lanes, Volumes, Timings
12: Vanier & McArthur

2029 Future Background
PM Peak Hour

Lane Group	EBL	EBT	EBR	WBL	WBT	WBR	NBL	NBT	NBR	SBL	SBT	SBR
Lane Configurations	↔	↕	↔	↔	↕	↔	↔	↕	↔	↔	↕	↔
Traffic Volume (vph)	55	254	446	333	257	170	234	1259	251	122	1246	66
Future Volume (vph)	55	254	446	333	257	170	234	1259	251	122	1246	66
Satd. Flow (prot)	1658	1712	1483	3154	1712	1483	1658	3316	1469	1658	3316	1469
Fit Permitted	0.950			0.950			0.950			0.950		
Satd. Flow (perm)	1578	1712	1323	2940	1712	1360	1614	3316	1400	1648	3316	1223
Satd. Flow (RTOR)			240			170			203			121
Lane Group Flow (vph)	55	254	446	333	257	170	234	1259	251	122	1246	66
Turn Type	Prot	NA	Perm	Prot	NA	Perm	Prot	NA	Perm	Prot	NA	Perm
Protected Phases	7	4		3	8		5	2		1	6	
Permitted Phases			4			8			2			6
Detector Phase	7	4	4	3	8	8	5	2	2	1	6	6
Switch Phase												
Minimum Initial (s)	5.0	10.0	10.0	5.0	10.0	10.0	5.0	10.0	10.0	5.0	10.0	10.0
Minimum Split (s)	11.2	36.2	36.2	11.2	36.2	36.2	11.1	36.1	36.1	11.1	36.1	36.1
Total Split (s)	20.0	36.2	36.2	20.0	36.2	36.2	23.0	59.8	59.8	24.0	60.8	60.8
Total Split (%)	14.3%	25.9%	25.9%	14.3%	25.9%	25.9%	16.4%	42.7%	42.7%	17.1%	43.4%	43.4%
Yellow Time (s)	3.3	3.3	3.3	3.3	3.3	3.3	3.7	3.7	3.7	3.7	3.7	3.7
All-Red Time (s)	2.9	2.9	2.9	2.9	2.9	2.9	2.4	2.4	2.4	2.4	2.4	2.4
Lost Time Adjust (s)	0.0	0.0	0.0	0.0	0.0	0.0	0.0	0.0	0.0	0.0	0.0	0.0
Total Lost Time (s)	6.2	6.2	6.2	6.2	6.2	6.2	6.1	6.1	6.1	6.1	6.1	6.1
Lead/Lag	Lag	Lead	Lead	Lag	Lead	Lead	Lag	Lag	Lag	Lead	Lead	Lead
Lead-Lag Optimize?	Yes	Yes	Yes	Yes	Yes	Yes	Yes	Yes	Yes	Yes	Yes	Yes
Recall Mode	None	None	None	None	None	None	C-Max	C-Max	C-Max	None	C-Max	C-Max
Act Effct Green (s)	12.2	28.3	28.3	15.5	34.0	34.0	16.9	56.8	56.8	14.8	54.7	54.7
Actuated g/C Ratio	0.09	0.20	0.20	0.11	0.24	0.24	0.12	0.41	0.41	0.11	0.39	0.39
v/c Ratio	0.38	0.73	0.97	0.96	0.62	0.37	1.17	0.94	0.36	0.70	0.96	0.12
Control Delay	67.2	65.4	60.7	100.1	56.6	8.8	169.0	53.8	8.3	81.0	85.9	18.9
Queue Delay	0.0	0.0	0.0	0.0	0.0	0.0	0.0	0.0	0.0	0.0	0.0	0.0
Total Delay	67.2	65.4	60.7	100.1	56.6	8.8	169.0	53.8	8.3	81.0	85.9	18.9
LOS	E	E	E	F	E	A	F	D	A	F	F	B
Approach Delay	62.8			65.0			62.7			82.4		
Approach LOS	E			E			E			F		
Queue Length 50th (m)	14.5	65.5	63.7	~52.5	66.4	0.0	~76.9	176.0	8.2	35.7	184.2	5.4
Queue Length 95th (m)	28.5	95.9	#131.1	#83.3	97.3	19.2	#129.8	#231.0	28.6	m40.3	m187.0	m7.7
Internal Link Dist (m)		122.9			146.0		119.5			202.0		
Turn Bay Length (m)	30.0		50.0	120.0		115.0	90.0		90.0	90.0		90.0
Base Capacity (vph)	163	366	472	347	415	459	200	1344	688	211	1295	551
Starvation Cap Reductn	0	0	0	0	0	0	0	0	0	0	0	0
Spillback Cap Reductn	0	0	0	0	0	0	0	0	0	0	0	0
Storage Cap Reductn	0	0	0	0	0	0	0	0	0	0	0	0
Reduced v/c Ratio	0.34	0.69	0.94	0.96	0.62	0.37	1.17	0.94	0.36	0.58	0.96	0.12

Intersection Summary												
Cycle Length: 140												
Actuated Cycle Length: 140												
Offset: 54 (39%), Referenced to phase 2:NBT and 6:SBT, Start of Green												
Natural Cycle: 145												
Control Type: Actuated-Coordinated												

Lanes, Volumes, Timings
12: Vanier & McArthur

2029 Future Background
PM Peak Hour

Maximum v/c Ratio: 1.17	Intersection LOS: E
Intersection Signal Delay: 69.1	ICU Level of Service G
Intersection Capacity Utilization 104.5%	
Analysis Period (min) 15	
~ Volume exceeds capacity, queue is theoretically infinite. Queue shown is maximum after two cycles.	
# 95th percentile volume exceeds capacity, queue may be longer. Queue shown is maximum after two cycles.	
m Volume for 95th percentile queue is metered by upstream signal.	

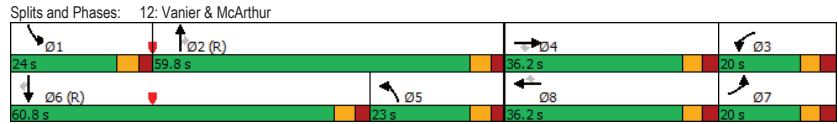

HCM 2010 TWSC
15: McArthur & Mayfield

2029 Future Background
PM Peak Hour

Intersection						
Int Delay, s/veh	0.8					
Movement	EBL	EBT	WBT	WBR	SBL	SBR
Lane Configurations		↑	↑		↓	↓
Traffic Vol, veh/h	0	545	446	0	35	8
Future Vol, veh/h	0	545	446	0	35	8
Conflicting Peds, #/hr	0	0	0	0	0	0
Sign Control	Free	Free	Free	Free	Stop	Stop
RT Channelized	-	None	-	None	-	None
Storage Length	-	-	-	-	0	0
Veh in Median Storage, #	-	0	0	-	0	-
Grade, %	-	0	0	-	0	-
Peak Hour Factor	100	100	100	100	100	100
Heavy Vehicles, %	2	2	2	2	2	2
Mvmt Flow	0	545	446	0	35	8

Major/Minor	Major1	Major2	Minor2
Conflicting Flow All	-	0	991
Stage 1	-	-	446
Stage 2	-	-	545
Critical Hdwy	-	-	6.42
Critical Hdwy Stg 1	-	-	5.42
Critical Hdwy Stg 2	-	-	5.42
Follow-up Hdwy	-	-	3.518
Pot Cap-1 Maneuver	0	-	273
Stage 1	0	-	645
Stage 2	0	-	581
Platoon blocked, %	-	-	-
Mov Cap-1 Maneuver	-	-	273
Mov Cap-2 Maneuver	-	-	273
Stage 1	-	-	645
Stage 2	-	-	581

Approach	EB	WB	SB
HCM Control Delay, s	0	0	18.4
HCM LOS			C

Minor Lane/Major Mvmt	EBT	WBT	SBLn1	SBLn2
Capacity (veh/h)	-	-	273	612
HCM Lane V/C Ratio	-	-	0.128	0.013
HCM Control Delay (s)	-	-	20.1	11
HCM Lane LOS	-	-	C	B
HCM 95th %tile Q(veh)	-	-	0.4	0

Appendix I

Site Turning Templates

Notes:

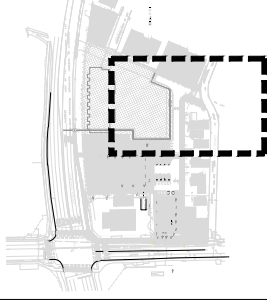

11500

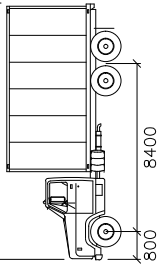

HSU

mm
Width : 2600
Track : 2600
Lock to Lock Time : 6.0
Steering Angle : 40.0

02	Updated Site Plan	AN	2022-03-16
01	Issued for Review	AN	2022-01-27
REV	DESCRIPTION	BY	DATE
STATUS:			

CGH Transportation
6 Plaza Court
Oshawa, ON
K2H 7W1
(416) 999-9117



CLIENT: 2705460 Ontario Inc.

ARCHITECT:

SITE:

112 Montreal

TITLE: Turning Movement Analysis
Garbage Turning Movements

SCALE AT AS	DATE	DRAWN	CHECKED
NTS	2022-03-16	AN	AH
PROJECT NO.	DRAWING NO.	REVISION	
2022-109	001	02	

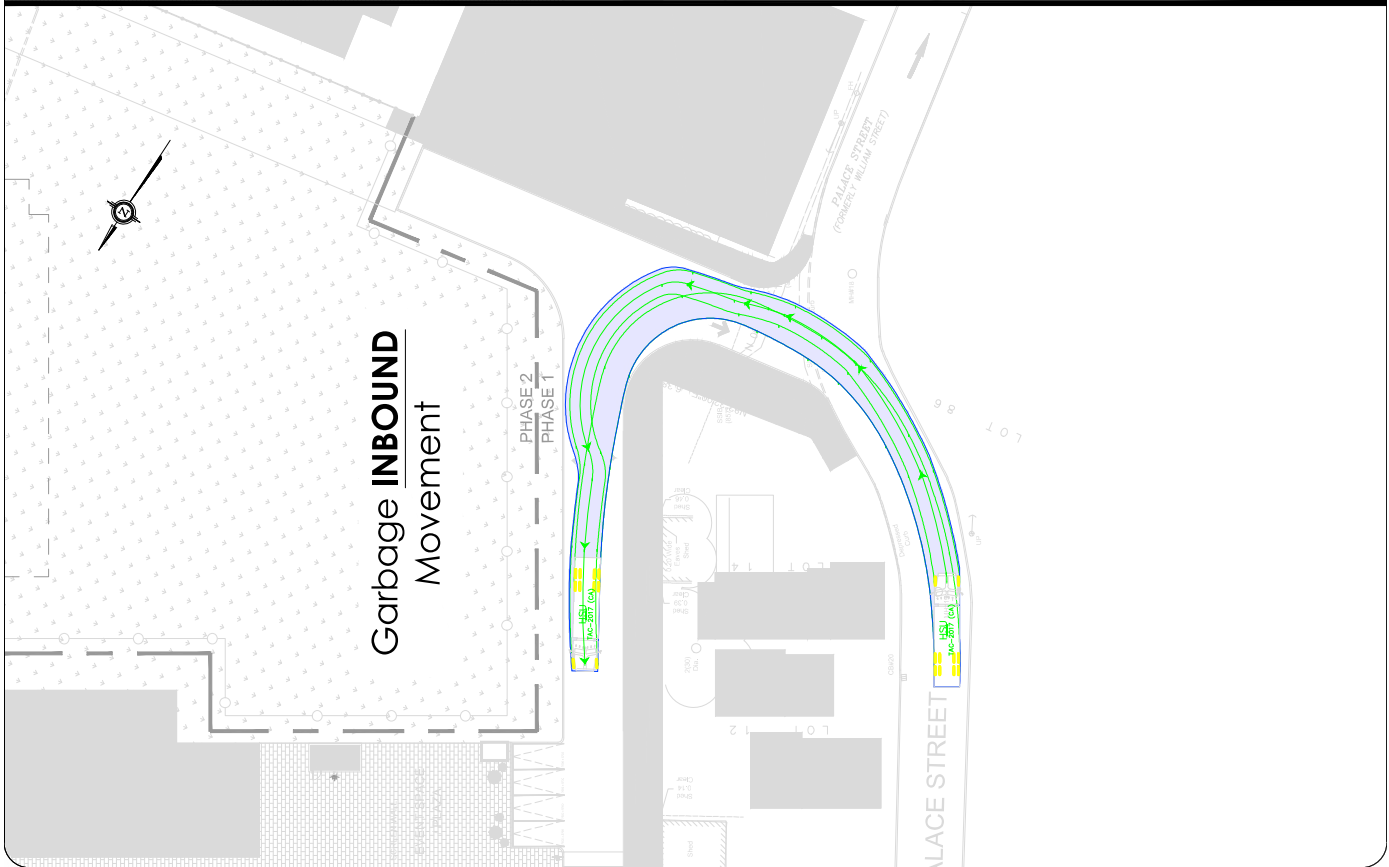
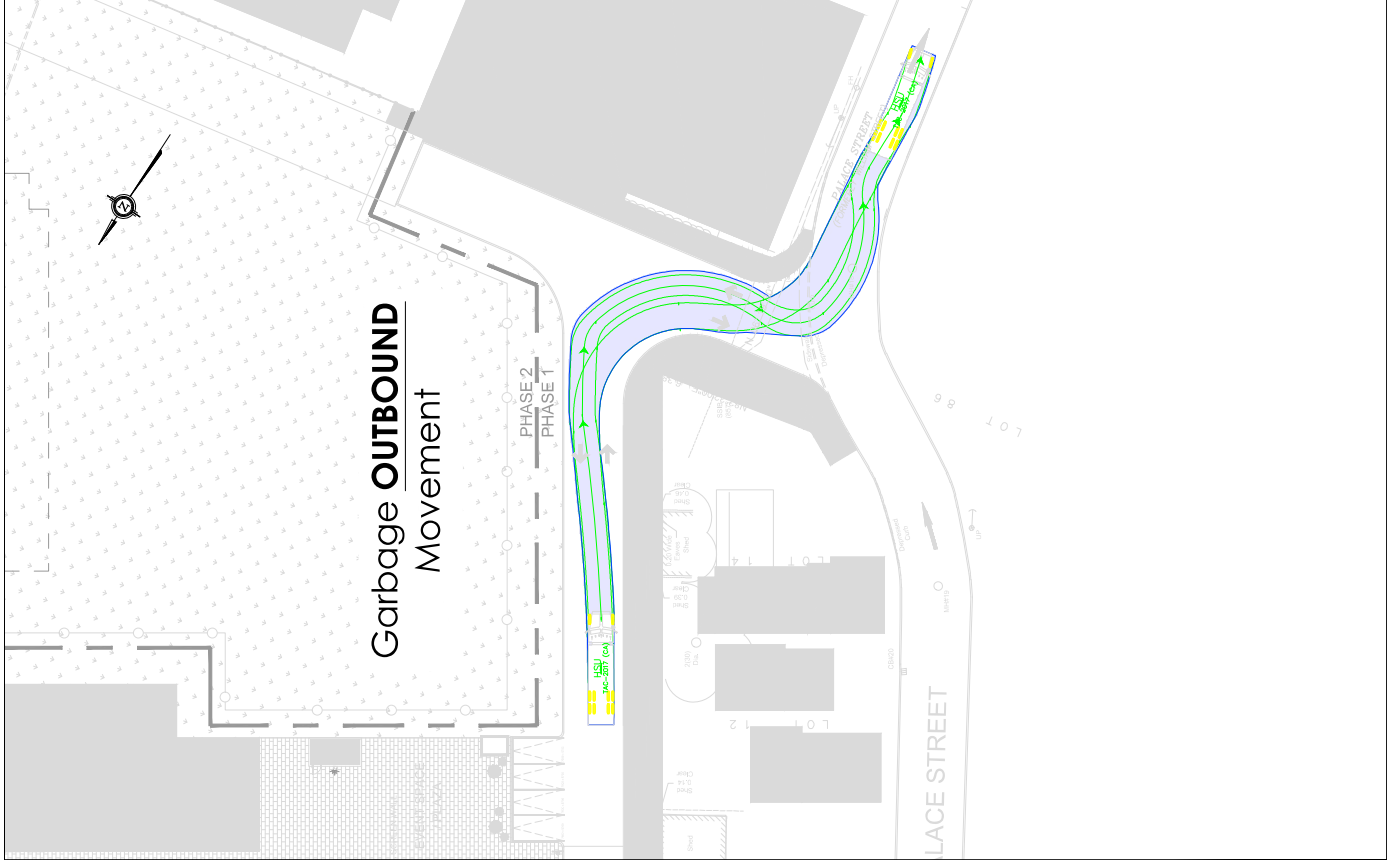

Notes:

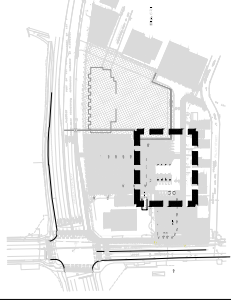

11500

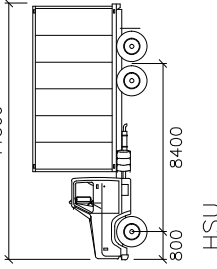

HSU

Width : 2600 mm
Track : 2600 mm
Lock to Lock Time : 6.0
Steering Angle : 40.0

02	Updated Site Plan	AN	2022-03-16
01	Issued for Review	AN	2022-01-27
REV.	DESCRIPTION	BY:	DATE:
STATUS:			

CGH Transportation
6 Plaza Court
Ottawa, ON
K2H 7W1
(343) 999-117

CLIENT: 2705460 Ontario Inc.

ARCHITECT:

SITE:

112 Montreal

TITLE: Turning Movement Analysis
HSU Loading Movements

SCALE AT A3:	DATE:	DRAWN:	CHECKED:
	2022-03-16	AN	AH
PROJECT NO.:	DRAWING NO.:	REVISION:	
2022-109	002	02	

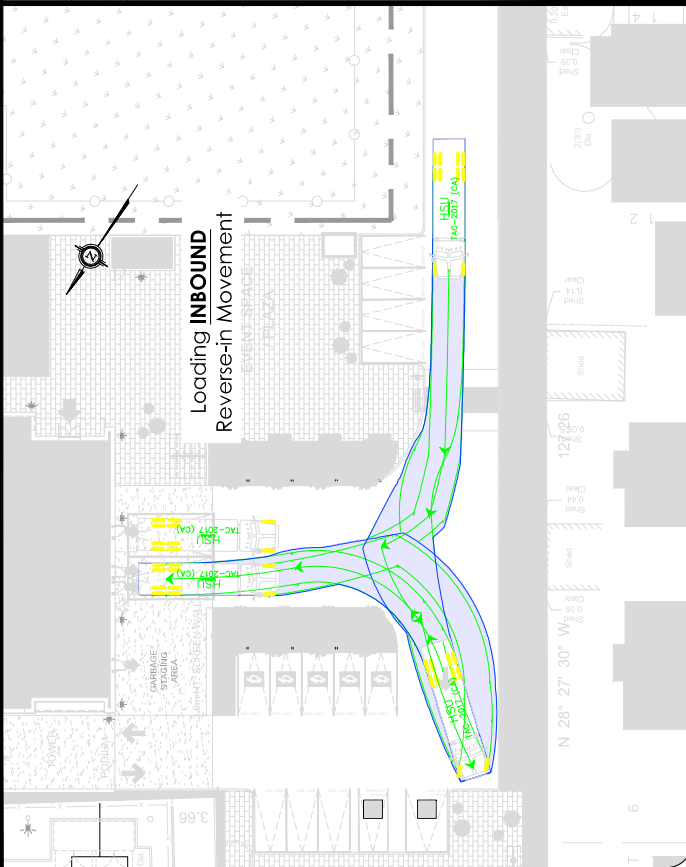
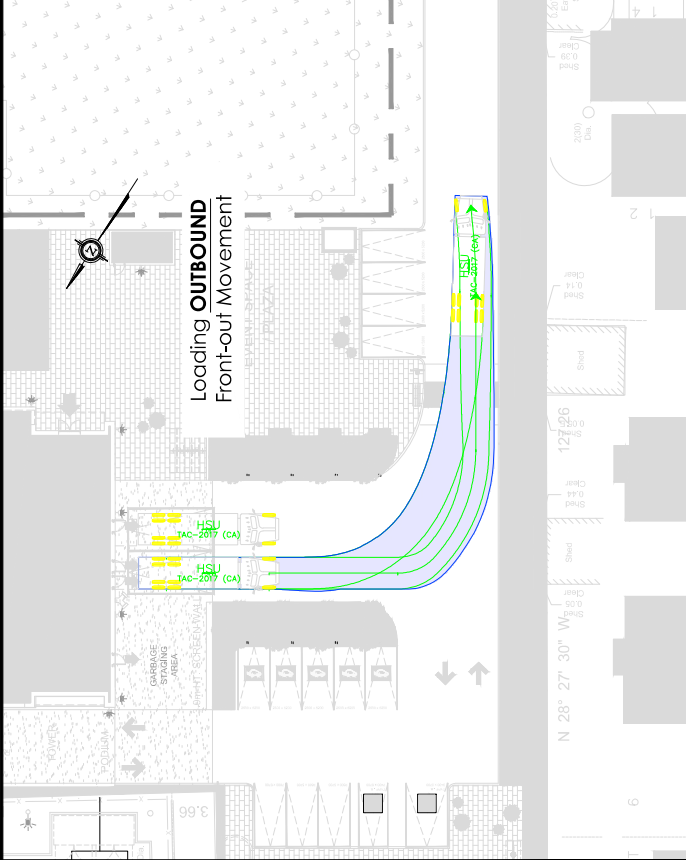
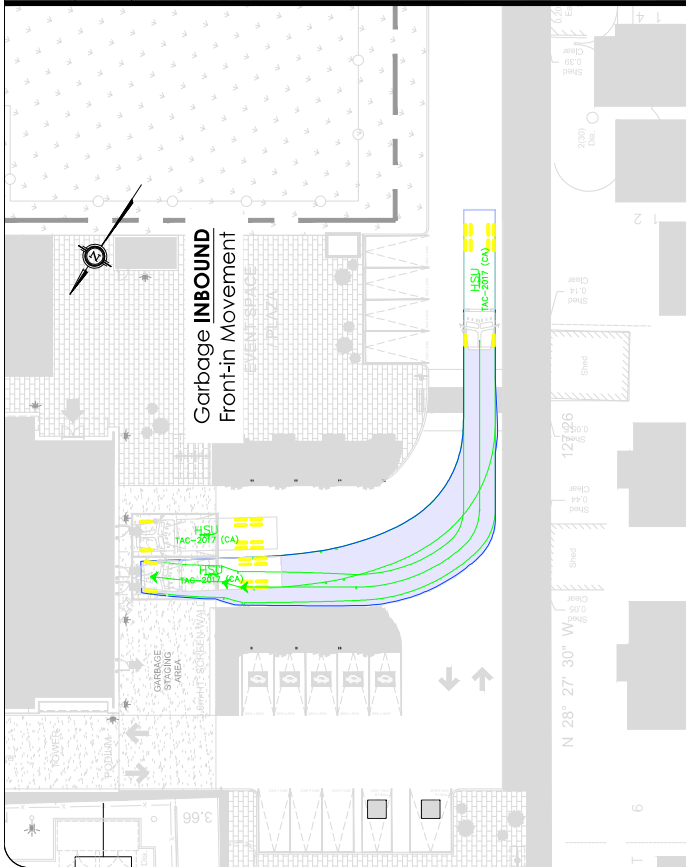
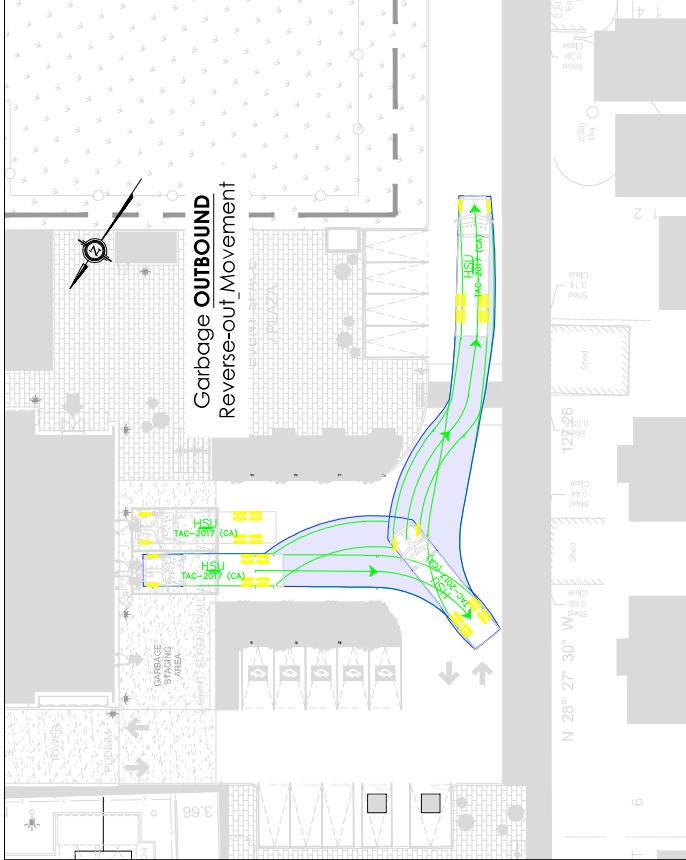

Notes:

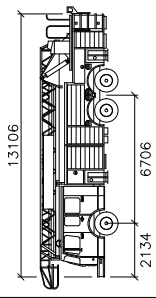
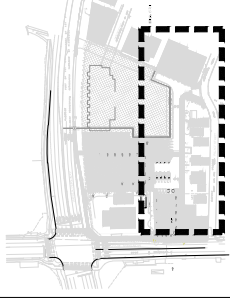

Aerial Fire Truck

Width : 2591 mm
Track : 2591 mm
Lock to Lock Time : 6.0 s
Steering Angle : 33.3°

REV	DESCRIPTION	BY	DATE
02	Updated Site Plan	AN	2022-03-16
01	Issued for Review	AN	2022-01-27

CGH Transportation
 6 Plaza Court
 Ottawa, ON
 K2H 7W1
 (343) 999-117

CLIENT: 2705460 Ontario Inc.
 ARCHITECT:

SITE:	112 Montreal
TITLE:	Turning Movement Analysis Fire Turning Movements
SCALE AT A3:	N/A
DATE:	2022-03-16
DRAWN:	AN
CHECKED:	AH
PROJECT NO.:	2022-109
DRAWING NO.:	003
REVISION:	02

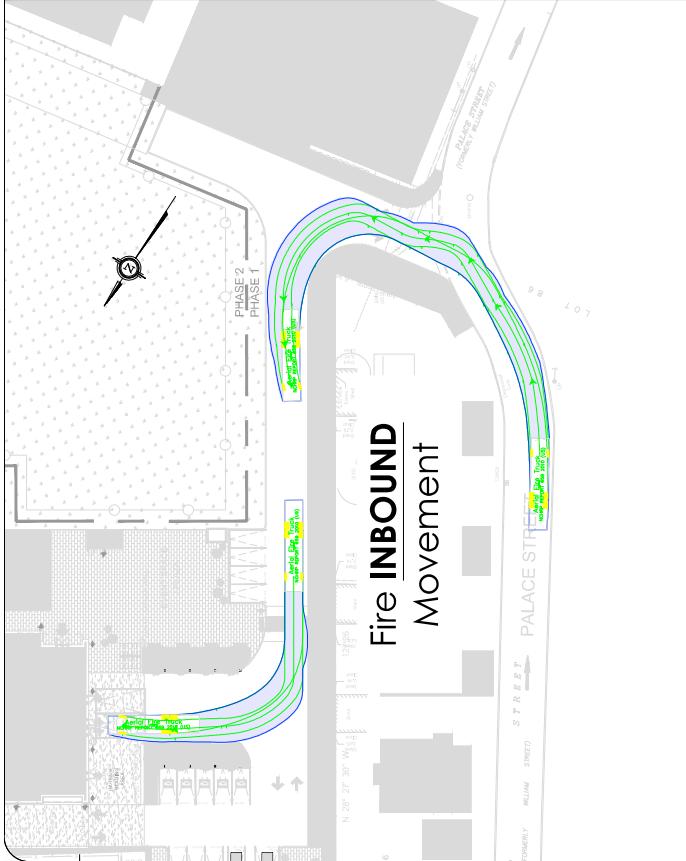
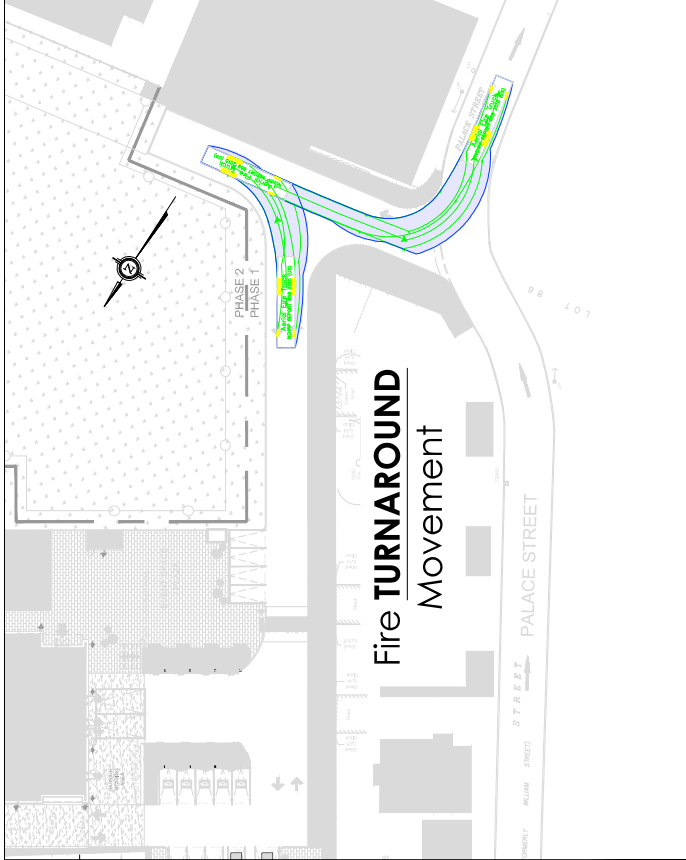

Appendix J

MMLOS Analysis

Multi-Modal Level of Service - Segments Form

Consultant	CGH Transportation Inc.
Scenario	Existing/Future
Comments	

Project	112 Montreal Road
Date	August 30, 2022

SEGMENTS		Vanier Existing	Montreal Ex/Fut	Palace Ex/Fut	Vanier Future
Pedestrian	Sidewalk Width	≥ 2 m	≥ 2 m	no sidewalk	≥ 2 m
	Boulevard Width	< 0.5	< 0.5	n/a	> 2 m
	Avg Daily Curb Lane Traffic Volume	> 3000	> 3000	≤ 3000	> 3000
	Operating Speed	> 60 km/h	> 30 to 50 km/h	> 30 to 50 km/h	> 60 km/h
	On-Street Parking	no	no	no	no
	Exposure to Traffic PLoS	F	C	F	D
	Effective Sidewalk Width				
Pedestrian Volume					
Crowding PLoS	-	-	-	-	
Level of Service	-	-	-	-	
Bicycle	Type of Cycling Facility	Mixed Traffic	Mixed Traffic	Mixed Traffic	Physically Separated
	Number of Travel Lanes	≥ 6 lanes total	4-5 lanes total	≤ 2 (no centreline)	≥ 6 lanes total
	Operating Speed	≥ 60 km/h	≥ 50 to 60 km/h	>40 to <50 km/h	≥ 60 km/h
	# of Lanes & Operating Speed LoS	F	E	B	A
	Bike Lane (+ Parking Lane) Width				
	Bike Lane Width LoS	-	-	-	-
	Bike Lane Blockages				
	Blockage LoS	-	-	-	-
	Median Refuge Width (no median = < 1.8 m)	< 1.8 m refuge	< 1.8 m refuge	< 1.8 m refuge	< 1.8 m refuge
	No. of Lanes at Unsignalized Crossing	≤ 3 lanes	≤ 3 lanes	≤ 3 lanes	≤ 3 lanes
Sidestreet Operating Speed	≤ 40 km/h	>40 to 50 km/h	>40 to 50 km/h	>40 to 50 km/h	
Unsignalized Crossing - Lowest LoS	A	A	A	A	
Level of Service	F	E	B	A	
Transit	Facility Type	Mixed Traffic	Mixed Traffic		Mixed Traffic
	Friction or Ratio Transit:Posted Speed	Vt/Vp ≥ 0.8	Vt/Vp ≥ 0.8		Vt/Vp ≥ 0.8
	Level of Service	D	D	-	D
Truck	Truck Lane Width	> 3.7 m	≤ 3.5 m		> 3.7 m
	Travel Lanes per Direction	> 1	1		> 1
	Level of Service	A	C	-	A

Multi-Modal Level of Service - Intersections Form

Consultant
Scenario
Comments

CGH Transportation Inc.
Existing/Future

Project
Date

112 Montreal Road
August 30, 2022

INTERSECTIONS															
	Crossing Side	Montreal & North River				Montreal & Montgomery				Montreal & Vanier					
		NORTH	SOUTH	EAST	WEST	NORTH	SOUTH	EAST	WEST	NORTH	SOUTH	EAST	WEST		
Pedestrian	Lanes	0 - 2	4	4	4		5	4	4	7	7	5	5		
	Median	No Median - 2.4 m	No Median - 2.4 m	No Median - 2.4 m	No Median - 2.4 m		No Median - 2.4 m	No Median - 2.4 m	No Median - 2.4 m	No Median - 2.4 m	No Median - 2.4 m	No Median - 2.4 m	No Median - 2.4 m		
	Conflicting Left Turns	Permissive	No left turn / Prohib.	Protected/ Permissive	Protected		Permissive	No left turn / Prohib.	Permissive	Protected/ Permissive	Protected/ Permissive	Protected	Protected		
	Conflicting Right Turns	Permissive or yield control	Permissive or yield control	Permissive or yield control	Permissive or yield control		Permissive or yield control	Permissive or yield control	No right turn	Permissive or yield control	Permissive or yield control	Permissive or yield control	Permissive or yield control		
	Right Turns on Red (RTor) ?	RTOR allowed	RTOR prohibited	RTOR allowed	RTOR allowed		RTOR allowed	RTOR allowed	RTOR prohibited	RTOR allowed	RTOR allowed	RTOR allowed	RTOR allowed		
	Ped Signal Leading Interval?	No	No	No	No		No	No	No	No	No	No	No		
	Right Turn Channel	No Channel	No Channel	No Channel	No Channel		No Channel	No Right Turn	No Channel	No Channel	No Channel	No Channel	No Channel		
	Corner Radius	10-15m	5-10m	5-10m	5-10m		3-5m	No Right Turn	10-15m	5-10m	5-10m	5-10m	5-10m		
	Crosswalk Type	Zebra stripe hi-vis markings	Zebra stripe hi-vis markings	Zebra stripe hi-vis markings	Zebra stripe hi-vis markings		Std transverse markings	Zebra stripe hi-vis markings	Std transverse markings	Zebra stripe hi-vis markings	Zebra stripe hi-vis markings	Zebra stripe hi-vis markings	Zebra stripe hi-vis markings		
	PETSI Score	88	68	57	65		39	74	61	8	8	49	49		
	Ped. Exposure to Traffic LoS	B	C	D	C		-	E	C	C	F	F	D	D	
	Cycle Length	120	95	95	95		100	80	80	140	140	140	140		
Effective Walk Time	3	35	14	14		10	50	43	17	17	8	8			
Average Pedestrian Delay	57	19	35	35		41	6	9	54	54	62	62			
Pedestrian Delay LoS	E	B	D	D		-	E	A	A	E	E	F	F		
Level of Service	E	C	D	D		-	E	C	C	F	F	F	F		
		E					E					F			
	Approach From	NORTH	SOUTH	EAST	WEST	NORTH	SOUTH	EAST	WEST	NORTH	SOUTH	EAST	WEST		
Bicycle	Bicycle Lane Arrangement on Approach	Curb Bike Lane, Cycletrack or MUP	Mixed Traffic	Mixed Traffic	Mixed Traffic		Mixed Traffic	Mixed Traffic	Mixed Traffic	Curb Bike Lane, Cycletrack or MUP	Curb Bike Lane, Cycletrack or MUP	Curb Bike Lane, Cycletrack or MUP	Mixed Traffic		
	Right Turn Lane Configuration	Not Applicable											> 50 m		
	Right Turning Speed	Not Applicable											≤ 25 km/h		
	Cyclist relative to RT motorists	Not Applicable	-	-	-		-	-	-	-	Not Applicable	Not Applicable	Not Applicable	F	
	Separated or Mixed Traffic	Separated	Mixed Traffic	Mixed Traffic	Mixed Traffic		Mixed Traffic	Mixed Traffic	Mixed Traffic	Separated	Separated	Separated	Mixed Traffic		
	Left Turn Approach	2-stage, LT box	One lane crossed				One lane crossed	One lane crossed		2-stage, LT box	2-stage, LT box	2-stage, LT box	One lane crossed		
	Operating Speed	> 50 to < 60 km/h	> 50 to < 60 km/h				> 50 to < 60 km/h	> 40 to ≤ 50 km/h		≥ 60 km/h	≥ 60 km/h	> 40 to ≤ 50 km/h	> 40 to ≤ 50 km/h		
Left Turning Cyclist	A	E	-	-		-	E	D	-	A	A	A	D		
Level of Service	A	E	-	-		-	E	D	-	A	A	A	F		
		E					E					F			
Transit	Average Signal Delay		≤ 10 sec	> 40 sec	> 40 sec			≤ 10 sec	≤ 10 sec	> 40 sec	> 40 sec	> 40 sec	> 40 sec		
	Level of Service	-	B	F	F		-	-	B	B	F	F	F	F	
		F					B					F			
Truck	Effective Corner Radius									< 10 m			< 10 m		
	Number of Receiving Lanes on Departure from Intersection									1			≥ 2		
Level of Service	-	-	-	-		-	-	-	-	-	F	-	D		
		-					-					F			
Auto	Volume to Capacity Ratio		0.81 - 0.90				0.0 - 0.60				0.91 - 1.00				
	Level of Service	-	D				-	A				-	E		

McArthur & North River				McArthur & Marguerite				McArthur & Vanier				
NORTH	SOUTH	EAST	WEST	NORTH	SOUTH	EAST	WEST	NORTH	SOUTH	EAST	WEST	
4	5	6	5		4	5	5	7	7	7	6	
No Median - 2.4 m	No Median - 2.4 m	No Median - 2.4 m	No Median - 2.4 m		No Median - 2.4 m	No Median - 2.4 m	No Median - 2.4 m	No Median - 2.4 m	No Median - 2.4 m	No Median - 2.4 m	No Median - 2.4 m	
Permissive	Permissive	Permissive	Permissive		Permissive	No left turn / Prohib.	Permissive	Protected	Protected	Protected	Protected	
Permissive or yield control	Permissive or yield control	Permissive or yield control	Permissive or yield control		Permissive or yield control	Permissive or yield control	No right turn	Permissive or yield control	Permissive or yield control	Permissive or yield control	Permissive or yield control	
RTOR allowed	RTOR allowed	RTOR allowed	RTOR allowed		RTOR allowed	RTOR allowed	RTOR prohibited	RTOR allowed	RTOR allowed	RTOR allowed	RTOR allowed	
No	No	No	No		No	No	No	No	No	No	No	
No Channel	No Channel	No Channel	No Channel		No Channel	No Right Turn	No Channel	Conv'tl without Receiving Lane	Conventional with Receiving Lane	Conv'tl without Receiving Lane	Conventional with Receiving Lane	
5-10m	5-10m	10-15m	5-10m		5-10m	No Right Turn	5-10m	15-25m	15-25m	15-25m	10-15m	
Std transverse markings	Std transverse markings	Std transverse markings	Std transverse markings		Std transverse markings	Std transverse markings	Std transverse markings	Std transverse markings	Textured/coloured pavement	Textured/coloured pavement	Std transverse markings	
54	38	20	38		54	55	46	14	14	17	29	
D	E	F	E		D	D	D	F	F	F	F	
70	70	75	75		75	70	70	140	140	140	140	
25	25	7	7		8	40	28	32	31	7	7	
14	14	31	31		30	6	13	42	42	63	63	
B	B	D	D		D	A	B	E	E	F	F	
D	E	F	E		D	D	D	F	F	F	F	
F					D				F			
NORTH	SOUTH	EAST	WEST	NORTH	SOUTH	EAST	WEST	NORTH	SOUTH	EAST	WEST	
Mixed Traffic	Mixed Traffic	Pocket Bike Lane	Pocket Bike Lane		Mixed Traffic	Curb Bike Lane, Cycletrack or MUP	Curb Bike Lane, Cycletrack or MUP	Mixed Traffic	Mixed Traffic	Curb Bike Lane, Cycletrack or MUP	Curb Bike Lane, Cycletrack or MUP	
			Bike lane shifts to the left of right turn ≤ 25 km/h					> 50 m	> 50 m	Not Applicable	Not Applicable	
						Not Applicable	Not Applicable	>25 km/h	>25 km/h	Not Applicable	Not Applicable	
			D					F	F	Not Applicable	Not Applicable	
Mixed Traffic	Mixed Traffic	Separated	Separated		Mixed Traffic	Separated	Separated	Mixed Traffic	Mixed Traffic	Separated	Separated	
One lane crossed	No lane crossed	1 lane crossed	No lane crossed		One lane crossed	1 lane crossed		≥ 2 lanes crossed	≥ 2 lanes crossed	≥ 2 lanes crossed	≥ 2 lanes crossed	
> 50 to < 60 km/h	> 50 to < 60 km/h	> 50 to < 60 km/h	> 50 to < 60 km/h		> 50 to < 60 km/h	> 50 to < 60 km/h		≥ 60 km/h	≥ 60 km/h	> 50 to < 60 km/h	> 50 to < 60 km/h	
E	C	D	C		E	D	-	F	F	F	F	
E	C	D	D		E	D	-	F	F	F	F	
E					E				F			
≤ 30 sec			≤ 30 sec			≤ 10 sec	≤ 10 sec	> 40 sec	> 40 sec	> 40 sec	> 40 sec	
D	-	-	D		-	B	B	F	F	F	F	
D					B				F			
										> 15 m		
										≥ 2		
										A	-	
										A		
	0.0 - 0.60				0.0 - 0.60				0.81 - 0.90			
A					A				D			

Appendix K

Synchro Intersection Worksheets – 2024 Future Total Conditions

Lanes, Volumes, Timings
1: North River & Montreal

2024 Future Total
AM Peak Hour

Lane Group	EBL	EBT	EBR	WBL	WBT	WBR	NBL	NBT	NBR	SBL	SBT	SBR
Lane Configurations		↑↑			↑↑		↑	↑			↑↑	
Traffic Volume (vph)	0	481	362	0	728	13	252	10	44	17	25	15
Future Volume (vph)	0	481	362	0	728	13	252	10	44	17	25	15
Satd. Flow (prot)	0	2932	0	0	3167	0	1595	1330	0	0	1518	0
Fit Permitted							0.950				0.985	
Satd. Flow (perm)	0	2932	0	0	3167	0	1581	1330	0	0	1499	0
Satd. Flow (RTOR)								44			15	
Lane Group Flow (vph)	0	843	0	0	741	0	252	54	0	0	57	0
Turn Type		NA			NA		Prot	NA		Split	NA	
Protected Phases		2			6		3!	8		7	7!	
Permitted Phases												
Detector Phase		2			6		3	8		7	7	
Switch Phase												
Minimum Initial (s)		10.0			10.0		5.0	10.0		10.0	10.0	
Minimum Split (s)		21.7			21.7		11.5	24.5		16.5	16.5	
Total Split (s)		29.0			29.0		24.0	49.0		17.0	17.0	
Total Split (%)		30.5%			30.5%		25.3%	51.6%		17.9%	17.9%	
Yellow Time (s)		3.0			3.0		3.3	3.3		3.3	3.3	
All-Red Time (s)		3.7			3.7		3.2	3.2		3.2	3.2	
Lost Time Adjust (s)		0.0			0.0		0.0	0.0		0.0	0.0	
Total Lost Time (s)		6.7			6.7		6.5	6.5		6.5	6.5	
Lead/Lag							Lag	Lag		Lead	Lead	
Lead-Lag Optimize?							Yes	Yes		Yes	Yes	
Recall Mode		C-Max			C-Max		None	Ped		None	None	
Act Effct Green (s)		36.2			36.2		21.1	32.3		10.1	10.1	
Actuated g/C Ratio		0.38			0.38		0.22	0.34		0.11	0.11	
v/c Ratio		0.75			0.61		0.71	0.11		0.33	0.33	
Control Delay		32.0			27.4		45.2	9.1		36.4	36.4	
Queue Delay		0.0			36.9		0.0	0.0		0.0	0.0	
Total Delay		32.0			64.2		45.2	9.1		36.4	36.4	
LOS		C			E		D	A		D	D	
Approach Delay		32.0			64.2			38.9		36.4	36.4	
Approach LOS		C			E			D		D	D	
Queue Length 50th (m)		70.2			57.4		42.5	1.3		7.2	7.2	
Queue Length 95th (m)		#110.2			83.0		64.2	8.8		18.7	18.7	
Internal Link Dist (m)		194.5			52.8			112.9		59.0	59.0	
Turn Bay Length (m)							90.0					
Base Capacity (vph)		1117			1207		363	619		181	181	
Starvation Cap Reductn		0			509		0	0		0	0	
Spillback Cap Reductn		0			0		0	0		0	0	
Storage Cap Reductn		0			0		0	0		0	0	
Reduced v/c Ratio		0.75			1.06		0.69	0.09		0.31	0.31	

Intersection Summary	
Cycle Length: 95	
Actuated Cycle Length: 95	
Offset: 0 (0%), Referenced to phase 2:EBT and 6:WBT, Start of Green	
Natural Cycle: 80	
Control Type: Actuated-Coordinated	

Lanes, Volumes, Timings
1: North River & Montreal

2024 Future Total
AM Peak Hour

Lane Group	Ø4
Lane Configurations	
Traffic Volume (vph)	
Future Volume (vph)	
Satd. Flow (prot)	
Fit Permitted	
Satd. Flow (perm)	
Satd. Flow (RTOR)	
Lane Group Flow (vph)	
Turn Type	
Protected Phases	4
Permitted Phases	
Detector Phase	
Switch Phase	
Minimum Initial (s)	5.0
Minimum Split (s)	24.5
Total Split (s)	42.0
Total Split (%)	44%
Yellow Time (s)	3.3
All-Red Time (s)	3.2
Lost Time Adjust (s)	
Total Lost Time (s)	
Lead/Lag	Lead
Lead-Lag Optimize?	Yes
Recall Mode	Ped
Act Effct Green (s)	
Actuated g/C Ratio	
v/c Ratio	
Control Delay	
Queue Delay	
Total Delay	
LOS	
Approach Delay	
Approach LOS	
Queue Length 50th (m)	
Queue Length 95th (m)	
Internal Link Dist (m)	
Turn Bay Length (m)	
Base Capacity (vph)	
Starvation Cap Reductn	
Spillback Cap Reductn	
Storage Cap Reductn	
Reduced v/c Ratio	

Intersection Summary	
Cycle Length: 95	
Actuated Cycle Length: 95	
Offset: 0 (0%), Referenced to phase 2:EBT and 6:WBT, Start of Green	
Natural Cycle: 80	
Control Type: Actuated-Coordinated	

Lanes, Volumes, Timings
1: North River & Montreal

2024 Future Total
AM Peak Hour

Maximum v/c Ratio: 0.75
 Intersection Signal Delay: 45.5 Intersection LOS: D
 Intersection Capacity Utilization 59.9% ICU Level of Service B
 Analysis Period (min) 15
 # 95th percentile volume exceeds capacity, queue may be longer.
 Queue shown is maximum after two cycles.
 ! Phase conflict between lane groups.

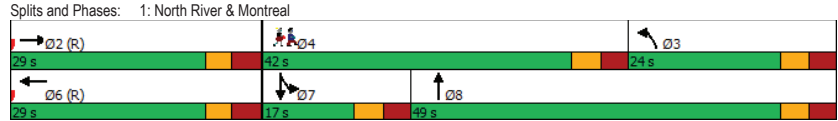

Lanes, Volumes, Timings
2: Montgomery & Montreal

2024 Future Total
AM Peak Hour

Lane Group	EBT	EBR	WBL	WBT	NBL	NBR
Lane Configurations	↔↔			↔↔	↔↔	↔↔
Traffic Volume (vph)	444	98	74	689	52	77
Future Volume (vph)	444	98	74	689	52	77
Satd. Flow (prot)	3124	0	0	3180	1658	1401
Fit Permitted				0.840	0.950	
Satd. Flow (perm)	3124	0	0	2682	1649	1379
Satd. Flow (RTOR)	62					77
Lane Group Flow (vph)	542	0	0	763	52	77
Turn Type	NA		Perm	NA	Perm	Perm
Protected Phases	2			6		
Permitted Phases			6		8	8
Detector Phase	2		6	6	8	8
Switch Phase						
Minimum Initial (s)	10.0		10.0	10.0	10.0	10.0
Minimum Split (s)	40.4		16.4	16.4	19.5	19.5
Total Split (s)	56.0		56.0	56.0	24.0	24.0
Total Split (%)	70.0%		70.0%	70.0%	30.0%	30.0%
Yellow Time (s)	3.0		3.0	3.0	3.3	3.3
All-Red Time (s)	3.4		3.4	3.4	2.2	2.2
Lost Time Adjust (s)	0.0		0.0	0.0	0.0	0.0
Total Lost Time (s)	6.4		6.4	6.4	5.5	5.5
Lead/Lag						
Lead-Lag Optimize?						
Recall Mode	C-Max		C-Max	C-Max	None	None
Act Effct Green (s)	61.7		61.7	61.7	10.8	10.8
Actuated g/C Ratio	0.77		0.77	0.77	0.14	0.14
v/c Ratio	0.22		0.37	0.37	0.23	0.31
Control Delay	3.5		4.8	4.8	33.2	11.3
Queue Delay	0.5		0.0	0.0	0.0	0.0
Total Delay	3.9		4.8	4.8	33.2	11.3
LOS	A		A	A	C	B
Approach Delay	3.9		4.8	4.8	20.1	
Approach LOS	A		A	A	C	
Queue Length 50th (m)	10.0		18.9	18.9	7.3	0.0
Queue Length 95th (m)	18.4		33.1	33.1	16.3	10.8
Internal Link Dist (m)	52.8		138.9	138.9	214.6	
Turn Bay Length (m)					35.0	
Base Capacity (vph)	2422		2067	2067	381	378
Starvation Cap Reductn	1352		0	0	0	0
Spillback Cap Reductn	0		0	0	0	0
Storage Cap Reductn	0		0	0	0	0
Reduced v/c Ratio	0.51		0.37	0.37	0.14	0.20

Intersection Summary
 Cycle Length: 80
 Actuated Cycle Length: 80
 Offset: 0 (0%), Referenced to phase 2:EBT and 6:WBTL, Start of Green
 Natural Cycle: 60
 Control Type: Actuated-Coordinated

Lanes, Volumes, Timings
2: Montgomery & Montreal

2024 Future Total
AM Peak Hour

Maximum v/c Ratio: 0.37	Intersection LOS: A
Intersection Signal Delay: 5.8	ICU Level of Service C
Intersection Capacity Utilization 72.8%	
Analysis Period (min) 15	

Splits and Phases: 2: Montgomery & Montreal

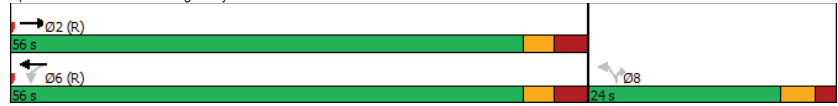

Lanes, Volumes, Timings
4: Vanier & Montreal

2024 Future Total
AM Peak Hour

Lane Group	EBL	EBT	EBR	WBL	WBT	WBR	NBL	NBT	NBR	SBL	SBT	SBR
Lane Configurations	↔	↕	↔	↔	↕	↔	↔	↕	↔	↔	↕	↔
Traffic Volume (vph)	41	310	138	165	495	194	183	879	166	213	1124	141
Future Volume (vph)	41	310	138	165	495	194	183	879	166	213	1124	141
Satd. Flow (prot)	1642	1695	1483	1658	3026	0	1642	4575	0	1642	4649	0
Fit Permitted	0.950			0.950			0.950			0.950		
Satd. Flow (perm)	1594	1695	1385	1599	3026	0	1626	4575	0	1610	4649	0
Satd. Flow (RTOR)			138		39			28			16	
Lane Group Flow (vph)	41	310	138	165	689	0	183	1045	0	213	1265	0
Turn Type	Prot	NA	Perm	Prot	NA		Prot	NA		Prot	NA	
Protected Phases	7	4		3	8		5	2		1	6	
Permitted Phases			4									
Detector Phase	7	4	4	3	8		5	2		1	6	
Switch Phase												
Minimum Initial (s)	5.0	10.0	10.0	5.0	10.0		5.0	10.0		5.0	10.0	
Minimum Split (s)	12.1	40.1	40.1	12.1	40.1		11.1	28.9		11.1	28.9	
Total Split (s)	20.0	41.0	41.0	20.0	41.0		30.0	49.0		30.0	49.0	
Total Split (%)	14.3%	29.3%	29.3%	14.3%	29.3%		21.4%	35.0%		21.4%	35.0%	
Yellow Time (s)	3.0	3.0	3.0	3.0	3.0		3.7	3.7		3.7	3.7	
All-Red Time (s)	4.1	4.1	4.1	4.1	4.1		2.4	2.2		2.4	2.2	
Lost Time Adjust (s)	0.0	0.0	0.0	0.0	0.0		0.0	0.0		0.0	0.0	
Total Lost Time (s)	7.1	7.1	7.1	7.1	7.1		6.1	5.9		6.1	5.9	
Lead/Lag	Lead	Lag	Lag	Lead	Lag		Lead	Lag		Lead	Lag	
Lead-Lag Optimize?	Yes	Yes	Yes	Yes	Yes		Yes	Yes		Yes	Yes	
Recall Mode	None	Max	Max	None	Max		None	C-Max		None	C-Max	
Act Effct Green (s)	8.9	33.9	33.9	12.9	40.4		19.9	45.4		21.6	47.1	
Actuated g/C Ratio	0.06	0.24	0.24	0.09	0.29		0.14	0.32		0.15	0.34	
v/c Ratio	0.39	0.76	0.31	1.09	0.77		0.79	0.70		0.84	0.80	
Control Delay	73.0	62.2	8.4	155.2	50.4		89.2	44.4		84.5	47.0	
Queue Delay	0.0	0.0	0.0	0.0	0.0		0.0	0.0		0.0	0.0	
Total Delay	73.0	62.2	8.4	155.2	50.4		89.2	44.4		84.5	47.0	
LOS	E	E	A	F	D		F	D		F	D	
Approach Delay		47.9			70.6			51.1			52.4	
Approach LOS		D			E			D			D	
Queue Length 50th (m)	11.1	80.2	0.0	-50.9	89.5		53.0	61.5		57.0	116.4	
Queue Length 95th (m)	23.0	#114.9	16.5	#96.9	#125.7		m73.1	80.4		#93.0	140.0	
Internal Link Dist (m)		99.5			262.7			154.6			239.2	
Turn Bay Length (m)	30.0			35.0			94.5			90.0		
Base Capacity (vph)	151	410	439	152	900		280	1501		280	1573	
Starvation Cap Reductn	0	0	0	0	0		0	0		0	0	
Spillback Cap Reductn	0	0	0	0	0		0	0		0	0	
Storage Cap Reductn	0	0	0	0	0		0	0		0	0	
Reduced v/c Ratio	0.27	0.76	0.31	1.09	0.77		0.65	0.70		0.76	0.80	

Intersection Summary

Cycle Length: 140
Actuated Cycle Length: 140
Offset: 102 (73%), Referenced to phase 2:NBT and 6:SBT, Start of Green
Natural Cycle: 115
Control Type: Actuated-Coordinated

Lanes, Volumes, Timings
4: Vanier & Montreal

2024 Future Total
AM Peak Hour

Maximum v/c Ratio: 1.09	Intersection LOS: E
Intersection Signal Delay: 55.3	ICU Level of Service F
Intersection Capacity Utilization 96.2%	
Analysis Period (min) 15	
~ Volume exceeds capacity, queue is theoretically infinite. Queue shown is maximum after two cycles.	
# 95th percentile volume exceeds capacity, queue may be longer. Queue shown is maximum after two cycles.	
m Volume for 95th percentile queue is metered by upstream signal.	

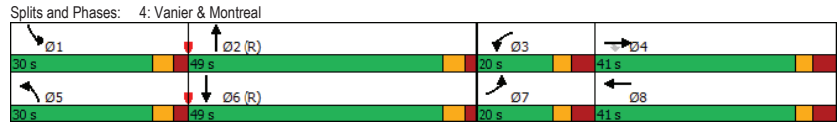

HCM 2010 TWSC
6: North River & Selkirk

2024 Future Total
AM Peak Hour

Intersection						
Int Delay, s/veh	1.3					
Movement	WBL	WBR	NBT	NBR	SBL	SBT
Lane Configurations	↔	↔	↑	↑	↔	↔
Traffic Vol, veh/h	35	40	284	1	0	397
Future Vol, veh/h	35	40	284	1	0	397
Conflicting Peds, #/hr	3	0	0	90	90	0
Sign Control	Stop	Stop	Free	Free	Free	Free
RT Channelized	-	None	-	None	-	None
Storage Length	0	-	-	-	-	-
Veh in Median Storage, #	0	-	0	-	-	0
Grade, %	0	-	0	-	-	0
Peak Hour Factor	100	100	100	100	100	100
Heavy Vehicles, %	7	2	8	2	2	2
Mvmt Flow	35	40	284	1	0	397

Major/Minor	Minor1	Major1	Major2
Conflicting Flow All	577	375	0
Stage 1	375	-	-
Stage 2	202	-	-
Critical Hdwy	6.705	6.23	-
Critical Hdwy Stg 1	5.505	-	-
Critical Hdwy Stg 2	5.905	-	-
Follow-up Hdwy	3.5665	3.319	-
Pot Cap-1 Maneuver	452	670	-
Stage 1	681	-	-
Stage 2	800	-	-
Platoon blocked, %	-	-	-
Mov Cap-1 Maneuver	419	623	-
Mov Cap-2 Maneuver	419	-	-
Stage 1	633	-	-
Stage 2	798	-	-

Approach	WB	NB	SB
HCM Control Delay, s	13.3	0	0
HCM LOS	B		

Minor Lane/Major Mvmt	NBT	NBRWBLn1	SBT
Capacity (veh/h)	-	-	508
HCM Lane V/C Ratio	-	-	0.148
HCM Control Delay (s)	-	-	13.3
HCM Lane LOS	-	-	B
HCM 95th %tile Q(veh)	-	-	0.5

HCM 2010 TWSC
7: Dundas & Selkirk

2024 Future Total
AM Peak Hour

Intersection						
Int Delay, s/veh	0					
Movement	EBT	EBR	WBL	WBT	NBL	NBR
Lane Configurations				↕	↕	
Traffic Vol, veh/h	0	0	30	99	5	79
Future Vol, veh/h	0	0	30	99	5	79
Conflicting Peds, #/hr	0	0	0	0	0	0
Sign Control	Free	Free	Free	Free	Stop	Stop
RT Channelized	-	None	-	None	-	None
Storage Length	-	-	-	-	0	-
Veh in Median Storage, #	-	-	-	-	0	-
Grade, %	0	-	-	0	0	-
Peak Hour Factor	100	100	100	100	100	100
Heavy Vehicles, %	2	2	2	2	2	2
Mvmt Flow	0	0	30	99	5	79

Major/Minor	Major2	Minor1
Conflicting Flow All	0	159
Stage 1	-	0
Stage 2	-	159
Critical Hdwy	4.12	6.42
Critical Hdwy Stg 1	-	-
Critical Hdwy Stg 2	-	5.42
Follow-up Hdwy	2.218	3.518
Pot Cap-1 Maneuver	-	832
Stage 1	-	-
Stage 2	-	870
Platoon blocked, %	-	-
Mov Cap-1 Maneuver	-	832
Mov Cap-2 Maneuver	-	832
Stage 1	-	-
Stage 2	-	870

Approach	WB	NB
HCM Control Delay, s		
HCM LOS		

Minor Lane/Major Mvmt	NBLn1	WBL	WBT
Capacity (veh/h)	-	-	-
HCM Lane V/C Ratio	-	-	-
HCM Control Delay (s)	-	-	-
HCM Lane LOS	-	-	-
HCM 95th %tile Q(veh)	-	-	-

HCM 2010 TWSC
8: Montgomery & Selkirk

2024 Future Total
AM Peak Hour

Intersection												
Int Delay, s/veh	5.9											
Movement	EBL	EBT	EBR	WBL	WBT	WBR	NBL	NBT	NBR	SBL	SBT	SBR
Lane Configurations		↕			↕			↕			↕	
Traffic Vol, veh/h	64	10	5	33	35	29	5	5	0	10	29	90
Future Vol, veh/h	64	10	5	33	35	29	5	5	0	10	29	90
Conflicting Peds, #/hr	0	0	0	0	0	0	0	0	0	0	0	0
Sign Control	Stop	Stop	Stop	Stop	Stop	Stop	Free	Free	Free	Free	Free	Free
RT Channelized	-	-	None	-	-	None	-	-	None	-	-	None
Storage Length	-	-	-	-	-	-	-	-	-	-	-	-
Veh in Median Storage, #	-	0	-	-	0	-	-	0	-	-	0	-
Grade, %	-	0	-	-	0	-	-	0	-	-	0	-
Peak Hour Factor	100	100	100	100	100	100	100	100	100	100	100	100
Heavy Vehicles, %	2	2	2	2	2	2	2	2	2	2	2	2
Mvmt Flow	64	10	5	33	35	29	5	5	0	10	29	90

Major/Minor	Minor2	Minor1	Major1	Major2
Conflicting Flow All	141	109	74	117
Stage 1	94	94	-	15
Stage 2	47	15	-	102
Critical Hdwy	7.12	6.52	6.22	7.12
Critical Hdwy Stg 1	6.12	5.52	-	6.12
Critical Hdwy Stg 2	6.12	5.52	-	6.12
Follow-up Hdwy	3.518	4.018	3.318	3.518
Pot Cap-1 Maneuver	829	781	988	859
Stage 1	913	817	-	1005
Stage 2	967	883	-	904
Platoon blocked, %	-	-	-	-
Mov Cap-1 Maneuver	771	773	988	840
Mov Cap-2 Maneuver	771	773	-	840
Stage 1	910	811	-	1002
Stage 2	901	880	-	882

Approach	EB	WB	NB	SB
HCM Control Delay, s	10.1	9.8	3.7	0.6
HCM LOS	B	A		

Minor Lane/Major Mvmt	NBL	NBT	NBR	EBLn1	WBLn1	SBL	SBT	SBR
Capacity (veh/h)	1469	-	-	782	850	1616	-	-
HCM Lane V/C Ratio	0.003	-	-	0.101	0.114	0.006	-	-
HCM Control Delay (s)	7.5	0	-	10.1	9.8	7.2	0	-
HCM Lane LOS	A	A	-	B	A	A	A	-
HCM 95th %tile Q(veh)	0	-	-	0.3	0.4	0	-	-

Lanes, Volumes, Timings
9: North River & McArthur

2024 Future Total
AM Peak Hour

Lane Group	EBL	EBT	EBR	WBL	WBT	WBR	NBL	NBT	NBR	SBL	SBT	SBR
Lane Configurations		↔			↔	↔		↔		↔	↔	
Traffic Volume (vph)	1	6	3	8	9	169	3	121	29	322	106	4
Future Volume (vph)	1	6	3	8	9	169	3	121	29	322	106	4
Satd. Flow (prot)	0	1652	0	0	1705	1441	0	1627	0	1658	1687	0
Fit Permitted		0.988			0.925			0.997		0.660		
Satd. Flow (perm)	0	1633	0	0	1610	1341	0	1624	0	1050	1687	0
Satd. Flow (RTOR)		3			169			25		4		
Lane Group Flow (vph)	0	10	0	0	17	169	0	153	0	322	110	0
Turn Type	Perm	NA		Perm	NA	Perm	Perm	NA		Perm	NA	
Protected Phases		4			8			2			6	
Permitted Phases	4			8		8	2			6		
Detector Phase	4	4		8	8	8	2	2		6	6	
Switch Phase												
Minimum Initial (s)	10.0	10.0		10.0	10.0	10.0	10.0	10.0		10.0	10.0	
Minimum Split (s)	25.6	25.6		25.6	25.6	25.6	31.1	31.1		31.1	31.1	
Total Split (s)	28.0	28.0		28.0	28.0	28.0	42.0	42.0		42.0	42.0	
Total Split (%)	40.0%	40.0%		40.0%	40.0%	40.0%	60.0%	60.0%		60.0%	60.0%	
Yellow Time (s)	3.3	3.3		3.3	3.3	3.3	3.3	3.3		3.3	3.3	
All-Red Time (s)	2.3	2.3		2.3	2.3	2.3	2.8	2.8		2.8	2.8	
Lost Time Adjust (s)		0.0			0.0	0.0		0.0		0.0	0.0	
Total Lost Time (s)		5.6			5.6	5.6		6.1		6.1	6.1	
Lead/Lag												
Lead-Lag Optimize?												
Recall Mode	Max	Max		Max	Max	Max	C-Max	C-Max		C-Max	C-Max	
Act Effct Green (s)		22.4			22.4	22.4		35.9		35.9	35.9	
Actuated g/C Ratio		0.32			0.32	0.32		0.51		0.51	0.51	
v/c Ratio		0.02			0.03	0.31		0.18		0.60	0.13	
Control Delay		14.4			11.6	8.2		8.3		17.8	9.1	
Queue Delay		0.0			0.0	0.0		0.0		0.0	0.0	
Total Delay		14.4			11.6	8.2		8.3		17.8	9.1	
LOS		B			B	A		A		B	A	
Approach Delay		14.4			8.5			8.3		15.6		
Approach LOS		B			A			A		B		
Queue Length 50th (m)		0.6			1.6	13.6		8.3		27.6	6.7	
Queue Length 95th (m)		3.5			5.4	22.6		17.0		52.8	14.0	
Internal Link Dist (m)		22.5			128.8			367.7			94.3	
Turn Bay Length (m)						60.0				55.0		
Base Capacity (vph)		524			515	544		845		538	867	
Starvation Cap Reductn		0			0	0		0		0	0	
Spillback Cap Reductn		0			0	0		0		0	0	
Storage Cap Reductn		0			0	0		0		0	0	
Reduced v/c Ratio		0.02			0.03	0.31		0.18		0.60	0.13	

Intersection Summary												
Cycle Length: 70												
Actuated Cycle Length: 70												
Offset: 0 (0%), Referenced to phase 2:NBTL and 6:SBTL, Start of Green												
Natural Cycle: 60												
Control Type: Actuated-Coordinated												

Lanes, Volumes, Timings
9: North River & McArthur

2024 Future Total
AM Peak Hour

Maximum v/c Ratio: 0.60	Intersection LOS: B
Intersection Signal Delay: 12.5	ICU Level of Service D
Intersection Capacity Utilization 73.2%	
Analysis Period (min) 15	

Splits and Phases: 9: North River & McArthur

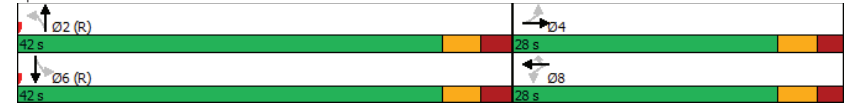

HCM 2010 TWSC
10: McArthur & Dundas

2024 Future Total
AM Peak Hour

Intersection						
Int Delay, s/veh	0.6					
Movement	EBL	EBT	WBT	WBR	SBL	SBR
Lane Configurations		↔	↔		↔	↔
Traffic Vol, veh/h	10	361	322	88	10	16
Future Vol, veh/h	10	361	322	88	10	16
Conflicting Peds, #/hr	100	0	0	100	1	9
Sign Control	Free	Free	Free	Free	Stop	Stop
RT Channelized	-	None	-	None	-	None
Storage Length	-	-	-	-	0	-
Veh in Median Storage, #	-	0	0	-	0	-
Grade, %	-	0	0	-	0	-
Peak Hour Factor	100	100	100	100	100	100
Heavy Vehicles, %	10	2	5	3	2	2
Mvmt Flow	10	361	322	88	10	16
Major/Minor	Major1	Major2	Minor2			
Conflicting Flow All	510	0	0	848	475	
Stage 1	-	-	-	466	-	
Stage 2	-	-	-	382	-	
Critical Hdwy	4.2	-	-	6.42	6.22	
Critical Hdwy Stg 1	-	-	-	5.42	-	
Critical Hdwy Stg 2	-	-	-	5.42	-	
Follow-up Hdwy	2.29	-	-	3.518	3.318	
Pot Cap-1 Maneuver	1015	-	-	332	590	
Stage 1	-	-	-	632	-	
Stage 2	-	-	-	690	-	
Platoon blocked, %	-	-	-	-	-	
Mov Cap-1 Maneuver	936	-	-	279	540	
Mov Cap-2 Maneuver	-	-	-	279	-	
Stage 1	-	-	-	575	-	
Stage 2	-	-	-	636	-	
Approach	EB	WB	SB			
HCM Control Delay, s	0.2	0	14.7			
HCM LOS				B		
Minor Lane/Major Mvmt	EBL	EBT	WBT	WBR	SBLn1	
Capacity (veh/h)	936	-	-	-	397	
HCM Lane V/C Ratio	0.011	-	-	-	0.065	
HCM Control Delay (s)	8.9	0	-	-	14.7	
HCM Lane LOS	A	A	-	-	B	
HCM 95th %tile Q(veh)	0	-	-	-	0.2	

Lanes, Volumes, Timings
11: Marguerite & McArthur

2024 Future Total
AM Peak Hour

Lane Group	EBT	EBR	WBL	WBT	NBL	NBR
Lane Configurations	↔			↔	↔	↔
Traffic Volume (vph)	353	19	46	408	9	31
Future Volume (vph)	353	19	46	408	9	31
Satd. Flow (prot)	1728	0	0	1736	1658	1483
Fit Permitted				0.938	0.950	
Satd. Flow (perm)	1728	0	0	1634	1551	1426
Satd. Flow (RTOR)	6					31
Lane Group Flow (vph)	372	0	0	454	9	31
Turn Type	NA		Perm	NA	Prot	Perm
Protected Phases	2			6	8	
Permitted Phases			6			8
Detector Phase	2		6	6	8	8
Switch Phase						
Minimum Initial (s)	10.0		10.0	10.0	5.0	5.0
Minimum Split (s)	27.5		15.5	15.5	24.5	24.5
Total Split (s)	45.0		45.0	45.0	25.0	25.0
Total Split (%)	64.3%		64.3%	64.3%	35.7%	35.7%
Yellow Time (s)	3.3		3.3	3.3	3.3	3.3
All-Red Time (s)	2.2		2.2	2.2	2.2	2.2
Lost Time Adjust (s)	0.0		0.0	0.0	0.0	0.0
Total Lost Time (s)	5.5		5.5	5.5	5.5	5.5
Lead/Lag						
Lead-Lag Optimize?						
Recall Mode	C-Max		C-Max	C-Max	None	None
Act Effct Green (s)	54.6		54.6	11.1	11.1	11.1
Actuated g/C Ratio	0.78		0.78	0.16	0.16	0.16
v/c Ratio	0.28		0.36	0.03	0.12	0.12
Control Delay	4.0		7.3	20.6	8.9	8.9
Queue Delay	0.0		0.0	0.0	0.0	0.0
Total Delay	4.0		7.3	20.6	8.9	8.9
LOS	A		A	C	A	A
Approach Delay	4.0		7.3	11.5		
Approach LOS	A		A	B		
Queue Length 50th (m)	9.1		37.4	1.1	0.0	0.0
Queue Length 95th (m)	21.2		m48.1	3.9	5.5	5.5
Internal Link Dist (m)	36.3		7.3	144.2		
Turn Bay Length (m)				20.0		
Base Capacity (vph)	1349		1274	461	419	
Starvation Cap Reductn	0		0	0	0	
Spillback Cap Reductn	0		0	0	0	
Storage Cap Reductn	0		0	0	0	
Reduced v/c Ratio	0.28		0.36	0.02	0.07	

Intersection Summary	
Cycle Length:	70
Actuated Cycle Length:	70
Offset:	0 (0%), Referenced to phase 2:EBT and 6:WBTL, Start of Green
Natural Cycle:	55
Control Type:	Actuated-Coordinated

Lanes, Volumes, Timings
11: Marguerite & McArthur

2024 Future Total
AM Peak Hour

Maximum v/c Ratio: 0.36	Intersection LOS: A
Intersection Signal Delay: 6.1	ICU Level of Service C
Intersection Capacity Utilization 67.2%	
Analysis Period (min) 15	

m Volume for 95th percentile queue is metered by upstream signal.

Splits and Phases: 11: Marguerite & McArthur



Lanes, Volumes, Timings
12: Vanier & McArthur

2024 Future Total
AM Peak Hour

Lane Group	EBL	EBT	EBR	WBL	WBT	WBR	NBL	NBT	NBR	SBL	SBT	SBR
Lane Configurations	↔	↗	↘	↔	↗	↘	↔	↗	↘	↔	↗	↘
Traffic Volume (vph)	34	131	308	209	198	104	225	1073	225	140	1241	60
Future Volume (vph)	34	131	308	209	198	104	225	1073	225	140	1241	60
Satd. Flow (prot)	1551	1695	1483	3216	1695	1483	1658	3316	1483	1658	3316	1441
Fit Permitted	0.950			0.950			0.950			0.950		
Satd. Flow (perm)	1436	1695	1398	3092	1695	1320	1643	3316	1407	1643	3316	1342
Satd. Flow (RTOR)			251			168			213			121
Lane Group Flow (vph)	34	131	308	209	198	104	225	1073	225	140	1241	60
Turn Type	Prot	NA	Perm	Prot	NA	Perm	Prot	NA	Perm	Prot	NA	Perm
Protected Phases	7	4		3	8		5	2		1	6	
Permitted Phases			4			8			2			6
Detector Phase	7	4	4	3	8	8	5	2	2	1	6	6
Switch Phase												
Minimum Initial (s)	5.0	10.0	10.0	5.0	10.0	10.0	5.0	10.0	10.0	5.0	10.0	10.0
Minimum Split (s)	11.2	36.2	36.2	11.2	36.2	36.2	11.1	36.1	36.1	11.1	36.1	36.1
Total Split (s)	20.0	36.2	36.2	20.0	36.2	36.2	23.0	59.8	59.8	24.0	60.8	60.8
Total Split (%)	14.3%	25.9%	25.9%	14.3%	25.9%	25.9%	16.4%	42.7%	42.7%	17.1%	43.4%	43.4%
Yellow Time (s)	3.3	3.3	3.3	3.3	3.3	3.3	3.7	3.7	3.7	3.7	3.7	3.7
All-Red Time (s)	2.9	2.9	2.9	2.9	2.9	2.9	2.4	2.4	2.4	2.4	2.4	2.4
Lost Time Adjust (s)	0.0	0.0	0.0	0.0	0.0	0.0	0.0	0.0	0.0	0.0	0.0	0.0
Total Lost Time (s)	6.2	6.2	6.2	6.2	6.2	6.2	6.1	6.1	6.1	6.1	6.1	6.1
Lead/Lag	Lag	Lead	Lead	Lag	Lead	Lead	Lag	Lag	Lag	Lead	Lead	Lead
Lead-Lag Optimize?	Yes	Yes	Yes	Yes	Yes	Yes	Yes	Yes	Yes	Yes	Yes	Yes
Recall Mode	None	None	None	None	None	None	C-Max	C-Max	C-Max	None	C-Max	C-Max
Act Effct Green (s)	10.8	26.0	26.0	12.9	33.1	33.1	16.9	60.8	60.8	15.7	59.6	59.6
Actuated g/C Ratio	0.08	0.19	0.19	0.09	0.24	0.24	0.12	0.43	0.43	0.11	0.43	0.43
v/c Ratio	0.29	0.42	0.67	0.71	0.49	0.24	1.12	0.75	0.31	0.76	0.88	0.09
Control Delay	66.0	46.4	18.8	75.0	51.8	1.4	155.3	39.2	5.5	84.0	72.5	14.9
Queue Delay	0.0	0.0	0.0	0.0	0.0	0.0	0.0	0.0	0.0	0.0	0.0	0.0
Total Delay	66.0	46.4	18.8	75.0	51.8	1.4	155.3	39.2	5.5	84.0	72.5	14.9
LOS	E	D	B	E	D	A	F	D	A	F	E	B
Approach Delay		29.8			51.1			51.4			71.2	
Approach LOS		C			D			D			E	
Queue Length 50th (m)	9.4	26.0	17.8	29.2	49.2	0.0	~71.8	140.3	2.0	40.8	172.3	3.0
Queue Length 95th (m)	21.3	43.3	34.9	42.8	74.9	0.5	#123.5	170.2	18.8	m51.3 m#211.4	m5.9	
Internal Link Dist (m)		122.9			141.8			130.7			202.5	
Turn Bay Length (m)	30.0		50.0	120.0		115.0	90.0		90.0	90.0		90.0
Base Capacity (vph)	152	363	496	317	409	445	200	1439	731	211	1411	640
Starvation Cap Reductn	0	0	0	0	0	0	0	0	0	0	0	0
Spillback Cap Reductn	0	0	0	0	0	0	0	0	0	0	0	0
Storage Cap Reductn	0	0	0	0	0	0	0	0	0	0	0	0
Reduced v/c Ratio	0.22	0.36	0.62	0.66	0.48	0.23	1.13	0.75	0.31	0.66	0.88	0.09

Intersection Summary												
Cycle Length: 140												
Actuated Cycle Length: 140												
Offset: 100 (71%), Referenced to phase 2:NBT and 6:SBT, Start of Green												
Natural Cycle: 135												
Control Type: Actuated-Coordinated												

Lanes, Volumes, Timings
12: Vanier & McArthur

2024 Future Total
AM Peak Hour

Maximum v/c Ratio: 1.13	Intersection LOS: E
Intersection Signal Delay: 56.0	ICU Level of Service F
Intersection Capacity Utilization 97.7%	
Analysis Period (min) 15	
~ Volume exceeds capacity, queue is theoretically infinite. Queue shown is maximum after two cycles.	
# 95th percentile volume exceeds capacity, queue may be longer. Queue shown is maximum after two cycles.	
m Volume for 95th percentile queue is metered by upstream signal.	

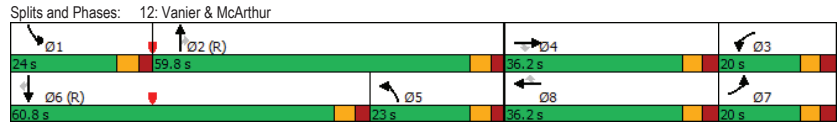

HCM 2010 TWSC
13: Palace & Site Access

2024 Future Total
AM Peak Hour

Intersection						
Int Delay, s/veh	3.8					
Movement	WBL	WBR	NBT	NBR	SBL	SBT
Lane Configurations	↔	↔	↔	↔	↔	↔
Traffic Vol, veh/h	41	0	0	0	20	37
Future Vol, veh/h	41	0	0	0	20	37
Conflicting Peds, #/hr	0	0	0	0	0	0
Sign Control	Stop	Stop	Free	Free	Free	Free
RT Channelized	-	None	-	None	-	None
Storage Length	0	-	-	-	-	-
Veh in Median Storage, #	0	-	-	-	-	0
Grade, %	0	-	0	-	-	0
Peak Hour Factor	100	100	100	100	100	100
Heavy Vehicles, %	2	2	2	2	2	2
Mvmt Flow	41	0	0	0	20	37

Major/Minor	Minor1	Major2	
Conflicting Flow All	77	-	0 0
Stage 1	0	-	-
Stage 2	77	-	-
Critical Hdwy	6.42	-	4.12 -
Critical Hdwy Stg 1	-	-	- -
Critical Hdwy Stg 2	5.42	-	- -
Follow-up Hdwy	3.518	-	2.218 -
Pot Cap-1 Maneuver	926	0	- -
Stage 1	-	0	- -
Stage 2	946	0	- -
Platoon blocked, %			-
Mov Cap-1 Maneuver	926	-	- -
Mov Cap-2 Maneuver	926	-	- -
Stage 1	-	-	- -
Stage 2	946	-	- -

Approach	WB	SB
HCM Control Delay, s	9.1	
HCM LOS	A	

Minor Lane/Major Mvmt	WBLn1	SBL	SBT
Capacity (veh/h)	926	-	-
HCM Lane V/C Ratio	0.044	-	-
HCM Control Delay (s)	9.1	-	-
HCM Lane LOS	A	-	-
HCM 95th %tile Q(veh)	0.1	-	-

HCM 2010 TWSC
15: McArthur & Mayfield

2024 Future Total
AM Peak Hour

Intersection						
Int Delay, s/veh	0.7					
Movement	EBL	EBT	WBT	WBR	SBL	SBR
Lane Configurations		↑	↑		↓	↓
Traffic Vol, veh/h	0	384	453	0	36	4
Future Vol, veh/h	0	384	453	0	36	4
Conflicting Peds, #/hr	0	0	0	0	0	0
Sign Control	Free	Free	Free	Free	Stop	Stop
RT Channelized	-	None	-	None	-	None
Storage Length	-	-	-	-	0	0
Veh in Median Storage, #	-	0	0	-	0	-
Grade, %	-	0	0	-	0	-
Peak Hour Factor	100	100	100	100	100	100
Heavy Vehicles, %	2	2	2	2	2	2
Mvmt Flow	0	384	453	0	36	4
Major/Minor	Major1	Major2	Minor2			
Conflicting Flow All	-	0	-	0	837	453
Stage 1	-	-	-	-	453	-
Stage 2	-	-	-	-	384	-
Critical Hdwy	-	-	-	-	6.42	6.22
Critical Hdwy Stg 1	-	-	-	-	5.42	-
Critical Hdwy Stg 2	-	-	-	-	5.42	-
Follow-up Hdwy	-	-	-	-	3.518	3.318
Pot Cap-1 Maneuver	0	-	-	0	337	607
Stage 1	0	-	-	0	640	-
Stage 2	0	-	-	0	688	-
Platoon blocked, %	-	-	-	-	-	-
Mov Cap-1 Maneuver	-	-	-	-	337	607
Mov Cap-2 Maneuver	-	-	-	-	337	-
Stage 1	-	-	-	-	640	-
Stage 2	-	-	-	-	688	-
Approach	EB	WB	SB			
HCM Control Delay, s	0	0	16.4			
HCM LOS			C			
Minor Lane/Major Mvmt	EBT	WBT	SBLn1	SBLn2		
Capacity (veh/h)	-	-	337	607		
HCM Lane V/C Ratio	-	-	0.107	0.007		
HCM Control Delay (s)	-	-	17	11		
HCM Lane LOS	-	-	C	B		
HCM 95th %tile Q(veh)	-	-	0.4	0		

Lanes, Volumes, Timings
1: North River & Montreal

2024 Future Total
PM Peak Hour

Lane Group	EBL	EBT	EBR	WBL	WBT	WBR	NBL	NBT	NBR	SBL	SBT	SBR
Lane Configurations		↑↑			↑↑		↑	↑			↓	↓
Traffic Volume (vph)	0	630	410	0	701	18	364	17	51	21	15	21
Future Volume (vph)	0	630	410	0	701	18	364	17	51	21	15	21
Satd. Flow (prot)	0	2928	0	0	3243	0	1658	1449	0	0	1506	0
Fit Permitted							0.950				0.982	
Satd. Flow (perm)	0	2928	0	0	3243	0	1634	1449	0	0	1474	0
Satd. Flow (RTOR)		123					51				19	
Lane Group Flow (vph)	0	1040	0	0	719	0	364	68	0	0	57	0
Turn Type		NA			NA		Prot	NA		Split	NA	
Protected Phases		2			6		3!	8		7	7!	
Permitted Phases												
Detector Phase		2			6		3	8		7	7	
Switch Phase												
Minimum Initial (s)		10.0			10.0		5.0	10.0		10.0	10.0	
Minimum Split (s)		21.7			21.7		11.5	24.5		16.5	16.5	
Total Split (s)		39.0			39.0		39.0	64.0		17.0	17.0	
Total Split (%)		32.5%			32.5%		32.5%	53.3%		14.2%	14.2%	
Yellow Time (s)		3.0			3.0		3.3	3.3		3.3	3.3	
All-Red Time (s)		3.7			3.7		3.2	3.2		3.2	3.2	
Lost Time Adjust (s)		0.0			0.0		0.0	0.0		0.0	0.0	
Total Lost Time (s)		6.7			6.7		6.5	6.5		6.5	6.5	
Lead/Lag							Lag	Lag		Lead	Lead	
Lead-Lag Optimize?							Yes	Yes		Yes	Yes	
Recall Mode		C-Max			C-Max		None	Ped		None	None	
Act Effct Green (s)		50.7			50.7		31.6	42.7			10.1	
Actuated g/C Ratio		0.42			0.42		0.26	0.36			0.08	
v/c Ratio		0.80			0.52		0.83	0.12			0.40	
Control Delay		32.9			28.6		58.1	10.1			45.7	
Queue Delay		0.0			48.7		0.0	0.0			0.0	
Total Delay		32.9			77.3		58.1	10.1			45.7	
LOS		C			E		E	B			D	
Approach Delay		32.9			77.3			50.6			45.7	
Approach LOS		C			E			D			D	
Queue Length 50th (m)		99.5			65.4		80.7	2.7			8.6	
Queue Length 95th (m)		#152.6			92.7		107.5	11.6			21.9	
Internal Link Dist (m)		179.1			52.8			112.9			59.0	
Turn Bay Length (m)							90.0					
Base Capacity (vph)		1308			1370		475	720			149	
Starvation Cap Reductn		0			711		0	0			0	
Spillback Cap Reductn		0			0		0	0			0	
Storage Cap Reductn		0			0		0	0			0	
Reduced v/c Ratio		0.80			1.09		0.77	0.09			0.38	

Intersection Summary	
Cycle Length:	120
Actuated Cycle Length:	120
Offset:	0 (0%), Referenced to phase 2:EBT and 6:WBT, Start of Green
Natural Cycle:	90
Control Type:	Actuated-Coordinated

Lanes, Volumes, Timings
1: North River & Montreal

2024 Future Total
PM Peak Hour

Lane Group	Ø4
Lane Configurations	
Traffic Volume (vph)	
Future Volume (vph)	
Satd. Flow (prot)	
Fit Permitted	
Satd. Flow (perm)	
Satd. Flow (RTOR)	
Lane Group Flow (vph)	
Turn Type	
Protected Phases	4
Permitted Phases	
Detector Phase	
Switch Phase	
Minimum Initial (s)	5.0
Minimum Split (s)	24.5
Total Split (s)	42.0
Total Split (%)	35%
Yellow Time (s)	3.3
All-Red Time (s)	3.2
Lost Time Adjust (s)	
Total Lost Time (s)	
Lead/Lag	Lead
Lead-Lag Optimize?	Yes
Recall Mode	Ped
Act Effct Green (s)	
Actuated g/C Ratio	
v/c Ratio	
Control Delay	
Queue Delay	
Total Delay	
LOS	
Approach Delay	
Approach LOS	
Queue Length 50th (m)	
Queue Length 95th (m)	
Internal Link Dist (m)	
Turn Bay Length (m)	
Base Capacity (vph)	
Starvation Cap Reductn	
Spillback Cap Reductn	
Storage Cap Reductn	
Reduced v/c Ratio	
Intersection Summary	

Lanes, Volumes, Timings
1: North River & Montreal

2024 Future Total
PM Peak Hour

Maximum v/c Ratio: 0.83
 Intersection Signal Delay: 50.8
 Intersection Capacity Utilization 72.5%
 Analysis Period (min) 15
 Intersection LOS: D
 ICU Level of Service C
 # 95th percentile volume exceeds capacity, queue may be longer.
 Queue shown is maximum after two cycles.
 ! Phase conflict between lane groups.

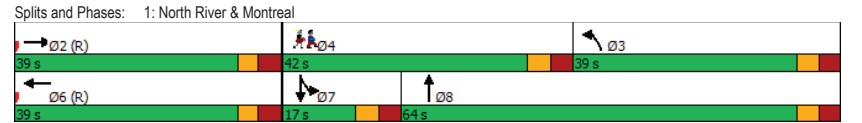

Lanes, Volumes, Timings
2: Montgomery & Montreal

2024 Future Total
PM Peak Hour

Lane Group	EBT	EBR	WBL	WBT	NBL	NBR
Lane Configurations	↕↕			↕↕	↕	↕
Traffic Volume (vph)	578	124	117	571	153	101
Future Volume (vph)	578	124	117	571	153	101
Satd. Flow (prot)	3176	0	0	3252	1658	1401
Fit Permitted				0.711	0.950	
Satd. Flow (perm)	3176	0	0	2326	1647	1314
Satd. Flow (RTOR)	62					101
Lane Group Flow (vph)	702	0	0	688	153	101
Turn Type	NA		Perm	NA	Prot	Perm
Protected Phases	2			6	8	
Permitted Phases			6			8
Detector Phase	2		6	6	8	8
Switch Phase						
Minimum Initial (s)	10.0		10.0	10.0	10.0	10.0
Minimum Split (s)	39.9		15.9	15.9	19.5	19.5
Total Split (s)	76.0		76.0	76.0	24.0	24.0
Total Split (%)	76.0%		76.0%	76.0%	24.0%	24.0%
Yellow Time (s)	3.0		3.0	3.0	3.3	3.3
All-Red Time (s)	2.6		2.6	2.6	2.2	2.2
Lost Time Adjust (s)	0.0		0.0	0.0	0.0	0.0
Total Lost Time (s)	5.6		5.6	5.6	5.5	5.5
Lead/Lag						
Lead-Lag Optimize?						
Recall Mode	C-Max		C-Max	C-Max	None	None
Act Effct Green (s)	74.5		74.5	14.4	14.4	14.4
Actuated g/C Ratio	0.74		0.74	0.14	0.14	0.14
v/c Ratio	0.29		0.40	0.65	0.37	
Control Delay	4.4		5.8	52.6	11.4	
Queue Delay	1.5		0.0	0.0	0.0	
Total Delay	5.9		5.8	52.6	11.4	
LOS	A		A	D	B	
Approach Delay	5.9		5.8	36.3		
Approach LOS	A		A	D		
Queue Length 50th (m)	17.3		21.2	28.3	0.0	
Queue Length 95th (m)	28.5		35.3	46.5	13.4	
Internal Link Dist (m)	52.8		138.9	214.6		
Turn Bay Length (m)				35.0		
Base Capacity (vph)	2383		1733	306	325	
Starvation Cap Reductn	1434		0	0	0	
Spillback Cap Reductn	0		0	0	0	
Storage Cap Reductn	0		0	0	0	
Reduced v/c Ratio	0.74		0.40	0.50	0.31	

Intersection Summary	
Cycle Length:	100
Actuated Cycle Length:	100
Offset:	0 (0%), Referenced to phase 2:EBT and 6:WBTL, Start of Green
Natural Cycle:	60
Control Type:	Actuated-Coordinated

Lanes, Volumes, Timings
2: Montgomery & Montreal

2024 Future Total
PM Peak Hour

Maximum v/c Ratio: 0.65	Intersection LOS: B
Intersection Signal Delay: 10.5	ICU Level of Service C
Intersection Capacity Utilization 71.3%	
Analysis Period (min) 15	

Splits and Phases: 2: Montgomery & Montreal

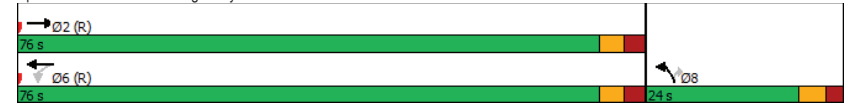

Lanes, Volumes, Timings
4: Vanier & Montreal

2024 Future Total
PM Peak Hour

Lane Group	EBL	EBT	EBR	WBL	WBT	WBR	NBL	NBT	NBR	SBL	SBT	SBR
Lane Configurations	↖	↗	↘	↖	↗	↘	↖	↗	↘	↖	↗	↘
Traffic Volume (vph)	55	392	180	156	380	198	235	1037	210	142	1045	105
Future Volume (vph)	55	392	180	156	380	198	235	1037	210	142	1045	105
Satd. Flow (prot)	1626	1695	1483	1658	2962	0	1658	4563	0	1658	4658	0
Fit Permitted	0.950			0.950			0.950			0.950		
Satd. Flow (perm)	1561	1695	1376	1599	2962	0	1630	4563	0	1633	4658	0
Satd. Flow (RTOR)			171		63			29			11	
Lane Group Flow (vph)	55	392	180	156	578	0	235	1247	0	142	1150	0
Turn Type	Prot	NA	Perm	Prot	NA		Prot	NA		Prot	NA	
Protected Phases	7	4		3	8		5	2		1	6	
Permitted Phases			4									
Detector Phase	7	4	4	3	8		5	2		1	6	
Switch Phase												
Minimum Initial (s)	5.0	10.0	10.0	5.0	10.0		5.0	10.0		5.0	10.0	
Minimum Split (s)	12.1	40.1	40.1	12.1	40.1		11.1	28.9		11.1	28.9	
Total Split (s)	30.0	41.0	41.0	30.0	41.0		30.0	39.0		30.0	39.0	
Total Split (%)	21.4%	29.3%	29.3%	21.4%	29.3%		21.4%	27.9%		21.4%	27.9%	
Yellow Time (s)	3.0	3.0	3.0	3.0	3.0		3.7	3.7		3.7	3.7	
All-Red Time (s)	4.1	4.1	4.1	4.1	4.1		2.4	2.2		2.4	2.2	
Lost Time Adjust (s)	0.0	0.0	0.0	0.0	0.0		0.0	0.0		0.0	0.0	
Total Lost Time (s)	7.1	7.1	7.1	7.1	7.1		6.1	5.9		6.1	5.9	
Lead/Lag	Lead	Lag	Lag	Lead	Lag		Lead	Lag		Lead	Lag	
Lead-Lag Optimize?	Yes	Yes	Yes	Yes	Yes		Yes	Yes		Yes	Yes	
Recall Mode	None	Max	Max	None	Max		None	C-Max		None	C-Max	
Act Effct Green (s)	10.1	38.8	38.8	18.0	49.3		22.5	39.8		17.2	34.5	
Actuated g/C Ratio	0.07	0.28	0.28	0.13	0.35		0.16	0.28		0.12	0.25	
v/c Ratio	0.47	0.83	0.36	0.74	0.53		0.88	0.95		0.70	0.99	
Control Delay	74.5	64.5	9.0	78.3	35.4		88.8	72.3		76.2	77.0	
Queue Delay	0.0	0.0	0.0	0.0	0.0		0.0	0.0		0.0	0.0	
Total Delay	74.5	64.5	9.0	78.3	35.4		88.8	72.3		76.2	77.0	
LOS	E	E	A	E	D		F	E		E	E	
Approach Delay		49.5			44.5			75.0			76.9	
Approach LOS		D			D			E			E	
Queue Length 50th (m)	14.9	102.9	1.8	42.0	61.5		68.9	102.4		38.3	~124.4	
Queue Length 95th (m)	28.4	#169.9	21.4	63.9	84.3		m78.8	m#163.3		58.2	#154.3	
Internal Link Dist (m)		99.5			237.5			154.5			139.4	
Turn Bay Length (m)	30.0			35.0			94.5			90.0		
Base Capacity (vph)	265	470	505	271	1084		283	1317		283	1156	
Starvation Cap Reductn	0	0	0	0	0		0	0		0	0	
Spillback Cap Reductn	0	0	0	0	0		0	0		0	0	
Storage Cap Reductn	0	0	0	0	0		0	0		0	0	
Reduced v/c Ratio	0.21	0.83	0.36	0.58	0.53		0.83	0.95		0.50	0.99	

Intersection Summary
 Cycle Length: 140
 Actuated Cycle Length: 140
 Offset: 56 (40%), Referenced to phase 2:NBT and 6:SBT, Start of Green
 Natural Cycle: 115
 Control Type: Actuated-Coordinated

Lanes, Volumes, Timings
4: Vanier & Montreal

2024 Future Total
PM Peak Hour

Maximum v/c Ratio: 0.99
 Intersection Signal Delay: 66.3
 Intersection Capacity Utilization 96.3%
 Analysis Period (min) 15
 Intersection LOS: E
 ICU Level of Service F
 ~ Volume exceeds capacity, queue is theoretically infinite.
 Queue shown is maximum after two cycles.
 # 95th percentile volume exceeds capacity, queue may be longer.
 Queue shown is maximum after two cycles.
 m Volume for 95th percentile queue is metered by upstream signal.

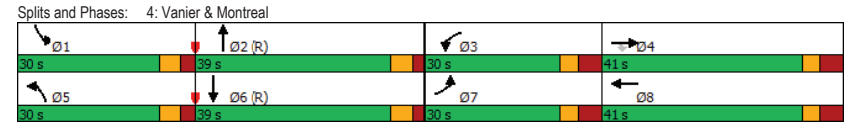

HCM 2010 TWSC
6: North River & Selkirk

2024 Future Total
PM Peak Hour

Intersection						
Int Delay, s/veh	3.3					
Movement	WBL	WBR	NBT	NBR	SBL	SBT
Lane Configurations	↔		↑			↑↑
Traffic Vol, veh/h	120	51	391	2	0	434
Future Vol, veh/h	120	51	391	2	0	434
Conflicting Peds, #/hr	2	2	0	66	66	0
Sign Control	Stop	Stop	Free	Free	Free	Free
RT Channelized	-	None	-	None	-	None
Storage Length	0	-	-	-	-	-
Veh in Median Storage, #	0	-	0	-	-	0
Grade, %	0	-	0	-	-	0
Peak Hour Factor	100	100	100	100	100	100
Heavy Vehicles, %	2	2	3	2	2	4
Mvmt Flow	120	51	391	2	0	434
Major/Minor	Minor1	Major1	Major2			
Conflicting Flow All	677	460	0	0	-	-
Stage 1	458	-	-	-	-	-
Stage 2	219	-	-	-	-	-
Critical Hdwy	6.63	6.23	-	-	-	-
Critical Hdwy Stg 1	5.43	-	-	-	-	-
Critical Hdwy Stg 2	5.83	-	-	-	-	-
Follow-up Hdwy	3.519	3.319	-	-	-	-
Pot Cap-1 Maneuver	402	600	-	-	0	-
Stage 1	636	-	-	-	0	-
Stage 2	797	-	-	-	0	-
Platoon blocked, %	-	-	-	-	-	-
Mov Cap-1 Maneuver	381	568	-	-	-	-
Mov Cap-2 Maneuver	381	-	-	-	-	-
Stage 1	604	-	-	-	-	-
Stage 2	795	-	-	-	-	-
Approach	WB	NB	SB			
HCM Control Delay, s	19.2	0	0			
HCM LOS	C					
Minor Lane/Major Mvmt	NBT	NBR	WBLn1	SBT		
Capacity (veh/h)	-	-	422	-		
HCM Lane V/C Ratio	-	-	0.405	-		
HCM Control Delay (s)	-	-	19.2	-		
HCM Lane LOS	-	-	C	-		
HCM 95th %tile Q(veh)	-	-	1.9	-		

HCM 2010 TWSC
7: Dundas & Selkirk

2024 Future Total
PM Peak Hour

Intersection						
Int Delay, s/veh	0					
Movement	EBT	EBR	WBL	WBT	NBL	NBR
Lane Configurations				↑	↔	
Traffic Vol, veh/h	0	0	30	54	10	122
Future Vol, veh/h	0	0	30	54	10	122
Conflicting Peds, #/hr	0	0	0	0	0	0
Sign Control	Free	Free	Free	Free	Stop	Stop
RT Channelized	-	None	-	None	-	None
Storage Length	-	-	-	-	0	-
Veh in Median Storage, #	-	-	-	0	0	-
Grade, %	0	-	-	0	0	-
Peak Hour Factor	100	100	100	100	100	100
Heavy Vehicles, %	2	2	2	2	2	2
Mvmt Flow	0	0	30	54	10	122
Major/Minor	Major2	Minor1				
Conflicting Flow All	0	0	114	0		
Stage 1	-	-	0	-		
Stage 2	-	-	114	-		
Critical Hdwy	4.12	-	6.42	6.22		
Critical Hdwy Stg 1	-	-	-	-		
Critical Hdwy Stg 2	-	-	5.42	-		
Follow-up Hdwy	2.218	-	3.518	3.318		
Pot Cap-1 Maneuver	-	-	882	-		
Stage 1	-	-	-	-		
Stage 2	-	-	911	-		
Platoon blocked, %	-	-	-	-		
Mov Cap-1 Maneuver	-	-	882	-		
Mov Cap-2 Maneuver	-	-	882	-		
Stage 1	-	-	-	-		
Stage 2	-	-	911	-		
Approach	WB	NB				
HCM Control Delay, s						
HCM LOS						
Minor Lane/Major Mvmt	NBLn1	WBL	WBT			
Capacity (veh/h)	-	-	-			
HCM Lane V/C Ratio	-	-	-			
HCM Control Delay (s)	-	-	-			
HCM Lane LOS	-	-	-			
HCM 95th %tile Q(veh)	-	-	-			

HCM 2010 TWSC
8: Montgomery & Selkirk

2024 Future Total
PM Peak Hour

Intersection												
Int Delay, s/veh	6.5											
Movement	EBL	EBT	EBR	WBL	WBT	WBR	NBL	NBT	NBR	SBL	SBT	SBR
Lane Configurations	↔		↔		↔		↔		↔		↔	
Traffic Vol, veh/h	92	20	10	17	21	27	5	10	0	15	33	60
Future Vol, veh/h	92	20	10	17	21	27	5	10	0	15	33	60
Conflicting Peds, #/hr	0	0	0	0	0	0	0	0	0	0	0	0
Sign Control	Stop	Stop	Stop	Stop	Stop	Stop	Free	Free	Free	Free	Free	Free
RT Channelized	-	-	None	-	-	None	-	-	None	-	-	None
Storage Length	-	-	-	-	-	-	-	-	-	-	-	-
Veh in Median Storage, #	-	0	-	-	0	-	-	0	-	-	0	-
Grade, %	-	0	-	-	0	-	-	0	-	-	0	-
Peak Hour Factor	100	100	100	100	100	100	100	100	100	100	100	100
Heavy Vehicles, %	2	2	2	2	2	2	2	2	2	2	2	2
Mvmt Flow	92	20	10	17	21	27	5	10	0	15	33	60
Major/Minor	Minor2	Minor1	Major1	Major2								
Conflicting Flow All	137	113	63	128	143	10	93	0	0	10	0	0
Stage 1	93	93	-	20	20	-	-	-	-	-	-	-
Stage 2	44	20	-	108	123	-	-	-	-	-	-	-
Critical Hdwy	7.12	6.52	6.22	7.12	6.52	6.22	4.12	-	-	4.12	-	-
Critical Hdwy Stg 1	6.12	5.52	-	6.12	5.52	-	-	-	-	-	-	-
Critical Hdwy Stg 2	6.12	5.52	-	6.12	5.52	-	-	-	-	-	-	-
Follow-up Hdwy	3.518	4.018	3.318	3.518	4.018	3.318	2.218	-	-	2.218	-	-
Pot Cap-1 Maneuver	834	777	1002	845	748	1071	1501	-	-	1610	-	-
Stage 1	914	818	-	999	879	-	-	-	-	-	-	-
Stage 2	970	879	-	897	794	-	-	-	-	-	-	-
Platoon blocked, %	-	-	-	-	-	-	-	-	-	-	-	-
Mov Cap-1 Maneuver	787	767	1002	812	738	1071	1501	-	-	1610	-	-
Mov Cap-2 Maneuver	787	767	-	812	738	-	-	-	-	-	-	-
Stage 1	911	810	-	996	876	-	-	-	-	-	-	-
Stage 2	920	876	-	857	786	-	-	-	-	-	-	-
Approach	EB	WB	NB	SB								
HCM Control Delay, s	10.3	9.5	2.5	1								
HCM LOS	B	A										
Minor Lane/Major Mvmt	NBL	NBT	NBR	EBLn1	WBLn1	SBL	SBT	SBR				
Capacity (veh/h)	1501	-	-	798	871	1610	-	-				
HCM Lane V/C Ratio	0.003	-	-	0.153	0.075	0.009	-	-				
HCM Control Delay (s)	7.4	0	-	10.3	9.5	7.3	0	-				
HCM Lane LOS	A	A	-	B	A	A	A	-				
HCM 95th %tile Q(veh)	0	-	-	0.5	0.2	0	-	-				

Lanes, Volumes, Timings
9: North River & McArthur

2024 Future Total
PM Peak Hour

Lane Group	EBL	EBT	EBR	WBL	WBT	WBR	NBL	NBT	NBR	SBL	SBT	SBR
Lane Configurations		↔			↔	↔		↔		↔	↔	
Traffic Volume (vph)	4	25	6	24	11	224	2	161	36	409	144	1
Future Volume (vph)	4	25	6	24	11	224	2	161	36	409	144	1
Satd. Flow (prot)	0	1636	0	0	1571	1483	0	1642	0	1642	1709	0
Fit Permitted		0.980			0.841			0.998		0.633		
Satd. Flow (perm)	0	1599	0	0	1330	1334	0	1640	0	981	1709	0
Satd. Flow (RTOR)		6			224			25		1		
Lane Group Flow (vph)	0	35	0	0	35	224	0	199	0	409	145	0
Turn Type	Perm	NA		Perm	NA	Perm	Perm	NA		Perm	NA	
Protected Phases		4			8			2			6	
Permitted Phases	4			8		8	2			6		
Detector Phase	4	4		8	8	8	2	2		6	6	
Switch Phase												
Minimum Initial (s)	10.0	10.0		10.0	10.0	10.0	10.0	10.0		10.0	10.0	
Minimum Split (s)	25.6	25.6		25.6	25.6	25.6	31.1	31.1		31.1	31.1	
Total Split (s)	26.0	26.0		26.0	26.0	26.0	49.0	49.0		49.0	49.0	
Total Split (%)	34.7%	34.7%		34.7%	34.7%	34.7%	65.3%	65.3%		65.3%	65.3%	
Yellow Time (s)	3.3	3.3		3.3	3.3	3.3	3.3	3.3		3.3	3.3	
All-Red Time (s)	2.3	2.3		2.3	2.3	2.3	2.8	2.8		2.8	2.8	
Lost Time Adjust (s)		0.0			0.0	0.0		0.0		0.0	0.0	
Total Lost Time (s)		5.6			5.6	5.6		6.1		6.1	6.1	
Lead/Lag												
Lead-Lag Optimize?												
Recall Mode	Max	Max		Max	Max	Max	C-Max	C-Max		C-Max	C-Max	
Act Effct Green (s)		20.4			20.4	20.4		42.9		42.9	42.9	
Actuated g/C Ratio		0.27			0.27	0.27		0.57		0.57	0.57	
v/c Ratio		0.08			0.10	0.43		0.21		0.73	0.15	
Control Delay		18.4			21.0	12.6		7.4		21.6	8.0	
Queue Delay		0.0			0.0	0.0		0.0		0.0	0.0	
Total Delay		18.4			21.0	12.6		7.4		21.6	8.0	
LOS		B			C	B		A		C	A	
Approach Delay		18.4			13.7			7.4			18.0	
Approach LOS		B			B			A			B	
Queue Length 50th (m)		3.0			4.3	0.2		10.7		38.7	8.7	
Queue Length 95th (m)		9.4			11.6	33.6		20.2		#81.4	16.4	
Internal Link Dist (m)		22.5			128.8			119.0			94.3	
Turn Bay Length (m)						60.0					55.0	
Base Capacity (vph)		439			361	525		948		561	977	
Starvation Cap Reductn		0			0	0		0		0	0	
Spillback Cap Reductn		0			0	0		0		0	0	
Storage Cap Reductn		0			0	0		0		0	0	
Reduced v/c Ratio		0.08			0.10	0.43		0.21		0.73	0.15	

Intersection Summary												
Cycle Length: 75												
Actuated Cycle Length: 75												
Offset: 0 (0%), Referenced to phase 2:NBT and 6:SBTL, Start of Green												
Natural Cycle: 60												
Control Type: Actuated-Coordinated												

Lanes, Volumes, Timings
9: North River & McArthur

2024 Future Total
PM Peak Hour

Maximum v/c Ratio: 0.73	Intersection LOS: B
Intersection Signal Delay: 15.0	ICU Level of Service D
Intersection Capacity Utilization 76.3%	
Analysis Period (min) 15	
# 95th percentile volume exceeds capacity, queue may be longer.	
Queue shown is maximum after two cycles.	

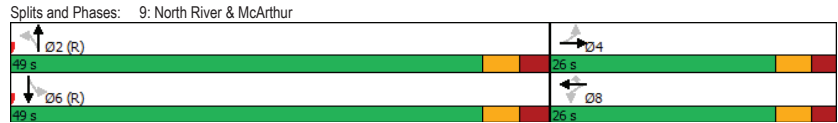

HCM 2010 TWSC
10: McArthur & Dundas

2024 Future Total
PM Peak Hour

Intersection						
Int Delay, s/veh	0.7					
Movement	EBL	EBT	WBT	WBR	SBL	SBR
Lane Configurations		↕	↕		↕	↕
Traffic Vol, veh/h	7	469	274	114	26	4
Future Vol, veh/h	7	469	274	114	26	4
Conflicting Peds, #/hr	76	0	0	76	0	9
Sign Control	Free	Free	Free	Free	Stop	Stop
RT Channelized	-	None	-	None	-	None
Storage Length	-	-	-	-	0	-
Veh in Median Storage, #	-	0	0	-	0	-
Grade, %	-	0	0	-	0	-
Peak Hour Factor	100	100	100	100	100	100
Heavy Vehicles, %	2	3	3	2	8	2
Mvmt Flow	7	469	274	114	26	4

Major/Minor	Major1	Major2	Minor2		
Conflicting Flow All	464	0	0	890	416
Stage 1	-	-	-	407	-
Stage 2	-	-	-	483	-
Critical Hdwy	4.12	-	-	6.48	6.22
Critical Hdwy Stg 1	-	-	-	5.48	-
Critical Hdwy Stg 2	-	-	-	5.48	-
Follow-up Hdwy	2,218	-	-	3,572	3,318
Pot Cap-1 Maneuver	1097	-	-	306	637
Stage 1	-	-	-	659	-
Stage 2	-	-	-	608	-
Platoon blocked, %	-	-	-	-	-
Mov Cap-1 Maneuver	1032	-	-	269	595
Mov Cap-2 Maneuver	-	-	-	269	-
Stage 1	-	-	-	615	-
Stage 2	-	-	-	572	-

Approach	EB	WB	SB
HCM Control Delay, s	0.1	0	18.8
HCM LOS			C

Minor Lane/Major Mvmt	EBL	EBT	WBT	WBR	SBLn1
Capacity (veh/h)	1032	-	-	-	290
HCM Lane V/C Ratio	0.007	-	-	-	0.103
HCM Control Delay (s)	8.5	0	-	-	18.8
HCM Lane LOS	A	A	-	-	C
HCM 95th %tile Q(veh)	0	-	-	-	0.3

Lanes, Volumes, Timings
11: Marguerite & McArthur

2024 Future Total
PM Peak Hour

Lane Group	EBT	EBR	WBL	WBT	NBL	NBR
Lane Configurations	↔	↔	↔	↔	↔	↔
Traffic Volume (vph)	481	21	40	375	20	52
Future Volume (vph)	481	21	40	375	20	52
Satd. Flow (prot)	1730	0	0	1736	1658	1483
Fit Permitted				0.929	0.950	
Satd. Flow (perm)	1730	0	0	1618	1586	1425
Satd. Flow (RTOR)	5					52
Lane Group Flow (vph)	502	0	0	415	20	52
Turn Type	NA		Perm	NA	Prot	Perm
Protected Phases	2			6	8	
Permitted Phases			6			8
Detector Phase	2		6	6	8	8
Switch Phase						
Minimum Initial (s)	10.0		10.0	10.0	5.0	5.0
Minimum Split (s)	27.5		15.5	15.5	24.5	24.5
Total Split (s)	50.0		50.0	50.0	25.0	25.0
Total Split (%)	66.7%		66.7%	66.7%	33.3%	33.3%
Yellow Time (s)	3.3		3.3	3.3	3.3	3.3
All-Red Time (s)	2.2		2.2	2.2	2.2	2.2
Lost Time Adjust (s)	0.0		0.0	0.0	0.0	0.0
Total Lost Time (s)	5.5		5.5	5.5	5.5	5.5
Lead/Lag						
Lead-Lag Optimize?						
Recall Mode	C-Max		C-Max	C-Max	None	None
Act Effct Green (s)	59.5		59.5	11.2	11.2	
Actuated g/C Ratio	0.79		0.79	0.15	0.15	
v/c Ratio	0.37		0.32	0.08	0.20	
Control Delay	4.9		6.0	24.2	9.0	
Queue Delay	0.0		0.0	0.0	0.0	
Total Delay	4.9		6.0	24.2	9.0	
LOS	A		A	C	A	
Approach Delay	4.9		6.0	13.2		
Approach LOS	A		A	B		
Queue Length 50th (m)	14.0		13.6	2.7	0.0	
Queue Length 95th (m)	37.4		46.1	7.0	7.7	
Internal Link Dist (m)	36.3		7.3	144.2		
Turn Bay Length (m)				30.0		
Base Capacity (vph)	1373		1283	431	408	
Starvation Cap Reductn	0		0	0	0	
Spillback Cap Reductn	0		0	0	0	
Storage Cap Reductn	0		0	0	0	
Reduced v/c Ratio	0.37		0.32	0.05	0.13	

Intersection Summary	
Cycle Length:	75
Actuated Cycle Length:	75
Offset:	0 (0%), Referenced to phase 2:EBT and 6:WBTL, Start of Green
Natural Cycle:	55
Control Type:	Actuated-Coordinated

Lanes, Volumes, Timings
11: Marguerite & McArthur

2024 Future Total
PM Peak Hour

Maximum v/c Ratio: 0.37	Intersection LOS: A
Intersection Signal Delay: 6.0	ICU Level of Service C
Intersection Capacity Utilization 72.6%	
Analysis Period (min) 15	

Splits and Phases: 11: Marguerite & McArthur

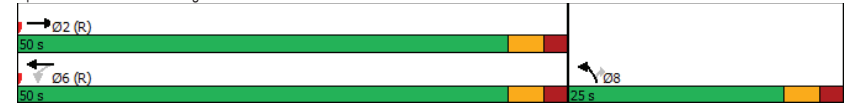

Lanes, Volumes, Timings
12: Vanier & McArthur

2024 Future Total
PM Peak Hour

Lane Group	EBL	EBT	EBR	WBL	WBT	WBR	NBL	NBT	NBR	SBL	SBT	SBR
Lane Configurations	↔	↔	↔	↔	↔	↔	↔	↔	↔	↔	↔	↔
Traffic Volume (vph)	55	241	447	333	235	170	219	1234	251	122	1211	66
Future Volume (vph)	55	241	447	333	235	170	219	1234	251	122	1211	66
Satd. Flow (prot)	1658	1712	1483	3154	1712	1483	1658	3316	1469	1658	3316	1469
Fit Permitted	0.950			0.950			0.950			0.950		
Satd. Flow (perm)	1576	1712	1323	2936	1712	1360	1612	3316	1400	1647	3316	1223
Satd. Flow (RTOR)			240			170			207			121
Lane Group Flow (vph)	55	241	447	333	235	170	219	1234	251	122	1211	66
Turn Type	Prot	NA	Perm	Prot	NA	Perm	Prot	NA	Perm	Prot	NA	Perm
Protected Phases	7	4		3	8		5	2		1	6	
Permitted Phases			4			8			2			6
Detector Phase	7	4	4	3	8	8	5	2	2	1	6	6
Switch Phase												
Minimum Initial (s)	5.0	10.0	10.0	5.0	10.0	10.0	5.0	10.0	10.0	5.0	10.0	10.0
Minimum Split (s)	11.2	36.2	36.2	11.2	36.2	36.2	11.1	36.1	36.1	11.1	36.1	36.1
Total Split (s)	20.0	36.2	36.2	20.0	36.2	36.2	23.0	59.8	59.8	24.0	60.8	60.8
Total Split (%)	14.3%	25.9%	25.9%	14.3%	25.9%	25.9%	16.4%	42.7%	42.7%	17.1%	43.4%	43.4%
Yellow Time (s)	3.3	3.3	3.3	3.3	3.3	3.3	3.7	3.7	3.7	3.7	3.7	3.7
All-Red Time (s)	2.9	2.9	2.9	2.9	2.9	2.9	2.4	2.4	2.4	2.4	2.4	2.4
Lost Time Adjust (s)	0.0	0.0	0.0	0.0	0.0	0.0	0.0	0.0	0.0	0.0	0.0	0.0
Total Lost Time (s)	6.2	6.2	6.2	6.2	6.2	6.2	6.1	6.1	6.1	6.1	6.1	6.1
Lead/Lag	Lag	Lead	Lead	Lag	Lead	Lead	Lag	Lag	Lag	Lead	Lead	Lead
Lead-Lag Optimize?	Yes	Yes	Yes	Yes	Yes	Yes	Yes	Yes	Yes	Yes	Yes	Yes
Recall Mode	None	None	None	None	None	None	C-Max	C-Max	None	C-Max	C-Max	C-Max
Act Effct Green (s)	12.2	28.4	28.4	15.4	34.0	34.0	16.9	56.8	56.8	14.8	54.7	54.7
Actuated g/C Ratio	0.09	0.20	0.20	0.11	0.24	0.24	0.12	0.41	0.41	0.11	0.39	0.39
v/c Ratio	0.38	0.69	0.97	0.96	0.57	0.37	1.09	0.92	0.36	0.70	0.94	0.12
Control Delay	67.2	62.9	60.9	100.9	54.6	8.8	146.8	51.4	8.0	82.0	84.0	19.2
Queue Delay	0.0	0.0	0.0	0.0	0.0	0.0	0.0	0.0	0.0	0.0	0.0	0.0
Total Delay	67.2	62.9	60.9	100.9	54.6	8.8	146.8	51.4	8.0	82.0	84.0	19.2
LOS	E	E	E	F	D	A	F	D	A	F	F	B
Approach Delay		62.0			64.9			57.3			80.8	
Approach LOS		E			E			E			F	
Queue Length 50th (m)	14.5	61.6	64.1	~52.5	59.9	0.0	~68.3	170.3	7.5	35.9	178.6	5.4
Queue Length 95th (m)	28.5	90.8	#131.7	#83.3	88.7	19.2	#119.4	#223.1	27.6	m41.3	m185.6	m8.4
Internal Link Dist (m)		122.9			146.0			119.5			202.0	
Turn Bay Length (m)	30.0		50.0	120.0		115.0	90.0		90.0	90.0		90.0
Base Capacity (vph)	163	366	472	346	415	459	200	1344	690	211	1295	551
Starvation Cap Reductn	0	0	0	0	0	0	0	0	0	0	0	0
Spillback Cap Reductn	0	0	0	0	0	0	0	0	0	0	0	0
Storage Cap Reductn	0	0	0	0	0	0	0	0	0	0	0	0
Reduced v/c Ratio	0.34	0.66	0.95	0.96	0.57	0.37	1.09	0.92	0.36	0.58	0.94	0.12

Intersection Summary	
Cycle Length:	140
Actuated Cycle Length:	140
Offset:	54 (39%), Referenced to phase 2:NBT and 6:SBT, Start of Green
Natural Cycle:	135
Control Type:	Actuated-Coordinated

Lanes, Volumes, Timings
12: Vanier & McArthur

2024 Future Total
PM Peak Hour

Maximum v/c Ratio:	1.09
Intersection Signal Delay:	66.5
Intersection Capacity Utilization:	102.5%
Analysis Period (min):	15
~ Volume exceeds capacity, queue is theoretically infinite.	
# 95th percentile volume exceeds capacity, queue may be longer.	
m Volume for 95th percentile queue is metered by upstream signal.	

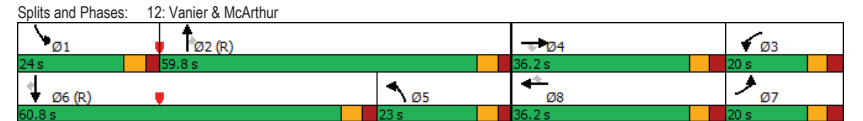

HCM 2010 TWSC
13: Palace & Site Access

2024 Future Total
PM Peak Hour

Intersection						
Int Delay, s/veh	3.1					
Movement	WBL	WBR	NBT	NBR	SBL	SBT
Lane Configurations	↔					↔
Traffic Vol, veh/h	31	0	0	0	41	19
Future Vol, veh/h	31	0	0	0	41	19
Conflicting Peds, #/hr	0	0	0	0	0	0
Sign Control	Stop	Stop	Free	Free	Free	Free
RT Channelized	-	None	-	None	-	None
Storage Length	0	-	-	-	-	-
Veh in Median Storage, #	0	-	-	-	-	0
Grade, %	0	-	0	-	-	0
Peak Hour Factor	100	100	100	100	100	100
Heavy Vehicles, %	2	2	2	2	2	2
Mvmt Flow	31	0	0	0	41	19

Major/Minor	Minor1	Major2	Minor2
Conflicting Flow All	101	-	0
Stage 1	0	-	-
Stage 2	101	-	-
Critical Hdwy	6.42	-	4.12
Critical Hdwy Stg 1	-	-	-
Critical Hdwy Stg 2	5.42	-	-
Follow-up Hdwy	3.518	-	2.218
Pot Cap-1 Maneuver	898	0	-
Stage 1	-	0	-
Stage 2	923	0	-
Platoon blocked, %	-	-	-
Mov Cap-1 Maneuver	898	-	-
Mov Cap-2 Maneuver	898	-	-
Stage 1	-	-	-
Stage 2	923	-	-

Approach	WB	SB
HCM Control Delay, s	9.2	
HCM LOS	A	

Minor Lane/Major Mvmt	WBLn1	SBL	SBT
Capacity (veh/h)	898	-	-
HCM Lane V/C Ratio	0.035	-	-
HCM Control Delay (s)	9.2	-	-
HCM Lane LOS	A	-	-
HCM 95th %tile Q(veh)	0.1	-	-

HCM 2010 TWSC
15: McArthur & Mayfield

2024 Future Total
PM Peak Hour

Intersection						
Int Delay, s/veh	0.7					
Movement	EBL	EBT	WBT	WBR	SBL	SBR
Lane Configurations		↑	↑		↔	↔
Traffic Vol, veh/h	0	535	407	0	33	8
Future Vol, veh/h	0	535	407	0	33	8
Conflicting Peds, #/hr	0	0	0	0	0	0
Sign Control	Free	Free	Free	Free	Stop	Stop
RT Channelized	-	None	-	None	-	None
Storage Length	-	-	-	-	0	0
Veh in Median Storage, #	-	0	0	-	0	-
Grade, %	-	0	0	-	0	-
Peak Hour Factor	100	100	100	100	100	100
Heavy Vehicles, %	2	2	2	2	2	2
Mvmt Flow	0	535	407	0	33	8

Major/Minor	Major1	Major2	Minor2
Conflicting Flow All	-	0	0
Stage 1	-	-	407
Stage 2	-	-	535
Critical Hdwy	-	-	6.42
Critical Hdwy Stg 1	-	-	5.42
Critical Hdwy Stg 2	-	-	5.42
Follow-up Hdwy	-	-	3.518
Pot Cap-1 Maneuver	0	-	0
Stage 1	0	-	0
Stage 2	0	-	0
Platoon blocked, %	-	-	-
Mov Cap-1 Maneuver	-	-	292
Mov Cap-2 Maneuver	-	-	292
Stage 1	-	-	672
Stage 2	-	-	587

Approach	EB	WB	SB
HCM Control Delay, s	0	0	17.3
HCM LOS			C

Minor Lane/Major Mvmt	EBT	WBT	SBLn1	SBLn2
Capacity (veh/h)	-	-	292	644
HCM Lane V/C Ratio	-	-	0.113	0.012
HCM Control Delay (s)	-	-	18.9	10.7
HCM Lane LOS	-	-	C	B
HCM 95th %tile Q(veh)	-	-	0.4	0

Appendix L

Synchro Intersection Worksheets – 2029 Future Total Conditions

Lanes, Volumes, Timings
1: North River & Montreal

2029 Future Total
AM Peak Hour

Lane Group	EBL	EBT	EBR	WBL	WBT	WBR	NBL	NBT	NBR	SBL	SBT	SBR
Lane Configurations		↑↑			↑↑		↑	↑			↑↑	
Traffic Volume (vph)	0	502	362	0	762	13	288	10	44	17	25	15
Future Volume (vph)	0	502	362	0	762	13	288	10	44	17	25	15
Satd. Flow (prot)	0	2937	0	0	3168	0	1595	1330	0	0	1518	0
Fit Permitted							0.950				0.985	
Satd. Flow (perm)	0	2937	0	0	3168	0	1581	1330	0	0	1499	0
Satd. Flow (RTOR)								44			15	
Lane Group Flow (vph)	0	864	0	0	775	0	288	54	0	0	57	0
Turn Type		NA			NA		Prot	NA		Split	NA	
Protected Phases		2			6		3!	8		7	7!	
Permitted Phases												
Detector Phase		2			6		3	8		7	7	
Switch Phase												
Minimum Initial (s)		10.0			10.0		5.0	10.0		10.0	10.0	
Minimum Split (s)		21.7			21.7		11.5	24.5		16.5	16.5	
Total Split (s)		29.0			29.0		24.0	49.0		17.0	17.0	
Total Split (%)		30.5%			30.5%		25.3%	51.6%		17.9%	17.9%	
Yellow Time (s)		3.0			3.0		3.3	3.3		3.3	3.3	
All-Red Time (s)		3.7			3.7		3.2	3.2		3.2	3.2	
Lost Time Adjust (s)		0.0			0.0		0.0	0.0		0.0	0.0	
Total Lost Time (s)		6.7			6.7		6.5	6.5		6.5	6.5	
Lead/Lag							Lag	Lag		Lead	Lead	
Lead-Lag Optimize?							Yes	Yes		Yes	Yes	
Recall Mode		C-Max			C-Max		None	Ped		None	None	
Act Effct Green (s)		32.3			32.3		25.0	36.2		10.1	10.1	
Actuated g/C Ratio		0.34			0.34		0.26	0.38		0.11	0.11	
v/c Ratio		0.86			0.72		0.69	0.10		0.33	0.33	
Control Delay		40.7			32.6		40.5	8.4		36.4	36.4	
Queue Delay		0.0			51.5		0.0	0.0		0.0	0.0	
Total Delay		40.7			84.1		40.5	8.4		36.4	36.4	
LOS		D			F		D	A		D	D	
Approach Delay		40.7			84.1			35.4		36.4	36.4	
Approach LOS		D			F			D		D	D	
Queue Length 50th (m)		77.4			64.8		47.3	1.2		7.2	7.2	
Queue Length 95th (m)		#120.6			90.5		71.8	8.4		18.7	18.7	
Internal Link Dist (m)		194.5			52.8			112.9		59.0	59.0	
Turn Bay Length (m)							90.0					
Base Capacity (vph)		999			1078		419	627		181	181	
Starvation Cap Reductn		0			428		0	0		0	0	
Spillback Cap Reductn		0			0		0	0		0	0	
Storage Cap Reductn		0			0		0	0		0	0	
Reduced v/c Ratio		0.86			1.19		0.69	0.09		0.31	0.31	

Intersection Summary
 Cycle Length: 95
 Actuated Cycle Length: 95
 Offset: 0 (0%), Referenced to phase 2:EBT and 6:WBT, Start of Green
 Natural Cycle: 80
 Control Type: Actuated-Coordinated

Lanes, Volumes, Timings
1: North River & Montreal

2029 Future Total
AM Peak Hour

Lane Group	Ø4
Lane Configurations	
Traffic Volume (vph)	
Future Volume (vph)	
Satd. Flow (prot)	
Fit Permitted	
Satd. Flow (perm)	
Satd. Flow (RTOR)	
Lane Group Flow (vph)	
Turn Type	
Protected Phases	4
Permitted Phases	
Detector Phase	
Switch Phase	
Minimum Initial (s)	5.0
Minimum Split (s)	24.5
Total Split (s)	42.0
Total Split (%)	44%
Yellow Time (s)	3.3
All-Red Time (s)	3.2
Lost Time Adjust (s)	
Total Lost Time (s)	
Lead/Lag	Lead
Lead-Lag Optimize?	Yes
Recall Mode	Ped
Act Effct Green (s)	
Actuated g/C Ratio	
v/c Ratio	
Control Delay	
Queue Delay	
Total Delay	
LOS	
Approach Delay	
Approach LOS	
Queue Length 50th (m)	
Queue Length 95th (m)	
Internal Link Dist (m)	
Turn Bay Length (m)	
Base Capacity (vph)	
Starvation Cap Reductn	
Spillback Cap Reductn	
Storage Cap Reductn	
Reduced v/c Ratio	

Intersection Summary

Lanes, Volumes, Timings
1: North River & Montreal

2029 Future Total
AM Peak Hour

Maximum v/c Ratio: 0.86	Intersection LOS: E
Intersection Signal Delay: 56.2	ICU Level of Service B
Intersection Capacity Utilization 62.6%	
Analysis Period (min) 15	
# 95th percentile volume exceeds capacity, queue may be longer.	
Queue shown is maximum after two cycles.	
! Phase conflict between lane groups.	

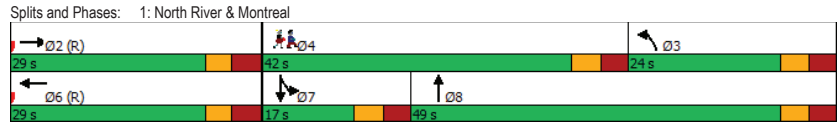

Lanes, Volumes, Timings
2: Montgomery & Montreal

2029 Future Total
AM Peak Hour

Lane Group	EBT	EBR	WBL	WBT	NBL	NBR
Lane Configurations	↕↕			↕↕	↕	↕
Traffic Volume (vph)	443	120	102	688	87	162
Future Volume (vph)	443	120	102	688	87	162
Satd. Flow (prot)	3106	0	0	3179	1658	1401
Fit Permitted				0.791	0.950	
Satd. Flow (perm)	3106	0	0	2526	1649	1379
Satd. Flow (RTOR)	81					162
Lane Group Flow (vph)	563	0	0	790	87	162
Turn Type	NA		Perm	NA	Perm	Perm
Protected Phases	2			6		
Permitted Phases			6		8	8
Detector Phase	2		6	6	8	8
Switch Phase						
Minimum Initial (s)	10.0		10.0	10.0	10.0	10.0
Minimum Split (s)	40.4		16.4	16.4	19.5	19.5
Total Split (s)	56.0		56.0	56.0	24.0	24.0
Total Split (%)	70.0%		70.0%	70.0%	30.0%	30.0%
Yellow Time (s)	3.0		3.0	3.0	3.3	3.3
All-Red Time (s)	3.4		3.4	3.4	2.2	2.2
Lost Time Adjust (s)	0.0		0.0	0.0	0.0	0.0
Total Lost Time (s)	6.4		6.4	6.4	5.5	5.5
Lead/Lag						
Lead-Lag Optimize?						
Recall Mode	C-Max		C-Max	C-Max	None	None
Act Effct Green (s)	57.1		57.1	57.1	11.0	11.0
Actuated g/C Ratio	0.71		0.71	0.71	0.14	0.14
v/c Ratio	0.25		0.44	0.44	0.38	0.49
Control Delay	3.8		5.9	5.9	36.2	10.9
Queue Delay	0.9		0.0	0.0	0.0	0.0
Total Delay	4.7		5.9	5.9	36.2	10.9
LOS	A		A	A	D	B
Approach Delay	4.7		5.9	5.9	19.7	
Approach LOS	A		A	A	B	
Queue Length 50th (m)	10.1		20.3	20.3	12.4	0.0
Queue Length 95th (m)	18.6		36.0	36.0	24.2	15.2
Internal Link Dist (m)	52.8		138.9	138.9	214.6	
Turn Bay Length (m)					35.0	
Base Capacity (vph)	2239		1802	1802	381	443
Starvation Cap Reductn	1328		0	0	0	0
Spillback Cap Reductn	0		0	0	0	0
Storage Cap Reductn	0		0	0	0	0
Reduced v/c Ratio	0.62		0.44	0.44	0.23	0.37

Intersection Summary						
Cycle Length:	80					
Actuated Cycle Length:	80					
Offset:	0 (0%), Referenced to phase 2:EBT and 6:WBTL, Start of Green					
Natural Cycle:	60					
Control Type:	Actuated-Coordinated					

Lanes, Volumes, Timings
2: Montgomery & Montreal

2029 Future Total
AM Peak Hour

Maximum v/c Ratio: 0.49	Intersection LOS: A
Intersection Signal Delay: 7.6	ICU Level of Service D
Intersection Capacity Utilization 73.7%	
Analysis Period (min) 15	

Splits and Phases: 2: Montgomery & Montreal

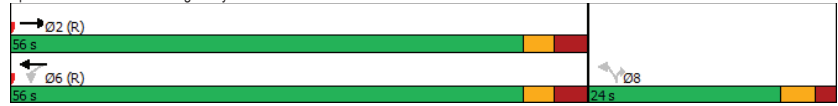

Lanes, Volumes, Timings
4: Vanier & Montreal

2029 Future Total
AM Peak Hour

Lane Group	EBL	EBT	EBR	WBL	WBT	WBR	NBL	NBT	NBR	SBL	SBT	SBR
Lane Configurations	↔	↕	↔	↔	↕	↔	↔	↕	↔	↔	↕	↔
Traffic Volume (vph)	52	374	147	165	516	194	183	901	166	213	1152	148
Future Volume (vph)	52	374	147	165	516	194	183	901	166	213	1152	148
Satd. Flow (prot)	1642	1695	1483	1658	3031	0	1642	4581	0	1642	4648	0
Fit Permitted	0.950			0.950			0.950			0.950		
Satd. Flow (perm)	1595	1695	1385	1604	3031	0	1627	4581	0	1611	4648	0
Satd. Flow (RTOR)			147		37			27			17	
Lane Group Flow (vph)	52	374	147	165	710	0	183	1067	0	213	1300	0
Turn Type	Prot	NA	Perm	Prot	NA		Prot	NA		Prot	NA	
Protected Phases	7	4		3	8		5	2		1	6	
Permitted Phases			4									
Detector Phase	7	4	4	3	8		5	2		1	6	
Switch Phase												
Minimum Initial (s)	5.0	10.0	10.0	5.0	10.0		5.0	10.0		5.0	10.0	
Minimum Split (s)	12.1	40.1	40.1	12.1	40.1		11.1	28.9		11.1	28.9	
Total Split (s)	20.0	41.0	41.0	20.0	41.0		30.0	49.0		30.0	49.0	
Total Split (%)	14.3%	29.3%	29.3%	14.3%	29.3%		21.4%	35.0%		21.4%	35.0%	
Yellow Time (s)	3.0	3.0	3.0	3.0	3.0		3.7	3.7		3.7	3.7	
All-Red Time (s)	4.1	4.1	4.1	4.1	4.1		2.4	2.2		2.4	2.2	
Lost Time Adjust (s)	0.0	0.0	0.0	0.0	0.0		0.0	0.0		0.0	0.0	
Total Lost Time (s)	7.1	7.1	7.1	7.1	7.1		6.1	5.9		6.1	5.9	
Lead/Lag	Lead	Lag	Lag	Lead	Lag		Lead	Lag		Lead	Lag	
Lead-Lag Optimize?	Yes	Yes	Yes	Yes	Yes		Yes	Yes		Yes	Yes	
Recall Mode	None	Max	Max	None	Max		None	C-Max		None	C-Max	
Act Effct Green (s)	9.6	33.9	33.9	12.9	39.8		19.9	45.4		21.6	47.1	
Actuated g/C Ratio	0.07	0.24	0.24	0.09	0.28		0.14	0.32		0.15	0.34	
v/c Ratio	0.46	0.91	0.33	1.09	0.80		0.79	0.71		0.84	0.83	
Control Delay	75.0	78.8	8.4	155.2	52.8		88.4	45.1		84.5	48.0	
Queue Delay	0.0	0.0	0.0	0.0	0.0		0.0	0.0		0.0	0.0	
Total Delay	75.0	78.8	8.4	155.2	52.8		88.4	45.1		84.5	48.0	
LOS	E	E	A	F	D		F	D		F	D	
Approach Delay		60.4			72.1			51.4			53.1	
Approach LOS		E			E			D			D	
Queue Length 50th (m)	14.1	101.4	0.0	-50.9	94.4		52.7	64.1		57.0	120.8	
Queue Length 95th (m)	27.5	#159.0	17.0	#96.9	#134.4		m71.0	81.8		#93.0	144.9	
Internal Link Dist (m)		99.5			262.7			154.6			239.2	
Turn Bay Length (m)	30.0			35.0			94.5			90.0		
Base Capacity (vph)	151	410	446	152	887		280	1503		280	1574	
Starvation Cap Reductn	0	0	0	0	0		0	0		0	0	
Spillback Cap Reductn	0	0	0	0	0		0	0		0	0	
Storage Cap Reductn	0	0	0	0	0		0	0		0	0	
Reduced v/c Ratio	0.34	0.91	0.33	1.09	0.80		0.65	0.71		0.76	0.83	

Intersection Summary

Cycle Length: 140
 Actuated Cycle Length: 140
 Offset: 102 (73%), Referenced to phase 2:NBT and 6:SBT, Start of Green
 Natural Cycle: 115
 Control Type: Actuated-Coordinated

Lanes, Volumes, Timings
4: Vanier & Montreal

2029 Future Total
AM Peak Hour

Maximum v/c Ratio: 1.09	Intersection LOS: E
Intersection Signal Delay: 57.6	ICU Level of Service F
Intersection Capacity Utilization 97.0%	
Analysis Period (min) 15	
~ Volume exceeds capacity, queue is theoretically infinite. Queue shown is maximum after two cycles.	
# 95th percentile volume exceeds capacity, queue may be longer. Queue shown is maximum after two cycles.	
m Volume for 95th percentile queue is metered by upstream signal.	

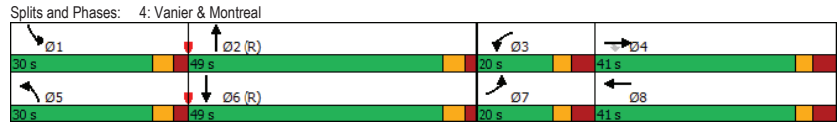

HCM 2010 TWSC
6: North River & Selkirk

2029 Future Total
AM Peak Hour

Intersection						
Int Delay, s/veh	2.1					
Movement	WBL	WBR	NBT	NBR	SBL	SBT
Lane Configurations	↔	↔	↑	↔	↔	↔
Traffic Vol, veh/h	44	76	284	1	0	397
Future Vol, veh/h	44	76	284	1	0	397
Conflicting Peds, #/hr	3	0	0	90	90	0
Sign Control	Stop	Stop	Free	Free	Free	Free
RT Channelized	-	None	-	None	-	None
Storage Length	0	-	-	-	-	-
Veh in Median Storage, #	0	-	0	-	-	0
Grade, %	0	-	0	-	-	0
Peak Hour Factor	100	100	100	100	100	100
Heavy Vehicles, %	7	2	8	2	2	2
Mvmt Flow	44	76	284	1	0	397

Major/Minor	Minor1	Major1	Major2		
Conflicting Flow All	577	375	0	0	-
Stage 1	375	-	-	-	-
Stage 2	202	-	-	-	-
Critical Hdwy	6.705	6.23	-	-	-
Critical Hdwy Stg 1	5.505	-	-	-	-
Critical Hdwy Stg 2	5.905	-	-	-	-
Follow-up Hdwy	3.5665	3.319	-	-	-
Pot Cap-1 Maneuver	452	670	-	-	0
Stage 1	681	-	-	-	0
Stage 2	800	-	-	-	0
Platoon blocked, %	-	-	-	-	-
Mov Cap-1 Maneuver	419	623	-	-	-
Mov Cap-2 Maneuver	419	-	-	-	-
Stage 1	633	-	-	-	-
Stage 2	798	-	-	-	-

Approach	WB	NB	SB
HCM Control Delay, s	13.8	0	0
HCM LOS	B		

Minor Lane/Major Mvmt	NBT	NBRWBLn1	SBT
Capacity (veh/h)	-	-	529
HCM Lane V/C Ratio	-	-	0.227
HCM Control Delay (s)	-	-	13.8
HCM Lane LOS	-	-	B
HCM 95th %tile Q(veh)	-	-	0.9

HCM 2010 TWSC
7: Dundas & Selkirk

2029 Future Total
AM Peak Hour

Intersection						
Int Delay, s/veh	0					
Movement	EBT	EBR	WBL	WBT	NBL	NBR
Lane Configurations				↕	↕	
Traffic Vol, veh/h	0	0	39	99	19	84
Future Vol, veh/h	0	0	39	99	19	84
Conflicting Peds, #/hr	0	0	0	0	0	0
Sign Control	Free	Free	Free	Free	Stop	Stop
RT Channelized	-	None	-	None	-	None
Storage Length	-	-	-	-	0	-
Veh in Median Storage, #	-	-	-	-	0	-
Grade, %	0	-	-	0	0	-
Peak Hour Factor	100	100	100	100	100	100
Heavy Vehicles, %	2	2	2	2	2	2
Mvmt Flow	0	0	39	99	19	84

Major/Minor	Major2	Minor1
Conflicting Flow All	0	0
Stage 1	-	0
Stage 2	-	177
Critical Hdwy	4.12	6.42
Critical Hdwy Stg 1	-	-
Critical Hdwy Stg 2	-	5.42
Follow-up Hdwy	2.218	3.518
Pot Cap-1 Maneuver	-	813
Stage 1	-	-
Stage 2	-	854
Platoon blocked, %	-	-
Mov Cap-1 Maneuver	-	813
Mov Cap-2 Maneuver	-	813
Stage 1	-	-
Stage 2	-	854

Approach	WB	NB
HCM Control Delay, s		
HCM LOS		

Minor Lane/Major Mvmt	NBLn1	WBL	WBT
Capacity (veh/h)	-	-	-
HCM Lane V/C Ratio	-	-	-
HCM Control Delay (s)	-	-	-
HCM Lane LOS	-	-	-
HCM 95th %tile Q(veh)	-	-	-

HCM 2010 TWSC
8: Montgomery & Selkirk

2029 Future Total
AM Peak Hour

Intersection												
Int Delay, s/veh	5.9											
Movement	EBL	EBT	EBR	WBL	WBT	WBR	NBL	NBT	NBR	SBL	SBT	SBR
Lane Configurations		↕			↕			↕			↕	
Traffic Vol, veh/h	64	15	5	33	44	41	5	5	0	10	56	90
Future Vol, veh/h	64	15	5	33	44	41	5	5	0	10	56	90
Conflicting Peds, #/hr	0	0	0	0	0	0	0	0	0	0	0	0
Sign Control	Stop	Stop	Stop	Stop	Stop	Stop	Free	Free	Free	Free	Free	Free
RT Channelized	-	-	None	-	-	None	-	-	None	-	-	None
Storage Length	-	-	-	-	-	-	-	-	-	-	-	-
Veh in Median Storage, #	-	0	-	-	0	-	-	0	-	-	0	-
Grade, %	-	0	-	-	0	-	-	0	-	-	0	-
Peak Hour Factor	100	100	100	100	100	100	100	100	100	100	100	100
Heavy Vehicles, %	2	2	2	2	2	2	2	2	2	2	2	2
Mvmt Flow	64	15	5	33	44	41	5	5	0	10	56	90

Major/Minor	Minor2	Minor1	Major1	Major2
Conflicting Flow All	179	136	101	146
Stage 1	121	121	-	15
Stage 2	58	15	-	131
Critical Hdwy	7.12	6.52	6.22	7.12
Critical Hdwy Stg 1	6.12	5.52	-	6.12
Critical Hdwy Stg 2	6.12	5.52	-	6.12
Follow-up Hdwy	3.518	4.018	3.318	3.518
Pot Cap-1 Maneuver	783	755	954	823
Stage 1	883	796	-	1005
Stage 2	954	883	-	873
Platoon blocked, %	-	-	-	-
Mov Cap-1 Maneuver	712	747	954	800
Mov Cap-2 Maneuver	712	747	-	800
Stage 1	880	790	-	1002
Stage 2	869	880	-	846

Approach	EB	WB	NB	SB
HCM Control Delay, s	10.6	10	3.8	0.5
HCM LOS	B	B		

Minor Lane/Major Mvmt	NBL	NBT	NBR	EBLn1	WBLn1	SBL	SBT	SBR
Capacity (veh/h)	1436	-	-	729	833	1616	-	-
HCM Lane V/C Ratio	0.003	-	-	0.115	0.142	0.006	-	-
HCM Control Delay (s)	7.5	0	-	10.6	10	7.2	0	-
HCM Lane LOS	A	A	-	B	B	A	A	-
HCM 95th %tile Q(veh)	0	-	-	0.4	0.5	0	-	-

Lanes, Volumes, Timings
9: North River & McArthur

2029 Future Total
AM Peak Hour

Lane Group	EBL	EBT	EBR	WBL	WBT	WBR	NBL	NBT	NBR	SBL	SBT	SBR
Lane Configurations		↔			↔	↔		↔		↔	↔	
Traffic Volume (vph)	1	6	3	10	9	169	3	121	30	331	106	4
Future Volume (vph)	1	6	3	10	9	169	3	121	30	331	106	4
Satd. Flow (prot)	0	1652	0	0	1700	1441	0	1626	0	1658	1687	0
Fit Permitted		0.988			0.912			0.997		0.659		
Satd. Flow (perm)	0	1633	0	0	1587	1341	0	1623	0	1049	1687	0
Satd. Flow (RTOR)		3				169		26			4	
Lane Group Flow (vph)	0	10	0	0	19	169	0	154	0	331	110	0
Turn Type	Perm	NA		Perm	NA	Perm	Perm	NA		Perm	NA	
Protected Phases		4			8			2			6	
Permitted Phases	4			8		8	2			6		
Detector Phase	4	4		8	8	8	2	2		6	6	
Switch Phase												
Minimum Initial (s)	10.0	10.0		10.0	10.0	10.0	10.0	10.0		10.0	10.0	
Minimum Split (s)	25.6	25.6		25.6	25.6	25.6	31.1	31.1		31.1	31.1	
Total Split (s)	28.0	28.0		28.0	28.0	28.0	42.0	42.0		42.0	42.0	
Total Split (%)	40.0%	40.0%		40.0%	40.0%	40.0%	60.0%	60.0%		60.0%	60.0%	
Yellow Time (s)	3.3	3.3		3.3	3.3	3.3	3.3	3.3		3.3	3.3	
All-Red Time (s)	2.3	2.3		2.3	2.3	2.3	2.8	2.8		2.8	2.8	
Lost Time Adjust (s)		0.0			0.0	0.0		0.0			0.0	
Total Lost Time (s)		5.6			5.6	5.6		6.1			6.1	
Lead/Lag												
Lead-Lag Optimize?												
Recall Mode	Max	Max		Max	Max	Max	C-Max	C-Max		C-Max	C-Max	
Act Effct Green (s)		22.4			22.4	22.4		35.9		35.9	35.9	
Actuated g/C Ratio		0.32			0.32	0.32		0.51		0.51	0.51	
v/c Ratio		0.02			0.04	0.31		0.18		0.62	0.13	
Control Delay		14.4			11.5	8.1		8.2		18.4	9.1	
Queue Delay		0.0			0.0	0.0		0.0		0.0	0.0	
Total Delay		14.4			11.5	8.1		8.2		18.4	9.1	
LOS		B			B	A		A		B	A	
Approach Delay		14.4			8.4			8.2			16.1	
Approach LOS		B			A			A			B	
Queue Length 50th (m)		0.6			1.7	12.6		8.3		28.8	6.7	
Queue Length 95th (m)		3.5			5.7	23.2		17.0		54.9	14.0	
Internal Link Dist (m)		22.5			128.8			367.7			94.3	
Turn Bay Length (m)						60.0				55.0		
Base Capacity (vph)		524			507	544		845		537	867	
Starvation Cap Reductn		0			0	0		0		0	0	
Spillback Cap Reductn		0			0	0		0		0	0	
Storage Cap Reductn		0			0	0		0		0	0	
Reduced v/c Ratio		0.02			0.04	0.31		0.18		0.62	0.13	

Intersection Summary												
Cycle Length: 70												
Actuated Cycle Length: 70												
Offset: 0 (0%), Referenced to phase 2:NBTL and 6:SBTL, Start of Green												
Natural Cycle: 60												
Control Type: Actuated-Coordinated												

Lanes, Volumes, Timings
9: North River & McArthur

2029 Future Total
AM Peak Hour

Maximum v/c Ratio: 0.62	Intersection LOS: B
Intersection Signal Delay: 12.7	ICU Level of Service D
Intersection Capacity Utilization 73.2%	
Analysis Period (min) 15	

Splits and Phases: 9: North River & McArthur

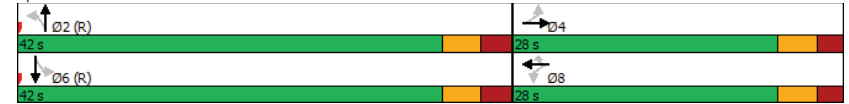

Intersection						
Int Delay, s/veh	0.6					
Movement	EBL	EBT	WBT	WBR	SBL	SBR
Lane Configurations		↕	↕		↕	↕
Traffic Vol, veh/h	11	370	322	106	10	16
Future Vol, veh/h	11	370	322	106	10	16
Conflicting Peds, #/hr	100	0	0	100	1	9
Sign Control	Free	Free	Free	Free	Stop	Stop
RT Channelized	-	None	-	None	-	None
Storage Length	-	-	-	-	0	-
Veh in Median Storage, #	-	0	0	-	0	-
Grade, %	-	0	0	-	0	-
Peak Hour Factor	100	100	100	100	100	100
Heavy Vehicles, %	10	2	5	3	2	2
Mvmt Flow	11	370	322	106	10	16
Major/Minor	Major1	Major2	Minor2			
Conflicting Flow All	528	0	0	868	484	
Stage 1	-	-	-	475	-	
Stage 2	-	-	-	393	-	
Critical Hdwy	4.2	-	-	6.42	6.22	
Critical Hdwy Stg 1	-	-	-	5.42	-	
Critical Hdwy Stg 2	-	-	-	5.42	-	
Follow-up Hdwy	2.29	-	-	3.518	3.318	
Pot Cap-1 Maneuver	1000	-	-	323	583	
Stage 1	-	-	-	626	-	
Stage 2	-	-	-	682	-	
Platoon blocked, %	-	-	-	-	-	
Mov Cap-1 Maneuver	922	-	-	270	534	
Mov Cap-2 Maneuver	-	-	-	270	-	
Stage 1	-	-	-	568	-	
Stage 2	-	-	-	629	-	
Approach	EB	WB	SB			
HCM Control Delay, s	0.3	0	14.9			
HCM LOS				B		
Minor Lane/Major Mvmt	EBL	EBT	WBT	WBR	SBLn1	
Capacity (veh/h)	922	-	-	-	388	
HCM Lane V/C Ratio	0.012	-	-	-	0.067	
HCM Control Delay (s)	9	0	-	-	14.9	
HCM Lane LOS	A	A	-	-	B	
HCM 95th %tile Q(veh)	0	-	-	-	0.2	

Lane Group	EBT	EBR	WBL	WBT	NBL	NBR
Lane Configurations	↕			↕	↕	↕
Traffic Volume (vph)	369	19	46	426	9	31
Future Volume (vph)	369	19	46	426	9	31
Satd. Flow (prot)	1728	0	0	1736	1658	1483
Fit Permitted				0.938	0.950	
Satd. Flow (perm)	1728	0	0	1634	1551	1426
Satd. Flow (RTOR)	6					31
Lane Group Flow (vph)	388	0	0	472	9	31
Turn Type	NA		Perm	NA	Prot	Perm
Protected Phases	2			6	8	
Permitted Phases			6			8
Detector Phase	2		6	6	8	8
Switch Phase						
Minimum Initial (s)	10.0		10.0	10.0	5.0	5.0
Minimum Split (s)	27.5		15.5	15.5	24.5	24.5
Total Split (s)	45.0		45.0	45.0	25.0	25.0
Total Split (%)	64.3%		64.3%	64.3%	35.7%	35.7%
Yellow Time (s)	3.3		3.3	3.3	3.3	3.3
All-Red Time (s)	2.2		2.2	2.2	2.2	2.2
Lost Time Adjust (s)	0.0		0.0	0.0	0.0	0.0
Total Lost Time (s)	5.5		5.5	5.5	5.5	5.5
Lead/Lag						
Lead-Lag Optimize?						
Recall Mode	C-Max		C-Max	C-Max	None	None
Act Effct Green (s)	54.6		54.6	11.1	11.1	11.1
Actuated g/C Ratio	0.78		0.78	0.16	0.16	0.16
v/c Ratio	0.29		0.37	0.03	0.12	0.12
Control Delay	4.2		7.8	20.6	8.9	8.9
Queue Delay	0.0		0.0	0.0	0.0	0.0
Total Delay	4.2		7.8	20.6	8.9	8.9
LOS	A		A	C	A	A
Approach Delay	4.2		7.8	11.5		
Approach LOS	A		A	B		
Queue Length 50th (m)	9.5		40.7	1.1	0.0	0.0
Queue Length 95th (m)	23.3		m50.4	3.9	5.5	5.5
Internal Link Dist (m)	36.3		7.3	144.2		
Turn Bay Length (m)				20.0		
Base Capacity (vph)	1349		1274	461	419	
Starvation Cap Reductn	0		0	0	0	
Spillback Cap Reductn	0		0	0	0	
Storage Cap Reductn	0		0	0	0	
Reduced v/c Ratio	0.29		0.37	0.02	0.07	

Intersection Summary	
Cycle Length:	70
Actuated Cycle Length:	70
Offset:	0 (0%), Referenced to phase 2:EBT and 6:WBTL, Start of Green
Natural Cycle:	55
Control Type:	Actuated-Coordinated

Lanes, Volumes, Timings
11: Marguerite & McArthur

2029 Future Total
AM Peak Hour

Maximum v/c Ratio: 0.37	Intersection Signal Delay: 6.4	Intersection LOS: A
Intersection Capacity Utilization 69.1%	ICU Level of Service C	
Analysis Period (min) 15		
m Volume for 95th percentile queue is metered by upstream signal.		

Splits and Phases: 11: Marguerite & McArthur



Lanes, Volumes, Timings
12: Vanier & McArthur

2029 Future Total
AM Peak Hour

Lane Group	EBL	EBT	EBR	WBL	WBT	WBR	NBL	NBT	NBR	SBL	SBT	SBR
Lane Configurations	↔	↗	↘	↔	↗	↘	↔	↗	↘	↔	↗	↘
Traffic Volume (vph)	34	161	321	209	208	104	233	1100	225	140	1282	60
Future Volume (vph)	34	161	321	209	208	104	233	1100	225	140	1282	60
Satd. Flow (prot)	1551	1695	1483	3216	1695	1483	1658	3316	1483	1658	3316	1441
Fit Permitted	0.950			0.950			0.950			0.950		
Satd. Flow (perm)	1437	1695	1398	3097	1695	1320	1644	3316	1407	1643	3316	1342
Satd. Flow (RTOR)			250				168			208		
Lane Group Flow (vph)	34	161	321	209	208	104	233	1100	225	140	1282	60
Turn Type	Prot	NA	Perm	Prot	NA	Perm	Prot	NA	Perm	Prot	NA	Perm
Protected Phases	7	4		3	8		5	2		1	6	
Permitted Phases			4			8			2			6
Detector Phase	7	4	4	3	8	8	5	2	2	1	6	6
Switch Phase												
Minimum Initial (s)	5.0	10.0	10.0	5.0	10.0	10.0	5.0	10.0	10.0	5.0	10.0	10.0
Minimum Split (s)	11.2	36.2	36.2	11.2	36.2	36.2	11.1	36.1	36.1	11.1	36.1	36.1
Total Split (s)	20.0	36.2	36.2	20.0	36.2	36.2	23.0	59.8	59.8	24.0	60.8	60.8
Total Split (%)	14.3%	25.9%	25.9%	14.3%	25.9%	25.9%	16.4%	42.7%	42.7%	17.1%	43.4%	43.4%
Yellow Time (s)	3.3	3.3	3.3	3.3	3.3	3.3	3.7	3.7	3.7	3.7	3.7	3.7
All-Red Time (s)	2.9	2.9	2.9	2.9	2.9	2.9	2.4	2.4	2.4	2.4	2.4	2.4
Lost Time Adjust (s)	0.0	0.0	0.0	0.0	0.0	0.0	0.0	0.0	0.0	0.0	0.0	0.0
Total Lost Time (s)	6.2	6.2	6.2	6.2	6.2	6.2	6.1	6.1	6.1	6.1	6.1	6.1
Lead/Lag	Lag	Lead	Lead	Lag	Lead	Lead	Lag	Lag	Lag	Lead	Lead	Lead
Lead-Lag Optimize?	Yes	Yes	Yes	Yes	Yes	Yes	Yes	Yes	Yes	Yes	Yes	Yes
Recall Mode	None	None	None	None	None	None	C-Max	C-Max	C-Max	None	C-Max	C-Max
Act Effct Green (s)	10.8	26.4	26.4	12.9	33.5	33.5	16.9	60.4	60.4	15.7	59.2	59.2
Actuated g/C Ratio	0.08	0.19	0.19	0.09	0.24	0.24	0.12	0.43	0.43	0.11	0.42	0.42
v/c Ratio	0.29	0.50	0.69	0.71	0.51	0.23	1.17	0.77	0.31	0.76	0.91	0.09
Control Delay	65.9	48.6	19.8	75.0	52.2	1.4	167.4	40.2	5.9	83.5	74.4	14.8
Queue Delay	0.0	0.0	0.0	0.0	0.0	0.0	0.0	0.0	0.0	0.0	0.0	0.0
Total Delay	65.9	48.6	19.8	75.0	52.2	1.4	167.4	40.2	5.9	83.5	74.4	14.8
LOS	E	D	B	E	D	A	F	D	A	F	E	B
Approach Delay	31.8			51.2			54.3			72.8		
Approach LOS	C			D			D			E		
Queue Length 50th (m)	9.7	32.3	18.3	29.2	52.1	0.0	~76.4	145.5	2.9	41.1	178.9	2.9
Queue Length 95th (m)	21.7	53.1	38.5	42.8	78.5	0.5	#128.6	176.4	20.0	m50.0 m#224.2	m5.5	
Internal Link Dist (m)	122.9			141.8			130.7			202.5		
Turn Bay Length (m)	30.0		50.0	120.0		115.0	90.0		90.0	90.0		90.0
Base Capacity (vph)	152	363	496	317	409	445	200	1431	725	211	1402	637
Starvation Cap Reductn	0	0	0	0	0	0	0	0	0	0	0	0
Spillback Cap Reductn	0	0	0	0	0	0	0	0	0	0	0	0
Storage Cap Reductn	0	0	0	0	0	0	0	0	0	0	0	0
Reduced v/c Ratio	0.22	0.44	0.65	0.66	0.51	0.23	1.17	0.77	0.31	0.66	0.91	0.09

Intersection Summary

Cycle Length: 140
Actuated Cycle Length: 140
Offset: 100 (71%), Referenced to phase 2:NBT and 6:SBT, Start of Green
Natural Cycle: 135
Control Type: Actuated-Coordinated

Lanes, Volumes, Timings
12: Vanier & McArthur

2029 Future Total
AM Peak Hour

Maximum v/c Ratio: 1.17	Intersection LOS: E
Intersection Signal Delay: 57.8	ICU Level of Service F
Intersection Capacity Utilization 99.4%	
Analysis Period (min) 15	
~ Volume exceeds capacity, queue is theoretically infinite. Queue shown is maximum after two cycles.	
# 95th percentile volume exceeds capacity, queue may be longer. Queue shown is maximum after two cycles.	
m Volume for 95th percentile queue is metered by upstream signal.	

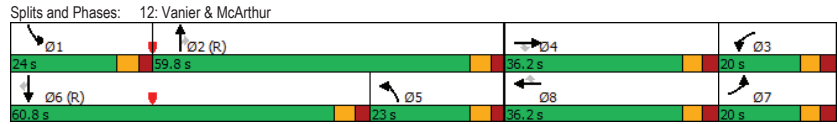

HCM 2010 TWSC
13: Palace & Site Access

2029 Future Total
AM Peak Hour

Intersection						
Int Delay, s/veh	3.8					
Movement	WBL	WBR	NBT	NBR	SBL	SBT
Lane Configurations	↔ ↘ ↙ ↗ ↘ ↗					
Traffic Vol, veh/h	41	0	0	0	20	37
Future Vol, veh/h	41	0	0	0	20	37
Conflicting Peds, #/hr	0	0	0	0	0	0
Sign Control	Stop	Stop	Free	Free	Free	Free
RT Channelized	-	None	-	None	-	None
Storage Length	0	-	-	-	-	-
Veh in Median Storage, #	0	-	-	-	-	0
Grade, %	0	-	0	-	-	0
Peak Hour Factor	100	100	100	100	100	100
Heavy Vehicles, %	2	2	2	2	2	2
Mvmt Flow	41	0	0	0	20	37

Major/Minor	Minor1	Major2	
Conflicting Flow All	77	-	0 0
Stage 1	0	-	-
Stage 2	77	-	-
Critical Hdwy	6.42	-	4.12 -
Critical Hdwy Stg 1	-	-	-
Critical Hdwy Stg 2	5.42	-	-
Follow-up Hdwy	3.518	-	2.218 -
Pot Cap-1 Maneuver	926	0	-
Stage 1	-	0	-
Stage 2	946	0	-
Platoon blocked, %			-
Mov Cap-1 Maneuver	926	-	-
Mov Cap-2 Maneuver	926	-	-
Stage 1	-	-	-
Stage 2	946	-	-

Approach	WB	SB
HCM Control Delay, s	9.1	
HCM LOS	A	

Minor Lane/Major Mvmt	WBLn1	SBL	SBT
Capacity (veh/h)	926	-	-
HCM Lane V/C Ratio	0.044	-	-
HCM Control Delay (s)	9.1	-	-
HCM Lane LOS	A	-	-
HCM 95th %tile Q(veh)	0.1	-	-

HCM 2010 TWSC
15: McArthur & Mayfield

2029 Future Total
AM Peak Hour

Intersection						
Int Delay, s/veh	1.3					
Movement	EBL	EBT	WBT	WBR	SBL	SBR
Lane Configurations		↑	↑		↓	↓
Traffic Vol, veh/h	0	400	471	0	63	4
Future Vol, veh/h	0	400	471	0	63	4
Conflicting Peds, #/hr	0	0	0	0	0	0
Sign Control	Free	Free	Free	Free	Stop	Stop
RT Channelized	-	None	-	None	-	None
Storage Length	-	-	-	-	0	0
Veh in Median Storage, #	-	0	0	-	0	-
Grade, %	-	0	0	-	0	-
Peak Hour Factor	100	100	100	100	100	100
Heavy Vehicles, %	2	2	2	2	2	2
Mvmt Flow	0	400	471	0	63	4
Major/Minor	Major1	Major2	Minor2			
Conflicting Flow All	-	0	-	0	871	471
Stage 1	-	-	-	-	471	-
Stage 2	-	-	-	-	400	-
Critical Hdwy	-	-	-	-	6.42	6.22
Critical Hdwy Stg 1	-	-	-	-	5.42	-
Critical Hdwy Stg 2	-	-	-	-	5.42	-
Follow-up Hdwy	-	-	-	-	3.518	3.318
Pot Cap-1 Maneuver	0	-	-	0	322	593
Stage 1	0	-	-	0	628	-
Stage 2	0	-	-	0	677	-
Platoon blocked, %	-	-	-	-	-	-
Mov Cap-1 Maneuver	-	-	-	-	322	593
Mov Cap-2 Maneuver	-	-	-	-	322	-
Stage 1	-	-	-	-	628	-
Stage 2	-	-	-	-	677	-
Approach	EB	WB	SB			
HCM Control Delay, s	0	0	18.4			
HCM LOS			C			
Minor Lane/Major Mvmt	EBT	WBT	SBLn1	SBLn2		
Capacity (veh/h)	-	-	322	593		
HCM Lane V/C Ratio	-	-	0.196	0.007		
HCM Control Delay (s)	-	-	18.9	11.1		
HCM Lane LOS	-	-	C	B		
HCM 95th %tile Q(veh)	-	-	0.7	0		

Lanes, Volumes, Timings
1: North River & Montreal

2029 Future Total
PM Peak Hour

Lane Group	EBL	EBT	EBR	WBL	WBT	WBR	NBL	NBT	NBR	SBL	SBT	SBR
Lane Configurations		↑↑			↑↑		↓	↓			↓	↓
Traffic Volume (vph)	0	683	410	0	720	18	383	17	51	21	15	21
Future Volume (vph)	0	683	410	0	720	18	383	17	51	21	15	21
Satd. Flow (prot)	0	2945	0	0	3243	0	1658	1449	0	0	1506	0
Fit Permitted							0.950					0.982
Satd. Flow (perm)	0	2945	0	0	3243	0	1634	1449	0	0	1474	0
Satd. Flow (RTOR)		102						51				19
Lane Group Flow (vph)	0	1093	0	0	738	0	383	68	0	0	57	0
Turn Type		NA			NA		Prot	NA		Split	NA	
Protected Phases		2			6		3!	8		7	7!	
Permitted Phases												
Detector Phase		2			6		3	8		7	7	
Switch Phase												
Minimum Initial (s)		10.0			10.0		5.0	10.0		10.0	10.0	
Minimum Split (s)		21.7			21.7		11.5	24.5		16.5	16.5	
Total Split (s)		39.0			39.0		39.0	64.0		17.0	17.0	
Total Split (%)		32.5%			32.5%		32.5%	53.3%		14.2%	14.2%	
Yellow Time (s)		3.0			3.0		3.3	3.3		3.3	3.3	
All-Red Time (s)		3.7			3.7		3.2	3.2		3.2	3.2	
Lost Time Adjust (s)		0.0			0.0		0.0	0.0		0.0	0.0	
Total Lost Time (s)		6.7			6.7		6.5	6.5		6.5	6.5	
Lead/Lag							Lag	Lag		Lead	Lead	
Lead-Lag Optimize?							Yes	Yes		Yes	Yes	
Recall Mode		C-Max			C-Max		None	Ped		None	None	
Act Effct Green (s)		49.2			49.2		33.1	44.3			10.1	
Actuated g/C Ratio		0.41			0.41		0.28	0.37			0.08	
v/c Ratio		0.86			0.56		0.84	0.12			0.40	
Control Delay		38.6			30.2		56.9	9.7			45.7	
Queue Delay		0.0			52.3		0.0	0.0			0.0	
Total Delay		38.6			82.4		56.9	9.7			45.7	
LOS		D			F		E	A			D	
Approach Delay		38.6			82.4		49.7				45.7	
Approach LOS		D			F		D				D	
Queue Length 50th (m)		113.6			69.5		84.3	2.6			8.6	
Queue Length 95th (m)		#172.6			97.1		112.6	11.4			21.9	
Internal Link Dist (m)		179.1			52.8		112.9				59.0	
Turn Bay Length (m)							90.0					
Base Capacity (vph)		1266			1328		486	720			149	
Starvation Cap Reductn		0			676		0	0			0	
Spillback Cap Reductn		0			0		0	0			0	
Storage Cap Reductn		0			0		0	0			0	
Reduced v/c Ratio		0.86			1.13		0.79	0.09			0.38	

Intersection Summary	
Cycle Length:	120
Actuated Cycle Length:	120
Offset:	0 (0%), Referenced to phase 2:EBT and 6:WBT, Start of Green
Natural Cycle:	90
Control Type:	Actuated-Coordinated

Lanes, Volumes, Timings
1: North River & Montreal

2029 Future Total
PM Peak Hour

Lane Group	Ø4
Lane Configurations	
Traffic Volume (vph)	
Future Volume (vph)	
Satd. Flow (prot)	
Fit Permitted	
Satd. Flow (perm)	
Satd. Flow (RTOR)	
Lane Group Flow (vph)	
Turn Type	
Protected Phases	4
Permitted Phases	
Detector Phase	
Switch Phase	
Minimum Initial (s)	5.0
Minimum Split (s)	24.5
Total Split (s)	42.0
Total Split (%)	35%
Yellow Time (s)	3.3
All-Red Time (s)	3.2
Lost Time Adjust (s)	
Total Lost Time (s)	
Lead/Lag	Lead
Lead-Lag Optimize?	Yes
Recall Mode	Ped
Act Effct Green (s)	
Actuated g/C Ratio	
v/c Ratio	
Control Delay	
Queue Delay	
Total Delay	
LOS	
Approach Delay	
Approach LOS	
Queue Length 50th (m)	
Queue Length 95th (m)	
Internal Link Dist (m)	
Turn Bay Length (m)	
Base Capacity (vph)	
Starvation Cap Reductn	
Spillback Cap Reductn	
Storage Cap Reductn	
Reduced v/c Ratio	
Intersection Summary	

Lanes, Volumes, Timings
1: North River & Montreal

2029 Future Total
PM Peak Hour

Maximum v/c Ratio: 0.86
 Intersection Signal Delay: 54.7 Intersection LOS: D
 Intersection Capacity Utilization 75.1% ICU Level of Service D
 Analysis Period (min) 15
 # 95th percentile volume exceeds capacity, queue may be longer.
 Queue shown is maximum after two cycles.
 ! Phase conflict between lane groups.

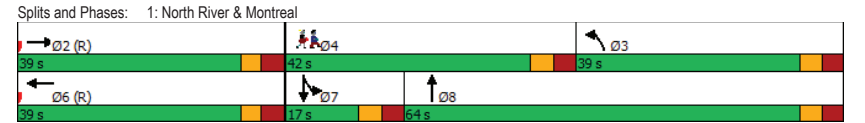

Lanes, Volumes, Timings
2: Montgomery & Montreal

2029 Future Total
PM Peak Hour

Lane Group	EBT	EBR	WBL	WBT	NBL	NBR
Lane Configurations	↔↔			↔↔	↔	↔
Traffic Volume (vph)	577	178	191	570	173	148
Future Volume (vph)	577	178	191	570	173	148
Satd. Flow (prot)	3139	0	0	3236	1658	1401
Fit Permitted				0.623	0.950	
Satd. Flow (perm)	3139	0	0	2036	1647	1314
Satd. Flow (RTOR)	99					148
Lane Group Flow (vph)	755	0	0	761	173	148
Turn Type	NA		Perm	NA	Prot	Perm
Protected Phases	2			6	8	
Permitted Phases			6			8
Detector Phase	2		6	6	8	8
Switch Phase						
Minimum Initial (s)	10.0		10.0	10.0	10.0	10.0
Minimum Split (s)	39.9		15.9	15.9	19.5	19.5
Total Split (s)	76.0		76.0	76.0	24.0	24.0
Total Split (%)	76.0%		76.0%	76.0%	24.0%	24.0%
Yellow Time (s)	3.0		3.0	3.0	3.3	3.3
All-Red Time (s)	2.6		2.6	2.6	2.2	2.2
Lost Time Adjust (s)	0.0		0.0	0.0	0.0	0.0
Total Lost Time (s)	5.6		5.6	5.6	5.5	5.5
Lead/Lag						
Lead-Lag Optimize?						
Recall Mode	C-Max		C-Max	C-Max	None	None
Act Effct Green (s)	73.8		73.8	15.1	15.1	
Actuated g/C Ratio	0.74		0.74	0.15	0.15	
v/c Ratio	0.32		0.51	0.69	0.46	
Control Delay	4.5		7.3	54.7	11.0	
Queue Delay	1.6		0.0	0.0	0.0	
Total Delay	6.1		7.3	54.7	11.0	
LOS	A		A	D	B	
Approach Delay	6.1		7.3	34.6		
Approach LOS	A		A	C		
Queue Length 50th (m)	19.0		28.0	32.0	0.0	
Queue Length 95th (m)	29.7		44.8	52.1	16.0	
Internal Link Dist (m)	52.8		138.9	214.6		
Turn Bay Length (m)				35.0		
Base Capacity (vph)	2343		1503	306	363	
Starvation Cap Reductn	1355		0	0	0	
Spillback Cap Reductn	0		0	0	0	
Storage Cap Reductn	0		0	0	0	
Reduced v/c Ratio	0.76		0.51	0.57	0.41	

Intersection Summary	
Cycle Length:	100
Actuated Cycle Length:	100
Offset:	0 (0%), Referenced to phase 2:EBT and 6:WBTL, Start of Green
Natural Cycle:	60
Control Type:	Actuated-Coordinated

Lanes, Volumes, Timings
2: Montgomery & Montreal

2029 Future Total
PM Peak Hour

Maximum v/c Ratio:	0.69
Intersection Signal Delay:	11.6
Intersection Capacity Utilization:	74.0%
Analysis Period (min):	15
Intersection LOS:	B
ICU Level of Service:	D

Splits and Phases: 2: Montgomery & Montreal

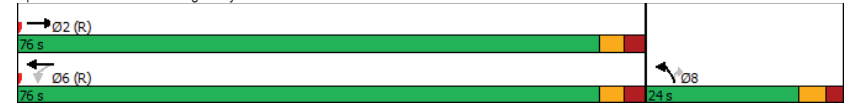

Lanes, Volumes, Timings
4: Vanier & Montreal

2029 Future Total
PM Peak Hour

Lane Group	EBL	EBT	EBR	WBL	WBT	WBR	NBL	NBT	NBR	SBL	SBT	SBR
Lane Configurations	↖	↗	↘	↖	↗	↘	↖	↗	↘	↖	↗	↘
Traffic Volume (vph)	61	426	185	156	436	198	235	1063	210	142	1071	122
Future Volume (vph)	61	426	185	156	436	198	235	1063	210	142	1071	122
Satd. Flow (prot)	1626	1695	1483	1658	2981	0	1658	4565	0	1658	4648	0
Fit Permitted	0.950			0.950			0.950			0.950		
Satd. Flow (perm)	1566	1695	1376	1602	2981	0	1632	4565	0	1634	4648	0
Satd. Flow (RTOR)			162		49			28			13	
Lane Group Flow (vph)	61	426	185	156	634	0	235	1273	0	142	1193	0
Turn Type	Prot	NA	Perm	Prot	NA		Prot	NA		Prot	NA	
Protected Phases	7	4		3	8		5	2		1	6	
Permitted Phases			4									
Detector Phase	7	4	4	3	8		5	2		1	6	
Switch Phase												
Minimum Initial (s)	5.0	10.0	10.0	5.0	10.0		5.0	10.0		5.0	10.0	
Minimum Split (s)	12.1	40.1	40.1	12.1	40.1		11.1	28.9		11.1	28.9	
Total Split (s)	30.0	41.0	41.0	30.0	41.0		30.0	39.0		30.0	39.0	
Total Split (%)	21.4%	29.3%	29.3%	21.4%	29.3%		21.4%	27.9%		21.4%	27.9%	
Yellow Time (s)	3.0	3.0	3.0	3.0	3.0		3.7	3.7		3.7	3.7	
All-Red Time (s)	4.1	4.1	4.1	4.1	4.1		2.4	2.2		2.4	2.2	
Lost Time Adjust (s)	0.0	0.0	0.0	0.0	0.0		0.0	0.0		0.0	0.0	
Total Lost Time (s)	7.1	7.1	7.1	7.1	7.1		6.1	5.9		6.1	5.9	
Lead/Lag	Lead	Lag	Lag	Lead	Lag		Lead	Lag		Lead	Lag	
Lead-Lag Optimize?	Yes	Yes	Yes	Yes	Yes		Yes	Yes		Yes	Yes	
Recall Mode	None	Max	Max	None	Max		None	C-Max		None	C-Max	
Act Effct Green (s)	10.6	38.8	38.8	18.0	48.9		22.5	39.8		17.2	34.5	
Actuated g/C Ratio	0.08	0.28	0.28	0.13	0.35		0.16	0.28		0.12	0.25	
v/c Ratio	0.50	0.91	0.37	0.74	0.59		0.88	0.97		0.70	1.03	
Control Delay	74.9	73.1	11.0	78.3	38.4		87.6	74.8		76.2	85.6	
Queue Delay	0.0	0.0	0.0	0.0	0.0		0.0	0.0		0.0	0.0	
Total Delay	74.9	73.1	11.0	78.3	38.4		87.6	74.8		76.2	85.6	
LOS	E	E	B	E	D		F	E		E	F	
Approach Delay		56.2			46.3			76.8			84.6	
Approach LOS		E			D			E			F	
Queue Length 50th (m)	16.5	114.9	4.7	42.0	72.0		68.6	105.4		38.3	~133.5	
Queue Length 95th (m)	30.6	#191.2	25.3	63.9	97.3		m76.8	m#163.3		58.2	#163.4	
Internal Link Dist (m)		99.5			237.5			154.5			139.4	
Turn Bay Length (m)	30.0			35.0			94.5			90.0		
Base Capacity (vph)	265	470	498	271	1072		283	1317		283	1155	
Starvation Cap Reductn	0	0	0	0	0		0	0		0	0	
Spillback Cap Reductn	0	0	0	0	0		0	0		0	0	
Storage Cap Reductn	0	0	0	0	0		0	0		0	0	
Reduced v/c Ratio	0.23	0.91	0.37	0.58	0.59		0.83	0.97		0.50	1.03	

Intersection Summary

Cycle Length: 140
Actuated Cycle Length: 140
Offset: 56 (40%), Referenced to phase 2:NBT and 6:SBT, Start of Green
Natural Cycle: 115
Control Type: Actuated-Coordinated

Lanes, Volumes, Timings
4: Vanier & Montreal

2029 Future Total
PM Peak Hour

Maximum v/c Ratio: 1.03	Intersection LOS: E
Intersection Signal Delay: 70.4	ICU Level of Service F
Intersection Capacity Utilization 97.3%	
Analysis Period (min) 15	
~ Volume exceeds capacity, queue is theoretically infinite.	
Queue shown is maximum after two cycles.	
# 95th percentile volume exceeds capacity, queue may be longer.	
Queue shown is maximum after two cycles.	
m Volume for 95th percentile queue is metered by upstream signal.	

Splits and Phases: 4: Vanier & Montreal

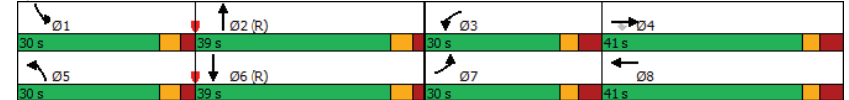

HCM 2010 TWSC
6: North River & Selkirk

2029 Future Total
PM Peak Hour

Intersection						
Int Delay, s/veh	3.8					
Movement	WBL	WBR	NBT	NBR	SBL	SBT
Lane Configurations	↔		↑			↑↑
Traffic Vol, veh/h	125	70	391	2	0	434
Future Vol, veh/h	125	70	391	2	0	434
Conflicting Peds, #/hr	2	2	0	66	66	0
Sign Control	Stop	Stop	Free	Free	Free	Free
RT Channelized	-	None	-	None	-	None
Storage Length	0	-	-	-	-	-
Veh in Median Storage, #	0	-	0	-	-	0
Grade, %	0	-	0	-	-	0
Peak Hour Factor	100	100	100	100	100	100
Heavy Vehicles, %	2	2	3	2	2	4
Mvmt Flow	125	70	391	2	0	434
Major/Minor	Minor1	Major1	Major2			
Conflicting Flow All	677	460	0	0	-	-
Stage 1	458	-	-	-	-	-
Stage 2	219	-	-	-	-	-
Critical Hdwy	6.63	6.23	-	-	-	-
Critical Hdwy Stg 1	5.43	-	-	-	-	-
Critical Hdwy Stg 2	5.83	-	-	-	-	-
Follow-up Hdwy	3.519	3.319	-	-	-	-
Pot Cap-1 Maneuver	402	600	-	-	0	-
Stage 1	636	-	-	-	0	-
Stage 2	797	-	-	-	0	-
Platoon blocked, %	-	-	-	-	-	-
Mov Cap-1 Maneuver	381	568	-	-	-	-
Mov Cap-2 Maneuver	381	-	-	-	-	-
Stage 1	604	-	-	-	-	-
Stage 2	795	-	-	-	-	-
Approach	WB	NB	SB			
HCM Control Delay, s	20	0	0			
HCM LOS	C					
Minor Lane/Major Mvmt	NBT	NBRWBLn1	SBT			
Capacity (veh/h)	-	-	432			
HCM Lane V/C Ratio	-	-	0.451			
HCM Control Delay (s)	-	-	20			
HCM Lane LOS	-	-	C			
HCM 95th %tile Q(veh)	-	-	2.3			

HCM 2010 TWSC
7: Dundas & Selkirk

2029 Future Total
PM Peak Hour

Intersection						
Int Delay, s/veh	0					
Movement	EBT	EBR	WBL	WBT	NBL	NBR
Lane Configurations				↔	↔	
Traffic Vol, veh/h	0	0	36	54	49	131
Future Vol, veh/h	0	0	36	54	49	131
Conflicting Peds, #/hr	0	0	0	0	0	0
Sign Control	Free	Free	Free	Free	Stop	Stop
RT Channelized	-	None	-	None	-	None
Storage Length	-	-	-	-	0	-
Veh in Median Storage, #	-	-	-	0	0	-
Grade, %	0	-	-	0	0	-
Peak Hour Factor	100	100	100	100	100	100
Heavy Vehicles, %	2	2	2	2	2	2
Mvmt Flow	0	0	36	54	49	131
Major/Minor	Major2	Minor1				
Conflicting Flow All	0	0	126	0		
Stage 1	-	-	0	-		
Stage 2	-	-	126	-		
Critical Hdwy	4.12	-	6.42	6.22		
Critical Hdwy Stg 1	-	-	-	-		
Critical Hdwy Stg 2	-	-	5.42	-		
Follow-up Hdwy	2.218	-	3.518	3.318		
Pot Cap-1 Maneuver	-	-	869	-		
Stage 1	-	-	-	-		
Stage 2	-	-	900	-		
Platoon blocked, %	-	-	-	-		
Mov Cap-1 Maneuver	-	-	869	-		
Mov Cap-2 Maneuver	-	-	869	-		
Stage 1	-	-	-	-		
Stage 2	-	-	900	-		
Approach	WB	NB				
HCM Control Delay, s						
HCM LOS						
Minor Lane/Major Mvmt	NBLn1	WBL	WBT			
Capacity (veh/h)	-	-	-			
HCM Lane V/C Ratio	-	-	-			
HCM Control Delay (s)	-	-	-			
HCM Lane LOS	-	-	-			
HCM 95th %tile Q(veh)	-	-	-			

HCM 2010 TWSC
8: Montgomery & Selkirk

2029 Future Total
PM Peak Hour

Intersection												
Int Delay, s/veh	6.6											
Movement	EBL	EBT	EBR	WBL	WBT	WBR	NBL	NBT	NBR	SBL	SBT	SBR
Lane Configurations	↔			↔			↔			↔		
Traffic Vol, veh/h	92	29	10	17	27	35	5	10	0	15	47	60
Future Vol, veh/h	92	29	10	17	27	35	5	10	0	15	47	60
Conflicting Peds, #/hr	0	0	0	0	0	0	0	0	0	0	0	0
Sign Control	Stop	Stop	Stop	Stop	Stop	Stop	Free	Free	Free	Free	Free	Free
RT Channelized	-	-	None	-	-	None	-	-	None	-	-	None
Storage Length	-	-	-	-	-	-	-	-	-	-	-	-
Veh in Median Storage, #	-	0	-	-	0	-	-	0	-	-	0	-
Grade, %	-	0	-	-	0	-	-	0	-	-	0	-
Peak Hour Factor	100	100	100	100	100	100	100	100	100	100	100	100
Heavy Vehicles, %	2	2	2	2	2	2	2	2	2	2	2	2
Mvmt Flow	92	29	10	17	27	35	5	10	0	15	47	60
Major/Minor	Minor2	Minor1	Major1	Major2								
Conflicting Flow All	158	127	77	147	157	10	107	0	0	10	0	0
Stage 1	107	107	-	20	20	-	-	-	-	-	-	-
Stage 2	51	20	-	127	137	-	-	-	-	-	-	-
Critical Hdwy	7.12	6.52	6.22	7.12	6.52	6.22	4.12	-	-	4.12	-	-
Critical Hdwy Stg 1	6.12	5.52	-	6.12	5.52	-	-	-	-	-	-	-
Critical Hdwy Stg 2	6.12	5.52	-	6.12	5.52	-	-	-	-	-	-	-
Follow-up Hdwy	3.518	4.018	3.318	3.518	4.018	3.318	2.218	-	-	2.218	-	-
Pot Cap-1 Maneuver	808	764	984	821	735	1071	1484	-	-	1610	-	-
Stage 1	898	807	-	999	879	-	-	-	-	-	-	-
Stage 2	962	879	-	877	783	-	-	-	-	-	-	-
Platoon blocked, %	-	-	-	-	-	-	-	-	-	-	-	-
Mov Cap-1 Maneuver	752	754	984	781	725	1071	1484	-	-	1610	-	-
Mov Cap-2 Maneuver	752	754	-	781	725	-	-	-	-	-	-	-
Stage 1	895	799	-	996	876	-	-	-	-	-	-	-
Stage 2	899	876	-	828	775	-	-	-	-	-	-	-
Approach	EB	WB	NB	SB								
HCM Control Delay, s	10.7	9.6	2.5	0.9								
HCM LOS	B	A										
Minor Lane/Major Mvmt	NBL	NBT	NBR	EBLn1	WBLn1	SBL	SBT	SBR				
Capacity (veh/h)	1484	-	-	766	862	1610	-	-				
HCM Lane V/C Ratio	0.003	-	-	0.171	0.092	0.009	-	-				
HCM Control Delay (s)	7.4	0	-	10.7	9.6	7.3	0	-				
HCM Lane LOS	A	A	-	B	A	A	A	-				
HCM 95th %tile Q(veh)	0	-	-	0.6	0.3	0	-	-				

Lanes, Volumes, Timings
9: North River & McArthur

2029 Future Total
PM Peak Hour

Lane Group	EBL	EBT	EBR	WBL	WBT	WBR	NBL	NBT	NBR	SBL	SBT	SBR
Lane Configurations		↔			↔	↔		↔		↔	↔	
Traffic Volume (vph)	4	25	6	25	11	224	2	161	38	414	144	1
Future Volume (vph)	4	25	6	25	11	224	2	161	38	414	144	1
Satd. Flow (prot)	0	1636	0	0	1568	1483	0	1638	0	1642	1709	0
Fit Permitted		0.979			0.838			0.998		0.632		
Satd. Flow (perm)	0	1598	0	0	1323	1334	0	1634	0	979	1709	0
Satd. Flow (RTOR)		6			224			26		1		
Lane Group Flow (vph)	0	35	0	0	36	224	0	201	0	414	145	0
Turn Type	Perm	NA		Perm	NA	Perm	Perm	NA		Perm	NA	
Protected Phases		4			8			2			6	
Permitted Phases	4			8		8	2			6		
Detector Phase	4	4		8	8	8	2	2		6	6	
Switch Phase												
Minimum Initial (s)	10.0	10.0		10.0	10.0	10.0	10.0	10.0		10.0	10.0	
Minimum Split (s)	25.6	25.6		25.6	25.6	25.6	31.1	31.1		31.1	31.1	
Total Split (s)	26.0	26.0		26.0	26.0	26.0	49.0	49.0		49.0	49.0	
Total Split (%)	34.7%	34.7%		34.7%	34.7%	34.7%	65.3%	65.3%		65.3%	65.3%	
Yellow Time (s)	3.3	3.3		3.3	3.3	3.3	3.3	3.3		3.3	3.3	
All-Red Time (s)	2.3	2.3		2.3	2.3	2.3	2.8	2.8		2.8	2.8	
Lost Time Adjust (s)		0.0			0.0	0.0		0.0		0.0	0.0	
Total Lost Time (s)		5.6			5.6	5.6		6.1		6.1	6.1	
Lead/Lag												
Lead-Lag Optimize?												
Recall Mode	Max	Max		Max	Max	Max	C-Max	C-Max		C-Max	C-Max	
Act Effct Green (s)		20.4			20.4	20.4		42.9		42.9	42.9	
Actuated g/C Ratio		0.27			0.27	0.27		0.57		0.57	0.57	
v/c Ratio		0.08			0.10	0.43		0.21		0.74	0.15	
Control Delay		18.4			20.8	12.4		7.4		22.3	8.0	
Queue Delay		0.0			0.0	0.0		0.0		0.0	0.0	
Total Delay		18.4			20.8	12.4		7.4		22.3	8.0	
LOS		B			C	B		A		C	A	
Approach Delay		18.4			13.6			7.4			18.6	
Approach LOS		B			B			A			B	
Queue Length 50th (m)		3.0			4.4	1.7		10.8		39.6	8.7	
Queue Length 95th (m)		9.4			11.8	33.9		20.3		#90.3	16.4	
Internal Link Dist (m)		22.5			128.8			119.0			94.3	
Turn Bay Length (m)						60.0					55.0	
Base Capacity (vph)		439			359	525		945		559	977	
Starvation Cap Reductn		0			0	0		0		0	0	
Spillback Cap Reductn		0			0	0		0		0	0	
Storage Cap Reductn		0			0	0		0		0	0	
Reduced v/c Ratio		0.08			0.10	0.43		0.21		0.74	0.15	
Intersection Summary												
Cycle Length: 75												
Actuated Cycle Length: 75												
Offset: 0 (0%), Referenced to phase 2:NBT and 6:SBTL, Start of Green												
Natural Cycle: 60												
Control Type: Actuated-Coordinated												

Lanes, Volumes, Timings
9: North River & McArthur

2029 Future Total
PM Peak Hour

Maximum v/c Ratio: 0.74	Intersection LOS: B
Intersection Signal Delay: 15.2	ICU Level of Service D
Intersection Capacity Utilization 76.5%	
Analysis Period (min) 15	
# 95th percentile volume exceeds capacity, queue may be longer.	
Queue shown is maximum after two cycles.	

Splits and Phases: 9: North River & McArthur

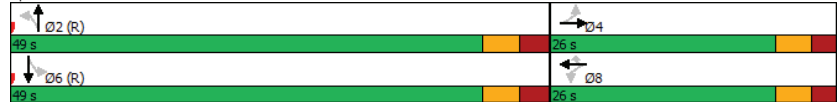

HCM 2010 TWSC
10: McArthur & Dundas

2029 Future Total
PM Peak Hour

Intersection						
Int Delay, s/veh	0.7					
Movement	EBL	EBT	WBT	WBR	SBL	SBR
Lane Configurations		↔	↔		↔	↔
Traffic Vol, veh/h	9	474	274	160	26	4
Future Vol, veh/h	9	474	274	160	26	4
Conflicting Peds, #/hr	76	0	0	76	0	9
Sign Control	Free	Free	Free	Free	Stop	Stop
RT Channelized	-	None	-	None	-	None
Storage Length	-	-	-	-	0	-
Veh in Median Storage, #	-	0	0	-	0	-
Grade, %	-	0	0	-	0	-
Peak Hour Factor	100	100	100	100	100	100
Heavy Vehicles, %	2	3	3	2	8	2
Mvmt Flow	9	474	274	160	26	4

Major/Minor	Major1	Major2	Minor2
Conflicting Flow All	510	0	922
Stage 1	-	-	430
Stage 2	-	-	492
Critical Hdwy	4.12	-	6.48
Critical Hdwy Stg 1	-	-	5.48
Critical Hdwy Stg 2	-	-	5.48
Follow-up Hdwy	2,218	-	3,318
Pot Cap-1 Maneuver	1055	-	293
Stage 1	-	-	643
Stage 2	-	-	602
Platoon blocked, %	-	-	-
Mov Cap-1 Maneuver	993	-	256
Mov Cap-2 Maneuver	-	-	256
Stage 1	-	-	598
Stage 2	-	-	566

Approach	EB	WB	SB
HCM Control Delay, s	0.2	0	19.6
HCM LOS			C

Minor Lane/Major Mvmt	EBL	EBT	WBT	WBR	SBLn1
Capacity (veh/h)	993	-	-	-	277
HCM Lane V/C Ratio	0.009	-	-	-	0.108
HCM Control Delay (s)	8.7	0	-	-	19.6
HCM Lane LOS	A	A	-	-	C
HCM 95th %tile Q(veh)	0	-	-	-	0.4

Lanes, Volumes, Timings
11: Marguerite & McArthur

2029 Future Total
PM Peak Hour

Lane Group	EBT	EBR	WBL	WBT	NBL	NBR
Lane Configurations	↔	↔	↔	↔	↔	↔
Traffic Volume (vph)	491	21	40	421	20	52
Future Volume (vph)	491	21	40	421	20	52
Satd. Flow (prot)	1730	0	0	1738	1658	1483
Fit Permitted				0.934	0.950	
Satd. Flow (perm)	1730	0	0	1627	1586	1425
Satd. Flow (RTOR)	5					52
Lane Group Flow (vph)	512	0	0	461	20	52
Turn Type	NA		Perm	NA	Prot	Perm
Protected Phases	2			6	8	
Permitted Phases			6			8
Detector Phase	2		6	6	8	8
Switch Phase						
Minimum Initial (s)	10.0		10.0	10.0	5.0	5.0
Minimum Split (s)	27.5		15.5	15.5	24.5	24.5
Total Split (s)	50.0		50.0	50.0	25.0	25.0
Total Split (%)	66.7%		66.7%	66.7%	33.3%	33.3%
Yellow Time (s)	3.3		3.3	3.3	3.3	3.3
All-Red Time (s)	2.2		2.2	2.2	2.2	2.2
Lost Time Adjust (s)	0.0		0.0	0.0	0.0	0.0
Total Lost Time (s)	5.5		5.5	5.5	5.5	5.5
Lead/Lag						
Lead-Lag Optimize?						
Recall Mode	C-Max		C-Max	C-Max	None	None
Act Effct Green (s)	59.5		59.5	11.2	11.2	
Actuated g/C Ratio	0.79		0.79	0.15	0.15	
v/c Ratio	0.37		0.36	0.08	0.20	
Control Delay	5.0		6.3	24.2	9.0	
Queue Delay	0.0		0.0	0.0	0.0	
Total Delay	5.0		6.3	24.2	9.0	
LOS	A		A	C	A	
Approach Delay	5.0		6.3	13.2		
Approach LOS	A		A	B		
Queue Length 50th (m)	14.3		15.7	2.7	0.0	
Queue Length 95th (m)	38.2		52.9	7.0	7.7	
Internal Link Dist (m)	36.3		7.3	144.2		
Turn Bay Length (m)				30.0		
Base Capacity (vph)	1373		1291	431	408	
Starvation Cap Reductn	0		0	0	0	
Spillback Cap Reductn	0		0	0	0	
Storage Cap Reductn	0		0	0	0	
Reduced v/c Ratio	0.37		0.36	0.05	0.13	

Intersection Summary

Cycle Length: 75
Actuated Cycle Length: 75
Offset: 0 (0%), Referenced to phase 2:EBT and 6:WBTL, Start of Green
Natural Cycle: 55
Control Type: Actuated-Coordinated

Lanes, Volumes, Timings
11: Marguerite & McArthur

2029 Future Total
PM Peak Hour

Maximum v/c Ratio: 0.37	Intersection LOS: A
Intersection Signal Delay: 6.1	ICU Level of Service D
Intersection Capacity Utilization 75.1%	
Analysis Period (min) 15	

Splits and Phases: 11: Marguerite & McArthur

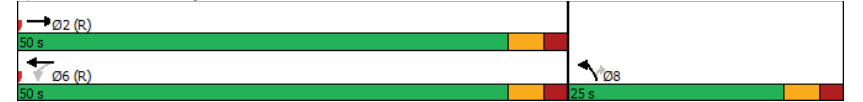

Lanes, Volumes, Timings
12: Vanier & McArthur

2029 Future Total
PM Peak Hour

Lane Group	EBL	EBT	EBR	WBL	WBT	WBR	NBL	NBT	NBR	SBL	SBT	SBR
Lane Configurations	↔	↔	↔	↔	↔	↔	↔	↔	↔	↔	↔	↔
Traffic Volume (vph)	55	257	455	333	261	170	238	1265	251	122	1246	66
Future Volume (vph)	55	257	455	333	261	170	238	1265	251	122	1246	66
Satd. Flow (prot)	1658	1712	1483	3154	1712	1483	1658	3316	1469	1658	3316	1469
Fit Permitted	0.950			0.950			0.950			0.950		
Satd. Flow (perm)	1579	1712	1323	2941	1712	1360	1614	3316	1400	1648	3316	1223
Satd. Flow (RTOR)			240			170			202			121
Lane Group Flow (vph)	55	257	455	333	261	170	238	1265	251	122	1246	66
Turn Type	Prot	NA	Perm	Prot	NA	Perm	Prot	NA	Perm	Prot	NA	Perm
Protected Phases	7	4		3	8		5	2		1	6	
Permitted Phases			4			8			2			6
Detector Phase	7	4	4	3	8	8	5	2	2	1	6	6
Switch Phase												
Minimum Initial (s)	5.0	10.0	10.0	5.0	10.0	10.0	5.0	10.0	10.0	5.0	10.0	10.0
Minimum Split (s)	11.2	36.2	36.2	11.2	36.2	36.2	11.1	36.1	36.1	11.1	36.1	36.1
Total Split (s)	20.0	36.2	36.2	20.0	36.2	36.2	23.0	59.8	59.8	24.0	60.8	60.8
Total Split (%)	14.3%	25.9%	25.9%	14.3%	25.9%	25.9%	16.4%	42.7%	42.7%	17.1%	43.4%	43.4%
Yellow Time (s)	3.3	3.3	3.3	3.3	3.3	3.3	3.7	3.7	3.7	3.7	3.7	3.7
All-Red Time (s)	2.9	2.9	2.9	2.9	2.9	2.9	2.4	2.4	2.4	2.4	2.4	2.4
Lost Time Adjust (s)	0.0	0.0	0.0	0.0	0.0	0.0	0.0	0.0	0.0	0.0	0.0	0.0
Total Lost Time (s)	6.2	6.2	6.2	6.2	6.2	6.2	6.1	6.1	6.1	6.1	6.1	6.1
Lead/Lag	Lag	Lead	Lead	Lag	Lead	Lead	Lag	Lag	Lag	Lead	Lead	Lead
Lead-Lag Optimize?	Yes	Yes	Yes	Yes	Yes	Yes	Yes	Yes	Yes	Yes	Yes	Yes
Recall Mode	None	None	None	None	None	None	C-Max	C-Max	None	C-Max	C-Max	C-Max
Act Effct Green (s)	12.2	28.9	28.9	14.9	34.0	34.0	16.9	56.8	56.8	14.8	54.7	54.7
Actuated g/C Ratio	0.09	0.21	0.21	0.11	0.24	0.24	0.12	0.41	0.41	0.11	0.39	0.39
v/c Ratio	0.38	0.73	0.98	0.99	0.63	0.37	1.19	0.94	0.37	0.70	0.96	0.12
Control Delay	67.2	64.7	63.3	109.4	57.0	8.8	175.4	54.4	8.4	80.6	86.2	18.9
Queue Delay	0.0	0.0	0.0	0.0	0.0	0.0	0.0	0.0	0.0	0.0	0.0	0.0
Total Delay	67.2	64.7	63.3	109.4	57.0	8.8	175.4	54.4	8.4	80.6	86.2	18.9
LOS	E	E	E	F	E	A	F	D	A	F	F	B
Approach Delay		64.1			69.1			64.3			82.6	
Approach LOS		E			E			E			F	
Queue Length 50th (m)	14.5	66.4	67.4	~52.5	67.6	0.0	~79.2	177.3	8.4	35.7	184.4	5.3
Queue Length 95th (m)	28.5	97.3	#136.9	#83.3	98.7	19.2	#132.1	#232.7	28.8	m40.1	m185.8	m7.7
Internal Link Dist (m)		122.9			146.0			119.5			202.0	
Turn Bay Length (m)	30.0		50.0	120.0		115.0	90.0		90.0	90.0		90.0
Base Capacity (vph)	163	366	472	335	415	459	200	1344	687	211	1295	551
Starvation Cap Reductn	0	0	0	0	0	0	0	0	0	0	0	0
Spillback Cap Reductn	0	0	0	0	0	0	0	0	0	0	0	0
Storage Cap Reductn	0	0	0	0	0	0	0	0	0	0	0	0
Reduced v/c Ratio	0.34	0.70	0.96	0.99	0.63	0.37	1.19	0.94	0.37	0.58	0.96	0.12

Intersection Summary	
Cycle Length:	140
Actuated Cycle Length:	140
Offset:	54 (39%), Referenced to phase 2:NBT and 6:SBT, Start of Green
Natural Cycle:	145
Control Type:	Actuated-Coordinated

Lanes, Volumes, Timings
12: Vanier & McArthur

2029 Future Total
PM Peak Hour

Maximum v/c Ratio:	1.19
Intersection Signal Delay:	70.6
Intersection Capacity Utilization:	104.7%
Analysis Period (min):	15
~ Volume exceeds capacity, queue is theoretically infinite.	
# 95th percentile volume exceeds capacity, queue may be longer.	
m Volume for 95th percentile queue is metered by upstream signal.	

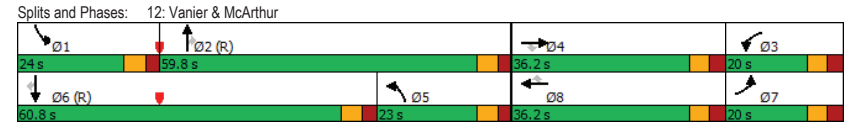

HCM 2010 TWSC
13: Palace & Site Access

2029 Future Total
PM Peak Hour

Intersection						
Int Delay, s/veh	3.1					
Movement	WBL	WBR	NBT	NBR	SBL	SBT
Lane Configurations	↔					↔
Traffic Vol, veh/h	31	0	0	0	41	19
Future Vol, veh/h	31	0	0	0	41	19
Conflicting Peds, #/hr	0	0	0	0	0	0
Sign Control	Stop	Stop	Free	Free	Free	Free
RT Channelized	-	None	-	None	-	None
Storage Length	0	-	-	-	-	-
Veh in Median Storage, #	0	-	-	-	-	0
Grade, %	0	-	0	-	-	0
Peak Hour Factor	100	100	100	100	100	100
Heavy Vehicles, %	2	2	2	2	2	2
Mvmt Flow	31	0	0	0	41	19

Major/Minor	Minor1	Major2	Minor2
Conflicting Flow All	101	-	0
Stage 1	0	-	-
Stage 2	101	-	-
Critical Hdwy	6.42	-	4.12
Critical Hdwy Stg 1	-	-	-
Critical Hdwy Stg 2	5.42	-	-
Follow-up Hdwy	3.518	-	2.218
Pot Cap-1 Maneuver	898	0	-
Stage 1	-	0	-
Stage 2	923	0	-
Platoon blocked, %	-	-	-
Mov Cap-1 Maneuver	898	-	-
Mov Cap-2 Maneuver	898	-	-
Stage 1	-	-	-
Stage 2	923	-	-

Approach	WB	SB
HCM Control Delay, s	9.2	
HCM LOS	A	

Minor Lane/Major Mvmt	WBLn1	SBL	SBT
Capacity (veh/h)	898	-	-
HCM Lane V/C Ratio	0.035	-	-
HCM Control Delay (s)	9.2	-	-
HCM Lane LOS	A	-	-
HCM 95th %tile Q(veh)	0.1	-	-

HCM 2010 TWSC
15: McArthur & Mayfield

2029 Future Total
PM Peak Hour

Intersection						
Int Delay, s/veh	1					
Movement	EBL	EBT	WBT	WBR	SBL	SBR
Lane Configurations		↑	↑		↔	↔
Traffic Vol, veh/h	0	545	453	0	47	8
Future Vol, veh/h	0	545	453	0	47	8
Conflicting Peds, #/hr	0	0	0	0	0	0
Sign Control	Free	Free	Free	Free	Stop	Stop
RT Channelized	-	None	-	None	-	None
Storage Length	-	-	-	-	0	0
Veh in Median Storage, #	-	0	0	-	0	-
Grade, %	-	0	0	-	0	-
Peak Hour Factor	100	100	100	100	100	100
Heavy Vehicles, %	2	2	2	2	2	2
Mvmt Flow	0	545	453	0	47	8

Major/Minor	Major1	Major2	Minor2
Conflicting Flow All	-	0	998
Stage 1	-	-	453
Stage 2	-	-	545
Critical Hdwy	-	-	6.42
Critical Hdwy Stg 1	-	-	5.42
Critical Hdwy Stg 2	-	-	5.42
Follow-up Hdwy	-	-	3.518
Pot Cap-1 Maneuver	0	-	607
Stage 1	0	-	640
Stage 2	0	-	581
Platoon blocked, %	-	-	-
Mov Cap-1 Maneuver	-	-	270
Mov Cap-2 Maneuver	-	-	270
Stage 1	-	-	640
Stage 2	-	-	581

Approach	EB	WB	SB
HCM Control Delay, s	0	0	19.6
HCM LOS			C

Minor Lane/Major Mvmt	EBT	WBT	SBLn1	SBLn2
Capacity (veh/h)	-	-	270	607
HCM Lane V/C Ratio	-	-	0.174	0.013
HCM Control Delay (s)	-	-	21.1	11
HCM Lane LOS	-	-	C	B
HCM 95th %tile Q(veh)	-	-	0.6	0

Appendix M

TDM Checklist

TDM Measures Checklist:
*Non-Residential Developments (office, institutional, **retail** or industrial)*

Legend

BASIC The measure is generally feasible and effective, and in most cases would benefit the development and its users

BETTER The measure could maximize support for users of sustainable modes, and optimize development performance

★ The measure is one of the most dependably effective tools to encourage the use of sustainable modes

TDM measures: <i>Non-residential developments</i>		Check if proposed & add descriptions
1. TDM PROGRAM MANAGEMENT		
1.1 Program coordinator		
BASIC ★	1.1.1 Designate an internal coordinator, or contract with an external coordinator	<input type="checkbox"/>
1.2 Travel surveys		
BETTER	1.2.1 Conduct periodic surveys to identify travel-related behaviours, attitudes, challenges and solutions, and to track progress	<input type="checkbox"/>
2. WALKING AND CYCLING		
2.1 Information on walking/cycling routes & destinations		
BASIC	2.1.1 Display local area maps with walking/cycling access routes and key destinations at major entrances	<input checked="" type="checkbox"/>
2.2 Bicycle skills training		
<i>Commuter travel</i>		
BETTER ★	2.2.1 Offer on-site cycling courses for commuters, or subsidize off-site courses	<input type="checkbox"/>
2.3 Valet bike parking		
<i>Visitor travel</i>		
BETTER	2.3.1 Offer secure valet bike parking during public events when demand exceeds fixed supply (e.g. for festivals, concerts, games)	<input type="checkbox"/>

TDM measures: <i>Non-residential developments</i>		Check if proposed & add descriptions
3. TRANSIT		
3.1 Transit information		
BASIC	3.1.1 Display relevant transit schedules and route maps at entrances	<input checked="" type="checkbox"/>
BASIC	3.1.2 Provide online links to OC Transpo and STO information	<input checked="" type="checkbox"/>
BETTER	3.1.3 Provide real-time arrival information display at entrances	<input type="checkbox"/>
3.2 Transit fare incentives		
<i>Commuter travel</i>		
BETTER	3.2.1 Offer preloaded PRESTO cards to encourage commuters to use transit	<input type="checkbox"/>
BETTER ★	3.2.2 Subsidize or reimburse monthly transit pass purchases by employees	<input type="checkbox"/>
<i>Visitor travel</i>		
BETTER	3.2.3 Arrange inclusion of same-day transit fare in price of tickets (e.g. for festivals, concerts, games)	<input type="checkbox"/>
3.3 Enhanced public transit service		
<i>Commuter travel</i>		
BETTER	3.3.1 Contract with OC Transpo to provide enhanced transit services (e.g. for shift changes, weekends)	<input type="checkbox"/>
<i>Visitor travel</i>		
BETTER	3.3.2 Contract with OC Transpo to provide enhanced transit services (e.g. for festivals, concerts, games)	<input type="checkbox"/>
3.4 Private transit service		
<i>Commuter travel</i>		
BETTER	3.4.1 Provide shuttle service when OC Transpo cannot offer sufficient quality or capacity to serve demand (e.g. for shift changes, weekends)	<input type="checkbox"/>
<i>Visitor travel</i>		
BETTER	3.4.2 Provide shuttle service when OC Transpo cannot offer sufficient quality or capacity to serve demand (e.g. for festivals, concerts, games)	<input type="checkbox"/>

TDM measures: Non-residential developments		Check if proposed & add descriptions
4. RIDESHARING		
<i>Commuter travel</i>		
BASIC ★	4.1.1 Provide a dedicated ride-matching portal at OttawaRideMatch.com	<input type="checkbox"/>
4.2 Carpool parking price incentives		
<i>Commuter travel</i>		
BETTER	4.2.1 Provide discounts on parking costs for registered carpools	<input type="checkbox"/>
4.3 Vanpool service		
<i>Commuter travel</i>		
BETTER	4.3.1 Provide a vanpooling service for long-distance commuters	<input type="checkbox"/>
5. CARSHARING & BIKESHARING		
5.1 Bikeshare stations & memberships		
BETTER	5.1.1 Contract with provider to install on-site bikeshare station for use by commuters and visitors	<input type="checkbox"/>
<i>Commuter travel</i>		
BETTER	5.1.2 Provide employees with bikeshare memberships for local business travel	<input type="checkbox"/>
5.2 Carshare vehicles & memberships		
<i>Commuter travel</i>		
BETTER	5.2.1 Contract with provider to install on-site carshare vehicles and promote their use by tenants	<input type="checkbox"/>
BETTER	5.2.2 Provide employees with carshare memberships for local business travel	<input type="checkbox"/>
6. PARKING		
<i>Commuter travel</i>		
BASIC ★	6.1.1 Charge for long-term parking (daily, weekly, monthly)	<input checked="" type="checkbox"/>
BASIC	6.1.2 Unbundle parking cost from lease rates at multi-tenant sites	<input checked="" type="checkbox"/>
<i>Visitor travel</i>		
BETTER	6.1.3 Charge for short-term parking (hourly)	<input type="checkbox"/>

TDM measures: Non-residential developments		Check if proposed & add descriptions
7. TDM MARKETING & COMMUNICATIONS		
7.1 Multimodal travel information		
<i>Commuter travel</i>		
BASIC ★	7.1.1 Provide a multimodal travel option information package to new/relocating employees and students	<input checked="" type="checkbox"/>
<i>Visitor travel</i>		
BETTER ★	7.1.2 Include multimodal travel option information in invitations or advertising that attract visitors or customers (e.g. for festivals, concerts, games)	<input type="checkbox"/>
7.2 Personalized trip planning		
<i>Commuter travel</i>		
BETTER ★	7.2.1 Offer personalized trip planning to new/relocating employees	<input type="checkbox"/>
7.3 Promotions		
<i>Commuter travel</i>		
BETTER	7.3.1 Deliver promotions and incentives to maintain awareness, build understanding, and encourage trial of sustainable modes	<input type="checkbox"/>
8. OTHER INCENTIVES & AMENITIES		
8.1 Emergency ride home		
<i>Commuter travel</i>		
BETTER ★	8.1.1 Provide emergency ride home service to non-driving commuters	<input type="checkbox"/>
8.2 Alternative work arrangements		
<i>Commuter travel</i>		
BASIC ★	8.2.1 Encourage flexible work hours	<input type="checkbox"/>
BETTER	8.2.2 Encourage compressed workweeks	<input type="checkbox"/>
BETTER ★	8.2.3 Encourage telework	<input type="checkbox"/>
8.3 Local business travel options		
<i>Commuter travel</i>		
BASIC ★	8.3.1 Provide local business travel options that minimize the need for employees to bring a personal car to work	<input type="checkbox"/>
8.4 Commuter incentives		
<i>Commuter travel</i>		
BETTER	8.4.1 Offer employees a taxable, mode-neutral commuting allowance	<input type="checkbox"/>
8.5 On-site amenities		
<i>Commuter travel</i>		
BETTER	8.5.1 Provide on-site amenities/services to minimize mid-day or mid-commute errands	<input type="checkbox"/>

TDM Measures Checklist:
Residential Developments (multi-family, condominium or subdivision)

Legend

BASIC The measure is generally feasible and effective, and in most cases would benefit the development and its users

BETTER The measure could maximize support for users of sustainable modes, and optimize development performance

★ The measure is one of the most dependably effective tools to encourage the use of sustainable modes

TDM measures: Residential developments		Check if proposed & add descriptions
1. TDM PROGRAM MANAGEMENT		
1.1 Program coordinator		
BASIC ★	1.1.1 Designate an internal coordinator, or contract with an external coordinator	<input type="checkbox"/>
1.2 Travel surveys		
BETTER	1.2.1 Conduct periodic surveys to identify travel-related behaviours, attitudes, challenges and solutions, and to track progress	<input type="checkbox"/>
2. WALKING AND CYCLING		
2.1 Information on walking/cycling routes & destinations		
BASIC	2.1.1 Display local area maps with walking/cycling access routes and key destinations at major entrances (<i>multi-family, condominium</i>)	<input checked="" type="checkbox"/>
2.2 Bicycle skills training		
BETTER	2.2.1 Offer on-site cycling courses for residents, or subsidize off-site courses	<input type="checkbox"/>

TDM measures: Residential developments		Check if proposed & add descriptions
3. TRANSIT		
3.1 Transit information		
BASIC	3.1.1 Display relevant transit schedules and route maps at entrances (<i>multi-family, condominium</i>)	<input checked="" type="checkbox"/>
BETTER	3.1.2 Provide real-time arrival information display at entrances (<i>multi-family, condominium</i>)	<input type="checkbox"/>
3.2 Transit fare incentives		
BASIC ★	3.2.1 Offer PRESTO cards preloaded with one monthly transit pass on residence purchase/move-in, to encourage residents to use transit	<input type="checkbox"/>
BETTER	3.2.2 Offer at least one year of free monthly transit passes on residence purchase/move-in	<input checked="" type="checkbox"/>
3.3 Enhanced public transit service		
BETTER ★	3.3.1 Contract with OC Transpo to provide early transit services until regular services are warranted by occupancy levels (<i>subdivision</i>)	<input type="checkbox"/>
3.4 Private transit service		
BETTER	3.4.1 Provide shuttle service for seniors homes or lifestyle communities (e.g. scheduled mall or supermarket runs)	<input type="checkbox"/>
4. CARSHARING & BIKESHARING		
4.1 Bikeshare stations & memberships		
BETTER	4.1.1 Contract with provider to install on-site bikeshare station (<i>multi-family</i>)	<input checked="" type="checkbox"/>
BETTER	4.1.2 Provide residents with bikeshare memberships, either free or subsidized (<i>multi-family</i>)	<input type="checkbox"/>
4.2 Carshare vehicles & memberships		
BETTER	4.2.1 Contract with provider to install on-site carshare vehicles and promote their use by residents	<input checked="" type="checkbox"/>
BETTER	4.2.2 Provide residents with carshare memberships, either free or subsidized	<input type="checkbox"/>
5. PARKING		
5.1 Priced parking		
BASIC ★	5.1.1 Unbundle parking cost from purchase price (<i>condominium</i>)	<input checked="" type="checkbox"/>
BASIC ★	5.1.2 Unbundle parking cost from monthly rent (<i>multi-family</i>)	<input checked="" type="checkbox"/>

TDM measures: Residential developments		Check if proposed & add descriptions
6. TDM MARKETING & COMMUNICATIONS		
6.1 Multimodal travel information		
BASIC ★	6.1.1 Provide a multimodal travel option information package to new residents	<input checked="" type="checkbox"/>
6.2 Personalized trip planning		
BETTER ★	6.2.1 Offer personalized trip planning to new residents	<input type="checkbox"/>

**TDM-Supportive Development Design and Infrastructure Checklist:
Non-Residential Developments (office, institutional, retail or industrial)**

Legend	
REQUIRED	The Official Plan or Zoning By-law provides related guidance that must be followed
BASIC	The measure is generally feasible and effective, and in most cases would benefit the development and its users
BETTER	The measure could maximize support for users of sustainable modes, and optimize development performance

TDM-supportive design & infrastructure measures: Non-residential developments		Check if completed & add descriptions, explanations or plan/drawing references
1. WALKING & CYCLING: ROUTES		
1.1 Building location & access points		
BASIC	1.1.1 Locate building close to the street, and do not locate parking areas between the street and building entrances	<input checked="" type="checkbox"/>
BASIC	1.1.2 Locate building entrances in order to minimize walking distances to sidewalks and transit stops/stations	<input checked="" type="checkbox"/>
BASIC	1.1.3 Locate building doors and windows to ensure visibility of pedestrians from the building, for their security and comfort	<input checked="" type="checkbox"/>
1.2 Facilities for walking & cycling		
REQUIRED	1.2.1 Provide convenient, direct access to stations or major stops along rapid transit routes within 600 metres; minimize walking distances from buildings to rapid transit; provide pedestrian-friendly, weather-protected (where possible) environment between rapid transit accesses and building entrances; ensure quality linkages from sidewalks through building entrances to integrated stops/stations (see <i>Official Plan policy 4.3.3</i>)	<input checked="" type="checkbox"/>
REQUIRED	1.2.2 Provide safe, direct and attractive pedestrian access from public sidewalks to building entrances through such measures as: reducing distances between public sidewalks and major building entrances; providing walkways from public streets to major building entrances; within a site, providing walkways along the front of adjoining buildings, between adjacent buildings, and connecting areas where people may congregate, such as courtyards and transit stops; and providing weather protection through canopies, colonnades, and other design elements wherever possible (see <i>Official Plan policy 4.3.12</i>)	<input checked="" type="checkbox"/>

TDM-supportive design & infrastructure measures: Non-residential developments		Check if completed & add descriptions, explanations or plan/drawing references
REQUIRED	1.2.3 Provide sidewalks of smooth, well-drained walking surfaces of contrasting materials or treatments to differentiate pedestrian areas from vehicle areas, and provide marked pedestrian crosswalks at intersection sidewalks (see <i>Official Plan policy 4.3.10</i>)	<input checked="" type="checkbox"/>
REQUIRED	1.2.4 Make sidewalks and open space areas easily accessible through features such as gradual grade transition, depressed curbs at street corners and convenient access to extra-wide parking spaces and ramps (see <i>Official Plan policy 4.3.10</i>)	<input checked="" type="checkbox"/>
REQUIRED	1.2.5 Include adequately spaced inter-block/street cycling and pedestrian connections to facilitate travel by active transportation. Provide links to the existing or planned network of public sidewalks, multi-use pathways and on-road cycle routes. Where public sidewalks and multi-use pathways intersect with roads, consider providing traffic control devices to give priority to cyclists and pedestrians (see <i>Official Plan policy 4.3.11</i>)	<input checked="" type="checkbox"/>
BASIC	1.2.6 Provide safe, direct and attractive walking routes from building entrances to nearby transit stops	<input checked="" type="checkbox"/>
BASIC	1.2.7 Ensure that walking routes to transit stops are secure, visible, lighted, shaded and wind-protected wherever possible	<input type="checkbox"/>
BASIC	1.2.8 Design roads used for access or circulation by cyclists using a target operating speed of no more than 30 km/h, or provide a separated cycling facility	<input type="checkbox"/>
1.3 Amenities for walking & cycling		
BASIC	1.3.1 Provide lighting, landscaping and benches along walking and cycling routes between building entrances and streets, sidewalks and trails	<input type="checkbox"/>
BASIC	1.3.2 Provide wayfinding signage for site access (where required, e.g. when multiple buildings or entrances exist) and egress (where warranted, such as when directions to reach transit stops/stations, trails or other common destinations are not obvious)	<input type="checkbox"/>

TDM-supportive design & infrastructure measures: Non-residential developments		Check if completed & add descriptions, explanations or plan/drawing references
2. WALKING & CYCLING: END-OF-TRIP FACILITIES		
2.1 Bicycle parking		
REQUIRED	2.1.1 Provide bicycle parking in highly visible and lighted areas, sheltered from the weather wherever possible (see <i>Official Plan policy 4.3.6</i>)	<input checked="" type="checkbox"/>
REQUIRED	2.1.2 Provide the number of bicycle parking spaces specified for various land uses in different parts of Ottawa; provide convenient access to main entrances or well-used areas (see <i>Zoning By-law Section 111</i>)	<input checked="" type="checkbox"/>
REQUIRED	2.1.3 Ensure that bicycle parking spaces and access aisles meet minimum dimensions, that no more than 50% of spaces are vertical spaces, and that parking racks are securely anchored (see <i>Zoning By-law Section 111</i>)	<input checked="" type="checkbox"/>
BASIC	2.1.4 Provide bicycle parking spaces equivalent to the expected number of commuter cyclists (assuming the cycling mode share target is met), plus the expected peak number of customer/visitor cyclists	<input type="checkbox"/>
BETTER	2.1.5 Provide bicycle parking spaces equivalent to the expected number of commuter and customer/visitor cyclists, plus an additional buffer (e.g. 25 percent extra) to encourage other cyclists and ensure adequate capacity in peak cycling season	<input type="checkbox"/>
2.2 Secure bicycle parking		
REQUIRED	2.2.1 Where more than 50 bicycle parking spaces are provided for a single office building, locate at least 25% of spaces within a building/structure, a secure area (e.g. supervised parking lot or enclosure) or bicycle lockers (see <i>Zoning By-law Section 111</i>)	<input type="checkbox"/>
BETTER	2.2.2 Provide secure bicycle parking spaces equivalent to the expected number of commuter cyclists (assuming the cycling mode share target is met)	<input type="checkbox"/>
2.3 Shower & change facilities		
BASIC	2.3.1 Provide shower and change facilities for the use of active commuters	<input type="checkbox"/>
BETTER	2.3.2 In addition to shower and change facilities, provide dedicated lockers, grooming stations, drying racks and laundry facilities for the use of active commuters	<input type="checkbox"/>
2.4 Bicycle repair station		
BETTER	2.4.1 Provide a permanent bike repair station, with commonly used tools and an air pump, adjacent to the main bicycle parking area (or secure bicycle parking area, if provided)	<input checked="" type="checkbox"/>

TDM-supportive design & infrastructure measures: Non-residential developments		Check if completed & add descriptions, explanations or plan/drawing references
3. TRANSIT		
3.1 Customer amenities		
BASIC	3.1.1 Provide shelters, lighting and benches at any on-site transit stops	<input type="checkbox"/>
BASIC	3.1.2 Where the site abuts an off-site transit stop and insufficient space exists for a transit shelter in the public right-of-way, protect land for a shelter and/or install a shelter	<input type="checkbox"/>
BETTER	3.1.3 Provide a secure and comfortable interior waiting area by integrating any on-site transit stops into the building	<input type="checkbox"/>
4. RIDESHARING		
4.1 Pick-up & drop-off facilities		
BASIC	4.1.1 Provide a designated area for carpool drivers (plus taxis and ride-hailing services) to drop off or pick up passengers without using fire lanes or other no-stopping zones	<input type="checkbox"/>
4.2 Carpool parking		
BASIC	4.2.1 Provide signed parking spaces for carpools in a priority location close to a major building entrance, sufficient in number to accommodate the mode share target for carpools	<input type="checkbox"/>
BETTER	4.2.2 At large developments, provide spaces for carpools in a separate, access-controlled parking area to simplify enforcement	<input type="checkbox"/>
5. CARSHARING & BIKESHARING		
5.1 Carshare parking spaces		
BETTER	5.1.1 Provide carshare parking spaces in permitted non-residential zones, occupying either required or provided parking spaces (see <i>Zoning By-law Section 94</i>)	<input type="checkbox"/>
5.2 Bikeshare station location		
BETTER	5.2.1 Provide a designated bikeshare station area near a major building entrance, preferably lighted and sheltered with a direct walkway connection	<input type="checkbox"/>

TDM-supportive design & infrastructure measures: Non-residential developments		Check if completed & add descriptions, explanations or plan/drawing references
6. PARKING		
6.1 Number of parking spaces		
REQUIRED	6.1.1 Do not provide more parking than permitted by zoning, nor less than required by zoning, unless a variance is being applied for	<input checked="" type="checkbox"/>
BASIC	6.1.2 Provide parking for long-term and short-term users that is consistent with mode share targets, considering the potential for visitors to use off-site public parking	<input type="checkbox"/>
BASIC	6.1.3 Where a site features more than one use, provide shared parking and reduce the cumulative number of parking spaces accordingly (see <i>Zoning By-law Section 704</i>)	<input type="checkbox"/>
BETTER	6.1.4 Reduce the minimum number of parking spaces required by zoning by one space for each 13 square metres of gross floor area provided as shower rooms, change rooms, locker rooms and other facilities for cyclists in conjunction with bicycle parking (see <i>Zoning By-law Section 111</i>)	<input type="checkbox"/>
6.2 Separate long-term & short-term parking areas		
BETTER	6.2.1 Separate short-term and long-term parking areas using signage or physical barriers, to permit access controls and simplify enforcement (i.e. to discourage employees from parking in visitor spaces, and vice versa)	<input type="checkbox"/>
7. OTHER		
7.1 On-site amenities to minimize off-site trips		
BETTER	7.1.1 Provide on-site amenities to minimize mid-day or mid-commute errands	<input type="checkbox"/>

Legend

REQUIRED The Official Plan or Zoning By-law provides related guidance that must be followed

BASIC The measure is generally feasible and effective, and in most cases would benefit the development and its users

BETTER The measure could maximize support for users of sustainable modes, and optimize development performance

TDM-supportive design & infrastructure measures: Residential developments		Check if completed & add descriptions, explanations or plan/drawing references
1. WALKING & CYCLING: ROUTES		
1.1 Building location & access points		
BASIC	1.1.1 Locate building close to the street, and do not locate parking areas between the street and building entrances	<input checked="" type="checkbox"/>
BASIC	1.1.2 Locate building entrances in order to minimize walking distances to sidewalks and transit stops/stations	<input checked="" type="checkbox"/>
BASIC	1.1.3 Locate building doors and windows to ensure visibility of pedestrians from the building, for their security and comfort	<input checked="" type="checkbox"/>
1.2 Facilities for walking & cycling		
REQUIRED	1.2.1 Provide convenient, direct access to stations or major stops along rapid transit routes within 600 metres; minimize walking distances from buildings to rapid transit; provide pedestrian-friendly, weather-protected (where possible) environment between rapid transit accesses and building entrances; ensure quality linkages from sidewalks through building entrances to integrated stops/stations (see <i>Official Plan policy 4.3.3</i>)	<input checked="" type="checkbox"/>
REQUIRED	1.2.2 Provide safe, direct and attractive pedestrian access from public sidewalks to building entrances through such measures as: reducing distances between public sidewalks and major building entrances; providing walkways from public streets to major building entrances; within a site, providing walkways along the front of adjoining buildings; between adjacent buildings, and connecting areas where people may congregate, such as courtyards and transit stops; and providing weather protection through canopies, colonnades, and other design elements wherever possible (see <i>Official Plan policy 4.3.12</i>)	<input checked="" type="checkbox"/>

TDM-supportive design & infrastructure measures: Residential developments		Check if completed & add descriptions, explanations or plan/drawing references
REQUIRED	1.2.3 Provide sidewalks of smooth, well-drained walking surfaces of contrasting materials or treatments to differentiate pedestrian areas from vehicle areas, and provide marked pedestrian crosswalks at intersection sidewalks (see <i>Official Plan policy 4.3.10</i>)	<input checked="" type="checkbox"/>
REQUIRED	1.2.4 Make sidewalks and open space areas easily accessible through features such as gradual grade transition, depressed curbs at street corners and convenient access to extra-wide parking spaces and ramps (see <i>Official Plan policy 4.3.10</i>)	<input checked="" type="checkbox"/>
REQUIRED	1.2.5 Include adequately spaced inter-block/street cycling and pedestrian connections to facilitate travel by active transportation. Provide links to the existing or planned network of public sidewalks, multi-use pathways and on-road cycle routes. Where public sidewalks and multi-use pathways intersect with roads, consider providing traffic control devices to give priority to cyclists and pedestrians (see <i>Official Plan policy 4.3.11</i>)	<input checked="" type="checkbox"/>
BASIC	1.2.6 Provide safe, direct and attractive walking routes from building entrances to nearby transit stops	<input checked="" type="checkbox"/>
BASIC	1.2.7 Ensure that walking routes to transit stops are secure, visible, lighted, shaded and wind-protected wherever possible	<input type="checkbox"/>
BASIC	1.2.8 Design roads used for access or circulation by cyclists using a target operating speed of no more than 30 km/h, or provide a separated cycling facility	<input type="checkbox"/>
1.3 Amenities for walking & cycling		
BASIC	1.3.1 Provide lighting, landscaping and benches along walking and cycling routes between building entrances and streets, sidewalks and trails	<input type="checkbox"/>
BASIC	1.3.2 Provide wayfinding signage for site access (where required, e.g. when multiple buildings or entrances exist) and egress (where warranted, such as when directions to reach transit stops/stations, trails or other common destinations are not obvious)	<input type="checkbox"/>

TDM-supportive design & infrastructure measures: Residential developments		Check if completed & add descriptions, explanations or plan/drawing references
2. WALKING & CYCLING: END-OF-TRIP FACILITIES		
2.1 Bicycle parking		
REQUIRED	2.1.1 Provide bicycle parking in highly visible and lighted areas, sheltered from the weather wherever possible (see <i>Official Plan policy 4.3.6</i>)	<input checked="" type="checkbox"/>
REQUIRED	2.1.2 Provide the number of bicycle parking spaces specified for various land uses in different parts of Ottawa; provide convenient access to main entrances or well-used areas (see <i>Zoning By-law Section 111</i>)	<input checked="" type="checkbox"/>
REQUIRED	2.1.3 Ensure that bicycle parking spaces and access aisles meet minimum dimensions, that no more than 50% of spaces are vertical spaces; and that parking racks are securely anchored (see <i>Zoning By-law Section 111</i>)	<input checked="" type="checkbox"/>
BASIC	2.1.4 Provide bicycle parking spaces equivalent to the expected number of resident-owned bicycles, plus the expected peak number of visitor cyclists	<input type="checkbox"/>
2.2 Secure bicycle parking		
REQUIRED	2.2.1 Where more than 50 bicycle parking spaces are provided for a single residential building, locate at least 25% of spaces within a building/structure, a secure area (e.g. supervised parking lot or enclosure) or bicycle lockers (see <i>Zoning By-law Section 111</i>)	<input checked="" type="checkbox"/>
BETTER	2.2.2 Provide secure bicycle parking spaces equivalent to at least the number of units at condominiums or multi-family residential developments	<input checked="" type="checkbox"/>
2.3 Bicycle repair station		
BETTER	2.3.1 Provide a permanent bike repair station, with commonly used tools and an air pump, adjacent to the main bicycle parking area (or secure bicycle parking area, if provided)	<input type="checkbox"/>
3. TRANSIT		
3.1 Customer amenities		
BASIC	3.1.1 Provide shelters, lighting and benches at any on-site transit stops	<input type="checkbox"/>
BASIC	3.1.2 Where the site abuts an off-site transit stop and insufficient space exists for a transit shelter in the public right-of-way, protect land for a shelter and/or install a shelter	<input type="checkbox"/>
BETTER	3.1.3 Provide a secure and comfortable interior waiting area by integrating any on-site transit stops into the building	<input type="checkbox"/>

TDM-supportive design & infrastructure measures: <i>Residential developments</i>		Check if completed & add descriptions, explanations or plan/drawing references
4. RIDESHARING		
4.1 Pick-up & drop-off facilities		
BASIC	4.1.1 Provide a designated area for carpool drivers (plus taxis and ride-hailing services) to drop off or pick up passengers without using fire lanes or other no-stopping zones	<input type="checkbox"/>
5. CARSHARING & BIKESHARING		
5.1 Carshare parking spaces		
BETTER	5.1.1 Provide up to three carshare parking spaces in an R3, R4 or RS Zone for specified residential uses (see <i>Zoning By-law Section 94</i>)	<input type="checkbox"/>
5.2 Bikeshare station location		
BETTER	5.2.1 Provide a designated bikeshare station area near a major building entrance, preferably lighted and sheltered with a direct walkway connection	<input type="checkbox"/>
6. PARKING		
6.1 Number of parking spaces		
REQUIRED	6.1.1 Do not provide more parking than permitted by zoning, nor less than required by zoning, unless a variance is being applied for	<input checked="" type="checkbox"/>
BASIC	6.1.2 Provide parking for long-term and short-term users that is consistent with mode share targets, considering the potential for visitors to use off-site public parking	<input type="checkbox"/>
BASIC	6.1.3 Where a site features more than one use, provide shared parking and reduce the cumulative number of parking spaces accordingly (see <i>Zoning By-law Section 104</i>)	<input type="checkbox"/>
BETTER	6.1.4 Reduce the minimum number of parking spaces required by zoning by one space for each 13 square metres of gross floor area provided as shower rooms, change rooms, locker rooms and other facilities for cyclists in conjunction with bicycle parking (see <i>Zoning By-law Section 111</i>)	<input type="checkbox"/>
6.2 Separate long-term & short-term parking areas		
BETTER	6.2.1 Provide separate areas for short-term and long-term parking (using signage or physical barriers) to permit access controls and simplify enforcement (i.e. to discourage residents from parking in visitor spaces, and vice versa)	<input type="checkbox"/>