

Forum/SLP 112 Nelson Limited Partnership

112-134 Nelson Street Stormwater Management Report

February 10, 2023





112-134 Nelson Street Stormwater Management Report

Forum/SLP 112 Nelson Limited Partnership

Confidential
Issue for City Review
Project No.: 211-04788-00
Date: February 10, 2023

WSP
Suite 300
2611 Queensview Drive
Ottawa, ON, Canada K2B 8K2

T: +1 613 829-2800
F: +1 613 829-8299
wsp.com

Revision History

FIRST ISSUE

July 16, 2021	First Submission			
Prepared by	Reviewed by	Approved By		
Kathryn Kerker Water Resources E.I.T.	Michelle Hughes, P.Eng Team Lead, Water Resources	Michelle Hughes, P.Eng Team Lead, Water Resources		
REVISION 1				
August 27, 2021	Second submission			
Prepared by	Reviewed by	Approved By		
Kathryn Kerker Water Resources E.I.T.	Michelle Hughes, P.Eng Team Lead, Water Resources	Michelle Hughes, P.Eng Team Lead, Water Resources		
REVISION 2				
February 10, 2023	Third Submission			
Prepared by	Reviewed by	Approved By		
Kathryn Kerker Water Resources E.I.T.	Alex Sereda, P.Eng. Project Engineer	Alex Sereda, P.Eng. Project Engineer		

Signatures

Prepared by



February 10, 2023

Kathryn Kerker
Water Resources E.I.T.

Date

APPROVED BY



February 10, 2023

Alex Sereda, P.Eng.
Project Engineer

Date

WSP Canada Inc. prepared this report solely for the use of the intended recipient, Forum/SLP 112 Nelson Limited Partnership, in accordance with the professional services agreement. The intended recipient is solely responsible for the disclosure of any information contained in this report. The content and opinions contained in the present report are based on the observations and/or information available to WSP Canada Inc. at the time of preparation. If a third party makes use of, relies on, or makes decisions in accordance with this report, said third party is solely responsible for such use, reliance or decisions. WSP Canada Inc. does not accept responsibility for damages, if any, suffered by any third party as a result of decisions made or actions taken by said third party based on this report. This limitations statement is considered an integral part of this report.

The original of this digital file will be conserved by WSP Canada Inc. for a period of not less than 10 years. As the digital file transmitted to the intended recipient is no longer under the control of WSP Canada Inc., its integrity cannot be assured. As such, WSP Canada Inc. does not guarantee any modifications made to this digital file subsequent to its transmission to the intended recipient.



1	INTRODUCTION.....	1
1.1	Scope	1
1.2	Site Location.....	1
1.3	Stormwater Management Plan Objectives.....	1
1.4	Design Criteria.....	2
2	PRE-DEVELOPMENT CONDITIONS	3
2.1	General	3
2.2	Rainfall Information.....	3
2.3	Allowable Flow Rates	3
3	POST-DEVELOPMENT CONDITIONS.....	5
3.1	General	5
3.2	Water Quantity	7
3.3	Water Quality.....	8
4	CONCLUSIONS.....	9

Tables

Table 2-1: Pre-Development Peak Flow Rate
Calculations (Runoff Coefficient,
C = 0.50 and T_c=10 min) 4

Table 3-1: Post-development area breakdown 5

Table 3-2: Summary of Modelling Results 8

Figures

Figure 1: Site Location 1

Figure 2: Proposed Drainage Areas..... 6

Appendices

- A** Pre-consultation meeting minutes (October 22, 2020)
- B** Pre-Development Stormwater Management Calculations
- C** HydroCAD Model Output
 - C-1 100-Year Analysis (Peak Discharge, $T_C = 24$ Min)
 - C-2 100-Year Analysis (Peak Storage, $T_C = 29$ Min)
- D** OGS Sizing

1 INTRODUCTION

1.1 Scope

WSP Canada Inc. was retained by FORUM/SLP 112 Nelson Limited Partnership to conduct a stormwater management study in support of proposals to develop a 9-storey residential building on land which previously contained a two-storey multi-tenant warehouse with surface parking.

1.2 Site Location

The site is located at 112 Nelson Street, Ottawa, Ontario, between Rideau Street and York Street. The location of the proposed development is illustrated in **Figure 1**.

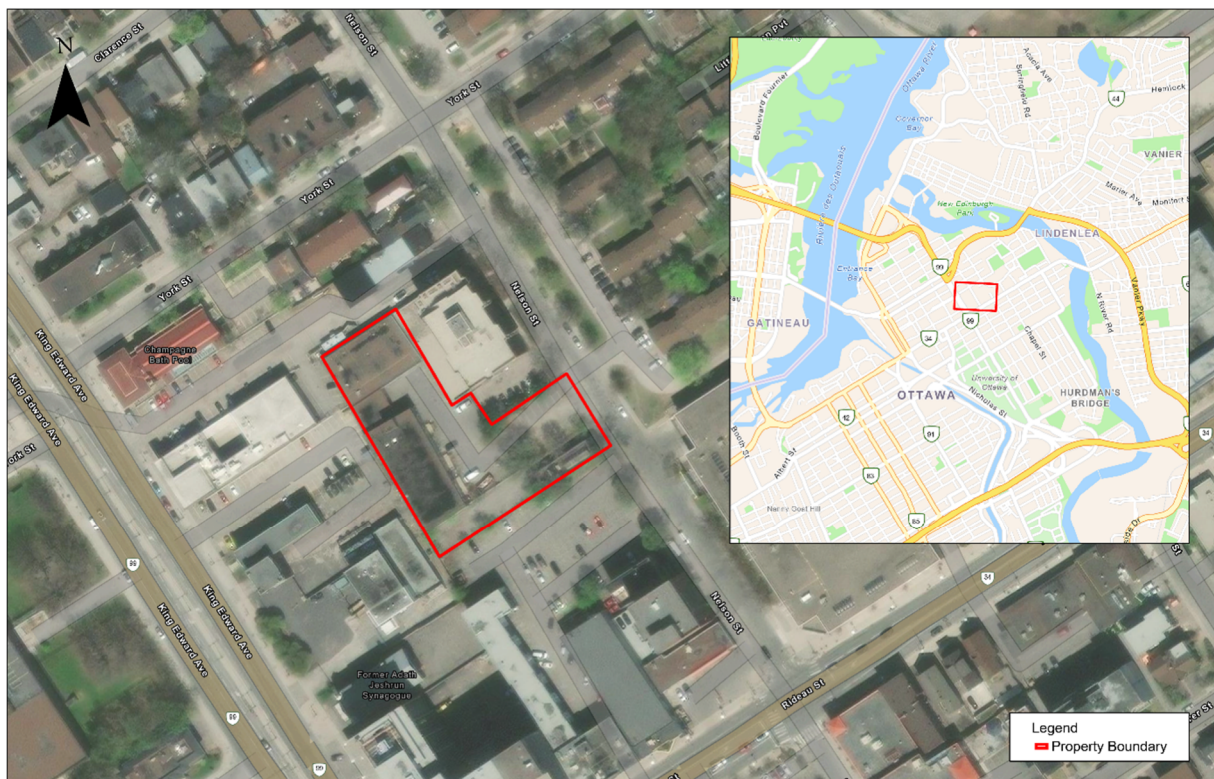

Figure 1: Site Location

1.3 Stormwater Management Plan Objectives

The objectives of the stormwater management (SWM) study are as follows:

- Collect and review background information.
 - Confirm applicable SWM design criteria with City of Ottawa staff.
 - Evaluate various SWM practices that meet the stormwater management requirements and recommend a preferred strategy—specifically related to the applicable quantity and quality control criteria.
-

1.4 Design Criteria

Design criteria were confirmed through pre-consultation with the city of Ottawa held on October 22, 2020 (Meeting minutes included in **Appendix A**), with follow-up email on April 14, 2021. Criteria for 112 Nelson Street are as follows:

Water Quantity Control and Discharge to Municipal Infrastructure

- Stormwater must be controlled to the peak flow for the 2-year pre-development storm event. Runoff must be detained onsite to control all storm events up to and including the 100-year event.
- Allowable Runoff coefficient (C): C = the lesser of the existing pre-development conditions to a maximum of 0.5 (OSDG 8.3.7.3)
- Time of concentration (Tc): Tc = pre-development (Calculated); maximum Tc = 10 min

Water Quality

- RVCA requires enhanced water quality protection (80% TSS removal) be provided on-site

2 PRE-DEVELOPMENT CONDITIONS

2.1 General

Currently the land proposed for the new development contains a two-storey multi-tenant warehouse with surface parking. The overall existing site has an estimated runoff coefficient of 0.90. The total study area (i.e. portion of the site affected by the proposed works) is 0.36 ha.

2.2 Rainfall Information

The rainfall intensity is calculated in accordance with Section 5.4.2 of the Ottawa Sewer Design Guidelines (October 2012):

$$i = \left[\frac{A}{(T_d + C)^B} \right]$$

Where;

- A, B, C = regression constants for each return period (defined in section 5.4.2)
 - i = rainfall intensity (mm/hour)
 - T_d = storm duration (minutes)
 - The IDF parameters/regression constants are included in **Appendix B**.
-

2.3 Allowable Flow Rates

As noted in **Section 1.4**, post-development stormwater runoff from the 2-year to 100-year design storms must not exceed the pre-development peak 2-year flow rate, calculated using a runoff coefficient being the lesser of 0.50 or existing conditions. In this instance existing conditions have a runoff coefficient of 0.90, therefore a value of 0.5 has been used to calculate the allowable release rate.

The area will discharge east to a 450 mm concrete storm pipe on Nelson Street through a new storm connection. The calculated peak flow rates for the site in the pre-development condition are summarized below in Table 2-1.

Table 2-1: Pre-Development Peak Flow Rate Calculations (Runoff Coefficient, C = 0.50 and T_c=10 min)

Return Period (Years)	Rainfall Intensity (mm/hour)	Peak Flow Rate (l/s)	Target Release Rate (l/s)
2	76.8	39	39
5	104.2	53	
10	122.1	62	
25	144.7	81	
50	161.5	98	
100	178.6	113	

3 POST-DEVELOPMENT CONDITIONS

3.1 General

The site will be developed with a new 9-storey residential building. The developed site will have a runoff coefficient of 0.72 and study area of 0.365 ha. A cistern will be used to control the peak discharge of the newly developed site to 39 L/s. Figure 2 shows the proposed controlled and uncontrolled drainage areas for the developed site. The post-development area breakdown is shown in Table 3-1.

Uncontrolled areas of the site are primarily pervious and border the property boundary. These uncontrolled areas cannot be captured due to grading constraints. The cistern outflow to Nelson Street is overcontrolled to account for these areas.

Note that this report should be read in conjunction with the proposed site servicing drawing package—specifically drawings C001 (Servicing Plan) and C002 (Grading Plan).

Table 3-1: Post-development area breakdown

	Area (ha)	Runoff Coefficient
Controlled area		
Impervious	0.261	0.90
Pervious	0.074	0.20
Total controlled	0.335	0.75
Uncontrolled area		
Impervious	0.010	0.90
Pervious	0.020	0.20
Total Uncontrolled	0.030	0.43
Total	0.365	0.72

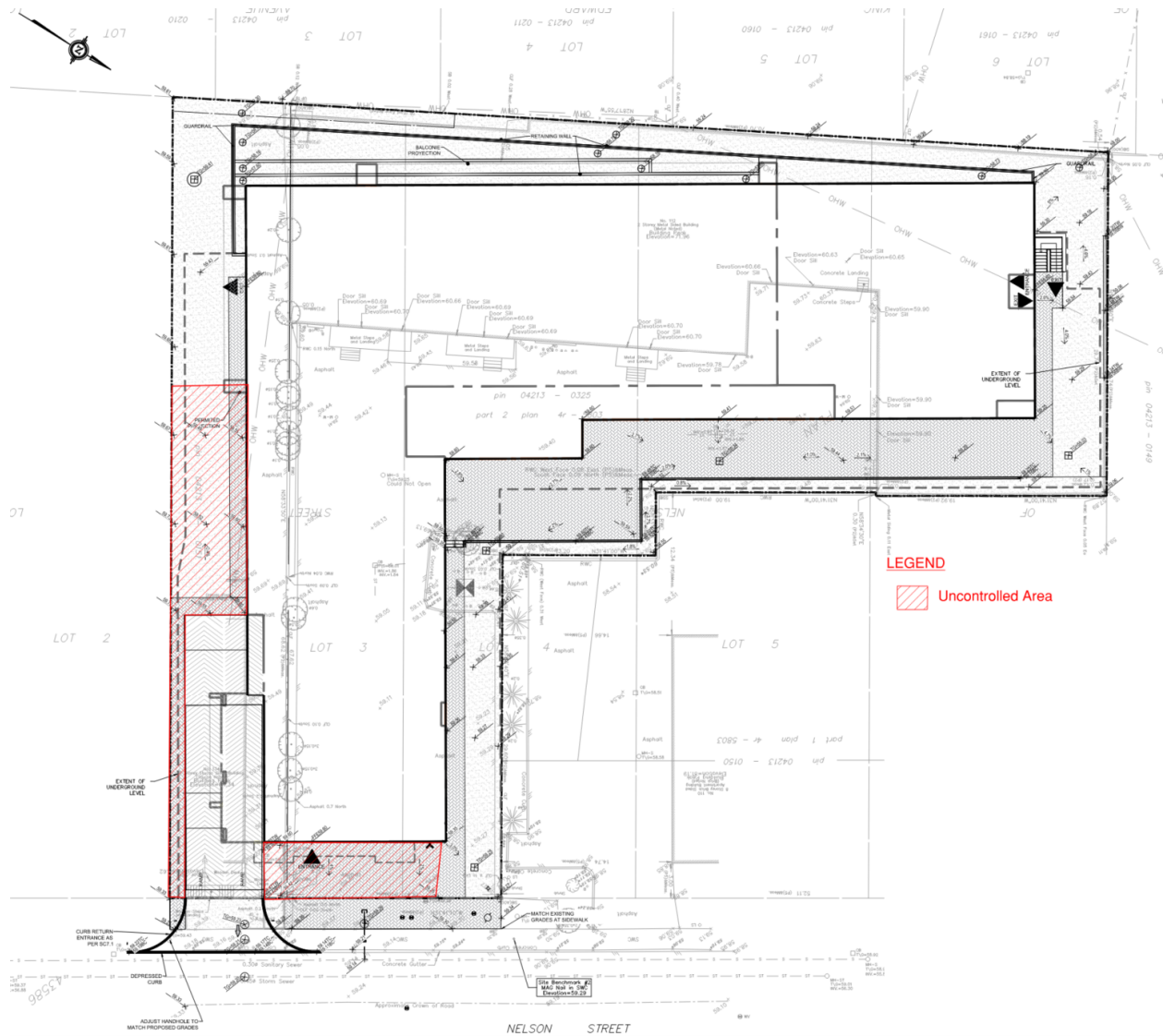

Figure 2: Proposed Drainage Areas

3.2 Water Quantity

As noted in **Section 2.3**, the target allowable discharge rate to the Nelson Street sewer is 39 L/s. This is equivalent to the peak runoff rate under pre-development conditions during a 2-year design storm event with a runoff coefficient of 0.50. Compliance with the 100-yr target offsite discharge rate will be achieved through use of a cistern with outlet control prior to discharge into the Nelson Street storm sewer.

It is noted that a small portion of the study area will not drain to the proposed cistern. Post-development runoff calculations have accounted for uncontrolled runoff from these areas, and the following analysis results report on the cumulative release rates from the study area (controlled plus uncontrolled). There are no external areas draining to the site.

A HydroCAD model of the project was created and includes:

- Cistern (minimum volume 90 m³), with outlet controlled using flow control ICD (IPEX C) to detain 0.335 ha of the new development with a runoff coefficient of 0.75 (+25% for 100-year event as per OSDG 5.4.5.2.1; C = 0.94).
- Uncontrolled runoff from 0.03 ha area with C = 0.43 (+25% for 100-year event as per OSDG 5.4.5.2.1; C = 0.54).

The Modified Rational Method (an inherent subroutine of the HydroCAD software) has been used for the modelling exercise, and the model has informed the maximum storage volume used in the cistern based on the proposed flow. The peak flow rate generated from the uncontrolled drainage area within the project site and controlled flow from the cistern is 39 L/s, which meets the total allowable 100-year release rate of 39 L/s. Modelling results are summarized below in **Table 3-1** and shown in **Appendix C**.

Note that results provided below describe performance of the proposed system at multiple storm durations, which have been solved iteratively within HydroCAD to represent critical conditions (i.e. maximum storage utilized within storage features, and peak release rate at the system discharge point). The results demonstrate that the target allowable 100-year release rate is satisfied at all durations.

Table 3-2: Summary of Modelling Results

Return Period (Years)	Time of Conc. (min)	Utilized Storage (m ³)	Peak Water Elevation in storage (m)	Peak Flow Rate at control (L/s)	Total Flow Leaving Site* (L/s)	Allowable 100-yr Flow Rate (L/s)
100-year (Peak Discharge)	24	84	58.102	34	39	39
100-year (Peak Storage)	29	84.6	58.110	36	39	

*Total Flow Leaving Site' includes uncontrolled area and cistern discharge.

3.3 Water Quality

As noted in section 1.4, quality control is required to provide enhanced water quality treatment of the site (80% TSS removal). An OGS unit (Stormceptor EFO4 or equivalent) will be installed just upstream of the city storm sewer connection to provide the required quality treatment. OGS sizing is provided in **Appendix D**.

4 CONCLUSIONS

A stormwater management plan has been prepared to support the site plan application for the 112 Nelson Street development in the City of Ottawa. The key points are summarized below.

WATER QUANTITY

Runoff collected from the project site will be directed to a cistern with a minimum storage volume of 90 m³ to control the 100-year event. The peak 100-year discharge from the site is 39 L/s, which meets the allowable release rate of 39 L/s.

WATER QUALITY

Water treatment is provided by an OGS unit placed just upstream of the city storm sewer connection.

This report demonstrates that the proposed SWM strategy will address stormwater management related impacts from this project and meet the requirements of the City of Ottawa.

APPENDIX

A

Pre-consultation meeting minutes
(October 22, 2020)

Pre-Application Consultation Meeting Minutes

112 Nelson

PC2020-0262

October 22, 2020, Videoconference Call

Applicant Team (invitees)

- Paul Black, Fotenn
- Aly Damji, Forum Equity
- Hoa Nguyen, Forum Equity
- Jeremy Silburt, Smart Living Properties
- Dany Elsalibi, Smart Living Properties
- Bob Woodman, Woodman Architects
- Juan Gomez, Woodman Architects
- Christopher Gordon, CHG Transportation
- Andrew Harte, CHG Transportation

Lowertown Community Association

- Warren Waters

City of Ottawa

- Andrew McCreight, Planner, File Lead
 - John Wu, Engineering
 - Christopher Moise, Urban Design
 - Wally Dubyk, Transportation
-

Subject: 112 Nelson Street

Opening & attendee introduction

- Introduction of meeting attendees
- Andrew explained NDA process with Lowertown CA.

Project Overview (applicant team)

Intro to team and partnership

- Presentation and Intro made to forum equity and smart living properties partnership and business approach.
 - **Note:** Staff request a copy of the presentation made during the meeting.
- Development focuses on millennial form housing.

- Forum has worked on various Ottawa projects, as well as student residents in Manitoba, and many rental projects.
- Proposed development is intended for Rental.
- Location is priority for our projects, and target active transit tenants
- All inclusive rental package, and tenant mix
- Fully furnished suites etc.
- Rental affordability with efficient units and location with amenity proximity etc. Tenants will be enjoying the outside of the unit with quality amenities in the building and surrounding neighbourhood

Proposal Overview

- Goal of project is to try to design the building to meet zoning as close as possible.
- The built form and envelope is intended to meet previous Schedule as much as possible.
- Parking complies with plans submitted, but there will likely be a request to further reduce parking requirement.
- Biggest difference from previous rezoning concept (and approval) is the building is now 10-storeys, but fits within previous zoning height.
- Architect description
 - Previous proposal was 150+ condo type units. We are looking at very different market (rental) and creating flexible use spaces.
 - Looking to maintain 10% as 3-bedroom units.
 - Fit within the envelope but not necessarily maximizing.
 - Meeting envelope and setbacks
 - Change of use to high-rise but within permitted form.
 - Residential building
 - Amenity – interior and roof-top. Meet calc. requirements
 - 342 keys (units)
 - This is not specifically designed for student. May include student but looking for young professionals etc.

Preliminary Comments from Related Discipline

Andrew McCreight – File Lead

- The Pre-con Form notes Site Plan but based on the discussion it is clear that a Zoning By-law amendment will be required as well.
- Provided a brief overview of the ownership, site history and previous rezoning application (recently approved via Omnibus Report)
- Question was raised about the design if the intent was for the design to result in every “suite” satisfying the definition of a dwelling unit?
 - Answer: Jeremy – all units will be designed to comply as dwelling units.

- Section 37 requirements will require re-negotiation based on the changes to the proposed development.
 - Applicant acknowledged.
- Any submission needs to provide a clear breakdown of the how the proposed GFA compares to the previous rezoning concept.
 - Planning Rationale to include a section of S. 37. See guidelines.
- The assessment and rationale that the built form and envelopment is consistent with the previous approval, except going to 10-storeys, is not accurate. Comparing this proposal to the approved Zoning Schedule highlights some concerning inconsistencies, such as the height (storeys), but also some of the stepbacks have not been incorporated.
- Staff fully expect that building heights (including storeys), setbacks and stepbacks previously established and approved through the Omnibus Report will be maintained.
- The design seems to intentionally maximize the number of units in this development and in a manner that is not desirable.
 - Floor heights seem to be squeezed to the minimum code requirement and paired with exceptionally small units
 - The concept incorporates dwelling units within the P1 garage level. This seems unnecessary and may contribute to a discussion around overdevelopment.
- Visitor parking – the zoning provision specific to minimum of 6 spaces was based on the previous concept. More visitor parking should be provided and relate the number of units.
- Waste Room access does not appear sufficient, at least for City collection. Consider the number of units proposed and design the waste/recycling room accordingly.
- Part of the business plan presentation spoke to tenants having excellent access to amenity outside of their unit. With the proposal development concept, which raises concern about the number and type of units proposed, it will be very important to see proper indoor Amenity Areas for ease of access by all tenants.
- Bicycle parking – the desire to achieve a 1:1 ratio is supported but further the design and location of bike parking for ease of use. Bicycle rooms within parking garage may work, but they need to be easy to access with a bike. Prefer to see a ground floor facility. Also look at option for visitor bicycle parking.
- More information will be required on affordable housing relative to the previous S. 37 items.
- Discuss this proposal with the Ward Councillor as he may have other ideas in mind for S. 37, and for the proposed development in general.
- Further pre-consultation is strongly recommended in response to comments received. The current proposal raises many concerns, and with the high-level issues addressed, staff can provide more detailed feedback.

Christopher – Urban Design

- Convincing business plan
 - Location
 - Quality design with efficient spaces, shared amenities, quality finishes etc.
 - Convenience
 - Shortage of rental housing, proforma, small units, amenities.
- However, while the strong business plan discussion is appreciated, but the missing piece is how the building itself contributes to the immediate community and the design of the City.

Specific Areas of Concern:

- The project is ten storeys and triggers the tall building guidelines and this proposal doesn't come close to meeting the max 750m² floorplate. Bringing this proposal down to nine storeys would avoid that.
- Would like further analysis of building relationship with surrounding context, especially planned function. Provide visualization.
- It might be helpful to see how this proposal relates to its surrounding properties within their planned context. Perhaps some modelling with ghosted blocks that illustrate what could be built around it to investigate side yard conditions.
- How the building presents a street scale and how the design relates to the context of Nelson.
- The massing and materiality of the design seems akin to a campus building on a green field site, so additional investigation would be valuable to recognize the diverse local context.
- No balconies which are a common way to visually break up a long facade and provide an architectural element that signifies a residential use.
- Concern about livability of below grade units. More elaboration of this approach needs to be provided (perhaps with a section).
- Quality of life of the building needs further description from a built form and design perspective. Not sure the business plan idea has translated into this form. This is not a convincing proposal.
- The P1 level units are very concerning.
- There is no landscaping plan provided yet and this will be a critical component of the success of the design and how it stitches itself into the context of the block as a whole.

Other

- This building will be highly visible in the middle of a downtown block, and although it does not sit within one of the City's Design Priority Areas we

recommend the proposal consider attending an Informal visit (prior to a full submission and is not a public meeting), with the City's UDRP to further discuss and evaluate various scenarios of development for the whole site;

- A Design Brief is a required submittal for all site plan applications. Please see the Design Brief Terms of Reference provided for details and consult the City's website for details regarding the UDRP schedule (if applicable).

John Wu - Engineering

- Major concern is to check sanitary capacity.
- Storm and water should not cause any concerns.
- Noise study will be required due to proximity of Rideau and King Edward.
- Jeremy – similar number of occupants from previous proposal, so capacity should not be an issue.

Wally - Transportation

- The remaining steps (Forecasting & Analysis) of the TIA report to be submitted during the Site Plan application. All other Transportation comments have been noted by the consultant and should be addressed on the site plan.
- Applicant
 - We will be further discussing additional transit demand strategies with staff such as car share, e-bike spaces etc.

Preliminary Comments from Community Association Representatives:

Warren is currently the only member from Lowertown Community Association who has signed the non-disclosure agreement.

- Welcome to the neighbourhood. There is an affordability emergency.
- We need more family housing.
- We do welcome student and young professions.
- You will receive concerns about this being a student bunkhouse.
- Beautiful neighbourhood and I recommend you get to know your neighbours and get to know the people who are affected by this development.
- City – don't hold up good housing projects.
- Investment with rental real estate with high turnover results in higher rents and increasement. Don't make this your business approach.
- Increase stress on infrastructure and more property taxes etc.

Note: there was a response discussion about Development Charges, and application process

Next Steps:

- Warren has signed non-disclosure agreement. If the applicant decides to go to the public, please email Warren to break this agreement. Andrew must be copied on such an e-mail if this occurs.
- Recommend consulting the Ward Councillor, as well as Lowertown Community Association.
- The plans and studies list will be provided for submission requirements.

McCaughey, Stephen

From: Wu, John <John.Wu@ottawa.ca>
Sent: Wednesday, April 14, 2021 11:10 AM
To: McCaughey, Stephen
Subject: RE: 112 Nelson St. - Design Criteria from Pre-consultation

Follow Up Flag: Follow up
Flag Status: Flagged

Please use C 0.5 , 2 year's storm to restrict up to 100 year's storm on site.

From: McCaughey, Stephen <Stephen.Mccaughey@wsp.com>
Sent: April 14, 2021 11:06 AM
To: Wu, John <John.Wu@ottawa.ca>
Cc: Blanchette, Erin <Erin.Blanchette@wsp.com>
Subject: 112 Nelson St. - Design Criteria from Pre-consultation

CAUTION: This email originated from an External Sender. Please do not click links or open attachments unless you recognize the source.

ATTENTION : Ce courriel provient d'un expéditeur externe. Ne cliquez sur aucun lien et n'ouvrez pas de pièce jointe, excepté si vous connaissez l'expéditeur.

I understand you're the engineering contact for this 112 Nelson St. proposed development and possible re-zoning.

We'll be generating the proposed water and sanitary demands shortly but what isn't clear from the pre-consultation minutes is what are the stormwater management requirements for this site development?

Thanks very much,

Stephen McCaughey, P.Eng.

Project Engineer
Municipal Infrastructure



T +1 613-690-3955 (Direct)
T +1 613-829-2800 (Office)

300-2611 Queensview Drive
Ottawa, Ontario
K2B 8K2 Canada

wsp.com

restricted disclosure under applicable law. This message is for the sole use of the intended recipient(s). Any unauthorized use, disclosure, viewing, copying, alteration, dissemination or distribution of, or reliance on, this message is strictly prohibited. If you have received this message in error, or you are not an authorized or intended recipient, please notify the sender immediately by replying to this message, delete this message and all copies from your e-mail system and destroy any printed copies. You are receiving this communication because you are listed as a current WSP contact. Should you have any questions regarding WSP's electronic communications policy, please consult our Anti-Spam Commitment at www.wsp.com/cas. For any concern or if you believe you should not be receiving this message, please forward this message to cascompliance@wsp.com so that we can promptly address your request. Note that not all messages sent by WSP qualify as commercial electronic messages.

AVIS : Ce message, incluant tout fichier l'accompagnant (« le message »), peut contenir des renseignements ou de l'information privilégiés, confidentiels, propriétaires ou à divulgation restreinte en vertu de la loi. Ce message est destiné à l'usage exclusif du/des destinataire(s) voulu(s). Toute utilisation non permise, divulgation, lecture, reproduction, modification, diffusion ou distribution est interdite. Si vous avez reçu ce message par erreur, ou que vous n'êtes pas un destinataire autorisé ou voulu, veuillez en aviser l'expéditeur immédiatement et détruire le message et toute copie électronique ou imprimée. Vous recevez cette communication car vous faites partie des contacts de WSP. Si vous avez des questions concernant la politique de communications électroniques de WSP, veuillez consulter notre Engagement anti-pourriel au www.wsp.com/lcap. Pour toute question ou si vous croyez que vous ne devriez pas recevoir ce message, prière de le transférer au conformitelcap@wsp.com afin que nous puissions rapidement traiter votre demande. Notez que ce ne sont pas tous les messages transmis par WSP qui constituent des messages électroniques commerciaux.

-LAEmHhHzdJzBITWfa4Hgs7pbKl
,

This e-mail originates from the City of Ottawa e-mail system. Any distribution, use or copying of this e-mail or the information it contains by other than the intended recipient(s) is unauthorized. Thank you.

Le présent courriel a été expédié par le système de courriels de la Ville d'Ottawa. Toute distribution, utilisation ou reproduction du courriel ou des renseignements qui s'y trouvent par une personne autre que son destinataire prévu est interdite. Je vous remercie de votre collaboration.

,

APPENDIX

B

Pre-Development Stormwater Management Calculations



Project:	112 Nelson Street	No.:	211-04788-00
By:	KK	Date:	2021-07-14
Checked:	MH	Checked:	2021-07-14

Page: 1

Subject: SWM CALCULATIONS- Pre-Development Peak Flow

Calculation of existing runoff rate is undertaken using the Rational Method:

$$Q = 2.78CiA$$

Where: Q = peak flow rate (litres/second)
C = runoff coefficient
i = rainfall intensity (mm/hour)
A = catchment area (hectares)

Site Area, A	2,948	m ²
Site Area, A	0.29	hectares
Runoff Coefficient, C	0.50	

Rainfall intensity calculated in accordance with City of Ottawa Sewer Design Guidelines (section 5.4.2):

$$i = \left[\frac{A}{(Td + C)^B} \right]$$

Where: A, B, C = regression constants for each return period (defined in section 5.4.2)
i = rainfall intensity (mm/hour)
Td = storm duration (minutes) 10 minutes

Return Period (Years)	2	5	10	25	50	100*
A	733.0	998.1	1,174.2	1,402.9	1,569.6	1,735.7
B	0.810	0.814	0.816	0.819	0.820	0.820
C	6.199	6.053	6.014	6.018	6.014	6.014
T (mins)	10	10	10	10	10	10
I (mm/hr)	76.8	104.2	122.1	144.7	161.5	178.6
Runoff Coefficient C	0.50	0.50	0.50	0.50	0.50	0.50
C Multiplier (OSDG Table 5.7)	1.00	1.00	1.00	1.10	1.20	1.25
Revised Runoff Coefficient C	0.50	0.50	0.50	0.55	0.60	0.63
Q (litres/sec)	31	43	50	65	79	91
Q (m3/sec)	0.03	0.04	0.05	0.07	0.08	0.09

APPENDIX

C

HydroCAD Model Output

APPENDIX

C-1

100-Year Analysis (Peak Discharge, $T_c = 24$ Min)

The storm system for the site is governed by the 100-year storm. Peak storage and peak discharge occur at separate times of concentration and are therefore reported separately.

APPENDIX

C-2

100-Year Analysis (Peak Storage, $T_c = 29$ Min)

The storm system for the site is governed by the 100-year storm. Peak storage and peak discharge occur at separate times of concentration and are therefore reported separately.

20230126_112_Nelson

Prepared by WSP Canada inc.

HydroCAD® 10.00-22 s/n 10697 © 2018 HydroCAD Software Solutions LLC

Printed 2023-02-10

Page 2

Area Listing (selected nodes)

Area (sq-meters)	C	Description (subcatchment-numbers)
3,350.0	0.94	Controlled Area (0.75) (31S)
300.0	0.54	Uncontrolled Area (0.43) (42S)
3,650.0	0.91	TOTAL AREA

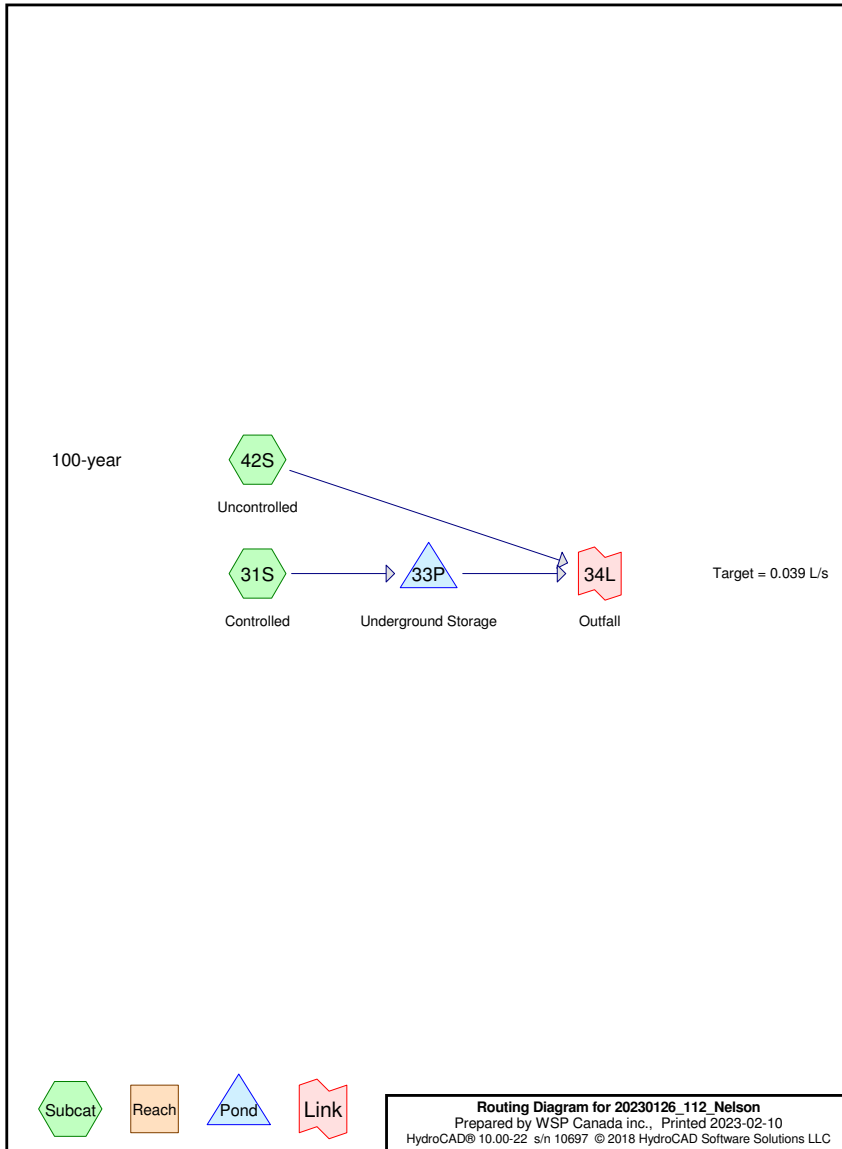

Time span=0.00-4.00 hrs, dt=0.01 hrs, 401 points
 Runoff by Rational method, Rise/Fall=1.0/1.0 xTc

Reach routing by Stor-Ind+Trans method - Pond routing by Stor-Ind method

Subcatchment 31S: Controlled Runoff Area=0.3350 ha 0.00% Impervious Runoff Depth=40 mm
 Tc=10.0 min C=0.94 Runoff=0.09331 m³/s 134.4 m³

Subcatchment 42S: Uncontrolled Runoff Area=0.0300 ha 0.00% Impervious Runoff Depth=23 mm
 Tc=10.0 min C=0.54 Runoff=0.00480 m³/s 6.9 m³

Pond 33P: Underground Storage Peak Elev=58.102 m Storage=83.9 m³ Inflow=0.09331 m³/s 134.4 m³
 Outflow=0.03583 m³/s 134.4 m³

Link 34L: Outfall Inflow=0.03922 m³/s 141.3 m³
 Primary=0.03922 m³/s 141.3 m³

Total Runoff Area = 3,650.0 m² Runoff Volume = 141.3 m³ Average Runoff Depth = 39 mm
100.00% Pervious = 3,650.0 m² 0.00% Impervious = 0.0 m²

Summary for Subcatchment 31S: Controlled

Runoff = 0.09331 m³/s @ 0.17 hrs, Volume= 134.4 m³, Depth= 40 mm

Runoff by Rational method, Rise/Fall=1.0/1.0 xTc, Time Span= 0.00-4.00 hrs, dt= 0.01 hrs
 Ottawa_+4hr25mm 100-Year Duration=24 min, Inten=106.7 mm/hr

Area (ha)	C	Description
0.3350	0.94	Controlled Area (0.75)
0.3350		100.00% Pervious Area

Tc (min)	Length (meters)	Slope (m/m)	Velocity (m/sec)	Capacity (m³/s)	Description
10.0					Direct Entry,

Subcatchment 31S: Controlled

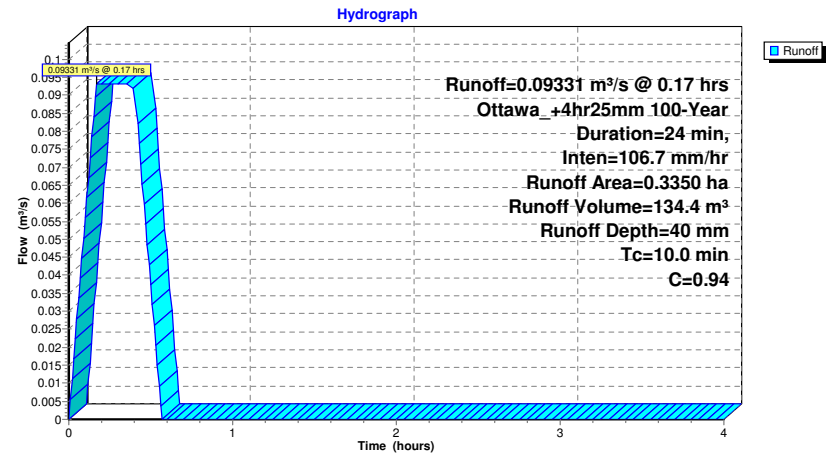

Summary for Subcatchment 42S: Uncontrolled

Runoff = 0.00480 m³/s @ 0.17 hrs, Volume= 6.9 m³, Depth= 23 mm

Runoff by Rational method, Rise/Fall=1.0/1.0 xTc, Time Span= 0.00-4.00 hrs, dt= 0.01 hrs
 Ottawa_+4hr25mm 100-Year Duration=24 min, Inten=106.7 mm/hr

Area (ha)	C	Description
0.0300	0.54	Uncontrolled Area (0.43)
0.0300		100.00% Pervious Area

Tc (min)	Length (meters)	Slope (m/m)	Velocity (m/sec)	Capacity (m³/s)	Description
10.0					Direct Entry,

Subcatchment 42S: Uncontrolled

Hydrograph

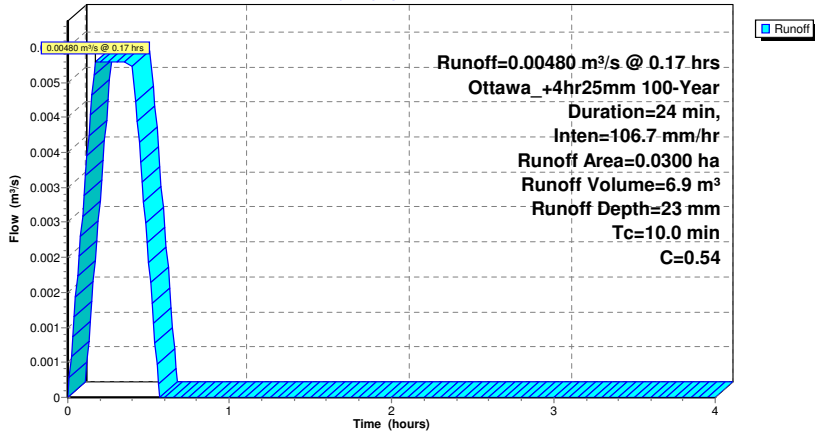

Summary for Pond 33P: Underground Storage

[44] Hint: Outlet device #1 is below defined storage

Inflow Area = 3,350.0 m², 0.00% Impervious, Inflow Depth = 40 mm for 100-Year event
 Inflow = 0.09331 m³/s @ 0.17 hrs, Volume= 134.4 m³
 Outflow = 0.03583 m³/s @ 0.50 hrs, Volume= 134.4 m³, Atten= 62%, Lag= 20.0 min
 Primary = 0.03583 m³/s @ 0.50 hrs, Volume= 134.4 m³

Routing by Stor-Ind method, Time Span= 0.00-4.00 hrs, dt= 0.01 hrs
 Peak Elev= 58.102 m @ 0.50 hrs Surf.Area= 90.0 m² Storage= 83.9 m³

Plug-Flow detention time= 24.9 min calculated for 134.4 m³ (100% of inflow)
 Center-of-Mass det. time= 24.8 min (41.8 - 17.0)

Volume	Invert	Avail.Storage	Storage Description
#1	57.170 m	90.0 m³	Custom Stage Data (Prismatic) Listed below

Elevation (meters)	Surf.Area (sq-meters)	Inc.Store (cubic-meters)	Cum.Store (cubic-meters)
57.170	90.0	0.0	0.0
58.170	90.0	90.0	90.0

Device	Routing	Invert	Outlet Devices
#1	Primary	56.950 m	IPEX_ICD_C
			Head (meters) 0.000 0.200 0.500 1.000 1.500 1.800
			Disch. (m³/s) 0.000000 0.016000 0.024000 0.034000 0.040000 0.041500

Primary OutFlow Max=0.03582 m³/s @ 0.50 hrs HW=58.102 m (Free Discharge)
 ↳IPEX_ICD_C (Custom Controls 0.03582 m³/s)

Pond 33P: Underground Storage

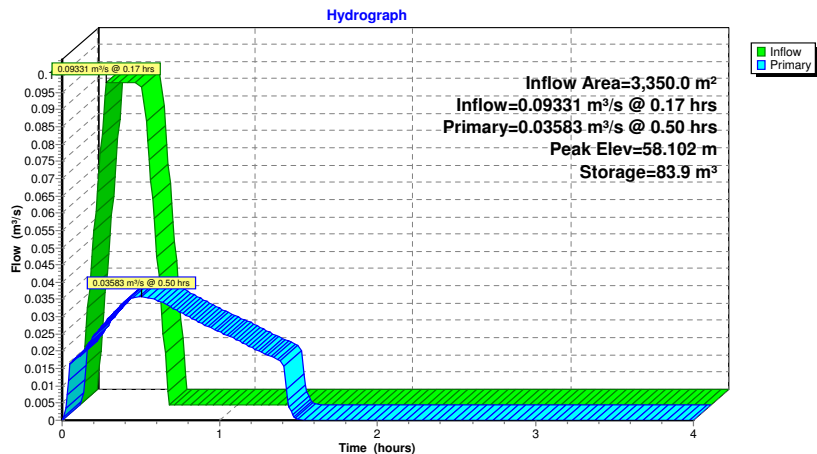

Summary for Link 34L: Outfall

Inflow Area = 3,650.0 m², 0.00% Impervious, Inflow Depth = 39 mm for 100-Year event
 Inflow = 0.03922 m³/s @ 0.40 hrs, Volume= 141.3 m³
 Primary = 0.03922 m³/s @ 0.40 hrs, Volume= 141.3 m³, Atten= 0%, Lag= 0.0 min

Primary outflow = Inflow, Time Span= 0.00-4.00 hrs, dt= 0.01 hrs

Link 34L: Outfall

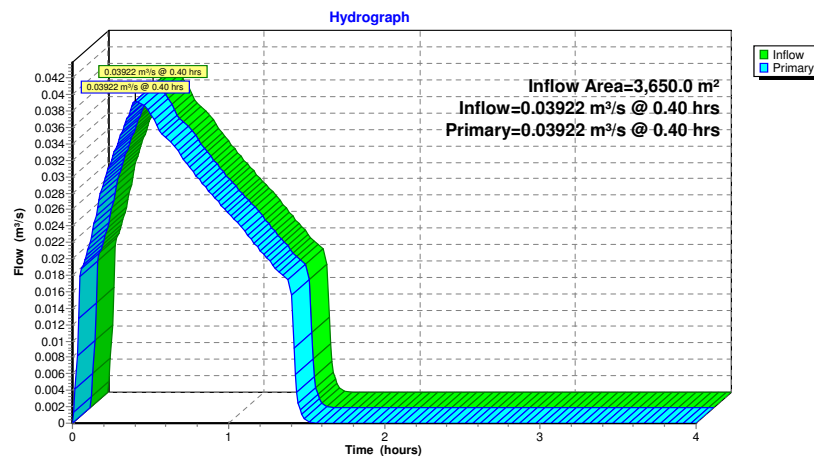

20230126_112_Nelson

Prepared by WSP Canada inc.

HydroCAD® 10.00-22 s/n 10697 © 2018 HydroCAD Software Solutions LLC

Printed 2023-02-10

Page 2

Area Listing (selected nodes)

Area (sq-meters)	C	Description (subcatchment-numbers)
3,350.0	0.94	Controlled Area (0.75) (31S)
300.0	0.54	Uncontrolled Area (0.43) (42S)
3,650.0	0.91	TOTAL AREA

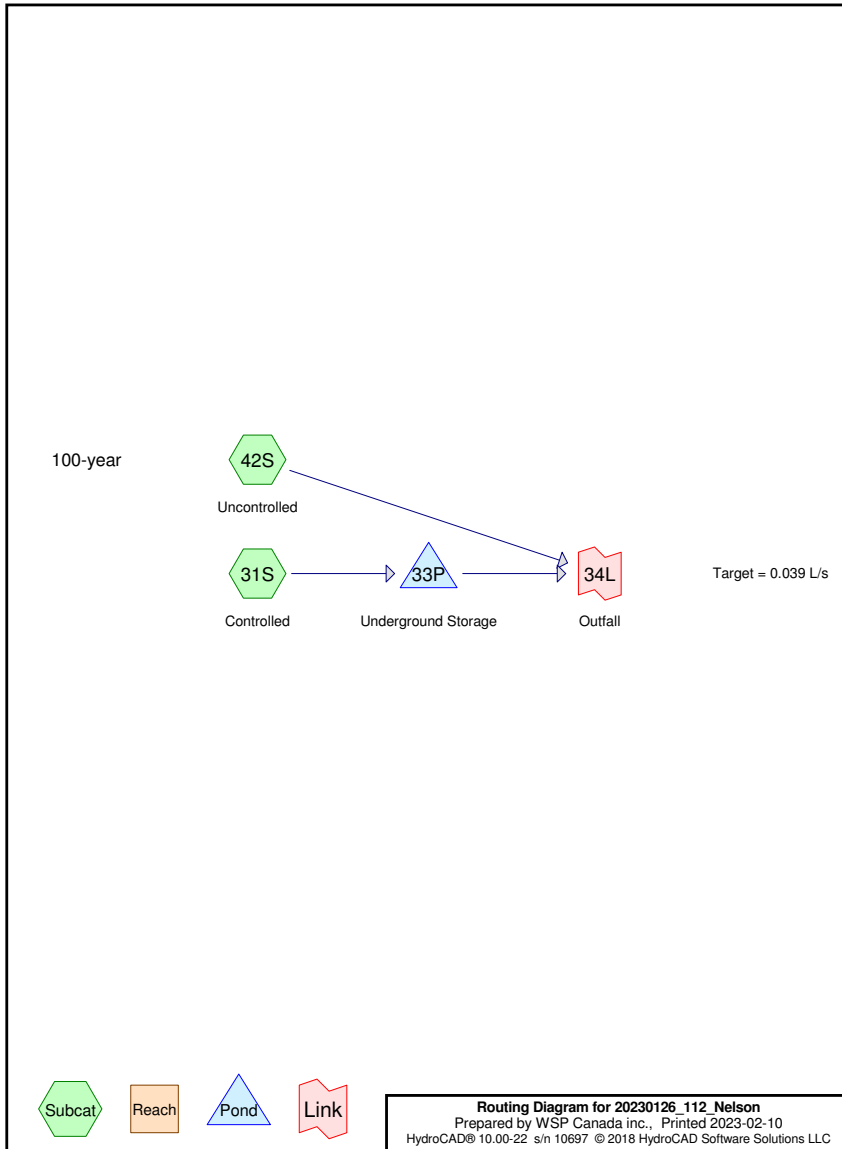

Time span=0.00-4.00 hrs, dt=0.01 hrs, 401 points
 Runoff by Rational method, Rise/Fall=1.0/1.0 xTc

Reach routing by Stor-Ind+Trans method - Pond routing by Stor-Ind method

Subcatchment 31S: Controlled Runoff Area=0.3350 ha 0.00% Impervious Runoff Depth=43 mm
 Tc=10.0 min C=0.94 Runoff=0.08224 m³/s 143.1 m³

Subcatchment 42S: Uncontrolled Runoff Area=0.0300 ha 0.00% Impervious Runoff Depth=25 mm
 Tc=10.0 min C=0.54 Runoff=0.00423 m³/s 7.4 m³

Pond 33P: Underground Storage Peak Elev=58.110 m Storage=84.6 m³ Inflow=0.08224 m³/s 143.1 m³
 Outflow=0.03593 m³/s 143.1 m³

Link 34L: Outfall Inflow=0.03907 m³/s 150.4 m³
 Primary=0.03907 m³/s 150.4 m³

Total Runoff Area = 3,650.0 m² Runoff Volume = 150.4 m³ Average Runoff Depth = 41 mm
100.00% Pervious = 3,650.0 m² 0.00% Impervious = 0.0 m²

Summary for Subcatchment 31S: Controlled

Runoff = 0.08224 m³/s @ 0.17 hrs, Volume= 143.1 m³, Depth= 43 mm

Runoff by Rational method, Rise/Fall=1.0/1.0 xTc, Time Span= 0.00-4.00 hrs, dt= 0.01 hrs
 Ottawa_+4hr25mm 100-Year Duration=29 min, Inten=94.0 mm/hr

Area (ha)	C	Description
0.3350	0.94	Controlled Area (0.75)
0.3350		100.00% Pervious Area

Tc (min)	Length (meters)	Slope (m/m)	Velocity (m/sec)	Capacity (m³/s)	Description
10.0					Direct Entry,

Subcatchment 31S: Controlled

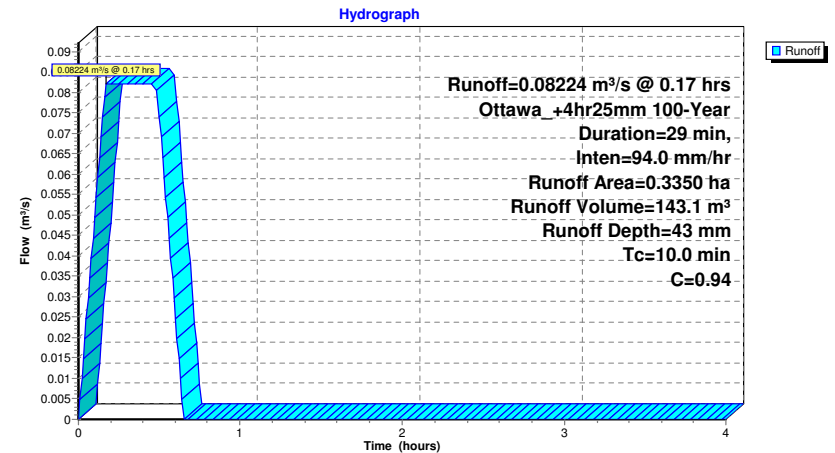

Summary for Subcatchment 42S: Uncontrolled

Runoff = 0.00423 m³/s @ 0.17 hrs, Volume= 7.4 m³, Depth= 25 mm

Runoff by Rational method, Rise/Fall=1.0/1.0 xTc, Time Span= 0.00-4.00 hrs, dt= 0.01 hrs
 Ottawa_+4hr25mm 100-Year Duration=29 min, Inten=94.0 mm/hr

Area (ha)	C	Description
0.0300	0.54	Uncontrolled Area (0.43)
0.0300		100.00% Pervious Area

Tc (min)	Length (meters)	Slope (m/m)	Velocity (m/sec)	Capacity (m³/s)	Description
10.0					Direct Entry,

Subcatchment 42S: Uncontrolled

Hydrograph

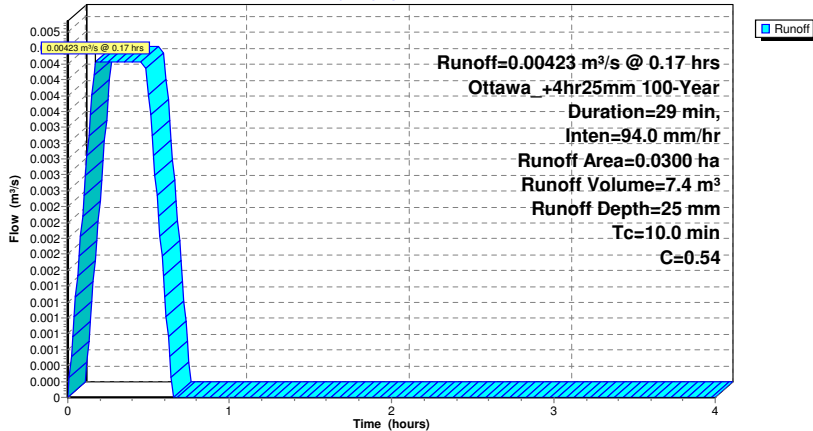

Summary for Pond 33P: Underground Storage

[44] Hint: Outlet device #1 is below defined storage

Inflow Area = 3,350.0 m², 0.00% Impervious, Inflow Depth = 43 mm for 100-Year event
 Inflow = 0.08224 m³/s @ 0.17 hrs, Volume= 143.1 m³
 Outflow = 0.03593 m³/s @ 0.58 hrs, Volume= 143.1 m³, Atten= 56%, Lag= 24.4 min
 Primary = 0.03593 m³/s @ 0.58 hrs, Volume= 143.1 m³

Routing by Stor-Ind method, Time Span= 0.00-4.00 hrs, dt= 0.01 hrs
 Peak Elev= 58.110 m @ 0.58 hrs Surf.Area= 90.0 m² Storage= 84.6 m³

Plug-Flow detention time= 25.2 min calculated for 143.1 m³ (100% of inflow)
 Center-of-Mass det. time= 25.1 min (44.6 - 19.5)

Volume	Invert	Avail.Storage	Storage Description
#1	57.170 m	90.0 m³	Custom Stage Data (Prismatic) Listed below

Elevation (meters)	Surf.Area (sq-meters)	Inc.Store (cubic-meters)	Cum.Store (cubic-meters)
57.170	90.0	0.0	0.0
58.170	90.0	90.0	90.0

Device	Routing	Invert	Outlet Devices
#1	Primary	56.950 m	IPEX_ICD_C Head (meters) 0.000 0.200 0.500 1.000 1.500 1.800 Disch. (m³/s) 0.000000 0.016000 0.024000 0.034000 0.040000 0.041500

Primary OutFlow Max=0.03592 m³/s @ 0.58 hrs HW=58.110 m (Free Discharge)
 ↳IPEX_ICD_C (Custom Controls 0.03592 m³/s)

Pond 33P: Underground Storage

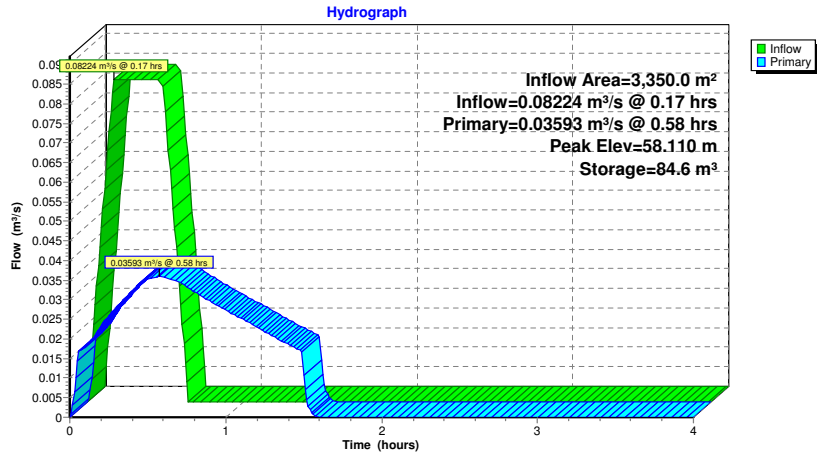

Summary for Link 34L: Outfall

Inflow Area = 3,650.0 m², 0.00% Impervious, Inflow Depth = 41 mm for 100-Year event
 Inflow = 0.03907 m³/s @ 0.49 hrs, Volume= 150.4 m³
 Primary = 0.03907 m³/s @ 0.49 hrs, Volume= 150.4 m³, Atten= 0%, Lag= 0.0 min

Primary outflow = Inflow, Time Span= 0.00-4.00 hrs, dt= 0.01 hrs

Link 34L: Outfall

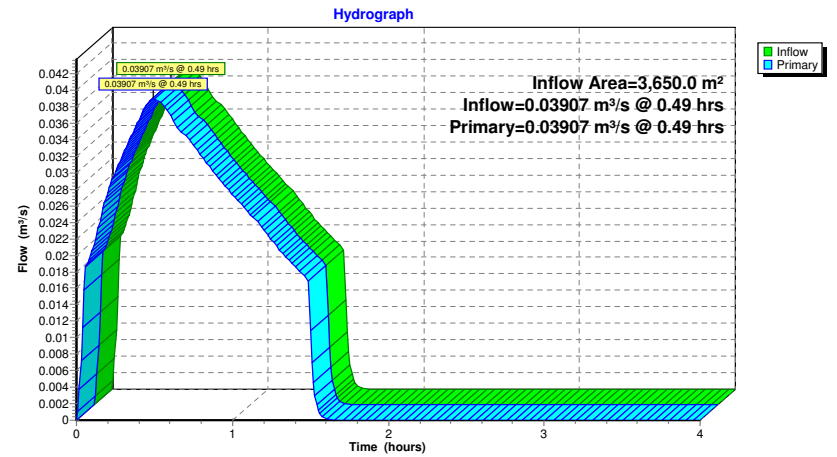

APPENDIX

D

OGS Sizing



Stormceptor® EF Sizing Report

STORMCEPTOR®

ESTIMATED NET ANNUAL SEDIMENT (TSS) LOAD REDUCTION

08/25/2021

Province:	Ontario
City:	Ottawa
Nearest Rainfall Station:	OTTAWA MACDONALD-CARTIER INT'L AP
NCDC Rainfall Station Id:	6000
Years of Rainfall Data:	37

Project Name:	112 Nelson Street
Project Number:	211-04788-00
Designer Name:	Kathryn Kerker
Designer Company:	WSP
Designer Email:	kathryn.kerker@wsp.com
Designer Phone:	613-690-1206
EOR Name:	
EOR Company:	
EOR Email:	
EOR Phone:	

Site Name:	
------------	--

Drainage Area (ha):	0.24
% Imperviousness:	100.00

Runoff Coefficient 'c': 0.90

Particle Size Distribution:	Fine
Target TSS Removal (%):	80.0

Required Water Quality Runoff Volume Capture (%):	90.00
Estimated Water Quality Flow Rate (L/s):	7.81
Oil / Fuel Spill Risk Site?	Yes
Upstream Flow Control?	Yes
Upstream Orifice Control Flow Rate to Stormceptor (L/s):	31.00
Peak Conveyance (maximum) Flow Rate (L/s):	
Site Sediment Transport Rate (kg/ha/yr):	

Net Annual Sediment (TSS) Load Reduction Sizing Summary	
Stormceptor Model	TSS Removal Provided (%)
EFO4	84
EFO6	89
EFO8	91
EFO10	92
EFO12	93

Recommended Stormceptor EFO Model: EFO4
Estimated Net Annual Sediment (TSS) Load Reduction (%): 84
Water Quality Runoff Volume Capture (%): > 90

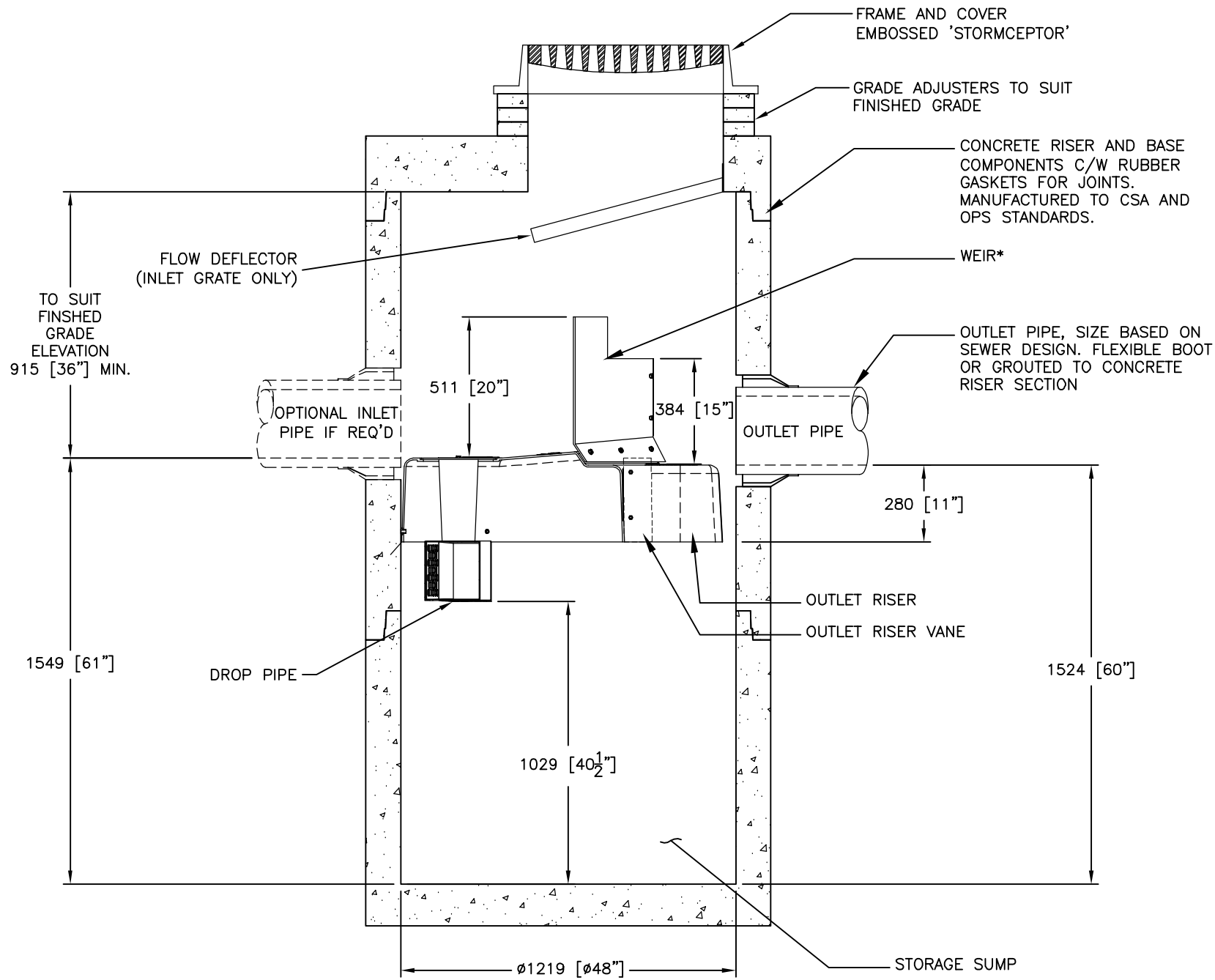

SECTION VIEW

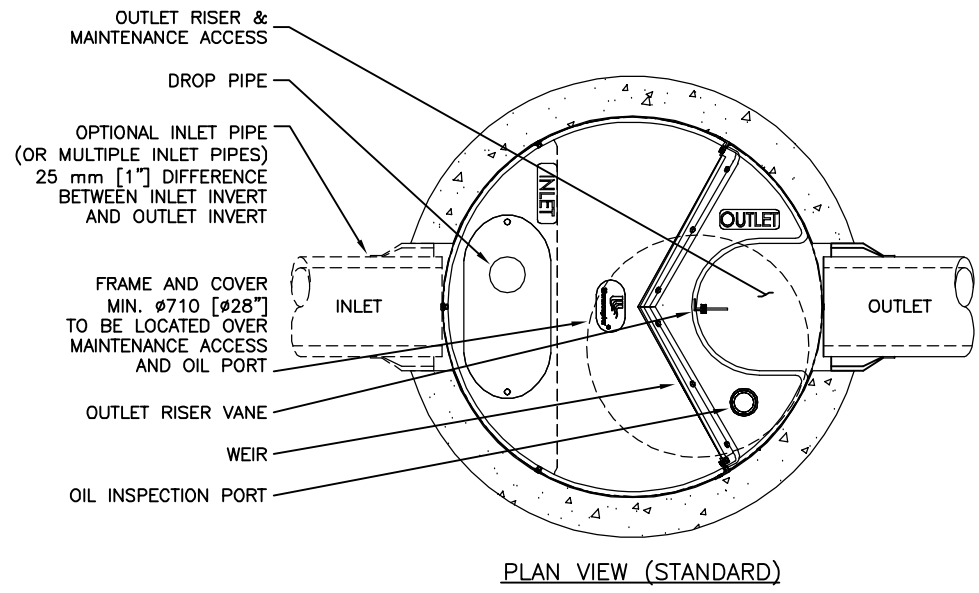

PLAN VIEW (STANDARD)

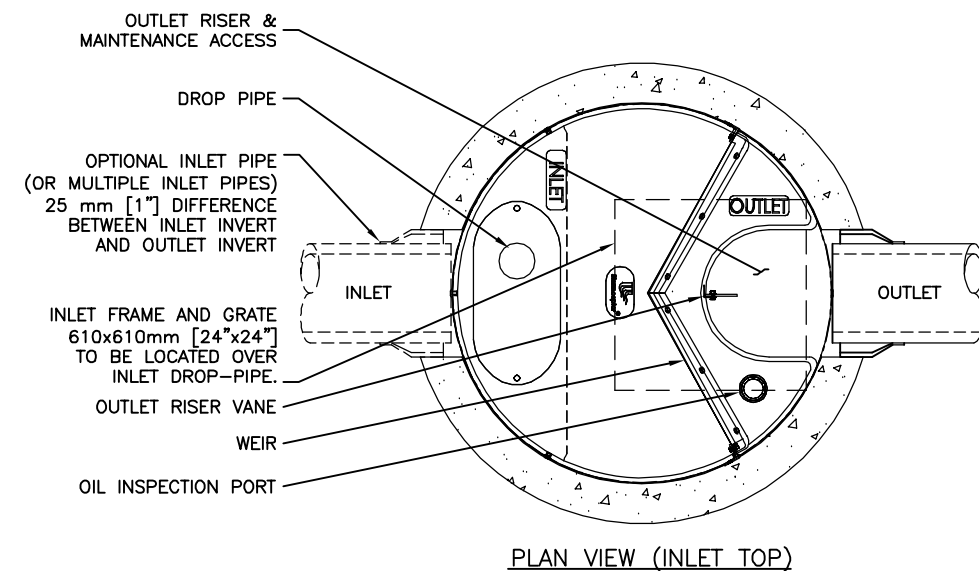

PLAN VIEW (INLET TOP)

FOR SITE SPECIFIC DRAWINGS PLEASE CONTACT YOUR LOCAL STORMCEPTOR REPRESENTATIVE. SITE SPECIFIC DRAWINGS ARE BASED ON THE BEST AVAILABLE INFORMATION AT THE TIME. SOME FIELD REVISIONS TO THE SYSTEM LOCATION OR CONNECTION PIPING MAY BE NECESSARY BASED ON AVAILABLE SPACE OR SITE CONFIGURATION REVISIONS. ELEVATIONS SHOULD BE MAINTAINED EXCEPT WHERE NOTED ON BYPASS STRUCTURE (IF REQUIRED).

GENERAL NOTES:

- * MAXIMUM SURFACE LOADING RATE (SLR) INTO LOWER CHAMBER THROUGH DROP PIPE IS 1135 L/min/m² (27.9 gpm/ft²) FOR STORMCEPTOR EF4 AND 535 L/min/m² (13.1 gpm/ft²) FOR STORMCEPTOR EFO4 (OIL CAPTURE CONFIGURATION). WEIR HEIGHT IS 150 mm (6 INCH) FOR EF04.
- 1. ALL DIMENSIONS INDICATED ARE IN MILLIMETERS (INCHES) UNLESS OTHERWISE SPECIFIED.
- 2. STORMCEPTOR STRUCTURE INLET AND OUTLET PIPE SIZE AND ORIENTATION SHOWN FOR INFORMATIONAL PURPOSES ONLY.
- 3. UNLESS OTHERWISE NOTED, BYPASS INFRASTRUCTURE, SUCH AS ALL UPSTREAM DIVERSION STRUCTURES, CONNECTING STRUCTURES, OR PIPE CONDUITS CONNECTING TO COMPLETE THE STORMCEPTOR SYSTEM SHALL BE PROVIDED AND ADDRESSED SEPARATELY.
- 4. DRAWING FOR INFORMATION PURPOSES ONLY. REFER TO ENGINEER'S SITE/UTILITY PLAN FOR STRUCTURE ORIENTATION.
- 5. NO PRODUCT SUBSTITUTIONS SHALL BE ACCEPTED UNLESS SUBMITTED 10 DAYS PRIOR TO PROJECT BID DATE, OR AS DIRECTED BY THE ENGINEER OF RECORD.

INSTALLATION NOTES

- A. ANY SUB-BASE, BACKFILL DEPTH, AND/OR ANTI-FLOTATION PROVISIONS ARE SITE-SPECIFIC DESIGN CONSIDERATIONS AND SHALL BE SPECIFIED BY ENGINEER OF RECORD.
- B. CONTRACTOR TO PROVIDE EQUIPMENT WITH SUFFICIENT LIFTING AND REACH CAPACITY TO LIFT AND SET THE STRUCTURE (LIFTING CLUTCHES PROVIDED)
- C. CONTRACTOR WILL INSTALL AND LEVEL THE STRUCTURE, SEALING THE JOINTS, LINE ENTRY AND EXIT POINTS (NON-SHRINK GROUT WITH APPROVED WATERSTOP OR FLEXIBLE BOOT)
- D. CONTRACTOR TO TAKE APPROPRIATE MEASURES TO PROTECT THE DEVICE FROM CONSTRUCTION-RELATED EROSION RUNOFF.
- E. DEVICE ACTIVATION, BY CONTRACTOR, SHALL OCCUR ONLY AFTER SITE HAS BEEN STABILIZED AND THE STORMCEPTOR UNIT IS CLEAN AND FREE OF DEBRIS.

STANDARD DETAIL

NOT FOR CONSTRUCTION

SITE SPECIFIC DATA REQUIREMENTS					
STORMCEPTOR MODEL	EF4				
STRUCTURE ID	*				
WATER QUALITY FLOW RATE (L/s)	*				
PEAK FLOW RATE (L/s)	*				
RETURN PERIOD OF PEAK FLOW (yrs)	*				
DRAINAGE AREA (HA)	*				
DRAINAGE AREA IMPERVIOUSNESS (%)	*				
PIPE DATA:	I.E.	MAT'L	DIA	SLOPE %	HGL
INLET #1	*	*	*	*	*
INLET #2	*	*	*	*	*
OUTLET	*	*	*	*	*
* PER ENGINEER OF RECORD					

The design and information shown on this drawing is provided as a service to the project owner, engineer and contractor by Imbrium Systems ("Imbrium"). Neither the drawing, nor any part thereof, may be reproduced, stored in a retrieval system, or transmitted in any form or by any means, electronic, mechanical, photocopying, recording, or otherwise, without the prior written consent of Imbrium. Imbrium expressly disclaims any liability or responsibility for such use. If discrepancies between the supplied information upon which the drawing is based and actual field conditions are discovered, the contractor shall be responsible for re-evaluation of the design. Imbrium accepts no liability for designs based on missing, incomplete or inaccurate information supplied by others.

MARK	DATE	REVISION DESCRIPTION	BY
1	6/8/18	UPDATES	JSK
0	5/26/17	INITIAL RELEASE	JSK

Stormceptor® EF

imbrium

7037 RIDGE ROAD, SUITE 300, HANOVER, MD 21076
 USA 888-276-8828 CA 800-988-4801 INTL. +1-410-960-9600

DATE: 5/26/2017

DESIGNED: JSK
 DRAWN: JSK
 CHECKED: BSF
 APPROVED: SP

PROJECT No.: EF4
 SEQUENCE No.: *

SHEET: 1 OF 1

SCALE = NTS