

**Servicing and Stormwater
Management Brief –
Wellings of Stittsville Phase 2,
20 Cedarow Court**

Project # 160401511



Prepared for:
Nautical Lands Group

Prepared by:
Stantec Consulting Ltd.

September 21, 2022

Revision	Description	Author		Quality Check	
1	Issued for Review	2020-05-19	TR	2020-05-20	DT
2	Issued for Review	2021-08-30	TR	2021-08-31	DT
3	Issued for Review	2022-03-29	DT	2022-03-29	PM
4	Issued for Review	2022-07-14	DT	2022-07-14	PM
5	Revised Site Plan	2022-09-21	DT	2022-09-21	PM

Sign-off Sheet

This document entitled Servicing and Stormwater Management Brief – Wellings of Stittsville Phase 2, 20 Cedarow Court was prepared by Stantec Consulting Ltd. ("Stantec") for the account of Nautical Lands Group. (the "Client"). Any reliance on this document by any third party is strictly prohibited. The material in it reflects Stantec's professional judgment in light of the scope, schedule and other limitations stated in the document and in the contract between Stantec and the Client. The opinions in the document are based on conditions and information existing at the time the document was published and do not take into account any subsequent changes. In preparing the document, Stantec did not verify information supplied to it by others. Any use which a third party makes of this document is the responsibility of such third party. Such third party agrees that Stantec shall not be responsible for costs or damages of any kind, if any, suffered by it or any other third party as a result of decisions made or actions taken based on this document.

Prepared by  _____
(signature)

Dustin Thiffault, P.Eng.

Reviewed by  _____
(signature)

Peter Moroz, P.Eng.

**SERVICING AND STORMWATER MANAGEMENT BRIEF –
WELLINGS OF STITTSVILLE PHASE 2, 20 CEDAROW COURT**

September 21, 2022

Table of Contents

1.0 INTRODUCTION 1.4

2.0 BACKGROUND 2.1

3.0 WATER SUPPLY SERVICING 3.1

3.1 BACKGROUND 3.1

3.2 WATER DEMANDS 3.1

3.3 PROPOSED SERVICING 3.2

3.4 SUMMARY OF FINDINGS 3.2

4.0 WASTEWATER SERVICING 4.1

4.1 BACKGROUND 4.1

4.2 DESIGN CRITERIA 4.1

4.3 PROPOSED SERVICING 4.1

5.0 STORMWATER MANAGEMENT 5.1

5.1 OBJECTIVES 5.1

5.2 SWM CRITERIA AND CONSTRAINTS 5.1

5.2.1 Pre-Development Conditions 5.2

5.3 STORMWATER MANAGEMENT DESIGN 5.3

5.3.1 Design Methodology 5.3

5.3.2 Modeling Rationale 5.4

5.3.3 Input Parameters 5.6

5.3.4 Model Results 5.9

5.3.5 Water Quality Control 5.11

6.0 GRADING AND DRAINAGE 6.1

7.0 UTILITIES 7.1

8.0 APPROVALS 8.1

9.0 EROSION CONTROL DURING CONSTRUCTION 9.1

10.0 GEOTECHNICAL INVESTIGATION 10.1

11.0 CONCLUSIONS 11.1

11.1 WATER SERVICING 11.1

11.2 SANITARY SERVICING 11.1

11.3 STORMWATER SERVICING 11.1

11.4 GRADING 11.1

11.5 UTILITIES 11.1

11.6 APPROVALS/PERMITS 11.2

**SERVICING AND STORMWATER MANAGEMENT BRIEF –
WELLINGS OF STITTSVILLE PHASE 2, 20 CEDAROW COURT**

September 21, 2022

LIST OF TABLES

Table 1: General Subcatchment Parameters5.6
Table 2: Subcatchment Parameters.....5.6
Table 3: Storage Node Parameters5.7
Table 4: Outlet/Orifice Parameters.....5.9
Table 5: Site Peak Discharge Rates.....5.10
Table 6: Schedule of Roof Release Rates5.10
Table 7: Maximum Surface Water Depths5.11
Table 8: Recommended Pavement Structure – At-Grade Parking Areas 10.1
Table 9: Recommended Pavement Structure – Access Lanes and Heavy Truck Parking
Areas 10.2

LIST OF FIGURES

Figure 1 Location Plan..... 1.4
Figure 2: Schematic Representing Model Object Roles.....5.5

**SERVICING AND STORMWATER MANAGEMENT BRIEF –
WELLINGS OF STITTSVILLE PHASE 2, 20 CEDAROW COURT**

September 21, 2022

LIST OF APPENDICES

APPENDIX A	WATER SUPPLY SERVICING	A.1
A.1	Domestic Water Demand Estimate	A.1
A.2	Fire Flow Requirements Per FUS	A.2
A.3	Boundry Conditions	A.3
APPENDIX B	WASTEWATER SERVICING	B.1
B.1	Sanitary Sewer Design	B.1
B.2	Sanitary Excerpts from the KWMSS.....	B.1
APPENDIX C	STORMWATER MANAGEMENT	C.1
C.1	Storm Sewer Design Sheet And Roof Storage Calculations.....	C.1
C.2	SAMPLE PCSWMM Model Input (12HR 100YR SCS).....	C.2
C.3	SAMPLE PCSWMM Model Output (12HR 100yr SCS).....	C.3
C.4	Oil/Grit Separator Sizing Calculations.....	C.4
C.5	Cedarow Court Storm Sewer Capacity	C.5
C.6	Excerpts from WOS Phase 1	C.6
C.7	Water Balance Calculations	C.7
APPENDIX D	GEOTECHNICAL INVESTIGATION	D.1
APPENDIX E	DRAWINGS.....	E.1

SERVICING AND STORMWATER MANAGEMENT BRIEF – WELLINGS OF STITTSVILLE PHASE 2, 20 CEDAROW COURT

Introduction
September 21, 2022

1.0 INTRODUCTION

Stantec Consulting Ltd. has been commissioned by Nautical Land Group to prepare the following servicing study in support of the development at 20 Cedarow Court located within the City of Ottawa. The subject property is located northwest of the intersection of Huntmar Road and Hazeldean Road. The property location is indicated in **Figure 1**. The proposed mixed use residential and commercial development comprises approximately 2.29ha of land and proposes construction of a 344 unit, six storey mixed use building (Phase 2 and 3), and one level of underground parking. The site will be constructed in two phases, beginning with building phase 2 along the eastern property line of the development. The intent of this report is to provide a servicing scenario for the site that is free of conflicts, provides on-site servicing in accordance with City of Ottawa design guidelines, and utilizes the existing local infrastructure in accordance with the guidelines outlined in background documents, and as per consultation with City of Ottawa.

Figure 1 Location Plan



SERVICING AND STORMWATER MANAGEMENT BRIEF – WELLINGS OF STITTSVILLE PHASE 2, 20 CEDAROW COURT

Background
September 21, 2022

2.0 BACKGROUND

Documents referenced in preparing the site design for the 20 Cedarow Court Development include:

- Kanata West Master Servicing Study, Stantec Consulting Ltd., Cumming Cockburn Limited / IBI, October 1, 2014.
- Carp River PCSWMM Model Documentation Draft Report, City of Ottawa, March 2016.
- Geotechnical Investigation, Proposed Mixed Use Development Wellings of Stittsville – Phase 2 20 Cedarow Court, Ottawa, Ontario, Paterson Group, March 7, 2019.
- Geotechnical Plan Review, Proposed Mixed Use Development Wellings of Stittsville – Phase 2 20 Cedarow Court, Ottawa, Ontario, Paterson Group, August 12, 2021.
- Servicing and Stormwater Management Brief-5731 Hazeldean Road, Stantec Consulting Ltd., March 22, 2017
- Tree Conservation Report – 5731 Hazeldean Road, IFS Associates, March 11, 2016.
- City of Ottawa Sewer Design Guidelines, City of Ottawa, October 2012.f
- City of Ottawa Design Guidelines – Water Distribution, City of Ottawa, July 2010.

SERVICING AND STORMWATER MANAGEMENT BRIEF – WELLINGS OF STITTSVILLE PHASE 2, 20 CEDAROW COURT

Water Supply Servicing
September 21, 2022

3.0 WATER SUPPLY SERVICING

3.1 BACKGROUND

The proposed development comprises one phased mixed-use residential apartment building with commercial space fronting Hazeldean Road, and complete with associated infrastructure and underground parking. The site is located west of Huntmar Drive, north of Hazeldean Road, and south of Poole Creek, and lies within the City's 3W pressure zone. The site will be serviced at two connection points via a proposed 200mm diameter tee connection to the existing 250mm main within the northern continuation of the Fringewood Avenue ROW at the eastern quadrant of the site, and a 300mm diameter connection to the existing 300mm diameter watermain within Cedarow Court along the western boundary of the site. Two building service connections for redundancy are proposed to the existing main and water stub at Fringewood Avenue, which in turn connects directly to the existing 762mm feedermain within Hazeldean Road immediately south of the site.

3.2 WATER DEMANDS

Water demands for the development were estimated using the Ministry of Environment's Design Guidelines for Drinking Water Systems (2008) and the Ottawa Design Guidelines – Water Distribution (2010). A daily rate of 28,000 L/gross ha/day has been applied for commercial building space, whereas the residential facility demand was estimated at 280L/person/day with an estimated population of 1.4 persons/unit for bachelor or one bedroom apartments, and 2.1 persons/unit for two bedroom apartments. See **Appendix A.1** for detailed domestic water demand estimates.

The average day demand (AVDY) for the entire site was determined to be 1.7 L/s. The maximum daily demand (MXDY) is 1.5 times the AVDY for commercial property demand and 2.5 times the AVDY for residential demand, which equates to 4.3 L/s. The peak hour demand (PKHR) is 1.8 times the MXDY for commercial property and 2.2 times the MXDY for residential properties, totaling 9.4 L/s.

Non-combustible construction with 2-hour fire rated structural members were considered in the assessment of the fire flow requirements for the site according to the FUS Guidelines. The FUS Guidelines indicate that low hazard occupancies include apartments, dwellings, dormitories, hotels, and schools, and as such, a low hazard occupancy / limited combustible building contents credit was applied. A sprinkler system conforming to NFPA 13 was considered, and a credit applied per FUS Guidelines. Based on calculations per the FUS Guidelines (**Appendix A.2**), the maximum required fire flows for this development is 200 L/s (12,000 L/min). An additional hydrant located in proximity to the building siamese connection is proposed on the subject site. The existing hydrants along the northeastern boundary in addition to the proposed on-site hydrant will provide ample fire flow to support the development.

SERVICING AND STORMWATER MANAGEMENT BRIEF – WELLINGS OF STITTSVILLE PHASE 2, 20 CEDAROW COURT

Water Supply Servicing
September 21, 2022

3.3 PROPOSED SERVICING

Per boundary conditions provided by the City of Ottawa and an approximate elevation on-site of 104.7m, adequate domestic water supply is available for the subject site with pressures ranging from 44.9m (75.4psi) to 56.4m (80.3psi). These values are within the normal operating pressure range as defined by the MECP and City of Ottawa design guidelines (desired 50-80 psi and not less than 40 psi). A pressure check once construction is completed is required to determine if pressure reducing valves are needed.

The boundary conditions for the proposed development under maximum day demands were initially provided under an assumed fire flow demand of 267L/s. As such, it can be confirmed that the system will maintain a residual pressure which is in excess of the required 140 kPa (20 psi) under the required fire flow demand of 200L/s. The above demonstrates that the existing watermain within Fringewood Avenue and Cedarow Court can provide adequate fire and domestic flows in excess of flow requirements for the subject site. An existing hydrant is located approximately 18m northeast of the subject site and at least one proposed hydrant is to be located within 45m of the building fire department connection (siamese) per OBC requirements.

3.4 SUMMARY OF FINDINGS

The proposed development is located in an area of the City's water distribution system that has sufficient capacity to provide both the required domestic and emergency fire flows. Based on the boundary conditions as provided by the City of Ottawa staff, fire flows are available for this development based on FUS guidelines and as per the City of Ottawa water distribution guidelines.

SERVICING AND STORMWATER MANAGEMENT BRIEF – WELLINGS OF STITTSVILLE PHASE 2, 20 CEDAROW COURT

Wastewater Servicing
September 21, 2022

4.0 WASTEWATER SERVICING

4.1 BACKGROUND

The site will be serviced via an existing 675mm dia. sanitary sewer located within the Hazeldean Road ROW south of the site and west of the intersection of Hazeldean Road and Huntmar Drive, which will ultimately outlet to the Kanata West Pump Station (see **Drawing SSP-1**).

4.2 DESIGN CRITERIA

As outlined in the City of Ottawa Sewer Design Guidelines and the MECP's Design Guidelines for Sewage Works, the following criteria were used to calculate estimated wastewater flow rates and to size the sanitary sewers:

- Minimum Velocity – 0.6 m/s (0.8 m/s for upstream sections)
- Maximum Velocity – 3.0 m/s
- Manning roughness coefficient for all smooth wall pipes – 0.013
- Minimum size – 250mm dia. for commercial areas
- Average Wastewater Generation (Commercial) – 28,000L/gross ha/day of building space
- Average Wastewater Generation (Residential) – 280L/cap/day
- Peak Factor (Commercial) – 1.5 (Max Day Demand per MOE Design Guidelines for Drinking Water Systems)
- Peak Factor (Residential) – 4.0 (Harmon's)
- Extraneous Flow Allowance – 0.33 l/s/ha (conservative value)
- Manhole Spacing – 120 m
- Minimum Cover – 2.5m
- Population density for single-bedroom and bachelor apartments – 1.4 pers./apartment
- Population density for two-bedroom apartments – 2.1 pers./apartment

4.3 PROPOSED SERVICING

The proposed site will be serviced by a gravity sewer which will direct the wastewater flows (approx. 7.5 L/s with allowance for infiltration) to the existing 675mm dia. Hazeldean Road sanitary sewer. A backflow preventer will be required for the on-site building in the event of surcharge of the sanitary sewer and will be coordinated with building mechanical engineers. A proposed excavation cross section of the Hazeldean Road connection to the existing 675mm diameter sanitary sewer has been included on **Drawing SSP-1**. Extra precaution should be taken to ensure no damages are made to the existing 762 backbone watermain located 2.9m south of the proposed sanitary connection. Additional construction details will be included by the contractor prior to construction.

SERVICING AND STORMWATER MANAGEMENT BRIEF – WELLINGS OF STITTSVILLE PHASE 2, 20 CEDAROW COURT

Wastewater Servicing
September 21, 2022

The proposed drainage pattern is in accordance with the Kanata West Master Servicing Study (KWMSS) for Hazeldean Road and is detailed on **Drawing SAN-1**. Sanitary flows will ultimately be discharging to the downstream Kanata West Pump Station. A Sanitary sewer design sheet is included in **Appendix B.1**. Excerpts of the overall sanitary system discharging to the Kanata West Pump Station based on the KWMSS are included in **Appendix B.2**. It is noted that peak ultimate sanitary discharge to the KWPS is likely to be far lower than that indicated within the KWMSS design sheet, as current operational parameters estimating peak flow from residential uses have decreased from 350L/person/day to 280L/person/day, and commercial lands contributions have decreased from 50,000L/ha/day to 28,000L/ha/day. As a result, it is assumed that there is ample capacity within the downstream conveyance network and KWPS to receive any additional flows from that originally assumed for the area (50,000L/ha/day x 2.29ha x 1.5 P.F. = approximately 2.0L/s). Additional confirmation of the above has been provided by City of Ottawa staff and included within **Appendix B**.

SERVICING AND STORMWATER MANAGEMENT BRIEF – WELLINGS OF STITTSVILLE PHASE 2, 20 CEDAROW COURT

Stormwater Management
September 21, 2022

5.0 STORMWATER MANAGEMENT

5.1 OBJECTIVES

The objective of this stormwater management plan is to determine the measures necessary to control the quantity of stormwater released from the proposed development to established criteria, and to provide sufficient detail for approval and construction. The proposed development will discharge treated and controlled stormwater runoff to Poole Creek.

5.2 SWM CRITERIA AND CONSTRAINTS

Criteria were established by combining current design practices outlined by the City of Ottawa Design Guidelines (2012), Ministry of Environment Conservation and Parks (MECP) and Mississippi Valley Conservation Authority (MVCA). The following summarizes the criteria, with the source of each criterion indicated in italics:

General

- Use of the dual drainage principle (City of Ottawa)
- Assess impact of 100-year event outlined in the City of Ottawa Sewer Design Guidelines, and climate change scenarios with a 20% increase of rainfall intensity, on major & minor drainage system (City of Ottawa)
- Quality control to be provided for 80% TSS removal (MVCA, MECP)
- Site discharge to be controlled to pre-development rates (City of Ottawa)

Storm Sewer & Inlet Controls

- Size storm sewers to convey the 2-year storm event under free-flow conditions using City of Ottawa I-D-F parameters (City of Ottawa)
- Minimum sewer inlet capture rates to be set such that no ponding occurs at the end of the 2-year event (City of Ottawa)
- Hydraulic Grade Line (HGL) analysis to be conducted using the 100 year 12 hour SCS storm distribution (City of Ottawa)
- 100-year Storm HGL to be a minimum of 0.30 m below building foundation footing otherwise foundation drains will be pumped (City of Ottawa)

SERVICING AND STORMWATER MANAGEMENT BRIEF – WELLINGS OF STITTSVILLE PHASE 2, 20 CEDAROW COURT

Stormwater Management
September 21, 2022

Surface Storage & Overland Flow

- Building openings to be a minimum of 0.30m above the 100-year water level (City of Ottawa)
- Maximum depth of flow under either static or dynamic conditions shall be less than 0.35m (City of Ottawa)
- Subdrains required in swales where longitudinal gradient is less than 1.5% (City of Ottawa)
- Provide adequate emergency overflow conveyance off-site (City of Ottawa)

5.2.1 Pre-Development Conditions

A background report for 20 Cedarow Court Commercial Development was completed on April 6, 2009 by Novatech Engineering for the proposed property. Currently, a large portion of the site is pervious, and sheet drains northwest towards Poole Creek. Based on topography, existing drainage is directed through the site from properties on Cedarow Court adjacent to the subject lands. The additional runoff will be returned to the Cedarow Court storm sewer and was not included in the overall area contributing to the pre-development rate. The sewers on Cedarow Court were analyzed based on 2K mapping data corroborated by field investigation, and the additional flows were determined not to impact the downstream 525mm diameter storm sewer. The design sheet and area map for the Cedarow Court sewer can be found in **Appendix C.5**.

The site discharge will be conveyed to the approved outlet located at the northwestern boundary of the subject site. The outlet was constructed as part of Wellings of Stittsville Inc. and Extendicare Inc. Phase 1 and was sized to convey flows from both sites. Excerpts from the Wellings of Stittsville Phase 1 servicing and stormwater management brief can be found in **Appendix C.6**.

A lumped catchment PCSWMM model was created for the subject site based on a site area of 2.3ha, and utilizing an existing SCS curve number of 82 per background documents (Carp River Full Restoration PCSWMM Model). Additional subcatchment parameters were defined based upon recent topographical survey of the property:

Area (ha)	Width (m)	Slope (%)	Imperv. (%)	Subarea Routing
2.29	143	1.0	0.0	Outlet

Based on the above, 2 through 100-year 12hr SCS event (MTO Distribution curves) peak pre-development outflow rates from the subject site were identified per the tables below:

SERVICING AND STORMWATER MANAGEMENT BRIEF – WELLINGS OF STITTSVILLE PHASE 2, 20 CEDAROW COURT

Stormwater Management
September 21, 2022

Storm Event	Peak Outflow Rate (L/s)
2-Year	17.9
5-Year	43.4
10-Year	69.8
25-Year	111.6
50-Year	142.4
100-Year	182.1

PCSWMM model input and output files for the predevelopment scenario are included within **Appendix C**.

5.3 STORMWATER MANAGEMENT DESIGN

5.3.1 Design Methodology

The intent of the stormwater management plan presented herein is to mitigate negative impacts that the proposed development might have on the receiving watercourse (Poole Creek), while providing adequate capacity to service the proposed buildings, underground parking and access areas. The proposed stormwater management plan is designed to detain runoff on available flat rooftops, surface storage within parking regions, and in a subsurface storage unit to ensure that peak flows after construction will not exceed the target discharge rates.

Runoff from the site is captured via catchbasins and roof drains and conveyed to a hydrodynamic separator for water quality treatment before entering an underground storage unit for quantity control. The storage unit is restricted by ICDs and a flow control weir at the downstream end while the roof runoff is controlled via roof drains discharging through the internal building plumbing. A StormTech system is proposed to provide subsurface storage in addition to meeting water balance requirements. The StormTech unit is required to store up to 485m³ of runoff above the clear stone bedding layer which is situated below the lowest connected ICD invert. The underground storage unit is sized assuming that roof areas are available to capture and store water up to 150mm in depth during the 100-year storm event.

In case of subsurface storage tank failure, overflows are managed via installed weir wall within STM 101 to address orifice blockage. Each cell of the StormTech unit is interconnected to prevent blockage of a cell from impacting the overall unit, and each cell is open to infiltration to soils below.

The proposed hydrodynamic separator maintains an internal overflow weir for large storm events for protection of building internal plumbing, and will not impede inflow to the downstream storage unit.

SERVICING AND STORMWATER MANAGEMENT BRIEF – WELLINGS OF STITTSVILLE PHASE 2, 20 CEDAROW COURT

Stormwater Management
September 21, 2022

The site discharge will be conveyed to the previously approved outlet location at the western boundary of the site which ultimately directs flow into Poole Creek. The existing outlet is designed to convey flows from the proposed site as well as the existing adjacent site to the northeast, Wellings of Stittsville Inc. and Extencicare Inc Phase 1.

The site will be constructed in two phases, including build out of the underground parking structure. As the first phase is built, the entirety of the StormTech unit will be constructed.

5.3.2 Modeling Rationale

A comprehensive hydrologic modeling exercise was completed with PCSWMM, accounting for the estimated major and minor systems to evaluate the storm sewer infrastructure. The use of PCSWMM for modeling of the site hydrology and hydraulics allowed for an analysis of the systems response during various storm events. Surface storage estimates were based on the final grading plan design (see **Drawing GP-1**). The following assumptions were applied to the detailed model:

- Hydrologic parameters as per Ottawa Sewer Design Guidelines, including Horton infiltration, Manning's 'n', and depression storage values
- 12-hour SCS Storm distribution for the 100-year analysis to model 'worst-case' scenario in regards to on-site storage volume.
- 12hr SCS distributions (2 and 100-year events) with free flowing boundary condition to model 'worst-case' scenario in regards to site discharge rates to meet target rate. It is of note that the 100-Year floodplain elevation of the Creek at the site discharge point will not affect upstream HGLs or storage volumes provided.
- To 'stress test' the system a 'climate change' scenario was created by adding 20% of the individual intensity values of the 100-year SCS storm event at their specified time step.
- Percent imperviousness calculated based on actual soft and hard surfaces on each subcatchment, converted to equivalent Runoff Coefficient using the relationship $C = (\text{Imp.} \times 0.7) + 0.2$
- Subcatchment areas are defined from high-point to high-point where sags occur. Subcatchment width (average length of overland sheet flow) determined by dividing subcatchment area by subcatchment length (length of overland flow path measured from high-point to high-point).
- Number of catchbasins based on servicing plan (**Drawing SP-1**)

5.3.2.1 SWMM Dual Drainage Methodology

The proposed site is modeled in one modeling program as a dual conduit system (see **Figure 2**), with: 1) circular conduits representing the sewers & junction nodes representing manholes; 2) irregular conduits using street-shaped cross-sections to represent the sawtoothed overland road network from high-point to low-point and storage nodes representing catchbasins. The dual drainage systems are connected via outlet link objects (or orifices) from storage node (i.e. CB) to

SERVICING AND STORMWATER MANAGEMENT BRIEF – WELLINGS OF STITTSVILLE PHASE 2, 20 CEDAROW COURT

Stormwater Management
September 21, 2022

junction (i.e. MH), and represent inlet control devices (ICDs). Subcatchments are linked to the storage node on the surface so that generated hydrographs are directed there firstly.

Figure 2: Schematic Representing Model Object Roles

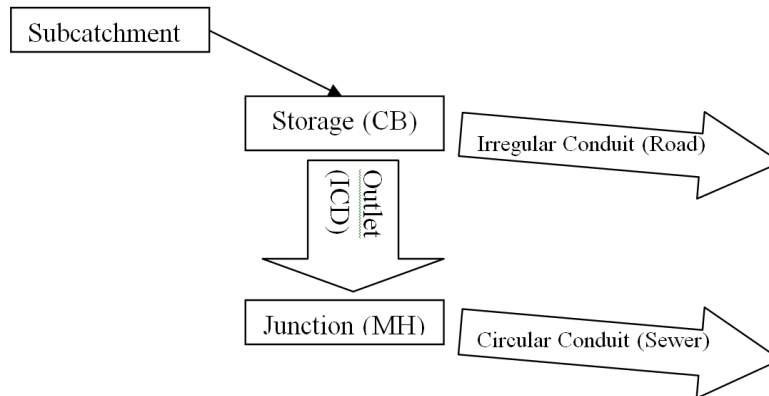

Storage nodes are used in the model to represent catchbasins as well as major system junctions. For storage nodes representing catchbasins (CBs), the invert of the storage node represents the invert of the CB and the rim of the storage node is the top of the CB plus the maximum above ground storage depth (all catch basins on top of the underground structure will not have any surface storage). An additional 0.3m has been added to rim elevations to allow routing from one surface storage to the next and is unused where no spillage occurs between ponding areas.

Inlet control devices, as represented by orifice links, use a user-specified discharge coefficient to approximate manufacturer's specifications for the chosen ICD model. Discharge rates from the rooftops are based on the quantity of roof drains provided in the site plan per roof level. The roof drains are modelled using outlets with rating curves which specifies the outflows per roof level.

Subcatchment imperviousness was calculated via impervious area measured from **Drawing SSP-1**.

5.3.2.2 Boundary Conditions

The detailed PCSWMM hydrology and the proposed storm sewers were used to assess the peak inflows and hydraulic grade line (HGL) for the site. The elevation of the outlet sewer downstream of STM 100 immediately upstream of Poole Creek has been set conservatively to be above the 100-Year water elevation of the Creek per MVCA Flood Risk Mapping at an invert elevation of 99.83m to enable free-flowing model condition for the site outlet. The elevation of the water level within Cedarow Court was conservatively set to an obvert of the receiving sewer at 102.17m.

SERVICING AND STORMWATER MANAGEMENT BRIEF – WELLINGS OF STITTSVILLE PHASE 2, 20 CEDAROW COURT

Stormwater Management
September 21, 2022

5.3.3 Input Parameters

Drawing SD-1 summarizes the discretized subcatchments used in the analysis of the proposed site, and outlines the major overland flow paths. The grading plans are also enclosed for review.

Appendices C2 and C3 summarize the modeling input parameters and results for the subject area; an example input and output file are provided for the 100-year 12hr SCS storm. For all other input files and results of storm scenarios, please examine the electronic model files located on the CD provided with this report. This analysis was performed using PCSWMM, which is a front-end GUI to the EPA-SWMM engine. Model files can be examined in any program which can read EPA-SWMM files version 5.1.014.

5.3.3.1 Hydrologic Parameters

Table 1 presents the general subcatchment parameters used:

Table 1: General Subcatchment Parameters

Parameter	Value
Infiltration Method	Horton
Max. Infil. Rate (mm/hr)	76.2
Min. Infil. Rate (mm/hr)	13.2
Decay Constant (1/hr)	4.14
N Impervious	0.013
N Pervious	0.25
Dstore Imperv. (mm)	1.57
Dstore perv. (mm)	4.67
Zero Imperv. (%)	0

Table 2 presents the individual parameters that vary for each of the proposed subcatchments.

Table 2: Subcatchment Parameters

Name	Outlet	Area (ha)	Width (m)	Slope (%)	Imperv. (%)
EXT-1	105	0.069	95	1.5	38.57
L102A	CB102A-1	0.061	19	2.5	82.86
L103A	CB103A-1	0.156	28	2.5	75.71
L103B	CB103B-1	0.059	29	2.5	80.00
L103C	CB103C-1	0.072	30	2.5	71.43

**SERVICING AND STORMWATER MANAGEMENT BRIEF –
WELLINGS OF STITTSVILLE PHASE 2, 20 CEDAROW COURT**

Stormwater Management
September 21, 2022

L103D	CB103D-1	0.239	32	2.5	65.71
L103E	CB103E-1	0.237	21	2.5	72.86
L104A	104	0.068	39	2.5	82.86
L104B	104	0.059	25	2.5	80.00
L106A	CB106A-1	0.142	27	2.5	72.86
RAMP	BLDG	0.022	8	15.0	100.00
ROOF2	ROOF2-S	0.220	50	1.5	100.00
ROOF1	ROOF1-S	0.020	5	1.5	100.00
ROOF3	ROOF3-S	0.185	42	1.5	100.00
ROOF4	ROOF4-S	0.020	5	1.5	100.00
UNC-1	OF1	0.084	95	25.0	41.43
UNC-2	POOLE	0.526	25	1.0	8.57
UNC-3	OF3	0.069	126	3.0	61.43
UNC-4	105	0.052	90	10.0	37.14

Table 3 summarizes the storage node parameters used in the model. Storage curves for each node have been created based on available volumes within each roof top or subsurface storage as applicable. Rim elevations for each node correspond to the rim elevation of the associated area's roof top drain or catch basin plus maximum depth of storage. No quantity storage has been assumed for model conservatism for the subsurface storage clear stone bedding below pipe inverts being utilized as a water balance BMP described in **Section 5.3.6**.

Required storage volumes and release rates for the underground storage unit were obtained through PCSWMM hydrologic/hydraulic modeling:

Table 3: Storage Node Parameters

Name	Invert El. (m)	Rim Elev. (m)	Depth (m)	Curve Name	Storage Curve
100	99.60	103.56	3.96	*	FUNCTIONAL
101	101.09	104.14	3.04	*	FUNCTIONAL
102	101.60	104.33	2.73	*	FUNCTIONAL
103	101.91	104.07	2.16	*	FUNCTIONAL
104	102.61	104.10	1.49	CB104A-V	TABULAR
105	102.68	104.51	1.83	*	FUNCTIONAL
ADS	101.37	103.90	2.53	TANK-V	TABULAR
BLDG	102.78	104.69	1.91	*	FUNCTIONAL
CB102A-1	102.70	104.19	1.49	CB102A-V	TABULAR

**SERVICING AND STORMWATER MANAGEMENT BRIEF –
WELLINGS OF STITTSVILLE PHASE 2, 20 CEDAROW COURT**

Stormwater Management
September 21, 2022

CB103A-1	103.07	104.60	1.53	CB103A-V	TABULAR
CB103B-1	102.42	104.10	1.68	CB103B-V	TABULAR
CB103C-1	102.70	104.30	1.60	CB103C-V	TABULAR
CB103D-1	102.62	104.28	1.66	CB103D-V	TABULAR
CB103E-1	102.43	104.11	1.68	CB103E-V	TABULAR
CB106A-1	101.97	103.65	1.68	CB106A-V	TABULAR
EX	99.61	101.69	2.08	*	FUNCTIONAL
ROOF1-S	110.00	110.15	0.15	ROOF1-V	TABULAR
ROOF2-S	110.00	110.15	0.15	ROOF2-V	TABULAR
ROOF3-S	110.00	110.15	0.15	ROOF3-V	TABULAR
ROOF4-S	110.00	110.15	0.15	ROOF4-V	TABULAR

5.3.3.2 Hydraulic Parameters

As per the Ottawa Sewer Design Guidelines (OSDG 2012), Manning's roughness values of 0.013 were used for sewer modeling.

Storm sewers were modeled to confirm flow capacities and hydraulic grade lines (HGLs) in the proposed condition. The detailed storm sewer design sheet is included in **Appendix C**.

PCSWMM output hydrographs from Phase 1 for each storm event were applied at the downstream connecting manhole (EX) in the current PCSWMM model to accurately represent to total outflow from both properties at the headwall.

Table 4 below presents the parameters for the orifice and outlet link objects in the model, which represent ICDs and restricted roof release drains respectively. The 200mm circular orifice was assigned a discharge coefficient of 0.61, whereas ICDs representing IPEX Tempest HF controls were assigned a discharge coefficient of 0.572 to match manufacturer discharge curves. The subsurface storage unit is designed with an 83mm Tempest ICD to restrict flows during lesser storm event, as well as a higher elevation 200mm circular orifice and an overflow weir to allow additional flows to be directed towards the outlet during larger storm events. The weir is placed in manhole structure 100 and designed with a width of 1.2m (see **Table 4** for invert elevation).

The roof release discharge curves assume the use of standard Watts Model R1100 Accutrol controlled release roof drains as noted in the calculation sheets in **Appendix C**. The number of roof notches for each roof level was confirmed with the building mechanical engineer. Details for the IPEX ICDs and Watts drains are included as part of **Appendix C**.

**SERVICING AND STORMWATER MANAGEMENT BRIEF –
WELLINGS OF STITTSVILLE PHASE 2, 20 CEDAROW COURT**

Stormwater Management
September 21, 2022

Table 4: Outlet/Orifice Parameters

Name	Inlet	Outlet	Inlet Elev.	Type	Diameter (m)
100-O1	ADS	100	101.37	CIRCULAR	0.083
100-O2	ADS	100	102.30	CIRCULAR	0.200
100-W1	ADS	100	103.00	WEIR	1.2 (Width)
CB102A-O	CB102A-1	102	102.70	CIRCULAR	0.095
CB103A-O	CB103A-1	103	103.07	CIRCULAR	0.152
CB103B-O	CB103B-1	103	102.42	CIRCULAR	0.083
CB103C-O	CB103C-1	103	102.70	CIRCULAR	0.083
CB103D-O	CB103D-1	103	102.62	CIRCULAR	0.152
CB103E-O	CB103E-1	103	102.43	CIRCULAR	0.127
CB106A-O	CB106A-1	ADS	101.97	CIRCULAR	0.083
CBMH104A-O	104	103	102.61	CIRCULAR	0.083
ROOF1-O	ROOF1-S	BLDG	110.00	ROOF CONTROL	*
ROOF2-O	ROOF2-S	BLDG	110.00	ROOF CONTROL	*
ROOF3-O	ROOF3-S	BLDG	110.00	ROOF CONTROL	*
ROOF4-O	ROOF4-S	BLDG	110.00	ROOF CONTROL	*

5.3.4 Model Results

The following section summarizes the key hydrologic and hydraulic model results. For detailed model results or inputs, please refer to the example input file in **Appendix C.2 and C.3** and the electronic model files provided.

5.3.4.1 Hydrologic Results

The following tables demonstrate the peak outflow from each modeled outfall during the design storm (12hr SCS 2-100yr) events. A free-flowing outfall condition has been modeled for these events to be conservative with respect to site peak release rates. Outfalls OF1 to OF4 denote uncontrolled flows from the perimeter of the site that, due to grading restrictions, are captured by the existing ROW on Fringewood Avenue at the eastern boundary, Poole Creek at the north boundaries of the site, Hazeldean Road to the south and Cedarow Court Row to the west. The adjacent site on the eastern boundary (2500 Wellings Private) has sufficient capacity to capture minor uncontrolled flows from subcatchment UNC1. Flows from area UNC3-OF will have a minimal contribution to the infrastructure within Hazeldean Road. Based on existing external and proposed grading, subcatchments EXT-1 and UNC-4 are proposed to drain to a swale and runoff

**SERVICING AND STORMWATER MANAGEMENT BRIEF –
WELLINGS OF STITTSVILLE PHASE 2, 20 CEDAROW COURT**

Stormwater Management
September 21, 2022

is to be captured in the subdrain. Connection to the existing 300mm diameter storm sewer on Cedarow Court is proposed to direct the flows captured from the subdrain. The storm sewer along Cedarow Court ultimately discharges to Poole Creek upstream of the proposed site.

Results of the PCSWMM model run have been provided in **Appendix C**. Peaks from the uncontrolled flows with the exception of UNC-2 are non-coincident with peaks from the subsurface storage unit/weir, and as such, flows from the conduit downstream of the subsurface storage unit (conduit C2) and UNC-2 have been considered in meeting the site pre-development release rate target. The required subsurface storage unit volume was determined through iteration of each event and sized to mirror the site release rate target.

Table 5: Site Peak Discharge Rates

Event	Location	Discharge Rate (L/s)	Target (L/s)
2-Year 12 Hour SCS	Outlet Headwall	12.8	17.9
5-Year 12 Hour SCS	Outlet Headwall	37.4	43.4
10-Year 12 Hour SCS	Outlet Headwall	61.4	69.8
25-Year 12 Hour SCS	Outlet Headwall	87.8	111.6
50-Year 12 Hour SCS	Outlet Headwall	119.7	142.4
100-Year 12 Hour SCS	Outlet Headwall	181.6	182.1
100-Year 12 Hour SCS +20%	Outlet Headwall	248.7	-

*Post-development flows are a sum of the hydrographs from conduit C2 and outfall OF2

Table 6: Schedule of Roof Release Rates

Roof Area ID	Storage Depth (mm)	Discharge (L/s)	Required Volume (m3)	Available Volume (m3)
1	130	2.3	5.3	8.0
2	146	9.9	69.0	74.0
3	147	11.2	83.8	88.0
4	130	2.3	5.3	8.0

5.3.4.2 Hydraulic Results

The City of Ottawa requires that during major storm events, the maximum hydraulic grade line be kept at least 0.30 m below the underside-of-footing (USF) of any adjacent units connected to the storm sewer during design storm events. The USFs elevations have been considered at 0.5m below the lowest top of basement slab elevation of the proposed buildings. As the proposed

SERVICING AND STORMWATER MANAGEMENT BRIEF – WELLINGS OF STITTSVILLE PHASE 2, 20 CEDAROW COURT

Stormwater Management
September 21, 2022

building perimeter foundation drain will be disconnected from the storm sewer and pumped to the surface, the proposed building footings will not be hydraulically connected to the underground storage tank. The ramp drain is to be pumped to the storage unit. The maximum hydraulic grade line (HGL) of the underground storage unit reaches 103.10m and 103.16m during the 100 year and 100year +20% event. The HGL elevations in both scenarios remain below the proposed surface elevations as the lowest elevation of the connected catch basins within the aboveground parking structure are at 103.35m.

Table 7 presents the maximum total surface water depths (static ponding depth + dynamic flow) above the top-of-grate of catch basins for the 100-year design storm and climate change storm. Based on the model results, no surface ponding is anticipated within the swale/subdrain within area UNC-4.

Table 7: Maximum Surface Water Depths

Storage node ID	Structure ID	T/G Elevation (m)	100 year, 12hr SCS		100 year, 12hr SCS +20%	
			Max HGL (m)	Total Surface Water Depth (m)	Max HGL (m)	Total Surface Water Depth (m)
CB102A-1	CB 102A-1	104.08	104.10	0.02	104.18	0.10
CB103A-1	CB 103A-1	104.45	104.46	0.01	104.60	0.15
CB103B-1	CB 103B-1	103.80	103.88	0.08	103.92	0.12
CB103C-1	CB 103C-1	104.08	104.18	0.10	104.22	0.14
CB103D-1	CB 104D-1	104.00	104.17	0.17	104.26	0.26
CB103E-1	CB 103E-1	103.81	104.01	0.20	104.07	0.26
CB106A-1	CB 106A-1	103.35	103.53	0.18	103.57	0.22
104	CBMH 104A-1	103.80	104.01	0.21	104.06	0.26
105	CBMH 105	104.51	102.86	0.00	102.90	0.00

5.3.5 Water Quality Control

On-site water quality control is required to provide 80% TSS removal prior to discharging to Poole Creek. A Stormceptor unit STC300 is proposed upstream of the underground storage unit. Runoff from roof top areas are considered clean for calculation of the total treatment requirement of the contributing catchment area to the stormceptor. Design calculations for the Stormceptor indicate that the selected model will provide greater than 80% TSS removal on an annual basis. The Stormceptor unit will be privately maintained. The location and general arrangement of the Stormceptor unit is indicated on **Drawing SD-1**. Detailed sizing calculations for the Stormceptor unit are included in **Appendix C.4**.

SERVICING AND STORMWATER MANAGEMENT BRIEF – WELLINGS OF STITTSVILLE PHASE 2, 20 CEDAROW COURT

Stormwater Management
September 21, 2022

5.3.6 Water Balance

The KWMSS and Carp River Watershed Study report identify that the site is located within a low groundwater recharge area. The Watershed Study in particular recommends a minimum of 73mm per year of infiltration (or 1171m³/yr for the 2.29ha site) for water balance purposes and to support Poole Creek baseflow. As such, it is proposed that runoff from the development be directed to an infiltration BMP composed of clear stone be located directly underneath the proposed StormTech subsurface storage unit to provide baseflow to the creek during the inter-event period. The BMP is to tie in behind the orifice control for the subsurface storage to allow overflow via ICDs within the outlet manhole for larger storm events to be controlled prior to release to the creek. Inverts of the BMP have been set to avoid high groundwater elevations and provide a minimum offset of 1.0m from anticipated bedrock elevations. Sizing of the BMP has been provided within **Appendix C.8**, and demonstrates that sufficient storage exists below the perforated pipe drain to sequester 4mm of runoff from onsite impervious areas, and provide up to 3104m³ of annual infiltration.

SERVICING AND STORMWATER MANAGEMENT BRIEF – WELLINGS OF STITTSVILLE PHASE 2, 20 CEDAROW COURT

Grading and Drainage
September 21, 2022

6.0 GRADING AND DRAINAGE

The proposed development site measures approximately 2.29 ha in area. The topography across the site decreases from south to north, with a change in elevation of approximately 1.5 m to the top of bank of the existing Poole Creek. A detailed grading plan (see **Drawing GP-1**) has been provided to satisfy the stormwater management requirements, adhere to permissible grade raise restrictions (see **Section 10.0**) for the site, and provide for minimum cover requirements for storm and sanitary sewers where possible. Site grading has been established to provide emergency overland flow routes required for stormwater management in accordance with City of Ottawa requirements.

The subject site in its majority maintains emergency overland flow routes for flows deriving from storm events in excess of the maximum design event to Poole Creek as depicted in **Drawings GP-1, SD-1**.

SERVICING AND STORMWATER MANAGEMENT BRIEF – WELLINGS OF STITTSVILLE PHASE 2, 20 CEDAROW COURT

Utilities
September 21, 2022

7.0 UTILITIES

Utility infrastructure exists within the Hazeldean Road ROW at the south property boundary of the proposed site. Overhead utility poles are located along the south side of Hazeldean Road. It is anticipated that existing infrastructure will be sufficient to provide a means of distribution for the proposed site. Exact size, location and routing of utilities will be finalized after design circulation.

8.0 APPROVALS

As the site will be discharging to an existing storm sewer outlet, will remain under singular ownership, and will not drain industrial lands or industrial land uses, exemption from the Ontario Ministry of Environment, Conservation and Parks (MECP) Environmental Compliance Approval (ECA) process is expected for works within the subject site.

The outlet headwall has been previously approved under the neighboring property. The ECA application number is NUMBER 7185-ARZMHZ.

The Mississippi Valley Conservation Authority (MVCA) will need to be consulted in order to obtain municipal approval for site development, and permits acquired for any proposed fill within the Poole Creek regulatory limit.

Requirement for a MECP Permit to Take Water (PTTW) for sewer construction is unlikely for the site as the proposed works are above the groundwater elevations shown in the geotechnical report. Building excavation areas, however, will likely be within the groundwater table and may require a PTTW. The geotechnical consultant shall confirm at the time of application that a PTTW is not required.

SERVICING AND STORMWATER MANAGEMENT BRIEF – WELLINGS OF STITTSVILLE PHASE 2, 20 CEDAROW COURT

Erosion Control During Construction
September 21, 2022

9.0 EROSION CONTROL DURING CONSTRUCTION

Erosion and sediment controls must be in place during construction. The following recommendations to the contractor will be included in contract documents.

1. Implement best management practices to provide appropriate protection of the existing and proposed drainage system and the receiving water course(s).
2. Limit extent of exposed soils at any given time.
3. Re-vegetate exposed areas as soon as possible.
4. Minimize the area to be cleared and grubbed.
5. Protect exposed slopes with plastic or synthetic mulches.
6. Provide sediment traps and basins during dewatering.
7. Install sediment traps (such as SiltSack® by Terrafix) between catch basins and frames.
8. Plan construction at proper time to avoid flooding.
9. Installation of a mud matt to prevent mud and debris from being transported off site.
10. Installation of a silt fence to prevent sediment runoff.

The contractor will, at every rainfall, complete inspections and guarantee proper performance. The inspection is to include:

11. Verification that water is not flowing under silt barriers.
12. Clean and change silt traps at catch basins.

Refer to **Drawing EC/DS-1** for the proposed location of silt fences, straw bales, and other erosion control structures.

SERVICING AND STORMWATER MANAGEMENT BRIEF – WELLINGS OF STITTSVILLE PHASE 2, 20 CEDAROW COURT

Geotechnical Investigation
September 21, 2022

10.0 GEOTECHNICAL INVESTIGATION

A geotechnical investigation was completed by Paterson Group Ltd. in March of 2019. The report summarizes the existing soil conditions within the subject area and construction recommendations. For details which are not summarized below, please see the original Paterson report.

Subsurface soil conditions within the subject area were determined from 29 boreholes distributed across the proposed site. In general soil stratigraphy consisted of topsoil underlain by a hard to very stiff silty clay, followed by very stiff to stiff silty clay layer over a glacial till layer.

Groundwater Levels were measured on January 29, 2019 and vary in elevation from 1.7 to 3.2m below the original ground surface. It is expected that construction occur below the existing groundwater table and therefore a permit to take water may be required as well as requirements for damp proofing or foundation waterproofing may be required.

A permissible grade raise restriction of 2.0 m has been recommended within the Paterson Group report. The grade raise restrictions were accounted for in the grading design of the property.

The required pavement structure for the at-grade parking areas and access lanes are outlined in **Table 8** and **Table 9** below:

Table 8: Recommended Pavement Structure – At-Grade Parking Areas

Thickness (mm)	Material Description
50	Wear Course – HL-3 or Superpave 12.5 Asphaltic Concrete
150	Base – OPSS Granular A Crushed Stone
300	Subbase - OPSS Granular B Type II
-	Subgrade – In situ soil, or OPSS Granular B Type I or II material placed over in situ soil

**SERVICING AND STORMWATER MANAGEMENT BRIEF –
WELLINGS OF STITTSVILLE PHASE 2, 20 CEDAROW COURT**

Geotechnical Investigation
September 21, 2022

Table 9: Recommended Pavement Structure – Access Lanes and Heavy Truck Parking Areas

Thickness (mm)	Material Description
40	Wear Course – HL-3 or Superpave 12.5 Asphaltic Concrete
50	Binder Course – HL-8 or Superpave 19.0 Asphaltic Concrete
150	Base – OPSS Granular A Crushed Stone
450	Subbase - OPSS Granular B Type II
-	Subgrade – In situ soil, or OPSS Granular B Type I or II material placed over in situ soil.

SERVICING AND STORMWATER MANAGEMENT BRIEF – WELLINGS OF STITTSVILLE PHASE 2, 20 CEDAROW COURT

Conclusions
September 21, 2022

11.0 CONCLUSIONS

11.1 WATER SERVICING

Based on the supplied boundary conditions for existing watermains and estimated domestic and fire flow demands for the subject site, it is anticipated that the proposed servicing in this development will provide sufficient capacity to sustain both the required domestic demands and emergency fire flow demands of the proposed site. Fire flows greater than those required per the FUS Guidelines are available for this development.

11.2 SANITARY SERVICING

The proposed sanitary sewer network is sufficiently sized to provide gravity drainage of the site. The proposed site will be serviced by a gravity sewer which will direct the proposed wastewater flows to the existing 675mm dia. Hazeldean Road sanitary sewer. The proposed drainage pattern is in accordance with the Kanata West Master Servicing Report for the Hazeldean Road sewer.

11.3 STORMWATER SERVICING

The proposed stormwater management plan is in compliance with the criteria established for the site. Rooftop and subsurface storage have been designed to limit outflows from the subject site to calculated predevelopment levels. Poole Creek is located downstream of the site and has sufficient capacity to receive runoff volumes from the site based on anticipated peak flows and detention times for the subsurface storage unit servicing the development.

11.4 GRADING

Grading for the site has been designed to provide an emergency overland flow route as per City requirements and reflects the grade raise restrictions recommended in the Supplemental Geotechnical Investigation prepared by Paterson Group (March, 2019). Erosion and sediment control measures will be implemented during construction to reduce the impact on existing facilities.

11.5 UTILITIES

Utility infrastructure exists within the Hazeldean Road ROW at the south property boundary of the proposed site. Overhead poles are located along the south side of Hazeldean Road. It is anticipated that existing infrastructure will be sufficient to provide a means of distribution for the proposed site. Exact size, location and routing of utilities will be finalized after design circulation.

SERVICING AND STORMWATER MANAGEMENT BRIEF – WELLINGS OF STITTSVILLE PHASE 2, 20 CEDAROW COURT

Conclusions
September 21, 2022

11.6 APPROVALS/PERMITS

MECP Environmental Compliance Approval is not expected to be required for the proposed site works. A Permit to Take Water is not anticipated to be required for pumping requirements for sewer installation, however, will likely be a requirement for building excavation. The Mississippi Valley Conservation Authority will need to be consulted in order to obtain municipal approval for site development. No other approval requirements from other regulatory agencies are anticipated.

**SERVICING AND STORMWATER MANAGEMENT BRIEF –
WELLINGS OF STITTSVILLE PHASE 2, 20 CEDAROW COURT**

Appendix A Water Supply Servicing
September 21, 2022

Appendix A **WATER SUPPLY SERVICING**

A.1 **DOMESTIC WATER DEMAND ESTIMATE**

Wellings of Stittsville Phase 2 - 20 Cedarow Court - Domestic Water Demand Estimates

- Based on Wellings of Stittsville Site Phase 2 (160401511)

Building ID	Area (m ²)	Population	Daily Rate of Demand ¹	Avg Day Demand		Max Day Demand ^{2,3}		Peak Hour Demand ^{2,3}	
				(L/min)	(L/s)	(L/min)	(L/s)	(L/min)	(L/s)
Phase 2 and Phase 3									
Residential	-	522	280	101.5	1.69	253.8	4.23	558.5	9.31
Commercial and Communal Amenity Areas	950	-	28,000	1.8	0.03	2.8	0.05	5.0	0.08
Total Site :				103.4	1.72	256.6	4.28	563.5	9.39

1. 28,000 L/gross ha/day is used to calculate water demand for retail, restaurants and office space.
2. The City of Ottawa water demand criteria used to estimate peak demand rates for commercial space are as follows:
 maximum day demand rate = 1.5 x average day demand rate
 maximum hour demand rate = 1.8 x maximum day demand rate
3. The City of Ottawa water demand criteria used to estimate peak demand rates for residential areas are as follows:
 maximum day demand rate = 2.5 x average day demand rate
 maximum hour demand rate = 2.2 x maximum day demand rate

**SERVICING AND STORMWATER MANAGEMENT BRIEF –
WELLINGS OF STITTSVILLE PHASE 2, 20 CEDAROW COURT**

Appendix A Water Supply Servicing
September 21, 2022

A.2 FIRE FLOW REQUIREMENTS PER FUS



FUS Fire Flow Calculation Sheet - 2020 FUS Guidelines

Stantec Project #: 160401511
 Project Name: 20 Cedarow (Phases 2-3)
 Date: 9/26/2022
 Fire Flow Calculation #: 1
 Description: 6-Storey Mixed Use

Notes: Assumed no internal fire walls at Phase line

Step	Task	Notes	Value Used	Req'd Fire Flow (L/min)						
1	Determine Type of Construction	Type II - Noncombustible Construction / Type IV-A - Mass Timber Construction	0.8	-						
2	Determine Effective Floor Area	Sum of Two Largest Floors + 50% of Six Additional Floors	Vertical Openings Protected?	NO	-					
		6096 4081 4250 4188 4077 3987			18428	-				
3	Determine Required Fire Flow	(F = 220 x C x A ^{1/2}). Round to nearest 1000 L/min	-	24000						
4	Determine Occupancy Charge	Limited Combustible	-15%	20400						
5	Determine Sprinkler Reduction	Conforms to NFPA 13	-30%	-10200						
		Standard Water Supply	-10%							
		Fully Supervised	-10%							
		% Coverage of Sprinkler System	100%							
6	Determine Increase for Exposures (Max. 75%)	Direction	Exposure Distance (m)	Exposed Length (m)	Exposed Height (Stories)	Length-Height Factor (m x stories)	Construction of Adjacent Wall	Firewall / Sprinklered ?	-	-
		North	> 30	0	0	0-20	Type V	NO	0%	2040
		East	> 30	0	0	0-20	Type I-II - Unprotected Openings	YES	0%	
		South	> 30	0	0	0-20	Type V	NO	0%	
		West	10.1 to 20	12	1	0-20	Type V	NO	10%	
7	Determine Final Required Fire Flow	Total Required Fire Flow in L/min, Rounded to Nearest 1000L/min							12000	
		Total Required Fire Flow in L/s							200.0	
		Required Duration of Fire Flow (hrs)							2.50	
		Required Volume of Fire Flow (m ³)							1800	

**SERVICING AND STORMWATER MANAGEMENT BRIEF –
WELLINGS OF STITTSVILLE PHASE 2, 20 CEDAROW COURT**

Appendix A Water Supply Servicing
September 21, 2022

A.3 BOUNDARY CONDITIONS

Boundary Conditions - 20 Cedarow Court

Date Provided

October-19

Scenario	Demand	
	L/min	L/s
Average Daily Demand	156	2.60
Maximum Daily Demand	388	6.46
Peak Hour	850	14.17
Fire Flow Demand #1	16,020	267

of connections

2

Location:



Results:

Connection 1 - Cedarow Crescent

Demand Scenario	Head (m)	Pressure ¹ (psi)
Maximum HGL	161.1	80.3
Peak Hour	157.7	75.5
Max Day plus Fire 1	150.2	64.8

¹ Ground Elevation = 104.6m

Connection 2 - Wellings Pvt

Demand Scenario	Head (m)	Pressure ¹ (psi)
Maximum HGL	161.1	80.3
Peak Hour	157.7	75.4
Max Day plus Fire 1	149.6	63.9

¹ Ground Elevation = 104.7m

Notes:

1. Pressure reducing valve is required since the maximum pressure exceeds 80 psi.
2. Looping of the watermain is required to decrease vulnerability of the water system in case of breaks.
3. Confirm the ownership of the watermain on Wellings Private.

Disclaimer

The boundary condition information is based on current operation of the city water distribution system. The computer model simulation is based on the best information available at the time. The operation of the water distribution system can change on a regular basis, resulting in a variation in boundary conditions. The physical properties of watermains deteriorate over time, as such must be assumed in the absence of actual field test data. The variation in physical watermain properties can therefore alter the results of the computer model simulation. Fire Flow analysis is a reflection of available flow in the watermain; there may be additional restrictions that occur between the watermain and the hydrant that the model cannot take into account.

**SERVICING AND STORMWATER MANAGEMENT BRIEF –
WELLINGS OF STITTSVILLE PHASE 2, 20 CEDAROW COURT**

Appendix B Wastewater Servicing
September 21, 2022

Appendix B WASTEWATER SERVICING

B.1 SANITARY SEWER DESIGN



SUBDIVISION:
Nautical Lands Group - 20 Cedarow

DATE: 9/26/2022
 REVISION: 3
 DESIGNED BY: MS
 CHECKED BY: DT

SANITARY SEWER DESIGN SHEET
 (City of Ottawa)

FILE NUMBER: 1604-01511

DESIGN PARAMETERS			
MAX PEAK FACTOR (RES.)=	4.0	AVG. DAILY FLOW / PERSON	280 L/p/day
MIN PEAK FACTOR (RES.)=	2.0	COMMERCIAL	28,000 L/ha/day
PEAKING FACTOR (INDUSTRIAL):	2.4	INDUSTRIAL (HEAVY)	55,000 L/ha/day
PEAKING FACTOR (COMM., INST.):	1.5	INDUSTRIAL (LIGHT)	35,000 L/ha/day
STUDIO APARTMENT	1.4	INSTITUTIONAL	28,000 L/ha/day
1 BEDROOM	1.4	INFILTRATION	0.33 L/s/ha
2 BEDROOM	2.1		
MINIMUM VELOCITY	0.60 m/s	MAXIMUM VELOCITY	3.00 m/s
		MANNINGS n	0.013
		BEDDING CLASS	B
		MINIMUM COVER	2.50 m

LOCATION			RESIDENTIAL AREA AND POPULATION										COMMERCIAL		INDUSTRIAL (L)		INDUSTRIAL (H)		INSTITUTIONAL		GREEN / UNUSED		C+H	INFILTRATION			TOTAL	PIPE								
AREA ID NUMBER	FROM M.H.	TO M.H.	AREA (ha)	Studio	Single 1 Bedroom Units	2 Bedroom	POP.	CUMULATIVE AREA (ha)	POP.	PEAK FACT.	PEAK FLOW (L/s)	AREA (ha)	ACCU. AREA (ha)	AREA (ha)	ACCU. AREA (ha)	AREA (ha)	ACCU. AREA (ha)	AREA (ha)	ACCU. AREA (ha)	AREA (ha)	ACCU. AREA (ha)	PEAK FLOW (L/s)	TOTAL AREA (ha)	ACCU. AREA (ha)	INFILT. FLOW (L/s)	FLOW (L/s)	LENGTH (m)	DIA (mm)	MATERIAL	CLASS	SLOPE (%)	CAP. (FULL) (l/s)	CAP. V. PEAK FLOW (%)	VEL. (FULL) (m/s)	VEL. (ACT.) (m/s)	
Wellings of Stittsville Ph2																																				
ENTIRE SITE	STUB	MAIN	2.20	34	252	58	522	2.20	522	3.96	6.7	0.10	0.10	0.00	0.00	0.00	0.00	0.00	0.00	0.00	0.00	0.0	2.29	2.29	0.8	7.5	23.0	300 675	PVC	SDR 35	1.00	96.0	7.82%	1.36	0.68	

From: [Tousignant, Eric](#)
To: [Thiffault, Dustin](#)
Cc: [Moroz, Peter](#)
Subject: RE: Confirmation of Sanitary Capacity - 20 Cedarow Court
Date: Tuesday, July 12, 2022 10:03:53 AM

Hi Dustin

I don't see a problem with this additional flow, there is capacity in the sanitary sewer system.

Regards
Eric

Eric Tousignant, P.Eng.

Senior Water Resources Engineer/ Ingénieur principal en ressources hydriques
Infrastructure and Water Services / services d'infrastructure et d'eau
613-580-2424 ext 25129

Vacation Notice : Note that I will be away on vacation from July 25th to August 12, but will be checking emails periodically to forward them to appropriate staff.

From: Thiffault, Dustin <Dustin.Thiffault@stantec.com>
Sent: July 05, 2022 4:44 PM
To: Tousignant, Eric <Eric.Tousignant@ottawa.ca>
Cc: Moroz, Peter <peter.moroz@stantec.com>
Subject: Confirmation of Sanitary Capacity - 20 Cedarow Court

CAUTION: This email originated from an External Sender. Please do not click links or open attachments unless you recognize the source.

ATTENTION : Ce courriel provient d'un expéditeur externe. Ne cliquez sur aucun lien et n'ouvrez pas de pièce jointe, excepté si vous connaissez l'expéditeur.

Hi Eric,

We are working on a site plan control application for a residential development on 20 Cedarow Court set to have sanitary discharge to the 675mm trunk sewer within Hazeldean Road just west of Huntmar. The KWMSS had previously assumed the site to be entirely commercial, and so development review is asking for confirmation that the trunk can accept the increase in expected flows.

The KWMSS had estimated peak flows from the development at approx. 2.0L/s (under the older discharge parameters), whereas we are anticipating approximately 10.4L/s including allowance for infiltration. Would you be able to confirm that the 10.4L/s rate can be sufficiently accommodated within the Hazeldean sewer? I've attached a servicing drawing for your reference.

Thanks very much for your help!

Dustin Thiffault P.Eng.

Project Engineer

Mobile: 343-996-2211

dustin.thiffault@stantec.com

Stantec

300-1331 Clyde Avenue

Ottawa ON K2C 3G4



The content of this email is the confidential property of Stantec and should not be copied, modified, retransmitted, or used for any purpose except with Stantec's written authorization. If you are not the intended recipient, please delete all copies and notify us immediately.

This e-mail originates from the City of Ottawa e-mail system. Any distribution, use or copying of this e-mail or the information it contains by other than the intended recipient(s) is unauthorized. Thank you.

Le présent courriel a été expédié par le système de courriels de la Ville d'Ottawa. Toute distribution, utilisation ou reproduction du courriel ou des renseignements qui s'y trouvent par une personne autre que son destinataire prévu est interdite. Je vous remercie de votre collaboration.

**SERVICING AND STORMWATER MANAGEMENT BRIEF –
WELLINGS OF STITTSVILLE PHASE 2, 20 CEDAROW COURT**

Appendix B Wastewater Servicing
September 21, 2022

B.2 SANITARY EXCERPTS FROM THE KWMSS

4.0 SANITARY SEWER SERVICING

4.1 Introduction

This section outlines the evaluation criteria for wastewater servicing options, describes the alternative wastewater servicing alignments, summarizes the evaluation process, and compares the recommended alternatives to select the preferred option.

4.2 Evaluation Criteria and Weightings

The evaluation of alternatives is based, in part, on criteria previously developed for the Regional Master Plan for Water, Wastewater and Transportation, which can be found in Volume 2 of the "Planning and Environmental Assessment Summary Report" prepared by the former Region of Ottawa-Carleton.

The criteria are divided into four categories. The first three categories consider environmental, social, and economic impacts of the project on the Study area. The fourth category (Constructability/Functionality) considers project-specific criteria assessing the technical aspects and impacts of the project on the Study area. A list of each criteria and its respective category, as well as an explanation of their indicators, is provided in **Table 4.1-1**.

TABLE 4.1-1 Evaluation Criteria		
Category	Criteria	Indicator
Constructability/Functionality		
CO1.1	Geotechnical Issues and Construction Risks	Potential for encountering poor soils and/or elevated groundwater conditions.
CO1.2	Infrastructure Requirements	Extent of works required.
CO1.3	Operational Impacts	Amount of maintenance intensive infrastructure required.
CO1.4	Construction Scheduling	Impact of construction on development timing/phasing.
CO1.5	Property Acquisition	Ease of property acquisition. Depends on status of required and adjacent lands (i.e. vacant, leased or owner occupied).
CO1.6	System Reliability	Proximity of a storm sewer, SWM or other surface water for emergency overflow.
CO1.7	System Flexibility	Ease of accommodating potential changes in servicing plans.
Economy		
E1	Potential to Use Combined Service Corridor	Length and area of combined service corridor.
E2	Efficiency of use of existing infrastructure	Use of existing capacity.
E3	Energy consumption	Pumping requirements.
E5	Impact on Agriculture	Agricultural area likely to be affected by infrastructure.

E9	Construction Cost	Estimated construction cost.
Caring and Healthy Community		
C3	Displacement of Residents, Community/Recreation Features and Institutions	Affects on residential areas, institutions or businesses.
C4	Disruption to Existing Community	Extent of works affecting existing residences and businesses.
C9	Consistency with Planned Land Use and Infrastructure	Compatibility with City land use, design guidelines and infrastructure servicing corridor planning (Kanata West Transportation Master Plan Report and Storm Sewer and Watermain Needs).
Natural Environment		
N1	Impact on Significant Natural Features	Loss of natural areas due to installation of works.
N3	Impact on Aquatic Systems	Potential impact on fish habitat due to installation of works.
N4	Impact on Quality and Quantity of Surface Water and Groundwater	Potential impact on water quality in the Carp River resulting from rare emergency overflows to the SWM pond due to pumping station failure.
N5	Impact on Global Warming	Difference in carbon dioxide emissions resulting from occasional use of diesel generator.
N6	Effects on Urban Green Space, Open Space and Vegetation	Disruption to green space and trees.

4.2.1 Description of Evaluation Categories

Presented below is a description of the categories used to assess each of the three servicing alternatives. The four categories were selected to ensure that the various servicing alternatives were evaluated in a consistent and comprehensive manner. Further details on the criteria and weightings for each category are provided in Appendix 2.1.

Constructability/Functionality (C/F) – 36%

Wastewater infrastructure is required to facilitate the development of Kanata West. The infrastructure needs to provide a flexible servicing solution to accommodate the orderly development of the entire area in a series of phases. It is important that the construction of the wastewater servicing be coordinated with other major infrastructure projects such as storm sewers, watermain and transportation, to ensure all services are available when required. Various alignment alternatives, construction techniques and phasing options will be assessed.

Economy (E) – 25 %

The Kanata West area is recognized within the City of Ottawa Official Plan as a future growth area comprised of a mixture of residential, business, and commercial lands. The accelerated rate of development and design concerns within the Study area requires a cost-effective solution to providing municipal wastewater services.

Caring and Healthy Communities (CHC) – 25 %

Impact to the surrounding community is an important factor when determining the preferred servicing alternative. The selected alignment and construction techniques are evaluated to minimize disruption to surrounding communities. It is anticipated that impacts will be limited to the time of construction for the off-site servicing.

Natural Environment (NE) – 14%

The majority of the required wastewater infrastructure is aligned within existing or proposed public roads to limit the impacts to the natural environment. Servicing alignments selected outside of roadways were chosen to minimize impacts where possible. Construction of the wastewater services will be performed in conjunction with other servicing projects required as part of the overall development. Further information on the environmental impacts of the proposed road allowances are documented in the Kanata West Transportation Master Plan Report.

In the rare event that the pump station overflows, impacts to surface water quality are anticipated to be minimal. All discharges from the overflow will be directed to the stormwater management pond where they will be collected. Increases in CO₂ emissions from the emergency diesel generators during power failures or maintenance procedures will be negligible.

4.2.2 Outlet Alternatives

4.2.2.1 Description of Outlet Alternatives

To provide an adequate outlet for the KWCP wastewater system three servicing options were evaluated. Each of these options will ultimately discharge to the Tri Township Collector Sewer. The first servicing option utilizes a gravity sewer (tunnel), the remaining two options make use of a pumping station located at the intersection of Maple Grove Road and Silver Seven Road, with alternate forcemain alignments. **Figures 4.1-1, 4.1-2 and 4.1-3** illustrate the alternative outlet alignments, which are further described below:

- Alternative I (Gravity Outlet) – A gravity sewer (tunnel) along the Highway 417 corridor to the Tri Township Collector. The tunnel would be constructed within the existing road allowance, adjacent to the travel lanes. The alignment crosses Highway 417 east of Eagleson Road and parallels the Glen Cairn Collector. Refer to **Figure 4.1-1**.
- Alternative II (Forcemain Alignment 1) - A forcemain along the Highway 417 corridor from a proposed pumping station on Maple Grove Road, extending to the Glen Cairn Collector Sewer east of Eagleson Road. Refer to **Figure 4.1-2**.
- Alternative III (Forcemain Alignment 2) - A forcemain along Katimavik Road and Palladium Drive from a proposed Pumping Station on Maple Grove Road to the Glen Cairn Collector Sewer east of Eagleson Road. Refer to **Figure 4.1-3**.

4.2.2.2 Evaluation of Outlet Alternatives

Evaluation of the criteria was completed using the “standard pair-wise comparison” methodology. The weightings assigned to each of the criteria were selected based on the weightings applied for past similar projects, knowledge of environmental constraints, community concerns and professional judgment. The scores for each category and criterion were summed to determine the overall category weighting. Evaluation results are summarized in **Table 4.1-2**. An explanation of the category rankings and weightings are provided below.

Constructability/Functionality (C/F) (36%)

A review of the three proposed servicing options indicates that the forcemain alternatives present fewer issues with respect to the geotechnical constraints when compared to the gravity sewer alternative. The forcemain alternatives would require a relatively shallow excavation, reducing the conflict with the shallow bedrock formations that exist along each forcemain alignment. The shallow depth of the forcemains would also minimize the technical difficulties arising from earth to rock transitions along the trench. The effort required to install either of the forcemain alternatives would be much less than the gravity outlet alternative because the need to tunnel would be eliminated.

When comparing the two forcemain alternatives, an obvious benefit of Alternative II is its location along Katimavik Road as compared to the location of Alternative III, along Highway 417. Katimavik Road has a lower classification than Highway 417, reducing traffic management issues during construction and routine maintenance operations. The central location of the Alternative II forcemain alignment in relation to the area to be serviced also improves the flexibility for developing internal servicing options. The various alignments available for Alternative II, west of Terry Fox Drive (see **Figure 4.1-3**), are all located within existing road allowances and are considered equal when evaluated with the prescribed criteria. The Alternative II alignment along Silver Seven Road also allows the opportunity for the services to be installed in an easement located immediately adjacent to the east side of the right-of-way. Construction in this easement would eliminate the need to reconstruct this portion of the road. The use of easements for construction of the necessary services was not factored into the evaluation criteria and therefore the ranking was not affected.

Economy (E) (25%)

The costs of both forcemain alternatives are similar and much less expensive than the gravity sewer alternative. The increased costs of the gravity sewer are attributed to the need to tunnel through the existing bedrock. The forcemain alternatives allow for a relatively shallow excavation over the entire length of the alignment. The level of effort required to construct the gravity sewer would also be significantly greater than the effort required to install either of the forcemain alternatives.

Caring and Healthy Community (CHC) (25%)

Both the gravity outlet and the Alternative I forcemain would have minimal impact on the community given that the majority of the work would occur within the Highway 417 road allowance. The Alignment II forcemain alignment along Katimavik Road would require open cut excavation and would have a temporary impact on the residents during construction.

GRAVITY SANITARY OUTLET LOCATION

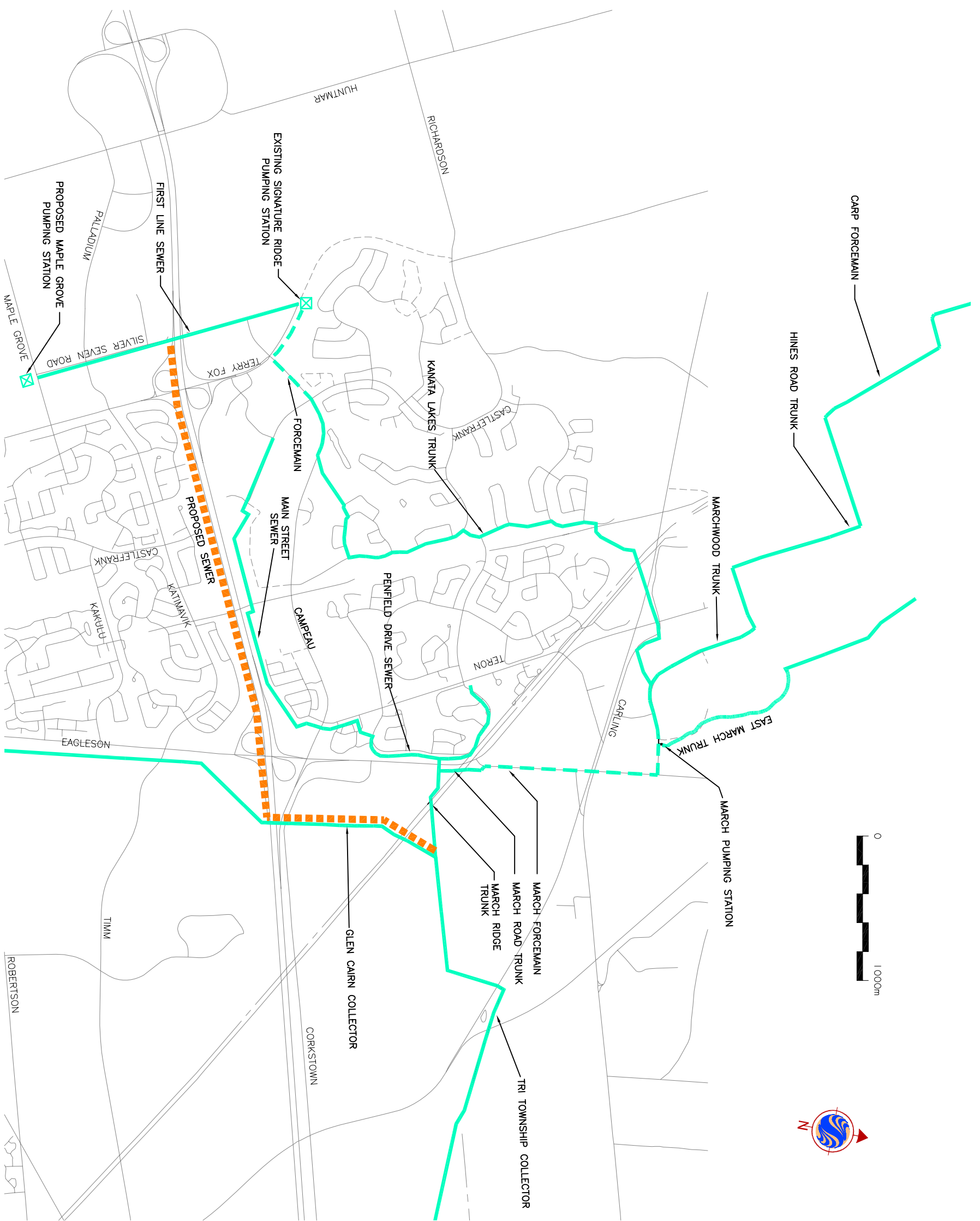

- Legend:**
- Gravity Outlet (Tunnel)
 - Existing Trunk Sewer

MAY 2006

FIG. 4.1-1

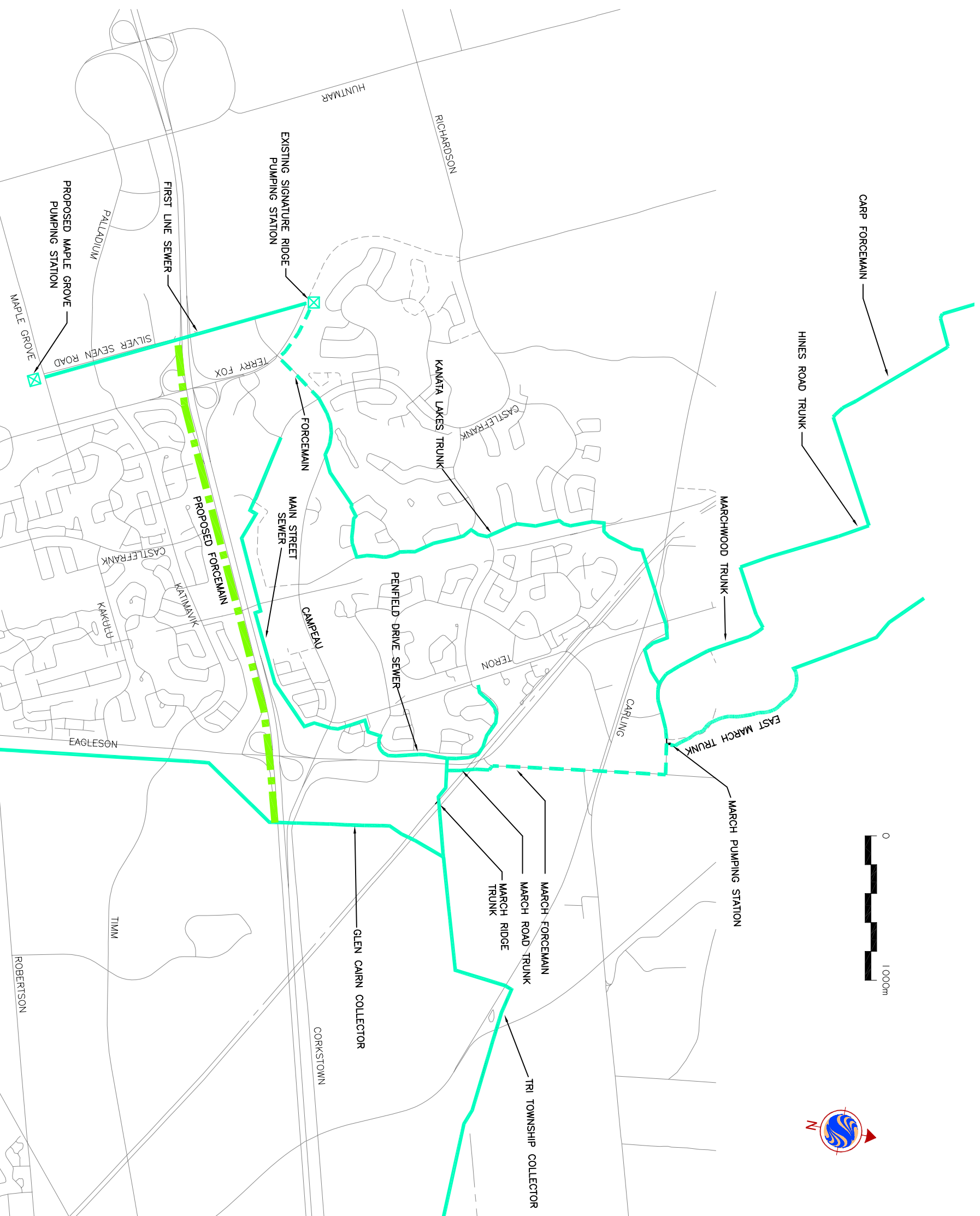
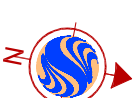

SANITARY FORCEMAIN OUTLET ALIGNMENT 1 HWY 417

- Legend:**
-  Forcemain
 -  Existing Trunk Sewer

FIG. 4.1-2

MAY 2006





SANITARY

FORCEMAIN OUTLET

ALIGNMENT 2

KATIMAVIK RD.

(PREFERRED OPTION)



- Legend:**
- Forcemain
 - - - Optional F.M. locations to accommodate internal servicing
 - Existing Trunk Sewer

MAY 2006



Stantec



FIG. 4.1-3

The construction of both forcemain alternatives is compatible with existing City design standards and construction practices. However, only Alignment II can easily be integrated into other servicing or roadway improvements. The time required for the construction of the gravity outlet would be significantly longer than that of the forcemain alternatives.

Natural Environment (NE) (14%)

There are no significant differences on the impacts to the natural environment between the gravity outlet and forcemain Alternative II. The gravity outlet will be tunneled below ground for the majority of the alignment resulting in minimal impact to surface conditions. Forcemain Alternative II is located within the Katimavik Road allowance, which is already developed and has minimal environmental impact. Forcemain Alternative I has a greater impact on the natural areas located along the Highway 417 corridor than the gravity sewer.

4.2.2.3 Selection of Preferred Outlet Alternative

Based on the above evaluation Alternative II, the Katimavik Road alignment, is selected as the preferred outlet alternative. This alignment offers the greatest amount of flexibility for internal servicing design, uses a lower road classification corridor, which simplifies routine maintenance operations, and provides maximum separation from the sensitive natural areas located in the 417 corridor east of Terry Fox Drive.

While Forcemain Alignment II has a marginal cost increase over Alignment I, the benefits of improved internal servicing and phasing options more than offset this discrepancy.

4.2.3 Internal Servicing Alternatives

4.2.3.1 Description of Internal Servicing Alternatives

The preliminary servicing report prepared in support of the approved Community Design Plan identified the need for two pumping stations for the wastewater discharge from KWCP. The two stations identified are required to satisfy phasing needs for construction of the overall development area and to produce a cost effective initial phasing scheme. The new sanitary pumping station(s) south of Highway 417 will be required to provide internal wastewater service to that portion of KWCP south of Highway 417.

Three potential servicing alternatives were considered for the configuration and location for the pumping station(s) required to service these lands south of Hwy. 417. Internal servicing alternatives were chosen based on their proximity to the preferred outlet described in Section 4.2.3.3. above, and accessibility to the servicing areas as illustrated in **Figures 4.1-4, 4.1-5, 4.1-6 and 4.1-6A**. A brief description of the alternative pumping station locations are as follows:

- Alternative I - Two pumping stations connected with a combination of gravity sewer and forcemain. One pumping station will be located on Silver Seven Road at Highway 417. The second station will be located on Maple Grove Road at the Carp River. Refer to **Figure 4.1-4**.
- Alternative II - Two pumping stations connected with a gravity sewer. One station will be located on Maple Grove Road near the Carp River and will discharge to the main station located near the Carp River south of Highway 417. A diversion sewer will also be required to intercept the existing Silver Seven Road sanitary sewer. Refer to **Figure 4.1-5**.

TABLE 4.1-2



Kanata West Wastewater - Outlet Alternatives

Criteria		Indicators	Weighting	Rationale for Relative Weights	Alternatives		
					Gravity Sewer Outlet	PS FM Alignment I	PS FM Alignment II
CONSTRUCTABILITY/FUNCTIONALITY					16	20	22
CO1.1	Geotechnical Issues and Construction Risks	Potential for encountering poor soils and/or elevated groundwater conditions.	36%	Alt. I has potential for poor soils conditions due to depth and tunnelling in and out of rock.	2	3	3
CO1.2	Infrastructure Requirements	Extent of works required.	7%	Alt. I with tunnelling is a very large scale operation.	1	3	3
CO1.3	Operational Impacts	Amount of maintenance intensive infrastructure required.	6%	Alt. II and III require more extensive maintenance due to pumping.	3	2	2
CO1.4	Construction Scheduling	Impact of construction on development timing.	4%	Alt. I with tunnelling is an extended construction schedule.	1	3	3
CO1.5	Property Acquisition	Ease of property acquisition. (Depends on status of lands and adjacent lands, i.e. vacant, leased or owner occupied.)	2%		4	4	4
CO1.6	System Reliability	Proximity of a storm sewer, SWM or other surface water for emergency overflow	6%		3	3	3
CO1.7	Servicing Flexibility	Ease of accommodating potential changes in servicing plans.	5%	Alt. I and II have fixed alignments along the north limit of the servicing area. Alt. II has some flexibility to be realigned within the development area, but Alt. III due to its more central location has maximum flexibility within Kanata West.	2	2	4
ECONOMY					9	13	15
E1	Potential to Use Combined Service Corridor	Length and area of combined service corridor.	6%	Alt. I with the requirement for tunnelling does not offer any potential to use combined corridors.	1	2	3
E2	Efficiency of Use of Existing Infrastructure	Use of existing capacity	5%	Alt. I requires reconstruction beyond the closest connection point to the Glen Cairn Collector sewer.	1	3	4
E3	Energy Consumption	Pumping requirements	4%	Alt. II & III require pumping.	3	2	2
E5	Impact on Agriculture	Agriculture area likely to be affected by infrastructure.	2%		3	3	3
E9	Capital Cost	Estimated cost of construction.	8%	Alt. I is very expensive due to the tunnelling requirement.	1	3	3
CARING AND HEALTHY COMMUNITIES					7	9	9
C3	Displacement of Residents, Community/Recreation Features and Institutions.	Affects areas of residence, institutions or businesses.	6%	Length of Construction for Alt. I will result in increased construction traffic, etc.	3	3	3
C4	Disruption to Existing Community	Extent of works affecting existing residences and businesses and visibility of additional infrastructure.	11%		3	3	3
C9	Consistency with Planned Land Use and Infrastructure	Compatibility with City land use, design guidelines and infrastructure servicing corridor planning (Kanata West Roadwork Environmental Study Report and Storm Sewer and Watermain Needs).	8%	Alt. I would provide service for larger area than the existing urban boundary due to size of pipe required to tunnel. Alt. II provides greater flexibility for internal servicing.	1	3	3
NATURAL ENVIRONMENT					16	12	14
N1	Impact on Significant Natural Features	Loss of natural area due to installation of works.	3%	Alt. I mostly tunnel therefore minimal impact. Alt. II in vicinity of ANSI in 417 corridor at Terry Fox.	4	1	3
N3	Impact on Aquatic Systems	Potential impact on fish habitat due to installation of works.	3%		3	3	3
N4	Impact on Quality and Quantity of Surface Water and Groundwater	Potential impact on water quality in the Carp River resulting from rare emergency overflows to the SWM pond due to pump station failure.	3%		3	3	3
N5	Impact on Global Warming	Difference in carbon dioxide emissions resulting from occasional use of diesel generator.	1%	Alt. II and III require pumping in long term. Alt. I does not.	3	2	2
N6	Effects on Urban Greenspace, Open Space and Vegetation (i.e. trees, shrubs, etc.)	Disruption to greenspace and trees.	5%		3	3	3
Total Score					2.17	2.75	3.01
Ranking					3	2	1
Estimated Capital Cost (in \$million)					30	8.8	9

Description of Alternatives

Gravity Sewer Outlet
 Pump Station - Forcemain Alignment I - HWY 417
 Pump Station - Forcemain Alignment II - Katimavik Rd.

Evaluation Ranking

1 -2 High or Negative Impact
 3 Moderate or No Impact
 4-5 Low or Positive Impact

- Alternatives III and IIIA – Alternative III is a single pumping station with a gravity sewer intercepting the existing Silver Seven Road sanitary sewer. The gravity sewer alignment will be adjacent to the Carp River and connect to the pump station located at Maple Grove Road west of the Carp River. Alternative IIIA is a variation of this alternative utilizing a single pumping station and gravity sewer intercepting the existing Silver Seven Road sewer. The variation from Alternative III is that the gravity sewer will be located within a proposed road right-of-way, or an easement, north of Palladium Drive. Refer to **Figures 4.1-6 and 4.1-6A.**

4.2.3.2 Evaluation of Internal Servicing Alternatives

The alternative internal servicing alignments were evaluated as discussed in Section 4.2. The results of the evaluation are summarized in **Table 4.1-3**. An explanation of the category rankings and weightings are provided below.

Constructability/Functionality (C/F) (36%)

All proposed alternatives use pumping stations to provide internal wastewater servicing. The use of pumps allows the sewer system to be constructed at a relatively shallow depth. This reduces the potential for contact with poor subsurface conditions during construction. Deep Excavations will be confined to a limited area in the vicinity of the pumping station.

A benefit of Alternatives III and IIIA is that a single pumping station is required to provide the internal servicing. This is advantageous from a constructability and operational point of view when compared to Alternatives I and II which require two pumping stations to service the same area. A further benefit of Alternatives III and IIIA is that either servicing scenario will eliminate the need for the existing Palladium siphon under the Carp River. Removing the siphon will improve the overall reliability to the system.

A benefit of Alternative IIIA over Alternative III is that work in the Carp River corridor is reduced to a single crossing at Palladium Drive. Both Alternatives are close to a stormwater management pond which can be used as an emergency overflow in the rare event of flooding. (see **Figures 4.1-6 and 4.1-6A**)

All alternatives are capable of satisfying a phased development process.

Economy (E) (25%)

Alternatives I and II use two pumping stations and are significantly more expensive than Alternatives III and IIIA which use a single pump station. The additional pump stations in Alternatives I and II also increase the energy demand over the remaining options. Alternatives III and IIIA are able to service the entire KWCP with a single pump station resulting in equal or fewer economic impacts.

Caring and Healthy Community (CHC) (25%)

In terms of impact on the community, there are no differences between the alternatives. All options require construction in the vicinity of existing businesses. Impacts are anticipated to be relatively short in duration (less than two years).

INTERNAL SANITARY SERVICING ALTERNATIVE I

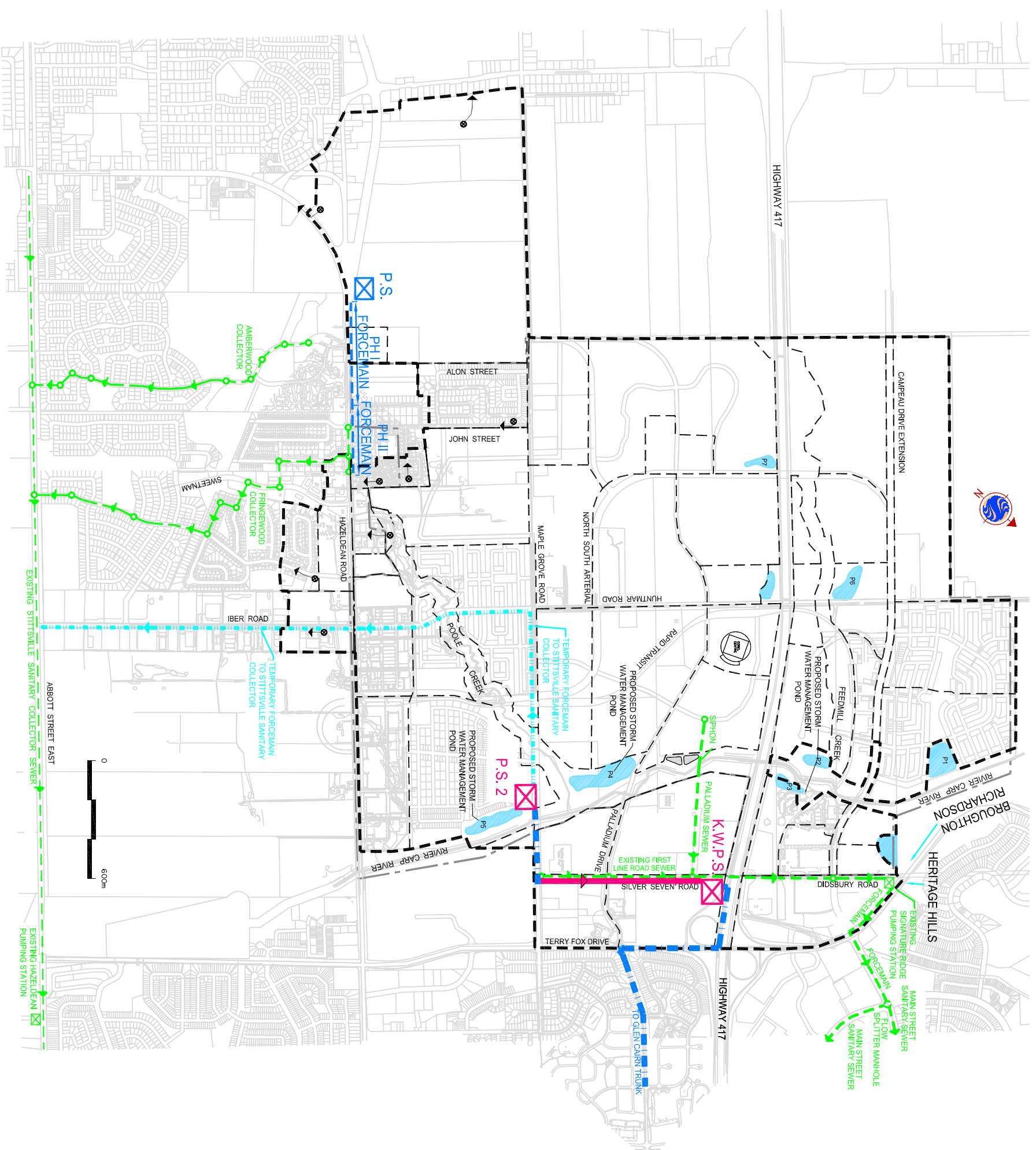

- Ultimate Major Drainage Limit
- Proposed Trunk Sewer
- - - Forcemain
- · - · - Temporary Frocemain
- - - Existing Trunk Sewers
- Existing Pumping Station and Forcemain (To be Decommissioned)
- ⊗ Pump Station

MAY 2006

FIG. 4.1-4



Stantec



CCCL/BI

CCCL/BI

INTERNAL SANITARY SERVICING ALTERNATIVE II

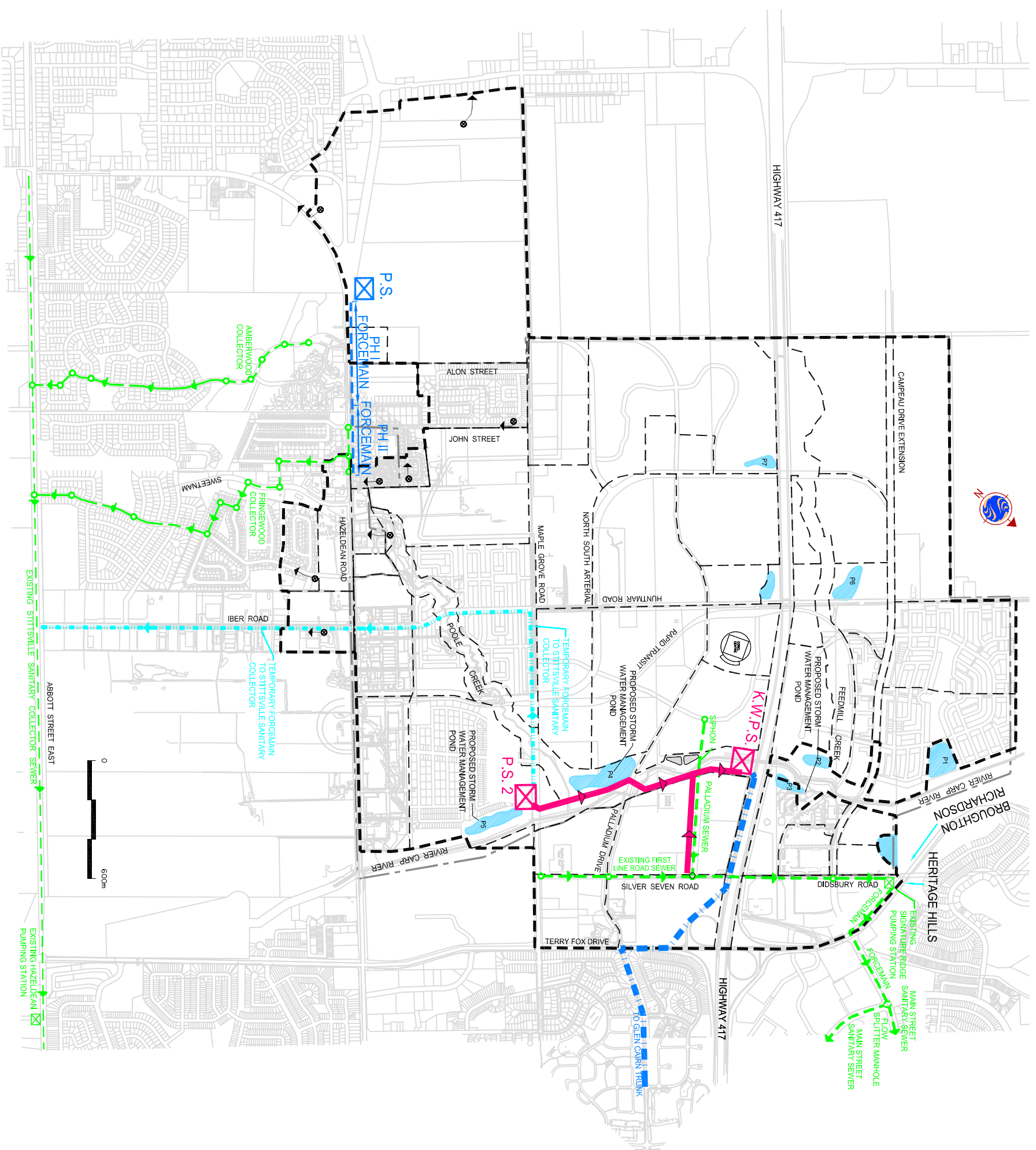

- Ultimate Major Drainage Limit
- Proposed Trunk Sewer
- - - Forcemain
- - - Temporary Frocemain
- - - Existing Trunk Sewers
- ⊗ Existing Pumping Station and Forcemain (To be Decommissioned)
- ⊗ Pump Station

FIG. 4.1-5

MAY 2006



Stantec



Canadian Coluburn Limited

INTERNAL SANITARY SERVICING ALTERNATIVE III

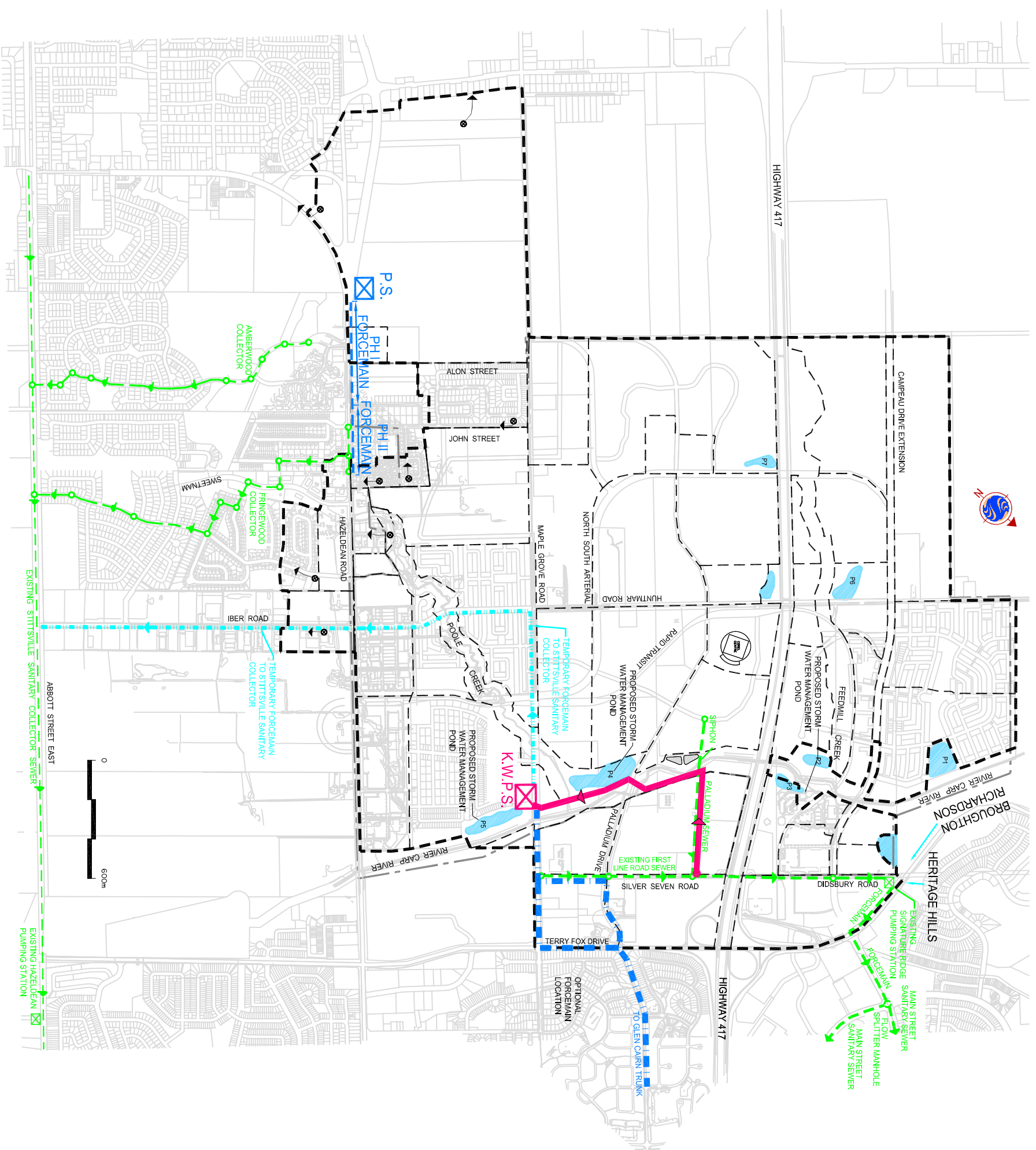

- Ultimate Major Drainage Limit
- Proposed Trunk Sewer
- - - Forcemain
- · - · - Temporary Frocemain
- - - Existing Trunk Sewers
- ⊗ Existing Pumping Station and Forcemain (To be Decommissioned)
- ⊗ Pump Station

FIG. 4.1-6

MAY 2006

INTERNAL SANITARY SERVICING ALTERNATIVE IIIA (PREFERRED OPTION)

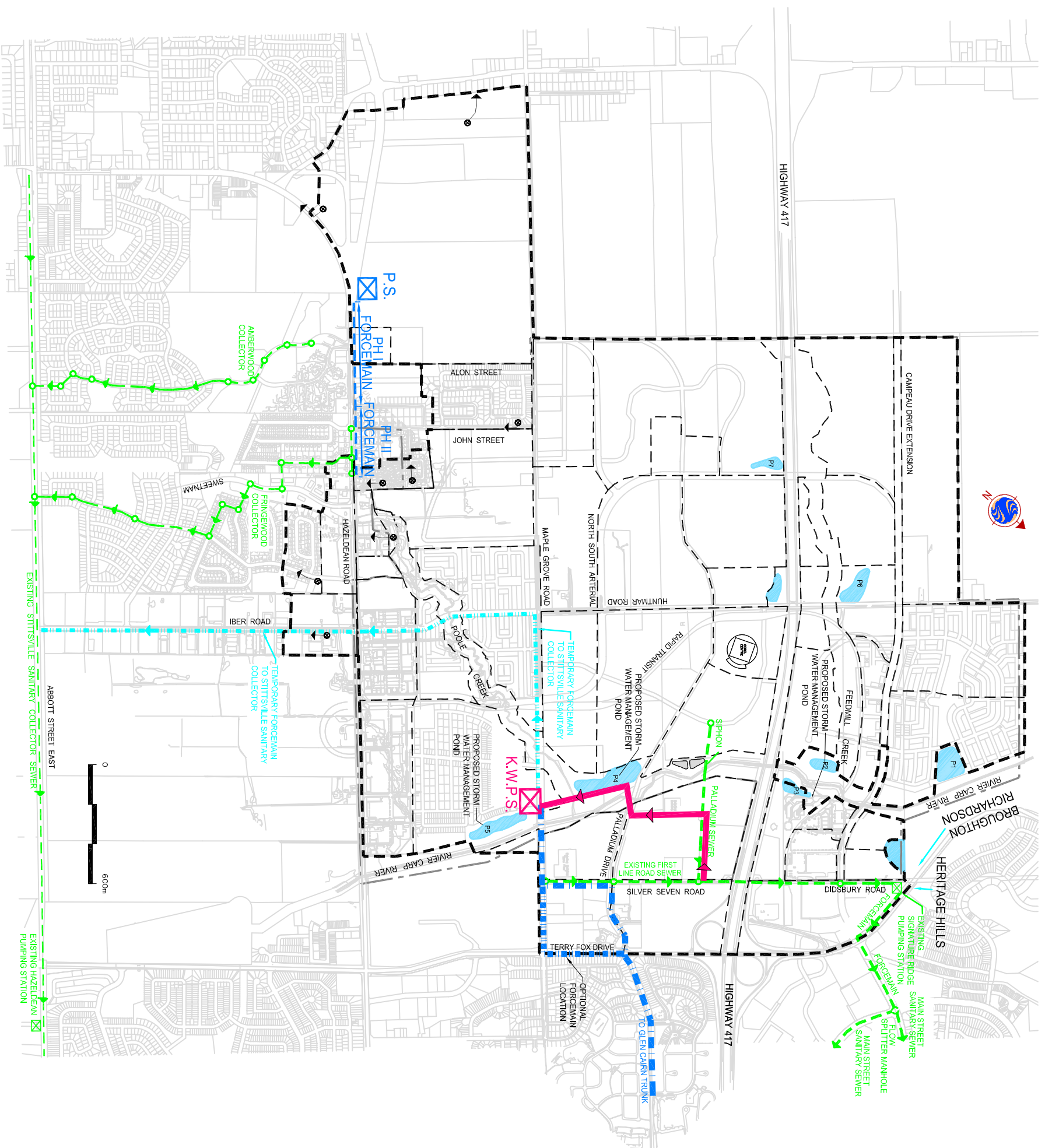

- Ultimate Major Drainage Limit
- Proposed Trunk Sewer
- Forcemain
- Temporary Frocemain
- Existing Trunk Sewers
- Existing Pumping Station and Forcemain (To be Decommissioned)
- ⊗ Pump Station

MAY 2006

FIG. 4.1-6A



Startec



Eccl/IBI
Cumulab Cochrane Limited

Natural Environment (NE) (14%)

All four servicing options have a similar level of impact on the natural environment. Alternatives III and IIIA use a gravity sewer and a single pump station, thereby using less energy to discharge the sanitary flow from the KWCP. Alternatives II & III require the greatest amount of construction within the Carp River corridor.

Alternatives I and II both require two pumping stations. This increases the potential for impacts over the remaining options from the use of the emergency diesel generators and construction and construction.

4.2.3.3 Selection of Preferred Internal Servicing Alternative

Based on the above evaluation, Alternatives III and IIIA are considered to be the most viable options for the internal wastewater servicing for the KWCP. When comparing the two options, all of the evaluation criteria are similar. However, Alternative III requires the construction of the trunk sanitary sewer within the Carp River corridor. Alternative IIIA utilizes the proposed road allowances for the construction of a portion of the trunk sewer alignment, minimizing the potential for impacts to the Carp River. Based on the evaluation results, Alternative IIIA is selected as the preferred servicing alternative.

4.2.4 Temporary Forcemain Alternatives

4.2.4.1 Description of Temporary Forcemain Alternatives

A temporary forcemain will be required to service the initial phases of development within the KWCP. Three potential alignments were selected based on available corridors through the existing community. Each alignment begins at the preferred location of the Kanata West Pump Station, located on Maple Grove Road and west of the Carp River. All three servicing scenarios ultimately discharge to a temporary outlet, the Stittsville Collector Sewer. As illustrated on **Figure 4.1-7** the alternative forcemain alignments are:

- Alternative I – West along Maple Grove Road to Huntmar Road. South along Huntmar Road and Iber Road to the Stittsville Collector Sewer situated along Abbott Street East.
- Alternative II – South, parallel to the west side of the Carp River and through the proposed development lands to the Glen Cairn stormwater pond. East to Terry Fox Drive, then south along Terry Fox Drive to the Stittsville Collector Sewer.
- Alternative III – East on Maple Grove Road to Terry Fox Drive. South on Terry Fox Drive to the Stittsville Collector Sewer.

4.2.4.2 Evaluation of Temporary Forcemain Alternatives

The temporary forcemain alternatives were evaluated and ranked using the criteria discussed in Section 4.2. The results of the evaluation are summarized in **Table 4.1-4**. An explanation of the category rankings and weightings are provided below.

TABLE 4.1-3



Kanata West Wastewater - Internal Servicing Alternatives

Criteria	Indicators	Weighting	Rationale for Relative Weights	Alternatives			
				Internal Servicing			
				I	II	III	IIIA
CONSTRUCTABILITY/FUNCTIONALITY			36%	14	14	23	22
CO1.1	Geotechnical Issues and Construction Risks	Potential for encountering poor soils and/or elevated groundwater conditions.	7%	3	3	3	3
CO1.2	Infrastructure Requirements	Extent of works required.	7%	1	1	3	3
CO1.3	Operational Impacts	Amount of maintenance intensive infrastructure required.	6%	1	1	2	2
CO1.4	Construction Scheduling	Impact of construction on development timing.	4%	3	3	3	3
CO1.5	Property Acquisition	Ease of property acquisition. (Depends on status of lands and adjacent lands, i.e. vacant, leased or owner occupied.)	2%	2	2	4	3
CO1.6	System Reliability	Proximity of a storm sewer, SWM or other surface water for emergency overflow	6%	2	2	4	4
CO1.7	Servicing Flexibility	Ease of accommodating potential changes in servicing plans.	5%	2	2	4	4
ECONOMY			25%	11	11	18	18
E1	Potential to Use Combined Service Corridor	Length and area of combined service corridor.	6%	2	2	4	4
E2	Efficiency of Use of Existing Infrastructure	Use of existing capacity	5%	4	4	4	4
E3	Energy Consumption	Pumping requirements	4%	1	1	3	3
E5	Impact on Agriculture	Agriculture area likely to be affected by infrastructure.	2%	3	3	3	3
E9	Capital Cost	Estimated cost of construction.	8%	1	1	4	4
CARING AND HEALTHY COMMUNITIES			25%	10	10	10	10
C3	Displacement of Residents, Community/Recreation Features and Institutions.	Affects areas of residence, institutions or businesses.	6%	4	4	4	4
C4	Disruption to Existing Community	Extent of works affecting existing residences and businesses and visibility of additional infrastructure.	11%	3	3	3	3
C9	Consistency with Planned Land Use and Infrastructure	Compatibility with City land use, design guidelines and infrastructure servicing corridor planning (Kanata West Roadwork Environmental Study Report and Storm Sewer and Watermain Needs).	8%	3	3	3	3
NATURAL ENVIRONMENT			14%	13	9	11	14
N1	Impact on Significant Natural Features	Loss of natural area due to installation of works.	3%	4	2	2	3
N3	Impact on Aquatic Systems	Potential impact on fish habitat due to installation of works.	3%	3	2	2	3
N4	Impact on Quality and Quantity of Surface Water and Groundwater	Potential impact on water quality in the Carp River resulting from rare emergency overflows to the SWM pond due to pump station failure.	3%	2	2	3	3
N5	Impact on Global Warming	Difference in carbon dioxide emissions resulting from occasional use of diesel generator.	1%	1	1	2	2
N6	Effects on Urban Greenspace, Open Space and Vegetation (i.e.trees,shrubs,etc.)	Disruption to greenspace and trees.	5%	3	2	2	3
Total Score			100%	2.39	2.26	3.21	3.29
Ranking				3	4	2	1
Estimated Capital Cost (in \$million)				8.5	8.5	5.5	5.5

Description of Alternatives

Internal Servicing Alternative I - Silver Seven Road at HWY 417
 Internal Servicing Alternative II - HWY 417 East of Carp River
 Internal Servicing Alternative III - Maple Grove Road West of the Carp River
 Internal Servicing Alternative IIIA - Maple Grove Road West of the Carp River with an Alternative Sewer Alignment

Evaluation Ranking

1 - 2 High or Negative Impact
 3 Moderate or No Impact
 4-5 Low or Positive Impact

Constructability/Functionality (C/F) –36%

All three alternatives require the construction of a shallow forcemain so geotechnical issues are not considered to be a concern along the selected alignments. However, an assessment of the subsurface conditions indicates that unlike Alternative III, Alternatives I and II will not require rock excavation.

Alternatives I and III are located entirely within existing or proposed road allowances eliminating the need for additional land or easements. A benefit of Alternative II is that the length of the require forcemain is moderately less than Alternatives I and III.

Alternative I is advantageous for routine maintenance operations as the alignment is located within a lower classification of roadway when compared to Alternative III.

Economy (E) – 25%

Approximately 50% of the Alternative I forcemain will be installed in conjunction with other development works minimizing the amount of reinstatement required. This reduces the overall cost of Alternative I relative to the other remaining options. A large portion of Alternative II would be constructed in open fields requiring fewer costs for reinstatement when compared to Alternative III.

Caring and Healthy Community (CHC) – 25%

All three alternatives present similar impacts to the community. These impacts are limited to the duration of construction and are therefore considered minimal. Alternative I creates the least amount of impact when compared to Alternatives II and III. This is due to the fact that approximately half of the construction of the temporary forcemain will be done with other development works. Alternative II requires construction along major arterials within existing communities east of the KWCP, resulting in the highest level of impact.

Natural Environment (NE) – 14%

Alternatives I and III are entirely contained within existing or proposed road allowances. However, Alternative III would require a crossing at the Carp River. Construction monitoring to detect any required mitigation measures for potential impacts to water quality would be required. A large portion of the Alternative II alignment is within the Carp River corridor and will have the highest impact on existing natural features.

4.2.4.3 Selection of Preferred Temporary Forcemain Alternative

Based on the above evaluation, temporary forcemain Alternative I, the Huntmar Road/Iber Road alignment, is selected as the preferred alternative. This alignment facilitates routine maintenance operations, as it is located within a roadway of lower classification when compared to the other alternatives (Terry Fox Drive). This alignment also results in the least amount of impact on the existing natural features. The Alternative I alignment is similar to Alternative II as the most economical options. Over half of the alignment will be constructed in conjunction with other works, unlike Alternative II.

TEMPORARY SANITARY FORCEMAIN ALTERNATIVES

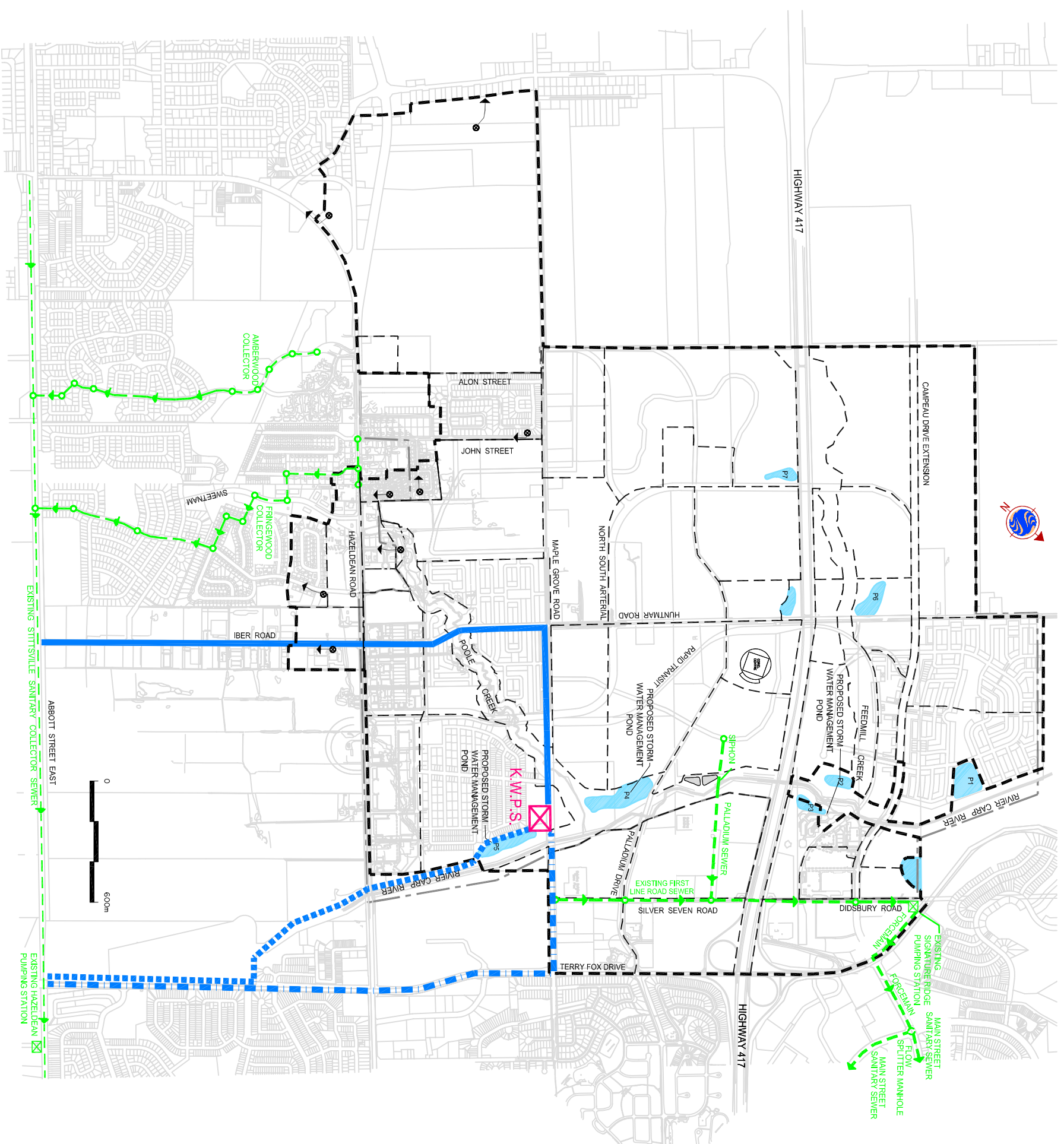

- Ultimate Major Drainage Limit
- Alternate I (Preferred Option)
- - - Alternate II
- . - . Alternate III
- - - Existing Trunk Sewers
- Existing Pumping Station and Forcemain (To be Decommissioned)
- ⊗ Pump Station

MAY 2006

FIG. 4.1-7

TABLE 4.1-4

Kanata West Wastewater - Temporary Forcemain Alternatives



Criteria	Indicators	Weighting	Rationale for Relative Weights	Temporary Forcemain Alternatives		
				I	II	III
CONSTRUCTABILITY/FUNCTIONALITY			36%	21	18	20
CO1.1	Geotechnical Issues and Construction Risks	Potential for encountering poor soils and/or elevated groundwater conditions.	Alt. III requires crossing of the Carp River through deep clay deposits.	3	3	2
CO1.2	Infrastructure Requirements	Extent of works required.		2	2	2
CO1.3	Operational Impacts	Amount of maintenance intensive infrastructure required.		3	3	3
CO1.4	Construction Scheduling	Impact of construction on development timing.		3	3	3
CO1.5	Property Acquisition	Ease of property acquisition. (Depends on status of lands and adjacent lands, i.e. vacant, leased or owner occupied.)	Alt. II requires property acquisition from private owners.	4	1	4
CO1.6	System Reliability	Proximity of a storm sewer, SWM or other surface water for emergency overflow		3	3	3
CO1.7	Servicing Flexibility	Ease of accommodating potential changes in servicing plans.		3	3	3
ECONOMY			25%	16	14	13
E1	Potential to Use Combined Service Corridor	Length and area of combined service corridor.	Alts. I uses a common corridor with other new works for half of length. Alt. II requires a new single use corridor for 1/3 of its length.	4	1	2
E2	Efficiency of Use of Existing Infrastructure	Use of existing capacity		3	3	3
E3	Energy Consumption	Pumping requirements		3	3	3
E5	Impact on Agriculture	Agriculture area likely to be affected by infrastructure.		3	3	3
E9	Capital Cost	Estimated cost of construction.	Alt. II is the least expensive and Alt. III is the most expensive to install.	3	4	2
CARING AND HEALTHY COMMUNITIES			25%	8	5	7
C3	Displacement of Residents, Community/Recreation Features and Institutions.	Affects areas of residence, institutions or businesses.	Alt. II is adjacent to Carp River corridor.	3	2	3
C4	Disruption to Existing Community	Extent of works affecting existing residences and businesses and visibility of additional infrastructure.	Alt. II and III are along major arterials in existing communities.	3	1	2
C9	Consistency with Planned Land Use and Infrastructure	Competibility with City land use, design guidelines and infrastructure servicing corridor planning (Kanata West Roadwork Environmental Study Report and Storm Sewer and Watermain Needs).		2	2	2
NATURAL ENVIRONMENT			14%	15	9	14
N1	Impact on Significant Natural Features	Loss of natural area due to installation of works.	Alt. II is adjacent to Carp River corridor.	3	1	2
N3	Impact on Aquatic Systems	Potential impact on fish habitat due to installation of works.	Alt. II is adjacent to the Carp River corridor which presents a potential for impacts to aquatic systems..	3	2	3
N4	Impact on Quality and Quantity of Surface Water and Groundwater	Potential impact on water quality in the Carp River resulting from rare emergency overflows to the SWM pond due to pump station failure.	Alt. II requires construction along a significant portion of the Carp River corridor which is currently vegetated.	3	2	3
N5	Impact on Global Warming	Difference in carbon dioxide emissions resulting from occasional use of diesel generator.		3	3	3
N6	Effects on Urban Greenspace, Open Space and Vegetation (i.e. trees, shrubs, etc.)	Disruption to greenspace and trees.	Alt. II is adjacent to Carp River corridor which presents a potential for impacts to aquatic systems..	3	1	3
Total Score			100%	2.93	2.29	2.52
Ranking				1	3	2
Estimated Capital Cost (in \$million)				1.5	1.5	2

Description of Alternatives

Temporary Forcemain Alternative I - Maple Grove/Huntmar/Iber Road to the Stittsville Collector
 Temporary Forcemain Alternative II- Carp River/Terry Fox to the Stittsville Collector
 Temporary Forcemain Alternative III- Maple Grove/Terry Fox to the Stittsville Collector

Evaluation Ranking

1 -2 High or Negative Impact
 3 Moderate or No Impact
 4-5 Low or Positive Impact

4.2.5 Trunk Sewer Alignment Alternatives

4.2.5.1 Description of Trunk Sewer Alignment Alternatives

Three potential alignments were considered for the gravity sewer that will service the un-serviced lands on Hazeldean Road. This sewer will also permit the decommissioning of several small existing pumping stations located along the north limit of the Village of Stittsville. As illustrated in **Figure 4.1-8** the alternative alignments considered for this sewer are:

- Alternative I - Maple Grove Road from the proposed pumping station to Huntmar Road, south on Huntmar Road to Hazeldean Road at Iber Road.
- Alternative II - Maple Grove Road to south of Poole Creek, southerly along Poole Creek to the transit corridor, southerly along the transitway to Hazeldean Road at Iber Road.
- Alternative III - South from the Maple Grove Road Pumping Station through the proposed development lands adjacent to the Carp River to Hazeldean Road, west on Hazeldean Road to Iber Road.

4.2.5.2 Evaluation of the Trunk Sewer Alignment Alternatives

The alternative sewer alignments were evaluated and ranked using the criteria discussed in Section 4.2. The results of the evaluation are summarized in **Table 4.1-5**. . An explanation of the category rankings and weightings are provided below.

Constructability/Functionality (C/F) – 36%

All three alternatives require approximately the same depth of excavation and present similar geotechnical issues. A benefit of Alternative I is that at least half of the works will be installed in conjunction with other infrastructure. In addition, the Alternative I alignment will be installed in a corridor that will be part of Phase One of construction providing flexibility in phasing works outside the KWCP area.

Alternatives I and II require the least amount of infrastructure to reach Iber Road.

Economy (E) – 25%

Alternatives I and II offer the opportunity to use combined service corridors along Maple Grove Road and Huntmar Road (Alternative I) and Hazeldean Road and the transitway (Alternative II). Alternative I would be part of Phase 1 of construction and will ensure that the timing of installation will coincide with other joint use utilities. This ensures that the economies of the combined corridor servicing will materialize for Alternative I.

Alternatives I and II are the least costly to install as they require the least amount of infrastructure.

Caring and Healthy Community (CHC) – 25%

There are no significant differences between the three alternatives in terms of the impact on the community. The alignment of all three alternatives is primarily confined to within the development area. Impacts will be confined to the period of construction in all cases.

Natural Environment (NE) – 14%

All three sewer alignment alternatives have a similar impact on the environment. Each alignment is confined to existing right-of-ways or in new right-of-ways proposed within the development area. Alternative I requires crossing Poole Creek that may impact water quality.

4.2.5.3 Selection of Preferred Huntmar Road Sewer Alignment Alternative

Based on the above evaluation, Huntmar Road sewer Alternative I is selected as the preferred alignment for the gravity sewer. This sewer will service Hazeldean Road and the southern portion of the KWCP. The alignment is preferred because it maximizes the flexibility for development within the KWCP without compromising the surrounding communities or natural environment.

4.2.6 Signature Ridge Pumping Station Alternatives

4.2.6.1 Description of Signature Ridge Pumping Station Alternatives

The Signature Ridge Pumping Station is a critical element for providing sanitary service to the KWCP. The present condition of the station is insufficient to provide the necessary level of service required to service the proposed area. To the capacity, two alternatives were considered for the Station. The station can be upgraded (Alternative II) or it can be completely rebuilt (Alternative I), including the construction of a new wet well, pumps and auxiliary power facility. Upgrade recommendations have been described in the "Signature Ridge Pumping Station Feasibility Study" by R.V. Anderson Assoc. Ltd., dated Sept. 2003.

These alternatives were considered because of the significant amount of infrastructure that is currently dependent on the Signature Ridge Pumping Station for an outlet. The station is also located in close proximity to the northeast portion of the KWCP. **Figure 4.1-9** illustrates the location of the Signature Ridge Pumping Station.

4.2.6.2 Evaluation of Signature Ridge Pumping Station Alternatives

The alternative pumping station alternatives were evaluated and ranked using the criteria discussed in Section 4.2. The results of the evaluation are summarized in **Table 4.1-6**. An explanation of the category rankings and weightings are provided below.

Constructability/Functionality (C/F) 36%

The Signature Ridge Pumping Station requires only mechanical upgrades to provide the necessary level of service, which can be accomplished through Alternative I (Station up-grade). This eliminates the need to perform deep excavations in soft clays for reconstruction of the wet well. A benefit of constructing a new pumping station would be the ability to increase the pumping capacity to more than that required for the KWCP, increasing the flexibility of the overall wastewater system.

Upgrading the existing station will not require any property acquisition and can be completed in stages to meet the needs of future development over time.

TRUNK SEWER ALIGNMENT ALTERNATIVES

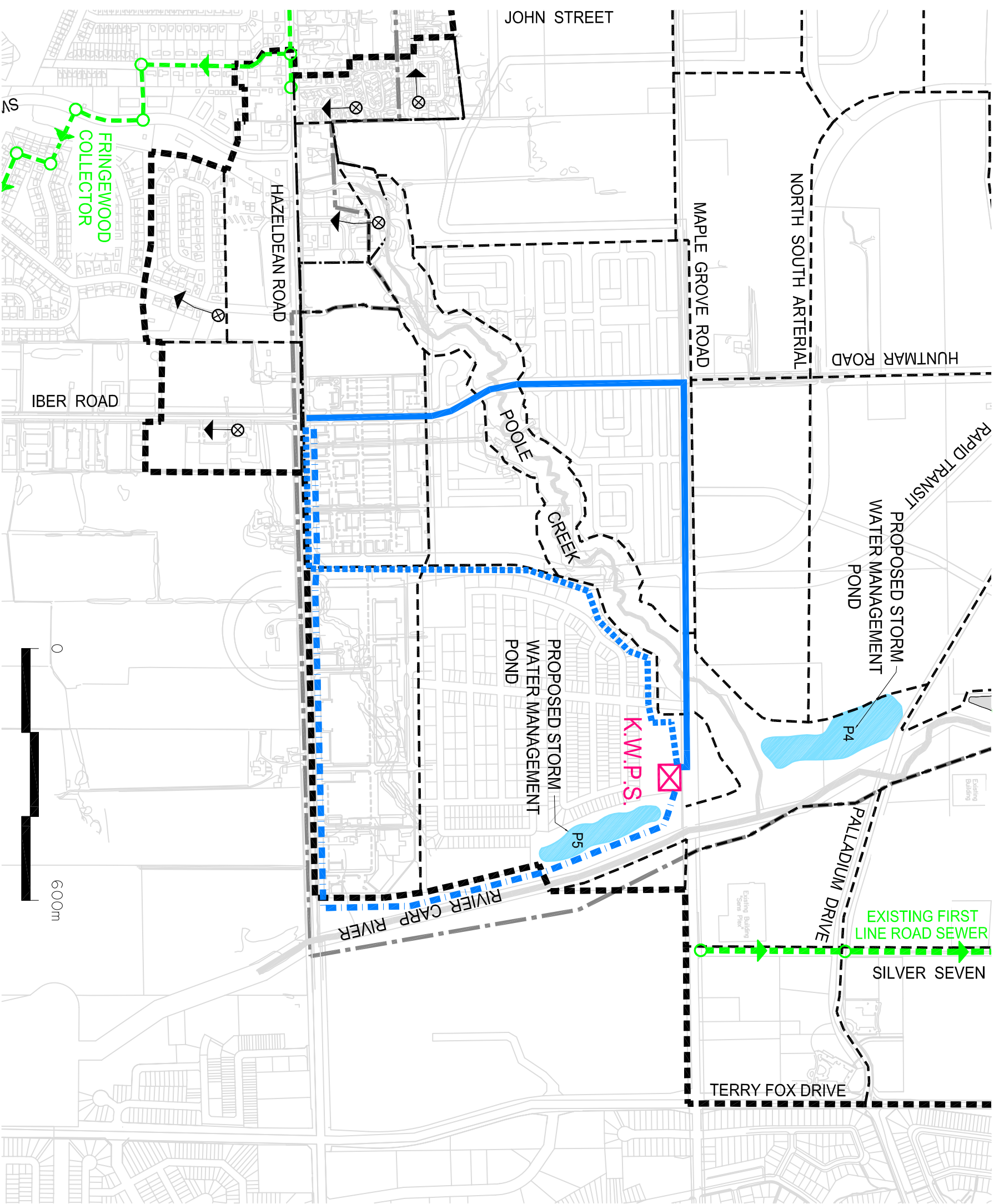

- Ultimate Major Drainage Limit
- Alternate I (Preferred Option)
- Alternate II
- - - Alternate III
- - - Existing Trunk Sewers
- Existing Pumping Station and Forcemain (To be Decommissioned)
- ⊗ Pump Station

FIG. 4.1-8

MAY 2006



Starbuc



Consulting Engineers Limited

TABLE 4.1-5

Kanata West Wastewater - Trunk Sewer Alternatives



Criteria	Indicators	Weighting	Rationale for Relative Weights	Trunk Sewer Alternatives		
				I	II	III
CONSTRUCTABILITY/FUNCTIONALITY			36%			
CO1.1	Geotechnical Issues and Construction Risks	Potential for encountering poor soils and/or elevated groundwater conditions.	7%			
CO1.2	Infrastructure Requirements	Extent of works required.	7%	Alt. III requires the most sewer .		
CO1.3	Operational Impacts	Amount of maintenance intensive infrastructure required.	6%			
CO1.4	Construction Scheduling	Impact of construction on development timing.	4%	Alt. I ensures the trunk sewer is constructed as part of Phase I due to the requirement to install Huntmar Road as part of Phase I.		
CO1.5	Property Acquisition	Ease of property acquisition. (Depends on status of lands and adjacent lands, i.e. vacant, leased or owner occupied.)	2%			
CO1.6	System Reliability	Proximity of a storm sewer, SWM or other surface water for emergency overflow	6%			
CO1.7	Servicing Flexibility	Ease of accommodating potential changes in servicing plans.	5%	The central location of Alt. I to the service area maximizes flexibility.		
ECONOMY			25%			
E1	Potential to Use Combined Service Corridor	Length and area of combined service corridor.	6%	Alt. I is entirely within a joint use corridor where Alt. II and III require extensive specific corridors.		
E2	Efficiency of Use of Existing Infrastructure	Use of existing capacity	5%			
E3	Energy Consumption	Pumping requirements	4%			
E5	Impact on Agriculture	Agriculture area likely to be affected by infrastructure.	2%			
E9	Capital Cost	Estimated cost of construction.	8%	Alt. III is significantly more expensive than Alt. I and II due to overall length and singular service construction.		
CARING AND HEALTHY COMMUNITIES			25%			
C3	Displacement of Residents, Community/Recreation Features and Institutions.	Affects areas of residence, institutions or businesses.	6%			
C4	Disruption to Existing Community	Extent of works affecting existing residences and businesses and visibility of additional infrastructure.	11%			
C9	Consistency with Planned Land Use and Infrastructure	Compatibility with City land use, design guidelines and infrastructure servicing corridor planning (Kanata West Roadwork Environmental Study Report and Storm Sewer and Watermain Needs).	8%			
NATURAL ENVIRONMENT			14%			
N1	Impact on Significant Natural Features	Loss of natural area due to installation of works.	3%	Alt. I crosses Poole Creek requiring construction within the river corridor.		
N3	Impact on Aquatic Systems	Potential impact on fish habitat due to installation of works.	3%	Alt. I crosses Poole Creek increasing the potential to impact fish habitat.		
N4	Impact on Quality and Quantity of Surface Water and Groundwater	Potential impact on water quality in the Carp River resulting from rare emergency overflows to the SWM pond due to pump station failure.	3%			
N5	Impact on Global Warming	Difference in carbon dioxide emissions resulting from occasional use of diesel generator.	1%			
N6	Effects on Urban Greenspace, Open Space and Vegetation (i.e.trees,shrubs,etc.)	Disruption to greenspace and trees.	5%			
Total Score			100%			
Ranking						
Estimated Capital Cost (in \$million)						
				3.29	2.84	2.61
				1	2	3
				1.5	1.5	2.5

Description of Alternatives
 Trunk Sewer Alternative I - Maple Grove/Huntmar/Hazeldean Road
 Trunk Sewer Alternative II- Maple Grove/Poole Creek/Transitway/Hazeldean Road
 Trunk Sewer Alternative III - Maple Grove/Hazeldean Road

Evaluation Ranking
 1 -2 High or Negative Impact
 3 Moderate or No Impact
 4-5 Low or Positive Impact

Economy (E) 25%

The reconstruction of the Signature Ridge Pumping Station is significantly more than the costs to upgrade the existing station.

Caring and Healthy Community (CHC) 25%

In terms of the impact on the Community, there are no significant differences between the two alternatives.

Natural Environment (NE) 14%

There are no significant differences between the two options with respect to impacts to the natural environment. Both alternatives require the construction of an emergency overflow to the Carp River. Impacts to surface water quality as a result of potential station overflows during an emergency situation are not expected to occur. Should an overflow occur for either alternative, the impacts would be mitigated by a SWM pond. Increases in CO₂ emissions as a result of the use of diesel generators during power failures or maintenance procedures will be negligible and are similar in both alternatives.

4.2.6.3 Selection of Preferred Signature Ridge Pumping Station Alternative

Based on the above evaluation, the Signature Ridge Pumping Station Alternative I, station upgrade, is selected as the preferred alternative. This alternative maximizes the use of existing infrastructure and offers the most flexibility in phasing of the works with the least amount of capital expenditure or impacts.

4.2.6.4 Summary

The preferred alternatives selected for the wastewater outlet, the internal servicing system, the temporary forcemain, the trunk sewer alignment, and the Signature Ridge Pumping Station have been used to develop a comprehensive wastewater servicing plan for the KWCP. This servicing plan is discussed in future detail in the following section of this report.

4.3 Preferred Sanitary Sewer Servicing Plan

Section 4.2 has detailed the selection of preferred alternatives for the major infrastructure required to provide sanitary sewer service to the KWCP. These preferred alternatives have been used to develop a Master Sanitary Servicing Plan for the area. This plan is illustrated on **Drawing S-1** (appended to this report). The major features of this plan are:

- (i.) An upgraded Signature Ridge Pumping Station (SRPS) to service all the KWCP lands north of the Queensway, the existing urban area north of the Queensway currently proposed to drain to the SRPS, and the Broughton/Richardson Interstitial lands. A spreadsheet detailing the exact areas and flows tributary to the SRPS is included in **Figure 4.2-1**.

The 400 l/sec peak flow capacity identified in **Figure 4.2-1** for the upgraded SRPS, is consistent with the findings of the R.V. Anderson Report titled "Signature Ridge Pumping Station Upgrades Feasibility Study".

SIGNATURE RIDGE PUMPING STATION LOCATION

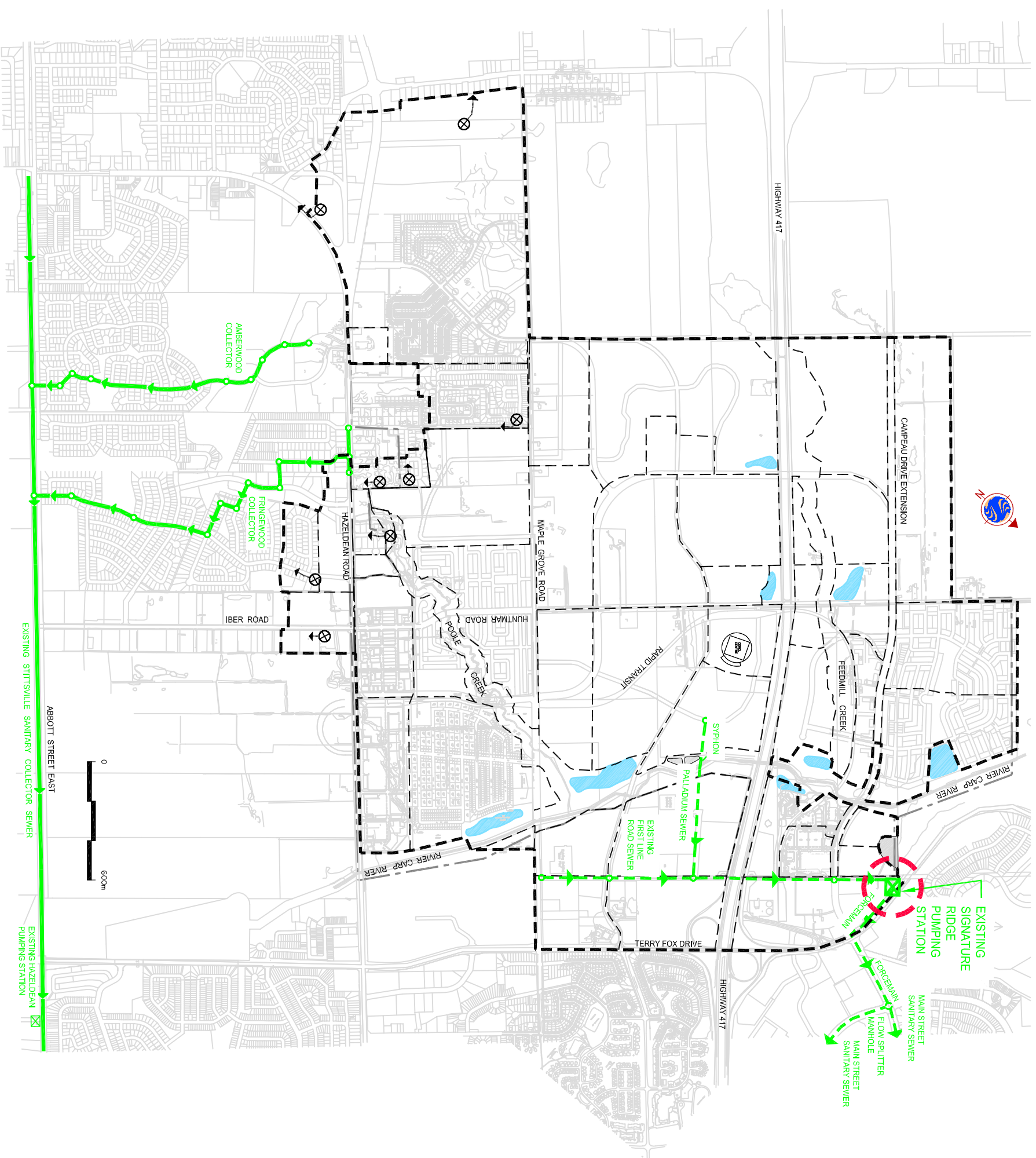

- Legend:**
- Ultimate Drainage Limit
 - Existing Stittsville Sewer
 - - - Existing Trunk Sewer
 - ⊗ → Existing Pumping Station and Foremain (To be Decommissioned)

MAY 2006

FIG. 4.1-9



Stantec



Canning Consultants Limited

TABLE 4.1-6



Kanata West Wastewater - Temporary Forcemain/Trunk Sewer/Signature Ridge Alternatives

Criteria		Indicators	Weighting	Rationale for Relative Weights	Signature Ridge PS Alternative	
					Upgrade	Rebuild
CONSTRUCTABILITY/FUNCTIONALITY			36%		24	16
CO1.1	Geotechnical Issues and Construction Risks	Potential for encountering poor soils and/or elevated groundwater conditions.	7%	Alt. II requires reconstruction of the pumping station in very soft clays where Alt. I does not require reconstruction of the wet well.	3	1
CO1.2	Infrastructure Requirements	Extent of works required.	7%	Alt. I only requires upgrading of hardware within the existing pumping station.	4	1
CO1.3	Operational Impacts	Amount of maintenance intensive infrastructure required.	6%		3	3
CO1.4	Construction Scheduling	Impact of construction on development timing.	4%	Alt. I can be phased to suit development timing where Alt. II requires a lengthy total reconstruction program.	4	2
CO1.5	Property Acquisition	Ease of property acquisition. (Depends on status of lands and adjacent lands, i.e. vacant, leased or owner occupied.)	2%	Alt. II requires property acquisition for a new station because existing station will have to remain in service during construction.	5	2
CO1.6	System Reliability	Proximity of a storm sewer, SWM or other surface water for emergency overflow	6%		3	3
CO1.7	Servicing Flexibility	Ease of accommodating potential changes in servicing plans.	5%	Alt. II can be built to accommodate changes where Alt. I is designed to the maximum.	2	4
ECONOMY			25%		19	12
E1	Potential to Use Combined Service Corridor	Length and area of combined service corridor.	6%		3	3
E2	Efficiency of Use of Existing Infrastructure	Use of existing capacity	5%	Alt. I maximizes the use of the existing station.	5	2
E3	Energy Consumption	Pumping requirements	4%		3	3
E5	Impact on Agriculture	Agriculture area likely to be affected by infrastructure.	2%		3	3
E9	Capital Cost	Estimated cost of construction.	8%	Alt. II is significantly more expensive to construct.	5	1
CARING AND HEALTHY COMMUNITIES			25%		12	9
C3	Displacement of Residents, Community/Recreation Features and Institutions.	Affects areas of residence, institutions or businesses.	6%		4	4
C4	Disruption to Existing Community	Extent of works affecting existing residences and businesses and visibility of additional infrastructure.	11%	Alt. 1 requires only internal up-grades and will have minimal construction traffic or related impacts.	4	3
G9	Consistency with Planned Land Use and Infrastructure	Compatibility with City land use, design guidelines and infrastructure servicing corridor planning (Kanata West Roadwork Environmental Study Report and Storm Sewer and Watermain Needs).	8%	Alt. I maximizes use of currently planned infrastructure by upgrading existing station to its maximum potential.	4	2
NATURAL ENVIRONMENT			14%		14	14
N1	Impact on Significant Natural Features	Loss of natural area due to installation of works.	3%		3	3
N3	Impact on Aquatic Systems	Potential impact on fish habitat due to installation of works.	3%		3	3
N4	Impact on Quality and Quantity of Surface Water and Groundwater	Potential impact on water quality in the Carp River resulting from rare emergency overflows to the SWM pond due to pump station failure.	3%		3	3
N5	Impact on Global Warming	Difference in carbon dioxide emissions resulting from occasional use of diesel generator.	1%		2	2
N6	Effects on Urban Greenspace, Open Space and Vegetation (i.e.trees,shrubs,etc.)	Disruption to greenspace and trees.	5%		3	3
Total Score			100%		3.60	2.48
Ranking					1	2
Estimated Capital Cost (in \$million)					1	4

Description of Alternatives
 Signature Ridge PS Alternative 1 - Rebuild
 Signature Ridge PS Alternative II - Upgrade

Evaluation Ranking
 1 -2 High or Negative Impact
 3 Moderate or No Impact
 4-5 Low or Positive Impact

The Signature Ridge Pumping Station is currently not equipped with catastrophic failure protection in the form of a gravity overflow. A hydraulic analysis of the proposed sewer system was therefore completed to evaluate the potential for providing a gravity overflow. This analysis demonstrates that catastrophic protection can be provided by gravity. The analysis is included in **Appendix 4.2** and demonstrates that overflows to the existing stormwater management pond on First Line Road and to Pond I can provide the necessary level of protection.

- (ii.) A single new pumping station and forcemain located south of Maple Grove Road and west of the Carp River.

This new pumping station ultimately services all the KWCP south of Highway 417, the lands south of the 417 originally tributary to the SRPS, and the lands in the Village of Stittsville, along Hazeldean Road which are currently unserviceable by gravity to the Stittsville Sanitary Sewer System. This new pumping station has also been designed to accommodate the decommissioning of up to eight small public and private pumping stations along Hazeldean Road without deepening the Kanata West system. **Figure 4.2-1** details the exact areas and flows from Stittsville which will ultimately be tributary to the new pumping station. The areas are also illustrated on **Drawing S-1**.

Figures 4.2-3 and 4.2-4 illustrate a conceptual layout and cross-section for the new pumping station and **Appendix 4.3** details the conceptual design of the pumping station.

The new pumping station will temporarily outlet to the Stittsville Collector Sewer via a temporary forcemain in Huntmar Road and Iber Road. This temporary forcemain is designed to accommodate a flow of 190 l/sec (approximately 3,000 units). The temporary outlet will be located entirely within a public right-of-way. The single 405 mm diameter forcemain used for the initial outlet can be kept in service for long-term use as an emergency back up outlet. Rationale on the availability of capacity in the Stittsville Collector Sewer is attached as **Appendix 4.1**.

The permanent outlet for the new pumping station consists of a forcemain leading from the pumping station to the Glen Cairn Collector Sewer east of Eagleson Road. The preferred route for this forcemain is along Maple Grove Road to Silver Seven Road; along the east side of Silver Seven Road, in an easement, in the undeveloped lands between Maple Grove Road and Palladium Drive; easterly along Palladium Drive to Katimavik Road; and easterly along the north side of Katimavik Road, in the corridor for the unbuilt westbound lanes of Katimavik Road, to Eagleson Road and the Glen Cairn Collector Sewer. The location of the new pumping station is in close proximity to Stormwater Management Ponds 4 and 5. This provides catastrophic failure protection to the new pumping station in the form of a gravity overflow. The hydraulic analysis of this overflow system is attached as **Appendix 4.2**.

The preferred sanitary sewer system also includes a gravity sewer, which collects flow from several minor internal sanitary sewers and directs this flow to the new pumping station location. As illustrated on **Drawing S-1** this minor collector sewer runs parallel to the west side of the Carp River corridor between Maple Grove Road and Palladium Drive, crossing under the Carp River by boring beneath the river. The sewer extends northerly to intercept flows from Silver Seven Road and diverts them from the Signature Ridge Pumping Station. The inclusion of this north south sewer is a key element in eliminating the need for double pumping within Kanata

SANITARY SEWER DESIGN SHEET
PROJECT : Kanata West Servicibility Stury
LOCATION : CITY OF OTTAWA

PAGE 1 OF 1
 PROJECT: 3598-LD-03
 DATE: Apr 2005
 DESIGN: JIM
 FILE: 3598LD.sewers.XLS

PHASE 1 SIGNATURE RIDGE (population based criteria..ICI simultaneous peaking)

STREET	LOCATION			TOTAL AREA (Ha)	RESIDENTIAL							EMPLOYMENT/RETAIL/BUSINESS PARK/OPEN SPACES						INFILTRATION			TOTAL FLOW (l/s)	PROPOSED SEWER											
	FROM MH	TO MH	APPLIC AREA (Ha)		UNIT/Ha	TOTAL UNITS	POPULATION		PEAK FACTOR	PEAK FLOW (l/s)	APPLIC AREA (Ha)	ACCUM AREA (Ha)	TOTAL AREA (Ha)	FLOW RATE (l/Ha/d)	PEAK FLOW			INDIV	AREA (Ha)			PEAK FLOW (l/s)	CAPACITY l/s	VELOCITY (ful) m/s	LGTH. (m)	PIPE (mm)	GRADE %	AVAIL. CAP. (%)					
							INDIV	ACCUM							INDIV	ACCUM	TOTAL		CUMUL	TOTAL CUMUL													
							(l/s)	(l/s)							(l/s)	(l/s)	(l/s)																
Campeau Drive Trunk Sewer	1	2											0.00	0.00	0.00		0.00	0.00															
			Area 1 (PBP)	0.00									0.00	0.00	35000	0.00	0.00																
			Area 2 (PBP)	0.00									0.00	0.00	35000	0.00	0.00																
			Area 3 Ext Employment	0.00									0.00	0.00	50000	0.00	0.00																
			Area 4 HP Employment	0.00									0.00	0.00	0.00	50000	0.00	0.00	0.00	0.00	0.00	0.00	0.00	0.00	0.00	0.00	283.79	1.27	500.0	525	0.40	100.00%	
	2	3	Area 5 Residential	29.19	29.19	19	555	1664	1664	3.65	24.58																						
			Area 9 Ext Employment	0.00									0.00	0.00	50000	0.00	0.00	0.00	0.00	0.00	29.19	8.17	32.75	286.61	0.98	700.0	600	0.20	88.57%				
	14	3	Area 6/8 Ext Employment	0.00									0.00	0.00	0.00	50000	0.00	0.00	0.00	0.00	0.00	0.00	0.00	0.00	0.00	0.00							
			Area 7 HP Employment	0.00									0.00	0.00	0.00	50000	0.00	0.00	0.00	0.00	0.00	0.00	0.00	0.00	0.00	0.00	148.74	0.91	920.0	450	0.25	100.00%	
	3	4					1664	3.65	24.58				0.00	0.00	0.00	0.00	0.00	0.00	29.19	8.17	32.75	200.67	0.90	150.0	675	0.20	83.68%						
	4A	4	Area 10 Residential	27.86	27.86	19	529	1588	1588	3.66	23.55																						
	4	5	14 Mixed Use	4.13	1.76	50	88	263	3515	3.38	48.17																						
Corel Centre Etc. (Existing Sewer)		15	Area 35 HP Employment	6.05									6.05	6.05	30000	3.15	3.15																
			Area 36 (Corel Centre)																														
			Area 38 Exten Employment	20.15									20.15	26.20	26.20	14400	5.04	8.19	8.19	20.15	26.20	26.20	7.34	45.52									
First Line Road Sewer		15	Area 40 Employment	14.59									14.59	14.59	35000	8.87	8.87																
			Area 41 Employment	11.97									11.97	26.56	35000	7.27	16.14																
			Area 42 Employment	20.66									20.66	47.22	35000	12.55	28.69																
			Area 43 Employment	28.89									28.89	76.11	76.11	35000	17.55	46.25	46.25	28.89	76.11	76.11	21.31	67.56	100.21	0.88	694.0	375	0.30	32.59%			
Totals South Of Queensway To SRPS	15	5A		102.31	0.00	0	0	0	0	0.00	0.00	102.31							54.44	102.31	102.31	58.65	113.08	113.08	203.90	1.24	230.0	450	0.47	44.54%			
	Queensway	5	Area 13 Community Retail	6.35									6.35	108.66	35000	3.86	58.29																
			Area 11/12 Mixed Use	11.80	5.02	50	251	752	752	3.88	11.81		6.79	115.45	115.45	35000	4.12	62.42	62.42	11.80	18.15	120.46	63.73	137.96	203.90	1.24	420.0	450	0.47	32.34%			
	5	5A	Area 15 Community Retail	3.88									3.88	119.33	35000	2.36	64.77																
			Area 44	25.54									25.54	144.87	268.20	35000	15.52	81.73	81.73	25.54	149.88	211.06	89.10	230.81	519.43	1.14	300.0	750	0.20	55.56%			
				149.88																													
Heritage Hills		5A	Area 100 Residential	90.20	90.20	19	1714	5141	5141	3.23	67.35		0.00							90.20													
Heritage Hills		5A	Area 100 Non-Residential	4.88									4.88	4.88	4.88	50000	4.24	4.24	4.24	4.88	95.08	95.08	26.62	98.21									
Broughton-Richardson / Interstitial		5A																															
Total To SRPS	5A	SRPS		306.14	154.03	3136	9409	9409	9409	127.33	152.12								85.97		306.14	115.72	394.02	625.68	1.37	30.0	750	0.29	37.03%				

Revision No. 1: April 11, 2005
 Revision No. 2: April 20, 2005
 Revision No. 3: June 07, 2005
 Revision No. 4: Oct. 14, 2005
 Revision No. 5: Feb. 15, 2006

Average Daily Per capita Flow Rate = 350 l/cap/d
 Infiltration Allowance Flow Rate = 0.28 l/sec/Ha
 Residential Peaking Factor = $1+(14/(4+(P^{0.5})))$, P=Pop. in 1000's, Max of 4
 Population density per unit = 3.00
 P. F. For Employment/Retail/Business Park = 1.50

Mixed Uses Assumes: 15% Community Retail, 42.5% Business Park and 42.5% Residential

Note: Sewer from node 5 to SRPS is existing and is to be replaced.



FIG. 4.2-2

**SERVICING AND STORMWATER MANAGEMENT BRIEF –
WELLINGS OF STITTSVILLE PHASE 2, 20 CEDAROW COURT**

Appendix C Stormwater Management
September 21, 2022

Appendix C STORMWATER MANAGEMENT

**C.1 STORM SEWER DESIGN SHEET AND ROOF STORAGE
CALCULATIONS**



20 Cedarow

STORM SEWER DESIGN SHEET (City of Ottawa)

DESIGN PARAMETERS

I = a / (t+b)^c (As per City of Ottawa Guidelines, 2012)

Table with 4 columns: 1:2 yr, 1:5 yr, 1:10 yr, 1:100 yr. Values for a, b, c are provided.

MANNING'S n = 0.013, MINIMUM COVER: 2.00 m, TIME OF ENTRY 10 min, BEDDING CLASS = B

DATE: 2022-09-29, REVISION: 5, DESIGNED BY: MS, CHECKED BY: DT

FILE NUMBER: 160401511

Main data table with columns: LOCATION, AREA ID NUMBER, FROM M.H., TO M.H., AREA (2-YEAR to 100-YEAR), C (2-YEAR to 100-YEAR), A x C, ACCUM., T of C, I 1/2-YEAR to I 100-YEAR, Q CONTROL, ACCUM., Q ACT, LENGTH, PIPE WIDTH, PIPE HEIGHT, PIPE SHAPE, MATERIAL, CLASS, SLOPE, Q CAP, % FULL, VEL. (FULL), VEL. (ACT), TIME OF FLOW.

Roof Drain Design Calculation Sheet

**Project #160401511, 20 Cedarow
Roof Drain Design Sheet, Area ROOF1**

Rating Curve				Volume Estimation				Water Depth (m)
Elevation (m)	Discharge Rate (cu.m/s)	Outlet Discharge (cu.m/s)	Storage (cu. m)	Elevation (m)	Area (sq. m)	Volume (cu. m)		
						Increment	Accumulated	
0.000	0.0000	0.0000	0	0.000	0	0	0	0.000
0.025	0.0003	0.0006	0	0.025	4	0	0	0.025
0.050	0.0006	0.0013	0	0.050	18	0	0	0.050
0.075	0.0008	0.0016	1	0.075	40	1	1	0.075
0.100	0.0009	0.0019	2	0.100	71	1	2	0.100
0.125	0.0011	0.0022	5	0.125	111	2	5	0.125
0.150	0.0013	0.0025	8	0.150	160	3	8	0.150

Drawdown Estimate			
Total Volume (cu.m)	Total Time (sec)	Vol (cu.m)	Detention Time (hr)
0.0	0.0	0.0	0
0.3	205.5	0.3	0.05707
1.0	446.2	0.7	0.18101
2.3	724.0	1.4	0.38213
4.6	1023.1	2.3	0.66633
8.0	1335.5	3.4	1.03731

Rooftop Storage Summary

Total Building Area (sq.m)		200	
Assume Available Roof Area (sq. m)	80%	160	
Roof Imperviousness		0.99	
Roof Drain Requirement (sq.m/Notch)		232	
Number of Roof Notches*		2	
Max. Allowable Depth of Roof Ponding (m)		0.15	* As per Ontario Building Code section OBC 7.4.10.4.(2)(c).
Max. Allowable Storage (cu.m)		8	
Estimated 100 Year Drawdown Time (h)		0.7	

From Watts Drain Catalogue

Head (m)	L/s					
	Open	0.75	0.5	0.25	Closed	
0.025	0.3155	0.3155	0.3155	0.3155	0.3155	
0.05	0.6309	0.6309	0.6309	0.6309	0.6309	
0.075	0.9464	0.8675	0.7886	0.7098	0.6309	
0.1	1.2618	1.1041	0.9464	0.7886	0.6309	
0.125	1.5773	1.3407	1.1041	0.8675	0.6309	
0.15	1.8927	1.5773	1.2618	0.9464	0.6309	

* Note: Number of drains can be reduced if multiple-notch drain used.

Calculation Results

	5yr	100yr	Available
Qresult (cu.m/s)	0.002	0.002	-
Depth (m)	0.081	0.130	0.150
Volume (cu.m)	1.3	5.3	8.0
Drain time (hrs)	0.2	0.7	

Roof Drain Design Calculation Sheet

**Project #160401511, 20 Cedarow
Roof Drain Design Sheet, Area ROOF2**

Rating Curve				Volume Estimation				Water Depth (m)
Elevation (m)	Discharge Rate (cu.m/s)	Outlet Discharge (cu.m/s)	Storage (cu. m)	Elevation (m)	Area (sq. m)	Volume (cu. m)		
						Increment	Accumulated	
0.000	0.0000	0.0000	0	0.000	0	0	0	0.000
0.025	0.0003	0.0028	0	0.025	49	0	0	0.025
0.050	0.0006	0.0057	3	0.050	196	3	3	0.050
0.075	0.0008	0.0071	11	0.075	440	8	11	0.075
0.100	0.0009	0.0085	26	0.100	782	15	26	0.100
0.125	0.0011	0.0099	51	0.125	1222	25	51	0.125
0.150	0.0013	0.0114	88	0.150	1760	37	88	0.150

Drawdown Estimate			
Total Volume (cu.m)	Total Time (sec)	Vol (cu.m)	Detention Time (hr)
0.0	0.0	0.0	0
2.9	502.3	2.9	0.13951
10.6	1090.6	7.7	0.44246
25.7	1769.8	15.1	0.93408
50.5	2501.0	24.9	1.62881
87.6	3264.6	37.1	2.53566

Rooftop Storage Summary

Total Building Area (sq.m)		2200	
Assume Available Roof Area (sq. m)	80%	1760	
Roof Imperviousness		0.99	
Roof Drain Requirement (sq.m/Notch)		232	
Number of Roof Notches*		9	
Max. Allowable Depth of Roof Ponding (m)		0.15	* As per Ontario Building Code section OBC 7.4.10.4.(2)(c).
Max. Allowable Storage (cu.m)		88	
Estimated 100 Year Drawdown Time (h)		2.4	

From Watts Drain Catalogue

Head (m)	L/s				
	Open	0.75	0.5	0.25	Closed
0.025	0.3155	0.3155	0.3155	0.3155	0.3155
0.05	0.6309	0.6309	0.6309	0.6309	0.6309
0.075	0.9464	0.8675	0.7886	0.7098	0.6309
0.1	1.2618	1.1041	0.9464	0.7886	0.6309
0.125	1.5773	1.3407	1.1041	0.8675	0.6309
0.15	1.8927	1.5773	1.2618	0.9464	0.6309

* Note: Number of drains can be reduced if multiple-notch drain used.

Calculation Results

	5yr	100yr	Available
Qresult (cu.m/s)	0.008	0.011	-
Depth (m)	0.098	0.147	0.150
Volume (cu.m)	24.6	83.8	88.0
Draintime (hrs)	0.9	2.4	

Roof Drain Design Calculation Sheet

**Project #160401511, 20 Cedarow
Roof Drain Design Sheet, Area ROOF3**

Rating Curve				Volume Estimation				Water Depth (m)
Elevation (m)	Discharge Rate (cu.m/s)	Outlet Discharge (cu.m/s)	Storage (cu. m)	Elevation (m)	Area (sq. m)	Volume (cu. m)		
						Increment	Accumulated	
0.000	0.0000	0.0000	0	0.000	0	0	0	0.000
0.025	0.0003	0.0025	0	0.025	41	0	0	0.025
0.050	0.0006	0.0050	3	0.050	164	2	3	0.050
0.075	0.0008	0.0063	9	0.075	370	7	9	0.075
0.100	0.0009	0.0076	22	0.100	658	13	22	0.100
0.125	0.0011	0.0088	43	0.125	1028	21	43	0.125
0.150	0.0013	0.0101	74	0.150	1480	31	74	0.150

Drawdown Estimate			
Total Volume (cu.m)	Total Time (sec)	Vol (cu.m)	Detention Time (hr)
0.0	0.0	0.0	0
2.4	475.1	2.4	0.13198
8.9	1031.7	6.5	0.41858
21.6	1674.3	12.7	0.88367
42.5	2366.0	20.9	1.54089
73.7	3088.4	31.2	2.39879

Rooftop Storage Summary

Total Building Area (sq.m)		1850	
Assume Available Roof Area (sq. 80%)		1480	
Roof Imperviousness		0.99	
Roof Drain Requirement (sq.m/Notch)		232	
Number of Roof Notches*		8	
Max. Allowable Depth of Roof Ponding (m)		0.15	* As per Ontario Building Code section OBC 7.4.10.4.(2)(c).
Max. Allowable Storage (cu.m)		74	
Estimated 100 Year Drawdown Time (h)		2.3	

From Watts Drain Catalogue

Head (m)	L/s				
Open	0.75	0.5	0.25	Closed	
0.025	0.3155	0.3155	0.3155	0.3155	0.3155
0.05	0.6309	0.6309	0.6309	0.6309	0.6309
0.075	0.9464	0.8675	0.7886	0.7098	0.6309
0.1	1.2618	1.1041	0.9464	0.7886	0.6309
0.125	1.5773	1.3407	1.1041	0.8675	0.6309
0.15	1.8927	1.5773	1.2618	0.9464	0.6309

* Note: Number of drains can be reduced if multiple-notch drain used.

Calculation Results	5yr	100yr	Available
Qresult (cu.m/s)	0.007	0.010	-
Depth (m)	0.096	0.146	0.150
Volume (cu.m)	20.1	69.0	74.0
Drain time (hrs)	0.8	2.3	

Roof Drain Design Calculation Sheet

**Project #160401511, 20 Cedarow
Roof Drain Design Sheet, Area ROOF4**

Rating Curve				Volume Estimation				Water Depth (m)
Elevation (m)	Discharge Rate (cu.m/s)	Outlet Discharge (cu.m/s)	Storage (cu. m)	Elevation (m)	Area (sq. m)	Volume (cu. m)		
						Increment	Accumulated	
0.000	0.0000	0.0000	0	0.000	0	0	0	0.000
0.025	0.0003	0.0006	0	0.025	4	0	0	0.025
0.050	0.0006	0.0013	0	0.050	18	0	0	0.050
0.075	0.0008	0.0016	1	0.075	40	1	1	0.075
0.100	0.0009	0.0019	2	0.100	71	1	2	0.100
0.125	0.0011	0.0022	5	0.125	111	2	5	0.125
0.150	0.0013	0.0025	8	0.150	160	3	8	0.150

Drawdown Estimate			
Total Volume (cu.m)	Total Time (sec)	Vol (cu.m)	Detention Time (hr)
0.0	0.0	0.0	0
0.3	205.5	0.3	0.05707
1.0	446.2	0.7	0.18101
2.3	724.0	1.4	0.38213
4.6	1023.1	2.3	0.66633
8.0	1335.5	3.4	1.03731

Rooftop Storage Summary

Total Building Area (sq.m)		200	
Assume Available Roof Area (sq. m)	80%	160	
Roof Imperviousness		0.99	
Roof Drain Requirement (sq.m/Notch)		232	
Number of Roof Notches*		2	
Max. Allowable Depth of Roof Ponding (m)		0.15	* As per Ontario Building Code section OBC 7.4.10.4.(2)(c).
Max. Allowable Storage (cu.m)		8	
Estimated 100 Year Drawdown Time (h)		0.7	

From Watts Drain Catalogue

Head (m)	L/s					
	Open	0.75	0.5	0.25	Closed	
0.025	0.3155	0.3155	0.3155	0.3155	0.3155	
0.05	0.6309	0.6309	0.6309	0.6309	0.6309	
0.075	0.9464	0.8675	0.7886	0.7098	0.6309	
0.1	1.2618	1.1041	0.9464	0.7886	0.6309	
0.125	1.5773	1.3407	1.1041	0.8675	0.6309	
0.15	1.8927	1.5773	1.2618	0.9464	0.6309	

* Note: Number of drains can be reduced if multiple-notch drain used.

Calculation Results

	5yr	100yr	Available
Qresult (cu.m/s)	0.002	0.002	-
Depth (m)	0.081	0.130	0.150
Volume (cu.m)	1.3	5.3	8.0
Drain time (hrs)	0.2	0.7	

Stormwater Management Calculations

Project #160401511, 20 Cedarow Modified Rational Method Calculators for Storage

2 yr Intensity City of Ottawa	$I = a/(t + b)^c$	a = 732.951	t (min)	I (mm/hr)
		b = 6.199	10	76.81
		c = 0.81	20	52.03
			30	40.04
			40	32.86
			50	28.04
			60	24.56
			70	21.91
			80	19.83
			90	18.14
			100	16.75
			110	15.57
			120	14.56

2 YEAR Modified Rational Method for Entire Site

Subdrainage Area: ROOF4
Area (ha): 0.02
C: 0.90
Maximum Storage Depth: Roof 150 mm

tc (min)	I (5 yr) (mm/hr)	Qactual (L/s)	Qrelease (L/s)	Qstored (L/s)	Vstored (m³)	Depth (mm)
10	76.81	3.84	1.65	2.19	1.32	80.8
20	52.03	2.60	1.62	0.98	1.18	78.3
30	40.04	2.00	1.52	0.48	0.87	70.4
40	32.86	1.64	1.40	0.25	0.60	60.6
50	28.04	1.40	1.29	0.12	0.35	51.9
60	24.56	1.23	1.16	0.07	0.25	45.9
70	21.91	1.10	1.05	0.05	0.21	41.5
80	19.83	0.99	0.96	0.04	0.17	37.9
90	18.14	0.91	0.88	0.03	0.14	34.9
100	16.75	0.84	0.82	0.02	0.11	32.5
110	15.57	0.78	0.77	0.01	0.09	30.3
120	14.56	0.73	0.72	0.01	0.07	28.5

Storage: Roof Storage

Depth (mm)	Head (m)	Discharge (L/s)	Vreq (cu. m)	Vavail (cu. m)	Discharge Check	
2-year Water Level	80.76	0.08	1.65	1.32	8.00	0.00

Subdrainage Area: ROOF3
Area (ha): 0.19
C: 0.90
Maximum Storage Depth: Roof 150 mm

tc (min)	I (5 yr) (mm/hr)	Qactual (L/s)	Qrelease (L/s)	Qstored (L/s)	Vstored (m³)	Depth (mm)
10	76.81	35.55	7.09	28.46	17.08	90.4
20	52.03	24.08	7.38	16.70	20.04	96.3
30	40.04	18.53	7.39	11.15	20.07	96.3
40	32.86	15.21	7.28	7.93	19.03	94.3
50	28.04	12.98	7.13	5.85	17.54	91.3
60	24.56	11.37	6.97	4.40	15.85	88.0
70	21.91	10.14	6.79	3.35	14.08	84.5
80	19.83	9.18	6.61	2.56	12.31	81.0
90	18.14	8.40	6.44	1.96	10.57	77.6
100	16.75	7.75	6.26	1.50	8.97	73.9
110	15.57	7.21	6.03	1.18	7.79	69.4
120	14.56	6.74	5.81	0.93	6.69	65.1

Storage: Roof Storage

Depth (mm)	Head (m)	Discharge (L/s)	Vreq (cu. m)	Vavail (cu. m)	Discharge Check	
2-year Water Level	96.34	0.10	7.39	20.07	74.00	0.00

Subdrainage Area: ROOF2
Area (ha): 0.22
C: 0.90
Maximum Storage Depth: Roof 150 mm

tc (min)	I (5 yr) (mm/hr)	Qactual (L/s)	Qrelease (L/s)	Qstored (L/s)	Vstored (m³)	Depth (mm)
10	76.81	42.28	8.00	34.28	20.57	90.9
20	52.03	28.64	8.35	20.29	24.34	97.1
30	40.04	22.04	8.38	13.66	24.59	97.5
40	32.86	18.09	8.28	9.81	23.55	95.8
50	28.04	15.43	8.13	7.31	21.93	93.1
60	24.56	13.52	7.95	5.57	20.04	90.0
70	21.91	12.06	7.76	4.30	18.06	86.7
80	19.83	10.92	7.57	3.34	16.04	83.4
90	18.14	9.99	7.38	2.60	14.05	80.1
100	16.75	9.22	7.20	2.02	12.10	76.8
110	15.57	8.57	6.99	1.58	10.42	73.1
120	14.56	8.02	6.75	1.26	9.11	68.9

Storage: Roof Storage

Depth (mm)	Head (m)	Discharge (L/s)	Vreq (cu. m)	Vavail (cu. m)	Discharge Check	
2-year Water Level	97.55	0.10	8.38	24.59	88.00	0.00

Subdrainage Area: ROOF1
Area (ha): 0.02
C: 0.90
Maximum Storage Depth: Roof 150 mm

tc (min)	I (5 yr) (mm/hr)	Qactual (L/s)	Qrelease (L/s)	Qstored (L/s)	Vstored (m³)	Depth (mm)
10	76.81	3.84	1.65	2.19	1.32	80.8
20	52.03	2.60	1.62	0.98	1.18	78.3
30	40.04	2.00	1.52	0.48	0.87	70.4
40	32.86	1.64	1.40	0.25	0.60	60.6
50	28.04	1.40	1.29	0.12	0.35	51.9
60	24.56	1.23	1.16	0.07	0.25	45.9

Project #160401511, 20 Cedarow Modified Rational Method Calculators for Storage

100 yr Intensity City of Ottawa	$I = a/(t + b)^c$	a = 1735.688	t (min)	I (mm/hr)
		b = 6.014	10	178.56
		c = 0.820	20	119.95
			30	91.87
			40	75.15
			50	63.95
			60	55.89
			70	49.79
			80	44.99
			90	41.11
			100	37.90
			110	35.20
			120	32.89

100 YEAR Modified Rational Method for Entire Site

Subdrainage Area: ROOF4
Area (ha): 0.02
C: 1.00
Maximum Storage Depth: Roof 150 mm

tc (min)	I (100 yr) (mm/hr)	Qactual (L/s)	Qrelease (L/s)	Qstored (L/s)	Vstored (m³)	Depth (mm)
10	178.56	9.93	2.21	7.72	4.63	125.0
20	119.95	6.67	2.27	4.40	5.28	129.8
30	91.87	5.11	2.26	2.85	5.13	128.7
40	75.15	4.18	2.22	1.96	4.71	125.6
50	63.95	3.56	2.15	1.41	4.22	120.4
60	55.89	3.11	2.08	1.03	3.70	114.8
70	49.79	2.77	2.01	0.76	3.19	109.1
80	44.99	2.50	1.94	0.56	2.70	103.7
90	41.11	2.29	1.87	0.42	2.26	98.0
100	37.90	2.11	1.79	0.32	1.92	91.7
110	35.20	1.96	1.72	0.24	1.60	85.9
120	32.89	1.83	1.65	0.18	1.31	80.6

Storage: Roof Storage

Depth (mm)	Head (m)	Discharge (L/s)	Vreq (cu. m)	Vavail (cu. m)	Discharge Check	
100-year Water Level	129.83	0.13	2.27	5.28	8.00	0.00

Subdrainage Area: ROOF3
Area (ha): 0.19
C: 1.00
Maximum Storage Depth: Roof 150 mm

tc (min)	I (100 yr) (mm/hr)	Qactual (L/s)	Qrelease (L/s)	Qstored (L/s)	Vstored (m³)	Depth (mm)
10	178.56	91.83	9.11	82.72	49.63	130.5
20	119.95	61.69	9.63	52.06	62.48	140.8
30	91.87	47.25	9.83	37.42	67.36	144.7
40	75.15	38.65	9.89	28.75	69.01	146.0
50	63.95	32.89	9.89	23.00	69.00	146.0
60	55.89	28.75	9.85	18.89	68.02	145.2
70	49.79	25.61	9.79	15.82	66.44	143.9
80	44.99	23.14	9.71	13.43	64.47	142.4
90	41.11	21.14	9.62	11.53	62.24	140.6
100	37.90	19.49	9.52	9.97	59.83	138.6
110	35.20	18.10	9.42	8.69	57.32	136.6
120	32.89	16.92	9.31	7.60	54.74	134.6

Storage: Roof Storage

Depth (mm)	Head (m)	Discharge (L/s)	Vreq (cu. m)	Vavail (cu. m)	Discharge Check	
100-year Water Level	146.00	0.15	9.89	69.01	74.00	0.00

Subdrainage Area: ROOF2
Area (ha): 0.22
C: 1.00
Maximum Storage Depth: Roof 150 mm

tc (min)	I (100 yr) (mm/hr)	Qactual (L/s)	Qrelease (L/s)	Qstored (L/s)	Vstored (m³)	Depth (mm)
10	178.56	109.21	10.26	98.95	59.37	130.7
20	119.95	73.36	10.86	62.50	75.00	141.2
30	91.87	56.19	11.09	45.09	81.17	145.4
40	75.15	45.96	11.18	34.78	83.46	146.9
50	63.95	39.11	11.19	27.92	83.76	147.1
60	55.89	34.19	11.16	23.02	82.89	146.6
70	49.79	30.45	11.10	19.35	81.28	145.5
80	44.99	27.52	11.02	16.50	79.19	144.1
90	41.11	25.14	10.93	14.22	76.77	142.4
100	37.90	23.18	10.83	12.36	74.14	140.7
110	35.20	21.53	10.72	10.81	71.35	138.8
120	32.89	20.12	10.61	9.51	68.47	136.8

Storage: Roof Storage

Depth (mm)	Head (m)	Discharge (L/s)	Vreq (cu. m)	Vavail (cu. m)	Discharge Check	
100-year Water Level	147.14	0.15	11.19	83.76	88.00	0.00

Subdrainage Area: ROOF1
Area (ha): 0.02
C: 1.00
Maximum Storage Depth: Roof 150 mm

tc (min)	I (100 yr) (mm/hr)	Qactual (L/s)	Qrelease (L/s)	Qstored (L/s)	Vstored (m³)	Depth (mm)
10	178.56	9.93	2.21	7.72	4.63	125.0
20	119.95	6.67	2.27	4.40	5.28	129.8
30	91.87	5.11	2.26	2.85	5.13	128.7
40	75.15	4.18	2.22	1.96	4.71	125.6
50	63.95	3.56	2.15	1.41	4.22	120.4
60	55.89	3.11	2.08	1.03	3.70	114.8

Stormwater Management Calculations

Project #160401511, 20 Cedarow

Modified Rational Method Calculatons for Storage

70	21.91	1.10	1.05	0.05	0.21	41.5	0.00
80	19.83	0.99	0.96	0.04	0.17	37.9	0.00
90	18.14	0.91	0.88	0.03	0.14	34.9	0.00
100	16.75	0.84	0.82	0.02	0.11	32.5	0.00
110	15.57	0.78	0.77	0.01	0.09	30.3	0.00
120	14.56	0.73	0.72	0.01	0.07	28.5	0.00

Storage: Roof Storage

	Depth (mm)	Head (m)	Discharge (L/s)	Vreq (cu. m)	Vavail (cu. m)	Discharge Check
2-year Water Level	80.76	0.08	1.65	1.32	8.00	0.00

SUMMARY TO OUTLET

		Vrequired	Vavailable*
Tributary Area	0.445 ha		
Total 2yr Flow to Sewer	24 L/s	0	0 m ³ Ok
Non-Tributary Area	0.000 ha		
Total 2yr Flow Uncontrolled	0 L/s		
Total Area	0.445 ha		
Total 2yr Flow	24 L/s		

Project #160401511, 20 Cedarow

Modified Rational Method Calculatons for Storage

70	49.79	2.77	2.01	0.76	3.19	109.1	0.00
80	44.99	2.50	1.94	0.56	2.70	103.7	0.00
90	41.11	2.29	1.87	0.42	2.26	98.0	0.00
100	37.90	2.11	1.79	0.32	1.92	91.7	0.00
110	35.20	1.96	1.72	0.24	1.60	85.9	0.00
120	32.89	1.83	1.65	0.18	1.31	80.6	0.00

Storage: Roof Storage

	Depth (mm)	Head (m)	Discharge (L/s)	Vreq (cu. m)	Vavail (cu. m)	Discharge Check
100-year Water Level	129.83	0.13	2.27	5.28	8.00	0.00

SUMMARY TO OUTLET

		Vrequired	Vavailable*
Tributary Area	0.445 ha		
Total 100yr Flow to Sewer	24 L/s	0	0 m ³ Ok
Non-Tributary Area	0.000 ha		
Total 100yr Flow Uncontrolled	0 L/s		
Total Area	0.445 ha		
Total 100yr Flow	24 L/s		



Adjustable Accutrol Weir
 Tag: _____

**Adjustable Flow Control
 for Roof Drains**

ADJUSTABLE ACCUTROL (for Large Sump Roof Drains only)

For more flexibility in controlling flow with heads deeper than 2", Watts Drainage offers the Adjustable Accutrol. The Adjustable Accutrol Weir is designed with a single parabolic opening that can be covered to restrict flow above 2" of head to less than 5 gpm per inch, up to 6" of head. To adjust the flow rate for depths over 2" of head, set the slot in the adjustable upper cone according to the flow rate required. Refer to Table 1 below.

Note: Flow rates are directly proportional to the amount of weir opening that is exposed.

EXAMPLE:

For example, if the adjustable upper cone is set to cover 1/2 of the weir opening, flow rates above 2" of head will be restricted to 2-1/2 gpm per inch of head.

Therefore, at 3" of head, the flow rate through the Accutrol Weir that has 1/2 the slot exposed will be:
 [5 gpm(per inch of head) x 2 inches of head] + 2-1/2 gpm(for the third inch of head) = 12-1/2 gpm.

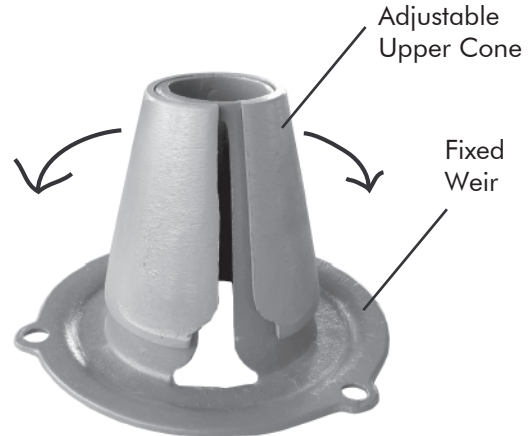
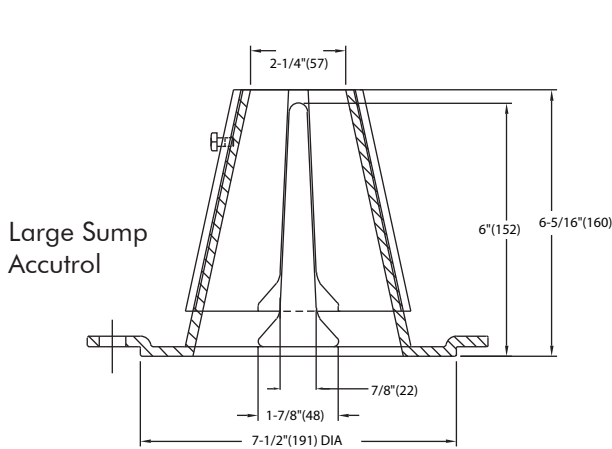

1/2 Weir Opening Exposed Shown Above

TABLE 1. Adjustable Accutrol Flow Rate Settings

Weir Opening Exposed	Head of Water					
	1"	2"	3"	4"	5"	6"
	Flow Rate (gallons per minute)					
Fully Exposed	5	10	15	20	25	30
3/4	5	10	13.75	17.5	21.25	25
1/2	5	10	12.5	15	17.5	20
1/4	5	10	11.25	12.5	13.75	15
Closed	5	10	10	10	10	10

Job Name _____ Contractor _____
 Job Location _____ Contractor's P.O. No. _____
 Engineer _____ Representative _____

WATTS Drainage reserves the right to modify or change product design or construction without prior notice and without incurring any obligation to make similar changes and modifications to products previously or subsequently sold. See your WATTS Drainage representative for any clarification. Dimensions are subject to manufacturing tolerances.



CANADA: 5435 North Service Road, Burlington, ON, L7L 5H7 TEL: 905-332-6718 TOLL-FREE: 1-888-208-8927 Website: www.wattsdrainage.ca



Volume III: TEMPEST™ INLET CONTROL DEVICES

Municipal Technical
Manual Series

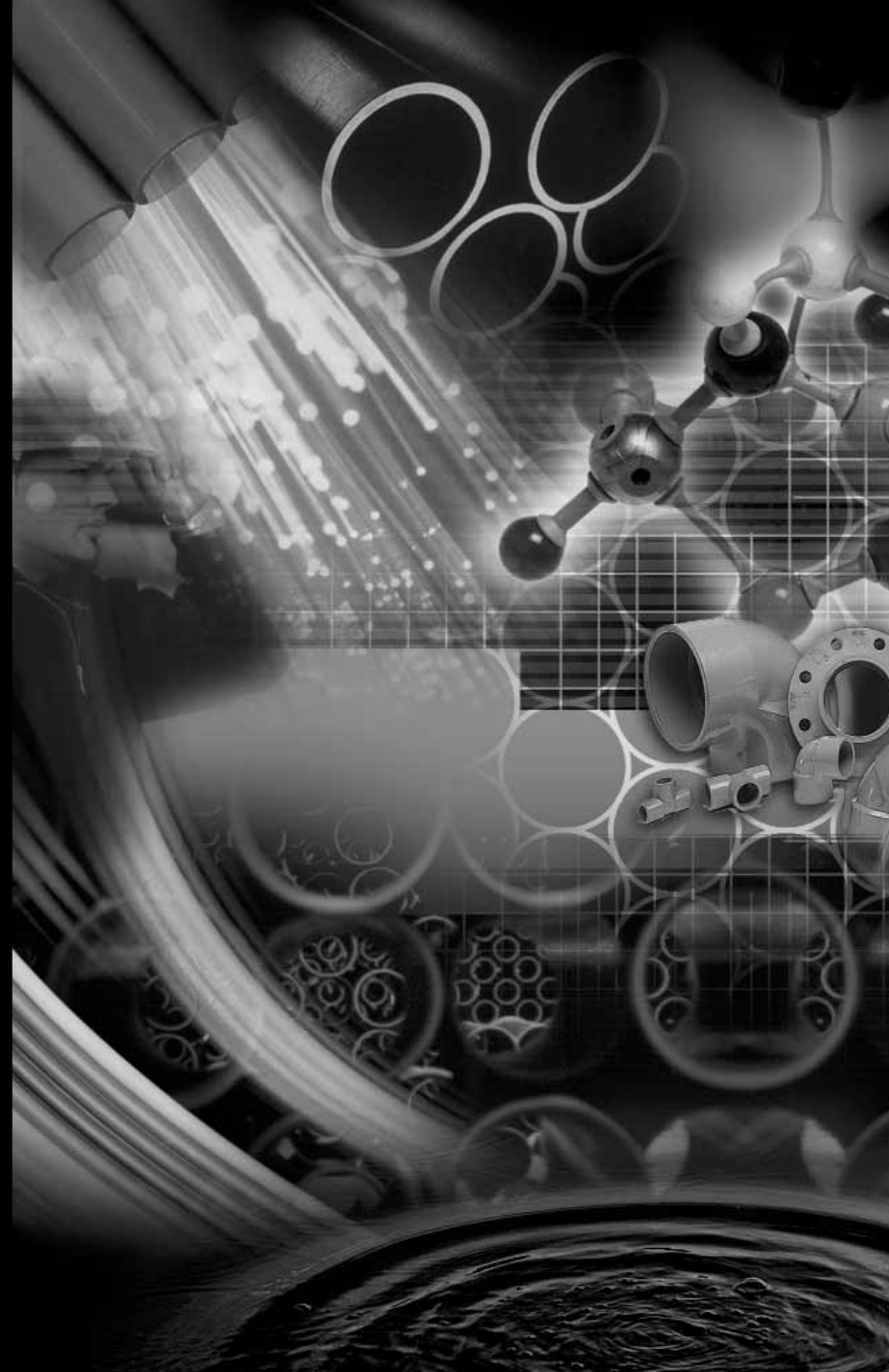

FIRST EDITION

LMF (Low to Medium Flow) ICD

HF (High Flow) ICD

MHF (Medium to High Flow) ICD



IPEX

IPEX Tempest™ Inlet Control Devices

Municipal Technical Manual Series

Vol. I, 1st Edition

© 2011 by IPEX. All rights reserved. No part of this book may be used or reproduced in any manner whatsoever without prior written permission. For information contact: IPEX, Marketing, 2441 Royal Windsor Drive, Mississauga, Ontario, Canada, L5J 4C7.

The information contained here within is based on current information and product design at the time of publication and is subject to change without notification. IPEX does not guarantee or warranty the accuracy, suitability for particular applications, or results to be obtained therefrom.

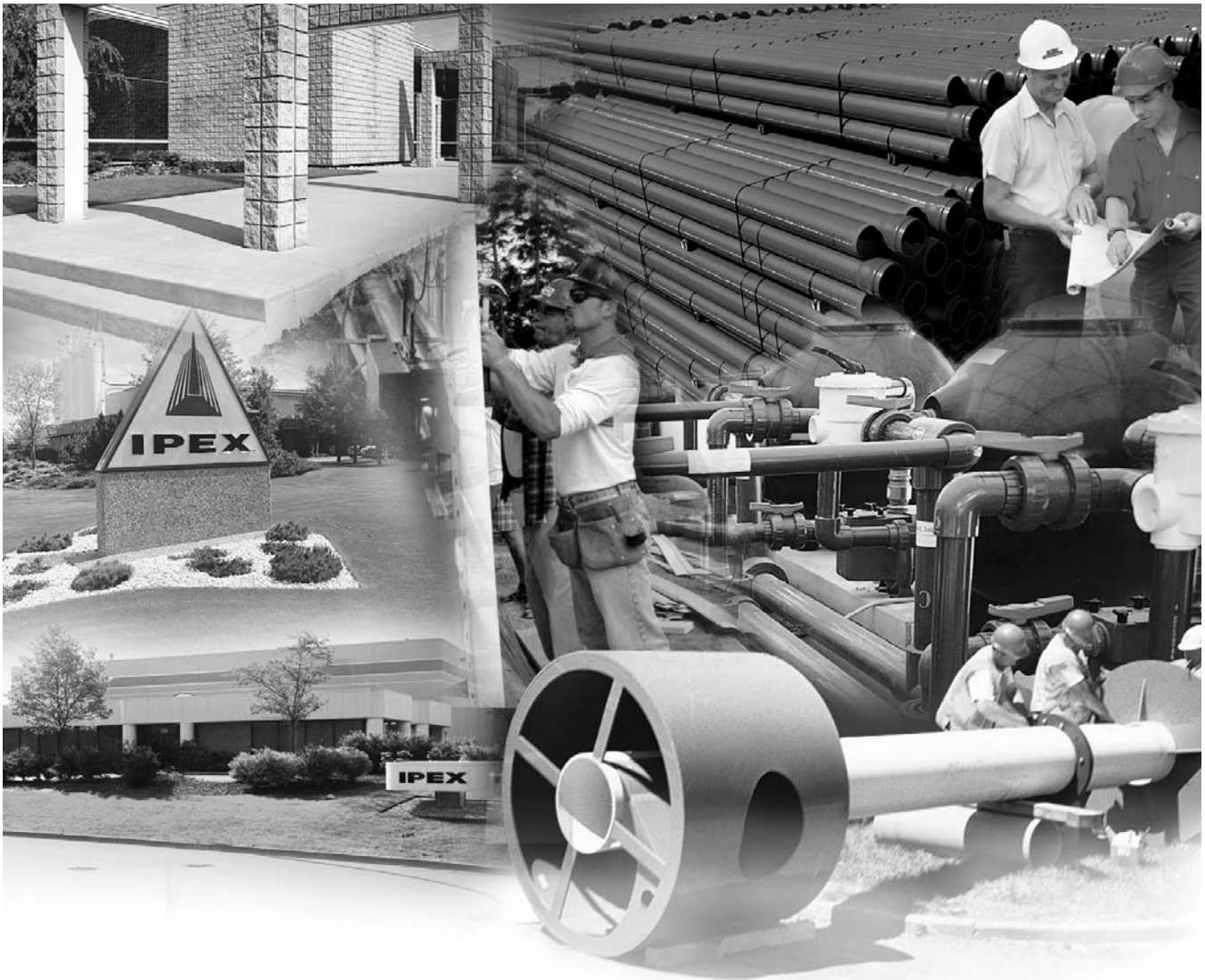

ABOUT IPEX

At IPEX, we have been manufacturing non-metallic pipe and fittings since 1951. We formulate our own compounds and maintain strict quality control during production. Our products are made available for customers thanks to a network of regional stocking locations throughout North America. We offer a wide variety of systems including complete lines of piping, fittings, valves and custom-fabricated items.

More importantly, we are committed to meeting our customers' needs. As a leader in the plastic piping industry, IPEX continually develops new products, modernizes manufacturing facilities and acquires innovative process technology. In addition, our staff take pride in their work, making available to customers their extensive thermoplastic knowledge and field experience. IPEX personnel are committed to improving the safety, reliability and performance of thermoplastic materials. We are involved in several standards committees and are members of and/or comply with the organizations listed on this page.

For specific details about any IPEX product, contact our customer service department.

CONTENTS

TEMPEST INLET CONTROL DEVICES Technical Manual

About IPEX

Section One:	Product Information: TEMPEST Low, Medium Flow (LMF) ICD	
	Purpose	5
	Product Description	5
	Product Function	5
	Product Construction	5
	Product Applications	5
	Product Installation	
	Instructions to assemble a TEMPEST LMF ICD into a square catch basin:	6
	Instructions to assemble a TEMPEST LMF ICD into a round catch basin:	6
	Product Technical Specification	
	General	7
	Materials	7
	Dimensioning	7
	Installation	7
Section Two:	Product Information: TEMPEST High Flow (HF) & Medium, High Flow (MHF) ICD	
	Product Description	9
	Product Function	9
	Product Construction	9
	Product Applications	9
	Product Installation	
	Instructions to assemble a TEMPEST HF or MHF ICD into a square catch basin:	10
	Instructions to assemble a TEMPEST HF or MHF ICD into a round catch basin:	10
	Instructions to assemble a TEMPEST HF Sump into a square or round catch basin:	11
	Product Technical Specification	
	General	11
	Materials	11
	Dimensioning	11
	Installation	11

PRODUCT INFORMATION: TEMPEST LOW, MEDIUM FLOW (LMF) ICD

Purpose

To control the amount of storm water runoff entering a sewer system by allowing a specified flow volume out of a catch basin or manhole at a specified head. This approach conserves pipe capacity so that catch basins downstream do not become uncontrollably surcharged, which can lead to basement floods, flash floods and combined sewer overflows.

Product Description

Our LMF ICD is designed to accommodate catch basins or manholes with sewer outlet pipes 6" in diameter and larger. Any storm sewer larger than 12" may require custom modification. However, IPEX can custom build a TEMPEST device to accommodate virtually any storm sewer size.

Available in 14 preset flow curves, the LMF ICD has the ability to provide flow rates: 2lps – 17lps (31gpm – 270gpm)

LMF 14 Preset Flow Curves

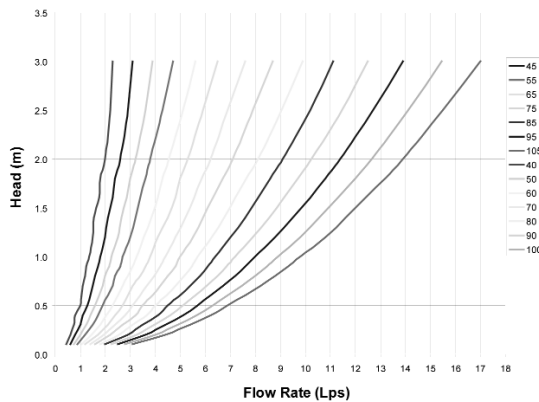

Product Function

The LMF ICD vortex flow action allows the LMF ICD to provide a narrower flow curve using a larger orifice than a conventional orifice plate ICD, making it less likely to clog. When comparing flows at the same head level, the LMF ICD has the ability to restrict more flow than a conventional ICD during a rain event, preserving greater sewer capacity.

LMF Flow vs. ICD Alternatives

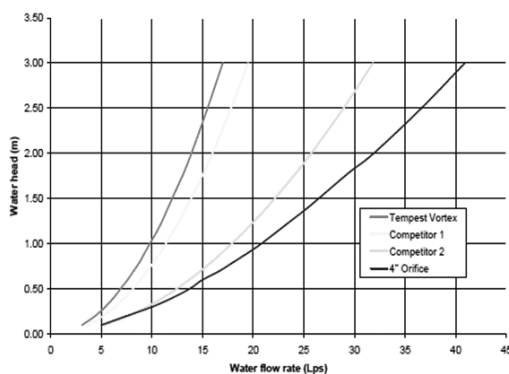

Product Construction

Constructed from durable PVC, the LMF ICD is light weight 8.95 Kg (19.7 lbs).

Product Applications

Will accommodate both square and round applications:

Square Application



Universal Mounting Plate

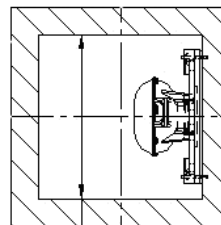

Round Application

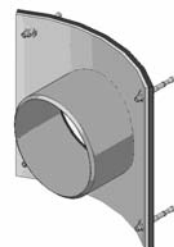

Spigot CB Wall Plate



Universal Mounting Plate Hub Adapter

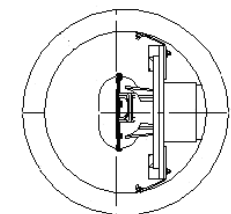

PRODUCT INSTALLATION

Instructions to assemble a TEMPEST LMF ICD into a Square Catch Basin:

STEPS:

1. Materials and tooling verification:
 - Tooling: impact drill, 3/8" concrete bit, torque wrench for 9/16" nut, hand hammer, level, and marker.
 - Material: (4) concrete anchor 3/8 x 3-1/2, (4) washers, (4) nuts, universal mounting plate, ICD device.
2. Use the mounting wall plate to locate and mark the hole (4) pattern on the catch basin wall. You should use a level to ensure that the plate is at the horizontal.
3. Use an impact drill with a 3/8" concrete bit to make the four holes at a minimum of 1-1/2" depth up to 2-1/2". Clean the concrete dust from the holes.
4. Install the anchors (4) in the holes by using a hammer. Thread the nuts on the top of the anchors to protect the threads when you will hit the anchors with the hammer. Remove the nuts the ends of the anchors
5. Install the universal mounting plate on the anchors and screw the 4 nuts in place with a maximum torque of 40 N.m (30 lbf-ft). There should be no gap between the wall mounting plate and the catch basin wall.
6. From the ground above using a reach bar, lower the ICD device by hooking the end of the reach bar to the handle of the ICD device. Align the triangular plate portion into the mounting wall plate. Push down the device to be sure it has centered in to the universal mounting plate and has created a seal.



WARNING

- Verify that the outlet pipe doesn't protrude into the catch basin. If it does, cut down the pipe flush to the catch basin wall.
- Call your IPEX representative for more information or if you have any questions about our products.

Instructions to assemble a TEMPEST LMF ICD into a Round Catch Basin:

STEPS:

1. Materials and tooling verification.
 - Tooling: impact drill, 3/8" concrete bit, torque wrench for 9/16" nut, hand hammer, level and marker.
 - Material: (4) concrete anchor 3/8 x 3-1/2, (4) washers and (4) nuts, spigot CB wall plate, universal mounting plate hub adapter, ICD device.
2. Use the spigot catch basin wall plate to locate and mark the hole (4) pattern on the catch basin wall. You should use a level to sure that the plate is at the horizontal.
3. Use an impact drill with a 3/8" concrete bit to make the four holes at a depth between 1-1/2" to 2-1/2". Clean the concrete dust from the holes.
4. Install the anchors (4) in the holes by using a hammer. Thread the nuts on the top of the anchors to protect the threads when you will hit the anchors with the hammer. Remove the nuts from the ends of the anchors
5. Install the CB spigot wall plate on the anchors and screw the 4 nuts in place with a maximum torque of 40 N.m (30 lbf-ft). There should be no gap between CB the spigot wall plate and the catch basin wall.
6. Apply solvent cement on the hub of universal mounting plate, hub adapter and the spigot of spigot CB wall plate slide the hub over the spigot. Make sure the universal mounting plate is at the horizontal and its hub is completely inserted onto the spigot. Normally, the corners of the universal mounting plate hub adapter should touch the catch basin wall.
7. From ground above using a reach bar, lower the ICD device by hooking the end of the reach bar to the handle of the ICD device. Align the triangular plate portion into the mounting wall plate. Push down the device to be sure it has centered in to the mounting plate and has created a seal.



WARNING

- Verify that the outlet pipe doesn't protrude into the catch basin. If it does, cut back the pipe flush to the catch basin wall.
- The solvent cement which is used in this installation is to be approved for PVC.
- The solvent cement should not be used below 0°C (32°F) or in a high humidity environment. Refer to the IPEX solvent cement guide to confirm the required curing time or visit the IPEX Online Solvent Cement Training Course available at www.ipexinc.com.
- Call your IPEX representative for more information or if you have any questions about our products.

PRODUCT TECHNICAL SPECIFICATION

General

Inlet control devices (ICD's) are designed to provide flow control at a specified rate for a given water head level and also provide odour and floatable control. All ICD's will be IPEX Tempest or approved equal.

All devices shall be removable from a universal mounting plate. An operator from street level using only a T-bar with a hook will be able to retrieve the device while leaving the universal mounting plate secured to the catch basin wall face. The removal of the TEMPEST devices listed above must not require any unbolting or special manipulation or any special tools.

High Flow (HF) Sump devices will consist of a removable threaded cap which can be accessible from street level with out entry into the catchbasin (CB). The removal of the threaded cap shall not require any special tools other than the operator's hand.

ICD's must have no moving parts.

Materials

ICD's are to be manufactured from Polyvinyl Chloride (PVC) or Polyurethane material, designed to be durable enough to withstand multiple freeze-thaw cycles and exposure to harsh elements.

The inner ring seal will be manufactured using a Buna or Nitrile material with hardness between Duro 50 and Duro 70.

The wall seal is to be comprised of a 3/8" thick Neoprene Closed Cell Sponge gasket which is attached to the back of the wall plate.

All hardware will be made from 304 stainless steel.

Dimensioning

The Low Medium Flow (LMF), High Flow (HF) and the High Flow (HF) Sump shall allow for a minimum outlet pipe diameter of 200mm with a 600mm deep Catch Basin sump.

Installation

Contractor shall be responsible for securing, supporting and connecting the ICD's to the existing influent pipe and catchbasin/manhole structure as specified and designed by the Engineer.

PRODUCT INFORMATION: TEMPEST HF & MHF ICD

Product Description

Our HF, HF Sump and MHF ICD is designed to accommodate catch basins or manholes with sewer outlet pipes 6" in diameter or larger. Any storm sewer larger than 12" may require custom modification. However, IPEX can custom build a TEMPEST device virtually to accommodate any storm sewer size.

Available in 5 preset flow curves, these ICDs have the ability to provide constant flow rates: 9lps (143 gpm) and greater

HF & MHF Preset Flow Curves

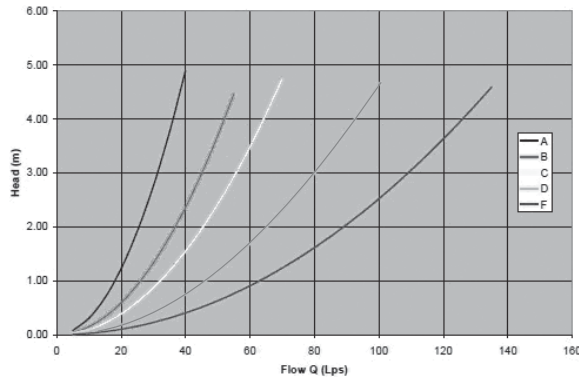

Product Function

TEMPEST HF (High Flow): designed to manage moderate to higher flows between 15 L/s (240 gpm) or greater and prevents the propagation of odour and floatables. With this device, the cross-sectional area of the device is larger than the orifice diameter and has been designed to limit head losses. The HF ICD can also be ordered without flow control when only odour and floatable control is required.



TEMPEST HF (High Flow) Sump: The height of a sewer outlet pipe in a catch basin is not always conveniently located. At times it may be located very close to the catch basin floor, not providing enough sump for one of the other TEMPEST ICDs with universal back plate to be installed. In these applications, a HF Sump is offered. The HF Sump offers the same features and benefits as the HF ICD; however, is designed to raise the outlet in a square or round catch basin structure. When installed, the HF sump is fixed in place and not easily removed. Any required service to the device is performed through a clean-out located in the top of the device which can be often accessed from ground level.

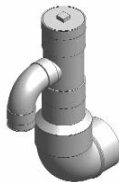

TEMPEST MHF (Medium to High Flow):

The MHF plate or plug is designed to control flow rates 9 L/s (143 gpm) or greater. It is not designed to prevent the propagation of odour and floatables.



Product Construction

The HF, HF Sump and MHF ICDs are built to be light weight at a maximum weight of 6.82 Kg (14.6 lbs).

Product Applications

The HF and MHF ICD are available to accommodate both square and round applications:

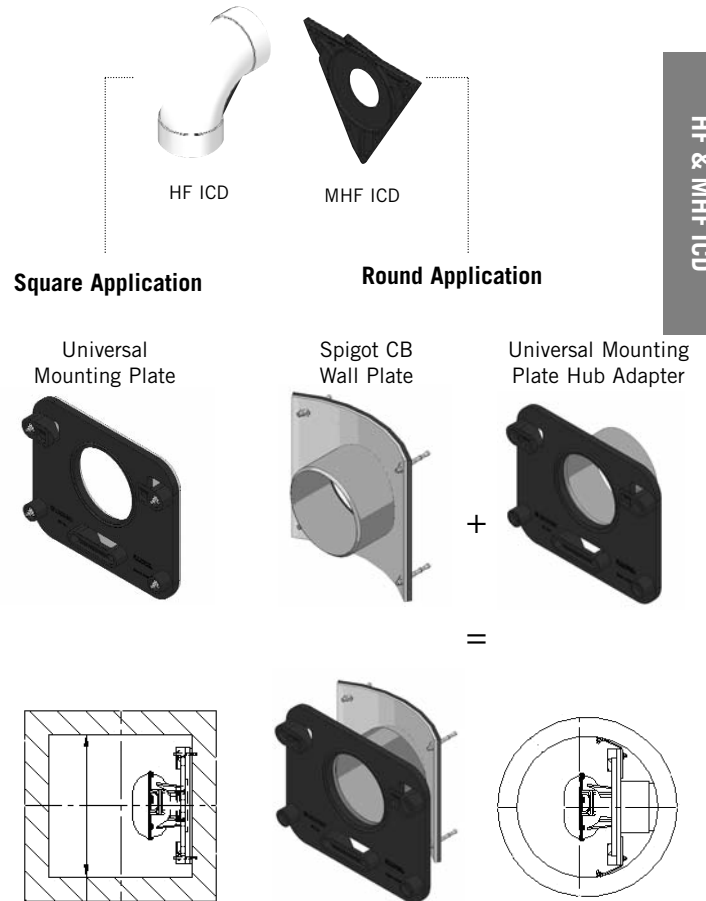

The HF Sump is available to accommodate low to no sump applications in both square and round catch basins:

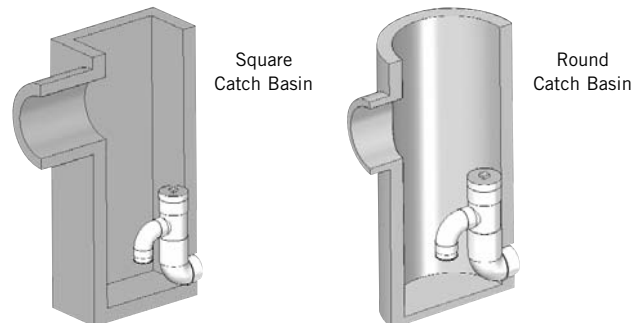

PRODUCT INSTALLATION

Instructions to assemble a TEMPEST HF or MHF ICD into a Square Catch Basin:

1. Materials and tooling verification:
 - Tooling: impact drill, 3/8" concrete bit, torque wrench for 9/16" nut, hand hammer, level, and marker.
 - Material: (4) concrete anchor 3/8 x 3-1/2, (4) washers, (4) nuts, universal mounting plate, ICD device
2. Use the mounting wall plate to locate and mark the hole (4) pattern on the catch basin wall. You should use a level to ensure that the plate is at the horizontal.
3. Use an impact drill with a 3/8" concrete bit to make the four holes at a minimum of 1-1/2" depth up to 2-1/2". Clean the concrete dust from the holes.
4. Install the anchors (4) in the holes by using a hammer. Thread the nuts on the top of the anchors to protect the threads when you will hit the anchors with the hammer. Remove the nuts the ends of the anchors
5. Install the universal from wall mounting plate on the anchors and screw the 4 nuts in place with a maximum torque of 40 N.m (30 lbf-ft). There should be no gap between the wall mounting plate and the catch basin wall.
6. From the ground above using a reach bar, lower the device by hooking the end of the reach bar to the handle of the LMF device. Align the triangular plate portion into the mounting wall plate. Push down the device to be sure it has centered in to the universal wall mounting plate and has created a seal.



WARNING

- Verify that the outlet pipe doesn't protrude into the catch basin. If it does, cut down the pipe flush to the catch basin wall.
- Call your IPEX representative for more information or if you have any questions about our products.

Instructions to assemble a TEMPEST HF or MHF ICD into a Round Catch Basin:

STEPS:

1. Materials and tooling verification.
 - Tooling: impact drill, 3/8" concrete bit, torque wrench for 9/16" nut, hand hammer, level and marker.
 - Material: (4) concrete anchor 3/8 x 3-1/2, (4) washers and (4) nuts, spigot CB wall plate, universal mounting plate hub adaptor, ICD device.
2. Use the round catch basin spigot adaptor to locate and mark the hole (4) pattern on the catch basin wall. You should use a level to sure that the plate is at the horizontal.
3. Use an impact drill with a 3/8" concrete bit to make the four holes at a depth between 1-1/2" to 2-1/2". Clean the concrete dust from the holes.
4. Install the anchors (4) in the holes by using a hammer. Thread the nuts on the top of the anchors to protect the threads when you will hit the anchors with the hammer. Remove the nuts from the ends of the anchors
5. Install the spigot CB wall plate on the anchors and screw the 4 nuts in place with a maximum torque of 40 N.m (30 lbf-ft). There should be no gap between the spigot CB wall plate and the catch basin wall.
6. Put solvent cement on the hub of the universal mounting plate, hub adaptor and the spigot of spigot CB wall plate and slide the hub over the spigot. Make sure the universal mounting plate is at the horizontal and its hub is completely inserted onto the spigot. Normally, the corners of the hub adaptor should touch the catch basin wall.
7. From ground above using a reach bar, lower the ICD device by hooking the end of the reach bar to the handle of the ICD device. Align the triangular plate portion into the mounting wall plate. Push down the device to be sure it has centered in to the wall mounting plate and has created a seal.



WARNING

- Verify that the outlet pipe doesn't protrude into the catch basin. If it does, cut down the pipe flush to the catch basin wall.
- The solvent cement which is used in this installation is to be approved for PVC.
- The solvent cement should not be used below 0°C (32°F) or in a high humidity environment. Refer to the IPEX solvent cement guide to confirm the required curing time or visit the IPEX Online Solvent Cement Training Course available at www.ipexinc.com.
- Call your IPEX representative for more information or if you have any questions about our products.

PRODUCT TECHNICAL SPECIFICATION

Instructions to assemble a TEMPEST HF Sump into a Square or Round Catch Basin:

STEPS:

1. Materials and tooling verification:
 - Tooling: impact drill, 3/8" concrete bit, torque wrench for 9/16" nut, hand hammer, level, mastic tape and metal strapping
 - Material: (2) concrete anchor 3/8 x 3-1/2, (2) washers, (2) nuts, HF Sump pieces (2).
2. Apply solvent cement to the spigot end of the top half of the sump. Apply solvent cement to the hub of the bottom half of the sump. Insert the spigot of the top half of the sump into the hub of the bottom half of the sump.
3. Install the 8" spigot of the device into the outlet pipe. Use the mastic tape to seal the device spigot into the outlet pipe. You should use a level to be sure that the fitting is standing at the vertical.
4. Use an impact drill with a 3/8" concrete bit to make a series of 2 holes along each side of the body throat. The depth of the hole should be between 1-1/2" to 2-1/2". Clean the concrete dust from the 2 holes.
5. Install the anchors (2) in the holes by using a hammer. Put the nuts on the top of the anchors to protect the threads when you will hit the anchors. Remove the nuts on the anchors at the end.
6. Cut the metal strapping to length and connect each end of the strapping to the anchors. Screw the nuts in place with a maximum torque of 40 N.m (30 lbf-ft). The device should be completely flush with the catch basin wall.



WARNING

- Verify that the outlet pipe doesn't protrude into the catch basin. If it does, cut down the pipe flush to the catch basin wall.
- The solvent cement which is used in this installation is to be approved for PVC.
- The solvent cement should not be used below 0°C (32°F) or in a high humidity environment. Refer to the IPEX solvent cement guide to confirm the required curing time or visit the IPEX Online Solvent Cement Training Course available at www.ipexinc.com.
- Call your IPEX representative for more information or if you have any questions about our products.

General

Inlet control devices (ICD's) are designed to provide flow control at a specified rate for a given water head level and also provide odour and floatable control where specified. All ICD's will be IPEX Tempest or approved equal.

All devices shall be removable from a universal mounting plate. An operator from street level using only a T-bar with a hook will be able to retrieve the device while leaving the universal mounting plate secured to the catch basin wall face. The removal of the TEMPEST devices listed above must not require any unbolting or special manipulation or any special tools.

High Flow (HF) Sump devices will consist of a removable threaded cap which can be accessible from street level with out entry into the catchbasin (CB). The removal of the threaded cap shall not require any special tools other than the operator's hand.

ICD's must have no moving parts.

Materials

ICD's are to be manufactured from Polyvinyl Chloride (PVC) or Polyurethane material, designed to be durable enough to withstand multiple freeze-thaw cycles and exposure to harsh elements.

The inner ring seal will be manufactured using a Buna or Nitrile material with hardness between Duro 50 and Duro 70.

The wall seal is to be comprised of a 3/8" thick Neoprene Closed Cell Sponge gasket which is attached to the back of the wall plate.

All hardware will be made from 304 stainless steel.

Dimensioning

The Low Medium Flow (LMF), High Flow (HF) and the High Flow (HF) Sump shall allow for a minimum outlet pipe diameter of 200mm with a 600mm deep Catch Basin sump.

Installation

Contractor shall be responsible for securing, supporting and connecting the ICD's to the existing influent pipe and catchbasin/manhole structure as specified and designed by the Engineer.

SALES AND CUSTOMER SERVICE

Canadian Customers call IPEX Inc.

Toll free: (866) 473-9462

www.ipexinc.com

U.S. Customers call IPEX USA LLC

Toll free: (800) 463-9572

www.ipexamerica.com

About the IPEX Group of Companies

As leading suppliers of thermoplastic piping systems, the IPEX Group of Companies provides our customers with some of the largest and most comprehensive product lines. All IPEX products are backed by more than 50 years of experience. With state-of-the-art manufacturing facilities and distribution centers across North America, we have established a reputation for product innovation, quality, end-user focus and performance.

Markets served by IPEX group products are:

- Electrical systems
- Telecommunications and utility piping systems
- PVC, CPVC, PP, ABS, PEX, FR-PVDF and PE pipe and fittings (1/4" to 48")
- Industrial process piping systems
- Municipal pressure and gravity piping systems
- Plumbing and mechanical piping systems
- PE Electrofusion systems for gas and water
- Industrial, plumbing and electrical cements
- Irrigation systems

Products manufactured by IPEX Inc. and distributed in the United States by IPEX USA LLC.

Tempest™ is a trademark of IPEX Branding Inc.

This literature is published in good faith and is believed to be reliable. However it does not represent and/or warrant in any manner the information and suggestions contained in this brochure. Data presented is the result of laboratory tests and field experience.

A policy of ongoing product improvement is maintained. This may result in modifications of features and/or specifications without notice.

MNMNTPIP110817
© 2011 IPEX MN0038UC



IPEX

**SERVICING AND STORMWATER MANAGEMENT BRIEF –
WELLINGS OF STITTSVILLE PHASE 2, 20 CEDAROW COURT**

Appendix C Stormwater Management
September 21, 2022

C.2 SAMPLE PCSWMM MODEL INPUT (12HR 100YR SCS)

```

[TITLE]
;;Project Title/Notes

[OPTIONS]
;;Option          Value
FLOW_UNITS        LPS
INFILTRATION      HORTON
FLOW_ROUTING      DYNWAVE
LINK_OFFSETS      ELEVATION
MIN_SLOPE         0
ALLOW_PONDING     YES
SKIP_STEADY_STATE NO

START_DATE        07/23/2009
START_TIME        00:00:00
REPORT_START_DATE 07/23/2009
REPORT_START_TIME 00:00:00
END_DATE          07/24/2009
END_TIME          00:00:00
SWEEP_START       01/01
SWEEP_END         12/31
DRY_DAYS          0
REPORT_STEP       00:05:00
WET_STEP          00:05:00
DRY_STEP          00:05:00
ROUTING_STEP      1
RULE_STEP         00:00:00

INERTIAL_DAMPING  PARTIAL
NORMAL_FLOW_LIMITED BOTH
FORCE_MAIN_EQUATION H-W
VARIABLE_STEP     0
LENGTHENING_STEP 0
MIN_SURFAREA      0
MAX_TRIALS        8
HEAD_TOLERANCE    0.0015
SYS_FLOW_TOL      5
LAT_FLOW_TOL      5
MINIMUM_STEP      0.5

```

```

THREADS          4

```

```

[EVAPORATION]
;;Data Source    Parameters
;;-----
CONSTANT         0.0
DRY_ONLY         NO

```

```

[RAINGAGES]
;;Name           Format   Interval SCF   Source
;;-----
RG1              INTENSITY 0:15   1.0   TIMESERIES 100SCS

```

```

[SUBCATCHMENTS]
;;Name           Rain Gage      Outlet          Area    %Imperv  Width  %Slope  CurbLen  SnowPack
;;-----
;0.47
EXT-1            RG1           105             0.068859 38.571  95     1.5     0
;0.78
L102A           RG1           CB102A-1        0.061494 82.86   18.5   2.5     0
;0.73
L103A           RG1           CB103A-1        0.155713 75.71   28.2   2.5     0
;0.76
L103B           RG1           CB103B-1        0.059451 80       28.6   2.5     0
;0.70
L103C           RG1           CB103C-1        0.072415 71.43   29.9   2.5     0
;0.66
L103D           RG1           CB103D-1        0.239253 65.71   31.7   2.5     0
;0.71
L103E           RG1           CB103E-1        0.237258 72.86   21     2.5     0

```

;0.78 L104A	RG1	104	0.068012	82.86	38.6	2.5	0
;0.76 L104B	RG1	104	0.059101	80	24.6	2.5	0
;0.71 L106A	RG1	CB106A-1	0.142402	72.86	26.5	2.5	0
;0.90 RAMP	RG1	BLDG	0.021989	100	7.5	15	0
ROOF1	RG1	ROOF1-S	0.0203	100	4.568	1.5	0
;0.90 ROOF2	RG1	ROOF2-S	0.220177	100	49.54	1.5	0
;0.90 ROOF3	RG1	ROOF3-S	0.184975	100	41.619	1.5	0
;0.90 ROOF4	RG1	ROOF4-S	0.020313	100	4.57	1.5	0
;0.49 UNC-1	RG1	OF1	0.083714	41.43	95	25	0
;0.26 UNC-2	RG1	POOLE	0.526055	8.57	25	1	0
;0.63 UNC-3	RG1	OF3	0.069306	61.43	126	3	0
;0.46 UNC-4	RG1	105	0.051524	37.14	90	10	0

[SUBAREAS]

;;Subcatchment	N-Imperv	N-Perv	S-Imperv	S-Perv	PctZero	RouteTo	PctRouted
;;-----	-----	-----	-----	-----	-----	-----	-----

EXT-1	0.013	0.25	1.57	4.67	0	PERVIOUS	100
L102A	0.013	0.25	1.57	4.67	0	OUTLET	
L103A	0.013	0.25	1.57	4.67	0	OUTLET	
L103B	0.013	0.25	1.57	4.67	0	OUTLET	
L103C	0.013	0.25	1.57	4.67	0	OUTLET	
L103D	0.013	0.25	1.57	4.67	0	OUTLET	
L103E	0.013	0.25	1.57	4.67	0	OUTLET	
L104A	0.013	0.25	1.57	4.67	0	OUTLET	
L104B	0.013	0.25	1.57	4.67	0	OUTLET	
L106A	0.013	0.25	1.57	4.67	0	OUTLET	
RAMP	0.013	0.25	1.57	4.67	0	OUTLET	
ROOF1	0.013	0.25	1.57	4.67	0	OUTLET	
ROOF2	0.013	0.25	1.57	4.67	0	OUTLET	
ROOF3	0.013	0.25	1.57	4.67	0	OUTLET	
ROOF4	0.013	0.25	1.57	4.67	0	OUTLET	
UNC-1	0.013	0.25	1.57	4.67	0	OUTLET	
UNC-2	0.013	0.25	1.57	4.67	0	PERVIOUS	100
UNC-3	0.013	0.25	1.57	4.67	0	PERVIOUS	100
UNC-4	0.013	0.25	1.57	4.67	0	PERVIOUS	100

[INFILTRATION]

;;Subcatchment	Param1	Param2	Param3	Param4	Param5
;;-----	-----	-----	-----	-----	-----
EXT-1	76.2	13.2	4.14	7	0
L102A	76.2	13.2	4.14	7	0
L103A	76.2	13.2	4.14	7	0
L103B	76.2	13.2	4.14	7	0
L103C	76.2	13.2	4.14	7	0
L103D	76.2	13.2	4.14	7	0
L103E	76.2	13.2	4.14	7	0
L104A	76.2	13.2	4.14	7	0
L104B	76.2	13.2	4.14	7	0
L106A	76.2	13.2	4.14	7	0
RAMP	76.2	13.2	4.14	7	0
ROOF1	76.2	13.2	4.14	7	0
ROOF2	76.2	13.2	4.14	7	0
ROOF3	76.2	13.2	4.14	7	0
ROOF4	76.2	13.2	4.14	7	0
UNC-1	76.2	13.2	4.14	7	0

UNC-2	76.2	13.2	4.14	7	0
UNC-3	76.2	13.2	4.14	7	0
UNC-4	76.2	13.2	4.14	7	0

[OUTFALLS]

;;Name	Elevation	Type	Stage Data	Gated	Route To
HEADWALL	98.48	FREE		NO	
OF1	0	FREE		NO	
OF3	0	FREE		NO	
OF4	101.87	FIXED	102.17	NO	
POOLE	0	FREE		NO	

[STORAGE]

;;Name	Psi	Ksat	Elev. IMD	MaxDepth	InitDepth	Shape	Curve Name/Params	N/A	Fevap
100			99.603	3.956	0	FUNCTIONAL	0 0 0	0	0
101			101.093	3.043	0	FUNCTIONAL	0 0 0	0	0
102			101.6	2.73	0	FUNCTIONAL	0 0 0	0	0
103			101.906	2.161	0	FUNCTIONAL	0 0 0	0	0
104			102.61	1.49	0	TABULAR	CB104A-V	0	0
105			102.68	1.83	0	FUNCTIONAL	0 0 0	0	0
ADS			101.37	2.53	0	TABULAR	TANK-V	0	0
BLDG			102.78	1.91	0	FUNCTIONAL	0 0 0	0	0
CB102A-1			102.7	1.49	0	TABULAR	CB102A-V	0	0
CB103A-1			103.07	1.53	0	TABULAR	CB103A-V	0	0
CB103B-1			102.42	1.68	0	TABULAR	CB103B-V	0	0
CB103C-1			102.7	1.6	0	TABULAR	CB103C-V	0	0
CB103D-1			102.62	1.66	0	TABULAR	CB103D-V	0	0
CB103E-1			102.43	1.68	0	TABULAR	CB103E-V	0	0
CB106A-1			101.97	1.68	0	TABULAR	CB106A-V	0	0
EX			99.608	2.082	0	FUNCTIONAL	0 0 0	0	0
ROOF1-S			110	0.15	0	TABULAR	ROOF1-V	0	0
ROOF2-S			110	0.15	0	TABULAR	ROOF2-V	0	0
ROOF3-S			110	0.15	0	TABULAR	ROOF3-V	0	0
ROOF4-S			110	0.15	0	TABULAR	ROOF4-V	0	0

[CONDUITS]

;;Name	From Node	To Node	Length	Roughness	InOffset	OutOffset	InitFlow
100--EX	100	EX	34.915	0.013	99.903	99.833	0 0
101--ADS	101	ADS	2.204	0.013	101.393	101.371	0 0
102--101	102	101	9.553	0.013	101.9	101.805	0 0
103--102	103	102	57.54	0.013	102.131	101.956	0 0
105--OF4	105	OF4	20.367	0.013	102.68	102.476	0 0
BLDG--102	BLDG	102	37.121	0.013	102.78	102.408	0 0
EX--HEADWALL	EX	HEADWALL	11.1	0.013	99.608	98.48	0 0

[ORIFICES]

;;Name	From Node	To Node	Type	Offset	Qcoeff	Gated	CloseTime
100-01	ADS	100	SIDE	101.37	0.572	NO	0
100-02	ADS	100	SIDE	102.3	0.61	NO	0
CB102A-0	CB102A-1	102	SIDE	102.7	0.572	NO	0
CB103A-0	CB103A-1	103	SIDE	103.07	0.572	NO	0
CB103B-0	CB103B-1	103	SIDE	102.42	0.572	NO	0
CB103C-0	CB103C-1	103	SIDE	102.7	0.572	NO	0
CB103D-0	CB103D-1	103	SIDE	102.62	0.572	NO	0
CB103E-0	CB103E-1	103	SIDE	102.43	0.572	NO	0
CB106A-0	CB106A-1	ADS	SIDE	101.97	0.572	NO	0
CBMH104A-0	104	103	SIDE	102.61	0.572	NO	0

[WEIRS]

;;Name	From Node	To Node	Type	CrestHt	Qcoeff	Gated	EndCon
EndCoeff	Surcharge	RoadWidth	RoadSurf	Coeff.	Curve		

100-W1 ADS 100 TRANSVERSE 103 1.68 NO 0 0

YES

[OUTLETS]

;;Name From Node To Node Offset Type QTable/Qcoeff Qexpon
Gated

```

-----
ROOF1-0 ROOF1-S BLDG 110 TABULAR/DEPTH ROOF1-Q
NO
ROOF2-0 ROOF2-S BLDG 110 TABULAR/DEPTH ROOF2-Q
NO
ROOF3-0 ROOF3-S BLDG 110 TABULAR/DEPTH ROOF3-Q
NO
ROOF4-0 ROOF4-S BLDG 110 TABULAR/DEPTH ROOF4-Q
NO
  
```

[XSECTIONS]

;;Link Shape Geom1 Geom2 Geom3 Geom4 Barrels Culvert

```

-----
100--EX CIRCULAR 0.525 0 0 0 1
101--ADS CIRCULAR 0.45 0 0 0 1
102--101 CIRCULAR 0.45 0 0 0 1
103--102 CIRCULAR 0.45 0 0 0 1
105--OF4 CIRCULAR 0.25 0 0 0 1
BLDG--102 CIRCULAR 0.45 0 0 0 1
EX--HEADWALL CIRCULAR 0.675 0 0 0 1
100-01 CIRCULAR 0.083 0 0 0 0
100-02 CIRCULAR 0.2 0 0 0 0
CB102A-0 CIRCULAR 0.095 0 0 0 0
CB103A-0 CIRCULAR 0.152 0 0 0 0
CB103B-0 CIRCULAR 0.083 0 0 0 0
CB103C-0 CIRCULAR 0.083 0 0 0 0
CB103D-0 CIRCULAR 0.152 0 0 0 0
CB103E-0 CIRCULAR 0.127 0 0 0 0
CB106A-0 CIRCULAR 0.083 0 0 0 0
CBMH104A-0 CIRCULAR 0.083 0 0 0 0
100-W1 RECT_OPEN 0.3 1.2 0 0 0
  
```

[TRANSECTS]

;;Transect Data in HEC-2 format

```

;
NC 0.013 0.013 0.013
X1 Overland 5 0.15 6.85 0.0 0.0 0.0 0.0 0.0
GR 0.15 0 0 0.15 0 6.85 0.15 7 0.15 7
;
;[LE: 0][RE: 7]
NC 0.013 0.013 0.013
X1 Overland(orig) 4 0.15 6.85 0.0 0.0 0.0 0.0 0.0
GR 0.15 0 0 0.15 0 6.85 0.15 7
  
```

[LOSSES]

;;Link Kentry Kexit Kavg Flap Gate Seepage

```

-----
100--EX 0 0.157 0 NO 0
101--ADS 0 0.021 0 NO 0
102--101 0 0.141 0 NO 0
103--102 0 1.344 0 NO 0
105--OF4 0 1.344 0 NO 0
BLDG--102 0 0.021 0 NO 0
EX--HEADWALL 0 0.021 0 NO 0
  
```

[INFLOWS]

;;Node Constituent Time Series Type Mfactor Sfactor Baseline Pattern

```

-----
EX FLOW 100yrHydrograph FLOW 1.0 1 0
  
```

[CURVES]

;;Name Type X-Value Y-Value

```

-----
ROOF1-Q Rating 0 0
ROOF1-Q 0.025 0.6309
ROOF1-Q 0.05 1.2618
ROOF1-Q 0.075 1.5773
ROOF1-Q 0.1 1.8927
ROOF1-Q 0.125 2.2082
ROOF1-Q 0.15 2.5236
  
```

ROOF2-Q	Rating	0	0
ROOF2-Q		0.025	2.8391
ROOF2-Q		0.05	5.6781
ROOF2-Q		0.075	7.0976
ROOF2-Q		0.1	8.5172
ROOF2-Q		0.125	9.9367
ROOF2-Q		0.15	11.3562
ROOF3-Q	Rating	0	0
ROOF3-Q		0.025	2.5236
ROOF3-Q		0.05	5.0472
ROOF3-Q		0.075	6.309
ROOF3-Q		0.1	7.5708
ROOF3-Q		0.125	8.8326
ROOF3-Q		0.15	10.0944
ROOF4-Q	Rating	0	0
ROOF4-Q		0.025	0.6309
ROOF4-Q		0.05	1.2618
ROOF4-Q		0.075	1.5773
ROOF4-Q		0.1	1.8927
ROOF4-Q		0.125	2.2082
ROOF4-Q		0.15	2.5236
CB102A-V	Storage	0	0.36
CB102A-V		1.38	0.36
CB102A-V		1.49	65.4
CB103A-V	Storage	0	0.36
CB103A-V		1.38	0.36
CB103A-V		1.53	51.1
CB103B-V	Storage	0	0.36
CB103B-V		1.38	0.36
CB103B-V		1.68	350.5
CB103C-V	Storage	0	0.36
CB103C-V		1.38	0.36
CB103C-V		1.6	247.3

CB103D-V	Storage	0	0.36
CB103D-V		1.38	0.36
CB103D-V		1.66	265
CB103E-V	Storage	0	0.36
CB103E-V		1.38	0.36
CB103E-V		1.68	447.9
CB104A-V	Storage	0	0.36
CB104A-V		1.19	0.36
CB104A-V		1.49	333.3
CB106A-V	Storage	0	0.36
CB106A-V		1.38	0.36
CB106A-V		1.68	519.3
ROOF1-V	Storage	0	0
ROOF1-V		0.025	4
ROOF1-V		0.05	18
ROOF1-V		0.075	40
ROOF1-V		0.1	71
ROOF1-V		0.125	111
ROOF1-V		0.15	160
ROOF2-V	Storage	0	0
ROOF2-V		0.025	49
ROOF2-V		0.05	196
ROOF2-V		0.075	440
ROOF2-V		0.1	782
ROOF2-V		0.125	1222
ROOF2-V		0.15	1760
ROOF3-V	Storage	0	0
ROOF3-V		0.025	41
ROOF3-V		0.05	164
ROOF3-V		0.075	370
ROOF3-V		0.1	658
ROOF3-V		0.125	1028

ROOF3-V		0.15	1480
ROOF4-V	Storage	0	0
ROOF4-V		0.025	4
ROOF4-V		0.05	18
ROOF4-V		0.075	40
ROOF4-V		0.1	71
ROOF4-V		0.125	111
ROOF4-V		0.15	160
TANK-V	Storage	0	378.9370079
TANK-V		0.0254	378.9370079
TANK-V		0.051	378.94
TANK-V		0.076	378.94
TANK-V		0.102	378.94
TANK-V		0.127	378.94
TANK-V		0.152	378.94
TANK-V		0.178	369.09
TANK-V		0.203	378.94
TANK-V		0.229	369.09
TANK-V		0.254	378.94
TANK-V		0.279	369.09
TANK-V		0.305	369.09
TANK-V		0.33	369.09
TANK-V		0.356	369.09
TANK-V		0.381	369.09
TANK-V		0.406	359.25
TANK-V		0.432	369.09
TANK-V		0.457	359.25
TANK-V		0.483	359.25
TANK-V		0.508	359.25
TANK-V		0.533	359.25
TANK-V		0.559	349.41
TANK-V		0.584	359.25
TANK-V		0.61	349.41
TANK-V		0.635	349.41
TANK-V		0.66	349.41
TANK-V		0.686	339.57
TANK-V		0.711	349.41

TANK-V		0.737	339.57
TANK-V		0.762	339.57
TANK-V		0.787	329.72
TANK-V		0.813	339.57
TANK-V		0.838	319.88
TANK-V		0.864	339.57
TANK-V		0.889	310.04
TANK-V		0.914	339.57
TANK-V		0.94	300.2
TANK-V		0.965	329.72
TANK-V		0.991	290.35
TANK-V		1.016	329.72
TANK-V		1.041	280.51
TANK-V		1.067	319.88
TANK-V		1.092	280.51
TANK-V		1.118	300.2
TANK-V		1.143	280.51
TANK-V		1.168	290.35
TANK-V		1.194	260.83
TANK-V		1.219	290.35
TANK-V		1.245	241.14
TANK-V		1.27	280.51
TANK-V		1.295	231.3
TANK-V		1.321	260.83
TANK-V		1.346	211.61
TANK-V		1.372	231.3
TANK-V		1.397	191.93
TANK-V		1.422	191.93
TANK-V		1.448	182.09
TANK-V		1.473	182.09
TANK-V		1.499	182.09
TANK-V		1.524	162.4
TANK-V		1.525	0
TANK-V		3	0

```

[TIMESERIES]
;Name      Date      Time      Value
;-----
;MTO Distribution, 15min intervals

```

002SCS	0:00	0
002SCS	0:15	1.08
002SCS	0:30	1.08
002SCS	0:45	1.08
002SCS	1:00	1.08
002SCS	1:15	1.08
002SCS	1:30	1.08
002SCS	1:45	1.08
002SCS	2:00	1.296
002SCS	2:15	1.296
002SCS	2:30	1.296
002SCS	2:45	1.296
002SCS	3:00	1.728
002SCS	3:15	1.728
002SCS	3:30	1.728
002SCS	3:45	1.728
002SCS	4:00	2.592
002SCS	4:15	2.592
002SCS	4:30	3.456
002SCS	4:45	3.456
002SCS	5:00	5.184
002SCS	5:15	5.184
002SCS	5:30	20.736
002SCS	5:45	57.024
002SCS	6:00	7.776
002SCS	6:15	7.776
002SCS	6:30	3.456
002SCS	6:45	3.456
002SCS	7:00	2.592
002SCS	7:15	2.592
002SCS	7:30	2.592
002SCS	7:45	2.592
002SCS	8:00	1.512
002SCS	8:15	1.512
002SCS	8:30	1.512
002SCS	8:45	1.512
002SCS	9:00	1.512
002SCS	9:15	1.512
002SCS	9:30	1.512

002SCS	9:45	1.512
002SCS	10:00	0.864
002SCS	10:15	0.864
002SCS	10:30	0.864
002SCS	10:45	0.864
002SCS	11:00	0.864
002SCS	11:15	0.864
002SCS	11:30	0.864
002SCS	11:45	0.864
002SCS	12:00	0
005SCS	0:00:00	0
005SCS	0:15:00	1.44
005SCS	0:30:00	1.44
005SCS	0:45:00	1.44
005SCS	1:00:00	1.44
005SCS	1:15:00	1.44
005SCS	1:30:00	1.44
005SCS	1:45:00	1.44
005SCS	2:00:00	1.728
005SCS	2:15:00	1.728
005SCS	2:30:00	1.728
005SCS	2:45:00	1.728
005SCS	3:00:00	2.304
005SCS	3:15:00	2.304
005SCS	3:30:00	2.304
005SCS	3:45:00	2.304
005SCS	4:00:00	3.456
005SCS	4:15:00	3.456
005SCS	4:30:00	4.608
005SCS	4:45:00	4.608
005SCS	5:00:00	6.912
005SCS	5:15:00	6.912
005SCS	5:30:00	27.648
005SCS	5:45:00	76.032
005SCS	6:00:00	10.368
005SCS	6:15:00	10.368
005SCS	6:30:00	4.608
005SCS	6:45:00	4.608

005SCS	7:00:00	3.456
005SCS	7:15:00	3.456
005SCS	7:30:00	3.456
005SCS	7:45:00	3.456
005SCS	8:00:00	2.016
005SCS	8:15:00	2.016
005SCS	8:30:00	2.016
005SCS	8:45:00	2.016
005SCS	9:00:00	2.016
005SCS	9:15:00	2.016
005SCS	9:30:00	2.016
005SCS	9:45:00	2.016
005SCS	10:00:00	1.152
005SCS	10:15:00	1.152
005SCS	10:30:00	1.152
005SCS	10:45:00	1.152
005SCS	11:00:00	1.152
005SCS	11:15:00	1.152
005SCS	11:30:00	1.152
005SCS	11:45:00	1.152
005SCS	12:00:00	0
010SCS	0:00:00	0
010SCS	0:15:00	1.68
010SCS	0:30:00	1.68
010SCS	0:45:00	1.68
010SCS	1:00:00	1.68
010SCS	1:15:00	1.68
010SCS	1:30:00	1.68
010SCS	1:45:00	1.68
010SCS	2:00:00	2.02
010SCS	2:15:00	2.02
010SCS	2:30:00	2.02
010SCS	2:45:00	2.02
010SCS	3:00:00	2.69
010SCS	3:15:00	2.69
010SCS	3:30:00	2.69
010SCS	3:45:00	2.69
010SCS	4:00:00	4.03

010SCS	4:15:00	4.03
010SCS	4:30:00	5.38
010SCS	4:45:00	5.38
010SCS	5:00:00	8.06
010SCS	5:15:00	8.06
010SCS	5:30:00	32.26
010SCS	5:45:00	88.7
010SCS	6:00:00	12.1
010SCS	6:15:00	12.1
010SCS	6:30:00	5.38
010SCS	6:45:00	5.38
010SCS	7:00:00	4.03
010SCS	7:15:00	4.03
010SCS	7:30:00	4.03
010SCS	7:45:00	4.03
010SCS	8:00:00	2.35
010SCS	8:15:00	2.35
010SCS	8:30:00	2.35
010SCS	8:45:00	2.35
010SCS	9:00:00	2.35
010SCS	9:15:00	2.35
010SCS	9:30:00	2.35
010SCS	9:45:00	2.35
010SCS	10:00:00	1.34
010SCS	10:15:00	1.34
010SCS	10:30:00	1.34
010SCS	10:45:00	1.34
010SCS	11:00:00	1.34
010SCS	11:15:00	1.34
010SCS	11:30:00	1.34
010SCS	11:45:00	1.34
010SCS	12:00:00	0
025SCS	0:00:00	0
025SCS	0:15:00	1.98
025SCS	0:30:00	1.98
025SCS	0:45:00	1.98
025SCS	1:00:00	1.98
025SCS	1:15:00	1.98

025SCS	1:30:00	1.98
025SCS	1:45:00	1.98
025SCS	2:00:00	2.376
025SCS	2:15:00	2.376
025SCS	2:30:00	2.376
025SCS	2:45:00	2.376
025SCS	3:00:00	3.168
025SCS	3:15:00	3.168
025SCS	3:30:00	3.168
025SCS	3:45:00	3.168
025SCS	4:00:00	4.752
025SCS	4:15:00	4.752
025SCS	4:30:00	6.336
025SCS	4:45:00	6.336
025SCS	5:00:00	9.504
025SCS	5:15:00	9.504
025SCS	5:30:00	38.016
025SCS	5:45:00	104.544
025SCS	6:00:00	14.256
025SCS	6:15:00	14.256
025SCS	6:30:00	6.336
025SCS	6:45:00	6.336
025SCS	7:00:00	4.752
025SCS	7:15:00	4.752
025SCS	7:30:00	4.752
025SCS	7:45:00	4.752
025SCS	8:00:00	2.772
025SCS	8:15:00	2.772
025SCS	8:30:00	2.772
025SCS	8:45:00	2.772
025SCS	9:00:00	2.772
025SCS	9:15:00	2.772
025SCS	9:30:00	2.772
025SCS	9:45:00	2.772
025SCS	10:00:00	1.584
025SCS	10:15:00	1.584
025SCS	10:30:00	1.584
025SCS	10:45:00	1.584
025SCS	11:00:00	1.584

025SCS	11:15:00	1.584
025SCS	11:30:00	1.584
025SCS	11:45:00	1.584
025SCS	12:00:00	0
050SCS	0:00:00	0
050SCS	0:15:00	2.19
050SCS	0:30:00	2.19
050SCS	0:45:00	2.19
050SCS	1:00:00	2.19
050SCS	1:15:00	2.19
050SCS	1:30:00	2.19
050SCS	1:45:00	2.19
050SCS	2:00:00	2.628
050SCS	2:15:00	2.628
050SCS	2:30:00	2.628
050SCS	2:45:00	2.628
050SCS	3:00:00	3.504
050SCS	3:15:00	3.504
050SCS	3:30:00	3.504
050SCS	3:45:00	3.504
050SCS	4:00:00	5.256
050SCS	4:15:00	5.256
050SCS	4:30:00	7.008
050SCS	4:45:00	7.008
050SCS	5:00:00	10.512
050SCS	5:15:00	10.512
050SCS	5:30:00	42.048
050SCS	5:45:00	115.632
050SCS	6:00:00	15.768
050SCS	6:15:00	15.768
050SCS	6:30:00	7.008
050SCS	6:45:00	7.008
050SCS	7:00:00	5.256
050SCS	7:15:00	5.256
050SCS	7:30:00	5.256
050SCS	7:45:00	5.256
050SCS	8:00:00	3.066
050SCS	8:15:00	3.066

050SCS	8:30:00	3.066
050SCS	8:45:00	3.066
050SCS	9:00:00	3.066
050SCS	9:15:00	3.066
050SCS	9:30:00	3.066
050SCS	9:45:00	3.066
050SCS	10:00:00	1.752
050SCS	10:15:00	1.752
050SCS	10:30:00	1.752
050SCS	10:45:00	1.752
050SCS	11:00:00	1.752
050SCS	11:15:00	1.752
050SCS	11:30:00	1.752
050SCS	11:45:00	1.752
050SCS	12:00:00	0

;MTO Distribution, 15min intervals

100SCS	0:00	0
100SCS	0:15	2.4
100SCS	0:30	2.4
100SCS	0:45	2.4
100SCS	1:00	2.4
100SCS	1:15	2.4
100SCS	1:30	2.4
100SCS	1:45	2.4
100SCS	2:00	2.4
100SCS	2:15	2.88
100SCS	2:30	2.88
100SCS	2:45	2.88
100SCS	3:00	2.88
100SCS	3:15	3.84
100SCS	3:30	3.84
100SCS	3:45	3.84
100SCS	4:00	3.84
100SCS	4:15	5.76
100SCS	4:30	5.76
100SCS	4:45	7.68
100SCS	5:00	7.68
100SCS	5:15	11.52

100SCS	5:30	11.52
100SCS	5:45	46.08
100SCS	6:00	126.72
100SCS	6:15	17.28
100SCS	6:30	17.28
100SCS	6:45	7.68
100SCS	7:00	7.68
100SCS	7:15	5.76
100SCS	7:30	5.76
100SCS	7:45	5.76
100SCS	8:00	5.76
100SCS	8:15	3.36
100SCS	8:30	3.36
100SCS	8:45	3.36
100SCS	9:00	3.36
100SCS	9:15	3.36
100SCS	9:30	3.36
100SCS	9:45	3.36
100SCS	10:00	3.36
100SCS	10:15	1.92
100SCS	10:30	1.92
100SCS	10:45	1.92
100SCS	11:00	1.92
100SCS	11:15	1.92
100SCS	11:30	1.92
100SCS	11:45	1.92
100SCS	12:00	0

100yrHydrograph	0:05	0
100yrHydrograph	0:10	0
100yrHydrograph	0:15	0
100yrHydrograph	0:20	0
100yrHydrograph	0:25	0
100yrHydrograph	0:30	0
100yrHydrograph	0:35	0
100yrHydrograph	0:40	0
100yrHydrograph	0:45	0
100yrHydrograph	0:50	0
100yrHydrograph	0:55	0

100yrHydrograph	1:00	0
100yrHydrograph	1:05	0
100yrHydrograph	1:10	0
100yrHydrograph	1:15	0
100yrHydrograph	1:20	0
100yrHydrograph	1:25	0
100yrHydrograph	1:30	0
100yrHydrograph	1:35	0
100yrHydrograph	1:40	0
100yrHydrograph	1:45	0
100yrHydrograph	1:50	0
100yrHydrograph	1:55	0
100yrHydrograph	2:00	0
100yrHydrograph	2:05	0.03368589
100yrHydrograph	2:10	0.400265
100yrHydrograph	2:15	0.6780789
100yrHydrograph	2:20	0.8096212
100yrHydrograph	2:25	0.9188437
100yrHydrograph	2:30	1.041047
100yrHydrograph	2:35	1.160273
100yrHydrograph	2:40	1.279933
100yrHydrograph	2:45	1.400491
100yrHydrograph	2:50	1.521803
100yrHydrograph	2:55	1.6431
100yrHydrograph	3:00	1.770213
100yrHydrograph	3:05	1.89238
100yrHydrograph	3:10	2.011746
100yrHydrograph	3:15	2.129715
100yrHydrograph	3:20	2.24681
100yrHydrograph	3:25	2.372673
100yrHydrograph	3:30	2.52147
100yrHydrograph	3:35	2.690327
100yrHydrograph	3:40	2.870473
100yrHydrograph	3:45	3.049115
100yrHydrograph	3:50	3.225464
100yrHydrograph	3:55	3.398892
100yrHydrograph	4:00	3.569112
100yrHydrograph	4:05	3.736014
100yrHydrograph	4:10	3.899172

100yrHydrograph	4:15	4.062318
100yrHydrograph	4:20	4.221156
100yrHydrograph	4:25	4.414243
100yrHydrograph	4:30	4.674353
100yrHydrograph	4:35	4.971942
100yrHydrograph	4:40	5.279111
100yrHydrograph	4:45	6.154143
100yrHydrograph	4:50	6.507444
100yrHydrograph	4:55	6.698976
100yrHydrograph	5:00	6.914319
100yrHydrograph	5:05	7.139013
100yrHydrograph	5:10	7.358335
100yrHydrograph	5:15	7.568453
100yrHydrograph	5:20	7.776987
100yrHydrograph	5:25	8.043731
100yrHydrograph	5:30	8.375088
100yrHydrograph	5:35	8.720076
100yrHydrograph	5:40	9.065854
100yrHydrograph	5:45	9.411835
100yrHydrograph	5:50	9.817601
100yrHydrograph	5:55	10.7888
100yrHydrograph	6:00	12.18063
100yrHydrograph	6:05	13.55768
100yrHydrograph	6:10	15.79406
100yrHydrograph	6:15	18.70004
100yrHydrograph	6:20	42.87194
100yrHydrograph	6:25	89.41938
100yrHydrograph	6:30	110.0801
100yrHydrograph	6:35	120.6727
100yrHydrograph	6:40	126.8955
100yrHydrograph	6:45	131.1839
100yrHydrograph	6:50	135.1019
100yrHydrograph	6:55	136.1944
100yrHydrograph	7:00	134.3278
100yrHydrograph	7:05	133.2315
100yrHydrograph	7:10	131.9975
100yrHydrograph	7:15	130.5499
100yrHydrograph	7:20	128.9494
100yrHydrograph	7:25	127.0917

100yrHydrograph	7:30	124.968
100yrHydrograph	7:35	122.8077
100yrHydrograph	7:40	120.8129
100yrHydrograph	7:45	118.6745
100yrHydrograph	7:50	116.2747
100yrHydrograph	7:55	113.7336
100yrHydrograph	8:00	111.03
100yrHydrograph	8:05	107.4665
100yrHydrograph	8:10	103.368
100yrHydrograph	8:15	99.26289
100yrHydrograph	8:20	95.15655
100yrHydrograph	8:25	90.6512
100yrHydrograph	8:30	85.96979
100yrHydrograph	8:35	81.40397
100yrHydrograph	8:40	77.20897
100yrHydrograph	8:45	73.056
100yrHydrograph	8:50	68.54881
100yrHydrograph	8:55	63.82666
100yrHydrograph	9:00	59.70413
100yrHydrograph	9:05	56.16789
100yrHydrograph	9:10	53.06845
100yrHydrograph	9:15	50.40911
100yrHydrograph	9:20	48.21593
100yrHydrograph	9:25	46.66951
100yrHydrograph	9:30	45.38166
100yrHydrograph	9:35	44.14623
100yrHydrograph	9:40	42.96396
100yrHydrograph	9:45	41.84916
100yrHydrograph	9:50	40.78232
100yrHydrograph	9:55	39.74205
100yrHydrograph	10:00	38.7661
100yrHydrograph	10:05	37.83093
100yrHydrograph	10:10	36.92952
100yrHydrograph	10:15	36.06311
100yrHydrograph	10:20	35.16625
100yrHydrograph	10:25	33.88804
100yrHydrograph	10:30	32.4535
100yrHydrograph	10:35	31.05881
100yrHydrograph	10:40	29.78304

100yrHydrograph	10:45	28.63077
100yrHydrograph	10:50	27.58944
100yrHydrograph	10:55	26.653
100yrHydrograph	11:00	25.66802
100yrHydrograph	11:05	24.91771
100yrHydrograph	11:10	24.2445
100yrHydrograph	11:15	23.63535
100yrHydrograph	11:20	23.08379
100yrHydrograph	11:25	22.58303
100yrHydrograph	11:30	22.12786
100yrHydrograph	11:35	21.71402
100yrHydrograph	11:40	21.33782
100yrHydrograph	11:45	20.99621
100yrHydrograph	11:50	20.68643
100yrHydrograph	11:55	20.40586
100yrHydrograph	12:00	20.1529
100yrHydrograph	12:05	19.91762
100yrHydrograph	12:10	19.63007
100yrHydrograph	12:15	19.3239
100yrHydrograph	12:20	19.12781
100yrHydrograph	12:25	18.97093
100yrHydrograph	12:30	18.80998
100yrHydrograph	12:35	18.64461
100yrHydrograph	12:40	18.47622
100yrHydrograph	12:45	18.30533
100yrHydrograph	12:50	18.13219
100yrHydrograph	12:55	17.95722
100yrHydrograph	13:00	17.74718
100yrHydrograph	13:05	17.56915
100yrHydrograph	13:10	17.39227
100yrHydrograph	13:15	17.21504
100yrHydrograph	13:20	17.03772
100yrHydrograph	13:25	16.86038
100yrHydrograph	13:30	16.68295
100yrHydrograph	13:35	16.50546
100yrHydrograph	13:40	16.32839
100yrHydrograph	13:45	16.15076
100yrHydrograph	13:50	15.97309
100yrHydrograph	13:55	15.79539

100yrHydrograph	14:00	15.61763
100yrHydrograph	14:05	15.44018
100yrHydrograph	14:10	15.26246
100yrHydrograph	14:15	15.08446
100yrHydrograph	14:20	14.90619
100yrHydrograph	14:25	14.72721
100yrHydrograph	14:30	14.54815
100yrHydrograph	14:35	14.36913
100yrHydrograph	14:40	14.19005
100yrHydrograph	14:45	14.011
100yrHydrograph	14:50	13.83076
100yrHydrograph	14:55	13.65002
100yrHydrograph	15:00	13.46919
100yrHydrograph	15:05	13.27224
100yrHydrograph	15:10	13.09266
100yrHydrograph	15:15	12.91431
100yrHydrograph	15:20	12.73593
100yrHydrograph	15:25	12.55792
100yrHydrograph	15:30	12.37996
100yrHydrograph	15:35	12.2021
100yrHydrograph	15:40	12.02427
100yrHydrograph	15:45	11.84651
100yrHydrograph	15:50	11.66898
100yrHydrograph	15:55	11.49166
100yrHydrograph	16:00	11.3145
100yrHydrograph	16:05	11.13787
100yrHydrograph	16:10	10.96224
100yrHydrograph	16:15	10.78573
100yrHydrograph	16:20	10.60909
100yrHydrograph	16:25	10.43269
100yrHydrograph	16:30	10.25677
100yrHydrograph	16:35	10.08101
100yrHydrograph	16:40	9.904943
100yrHydrograph	16:45	9.728643
100yrHydrograph	16:50	9.552533
100yrHydrograph	16:55	9.376752
100yrHydrograph	17:00	9.201365
100yrHydrograph	17:05	9.026419
100yrHydrograph	17:10	8.854236

100yrHydrograph	17:15	8.68074
100yrHydrograph	17:20	8.507633
100yrHydrograph	17:25	8.335072
100yrHydrograph	17:30	8.163301
100yrHydrograph	17:35	7.992058
100yrHydrograph	17:40	7.821409
100yrHydrograph	17:45	7.651455
100yrHydrograph	17:50	7.482112
100yrHydrograph	17:55	7.313401
100yrHydrograph	18:00	7.145336
100yrHydrograph	18:05	6.979621
100yrHydrograph	18:10	6.813243
100yrHydrograph	18:15	6.647324
100yrHydrograph	18:20	6.482216
100yrHydrograph	18:25	5.824821
100yrHydrograph	18:30	5.295127
100yrHydrograph	18:35	5.060137
100yrHydrograph	18:40	4.84829
100yrHydrograph	18:45	4.645963
100yrHydrograph	18:50	4.453671
100yrHydrograph	18:55	4.270811
100yrHydrograph	19:00	4.09688
100yrHydrograph	19:05	3.932506
100yrHydrograph	19:10	3.778864
100yrHydrograph	19:15	3.629502
100yrHydrograph	19:20	3.486742
100yrHydrograph	19:25	3.350802
100yrHydrograph	19:30	3.221082
100yrHydrograph	19:35	3.097033
100yrHydrograph	19:40	2.978455
100yrHydrograph	19:45	2.864869
100yrHydrograph	19:50	2.756282
100yrHydrograph	19:55	2.654007
100yrHydrograph	20:00	2.556878
100yrHydrograph	20:05	2.461823
100yrHydrograph	20:10	2.370567
100yrHydrograph	20:15	2.283155
100yrHydrograph	20:20	2.199545
100yrHydrograph	20:25	2.119371

100yrHydrograph	20:30	2.0424
100yrHydrograph	20:35	1.968455
100yrHydrograph	20:40	1.897445
100yrHydrograph	20:45	1.82913
100yrHydrograph	20:50	1.763424
100yrHydrograph	20:55	1.701357
100yrHydrograph	21:00	1.642923
100yrHydrograph	21:05	1.586518
100yrHydrograph	21:10	1.530593
100yrHydrograph	21:15	1.476459
100yrHydrograph	21:20	1.424285
100yrHydrograph	21:25	1.373979
100yrHydrograph	21:30	1.325569
100yrHydrograph	21:35	1.278883
100yrHydrograph	21:40	1.233917
100yrHydrograph	21:45	1.190506
100yrHydrograph	21:50	1.148588
100yrHydrograph	21:55	1.108119
100yrHydrograph	22:00	1.069048
100yrHydrograph	22:05	1.031321
100yrHydrograph	22:10	0.9948828
100yrHydrograph	22:15	0.9598325
100yrHydrograph	22:20	0.9265975
100yrHydrograph	22:25	0.895036
100yrHydrograph	22:30	0.8651206
100yrHydrograph	22:35	0.8349182
100yrHydrograph	22:40	0.8052853
100yrHydrograph	22:45	0.7765169
100yrHydrograph	22:50	0.7486013
100yrHydrograph	22:55	0.721274
100yrHydrograph	23:00	0.6946917
100yrHydrograph	23:05	0.6689637
100yrHydrograph	23:10	0.6440647
100yrHydrograph	23:15	0.619979
100yrHydrograph	23:20	0.5967006
100yrHydrograph	23:25	0.5741587
100yrHydrograph	23:30	0.5523183
100yrHydrograph	23:35	0.5311568
100yrHydrograph	23:40	0.5106529

100yrHydrograph	23:45	0.4907854
100yrHydrograph	23:50	0.4715335
100yrHydrograph	23:55	0.4528767
10yrHydrograph	0:05	0
10yrHydrograph	0:10	0
10yrHydrograph	0:15	0
10yrHydrograph	0:20	0
10yrHydrograph	0:25	0
10yrHydrograph	0:30	0
10yrHydrograph	0:35	0
10yrHydrograph	0:40	0
10yrHydrograph	0:45	0
10yrHydrograph	0:50	0
10yrHydrograph	0:55	0
10yrHydrograph	1:00	0
10yrHydrograph	1:05	0
10yrHydrograph	1:10	0
10yrHydrograph	1:15	0
10yrHydrograph	1:20	0
10yrHydrograph	1:25	0
10yrHydrograph	1:30	0
10yrHydrograph	1:35	0
10yrHydrograph	1:40	0
10yrHydrograph	1:45	0
10yrHydrograph	1:50	0
10yrHydrograph	1:55	0
10yrHydrograph	2:00	0
10yrHydrograph	2:05	0
10yrHydrograph	2:10	0
10yrHydrograph	2:15	0
10yrHydrograph	2:20	0
10yrHydrograph	2:25	0
10yrHydrograph	2:30	0
10yrHydrograph	2:35	0
10yrHydrograph	2:40	0.2091637
10yrHydrograph	2:45	0.4970559
10yrHydrograph	2:50	0.6621942
10yrHydrograph	2:55	0.7450011

10yrHydrograph	3:00	0.8098456
10yrHydrograph	3:05	0.8846287
10yrHydrograph	3:10	0.9675194
10yrHydrograph	3:15	1.05528
10yrHydrograph	3:20	1.151164
10yrHydrograph	3:25	1.254475
10yrHydrograph	3:30	1.361697
10yrHydrograph	3:35	1.470532
10yrHydrograph	3:40	1.579763
10yrHydrograph	3:45	1.69078
10yrHydrograph	3:50	1.803118
10yrHydrograph	3:55	1.911144
10yrHydrograph	4:00	2.017152
10yrHydrograph	4:05	2.122659
10yrHydrograph	4:10	2.240417
10yrHydrograph	4:15	2.389848
10yrHydrograph	4:20	2.566833
10yrHydrograph	4:25	2.760122
10yrHydrograph	4:30	2.955965
10yrHydrograph	4:35	3.15057
10yrHydrograph	4:40	3.364651
10yrHydrograph	4:45	3.620815
10yrHydrograph	4:50	3.904942
10yrHydrograph	4:55	4.202277
10yrHydrograph	5:00	4.49131
10yrHydrograph	5:05	4.779599
10yrHydrograph	5:10	5.130579
10yrHydrograph	5:15	6.106522
10yrHydrograph	5:20	6.627988
10yrHydrograph	5:25	6.905078
10yrHydrograph	5:30	7.156063
10yrHydrograph	5:35	7.436275
10yrHydrograph	5:40	8.155813
10yrHydrograph	5:45	9.272655
10yrHydrograph	5:50	10.49713
10yrHydrograph	5:55	12.46128
10yrHydrograph	6:00	14.55868
10yrHydrograph	6:05	16.69105
10yrHydrograph	6:10	17.57468

10yrHydrograph	6:15	17.73389
10yrHydrograph	6:20	18.406
10yrHydrograph	6:25	20.56863
10yrHydrograph	6:30	26.55472
10yrHydrograph	6:35	34.31078
10yrHydrograph	6:40	39.67621
10yrHydrograph	6:45	44.02234
10yrHydrograph	6:50	47.93614
10yrHydrograph	6:55	53.37497
10yrHydrograph	7:00	58.61012
10yrHydrograph	7:05	62.00156
10yrHydrograph	7:10	63.79604
10yrHydrograph	7:15	64.48611
10yrHydrograph	7:20	64.4265
10yrHydrograph	7:25	63.8186
10yrHydrograph	7:30	62.8089
10yrHydrograph	7:35	61.51538
10yrHydrograph	7:40	60.02477
10yrHydrograph	7:45	58.40065
10yrHydrograph	7:50	56.68561
10yrHydrograph	7:55	54.9119
10yrHydrograph	8:00	53.13997
10yrHydrograph	8:05	51.36214
10yrHydrograph	8:10	49.42586
10yrHydrograph	8:15	47.58556
10yrHydrograph	8:20	46.1135
10yrHydrograph	8:25	44.63068
10yrHydrograph	8:30	43.10273
10yrHydrograph	8:35	41.60753
10yrHydrograph	8:40	40.13668
10yrHydrograph	8:45	38.70065
10yrHydrograph	8:50	37.30282
10yrHydrograph	8:55	35.92665
10yrHydrograph	9:00	34.34184
10yrHydrograph	9:05	32.64213
10yrHydrograph	9:10	31.15942
10yrHydrograph	9:15	29.89203
10yrHydrograph	9:20	28.79363
10yrHydrograph	9:25	27.82757

10yrHydrograph	9:30	26.9729
10yrHydrograph	9:35	26.1101
10yrHydrograph	9:40	25.41559
10yrHydrograph	9:45	24.81808
10yrHydrograph	9:50	24.27901
10yrHydrograph	9:55	23.79137
10yrHydrograph	10:00	23.34904
10yrHydrograph	10:05	22.9389
10yrHydrograph	10:10	22.48323
10yrHydrograph	10:15	21.97798
10yrHydrograph	10:20	21.4708
10yrHydrograph	10:25	20.99098
10yrHydrograph	10:30	20.551
10yrHydrograph	10:35	20.15655
10yrHydrograph	10:40	19.81021
10yrHydrograph	10:45	19.51671
10yrHydrograph	10:50	19.28836
10yrHydrograph	10:55	19.15544
10yrHydrograph	11:00	19.05533
10yrHydrograph	11:05	18.95734
10yrHydrograph	11:10	18.85984
10yrHydrograph	11:15	18.76283
10yrHydrograph	11:20	18.66638
10yrHydrograph	11:25	18.57057
10yrHydrograph	11:30	18.47535
10yrHydrograph	11:35	18.38071
10yrHydrograph	11:40	18.28652
10yrHydrograph	11:45	18.19275
10yrHydrograph	11:50	18.09945
10yrHydrograph	11:55	17.99856
10yrHydrograph	12:00	17.8955
10yrHydrograph	12:05	17.80235
10yrHydrograph	12:10	17.68764
10yrHydrograph	12:15	17.55217
10yrHydrograph	12:20	17.40501
10yrHydrograph	12:25	17.25057
10yrHydrograph	12:30	17.0913
10yrHydrograph	12:35	16.92862
10yrHydrograph	12:40	16.76336

10yrHydrograph	12:45	16.59601
10yrHydrograph	12:50	16.4273
10yrHydrograph	12:55	16.25765
10yrHydrograph	13:00	16.08657
10yrHydrograph	13:05	15.91465
10yrHydrograph	13:10	15.74201
10yrHydrograph	13:15	15.56869
10yrHydrograph	13:20	15.39524
10yrHydrograph	13:25	15.22079
10yrHydrograph	13:30	15.04575
10yrHydrograph	13:35	14.86994
10yrHydrograph	13:40	14.6931
10yrHydrograph	13:45	14.51619
10yrHydrograph	13:50	14.33899
10yrHydrograph	13:55	14.16153
10yrHydrograph	14:00	13.98371
10yrHydrograph	14:05	13.80437
10yrHydrograph	14:10	13.62443
10yrHydrograph	14:15	13.44434
10yrHydrograph	14:20	13.24739
10yrHydrograph	14:25	13.06937
10yrHydrograph	14:30	12.8914
10yrHydrograph	14:35	12.71344
10yrHydrograph	14:40	12.53581
10yrHydrograph	14:45	12.35817
10yrHydrograph	14:50	12.1806
10yrHydrograph	14:55	12.00298
10yrHydrograph	15:00	11.82543
10yrHydrograph	15:05	11.6481
10yrHydrograph	15:10	11.47097
10yrHydrograph	15:15	11.29398
10yrHydrograph	15:20	11.11775
10yrHydrograph	15:25	10.94209
10yrHydrograph	15:30	10.76561
10yrHydrograph	15:35	10.58907
10yrHydrograph	15:40	10.41278
10yrHydrograph	15:45	10.23698
10yrHydrograph	15:50	10.06127
10yrHydrograph	15:55	9.885192

10yrHydrograph	16:00	9.708944
10yrHydrograph	16:05	9.532918
10yrHydrograph	16:10	9.357235
10yrHydrograph	16:15	9.181952
10yrHydrograph	16:20	9.007167
10yrHydrograph	16:25	8.835125
10yrHydrograph	16:30	8.6617
10yrHydrograph	16:35	8.488708
10yrHydrograph	16:40	8.316278
10yrHydrograph	16:45	8.144634
10yrHydrograph	16:50	7.973507
10yrHydrograph	16:55	7.802979
10yrHydrograph	17:00	7.63315
10yrHydrograph	17:05	7.463927
10yrHydrograph	17:10	7.295335
10yrHydrograph	17:15	7.12746
10yrHydrograph	17:20	6.961874
10yrHydrograph	17:25	6.795524
10yrHydrograph	17:30	6.62971
10yrHydrograph	17:35	6.464724
10yrHydrograph	17:40	5.728798
10yrHydrograph	17:45	5.266542
10yrHydrograph	17:50	5.03733
10yrHydrograph	17:55	4.826485
10yrHydrograph	18:00	4.625267
10yrHydrograph	18:05	4.434051
10yrHydrograph	18:10	4.252188
10yrHydrograph	18:15	4.079206
10yrHydrograph	18:20	3.915943
10yrHydrograph	18:25	3.763072
10yrHydrograph	18:30	3.614366
10yrHydrograph	18:35	3.472344
10yrHydrograph	18:40	3.337124
10yrHydrograph	18:45	3.208032
10yrHydrograph	18:50	3.084581
10yrHydrograph	18:55	2.966579
10yrHydrograph	19:00	2.853495
10yrHydrograph	19:05	2.745559
10yrHydrograph	19:10	2.644138

10yrHydrograph	19:15	2.547041
10yrHydrograph	19:20	2.452365
10yrHydrograph	19:25	2.361523
10yrHydrograph	19:30	2.274521
10yrHydrograph	19:35	2.191282
10yrHydrograph	19:40	2.111462
10yrHydrograph	19:45	2.034816
10yrHydrograph	19:50	1.961183
10yrHydrograph	19:55	1.89047
10yrHydrograph	20:00	1.822429
10yrHydrograph	20:05	1.757003
10yrHydrograph	20:10	1.69533
10yrHydrograph	20:15	1.637367
10yrHydrograph	20:20	1.580895
10yrHydrograph	20:25	1.525128
10yrHydrograph	20:30	1.471199
10yrHydrograph	20:35	1.419219
10yrHydrograph	20:40	1.369106
10yrHydrograph	20:45	1.320877
10yrHydrograph	20:50	1.274369
10yrHydrograph	20:55	1.229568
10yrHydrograph	21:00	1.186311
10yrHydrograph	21:05	1.144543
10yrHydrograph	21:10	1.104219
10yrHydrograph	21:15	1.065286
10yrHydrograph	21:20	1.027691
10yrHydrograph	21:25	0.9913799
10yrHydrograph	21:30	0.9565145
10yrHydrograph	21:35	0.9234093
10yrHydrograph	21:40	0.8921673
10yrHydrograph	21:45	0.8621652
10yrHydrograph	21:50	0.8319955
10yrHydrograph	21:55	0.802442
10yrHydrograph	22:00	0.7737648
10yrHydrograph	22:05	0.7459148
10yrHydrograph	22:10	0.7186539
10yrHydrograph	22:15	0.6921548
10yrHydrograph	22:20	0.6665107
10yrHydrograph	22:25	0.6416928

10yrHydrograph	22:30	0.6176897
10yrHydrograph	22:35	0.5944871
10yrHydrograph	22:40	0.5720161
10yrHydrograph	22:45	0.550244
10yrHydrograph	22:50	0.5291486
10yrHydrograph	22:55	0.5087084
10yrHydrograph	23:00	0.4889024
10yrHydrograph	23:05	0.4697101
10yrHydrograph	23:10	0.4511109
10yrHydrograph	23:15	0.4330854
10yrHydrograph	23:20	0.4156212
10yrHydrograph	23:25	0.3988013
10yrHydrograph	23:30	0.3825136
10yrHydrograph	23:35	0.3673834
10yrHydrograph	23:40	0.3523415
10yrHydrograph	23:45	0.3374563
10yrHydrograph	23:50	0.322884
10yrHydrograph	23:55	0.3086887

120SCS	0:00	0
120SCS	0:15	2.88
120SCS	0:30	2.88
120SCS	0:45	2.88
120SCS	1:00	2.88
120SCS	1:15	2.88
120SCS	1:30	2.88
120SCS	1:45	2.88
120SCS	2:00	2.88
120SCS	2:15	3.456
120SCS	2:30	3.456
120SCS	2:45	3.456
120SCS	3:00	3.456
120SCS	3:15	4.608
120SCS	3:30	4.608
120SCS	3:45	4.608
120SCS	4:00	4.608
120SCS	4:15	6.912
120SCS	4:30	6.912
120SCS	4:45	9.216

120SCS	5:00	9.216
120SCS	5:15	13.824
120SCS	5:30	13.824
120SCS	5:45	55.296
120SCS	6:00	152.064
120SCS	6:15	20.736
120SCS	6:30	20.736
120SCS	6:45	9.216
120SCS	7:00	9.216
120SCS	7:15	6.912
120SCS	7:30	6.912
120SCS	7:45	6.912
120SCS	8:00	6.912
120SCS	8:15	4.032
120SCS	8:30	4.032
120SCS	8:45	4.032
120SCS	9:00	4.032
120SCS	9:15	4.032
120SCS	9:30	4.032
120SCS	9:45	4.032
120SCS	10:00	4.032
120SCS	10:15	2.304
120SCS	10:30	2.304
120SCS	10:45	2.304
120SCS	11:00	2.304
120SCS	11:15	2.304
120SCS	11:30	2.304
120SCS	11:45	2.304
120SCS	12:00	0

120yrHydrograph	0:05	0
120yrHydrograph	0:10	0
120yrHydrograph	0:15	0
120yrHydrograph	0:20	0
120yrHydrograph	0:25	0
120yrHydrograph	0:30	0
120yrHydrograph	0:35	0
120yrHydrograph	0:40	0
120yrHydrograph	0:45	0

120yrHydrograph	0:50	0
120yrHydrograph	0:55	0
120yrHydrograph	1:00	0
120yrHydrograph	1:05	0
120yrHydrograph	1:10	0
120yrHydrograph	1:15	0
120yrHydrograph	1:20	0
120yrHydrograph	1:25	0
120yrHydrograph	1:30	0
120yrHydrograph	1:35	0
120yrHydrograph	1:40	0
120yrHydrograph	1:45	0
120yrHydrograph	1:50	0
120yrHydrograph	1:55	0.344241
120yrHydrograph	2:00	0.7189155
120yrHydrograph	2:05	0.9002669
120yrHydrograph	2:10	1.06309
120yrHydrograph	2:15	1.208622
120yrHydrograph	2:20	1.339344
120yrHydrograph	2:25	1.467497
120yrHydrograph	2:30	1.60491
120yrHydrograph	2:35	1.75987
120yrHydrograph	2:40	1.918853
120yrHydrograph	2:45	2.077065
120yrHydrograph	2:50	2.234614
120yrHydrograph	2:55	2.391056
120yrHydrograph	3:00	2.546204
120yrHydrograph	3:05	2.700942
120yrHydrograph	3:10	2.855207
120yrHydrograph	3:15	3.004697
120yrHydrograph	3:20	3.152104
120yrHydrograph	3:25	3.314249
120yrHydrograph	3:30	3.509691
120yrHydrograph	3:35	3.728292
120yrHydrograph	3:40	3.955694
120yrHydrograph	3:45	4.183218
120yrHydrograph	3:50	4.403465
120yrHydrograph	3:55	4.618955
120yrHydrograph	4:00	4.829294

120yrHydrograph	4:05	5.0349
120yrHydrograph	4:10	5.235206
120yrHydrograph	4:15	5.540944
120yrHydrograph	4:20	6.294454
120yrHydrograph	4:25	6.504807
120yrHydrograph	4:30	6.683425
120yrHydrograph	4:35	6.874739
120yrHydrograph	4:40	7.064317
120yrHydrograph	4:45	7.249343
120yrHydrograph	4:50	7.429554
120yrHydrograph	4:55	7.642233
120yrHydrograph	5:00	7.89349
120yrHydrograph	5:05	8.152265
120yrHydrograph	5:10	8.405735
120yrHydrograph	5:15	8.653997
120yrHydrograph	5:20	8.908699
120yrHydrograph	5:25	9.24717
120yrHydrograph	5:30	9.663168
120yrHydrograph	5:35	10.09873
120yrHydrograph	5:40	10.52877
120yrHydrograph	5:45	10.95266
120yrHydrograph	5:50	11.4424
120yrHydrograph	5:55	12.55669
120yrHydrograph	6:00	13.91015
120yrHydrograph	6:05	15.48645
120yrHydrograph	6:10	18.21065
120yrHydrograph	6:15	50.59299
120yrHydrograph	6:20	270.0371
120yrHydrograph	6:25	307.4776
120yrHydrograph	6:30	250.8829
120yrHydrograph	6:35	217.0673
120yrHydrograph	6:40	203.1162
120yrHydrograph	6:45	195.6699
120yrHydrograph	6:50	174.3307
120yrHydrograph	6:55	153.1465
120yrHydrograph	7:00	144.5096
120yrHydrograph	7:05	138.6253
120yrHydrograph	7:10	135.8059
120yrHydrograph	7:15	134.0851

120yrHydrograph	7:20	133.2594
120yrHydrograph	7:25	132.0687
120yrHydrograph	7:30	130.5854
120yrHydrograph	7:35	128.9982
120yrHydrograph	7:40	127.378
120yrHydrograph	7:45	125.6711
120yrHydrograph	7:50	123.9028
120yrHydrograph	7:55	122.2741
120yrHydrograph	8:00	120.7318
120yrHydrograph	8:05	119.0969
120yrHydrograph	8:10	117.2463
120yrHydrograph	8:15	115.2692
120yrHydrograph	8:20	113.1534
120yrHydrograph	8:25	110.5649
120yrHydrograph	8:30	107.6246
120yrHydrograph	8:35	104.5265
120yrHydrograph	8:40	101.2558
120yrHydrograph	8:45	97.00304
120yrHydrograph	8:50	91.96757
120yrHydrograph	8:55	86.90826
120yrHydrograph	9:00	82.11443
120yrHydrograph	9:05	77.84784
120yrHydrograph	9:10	73.76848
120yrHydrograph	9:15	69.56462
120yrHydrograph	9:20	65.01967
120yrHydrograph	9:25	61.00045
120yrHydrograph	9:30	57.59517
120yrHydrograph	9:35	54.63307
120yrHydrograph	9:40	52.07724
120yrHydrograph	9:45	49.90475
120yrHydrograph	9:50	48.12168
120yrHydrograph	9:55	46.86055
120yrHydrograph	10:00	45.83988
120yrHydrograph	10:05	44.8803
120yrHydrograph	10:10	43.96325
120yrHydrograph	10:15	43.09737
120yrHydrograph	10:20	42.26453
120yrHydrograph	10:25	41.30003
120yrHydrograph	10:30	40.17061

120yrHydrograph	10:35	38.96439
120yrHydrograph	10:40	37.72797
120yrHydrograph	10:45	36.47209
120yrHydrograph	10:50	35.16019
120yrHydrograph	10:55	33.54345
120yrHydrograph	11:00	32.03094
120yrHydrograph	11:05	30.71702
120yrHydrograph	11:10	29.58024
120yrHydrograph	11:15	28.58254
120yrHydrograph	11:20	27.69443
120yrHydrograph	11:25	26.90261
120yrHydrograph	11:30	26.09016
120yrHydrograph	11:35	25.44282
120yrHydrograph	11:40	24.87686
120yrHydrograph	11:45	24.36362
120yrHydrograph	11:50	23.89707
120yrHydrograph	11:55	23.47196
120yrHydrograph	12:00	23.08405
120yrHydrograph	12:05	22.71103
120yrHydrograph	12:10	22.19095
120yrHydrograph	12:15	21.52439
120yrHydrograph	12:20	20.83647
120yrHydrograph	12:25	20.20144
120yrHydrograph	12:30	19.65854
120yrHydrograph	12:35	19.26827
120yrHydrograph	12:40	19.0627
120yrHydrograph	12:45	18.88801
120yrHydrograph	12:50	18.71292
120yrHydrograph	12:55	18.53678
120yrHydrograph	13:00	18.35976
120yrHydrograph	13:05	18.18163
120yrHydrograph	13:10	18.00247
120yrHydrograph	13:15	17.79796
120yrHydrograph	13:20	17.60665
120yrHydrograph	13:25	17.42745
120yrHydrograph	13:30	17.24798
120yrHydrograph	13:35	17.06869
120yrHydrograph	13:40	16.88965
120yrHydrograph	13:45	16.71072

120yrHydrograph	13:50	16.53184
120yrHydrograph	13:55	16.35356
120yrHydrograph	14:00	16.17495
120yrHydrograph	14:05	15.9964
120yrHydrograph	14:10	15.81794
120yrHydrograph	14:15	15.63952
120yrHydrograph	14:20	15.46145
120yrHydrograph	14:25	15.28333
120yrHydrograph	14:30	15.10489
120yrHydrograph	14:35	14.92619
120yrHydrograph	14:40	14.74685
120yrHydrograph	14:45	14.56751
120yrHydrograph	14:50	14.38831
120yrHydrograph	14:55	14.20906
120yrHydrograph	15:00	14.03001
120yrHydrograph	15:05	13.8497
120yrHydrograph	15:10	13.6689
120yrHydrograph	15:15	13.488
120yrHydrograph	15:20	13.29222
120yrHydrograph	15:25	13.11104
120yrHydrograph	15:30	12.9327
120yrHydrograph	15:35	12.75426
120yrHydrograph	15:40	12.57617
120yrHydrograph	15:45	12.39816
120yrHydrograph	15:50	12.22025
120yrHydrograph	15:55	12.04239
120yrHydrograph	16:00	11.86458
120yrHydrograph	16:05	11.687
120yrHydrograph	16:10	11.50963
120yrHydrograph	16:15	11.33242
120yrHydrograph	16:20	11.15543
120yrHydrograph	16:25	10.98002
120yrHydrograph	16:30	10.80355
120yrHydrograph	16:35	10.62688
120yrHydrograph	16:40	10.45045
120yrHydrograph	16:45	10.27446
120yrHydrograph	16:50	10.09868
120yrHydrograph	16:55	9.922655
120yrHydrograph	17:00	9.746346

120yrHydrograph	17:05	9.570194
120yrHydrograph	17:10	9.394366
120yrHydrograph	17:15	9.218925
120yrHydrograph	17:20	9.043921
120yrHydrograph	17:25	8.871584
120yrHydrograph	17:30	8.698081
120yrHydrograph	17:35	8.524907
120yrHydrograph	17:40	8.352276
120yrHydrograph	17:45	8.180416
120yrHydrograph	17:50	8.009106
120yrHydrograph	17:55	7.838382
120yrHydrograph	18:00	7.668346
120yrHydrograph	18:05	7.49893
120yrHydrograph	18:10	7.330142
120yrHydrograph	18:15	7.16198
120yrHydrograph	18:20	6.996102
120yrHydrograph	18:25	6.829738
120yrHydrograph	18:30	6.663744
120yrHydrograph	18:35	6.498552
120yrHydrograph	18:40	5.923402
120yrHydrograph	18:45	5.323525
120yrHydrograph	18:50	5.081725
120yrHydrograph	18:55	4.868935
120yrHydrograph	19:00	4.66559
120yrHydrograph	19:05	4.472305
120yrHydrograph	19:10	4.288525
120yrHydrograph	19:15	4.11372
120yrHydrograph	19:20	3.948307
120yrHydrograph	19:25	3.79392
120yrHydrograph	19:30	3.643987
120yrHydrograph	19:35	3.500546
120yrHydrograph	19:40	3.363935
120yrHydrograph	19:45	3.233629
120yrHydrograph	19:50	3.109023
120yrHydrograph	19:55	2.989908
120yrHydrograph	20:00	2.875853
120yrHydrograph	20:05	2.766674
120yrHydrograph	20:10	2.663531
120yrHydrograph	20:15	2.566401

120yrHydrograph	20:20	2.471008
120yrHydrograph	20:25	2.379363
120yrHydrograph	20:30	2.291567
120yrHydrograph	20:35	2.207602
120yrHydrograph	20:40	2.127092
120yrHydrograph	20:45	2.049814
120yrHydrograph	20:50	1.975573
120yrHydrograph	20:55	1.904281
120yrHydrograph	21:00	1.835704
120yrHydrograph	21:05	1.769742
120yrHydrograph	21:10	1.707285
120yrHydrograph	21:15	1.648343
120yrHydrograph	21:20	1.59205
120yrHydrograph	21:25	1.535988
120yrHydrograph	21:30	1.481661
120yrHydrograph	21:35	1.429297
120yrHydrograph	21:40	1.378807
120yrHydrograph	21:45	1.330218
120yrHydrograph	21:50	1.283362
120yrHydrograph	21:55	1.238236
120yrHydrograph	22:00	1.194676
120yrHydrograph	22:05	1.152613
120yrHydrograph	22:10	1.112003
120yrHydrograph	22:15	1.072797
120yrHydrograph	22:20	1.03494
120yrHydrograph	22:25	0.9983785
120yrHydrograph	22:30	0.963154
120yrHydrograph	22:35	0.929782
120yrHydrograph	22:40	0.8978769
120yrHydrograph	22:45	0.8680665
120yrHydrograph	22:50	0.8378413
120yrHydrograph	22:55	0.8081332
120yrHydrograph	23:00	0.7792751
120yrHydrograph	23:05	0.751291
120yrHydrograph	23:10	0.723901
120yrHydrograph	23:15	0.6972384
120yrHydrograph	23:20	0.6714275
120yrHydrograph	23:25	0.6464488
120yrHydrograph	23:30	0.6222823

120yrHydrograph	23:35	0.5989287
120yrHydrograph	23:40	0.5763167
120yrHydrograph	23:45	0.5544087
120yrHydrograph	23:50	0.5331817
120yrHydrograph	23:55	0.5126142
25yrHydrograph	0:05	0
25yrHydrograph	0:10	0
25yrHydrograph	0:15	0
25yrHydrograph	0:20	0
25yrHydrograph	0:25	0
25yrHydrograph	0:30	0
25yrHydrograph	0:35	0
25yrHydrograph	0:40	0
25yrHydrograph	0:45	0
25yrHydrograph	0:50	0
25yrHydrograph	0:55	0
25yrHydrograph	1:00	0
25yrHydrograph	1:05	0
25yrHydrograph	1:10	0
25yrHydrograph	1:15	0
25yrHydrograph	1:20	0
25yrHydrograph	1:25	0
25yrHydrograph	1:30	0
25yrHydrograph	1:35	0
25yrHydrograph	1:40	0
25yrHydrograph	1:45	0
25yrHydrograph	1:50	0
25yrHydrograph	1:55	0
25yrHydrograph	2:00	0
25yrHydrograph	2:05	0
25yrHydrograph	2:10	0
25yrHydrograph	2:15	0
25yrHydrograph	2:20	0.001632289
25yrHydrograph	2:25	0.2622457
25yrHydrograph	2:30	0.5765883
25yrHydrograph	2:35	0.7342812
25yrHydrograph	2:40	0.8252636
25yrHydrograph	2:45	0.9269882

25yrHydrograph	2:50	1.032204
25yrHydrograph	2:55	1.12902
25yrHydrograph	3:00	1.221809
25yrHydrograph	3:05	1.313194
25yrHydrograph	3:10	1.408893
25yrHydrograph	3:15	1.518456
25yrHydrograph	3:20	1.642777
25yrHydrograph	3:25	1.783491
25yrHydrograph	3:30	1.923347
25yrHydrograph	3:35	2.061834
25yrHydrograph	3:40	2.199286
25yrHydrograph	3:45	2.335316
25yrHydrograph	3:50	2.470035
25yrHydrograph	3:55	2.602826
25yrHydrograph	4:00	2.736065
25yrHydrograph	4:05	2.867362
25yrHydrograph	4:10	3.017547
25yrHydrograph	4:15	3.213564
25yrHydrograph	4:20	3.443073
25yrHydrograph	4:25	3.684345
25yrHydrograph	4:30	3.926774
25yrHydrograph	4:35	4.171638
25yrHydrograph	4:40	4.441309
25yrHydrograph	4:45	4.766339
25yrHydrograph	4:50	5.121798
25yrHydrograph	4:55	5.884091
25yrHydrograph	5:00	6.467876
25yrHydrograph	5:05	6.681189
25yrHydrograph	5:10	6.9106
25yrHydrograph	5:15	7.199862
25yrHydrograph	5:20	7.500936
25yrHydrograph	5:25	7.79267
25yrHydrograph	5:30	8.072257
25yrHydrograph	5:35	8.390318
25yrHydrograph	5:40	9.215314
25yrHydrograph	5:45	10.46289
25yrHydrograph	5:50	11.82743
25yrHydrograph	5:55	13.81016
25yrHydrograph	6:00	16.30336

25yrHydrograph	6:05	18.52387
25yrHydrograph	6:10	21.79064
25yrHydrograph	6:15	33.77943
25yrHydrograph	6:20	43.20488
25yrHydrograph	6:25	54.80698
25yrHydrograph	6:30	69.68421
25yrHydrograph	6:35	80.71678
25yrHydrograph	6:40	88.15202
25yrHydrograph	6:45	92.7329
25yrHydrograph	6:50	95.59068
25yrHydrograph	6:55	97.34319
25yrHydrograph	7:00	98.31504
25yrHydrograph	7:05	98.65141
25yrHydrograph	7:10	98.27661
25yrHydrograph	7:15	97.332
25yrHydrograph	7:20	95.19835
25yrHydrograph	7:25	92.09679
25yrHydrograph	7:30	88.82446
25yrHydrograph	7:35	85.59274
25yrHydrograph	7:40	82.45365
25yrHydrograph	7:45	79.58022
25yrHydrograph	7:50	76.78926
25yrHydrograph	7:55	74.01968
25yrHydrograph	8:00	71.22165
25yrHydrograph	8:05	68.00592
25yrHydrograph	8:10	64.24236
25yrHydrograph	8:15	60.50372
25yrHydrograph	8:20	57.06802
25yrHydrograph	8:25	53.89598
25yrHydrograph	8:30	51.03894
25yrHydrograph	8:35	48.5897
25yrHydrograph	8:40	46.78022
25yrHydrograph	8:45	45.29158
25yrHydrograph	8:50	43.83835
25yrHydrograph	8:55	42.43797
25yrHydrograph	9:00	41.09942
25yrHydrograph	9:05	39.78819
25yrHydrograph	9:10	38.53657
25yrHydrograph	9:15	37.32283

25yrHydrograph	9:20	36.13959
25yrHydrograph	9:25	34.88116
25yrHydrograph	9:30	33.41477
25yrHydrograph	9:35	32.09751
25yrHydrograph	9:40	30.95746
25yrHydrograph	9:45	29.97478
25yrHydrograph	9:50	29.11481
25yrHydrograph	9:55	28.35425
25yrHydrograph	10:00	27.67503
25yrHydrograph	10:05	27.05764
25yrHydrograph	10:10	26.32501
25yrHydrograph	10:15	25.50807
25yrHydrograph	10:20	24.74522
25yrHydrograph	10:25	24.01871
25yrHydrograph	10:30	23.34307
25yrHydrograph	10:35	22.72353
25yrHydrograph	10:40	22.15742
25yrHydrograph	10:45	21.64292
25yrHydrograph	10:50	21.17765
25yrHydrograph	10:55	20.75909
25yrHydrograph	11:00	20.38477
25yrHydrograph	11:05	20.05307
25yrHydrograph	11:10	19.76257
25yrHydrograph	11:15	19.51477
25yrHydrograph	11:20	19.3151
25yrHydrograph	11:25	19.18726
25yrHydrograph	11:30	19.10144
25yrHydrograph	11:35	19.01951
25yrHydrograph	11:40	18.93828
25yrHydrograph	11:45	18.85769
25yrHydrograph	11:50	18.77772
25yrHydrograph	11:55	18.69841
25yrHydrograph	12:00	18.6198
25yrHydrograph	12:05	18.54006
25yrHydrograph	12:10	18.43951
25yrHydrograph	12:15	18.31268
25yrHydrograph	12:20	18.16971
25yrHydrograph	12:25	18.01683
25yrHydrograph	12:30	17.83426

25yrHydrograph	12:35	17.66102
25yrHydrograph	12:40	17.49463
25yrHydrograph	12:45	17.3259
25yrHydrograph	12:50	17.15563
25yrHydrograph	12:55	16.98421
25yrHydrograph	13:00	16.81187
25yrHydrograph	13:05	16.63874
25yrHydrograph	13:10	16.46504
25yrHydrograph	13:15	16.29125
25yrHydrograph	13:20	16.11657
25yrHydrograph	13:25	15.94155
25yrHydrograph	13:30	15.76617
25yrHydrograph	13:35	15.5904
25yrHydrograph	13:40	15.41475
25yrHydrograph	13:45	15.23849
25yrHydrograph	13:50	15.06182
25yrHydrograph	13:55	14.88464
25yrHydrograph	14:00	14.70663
25yrHydrograph	14:05	14.52861
25yrHydrograph	14:10	14.35047
25yrHydrograph	14:15	14.17213
25yrHydrograph	14:20	13.99351
25yrHydrograph	14:25	13.81356
25yrHydrograph	14:30	13.6331
25yrHydrograph	14:35	13.45256
25yrHydrograph	14:40	13.25532
25yrHydrograph	14:45	13.07675
25yrHydrograph	14:50	12.89854
25yrHydrograph	14:55	12.72034
25yrHydrograph	15:00	12.5425
25yrHydrograph	15:05	12.36468
25yrHydrograph	15:10	12.18695
25yrHydrograph	15:15	12.00922
25yrHydrograph	15:20	11.83156
25yrHydrograph	15:25	11.65413
25yrHydrograph	15:30	11.4769
25yrHydrograph	15:35	11.29981
25yrHydrograph	15:40	11.12345
25yrHydrograph	15:45	10.94775

25yrHydrograph	15:50	10.77124
25yrHydrograph	15:55	10.59464
25yrHydrograph	16:00	10.41831
25yrHydrograph	16:05	10.24246
25yrHydrograph	16:10	10.06672
25yrHydrograph	16:15	9.890636
25yrHydrograph	16:20	9.714363
25yrHydrograph	16:25	9.538301
25yrHydrograph	16:30	9.362578
25yrHydrograph	16:35	9.187253
25yrHydrograph	16:40	9.012401
25yrHydrograph	16:45	8.840317
25yrHydrograph	16:50	8.666858
25yrHydrograph	16:55	8.493819
25yrHydrograph	17:00	8.32134
25yrHydrograph	17:05	8.14965
25yrHydrograph	17:10	7.978478
25yrHydrograph	17:15	7.807906
25yrHydrograph	17:20	7.638032
25yrHydrograph	17:25	7.468765
25yrHydrograph	17:30	7.30013
25yrHydrograph	17:35	7.13219
25yrHydrograph	17:40	6.966566
25yrHydrograph	17:45	6.800201
25yrHydrograph	17:50	6.634353
25yrHydrograph	17:55	6.469327
25yrHydrograph	18:00	5.751874
25yrHydrograph	18:05	5.273855
25yrHydrograph	18:10	5.043334
25yrHydrograph	18:15	4.832212
25yrHydrograph	18:20	4.630692
25yrHydrograph	18:25	4.439184
25yrHydrograph	18:30	4.257051
25yrHydrograph	18:35	4.083813
25yrHydrograph	18:40	3.920253
25yrHydrograph	18:45	3.767176
25yrHydrograph	18:50	3.618289
25yrHydrograph	18:55	3.476068
25yrHydrograph	19:00	3.340655

25yrHydrograph	19:05	3.211395
25yrHydrograph	19:10	3.087783
25yrHydrograph	19:15	2.969627
25yrHydrograph	19:20	2.856409
25yrHydrograph	19:25	2.7483
25yrHydrograph	19:30	2.646666
25yrHydrograph	19:35	2.54955
25yrHydrograph	19:40	2.454772
25yrHydrograph	19:45	2.363821
25yrHydrograph	19:50	2.276711
25yrHydrograph	19:55	2.193374
25yrHydrograph	20:00	2.113461
25yrHydrograph	20:05	2.03673
25yrHydrograph	20:10	1.963015
25yrHydrograph	20:15	1.892225
25yrHydrograph	20:20	1.824112
25yrHydrograph	20:25	1.758609
25yrHydrograph	20:30	1.696838
25yrHydrograph	20:35	1.638761
25yrHydrograph	20:40	1.5823
25yrHydrograph	20:45	1.526491
25yrHydrograph	20:50	1.472508
25yrHydrograph	20:55	1.420478
25yrHydrograph	21:00	1.370315
25yrHydrograph	21:05	1.32204
25yrHydrograph	21:10	1.275487
25yrHydrograph	21:15	1.230644
25yrHydrograph	21:20	1.187347
25yrHydrograph	21:25	1.14554
25yrHydrograph	21:30	1.105179
25yrHydrograph	21:35	1.066211
25yrHydrograph	21:40	1.028582
25yrHydrograph	21:45	0.9922396
25yrHydrograph	21:50	0.9573277
25yrHydrograph	21:55	0.9241908
25yrHydrograph	22:00	0.892872
25yrHydrograph	22:05	0.8628887
25yrHydrograph	22:10	0.8327096
25yrHydrograph	22:15	0.8031358

25yrHydrograph	22:20	0.7744356
25yrHydrograph	22:25	0.7465697
25yrHydrograph	22:30	0.7192923
25yrHydrograph	22:35	0.6927726
25yrHydrograph	22:40	0.6671077
25yrHydrograph	22:45	0.6422694
25yrHydrograph	22:50	0.6182455
25yrHydrograph	22:55	0.595024
25yrHydrograph	23:00	0.5725354
25yrHydrograph	23:05	0.5507464
25yrHydrograph	23:10	0.5296347
25yrHydrograph	23:15	0.5091786
25yrHydrograph	23:20	0.4893577
25yrHydrograph	23:25	0.4701509
25yrHydrograph	23:30	0.4515376
25yrHydrograph	23:35	0.4334984
25yrHydrograph	23:40	0.4160193
25yrHydrograph	23:45	0.3991844
25yrHydrograph	23:50	0.3828847
25yrHydrograph	23:55	0.3677303

2yrHydrograph	0:05	0
2yrHydrograph	0:10	0
2yrHydrograph	0:15	0
2yrHydrograph	0:20	0
2yrHydrograph	0:25	0
2yrHydrograph	0:30	0
2yrHydrograph	0:35	0
2yrHydrograph	0:40	0
2yrHydrograph	0:45	0
2yrHydrograph	0:50	0
2yrHydrograph	0:55	0
2yrHydrograph	1:00	0
2yrHydrograph	1:05	0
2yrHydrograph	1:10	0
2yrHydrograph	1:15	0
2yrHydrograph	1:20	0
2yrHydrograph	1:25	0
2yrHydrograph	1:30	0

2yrHydrograph	1:35	0
2yrHydrograph	1:40	0
2yrHydrograph	1:45	0
2yrHydrograph	1:50	0
2yrHydrograph	1:55	0
2yrHydrograph	2:00	0
2yrHydrograph	2:05	0
2yrHydrograph	2:10	0
2yrHydrograph	2:15	0
2yrHydrograph	2:20	0
2yrHydrograph	2:25	0
2yrHydrograph	2:30	0
2yrHydrograph	2:35	0
2yrHydrograph	2:40	0
2yrHydrograph	2:45	0
2yrHydrograph	2:50	0
2yrHydrograph	2:55	0
2yrHydrograph	3:00	0
2yrHydrograph	3:05	0
2yrHydrograph	3:10	0
2yrHydrograph	3:15	0
2yrHydrograph	3:20	0
2yrHydrograph	3:25	0.003563957
2yrHydrograph	3:30	0.1682276
2yrHydrograph	3:35	0.3771983
2yrHydrograph	3:40	0.5159206
2yrHydrograph	3:45	0.6017497
2yrHydrograph	3:50	0.6697975
2yrHydrograph	3:55	0.7231919
2yrHydrograph	4:00	0.7669547
2yrHydrograph	4:05	0.820766
2yrHydrograph	4:10	0.880134
2yrHydrograph	4:15	0.9540438
2yrHydrograph	4:20	1.04035
2yrHydrograph	4:25	1.1353
2yrHydrograph	4:30	1.235741
2yrHydrograph	4:35	1.33869
2yrHydrograph	4:40	1.448107
2yrHydrograph	4:45	1.573878

2yrHydrograph	4:50	1.720981
2yrHydrograph	4:55	1.879236
2yrHydrograph	5:00	2.037325
2yrHydrograph	5:05	2.196208
2yrHydrograph	5:10	2.374235
2yrHydrograph	5:15	2.598158
2yrHydrograph	5:20	2.867055
2yrHydrograph	5:25	3.149988
2yrHydrograph	5:30	3.435339
2yrHydrograph	5:35	3.741842
2yrHydrograph	5:40	4.43628
2yrHydrograph	5:45	6.246645
2yrHydrograph	5:50	7.538581
2yrHydrograph	5:55	9.078191
2yrHydrograph	6:00	10.93573
2yrHydrograph	6:05	12.56826
2yrHydrograph	6:10	13.39444
2yrHydrograph	6:15	13.77394
2yrHydrograph	6:20	14.07615
2yrHydrograph	6:25	14.32379
2yrHydrograph	6:30	14.47786
2yrHydrograph	6:35	14.56697
2yrHydrograph	6:40	14.58446
2yrHydrograph	6:45	14.54862
2yrHydrograph	6:50	14.4947
2yrHydrograph	6:55	14.4348
2yrHydrograph	7:00	14.37298
2yrHydrograph	7:05	14.31037
2yrHydrograph	7:10	14.25763
2yrHydrograph	7:15	14.47936
2yrHydrograph	7:20	14.7036
2yrHydrograph	7:25	14.87247
2yrHydrograph	7:30	14.99324
2yrHydrograph	7:35	15.07008
2yrHydrograph	7:40	15.11274
2yrHydrograph	7:45	15.13689
2yrHydrograph	7:50	15.15322
2yrHydrograph	7:55	15.16643
2yrHydrograph	8:00	15.17813

2yrHydrograph	8:05	15.18739
2yrHydrograph	8:10	15.17762
2yrHydrograph	8:15	15.14478
2yrHydrograph	8:20	15.09864
2yrHydrograph	8:25	15.04534
2yrHydrograph	8:30	14.98804
2yrHydrograph	8:35	14.92799
2yrHydrograph	8:40	14.86625
2yrHydrograph	8:45	14.80354
2yrHydrograph	8:50	14.74021
2yrHydrograph	8:55	14.67653
2yrHydrograph	9:00	14.61272
2yrHydrograph	9:05	14.54884
2yrHydrograph	9:10	14.485
2yrHydrograph	9:15	14.42128
2yrHydrograph	9:20	14.35775
2yrHydrograph	9:25	14.29445
2yrHydrograph	9:30	14.23138
2yrHydrograph	9:35	14.16841
2yrHydrograph	9:40	14.10578
2yrHydrograph	9:45	14.04353
2yrHydrograph	9:50	13.98165
2yrHydrograph	9:55	13.92018
2yrHydrograph	10:00	13.85909
2yrHydrograph	10:05	13.79762
2yrHydrograph	10:10	13.72651
2yrHydrograph	10:15	13.64181
2yrHydrograph	10:20	13.54882
2yrHydrograph	10:25	13.45119
2yrHydrograph	10:30	13.34604
2yrHydrograph	10:35	13.23994
2yrHydrograph	10:40	13.13883
2yrHydrograph	10:45	13.03711
2yrHydrograph	10:50	12.93486
2yrHydrograph	10:55	12.83252
2yrHydrograph	11:00	12.73052
2yrHydrograph	11:05	12.6288
2yrHydrograph	11:10	12.52729
2yrHydrograph	11:15	12.42613

2yrHydrograph	11:20	12.32541
2yrHydrograph	11:25	12.22535
2yrHydrograph	11:30	12.12588
2yrHydrograph	11:35	12.02698
2yrHydrograph	11:40	11.92852
2yrHydrograph	11:45	11.83012
2yrHydrograph	11:50	11.73236
2yrHydrograph	11:55	11.63541
2yrHydrograph	12:00	11.53908
2yrHydrograph	12:05	11.4425
2yrHydrograph	12:10	11.33366
2yrHydrograph	12:15	11.20708
2yrHydrograph	12:20	11.06886
2yrHydrograph	12:25	10.92265
2yrHydrograph	12:30	10.77066
2yrHydrograph	12:35	10.61468
2yrHydrograph	12:40	10.45481
2yrHydrograph	12:45	10.29258
2yrHydrograph	12:50	10.12861
2yrHydrograph	12:55	9.963152
2yrHydrograph	13:00	9.796572
2yrHydrograph	13:05	9.629131
2yrHydrograph	13:10	9.460951
2yrHydrograph	13:15	9.292142
2yrHydrograph	13:20	9.122916
2yrHydrograph	13:25	8.954589
2yrHydrograph	13:30	8.786025
2yrHydrograph	13:35	8.616723
2yrHydrograph	13:40	8.447497
2yrHydrograph	13:45	8.278463
2yrHydrograph	13:50	8.109735
2yrHydrograph	13:55	7.941167
2yrHydrograph	14:00	7.772891
2yrHydrograph	14:05	7.605002
2yrHydrograph	14:10	7.437465
2yrHydrograph	14:15	7.270429
2yrHydrograph	14:20	7.103953
2yrHydrograph	14:25	6.939199
2yrHydrograph	14:30	6.773605

2yrHydrograph	14:35	6.608643
2yrHydrograph	14:40	6.444577
2yrHydrograph	14:45	5.63632
2yrHydrograph	14:50	5.237718
2yrHydrograph	14:55	5.014342
2yrHydrograph	15:00	4.805491
2yrHydrograph	15:05	4.606251
2yrHydrograph	15:10	4.416846
2yrHydrograph	15:15	4.236616
2yrHydrograph	15:20	4.06511
2yrHydrograph	15:25	3.903342
2yrHydrograph	15:30	3.751597
2yrHydrograph	15:35	3.603906
2yrHydrograph	15:40	3.462873
2yrHydrograph	15:45	3.328566
2yrHydrograph	15:50	3.200271
2yrHydrograph	15:55	3.077553
2yrHydrograph	16:00	2.960224
2yrHydrograph	16:05	2.847737
2yrHydrograph	16:10	2.740435
2yrHydrograph	16:15	2.639661
2yrHydrograph	16:20	2.542856
2yrHydrograph	16:25	2.448588
2yrHydrograph	16:30	2.358142
2yrHydrograph	16:35	2.271509
2yrHydrograph	16:40	2.1886
2yrHydrograph	16:45	2.109083
2yrHydrograph	16:50	2.03271
2yrHydrograph	16:55	1.959329
2yrHydrograph	17:00	1.888847
2yrHydrograph	17:05	1.821015
2yrHydrograph	17:10	1.755789
2yrHydrograph	17:15	1.69431
2yrHydrograph	17:20	1.636534
2yrHydrograph	17:25	1.580162
2yrHydrograph	17:30	1.524522
2yrHydrograph	17:35	1.470705
2yrHydrograph	17:40	1.418804
2yrHydrograph	17:45	1.368765

2yrHydrograph	17:50	1.320616
2yrHydrograph	17:55	1.274188
2yrHydrograph	18:00	1.229466
2yrHydrograph	18:05	1.186283
2yrHydrograph	18:10	1.144584
2yrHydrograph	18:15	1.104323
2yrHydrograph	18:20	1.065448
2yrHydrograph	18:25	1.027906
2yrHydrograph	18:30	0.9916432
2yrHydrograph	18:35	0.9568146
2yrHydrograph	18:40	0.9237459
2yrHydrograph	18:45	0.8925131
2yrHydrograph	18:50	0.8625606
2yrHydrograph	18:55	0.8324248
2yrHydrograph	19:00	0.8028972
2yrHydrograph	19:05	0.7742414
2yrHydrograph	19:10	0.7464148
2yrHydrograph	19:15	0.7191743
2yrHydrograph	19:20	0.6926898
2yrHydrograph	19:25	0.6670574
2yrHydrograph	19:30	0.6422487
2yrHydrograph	19:35	0.6182515
2yrHydrograph	19:40	0.5950544
2yrHydrograph	19:45	0.5725881
2yrHydrograph	19:50	0.5508193
2yrHydrograph	19:55	0.5297256
2yrHydrograph	20:00	0.5092856
2yrHydrograph	20:05	0.4894789
2yrHydrograph	20:10	0.4702851
2yrHydrograph	20:15	0.4516833
2yrHydrograph	20:20	0.4336542
2yrHydrograph	20:25	0.4161834
2yrHydrograph	20:30	0.3993552
2yrHydrograph	20:35	0.3830626
2yrHydrograph	20:40	0.3679075
2yrHydrograph	20:45	0.352874
2yrHydrograph	20:50	0.3379888
2yrHydrograph	20:55	0.3234121
2yrHydrograph	21:00	0.3092104

2yrHydrograph	21:05	0.2954019
2yrHydrograph	21:10	0.2819829
2yrHydrograph	21:15	0.2689412
2yrHydrograph	21:20	0.2562622
2yrHydrograph	21:25	0.2439416
2yrHydrograph	21:30	0.2319621
2yrHydrograph	21:35	0.2203049
2yrHydrograph	21:40	0.2092342
2yrHydrograph	21:45	0.1986824
2yrHydrograph	21:50	0.1884339
2yrHydrograph	21:55	0.1784449
2yrHydrograph	22:00	0.1687503
2yrHydrograph	22:05	0.1591294
2yrHydrograph	22:10	0.1495827
2yrHydrograph	22:15	0.1404474
2yrHydrograph	22:20	0.1318642
2yrHydrograph	22:25	0.1238625
2yrHydrograph	22:30	0.1164191
2yrHydrograph	22:35	0.1094914
2yrHydrograph	22:40	0.1030329
2yrHydrograph	22:45	0.09700606
2yrHydrograph	22:50	0.09149565
2yrHydrograph	22:55	0.08641619
2yrHydrograph	23:00	0.08192892
2yrHydrograph	23:05	0.07774525
2yrHydrograph	23:10	0.07367536
2yrHydrograph	23:15	0.0697474
2yrHydrograph	23:20	0.0659826
2yrHydrograph	23:25	0.0623938
2yrHydrograph	23:30	0.05898625
2yrHydrograph	23:35	0.05575913
2yrHydrograph	23:40	0.05270706
2yrHydrograph	23:45	0.049652
2yrHydrograph	23:50	0.04723772
2yrHydrograph	23:55	0.04519615

50yrHydrograph	0:05	0
50yrHydrograph	0:10	0
50yrHydrograph	0:15	0

50yrHydrograph	0:20	0
50yrHydrograph	0:25	0
50yrHydrograph	0:30	0
50yrHydrograph	0:35	0
50yrHydrograph	0:40	0
50yrHydrograph	0:45	0
50yrHydrograph	0:50	0
50yrHydrograph	0:55	0
50yrHydrograph	1:00	0
50yrHydrograph	1:05	0
50yrHydrograph	1:10	0
50yrHydrograph	1:15	0
50yrHydrograph	1:20	0
50yrHydrograph	1:25	0
50yrHydrograph	1:30	0
50yrHydrograph	1:35	0
50yrHydrograph	1:40	0
50yrHydrograph	1:45	0
50yrHydrograph	1:50	0
50yrHydrograph	1:55	0
50yrHydrograph	2:00	0
50yrHydrograph	2:05	0
50yrHydrograph	2:10	0
50yrHydrograph	2:15	0.1896701
50yrHydrograph	2:20	0.5472082
50yrHydrograph	2:25	0.7396636
50yrHydrograph	2:30	0.8484906
50yrHydrograph	2:35	0.9710755
50yrHydrograph	2:40	1.091995
50yrHydrograph	2:45	1.204302
50yrHydrograph	2:50	1.312206
50yrHydrograph	2:55	1.418368
50yrHydrograph	3:00	1.524127
50yrHydrograph	3:05	1.62965
50yrHydrograph	3:10	1.746479
50yrHydrograph	3:15	1.878949
50yrHydrograph	3:20	2.026683
50yrHydrograph	3:25	2.183036
50yrHydrograph	3:30	2.341848

50yrHydrograph	3:35	2.500659
50yrHydrograph	3:40	2.657861
50yrHydrograph	3:45	2.817623
50yrHydrograph	3:50	2.971852
50yrHydrograph	3:55	3.122654
50yrHydrograph	4:00	3.27065
50yrHydrograph	4:05	3.41763
50yrHydrograph	4:10	3.590356
50yrHydrograph	4:15	3.818011
50yrHydrograph	4:20	4.087829
50yrHydrograph	4:25	4.364322
50yrHydrograph	4:30	4.638282
50yrHydrograph	4:35	4.910603
50yrHydrograph	4:40	5.222383
50yrHydrograph	4:45	6.152192
50yrHydrograph	4:50	6.578424
50yrHydrograph	4:55	6.798974
50yrHydrograph	5:00	6.998712
50yrHydrograph	5:05	7.196966
50yrHydrograph	5:10	7.446401
50yrHydrograph	5:15	7.756927
50yrHydrograph	5:20	8.079263
50yrHydrograph	5:25	8.39279
50yrHydrograph	5:30	8.695212
50yrHydrograph	5:35	9.04722
50yrHydrograph	5:40	9.948486
50yrHydrograph	5:45	11.276
50yrHydrograph	5:50	12.71181
50yrHydrograph	5:55	14.74882
50yrHydrograph	6:00	17.45177
50yrHydrograph	6:05	22.92022
50yrHydrograph	6:10	42.51123
50yrHydrograph	6:15	65.40152
50yrHydrograph	6:20	83.9911
50yrHydrograph	6:25	96.50188
50yrHydrograph	6:30	105.2421
50yrHydrograph	6:35	111.2476
50yrHydrograph	6:40	114.2913
50yrHydrograph	6:45	115.6881

50yrHydrograph	6:50	116.1683
50yrHydrograph	6:55	116.0541
50yrHydrograph	7:00	115.5264
50yrHydrograph	7:05	114.6432
50yrHydrograph	7:10	113.2731
50yrHydrograph	7:15	111.5772
50yrHydrograph	7:20	109.6637
50yrHydrograph	7:25	107.5958
50yrHydrograph	7:30	105.2636
50yrHydrograph	7:35	101.9584
50yrHydrograph	7:40	98.11825
50yrHydrograph	7:45	94.24832
50yrHydrograph	7:50	90.45274
50yrHydrograph	7:55	86.8265
50yrHydrograph	8:00	83.38847
50yrHydrograph	8:05	80.18378
50yrHydrograph	8:10	76.73662
50yrHydrograph	8:15	73.00931
50yrHydrograph	8:20	68.81713
50yrHydrograph	8:25	64.24008
50yrHydrograph	8:30	60.13707
50yrHydrograph	8:35	56.5633
50yrHydrograph	8:40	53.3765
50yrHydrograph	8:45	50.59797
50yrHydrograph	8:50	48.27942
50yrHydrograph	8:55	46.62717
50yrHydrograph	9:00	45.23665
50yrHydrograph	9:05	43.89004
50yrHydrograph	9:10	42.60054
50yrHydrograph	9:15	41.37586
50yrHydrograph	9:20	40.18433
50yrHydrograph	9:25	39.04485
50yrHydrograph	9:30	37.95589
50yrHydrograph	9:35	36.90046
50yrHydrograph	9:40	35.87971
50yrHydrograph	9:45	34.75984
50yrHydrograph	9:50	33.50101
50yrHydrograph	9:55	32.37787
50yrHydrograph	10:00	31.39983

50yrHydrograph	10:05	30.53877
50yrHydrograph	10:10	29.62945
50yrHydrograph	10:15	28.63754
50yrHydrograph	10:20	27.63845
50yrHydrograph	10:25	26.68855
50yrHydrograph	10:30	25.6612
50yrHydrograph	10:35	24.86332
50yrHydrograph	10:40	24.14356
50yrHydrograph	10:45	23.48956
50yrHydrograph	10:50	22.89704
50yrHydrograph	10:55	22.35884
50yrHydrograph	11:00	21.87083
50yrHydrograph	11:05	21.42837
50yrHydrograph	11:10	21.02859
50yrHydrograph	11:15	20.66824
50yrHydrograph	11:20	20.34467
50yrHydrograph	11:25	20.05586
50yrHydrograph	11:30	19.80022
50yrHydrograph	11:35	19.57776
50yrHydrograph	11:40	19.39031
50yrHydrograph	11:45	19.24617
50yrHydrograph	11:50	19.16006
50yrHydrograph	11:55	19.08932
50yrHydrograph	12:00	19.01986
50yrHydrograph	12:05	18.94899
50yrHydrograph	12:10	18.85444
50yrHydrograph	12:15	18.73025
50yrHydrograph	12:20	18.58861
50yrHydrograph	12:25	18.43676
50yrHydrograph	12:30	18.27811
50yrHydrograph	12:35	18.11454
50yrHydrograph	12:40	17.9473
50yrHydrograph	12:45	17.7435
50yrHydrograph	12:50	17.57187
50yrHydrograph	12:55	17.39914
50yrHydrograph	13:00	17.2255
50yrHydrograph	13:05	17.05125
50yrHydrograph	13:10	16.87654
50yrHydrograph	13:15	16.7014

50yrHydrograph	13:20	16.52585
50yrHydrograph	13:25	16.35056
50yrHydrograph	13:30	16.17458
50yrHydrograph	13:35	15.99831
50yrHydrograph	13:40	15.82184
50yrHydrograph	13:45	15.64514
50yrHydrograph	13:50	15.46854
50yrHydrograph	13:55	15.29174
50yrHydrograph	14:00	15.11445
50yrHydrograph	14:05	14.93687
50yrHydrograph	14:10	14.75854
50yrHydrograph	14:15	14.58004
50yrHydrograph	14:20	14.40156
50yrHydrograph	14:25	14.22281
50yrHydrograph	14:30	14.04426
50yrHydrograph	14:35	13.86423
50yrHydrograph	14:40	13.6837
50yrHydrograph	14:45	13.50301
50yrHydrograph	14:50	13.30914
50yrHydrograph	14:55	13.12618
50yrHydrograph	15:00	12.94802
50yrHydrograph	15:05	12.76969
50yrHydrograph	15:10	12.59169
50yrHydrograph	15:15	12.4138
50yrHydrograph	15:20	12.23598
50yrHydrograph	15:25	12.05821
50yrHydrograph	15:30	11.88046
50yrHydrograph	15:35	11.70293
50yrHydrograph	15:40	11.52561
50yrHydrograph	15:45	11.34845
50yrHydrograph	15:50	11.17146
50yrHydrograph	15:55	10.99606
50yrHydrograph	16:00	10.8197
50yrHydrograph	16:05	10.64304
50yrHydrograph	16:10	10.46662
50yrHydrograph	16:15	10.29062
50yrHydrograph	16:20	10.11486
50yrHydrograph	16:25	9.938902
50yrHydrograph	16:30	9.762617

50yrHydrograph	16:35	9.586464
50yrHydrograph	16:40	9.410628
50yrHydrograph	16:45	9.235176
50yrHydrograph	16:50	9.060157
50yrHydrograph	16:55	8.8877
50yrHydrograph	17:00	8.714247
50yrHydrograph	17:05	8.541053
50yrHydrograph	17:10	8.368399
50yrHydrograph	17:15	8.196492
50yrHydrograph	17:20	8.02516
50yrHydrograph	17:25	7.854405
50yrHydrograph	17:30	7.68433
50yrHydrograph	17:35	7.514884
50yrHydrograph	17:40	7.346062
50yrHydrograph	17:45	7.177868
50yrHydrograph	17:50	7.011817
50yrHydrograph	17:55	6.845519
50yrHydrograph	18:00	6.679473
50yrHydrograph	18:05	6.514217
50yrHydrograph	18:10	6.030243
50yrHydrograph	18:15	5.35311
50yrHydrograph	18:20	5.102541
50yrHydrograph	18:25	4.888823
50yrHydrograph	18:30	4.684548
50yrHydrograph	18:35	4.490335
50yrHydrograph	18:40	4.305697
50yrHydrograph	18:45	4.130076
50yrHydrograph	18:50	3.963681
50yrHydrograph	18:55	3.808549
50yrHydrograph	19:00	3.658127
50yrHydrograph	19:05	3.514045
50yrHydrograph	19:10	3.376799
50yrHydrograph	19:15	3.245937
50yrHydrograph	19:20	3.120808
50yrHydrograph	19:25	3.001184
50yrHydrograph	19:30	2.886683
50yrHydrograph	19:35	2.776967
50yrHydrograph	19:40	2.67334
50yrHydrograph	19:45	2.575817

50yrHydrograph	19:50	2.480122
50yrHydrograph	19:55	2.388107
50yrHydrograph	20:00	2.299947
50yrHydrograph	20:05	2.215632
50yrHydrograph	20:10	2.1348
50yrHydrograph	20:15	2.057227
50yrHydrograph	20:20	1.982703
50yrHydrograph	20:25	1.911137
50yrHydrograph	20:30	1.842309
50yrHydrograph	20:35	1.776098
50yrHydrograph	20:40	1.713254
50yrHydrograph	20:45	1.653753
50yrHydrograph	20:50	1.597621
50yrHydrograph	20:55	1.541439
50yrHydrograph	21:00	1.486925
50yrHydrograph	21:05	1.434374
50yrHydrograph	21:10	1.383702
50yrHydrograph	21:15	1.334931
50yrHydrograph	21:20	1.287907
50yrHydrograph	21:25	1.24262
50yrHydrograph	21:30	1.198912
50yrHydrograph	21:35	1.156705
50yrHydrograph	21:40	1.115956
50yrHydrograph	21:45	1.076615
50yrHydrograph	21:50	1.038629
50yrHydrograph	21:55	1.001943
50yrHydrograph	22:00	0.966554
50yrHydrograph	22:05	0.9330333
50yrHydrograph	22:10	0.9007493
50yrHydrograph	22:15	0.8710659
50yrHydrograph	22:20	0.8408281
50yrHydrograph	22:25	0.8110486
50yrHydrograph	22:30	0.7821017
50yrHydrograph	22:35	0.7540459
50yrHydrograph	22:40	0.7265956
50yrHydrograph	22:45	0.6998537
50yrHydrograph	22:50	0.6739593
50yrHydrograph	22:55	0.6489003
50yrHydrograph	23:00	0.6246529

50yrHydrograph	23:05	0.6012228
50yrHydrograph	23:10	0.57854
50yrHydrograph	23:15	0.556564
50yrHydrograph	23:20	0.535271
50yrHydrograph	23:25	0.5146395
50yrHydrograph	23:30	0.4946485
50yrHydrograph	23:35	0.4752773
50yrHydrograph	23:40	0.4565056
50yrHydrograph	23:45	0.438313
50yrHydrograph	23:50	0.4206813
50yrHydrograph	23:55	0.4036704

5yrHydrograph	0:05	0
5yrHydrograph	0:10	0
5yrHydrograph	0:15	0
5yrHydrograph	0:20	0
5yrHydrograph	0:25	0
5yrHydrograph	0:30	0
5yrHydrograph	0:35	0
5yrHydrograph	0:40	0
5yrHydrograph	0:45	0
5yrHydrograph	0:50	0
5yrHydrograph	0:55	0
5yrHydrograph	1:00	0
5yrHydrograph	1:05	0
5yrHydrograph	1:10	0
5yrHydrograph	1:15	0
5yrHydrograph	1:20	0
5yrHydrograph	1:25	0
5yrHydrograph	1:30	0
5yrHydrograph	1:35	0
5yrHydrograph	1:40	0
5yrHydrograph	1:45	0
5yrHydrograph	1:50	0
5yrHydrograph	1:55	0
5yrHydrograph	2:00	0
5yrHydrograph	2:05	0
5yrHydrograph	2:10	0
5yrHydrograph	2:15	0

5yrHydrograph	2:20	0
5yrHydrograph	2:25	0
5yrHydrograph	2:30	0
5yrHydrograph	2:35	0
5yrHydrograph	2:40	0
5yrHydrograph	2:45	0
5yrHydrograph	2:50	0
5yrHydrograph	2:55	0.1359298
5yrHydrograph	3:00	0.3930297
5yrHydrograph	3:05	0.5591156
5yrHydrograph	3:10	0.6563269
5yrHydrograph	3:15	0.7263873
5yrHydrograph	3:20	0.7832466
5yrHydrograph	3:25	0.8602272
5yrHydrograph	3:30	0.949561
5yrHydrograph	3:35	1.040848
5yrHydrograph	3:40	1.129301
5yrHydrograph	3:45	1.216549
5yrHydrograph	3:50	1.303134
5yrHydrograph	3:55	1.38916
5yrHydrograph	4:00	1.474818
5yrHydrograph	4:05	1.560286
5yrHydrograph	4:10	1.653159
5yrHydrograph	4:15	1.774101
5yrHydrograph	4:20	1.914395
5yrHydrograph	4:25	2.065953
5yrHydrograph	4:30	2.221644
5yrHydrograph	4:35	2.378466
5yrHydrograph	4:40	2.548352
5yrHydrograph	4:45	2.751761
5yrHydrograph	4:50	2.979939
5yrHydrograph	4:55	3.21575
5yrHydrograph	5:00	3.452507
5yrHydrograph	5:05	3.68941
5yrHydrograph	5:10	3.970027
5yrHydrograph	5:15	4.336559
5yrHydrograph	5:20	4.746371
5yrHydrograph	5:25	5.167806
5yrHydrograph	5:30	6.125247

5yrHydrograph	5:35	6.60618
5yrHydrograph	5:40	7.26016
5yrHydrograph	5:45	8.276287
5yrHydrograph	5:50	9.40118
5yrHydrograph	5:55	11.18117
5yrHydrograph	6:00	13.27669
5yrHydrograph	6:05	15.05454
5yrHydrograph	6:10	16.05738
5yrHydrograph	6:15	16.35877
5yrHydrograph	6:20	16.5261
5yrHydrograph	6:25	16.64606
5yrHydrograph	6:30	16.8107
5yrHydrograph	6:35	17.73345
5yrHydrograph	6:40	18.56983
5yrHydrograph	6:45	19.41413
5yrHydrograph	6:50	21.27034
5yrHydrograph	6:55	23.88992
5yrHydrograph	7:00	26.86422
5yrHydrograph	7:05	29.48862
5yrHydrograph	7:10	32.33274
5yrHydrograph	7:15	34.75698
5yrHydrograph	7:20	36.25337
5yrHydrograph	7:25	37.2498
5yrHydrograph	7:30	37.93416
5yrHydrograph	7:35	38.35898
5yrHydrograph	7:40	38.55013
5yrHydrograph	7:45	38.52993
5yrHydrograph	7:50	38.31598
5yrHydrograph	7:55	37.92754
5yrHydrograph	8:00	37.38509
5yrHydrograph	8:05	36.69696
5yrHydrograph	8:10	35.77127
5yrHydrograph	8:15	34.42931
5yrHydrograph	8:20	32.79601
5yrHydrograph	8:25	31.2692
5yrHydrograph	8:30	29.91289
5yrHydrograph	8:35	28.71217
5yrHydrograph	8:40	27.64098
5yrHydrograph	8:45	26.68515

5yrHydrograph	8:50	25.68662
5yrHydrograph	8:55	24.92772
5yrHydrograph	9:00	24.24983
5yrHydrograph	9:05	23.63789
5yrHydrograph	9:10	23.08488
5yrHydrograph	9:15	22.58359
5yrHydrograph	9:20	22.12847
5yrHydrograph	9:25	21.71508
5yrHydrograph	9:30	21.33958
5yrHydrograph	9:35	20.99883
5yrHydrograph	9:40	20.69
5yrHydrograph	9:45	20.41037
5yrHydrograph	9:50	20.15836
5yrHydrograph	9:55	19.93183
5yrHydrograph	10:00	19.7298
5yrHydrograph	10:05	19.54918
5yrHydrograph	10:10	19.36684
5yrHydrograph	10:15	19.2122
5yrHydrograph	10:20	19.10802
5yrHydrograph	10:25	19.00704
5yrHydrograph	10:30	18.90381
5yrHydrograph	10:35	18.7992
5yrHydrograph	10:40	18.69384
5yrHydrograph	10:45	18.58822
5yrHydrograph	10:50	18.48252
5yrHydrograph	10:55	18.37688
5yrHydrograph	11:00	18.27123
5yrHydrograph	11:05	18.16563
5yrHydrograph	11:10	18.06016
5yrHydrograph	11:15	17.93639
5yrHydrograph	11:20	17.82903
5yrHydrograph	11:25	17.72502
5yrHydrograph	11:30	17.62141
5yrHydrograph	11:35	17.51838
5yrHydrograph	11:40	17.41596
5yrHydrograph	11:45	17.31414
5yrHydrograph	11:50	17.21291
5yrHydrograph	11:55	17.1123
5yrHydrograph	12:00	17.01231

5yrHydrograph	12:05	16.91126
5yrHydrograph	12:10	16.79244
5yrHydrograph	12:15	16.65569
5yrHydrograph	12:20	16.50852
5yrHydrograph	12:25	16.35518
5yrHydrograph	12:30	16.19693
5yrHydrograph	12:35	16.03533
5yrHydrograph	12:40	15.8712
5yrHydrograph	12:45	15.70505
5yrHydrograph	12:50	15.53723
5yrHydrograph	12:55	15.36853
5yrHydrograph	13:00	15.19821
5yrHydrograph	13:05	15.02684
5yrHydrograph	13:10	14.85402
5yrHydrograph	13:15	14.67999
5yrHydrograph	13:20	14.50557
5yrHydrograph	13:25	14.33055
5yrHydrograph	13:30	14.15497
5yrHydrograph	13:35	13.9786
5yrHydrograph	13:40	13.80049
5yrHydrograph	13:45	13.62188
5yrHydrograph	13:50	13.44306
5yrHydrograph	13:55	13.24735
5yrHydrograph	14:00	13.07019
5yrHydrograph	14:05	12.89289
5yrHydrograph	14:10	12.71552
5yrHydrograph	14:15	12.53842
5yrHydrograph	14:20	12.36123
5yrHydrograph	14:25	12.18404
5yrHydrograph	14:30	12.00669
5yrHydrograph	14:35	11.82936
5yrHydrograph	14:40	11.65223
5yrHydrograph	14:45	11.47529
5yrHydrograph	14:50	11.29847
5yrHydrograph	14:55	11.12236
5yrHydrograph	15:00	10.94688
5yrHydrograph	15:05	10.77053
5yrHydrograph	15:10	10.59407
5yrHydrograph	15:15	10.41786

5yrHydrograph	15:20	10.24212
5yrHydrograph	15:25	10.06648
5yrHydrograph	15:30	9.890451
5yrHydrograph	15:35	9.714251
5yrHydrograph	15:40	9.538265
5yrHydrograph	15:45	9.362621
5yrHydrograph	15:50	9.187378
5yrHydrograph	15:55	9.012606
5yrHydrograph	16:00	8.840601
5yrHydrograph	16:05	8.66722
5yrHydrograph	16:10	8.494259
5yrHydrograph	16:15	8.321853
5yrHydrograph	16:20	8.150234
5yrHydrograph	16:25	7.979133
5yrHydrograph	16:30	7.808626
5yrHydrograph	16:35	7.638818
5yrHydrograph	16:40	7.469615
5yrHydrograph	16:45	7.301042
5yrHydrograph	16:50	7.133159
5yrHydrograph	16:55	6.967582
5yrHydrograph	17:00	6.80125
5yrHydrograph	17:05	6.635427
5yrHydrograph	17:10	6.470431
5yrHydrograph	17:15	5.757764
5yrHydrograph	17:20	5.275753
5yrHydrograph	17:25	5.044955
5yrHydrograph	17:30	4.833824
5yrHydrograph	17:35	4.632282
5yrHydrograph	17:40	4.44075
5yrHydrograph	17:45	4.258595
5yrHydrograph	17:50	4.08533
5yrHydrograph	17:55	3.921725
5yrHydrograph	18:00	3.768626
5yrHydrograph	18:05	3.619721
5yrHydrograph	18:10	3.477474
5yrHydrograph	18:15	3.342031
5yrHydrograph	18:20	3.212744
5yrHydrograph	18:25	3.089107
5yrHydrograph	18:30	2.970923

5yrHydrograph	18:35	2.857682
5yrHydrograph	18:40	2.74953
5yrHydrograph	18:45	2.647825
5yrHydrograph	18:50	2.55073
5yrHydrograph	18:55	2.455931
5yrHydrograph	19:00	2.364952
5yrHydrograph	19:05	2.277812
5yrHydrograph	19:10	2.19445
5yrHydrograph	19:15	2.114511
5yrHydrograph	19:20	2.037755
5yrHydrograph	19:25	1.964015
5yrHydrograph	19:30	1.893201
5yrHydrograph	19:35	1.825066
5yrHydrograph	19:40	1.759538
5yrHydrograph	19:45	1.697725
5yrHydrograph	19:50	1.639592
5yrHydrograph	19:55	1.583153
5yrHydrograph	20:00	1.527332
5yrHydrograph	20:05	1.473329
5yrHydrograph	20:10	1.421277
5yrHydrograph	20:15	1.37109
5yrHydrograph	20:20	1.322793
5yrHydrograph	20:25	1.27622
5yrHydrograph	20:30	1.231358
5yrHydrograph	20:35	1.188044
5yrHydrograph	20:40	1.14622
5yrHydrograph	20:45	1.105842
5yrHydrograph	20:50	1.066858
5yrHydrograph	20:55	1.029213
5yrHydrograph	21:00	0.9928537
5yrHydrograph	21:05	0.957914
5yrHydrograph	21:10	0.9247589
5yrHydrograph	21:15	0.8933879
5yrHydrograph	21:20	0.8634235
5yrHydrograph	21:25	0.8332421
5yrHydrograph	21:30	0.8036575
5yrHydrograph	21:35	0.7749439
5yrHydrograph	21:40	0.7470686
5yrHydrograph	21:45	0.7197814

SyrHydrograph	21:50	0.6932487
SyrHydrograph	21:55	0.6675706
SyrHydrograph	22:00	0.6427196
SyrHydrograph	22:05	0.6186827
SyrHydrograph	22:10	0.5954496
SyrHydrograph	22:15	0.5729498
SyrHydrograph	22:20	0.5511498
SyrHydrograph	22:25	0.5300273
SyrHydrograph	22:30	0.5095608
SyrHydrograph	22:35	0.4897293
SyrHydrograph	22:40	0.4705123
SyrHydrograph	22:45	0.4518893
SyrHydrograph	22:50	0.4338406
SyrHydrograph	22:55	0.4163517
SyrHydrograph	23:00	0.3995065
SyrHydrograph	23:05	0.383199
SyrHydrograph	23:10	0.3680256
SyrHydrograph	23:15	0.3529832
SyrHydrograph	23:20	0.338088
SyrHydrograph	23:25	0.3235011
SyrHydrograph	23:30	0.3092898
SyrHydrograph	23:35	0.2954722
SyrHydrograph	23:40	0.2820446
SyrHydrograph	23:45	0.2689951
SyrHydrograph	23:50	0.2563089
SyrHydrograph	23:55	0.2439816

[REPORT]
 ;;Reporting Options
 INPUT YES
 CONTROLS NO
 SUBCATCHMENTS ALL
 NODES ALL
 LINKS ALL

[TAGS]

[MAP]
 DIMENSIONS 350504.70725 5015809.991 350738.97975 5016090.183

UNITS Meters

[COORDINATES]

;;Node	X-Coord	Y-Coord

HEADWALL	350565.848	5016038.828
OF1	350702.274	5015973.798
OF3	350691.907	5015873.685
OF4	350536.617	5015877.154
POOLE	350547.792	5015987.469
100	350604.4	5016006
101	350613.6	5015987
102	350620.1	5015980
103	350577.8	5015941
104	350559.9	5015927
105	350565.233	5015895.797
ADS	350609.954	5015996.177
BLDG	350645.2	5015953
CB102A-1	350645.2	5015989
CB103A-1	350602.8	5015914
CB103B-1	350583.627	5015951.403
CB103C-1	350601.334	5015932.043
CB103D-1	350623.764	5015950.695
CB103E-1	350606.056	5015973.833
CB106A-1	350619.75	5016018.928
EX	350580.8	5016032
ROOF1-S	350665.79	5015960.847
ROOF2-S	350684.678	5015939.598
ROOF3-S	350606.529	5015873.726
ROOF4-S	350590.71	5015890.961

[VERTICES]

;;Link	X-Coord	Y-Coord

100-02	350604.96	5015999.311
100-W1	350601.524	5015996.977

[POLYGONS]

;;Subcatchment	X-Coord	Y-Coord
----------------	---------	---------

```

;;-----
EXT-1      350626.393      5015829.475
EXT-1      350627.232      5015826.033
EXT-1      350627.232      5015826.033
EXT-1      350624.127      5015822.727
EXT-1      350624.127      5015822.727
EXT-1      350620.936      5015826.468
EXT-1      350620.936      5015826.468
EXT-1      350613.689      5015833.765
EXT-1      350613.689      5015833.765
EXT-1      350600.76       5015840.764
EXT-1      350600.76       5015840.764
EXT-1      350604.251      5015844.185
EXT-1      350604.251      5015844.185
EXT-1      350595.149      5015854.34
EXT-1      350595.149      5015854.34
EXT-1      350595.45       5015854.616
EXT-1      350595.45       5015854.616
EXT-1      350587.232      5015863.596
EXT-1      350587.232      5015863.596
EXT-1      350583.047      5015859.746
EXT-1      350583.047      5015859.746
EXT-1      350582.128      5015861.965
EXT-1      350582.128      5015861.965
EXT-1      350581.002      5015863.66
EXT-1      350581.002      5015863.66
EXT-1      350574.449      5015871.047
EXT-1      350574.449      5015871.047
EXT-1      350569.16       5015876.374
EXT-1      350569.16       5015876.374
EXT-1      350569.521      5015882.427
EXT-1      350569.521      5015882.427
EXT-1      350565.233      5015887.407
EXT-1      350565.233      5015887.407
EXT-1      350564.373      5015890.234
EXT-1      350564.373      5015890.234
EXT-1      350564.403      5015893.181
EXT-1      350564.403      5015893.181
EXT-1      350565.137      5015896.048

```

```

EXT-1      350565.137      5015896.048
EXT-1      350569.544      5015891.262
EXT-1      350569.544      5015891.262
EXT-1      350626.393      5015829.475
L102A     350656.417      5015992.343
L102A     350662.013      5015986.146
L102A     350662.013      5015986.146
L102A     350661.506      5015979.248
L102A     350661.506      5015979.248
L102A     350656.004      5015974.225
L102A     350656.004      5015974.225
L102A     350648.407      5015967.196
L102A     350648.407      5015967.196
L102A     350670.181      5015943.531
L102A     350670.181      5015943.531
L102A     350667.053      5015940.653
L102A     350667.053      5015940.653
L102A     350647.202      5015962.229
L102A     350647.202      5015962.229
L102A     350636.422      5015973.945
L102A     350636.422      5015973.945
L102A     350634.153      5015976.411
L102A     350634.153      5015976.411
L102A     350637.369      5015981.883
L102A     350637.369      5015981.883
L102A     350645.132      5015989.027
L102A     350645.132      5015989.027
L102A     350652.896      5015996.17
L102A     350652.896      5015996.17
L102A     350656.417      5015992.343
L103A     350587.998      5015906.399
L103A     350591.578      5015909.693
L103A     350591.578      5015909.693
L103A     350594.791      5015914.103
L103A     350594.791      5015914.103
L103A     350599.312      5015918.272
L103A     350599.312      5015918.272
L103A     350608.056      5015919.042
L103A     350608.056      5015919.042

```

L103A	350612.742	5015920.065
L103A	350612.742	5015920.065
L103A	350613.623	5015919.072
L103A	350613.623	5015919.072
L103A	350617.114	5015918.637
L103A	350617.114	5015918.637
L103A	350618.009	5015916.055
L103A	350618.009	5015916.055
L103A	350619.11	5015913.655
L103A	350619.11	5015913.655
L103A	350620.754	5015910.826
L103A	350620.754	5015910.826
L103A	350622.577	5015908.477
L103A	350622.577	5015908.477
L103A	350624.122	5015906.796
L103A	350624.122	5015906.796
L103A	350625.992	5015905.133
L103A	350625.992	5015905.133
L103A	350627.517	5015903.901
L103A	350627.517	5015903.901
L103A	350628.948	5015902.932
L103A	350628.948	5015902.932
L103A	350630.209	5015902.181
L103A	350630.209	5015902.181
L103A	350631.694	5015901.401
L103A	350631.694	5015901.401
L103A	350634.83	5015889.695
L103A	350634.83	5015889.695
L103A	350636.618	5015891.012
L103A	350636.618	5015891.012
L103A	350638.49	5015892.726
L103A	350638.49	5015892.726
L103A	350643.944	5015886.798
L103A	350643.944	5015886.798
L103A	350647.671	5015882.748
L103A	350647.671	5015882.748
L103A	350628.262	5015864.89
L103A	350628.262	5015864.89
L103A	350627.229	5015866.013

L103A	350627.229	5015866.013
L103A	350626.107	5015864.98
L103A	350626.107	5015864.98
L103A	350621.695	5015869.775
L103A	350621.695	5015869.775
L103A	350587.998	5015906.399
L103B	350592.984	5015961.992
L103B	350603.421	5015950.649
L103B	350603.421	5015950.649
L103B	350601.691	5015949.057
L103B	350601.691	5015949.057
L103B	350594.884	5015942.794
L103B	350594.884	5015942.794
L103B	350588.077	5015936.531
L103B	350588.077	5015936.531
L103B	350582.337	5015931.25
L103B	350582.337	5015931.25
L103B	350568.36	5015946.662
L103B	350568.36	5015946.662
L103B	350589.334	5015965.959
L103B	350589.334	5015965.959
L103B	350592.984	5015961.992
L103C	350594.791	5015914.103
L103C	350585.834	5015927.448
L103C	350585.834	5015927.448
L103C	350582.337	5015931.25
L103C	350582.337	5015931.25
L103C	350588.077	5015936.531
L103C	350588.077	5015936.531
L103C	350594.884	5015942.794
L103C	350594.884	5015942.794
L103C	350601.691	5015949.057
L103C	350601.691	5015949.057
L103C	350603.421	5015950.649
L103C	350603.421	5015950.649
L103C	350607.043	5015946.712
L103C	350617.881	5015934.933
L103C	350617.881	5015934.933

L103C	350616.625	5015931.295
L103C	350616.625	5015931.295
L103C	350612.742	5015920.065
L103C	350612.742	5015920.065
L103C	350608.056	5015919.042
L103C	350608.056	5015919.042
L103C	350599.312	5015918.272
L103C	350599.312	5015918.272
L103C	350594.791	5015914.103
L103D	350641.315	5015948.69
L103D	350641.633	5015946.325
L103D	350641.633	5015946.325
L103D	350633.45	5015938.797
L103D	350633.45	5015938.797
L103D	350637.129	5015934.8
L103D	350637.129	5015934.8
L103D	350638.437	5015936.003
L103D	350638.437	5015936.003
L103D	350642.019	5015934.099
L103D	350642.019	5015934.099
L103D	350644.883	5015932.006
L103D	350644.883	5015932.006
L103D	350647.556	5015929.428
L103D	350647.556	5015929.428
L103D	350649.614	5015926.84
L103D	350649.614	5015926.84
L103D	350651.337	5015924.017
L103D	350651.337	5015924.017
L103D	350652.503	5015921.504
L103D	350652.503	5015921.504
L103D	350653.159	5015919.682
L103D	350653.159	5015919.682
L103D	350663.248	5015916.348
L103D	350663.248	5015916.348
L103D	350662.404	5015914.954
L103D	350662.404	5015914.954
L103D	350661.17	5015913.603
L103D	350661.17	5015913.603
L103D	350659.227	5015911.815

L103D	350659.227	5015911.815
L103D	350668.411	5015901.832
L103D	350668.411	5015901.832
L103D	350664.259	5015898.011
L103D	350664.259	5015898.011
L103D	350661.571	5015900.974
L103D	350661.571	5015900.974
L103D	350655.925	5015895.778
L103D	350655.925	5015895.778
L103D	350650.28	5015890.585
L103D	350650.28	5015890.585
L103D	350652.989	5015887.641
L103D	350652.989	5015887.641
L103D	350647.671	5015882.748
L103D	350647.671	5015882.748
L103D	350643.944	5015886.798
L103D	350643.944	5015886.798
L103D	350638.49	5015892.726
L103D	350638.49	5015892.726
L103D	350636.618	5015891.012
L103D	350636.618	5015891.012
L103D	350634.83	5015889.695
L103D	350634.83	5015889.695
L103D	350631.694	5015901.401
L103D	350631.694	5015901.401
L103D	350630.209	5015902.181
L103D	350630.209	5015902.181
L103D	350628.948	5015902.932
L103D	350628.948	5015902.932
L103D	350627.517	5015903.901
L103D	350627.517	5015903.901
L103D	350625.992	5015905.133
L103D	350625.992	5015905.133
L103D	350624.122	5015906.796
L103D	350624.122	5015906.796
L103D	350622.577	5015908.477
L103D	350622.577	5015908.477
L103D	350620.754	5015910.826
L103D	350620.754	5015910.826

L103D	350619.11	5015913.655
L103D	350619.11	5015913.655
L103D	350618.009	5015916.055
L103D	350618.009	5015916.055
L103D	350617.114	5015918.637
L103D	350617.114	5015918.637
L103D	350613.623	5015919.072
L103D	350613.623	5015919.072
L103D	350612.742	5015920.065
L103D	350612.742	5015920.065
L103D	350616.625	5015931.295
L103D	350616.625	5015931.295
L103D	350617.881	5015934.933
L103D	350617.881	5015934.933
L103D	350607.043	5015946.712
L103D	350607.043	5015946.712
L103D	350603.421	5015950.649
L103D	350603.421	5015950.649
L103D	350605.646	5015952.694
L103D	350605.646	5015952.694
L103D	350607.357	5015954.271
L103D	350607.357	5015954.271
L103D	350626.712	5015972.078
L103D	350626.712	5015972.078
L103D	350630.209	5015968.277
L103D	350630.209	5015968.277
L103D	350641.315	5015948.69
L103E	350603.421	5015950.649
L103E	350592.984	5015961.992
L103E	350592.984	5015961.992
L103E	350589.334	5015965.959
L103E	350589.334	5015965.959
L103E	350593.271	5015969.581
L103E	350593.271	5015969.581
L103E	350590.44	5015972.299
L103E	350590.44	5015972.299
L103E	350599.149	5015988.382
L103E	350599.149	5015988.382
L103E	350606.733	5015981.967

L103E	350606.733	5015981.967
L103E	350612.514	5015987.287
L103E	350612.514	5015987.287
L103E	350618.814	5015993.083
L103E	350618.814	5015993.083
L103E	350628.464	5015982.595
L103E	350628.464	5015982.595
L103E	350634.153	5015976.411
L103E	350634.153	5015976.411
L103E	350636.422	5015973.945
L103E	350636.422	5015973.945
L103E	350647.202	5015962.229
L103E	350647.202	5015962.229
L103E	350641.682	5015957.151
L103E	350641.682	5015957.151
L103E	350645.73	5015952.752
L103E	350645.73	5015952.752
L103E	350661.534	5015935.575
L103E	350661.534	5015935.575
L103E	350667.053	5015940.653
L103E	350667.053	5015940.653
L103E	350670.181	5015943.531
L103E	350670.181	5015943.531
L103E	350684.703	5015927.748
L103E	350684.703	5015927.748
L103E	350689.115	5015922.953
L103E	350689.115	5015922.953
L103E	350688.031	5015921.956
L103E	350688.031	5015921.956
L103E	350689.064	5015920.834
L103E	350689.064	5015920.834
L103E	350668.411	5015901.832
L103E	350668.411	5015901.832
L103E	350659.227	5015911.815
L103E	350659.227	5015911.815
L103E	350661.17	5015913.603
L103E	350661.17	5015913.603
L103E	350662.404	5015914.954
L103E	350662.404	5015914.954

L103E	350663.248	5015916.348
L103E	350663.248	5015916.348
L103E	350653.159	5015919.682
L103E	350653.159	5015919.682
L103E	350652.503	5015921.504
L103E	350652.503	5015921.504
L103E	350651.337	5015924.017
L103E	350651.337	5015924.017
L103E	350649.614	5015926.84
L103E	350649.614	5015926.84
L103E	350647.556	5015929.428
L103E	350647.556	5015929.428
L103E	350644.883	5015932.006
L103E	350644.883	5015932.006
L103E	350642.019	5015934.099
L103E	350642.019	5015934.099
L103E	350638.437	5015936.003
L103E	350638.437	5015936.003
L103E	350637.129	5015934.8
L103E	350637.129	5015934.8
L103E	350633.45	5015938.797
L103E	350633.45	5015938.797
L103E	350641.633	5015946.325
L103E	350641.633	5015946.325
L103E	350641.315	5015948.69
L103E	350641.315	5015948.69
L103E	350630.209	5015968.277
L103E	350630.209	5015968.277
L103E	350626.712	5015972.078
L103E	350626.712	5015972.078
L103E	350607.357	5015954.271
L103E	350607.357	5015954.271
L103E	350605.646	5015952.694
L103E	350605.646	5015952.694
L103E	350603.421	5015950.649
L104A	350568.36	5015946.662
L104A	350582.337	5015931.25
L104A	350582.337	5015931.25
L104A	350585.834	5015927.448

L104A	350585.834	5015927.448
L104A	350578.409	5015920.366
L104A	350578.409	5015920.366
L104A	350575.912	5015922.142
L104A	350575.912	5015922.142
L104A	350572.984	5015922.644
L104A	350572.984	5015922.644
L104A	350567.133	5015917.261
L104A	350567.133	5015917.261
L104A	350561.283	5015911.878
L104A	350561.283	5015911.878
L104A	350558.977	5015914.384
L104A	350558.977	5015914.384
L104A	350553.55	5015916.457
L104A	350553.55	5015916.457
L104A	350548.811	5015921.608
L104A	350548.811	5015921.608
L104A	350550.724	5015923.369
L104A	350550.724	5015923.369
L104A	350547.203	5015927.195
L104A	350547.203	5015927.195
L104A	350568.36	5015946.662
L104B	350587.998	5015906.399
L104B	350585.38	5015909.245
L104B	350585.38	5015909.245
L104B	350577.763	5015902.236
L104B	350577.763	5015902.236
L104B	350572.281	5015897.192
L104B	350572.281	5015897.192
L104B	350565.137	5015896.048
L104B	350559.299	5015902.395
L104B	350559.299	5015902.395
L104B	350561.119	5015904.66
L104B	350561.119	5015904.66
L104B	350561.283	5015911.878
L104B	350561.283	5015911.878
L104B	350567.133	5015917.261
L104B	350567.133	5015917.261

L104B	350572.984	5015922.644
L104B	350572.984	5015922.644
L104B	350575.912	5015922.142
L104B	350575.912	5015922.142
L104B	350578.409	5015920.366
L104B	350578.409	5015920.366
L104B	350585.834	5015927.448
L104B	350585.834	5015927.448
L104B	350594.791	5015914.103
L104B	350594.791	5015914.103
L104B	350591.578	5015909.693
L104B	350591.578	5015909.693
L104B	350587.998	5015906.399
L106A	350614.163	5016038.267
L106A	350635.769	5016020.983
L106A	350635.769	5016020.983
L106A	350658.795	5015995.921
L106A	350658.795	5015995.921
L106A	350656.417	5015992.343
L106A	350656.417	5015992.343
L106A	350652.896	5015996.17
L106A	350652.896	5015996.17
L106A	350645.132	5015989.027
L106A	350645.132	5015989.027
L106A	350637.369	5015981.883
L106A	350637.369	5015981.883
L106A	350634.153	5015976.411
L106A	350634.153	5015976.411
L106A	350628.464	5015982.595
L106A	350628.464	5015982.595
L106A	350618.814	5015993.083
L106A	350618.814	5015993.083
L106A	350624.105	5015997.951
L106A	350624.105	5015997.951
L106A	350626.208	5015999.478
L106A	350626.208	5015999.478
L106A	350601.359	5016026.486
L106A	350601.359	5016026.486
L106A	350605.185	5016030.007

L106A	350605.185	5016030.007
L106A	350603.425	5016031.92
L106A	350603.425	5016031.92
L106A	350608.576	5016036.66
L106A	350608.576	5016036.66
L106A	350610.336	5016034.746
L106A	350610.336	5016034.746
L106A	350614.163	5016038.267
RAMP	350667.053	5015940.653
RAMP	350661.534	5015935.575
RAMP	350661.534	5015935.575
RAMP	350645.73	5015952.752
RAMP	350645.73	5015952.752
RAMP	350641.682	5015957.151
RAMP	350641.682	5015957.151
RAMP	350647.202	5015962.229
RAMP	350647.202	5015962.229
RAMP	350667.053	5015940.653
ROOF1	350655.172	5015964.927
ROOF1	350669.21	5015949.669
ROOF1	350669.21	5015949.669
ROOF1	350676.087	5015955.997
ROOF1	350676.087	5015955.997
ROOF1	350666.993	5015965.881
ROOF1	350666.993	5015965.881
ROOF1	350668.776	5015967.522
ROOF1	350668.776	5015967.522
ROOF1	350666.627	5015969.858
ROOF1	350666.627	5015969.858
ROOF1	350665.144	5015968.494
ROOF1	350665.144	5015968.494
ROOF1	350662.35	5015971.531
ROOF1	350662.35	5015971.531
ROOF1	350655.172	5015964.927
ROOF2	350684.703	5015927.748
ROOF2	350670.181	5015943.531
ROOF2	350670.181	5015943.531
ROOF2	350648.407	5015967.196
ROOF2	350648.407	5015967.196

ROOF2	350656.004	5015974.225
ROOF2	350656.004	5015974.225
ROOF2	350661.506	5015979.248
ROOF2	350661.506	5015979.248
ROOF2	350697.802	5015939.8
ROOF2	350697.802	5015939.8
ROOF2	350705.836	5015931.068
ROOF2	350705.836	5015931.068
ROOF2	350704.949	5015930.251
ROOF2	350704.949	5015930.251
ROOF2	350708.066	5015926.864
ROOF2	350708.066	5015926.864
ROOF2	350709.118	5015927.832
ROOF2	350709.118	5015927.832
ROOF2	350715.379	5015921.027
ROOF2	350715.379	5015921.027
ROOF2	350715.498	5015920.899
ROOF2	350715.498	5015920.899
ROOF2	350680.304	5015888.517
ROOF2	350680.304	5015888.517
ROOF2	350681.336	5015887.396
ROOF2	350681.336	5015887.396
ROOF2	350662.188	5015869.777
ROOF2	350662.188	5015869.777
ROOF2	350661.155	5015870.899
ROOF2	350661.155	5015870.899
ROOF2	350661.818	5015871.509
ROOF2	350661.818	5015871.509
ROOF2	350661.164	5015872.22
ROOF2	350661.164	5015872.22
ROOF2	350663.178	5015874.074
ROOF2	350663.178	5015874.074
ROOF2	350663.698	5015873.512
ROOF2	350663.698	5015873.512
ROOF2	350666.032	5015875.66
ROOF2	350666.032	5015875.66
ROOF2	350662.217	5015879.806
ROOF2	350662.217	5015879.806
ROOF2	350661.499	5015879.145

ROOF2	350661.499	5015879.145
ROOF2	350653.364	5015887.987
ROOF2	350653.364	5015887.987
ROOF2	350652.989	5015887.641
ROOF2	350652.989	5015887.641
ROOF2	350650.28	5015890.585
ROOF2	350650.28	5015890.585
ROOF2	350655.925	5015895.778
ROOF2	350655.925	5015895.778
ROOF2	350661.571	5015900.974
ROOF2	350661.571	5015900.974
ROOF2	350664.259	5015898.011
ROOF2	350664.259	5015898.011
ROOF2	350668.411	5015901.832
ROOF2	350668.411	5015901.832
ROOF2	350689.064	5015920.834
ROOF2	350689.064	5015920.834
ROOF2	350688.031	5015921.956
ROOF2	350688.031	5015921.956
ROOF2	350689.115	5015922.953
ROOF2	350689.115	5015922.953
ROOF2	350684.703	5015927.748
ROOF3	350608.596	5015857.723
ROOF3	350572.281	5015897.192
ROOF3	350572.281	5015897.192
ROOF3	350577.763	5015902.236
ROOF3	350577.763	5015902.236
ROOF3	350585.38	5015909.245
ROOF3	350585.38	5015909.245
ROOF3	350587.998	5015906.399
ROOF3	350587.998	5015906.399
ROOF3	350621.695	5015869.775
ROOF3	350621.695	5015869.775
ROOF3	350626.107	5015864.98
ROOF3	350626.107	5015864.98
ROOF3	350627.229	5015866.013
ROOF3	350627.229	5015866.013
ROOF3	350628.262	5015864.89
ROOF3	350628.262	5015864.89

ROOF3	350647.671	5015882.748
ROOF3	350647.671	5015882.748
ROOF3	350652.989	5015887.641
ROOF3	350652.989	5015887.641
ROOF3	350653.364	5015887.987
ROOF3	350653.364	5015887.987
ROOF3	350661.499	5015879.145
ROOF3	350661.499	5015879.145
ROOF3	350662.217	5015879.806
ROOF3	350662.217	5015879.806
ROOF3	350666.032	5015875.66
ROOF3	350666.032	5015875.66
ROOF3	350663.698	5015873.512
ROOF3	350663.698	5015873.512
ROOF3	350663.178	5015874.074
ROOF3	350663.178	5015874.074
ROOF3	350661.164	5015872.22
ROOF3	350661.164	5015872.22
ROOF3	350661.818	5015871.509
ROOF3	350661.818	5015871.509
ROOF3	350661.155	5015870.899
ROOF3	350661.155	5015870.899
ROOF3	350641.946	5015853.225
ROOF3	350641.946	5015853.225
ROOF3	350631.461	5015843.578
ROOF3	350631.461	5015843.578
ROOF3	350625.961	5015838.518
ROOF3	350625.961	5015838.518
ROOF3	350619.582	5015845.452
ROOF3	350619.582	5015845.452
ROOF3	350620.634	5015846.42
ROOF3	350620.634	5015846.42
ROOF3	350617.479	5015849.849
ROOF3	350617.479	5015849.849
ROOF3	350616.591	5015849.033
ROOF3	350616.591	5015849.033
ROOF3	350608.596	5015857.723
ROOF4	350579.92	5015895.689
ROOF4	350587.098	5015902.293

ROOF4	350587.098	5015902.293
ROOF4	350601.137	5015887.036
ROOF4	350601.137	5015887.036
ROOF4	350594.26	5015880.708
ROOF4	350594.26	5015880.708
ROOF4	350585.165	5015890.593
ROOF4	350585.165	5015890.593
ROOF4	350583.382	5015888.952
ROOF4	350583.382	5015888.952
ROOF4	350581.233	5015891.288
ROOF4	350581.233	5015891.288
ROOF4	350582.715	5015892.652
ROOF4	350582.715	5015892.652
ROOF4	350579.92	5015895.689
UNC-1	350662.013	5015986.146
UNC-1	350656.417	5015992.343
UNC-1	350656.417	5015992.343
UNC-1	350658.795	5015995.921
UNC-1	350658.795	5015995.921
UNC-1	350666.437	5015987.603
UNC-1	350666.437	5015987.603
UNC-1	350680.128	5015972.702
UNC-1	350697.467	5015951.476
UNC-1	350708.751	5015945.742
UNC-1	350714.443	5015941.425
UNC-1	350728.331	5015926.314
UNC-1	350728.331	5015926.314
UNC-1	350725.596	5015923.69
UNC-1	350725.596	5015923.69
UNC-1	350717.757	5015932.343
UNC-1	350717.757	5015932.343
UNC-1	350717.387	5015932.007
UNC-1	350717.387	5015932.007
UNC-1	350717.01	5015921.94
UNC-1	350717.01	5015921.94
UNC-1	350715.379	5015921.027
UNC-1	350715.379	5015921.027
UNC-1	350709.118	5015927.832
UNC-1	350709.118	5015927.832

UNC -1	350708.066	5015926.864
UNC -1	350708.066	5015926.864
UNC -1	350704.949	5015930.251
UNC -1	350704.949	5015930.251
UNC -1	350705.836	5015931.068
UNC -1	350705.836	5015931.068
UNC -1	350697.802	5015939.8
UNC -1	350697.802	5015939.8
UNC -1	350661.506	5015979.248
UNC -1	350661.506	5015979.248
UNC -1	350662.013	5015986.146
UNC -2	350593.271	5015969.581
UNC -2	350589.334	5015965.959
UNC -2	350568.36	5015946.662
UNC -2	350547.203	5015927.195
UNC -2	350550.724	5015923.369
UNC -2	350548.811	5015921.608
UNC -2	350553.55	5015916.457
UNC -2	350558.977	5015914.384
UNC -2	350561.283	5015911.878
UNC -2	350561.119	5015904.66
UNC -2	350559.299	5015902.395
UNC -2	350553.489	5015908.711
UNC -2	350515.356	5015950.141
UNC -2	350573.06	5016012.241
UNC -2	350574.15	5016017.199
UNC -2	350578.762	5016038.957
UNC -2	350580.464	5016049.762
UNC -2	350580.012	5016055.868
UNC -2	350579.4	5016059.051
UNC -2	350577.23	5016064.74
UNC -2	350581.761	5016069.817
UNC -2	350585.991	5016074.317
UNC -2	350587.836	5016075.223
UNC -2	350588.677	5016077.447
UNC -2	350604.978	5016059.728
UNC -2	350611.128	5016053.042
UNC -2	350615.294	5016043.268
UNC -2	350635.769	5016020.983

UNC -2	350614.163	5016038.267
UNC -2	350610.336	5016034.746
UNC -2	350608.576	5016036.66
UNC -2	350603.425	5016031.92
UNC -2	350605.185	5016030.007
UNC -2	350601.359	5016026.486
UNC -2	350626.208	5015999.478
UNC -2	350624.105	5015997.951
UNC -2	350618.814	5015993.083
UNC -2	350612.514	5015987.287
UNC -2	350606.733	5015981.967
UNC -2	350599.149	5015988.382
UNC -2	350590.44	5015972.299
UNC -2	350593.271	5015969.581
UNC -3	350641.946	5015853.225
UNC -3	350661.155	5015870.899
UNC -3	350661.155	5015870.899
UNC -3	350662.188	5015869.777
UNC -3	350662.188	5015869.777
UNC -3	350681.336	5015887.396
UNC -3	350681.336	5015887.396
UNC -3	350680.304	5015888.517
UNC -3	350680.304	5015888.517
UNC -3	350715.498	5015920.899
UNC -3	350715.498	5015920.899
UNC -3	350715.379	5015921.027
UNC -3	350715.379	5015921.027
UNC -3	350717.01	5015921.94
UNC -3	350717.01	5015921.94
UNC -3	350716.764	5015915.35
UNC -3	350716.764	5015915.35
UNC -3	350634.018	5015836.721
UNC -3	350634.018	5015836.721
UNC -3	350626.393	5015829.475
UNC -3	350626.393	5015829.475
UNC -3	350625.961	5015838.518
UNC -3	350625.961	5015838.518
UNC -3	350631.461	5015843.578
UNC -3	350631.461	5015843.578

UNC-3	350641.946	5015853.225
UNC-4	350572.281	5015897.192
UNC-4	350608.596	5015857.723
UNC-4	350608.596	5015857.723
UNC-4	350616.591	5015849.033
UNC-4	350616.591	5015849.033
UNC-4	350617.479	5015849.849
UNC-4	350617.479	5015849.849
UNC-4	350620.634	5015846.42
UNC-4	350620.634	5015846.42
UNC-4	350619.582	5015845.452
UNC-4	350619.582	5015845.452
UNC-4	350625.961	5015838.518
UNC-4	350625.961	5015838.518
UNC-4	350626.393	5015829.475
UNC-4	350626.393	5015829.475
UNC-4	350569.544	5015891.262
UNC-4	350569.544	5015891.262
UNC-4	350565.137	5015896.048
UNC-4	350565.137	5015896.048
UNC-4	350572.281	5015897.192

[SYMBOLS]

;Gage

X-Coord

Y-Coord

;;-----

**SERVICING AND STORMWATER MANAGEMENT BRIEF –
WELLINGS OF STITTSVILLE PHASE 2, 20 CEDAROW COURT**

Appendix C Stormwater Management
September 21, 2022

C.3 SAMPLE PCSWMM MODEL OUTPUT (12HR 100YR SCS)

EPA STORM WATER MANAGEMENT MODEL - VERSION 5.1 (Build 5.1.015)

Element Count

Number of rain gages 1
 Number of subcatchments ... 19
 Number of nodes 25
 Number of links 22
 Number of pollutants 0
 Number of land uses 0

Raingage Summary

Name	Data Source	Data Type	Recording Interval
RG1	100SCS	INTENSITY	15 min.

Subcatchment Summary

Name	Area	Width	%Imperv	%Slope	Rain Gage	Outlet
EXT-1	0.07	95.00	38.57	1.5000	RG1	105
L102A	0.06	18.50	82.86	2.5000	RG1	CB102A-1
L103A	0.16	28.20	75.71	2.5000	RG1	CB103A-1
L103B	0.06	28.60	80.00	2.5000	RG1	CB103B-1
L103C	0.07	29.90	71.43	2.5000	RG1	CB103C-1
L103D	0.24	31.70	65.71	2.5000	RG1	CB103D-1
L103E	0.24	21.00	72.86	2.5000	RG1	CB103E-1
L104A	0.07	38.60	82.86	2.5000	RG1	104

L104B	0.06	24.60	80.00	2.5000	RG1	104
L106A	0.14	26.50	72.86	2.5000	RG1	CB106A-1
RAMP	0.02	7.50	100.00	15.0000	RG1	BLDG
ROOF1	0.02	4.57	100.00	1.5000	RG1	ROOF1-S
ROOF2	0.22	49.54	100.00	1.5000	RG1	ROOF2-S
ROOF3	0.18	41.62	100.00	1.5000	RG1	ROOF3-S
ROOF4	0.02	4.57	100.00	1.5000	RG1	ROOF4-S
UNC-1	0.08	95.00	41.43	25.0000	RG1	OF1
UNC-2	0.53	25.00	8.57	1.0000	RG1	POOLE
UNC-3	0.07	126.00	61.43	3.0000	RG1	OF3
UNC-4	0.05	90.00	37.14	10.0000	RG1	105

Node Summary

Name	Type	Invert Elev.	Max. Depth	Ponded Area	External Inflow
HEADWALL	OUTFALL	98.48	0.68	0.0	
OF1	OUTFALL	0.00	0.00	0.0	
OF3	OUTFALL	0.00	0.00	0.0	
OF4	OUTFALL	101.87	0.86	0.0	
POOLE	OUTFALL	0.00	0.00	0.0	
100	STORAGE	99.60	3.96	0.0	
101	STORAGE	101.09	3.04	0.0	
102	STORAGE	101.60	2.73	0.0	
103	STORAGE	101.91	2.16	0.0	
104	STORAGE	102.61	1.49	0.0	
105	STORAGE	102.68	1.83	0.0	
ADS	STORAGE	101.37	2.53	0.0	
BLDG	STORAGE	102.78	1.91	0.0	
CB102A-1	STORAGE	102.70	1.49	0.0	
CB103A-1	STORAGE	103.07	1.53	0.0	
CB103B-1	STORAGE	102.42	1.68	0.0	
CB103C-1	STORAGE	102.70	1.60	0.0	
CB103D-1	STORAGE	102.62	1.66	0.0	
CB103E-1	STORAGE	102.43	1.68	0.0	
CB106A-1	STORAGE	101.97	1.68	0.0	

EX	STORAGE	99.61	2.08	0.0	Yes
ROOF1-S	STORAGE	110.00	0.15	0.0	
ROOF2-S	STORAGE	110.00	0.15	0.0	
ROOF3-S	STORAGE	110.00	0.15	0.0	
ROOF4-S	STORAGE	110.00	0.15	0.0	

Link Summary

Name	From Node	To Node	Type	Length	%Slope	Roughness
100--EX	100	EX	CONDUIT	34.9	0.2005	0.0130
101--ADS	101	ADS	CONDUIT	2.2	0.9982	0.0130
102--101	102	101	CONDUIT	9.6	0.9945	0.0130
103--102	103	102	CONDUIT	57.5	0.3041	0.0130
105--OF4	105	OF4	CONDUIT	20.4	1.0017	0.0130
BLDG--102	BLDG	102	CONDUIT	37.1	1.0022	0.0130
EX--HEADWALL	EX	HEADWALL	CONDUIT	11.1	10.2150	0.0130
100-01	ADS	100	ORIFICE			
100-02	ADS	100	ORIFICE			
CB102A-0	CB102A-1	102	ORIFICE			
CB103A-0	CB103A-1	103	ORIFICE			
CB103B-0	CB103B-1	103	ORIFICE			
CB103C-0	CB103C-1	103	ORIFICE			
CB103D-0	CB103D-1	103	ORIFICE			
CB103E-0	CB103E-1	103	ORIFICE			
CB106A-0	CB106A-1	ADS	ORIFICE			
CBMH104A-0	104	103	ORIFICE			
100-W1	ADS	100	WEIR			
ROOF1-0	ROOF1-S	BLDG	OUTLET			
ROOF2-0	ROOF2-S	BLDG	OUTLET			
ROOF3-0	ROOF3-S	BLDG	OUTLET			
ROOF4-0	ROOF4-S	BLDG	OUTLET			

Cross Section Summary

Conduit	Shape	Full Depth	Full Area	Hyd. Rad.	Max. Width	No. of Barrels	Full Flow
100--EX	CIRCULAR	0.53	0.22	0.13	0.53	1	192.58
101--ADS	CIRCULAR	0.45	0.16	0.11	0.45	1	284.87
102--101	CIRCULAR	0.45	0.16	0.11	0.45	1	284.34
103--102	CIRCULAR	0.45	0.16	0.11	0.45	1	157.24
105--OF4	CIRCULAR	0.25	0.05	0.06	0.25	1	59.52
BLDG--102	CIRCULAR	0.45	0.16	0.11	0.45	1	285.43
EX--HEADWALL	CIRCULAR	0.68	0.36	0.17	0.68	1	2686.76

Transect Summary

Transect Overland
Area:

0.0196	0.0392	0.0588	0.0784	0.0980
0.1177	0.1374	0.1571	0.1768	0.1965
0.2162	0.2360	0.2558	0.2756	0.2954
0.3152	0.3351	0.3550	0.3748	0.3947
0.4147	0.4346	0.4546	0.4745	0.4945
0.5145	0.5346	0.5546	0.5747	0.5947
0.6148	0.6350	0.6551	0.6752	0.6954
0.7156	0.7358	0.7560	0.7762	0.7965
0.8168	0.8371	0.8574	0.8777	0.8980
0.9184	0.9388	0.9592	0.9796	1.0000

Hrad:

0.0208	0.0415	0.0622	0.0829	0.1036
0.1242	0.1448	0.1653	0.1858	0.2063
0.2268	0.2472	0.2676	0.2879	0.3083
0.3285	0.3488	0.3690	0.3892	0.4094
0.4295	0.4496	0.4697	0.4897	0.5097
0.5297	0.5496	0.5695	0.5894	0.6093
0.6291	0.6489	0.6686	0.6884	0.7081
0.7277	0.7474	0.7670	0.7865	0.8061
0.8256	0.8451	0.8646	0.8840	0.9034

	0.9228	0.9421	0.9614	0.9807	1.0000
Width:	0.9580	0.9589	0.9597	0.9606	0.9614
	0.9623	0.9631	0.9640	0.9649	0.9657
	0.9666	0.9674	0.9683	0.9691	0.9700
	0.9709	0.9717	0.9726	0.9734	0.9743
	0.9751	0.9760	0.9769	0.9777	0.9786
	0.9794	0.9803	0.9811	0.9820	0.9829
	0.9837	0.9846	0.9854	0.9863	0.9871
	0.9880	0.9889	0.9897	0.9906	0.9914
	0.9923	0.9931	0.9940	0.9949	0.9957
	0.9966	0.9974	0.9983	0.9991	1.0000

Transect Overland(orig)

Area:	0.0196	0.0392	0.0588	0.0784	0.0980
	0.1177	0.1374	0.1571	0.1768	0.1965
	0.2162	0.2360	0.2558	0.2756	0.2954
	0.3152	0.3351	0.3550	0.3748	0.3947
	0.4147	0.4346	0.4546	0.4745	0.4945
	0.5145	0.5346	0.5546	0.5747	0.5947
	0.6148	0.6350	0.6551	0.6752	0.6954
	0.7156	0.7358	0.7560	0.7762	0.7965
	0.8168	0.8371	0.8574	0.8777	0.8980
	0.9184	0.9388	0.9592	0.9796	1.0000

Hrad:	0.0208	0.0415	0.0622	0.0829	0.1036
	0.1242	0.1448	0.1653	0.1858	0.2063
	0.2268	0.2472	0.2676	0.2879	0.3083
	0.3285	0.3488	0.3690	0.3892	0.4094
	0.4295	0.4496	0.4697	0.4897	0.5097
	0.5297	0.5496	0.5695	0.5894	0.6093
	0.6291	0.6489	0.6686	0.6884	0.7081
	0.7277	0.7474	0.7670	0.7865	0.8061
	0.8256	0.8451	0.8646	0.8840	0.9034
	0.9228	0.9421	0.9614	0.9807	1.0000

Width:	0.9580	0.9589	0.9597	0.9606	0.9614
	0.9623	0.9631	0.9640	0.9649	0.9657

	0.9666	0.9674	0.9683	0.9691	0.9700
	0.9709	0.9717	0.9726	0.9734	0.9743
	0.9751	0.9760	0.9769	0.9777	0.9786
	0.9794	0.9803	0.9811	0.9820	0.9829
	0.9837	0.9846	0.9854	0.9863	0.9871
	0.9880	0.9889	0.9897	0.9906	0.9914
	0.9923	0.9931	0.9940	0.9949	0.9957
	0.9966	0.9974	0.9983	0.9991	1.0000

NOTE: The summary statistics displayed in this report are based on results found at every computational time step, not just on results from each reporting time step.

Analysis Options

Flow Units LPS

Process Models:

Rainfall/Runoff YES
RDII NO
Snowmelt NO
Groundwater NO
Flow Routing YES
Ponding Allowed YES
Water Quality NO

Infiltration Method HORTON

Flow Routing Method DYNWAVE

Surcharge Method EXTRAN

Starting Date 07/23/2009 00:00:00

Ending Date 07/24/2009 00:00:00

Antecedent Dry Days 0.0

Report Time Step 00:05:00

Wet Time Step 00:05:00

Dry Time Step 00:05:00

Routing Time Step 1.00 sec

Variable Time Step NO

L103E			95.52	0.00	0.00	17.77	68.77	8.26	77.04
0.18	77.22	0.806							
L104A			95.52	0.00	0.00	10.77	77.96	5.72	83.68
0.06	23.49	0.876							
L104B			95.52	0.00	0.00	12.61	75.31	6.64	81.95
0.05	20.34	0.858							
L106A			95.52	0.00	0.00	17.39	68.71	8.70	77.41
0.11	48.06	0.810							
RAMP			95.52	0.00	0.00	0.00	94.06	0.00	94.06
0.02	7.74	0.985							
ROOF1			95.52	0.00	0.00	0.00	94.37	0.00	94.37
0.02	7.14	0.988							
ROOF2			95.52	0.00	0.00	0.00	94.37	0.00	94.37
0.21	77.50	0.988							
ROOF3			95.52	0.00	0.00	0.00	94.37	0.00	94.37
0.17	65.11	0.988							
ROOF4			95.52	0.00	0.00	0.00	94.37	0.00	94.37
0.02	7.15	0.988							
UNC-1			95.52	0.00	0.00	36.71	38.95	19.60	58.55
0.05	27.60	0.613							
UNC-2			95.52	0.00	0.00	73.93	8.08	21.55	21.55
0.11	32.31	0.226							
UNC-3			95.52	0.00	0.00	43.06	57.72	51.73	51.73
0.04	23.41	0.542							
UNC-4			95.52	0.00	0.00	53.14	34.91	42.24	42.24
0.02	16.95	0.442							

Node Depth Summary

Node	Type	Average Depth Meters	Maximum Depth Meters	Maximum HGL Meters	Time of Max Occurrence days hr:min	Reported Max Depth Meters
HEADWALL	OUTFALL	0.04	0.14	98.62	0 06:28	0.14
OF1	OUTFALL	0.00	0.00	0.00	0 00:00	0.00

OF3	OUTFALL	0.00	0.00	0.00	0 00:00	0.00
OF4	OUTFALL	0.30	0.30	102.17	0 00:00	0.30
POOLE	OUTFALL	0.00	0.00	0.00	0 00:00	0.00
100	STORAGE	0.37	0.63	100.23	0 06:25	0.63
101	STORAGE	0.78	2.01	103.11	0 06:24	2.01
102	STORAGE	0.49	1.54	103.14	0 06:24	1.54
103	STORAGE	0.34	1.36	103.26	0 06:24	1.36
104	STORAGE	0.09	1.40	104.01	0 06:19	1.40
105	STORAGE	0.00	0.18	102.86	0 06:15	0.18
ADS	STORAGE	0.51	1.73	103.10	0 06:24	1.73
BLDG	STORAGE	0.03	0.36	103.14	0 06:23	0.36
CB102A-1	STORAGE	0.04	1.40	104.10	0 06:15	1.40
CB103A-1	STORAGE	0.03	1.39	104.46	0 06:15	1.39
CB103B-1	STORAGE	0.07	1.46	103.88	0 06:17	1.46
CB103C-1	STORAGE	0.05	1.48	104.18	0 06:17	1.48
CB103D-1	STORAGE	0.06	1.55	104.17	0 06:17	1.54
CB103E-1	STORAGE	0.09	1.58	104.01	0 06:19	1.58
CB106A-1	STORAGE	0.22	1.56	103.53	0 06:20	1.56
EX	STORAGE	0.04	0.14	99.75	0 06:28	0.14
ROOF1-S	STORAGE	0.01	0.13	110.13	0 06:19	0.13
ROOF2-S	STORAGE	0.03	0.15	110.15	0 06:28	0.15
ROOF3-S	STORAGE	0.03	0.15	110.15	0 06:25	0.15
ROOF4-S	STORAGE	0.01	0.13	110.13	0 06:19	0.13

Node Inflow Summary

Node	Type	Maximum Lateral Inflow LPS	Maximum Total Inflow LPS	Time of Max Occurrence days hr:min	Lateral Inflow Volume 10^6 ltr	Total Inflow Volume 10^6 ltr	Flow Balance Error Percent
HEADWALL	OUTFALL	0.00	251.79	0 06:28	0	3.1	0.000
OF1	OUTFALL	27.60	27.60	0 06:15	0.049	0.049	0.000
OF3	OUTFALL	23.41	23.41	0 06:15	0.0359	0.0359	0.000
OF4	OUTFALL	0.00	39.55	0 06:15	0	0.0511	0.000

POOLE	OUTFALL	32.31	32.31	0	06:15	0.113	0.113	0.000
100	STORAGE	0.00	153.17	0	06:24	0	1.27	0.046
101	STORAGE	0.00	226.52	0	06:06	0	1.18	0.021
102	STORAGE	0.00	228.99	0	06:10	0	1.18	-0.275
103	STORAGE	0.00	183.24	0	06:07	0	0.689	0.697
104	STORAGE	43.84	43.84	0	06:15	0.105	0.105	0.003
105	STORAGE	39.58	39.58	0	06:15	0.0511	0.0511	0.000
ADS	STORAGE	0.00	240.50	0	06:06	0	1.29	-0.001
BLDG	STORAGE	7.74	47.32	0	06:22	0.0207	0.442	0.032
CB102A-1	STORAGE	21.23	21.23	0	06:15	0.0515	0.0515	-0.000
CB103A-1	STORAGE	52.89	52.89	0	06:15	0.123	0.123	0.000
CB103B-1	STORAGE	20.46	20.46	0	06:15	0.0487	0.0487	0.004
CB103C-1	STORAGE	24.66	24.66	0	06:15	0.0555	0.0555	0.009
CB103D-1	STORAGE	77.30	77.30	0	06:15	0.174	0.174	0.003
CB103E-1	STORAGE	77.22	77.22	0	06:15	0.183	0.183	0.008
CB106A-1	STORAGE	48.06	48.06	0	06:15	0.11	0.11	0.017
EX	STORAGE	136.19	251.77	0	06:28	1.83	3.1	0.001
ROOF1-S	STORAGE	7.14	7.14	0	06:15	0.0192	0.0192	-0.002
ROOF2-S	STORAGE	77.50	77.50	0	06:15	0.208	0.208	-0.001
ROOF3-S	STORAGE	65.11	65.11	0	06:15	0.175	0.175	-0.001
ROOF4-S	STORAGE	7.15	7.15	0	06:15	0.0192	0.0192	-0.002

Node Surcharge Summary

No nodes were surcharged.

Node Flooding Summary

No nodes were flooded.

Storage Volume Summary

Storage Unit	Average Volume 1000 m3	Avg Pcnt Full	Evap Pcnt Loss	Exfil Pcnt Loss	Maximum Volume 1000 m3	Max Pcnt Full	Time of Max Occurrence days hr:min	Maximum Outflow LPS
100	0.000	0	0	0	0.000	0	0 00:00	152.50
101	0.000	0	0	0	0.000	0	0 00:00	225.87
102	0.000	0	0	0	0.000	0	0 00:00	226.52
103	0.000	0	0	0	0.000	0	0 00:00	180.50
104	0.001	1	0	0	0.026	51	0 06:19	15.34
105	0.000	0	0	0	0.000	0	0 00:00	39.55
ADS	0.181	37	0	0	0.485	100	0 06:22	153.17
BLDG	0.000	0	0	0	0.000	0	0 00:00	39.48
CB102A-1	0.000	0	0	0	0.001	14	0 06:15	20.86
CB103A-1	0.000	0	0	0	0.001	12	0 06:15	52.64
CB103B-1	0.000	0	0	0	0.005	9	0 06:17	14.82
CB103C-1	0.000	0	0	0	0.006	23	0 06:17	16.15
CB103D-1	0.000	0	0	0	0.015	40	0 06:17	53.74
CB103E-1	0.001	1	0	0	0.032	47	0 06:19	36.86
CB106A-1	0.001	1	0	0	0.029	37	0 06:20	15.28
EX	0.000	0	0	0	0.000	0	0 00:00	251.79
ROOF1-S	0.000	2	0	0	0.006	68	0 06:19	2.29
ROOF2-S	0.009	10	0	0	0.084	94	0 06:28	11.19
ROOF3-S	0.007	9	0	0	0.069	93	0 06:25	9.90
ROOF4-S	0.000	2	0	0	0.006	68	0 06:19	2.29

Outfall Loading Summary

Outfall Node	Flow Freq Pcnt	Avg Flow LPS	Max Flow LPS	Total Volume 10^6 ltr
HEADWALL	93.50	38.32	251.79	3.095

OF1	46.71	1.21	27.60	0.049
OF3	12.62	3.29	23.41	0.036
OF4	6.45	9.16	39.55	0.051
POOLE	12.30	10.66	32.31	0.113

System	34.32	62.64	288.76	3.344

Link Flow Summary

Link	Type	Maximum Flow LPS	Time of Max Occurrence days hr:min	Maximum Veloc m/sec	Max/ Full Flow	Max/ Full Depth

100--EX	CONDUIT	152.50	0 06:25	1.22	0.79	0.56
101--ADS	CONDUIT	225.87	0 06:06	1.42	0.79	1.00
102--101	CONDUIT	226.52	0 06:06	1.61	0.80	1.00
103--102	CONDUIT	180.50	0 06:05	1.19	1.15	1.00
105--OF4	CONDUIT	39.55	0 06:15	1.17	0.66	0.65
BLDG--102	CONDUIT	39.48	0 06:23	1.17	0.14	0.90
EX--HEADWALL	CONDUIT	251.79	0 06:28	4.69	0.09	0.21
100-01	ORIFICE	17.82	0 06:24			1.00
100-02	ORIFICE	71.06	0 06:24			1.00
CB102A-0	ORIFICE	20.86	0 06:15			1.00
CB103A-0	ORIFICE	52.64	0 06:15			1.00
CB103B-0	ORIFICE	14.82	0 06:06			1.00
CB103C-0	ORIFICE	16.15	0 06:07			1.00
CB103D-0	ORIFICE	53.74	0 06:07			1.00
CB103E-0	ORIFICE	36.86	0 06:02			1.00
CB106A-0	ORIFICE	15.28	0 06:01			1.00
CBMH104A-0	ORIFICE	15.34	0 06:06			1.00
100-W1	WEIR	64.28	0 06:24			0.34
ROOF1-0	DUMMY	2.29	0 06:19			
ROOF2-0	DUMMY	11.19	0 06:28			
ROOF3-0	DUMMY	9.90	0 06:25			
ROOF4-0	DUMMY	2.29	0 06:19			

Flow Classification Summary

Conduit	Adjusted /Actual Length	Fraction of Time in Flow Class								
		Dry	Up Dry	Down Dry	Sub Crit	Sup Crit	Up Crit	Down Crit	Norm Ltd	Inlet Ctrl

100--EX	1.00	0.06	0.00	0.00	0.00	0.00	0.00	0.94	0.00	0.00
101--ADS	1.00	0.05	0.00	0.00	0.91	0.01	0.00	0.03	0.00	0.00
102--101	1.00	0.04	0.00	0.00	0.44	0.00	0.00	0.52	0.05	0.00
103--102	1.00	0.04	0.00	0.00	0.37	0.00	0.00	0.59	0.07	0.00
105--OF4	1.00	0.24	0.00	0.00	0.00	0.00	0.00	0.76	0.00	0.00
BLDG--102	1.00	0.04	0.00	0.00	0.09	0.01	0.00	0.86	0.07	0.00
EX--HEADWALL	1.00	0.06	0.00	0.00	0.00	0.94	0.00	0.00	0.01	0.00

Conduit Surge Summary

Conduit	Both Ends	Hours Full			Hours Above Full Normal Flow	Hours Capacity Limited
		Upstream	Dnstream			

101--ADS	10.32	10.32	10.64	0.01	0.01	
102--101	4.66	4.66	6.02	0.01	0.01	
103--102	1.91	1.96	3.75	0.23	0.21	
BLDG--102	0.01	0.01	0.81	0.01	0.01	

Analysis begun on: Mon Sep 26 11:32:46 2022
Analysis ended on: Mon Sep 26 11:32:59 2022
Total elapsed time: 00:00:13

**SERVICING AND STORMWATER MANAGEMENT BRIEF –
WELLINGS OF STITTSVILLE PHASE 2, 20 CEDAROW COURT**

Appendix C Stormwater Management
September 21, 2022

C.4 OIL/GRIT SEPARATOR SIZING CALCULATIONS

Detailed Stormceptor Sizing Report – WOS PH2 20 Cedarow Crt

Project Information & Location			
Project Name	WOS PH2	Project Number	20349
City	Ottawa	State/ Province	Ontario
Country	Canada	Date	11/4/2019
Designer Information		EOR Information (optional)	
Name	thakshika rathnasooriya	Name	
Company	stantec	Company	
Phone #	613-724-4081	Phone #	
Email	thakshika.rathnasooriya@stantec.com	Email	

Stormwater Treatment Recommendation

The recommended Stormceptor Model(s) which achieve or exceed the user defined water quality objective for each site within the project are listed in the below Sizing Summary table.

Site Name	WOS PH2 20 Cedarow Crt
Recommended Stormceptor Model	STC 300
Target TSS Removal (%)	80.0
TSS Removal (%) Provided	80
PSD	Fine Distribution
Rainfall Station	OTTAWA MACDONALD-CARTIER INT'L A

The recommended Stormceptor model achieves the water quality objectives based on the selected inputs, historical rainfall records and selected particle size distribution.

Stormceptor Sizing Summary	
Stormceptor Model	% TSS Removal Provided
STC 300	80
STC 750	85
STC 1000	85
STC 1500	85
STC 2000	86
STC 3000	87
STC 4000	88
STC 5000	89
STC 6000	90
STC 9000	92
STC 10000	92
STC 14000	94
StormceptorMAX	Custom

Stormceptor

The Stormceptor oil and sediment separator is sized to treat stormwater runoff by removing pollutants through gravity separation and flotation. Stormceptor’s patented design generates positive TSS removal for each rainfall event, including large storms. Significant levels of pollutants such as heavy metals, free oils and nutrients are prevented from entering natural water resources and the re-suspension of previously captured sediment (scour) does not occur. Stormceptor provides a high level of TSS removal for small frequent storm events that represent the majority of annual rainfall volume and pollutant load. Positive treatment continues for large infrequent events, however, such events have little impact on the average annual TSS removal as they represent a small percentage of the total runoff volume and pollutant load.

Design Methodology

Stormceptor is sized using PCSWMM for Stormceptor, a continuous simulation model based on US EPA SWMM. The program calculates hydrology using local historical rainfall data and specified site parameters. With US EPA SWMM’s precision, every Stormceptor unit is designed to achieve a defined water quality objective. The TSS removal data presented follows US EPA guidelines to reduce the average annual TSS load. The Stormceptor’s unit process for TSS removal is settling. The settling model calculates TSS removal by analyzing:

- Site parameters
- Continuous historical rainfall data, including duration, distribution, peaks & inter-event dry periods
- Particle size distribution, and associated settling velocities (Stokes Law, corrected for drag)
- TSS load
- Detention time of the system

Hydrology Analysis

PCSWMM for Stormceptor calculates annual hydrology with the US EPA SWMM and local continuous historical rainfall data. Performance calculations of Stormceptor are based on the average annual removal of TSS for the selected site parameters. The Stormceptor is engineered to capture sediment particles by treating the required average annual runoff volume, ensuring positive removal efficiency is maintained during each rainfall event, and preventing negative removal efficiency (scour). Smaller recurring storms account for the majority of rainfall events and average annual runoff volume, as observed in the historical rainfall data analyses presented in this section.

Rainfall Station

State/Province	Ontario	Total Number of Rainfall Events	4093
Rainfall Station Name	OTTAWA MACDONALD-CARTIER INT’L A	Total Rainfall (mm)	20978.1
Station ID #	6000	Average Annual Rainfall (mm)	567.0
Coordinates	45°19’N, 75°40’W	Total Evaporation (mm)	982.0
Elevation (ft)	370	Total Infiltration (mm)	10341.2
Years of Rainfall Data	37	Total Rainfall that is Runoff (mm)	9654.9

Notes

- Stormceptor performance estimates are based on simulations using PCSWMM for Stormceptor, which uses the EPA Rainfall and Runoff modules.
- Design estimates listed are only representative of specific project requirements based on total suspended solids (TSS) removal defined by the selected PSD, and based on stable site conditions only, after construction is completed.
- For submerged applications or sites specific to spill control, please contact your local Stormceptor representative for further design assistance.

Drainage Area	
Total Area (ha)	1.60
Imperviousness %	50.60

Up Stream Storage	
Storage (ha-m)	Discharge (cms)
0.000	0.000
0.030	0.007
0.060	0.015
0.090	0.022

Water Quality Objective	
TSS Removal (%)	80.0
Runoff Volume Capture (%)	
Oil Spill Capture Volume (L)	
Peak Conveyed Flow Rate (L/s)	126.00
Water Quality Flow Rate (L/s)	

Up Stream Flow Diversion	
Max. Flow to Stormceptor (cms)	

Design Details	
Stormceptor Inlet Invert Elev (m)	
Stormceptor Outlet Invert Elev (m)	
Stormceptor Rim Elev (m)	
Normal Water Level Elevation (m)	
Pipe Diameter (mm)	
Pipe Material	
Multiple Inlets (Y/N)	No
Grate Inlet (Y/N)	No

Particle Size Distribution (PSD)		
Removing the smallest fraction of particulates from runoff ensures the majority of pollutants, such as metals, hydrocarbons and nutrients are captured. The table below identifies the Particle Size Distribution (PSD) that was selected to define TSS removal for the Stormceptor design.		
Fine Distribution		
Particle Diameter (microns)	Distribution %	Specific Gravity
20.0	20.0	1.30
60.0	20.0	1.80
150.0	20.0	2.20
400.0	20.0	2.65
2000.0	20.0	2.65

Site Name		WOS PH2 20 Cedarow Crt	
Site Details			
Drainage Area		Infiltration Parameters	
Total Area (ha)	1.60	Horton's equation is used to estimate infiltration	
Imperviousness %	50.60	Max. Infiltration Rate (mm/hr)	61.98
Surface Characteristics		Min. Infiltration Rate (mm/hr)	10.16
Width (m)	253.00	Decay Rate (1/sec)	0.00055
Slope %	2	Regeneration Rate (1/sec)	0.01
Impervious Depression Storage (mm)	0.508	Evaporation	
Pervious Depression Storage (mm)	5.08	Daily Evaporation Rate (mm/day)	2.54
Impervious Manning's n	0.015	Dry Weather Flow	
Pervious Manning's n	0.25	Dry Weather Flow (lps)	0
Maintenance Frequency		Winter Months	
Maintenance Frequency (months) >	12	Winter Infiltration	0
TSS Loading Parameters			
TSS Loading Function			
Buildup/Wash-off Parameters		TSS Availability Parameters	
Target Event Mean Conc. (EMC) mg/L		Availability Constant A	
Exponential Buildup Power		Availability Factor B	
Exponential Washoff Exponent		Availability Exponent C	
		Min. Particle Size Affected by Availability (micron)	

Cumulative Runoff Volume by Runoff Rate			
Runoff Rate (L/s)	Runoff Volume (m³)	Volume Over (m³)	Cumulative Runoff Volume (%)
1	111983	43648	72.1
4	151637	3654	97.7
9	154907	370	99.8
16	155201	73	100.0
25	155273	0	100.0
36	155273	0	100.0

Cumulative Runoff Volume by Runoff Rate

For area: 1.60(ha), imperviousness: 50.60%, rainfall station: OTTAWA MACDONALD-CARTIER INT'L A

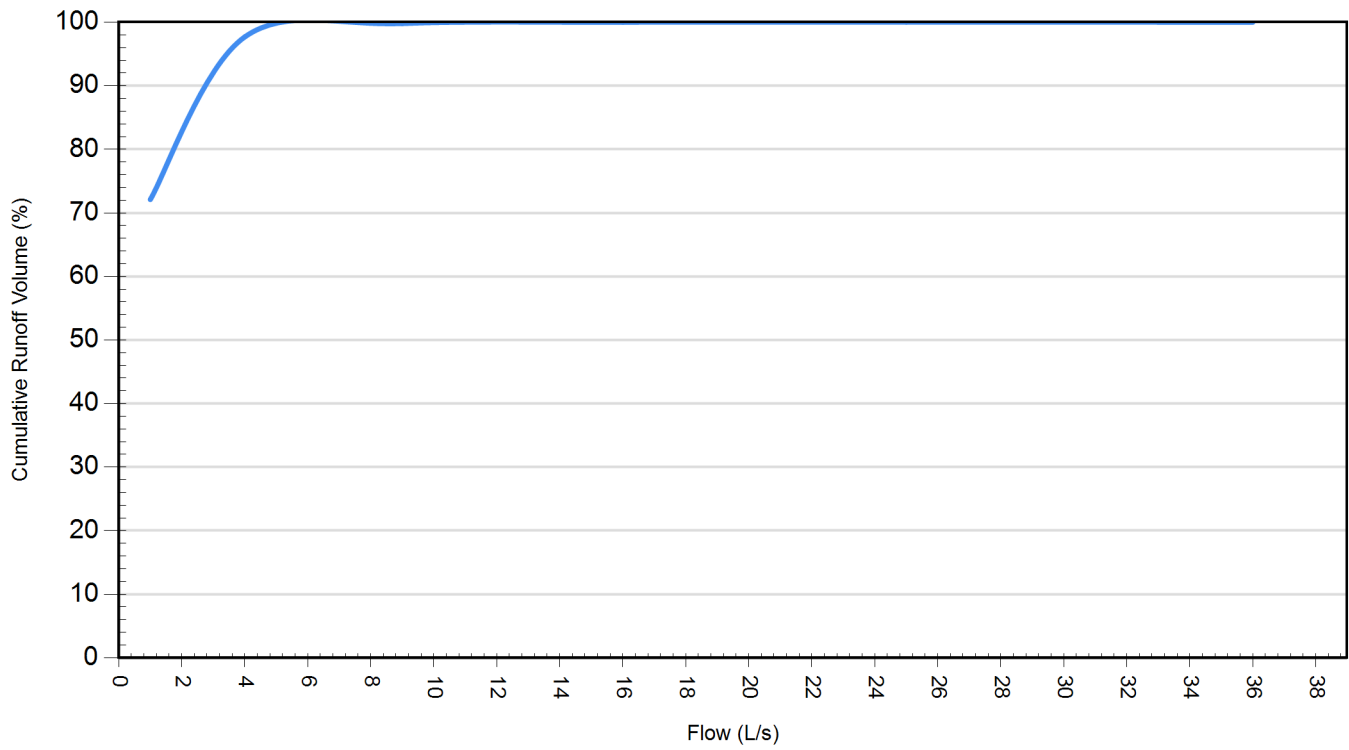

Rainfall Event Analysis				
Rainfall Depth (mm)	No. of Events	Percentage of Total Events (%)	Total Volume (mm)	Percentage of Annual Volume (%)
6.35	3113	76.1	5230	24.9
12.70	501	12.2	4497	21.4
19.05	225	5.5	3469	16.5
25.40	105	2.6	2317	11.0
31.75	62	1.5	1765	8.4
38.10	35	0.9	1206	5.8
44.45	28	0.7	1163	5.5
50.80	12	0.3	557	2.7
57.15	7	0.2	378	1.8
63.50	1	0.0	63	0.3
69.85	1	0.0	64	0.3
76.20	1	0.0	76	0.4
82.55	0	0.0	0	0.0
88.90	1	0.0	84	0.4
95.25	0	0.0	0	0.0
101.60	0	0.0	0	0.0
107.95	0	0.0	0	0.0
114.30	1	0.0	109	0.5
120.65	0	0.0	0	0.0
127.00	0	0.0	0	0.0

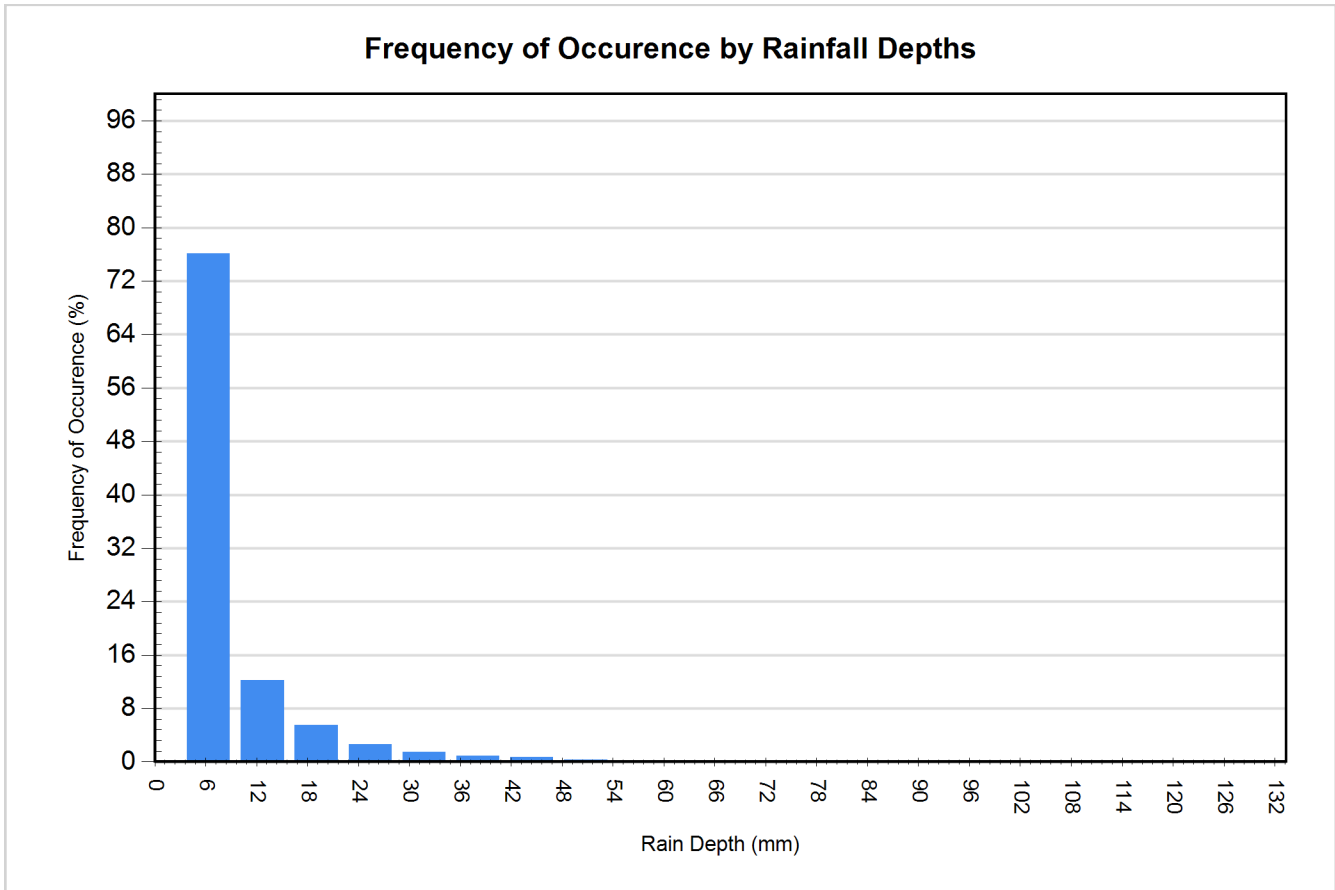

**For Stormceptor Specifications and Drawings Please Visit:
<http://www.imbriumsystems.com/technical-specifications>**

**SERVICING AND STORMWATER MANAGEMENT BRIEF –
WELLINGS OF STITTSVILLE PHASE 2, 20 CEDAROW COURT**

Appendix C Stormwater Management
September 21, 2022

C.5 CEDAROW COURT STORM SEWER CAPACITY

V:\01-604\active\160401511\design\drawing\160401511-SD.dwg
 2021/08/31 7:53 AM By: Sharp, Mike

ORIGINAL SHEET - ANSI B

Legend

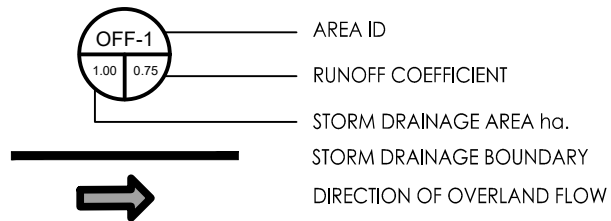

Notes

Client/Project
 NAUTICAL LANDS GROUP
 WELLINGS OF STITTSVILLE PH 2
 20 CEDAROW COURT
 Figure No.
 1.0
 Title
**CEDAROW COURT
 EXISTING STORM DRAINAGE PLAN**

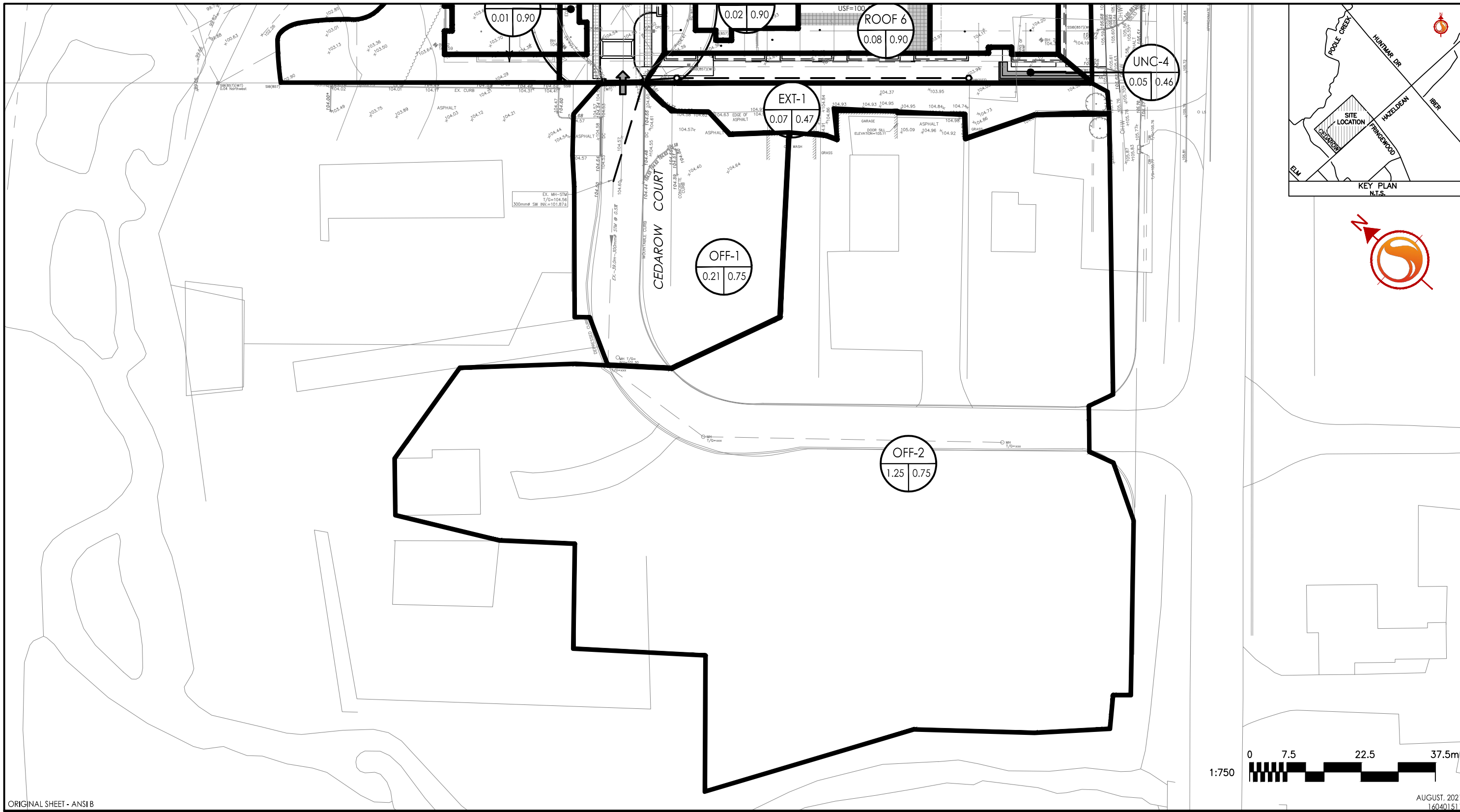



Cedarow Court

**STORM SEWER
DESIGN SHEET
(City of Ottawa)**

DESIGN PARAMETERS

$I = a / (t+b)^c$ (As per City of Ottawa Guidelines, 2012)

	1:2 yr	1:5 yr	1:10 yr	1:100 yr	
a =	732.951	998.071	1174.184	1735.688	MANNING'S n = 0.013
b =	6.199	6.053	6.014	6.014	MINIMUM COVER: 2.00 m
c =	0.810	0.814	0.816	0.820	TIME OF ENTRY 10 min

BEDDING CLASS = B

DATE: 2021-09-01
REVISION: 1
DESIGNED BY: TR
CHECKED BY: -
FILE NUMBER: 160401511

LOCATION			DRAINAGE AREA																PIPE SELECTION																					
AREA ID NUMBER	FROM M.H.	TO M.H.	AREA (2-YEAR) (ha)	AREA (5-YEAR) (ha)	AREA (10-YEAR) (ha)	AREA (100-YEAR) (ha)	AREA (ROOF) (ha)	C (2-YEAR) (-)	C (5-YEAR) (-)	C (10-YEAR) (-)	C (100-YEAR) (-)	A x C (2-YEAR) (ha)	ACCUM AxC (2YR) (ha)	A x C (5-YEAR) (ha)	ACCUM AxC (5YR) (ha)	A x C (10-YEAR) (ha)	ACCUM AxC (10YR) (ha)	A x C (100-YEAR) (ha)	ACCUM AxC (100YR) (ha)	T of C (min)	I ₂ -YEAR (mm/h)	I ₅ -YEAR (mm/h)	I ₁₀ -YEAR (mm/h)	I ₁₀₀ -YEAR (mm/h)	Q _{CONTROL} (L/s)	ACCUM. Q _{CONTROL} (L/s)	Q _{ACT} (CIA/360) (L/s)	LENGTH (m)	PIPE WIDTH OR DIAMETE (mm)	PIPE HEIGHT (mm)	PIPE SHAPE (-)	MATERIAL (-)	CLASS (-)	SLOPE (%)	Q _{CAP} (FULL) (L/s)	% FULL (-)	VEL. (FULL) (m/s)	VEL. (ACT) (m/s)	TIME OF FLOW (min)	
UNC-4 + EXT-1	CB507	EX1	0.00	0.12	0.00	0.00	0.00	0.00	0.47	0.00	0.00	0.000	0.000	0.056	0.056	0.000	0.000	0.000	0.000	0.000	10.00	76.81	104.19	122.14	178.56	0.0	0.0	16.2	21.3	250	250	CIRCULAR	CONCRETE	-	0.50	42.7	37.91%	0.86	0.68	0.52
OFF-1	EX1	EX2	0.00	0.21	0.00	0.00	0.00	0.00	0.75	0.00	0.00	0.000	0.000	0.154	0.210	0.000	0.000	0.000	0.000	0.000	10.52	74.85	101.50	118.97	173.90	0.0	0.0	59.2	39.0	300	300	CIRCULAR	CONCRETE	-	0.50	68.0	87.02%	0.97	0.98	0.67
OFF-2	EX2	POOLE CREEK	0.00	1.25	0.00	0.00	0.00	0.00	0.75	0.00	0.00	0.000	0.000	0.937	1.147	0.000	0.000	0.000	0.000	0.000	11.19	72.52	98.30	115.20	168.37	0.0	0.0	313.1	86.8	525	525	CIRCULAR	CONCRETE	-	0.62	353.3	88.62%	1.58	1.61	0.90

**SERVICING AND STORMWATER MANAGEMENT BRIEF –
WELLINGS OF STITTSVILLE PHASE 2, 20 CEDAROW COURT**

Appendix C Stormwater Management
September 21, 2022

C.6 EXCERPTS FROM WOS PHASE 1

SERVICING AND STORMWATER MANAGEMENT BRIEF – 5731 HAZELDEAN ROAD

Stormwater Management
March 22, 2017

5.0 STORMWATER MANAGEMENT

5.1 OBJECTIVES

The objective of this stormwater management plan is to determine the measures necessary to control the quantity of stormwater released from the proposed development to established criteria, and to provide sufficient detail for approval and construction. The proposed development will discharge treated and controlled stormwater runoff to Poole Creek.

5.2 SWM CRITERIA AND CONSTRAINTS

Criteria were established by combining current design practices outlined by the City of Ottawa Design Guidelines (2012), Ministry of Environment and Climate Change (MOECC) and Mississippi Valley Conservation Authority (MVCA). The following summarizes the criteria, with the source of each criterion indicated in italics:

General

- Use of the dual drainage principle (City of Ottawa)
- Wherever feasible and practical, site-level measures should be used to reduce and control the volume and rate of runoff (City of Ottawa)
- Site-level infiltration measures to be implemented to meet infiltration criteria of minimum 50 mm/yr (MVCA)
- Assess impact of 100 year event outlined in the City of Ottawa Sewer Design Guidelines, and climate change scenarios with a 20% increase of rainfall intensity, on major & minor drainage system (City of Ottawa)
- Quality control to be provided for 80% TSS removal (MVCA, MOECC)
- Site discharge to be controlled to pre-development rates (MVCA, City of Ottawa)
- Site design to mitigate erosion impacts on Poole Creek (City of Ottawa)

Storm Sewer & Inlet Controls

- Size storm sewers to convey the 5 year storm event under free-flow conditions using City of Ottawa I-D-F parameters (City of Ottawa) with the exception of the outlet sewer from the proposed underground storage facility.
- Minimum sewer inlet capture rates to be set such that no ponding occurs at the end of the 5-year event (City of Ottawa)
- Hydraulic Grade Line (HGL) analysis to be conducted using the 100 year 12 hour SCS storm distribution (City of Ottawa).
- 100-year Storm HGL to be a minimum of 0.30 m below building foundation footing otherwise foundation drains will be pumped (City of Ottawa)

SERVICING AND STORMWATER MANAGEMENT BRIEF – 5731 HAZELDEAN ROAD

Stormwater Management
March 22, 2017

Surface Storage & Overland Flow

- Building openings to be a minimum of 0.30m above the 100-year water level (City of Ottawa)
- Maximum depth of flow under either static or dynamic conditions shall be less than 0.30m (City of Ottawa)
- Subdrains required in swales where longitudinal gradient is less than 1.5% (City of Ottawa)
- Provide adequate emergency overflow conveyance off-site (City of Ottawa)

5.2.1 Pre-Development Conditions

A lumped catchment PCSWMM model was created for the subject site based on a site area of 2.9ha, and utilizing an existing SCS curve number of 80 per background documents. Additional subcatchment parameters were defined based upon recent topographical survey of the property:

Area (ha)	Width (m)	Slope (%)	Imperv. (%)	Subarea Routing
2.90	161.1	1.0	0.0	Outlet

Based on the above and during the 2 through 100-year 12hr SCS events (MTO Distribution curves), peak pre-development outflow rates from the subject site were identified per the tables below:

Storm Event	2-Year	5-Year	10-Year
Peak Outflow Rate	17.7L/s	43.9L/s	66.2L/s

Storm Event	25-Year	50-Year	100-Year
Peak Outflow Rate	103.7L/s	136.5L/s	176.3L/s

PCSWMM model input and output files for the predevelopment scenario are included within **Appendix C**.

5.3 STORMWATER MANAGEMENT DESIGN

5.3.1 Rationale for Design and Servicing Deviations

5.3.1.1 Deviation from Kanata West MSS

Per the findings of the Kanata West MSS, stormwater outflows from the proposed site were intended to be directed to the storm sewer within Huntmar Drive, and in turn directed to the

SERVICING AND STORMWATER MANAGEMENT BRIEF – 5731 HAZELDEAN ROAD

Stormwater Management
March 22, 2017

downstream Fairwinds temporary pond 5. The MSS had assumed that the entire area of land west of Huntmar Drive and bound by Poole creek to the north and Hazeldean Road to the south was to be directed to the Huntmar Drive sewer, however, the proposed site forms only part of the tributary area, within lands owned by others blocking direct access to the storm sewer within Huntmar Drive. Rather than encumbering the adjacent property, and to avoid considerable connection fees associated with the outlet from the Kanata West Owners Group (KWOG), a separate outlet for the site to Poole Creek has been considered. As the downstream Pond 5 discharges to Poole Creek as well, by restricting flows to predevelopment levels, and assessing the erosive potential of such flows for the Poole Creek reach between the site outlet and that of the downstream Pond 5, no deleterious effects to the downstream watercourse are expected. Additionally, this option provides additional potential to supplement baseflows to Poole Creek in accordance with recommendations from the MVCA.

5.3.1.2 Deviation from Standard SWM Design

The proposed SWM design includes three LID measures to encourage on-site infiltration and water re-use for irrigation. It is recognized that these measures are not currently standard SWM controls and when they are used for water balance purposes are not traditionally included in SWM calculations due to concerns over longterm reliability. The proposed SWM design has included some of the storage and infiltration/reuse rates from these measures in the supporting analysis as discussed in the following sections. However the analysis has also included simulations assuming that these measures fail in order to assess the potential associated impacts. The benefit of including some of the storage and infiltration losses associated with the LID measures was that the end-of-pipe underground storage component of the infiltration gallery was able to be reduced by 30% as compared to previous design requirements when no credit was assigned for the LID measures. As discussed later in this report, a monitoring plan will be developed and implemented to ensure that constructed LID measures are performing as designed.

5.3.2 Design Methodology

The intent of the stormwater management plan presented herein is to mitigate negative impacts that the proposed development might have on the receiving watercourse (Poole Creek), while providing adequate capacity to service the proposed buildings, underground parking and access areas. The proposed stormwater management plan is designed to detain runoff on the rooftop, surface and in the subsurface (StormTech chamber) to ensure that peak flows after construction will not exceed the target discharge rates and erosion mitigation requirements.

Runoff from the site is captured via catchbasins, landscaping drains and roof drains and conveyed to a hydrodynamic separator for water quality treatment followed by an underground storage unit for quantity control. The storage unit is restricted by an ICD at the downstream end and is an open bottom unit designed to also promote infiltration. Roof runoff is controlled via roof drains discharging through the internal building plumbing to rainwater harvesting tanks. Two rainwater harvesting tanks are proposed for each building. Each rainwater

SERVICING AND STORMWATER MANAGEMENT BRIEF – 5731 HAZELDEAN ROAD

Stormwater Management
March 22, 2017

tank is capable of storing up to 91 m³ of runoff (approximately 32mm of rainfall) beyond which it will overflow into the storm sewer and be conveyed to the storage unit. The underground storage unit is sized assuming that the rainwater harvesting tanks are available at the start of the rainfall event.

Additional infiltration will be achieved on-site through the implementation of a bioswale along the east side of the site. The granular subbase of the swale is sized to store runoff from its tributary area. An overflow drain is also provided to convey excess water to the underground storage unit.

The site discharge will be conveyed to the approved outlet location for the adjacent CMHC lands to the west of the subject site. The outlet will be sized to convey flows from both sites. Utilizing this location addresses concerns regarding an additional outlet to Poole Creek and prevents disturbance of the natural area to the north of the site.

5.3.3 Modeling Rationale

A comprehensive hydrologic modeling exercise was completed with PCSWMM, accounting for the estimated major and minor systems to evaluate the storm sewer infrastructure. The use of PCSWMM for modeling of the site hydrology and hydraulics allowed for an analysis of the systems response during various storm events. Surface storage estimates were based on the final grading plan design (see **Drawing GP-1**). The following assumptions were applied to the detailed model:

- Hydrologic parameters as per Ottawa Sewer Design Guidelines, including Horton infiltration, Manning's 'n', and depression storage values
- 12-hour SCS Storm distribution for the 100-year analysis to model 'worst-case' scenario in regards to on-site HGLs.
- 12hr SCS distributions (2 and 100-year events) with free flowing boundary condition to model 'worst-case' scenario in regards to site discharge rates to meet target rate.
- To 'stress test' the system a 'climate change' scenario was created by adding 20% of the individual intensity values of the 100-year SCS storm event at their specified time step.
- All LID measures were designed outside of PCSWMM (as documented in the report and calculations included in **Appendix E**) in order to allow routing of LID overflows to the next downstream LID which cannot be done in PCSWMM where an LID is defined as part of a given subcatchment. Total design storage and calculated infiltration losses were then input into PCSWMM as storage nodes with separate outlets for infiltration losses.
- Percent imperviousness calculated based on actual soft and hard surfaces on each subcatchment, converted to equivalent Runoff Coefficient using the relationship $C = (\text{Imp.} \times 0.7) + 0.2$
- Subcatchment areas are defined from high-point to high-point where sags occur. Subcatchment width (average length of overland sheet flow) determined by dividing

SERVICING AND STORMWATER MANAGEMENT BRIEF – 5731 HAZELDEAN ROAD

Stormwater Management
March 22, 2017

subcatchment area by subcatchment length (length of overland flow path measured from high-point to high-point).

- Number of catchbasins based on servicing plan (**Drawing SP-1**)
- Catchbasin inflow restricted with inlet-control devices (ICDs) as necessary to maintain inflow target rate and maximize use of surface storage where possible.
- Surface ponding in sag storage calculated based on grading plans (**Drawing GP-1**).

5.3.3.1 SWMM Dual Drainage Methodology

The proposed site is modeled in one modeling program as a dual conduit system (see **Figure 3**), with: 1) circular conduits representing the sewers & junction nodes representing manholes; 2) irregular conduits using street-shaped cross-sections to represent the sawtoothed overland road network from high-point to low-point and storage nodes representing catchbasins. The dual drainage systems are connected via outlet link objects (or orifices) from storage node (i.e. CB) to junction (i.e. MH), and represent inlet control devices (ICDs). Subcatchments are linked to the storage node on the surface so that generated hydrographs are directed there firstly.

Figure 3: Schematic Representing Model Object Roles

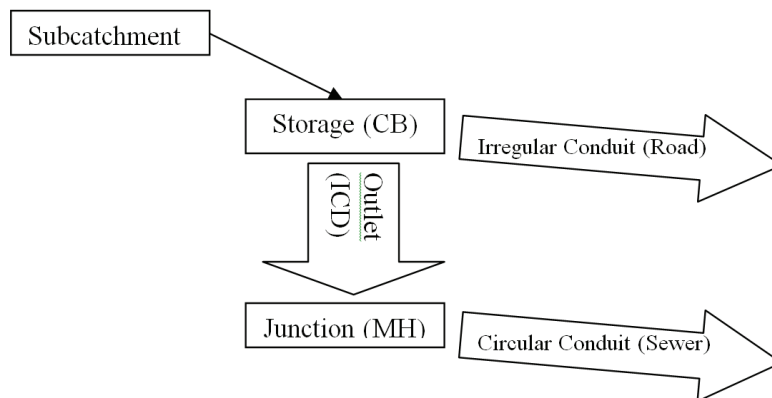

Storage nodes are used in the model to represent catchbasins as well as major system junctions. For storage nodes representing catchbasins (CBs), the invert of the storage node represents the invert of the CB and the rim of the storage node is the top of the CB plus the maximum above ground storage depth. An additional 0.3m has been added to rim elevations to allow routing from one surface storage to the next, and is unused where no spillage occurs between ponding areas. Ponding at low points is represented via storage area-depth curves for each individual storage node to match ponding volumes demonstrated on the grading plan **Drawing GP-1**. Storage volumes exceeding the sag storage available in the node will route through the connected irregular conduit to the next storage node and continue routing through the system until, ultimately, flows either re-enter the minor system or reach the outfall of the major system.

SERVICING AND STORMWATER MANAGEMENT BRIEF – 5731 HAZELDEAN ROAD

Stormwater Management
March 22, 2017

Inlet control devices, as represented by orifice links, use a user-specified discharge coefficient to approximate manufacturer's specifications for the chosen ICD model.

Subcatchment imperviousness was calculated via impervious area measured from **Drawing SSP-1**.

5.3.3.2 Boundary Conditions

The detailed PCSWMM hydrology and the proposed storm sewers were used to assess the peak inflows and hydraulic grade line (HGL) for the site. The elevation of the outlet sewer at MH100 immediately upstream of Poole Creek has been set conservatively to be above the 100-Year water elevation of the Creek per MVCA Flood Risk Mapping at an invert elevation of 99.7m to enable free-flowing model condition for the site outlet.

5.3.4 Input Parameters

Drawing SD-1 summarizes the discretized subcatchments used in the analysis of the proposed site, and outlines the major overland flow paths. The grading plans are also enclosed for review.

Appendices A1 to A3 summarize the modeling input parameters and results for the subject area; an example input and output file are provided for the 100-year 12hr SCS storm. For all other input files and results of storm scenarios, please examine the electronic model files located on the CD provided with this report. This analysis was performed using PCSWMM, which is a front-end GUI to the EPA-SWMM engine. Model files can be examined in any program which can read EPA-SWMM files version 5.1.010.

5.3.4.1 Hydrologic Parameters

Table 4 presents the general subcatchment parameters used:

Table 4: General Subcatchment Parameters

Parameter	Value
Infiltration Method	Curve Number
Drying Time (days)	7
Curve Number	80
N Impervious	0.013
N Pervious	0.2
Dstore Imperv. (mm)	1.57
Dstore perv. (mm)	4.67
Zero Imperv. (%)	0

**SERVICING AND STORMWATER MANAGEMENT BRIEF –
5731 HAZELDEAN ROAD**

Stormwater Management
March 22, 2017

Table 5 presents the individual parameters that vary for each of the proposed subcatchments.

Table 5: Subcatchment Parameters

Name	Outlet	Area (ha)	Width (m)	Slope (%)	Imperv. (%)
EXT1	EXT1-OF	0.07	15.1	33.3	0
EXT2	EXT2-OF	0.06	14.4	2	72.857
ST104A	ST104A-S	0.15	69	2	84.286
ST107A	ST107A-S	0.37	225.0	1.5	64.286
ST108A	ST108A-S	0.40	90.9	1.5	100
ST108B	ST108B-S	0.36	82.0	1.5	100
ST108C	ST108C-S	0.05	12.1	1.5	100
ST108D	ST108D-S	0.05	10.9	1.5	100
ST108E	ST108E-S	0.03	25.0	1.5	100
ST108F	108	0.38	86.0	1.2	44.286
ST109A	109	0.01	18.2	10	100
ST109C	ST109C-S	0.06	25.8	1	100
ST109B	ST109B-S	0.05	24.8	1	100
ST110A	110	0.07	16.8	0.8	7.143
ST110B	110	0.03	24.5	10	100
ST110C	110	0.03	26.6	10	100
ST110D	110	0.07	16.7	0.8	7.143
ST111A	ST111A-S	0.24	107.5	0.8	72.857
ST111B	ST111B-S	0.04	88.0	0.8	100
ST111C	ST111C-S	0.04	36.8	1.5	85.714
ST507A	ST507A-S	0.05	33.5	1.5	72.857
ST508A	508	0.34	189.2	1	7.143

Table 6 summarizes the storage node parameters used in the model. Storage curves for each node have been created based on volumes presented for each individual ponding area within **Drawing GP-1**. Rim elevations for each node correspond to the rim elevation of the associated area's catchbasin plus maximum depth of storage plus 0.30m to allow for demonstration of overland flow in the climate change event scenario. The 0.30m buffer is unused during other modeled events.

SERVICING AND STORMWATER MANAGEMENT BRIEF – 5731 HAZELDEAN ROAD

Stormwater Management
March 22, 2017

Storage volumes and release rates for the rainwater harvesting tank, bioswale/rain garden, and infiltration basin were obtained through iterations between design sizing calculations (final sizing attached in **Appendix E**) and PCSWMM hydrologic/hydraulic modeling.

Table 6: Storage Node Parameters

Name	Invert El. (m)	Rim Elev. (m)	Depth (m)	Coefficient	Exponent	Constant (m ²)	Curve Name	Storage Curve
108	99.27	104.37	5.10	0	0	0	RWhtank	TABULAR
508	101.06	102.85	1.79	0	0	0	ST508A-S	TABULAR
ST104A-S	101.52	103.62	2.1	1000	0	0	ST104A-S	TABULAR
ST107A-S	101.13	103.23	2.1	1000	0	0	ST107A-S	TABULAR
ST108A-S	118.6	118.75	0.15	1000	0	0	ST108A	TABULAR
ST108B-S	115.75	115.9	0.15	1000	0	0	ST108B	TABULAR
ST108C-S	110.4	110.55	0.15	1000	0	0	ST108C	TABULAR
ST108D-S	110.1	110.25	0.15	1000	0	0	ST108D	TABULAR
ST108E-S	107.2	107.35	0.15	1000	0	0	ST108E	TABULAR
ST109B-S	102.81	104.31	1.5	0	0	0	*	FUNCTIONAL
ST109C-S	102.81	104.31	1.5	0	0	0	*	FUNCTIONAL
ST111A-S	101.86	104.26	2.4	1000	0	0	ST111A-S	TABULAR
ST111C-S	101.95	104.05	2.1	0	0	0	*	FUNCTIONAL
ST507A-S	101.57	103.67	2.1	1000	0	0	ST504A-S	TABULAR
TANK	100.10	103.37	3.27	1000	0	0	TANK	TABULAR

5.3.4.2 Hydraulic Parameters

As per the Ottawa Sewer Design Guidelines (OSDG 2012), Manning's roughness values of 0.013 were used for sewer modeling and overland flow corridors representing roadways.

Storm sewers were modeled to confirm flow capacities and hydraulic grade lines (HGLs) in the proposed condition. The detailed storm sewer design sheet is included in **Appendix C**.

Table 7 below presents the parameters for the orifice and outlet link objects in the model, which represent ICDs and restricted roof release drains respectively. CB leads modeled as orifices were assigned a discharge coefficient of 0.65. The roof release discharge curves assume the use of standard Zurn model Z-105-5 controlled release roof drains as noted in the calculation sheet in **Appendix C**. The number of roof notches for each building area is to be confirmed with the

SERVICING AND STORMWATER MANAGEMENT BRIEF – 5731 HAZELDEAN ROAD

Stormwater Management
March 22, 2017

building mechanical engineer. Details for the IPEX ICDs and Zurn drains are included as part of **Appendix G**.

Table 7: Outlet/Orifice Parameters

Name	Inlet	Outlet	Inlet Elev.	Type	Diameter
OR1	TANK	102	100.10	CIRCULAR	0.11
OR2	TANK	102	100.70	CIRCULAR	0.15
OR3	TANK	102	101.00	CIRCULAR	0.15
ST104A-O	ST104A-S	104	101.52	IPEX HF	0.140
ST107A-O	ST107A-S	107	101.13	CIRCULAR	0.2
ST109B-O	ST109B-S	109	102.81	CIRCULAR	0.2
ST109C-O	ST109C-S	109	102.81	CIRCULAR	0.2
ST111A-O	ST111A-S	111	101.86	IPEX HF	0.076
ST111C-O	ST111C-S	111	101.95	CIRCULAR	0.2
ST111C-O1	ST111C-S	111	101.95	CIRCULAR	0.2
OL-1	TANK	P_OF1	100.10	0.66L/s	-
OL-2	508	P_OF2	101.06	0.3L/s	-
ST507A-O	ST507A-S	TANK	101.57	IPEX LMF 95	-
ST108A-O	ST108A-S	108	118.60	ROOF	-
ST108B-O	ST108B-S	108	115.75	ROOF	-
ST108C-O	ST108C-S	108	110.40	ROOF	-
ST108D-O	ST108D-S	108	110.10	ROOF	-
ST108E-O	ST108E-S	108	107.20	ROOF	-

5.3.5 Model Results

The following section summarizes the key hydrologic and hydraulic model results. For detailed model results or inputs please refer to the example input file in **Appendix C.2 and C.3** and the electronic model files on the enclosed CD.

5.3.5.1 Hydrologic Results

The following tables demonstrate the peak outflow from each modeled outfall during the design storm (12hr SCS 2-100yr) events. A free-flowing outfall condition has been modeled for these events to be conservative with respect to site peak release rates. Outfalls EXT1-OF and EXT2-OF denote uncontrolled flows from the perimeter of the site that, due to grading restrictions, are captured by the existing right-of-way/Poole Creek at the south and north boundaries of the site.

SERVICING AND STORMWATER MANAGEMENT BRIEF – 5731 HAZELDEAN ROAD

Stormwater Management
March 22, 2017

Flows from area EXT2 will have a minimal contribution to the infrastructure within Hazeldean Road. Peaks from these uncontrolled flows are non-coincident with peaks from the subsurface storage tank/weir, and as such, flows from the outlet headwall are the only values considered in meeting the release rate target. The required subsurface storage tank volume was determined through iteration of each event, and sized to mirror the site release rate target.

Table 8: Site Peak Discharge Rates

Event	Location	Discharge Rate (L/s)	Target (L/s)
2-Year 12 Hour SCS	Outlet Headwall	15.2	17.7
5-Year 12 Hour SCS	Outlet Headwall	38.6	43.9
10-Year 12 Hour SCS	Outlet Headwall	64.5	66.2
25-Year 12 Hour SCS	Outlet Headwall	98.7	103.7
50-Year 12 Hour SCS	Outlet Headwall	116.2	136.5
100-Year 12 Hour SCS	Outlet Headwall	136.3	176.3
100-Year 12 Hour SCS +20%	Outlet Headwall	317.0	-

5.3.5.2 Hydraulic Results

Table 9 summarizes the HGL results within the site for the 100 year storm events and the 'climate change' scenario storm required by the City of Ottawa Sewer Design Guidelines (2012), where intensities are increased by 20%. The City of Ottawa requires that during major storm events, the maximum hydraulic grade line be kept at least 0.30 m below the underside-of-footing (USF) of any adjacent units connected to the storm sewer during design storm events. As the proposed building perimeter drain and ramp drains will be disconnected from the storm sewer and pumped to the surface, USFs are considered at 0.3m below the lowest finished floor elevation of the building.

Table 9: Modeled Hydraulic Grade Line Results

STM MH	Proposed Ground Elev. (m)	100-year 12hr SCS		100-year 12hr SCS + 20%	
		HGL (m)	USF-HGL Clearance (m)	HGL (m)	USF-HGL Clearance (m)
103	104.20	101.97	2.23	102.78	1.42
104	104.20	101.98	2.22	102.80	1.40
105	104.20	101.99	2.21	102.86	1.34
106	104.20	101.99	2.21	102.87	1.33
107	104.20	102.00	2.20	102.89	1.31

**SERVICING AND STORMWATER MANAGEMENT BRIEF –
5731 HAZELDEAN ROAD**

Stormwater Management
March 22, 2017

STM MH	Proposed Ground Elev. (m)	100-year 12hr SCS		100-year 12hr SCS + 20%	
		HGL (m)	USF-HGL Clearance (m)	HGL (m)	USF-HGL Clearance (m)
108	104.20	102.04	2.16	103.04	1.16

As is demonstrated in the table above, the worst-case scenario results in HGL elevations remain at least 0.30 m below the proposed surface elevations, and HGL elevations remain below the proposed surface elevations during the 20% increased intensity 'climate change' scenario.

Table 10 presents the maximum total surface water depths (static ponding depth + dynamic flow) above the top-of-grate of catchbasins for the 100-year design storm and climate change storm. Based on the model results, the total ponding depth (static + dynamic) does not exceed the required 0.30m maximum during the 100-year event. Total ponding depths during the climate change scenario are below adjacent building openings and should not impact the proposed building.

Table 10: Maximum Surface Water Depths

Storage node ID	Structure ID	Rim Elevation (m)	100 year, 12hr SCS		100 year, 12hr SCS +20%	
			Max HGL (m)	Total Surface Water Depth (m)	Max HGL (m)	Total Surface Water Depth (m)
ST104A-S	CB 506	103.32	103.23	0.00	103.47	0.15
ST107A-S	CB 505	102.93	102.85	0.00	103.09	0.16
ST111A-S	CB 501	103.96	104.18	0.22	104.22	0.26
ST111C-S	CB 504	103.75	102.03	0.00	102.91	0.00
ST507A-S	CB 507	103.37	103.44	0.07	103.47	0.10
508	CB T 508	102.60	102.01	0.00	102.83	0.23

5.3.6 Water Quality Control

On-site water quality control is required to provide 80% TSS removal prior to discharging to Poole Creek. A Stormceptor unit STC300 is proposed upstream of the underground storage/infiltration basin. The Stormceptor will provide greater than 80% TSS removal in the 25mm event and will act as pre-treatment for the storage/ infiltration basin thereby reducing maintenance requirements of the facility and improving long-term performance. The Stormceptor unit will be privately maintained. The location and general arrangement of the Stormceptor unit is indicated on **Drawing SD-1**. Detailed sizing calculations for the Stormceptor unit are included in **Appendix C.5**

SERVICING AND STORMWATER MANAGEMENT BRIEF – 5731 HAZELDEAN ROAD

Stormwater Management
March 22, 2017

5.3.7 Infiltration Targets

The MVCA requires that BMP measures be implemented on-site to meet the minimum infiltration target rate of 50 mm/yr (as identified in the Kanata West Master Servicing Study, Stantec, 2006). For a site area of 2.9ha with an average imperviousness of 56% the total annual infiltration requirement is therefore 812m³/yr. The KWMSS also requires a 25% augmentation to site infiltration requirements to account for off-site road areas for which no infiltration measures were required. Therefore, the total site infiltration target is 1,015 m³/yr. Past correspondence with the MVCA indicated that the target infiltration rates were in fact “target hydrograph volume reduction rates”.

The LID bioswale and infiltration gallery proposed for the site will provide significant opportunity for stormwater infiltration. Infiltration calculations completed for the design and sizing of these LID measures were used to approximate an expected annual infiltration rate. Water balance calculations for a continuous rainfall scenario from August 2, 2009 to March 1, 2012 (see **Appendix E**) were used to determine an average daily infiltration rate over a one year period. The average rate was estimated to be 44m³/day. Note that this rate is averaged over 365 days per year and would underestimate summer months and overestimate winter. Nevertheless, the average annual infiltration that could be provided through the LID measures would be approximately 16,262 m³/yr. Therefore, only about 10% of the total possible infiltration is required to meet the infiltration target for the site.

The infiltration contribution from the bioswale and infiltration gallery is included in **Table 11** below. Note that this summary does not include infiltration resulting from the rainwater harvesting reuse for irrigation. The results in **Table 11** suggest that the infiltration target could be met with the bioswale infiltration only.

Table 11: Summary of Infiltration from LID Features

LID Feature	Estimated Total Annual Infiltration (m ³ /yr)
Bioswale	2,568
Infiltration Gallery	13,694
Total Infiltration	16,262

5.3.7.1 Potential Groundwater Mounding

Groundwater levels at the site were measured by Paterson Group during two separate site visits and are summarized in the attached Paterson memos in **Appendix F**. Based on the results of the

**SERVICING AND STORMWATER MANAGEMENT BRIEF –
5731 HAZELDEAN ROAD**

Stormwater Management
March 22, 2017

groundwater monitoring Paterson Group prepared a memo discussing the variation in groundwater level measurements and anticipated seasonally high and normal groundwater levels. The results for the boreholes near the LID features are summarized in **Table 12** below. The complete memo dated January 25, 2017 is included in **Appendix F**.

Table 12: Expected Seasonal Variation of Groundwater Levels

Borehole Number	Ground Elevation (m)	Long-term Groundwater Levels		Seasonally High Groundwater Level	
		Depth (m)	Elevation (m)	Depth (m)	Elevation (m)
BH 1	102.93	3.7	99.23	3.2	99.73
BH 2	103.02	3.7	99.32	3.2	99.82
BH 3	103.07	3.7	99.37	3.2	99.87
BH 4	103.15	3.7	99.45	3.2	99.95
BH 5	103.22	3.7	99.52	3.2	100.02
BH 6	103.25	3.7	99.55	3.2	100.05
BH 7	102.91	4.5	98.41	4.0	98.91

Since the clearance from the bottom of the infiltration tank to the groundwater table is less than 1.0m the potential for groundwater mounding was considered. Groundwater mounding calculations were completed for both the seasonally high groundwater condition and the normal groundwater condition. However, per the Paterson memo, the seasonally high level is expected to occur during March-April, as such historical rainfall data was used to establish the average rainfall event volume for March-April. The analysis indicated approximately a 10mm event. The duration of infiltration for the infiltration gallery was obtained from the PCSWMM hydraulic model based on the modeled time for the infiltration gallery to empty. No PCSWMM model was run for the 10mm event so the 2-year event was used as a conservative estimate. These durations were input into the groundwater mounding calculation spreadsheet in **Appendix E**. It is noted that the calculations are based on the Hantush (1967) equation for groundwater mounding and use the hydraulic conductivity (measured by Paterson and summarized in the attached memo from September 2016) as the recharge rate and typical specific yield for silty clay. It is also noted that spreadsheet inputs and results are in imperial units. **Table 13** below summarizes the results of the groundwater mounding calculations.

SERVICING AND STORMWATER MANAGEMENT BRIEF – 5731 HAZELDEAN ROAD

Stormwater Management
March 22, 2017

Table 13: Estimated Maximum Groundwater Mounding below Infiltration Gallery

Groundwater Condition	Mounding Height (m)	Mounding Elevation (m)	Distance to Bottom of Infiltration Gallery (m)
Long-term (99.23)	0.31	99.54	0.56
Seasonally High (99.73)	0.26	99.99	0.11

It is noted the above mounding depths are still below the bottom of the infiltration gallery. Should a larger rainfall even occur during the seasonally high groundwater condition there could be potential for the groundwater mound to extend into the infiltration gallery. However, there is a storm sewer outlet proposed at the bottom of the infiltration gallery (Invert =100.10m per attached **Drawing SSP-1**) which will limit the maximum groundwater height to the bottom of the infiltration gallery. Once the mounding reaches the bottom, the stored stormwater would discharge only through the controlled outlets and would not infiltrate. Since the groundwater mounding is caused only by infiltrating stormwater and not by external sources, there should be no loss of storage volume due to groundwater mounding.

5.3.8 Thermal Controls

The MVCA and MOECC confirmed that Poole Creek is designated as a “cool-water fish habitat”. As the proposed development will increase the amount of impervious area on the site and roof top detention will increase water temperatures, thermal mitigation measures are required for the site.

As the majority of heat transfer from paved surfaces occurs during the first flush (considered as the initial 10mm of each design event), storage of the 10mm event has been given priority. With exception of the rooftop areas, the site is designed with minimal surface storage. All runoff will be captured and detained in the underground storage unit which will allow for heat dumping into the surrounding ground and granular material. Similarly, runoff conveyed through the granular subbase of the bioswale will experience cooling. Roof discharge will be the most thermally impacted water as it will be retained on the rooftops for several hours. This water will be discharged to the underground rainwater harvesting tank and will inlet at the bottom of the tank such that if the tank is full, the cooler water will be discharged first through the overflow. With 167m³ of storage available in each of the rainwater harvesting tanks, the only occurrence where roof discharge would not experience any temperature mitigation via mixing or detention would be when total rainfall exceeds approximately a 2-year event. The reverse temperature mitigation effect (warming water during cold weather) would also occur with these measures as ground temperatures would warm the runoff.

SERVICING AND STORMWATER MANAGEMENT BRIEF – 5731 HAZELDEAN ROAD

Stormwater Management
March 22, 2017

5.3.9 Monitoring Plan

In addition to monitoring requirements to be identified by the MOECC in the Environmental Compliance Approval (ECA), the site will require regular monitoring of the LID measures installed on the site. A detailed monitoring program will be developed through consultation with the City of Ottawa and MVCA. In general, the monitoring plan will required pre-construction, during construction and post-construction monitoring and include the following:

- Installation of water level loggers in both the rainwater harvesting tank, infiltration gallery, and bioswale (monitoring “well” to be installed) to assess frequency of overflow and drawdown rates and compare with design values;
- Installation of temperature logger in the outlet manhole from the site to monitor temperature of the storm discharge. The temperature logger cannot be installed at the outlet to Poole Creek as this outlet will include discharge from the CMHC lands as well and would not be representative of the subject site;
- Collection of water quality samples upstream and downstream of the proposed OGS unit;
- Visual inspection of all LID systems at least once per month and following all large rainfall events. Including observations for:
 - o Debris accumulation on the surface
 - o Measurement of/inspection for sediment accumulation in rainwater harvesting tank and infiltration gallery
 - o Presence of ponded water on the surface of the bioswale beyond design duration
 - o Outlet/inlet blockages of tanks and OGS

A detailed monitoring plan is included in **Appendix H**.

5.3.10 Contingency Plan

It is recognized that the proposed stormwater management plan is considered a “pilot project” by the City of Ottawa and has allowed for credit from the LID measures toward the stormwater management design. As such the monitoring plan for the site will be critical in assessing the performance of the system. Should either the pre-construction monitoring result in findings that will impact the function of the system, then additional assessment of the design will be required to assess system performance and determine whether additional storage is required. Additional storage would be provided by expanding the size of the proposed infiltration gallery. This assessment would be required prior to constructing the facility. A memo will be issued to the City of Ottawa outlining the monitoring results and confirming whether there is any need for expansion of the infiltration system.

Similarly, post-construction monitoring will assess the performance of the system. Data analysis and reporting will be completed and review whether any retrofits to the system are required. The

SERVICING AND STORMWATER MANAGEMENT BRIEF – 5731 HAZELDEAN ROAD

Stormwater Management
March 22, 2017

greatest benefit to the SWM design is the storage available in the rainwater harvesting system. It is estimated that the greatest impact to the system storage requirements would be if this system does not operate as designed and this entire volume cannot be relied upon for the SWM system. This would result in the need for an additional 335m³ to be added to the infiltration gallery. While this extreme is assumed to be unlikely, it is recommended that the site MOECC ECA include this contingency volume of 335m³ to allow for the expansion if needed without requiring an amendment to the ECA before proceeding.

Post-construction monitoring will include groundwater level monitoring and water level monitoring within the infiltration gallery. Results will be monitored to ensure no storage volume is lost as a result of groundwater influences and storage volume would be adjusted as necessary. However, it is anticipated that since the infiltration gallery design includes an outlet at the bottom of the storage area, there should be no significant loss of volume caused by seasonal groundwater fluctuations or mounding.

5.4 SUMMARY OF FINDINGS

Based on the preceding, the following conclusions can be drawn:

- The proposed stormwater management plan is in compliance with the criteria established for the site and the 2012 City of Ottawa Sewer Guidelines.
- Inlet control devices are proposed to limit inflow from the site area into the minor system to maximize the use of surface storage.
- Subsurface storage has been provided to further limit site outflows to the peak site discharge rate determined via PCSWMM model (See **Table 14** below).
- The storm sewer hydraulic grade line is maintained at least 0.30 m below finished ground elevations during design storm events.
- All dynamic surface water depths are less than 0.30 m during all design storm events.
- Quality control is provided by a Stormceptor model STC3000 upstream of the underground storage facility to maintain water quality objectives outlined in the background reports.

Table 14: Site Peak Discharge Rates/Targets

Storm Event	Site Peak Discharge Rate (L/s)	Target Discharge Rate (L/s)
2-Year 12 Hour SCS	15.2	17.7
5-Year 12 Hour SCS	38.6	43.9
10-Year 12 Hour SCS	64.5	66.2
25-Year 12 Hour SCS	98.7	103.7
50-Year 12 Hour SCS	116.2	136.5
100-Year 12 Hour SCS	136.3	176.3
100-Year 12 Hour SCS +20%	317.0	-

**SERVICING AND STORMWATER MANAGEMENT BRIEF –
5731 HAZELDEAN ROAD**

Appendix C Stormwater Management
March 22, 2017

Appendix C STORMWATER MANAGEMENT

**C.1 STORM SEWER DESIGN SHEET AND ROOF STORAGE
CALCULATIONS**

FLOOD RISK MAP POOLE CREEK CARTE DU RISQUE D'INONDATION

LEGEND / LÉGENDE

-  Regulatory Floodplain / La Crue Régulatrice
-  Regulatory Limit / Limite Réglementaire
-  Contours / Courbes
-  Stream / Ruisseau
-  Cross Sections / La coupe transversale

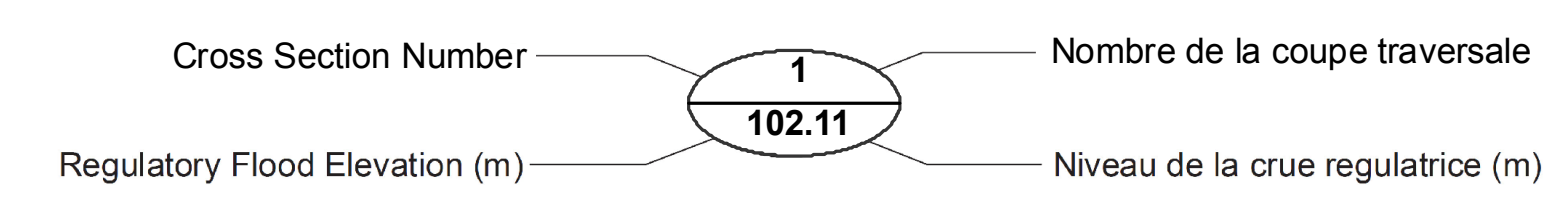

INDEX CONTOUR INTERVAL 2 METRES
WITH 0.5 METRE INTERMEDIATE CONTOUR
NORTH AMERICAN DATUM 1983
COURBES DE NIVEAU PRINCIPALES DE 2.0 MÈTRE
AVEC COURBES DE NIVEAU INTERMÉDIAIRES DE 0.5 MÈTRES
SYSTÈME DE RÉFÉRENCE GÉODÉSIQUE NORD-AMÉRIQUE 1983

GENERAL INFORMATION
Vertical Datum: Mean sea level
Horizontal Datum: North American 1983
Map Projection: Ottawa Transverse Mercator Projection

RENSEIGNEMENTS GÉNÉRAUX
Niveau de référence vertical: Niveau moyen de la mer
Niveau de référence horizontal: Nord-américain 1983
Projection cartographique: Projection Mercator Transverse d'Ottawa



SHEET INDEX / TABLEAU D'ASSEMBLAGE

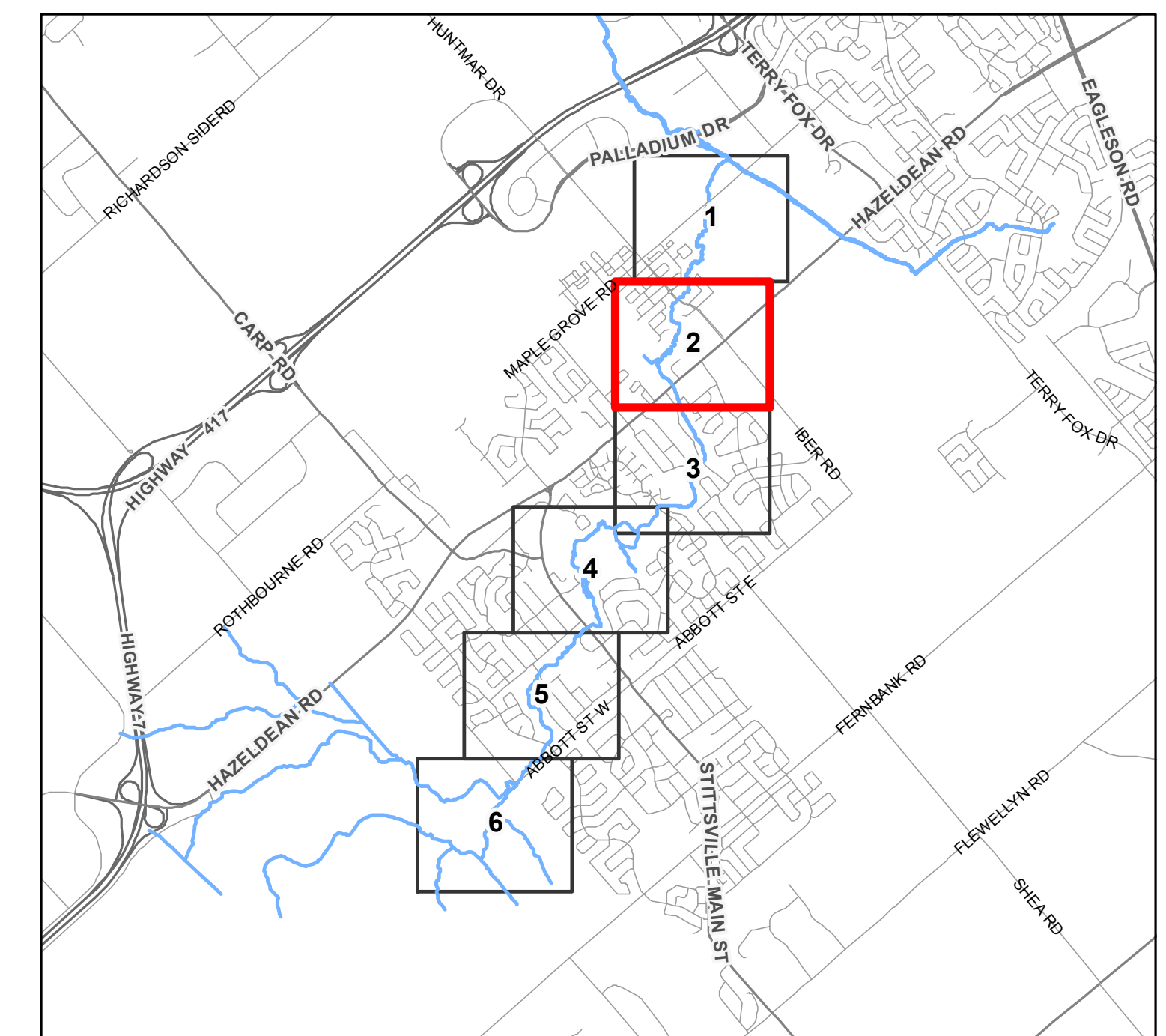

Revision #	Issue
1 - Nov 14 2013	Public review
2 - Dec 4, 2013	Board approval
3 - Jan 21, 2015	Final

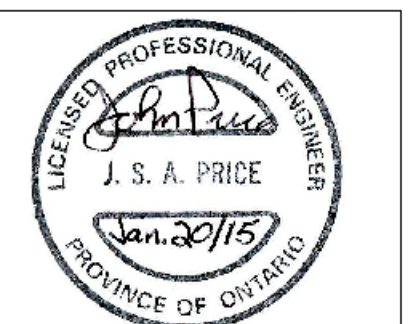

Date Modified / Date de modification: 29/01/2015

This map and the associated information displayed are to be used for general illustrative purposes only. Although best efforts have been made to create accuracy, due to the complex and extensive nature of the data, all representations and/or information provided herein are approximate and to be verified by user. User hereby acknowledges that this map is not intended for true and accurate navigational purposes and hereby accepts and assumes all inherent risks associated with the use of this map.

This map is produced in part with data provided by the Ontario Geographic Data Exchange under Licence with the Ontario Ministry of Natural Resources and the Queen's Printer for Ontario, 2013

Imagery © City of Ottawa, 2011
Digital Elevation Information © GeoDigital International Inc, Spring 2008

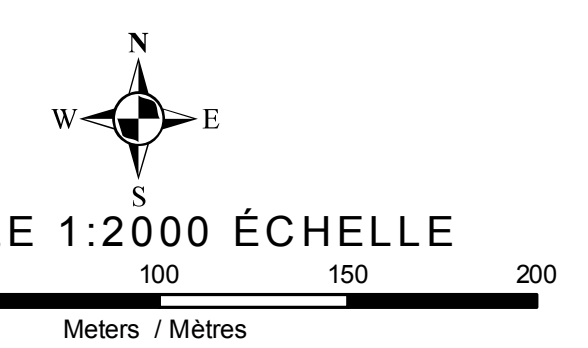

This map and the associated information displayed are to be used for general illustrative purposes only. Although best efforts have been made to create accuracy, due to the complex and extensive nature of the data, all representations and/or information provided herein are approximate and to be verified by user. User hereby acknowledges that this map is not intended for true and accurate navigational purposes and hereby accepts and assumes all inherent risks associated with the use of this map.

This map is produced in part with data provided by the Ontario Geographic Data Exchange under Licence with the Ontario Ministry of Natural Resources and the Queen's Printer for Ontario, 2013

Imagery © City of Ottawa, 2011
Digital Elevation Information © GeoDigital International Inc, Spring 2008

Stormwater Management Calculations

File No: 160401195
 Project: 5731 Hazeldean
 Date: 30-Jan-17

SWM Approach:
 Post-development to Pre-development flows

Post-Development Site Conditions:

Overall Runoff Coefficient for Site and Sub-Catchment Areas

Runoff Coefficient Table									
Catchment Type	Sub-catchment Area		Area (ha) "A"	Runoff Coefficient "C"		"A x C"	Overall Runoff Coefficient		
	ID / Description								
Roof	ST108D	Hard	0.05	0.9	0.047				
		Soft	0.00	0.2	0.000				
		Subtotal		0.052		0.047		0.900	
Roof	ST108E	Hard	0.03	0.9	0.024				
		Soft	0.00	0.2	0.000				
		Subtotal		0.027		0.024		0.900	
Roof	ST108B	Hard	0.36	0.9	0.328				
		Soft	0.00	0.2	0.000				
		Subtotal		0.364		0.328		0.900	
Roof	ST108A	Hard	0.40	0.9	0.363				
		Soft	0.00	0.2	0.000				
		Subtotal		0.404		0.363		0.900	
Roof	ST108C	Hard	0.05	0.9	0.042				
		Soft	0.00	0.2	0.000				
		Subtotal		0.047		0.042		0.900	
Total				0.894		0.805			
Overall Runoff Coefficient= C:								0.90	

Total Roof Areas	0.894 ha
Total Tributary Surface Areas (Controlled and Uncontrolled)	0.000 ha
Total Tributary Area to Outlet	0.894 ha
 Total Uncontrolled Areas (Non-Tributary)	 0.000 ha
 Total Site	 0.894 ha

Stormwater Management Calculations

Project #160401195, 5731 Hazeldean Modified Rational Method Calculators for Storage

5 yr Intensity City of Ottawa	$I = a/(t + b)^c$	a =	998.071	t (min)	I (mm/hr)
		b =	6.053	10	141.18
		c =	0.814	15	83.56
				20	70.25

5 YEAR Modified Rational Method for Entire Site

Subdrainage Area: ST108D Roof
Area (ha): 0.05 Maximum Storage Depth: 150 mm
C: 0.90

tc (min)	I (5 yr) (mm/hr)	Qactual (L/s)	Qrelease (L/s)	Qstored (L/s)	Vstored (m³)	Depth (mm)
5	141.18	18.26	2.75	15.51	4.65	89.6
10	104.19	13.48	3.09	10.39	6.24	100.5
15	83.56	10.81	3.17	7.64	6.88	103.2
20	70.25	9.09	3.20	5.89	7.07	104.0
25	60.90	7.88	3.19	4.69	7.03	103.9
30	53.93	6.98	3.17	3.81	6.86	103.1
35	48.52	6.28	3.13	3.14	6.60	102.0
40	44.18	5.72	3.09	2.62	6.29	100.7
45	40.63	5.26	3.04	2.22	5.98	99.0
50	37.65	4.87	2.98	1.90	5.69	96.9
55	35.12	4.54	2.91	1.63	5.39	94.8
60	32.94	4.26	2.85	1.41	5.09	92.7

Storage: Roof Storage

Depth (mm)	Head (m)	Discharge (L/s)	Vreq (cu. m)	Vavail (cu. m)	Discharge Check	
5-year Water Level	104.03	0.10	3.20	7.07	20.68	0.00

Subdrainage Area: ST108E Roof
Area (ha): 0.03 Maximum Storage Depth: 150 mm
C: 0.90

tc (min)	I (5 yr) (mm/hr)	Qactual (L/s)	Qrelease (L/s)	Qstored (L/s)	Vstored (m³)	Depth (mm)
5	141.18	9.61	1.38	8.23	2.47	89.9
10	104.19	7.09	1.55	5.54	3.32	100.8
15	83.56	5.68	1.59	4.09	3.68	103.7
20	70.25	4.78	1.61	3.17	3.81	104.7
25	60.90	4.14	1.61	2.53	3.80	104.7
30	53.93	3.67	1.60	2.07	3.73	104.1
35	48.52	3.30	1.58	1.72	3.61	103.1
40	44.18	3.01	1.57	1.44	3.46	101.9
45	40.63	2.76	1.54	1.22	3.29	100.6
50	37.65	2.56	1.52	1.04	3.13	98.8
55	35.12	2.39	1.49	0.90	2.98	96.8
60	32.94	2.24	1.46	0.79	2.83	94.7

Storage: Roof Storage

Depth (mm)	Head (m)	Discharge (L/s)	Vreq (cu. m)	Vavail (cu. m)	Discharge Check	
5-year Water Level	104.74	0.10	1.61	3.81	10.88	0.00

Subdrainage Area: ST108B Roof
Area (ha): 0.36 Maximum Storage Depth: 150 mm
C: 0.90

tc (min)	I (5 yr) (mm/hr)	Qactual (L/s)	Qrelease (L/s)	Qstored (L/s)	Vstored (m³)	Depth (mm)
5	141.18	128.71	17.98	110.73	33.22	90.0
10	104.19	94.99	20.17	74.81	44.89	101.0
15	83.56	76.18	20.78	55.40	49.86	104.1
20	70.25	64.04	21.00	43.05	51.66	105.1
25	60.90	55.52	21.01	34.51	51.76	105.2
30	53.93	49.16	20.90	28.26	50.87	104.7
35	48.52	44.23	20.72	23.51	49.38	103.8
40	44.18	40.28	20.49	19.79	47.50	102.6
45	40.63	37.04	20.23	16.81	45.38	101.3
50	37.65	34.33	19.95	14.37	43.12	99.9
55	35.12	32.02	19.56	12.46	41.13	97.9
60	32.94	30.03	19.16	10.87	39.14	96.0

Storage: Roof Storage

Depth (mm)	Head (m)	Discharge (L/s)	Vreq (cu. m)	Vavail (cu. m)	Discharge Check	
5-year Water Level	105.21	0.11	21.01	51.76	145.75	0.00

Subdrainage Area: ST108A Roof
Area (ha): 0.40 Maximum Storage Depth: 150 mm
C: 0.90

tc (min)	I (5 yr) (mm/hr)	Qactual (L/s)	Qrelease (L/s)	Qstored (L/s)	Vstored (m³)	Depth (mm)
5	141.18	142.64	19.39	123.25	36.97	90.2
10	104.19	105.27	21.77	83.50	50.10	101.2
15	83.56	84.42	22.44	61.98	55.78	104.3
20	70.25	70.98	22.69	48.28	57.94	105.5
25	60.90	61.53	22.72	38.80	58.20	105.7
30	53.93	54.48	22.62	31.86	57.35	105.2
35	48.52	49.02	22.44	26.58	55.81	104.4
40	44.18	44.64	22.21	22.43	53.84	103.3
45	40.63	41.05	21.94	19.11	51.58	102.0

Project #160401195, 5731 Hazeldean Modified Rational Method Calculators for Storage

100 yr Intensity City of Ottawa	$I = a/(t + b)^c$	a =	1735.688	t (min)	I (mm/hr)
		b =	6.014	10	242.70
		c =	0.820	15	142.89
				20	119.95

100 YEAR Modified Rational Method for Entire Site

Subdrainage Area: ST108D Roof
Area (ha): 0.05 Maximum Storage Depth: 150 mm
C: 1.00

tc (min)	I (100 yr) (mm/hr)	Qactual (L/s)	Qrelease (L/s)	Qstored (L/s)	Vstored (m³)	Depth (mm)
10	178.56	25.67	3.93	21.73	13.04	128.1
20	119.95	17.24	4.17	13.07	15.69	135.7
30	91.87	13.21	4.21	8.99	16.19	137.1
40	75.15	10.80	4.18	6.62	15.88	136.2
50	63.95	9.19	4.13	5.07	15.20	134.3
60	55.89	8.03	4.05	3.98	14.35	131.8
70	49.79	7.16	3.97	3.19	13.40	129.1
80	44.99	6.47	3.88	2.59	12.42	126.3
90	41.11	5.91	3.78	2.13	11.50	123.0
100	37.90	5.45	3.67	1.78	10.67	119.5
110	35.20	5.06	3.56	1.50	9.87	116.0
120	32.89	4.73	3.46	1.26	9.11	112.7

Storage: Roof Storage

Depth (mm)	Head (m)	Discharge (L/s)	Vreq (cu. m)	Vavail (cu. m)	Discharge Check	
100-year Water Level	137.11	0.14	4.21	16.19	20.68	0.00

Subdrainage Area: ST108E Roof
Area (ha): 0.03 Maximum Storage Depth: 150 mm
C: 1.00

tc (min)	I (100 yr) (mm/hr)	Qactual (L/s)	Qrelease (L/s)	Qstored (L/s)	Vstored (m³)	Depth (mm)
10	178.56	13.50	1.97	11.53	6.92	128.4
20	119.95	9.07	2.09	6.97	8.37	136.3
30	91.87	6.94	2.12	4.82	8.68	138.0
40	75.15	5.68	2.11	3.57	8.57	137.4
50	63.95	4.83	2.08	2.75	8.25	135.7
60	55.89	4.23	2.05	2.18	7.83	133.4
70	49.79	3.76	2.01	1.75	7.37	130.9
80	44.99	3.40	1.97	1.43	6.88	128.2
90	41.11	3.11	1.93	1.18	6.38	125.4
100	37.90	2.87	1.88	0.99	5.94	122.1
110	35.20	2.66	1.82	0.84	5.53	118.8
120	32.89	2.49	1.77	0.71	5.13	115.5

Storage: Roof Storage

Depth (mm)	Head (m)	Discharge (L/s)	Vreq (cu. m)	Vavail (cu. m)	Discharge Check	
100-year Water Level	138.04	0.14	2.12	8.68	10.88	0.00

Subdrainage Area: ST108B Roof
Area (ha): 0.36 Maximum Storage Depth: 150 mm
C: 1.00

tc (min)	I (100 yr) (mm/hr)	Qactual (L/s)	Qrelease (L/s)	Qstored (L/s)	Vstored (m³)	Depth (mm)
10	178.56	180.87	25.67	155.20	93.12	128.6
20	119.95	121.50	27.29	94.21	113.05	136.7
30	91.87	93.06	27.67	65.39	117.70	138.6
40	75.15	76.12	27.57	48.54	116.51	138.1
50	63.95	64.78	27.26	37.53	112.58	136.5
60	55.89	56.62	26.82	29.80	107.26	134.3
70	49.79	50.43	26.33	24.10	101.23	131.9
80	44.99	45.57	25.81	19.76	94.85	129.3
90	41.11	41.64	25.28	16.36	88.34	126.6
100	37.90	38.39	24.70	13.70	82.18	123.7
110	35.20	35.66	24.03	11.62	76.72	120.4
120	32.89	33.32	23.40	9.92	71.45	117.2

Storage: Roof Storage

Depth (mm)	Head (m)	Discharge (L/s)	Vreq (cu. m)	Vavail (cu. m)	Discharge Check	
100-year Water Level	138.58	0.14	27.67	117.70	145.75	0.00

Subdrainage Area: ST108A Roof
Area (ha): 0.40 Maximum Storage Depth: 150 mm
C: 1.00

tc (min)	I (100 yr) (mm/hr)	Qactual (L/s)	Qrelease (L/s)	Qstored (L/s)	Vstored (m³)	Depth (mm)
10	178.56	200.45	27.68	172.76	103.66	128.7
20	119.95	134.66	29.47	105.19	126.23	137.0
30	91.87	103.13	29.91	73.22	131.80	139.1
40	75.15	84.36	29.83	54.52	130.86	138.7
50	63.95	71.79	29.52	42.28	128.84	137.3
60	55.89	62.75	29.07	33.67	121.23	135.2
70	49.79	55.89	28.56	27.33	114.78	132.8
80	44.99	50.51	28.02	22.48	107.93	130.3
90	41.11	46.15	27.47	18.68	100.90	127.7

Stormwater Management Calculations

Project #160401195, 5731 Hazeldean
Modified Rational Method Calculatons for Storage

50	37.65	38.04	21.66	16.39	49.16	100.7	0.00
55	35.12	35.49	21.30	14.19	46.81	99.1	0.00
60	32.94	33.28	20.88	12.40	44.65	97.1	0.00

Storage: Roof Storage

Depth (mm)	Head (m)	Discharge (L/s)	Vreq (cu. m)	Vavail (cu. m)	Discharge Check	
5-year Water Level	105.67	0.11	22.72	58.20	161.52	0.00

Subdrainage Area: ST108C
 Area (ha): 0.05
 C: 0.90
 Maximum Storage Depth: Roof 150 mm

tc (min)	I (5 yr) (mm/hr)	Qactual (L/s)	Qrelease (L/s)	Qstored (L/s)	Vstored (m³)	Depth (mm)
5	141.18	16.63	2.74	13.90	4.17	89.1
10	104.19	12.27	3.06	9.21	5.53	99.6
15	83.56	9.84	3.14	6.71	6.03	102.1
20	70.25	8.28	3.15	5.12	6.15	102.7
25	60.90	7.17	3.14	4.03	6.05	102.2
30	53.93	6.35	3.11	3.24	5.84	101.2
35	48.52	5.72	3.07	2.65	5.56	99.9
40	44.18	5.21	3.00	2.20	5.29	97.7
45	40.63	4.79	2.93	1.85	5.00	95.5
50	37.65	4.44	2.87	1.57	4.71	93.3
55	35.12	4.14	2.80	1.34	4.42	91.0
60	32.94	3.88	2.73	1.15	4.14	88.9

Storage: Roof Storage

Depth (mm)	Head (m)	Discharge (L/s)	Vreq (cu. m)	Vavail (cu. m)	Discharge Check	
5-year Water Level	102.66	0.10	3.15	6.15	18.83	0.00

Project #160401195, 5731 Hazeldean
Modified Rational Method Calculatons for Storage

100	37.90	42.55	26.91	15.64	93.84	125.1	0.00
110	35.20	39.52	26.21	13.31	87.81	121.9	0.00
120	32.89	36.93	25.53	11.39	82.04	118.7	0.00

Storage: Roof Storage

Depth (mm)	Head (m)	Discharge (L/s)	Vreq (cu. m)	Vavail (cu. m)	Discharge Check	
100-year Water Level	139.08	0.14	29.91	131.80	161.52	0.00

Subdrainage Area: ST108C
 Area (ha): 0.05
 C: 1.00
 Maximum Storage Depth: Roof 150 mm

tc (min)	I (100 yr) (mm/hr)	Qactual (L/s)	Qrelease (L/s)	Qstored (L/s)	Vstored (m³)	Depth (mm)
10	178.56	23.37	3.92	19.46	11.67	127.4
20	119.95	15.70	4.13	11.57	13.89	134.4
30	91.87	12.02	4.16	7.87	14.16	135.3
40	75.15	9.84	4.11	5.72	13.73	133.9
50	63.95	8.37	4.04	4.33	12.99	131.6
60	55.89	7.32	3.96	3.36	12.10	128.8
70	49.79	6.52	3.86	2.65	11.14	125.8
80	44.99	5.89	3.75	2.14	10.27	122.0
90	41.11	5.38	3.63	1.75	9.45	118.2
100	37.90	4.96	3.52	1.44	8.66	114.5
110	35.20	4.61	3.41	1.20	7.91	111.0
120	32.89	4.31	3.31	1.00	7.20	107.6

Storage: Roof Storage

Depth (mm)	Head (m)	Discharge (L/s)	Vreq (cu. m)	Vavail (cu. m)	Discharge Check	
100-year Water Level	135.29	0.14	4.16	14.16	18.83	0.00

Roof Drain Design Calculation Sheet

**Project #160401195, 5731 Hazeldean
Roof Drain Design Sheet, Area ST108A
Standard Zurn Model Z-105-5 Control-Flo Single Notch Roof Drain**

Rating Curve				Volume Estimation				Water Depth (m)
Elevation (m)	Discharge Rate (cu.m/s)	Outlet Discharge (cu.m/s)	Storage (cu. m)	Elevation (m)	Area (sq. m)	Volume (cu. m)		
						Increment	Accumulated	
0.000	0.0000	0.0000	0	0.000	0	0	0	0.000
0.025	0.0004	0.0054	1	0.025	90	1	1	0.025
0.050	0.0008	0.0108	6	0.050	359	5	6	0.050
0.075	0.0012	0.0161	20	0.075	808	14	20	0.075
0.100	0.0015	0.0215	48	0.100	1436	28	48	0.100
0.125	0.0019	0.0269	93	0.125	2243	46	93	0.125
0.150	0.0023	0.0323	162	0.150	3230	68	162	0.150

Drawdown Estimate			
Total Volume (cu.m)	Total Time (sec)	Total Vol (cu.m)	Detention Time (hr)
0.0	0.0	0.0	0
5.2	486.8	5.2	0.13523
19.4	881.0	14.2	0.37995
47.1	1286.7	27.7	0.73735
92.7	1697.0	45.6	1.20874
160.8	2109.7	68.0	1.79476

Rooftop Storage Summary

Total Building Area (sq.m)		4038
Assume Available Roof Area (sq.	80%	3230
Roof Imperviousness		0.99
Roof Drain Requirement (sq.m/Notch)		232
Number of Roof Notches*		14
Max. Allowable Depth of Roof Ponding (m)		0.15
Max. Allowable Storage (cu.m)		162
Estimated 100 Year Drawdown Time (h)		1.5

* As per Ontario Building Code section OBC 7.4.10.4.(2)(c).

From Zurn Drain Catalogue

Head (m)	L/min	L/s	Notch Rating
0.051	45.5	0.00076	232

* Note: Number of drains can be reduced if multiple-notch drain used.

Calculation Results	5yr	100yr	Available
Qresult (cu.m/s)	0.023	0.030	-
Depth (m)	0.106	0.139	0.150
Volume (cu.m)	58.2	131.8	161.5
Drain time (hrs)	0.9	1.5	

Roof Drain Design Calculation Sheet

**Project #160401195, 5731 Hazeldean
Roof Drain Design Sheet, Area ST108B
Standard Zurn Model Z-105-5 Control-Flo Single Notch Roof Drain**

Rating Curve				Volume Estimation				Water Depth (m)
Elevation (m)	Discharge Rate (cu.m/s)	Outlet Discharge (cu.m/s)	Storage (cu. m)	Elevation (m)	Area (sq. m)	Volume (cu. m)		
						Increment	Accumulated	
0.000	0.0000	0.0000	0	0.000	0	0	0	0.000
0.025	0.0004	0.0050	1	0.025	81	1	1	0.025
0.050	0.0008	0.0100	5	0.050	324	5	5	0.050
0.075	0.0012	0.0150	18	0.075	729	13	18	0.075
0.100	0.0015	0.0200	43	0.100	1296	25	43	0.100
0.125	0.0019	0.0250	84	0.125	2024	41	84	0.125
0.150	0.0023	0.0300	146	0.150	2915	61	146	0.150

Drawdown Estimate			
Total Volume (cu.m)	Total Time (sec)	Vol (cu.m)	Detention Time (hr)
0.0	0.0	0.0	0
4.7	473.1	4.7	0.13141
17.5	856.1	12.8	0.36921
42.5	1250.3	25.0	0.71652
83.7	1649.1	41.2	1.17459
145.1	2050.0	61.4	1.74404

Rooftop Storage Summary

Total Building Area (sq.m)		3644	
Assume Available Roof Area (sq.	80%	2915	
Roof Imperviousness		0.99	
Roof Drain Requirement (sq.m/Notch)		232	
Number of Roof Notches*		13	
Max. Allowable Depth of Roof Ponding (m)		0.15	* As per Ontario Building Code section OBC 7.4.10.4.(2)(c).
Max. Allowable Storage (cu.m)		146	
Estimated 100 Year Drawdown Time (h)		1.5	

From Zurn Drain Catalogue

Head (m)	L/min	L/s	Notch Rating
0.051	45.5	0.00076	232

* Note: Number of drains can be reduced if multiple-notch drain used.

Calculation Results	5yr	100yr	Available
Qresult (cu.m/s)	0.021	0.028	-
Depth (m)	0.105	0.139	0.150
Volume (cu.m)	51.8	117.7	145.7
Drain time (hrs)	0.8	1.5	

Roof Drain Design Calculation Sheet

**Project #160401195, 5731 Hazeldean
Roof Drain Design Sheet, Area ST108C
Standard Zurn Model Z-105-5 Control-Flo Single Notch Roof Drain**

Rating Curve				Volume Estimation				Water Depth (m)
Elevation (m)	Discharge Rate (cu.m/s)	Outlet Discharge (cu.m/s)	Storage (cu. m)	Elevation (m)	Area (sq. m)	Volume (cu. m)		
						Increment	Accumulated	
0.000	0.0000	0.0000	0	0.000	0	0	0	0.000
0.025	0.0004	0.0008	0	0.025	10	0	0	0.025
0.050	0.0008	0.0015	1	0.050	42	1	1	0.050
0.075	0.0012	0.0023	2	0.075	94	2	2	0.075
0.100	0.0015	0.0031	6	0.100	167	3	6	0.100
0.125	0.0019	0.0038	11	0.125	262	5	11	0.125
0.150	0.0023	0.0046	19	0.150	377	8	19	0.150

Drawdown Estimate			
Total Volume (cu.m)	Total Time (sec)	Vol (cu.m)	Detention Time (hr)
0.0	0.0	0.0	0
0.6	397.4	0.6	0.11038
2.3	719.0	1.7	0.3101
5.5	1050.1	3.2	0.60181
10.8	1385.1	5.3	0.98655
18.7	1721.9	7.9	1.46485

Rooftop Storage Summary

Total Building Area (sq.m)	471
Assume Available Roof Area (sq. 80%)	377
Roof Imperviousness	0.99
Roof Drain Requirement (sq.m/Notch)	232
Number of Roof Notches*	2
Max. Allowable Depth of Roof Ponding (m)	0.15
Max. Allowable Storage (cu.m)	19
Estimated 100 Year Drawdown Time (h)	1.2

* As per Ontario Building Code section OBC 7.4.10.4.(2)(c).

From Zurn Drain Catalogue

Head (m)	L/min	L/s	Notch Rating
0.051	45.5	0.00076	232

* Note: Number of drains can be reduced if multiple-notch drain used.

Calculation Results	5yr	100yr	Available
Qresult (cu.m/s)	0.003	0.004	-
Depth (m)	0.103	0.135	0.150
Volume (cu.m)	6.1	14.2	18.8
Drain time (hrs)	0.6	1.2	

Roof Drain Design Calculation Sheet

**Project #160401195, 5731 Hazeldean
Roof Drain Design Sheet, Area ST108D
Standard Zurn Model Z-105-5 Control-Flo Single Notch Roof Drain**

Rating Curve				Volume Estimation				Water Depth (m)
Elevation (m)	Discharge Rate (cu.m/s)	Outlet Discharge (cu.m/s)	Storage (cu. m)	Elevation (m)	Area (sq. m)	Volume (cu. m)		
						Increment	Accumulated	
0.000	0.0000	0.0000	0	0.000	0	0	0	0.000
0.025	0.0004	0.0008	0	0.025	11	0	0	0.025
0.050	0.0008	0.0015	1	0.050	46	1	1	0.050
0.075	0.0012	0.0023	3	0.075	103	2	3	0.075
0.100	0.0015	0.0031	6	0.100	184	4	6	0.100
0.125	0.0019	0.0038	12	0.125	287	6	12	0.125
0.150	0.0023	0.0046	21	0.150	414	9	21	0.150

Drawdown Estimate			
Total Volume (cu.m)	Total Time (sec)	Total Vol (cu.m)	Detention Time (hr)
0.0	0.0	0.0	0
0.7	436.4	0.7	0.12121
2.5	789.6	1.8	0.34055
6.0	1153.3	3.5	0.6609
11.9	1521.1	5.8	1.08342
20.6	1890.9	8.7	1.60868

Rooftop Storage Summary

Total Building Area (sq.m)	517
Assume Available Roof Area (sq. 80%)	414
Roof Imperviousness	0.99
Roof Drain Requirement (sq.m/Notch)	232
Number of Roof Notches*	2
Max. Allowable Depth of Roof Ponding (m)	0.15
Max. Allowable Storage (cu.m)	21
Estimated 100 Year Drawdown Time (h)	1.3

* As per Ontario Building Code section OBC 7.4.10.4.(2)(c).

From Zurn Drain Catalogue

Head (m)	L/min	L/s	Notch Rating
0.051	45.5	0.00076	232

* Note: Number of drains can be reduced if multiple-notch drain used.

Calculation Results

	5yr	100yr	Available
Qresult (cu.m/s)	0.003	0.004	-
Depth (m)	0.104	0.137	0.150
Volume (cu.m)	7.1	16.2	20.7
Drain time (hrs)	0.7	1.3	

Roof Drain Design Calculation Sheet

**Project #160401195, 5731 Hazeldean
Roof Drain Design Sheet, Area ST108E
Standard Zurn Model Z-105-5 Control-Flo Single Notch Roof Drain**

Rating Curve				Volume Estimation				Water Depth (m)
Elevation (m)	Discharge Rate (cu.m/s)	Outlet Discharge (cu.m/s)	Storage (cu. m)	Elevation (m)	Area (sq. m)	Volume (cu. m)		
						Increment	Accumulated	
0.000	0.0000	0.0000	0	0.000	0	0	0	0.000
0.025	0.0004	0.0004	0	0.025	6	0	0	0.025
0.050	0.0008	0.0008	0	0.050	24	0	0	0.050
0.075	0.0012	0.0012	1	0.075	54	1	1	0.075
0.100	0.0015	0.0015	3	0.100	97	2	3	0.100
0.125	0.0019	0.0019	6	0.125	151	3	6	0.125
0.150	0.0023	0.0023	11	0.150	218	5	11	0.150

Drawdown Estimate			
Total Volume (cu.m)	Total Time (sec)	Total Vol (cu.m)	Detention Time (hr)
0.0	0.0	0.0	0
0.4	459.0	0.4	0.1275
1.3	830.5	1.0	0.3582
3.2	1213.0	1.9	0.69516
6.2	1599.9	3.1	1.13957
10.8	1988.9	4.6	1.69206

Rooftop Storage Summary

Total Building Area (sq.m)		272	
Assume Available Roof Area (sq.	80%	218	
Roof Imperviousness		0.99	
Roof Drain Requirement (sq.m/Notch)		232	
Number of Roof Notches*		1	
Max. Allowable Depth of Roof Ponding (m)		0.15	* As per Ontario Building Code section OBC 7.4.10.4.(2)(c).
Max. Allowable Storage (cu.m)		11	
Estimated 100 Year Drawdown Time (h)		1.4	

From Zurn Drain Catalogue

Head (m)	L/min	L/s	Notch Rating
0.051	45.5	0.00076	232

* Note: Number of drains can be reduced if multiple-notch drain used.

Calculation Results	5yr	100yr	Available
Qresult (cu.m/s)	0.002	0.002	-
Depth (m)	0.105	0.138	0.150
Volume (cu.m)	3.8	8.7	10.9
Drain time (hrs)	0.8	1.4	

Outlet Rip-Rap Sizing

US Army Corps of Engineers

1991 Procedure

EM1601

Common values

V	1.62	m/s
y	0.37125	m
Z	3.00	H:1V
phi	42	degrees
r	300	m
W	1	m
Ss	2.5	rock specific gravity
g	9.806	m/s ²
theta	18.4	degrees bank angle with horizontal

SF	1.1
Cs	0.3
KI	1
Cv	0.79
Ct	1

D ₅₀ =	0.048	m
M ₅₀ =	0.147	kg

Selected D50	0.060	m
Min. thickness	0.120	m

**SERVICING AND STORMWATER MANAGEMENT BRIEF –
5731 HAZELDEAN ROAD**

Appendix C Stormwater Management
March 22, 2017

C.2 SAMPLE PCSWMM MODEL INPUT (12HR 100YR SCS)

[TITLE]

```

[OPTIONS]
;;Options      Value
-----
FLOW_UNITS     LPS
INFILTRATION   CURVE_NUMBER
FLOW_ROUTING   DYNWAVE
START_DATE     07/23/2009
START_TIME     00:00:00
REPORT_START_DATE 07/23/2009
REPORT_START_TIME 00:00:00
END_DATE       07/24/2009
END_TIME       00:00:00
SWEEP_START    01/01
SWEEP_END      12/31
DRY_DAYS       0
REPORT_STEP    00:05:00
WET_STEP       00:05:00
DRY_STEP       00:05:00
ROUTING_STEP   1
ALLOW_PONDING YES
INERTIAL_DAMPING PARTIAL
VARIABLE_STEP  0
LENGTHENING_STEP 0
MIN_SURFAREA  0
NORMAL_FLOW_LIMITED BOTH
SKIP_STEADY_STATE NO
FORCE_MAIN_EQUATION H-W
LINK_OFFSETS  ELEVATION
MIN_SLOPE      0
MAX_TRIALS     8
HEAD_TOLERANCE 0.0015
SYS_FLOW_TOL   5
LAT_FLOW_TOL   5
MINIMUM_STEP   0.5
THREADS        4
    
```

```

[EVAPORATION]
;;Type      Parameters
-----
CONSTANT    0.0
DRY_ONLY    NO
    
```

```

[RAINGAGES]
;;
;;Name      Rain      Time      Snow      Data
            Type      Intrvl   Catch    Source
    
```

```

;;
RG1          INTENSITY 0:15  1.0  TIMESERIES 100SCS
[SUBCATCHMENTS]
;;
;;Name      Raingage      Outlet      Total      Pcnt.      width      Pcnt.      Curb      Snow
            Raingage      Outlet      Area      Imperv      width      Slope      Length    Pack
            -----
EXT1        RG1          EXT1-OF     0.067219  0          15.124    33.3      0
EXT2        RG1          EXT2-OF     0.063791  72.857    14.353    2          0
ST104A     RG1          ST104A-S   0.149935  84.286    69        2          0
ST107A     RG1          ST107A-S   0.373344  64.286    225       1.5        0
ST108A     RG1          ST108A-S   0.403809  100       90.857    1.5        0
ST108B     RG1          ST108B-S   0.36437   100       81.983    1.5        0
ST108C     RG1          ST108C-S   0.047083  100       12.1      1.5        0
ST108D     RG1          ST108D-S   0.051706  100       10.9      1.5        0
ST108E     RG1          ST108E-S   0.027193  100       25        1.5        0
ST108F     RG1          108        0.382042  44.286    85.96     1.2        0
ST109A     RG1          109        0.013537  100       18.2      10         0
ST109B     RG1          ST109B-S   0.054305  100       24.8      1          0
ST109C     RG1          ST109C-S   0.058618  100       25.8      1          0
ST110A     RG1          110        0.074661  7.143     16.799    0.8        0
ST110B     RG1          110        0.031906  100       24.5      10         0
ST110C     RG1          110        0.029561  100       26.6      10         0
ST110D     RG1          110        0.074098  7.143     16.672    0.8        0
ST111A     RG1          ST111A-S   0.242699  72.857    107.5     0.8        0
ST111B     RG1          111        0.037296  100       88        0.8        0
ST111C     RG1          ST111C-S   0.043507  85.714    36.8      1.5        0
ST507A     RG1          ST507A-S   0.054432  72.857    33.5      1.5        0
    
```

160401195_100SCS.inp

ST508A RG1 508 0.3356 7.143 189.2 1 0

[SUBAREAS]

Subcatchment	N-Imperv	N-Perv	S-Imperv	S-Perv	PctZero	RouteTo	PctRouted
EXT1	0.013	0.2	1.57	4.67	0	PERVIOUS	100
EXT2	0.013	0.2	1.57	4.67	0	PERVIOUS	100
ST104A	0.013	0.2	1.57	4.67	0	IMPERVIOUS	100
ST107A	0.013	0.2	1.57	4.67	0	IMPERVIOUS	100
ST108A	0.013	0.2	1.57	4.67	0	IMPERVIOUS	100
ST108B	0.013	0.2	1.57	4.67	0	IMPERVIOUS	100
ST108C	0.013	0.2	1.57	4.67	0	IMPERVIOUS	100
ST108D	0.013	0.2	1.57	4.67	0	IMPERVIOUS	100
ST108E	0.013	0.2	1.57	4.67	0	IMPERVIOUS	100
ST108F	0.013	0.2	1.57	4.67	0	PERVIOUS	100
ST109A	0.013	0.2	1.57	4.67	0	IMPERVIOUS	100
ST109B	0.013	0.2	1.57	4.67	0	IMPERVIOUS	100
ST109C	0.013	0.2	1.57	4.67	0	IMPERVIOUS	100
ST110A	0.013	0.2	1.57	4.67	0	PERVIOUS	100
ST110B	0.013	0.2	1.57	4.67	0	IMPERVIOUS	100
ST110C	0.013	0.2	1.57	4.67	0	IMPERVIOUS	100
ST110D	0.013	0.2	1.57	4.67	0	PERVIOUS	100
ST111A	0.013	0.2	1.57	4.67	0	IMPERVIOUS	100
ST111B	0.013	0.2	1.57	4.67	0	IMPERVIOUS	100
ST111C	0.013	0.2	1.57	4.67	0	IMPERVIOUS	100
ST507A	0.013	0.2	1.57	4.67	0	IMPERVIOUS	100
ST508A	0.013	0.2	1.57	4.67	0	PERVIOUS	100

[INFILTRATION]

Subcatchment	CurveNum	HydCon	DryTime
EXT1	80	0	7
EXT2	80	0	7
ST104A	80	0	7
ST107A	80	0	7
ST108A	80	0	7
ST108B	80	0	7
ST108C	80	0	7
ST108D	80	0	7
ST108E	80	0	7
ST108F	80	0	7
ST109A	80	0	7
ST109B	80	0	7
ST109C	80	0	7
ST110A	80	0	7
ST110B	80	0	7

160401195_100SCS.inp

ST110C	80	0	7
ST110D	80	0	7
ST111A	80	0	7
ST111B	80	0.5	7
ST111C	80	0	7
ST507A	80	0	7
ST508A	80	0	7

[JUNCTIONS]

Name	Invert Elev.	Max. Depth	Init. Depth	Surcharge Depth	Ponded Area
100	99.4	2.735	0	0	0
101	99.60313	3.691	0	0	0
102	99.7793	3.752	0	0	0
103	100.035	3.526	0	0	0
104	100.0785	3.492	0	0	0
105	100.2317	3.406	0	0	0
106	100.3418	2.976	0	0	0
107	100.8033	2.417	0	0	0
109	100.83	3.67	0	0	0
110	100.686	3.814	0	0	0
111	101.4225	2.65	0	0	0

[OUTFALLS]

Name	Invert Elev.	Outfall Type	Stage/Table Time Series	Tide Gate	Route To
EXT1-OF	102.88	FREE		NO	
EXT2-OF	104.2	FREE		NO	
HEADWALL	98.7	FREE		NO	
POOLE_OF1	100.1	FREE		NO	
POOLE_OF2	101.059	FREE		NO	
ST104A-OF	0	FREE		NO	
ST107A-OF	0	FREE		NO	

[STORAGE]

Name	Invert Elev.	Max. Depth	Init. Depth	Storage Curve	Curve Params	Ponded Area	Evap. Frac.
Infiltration parameters							
108	97.239	7.127	0	TABULAR	RWhtank	0	0
508	101.06	1.79	0	TABULAR	ST508A-S	0	0
ST104A-S	101.52	2.1	0	TABULAR	ST104A-S	0.01	0
ST107A-S	101.13	2.1	0	TABULAR	ST107A-S	0.01	0
ST108A-S	118.6	0.15	0	TABULAR	ST108A	0.01	0
ST108B-S	115.75	0.15	0	TABULAR	ST108B	0.01	0

160401195_100SCS.inp							
ST108C-S	110.4	0.15	0	TABULAR	ST108C	0.01	0
ST108D-S	110.1	0.15	0	TABULAR	ST108D	0.01	0
ST108E-S	107.2	0.15	0	TABULAR	ST108E	0.01	0
ST109B-S	102.81	1.5	0	FUNCTIONAL	0	0	0
ST109C-S	102.81	1.5	0	FUNCTIONAL	0	0	0
ST111A-S	101.86	2.4	0	TABULAR	ST111A-S	0.01	0
ST111C-S	101.95	2.1	0	FUNCTIONAL	0	0	0
ST507A-S	101.57	2.1	0	TABULAR	ST504A-S	0.01	0
TANK	100.1	3.27	0	TABULAR	TANK	0.01	0

[CONDUITS]							
;;	Inlet	Outlet		Manning	Inlet	Outlet	Init.
Max. Flow	Node	Node	Length	N	Offset	Offset	Flow
;;	-----						
Pipe_13	100	HEADWALL	11.135	0.013	99.548	99.52	0 0
Pipe_14	106	105	17.55995	0.013	100.411	100.376	0 0
Pipe_14_(1)	105	104	39.10268	0.013	100.301	100.222	0 0
Pipe_15	109	104	38.24086	0.013	100.83	100.447	0 0
Pipe_16	110	106	12.50838	0.013	100.686	100.561	0 0
Pipe_17	111	107	110.3626	0.013	101.65	100.877	0 0
Pipe_21	104	103	16.284	0.013	100.143	100.11	0 0
Pipe_23	508	TANK	8.730414	0.013	101.6588	101.637	0 0
Pipe_26	101	100	101.5684	0.013	99.936	99.733	0 0
Pipe_27	108	105	36.34	0.013	100.441	100.332	0 0
Pipe_29	107	106	63.29649	0.013	100.802	100.486	0 0
Pipe_31	102	101	70.701	0.013	100.083	99.942	0 0
Pipe_34	103	TANK	2.81	0.013	100.106	100.1	0 0
ST104A-T	ST104A-S	ST104A-OF	2.5	0.025	103.47	102.88	0 0
ST107A-T	ST107A-S	ST107A-OF	2.5	0.025	103.08	103.04	0 0
ST111A-T	ST111A-S	ST111C-S	40.9	0.013	104.26	103.75	0 0

160401195_100SCS.inp							
ST111B-T	ST111C-S	ST107A-S	60	0.013	103.75	103.08	0 0
ST507A-T	ST507A-S	ST104A-S	14.9	0.013	103.5	103.47	0 0
W1	103	102	3	0.013	102	101.97	0 0

[ORIFICES]							
;;	Inlet	Outlet	Orifice	Crest	Disch.	Flap	Open/Close
;;Name	Node	Node	Type	Height	Coeff.	Gate	Time
;;	-----						
OR1	TANK	102	SIDE	100.1	0.65	NO	0
OR2	TANK	102	SIDE	100.7	0.65	NO	0
OR3	TANK	102	SIDE	101	0.65	NO	0
ST104A-0	ST104A-S	104	SIDE	101.52	0.572	NO	0
ST107A-0	ST107A-S	107	SIDE	101.13	0.65	NO	0
ST109B-0	ST109B-S	109	SIDE	102.81	0.65	NO	0
ST109C-0	ST109C-S	109	SIDE	102.81	0.65	NO	0
ST111A-0	ST111A-S	111	SIDE	101.86	0.572	NO	0
ST111C-0	ST111C-S	111	SIDE	101.95	0.65	NO	0
ST111C-01	ST111C-S	111	SIDE	101.95	0.65	NO	0

[OUTLETS]							
;;	Inlet	Outlet	Outflow	Outlet	Qcoeff/		
Flap	Node	Node	Height	Type	QTable	Qexpon	
;;Name Gate	-----						
OL1	TANK	POOLE_OF1	100.1	TABULAR/HEAD	TANK_BASEFLOW		
NO							
OL2	508	POOLE_OF2	101.06	TABULAR/HEAD	BIOSWALE_BASEFLOW		
NO							
ST108A-0	ST108A-S	108	118.6	TABULAR/HEAD	ST108A-0		
NO							
ST108B-0	ST108B-S	108	115.75	TABULAR/HEAD	ST108B-0		
NO							
ST108C-0	ST108C-S	108	110.4	TABULAR/HEAD	ST108C-0		
NO							
ST108D-0	ST108D-S	108	110.1	TABULAR/HEAD	ST108D-0		
NO							
ST108E-0	ST108E-S	108	107.2	TABULAR/HEAD	ST108E-0		
NO							
ST507A-0	ST507A-S	TANK	101.57	FUNCTIONAL/HEAD	7.996	0.499	
NO							

[XSECTIONS]

160401195_100SCS.inp

;;Link	Shape	Geom1	Geom2	Geom3	Geom4	Barrels
Pipe_13	CIRCULAR	0.675	0	0	0	1
Pipe_14	CIRCULAR	0.525	0	0	0	1
Pipe_14_(1)	CIRCULAR	0.6	0	0	0	1
Pipe_15	CIRCULAR	0.375	0	0	0	1
Pipe_16	CIRCULAR	0.375	0	0	0	1
Pipe_17	CIRCULAR	0.375	0	0	0	1
Pipe_21	CIRCULAR	0.675	0	0	0	1
Pipe_23	CIRCULAR	0.25	0	0	0	1
Pipe_26	CIRCULAR	0.45	0	0	0	1
Pipe_27	CIRCULAR	0.45	0	0	0	1
Pipe_29	CIRCULAR	0.45	0	0	0	1
Pipe_31	CIRCULAR	0.45	0	0	0	1
Pipe_34	CIRCULAR	0.675	0	0	0	1
ST104A-T	IRREGULAR	overland	0	0	0	1
ST107A-T	IRREGULAR	overland	0	0	0	1
ST111A-T	IRREGULAR	overland	0	0	0	1
ST111B-T	IRREGULAR	overland	0	0	0	1
ST507A-T	IRREGULAR	overland	0	0	0	1
W1	CIRCULAR	0.45	0	0	0	1
OR1	CIRCULAR	0.11	0	0	0	
OR2	CIRCULAR	0.15	0	0	0	
OR3	CIRCULAR	0.15	0	0	0	
ST104A-O	CIRCULAR	0.14	0	0	0	
ST107A-O	CIRCULAR	0.2	0	0	0	
ST109B-O	CIRCULAR	0.2	0	0	0	
ST109C-O	CIRCULAR	0.2	0	0	0	
ST111A-O	CIRCULAR	0.076	0	0	0	
ST111C-O	CIRCULAR	0.2	0	0	0	
ST111C-O1	CIRCULAR	0.2	0	0	0	

[TRANSECTS]

NC 0.013	0.013	0.013								
X1 overland	5	0	0.15	6.85	0.0	0.0	0.0	0.0	0.0	0.0
GR 0.15	0	0	0.15	0	6.85	0.15	7	0.15	7	

;;[LE: 0][RE: 7]

NC 0.013	0.013	0.013								
X1 overland(orig)	4	0	0.15	6.85	0.0	0.0	0.0	0.0	0.0	0.0
GR 0.15	0	0	0.15	0	6.85	0.15	7			

[LOSSES]

;;Link	Inlet	Outlet	Average	Flap Gate	SeepageRate
Pipe_14	0	0.053	0	NO	0
Pipe_14_(1)	0	0.022	0	NO	0

Page 7

160401195_100SCS.inp

Pipe_15	0	1.344	0	NO	0
Pipe_16	0	1.344	0	NO	0
Pipe_17	0	1.344	0	NO	0
Pipe_21	0	0.022	0	NO	0
Pipe_26	0	0.423	0	NO	0
Pipe_27	0	1.344	0	NO	0
Pipe_29	0	0.053	0	NO	0
Pipe_31	0	1.344	0	NO	0
W1	0	1.344	0	NO	0

[INFLOWS]

;;Node	Parameter	Time Series	Param Type	Units Factor	Scale Factor	Baseline Value	Baseline Pattern
100	FLOW	""	FLOW	1.0	1	175	

[CURVES]

;;Name	Type	X-Value	Y-Value
BIOSWALE_BASEFLOW	Rating	0.00	0
BIOSWALE_BASEFLOW		0.01	0.3
BIOSWALE_BASEFLOW		10.00	0.3
ST108A-O	Rating	0	0
ST108A-O		0.025	5.4
ST108A-O		0.050	10.8
ST108A-O		0.075	16.1
ST108A-O		0.100	21.5
ST108A-O		0.125	26.9
ST108A-O		0.150	32.3
ST108B-O	Rating	0	0
ST108B-O		0.025	5.0
ST108B-O		0.050	10.0
ST108B-O		0.075	15.0
ST108B-O		0.100	20.0
ST108B-O		0.125	25.0
ST108B-O		0.150	30.0
ST108C-O	Rating	0	0
ST108C-O		0.025	0.8
ST108C-O		0.050	1.5
ST108C-O		0.075	2.3
ST108C-O		0.100	3.1
ST108C-O		0.125	3.8
ST108C-O		0.150	4.6
ST108D-O	Rating	0	0

Page 8

ST108D-0		0.025	0.8
ST108D-0		0.050	1.5
ST108D-0		0.075	2.3
ST108D-0		0.100	3.1
ST108D-0		0.125	3.8
ST108D-0		0.150	4.6
ST108E-0	Rating	0	0
ST108E-0		0.025	0.4
ST108E-0		0.050	0.8
ST108E-0		0.075	1.2
ST108E-0		0.100	1.5
ST108E-0		0.125	1.9
ST108E-0		0.150	2.3
TANK_BASEFLOW	Rating	0.00	0
TANK_BASEFLOW		0.01	0.66
TANK_BASEFLOW		10.00	0.66
RWhtank	Storage	0	113.747
RWhtank		3.202	113.747
RWhtank		3.203	0
RWhtank		5	0
ST104A-S	Storage	0	0
ST104A-S		1.8	0
ST104A-S		1.95	32
ST107A-S	Storage	0	0
ST107A-S		1.8	0
ST107A-S		1.95	30.67
ST108A	Storage	0	0
ST108A		0.025	90
ST108A		0.050	359
ST108A		0.075	808
ST108A		0.100	1436
ST108A		0.125	2243
ST108A		0.150	3230
ST108B	Storage	0	0
ST108B		0.025	81
ST108B		0.050	324
ST108B		0.075	729
ST108B		0.100	1296
ST108B		0.125	2024
ST108B		0.150	2915

ST108C	Storage	0	0
ST108C		0.025	10
ST108C		0.050	42
ST108C		0.075	94
ST108C		0.100	167
ST108C		0.125	262
ST108C		0.150	377
ST108D	Storage	0	0
ST108D		0.025	11
ST108D		0.050	46
ST108D		0.075	103
ST108D		0.100	184
ST108D		0.125	287
ST108D		0.150	414
ST108E	Storage	0	0
ST108E		0.025	6
ST108E		0.050	24
ST108E		0.075	54
ST108E		0.100	97
ST108E		0.125	151
ST108E		0.150	218
ST111A-S	Storage	0	0
ST111A-S		2.10	0
ST111A-S		2.40	724
ST504A-S	Storage	0	0
ST504A-S		1.8	0
ST504A-S		1.93	181.54
ST508A-S	Storage	0	0
ST508A-S		0.7	152
ST508A-S		0.701	0
ST508A-S		1.741	0
ST508A-S		1.991	114.4
TANK	Storage	0	560.7
TANK		0.026	560.7
TANK		0.051	560.7
TANK		0.077	560.7
TANK		0.102	559.44
TANK		0.127	559.44
TANK		0.153	558.18
TANK		0.178	556.92
TANK		0.204	555.66
TANK		0.229	554.4

160401195_100SCS.inp

TANK	0.254	551.88
TANK	0.28	549.36
TANK	0.305	546.84
TANK	0.331	543.06
TANK	0.356	539.28
TANK	0.381	534.24
TANK	0.407	527.94
TANK	0.432	521.64
TANK	0.458	514.08
TANK	0.483	505.26
TANK	0.508	495.18
TANK	0.534	483.84
TANK	0.559	478.8
TANK	0.585	464.94
TANK	0.61	449.82
TANK	0.635	434.7
TANK	0.661	419.58
TANK	0.686	403.2
TANK	0.712	383.04
TANK	0.737	360.36
TANK	0.762	347.76
TANK	0.796	335.16
TANK	0.813	320.04
TANK	0.839	304.92
TANK	0.864	289.8
TANK	0.889	272.16
TANK	0.915	258.3
TANK	0.94	244.44
TANK	0.965	233.1
TANK	0.991	221.76
TANK	1.016	211.68
TANK	1.041	201.6
TANK	1.067	192.78
TANK	1.092	185.22
TANK	1.118	180.18
TANK	1.143	176.4
TANK	1.168	172.62
TANK	1.194	170.1
TANK	1.219	167.58
TANK	1.245	165.06
TANK	1.27	163.8
TANK	1.295	162.54
TANK	1.321	162.54
TANK	1.346	162.54
TANK	1.372	161.28
TANK	1.397	161.28
TANK	1.422	161.28
TANK	1.448	161.28

Page 11

160401195_100SCS.inp

TANK	1.473	161.28
TANK	1.499	161.28
TANK	1.524	161.28
TANK	1.549	161.28
TANK	1.575	161.28
TANK	1.6	161.28
TANK	1.626	161.28
TANK	1.651	161.28
TANK	1.676	161.28
TANK	1.702	161.28
TANK	1.727	161.28
TANK	1.753	161.28
TANK	1.778	161.28
TANK	1.803	161.28
TANK	1.829	161.28
TANK	1.83	0
TANK	5	0

Page 12

**SERVICING AND STORMWATER MANAGEMENT BRIEF –
5731 HAZELDEAN ROAD**

Appendix C Stormwater Management
March 22, 2017

C.3 SAMPLE PCSWMM MODEL OUTPUT (12HR 100YR SCS)

Legend

- Junctions
- ▲ Outfalls
- Storages
- Conduits
 - Visible
 - - - Major_Overland
 - Orifices
 - Outlets
- Subcatchments
- ACAD-160401195 SP

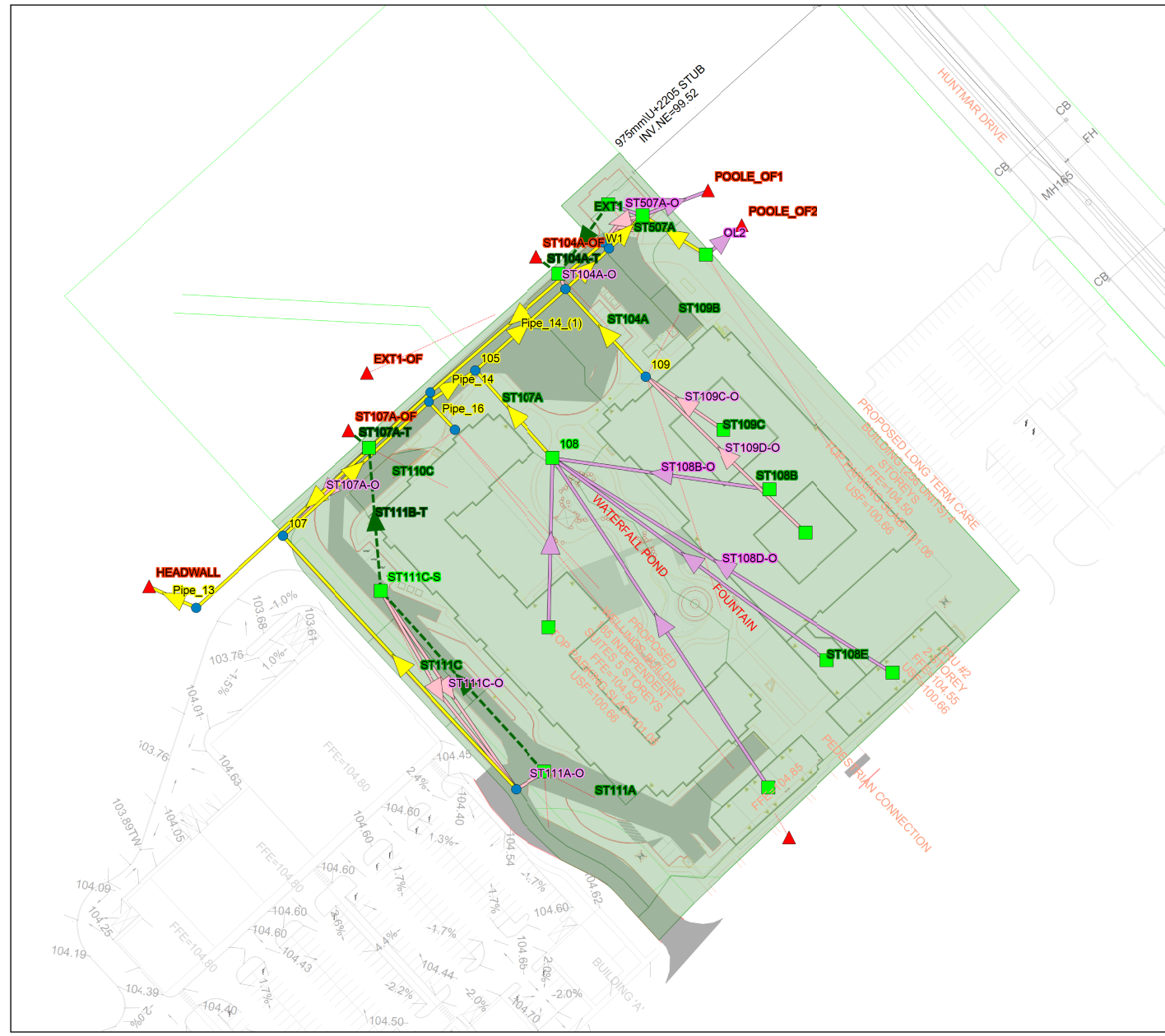
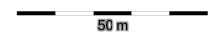

WARNING 03: negative offset ignored for Link Pipe_29

Element Count

Number of rain gages 1
Number of subcatchments ... 22
Number of nodes 33
Number of links 37
Number of pollutants 0
Number of land uses 0

Raingage Summary

Name	Data Source	Data Type	Recording Interval
RG1	100SCS	INTENSITY	15 min.

Subcatchment Summary

Name	Area	Width	%Imperv	%Slope	Rain Gage	Outlet
EXT1	0.07	15.12	0.00	33.3000	RG1	EXT1-OF
EXT2	0.06	14.35	72.86	2.0000	RG1	EXT2-OF
ST104A	0.15	69.00	84.29	2.0000	RG1	ST104A-S
ST107A	0.37	225.00	64.29	1.5000	RG1	ST107A-S
ST108A	0.40	90.86	100.00	1.5000	RG1	ST108A-S
ST108B	0.36	81.98	100.00	1.5000	RG1	ST108B-S
ST108C	0.05	12.10	100.00	1.5000	RG1	ST108C-S
ST108D	0.05	10.90	100.00	1.5000	RG1	ST108D-S
ST108E	0.03	25.00	100.00	1.5000	RG1	ST108E-S
ST108F	0.38	85.96	44.29	1.2000	RG1	108
ST109A	0.01	18.20	100.00	10.0000	RG1	109
ST109B	0.05	24.80	100.00	1.0000	RG1	ST109B-S
ST109C	0.06	25.80	100.00	1.0000	RG1	ST109C-S
ST110A	0.07	16.80	7.14	0.8000	RG1	110
ST110B	0.03	24.50	100.00	10.0000	RG1	110
ST110C	0.03	26.60	100.00	10.0000	RG1	110

Name	Area	Width	%Imperv	%Slope	Rain Gage	Outlet
ST110D	0.07	16.67	7.14	0.8000	RG1	110
ST111A	0.24	107.50	72.86	0.8000	RG1	ST111A-S
ST111B	0.04	88.00	100.00	0.8000	RG1	111
ST111C	0.04	36.80	85.71	1.5000	RG1	ST111C-S
ST507A	0.05	33.50	72.86	1.5000	RG1	ST507A-S
ST508A	0.34	189.20	7.14	1.0000	RG1	508

Node Summary

Name	Type	Invert Elev.	Max. Depth	Ponded Area	External Inflow
100	JUNCTION	99.40	2.73	0.0	Yes
101	JUNCTION	99.60	3.69	0.0	
102	JUNCTION	99.78	3.75	0.0	
103	JUNCTION	100.04	3.53	0.0	
104	JUNCTION	100.08	3.49	0.0	
105	JUNCTION	100.23	3.41	0.0	
106	JUNCTION	100.34	2.98	0.0	
107	JUNCTION	100.80	2.42	0.0	
109	JUNCTION	100.83	3.67	0.0	
110	JUNCTION	100.69	3.81	0.0	
111	JUNCTION	101.42	2.65	0.0	
EXT1-OF	OUTFALL	102.88	0.00	0.0	
EXT2-OF	OUTFALL	104.20	0.00	0.0	
HEADWALL	OUTFALL	98.70	1.50	0.0	
POOLE_OF1	OUTFALL	100.10	0.00	0.0	
POOLE_OF2	OUTFALL	101.06	0.00	0.0	
ST104A-OF	OUTFALL	0.00	103.03	0.0	
ST107A-OF	OUTFALL	0.00	103.19	0.0	
108	STORAGE	97.24	7.13	0.0	
508	STORAGE	101.06	1.79	0.0	
ST104A-S	STORAGE	101.52	2.10	0.0	
ST107A-S	STORAGE	101.13	2.10	0.0	
ST108A-S	STORAGE	118.60	0.15	0.0	
ST108B-S	STORAGE	115.75	0.15	0.0	
ST108C-S	STORAGE	110.40	0.15	0.0	
ST108D-S	STORAGE	110.10	0.15	0.0	
ST108E-S	STORAGE	107.20	0.15	0.0	
ST109B-S	STORAGE	102.81	1.50	0.0	
ST109C-S	STORAGE	102.81	1.50	0.0	
ST111A-S	STORAGE	101.86	2.40	0.0	
ST111C-S	STORAGE	101.95	2.10	0.0	
ST507A-S	STORAGE	101.57	2.10	0.0	
TANK	STORAGE	100.10	3.27	0.0	

Link Summary

Name	From Node	To Node	Type	Length	%Slope	Roughness
Pipe_13	100	HEADWALL	CONDUIT	11.1	0.2515	0.0130
Pipe_14	106	105	CONDUIT	17.6	0.1993	0.0130
Pipe_14_(1)	105	104	CONDUIT	39.1	0.2020	0.0130
Pipe_15	109	104	CONDUIT	38.2	1.0016	0.0130
Pipe_16	110	106	CONDUIT	12.5	0.9994	0.0130
Pipe_17	111	107	CONDUIT	110.4	0.7004	0.0130
Pipe_21	104	103	CONDUIT	16.3	0.2027	0.0130
Pipe_23	508	TANK	CONDUIT	8.7	0.2497	0.0130
Pipe_26	101	100	CONDUIT	101.6	0.1999	0.0130
Pipe_27	108	105	CONDUIT	36.3	0.2999	0.0130
Pipe_29	107	106	CONDUIT	63.3	0.5013	0.0130
Pipe_31	102	101	CONDUIT	70.7	0.1994	0.0130
Pipe_34	103	TANK	CONDUIT	2.8	0.2135	0.0130
ST104A-T	ST104A-S	ST104A-OF	CONDUIT	2.5	24.2860	0.0130
ST107A-T	ST107A-S	ST107A-OF	CONDUIT	2.5	1.6002	0.0130
ST111A-T	ST111A-S	ST111C-S	CONDUIT	40.9	1.2470	0.0130
ST111B-T	ST111C-S	ST107A-S	CONDUIT	60.0	1.1167	0.0130
ST507A-T	ST507A-S	ST104A-S	CONDUIT	14.9	0.2013	0.0130
w1	103	102	CONDUIT	3.0	1.0001	0.0130
OR1	TANK	102	ORIFICE			
OR2	TANK	102	ORIFICE			
OR3	TANK	102	ORIFICE			
ST104A-O	ST104A-S	104	ORIFICE			
ST107A-O	ST107A-S	107	ORIFICE			
ST109B-O	ST109B-S	109	ORIFICE			
ST109C-O	ST109C-S	109	ORIFICE			
ST111A-O	ST111A-S	111	ORIFICE			
ST111C-O	ST111C-S	111	ORIFICE			
ST111C-01	ST111C-S	111	ORIFICE			
OL1	TANK	POOLE_OF1	OUTLET			
OL2	508	POOLE_OF2	OUTLET			
ST108A-O	ST108A-S	108	OUTLET			
ST108B-O	ST108B-S	108	OUTLET			
ST108C-O	ST108C-S	108	OUTLET			
ST108D-O	ST108D-S	108	OUTLET			
ST108E-O	ST108E-S	108	OUTLET			
ST507A-O	ST507A-S	TANK	OUTLET			

Cross Section Summary

Conduit	Shape	Full Depth	Full Area	Hyd. Rad.	Max. Width	No. of Barrels	Full Flow
Pipe_13	CIRCULAR	0.68	0.36	0.17	0.68	1	421.55
Pipe_14	CIRCULAR	0.53	0.22	0.13	0.53	1	192.01
Pipe_14_(1)	CIRCULAR	0.60	0.28	0.15	0.60	1	276.00
Pipe_15	CIRCULAR	0.38	0.11	0.09	0.38	1	175.48
Pipe_16	CIRCULAR	0.38	0.11	0.09	0.38	1	175.29
Pipe_17	CIRCULAR	0.38	0.11	0.09	0.38	1	146.75
Pipe_21	CIRCULAR	0.68	0.36	0.17	0.68	1	378.43
Pipe_23	CIRCULAR	0.25	0.05	0.06	0.25	1	29.72
Pipe_26	CIRCULAR	0.45	0.16	0.11	0.45	1	127.47
Pipe_27	CIRCULAR	0.45	0.16	0.11	0.45	1	156.15
Pipe_29	CIRCULAR	0.45	0.16	0.11	0.45	1	201.87
Pipe_31	CIRCULAR	0.45	0.16	0.11	0.45	1	127.33
Pipe_34	CIRCULAR	0.68	0.36	0.17	0.68	1	388.45
ST104A-T	overland	0.15	1.03	0.14	7.00	1	10684.06
ST107A-T	overland	0.15	1.03	0.14	7.00	1	2742.50
ST111A-T	overland	0.15	1.03	0.14	7.00	1	2421.02
ST111B-T	overland	0.15	1.03	0.14	7.00	1	2291.05
ST507A-T	overland	0.15	1.03	0.14	7.00	1	972.81
w1	CIRCULAR	0.45	0.16	0.11	0.45	1	285.13

Transect Summary

Transect Overland Area:

0.0196	0.0392	0.0588	0.0784	0.0980
0.1177	0.1374	0.1571	0.1768	0.1965
0.2162	0.2360	0.2558	0.2756	0.2954
0.3152	0.3351	0.3550	0.3748	0.3947
0.4147	0.4346	0.4546	0.4745	0.4945
0.5145	0.5346	0.5546	0.5747	0.5947
0.6148	0.6350	0.6551	0.6752	0.6954
0.7156	0.7358	0.7560	0.7762	0.7965
0.8168	0.8371	0.8574	0.8777	0.8980
0.9184	0.9388	0.9592	0.9796	1.0000
Hrad:				
0.0208	0.0415	0.0622	0.0829	0.1036
0.1242	0.1448	0.1653	0.1858	0.2063
0.2268	0.2472	0.2676	0.2879	0.3083
0.3285	0.3488	0.3690	0.3892	0.4094
0.4295	0.4496	0.4697	0.4897	0.5097
0.5297	0.5496	0.5695	0.5894	0.6093

	0.6291	0.6489	0.6686	0.6884	0.7081
	0.7277	0.7474	0.7670	0.7865	0.8061
	0.8256	0.8451	0.8646	0.8840	0.9034
	0.9228	0.9421	0.9614	0.9807	1.0000
width:	0.9580	0.9589	0.9597	0.9606	0.9614
	0.9623	0.9631	0.9640	0.9649	0.9657
	0.9666	0.9674	0.9683	0.9691	0.9700
	0.9709	0.9717	0.9726	0.9734	0.9743
	0.9751	0.9760	0.9769	0.9777	0.9786
	0.9794	0.9803	0.9811	0.9820	0.9829
	0.9837	0.9846	0.9854	0.9863	0.9871
	0.9880	0.9889	0.9897	0.9906	0.9914
	0.9923	0.9931	0.9940	0.9949	0.9957
	0.9966	0.9974	0.9983	0.9991	1.0000
Transect overland(orig)					
Area:	0.0196	0.0392	0.0588	0.0784	0.0980
	0.1177	0.1374	0.1571	0.1768	0.1965
	0.2162	0.2360	0.2558	0.2756	0.2954
	0.3152	0.3351	0.3550	0.3748	0.3947
	0.4147	0.4346	0.4546	0.4745	0.4945
	0.5145	0.5346	0.5546	0.5747	0.5947
	0.6148	0.6350	0.6551	0.6752	0.6954
	0.7156	0.7358	0.7560	0.7762	0.7965
	0.8168	0.8371	0.8574	0.8777	0.8980
	0.9184	0.9388	0.9592	0.9796	1.0000
Hrad:	0.0208	0.0415	0.0622	0.0829	0.1036
	0.1242	0.1448	0.1653	0.1858	0.2063
	0.2268	0.2472	0.2676	0.2879	0.3083
	0.3285	0.3488	0.3690	0.3892	0.4094
	0.4295	0.4496	0.4697	0.4897	0.5097
	0.5297	0.5496	0.5695	0.5894	0.6093
	0.6291	0.6489	0.6686	0.6884	0.7081
	0.7277	0.7474	0.7670	0.7865	0.8061
	0.8256	0.8451	0.8646	0.8840	0.9034
	0.9228	0.9421	0.9614	0.9807	1.0000
width:	0.9580	0.9589	0.9597	0.9606	0.9614
	0.9623	0.9631	0.9640	0.9649	0.9657
	0.9666	0.9674	0.9683	0.9691	0.9700
	0.9709	0.9717	0.9726	0.9734	0.9743
	0.9751	0.9760	0.9769	0.9777	0.9786
	0.9794	0.9803	0.9811	0.9820	0.9829
	0.9837	0.9846	0.9854	0.9863	0.9871
	0.9880	0.9889	0.9897	0.9906	0.9914

	0.9923	0.9931	0.9940	0.9949	0.9957
	0.9966	0.9974	0.9983	0.9991	1.0000

 NOTE: The summary statistics displayed in this report are based on results found at every computational time step, not just on results from each reporting time step.

 Analysis Options

Flow Units LPS
 Process Models:
 Rainfall/Runoff YES
 RDII NO
 Snowmelt NO
 Groundwater NO
 Flow Routing YES
 Ponding Allowed YES
 Water Quality NO
 Infiltration Method CURVE_NUMBER
 Flow Routing Method DYNWAVE
 Starting Date 07/23/2009 00:00:00
 Ending Date 07/24/2009 00:00:00
 Antecedent Dry Days 0.0
 Report Time Step 00:05:00
 Wet Time Step 00:05:00
 Dry Time Step 00:05:00
 Routing Time Step 1.00 sec
 Variable Time Step NO
 Maximum Trials 8
 Number of Threads 4
 Head Tolerance 0.001500 m

	Volume hectare-m	Depth mm

Runoff Quantity Continuity		

Total Precipitation	0.285	95.520
Evaporation Loss	0.000	0.000
Infiltration Loss	0.041	13.902
Surface Runoff	0.239	80.308
Final Storage	0.005	1.589
Continuity Error (%)	-0.292	

Flow Routing Continuity	Volume hectare-m	Volume 10 ⁶ ltr
Dry weather Inflow	0.000	0.000
Wet weather Inflow	0.239	2.394
Groundwater Inflow	0.000	0.000
RDII Inflow	0.000	0.000
External Inflow	1.512	15.120
External Outflow	1.711	17.108
Flooding Loss	0.000	0.000
Evaporation Loss	0.000	0.000
Exfiltration Loss	0.000	0.000
Initial Stored Volume	0.000	0.000
Final Stored Volume	0.041	0.409
Continuity Error (%)	-0.017	

 Highest Flow Instability Indexes

 Link Pipe_34 (3)

 Routing Time Step Summary

Minimum Time Step	: 1.00 sec
Average Time Step	: 1.00 sec
Maximum Time Step	: 1.00 sec
Percent in Steady State	: 0.00
Average Iterations per Step	: 2.00
Percent Not Converging	: 0.05

 Subcatchment Runoff Summary

Subcatchment	Total Precip mm	Total Runon mm	Total Evap mm	Total Infil mm	Total Runoff mm	Total Runoff 10 ⁶ ltr	Peak Runoff LPS	Runoff Coeff
EXT1	95.52	0.00	0.00	41.82	52.63	0.04	16.91	0.551
EXT2	95.52	0.00	0.00	11.35	83.12	0.05	20.73	0.870
ST104A	95.52	0.00	0.00	6.56	87.63	0.13	50.18	0.917
ST107A	95.52	0.00	0.00	14.94	79.28	0.30	115.66	0.830
ST108A	95.52	0.00	0.00	0.00	94.37	0.38	142.13	0.988

ST108B	95.52	0.00	0.00	0.00	94.37	0.34	128.25	0.988
ST108C	95.52	0.00	0.00	0.00	94.35	0.04	16.57	0.988
ST108D	95.52	0.00	0.00	0.00	94.37	0.05	18.20	0.988
ST108E	95.52	0.00	0.00	0.00	94.08	0.03	9.57	0.985
ST108F	95.52	0.00	0.00	23.30	70.82	0.27	102.04	0.741
ST109A	95.52	0.00	0.00	0.00	93.98	0.01	4.76	0.984
ST109B	95.52	0.00	0.00	0.00	94.28	0.05	19.11	0.987
ST109C	95.52	0.00	0.00	0.00	94.29	0.06	20.63	0.987
ST110A	95.52	0.00	0.00	38.83	54.74	0.04	12.92	0.573
ST110B	95.52	0.00	0.00	0.00	93.99	0.03	11.23	0.984
ST110C	95.52	0.00	0.00	0.00	93.99	0.03	10.41	0.984
ST110D	95.52	0.00	0.00	38.83	54.74	0.04	12.82	0.573
ST111A	95.52	0.00	0.00	11.35	82.89	0.20	77.09	0.868
ST111B	95.52	0.00	0.00	0.00	94.00	0.04	13.13	0.984
ST111C	95.52	0.00	0.00	5.96	88.16	0.04	14.64	0.923
ST507A	95.52	0.00	0.00	11.34	82.85	0.05	17.48	0.867
ST508A	95.52	0.00	0.00	38.83	55.31	0.19	79.58	0.579

 Node Depth Summary

Node	Type	Average Depth Meters	Maximum Depth Meters	Maximum HGL Meters	Time of Max Occurrence days hr:min	Reported Max Depth Meters
100	JUNCTION	0.44	0.52	99.92	0 06:53	0.52
101	JUNCTION	0.41	0.74	100.34	0 06:53	0.74
102	JUNCTION	0.39	0.76	100.54	0 06:52	0.76
103	JUNCTION	0.45	1.94	101.97	0 06:52	1.93
104	JUNCTION	0.41	1.90	101.98	0 06:52	1.89
105	JUNCTION	0.34	1.76	101.99	0 06:52	1.75
106	JUNCTION	0.29	1.65	101.99	0 06:52	1.64
107	JUNCTION	0.12	1.20	102.00	0 06:52	1.19
109	JUNCTION	0.10	1.15	101.98	0 06:52	1.14
110	JUNCTION	0.13	1.31	101.99	0 06:52	1.30
111	JUNCTION	0.25	0.59	102.02	0 06:51	0.59
EXT1-OF	OUTFALL	0.00	0.00	102.88	0 00:00	0.00
EXT2-OF	OUTFALL	0.00	0.00	104.20	0 00:00	0.00
HEADWALL	OUTFALL	0.00	0.00	98.70	0 00:00	0.00
POOLE_OF1	OUTFALL	0.00	0.00	100.10	0 00:00	0.00
POOLE_OF2	OUTFALL	0.00	0.00	101.06	0 00:00	0.00
ST104A-OF	OUTFALL	0.00	0.00	0.00	0 00:00	0.00
ST107A-OF	OUTFALL	0.00	0.00	0.00	0 00:00	0.00
108	STORAGE	2.74	4.80	102.04	0 06:48	4.79
508	STORAGE	0.46	0.95	102.01	0 06:14	0.95

160401195_100SCS.rpt

ST104A-S	STORAGE	0.05	1.71	103.23	0	06:15	1.71
ST107A-S	STORAGE	0.09	1.72	102.85	0	06:15	1.71
ST108A-S	STORAGE	0.02	0.14	118.74	0	06:20	0.14
ST108B-S	STORAGE	0.02	0.14	115.89	0	06:20	0.14
ST108C-S	STORAGE	0.02	0.14	110.54	0	06:19	0.14
ST108D-S	STORAGE	0.02	0.14	110.24	0	06:19	0.14
ST108E-S	STORAGE	0.02	0.14	107.34	0	06:19	0.14
ST109B-S	STORAGE	0.01	0.15	102.96	0	06:10	0.15
ST109C-S	STORAGE	0.01	0.16	102.97	0	06:15	0.16
ST111A-S	STORAGE	0.23	2.32	104.18	0	06:24	2.32
ST111C-S	STORAGE	0.01	0.08	102.03	0	06:15	0.08
ST507A-S	STORAGE	0.06	1.87	103.44	0	06:17	1.87
TANK	STORAGE	0.38	1.87	101.97	0	06:52	1.86

Node Inflow Summary

Node	Type	Maximum Lateral Inflow LPS	Maximum Total Inflow LPS	Time of Max Occurrence days hr:min	Lateral Inflow Volume 10^6 ltr	Total Inflow Volume 10^6 ltr	Flow Balance Error Percent
100	JUNCTION	175.00	311.33	0 06:53	15.1	16.9	0.017
101	JUNCTION	0.00	136.63	0 06:52	0	1.83	-0.075
102	JUNCTION	0.00	136.71	0 06:52	0	1.83	0.036
103	JUNCTION	0.00	457.04	0 06:14	0	1.71	-0.003
104	JUNCTION	0.00	457.02	0 06:14	0	1.71	-0.145
105	JUNCTION	0.00	368.34	0 06:14	0	1.49	0.141
106	JUNCTION	0.00	206.19	0 06:14	0	0.707	-0.315
107	JUNCTION	0.00	159.99	0 06:15	0	0.569	0.194
109	JUNCTION	4.76	44.51	0 06:10	0.0127	0.119	0.473
110	JUNCTION	47.37	74.61	0 06:14	0.139	0.139	0.082
111	JUNCTION	13.13	45.04	0 06:15	0.0351	0.275	0.493
EXT1-OF	OUTFALL	16.91	16.91	0 06:15	0.0354	0.0354	0.000
EXT2-OF	OUTFALL	20.73	20.73	0 06:15	0.053	0.053	0.000
HEADWALL	OUTFALL	0.00	311.33	0 06:54	0	16.9	0.000
POOLE_OF1	OUTFALL	0.00	0.66	0 01:27	0	0.054	0.000
POOLE_OF2	OUTFALL	0.00	0.30	0 05:14	0	0.0203	0.000
ST104A-OF	OUTFALL	0.00	0.00	0 00:00	0	0	0.000
ST107A-OF	OUTFALL	0.00	0.00	0 00:00	0	0	0.000
108	STORAGE	102.04	240.16	0 06:13	0.271	1.14	-0.083
508	STORAGE	79.58	79.58	0 06:15	0.186	0.186	0.039
ST104A-S	STORAGE	50.18	50.18	0 06:15	0.131	0.131	0.004
ST107A-S	STORAGE	115.66	115.66	0 06:15	0.296	0.296	0.014
ST108A-S	STORAGE	142.13	142.13	0 06:15	0.381	0.381	-0.001

160401195_100SCS.rpt

ST108B-S	STORAGE	128.25	128.25	0 06:15	0.344	0.344	-0.001
ST108C-S	STORAGE	16.57	16.57	0 06:15	0.0444	0.0444	-0.001
ST108D-S	STORAGE	18.20	18.20	0 06:15	0.0488	0.0488	-0.001
ST108E-S	STORAGE	9.57	9.57	0 06:10	0.0256	0.0256	-0.000
ST109B-S	STORAGE	19.11	19.11	0 06:10	0.0512	0.0512	-0.000
ST109C-S	STORAGE	20.63	20.63	0 06:15	0.0553	0.0553	-0.000
ST111A-S	STORAGE	77.09	77.09	0 06:15	0.201	0.201	-0.001
ST111C-S	STORAGE	14.64	14.64	0 06:15	0.0384	0.0384	0.078
ST507A-S	STORAGE	17.48	17.48	0 06:15	0.0451	0.0451	-0.002
TANK	STORAGE	0.00	548.41	0 06:15	0	1.89	-0.001

Node Surcharge Summary

Surcharging occurs when water rises above the top of the highest conduit.

Node	Type	Hours Surcharged	Max. Height Above Crown Meters	Min. Depth Below Rim Meters
104	JUNCTION	4.28	1.156	1.592
105	JUNCTION	3.62	1.092	1.645
106	JUNCTION	3.40	1.058	1.324
107	JUNCTION	2.19	0.747	1.220
109	JUNCTION	2.28	0.773	2.522
110	JUNCTION	2.81	0.933	2.506

Node Flooding Summary

No nodes were flooded.

Storage Volume Summary

Storage Unit	Average Volume 1000 m3	Avg Pcnt Full	Evap Pcnt Loss	Exfil Pcnt Loss	Maximum Volume 1000 m3	Max Pcnt Full	Time of Max Occurrence days hr:min	Maximum Outflow LPS
108	0.288	79	0	0	0.364	100	0 06:13	210.40
508	0.030	55	0	0	0.053	99	0 06:13	79.31

160401195_100scs.rpt

ST104A-S	0.000	0	0	0	0.000	0	0	00:00	49.96
ST107A-S	0.000	0	0	0	0.000	0	0	00:00	114.99
ST108A-S	0.010	6	0	0	0.141	86	0	06:20	30.68
ST108B-S	0.008	6	0	0	0.126	85	0	06:20	28.40
ST108C-S	0.001	4	0	0	0.015	80	0	06:19	4.26
ST108D-S	0.001	5	0	0	0.017	83	0	06:19	4.30
ST108E-S	0.001	5	0	0	0.009	85	0	06:19	2.17
ST109B-S	0.000	0	0	0	0.000	0	0	00:00	19.11
ST109C-S	0.000	0	0	0	0.000	0	0	00:00	20.63
ST111A-S	0.003	3	0	0	0.058	53	0	06:24	17.36
ST111C-S	0.000	0	0	0	0.000	0	0	00:00	14.64
ST507A-S	0.000	0	0	0	0.004	6	0	06:17	10.93
TANK	0.175	30	0	0	0.592	100	0	06:47	137.37

 Outfall Loading Summary

Outfall Node	Flow Freq Pcmt	Avg Flow LPS	Max Flow LPS	Total Volume 10 ⁶ ltr
EXT1-OF	30.18	1.36	16.91	0.035
EXT2-OF	45.84	1.34	20.73	0.053
HEADWALL	100.00	196.13	311.33	16.945
POOLE_OF1	95.39	0.65	0.66	0.054
POOLE_OF2	78.72	0.30	0.30	0.020
ST104A-OF	0.00	0.00	0.00	0.000
ST107A-OF	0.00	0.00	0.00	0.000
System	50.02	199.78	316.10	17.108

 Link Flow Summary

Link	Type	Maximum Flow LPS	Time of Max Occurrence days hr:min	Maximum Veloc m/sec	Max/Full Flow	Max/Full Depth
Pipe_13	CONDUIT	311.33	0 06:54	1.60	0.74	0.54
Pipe_14	CONDUIT	210.46	0 06:14	1.40	1.10	1.00
Pipe_14_(1)	CONDUIT	362.62	0 06:14	1.29	1.31	1.00
Pipe_15	CONDUIT	45.52	0 06:11	1.24	0.26	1.00

160401195_100scs.rpt

Pipe_16	CONDUIT	64.13	0 06:14	0.94	0.37	1.00
Pipe_17	CONDUIT	45.00	0 06:15	1.00	0.31	0.99
Pipe_21	CONDUIT	457.04	0 06:14	1.28	1.21	1.00
Pipe_23	CONDUIT	79.01	0 06:15	1.65	2.66	1.00
Pipe_26	CONDUIT	136.33	0 06:53	1.08	1.07	0.74
Pipe_27	CONDUIT	210.40	0 06:14	1.32	1.35	1.00
Pipe_29	CONDUIT	158.73	0 06:14	1.45	0.79	1.00
Pipe_31	CONDUIT	136.63	0 06:52	0.88	1.07	0.94
Pipe_34	CONDUIT	458.73	0 06:15	1.35	1.18	1.00
ST104A-T	CHANNEL	0.00	0 00:00	0.00	0.00	0.00
ST107A-T	CHANNEL	0.00	0 00:00	0.00	0.00	0.00
ST111A-T	CHANNEL	0.00	0 00:00	0.00	0.00	0.00
ST111B-T	CHANNEL	0.00	0 00:00	0.00	0.00	0.00
ST507A-T	CHANNEL	0.00	0 00:00	0.00	0.00	0.00
W1	CONDUIT	0.00	0 00:00	0.00	0.00	0.00
OR1	ORIFICE	32.79	0 06:48			1.00
OR2	ORIFICE	55.72	0 06:52			1.00
OR3	ORIFICE	48.25	0 06:52			1.00
ST104A-O	ORIFICE	49.96	0 06:15			1.00
ST107A-O	ORIFICE	114.99	0 06:15			1.00
ST109B-O	ORIFICE	19.11	0 06:10			0.76
ST109C-O	ORIFICE	20.63	0 06:15			0.80
ST111A-O	ORIFICE	17.36	0 06:24			1.00
ST111C-O	ORIFICE	7.32	0 06:15			0.40
ST111C-O1	ORIFICE	7.32	0 06:15			0.40
OL1	DUMMY	0.66	0 01:27			
OL2	DUMMY	0.30	0 05:14			
ST108A-O	DUMMY	30.68	0 06:20			
ST108B-O	DUMMY	28.40	0 06:20			
ST108C-O	DUMMY	4.26	0 06:19			
ST108D-O	DUMMY	4.30	0 06:19			
ST108E-O	DUMMY	2.17	0 06:19			
ST507A-O	DUMMY	10.93	0 06:17			

 Flow Classification Summary

Conduit	Adjusted /Actual Length	Fraction of Time in Flow Class								
		Dry	Up Dry	Down Dry	Sub Crit	Sup Crit	Up Crit	Down Crit	Norm Ltd	Inlet Ctrl
Pipe_13	1.00	0.00	0.00	0.00	0.00	0.00	0.00	1.00	0.00	0.00
Pipe_14	1.00	0.04	0.00	0.00	0.39	0.00	0.00	0.56	0.02	0.00
Pipe_14_(1)	1.00	0.04	0.00	0.00	0.51	0.00	0.00	0.45	0.06	0.00
Pipe_15	1.00	0.04	0.00	0.00	0.36	0.00	0.00	0.61	0.19	0.00

Pipe_16	1.00	0.04	0.00	0.00	0.31	0.00	0.00	0.65	0.05	0.00
Pipe_17	1.00	0.04	0.00	0.00	0.15	0.00	0.00	0.80	0.11	0.00
Pipe_21	1.00	0.04	0.00	0.00	0.94	0.00	0.00	0.02	0.14	0.00
Pipe_23	1.00	0.62	0.00	0.00	0.05	0.00	0.00	0.33	0.00	0.00
Pipe_26	1.00	0.00	0.09	0.00	0.72	0.00	0.00	0.19	0.54	0.00
Pipe_27	1.00	0.05	0.20	0.00	0.42	0.00	0.02	0.32	0.06	0.00
Pipe_29	1.00	0.04	0.00	0.00	0.34	0.00	0.00	0.63	0.17	0.00
Pipe_31	1.00	0.07	0.00	0.00	0.90	0.00	0.00	0.02	0.00	0.00
Pipe_34	1.00	0.04	0.00	0.00	0.89	0.07	0.00	0.00	0.01	0.00
ST104A-T	1.00	1.00	0.00	0.00	0.00	0.00	0.00	0.00	0.00	0.00
ST107A-T	1.00	1.00	0.00	0.00	0.00	0.00	0.00	0.00	0.00	0.00
ST111A-T	1.00	1.00	0.00	0.00	0.00	0.00	0.00	0.00	0.00	0.00
ST111B-T	1.00	1.00	0.00	0.00	0.00	0.00	0.00	0.00	0.00	0.00
ST507A-T	1.00	1.00	0.00	0.00	0.00	0.00	0.00	0.00	0.00	0.00
W1	1.00	1.00	0.00	0.00	0.00	0.00	0.00	0.00	0.00	0.00

 Conduit Surcharge Summary

Conduit	----- Both Ends	Hours Full Upstream	----- Dnstream	Hours Above Full Normal Flow	Hours Capacity Limited
Pipe_14	3.40	3.40	3.62	0.05	0.01
Pipe_14_(1)	3.61	3.62	4.28	0.07	0.05
Pipe_15	2.28	2.28	4.28	0.01	0.01
Pipe_16	2.81	2.81	3.40	0.01	0.01
Pipe_17	0.01	0.01	2.19	0.01	0.01
Pipe_21	4.31	4.31	4.63	0.05	0.03
Pipe_23	0.34	0.42	0.44	0.19	0.01
Pipe_26	0.01	0.01	0.01	0.72	0.01
Pipe_27	3.71	3.71	4.69	0.06	0.16
Pipe_29	2.19	2.19	3.40	0.01	0.01
Pipe_31	0.01	0.16	0.01	0.73	0.01
Pipe_34	4.68	4.68	4.75	0.04	0.02

Analysis begun on: Thu Mar 23 14:03:56 2017
 Analysis ended on: Thu Mar 23 14:03:58 2017
 Total elapsed time: 00:00:02

**SERVICING AND STORMWATER MANAGEMENT BRIEF –
5731 HAZELDEAN ROAD**

Appendix C Stormwater Management
March 22, 2017

C.4 OIL/GRIT SEPARATOR SIZING CALCULATIONS



Stormceptor Design Summary

PCSWMM for Stormceptor

Project Information

Date	11/4/2016
Project Name	5731 Hazeldean
Project Number	160401195
Location	Ottawa, ON

Designer Information

Company	Stantec Consulting Ltd.
Contact	N/A

Rainfall

Name	OTTAWA MACDONALD-CARTIER INT'L A
State	ON
ID	6000
Years of Records	1967 to 2003
Latitude	45°19'N
Longitude	75°40'W

Notes

N/A

Water Quality Objective

TSS Removal (%)	80
-----------------	----

Drainage Area

Total Area (ha)	2.72
Imperviousness (%)	70

Upstream Storage

Storage (ha-m)	Discharge (L/s)
0	0

The Stormceptor System model STC 3000 achieves the water quality objective removing 80% TSS for a CLOCA (clay, silt and sand) particle size distribution.

Stormceptor Sizing Summary

Stormceptor Model	TSS Removal %
STC 300	60
STC 750	73
STC 1000	73
STC 1500	74
STC 2000	79
STC 3000	80
STC 4000	84
STC 5000	84
STC 6000	87
STC 9000	90
STC 10000	90
STC 14000	92



Particle Size Distribution

Removing silt particles from runoff ensures that the majority of the pollutants, such as hydrocarbons and heavy metals that adhere to fine particles, are not discharged into our natural water courses. The table below lists the particle size distribution used to define the annual TSS removal.

CLOCA (clay, silt and sand)							
Particle Size µm	Distribution %	Specific Gravity	Settling Velocity m/s	Particle Size µm	Distribution %	Specific Gravity	Settling Velocity m/s
850	3.3	2.65	0.1465	50	3.9	2.65	0.0022
425	23.4	2.65	0.0698	36	2.6	2.65	0.0012
300	17.5	2.65	0.0439	22	1.3	2.65	0.0004
250	6.5	2.65	0.0335	12	1.9	2.65	0.0004
212	6.5	2.65	0.0259	9	0	2.65	0.0004
150	11.7	2.65	0.0145	6.5	1.3	2.65	0.0004
125	5.2	2.65	0.0105	3	1.3	2.65	0.0004
100	3.9	2.65	0.0070	1.5	1.3	2.65	0.0004
75	3.9	2.65	0.0040	1	4.5	2.65	0.0004

Stormceptor Design Notes

- Stormceptor performance estimates are based on simulations using PCSWMM for Stormceptor version 1.0
- Design estimates listed are only representative of specific project requirements based on total suspended solids (TSS) removal.
- Only the STC 300 is adaptable to function with a catch basin inlet and/or inline pipes.
- Only the Stormceptor models STC 750 to STC 6000 may accommodate multiple inlet pipes.
- Inlet and outlet invert elevation differences are as follows:

Inlet and Outlet Pipe Invert Elevations Differences

Inlet Pipe Configuration	STC 300	STC 750 to STC 6000	STC 9000 to STC 14000
Single inlet pipe	75 mm	25 mm	75 mm
Multiple inlet pipes	75 mm	75 mm	Only one inlet pipe.

- Design estimates are based on stable site conditions only, after construction is completed.
- Design estimates assume that the storm drain is not submerged during zero flows. For submerged applications, please contact your local Stormceptor representative.
- Design estimates may be modified for specific spills controls. Please contact your local Stormceptor representative for further assistance.
- For pricing inquiries or assistance, please contact Imbrium Systems Inc., 1-800-565-4801.

Copyright Reserved

The Contractor shall verify and be responsible for all dimensions. DO NOT scale the drawing - any errors or omissions shall be reported to Stantec without delay.
The Copyrights to all designs and drawings are the property of Stantec. Reproduction or use for any purpose other than that authorized by Stantec is forbidden.

Legend

- 1 AREA ID
- 1.13 0.60 RUNOFF COEFFICIENT
- STORM DRAINAGE AREA
- STORM DRAINAGE BOUNDARY
- 100 YEAR PONDING LIMITS
- DIRECTION OF OVERLAND FLOW
- PROPOSED STORM SEWER
- PROPOSED CATCHBASIN MANHOLE
- PROPOSED CATCHBASIN
- PROPOSED BUILDING CATCHBASIN
- PROPOSED SUB DRAIN CATCH BASIN AS PER CITY OF OTTAWA STANDARD DETAIL DRAWINGS LTD AND LTI.
- PROPOSED PERFORATED SUBDRAIN
- EXISTING STORM SEWER
- EXISTING CATCHBASIN

APPROVED REFUSED
THIS 17 DAY OF May 20 17
Judith Woodie
Judith Woodie, Manager
Development Review West
Planning, Infrastructure and Economic
Development Department, City of Ottawa

Revision	By	Appd.	YYMMDD
6	ISSUED FOR MYLARS	MJS	PM 17.04.12
5	REVISED AS PER CITY COMMENTS	MJS	PM 17.03.24
4	ISSUED FOR TENDER	MJS	GR 17.03.22
3	REVISED AS PER CITY COMMENTS	DT	PM 17.01.27
2	REVISED AS PER CITY COMMENTS	MJS	PM 16.09.09
1	ISSUED TO CITY FOR SPA	MJS	PM 16.04.11

File Name:	MJS	PM	MJS	16.02.08
160401195-D8.dwg	Dwn.	Chkd.	Dgn.	YYMMDD

Permit-Seal



Client/Project
WELLINGS OF STITTSVILLE INC. AND
EXTENDICARE (CANADA) INC.
WELLINGS OF STITTSVILLE SENIOR'S LIVING
AND EXTENDICARE L.T.C. STITTSVILLE
5731 HAZELDEAN ROAD
OTTAWA, ON

Title
STORM DRAINAGE PLAN

Project No. 160401195 Scale 1:500

Drawing No. SD-1 Sheet 6 of 7 Revision 6

Plan # 17404

SCHEDULE OF INLET CONTROL DEVICES					
STRUCTURE ID	DRAINAGE AREA	ORIFICE DIA. (mm)	100 YEAR HEAD (m)	100 YEAR FLOW (L/s)	100 YEAR FLOW (L/s)
CB 501	ST111A	IPX HF (3.0'')	101.86	2.32	17.4
CB 503/504	ST111C	200mm PIPE (42)	101.85	0.08	7.3 (42)
CB 505	ST107A	200mm PIPE	101.13	1.72	115.0
CB 506	ST104A	IPX HF (5.5'')	101.52	1.71	50.0
CB 507	ST507A	IPX LMF 65	101.57	1.87	10.9
SWM TANK	-	150	101.00	0.97	48.3
SWM TANK	-	150	100.70	1.27	55.7
SWM TANK	-	110	100.10	1.87	32.8

SCHEDULE OF ROOF RELEASE RATES			
BUILDING	Head (m)	100R TYPE	100R RELEASE RATE (L/s)
WELLINGS BUILDING	0.14	ZURN Z-105-5	29.9
LONG TERM CARE BUILDING	0.14	ZURN Z-105-5	27.7
CRU 1	0.14	ZURN Z-105-5	4.2
CRU 2	0.14	ZURN Z-105-5	4.2
CRU 3	0.14	ZURN Z-105-5	2.1

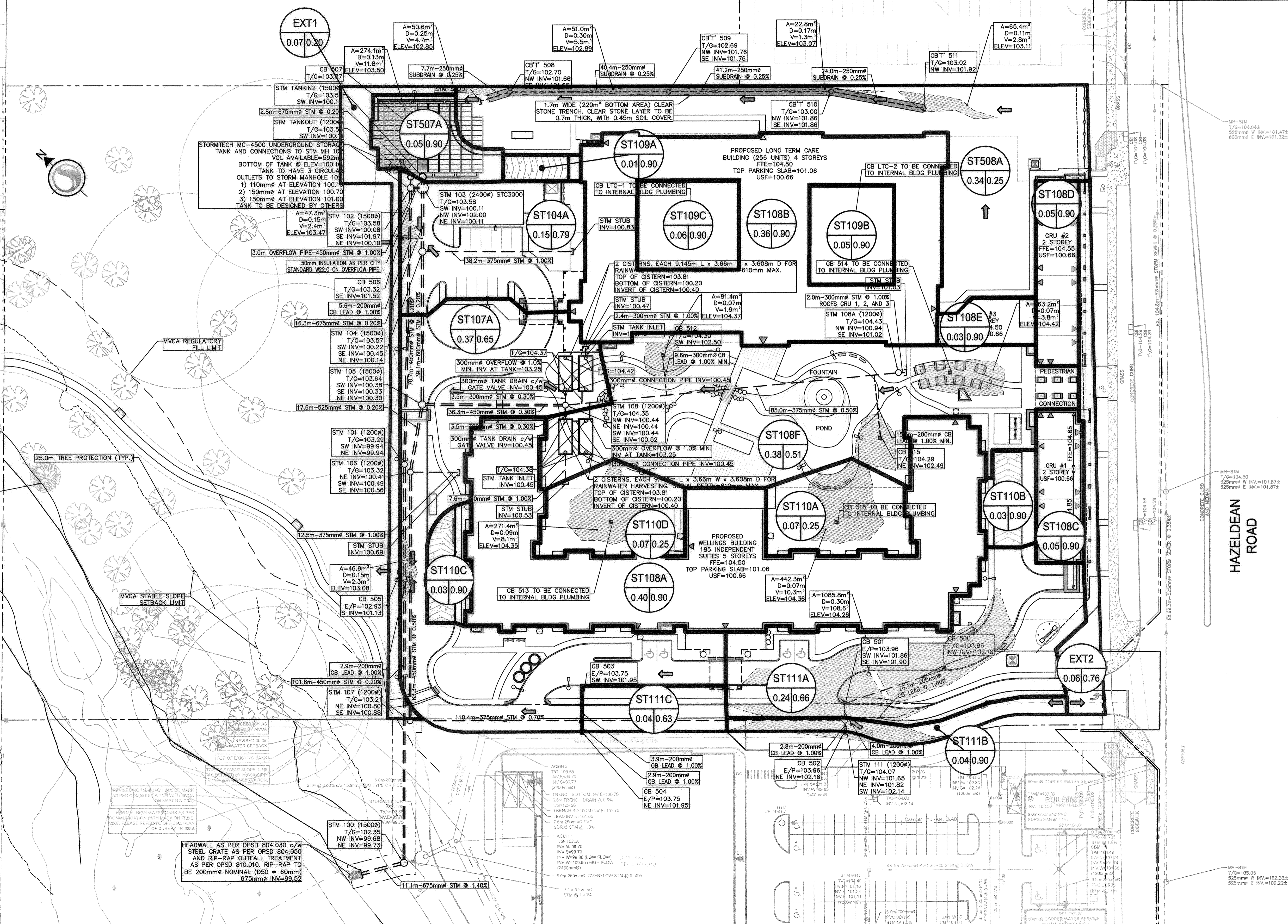
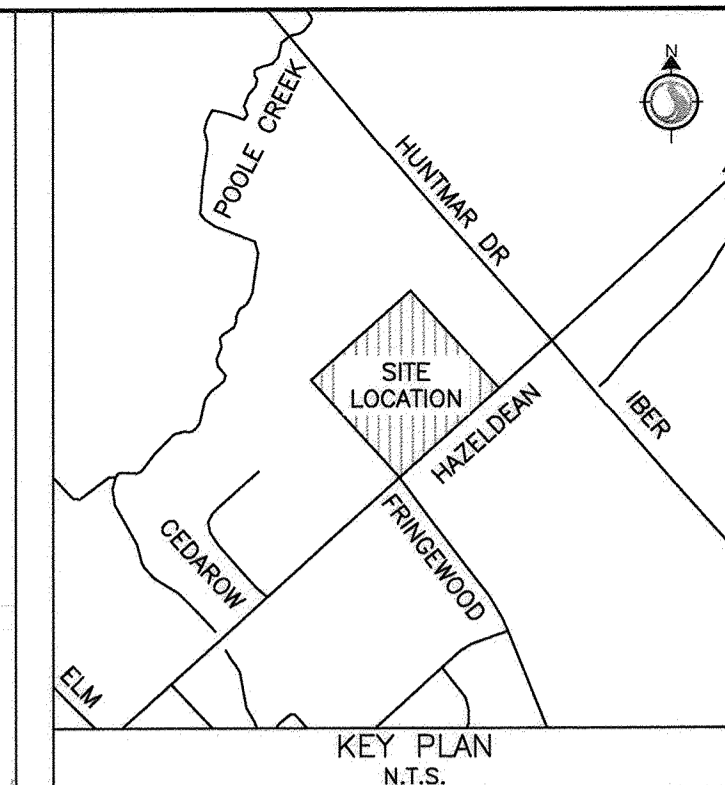

V:\01-600-act\160401195_5731_Hazeldean Road\design\storm\160401195-D8.dwg
2017/04/12 2:14 PM BY: Short, Mike

D07-12-16-0046

**SERVICING AND STORMWATER MANAGEMENT BRIEF –
WELLINGS OF STITTSVILLE PHASE 2, 20 CEDAROW COURT**

Appendix C Stormwater Management
September 21, 2022

C.7 WATER BALANCE CALCULATIONS

Project #160401511 - 20 Cedarow Drive

Infiltration calculations

Required Infiltration Rate (KWMSS) 73 mm/yr
Site Area 2.29 ha
Pre-Development Imperviousness 0 %
Pre-Development Infiltration 1674.5 m³/yr

Post Development Imperviousness 61 %
Post Development Pervious Area 0.89 ha
Post Development Infiltration in Pervious Areas 653.0 m³/yr

Post Development Infiltration Volume Req. 1021.4 m³/yr

Determine Volume of Water to be Sequestered in Infiltration Trench (Assume storage up to 10mm event)

Area Tributary to Infiltration Trench 14200 m²
Impervious Area to Infiltration Trench 11701 m² 82.4 % *Impervious*
Total Depth of Annual Runoff to Infiltration Trench 760.5 mm/yr (910.5mm/yr annual precipitation less urban ET of 150mm/yr)
% of total precipitation of up to 4mm runoff from historical rainfall events > 2mm 35% (Historical rainfall from MacDonald Cartier Airport 2009-2011)
Volume of Runoff from Impervious Area to Infiltration Trench 3103.7 m³/yr for all rainfall events with rainfall >2mm

In order to store up to 4mm from catchment area:

Max. Capacity Required (4mm)= 57 m³ volume of runoff
Infiltration Area (m) 283.00 m 40% Trench Porosity
Clear Stone Depth (m) 0.50 m
Volume Provided 57 m³

Station Name OTTAWA MACDONALD-CARTIER INT'L A
 Province ONTARIO
 Latitude 45.32
 Longitude -75.67
 Elevation 114
 Climate Identifier 6106000
 WMO Identifier 71628
 TC Identifier YOW

Legend
 [Empty] No Data Available
 M Missing

E Estimated
 A Accumulated
 C Precipitation Occurred; Amount Uncertain
 L Precipitation May or May Not Have Occurred
 F Accumulated and Estimated
 N Temperature Missing but Known to be > 0
 Y Temperature Missing but Known to be < 0
 S More Than One Occurrence
 T Trace
 * Data for this day has undergone only preliminary quality checking
 ** Partner data that is not subject to review by the National Climate Archives

Date/Time	Year	Month	Day	Total Rain	Total Rain	Total Snow	Total Snow Flag	Total Precip (mm)
1/1/2009	2009	1	1	1	0	0		0
1/2/2009	2009	1	2	2	0	5.2		3.4
1/3/2009	2009	1	3	3	0	0	T	0
1/4/2009	2009	1	4	4	0	0	T	0
1/5/2009	2009	1	5	5	0	0.4		0.4
1/6/2009	2009	1	6	6	0	0	T	0
1/7/2009	2009	1	7	7	0	22.4		14.8
1/8/2009	2009	1	8	8	0	1.6		0.7
1/9/2009	2009	1	9	9	0	0		0
1/10/2009	2009	1	10	10	0	0		0
1/11/2009	2009	1	11	11	0	0		0
1/12/2009	2009	1	12	12	0	0	T	0
1/13/2009	2009	1	13	13	0	4.6		3
1/14/2009	2009	1	14	14	0	0		0
1/15/2009	2009	1	15	15	0	<--- should be from centreline o		0
1/16/2009	2009	1	16	16	0	water level		0.2
1/17/2009	2009	1	17	17	0	0.6		0.6
1/18/2009	2009	1	18	18	0	10.2		7.2
1/19/2009	2009	1	19	19	0	<-- use Goal Seek to quickly find		3.6
1/20/2009	2009	1	20	20	0	provides tT		
1/21/2009	2009	1	21	21	0	2.6		1.4
1/22/2009	2009	1	22	22	0	0.4		0.2
1/23/2009	2009	1	23	23	0	1.2		0.6
1/24/2009	2009	1	24	24	0	0		0
1/25/2009	2009	1	25	25	0	0		0
1/26/2009	2009	1	26	26	0	0.6		0
1/27/2009	2009	1	27	27	0	0	T	0
1/28/2009	2009	1	28	28	0	18		13
1/29/2009	2009	1	29	29	0	1.2		0.4
1/30/2009	2009	1	30	30	0	6.8		5
1/31/2009	2009	1	31	31	0	0	T	0
2/1/2009	2009	2	1	1	0	0	T	0.2
2/2/2009	2009	2	2	2	0	0	T	0
2/3/2009	2009	2	3	3	0	0		0
2/4/2009	2009	2	4	4	0	0		0
2/5/2009	2009	2	5	5	0	0		0
2/6/2009	2009	2	6	6	0	0.6		0
2/7/2009	2009	2	7	7	0	0		0
2/8/2009	2009	2	8	8	0	0	T	0.2
2/9/2009	2009	2	9	9	0	0.6		0.4
2/10/2009	2009	2	10	10	0	0	T	0
2/11/2009	2009	2	11	11	6.4	0		6.4
2/12/2009	2009	2	12	12	21.2	0	T	21.2
2/13/2009	2009	2	13	13	0	0		0
2/14/2009	2009	2	14	14	0	0		0

2/15/2009	2009	2	15	0	0	0
2/16/2009	2009	2	16	0	0	0
2/17/2009	2009	2	17	0	0	0
2/18/2009	2009	2	18	0	4.2	3.6
2/19/2009	2009	2	19	0	2.6	2.6
2/20/2009	2009	2	20	0	1.2	0.8
2/21/2009	2009	2	21	0	0 T	0
2/22/2009	2009	2	22	0	3.8	2.6
2/23/2009	2009	2	23	0	0.2	0.2
2/24/2009	2009	2	24	0	0 T	0
2/25/2009	2009	2	25	0	0 T	0
2/26/2009	2009	2	26	0	1.2	1.2
2/27/2009	2009	2	27	9.4	0.4	9.8
2/28/2009	2009	2	28	0	0	0
3/1/2009	2009	3	1	0	0	0
3/2/2009	2009	3	2	0	0	0
3/3/2009	2009	3	3	0	0	0
3/4/2009	2009	3	4	0	0	0
3/5/2009	2009	3	5	0 T	0 T	0
3/6/2009	2009	3	6	0.2	0	0.2
3/7/2009	2009	3	7	1.2	0	1.2
3/8/2009	2009	3	8	0	0	0
3/9/2009	2009	3	9	0.2	2.2	1.8
3/10/2009	2009	3	10	0.6	0.2	0.8
3/11/2009	2009	3	11	9	0 T	9
3/12/2009	2009	3	12	0	0	0
3/13/2009	2009	3	13	0	0	0
3/14/2009	2009	3	14	0	0	0
3/15/2009	2009	3	15	0	0	0
3/16/2009	2009	3	16	0	0	0
3/17/2009	2009	3	17	0	0	0
3/18/2009	2009	3	18	0.6	0	0.6
3/19/2009	2009	3	19	0	0	0
3/20/2009	2009	3	20	0	0	0
3/21/2009	2009	3	21	0	0.4	0
3/22/2009	2009	3	22	0	0.4	0
3/23/2009	2009	3	23	0	0	0
3/24/2009	2009	3	24	0	0	0
3/25/2009	2009	3	25	0	0	0
3/26/2009	2009	3	26	8.2	0	8.2
3/27/2009	2009	3	27	0.2	0	0.2
3/28/2009	2009	3	28	0	0	0
3/29/2009	2009	3	29	19.2	0	19.2
3/30/2009	2009	3	30	4	0 T	4
3/31/2009	2009	3	31	0	0	0
4/1/2009	2009	4	1	3	0	3
4/2/2009	2009	4	2	0	0	0
4/3/2009	2009	4	3	15.4	0	15.4
4/4/2009	2009	4	4	6	0 T	6
4/5/2009	2009	4	5	0	0 T	0
4/6/2009	2009	4	6	13	2	17.6
4/7/2009	2009	4	7	1.2	2.4	3.6
4/8/2009	2009	4	8	0 T	0 T	0
4/9/2009	2009	4	9	0	0	0
4/10/2009	2009	4	10	0	0	0
4/11/2009	2009	4	11	0	0	0
4/12/2009	2009	4	12	0	0	0
4/13/2009	2009	4	13	0	0	0
4/14/2009	2009	4	14	0	0	0
4/15/2009	2009	4	15	0	0	0
4/16/2009	2009	4	16	0	0	0
4/17/2009	2009	4	17	0	0	0
4/18/2009	2009	4	18	0.4	0	0.4
4/19/2009	2009	4	19	0	0	0
4/20/2009	2009	4	20	8.6	0	8.6
4/21/2009	2009	4	21	9.4	0	9.4
4/22/2009	2009	4	22	4.2	0	4.2
4/23/2009	2009	4	23	0.4	0	0.4
4/24/2009	2009	4	24	0.4	0	0.4
4/25/2009	2009	4	25	1.6	0	1.6
4/26/2009	2009	4	26	0 T	0	0
4/27/2009	2009	4	27	0	0	0

4/28/2009	2009	4	28	6.4	0	6.4
4/29/2009	2009	4	29	0	0	0
4/30/2009	2009	4	30	12	0	12
5/1/2009	2009	5	1	1	0	1
5/2/2009	2009	5	2	0.6	0	0.6
5/3/2009	2009	5	3	0	0	0
5/4/2009	2009	5	4	0	0	0
5/5/2009	2009	5	5	0 T	0	0
5/6/2009	2009	5	6	0 T	0	0
5/7/2009	2009	5	7	8	0	8
5/8/2009	2009	5	8	5	0	5
5/9/2009	2009	5	9	26	0	26
5/10/2009	2009	5	10	0	0	0
5/11/2009	2009	5	11	0	0	0
5/12/2009	2009	5	12	0	0	0
5/13/2009	2009	5	13	0	0	0
5/14/2009	2009	5	14	4.2	0	4.2
5/15/2009	2009	5	15	0	0	0
5/16/2009	2009	5	16	6.8	0	6.8
5/17/2009	2009	5	17	0	0	0
5/18/2009	2009	5	18	0	0	0
5/19/2009	2009	5	19	0 T	0	0
5/20/2009	2009	5	20	1	0	1
5/21/2009	2009	5	21	0	0	0
5/22/2009	2009	5	22	0 T	0	0
5/23/2009	2009	5	23	0	0	0
5/24/2009	2009	5	24	0 T	0	0
5/25/2009	2009	5	25	0	0	0
5/26/2009	2009	5	26	0	0	0
5/27/2009	2009	5	27	11.4	0	11.4
5/28/2009	2009	5	28	2.6	0	2.6
5/29/2009	2009	5	29	10.6	0	10.6
5/30/2009	2009	5	30	6	0	6
5/31/2009	2009	5	31	1	0	1
6/1/2009	2009	6	1	7.6	0	7.6
6/2/2009	2009	6	2	0	0	0
6/3/2009	2009	6	3	0 T	0	0
6/4/2009	2009	6	4	0	0	0
6/5/2009	2009	6	5	0	0	0
6/6/2009	2009	6	6	0	0	0
6/7/2009	2009	6	7	1.8	0	1.8
6/8/2009	2009	6	8	0.6	0	0.6
6/9/2009	2009	6	9	12.4	0	12.4
6/10/2009	2009	6	10	0	0	0
6/11/2009	2009	6	11	0 T	0	0
6/12/2009	2009	6	12	0 T	0	0
6/13/2009	2009	6	13	0	0	0
6/14/2009	2009	6	14	0.8	0	0.8
6/15/2009	2009	6	15	0.4	0	0.4
6/16/2009	2009	6	16	0	0	0
6/17/2009	2009	6	17	0	0	0
6/18/2009	2009	6	18	7.2	0	7.2
6/19/2009	2009	6	19	0.6	0	0.6
6/20/2009	2009	6	20	0	0	0
6/21/2009	2009	6	21	2.2	0	2.2
6/22/2009	2009	6	22	0	0	0
6/23/2009	2009	6	23	0	0	0
6/24/2009	2009	6	24	0	0	0
6/25/2009	2009	6	25	0	0	0
6/26/2009	2009	6	26	15.4	0	15.4
6/27/2009	2009	6	27	0	0	0
6/28/2009	2009	6	28	0.6	0	0.6
6/29/2009	2009	6	29	13.4	0	13.4
6/30/2009	2009	6	30	6.8	0	6.8
7/1/2009	2009	7	1	0 T	0	0
7/2/2009	2009	7	2	8.4	0	8.4
7/3/2009	2009	7	3	10.2	0	10.2
7/4/2009	2009	7	4	0	0	0
7/5/2009	2009	7	5	0	0	0
7/6/2009	2009	7	6	1.6	0	1.6
7/7/2009	2009	7	7	7	0	7
7/8/2009	2009	7	8	0 T	0	0

7/9/2009	2009	7	9	0	0	0
7/10/2009	2009	7	10	0	0	0
7/11/2009	2009	7	11	25.2	0	25.2
7/12/2009	2009	7	12	1.2	0	1.2
7/13/2009	2009	7	13	0 T	0	0
7/14/2009	2009	7	14	0.2	0	0.2
7/15/2009	2009	7	15	0 T	0	0
7/16/2009	2009	7	16	1	0	1
7/17/2009	2009	7	17	19.2	0	19.2
7/18/2009	2009	7	18	47.8	0	47.8
7/19/2009	2009	7	19	0 T	0	0
7/20/2009	2009	7	20	0	0	0
7/21/2009	2009	7	21	1.2	0	1.2
7/22/2009	2009	7	22	2.8	0	2.8
7/23/2009	2009	7	23	11.4	0	11.4
7/24/2009	2009	7	24	40.6	0	40.6
7/25/2009	2009	7	25	5.8	0	5.8
7/26/2009	2009	7	26	3.2	0	3.2
7/27/2009	2009	7	27	9.6	0	9.6
7/28/2009	2009	7	28	0	0	0
7/29/2009	2009	7	29	47	0	47
7/30/2009	2009	7	30	0	0	0
7/31/2009	2009	7	31	0.2	0	0.2
8/1/2009	2009	8	1	0	0	0
8/2/2009	2009	8	2	9	0	9
8/3/2009	2009	8	3	0.2	0	0.2
8/4/2009	2009	8	4	20.8	0	20.8
8/5/2009	2009	8	5	0	0	0
8/6/2009	2009	8	6	1.8	0	1.8
8/7/2009	2009	8	7	0	0	0
8/8/2009	2009	8	8	0	0	0
8/9/2009	2009	8	9	0	0	0
8/10/2009	2009	8	10	0.2	0	0.2
8/11/2009	2009	8	11	0.2	0	0.2
8/12/2009	2009	8	12	0	0	0
8/13/2009	2009	8	13	0	0	0
8/14/2009	2009	8	14	0	0	0
8/15/2009	2009	8	15	0	0	0
8/16/2009	2009	8	16	0	0	0
8/17/2009	2009	8	17	0.8	0	0.8
8/18/2009	2009	8	18	1.2	0	1.2
8/19/2009	2009	8	19	0	0	0
8/20/2009	2009	8	20	8.2	0	8.2
8/21/2009	2009	8	21	8.2	0	8.2
8/22/2009	2009	8	22	1.8	0	1.8
8/23/2009	2009	8	23	0	0	0
8/24/2009	2009	8	24	0	0	0
8/25/2009	2009	8	25	0	0	0
8/26/2009	2009	8	26	0	0	0
8/27/2009	2009	8	27	0	0	0
8/28/2009	2009	8	28	0 T	0	0
8/29/2009	2009	8	29	37.6	0	37.6
8/30/2009	2009	8	30	0.6	0	0.6
8/31/2009	2009	8	31	0	0	0
9/1/2009	2009	9	1	0	0	0
9/2/2009	2009	9	2	0	0	0
9/3/2009	2009	9	3	0	0	0
9/4/2009	2009	9	4	0	0	0
9/5/2009	2009	9	5	0	0	0
9/6/2009	2009	9	6	0	0	0
9/7/2009	2009	9	7	0	0	0
9/8/2009	2009	9	8	0	0	0
9/9/2009	2009	9	9	0	0	0
9/10/2009	2009	9	10	0	0	0
9/11/2009	2009	9	11	0	0	0
9/12/2009	2009	9	12	0	0	0
9/13/2009	2009	9	13	0	0	0
9/14/2009	2009	9	14	9.6	0	9.6
9/15/2009	2009	9	15	0	0	0
9/16/2009	2009	9	16	0	0	0
9/17/2009	2009	9	17	0	0	0

9/18/2009	2009	9	18	2.8	0	2.8
9/19/2009	2009	9	19	0	0	0
9/20/2009	2009	9	20	0	0	0
9/21/2009	2009	9	21	0.6	0	0.6
9/22/2009	2009	9	22	0.8	0	0.8
9/23/2009	2009	9	23	12.6	0	12.6
9/24/2009	2009	9	24	0 T	0	0
9/25/2009	2009	9	25	0	0	0
9/26/2009	2009	9	26	5.6	0	5.6
9/27/2009	2009	9	27	15.4	0	15.4
9/28/2009	2009	9	28	3.4	0	3.4
9/29/2009	2009	9	29	9.2	0	9.2
9/30/2009	2009	9	30	1	0	1
10/1/2009	2009	10	1	1.2	0	1.2
10/2/2009	2009	10	2	6.4	0	6.4
10/3/2009	2009	10	3	7.2	0	7.2
10/4/2009	2009	10	4	0.4	0	0.4
10/5/2009	2009	10	5	4.8	0	4.8
10/6/2009	2009	10	6	3.8	0	3.8
10/7/2009	2009	10	7	16.4	0	16.4
10/8/2009	2009	10	8	0.6	0	0.6
10/9/2009	2009	10	9	11.4	0	11.4
10/10/2009	2009	10	10	0.2	0	0.2
10/11/2009	2009	10	11	0 T	0	0
10/12/2009	2009	10	12	1	0	1
10/13/2009	2009	10	13	4.4	0	4.4
10/14/2009	2009	10	14	0	0	0
10/15/2009	2009	10	15	0	0	0
10/16/2009	2009	10	16	0	0	0
10/17/2009	2009	10	17	0	0	0
10/18/2009	2009	10	18	0	0	0
10/19/2009	2009	10	19	0	0	0
10/20/2009	2009	10	20	0	0	0
10/21/2009	2009	10	21	7	0	7
10/22/2009	2009	10	22	8.8	0 T	8.8
10/23/2009	2009	10	23	10	0	10
10/24/2009	2009	10	24	5.4	0	5.4
10/25/2009	2009	10	25	0	0	0
10/26/2009	2009	10	26	0 T	0	0
10/27/2009	2009	10	27	0.2	0	0.2
10/28/2009	2009	10	28	2.4	0	2.4
10/29/2009	2009	10	29	0.2	0	0.2
10/30/2009	2009	10	30	7	0	7
10/31/2009	2009	10	31	7.8	0	7.8
11/1/2009	2009	11	1	0	0	0
11/2/2009	2009	11	2	0.2	0	0.2
11/3/2009	2009	11	3	0.4	0	0.4
11/4/2009	2009	11	4	0	0	0
11/5/2009	2009	11	5	2.4	1.4	3.8
11/6/2009	2009	11	6	0	0 T	0
11/7/2009	2009	11	7	0	0	0
11/8/2009	2009	11	8	0	0	0
11/9/2009	2009	11	9	0	0	0
11/10/2009	2009	11	10	0	0	0
11/11/2009	2009	11	11	0	0	0
11/12/2009	2009	11	12	0	0	0
11/13/2009	2009	11	13	0	0	0
11/14/2009	2009	11	14	1.6	0	1.6
11/15/2009	2009	11	15	0.4	0	0.4
11/16/2009	2009	11	16	0	0	0
11/17/2009	2009	11	17	0	0	0
11/18/2009	2009	11	18	0	0	0
11/19/2009	2009	11	19	6	0	6
11/20/2009	2009	11	20	8.8	0	8.8
11/21/2009	2009	11	21	0	0	0
11/22/2009	2009	11	22	0	0	0
11/23/2009	2009	11	23	0	0	0
11/24/2009	2009	11	24	0.2	0	0.2
11/25/2009	2009	11	25	5.2	0	5.2
11/26/2009	2009	11	26	0.2	0	0.2
11/27/2009	2009	11	27	6.6	0	6.6

11/28/2009	2009	11	28	0	0	0
11/29/2009	2009	11	29	3.4	0.4	3.8
11/30/2009	2009	11	30	0	2	3.8
12/1/2009	2009	12	1	0	0.2	0.2
12/2/2009	2009	12	2	6.8	0	6.8
12/3/2009	2009	12	3	16	0	16
12/4/2009	2009	12	4	0	0	0
12/5/2009	2009	12	5	0	0	0
12/6/2009	2009	12	6	0	0.6	0.2
12/7/2009	2009	12	7	0	1.4	1.6
12/8/2009	2009	12	8	0	0 T	0
12/9/2009	2009	12	9	0	22.2	18.2
12/10/2009	2009	12	10	0	3.6	2.4
12/11/2009	2009	12	11	0	0 T	0
12/12/2009	2009	12	12	0	0 T	0
12/13/2009	2009	12	13	0	5	5
12/14/2009	2009	12	14	0 T	3	2.4
12/15/2009	2009	12	15	0	3.8	2.6
12/16/2009	2009	12	16	0	0.6	0.2
12/17/2009	2009	12	17	0	0	0
12/18/2009	2009	12	18	0	0	0
12/19/2009	2009	12	19	0	0	0
12/20/2009	2009	12	20	0	0	0
12/21/2009	2009	12	21	0	0	0
12/22/2009	2009	12	22	0	0.2	0
12/23/2009	2009	12	23	0	5.2	3.6
12/24/2009	2009	12	24	0	0	0
12/25/2009	2009	12	25	0	0	0
12/26/2009	2009	12	26	17.6	1.8	20.2
12/27/2009	2009	12	27	2.6	0 T	2.6
12/28/2009	2009	12	28	0	2.4	2
12/29/2009	2009	12	29	0	0.4	0.2
12/30/2009	2009	12	30	0	0 T	0
12/31/2009	2009	12	31	0	7	6.2
1/1/2010	2010	1	1	0	9.4	6.4
1/2/2010	2010	1	2	0	4	3
1/3/2010	2010	1	3	0	3.8	3.4
1/4/2010	2010	1	4	0	2	0.8
1/5/2010	2010	1	5	0 T	2	1.4
1/6/2010	2010	1	6	0	0 T	0
1/7/2010	2010	1	7	0	0 T	0
1/8/2010	2010	1	8	0	0.2	0.2
1/9/2010	2010	1	9	0	0	0
1/10/2010	2010	1	10	0	0	0
1/11/2010	2010	1	11	0	0 T	0
1/12/2010	2010	1	12	0	0 T	0
1/13/2010	2010	1	13	0.4	2.6	2
1/14/2010	2010	1	14	0 T	0 T	0
1/15/2010	2010	1	15	0.4	0	0.4
1/16/2010	2010	1	16	0	0	0
1/17/2010	2010	1	17	0	0	0
1/18/2010	2010	1	18	0 T	0 T	0
1/19/2010	2010	1	19	0	0.2	0
1/20/2010	2010	1	20	0	0.2	0
1/21/2010	2010	1	21	0	0	0
1/22/2010	2010	1	22	0	0	0
1/23/2010	2010	1	23	0	0	0
1/24/2010	2010	1	24	3	0 T	3
1/25/2010	2010	1	25	43.6	0	43.6
1/26/2010	2010	1	26	0.2	2.6	1.8
1/27/2010	2010	1	27	0	1.6	0.4
1/28/2010	2010	1	28	0	3.6	1.6
1/29/2010	2010	1	29	0	0	0
1/30/2010	2010	1	30	0	0 T	0
1/31/2010	2010	1	31	0	0.2	0.2
2/1/2010	2010	2	1	0	0 T	0
2/2/2010	2010	2	2	0	0 T	0
2/3/2010	2010	2	3	0	1.6	0.8
2/4/2010	2010	2	4	0	0	0
2/5/2010	2010	2	5	0	0	0
2/6/2010	2010	2	6	0	0	0

2/7/2010	2010	2	7	0	0 T	0
2/8/2010	2010	2	8	0	0.2	0.2
2/9/2010	2010	2	9	0	0	0
2/10/2010	2010	2	10	0	0 T	0
2/11/2010	2010	2	11	0	0	0
2/12/2010	2010	2	12	0	0 T	0
2/13/2010	2010	2	13	0	1	0.8
2/14/2010	2010	2	14	0	0 T	0
2/15/2010	2010	2	15	0	0	0
2/16/2010	2010	2	16	0	0 T	0
2/17/2010	2010	2	17	0	3.4	3.4
2/18/2010	2010	2	18	0	0.2	0.2
2/19/2010	2010	2	19	0	0.2	0.2
2/20/2010	2010	2	20	0	0.6	0.6
2/21/2010	2010	2	21	0	1	1
2/22/2010	2010	2	22	0	0 T	0
2/23/2010	2010	2	23	1.2	7	7
2/24/2010	2010	2	24	0	9.6	7.4
2/25/2010	2010	2	25	0.2	15.4	12.6
2/26/2010	2010	2	26	0	0 T	0
2/27/2010	2010	2	27	0 T	0.2	1.4
2/28/2010	2010	2	28	0.2	0	0.2
3/1/2010	2010	3	1	0	0	0
3/2/2010	2010	3	2	0	0	0
3/3/2010	2010	3	3	0	0	0
3/4/2010	2010	3	4	0	0	0
3/5/2010	2010	3	5	0	0	0
3/6/2010	2010	3	6	0	0	0
3/7/2010	2010	3	7	0	0	0
3/8/2010	2010	3	8	0	0	0
3/9/2010	2010	3	9	0	0	0
3/10/2010	2010	3	10	0	0	0
3/11/2010	2010	3	11	0	0	0
3/12/2010	2010	3	12	0	0	0
3/13/2010	2010	3	13	0.2	0	0.2
3/14/2010	2010	3	14	18.6	0	18.6
3/15/2010	2010	3	15	0	0	0
3/16/2010	2010	3	16	0	0	0
3/17/2010	2010	3	17	0	0	0
3/18/2010	2010	3	18	0	0	0
3/19/2010	2010	3	19	0	0	0
3/20/2010	2010	3	20	0 T	0	0
3/21/2010	2010	3	21	0	0	0
3/22/2010	2010	3	22	0.2	0	0.2
3/23/2010	2010	3	23	10.2	0	10.2
3/24/2010	2010	3	24	0	0	0
3/25/2010	2010	3	25	0	0	0
3/26/2010	2010	3	26	0	0	0
3/27/2010	2010	3	27	0	0	0
3/28/2010	2010	3	28	8	0	8
3/29/2010	2010	3	29	10.2	0	10.2
3/30/2010	2010	3	30	0	0	0
3/31/2010	2010	3	31	0	0	0
4/1/2010	2010	4	1	0	0	0
4/2/2010	2010	4	2	0	0	0
4/3/2010	2010	4	3	0	0	0
4/4/2010	2010	4	4	0	0	0
4/5/2010	2010	4	5	0.2	0	0.2
4/6/2010	2010	4	6	13.8	0	13.8
4/7/2010	2010	4	7	4.2	0	4.2
4/8/2010	2010	4	8	15	0	15
4/9/2010	2010	4	9	0 T	0 T	0
4/10/2010	2010	4	10	0 T	0 T	0
4/11/2010	2010	4	11	0.4	0	0.4
4/12/2010	2010	4	12	0	0	0
4/13/2010	2010	4	13	0	0	0
4/14/2010	2010	4	14	0	0	0
4/15/2010	2010	4	15	1.8	0	1.8
4/16/2010	2010	4	16	7.6	0	7.6
4/17/2010	2010	4	17	6.4	0	6.4
4/18/2010	2010	4	18	0 T	0	0
4/19/2010	2010	4	19	0	0	0

4/20/2010	2010	4	20	0	0	0
4/21/2010	2010	4	21	0	0	0
4/22/2010	2010	4	22	0 T	0	0
4/23/2010	2010	4	23	0	0	0
4/24/2010	2010	4	24	0	0	0
4/25/2010	2010	4	25	0	0	0
4/26/2010	2010	4	26	0	0	0
4/27/2010	2010	4	27	1.4	4.2	6
4/28/2010	2010	4	28	0 T	0	0
4/29/2010	2010	4	29	0	0	0
4/30/2010	2010	4	30	0 T	0	0
5/1/2010	2010	5	1	1.6	0	1.6
5/2/2010	2010	5	2	0	0	0
5/3/2010	2010	5	3	7.2	0	7.2
5/4/2010	2010	5	4	1.2	0	1.2
5/5/2010	2010	5	5	8.2	0	8.2
5/6/2010	2010	5	6	0.4	0	0.4
5/7/2010	2010	5	7	1	0	1
5/8/2010	2010	5	8	12.4	0 T	12.4
5/9/2010	2010	5	9	0	0 T	0
5/10/2010	2010	5	10	0	0	0
5/11/2010	2010	5	11	0	0	0
5/12/2010	2010	5	12	0	0	0
5/13/2010	2010	5	13	0.4	0	0.4
5/14/2010	2010	5	14	0	0	0
5/15/2010	2010	5	15	0 T	0	0
5/16/2010	2010	5	16	0	0	0
5/17/2010	2010	5	17	0	0	0
5/18/2010	2010	5	18	0	0	0
5/19/2010	2010	5	19	0	0	0
5/20/2010	2010	5	20	0	0	0
5/21/2010	2010	5	21	0	0	0
5/22/2010	2010	5	22	0.2	0	0.2
5/23/2010	2010	5	23	0	0	0
5/24/2010	2010	5	24	0	0	0
5/25/2010	2010	5	25	0	0	0
5/26/2010	2010	5	26	0	0	0
5/27/2010	2010	5	27	0	0	0
5/28/2010	2010	5	28	1	0	1
5/29/2010	2010	5	29	0.2	0	0.2
5/30/2010	2010	5	30	0	0	0
5/31/2010	2010	5	31	0	0	0
6/1/2010	2010	6	1	10	0	10
6/2/2010	2010	6	2	6.4	0	6.4
6/3/2010	2010	6	3	4.8	0	4.8
6/4/2010	2010	6	4	1.8	0	1.8
6/5/2010	2010	6	5	0.6	0	0.6
6/6/2010	2010	6	6	12	0	12
6/7/2010	2010	6	7	1.8	0	1.8
6/8/2010	2010	6	8	0	0	0
6/9/2010	2010	6	9	4.4	0	4.4
6/10/2010	2010	6	10	1.4	0	1.4
6/11/2010	2010	6	11	0	0	0
6/12/2010	2010	6	12	7.6	0	7.6
6/13/2010	2010	6	13	0	0	0
6/14/2010	2010	6	14	1.4	0	1.4
6/15/2010	2010	6	15	0	0	0
6/16/2010	2010	6	16	21.2	0	21.2
6/17/2010	2010	6	17	1.6	0	1.6
6/18/2010	2010	6	18	0	0	0
6/19/2010	2010	6	19	5.6	0	5.6
6/20/2010	2010	6	20	0	0	0
6/21/2010	2010	6	21	0	0	0
6/22/2010	2010	6	22	6	0	6
6/23/2010	2010	6	23	9.4	0	9.4
6/24/2010	2010	6	24	8.6	0	8.6
6/25/2010	2010	6	25	0	0	0
6/26/2010	2010	6	26	1.4	0	1.4
6/27/2010	2010	6	27	0.6	0	0.6
6/28/2010	2010	6	28	9.8	0	9.8
6/29/2010	2010	6	29	1.6	0	1.6
6/30/2010	2010	6	30	2.2	0	2.2

7/1/2010	2010	7	1	0 T	0	0
7/2/2010	2010	7	2	0	0	0
7/3/2010	2010	7	3	0	0	0
7/4/2010	2010	7	4	0	0	0
7/5/2010	2010	7	5	0	0	0
7/6/2010	2010	7	6	0	0	0
7/7/2010	2010	7	7	0	0	0
7/8/2010	2010	7	8	0.2	0	0.2
7/9/2010	2010	7	9	17.6	0	17.6
7/10/2010	2010	7	10	0	0	0
7/11/2010	2010	7	11	0	0	0
7/12/2010	2010	7	12	0.6	0	0.6
7/13/2010	2010	7	13	14.6	0	14.6
7/14/2010	2010	7	14	0	0	0
7/15/2010	2010	7	15	0	0	0
7/16/2010	2010	7	16	0.4	0	0.4
7/17/2010	2010	7	17	0.2	0	0.2
7/18/2010	2010	7	18	0.2	0	0.2
7/19/2010	2010	7	19	11.8	0	11.8
7/20/2010	2010	7	20	0	0	0
7/21/2010	2010	7	21	3.6	0	3.6
7/22/2010	2010	7	22	0	0	0
7/23/2010	2010	7	23	0.8	0	0.8
7/24/2010	2010	7	24	0 T	0	0
7/25/2010	2010	7	25	0	0	0
7/26/2010	2010	7	26	0	0	0
7/27/2010	2010	7	27	0	0	0
7/28/2010	2010	7	28	0 T	0	0
7/29/2010	2010	7	29	0	0	0
7/30/2010	2010	7	30	0	0	0
7/31/2010	2010	7	31	0	0	0
8/1/2010	2010	8	1	0	0	0
8/2/2010	2010	8	2	1.2	0	1.2
8/3/2010	2010	8	3	34.2	0	34.2
8/4/2010	2010	8	4	34	0	34
8/5/2010	2010	8	5	0	0	0
8/6/2010	2010	8	6	0	0	0
8/7/2010	2010	8	7	0	0	0
8/8/2010	2010	8	8	19.6	0	19.6
8/9/2010	2010	8	9	0	0	0
8/10/2010	2010	8	10	0.2	0	0.2
8/11/2010	2010	8	11	0	0	0
8/12/2010	2010	8	12	0	0	0
8/13/2010	2010	8	13	0	0	0
8/14/2010	2010	8	14	0	0	0
8/15/2010	2010	8	15	42.4	0	42.4
8/16/2010	2010	8	16	4.2	0	4.2
8/17/2010	2010	8	17	0	0	0
8/18/2010	2010	8	18	0	0	0
8/19/2010	2010	8	19	3.2	0	3.2
8/20/2010	2010	8	20	0	0	0
8/21/2010	2010	8	21	3.8	0	3.8
8/22/2010	2010	8	22	5.2	0	5.2
8/23/2010	2010	8	23	24.4	0	24.4
8/24/2010	2010	8	24	0	0	0
8/25/2010	2010	8	25	0.2	0	0.2
8/26/2010	2010	8	26	0.8	0	0.8
8/27/2010	2010	8	27	0	0	0
8/28/2010	2010	8	28	0	0	0
8/29/2010	2010	8	29	0	0	0
8/30/2010	2010	8	30	0	0	0
8/31/2010	2010	8	31	0	0	0
9/1/2010	2010	9	1	0	0	0
9/2/2010	2010	9	2	19.6	0	19.6
9/3/2010	2010	9	3	12	0	12
9/4/2010	2010	9	4	2.4	0	2.4
9/5/2010	2010	9	5	1	0	1
9/6/2010	2010	9	6	6.4	0	6.4
9/7/2010	2010	9	7	17	0	17
9/8/2010	2010	9	8	1	0	1
9/9/2010	2010	9	9	1	0	1
9/10/2010	2010	9	10	0	0	0

9/11/2010	2010	9	11	0	0	0
9/12/2010	2010	9	12	1.8	0	1.8
9/13/2010	2010	9	13	5.2	0	5.2
9/14/2010	2010	9	14	2	0	2
9/15/2010	2010	9	15	0	0	0
9/16/2010	2010	9	16	18.4	0	18.4
9/17/2010	2010	9	17	0	0	0
9/18/2010	2010	9	18	0 T	0	0
9/19/2010	2010	9	19	0	0	0
9/20/2010	2010	9	20	0	0	0
9/21/2010	2010	9	21	8	0	8
9/22/2010	2010	9	22	5.6	0	5.6
9/23/2010	2010	9	23	8.8	0	8.8
9/24/2010	2010	9	24	1.6	0	1.6
9/25/2010	2010	9	25	4.4	0	4.4
9/26/2010	2010	9	26	0.6	0	0.6
9/27/2010	2010	9	27	13	0	13
9/28/2010	2010	9	28	20	0	20
9/29/2010	2010	9	29	0.6	0	0.6
9/30/2010	2010	9	30	19.6	0	19.6
10/1/2010	2010	10	1	0	0	0
10/2/2010	2010	10	2	0.2	0	0.2
10/3/2010	2010	10	3	0	0	0
10/4/2010	2010	10	4	0	0	0
10/5/2010	2010	10	5	0	0	0
10/6/2010	2010	10	6	20.8	0	20.8
10/7/2010	2010	10	7	0.6	0	0.6
10/8/2010	2010	10	8	0	0	0
10/9/2010	2010	10	9	0	0	0
10/10/2010	2010	10	10	0	0	0
10/11/2010	2010	10	11	0	0	0
10/12/2010	2010	10	12	0	0	0
10/13/2010	2010	10	13	0	0	0
10/14/2010	2010	10	14	6.8	0	6.8
10/15/2010	2010	10	15	10.2	0	10.2
10/16/2010	2010	10	16	0	0	0
10/17/2010	2010	10	17	0	0	0
10/18/2010	2010	10	18	0	0	0
10/19/2010	2010	10	19	0 T	0	0
10/20/2010	2010	10	20	2.4	0	2.4
10/21/2010	2010	10	21	1	0	1
10/22/2010	2010	10	22	0	0 T	0
10/23/2010	2010	10	23	0	0	0
10/24/2010	2010	10	24	4.2	0	4.2
10/25/2010	2010	10	25	0.6	0	0.6
10/26/2010	2010	10	26	4.8	0	4.8
10/27/2010	2010	10	27	0.2	0	0.2
10/28/2010	2010	10	28	0	0	0
10/29/2010	2010	10	29	0 T	0 T	0
10/30/2010	2010	10	30	4.6	7.4	15.4
10/31/2010	2010	10	31	0	0 T	0
11/1/2010	2010	11	1	0	0	0
11/2/2010	2010	11	2	0	0	0
11/3/2010	2010	11	3	0	0	0
11/4/2010	2010	11	4	8.6	0	8.6
11/5/2010	2010	11	5	8.2	0 T	8.2
11/6/2010	2010	11	6	0	0	0
11/7/2010	2010	11	7	0	0	0
11/8/2010	2010	11	8	0	0	0
11/9/2010	2010	11	9	0	0	0
11/10/2010	2010	11	10	0	0	0
11/11/2010	2010	11	11	0	0	0
11/12/2010	2010	11	12	0	0	0
11/13/2010	2010	11	13	0	0	0
11/14/2010	2010	11	14	2.2	0	2.2
11/15/2010	2010	11	15	0	0	0
11/16/2010	2010	11	16	15.2	0	15.2
11/17/2010	2010	11	17	16.8	0	16.8
11/18/2010	2010	11	18	0	0 T	0
11/19/2010	2010	11	19	0 T	0 T	0
11/20/2010	2010	11	20	0.4	0	0.4
11/21/2010	2010	11	21	0 T	0 T	0

11/22/2010	2010	11	22	5.8	0	5.8
11/23/2010	2010	11	23	5.2	0 T	5.2
11/24/2010	2010	11	24	0	0	0
11/25/2010	2010	11	25	0 T	0	0
11/26/2010	2010	11	26	7	1	7.8
11/27/2010	2010	11	27	0	1	0.6
11/28/2010	2010	11	28	0	0	0
11/29/2010	2010	11	29	0	0	0
11/30/2010	2010	11	30	8.4	0	8.4
12/1/2010	2010	12	1	30	0.6	31
12/2/2010	2010	12	2	0	0 T	0
12/3/2010	2010	12	3	0	1.6	0.4
12/4/2010	2010	12	4	0	0 T	0
12/5/2010	2010	12	5	0	3.6	1.6
12/6/2010	2010	12	6	0	0 T	0
12/7/2010	2010	12	7	0	1	0.2
12/8/2010	2010	12	8	0	0.6	0.2
12/9/2010	2010	12	9	0	0 T	0
12/10/2010	2010	12	10	0	0.4	0.2
12/11/2010	2010	12	11	0	0 T	0
12/12/2010	2010	12	12	21.4	1	24.6
12/13/2010	2010	12	13	0 T	2.4	1.4
12/14/2010	2010	12	14	0	7.6	4
12/15/2010	2010	12	15	0	1	0.4
12/16/2010	2010	12	16	0	2.5	0.6
12/17/2010	2010	12	17	0	0.8	0.2
12/18/2010	2010	12	18	0	0.6	0.2
12/19/2010	2010	12	19	0	1	0.2
12/20/2010	2010	12	20	0	0 T	0
12/21/2010	2010	12	21	0	0 T	0
12/22/2010	2010	12	22	0	0 T	0
12/23/2010	2010	12	23	0	0	0
12/24/2010	2010	12	24	0	0	0
12/25/2010	2010	12	25	0	0	0
12/26/2010	2010	12	26	0	0	0
12/27/2010	2010	12	27	0	0	0
12/28/2010	2010	12	28	0.2	0 T	0.2
12/29/2010	2010	12	29	0	0 T	0
12/30/2010	2010	12	30	0 T	0	0
12/31/2010	2010	12	31	0.8	0	0.8
1/1/2011	2011	1	1	3.8	0	3.8
1/2/2011	2011	1	2	0 T	0 T	0
1/3/2011	2011	1	3	0	1	0.2
1/4/2011	2011	1	4	0	2.8	1.6
1/5/2011	2011	1	5	0	0 T	0
1/6/2011	2011	1	6	0	1.4	0.8
1/7/2011	2011	1	7	0	5.8	3.2
1/8/2011	2011	1	8	0	6.4	3.2
1/9/2011	2011	1	9	0	0 T	0
1/10/2011	2011	1	10	0	0	0
1/11/2011	2011	1	11	0	0 T	0
1/12/2011	2011	1	12	0	0.8	0.2
1/13/2011	2011	1	13	0	0.2	0
1/14/2011	2011	1	14	0	0.2	0
1/15/2011	2011	1	15	0	10.4	6
1/16/2011	2011	1	16	0	0 T	0
1/17/2011	2011	1	17	0	0	0
1/18/2011	2011	1	18	0	2.4	1.6
1/19/2011	2011	1	19	0	0 T	0
1/20/2011	2011	1	20	0	0.4	0.2
1/21/2011	2011	1	21	0	2.2	1.2
1/22/2011	2011	1	22	0	0.4	0
1/23/2011	2011	1	23	0	0 T	0
1/24/2011	2011	1	24	0	0 T	0
1/25/2011	2011	1	25	0	3	1.2
1/26/2011	2011	1	26	0	0.4	0.4
1/27/2011	2011	1	27	0	3	0.6
1/28/2011	2011	1	28	0	3.4	1.6
1/29/2011	2011	1	29	0	7.8	4
1/30/2011	2011	1	30	0	1	0.4
1/31/2011	2011	1	31	0	0	0
2/1/2011	2011	2	1	0	0 T	0

2/2/2011	2011	2	2	0	17.2	11
2/3/2011	2011	2	3	0	0	0
2/4/2011	2011	2	4	0	0	0
2/5/2011	2011	2	5	0	1.4	0.6
2/6/2011	2011	2	6	0	1	0.2
2/7/2011	2011	2	7	0	5.4	2.4
2/8/2011	2011	2	8	0	0 T	0
2/9/2011	2011	2	9	0	6	3.4
2/10/2011	2011	2	10	0	0	0
2/11/2011	2011	2	11	0	0 T	0
2/12/2011	2011	2	12	0	1.6	0.6
2/13/2011	2011	2	13	1.8	0.4	2
2/14/2011	2011	2	14	2.2	0.2	2.4
2/15/2011	2011	2	15	0	0	0
2/16/2011	2011	2	16	0	0	0
2/17/2011	2011	2	17	3	0	3
2/18/2011	2011	2	18	0.6	0.6	0.6
2/19/2011	2011	2	19	0	0.6	0.4
2/20/2011	2011	2	20	0	1.4	1
2/21/2011	2011	2	21	0	0 T	0
2/22/2011	2011	2	22	0	0	0
2/23/2011	2011	2	23	0	0	0
2/24/2011	2011	2	24	0	0 T	0
2/25/2011	2011	2	25	0	1.2	0.6
2/26/2011	2011	2	26	0	1	0.6
2/27/2011	2011	2	27	0	1.8	1.2
2/28/2011	2011	2	28	1	10.2	13.4
3/1/2011	2011	3	1	0	0	0
3/2/2011	2011	3	2	0	0 T	0
3/3/2011	2011	3	3	0	0	0
3/4/2011	2011	3	4	0	0 T	0
3/5/2011	2011	3	5	23.4	3.6	30
3/6/2011	2011	3	6	0	12.6	8.6
3/7/2011	2011	3	7	0	0	0
3/8/2011	2011	3	8	0	0	0
3/9/2011	2011	3	9	0	6	5.8
3/10/2011	2011	3	10	15.4	7.6	21.4
3/11/2011	2011	3	11	9.6	0	9.6
3/12/2011	2011	3	12	0	0.2	0.2
3/13/2011	2011	3	13	0	0.6	0.4
3/14/2011	2011	3	14	0	0	0
3/15/2011	2011	3	15	0	0	0
3/16/2011	2011	3	16	1.2	0	1.2
3/17/2011	2011	3	17	1.6	0	1.6
3/18/2011	2011	3	18	0 T	0 T	0
3/19/2011	2011	3	19	0	0	0
3/20/2011	2011	3	20	0	0	0
3/21/2011	2011	3	21	0	3.8	2.8
3/22/2011	2011	3	22	0	0	0
3/23/2011	2011	3	23	0	0	0
3/24/2011	2011	3	24	0	0	0
3/25/2011	2011	3	25	0	0	0
3/26/2011	2011	3	26	0	0	0
3/27/2011	2011	3	27	0	0	0
3/28/2011	2011	3	28	0	0	0
3/29/2011	2011	3	29	0	0 T	0
3/30/2011	2011	3	30	0	0	0
3/31/2011	2011	3	31	0 T	0	0
4/1/2011	2011	4	1	0.8	0 T	0.8
4/2/2011	2011	4	2	0	0	0
4/3/2011	2011	4	3	0	0	0
4/4/2011	2011	4	4	15.4	0.4	16
4/5/2011	2011	4	5	2.6	0 T	2.6
4/6/2011	2011	4	6	0	0 T	0
4/7/2011	2011	4	7	0	0	0
4/8/2011	2011	4	8	0	0	0
4/9/2011	2011	4	9	0	0	0
4/10/2011	2011	4	10	21	0	21
4/11/2011	2011	4	11	25.4	0	25.4
4/12/2011	2011	4	12	0	0	0
4/13/2011	2011	4	13	6.2	0	6.2
4/14/2011	2011	4	14	0	0	0

4/15/2011	2011	4	15	0	0	0
4/16/2011	2011	4	16	23.8	0	23.8
4/17/2011	2011	4	17	5.4	0 T	5.4
4/18/2011	2011	4	18	0	0	0
4/19/2011	2011	4	19	0	0	0
4/20/2011	2011	4	20	18.8	0 T	18.8
4/21/2011	2011	4	21	0	0.4	0.4
4/22/2011	2011	4	22	0	0	0
4/23/2011	2011	4	23	4.2	0	4.2
4/24/2011	2011	4	24	0	0	0
4/25/2011	2011	4	25	0	0	0
4/26/2011	2011	4	26	20.6	0	20.6
4/27/2011	2011	4	27	16.6	0	16.6
4/28/2011	2011	4	28	4.6	0	4.6
4/29/2011	2011	4	29	0.6	0	0.6
4/30/2011	2011	4	30	0	0	0
5/1/2011	2011	5	1	0	0	0
5/2/2011	2011	5	2	7.8	0	7.8
5/3/2011	2011	5	3	7.6	0	7.6
5/4/2011	2011	5	4	1.2	0	1.2
5/5/2011	2011	5	5	0	0	0
5/6/2011	2011	5	6	0.8	0	0.8
5/7/2011	2011	5	7	0	0	0
5/8/2011	2011	5	8	0	0	0
5/9/2011	2011	5	9	0	0	0
5/10/2011	2011	5	10	0	0	0
5/11/2011	2011	5	11	0	0	0
5/12/2011	2011	5	12	0	0	0
5/13/2011	2011	5	13	6	0	6
5/14/2011	2011	5	14	24.2	0	24.2
5/15/2011	2011	5	15	4.6	0	4.6
5/16/2011	2011	5	16	4.8	0	4.8
5/17/2011	2011	5	17	1.4	0	1.4
5/18/2011	2011	5	18	1.4	0	1.4
5/19/2011	2011	5	19	6	0	6
5/20/2011	2011	5	20	0 T	0	0
5/21/2011	2011	5	21	0	0	0
5/22/2011	2011	5	22	1.6	0	1.6
5/23/2011	2011	5	23	0.2	0	0.2
5/24/2011	2011	5	24	2.2	0	2.2
5/25/2011	2011	5	25	0.4	0	0.4
5/26/2011	2011	5	26	6	0	6
5/27/2011	2011	5	27	13.8	0	13.8
5/28/2011	2011	5	28	3	0	3
5/29/2011	2011	5	29	1.8	0	1.8
5/30/2011	2011	5	30	0	0	0
5/31/2011	2011	5	31	0	0	0
6/1/2011	2011	6	1	0	0	0
6/2/2011	2011	6	2	0	0	0
6/3/2011	2011	6	3	0	0	0
6/4/2011	2011	6	4	0	0	0
6/5/2011	2011	6	5	0	0	0
6/6/2011	2011	6	6	0	0	0
6/7/2011	2011	6	7	0 T	0	0
6/8/2011	2011	6	8	0.4	0	0.4
6/9/2011	2011	6	9	0	0	0
6/10/2011	2011	6	10	0	0	0
6/11/2011	2011	6	11	3.4	0	3.4
6/12/2011	2011	6	12	1	0	1
6/13/2011	2011	6	13	6.8	0	6.8
6/14/2011	2011	6	14	0	0	0
6/15/2011	2011	6	15	0	0	0
6/16/2011	2011	6	16	0	0	0
6/17/2011	2011	6	17	0.4	0	0.4
6/18/2011	2011	6	18	0	0	0
6/19/2011	2011	6	19	0	0	0
6/20/2011	2011	6	20	0	0	0
6/21/2011	2011	6	21	0	0	0
6/22/2011	2011	6	22	2.8	0	2.8
6/23/2011	2011	6	23	7	0	7
6/24/2011	2011	6	24	90.4	0	90.4
6/25/2011	2011	6	25	0.4	0	0.4

6/26/2011	2011	6	26	0	0	0
6/27/2011	2011	6	27	0	0	0
6/28/2011	2011	6	28	16	0	16
6/29/2011	2011	6	29	0.6	0	0.6
6/30/2011	2011	6	30	0.8	0	0.8
7/1/2011	2011	7	1	0	0	0
7/2/2011	2011	7	2	0	0	0
7/3/2011	2011	7	3	0	0	0
7/4/2011	2011	7	4	0	0	0
7/5/2011	2011	7	5	0	0	0
7/6/2011	2011	7	6	3.8	0	3.8
7/7/2011	2011	7	7	0	0	0
7/8/2011	2011	7	8	4.2	0	4.2
7/9/2011	2011	7	9	0	0	0
7/10/2011	2011	7	10	0	0	0
7/11/2011	2011	7	11	8.4	0	8.4
7/12/2011	2011	7	12	0	0	0
7/13/2011	2011	7	13	0.4	0	0.4
7/14/2011	2011	7	14	0	0	0
7/15/2011	2011	7	15	0	0	0
7/16/2011	2011	7	16	0	0	0
7/17/2011	2011	7	17	17.4	0	17.4
7/18/2011	2011	7	18	2.8	0	2.8
7/19/2011	2011	7	19	0	0	0
7/20/2011	2011	7	20	0	0	0
7/21/2011	2011	7	21	0	0	0
7/22/2011	2011	7	22	0	0	0
7/23/2011	2011	7	23	0	0	0
7/24/2011	2011	7	24	0	0	0
7/25/2011	2011	7	25	0.4	0	0.4
7/26/2011	2011	7	26	15.8	0	15.8
7/27/2011	2011	7	27	0	0	0
7/28/2011	2011	7	28	0	0	0
7/29/2011	2011	7	29	6.2	0	6.2
7/30/2011	2011	7	30	0	0	0
7/31/2011	2011	7	31	0	0	0
8/1/2011	2011	8	1	0	0	0
8/2/2011	2011	8	2	0	0	0
8/3/2011	2011	8	3	0	0	0
8/4/2011	2011	8	4	0	0	0
8/5/2011	2011	8	5	0	0	0
8/6/2011	2011	8	6	0	0	0
8/7/2011	2011	8	7	1.4	0	1.4
8/8/2011	2011	8	8	0	0	0
8/9/2011	2011	8	9	6.2	0	6.2
8/10/2011	2011	8	10	7.6	0	7.6
8/11/2011	2011	8	11	0 T	0	0
8/12/2011	2011	8	12	0	0	0
8/13/2011	2011	8	13	1	0	1
8/14/2011	2011	8	14	13.4	0	13.4
8/15/2011	2011	8	15	0.4	0	0.4
8/16/2011	2011	8	16	0	0	0
8/17/2011	2011	8	17	0	0	0
8/18/2011	2011	8	18	2.8	0	2.8
8/19/2011	2011	8	19	0	0	0
8/20/2011	2011	8	20	3	0	3
8/21/2011	2011	8	21	12	0	12
8/22/2011	2011	8	22	0.4	0	0.4
8/23/2011	2011	8	23	0 T	0	0
8/24/2011	2011	8	24	2.2	0	2.2
8/25/2011	2011	8	25	2.6	0	2.6
8/26/2011	2011	8	26	0	0	0
8/27/2011	2011	8	27	0	0	0
8/28/2011	2011	8	28	0	0	0
8/29/2011	2011	8	29	0	0	0
8/30/2011	2011	8	30	1.2	0	1.2
8/31/2011	2011	8	31	0	0	0
9/1/2011	2011	9	1	0.4	0	0.4
9/2/2011	2011	9	2	0	0	0
9/3/2011	2011	9	3	0 T	0	0
9/4/2011	2011	9	4	14	0	14
9/5/2011	2011	9	5	4	0	4

9/6/2011	2011	9	6	0	0	0
9/7/2011	2011	9	7	0.2	0	0.2
9/8/2011	2011	9	8	0	0	0
9/9/2011	2011	9	9	0	0	0
9/10/2011	2011	9	10	0	0	0
9/11/2011	2011	9	11	0	0	0
9/12/2011	2011	9	12	2.4	0	2.4
9/13/2011	2011	9	13	21.6	0	21.6
9/14/2011	2011	9	14	0.2	0	0.2
9/15/2011	2011	9	15	1.8	0	1.8
9/16/2011	2011	9	16	0	0	0
9/17/2011	2011	9	17	0	0	0
9/18/2011	2011	9	18	0	0	0
9/19/2011	2011	9	19	5	0	5
9/20/2011	2011	9	20	1.8	0	1.8
9/21/2011	2011	9	21	M	M	2.2
9/22/2011	2011	9	22	0 T	0	0
9/23/2011	2011	9	23	0 T	0	0
9/24/2011	2011	9	24	0	0	0
9/25/2011	2011	9	25	0	0	0
9/26/2011	2011	9	26	0	0	0
9/27/2011	2011	9	27	0.2	0	0.2
9/28/2011	2011	9	28	1.2	0	1.2
9/29/2011	2011	9	29	6.6	0	6.6
9/30/2011	2011	9	30	5.4	0	5.4
10/1/2011	2011	10	1	0.2	0	0.2
10/2/2011	2011	10	2	3.4	0	3.4
10/3/2011	2011	10	3	4.4	0	4.4
10/4/2011	2011	10	4	0 T	0	0
10/5/2011	2011	10	5	0	0	0
10/6/2011	2011	10	6	0	0	0
10/7/2011	2011	10	7	0	0	0
10/8/2011	2011	10	8	0	0	0
10/9/2011	2011	10	9	0	0	0
10/10/2011	2011	10	10	0	0	0
10/11/2011	2011	10	11	0	0	0
10/12/2011	2011	10	12	1	0	1
10/13/2011	2011	10	13	6.2	0	6.2
10/14/2011	2011	10	14	19.2	0	19.2
10/15/2011	2011	10	15	7	0	7
10/16/2011	2011	10	16	0.2	0	0.2
10/17/2011	2011	10	17	2.6	0	2.6
10/18/2011	2011	10	18	0	0	0
10/19/2011	2011	10	19	5	0	5
10/20/2011	2011	10	20	27	0	27
10/21/2011	2011	10	21	2	0	2
10/22/2011	2011	10	22	0	0	0
10/23/2011	2011	10	23	0	0	0
10/24/2011	2011	10	24	1.4	0	1.4
10/25/2011	2011	10	25	0.2	0	0.2
10/26/2011	2011	10	26	0	0	0
10/27/2011	2011	10	27	0	0	0
10/28/2011	2011	10	28	0	0	0
10/29/2011	2011	10	29	0	0	0
10/30/2011	2011	10	30	0	0	0
10/31/2011	2011	10	31	0	0	0
11/1/2011	2011	11	1	0	0	0
11/2/2011	2011	11	2	0	0	0
11/3/2011	2011	11	3	1.4	0	1.4
11/4/2011	2011	11	4	0	0	0
11/5/2011	2011	11	5	0	0	0
11/6/2011	2011	11	6	0	0	0
11/7/2011	2011	11	7	0	0	0
11/8/2011	2011	11	8	0	0	0
11/9/2011	2011	11	9	0.2	0	0.2
11/10/2011	2011	11	10	0 T	0	0
11/11/2011	2011	11	11	0	0	0
11/12/2011	2011	11	12	0	0	0
11/13/2011	2011	11	13	0.4	0	0.4
11/14/2011	2011	11	14	2.2	0	2.2
11/15/2011	2011	11	15	0 T	0	0
11/16/2011	2011	11	16	0	0	0

11/17/2011	2011	11	17	0	0 T	0
11/18/2011	2011	11	18	0	0	0
11/19/2011	2011	11	19	0 T	0	0
11/20/2011	2011	11	20	1.8	0	1.8
11/21/2011	2011	11	21	0	0	0
11/22/2011	2011	11	22	0	0 T	0
11/23/2011	2011	11	23	0	8.8	6.6
11/24/2011	2011	11	24	0	0	0
11/25/2011	2011	11	25	0	0	0
11/26/2011	2011	11	26	0	0	0
11/27/2011	2011	11	27	1	0	1
11/28/2011	2011	11	28	3	0	3
11/29/2011	2011	11	29	37.2	0	37.2
11/30/2011	2011	11	30	7.2	0	7.2
12/1/2011	2011	12	1	0	0 T	0
12/2/2011	2011	12	2	0.2	3.6	3.8
12/3/2011	2011	12	3	0	0	0
12/4/2011	2011	12	4	0.2	0	0.2
12/5/2011	2011	12	5	12.4	0.8	13.2
12/6/2011	2011	12	6	0	2.8	2.2
12/7/2011	2011	12	7	0	0.4	0.2
12/8/2011	2011	12	8	0	0.2	0
12/9/2011	2011	12	9	0	0.4	0.2
12/10/2011	2011	12	10	0	0.2	0
12/11/2011	2011	12	11	0	0	0
12/12/2011	2011	12	12	0	0	0
12/13/2011	2011	12	13	0.8	0	0.8
12/14/2011	2011	12	14	M	M	4.2
12/15/2011	2011	12	15			
12/16/2011	2011	12	16			
12/17/2011	2011	12	17			
12/18/2011	2011	12	18			
12/19/2011	2011	12	19			
12/20/2011	2011	12	20			
12/21/2011	2011	12	21			
12/22/2011	2011	12	22			
12/23/2011	2011	12	23			
12/24/2011	2011	12	24			
12/25/2011	2011	12	25			
12/26/2011	2011	12	26			
12/27/2011	2011	12	27			
12/28/2011	2011	12	28			
12/29/2011	2011	12	29			
12/30/2011	2011	12	30			
12/31/2011	2011	12	31			

**SERVICING AND STORMWATER MANAGEMENT BRIEF –
WELLINGS OF STITTSVILLE PHASE 2, 20 CEDAROW COURT**

Appendix D Geotechnical Investigation
September 21, 2022

Appendix D GEOTECHNICAL INVESTIGATION

Geotechnical
Engineering

Environmental
Engineering

Hydrogeology

Geological
Engineering

Materials Testing

Building Science

Archaeological Services

Geotechnical Investigation

Proposed Mixed-Use Development
Wellings of Stittsville - Phase 2
20 Cedarow Court
Ottawa, Ontario

Prepared For

Nautical Lands Group

Paterson Group Inc.

Consulting Engineers
154 Colonnade Road South
Ottawa (Nepean), Ontario
Canada K2E 7J5

Tel: (613) 226-7381
Fax: (613) 226-6344
www.patersongroup.ca

March 7, 2019

Report PG4772-1

Table of Contents

		Page
1.0	Introduction	1
2.0	Proposed Project	1
3.0	Method of Investigation	
	3.1 Field Investigation	2
	3.2 Field Survey	3
	3.3 Laboratory Testing	3
	3.4 Analytical Testing	3
4.0	Observations	
	4.1 Surface Conditions	4
	4.2 Subsurface Profile	4
	4.3 Groundwater	4
5.0	Discussion	
	5.1 Geotechnical Assessment	5
	5.2 Site Grading and Preparation	5
	5.3 Foundation Design	8
	5.4 Design for Earthquakes	10
	5.5 Basement Slab	11
	5.6 Basement Wall	11
	5.7 Pavement Structure	12
6.0	Design and Construction Precautions	
	6.1 Foundation Drainage and Backfill	14
	6.2 Protection of Footings Against Frost Action	15
	6.3 Excavation Side Slopes	15
	6.4 Pipe Bedding and Backfill	17
	6.5 Groundwater Control	18
	6.6 Winter Construction	18
	6.7 Corrosion Potential and Sulphate	19
	6.8 Limit of Hazard Lands	19
	6.9 Landscaping Considerations	22
7.0	Recommendations	23
8.0	Statement of Limitations	24

Appendices

- Appendix 1 Soil Profile and Test Data Sheets
 Symbols and Terms
 Analytical Testing Results
- Appendix 2 Figure 1 - Key Plan
 Figures 2 to 4 - Slope Stability Analysis Sections
 Drawing PG4772-1 - Test Hole Location Plan

1.0 Introduction

Paterson Group (Paterson) was commissioned by Nautical Lands Group to conduct a geotechnical investigation for the proposed mixed-use development to be located at 20 Cedarow Court in the City of Ottawa, Ontario (refer to Figure 1 - Key Plan in Appendix 2).

The objectives of the current investigation were to:

- Determine the subsurface conditions by means of boreholes.
- Provide geotechnical recommendations for the design of the proposed development including construction considerations which may affect the design.

The following report has been prepared specifically and solely for the aforementioned project. This report contains geotechnical findings and includes recommendations pertaining to the design and construction of the proposed development as understood at the time of writing this report.

2.0 Proposed Development

Based on the available drawings, it is our understanding that the proposed development will consist of four, five (5) storey mixed-use buildings with a shared underground parking level occupying the majority of the footprint of the subject site. The buildings are understood to include retail, office space and residential units. A one (1) storey restaurant building is also proposed within the centre of the site. At-grade parking areas, access lanes and landscaped areas are also anticipated a part of the development. It is anticipated that the proposed development will be municipally serviced.

3.0 Method of Investigation

3.1 Field Investigation

Field Program

The field program for the current investigation was carried out from January 14, 2019 to January 18, 2019. At that time, 29 boreholes were drilled to a maximum depth of 4 m below existing grade. The borehole locations were distributed in a manner to provide general coverage of the proposed development. The locations of the boreholes are shown on Drawing PG4772-1 - Test Hole Location Plan included in Appendix 2.

The boreholes were drilled using a track-mounted auger drill rig operated by a two-person crew. All fieldwork was conducted under the full-time supervision of Paterson personnel with the direction of a senior engineer. The drilling procedure consisted of augering to the required depths at the selected locations, sampling and testing the overburden.

Sampling and In Situ Testing

Soil samples were recovered from a 50 mm diameter split-spoon or the auger flights. The split-spoon and auger samples were classified on site and placed in sealed plastic bags. All samples were transported to our laboratory. The depths at which the split-spoon and auger samples were recovered from the boreholes are presented as SS and AU, respectively, on the Soil Profile and Test Data sheets.

Standard Penetration Tests (SPT) were conducted and recorded as “N” values on the Soil Profile and Test Data sheets. The “N” value is the number of blows required to drive the split-spoon sample 300 mm into the soil after the initial penetration of 150 mm using a 63.5 kg hammer falling from a height of 760 mm.

Undrained shear strength tests were conducted in cohesive soils with a field vane apparatus.

The subsurface conditions observed in the boreholes were recorded in detail in the field. The soil profiles are presented on the Soil Profile and Test Data sheets in Appendix 1.

Groundwater

Flexible polyethylene standpipes were installed in the majority of the boreholes to permit groundwater results subsequent to the sampling program completion. Monitoring wells were installed in BH 4, BH 9, BH 15, BH 22, and BH 27 to provide general site coverage as part of our hydrogeological study. The groundwater observations are discussed in Subsection 4.3 and presented in the Soil Profile and Test Data Sheets in Appendix 1.

Sample Storage

All samples will be stored in the laboratory for a period of one month after issuance of this report at which time the samples will be discarded unless otherwise directed.

3.2 Field Survey

The borehole locations were selected by Paterson taking in consideration site features. The ground surface at the test pit locations was located and surveyed by Annis, O'Sullivan, Vollebekk LTD. It is understood that the ground surface elevations at the borehole locations were referenced to a geodetic datum. The locations and ground surface elevation at the boreholes are presented on Drawing PG4772-1 - Test Hole Location Plan in Appendix 2.

3.3 Laboratory Testing

Soil samples recovered from the subject site were visually examined in our laboratory to review the field logs. All samples will be stored in the laboratory for a period of one month after the issuance of this report. They will then be discarded unless we are otherwise directed.

3.4 Analytical Testing

One (1) soil sample was submitted for analytical testing to assess the potential for exposed ferrous metals and the sulphate potential against subsurface concrete structures. The results are discussed further in Subsection 6.7.

4.0 Observations

4.1 Surface Conditions

The subject site is currently undeveloped and grass covered with a tree-line located along the west boundary line of Cedarow Court. The ground surface across the site is relatively flat and approximately 1 m lower than adjacent properties and Hazeldean Road. Poole Creek ravine runs along the western border of the subject site approximately 3 m below the subject site.

The subject site is bordered by an active construction site for Phase 1 of the Wellings of Stittsville development along the north, Hazeldean Road along the east, and commercial buildings at the edge of Cedarow Court along the south.

4.2 Subsurface Profile

Overburden

The subsurface profile at the borehole locations consists of topsoil overlying a hard to very stiff silty clay crust followed by a grey, very stiff to stiff silty clay layer. Glacial till was encountered below the silty clay layer consisting of compact silty sand to sandy silt with clay, gravel, cobbles and boulders. A deposit of very stiff to hard clayey silt was encountered below the topsoil in BH 17, BH 18, BH 24, BH 25, BH 26, and BH 27. Practical refusal to augering on inferred bedrock was encountered in all boreholes at depths ranging between 1.6 to 4.0 m. Specific details of the soil profile at each test hole location are presented on the Soil Profile and Test Data sheets provided in Appendix 1.

Bedrock

Based on available geological mapping, the subject site consists of interbedded dolostone and limestone of the Gull River formation and an approximate drift thickness of 2 to 15 m.

4.3 Groundwater

The measured groundwater levels at the borehole locations are presented in Table 1. Groundwater readings recorded in flexible piezometers could be influenced by surface water infiltrating the backfilled boreholes. The long-term groundwater level can also be estimated based on observations of the recovered soil samples, such as the moisture level, soil consistency and colouring. Based on these observations, the long-term groundwater level is anticipated at a depth ranging between 2.5 to 3.5 m below existing grade. Groundwater levels are subject to seasonal fluctuations and could vary at the time of construction.

Table 1 - Groundwater Readings Summary				
Test Hole Number	Ground Elevation (m)	Groundwater Levels (m)		Recording Date
		Depth	Elevation	
BH 1	104.37	DRY	n/a	January 29, 2019
BH 2	103.59	3.05	100.54	January 29, 2019
BH 3	103.55	1.81	101.74	January 29, 2019
BH 4	103.28	3.05	100.23	January 29, 2019
BH 5	103.45	3.05	100.40	January 29, 2019
BH 6	103.49	3.04	100.45	January 29, 2019
BH 7	103.41	DRY	n/a	January 29, 2019
BH 8	103.46	DRY	n/a	January 29, 2019
BH 9	103.42	3.17	100.25	January 29, 2019
BH 10	103.31	2.18	101.13	January 29, 2019
BH 11	103.44	DRY	n/a	January 29, 2019
BH 12	103.58	DRY	n/a	January 29, 2019
BH 13	103.55	DRY	n/a	January 29, 2019
BH 14	104.18	DRY	n/a	January 29, 2019
BH 15	103.65	2.92	100.73	January 29, 2019
BH 16	103.66	DRY	n/a	January 29, 2019
BH 17	104.19	DRY	n/a	January 29, 2019
BH 18	104.15	DRY	n/a	January 29, 2019
BH 19	103.78	DRY	n/a	January 29, 2019
BH 20	103.59	DRY	n/a	January 29, 2019
BH 21	103.58	DRY	n/a	January 29, 2019
BH 22	103.65	DRY	n/a	January 29, 2019
BH 23	103.87	2.62	101.25	January 29, 2019
BH 24	104.04	2.55	101.49	January 29, 2019
BH 25	104.07	1.68	102.39	January 29, 2019
BH 26	104.30	DRY	n/a	January 29, 2019
BH 27	103.97	DRY	n/a	January 29, 2019
BH 28	103.78	DRY	n/a	January 29, 2019
BH 29	103.71	DRY	n/a	January 29, 2019

Note: The ground surface elevation at the borehole locations was provided by Annis, O'Sullivan, Vollebakk Ltd.

5.0 Discussion

5.1 Geotechnical Assessment

From a geotechnical perspective, the subject site is suitable for the proposed development. The proposed structures will be founded on conventional shallow foundations placed on an undisturbed, hard to very stiff silty clay, compact to dense glacial till and/or clean, surface sounded bedrock bearing surface. Alternatively, conventional shallow footings can be placed over a near vertical, zero entry, concrete in-filled trenches extending to a clean, surface sounded bedrock bearing surface.

Permissible grade raise restriction areas are also required due to the silty clay deposit. A permissible grade raise restriction of **2 m** is recommended for areas where settlement sensitive structures are founded over the silty clay deposit.

Depending on the extent of the underground parking garage and potential grade raise, the bedrock may be encountered during excavation and construction. All contractors should be prepared for bedrock removal within the subject site.

Prior to considering blasting operations, if required, the blasting effects on the existing services, buildings and other structures should be addressed. A pre-blast or pre-construction survey of the existing structures located in proximity of the blasting operations should be carried out prior to commencing site activities. The extent of the survey should be determined by the blasting consultant and should be sufficient to respond to any inquiries/claims related to the blasting operations.

The blasting operations should be planned and conducted under the supervision of a licensed professional engineer who is also an experienced blasting consultant.

The above and other considerations are discussed in the following sections.

5.2 Site Grading and Preparation

Stripping Depth

Topsoil and deleterious fill, such as those containing organic materials, should be stripped from under any buildings, paved areas, pipe bedding, and other settlement sensitive structures.

Bedrock Removal

Bedrock removal can be accomplished by hoe ramming where only small quantity of the bedrock needs to be removed. Sound bedrock may be removed by line drilling and controlled blasting and/or hoe ramming.

Prior to considering blasting operations, the blasting effects on the existing services, buildings and other structures should be addressed. A pre-blast or pre-construction survey of the existing structures located in proximity of the blasting operations should be completed prior to commencing site activities. The extent of the survey should be determined by the blasting consultant and should be sufficient to respond to any inquiries/claims related to the blasting operations.

As a general guideline, peak particle velocities (measured at the structures) should not exceed 25 mm/s during the blasting program to reduce the risks of damage to the existing structures.

The blasting operations should be planned and conducted under the supervision of a licensed professional engineer who is also an experienced blasting consultant.

Excavation side slopes in sound bedrock can be excavated almost vertical side walls. A minimum 1 m horizontal ledge, should remain between the overburden excavation and the bedrock surface. The ledge will provide an area to allow for potential sloughing or a stable base for the overburden shoring system.

Vibration Considerations

Construction operations are the cause of vibrations, and possibly, sources of nuisance to the community. Therefore, means to reduce the vibration levels as much as possible should be incorporated in the construction operations to maintain, as much as possible, a cooperative environment with the residents.

The following construction equipments could be the source of vibrations: hoe ram, compactor, dozer, crane, truck traffic, etc. Vibrations, whether caused by blasting operations or by construction operations, could be the source of detrimental vibrations on the nearby buildings and structures. Therefore, all vibrations are recommended to be limited.

Two parameters are used to determine the permissible vibrations, namely, the maximum peak particle velocity and the frequency. For low frequency vibrations, the maximum allowable peak particle velocity is less than that for high frequency vibrations. As a guideline, the peak particle velocity should be less than 15 mm/s between frequencies of 4 to 12 Hz, and 50 mm/s above a frequency of 40 Hz (interpolate between 12 and 40 Hz). The guidelines are for current construction standards. Considering that these guidelines are above perceptible human level and, in some cases, could be very disturbing to some people, a pre-construction survey is recommended be completed to minimize the risks of claims during or following the construction of the proposed buildings.

Fill Placement

Fill placed for grading beneath the structure(s) or other settlement sensitive areas should consist, unless otherwise specified, of clean imported granular fill, such as Ontario Provincial Standard Specifications (OPSS) Granular A or Granular B Type II. This material should be tested and approved prior to delivery to the site. The engineered fill should be placed in maximum 300 mm thick lifts and compacted to 98% of the material's standard Proctor maximum dry density (SPMDD).

Non-specified existing fill along with site-excavated soil can be placed as general landscaping fill where surface settlement is a minor concern. The backfill materials should be spread in thin lifts and at a minimum compacted by the tracks of the spreading equipment to minimize voids. If the non-specified backfill is to be placed to increase the subgrade level for areas to be paved, the fill should be compacted in maximum 300 mm lifts and compacted to 95% of the material's SPMDD. Non-specified existing fill and site-excavated soils are not suitable for placement as backfill against foundation walls unless a composite drainage blanket connected to a perimeter drainage system is provided.

5.3 Foundation Design

Bearing Resistance Values (Shallow Foundation)

Footings for the proposed buildings can be designed with the following bearing resistance values presented in Table 2.

Table 2 - Bearing Resistance Values		
Bearing Surface	Bearing Resistance Value at SLS (kPa)	Factored Bearing Resistance Value at ULS (kPa)
Very stiff to hard silty clay	150	250
Compact to dense glacial till	200	300
Lean Concrete In-filled Trenches	-	1,500
Clean, Surface Sounded Limestone Bedrock	-	1,500
<p>Note: Strip footings, up to 3 m wide, and pad footings, up to 8 m wide, placed over an undisturbed, silty clay bearing surface can be designed using the abovenoted bearing resistance values. - A geotechnical resistance factor of 0.5 was applied to the above noted bearing resistance value at ULS.</p>		

The above-noted bearing resistance values at SLS for soil bearing surfaces will be subjected to potential post-construction total and differential settlements of 25 and 20 mm, respectively. Footings bearing on an acceptable bedrock bearing surface and designed for the bearing resistance values provided herein will be subjected to negligible potential post-construction total and differential settlements.

The bearing resistance values are provided on the assumption that the footings are placed on undisturbed soil bearing surfaces. An undisturbed soil bearing surface consists of one from which all topsoil and deleterious materials, such as loose, frozen or disturbed soil, whether in situ or not, have been removed, in the dry, prior to the placement of concrete for footings.

A clean, surface-sounded bedrock bearing surface should be free of loose materials, and have no near surface seams, voids, fissures or open joints which can be detected from surface sounding with a rock hammer.

Lean Concrete Filled Trenches

Where bedrock is encountered below the design underside of footing elevation, consideration should be given to excavating vertical trenches to expose the underlying bedrock surface and backfilling with lean concrete (**15 MPa** 28-day compressive strength). Typically, the excavation sidewalls will be used as the form to support the concrete. The additional width of the concrete poured against an undisturbed trench sidewall will suffice in providing a direct transfer of the footing load to the underlying bedrock.

The effectiveness of this operation will depend on the ability of maintaining vertical trenches until the lean concrete can be poured. It is suggested that once the bottom of the excavation is exposed, an assessment should be completed to determine the water infiltration and stability of the excavation sidewalls extending to the bedrock surface.

The trench excavation should be at least 300 mm wider than all sides of the footing at the base of the excavation. The excavation bottom should be relatively clean using the hydraulic shovel only (workers will not be permitted in the excavation below a 1.5 m depth). Once approved by the geotechnical engineer, lean concrete can be poured up to the proposed founding elevation.

Bedrock/Soil Transition

Where a building is founded partly on bedrock and partly on soil, it is recommended to decrease the soil bearing resistance value by 25% for the footings placed on soil bearing media to reduce the potential long term total and differential settlements. Also, at the soil/bedrock and bedrock/soil transitions, it is recommended that the upper 0.5 m of the bedrock be removed for a minimum length of 2 m (on the bedrock side) and replaced with nominally compacted OPSS Granular A or Granular B Type II material. The width of the sub-excavation should be at least the proposed footing width plus 0.5 m. Steel reinforcement, extending at least 3 m on both sides of the 2 m long transition, should be placed in the top part of the footings and foundation walls.

Lateral Support

The bearing medium under footing-supported structures is required to be provided with adequate lateral support with respect to excavations and different foundation levels. Adequate lateral support is provided to an engineered fill, stiff silty clay or glacial till above the groundwater table when a plane extending horizontally and vertically from the underside of the footing at a minimum of 1.5H:1V passing through in situ soil of the same or higher bearing capacity as the bearing medium soil.

Permissible Grade Raise Restriction

Based on the current borehole information, a **permissible grade raise restriction of 2 m** is recommended for the proposed buildings and settlement sensitive structures where founded over a silty clay deposit. A post-development groundwater lowering of 0.5 m was assumed for our calculations.

5.4 Design for Earthquakes

The site class for seismic site response can be taken as **Class C** for the foundations considered at this site. However, a higher site class, such as Class A or B can be provided if a site specific shear wave velocity test is completed to confirm the seismic site classification. The soils underlying the subject site are not susceptible to liquefaction. Refer to the latest revision of the Ontario Building Code for a full discussion of the earthquake design requirements.

5.5 Basement Slab

The basement area for the proposed project will be mostly parking and the recommended pavement structure noted in Subsection 5.7 will be applicable. However, if storage or other uses of the lower level where a concrete floor slab will be constructed, the upper 200 mm of sub-slab fill is recommended to consist of 19 mm clear crushed stone. The upper 200 mm of sub-slab fill is recommended to consist of OPSS Granular A crushed stone for slab on grade construction. All backfill material within the footprint of the proposed building(s) should be placed in maximum 300 mm thick loose layers and compacted to a minimum of 98% of the SPMDD.

Any soft areas should be removed and backfilled with appropriate backfill material prior to placing any fill. OPSS Granular A or Granular B Type II, with a maximum particle size of 50 mm, are recommended for backfilling below the floor slab. All backfill material within the footprint of the proposed building(s) should be placed in maximum 300 mm thick loose layers and compacted to a minimum of 98% of the SPMDD.

A subfloor drainage system, consisting of lines of perforated drainage pipe subdrains connected to a positive outlet, should be provided in the clear stone under the lower basement floor (discussed in Subsection 6.1).

5.6 Basement Wall

There are several combinations of backfill materials and retained soils that could be applicable for the proposed structure's basement walls. However, the conditions can be well-represented by assuming the retained soil consists of a material with an angle of internal friction of 30 degrees and a dry unit weight of 20 kN/m³.

The foundation wall is anticipated to be provided with a perimeter drainage system; therefore, the retained soils should be considered drained. For the undrained conditions, the applicable effective unit weight of the retained soil can be designed with 13 kN/m³. A hydrostatic pressure should be added to the total static earth pressure when calculating the effective unit weight. The total earth pressure (P_{AE}) includes both the static earth pressure component (P_o) and the seismic component (ΔP_{AE}).

Two distinct conditions, static and seismic, should be reviewed for design calculations. The parameters for design calculations for the two conditions are presented below.

Static Conditions

The static horizontal earth pressure (p_o) could be calculated with a triangular earth pressure distribution equal to $K_o \cdot \gamma \cdot H$ where:

- K_o = at-rest earth pressure coefficient of the applicable retained soil, 0.5
 γ = unit weight of fill of the applicable retained soil (kN/m³)
 H = height of the wall (m)

An additional pressure with a magnitude equal to $K_o \cdot q$ and acting on the entire height of the wall should be added to the above formula for any surcharge loading, q (kPa), that may be placed at ground surface adjacent to the wall. The surcharge pressure should only be applicable for static analyses and not be calculated in conjunction with the seismic loading case. Actual earth pressures could be higher than the “at-rest” case if care is not exercised during the compaction of the backfill materials to maintain a minimum separation of 0.3 m from the walls with the compaction equipment.

Seismic Conditions

The total seismic force (P_{AE}) includes both the earth force component (P_o) and the seismic component (ΔP_{AE}).

The seismic earth force (ΔP_{AE}) could be calculated using $0.375 \cdot a_c \cdot \gamma \cdot H^2/g$ where:

- $a_c = (1.45 - a_{max}/g) a_{max}$
 γ = unit weight of fill of the applicable retained soil (kN/m³)
 H = height of the wall (m)
 g = gravity, 9.81 m/s²

The peak ground acceleration, (a_{max}), for the Ottawa area is 0.32g according to OBC 2012. The vertical seismic coefficient is assumed to be zero. The earth force component (P_o) under seismic conditions could be calculated using $P_o = 0.5 K_o \gamma H^2$, where $K_o = 0.5$ for the soil conditions presented above.

The total earth force (P_{AE}) is considered to act at a height, h (m), from the base of the wall, where:

$$h = \{P_o \cdot (H/3) + \Delta P_{AE} \cdot (0.6 \cdot H)\} / P_{AE}$$

The earth forces calculated are unfactored. For the ULS case, the earth loads should be factored as live loads, as per OBC 2012.

5.7 Pavement Structure

For design purposes, the pavement structure presented in the following tables could be used for the design of car only parking areas and access lanes, if required.

Table 3 - Recommended Flexible Pavement Structure - At-Grade Parking Areas	
Thickness (mm)	Material Description
50	Wear Course - HL-3 or Superpave 12.5 Asphaltic Concrete
150	BASE - OPSS Granular A Crushed Stone
300	SUBBASE - OPSS Granular B Type II
	SUBGRADE - In situ soil, or OPSS Granular B Type I or II material placed over in situ soil

Table 4 - Recommended Flexible Pavement Structure - Access Lanes and Heavy Truck Parking Areas	
Thickness (mm)	Material Description
40	Wear Course - HL-3 or Superpave 12.5 Asphaltic Concrete
50	Binder Course - HL-8 or Superpave 19.0 Asphaltic Concrete
150	BASE - OPSS Granular A Crushed Stone
450	SUBBASE - OPSS Granular B Type II
	SUBGRADE - In situ soil, or OPSS Granular B Type I or II material placed over in situ soil

Minimum Performance Graded (PG) 58-34 asphalt cement should be used for this project.

If soft spots develop in the subgrade during compaction or due to construction traffic, the affected areas should be sub-excavated and replaced with OPSS Granular B Type II material.

The pavement granular base and subbase should be placed in maximum 300 mm thick lifts and compacted to a minimum of 98% of the SPMDD.

6.0 Design and Construction Precautions

6.1 Foundation Drainage and Backfill

Foundation Drainage

A perimeter foundation drainage system is recommended to be provided for the proposed structures. The composite drainage system (such as Miradrain G100N, Delta Drain 6000 or an approved equivalent) is recommended to extend to the footing level. Sleeves, 150 mm diameter, at 3 m centres are recommended to be placed in the footing or at the foundation wall/footing interface for blind sided pours to allow the infiltration of water to flow to the interior perimeter drainage pipe. The perimeter drainage pipe and underfloor drainage system should direct water to sump pit(s) within the lower basement area.

Underfloor Drainage

Underfloor drainage is recommend to control water infiltration for the proposed structures. For design purposes, Paterson recommends 150 mm diameter PVC, corrugated, perforated pipes be placed at 3 to 6 m centres. The spacing of the underfloor drainage system should be confirmed at the time of completing the excavation when water infiltration can be better assessed.

Adverse Effects of Dewatering on Adjacent Properties

Due to the low permeability of the subsoils profile, any minor dewatering will be considered relatively minor due to the proposed building. Therefore, adverse effects to the surrounding buildings or properties are not expected with respect to any groundwater lowering.

Foundation Backfill

Backfill against the exterior sides of the foundation walls should consist of free-draining non frost susceptible granular materials. The greater part of the site excavated materials will be frost susceptible and, as such, are not recommended for re-use as backfill against the foundation walls where frost heave sensitive structures, such as a concrete sidewalk, will be placed. Imported granular materials, such as clean sand or OPSS Granular B Type I granular material may be used for this purpose. A composite drainage system, such as Delta Drain 6000, Miradrain G100 or an approved equivalent, should be placed against the foundation wall to promote drainage toward the perimeter drainage pipe.

6.2 Protection of Footings Against Frost Action

Perimeter footings of heated structures are recommended to be protected against the deleterious effects of frost action. A minimum of 1.5 m of soil cover alone, or a combination of soil cover and foundation insulation should be provided.

Exterior unheated footings, such as isolated exterior piers, are more prone to deleterious movement associated with frost action than the exterior walls of the structure proper and require additional protection, such as soil cover of 2.1 m or a combination of soil cover and foundation insulation.

The parking garage should not require protection against frost action due to the founding depth. Unheated structures, such as the access ramp wall footings, may be required to be insulated against the deleterious effect of frost action. A minimum of 2.1 m of soil cover alone, or a minimum of 0.6 m of soil cover, in conjunction with foundation insulation, should be provided.

6.3 Excavation Side Slopes

Temporary Side Slopes

The temporary excavation side slopes should either be excavated to acceptable slopes or retained by shoring systems from the beginning of the excavation until the structure is backfilled.

The excavation side slopes above the groundwater level extending to a maximum depth of 3 m should be excavated at 1H:1V or shallower. The shallower slope is required for excavation below groundwater level. The subsurface soil is considered to be mainly Type 2 and 3 soil according to the Occupational Health and Safety Act and Regulations for Construction Projects.

Excavated soil should not be stockpiled directly at the top of excavations and heavy equipment should maintain safe working distance from the excavation sides.

Slopes in excess of 3 m in height should be periodically inspected by the geotechnical consultant in order to detect if the slopes are exhibiting signs of distress.

A trench box is recommended to be installed at all times to protect personnel working in trenches with steep or vertical sides. Services are expected to be installed by “cut and cover” methods and excavations should not be remain exposed for extended periods of time.

Temporary Shoring

Temporary shoring may be required for the overburden soil to complete the required excavations where insufficient room is available for open cut methods. The shoring requirements designed by a structural engineer specializing in those works will depend on the excavation depths, the proximity of the adjacent structures and the elevation of the adjacent building foundations and underground services. The design and implementation of these temporary systems will be the responsibility of the excavation contractor and their design team. Inspections and approval of the temporary system will also be the responsibility of the designer. Geotechnical information provided below is to assist the designer in completing a suitable and safe shoring system. The designer should take into account the impact of a significant precipitation event and designate design measures to ensure that a precipitation will not negatively impact the shoring system or soils supported by the system. Any changes to the approved shoring design system should be reported immediately to the owner's structural designer prior to implementation.

The temporary system could consist of soldier pile and lagging system or interlocking steel sheet piling. Any additional loading due to street traffic, construction equipment, adjacent structures and facilities, etc., should be included to the earth pressures described below. These systems could be cantilevered, anchored or braced. Generally, it is expected that the shoring systems will be provided with tie-back rock anchors to ensure their stability. The shoring system is recommended to be adequately supported to resist toe failure and inspected to ensure that the sheet piles extend well below the excavation base. It should be noted if consideration is being given to utilizing a raker style support for the shoring system that lateral movements can occur and the structural engineer should ensure that the design selected minimizes these movements to tolerable levels.

The earth pressures acting on the shoring system may be calculated with the following parameters.

Table 6 - Soil Parameters	
Parameters	Values
Active Earth Pressure Coefficient (K_a)	0.33
Passive Earth Pressure Coefficient (K_p)	3
At-Rest Earth Pressure Coefficient (K_0)	0.5
Dry Unit Weight (γ), kN/m ³	20
Effective Unit Weight (γ), kN/m ³	13

The active earth pressure should be calculated where wall movements are permissible while the at-rest pressure should be calculated if no movement is permissible. The dry unit weight should be calculated above the groundwater level while the effective unit weight should be calculated below the groundwater level.

The hydrostatic groundwater pressure should be included to the earth pressure distribution wherever the effective unit weight are calculated for earth pressures. If the groundwater level is lowered, the dry unit weight for the soil/bedrock should be calculated full weight, with no hydrostatic groundwater pressure component.

For design purposes, the minimum factor of safety of 1.5 should be calculated.

6.4 Pipe Bedding and Backfill

Bedding and backfill materials should be in accordance with the most recent Material Specifications and Standard Detail Drawings from the Department of Public Works and Services, Infrastructure Services Branch of the City of Ottawa.

A minimum of a 150 mm layer of OPSS Granular A crushed stone should be placed for pipe bedding for sewer and water pipes for a soil subgrade. The bedding thickness should be increased to 300 mm for areas where the subgrade consists of bedrock. The bedding should extend to the spring line of the pipe. Cover material, from the spring line to at least 300 mm above the obvert of the pipe should consist of OPSS Granular A. The bedding and cover materials should be placed in maximum 300 mm thick lifts compacted to a minimum of 95% of the SPMDD.

The site excavated material may be placed above cover material if the excavation operations are completed in dry weather conditions and the site excavated material is approved by the geotechnical consultant. All cobbles greater than 200 mm in the longest dimension should be removed prior to the site materials being reused.

Where hard surface areas are considered above the trench backfill, the trench backfill material within the frost zone (about 1.8 m below finished grade) should match the soils exposed at the trench walls to reduce differential frost heaving. The trench backfill should be placed in maximum 225 mm thick loose lifts and compacted to a minimum of 95% of the SPMDD. Within the frost zone (1.8 m below finished grade), non frost susceptible materials should be used when backfilling trenches below the original bedrock level.

Clay seals are recommended for the subject site. The seals should be a minimum of 1.5 m long (in the trench direction) and should extend from trench wall to trench wall. Generally, the seals should extend from the frost line and fully penetrate the bedding, subbedding and cover material. The barriers should consist of relatively dry and compactable brown silty clay placed in maximum 225 mm thick loose layers and compacted to a minimum of 95% of the SPMDD. The clay seals should be placed at the site boundaries, roadway intersections and at a maximum distance of every 50 m in the service trenches.

6.5 Groundwater Control

Groundwater Control for Building Construction

It is anticipated that groundwater infiltration into the excavations should be low and controllable using open sumps. Pumping from open sumps should be sufficient to control the groundwater influx through the sides of shallow excavations. The contractor should be prepared to direct water away from all bearing surfaces and subgrades, regardless of the source, to prevent disturbance to the founding medium.

A temporary Ministry of the Environment, Conservation and Parks (MECP) permit to take water (PTTW) may be required for this project if more than 400,000 L/day of ground and/or surface water is to be pumped during the construction phase. A minimum 4 to 5 months should be allowed for completion of the PTTW application package and issuance of the permit by the MECP.

For typical ground or surface water volumes, being pumped during the construction phase, between 50,000 to 400,000 L/day, it is required to register on the Environmental Activity and Sector Registry (EASR). A minimum of two to four weeks should be allotted for completion of the EASR registration and the Water Taking and Discharge Plan to be prepared by a Qualified Person as stipulated under O.Reg. 63/16. If a project qualifies for a PTTW based upon anticipated conditions, an EASR will not be allowed as a temporary dewatering measure while awaiting the MECP review of the PTTW application.

6.6 Winter Construction

Precautions must be provided if winter construction is considered for this project. Where excavations are completed in proximity of existing structures which may be adversely affected due to the freezing conditions. In particular, where a shoring system is constructed, the soil behind the shoring system will be subjected to freezing conditions and could result in heaving of the structure(s) placed within or above frozen soil. Provisions in the contract documents should be provided to protect the excavation walls from freezing, if applicable.

In the event of construction during below zero temperatures, the founding stratum should be protected from freezing temperatures by the installation of straw, propane heaters and tarpaulins or other suitable means. The excavation base should be insulated from sub-zero temperatures immediately upon exposure and until such time as heat is adequately supplied to the building and the footings are protected with sufficient soil cover to prevent freezing at founding level.

Trench excavations and pavement construction are difficult activities to complete during freezing conditions without introducing frost in the subgrade or in the excavation walls and bottoms. Precautions should be considered if such activities are to be completed during freezing conditions. Additional information could be provided, if required.

6.7 Corrosion Potential and Sulphate

The results on analytical testing show that the sulphate content is less than 0.1%. The results are indicative that Type 10 Portland Cement (Type GU) would be appropriate for this site. The chloride content and the pH of the sample indicate that they are not significant factors in creating a corrosive environment for exposed ferrous metals at this site, whereas the resistivity is indicative of a low to moderate corrosive environment.

6.8 Limit of Hazard Lands

Field Observations

Paterson conducted a site visit on January 13, 2019 to review the slope located along the west boundary of the subject site, assess the current slope conditions and confirm the grades provided in the existing topographic mapping. A section of Poole Creek is located within the west portion of the site and shown in Drawing PG4772-1 - Test Hole Location Plan.

Three (3) slope cross-sections were reviewed in the field as the worst case scenarios. The cross section locations are presented on Drawing PG4772-1 - Test Hole Location Plan in Appendix 2. Generally, the riverbanks along both sides of Poole Creek are currently well vegetated and were observed in an acceptable condition. Poole Creek was observed within a 20 to 40 m wide flood plain. The slope along the east side of Poole Creek ranged in height between 3 and 5 m with an inclination ranging between 2.3H:1V and 3.3H:1V. The upper slope was observed to be well vegetated with little to no signs of active surficial erosion.

Slope Stability Analysis

Limit of Hazard Lands

The slope condition was reviewed based on available topographic mapping along the east side slopes of Poole Creek within the west portion of the subject development. A total of 3 slope cross-sections were assessed as the worst case scenarios. The cross section locations are presented on Drawing PG4772-1 - Test Hole Location Plan in Appendix 2.

A slope stability assessment was carried out to determine the required stable slope allowance setback from the top of slope based on a factor of safety of 1.5. A toe erosion and 6 m erosion access allowances were also included in the determination of limits of hazard lands and are discussed below. The proposed limit of hazard lands (as shown on Drawing PG4772-1 - Test Hole Location Plan) includes:

- a geotechnical slope stability allowance with a factor of safety of 1.5
- a toe erosion allowance
- a 6 m erosion access allowance and top of slope

Slope Stability Analysis

The analysis of the stability of the slope sections was carried out using SLIDE, a computer program which permits a two-dimensional slope stability analysis using several methods including the Bishop's method, which is a widely used and accepted analysis method. The program calculates a factor of safety, which represents the ratio of the forces resisting failure to those favoring failure. Theoretically, a factor of safety of 1.0 represents a condition where the slope is stable. However, due to intrinsic limitations of the calculation methods and the variability of the subsoil and groundwater conditions, a factor of safety greater than one is usually required to ascertain that the risks of failure are acceptable. A minimum factor of safety of 1.5 is generally recommended for conditions where the failure of the slope would endanger permanent structures.

An analysis considering seismic loading was also completed. A horizontal acceleration of 0.16G was considered for the sections for the seismic loading condition. A factor of safety of 1.1 is considered to be satisfactory for stability analyses including seismic loading.

The cross-sections were analysed taking into account a groundwater level at ground surface, which represents a worse-case scenario that can be reasonably expected to occur in cohesive soils. The stability analysis assumes full saturation of the soil with groundwater flow parallel to the slope face. Subsoil conditions at the cross-sections were inferred based on the findings at borehole locations along the top of slope and general knowledge of the area's geology.

Stable Slope Allowance

The results of the stability analysis for static conditions at Sections A through C are presented in Figures 2A to 4A in Appendix 2. All the reviewed slope sections along the subject creek were noted to be shaped to at least a 2.3H:1V. Based on the soil conditions observed and the results of the slope stability analysis, the slope stability factor of safety was calculated to be 1.5 or greater for all the slope sections which indicates that a stable slope allowance is not required for the subject slope.

The results of the analyses including seismic loading are shown in Figures 2B to 4B for the slope sections. The results indicate that the factor of safety for the sections are greater than 1.1.

It should be noted that the existing vegetation on the slope face should not be removed as it contributes to the stability of the slope and reduces erosion. If the existing vegetation needs to be removed, it is recommended that a 100 to 150 mm of topsoil mixed with a hardy seed and/or topped with an erosion control blanket be which can be placed across the exposed slope face.

Toe Erosion and Erosion Access Allowance

The toe erosion allowance for the valley corridor wall slope was based on the cohesive nature of the top layers of the subsoils, the observed current erosional activities and the width and location of the current watercourse. It should be noted that if the flood plain is measured to be greater than 20 m, no toe erosion will be required. Therefore, based on the above factors, no toe erosion allowance is considered for the subject slope.

An erosion access allowance of 6 m is required from the top of slope to ensure access is provided should future maintenance to the slope face is required. The limit of hazard lands, which includes these allowances, is indicated on Drawing PG4772-1 - Test Hole Location Plan in Appendix 2.

6.9 Landscaping Considerations

Tree Planting Restrictions

According to the City of Ottawa Guidelines for tree planting, where a sensitive silty clay deposit is present within the vicinity of the site, tree planting restrictions should be determined. However, for this site, based on the founding medium of the underground parking level which will occupy the majority of the site, tree planting restrictions are not required from a geotechnical perspective.

7.0 Recommendations

A materials testing and observation services program is a requirement for the provided foundation design data to be applicable. The following aspects of the program should be performed by the geotechnical consultant:

- Review detailed grading plan(s) from a geotechnical perspective.
- Review groundwater conditions at the time of construction to determine if waterproofing is required.
- Observation of all bearing surfaces prior to the placement of concrete.
- Sampling and testing of the concrete and fill materials used.
- Periodic observation of the condition of unsupported excavation side slopes in excess of 3 m in height, if applicable.
- Observation of all subgrades prior to backfilling.
- Field density tests to determine the level of compaction achieved.
- Sampling and testing of the bituminous concrete including mix design reviews.

A report confirming that the construction work has been conducted in general accordance with the above recommendations could be issued, upon request, following the completion of a satisfactory materials testing and observation program by the geotechnical consultant.

8.0 Statement of Limitations

The recommendations provided in the report are in accordance with Paterson's present understanding of the project. Paterson request permission to review the recommendations when the drawings and specifications are completed.

A geotechnical investigation is a limited sampling of a site. Should any conditions encountered during construction differ from the borehole locations, Paterson requests immediate notification to permit reassessment of the recommendations provided herein.

The recommendations provided should only be used by the design professionals associated with this project. The recommendations are not intended for contractors bidding on or constructing the project. The latter should evaluate the factual information provided in the report. The contractor should also determine the suitability and completeness for the intended construction schedule and methods. Additional testing may be required for the contractors purpose.

The present report applies only to the project described in this document. Use of this report for purposes other than those described herein or by person(s) other than Nautical Lands Group or their agent(s) is not authorized without review by Paterson for the applicability of our recommendations to the altered use of the report.

Paterson Group Inc.



Faisal I. Abou-Seido, P.Eng.



David J. Gilbert, P.Eng.

Report Distribution:

- Nautical Lands Group (3 copies)
- Paterson Group (1 copy)

APPENDIX 1

SOIL PROFILE AND TEST DATA SHEETS

SYMBOLS AND TERMS

ANALYTICAL TESTING RESULTS

DATUM Ground surface elevations provided by Annis, O'Sullivan, Vollebakk Ltd.

FILE NO. **PG4772**

REMARKS

HOLE NO. **BH 1**

BORINGS BY CME 55 Power Auger

DATE 2019 January 14

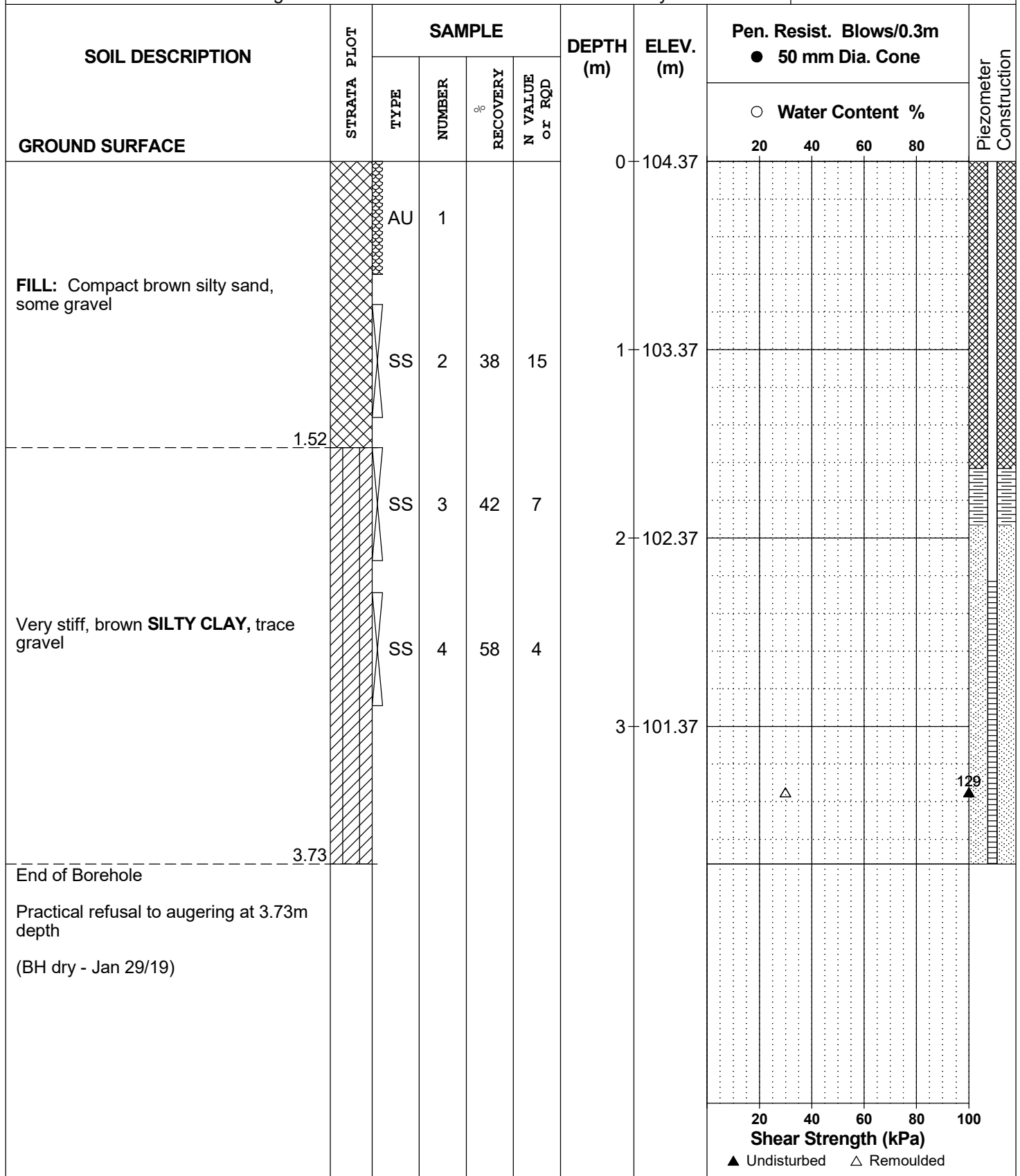

DATUM Ground surface elevations provided by Annis, O'Sullivan, Vollebakk Ltd.

FILE NO. **PG4772**

REMARKS

HOLE NO. **BH 2**

BORINGS BY CME 55 Power Auger

DATE 2019 January 14

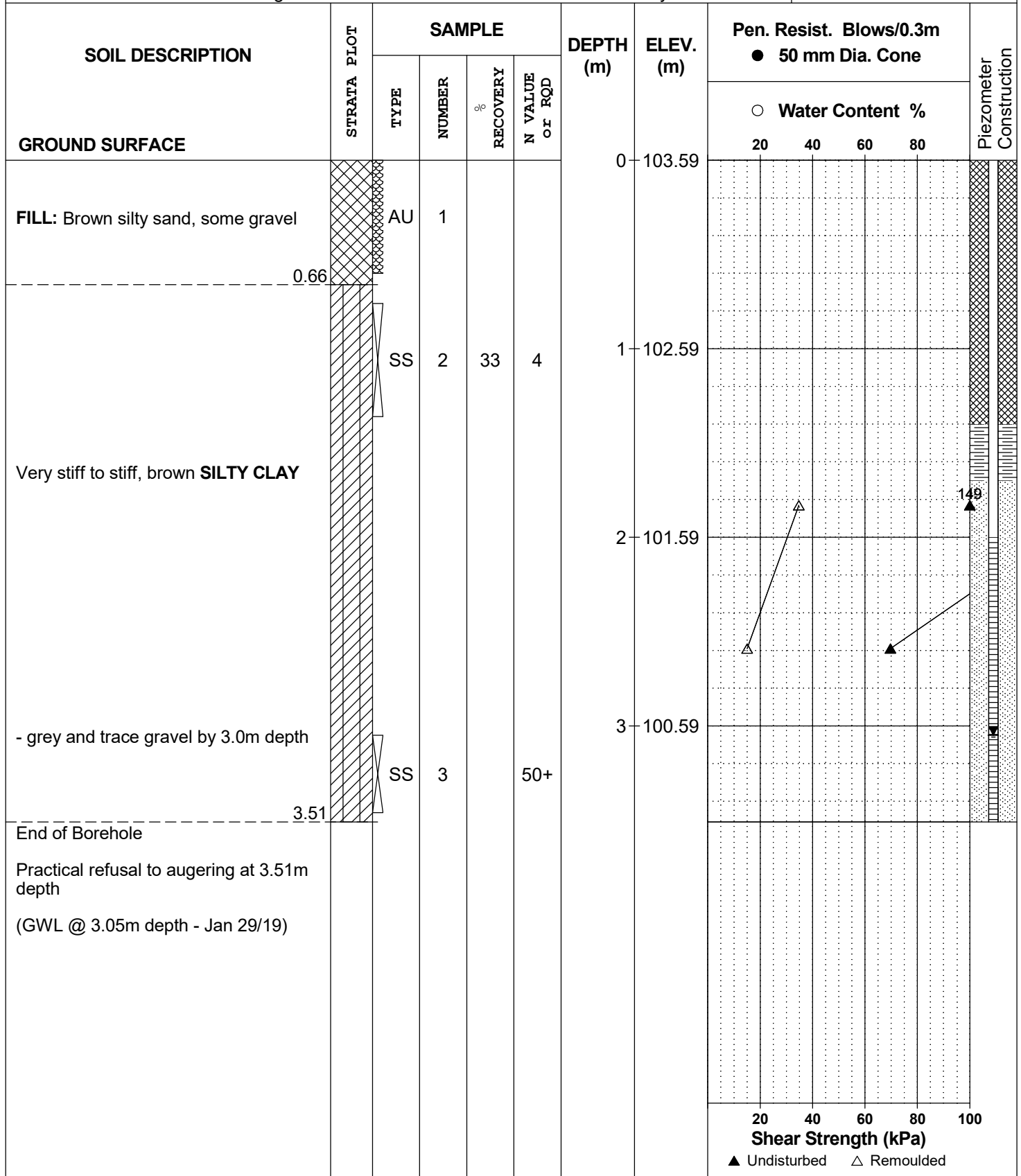

DATUM Ground surface elevations provided by Annis, O'Sullivan, Vollebakk Ltd.

FILE NO. **PG4772**

REMARKS

HOLE NO. **BH 3**

BORINGS BY CME 55 Power Auger

DATE 2019 January 14

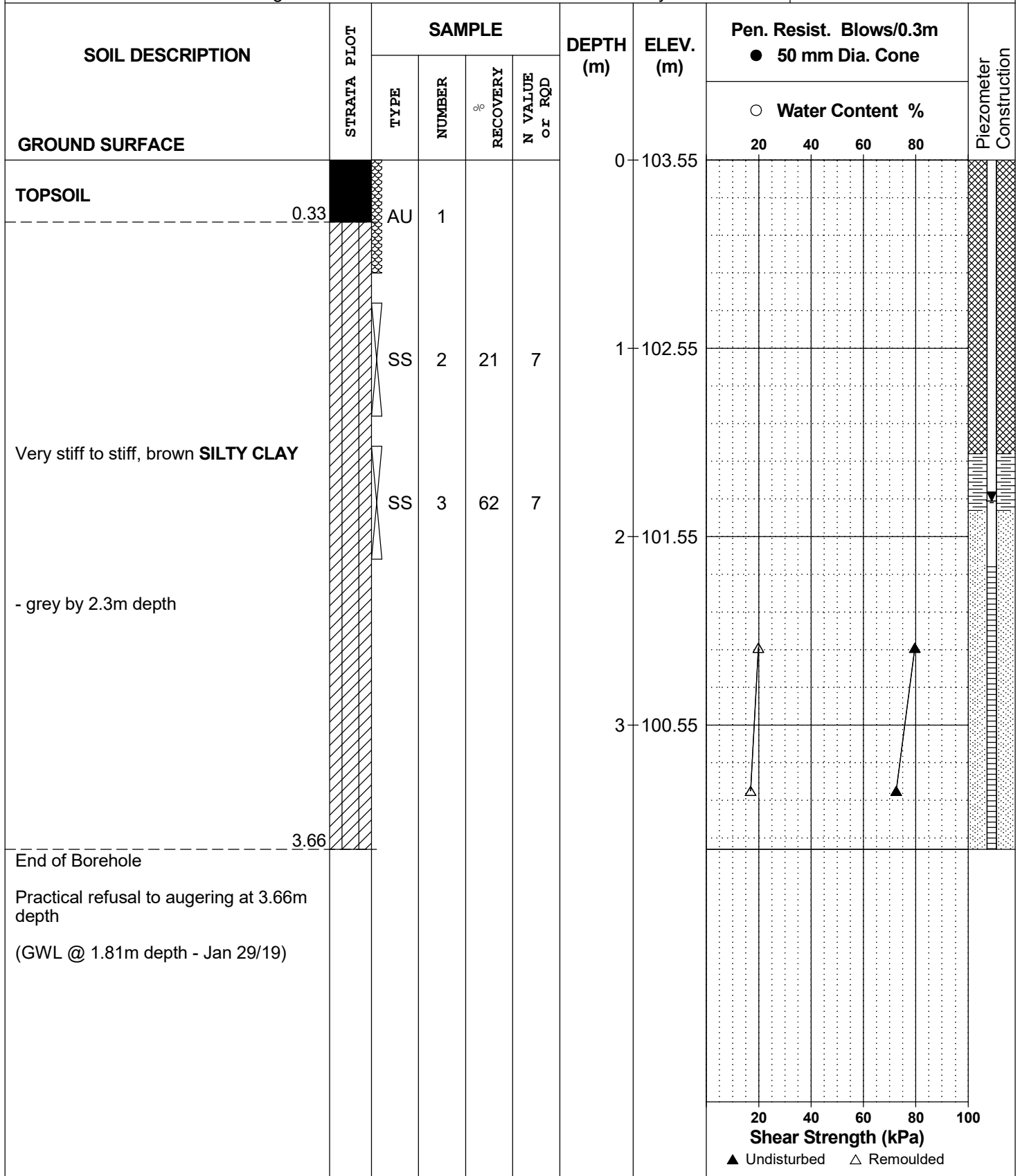

DATUM Ground surface elevations provided by Annis, O'Sullivan, Vollebakk Ltd.

FILE NO. **PG4772**

REMARKS

HOLE NO. **BH 4**

BORINGS BY CME 55 Power Auger

DATE 2019 January 14

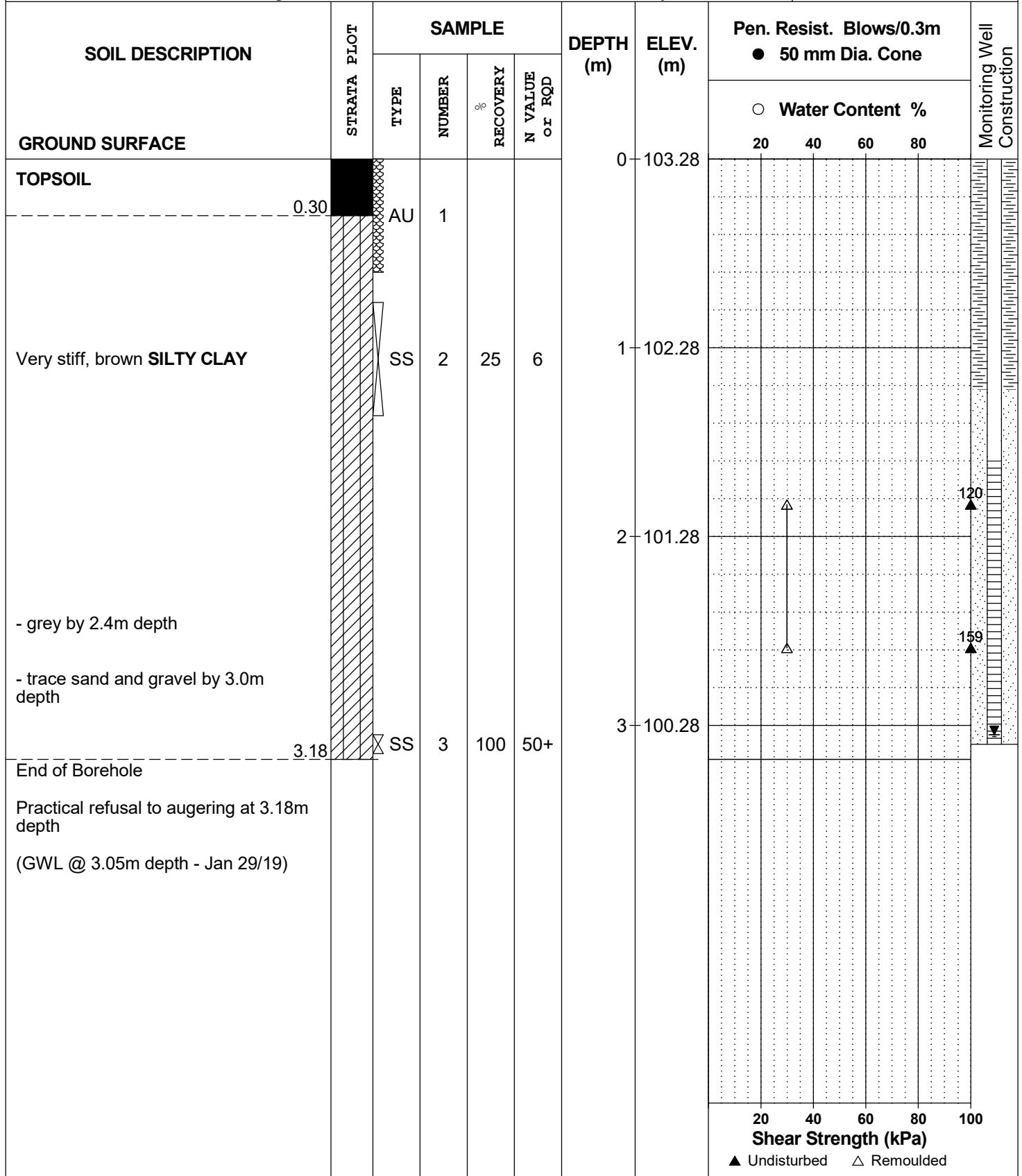

DATUM Ground surface elevations provided by Annis, O'Sullivan, Vollebakk Ltd.

FILE NO. **PG4772**

REMARKS

HOLE NO. **BH 5**

BORINGS BY CME 55 Power Auger

DATE 2019 January 14

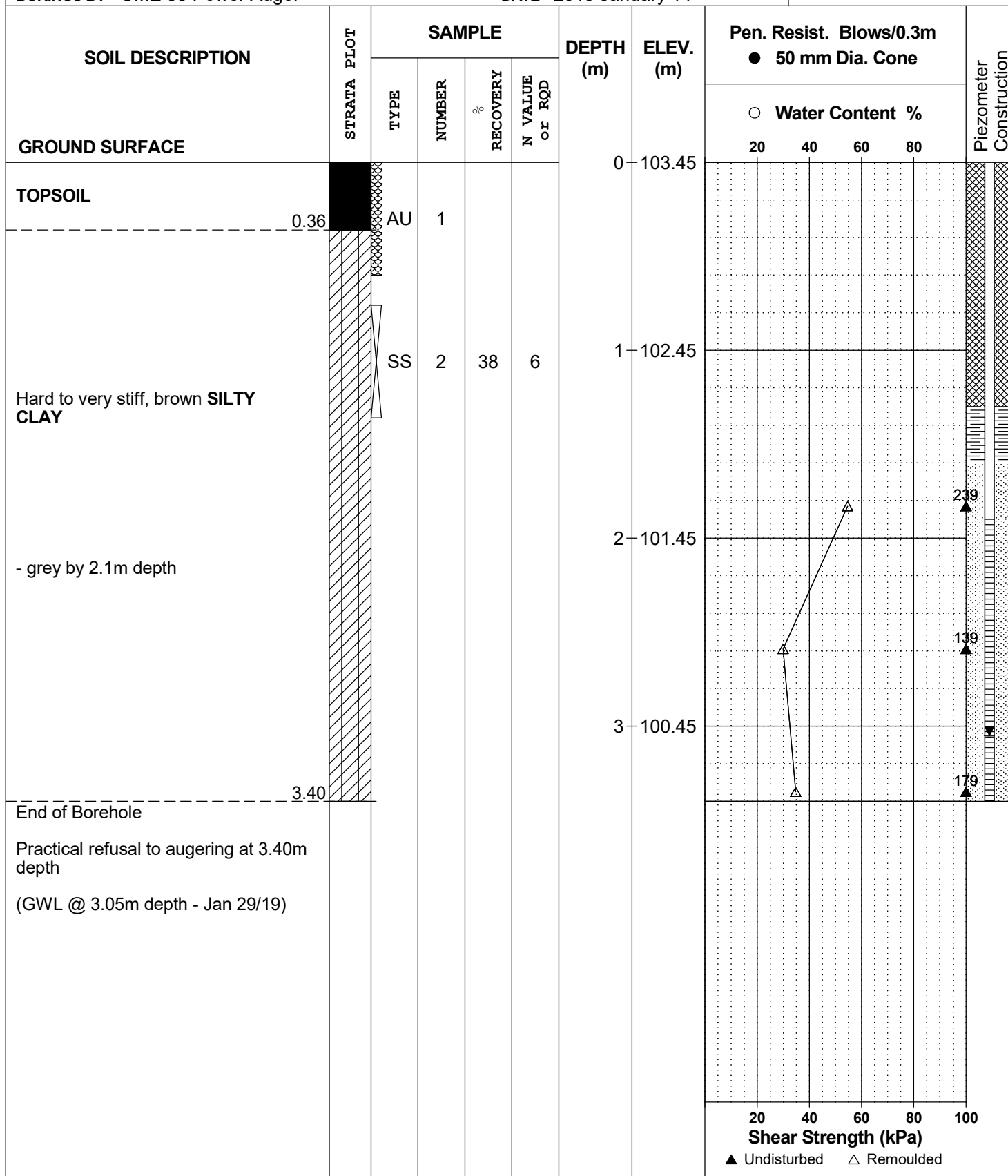

DATUM Ground surface elevations provided by Annis, O'Sullivan, Vollebekk Ltd.

FILE NO. **PG4772**

REMARKS

HOLE NO. **BH 6**

BORINGS BY CME 55 Power Auger

DATE 2019 January 14

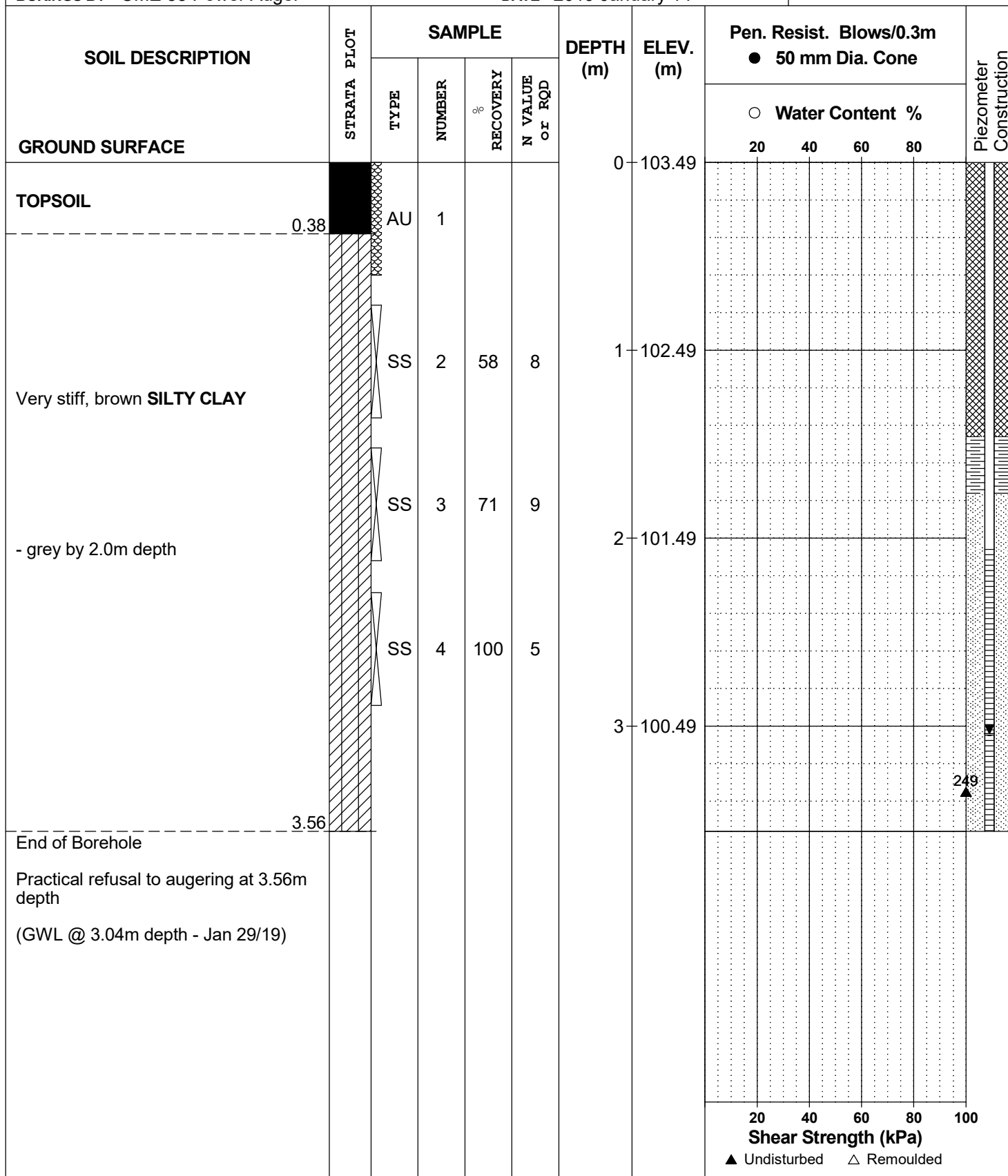

DATUM Ground surface elevations provided by Annis, O'Sullivan, Vollebakk Ltd.

FILE NO. **PG4772**

REMARKS

HOLE NO. **BH 7**

BORINGS BY CME 55 Power Auger

DATE 2019 January 14

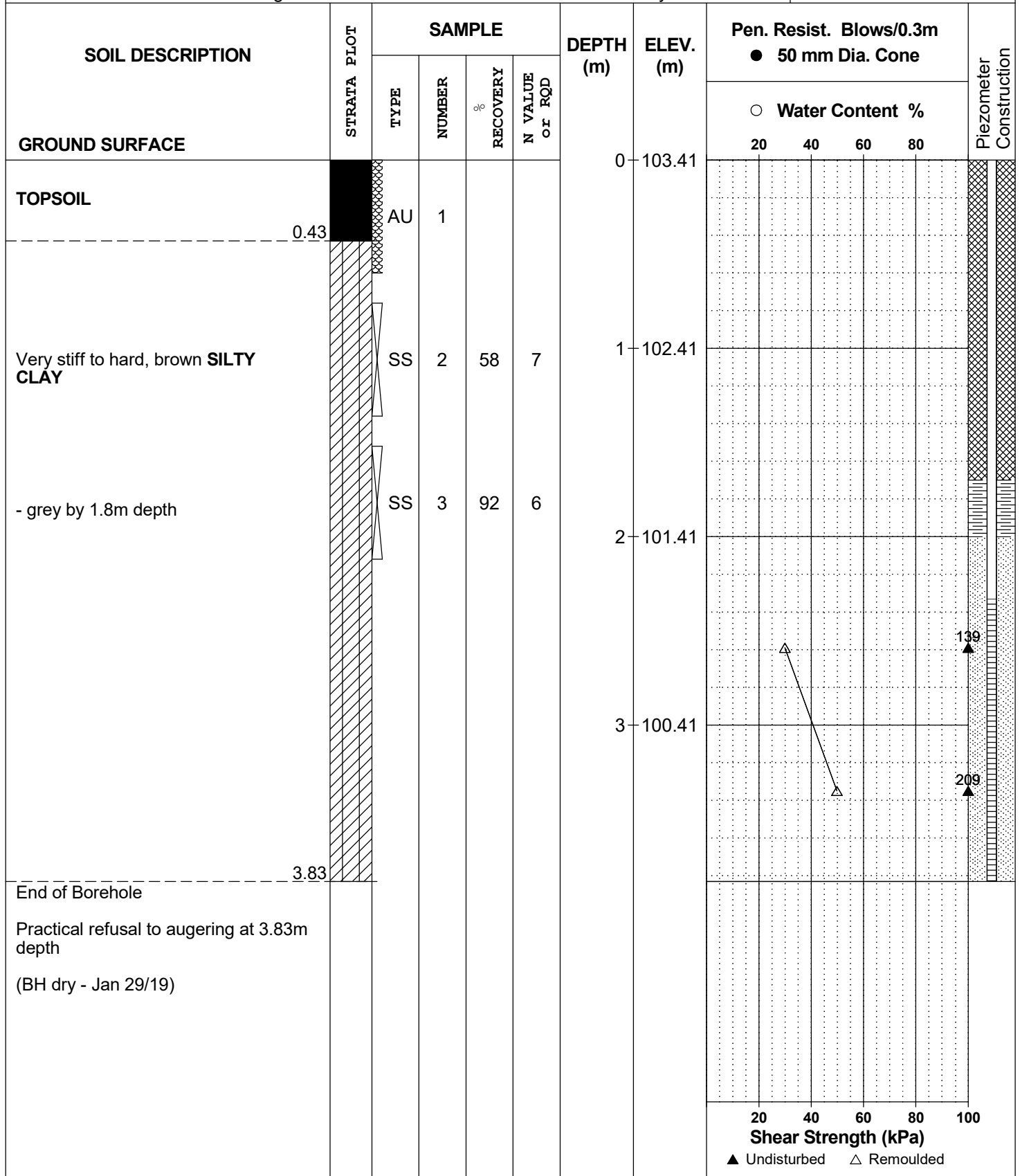

DATUM Ground surface elevations provided by Annis, O'Sullivan, Vollebakk Ltd.

FILE NO. **PG4772**

REMARKS

HOLE NO. **BH 8**

BORINGS BY CME 55 Power Auger

DATE 2019 January 14

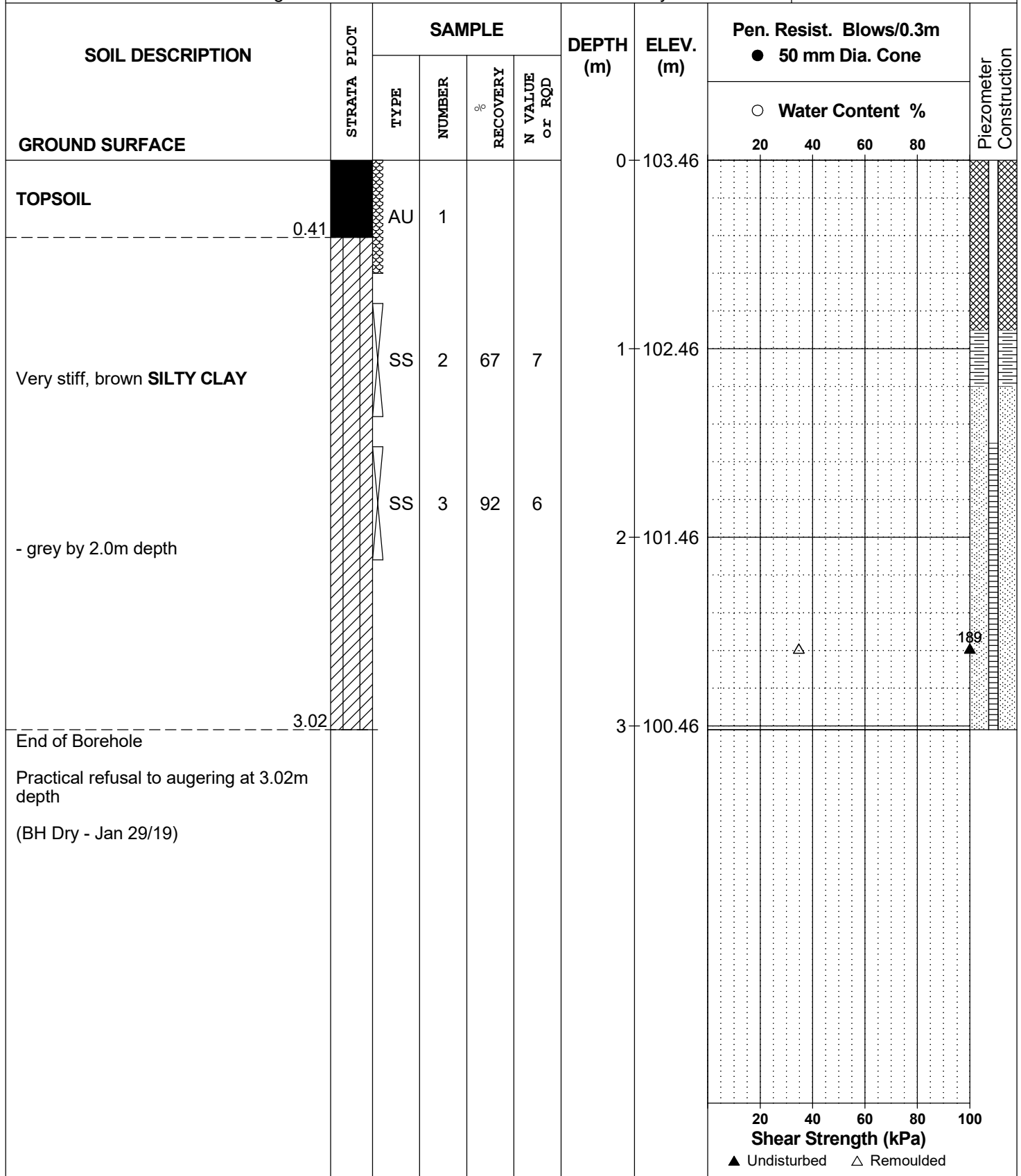

DATUM Ground surface elevations provided by Annis, O'Sullivan, Vollebakk Ltd.

FILE NO. **PG4772**

REMARKS

HOLE NO. **BH 9**

BORINGS BY CME 55 Power Auger

DATE 2019 January 15

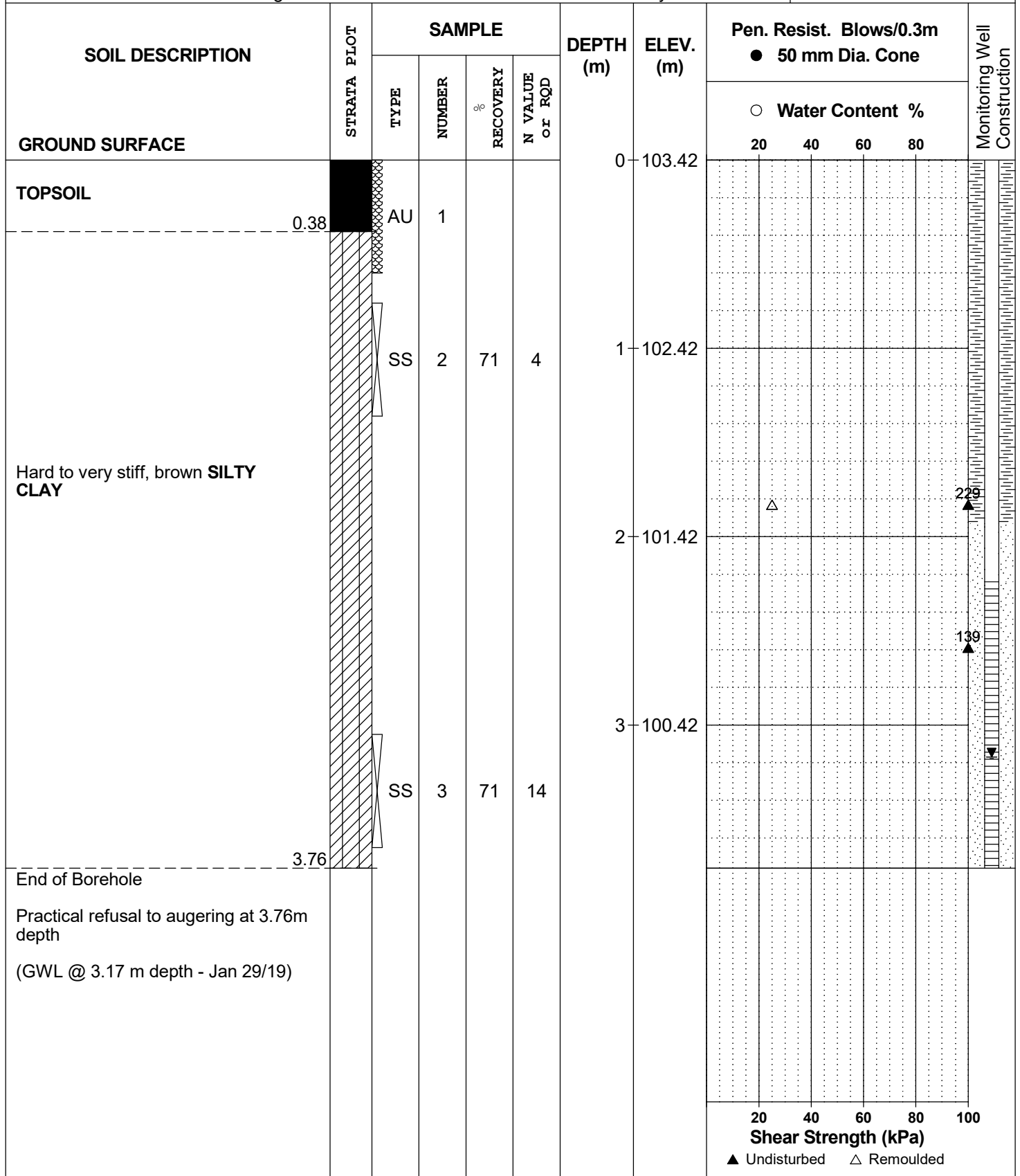

DATUM Ground surface elevations provided by Annis, O'Sullivan, Vollebakk Ltd.

FILE NO. **PG4772**

REMARKS

HOLE NO. **BH11**

BORINGS BY CME 55 Power Auger

DATE 2019 January 15

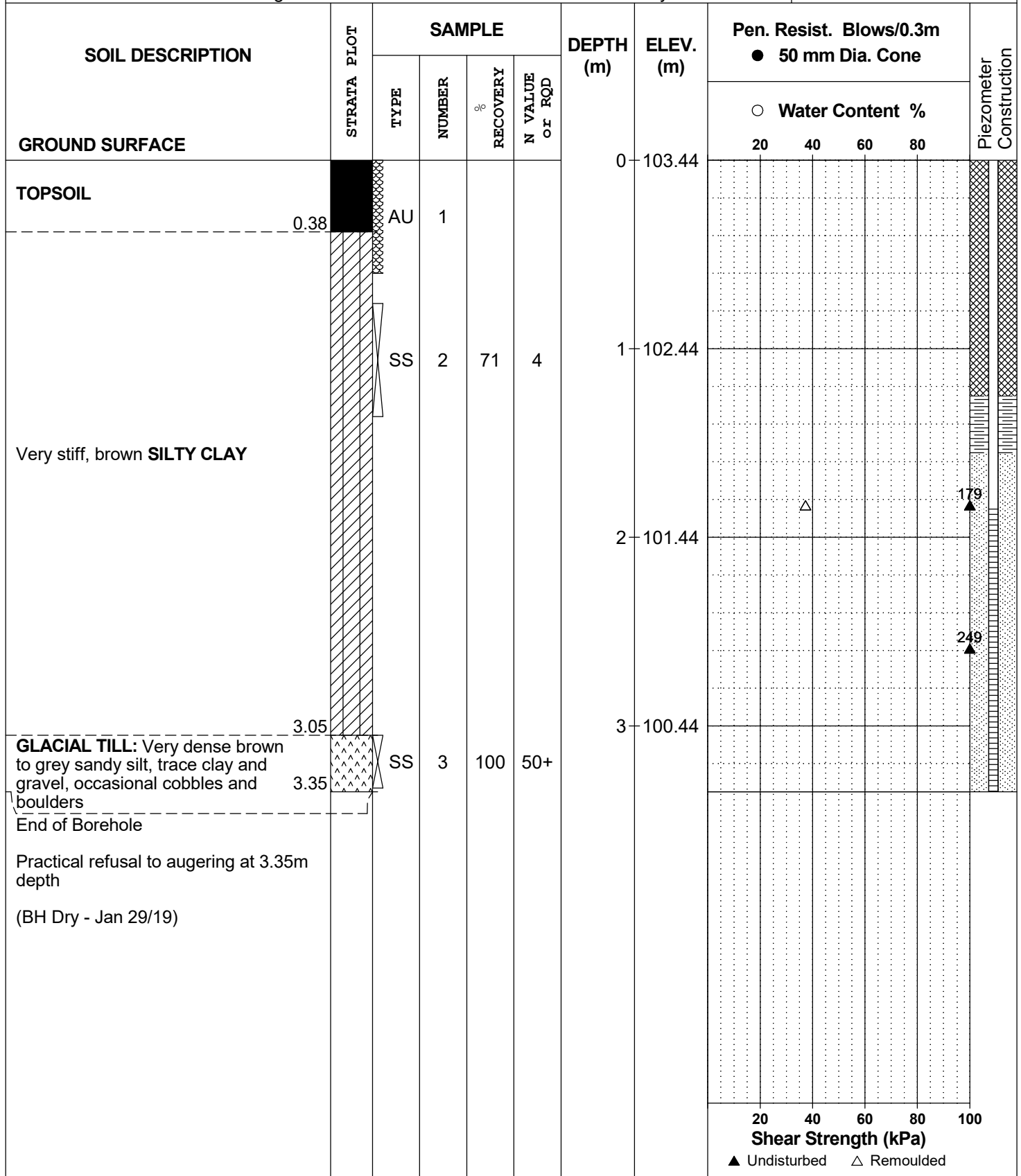

DATUM Ground surface elevations provided by Annis, O'Sullivan, Vollebakk Ltd.

FILE NO. **PG4772**

REMARKS

HOLE NO. **BH12**

BORINGS BY CME 55 Power Auger

DATE 2019 January 15

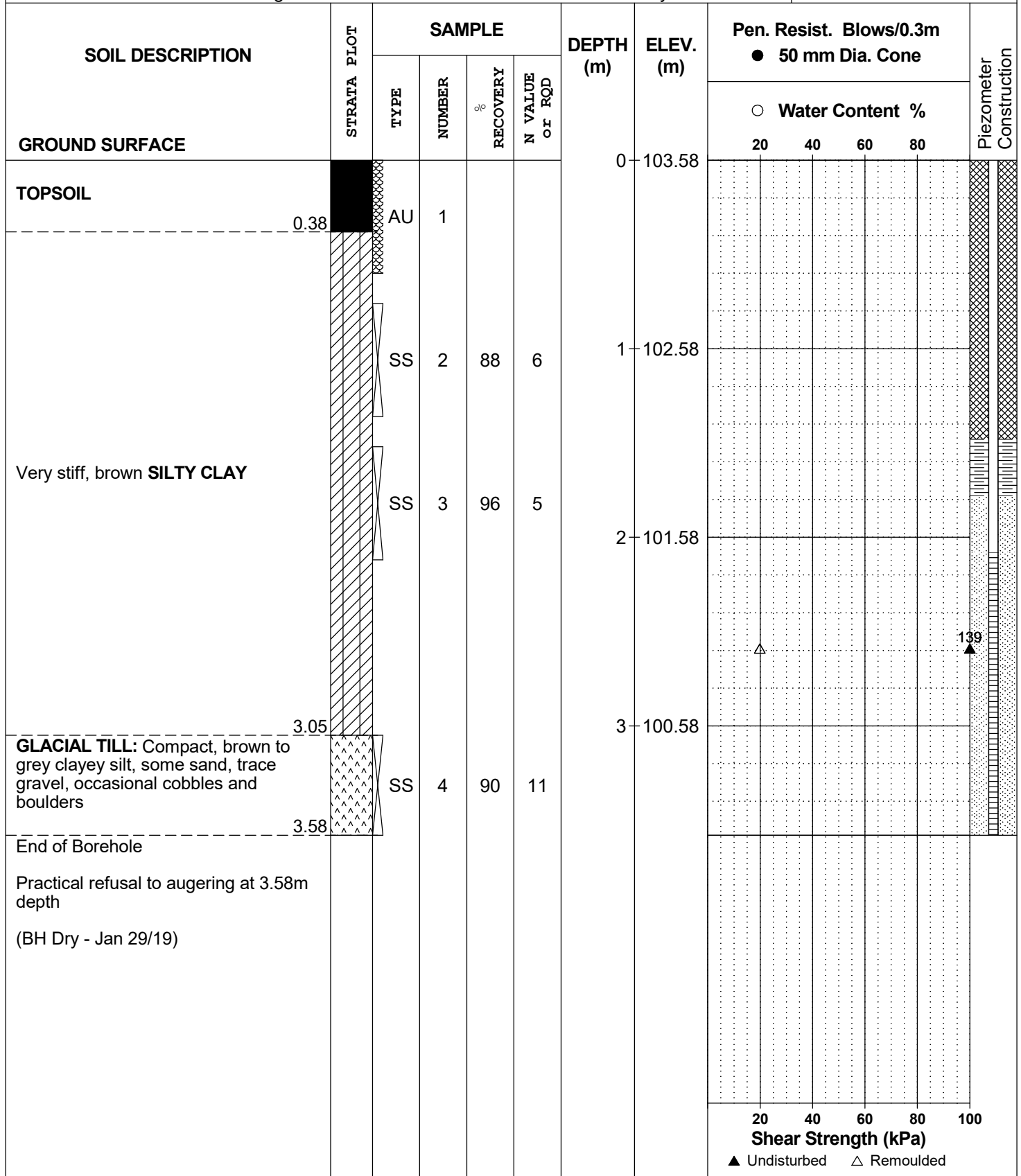

DATUM Ground surface elevations provided by Annis, O'Sullivan, Vollebakk Ltd.

FILE NO. **PG4772**

REMARKS

HOLE NO. **BH13**

BORINGS BY CME 55 Power Auger

DATE 2019 January 15

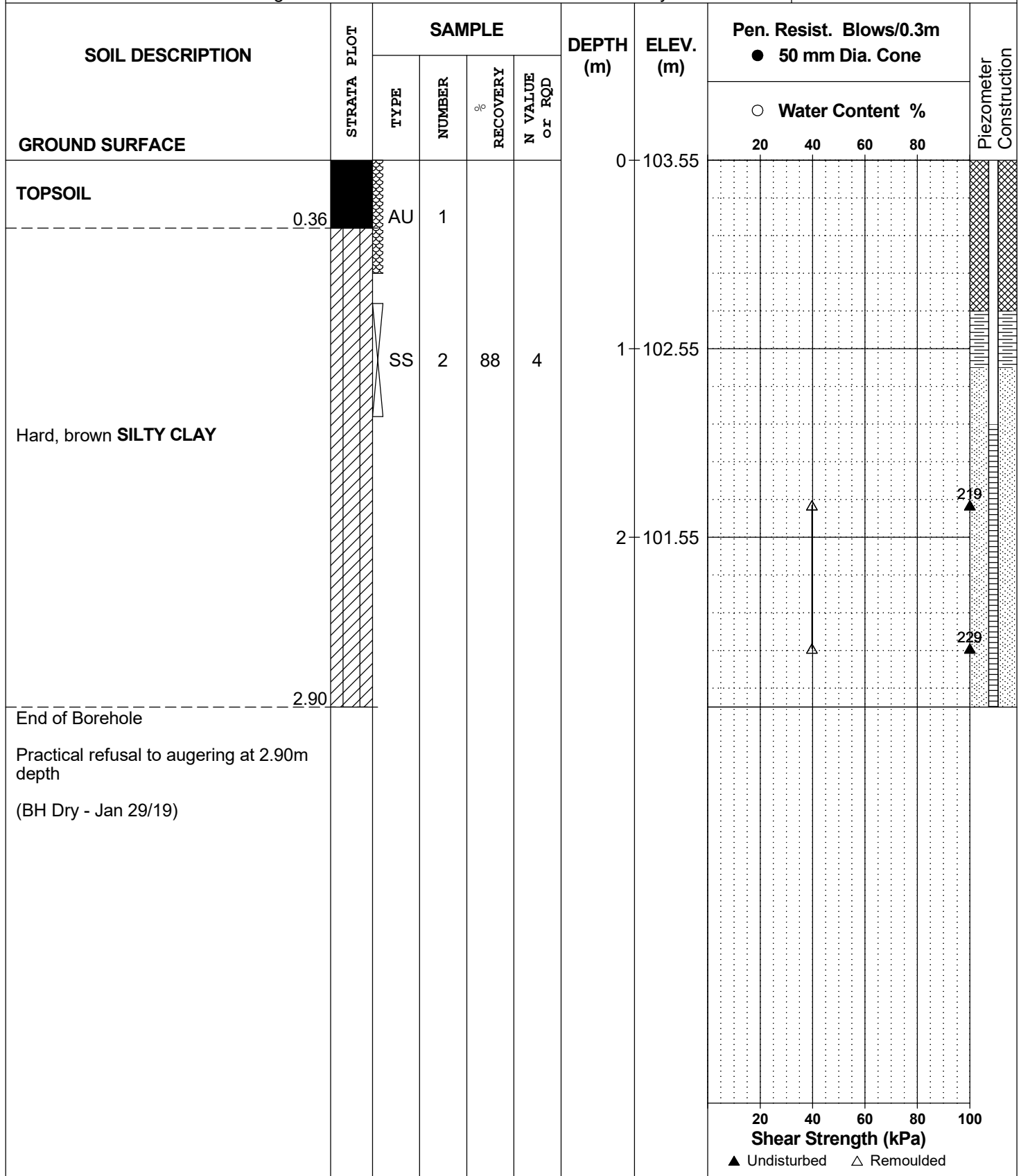

DATUM Ground surface elevations provided by Annis, O'Sullivan, Vollebakk Ltd.

FILE NO. **PG4772**

REMARKS

HOLE NO. **BH15**

BORINGS BY CME 55 Power Auger

DATE 2019 January 15

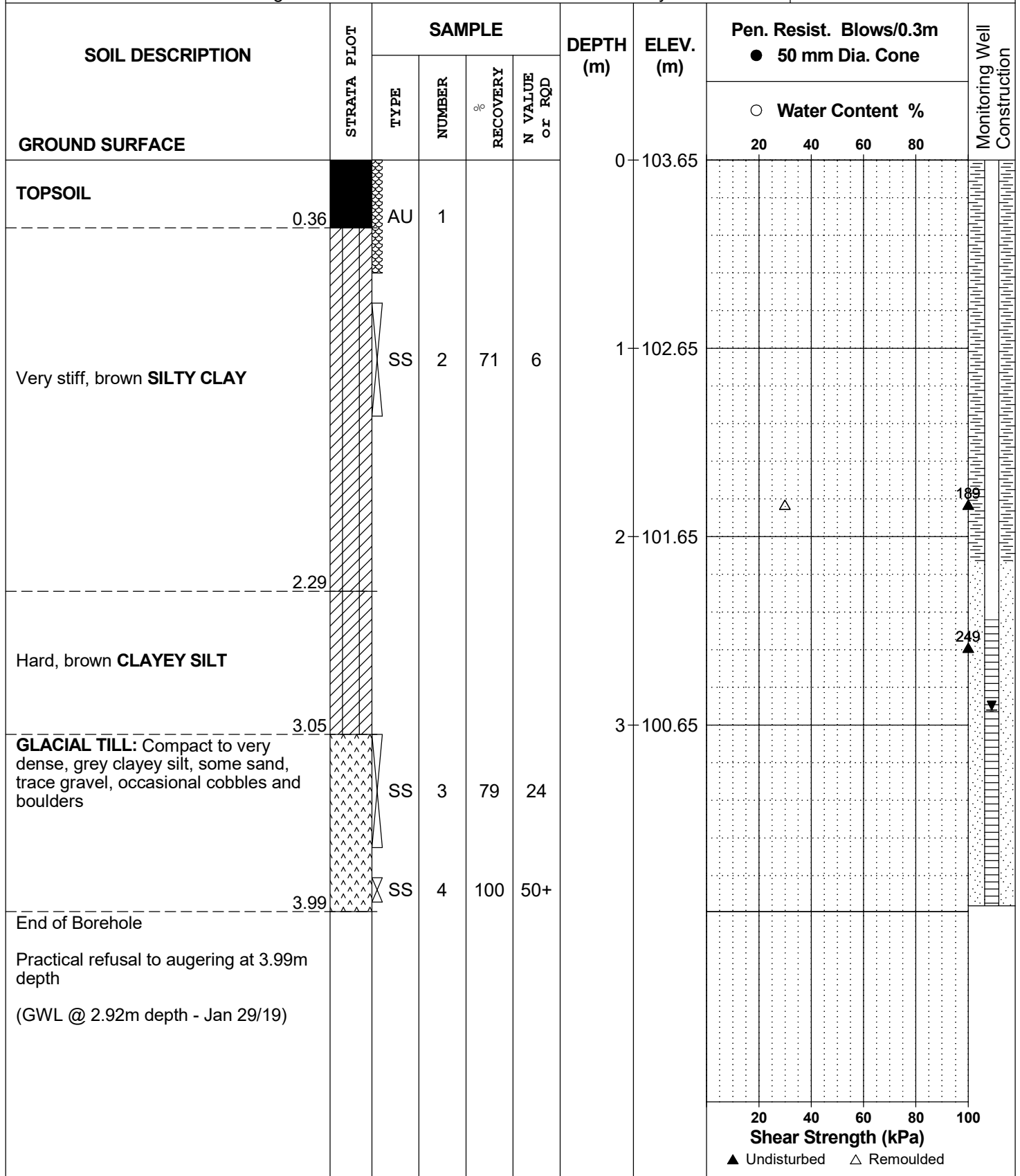

DATUM Ground surface elevations provided by Annis, O'Sullivan, Vollebakk Ltd.

FILE NO. **PG4772**

REMARKS

HOLE NO. **BH17**

BORINGS BY CME 55 Power Auger

DATE 2019 January 16

SOIL DESCRIPTION	STRATA PLOT	SAMPLE			DEPTH (m)	ELEV. (m)	Pen. Resist. Blows/0.3m ● 50 mm Dia. Cone				Piezometer Construction	
		TYPE	NUMBER	RECOVERY %			N VALUE or RQD	20	40	60		80
GROUND SURFACE					0	104.19						
TOPSOIL		AU	1									
Very stiff to hard, brown CLAYEY SILT		SS	2	79	7	1	103.19					
- grey by 1.8m depth		SS	3	100	55	2	102.19					
End of Borehole Practical refusal to augering at 2.23m depth (BH Dry - Jan 29/19)												

20 40 60 80 100
Shear Strength (kPa)
▲ Undisturbed △ Remoulded

DATUM Ground surface elevations provided by Annis, O'Sullivan, Vollebakk Ltd.

FILE NO. **PG4772**

REMARKS

HOLE NO. **BH18**

BORINGS BY CME 55 Power Auger

DATE 2019 January 16

SOIL DESCRIPTION	STRATA PLOT	SAMPLE				DEPTH (m)	ELEV. (m)	Pen. Resist. Blows/0.3m ● 50 mm Dia. Cone				Piezometer Construction	
		TYPE	NUMBER	RECOVERY %	N VALUE or RQD			20	40	60	80		
GROUND SURFACE						0	104.15						
TOPSOIL	0.33	AU	1										
Hard, brown CLAYEY SILT	1.96	SS	2	88	11	1	103.15						
- grey by 1.8m depth		SS	3	88	50+								
End of Borehole Practical refusal to augering at 1.96m depth (BH Dry - Jan 29/19)													

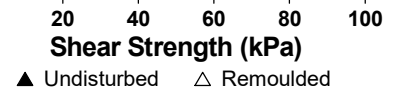

DATUM Ground surface elevations provided by Annis, O'Sullivan, Vollebakk Ltd.

FILE NO. **PG4772**

REMARKS

HOLE NO. **BH19**

BORINGS BY CME 55 Power Auger

DATE 2019 January 16

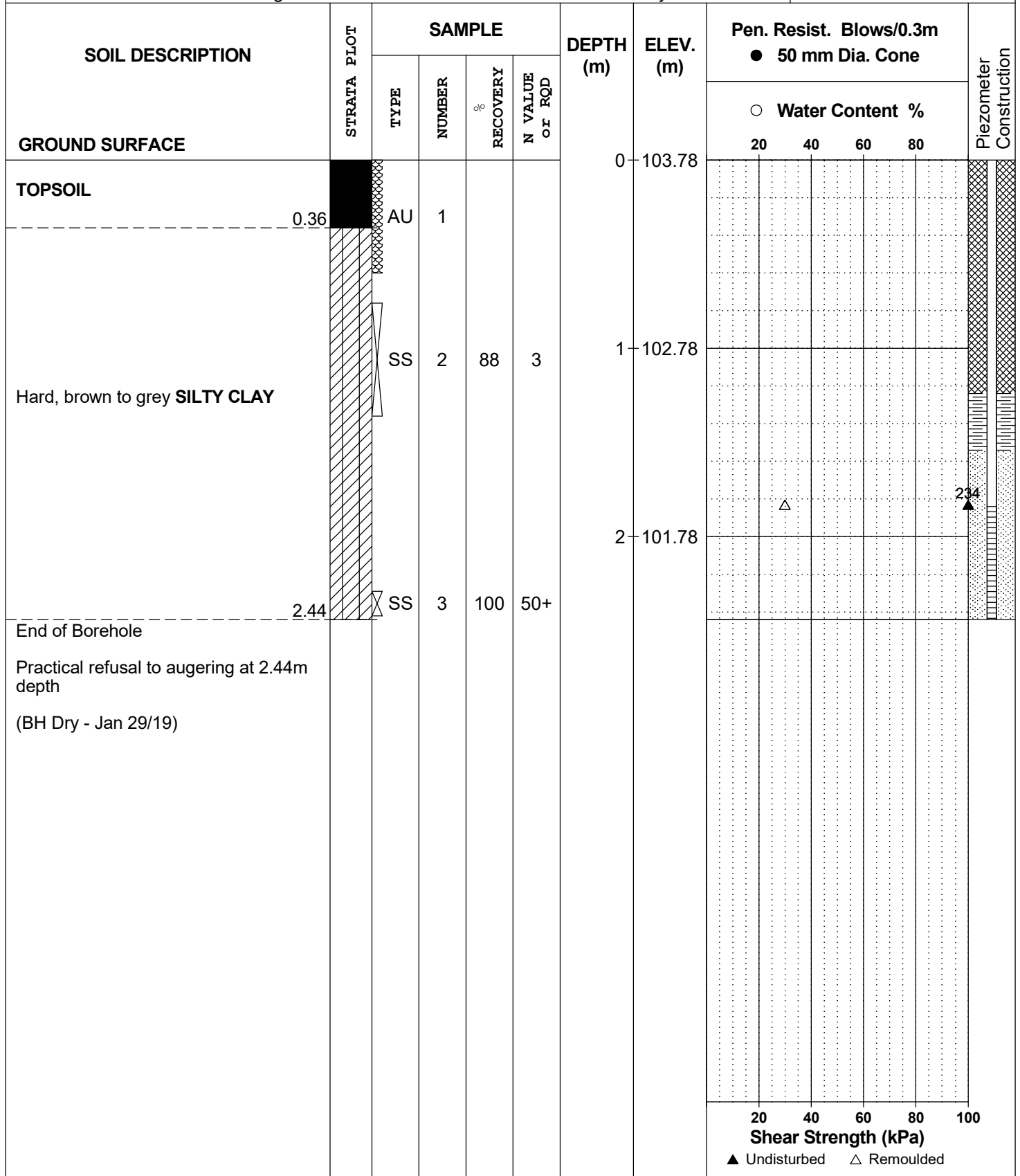

DATUM Ground surface elevations provided by Annis, O'Sullivan, Vollebakk Ltd.

FILE NO. **PG4772**

REMARKS

HOLE NO. **BH21**

BORINGS BY CME 55 Power Auger

DATE 2019 January 16

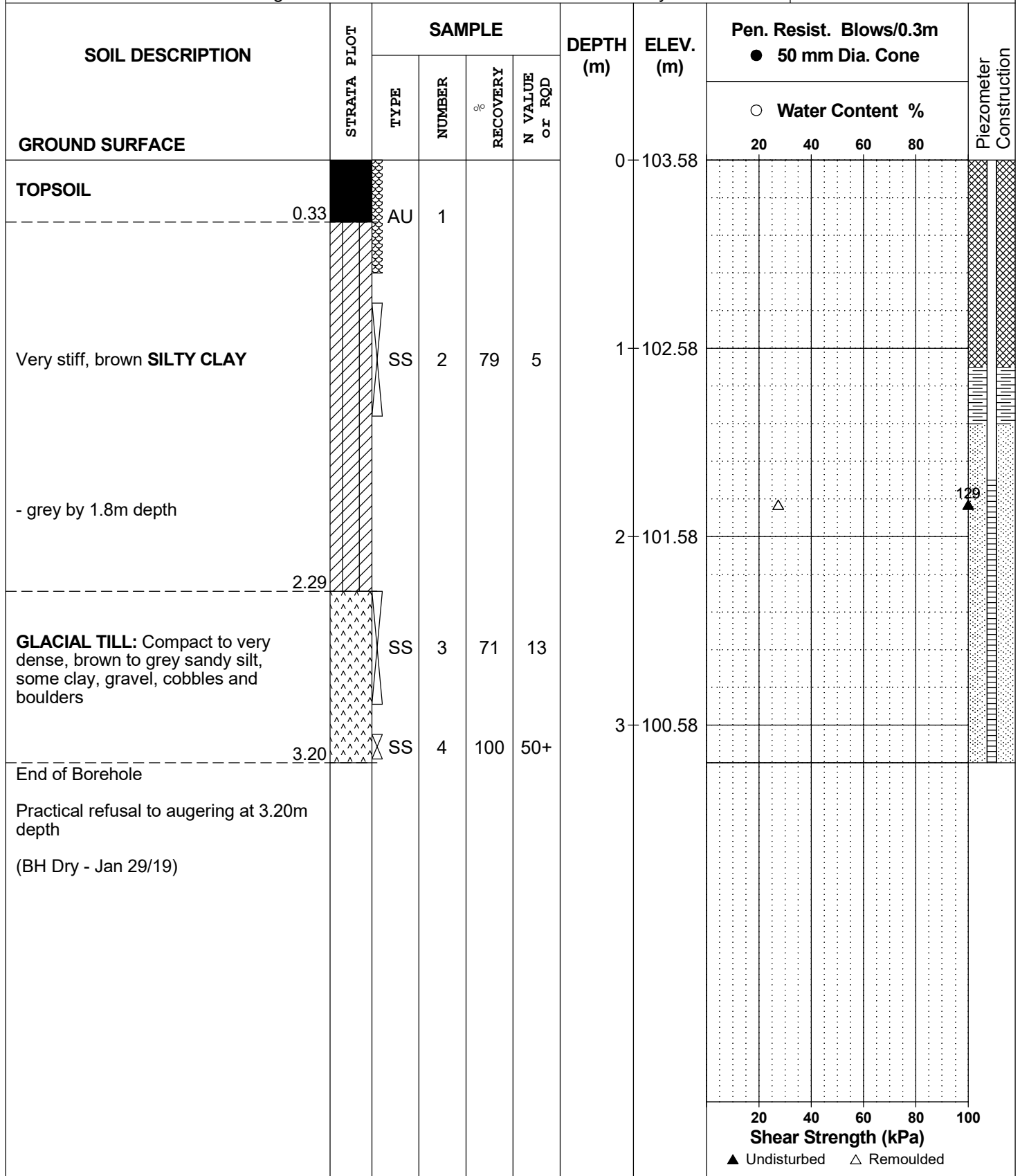

DATUM Ground surface elevations provided by Annis, O'Sullivan, Vollebakk Ltd.

FILE NO. **PG4772**

REMARKS

HOLE NO. **BH25**

BORINGS BY CME 55 Power Auger

DATE 2019 January 16

SOIL DESCRIPTION	STRATA PLOT	SAMPLE			DEPTH (m)	ELEV. (m)	Pen. Resist. Blows/0.3m ● 50 mm Dia. Cone				Piezometer Construction	
		TYPE	NUMBER	RECOVERY %			N VALUE or RQD	20	40	60		80
GROUND SURFACE					0	104.07						
TOPSOIL	0.38	AU	1									
Very stiff, brown CLAYEY SILT	1.52	SS	2	75	11	1	103.07					
GLACIAL TILL: Very dense, grey clayey silt with sand, gravel, cobbles, boulders	1.62	SS	3	75	50+							
End of Borehole												
Practical refusal to augering at 1.62m depth (GWL @ 1.68m depth - Jan 29/19)												

20 40 60 80 100
Shear Strength (kPa)
▲ Undisturbed △ Remoulded

DATUM Ground surface elevations provided by Annis, O'Sullivan, Vollebakk Ltd.

FILE NO. **PG4772**

REMARKS

HOLE NO. **BH27**

BORINGS BY CME 55 Power Auger

DATE 2019 January 17

SOIL DESCRIPTION	STRATA PLOT	SAMPLE				DEPTH (m)	ELEV. (m)	Pen. Resist. Blows/0.3m ● 50 mm Dia. Cone				Monitoring Well Construction	
		TYPE	NUMBER	RECOVERY %	N VALUE or RQD			20	40	60	80		
GROUND SURFACE						0	103.97						
TOPSOIL		AU	1										
Very stiff, brown CLAYEY SILT		SS	2	71	8	1	102.97						
- grey by 1.7m depth		SS	3	88	50+								
End of Borehole													
Practical refusal to augering at 1.93m depth (BH Dry - Jan 29/19)													

20 40 60 80 100
Shear Strength (kPa)
▲ Undisturbed △ Remoulded

DATUM Ground surface elevations provided by Annis, O'Sullivan, Vollebakk Ltd.

FILE NO. **PG4772**

REMARKS

HOLE NO. **BH28**

BORINGS BY CME 55 Power Auger

DATE 2019 January 17

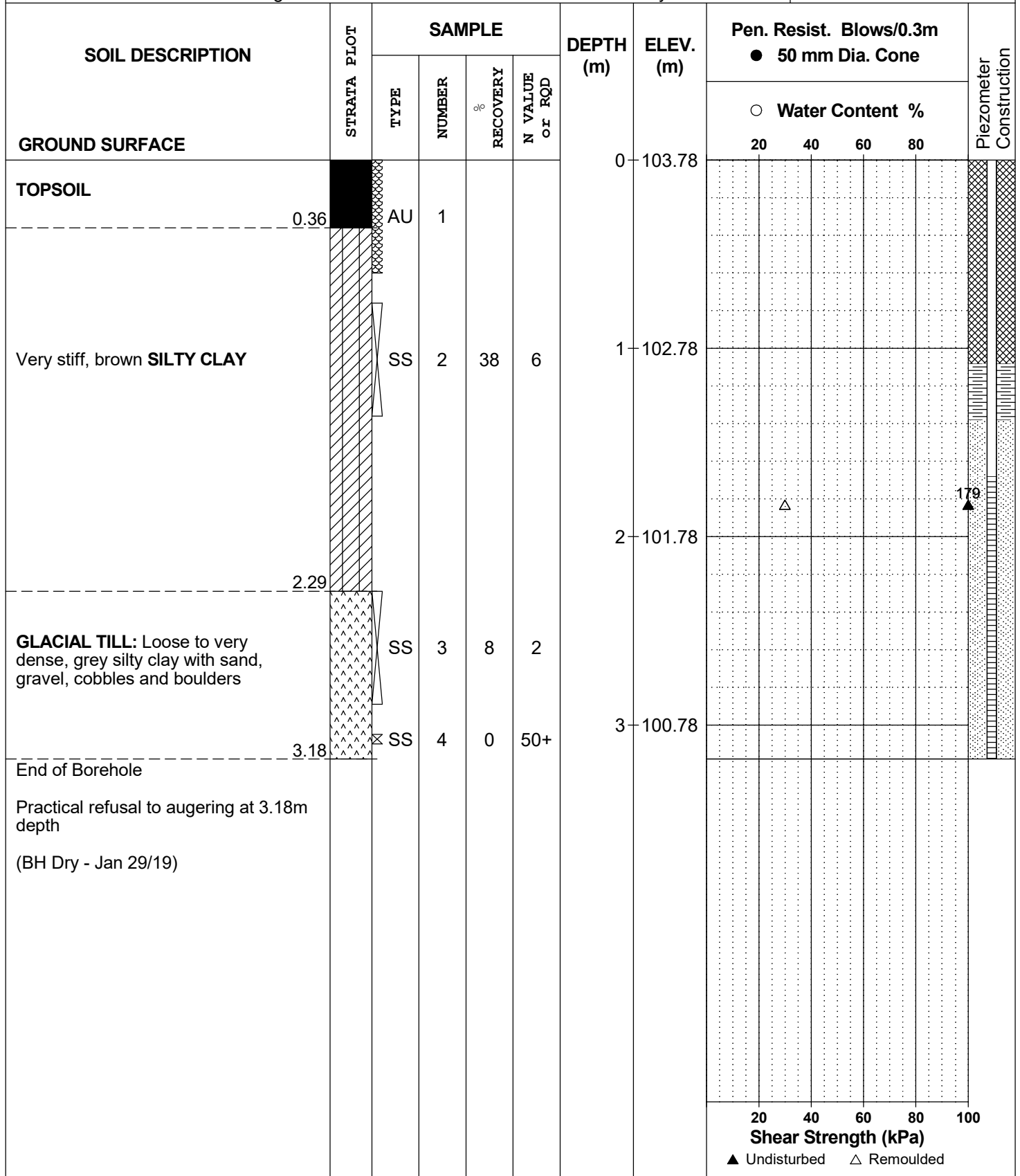

DATUM Ground surface elevations provided by Annis, O'Sullivan, Vollebakk Ltd.

FILE NO. **PG4772**

REMARKS

HOLE NO. **BH29**

BORINGS BY CME 55 Power Auger

DATE 2019 January 17

SOIL DESCRIPTION	STRATA PLOT	SAMPLE			DEPTH (m)	ELEV. (m)	Pen. Resist. Blows/0.3m ● 50 mm Dia. Cone				Piezometer Construction	
		TYPE	NUMBER	RECOVERY %			N VALUE or RQD	20	40	60		80
GROUND SURFACE					0	103.71						
TOPSOIL	0.38	AU	1									
Very stiff, brown SILTY CLAY		SS	2	50	7	1	102.71					
		SS	3	71	4	2	101.71					
GLACIAL TILL: Loose, grey silty clay with sand, gravel, cobbles and boulders	2.29	SS	4	17	7							
End of Borehole	2.95											
Practical refusal to augering at 2.95m depth (BH Dry - Jan 29/19)												
							20	40	60	80	100	
							Shear Strength (kPa)					
							▲ Undisturbed △ Remoulded					

SYMBOLS AND TERMS

SOIL DESCRIPTION

Behavioural properties, such as structure and strength, take precedence over particle gradation in describing soils. Terminology describing soil structure are as follows:

Desiccated	-	having visible signs of weathering by oxidation of clay minerals, shrinkage cracks, etc.
Fissured	-	having cracks, and hence a blocky structure.
Varved	-	composed of regular alternating layers of silt and clay.
Stratified	-	composed of alternating layers of different soil types, e.g. silt and sand or silt and clay.
Well-Graded	-	Having wide range in grain sizes and substantial amounts of all intermediate particle sizes (see Grain Size Distribution).
Uniformly-Graded	-	Predominantly of one grain size (see Grain Size Distribution).

The standard terminology to describe the strength of cohesionless soils is the relative density, usually inferred from the results of the Standard Penetration Test (SPT) 'N' value. The SPT N value is the number of blows of a 63.5 kg hammer, falling 760 mm, required to drive a 51 mm O.D. split spoon sampler 300 mm into the soil after an initial penetration of 150 mm.

Relative Density	'N' Value	Relative Density %
Very Loose	<4	<15
Loose	4-10	15-35
Compact	10-30	35-65
Dense	30-50	65-85
Very Dense	>50	>85

The standard terminology to describe the strength of cohesive soils is the consistency, which is based on the undisturbed undrained shear strength as measured by the in situ or laboratory vane tests, penetrometer tests, unconfined compression tests, or occasionally by Standard Penetration Tests.

Consistency	Undrained Shear Strength (kPa)	'N' Value
Very Soft	<12	<2
Soft	12-25	2-4
Firm	25-50	4-8
Stiff	50-100	8-15
Very Stiff	100-200	15-30
Hard	>200	>30

SYMBOLS AND TERMS (continued)

SOIL DESCRIPTION (continued)

Cohesive soils can also be classified according to their "sensitivity". The sensitivity is the ratio between the undisturbed undrained shear strength and the remoulded undrained shear strength of the soil.

Terminology used for describing soil strata based upon texture, or the proportion of individual particle sizes present is provided on the Textural Soil Classification Chart at the end of this information package.

ROCK DESCRIPTION

The structural description of the bedrock mass is based on the Rock Quality Designation (RQD).

The RQD classification is based on a modified core recovery percentage in which all pieces of sound core over 100 mm long are counted as recovery. The smaller pieces are considered to be a result of closely-spaced discontinuities (resulting from shearing, jointing, faulting, or weathering) in the rock mass and are not counted. RQD is ideally determined from NXL size core. However, it can be used on smaller core sizes, such as BX, if the bulk of the fractures caused by drilling stresses (called "mechanical breaks") are easily distinguishable from the normal in situ fractures.

RQD %	ROCK QUALITY
90-100	Excellent, intact, very sound
75-90	Good, massive, moderately jointed or sound
50-75	Fair, blocky and seamy, fractured
25-50	Poor, shattered and very seamy or blocky, severely fractured
0-25	Very poor, crushed, very severely fractured

SAMPLE TYPES

SS	-	Split spoon sample (obtained in conjunction with the performing of the Standard Penetration Test (SPT))
TW	-	Thin wall tube or Shelby tube
PS	-	Piston sample
AU	-	Auger sample or bulk sample
WS	-	Wash sample
RC	-	Rock core sample (Core bit size AXT, BXL, etc.). Rock core samples are obtained with the use of standard diamond drilling bits.

SYMBOLS AND TERMS (continued)

GRAIN SIZE DISTRIBUTION

MC%	-	Natural moisture content or water content of sample, %
LL	-	Liquid Limit, % (water content above which soil behaves as a liquid)
PL	-	Plastic limit, % (water content above which soil behaves plastically)
PI	-	Plasticity index, % (difference between LL and PL)
Dxx	-	Grain size which xx% of the soil, by weight, is of finer grain sizes These grain size descriptions are not used below 0.075 mm grain size
D10	-	Grain size at which 10% of the soil is finer (effective grain size)
D60	-	Grain size at which 60% of the soil is finer
Cc	-	Concavity coefficient = $(D_{30})^2 / (D_{10} \times D_{60})$
Cu	-	Uniformity coefficient = D_{60} / D_{10}

Cc and Cu are used to assess the grading of sands and gravels:

Well-graded gravels have: $1 < Cc < 3$ and $Cu > 4$

Well-graded sands have: $1 < Cc < 3$ and $Cu > 6$

Sands and gravels not meeting the above requirements are poorly-graded or uniformly-graded.

Cc and Cu are not applicable for the description of soils with more than 10% silt and clay (more than 10% finer than 0.075 mm or the #200 sieve)

CONSOLIDATION TEST

p'_o	-	Present effective overburden pressure at sample depth
p'_c	-	Preconsolidation pressure of (maximum past pressure on) sample
Ccr	-	Recompression index (in effect at pressures below p'_c)
Cc	-	Compression index (in effect at pressures above p'_c)
OC Ratio		Overconsolidation ratio = p'_c / p'_o
Void Ratio		Initial sample void ratio = volume of voids / volume of solids
Wo	-	Initial water content (at start of consolidation test)

PERMEABILITY TEST

k	-	Coefficient of permeability or hydraulic conductivity is a measure of the ability of water to flow through the sample. The value of k is measured at a specified unit weight for (remoulded) cohesionless soil samples, because its value will vary with the unit weight or density of the sample during the test.
---	---	--

SYMBOLS AND TERMS (continued)

STRATA PLOT



Topsoil

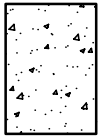

Asphalt

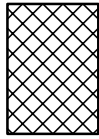

Fill



Peat

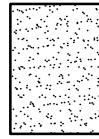

Sand

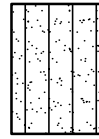

Silty Sand

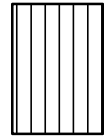

Silt



Sandy Silt

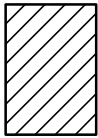

Clay

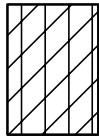

Silty Clay

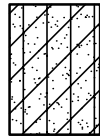

Clayey Silty Sand



Glacial Till

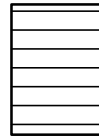

Shale

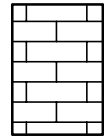

Bedrock

MONITORING WELL AND PIEZOMETER CONSTRUCTION

MONITORING WELL CONSTRUCTION

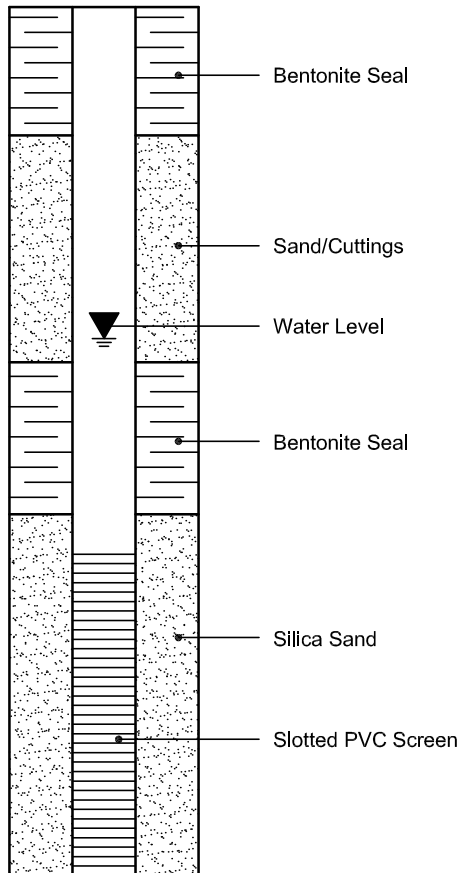

PIEZOMETER CONSTRUCTION

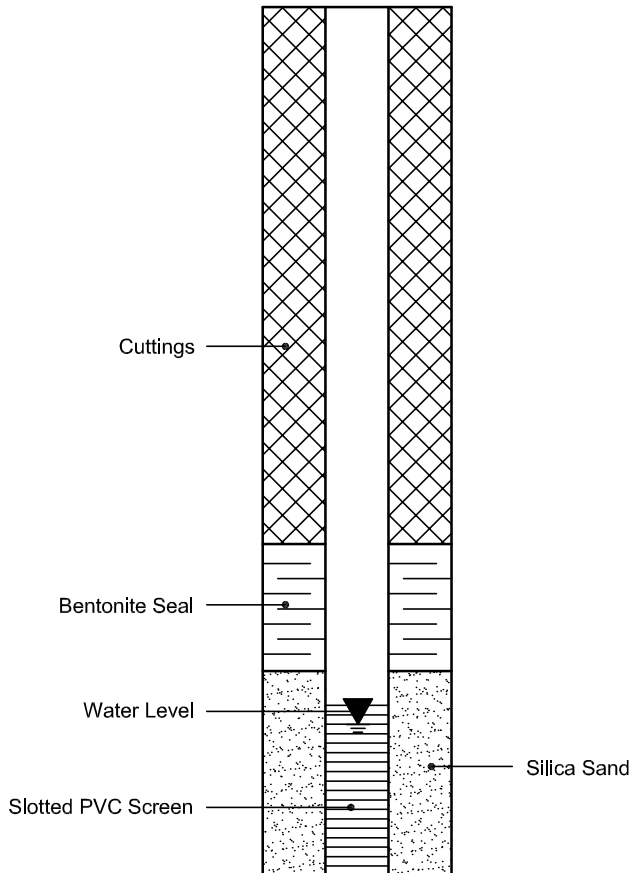

Certificate of Analysis
 Client: Paterson Group Consulting Engineers
 Client PO: 25648

Report Date: 22-Jan-2019

Order Date: 16-Jan-2019

Project Description: PG4772

Client ID:	BH#16-19 SS#3	-	-	-
Sample Date:	01/15/2019 09:00	-	-	-
Sample ID:	1903309-01	-	-	-
MDL/Units	Soil	-	-	-

Physical Characteristics

% Solids	0.1 % by Wt.	85.8	-	-	-
----------	--------------	------	---	---	---

General Inorganics

pH	0.05 pH Units	7.80	-	-	-
Resistivity	0.10 Ohm.m	76.2	-	-	-

Anions

Chloride	5 ug/g dry	6	-	-	-
Sulphate	5 ug/g dry	6	-	-	-

APPENDIX 2

FIGURE 1 - KEY PLAN

FIGURES 2 TO 4 - SLOPE STABILITY ANALYSIS SECTIONS

DRAWING PG4772-1 - TEST HOLE LOCATION PLAN

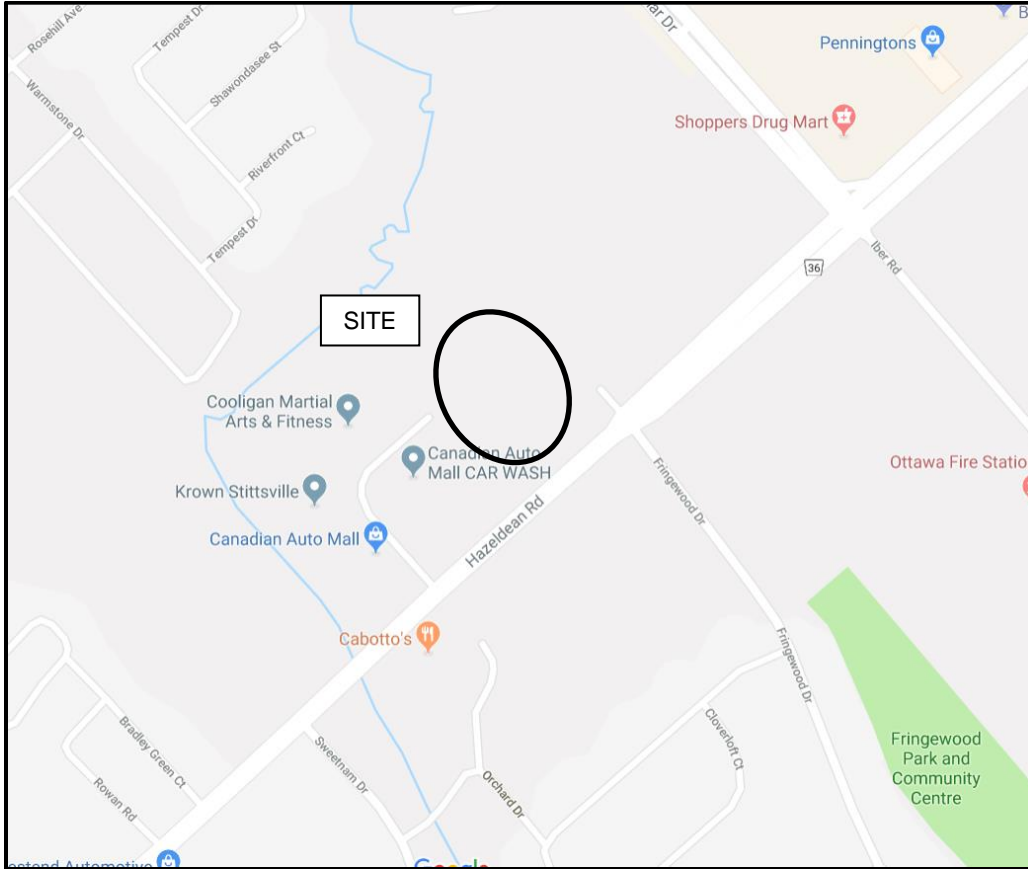
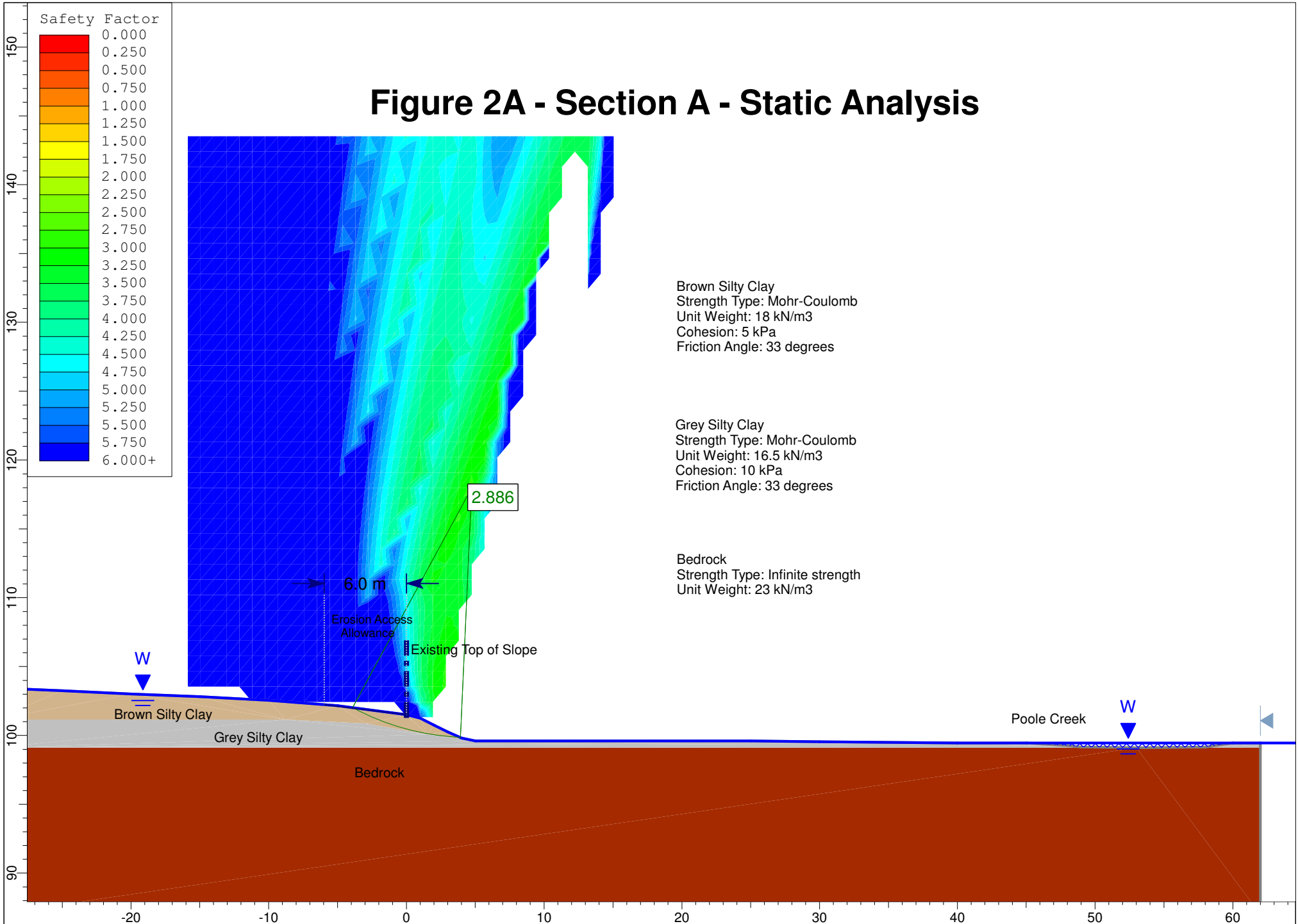

FIGURE 1

KEY PLAN

Figure 2A - Section A - Static Analysis



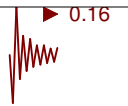

Figure 2B - Section A - Seismic Loading

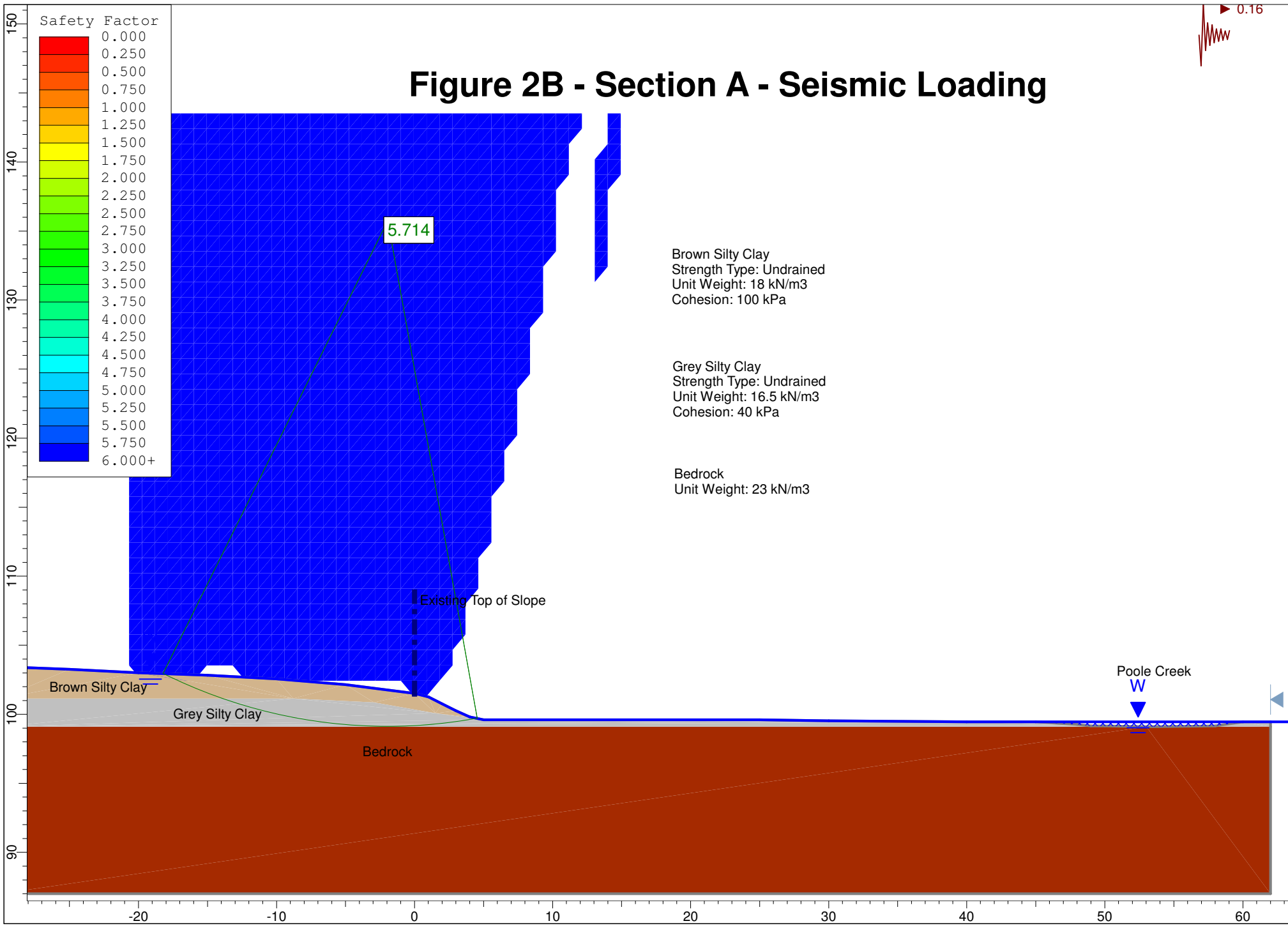

Figure 3A - Section B - Static Analysis

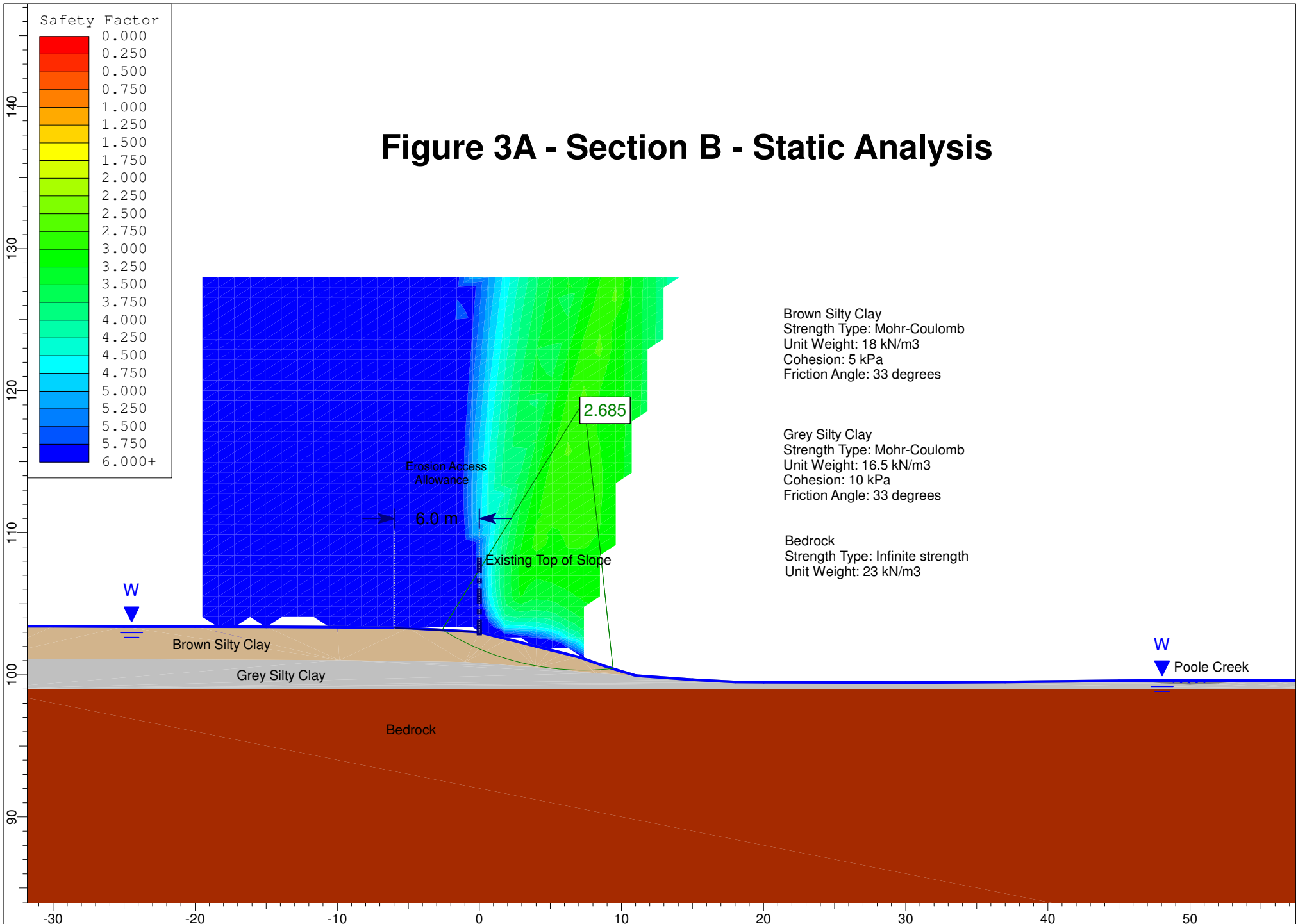

Figure 3B - Section B - Seismic Loading

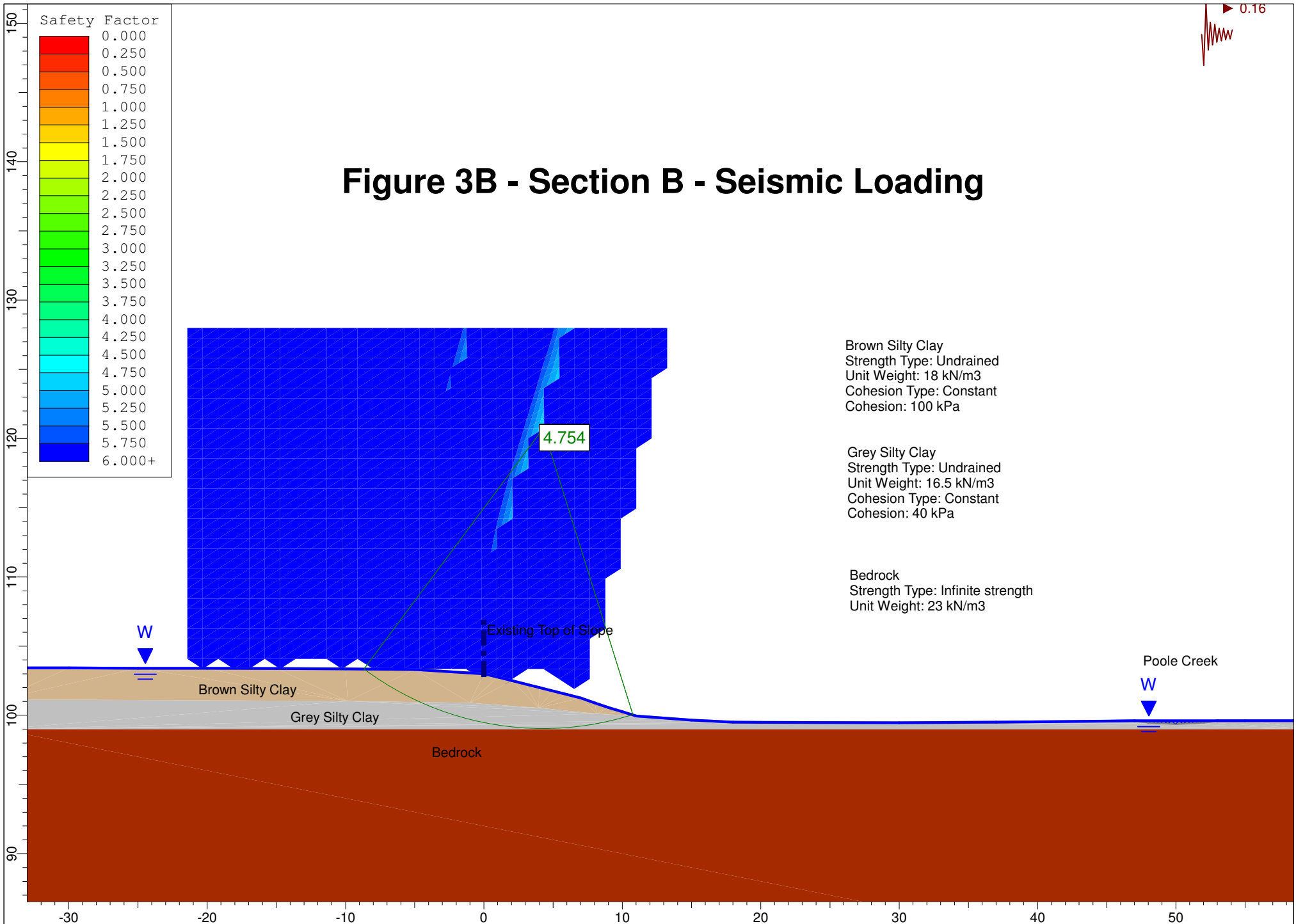

Figure 4A - Section C - Static Analysis

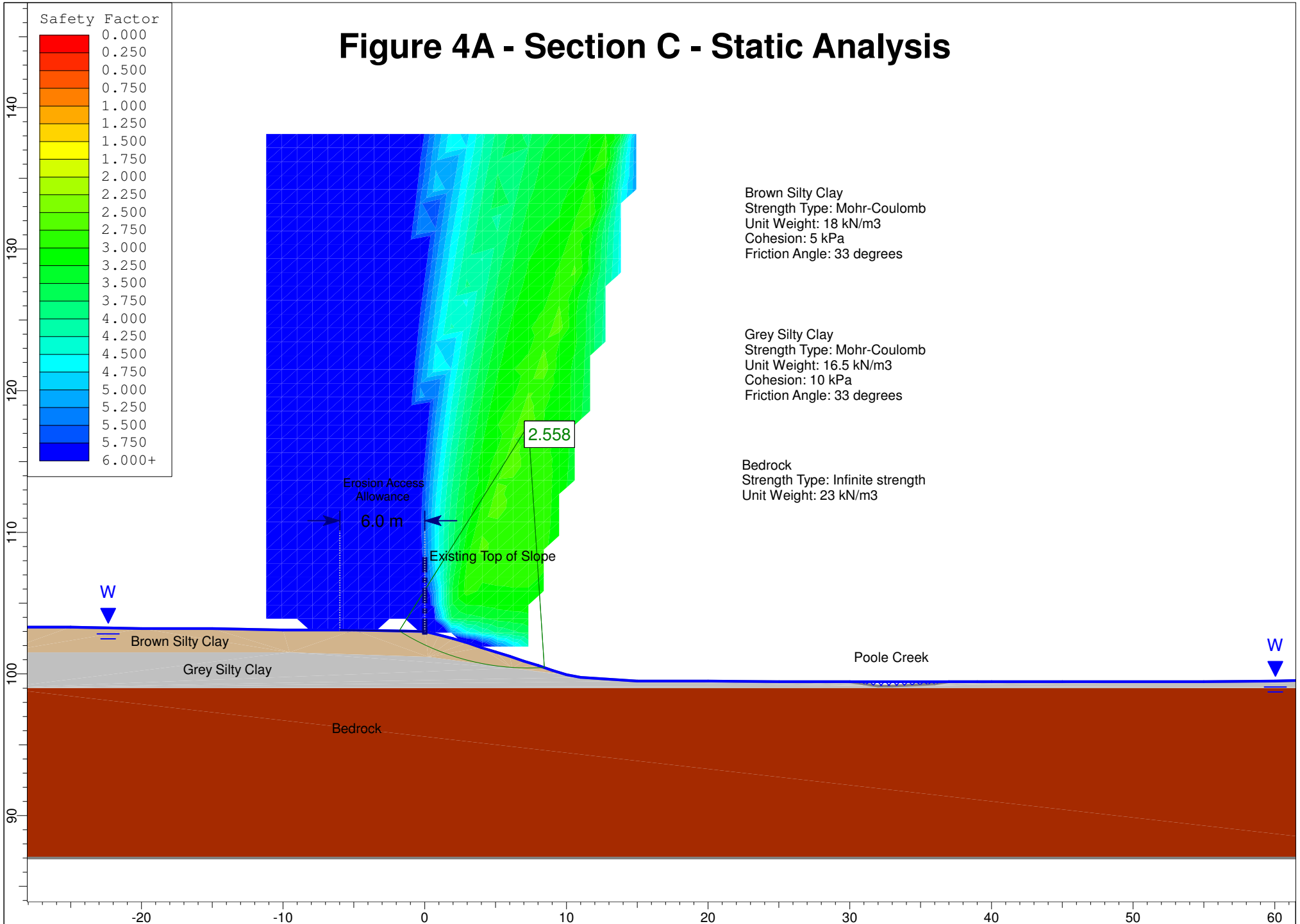
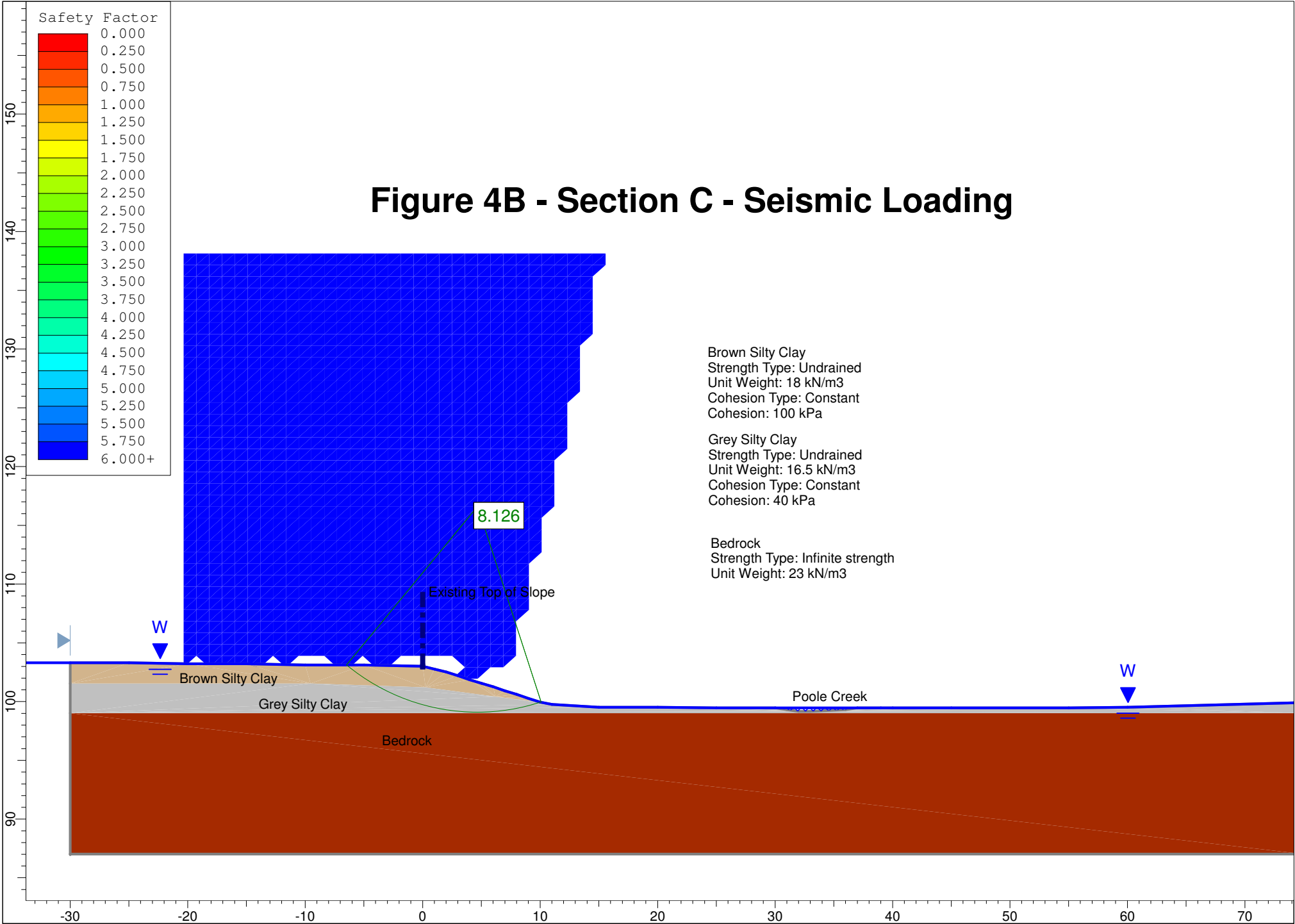
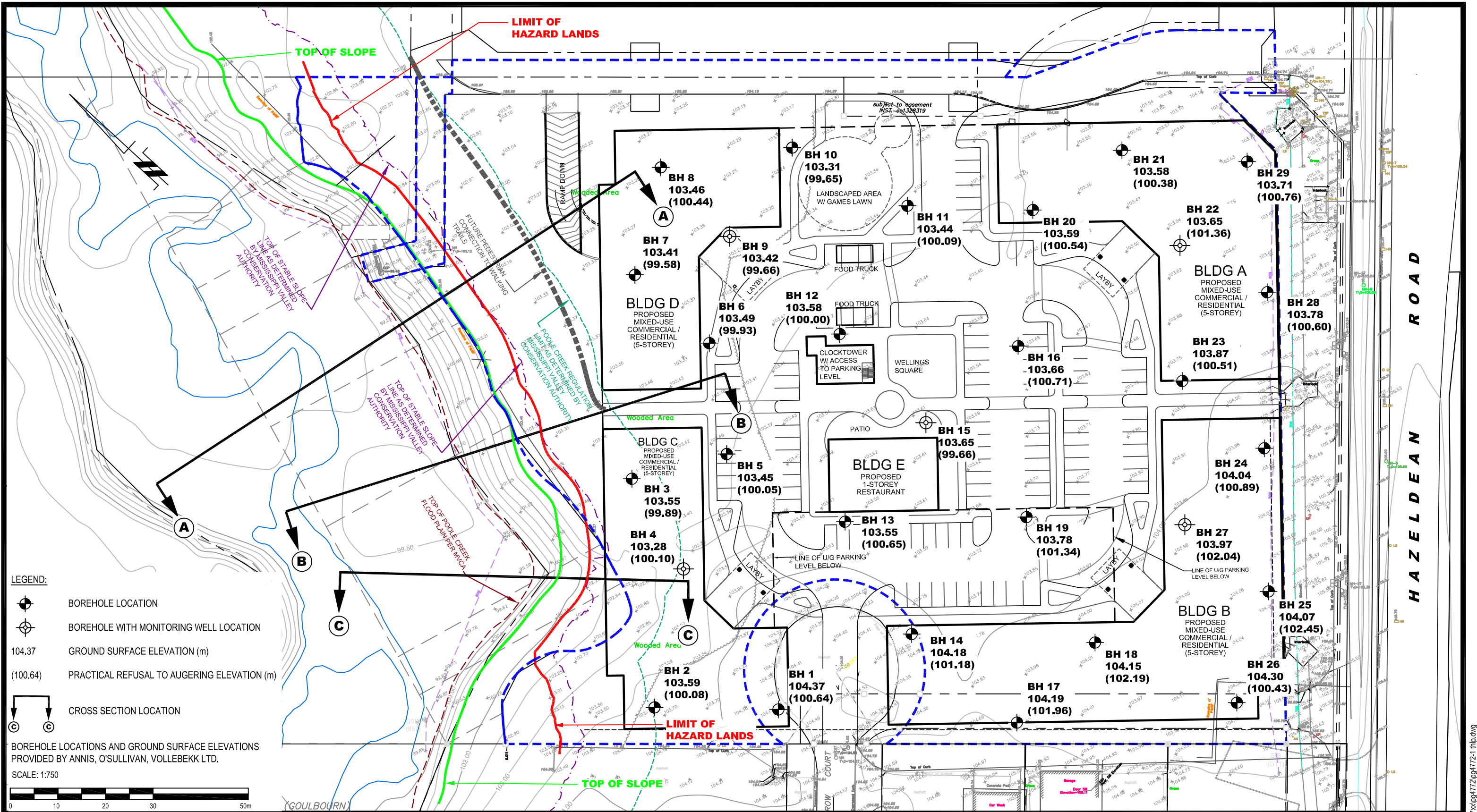

Figure 4B - Section C - Seismic Loading





LEGEND:

- BOREHOLE LOCATION
- BOREHOLE WITH MONITORING WELL LOCATION
- 104.37 GROUND SURFACE ELEVATION (m)
- (100.64) PRACTICAL REFUSAL TO AUGERING ELEVATION (m)
- CROSS SECTION LOCATION

BOREHOLE LOCATIONS AND GROUND SURFACE ELEVATIONS PROVIDED BY ANNIS, O'SULLIVAN, VOLLEBEKK LTD.
 SCALE: 1:750



patersongroup
 consulting engineers

154 Colonnade Road South
 Ottawa, Ontario K2E 7J5
 Tel: (613) 226-7381 Fax: (613) 226-6344

NO.	REVISIONS	DATE	INITIAL
1	LIMIT OF HAZARD LANDS REVISED	28/02/2019	FA

NAUTICAL LANDS GROUP
GEOTECHNICAL INVESTIGATION
 PROP. MIXED-USE DEVELOPMENT - WELLINGS OF STITTSVILLE PHASE 2 - 20 CEDAROW CT.
 OTTAWA, ONTARIO

Title: TEST HOLE LOCATION PLAN

Scale:	1:750	Date:	01/2019
Drawn by:	MPG	Report No.:	PG4772-1
Checked by:	FA	Dwg. No.:	PG4772-1
Approved by:	DJG	Revision No.:	1

p:\autocad drawings\geotechnical\pg4772\pg4772-1.tblp.dwg

re: **Grading Plan Review**
Proposed Mixed-Use Development – Wellings of Stittsville Phase 2
20 Cedarow Court - Ottawa

to: Nautical Lands Group – **Mr. Mark Williams** – mwilliams@nauticallandsgroup.com

cc: Stantec – **Mr. Mike Sharp** – Mike.Sharp@stantec.com

date: August 12, 2021

file: PG4772-MEMO.03

Following your request and authorization, Paterson Group (Paterson) prepared the current memorandum to complete a grading plan review from a geotechnical perspective for Phase 2 of the mixed-use development to be constructed at the aforementioned site. The following memorandum should be read in conjunction with Paterson Group Report PG4772-1 Revision 1, dated September 29, 2020.

Grading Plan Review

Paterson reviewed the following grading plan prepared by Stantec regarding the aforementioned development:

- ☐ Grading Plan - Wellings of Stittsville Phase 2 - Project No. 160401511 - Drawing No. GP-1 - Sheet No. 4 of 7 - Revision 2 - dated August 3, 2021.

Based on our review of the above noted grading plan, the proposed grades within Phase 2 of the aforementioned development are within the permissible grade raise restriction of 2 m provided throughout the subject site in the aforementioned geotechnical investigation report. Therefore, the proposed grading is considered acceptable from a geotechnical perspective. No exceedances of the grade raise restriction were noted, therefore lightweight fill or other considerations to accommodate the proposed grades are not required at this time.

We trust that this information satisfies your immediate requirements.

Best Regards,

Paterson Group Inc.



Maha Saleh, Provisional P. Eng.

Paterson Group Inc.

Ottawa Head Office
154 Colonnade Road South
Ottawa – Ontario – K2E 7S8
Tel: (613) 226-7381

Ottawa Laboratory
28 Concourse Gate
Ottawa – Ontario – K2E 7T7
Tel: (613) 226-7381

Northern Office and Laboratory
63 Gibson Street
North Bay – Ontario – P1B 8Z4
Tel: (705) 472-5331



Faisal Abou-Seido, P. Eng.

**SERVICING AND STORMWATER MANAGEMENT BRIEF –
WELLINGS OF STITTSVILLE PHASE 2, 20 CEDAROW COURT**

Appendix E Drawings
September 21, 2022

Appendix E DRAWINGS