

CHORAC OTTAWA
2375 ST. LAURENT BOULEVARD,
OTTAWA, ONTARIO

SERVICING & STORM WATER
MANAGEMENT REPORT

December 07, 2022



REINDERS + LAW LTD.
64 Ontario Street North
Milton, Ontario, Canada L9T 2T1
Phone: 905-457-1618 Fax: 905-478-8552
www.reinders.ca

Ref: RRL/20037/REP/SWM/Rev.1

Table of Contents

1.0	Introduction.....	3
1.1	Statement of Objectives and Servicing Criteria	3
1.2	Location Map and Plan	3
1.3	Background Documents	4
1.4	Consultation and Permits.....	4
1.4.1	Pre-consultation Meetings	4
1.5	Available Existing Infrastructure	5
2.0	Geotechnical Study	5
3.0	Water Service.....	6
3.1	Design Criteria	6
3.2	Water Demand	6
3.3	Adequacy of Supply for Domestic and Fire Flows.....	7
3.4	Pressure Check.....	7
3.5	Reliability Requirements	7
3.6	Water Supply Conclusion	7
4.0	Sanitary Service	8
4.1	Sanitary Flows	8
4.2	Effect of Proposed Development on Downstream Sanitary Infrastructure	9
4.3	Summary and Conclusions	9
5.0	Storm Servicing and Stormwater Management	9
5.1	Background	9
5.2	Storm Servicing Strategy	9
5.3	Proposed Storm Servicing	9
5.4	Design Criteria (Minor and Major Systems)	9
5.5	Stormwater Quantity Control	10
5.5.1	Catchment Areas	10
5.5.2	Peak Flows	10
5.5.3	Allowable Flow/Orifice Control	10
5.5.4	Onsite Storage.....	10
5.5.5	Impact on Existing Storm Infrastructure.....	11
5.6	Storm Water Quality Control	11
5.7	MECP and Conservation Authority Approvals.....	11
5.8	Minor and Major Systems.....	11
5.9	Impacts to Receiving Watercourses	11
5.10	100-year Flood Levels and Major Flow Routing	11
6.0	Grading	11
7.0	Erosion and Sediment Control.....	12

LIST OF APPENDICES

Appendix A- Site Servicing, Grading and Erosion and Sediment Control, Catchments Plans

Appendix B- Correspondence with Regulatory Authorities

Appendix C- Boundary Conditions, FUS Calculations, Fire Hydrant Coverage Map

Appendix D- Sanitary Flow Calculations and Drainage Area Plan

Appendix E- Design Calculations

Appendix F- Site Servicing Checklist

Appendix G- Topographic and Legal Survey

1.0 Introduction

Reinders + Law Ltd. has been retained by the owner (CHORAC) as engineering / architectural consultants responsible for the preparation of functional servicing and storm water management study in support of obtaining site plan approval for the proposed development at 2375 St. Laurent Boulevard.

The total site area is approximately 0.66 ha. Currently, the site is undeveloped and consists of an open grassed area. The proposal is to develop a single storey, church facility including an assembly area. The site will include an associated surface level parking lot. The site will be accessed with one new entrance driveway from St. Laurent Boulevard.

1.1 Statement of Objectives and Servicing Criteria

The objective of this Servicing and Stormwater Management Report is to demonstrate that the proposed design meets the servicing requirements for the proposed development, while adhering to the appropriate regulatory requirements.

1.2 Location Map and Plan

The location of the site is illustrated in Figure 1. A detailed site layout is provided within the drawings in **Appendix A**.



Figure 1 – Location Plan.

Proposed grading, servicing and erosion & control plans are shown on the drawings included in **Appendix A**.

1.3 Background Documents

Existing conditions are shown on the Topographic and Legal Survey (**Appendix G**).

1.4 Consultation and Permits

1.4.1 Pre-consultation Meetings

A pre-consultation meeting was held with the City of Ottawa in April 2021. The comments related to site servicing are summarized as follows;

Stormwater Management

- There is an available 1050 mm diameter concrete storm trunk sewer located on St. Laurent Blvd.
- Existing maintenance hole is available for potential connection.
- Per the RVCA, the downstream outlet to a watercourse for stormwater is less than 1km from the site, therefore, a water quality objective of enhanced (80% TSS removal) is required. LID measures are encouraged into the stormwater management plan.
- The pre-development runoff coefficient or a maximum equivalent 'C' of 0.50.
- Time of concentration (Tc) = 10 minutes
- Post development 100-year storm flows to be controlled to pre development 5-year storm event.

Watermain

- There is an available 305 mm diameter DI watermain located on St. Laurent Blvd.
- Existing water stub on north east side of the property requires check whether it is feasible to re-use this service, or whether a new lateral is required.
- Water boundary condition request must include the location of the service connection and the expected loads required by the proposed developments.
- Determine the total water demand based on maximum daily demand and required fire flow as per FUS,199 for water boundary conditions.
- Fire Hydrant Locations.
- Water supply redundancy is required for a water demand exceeding 50 m³ per day.

Sanitary Sewer

- There is an available 300 mm diameter concrete sanitary sewer located on St. Laurent Blvd.
- Sanitary Control Manhole is required at the property.
- The sanitary demand needs to be coordinated with the City Planning Dept. to determine if the existing sanitary sewer system has sufficient capacity to support the proposed rezoning.
- The requirement of an approval for sewage works from Ministry of Environment, Conservation and Parks Environmental Compliance Approval (MECP ECA) will be determined. An ECA will be required where the stormwater management services more than one property parcel.

General Service Design

- All new services be located within the existing service trench to minimize necessary road cuts.

- Monitoring manholes should be located within the property near the property line in an accessible location to City forces and free from obstruction (i.e. not a parking).
- Where service length is greater than 30 m between the building and the first maintenance hole / connection, a cleanout is required.

The full comments regarding site-servicing and stormwater management-specific requirements can be found in **Appendix B**.

1.5 Available Existing Infrastructure

Sewer and watermain mapping collected from the City of Ottawa indicate that the following services exist across the property frontage on St. Laurent Boulevard.

- 305 mm diameter DI watermain
- 1050 mm diameter Conc. storm sewer
- 300 mm diameter Conc. sanitary sewer

Currently, the property is not served by sanitary and storm service connections. The existing water stub at the property development will be used for proposed building connection.

2.0 Geotechnical Study

A Geotechnical Investigation was completed by Kollaard Associates and is documented as Project No. 170549 dated August 9, 2017.

A total of 3 boreholes were drilled to a maximum depth of 9.75 – 14.88 m below the existing ground surface. The subsurface profile at the borehole locations consists of 150mm topsoil layer underlain by deposit of silty clay deposit up to 9.75 m. Silt clay deposit is underlain by glacial till at about 13.4 m below existing ground surface.

Groundwater was encountered at depths of 5.5 to 7.0 m below the existing ground surface.

The geotechnical report provides recommendations for foundation, excavation, backfill, pavement structure and pipe bedding and backfill.

3.0 Water Service

3.1 Design Criteria

The water service will be designed in accordance with the 2010 City of Ottawa Water Design Guidelines.

The required water demand and pressure design parameters for the development has been calculated based in Table 1:

Table 1– Summary of Water Demand Parameters

Design Parameter	Value
	Residential
Average Daily Demand	30 L/d/P ¹
Max. Daily Peaking Factor	1.5 x Average Daily ²
Max. Hourly Peaking Factor	1.8 x Max. Daily ²
Minimum Watermain Size	200mm diameter
Minimum Depth of Cover	2.4m from top of watermain to finished grade
Min. pressure during normal operating conditions	345kPa
Max. pressure during normal operating conditions	552kPa
Min. pressure during maximum hourly demand	276kPa
Min. pressure during maximum daily demand + fire flow	140kPa
¹ Daily average based on Appendix 4-A from city design guidelines	
² Institutional Max. Daily and Max. Hourly peaking factors per city design guidelines	

3.2 Water Demand

Church Building GFA = 1498.4 m² (0.15 ha)

No. of Seats = 239 (As per Architect)

Daily Average Water Demand = 239 x 30 l/cap/day = 7,170 L/Day = 0.083 L/sec

Maximum Daily Demand = 0.083 x 1.5 = 0.124 L/sec

Maximum Hourly Demand = 0.124 x 1.8 = 0.223 L/sec

The water demand/fire flow for the development based on the Ottawa Design Guidelines (2010 incl. Technical Bulletins) and the Fire Underwriters Survey (1999) is summarized below;

Table 2– Summary of Water Demand Calculations

Design Parameter	Water Demand (L/s)
	Residential
Average Daily Demand	0.083
Maximum Daily Demand	0.124
Maximum Hourly Demand	0.223
Fire Flow	83.00
Total Max Daily Demand + Fire Flow	83.124

Fire flow calculations, Fire hydrant coverage map (**DR3**) are provided in **Appendix C**.

The existing 200 mm diameter water stub at property limit is extended up to building for service connection. Refer **Drawing SP3** for details.

3.3 Adequacy of Supply for Domestic and Fire Flows

Preliminary water demands and fire flow requirements for the proposed development were provided to the City of Ottawa (Table 2). The City of Ottawa was contacted to obtain boundary conditions associated with the estimated water demand, as indicated in the boundary request correspondence included in **Appendix B**.

The City provided both the anticipated minimum and maximum water pressures, as well as, the estimated water pressure during fire flow, as indicated by the correspondence and results of boundary conditions (**Appendix C**).

Fire flow calculated using the ISTDB-2018-02 method used the following assumptions from the Architect:

- Type of construction – Ordinary;
- Occupancy type – Limited Combustibility;
- Sprinkler Protection – Automatic

The above assumptions result in a maximum estimated fire flow of approximately 5,000 L/min. See **Appendix C** for detailed calculations using the ISDTB-2018-02 method. The minimum and maximum pressures fall within the required range identified in Table 1.

Table 3 - Results from Boundary Condition Analysis

Design Scenario	Head (m)	Pressure (psi)
Maximum HGL	124.7	58.59
Peak Hour	130.2	66.41
Maximum Day plus Fire	125.8	60.15

Ground Elevation = 83.50

It was concluded that fire hydrants available within the 75m radius from the proposed development are shown on Fire hydrant coverage map **DR03, Appendix C**. Two fire hydrants rated AA (blue top) having 5700 l/min flow available from each hydrant, thus providing a total flow of 11,440 l/min within the 75m radius. Therefore, the required demand of 83.12 l/sec (5000 l/min) will be met by the two existing hydrants.

3.4 Pressure Check

The site is within Pressure Zone 2W2C, which operates at a maximum head of 115 m (City of Ottawa Water Master Plan, 2013). This would result in a maximum pressure above the finished floor elevation of approximately 519kPa, which falls under the maximum 552kPa defined in the guidelines.

The average day pressures throughout the system are below 552 kPa (Refer **Appendix C**), therefore pressure reducing valves are not required.

3.5 Reliability Requirements

A shut off valve for the water service will be provided at the property line.

3.6 Water Supply Conclusion

The existing water stub at property limit is proposed to be extended up to building for service.

The anticipated water demand was submitted to the City of Ottawa for establishing boundary conditions. The City provided both the anticipated minimum and maximum water pressures, as well as, the estimated water pressure during fire flow. As demonstrated by Table 2 & 3, based on the City’s model, the municipal system is capable of delivering water within the pressure range prescribed in the Water Supply Guidelines.

The required fire and domestic flow can be met with the two existing hydrants on St. Laurent Boulevard.

The available pressure during the fire flow scenario as per the OBC and ISDTB-2018-02 calculations exceeds 140 kPa. The proposed water supply design conforms to all relevant City Guidelines and Policies.

4.0 Sanitary Service

4.1 Sanitary Flows

The sanitary service will be designed in accordance with the 2010 City of Ottawa Water Design Guidelines.

The estimated sanitary flows for the development have been calculated based on design parameters as defined in Table 4.

Table 4 - Summarization of Sanitary Servicing Design Parameters

Design Parameter	Value
Average Daily Flow	30 L/d/P
Institutional Peaking Factor	1.5
Infiltration and Inflow Allowance	0.33 L/ha/s
Manning’s Coefficient ‘n’	0.013
Minimum Depth of Cover	2.5m from obvert of sewer to grade
Minimum Full Flowing Velocity	0.6m/s
Maximum Full Flowing Velocity	3.0m/s
As per Sections 4 and 6 of the City of Ottawa Sewer Design Guidelines, October 2012 incl. all Tech. Bulletins as of November 2019	

No. of Seats = 239 (As per Architect)

Average sanitary flow = $239 \times 30 \text{ l/cap/day} = 7,170 \text{ L/Day} = 0.083 \text{ L/sec}$

Peak sanitary flow = $0.083 \times 1.5 = 0.124 \text{ L/sec}$

Catchment Area = 0.66 ha (Refer sanitary drainage plan **DR4** attached in **Appendix D**)

Infiltration Allowance = $0.33 \times 0.66 \text{ l/day} = 0.218 \text{ l/sec}$

Total Peak Sanitary Flow = $0.124 + 0.218 = 0.34 \text{ l/sec}$.

A 200 mm diameter sanitary service connection is proposed for the development. Refer **Drawing SP3** for details.

4.2 Effect of Proposed Development on Downstream Sanitary Infrastructure

As per sanitary flow calculations, an additional flow of 0.31 l/sec is added to the existing 300 mm sanitary sewer on St. Laurent Boulevard. The existing 300 diameter sanitary sewer has the capacity to accommodate the projected sanitary flows. Refer sanitary design sheet attached in **Appendix D**.

4.3 Summary and Conclusions

A 200 mm diameter sanitary service connection is proposed. An additional flow of 0.31 l/sec is added to the existing sanitary sewer which is considered a minor addition that will not compromise sanitary sewer capacity or result in significant change to the sanitary hydraulic grade line.

5.0 Storm Servicing and Stormwater Management

5.1 Background

The existing site does not have a piped storm connection. The site sheet drains towards existing catch basin on St. Laurent Boulevard without any storm water management controls.

5.2 Storm Servicing Strategy

The proposed stormwater management system will provide the necessary detention storage on site to meet the stormwater management requirements. Quantity control will be provided to control the post development 100-year flows to pre development 5-year storm event flows.

5.3 Proposed Storm Servicing

The storm network is proposed to collect the site flows and outlet to the existing 1050 mm storm sewer on St. Laurent Boulevard. Refer **Drawing SP3** for details. Storm design sheet is attached in **Appendix E**.

The proposed pre-development and post-development catchment areas, runoff coefficients and catchment total areas are indicated in **Appendix E**.

5.4 Design Criteria (Minor and Major Systems)

The site specific SWM criteria are as follows,

- Minor site storm is designed for 5-year return period.
- Rational method is used to calculate pre and post development flows

Rational Method (Q) = $2.78CIA$, where

Q = peak flow (L/s)

C = runoff coefficient

I = rainfall intensity

Intensity is calculated by the following formulae, $i = \frac{A}{(Td+C)^B}$

where A, B and C are all factors of the IDF Return Period, T_d being the time of concentration and A the drainage area (Detailed calculations provided in **Appendix E**).

Time of concentration is determined using the inlet time graph (Appendix 5D Ottawa City Sewer Design Guidelines) which results in a value less than 10 minutes. Therefore 10 minutes will be used to calculate peak flows.

5.5 Stormwater Quantity Control

5.5.1 Catchment Areas

The whole site is considered as one catchment based on proposed development and grading. Catchment Area (A1 - 0.66 ha) consists of building footprint and parking area. Area A1 will be controlled and outlet to existing storm network on St. Laurent Boulevard.

In predevelopment conditions, the whole site runoff is flowing uncontrolled. After development site runoff will be controlled to pre-development flows.

Pre and post development drainage area plans are attached as DR1 and DR2 in **Appendix A**. Pre and post development runoff coefficients are calculated as detailed in **Appendix E**.

The pre and post development runoff coefficients are summarised in Table 5.1 below;

Table 5.1– Pre and Post Development Runoff Coefficients

Conditions	Area (ha)	Runoff Coefficient (R)
Pre Development	0.66	0.25
Post Development	0.66	0.71

5.5.2 Peak Flows

Pre and post development flows are calculated as detailed in **Appendix E**.

Table 5.2 below summarize the pre and post developments uncontrolled and controlled flows with storage requirements.

Table 5.2– Allowable Flow and Storage Summary

Return Period	Uncontrolled Pre Development Flow	Uncontrolled Post Development Flow	Controlled Post Development Flow	Storage Required
(years)	(liters/sec)	(liters/sec)	(liters/sec)	(m ³)
Q ₅	47.62	135.90	47.62	47
Q ₁₀₀	81.50	232.58	47.62	122*

* Maximum storage required.

5.5.3 Allowable Flow/Orifice Control

To ensure that only allowable 5-year pre development flow of 47.62 l/sec is released from the project area, a 132 mm diameter orifice plate is proposed to be installed downstream of storm manhole CBMH2. The orifice sizing calculations are attached in **Appendix E**.

5.5.4 Onsite Storage

An allowable flow of 47.62 l/sec has been used for storage calculations using Rational formula. The calculation of required onsite storage volume is given in **Appendix E**.

The required onsite storage is summarized for 5-year and 100-year storms (Refer Table 5.2 above). The maximum onsite storage volume of 122 m³ is required to control 100-year post development site flows to 5-year pre development level.

Parking Detention

Parking surface has the potential to provide 98.34 m³ of detention storage with a 210 mm maximum storage depth for 100-year rainfall event (Refer **Drawing SP4**).

Storm Network Storage

Storm network (pipes, manholes & catch basins) has 28.75 m³ available storage (Refer **Appendix E**).

Therefore, total available storage is (108.77+29.83) = **127.09 m³** which is higher than the required storage of **122 m³**

5.5.5 Impact on Existing Storm Infrastructure

The onsite quantity controls limit the site discharge to 47.62 l/sec (5-year predevelopment) to ensure that the downstream storm sewers capacity and hydraulic grade line is not affected by the proposed development.

Storm Sewer Design calculations are provided in **Appendix E**.

5.6 Storm Water Quality Control

The required water quality treatment is achieved with the help of a treatment train approach comprising of the following measures,

- 1- RVCA considers run-off from building roof areas to be “clean”, and therefore not require quality control.
- 2- Oil/grit separator (OGS) has been proposed as Stormceptor EFO4 unit shown on **Drawing SP3, Appendix A**. The sizing calculations are attached in **Appendix E** which shows that the unit is capable of achieving 84% TSS removal for site flows.

5.7 MECP and Conservation Authority Approvals

MECP approval and ECA will not be required for the proposed design.

5.8 Minor and Major Systems

The minor storm sewer system consists of the site storm network up to the city storm sewer on St. Laurent Boulevard. The major system consists of run-off from storms in excess of the 100-year event. The site has been graded to direct run-off from storms in excess of the 100-year event safely to St. Laurent Boulevard. The overland flow routes are shown on **Drawing SP4**.

5.9 Impacts to Receiving Watercourses

No negative impacts to receiving watercourses are anticipated.

5.10 100-year Flood Levels and Major Flow Routing

The site is not within a 100-year floodplain.

6.0 Grading

The proposed grading plan is shown on **Drawing SP4**. The development will be tied into existing grades along St. Laurent Boulevard.

The existing grades will be matched at the property limits along the adjacent property boundary.

7.0 Erosion and Sediment Control

During all construction activities, erosion and sedimentation shall be controlled by the following techniques:

- Extent of exposed soils shall be limited at any given time;
- Exposed areas shall be re-vegetated as soon as possible;
- Minimize the area to be cleared and disruption of adjacent areas;
- Silt sack or approved equivalent shall be installed inside all catch basins, catch basin manholes, and storm manholes as identified on the erosion and sediment control plan;
- Mud matt is required at the construction entrance to prevent mud tracking on municipal roads. Mud matt to be installed and maintained as indicated on the erosion and sediment control plan;
- Visual inspection shall be completed daily on sediment control barriers and any damage repaired immediately. Care will be taken to prevent damage during construction operations;
- In some cases, barriers may be removed temporarily to accommodate the construction operations. The affected barriers will be reinstated at night when construction is completed;
- Sediment control devices will be cleaned of accumulated silt as required. The deposits will be disposed of as per the requirements of the contract;
- During construction, if the engineer believes that additional prevention methods are required to control erosion and sedimentation, the contractor will install additional silt fences or other methods as required to the satisfaction of the engineer; and,
- Construction and maintenance requirements for erosion and sediment controls are to comply with Ontario Provincial Standard Specification (OPSS) 805.

We trust you will find this submission complete and in order. Should you have any questions, please contact the undersigned.

Respectfully submitted,

Reinders + Law Ltd.



Yasar Ayub, M.Eng., P.Eng.
Senior Municipal Engineer
905-457-1618 x 1324

Appendix A
Figures

DR01 Pre Development Drainage Areas

DR02 Post Development Drainage Areas

Site Servicing, Grading and Erosion and Sediment Control Plan

TOPOGRAPHICAL PLAN OF SURVEY
 PART OF LOT 1
 CONCESSION 5 (RIDEAU FRONT)
 Geographic Township of Nepean
 CITY OF OTTAWA
 Surveyed by Annis, O'Sullivan, Vollebek Ltd.
 Plan Amended September 7, 2017 to illustrate additional services.

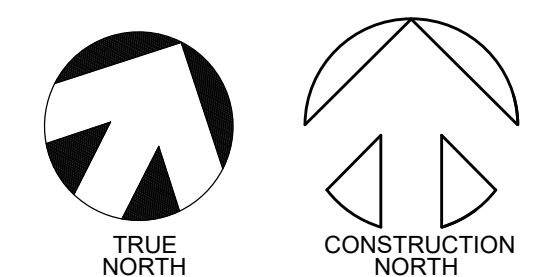

OWNERS	APPLICANT
OWNERS NAME The CornerStone House of Refuge Apostolic Church (CHORAC) ADDRESS 1196 Wellington St West, Ottawa, ON, K1Y 2Z5 (613) PHONE #: 725-1432	REINDERS + LAW LTD. 64 ONTARIO STREET NORTH, MILTON ON L9T 2T1 P (905)457-1618 F (905)457-8852

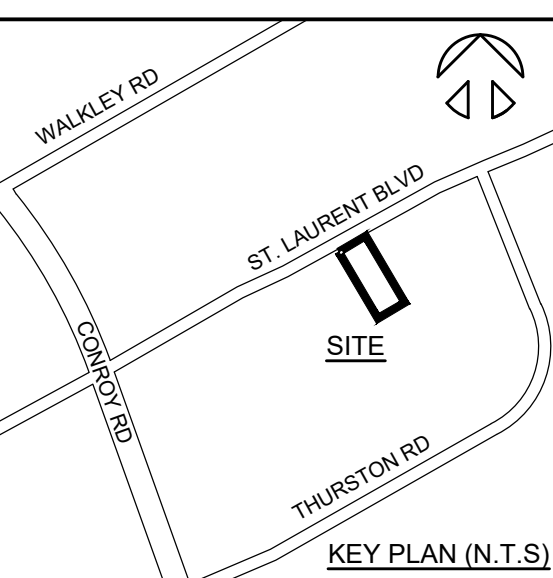

LEGEND:

- CATCHMENT AREA BOUNDARY
- CATCHMENT AREA No.
- CATCHMENT AREA IN HECTARES.
- WEIGHTED RUN-OFF COEFFICIENT

0	ISSUED FOR APPROVAL	10/12/2022	YA
no.	revisions	date	init.

GENERAL NOTE:
 THESE DRAWINGS ARE COPYRIGHT AND THE PROPERTY OF REINDERS + LAW LTD. THE DRAWINGS MAY NOT BE USED FOR CONSTRUCTION WITHOUT THE PERMISSION OF REINDERS + LAW LTD. AND UNLESS SEALED AND SIGNED BY THE ARCHITECT/ENGINEER REPRODUCTION OF THESE DRAWINGS WITHOUT THE CONSENT OF REINDERS + LAW LTD. IS STRICTLY PROHIBITED.
 DO NOT SCALE THESE DRAWINGS. ANY ERROR OR DISCREPANCY IS TO BE REPORTED IMMEDIATELY TO: REINDERS + LAW LTD.

cad file 20037_DR
 date plotted 12/7/2022 plot scale 1:1

drawn	CC
designed	YA
reviewed	YA
date	12/7/2022
scale	1:300

project
 CHORAC OTTAWA
 2375 ST. LAURENT BLVD
 OTTAWA, ON

drawing
 PRE DEVELOPMENT
 DRAINAGE PLAN

REINDERS + LAW LTD.
 ARCHITECTURE ENGINEERING
 64 ONTARIO STREET NORTH
 MILTON ON L9T 2T1
 T. 905.457.1618 F. 905.457.8852
 EMAIL@REINDERS.CA WWW.REINDERS.CA

drawing no.	20037_DR1	rev. no.	0
-------------	-----------	----------	---

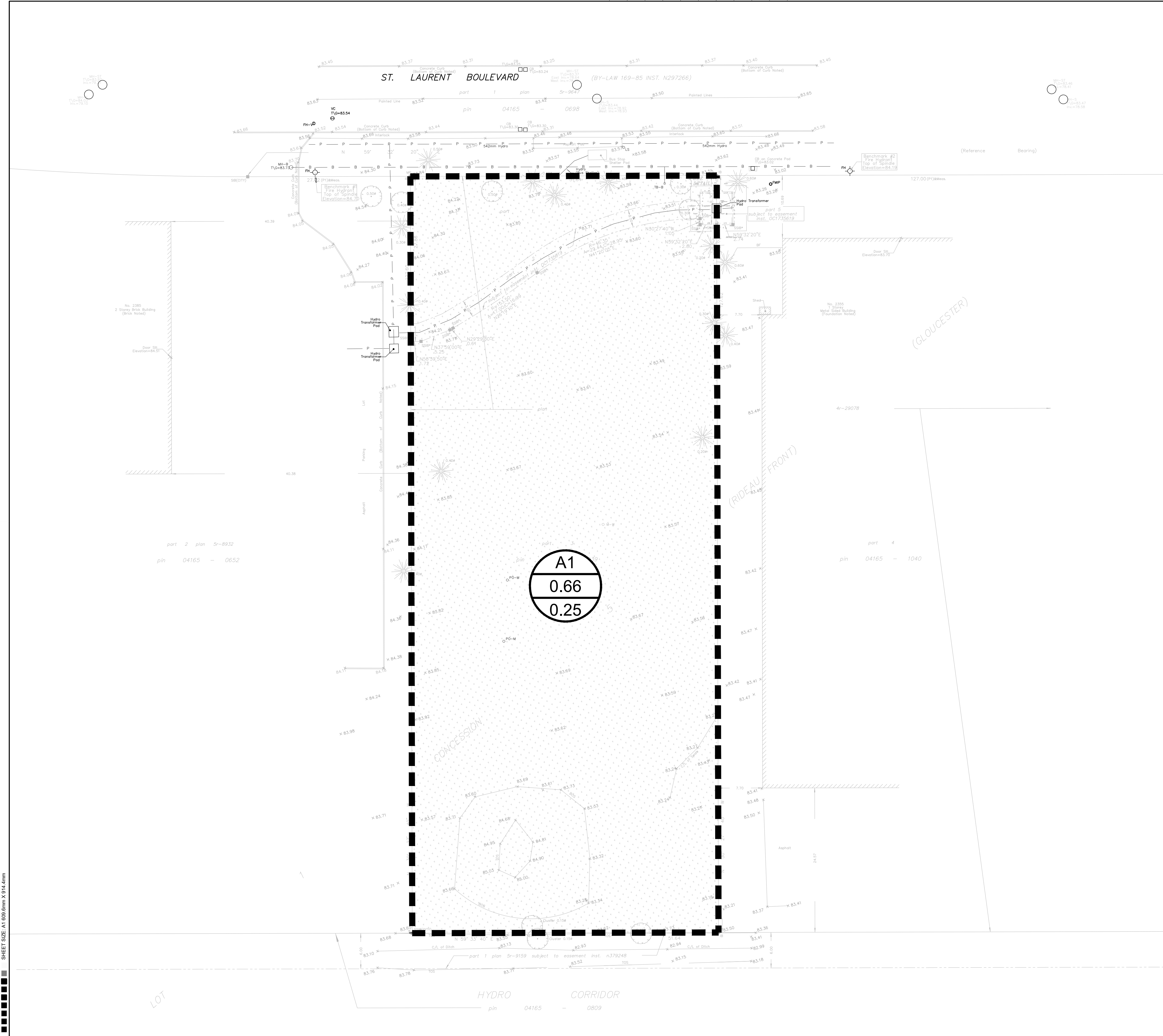

SHEET SIZE: A1 600.0mm X 914.4mm

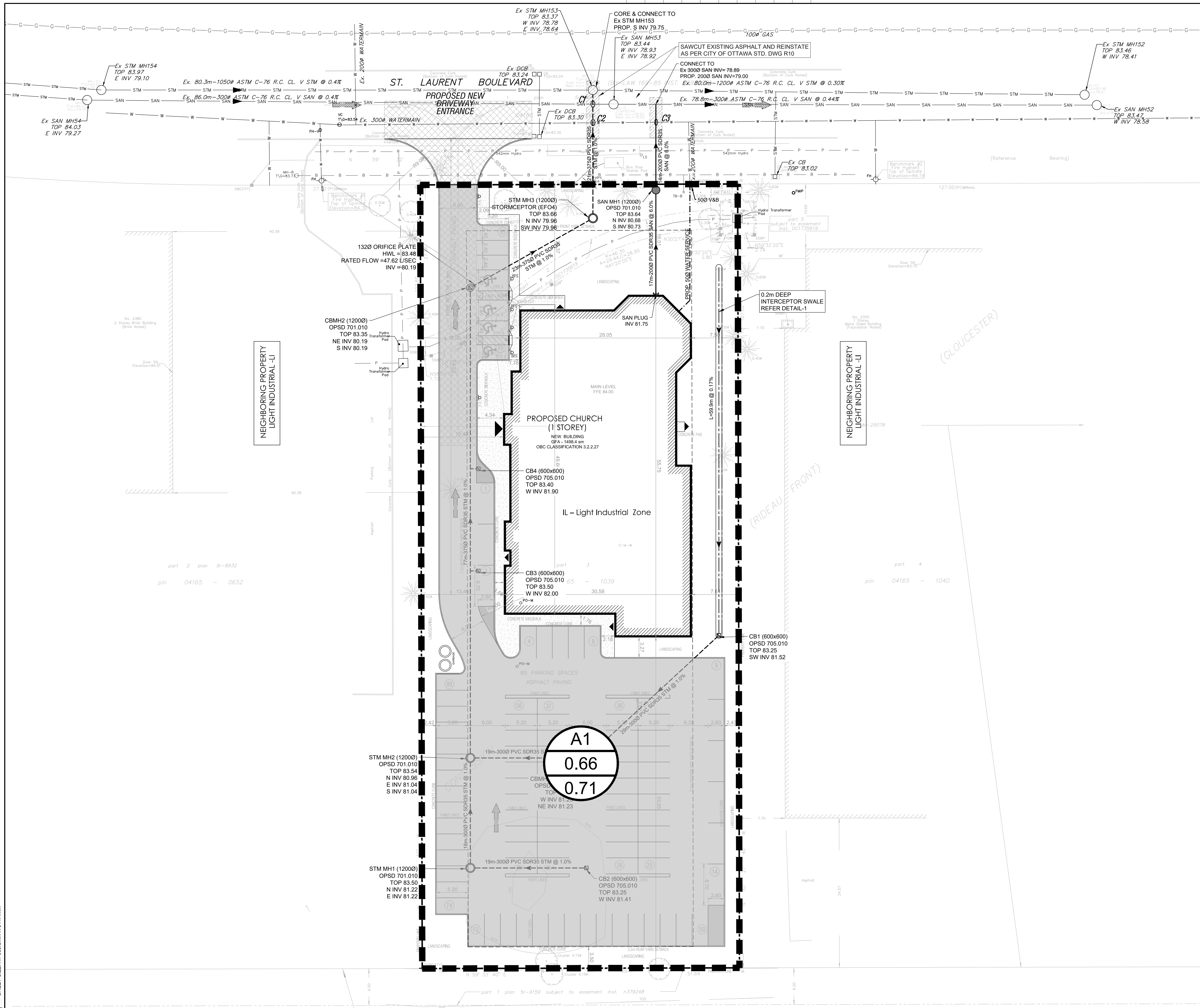

TOPOGRAPHICAL PLAN OF SURVEY
 PART OF LOT 1
 CONCESSION 5 (RIDEAU FRONT)
 Geographic Township of Nepean
 CITY OF OTTAWA
 Surveyed by Annis, O'Sullivan, Vollebakk Ltd.
 Plan Amended September 7, 2017 to illustrate additional services.

OWNERS	APPLICANT
OWNERS NAME: The Carroll House of Refuge Apostolic Church (CHORAC) ADDRESS: 1196 Wellington St West, Ottawa, ON, K1Y 2Z5 (613) PHONE #: 725-1432	REINDERS + LAW LTD. 64 ONTARIO STREET NORTH, MILTON ON L9T 2T1 P (905)457-1618 F (905)457-8852

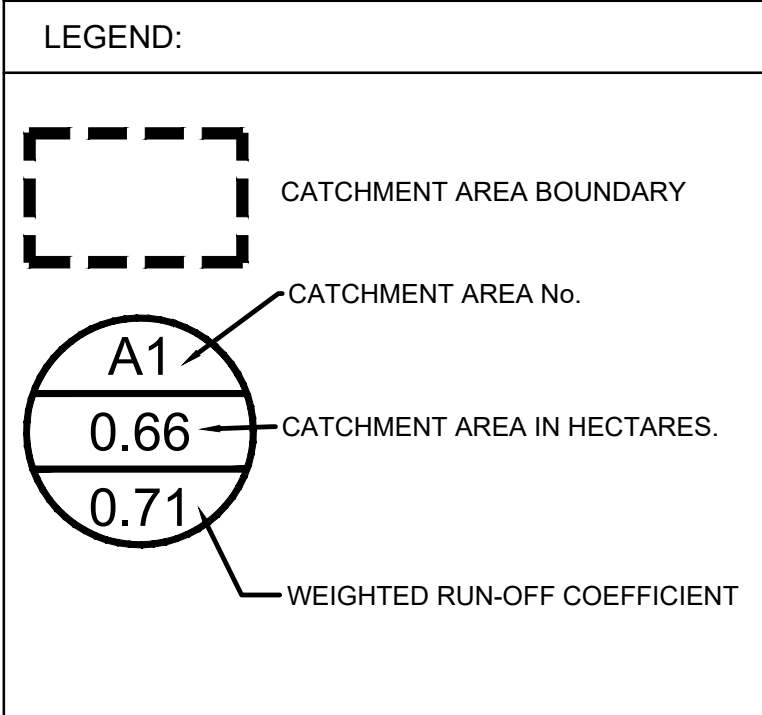
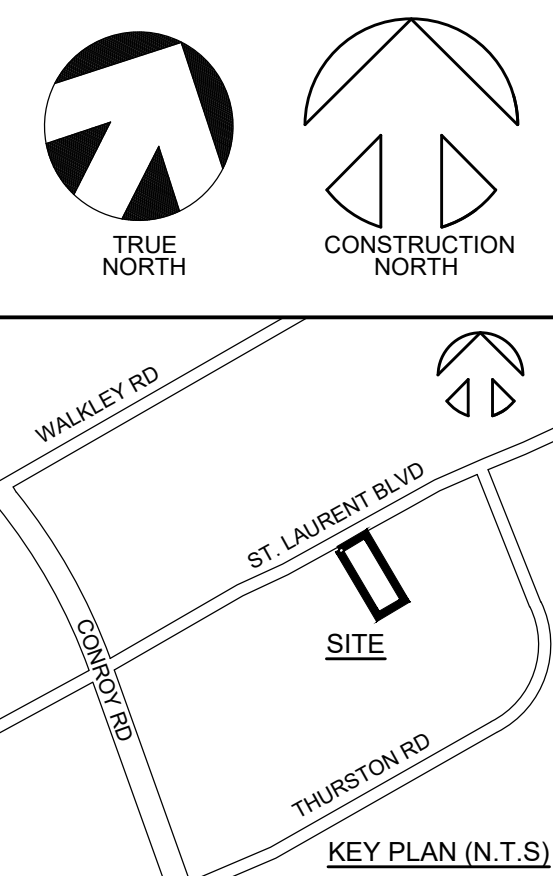

no.	revisions	date	INIT.
1	ISSUED FOR APPROVAL	12/07/2022	YA
0	ISSUED FOR APPROVAL	10/12/2022	YA

GENERAL NOTE:
 THESE DRAWINGS ARE COPYRIGHT AND THE PROPERTY OF REINDERS + LAW LTD. THE DRAWINGS MAY NOT BE USED FOR CONSTRUCTION WITHOUT THE PERMISSION OF REINDERS + LAW LTD. AND UNLESS SEALED AND SIGNED BY THE ARCHITECT/ENGINEER REPRODUCTION OF THESE DRAWINGS WITHOUT THE CONSENT OF REINDERS + LAW LTD. IS STRICTLY PROHIBITED.
 DO NOT SCALE THESE DRAWINGS. ANY ERROR OR DISCREPANCY IS TO BE REPORTED IMMEDIATELY TO: REINDERS + LAW LTD.

cad file 20037_DR
 date plotted 12/7/2022 plot scale 1:1

drawn	CC
designed	YA
reviewed	YA
date	12/7/2022
scale	1:300

project
 CHORAC OTTAWA
 2375 ST. LAURENT BLVD
 OTTAWA, ON

drawing
 POST DEVELOPMENT
 DRAINAGE PLAN

REINDERS + LAW
 ARCHITECTURE, ENGINEERING
 REINDERS + LAW LTD.
 ARCHITECTURE, ENGINEERING
 64 ONTARIO STREET NORTH
 MILTON ON L9T 2T1
 T. 905.457.1618 F. 905.457.8852
 EMAIL@REINDERS.CA WWW.REINDERS.CA

drawing no.	20037_DR2	rev. no.	1
-------------	-----------	----------	---

SHEET SIZE: A1 600.0mm X 914.4mm

TOPOGRAPHICAL PLAN OF SURVEY
PART OF LOT 1
CONCESSION 5 (RIDEAU FRONT)
Geographic Township of Nepean
CITY OF OTTAWA
Surveyed by Annis, O'Sullivan, Vollebek Ltd.
Plan Amended September 7, 2017 to illustrate additional services.

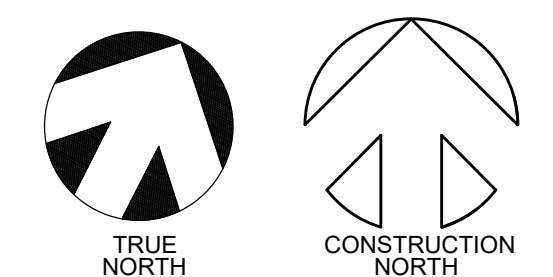

OWNERS	APPLICANT
OWNERS NAME: The Catholic House of Refuge Apostolic Church (CHORAC) ADDRESS: 1196 Wellington St. West, Ottawa, ON, K1Y 2Z5 (613) PHONE #: 725-1432	REINDERS + LAW LTD. 64 ONTARIO STREET NORTH, MILTON ON L9T 2T1 P (905)457-1618 F (905)457-8852

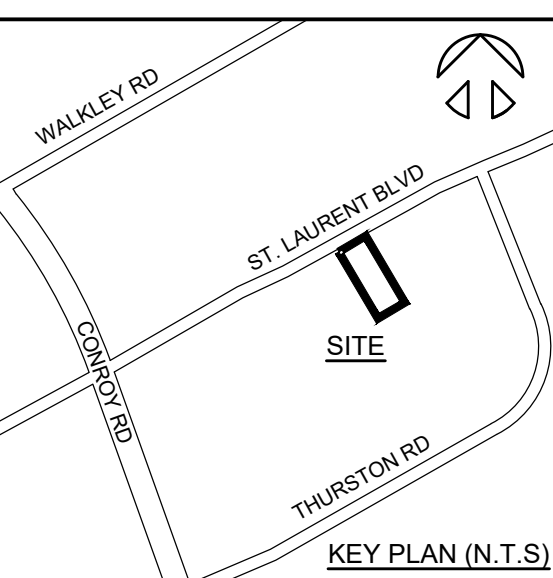

LEGEND:

	PROPERTY LINE		PROPOSED SANITARY MANHOLE
	BUILDING SETBACK LINE		PROPOSED STORM MANHOLE
	PROPOSED FIRE ROUTE (USING HEAVY DUTY PAVING)		PROPOSED CATCH BASIN MANHOLE
	HEAVY DUTY PAVING		PROPOSED CATCH BASIN
	LIGHT DUTY PAVING		PROPOSED VALVE & BOX
	CONCRETE PAD OR SIDEWALK		OVERLAND FLOW ROUTE
	PROPOSED CONCRETE CURB		PROPOSED SLOPE
	PROPOSED CONCRETE CURB WITH CURB CUT OR DEPRESSED CURB		EXISTING ELEVATION FROM SURVEY
	NEW BUILDING AREA (FOOTPRINT)		PROPOSED GRADES
	PRINCIPAL ENTRANCE TO THE BUILDING		EXISTING ELEVATION TO REMAIN
	BARRIER FREE LOGO (PAVED ON ASPHALT)		PONDING AREA
	EXISTING MANHOLE		RAIN WATER LEADER
	EXISTING CATCH BASIN		SLOPE ROOF DOWN IN DIRECTION INDICATED
	EXISTING DOUBLE CATCH BASIN		
	EXISTING FIRE HYDRANT		
	EXISTING WATER VALVE		
	EXISTING VALVE CHAMBER FOR WATERMAIN		
	EXISTING FIRE HYDRANT VALVE		

no.	revisions	date	init.
1	ISSUED FOR APPROVAL	12/07/2022	YA
0	ISSUED FOR APPROVAL	02/14/2022	YA

GENERAL NOTE:
THESE DRAWINGS ARE COPYRIGHT AND THE PROPERTY OF REINDERS + LAW LTD. THE DRAWINGS MAY NOT BE USED FOR CONSTRUCTION WITHOUT THE PERMISSION OF REINDERS + LAW LTD. AND UNLESS SEALED AND SIGNED BY THE ARCHITECT/ENGINEER REPRODUCTION OF THESE DRAWINGS WITHOUT THE CONSENT OF REINDERS + LAW LTD. IS STRICTLY PROHIBITED.
DO NOT SCALE THESE DRAWINGS. ANY ERROR OR DISCREPANCY IS TO BE REPORTED IMMEDIATELY TO: REINDERS + LAW LTD.

cad file 20037_SP3
date plotted 12/7/2022 plot scale 1:1

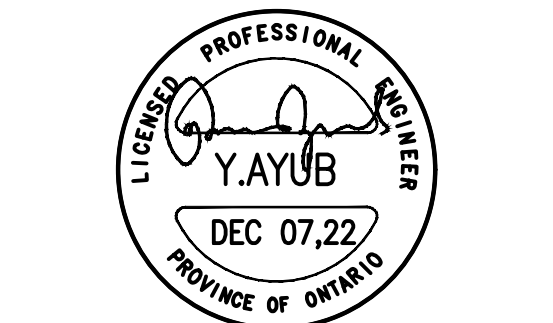

drawn CC
designed YA
reviewed YA
date 12/7/2022
scale 1:300

project CHORAC OTTAWA
2375 ST. LAURENT BLVD
OTTAWA, ON

drawing SITE GRADING PLAN

REINDERS + LAW
ARCHITECTURE, ENGINEERING

REINDERS + LAW LTD.
ARCHITECTURE, ENGINEERING
64 ONTARIO STREET NORTH
MILTON ON L9T 2T1
T. 905.457.1618 F. 905.457.8852
EMAIL@REINDERS.CA WWW.REINDERS.CA

drawing no. 20037_SP4 rev. no. 1

SAWCUT EXISTING ASPHALT AND REINSTATE AS PER CITY OF OTTAWA STD. DWG R10

ST. LAURENT BOULEVARD

PROPOSED NEW DRIVEWAY ENTRANCE PROP. CURB CUT - 23.54m

PROPOSED CHURCH (1 STOREY)
NEW BUILDING GFA - 1498.4 sqm
OBC CLASSIFICATION 3.2.2.27

IL - Light Industrial Zone

NEIGHBORING PROPERTY LIGHT INDUSTRIAL -U

NEIGHBORING PROPERTY LIGHT INDUSTRIAL -U

NEIGHBORING PROPERTY LIGHT INDUSTRIAL -U

NEIGHBORING PROPERTY LIGHT INDUSTRIAL -U

NEIGHBORING PROPERTY LIGHT INDUSTRIAL -U

NEIGHBORING PROPERTY LIGHT INDUSTRIAL -U

NEIGHBORING PROPERTY LIGHT INDUSTRIAL -U

NEIGHBORING PROPERTY LIGHT INDUSTRIAL -U

NEIGHBORING PROPERTY LIGHT INDUSTRIAL -U

NEIGHBORING PROPERTY LIGHT INDUSTRIAL -U

NEIGHBORING PROPERTY LIGHT INDUSTRIAL -U

NEIGHBORING PROPERTY LIGHT INDUSTRIAL -U

NEIGHBORING PROPERTY LIGHT INDUSTRIAL -U

NEIGHBORING PROPERTY LIGHT INDUSTRIAL -U

NEIGHBORING PROPERTY LIGHT INDUSTRIAL -U

NEIGHBORING PROPERTY LIGHT INDUSTRIAL -U

NEIGHBORING PROPERTY LIGHT INDUSTRIAL -U

NEIGHBORING PROPERTY LIGHT INDUSTRIAL -U

NEIGHBORING PROPERTY LIGHT INDUSTRIAL -U

NEIGHBORING PROPERTY LIGHT INDUSTRIAL -U

NEIGHBORING PROPERTY LIGHT INDUSTRIAL -U

NEIGHBORING PROPERTY LIGHT INDUSTRIAL -U

NEIGHBORING PROPERTY LIGHT INDUSTRIAL -U

NEIGHBORING PROPERTY LIGHT INDUSTRIAL -U

NEIGHBORING PROPERTY LIGHT INDUSTRIAL -U

NEIGHBORING PROPERTY LIGHT INDUSTRIAL -U

NEIGHBORING PROPERTY LIGHT INDUSTRIAL -U

NEIGHBORING PROPERTY LIGHT INDUSTRIAL -U

NEIGHBORING PROPERTY LIGHT INDUSTRIAL -U

NEIGHBORING PROPERTY LIGHT INDUSTRIAL -U

NEIGHBORING PROPERTY LIGHT INDUSTRIAL -U

NEIGHBORING PROPERTY LIGHT INDUSTRIAL -U

NEIGHBORING PROPERTY LIGHT INDUSTRIAL -U

NEIGHBORING PROPERTY LIGHT INDUSTRIAL -U

NEIGHBORING PROPERTY LIGHT INDUSTRIAL -U

NEIGHBORING PROPERTY LIGHT INDUSTRIAL -U

NEIGHBORING PROPERTY LIGHT INDUSTRIAL -U

NEIGHBORING PROPERTY LIGHT INDUSTRIAL -U

NEIGHBORING PROPERTY LIGHT INDUSTRIAL -U

NEIGHBORING PROPERTY LIGHT INDUSTRIAL -U

NEIGHBORING PROPERTY LIGHT INDUSTRIAL -U

PAVEMENT SPECIFICATION

FOR THE ACCESS ROADWAYS AND PARKING LOTS, THE FOLLOWING MINIMUM PAVEMENT STRUCTURE SHOULD BE USED:

- 100 MILLIMETRES OF HOT MIX ASPHALTIC CONCRETE, OVER
- 150 MILLIMETRES OF OPSS GRANULAR A BASE, OVER
- 450 MILLIMETRES OF OPSS GRANULAR B, TYPE II SUBBASE

THE HOT MIX ASPHALT SHOULD CONSIST OF THE FOLLOWING LAYERS:

- 40 MILLIMETRES OF SUPERPAVE 12.5 (TRAFFIC LEVEL B), OVER
- 60 MILLIMETRES OF SUPERPAVE 19.0 (TRAFFIC LEVEL B)

PARKING DETENTION-5 YEAR

Ponding Area No.	Area (sq.m.)	Depth (m)	Volume (cu.m.)	HWL (m) (5yr)
A1	11.00	0.02	0.07	83.37
A2	0.00	0.00	0.00	83.37
A3	556.00	0.12	22.24	83.37
A4	18.00	0.12	0.72	83.37
TOTAL VOLUME:			23.03	

PARKING DETENTION -100 YEAR

Ponding Area No.	Area (sq.m.)	Depth (m)	Volume (cu.m.)	HWL (m) (100yr)
A1	125.00	0.11	4.58	83.46
A2	19.00	0.06	0.38	83.46
A3	1286.00	0.21	90.02	83.46
A4	48.00	0.21	3.36	83.46
TOTAL VOLUME:			98.34	

PARKING DETENTION - 100 YEAR +20%

Ponding Area No.	Area (sq.m.)	Depth (m)	Volume (cu.m.)	HWL (m) (100yr+20%)
A1	243.00	0.14	11.34	83.49
A2	59.00	0.09	1.77	83.49
A3	1677.00	0.24	134.16	83.49
A4	70.00	0.24	5.60	83.49
TOTAL VOLUME:			152.87	

NEIGHBORING PROPERTY HYDRO CORRIDOR SUBZONE -OIP

SHEET SIZE: A1 (890.0mm X 914.4mm)

EROSION AND SEDIMENT CONTROL NOTES

1. THE CONTRACTOR SHALL IMPLEMENT BEST MANAGEMENT PRACTICES, TO PROVIDE FOR PROTECTION OF THE AREA DRAINAGE SYSTEM AND THE RECEIVING WATERCOURSE, DURING CONSTRUCTION ACTIVITIES. THIS INCLUDES LIMITING THE AMOUNT OF EXPOSED SOIL, USING FILTER CLOTH UNDER THE GRATES OF CATCHBASINS AND MANHOLES, AND INSTALLING SILT FENCES AND OTHER EFFECTIVE SEDIMENT TRAPS. THE CONTRACTOR ACKNOWLEDGES THAT FAILURE TO IMPLEMENT APPROPRIATE EROSION AND SEDIMENT CONTROL MEASURES MAY BE SUBJECT TO PENALTIES IMPOSED BY ANY APPLICABLE REGULATORY AGENCY.
2. THE SEDIMENT CONTROL MEASURES SHALL ONLY BE REMOVED WHEN, IN THE OPINION OF THE ENGINEER, THE MEASURES ARE NO LONGER REQUIRED. NO CONTROL MEASURES MAY BE PERMANENTLY REMOVED WITHOUT PRIOR AUTHORIZATION FROM THE ENGINEER.
3. REGULAR INSPECTION AND MAINTENANCE OF THE EROSION AND SEDIMENT MEASURES SHALL BE UNDERTAKEN. THE IMPLEMENTATION AND ADJUSTMENT AND/OR CORRECTIVE MAINTENANCE OF THE EROSION AND SEDIMENT MEASURES IS AN INTEGRAL PART OF THE PLAN AND MUST BE PERFORMED.
4. GEOTEXTILE FILTER FABRIC SHALL BE PLACED BETWEEN THE STRUCTURE FRAME AND COVER FOR ALL MANHOLES, CATCHBASINS, AND CATCHBASIN MANHOLES IN THE VICINITY OF WORK.
5. THE CONTRACTOR SHALL MAINTAIN ADJACENT ROADS IN A CLEAN CONDITION AT ALL TIMES.
6. PROVIDE MUD MATS AT SITE CONSTRUCTION ENTRANCE(S) AND EGRESS(S).

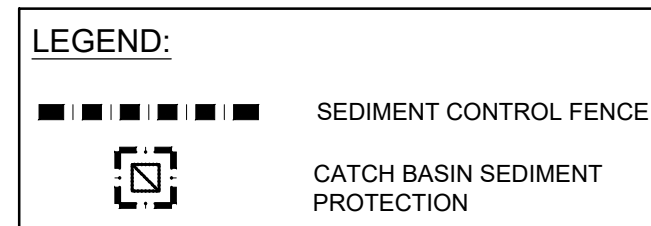

TOPOGRAPHICAL PLAN OF SURVEY
PART OF LOT 1
CONCESSION 5 (RIDEAU FRONT)
Geographic Township of Nepean
CITY OF OTTAWA
Surveyed by Annis, O'Sullivan, Vollebek Ltd.
Plan Amended September 7, 2017 to illustrate additional services.

OWNERS	APPLICANT
OWNERS NAME: The Catholic House of Refuge Apostolic Church (CHORAC) ADDRESS: 1196 Wellington St. West, Ottawa, ON, K1Y 2Z5 (613) PHONE #: 725-1432	REINDERS + LAW LTD. 64 ONTARIO STREET NORTH, MILTON ON L9T 2T1 P (905)457-1618 F (905)457-8852

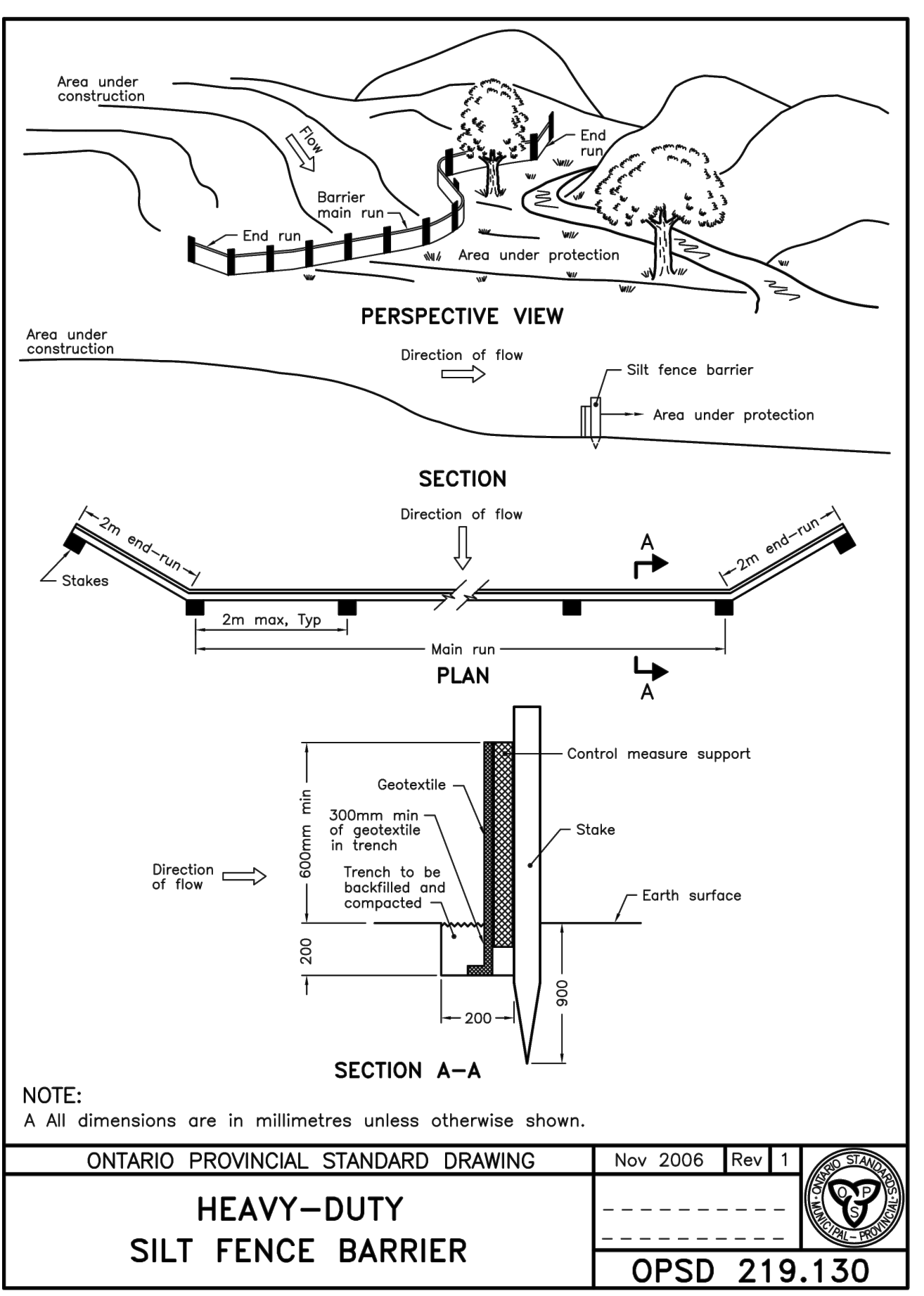
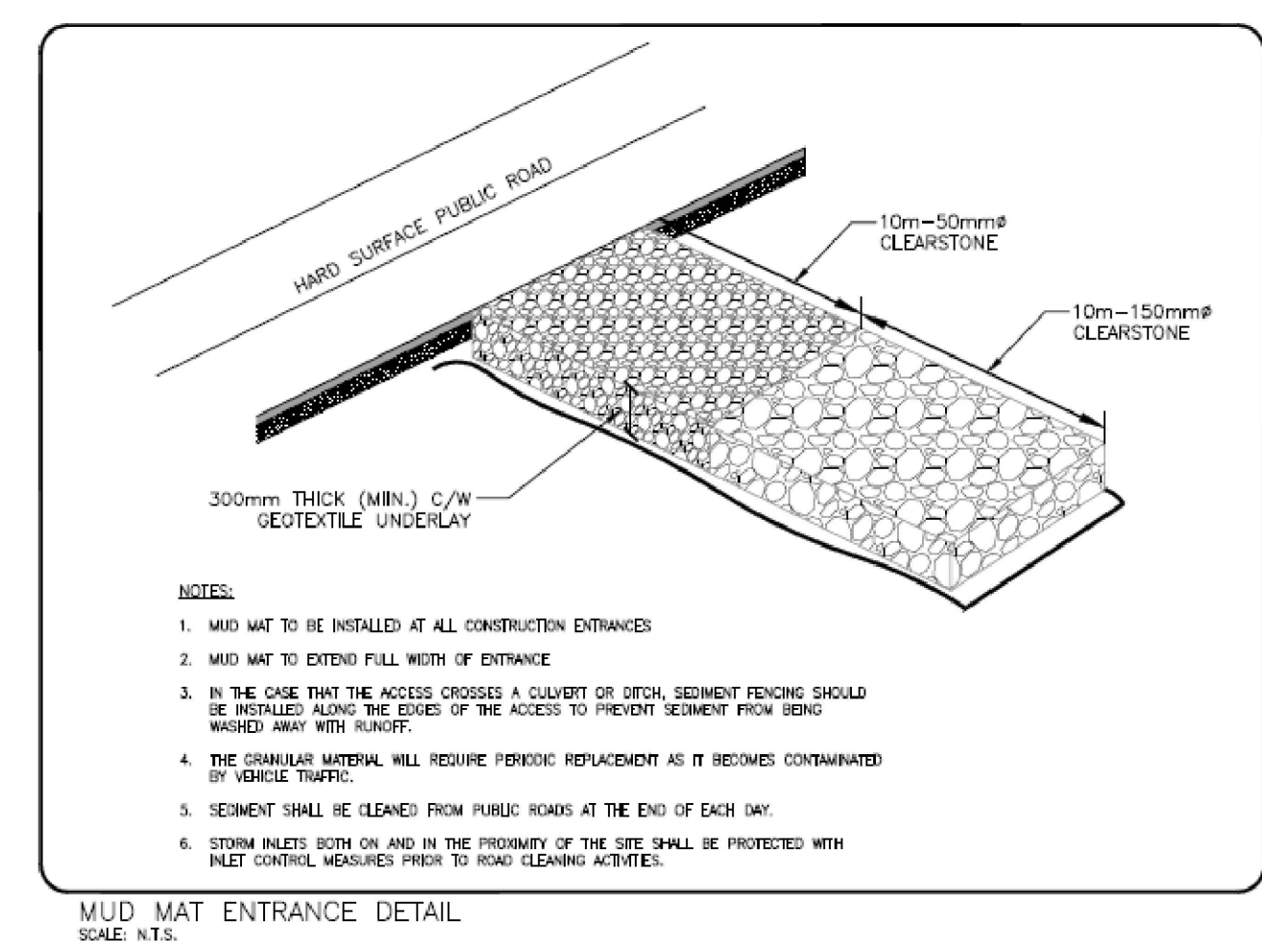
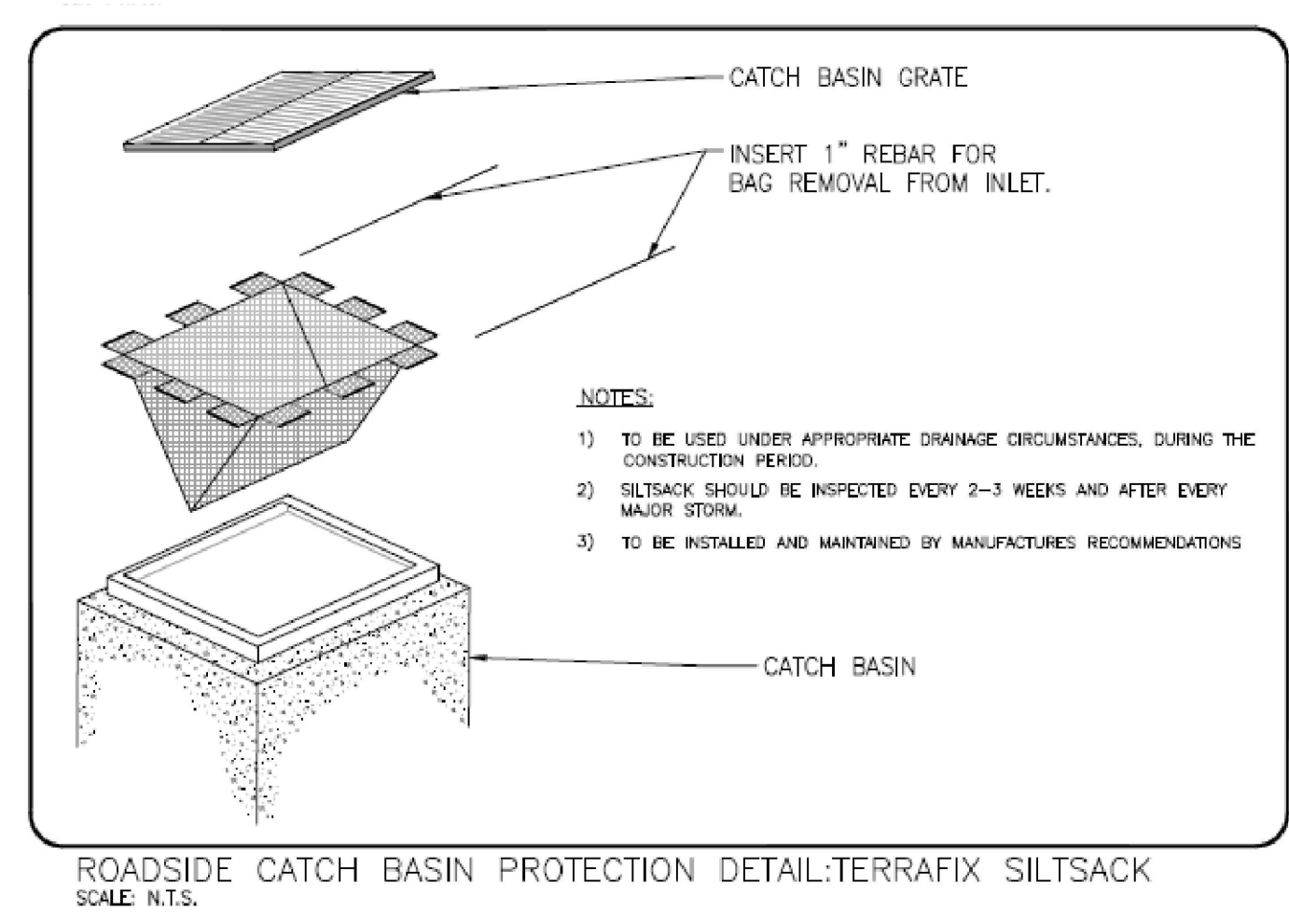
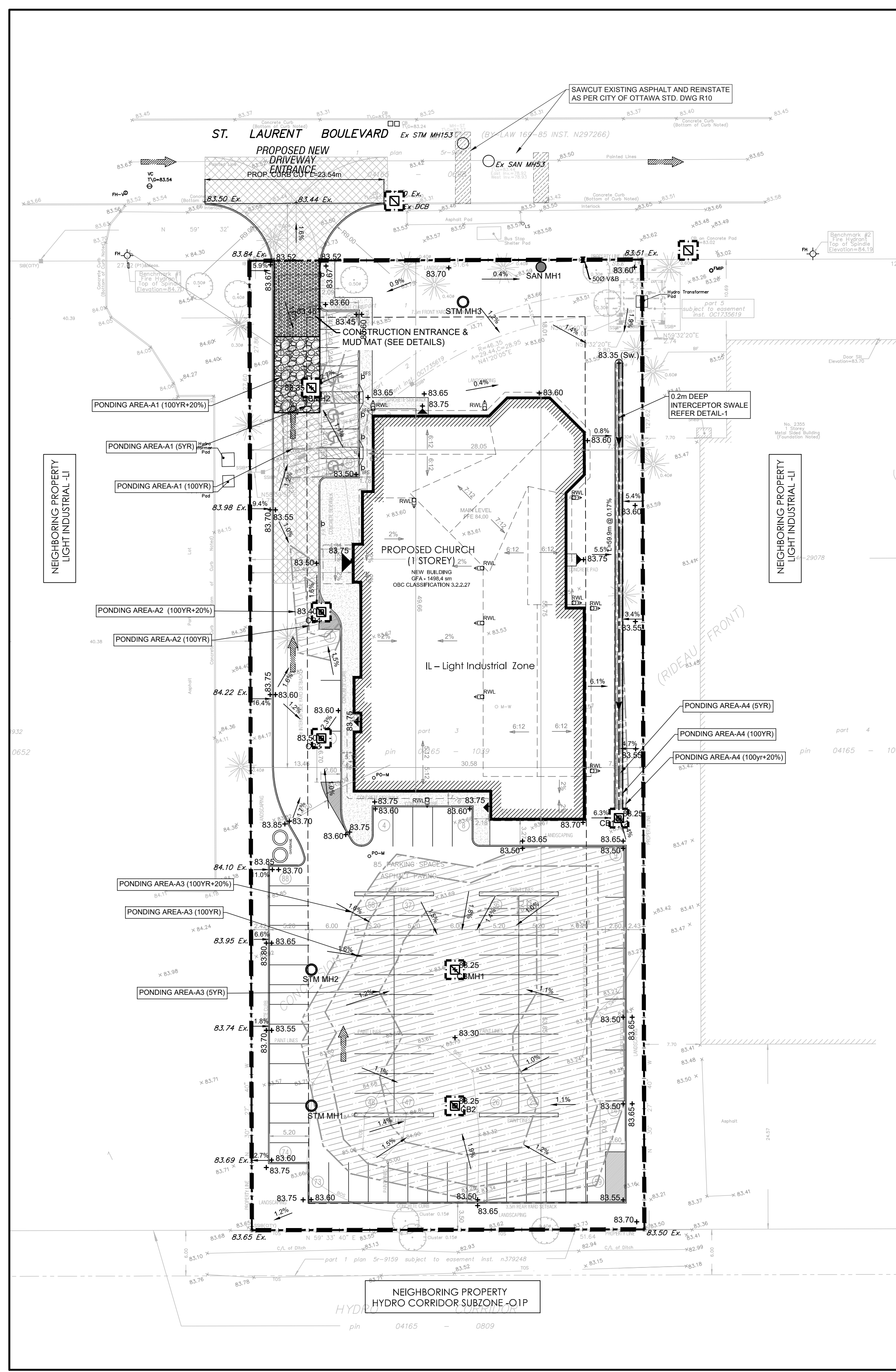
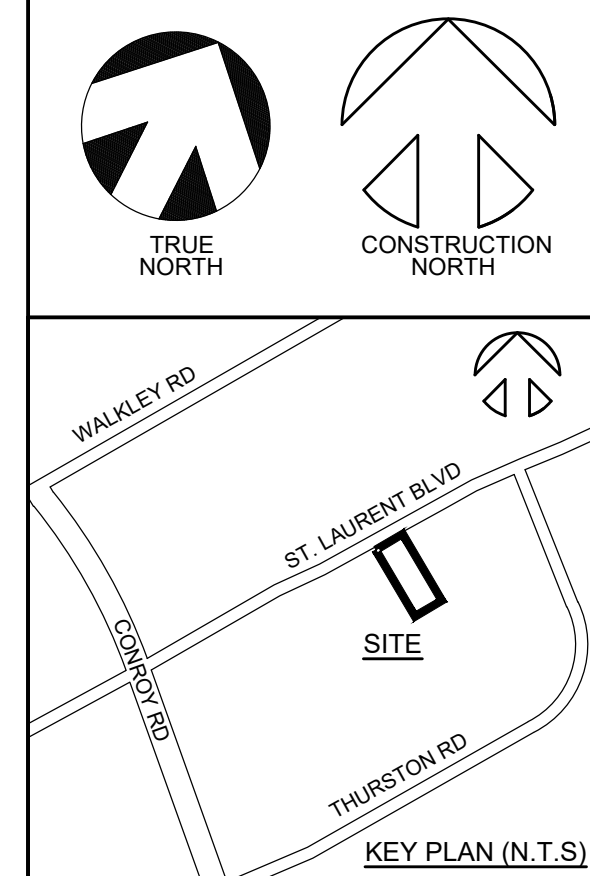

1	ISSUED FOR APPROVAL	12/07/2022	YA
0	ISSUED FOR APPROVAL	02/14/2022	YA

GENERAL NOTE:
THESE DRAWINGS ARE COPYRIGHT AND THE PROPERTY OF REINDERS + LAW LTD. THE DRAWINGS MAY NOT BE USED FOR CONSTRUCTION WITHOUT THE PERMISSION OF REINDERS + LAW LTD. AND UNLESS SEALED AND SIGNED BY THE ARCHITECT/ENGINEER REPRODUCTION OF THESE DRAWINGS WITHOUT THE CONSENT OF REINDERS + LAW LTD. IS STRICTLY PROHIBITED.
DO NOT SCALE THESE DRAWINGS. ANY ERROR OR DISCREPANCY IS TO BE REPORTED IMMEDIATELY TO: REINDERS + LAW LTD.

cad file 20037_SP3
date plotted 12/7/2022 plot scale 1:1

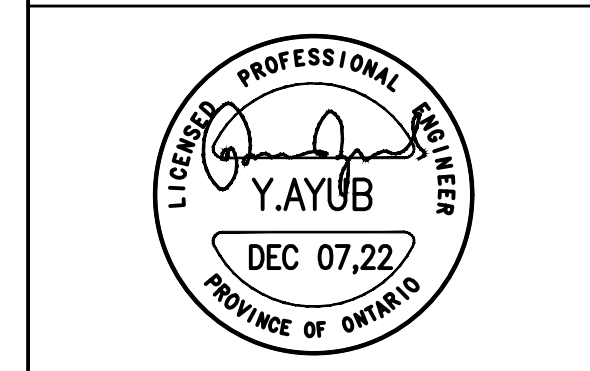

drawn CC
designed YA
reviewed YA
date 12/7/2022
scale AS SHOWN

project
CHORAC OTTAWA
2375 ST. LAURENT BLVD
OTTAWA, ON

drawing
EROSION AND SEDIMENT CONTROL PLAN, NOTES & DETAILS

REINDERS + LAW
ARCHITECTURE, ENGINEERING
REINDERS + LAW LTD.
ARCHITECTURE, ENGINEERING
64 ONTARIO STREET NORTH
MILTON ON L9T 2T1
T. 905.457.1618 F. 905.457.8852
EMAIL@REINDERS.CA WWW.REINDERS.CA

drawing no. 20037_SP5 rev. no. 1

Appendix B
Correspondence with Regulatory Authorities

Site Plan Pre- Application Consultation Notes

Date: April 14, 2021

Site Location: 2375 St.Laurent

Type of Development: Residential (townhomes, stacked, singles, apartments), Office Space, Commercial, Retail, Institutional, Industrial, Other: N/A

Representative/Agent:

Project Manager: Eric Harrold

Assigned Planner: Sarah Ezzio

Infrastructure

Confirmation from the easement holder will be required for the proposed services location.

The previous geotechnical report for this site indicated potential sensitive soils which will require additional considerations.

Water

Existing public services:

- St.Laurent Blvd. – 305mm DI
- Existing water stub existing on north east side of the property. The applicants consultant should determine whether it is feasible to re-use this service, or whether a new lateral is required.
- Watermain Frontage Fees to be paid (\$190.00 per metre) Yes No

Boundary conditions:

Civil consultant must request boundary conditions from the City's assigned Project Manager prior to first submission.

- Water boundary condition requests must include the location of the service(s) and the expected loads required by the proposed developments. Please provide all the following information:
 - Location of service(s)
 - Type of development and the amount of fire flow required (as per FUS, 1999).
 - Average daily demand: ___ l/s.
 - Maximum daily demand: ___ l/s.
 - Maximum hourly daily demand: ___ l/s.
- Fire protection (Fire demand, Hydrant Locations)
- A water meter sizing questionnaire (water data card) will have to be completed prior to receiving a water permit (water card will be provided post approval)
- Water supply redundancy is required for a water demand exceeding 50 m³ per day

Sanitary Sewer

Existing public services:

- St.Laurent Blvd. – 300mm Conc

Is a monitoring manhole required on private property? Yes No

- The designer should be aware there may be limited capacity in the downstream sanitary sewer system. The sanitary demand needs to be coordinated with the City Planning Dept. to determine if the existing sanitary sewer system has sufficient capacity to support the proposed rezoning. Provide sanitary demands to the City project manager for coordination.

Storm Sewer

Existing public services:

- St.Laurent Blvd. – 1050mm Conc (Trunk)
- Maintenance hole will be required at the connection to the storm main. (Existing maintenance hole present for potential connection)

- The Environmental Site Assessment (ESA) may provide recommendations where site contamination may be present. The recommendations from the ESA need to be coordinated with the servicing report to ensure compliance with the Sewer Use By-Law.

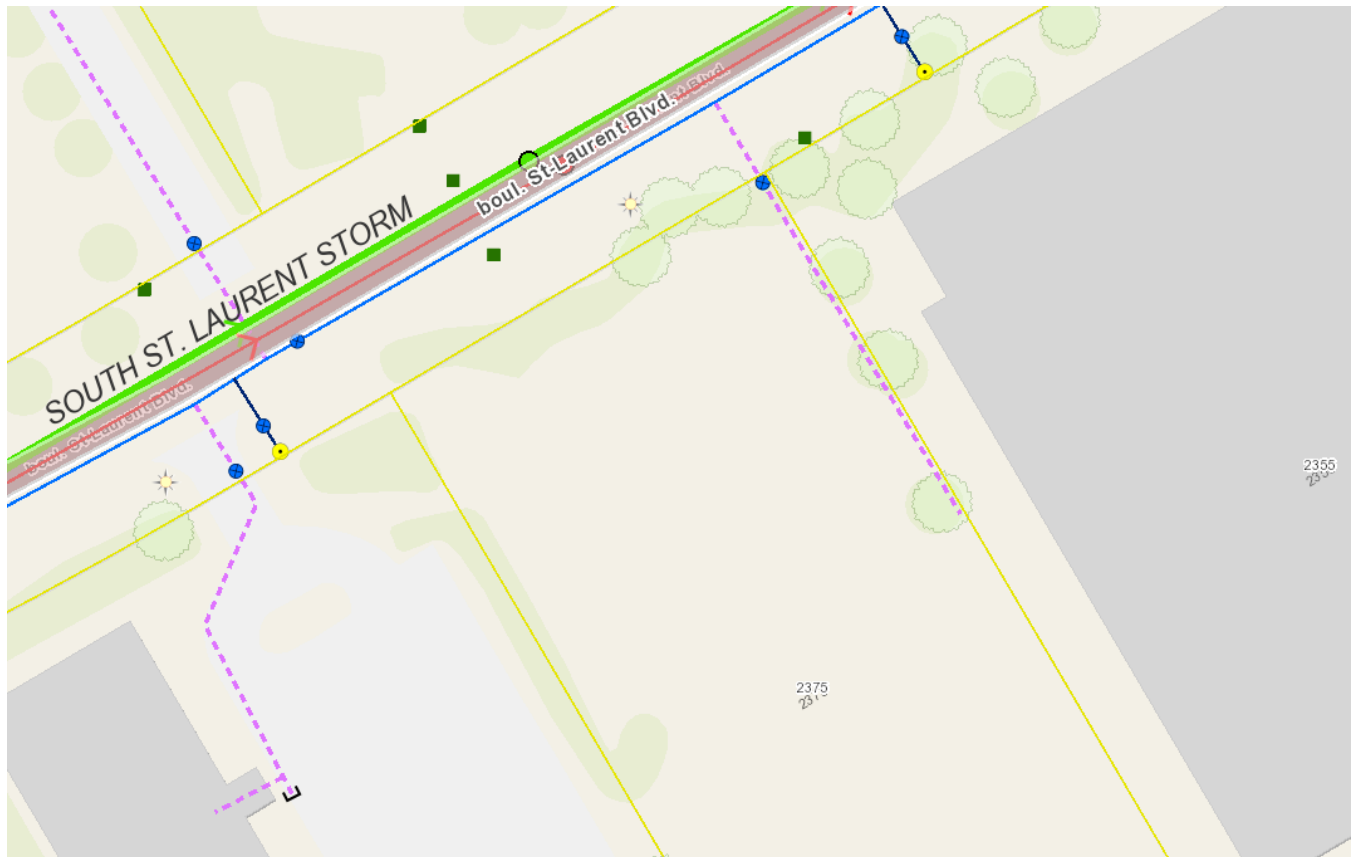

Stormwater Management

Quality Control:

- Per the RVCA, the downstream outlet to a watercourse for stormwater is less than 1km from the site, therefore, a water quality objective of enhanced (80% TSS removal) is required. The applicant is encouraged to incorporate LID measures into the stormwater management plan for this site.

Quantity Control:

- Allowable Runoff coefficient (C): C = the lesser of the existing pre-development conditions to a maximum of 0.5.
- Time of concentration (Tc): Tc = pre-development; maximum Tc = 10 minutes
- Allowable flowrate: Control the 100-year storm events to the 5-year storm event.

Ministry of Environment, Conservation and Parks (MECEP)

All development applications should be considered for an Environmental Compliance Approval, under MECP regulations.

- The consultants determine if an approval for sewage works under Section 53 of OWRA is required and determines what type of application. The City's project manager may help confirm and coordinate with the MECP as required.
- The project will be either transfer of review (standard), transfer of review (additional), direct submission, or exempt as per O. Reg. 525/98.
- Pre-consultation is not required if applying for standard or additional works (Schedule A of the Agreement) under Transfer Review.
- Pre-consultation with local District office of MECP is recommended for direct submission.
- Consultant completes an MECP request form for a pre-consultation. Sends request to moeccottawasewage@ontario.ca
- ECA applications are required to be submitted online through the MECP portal. A business account required to submit ECA application. For more information visit <https://www.ontario.ca/page/environmental-compliance-approval>

- g. An ECA will be required where the stormwater management services more than one property parcel.

NOTE: Site Plan Approval, or Draft Approval, is required before any Ministry of the Environment and Climate Change (MOECC) application is sent.

General Service Design Comments

- The City of Ottawa requests that all new services be located within the existing service trench to minimize necessary road cuts.
- Monitoring manholes should be located within the property near the property line in an accessible location to City forces and free from obstruction (i.e. not a parking).
- Where service length is greater than 30 m between the building and the first maintenance hole / connection, a cleanout is required.
- The City of Ottawa Standard Detail Drawings should be referenced where possible for all work within the Public Right-of-Way.
- The upstream and downstream manhole top of grate and invert elevations are required for all new sewer connections.
- Services crossing the existing watermain or sewers need to clearly provide the obvert/invert elevations to demonstrate minimum separation distances. A watermain crossing table may be provided.

Other

Are there are Capital Works Projects scheduled that will impact the application? Yes No

References and Resources

- A previous Site Plan application was processed for this property in 2017. The geotechnical report indicated that the site is underlain by sensitive soils, which may have an impact on the grade raise, foundation design, and other geotechnical considerations. The applicant may acquire the report through the ISD Information Centre by emailing informationcentre@ottawa.ca. Any potential for re-use of the findings in the geotechnical report should be discussed with the preparer of the report, and an addendum would also be required.
- As per section 53 of the Professional Engineers Act, O. Reg 941/40, R.S.O. 1990, all documents prepared by engineers must be signed and dated on the seal.
- All required plans are to be submitted on standard A1 size sheets (594mm x 841mm) sheets, utilizing a reasonable and appropriate metric scale as per City of Ottawa Servicing and Grading Plan Requirements: title blocks are to be placed on the right of the sheets and not along the bottom. Engineering plans may be combined, but the Site Plans must be provided separately. Plans shall include the survey monument used to confirm datum. Information shall be provided to enable a non-surveyor to locate the survey monument presented by the consultant.
- All required plans & reports are to be provided in *.pdf format (at application submission and for any, and all, re-submissions)
- Please find relevant City of Ottawa Links to Preparing Studies and Plans below:
<https://ottawa.ca/en/city-hall/planning-and-development/information-developers/development-application-review-process/development-application-submission/guide-preparing-studies-and-plans#standards-policies-and-guidelines>
- To request City of Ottawa plan(s) or report information please contact the City of Ottawa Information Centre:
InformationCentre@ottawa.ca
(613) 580-2424 ext. 44455
- geoOttawa
<http://maps.ottawa.ca/geoOttawa/>

PLEASE NOTE – THESE ARE ONLY THE INFRASTRUCTURE PLANS & STUDIES REQUIREMENTS. THE COMBINED SUBMISSION REQUIREMENTS WILL BE PROVIDED BY THE FILE LEAD FOR THE APPLICATION.

For information on preparing required studies and plans refer to:

<http://ottawa.ca/en/development-application-review-process-0/guide-preparing-studies-and-plans>

S/A	Number of copies	ENGINEERING		S/A	Number of copies
S		1. Site Servicing Plan	2. Assessment of Adequacy of Public Services / Site Servicing Study	S	
S		3. Grade Control and Drainage Plan	4. Geotechnical Study	S	
		5. Composite Utility Plan	6. Groundwater Impact Study		
		7. Servicing Options Report	8. Wellhead Protection Study		
		9. Community Transportation Study and/or Transportation Impact Study / Brief	10. Erosion and Sediment Control Plan / Brief	S	
S		11. Storm water Management Report	12. Hydro-geological and Terrain Analysis		
		13. Water main Analysis	14. Noise / Vibration Study		
		15. Roadway Modification Design Plan	16. Confederation Line Proximity Study		

It is important to note that the need for additional studies and plans may result during application review. If following the submission of your application, it is determined that material that is not identified in this checklist is required to achieve complete application status, in accordance with the Planning Act and Official Plan requirements, City Planning will notify you of outstanding material required within the required 30 day period. Mandatory pre-application consultation will not shorten the City's standard processing timelines, or guarantee that an application will be approved. It is intended to help educate and inform the applicant about submission requirements as well as municipal processes, policies, and key issues in advance of submitting a formal development application. This list is valid for one year following the meeting date. If the application is not submitted within this timeframe the applicant must again pre-consult with the City.

Appendix C
Boundary Conditions and FUS Calculations
DR03 Fire Hydrant Coverage Map

Please provide the boundary conditions for the water service connection for the proposed Church Building at 2375 St. Laurent Boulevard.

a. Location of service (map/plan view)

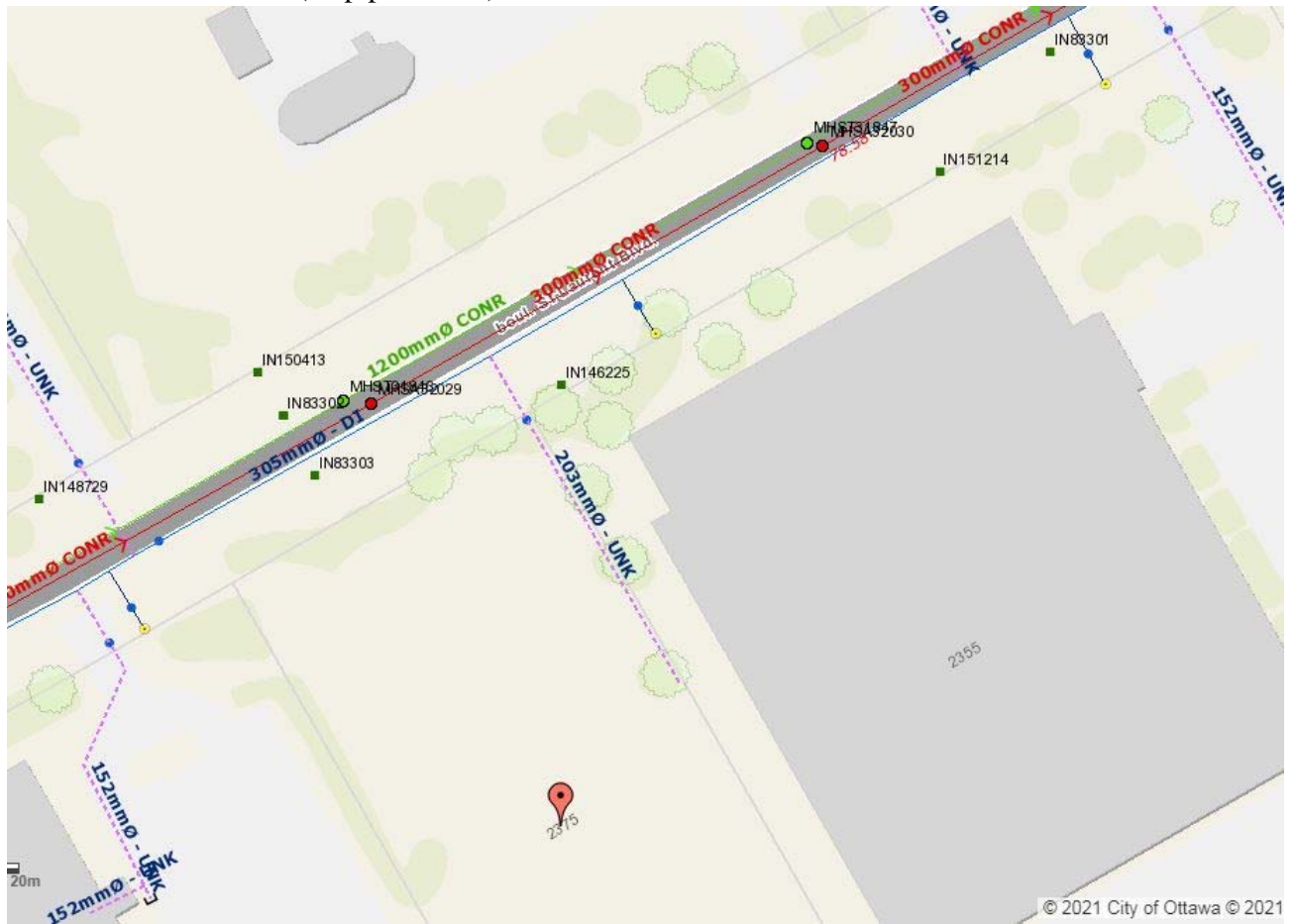

b. Site plan or similar plan for building location (Attached)

Design Parameter	Water Demand (L/s)
Average Daily Demand	0.083
Maximum Daily Demand	0.124
Maximum Hourly Demand	0.149
Fire Flow	100.00
Total Max Daily Demand + Fire Flow	100.124

c. Supporting calculations for domestic demands

Church Building GFA = 1498.4 m² (0.15 ha)

No. of Seats = 239

Daily Average Water Demand = 239 x 30 = 7,170 L/Day (0.083 L/sec)

Maximum Daily Demand = 0.083 x 1.5 = 0.124 L/sec

Maximum Hourly Demand = 0.083 x 1.8 = 0.149 L/sec

d. Supporting calculations for FUS required fire flow
Attached

e. Offset distance from adjacent buildings

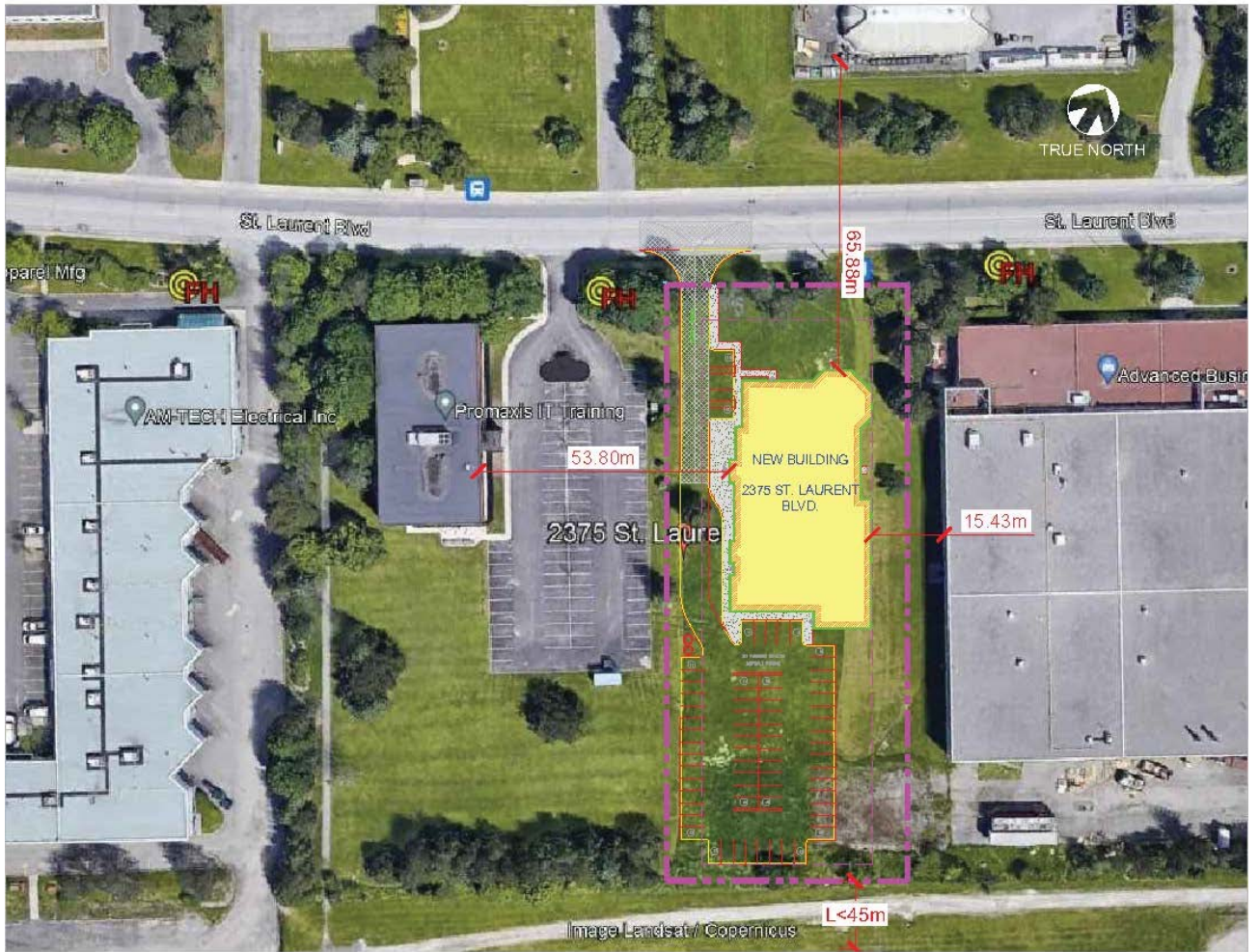

**FIRE FLOW CALCULATION as per
FIRE UNDERWRITERS SURVEY (1999)**

Date: 12-Oct-22
Designer: UA
Checked By: YA

PROJECT: 2375 St. Laurent Boulevard
Ottawa, ON

1. Fire Flow Equation

$$F = 220 C \sqrt{A}$$

where F is the required fire flow [LPM]
C is the coefficient determined by type of construction [unitless]
A is the total protection area [sq.m]

2. Architecture Information (To be confirmed)

Type of Construction	Ordinary	
Fire Rating	Joisted Masonary	
Sprinkler Provided (Y/N)	N	
Total Floor Area [sq.m]	1498	GFA
Coefficient, C [1]	1.0	
Fire Flow, F [LPM]	8516	

3. Occupancy Reduction

Occupancy Adjustment	0.85	- 15 % reduction (Limited Combustible)
Fire Flow, F [LPM]	7239	

4. Sprinkler Reduction

Sprinkler Reduction	0.30	Automatic sprinkler system
Sprinkler Reduction [LPM]	2172	
Standard water supply for sprinkler system and fire department hose	0.10	Additional 10 % credit
	724	

5. Exposure Adjustment

North	0.00	More than 45 m	See attachment for off set distance
East	0.15	15 m	
South	0.00	More than 45 m	
West	0.00	More than 45 m	
Total	0.15		
Exposure Adjustment [LPM]	1086		

6. Required Fire Flow, Duration & Volume

Fire Flow, F [LPM]	7239	
Sprinkler Reduction [LPM]	2895	
Exposure Adjustment [LPM]	1086	
Required Fire Flow [LPM]	5429	
Required Fire Flow [LPM]	5000	Round to nearest 1000
Required Fire Flow [LPS]	83	
Req. Duration of Fire Flow [hrs]	2	
Req. Storage [cubic.m]	600	

----- Original message -----

From: "Harrold, Eric" <eric.harrold@ottawa.ca>

Date: 2022-02-17 7:35 a.m. (GMT-05:00)

To: Yasar Ayub <yayub@jainconsultants.com>, yasara@reinders.ca

Subject: RE: 2375 St. Laurent Boulevard (Cornerstone Church) - Boundary Conditions Request

Good morning Yasar,

Please see the below boundary conditions for 2375 St. Laurent, based on the attached condition request.

The following are boundary conditions, HGL, for hydraulic analysis at 2375 St-Laurent Boulevard (zone 2W2C) assumed to be connected to the 305 mm watermain on St-Laurent Boulevard (see attached PDF for location).

Minimum HGL: 124.7 m

Maximum HGL: 130.2 m

Max Day + Fire Flow (100 L/s): 125.8 m

These are for current conditions and are based on computer model simulation.

Disclaimer: The boundary condition information is based on current operation of the city water distribution system. The computer model simulation is based on the best information available at the time. The operation of the water distribution system can change on a regular basis, resulting in a variation in boundary conditions. The physical properties of watermains deteriorate over time, as such must be assumed in the absence of actual field test data. The variation in physical watermain properties can therefore alter the results of the computer model simulation.

Please advise me if you have any questions.

Best regards,

Eric

Eric Harrold, P.Eng

Project Manager, Infrastructure Approvals

Planning, Real Estate and Economic Development Department

City of Ottawa | Ville d'Ottawa

110 Laurier Avenue West, Ottawa, ON
613.580.2424 ext. 21447, eric.harrold@ottawa.ca

*** Out of Office Alert – Please note that I will be out of office from February 11-16th, 2022 ***

From: Armstrong, Justin <justin.armstrong@ottawa.ca>
Sent: February 10, 2022 4:32 PM
To: Yasar Ayub <yayub@jainconsultants.com>
Cc: Harrold, Eric <eric.harrold@ottawa.ca>; Ezzio, Sarah <sarah.ezzio@ottawa.ca>
Subject: FW: 2375 St. Laurent Boulevard (Cornerstone Church) - Boundary Conditions Request

Hi Yasar,

I am looping in Eric and Sarah to this request as they were the Development Review Infrastructure Project Manager and File Lead respectively who handled the pre-consultation meeting. They should be able to let you know who the Project Manager will be to handle this request and moving forward on the file (if it is not still Eric).

Regards,

Justin

Justin Armstrong, E.I.T.

Project Manager

Planning, Real Estate and Economic Development Department – Direction générale de la planification, des biens immobiliers et du développement économique

Development Review - West Branch

City of Ottawa | Ville d'Ottawa

110 Laurier Avenue West Ottawa, ON | 110, avenue. Laurier Ouest. Ottawa (Ontario) K1P 1J1

613.580.2424 ext./poste 21746, justin.armstrong@ottawa.ca

From: Yasar Ayub <yasara@reinders.ca>
Sent: February 10, 2022 2:47 PM
To: Armstrong, Justin <justin.armstrong@ottawa.ca>
Subject: 2375 St. Laurent Boulevard (Cornerstone Church) - Boundary Conditions Request

CAUTION: This email originated from an External Sender. Please do not click links or open attachments unless you recognize the source.

ATTENTION : Ce courriel provient d'un expéditeur externe. Ne cliquez sur aucun lien et n'ouvrez pas de pièce jointe, excepté si vous connaissez l'expéditeur.

The request for water boundary conditions is attached. Pl review and let us know if any other project info is required. Pl let us know when we can expect a response so that we can schedule our submission accordingly. Request to expedite it as much as possible.

REGARDS,

Yasar Ayub, P. Eng. SENIOR MUNICIPAL ENGINEER



ARCHITECTURE . ENGINEERING

64 Ontario Street North
Milton, Ontario, Canada L9T 2T1

yasara@reinders.ca / www.reinders.ca

☎ (905) 457-1618 EXT 1324

☎ (905) 457-8852 CELL (416) 668-6367

We are excited to announce that our Company's name has changed to Reinders + Law Ltd.

THIS EMAIL MESSAGE, INCLUDING ITS CONTENTS AND ATTACHMENTS, IS THE CONFIDENTIAL PROPERTY OF REINDERS + LAW LTD. AND IS INTENDED FOR USE BY THE INDIVIDUAL(S) OR INSTITUTION(S) TO WHICH IT IS ADDRESSED. THIS EMAIL MESSAGE MAY NOT BE COPIED, MODIFIED, RETRANSMITTED, OR USED FOR ANY PURPOSE EXCEPT BY THE INTENDED RECIPIENT. IF YOU ARE NOT THE INTENDED RECIPIENT, PLEASE DELETE ALL COPIES AND NOTIFY US IMMEDIATELY.

THE ACCOMPANYING INFORMATION IS SUPPLIED AS A MATTER OF COURTESY . THE DATA IS PROVIDED "AS IS" WITHOUT WARRANTY OF ANY KIND EITHER EXPRESSED OR IMPLIED. ANY PERSON(S) OR ORGANIZATION(S) MAKING USE OF OR RELYING UPON THIS DATA IS RESPONSIBLE FOR CONFIRMING ITS ACCURACY AND COMPLETENESS AGAINST THE HARD COPY OF THE SAME DATA. ONLY HARD COPIES INCLUDE A PROFESSIONAL'S STAMP AND SIGNATURE ARE TO BE CONSIDERED AS TRUE AND FINAL. REINDERS + LAW LTD. IS NOT RESPONSIBLE FOR EDITED OR REPRODUCED VERSIONS OF THIS DIGITAL DATA. THE ACCOMPANYING FILES AND THE INFORMATION CONTAINED WITHIN ARE THE COPYRIGHTED PROPERTY OF R+L AND ARE NOT TO BE DISTRIBUTED WITHOUT THE EXPRESSED WRITTEN CONSENT OF R+L.

This e-mail originates from the City of Ottawa e-mail system. Any distribution, use or copying of this e-mail or the information it contains by other than the intended recipient(s) is unauthorized. Thank you.

Le présent courriel a été expédié par le système de courriels de la Ville d'Ottawa. Toute distribution, utilisation ou reproduction du courriel ou des renseignements qui s'y trouvent par une personne autre que son destinataire prévu est interdite. Je vous remercie de votre collaboration.

Boundary Conditions for 2375 St-Laurent Boulevard



Legend

- PRIVATE
- PUBLIC

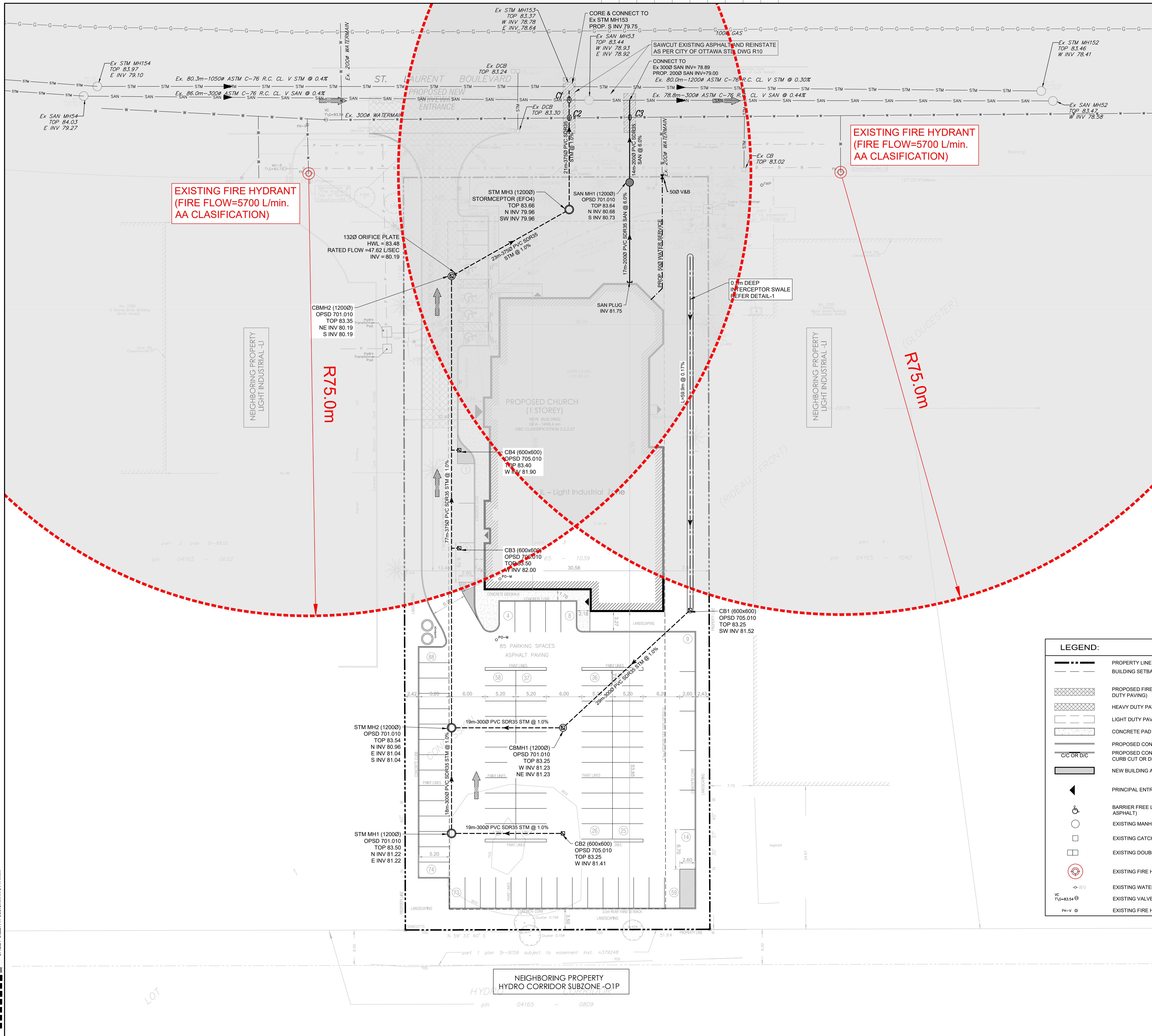

TOPOGRAPHICAL PLAN OF SURVEY
 PART OF LOT 1
 CONCESSION 5 (RIDEAU FRONT)
 Geographic Township of Nepean
 CITY OF OTTAWA
 Surveyed by Annis, O'Sullivan, Vollebek Ltd.
 Plan Amended September 7, 2017 to illustrate additional services.

OWNERS	APPLICANT
OWNERS NAME: The CarverStone House of Refuge Apostolic Church (CHORAC) ADDRESS: 1196 Wellington St West, Ottawa, ON, K1Y 2Z5 (613) PHONE #: 725-1432	REINDERS + LAW LTD. 64 ONTARIO STREET NORTH, MILTON ON L9T 2T1 P (905)457-1618 F (905)457-8852

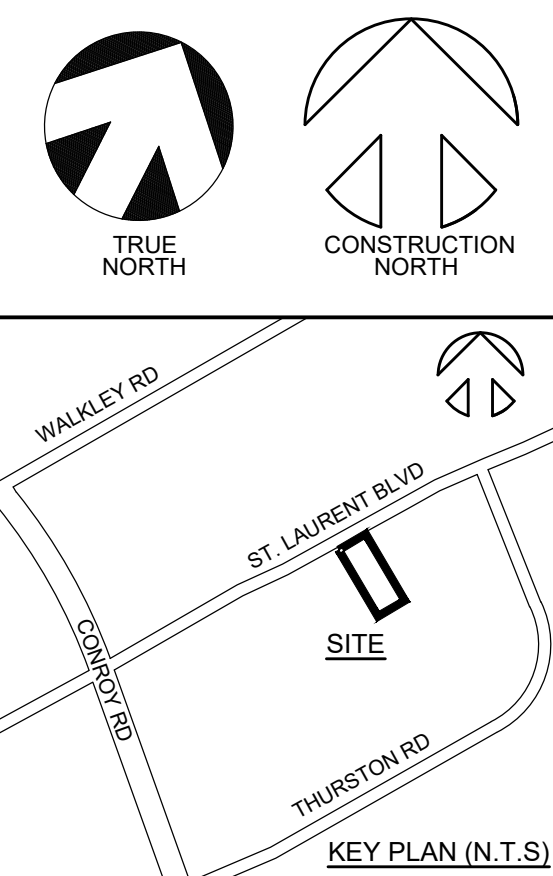

EXISTING FIRE HYDRANT
 (FIRE FLOW=5700 L/min.
 AA CLASSIFICATION)

EXISTING FIRE HYDRANT
 (FIRE FLOW=5700 L/min.
 AA CLASSIFICATION)

R75.0m

R75.0m

LEGEND:

	PROPERTY LINE		PROPOSED SANITARY MANHOLE
	BUILDING SETBACK LINE		PROPOSED STORM MANHOLE
	PROPOSED FIRE ROUTE (USING HEAVY DUTY PAVING)		PROPOSED CATCH BASIN MANHOLE
	HEAVY DUTY PAVING		PROPOSED CATCH BASIN
	LIGHT DUTY PAVING		PROPOSED VALVE & BOX
	CONCRETE PAD OR SIDEWALK		EXISTING GAS
	PROPOSED CONCRETE CURB		EXISTING UNDERGROUND POWER
	PROPOSED CONCRETE CURB WITH CURB CUT OR DEPRESSED CURB		EXISTING UNDERGROUND BELL
	NEW BUILDING AREA (FOOTPRINT)		EXISTING WATER PIPE
	PRINCIPAL ENTRANCE TO THE BUILDING		EXISTING SANITARY PIPE
	BARRIER FREE LOGO (PAVED ON ASPHALT)		EXISTING STORM PIPE
	EXISTING MANHOLE		PROPOSED WATER PIPE
	EXISTING CATCH BASIN		PROPOSED SANITARY PIPE
	EXISTING DOUBLE CATCH BASIN		PROPOSED STORM PIPE
	EXISTING FIRE HYDRANT		FIRE HYDRANT COVERAGE BOUNDARY
	EXISTING WATER VALVE		
	EXISTING VALVE CHAMBER FOR WATERMAIN		
	EXISTING FIRE HYDRANT VALVE		

no.	revisions	date	INIT.
1	ISSUED FOR APPROVAL	12/07/2022	YA
0	ISSUED FOR APPROVAL	10/12/2022	YA

GENERAL NOTE:
 THESE DRAWINGS ARE COPYRIGHT AND THE PROPERTY OF REINDERS + LAW LTD. THE DRAWINGS MAY NOT BE USED FOR CONSTRUCTION WITHOUT THE PERMISSION OF REINDERS + LAW LTD. AND UNLESS SEALED AND SIGNED BY THE ARCHITECT/ENGINEER REPRODUCTION OF THESE DRAWINGS WITHOUT THE CONSENT OF REINDERS + LAW LTD. IS STRICTLY PROHIBITED.
 DO NOT SCALE THESE DRAWINGS. ANY ERROR OR DISCREPANCY IS TO BE REPORTED IMMEDIATELY TO: REINDERS + LAW LTD.

cad file 20037_DR
 date plotted 12/7/2022 plot scale 1:1

drawn CC
 designed YA
 reviewed YA
 date 12/7/2022

scale 1:300
 project CHORAC OTTAWA
 2375 ST. LAURENT BLVD
 OTTAWA, ON

drawing FIRE HYDRANT COVERAGE MAP FOR 2375 ST. LAURENT BLVD

REINDERS + LAW
 ARCHITECTURE, ENGINEERING
 REINDERS + LAW LTD.
 ARCHITECTURE, ENGINEERING
 64 ONTARIO STREET NORTH
 MILTON ON L9T 2T1
 T. 905.457.1618 F. 905.457.8852
 EMAIL@REINDERS.CA WWW.REINDERS.CA

drawing no. 20037_DR3 rev. no. 1

SHEET SIZE: A1 800.0mm X 914.4mm

Appendix D
DR04 Sanitary Drainage Plan
Sanitary Flow Calculations

TOPOGRAPHICAL PLAN OF SURVEY
 PART OF LOT 1
 CONCESSION 5 (RIDEAU FRONT)
 Geographic Township of Nepean
 CITY OF OTTAWA
 Surveyed by Annis, O'Sullivan, Vollebakk Ltd.
 Plan Amended September 7, 2017 to illustrate additional services.

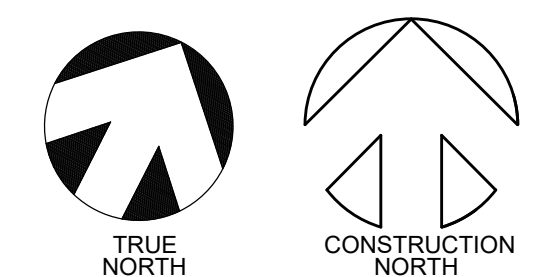

OWNERS	APPLICANT
OWNERS NAME: The CornerStone House of Refuge Apostolic Church (CHORAC) ADDRESS: 1196 Wellington St West, Ottawa, ON, K1Y 2Z5 (613) PHONE #: 725-1432	REINDERS + LAW LTD. 64 ONTARIO STREET NORTH, MILTON ON L9T 2T1 P (905)457-1618 F (905)457-8852

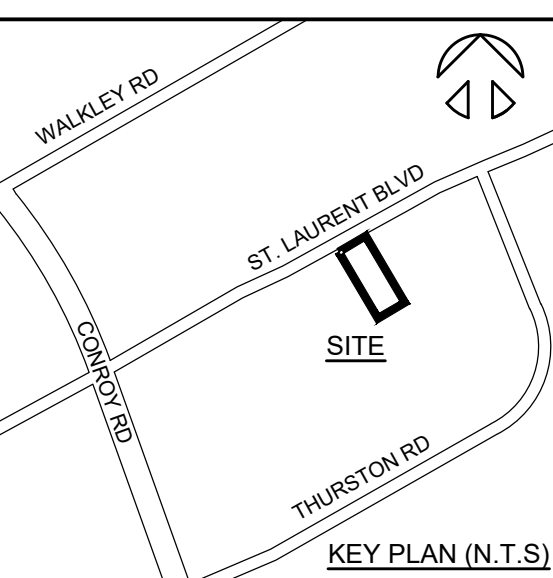

LEGEND:

- CATCHMENT AREA BOUNDARY
- DRAINAGE AREA IN HECTARES
POPULATION

no.	revisions	date	init.
0	ISSUED FOR APPROVAL	10/12/2022	YA

GENERAL NOTE:
 THESE DRAWINGS ARE COPYRIGHT AND THE PROPERTY OF REINDERS + LAW LTD. THE DRAWINGS MAY NOT BE USED FOR CONSTRUCTION WITHOUT THE PERMISSION OF REINDERS + LAW LTD. AND UNLESS SEALED AND SIGNED BY THE ARCHITECT/ENGINEER REPRODUCTION OF THESE DRAWINGS WITHOUT THE CONSENT OF REINDERS + LAW LTD. IS STRICTLY PROHIBITED.
 DO NOT SCALE THESE DRAWINGS. ANY ERROR OR DISCREPANCY IS TO BE REPORTED IMMEDIATELY TO: REINDERS + LAW LTD.

cad file 20037_DR
 date plotted 12/7/2022 plot scale 1:1

drawn CC
 designed YA
 reviewed YA
 date 12/7/2022
 scale 1:300

project
 CHORAC OTTAWA
 2375 ST. LAURENT BLVD
 OTTAWA, ON

drawing
 SANITARY DRAINAGE PLAN

REINDERS + LAW
 ARCHITECTURE, ENGINEERING
 REINDERS + LAW LTD.
 ARCHITECTURE, ENGINEERING
 64 ONTARIO STREET NORTH
 MILTON ON L9T 2T1
 T. 905.457.1618 F. 905.457.8852
 EMAIL@REINDERS.CA WWW.REINDERS.CA

drawing no. 20037_DR4 rev. no. 0

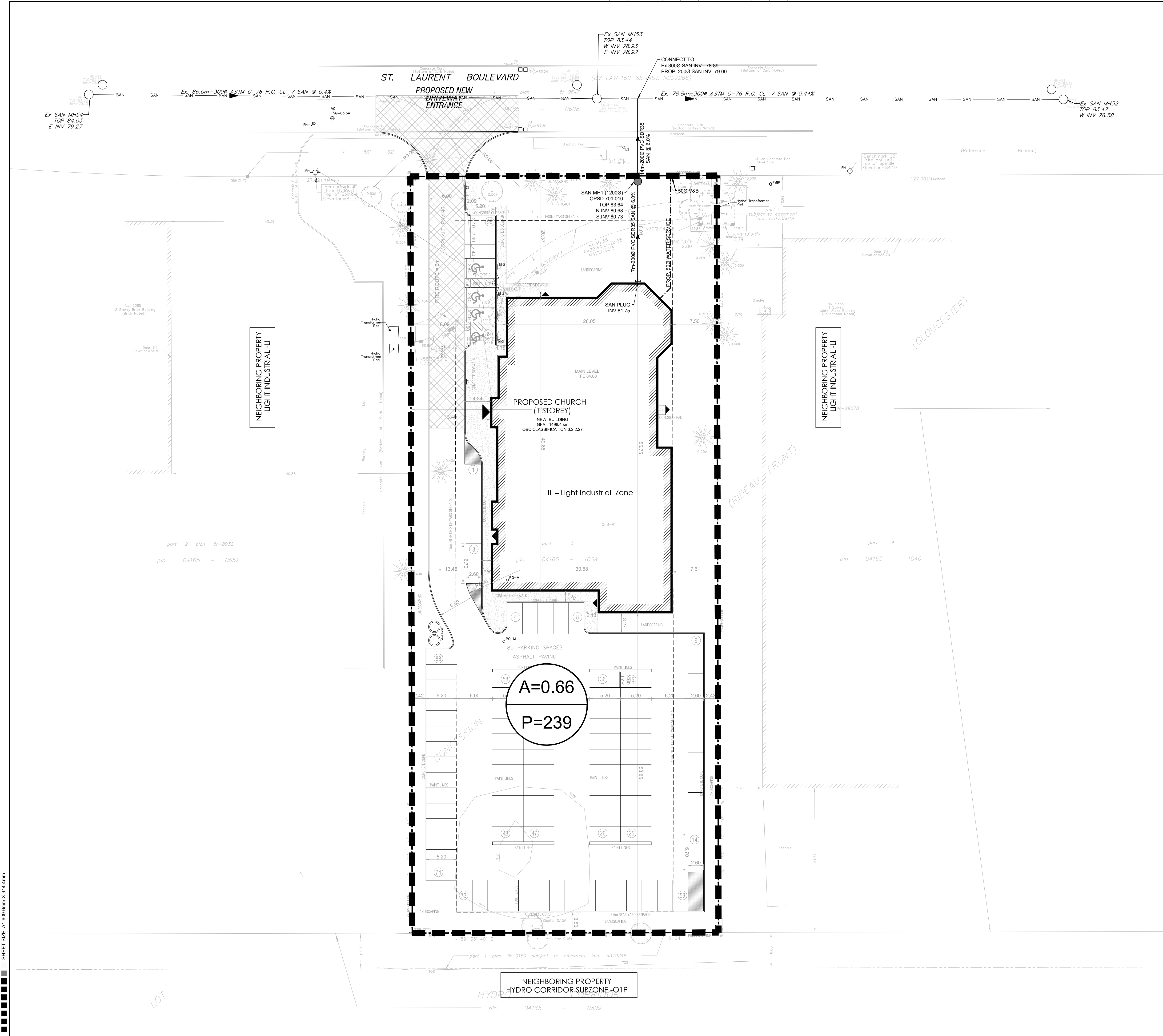

SHEET SIZE: A1 600.0mm X 914.4mm

City of Ottawa, Ontario
Table D1: Sanitary Sewer Design Sheet

Reinders and Law Ltd.	
Project:	2375 St. Laurent Boulevard
PREPARED BY:	Y.A
FILE No.:	--
DATE PREPARED	12-Oct-22

Manhole No.		No. of Seats	Accumulated No. of Seats	Average Flow @ 30 lpcd	Accu. Average Flow	Line Area	Infiltration @ 0.33 lit/sec/ha	Peak Factor	Peak Flow	Total Sanitary Flow	DESIGN PROFILE							
											Length	Pipe Size	Slope	CAPACITY 1/2(Qfull)	CAPACITY 3/4(Qfull)	Capacity (Qfull)	Full Velocity	Actual Velocity
From	TO	No.	No.	lit/s	lit/s	ha	lit/s	-	lit/s	lit/s	m	mm	m/m	lit/sec	lit/sec	lit/s	m/s	m/s
SAN PLUG	SAN MH 1	239	239	0.083	0.08	0.66	0.22	1.50	0.12	0.34	17.00	200.00	6.00%	43.52	65.28	87.03	2.77	0.63
SAN MH 1	Ex. 300 Ø Sewer	0	239	0.000	0.08	0.00	0.22	1.50	0.12	0.34	14.00	200.00	6.00%	43.52	65.28	87.03	2.77	0.63
Ex. 300 Ø Sewer	Ex. SAN MH52	0	239	0.000	0.08	0.00	0.22	1.50	0.12	0.34	6.00	200.00	0.44%	11.78	17.68	23.57	0.75	0.27

Appendix E

Pre and post Development Runoff Coefficients Calculations

Pre and post Development Flow Calculations

Orifice Sizing Calculations

On-Site Storage Calculations

Storm Network Storage Calculations

Storm Sewer Design Sheet

Stormceptor Sizing Calculations

TABLE E1. Land use Breakdown and Composite Runoff Coefficients Calculations Existing Conditions

Project: 2375 St. Laurent Boulevard, Ottawa, ON
RRL No: 20037

Date: 01-Mar-22
By: YA

TABLE E1.1 AREA A1

Existing Land Use Cover	A, Area (hectares)	R, Runoff Coefficient	A x R
Landscape	0.658	0.25	0.16
Overall	0.658	0.25	0.16

**TABLE E2. Land use Breakdown and Composite Runoff Coefficients Calculations
Proposed Conditions**

Project: 2375 St. Laurent Boulevard, Ottawa, ON
RRL No: 20037

Date: 07-Dec-22
By: YA

TABLE E2.1 AREA A1

Proposed Land Use/ Cover	A, Area (hectares)	R, Runoff Coefficient	A x R
Building	0.150	0.90	0.135
Concrete/Asphalt	0.319	0.90	0.287
Landscape	0.189	0.25	0.047
Overall	0.658	0.71	0.470

**TABLE E3 PEAK FLOWS CALCULATION USING RATIONAL METHOD
EXISTING AND PROPOSED CONDITIONS**

Project: 2375 St. Laurent Boulevard, Ottawa, ON
RRL No: 20037

Date: 07-Dec-22
By: YA

TABLE E3.1 Intensity-Duration-Frequency Parameters, Ottawa

$$I = A / (td + C)^B \quad td = 10 \text{ min}$$

Return Period	A	B	C
2 year	732.951	0.810	6.199
5 year	998.071	0.814	6.053
10 year	1174.184	0.816	6.014
25 year	1402.884	0.819	6.018
50 year	1569.580	0.820	6.014
100 year	1735.688	0.820	6.041

TABLE E3.2 Peak Flows - Existing Condition for Addition Areas

Existing Condition		Area (ha.)	R	A x R	
Area A1		0.658	0.25	0.16	
T c = 10 minutes					
Storm Event					
2 year	5 year	10 year	25 year	50 year	100 year
Intensity (mm/hr)					
76.8	104.2	122.1	144.7	161.5	178.3
Peak Flow (l/sec)					
35.11	47.62	55.83	66.14	73.81	81.50

TABLE E3.3 Peak Flows - Proposed Condition

Proposed Condition		Area (ha.)	R	A x R	
Area A1		0.658	0.71	0.47	
T c = 10 minutes					
Storm Event					
2 year	5 year	10 year	25 year	50 year	100 year
Intensity (mm/hr)					
76.8	104.2	122.1	144.7	161.5	178.3
Peak Flow (l/sec) - Uncontrolled					
100.18	135.90	159.31	188.73	210.61	232.58
Peak Flow (l/sec) - Controlled					
47.62	47.62	47.62	47.62	47.62	47.62

Allowable 5 year pre development release rate 47.62 l/sec via orifice control

TABLE E3.4 Change in Peak Flows (Reduction -ve; Increase +ve)

Percent Change (%)					
35.7%	0.0%	-14.7%	-28.0%	-35.5%	-41.6%

Table E4 – Orifice Sizing Calculations

Project: 2375 St. Laurent Boulevard, Ottawa, ON

Date: 07-Dec-22

RRL No: 20037

By: YA

Orifice Formula $Q = ca(2gh)^{1/2}$

C (Orifice plate) = 0.62

Manhole	HWL	Orifice Inv.	c	a	g	Orifice dia.	h	Q	
								(m ³ /sec)	(lit/sec)
	(m)	(m)		(m ²)	(m/sec ²)	(m)	(m)		
STMH3	83.46	80.19	0.62	0.013678	9.81	0.132	1.60 *	0.048	47.62

* Average Head used

**TABLE E5: ON-SITE STORAGE CALCULATION USING RATIONAL METHOD
100 YEAR RETURN STORM - 5 yr Pre-Development**

Project: 2375 St. Laurent Boulevard, Ottawa, ON

Date: 07-Dec-22

By: YA

RRL No: 20037

Area	0.658 ha.
Runoff Coefficient	0.71
Release Rate	0.048 m ³ /s

Duration (min)	Intensity (mm/hr)	Release (m³/s)	Inflow (m³/s)	Inflow Volume (m³)	Outflow Volume (m³)	Storage (m³)
10	178.31	0.04762	0.233	139.5	39.9	100
15	142.74	0.04762	0.186	167.6	53.5	114
20	119.85	0.04762	0.156	187.6	67.1	121
25	103.77	0.04762	0.135	203.0	80.7	122
30	91.81	0.04762	0.120	215.6	94.3	121
35	82.53	0.04762	0.108	226.1	108.0	118
40	75.11	0.04762	0.098	235.1	121.6	113
45	69.02	0.04762	0.090	243.1	135.3	108
50	63.93	0.04762	0.083	250.2	149.0	101
55	59.60	0.04762	0.078	256.5	162.7	94
60	55.88	0.04762	0.073	262.4	176.4	86
65	52.63	0.04762	0.069	267.7	190.1	78
70	49.78	0.04762	0.065	272.7	203.8	69
75	47.24	0.04762	0.062	277.3	217.5	60
80	44.98	0.04762	0.059	281.6	231.3	50
85	42.94	0.04762	0.056	285.7	245.0	41
90	41.10	0.04762	0.054	289.5	258.7	31
95	39.43	0.04762	0.051	293.1	272.5	21
Required Storage (m³)						122

TABLE E6 Parking, Pipes, Manholes Storage Calculation

Project: 2375 ST. LAURENT BLVD, OTTAWA, ONTARIO

Date: 07-Dec-22

By YA

MANHOLES/ CB'S STORAGE

Description	Length (m)	Width (m)	Height (m)	Volume (m ³)
CB1	0.6	0.6	1.94	0.70
CB2	0.6	0.6	2.05	0.74
CB3	0.6	0.6	1.46	0.53
CB4	0.6	0.6	1.56	0.56
CBMH1	1.2	1.2	2.23	2.52
CBMH2	1.2	1.2	3.27	3.70
STM MH1	1.2	1.2	2.24	2.53
STM MH2	1.2	1.2	2.5	2.83
TOTAL				14.10

PIPES STORAGE

FROM MH	TO MH	Length (m)	DIA (m)	Volume (m ³)
CB1	CBMH1	29	0.3	2.05
CB2	STM MH1	19	0.3	1.34
CB3	375 DIA PIPE	1	0.3	0.07
CB4	375 DIA PIPE	1	0.3	0.07
CBMH1	STM MH2	19	0.3	1.34
STM MH1	STM MH2	18	0.3	1.27
STM MH2	CBMH2	77	0.375	8.50
TOTAL				14.65

VOLUME: 28.75 m³

PARKING DETENTION -100 YEAR				
Ponding Area No.	Area (sq.m.)	Depth (m)	Volume (cu.m.)	HWL (m) (100yr)
A1	125.00	0.11	4.58	83.46
A2	19.00	0.06	0.38	83.46
A3	1286.00	0.21	90.02	83.46
A4	48.00	0.21	3.36	83.46

TOTAL VOLUME: 98.34

TOTAL VOLUME: 127.09 m³

City of Ottawa, Ontario
Table E7 - Storm Drainage Design Chart

DESIGN STORM:	5 YEAR RETURN
I (5-YEAR):	$I = A / (td + C)^B$ (mm/hr)
td (start):	10.0 minutes

Reinders and Law Ltd.	
PROJECT:	2375 St. Laurent Boulevard
PREPARED BY:	YA
Project No.:	20037
DATE PREPARED	07-Dec-22

LOCATION	MANHOLES		A area (ha)	C runoff Coeffi.	A x C	ACC. A x C	td (min)	I (mm/hr)	Q (5-YR) (l/s)	STORM SEWER DESIGN INFORMATION				V full (m/s)	TIME SECT. (min)	REMARKS
	FROM MH#	TO MH#								size (mm)	slope (%)	length (m)	Q full (l/s)			
Parking	CB2	STM MH1	0.10	0.71	0.07	0.07	10.00	104.91	21	300	1.00	19.00	97	1.37	0.23	
Parking	STM MH1	STM MH2	0.00	0.71	0.00	0.07	10.23	103.80	20	300	1.00	18.00	97	1.37	0.22	
Parking	CB1	CBMH1	0.10	0.71	0.07	0.07	10.00	104.91	21	300	1.00	29.00	97	1.37	0.35	
Parking	CBMH1	STM MH2	0.10	0.71	0.07	0.14	10.35	103.22	41	300	1.00	19.00	97	1.37	0.23	
Parking	STM MH2	CBMH2	0.11	0.71	0.08	0.29	10.45	102.76	83	375	1.00	77.00	175	1.59	0.81	
Parking	CBMH2	STM MH3	0.25	0.71	0.18	0.47	11.26	99.13	129	375	1.00	23.00	175	1.59	0.24	
Parking	STM MH3	EX. STM MH153	0.00	0.71	0.00	0.47	11.50	98.10	128	375	1.00	21.00	175	1.59	0.22	Orifice Control @ 47.62 l/sec

Stormceptor® EF Sizing Report

STORMCEPTOR®

ESTIMATED NET ANNUAL SEDIMENT (TSS) LOAD REDUCTION

12/06/2022

Province:	Ontario
City:	Ottawa
Nearest Rainfall Station:	OTTAWA CDA RCS
Climate Station Id:	6105978
Years of Rainfall Data:	20

Project Name:	2375 St. Laurent Blvd
Project Number:	20037
Designer Name:	USMAN ARIF
Designer Company:	Jain Infrastructure Consultants
Designer Email:	uarif@jainconsultants.com
Designer Phone:	647-510-0353
EOR Name:	
EOR Company:	
EOR Email:	
EOR Phone:	

Site Name:	
------------	--

Drainage Area (ha):	0.66
Runoff Coefficient 'c':	0.71

Particle Size Distribution:	Fine
Target TSS Removal (%):	80.0

Required Water Quality Runoff Volume Capture (%):	90.00
Estimated Water Quality Flow Rate (L/s):	15.12
Oil / Fuel Spill Risk Site?	Yes
Upstream Flow Control?	Yes
Upstream Orifice Control Flow Rate to Stormceptor (L/s):	47.62
Peak Conveyance (maximum) Flow Rate (L/s):	
Site Sediment Transport Rate (kg/ha/yr):	

Net Annual Sediment (TSS) Load Reduction Sizing Summary	
Stormceptor Model	TSS Removal Provided (%)
EFO4	84
EFO6	92
EFO8	96
EFO10	98
EFO12	100

Recommended Stormceptor EFO Model: EFO4
Estimated Net Annual Sediment (TSS) Load Reduction (%): 84
Water Quality Runoff Volume Capture (%): > 90

Stormceptor® EF Sizing Report

THIRD-PARTY TESTING AND VERIFICATION

► **Stormceptor® EF and Stormceptor® EFO** are the latest evolutions in the Stormceptor® oil-grit separator (OGS) technology series, and are designed to remove a wide variety of pollutants from stormwater and snowmelt runoff. These technologies have been third-party tested in accordance with the Canadian ETV **Procedure for Laboratory Testing of Oil-Grit Separators** and performance has been third-party verified in accordance with the **ISO 14034 Environmental Technology Verification (ETV)** protocol.

PERFORMANCE

► **Stormceptor® EF and EFO** remove stormwater pollutants through gravity separation and floatation, and feature a patent-pending design that generates positive removal of total suspended solids (TSS) throughout each storm event, including high-intensity storms. Captured pollutants include sediment, free oils, and sediment-bound pollutants such as nutrients, heavy metals, and petroleum hydrocarbons. Stormceptor is sized to remove a high level of TSS from the frequent rainfall events that contribute the vast majority of annual runoff volume and pollutant load. The technology incorporates an internal bypass to convey excessive stormwater flows from high-intensity storms through the device without resuspension and washout (scour) of previously captured pollutants. Proper routine maintenance ensures high pollutant removal performance and protection of downstream waterways.

PARTICLE SIZE DISTRIBUTION (PSD)

► The **Canadian ETV PSD** shown in the table below was used, or in part, for this sizing. This is the identical PSD that is referenced in the Canadian ETV **Procedure for Laboratory Testing of Oil-Grit Separators** for both sediment removal testing and scour testing. The Canadian ETV PSD contains a wide range of particle sizes in the sand and silt fractions, and is considered reasonably representative of the particle size fractions found in typical urban stormwater runoff.

Particle Size (µm)	Percent Less Than	Particle Size Fraction (µm)	Percent
1000	100	500-1000	5
500	95	250-500	5
250	90	150-250	15
150	75	100-150	15
100	60	75-100	10
75	50	50-75	5
50	45	20-50	10
20	35	8-20	15
8	20	5-8	10
5	10	2-5	5
2	5	<2	5

Stormceptor®EF Sizing Report

Upstream Flow Controlled Results

Rainfall Intensity (mm / hr)	Percent Rainfall Volume (%)	Cumulative Rainfall Volume (%)	Flow Rate (L/s)	Flow Rate (L/min)	Surface Loading Rate (L/min/m ²)	Removal Efficiency (%)	Incremental Removal (%)	Cumulative Removal (%)
0.5	8.6	8.6	0.65	39.0	33.0	100	8.6	8.6
1	20.3	29.0	1.30	78.0	65.0	100	20.3	29.0
2	16.2	45.2	2.61	156.0	130.0	92	14.9	43.9
3	12.0	57.2	3.91	234.0	195.0	84	10.1	54.0
4	8.4	65.6	5.21	313.0	261.0	80	6.8	60.8
5	5.9	71.6	6.51	391.0	326.0	78	4.6	65.4
6	4.6	76.2	7.82	469.0	391.0	74	3.4	68.8
7	3.1	79.3	9.12	547.0	456.0	72	2.2	71.0
8	2.7	82.0	10.42	625.0	521.0	68	1.9	72.9
9	3.3	85.3	11.72	703.0	586.0	66	2.2	75.1
10	2.3	87.6	13.03	782.0	651.0	64	1.5	76.6
11	1.6	89.2	14.33	860.0	716.0	64	1.0	77.6
12	1.3	90.5	15.63	938.0	782.0	63	0.8	78.4
13	1.7	92.2	16.94	1016.0	847.0	63	1.1	79.5
14	1.2	93.5	18.24	1094.0	912.0	62	0.8	80.2
15	1.2	94.6	19.54	1172.0	977.0	62	0.7	81.0
16	0.7	95.3	20.84	1251.0	1042.0	61	0.4	81.4
17	0.7	96.1	22.15	1329.0	1107.0	59	0.4	81.8
18	0.4	96.5	23.45	1407.0	1172.0	58	0.2	82.0
19	0.4	96.9	24.75	1485.0	1238.0	56	0.2	82.3
20	0.2	97.1	26.05	1563.0	1303.0	55	0.1	82.4
21	0.5	97.5	27.36	1641.0	1368.0	53	0.2	82.6
22	0.2	97.8	28.66	1720.0	1433.0	51	0.1	82.8
23	1.0	98.8	29.96	1798.0	1498.0	49	0.5	83.3
24	0.3	99.1	31.26	1876.0	1563.0	47	0.1	83.4
25	0.9	100.0	32.57	1954.0	1628.0	45	0.4	83.8
30	0.9	100.9	39.08	2345.0	1954.0	38	0.4	84.2
35	-0.9	100.0	45.59	2736.0	2280.0	32	N/A	83.9
40	0.0	100.0	48.00	2880.0	2400.0	31	0.0	83.9
45	0.0	100.0	48.00	2880.0	2400.0	31	0.0	83.9
Estimated Net Annual Sediment (TSS) Load Reduction =								84 %

Climate Station ID: 6105978 Years of Rainfall Data: 20



Stormceptor® EF Sizing Report

RAINFALL DATA FROM OTTAWA CDA RCS RAINFALL STATION

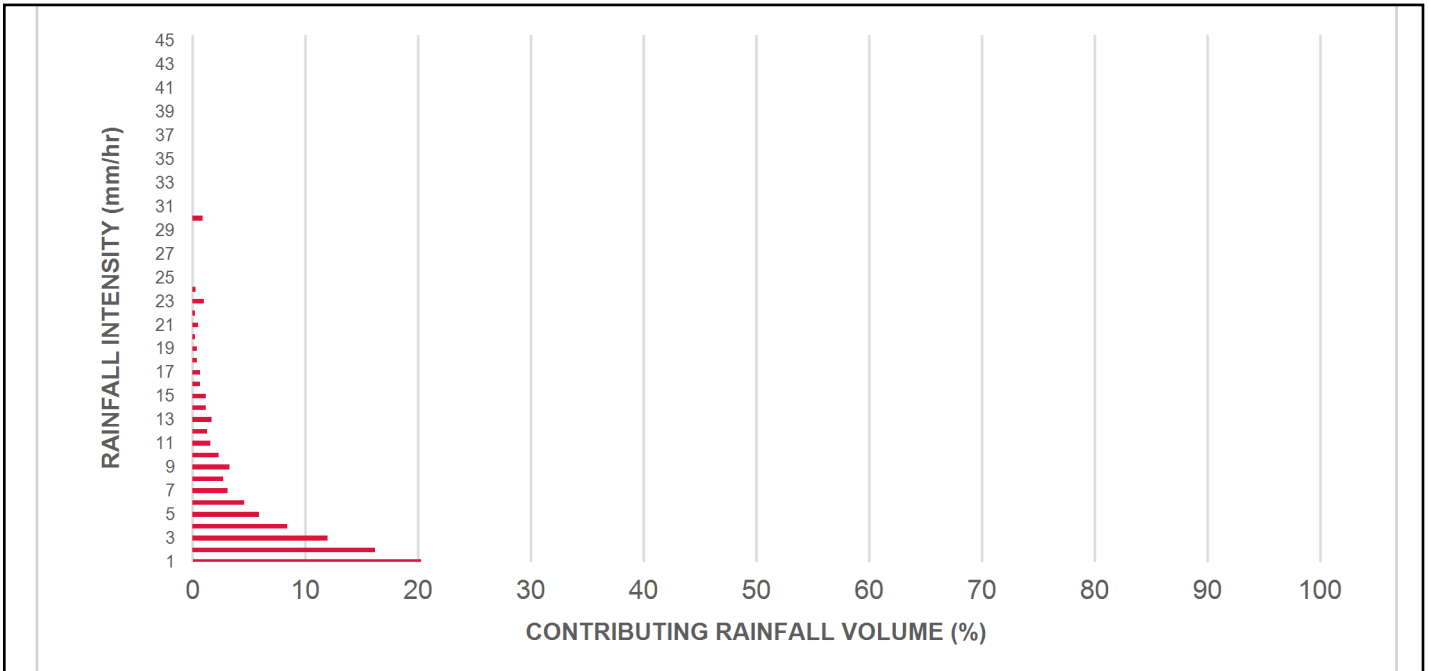

INCREMENTAL AND CUMULATIVE TSS REMOVAL FOR THE RECOMMENDED STORMCEPTOR® MODEL

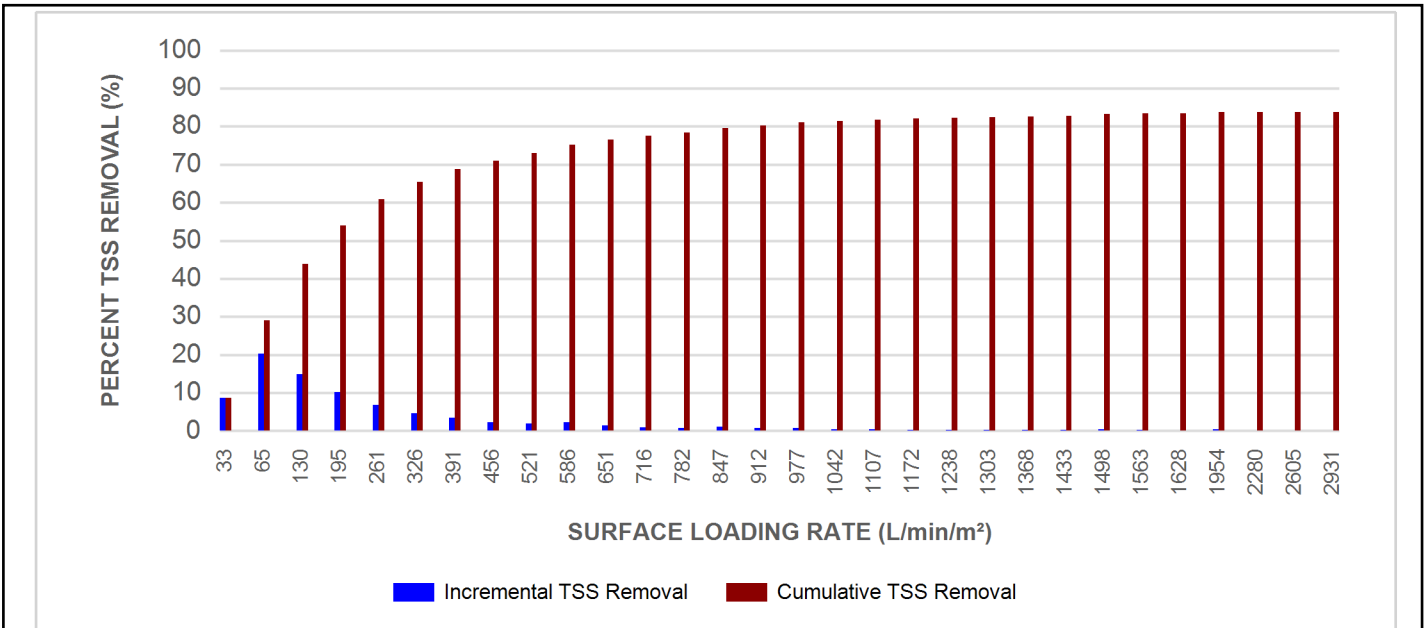

Stormceptor® **EF** Sizing Report

Maximum Pipe Diameter / Peak Conveyance

Stormceptor EF / EFO	Model Diameter		Min Angle Inlet / Outlet Pipes	Max Inlet Pipe Diameter		Max Outlet Pipe Diameter		Peak Conveyance Flow Rate	
	(m)	(ft)		(mm)	(in)	(mm)	(in)	(L/s)	(cfs)
EF4 / EFO4	1.2	4	90	609	24	609	24	425	15
EF6 / EFO6	1.8	6	90	914	36	914	36	990	35
EF8 / EFO8	2.4	8	90	1219	48	1219	48	1700	60
EF10 / EFO10	3.0	10	90	1828	72	1828	72	2830	100
EF12 / EFO12	3.6	12	90	1828	72	1828	72	2830	100

SCOUR PREVENTION AND ONLINE CONFIGURATION

► Stormceptor® EF and EFO feature an internal bypass and superior scour prevention technology that have been demonstrated in third-party testing according to the scour testing provisions of the Canadian ETV **Procedure for Laboratory Testing of Oil-Grit Separators**, and the exceptional scour test performance has been third-party verified in accordance with the ISO 14034 ETV protocol. As a result, Stormceptor EF and EFO are approved for online installation, eliminating the need for costly additional bypass structures, piping, and installation expense.

DESIGN FLEXIBILITY

► Stormceptor® EF and EFO offers design flexibility in one simplified platform, accepting stormwater flow from a single inlet pipe or multiple inlet pipes, and/or surface runoff through an inlet grate. The device can also serve as a junction structure, accommodate a 90-degree inlet-to-outlet bend angle, and can be modified to ensure performance in submerged conditions.

OIL CAPTURE AND RETENTION

► While Stormceptor® EF will capture and retain oil from dry weather spills and low intensity runoff, Stormceptor® EFO has demonstrated superior oil capture and greater than 99% oil retention in third-party testing according to the light liquid re-entrainment testing provisions of the Canadian ETV **Procedure for Laboratory Testing of Oil-Grit Separators**. Stormceptor EFO is recommended for sites where oil capture and retention is a requirement.

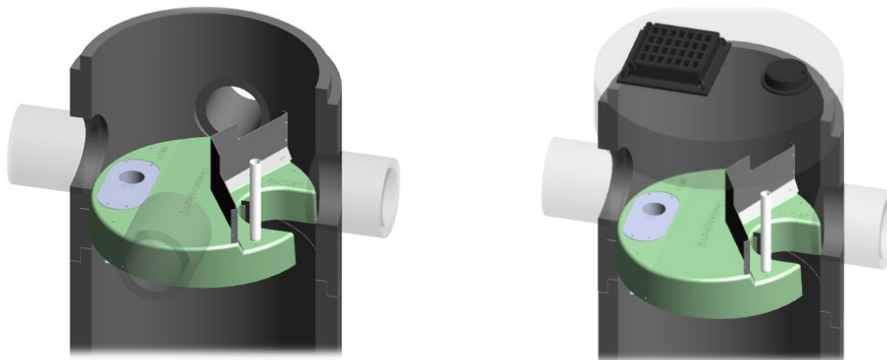

Stormceptor® EF Sizing Report

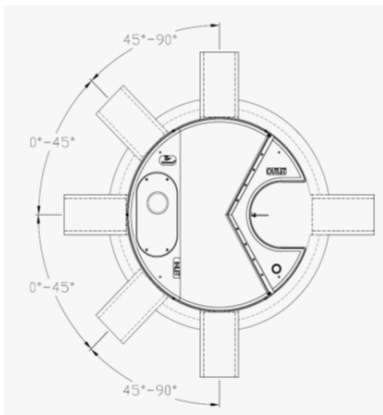

INLET-TO-OUTLET DROP

Elevation differential between inlet and outlet pipe inverts is dictated by the angle at which the inlet pipe(s) enters the unit.

0° - 45° : The inlet pipe is 1-inch (25mm) higher than the outlet pipe.

45° - 90° : The inlet pipe is 2-inches (50mm) higher than the outlet pipe.

HEAD LOSS

The head loss through Stormceptor EF is similar to that of a 60-degree bend structure. The applicable K value for calculating minor losses through the unit is 1.1.

For submerged conditions the applicable K value is 3.0.

Pollutant Capacity

Stormceptor EF / EFO	Model Diameter		Depth (Outlet Pipe Invert to Sump Floor)		Oil Volume		Recommended Sediment Maintenance Depth *		Maximum Sediment Volume *		Maximum Sediment Mass **	
	(m)	(ft)	(m)	(ft)	(L)	(Gal)	(mm)	(in)	(L)	(ft³)	(kg)	(lb)
EF4 / EFO4	1.2	4	1.52	5.0	265	70	203	8	1190	42	1904	5250
EF6 / EFO6	1.8	6	1.93	6.3	610	160	305	12	3470	123	5552	15375
EF8 / EFO8	2.4	8	2.59	8.5	1070	280	610	24	8780	310	14048	38750
EF10 / EFO10	3.0	10	3.25	10.7	1670	440	610	24	17790	628	28464	78500
EF12 / EFO12	3.6	12	3.89	12.8	2475	655	610	24	31220	1103	49952	137875

*Increased sump depth may be added to increase sediment storage capacity

** Average density of wet packed sediment in sump = 1.6 kg/L (100 lb/ft³)

Feature	Benefit	Feature Appeals To
Patent-pending enhanced flow treatment and scour prevention technology	Superior, verified third-party performance	Regulator, Specifying & Design Engineer
Third-party verified light liquid capture and retention for EFO version	Proven performance for fuel/oil hotspot locations	Regulator, Specifying & Design Engineer, Site Owner
Functions as bend, junction or inlet structure	Design flexibility	Specifying & Design Engineer
Minimal drop between inlet and outlet	Site installation ease	Contractor
Large diameter outlet riser for inspection and maintenance	Easy maintenance access from grade	Maintenance Contractor & Site Owner

STANDARD STORMCEPTOR EF/EFO DRAWINGS

For standard details, please visit <http://www.imbriumsystems.com/stormwater-treatment-solutions/stormceptor-ef>

STANDARD STORMCEPTOR EF/EFO SPECIFICATION

For specifications, please visit <http://www.imbriumsystems.com/stormwater-treatment-solutions/stormceptor-ef>

Stormceptor® **EF** Sizing Report

**STANDARD PERFORMANCE SPECIFICATION FOR
“OIL GRIT SEPARATOR” (OGS) STORMWATER QUALITY TREATMENT DEVICE**

PART 1 – GENERAL

1.1 WORK INCLUDED

This section specifies requirements for selecting, sizing, and designing an underground Oil Grit Separator (OGS) device for stormwater quality treatment, with third-party testing results and a Statement of Verification in accordance with ISO 14034 Environmental Management – Environmental Technology Verification (ETV).

1.2 REFERENCE STANDARDS & PROCEDURES

ISO 14034:2016 Environmental management – Environmental technology verification (ETV)

Canadian Environmental Technology Verification (ETV) Program’s **Procedure for Laboratory Testing of Oil-Grit Separators**

1.3 SUBMITTALS

1.3.1 All submittals, including sizing reports & shop drawings, shall be submitted upon request with each order to the contractor then forwarded to the Engineer of Record for review and acceptance. Shop drawings shall detail all OGS components, elevations, and sequence of construction.

1.3.2 Alternative devices shall have features identical to or greater than the specified device, including: treatment chamber diameter, treatment chamber wet volume, sediment storage volume, and oil storage volume.

1.3.3 Unless directed otherwise by the Engineer of Record, OGS stormwater quality treatment product substitutions or alternatives submitted within ten days prior to project bid shall not be accepted. All alternatives or substitutions submitted shall be signed and sealed by a local registered Professional Engineer, based on the exact same criteria detailed in Section 3, in entirety, subject to review and approval by the Engineer of Record.

PART 2 – PRODUCTS

2.1 OGS POLLUTANT STORAGE

The OGS device shall include a sump for sediment storage, and a protected volume for the capture and storage of petroleum hydrocarbons and buoyant gross pollutants. The minimum sediment & petroleum hydrocarbon storage capacity shall be as follows:

2.1.1	4 ft (1219 mm) Diameter OGS Units:	1.19 m ³ sediment / 265 L oil
	6 ft (1829 mm) Diameter OGS Units:	3.48 m ³ sediment / 609 L oil
	8 ft (2438 mm) Diameter OGS Units:	8.78 m ³ sediment / 1,071 L oil
	10 ft (3048 mm) Diameter OGS Units:	17.78 m ³ sediment / 1,673 L oil
	12 ft (3657 mm) Diameter OGS Units:	31.23 m ³ sediment / 2,476 L oil

PART 3 – PERFORMANCE & DESIGN

3.1 GENERAL

The OGS stormwater quality treatment device shall be verified in accordance with ISO 14034:2016 Environmental management – Environmental technology verification (ETV). The OGS stormwater quality treatment device shall



Stormceptor® EF Sizing Report

remove oil, sediment and gross pollutants from stormwater runoff during frequent wet weather events, and retain these pollutants during less frequent high flow wet weather events below the insert within the OGS for later removal during maintenance. The Manufacturer shall have at least ten (10) years of local experience, history and success in engineering design, manufacturing and production and supply of OGS stormwater quality treatment device systems, acceptable to the Engineer of Record.

3.2 SIZING METHODOLOGY

The OGS device shall be engineered, designed and sized to provide stormwater quality treatment based on treating a minimum of 90 percent of the average annual runoff volume and a minimum removal of an annual average 60% of the sediment (TSS) load based on the Particle Size Distribution (PSD) specified in the sizing report for the specified device. Sizing of the OGS shall be determined by use of a minimum ten (10) years of local historical rainfall data provided by Environment Canada. Sizing shall also be determined by use of the sediment removal performance data derived from the ISO 14034 ETV third-party verified laboratory testing data from testing conducted in accordance with the Canadian ETV protocol Procedure for Laboratory Testing of Oil-Grit Separators, as follows:

3.2.1 Sediment removal efficiency for a given surface loading rate and its associated flow rate shall be based on sediment removal efficiency demonstrated at the seven (7) tested surface loading rates specified in the protocol, ranging 40 L/min/m² to 1400 L/min/m², and as stated in the ISO 14034 ETV Verification Statement for the OGS device.

3.2.2 Sediment removal efficiency for surface loading rates between 40 L/min/m² and 1400 L/min/m² shall be based on linear interpolation of data between consecutive tested surface loading rates.

3.2.3 Sediment removal efficiency for surface loading rates less than the lowest tested surface loading rate of 40 L/min/m² shall be assumed to be identical to the sediment removal efficiency at 40 L/min/m². No extrapolation shall be allowed that results in a sediment removal efficiency that is greater than that demonstrated at 40 L/min/m².

3.2.4 Sediment removal efficiency for surface loading rates greater than the highest tested surface loading rate of 1400 L/min/m² shall assume zero sediment removal for the portion of flow that exceeds 1400 L/min/m², and shall be calculated using a simple proportioning formula, with 1400 L/min/m² in the numerator and the higher surface loading rate in the denominator, and multiplying the resulting fraction times the sediment removal efficiency at 1400 L/min/m².

The OGS device shall also have sufficient annual sediment storage capacity as specified and calculated in Section 2.1.

3.3 CANADIAN ETV or ISO 14034 ETV VERIFICATION OF SCOUR TESTING

The OGS device shall have Canadian ETV or ISO 14034 ETV Verification of third-party scour testing conducted in accordance with the Canadian ETV Program's **Procedure for Laboratory Testing of Oil-Grit Separators**.

3.3.1 To be acceptable for on-line installation, the OGS device must demonstrate an average scour test effluent concentration less than 10 mg/L at each surface loading rate tested, up to and including 2600 L/min/m².

3.4 LIGHT LIQUID RE-ENTRAINMENT SIMULATION TESTING

The OGS device shall have Canadian ETV or ISO 14034 ETV Verification of completed third-party Light Liquid Re-entrainment Simulation Testing in accordance with the Canadian ETV **Program's Procedure for Laboratory Testing of Oil-Grit Separators**, with results reported within the Canadian ETV or ISO 14034 ETV verification. This re-entrainment testing is conducted with the device pre-loaded with low density polyethylene (LDPE) plastic beads as a surrogate for light liquids such as oil and fuel. Testing is conducted on the same OGS unit tested for sediment removal to

Stormceptor® EF Sizing Report

assess whether light liquids captured after a spill are effectively retained at high flow rates.

3.4.1 For an OGS device to be an acceptable stormwater treatment device on a site where vehicular traffic occurs and the potential for an oil or fuel spill exists, the OGS device must have reported verified performance results of greater than 99% cumulative retention of LDPE plastic beads for the five specified surface loading rates (ranging 200 L/min/m² to 2600 L/min/m²) in accordance with the Light Liquid Re-entrainment Simulation Testing within the Canadian ETV Program's **Procedure for Laboratory Testing of Oil-Grit Separators**. However, an OGS device shall not be allowed if the Light Liquid Re-entrainment Simulation Testing was performed with screening components within the OGS device that are effective at retaining the LDPE plastic beads, but would not be expected to retain light liquids such as oil and fuel.

Appendix G
Topographic and Legal Survey

**PART OF LOT 1
CONCESSION 5 (RIDEAU FRONT)
Geographic Township of Nepean
CITY OF OTTAWA**
Surveyed by Annis, O'Sullivan, Vollebek Ltd.

Plan Amended September 7, 2017 to illustrate additional services.

Scale 1 : 250
10 7.5 5.0 2.5 0 2.5 5 7.5 10 Metres

Metric
DISTANCES SHOWN ON THIS PLAN ARE IN METRES AND CAN BE CONVERTED TO FEET BY DIVIDING BY 0.3048

Surveyor's Certificate

- I CERTIFY THAT:
- This survey and plan are correct and in accordance with the Surveys Act, the Surveyors Act and the Land Titles Act and the regulations made under them.
 - The survey was completed on the 1st day of August, 2017.

Date: _____
Andrew J. Brotham
Ontario Land Surveyor

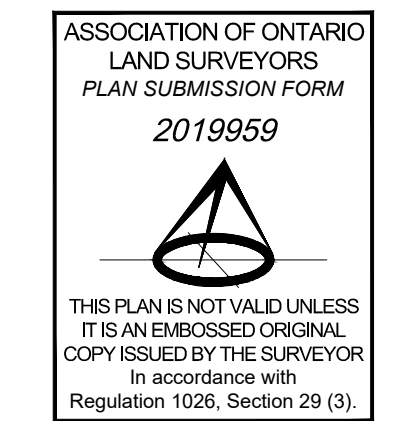

Notes & Legend

- Denotes Survey Monument Planted
- Denotes Survey Monument Found
- SIB Standard Iron Bar
- SSIB Short Standard Iron Bar
- IB Iron Bar
- +— 0.3m Long Survey Monument
- (WIT) Witness
- (AOG) Arnis, O'Sullivan, Vollebek Ltd. Measured
- (P1) Plan 4R-29078
- MH-ST Maintenance Hole (Storm Sewer)
- MH-S Maintenance Hole (Sanitary)
- MH-B Maintenance Hole (Bell)
- SS— Underground Storm Sewer
- S— Underground Sanitary Sewer
- W— Underground Water
- P— Underground Power
- B— Underground Bell
- LS Light Standard
- CB Catch Basin
- FH Fire Hydrant
- VC Valve Chamber - Watermain
- T/G Top of Gate
- FH-V Fire Hydrant Valve
- TB-B Bell Terminal Box
- Deciduous Tree
- Confiferous Tree
- BF Board Fence
- BOS Bottom of Slope
- TOS Top of Slope
- PO-M Metal Pole
- FMP Fire Main Indicator Post
- Diameter
- Location of Elevations
- C/L Centreline
- M-W Monitoring Well
- MP Metal Fence Post

ALL FOUND SURVEY MONUMENTS ARE (AOG) UNLESS OTHERWISE NOTED.

ALL BEARINGS AND DISTANCES ARE PER (P1) UNLESS OTHERWISE NOTED.

Bearings are grid bearings, derived from the Southern Limit of St. Laurent Boulevard, shown to be N59°32'20"E on Plan 4R-29078 and are referred to the Central Meridian of MTM Zone 9, (76°30' West Longitude) NAD-83 (original).

SITE AREA = 6589.8 m²

ELEVATION NOTES

- Elevations shown are geodetic and are referred to the CGVD28 geodetic datum.
- It is the responsibility of the user of this information to verify that the job benchmark has not been altered or disturbed and that its relative elevation and description agrees with the information shown on this drawing.

UTILITY NOTES

- This drawing cannot be accepted as acknowledging all of the utilities and it will be the responsibility of the user to contact the respective utility authorities for confirmation.
- Only visible surface utilities were located.
- A field location of underground plant by the pertinent utility authority is mandatory before any work involving breaking ground, probing, excavating etc.
- Location of underground buried services, pipe diameters and inverts are derived from City of Ottawa Engineering Plan No. 2304, (sheet 4 of 8) and City of Ottawa Utility Sheets M-19-17 (rev. date August 2017) and M-19-22 (rev. date August 2017).

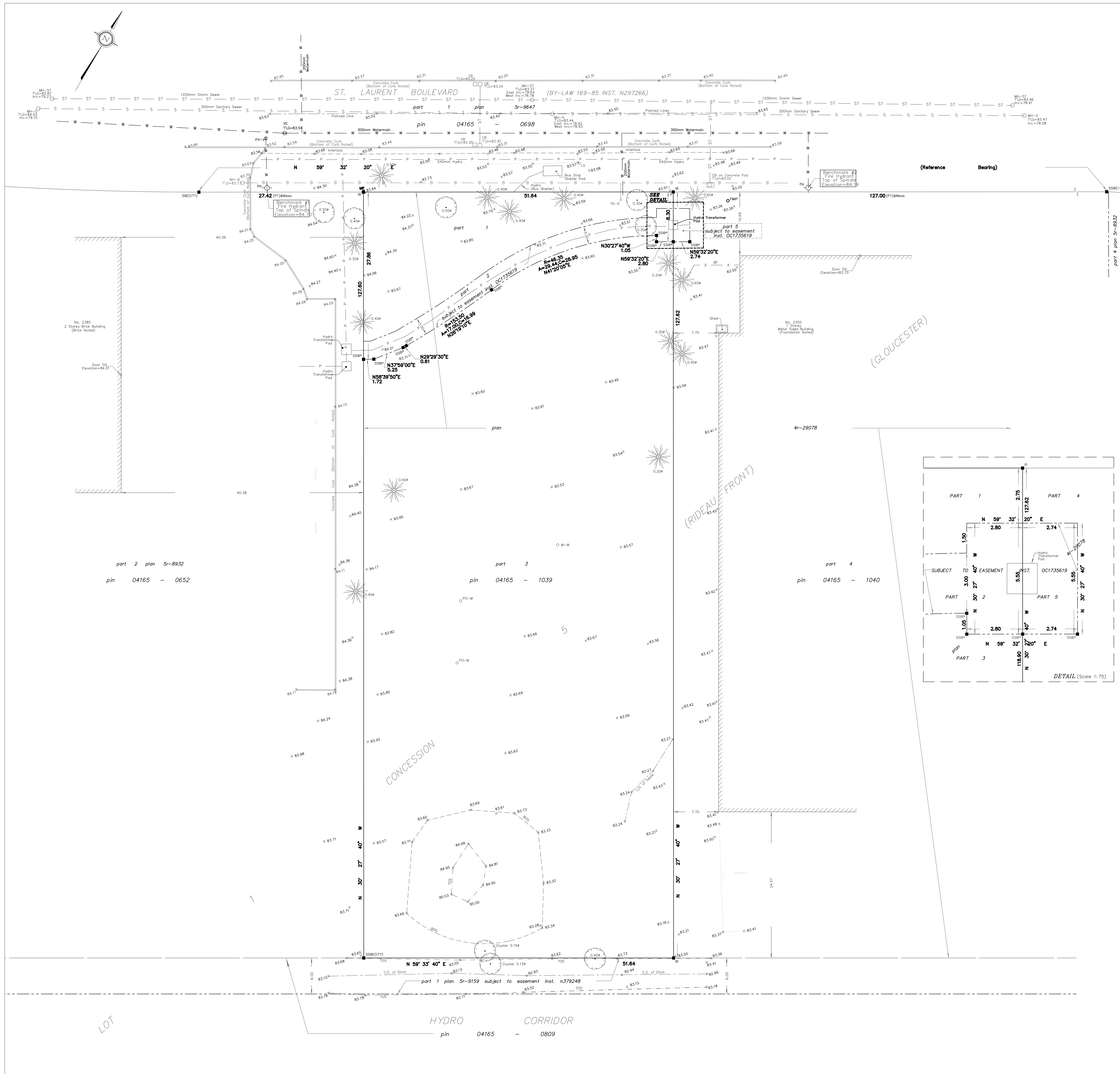

No. 2365
2 Storey Brick Building
(Brick Noted)
Door Sill
Elevation=84.51

part 2 plan 5r-8932
pin 04165 - 0652

part 3
pin 04165 - 1039

part 4
pin 04165 - 1040

part 1 plan 5r-9159 subject to assessment inst. n.379248
pin 04165 - 0809

