

# 1186-1194 Wellington Street West Transportation Impact Assessment

Step 1 Screening Report

Step 2 Scoping Report

Step 3 Forecasting Report

Step 4 Strategy Report

(Revision #3)

Prepared for:

Welldale Limited Partnership  
200-180 Kent Street  
Ottawa, ON K1P 0B6

Prepared by:



6 Plaza Court  
Ottawa, ON K2H 7W1

December 2022

PN: 2020-62

## Table of Contents

1	Screening .....	1
2	Existing and Planned Conditions.....	1
2.1	Proposed Development.....	1
2.2	Existing Conditions.....	3
2.2.1	Area Road Network.....	3
2.2.2	Existing Intersections.....	4
2.2.3	Existing Driveways .....	5
2.2.4	Cycling and Pedestrian Facilities.....	6
2.2.5	Existing Transit.....	10
2.2.6	Existing Area Traffic Management Measures.....	12
2.2.7	Existing Peak Hour Travel Demand.....	12
2.2.8	Collision Analysis.....	15
2.3	Planned Conditions.....	18
2.3.1	Changes to the Area Transportation Network.....	18
2.3.2	Other Study Area Developments .....	18
3	Study Area and Time Periods.....	19
3.1	Study Area .....	19
3.2	Time Periods .....	20
3.3	Horizon Years.....	20
4	Exemption Review .....	20
5	Development-Generated Travel Demand .....	20
5.1	Mode Shares.....	20
5.2	Trip Generation.....	21
5.3	Trip Distribution.....	22
5.4	Trip Assignment.....	23
6	Background Network Travel Demands .....	23
6.1	Transportation Network Plans.....	23
6.2	Background Growth.....	23
6.3	Other Developments .....	24
6.4	Trip Reductions.....	24
7	Demand Rationalization .....	25
7.1	2025 Future Background Operations.....	25
7.2	2030 Future Background Operations.....	28
7.3	Modal Share Sensitivity .....	30
8	Development Design .....	30
8.1	Design for Sustainable Modes .....	30
8.2	Circulation and Access .....	31
9	Parking.....	31
9.1	Parking Supply .....	31
10	Boundary Street Design.....	32
11	Access Intersections Design.....	32
11.1	Location and Design of Access.....	32

11.2	Intersection Control.....	32
11.3	Access Intersection Design .....	32
11.3.1	2025 Future Total Access Intersection Operations.....	32
11.3.2	2030 Future Total Access Intersection Operations.....	34
11.3.3	Access Intersection MMLOS .....	35
11.3.4	Recommended Design Elements .....	35
12	Transportation Demand Management.....	35
12.1	Context for TDM .....	35
12.2	Need and Opportunity.....	35
12.3	TDM Program .....	35
13	Neighbourhood Traffic Management.....	36
14	Transit.....	36
14.1	Route Capacity.....	36
14.2	Transit Priority .....	37
15	Network Intersection Design .....	37
15.1	Network Intersection Control.....	37
15.2	Network Intersection Design .....	37
15.2.1	2025 Future Total Network Intersection Operations .....	37
15.2.2	2030 Future Total Network Intersection Operations .....	39
15.2.3	Network Intersection MMLOS.....	40
15.2.4	Recommended Design Elements .....	41
16	Summary of Improvements Indicated and Modifications Options .....	41
17	Conclusion .....	45

## List of Figures

Figure 1: Area Context Plan .....	1
Figure 2: Concept Plan.....	2
Figure 3: Study Area Pedestrian Facilities .....	7
Figure 4: Study Area Cycling Facilities .....	8
Figure 5: Existing Pedestrian Volumes.....	9
Figure 6: Existing Cyclist Volumes.....	10
Figure 7: Existing Study Area Transit Service.....	11
Figure 8: Existing Study Area Transit Stops .....	12
Figure 9: Existing Traffic Counts .....	13
Figure 10: Study Area Collision Records – Representation of Study Area Collisions .....	16
Figure 11: New Site Generation Volumes.....	23
Figure 12: Auto Trip Reductions from Existing Land Use.....	25
Figure 13: 2025 Future Background Volumes .....	26
Figure 14: 2030 Future Background Volumes .....	28
Figure 15: 2025 Future Total Volumes .....	33
Figure 16: 2030 Future Total Volumes .....	34

## Table of Tables

Table 1: Intersection Count Date.....	12
Table 2: Existing Intersection Operations.....	14
Table 3: Study Area Collision Summary, 2016-2020.....	15
Table 4: Summary of Collision Locations, 2016-2020.....	16
Table 5: Parkdale Avenue at Wellington Street West Collision Summary.....	17
Table 6: Hamilton Avenue North at Wellington Street West Collision Summary.....	17
Table 7: Parkdale Avenue at Gladstone Avenue Collision Summary.....	18
Table 8: Exemption Review.....	20
Table 9: TRANS Trip Generation Manual Recommended Mode Shares – Ottawa West.....	21
Table 10: Trip Generation Person Trip Rates by Peak Period.....	21
Table 11: Total Residential Person Trip Generation by Peak Period.....	21
Table 12: Internal Capture Rates.....	21
Table 13: Trip Generation by Mode.....	22
Table 14: OD Survey Distribution – Ottawa West.....	22
Table 15: TRANS Regional Model Projections – Study Area Growth Rates.....	24
Table 16: Recommended Area Growth Rates.....	24
Table 17: 2025 Future Background Intersection Operations.....	26
Table 18: 2030 Future Background Intersection Operations.....	29
Table 19: Boundary Street MMLOS Analysis.....	32
Table 20: 2025 Future Total Access Intersection Operations.....	33
Table 21: 2030 Future Total Access Intersection Operations.....	34
Table 22: NTM Review.....	36
Table 23: Trip Generation by Transit Mode.....	36
Table 24: Forecasted Site-Generated Transit Ridership.....	37
Table 25: 2025 Future Total Intersection Operations.....	37
Table 26: 2030 Future Total Intersection Operations.....	39
Table 27: Study Area Intersection MMLOS Analysis.....	40

## List of Appendices

Appendix A – TIA Screening Form and Certification Form
Appendix B – Turning Movement Count Data
Appendix C – Synchro Intersection Worksheets – Existing Conditions
Appendix D – Collision Data
Appendix E – TRANS Model Plots
Appendix F – Synchro Intersection Worksheets – 2025 Future Background Conditions
Appendix G – Synchro Intersection Worksheets – 2030 Future Background Conditions
Appendix H – Turning Templates
Appendix I – MMLOS Analysis
Appendix J – Synchro Intersection Worksheets – 2025 Future Total Conditions
Appendix K – Synchro Intersection Worksheets – 2030 Future Total Conditions
Appendix L – TDM Checklist



## 1 Screening

This study has been prepared according to the City of Ottawa’s 2017 Transportation Impact Assessment (TIA) Guidelines. Accordingly, a Step 1 Screening Form has been prepared and is included as Appendix A, along with the Certification Form for the TIA Study PM. As shown in the Screening Form, a TIA is required including the Network Impact and Design Review Components. This study has been prepared to support a site plan application.

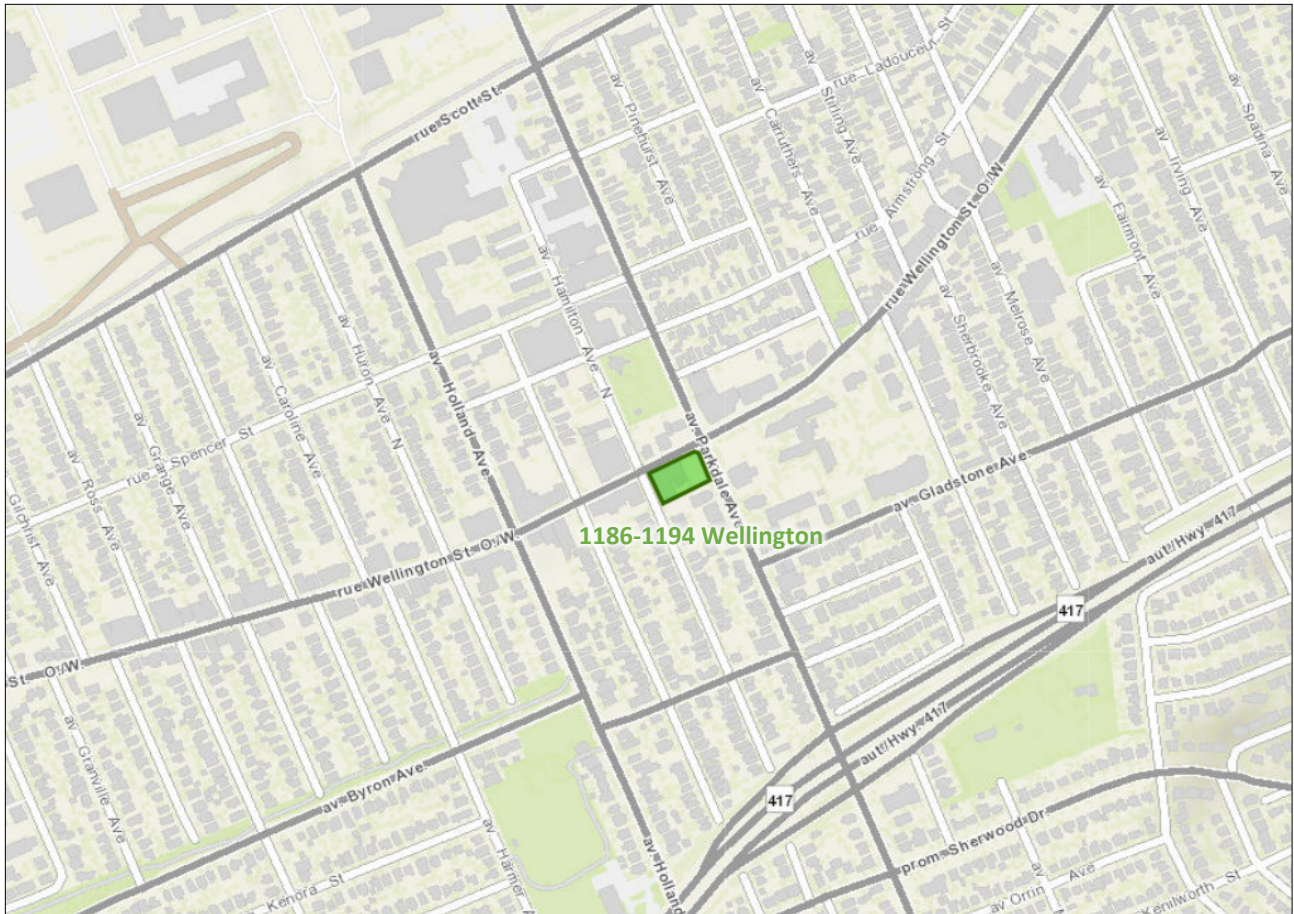
## 2 Existing and Planned Conditions

### 2.1 Proposed Development

The existing site, zoned as Traditional Mainstreet (TM11, TM11[18415]), intersecting the Wellington Traditional Mainstreet Design Priority Area (DPA), and within the area considered by the Wellington Street Community Design Plan (CDP) currently includes a drug store, a church, and a surface parking lot. The subject development proposes the construction of a 16-storey mixed-use building on a six-storey podium comprising 212 residential dwelling units 12,518 sq. ft. of ground floor retail with 140 underground parking spaces, 212 resident bike parking spaces, 5 retail bike parking spaces and additional surface bike parking racks. Access to is to be provided via the existing rear lane connecting to Parkdale Avenue and Hamilton Avenue North, restricting the lane to outbound only onto Parkdale Avenue, and build-out is anticipated as occurring in a single phase by 2025.

Figure 1 illustrates the study area context. Figure 2 illustrates the proposed concept plan.

Figure 1: Area Context Plan



Source: <http://maps.ottawa.ca/geoOttawa/> Accessed: May 25, 2022





## 2.2 Existing Conditions

### 2.2.1 Area Road Network

**Highway 417:** Highway 417 is a provincially owned urban freeway with a divided eight-lane cross-section with a posted speed limit of 100 km/h within the study area. Highway 417 is a truck route.

**Parkdale Avenue:** Parkdale Avenue is a City of Ottawa arterial road with a two-lane urban cross-section including sidewalks on both sides of the road. On-street parking is permitted on the west side of the road along the Parkdale Market frontage and on the west side of the road north of Oxford Street (no stopping weekdays 3:30PM-5:30PM) within the study area. The posted speed limit is 40 km/h, and the Ottawa Official Plan reserves a 26.0-metre right of way to the north and the measured right of way is 20.0 metres to the south of Wellington Street West within the study area.

**Wellington Street West:** Wellington Street West is a City of Ottawa arterial road with an urban cross-section including two travel lanes, and on-street parking lanes and sidewalks on both sides of the road. No stopping provisions are in place 7:00AM-9:00AM on the south side of the road between Hamilton Avenue North and Parkdale Avenue, and on-street parking is not permitted on the on the south side of the road between Huron Avenue North and Holland Avenue and on the north side of the road between Holland Avenue between Hinton Avenue North. Sharrow pavement markings are present between Holland Avenue and Parkdale Avenue. Between Huron Avenue and Hamilton Avenue West, the posted speed limit is 40 km/h, and the unposted speed limit is assumed to be 50 km/h outside of this segment. The Ottawa Official Plan reserves a 20.0-metre right of way within the study area. Wellington Street West is a truck route.

**Holland Avenue:** Holland Avenue is a City of Ottawa major collector road with a four-lane urban cross-section to the north and a two-lane urban cross-section to the south of Byron Avenue, each including sidewalks on both sides of the road. South of Tyndall Street, bike lanes are on both sides of the road, and on-street parking is permitted on the west side of the road for 40 metres midblock between Tyndall Street and the Fisher Park Public School access. Between Byron Avenue and Wellington Street West, on-street parking is permitted on the east side of the road (no stopping weekdays 7:00AM-9:00AM) and the west side of the road (no-stopping weekdays 3:30PM-5:30PM). Between Wellington Street West and Armstrong Street, on-street parking is permitted on the east side of the road and the west side of the road (no-stopping weekdays 3:30PM-5:30PM), and north of Holland Avenue, within the study area, on-street parking is permitted on the east side of the road. Twenty-five metres south of Tyndall Street, the posted speed limit is 30 km/h, and the unposted speed limit is assumed to be 50 km/h to the north. The Ottawa Official Plan reserves a 26.0-metre right of way within the study area. Holland Avenue is a truck route.

**Gladstone Avenue:** Gladstone Avenue is a City of Ottawa major collector road with a two-lane urban cross-section including sidewalks on both sides of the road. Within the study area, the posted speed limit is 40 km/h, and the measured right of way varies between 15.5 metres and 17.5 metres.

**Tyndall Street:** Tyndall Street is a City of Ottawa collector road with a two-lane urban cross-section including sidewalks on both sides of the road. The unposted speed limit is assumed to be 50 km/h and the measured right of way is 18.0 metres.

**Carruthers Avenue:** Carruthers Avenue is a southbound one-way City of Ottawa local road with a one-lane urban cross-section sidewalks on both sides of the road. Between Wellington Street West and Armstrong Street, on-street parking is permitted on the west side of the road and north of Armstrong Street within the study area, on-

street parking is permitted on the east side of the road. The posted speed limit is 40 km/h, and the measured right of way is 12.5 metres.

*Spencer Street:* Spencer Street is a City of Ottawa local road with a two-lane urban cross-section including sidewalks on both sides of the road. On-street parking is provided on the north side of the road between Holland Avenue and Hinton Avenue North, on the south side of the road between Hinton Avenue North and Hamilton Avenue North, and on both sides of the road east of Hamilton Avenue North. The posted speed limit is 40 km/h, and the measured right of way is 18.0 metres.

*Armstrong Street:* Armstrong Street is a City of Ottawa local road with a two-lane urban cross-section including sidewalks on both sides of the road. The posted speed limit is 40 km/h, and the measured right of way is 12.0 metres.

*Hamilton Avenue North:* Hamilton Avenue North is a City of Ottawa local road with a two-lane urban cross-section including sidewalks on both sides of the road. On-street parking is permitted on the east side of the road south of Tyndall Street, on the west side of the road between Tyndall Street and Wellington Street West, on the west side of the road north of Wellington Street West and on the east side of the road via angle parking along the Parkdale Park frontage. On-street parking is further permitted on both sides of the road between Armstrong Street and Spencer Street and on the west side of the road via both parallel and angle parking to the north within the study area. The posted speed limit is 40 km/h, and the measured right of way is 18.5 metres.

### 2.2.2 Existing Intersections

The key existing area intersections within 400 metres of the site have been summarized below:

<i>Holland Avenue &amp; Spencer Street</i>	The intersection of Holland Avenue & Spencer Street is a signalized intersection. The northbound and southbound approaches each consist of a shared left-turn/through lane and a shared through/right-turn lane. The eastbound and westbound approaches each consist of a shared all-movements lane. No turn restrictions were noted.
<i>Holland Avenue &amp; Wellington Street W</i>	The intersection of Holland Avenue & Wellington Street W is a signalized intersection. The northbound and southbound approaches each consist of a shared left-turn/through lane and a shared through/right-turn lane. The eastbound and westbound approaches each consist of a shared left-turn/through lane and a parking lane that operates as an auxiliary right-turn lane and through bypass during peak periods. Right turns on red all prohibited on all approaches at this intersection weekdays between 7:00AM and 7:00PM.
<i>Holland Avenue &amp; Tyndall Street</i>	The intersection of Holland Avenue & Tyndall Street is a signalized intersection. The northbound approach consists of an auxiliary through lane, a shared through/right-turn lane, and a bike lane and the southbound consists of a left-turn lane and a through lane. The westbound approach consists of a shared left-turn/right-turn lane and a pocket bike lane with a bike box. Westbound right turns on red are prohibited.
<i>Parkdale Avenue &amp; Armstrong Street</i>	The intersection of Parkdale Avenue & Armstrong Street is a signalized intersection. All approaches consist of shared all-movements lanes. No turn restrictions were noted.

<i>Parkdale Avenue &amp; Wellington Street W</i>	The intersection of Parkdale Avenue & Wellington Street W is a signalized intersection. The northbound and southbound approaches each consist of an auxiliary left-turn lane and a shared through/right-turn lane. The eastbound approach consists of a shared left-turn/through lane and an auxiliary through/right-turn lane and westbound approach consists of an auxiliary left-turn lane and a shared through-right lane. Right turns on red all prohibited on all approaches at this intersection weekdays between 7:00AM and 7:00PM.
<i>Parkdale Avenue &amp; Gladstone Avenue</i>	The intersection of Parkdale Avenue & Gladstone Avenue is a signalized t-intersection. The northbound approach consists of a shared through/right-turn lane and the southbound consists of an auxiliary left-turn lane and a through lane. The westbound approach consists of a shared left-turn/right-turn lane and includes a bike box. Northbound and westbound right-turns on red are prohibited.
<i>Parkdale Avenue &amp; Highway 417 WB OR</i>	The intersection of Parkdale Avenue & Highway 417 westbound off-ramp/on-ramp is a signalized intersection. The northbound approach consists of a left-turn lane and a through lane and the southbound consists of a shared through/right-turn lane. The westbound approach consists of a left-turn lane and a shared through/right-turn lane. Westbound through movements are prohibited weekdays 7:00AM- 9:00AM and 3:30PM- 5:30PM.
<i>Carruthers Avenue &amp; Wellington Street W</i>	The intersection of Carruthers Avenue & Wellington Street W is a signalized intersection. The southbound consists of a left-turn lane and an auxiliary right-turn lane and the eastbound and the westbound approaches each consist of a through lane. No turn restrictions were noted.
<i>Hamilton Avenue N &amp; Wellington Street W</i>	The intersection of Hamilton Avenue N & Wellington Street W is a stop-controlled intersection on the minor approach of Hamilton Avenue N. Each approach consists of a shared all-movement lane. No turn restrictions were noted.
<i>Hamilton Avenue N &amp; Tyndall Street</i>	The intersection of Hamilton Avenue N & Tyndall Street is a stop-controlled intersection on the minor approach of Hamilton Avenue N. Each approach consists of a shared all-movement lane. No turn restrictions were noted.

2.2.3 Existing Driveways

The existing site driveway onto Wellington Street West is proposed as being removed as part of the redevelopment. The rear lane additionally provides access to another church’s parking lot to the south.

South of Wellington Street West along Hamilton Avenue North, a driveway accessing the rear parking and loading for the commercial strip on the south side of Wellington Street West opposite the subject site is present, and a driveway to a church parking lot and numerous driveways accessing attached and detached residential dwellings are present within 200 metres of the site access. On the north side of Wellington Street West along Hamilton Avenue North, driveways to commercial land uses, to a single detached dwelling, and to a mid-rise residential building are present on the west side of the road.

On Wellington Street West, driveways to a salon parking lot, to a gas station, and to a commercial parking lot are present on the north side of the road and a driveway to a mid-rise mixed-use building is present on the south side of the road.

South of Wellington Street West on Parkdale Avenue, driveways to commercial land uses, detached residential dwellings, to a high-rise residential building, to a postal station, to a seniors' residence and parking lot, and to a church are present. North of Wellington Street West on Parkdale Avenue, a municipal lane accessing the Parkdale Market and Parkdale Park, and driveways to a gas station, to a midrise residential building, to a commercial building, and to detached residential dwellings are present.

#### 2.2.4 Cycling and Pedestrian Facilities

Figure 3 illustrates the pedestrian facilities in the study area and Figure 4 illustrates the cycling facilities.

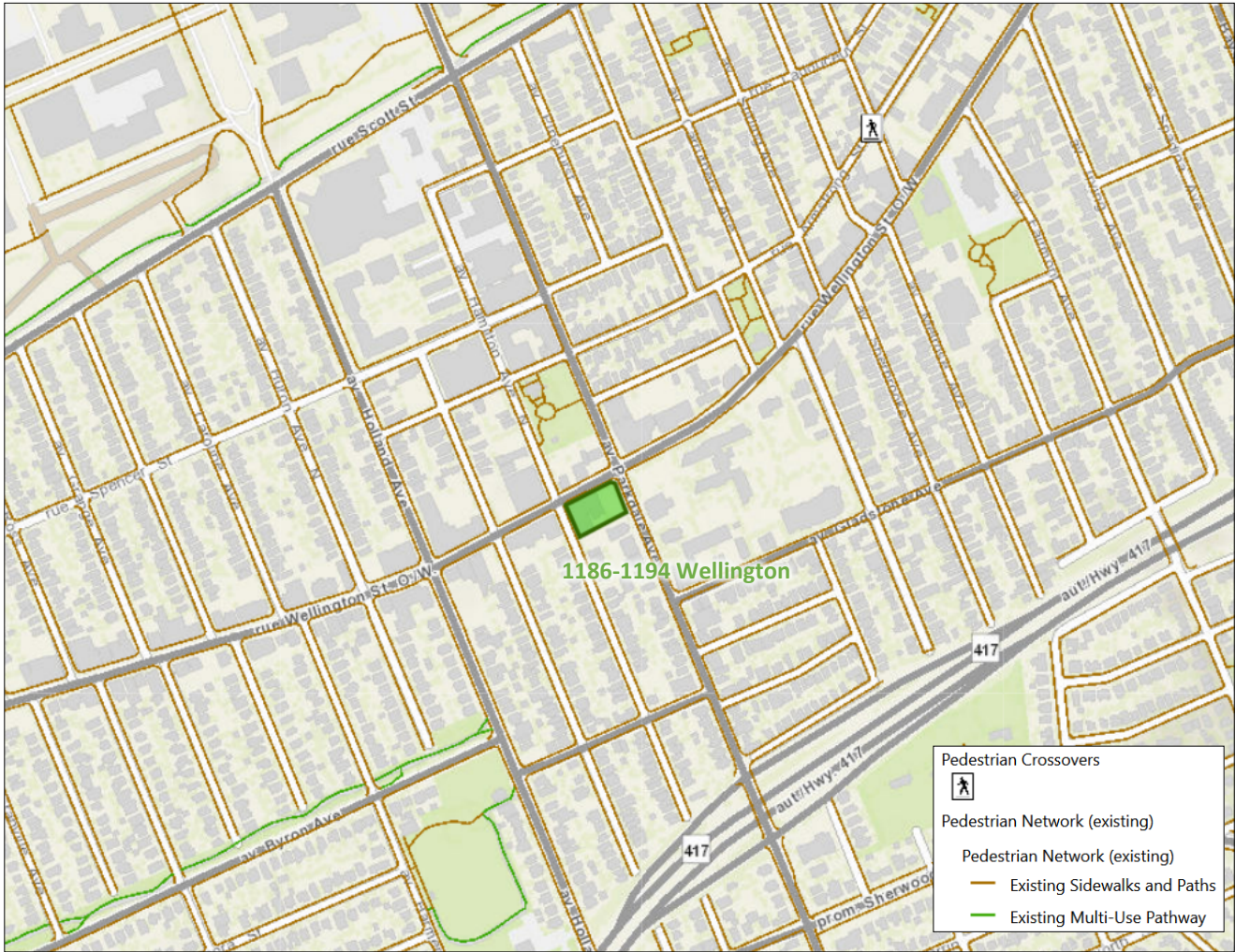
Sidewalks are provided along both sides of all study area roadways excluding the interchange ramps.

Cycling facilities include a westbound bike lane on Byron Avenue and a mixed-use path (MUP) north of Byron Avenue, a MUP west of Holland Avenue South of Tyndall Street, an eastbound buffered bike lane on Scott Street, and a MUP on the north side of Scott Street. Additional cycling facilities include sharrows along Wellington Street West between Holland Avenue and Parkdale Avenue, with buffered dooring zone pavement markings along the parking lanes for this section of roadway.

Holland Avenue, Parkdale Avenue between Gladstone Avenue and Tyndall Street, Scott Street, Wellington Street West, Tyndall Street, and Gladstone Avenue are spine cycling routes. Local routes include Tunney's Pasture Driveway, Hamilton Avenue North between Spencer Street and Armstrong Street, Fairmont Avenue, Spencer Street west of Hamilton Avenue North, Armstrong Street east of Hamilton Avenue North, and Byron Avenue. Scott Street is a cross-town bikeway, and the corridor from the pathway west of Holland Avenue, north to Holland Avenue, east to Tyndall Street, north to Parkdale Avenue, east to Gladstone Avenue and south to Fairmont Street is a neighbourhood bikeway.

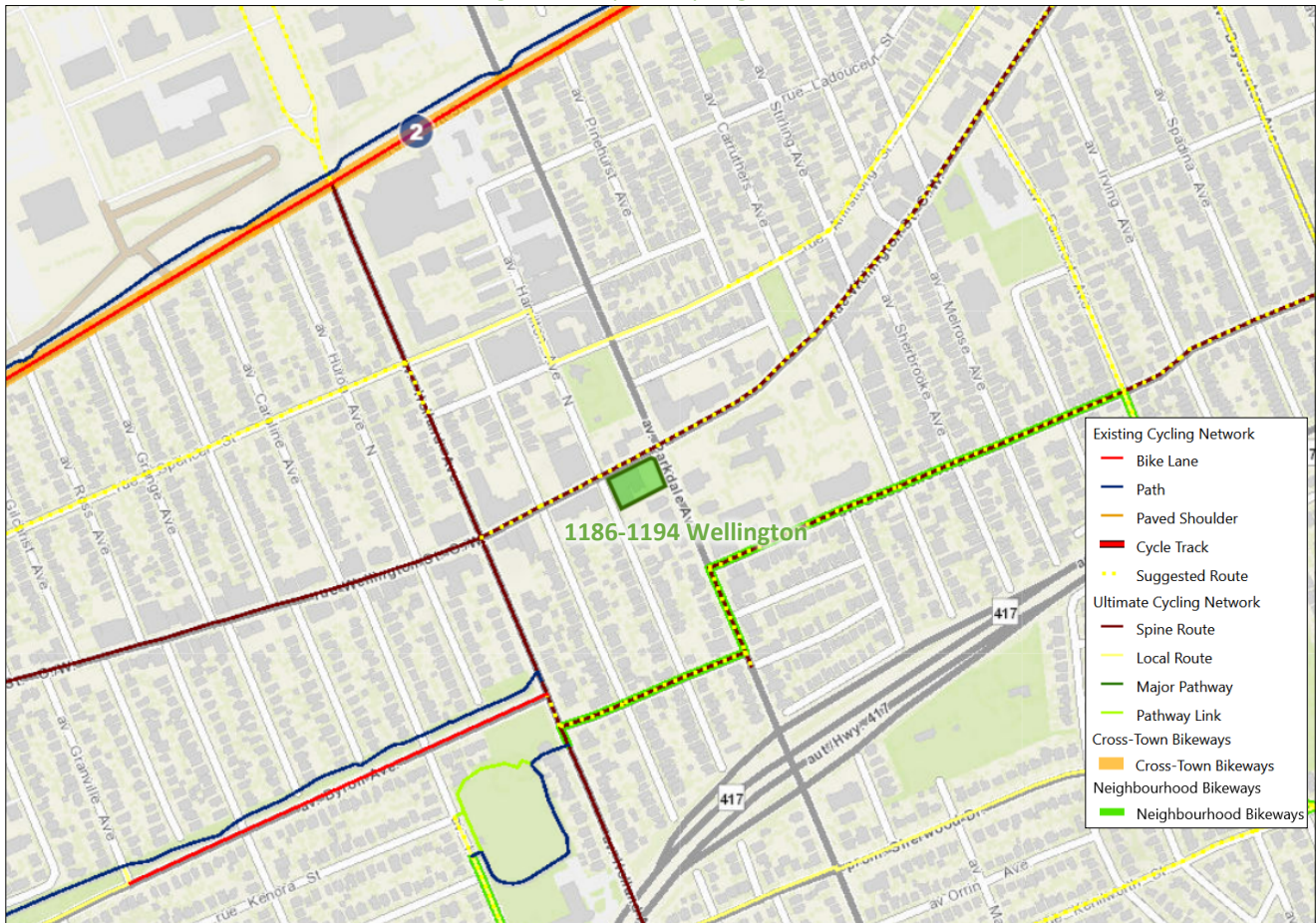


Figure 3: Study Area Pedestrian Facilities



Source: <http://maps.ottawa.ca/geoOttawa/> Accessed: May 25, 2022

Figure 4: Study Area Cycling Facilities



Source: <http://maps.ottawa.ca/geoOttawa/> Accessed: May 25, 2022

Pedestrian and cyclist volumes included in study area intersection counts, presented in Section 2.2.7, have been compiled and are illustrated in Figure 5 and Figure 6 respectively.



Figure 5: Existing Pedestrian Volumes

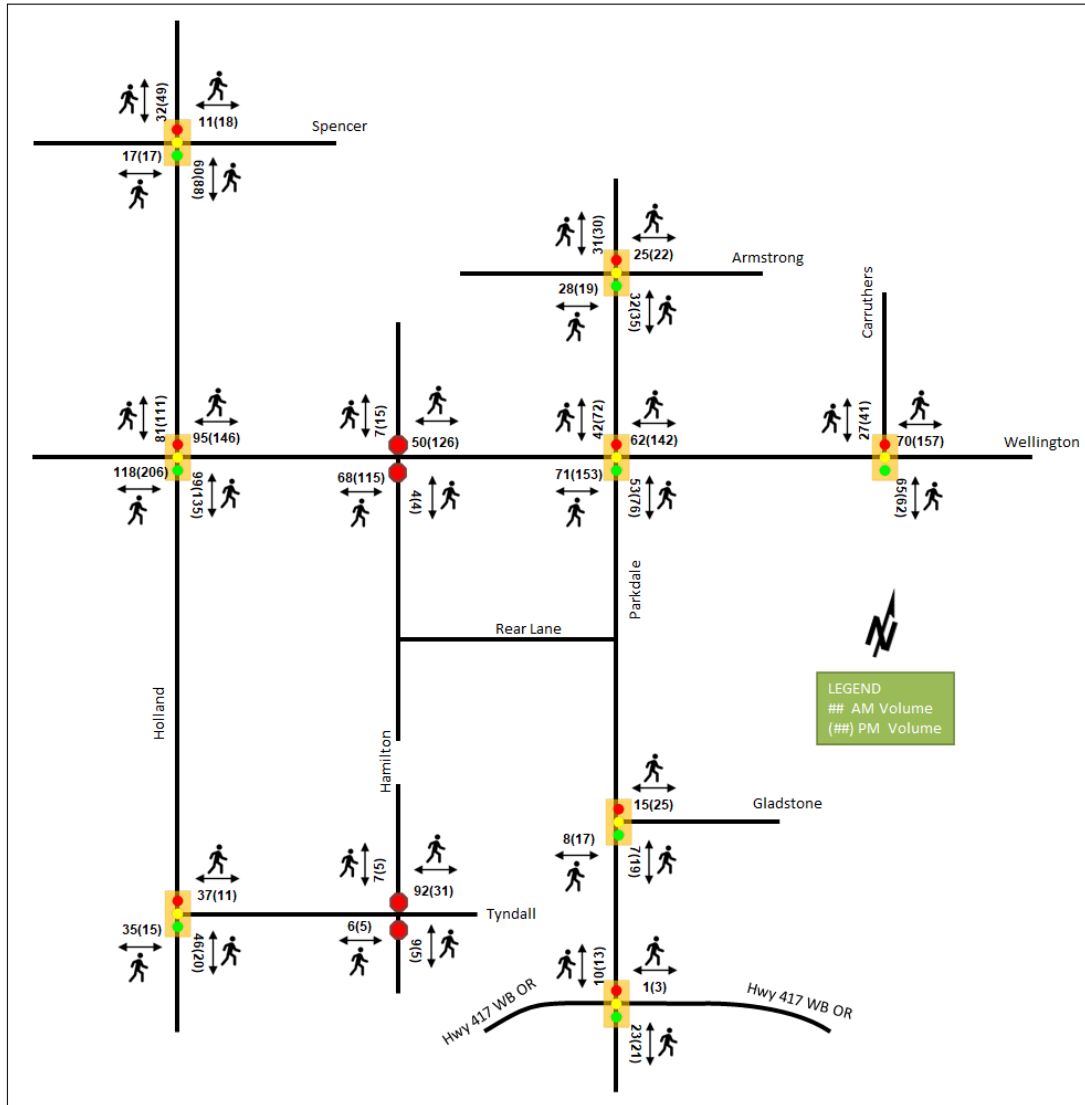
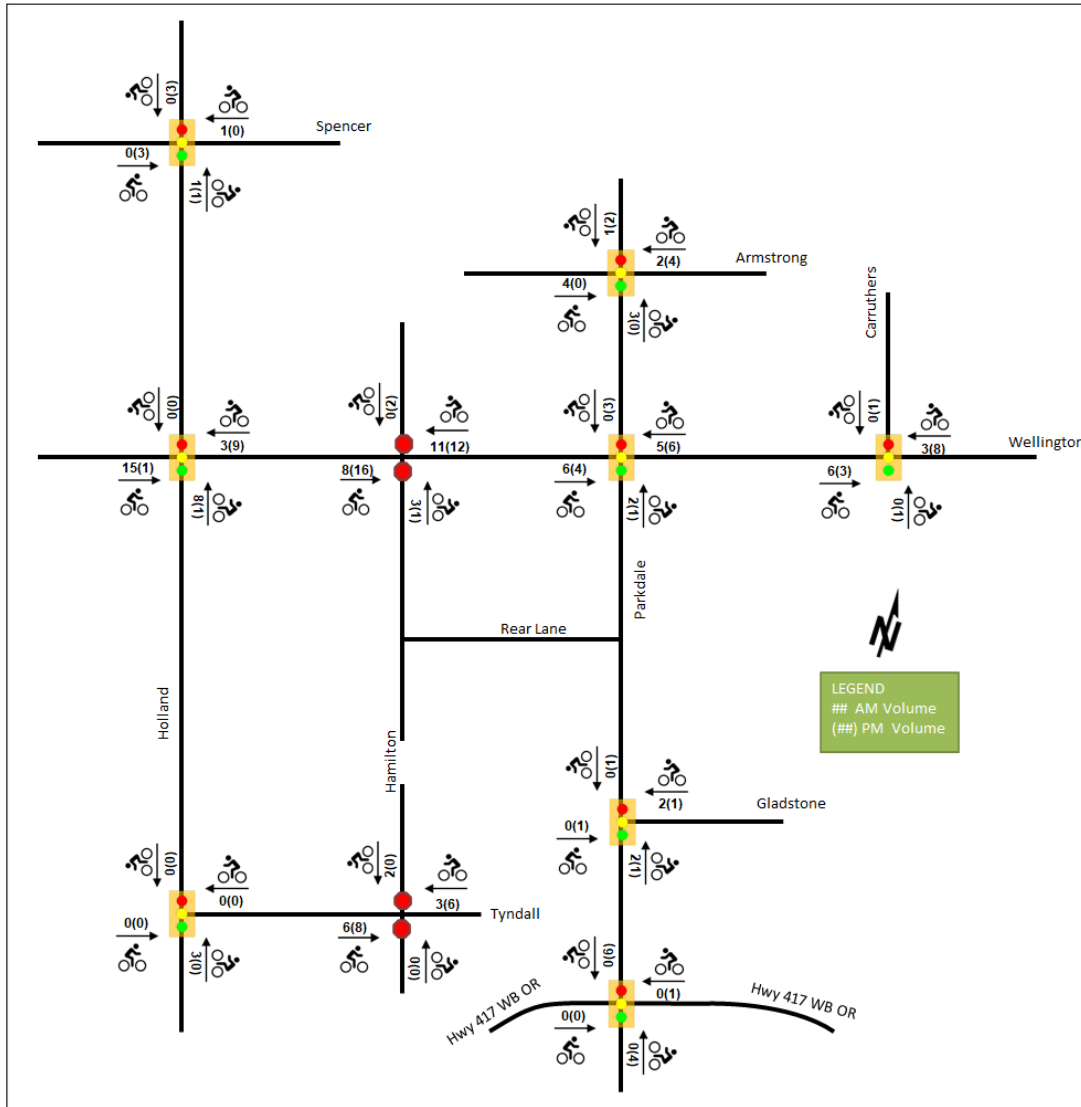


Figure 6: Existing Cyclist Volumes



### 2.2.5 Existing Transit

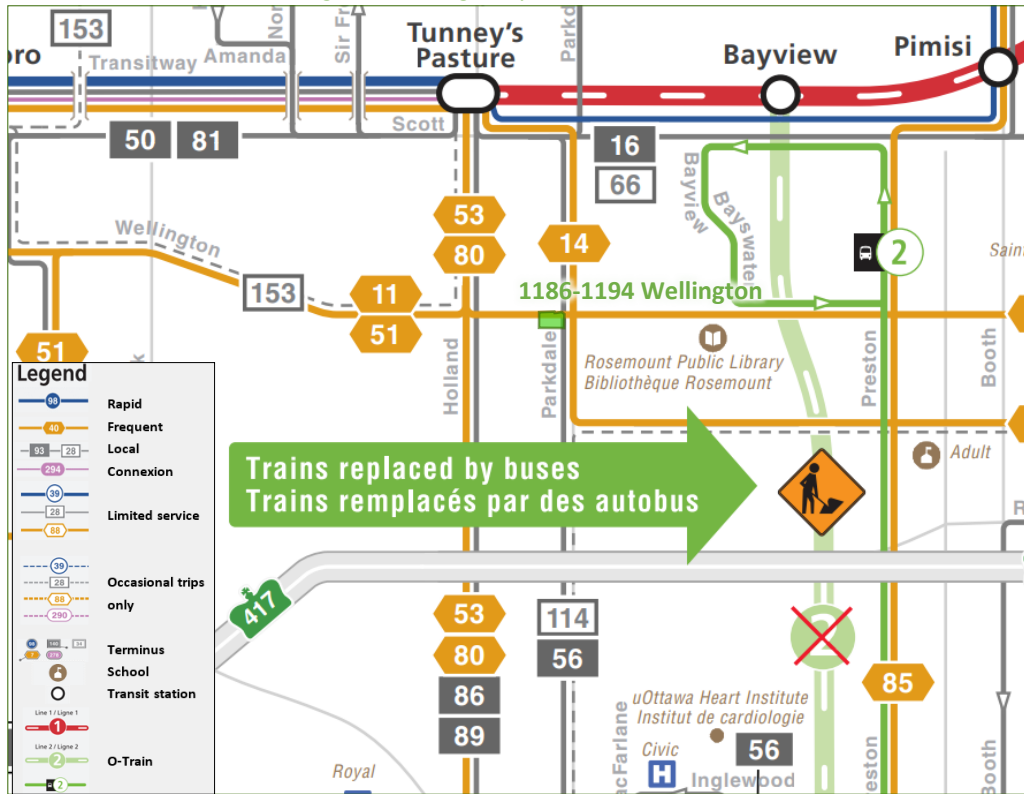
Figure 7 illustrates the transit system map in the study area and Figure 8 illustrates nearby transit stops. The transit information summarized within the TIA is a representative transit service, as OC Transpo changes service routines multiple times a year. All transit information is from May 25, 2022 and is included for general information purposes and context to the surrounding area.

Within the study area, the routes #11, #51, #153 travel along Wellington Street West, with the routes # 11 and #153 continuing along Holland Avenue, the routes #53, #80, #86, #89 travel along Holland Avenue, and the routes #14, #56 and #114 travel along Parkdale Avenue, with the routes #14 and #114 continuing along Gladstone Avenue. The frequency of these routes within proximity of the proposed site based on May 25, 2022 service levels are:

- Route # 11 – 15-minute daytime service, 20-30-minute service after 7:00PM
- Route # 14 – 15-minute daytime service, 30-minute service after 6:00PM
- Route # 51 – 15-minute daytime service, 30-minute service after 7:00PM

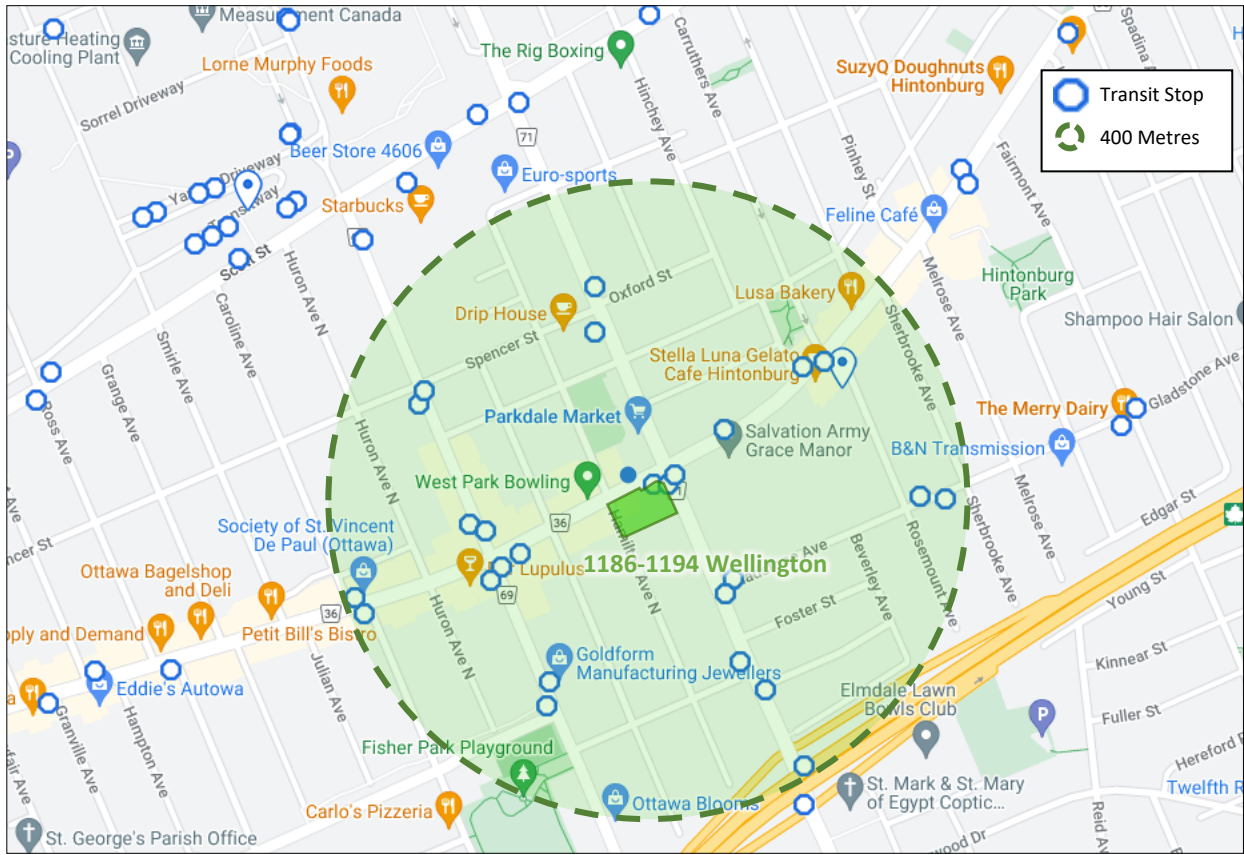
- Route # 53 – 15-minute daytime service, 20-minute service after 7:00PM, 30-minute service after 9:30PM
- Route # 56 – 15-20-minute service in the peak direction during peak periods, 30-minute service off-peak
- Route # 80 – 15-minute daytime service, 30-minute service after 7:00PM
- Route # 86 – 30-minute service all day, 15-minute service during peak periods
- Route # 89 – 30-minute service all day, 12-15-minute service in the peak direction/period
- Route # 114 – two buses per direction per day

Figure 7: Existing Study Area Transit Service



Source: <http://www.octranspo.com/> Accessed: May 25, 2022

Figure 8: Existing Study Area Transit Stops



Source: <http://www.octranspo.com/> Accessed: May 25, 2022

### 2.2.6 Existing Area Traffic Management Measures

Extensive use of bulb-outs along the Wellington Street West at local road intersections, including those framing parking lanes, and extensive use of on-street parking are present throughout the study area. Speed humps are present on Spencer Street and Tyndall Street and on-road speed limit messaging is present on Spencer Street.

### 2.2.7 Existing Peak Hour Travel Demand

Existing turning movement counts were acquired from the City of Ottawa for the existing study area intersections. Table 1 summarizes the intersection count dates.

Table 1: Intersection Count Date

Intersection	Count Date
Holland Avenue & Spencer Street	Wednesday, January 11, 2017
Holland Avenue & Wellington Street W	Wednesday, November 22, 2017
Holland Avenue & Tyndall Street	Wednesday, January 11, 2017
Parkdale Avenue & Armstrong Street	Wednesday, November 20, 2019
Parkdale Avenue & Wellington Street W	Tuesday, March 10, 2020
Parkdale Avenue & Gladstone Avenue	Thursday, December 5, 2019
Parkdale Avenue & Highway 417 WB OR	Thursday, April 5, 2018
Carruthers Avenue & Wellington Street W	Thursday, February 22, 2018
Hamilton Avenue N & Wellington Street W	Tuesday, April 26, 2022
Hamilton Avenue N & Tyndall Street	Tuesday, April 26, 2022

Figure 9 illustrates the existing traffic counts, balanced along Parkdale Avenue, and Table 2 summarizes the existing intersection operations. The level of service for signalized intersections is based on volume to capacity ratio (v/c) calculations for individual lane movements and HCM 2000 v/c calculations for the overall intersection, and average delay for unsignalized intersections. At the intersection Detailed turning movement count data is included in Appendix B and the Synchro worksheets are provided in Appendix C.

Figure 9: Existing Traffic Counts

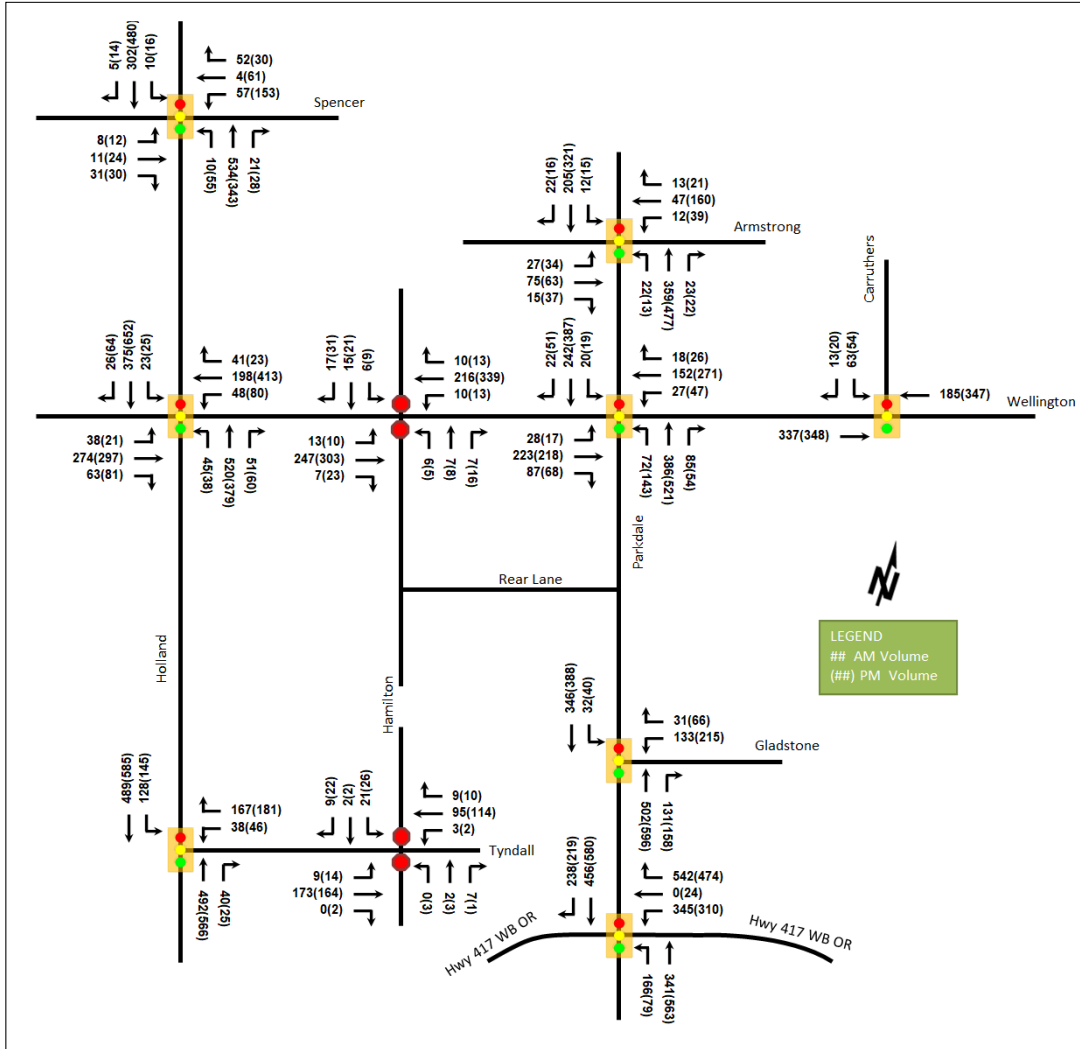


Table 2: Existing Intersection Operations

Intersection	Lane	AM Peak Hour				PM Peak Hour			
		LOS	V/C	Delay(s)	Q (95 <sup>th</sup> )	LOS	V/C	Delay(s)	Q (95 <sup>th</sup> )
Holland Avenue & Spencer Street <i>Signalized</i>	EB	A	0.24	20.7	13.7	A	0.20	19.4	16.8
	WB	A	0.58	38.3	32.5	D	0.87	62.4	#87.3
	NB	A	0.27	1.0	4.3	A	0.27	1.2	2.7
	SB	A	0.15	3.9	14.7	A	0.28	7.8	31.4
	<b>Overall</b>	<b>A</b>	<b>0.30</b>	<b>6.8</b>	-	<b>A</b>	<b>0.43</b>	<b>16.8</b>	-
Holland Avenue & Wellington Street W <i>Signalized</i>	EB	A	0.39	23.0	42.2	A	0.41	23.4	45.3
	WB	A	0.32	34.9	41.2	A	0.59	20.9	m44.6
	NB	B	0.61	26.8	73.1	A	0.54	21.9	53.2
	SB	A	0.41	19.9	39.3	B	0.70	25.3	78.6
	<b>Overall</b>	<b>A</b>	<b>0.46</b>	<b>25.6</b>	-	<b>A</b>	<b>0.60</b>	<b>23.1</b>	-
Holland Avenue & Tyndall Street <i>Signalized</i>	WB	C	0.74	41.6	49.7	C	0.78	52.2	66.9
	NBT/R	B	0.61	15.1	92.0	B	0.62	16.3	129.7
	SBL	A	0.44	16.7	29.0	A	0.49	10.4	m12.4
	SBT	A	0.55	14.1	81.1	A	0.60	8.5	44.0
	<b>Overall</b>	<b>B</b>	<b>0.61</b>	<b>18.9</b>	-	<b>B</b>	<b>0.63</b>	<b>18.0</b>	-
Parkdale Avenue & Armstrong Street <i>Signalized</i>	EB	A	0.39	35.8	37.7	A	0.34	26.6	36.2
	WB	A	0.23	30.3	23.6	A	0.52	33.6	62.3
	NB	A	0.39	2.7	8.1	A	0.56	5.9	m10.5
	SB	A	0.23	6.5	26.6	A	0.39	11.9	55.2
	<b>Overall</b>	<b>A</b>	<b>0.39</b>	<b>10.8</b>	-	<b>A</b>	<b>0.54</b>	<b>14.9</b>	-
Parkdale Avenue & Wellington Street W <i>Signalized</i>	EB	A	0.48	20.7	24.7	A	0.60	60.7	50.2
	WBL	A	0.14	28.2	11.6	A	0.37	41.1	20.3
	WBT/R	A	0.38	30.8	48.3	D	0.85	58.4	#107.1
	NBL	A	0.19	3.7	m3.1	A	0.44	12.1	m18.6
	NBT/R	B	0.64	12.5	92.9	B	0.68	18.5	m90.4
	SBL	A	0.08	19.1	m6.5	A	0.08	15.4	m5.1
	SBT/R	A	0.46	22.6	47.5	C	0.72	24.9	66.7
	<b>Overall</b>	<b>A</b>	<b>0.58</b>	<b>18.7</b>	-	<b>C</b>	<b>0.74</b>	<b>33.6</b>	-
Parkdale Avenue & Gladstone Avenue <i>Signalized</i>	WBL/R	A	0.46	35.9	50.2	D	0.81	53.1	#99.0
	NBT/R	B	0.67	12.7	m84.5	C	0.80	17.4	m121.9
	SBL	A	0.12	13.2	m7.5	A	0.20	6.5	m3.2
	SBT	A	0.35	14.2	71.0	A	0.39	6.0	27.8
	<b>Overall</b>	<b>B</b>	<b>0.61</b>	<b>16.4</b>	-	<b>C</b>	<b>0.80</b>	<b>20.9</b>	-
Parkdale Avenue & Highway 417 WB OR <i>Signalized</i>	WBL	E	0.98	81.6	#131.1	D	0.88	62.5	#113.2
	WBT/R	D	0.86	22.8	#91.5	E	0.99	56.8	#128.6
	NBL	A	0.59	25.6	20.6	A	0.38	18.0	10.8
	NBT	A	0.34	9.0	45.1	A	0.55	12.1	88.7
	SBT/R	D	0.89	39.0	#209.0	E	0.95	40.7	#251.7
	<b>Overall</b>	<b>D</b>	<b>0.89</b>	<b>35.9</b>	-	<b>E</b>	<b>0.96</b>	<b>39.3</b>	-
Carruthers Avenue & Wellington Street W <i>Signalized</i>	EBT	A	0.37	9.6	41.3	A	0.29	4.6	28.5
	WBT	A	0.20	8.0	22.0	A	0.29	4.6	28.5
	SBL	A	0.15	21.9	16.8	A	0.24	30.5	17.4
	SBR	A	0.04	10.8	3.9	A	0.11	13.4	5.7
	<b>Overall</b>	<b>A</b>	<b>0.30</b>	<b>10.4</b>	-	<b>A</b>	<b>0.30</b>	<b>6.7</b>	-

Intersection	Lane	AM Peak Hour				PM Peak Hour			
		LOS	V/C	Delay(s)	Q (95 <sup>th</sup> )	LOS	V/C	Delay(s)	Q (95 <sup>th</sup> )
Hamilton Avenue N & Wellington Street W <i>Unsignalized</i>	EB	A	0.01	7.8	0.0	A	0.01	8.1	0.0
	WB	A	0.01	7.8	0.0	A	0.01	8.0	0.0
	NB	B	0.05	12.8	0.8	B	0.08	14.1	1.5
	SB	B	0.08	12.4	2.3	C	0.16	15.3	4.5
	<b>Overall</b>	<b>A</b>	-	<b>1.6</b>	-	<b>A</b>	-	<b>1.9</b>	-
Hamilton Avenue N & Tyndall Street <i>Unsignalized</i>	EB	A	0.01	7.5	0.0	A	0.01	7.5	0.0
	WB	A	0.00	7.6	0.0	A	0.00	7.6	0.0
	NB	A	0.01	9.7	0.0	B	0.01	11.2	0.0
	SB	B	0.05	10.6	1.5	B	0.08	10.6	2.3
	<b>Overall</b>	<b>A</b>	-	<b>1.6</b>	-	<b>A</b>	-	<b>2.0</b>	-

Notes: Saturation flow rate of 1800 veh/h/lane  
Queue is measured in metres  
Peak Hour Factor = 0.90

m = metered queue  
# = volume for the 95th %ile cycle exceeds capacity

The intersection of Parkdale Avenue and the Highway 417 westbound ramps is expected to experience queuing across multiple movements during both peak hours. During the AM peak hour, the westbound left movement is near capacity with potential for high delays and extended queues and the westbound through/right and southbound through/right movements may experience extended queueing. During the PM peak hour, the westbound through/right and southbound through/right are nearing capacity and these movements along with the westbound left may exhibit extended queuing.

Additionally, within the study area, extended queuing may be observed during the PM peak hour on the westbound approaches of the intersections of Holland Avenue at Spencer Street, Parkdale Avenue at Wellington Street West, and Parkdale Avenue and Gladstone Avenue.

### 2.2.8 Collision Analysis

Collision data have been acquired from the City of Ottawa open data website (data.ottawa.ca) for five years prior to the commencement of this TIA for the surrounding study area road network. Table 3 summarizes the collision types and conditions in the study area, Figure 10 illustrates the intersections and segments analyzed, and Table 4 summarizes the total collisions for each of these locations. Collision data are included in Appendix D.

Table 3: Study Area Collision Summary, 2016-2020

Total Collisions		Number	%
Total Collisions		88	100%
Classification	Fatality	0	0%
	Non-Fatal Injury	7	8%
	Property Damage Only	81	92%
Initial Impact Type	Approaching	1	1%
	Angle	17	19%
	Rear end	16	18%
	Sideswipe	24	27%
	Turning Movement	13	15%
	SMV Unattended	10	11%
	SMV Other	2	2%
	Other	5	6%



		Number	%
<b>Total Collisions</b>		88	100%
<b>Road Surface Condition</b>	Dry	58	66%
	Wet	15	17%
	Loose Snow	4	5%
	Slush	6	7%
	Packed Snow	2	2%
	Ice	3	3%
<b>Pedestrian Involved</b>		1	1%
<b>Cyclists Involved</b>		2	2%

Figure 10: Study Area Collision Records – Representation of Study Area Collisions

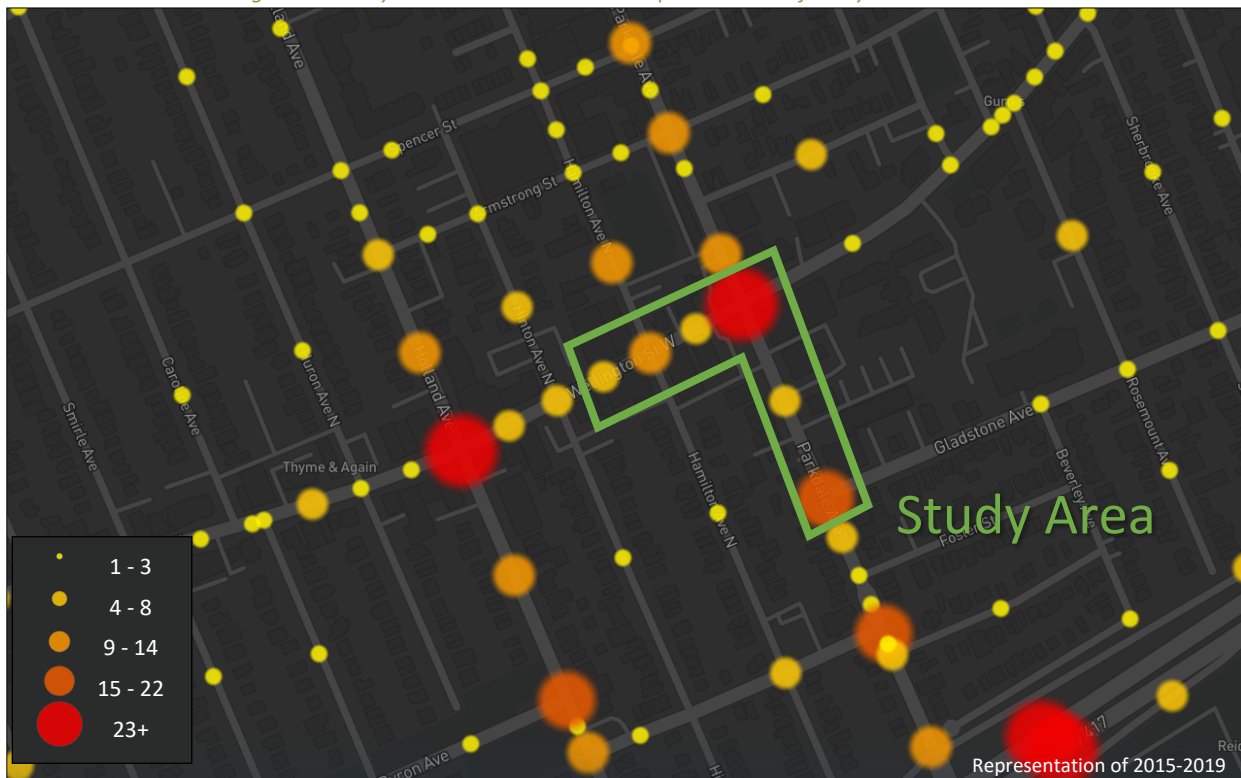


Table 4: Summary of Collision Locations, 2016-2020

Intersections / Segments	Number	%
<b>Parkdale Ave @ Wellington St W</b>	36	41%
<b>Hamilton Ave N @ Wellington St W</b>	16	18%
<b>Parkdale Ave @ Gladstone Ave</b>	16	18%
<b>Wellington St W between Hamilton Ave N &amp; Parkdale Ave</b>	8	9%
<b>Wellington St W between Hinton Ave N &amp; Hamilton Ave N</b>	6	7%
<b>Parkdale Ave between Wellington St W &amp; Gladstone Ave</b>	6	7%

Within the study area, the intersections of Parkdale Avenue at Wellington Street West, Hamilton Avenue North at Wellington Street West, and Parkdale Avenue at Gladstone Avenue are noted to have experienced higher collisions than other locations. Table 5, Table 6, and Table 7 summarize the collision types and conditions for each of the Parkdale Avenue at Wellington Street West, Hamilton Avenue North at Wellington Street West, and Parkdale Avenue at Gladstone Avenue intersections, respectively.



Table 5: Parkdale Avenue at Wellington Street West Collision Summary

		Number	%
<b>Total Collisions</b>		<b>41</b>	<b>100%</b>
<b>Classification</b>	<b>Fatality</b>	0	0%
	<b>Non-Fatal Injury</b>	2	5%
	<b>Property Damage Only</b>	39	95%
<b>Initial Impact Type</b>	<b>Approaching</b>	1	2%
	<b>Angle</b>	6	15%
	<b>Rear end</b>	9	22%
	<b>Sideswipe</b>	12	29%
	<b>Turning Movement</b>	9	22%
	<b>SMV Other</b>	1	2%
	<b>Other</b>	3	7%
<b>Road Surface Condition</b>	<b>Dry</b>	26	63%
	<b>Wet</b>	7	17%
	<b>Loose Snow</b>	3	7%
	<b>Slush</b>	3	7%
	<b>Packed Snow</b>	1	2%
	<b>Ice</b>	1	2%
<b>Pedestrian Involved</b>		0	0%
<b>Cyclists Involved</b>		1	2%

The Parkdale Avenue at Wellington Street West intersection had a total of 41 collisions during the 2016-2020 time period, with 39 involving property damage only and the remaining two having non-fatal injuries. The collision types are most represented by sideswipe with twelve collisions, followed by turning movement and rear end each with nine, angle with six, other with three, and one each for SMV (other) and approaching. Sideswipe collisions may be influenced by east and westbound drivers weaving around left-turning vehicles in the shared left-turn/through lane on each approach. Turning movement and angle collisions may be influenced by the gas station occupying the northwest quadrant of the intersection which introduces movements on the southbound approach and the westbound departure. Weather conditions do not affect collisions at this location. No mitigation is recommended for this intersection as part of this study.

Table 6: Hamilton Avenue North at Wellington Street West Collision Summary

		Number	%
<b>Total Collisions</b>		<b>16</b>	<b>100%</b>
<b>Classification</b>	<b>Fatality</b>	0	0%
	<b>Non-Fatal Injury</b>	2	13%
	<b>Property Damage Only</b>	14	88%
<b>Initial Impact Type</b>	<b>Angle</b>	7	44%
	<b>Rear end</b>	1	6%
	<b>Sideswipe</b>	4	25%
	<b>Turning Movement</b>	2	13%
	<b>Other</b>	2	13%
<b>Road Surface Condition</b>	<b>Dry</b>	12	75%
	<b>Wet</b>	3	19%
	<b>Packed Snow</b>	1	6%
<b>Pedestrian Involved</b>		0	0%
<b>Cyclists Involved</b>		0	0%

The Hamilton Avenue North at Wellington Street West intersection had a total of 16 collisions during the 2016-2020 time period, with 14 involving property damage only and the remaining two having non-fatal injuries. The collision types are most represented by angle with seven collisions, followed by sideswipe with four collisions, turning movement and other with two each, and rear end with one. Angle collisions may be influenced by left-turning vehicles pushing gaps in the traffic stream. Weather conditions do not affect collisions at this location. No mitigation is recommended for this intersection as part of this study.

*Table 7: Parkdale Avenue at Gladstone Avenue Collision Summary*

		Number	%
<b>Total Collisions</b>		<b>16</b>	<b>100%</b>
<b>Classification</b>	<b>Fatality</b>	0	0%
	<b>Non-Fatal Injury</b>	3	19%
	<b>Property Damage Only</b>	13	81%
<b>Initial Impact Type</b>	<b>Angle</b>	3	19%
	<b>Rear end</b>	7	44%
	<b>Sideswipe</b>	5	31%
	<b>Turning Movement</b>	1	6%
<b>Road Surface Condition</b>	<b>Dry</b>	9	56%
	<b>Wet</b>	3	19%
	<b>Slush</b>	3	19%
	<b>Ice</b>	1	6%
<b>Pedestrian Involved</b>		0	0%
<b>Cyclists Involved</b>		1	6%

The Parkdale Avenue at Gladstone Avenue intersection had a total of 16 collisions during the 2015-2019 time period, with 13 involving property damage only and the remaining three having non-fatal injuries. The collision types are most represented by rear end with seven, followed by sideswipe with five, angle with three, and turning movement with one. Rear end collisions are typically associated with congestion, but no patterns were noted for the collisions. Weather conditions are not considered to affect collisions at this location. No mitigation is recommended for this intersection as part of this study.

### 2.3 Planned Conditions

#### 2.3.1 Changes to the Area Transportation Network

The subject development is within the Wellington Street CDP Area, however no relevant policies from this document are noted with respect to study area transportation.

Within the Transportation Master Plan, the Rapid Transit and Transit Priority (RTTP) Network’s Network Concept diagram shows continuous transit priority measures along Holland Avenue, however the Affordable Network diagram only includes isolated measures along Holland Avenue, and both diagrams include isolated measures along Wellington Street West.

#### 2.3.2 Other Study Area Developments

##### 3 Grant Street

The proposed development application includes a demolition application for a garage. No TIA is available for this development.

##### 177-179 Armstrong Street, 268 Carruthers Avenue

The proposed development application includes a zoning amendment to allow the construction of a three-storey 33-unit apartment building. No TIA is available for this development.

*83 Hinton Avenue North*

The proposed development application includes a site plan for the construction of a new seven-storey mixed-use building comprising 30 residential units with ground floor commercial space. No TIA is available for this development.

*16, 20 Hamilton Avenue North*

The proposed development application includes a site plan for the construction of an eight-storey, 75-unit mixed-use building including 260 m<sup>2</sup> of office space and 120 m<sup>2</sup> of commercial space. The development was anticipated to be completed by 2020 and was anticipated to generate 23 new AM and PM peak hour two-way auto trips and to have minimal impact on the transportation network. The development is no expected to be occupied in early 2023. (Parsons, 2018)

*260 Armstrong Street*

The proposed development application includes a site plan for the construction of a three-storey 8-unit building and a rooftop amenity area for residents. No TIA is available for this development.

*91 & 93 Holland Avenue*

The proposed development application includes a site plan for the construction of a 6-storey apartment building with 32 dwelling units and ground floor retail. No TIA is available for this development.

*1560 Scott Street*

The proposed development application includes a site plan for the construction of a 25-storey mixed-use building. No TIA is available for this development.

### 3 Study Area and Time Periods

#### 3.1 Study Area

The study area will include the intersections of:

- Holland Avenue at:
  - Spencer Street
  - Wellington Street West
  - Tyndall Street
- Parkdale Avenue at:
  - Armstrong Street
  - Wellington Street West
  - Rear lane (future conditions)
  - Gladstone Avenue
  - Highway 417 Westbound On/Off-Ramp
- Carruthers Avenue at Wellington Street West
- Hamilton Avenue North at
  - Wellington Street West
  - Tyndall Street

The boundary roads will be Hamilton Avenue North, Parkdale Avenue, and Wellington Street West, and no screenlines are present within proximity to the site.

### 3.2 Time Periods

As the proposed development is composed primarily of residential units the AM and PM peak hours will be examined.

### 3.3 Horizon Years

The anticipated build-out year is 2025. As a result, the full build-out plus five years horizon year is 2030.

## 4 Exemption Review

Table 8 summarizes the exemptions for this TIA.

*Table 8: Exemption Review*

Module	Element	Explanation	Exempt/Required
<b>Design Review Component</b>			
<b>4.1 Development Design</b>	4.1.2 Circulation and Access	Only required for site plans	Required
	4.1.3 New Street Networks	Only required for plans of subdivision	Exempt
<b>4.2 Parking</b>	4.2.1 Parking Supply	Only required for site plans	Required
	4.2.2 Spillover Parking	Only required for site plans where parking supply is 15% below unconstrained demand	Exempt
<b>Network Impact Component</b>			
<b>4.5 Transportation Demand Management</b>	All Elements	Not required for site plans expected to have fewer than 60 employees and/or students on location at any given time	Required
<b>4.6 Neighbourhood Traffic Management</b>	4.6.1 Adjacent Neighbourhoods	Only required when the development relies on local or collector streets for access and total volumes exceed ATM capacity thresholds	Required
<b>4.8 Network Concept</b>		Only required when proposed development generates more than 200 person-trips during the peak hour in excess of equivalent volume permitted by established zoning	Exempt

## 5 Development-Generated Travel Demand

### 5.1 Mode Shares

Examining the mode shares recommended in the TRANS Trip Generation Manual (2020) for the subject district, derived from the most recent National Capital Region Origin-Destination survey (OD Survey). The recommended district mode shares by land use for Ottawa West, which will be applied to the subject development, have been summarized in Table 9.

Table 9: TRANS Trip Generation Manual Recommended Mode Shares – Ottawa West

Travel Mode	Multi-Unit (High-Rise)		Commercial Generator	
	AM	PM	AM	PM
Auto Driver	28%	33%	55%	50%
Auto Passenger	11%	11%	11%	16%
Transit	41%	26%	11%	11%
Cycling	3%	7%	0%	5%
Walking	16%	23%	23%	18%
<b>Total</b>	<b>100%</b>	<b>100%</b>	<b>100%</b>	<b>100%</b>

## 5.2 Trip Generation

This TIA has been prepared using the vehicle and person trip rates for the residential dwellings using the TRANS Trip Generation Manual (2020) and the vehicle trip rates and derived person trip rates for commercial component from the ITE Trip Generation Manual 10th Edition (2017) using the City-prescribed conversion factor of 1.28. Table 10 summarizes the person trip rates for the proposed residential land use for each peak period and the person trip rates for the non-residential land use by peak hour.

Table 10: Trip Generation Person Trip Rates by Peak Period

Land Use	Land Use Code	Peak Period	Vehicle Trip Rate	Person Trip Rates
Multi-Unit (High-Rise)	221 & 222 (TRANS)	AM	-	0.80
		PM	-	0.90
Land Use	Land Use Code	Peak Hour	Vehicle Trip Rate	Person Trip Rates
Strip Retail Plaza (<40k)	822 (ITE)	AM	2.36	3.02
		PM	6.59	8.44

Using the above person trip rates, the total person trip generation has been estimated. Table 11 summarizes the total person trip generation for the residential land use by peak period and for the non-residential land use by peak hour.

Table 11: Total Residential Person Trip Generation by Peak Period

Land Use	Units	AM Peak Period			PM Peak Period		
		In	Out	Total	In	Out	Total
Multi-Unit (High-Rise)	212	53	117	170	111	80	191
Land Use	GFA (sq. ft.)	AM Peak Hour			PM Peak Hour		
		In	Out	Total	In	Out	Total
Retail (<40k sq. ft.)	12,518	23	15	38	53	53	106

Internal capture rates from the ITE Trip Generation Handbook 3<sup>rd</sup> Edition have been assigned to the development’s retail component for mixed-use developments. The rates summarized in Table 12 represent the percentage of trips to/from the retail use based on the residential component.

Table 12: Internal Capture Rates

Land Use	AM		PM	
	In	Out	In	Out
Residential to/from Shopping Centre	17%	14%	10%	26%

Pass-by reductions applied to the retail trip generation at a rate of 35% have been included, a value taken as a moderately conservative interpretation from the rates presented in the ITE Trip Generation Handbook 3<sup>rd</sup> Edition.

Using the above mode share targets, the internal capture and pass-by rates, and the person trip rates, the person trips by mode have been projected. Trip generation by peak hour has been forecasted using the prescribed peak period conversion factors presented in the TRANS Trip Generation Manual (2020) for the residential component. Table 13 summarizes the residential and non-residential trip generation by mode and peak hour.

Table 13: Trip Generation by Mode

Travel Mode		AM Peak Hour				PM Peak Hour			
		Mode Share	In	Out	Total	Mode Share	In	Out	Total
Multi-Unit (High-Rise)	Auto Driver	28%	7	16	23	33%	16	11	28
	Auto Passenger	11%	3	6	9	11%	5	4	9
	Transit	41%	12	26	39	26%	14	10	24
	Cycling	3%	1	2	3	7%	4	3	6
	Walking	16%	5	11	16	23%	14	9	23
	<b>Total</b>	<b>100%</b>	<b>28</b>	<b>61</b>	<b>90</b>	<b>100%</b>	<b>53</b>	<b>37</b>	<b>90</b>
Retail (<40k sq. ft.)	Auto Driver	55%	6	5	12	50%	6	1	7
	Auto Passenger	11%	2	2	4	16%	8	6	14
	Transit	11%	2	2	4	11%	5	4	10
	Cycling	0%	0	0	0	5%	2	2	4
	Walking	23%	4	3	8	18%	9	7	16
	Pass-by	35%	-4	-3	-6	35%	-19	-19	-38
	Internal Capture	varies	-4	-2	-6	varies	-5	-14	-19
<b>Total</b>	<b>100%</b>	<b>14</b>	<b>12</b>	<b>28</b>	<b>100%</b>	<b>30</b>	<b>20</b>	<b>51</b>	
Total	Auto Driver	-	13	21	35	-	22	12	35
	Auto Passenger	-	5	8	13	-	13	10	23
	Transit	-	14	28	43	-	19	14	34
	Cycling	-	1	2	3	-	6	5	10
	Walking	-	9	14	24	-	23	16	39
	<b>Total</b>	-	<b>42</b>	<b>73</b>	<b>118</b>	-	<b>83</b>	<b>57</b>	<b>141</b>

As shown above, a total of 35 new AM and 35 new PM peak hour two-way vehicle trips are projected as a result of the proposed development.

### 5.3 Trip Distribution

To understand the travel for the subject development, the OD Survey has been reviewed to determine the travel patterns for the residential component, which were then applied to the development based on the build-out of Ottawa West. Table 14 below summarizes the distributions.

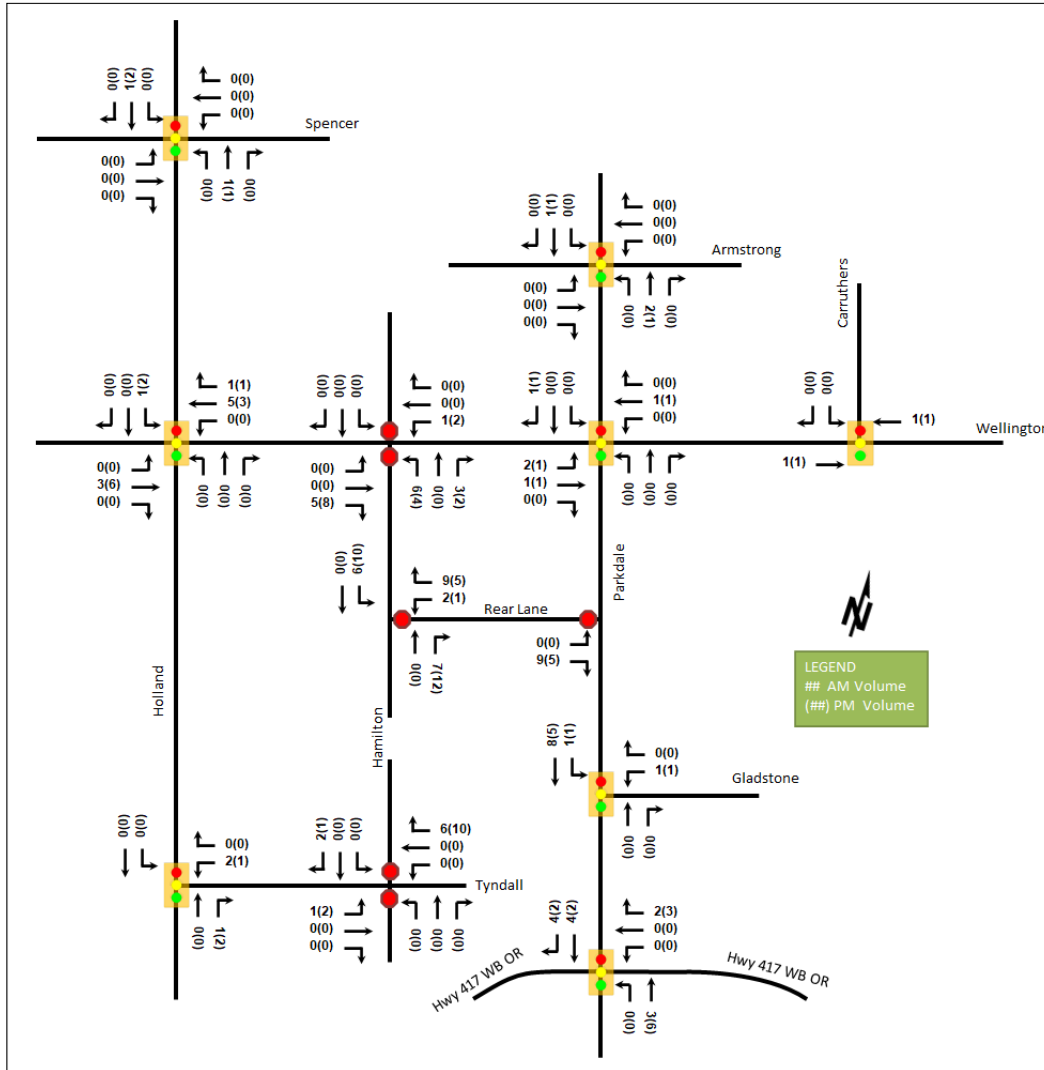
Table 14: OD Survey Distribution – Ottawa West

To/From	Residential % of Trips	Via
North	10%	5% Parkdale Ave, 5% Wellington St W (W)
South	30%	10% Holland Ave, 5% Parkdale, 15% Hwy 417
East	30%	5% Wellington St W, 5% Gladstone Ave, 5% Holland Ave (N), 15% Hwy 417
West	30%	20% Wellington St W, 5% Holland Ave (N), 5% Hwy 417
<b>Total</b>	<b>100%</b>	

### 5.4 Trip Assignment

Using the distribution outlined above, turning movement splits, and access to major transportation infrastructure, the trips generated by the site have been assigned to the study area road network. Figure 11 illustrates the new site generated volumes. Pass-by trips are assumed to be accommodated by on-street parking, and therefore no resultant re-assignment of traffic is expected.

Figure 11: New Site Generation Volumes



## 6 Background Network Travel Demands

### 6.1 Transportation Network Plans

The transportation network plans were discussed in Section 2.3. No presently scheduled improvements within the study area are anticipated to impact traffic volumes and travel patterns.

### 6.2 Background Growth

A review of the background projections from the City’s TRANS Regional Model for the 2011 and 2031 horizons was completed to determine the background growth for each of the study area roadways. The background TRANS model growth rates are summarized in Table 15 and the TRANS model plots are provided in Appendix E.

Table 15: TRANS Regional Model Projections – Study Area Growth Rates

Street	2011 to 2031	
	Eastbound	Westbound
Wellington St W	3.30%	2.52%
Gladstone Ave	-0.49%	-1.48%
Tyndall St	-0.82%	-0.67%
Hwy 417 Off-Ramp	1.51%	-1.30%
Hwy 417 On-Ramp	2.04%	1.14%
	Northbound	Southbound
Holland Ave	-0.26%	1.06%
Parkdale Ave	0.29%	1.12%

A review of the 2011 and 2031 TRANS model horizons reveals the highest area growth forecasted in both directions along Wellington Street West, modest growth in the southbound direction within the study area, and minor growth forecasted on Parkdale Avenue in the northbound direction in the AM peak hour.

Growth rates rounded to the nearest 0.25% will be applied to the mainline volumes of the appropriate links and the turning movements at the intersection of Parkdale Avenue at the Highway 417 WB ramps in the AM peak hour and reversed during the PM peak hour. Negative growth rates will be taken as zero.

In the case of the highway ramps, the PM rates have been estimated from the AM rates for the opposite ramp at the eastbound interchange. For example, the PM westbound off-ramp growth rates were estimated from the forecasted AM eastbound on-ramp growth. Table 16 summarizes the growth rates applied with for the background road network.

Table 16: Recommended Area Growth Rates

Street	AM Peak Hour		PM Peak Hour	
	Eastbound	Westbound	Eastbound	Westbound
Wellington St W	3.25%	2.50%	2.50%	3.25%
Gladstone Ave	-	-	-	-
Tyndall St	-	-	-	-
Hwy 417 Off-Ramp	1.50%	-	-	1.50%
Hwy 417 On-Ramp	2.00%	1.25%	1.25%	2.00%
	Northbound	Southbound	Northbound	Southbound
Holland Ave	-	1.00%	1.00%	-
Parkdale Ave	0.25%	1.00%	1.00%	0.25%

### 6.3 Other Developments

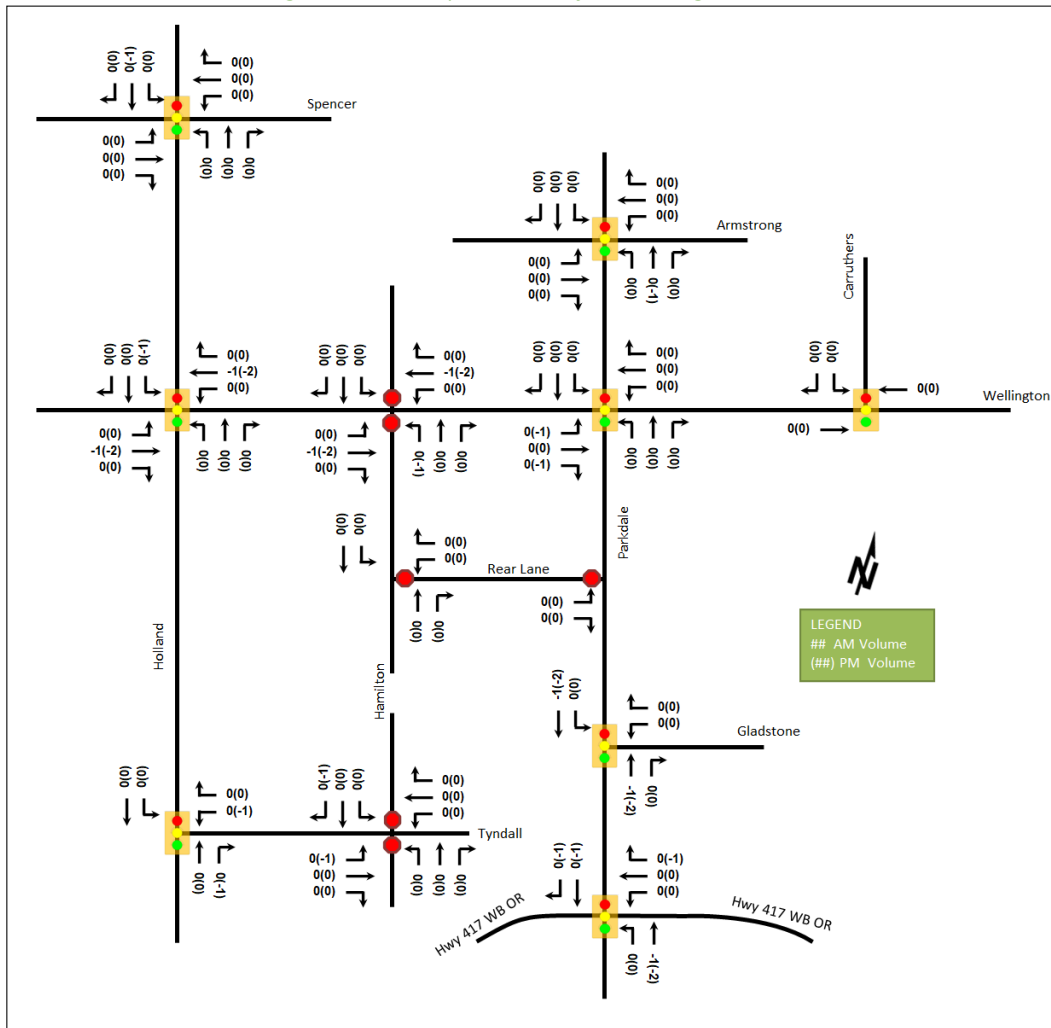
As background developments either do not include traffic studies or are not appreciable traffic generators, all study area growth is assumed to be captured by the background growth rates applied.

### 6.4 Trip Reductions

Based upon the existing pharmacy land use on the site, a reduction in vehicle volumes for the study area network will be accounted for in the redevelopment scenarios of the future total conditions. The Pharmacy/Drugstore without Drive-Through land use (land use code 880) from the ITE Trip Generation Manual 10th Edition (2017) was used to arrive at vehicle trip rates, which were converted to person trips using the City-prescribed conversion factor of 1.28. The recommended district mode shares presented in Section 5.1 were applied to the person trips and the trip distribution presented in Section 5.3 was used to assign the trips to the network. Figure 12 illustrates the trip reductions from the existing land use for application to the future total horizons.



Figure 12: Auto Trip Reductions from Existing Land Use



## 7 Demand Rationalization

### 7.1 2025 Future Background Operations

Figure 13 illustrates the 2025 background volumes and Table 17 summarizes the 2025 background intersection operations. The level of service for signalized intersections is based on v/c calculations for individual lane movements and HCM 2000 v/c calculations for the overall intersection, and average delay for unsignalized intersections. The synchro worksheets for the 2025 future background horizon are provided in Appendix F.

Figure 13: 2025 Future Background Volumes

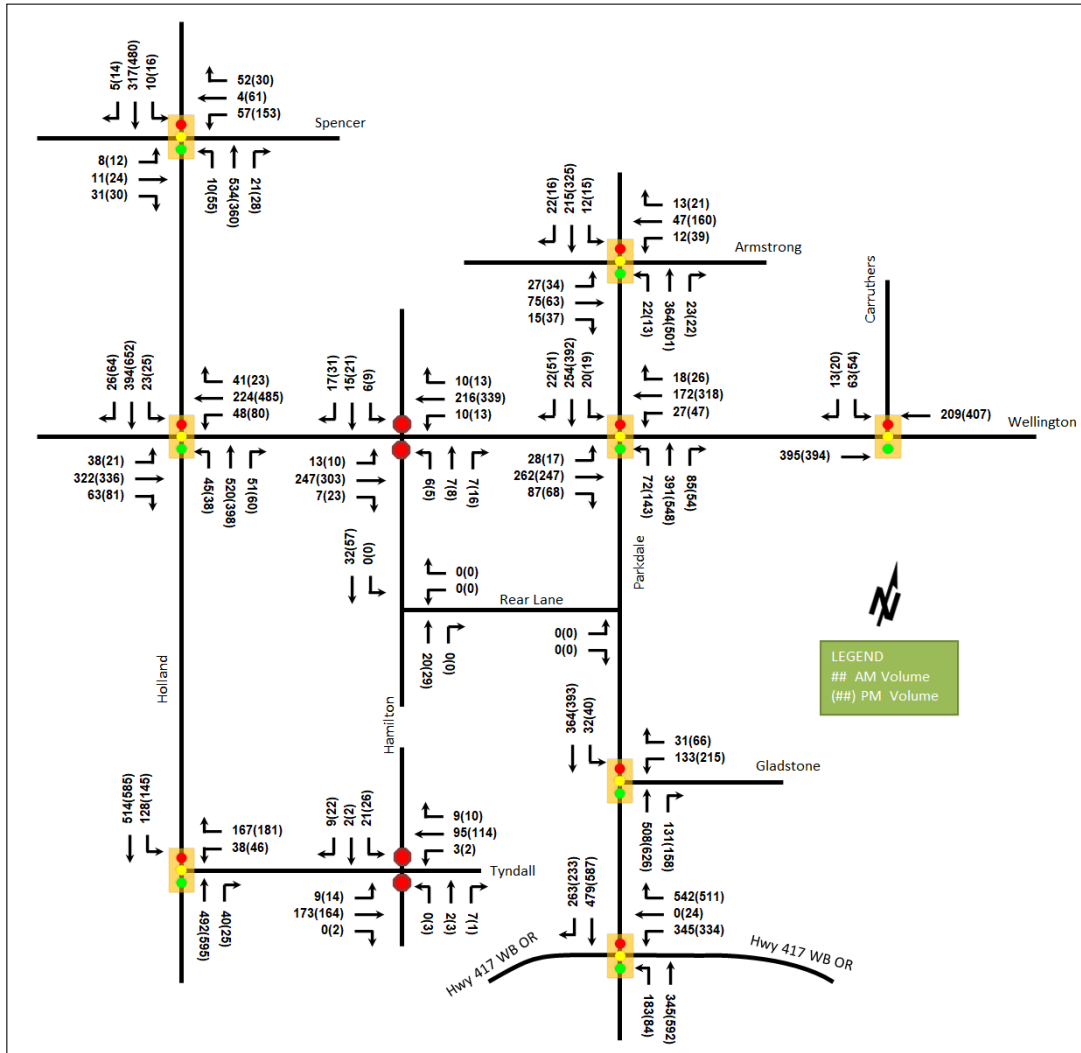


Table 17: 2025 Future Background Intersection Operations

Intersection	Lane	AM Peak Hour				PM Peak Hour			
		LOS	V/C	Delay(s)	Q (95 <sup>th</sup> )	LOS	V/C	Delay(s)	Q (95 <sup>th</sup> )
Holland Avenue & Spencer Street <i>Signalized</i>	EB	A	0.22	21.0	13.0	A	0.19	19.7	15.7
	WB	A	0.55	36.4	29.3	D	0.82	57.8	#74.0
	NB	A	0.24	0.8	4.0	A	0.24	1.0	2.4
	SB	A	0.14	3.8	13.5	A	0.25	7.2	28.0
	<b>Overall</b>	<b>A</b>	<b>0.27</b>	<b>6.5</b>	-	<b>A</b>	<b>0.39</b>	<b>15.4</b>	-
Holland Avenue & Wellington Street <i>W Signalized</i>	EB	A	0.39	23.0	42.8	A	0.40	23.3	44.7
	WB	A	0.31	30.6	38.2	A	0.58	20.5	m44.6
	NB	A	0.55	25.3	64.2	A	0.47	19.9	47.2
	SB	A	0.38	19.7	37.0	B	0.63	22.5	66.4
	<b>Overall</b>	<b>A</b>	<b>0.43</b>	<b>24.3</b>	-	<b>A</b>	<b>0.56</b>	<b>21.6</b>	-

Intersection	Lane	AM Peak Hour				PM Peak Hour			
		LOS	V/C	Delay(s)	Q (95 <sup>th</sup> )	LOS	V/C	Delay(s)	Q (95 <sup>th</sup> )
<b>Holland Avenue &amp; Tyndall Street</b> <i>Signalized</i>	WB	B	0.68	38.3	44.4	C	0.75	51.8	60.9
	NBT/R	A	0.54	13.5	78.7	A	0.57	14.3	114.8
	SBL	A	0.35	13.6	23.4	A	0.40	8.0	m12.1
	SBT	A	0.52	13.2	74.9	A	0.53	7.4	39.9
	<b>Overall</b>	<b>A</b>	<b>0.55</b>	<b>17.1</b>	-	<b>A</b>	<b>0.59</b>	<b>16.6</b>	-
<b>Parkdale Avenue &amp; Armstrong Street</b> <i>Signalized</i>	EB	A	0.35	34.7	34.3	A	0.30	25.5	32.5
	WB	A	0.21	29.8	21.7	A	0.47	32.2	55.7
	NB	A	0.36	2.5	7.3	A	0.52	5.5	m9.3
	SB	A	0.22	6.4	25.0	A	0.35	11.4	49.3
	<b>Overall</b>	<b>A</b>	<b>0.35</b>	<b>10.4</b>	-	<b>A</b>	<b>0.50</b>	<b>14.0</b>	-
<b>Parkdale Avenue &amp; Wellington Street W</b> <i>Signalized</i>	EB	A	0.47	21.1	25.7	A	0.58	60.8	49.3
	WBL	A	0.13	27.9	10.6	A	0.33	39.5	18.7
	WBT/R	A	0.38	30.7	48.3	D	0.88	61.7	#112.9
	NBL	A	0.16	3.7	m3.2	A	0.36	11.0	m17.1
	NBT/R	A	0.58	11.6	84.2	B	0.64	17.1	82.3
	SBL	A	0.07	18.9	m6.3	A	0.07	15.3	m4.9
	SBT/R	A	0.44	22.3	45.1	B	0.65	22.8	61.0
	<b>Overall</b>	<b>A</b>	<b>0.54</b>	<b>18.8</b>	-	<b>C</b>	<b>0.72</b>	<b>33.7</b>	-
<b>Parkdale Avenue &amp; Gladstone Avenue</b> <i>Signalized</i>	WBL/R	A	0.41	34.9	45.3	C	0.73	46.8	#84.4
	NBT/R	B	0.61	12.0	75.1	C	0.75	15.5	m105.8
	SBL	A	0.09	12.4	m7.0	A	0.16	5.9	m3.2
	SBT	A	0.33	13.5	64.7	A	0.36	5.8	25.5
	<b>Overall</b>	<b>A</b>	<b>0.55</b>	<b>15.6</b>	-	<b>C</b>	<b>0.74</b>	<b>18.6</b>	-
<b>Parkdale Avenue &amp; Highway 417 WB OR</b> <i>Signalized</i>	WBL	E	0.92	68.4	#113.6	D	0.90	65.0	#108.8
	WBT/R	C	0.76	12.3	43.5	E	0.95	44.5	#113.5
	NBL	A	0.54	21.0	20.5	A	0.29	11.9	10.3
	NBT	A	0.30	8.5	40.5	A	0.52	11.1	81.2
	SBT/R	D	0.85	34.6	#195.0	D	0.86	30.1	#222.3
	<b>Overall</b>	<b>D</b>	<b>0.84</b>	<b>29.0</b>	-	<b>D</b>	<b>0.87</b>	<b>32.9</b>	-
<b>Carruthers Avenue &amp; Wellington Street W</b> <i>Signalized</i>	EBT	A	0.39	9.9	44.0	A	0.30	4.6	29.2
	WBT	A	0.21	8.1	22.3	A	0.31	4.7	30.3
	SBL	A	0.14	21.7	15.4	A	0.22	30.1	16.1
	SBR	A	0.03	11.0	3.8	A	0.10	13.6	5.5
	<b>Overall</b>	<b>A</b>	<b>0.31</b>	<b>10.4</b>	-	<b>A</b>	<b>0.31</b>	<b>6.5</b>	-
<b>Hamilton Avenue N &amp; Wellington Street W</b> <i>Unsignalized</i>	EB	A	0.01	7.7	0.0	A	0.01	8.0	0.0
	WB	A	0.01	7.8	0.0	A	0.01	7.9	0.0
	NB	B	0.04	12.2	0.8	B	0.06	13.1	1.5
	SB	B	0.07	11.9	1.5	B	0.13	14.0	3.8
	<b>Overall</b>	<b>A</b>	-	<b>1.6</b>	-	<b>A</b>	-	<b>1.8</b>	-
<b>Hamilton Avenue N &amp; Tyndall Street</b> <i>Unsignalized</i>	EB	A	0.01	7.4	0.0	A	0.01	7.5	0.0
	WB	A	0.00	7.6	0.0	A	0.00	7.6	0.0
	NB	A	0.01	9.6	0.0	B	0.01	10.8	0.0
	SB	B	0.05	10.4	0.8	B	0.07	10.3	1.5
	<b>Overall</b>	<b>A</b>	-	<b>1.6</b>	-	<b>A</b>	-	<b>2.0</b>	-

Notes: Saturation flow rate of 1800 veh/h/lane  
Queue is measured in metres  
Peak Hour Factor = 1.00

m = metered queue  
# = volume for the 95th %ile cycle exceeds capacity

During both the AM and PM peak hours, the study area intersections at the 2025 future background horizon operate similarly to the existing conditions. No new capacity issues are noted, and minor operational improvements are noted with the peak hour factor of 1.00 for forecasted conditions.

### 7.2 2030 Future Background Operations

Figure 14 illustrates the 2030 background volumes and Table 18 summarizes the 2030 background intersection operations. The level of service for signalized intersections is based on v/c calculations for individual lane movements and HCM 2000 v/c calculations for the overall intersection, and average delay for unsignalized intersections. The synchro worksheets for the 2030 future background horizon are provided in Appendix G.

Figure 14: 2030 Future Background Volumes

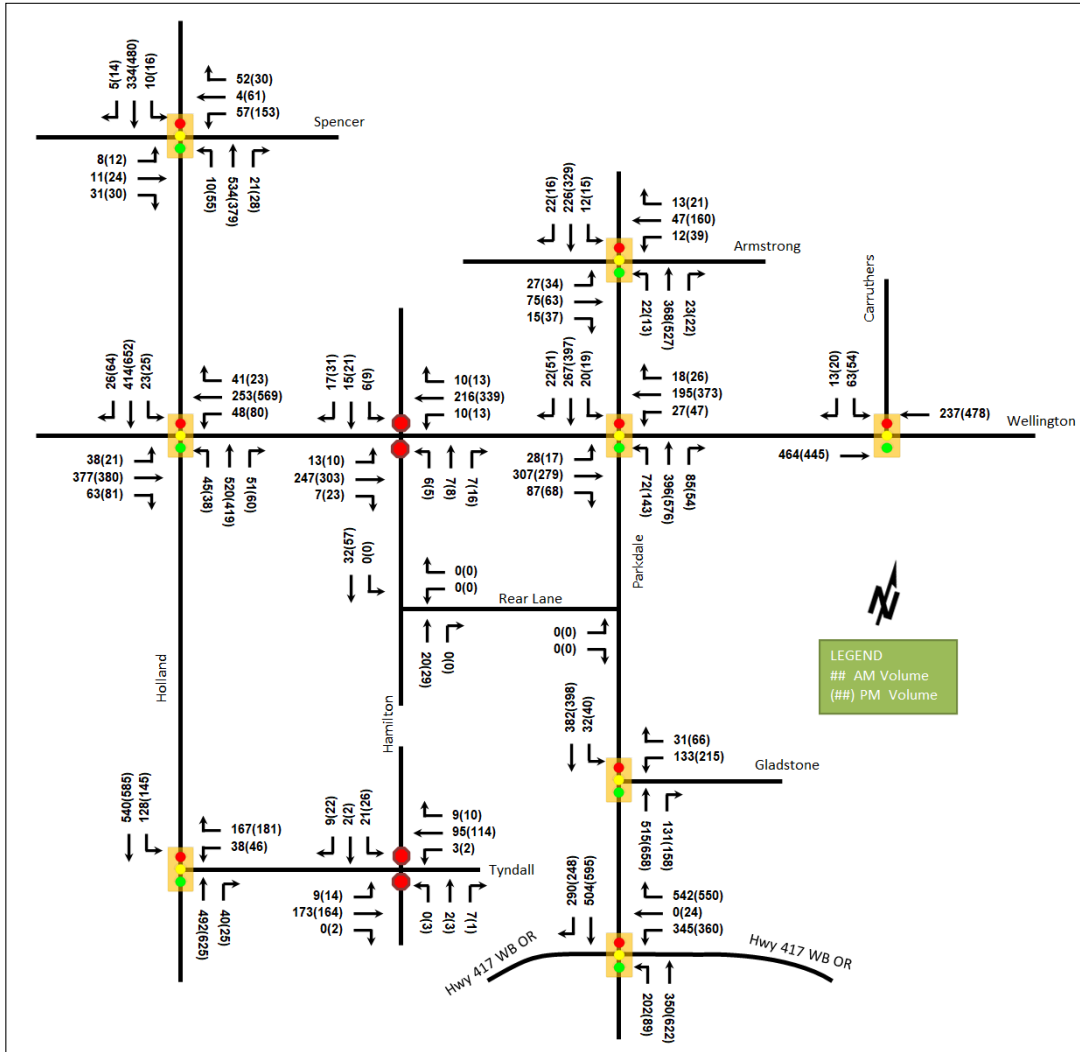


Table 18: 2030 Future Background Intersection Operations

Intersection	Lane	AM Peak Hour				PM Peak Hour			
		LOS	V/C	Delay(s)	Q (95 <sup>th</sup> )	LOS	V/C	Delay(s)	Q (95 <sup>th</sup> )
Holland Avenue & Spencer Street <i>Signalized</i>	EB	A	0.22	21.0	13.0	A	0.19	19.7	15.7
	WB	A	0.55	36.4	29.3	D	0.82	57.8	#74.0
	NB	A	0.24	0.9	4.5	A	0.25	1.1	2.6
	SB	A	0.15	3.8	14.3	A	0.25	7.2	28.0
	<b>Overall</b>	<b>A</b>	<b>0.27</b>	<b>6.5</b>	-	<b>A</b>	<b>0.39</b>	<b>15.3</b>	-
Holland Avenue & Wellington Street W <i>Signalized</i>	EB	A	0.43	23.7	48.7	A	0.44	23.8	49.3
	WB	A	0.33	31.6	41.5	B	0.66	22.7	m49.4
	NB	A	0.55	25.4	64.2	A	0.49	20.6	49.7
	SB	A	0.39	19.9	38.8	B	0.63	22.5	66.4
	<b>Overall</b>	<b>A</b>	<b>0.45</b>	<b>24.7</b>	-	<b>A</b>	<b>0.60</b>	<b>22.4</b>	-
Holland Avenue & Tyndall Street <i>Signalized</i>	WB	B	0.68	38.3	44.4	C	0.75	51.8	60.9
	NBT/R	A	0.54	13.5	78.7	A	0.59	14.9	123.8
	SBL	A	0.35	13.6	23.4	A	0.41	8.5	m12.2
	SBT	A	0.54	13.7	80.4	A	0.53	7.3	40.0
	<b>Overall</b>	<b>A</b>	<b>0.55</b>	<b>17.2</b>	-	<b>B</b>	<b>0.61</b>	<b>16.8</b>	-
Parkdale Avenue & Armstrong Street <i>Signalized</i>	EB	A	0.35	34.7	34.3	A	0.30	25.5	32.5
	WB	A	0.21	29.8	21.7	A	0.47	32.2	55.7
	NB	A	0.36	2.6	7.6	A	0.55	5.5	m8.8
	SB	A	0.23	6.5	26.1	A	0.36	11.4	49.8
	<b>Overall</b>	<b>A</b>	<b>0.36</b>	<b>10.4</b>	-	<b>A</b>	<b>0.52</b>	<b>13.9</b>	-
Parkdale Avenue & Wellington Street W <i>Signalized</i>	EB	A	0.52	22.4	29.6	B	0.69	63.6	53.2
	WBL	A	0.14	28.3	10.7	A	0.35	40.4	18.9
	WBT/R	A	0.43	31.6	53.9	<b>F</b>	<b>1.02</b>	<b>88.7</b>	<b>#137.5</b>
	NBL	A	0.17	3.6	m3.1	A	0.37	11.4	m17.1
	NBT/R	A	0.59	11.6	85.0	B	0.67	18.2	87.7
	SBL	A	0.07	18.9	m6.3	A	0.07	15.4	m4.8
	SBT/R	A	0.45	22.5	46.5	B	0.66	23.0	61.4
	<b>Overall</b>	<b>A</b>	<b>0.56</b>	<b>19.5</b>	-	<b>C</b>	<b>0.78</b>	<b>41.0</b>	-
Parkdale Avenue & Gladstone Avenue <i>Signalized</i>	WBL/R	A	0.41	34.9	45.3	C	0.73	46.8	#84.4
	NBT/R	B	0.61	12.1	76.1	C	0.78	16.0	m106.0
	SBL	A	0.09	12.8	m6.8	A	0.17	5.9	m3.0
	SBT	A	0.35	14.2	68.8	A	0.36	5.6	25.5
	<b>Overall</b>	<b>A</b>	<b>0.55</b>	<b>15.8</b>	-	<b>C</b>	<b>0.76</b>	<b>18.7</b>	-
Parkdale Avenue & Highway 417 WB OR <i>Signalized</i>	WBL	E	0.92	68.4	#113.6	E	0.93	69.1	#120.5
	WBT/R	C	0.76	12.7	45.0	<b>F</b>	<b>1.02</b>	<b>65.0</b>	<b>#136.8</b>
	NBL	B	0.66	30.9	#25.0	A	0.34	14.4	10.9
	NBT	A	0.31	8.5	41.2	A	0.55	12.0	87.5
	SBT/R	E	0.91	40.5	#218.4	D	0.90	34.3	#231.9
	<b>Overall</b>	<b>D</b>	<b>0.89</b>	<b>32.2</b>	-	<b>E</b>	<b>0.94</b>	<b>40.1</b>	-
Carruthers Avenue & Wellington Street W <i>Signalized</i>	EBT	A	0.46	10.7	53.8	A	0.33	4.9	33.9
	WBT	A	0.23	8.3	25.2	A	0.36	5.1	37.2
	SBL	A	0.14	21.7	15.4	A	0.22	30.1	16.1
	SBR	A	0.03	11.0	3.8	A	0.10	13.6	5.5
	<b>Overall</b>	<b>A</b>	<b>0.36</b>	<b>10.9</b>	-	<b>A</b>	<b>0.36</b>	<b>6.5</b>	-

Intersection	Lane	AM Peak Hour				PM Peak Hour			
		LOS	V/C	Delay(s)	Q (95 <sup>th</sup> )	LOS	V/C	Delay(s)	Q (95 <sup>th</sup> )
Hamilton Avenue N & Wellington Street W <i>Unsignalized</i>	EB	A	0.01	7.7	0.0	A	0.01	8.0	0.0
	WB	A	0.01	7.8	0.0	A	0.01	7.9	0.0
	NB	B	0.04	12.2	0.8	B	0.06	13.1	1.5
	SB	B	0.07	11.9	1.5	B	0.13	14.0	3.8
	<b>Overall</b>	<b>A</b>	-	<b>1.6</b>	-	<b>A</b>	-	<b>1.8</b>	-
Hamilton Avenue N & Tyndall Street <i>Unsignalized</i>	EB	A	0.01	7.4	0.0	A	0.01	7.5	0.0
	WB	A	0.00	7.6	0.0	A	0.00	7.6	0.0
	NB	A	0.01	9.6	0.0	B	0.01	10.8	0.0
	SB	B	0.05	10.4	0.8	B	0.07	10.3	1.5
	<b>Overall</b>	<b>A</b>	-	<b>1.6</b>	-	<b>A</b>	-	<b>2.0</b>	-

Notes: Saturation flow rate of 1800 veh/h/lane  
Queue is measured in metres  
Peak Hour Factor = 1.00

m = metered queue  
# = volume for the 95th %ile cycle exceeds capacity

During both the AM and PM peak hours, the study area intersections at the 2030 future background horizon operate similarly to the existing and the 2025 future background conditions.

At the intersection of Parkdale Avenue at Wellington Street West, the westbound shared through/right-turn movement is forecast to be over theoretical capacity during the PM peak hour. To mitigate the capacity issues noted during the PM peak hour, an additional one second of split could be shifted from the north-south phases to the east-west phase at the intersection of Parkdale Avenue at Wellington Street West.

At the intersection of Parkdale Avenue and the Highway 417 westbound ramps, the northbound left movement may exhibit extended queues during the AM peak hour and the westbound through/right movement is forecasted to be over theoretical capacity during the PM peak hour. To mitigate the capacity issues noted during the PM peak hour, an additional two seconds of split could be shifted from the north-south phases to the east-west phase at the intersection of Parkdale Avenue and the Highway 417 westbound ramps.

### 7.3 Modal Share Sensitivity

Minor capacity issues have been noted at the intersections of Parkdale Avenue at Wellington Street West and Parkdale Avenue at the Highway 417 westbound ramps and can be mitigated through signal optimization. As such, no demand rationalization is necessary for the background conditions. Given the site trip generation assumes the typical district mode shares, and is within 800 metres walking distance of LRT, rationalization for adjusted demand is not required for the subject development.

## 8 Development Design

### 8.1 Design for Sustainable Modes

The proposed development is mixed-use development consisting of residential units above a ground floor retail component. Principal retail entrances will front Wellington Street West and the principal residential entrance will front Parkdale Avenue. Hard surface connections will be provided from all building entrances to the surround pedestrian network, and the rear lane will support all modes.

Vehicle parking is proposed across three underground parking levels. Bicycle parking for building residents is proposed as being located in secure rooms on the main floor and each underground parking level, with cycle-friendly 5% slopes on each of the ramps between levels. Bicycle parking for the retail component will be in an open rack on the first parking level and additional racks on the surface.

The proponent is seeking an exemption to the zoning by-law's stipulation that a minimum of 50% of bicycle parking must be via horizontal stalls at ground level.

Bus stops for the routes listed in Section 2.2.5 are within 400 metres' walking distance of the site entrances. The bus stop on the site frontage along Wellington Street West (stop #2302) is proposed to be integrated with the privately owned public space (POPS) area and the covered canopy and will include seating. The bus stop on the site frontage along Parkdale Avenue (stop #0882) will be proposed to be upgraded with a shelter pad and permanent pole at the property line and within the public right of way.

## 8.2 Circulation and Access

The proposed development will access the road network via the existing rear lane with a two-way connection to Hamilton Avenue North and outbound only movement to Parkdale Avenue. The laneway will be improved to serve as a multi-modal connection, upgrade the connection to the adjacent church parking lot and will continue to serve the needs of that land use through an improved interface.

Loading and garbage staging interface with the lane through a recessed section of the building, and the garbage collection movement is to be made by entering the lane from Hamilton Avenue North and exiting to Parkdale Avenue. Turning templates are included in Appendix H.

Emergency services are anticipated to be able to access the site via the three public road frontages.

# 9 Parking

## 9.1 Parking Supply

The site proposes bicycle parking ratio of 1:1 spaces per unit for 212 resident bicycle spaces and five retail bicycle spaces with eight additional bicycle parking spaces along Wellington Avenue, four along bike rack along Parkdale Avenue, and four along the rear lane. Eighteen bicycle parking spaces will be located on the ground level and 194 bicycle parking spaces will be located across three underground levels.

Vehicle parking is proposed at a ratio of 0.6 spaces per unit after the first twelve for 120 residential spaces and a ratio of 0.1 spaces per unit after the first twelve for 20 visitor parking spaces, with all vehicle parking located underground across three parking levels.

The minimum bicycle parking provision from the zoning by-law is five spaces for the commercial component and 106 spaces for tenants, which are being met by the development. The minimum vehicle parking provision from the zoning by-law is 90 spaces for tenants, as all spaces are located underground, 20 spaces for visitors, and 15 spaces for the retail component. The residential and visitor parking will meet the zoning by-law minimum requirements, and the retail component will be below the by-law minimum.

On-street parking is permitted on Parkdale, Wellington Street West, Holland Avenue, and Hamilton Avenue North. The Wellington West Local Area Parking Study estimates that midday and Saturday afternoon parking occupancy is 74% on Wellington Street West to the west of Parkdale Avenue. Both sides of Wellington Street west between Hinton Avenue and Armstrong Avenue were found to generally have a parking occupancy over 85% in less than 25% of the periods surveyed. Therefore, minimal parking impacts are anticipated from not designating retail spaces.

## 10 Boundary Street Design

Table 19 summarizes the MMLOS analysis for the boundary streets of Hamilton Avenue North, Parkdale Avenue, and Wellington Street West. The existing and future conditions are considered in separate rows. The boundary street analysis is based on the policy area of “Within 600m of a rapid transit station” and “Within 300m of a school”. The MMLOS worksheets has been provided in Appendix I.

Table 19: Boundary Street MMLOS Analysis

Segment		Pedestrian LOS		Bicycle LOS		Transit LOS		Truck LOS	
		PLOS	Target	BLOS	Target	TLOS	Target	TrLOS	Target
Hamilton Avenue N	Ex.	D	A	D	D	-	-	-	-
	Fut.	A	A	D	D	-	-	-	-
Parkdale Avenue	Ex.	F	A	E	D	-	-	-	-
	Fut.	C	A	E	D	-	-	-	-
Wellington Street West	Ex.	C	A	E	C	D	D	D	D
	Fut.	A	A	E	C	D	D	D	D

The pedestrian LOS targets are not met on all boundary streets and the bicycle LOS targets are not met on Parkdale Avenue and Wellington Street West in the existing conditions. In the future conditions, the pedestrian LOS targets will be met on Hamilton Avenue North and Wellington Street West.

While the development is proposing continuous hardscaping with trees along the Parkdale Avenue, the adjacent vehicle volumes are too high to meet pedestrian LOS targets.

Operating speeds limit the bicycle LOS on Parkdale Avenue and Wellington Street West, and each would require curbside bike lanes to meet targets. Along the site frontage of Wellington Street West, sharrows are present and a dooring zone designated through pavement markings which is not captured within the MMLOS analysis framework. No localized improvements are proposed on the boundary streets to address bicycle LOS, and future corridor needs should be assessed and addressed by the City.

## 11 Access Intersections Design

### 11.1 Location and Design of Access

The proposed development will access the study area road network via the existing rear lane connecting to Parkdale Avenue and Hamilton Avenue North. The lane is proposed as being restricted to outbound only on Parkdale Avenue and maintain two-way function west of the parking garage to Hamilton Avenue North. The access width at Hamilton Avenue North is 6.0 metres, and the access width at Parkdale Avenue is 4.25 metres.

At the access intersection on Parkdale Avenue, a No Left Turn sign (Rb-12 (OTM)) will be located on the eastbound approach, and One Way (Rb-21 (OTM)) and Do Not Enter signs (Rb-19 (OTM)) are proposed to be installed at an appropriate, visible location from Parkdale Avenue.

### 11.2 Intersection Control

The site accesses are proposed to remain stop-controlled on the minor approaches.

### 11.3 Access Intersection Design

#### 11.3.1 2025 Future Total Access Intersection Operations

The 2025 future total intersection volumes are illustrated in Figure 15 and the access intersection operations are summarized below in Table 20. The level of service is based average delay for individual lane movements and the overall intersection for unsignalized intersections. The synchro worksheets have been provided in Appendix J.



Figure 15: 2025 Future Total Volumes

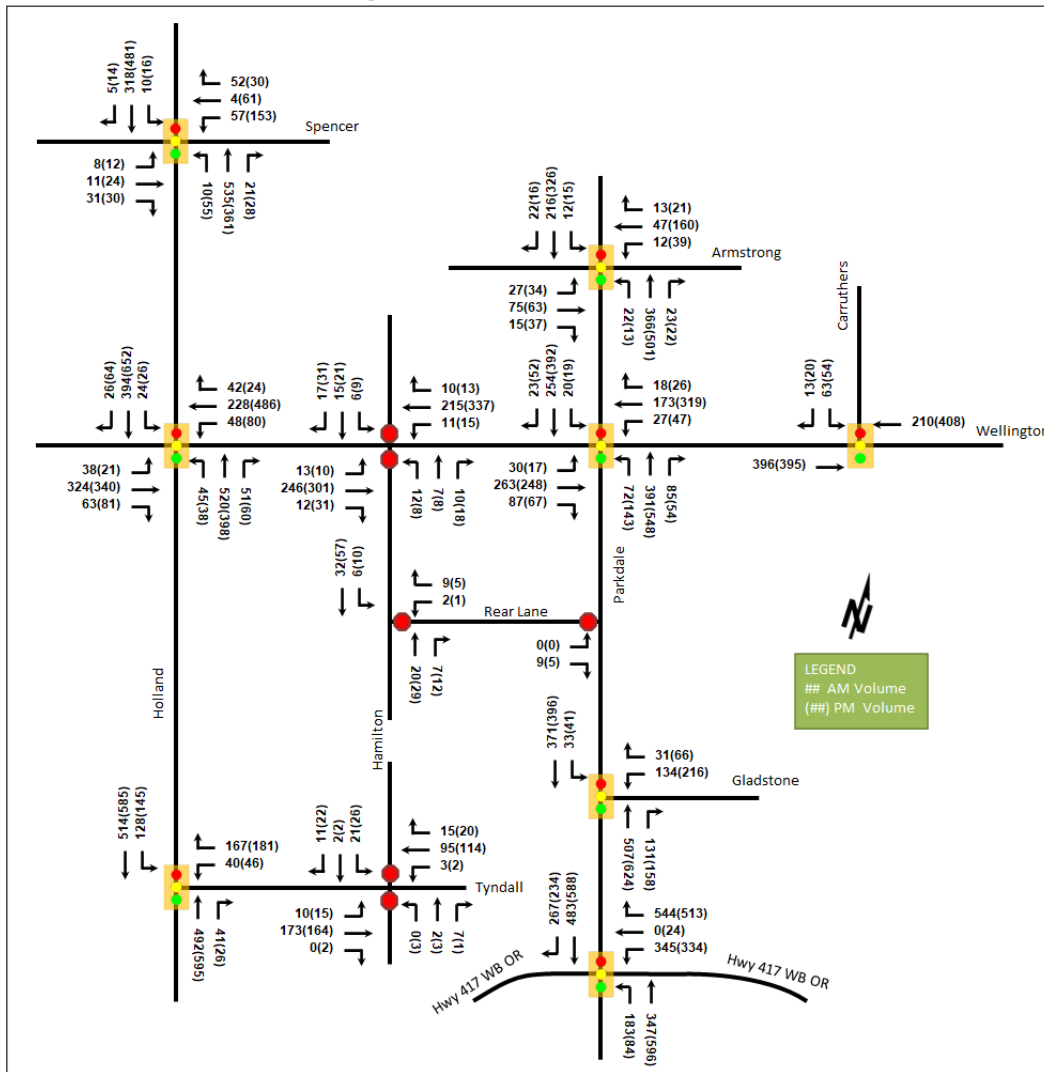


Table 20: 2025 Future Total Access Intersection Operations

Intersection	Lane	AM Peak Hour				PM Peak Hour			
		LOS	V/C	Delay(s)	Q (95 <sup>th</sup> )	LOS	V/C	Delay(s)	Q (95 <sup>th</sup> )
Hamilton Avenue N & Rear Lane <i>Unsignalized</i>	WB	A	0.01	8.6	0.0	A	0.00	8.6	0.0
	NB	-	-	-	-	-	-	-	-
	SB	A	0.00	7.3	0.0	A	0.01	7.3	0.0
	<b>Overall</b>	<b>A</b>	-	<b>1.8</b>	-	<b>A</b>	-	<b>1.0</b>	-
Parkdale Avenue & Rear Lane <i>Unsignalized</i>	EB	B	0.01	10.7	0.0	B	0.01	11.8	0.0
	NB	-	-	-	-	-	-	-	-
	SB	-	-	-	-	-	-	-	-
	<b>Overall</b>	<b>A</b>	-	<b>0.1</b>	-	<b>A</b>	-	<b>0.0</b>	-

Notes: Saturation flow rate of 1800 veh/h/lane  
Queue is measured in metres  
Peak Hour Factor = 1.00

m = metered queue  
# = volume for the 95th %ile cycle exceeds capacity

The 2025 future total access intersections operate well. No capacity issues are noted.

11.3.2 2030 Future Total Access Intersection Operations

The 2030 future total intersection volumes are illustrated in Figure 16 and the access intersection operations are summarized below in Table 21. The level of service is based average delay for individual lane movements and the overall intersection for unsignalized intersections. The synchro worksheets have been provided in Appendix K.

Figure 16: 2030 Future Total Volumes

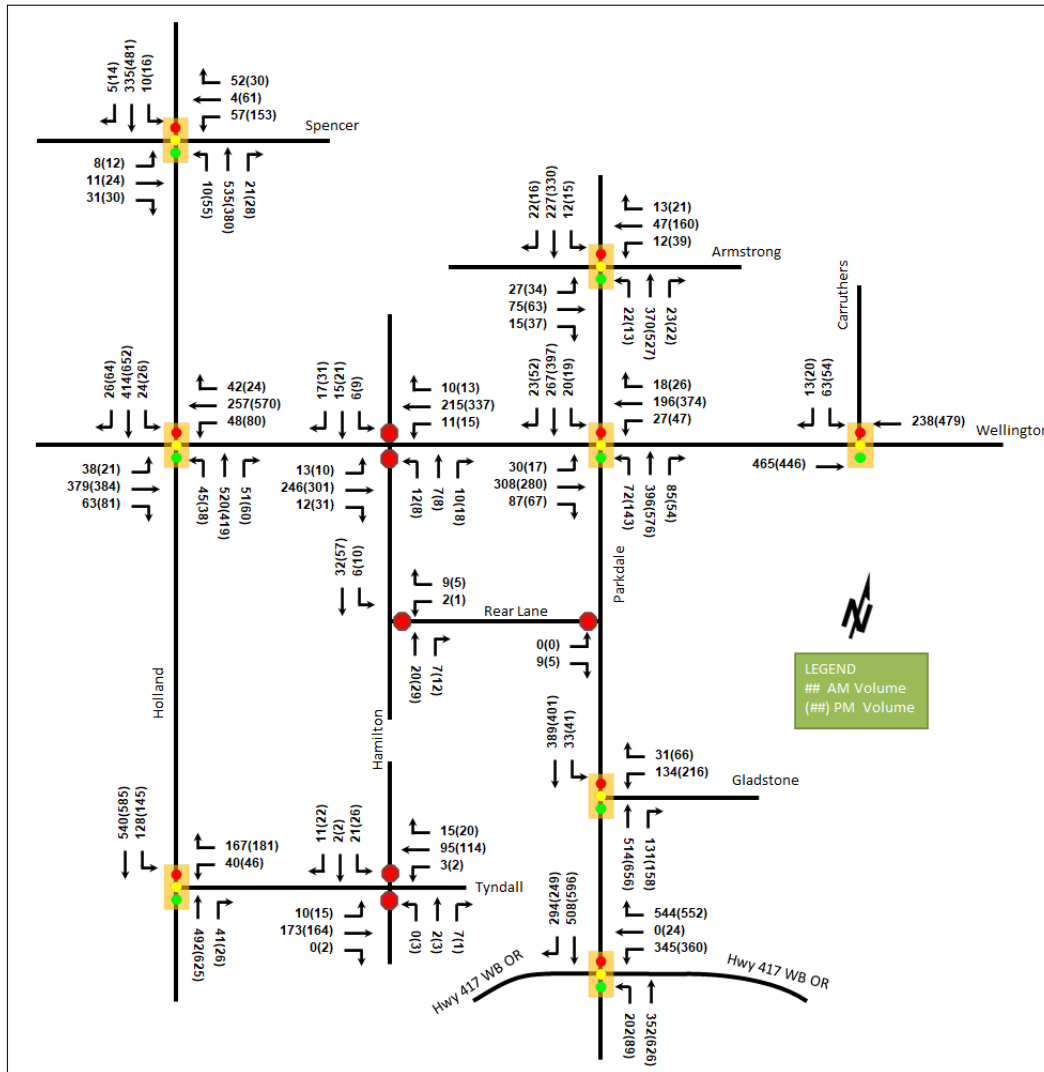


Table 21: 2030 Future Total Access Intersection Operations

Intersection	Lane	AM Peak Hour				PM Peak Hour			
		LOS	V/C	Delay(s)	Q (95 <sup>th</sup> )	LOS	V/C	Delay(s)	Q (95 <sup>th</sup> )
Hamilton Avenue N & Rear Lane <i>Unsignalized</i>	WB	A	0.01	8.6	0.0	A	0.01	8.7	0.0
	NB	-	-	-	-	-	-	-	-
	SB	A	0.00	7.3	0.0	A	0.01	7.3	0.0
	<b>Overall</b>	<b>A</b>	<b>-</b>	<b>1.8</b>	<b>-</b>	<b>A</b>	<b>-</b>	<b>1.1</b>	<b>-</b>

Intersection	Lane	AM Peak Hour				PM Peak Hour			
		LOS	V/C	Delay(s)	Q (95 <sup>th</sup> )	LOS	V/C	Delay(s)	Q (95 <sup>th</sup> )
Parkdale Avenue & Rear Lane <i>Unsignalized</i>	EB	B	0.01	10.8	0.0	B	0.01	11.9	0.0
	NB	-	-	-	-	-	-	-	-
	SB	-	-	-	-	-	-	-	-
	<b>Overall</b>	<b>A</b>	-	<b>0.1</b>	-	<b>A</b>	-	<b>0.0</b>	-

Notes: Saturation flow rate of 1800 veh/h/lane  
Queue is measured in metres  
Peak Hour Factor = 1.00

m = metered queue  
# = volume for the 95th %ile cycle exceeds capacity

The 2030 future total access intersections operate well. No capacity issues are noted.

### 11.3.3 Access Intersection MMLOS

As the site accesses are not signalized, no MMLOS analysis is required.

### 11.3.4 Recommended Design Elements

No changes to the site accesses are proposed.

## 12 Transportation Demand Management

### 12.1 Context for TDM

The mode shares used within the TIA represent the unmodified recommended district mode shares. Given the proximity of rapid transit, with Tunney’s Pasture Station being less than 800 metres-walk from the site, the typical modal shares are likely to be achieved and supporting TDM measures should be provided.

The subject site is within the Wellington Traditional Mainstreet design priority area. Total bedrooms within the development are 278 bedrooms with 156 one-bedroom units, 46 two-bedroom units, and ten three-bedroom units. No age restrictions are noted.

### 12.2 Need and Opportunity

The subject site has been assumed to rely on area levels of auto and transit use, and those assumptions have been carried through the analysis. As the study area intersections are generally anticipated to have residual capacity, the risks to other network users of not meeting the proposed modal share targets would be highest at the intersection of Parkdale Avenue and the Highway 417 westbound ramps where capacity issues were noted on the westbound approach during the PM peak hour. Failing to meet auto mode share targets by ten percent would be anticipated to add two southbound vehicles and one northbound vehicle during the PM peak hour at the intersection and therefore the risks are considered negligible.

### 12.3 TDM Program

The “suite of post occupancy TDM measures” has been summarized in the TDM checklists for the residential land uses. The checklist is provided in Appendix L. The key TDM measures recommended include:

- Display local area maps with bicycle, walking, transit information, and transit route schedules at building entrances
- Contract with provider to install on-site carshare vehicles and promote their use by residents
- Provide a permanent bicycle repair station
- Provide a multimodal travel option information package to new tenants
- Inclusion of a 1-year Presto card for first time and apartment rental, with a set time frame for this offer (e.g., 6-months) from the initial opening of the site
- Unbundle parking cost from purchase or rental costs

### 13 Neighbourhood Traffic Management

The proposed development will connect to the arterial road network via the rear lane, via Hamilton Avenue North (a local road), via Tyndall Street (a collector road), and via Holland Avenue (a major collector road). The TIA guidelines prescribe a classification threshold of 600-vehicle per peak hour for major collector roads, a 300-vehicle per peak hour for collector roads, and a 120-vehicle per peak hour for local roads, which are considered two-way volumes per City guidance. The existing volumes on the roadways of Tyndall Street, Holland Avenue, and Hamilton Avenue North are summarized below and compared to the forecasted site volumes for those links. The results of this analysis are summarized in Table 22.

Table 22: NTM Review

Segment	AM Peak				PM Peak			
	Existing EB	Existing WB	Existing Two-Way	Site Traffic	Existing EB	Existing WB	Existing Two-Way	Site Traffic
Tyndall St	168	167	335	6	170	227	397	10
Segment	AM Peak				PM Peak			
	Existing NB	Existing SB	Existing Two-Way	Site Traffic	Existing NB	Existing SB	Existing Two-Way	Site Traffic
Holland Ave (south of Tyndall St)	532	527	1,059	3	591	631	1,222	1
Holland Ave (north of Tyndall St)	659	617	1,276	0	747	730	1,477	0
Hamilton Ave N (north of Site)	20	32	52	15	29	57	86	14
Hamilton Ave N (south of Site)	20	32	52	9	29	57	86	11

The forecasted site traffic would amount to negligible increase in volumes on Tyndall Street and Holland Avenue. Increases in volumes on Hamilton Avenue North for the approximately 40 metre distance between the rear lane and Wellington Street West, where one other driveway to commercial land uses is present, are anticipated to be equivalent to one car every four minutes in both directions total. Increases in volumes on Hamilton Avenue North south of the rear lane in the residential neighbourhood context are anticipated to be equivalent to one car every five and a half minutes in both directions total.

The TIA guidelines have outlined thresholds for two-way traffic on local and collector roads and have been found to be too low for the purposes of analysis. City staff have noted that these thresholds are under review and will be updated in the future.

### 14 Transit

#### 14.1 Route Capacity

In Section 5.1 the trip generation by mode was estimated, including an estimate of the number of transit trips that will be generated by the proposed development. Table 23 summarizes the transit trip generation.

Table 23: Trip Generation by Transit Mode

Travel Mode	Residential Mode Share AM (PM)	AM Peak Period			PM Peak Period		
		In	Out	Total	In	Out	Total
Transit	41%(26%)	14	28	43	19	14	34

The proposed development is anticipated to generate an additional 43 AM and 34 PM peak hour two-way transit trips. From the trip distribution found in section 5.3, these values can be further broken down. Table 24 summarizes forecasted site-generated transit ridership trips by direction and the equivalent bus loads.

Table 24: Forecasted Site-Generated Transit Ridership

Direction	AM Peak Hour		PM Peak Hour		Service Type	Approximate Equivalent Peak Hour/Direction Bus Loads
	In	Out	In	Out		
North	2	4	1	2	Bus, LRT	Negligible
South	4	8	6	4	Bus	Negligible
East	4	8	6	4	Bus, LRT	Negligible
West	4	8	6	4	Bus, LRT	Negligible

### 14.2 Transit Priority

No site driveways are proposed onto any transit priority corridor. The turning movements to and from the transit priority corridor within the study area are the eastbound left, westbound right, southbound right, and southbound left at the intersection of Holland Avenue and Wellington Street West, and negligible impacts are anticipated on these movements due to the increase in site traffic with increases in delays of 2.7 seconds or less for each.

## 15 Network Intersection Design

### 15.1 Network Intersection Control

No change to the existing signalized control is recommended for the network intersections.

### 15.2 Network Intersection Design

#### 15.2.1 2025 Future Total Network Intersection Operations

Table 26 summarizes the 2025 total intersection operations. The level of service for signalized intersections is based on v/c calculations for individual lane movements and HCM 2000 v/c calculations for the overall intersection, and average delay for unsignalized intersections. The synchro worksheets have been provided in Appendix J.

Table 25: 2025 Future Total Intersection Operations

Intersection	Lane	AM Peak Hour				PM Peak Hour			
		LOS	V/C	Delay(s)	Q (95 <sup>th</sup> )	LOS	V/C	Delay(s)	Q (95 <sup>th</sup> )
Holland Avenue & Spencer Street <i>Signalized</i>	EB	A	0.22	21.0	13.0	A	0.19	19.7	15.7
	WB	A	0.55	36.6	29.4	D	0.82	58.3	#74.6
	NB	A	0.24	0.8	4.2	A	0.25	1.1	2.5
	SB	A	0.14	3.8	13.6	A	0.25	7.2	28.2
	<b>Overall</b>	<b>A</b>	<b>0.27</b>	<b>6.5</b>	-	<b>A</b>	<b>0.39</b>	<b>15.5</b>	-
Holland Avenue & Wellington Street <b>W</b> <i>Signalized</i>	EB	A	0.39	23.1	43.1	A	0.41	23.3	45.1
	WB	A	0.31	31.0	39.0	A	0.58	20.7	m45.2
	NB	A	0.55	25.4	64.2	A	0.47	20.1	47.4
	SB	A	0.38	19.7	37.1	B	0.63	22.6	66.8
	<b>Overall</b>	<b>A</b>	<b>0.44</b>	<b>24.5</b>	-	<b>A</b>	<b>0.57</b>	<b>21.7</b>	-
Holland Avenue & Tyndall Street <i>Signalized</i>	WB	B	0.69	38.5	44.9	C	0.75	52.0	60.9
	NBT/R	A	0.55	13.6	78.7	A	0.57	14.4	115.4
	SBL	A	0.35	13.6	23.4	A	0.40	8.1	m12.1
	SBT	A	0.52	13.3	74.9	A	0.53	7.4	39.9
	<b>Overall</b>	<b>A</b>	<b>0.55</b>	<b>17.2</b>	-	<b>A</b>	<b>0.59</b>	<b>16.6</b>	-

Intersection	Lane	AM Peak Hour				PM Peak Hour			
		LOS	V/C	Delay(s)	Q (95 <sup>th</sup> )	LOS	V/C	Delay(s)	Q (95 <sup>th</sup> )
<b>Parkdale Avenue &amp; Armstrong Street</b> <i>Signalized</i>	EB	A	0.35	34.7	34.3	A	0.30	25.5	32.5
	WB	A	0.21	29.8	21.7	A	0.47	32.2	55.7
	NB	A	0.36	2.6	7.7	A	0.52	5.5	m9.4
	SB	A	0.22	6.4	25.0	A	0.35	11.4	49.4
	<b>Overall</b>	<b>A</b>	<b>0.35</b>	<b>10.4</b>	-	<b>A</b>	<b>0.50</b>	<b>14.0</b>	-
<b>Parkdale Avenue &amp; Wellington Street W</b> <i>Signalized</i>	EB	A	0.48	21.5	26.2	A	0.59	61.0	49.4
	WBL	A	0.14	28.1	10.6	A	0.34	39.7	18.7
	WBT/R	A	0.39	30.8	48.5	D	0.88	62.4	#113.4
	NBL	A	0.16	3.6	m3.2	A	0.36	11.0	m16.9
	NBT/R	A	0.59	11.7	84.3	B	0.65	17.1	82.1
	SBL	A	0.07	18.9	m6.3	A	0.07	15.3	m4.9
	<b>Overall</b>	<b>A</b>	<b>0.55</b>	<b>18.9</b>	-	<b>C</b>	<b>0.72</b>	<b>34.2</b>	-
<b>Parkdale Avenue &amp; Gladstone Avenue</b> <i>Signalized</i>	WBL/R	A	0.41	35.0	45.8	C	0.74	47.3	#85.7
	NBT/R	B	0.61	12.0	74.7	C	0.75	15.4	m104.2
	SBL	A	0.09	12.4	m7.1	A	0.16	6.0	m3.2
	SBT	A	0.34	13.6	65.7	A	0.36	5.8	25.7
	<b>Overall</b>	<b>A</b>	<b>0.55</b>	<b>15.6</b>	-	<b>C</b>	<b>0.74</b>	<b>18.6</b>	-
<b>Parkdale Avenue &amp; Highway 417 WB OR</b> <i>Signalized</i>	WBL	E	0.92	68.4	#113.6	D	0.90	65.0	#108.8
	WBT/R	C	0.76	12.7	45.0	E	0.96	47.5	#116.3
	NBL	A	0.54	21.6	20.5	A	0.29	11.9	10.3
	NBT	A	0.30	8.5	40.8	A	0.52	11.2	82.0
	SBT/R	D	0.86	35.3	#199.2	D	0.87	30.4	#222.6
	<b>Overall</b>	<b>D</b>	<b>0.85</b>	<b>29.5</b>	-	<b>D</b>	<b>0.88</b>	<b>33.7</b>	-
<b>Carruthers Avenue &amp; Wellington Street W</b> <i>Signalized</i>	EBT	A	0.39	9.9	44.3	A	0.30	4.7	29.3
	WBT	A	0.21	8.1	22.4	A	0.31	4.7	30.4
	SBL	A	0.14	21.7	15.4	A	0.22	30.1	16.1
	SBR	A	0.03	11.0	3.8	A	0.10	13.6	5.5
	<b>Overall</b>	<b>A</b>	<b>0.31</b>	<b>10.4</b>	-	<b>A</b>	<b>0.31</b>	<b>6.5</b>	-
<b>Hamilton Avenue N &amp; Wellington Street W</b> <i>Unsignalized</i>	EB	A	0.01	7.7	0.0	A	0.01	8.0	0.0
	WB	A	0.01	7.8	0.0	A	0.01	8.0	0.0
	NB	B	0.06	12.4	1.5	B	0.08	13.6	1.5
	SB	B	0.07	11.9	1.5	B	0.13	14.1	3.8
	<b>Overall</b>	<b>A</b>	-	<b>1.8</b>	-	<b>A</b>	-	<b>1.9</b>	-
<b>Hamilton Avenue N &amp; Tyndall Street</b> <i>Unsignalized</i>	EB	A	0.01	7.4	0.0	A	0.01	7.5	0.0
	WB	A	0.00	7.6	0.0	A	0.00	7.6	0.0
	NB	A	0.01	9.6	0.0	B	0.01	10.9	0.0
	SB	B	0.05	10.3	1.5	B	0.07	10.3	1.5
	<b>Overall</b>	<b>A</b>	-	<b>1.6</b>	-	<b>A</b>	-	<b>1.9</b>	-

Notes: Saturation flow rate of 1800 veh/h/lane  
 Queue is measured in metres  
 Peak Hour Factor = 1.00

m = metered queue  
 # = volume for the 95th %ile cycle exceeds capacity

The network intersections for the 2025 future total horizon operate similarly to the 2025 future background conditions. No new capacity issues are noted.

15.2.2 2030 Future Total Network Intersection Operations

Table 26 summarizes the 2030 total intersection operations. The level of service for signalized intersections is based on v/c calculations for individual lane movements and HCM 2000 v/c calculations for the overall intersection. The synchro worksheets have been provided in Appendix K.

Table 26: 2030 Future Total Intersection Operations

Intersection	Lane	AM Peak Hour				PM Peak Hour			
		LOS	V/C	Delay(s)	Q (95 <sup>th</sup> )	LOS	V/C	Delay(s)	Q (95 <sup>th</sup> )
Holland Avenue & Spencer Street <i>Signalized</i>	EB	A	0.22	21.0	13.0	A	0.19	19.7	15.7
	WB	A	0.55	36.6	29.4	D	0.82	58.3	#74.6
	NB	A	0.24	1.0	4.8	A	0.26	1.1	2.7
	SB	A	0.15	3.8	14.3	A	0.25	7.2	28.2
	<b>Overall</b>	<b>A</b>	<b>0.27</b>	<b>6.6</b>	-	<b>A</b>	<b>0.39</b>	<b>15.4</b>	-
Holland Avenue & Wellington Street W <i>Signalized</i>	EB	A	0.44	23.8	49.0	A	0.45	23.9	49.8
	WB	A	0.34	34.4	43.5	B	0.67	22.8	m49.7
	NB	A	0.55	25.4	64.3	A	0.49	20.7	49.9
	SB	A	0.40	20.0	39.0	B	0.64	22.7	66.8
	<b>Overall</b>	<b>A</b>	<b>0.46</b>	<b>25.3</b>	-	<b>B</b>	<b>0.61</b>	<b>22.6</b>	-
Holland Avenue & Tyndall Street <i>Signalized</i>	WB	B	0.69	38.5	44.9	C	0.75	52.0	60.9
	NBT/R	A	0.55	13.6	78.7	A	0.60	15.0	124.4
	SBL	A	0.35	13.6	23.4	A	0.42	8.6	m12.1
	SBT	A	0.54	13.7	80.4	A	0.53	7.3	40.0
	<b>Overall</b>	<b>A</b>	<b>0.55</b>	<b>17.3</b>	-	<b>B</b>	<b>0.61</b>	<b>16.8</b>	-
Parkdale Avenue & Armstrong Street <i>Signalized</i>	EB	A	0.35	34.7	34.3	A	0.30	25.5	32.5
	WB	A	0.21	29.8	21.7	A	0.47	32.2	55.7
	NB	A	0.36	2.7	8.0	A	0.55	5.4	m8.9
	SB	A	0.23	6.5	26.2	A	0.36	11.4	50.1
	<b>Overall</b>	<b>A</b>	<b>0.36</b>	<b>10.4</b>	-	<b>A</b>	<b>0.52</b>	<b>13.9</b>	-
Parkdale Avenue & Wellington Street W <i>Signalized</i>	EB	A	0.53	22.8	30.1	B	0.69	63.5	53.3
	WBL	A	0.15	28.5	10.7	A	0.35	40.6	18.9
	WBT/R	A	0.43	31.7	54.2	<b>F</b>	<b>1.02</b>	<b>89.3</b>	<b>#138.0</b>
	NBL	A	0.17	3.6	m3.1	A	0.37	11.4	m17.1
	NBT/R	A	0.59	11.7	85.0	B	0.68	18.2	87.6
	SBL	A	0.07	18.9	m6.1	A	0.08	15.4	m4.8
	SBT/R	A	0.46	22.6	46.7	B	0.67	23.4	61.6
	<b>Overall</b>	<b>A</b>	<b>0.57</b>	<b>19.7</b>	-	<b>C</b>	<b>0.78</b>	<b>41.3</b>	-
Parkdale Avenue & Gladstone Avenue <i>Signalized</i>	WBL/R	A	0.41	35.0	45.8	C	0.74	47.3	#85.7
	NBT/R	B	0.61	12.0	76.0	C	0.78	16.0	m104.1
	SBL	A	0.10	12.9	m7.0	A	0.18	5.9	m3.1
	SBT	A	0.36	14.3	70.2	A	0.37	5.6	25.7
	<b>Overall</b>	<b>A</b>	<b>0.55</b>	<b>15.8</b>	-	<b>C</b>	<b>0.77</b>	<b>18.8</b>	-
Parkdale Avenue & Highway 417 WB OR <i>Signalized</i>	WBL	E	0.92	68.4	#113.6	E	0.93	69.1	#120.5
	WBT/R	C	0.77	13.2	46.6	<b>F</b>	<b>1.04</b>	<b>68.6</b>	<b>#140.0</b>
	NBL	B	0.68	32.5	#29.2	A	0.34	14.5	10.9
	NBT	A	0.31	8.5	41.4	A	0.55	12.1	88.7
	SBT/R	E	0.92	41.7	#222.1	E	0.91	35.0	#233.7
	<b>Overall</b>	<b>D</b>	<b>0.90</b>	<b>32.9</b>	-	<b>E</b>	<b>0.95</b>	<b>41.2</b>	-

Intersection	Lane	AM Peak Hour				PM Peak Hour			
		LOS	V/C	Delay(s)	Q (95 <sup>th</sup> )	LOS	V/C	Delay(s)	Q (95 <sup>th</sup> )
<b>Carruthers Avenue &amp; Wellington Street W</b> <i>Signalized</i>	EBT	A	0.46	10.7	54.1	A	0.34	4.9	34.0
	WBT	A	0.23	8.3	25.4	A	0.36	5.1	37.3
	SBL	A	0.14	21.7	15.4	A	0.22	30.1	16.1
	SBR	A	0.03	11.0	3.8	A	0.10	13.6	5.5
	<b>Overall</b>	<b>A</b>	<b>0.36</b>	<b>10.9</b>	-	<b>A</b>	<b>0.36</b>	<b>6.5</b>	-
<b>Hamilton Avenue N &amp; Wellington Street W</b> <i>Unsignalized</i>	EB	A	0.01	7.7	0.0	A	0.01	8.0	0.0
	WB	A	0.01	7.8	0.0	A	0.01	8.0	0.0
	NB	B	0.06	12.4	1.5	B	0.08	13.6	1.5
	SB	B	0.07	11.9	1.5	B	0.13	14.1	3.8
	<b>Overall</b>	<b>A</b>	-	<b>1.8</b>	-	<b>A</b>	-	<b>1.9</b>	-
<b>Hamilton Avenue N &amp; Tyndall Street</b> <i>Unsignalized</i>	EB	A	0.01	7.4	0.0	A	0.01	7.5	0.0
	WB	A	0.00	7.6	0.0	A	0.00	7.6	0.0
	NB	A	0.01	9.6	0.0	B	0.01	10.9	0.0
	SB	B	0.05	10.3	1.5	B	0.07	10.3	1.5
	<b>Overall</b>	<b>A</b>	-	<b>1.6</b>	-	<b>A</b>	-	<b>1.9</b>	-

Notes: Saturation flow rate of 1800 veh/h/lane  
Queue is measured in metres  
Peak Hour Factor = 1.00

m = metered queue  
# = volume for the 95th %ile cycle exceeds capacity

The network intersections for the 2030 future total horizon operate similarly to the 2030 future background conditions. No new capacity issues are noted.

Similarly to the background conditions, mitigation of the capacity issues at the intersections of Parkdale Avenue at Wellington Street West and Parkdale Avenue and the Highway 417 westbound ramps could be achieved by signal optimization. Shifting one second of split at Parkdale Avenue at Wellington Street West and three seconds at Parkdale Avenue and the Highway 417 westbound ramps each from the north-south phase to the east-west phase, would reduce all movements to a v/c of 1.00 or below.

15.2.3 Network Intersection MMLoS

Table 27 summarizes the MMLoS analysis for the network intersections. The existing and future conditions for both intersections will be the same and are considered in one row. The analysis is based on the policy area of “Within 600m of a rapid transit station” for the intersections of Holland Avenue at Spencer Street, Holland Avenue at Wellington Street West, Parkdale Avenue at Wellington Street W, and Parkdale Avenue at Armstrong Street. The intersection analysis is based on the policy area of “Within 300m of a school” for the intersections of Parkdale Avenue at Gladstone Avenue, Carruthers Avenue at Wellington Street West, Parkdale Avenue at the Highway 417 westbound ramps, and Holland Avenue at Tyndall Street, as these intersections are within this distance of either Fisher Park Public School, Connaught Public School, Parkdale Montessori School, or Saint Francis of Assisi Catholic Elementary School. Parkdale Avenue at Wellington Street West is additionally within 300 metres of Connaught Public School, however the targets for this policy area are the same for being within 600 metres of a rapid transit station. The MMLoS worksheets has been provided in Appendix I.

Table 27: Study Area Intersection MMLoS Analysis

Intersection	Pedestrian LOS		Bicycle LOS		Transit LOS		Truck LOS		Auto LOS	
	PLOS	Target	BLOS	Target	TLOS	Target	TrLOS	Target	ALOS	Target
<b>Holland Avenue &amp; Spencer Street</b>	<b>D</b>	A	<b>C</b>	B	B	D	-	-	A	E
<b>Holland Avenue &amp; Wellington Street W</b>	<b>C</b>	A	<b>C</b>	B	<b>E</b>	D	<b>F</b>	D	B	E



Intersection	Pedestrian LOS		Bicycle LOS		Transit LOS		Truck LOS		Auto LOS	
	PLOS	Target	BLOS	Target	TLOS	Target	TrLOS	Target	ALOS	Target
Holland Avenue & Tyndall Street	C	A	C	B	B	D	-	-	B	E
Parkdale Avenue & Armstrong Street	C	A	C	B	C	D	-	-	A	E
Parkdale Avenue & Wellington Street W	C	A	C	C	F	D	-	-	C	E
Parkdale Avenue & Gladstone Avenue	C	A	C	B	C	D	-	-	C	E
Parkdale Avenue & Highway 417 WB OR	C	A	-	D	F	D	-	-	E	E
Carruthers Avenue & Wellington Street W	B	A	B	C	C	D	-	-	A	E

The MMLOS targets will not be met for the pedestrian LOS at all study area intersections, bicycle LOS at the Holland Avenue intersections and the intersections of Parkdale Avenue at Armstrong Street, and Parkdale Avenue at Gladstone Avenue, transit LOS at the intersection of Holland Avenue at Wellington Street West, Parkdale Avenue at Wellington Street West, and Parkdale at Highway 417 westbound ramps, and truck LOS at the intersection of Holland Avenue and Wellington Street West.

To meet pedestrian LOS target score of “A,” all crossing distances at an intersection cannot generally exceed two lane widths. Pedestrian delay LOS is not considered in the PLOS calculation as it requires balanced intersection timing and short cycle lengths to achieve the targets. Therefore, it is not a suitable metric for the assessment of pedestrian LOS.

Bicycle LOS is limited by the mixed-traffic left-turn conditions at the Holland Avenue intersections and the intersections of Parkdale Avenue at Armstrong Street, and Parkdale Avenue at Gladstone Avenue and would require two-stage left turns or bike boxes to meet targets.

Transit LOS is limited by delays for the transit movements on the Wellington Street West approaches at Holland Avenue and at Parkdale Avenue, and the southbound approach on Parkdale Avenue at the westbound highway ramps.

Modifications required to meet truck LOS at the intersection of Holland Avenue and Wellington Street West, including increasing the effective radii to more than 15 metres, would negatively impact pedestrian LOS at this location.

No mitigation measures are proposed to address the levels of service for the study area intersections.

#### 15.2.4 Recommended Design Elements

No study area intersection design elements are proposed as part of this study.

## 16 Summary of Improvements Indicated and Modifications Options

The following summarizes the analysis and results presented in this TIA report:

### Proposed Site and Screening

- The proposed site includes 212 residential dwelling units and 12,518 sq. ft. of ground floor commercial space

- Accesses will be provided along the existing rear lane to Hamilton Avenue, and outbound to Parkdale Avenue through modifications to the lane
- The development is proposed to be completed as a single phase by 2025
- The Trip Generation, Location, and Safety triggers were met for the TIA Screening
- This study is in support of a site plan application

### **Existing Conditions**

- Highway 417 is a provincial freeway, Parkdale Avenue and Wellington Street West are arterial roads, Holland Avenue and Gladstone Avenue are major collector roads, and Tyndall Street is a collector road in the study area
- Sidewalks are generally provided on both sides of the study area roadways, a MUP is provided along the north sides of Byron Avenue and of Scott Street, a buffered bike lane is provided on the south side of Scott Street, and sharrows and a buffered dooring zone are present along Wellington Street West between Holland Avenue and Parkdale Avenue
- Holland Avenue, Parkdale Avenue between Gladstone Avenue and Tyndall Street, Scott Street, Wellington Street West, Tyndall Street, and Gladstone Avenue are spine cycling routes
- Local cycling routes include Tunney's Pasture Driveway, Hamilton Avenue North between Spencer Street and Armstrong Street, Fairmont Avenue, Spencer Street west of Hamilton Avenue North, Armstrong Street east of Hamilton Avenue North, and Byron Avenue
- Scott Street is a cross-town bikeway, and the corridor from the pathway west of Holland Avenue, north to Holland Avenue, east to Tyndall Street, north to Parkdale Avenue, east to Gladstone Avenue and south to Fairmont Street is a neighbourhood bikeway
- Higher incidence of collisions is primarily noted at the Parkdale Avenue at Wellington Street West intersection, which while likely impacted by congestion, may additionally be influenced by vehicles weaving around turning vehicles and movements introduced from the gas station on the northwest quadrant of the intersection
- Some high delays and queuing are noted at the intersection of Parkdale Avenue and the Highway 417 westbound ramps during both peak hours, with several movements and the overall intersection approaching capacity during the PM peak hour

### **Development Generated Travel Demand**

- The proposed development is forecasted produce 118 two-way people trips during the AM peak hour and 141 two-way people trips during the PM peak hour
- Of the forecasted people trips, 35 two-way trips will be vehicle trips during the AM peak hour and 35 two-way trips will be vehicle trips during the PM peak hour
- Of the forecasted trips, 10% are anticipated to travel north and 30% are anticipated to travel each south, east, and west
- Trips associated with the existing pharmacy land use were removed from the network in the future total horizons

### **Background Conditions**

- Given the availability of other study area development traffic studies, no background development traffic was explicitly included in the background conditions

- An annual background growth of 3.25% eastbound and 2.50% westbound along Wellington Street West, 1.00% southbound on Holland Avenue and Parkdale Avenue, and 0.25% northbound on Parkdale Avenue was applied in the AM peak hour and reversed in the PM peak hour, along with an annual growth of 1.50% during the PM peak hour at the highway off-ramp and 1.25% in the AM peak hour and 2.00% in the PM peak hour at the highway on-ramp
- The study area intersections at both horizons will operate similarly to the existing conditions, where capacity issues are present at the intersection of Parkdale Avenue at Wellington Street West on the westbound approach, and more developed on the westbound movement at the intersection of Parkdale Avenue and at highway ramps at the future horizons, however signal timing optimization can reduce all v/c ratios to 1.00 or lower at these intersections

### **Development Design**

- Retail entrances will front Wellington Street West and the main residential entrance will front Parkdale Avenue
- Hard surface connections will be provided from all building entrances to the surround pedestrian network, and the rear lane will support all modes
- The proponent is seeking an exemption to the zoning by-law's stipulation that a minimum of 50% of bicycle parking must be via horizontal stalls at ground level, and is proposing cycle-friendly 5% slopes between parking levels
- Vehicle and bicycle access will be via the rear lane, which will support all modes and garbage collection, and is proposed to be two-way at Hamilton Avenue North and one-way (outbound) at Parkdale Avenue
- Bus stops for area routes are within walking distance of site entrances, the bus stop on Wellington Street West will be integrated with the POPS which will provide shelter and seating, and a shelter pad will be installed at the stop on Parkdale Avenue

### **Parking**

- The development is proposed to provide 120 resident and 20 visitor vehicle parking spaces underground, and 212 residential and five retail bicycle parking spaces on the first floor and within the underground parking levels
- Surface racks will provide eight bicycle spaces along Wellington Street West, four along Parkdale Avenue, and four along the rear lane
- The zoning by-law minimums for resident and visitor vehicle parking and bicycle parking for each component is being met, but the development is not proposed as including any vehicle parking for the retail component for which the by-law requires 15 spaces
- The Wellington West Local Area Parking Study finds that generally parking is available on Wellington Street West in front of the site, and therefore minimal parking impacts are anticipated from the retail component

### **Boundary Street Design**

- The boundary streets do not meet pedestrian LOS targets in the existing conditions and Parkdale Avenue will not meet them in the future conditions, and Parkdale Avenue and Wellington Street West do not meet bicycle LOS targets in the existing or future conditions
- Parkdale Avenue traffic volumes are too high to meet Parkdale Avenue PLOS targets, and curbside bike lanes would be required on Parkdale Avenue and Wellington Street West to meet BLOS targets, although

the analysis does not account for the unique facility on Wellington Street West including sharrows and a dooring zone designated in pavement markings.

#### **Access Intersection Design**

- The access intersections are forecasted to operate well with no capacity issues
- The access intersection on Parkdale Avenue is proposed as including a No Left Turn sign (Rb-12 (OTM)) located on the eastbound approach, and One Way (Rb-21 (OTM)) and Do Not Enter signs (Rb-19 (OTM)) are proposed to be installed at an appropriate, visible location from Parkdale Avenue
- No additional access intersection design elements are proposed to support the development

#### **TDM**

- No risks are noted with not meeting proposed mode transit mode shares given the negligible impacts of minor increases to site auto traffic
- Supportive TDM measures to be included within the proposed development should include:
  - Display local area maps with bicycle, walking, transit information, and transit route schedules at building entrances
  - Contract with provider to install on-site carshare vehicles and promote their use by residents
  - Provide a permanent bicycle repair station
  - Provide a multimodal travel option information package to new tenants
  - Inclusion of a 1-month Presto card for first time new townhome purchase and apartment rental, with a set time frame for this offer (e.g., 6-months) from the initial opening of the site
  - Unbundle parking cost from purchase or rental costs

#### **NTM**

- The proposed development will connect to the arterial network via Hamilton Avenue North, Tyndall Street, and Holland Avenue
- The site traffic will contribute negligible volumes to the total volumes along Hamilton Avenue North and Tyndall Street and no mitigation is required and no change in the road function is anticipated

#### **Transit**

- The proposed development is anticipated to generate an additional 43 AM peak hour transit trips and 34 PM peak hour transit trips
- Negligible impact to existing area transit service is forecasted from site-generated transit trips
- Transit priority is not impacted by site driveways or from site-generated traffic on transit turning movements

#### **Network Intersection Design**

- The network intersections at the future total horizons will operate similarly to the future background horizons
- As in the background horizons, signal timing optimization can reduce the v/c ratios to 1.00 or lower for the overcapacity movement and the remaining movements at the intersections of Parkdale Avenue at Wellington Street West and Parkdale Avenue at the highway ramps
- The MMLOS targets will not be met for the pedestrian LOS at all study area intersections, bicycle LOS at the Holland Avenue intersections and the intersections of Parkdale Avenue at Armstrong Street and Parkdale Avenue at Gladstone Avenue, transit LOS at the intersection of Holland Avenue at Wellington

Street West, Parkdale Avenue at Wellington Street West, and Parkdale at Highway 417 westbound ramps, and truck LOS at the intersection of Holland Avenue and Wellington Street West

- Improved cycling left-turn configurations could meet the LOS targets, due to the crossing distances, the pedestrian and transit LOS cannot be met, and improvements to the truck LOS would negatively impact pedestrian LOS

## 17 Conclusion

It is recommended that, from a transportation perspective, the proposed development site plan application proceed.

Prepared By:

Reviewed By:



John Kingsley, EIT  
Transportation Engineering-Intern

Andrew Harte, P.Eng.  
Senior Transportation Engineer

# Appendix A

TIA Screening Form and PM Certification Form

City of Ottawa 2017 TIA Guidelines  
Step 1 - Screening Form

Date: 29-Jun-22  
Project Number: 2020-62  
Project Reference: 1186-1194 Wellington

1.1 Description of Proposed Development	
Municipal Address	1186-1194 Wellington Street
Description of Location	Existing pharmacy, church and parking lot
Land Use Classification	Traditional Mainstreet Zoning (TM11)
Development Size	16-storey residential (212 units), 1,148 sq.m. retails, 139 parking spaces, 212 bicycle parking spaces
Accesses	Existing laneway at rear property line
Phase of Development	Single phase
Buildout Year	2025
TIA Requirement	Full TIA Required

1.2 Trip Generation Trigger	
Land Use Type	Townhomes or apartments
Development Size	212 Units
Trip Generation Trigger	Yes

1.3 Location Triggers	
Does the development propose a new driveway to a boundary street that is designated as part of the City's Transit Priority, Rapid Transit or Spine Bicycle Networks?	No
Is the development in a Design Priority Area (DPA) or Transit-oriented Development (TOD) zone?	Yes Wellington Traditional Mainstreet, Wellington Street CDP
Location Trigger	Yes

1.4. Safety Triggers	
Are posted speed limits on a boundary street 80 km/hr or greater?	No
Are there any horizontal/vertical curvatures on a boundary street limits sight lines at a proposed driveway?	No
Is the proposed driveway within the area of influence of an adjacent traffic signal or roundabout (i.e. within 300 m of intersection in rural conditions, or within 150 m of intersection in urban/ suburban conditions)?	Yes Parkdale/Wellington
Is the proposed driveway within auxiliary lanes of an intersection?	No
Does the proposed driveway make use of an existing median break that serves an existing site?	No
Is there is a documented history of traffic operations or safety concerns on the boundary streets within 500 m of the development?	No
Does the development include a drive-thru facility?	No
Safety Trigger	Yes



## **TIA Plan Reports**

On 14 June 2017, the Council of the City of Ottawa adopted new Transportation Impact Assessment (TIA) Guidelines. In adopting the guidelines, Council established a requirement for those preparing and delivering transportation impact assessments and reports to sign a letter of certification.

Individuals submitting TIA reports will be responsible for all aspects of development-related transportation assessment and reporting, and undertaking such work, in accordance and compliance with the City of Ottawa's Official Plan, the Transportation Master Plan and the Transportation Impact Assessment (2017) Guidelines.

By submitting the attached TIA report (and any associated documents) and signing this document, the individual acknowledges that s/he meets the four criteria listed below.

### **CERTIFICATION**

1. I have reviewed and have a sound understanding of the objectives, needs and requirements of the City of Ottawa's Official Plan, Transportation Master Plan and the Transportation Impact Assessment (2017) Guidelines;
2. I have a sound knowledge of industry standard practice with respect to the preparation of transportation impact assessment reports, including multi modal level of service review;
3. I have substantial experience (more than 5 years) in undertaking and delivering transportation impact studies (analysis, reporting and geometric design) with strong background knowledge in transportation planning, engineering or traffic operations; and
4. I am either a licensed<sup>1</sup> or registered<sup>2</sup> professional in good standing, whose field of expertise [check  appropriate field(s)] is either transportation engineering  or transportation planning .

**1,2 License of registration body that oversees the profession is required to have a code of conduct and ethics guidelines that will ensure appropriate conduct and representation for transportation planning and/or transportation engineering works.**

City Of Ottawa  
Infrastructure Services and Community  
Sustainability  
Planning and Growth Management  
110 Laurier Avenue West, 4th fl.  
Ottawa, ON K1P 1J1  
Tel. : 613-580-2424  
Fax: 613-560-6006


Ville d'Ottawa  
Services d'infrastructure et Viabilité des  
collectivités  
Urbanisme et Gestion de la croissance  
110, avenue Laurier Ouest  
Ottawa (Ontario) K1P 1J1  
Tél. : 613-580-2424  
Télécopieur: 613-560-6006



Dated at Ottawa this 20 day of September, 2018.  
(City)

Name: Andrew Harte  
(Please Print)

Professional Title: Professional Engineer

  
Signature of Individual certifier that s/he meets the above four criteria

<b>Office Contact Information (Please Print)</b>
Address: 6 Plaza Court
City / Postal Code: Ottawa / K2H 7W1
Telephone / Extension: (613) 697-3797
E-Mail Address: Andrew.Harte@CGHTransportation.com



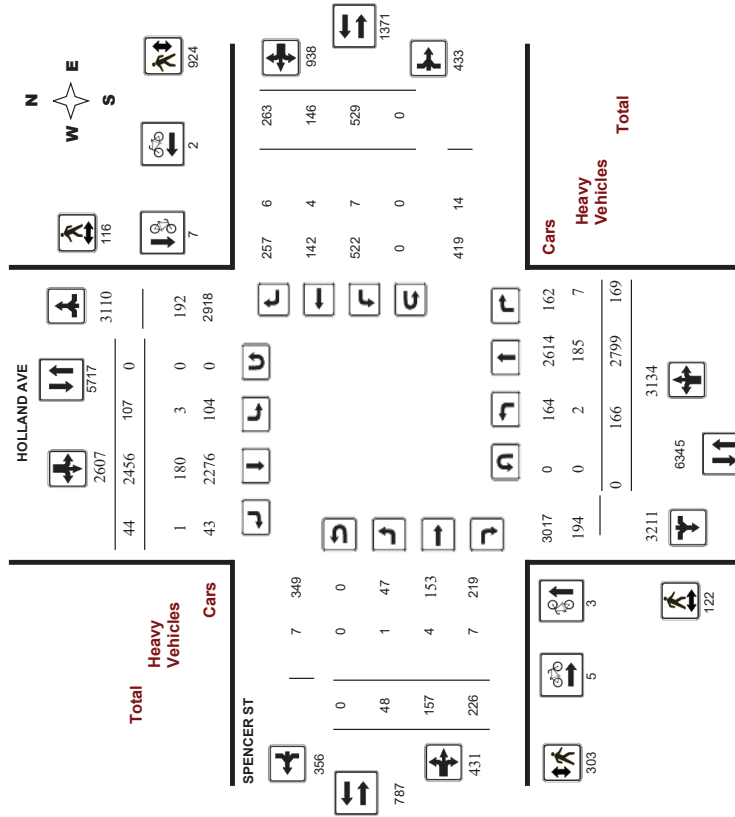
# Appendix B

Turning Movement Counts

Survey Date: Wednesday, January 11, 2017  
Start Time: 07:00

WO No: 36635  
Device: Miovision

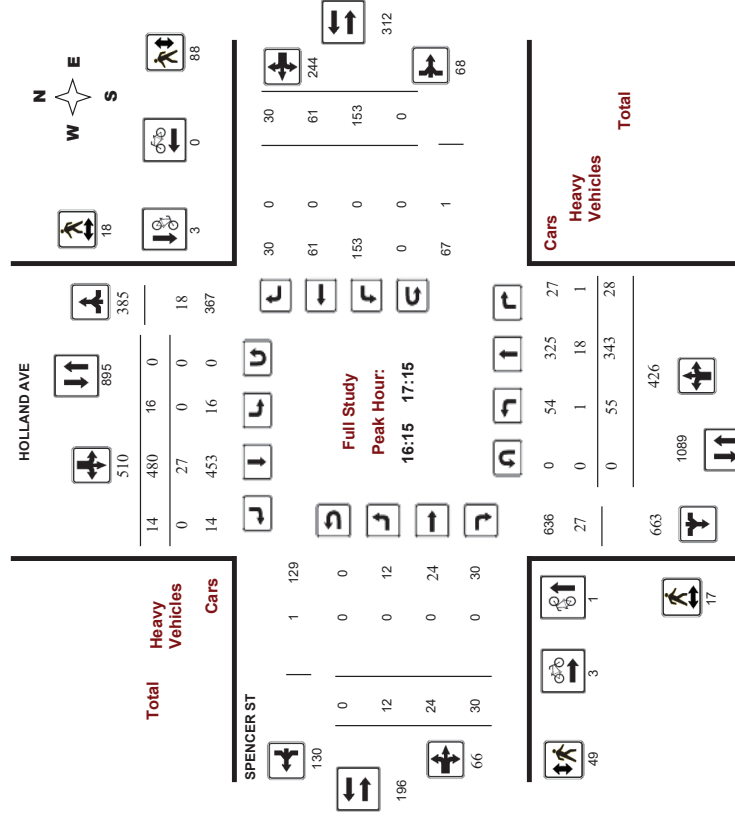
Full Study Diagram



Survey Date: Wednesday, January 11, 2017  
Start Time: 07:00

WO No: 36635  
Device: Miovision

Full Study Peak Hour Diagram







# Transportation Services - Traffic Services

## Turning Movement Count - Peak Hour Diagram

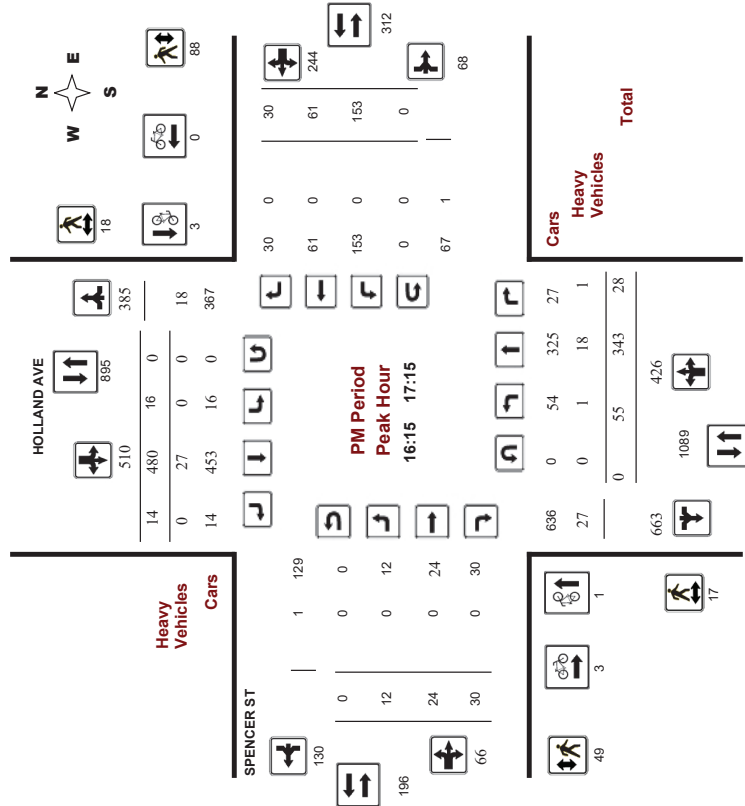
HOLLAND AVE @ SPENCER ST

Survey Date: Wednesday, January 11, 2017

Start Time: 07:00

WO No: 36635

Device: Miovision



Comments



# Transportation Services - Traffic Services

## Turning Movement Count - Study Results

HOLLAND AVE @ SPENCER ST

Survey Date: Wednesday, January 11, 2017

Start Time: 07:00

WO No: 36635

Device: Miovision

### Full Study Summary (8 HR Standard)

Survey Date: Wednesday, January 11, 2017

Total Observed U-Turns

Northbound: 0

Southbound: 0

Eastbound: 0

Westbound: 0

AADT Factor

1.00

HOLLAND AVE

SPENCER ST

Period	Northbound				Southbound				Eastbound				Westbound				WB TOT	STR TOT	Grand Total
	LT	ST	RT	TOT	NB	LT	ST	RT	TOT	SB	LT	ST	RT	TOT	EB	LT			
07:00-08:00	5	508	25	538	11	264	1	276	814	0	8	27	35	24	4	55	83	118	932
08:00-09:00	11	525	25	561	9	286	9	304	865	12	10	27	49	59	2	48	109	158	1023
09:00-10:00	10	327	18	355	11	209	2	222	577	4	12	25	41	22	4	36	62	103	680
11:30-12:30	9	175	12	196	5	199	6	210	406	6	24	34	64	31	10	16	57	121	527
12:30-13:30	27	184	17	238	11	191	3	205	443	7	24	31	62	27	6	22	55	117	560
15:00-16:00	17	407	23	447	23	428	3	454	901	3	25	27	55	101	25	36	162	217	1118
16:00-17:00	42	342	30	414	23	491	10	524	938	7	31	30	68	142	49	27	218	286	1224
17:00-18:00	45	321	19	385	14	388	10	412	797	9	23	25	57	123	46	23	192	249	1046
<b>Sub Total</b>	<b>166</b>	<b>2789</b>	<b>169</b>	<b>3134</b>	<b>107</b>	<b>2456</b>	<b>44</b>	<b>2607</b>	<b>5741</b>	<b>48</b>	<b>157</b>	<b>226</b>	<b>431</b>	<b>529</b>	<b>146</b>	<b>263</b>	<b>938</b>	<b>1369</b>	<b>7110</b>
<b>U-Turns</b>	<b>0</b>	<b>0</b>	<b>0</b>	<b>0</b>	<b>0</b>	<b>0</b>	<b>0</b>	<b>0</b>	<b>0</b>	<b>0</b>	<b>0</b>	<b>0</b>	<b>0</b>	<b>0</b>	<b>0</b>	<b>0</b>	<b>0</b>	<b>0</b>	<b>0</b>
<b>Total</b>	<b>166</b>	<b>2789</b>	<b>169</b>	<b>3134</b>	<b>107</b>	<b>2456</b>	<b>44</b>	<b>2607</b>	<b>5741</b>	<b>48</b>	<b>157</b>	<b>226</b>	<b>431</b>	<b>529</b>	<b>146</b>	<b>263</b>	<b>938</b>	<b>1369</b>	<b>7110</b>
<b>EQ 12hr</b>	<b>231</b>	<b>3891</b>	<b>235</b>	<b>4357</b>	<b>149</b>	<b>3414</b>	<b>61</b>	<b>3624</b>	<b>7981</b>	<b>67</b>	<b>218</b>	<b>314</b>	<b>599</b>	<b>735</b>	<b>203</b>	<b>366</b>	<b>1304</b>	<b>1903</b>	<b>9884</b>
Note: These values are calculated by multiplying the totals by the appropriate expansion factor: <b>1.39</b>																			
<b>AVG 12hr</b>	<b>231</b>	<b>3891</b>	<b>235</b>	<b>4357</b>	<b>149</b>	<b>3414</b>	<b>61</b>	<b>3624</b>	<b>7981</b>	<b>67</b>	<b>218</b>	<b>314</b>	<b>599</b>	<b>735</b>	<b>203</b>	<b>366</b>	<b>1304</b>	<b>1903</b>	<b>9884</b>
Note: These values are calculated by multiplying the Equivalent 12 hr. totals by the AADT factor: <b>1.00</b>																			
<b>AVG 24hr</b>	<b>303</b>	<b>5087</b>	<b>308</b>	<b>5708</b>	<b>195</b>	<b>4472</b>	<b>80</b>	<b>4747</b>	<b>10455</b>	<b>88</b>	<b>286</b>	<b>411</b>	<b>785</b>	<b>963</b>	<b>266</b>	<b>479</b>	<b>1708</b>	<b>2493</b>	<b>12948</b>
Note: These volumes are calculated by multiplying the Average Daily 12 hr. totals by 12 to 24 expansion factor: <b>1.31</b>																			
Note: U-Turns provided for approach totals. Refer to 'U-Turn' Report for specific breakdown.																			





**Transportation Services - Traffic Services**  
**Turning Movement Count - Study Results**  
**HOLLAND AVE @ SPENCER ST**

**Survey Date:** Wednesday, January 11, 2017  
**Start Time:** 07:00

**WO No:** 36635  
**Device:** Miovision

**Full Study Pedestrian Volume**  
**HOLLAND AVE**  
**SPENCER ST**

Time Period	SB Approach (E or W Crossing)		EB Approach (N or S Crossing)		Total	Grand Total
	NB	WB	SB	EB		
07:00 07:15	0	1	1	5	6	11
07:15 07:30	1	1	2	4	4	8
07:30 07:45	5	3	8	4	8	12
07:45 08:00	2	2	4	14	14	24
08:00 08:15	6	1	7	8	17	25
08:15 08:30	3	2	5	5	18	23
08:30 08:45	6	6	12	13	11	24
08:45 09:00	3	5	8	7	15	22
09:00 09:15	8	1	9	7	16	23
09:15 09:30	5	2	7	6	9	15
09:30 09:45	2	3	5	8	10	15
09:45 10:00	1	2	3	7	9	16
11:30 11:45	3	2	5	9	47	56
11:45 12:00	3	3	6	15	114	129
12:00 12:15	2	2	4	21	80	101
12:15 12:30	5	3	8	13	81	94
12:30 12:45	3	10	13	7	80	87
12:45 13:00	0	5	5	7	85	92
13:00 13:15	1	6	7	11	55	66
13:15 13:30	2	9	11	15	31	46
15:00 15:15	5	1	6	8	15	23
15:15 15:30	5	0	5	5	10	15
15:30 15:45	8	2	10	8	20	28
15:45 16:00	2	5	7	9	6	15
16:00 16:15	6	5	11	8	18	26
16:15 16:30	4	4	8	7	19	26
16:30 16:45	7	7	14	12	27	39
16:45 17:00	2	3	5	17	12	29
17:00 17:15	4	4	8	13	30	43
17:15 17:30	9	5	14	13	30	43
17:30 17:45	4	9	13	17	14	31
17:45 18:00	4	2	6	14	15	29
Total	122	116	238	303	924	1427



**Transportation Services - Traffic Services**  
**Turning Movement Count - Study Results**  
**HOLLAND AVE @ SPENCER ST**

**Survey Date:** Wednesday, January 11, 2017  
**Start Time:** 07:00

**WO No:** 36635  
**Device:** Miovision

**Full Study Heavy Vehicles**  
**HOLLAND AVE**  
**SPENCER ST**

Time Period	Northbound			Southbound			Eastbound			Westbound			W STR TOT	STR TOT	Grand Total	
	LT	ST	RT	LT	ST	RT	LT	ST	RT	LT	ST	RT				
07:00 07:15	0	5	0	5	0	5	0	5	0	5	0	5	10	0	0	10
07:15 07:30	0	5	3	8	0	5	0	13	0	1	0	0	0	0	0	14
07:30 07:45	0	5	0	5	0	6	0	6	11	0	0	0	0	0	0	11
07:45 08:00	0	10	0	10	0	5	0	5	0	0	1	1	0	0	0	16
08:00 08:15	0	6	0	6	0	7	0	7	13	0	0	0	0	0	0	13
08:15 08:30	0	6	0	6	0	7	1	8	14	0	0	0	0	0	0	14
08:30 08:45	0	10	0	10	1	5	0	6	16	0	0	0	0	0	0	16
08:45 09:00	0	11	0	11	0	4	0	4	15	0	0	1	1	0	2	18
09:00 09:15	0	6	0	6	1	5	0	6	12	0	0	0	0	0	0	12
09:15 09:30	1	9	0	10	0	7	0	7	17	1	0	0	0	0	0	18
09:30 09:45	0	6	0	6	0	5	0	5	11	0	0	1	1	0	0	12
09:45 10:00	0	6	0	6	0	2	0	2	8	0	0	0	0	0	0	8
11:30 11:45	0	7	1	8	0	4	0	4	12	0	0	0	0	0	0	13
11:45 12:00	0	5	0	5	1	4	0	5	10	0	0	0	0	0	0	11
12:00 12:15	0	5	0	5	0	3	0	3	6	0	0	1	1	0	3	14
12:15 12:30	0	3	0	3	0	3	0	3	6	0	0	0	0	0	0	9
12:30 12:45	0	7	0	7	0	5	0	5	12	0	0	0	0	0	0	12
12:45 13:00	0	6	0	6	0	4	0	4	10	0	0	0	0	0	0	11
13:00 13:15	0	7	0	7	0	4	0	4	11	0	0	1	1	0	0	12
13:15 13:30	0	1	0	1	0	3	0	3	4	0	0	1	1	0	0	5
15:00 15:15	0	6	0	6	0	7	0	7	13	0	0	0	0	0	0	14
15:15 15:30	0	5	0	5	0	8	0	8	13	0	2	0	0	0	0	15
15:30 15:45	0	8	0	8	0	6	0	6	14	0	0	0	0	0	0	15
15:45 16:00	0	6	1	7	0	8	0	8	15	0	1	1	2	0	1	18
16:00 16:15	0	3	1	4	0	9	0	9	13	0	0	0	0	0	0	15
16:15 16:30	1	4	0	5	0	6	0	6	11	0	0	0	0	0	0	11
16:30 16:45	0	7	0	7	0	7	0	7	14	0	0	0	0	0	0	14
16:45 17:00	0	3	1	4	0	5	0	5	9	0	0	0	0	0	0	9
17:00 17:15	0	4	0	4	0	9	0	9	13	0	0	0	0	0	0	13
17:15 17:30	0	3	0	3	0	8	0	8	11	0	0	0	0	0	0	13
17:30 17:45	0	5	0	5	0	7	0	7	12	0	0	0	0	0	0	12
17:45 18:00	0	2	1	3	0	4	0	4	9	0	0	0	0	0	0	9
Total	2	185	7	194	3	180	1	184	378	1	4	7	12	7	6	417

**Transportation Services - Traffic Services**  
**Turning Movement Count - Study Results**  
**HOLLAND AVE @ SPENCER ST**

**Survey Date:** Wednesday, January 11, 2017      **WO No:** 36635  
**Start Time:** 07:00      **Device:** Miovision

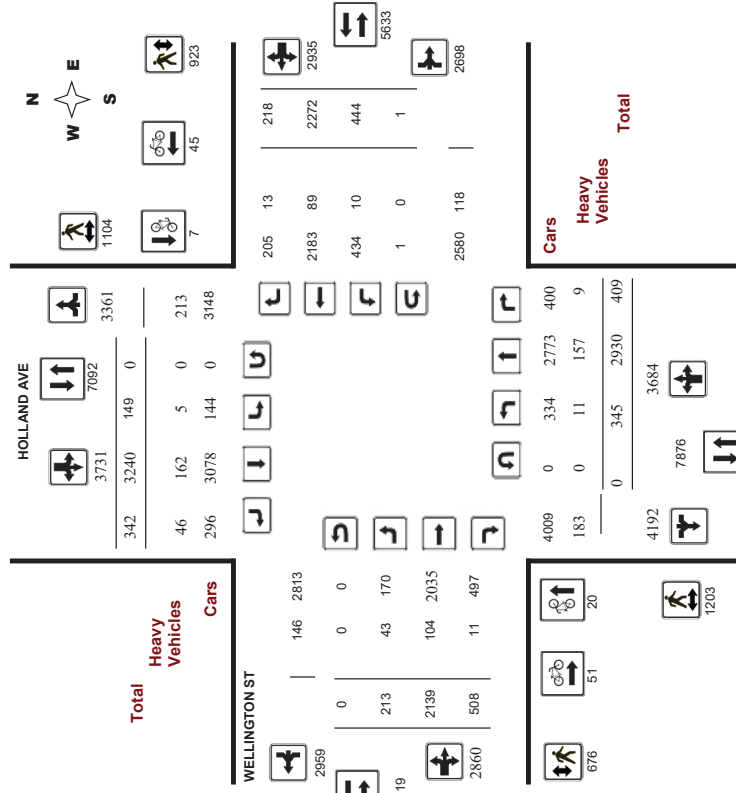
**Full Study 15 Minute U-Turn Total**

Time Period	HOLLAND AVE		Eastbound		Westbound		Total
	Northbound U-Turn Total	Southbound U-Turn Total	U-Turn Total	U-Turn Total	U-Turn Total	U-Turn Total	
07:00	0	0	0	0	0	0	0
07:15	0	0	0	0	0	0	0
07:30	0	0	0	0	0	0	0
07:45	0	0	0	0	0	0	0
08:00	0	0	0	0	0	0	0
08:15	0	0	0	0	0	0	0
08:30	0	0	0	0	0	0	0
08:45	0	0	0	0	0	0	0
09:00	0	0	0	0	0	0	0
09:15	0	0	0	0	0	0	0
09:30	0	0	0	0	0	0	0
09:45	0	0	0	0	0	0	0
10:00	0	0	0	0	0	0	0
11:30	0	0	0	0	0	0	0
11:45	0	0	0	0	0	0	0
12:00	0	0	0	0	0	0	0
12:15	0	0	0	0	0	0	0
12:30	0	0	0	0	0	0	0
12:45	0	0	0	0	0	0	0
13:00	0	0	0	0	0	0	0
13:15	0	0	0	0	0	0	0
13:30	0	0	0	0	0	0	0
15:00	0	0	0	0	0	0	0
15:15	0	0	0	0	0	0	0
15:30	0	0	0	0	0	0	0
15:45	0	0	0	0	0	0	0
16:00	0	0	0	0	0	0	0
16:15	0	0	0	0	0	0	0
16:30	0	0	0	0	0	0	0
16:45	0	0	0	0	0	0	0
17:00	0	0	0	0	0	0	0
17:15	0	0	0	0	0	0	0
17:30	0	0	0	0	0	0	0
17:45	0	0	0	0	0	0	0
18:00	0	0	0	0	0	0	0
<b>Total</b>	<b>0</b>	<b>0</b>	<b>0</b>	<b>0</b>	<b>0</b>	<b>0</b>	<b>0</b>

**Transportation Services - Traffic Services**  
**Turning Movement Count - Study Results**  
**HOLLAND AVE @ WELLINGTON ST**

**Survey Date:** Wednesday, November 22, 2017      **WO No:** 37317  
**Start Time:** 07:00      **Device:** Miovision

**Full Study Diagram**

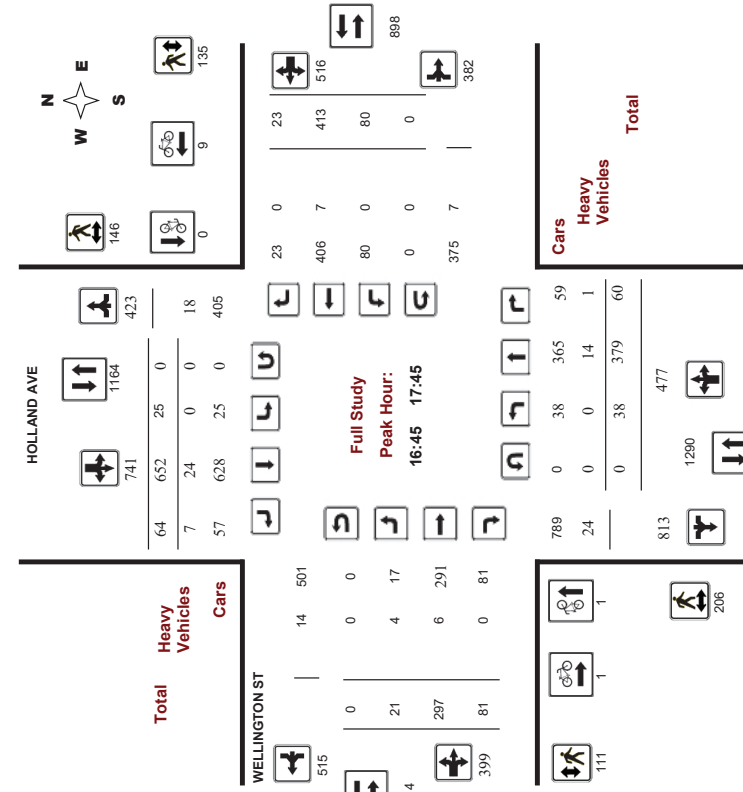




Survey Date: Wednesday, November 22, 2017  
 Start Time: 07:00

WO No: 37317  
 Device: Miovision

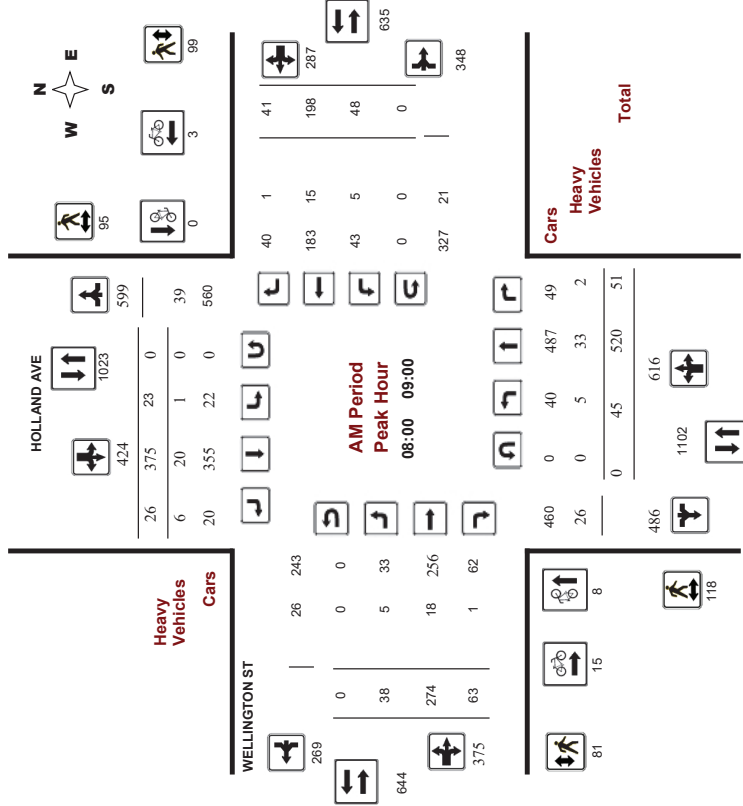
### Full Study Peak Hour Diagram



Comments

Survey Date: Wednesday, November 22, 2017  
 Start Time: 07:00

WO No: 37317  
 Device: Miovision



Comments



# Transportation Services - Traffic Services

## Turning Movement Count - Peak Hour Diagram

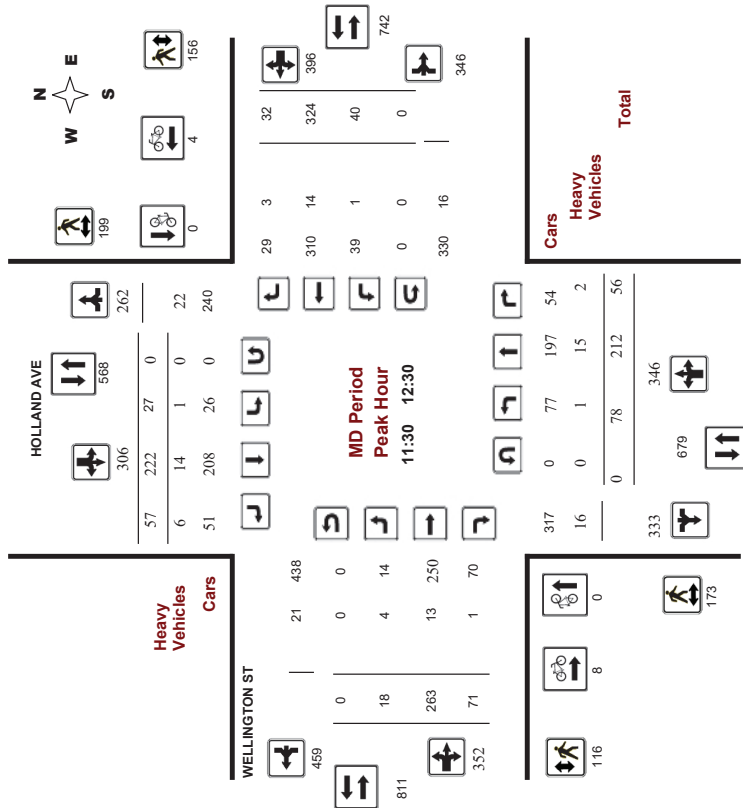
### HOLLAND AVE @ WELLINGTON ST

Survey Date: Wednesday, November 22, 2017

WO No: 37317

Start Time: 07:00

Device: Miovision



# Transportation Services - Traffic Services

## Turning Movement Count - Peak Hour Diagram

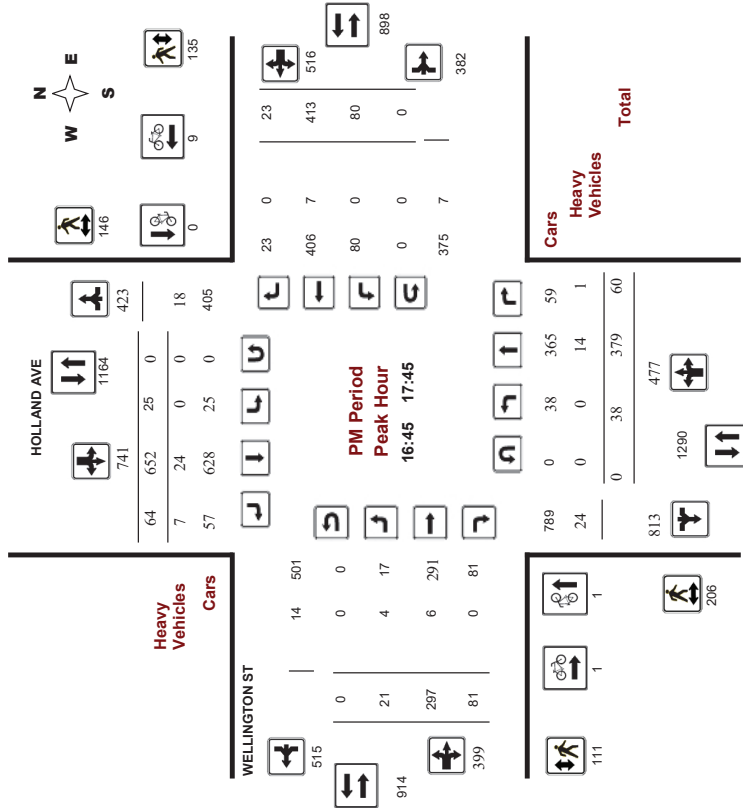
### HOLLAND AVE @ WELLINGTON ST

Survey Date: Wednesday, November 22, 2017

WO No: 37317

Start Time: 07:00

Device: Miovision





**Transportation Services - Traffic Services**  
**Turning Movement Count - Study Results**  
**HOLLAND AVE @ WELLINGTON ST**

**Survey Date:** Wednesday, November 22, 2017  
**Start Time:** 07:00

**WO No:** 37317  
**Device:** Miovision

**Full Study Summary (8 HR Standard)**

**Survey Date:** Wednesday, November 22, 2017  
**Total Observed U-Turns:** 90  
**AAADT Factor:** .90

Northbound: 0  
 Southbound: 0  
 Eastbound: 0  
 Westbound: 1

Period	Northbound				Southbound				Eastbound				Westbound				WB TOT	STR TOT	RT TOT	Grand Total
	LT	ST	RT	TOT	LT	ST	RT	TOT	LT	ST	RT	TOT	LT	ST	RT	TOT				
07:00-08:00	25	474	29	528	10	325	21	356	884	39	225	55	319	30	132	33	185	514	1398	
08:00-09:00	45	520	51	616	23	375	26	424	1040	38	274	63	375	48	198	41	287	662	1702	
09:00-10:00	42	351	48	441	16	255	34	305	746	21	257	48	326	37	203	23	263	589	1335	
11:30-12:30	78	212	56	346	27	222	57	306	652	18	263	71	352	40	324	32	396	748	1400	
12:30-13:30	47	206	53	306	19	213	39	271	577	20	278	64	362	60	258	32	350	712	1289	
15:00-16:00	28	423	60	511	12	607	37	656	1167	19	263	59	341	79	321	20	420	761	1928	
16:00-17:00	37	383	48	468	20	646	60	726	1194	28	278	67	373	90	428	15	533	906	2100	
17:00-18:00	43	361	64	468	22	597	68	687	1155	30	301	81	412	60	408	22	490	902	2057	
<b>Sub Total</b>	<b>345</b>	<b>2930</b>	<b>409</b>	<b>3684</b>	<b>149</b>	<b>3240</b>	<b>342</b>	<b>3731</b>	<b>7415</b>	<b>213</b>	<b>2139</b>	<b>508</b>	<b>2860</b>	<b>444</b>	<b>2272</b>	<b>218</b>	<b>2934</b>	<b>5794</b>	<b>13209</b>	
<b>U-Turns</b>	<b>0</b>	<b>0</b>	<b>0</b>	<b>0</b>	<b>0</b>	<b>0</b>	<b>0</b>	<b>0</b>	<b>0</b>	<b>0</b>	<b>0</b>	<b>0</b>	<b>0</b>	<b>1</b>	<b>1</b>	<b>1</b>	<b>1</b>	<b>1</b>		
<b>Total</b>	<b>345</b>	<b>2930</b>	<b>409</b>	<b>3684</b>	<b>149</b>	<b>3240</b>	<b>342</b>	<b>3731</b>	<b>7415</b>	<b>213</b>	<b>2139</b>	<b>508</b>	<b>2860</b>	<b>444</b>	<b>2272</b>	<b>218</b>	<b>2935</b>	<b>5795</b>	<b>13210</b>	
<b>EQ 12hr</b>	<b>480</b>	<b>4073</b>	<b>569</b>	<b>5121</b>	<b>207</b>	<b>4504</b>	<b>475</b>	<b>5186</b>	<b>10307</b>	<b>296</b>	<b>2973</b>	<b>706</b>	<b>3975</b>	<b>617</b>	<b>3158</b>	<b>303</b>	<b>4080</b>	<b>8655</b>	<b>18382</b>	
Note: These values are calculated by multiplying the totals by the appropriate expansion factor.																				
<b>AVG 12hr</b>	<b>407</b>	<b>3454</b>	<b>482</b>	<b>4343</b>	<b>176</b>	<b>3820</b>	<b>403</b>	<b>4399</b>	<b>9276</b>	<b>251</b>	<b>2522</b>	<b>599</b>	<b>3372</b>	<b>523</b>	<b>2679</b>	<b>257</b>	<b>3460</b>	<b>7250</b>	<b>16526</b>	
Note: These volumes are calculated by multiplying the Average Daily 12 hr. totals by 12 to 24 expansion factor.																				
<b>AVG 24hr</b>	<b>533</b>	<b>4525</b>	<b>632</b>	<b>5690</b>	<b>230</b>	<b>5004</b>	<b>528</b>	<b>5762</b>	<b>11452</b>	<b>329</b>	<b>3304</b>	<b>785</b>	<b>4417</b>	<b>686</b>	<b>3509</b>	<b>337</b>	<b>4533</b>	<b>8950</b>	<b>20402</b>	
Note: These volumes are calculated by multiplying the Average Daily 12 hr. totals by 12 to 24 expansion factor.																				
Note: U-Turns provided for approach totals. Refer to 'U-Turn' Report for specific breakdown.																				



**Transportation Services - Traffic Services**  
**Turning Movement Count - Study Results**  
**HOLLAND AVE @ WELLINGTON ST**

**Survey Date:** Wednesday, November 22, 2017  
**Start Time:** 07:00

**WO No:** 37317  
**Device:** Miovision

**Full Study 15 Minute Increments**

**Survey Date:** Wednesday, November 22, 2017  
**Total Observed U-Turns:** 90  
**AAADT Factor:** .90

Northbound: 0  
 Southbound: 0  
 Eastbound: 0  
 Westbound: 1

Time Period	Northbound				Southbound				Eastbound				Westbound				W TOT	STR TOT	RT TOT	Grand Total
	LT	ST	RT	TOT	LT	ST	RT	TOT	LT	ST	RT	TOT	LT	ST	RT	TOT				
07:00	3	108	5	116	5	71	2	78	11	11	56	11	78	5	26	7	38	11	310	
07:15	6	124	7	137	1	80	7	88	13	10	46	11	67	3	36	9	48	13	340	
07:30	7	111	7	125	4	69	3	76	11	8	49	7	64	12	31	12	55	11	320	
07:45	9	131	10	150	0	105	9	114	16	10	74	26	110	10	39	5	54	16	428	
08:00	7	148	8	163	4	100	5	109	14	11	70	21	102	8	39	11	58	14	432	
08:15	9	120	11	140	6	91	4	101	17	6	64	13	83	13	42	16	71	17	395	
08:30	16	123	16	155	10	94	10	114	18	10	69	20	99	15	53	9	77	18	445	
08:45	13	129	16	158	3	90	7	100	18	11	71	9	91	12	64	5	81	18	430	
09:00	14	124	19	157	5	78	8	91	16	3	70	15	88	13	46	7	66	16	402	
09:15	12	100	6	118	4	79	8	91	13	9	66	8	83	5	55	4	64	13	356	
09:30	10	72	13	95	2	61	4	67	11	7	63	9	79	10	52	7	69	11	310	
09:45	6	55	10	71	5	37	14	56	10	2	58	16	76	9	50	5	64	10	267	
11:30	18	53	12	83	6	47	13	66	10	3	62	14	79	12	84	8	104	10	332	
11:45	18	56	15	89	8	50	20	78	11	4	59	18	81	8	82	7	97	11	345	
12:00	19	54	17	90	4	62	11	77	6	6	67	14	87	12	76	7	95	6	349	
12:15	23	49	12	84	9	63	13	85	12	5	75	25	105	8	82	10	100	12	374	
12:30	16	42	14	72	6	56	11	73	7	7	60	18	85	15	61	8	84	7	314	
15:00	5	95	11	111	5	149	4	158	12	4	69	16	89	23	56	4	83	12	441	
15:15	8	58	15	81	4	44	9	57	14	4	75	13	92	11	76	4	91	14	321	
15:30	9	118	17	144	3	144	8	159	14	5	61	17	83	14	81	3	98	14	484	
15:45	10	97	16	123	3	158	11	172	12	4	66	15	85	18	87	10	115	12	495	
16:00	4	113	16	133	1	152	14	167	19	6	67	11	84	24	97	3	124	19	508	
16:15	5	83	16	104	6	157	10	173	8	7	76	17	100	19	106	3	128	8	505	
16:30	11	120	8	139	3	165	16	184	16	10	69	13	92	19	107	5	131	16	546	
16:45	14	86	9	109	4	161	15	180	9	8	60	16	84	26	104	1	131	9	504	
16:45-17:00	7	94	15	116	7	163	19	189	13	3	73	21	97	26	111	6	143	13	545	
17:00	7	84	12	103	8	181	17	206	15	9	74	14	97	23	90	5	118	15	524	
17:15	7	98	15	120	5	174	10	189	7	3	72	18	93	15	106	8	129	7	551	
17:30	17	103	18	138	5	134	18	157	11	6	78	28	112	16	106	4	126	11	533	
17:45	12	76	19	107	4	108	23	135	10	12	77	21	110	6	106	5	118	10	470	
<b>Total:</b>	<b>345</b>	<b>2930</b>	<b>409</b>	<b>3684</b>	<b>149</b>	<b>3240</b>	<b>342</b>	<b>3731</b>	<b>7415</b>	<b>213</b>	<b>2139</b>	<b>508</b>	<b>2860</b>	<b>444</b>	<b>2272</b>	<b>218</b>	<b>2935</b>	<b>5795</b>	<b>13210</b>	

Note: U-Turns are included in Totals.



**Transportation Services - Traffic Services**  
**Turning Movement Count - Study Results**  
**HOLLAND AVE @ WELLINGTON ST**

**Survey Date:** Wednesday, November 22, 2017  
**Start Time:** 07:00

**WO No:** 37317  
**Device:** Miovision

**Full Study Cyclist Volume**  
**HOLLAND AVE**  
**WELLINGTON ST**

Time Period	Northbound	Southbound	Street Total	Eastbound	Westbound	Street Total	Grand Total
07:00 07:15	0	0	0	3	0	3	3
07:15 07:30	1	0	1	0	1	1	2
07:30 07:45	2	0	2	1	2	3	5
07:45 08:00	1	1	2	5	4	9	11
08:00 08:15	2	0	2	3	0	3	5
08:15 08:30	2	0	2	3	0	3	5
08:30 08:45	1	0	1	6	1	7	8
08:45 09:00	3	0	3	3	2	5	8
09:00 09:15	0	0	0	1	3	4	4
09:15 09:30	2	0	2	1	1	2	4
09:30 09:45	0	0	0	0	1	1	1
09:45 10:00	1	0	1	0	3	3	4
10:00 10:15	0	0	0	1	2	3	3
10:15 10:30	0	0	0	4	1	5	5
10:30 10:45	0	0	0	2	1	3	3
10:45 11:00	0	0	0	1	0	1	1
11:00 11:15	0	0	0	1	0	1	1
11:15 11:30	0	0	0	2	0	2	2
11:30 11:45	0	0	0	1	1	2	2
11:45 12:00	0	0	0	3	0	3	3
12:00 12:15	0	0	0	1	0	1	1
12:15 12:30	0	0	0	2	0	2	2
12:30 12:45	0	0	0	1	1	2	2
12:45 13:00	0	0	0	3	1	4	4
13:00 13:15	0	0	0	2	2	4	4
13:15 13:30	1	1	2	2	1	3	5
13:30 13:45	0	0	0	0	0	0	0
13:45 14:00	0	0	0	0	0	0	0
14:00 14:15	0	0	0	1	1	2	3
14:15 14:30	1	2	3	1	0	4	4
14:30 14:45	1	1	2	2	4	6	8
14:45 15:00	1	0	1	1	2	3	4
15:00 15:15	0	0	0	1	2	3	3
15:15 15:30	0	0	0	0	0	0	0
15:30 15:45	0	0	0	0	0	0	0
15:45 16:00	0	1	1	1	1	2	3
16:00 16:15	1	2	3	1	0	4	4
16:15 16:30	1	1	2	2	4	6	8
16:30 16:45	1	0	1	1	2	3	4
16:45 17:00	0	0	0	0	2	2	2
17:00 17:15	0	0	0	0	2	2	2
17:15 17:30	0	0	0	0	1	1	1
17:30 17:45	0	0	0	0	4	4	4
17:45 18:00	0	1	1	0	2	2	3
<b>Total</b>	<b>20</b>	<b>7</b>	<b>27</b>	<b>51</b>	<b>45</b>	<b>96</b>	<b>123</b>



**Transportation Services - Traffic Services**  
**Turning Movement Count - Study Results**  
**HOLLAND AVE @ WELLINGTON ST**

**Survey Date:** Wednesday, November 22, 2017  
**Start Time:** 07:00

**WO No:** 37317  
**Device:** Miovision

**Full Study Pedestrian Volume**  
**HOLLAND AVE**  
**WELLINGTON ST**

Time Period	NB Approach (E or W Crossing)	SB Approach (E or W Crossing)	Total	EB Approach (N or S Crossing)	WB Approach (N or S Crossing)	Total	Grand Total
07:00 07:15	17	5	22	3	10	13	35
07:15 07:30	17	16	33	10	14	24	57
07:30 07:45	23	10	33	5	12	17	50
07:45 08:00	26	16	42	12	20	32	74
08:00 08:15	27	18	45	9	14	23	68
08:15 08:30	35	21	56	28	25	53	109
08:30 08:45	29	30	59	27	28	55	114
08:45 09:00	27	26	53	17	32	49	102
09:00 09:15	19	21	40	10	14	24	64
09:15 09:30	26	21	47	11	24	35	82
09:30 09:45	30	18	48	14	13	27	75
09:45 10:00	24	31	55	14	13	27	82
10:00 10:15	40	24	64	20	39	59	123
10:15 10:30	40	42	82	19	46	65	147
10:30 10:45	38	68	106	31	30	61	167
10:45 11:00	41	65	106	46	41	87	193
11:00 11:15	61	63	124	33	58	91	215
11:15 11:30	43	36	79	17	24	41	120
11:30 11:45	64	67	131	22	55	77	198
11:45 12:00	29	53	82	23	31	54	136
12:00 12:15	59	61	120	31	53	84	204
12:15 12:30	38	30	68	26	17	43	111
12:30 12:45	35	32	67	22	31	53	120
12:45 13:00	41	35	76	21	29	50	126
13:00 13:15	46	28	74	22	26	48	122
13:15 13:30	41	38	79	33	21	54	133
13:30 13:45	37	43	80	27	34	61	141
13:45 14:00	71	26	97	41	31	72	169
14:00 14:15	40	54	94	25	36	61	155
14:15 14:30	50	35	85	21	35	56	141
14:30 14:45	45	31	76	24	33	57	133
14:45 15:00	40	40	80	12	34	46	126
<b>Total</b>	<b>1203</b>	<b>1104</b>	<b>2307</b>	<b>676</b>	<b>923</b>	<b>1599</b>	<b>3906</b>



**Transportation Services - Traffic Services**  
**Turning Movement Count - Study Results**  
**HOLLAND AVE @ WELLINGTON ST**

**Survey Date:** Wednesday, November 22, 2017  
**Start Time:** 07:00

**WO No:** 37317  
**Device:** Miovision

**Full Study Heavy Vehicles**

Time Period	Northbound				Southbound				Eastbound				Westbound				Grand Total			
	LT	ST	RT	TOT	LT	ST	RT	TOT	LT	ST	RT	TOT	LT	ST	RT	TOT				
07:00	1	4	0	5	1	4	1	6	11	4	4	0	8	0	2	0	2	10	21	
07:15	0	7	0	7	0	5	0	5	13	2	5	1	8	0	2	0	2	10	23	
07:30	0	6	0	6	0	5	0	5	11	1	2	0	3	0	1	1	2	5	16	
07:45	0	6	0	6	0	6	2	8	16	2	3	1	6	0	3	0	3	9	25	
08:00	0	6	1	7	0	5	2	7	14	1	6	0	7	0	2	0	2	9	23	
08:15	0	8	0	8	0	6	1	7	17	1	0	0	1	0	3	1	4	5	22	
08:30	0	9	0	9	0	12	1	3	2	6	18	2	2	1	5	3	4	0	7	30
08:45	0	10	0	10	0	7	1	8	18	1	10	0	11	2	6	0	8	19	37	
09:00	0	7	0	7	0	8	1	9	16	1	3	0	4	1	1	3	5	9	25	
09:15	0	6	0	6	0	4	3	7	13	3	6	0	9	0	4	1	5	14	27	
09:30	0	2	1	3	0	7	1	8	11	2	4	1	7	0	1	0	1	8	19	
09:45	0	5	0	5	0	5	0	5	10	1	4	1	6	0	2	0	2	8	18	
10:00	0	3	0	3	0	3	1	4	7	10	1	4	0	5	0	5	10	20		
11:30	0	4	1	5	0	3	3	6	11	1	3	0	4	0	3	1	4	8	19	
12:00	0	4	0	4	0	1	1	2	6	2	3	0	5	1	2	0	3	8	14	
12:15	0	4	1	5	0	5	1	6	12	0	3	1	4	0	4	2	6	10	22	
12:30	0	2	0	2	0	3	2	5	7	1	2	0	3	0	3	0	3	4	7	14
15:00	0	7	1	8	0	3	1	4	12	0	3	0	3	1	1	0	2	5	17	
12:45	0	3	0	3	0	4	0	4	8	1	7	1	9	1	6	1	8	17	25	
13:00	0	3	0	3	0	4	1	5	8	0	5	1	6	0	5	0	5	11	19	
13:15	0	8	1	9	0	4	1	5	14	2	3	0	5	0	4	0	4	9	23	
15:15	0	6	0	6	0	7	1	8	14	2	5	0	7	0	6	1	7	14	28	
15:30	0	5	0	5	0	5	2	7	12	2	3	1	6	0	1	0	1	7	19	
15:45	0	5	0	5	0	11	2	14	19	2	1	0	3	1	0	0	1	4	23	
16:00	0	2	0	2	0	4	2	6	8	1	4	0	5	0	4	0	4	9	17	
16:15	0	6	1	7	1	8	0	9	16	1	0	2	3	0	4	0	4	7	23	
16:30	0	3	0	3	0	4	2	6	9	1	1	0	2	0	3	1	4	6	15	
16:45	0	4	0	4	0	7	2	9	13	1	4	0	5	0	2	0	2	7	20	
17:00	0	4	0	4	0	9	2	11	15	2	0	0	2	0	1	0	1	3	18	
17:15	0	2	1	3	0	4	0	4	7	0	0	0	0	0	2	0	2	2	9	
17:30	0	4	0	4	0	4	3	7	11	1	2	0	3	0	2	0	2	5	16	
17:45	0	2	0	2	0	7	1	8	10	1	2	0	3	0	0	0	0	3	13	
Total	11	157	9	177	5	162	46	213	390	43	104	11	156	10	89	13	112	270	660	



**Transportation Services - Traffic Services**  
**Turning Movement Count - Study Results**  
**HOLLAND AVE @ WELLINGTON ST**

**Survey Date:** Wednesday, November 22, 2017  
**Start Time:** 07:00

**WO No:** 37317  
**Device:** Miovision

**Full Study 15 Minute U-Turn Total**

Time Period	Northbound		Southbound		Eastbound		Westbound		Total
	U-Turn	Total	U-Turn	Total	U-Turn	Total	U-Turn	Total	
07:00	0	0	0	0	0	0	0	0	0
07:15	0	0	0	0	0	0	0	0	0
07:30	0	0	0	0	0	0	0	0	0
07:45	0	0	0	0	0	0	0	0	0
08:00	0	0	0	0	0	0	0	0	0
08:15	0	0	0	0	0	0	0	0	0
08:30	0	0	0	0	0	0	0	0	0
08:45	0	0	0	0	0	0	0	0	0
09:00	0	0	0	0	0	0	0	0	0
09:15	0	0	0	0	0	0	0	0	0
09:30	0	0	0	0	0	0	0	0	0
09:45	0	0	0	0	0	0	0	0	0
10:00	0	0	0	0	0	0	0	0	0
11:30	0	0	0	0	0	0	0	0	0
11:45	0	0	0	0	0	0	0	0	0
12:00	0	0	0	0	0	0	0	0	0
12:15	0	0	0	0	0	0	0	0	0
12:30	0	0	0	0	0	0	0	0	0
12:45	0	0	0	0	0	0	0	0	0
15:00	0	0	0	0	0	0	0	0	0
15:15	0	0	0	0	0	0	0	0	0
15:30	0	0	0	0	0	0	0	0	0
15:45	0	0	0	0	0	0	0	0	0
16:00	0	0	0	0	0	0	0	0	0
16:15	0	0	0	0	0	0	0	0	0
16:30	0	0	0	0	0	0	0	0	0
16:45	0	0	0	0	0	0	0	0	0
17:00	0	0	0	0	0	0	0	0	0
17:15	0	0	0	0	0	0	0	0	0
17:30	0	0	0	0	0	0	0	0	0
17:45	0	0	0	0	0	0	0	0	0
18:00	0	0	0	0	0	0	0	0	0
Total	0	0	0	0	0	0	0	0	0





# Transportation Services - Traffic Services

## Turning Movement Count - Peak Hour Diagram

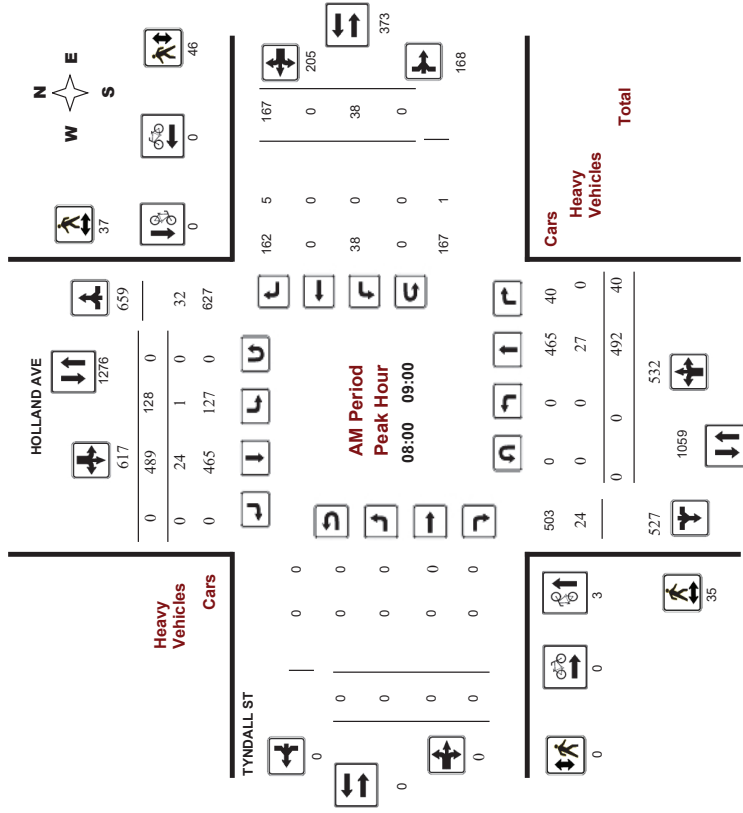
### HOLLAND AVE @ TYNDALL ST

Survey Date: Wednesday, January 11, 2017

WO No: 36638

Device: MiVision

Start Time: 07:00



# Transportation Services - Traffic Services

## Turning Movement Count - Peak Hour Diagram

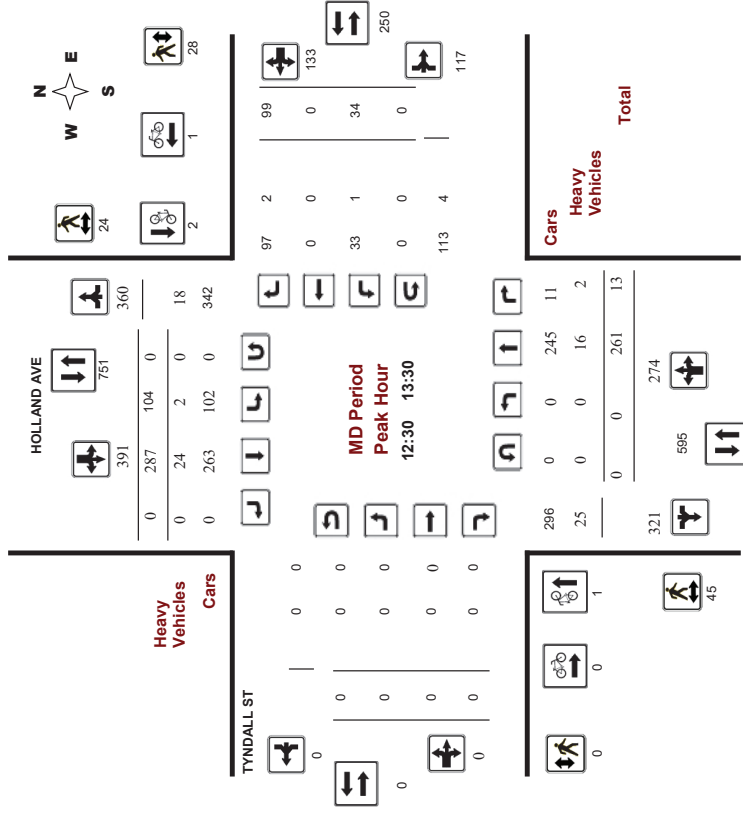
### HOLLAND AVE @ TYNDALL ST

Survey Date: Wednesday, January 11, 2017

WO No: 36638

Device: MiVision

Start Time: 07:00







# Transportation Services - Traffic Services

## Turning Movement Count - Peak Hour Diagram

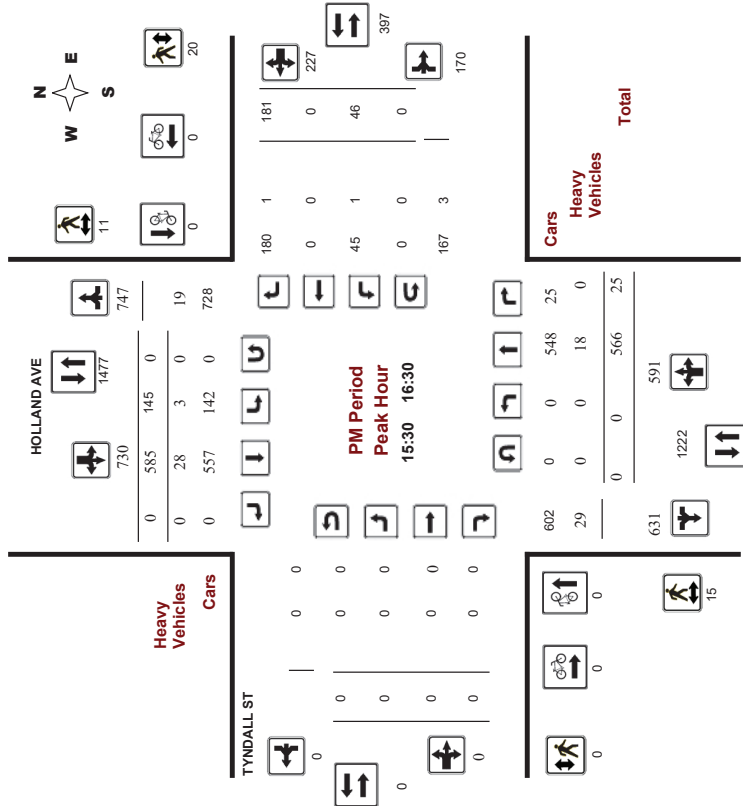
HOLLAND AVE @ TYNDALL ST

Survey Date: Wednesday, January 11, 2017

WO No: 36638

Start Time: 07:00

Device: Miovision



Comments



# Transportation Services - Traffic Services

## Turning Movement Count - Study Results

HOLLAND AVE @ TYNDALL ST

Survey Date: Wednesday, January 11, 2017

WO No: 36638

Start Time: 07:00

Device: Miovision

### Full Study Summary (8 HR Standard)

Survey Date: Wednesday, January 11, 2017

Total Observed U-Turns

Northbound: 0

Southbound: 0

Eastbound: 0

Westbound: 0

AADT Factor: 1.00

Period	HOLLAND AVE						TYNDALL ST						Grand Total				
	Northbound			Southbound			Eastbound			Westbound							
	LT	ST	RT	NB TOT	LT	ST	RT	SB TOT	LT	ST	RT	EB TOT	LT	ST	RT	WB TOT	
07:00-08:00	0	419	10	429	101	375	0	476	905	0	0	0	0	25	0	133	158
08:00-09:00	0	482	40	532	128	489	0	617	1149	0	0	0	0	38	0	167	205
09:00-10:00	0	363	26	389	107	285	0	392	781	0	0	0	0	20	0	121	141
11:30-12:30	0	235	19	254	99	237	0	336	590	0	0	0	0	16	0	109	125
12:30-13:30	0	281	13	274	104	287	0	391	665	0	0	0	0	34	0	99	133
15:00-16:00	0	540	31	571	161	563	0	724	1295	0	0	0	0	61	0	127	188
16:00-17:00	0	546	22	568	127	584	0	711	1279	0	0	0	0	47	0	179	226
17:00-18:00	0	497	24	521	123	521	0	644	1165	0	0	0	0	56	0	168	224
<b>Sub Total</b>	<b>0</b>	<b>3353</b>	<b>185</b>	<b>3538</b>	<b>950</b>	<b>3341</b>	<b>0</b>	<b>4291</b>	<b>7829</b>	<b>0</b>	<b>0</b>	<b>0</b>	<b>0</b>	<b>297</b>	<b>0</b>	<b>1103</b>	<b>1400</b>
<b>U-Turns</b>	<b>0</b>	<b>0</b>	<b>0</b>	<b>0</b>	<b>0</b>	<b>0</b>	<b>0</b>	<b>0</b>	<b>0</b>	<b>0</b>	<b>0</b>	<b>0</b>	<b>0</b>	<b>0</b>	<b>0</b>	<b>0</b>	<b>0</b>
<b>Total</b>	<b>0</b>	<b>3353</b>	<b>185</b>	<b>3538</b>	<b>950</b>	<b>3341</b>	<b>0</b>	<b>4291</b>	<b>7829</b>	<b>0</b>	<b>0</b>	<b>0</b>	<b>0</b>	<b>297</b>	<b>0</b>	<b>1103</b>	<b>1400</b>
<b>EQ 12hr</b>	<b>0</b>	<b>4681</b>	<b>257</b>	<b>4918</b>	<b>1320</b>	<b>4644</b>	<b>0</b>	<b>5964</b>	<b>10882</b>	<b>0</b>	<b>0</b>	<b>0</b>	<b>0</b>	<b>413</b>	<b>0</b>	<b>1533</b>	<b>1946</b>
Note: These values are calculated by multiplying the totals by the appropriate expansion factor. <b>1.39</b>																	
<b>AVG 12hr</b>	<b>0</b>	<b>4861</b>	<b>257</b>	<b>4918</b>	<b>1320</b>	<b>4644</b>	<b>0</b>	<b>5964</b>	<b>10882</b>	<b>0</b>	<b>0</b>	<b>0</b>	<b>0</b>	<b>413</b>	<b>0</b>	<b>1533</b>	<b>1946</b>
Note: These values are calculated by multiplying the Equivalent 12 hr. totals by the AADT factor. <b>1.00</b>																	
<b>AVG 24hr</b>	<b>0</b>	<b>6106</b>	<b>337</b>	<b>6443</b>	<b>1729</b>	<b>6084</b>	<b>0</b>	<b>7813</b>	<b>14256</b>	<b>0</b>	<b>0</b>	<b>0</b>	<b>0</b>	<b>541</b>	<b>0</b>	<b>2008</b>	<b>2549</b>
Note: These volumes are calculated by multiplying the Average Daily 12 hr. totals by 12 to 24 expansion factor. <b>1.31</b>																	
Note: U-Turns provided for approach totals. Refer to 'U-Turn' Report for specific breakdown.																	





**Transportation Services - Traffic Services**  
**Turning Movement Count - Study Results**  
**HOLLAND AVE @ TYNDALL ST**

**Survey Date:** Wednesday, January 11, 2017      **WO No:** 36638  
**Start Time:** 07:00      **Device:** Miovision

**Full Study Pedestrian Volume**  
**TYNDALL ST**

Time Period	SB Approach (E or W Crossing)		EB Approach (N or S Crossing)		Total	WB Approach (N or S Crossing)	Grand Total
	NB	SB	NB	SB			
07:00-07:15	2	1	3	0	1	1	4
07:15-07:30	5	1	6	0	4	4	10
07:30-07:45	1	2	3	0	1	1	4
07:45-08:00	0	5	5	0	4	4	9
08:00-08:15	4	3	7	0	10	10	17
08:15-08:30	6	17	23	0	11	11	34
08:30-08:45	21	16	37	0	22	22	59
08:45-09:00	4	1	5	0	3	3	8
09:00-09:15	4	1	5	0	2	2	7
09:15-09:30	3	3	6	0	0	0	6
09:30-09:45	0	0	0	0	3	3	3
09:45-10:00	0	0	0	0	0	0	0
10:00-10:15	3	0	3	0	3	3	6
10:15-10:30	0	3	3	0	7	7	10
10:30-10:45	1	3	4	0	4	4	8
10:45-11:00	1	2	3	0	3	3	6
11:00-11:15	24	5	29	0	1	1	30
11:15-11:30	5	7	12	0	6	6	18
11:30-11:45	2	7	9	0	6	6	15
11:45-12:00	14	5	19	0	15	15	34
12:00-12:15	1	3	4	0	8	8	12
12:15-12:30	15	19	34	0	14	14	48
12:30-12:45	4	4	8	0	3	3	11
12:45-13:00	3	3	6	0	6	6	12
13:00-13:15	5	2	7	0	6	6	13
13:15-13:30	3	2	5	0	5	5	10
13:30-13:45	7	8	15	0	7	7	22
13:45-14:00	2	1	3	0	3	3	6
14:00-14:15	2	2	4	0	5	5	9
14:15-14:30	3	3	6	0	7	7	13
14:30-14:45	5	1	6	0	6	6	12
14:45-15:00	5	1	6	0	2	2	8
Total	155	131	286	0	178	178	464



**Transportation Services - Traffic Services**  
**Turning Movement Count - Study Results**  
**HOLLAND AVE @ TYNDALL ST**

**Survey Date:** Wednesday, January 11, 2017      **WO No:** 36638  
**Start Time:** 07:00      **Device:** Miovision

**Full Study Heavy Vehicles**  
**TYNDALL ST**

Time Period	Northbound				Southbound				Eastbound				Westbound				Grand Total	
	HOLLAND AVE		TYNDALL ST		HOLLAND AVE		TYNDALL ST		HOLLAND AVE		TYNDALL ST		HOLLAND AVE		TYNDALL ST			
	LT	RT	LT	RT	LT	RT	LT	RT	LT	RT	LT	RT	LT	RT	LT	RT		
07:00-07:15	0	6	1	7	0	6	0	6	0	6	13	0	0	0	0	1	1	14
07:15-07:30	0	5	0	5	0	5	0	5	0	5	10	0	0	0	0	1	1	11
07:30-07:45	0	5	1	6	0	3	0	3	9	0	0	0	0	0	3	3	12	
07:45-08:00	0	10	0	10	0	8	0	8	18	0	0	0	0	0	2	2	20	
08:00-08:15	0	4	0	4	0	7	0	7	11	0	0	0	0	0	2	2	13	
08:15-08:30	0	5	0	5	0	7	0	7	12	0	0	0	0	0	1	1	13	
08:30-08:45	0	8	0	8	1	5	0	6	14	0	0	0	0	0	1	1	15	
08:45-09:00	0	10	0	10	0	5	0	5	15	0	0	0	0	0	1	1	16	
09:00-09:15	0	9	0	9	1	7	0	8	17	0	0	0	0	0	2	2	19	
09:15-09:30	0	8	0	8	0	5	0	5	13	0	0	0	0	0	0	0	13	
09:30-09:45	0	4	0	4	1	4	0	5	9	0	0	0	0	0	1	3	12	
09:45-10:00	0	3	0	3	0	1	0	1	4	0	0	0	0	0	0	0	4	
10:00-10:15	0	4	0	4	1	2	0	3	7	0	0	0	0	0	0	0	7	
10:15-10:30	0	4	0	4	2	3	0	5	9	0	0	0	0	0	1	1	10	
10:30-10:45	0	4	0	4	0	7	0	7	11	0	0	0	0	0	1	1	12	
10:45-11:00	0	2	0	2	0	2	0	2	4	0	0	0	0	0	0	0	4	
11:00-11:15	0	5	1	6	0	8	0	8	14	0	0	0	0	0	1	1	15	
11:15-11:30	0	4	0	4	0	4	0	4	8	0	0	0	0	0	1	1	9	
11:30-11:45	0	6	0	6	2	6	0	8	14	0	0	0	0	0	0	0	14	
11:45-12:00	0	1	1	2	0	6	0	6	8	0	0	0	0	0	0	0	9	
12:00-12:15	0	5	0	5	0	8	0	8	13	0	0	0	0	0	0	0	13	
12:15-12:30	0	4	0	4	0	8	0	8	12	0	0	0	0	0	0	0	12	
12:30-12:45	0	3	0	3	0	8	0	8	11	0	0	0	0	0	1	1	16	
12:45-13:00	0	5	1	6	0	8	0	8	14	0	0	0	0	0	0	0	11	
13:00-13:15	0	2	0	2	0	2	0	2	4	0	0	0	0	0	0	0	4	
13:15-13:30	0	4	0	4	0	4	0	4	8	0	0	0	0	0	1	1	9	
13:30-13:45	0	6	0	6	2	6	0	8	14	0	0	0	0	0	0	0	14	
13:45-14:00	0	1	1	2	0	6	0	6	8	0	0	0	0	0	0	0	9	
14:00-14:15	0	5	0	5	0	8	0	8	13	0	0	0	0	0	0	0	13	
14:15-14:30	0	4	0	4	0	8	0	8	12	0	0	0	0	0	0	0	12	
14:30-14:45	0	8	0	8	1	6	0	7	15	0	0	0	0	0	1	1	16	
14:45-15:00	0	3	0	3	0	8	0	8	11	0	0	0	0	0	0	0	11	
15:00-15:15	0	5	1	6	0	9	0	9	14	0	0	0	0	0	0	0	14	
15:15-15:30	0	2	0	2	1	6	0	7	9	0	0	0	0	0	0	0	10	
15:30-15:45	0	4	0	4	0	6	0	6	10	0	0	0	0	0	0	0	10	
15:45-16:00	0	4	0	4	0	6	0	6	10	0	0	0	0	0	0	0	10	
16:00-16:15	0	5	1	6	0	7	0	7	9	0	0	0	0	0	0	0	10	
16:15-16:30	0	2	0	2	1	6	0	7	9	0	0	0	0	0	0	0	10	
16:30-16:45	0	4	0	4	0	6	0	6	10	0	0	0	0	0	0	0	10	
16:45-17:00	0	3	0	3	0	3	0	3	6	0	0	0	0	0	0	0	6	
17:00-17:15	0	3	0	3	0	3	0	3	6	0	0	0	0	0	0	0	6	
17:15-17:30	0	2	0	2	0	6	0	6	8	0	0	0	0	0	0	0	8	
17:30-17:45	0	3	0	3	0	6	0	6	9	0	0	0	0	0	0	0	9	
17:45-18:00	0	4	0	4	0	7	0	7	11	0	0	0	0	0	0	0	11	
Total	0	153	4	157	11	177	0	188	345	0	0	0	0	5	0	22	27	372



**Transportation Services - Traffic Services**  
**Turning Movement Count - Study Results**  
**HOLLAND AVE @ TYNDALL ST**

**Survey Date:** Wednesday, January 11, 2017  
**Start Time:** 07:00  
**WO No:** 36638  
**Device:** Miovision

**Full Study 15 Minute U-Turn Total**  
**HOLLAND AVE**  
**TYNDALL ST**

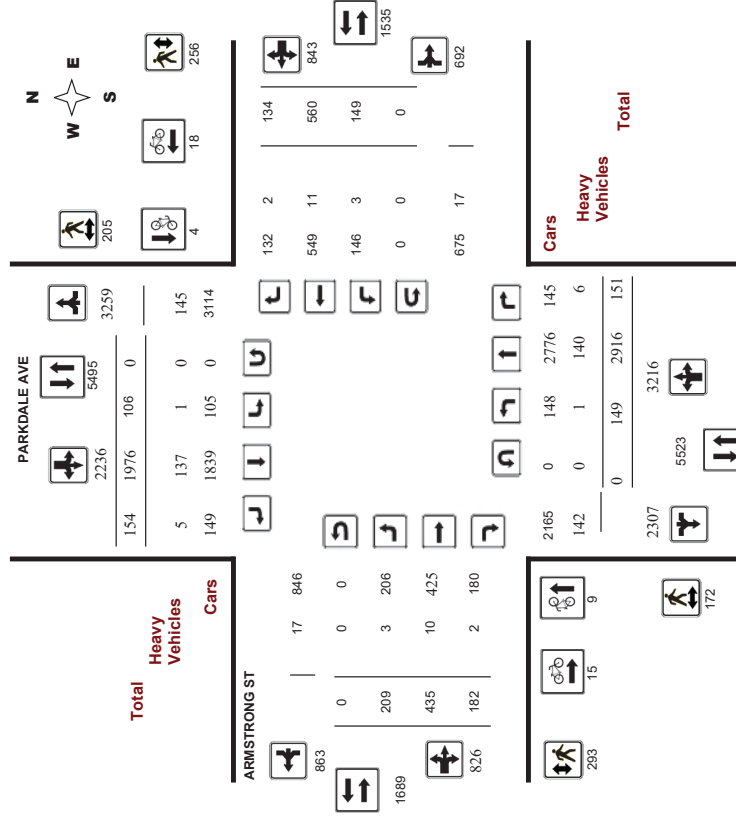
Time Period	Northbound		Southbound		Eastbound		Westbound		Total
	U-Turn	Total	U-Turn	Total	U-Turn	Total	U-Turn	Total	
07:00	0	0	0	0	0	0	0	0	0
07:15	0	0	0	0	0	0	0	0	0
07:30	0	0	0	0	0	0	0	0	0
07:45	0	0	0	0	0	0	0	0	0
08:00	0	0	0	0	0	0	0	0	0
08:15	0	0	0	0	0	0	0	0	0
08:30	0	0	0	0	0	0	0	0	0
08:45	0	0	0	0	0	0	0	0	0
09:00	0	0	0	0	0	0	0	0	0
09:15	0	0	0	0	0	0	0	0	0
09:30	0	0	0	0	0	0	0	0	0
09:45	0	0	0	0	0	0	0	0	0
10:00	0	0	0	0	0	0	0	0	0
11:30	0	0	0	0	0	0	0	0	0
11:45	0	0	0	0	0	0	0	0	0
12:00	0	0	0	0	0	0	0	0	0
12:15	0	0	0	0	0	0	0	0	0
12:30	0	0	0	0	0	0	0	0	0
12:45	0	0	0	0	0	0	0	0	0
13:00	0	0	0	0	0	0	0	0	0
13:15	0	0	0	0	0	0	0	0	0
13:30	0	0	0	0	0	0	0	0	0
15:00	0	0	0	0	0	0	0	0	0
15:15	0	0	0	0	0	0	0	0	0
15:30	0	0	0	0	0	0	0	0	0
15:45	0	0	0	0	0	0	0	0	0
16:00	0	0	0	0	0	0	0	0	0
16:15	0	0	0	0	0	0	0	0	0
16:30	0	0	0	0	0	0	0	0	0
16:45	0	0	0	0	0	0	0	0	0
17:00	0	0	0	0	0	0	0	0	0
17:15	0	0	0	0	0	0	0	0	0
17:30	0	0	0	0	0	0	0	0	0
17:45	0	0	0	0	0	0	0	0	0
18:00	0	0	0	0	0	0	0	0	0
Total	0	0	0	0	0	0	0	0	0



**Transportation Services - Traffic Services**  
**Turning Movement Count - Study Results**  
**ARMSTRONG ST @ PARKDALE AVE**

**Survey Date:** Wednesday, November 20, 2019  
**Start Time:** 07:00  
**WO No:** 39080  
**Device:** Miovision

**Full Study Diagram**

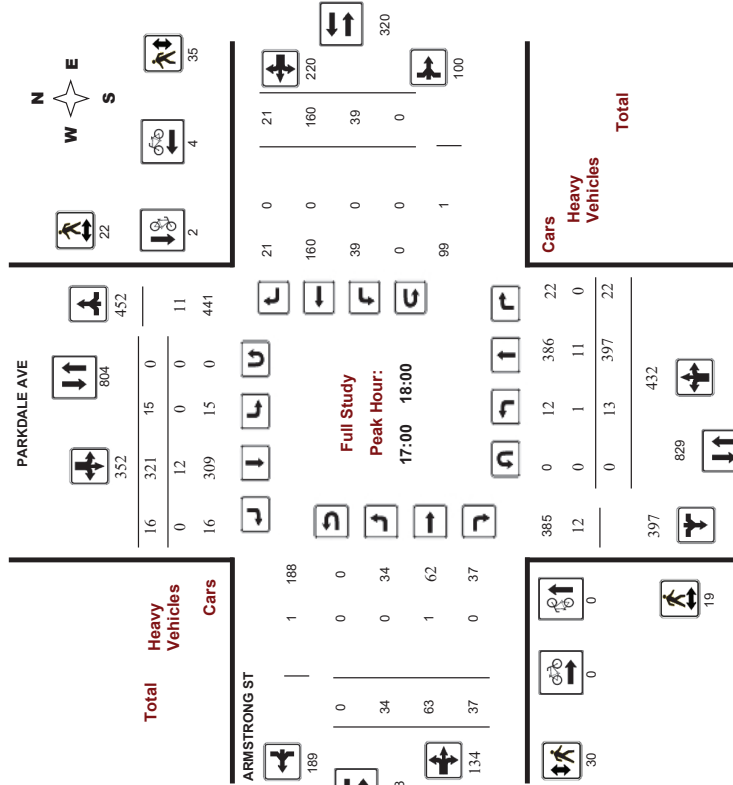




Transportation Services - Traffic Services  
Turning Movement Count - Study Results  
ARMSTRONG ST @ PARKDALE AVE

Survey Date: Wednesday, November 20, 2019  
Start Time: 07:00  
WO No: 39060  
Device: Miovision

Full Study Peak Hour Diagram



Transportation Services - Traffic Services  
Turning Movement Count - Study Results  
ARMSTRONG ST @ PARKDALE AVE

Survey Date: Wednesday, November 20, 2019  
Start Time: 07:00  
WO No: 39060  
Device: Miovision

Full Study Summary (8 HR Standard)

Survey Date: Wednesday, November 20, 2019  
Total Observed U-Turns: 0  
Southbound: 0  
Eastbound: 0  
Westbound: 0  
AAADT Factor: .90

Period	PARKDALE AVE						ARMSTRONG ST						WB TOT	STR TOT	Grand Total				
	Northbound			Southbound			Eastbound			Westbound									
	LT	ST	RT	NB TOT	LT	ST	RT	SB TOT	LT	ST	RT	EB TOT				LT	ST	RT	WB TOT
07:00-08:00	12	361	15	388	15	232	16	263	651	13	25	6	44	13	20	6	39	83	734
08:00-09:00	22	359	23	404	12	205	22	239	643	27	75	15	117	12	47	13	72	189	832
09:00-10:00	30	344	26	400	15	205	21	241	641	15	53	11	79	9	29	14	52	131	772
11:30-12:30	19	275	24	318	16	304	19	339	657	17	46	30	93	26	43	13	82	175	832
12:30-13:30	17	335	22	374	14	307	18	339	713	17	51	33	101	19	37	20	76	177	890
15:00-16:00	14	396	11	421	9	191	24	224	645	42	64	23	129	11	68	23	102	231	876
16:00-17:00	22	449	8	479	10	211	18	239	718	44	58	27	129	20	156	24	200	329	1047
17:00-18:00	13	397	22	432	15	321	16	352	764	34	63	37	134	39	160	21	220	354	1138
<b>Sub Total</b>	<b>149</b>	<b>2916</b>	<b>151</b>	<b>3216</b>	<b>106</b>	<b>1976</b>	<b>154</b>	<b>2236</b>	<b>5452</b>	<b>209</b>	<b>435</b>	<b>182</b>	<b>826</b>	<b>149</b>	<b>560</b>	<b>134</b>	<b>843</b>	<b>1669</b>	<b>7121</b>
<b>U-Turns</b>	<b>0</b>	<b>0</b>	<b>0</b>	<b>0</b>	<b>0</b>	<b>0</b>	<b>0</b>	<b>0</b>	<b>0</b>	<b>0</b>	<b>0</b>	<b>0</b>	<b>0</b>	<b>0</b>	<b>0</b>	<b>0</b>	<b>0</b>	<b>0</b>	<b>0</b>
<b>Total</b>	<b>149</b>	<b>2916</b>	<b>151</b>	<b>3216</b>	<b>106</b>	<b>1976</b>	<b>154</b>	<b>2236</b>	<b>5452</b>	<b>209</b>	<b>435</b>	<b>182</b>	<b>826</b>	<b>149</b>	<b>560</b>	<b>134</b>	<b>843</b>	<b>1669</b>	<b>7121</b>
<b>EQ 12hr</b>	<b>207</b>	<b>4053</b>	<b>210</b>	<b>4470</b>	<b>147</b>	<b>2747</b>	<b>214</b>	<b>3108</b>	<b>7578</b>	<b>291</b>	<b>605</b>	<b>253</b>	<b>1148</b>	<b>207</b>	<b>778</b>	<b>186</b>	<b>1172</b>	<b>2320</b>	<b>9898</b>

Note: These values are calculated by multiplying the totals by the appropriate expansion factor: 1.39

Note: These volumes are calculated by multiplying the Average Daily 12 hr. totals by 12 to 24 expansion factor: 1.31

Note: U-Turns provided for approach totals. Refer to 'U-Turn' Report for specific breakdown.



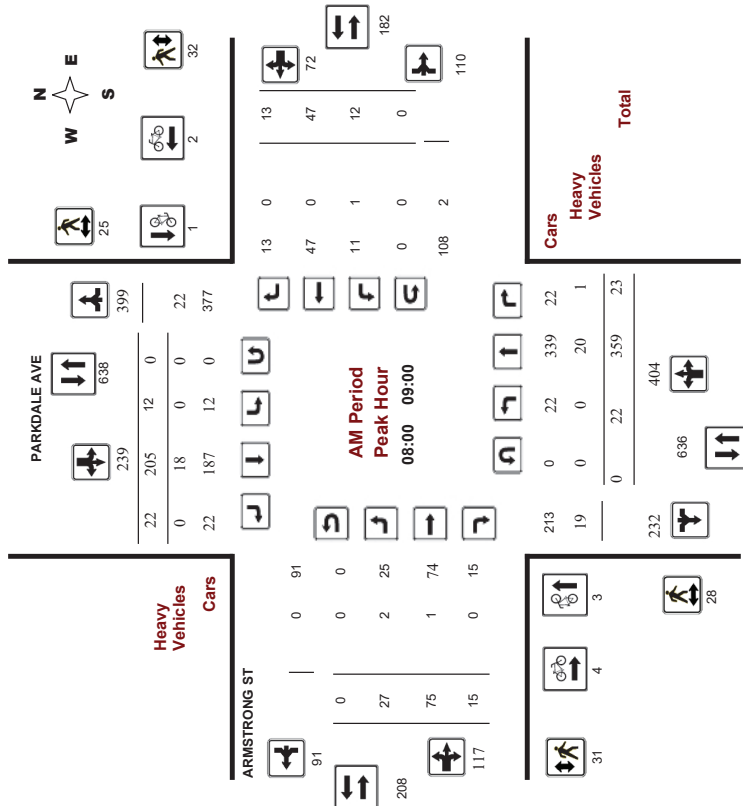
# Transportation Services - Traffic Services

## Turning Movement Count - Peak Hour Diagram

### ARMSTRONG ST @ PARKDALE AVE

Survey Date: Wednesday, November 20, 2019  
Start Time: 07:00

WO No: 39060  
Device: Miovision



Comments



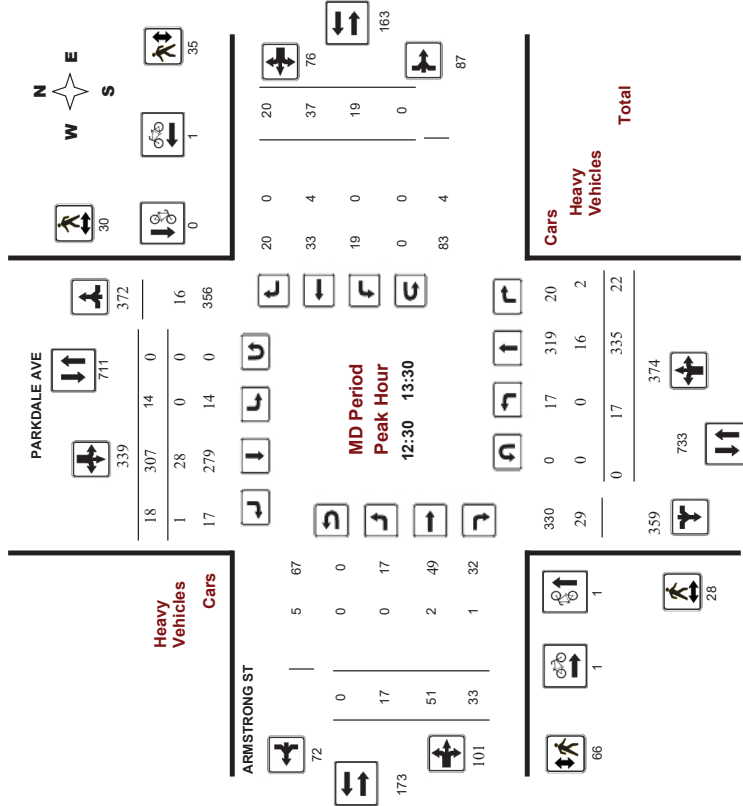
# Transportation Services - Traffic Services

## Turning Movement Count - Peak Hour Diagram

### ARMSTRONG ST @ PARKDALE AVE

Survey Date: Wednesday, November 20, 2019  
Start Time: 07:00

WO No: 39060  
Device: Miovision



Comments



# Transportation Services - Traffic Services

## Turning Movement Count - Peak Hour Diagram

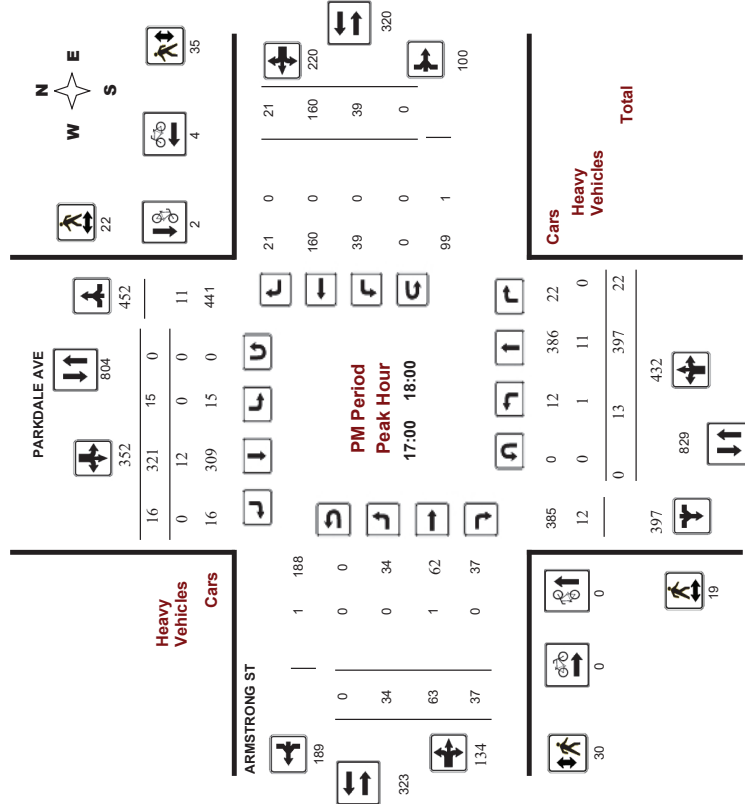
### ARMSTRONG ST @ PARKDALE AVE

Survey Date: Wednesday, November 20, 2019

Start Time: 07:00

WO No: 39060

Device: Miovision



Comments



# Transportation Services - Traffic Services

## Turning Movement Count - Study Results

### ARMSTRONG ST @ PARKDALE AVE

Survey Date: Wednesday, November 20, 2019

Start Time: 07:00

WO No: 39060

Device: Miovision

## Full Study 15 Minute Increments

### PARKDALE AVE

Time Period	Northbound			Southbound			Eastbound			Westbound			W	STR	Grand Total					
	LT	ST	RT	LT	ST	RT	LT	ST	RT	LT	ST	RT				LT	ST	RT	TOT	TOT
07:00	1	99	1	101	0	76	0	76	1	4	3	8	4	2	1	7	8	192		
07:15	07:30	3	78	4	85	5	59	4	68	8	2	4	0	6	1	5	3	9	168	
07:30	07:45	3	82	5	90	3	46	7	56	9	2	7	1	10	5	7	1	13	169	
07:45	08:00	5	102	5	112	7	51	5	63	3	8	10	2	20	3	6	1	10	205	
08:00	08:15	7	80	8	95	6	49	6	61	12	8	20	3	31	4	15	4	23	210	
08:15	08:30	5	99	1	105	3	47	5	55	6	8	16	5	29	1	15	3	19	208	
08:30	08:45	4	95	4	103	3	52	4	59	8	7	15	3	25	1	9	3	13	200	
08:45	09:00	6	85	10	101	0	57	7	64	13	4	24	4	32	6	8	3	17	214	
09:00	09:15	6	99	3	108	9	37	2	48	15	7	17	2	26	1	9	3	13	15	195
09:15	09:30	7	94	7	108	4	54	4	62	16	3	15	5	23	0	9	4	13	16	206
09:30	09:45	10	81	3	94	2	57	6	65	10	3	12	2	17	3	7	2	12	10	188
09:45	10:00	7	70	13	90	0	57	9	66	5	2	9	2	13	5	4	5	14	5	183
10:00	10:15	6	80	8	94	1	92	6	99	10	3	11	5	19	4	11	0	15	10	227
10:15	10:30	5	68	3	76	3	58	2	63	8	7	11	9	27	7	14	5	28	8	192
10:30	10:45	5	67	7	79	5	73	7	85	7	3	14	9	26	5	11	3	19	7	209
10:45	11:00	3	60	6	69	7	81	4	92	14	4	10	7	21	10	7	5	22	14	204
11:00	11:15	3	83	3	89	6	87	5	98	10	5	16	7	28	5	5	4	14	10	229
11:15	11:30	4	63	8	75	0	73	5	78	9	6	15	9	30	4	10	9	23	9	206
11:30	11:45	7	86	3	96	5	83	4	92	13	4	13	8	25	5	10	2	17	13	230
11:45	12:00	3	103	8	114	3	64	4	71	15	2	7	9	18	5	12	5	22	15	225
12:00	12:15	4	103	2	109	0	46	1	47	9	10	12	11	33	0	13	7	20	9	209
12:15	12:30	1	108	2	111	2	48	12	62	13	14	20	4	38	4	12	3	19	13	230
12:30	12:45	4	89	2	95	4	49	6	59	6	9	15	4	28	3	13	6	22	6	204
12:45	13:00	5	96	5	106	3	48	5	56	9	9	17	4	30	4	30	7	41	9	233
13:00	13:15	4	117	2	123	0	55	3	58	8	15	10	11	36	4	23	6	33	8	250
13:15	13:30	7	121	2	130	2	58	3	63	9	9	17	7	33	4	48	4	56	9	292
13:30	13:45	7	108	2	117	6	40	8	54	6	5	11	2	18	5	47	7	59	6	248
13:45	14:00	4	103	2	109	2	58	4	64	7	15	20	7	42	7	38	7	52	7	267
14:00	14:15	3	84	4	91	2	78	3	83	5	5	17	15	37	14	61	7	82	5	293
14:15	14:30	2	89	7	98	2	80	4	86	6	13	25	9	47	9	54	4	67	6	298
14:30	14:45	5	122	5	132	8	70	0	78	7	12	9	10	31	8	25	5	38	7	279
14:45	15:00	3	102	6	111	3	93	9	105	6	4	12	3	19	8	20	5	33	6	268
Total:		149	2916	151	3216	106	1976	154	2236	290	209	435	182	826	149	560	134	843	290	7,121

Note: U-Turns are included in Totals.





**Transportation Services - Traffic Services**  
**Turning Movement Count - Study Results**  
**ARMSTRONG ST @ PARKDALE AVE**

**Survey Date:** Wednesday, November 20, 2019  
**Start Time:** 07:00

**WO No:** 39060  
**Device:** Miovision

**Full Study Cyclist Volume**

PARKDALE AVE      Westbound      Street Total      Grand Total

Time Period	Northbound	Southbound	Street Total	Eastbound	Westbound	Street Total	Grand Total
07:00 07:15	0	0	0	0	1	1	1
07:15 07:30	0	0	0	0	1	1	1
07:30 07:45	0	0	0	0	1	1	1
07:45 08:00	0	0	0	0	1	1	1
08:00 08:15	2	0	2	2	0	2	4
08:15 08:30	0	0	0	0	0	0	0
08:30 08:45	1	0	1	0	1	1	2
08:45 09:00	2	0	2	1	3	3	5
09:00 09:15	0	0	0	0	0	0	0
09:15 09:30	0	0	0	1	2	2	2
09:30 09:45	0	0	0	0	0	0	0
09:45 10:00	0	0	0	0	0	0	0
10:00 10:15	0	0	0	0	0	0	0
10:15 10:30	0	0	0	0	0	0	0
10:30 10:45	0	0	0	0	0	0	0
10:45 11:00	0	0	0	0	0	0	0
11:00 11:15	0	0	0	0	0	0	0
11:15 11:30	1	0	1	1	0	1	2
11:30 11:45	0	0	0	0	0	0	0
11:45 12:00	0	0	0	0	0	0	0
12:00 12:15	0	0	0	0	0	0	0
12:15 12:30	0	0	0	0	0	0	0
12:30 12:45	0	0	0	0	0	0	0
12:45 13:00	0	0	0	0	1	1	1
13:00 13:15	1	0	1	0	1	1	1
13:15 13:30	0	0	0	1	0	1	1
13:30 13:45	0	0	0	1	2	3	3
13:45 14:00	0	0	0	0	0	0	0
14:00 14:15	1	0	1	1	0	1	2
14:15 14:30	0	0	0	0	0	0	0
14:30 14:45	0	0	0	0	0	0	0
14:45 15:00	0	0	0	0	0	0	0
15:00 15:15	1	0	1	3	0	3	4
15:15 15:30	0	0	0	0	0	0	0
15:30 15:45	0	0	0	0	0	0	0
15:45 16:00	0	0	0	0	0	0	0
16:00 16:15	0	0	0	0	0	0	0
16:15 16:30	0	0	0	0	0	0	0
16:30 16:45	0	1	1	0	2	2	3
16:45 17:00	0	0	0	1	0	1	1
17:00 17:15	0	1	1	0	2	2	3
17:15 17:30	0	0	0	0	0	0	0
17:30 17:45	0	1	1	0	1	1	2
17:45 18:00	0	0	0	0	1	1	1
<b>Total</b>	<b>9</b>	<b>4</b>	<b>13</b>	<b>15</b>	<b>18</b>	<b>33</b>	<b>46</b>



**Transportation Services - Traffic Services**  
**Turning Movement Count - Study Results**  
**ARMSTRONG ST @ PARKDALE AVE**

**Survey Date:** Wednesday, November 20, 2019  
**Start Time:** 07:00

**WO No:** 39060  
**Device:** Miovision

**Full Study Pedestrian Volume**

PARKDALE AVE      Eastbound      Street Total      Grand Total

Time Period	NB Approach (E or W Crossing)	SB Approach (E or W Crossing)	Total	EB Approach (N or S Crossing)	WB Approach (N or S Crossing)	Total	Grand Total
07:00 07:15	1	5	6	4	5	9	15
07:15 07:30	1	1	2	6	6	12	14
07:30 07:45	3	5	8	7	10	17	25
07:45 08:00	4	10	14	4	5	9	23
08:00 08:15	8	7	15	4	8	12	27
08:15 08:30	9	7	16	10	10	20	36
08:30 08:45	4	6	10	8	5	13	23
08:45 09:00	7	5	12	9	9	18	30
09:00 09:15	7	7	14	5	10	15	29
09:15 09:30	3	5	8	6	3	9	17
09:30 09:45	1	7	8	4	4	8	16
09:45 10:00	1	5	6	2	3	5	11
10:00 10:15	6	7	13	9	7	16	29
10:15 10:30	9	3	12	9	3	12	24
10:30 10:45	4	8	12	16	9	25	37
10:45 11:00	10	11	21	18	12	30	51
11:00 11:15	11	4	15	25	10	35	50
11:15 11:30	7	16	23	7	12	19	42
11:30 11:45	6	6	12	11	12	23	35
11:45 12:00	4	4	8	10	1	11	19
12:00 12:15	5	11	16	11	8	19	35
12:15 12:30	1	7	8	4	8	12	20
12:30 12:45	11	4	15	25	10	35	50
12:45 13:00	7	16	23	20	12	32	55
13:00 13:15	6	6	12	11	12	23	35
13:15 13:30	4	4	8	10	1	11	19
13:30 13:45	5	11	16	11	8	19	35
13:45 14:00	1	7	8	4	8	12	20
14:00 14:15	11	6	17	11	12	23	40
14:15 14:30	8	7	15	9	9	18	33
14:30 14:45	5	6	11	12	7	19	30
14:45 15:00	5	3	8	10	6	16	24
15:00 15:15	7	7	14	8	17	25	37
15:15 15:30	4	7	11	11	10	21	35
15:30 15:45	4	7	11	6	15	21	32
15:45 16:00	8	7	15	7	6	13	28
16:00 16:15	5	3	8	6	10	16	24
16:15 16:30	2	5	7	11	4	15	22
<b>Total</b>	<b>172</b>	<b>205</b>	<b>377</b>	<b>293</b>	<b>256</b>	<b>549</b>	<b>926</b>



**Transportation Services - Traffic Services**  
**Turning Movement Count - Study Results**  
**ARMSTRONG ST @ PARKDALE AVE**

**Survey Date:** Wednesday, November 20, 2019  
**Start Time:** 07:00

**WO No:** 39060  
**Device:** Miovision

**Full Study Heavy Vehicles**

Time Period	Northbound			Southbound			Eastbound			Westbound			W STR TOT	R STR TOT	Grand Total
	LT	ST	RT	LT	ST	RT	LT	ST	RT	LT	ST	RT			
07:00	0	3	0	3	0	5	0	5	0	0	0	0	0	0	8
07:15	0	4	0	4	0	4	0	4	0	0	0	0	0	0	9
07:30	0	5	0	5	0	4	0	4	0	0	0	0	0	0	9
07:45	0	1	0	1	0	2	0	2	0	1	0	1	2	3	6
08:00	0	7	0	7	0	5	0	5	0	0	0	0	0	0	13
08:15	0	2	0	2	0	4	0	4	0	1	0	0	0	0	7
08:30	0	4	0	4	0	4	0	4	0	0	0	0	0	0	8
08:45	0	7	1	8	0	5	0	5	0	1	0	0	1	2	15
09:00	0	10	0	10	0	5	0	5	0	2	0	0	0	2	17
09:15	0	6	1	7	1	8	0	9	0	2	0	0	1	3	19
09:30	0	5	0	5	0	5	0	5	0	0	0	0	0	0	10
09:45	0	2	0	2	0	2	0	2	0	0	0	0	0	0	5
10:00	0	5	0	5	0	5	0	5	0	0	0	0	0	0	10
10:15	0	5	0	5	0	5	0	5	0	0	0	0	0	0	10
10:30	0	2	0	2	0	6	0	6	0	0	0	0	0	0	8
10:45	0	2	1	3	0	3	1	4	0	0	0	0	0	0	8
11:00	0	8	0	8	0	6	0	6	0	1	0	0	1	1	16
11:15	0	8	0	8	0	6	0	6	0	1	0	0	1	2	16
11:30	0	2	1	3	0	7	0	7	0	1	0	0	1	2	12
11:45	0	3	0	3	0	5	1	6	0	1	0	0	1	2	11
12:00	0	5	1	6	0	7	0	7	0	0	0	0	0	0	14
12:15	0	6	0	6	0	9	0	9	0	0	0	0	0	0	17
12:30	0	6	0	6	0	3	0	3	0	0	0	0	0	0	9
12:45	0	8	0	8	0	4	1	5	0	0	0	0	0	0	13
13:00	0	3	0	3	0	3	0	3	0	0	0	0	0	0	7
13:15	0	4	0	4	0	4	1	5	0	0	0	0	0	0	9
13:30	0	5	1	6	0	2	0	2	0	1	0	0	2	3	11
13:45	0	6	0	6	0	2	0	2	0	0	0	0	0	0	10
14:00	0	6	0	6	0	2	0	2	0	0	0	0	0	0	8
14:15	0	6	0	6	0	2	0	2	0	0	0	0	0	0	8
14:30	0	6	0	6	0	2	0	2	0	0	0	0	0	0	8
14:45	0	6	0	6	0	2	0	2	0	0	0	0	0	0	8
15:00	0	6	0	6	0	2	0	2	0	0	0	0	0	0	8
15:15	0	6	0	6	0	2	0	2	0	0	0	0	0	0	8
15:30	0	6	0	6	0	2	0	2	0	0	0	0	0	0	8
15:45	0	6	0	6	0	2	0	2	0	0	0	0	0	0	8
16:00	0	6	0	6	0	2	0	2	0	0	0	0	0	0	8
16:15	0	6	0	6	0	2	0	2	0	0	0	0	0	0	8
16:30	0	6	0	6	0	2	0	2	0	0	0	0	0	0	8
16:45	0	6	0	6	0	2	0	2	0	0	0	0	0	0	8
17:00	0	6	0	6	0	2	0	2	0	0	0	0	0	0	8
17:15	0	6	0	6	0	2	0	2	0	0	0	0	0	0	8
17:30	0	6	0	6	0	2	0	2	0	0	0	0	0	0	8
17:45	0	6	0	6	0	2	0	2	0	0	0	0	0	0	8
18:00	0	6	0	6	0	2	0	2	0	0	0	0	0	0	8
Total	1	140	6	147	1	137	5	143	290	3	10	2	15	3	321



**Transportation Services - Traffic Services**  
**Turning Movement Count - Study Results**  
**ARMSTRONG ST @ PARKDALE AVE**

**Survey Date:** Wednesday, November 20, 2019  
**Start Time:** 07:00

**WO No:** 39060  
**Device:** Miovision

**Full Study 15 Minute U-Turn Total**

Time Period	PARKDALE AVE		PARKDALE AVE		PARKDALE AVE		PARKDALE AVE		Total
	Northbound U-Turn Total	Southbound U-Turn Total	Eastbound U-Turn Total	Westbound U-Turn Total	Northbound U-Turn Total	Southbound U-Turn Total	Eastbound U-Turn Total	Westbound U-Turn Total	
07:00	0	0	0	0	0	0	0	0	0
07:15	0	0	0	0	0	0	0	0	0
07:30	0	0	0	0	0	0	0	0	0
07:45	0	0	0	0	0	0	0	0	0
08:00	0	0	0	0	0	0	0	0	0
08:15	0	0	0	0	0	0	0	0	0
08:30	0	0	0	0	0	0	0	0	0
08:45	0	0	0	0	0	0	0	0	0
09:00	0	0	0	0	0	0	0	0	0
09:15	0	0	0	0	0	0	0	0	0
09:30	0	0	0	0	0	0	0	0	0
09:45	0	0	0	0	0	0	0	0	0
10:00	0	0	0	0	0	0	0	0	0
10:15	0	0	0	0	0	0	0	0	0
10:30	0	0	0	0	0	0	0	0	0
10:45	0	0	0	0	0	0	0	0	0
11:00	0	0	0	0	0	0	0	0	0
11:15	0	0	0	0	0	0	0	0	0
11:30	0	0	0	0	0	0	0	0	0
11:45	0	0	0	0	0	0	0	0	0
12:00	0	0	0	0	0	0	0	0	0
12:15	0	0	0	0	0	0	0	0	0
12:30	0	0	0	0	0	0	0	0	0
12:45	0	0	0	0	0	0	0	0	0
13:00	0	0	0	0	0	0	0	0	0
13:15	0	0	0	0	0	0	0	0	0
13:30	0	0	0	0	0	0	0	0	0
13:45	0	0	0	0	0	0	0	0	0
14:00	0	0	0	0	0	0	0	0	0
14:15	0	0	0	0	0	0	0	0	0
14:30	0	0	0	0	0	0	0	0	0
14:45	0	0	0	0	0	0	0	0	0
15:00	0	0	0	0	0	0	0	0	0
15:15	0	0	0	0	0	0	0	0	0
15:30	0	0	0	0	0	0	0	0	0
15:45	0	0	0	0	0	0	0	0	0
16:00	0	0	0	0	0	0	0	0	0
16:15	0	0	0	0	0	0	0	0	0
16:30	0	0	0	0	0	0	0	0	0
16:45	0	0	0	0	0	0	0	0	0
17:00	0	0	0	0	0	0	0	0	0
17:15	0	0	0	0	0	0	0	0	0
17:30	0	0	0	0	0	0	0	0	0
17:45	0	0	0	0	0	0	0	0	0
18:00	0	0	0	0	0	0	0	0	0
Total	0	0	0	0	0	0	0	0	0



# Transportation Services - Traffic Services

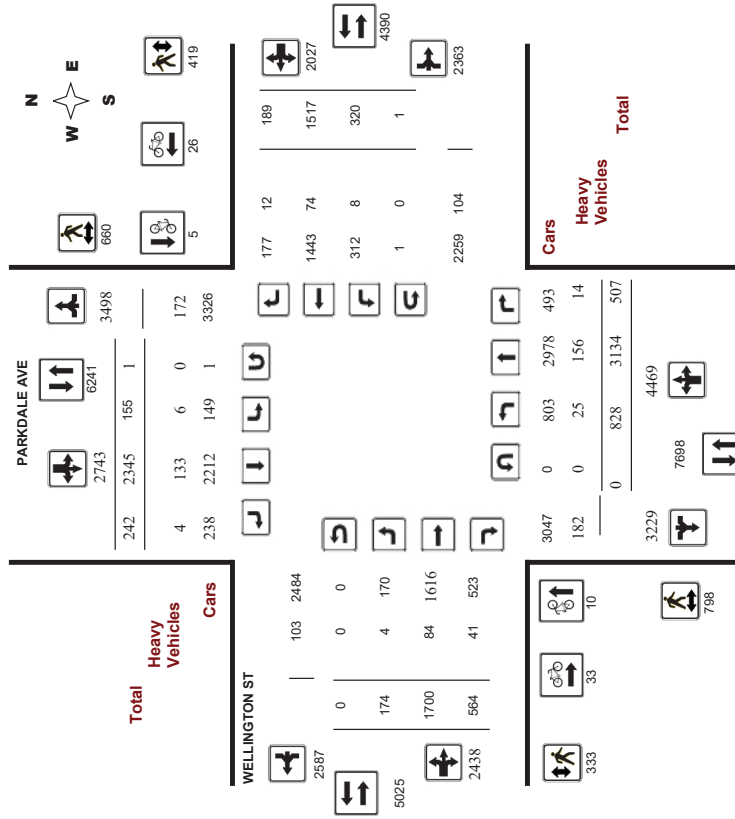
## Turning Movement Count - Study Results

### PARKDALE AVE @ WELLINGTON ST

Survey Date: Tuesday, March 10, 2020  
Start Time: 07:00

WO No: 39588  
Device: Miovision

#### Full Study Diagram



5479331 - MAR 10 2020 - 8HRS - LAUREN OGRADY



# Transportation Services - Traffic Services

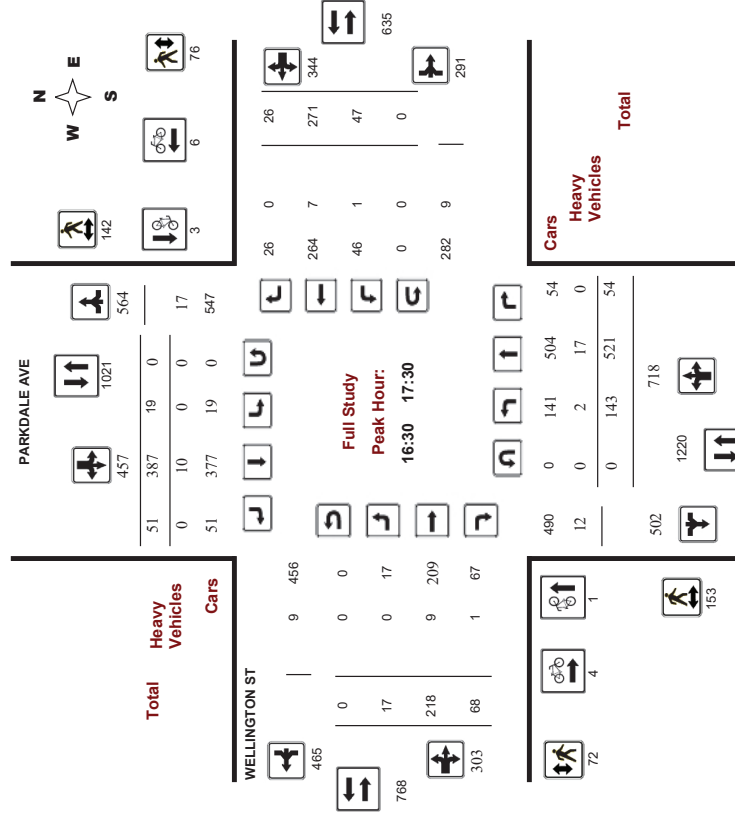
## Turning Movement Count - Study Results

### PARKDALE AVE @ WELLINGTON ST

Survey Date: Tuesday, March 10, 2020  
Start Time: 07:00

WO No: 39588  
Device: Miovision

#### Full Study Peak Hour Diagram



5479331 - MAR 10 2020 - 8HRS - LAUREN OGRADY



# Transportation Services - Traffic Services

## Turning Movement Count - Peak Hour Diagram

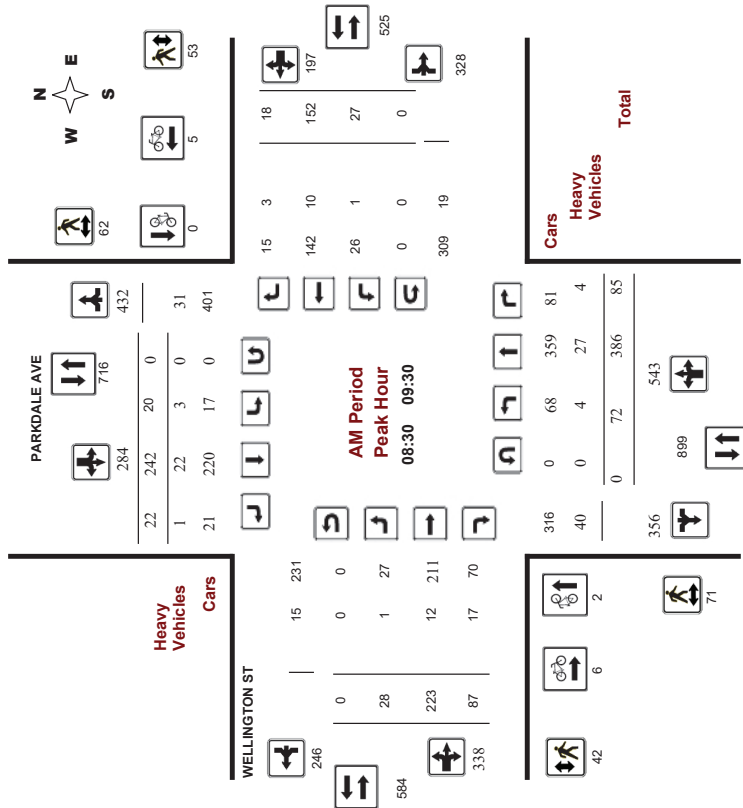
### PARKDALE AVE @ WELLINGTON ST

Survey Date: Tuesday, March 10, 2020

WO No: 39588

Start Time: 07:00

Device: Miovision



Comments 5479331 - MAR 10 2020 - 8HRS - LAUREN O'GRADY



# Transportation Services - Traffic Services

## Turning Movement Count - Peak Hour Diagram

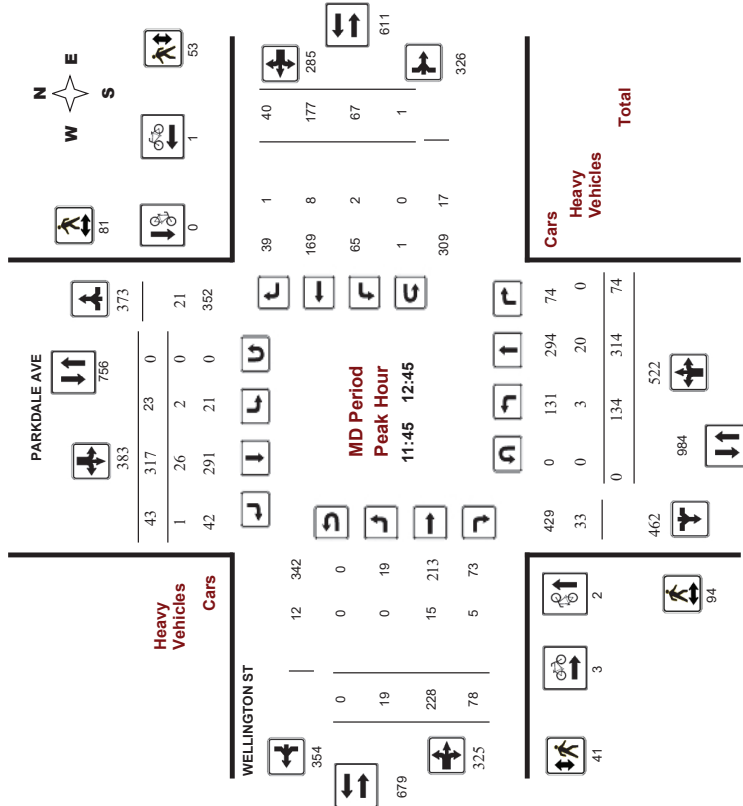
### PARKDALE AVE @ WELLINGTON ST

Survey Date: Tuesday, March 10, 2020

WO No: 39588

Start Time: 07:00

Device: Miovision



Comments 5479331 - MAR 10 2020 - 8HRS - LAUREN O'GRADY







**Transportation Services - Traffic Services**  
**Turning Movement Count - Study Results**  
**PARKDALE AVE @ WELLINGTON ST**

**Survey Date:** Tuesday, March 10, 2020      **WO No:** 39588  
**Start Time:** 07:00      **Device:** Miovision

**Full Study Pedestrian Volume**  
**PARKDALE AVE**      **WELLINGTON ST**

Time Period	SB Approach (E or W Crossing)		EB Approach (N or S Crossing)		WB Approach (N or S Crossing)		Total	Grand Total
	N	S	N	S	N	S		
07:00-07:15	16	13	2	6	8	8	37	
07:15-07:30	8	12	3	8	11	11	31	
07:30-07:45	14	10	6	9	15	15	39	
07:45-08:00	16	14	9	10	19	19	49	
08:00-08:15	18	14	7	5	12	12	44	
08:15-08:30	14	22	13	12	25	25	61	
08:30-08:45	15	11	11	15	26	26	52	
08:45-09:00	17	14	14	11	25	25	60	
09:00-09:15	14	16	9	7	16	16	46	
09:15-09:30	25	17	8	20	28	28	70	
09:30-09:45	21	38	7	15	22	22	60	
09:45-10:00	22	14	6	11	17	17	53	
11:30-11:45	24	15	8	12	20	20	59	
11:45-12:00	18	34	5	12	17	17	51	
12:00-12:15	23	20	12	19	31	31	74	
12:15-12:30	25	24	13	14	27	27	76	
12:30-12:45	28	21	11	8	19	19	68	
12:45-13:00	29	16	16	11	21	21	66	
13:00-13:15	29	17	5	17	22	22	68	
13:15-13:30	19	20	10	11	21	21	60	
15:00-15:15	25	33	15	21	36	36	94	
15:15-15:30	39	20	16	16	27	27	86	
15:30-15:45	28	34	9	19	28	28	90	
15:45-16:00	21	17	8	6	14	14	52	
16:00-16:15	21	16	5	13	18	18	55	
16:15-16:30	37	27	15	10	25	25	89	
16:30-16:45	37	34	16	18	34	34	112	
16:45-17:00	35	23	19	19	38	38	96	
17:00-17:15	38	33	25	26	51	51	122	
17:15-17:30	43	45	12	13	88	88	113	
17:30-17:45	41	27	16	12	28	28	96	
17:45-18:00	38	17	13	13	26	26	81	
Total	798	660	333	419	752	752	2210	

5479331 - MAR 10 2020 - 8HRS - LAUREN O'GRADY



**Transportation Services - Traffic Services**  
**Turning Movement Count - Study Results**  
**PARKDALE AVE @ WELLINGTON ST**

**Survey Date:** Tuesday, March 10, 2020      **WO No:** 39588  
**Start Time:** 07:00      **Device:** Miovision

**Full Study Heavy Vehicles**  
**PARKDALE AVE**      **WELLINGTON ST**

Time Period	Northbound			Southbound			Eastbound			Westbound			W	STR	Grand Total				
	LT	ST	RT	LT	ST	RT	LT	ST	RT	LT	ST	RT				RT	TOT	TOT	
07:00-07:15	0	3	0	3	0	2	0	2	5	1	1	0	2	0	3	5	10		
07:15-07:30	0	5	1	6	0	7	0	7	13	0	2	0	2	0	1	3	16		
07:30-07:45	0	1	0	1	0	3	0	3	4	0	2	2	4	0	2	6	10		
07:45-08:00	1	4	0	5	0	3	0	3	8	0	6	0	6	0	1	7	15		
08:00-08:15	1	4	1	6	0	4	0	4	10	0	1	3	4	1	6	12	22		
08:15-08:30	2	4	0	6	0	3	0	3	9	0	3	3	6	0	4	10	19		
08:30-08:45	0	6	0	6	0	4	1	5	11	0	1	2	3	0	2	5	16		
08:45-09:00	0	6	1	7	1	8	0	9	16	1	7	3	11	1	0	12	28		
09:00-09:15	2	5	2	9	2	4	0	6	15	0	1	6	7	0	2	14	29		
09:15-09:30	2	10	1	13	0	6	0	6	19	0	3	6	9	0	3	14	32		
09:30-09:45	3	7	1	11	1	7	0	8	19	1	2	3	6	0	5	11	30		
09:45-10:00	1	5	1	7	0	6	0	6	13	0	2	0	2	0	5	7	20		
11:30-11:45	4	4	2	10	0	5	1	6	16	0	4	1	5	0	4	9	25		
11:45-12:00	1	5	0	6	2	5	1	8	14	0	5	0	5	0	3	8	22		
12:00-12:15	1	4	0	5	0	5	0	5	10	0	3	2	5	1	1	3	18		
12:15-12:30	0	4	0	4	0	8	0	8	12	0	3	3	6	0	2	8	20		
12:30-12:45	1	7	0	8	0	8	0	8	16	0	4	0	4	1	2	3	23		
12:45-13:00	0	5	0	5	0	5	0	5	10	0	5	0	5	0	1	3	19		
13:00-13:15	1	8	1	10	0	1	0	1	11	0	3	2	5	1	2	4	20		
13:15-13:30	1	4	1	6	0	6	1	7	13	0	1	1	2	0	2	4	17		
15:00-15:15	0	5	1	6	0	0	0	6	6	0	3	1	4	0	1	5	11		
15:15-15:30	0	7	1	8	0	3	0	3	11	0	3	0	3	1	3	5	19		
15:30-15:45	1	5	0	6	0	4	0	4	10	0	2	0	2	0	3	5	15		
15:45-16:00	0	5	0	5	0	4	0	4	9	0	2	0	2	1	1	3	14		
16:00-16:15	1	4	0	5	0	4	0	4	9	1	1	2	4	0	1	5	14		
16:15-16:30	0	7	0	7	0	3	0	3	10	0	2	0	2	0	3	1	16		
16:30-16:45	1	8	0	9	0	2	0	2	11	0	2	0	2	0	4	6	17		
16:45-17:00	0	2	0	2	0	3	0	3	5	0	3	0	3	1	1	0	10		
17:00-17:15	0	5	0	5	0	1	0	1	6	0	2	1	3	0	2	5	11		
17:15-17:30	1	2	0	3	0	4	0	4	7	0	2	0	2	0	0	0	9		
17:30-17:45	0	4	0	4	0	2	0	2	6	0	1	0	1	0	1	2	8		
17:45-18:00	0	1	0	1	0	3	0	3	4	0	2	0	2	0	0	2	6		
Total	25	156	14	195	6	133	4	143	338	4	84	41	129	8	74	12	84	223	561







# Transportation Services - Traffic Services

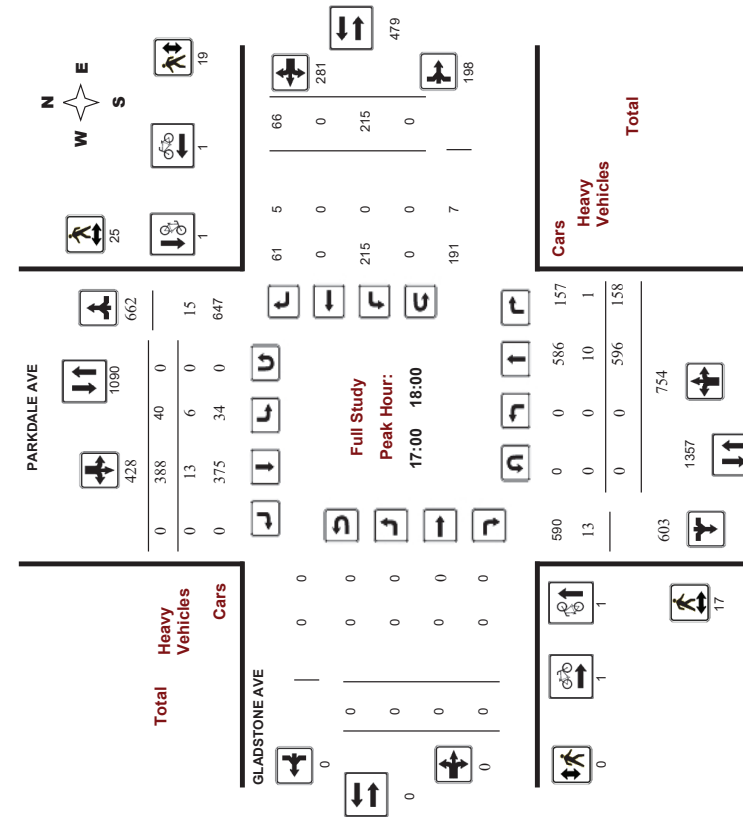
## Turning Movement Count - Study Results

### PARKDALE AVE @ GLADSTONE AVE

Survey Date: Thursday, December 05, 2019  
Start Time: 07:00

WO No: 39201  
Device: Miovision

#### Full Study Peak Hour Diagram



Comments



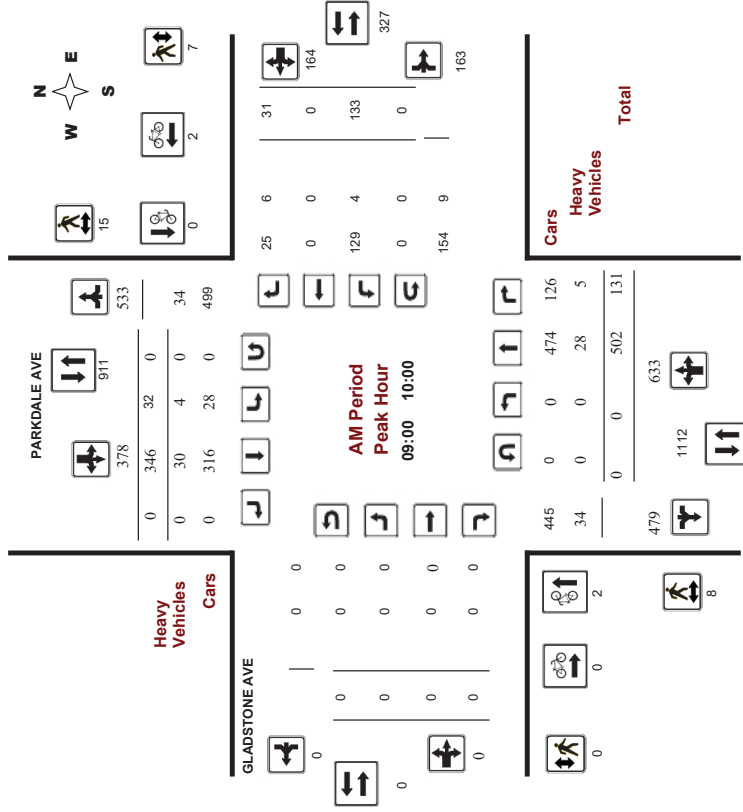
# Transportation Services - Traffic Services

## Turning Movement Count - Peak Hour Diagram

### PARKDALE AVE @ GLADSTONE AVE

Survey Date: Thursday, December 05, 2019  
Start Time: 07:00

WO No: 39201  
Device: Miovision



Comments



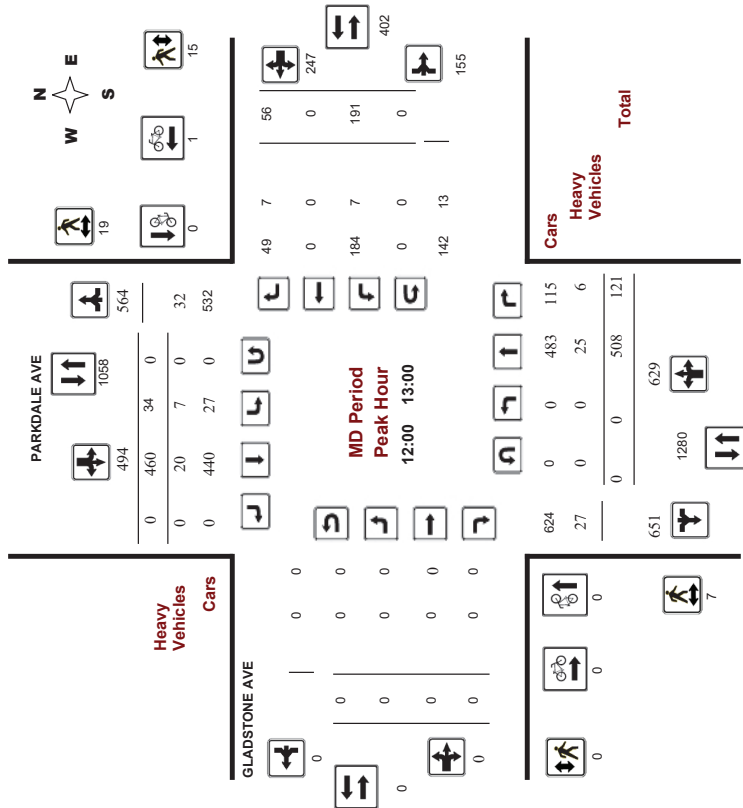
# Transportation Services - Traffic Services

## Turning Movement Count - Peak Hour Diagram

### PARKDALE AVE @ GLADSTONE AVE

Survey Date: Thursday, December 05, 2019  
Start Time: 07:00

WO No: 39201  
Device: Miovision



Comments



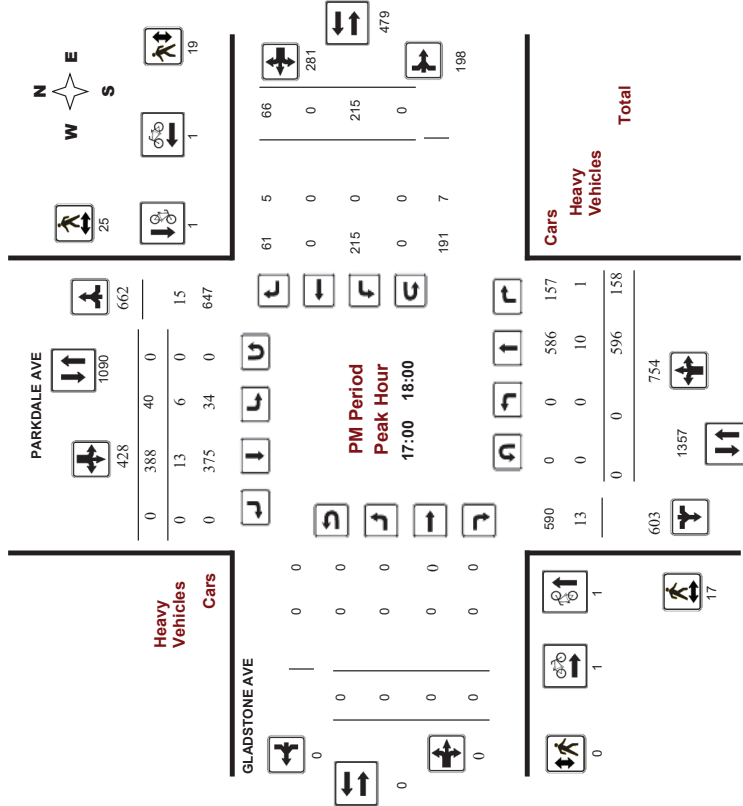
# Transportation Services - Traffic Services

## Turning Movement Count - Peak Hour Diagram

### PARKDALE AVE @ GLADSTONE AVE

Survey Date: Thursday, December 05, 2019  
Start Time: 07:00

WO No: 39201  
Device: Miovision



Comments



**Transportation Services - Traffic Services**  
**Turning Movement Count - Study Results**  
**PARKDALE AVE @ GLADSTONE AVE**

**Survey Date:** Thursday, December 05, 2019 **WO No:** 39201  
**Start Time:** 07:00 **Device:** Miovision

**Full Study Summary (8 HR Standard)**

**Survey Date:** Thursday, December 05, 2019 **Total Observed U-Turns** **AAADT Factor**  
 Northbound: 0 Southbound: 0 1.00  
 Eastbound: 0 Westbound: 0

Period	Northbound				Southbound				Eastbound				Westbound				WB TOT	STR TOT	Grand Total				
	LT	ST	RT	TOT	NB	LT	ST	RT	SB	STR	LT	ST	RT	TOT	EB	LT				ST	RT		
07:00-08:00	0	465	103	568	18	289	0	317	885	0	0	0	0	0	0	0	0	167	0	15	182	182	1067
08:00-09:00	0	484	118	602	19	275	0	294	896	0	0	0	0	0	0	0	0	171	0	34	205	205	1101
09:00-10:00	0	502	131	633	32	346	0	378	1011	0	0	0	0	0	0	0	0	133	0	31	164	164	1175
11:30-12:30	0	517	138	655	31	467	0	498	1153	0	0	0	0	0	0	0	0	162	0	53	215	215	1388
12:30-13:30	0	497	118	615	22	463	0	475	1090	0	0	0	0	0	0	0	0	186	0	49	235	235	1325
15:00-16:00	0	576	89	665	23	280	0	303	968	0	0	0	0	0	0	0	0	193	0	42	235	235	1203
16:00-17:00	0	602	119	721	33	346	0	379	1100	0	0	0	0	0	0	0	0	221	0	61	282	282	1382
17:00-18:00	0	596	158	754	40	388	0	428	1162	0	0	0	0	0	0	0	0	215	0	66	281	281	1463
<b>Sub Total</b>	<b>0</b>	<b>4239</b>	<b>974</b>	<b>5213</b>	<b>218</b>	<b>2854</b>	<b>0</b>	<b>3072</b>	<b>8285</b>	<b>0</b>	<b>0</b>	<b>0</b>	<b>0</b>	<b>0</b>	<b>0</b>	<b>0</b>	<b>0</b>	<b>1448</b>	<b>0</b>	<b>351</b>	<b>1799</b>	<b>1799</b>	<b>10084</b>
<b>U-Turns</b>	<b>0</b>	<b>0</b>	<b>0</b>	<b>0</b>	<b>0</b>	<b>0</b>	<b>0</b>	<b>0</b>	<b>0</b>	<b>0</b>	<b>0</b>	<b>0</b>	<b>0</b>	<b>0</b>	<b>0</b>	<b>0</b>	<b>0</b>	<b>0</b>	<b>0</b>	<b>0</b>	<b>0</b>	<b>0</b>	<b>0</b>
<b>Total</b>	<b>0</b>	<b>4239</b>	<b>974</b>	<b>5213</b>	<b>218</b>	<b>2854</b>	<b>0</b>	<b>3072</b>	<b>8285</b>	<b>0</b>	<b>0</b>	<b>0</b>	<b>0</b>	<b>0</b>	<b>0</b>	<b>0</b>	<b>0</b>	<b>1448</b>	<b>0</b>	<b>351</b>	<b>1799</b>	<b>1799</b>	<b>10084</b>
<b>EQ 12hr</b>	<b>0</b>	<b>5892</b>	<b>1354</b>	<b>7246</b>	<b>303</b>	<b>3967</b>	<b>0</b>	<b>4270</b>	<b>11516</b>	<b>0</b>	<b>0</b>	<b>0</b>	<b>0</b>	<b>0</b>	<b>0</b>	<b>0</b>	<b>0</b>	<b>2013</b>	<b>0</b>	<b>488</b>	<b>2501</b>	<b>2501</b>	<b>14017</b>

Note: These values are calculated by multiplying the totals by the appropriate expansion factor.

**AVG 12hr** 0 5892 1354 7246 303 3967 0 4270 11516 0 0 0 0 0 2013 0 488 2501 2501 14017  
 Note: These volumes are calculated by multiplying the Equivalent 12 hr. totals by the AADT factor. **1.00**

**AVG 24hr** 0 7719 1774 9493 397 5197 0 5994 15087 0 0 0 0 0 2837 0 639 3276 3276 18383

Note: These volumes are calculated by multiplying the Average Daily 12 hr. totals by 12 to 24 expansion factor. **1.31**

Note: U-Turns provided for approach totals. Refer to "U-Turn" Report for specific breakdown.



**Transportation Services - Traffic Services**  
**Turning Movement Count - Study Results**  
**PARKDALE AVE @ GLADSTONE AVE**

**Survey Date:** Thursday, December 05, 2019 **WO No:** 39201  
**Start Time:** 07:00 **Device:** Miovision

**Full Study 15 Minute Increments**

**Survey Date:** Thursday, December 05, 2019 **Total Observed U-Turns** **AAADT Factor**  
 Northbound: 0 Southbound: 0 1.00  
 Eastbound: 0 Westbound: 0

Time Period	Northbound				Southbound				Eastbound				Westbound				W TOT	STR TOT	Grand Total				
	LT	ST	RT	TOT	NB	LT	ST	RT	SB	STR	LT	ST	RT	TOT	EB	LT				ST	RT		
07:00-07:15	0	101	23	124	10	80	0	80	214	0	0	0	0	0	0	0	0	31	0	5	36	36	250
07:15-07:30	0	121	22	143	3	77	0	80	223	0	0	0	0	0	0	0	0	43	0	4	47	47	270
07:30-07:45	0	109	29	138	1	74	0	75	213	0	0	0	0	0	0	0	0	44	0	3	47	47	260
07:45-08:00	0	134	29	163	4	68	0	72	235	0	0	0	0	0	0	0	0	49	0	3	52	52	287
08:00-08:15	0	113	35	148	8	77	0	85	233	0	0	0	0	0	0	0	0	41	0	11	52	52	285
08:15-08:30	0	111	29	140	1	48	0	49	189	0	0	0	0	0	0	0	0	42	0	5	47	47	236
08:30-08:45	0	120	22	142	6	81	0	87	229	0	0	0	0	0	0	0	0	45	0	11	56	56	285
08:45-09:00	0	140	32	172	4	69	0	73	245	0	0	0	0	0	0	0	0	43	0	7	50	50	295
09:00-09:15	0	127	38	165	9	74	0	83	248	0	0	0	0	0	0	0	0	42	0	8	50	50	298
09:15-09:30	0	121	33	154	7	78	0	85	239	0	0	0	0	0	0	0	0	34	0	7	41	41	290
09:30-09:45	0	131	28	159	8	92	0	100	259	0	0	0	0	0	0	0	0	30	0	10	40	40	299
09:45-10:00	0	123	32	155	8	102	0	110	265	0	0	0	0	0	0	0	0	27	0	6	33	33	298
11:30-11:45	0	134	40	174	4	107	0	111	285	0	0	0	0	0	0	0	0	38	0	9	47	47	332
11:45-12:00	0	124	29	153	6	120	0	126	279	0	0	0	0	0	0	0	0	34	0	11	45	45	324
12:00-12:15	0	120	31	151	14	119	0	133	284	0	0	0	0	0	0	0	0	45	0	14	59	59	343
12:15-12:30	0	139	38	177	7	121	0	128	305	0	0	0	0	0	0	0	0	45	0	19	64	64	369
12:30-12:45	0	126	22	148	8	111	0	119	267	0	0	0	0	0	0	0	0	52	0	11	63	63	330
12:45-13:00	0	123	30	153	5	109	0	114	267	0	0	0	0	0	0	0	0	49	0	12	61	61	328
13:00-13:15	0	117	31	148	4	114	0	118	266	0	0	0	0	0	0	0	0	44	0	14	58	58	324
13:15-13:30	0	131	35	166	5	119	0	124	290	0	0	0	0	0	0	0	0	41	0	12	53	53	343
15:00-15:15	0	147	17	164	3	67	0	70	234	0	0	0	0	0	0	0	0	55	0	5	60	60	294
15:15-15:30	0	127	25	152	4	57	0	61	213	0	0	0	0	0	0	0	0	37	0	6	43	43	256
15:30-15:45	0	148	29	177	8	77	0	85	262	0	0	0	0	0	0	0	0	43	0	15	58	58	320
15:45-16:00	0	154	18	172	8	79	0	87	259	0	0	0	0	0	0	0	0	56	0	16	74	74	333
16:00-16:15	0	153	19	172	9	91	0	100	272	0	0	0	0	0	0	0	0	62	0	9	71	71	343
16:15-16:30	0	156	34	190	10	89	0	99	289	0	0	0	0	0	0	0	0	53	0	19	72	72	361
16:30-16:45	0	143	34	177	7	90	0	97	274	0	0	0	0	0	0	0	0	54	0	14	68	68	342
16:45-17:00	0	150	32	182	7	76	0	83	265	0	0	0	0	0	0	0	0	52	0	19	71	71	336
17:00-17:15	0	151	38	189	7	89	0	96	285	0	0	0	0	0	0	0	0	65	0	17	82	82	367
17:15-17:30	0	142	28	170	10	111	0	121	291	0	0	0	0	0	0	0	0	46	0	19	65	65	356
17:30-17:45	0	148	44	192	11	104	0	115	307	0	0	0	0	0	0	0	0	53	0	14	67	67	374
17:45-18:00	0	155	48	203	12	84	0	96	299	0	0	0	0	0	0	0	0	51	0	16	67	67	366
<b>Total:</b>	<b>0</b>	<b>4239</b>	<b>974</b>	<b>5213</b>	<b>218</b>	<b>2854</b>	<b>0</b>	<b>3072</b>	<b>8285</b>	<b>0</b>	<b>0</b>	<b>0</b>	<b>0</b>	<b>0</b>	<b>0</b>	<b>0</b>	<b>0</b>	<b>1448</b>	<b>0</b>	<b>351</b>	<b>1799</b>	<b>1799</b>	<b>10,084</b>

Note: U-Turns are included in Totals.



**Transportation Services - Traffic Services**  
**Turning Movement Count - Study Results**  
**PARKDALE AVE @ GLADSTONE AVE**

**Survey Date:** Thursday, December 05, 2019  
**Start Time:** 07:00

**WO No:** 39201  
**Device:** Miovision

**Full Study Cyclist Volume**

Time Period	PARKDALE AVE		GLADSTONE AVE		Street Total	Grand Total
	Northbound	Southbound	Eastbound	Westbound		
07:00 07:15	0	0	0	0	0	0
07:15 07:30	0	0	0	0	0	0
07:30 07:45	0	0	0	0	0	0
07:45 08:00	0	0	0	0	0	0
08:00 08:15	0	0	0	0	0	0
08:15 08:30	0	0	1	0	1	1
08:30 08:45	0	1	0	0	1	1
08:45 09:00	0	1	0	0	1	1
09:00 09:15	1	0	0	0	1	2
09:15 09:30	1	0	0	0	1	2
09:30 09:45	0	0	0	0	0	0
09:45 10:00	0	0	0	1	1	1
10:00 10:15	0	0	0	1	1	1
10:15 10:30	1	0	0	0	1	1
10:30 10:45	0	0	0	0	0	0
10:45 11:00	0	0	0	0	0	0
11:00 11:15	0	0	0	0	0	0
11:15 11:30	0	0	0	0	0	0
11:30 11:45	0	0	0	0	0	0
11:45 12:00	0	0	0	0	0	0
12:00 12:15	0	0	0	0	0	0
12:15 12:30	0	0	0	0	0	0
12:30 12:45	0	0	0	1	1	1
12:45 13:00	0	0	0	0	0	0
13:00 13:15	0	0	0	0	0	0
13:15 13:30	0	0	0	0	0	0
13:30 13:45	0	0	2	1	3	3
13:45 14:00	0	0	0	0	0	0
14:00 14:15	0	0	0	0	0	0
14:15 14:30	0	0	0	0	0	0
14:30 14:45	0	0	1	0	1	1
14:45 15:00	0	0	0	0	0	0
15:00 15:15	0	0	0	0	0	0
15:15 15:30	0	0	1	0	1	2
15:30 15:45	0	0	0	0	0	0
15:45 16:00	0	0	0	0	0	0
16:00 16:15	1	0	0	0	1	2
16:15 16:30	0	1	0	0	1	2
16:30 16:45	0	0	0	0	0	0
16:45 17:00	0	0	0	0	0	0
17:00 17:15	0	0	0	0	0	0
17:15 17:30	0	0	0	0	0	0
17:30 17:45	1	1	0	0	2	2
17:45 18:00	0	0	0	1	1	2
<b>Total</b>	<b>5</b>	<b>4</b>	<b>6</b>	<b>8</b>	<b>14</b>	<b>23</b>



**Transportation Services - Traffic Services**  
**Turning Movement Count - Study Results**  
**PARKDALE AVE @ GLADSTONE AVE**

**Survey Date:** Thursday, December 05, 2019  
**Start Time:** 07:00

**WO No:** 39201  
**Device:** Miovision

**Full Study Pedestrian Volume**

Time Period	PARKDALE AVE		GLADSTONE AVE		Total	Grand Total
	NB Approach (E or W Crossing)	SB Approach (E or W Crossing)	EB Approach (N or S Crossing)	WB Approach (N or S Crossing)		
07:00 07:15	1	0	0	0	1	3
07:15 07:30	3	3	0	0	6	8
07:30 07:45	4	5	0	0	9	12
07:45 08:00	3	8	0	0	11	15
08:00 08:15	7	13	0	0	20	31
08:15 08:30	15	33	0	0	48	58
08:30 08:45	23	13	0	0	36	62
08:45 09:00	2	8	0	0	10	11
09:00 09:15	3	5	0	0	8	10
09:15 09:30	0	1	0	0	1	1
09:30 09:45	2	4	0	0	6	10
09:45 10:00	3	5	0	0	8	9
10:00 10:15	0	5	0	0	5	10
10:15 10:30	2	4	0	0	6	8
10:30 10:45	3	2	0	0	5	7
10:45 11:00	1	5	0	0	6	9
11:00 11:15	1	5	0	0	6	9
11:15 11:30	2	7	0	0	9	16
11:30 11:45	1	6	0	0	7	8
11:45 12:00	3	1	0	0	4	8
12:00 12:15	1	5	0	0	6	9
12:15 12:30	1	5	0	0	6	9
12:30 12:45	1	5	0	0	6	9
12:45 13:00	2	7	0	0	9	16
13:00 13:15	1	6	0	0	7	8
13:15 13:30	3	1	0	0	4	8
13:30 13:45	4	15	0	0	19	24
13:45 14:00	14	21	0	0	35	44
14:00 14:15	2	30	0	0	32	35
14:15 14:30	6	2	0	0	8	13
14:30 14:45	8	7	0	0	15	23
14:45 15:00	4	1	0	0	5	14
15:00 15:15	9	9	0	0	18	26
15:15 15:30	3	8	0	0	11	24
15:30 15:45	3	5	0	0	8	14
15:45 16:00	7	9	0	0	16	19
16:00 16:15	3	6	0	0	9	13
16:15 16:30	4	5	0	0	9	15
16:30 16:45	1	1	0	0	2	6
16:45 17:00	9	8	0	0	17	24
17:00 17:15	3	8	0	0	11	13
17:15 17:30	3	5	0	0	8	6
17:30 17:45	7	9	0	0	16	3
17:45 18:00	3	6	0	0	9	4
<b>Total</b>	<b>146</b>	<b>251</b>	<b>0</b>	<b>0</b>	<b>397</b>	<b>569</b>









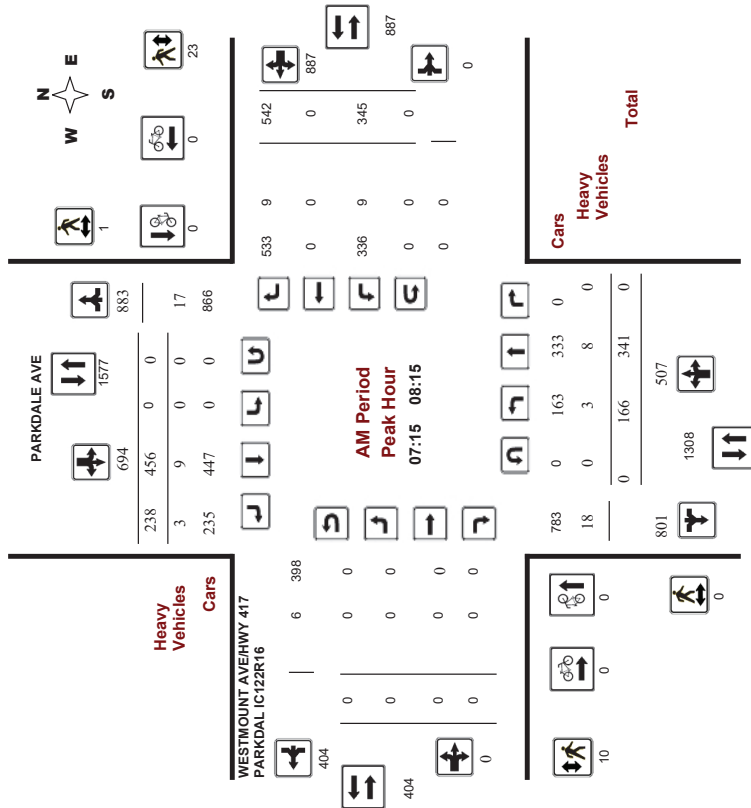
# Transportation Services - Traffic Services

## Turning Movement Count - Peak Hour Diagram

### PARKDALE AVE @ WESTMOUNT AVE/HWY 417 PARKDAL I

Survey Date: Thursday, April 05, 2018  
Start Time: 07:00

WO No: 37687  
Device: Miovision



Comments



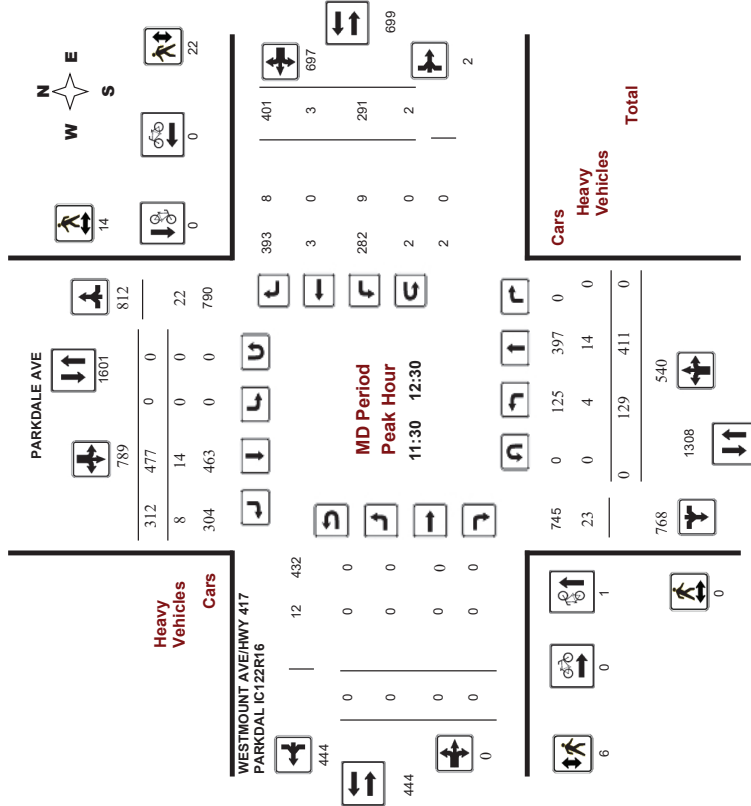
# Transportation Services - Traffic Services

## Turning Movement Count - Peak Hour Diagram

### PARKDALE AVE @ WESTMOUNT AVE/HWY 417 PARKDAL I

Survey Date: Thursday, April 05, 2018  
Start Time: 07:00

WO No: 37687  
Device: Miovision



Comments



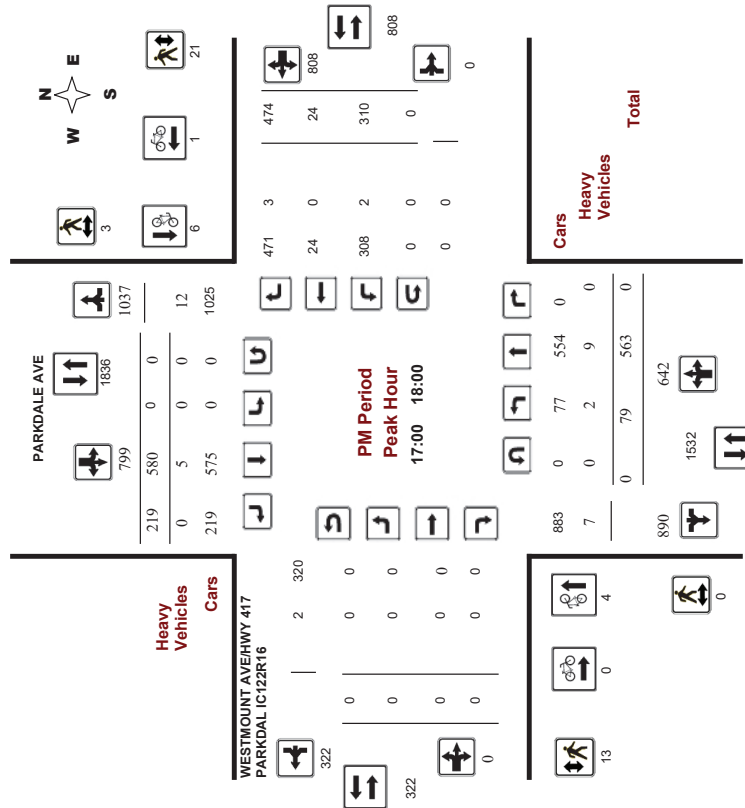
# Transportation Services - Traffic Services

## Turning Movement Count - Peak Hour Diagram

### PARKDALE AVE @ WESTMOUNT AVE/HWY 417 PARKDAL I

Survey Date: Thursday, April 05, 2018  
Start Time: 07:00

WO No: 37687  
Device: Miovision



Comments



# Transportation Services - Traffic Services

## Turning Movement Count - Study Results

### PARKDALE AVE @ WESTMOUNT AVE/HWY 417 PARKDAL I

Survey Date: Thursday, April 05, 2018  
Start Time: 07:00

WO No: 37687  
Device: Miovision

## Full Study Summary (8 HR Standard)

Survey Date: Thursday, April 05, 2018  
Total Observed U-Turns: 90  
Northbound: 0  
Southbound: 0  
Eastbound: 0  
Westbound: 2

### WESTMOUNT AVE/HWY 417 PARKDAL

### PARKDALE AVE

### IC122R16

Period	Northbound			Southbound			Eastbound			Westbound			WB STR TOT	WB ST RT TOT	WB STR TOT			
	LT	ST	RT	NB LT	NB ST	NB RT	SB LT	SB ST	SB RT	EB LT	EB ST	EB RT				WT	WT RT	WT TOT
07:00-08:00	165	320	0	485	0	469	246	715	1200	0	0	0	0	319	0	553	872	2072
08:00-09:00	120	363	0	483	0	449	254	703	1186	0	0	0	0	302	0	483	795	1981
09:00-10:00	113	364	0	477	0	486	236	722	1199	0	0	0	0	339	0	519	858	2057
11:30-12:30	129	411	0	540	0	477	312	789	1329	0	0	0	0	291	3	401	695	2024
12:30-13:30	119	403	0	522	0	491	285	776	1288	0	0	0	0	298	3	323	624	1922
15:00-16:00	123	453	0	576	0	517	191	708	1284	0	0	0	0	244	8	416	668	1952
16:00-17:00	90	456	0	546	0	564	236	800	1346	0	0	0	0	280	40	426	746	2092
17:00-18:00	79	563	0	642	0	580	219	799	1441	0	0	0	0	310	24	474	808	2249
<b>Sub Total</b>	<b>938</b>	<b>3333</b>	<b>0</b>	<b>4271</b>	<b>0</b>	<b>4033</b>	<b>1979</b>	<b>6012</b>	<b>10283</b>	<b>0</b>	<b>0</b>	<b>0</b>	<b>0</b>	<b>2383</b>	<b>78</b>	<b>3605</b>	<b>6066</b>	<b>16349</b>
<b>U-Turns</b>	<b>0</b>	<b>0</b>	<b>0</b>	<b>0</b>	<b>0</b>	<b>0</b>	<b>0</b>	<b>0</b>	<b>0</b>	<b>0</b>	<b>0</b>	<b>0</b>	<b>0</b>	<b>0</b>	<b>0</b>	<b>0</b>	<b>0</b>	<b>0</b>
<b>Total</b>	<b>938</b>	<b>3333</b>	<b>0</b>	<b>4271</b>	<b>0</b>	<b>4033</b>	<b>1979</b>	<b>6012</b>	<b>10283</b>	<b>0</b>	<b>0</b>	<b>0</b>	<b>0</b>	<b>2383</b>	<b>78</b>	<b>3605</b>	<b>6066</b>	<b>16351</b>

Note: These values are calculated by multiplying the totals by the appropriate expansion factor.

AVG 12hr: 1106 3930 0 5036 0 4755 2333 7088 12864 0 0 0 0 2810 92 4250 7154 7592 20455

Note: These volumes are calculated by multiplying the Equivalent 12 hr. totals by the AADT factor.

AVG 24hr: 1449 5148 0 6597 0 6229 3057 9285 15882 0 0 0 0 3681 120 5568 9372 9572 25254

Note: These volumes are calculated by multiplying the Average Daily 12 hr. totals by 12 to 24 expansion factor.

AVG 24hr: 1449 5148 0 6597 0 6229 3057 9285 15882 0 0 0 0 3681 120 5568 9372 9572 25254

Note: U-Turns provided for approach totals. Refer to 'U-Turn' Report for specific breakdown.





# Transportation Services - Traffic Services

## Turning Movement Count - Study Results

PARKDALE AVE @ WESTMOUNT AVE/HWY 417 PARKDAL I

Survey Date: Thursday, April 05, 2018  
Start Time: 07:00

WO No: 37687  
Device: Miovision

### Full Study Pedestrian Volume

PARKDALE AVE  
WESTMOUNT AVE/HWY 417  
PARKDAL IC122R16

Time Period	NB Approach (E or W Crossing)	SB Approach (E or W Crossing)	Total	EB Approach (N or S Crossing)	WB Approach (N or S Crossing)	Total	Grand Total
07:00 07:15	0	0	0	2	3	5	5
07:15 07:30	0	0	0	3	5	8	8
07:30 07:45	0	0	0	2	5	7	7
07:45 08:00	0	1	1	4	7	11	12
08:00 08:15	0	0	0	1	6	7	7
08:15 08:30	0	3	3	5	9	14	17
08:30 08:45	0	2	2	1	8	9	11
08:45 09:00	0	0	0	2	2	4	4
09:00 09:15	0	0	0	2	3	5	5
09:15 09:30	0	0	0	0	0	0	0
09:30 09:45	0	0	0	3	1	4	4
09:45 10:00	0	0	0	2	6	8	8
11:30 11:45	0	13	13	3	14	17	30
11:45 12:00	0	0	0	1	1	2	2
12:00 12:15	0	1	1	2	3	5	6
12:15 12:30	0	0	0	0	4	4	4
12:30 12:45	0	0	0	3	3	6	6
12:45 13:00	0	2	2	0	1	3	3
13:00 13:15	0	0	0	0	3	3	4
13:15 13:30	0	0	0	3	0	3	3
15:00 15:15	0	2	2	4	5	9	11
15:15 15:30	0	1	1	0	5	6	6
15:30 15:45	0	1	1	1	5	7	7
15:45 16:00	0	3	3	0	2	5	5
16:00 16:15	0	0	0	3	5	8	8
16:15 16:30	0	1	1	4	5	10	10
16:30 16:45	0	1	1	2	7	9	10
16:45 17:00	0	0	0	4	8	12	12
17:00 17:15	0	2	2	5	6	11	13
17:15 17:30	0	0	0	2	3	5	5
17:30 17:45	0	0	0	3	8	11	12
17:45 18:00	0	0	0	3	4	7	7
Total	0	34	34	71	147	218	252



# Transportation Services - Traffic Services

## Turning Movement Count - Study Results

PARKDALE AVE @ WESTMOUNT AVE/HWY 417 PARKDAL I

Survey Date: Thursday, April 05, 2018  
Start Time: 07:00

WO No: 37687  
Device: Miovision

### Full Study Heavy Vehicles

PARKDALE AVE  
WESTMOUNT AVE/HWY 417  
PARKDAL IC122R16

Time Period	Northbound			Southbound			Eastbound			Westbound			W	STR	Grand Total				
	LT	ST	RT	N	LT	ST	RT	S	LT	ST	RT	E				LT	ST	RT	
07:00 07:15	0	2	0	5	0	2	2	6	11	0	0	0	2	1	0	1	3	7	
07:15 07:30	2	1	0	7	0	1	1	3	10	0	0	0	3	3	0	0	6	8	
07:30 07:45	0	1	0	4	0	2	1	7	11	0	0	0	1	1	0	3	4	5	8
07:45 08:00	0	1	0	7	0	4	1	8	15	0	0	0	1	2	0	2	4	5	10
08:00 08:15	1	5	0	11	0	2	0	11	22	0	0	0	1	3	0	4	7	8	15
08:15 08:30	0	3	0	12	0	6	0	10	22	0	0	0	0	3	0	1	4	4	13
08:30 08:45	2	1	0	8	0	5	1	10	18	0	0	0	3	0	0	3	6	12	
08:45 09:00	0	1	0	14	0	9	0	12	26	0	0	0	0	4	0	2	6	6	16
09:00 09:15	0	1	0	12	0	8	2	12	24	0	0	0	2	3	0	1	4	6	15
09:15 09:30	1	1	0	11	0	7	3	14	25	0	0	0	4	2	0	3	5	9	17
09:30 09:45	1	1	0	11	0	7	1	9	20	0	0	0	2	2	0	0	2	4	12
09:45 10:00	2	1	0	7	0	2	1	10	17	0	0	0	3	2	0	6	8	11	14
11:30 11:45	1	5	0	8	0	2	3	12	20	0	0	0	4	0	0	2	6	13	13
11:45 12:00	1	2	0	14	0	7	1	12	26	0	0	0	2	4	0	2	6	8	17
12:00 12:15	1	2	0	8	0	2	2	8	16	0	0	0	3	3	0	2	5	8	12
12:15 12:30	1	5	0	11	0	3	2	12	23	0	0	0	3	2	0	2	4	7	15
12:30 12:45	2	3	0	11	0	3	2	9	20	0	0	0	4	3	0	1	4	8	14
12:45 13:00	2	1	0	8	0	4	3	10	18	0	0	0	6	1	1	2	4	10	14
13:00 13:15	1	3	0	13	0	5	2	11	24	0	0	0	3	4	0	1	5	8	16
13:15 13:30	0	5	0	8	0	2	0	8	16	0	0	0	0	1	0	1	2	2	9
15:00 15:15	0	4	0	8	0	2	1	8	16	0	0	0	1	2	0	1	3	4	10
15:15 15:30	1	7	0	13	0	5	0	17	30	0	0	0	1	0	0	5	6	18	18
15:30 15:45	0	3	0	5	0	0	2	8	13	0	0	0	2	2	0	3	5	7	10
15:45 16:00	1	3	0	9	0	2	1	9	18	0	0	0	2	3	0	3	6	8	13
16:00 16:15	0	2	0	6	0	3	1	8	14	0	0	0	1	1	0	2	3	4	9
16:15 16:30	1	0	0	7	0	6	1	9	16	0	0	0	2	0	0	2	2	4	10
16:30 16:45	1	4	0	7	0	2	0	7	14	0	0	0	2	0	1	1	2	4	9
16:45 17:00	0	1	0	3	0	2	0	4	7	0	0	0	0	0	0	1	1	1	4
17:00 17:15	0	2	0	4	0	1	0	4	8	0	0	0	0	1	0	1	2	2	5
17:15 17:30	1	3	0	7	0	2	0	5	12	0	0	0	1	1	0	1	2	2	7
17:30 17:45	0	1	0	1	0	0	0	1	2	0	0	0	0	0	0	0	0	0	1
17:45 18:00	1	3	0	6	0	2	0	7	13	0	0	0	1	1	0	2	3	8	8
Total	24	78	0	266	0	110	34	281	547	0	0	0	60	54	2	59	115	175	361





# Transportation Services - Traffic Services

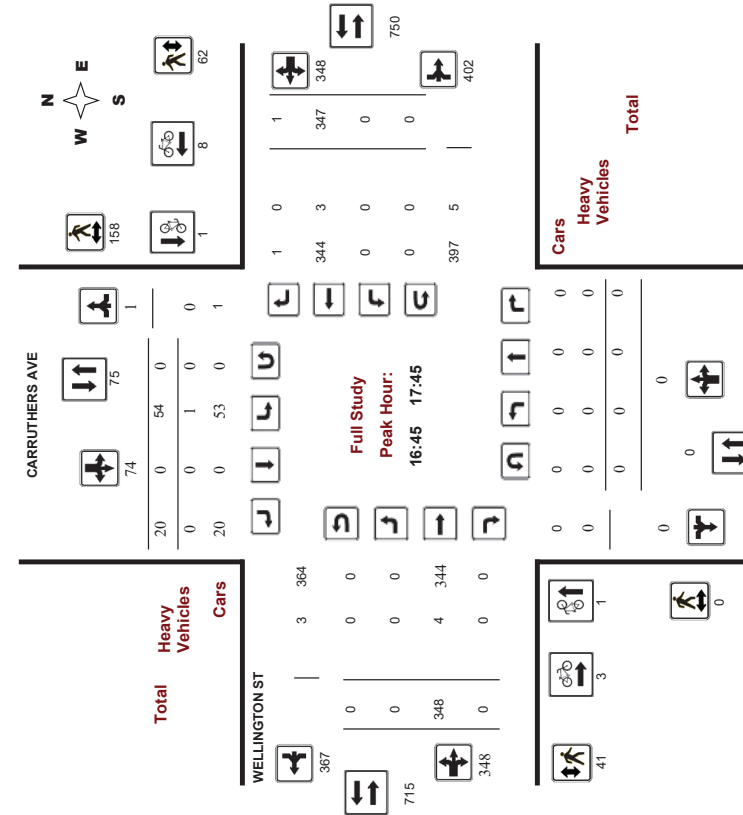
## Turning Movement Count - Study Results

### CARRUTHERS AVE @ WELLINGTON ST

Survey Date: Thursday, February 22, 2018  
Start Time: 07:00

WO No: 37569  
Device: Miovision

#### Full Study Peak Hour Diagram



Comments



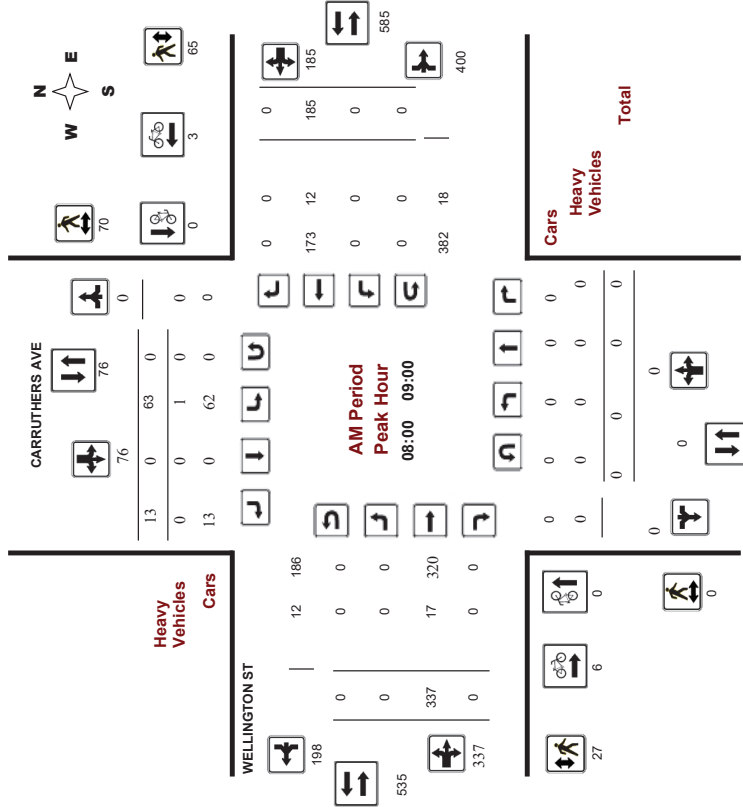
# Transportation Services - Traffic Services

## Turning Movement Count - Peak Hour Diagram

### CARRUTHERS AVE @ WELLINGTON ST

Survey Date: Thursday, February 22, 2018  
Start Time: 07:00

WO No: 37569  
Device: Miovision



Comments



# Transportation Services - Traffic Services

## Turning Movement Count - Peak Hour Diagram

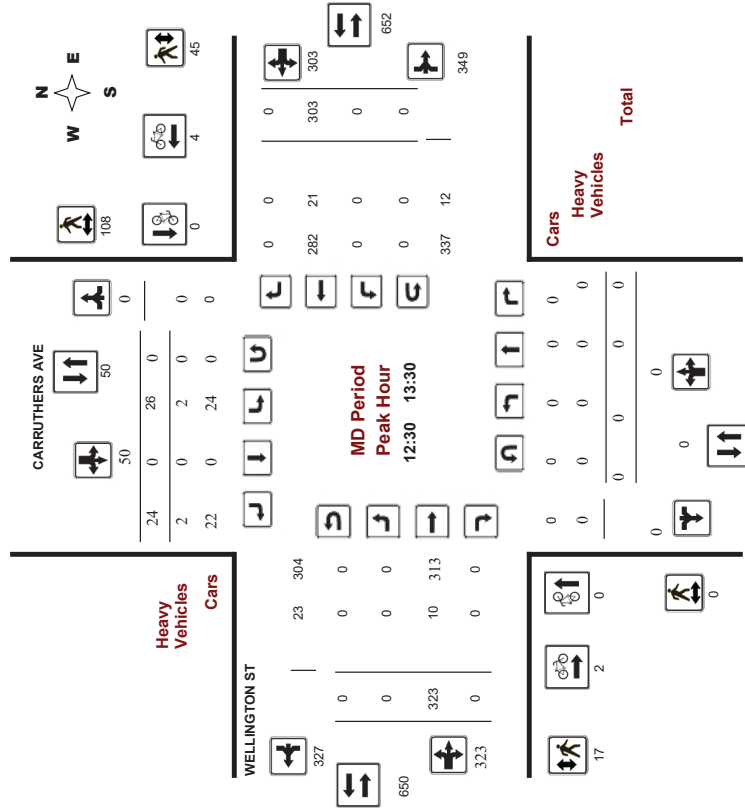
### CARRUTHERS AVE @ WELLINGTON ST

Survey Date: Thursday, February 22, 2018

Start Time: 07:00

WO No: 37569

Device: Miovision



# Transportation Services - Traffic Services

## Turning Movement Count - Peak Hour Diagram

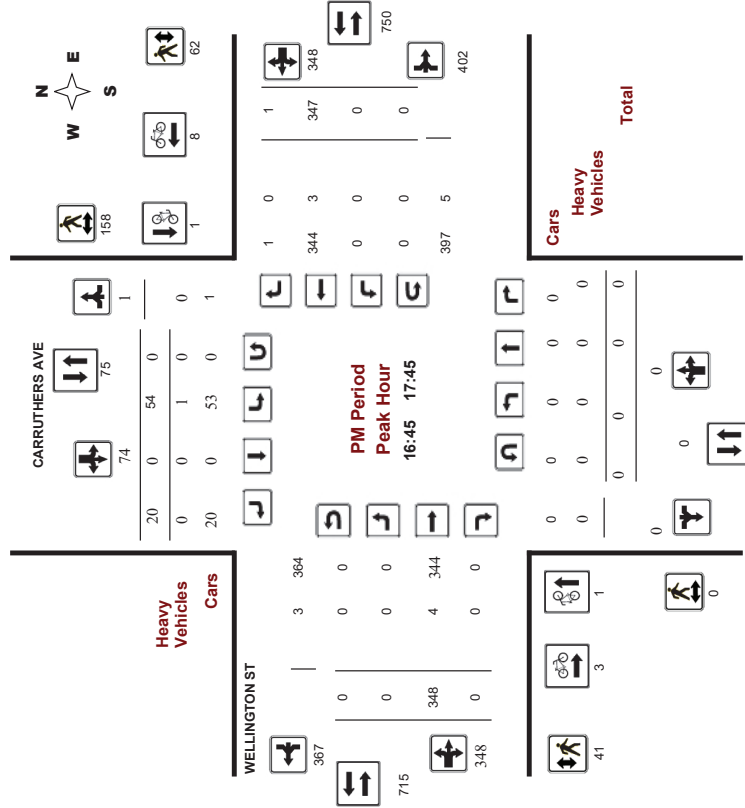
### CARRUTHERS AVE @ WELLINGTON ST

Survey Date: Thursday, February 22, 2018

Start Time: 07:00

WO No: 37569

Device: Miovision





**Transportation Services - Traffic Services**  
**Turning Movement Count - Study Results**  
**CARRUTHERS AVE @ WELLINGTON ST**

**Survey Date:** Thursday, February 22, 2018  
**Start Time:** 07:00

**WO No:** 37569  
**Device:** Miovision

**Full Study Summary (8 HR Standard)**

**Survey Date:** Thursday, February 22, 2018  
**Total Observed U-Turns** AADT Factor  
 0 Southbound: 0  
 0 Westbound: 0  
 90

Period	CARRUTHERS AVE				WELLINGTON ST				WB TOT	STR TOT	WB TOT	STR TOT	Grand Total			
	Northbound		Southbound		Eastbound		Westbound									
	LT	RT	TOT	LT	RT	TOT	LT	RT	TOT	LT	RT	TOT	WB	STR	Grand Total	
07:00-08:00	0	0	0	0	31	6	37	37	227	0	227	0	136	0	363	400
08:00-09:00	0	0	0	0	63	13	76	76	337	0	337	0	185	0	522	598
09:00-10:00	0	0	0	0	17	13	30	30	234	0	234	0	196	0	430	460
11:30-12:30	0	0	0	0	31	16	47	47	332	0	332	0	247	1	580	627
12:30-13:30	0	0	0	0	26	24	50	50	323	0	323	0	303	0	626	676
15:00-16:00	0	0	0	0	56	18	74	74	287	0	287	0	299	0	586	660
16:00-17:00	0	0	0	0	65	23	88	88	315	0	315	0	335	1	651	739
17:00-18:00	0	0	0	0	53	16	69	69	354	0	354	0	344	1	699	768
<b>Sub Total</b>	<b>0</b>	<b>0</b>	<b>0</b>	<b>0</b>	<b>342</b>	<b>129</b>	<b>471</b>	<b>471</b>	<b>2409</b>	<b>0</b>	<b>2409</b>	<b>0</b>	<b>2045</b>	<b>3</b>	<b>2048</b>	<b>4928</b>
<b>U-Turns</b>	<b>0</b>	<b>0</b>	<b>0</b>	<b>0</b>	<b>0</b>	<b>0</b>	<b>0</b>	<b>0</b>	<b>0</b>	<b>0</b>	<b>0</b>	<b>0</b>	<b>0</b>	<b>0</b>	<b>0</b>	<b>0</b>
<b>Total</b>	<b>0</b>	<b>0</b>	<b>0</b>	<b>0</b>	<b>342</b>	<b>129</b>	<b>471</b>	<b>471</b>	<b>2409</b>	<b>0</b>	<b>2409</b>	<b>0</b>	<b>2045</b>	<b>3</b>	<b>2048</b>	<b>4928</b>
<b>EQ 12hr</b>	<b>0</b>	<b>0</b>	<b>0</b>	<b>0</b>	<b>475</b>	<b>179</b>	<b>654</b>	<b>654</b>	<b>3349</b>	<b>0</b>	<b>3349</b>	<b>0</b>	<b>2843</b>	<b>4</b>	<b>2847</b>	<b>6850</b>
Note: These values are calculated by multiplying the totals by the appropriate expansion factor. 1.39																
<b>AVG 12hr</b>	<b>0</b>	<b>0</b>	<b>0</b>	<b>0</b>	<b>428</b>	<b>161</b>	<b>589</b>	<b>589</b>	<b>3014</b>	<b>0</b>	<b>3014</b>	<b>0</b>	<b>2559</b>	<b>4</b>	<b>2563</b>	<b>5777</b>
Note: These volumes are calculated by multiplying the Equivalent 12 hr. totals by the AADT factor. .90																
<b>AVG 24hr</b>	<b>0</b>	<b>0</b>	<b>0</b>	<b>0</b>	<b>561</b>	<b>211</b>	<b>772</b>	<b>772</b>	<b>3948</b>	<b>0</b>	<b>3948</b>	<b>0</b>	<b>3352</b>	<b>5</b>	<b>3357</b>	<b>8077</b>
Note: These volumes are calculated by multiplying the Average Daily 12 hr. totals by 12 to 24 expansion factor. 1.31																
Note: U-Turns provided for approach totals. Refer to U-Turn Report for specific breakdown.																



**Transportation Services - Traffic Services**  
**Turning Movement Count - Study Results**  
**CARRUTHERS AVE @ WELLINGTON ST**

**Survey Date:** Thursday, February 22, 2018  
**Start Time:** 07:00

**WO No:** 37569  
**Device:** Miovision

**Full Study 15 Minute Increments**

**Survey Date:** Thursday, February 22, 2018  
**Total Observed U-Turns** AADT Factor  
 0 Southbound: 0  
 0 Westbound: 0  
 90

Time Period	CARRUTHERS AVE				WELLINGTON ST				E	LT	ST	RT	TOT	S	STR	TOT	W	STR	TOT	Grand Total
	Northbound		Southbound		Eastbound		Westbound													
	LT	ST	RT	TOT	LT	ST	RT	TOT	LT	ST	RT	TOT	LT	ST	RT	TOT	LT	ST	TOT	Grand Total
07:00	0	0	0	0	2	0	0	2	0	45	0	45	0	29	0	29	0	29	74	76
07:15	0	0	0	0	3	0	3	6	0	45	0	45	0	30	0	30	0	30	75	81
07:30	0	0	0	0	11	0	11	12	0	61	0	61	0	43	0	43	0	43	104	116
07:45	0	0	0	0	15	0	15	17	0	76	0	76	0	34	0	34	0	34	110	127
08:00	0	0	0	0	21	0	21	25	0	97	0	97	0	43	0	43	0	43	140	165
08:15	0	0	0	0	21	0	21	23	0	79	0	79	0	50	0	50	0	50	129	152
08:30	0	0	0	0	12	0	12	16	0	79	0	79	0	55	0	55	0	55	134	150
08:45	0	0	0	0	9	0	9	12	0	82	0	82	0	37	0	37	0	37	119	131
09:00	0	0	0	0	5	0	5	8	0	50	0	50	0	46	0	46	0	46	96	104
09:15	0	0	0	0	3	0	3	6	0	63	0	63	0	59	0	59	0	59	122	131
09:30	0	0	0	0	5	0	5	7	0	57	0	57	0	53	0	53	0	53	110	117
09:45	0	0	0	0	4	0	4	6	0	64	0	64	0	38	0	38	0	38	102	108
11:30	0	0	0	0	3	0	3	5	0	83	0	83	0	52	0	52	0	52	135	143
11:45	0	0	0	0	5	0	5	7	0	89	0	89	0	56	0	56	0	56	145	152
12:00	0	0	0	0	14	0	14	18	0	80	0	80	0	75	1	76	1	76	156	174
12:15	0	0	0	0	9	0	9	14	0	80	0	80	0	64	0	64	0	64	144	158
12:30	0	0	0	0	6	0	6	14	0	69	0	69	0	72	0	72	0	72	141	155
12:45	0	0	0	0	10	0	10	14	0	96	0	96	0	78	0	78	0	78	174	188
13:00	0	0	0	0	4	0	4	12	0	78	0	78	0	66	0	66	0	66	144	156
13:15	0	0	0	0	6	0	6	10	0	80	0	80	0	87	0	87	0	87	167	177
15:00	0	0	0	0	12	0	12	16	0	72	0	72	0	63	0	63	0	63	135	151
15:15	0	0	0	0	19	0	19	23	0	75	0	75	0	77	0	77	0	77	152	175
15:30	0	0	0	0	14	0	14	19	0	64	0	64	0	91	0	91	0	91	155	174
15:45	0	0	0	0	11	0	11	16	0	76	0	76	0	68	0	68	0	68	144	160
16:00	0	0	0	0	18	0	18	27	0	74	0	74	0	74	0	74	0	74	162	189
16:15	0	0	0	0	19	0	19	22	0	80	0	80	0	86	0	86	0	86	166	188
16:30	0	0	0	0	17	0	17	20	0	80	0	80	0	79	0	79	0	79	159	179
16:45	0	0	0	0	11	0	11	19	0	81	0	81	0	83	0	83	0	83	164	183
17:00	0	0	0	0	18	0	18	21	0	82	0	82	0	81	1	82	1	82	164	185
17:15	0	0	0	0	15	0	15	18	0	97	0	97	0	86	0	86	0	86	183	201
17:30	0	0	0	0	10	0	10	16	0	88	0	88	0	87	0	87	0	87	185	201
17:45	0	0	0	0	14	0	14	14	0	87	0	87	0	80	0	80	0	80	167	181
<b>Total:</b>	<b>0</b>	<b>0</b>	<b>0</b>	<b>0</b>	<b>342</b>	<b>129</b>	<b>471</b>	<b>471</b>	<b>2409</b>	<b>0</b>	<b>2409</b>	<b>0</b>	<b>2045</b>	<b>3</b>	<b>2048</b>	<b>471</b>	<b>2048</b>	<b>471</b>	<b>4,928</b>	

Note: U-Turns are included in Totals.





**Transportation Services - Traffic Services**  
**Turning Movement Count - Study Results**  
**CARRUTHERS AVE @ WELLINGTON ST**

**Survey Date:** Thursday, February 22, 2018  
**Start Time:** 07:00

**WO No:** 37569  
**Device:** Miovision

**Full Study Cyclist Volume**  
**CARRUTHERS AVE**  
**WELLINGTON ST**

Time Period	Southbound		Eastbound		Street Total	Grand Total
	Northbound	Westbound	Southbound	Street Total		
07:00 07:15	0	0	3	0	3	3
07:15 07:30	0	0	0	1	1	1
07:30 07:45	0	0	2	0	2	2
07:45 08:00	0	0	1	1	2	2
08:00 08:15	0	0	4	2	6	6
08:15 08:30	0	0	2	1	3	3
08:30 08:45	0	0	0	0	0	0
08:45 09:00	0	0	0	0	0	0
09:00 09:15	0	0	0	0	0	0
09:15 09:30	0	0	0	1	1	1
09:30 09:45	0	0	2	0	2	2
09:45 10:00	0	0	1	0	1	1
10:00 10:15	0	0	0	2	2	2
10:15 10:30	0	0	0	0	0	0
10:30 10:45	0	0	0	0	0	0
10:45 11:00	0	0	0	0	0	0
11:00 11:15	0	0	0	0	0	0
11:15 11:30	0	0	0	0	0	0
11:30 11:45	0	0	0	0	0	0
11:45 12:00	0	0	0	0	0	0
12:00 12:15	0	0	0	0	0	0
12:15 12:30	0	0	0	0	0	0
12:30 12:45	0	0	0	0	0	0
12:45 13:00	0	0	1	1	2	2
13:00 13:15	0	0	0	1	1	1
13:15 13:30	0	0	1	2	3	3
13:30 13:45	0	0	1	1	2	2
13:45 14:00	0	0	1	3	4	4
14:00 14:15	0	0	0	2	2	2
14:15 14:30	0	0	0	0	0	0
14:30 14:45	0	0	0	0	0	0
14:45 15:00	0	0	0	5	5	5
15:00 15:15	0	0	0	1	1	1
15:15 15:30	0	0	0	0	0	0
15:30 15:45	0	0	1	0	1	1
15:45 16:00	0	0	0	0	0	0
16:00 16:15	0	0	0	0	0	0
16:15 16:30	0	0	1	1	2	2
16:30 16:45	0	0	0	0	0	0
16:45 17:00	0	0	0	2	2	2
17:00 17:15	1	0	1	2	4	5
17:15 17:30	0	1	0	4	4	5
17:30 17:45	0	0	1	0	1	1
17:45 18:00	0	0	0	3	3	3
<b>Total</b>	<b>1</b>	<b>2</b>	<b>24</b>	<b>34</b>	<b>58</b>	<b>61</b>



**Transportation Services - Traffic Services**  
**Turning Movement Count - Study Results**  
**CARRUTHERS AVE @ WELLINGTON ST**

**Survey Date:** Thursday, February 22, 2018  
**Start Time:** 07:00

**WO No:** 37569  
**Device:** Miovision

**Full Study Pedestrian Volume**  
**CARRUTHERS AVE**  
**WELLINGTON ST**

Time Period	NB Approach (E or W Crossing)		SB Approach (E or W Crossing)		Total	EB Approach (N or S Crossing)	WB Approach (N or S Crossing)	Total	Grand Total
	0	7	0	7					
07:00 07:15	0	7	0	7	7	1	5	6	13
07:15 07:30	0	10	0	10	10	1	7	8	18
07:30 07:45	0	16	0	16	16	6	2	8	24
07:45 08:00	0	20	0	20	20	9	12	21	41
08:00 08:15	0	24	0	24	24	4	17	21	45
08:15 08:30	0	20	0	20	20	15	36	51	71
08:30 08:45	0	10	0	10	10	6	10	16	26
08:45 09:00	0	16	0	16	16	2	2	4	20
09:00 09:15	0	12	0	12	12	2	7	9	21
09:15 09:30	0	17	0	17	17	1	4	5	22
09:30 09:45	0	9	0	9	9	1	5	6	15
09:45 10:00	0	15	0	15	15	4	7	11	26
10:00 10:15	0	19	0	19	19	1	13	14	33
10:15 10:30	0	21	0	21	21	3	9	12	33
10:30 10:45	0	21	0	21	21	8	7	15	36
10:45 11:00	0	46	0	46	46	3	17	20	66
11:00 11:15	0	34	0	34	34	6	8	14	48
11:15 11:30	0	24	0	24	24	3	14	17	41
11:30 11:45	0	22	0	22	22	4	8	12	34
11:45 12:00	0	28	0	28	28	4	15	19	47
12:00 12:15	0	46	0	46	46	15	41	56	102
12:15 12:30	0	33	0	33	33	4	20	24	43
12:30 12:45	0	22	0	22	22	8	16	24	57
12:45 13:00	0	22	0	22	22	8	16	24	46
13:00 13:15	0	28	0	28	28	8	17	25	54
13:15 13:30	0	21	0	21	21	6	13	19	40
13:30 13:45	0	35	0	35	35	18	16	34	69
13:45 14:00	0	40	0	40	40	13	21	34	74
14:00 14:15	0	38	0	38	38	7	12	19	57
14:15 14:30	0	45	0	45	45	3	13	16	61
14:30 14:45	0	28	0	28	28	8	10	18	46
14:45 15:00	0	77/2	0	77/2	77/2	188	422	610	1382



**Transportation Services - Traffic Services**  
**Turning Movement Count - Study Results**  
**CARRUTHERS AVE @ WELLINGTON ST**

**Survey Date:** Thursday, February 22, 2018  
**Start Time:** 07:00

**WO No:** 37569  
**Device:** Miovision

**Full Study Heavy Vehicles**

Time Period	Northbound			Southbound			Eastbound			Westbound			W	STR	Grand	
	LT	ST	RT	LT	ST	RT	LT	ST	RT	LT	ST	RT				TOT
07:00	0	0	0	0	0	0	0	0	0	0	0	0	0	3	7	
07:15	0	0	0	0	0	0	0	0	0	0	0	0	0	3	4	
07:30	0	0	0	0	0	0	0	0	0	0	0	0	0	2	4	
07:45	0	0	0	0	0	0	0	0	0	0	0	0	0	3	7	
08:00	0	0	0	0	0	0	0	0	0	0	0	0	0	5	10	
08:15	0	0	0	0	0	0	0	0	0	0	0	0	0	2	7	
08:30	0	0	0	0	0	0	0	0	0	0	0	0	0	3	5	
08:45	0	0	0	0	0	0	0	0	0	0	0	0	0	2	8	
09:00	0	0	0	0	0	0	0	0	0	0	0	0	0	3	6	
09:15	0	0	0	0	0	0	0	0	0	0	0	0	0	6	9	
09:30	0	0	0	0	0	0	0	0	0	0	0	0	0	2	6	
09:45	0	0	0	0	0	0	0	0	0	0	0	0	0	2	8	
10:00	0	0	0	0	0	0	0	0	0	0	0	0	0	2	10	
10:15	0	0	0	0	0	0	0	0	0	0	0	0	0	3	6	
10:30	0	0	0	0	0	0	0	0	0	0	0	0	0	4	8	
10:45	0	0	0	0	0	0	0	0	0	0	0	0	0	4	8	
11:00	0	0	0	0	0	0	0	0	0	0	0	0	0	4	12	
11:15	0	0	0	0	0	0	0	0	0	0	0	0	0	4	8	
11:30	0	0	0	0	0	0	0	0	0	0	0	0	0	5	9	
11:45	0	0	0	0	0	0	0	0	0	0	0	0	0	5	10	
12:00	0	0	0	0	0	0	0	0	0	0	0	0	0	4	8	
12:15	0	0	0	0	0	0	0	0	0	0	0	0	0	4	12	
12:30	0	0	0	0	0	0	0	0	0	0	0	0	0	4	6	
12:45	0	0	0	0	0	0	0	0	0	0	0	0	0	5	9	
13:00	0	0	0	0	0	0	0	0	0	0	0	0	0	8	11	
13:15	0	0	0	0	0	0	0	0	0	0	0	0	0	4	5	
13:30	0	0	0	0	0	0	0	0	0	0	0	0	0	2	7	
13:45	0	0	0	0	0	0	0	0	0	0	0	0	0	2	4	
14:00	0	0	0	0	0	0	0	0	0	0	0	0	0	1	3	
14:15	0	0	0	0	0	0	0	0	0	0	0	0	0	3	6	
14:30	0	0	0	0	0	0	0	0	0	0	0	0	0	0	3	
14:45	0	0	0	0	0	0	0	0	0	0	0	0	0	1	3	
15:00	0	0	0	0	0	0	0	0	0	0	0	0	0	0	2	
15:15	0	0	0	0	0	0	0	0	0	0	0	0	0	0	2	
15:30	0	0	0	0	0	0	0	0	0	0	0	0	0	1	3	
15:45	0	0	0	0	0	0	0	0	0	0	0	0	0	3	6	
16:00	0	0	0	0	0	0	0	0	0	0	0	0	0	0	3	
16:15	0	0	0	0	0	0	0	0	0	0	0	0	0	1	3	
16:30	0	0	0	0	0	0	0	0	0	0	0	0	0	1	2	
16:45	0	0	0	0	0	0	0	0	0	0	0	0	0	0	2	
17:00	0	0	0	0	0	0	0	0	0	0	0	0	0	0	0	
17:15	0	0	0	0	0	0	0	0	0	0	0	0	0	1	3	
17:30	0	0	0	0	0	0	0	0	0	0	0	0	0	2	3	
17:45	0	0	0	0	0	0	0	0	0	0	0	0	0	4	5	
Total	0	0	0	0	0	0	0	0	0	0	0	0	0	87	186	200



**Transportation Services - Traffic Services**  
**Turning Movement Count - Study Results**  
**CARRUTHERS AVE @ WELLINGTON ST**

**Survey Date:** Thursday, February 22, 2018  
**Start Time:** 07:00

**WO No:** 37569  
**Device:** Miovision

**Full Study 15 Minute U-Turn Total**

Time Period	Northbound		Southbound		Eastbound		Westbound		Total
	U-Turn	Total	U-Turn	Total	U-Turn	Total	U-Turn	Total	
07:00	0	0	0	0	0	0	0	0	0
07:15	0	0	0	0	0	0	0	0	0
07:30	0	0	0	0	0	0	0	0	0
07:45	0	0	0	0	0	0	0	0	0
08:00	0	0	0	0	0	0	0	0	0
08:15	0	0	0	0	0	0	0	0	0
08:30	0	0	0	0	0	0	0	0	0
08:45	0	0	0	0	0	0	0	0	0
09:00	0	0	0	0	0	0	0	0	0
09:15	0	0	0	0	0	0	0	0	0
09:30	0	0	0	0	0	0	0	0	0
09:45	0	0	0	0	0	0	0	0	0
10:00	0	0	0	0	0	0	0	0	0
10:15	0	0	0	0	0	0	0	0	0
10:30	0	0	0	0	0	0	0	0	0
10:45	0	0	0	0	0	0	0	0	0
11:00	0	0	0	0	0	0	0	0	0
11:15	0	0	0	0	0	0	0	0	0
11:30	0	0	0	0	0	0	0	0	0
11:45	0	0	0	0	0	0	0	0	0
12:00	0	0	0	0	0	0	0	0	0
12:15	0	0	0	0	0	0	0	0	0
12:30	0	0	0	0	0	0	0	0	0
12:45	0	0	0	0	0	0	0	0	0
13:00	0	0	0	0	0	0	0	0	0
13:15	0	0	0	0	0	0	0	0	0
13:30	0	0	0	0	0	0	0	0	0
13:45	0	0	0	0	0	0	0	0	0
14:00	0	0	0	0	0	0	0	0	0
14:15	0	0	0	0	0	0	0	0	0
14:30	0	0	0	0	0	0	0	0	0
14:45	0	0	0	0	0	0	0	0	0
15:00	0	0	0	0	0	0	0	0	0
15:15	0	0	0	0	0	0	0	0	0
15:30	0	0	0	0	0	0	0	0	0
15:45	0	0	0	0	0	0	0	0	0
16:00	0	0	0	0	0	0	0	0	0
16:15	0	0	0	0	0	0	0	0	0
16:30	0	0	0	0	0	0	0	0	0
16:45	0	0	0	0	0	0	0	0	0
17:00	0	0	0	0	0	0	0	0	0
17:15	0	0	0	0	0	0	0	0	0
17:30	0	0	0	0	0	0	0	0	0
17:45	0	0	0	0	0	0	0	0	0
Total	0	0	0	0	0	0	0	0	0



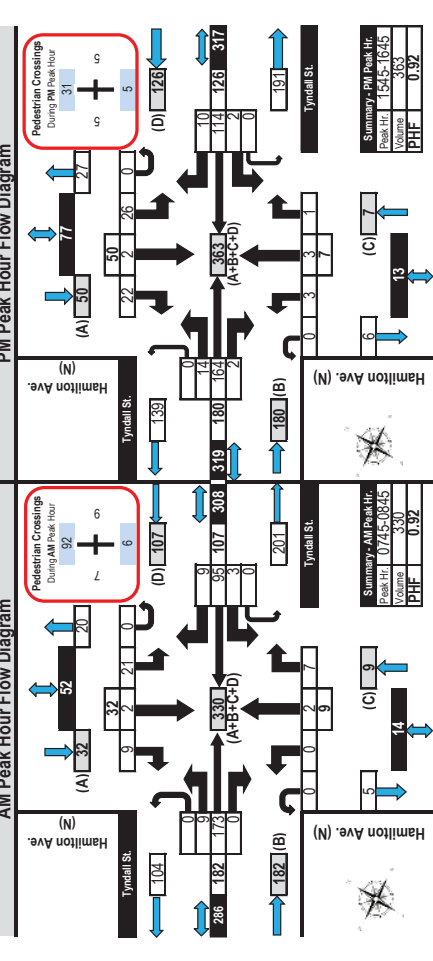
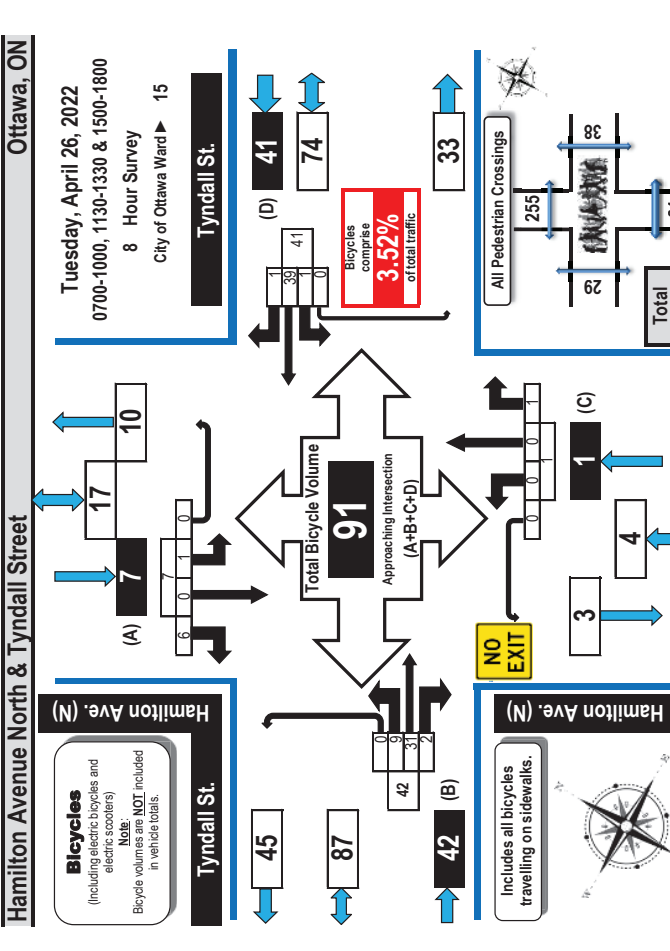
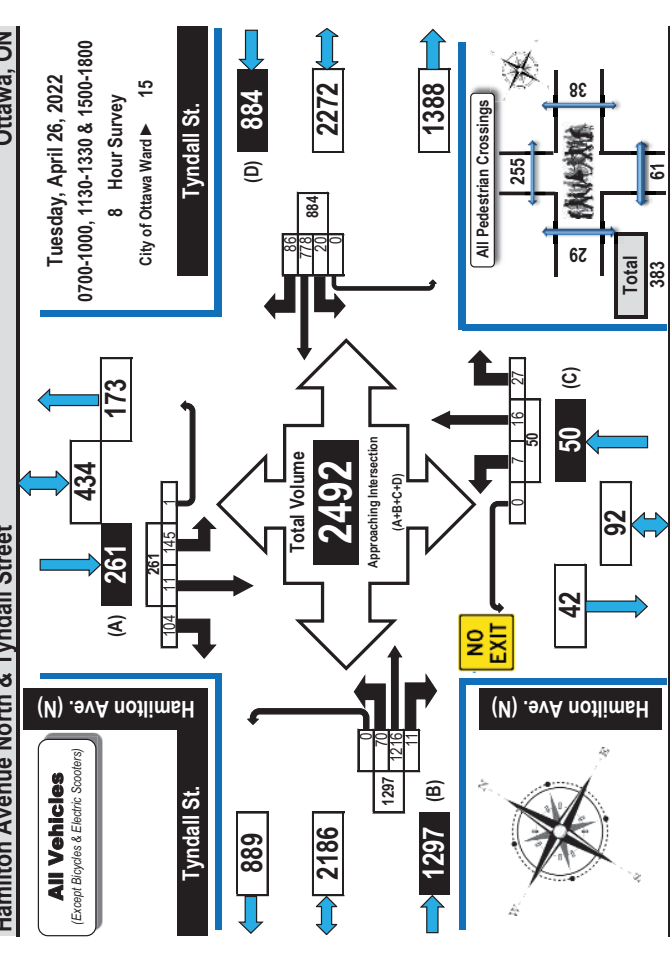
### Turning Movement Count Summary, AM and PM Peak Hour Flow Diagrams

All Vehicles Except Bicycles  
Hamilton Avenue North & Tyndall Street  
Ottawa, ON



### Turning Movement Count Bicycle Summary Flow Diagram

Bicycles  
(Including electric bicycles and electric scooters)  
Note: Bicycle volumes are NOT included in vehicle totals.  
Hamilton Avenue North & Tyndall Street  
Ottawa, ON



Time Period	Tyndall St. Eastbound						Tyndall St. Westbound						Hamilton Ave. (N) Northbound						Hamilton Ave. (N) Southbound					
	LT	ST	RT	UT	EB Tot	LT	ST	RT	UT	WB Tot	LT	ST	RT	UT	NB Tot	LT	ST	RT	UT	SB Tot				
0700-0800	1	5	0	0	6	0	7	0	0	7	0	0	0	0	0	0	0	0	0	0	0	13		
0800-0900	2	4	0	0	6	0	3	0	0	3	0	0	0	0	0	1	0	1	0	2	11			
0900-1000	1	2	0	0	3	0	3	0	0	3	0	0	0	0	0	0	0	0	0	0	6			
1130-1230	2	1	0	0	3	0	5	0	3	1	0	4	0	0	0	0	0	2	0	2	11			
1230-1330	2	1	0	0	3	0	3	0	0	3	0	0	0	0	0	0	0	0	1	0	7			
1500-1600	0	4	2	0	6	0	5	0	5	0	1	0	1	0	1	0	0	1	0	1	13			
1600-1700	2	6	0	0	8	0	6	0	0	6	0	0	0	0	0	0	0	0	0	0	14			
1700-1800	1	4	0	0	5	1	9	0	0	10	0	0	0	0	0	0	0	0	1	0	16			
<b>Totals</b>	<b>9</b>	<b>31</b>	<b>2</b>	<b>0</b>	<b>42</b>	<b>1</b>	<b>39</b>	<b>1</b>	<b>0</b>	<b>41</b>	<b>0</b>	<b>0</b>	<b>1</b>	<b>0</b>	<b>1</b>	<b>1</b>	<b>1</b>	<b>0</b>	<b>6</b>	<b>0</b>	<b>7</b>			

**Comments:**  
Para Transpo buses and school buses comprise 28.57% of the heavy vehicle traffic. Bicycles comprise 3.52% of traffic. Eastbound traffic on Tyndall Street backs up from Parkdale and during peak periods, occasionally backs up half way to Holland Avenue.



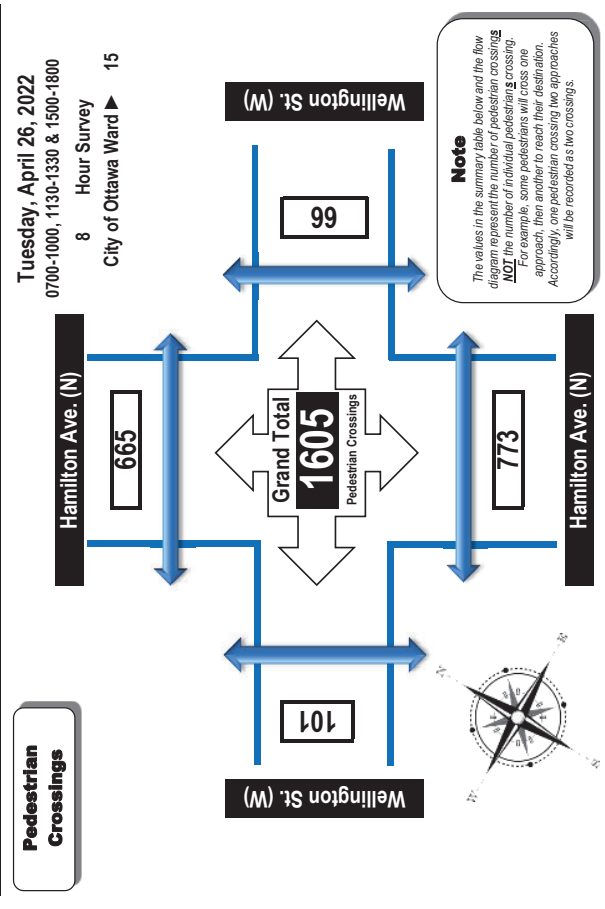




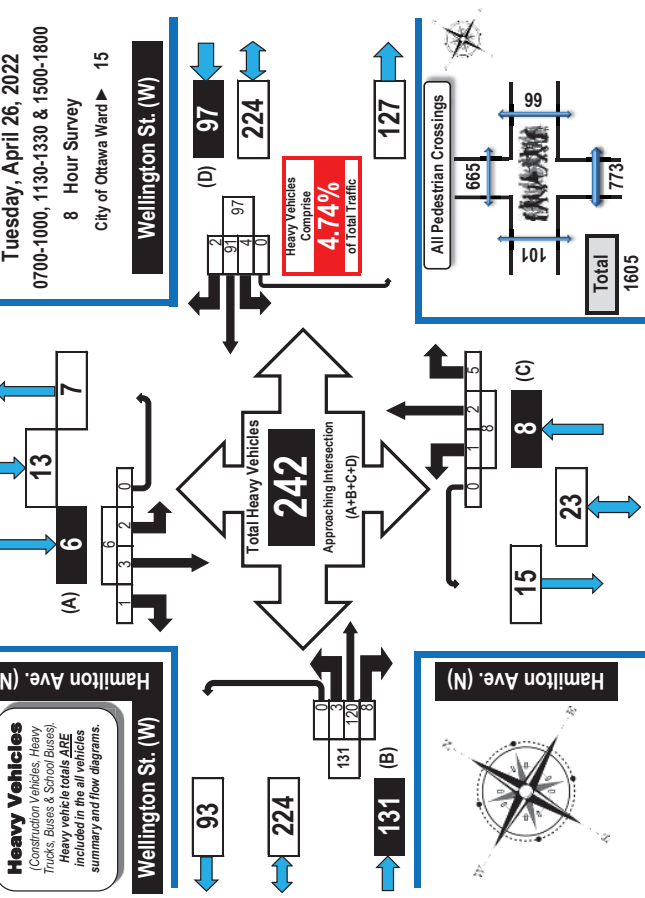
### Turning Movement Count Pedestrian Crossings Summary and Flow Diagram



Hamilton Avenue North & Wellington Street West  
Ottawa, ON



Hamilton Avenue North & Wellington Street West  
Ottawa, ON



Time Period	West Side Crossing Wellington St. (W)		East Side Crossing Wellington St. (W)		South Side Crossing Hamilton Ave. (N)		North Side Crossing Hamilton Ave. (N)		Street Total	Grand Total
	W	E	W	E	W	E	W	E		
0700-0800	9	7	7	4	16	49	36	50	85	101
0800-0900	7	4	4	4	11	68	10	51	118	129
0900-1000	6	4	4	6	10	67	4	102	118	128
1130-1230	17	11	11	8	28	87	102	114	189	217
1230-1330	15	16	16	10	31	103	114	123	217	248
1500-1600	12	6	6	9	18	128	86	115	251	269
1600-1700	20	9	9	29	29	115	103	156	201	230
1700-1800	15	9	9	24	24	156	103	167	259	283
<b>Totals</b>	<b>101</b>	<b>66</b>	<b>66</b>	<b>773</b>	<b>167</b>	<b>773</b>	<b>665</b>	<b>1438</b>	<b>1438</b>	<b>1605</b>

**Comments:**  
OC Transpo, Para Transpo and school buses comprise 33.88% of the heavy vehicle traffic. Bicycles comprise 3.53% of traffic. The bicycle totals include 17 electric types. Eastbound traffic backs up from Parkdale Avenue to beyond Hamilton Street North.

Printed on: 4/29/2022

Prepared by: thetrafficspecialist@gmail.com

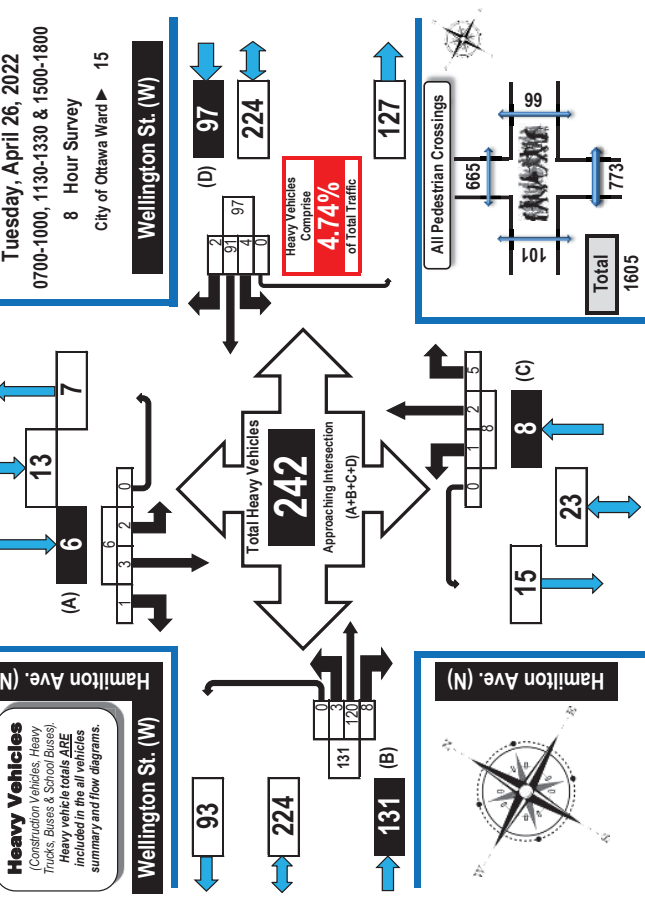
Summary: Pedestrian Crossings



### Turning Movement Count Heavy Vehicle Summary (FHWA Class 4-13) Flow Diagram



Hamilton Avenue North & Wellington Street West  
Ottawa, ON



Time Period	Westbound						Eastbound						SR Tot	OR Tot	
	LT	ST	RT	UT	WB Tot	EB Tot	LT	ST	RT	UT	NB Tot	SB Tot			
0700-0800	0	16	2	0	18	0	11	1	0	12	0	2	0	0	32
0800-0900	2	24	0	0	26	1	10	0	0	11	0	1	2	0	41
0900-1000	0	13	0	0	13	1	15	0	0	16	0	0	0	0	29
1130-1230	0	20	0	0	20	0	19	1	0	20	0	1	0	0	41
1230-1330	0	20	2	0	22	0	17	0	0	17	0	0	1	0	40
1500-1600	0	10	3	0	13	1	9	0	1	10	0	1	0	0	25
1600-1700	1	10	0	0	11	0	5	0	0	5	0	1	0	0	19
1700-1800	0	7	1	0	8	1	5	0	0	6	0	1	0	0	15
<b>Totals</b>	<b>3</b>	<b>120</b>	<b>8</b>	<b>0</b>	<b>131</b>	<b>4</b>	<b>91</b>	<b>2</b>	<b>0</b>	<b>97</b>	<b>1</b>	<b>2</b>	<b>3</b>	<b>1</b>	<b>242</b>

**Comments:**  
OC Transpo, Para Transpo and school buses comprise 33.88% of the heavy vehicle traffic. Bicycles comprise 3.53% of traffic. The bicycle totals include 17 electric types. Eastbound traffic backs up from Parkdale Avenue to beyond Hamilton Street North.

Printed on: 4/29/2022

Prepared by: thetrafficspecialist@gmail.com

Summary: Heavy Vehicles

# Appendix C

Synchro Intersection Worksheets – Existing Conditions

Lanes, Volumes, Timings  
1: Holland & Spencer

Existing AM Peak Hour  
1186-1194 Wellington STW

Lane Group	EBL	EBT	WBL	WBT	NBL	NBT	SBL	SBT
Lane Configurations	8	11	57	4	10	534	10	302
Traffic Volume (vph)	8	11	57	4	10	534	10	302
Future Volume (vph)	0	55	0	125	0	627	0	353
Lane Group Flow (vph)	Perm	NA	Perm	NA	Perm	NA	Perm	NA
Protected Phases	4	4	8	8	2	2	6	6
Permitted Phases	4	4	8	8	2	2	6	6
Detector Phase	4	4	8	8	2	2	6	6
Switch Phase								
Minimum Initial (s)	10.0	10.0	10.0	10.0	10.0	10.0	10.0	10.0
Minimum Split (s)	23.5	23.5	23.5	29.3	29.3	29.3	29.3	29.3
Total Split (s)	24.0	24.0	24.0	76.0	76.0	76.0	76.0	76.0
Total Split (%)	24.0%	24.0%	24.0%	76.0%	76.0%	76.0%	76.0%	76.0%
Maximum Green (s)	18.5	18.5	18.5	70.7	70.7	70.7	70.7	70.7
Yellow Time (s)	3.3	3.3	3.3	3.3	3.3	3.3	3.3	3.3
All-Red Time (s)	2.2	2.2	2.2	2.0	2.0	2.0	2.0	2.0
Lost Time Adjust (s)	0.0	0.0	0.0	0.0	0.0	0.0	0.0	0.0
Total Lost Time (s)	5.5	5.5	5.5	5.3	5.3	5.3	5.3	5.3
Lead/Lag								
Lead-Lag Optimize?								
Vehicle Extension (s)	3.0	3.0	3.0	3.0	3.0	3.0	3.0	3.0
Recall Mode	None	None	None	C-Max	C-Max	C-Max	C-Max	C-Max
Walk Time (s)	7.0	7.0	7.0	15.0	15.0	15.0	15.0	15.0
Flash Dont Walk (s)	11.0	11.0	11.0	9.0	9.0	9.0	9.0	9.0
Pedestrian Calls (#/hr)	17	17	11	11	60	60	32	32
Act Effr Green (s)	13.7	13.7	13.7	0.76	0.76	0.76	0.76	0.76
Actuated g/C Ratio	0.14	0.14	0.14	0.27	0.27	0.27	0.15	0.15
v/c Ratio	20.7	38.3	38.3	0.9	0.9	0.9	3.9	3.9
Control Delay	0.0	0.0	0.0	0.0	0.0	0.0	0.0	0.0
Queue Delay	20.7	38.3	38.3	0.9	0.9	0.9	3.9	3.9
Total Delay	20.7	38.3	38.3	0.9	0.9	0.9	3.9	3.9
LOS	C	D	D	A	A	A	A	A
Approach Delay	20.7	38.3	38.3	0.9	0.9	0.9	3.9	3.9
Approach LOS	C	D	D	A	A	A	A	A
Queue Length 50th (m)	3.7	16.1	16.1	1.4	1.4	1.4	7.4	7.4
Queue Length 95th (m)	13.7	32.5	32.5	4.9	4.9	4.9	14.7	14.7
Internal Link Dist (m)	151.9	132.2	132.2	211.0	211.0	211.0	210.0	210.0
Turn Bay Length (m)								
Base Capacity (vph)	302	276	276	2345	2345	2345	2325	2325
Starvation Cap Reductn	0	0	0	0	0	0	0	0
Spillback Cap Reductn	0	0	0	0	0	0	0	0
Storage Cap Reductn	0	0	0	0	0	0	0	0
Reduced v/c Ratio	0.18	0.45	0.45	0.27	0.27	0.27	0.15	0.15

Intersection Summary	
Cycle Length:	100
Actuated Cycle Length:	100
Offset:	40 (40%), Referenced to phase 2, NBT and 6, SBT, Start of Green
Natural Cycle:	55

Lanes, Volumes, Timings  
1: Holland & Spencer

Existing AM Peak Hour  
1186-1194 Wellington STW

Lane Group	EBL	EBT	WBL	WBT	NBL	NBT	SBL	SBT
Lane Configurations	8	11	57	4	10	534	10	302
Traffic Volume (vph)	8	11	57	4	10	534	10	302
Future Volume (vph)	0	55	0	125	0	627	0	353
Lane Group Flow (vph)	Perm	NA	Perm	NA	Perm	NA	Perm	NA
Protected Phases	4	4	8	8	2	2	6	6
Permitted Phases	4	4	8	8	2	2	6	6
Detector Phase	4	4	8	8	2	2	6	6
Switch Phase								
Minimum Initial (s)	10.0	10.0	10.0	10.0	10.0	10.0	10.0	10.0
Minimum Split (s)	23.5	23.5	23.5	29.3	29.3	29.3	29.3	29.3
Total Split (s)	24.0	24.0	24.0	76.0	76.0	76.0	76.0	76.0
Total Split (%)	24.0%	24.0%	24.0%	76.0%	76.0%	76.0%	76.0%	76.0%
Maximum Green (s)	18.5	18.5	18.5	70.7	70.7	70.7	70.7	70.7
Yellow Time (s)	3.3	3.3	3.3	3.3	3.3	3.3	3.3	3.3
All-Red Time (s)	2.2	2.2	2.2	2.0	2.0	2.0	2.0	2.0
Lost Time Adjust (s)	0.0	0.0	0.0	0.0	0.0	0.0	0.0	0.0
Total Lost Time (s)	5.5	5.5	5.5	5.3	5.3	5.3	5.3	5.3
Lead/Lag								
Lead-Lag Optimize?								
Vehicle Extension (s)	3.0	3.0	3.0	3.0	3.0	3.0	3.0	3.0
Recall Mode	None	None	None	C-Max	C-Max	C-Max	C-Max	C-Max
Walk Time (s)	7.0	7.0	7.0	15.0	15.0	15.0	15.0	15.0
Flash Dont Walk (s)	11.0	11.0	11.0	9.0	9.0	9.0	9.0	9.0
Pedestrian Calls (#/hr)	17	17	11	11	60	60	32	32
Act Effr Green (s)	13.7	13.7	13.7	0.76	0.76	0.76	0.76	0.76
Actuated g/C Ratio	0.14	0.14	0.14	0.27	0.27	0.27	0.15	0.15
v/c Ratio	20.7	38.3	38.3	0.9	0.9	0.9	3.9	3.9
Control Delay	0.0	0.0	0.0	0.0	0.0	0.0	0.0	0.0
Queue Delay	20.7	38.3	38.3	0.9	0.9	0.9	3.9	3.9
Total Delay	20.7	38.3	38.3	0.9	0.9	0.9	3.9	3.9
LOS	C	D	D	A	A	A	A	A
Approach Delay	20.7	38.3	38.3	0.9	0.9	0.9	3.9	3.9
Approach LOS	C	D	D	A	A	A	A	A
Queue Length 50th (m)	3.7	16.1	16.1	1.4	1.4	1.4	7.4	7.4
Queue Length 95th (m)	13.7	32.5	32.5	4.9	4.9	4.9	14.7	14.7
Internal Link Dist (m)	151.9	132.2	132.2	211.0	211.0	211.0	210.0	210.0
Turn Bay Length (m)								
Base Capacity (vph)	302	276	276	2345	2345	2345	2325	2325
Starvation Cap Reductn	0	0	0	0	0	0	0	0
Spillback Cap Reductn	0	0	0	0	0	0	0	0
Storage Cap Reductn	0	0	0	0	0	0	0	0
Reduced v/c Ratio	0.18	0.45	0.45	0.27	0.27	0.27	0.15	0.15





Lanes, Volumes, Timings  
2: Holland & Wellington

Lanes, Volumes, Timings  
2: Holland & Wellington

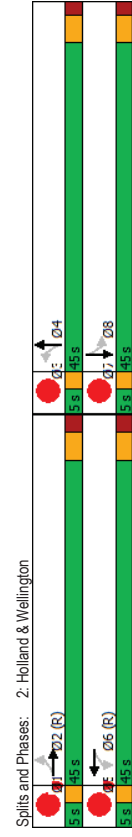
Existing AM Peak Hour  
1186-1194 Wellington STW

Existing AM Peak Hour  
1186-1194 Wellington STW

EBL	EBT	WBL	WBT	NBL	NBT	SBL	SBT	Ø1	Ø3	Ø5	Ø7
38	274	48	198	45	520	23	375				
38	274	48	198	45	520	23	375				
0	416	0	319	0	685	0	472				
Perm	NA	Perm	NA	Perm	NA	Perm	NA				
2	2	6	6	4	4	8	8	1	3	5	7
2	2	6	6	4	4	8	8				
10.0	10.0	10.0	10.0	10.0	10.0	10.0	10.0	1.0	1.0	1.0	1.0
23.6	23.6	24.5	24.5	20.1	20.1	20.1	20.1	3.0	3.0	3.0	3.0
45.0	45.0	45.0	45.0	45.0	45.0	45.0	45.0	5.0	5.0	5.0	5.0
45.0%	45.0%	45.0%	45.0%	45.0%	45.0%	45.0%	45.0%	5%	5%	5%	5%
39.4	39.4	39.4	39.4	39.9	39.9	39.9	39.9	3.0	3.0	3.0	3.0
3.3	3.3	3.3	3.3	3.3	3.3	3.3	3.3	2.0	2.0	2.0	2.0
2.3	2.3	2.3	2.3	1.8	1.8	1.8	1.8	0.0	0.0	0.0	0.0
0.0	0.0	0.0	0.0	0.0	0.0	0.0	0.0				
5.6	5.6	5.6	5.6	5.1	5.1	5.1	5.1				
Lag	Lag	Lag	Lag	Lag	Lag	Lag	Lag	Lead	Lead	Lead	Lead
Yes	Yes	Yes	Yes	Yes	Yes	Yes	Yes	Yes	Yes	Yes	Yes
3.0	3.0	3.0	3.0	3.0	3.0	3.0	3.0	3.0	3.0	3.0	3.0
C-Max	C-Max	C-Max	C-Max	Max	Max	Max	Max	Max	Max	Max	Max
4.0	4.0	4.0	4.0	2.0	2.0	2.0	2.0				
14.0	14.0	14.0	14.0	13.0	13.0	13.0	13.0				
118	118	95	95	99	99	81	81				
39.4	39.4	39.4	39.4	39.9	39.9	39.9	39.9				
0.39	0.39	0.39	0.39	0.40	0.40	0.40	0.40				
0.39	0.39	0.32	0.32	0.61	0.61	0.41	0.41				
23.0	23.0	34.9	34.9	26.8	26.8	19.9	19.9				
0.0	0.0	0.0	0.0	0.0	0.0	0.0	0.0				
23.0	23.0	34.9	34.9	26.8	26.8	19.9	19.9				
C	C	C	C	C	C	B	B				
23.0	23.0	34.9	34.9	26.8	26.8	19.9	19.9				
C	C	C	C	C	C	B	B				
29.7	29.7	27.6	27.6	54.4	54.4	30.4	30.4				
42.2	42.2	41.2	41.2	73.1	73.1	39.3	39.3				
16.0	16.0	33.9	33.9	193.2	193.2	211.0	211.0				
1075	1075	1005	1005	1121	1121	1153	1153				
0	0	0	0	0	0	0	0				
0	0	0	0	0	0	0	0				
0	0	0	0	0	0	0	0				
0.39	0.39	0.32	0.32	0.61	0.61	0.41	0.41				

Intersection Summary  
Cycle Length: 100  
Actuated Cycle Length: 100  
Offset: 64 (84%), Referenced to phase 2,EBTL and 6:WBTL, Start of Green  
Natural Cycle: 55

Control Type	Actuated-Coordinated
Maximum v/c Ratio:	0.61
Intersection Signal Delay:	25.6
Intersection LOS:	C
ICU Level of Service D	
Intersection Capacity Utilization:	79.4%
Analysis Period (min):	15



Lanes, Volumes, Timings  
3: Holland & Tyndall

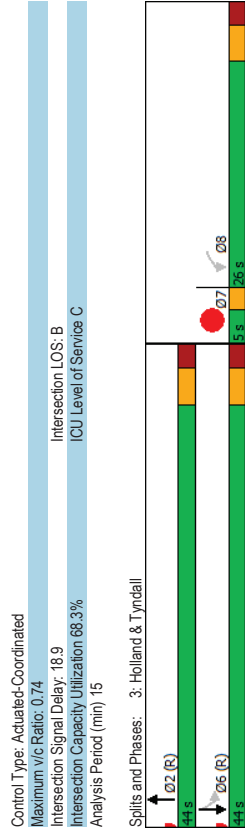
Lanes, Volumes, Timings  
3: Holland & Tyndall

Existing AM Peak Hour  
1186-1194 Wellington STW

Existing AM Peak Hour  
1186-1194 Wellington STW

	WBL	NBT	SBL	SBT	Ø7
Lane Group	W	B	B	B	Ø7
Lane Configurations	W	B	B	B	Ø7
Traffic Volume (vph)	38	492	128	489	
Future Volume (vph)	38	492	128	489	
Lane Group Flow (vph)	228	591	142	543	
Turn Type	Perm	NA	Perm	NA	
Protected Phases	2	2	6	7	
Permitted Phases	8	2	6	6	
Detector Phase	8	2	6	6	
Switch Phase					
Minimum Initial (s)	10.0	10.0	10.0	10.0	1.0
Minimum Split (s)	23.5	25.7	15.7	15.7	3.0
Total Split (s)	26.0	44.0	44.0	44.0	5.0
Total Split (%)	34.7%	58.7%	58.7%	58.7%	7%
Maximum Green (s)	20.5	38.3	38.3	38.3	3.0
Yellow Time (s)	3.3	3.3	3.3	3.3	2.0
All-Red Time (s)	2.2	2.4	2.4	2.4	0.0
Lost Time Adjust (s)	0.0	0.0	0.0	0.0	0.0
Total Lost Time (s)	5.5	5.7	5.7	5.7	
Lead/Lag	Lag	Lead	Lead	Lead	
Lead-Lag Optimize?	Yes	Yes	Yes	Yes	
Vehicle Extension (s)	3.0	3.0	3.0	3.0	3.0
Recall Mode	None	C-Max	C-Max	C-Max	Max
Walk Time (s)	5.0	10.0			
Pedestrian Calls (#/hr)	37	36			
Act Effr Green (s)	16.5	42.3	42.3	42.3	
Actuated g/C Ratio	0.22	0.56	0.56	0.56	
v/c Ratio	0.74	0.61	0.44	0.55	
Control Delay	41.6	15.1	16.7	14.1	
Queue Delay	0.0	0.0	0.0	0.0	
Total Delay	41.6	15.1	16.7	14.1	
LOS	D	B	B	B	
Approach Delay	41.6	15.1	14.6		
Approach LOS	D	B	B		
Queue Length 50th (m)	29.8	51.5	11.0	45.8	
Queue Length 95th (m)	49.7	92.0	29.0	81.1	
Internal Link Dist (m)	141.0	156.5		21.3	
Turn Bay Length (m)					
Base Capacity (vph)	382	969	320	983	
Starvation Cap Reductn	0	0	0	0	
Spillback Cap Reductn	0	0	0	0	
Storage Cap Reductn	0	0	0	0	
Reduced v/c Ratio	0.60	0.61	0.44	0.55	

Intersection Summary	
Cycle Length:	75
Actuated Cycle Length:	75
Offset:	2 (3%), Referenced to phase 2:NBT and 6:SBTL, Start of Green
Natural Cycle:	60



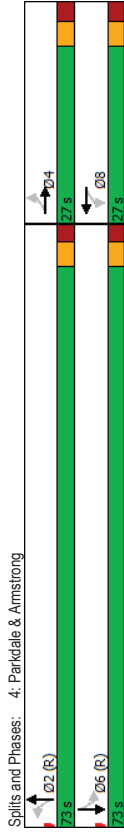
Lanes, Volumes, Timings  
4: Parkdale & Armstrong

Lanes, Volumes, Timings  
4: Parkdale & Armstrong

	EBL	EBT	WBL	WBT	NBL	NBT	SBL	SBT
Lane Group	EBL	EBT	WBL	WBT	NBL	NBT	SBL	SBT
Lane Configurations	27	75	12	47	22	359	12	205
Traffic Volume (vph)	27	75	12	47	22	359	12	205
Future Volume (vph)	0	130	0	79	0	449	0	265
Lane Group Flow (vph)	Perm	NA	Perm	NA	Perm	NA	Perm	NA
Protected Phases	4	4	8	8	2	2	6	6
Permitted Phases	4	4	8	8	2	2	6	6
Detector Phase	4	4	8	8	2	2	6	6
Switch Phase	10.0	10.0	10.0	10.0	10.0	10.0	10.0	10.0
Minimum Initial (s)	23.5	23.5	23.5	23.5	25.2	25.2	25.2	25.2
Minimum Split (s)	27.0	27.0	27.0	27.0	73.0	73.0	73.0	73.0
Total Split (s)	27.0%	27.0%	27.0%	27.0%	73.0%	73.0%	73.0%	73.0%
Total Split (%)	21.5	21.5	21.5	21.5	67.8	67.8	67.8	67.8
Maximum Green (s)	3.0	3.0	3.0	3.0	3.0	3.0	3.0	3.0
Yellow Time (s)	2.5	2.5	2.5	2.5	2.2	2.2	2.2	2.2
All-Red Time (s)	0.0	0.0	0.0	0.0	0.0	0.0	0.0	0.0
Lost Time Adjust (s)	5.5	5.5	5.5	5.5	5.2	5.2	5.2	5.2
Total Lost Time (s)	Lead/Lag							
Lead/Lag Optimize?	Vehicle Extension (s)							
Vehicle Extension (s)	3.0	3.0	3.0	3.0	3.0	3.0	3.0	3.0
Recall Mode	Max	Max	Max	Max	C-Max	C-Max	C-Max	C-Max
Walk Time (s)	10.0	10.0	10.0	10.0	15.0	15.0	15.0	15.0
Flash Dont Walk (s)	8.0	8.0	8.0	8.0	5.0	5.0	5.0	5.0
Pedestrian Calls (#/hr)	28	28	25	25	32	32	31	31
Act Effr Green (s)	21.5	21.5	21.5	21.5	67.8	67.8	67.8	67.8
Actuated g/C Ratio	0.22	0.22	0.22	0.22	0.68	0.68	0.68	0.68
v/c Ratio	0.39	0.39	0.23	0.39	0.23	0.23	0.23	0.23
Control Delay	35.8	30.3	30.3	2.2	2.2	6.5	6.5	6.5
Queue Delay	0.0	0.0	0.0	0.5	0.5	0.0	0.0	0.0
Total Delay	35.8	30.3	30.3	2.7	2.7	6.5	6.5	6.5
LOS	D	C	C	A	A	A	A	A
Approach Delay	35.8	30.3	30.3	2.7	2.7	6.5	6.5	6.5
Approach LOS	D	C	C	A	A	A	A	A
Queue Length 50th (m)	20.5	11.1	11.1	4.4	4.4	16.6	16.6	16.6
Queue Length 95th (m)	37.7	23.6	23.6	8.1	8.1	26.6	26.6	26.6
Internal Link Dist (m)	46.6	196.9	196.9	125.2	125.2	312.1	312.1	312.1
Turn Bay Length (m)	334	345	345	1137	1137	1132	1132	1132
Base Capacity (vph)	0	0	0	330	330	0	0	0
Starvation Cap Reductn	0	0	0	0	0	0	0	0
Spillback Cap Reductn	0	0	0	0	0	0	0	0
Storage Cap Reductn	0	0	0	0	0	0	0	0
Reduced v/c Ratio	0.39	0.23	0.23	0.56	0.56	0.23	0.23	0.23

Intersection Summary	
Cycle Length:	100
Actuated Cycle Length:	100
Offset:	52 (52%), Referenced to phase 2; NBT and 6; SBT, Start of Green
Natural Cycle:	50

Control Type:	Actuated-Coordinated
Maximum v/c Ratio:	0.39
Intersection Signal Delay:	10.8
Intersection LOS:	B
Intersection Capacity Utilization:	53.4%
Analysis Period (min):	15





Lanes, Volumes, Timings  
6: Parkdale & Gladstone

Lanes, Volumes, Timings  
6: Parkdale & Gladstone

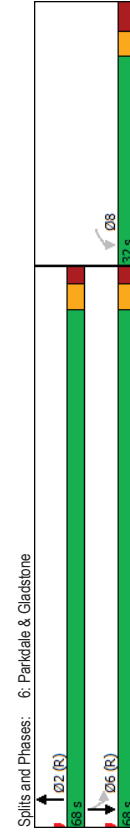
Existing AM Peak Hour  
1186-1194 Wellington STW

Existing AM Peak Hour  
1186-1194 Wellington STW

	WBL	NBT	SBL	SBT
Lane Group	WBL	NBT	SBL	SBT
Lane Configurations	W	T	T	T
Traffic Volume (vph)	133	502	32	346
Future Volume (vph)	133	502	32	346
Lane Group Flow (vph)	182	704	36	384
Turn Type	Perm	NA	Perm	NA
Protected Phases	8	2	6	6
Permitted Phases	8	2	6	6
Detector Phase	8	2	6	6
Switch Phase				
Minimum Initial (s)	10.0	10.0	10.0	10.0
Minimum Split (s)	22.7	20.3	15.3	15.3
Total Split (s)	32.0	68.0	68.0	68.0
Total Split (%)	32.0%	68.0%	68.0%	68.0%
Maximum Green (s)	25.3	62.7	62.7	62.7
Yellow Time (s)	3.0	3.0	3.0	3.0
All-Red Time (s)	3.7	2.3	2.3	2.3
Lost Time Adjust (s)	0.0	0.0	0.0	0.0
Total Lost Time (s)	6.7	5.3	5.3	5.3
Lead/Lag				
Lead-Lag Optimize?				
Vehicle Extension (s)	3.0	3.0	3.0	3.0
Recall Mode	Max	C-Max	C-Max	C-Max
Walk Time (s)	7.0	7.0		
Flash Dont Walk (s)	9.0	8.0		
Pedestrian Calls (#/hr)	15	7		
Act Effr Green (s)	25.3	62.7	62.7	62.7
Actuated g/C Ratio	0.25	0.63	0.63	0.63
v/c Ratio	0.46	0.67	0.12	0.35
Control Delay	35.9	12.5	13.2	14.1
Queue Delay	0.0	0.2	0.0	0.1
Total Delay	35.9	12.7	13.2	14.2
LOS	D	B	B	B
Approach Delay	35.9	12.7	14.1	
Approach LOS	D	B	B	
Queue Length 50th (m)	29.9	70.3	2.8	29.8
Queue Length 95th (m)	50.2	m84.5	m7.5	71.0
Internal Link Dist (m)	224.2	197.3		139.5
Turn Bay Length (m)			85.0	
Base Capacity (vph)	399	1053	305	1094
Starvation Cap Reductn	0	48	0	0
Spillback Cap Reductn	0	0	0	116
Storage Cap Reductn	0	0	0	0
Reduced v/c Ratio	0.46	0.70	0.12	0.39

Intersection Summary	
Cycle Length:	100
Actuated Cycle Length:	100
Offset:	12 (12%), Referenced to phase 2:NBT and 6:SBTL, Start of Green
Natural Cycle:	60

Control Type:	Actuated-Coordinated
Maximum v/c Ratio:	0.67
Intersection Signal Delay:	16.4
Intersection LOS:	B
Intersection Capacity Utilization:	59.8%
Analysis Period (min):	15
m:	Volume for 95th percentile queue is metered by upstream signal.



Lanes, Volumes, Timings  
7: Parkdale & 417 WB OR

Lanes, Volumes, Timings  
7: Parkdale & 417 WB OR

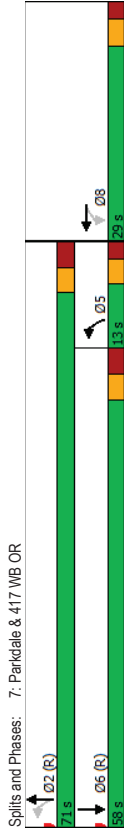
Existing AM Peak Hour  
1186-1194 Wellington STW

Existing AM Peak Hour  
1186-1194 Wellington STW

	WBL	WBT	NBL	NBT	SBT
Lane Group	WBL	WBT	NBL	NBT	SBT
Lane Configurations	345	0	166	341	456
Traffic Volume (vph)	345	0	166	341	456
Future Volume (vph)	383	602	184	379	771
Lane Group Flow (vph)	Perm	NA	pm-pt	NA	NA
Turn Type	8	5	2	2	6
Permitted Phases	8	5	2	2	6
Detector Phase	8	8	5	2	6
Switch Phase					
Minimum Initial (s)	10.0	10.0	5.0	10.0	10.0
Minimum Split (s)	20.5	20.5	10.2	27.3	21.3
Total Split (s)	29.0	29.0	13.0	71.0	68.0
Total Split (%)	29.0%	29.0%	13.0%	71.0%	58.0%
Maximum Green (s)	23.5	23.5	7.8	64.7	51.7
Yellow Time (s)	3.3	3.3	3.0	3.0	3.0
All-Red Time (s)	2.2	2.2	2.2	3.3	3.3
Lost Time Adjust (s)	0.0	0.0	0.0	0.0	0.0
Total Lost Time (s)	5.5	5.5	5.2	6.3	6.3
Lead/Lag			Lag	Lead	
Lead-Lag Optimize?			Yes	Yes	
Vehicle Extension (s)	3.0	3.0	3.0	3.0	3.0
Recall Mode	None	None	None	C-Max	C-Max
Walk Time (s)	7.0	7.0	7.0	7.0	7.0
Flash Dont Walk (s)	8.0	8.0	14.0	8.0	8.0
Pedestrian Calls (#/hr)	1	1		23	10
Act Effct Green (s)	23.5	23.5	65.8	64.7	51.7
Actuated g/C Ratio	0.24	0.24	0.66	0.65	0.52
v/c Ratio	0.98	0.86	0.69	0.34	0.89
Control Delay	81.6	22.8	25.6	9.0	39.1
Queue Delay	0.0	0.0	0.0	0.0	0.0
Total Delay	81.6	22.8	25.6	9.0	39.1
LOS	F	C	C	A	D
Approach Delay	45.6		14.4	39.1	
Approach LOS	D		B	D	
Queue Length 50th (m)	74.1	24.1	12.3	30.0	151.1
Queue Length 95th (m)	#131.1	#91.5	20.6	45.1	#208.9
Internal Link Dist (m)	462.5		38.8	197.3	
Turn Bay Length (m)					
Base Capacity (vph)	389	698	312	1129	864
Starvation Cap Reductn	0	0	0	0	0
Spillback Cap Reductn	0	0	0	0	0
Storage Cap Reductn	0	0	0	0	0
Reduced v/c Ratio	0.98	0.86	0.69	0.34	0.89

Intersection Summary	
Cycle Length:	100
Actuated Cycle Length:	100
Offset:	26 (26%), Referenced to phase 2, NBL and 6, SBT, Start of Green
Natural Cycle:	90

Control Type:	Actuated-Coordinated
Maximum v/c Ratio:	0.98
Intersection Signal Delay:	35.9
Intersection LOS:	D
Intersection Capacity Utilization:	100.4%
ICU Level of Service:	G
Analysis Period (min):	15
# 95th percentile volume exceeds capacity, queue may be longer.	
Queue shown is maximum after two cycles.	









Lanes, Volumes, Timings  
1: Holland & Spencer

Existing PM Peak Hour  
1186-1194 Wellington STW

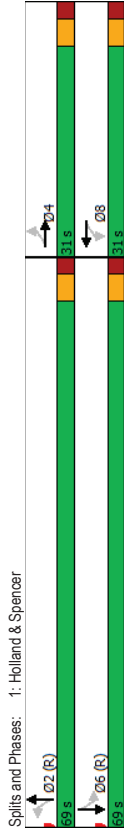
	EBL	EBT	WBL	WBT	NBL	NBT	SBL	SBT
Lane Configurations	4	4	8	8	2	2	6	6
Traffic Volume (vph)	12	24	153	61	55	343	16	480
Future Volume (vph)	12	24	153	61	55	343	16	480
Lane Group Flow (vph)	Perm	NA	Perm	NA	Perm	NA	Perm	NA
Protected Phases	4	4	8	8	2	2	6	6
Detector Phase	4	4	8	8	2	2	6	6
Switch Phase	10.0	10.0	10.0	10.0	10.0	10.0	10.0	10.0
Minimum Split (s)	23.5	23.5	23.5	29.3	29.3	29.3	29.3	29.3
Total Split (s)	31.0	31.0	31.0	69.0	69.0	69.0	69.0	69.0
Total Split (%)	31.0%	31.0%	31.0%	69.0%	69.0%	69.0%	69.0%	69.0%
Maximum Green (s)	25.5	25.5	25.5	63.7	63.7	63.7	63.7	63.7
Yellow Time (s)	3.3	3.3	3.3	3.3	3.3	3.3	3.3	3.3
All-Red Time (s)	2.2	2.2	2.2	2.0	2.0	2.0	2.0	2.0
Lost Time Adjust (s)	0.0	0.0	0.0	0.0	0.0	0.0	0.0	0.0
Total Lost Time (s)	5.5	5.5	5.5	5.3	5.3	5.3	5.3	5.3
Lead/Lag								
Lead-Lag Optimize?	3.0	3.0	3.0	3.0	3.0	3.0	3.0	3.0
Vehicle Extension (s)	None	None	None	C-Max	C-Max	C-Max	C-Max	C-Max
Recall Mode	7.0	7.0	7.0	15.0	15.0	15.0	15.0	15.0
Walk Time (s)	11.0	11.0	11.0	9.0	9.0	9.0	9.0	9.0
Flash Dont Walk (s)	17	17	18	18	88	88	49	49
Pedestrian Calls (#/hr)	23.1	23.1	23.1	66.1	66.1	66.1	66.1	66.1
Act Effr Green (s)	0.23	0.23	0.23	0.66	0.66	0.66	0.66	0.66
Actuated g/C Ratio	0.20	0.20	0.87	0.27	0.28	0.28	0.28	0.28
Control Delay	19.4	62.4	62.4	1.2	7.8	7.8	7.8	7.8
Queue Delay	0.0	0.0	0.0	0.0	0.0	0.0	0.0	0.0
Total Delay	19.4	62.4	62.4	1.2	7.8	7.8	7.8	7.8
LOS	B	E	E	A	A	A	A	A
Approach Delay	19.4	62.4	62.4	1.2	7.8	7.8	7.8	7.8
Approach LOS	B	E	E	A	A	A	A	A
Queue Length 50th (m)	5.9	47.8	47.8	1.3	23.1	23.1	23.1	23.1
Queue Length 95th (m)	16.8	#87.3	#87.3	2.8	31.4	31.4	31.4	31.4
Internal Link Dist (m)	151.9	132.2	132.2	211.0	210.0	210.0	210.0	210.0
Turn Bay Length (m)								
Base Capacity (vph)	406	345	345	1738	2028	2028	2028	2028
Starvation Cap Reductn	0	0	0	0	0	0	0	0
Spillback Cap Reductn	0	0	0	0	0	0	0	0
Storage Cap Reductn	0	0	0	0	0	0	0	0
Reduced v/c Ratio	0.18	0.79	0.79	0.27	0.28	0.28	0.28	0.28

Intersection Summary	
Cycle Length:	100
Actuated Cycle Length:	100
Offset:	38 (38%), Referenced to phase 2, NBT and 6, SBT, Start of Green
Natural Cycle:	55

Lanes, Volumes, Timings  
1: Holland & Spencer

Existing PM Peak Hour  
1186-1194 Wellington STW

Control Type:	Actuated-Coordinated
Maximum v/c Ratio:	0.87
Intersection Signal Delay:	16.8
Intersection LOS:	B
Intersection Capacity Utilization:	74.6%
Analysis Period (min):	15
# 95th percentile volume exceeds capacity, queue may be longer.	
Queue shown is maximum after two cycles.	



Lanes, Volumes, Timings  
2: Holland & Wellington

Lanes, Volumes, Timings  
2: Holland & Wellington

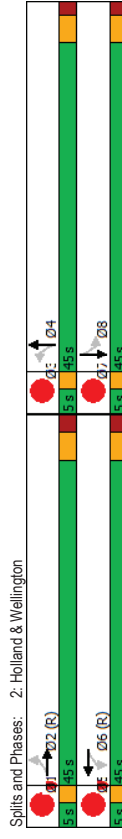
Existing PM Peak Hour  
1186-1194 Wellington STW

Existing PM Peak Hour  
1186-1194 Wellington STW

EBL	EBT	WBL	WBT	NBL	NBT	SBL	SBT	Ø1	Ø3	Ø5	Ø7
21	297	80	413	38	379	25	652				
21	297	80	413	38	379	25	652				
0	443	0	574	0	530	0	823				
Perm	NA	Perm	NA	Perm	NA	Perm	NA				
2	2	6	6	4	4	8	8	1	3	5	7
2	2	6	6	4	4	8	8				
10.0	10.0	10.0	10.0	10.0	10.0	10.0	10.0	1.0	1.0	1.0	1.0
23.6	23.6	24.5	24.5	20.1	20.1	20.1	20.1	3.0	3.0	3.0	3.0
45.0	45.0	45.0	45.0	45.0	45.0	45.0	45.0	5.0	5.0	5.0	5.0
45.0%	45.0%	45.0%	45.0%	45.0%	45.0%	45.0%	45.0%	5%	5%	5%	5%
39.4	39.4	39.4	39.4	39.9	39.9	39.9	39.9	3.0	3.0	3.0	3.0
3.3	3.3	3.3	3.3	3.3	3.3	3.3	3.3	2.0	2.0	2.0	2.0
2.3	2.3	2.3	2.3	1.8	1.8	1.8	1.8	0.0	0.0	0.0	0.0
0.0	0.0	0.0	0.0	0.0	0.0	0.0	0.0				
5.6	5.6	5.6	5.6	5.1	5.1	5.1	5.1				
Lag	Lag	Lag	Lag	Lag	Lag	Lag	Lag	Lead	Lead	Lead	Lead
Yes	Yes	Yes	Yes	Yes	Yes	Yes	Yes	Yes	Yes	Yes	Yes
3.0	3.0	3.0	3.0	3.0	3.0	3.0	3.0	3.0	3.0	3.0	3.0
C-Max	C-Max	C-Max	C-Max	Max	Max	Max	Max	Max	Max	Max	Max
4.0	4.0	4.0	4.0	2.0	2.0	2.0	2.0				
14.0	14.0	14.0	14.0	13.0	13.0	13.0	13.0				
206	206	146	146	135	135	111	111				
39.4	39.4	39.4	39.4	39.9	39.9	39.9	39.9				
0.39	0.39	0.39	0.39	0.40	0.40	0.40	0.40				
0.41	0.41	0.59	0.54	0.70	0.70	0.70	0.70				
23.4	20.9	20.9	21.9	25.3	25.3	25.3	25.3				
0.0	0.0	0.0	0.0	0.0	0.0	0.0	0.0				
23.4	20.9	20.9	21.9	25.3	25.3	25.3	25.3				
C	C	C	C	C	C	C	C				
23.4	20.9	20.9	21.9	25.3	25.3	25.3	25.3				
C	C	C	C	C	C	C	C				
32.1	32.3	32.3	29.6	55.6	55.6	55.6	55.6				
45.3	m44.6	m44.6	53.2	78.6	78.6	78.6	78.6				
18.7	38.0	38.0	190.8	211.0	211.0	211.0	211.0				
1069	970	970	990	1174	1174	1174	1174				
0	0	0	0	0	0	0	0				
0	0	0	0	0	0	0	0				
0	0	0	0	0	0	0	0				
0.41	0.59	0.59	0.54	0.70	0.70	0.70	0.70				

Intersection Summary	
Cycle Length:	100
Actuated Cycle Length:	100
Offset:	72 (72%), Referenced to phase 2,EBTL and 6:WBTL, Start of Green
Natural Cycle:	60

Control Type:	Actuated-Coordinated
Maximum v/c Ratio:	0.70
Intersection Signal Delay:	23.1
Intersection LOS:	C
ICU Level of Service:	E
Analysis Period (min):	15
m:	Volume for 95th percentile queue is metered by upstream signal.



Lanes, Volumes, Timings  
3: Holland & Tyndall

Lanes, Volumes, Timings  
3: Holland & Tyndall

Existing PM Peak Hour  
1186-1194 Wellington STW

Existing PM Peak Hour  
1186-1194 Wellington STW

	WBL	NBT	SBL	SBT	Ø7
Lane Group	W	B	B	B	Ø7
Lane Configurations	W	B	B	B	Ø7
Traffic Volume (vph)	46	566	145	585	
Future Volume (vph)	46	566	145	585	
Lane Group Flow (vph)	292	657	161	650	
Turn Type	Perm	NA	Perm	NA	
Protected Phases	8	2	6	7	
Permitted Phases	8	2	6	6	
Detector Phase	8	2	6	6	
Switch Phase					
Minimum Initial (s)	10.0	10.0	10.0	10.0	1.0
Minimum Split (s)	23.5	25.7	15.7	15.7	3.0
Total Split (s)	35.0	60.0	60.0	60.0	5.0
Total Split (%)	35.0%	60.0%	60.0%	60.0%	5%
Maximum Green (s)	29.5	54.3	54.3	54.3	3.0
Yellow Time (s)	3.3	3.3	3.3	3.3	2.0
All-Red Time (s)	2.2	2.4	2.4	2.4	0.0
Lost Time Adjust (s)	0.0	0.0	0.0	0.0	0.0
Total Lost Time (s)	5.5	5.7	5.7	5.7	
Lead/Lag	Lag	Lead	Lead	Lead	
Lead-Lag Optimize?	Yes	Yes	Yes	Yes	
Vehicle Extension (s)	3.0	3.0	3.0	3.0	3.0
Recall Mode	None	C-Max	C-Max	C-Max	Max
Walk Time (s)	5.0	10.0			
Pedestrian Calls (#/hr)	15	20			
Act Effr Green (s)	22.2	61.6	61.6	61.6	
Actuated g/C Ratio	0.22	0.62	0.62	0.62	
v/c Ratio	0.78	0.62	0.49	0.60	
Control Delay	52.2	16.3	10.4	8.5	
Queue Delay	0.0	0.0	0.0	0.0	
Total Delay	52.2	16.3	10.4	8.5	
LOS	D	B	B	A	
Approach Delay	52.2	16.3	8.9		
Approach LOS	D	B	A		
Queue Length 50th (m)	46.0	72.4	7.9	34.0	
Queue Length 95th (m)	66.9	129.7	12.4	44.0	
Internal Link Dist (m)	145.6	156.5		23.7	
Turn Bay Length (m)					
Base Capacity (vph)	432	1067	327	1075	
Starvation Cap Reductn	0	0	0	0	
Spillback Cap Reductn	0	0	0	0	
Storage Cap Reductn	0	0	0	0	
Reduced v/c Ratio	0.56	0.62	0.49	0.60	

Intersection Summary	
Cycle Length:	100
Actuated Cycle Length:	100
Offset:	24 (24%), Referenced to phase 2:NBT and 6:SBTL, Start of Green
Natural Cycle:	65

Control Type:	Actuated-Coordinated
Maximum v/c Ratio:	0.78
Intersection Signal Delay:	18.0
Intersection LOS:	B
Intersection Capacity Utilization:	71.1%
Analysis Period (min):	15
m:	Volume for 95th percentile queue is metered by upstream signal.



Lanes, Volumes, Timings  
4: Parkdale & Armstrong

Existing PM Peak Hour  
1186-1194 Wellington STW

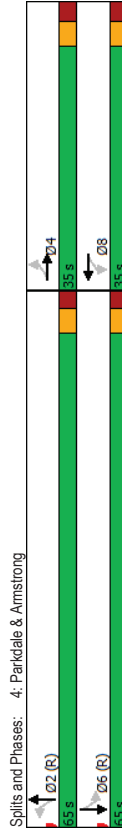
	EBL	EBT	WBL	WBT	NBL	NBT	SBL	SBT
Lane Group	EBL	EBT	WBL	WBT	NBL	NBT	SBL	SBT
Lane Configurations	34	63	39	160	13	477	15	321
Traffic Volume (vph)	34	63	39	160	13	477	15	321
Future Volume (vph)	0	149	0	244	0	568	0	392
Lane Group Flow (vph)	Perm	NA	Perm	NA	Perm	NA	Perm	NA
Turn Type	4	8	8	2	2	2	6	6
Protected Phases	4	8	8	2	2	2	6	6
Permitted Phases	4	8	8	2	2	2	6	6
Detector Phase	4	8	8	2	2	2	6	6
Switch Phase	4	8	8	2	2	2	6	6
Minimum Initial (s)	10.0	10.0	10.0	10.0	10.0	10.0	10.0	10.0
Minimum Split (s)	23.5	23.5	23.5	25.2	25.2	25.2	25.2	25.2
Total Split (s)	35.0	35.0	35.0	65.0	65.0	65.0	65.0	65.0
Total Split (%)	35.0%	35.0%	35.0%	65.0%	65.0%	65.0%	65.0%	65.0%
Maximum Green (s)	29.5	29.5	29.5	59.8	59.8	59.8	59.8	59.8
Yellow Time (s)	3.0	3.0	3.0	3.0	3.0	3.0	3.0	3.0
All-Red Time (s)	2.5	2.5	2.5	2.2	2.2	2.2	2.2	2.2
Lost Time Adjust (s)	0.0	0.0	0.0	0.0	0.0	0.0	0.0	0.0
Total Lost Time (s)	5.5	5.5	5.5	5.2	5.2	5.2	5.2	5.2
Lead/Lag								
Lead-Lag Optimize?								
Vehicle Extension (s)	3.0	3.0	3.0	3.0	3.0	3.0	3.0	3.0
Recall Mode	Max	Max	Max	C-Max	C-Max	C-Max	C-Max	C-Max
Walk Time (s)	10.0	10.0	10.0	15.0	15.0	15.0	15.0	15.0
Flash Dont Walk (s)	8.0	8.0	8.0	5.0	5.0	5.0	5.0	5.0
Pedestrian Calls (#/hr)	19	19	30	30	35	35	22	22
Act Effr Green (s)	29.5	29.5	29.5	59.8	59.8	59.8	59.8	59.8
Actuated g/C Ratio	0.30	0.30	0.30	0.60	0.60	0.60	0.60	0.60
v/c Ratio	0.34	0.34	0.34	0.52	0.56	0.39	0.39	0.39
Control Delay	26.6	33.6	33.6	5.2	5.2	11.9	11.9	11.9
Queue Delay	0.0	0.0	0.0	0.6	0.6	0.0	0.0	0.0
Total Delay	26.6	33.6	33.6	5.9	5.9	11.9	11.9	11.9
LOS	C	C	C	A	A	B	B	B
Approach Delay	26.6	33.6	33.6	5.9	5.9	11.9	11.9	11.9
Approach LOS	C	C	C	A	A	B	B	B
Queue Length 50th (m)	19.5	38.5	38.5	8.7	8.7	36.5	36.5	36.5
Queue Length 95th (m)	36.2	62.3	62.3	m10.5	m10.5	55.2	55.2	55.2
Internal Link Dist (m)	46.6	196.9	196.9	125.2	125.2	312.1	312.1	312.1
Turn Bay Length (m)								
Base Capacity (vph)	437	465	465	1021	1021	1002	1002	1002
Starvation Cap Reductn	0	0	0	178	178	0	0	0
Spillback Cap Reductn	0	0	0	0	0	0	0	0
Storage Cap Reductn	0	0	0	0	0	0	0	0
Reduced v/c Ratio	0.34	0.52	0.52	0.67	0.67	0.40	0.40	0.40

Intersection Summary	
Cycle Length:	100
Actuated Cycle Length:	100
Offset:	20 (20%), Referenced to phase 2, NBT and 6, SBT, Start of Green
Natural Cycle:	55

Lanes, Volumes, Timings  
4: Parkdale & Armstrong

Existing PM Peak Hour  
1186-1194 Wellington STW

Control Type:	Actuated-Coordinated
Maximum v/c Ratio:	0.56
Intersection Signal Delay:	14.9
Intersection LOS:	B
Intersection Capacity Utilization:	57.2%
Analysis Period (min):	15
m. Volume for 95th percentile queue is metered by upstream signal.	



Lanes, Volumes, Timings  
5: Parkdale & Wellington

Existing PM Peak Hour  
1186-1194 Wellington STW

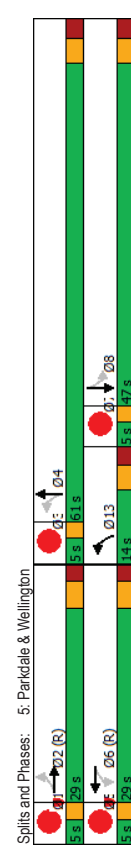
EBL	EBT	WBL	WBT	NBL	NBT	SBL	SBT	Ø1	Ø3	Ø5	Ø7
17	218	47	271	143	521	19	387				
17	218	47	271	143	521	19	387				
0	337	62	330	159	639	21	487				
Perm	NA	Perm	NA	pin-pt	NA	Perm	NA				
2	2	6	6	13	4	8	1	3	5	7	
2	2	6	6	13	4	8	8				
10.0	10.0	10.0	10.0	5.0	10.0	10.0	10.0	1.0	1.0	1.0	1.0
23.4	23.4	23.4	23.4	10.2	15.5	20.5	20.5	3.0	3.0	3.0	3.0
29.0	29.0	29.0	29.0	14.0	61.0	47.0	47.0	5.0	5.0	5.0	5.0
29.0%	29.0%	29.0%	29.0%	14.0%	61.0%	47.0%	47.0%	5%	5%	5%	5%
23.6	23.6	23.6	23.6	8.8	55.5	41.5	41.5	3.0	3.0	3.0	3.0
3.3	3.3	3.3	3.3	3.0	3.0	3.0	3.0	2.0	2.0	2.0	2.0
2.1	2.1	2.1	2.1	2.2	2.5	2.5	2.5	0.0	0.0	0.0	0.0
0.0	0.0	0.0	0.0	0.0	0.0	0.0	0.0	0.0	0.0	0.0	0.0
5.4	5.4	5.4	5.4	5.2	5.5	5.5	5.5				
Lag	Lag	Lag	Lag	Lead	Lead	Lead	Lead				
Yes	Yes	Yes	Yes	Yes	Yes	Yes	Yes				
3.0	3.0	3.0	3.0	3.0	3.0	3.0	3.0	3.0	3.0	3.0	3.0
C-Max	C-Max	C-Max	C-Max	Max	Max	Max	Max	Max	Max	Max	Max
5.0	5.0	5.0	5.0	2.0	2.0	2.0	2.0				
8.0	8.0	8.0	8.0	8.0	8.0	8.0	8.0				
153	153	142	142	76	72	72	72				
23.6	23.6	23.6	23.6	60.8	55.5	41.5	41.5				
0.24	0.24	0.24	0.24	0.61	0.56	0.42	0.42				
0.60	0.37	0.85	0.44	0.68	0.08	0.72					
60.7	41.1	58.4	12.1	17.7	15.4	24.5					
0.0	0.0	0.0	0.0	0.8	0.0	0.4					
60.7	41.1	58.4	12.1	18.5	15.4	24.9					
E	D	E	B	B	B	C					
60.7	56.0	17.2	24.5								
E	E	B	C								
35.0	8.5	61.4	12.0	61.1	2.0	50.2					
50.2	20.3	#107.1	m18.6	m5.1	66.7						
54.8	40.2	139.5	125.2								
30.0	40.0	40.0	40.0								
560	140	387	361	934	249	680					
0	0	0	0	96	0	27					
0	0	0	0	0	0	0					
0	0	0	0	0	0	0					
0.60	0.37	0.85	0.44	0.76	0.08	0.75					

Intersection Summary	
Cycle Length:	100
Actuated Cycle Length:	100
Offset:	70 (70%), Referenced to phase 2,EBTL and 6:WBTL, Start of Green
Natural Cycle:	70

Lanes, Volumes, Timings  
5: Parkdale & Wellington

Existing PM Peak Hour  
1186-1194 Wellington STW

Control Type:	Actuated-Coordinated
Maximum v/c Ratio:	0.85
Intersection Signal Delay:	33.6
Intersection LOS:	C
Intersection Capacity Utilization:	87.5%
ICU Level of Service:	E
Analysis Period (min):	15
# 95th percentile volume exceeds capacity, queue may be longer.	
Queue shown is maximum after two cycles.	
m Volume for 95th percentile queue is metered by upstream signal.	



Lanes, Volumes, Timings  
6: Parkdale & Gladstone

Lanes, Volumes, Timings  
6: Parkdale & Gladstone

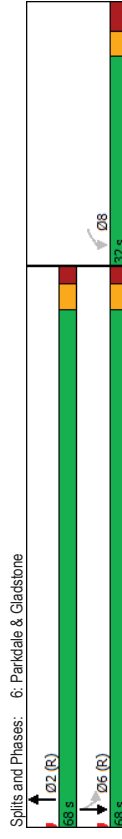
Existing PM Peak Hour  
1186-1194 Wellington STW

Existing PM Peak Hour  
1186-1194 Wellington STW

	WBL	NBT	SBL	SBT
Lane Group	WBL	NBT	SBL	SBT
Lane Configurations	W	T	T	T
Traffic Volume (vph)	215	596	40	388
Future Volume (vph)	215	596	40	388
Lane Group Flow (vph)	312	838	44	431
Turn Type	Perm	NA	Perm	NA
Protected Phases	8	2	6	6
Permitted Phases	8	2	6	6
Detector Phase	8	2	6	6
Switch Phase				
Minimum Initial (s)	10.0	10.0	10.0	10.0
Minimum Split (s)	22.7	20.3	15.3	15.3
Total Split (s)	32.0	68.0	68.0	68.0
Total Split (%)	32.0%	68.0%	68.0%	68.0%
Maximum Green (s)	25.3	62.7	62.7	62.7
Yellow Time (s)	3.0	3.0	3.0	3.0
All-Red Time (s)	3.7	2.3	2.3	2.3
Lost Time Adjust (s)	0.0	0.0	0.0	0.0
Total Lost Time (s)	6.7	5.3	5.3	5.3
Lead/Lag				
Lead-Lag Optimize?				
Vehicle Extension (s)	3.0	3.0	3.0	3.0
Recall Mode	Max	C-Max	C-Max	C-Max
Walk Time (s)	7.0	7.0		
Flash Dont Walk (s)	9.0	8.0		
Pedestrian Calls (#/hr)	25	19		
Act Effr Green (s)	25.3	62.7	62.7	62.7
Actuated g/C Ratio	0.25	0.63	0.63	0.63
v/c Ratio	0.81	0.80	0.20	0.39
Control Delay	53.1	17.1	6.5	5.9
Queue Delay	0.0	0.2	0.0	0.1
Total Delay	53.1	17.4	6.5	6.0
LOS	D	B	A	A
Approach Delay	53.1	17.4	6.0	6.0
Approach LOS	D	B	A	A
Queue Length 50th (m)	56.9	75.8	2.1	21.0
Queue Length 95th (m)	#99.0	m121.9	m3.2	27.8
Internal Link Dist (m)	224.2	197.3		139.5
Turn Bay Length (m)			85.0	
Base Capacity (vph)	385	1045	217	1094
Starvation Cap Reductn	0	19	0	0
Spillback Cap Reductn	0	0	0	102
Storage Cap Reductn	0	0	0	0
Reduced v/c Ratio	0.81	0.82	0.20	0.43

Intersection Summary	
Cycle Length:	100
Actuated Cycle Length:	100
Offset:	12 (12%), Referenced to phase 2:NBT and 6:SBTL, Start of Green
Natural Cycle:	70

Control Type:	Actuated-Coordinated
Maximum v/c Ratio:	0.81
Intersection Signal Delay:	20.9
Intersection LOS:	C
Intersection Capacity Utilization:	71.0%
Analysis Period (min):	15
# 95th percentile volume exceeds capacity, queue may be longer.	
Queue shown is maximum after two cycles.	
m Volume for 95th percentile queue is metered by upstream signal.	



Splits and Phases: 6: Parkdale & Gladstone

Lanes, Volumes, Timings  
7: Parkdale & 417 WB OR

Lanes, Volumes, Timings  
7: Parkdale & 417 WB OR

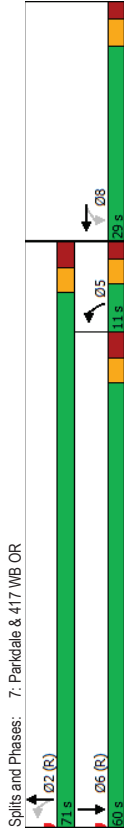
Existing PM Peak Hour  
1186-1194 Wellington STW

Existing PM Peak Hour  
1186-1194 Wellington STW

Lane Group	WBL	WBT	NBL	NBT	SBT
Lane Configurations	←	←	←	←	←
Traffic Volume (vph)	310	24	79	563	580
Future Volume (vph)	310	24	79	563	580
Lane Group Flow (vph)	344	554	88	626	887
Turn Type	Perm	NA	pm-pt	NA	NA
Protected Phases	8	5	2	2	6
Permitted Phases	8	8	5	2	6
Detector Phase	8	8	5	2	6
Switch Phase					
Minimum Initial (s)	10.0	10.0	5.0	10.0	10.0
Minimum Split (s)	20.5	20.5	10.2	27.3	21.3
Total Split (s)	29.0	29.0	11.0	71.0	60.0
Total Split (%)	29.0%	29.0%	11.0%	71.0%	60.0%
Maximum Green (s)	23.5	23.5	5.8	64.7	53.7
Yellow Time (s)	3.3	3.3	3.0	3.0	3.0
All-Red Time (s)	2.2	2.2	2.2	3.3	3.3
Lost Time Adjust (s)	0.0	0.0	0.0	0.0	0.0
Total Lost Time (s)	5.5	5.5	5.2	6.3	6.3
Lead/Lag			Lag	Lead	
Lead-Lag Optimize?			Yes	Yes	
Vehicle Extension (s)	3.0	3.0	3.0	3.0	3.0
Recall Mode	None	None	None	C-Max	C-Max
Walk Time (s)	7.0	7.0	7.0	7.0	7.0
Flash Dont Walk (s)	8.0	8.0	14.0	8.0	8.0
Pedestrian Calls (#/hr)	3	3		21	13
Act Effct Green (s)	23.5	23.5	65.8	64.7	55.9
Actuated g/C Ratio	0.24	0.24	0.66	0.65	0.56
v/c Ratio	0.88	0.99	0.38	0.55	0.95
Control Delay	62.5	56.0	18.0	12.1	40.7
Queue Delay	0.0	0.8	0.0	0.0	0.0
Total Delay	62.5	56.8	18.0	12.1	40.7
LOS	E	E	B	B	D
Approach Delay	59.0		12.8	40.7	
Approach LOS	E		B	D	
Queue Length 50th (m)	64.7	59.1	5.6	60.5	174.4
Queue Length 95th (m)	#113.2	#128.6	10.8	88.7	#247.0
Internal Link Dist (m)	462.5		38.8	197.3	
Turn Bay Length (m)					
Base Capacity (vph)	389	559	232	1129	935
Starvation Cap Reductn	0	0	0	0	0
Spillback Cap Reductn	0	2	0	12	0
Storage Cap Reductn	0	0	0	0	0
Reduced v/c Ratio	0.88	0.99	0.38	0.56	0.95

Intersection Summary	
Cycle Length:	100
Actuated Cycle Length:	100
Offset:	39 (39%), Referenced to phase 2, NBL and 6: SBT, Start of Green
Natural Cycle:	110

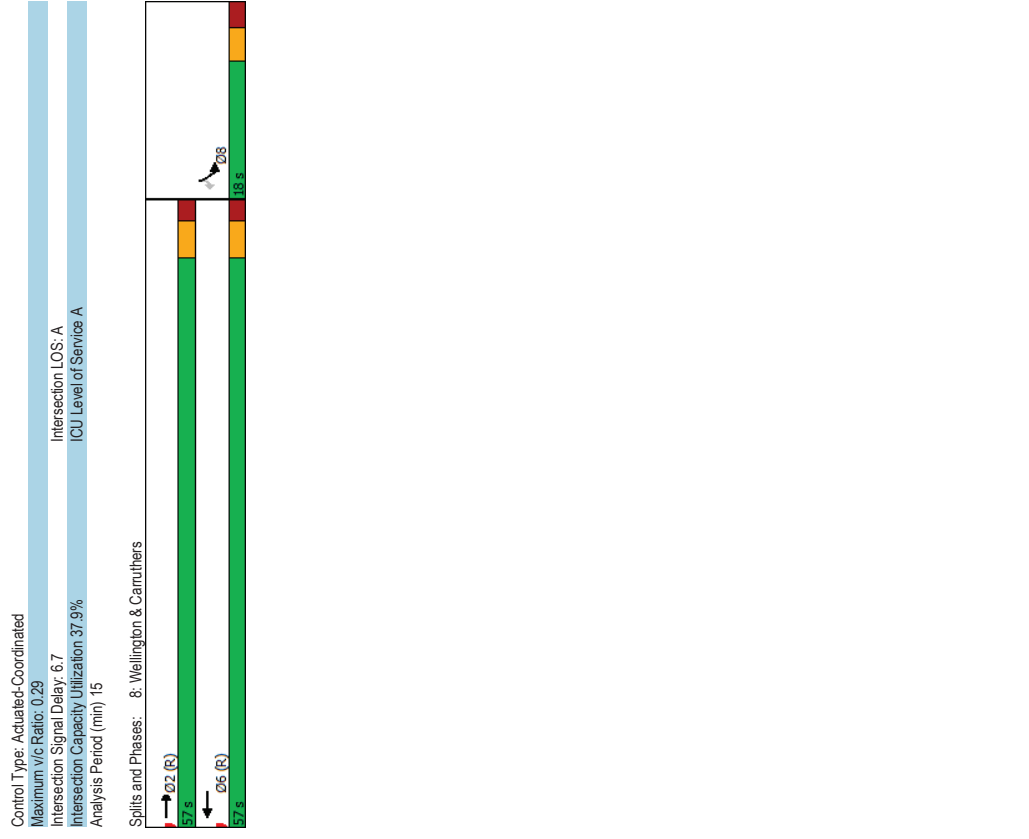
Control Type:	Actuated-Coordinated
Maximum v/c Ratio:	0.99
Intersection Signal Delay:	39.3
Intersection LOS:	D
Intersection Capacity Utilization:	98.0%
Analysis Period (min):	15
# 95th percentile volume exceeds capacity, queue may be longer.	
Queue shown is maximum after two cycles.	



Lanes, Volumes, Timings  
8: Wellington & Carruthers

Lanes, Volumes, Timings  
8: Wellington & Carruthers

Lane Group	EBT	WBT	SBL	SBR
Lane Configurations	←	←	←	←
Traffic Volume (vph)	348	347	54	20
Future Volume (vph)	348	347	54	20
Lane Group Flow (vph)	387	386	60	22
Turn Type	NA	NA	Prot	Perm
Protected Phases	2	6	8	8
Permitted Phases				
Detector Phase	2	6	8	8
Switch Phase				
Minimum Initial (s)	10.0	10.0	10.0	10.0
Minimum Split (s)	15.3	26.3	17.5	17.5
Total Split (s)	57.0	57.0	18.0	18.0
Total Split (%)	76.0%	76.0%	24.0%	24.0%
Maximum Green (s)	51.7	51.7	12.5	12.5
Yellow Time (s)	3.3	3.3	3.0	3.0
All-Red Time (s)	2.0	2.0	2.5	2.5
Lost Time Adjust (s)	0.0	0.0	0.0	0.0
Total Lost Time (s)	5.3	5.3	5.5	5.5
Lead/Lag				
Lead-Lag Optimize?				
Vehicle Extension (s)	3.0	3.0	3.0	3.0
Recall Mode	C-Mix	C-Mix	None	None
Walk Time (s)	14.0	14.0	7.0	7.0
Flash Dont Walk (s)	7.0	5.0	5.0	6.2
Pedestrian Calls (#/hr)	157	62	62	62
Act Effr Green (s)	57.2	57.2	11.2	11.2
Actuated g/C Ratio	0.76	0.76	0.15	0.15
v/c Ratio	0.29	0.29	0.24	0.11
Control Delay	4.6	4.6	30.5	13.4
Queue Delay	0.0	0.0	0.0	0.0
Total Delay	4.6	4.6	30.5	13.4
LOS	A	A	C	B
Approach Delay	4.6	4.6	25.9	
Approach LOS	A	A	C	
Queue Length 50th (m)	17.6	17.6	7.5	0.0
Queue Length 95th (m)	28.5	28.5	17.4	5.7
Internal Link Dist (m)	151.9	153.4	73.2	
Turn Bay Length (m)				30.0
Base Capacity (vph)	1330	1330	276	229
Starvation Cap Reductn	0	0	0	0
Spillback Cap Reductn	0	0	0	0
Storage Cap Reductn	0	0	0	0
Reduced v/c Ratio	0.29	0.29	0.22	0.10
<b>Intersection Summary</b>				
Cycle Length: 75				
Actuated Cycle Length: 75				
Offset: 72 (96%), Referenced to phase 2,EBT and 6:WBT, Start of Green				
Natural Cycle: 45				





HCM 2010 TWSC  
11: Hamilton & Wellington

HCM 2010 TWSC  
12: Hamilton & Tyndall

Existing PM Peak Hour  
1186-1194 Wellington STW

Existing PM Peak Hour  
1186-1194 Wellington STW

Intersection													
Int'Delay, s/veh													
1.9													
Movement	EBL	EBT	EBR	WBL	WBT	WBR	NBL	NBT	NBR	SBL	SBT	SBR	
Lane Configurations													
Traffic Vol, veh/h	10	303	23	13	339	13	5	8	16	9	21	31	
Future Vol, veh/h	10	303	23	13	339	13	5	8	16	9	21	31	
Conflicting Peds. #/hr	0	0	0	0	0	0	0	0	0	0	0	0	0
Sign Control	Free	Free	Free	Free	Free	Free	Free	Free	Free	Free	Free	Free	Free
RT Channelized	-	-	-	-	-	-	-	-	-	-	-	-	-
Storage Length	-	-	-	-	-	-	-	-	-	-	-	-	-
Veh in Median Storage, #	-	0	-	-	0	-	-	0	-	-	0	-	-
Grade, %	-	0	-	-	0	-	-	0	-	-	0	-	-
Peak Hour Factor	90	90	90	90	90	90	90	90	90	90	90	90	90
Heavy Vehicles, %	2	2	2	2	2	2	2	2	2	2	2	2	2
Mvmt Flow	11	337	26	14	377	14	6	9	18	10	23	34	
Major/Minor	Major1	Minor1	Minor2	Minor1	Minor2	Minor1	Minor2	Minor1	Minor2	Minor1	Minor2	Minor1	Minor2
Conflicting Flow All	391	0	0	363	0	0	813	791	350	798	797	384	
Stage 1	-	-	-	-	-	-	372	372	-	412	412	-	-
Stage 2	-	-	-	-	-	-	441	419	-	366	385	-	-
Critical Hdwy	4.12	-	-	4.12	-	-	7.12	6.52	6.22	7.12	6.52	6.22	
Critical Hdwy Stg 1	-	-	-	-	-	-	6.12	5.52	-	6.12	5.52	-	-
Critical Hdwy Stg 2	-	-	-	-	-	-	6.12	5.52	-	6.12	5.52	-	-
Follow-up Hdwy	2.218	-	-	2.218	-	-	3.518	4.018	3.318	3.518	4.018	3.318	
Pot Cap-1 Maneuver	1168	-	-	1196	-	-	297	322	683	304	319	664	
Stage 1	-	-	-	-	-	-	648	619	-	617	594	-	-
Stage 2	-	-	-	-	-	-	595	590	-	637	611	-	-
Platoon blocked, %	-	-	-	-	-	-	-	-	-	-	-	-	-
Mov Cap-1 Maneuver	1168	-	-	1196	-	-	260	313	683	284	310	664	
Mov Cap-2 Maneuver	-	-	-	-	-	-	260	313	-	284	310	-	-
Stage 1	-	-	-	-	-	-	640	612	-	610	585	-	-
Stage 2	-	-	-	-	-	-	534	581	-	604	604	-	-
Approach	EB	WB	NB	WB	NB	SB							
HCM Control Delay, s	0.2	0.3	0.3	14.1	15.3	15.3							
HCM LOS	B	B	B	C	C	C							
Minor Lane/Major Mvmt	NBLn1	EBL	EBT	EBR	WBL	WBT	WBR	SBLn1					
Capacity (veh/h)	427	1168	-	-	1196	-	-	417					
HCM Lane V/C Ratio	0.075	0.01	-	-	0.012	-	-	0.163					
HCM Control Delay (s)	14.1	8.1	0	-	8	0	-	15.3					
HCM Lane LOS	B	A	A	A	A	A	A	C					
HCM 95th %tile Q(veh)	0.2	0	-	-	0	-	-	0.6					

Intersection													
Int'Delay, s/veh													
2													
Movement	EBL	EBT	EBR	WBL	WBT	WBR	NBL	NBT	NBR	SBL	SBT	SBR	
Lane Configurations													
Traffic Vol, veh/h	14	164	2	2	114	10	3	3	1	26	2	22	
Future Vol, veh/h	14	164	2	2	114	10	3	3	1	26	2	22	
Conflicting Peds. #/hr	0	0	0	0	0	0	0	0	0	0	0	0	0
Sign Control	Free	Free	Free	Free	Free	Free	Free	Free	Free	Free	Free	Free	Free
RT Channelized	-	-	-	-	-	-	-	-	-	-	-	-	-
Storage Length	-	-	-	-	-	-	-	-	-	-	-	-	-
Veh in Median Storage, #	-	0	-	-	0	-	-	0	-	-	0	-	-
Grade, %	-	0	-	-	0	-	-	0	-	-	0	-	-
Peak Hour Factor	90	90	90	90	90	90	90	90	90	90	90	90	90
Heavy Vehicles, %	2	2	2	2	2	2	2	2	2	2	2	2	2
Mvmt Flow	16	182	2	2	127	11	3	3	1	29	2	24	
Major/Minor	Major1	Minor1	Minor2	Minor1	Minor2	Minor1	Minor2	Minor1	Minor2	Minor1	Minor2	Minor1	Minor2
Conflicting Flow All	138	0	0	184	0	0	365	357	183	354	353	133	
Stage 1	-	-	-	-	-	-	215	215	-	137	137	-	-
Stage 2	-	-	-	-	-	-	150	142	-	217	216	-	-
Critical Hdwy	4.12	-	-	4.12	-	-	7.12	6.52	6.22	7.12	6.52	6.22	
Critical Hdwy Stg 1	-	-	-	-	-	-	6.12	5.52	-	6.12	5.52	-	-
Critical Hdwy Stg 2	-	-	-	-	-	-	6.12	5.52	-	6.12	5.52	-	-
Follow-up Hdwy	2.218	-	-	2.218	-	-	3.518	4.018	3.318	3.518	4.018	3.318	
Pot Cap-1 Maneuver	1446	-	-	1391	-	-	591	569	859	601	572	916	
Stage 1	-	-	-	-	-	-	787	725	-	866	783	-	-
Stage 2	-	-	-	-	-	-	853	779	-	785	724	-	-
Platoon blocked, %	-	-	-	-	-	-	-	-	-	-	-	-	-
Mov Cap-1 Maneuver	1446	-	-	1391	-	-	567	561	859	591	564	916	
Mov Cap-2 Maneuver	-	-	-	-	-	-	567	561	-	591	564	-	-
Stage 1	-	-	-	-	-	-	778	716	-	856	781	-	-
Stage 2	-	-	-	-	-	-	826	777	-	771	715	-	-
Approach	EB	WB	NB	WB	NB	SB							
HCM Control Delay, s	0.6	0.1	0.1	11.2	10.6	10.6							
HCM LOS	B	B	B	B	B	B							
Minor Lane/Major Mvmt	NBLn1	EBL	EBT	EBR	WBL	WBT	WBR	SBLn1					
Capacity (veh/h)	593	1446	-	-	1391	-	-	699					
HCM Lane V/C Ratio	0.013	0.011	-	-	0.002	-	-	0.079					
HCM Control Delay (s)	11.2	7.5	0	-	7.6	0	-	10.6					
HCM Lane LOS	B	A	A	A	A	A	A	B					
HCM 95th %tile Q(veh)	0	0	-	-	0	-	-	0.3					

# Appendix D

Collision Data

Accident Date	Accident Year	Accident Time	Location	Environment Condition	Light	Traffic Control	Traffic Control Condition	Classification of Accident	Initial Impact Type	Road Surface Condition	# Vehicles	# Motorcycles	# Bicycles	# Pedestrians
12/10/2017	2017	14:09	PARKDALE AVE @ HAMILTON AVE (0005150)	01 - Clear	01 - Daylight	02 - Stop sign	01 - Functioning	02 - P.B. only	02 - Angle	01 - Wet	2	0	0	0
12/12/2017	2017	24:00	WELLINGTON ST @ HAMILTON AVE (0005150)	01 - Clear	01 - Daylight	02 - Stop sign	00 - Unknown	02 - P.B. only	04 - Sweeping	01 - Dry	2	0	0	0
12/20/2017	2017	16:15	WELLINGTON ST @ HAMILTON AVE (0005150)	01 - Clear	05 - Dark	02 - Stop sign	00 - Unknown	03 - P.B. only	05 - Turning movement	05 - Picked snow	2	1	0	0
5/20/2017	2017	12:47	WELLINGTON ST @ HAMILTON AVE (0005150)	01 - Clear	01 - Daylight	02 - Stop sign	01 - Functioning	03 - P.B. only	99 - Other	01 - Dry	2	0	0	0
7/14/2017	2017	13:32	WELLINGTON ST @ HAMILTON AVE (0005150)	01 - Clear	01 - Daylight	02 - Stop sign	01 - Functioning	03 - P.B. only	05 - Turning movement	01 - Dry	2	0	0	0
7/19/2017	2017	13:33	WELLINGTON ST @ HAMILTON AVE (0005150)	01 - Clear	01 - Daylight	02 - Stop sign	01 - Functioning	03 - P.B. only	02 - Angle	02 - Wet	2	0	0	0
8/4/2017	2017	8:10	WELLINGTON ST @ HAMILTON AVE (0005150)	01 - Clear	01 - Daylight	02 - Stop sign	01 - Functioning	03 - P.B. only	02 - Angle	01 - Dry	2	0	0	0
8/20/2017	2017	10:24	WELLINGTON ST @ HAMILTON AVE (0005150)	01 - Clear	01 - Daylight	02 - Stop sign	01 - Functioning	03 - P.B. only	04 - Sweeping	01 - Dry	2	0	0	0
12/14/2019	2019	15:35	WELLINGTON ST @ HAMILTON AVE (0005150)	02 - Rain	01 - Daylight	02 - Stop sign	01 - Functioning	02 - Non-fatal injury	03 - Rear end	02 - Wet	2	0	0	0
6/17/2019	2019	8:31	WELLINGTON ST @ HAMILTON AVE (0005150)	01 - Clear	01 - Daylight	02 - Stop sign	01 - Functioning	02 - Non-fatal injury	02 - Angle	01 - Dry	2	0	0	0
10/27/2016	2016	12:26	WELLINGTON ST @ HAMILTON AVE (0005150)	01 - Clear	02 - Dark	02 - Stop sign	01 - Functioning	03 - P.B. only	02 - Angle	01 - Dry	2	0	0	0
10/27/2016	2016	13:26	PARKDALE AVE @ WELLINGTON ST (0002260)	01 - Clear	01 - Daylight	01 - Traffic signal	01 - Functioning	03 - P.B. only	04 - Sweeping	02 - Wet	2	0	0	0
10/27/2016	2016	15:00	WELLINGTON ST @ HAMILTON AVE (0005150)	01 - Clear	02 - Rain	02 - Stop sign	00 - Unknown	03 - P.B. only	05 - Turning movement	01 - Dry	2	0	0	0
12/16/2016	2016	15:30	PARKDALE AVE @ WELLINGTON ST (0002260)	01 - Clear	01 - Daylight	02 - Stop sign	01 - Functioning	03 - P.B. only	05 - Turning movement	01 - Dry	2	0	0	0
3/4/2016	2016	15:00	PARKDALE AVE @ WELLINGTON ST (0002260)	01 - Clear	01 - Daylight	01 - Traffic signal	01 - Functioning	03 - P.B. only	05 - Turning movement	03 - Loose snow	2	0	0	0
5/19/2016	2016	13:08	PARKDALE AVE @ WELLINGTON ST (0002260)	01 - Clear	01 - Daylight	01 - Traffic signal	01 - Functioning	03 - P.B. only	04 - Sweeping	01 - Dry	2	0	0	0
1/2/2016	2016	8:26	PARKDALE AVE @ WELLINGTON ST (0002260)	01 - Clear	01 - Daylight	01 - Traffic signal	01 - Functioning	03 - P.B. only	04 - Sweeping	01 - Dry	2	0	0	0
1/20/2016	2016	15:35	PARKDALE AVE @ WELLINGTON ST (0002260)	01 - Clear	01 - Daylight	01 - Traffic signal	01 - Functioning	03 - P.B. only	07 - SWV other	02 - Wet	1	0	0	0
1/20/2016	2016	17:09	PARKDALE AVE @ WELLINGTON ST (0002260)	01 - Clear	01 - Daylight	01 - Traffic signal	00 - Unknown	03 - P.B. only	04 - Sweeping	01 - Dry	2	0	0	0
1/20/2016	2016	17:09	PARKDALE AVE @ WELLINGTON ST (0002260)	01 - Clear	01 - Daylight	01 - Traffic signal	00 - Unknown	03 - P.B. only	04 - Sweeping	01 - Dry	2	0	0	0
7/7/2017	2017	16:59	PARKDALE AVE @ WELLINGTON ST (0002260)	01 - Clear	01 - Daylight	01 - Traffic signal	01 - Functioning	03 - P.B. only	99 - Other	01 - Dry	2	0	0	0
10/12/2018	2018	21:33	PARKDALE AVE @ WELLINGTON ST (0002260)	01 - Clear	07 - Dark	01 - Traffic signal	01 - Functioning	03 - P.B. only	03 - Rear end	01 - Dry	2	0	0	0
10/26/2018	2018	17:39	PARKDALE AVE @ WELLINGTON ST (0002260)	01 - Clear	01 - Daylight	01 - Traffic signal	01 - Functioning	03 - P.B. only	02 - Angle	01 - Dry	3	0	1	0
2/28/2018	2018	17:39	PARKDALE AVE @ WELLINGTON ST (0002260)	03 - Snow	07 - Dark	01 - Traffic signal	00 - Unknown	03 - P.B. only	02 - Angle	03 - Loose snow	2	0	0	0
5/15/2018	2018	7:37	PARKDALE AVE @ WELLINGTON ST (0002260)	01 - Clear	01 - Daylight	01 - Traffic signal	00 - Unknown	03 - P.B. only	01 - Approaching	02 - Wet	2	0	0	0
6/4/2018	2018	1:41	PARKDALE AVE @ WELLINGTON ST (0002260)	01 - Clear	07 - Dark	01 - Traffic signal	01 - Functioning	03 - P.B. only	05 - Turning movement	01 - Dry	2	0	0	0
6/4/2018	2018	11:36	PARKDALE AVE @ WELLINGTON ST (0002260)	01 - Clear	01 - Daylight	01 - Traffic signal	01 - Functioning	03 - P.B. only	05 - Turning movement	01 - Dry	2	0	0	0
8/10/2018	2018	11:36	PARKDALE AVE @ WELLINGTON ST (0002260)	01 - Clear	01 - Daylight	01 - Traffic signal	01 - Functioning	03 - P.B. only	05 - Turning movement	01 - Dry	2	0	0	0
7/28/2019	2019	15:51	PARKDALE AVE @ WELLINGTON ST (0002260)	01 - Clear	01 - Daylight	01 - Traffic signal	01 - Functioning	03 - P.B. only	02 - Angle	01 - Dry	2	0	0	0
11/21/2019	2019	15:30	PARKDALE AVE @ WELLINGTON ST (0002260)	01 - Clear	01 - Daylight	01 - Traffic signal	01 - Functioning	03 - P.B. only	99 - Other	04 - Slush	2	0	0	0
11/29/2019	2019	7:33	PARKDALE AVE @ WELLINGTON ST (0002260)	03 - Snow	05 - Down	01 - Traffic signal	01 - Functioning	03 - P.B. only	03 - Rear end	05 - Ice	2	0	0	0
11/29/2019	2019	14:41	PARKDALE AVE @ WELLINGTON ST (0002260)	01 - Clear	01 - Daylight	01 - Traffic signal	01 - Functioning	03 - P.B. only	03 - Rear end	01 - Dry	2	0	0	0
1/19/2019	2019	17:00	PARKDALE AVE @ WELLINGTON ST (0002260)	01 - Clear	05 - Dark	01 - Traffic signal	01 - Functioning	03 - P.B. only	04 - Sweeping	01 - Dry	3	0	0	0
6/28/2019	2019	10:35	PARKDALE AVE @ WELLINGTON ST (0002260)	01 - Clear	01 - Daylight	01 - Traffic signal	01 - Functioning	03 - P.B. only	04 - Sweeping	01 - Dry	2	0	0	0
8/20/2017	2017	18:38	PARKDALE AVE @ GASTONE AVE (0002382)	01 - Clear	01 - Daylight	01 - Traffic signal	01 - Functioning	03 - P.B. only	04 - Sweeping	01 - Dry	2	0	0	0
8/20/2017	2017	18:38	PARKDALE AVE @ GASTONE AVE (0002382)	01 - Clear	01 - Daylight	01 - Traffic signal	01 - Functioning	03 - P.B. only	04 - Sweeping	01 - Dry	2	0	0	0
8/20/2017	2017	18:38	PARKDALE AVE @ GASTONE AVE (0002382)	01 - Clear	07 - Dark	01 - Traffic signal	00 - Unknown	03 - P.B. only	05 - Turning movement	01 - Dry	2	0	0	0
6/2/2018	2018	13:20	PARKDALE AVE @ GASTONE AVE (0002382)	01 - Clear	01 - Daylight	01 - Traffic signal	01 - Functioning	03 - P.B. only	04 - Sweeping	04 - Slush	2	0	0	0
7/16/2018	2018	13:20	PARKDALE AVE @ GASTONE AVE (0002382)	01 - Clear	01 - Daylight	01 - Traffic signal	01 - Functioning	03 - P.B. only	02 - Angle	01 - Dry	2	0	0	0
9/9/2018	2018	16:32	PARKDALE AVE @ GASTONE AVE (0002382)	01 - Clear	01 - Daylight	01 - Traffic signal	01 - Functioning	03 - P.B. only	05 - Turning movement	01 - Dry	2	0	0	0
10/10/2018	2018	12:37	PARKDALE AVE @ GASTONE AVE (0002382)	01 - Clear	01 - Daylight	01 - Traffic signal	01 - Functioning	03 - P.B. only	03 - Rear end	01 - Dry	2	0	0	0
1/22/2019	2019	12:37	PARKDALE AVE @ GASTONE AVE (0002382)	01 - Clear	01 - Daylight	01 - Traffic signal	01 - Functioning	03 - P.B. only	03 - Rear end	01 - Dry	2	0	0	0
11/15/2019	2019	9:45	PARKDALE AVE @ GASTONE AVE (0002382)	03 - Snow	01 - Daylight	01 - Traffic signal	01 - Functioning	03 - P.B. only	04 - Sweeping	01 - Dry	2	0	0	0
2/22/2019	2019	17:00	PARKDALE AVE @ GASTONE AVE (0002382)	01 - Clear	01 - Daylight	01 - Traffic signal	01 - Functioning	03 - P.B. only	03 - Rear end	02 - Wet	2	0	0	0
7/12/2019	2019	10:07	PARKDALE AVE @ GASTONE AVE (0002382)	01 - Clear	01 - Daylight	01 - Traffic signal	01 - Functioning	03 - P.B. only	03 - Rear end	01 - Dry	2	0	0	0
11/4/2020	2020	12:42	PARKDALE AVE @ GASTONE AVE (0002382)	01 - Clear	01 - Daylight	01 - Traffic signal	01 - Functioning	03 - P.B. only	02 - Angle	02 - Wet	2	0	0	0
6/4/2016	2016	13:30	WELLINGTON ST @ BROWN HINTON AVE N & HAMILTON AVE N (32400)	02 - Rain	01 - Daylight	10 - No control	0	03 - P.B. only	05 - Turning movement	02 - Wet	1	0	0	0
1/5/2018	2018	9:08	WELLINGTON ST @ BROWN HINTON AVE N & HAMILTON AVE N (32400)	01 - Clear	01 - Daylight	10 - No control	0	03 - P.B. only	06 - SWV unattended vehicle	03 - Loose snow	1	0	0	0
12/23/2019	2019	Unknown	WELLINGTON ST @ BROWN HINTON AVE N & HAMILTON AVE N (32400)	01 - Clear	00 - Unknown	10 - No control	0	03 - P.B. only	06 - SWV unattended vehicle	01 - Dry	1	0	0	0
1/8/2019	2019	12:31	WELLINGTON ST @ BROWN HINTON AVE N & HAMILTON AVE N (32400)	01 - Clear	01 - Daylight	10 - No control	0	03 - P.B. only	04 - Sweeping	01 - Dry	2	0	0	0
10/11/2017	2017	16:38	WELLINGTON ST @ BROWN HINTON AVE N & HAMILTON AVE N (32400)	01 - Clear	00 - Unknown	10 - No control	0	03 - P.B. only	04 - Sweeping	01 - Dry	2	0	0	0
11/27/2017	2017	12:23	WELLINGTON ST @ BROWN HINTON AVE N & HAMILTON AVE N (32400)	01 - Clear	01 - Daylight	10 - No control	0	03 - P.B. only	04 - Sweeping	01 - Dry	1	0	0	0
4/10/2018	2018	15:35	WELLINGTON ST @ BROWN HINTON AVE N & HAMILTON AVE N (32400)	01 - Clear	01 - Daylight	10 - No control	0	03 - P.B. only	06 - SWV unattended vehicle	01 - Dry	1	0	0	0
11/4/2019	2019	18:30	WELLINGTON ST @ BROWN HINTON AVE N & HAMILTON AVE N (32400)	01 - Clear	07 - Dark	10 - No control	0	03 - P.B. only	06 - SWV unattended vehicle	01 - Dry	1	0	0	0
1/4/2020	2020	Unknown	WELLINGTON ST @ BROWN HINTON AVE N & HAMILTON AVE N (32400)	03 - Snow	00 - Unknown	10 - No control	0	03 - P.B. only	06 - SWV unattended vehicle	05 - Ice	1	0	0	0
1/6/2020	2020	Unknown	WELLINGTON ST @ BROWN HINTON AVE N & HAMILTON AVE N (32400)	03 - Snow	00 - Unknown	10 - No control	0	03 - P.B. only	06 - SWV unattended vehicle	05 - Ice	1	0	0	0
2/7/2020	2020	Unknown	WELLINGTON ST @ BROWN HINTON AVE N & HAMILTON AVE N (32400)	01 - Clear	00 - Unknown	10 - No control	0	03 - P.B. only	06 - SWV unattended vehicle	01 - Dry	1	0	0	0
3/17/2016	2016	14:19	PARKDALE AVE @ WELLSINGTON ST W & GASTONE AVE (32400)	01 - Clear	01 - Daylight	10 - No control	0	03 - P.B. only	03 - Rear end	01 - Dry	3	0	0	0
6/20/2016	2016	15:20	PARKDALE AVE @ WELLSINGTON ST W & GASTONE AVE (32400)	01 - Clear	01 - Daylight	10 - No control	0	03 - P.B. only	03 - Rear end	02 - Wet	2	0	0	0
9/26/2019	2019	17:30	PARKDALE AVE @ WELLSINGTON ST W & GASTONE AVE (32400)	02 - Rain	01 - Daylight	10 - No control	0	03 - P.B. only	02 - Angle	02 - Wet	2	0	0	0
5/24/2020	2020	15:37	PARKDALE AVE @ WELLSINGTON ST W & GASTONE AVE (32400)	01 - Clear	01 - Daylight	10 - No control	0	03 - P.B. only	05 - Turning movement	01 - Dry	2	0	0	0
1/3/2020	2020	15:37	PARKDALE AVE @ WELLSINGTON ST W & GASTONE AVE (32400)	01 - Clear	01 - Daylight	10 - No control	0	03 - P.B. only	07 - SWV other	02 - Wet	1	0	0	0

# Appendix E

TRANS Model Plots

# TRANS Regional Model

Version 2.15 - Assigned June 16, 2020

AM Peak Hour Total Traffic Volume

1194 Wellington

2011 Model - Basecase

N/A

User Initials: TIMW

Plot Prepared: March 25, 2021

EYME Scenario: 21711



## Legend

AM Peak Hour Total Traffic Volume



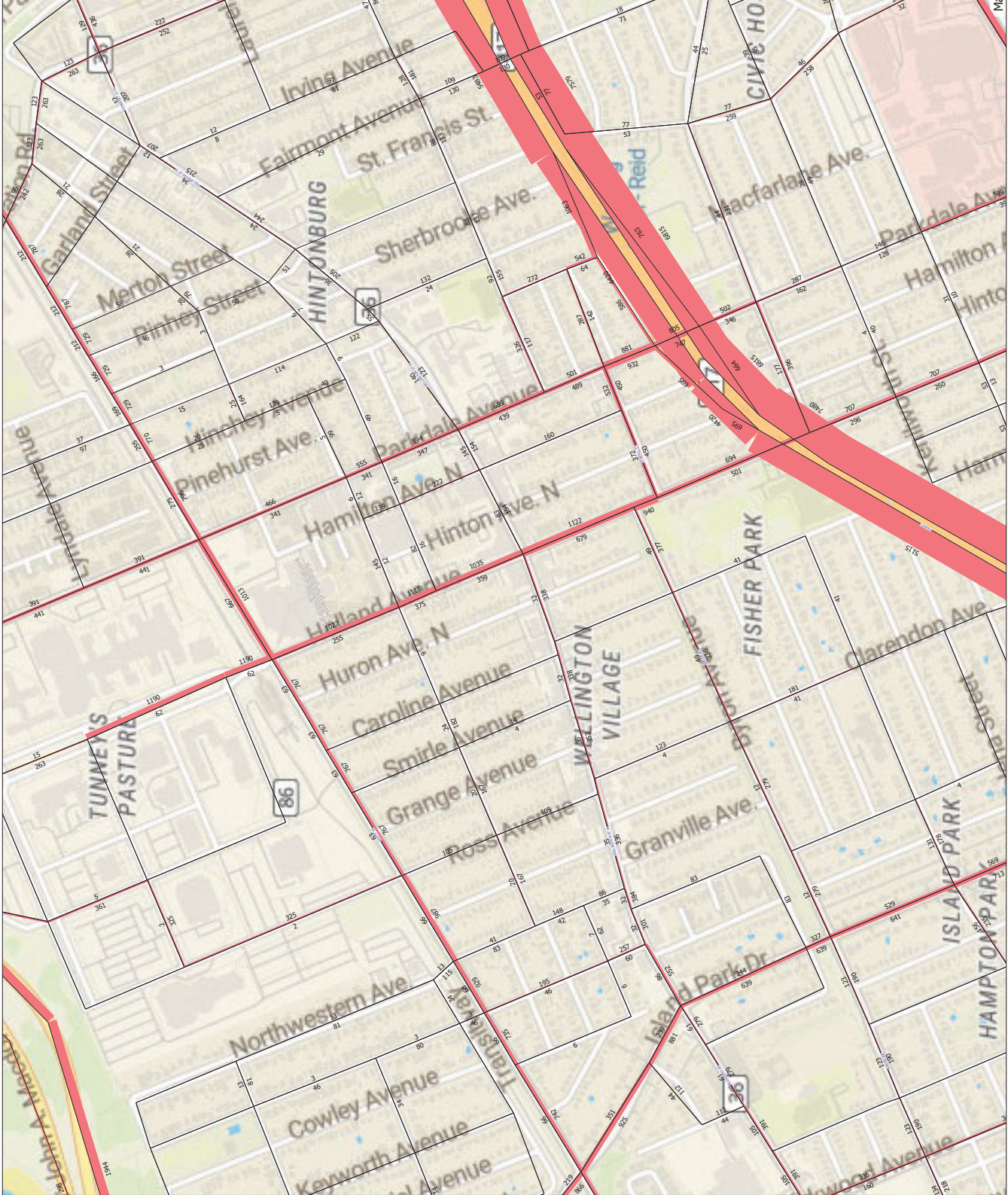
Distance (m)



The TRANS model is continuously refined & maintained, and all information is provided in good faith. However, model outputs are provided "as is", and no warranty or guarantee is provided as to the accuracy, reliability or reasonableness of the results. In using this data, you agree to accept any and all risks arising from any incorrect, incomplete, or misleading information.

Recipients are required to use caution and professional judgement in using and interpreting model outputs. In particular, caution should be used when focusing on a geographically limited area (such as a single road or intersection), as the model is primarily designed to simulate regional-scale phenomena and has been calibrated at a regional level.

As general good practice, it is recommended that the user confirm the network coding within the area of interest, and compare base year forecasts against traffic count data to assess the extent to which the model may be over- or under-estimating the travel demand.





# TRANS Regional Model

Version 2.15 - Assigned June 16, 2020

AM Peak Hour Total Traffic Volume

1194 Wellington

2031 Model - Basecase

N/A

User Initials: TIMW

Plot Prepared: March 25, 2021

EMME Scenario: 21711



## Legend

AM Peak Hour Total Traffic Volume



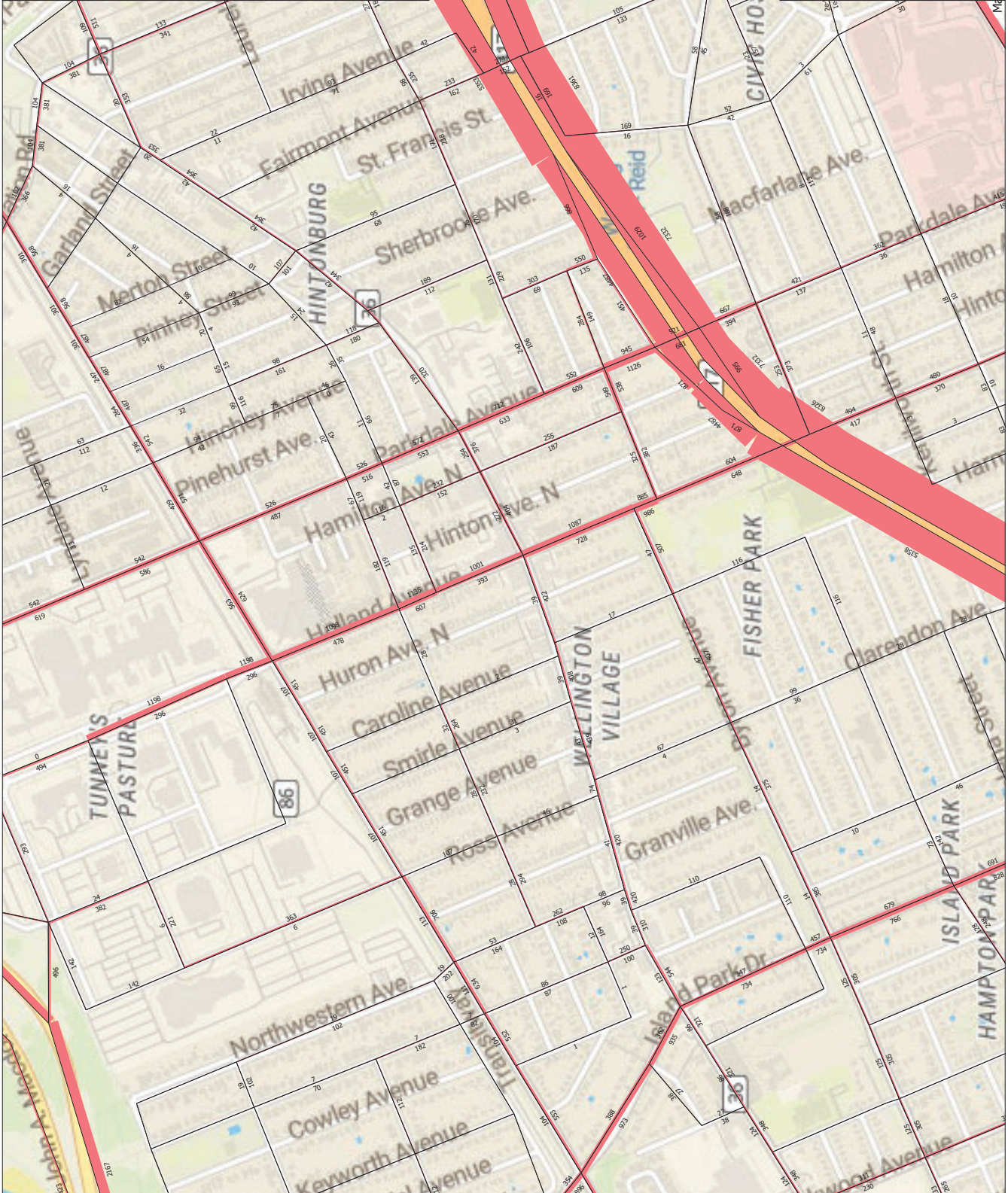
Distance (m)



The TRANS model is continuously refined & maintained, and all information is provided in good faith. However, model outputs are provided "as is", and no warranty or guarantee is provided as to the accuracy, reliability, or reasonableness of the results. In using this data, you agree to accept any and all risks arising from any incorrect, incomplete, or misleading information.

Recipients are required to use caution and professional judgement in using and interpreting model outputs. In particular, caution should be used when focusing on a geographically limited area (such as a single road or intersection), as the model is primarily designed to simulate regional-scale phenomena and has been calibrated at a regional level.

As general good practice, it is recommended that the user confirm the network coding within the area of interest, and compare base year forecasts against traffic count data to assess the extent to which the model may be over- or under-estimating the travel demand.



# Appendix F

Synchro Intersection Worksheets – 2025 Future Background Conditions

Lanes, Volumes, Timings  
1: Holland & Spencer

Future Background 2025AM Peak Hour  
1186-1194 Wellington STW

Lane Group	EBL	EBT	WBL	WBT	NBL	NBT	SBL	SBT
Lane Configurations	8	11	57	4	10	534	10	317
Traffic Volume (vph)	8	11	57	4	10	534	10	317
Future Volume (vph)	0	50	0	113	0	565	0	332
Lane Group Flow (vph)	Perm	NA	Perm	NA	Perm	NA	Perm	NA
Turn Type	4	4	8	8	2	2	6	6
Protected Phases	4	4	8	8	2	2	6	6
Permitted Phases	4	4	8	8	2	2	6	6
Detector Phase	4	4	8	8	2	2	6	6
Switch Phase	10.0	10.0	10.0	10.0	10.0	10.0	10.0	10.0
Minimum Initial (s)	23.5	23.5	23.5	23.5	29.3	29.3	29.3	29.3
Minimum Split (s)	24.0	24.0	24.0	24.0	76.0	76.0	76.0	76.0
Total Split (s)	24.0%	24.0%	24.0%	24.0%	76.0%	76.0%	76.0%	76.0%
Total Split (%)	18.5	18.5	18.5	18.5	70.7	70.7	70.7	70.7
Maximum Green (s)	3.3	3.3	3.3	3.3	3.3	3.3	3.3	3.3
Yellow Time (s)	2.2	2.2	2.2	2.2	2.0	2.0	2.0	2.0
All-Red Time (s)	0.0	0.0	0.0	0.0	0.0	0.0	0.0	0.0
Lost Time Adjust (s)	5.5	5.5	5.5	5.5	5.3	5.3	5.3	5.3
Total Lost Time (s)	3.0	3.0	3.0	3.0	3.0	3.0	3.0	3.0
Lead/Lag Optimize?	None	None	None	None	C-Max	C-Max	C-Max	C-Max
Vehicle Extension (s)	7.0	7.0	7.0	7.0	15.0	15.0	15.0	15.0
Recall Mode	11.0	11.0	11.0	11.0	9.0	9.0	9.0	9.0
Walk Time (s)	17	17	11	11	60	60	32	32
Pedestrian Calls (#/hr)	13.4	13.4	13.4	13.4	75.8	75.8	75.8	75.8
Act Effr Green (s)	0.13	0.13	0.13	0.13	0.76	0.76	0.76	0.76
Actuated g/C Ratio	0.22	0.22	0.55	0.24	0.24	0.14	0.14	0.14
v/c Ratio	21.0	21.0	36.4	0.8	3.8	3.8	3.8	3.8
Control Delay	0.0	0.0	0.0	0.0	0.0	0.0	0.0	0.0
Queue Delay	21.0	21.0	36.4	0.8	3.8	3.8	3.8	3.8
Total Delay	C	D	A	A	A	A	A	A
LOS	21.0	36.4	0.8	3.8	3.8	3.8	3.8	3.8
Approach Delay	C	D	A	A	A	A	A	A
Approach LOS	3.4	13.9	1.0	6.5	6.5	6.5	6.5	6.5
Queue Length 50th (m)	13.0	29.3	4.0	13.5	13.5	13.5	13.5	13.5
Queue Length 95th (m)	151.9	132.2	211.0	210.0	210.0	210.0	210.0	210.0
Internal Link Dist (m)	299	270	2354	2345	2345	2345	2345	2345
Turn Bay Length (m)	0	0	0	0	0	0	0	0
Base Capacity (vph)	0	0	0	0	0	0	0	0
Starvation Cap Reductn	0	0	0	0	0	0	0	0
Spillback Cap Reductn	0	0	0	0	0	0	0	0
Storage Cap Reductn	0.17	0.42	0.24	0.14	0.14	0.14	0.14	0.14
Reduced v/c Ratio	<b>Intersection Summary</b>							
Cycle Length: 100								
Actuated Cycle Length: 100								
Offset: 40 (40%), Referenced to phase 2, NBT, and 6, SBT, Start of Green								
Natural Cycle: 55								

Lanes, Volumes, Timings  
1: Holland & Spencer

Future Background 2025AM Peak Hour  
1186-1194 Wellington STW

Lane Group	EBL	EBT	WBL	WBT	NBL	NBT	SBL	SBT
Lane Configurations	8	11	57	4	10	534	10	317
Traffic Volume (vph)	8	11	57	4	10	534	10	317
Future Volume (vph)	0	50	0	113	0	565	0	332
Lane Group Flow (vph)	Perm	NA	Perm	NA	Perm	NA	Perm	NA
Turn Type	4	4	8	8	2	2	6	6
Protected Phases	4	4	8	8	2	2	6	6
Permitted Phases	4	4	8	8	2	2	6	6
Detector Phase	4	4	8	8	2	2	6	6
Switch Phase	10.0	10.0	10.0	10.0	10.0	10.0	10.0	10.0
Minimum Initial (s)	23.5	23.5	23.5	23.5	29.3	29.3	29.3	29.3
Minimum Split (s)	24.0	24.0	24.0	24.0	76.0	76.0	76.0	76.0
Total Split (s)	24.0%	24.0%	24.0%	24.0%	76.0%	76.0%	76.0%	76.0%
Total Split (%)	18.5	18.5	18.5	18.5	70.7	70.7	70.7	70.7
Maximum Green (s)	3.3	3.3	3.3	3.3	3.3	3.3	3.3	3.3
Yellow Time (s)	2.2	2.2	2.2	2.2	2.0	2.0	2.0	2.0
All-Red Time (s)	0.0	0.0	0.0	0.0	0.0	0.0	0.0	0.0
Lost Time Adjust (s)	5.5	5.5	5.5	5.5	5.3	5.3	5.3	5.3
Total Lost Time (s)	3.0	3.0	3.0	3.0	3.0	3.0	3.0	3.0
Lead/Lag Optimize?	None	None	None	None	C-Max	C-Max	C-Max	C-Max
Vehicle Extension (s)	7.0	7.0	7.0	7.0	15.0	15.0	15.0	15.0
Recall Mode	11.0	11.0	11.0	11.0	9.0	9.0	9.0	9.0
Walk Time (s)	17	17	11	11	60	60	32	32
Pedestrian Calls (#/hr)	13.4	13.4	13.4	13.4	75.8	75.8	75.8	75.8
Act Effr Green (s)	0.13	0.13	0.13	0.13	0.76	0.76	0.76	0.76
Actuated g/C Ratio	0.22	0.22	0.55	0.24	0.24	0.14	0.14	0.14
v/c Ratio	21.0	21.0	36.4	0.8	3.8	3.8	3.8	3.8
Control Delay	0.0	0.0	0.0	0.0	0.0	0.0	0.0	0.0
Queue Delay	21.0	21.0	36.4	0.8	3.8	3.8	3.8	3.8
Total Delay	C	D	A	A	A	A	A	A
LOS	21.0	36.4	0.8	3.8	3.8	3.8	3.8	3.8
Approach Delay	C	D	A	A	A	A	A	A
Approach LOS	3.4	13.9	1.0	6.5	6.5	6.5	6.5	6.5
Queue Length 50th (m)	13.0	29.3	4.0	13.5	13.5	13.5	13.5	13.5
Queue Length 95th (m)	151.9	132.2	211.0	210.0	210.0	210.0	210.0	210.0
Internal Link Dist (m)	299	270	2354	2345	2345	2345	2345	2345
Turn Bay Length (m)	0	0	0	0	0	0	0	0
Base Capacity (vph)	0	0	0	0	0	0	0	0
Starvation Cap Reductn	0	0	0	0	0	0	0	0
Spillback Cap Reductn	0	0	0	0	0	0	0	0
Storage Cap Reductn	0.17	0.42	0.24	0.14	0.14	0.14	0.14	0.14
Reduced v/c Ratio	<b>Intersection Summary</b>							
Cycle Length: 100								
Actuated Cycle Length: 100								
Offset: 40 (40%), Referenced to phase 2, NBT, and 6, SBT, Start of Green								
Natural Cycle: 55								



Lanes, Volumes, Timings  
2: Holland & Wellington

Lanes, Volumes, Timings  
2: Holland & Wellington

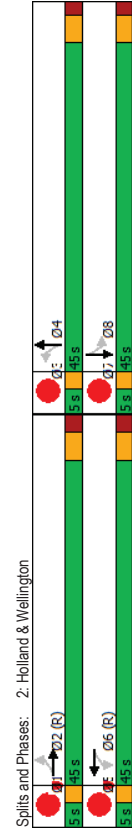
Future Background 2025AM Peak Hour  
1186-1194 Wellington STW

Future Background 2025AM Peak Hour  
1186-1194 Wellington STW

EBL	EBT	WBL	WBT	NBL	NBT	SBL	SBT	Ø1	Ø3	Ø5	Ø7
38	322	48	224	45	520	23	394				
38	322	48	224	45	520	23	394				
0	423	0	313	0	616	0	443				
Perm	NA	Perm	NA	Perm	NA	Perm	NA				
2	2	6	6	4	4	8	8	1	3	5	7
2	2	6	6	4	4	8	8				
10.0	10.0	10.0	10.0	10.0	10.0	10.0	10.0	1.0	1.0	1.0	1.0
23.6	23.6	24.5	24.5	20.1	20.1	20.1	20.1	3.0	3.0	3.0	3.0
45.0	45.0	45.0	45.0	45.0	45.0	45.0	45.0	5.0	5.0	5.0	5.0
45.0%	45.0%	45.0%	45.0%	45.0%	45.0%	45.0%	45.0%	5%	5%	5%	5%
39.4	39.4	39.4	39.9	39.9	39.9	39.9	39.9	3.0	3.0	3.0	3.0
3.3	3.3	3.3	3.3	3.3	3.3	3.3	3.3	2.0	2.0	2.0	2.0
2.3	2.3	2.3	2.3	1.8	1.8	1.8	1.8	0.0	0.0	0.0	0.0
0.0	0.0	0.0	0.0	0.0	0.0	0.0	0.0				
5.6	5.6	5.6	5.6	5.1	5.1	5.1	5.1				
Lag	Lag	Lag	Lag	Lag	Lag	Lag	Lag	Lead	Lead	Lead	Lead
Yes	Yes	Yes	Yes	Yes	Yes	Yes	Yes	Yes	Yes	Yes	Yes
3.0	3.0	3.0	3.0	3.0	3.0	3.0	3.0	3.0	3.0	3.0	3.0
C-Max	C-Max	C-Max	C-Max	Max	Max	Max	Max	Max	Max	Max	Max
4.0	4.0	4.0	4.0	2.0	2.0	2.0	2.0				
14.0	14.0	14.0	14.0	13.0	13.0	13.0	13.0				
118	118	95	95	99	99	81	81				
39.4	39.4	39.4	39.4	39.9	39.9	39.9	39.9				
0.39	0.39	0.39	0.39	0.40	0.40	0.40	0.40				
0.39	0.39	0.31	0.31	0.55	0.55	0.38	0.38				
23.0	23.0	30.6	30.6	25.3	25.3	19.7	19.7				
0.0	0.0	0.0	0.0	0.0	0.0	0.0	0.0				
23.0	23.0	30.6	30.6	25.3	25.3	19.7	19.7				
C	C	C	C	C	C	B	B				
23.0	23.0	30.6	30.6	25.3	25.3	19.7	19.7				
C	C	C	C	C	C	B	B				
30.2	30.2	24.5	24.5	47.2	47.2	28.2	28.2				
42.8	42.8	38.2	38.2	64.2	64.2	37.0	37.0				
12.1	12.1	38.4	38.4	191.6	191.6	211.0	211.0				
1096	1096	1023	1023	1130	1130	1169	1169				
0	0	0	0	0	0	0	0				
0	0	0	0	0	0	0	0				
0	0	0	0	0	0	0	0				
0.39	0.39	0.31	0.31	0.55	0.55	0.38	0.38				

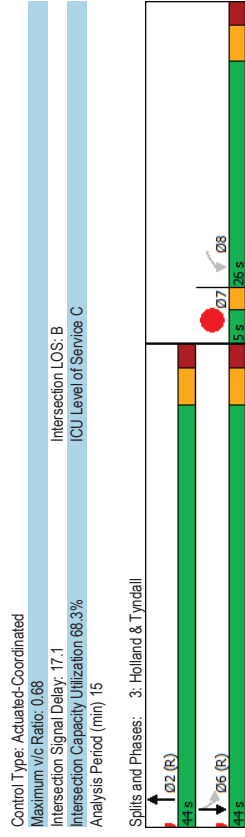
Intersection Summary	
Cycle Length:	100
Actuated Cycle Length:	100
Offset:	64 (84%), Referenced to phase 2,EBTL and 6:WBTL, Start of Green
Natural Cycle:	55

Control Type:	Actuated-Coordinated
Maximum v/c Ratio:	0.55
Intersection Signal Delay:	24.3
Intersection LOS:	C
ICU Level of Service D	
Intersection Capacity Utilization:	80.0%
Analysis Period (min):	15



	WBL	NBT	SBL	SBT	Ø7
Lane Group	W	B	B	B	Ø7
Lane Configurations	38	492	128	514	
Traffic Volume (vph)	38	492	128	514	
Future Volume (vph)	205	532	128	514	
Lane Group Flow (vph)	Perm	NA	Perm	NA	
Turn Type		2	6	6	7
Protected Phases	8	2	6	6	
Permitted Phases	8	2	6	6	
Detector Phase					
Switch Phase					
Minimum Initial (s)	10.0	10.0	10.0	10.0	1.0
Minimum Split (s)	23.5	25.7	15.7	15.7	3.0
Total Split (s)	26.0	44.0	44.0	44.0	5.0
Total Split (%)	34.7%	58.7%	58.7%	58.7%	7%
Maximum Green (s)	20.5	38.3	38.3	38.3	3.0
Yellow Time (s)	3.3	3.3	3.3	3.3	2.0
All-Red Time (s)	2.2	2.4	2.4	2.4	0.0
Lost Time Adjust (s)	0.0	0.0	0.0	0.0	0.0
Total Lost Time (s)	5.5	5.7	5.7	5.7	
Lead/Lag					Lead
Lead-Lag Optimize?	Yes				Yes
Vehicle Extension (s)	3.0	3.0	3.0	3.0	3.0
Recall Mode	None	C-Max	C-Max	C-Max	Max
Walk Time (s)	5.0	10.0			
Pedestrian Calls (#/hr)	37	36			
Act Effr Green (s)	16.1	42.7	42.7	42.7	
Actuated g/C Ratio	0.21	0.57	0.57	0.57	
v/c Ratio	0.68	0.54	0.35	0.52	
Control Delay	38.3	13.5	13.6	13.2	
Queue Delay	0.0	0.0	0.0	0.0	
Total Delay	38.3	13.5	13.6	13.2	
LOS	D	B	B	B	
Approach Delay	38.3	13.5	13.3		
Approach LOS	D	B	B		
Queue Length 50th (m)	25.9	45.1	9.5	43.4	
Queue Length 95th (m)	44.4	78.7	23.4	74.9	
Internal Link Dist (m)	141.1	156.5		22.9	
Turn Bay Length (m)					
Base Capacity (vph)	382	978	365	992	
Starvation Cap Reductn	0	0	0	0	
Spillback Cap Reductn	0	0	0	0	
Storage Cap Reductn	0	0	0	0	
Reduced v/c Ratio	0.54	0.54	0.35	0.52	

Intersection Summary	
Cycle Length:	75
Actuated Cycle Length:	75
Offset:	2 (3%), Referenced to phase 2:NBT and 6:SBTL, Start of Green
Natural Cycle:	60



Lanes, Volumes, Timings  
4: Parkdale & Armstrong

Future Background 2025AM Peak Hour  
1186-1194 Wellington STW

	EBL	EBT	WBL	WBT	NBL	NBT	SBL	SBT
Lane Group	EBL	EBT	WBL	WBT	NBL	NBT	SBL	SBT
Lane Configurations	27	75	12	47	22	364	12	215
Traffic Volume (vph)	27	75	12	47	22	364	12	215
Future Volume (vph)	0	117	0	72	0	409	0	249
Lane Group Flow (vph)	Perm	NA	Perm	NA	Perm	NA	Perm	NA
Protected Phases	4	4	8	8	2	2	6	6
Permitted Phases	4	4	8	8	2	2	6	6
Detector Phase	4	4	8	8	2	2	6	6
Switch Phase								
Minimum Initial (s)	10.0	10.0	10.0	10.0	10.0	10.0	10.0	10.0
Minimum Split (s)	23.5	23.5	23.5	25.2	25.2	25.2	25.2	25.2
Total Split (s)	27.0	27.0	27.0	27.0	73.0	73.0	73.0	73.0
Total Split (%)	27.0%	27.0%	27.0%	27.0%	73.0%	73.0%	73.0%	73.0%
Maximum Green (s)	21.5	21.5	21.5	21.5	67.8	67.8	67.8	67.8
All-Red Time (s)	3.0	3.0	3.0	3.0	3.0	3.0	3.0	3.0
Yellow Time (s)	2.5	2.5	2.5	2.5	2.2	2.2	2.2	2.2
Lost Time Adjust (s)	0.0	0.0	0.0	0.0	0.0	0.0	0.0	0.0
Total Lost Time (s)	5.5	5.5	5.5	5.5	5.2	5.2	5.2	5.2
Lead/Lag								
Lead-Lag Optimize?								
Vehicle Extension (s)	3.0	3.0	3.0	3.0	3.0	3.0	3.0	3.0
Recall Mode	Max	Max	Max	C-Max	C-Max	C-Max	C-Max	C-Max
Walk Time (s)	10.0	10.0	10.0	15.0	15.0	15.0	15.0	15.0
Flash Dont Walk (s)	8.0	8.0	8.0	5.0	5.0	5.0	5.0	5.0
Pedestrian Calls (#/hr)	28	28	25	25	32	32	31	31
Act Effr Green (s)	21.5	21.5	21.5	21.5	67.8	67.8	67.8	67.8
Actuated g/C Ratio	0.22	0.22	0.22	0.22	0.68	0.68	0.68	0.68
v/c Ratio	0.35	0.21	0.36	0.21	0.36	0.22	0.36	0.22
Control Delay	34.7	29.8	29.8	2.1	6.4	6.4	6.4	6.4
Queue Delay	0.0	0.0	0.0	0.4	0.0	0.0	0.0	0.0
Total Delay	34.7	29.8	29.8	2.5	6.4	6.4	6.4	6.4
LOS	C	C	C	A	A	A	A	A
Approach Delay	34.7	29.8	29.8	2.5	6.4	6.4	6.4	6.4
Approach LOS	C	C	C	A	A	A	A	A
Queue Length 50th (m)	18.1	9.9	9.9	3.8	15.4	15.4	15.4	15.4
Queue Length 95th (m)	34.3	21.7	21.7	7.3	25.0	25.0	25.0	25.0
Internal Link Dist (m)	46.6	196.9	196.9	125.2	312.1	312.1	312.1	312.1
Turn Bay Length (m)								
Base Capacity (vph)	336	345	345	1140	1135	1135	1135	1135
Starvation Cap Reductn	0	0	0	333	0	0	0	0
Spillback Cap Reductn	0	0	0	0	0	0	0	0
Storage Cap Reductn	0	0	0	0	0	0	0	0
Reduced v/c Ratio	0.35	0.21	0.21	0.51	0.22	0.22	0.22	0.22

Intersection Summary	
Cycle Length:	100
Actuated Cycle Length:	100
Offset:	52 (52%), Referenced to phase 2; NBT and 6; SBT, Start of Green
Natural Cycle:	50

Lanes, Volumes, Timings  
4: Parkdale & Armstrong

Future Background 2025AM Peak Hour  
1186-1194 Wellington STW

	EBL	EBT	WBL	WBT	NBL	NBT	SBL	SBT
Lane Group	EBL	EBT	WBL	WBT	NBL	NBT	SBL	SBT
Lane Configurations	27	75	12	47	22	364	12	215
Traffic Volume (vph)	27	75	12	47	22	364	12	215
Future Volume (vph)	0	117	0	72	0	409	0	249
Lane Group Flow (vph)	Perm	NA	Perm	NA	Perm	NA	Perm	NA
Protected Phases	4	4	8	8	2	2	6	6
Permitted Phases	4	4	8	8	2	2	6	6
Detector Phase	4	4	8	8	2	2	6	6
Switch Phase								
Minimum Initial (s)	10.0	10.0	10.0	10.0	10.0	10.0	10.0	10.0
Minimum Split (s)	23.5	23.5	23.5	25.2	25.2	25.2	25.2	25.2
Total Split (s)	27.0	27.0	27.0	27.0	73.0	73.0	73.0	73.0
Total Split (%)	27.0%	27.0%	27.0%	27.0%	73.0%	73.0%	73.0%	73.0%
Maximum Green (s)	21.5	21.5	21.5	21.5	67.8	67.8	67.8	67.8
All-Red Time (s)	3.0	3.0	3.0	3.0	3.0	3.0	3.0	3.0
Yellow Time (s)	2.5	2.5	2.5	2.5	2.2	2.2	2.2	2.2
Lost Time Adjust (s)	0.0	0.0	0.0	0.0	0.0	0.0	0.0	0.0
Total Lost Time (s)	5.5	5.5	5.5	5.5	5.2	5.2	5.2	5.2
Lead/Lag								
Lead-Lag Optimize?								
Vehicle Extension (s)	3.0	3.0	3.0	3.0	3.0	3.0	3.0	3.0
Recall Mode	Max	Max	Max	C-Max	C-Max	C-Max	C-Max	C-Max
Walk Time (s)	10.0	10.0	10.0	15.0	15.0	15.0	15.0	15.0
Flash Dont Walk (s)	8.0	8.0	8.0	5.0	5.0	5.0	5.0	5.0
Pedestrian Calls (#/hr)	28	28	25	25	32	32	31	31
Act Effr Green (s)	21.5	21.5	21.5	21.5	67.8	67.8	67.8	67.8
Actuated g/C Ratio	0.22	0.22	0.22	0.22	0.68	0.68	0.68	0.68
v/c Ratio	0.35	0.21	0.36	0.21	0.36	0.22	0.36	0.22
Control Delay	34.7	29.8	29.8	2.1	6.4	6.4	6.4	6.4
Queue Delay	0.0	0.0	0.0	0.4	0.0	0.0	0.0	0.0
Total Delay	34.7	29.8	29.8	2.5	6.4	6.4	6.4	6.4
LOS	C	C	C	A	A	A	A	A
Approach Delay	34.7	29.8	29.8	2.5	6.4	6.4	6.4	6.4
Approach LOS	C	C	C	A	A	A	A	A
Queue Length 50th (m)	18.1	9.9	9.9	3.8	15.4	15.4	15.4	15.4
Queue Length 95th (m)	34.3	21.7	21.7	7.3	25.0	25.0	25.0	25.0
Internal Link Dist (m)	46.6	196.9	196.9	125.2	312.1	312.1	312.1	312.1
Turn Bay Length (m)								
Base Capacity (vph)	336	345	345	1140	1135	1135	1135	1135
Starvation Cap Reductn	0	0	0	333	0	0	0	0
Spillback Cap Reductn	0	0	0	0	0	0	0	0
Storage Cap Reductn	0	0	0	0	0	0	0	0
Reduced v/c Ratio	0.35	0.21	0.21	0.51	0.22	0.22	0.22	0.22



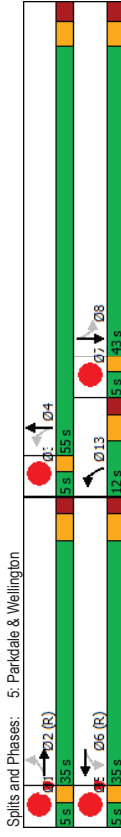
Control Type: Actuated-Coordinated  
 Maximum v/c Ratio: 0.36  
 Intersection Signal Delay: 10.4  
 Intersection LOS: B  
 ICU Level of Service A  
 Intersection Capacity Utilization 53.9%  
 Analysis Period (min) 15

Lanes, Volumes, Timings  
5: Parkdale & Wellington

Future Background 2025AM Peak Hour  
1186-1194 Wellington STW

Control Type: Actuated-Coordinated	Intersection LOS: B
Maximum v/c Ratio: 0.58	ICU Level of Service D
Intersection Signal Delay: 18.7	
Intersection Capacity Utilization 78.1%	
Analysis Period (min): 15	
m. Volume for 95th percentile queue is metered by upstream signal.	

Control Type: Actuated-Coordinated	Intersection LOS: B
Maximum v/c Ratio: 0.58	ICU Level of Service D
Intersection Signal Delay: 18.7	
Intersection Capacity Utilization 78.1%	
Analysis Period (min): 15	
m. Volume for 95th percentile queue is metered by upstream signal.	



EBL	EBT	WBL	WBT	NBL	NBT	SBL	SBT	Ø1	Ø3	Ø5	Ø7
28	262	27	172	72	391	20	254				
28	262	27	172	72	391	20	254				
0	377	27	190	72	476	20	276				
Perm	NA	Perm	NA	pm+pt	NA	Perm	NA				
2	2	6	6	13	4	8	8	1	3	5	7
2	2	6	6	13	4	8	8				
10.0	10.0	10.0	10.0	5.0	10.0	10.0	10.0	1.0	1.0	1.0	1.0
23.4	23.4	23.4	23.4	10.2	15.5	20.5	20.5	3.0	3.0	3.0	3.0
35.0	35.0	35.0	35.0	12.0	55.0	43.0	43.0	5.0	5.0	5.0	5.0
35.0%	35.0%	35.0%	35.0%	12.0%	55.0%	43.0%	43.0%	5%	5%	5%	5%
29.6	29.6	29.6	29.6	6.8	49.5	37.5	37.5	3.0	3.0	3.0	3.0
3.3	3.3	3.3	3.3	3.0	3.0	3.0	3.0	2.0	2.0	2.0	2.0
2.1	2.1	2.1	2.1	2.2	2.5	2.5	2.5	0.0	0.0	0.0	0.0
0.0	0.0	0.0	0.0	0.0	0.0	0.0	0.0	0.0	0.0	0.0	0.0
5.4	5.4	5.4	5.4	5.2	5.5	5.5	5.5				
Lag	Lag	Lag	Lag	Lead	Lead	Lead	Lead				
Yes	Yes	Yes	Yes	Yes	Yes	Yes	Yes				
3.0	3.0	3.0	3.0	3.0	3.0	3.0	3.0	3.0	3.0	3.0	3.0
C-Max	C-Max	C-Max	C-Max	Max	Max	Max	Max	Max	Max	Max	Max
5.0	5.0	5.0	5.0	2.0	2.0	2.0	2.0				
8.0	8.0	8.0	8.0	8.0	8.0	8.0	8.0				
71	71	62	62	53	42	42	42				
29.6	29.6	29.6	29.6	54.8	49.5	37.5	37.5				
0.30	0.30	0.30	0.30	0.50	0.38	0.38	0.38				
0.47	0.47	0.13	0.38	0.16	0.58	0.07	0.44				
21.1	27.9	30.7	3.7	11.4	18.9	22.3	22.3				
0.0	0.0	0.0	0.0	0.2	0.0	0.0	0.0				
21.1	27.9	30.7	3.7	11.6	18.9	22.3	22.3				
C	C	C	A	B	B	C	C				
21.1	30.4	30.4	10.5	22.0	22.0	22.0	22.0				
C	C	C	B	C	C	C	C				
18.5	3.8	29.1	2.0	55.8	2.2	30.9	30.9				
25.7	10.6	48.3	m3.2	84.2	m6.3	45.1	45.1				
59.9		34.4		139.5		125.2	125.2				
30.0		40.0		40.0		40.0	40.0				
802	208	496	441	815	290	634	634				
0	0	0	0	47	0	0	0				
0	0	0	0	0	0	0	0				
0	0	0	0	0	0	0	0				
0.47	0.13	0.38	0.16	0.62	0.07	0.44	0.44				

EBL	EBT	WBL	WBT	NBL	NBT	SBL	SBT	Ø1	Ø3	Ø5	Ø7
28	262	27	172	72	391	20	254				
28	262	27	172	72	391	20	254				
0	377	27	190	72	476	20	276				
Perm	NA	Perm	NA	pm+pt	NA	Perm	NA				
2	2	6	6	13	4	8	8	1	3	5	7
2	2	6	6	13	4	8	8				
10.0	10.0	10.0	10.0	5.0	10.0	10.0	10.0	1.0	1.0	1.0	1.0
23.4	23.4	23.4	23.4	10.2	15.5	20.5	20.5	3.0	3.0	3.0	3.0
35.0	35.0	35.0	35.0	12.0	55.0	43.0	43.0	5.0	5.0	5.0	5.0
35.0%	35.0%	35.0%	35.0%	12.0%	55.0%	43.0%	43.0%	5%	5%	5%	5%
29.6	29.6	29.6	29.6	6.8	49.5	37.5	37.5	3.0	3.0	3.0	3.0
3.3	3.3	3.3	3.3	3.0	3.0	3.0	3.0	2.0	2.0	2.0	2.0
2.1	2.1	2.1	2.1	2.2	2.5	2.5	2.5	0.0	0.0	0.0	0.0
0.0	0.0	0.0	0.0	0.0	0.0	0.0	0.0	0.0	0.0	0.0	0.0
5.4	5.4	5.4	5.4	5.2	5.5	5.5	5.5				
Lag	Lag	Lag	Lag	Lead	Lead	Lead	Lead				
Yes	Yes	Yes	Yes	Yes	Yes	Yes	Yes				
3.0	3.0	3.0	3.0	3.0	3.0	3.0	3.0	3.0	3.0	3.0	3.0
C-Max	C-Max	C-Max	C-Max	Max	Max	Max	Max	Max	Max	Max	Max
5.0	5.0	5.0	5.0	2.0	2.0	2.0	2.0				
8.0	8.0	8.0	8.0	8.0	8.0	8.0	8.0				
71	71	62	62	53	42	42	42				
29.6	29.6	29.6	29.6	54.8	49.5	37.5	37.5				
0.30	0.30	0.30	0.30	0.50	0.38	0.38	0.38				
0.47	0.47	0.13	0.38	0.16	0.58	0.07	0.44				
21.1	27.9	30.7	3.7	11.4	18.9	22.3	22.3				
0.0	0.0	0.0	0.0	0.2	0.0	0.0	0.0				
21.1	27.9	30.7	3.7	11.6	18.9	22.3	22.3				
C	C	C	A	B	B	C	C				
21.1	30.4	30.4	10.5	22.0	22.0	22.0	22.0				
C	C	C	B	C	C	C	C				
18.5	3.8	29.1	2.0	55.8	2.2	30.9	30.9				
25.7	10.6	48.3	m3.2	84.2	m6.3	45.1	45.1				
59.9		34.4		139.5		125.2	125.2				
30.0		40.0		40.0		40.0	40.0				
802	208	496	441	815	290	634	634				
0	0	0	0	47	0	0	0				
0	0	0	0	0	0	0	0				
0	0	0	0	0	0	0	0				
0.47	0.13	0.38	0.16	0.62	0.07	0.44	0.44				

Lanes, Volumes, Timings  
6: Parkdale & Gladstone

Lanes, Volumes, Timings  
6: Parkdale & Gladstone

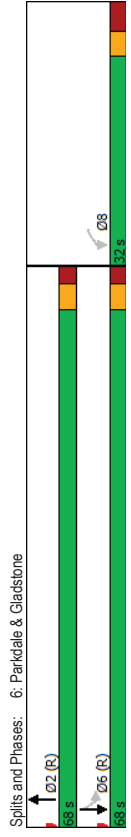
Future Background 2025AM Peak Hour  
1186-1194 Wellington STW

Future Background 2025AM Peak Hour  
1186-1194 Wellington STW

Lane Group	WBL	NBT	SBL	SBT
Lane Configurations	W	T	T	T
Traffic Volume (vph)	133	508	32	364
Future Volume (vph)	133	508	32	364
Lane Group Flow (vph)	164	639	32	364
Turn Type	Perm	NA	Perm	NA
Protected Phases		2		6
Permitted Phases	8		6	
Detector Phase	8	2	6	6
Switch Phase				
Minimum Initial (s)	10.0	10.0	10.0	10.0
Minimum Split (s)	22.7	20.3	15.3	15.3
Total Split (s)	32.0	68.0	68.0	68.0
Total Split (%)	32.0%	68.0%	68.0%	68.0%
Maximum Green (s)	25.3	62.7	62.7	62.7
Yellow Time (s)	3.0	3.0	3.0	3.0
All-Red Time (s)	3.7	2.3	2.3	2.3
Lost Time Adjust (s)	0.0	0.0	0.0	0.0
Total Lost Time (s)	6.7	5.3	5.3	5.3
Lead/Lag				
Lead-Lag Optimize?				
Vehicle Extension (s)	3.0	3.0	3.0	3.0
Recall Mode	Max	C-Max	C-Max	C-Max
Walk Time (s)	7.0	7.0		
Flash Dont Walk (s)	9.0	8.0		
Pedestrian Calls (#/hr)	15	7		
Act Effr Green (s)	25.3	62.7	62.7	62.7
Actuated g/C Ratio	0.25	0.63	0.63	0.63
v/c Ratio	0.41	0.61	0.09	0.33
Control Delay	34.9	12.0	12.4	13.5
Queue Delay	0.0	0.0	0.0	0.0
Total Delay	34.9	12.0	12.4	13.5
LOS	C	B	B	B
Approach Delay	34.9	12.0	13.4	
Approach LOS	C	B	B	
Queue Length 50th (m)	26.5	61.2	2.4	27.3
Queue Length 95th (m)	45.3	75.1	m7.0	64.7
Internal Link Dist (m)	224.2	197.3		139.5
Turn Bay Length (m)			85.0	
Base Capacity (vph)	399	1053	349	1094
Starvation Cap Reductn	0	0	0	0
Spillback Cap Reductn	0	0	0	0
Storage Cap Reductn	0	0	0	0
Reduced v/c Ratio	0.41	0.61	0.09	0.33

Intersection Summary	
Cycle Length:	100
Actuated Cycle Length:	100
Offset:	12 (12%), Referenced to phase 2:NBT and 6:SBTL, Start of Green
Natural Cycle:	60

Control Type:	Actuated-Coordinated
Maximum v/c Ratio:	0.61
Intersection Signal Delay:	15.6
Intersection LOS:	B
Intersection Capacity Utilization:	60.1%
Analysis Period (min):	15
m:	Volume for 95th percentile queue is metered by upstream signal.



Lanes, Volumes, Timings  
7: Parkdale & 417 WB OR

Lanes, Volumes, Timings  
7: Parkdale & 417 WB OR

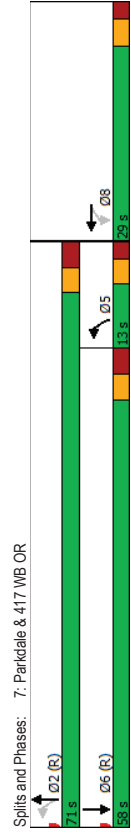
Future Background 2025AM Peak Hour  
1186-1194 Wellington STW

Future Background 2025AM Peak Hour  
1186-1194 Wellington STW

Lane Group	WBL	WBT	NBL	NBT	SBT
Lane Configurations	←	←	←	←	←
Traffic Volume (vph)	345	0	183	345	479
Future Volume (vph)	345	0	183	345	479
Lane Group Flow (vph)	345	542	183	345	742
Turn Type	Perim	NA	pm-pt	NA	NA
Protected Phases	8	5	2	2	6
Permitted Phases	8	5	2	2	6
Detector Phase	8	8	5	2	6
Switch Phase					
Minimum Initial (s)	10.0	10.0	5.0	10.0	10.0
Minimum Split (s)	20.5	20.5	10.2	27.3	21.3
Total Split (s)	29.0	29.0	13.0	71.0	58.0
Total Split (%)	29.0%	29.0%	13.0%	71.0%	58.0%
Maximum Green (s)	23.5	23.5	7.8	64.7	51.7
Yellow Time (s)	3.3	3.3	3.0	3.0	3.0
All-Red Time (s)	2.2	2.2	2.2	3.3	3.3
Lost Time Adjust (s)	0.0	0.0	0.0	0.0	0.0
Total Lost Time (s)	5.5	5.5	5.2	6.3	6.3
Lead/Lag			Lag	Lead	
Lead-Lag Optimize?			Yes	Yes	
Vehicle Extension (s)	3.0	3.0	3.0	3.0	3.0
Recall Mode	None	None	None	C-Max	C-Max
Walk Time (s)	7.0	7.0	7.0	7.0	7.0
Flash Dont Walk (s)	8.0	8.0	14.0	8.0	8.0
Pedestrian Calls (#/hr)	1	1		23	10
Act Effct Green (s)	22.7	22.7	66.6	65.5	62.5
Actuated g/C Ratio	0.23	0.23	0.67	0.66	0.52
v/c Ratio	0.92	0.76	0.54	0.30	0.85
Control Delay	68.4	12.3	21.0	8.5	34.6
Queue Delay	0.0	0.0	0.0	0.0	0.0
Total Delay	68.4	12.3	21.0	8.5	34.6
LOS	E	B	C	A	C
Approach Delay	34.1			12.8	34.6
Approach LOS	C			B	C
Queue Length 50th (m)	64.9	6.3	12.3	26.6	142.9
Queue Length 95th (m)	#113.6	43.5	20.5	40.5	#195.0
Internal Link Dist (m)	462.5			38.8	197.3
Turn Bay Length (m)					
Base Capacity (vph)	389	723	341	1143	874
Starvation Cap Reductn	0	0	0	0	0
Spillback Cap Reductn	0	0	0	0	0
Storage Cap Reductn	0	0	0	0	0
Reduced v/c Ratio	0.89	0.75	0.54	0.30	0.85

Intersection Summary	
Cycle Length:	100
Actuated Cycle Length:	100
Offset:	26 (26%), Referenced to phase 2, NBL and 6: SBT, Start of Green
Natural Cycle:	90

Control Type:	Actuated-Coordinated
Maximum v/c Ratio:	0.92
Intersection Signal Delay:	29.1
Intersection LOS:	C
Intersection Capacity Utilization:	104.3%
ICU Level of Service:	G
Analysis Period (min):	15
# 95th percentile volume exceeds capacity, queue may be longer.	
Queue shown is maximum after two cycles.	

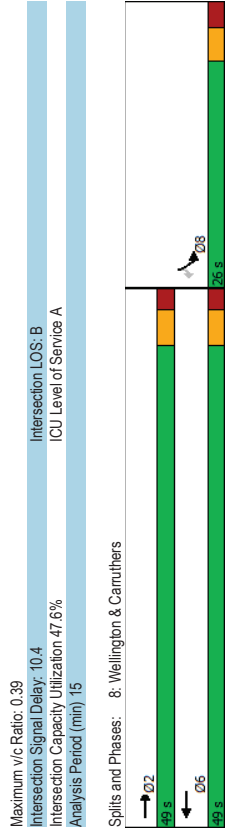


Lanes, Volumes, Timings  
8: Wellington & Carruthers

Lanes, Volumes, Timings  
8: Wellington & Carruthers

Lane Group	EBT	WBT	SBL	SBR
Lane Configurations	←	←	←	←
Traffic Volume (vph)	395	209	63	13
Future Volume (vph)	395	209	63	13
Lane Group Flow (vph)	395	209	63	13
Turn Type	NA	NA	Prot	Perm
Protected Phases	2	6	8	8
Permitted Phases				
Detector Phase	2	6	8	8
Switch Phase				
Minimum Initial (s)	10.0	10.0	10.0	10.0
Minimum Split (s)	15.3	26.3	25.5	25.5
Total Split (s)	49.0	49.0	26.0	26.0
Total Split (%)	65.3%	65.3%	34.7%	34.7%
Maximum Green (s)	43.7	43.7	20.5	20.5
Yellow Time (s)	3.3	3.3	3.0	3.0
All-Red Time (s)	2.0	2.0	2.5	2.5
Lost Time Adjust (s)	0.0	0.0	0.0	0.0
Total Lost Time (s)	5.3	5.3	5.5	5.5
Lead/Lag				
Lead-Lag Optimize?				
Vehicle Extension (s)	3.0	3.0	3.0	3.0
Recall Mode	Max	Max	Max	Max
Walk Time (s)	14.0	15.0	15.0	15.0
Flash Dont Walk (s)	7.0	5.0	5.0	5.0
Pedestrian Calls (#/hr)	70	65	65	65
Act Effr Green (s)	43.7	43.7	20.5	20.5
Actuated G/C Ratio	0.58	0.58	0.27	0.27
v/c Ratio	0.39	0.21	0.14	0.03
Control Delay	9.9	8.1	21.7	11.0
Queue Delay	0.0	0.0	0.0	0.0
Total Delay	9.9	8.1	21.7	11.0
LOS	A	A	C	B
Approach Delay	9.9	8.1	19.9	
Approach LOS	A	A	B	
Queue Length 50th (m)	27.3	12.7	6.7	0.0
Queue Length 95th (m)	44.0	22.3	15.4	3.8
Internal Link Dist (m)	158.0	153.4	73.2	
Turn Bay Length (m)			30.0	
Base Capacity (vph)	1016	1016	453	386
Starvation Cap Reductn	0	0	0	0
Spillback Cap Reductn	0	0	0	0
Storage Cap Reductn	0	0	0	0
Reduced v/c Ratio	0.39	0.21	0.14	0.03

Intersection Summary	
Cycle Length:	75
Actuated Cycle Length:	75
Natural Cycle:	55
Control Type:	Semi-Act-Uncoord



11: Hamilton & Wellington  
 HCM 2010 TWSC  
 Future Background 2025AM Peak Hour  
 1186-1194 Wellington STW

Intersection																
Int'Delay, s/veh																
1.6																
Movement	EBL	EBT	EBR	WBL	WBT	WBR	NBL	NBT	NBR	SBL	SBT	SBR				
Lane Configurations	↔	↔	↔	↔	↔	↔	↔	↔	↔	↔	↔	↔	↔	↔	↔	
Traffic Vol, veh/h	13	247	7	10	216	10	6	7	7	6	15	17				
Future Vol, veh/h	13	247	7	10	216	10	6	7	7	6	15	17				
Conflicting Peds. #/hr	0	0	0	0	0	0	0	0	0	0	0	0				
Sign Control	Free	Free	Free	Free	Free	Free	Free	Free	Free	Free	Free	Free	Stop	Stop	Stop	
RT Channelized	-	-	None	-	-	None	-	-	None	-	-	None	-	-	None	
Storage Length	-	-	-	-	-	-	-	-	-	-	-	-	-	-	-	
Veh in Median Storage, #	-	0	-	-	0	-	-	-	0	-	-	-	-	-	0	
Grade, %	-	0	-	-	0	-	-	-	0	-	-	-	-	-	0	
Peak Hour Factor	100	100	100	100	100	100	100	100	100	100	100	100				
Heavy Vehicles, %	2	2	2	2	2	2	2	2	2	2	2	2				
Mvmt Flow	13	247	7	10	216	10	6	7	7	6	15	17				
Major/Minor	Major1	Major2	Minor1	Minor2												
Conflicting Flow All	226	0	0	534	523	251	525	521	221							
Stage 1	-	-	-	277	277	-	241	241	-							
Stage 2	-	-	-	257	246	-	284	280	-							
Critical Hdwy	4.12	-	-	4.12	-	-	7.12	6.52	6.22	7.12	6.52	6.22				
Critical Hdwy Stg 1	-	-	-	-	-	-	6.12	5.52	-	6.12	5.52	-				
Critical Hdwy Stg 2	-	-	-	-	-	-	6.12	5.52	-	6.12	5.52	-				
Follow-up Hdwy	2.218	-	-	2.218	-	-	3.518	4.018	3.318	3.518	4.018	3.318				
Pot Cap-1 Maneuver	1342	-	-	1311	-	-	457	469	788	463	460	819				
Stage 1	-	-	-	-	-	-	729	681	-	762	706	-				
Stage 2	-	-	-	-	-	-	748	703	-	723	679	-				
Platoon blocked, %	-	-	-	-	-	-	-	-	-	-	-	-				
Mov Cap-1 Maneuver	1342	-	-	1311	-	-	430	450	788	447	451	819				
Mov Cap-2 Maneuver	-	-	-	-	-	-	430	450	-	447	451	-				
Stage 1	-	-	-	-	-	-	721	674	-	754	700	-				
Stage 2	-	-	-	-	-	-	710	697	-	701	672	-				
Approach	EB	WB	NB	SB												
HCM Control Delay, s	0.4	0.3	12.2	11.9												
HCM LOS	B	B	B	B												
Minor Lane/Major Mvmt	NBLn1	EBL	EBT	EBR	WBL	WBT	WBR	SBLn1								
Capacity (veh/h)	521	1342	-	-	1311	-	-	563								
HCM Lane V/C Ratio	0.038	0.01	-	-	0.008	-	-	0.067								
HCM Control Delay (s)	12.2	7.7	0	-	7.8	0	-	11.9								
HCM Lane LOS	B	A	A	A	A	A	A	B								
HCM 95th %tile Q(veh)	0.1	0	-	-	0	-	-	0.2								

12: Hamilton & Tyndall  
 HCM 2010 TWSC  
 Future Background 2025AM Peak Hour  
 1186-1194 Wellington STW

Intersection																
Int'Delay, s/veh																
1.6																
Movement	EBL	EBT	EBR	WBL	WBT	WBR	NBL	NBT	NBR	SBL	SBT	SBR				
Lane Configurations	↔	↔	↔	↔	↔	↔	↔	↔	↔	↔	↔	↔	↔	↔	↔	
Traffic Vol, veh/h	9	173	0	3	95	9	0	2	7	21	2	9				
Future Vol, veh/h	9	173	0	3	95	9	0	2	7	21	2	9				
Conflicting Peds. #/hr	0	0	0	0	0	0	0	0	0	0	0	0				
Sign Control	Free	Free	Free	Free	Free	Free	Free	Free	Free	Free	Free	Free	Stop	Stop	Stop	
RT Channelized	-	-	None	-	-	None	-	-	None	-	-	None	-	-	None	
Storage Length	-	-	-	-	-	-	-	-	-	-	-	-	-	-	-	
Veh in Median Storage, #	-	0	-	-	0	-	-	-	0	-	-	-	-	-	0	
Grade, %	-	0	-	-	0	-	-	-	0	-	-	-	-	-	0	
Peak Hour Factor	100	100	100	100	100	100	100	100	100	100	100	100				
Heavy Vehicles, %	2	2	2	2	2	2	2	2	2	2	2	2				
Mvmt Flow	9	173	0	3	95	9	0	2	7	21	2	9				
Major/Minor	Major1	Major2	Minor1	Minor2												
Conflicting Flow All	104	0	0	173	0	0	302	301	173	302	297	100				
Stage 1	-	-	-	-	-	-	191	191	-	106	106	-				
Stage 2	-	-	-	-	-	-	111	110	-	196	191	-				
Critical Hdwy	4.12	-	-	4.12	-	-	7.12	6.52	6.22	7.12	6.52	6.22				
Critical Hdwy Stg 1	-	-	-	-	-	-	6.12	5.52	-	6.12	5.52	-				
Critical Hdwy Stg 2	-	-	-	-	-	-	6.12	5.52	-	6.12	5.52	-				
Follow-up Hdwy	2.218	-	-	2.218	-	-	3.518	4.018	3.318	3.518	4.018	3.318				
Pot Cap-1 Maneuver	1488	-	-	1404	-	-	650	612	871	650	615	956				
Stage 1	-	-	-	-	-	-	811	742	-	900	807	-				
Stage 2	-	-	-	-	-	-	894	804	-	806	742	-				
Platoon blocked, %	-	-	-	-	-	-	-	-	-	-	-	-				
Mov Cap-1 Maneuver	1488	-	-	1404	-	-	638	606	871	639	609	956				
Mov Cap-2 Maneuver	-	-	-	-	-	-	638	606	-	639	609	-				
Stage 1	-	-	-	-	-	-	805	737	-	894	805	-				
Stage 2	-	-	-	-	-	-	882	802	-	792	737	-				
Approach	EB	WB	NB	SB												
HCM Control Delay, s	0.4	0.2	9.6	10.4												
HCM LOS	A	A	A	B												
Minor Lane/Major Mvmt	NBLn1	EBL	EBT	EBR	WBL	WBT	WBR	SBLn1								
Capacity (veh/h)	794	1488	-	-	1404	-	-	702								
HCM Lane V/C Ratio	0.011	0.006	-	-	0.002	-	-	0.046								
HCM Control Delay (s)	9.6	7.4	0	-	7.6	0	-	10.4								
HCM Lane LOS	A	A	A	A	A	A	A	B								
HCM 95th %tile Q(veh)	0	0	-	-	0	-	-	0.1								



Lanes, Volumes, Timings  
1: Holland & Spencer

Future Background 2025PM Peak Hour  
1186-1194 Wellington STW

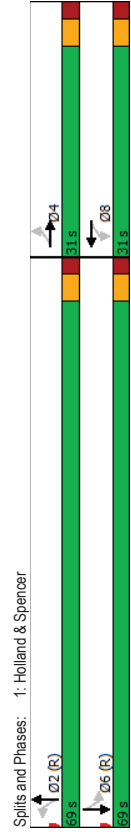
Lane Group	EBL	EBT	WBL	WBT	NBL	NBT	SBL	SBT
Lane Configurations	12	24	153	61	55	360	16	480
Traffic Volume (vph)	12	24	153	61	55	360	16	480
Future Volume (vph)	0	66	0	244	0	443	0	510
Lane Group Flow (vph)	Perm	NA	Perm	NA	Perm	NA	Perm	NA
Protected Phases	4	4	8	8	2	2	6	6
Permitted Phases	4	4	8	8	2	2	6	6
Detector Phase	4	4	8	8	2	2	6	6
Switch Phase								
Minimum Initial (s)	10.0	10.0	10.0	10.0	10.0	10.0	10.0	10.0
Minimum Split (s)	23.5	23.5	23.5	29.3	29.3	29.3	29.3	29.3
Total Split (s)	31.0	31.0	31.0	69.0	69.0	69.0	69.0	69.0
Total Split (%)	31.0%	31.0%	31.0%	69.0%	69.0%	69.0%	69.0%	69.0%
Maximum Green (s)	25.5	25.5	25.5	63.7	63.7	63.7	63.7	63.7
Yellow Time (s)	3.3	3.3	3.3	3.3	3.3	3.3	3.3	3.3
All-Red Time (s)	2.2	2.2	2.2	2.0	2.0	2.0	2.0	2.0
Lost Time Adjust (s)	0.0	0.0	0.0	0.0	0.0	0.0	0.0	0.0
Total Lost Time (s)	5.5	5.5	5.5	5.3	5.3	5.3	5.3	5.3
Lead/Lag								
Lead-Lag Optimize?								
Vehicle Extension (s)	3.0	3.0	3.0	3.0	3.0	3.0	3.0	3.0
Recall Mode	None	None	None	C-Max	C-Max	C-Max	C-Max	C-Max
Walk Time (s)	7.0	7.0	7.0	15.0	15.0	15.0	15.0	15.0
Flash Dont Walk (s)	11.0	11.0	11.0	9.0	9.0	9.0	9.0	9.0
Pedestrian Calls (#/hr)	17	17	18	18	88	88	49	49
Act Effr Green (s)	21.8	21.8	21.8	67.4	67.4	67.4	67.4	67.4
Actuated g/C Ratio	0.22	0.22	0.22	0.67	0.67	0.67	0.67	0.67
v/c Ratio	0.19	0.82	0.82	0.24	0.25	0.25	0.25	0.25
Control Delay	19.7	57.8	57.8	1.0	7.2	7.2	7.2	7.2
Queue Delay	0.0	0.0	0.0	0.0	0.0	0.0	0.0	0.0
Total Delay	19.7	57.8	57.8	1.0	7.2	7.2	7.2	7.2
LOS	B	E	E	A	A	A	A	A
Approach Delay	19.7	57.8	57.8	1.0	7.2	7.2	7.2	7.2
Approach LOS	B	E	E	A	A	A	A	A
Queue Length 50th (m)	5.5	43.1	43.1	1.0	19.0	19.0	19.0	19.0
Queue Length 95th (m)	15.7	#74.0	#74.0	2.4	28.0	28.0	28.0	28.0
Internal Link Dist (m)	151.9	132.2	132.2	211.0	210.0	210.0	210.0	210.0
Turn Bay Length (m)								
Base Capacity (vph)	405	346	346	1815	2070	2070	2070	2070
Starvation Cap Reductn	0	0	0	0	0	0	0	0
Spillback Cap Reductn	0	0	0	0	0	0	0	0
Storage Cap Reductn	0	0	0	0	0	0	0	0
Reduced v/c Ratio	0.16	0.71	0.71	0.24	0.25	0.25	0.25	0.25

Intersection Summary	
Cycle Length:	100
Actuated Cycle Length:	100
Offset:	38 (38%), Referenced to phase 2, NBT, and 6, SBT, Start of Green
Natural Cycle:	55

Lanes, Volumes, Timings  
1: Holland & Spencer

Future Background 2025PM Peak Hour  
1186-1194 Wellington STW

Control Type:	Actuated-Coordinated
Maximum v/c Ratio:	0.82
Intersection Signal Delay:	15.4
Intersection LOS:	B
Intersection Capacity Utilization:	74.6%
Analysis Period (min):	15
# 95th percentile volume exceeds capacity, queue may be longer.	
Queue shown is maximum after two cycles.	



Lanes, Volumes, Timings  
2: Holland & Wellington

Future Background 2025PM Peak Hour  
1186-1194 Wellington STW

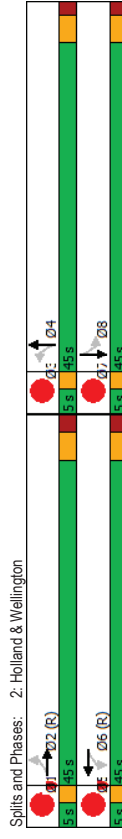
EBL	EBT	WBL	WBT	NBL	NBT	SBL	SBT	Ø1	Ø3	Ø5	Ø7
41P	41P	41P	41P	41P	41P	41P	41P				
21	336	80	485	38	398	25	652				
Future Volume (vph)	21	336	80	485	38	398	25	652			
Lane Group Flow (vph)	0	438	0	588	0	496	0	741			
Turn Type	Perm	NA	Perm	NA	Perm	NA	Perm	NA			
Protected Phases	2	2	6	6	4	4	8	1	3	5	7
Permitted Phases	2	2	6	6	4	4	8	8			
Detector Phase	2	2	6	6	4	4	8	8			
Switch Phase											
Minimum Initial (s)	10.0	10.0	10.0	10.0	10.0	10.0	10.0	1.0	1.0	1.0	1.0
Minimum Split (s)	23.6	23.6	24.5	20.1	20.1	20.1	20.1	3.0	3.0	3.0	3.0
Total Split (s)	45.0	45.0	45.0	45.0	45.0	45.0	45.0	5.0	5.0	5.0	5.0
Total Split (%)	45.0%	45.0%	45.0%	45.0%	45.0%	45.0%	45.0%	5%	5%	5%	5%
Maximum Green (s)	39.4	39.4	39.4	39.9	39.9	39.9	39.9	3.0	3.0	3.0	3.0
Yellow Time (s)	3.3	3.3	3.3	3.3	3.3	3.3	3.3	2.0	2.0	2.0	2.0
All-Red Time (s)	2.3	2.3	2.3	1.8	1.8	1.8	1.8	0.0	0.0	0.0	0.0
Lost Time Adjust (s)	0.0	0.0	0.0	0.0	0.0	0.0	0.0				
Total Lost Time (s)	5.6	5.6	5.6	5.1	5.1	5.1	5.1				
Lead/Lag	Lag	Lag	Lag	Lag	Lag	Lag	Lag	Lead	Lead	Lead	Lead
Lead-Lag Optimize?	Yes	Yes	Yes	Yes	Yes	Yes	Yes	Yes	Yes	Yes	Yes
Vehicle Extension (s)	3.0	3.0	3.0	3.0	3.0	3.0	3.0	3.0	3.0	3.0	3.0
Vehicle Extension (%)											
Recall Mode	C-Max	C-Max	C-Max	C-Max	C-Max	C-Max	C-Max	Max	Max	Max	Max
Walk Time (s)	4.0	4.0	4.0	2.0	2.0	2.0	2.0				
Pedestrian Calls (#/hr)	206	206	146	146	135	135	111				
Act Effr Green (s)	39.4	39.4	39.4	39.9	39.9	39.9	39.9				
Actuated G/C Ratio	0.39	0.39	0.39	0.40	0.40	0.40	0.40				
v/c Ratio	0.40	0.40	0.58	0.47	0.63	0.63	0.63				
Control Delay	23.3	20.5	20.5	19.9	22.5	22.5	22.5				
Queue Delay	0.0	0.0	0.0	0.0	0.0	0.0	0.0				
Total Delay	23.3	20.5	20.5	19.9	22.5	22.5	22.5				
LOS	C	C	C	B	C	C	C				
Approach Delay	23.3	20.5	20.5	19.9	22.5	22.5	22.5				
Approach LOS	C	C	C	B	C	C	C				
Queue Length 50th (m)	31.6	32.7	32.7	27.4	44.4	44.4	44.4				
Queue Length 95th (m)	44.7	m44.6	m44.6	47.2	66.4	66.4	66.4				
Internal Link Dist (m)	13.5	38.5	38.5	187.4	211.0	211.0	211.0				
Turn Bay Length (m)											
Base Capacity (vph)	1083	1014	1014	1055	1179	1179	1179				
Starvation Cap Reductn	0	0	0	0	0	0	0				
Spillback Cap Reductn	0	0	0	0	0	0	0				
Storage Cap Reductn	0	0	0	0	0	0	0				
Reduced v/c Ratio	0.40	0.58	0.58	0.47	0.63	0.63	0.63				

Intersection Summary	
Cycle Length:	100
Actuated Cycle Length:	100
Offset:	72 (72%), Referenced to phase 2,EBTL and 6:WBTL, Start of Green
Natural Cycle:	55

Lanes, Volumes, Timings  
2: Holland & Wellington

Future Background 2025PM Peak Hour  
1186-1194 Wellington STW

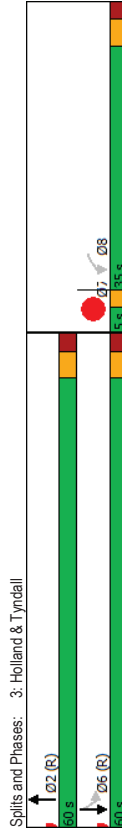
Control Type:	Actuated-Coordinated
Maximum v/c Ratio:	0.63
Intersection Signal Delay:	21.6
Intersection LOS:	C
ICU Level of Service:	E
Intersection Capacity Utilization:	68.6%
Analysis Period (min):	15
m:	Volume for 95th percentile queue is metered by upstream signal.



	WBL	NBT	SBL	SBT	Ø7
Lane Configurations	W	R	R	R	
Traffic Volume (vph)	46	595	145	585	
Future Volume (vph)	46	595	145	585	
Lane Group Flow (vph)	227	620	145	585	
Turn Type	Perm	NA	Perm	NA	
Protected Phases		2	6	6	7
Permitted Phases	8	2	6	6	
Detector Phase	8	2	6	6	
Switch Phase					
Minimum Initial (s)	10.0	10.0	10.0	10.0	1.0
Minimum Split (s)	23.5	25.7	15.7	15.7	3.0
Total Split (s)	35.0	60.0	60.0	60.0	5.0
Total Split (%)	35.0%	60.0%	60.0%	60.0%	5%
Maximum Green (s)	29.5	54.3	54.3	54.3	3.0
Yellow Time (s)	3.3	3.3	3.3	3.3	2.0
All-Red Time (s)	2.2	2.4	2.4	2.4	0.0
Lost Time Adjust (s)	0.0	0.0	0.0	0.0	0.0
Total Lost Time (s)	5.5	5.7	5.7	5.7	
Lead/Lag					Lead
Lead-Lag Optimize?	Yes				Yes
Vehicle Extension (s)	3.0	3.0	3.0	3.0	3.0
Recall Mode	None	C-Max	C-Max	C-Max	Max
Walk Time (s)	5.0	10.0			
Pedestrian Calls (#/hr)	15	20			
Act Effr Green (s)	20.7	63.1	63.1	63.1	
Actuated g/C Ratio	0.21	0.63	0.63	0.63	
v/c Ratio	0.75	0.57	0.40	0.53	
Control Delay	51.8	14.3	8.0	7.4	
Queue Delay	0.0	0.0	0.0	0.0	
Total Delay	51.8	14.3	8.0	7.4	
LOS	D	B	A	A	
Approach Delay	51.8	14.3	7.5		
Approach LOS	D	B	A		
Queue Length 50th (m)	41.5	62.9	5.2	23.7	
Queue Length 95th (m)	60.9	114.8	12.1	39.9	
Internal Link Dist (m)	141.9	156.5		27.0	
Turn Bay Length (m)					
Base Capacity (vph)	432	1093	365	1101	
Starvation Cap Reductn	0	0	0	0	
Spillback Cap Reductn	0	0	0	0	
Storage Cap Reductn	0	0	0	0	
Reduced v/c Ratio	0.53	0.57	0.40	0.53	

Intersection Summary	
Cycle Length:	100
Actuated Cycle Length:	100
Offset:	24 (24%), Referenced to phase 2:NBT and 6:SBTL, Start of Green
Natural Cycle:	60

Control Type:	Actuated-Coordinated
Maximum v/c Ratio:	0.75
Intersection Signal Delay:	16.6
ICU Level of Service:	B
Intersection Capacity Utilization:	72.7%
Analysis Period (min):	15
m:	Volume for 95th percentile queue is metered by upstream signal.



Lanes, Volumes, Timings  
4: Parkdale & Armstrong

Future Background 2025PM Peak Hour  
1186-1194 Wellington STW

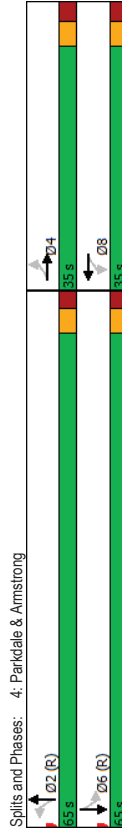
	EBL	EBT	WBL	WBT	NBL	NBT	SBL	SBT
Lane Group	EBL	EBT	WBL	WBT	NBL	NBT	SBL	SBT
Lane Configurations	34	63	39	160	13	501	15	325
Traffic Volume (vph)	34	63	39	160	13	501	15	325
Future Volume (vph)	0	134	0	220	0	536	0	366
Lane Group Flow (vph)	Perm	NA	Perm	NA	Perm	NA	Perm	NA
Turn Type	4	8	8	2	2	6	6	6
Protected Phases	4	8	8	2	2	6	6	6
Permitted Phases	4	8	8	2	2	6	6	6
Detector Phase	4	8	8	2	2	6	6	6
Switch Phase	4	8	8	2	2	6	6	6
Minimum Initial (s)	10.0	10.0	10.0	10.0	10.0	10.0	10.0	10.0
Minimum Split (s)	23.5	23.5	23.5	25.2	25.2	25.2	25.2	25.2
Total Split (s)	35.0	35.0	35.0	35.0	65.0	65.0	65.0	65.0
Total Split (%)	35.0%	35.0%	35.0%	35.0%	65.0%	65.0%	65.0%	65.0%
Maximum Green (s)	29.5	29.5	29.5	29.5	59.8	59.8	59.8	59.8
Yellow Time (s)	3.0	3.0	3.0	3.0	3.0	3.0	3.0	3.0
All-Red Time (s)	2.5	2.5	2.5	2.2	2.2	2.2	2.2	2.2
Lost Time Adjust (s)	0.0	0.0	0.0	0.0	0.0	0.0	0.0	0.0
Total Lost Time (s)	5.5	5.5	5.5	5.2	5.2	5.2	5.2	5.2
Lead/Lag								
Lead-Lag Optimize?								
Vehicle Extension (s)	3.0	3.0	3.0	3.0	3.0	3.0	3.0	3.0
Recall Mode	Max	Max	Max	C-Max	C-Max	C-Max	C-Max	C-Max
Walk Time (s)	10.0	10.0	10.0	10.0	15.0	15.0	15.0	15.0
Flash Dont Walk (s)	8.0	8.0	8.0	8.0	5.0	5.0	5.0	5.0
Pedestrian Calls (#/hr)	19	19	30	30	35	35	22	22
Act Effr Green (s)	29.5	29.5	29.5	29.5	59.8	59.8	59.8	59.8
Actuated g/C Ratio	0.30	0.30	0.30	0.47	0.52	0.35	0.35	0.35
v/c Ratio	25.5	32.2	32.2	5.0	5.0	11.4	11.4	11.4
Control Delay	0.0	0.0	0.0	0.5	0.5	0.0	0.0	0.0
Queue Delay	25.5	32.2	32.2	5.5	5.5	11.4	11.4	11.4
Total Delay	25.5	32.2	32.2	5.5	5.5	11.4	11.4	11.4
LOS	C	C	C	A	A	B	B	B
Approach Delay	25.5	32.2	32.2	5.5	5.5	11.4	11.4	11.4
Approach LOS	C	C	C	A	A	B	B	B
Queue Length 50th (m)	17.0	34.0	34.0	7.7	7.7	32.2	32.2	32.2
Queue Length 95th (m)	32.5	55.7	55.7	m9.3	m9.3	49.3	49.3	49.3
Internal Link Dist (m)	46.6	196.9	196.9	125.2	125.2	312.1	312.1	312.1
Turn Bay Length (m)								
Base Capacity (vph)	442	466	466	1021	1021	1006	1006	1006
Starvation Cap Reductn	0	0	0	177	177	0	0	0
Spillback Cap Reductn	0	0	0	0	0	0	0	0
Storage Cap Reductn	0	0	0	0	0	0	0	0
Reduced v/c Ratio	0.30	0.47	0.47	0.64	0.64	0.35	0.35	0.35

Intersection Summary	
Cycle Length:	100
Actuated Cycle Length:	100
Offset:	20 (20%), Referenced to phase 2, NBT, and 6, SBT, Start of Green
Natural Cycle:	55

Lanes, Volumes, Timings  
4: Parkdale & Armstrong

Future Background 2025PM Peak Hour  
1186-1194 Wellington STW

Control Type:	Actuated-Coordinated
Maximum v/c Ratio:	0.52
Intersection Signal Delay:	14.0
Intersection LOS:	B
Intersection Capacity Utilization:	58.5%
Analysis Period (min):	15
m. Volume for 95th percentile queue is metered by upstream signal.	



Lanes, Volumes, Timings  
5: Parkdale & Wellington

Future Background 2025PM Peak Hour  
1186-1194 Wellington STW

EBL	EBT	WBL	WBT	NBL	NBT	SBL	SBT	Ø1	Ø3	Ø5	Ø7
17	247	47	318	143	548	19	392				
17	247	47	318	143	548	19	392				
0	332	47	344	143	602	19	443				
Perm	NA	Perm	NA	pm-pt	NA	Perm	NA				
2	2	6	6	13	4	8	8	1	3	5	7
2	2	6	6	13	4	8	8				
10.0	10.0	10.0	10.0	5.0	10.0	10.0	10.0	1.0	1.0	1.0	1.0
23.4	23.4	23.4	23.4	10.2	15.5	20.5	20.5	3.0	3.0	3.0	3.0
29.0	29.0	29.0	29.0	14.0	61.0	47.0	47.0	5.0	5.0	5.0	5.0
29.0%	29.0%	29.0%	29.0%	14.0%	61.0%	47.0%	47.0%	5%	5%	5%	5%
23.6	23.6	23.6	23.6	8.8	55.5	41.5	41.5	3.0	3.0	3.0	3.0
3.3	3.3	3.3	3.3	3.0	3.0	3.0	3.0	2.0	2.0	2.0	2.0
2.1	2.1	2.1	2.1	2.2	2.5	2.5	2.5	0.0	0.0	0.0	0.0
0.0	0.0	0.0	0.0	0.0	0.0	0.0	0.0	0.0	0.0	0.0	0.0
5.4	5.4	5.4	5.4	5.2	5.5	5.5	5.5				
Lag	Lag	Lag	Lag	Lead	Lead	Lead	Lead				
Yes	Yes	Yes	Yes	Yes	Yes	Yes	Yes				
3.0	3.0	3.0	3.0	3.0	3.0	3.0	3.0	3.0	3.0	3.0	3.0
C-Max	C-Max	C-Max	C-Max	Max	Max	Max	Max	Max	Max	Max	Max
5.0	5.0	5.0	5.0	2.0	2.0	2.0	2.0				
8.0	8.0	8.0	8.0	8.0	8.0	8.0	8.0				
153	153	142	142	76	72	72	72				
23.6	23.6	23.6	23.6	60.8	55.5	41.5	41.5				
0.24	0.24	0.24	0.24	0.61	0.56	0.42	0.42				
0.58	0.58	0.33	0.88	0.36	0.64	0.07	0.65				
60.8	39.5	61.7	11.0	16.5	15.3	22.5	22.5				
0.0	0.0	0.0	0.0	0.6	0.0	0.3	0.3				
60.8	39.5	61.7	11.0	17.1	15.3	22.8	22.8				
E	D	E	B	B	B	C	C				
60.8	59.0	59.0	15.9	22.5	22.5						
E	E	E	B	C	C						
34.4	7.6	64.5	10.5	56.1	1.8	45.2					
49.3	18.7	#112.9	m17.1	82.3	m4.9	61.0					
55.1	42.0	139.5	125.2								
30.0	30.0	40.0	40.0								
568	141	391	333	935	269	681					
0	0	0	0	94	0	35					
0	0	0	0	0	0	0					
0	0	0	0	0	0	0					
0.58	0.33	0.88	0.36	0.72	0.07	0.69					

Intersection Summary	
Cycle Length:	100
Actuated Cycle Length:	100
Offset:	70 (70%), Referenced to phase 2,EBTL and 6:WBTL, Start of Green
Natural Cycle:	65

Lanes, Volumes, Timings  
5: Parkdale & Wellington

Future Background 2025PM Peak Hour  
1186-1194 Wellington STW

Control Type:	Actuated-Coordinated
Maximum v/c Ratio:	0.88
Intersection Signal Delay:	33.9
Intersection LOS:	C
Intersection Capacity Utilization:	92.2%
ICU Level of Service:	F
Analysis Period (min):	15
# 95th percentile volume exceeds capacity, queue may be longer.	
Queue shown is maximum after two cycles.	
m Volume for 95th percentile queue is metered by upstream signal.	



Lanes, Volumes, Timings  
6: Parkdale & Gladstone

Lanes, Volumes, Timings  
6: Parkdale & Gladstone

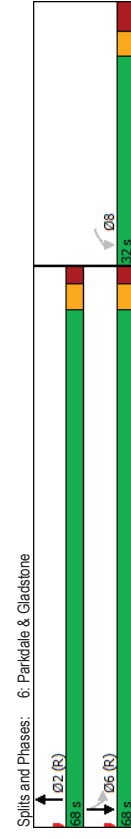
Future Background 2025PM Peak Hour  
1186-1194 Wellington STW

Future Background 2025PM Peak Hour  
1186-1194 Wellington STW

Lane Group	WBL	NBT	SBL	SBT
Lane Configurations	W	T	T	T
Traffic Volume (vph)	215	626	40	393
Future Volume (vph)	215	626	40	393
Lane Group Flow (vph)	281	784	40	393
Turn Type	Perm	NA	Perm	NA
Protected Phases	8	2	6	6
Permitted Phases	8	2	6	6
Detector Phase	8	2	6	6
Switch Phase				
Minimum Initial (s)	10.0	10.0	10.0	10.0
Minimum Split (s)	22.7	20.3	15.3	15.3
Total Split (s)	32.0	68.0	68.0	68.0
Total Split (%)	32.0%	68.0%	68.0%	68.0%
Maximum Green (s)	25.3	62.7	62.7	62.7
Yellow Time (s)	3.0	3.0	3.0	3.0
All-Red Time (s)	3.7	2.3	2.3	2.3
Lost Time Adjust (s)	0.0	0.0	0.0	0.0
Total Lost Time (s)	6.7	5.3	5.3	5.3
Lead/Lag				
Lead-Lag Optimize?				
Vehicle Extension (s)	3.0	3.0	3.0	3.0
Recall Mode	Max	C-Max	C-Max	C-Max
Walk Time (s)	7.0	7.0		
Flash Dont Walk (s)	9.0	8.0		
Pedestrian Calls (#/hr)	25	19		
Act Effr Green (s)	25.3	62.7	62.7	62.7
Actuated g/C Ratio	0.25	0.63	0.63	0.63
v/c Ratio	0.73	0.75	0.16	0.36
Control Delay	46.8	15.3	5.9	5.7
Queue Delay	0.0	0.2	0.0	0.1
Total Delay	46.8	15.5	5.9	5.8
LOS	D	B	A	A
Approach Delay	46.8	15.5	5.8	5.8
Approach LOS	D	B	A	A
Queue Length 50th (m)	50.0	69.9	1.9	18.9
Queue Length 95th (m)	#84.4	m105.8	m3.2	25.5
Internal Link Dist (m)	224.2	197.3		139.5
Turn Bay Length (m)			85.0	
Base Capacity (vph)	385	1047	252	1094
Starvation Cap Reductn	0	20	0	0
Spillback Cap Reductn	0	0	0	83
Storage Cap Reductn	0	0	0	0
Reduced v/c Ratio	0.73	0.76	0.16	0.39

Intersection Summary	
Cycle Length:	100
Actuated Cycle Length:	100
Offset:	12 (12%), Referenced to phase 2:NBT and 6:SBTL, Start of Green
Natural Cycle:	60

Control Type:	Actuated-Coordinated
Maximum v/c Ratio:	0.75
Intersection Signal Delay:	18.6
Intersection LOS:	B
Intersection Capacity Utilization:	72.7%
ICU Level of Service:	C
Analysis Period (min):	15
# 95th percentile volume exceeds capacity, queue may be longer.	
Queue shown is maximum after two cycles.	
m Volume for 95th percentile queue is metered by upstream signal.	



Splits and Phases: 6: Parkdale & Gladstone

Lanes, Volumes, Timings  
7: Parkdale & 417 WB OR

Lanes, Volumes, Timings  
7: Parkdale & 417 WB OR

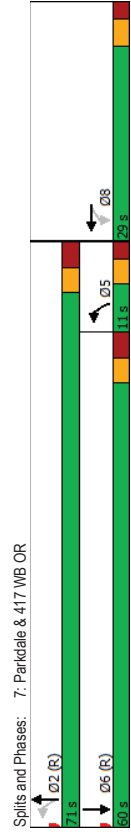
Future Background 2025PM Peak Hour  
1186-1194 Wellington STW

Future Background 2025PM Peak Hour  
1186-1194 Wellington STW

Lane Group	WBL	WBT	NBL	NBT	SBT
Lane Configurations	←	←	←	←	←
Traffic Volume (vph)	334	24	84	592	587
Future Volume (vph)	334	24	84	592	587
Lane Group Flow (vph)	334	535	84	592	820
Turn Type	Perm	NA	pm-pt	NA	NA
Protected Phases	8	5	2	2	6
Permitted Phases	8	5	2	2	6
Detector Phase	8	8	5	2	6
Switch Phase					
Minimum Initial (s)	10.0	10.0	5.0	10.0	10.0
Minimum Split (s)	20.5	20.5	10.2	27.3	21.3
Total Split (s)	29.0	29.0	11.0	71.0	60.0
Total Split (%)	29.0%	29.0%	11.0%	71.0%	60.0%
Maximum Green (s)	23.5	23.5	5.8	64.7	53.7
Yellow Time (s)	3.3	3.3	3.0	3.0	3.0
All-Red Time (s)	2.2	2.2	2.2	3.3	3.3
Lost Time Adjust (s)	0.0	0.0	0.0	0.0	0.0
Total Lost Time (s)	5.5	5.5	5.2	6.3	6.3
Lead/Lag			Lag	Lead	
Lead-Lag Optimize?			Yes	Yes	
Vehicle Extension (s)	3.0	3.0	3.0	3.0	3.0
Recall Mode	None	None	None	C-Max	C-Max
Walk Time (s)	7.0	7.0	7.0	7.0	7.0
Flash Dont Walk (s)	8.0	8.0	14.0	8.0	8.0
Pedestrian Calls (#/hr)	3	3		21	13
Act Effct Green (s)	22.5	22.5	66.8	65.7	56.9
Actuated g/C Ratio	0.22	0.22	0.67	0.66	0.57
v/c Ratio	0.90	0.95	0.29	0.52	0.86
Control Delay	65.0	44.5	11.9	11.1	30.1
Queue Delay	0.0	0.0	0.0	0.0	0.0
Total Delay	65.0	44.5	11.9	11.1	30.1
LOS	E	D	B	B	C
Approach Delay	52.4		11.2	30.1	
Approach LOS	D		B	C	
Queue Length 50th (m)	62.2	47.9	5.3	55.6	148.7
Queue Length 95th (m)	#108.8	#113.5	10.3	81.2	#222.3
Internal Link Dist (m)	462.5		38.8	197.3	
Turn Bay Length (m)					
Base Capacity (vph)	389	575	288	1146	949
Starvation Cap Reductn	0	0	0	0	0
Spillback Cap Reductn	0	0	0	0	0
Storage Cap Reductn	0	0	0	0	0
Reduced v/c Ratio	0.86	0.93	0.29	0.52	0.86

Intersection Summary	
Cycle Length:	100
Actuated Cycle Length:	100
Offset:	39 (39%), Referenced to phase 2, NBL and 6: SBT, Start of Green
Natural Cycle:	90

Control Type:	Actuated-Coordinated
Maximum v/c Ratio:	0.95
Intersection Signal Delay:	32.9
Intersection LOS:	C
Intersection Capacity Utilization:	102.0%
IOU Level of Service:	G
Analysis Period (min):	15
# 95th percentile volume exceeds capacity, queue may be longer.	
Queue shown is maximum after two cycles.	



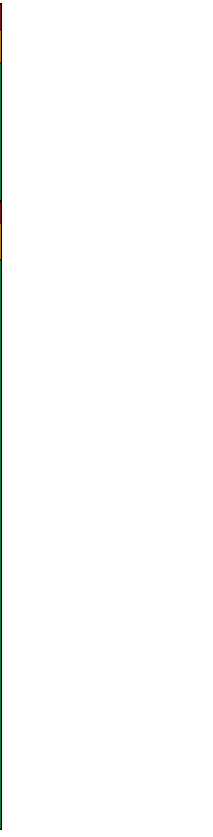
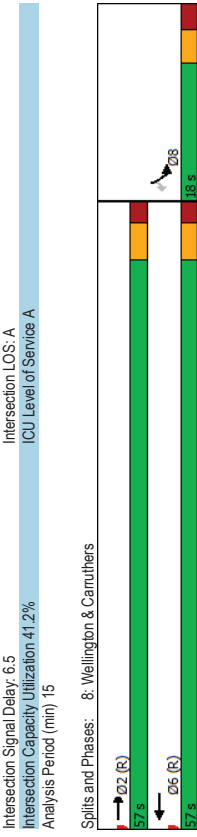
Lanes, Volumes, Timings  
8: Wellington & Carruthers

Lanes, Volumes, Timings  
8: Wellington & Carruthers



Lane Group	EBT	WBT	SBL	SBR
Lane Configurations	←	←	←	←
Traffic Volume (vph)	394	407	54	20
Future Volume (vph)	394	407	54	20
Lane Group Flow (vph)	394	407	54	20
Turn Type	NA	NA	Prot	Perm
Protected Phases	2	6	8	8
Permitted Phases	2	6	8	8
Detector Phase	2	6	8	8
Switch Phase				
Minimum Initial (s)	10.0	10.0	10.0	10.0
Minimum Split (s)	15.3	26.3	17.5	17.5
Total Split (s)	57.0	57.0	18.0	18.0
Total Split (%)	76.0%	76.0%	24.0%	24.0%
Maximum Green (s)	51.7	51.7	12.5	12.5
Yellow Time (s)	3.3	3.3	3.0	3.0
All-Red Time (s)	2.0	2.0	2.5	2.5
Lost Time Adjust (s)	0.0	0.0	0.0	0.0
Total Lost Time (s)	5.3	5.3	5.5	5.5
Lead/Lag				
Lead-Lag Optimize?				
Vehicle Extension (s)	3.0	3.0	3.0	3.0
Recall Mode	C-Mix	C-Mix	None	None
Walk Time (s)	14.0	7.0	7.0	7.0
Flash Dont Walk (s)	7.0	5.0	5.0	6.2
Pedestrian Calls (#/hr)	157	62	11.2	11.2
Act Effct Green (s)	57.2	57.2	11.2	11.2
Actuated g/C Ratio	0.76	0.76	0.15	0.15
v/c Ratio	0.30	0.31	0.22	0.10
Control Delay	4.6	4.7	30.1	13.6
Queue Delay	0.0	0.0	0.0	0.0
Total Delay	4.6	4.7	30.1	13.6
LOS	A	A	C	B
Approach Delay	4.6	4.7	25.6	
Approach LOS	A	A	C	
Queue Length 50th (m)	18.1	18.9	6.7	0.0
Queue Length 95th (m)	29.2	30.3	16.1	5.5
Internal Link Dist (m)	149.3	153.4	73.2	
Turn Bay Length (m)			30.0	
Base Capacity (vph)	1330	1330	276	227
Starvation Cap Reductn	0	0	0	0
Spillover Cap Reductn	0	0	0	0
Storage Cap Reductn	0	0	0	0
Reduced v/c Ratio	0.30	0.31	0.20	0.09
<b>Intersection Summary</b>				
Cycle Length: 75				
Actuated Cycle Length: 75				
Offset: 72 (96%), Referenced to phase 2,EBT and 6:WBT, Start of Green				
Natural Cycle: 45				

Control Type	Actuated-Coordinated
Maximum v/c Ratio: 0.31	
Intersection Signal Delay: 6.5	Intersection LOS: A
Intersection Capacity Utilization 41.2%	ICU Level of Service A
Analysis Period (min): 15	



Splits and Phases: 8: Wellington & Carruthers



Intersection													
Int'Delay, s/veh													
1.8													
Movement	EBL	EBT	EBR	WBL	WBT	WBR	NBL	NBT	NBR	SBL	SBT	SBR	
Lane Configurations	+	+	+	+	+	+	+	+	+	+	+	+	+
Traffic Vol, veh/h	10	303	23	13	339	13	5	8	16	9	21	31	
Future Vol, veh/h	10	303	23	13	339	13	5	8	16	9	21	31	
Conflicting Peds. #/hr	0	0	0	0	0	0	0	0	0	0	0	0	0
Sign Control	Free	Free	Free	Free	Free	Free	Free	Free	Free	Free	Free	Free	Free
RT Channelized	-	-	-	-	-	-	-	-	-	-	-	-	-
Storage Length	-	-	-	-	-	-	-	-	-	-	-	-	-
Veh in Median Storage, #	-	0	-	-	0	-	-	0	-	-	-	0	-
Grade, %	-	0	-	-	0	-	-	0	-	-	-	0	-
Peak Hour Factor	100	100	100	100	100	100	100	100	100	100	100	100	100
Heavy Vehicles, %	2	2	2	2	2	2	2	2	2	2	2	2	2
Mvmt Flow	10	303	23	13	339	13	5	8	16	9	21	31	
Major/Minor	Major1	Major2	Minor1	Minor2									
Conflicting Flow All	352	0	0	326	0	0	733	713	315	719	718	346	
Stage 1	-	-	-	-	-	-	335	335	-	372	372	-	
Stage 2	-	-	-	-	-	-	398	378	-	347	346	-	
Critical Hwy	4.12	-	-	4.12	-	-	7.12	6.52	6.22	7.12	6.52	6.22	
Critical Hwy Stg 1	-	-	-	-	-	-	6.12	5.52	-	6.12	5.52	-	
Critical Hwy Stg 2	-	-	-	-	-	-	6.12	5.52	-	6.12	5.52	-	
Follow-up Hwy	2.218	-	-	2.218	-	-	3.518	4.018	3.318	3.518	4.018	3.318	
Pot Cap-1 Maneuver	1207	-	-	1234	-	-	336	357	725	344	355	697	
Stage 1	-	-	-	-	-	-	679	643	-	648	619	-	
Stage 2	-	-	-	-	-	-	628	615	-	669	635	-	
Platoon blocked, %	-	-	-	-	-	-	-	-	-	-	-	-	
Mov Cap-1 Maneuver	1207	-	-	1234	-	-	301	349	725	325	347	697	
Mov Cap-2 Maneuver	-	-	-	-	-	-	301	349	-	325	347	-	
Stage 1	-	-	-	-	-	-	672	637	-	642	611	-	
Stage 2	-	-	-	-	-	-	572	607	-	640	629	-	
Approach	EB	WB	NB	SB									
HCM Control Delay, s	0.2	0.3	13.1	14									
HCM LOS	B	B	B	B									
Minor Lane/Major Mvmt	NBLn1	EBL	EBT	EBR	WBL	WBT	WBR	SBLn1					
Capacity (veh/h)	471	1207	-	-	1234	-	-	460					
HCM Lane V/C Ratio	0.062	0.008	-	-	0.011	-	-	0.133					
HCM Control Delay (s)	13.1	8	0	0	7.9	0	0	14					
HCM Lane LOS	B	A	A	A	A	A	A	B					
HCM 95th %ile Q(veh)	0.2	0	-	-	0	-	-	0.5					

Intersection													
Int'Delay, s/veh													
2													
Movement	EBL	EBT	EBR	WBL	WBT	WBR	NBL	NBT	NBR	SBL	SBT	SBR	
Lane Configurations	+	+	+	+	+	+	+	+	+	+	+	+	+
Traffic Vol, veh/h	14	164	2	2	114	10	3	3	1	26	2	22	
Future Vol, veh/h	14	164	2	2	114	10	3	3	1	26	2	22	
Conflicting Peds. #/hr	0	0	0	0	0	0	0	0	0	0	0	0	0
Sign Control	Free	Free	Free	Free	Free	Free	Free	Free	Free	Free	Free	Free	Free
RT Channelized	-	-	-	-	-	-	-	-	-	-	-	-	-
Storage Length	-	-	-	-	-	-	-	-	-	-	-	-	-
Veh in Median Storage, #	-	0	-	-	0	-	-	0	-	-	-	0	-
Grade, %	-	0	-	-	0	-	-	0	-	-	-	0	-
Peak Hour Factor	100	100	100	100	100	100	100	100	100	100	100	100	100
Heavy Vehicles, %	2	2	2	2	2	2	2	2	2	2	2	2	2
Mvmt Flow	14	164	2	2	114	10	3	3	1	26	2	22	
Major/Minor	Major1	Major2	Minor1	Minor2									
Conflicting Flow All	124	0	0	166	0	0	328	321	165	318	317	119	
Stage 1	-	-	-	-	-	-	193	193	-	123	123	-	
Stage 2	-	-	-	-	-	-	135	128	-	195	194	-	
Critical Hwy	4.12	-	-	4.12	-	-	7.12	6.52	6.22	7.12	6.52	6.22	
Critical Hwy Stg 1	-	-	-	-	-	-	6.12	5.52	-	6.12	5.52	-	
Critical Hwy Stg 2	-	-	-	-	-	-	6.12	5.52	-	6.12	5.52	-	
Follow-up Hwy	2.218	-	-	2.218	-	-	3.518	4.018	3.318	3.518	4.018	3.318	
Pot Cap-1 Maneuver	1463	-	-	1412	-	-	625	566	879	635	599	933	
Stage 1	-	-	-	-	-	-	809	741	-	881	794	-	
Stage 2	-	-	-	-	-	-	868	790	-	807	740	-	
Platoon blocked, %	-	-	-	-	-	-	-	-	-	-	-	-	
Mov Cap-1 Maneuver	1463	-	-	1412	-	-	603	588	879	625	591	933	
Mov Cap-2 Maneuver	-	-	-	-	-	-	603	588	-	625	591	-	
Stage 1	-	-	-	-	-	-	800	733	-	871	792	-	
Stage 2	-	-	-	-	-	-	844	788	-	794	732	-	
Approach	EB	WB	NB	SB									
HCM Control Delay, s	0.6	0.1	10.8	10.3									
HCM LOS	B	B	B	B									
Minor Lane/Major Mvmt	NBLn1	EBL	EBT	EBR	WBL	WBT	WBR	SBLn1					
Capacity (veh/h)	624	1463	-	-	1412	-	-	729					
HCM Lane V/C Ratio	0.011	0.01	-	-	0.001	-	-	0.069					
HCM Control Delay (s)	10.8	7.5	0	0	7.6	0	0	10.3					
HCM Lane LOS	B	A	A	A	A	A	A	B					
HCM 95th %ile Q(veh)	0	0	-	-	0	-	-	0.2					

# Appendix G

Synchro Intersection Worksheets – 2030 Future Background Conditions

Lanes, Volumes, Timings  
1: Holland & Spencer

Future Background 2030AM Peak Hour  
1186-1194 Wellington STW

Lane Group	EBL	EBT	WBL	WBT	NBL	NBT	SBL	SBT
Lane Configurations	8	11	57	4	10	534	10	334
Traffic Volume (vph)	8	11	57	4	10	534	10	334
Future Volume (vph)	0	50	0	113	0	565	0	349
Lane Group Flow (vph)	Perm	NA	Perm	NA	Perm	NA	Perm	NA
Turn Type	4	8	8	2	2	6	6	6
Protected Phases	4	8	8	2	2	6	6	6
Permitted Phases	4	8	8	2	2	6	6	6
Detector Phase	4	8	8	2	2	6	6	6
Switch Phase	4	8	8	2	2	6	6	6
Minimum Initial (s)	10.0	10.0	10.0	10.0	10.0	10.0	10.0	10.0
Minimum Split (s)	23.5	23.5	23.5	29.3	29.3	29.3	29.3	29.3
Total Split (s)	24.0	24.0	24.0	76.0	76.0	76.0	76.0	76.0
Total Split (%)	24.0%	24.0%	24.0%	76.0%	76.0%	76.0%	76.0%	76.0%
Maximum Green (s)	18.5	18.5	18.5	70.7	70.7	70.7	70.7	70.7
Yellow Time (s)	3.3	3.3	3.3	3.3	3.3	3.3	3.3	3.3
All-Red Time (s)	2.2	2.2	2.2	2.0	2.0	2.0	2.0	2.0
Lost Time Adjust (s)	0.0	0.0	0.0	0.0	0.0	0.0	0.0	0.0
Total Lost Time (s)	5.5	5.5	5.5	5.3	5.3	5.3	5.3	5.3
Lead/Lag								
Lead-Lag Optimize?								
Vehicle Extension (s)	3.0	3.0	3.0	3.0	3.0	3.0	3.0	3.0
Recall Mode	None	None	None	None	C-Max	C-Max	C-Max	C-Max
Walk Time (s)	7.0	7.0	7.0	15.0	15.0	15.0	15.0	15.0
Flash Dont Walk (s)	11.0	11.0	11.0	11.0	9.0	9.0	9.0	9.0
Pedestrian Calls (#/hr)	17	17	11	11	60	60	32	32
Act Effr Green (s)	13.4	13.4	13.4	0.13	0.76	0.76	0.76	0.76
Actuated g/C Ratio	0.13	0.22	0.55	0.24	0.24	0.15	0.15	0.15
v/c Ratio	21.0	36.4	0.9	3.8	0.9	3.8	0.9	3.8
Control Delay	0.0	0.0	0.0	0.0	0.0	0.0	0.0	0.0
Queue Delay	21.0	36.4	0.9	3.8	0.9	3.8	0.9	3.8
Total Delay	21.0	36.4	0.9	3.8	0.9	3.8	0.9	3.8
LOS	C	D	A	A	A	A	A	A
Approach Delay	21.0	36.4	0.9	3.8	0.9	3.8	0.9	3.8
Approach LOS	C	D	A	A	A	A	A	A
Queue Length 50th (m)	3.4	13.9	1.4	6.9	1.4	6.9	1.4	6.9
Queue Length 95th (m)	13.0	29.3	4.5	14.3	4.5	14.3	4.5	14.3
Internal Link Dist (m)	151.9	132.2	211.0	210.0	210.0	210.0	210.0	210.0
Turn Bay Length (m)								
Base Capacity (vph)	299	270	2355	2347	2355	2347	2355	2347
Starvation Cap Reductn	0	0	0	0	0	0	0	0
Spillback Cap Reductn	0	0	0	0	0	0	0	0
Storage Cap Reductn	0	0	0	0	0	0	0	0
Reduced v/c Ratio	0.17	0.42	0.24	0.15	0.24	0.15	0.15	0.15

Intersection Summary	
Cycle Length:	100
Actuated Cycle Length:	100
Offset:	40 (40%), Referenced to phase 2, NBT, and 6, SBT, Start of Green
Natural Cycle:	55

Lanes, Volumes, Timings  
1: Holland & Spencer

Future Background 2030AM Peak Hour  
1186-1194 Wellington STW

Lane Group	EBL	EBT	WBL	WBT	NBL	NBT	SBL	SBT
Lane Configurations	8	11	57	4	10	534	10	334
Traffic Volume (vph)	8	11	57	4	10	534	10	334
Future Volume (vph)	0	50	0	113	0	565	0	349
Lane Group Flow (vph)	Perm	NA	Perm	NA	Perm	NA	Perm	NA
Turn Type	4	8	8	2	2	6	6	6
Protected Phases	4	8	8	2	2	6	6	6
Permitted Phases	4	8	8	2	2	6	6	6
Detector Phase	4	8	8	2	2	6	6	6
Switch Phase	4	8	8	2	2	6	6	6
Minimum Initial (s)	10.0	10.0	10.0	10.0	10.0	10.0	10.0	10.0
Minimum Split (s)	23.5	23.5	23.5	29.3	29.3	29.3	29.3	29.3
Total Split (s)	24.0	24.0	24.0	76.0	76.0	76.0	76.0	76.0
Total Split (%)	24.0%	24.0%	24.0%	76.0%	76.0%	76.0%	76.0%	76.0%
Maximum Green (s)	18.5	18.5	18.5	70.7	70.7	70.7	70.7	70.7
Yellow Time (s)	3.3	3.3	3.3	3.3	3.3	3.3	3.3	3.3
All-Red Time (s)	2.2	2.2	2.2	2.0	2.0	2.0	2.0	2.0
Lost Time Adjust (s)	0.0	0.0	0.0	0.0	0.0	0.0	0.0	0.0
Total Lost Time (s)	5.5	5.5	5.5	5.3	5.3	5.3	5.3	5.3
Lead/Lag								
Lead-Lag Optimize?								
Vehicle Extension (s)	3.0	3.0	3.0	3.0	3.0	3.0	3.0	3.0
Recall Mode	None	None	None	None	C-Max	C-Max	C-Max	C-Max
Walk Time (s)	7.0	7.0	7.0	15.0	15.0	15.0	15.0	15.0
Flash Dont Walk (s)	11.0	11.0	11.0	11.0	9.0	9.0	9.0	9.0
Pedestrian Calls (#/hr)	17	17	11	11	60	60	32	32
Act Effr Green (s)	13.4	13.4	13.4	0.13	0.76	0.76	0.76	0.76
Actuated g/C Ratio	0.13	0.22	0.55	0.24	0.24	0.15	0.15	0.15
v/c Ratio	21.0	36.4	0.9	3.8	0.9	3.8	0.9	3.8
Control Delay	0.0	0.0	0.0	0.0	0.0	0.0	0.0	0.0
Queue Delay	21.0	36.4	0.9	3.8	0.9	3.8	0.9	3.8
Total Delay	21.0	36.4	0.9	3.8	0.9	3.8	0.9	3.8
LOS	C	D	A	A	A	A	A	A
Approach Delay	21.0	36.4	0.9	3.8	0.9	3.8	0.9	3.8
Approach LOS	C	D	A	A	A	A	A	A
Queue Length 50th (m)	3.4	13.9	1.4	6.9	1.4	6.9	1.4	6.9
Queue Length 95th (m)	13.0	29.3	4.5	14.3	4.5	14.3	4.5	14.3
Internal Link Dist (m)	151.9	132.2	211.0	210.0	210.0	210.0	210.0	210.0
Turn Bay Length (m)								
Base Capacity (vph)	299	270	2355	2347	2355	2347	2355	2347
Starvation Cap Reductn	0	0	0	0	0	0	0	0
Spillback Cap Reductn	0	0	0	0	0	0	0	0
Storage Cap Reductn	0	0	0	0	0	0	0	0
Reduced v/c Ratio	0.17	0.42	0.24	0.15	0.24	0.15	0.15	0.15



Control Type	Actuated-Coordinated
Maximum v/c Ratio:	0.55
Intersection Signal Delay:	6.5
Intersection LOS:	A
ICU Level of Service A	
Intersection Capacity Utilization:	47.4%
Analysis Period (min):	15

Lanes, Volumes, Timings  
2: Holland & Wellington

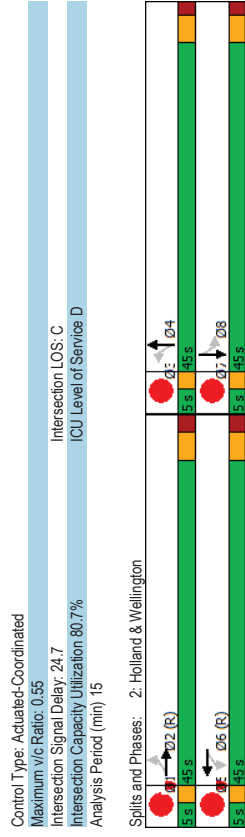
Lanes, Volumes, Timings  
2: Holland & Wellington

Future Background 2030AM Peak Hour  
1186-1194 Wellington STW

Future Background 2030AM Peak Hour  
1186-1194 Wellington STW

EBL	EBT	WBL	WBT	NBL	NBT	SBL	SBT	Ø1	Ø3	Ø5	Ø7
38	377	48	253	45	520	23	414				
38	377	48	253	45	520	23	414				
0	478	0	342	0	616	0	463				
Perm	NA	Perm	NA	Perm	NA	Perm	NA	3	5	7	
2	2	6	6	4	4	8	8				
2	2	6	6	4	4	8	8				
10.0	10.0	10.0	10.0	10.0	10.0	10.0	10.0	1.0	1.0	1.0	1.0
23.6	23.6	24.5	24.5	20.1	20.1	20.1	20.1	3.0	3.0	3.0	3.0
45.0	45.0	45.0	45.0	45.0	45.0	45.0	45.0	5.0	5.0	5.0	5.0
45.0%	45.0%	45.0%	45.0%	45.0%	45.0%	45.0%	45.0%	5%	5%	5%	5%
39.4	39.4	39.4	39.4	39.9	39.9	39.9	39.9	3.0	3.0	3.0	3.0
3.3	3.3	3.3	3.3	3.3	3.3	3.3	3.3	2.0	2.0	2.0	2.0
2.3	2.3	2.3	2.3	1.8	1.8	1.8	1.8	0.0	0.0	0.0	0.0
0.0	0.0	0.0	0.0	0.0	0.0	0.0	0.0	0.0	0.0	0.0	0.0
5.6	5.6	5.6	5.6	5.1	5.1	5.1	5.1				
Lag	Lag	Lag	Lag	Lag	Lag	Lag	Lag	Lead	Lead	Lead	Lead
Yes	Yes	Yes	Yes	Yes	Yes	Yes	Yes	Yes	Yes	Yes	Yes
3.0	3.0	3.0	3.0	3.0	3.0	3.0	3.0	3.0	3.0	3.0	3.0
C-Max	C-Max	C-Max	C-Max	Max	Max	Max	Max	Max	Max	Max	Max
4.0	4.0	4.0	4.0	2.0	2.0	2.0	2.0				
14.0	14.0	14.0	14.0	13.0	13.0	13.0	13.0				
118	118	95	95	99	99	81	81				
39.4	39.4	39.4	39.4	39.9	39.9	39.9	39.9				
0.39	0.39	0.39	0.39	0.40	0.40	0.40	0.40				
0.43	0.43	0.33	0.33	0.55	0.39						
23.7	23.7	31.6	31.6	25.4	19.9						
0.0	0.0	0.0	0.0	0.0	0.0						
23.7	23.7	31.6	31.6	25.4	19.9						
C	C	C	C	C	C	B	B				
23.7	23.7	31.6	31.6	25.4	19.9						
C	C	C	C	C	C	B	B				
35.0	35.0	27.5	27.5	47.3	29.9						
48.7	48.7	41.5	41.5	64.2	38.8						
19.5	19.5	38.8	38.8	191.3	211.0						
1106	1106	1027	1027	1127	1173						
0	0	0	0	0	0						
0	0	0	0	0	0						
0	0	0	0	0	0						
0.43	0.43	0.33	0.33	0.55	0.39						

Intersection Summary	
Cycle Length:	100
Actuated Cycle Length:	100
Offset:	64 (84%), Referenced to phase 2,EBTL and 6:WBTL, Start of Green
Natural Cycle:	55



Control Type: Actuated-Coordinated  
 Maximum v/c Ratio: 0.55  
 Intersection Signal Delay: 24.7  
 Intersection LOS: C  
 ICU Level of Service D  
 Intersection Capacity Utilization: 80.7%  
 Analysis Period (min): 15

Lanes, Volumes, Timings  
3: Holland & Tyndall

Lanes, Volumes, Timings  
3: Holland & Tyndall

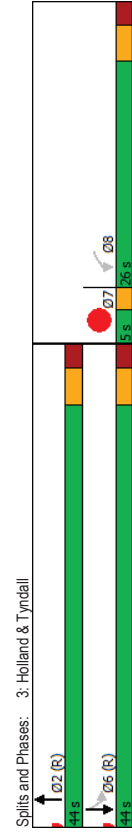
Future Background 2030AM Peak Hour  
1186-1194 Wellington STW

Future Background 2030AM Peak Hour  
1186-1194 Wellington STW

	WBL	NBT	SBL	SBT	Ø7
Lane Group	W	B	B	B	Ø7
Lane Configurations	W	B	B	B	Ø7
Traffic Volume (vph)	38	492	128	540	
Future Volume (vph)	38	492	128	540	
Lane Group Flow (vph)	205	532	128	540	
Turn Type	Perm	NA	Perm	NA	
Protected Phases	8	2	6	6	7
Permitted Phases	8	2	6	6	6
Detector Phase	8	2	6	6	6
Switch Phase					
Minimum Initial (s)	10.0	10.0	10.0	10.0	1.0
Minimum Split (s)	23.5	25.7	15.7	15.7	3.0
Total Split (s)	26.0	44.0	44.0	44.0	5.0
Total Split (%)	34.7%	58.7%	58.7%	58.7%	7%
Maximum Green (s)	20.5	38.3	38.3	38.3	3.0
Yellow Time (s)	3.3	3.3	3.3	3.3	2.0
All-Red Time (s)	2.2	2.4	2.4	2.4	0.0
Lost Time Adjust (s)	0.0	0.0	0.0	0.0	0.0
Total Lost Time (s)	5.5	5.7	5.7	5.7	5.7
Lead/Lag	Lag		Lead	Lead	
Lead-Lag Optimize?	Yes		Yes	Yes	
Vehicle Extension (s)	3.0	3.0	3.0	3.0	3.0
Recall Mode	None	C-Max	C-Max	C-Max	Max
Walk Time (s)	5.0	10.0			
Pedestrian Calls (#/hr)	37	36			
Act Effr Green (s)	16.1	42.7	42.7	42.7	
Actuated g/C Ratio	0.21	0.57	0.57	0.57	
v/c Ratio	0.68	0.54	0.35	0.54	
Control Delay	38.3	13.5	13.6	13.7	
Queue Delay	0.0	0.0	0.0	0.0	
Total Delay	38.3	13.5	13.6	13.7	
LOS	D	B	B	B	
Approach Delay	38.3	13.5	13.7		
Approach LOS	D	B	B		
Queue Length 50th (m)	25.9	45.1	9.5	46.6	
Queue Length 95th (m)	44.4	78.7	23.4	80.4	
Internal Link Dist (m)	138.9	156.5	23.1		
Turn Bay Length (m)					
Base Capacity (vph)	382	978	365	992	
Starvation Cap Reductn	0	0	0	0	
Spillback Cap Reductn	0	0	0	0	
Storage Cap Reductn	0	0	0	0	
Reduced v/c Ratio	0.54	0.54	0.35	0.54	

Intersection Summary	
Cycle Length:	75
Actuated Cycle Length:	75
Offset:	2 (3%), Referenced to phase 2:NBT and 6:SBTL, Start of Green
Natural Cycle:	60

Control Type:	Actuated-Coordinated
Maximum v/c Ratio:	0.68
Intersection Signal Delay:	17.2
Intersection LOS:	B
Intersection Capacity Utilization:	68.3%
Analysis Period (min):	15



Lanes, Volumes, Timings  
4: Parkdale & Armstrong

Future Background 2030AM Peak Hour  
1186-1194 Wellington STW

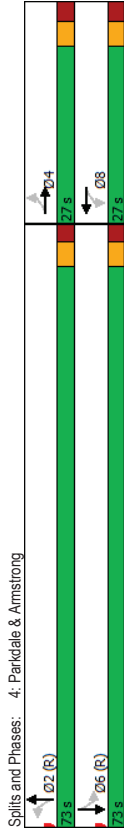
Lane Group	EBL	EBT	WBL	WBT	NBL	NBT	SBL	SBT
Lane Configurations	4	4	4	4	4	4	4	4
Traffic Volume (vph)	27	75	12	47	22	368	12	226
Future Volume (vph)	27	75	12	47	22	368	12	226
Lane Group Flow (vph)	0	117	0	72	0	413	0	260
Turn Type	Perm	NA	Perm	NA	Perm	NA	Perm	NA
Protected Phases	4	4	8	8	2	2	6	6
Permitted Phases	4	4	8	8	2	2	6	6
Detector Phase	4	4	8	8	2	2	6	6
Switch Phase								
Minimum Initial (s)	10.0	10.0	10.0	10.0	10.0	10.0	10.0	10.0
Minimum Split (s)	23.5	23.5	23.5	25.2	25.2	25.2	25.2	25.2
Total Split (s)	27.0	27.0	27.0	27.0	73.0	73.0	73.0	73.0
Total Split (%)	27.0%	27.0%	27.0%	27.0%	73.0%	73.0%	73.0%	73.0%
Maximum Green (s)	21.5	21.5	21.5	67.8	67.8	67.8	67.8	67.8
Yellow Time (s)	3.0	3.0	3.0	3.0	3.0	3.0	3.0	3.0
All-Red Time (s)	2.5	2.5	2.5	2.2	2.2	2.2	2.2	2.2
Lost Time Adjust (s)	0.0	0.0	0.0	0.0	0.0	0.0	0.0	0.0
Total Lost Time (s)	5.5	5.5	5.5	5.2	5.2	5.2	5.2	5.2
Lead/Lag								
Lead-Lag Optimize?								
Vehicle Extension (s)	3.0	3.0	3.0	3.0	3.0	3.0	3.0	3.0
Recall Mode	Max	Max	Max	C-Max	C-Max	C-Max	C-Max	C-Max
Walk Time (s)	10.0	10.0	10.0	15.0	15.0	15.0	15.0	15.0
Flash Dont Walk (s)	8.0	8.0	8.0	5.0	5.0	5.0	5.0	5.0
Pedestrian Calls (#/hr)	28	28	25	25	32	32	31	31
Act Effr Green (s)	21.5	21.5	21.5	67.8	67.8	67.8	67.8	67.8
Actuated g/C Ratio	0.22	0.22	0.22	0.68	0.68	0.68	0.68	0.68
v/c Ratio	0.35	0.21	0.36	0.21	0.36	0.23	0.23	0.23
Control Delay	34.7	29.8	29.8	2.1	2.1	6.5	6.5	6.5
Queue Delay	0.0	0.0	0.0	0.4	0.4	0.0	0.0	0.0
Total Delay	34.7	29.8	29.8	2.6	2.6	6.5	6.5	6.5
LOS	C	C	C	A	A	A	A	A
Approach Delay	34.7	29.8	29.8	2.6	2.6	6.5	6.5	6.5
Approach LOS	C	C	C	A	A	A	A	A
Queue Length 50th (m)	18.1	9.9	9.9	4.3	4.3	16.2	16.2	16.2
Queue Length 95th (m)	34.3	21.7	21.7	7.6	7.6	28.1	28.1	28.1
Internal Link Dist (m)	46.6	196.9	196.9	125.2	125.2	312.1	312.1	312.1
Turn Bay Length (m)								
Base Capacity (vph)	336	345	345	1140	1140	1137	1137	1137
Starvation Cap Reductn	0	0	0	333	333	0	0	0
Spillback Cap Reductn	0	0	0	0	0	0	0	0
Storage Cap Reductn	0	0	0	0	0	0	0	0
Reduced v/c Ratio	0.35	0.21	0.21	0.51	0.51	0.23	0.23	0.23

Intersection Summary	
Cycle Length:	100
Actuated Cycle Length:	100
Offset:	52 (52%), Referenced to phase 2, NBT and 6, SBT, Start of Green
Natural Cycle:	50

Lanes, Volumes, Timings  
4: Parkdale & Armstrong

Future Background 2030AM Peak Hour  
1186-1194 Wellington STW

Control Type:	Actuated-Coordinated
Maximum v/c Ratio:	0.36
Intersection Signal Delay:	10.4
Intersection LOS:	B
Intersection Capacity Utilization:	54.3%
Analysis Period (min):	15



Lanes, Volumes, Timings  
5: Parkdale & Wellington

Future Background 2030AM Peak Hour  
1186-1194 Wellington STW

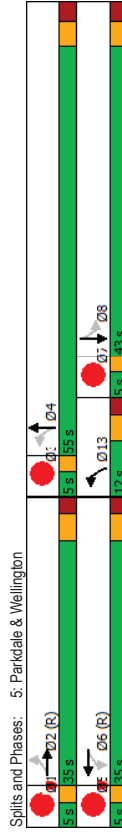
EBL	EBT	WBL	WBT	NBL	NBT	SBL	SBT	Ø1	Ø3	Ø5	Ø7
28	307	27	195	72	396	20	267				
28	307	27	195	72	396	20	267				
0	422	27	213	72	481	20	289				
Perm	NA	Perm	NA	pm+pt	NA	Perm	NA				
2	2	6	6	13	4	8	8	1	3	5	7
2	2	6	6	13	4	8	8				
10.0	10.0	10.0	10.0	5.0	10.0	10.0	10.0	1.0	1.0	1.0	1.0
23.4	23.4	23.4	23.4	10.2	15.5	20.5	20.5	3.0	3.0	3.0	3.0
35.0	35.0	35.0	35.0	12.0	55.0	43.0	43.0	5.0	5.0	5.0	5.0
35.0%	35.0%	35.0%	35.0%	12.0%	55.0%	43.0%	43.0%	5%	5%	5%	5%
29.6	29.6	29.6	29.6	6.8	49.5	37.5	37.5	3.0	3.0	3.0	3.0
3.3	3.3	3.3	3.3	3.0	3.0	3.0	3.0	2.0	2.0	2.0	2.0
2.1	2.1	2.1	2.1	2.2	2.5	2.5	2.5	0.0	0.0	0.0	0.0
0.0	0.0	0.0	0.0	0.0	0.0	0.0	0.0	0.0	0.0	0.0	0.0
5.4	5.4	5.4	5.4	5.2	5.5	5.5	5.5				
Lag	Lag	Lag	Lag	Lead	Lead	Lead	Lead				
Yes	Yes	Yes	Yes	Yes	Yes	Yes	Yes				
3.0	3.0	3.0	3.0	3.0	3.0	3.0	3.0	3.0	3.0	3.0	3.0
C-Max	C-Max	C-Max	C-Max	Max	Max	Max	Max	Max	Max	Max	Max
5.0	5.0	5.0	5.0	2.0	2.0	2.0	2.0				
8.0	8.0	8.0	8.0	8.0	8.0	8.0	8.0				
71	71	62	62	53	42	42	42				
29.6	29.6	29.6	29.6	54.8	49.5	37.5	37.5				
0.30	0.30	0.30	0.30	0.50	0.38	0.38	0.38				
0.52	0.14	0.43	0.17	0.59	0.07	0.45	0.45				
22.4	26.3	31.6	3.6	11.3	18.9	22.5	22.5				
0.0	0.0	0.0	0.0	0.2	0.0	0.0	0.0				
22.4	26.3	31.6	3.6	11.6	18.9	22.5	22.5				
C	C	C	A	B	B	C	C				
22.4	31.3	31.3	10.5	22.3	22.3	22.3	22.3				
C	C	C	B	C	C	C	C				
21.7	3.8	33.1	2.0	56.3	2.2	32.2	32.2				
29.6	10.7	53.9	m3.1	85.0	m6.3	46.5	46.5				
58.1	36.3	36.3	139.5	125.2	125.2	125.2	125.2				
30.0	30.0	40.0	40.0	40.0	40.0	40.0	40.0				
815	193	498	430	815	288	636	636				
0	0	0	0	0	47	0	0				
0	0	0	0	0	0	0	0				
0	0	0	0	0	0	0	0				
0.52	0.14	0.43	0.17	0.63	0.07	0.45	0.45				

Intersection Summary  
Cycle Length: 100  
Actuated Cycle Length: 100  
Offset: 0 (0%), Referenced to phase 2,EBTL and 6,WBTL, Start of Green  
Natural Cycle: 65

Lanes, Volumes, Timings  
5: Parkdale & Wellington

Future Background 2030AM Peak Hour  
1186-1194 Wellington STW

Control Type: Actuated-Coordinated  
Maximum v/c Ratio: 0.59  
Intersection Signal Delay: 19.5  
Intersection LOS: B  
Intersection Capacity Utilization: 80.8%  
Analysis Period (min): 15  
m. Volume for 95th percentile queue is metered by upstream signal.



Lanes, Volumes, Timings  
6: Parkdale & Gladstone

Lanes, Volumes, Timings  
6: Parkdale & Gladstone

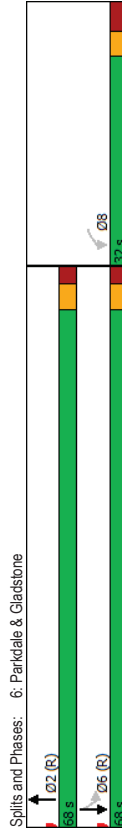
Future Background 2030AM Peak Hour  
1186-1194 Wellington STW

Future Background 2030AM Peak Hour  
1186-1194 Wellington STW

Lane Group	WBL	NBT	SBL	SBT
Lane Configurations	W	B	B	B
Traffic Volume (vph)	133	515	32	382
Future Volume (vph)	133	515	32	382
Lane Group Flow (vph)	164	646	32	382
Turn Type	Perm	NA	Perm	NA
Protected Phases	2	2	6	6
Permitted Phases	8	2	6	6
Detector Phase	8	2	6	6
Switch Phase				
Minimum Initial (s)	10.0	10.0	10.0	10.0
Minimum Split (s)	22.7	20.3	15.3	15.3
Total Split (s)	32.0	68.0	68.0	68.0
Total Split (%)	32.0%	68.0%	68.0%	68.0%
Maximum Green (s)	25.3	62.7	62.7	62.7
Yellow Time (s)	3.0	3.0	3.0	3.0
All-Red Time (s)	3.7	2.3	2.3	2.3
Lost Time Adjust (s)	0.0	0.0	0.0	0.0
Total Lost Time (s)	6.7	5.3	5.3	5.3
Lead/Lag				
Lead-Lag Optimize?				
Vehicle Extension (s)	3.0	3.0	3.0	3.0
Recall Mode	Max	C-Max	C-Max	C-Max
Walk Time (s)	7.0	7.0		
Flash Dont Walk (s)	9.0	8.0		
Pedestrian Calls (#/hr)	15	7		
Act Effct Green (s)	25.3	62.7	62.7	62.7
Actuated g/C Ratio	0.25	0.63	0.63	0.63
v/c Ratio	0.41	0.61	0.09	0.35
Control Delay	34.9	12.1	12.8	14.2
Queue Delay	0.0	0.0	0.0	0.0
Total Delay	34.9	12.1	12.8	14.2
LOS	C	B	B	B
Approach Delay	34.9	12.1	14.1	
Approach LOS	C	B	B	
Queue Length 50th (m)	26.5	62.0	2.5	30.0
Queue Length 95th (m)	45.3	76.1	m6.8	68.8
Internal Link Dist (m)	224.2	197.3		139.5
Turn Bay Length (m)			85.0	
Base Capacity (vph)	399	1055	344	1094
Starvation Cap Reductn	0	0	0	0
Spillback Cap Reductn	0	0	0	0
Storage Cap Reductn	0	0	0	0
Reduced v/c Ratio	0.41	0.61	0.09	0.35

Intersection Summary	
Cycle Length:	100
Actuated Cycle Length:	100
Offset:	12 (12%), Referenced to phase 2:NBT and 6:SBTL, Start of Green
Natural Cycle:	60

Control Type:	Actuated-Coordinated
Maximum v/c Ratio:	0.61
Intersection Signal Delay:	15.8
Intersection LOS:	B
Intersection Capacity Utilization:	60.5%
Analysis Period (min):	15
m:	Volume for 95th percentile queue is metered by upstream signal.





Lanes, Volumes, Timings  
7: Parkdale & 417 WB OR

Lanes, Volumes, Timings  
7: Parkdale & 417 WB OR

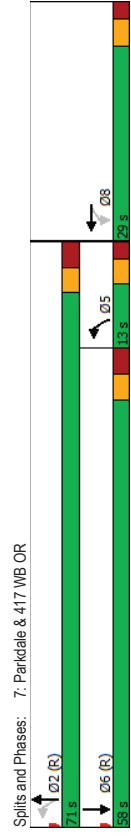
Future Background 2030AM Peak Hour  
1186-1194 Wellington STW

Future Background 2030AM Peak Hour  
1186-1194 Wellington STW

Lane Group	WBL	WBT	NBL	NBT	SBT
Lane Configurations	W	T	T	T	T
Traffic Volume (vph)	345	0	202	350	504
Future Volume (vph)	345	0	202	350	504
Lane Group Flow (vph)	345	542	202	350	794
Turn Type	Perim	NA	pm-pt	NA	NA
Protected Phases	8	5	2	2	6
Permitted Phases	8	5	2	2	6
Detector Phase	8	8	5	2	6
Switch Phase					
Minimum Initial (s)	10.0	10.0	5.0	10.0	10.0
Minimum Split (s)	20.5	20.5	10.2	27.3	21.3
Total Split (s)	29.0	29.0	13.0	71.0	58.0
Total Split (%)	29.0%	29.0%	13.0%	71.0%	58.0%
Maximum Green (s)	23.5	23.5	7.8	64.7	51.7
Yellow Time (s)	3.3	3.3	3.0	3.0	3.0
All-Red Time (s)	2.2	2.2	2.2	3.3	3.3
Lost Time Adjust (s)	0.0	0.0	0.0	0.0	0.0
Total Lost Time (s)	5.5	5.5	5.2	6.3	6.3
Lead/Lag			Lag	Lead	
Lead-Lag Optimize?			Yes	Yes	
Vehicle Extension (s)	3.0	3.0	3.0	3.0	3.0
Recall Mode	None	None	None	C-Max	C-Max
Walk Time (s)	7.0	7.0	7.0	7.0	7.0
Flash Dont Walk (s)	8.0	8.0	14.0	8.0	8.0
Pedestrian Calls (#/hr)	1	1		23	10
Act Effct Green (s)	22.7	22.7	66.6	65.5	62.5
Actuated g/C Ratio	0.23	0.23	0.67	0.66	0.52
v/c Ratio	0.92	0.76	0.66	0.31	0.91
Control Delay	68.4	12.7	30.9	8.5	40.5
Queue Delay	0.0	0.0	0.0	0.0	0.0
Total Delay	68.4	12.7	30.9	8.5	40.5
LOS	E	B	C	A	D
Approach Delay		34.4		16.7	40.5
Approach LOS		C		B	D
Queue Length 50th (m)	64.9	7.1	13.7	27.1	155.1
Queue Length 95th (m)	#113.6	45.0	#25.0	41.2	#218.4
Internal Link Dist (m)		462.5		38.8	197.3
Turn Bay Length (m)					
Base Capacity (vph)	389	719	305	1143	874
Starvation Cap Reductn	0	0	0	0	0
Spillback Cap Reductn	0	0	0	0	0
Storage Cap Reductn	0	0	0	0	0
Reduced v/c Ratio	0.89	0.75	0.66	0.31	0.91

Intersection Summary	
Cycle Length:	100
Actuated Cycle Length:	100
Offset:	26 (26%), Referenced to phase 2, NBL and 6: SBT, Start of Green
Natural Cycle:	90

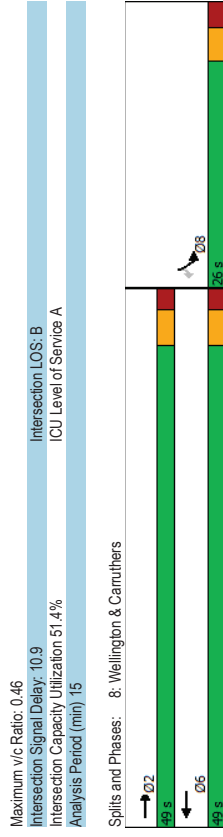
Control Type:	Actuated-Coordinated
Maximum v/c Ratio:	0.92
Intersection Signal Delay:	32.2
Intersection LOS:	C
Intersection Capacity Utilization:	108.6%
IOU Level of Service:	G
Analysis Period (min):	15
# 95th percentile volume exceeds capacity, queue may be longer.	
Queue shown is maximum after two cycles.	



Lanes, Volumes, Timings  
8: Wellington & Carruthers

Lanes, Volumes, Timings  
8: Wellington & Carruthers

Lane Group	EBT	WBT	SBL	SBR
Lane Configurations	←	←	←	←
Traffic Volume (vph)	464	237	63	13
Future Volume (vph)	464	237	63	13
Lane Group Flow (vph)	464	237	63	13
Turn Type	NA	NA	Prot	Perm
Protected Phases	2	6	8	8
Permitted Phases				
Detector Phase	2	6	8	8
Switch Phase				
Minimum Initial (s)	10.0	10.0	10.0	10.0
Minimum Split (s)	15.3	26.3	25.5	25.5
Total Split (s)	49.0	49.0	26.0	26.0
Total Split (%)	65.3%	65.3%	34.7%	34.7%
Maximum Green (s)	43.7	43.7	20.5	20.5
Yellow Time (s)	3.3	3.3	3.0	3.0
All-Red Time (s)	2.0	2.0	2.5	2.5
Lost Time Adjust (s)	0.0	0.0	0.0	0.0
Total Lost Time (s)	5.3	5.3	5.5	5.5
Lead/Lag				
Lead-Lag Optimize?				
Vehicle Extension (s)	3.0	3.0	3.0	3.0
Recall Mode	Max	Max	Max	Max
Walk Time (s)	14.0	15.0	15.0	15.0
Flash Dont Walk (s)	7.0	5.0	5.0	5.0
Pedestrian Calls (#/hr)	70	65	65	65
Act Effr Green (s)	43.7	43.7	20.5	20.5
Actuated G/C Ratio	0.58	0.58	0.27	0.27
v/c Ratio	10.7	8.3	21.7	11.0
Control Delay	0.0	0.0	0.0	0.0
Queue Delay	0.0	0.0	0.0	0.0
Total Delay	10.7	8.3	21.7	11.0
LOS	B	A	C	B
Approach Delay	10.7	8.3	19.9	
Approach LOS	B	A	B	
Queue Length 50th (m)	33.9	14.7	6.7	0.0
Queue Length 95th (m)	53.8	25.2	15.4	3.8
Internal Link Dist (m)	156.2	153.4	73.2	
Turn Bay Length (m)			30.0	
Base Capacity (vph)	1016	1016	453	386
Starvation Cap Reductn	0	0	0	0
Spillback Cap Reductn	0	0	0	0
Storage Cap Reductn	0	0	0	0
Reduced v/c Ratio	0.46	0.23	0.14	0.03
<b>Intersection Summary</b>				
Cycle Length: 75				
Actuated Cycle Length: 75				
Natural Cycle: 55				
Control Type: Semi-Act-Uncoord				





Lanes, Volumes, Timings  
1: Holland & Spencer

Future Background 2030PM Peak Hour  
1186-1194 Wellington STW

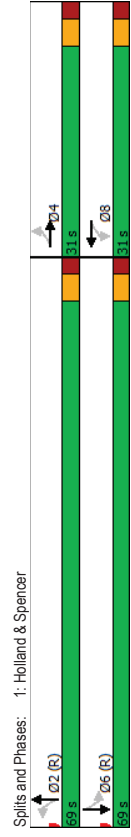
	EBL	EBT	WBL	WBT	NBL	NBT	SBL	SBT
Lane Configurations	4	4	8	8	2	2	6	6
Traffic Volume (vph)	12	24	153	61	55	379	16	480
Future Volume (vph)	12	24	153	61	55	379	16	480
Lane Group Flow (vph)	Perm	NA	Perm	NA	Perm	NA	Perm	NA
Protected Phases	4	4	8	8	2	2	6	6
Detector Phase	4	4	8	8	2	2	6	6
Switch Phase								
Minimum Initial (s)	10.0	10.0	10.0	10.0	10.0	10.0	10.0	10.0
Minimum Split (s)	23.5	23.5	23.5	29.3	29.3	29.3	29.3	29.3
Total Split (s)	31.0	31.0	31.0	69.0	69.0	69.0	69.0	69.0
Total Split (%)	31.0%	31.0%	31.0%	69.0%	69.0%	69.0%	69.0%	69.0%
Maximum Green (s)	25.5	25.5	25.5	63.7	63.7	63.7	63.7	63.7
Yellow Time (s)	3.3	3.3	3.3	3.3	3.3	3.3	3.3	3.3
All-Red Time (s)	2.2	2.2	2.2	2.0	2.0	2.0	2.0	2.0
Lost Time Adjust (s)	0.0	0.0	0.0	0.0	0.0	0.0	0.0	0.0
Total Lost Time (s)	5.5	5.5	5.5	5.3	5.3	5.3	5.3	5.3
Lead/Lag								
Lead-Lag Optimize?								
Vehicle Extension (s)	3.0	3.0	3.0	3.0	3.0	3.0	3.0	3.0
Recall Mode	None	None	None	C-Max	C-Max	C-Max	C-Max	C-Max
Walk Time (s)	7.0	7.0	7.0	15.0	15.0	15.0	15.0	15.0
Flash Dont Walk (s)	11.0	11.0	11.0	9.0	9.0	9.0	9.0	9.0
Pedestrian Calls (#/hr)	17	17	18	18	88	88	49	49
Act Effr Green (s)	21.8	21.8	21.8	0.22	0.67	0.67	0.67	0.67
Actuated g/C Ratio	0.19	0.19	0.82	0.25	0.25	0.25	0.25	0.25
v/c Ratio	19.7	57.8	1.1	1.1	7.2	7.2	7.2	7.2
Control Delay	0.0	0.0	0.0	0.0	0.0	0.0	0.0	0.0
Queue Delay	19.7	57.8	1.1	1.1	7.2	7.2	7.2	7.2
Total Delay	19.7	57.8	1.1	1.1	7.2	7.2	7.2	7.2
LOS	B	E	A	A	A	A	A	A
Approach Delay	19.7	57.8	1.1	1.1	7.2	7.2	7.2	7.2
Approach LOS	B	E	A	A	A	A	A	A
Queue Length 50th (m)	5.5	43.1	1.2	1.2	19.0	19.0	19.0	19.0
Queue Length 95th (m)	15.7	#74.0	2.6	2.6	28.0	28.0	28.0	28.0
Internal Link Dist (m)	151.9	132.2	211.0	211.0	210.0	210.0	210.0	210.0
Turn Bay Length (m)								
Base Capacity (vph)	405	346	1825	1825	2070	2070	2070	2070
Starvation Cap Reductn	0	0	0	0	0	0	0	0
Spillback Cap Reductn	0	0	0	0	0	0	0	0
Storage Cap Reductn	0	0	0	0	0	0	0	0
Reduced v/c Ratio	0.16	0.71	0.25	0.25	0.25	0.25	0.25	0.25

Intersection Summary	
Cycle Length:	100
Actuated Cycle Length:	100
Offset:	38 (38%), Referenced to phase 2; NBTL and 6; SBTL, Start of Green
Natural Cycle:	55

Lanes, Volumes, Timings  
1: Holland & Spencer

Future Background 2030PM Peak Hour  
1186-1194 Wellington STW

Control Type:	Actuated-Coordinated
Maximum v/c Ratio:	0.82
Intersection Signal Delay:	15.3
Intersection LOS:	B
Intersection Capacity Utilization:	74.6%
Analysis Period (min):	15
# 95th percentile volume exceeds capacity, queue may be longer.	
Queue shown is maximum after two cycles.	



Lanes, Volumes, Timings  
2: Holland & Wellington

Future Background 2030PM Peak Hour  
1186-1194 Wellington STW

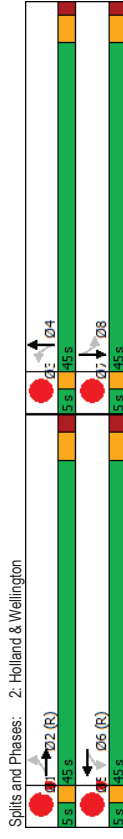
Lane Group	EBL	EBT	WBL	WBT	NBL	NBT	SBL	SBT	Ø1	Ø3	Ø5	Ø7
Lane Configurations	21	380	80	569	38	419	25	652				
Traffic Volume (vph)	21	380	80	569	38	419	25	652				
Future Volume (vph)	0	482	0	672	0	517	0	741				
Lane Group Flow (vph)	Perm	NA	Perm	NA	Perm	NA	Perm	NA				
Turn Type	2	2	6	6	4	4	8	8	1	3	5	7
Protected Phases	2	2	6	6	4	4	8	8				
Permitted Phases	2	2	6	6	4	4	8	8				
Detector Phase	2	2	6	6	4	4	8	8				
Switch Phase												
Minimum Initial (s)	10.0	10.0	10.0	10.0	10.0	10.0	10.0	10.0	1.0	1.0	1.0	1.0
Minimum Split (s)	23.6	23.6	24.5	24.5	20.1	20.1	20.1	20.1	3.0	3.0	3.0	3.0
Total Split (s)	45.0	45.0	45.0	45.0	45.0	45.0	45.0	45.0	5.0	5.0	5.0	5.0
Total Split (%)	45.0%	45.0%	45.0%	45.0%	45.0%	45.0%	45.0%	45.0%	5%	5%	5%	5%
Maximum Green (s)	39.4	39.4	39.4	39.9	39.9	39.9	39.9	39.9	3.0	3.0	3.0	3.0
Yellow Time (s)	3.3	3.3	3.3	3.3	3.3	3.3	3.3	3.3	2.0	2.0	2.0	2.0
All-Red Time (s)	2.3	2.3	2.3	2.3	1.8	1.8	1.8	1.8	0.0	0.0	0.0	0.0
Lost Time Adjust (s)	0.0	0.0	0.0	0.0	0.0	0.0	0.0	0.0				
Total Lost Time (s)	5.6	5.6	5.6	5.6	5.1	5.1	5.1	5.1				
Lead/Lag	Lag	Lag	Lag	Lag	Lag	Lag	Lag	Lag	Lead	Lead	Lead	Lead
Lead-Lag Optimize?	Yes	Yes	Yes	Yes	Yes	Yes	Yes	Yes	Yes	Yes	Yes	Yes
Vehicle Extension (s)	3.0	3.0	3.0	3.0	3.0	3.0	3.0	3.0	3.0	3.0	3.0	3.0
Vehicle Extension (s)	3.0	3.0	3.0	3.0	3.0	3.0	3.0	3.0	3.0	3.0	3.0	3.0
Recall Mode	C-Max	C-Max	C-Max	C-Max	C-Max	C-Max	C-Max	C-Max	Max	Max	Max	Max
Walk Time (s)	4.0	4.0	4.0	4.0	2.0	2.0	2.0	2.0				
Pedestrian Calls (#/hr)	206	206	146	146	135	135	111	111				
Act Effr Green (s)	39.4	39.4	39.4	39.4	39.9	39.9	39.9	39.9				
Actuated G/C Ratio	0.39	0.39	0.39	0.39	0.40	0.40	0.40	0.40				
v/c Ratio	0.44	0.44	0.66	0.66	0.49	0.49	0.63	0.63				
Control Delay	23.8	23.8	22.7	22.7	20.6	20.6	22.5	22.5				
Queue Delay	0.0	0.0	0.0	0.0	0.0	0.0	0.0	0.0				
Total Delay	23.8	23.8	22.7	22.7	20.6	20.6	22.5	22.5				
LOS	C	C	C	C	C	C	C	C				
Approach Delay	23.8	23.8	22.7	22.7	20.6	20.6	22.5	22.5				
Approach LOS	C	C	C	C	C	C	C	C				
Queue Length 50th (m)	35.4	35.4	41.7	41.7	28.3	28.3	44.4	44.4				
Queue Length 95th (m)	49.3	49.3	m49.4	m49.4	49.7	49.7	66.4	66.4				
Internal Link Dist (m)	21.3	21.3	37.0	37.0	192.3	192.3	211.0	211.0				
Turn Bay Length (m)												
Base Capacity (vph)	1091	1091	1011	1011	1062	1062	1178	1178				
Starvation Cap Reductn	0	0	0	0	0	0	0	0				
Spillback Cap Reductn	0	0	0	0	0	0	0	0				
Storage Cap Reductn	0	0	0	0	0	0	0	0				
Reduced v/c Ratio	0.44	0.44	0.66	0.66	0.49	0.49	0.63	0.63				

Intersection Summary	
Cycle Length:	100
Actuated Cycle Length:	100
Offset:	72 (72%), Referenced to phase 2,EBTL and 6:WBTL, Start of Green
Natural Cycle:	60

Lanes, Volumes, Timings  
2: Holland & Wellington

Future Background 2030PM Peak Hour  
1186-1194 Wellington STW

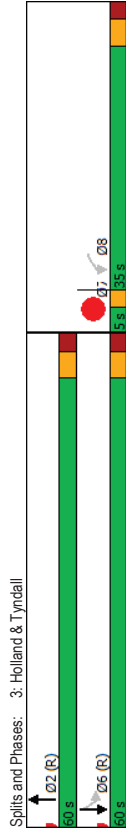
Control Type:	Actuated-Coordinated
Maximum v/c Ratio:	0.66
Intersection Signal Delay:	22.4
Intersection LOS:	C
ICU Level of Service F	
Intersection Capacity Utilization:	92.4%
Analysis Period (min):	15
m	Volume for 95th percentile queue is metered by upstream signal.



	WBL	NBT	SBL	SBT	Ø7
Lane Group	W	N	S	S	
Lane Configurations	W	N	S	S	
Traffic Volume (vph)	46	625	145	585	
Future Volume (vph)	46	625	145	585	
Lane Group Flow (vph)	227	650	145	585	
Turn Type	Perm	NA	Perm	NA	
Protected Phases	8	2	6	7	
Permitted Phases	8	2	6	6	
Detector Phase	8	2	6	6	
Switch Phase					
Minimum Initial (s)	10.0	10.0	10.0	10.0	1.0
Minimum Split (s)	23.5	25.7	15.7	15.7	3.0
Total Split (s)	35.0	60.0	60.0	60.0	5.0
Total Split (%)	35.0%	60.0%	60.0%	60.0%	5%
Maximum Green (s)	29.5	54.3	54.3	54.3	3.0
Yellow Time (s)	3.3	3.3	3.3	3.3	2.0
All-Red Time (s)	2.2	2.4	2.4	2.4	0.0
Lost Time Adjust (s)	0.0	0.0	0.0	0.0	0.0
Total Lost Time (s)	5.5	5.7	5.7	5.7	
Lead/Lag	Lag		Lead	Lead	
Lead-Lag Optimize?	Yes		Yes	Yes	
Vehicle Extension (s)	3.0	3.0	3.0	3.0	3.0
Recall Mode	None	C-Max	C-Max	C-Max	Max
Walk Time (s)	5.0	10.0			
Pedestrian Calls (#/hr)	15	20			
Act Effr Green (s)	20.7	63.1	63.1	63.1	
Actuated g/C Ratio	0.21	0.63	0.63	0.63	
v/c Ratio	0.75	0.59	0.41	0.53	
Control Delay	51.8	14.9	8.5	7.3	
Queue Delay	0.0	0.0	0.0	0.0	
Total Delay	51.8	14.9	8.5	7.3	
LOS	D	B	A	A	
Approach Delay	51.8	14.9	7.5		
Approach LOS	D	B	A		
Queue Length 50th (m)	41.5	67.8	5.3	24.0	
Queue Length 95th (m)	60.9	123.8	m12.2	40.0	
Internal Link Dist (m)	141.4	156.5		22.2	
Turn Bay Length (m)					
Base Capacity (vph)	432	1093	350	1101	
Starvation Cap Reductn	0	0	0	0	
Spillback Cap Reductn	0	0	0	0	
Storage Cap Reductn	0	0	0	0	
Reduced v/c Ratio	0.53	0.59	0.41	0.53	

Intersection Summary	
Cycle Length:	100
Actuated Cycle Length:	100
Offset:	24 (24%), Referenced to phase 2:NBT and 6:SBTL, Start of Green
Natural Cycle:	60

Control Type:	Actuated-Coordinated
Maximum v/c Ratio:	0.75
Intersection Signal Delay:	16.8
Intersection LOS:	B
Intersection Capacity Utilization:	74.3%
ICU Level of Service D	
Analysis Period (min):	15
m. Volume for 95th percentile queue is metered by upstream signal.	



Lanes, Volumes, Timings  
4: Parkdale & Armstrong

Future Background 2030PM Peak Hour  
1186-1194 Wellington STW

	EBL	EBT	WBL	WBT	NBL	NBT	SBL	SBT
Lane Group	EBL	EBT	WBL	WBT	NBL	NBT	SBL	SBT
Lane Configurations	34	63	39	160	13	527	15	329
Traffic Volume (vph)	34	63	39	160	13	527	15	329
Future Volume (vph)	0	134	0	220	0	562	0	360
Lane Group Flow (vph)	Perm	NA	Perm	NA	Perm	NA	Perm	NA
Turn Type	4	8	8	2	2	6	6	6
Protected Phases	4	8	8	2	2	6	6	6
Permitted Phases	4	8	8	2	2	6	6	6
Detector Phase	4	8	8	2	2	6	6	6
Switch Phase	4	8	8	2	2	6	6	6
Minimum Initial (s)	10.0	10.0	10.0	10.0	10.0	10.0	10.0	10.0
Minimum Split (s)	23.5	23.5	23.5	25.2	25.2	25.2	25.2	25.2
Total Split (s)	35.0	35.0	35.0	35.0	65.0	65.0	65.0	65.0
Total Split (%)	35.0%	35.0%	35.0%	35.0%	65.0%	65.0%	65.0%	65.0%
Maximum Green (s)	29.5	29.5	29.5	29.5	59.8	59.8	59.8	59.8
Yellow Time (s)	3.0	3.0	3.0	3.0	3.0	3.0	3.0	3.0
All-Red Time (s)	2.5	2.5	2.5	2.2	2.2	2.2	2.2	2.2
Lost Time Adjust (s)	0.0	0.0	0.0	0.0	0.0	0.0	0.0	0.0
Total Lost Time (s)	5.5	5.5	5.5	5.2	5.2	5.2	5.2	5.2
Lead/Lag								
Lead-Lag Optimize?								
Vehicle Extension (s)	3.0	3.0	3.0	3.0	3.0	3.0	3.0	3.0
Recall Mode	Max	Max	Max	C-Max	C-Max	C-Max	C-Max	C-Max
Walk Time (s)	10.0	10.0	10.0	10.0	15.0	15.0	15.0	15.0
Flash Dont Walk (s)	8.0	8.0	8.0	5.0	5.0	5.0	5.0	5.0
Pedestrian Calls (#/hr)	19	19	30	30	35	35	22	22
Act Effr Green (s)	29.5	29.5	29.5	29.5	59.8	59.8	59.8	59.8
Actuated g/C Ratio	0.30	0.30	0.30	0.47	0.55	0.55	0.36	0.36
v/c Ratio	0.30	0.30	0.30	0.47	0.55	0.55	0.36	0.36
Control Delay	25.5	25.5	25.5	32.2	4.9	11.4	11.4	11.4
Queue Delay	0.0	0.0	0.0	0.6	0.6	0.6	0.0	0.0
Total Delay	25.5	25.5	25.5	32.2	5.5	11.4	11.4	11.4
LOS	C	C	C	A	A	B	B	B
Approach Delay	25.5	25.5	25.5	32.2	5.5	11.4	11.4	11.4
Approach LOS	C	C	C	A	A	B	B	B
Queue Length 50th (m)	17.0	17.0	17.0	34.0	7.1	32.7	32.7	32.7
Queue Length 95th (m)	32.5	32.5	32.5	55.7	m8.8	49.8	49.8	49.8
Internal Link Dist (m)	46.6	46.6	46.6	196.9	125.2	312.1	312.1	312.1
Turn Bay Length (m)								
Base Capacity (vph)	442	442	442	466	1024	1005	1005	1005
Starvation Cap Reductn	0	0	0	0	176	0	0	0
Spillback Cap Reductn	0	0	0	0	0	2	2	2
Storage Cap Reductn	0	0	0	0	0	0	0	0
Reduced v/c Ratio	0.30	0.30	0.30	0.47	0.66	0.36	0.36	0.36

Intersection Summary	
Cycle Length:	100
Actuated Cycle Length:	100
Offset:	20 (20%), Referenced to phase 2, NBT, and 6, SBT, Start of Green
Natural Cycle:	55

Lanes, Volumes, Timings  
4: Parkdale & Armstrong

Future Background 2030PM Peak Hour  
1186-1194 Wellington STW

	D2 (R)	D4	D6 (R)
Control Type:	Actuated-Coordinated		
Maximum v/c Ratio:	0.55		
Intersection Signal Delay:	13.9		
Intersection LOS:	B		
ICU Level of Service:	B		
Intersection Capacity Utilization:	60.0%		
Analysis Period (min):	15		
m. Volume for 95th percentile queue is metered by upstream signal.			
Splits and Phases:	4: Parkdale & Armstrong		
D2 (R)	55 s	D4	35 s
D6 (R)	55 s	D6 (R)	35 s



Lanes, Volumes, Timings  
5: Parkdale & Wellington

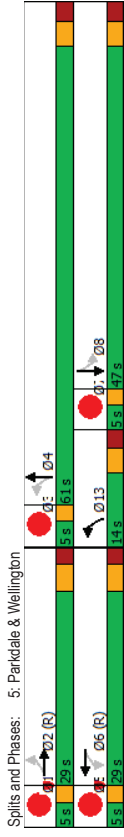
Future Background 2030PM Peak Hour  
1186-1194 Wellington STW

EBL	EBT	WBL	WBT	NBL	NBT	SBL	SBT	Ø1	Ø3	Ø5	Ø7
17	47	47	373	143	576	19	397				
17	279	47	373	143	576	19	397				
0	364	47	399	143	630	19	448				
Perm	NA	Perm	NA	pm-pt	NA	Perm	NA				
2	2	6	6	13	4	8	8	1	3	5	7
2	2	6	6	13	4	8	8				
10.0	10.0	10.0	10.0	5.0	10.0	10.0	10.0	1.0	1.0	1.0	1.0
23.4	23.4	23.4	23.4	10.2	15.5	20.5	20.5	3.0	3.0	3.0	3.0
29.0	29.0	29.0	29.0	14.0	61.0	47.0	47.0	5.0	5.0	5.0	5.0
29.0%	29.0%	29.0%	29.0%	14.0%	61.0%	47.0%	47.0%	5%	5%	5%	5%
23.6	23.6	23.6	23.6	8.8	55.5	41.5	41.5	3.0	3.0	3.0	3.0
3.3	3.3	3.3	3.3	3.0	3.0	3.0	3.0	2.0	2.0	2.0	2.0
2.1	2.1	2.1	2.1	2.2	2.5	2.5	2.5	0.0	0.0	0.0	0.0
0.0	0.0	0.0	0.0	0.0	0.0	0.0	0.0	0.0	0.0	0.0	0.0
5.4	5.4	5.4	5.4	5.2	5.5	5.5	5.5				
Lag	Lag	Lag	Lag	Lead	Lead	Lead	Lead				
Yes	Yes	Yes	Yes	Yes	Yes	Yes	Yes				
3.0	3.0	3.0	3.0	3.0	3.0	3.0	3.0	3.0	3.0	3.0	3.0
C-Max	C-Max	C-Max	C-Max	Max	Max	Max	Max	Max	Max	Max	Max
5.0	5.0	5.0	5.0	2.0	2.0	2.0	2.0				
8.0	8.0	8.0	8.0	8.0	8.0	8.0	8.0				
153	153	142	142	76	72	72	72				
23.6	23.6	23.6	23.6	60.8	55.5	41.5	41.5				
0.24	0.24	0.24	0.24	0.61	0.56	0.42	0.42				
0.69	0.69	0.35	1.02	0.37	0.67	0.07	0.66				
63.6	40.4	88.7	11.4	17.5	15.4	22.7					
0.0	0.0	0.0	0.0	0.7	0.0	0.3					
63.6	40.4	88.7	11.4	18.2	15.4	23.0					
E	D	F	B	B	B	C					
63.6		83.6		16.9		22.7					
E		F		B		C					
38.1	7.6	-79.3	10.9	59.7	1.8	45.6					
53.2	18.9	#17.5	m17.1	87.7	m4.8	61.4					
55.1		43.2		139.5		125.2					
30.0		40.0		40.0		40.0					
531	135	393	389	936	254	681					
0	0	0	0	91	0	34					
0	0	0	0	0	0	0					
0	0	0	0	0	0	0					
0.69	0.35	1.02	0.37	0.75	0.07	0.69					

Lanes, Volumes, Timings  
5: Parkdale & Wellington

Future Background 2030PM Peak Hour  
1186-1194 Wellington STW

Maximum v/c Ratio: 1.02	Intersection LOS: D
Intersection Signal Delay: 41.0	IOU Level of Service F
Intersection Capacity Utilization 97.5%	
Analysis Period (min) 15	
Volume exceeds capacity, queue is theoretically infinite.	
Queue shown is maximum after two cycles.	
# 95th percentile volume exceeds capacity, queue may be longer.	
Queue shown is maximum after two cycles.	
m Volume for 95th percentile queue is metered by upstream signal.	





Lanes, Volumes, Timings  
6: Parkdale & Gladstone

Lanes, Volumes, Timings  
6: Parkdale & Gladstone

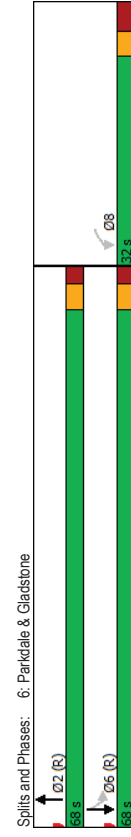
Future Background 2030PM Peak Hour  
1186-1194 Wellington STW

Future Background 2030PM Peak Hour  
1186-1194 Wellington STW

Lane Group	WBL	NBT	SBL	SBT
Lane Configurations	W	T	T	T
Traffic Volume (vph)	215	658	40	398
Future Volume (vph)	215	658	40	398
Lane Group Flow (vph)	281	816	40	398
Turn Type	Perm	NA	Perm	NA
Protected Phases		2		6
Permitted Phases	8	2	6	6
Detector Phase	8	2	6	6
Switch Phase				
Minimum Initial (s)	10.0	10.0	10.0	10.0
Minimum Split (s)	22.7	20.3	15.3	15.3
Total Split (s)	32.0	68.0	68.0	68.0
Total Split (%)	32.0%	68.0%	68.0%	68.0%
Maximum Green (s)	25.3	62.7	62.7	62.7
Yellow Time (s)	3.0	3.0	3.0	3.0
All-Red Time (s)	3.7	2.3	2.3	2.3
Lost Time Adjust (s)	0.0	0.0	0.0	0.0
Total Lost Time (s)	6.7	5.3	5.3	5.3
Lead/Lag				
Lead-Lag Optimize?				
Vehicle Extension (s)	3.0	3.0	3.0	3.0
Recall Mode	Max	C-Max	C-Max	C-Max
Walk Time (s)	7.0	7.0		
Flash Dont Walk (s)	9.0	8.0		
Pedestrian Calls (#/hr)	25	19		
Act Effct Green (s)	25.3	62.7	62.7	62.7
Actuated g/C Ratio	0.25	0.63	0.63	0.63
v/c Ratio	0.73	0.78	0.17	0.36
Control Delay	46.8	15.8	5.9	5.5
Queue Delay	0.0	0.2	0.0	0.1
Total Delay	46.8	16.0	5.9	5.6
LOS	D	B	A	A
Approach Delay	46.8	16.0	5.6	5.6
Approach LOS	D	B	A	A
Queue Length 50th (m)	50.0	72.5	1.9	18.9
Queue Length 95th (m)	#84.4	m106.0	m3.0	25.5
Internal Link Dist (m)	224.2	197.3		139.5
Turn Bay Length (m)			85.0	
Base Capacity (vph)	385	1048	231	1094
Starvation Cap Reductn	0	24	0	0
Spillback Cap Reductn	0	0	0	92
Storage Cap Reductn	0	0	0	0
Reduced v/c Ratio	0.73	0.80	0.17	0.40

Intersection Summary	
Cycle Length:	100
Actuated Cycle Length:	100
Offset:	12 (12%), Referenced to phase 2:NBT and 6:SBTL, Start of Green
Natural Cycle:	65

Control Type: Actuated-Coordinated	
Maximum v/c Ratio:	0.78
Intersection Signal Delay:	18.7
Intersection LOS:	B
Intersection Capacity Utilization:	74.4%
Analysis Period (min):	15
# 95th percentile volume exceeds capacity, queue may be longer.	
Queue shown is maximum after two cycles.	
m Volume for 95th percentile queue is metered by upstream signal.	



Splits and Phases: 6: Parkdale & Gladstone

Lanes, Volumes, Timings  
7: Parkdale & 417 WB OR

Lanes, Volumes, Timings  
7: Parkdale & 417 WB OR

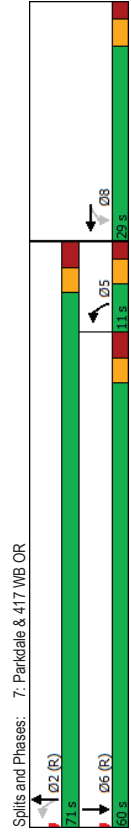
Future Background 2030PM Peak Hour  
1186-1194 Wellington STW

Future Background 2030PM Peak Hour  
1186-1194 Wellington STW

Lane Group	WBL	WBT	NBL	NBT	SBT
Lane Configurations	←	←	←	←	←
Traffic Volume (vph)	360	24	89	622	595
Future Volume (vph)	360	24	89	622	595
Lane Group Flow (vph)	360	574	89	622	843
Turn Type	Perm	NA	pm-pt	NA	NA
Protected Phases	8	5	2	2	6
Permitted Phases	8	5	2	2	6
Detector Phase	8	8	5	2	6
Switch Phase					
Minimum Initial (s)	10.0	10.0	5.0	10.0	10.0
Minimum Split (s)	20.5	20.5	10.2	27.3	21.3
Total Split (s)	29.0	29.0	11.0	71.0	60.0
Total Split (%)	29.0%	29.0%	11.0%	71.0%	60.0%
Maximum Green (s)	23.5	23.5	5.8	64.7	53.7
Yellow Time (s)	3.3	3.3	3.0	3.0	3.0
All-Red Time (s)	2.2	2.2	2.2	3.3	3.3
Lost Time Adjust (s)	0.0	0.0	0.0	0.0	0.0
Total Lost Time (s)	5.5	5.5	5.2	6.3	6.3
Lead/Lag			Lag	Lead	
Lead-Lag Optimize?			Yes	Yes	
Vehicle Extension (s)	3.0	3.0	3.0	3.0	3.0
Recall Mode	None	None	None	C-Max	C-Max
Walk Time (s)	7.0	7.0	7.0	7.0	7.0
Flash Dont Walk (s)	8.0	8.0	14.0	8.0	8.0
Pedestrian Calls (#/hr)	3	3		21	13
Act Effct Green (s)	23.5	23.5	65.8	64.7	55.9
Actuated G/C Ratio	0.24	0.24	0.66	0.65	0.56
v/c Ratio	0.93	1.02	0.34	0.55	0.90
Control Delay	69.1	65.0	14.4	12.0	34.3
Queue Delay	0.0	0.0	0.0	0.0	0.0
Total Delay	69.1	65.0	14.4	12.0	34.3
LOS	E	E	B	B	C
Approach Delay	66.5	66.5	12.3	34.3	
Approach LOS	E	E	B	B	C
Queue Length 50th (m)	68.4	-72.7	5.6	59.8	161.1
Queue Length 95th (m)	#120.5	#136.8	10.9	87.5	#231.9
Internal Link Dist (m)	462.5		38.8	197.3	
Turn Bay Length (m)					
Base Capacity (vph)	389	560	261	1129	932
Starvation Cap Reductn	0	0	0	0	0
Spillback Cap Reductn	0	0	0	4	0
Storage Cap Reductn	0	0	0	0	0
Reduced v/c Ratio	0.93	1.02	0.34	0.55	0.90

Intersection Summary	
Cycle Length:	100
Actuated Cycle Length:	100
Offset:	39 (39%), Referenced to phase 2,NBTL and 6:SBT, Start of Green
Natural Cycle:	110

Control Type:	Actuated-Coordinated
Maximum v/c Ratio:	1.02
Intersection Signal Delay:	40.1
Intersection LOS:	D
Intersection Capacity Utilization:	106.3%
ICU Level of Service:	G
Analysis Period (min):	15
~ Volume exceeds capacity, queue is theoretically infinite.	
Queue shown is maximum after two cycles.	
# 95th percentile volume exceeds capacity, queue may be longer.	
Queue shown is maximum after two cycles.	

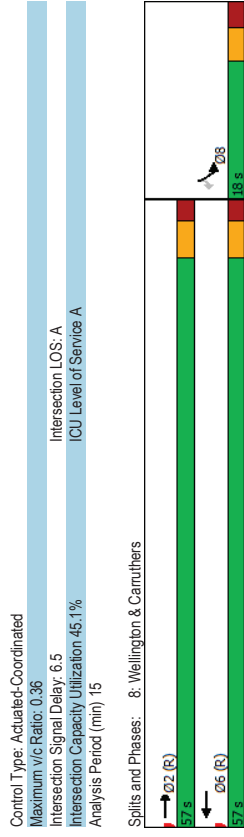


Lanes, Volumes, Timings  
8: Wellington & Carruthers

Lanes, Volumes, Timings  
8: Wellington & Carruthers

	EBT	WBT	SBL	SBR
Lane Group	EBT	WBT	SBL	SBR
Lane Configurations	←	←	←	←
Traffic Volume (vph)	445	478	54	20
Future Volume (vph)	445	478	54	20
Lane Group Flow (vph)	445	478	54	20
Turn Type	NA	NA	Prot	Perm
Protected Phases	2	6	8	8
Permitted Phases	2	6	8	8
Detector Phase	2	6	8	8
Switch Phase				
Minimum Initial (s)	10.0	10.0	10.0	10.0
Minimum Split (s)	15.3	26.3	17.5	17.5
Total Split (s)	57.0	57.0	18.0	18.0
Total Split (%)	76.0%	76.0%	24.0%	24.0%
Maximum Green (s)	51.7	51.7	12.5	12.5
Yellow Time (s)	3.3	3.3	3.0	3.0
All-Red Time (s)	2.0	2.0	2.5	2.5
Lost Time Adjust (s)	0.0	0.0	0.0	0.0
Total Lost Time (s)	5.3	5.3	5.5	5.5
Lead/Lag				
Lead-Lag Optimize?				
Vehicle Extension (s)	3.0	3.0	3.0	3.0
Recall Mode	C-Mix	C-Mix	None	None
Walk Time (s)	14.0	7.0	7.0	7.0
Flash Dont Walk (s)	7.0	5.0	5.0	6.2
Pedestrian Calls (#/hr)	157	62	62	62
Act Effr Green (s)	57.2	57.2	11.2	11.2
Actuated g/C Ratio	0.76	0.76	0.15	0.15
v/c Ratio	0.33	0.36	0.22	0.10
Control Delay	4.9	5.1	30.1	13.6
Queue Delay	0.0	0.0	0.0	0.0
Total Delay	4.9	5.1	30.1	13.6
LOS	A	A	C	B
Approach Delay	4.9	5.1	25.6	
Approach LOS	A	A	C	
Queue Length 50th (m)	21.3	23.5	6.7	0.0
Queue Length 95th (m)	33.9	37.2	16.1	5.5
Internal Link Dist (m)	149.5	153.4	73.2	
Turn Bay Length (m)				30.0
Base Capacity (vph)	1330	1330	276	227
Starvation Cap Reductn	0	0	0	0
Spillback Cap Reductn	0	0	0	0
Storage Cap Reductn	0	0	0	0
Reduced v/c Ratio	0.33	0.36	0.20	0.09

Intersection Summary	
Cycle Length:	75
Actuated Cycle Length:	75
Offset:	72 (96%), Referenced to phase 2,EBT and 6:WBT, Start of Green
Natural Cycle:	45



Control Type: Actuated-Coordinated	
Maximum v/c Ratio:	0.36
Intersection Signal Delay:	6.5
Intersection LOS:	A
ICU Level of Service A	
Intersection Capacity Utilization:	45.1%
Analysis Period (min):	15

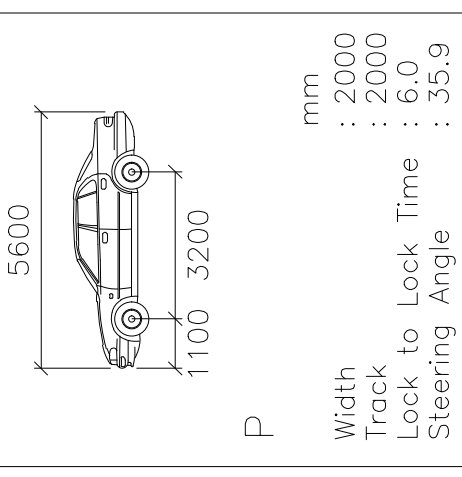
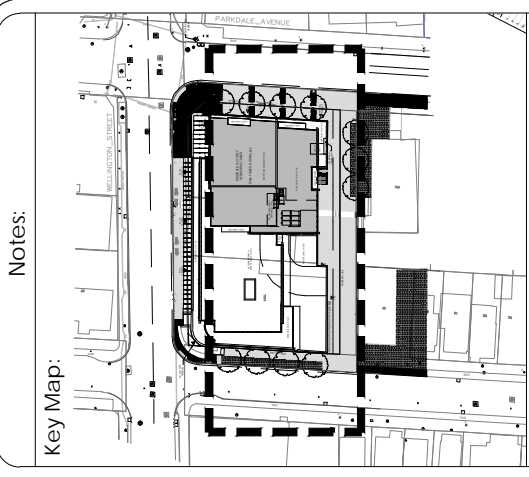
Splits and Phases: 8: Wellington & Carruthers

Intersection													
Int'Delay, s/veh													
1.8													
Movement	EBL	EBT	EBR	WBL	WBT	WBR	NBL	NBT	NBR	SBL	SBT	SBR	
Lane Configurations	+	+	+	+	+	+	+	+	+	+	+	+	+
Traffic Vol, veh/h	10	303	23	13	339	13	5	8	16	9	21	31	
Future Vol, veh/h	10	303	23	13	339	13	5	8	16	9	21	31	
Conflicting Peds. #/hr	0	0	0	0	0	0	0	0	0	0	0	0	0
Sign Control	Free	Free	Free	Free	Free	Free	Free	Free	Free	Free	Free	Free	Free
RT Channelized	-	-	-	-	-	-	-	-	-	-	-	-	-
Storage Length	-	-	-	-	-	-	-	-	-	-	-	-	-
Veh in Median Storage, #	-	0	-	-	0	-	-	0	-	-	-	0	-
Grade, %	-	0	-	-	0	-	-	0	-	-	-	0	-
Peak Hour Factor	100	100	100	100	100	100	100	100	100	100	100	100	100
Heavy Vehicles, %	2	2	2	2	2	2	2	2	2	2	2	2	2
Mvmt Flow	10	303	23	13	339	13	5	8	16	9	21	31	
Major/Minor	Major1	Major2			Minor1			Minor2					
Conflicting Flow All	352	0	0	326	0	0	733	713	315	719	718	346	
Stage 1	-	-	-	-	-	-	335	335	-	372	372	-	
Stage 2	-	-	-	-	-	-	398	378	-	347	346	-	
Critical Hwy	4.12	-	-	4.12	-	-	7.12	6.52	6.22	7.12	6.52	6.22	
Critical Hwy Stg 1	-	-	-	-	-	-	6.12	5.52	-	6.12	5.52	-	
Critical Hwy Stg 2	-	-	-	-	-	-	6.12	5.52	-	6.12	5.52	-	
Follow-up Hwy	2.218	-	-	2.218	-	-	3.518	4.018	3.318	3.518	4.018	3.318	
Pot Cap-1 Maneuver	1207	-	-	1234	-	-	336	357	725	344	355	697	
Stage 1	-	-	-	-	-	-	679	643	-	648	619	-	
Stage 2	-	-	-	-	-	-	628	615	-	669	635	-	
Platoon blocked, %	-	-	-	-	-	-	-	-	-	-	-	-	
Mov Cap-1 Maneuver	1207	-	-	1234	-	-	301	349	725	325	347	697	
Mov Cap-2 Maneuver	-	-	-	-	-	-	301	349	-	325	347	-	
Stage 1	-	-	-	-	-	-	672	637	-	642	611	-	
Stage 2	-	-	-	-	-	-	572	607	-	640	629	-	
Approach	EB	WB	NB	SB									
HCM Control Delay, s	0.2	0.3	13.1	14									
HCM LOS	B	B	B	B									
Minor Lane/Major Mvmt	NBLn1	EBL	EBT	EBR	WBL	WBT	WBR	NBLn1					
Capacity (veh/h)	471	1207	-	-	1234	-	-	460					
HCM Lane V/C Ratio	0.062	0.008	-	-	0.011	-	-	0.133					
HCM Control Delay (s)	13.1	8	0	0	7.9	0	0	14					
HCM Lane LOS	B	A	A	A	A	A	A	B					
HCM 95th %ile Q(veh)	0.2	0	-	-	0	-	-	0.5					

Intersection													
Int'Delay, s/veh													
2													
Movement	EBL	EBT	EBR	WBL	WBT	WBR	NBL	NBT	NBR	SBL	SBT	SBR	
Lane Configurations	+	+	+	+	+	+	+	+	+	+	+	+	+
Traffic Vol, veh/h	14	164	2	2	114	10	3	3	1	26	2	22	
Future Vol, veh/h	14	164	2	2	114	10	3	3	1	26	2	22	
Conflicting Peds. #/hr	0	0	0	0	0	0	0	0	0	0	0	0	0
Sign Control	Free	Free	Free	Free	Free	Free	Free	Free	Free	Free	Free	Free	Free
RT Channelized	-	-	-	-	-	-	-	-	-	-	-	-	-
Storage Length	-	-	-	-	-	-	-	-	-	-	-	-	-
Veh in Median Storage, #	-	0	-	-	0	-	-	0	-	-	-	0	-
Grade, %	-	0	-	-	0	-	-	0	-	-	-	0	-
Peak Hour Factor	100	100	100	100	100	100	100	100	100	100	100	100	100
Heavy Vehicles, %	2	2	2	2	2	2	2	2	2	2	2	2	2
Mvmt Flow	14	164	2	2	114	10	3	3	1	26	2	22	
Major/Minor	Major1	Major2			Minor1			Minor2					
Conflicting Flow All	124	0	0	166	0	0	328	321	165	318	317	119	
Stage 1	-	-	-	-	-	-	193	193	-	123	123	-	
Stage 2	-	-	-	-	-	-	135	128	-	195	194	-	
Critical Hwy	4.12	-	-	4.12	-	-	7.12	6.52	6.22	7.12	6.52	6.22	
Critical Hwy Stg 1	-	-	-	-	-	-	6.12	5.52	-	6.12	5.52	-	
Critical Hwy Stg 2	-	-	-	-	-	-	6.12	5.52	-	6.12	5.52	-	
Follow-up Hwy	2.218	-	-	2.218	-	-	3.518	4.018	3.318	3.518	4.018	3.318	
Pot Cap-1 Maneuver	1463	-	-	1412	-	-	625	566	879	635	599	933	
Stage 1	-	-	-	-	-	-	809	741	-	881	794	-	
Stage 2	-	-	-	-	-	-	868	790	-	807	740	-	
Platoon blocked, %	-	-	-	-	-	-	-	-	-	-	-	-	
Mov Cap-1 Maneuver	1463	-	-	1412	-	-	603	588	879	625	591	933	
Mov Cap-2 Maneuver	-	-	-	-	-	-	603	588	-	625	591	-	
Stage 1	-	-	-	-	-	-	800	733	-	871	792	-	
Stage 2	-	-	-	-	-	-	844	788	-	794	732	-	
Approach	EB	WB	NB	SB									
HCM Control Delay, s	0.6	0.1	10.8	10.3									
HCM LOS	B	B	B	B									
Minor Lane/Major Mvmt	NBLn1	EBL	EBT	EBR	WBL	WBT	WBR	NBLn1					
Capacity (veh/h)	624	1463	-	-	1412	-	-	729					
HCM Lane V/C Ratio	0.011	0.01	-	-	0.001	-	-	0.069					
HCM Control Delay (s)	10.8	7.5	0	0	7.6	0	0	10.3					
HCM Lane LOS	B	A	A	A	A	A	A	B					
HCM 95th %ile Q(veh)	0	0	-	-	0	-	-	0.2					

# Appendix H

Turning Templates

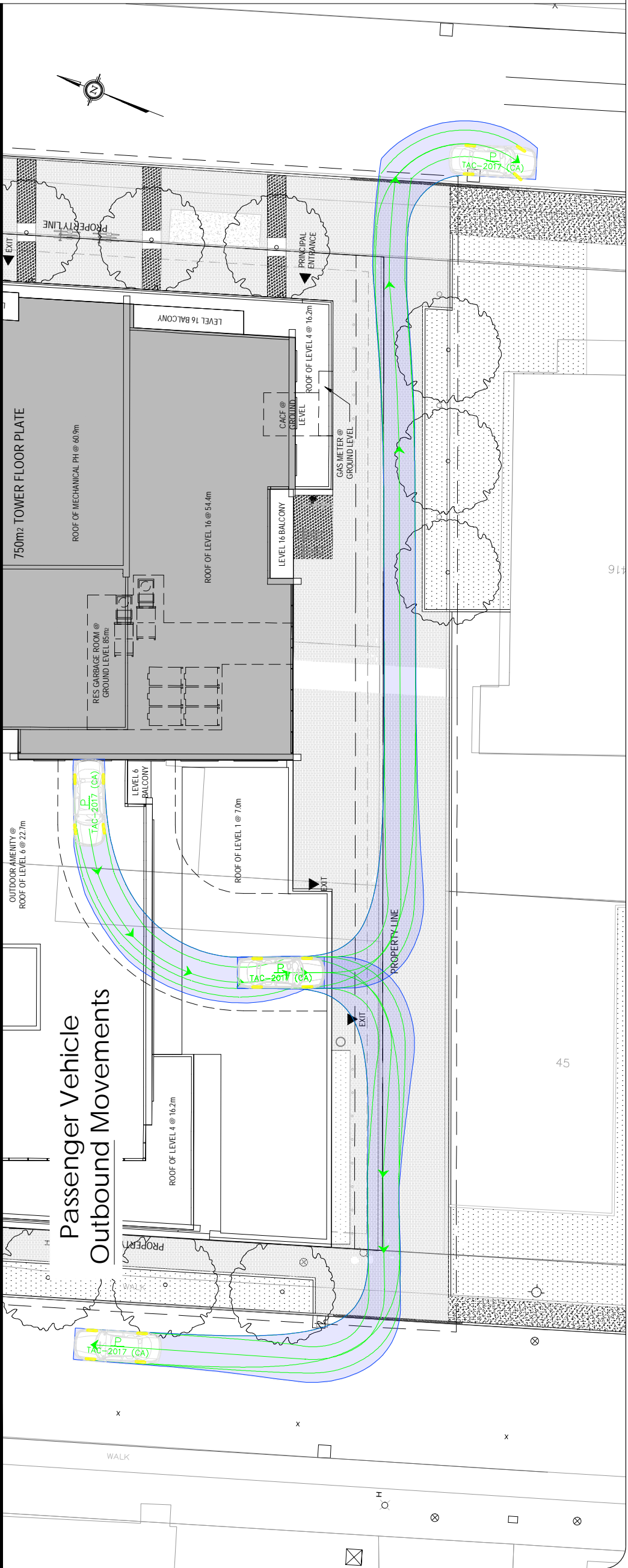
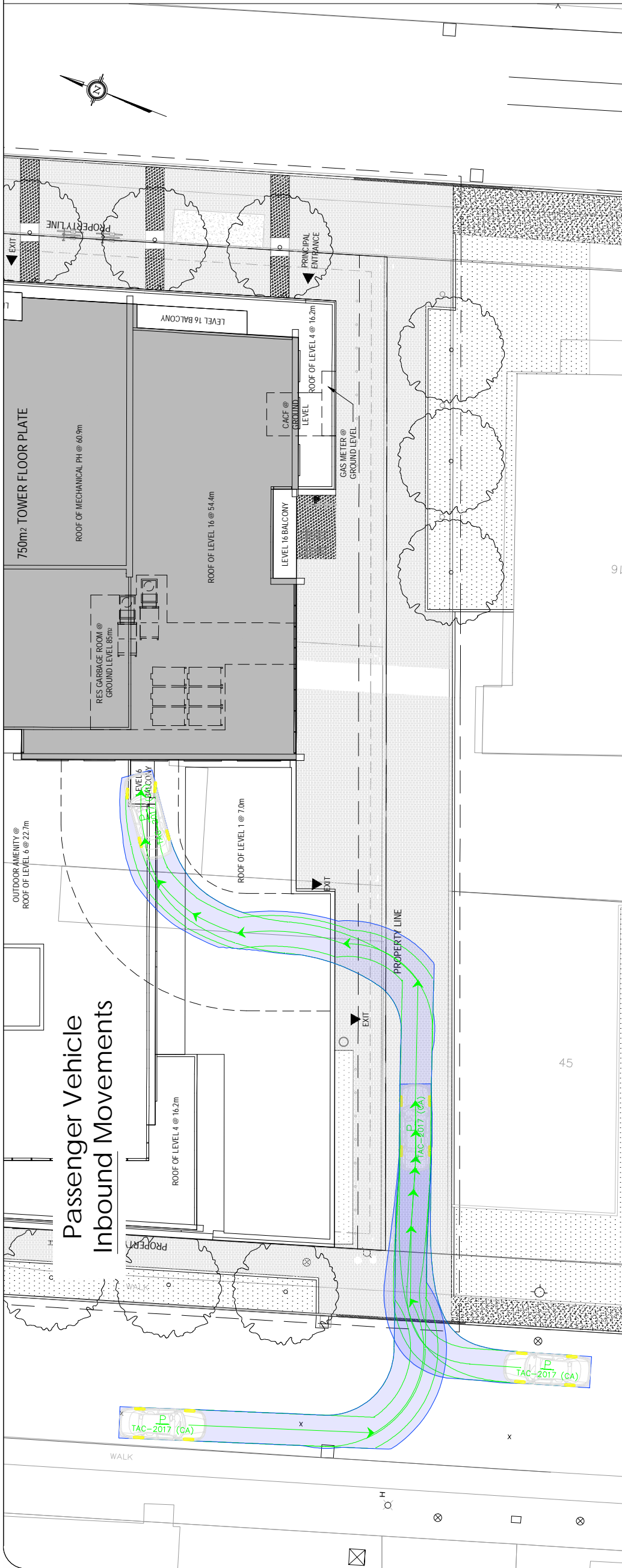


01	Issued for Review	AN	2022-12-09
REV:	DESCRIPTION:	BY:	DATE:
STATUS:			

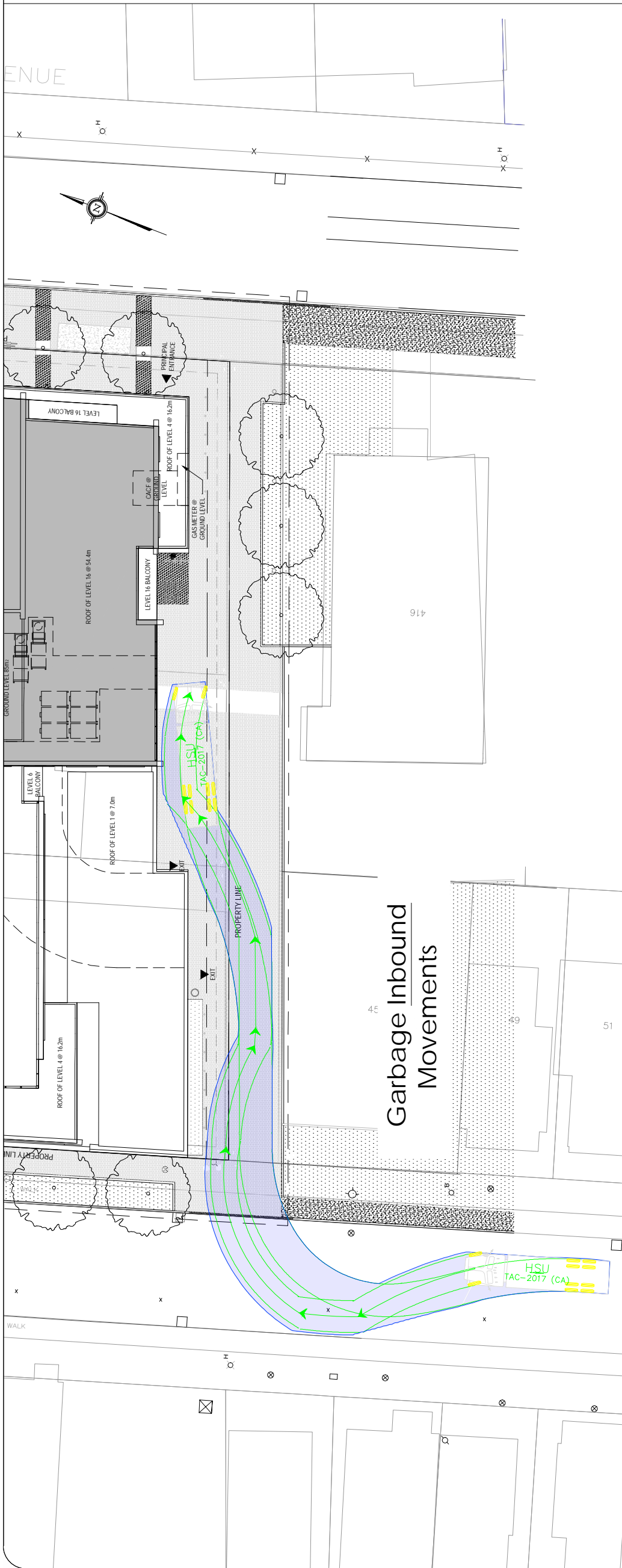
**CGH Transportation**  
 13 Markham Ave  
 Ottawa, ON  
 K2G 3Z1  
 (343) 999-9117

CLIENT: Welldale Limited Partnership  
 ARCHITECT:

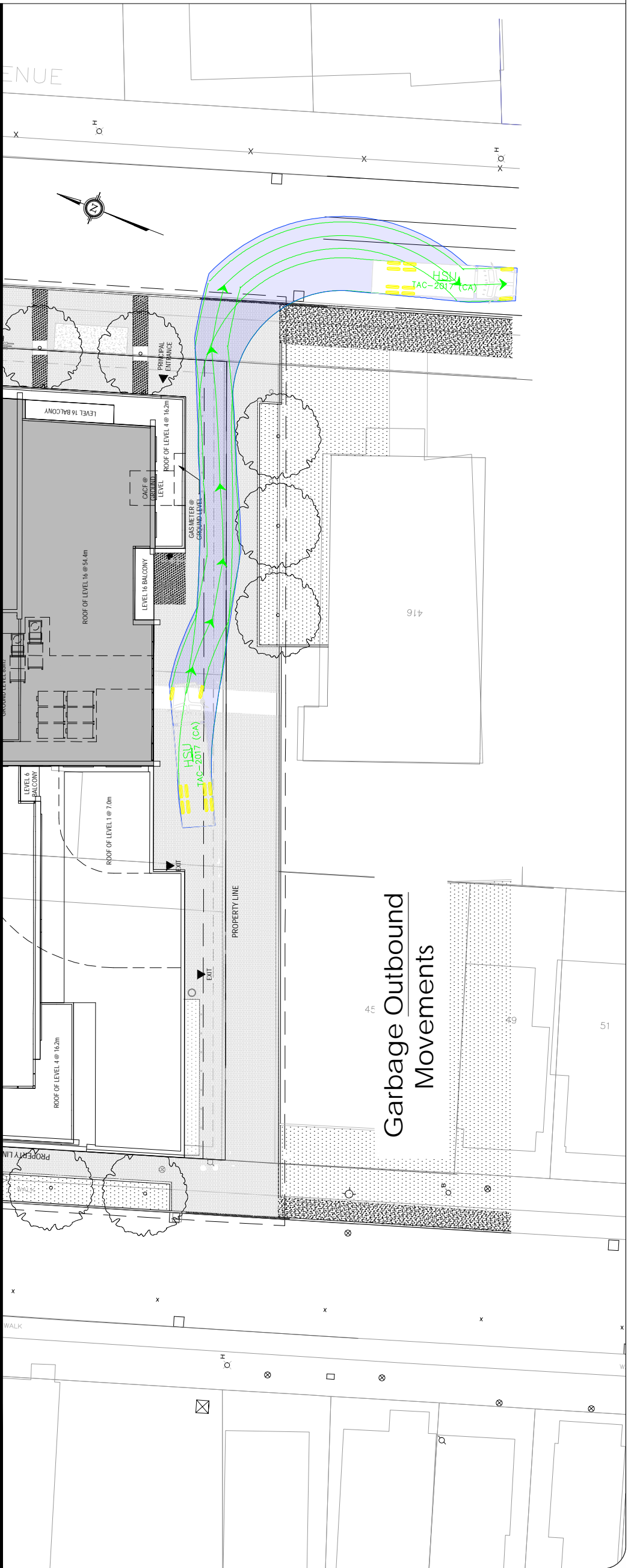
SITE:	1186-1194 Wellington Avenue		
TITLE:	Turning Movement Analysis Passenger Vehicle Turning Movements		
SCALE AT A3:	DATE:	DRAWN:	CHECKED:
NIS	2022-12-09	AN	AL
PROJECT NO:	DRAWING NO:	REVISION:	
2020-62	001	01	







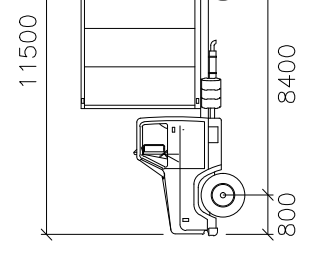
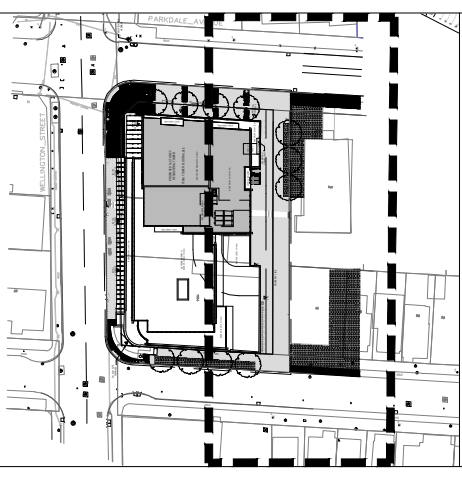
**Garbage Inbound Movements**



**Garbage Outbound Movements**

Notes:

Key Map:



HSU

mm  
 Width : 2600  
 Track : 2600  
 Lock to Lock Time : 6.0  
 Steering Angle : 40.0

01	Issued for Review	AN	2022-12-09
REV:	DESCRIPTION:	BY:	DATE:
STATUS:			



**CGH Transportation**  
 13 Markham Ave  
 Ottawa, ON  
 K2G 3Z1  
 (343) 999-9117

CLIENT: Welldale Limited Partnership  
 ARCHITECT:

SITE:		1186-1194 Wellington Avenue	
TITLE: Turning Movement Analysis Garbage Turning Movements			
SCALE AT A3:	DATE:	DRAWN:	CHECKED:
NIS	2022-12-09	AN	AL
PROJECT NO:	DRAWING NO:	REVISION:	
2020-62	002	01	

# Appendix I

MMLOS Analysis





Parkdale Ave & Armstrong St			Parkdale Ave & Wellington SW			Parkdale Ave & Gladstone Ave			Parkdale Ave & Highway 417 WB			Carruthers Ave & Wellington St W			
NORTH	SOUTH	EAST	NORTH	SOUTH	EAST	NORTH	SOUTH	EAST	NORTH	SOUTH	EAST	NORTH	SOUTH	EAST	WEST
3	3	0-2	3	3	4	3	3	3	3	5	3	3	3	0-2	3
No Median - 2.4 m	No Median - 2.4 m	No Median - 2.4 m	No Median - 2.4 m	No Median - 2.4 m	No Median - 2.4 m	No Median - 2.4 m	No Median - 2.4 m	No Median - 2.4 m	No Median - 2.4 m	No Median - 2.4 m	No Median - 2.4 m	No Median - 2.4 m	No Median - 2.4 m	No Median - 2.4 m	No Median - 2.4 m
Permissive	Permissive	Permissive	Permissive	Permissive	Permissive	Permissive	Permissive	Permissive	Permissive	No left turn / Prohib.	Permitted/ Permissive	No left turn / Prohib.	Permissive	Permissive	No left turn / Prohib.
Permissive or yield control	Permissive or yield control	Permissive or yield control	Permissive or yield control	Permissive or yield control	Permissive or yield control	Permissive or yield control	Permissive or yield control	Permissive or yield control	Permissive or yield control	No right turn	Permissive or yield control	No right turn	Permissive or yield control	No right turn	Permissive or yield control
RTOR allowed	RTOR allowed	RTOR allowed	RTOR prohibited	RTOR prohibited	RTOR prohibited	RTOR prohibited	RTOR prohibited	RTOR prohibited	RTOR prohibited	RTOR allowed	RTOR prohibited	RTOR allowed	RTOR prohibited	RTOR prohibited	RTOR prohibited
No	No	No	Yes	Yes	Yes	No	No	No	No	No	No	No	No	No	No
No Channel	No Channel	No Channel	No Channel	No Channel	No Channel	No Channel	No Channel	No Channel	No Channel	No Channel	No Channel	No Channel	No Channel	No Channel	No Channel
3.5m	3.5m	3.5m	3.5m	3.5m	3.5m	5-10m	5-10m	5-10m	5-10m	No Right Turn	5-10m	No Right Turn	5-10m	No Right Turn	No Channel
SHI In-house markings	SHI In-house markings	SHI In-house markings	Termed/closed pavement	Termed/closed pavement	Termed/closed pavement	SHI In-house markings	SHI In-house markings	SHI In-house markings	SHI In-house markings	SHI In-house markings	SHI In-house markings	Termed/closed pavement	Termed/closed pavement	Termed/closed pavement	Termed/closed pavement
72	72	67	80	79	63	80	88	74	82	60	74	78	60	74	96
C	C	B	B	B	C	B	B	C	B	C	C	B	C	C	A
100	100	100	100	100	100	100	100	100	100	100	100	100	100	100	70
55	55	22	21	35	47	63	54	17	83	44	17	44	16	16	8
B	B	D	D	D	C	B	B	D	A	B	D	B	D	D	C
C	C	D	D	D	C	B	B	D	B	D	D	B	D	D	C
D	D	D	D	D	D	D	D	D	D	D	D	D	D	D	C
D	D	D	D	D	D	D	D	D	D	D	D	D	D	D	C
NORTH	SOUTH	EAST	NORTH	SOUTH	EAST	NORTH	SOUTH	EAST	NORTH	SOUTH	EAST	NORTH	SOUTH	EAST	NORTH
Mixed Traffic	Mixed Traffic	Mixed Traffic	Mixed Traffic	Mixed Traffic	Mixed Traffic	Mixed Traffic	Mixed Traffic	Mixed Traffic	Mixed Traffic	Mixed Traffic	Mixed Traffic	Mixed Traffic	Mixed Traffic	Mixed Traffic	Mixed Traffic
Mixed Traffic	Mixed Traffic	Mixed Traffic	Mixed Traffic	Mixed Traffic	Mixed Traffic	Mixed Traffic	Mixed Traffic	Mixed Traffic	Mixed Traffic	Mixed Traffic	Mixed Traffic	Mixed Traffic	Mixed Traffic	Mixed Traffic	Mixed Traffic
No lane crossed	No lane crossed	No lane crossed	No lane crossed	No lane crossed	No lane crossed	No lane crossed	No lane crossed	No lane crossed	No lane crossed	No lane crossed	No lane crossed	No lane crossed	No lane crossed	No lane crossed	No lane crossed
> 50 to < 60 km/h	> 50 to < 60 km/h	> 40 to < 50 km/h	> 50 to < 60 km/h	> 50 to < 60 km/h	> 50 to < 60 km/h	> 50 to < 60 km/h	> 50 to < 60 km/h	> 50 to < 60 km/h	> 50 to < 60 km/h	> 50 to < 60 km/h	> 50 to < 60 km/h	> 40 to < 50 km/h	> 40 to < 50 km/h	> 40 to < 50 km/h	> 40 to < 50 km/h
C	C	B	C	C	C	C	C	A	C	C	A	C	C	C	B
-	-	-	-	-	-	-	-	-	-	-	-	-	-	-	-
-	-	-	-	-	-	-	-	-	-	-	-	-	-	-	-
≤ 20 sec	≤ 10 sec	≤ 10 sec	≤ 20 sec	≤ 20 sec	≤ 40 sec	≤ 20 sec	≤ 20 sec	≤ 20 sec	≤ 20 sec	≤ 20 sec	≤ 20 sec	> 40 sec	≤ 20 sec	≤ 20 sec	≤ 20 sec
C	B	C	C	C	E	F	C	C	C	C	C	F	C	C	B
C	C	C	F	F	F	F	C	C	C	F	F	C	F	C	C
-	-	-	-	-	-	-	-	-	-	-	-	-	-	-	-
-	-	-	-	-	-	-	-	-	-	-	-	-	-	-	-
0.0 - 0.60	0.0 - 0.60	0.0 - 0.60	0.71 - 0.80	0.71 - 0.80	0.71 - 0.80	0.71 - 0.80	0.71 - 0.80	0.71 - 0.80	0.71 - 0.80	0.91 - 1.00	0.91 - 1.00	0.91 - 1.00	0.91 - 1.00	0.91 - 1.00	0.0 - 0.60
A	A	A	C	C	C	C	C	C	C	E	E	E	E	E	A

## Multi-Modal Level of Service - Segments Form

Consultant Scenario Comments	CGH Transportation Inc. Existing/Future
Project Date	2020-62 12/5/2022

SEGMENTS	Existing Hamilton	Existing Parkdale	Existing Wellington	Future Hamilton	Future Parkdale	Future Wellington	
<b>Pedestrian</b>	Sidewalk Width	1.8 m	≥ 2 m	≥ 2 m	≥ 2 m	≥ 2 m	
	Boulevard Width	< 0.5 m	< 0.5 m	> 2 m	> 2 m	> 2 m	
	Avg Daily Curb Lane Traffic Volume	≤ 3000	> 3000	≤ 3000	> 3000	≤ 3000	
	Operating Speed	> 50 to 60 km/h	> 50 to 60 km/h	> 50 to 60 km/h	> 50 to 60 km/h	> 50 to 60 km/h	
	On-Street Parking	yes	no	yes	yes	yes	
	Exposure to Traffic PLoS	C	F	C	A	C	A
	Effective Sidewalk Width						
	Pedestrian Volume						
	Crowding PLoS						
	Level of Service	-	-	-	-	-	-
<b>Bicycle</b>	Type of Cycling Facility	Mixed Traffic	Mixed Traffic	Mixed Traffic	Mixed Traffic	Mixed Traffic	
	Number of Travel Lanes	≤ 2 (no centreline)	2-3 lanes total	2-3 lanes total	2-3 lanes total	2-3 lanes total	
	Operating Speed	≥ 50 to 60 km/h	≥ 50 to 60 km/h	≥ 50 to 60 km/h	≥ 50 to 60 km/h	≥ 50 to 60 km/h	
	# of Lanes & Operating Speed LoS	D	E	E	D	E	
	Bike Lane (+ Parking Lane) Width						
	Bike Lane Width LoS						
	Bike Lane Blockages						
	Blockage LoS						
	Median Refuge Width (no median = < 1.8 m)	< 1.8 m refuge	< 1.8 m refuge	< 1.8 m refuge	< 1.8 m refuge	< 1.8 m refuge	
	No. of Lanes at Unsignalized Crossing	≤ 3 lanes	≤ 3 lanes	≤ 3 lanes	≤ 3 lanes	≤ 3 lanes	
Sidestreet Operating Speed	> 50 to 60 km/h	> 50 to 60 km/h	> 50 to 60 km/h	> 50 to 60 km/h	> 50 to 60 km/h		
Unsignalized Crossing - Lowest LoS	C	B	B	B	B		
Level of Service	D	E	E	D	E	E	
<b>Transit</b>	Facility Type		Mixed Traffic	Mixed Traffic	Mixed Traffic	Mixed Traffic	
	Friction or Ratio Transit/Posted Speed		V/Vp ≥ 0.8	V/Vp ≥ 0.8	V/Vp ≥ 0.8	V/Vp ≥ 0.8	
	Level of Service	-	D	D	-	D	
<b>Truck</b>	Truck Lane Width						
	Travel Lanes per Direction		≤ 3.3 m	1		≤ 3.3 m	
	Level of Service	-	D	D	-	D	

# Appendix J

Synchro Intersection Worksheets – 2025 Future Total Conditions

Lanes, Volumes, Timings  
1: Holland & Spencer

Future Total 2025AM Peak Hour  
1186-1194 Wellington STW

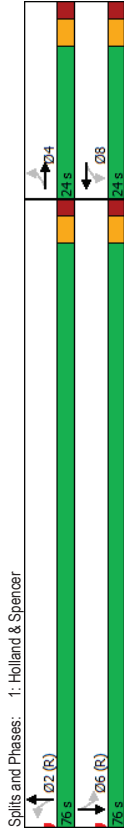
Lane Group	EBL	EBT	WBL	WBT	NBL	NBT	SBL	SBT
Lane Configurations	8	11	57	4	10	535	10	318
Traffic Volume (vph)	8	11	57	4	10	535	10	318
Future Volume (vph)	0	50	0	113	0	566	0	333
Lane Group Flow (vph)	Perm	NA	Perm	NA	Perm	NA	Perm	NA
Protected Phases	4	4	8	8	2	2	6	6
Permitted Phases	4	4	8	8	2	2	6	6
Detector Phase	4	4	8	8	2	2	6	6
Switch Phase								
Minimum Initial (s)	10.0	10.0	10.0	10.0	10.0	10.0	10.0	10.0
Minimum Split (s)	23.5	23.5	23.5	29.3	29.3	29.3	29.3	29.3
Total Split (s)	24.0	24.0	24.0	76.0	76.0	76.0	76.0	76.0
Total Split (%)	24.0%	24.0%	24.0%	76.0%	76.0%	76.0%	76.0%	76.0%
Maximum Green (s)	18.5	18.5	18.5	70.7	70.7	70.7	70.7	70.7
Yellow Time (s)	3.3	3.3	3.3	3.3	3.3	3.3	3.3	3.3
All-Red Time (s)	2.2	2.2	2.2	2.0	2.0	2.0	2.0	2.0
Lost Time Adjust (s)	0.0	0.0	0.0	0.0	0.0	0.0	0.0	0.0
Total Lost Time (s)	5.5	5.5	5.5	5.3	5.3	5.3	5.3	5.3
Lead/Lag								
Lead-Lag Optimize?								
Vehicle Extension (s)	3.0	3.0	3.0	3.0	3.0	3.0	3.0	3.0
Recall Mode	None	None	None	None	C-Max	C-Max	C-Max	C-Max
Walk Time (s)	7.0	7.0	7.0	15.0	15.0	15.0	15.0	15.0
Flash Dont Walk (s)	11.0	11.0	11.0	9.0	9.0	9.0	9.0	9.0
Pedestrian Calls (#/hr)	24	24	17	17	67	67	74	74
Act Effr Green (s)	13.5	13.5	13.5	0.14	0.14	0.14	0.14	0.14
Actuated g/C Ratio	0.22	0.22	0.55	0.24	0.24	0.24	0.14	0.14
v/c Ratio	21.0	21.0	36.6	0.8	0.8	0.8	3.8	3.8
Control Delay	0.0	0.0	0.0	0.0	0.0	0.0	0.0	0.0
Queue Delay	0.0	0.0	0.0	0.0	0.0	0.0	0.0	0.0
Total Delay	21.0	21.0	36.6	0.8	0.8	0.8	3.8	3.8
LOS	C	C	D	A	A	A	A	A
Approach Delay	21.0	21.0	36.6	0.8	0.8	0.8	3.8	3.8
Approach LOS	C	C	D	A	A	A	A	A
Queue Length 50th (m)	3.4	3.4	13.9	1.1	1.1	1.1	6.6	6.6
Queue Length 95th (m)	13.0	13.0	29.4	4.2	4.2	4.2	13.6	13.6
Internal Link Dist (m)	151.9	151.9	132.2	211.0	211.0	211.0	210.0	210.0
Turn Bay Length (m)								
Base Capacity (vph)	296	296	268	2350	2350	2341	2341	2341
Starvation Cap Reductn	0	0	0	0	0	0	0	0
Spillback Cap Reductn	0	0	0	0	0	0	0	0
Storage Cap Reductn	0	0	0	0	0	0	0	0
Reduced v/c Ratio	0.17	0.17	0.42	0.24	0.24	0.24	0.14	0.14

Intersection Summary	
Cycle Length:	100
Actuated Cycle Length:	100
Offset:	40 (40%), Referenced to phase 2,NBTL and 6:SBTL, Start of Green
Natural Cycle:	55

Lanes, Volumes, Timings  
1: Holland & Spencer

Future Total 2025AM Peak Hour  
1186-1194 Wellington STW

Control Type:	Actuated-Coordinated
Maximum v/c Ratio:	0.55
Intersection Signal Delay:	6.5
Intersection LOS:	A
Intersection Capacity Utilization:	47.7%
Analysis Period (min):	15



Lanes, Volumes, Timings  
2: Holland & Wellington

Future Total 2025AM Peak Hour  
1186-1194 Wellington STW

EBL	EBT	WBL	WBT	NBL	NBT	SBL	SBT	Ø1	Ø3	Ø5	Ø7
38	324	48	228	45	228	24	394				
38	324	48	228	45	228	24	394				
0	425	0	318	0	616	0	444				
Perm	NA	Perm	NA	Perm	NA	Perm	NA				
2	2	6	6	4	4	8	8	1	3	5	7
2	2	6	6	4	4	8	8				
10.0	10.0	10.0	10.0	10.0	10.0	10.0	10.0	1.0	1.0	1.0	1.0
23.6	23.6	24.5	24.5	20.1	20.1	20.1	20.1	3.0	3.0	3.0	3.0
45.0	45.0	45.0	45.0	45.0	45.0	45.0	45.0	5.0	5.0	5.0	5.0
45.0%	45.0%	45.0%	45.0%	45.0%	45.0%	45.0%	45.0%	5%	5%	5%	5%
39.4	39.4	39.4	39.4	39.9	39.9	39.9	39.9	3.0	3.0	3.0	3.0
3.3	3.3	3.3	3.3	3.3	3.3	3.3	3.3	2.0	2.0	2.0	2.0
2.3	2.3	2.3	2.3	1.8	1.8	1.8	1.8	0.0	0.0	0.0	0.0
0.0	0.0	0.0	0.0	0.0	0.0	0.0	0.0				
5.6	5.6	5.6	5.6	5.1	5.1	5.1	5.1				
Lag	Lag	Lag	Lag	Lag	Lag	Lag	Lag	Lead	Lead	Lead	Lead
Yes	Yes	Yes	Yes	Yes	Yes	Yes	Yes	Yes	Yes	Yes	Yes
3.0	3.0	3.0	3.0	3.0	3.0	3.0	3.0	3.0	3.0	3.0	3.0
C-Max	C-Max	C-Max	C-Max	Max	Max	Max	Max	Max	Max	Max	Max
4.0	4.0	4.0	4.0	2.0	2.0	2.0	2.0				
14.0	14.0	14.0	14.0	13.0	13.0	13.0	13.0				
153	153	113	113	123	123	116	116				
39.4	39.4	39.4	39.4	39.9	39.9	39.9	39.9				
0.39	0.39	0.39	0.39	0.40	0.40	0.40	0.40				
0.31	0.31	0.31	0.31	0.55	0.55	0.38	0.38				
23.1	23.1	31.0	31.0	25.4	25.4	19.7	19.7				
0.0	0.0	0.0	0.0	0.0	0.0	0.0	0.0				
23.1	23.1	31.0	31.0	25.4	25.4	19.7	19.7				
C	C	C	C	C	C	B	B				
23.1	23.1	31.0	31.0	25.4	25.4	19.7	19.7				
C	C	C	C	C	C	B	B				
30.4	30.4	25.2	25.2	47.4	47.4	28.4	28.4				
43.1	43.1	39.0	39.0	64.2	64.2	37.1	37.1				
18.7	18.7	36.6	36.6	191.3	191.3	211.0	211.0				
1085	1085	1015	1015	1123	1123	1169	1169				
0	0	0	0	0	0	0	0				
0	0	0	0	0	0	0	0				
0	0	0	0	0	0	0	0				
0.39	0.39	0.31	0.31	0.55	0.55	0.38	0.38				

Intersection Summary	
Cycle Length:	100
Actuated Cycle Length:	100
Offset:	64 (84%), Referenced to phase 2,EBTL and 6:WBTL, Start of Green
Natural Cycle:	55

Lanes, Volumes, Timings  
2: Holland & Wellington

Future Total 2025AM Peak Hour  
1186-1194 Wellington STW

EBL	EBT	WBL	WBT	NBL	NBT	SBL	SBT
38	324	48	228	45	228	24	394
38	324	48	228	45	228	24	394
0	425	0	318	0	616	0	444
Perm	NA	Perm	NA	Perm	NA	Perm	NA
2	2	6	6	4	4	8	8
2	2	6	6	4	4	8	8
10.0	10.0	10.0	10.0	10.0	10.0	10.0	10.0
23.6	23.6	24.5	24.5	20.1	20.1	20.1	20.1
45.0	45.0	45.0	45.0	45.0	45.0	45.0	45.0
45.0%	45.0%	45.0%	45.0%	45.0%	45.0%	45.0%	45.0%
39.4	39.4	39.4	39.4	39.9	39.9	39.9	39.9
3.3	3.3	3.3	3.3	3.3	3.3	3.3	3.3
2.3	2.3	2.3	2.3	1.8	1.8	1.8	1.8
0.0	0.0	0.0	0.0	0.0	0.0	0.0	0.0
5.6	5.6	5.6	5.6	5.1	5.1	5.1	5.1
Lag	Lag	Lag	Lag	Lag	Lag	Lag	Lag
Yes	Yes	Yes	Yes	Yes	Yes	Yes	Yes
3.0	3.0	3.0	3.0	3.0	3.0	3.0	3.0
C-Max	C-Max	C-Max	C-Max	Max	Max	Max	Max
4.0	4.0	4.0	4.0	2.0	2.0	2.0	2.0
14.0	14.0	14.0	14.0	13.0	13.0	13.0	13.0
153	153	113	113	123	123	116	116
39.4	39.4	39.4	39.4	39.9	39.9	39.9	39.9
0.39	0.39	0.39	0.39	0.40	0.40	0.40	0.40
0.31	0.31	0.31	0.31	0.55	0.55	0.38	0.38
23.1	23.1	31.0	31.0	25.4	25.4	19.7	19.7
0.0	0.0	0.0	0.0	0.0	0.0	0.0	0.0
23.1	23.1	31.0	31.0	25.4	25.4	19.7	19.7
C	C	C	C	C	C	B	B
23.1	23.1	31.0	31.0	25.4	25.4	19.7	19.7
C	C	C	C	C	C	B	B
30.4	30.4	25.2	25.2	47.4	47.4	28.4	28.4
43.1	43.1	39.0	39.0	64.2	64.2	37.1	37.1
18.7	18.7	36.6	36.6	191.3	191.3	211.0	211.0
1085	1085	1015	1015	1123	1123	1169	1169
0	0	0	0	0	0	0	0
0	0	0	0	0	0	0	0
0	0	0	0	0	0	0	0
0.39	0.39	0.31	0.31	0.55	0.55	0.38	0.38



Control Type: Actuated-Coordinated  
 Maximum v/c Ratio: 0.55  
 Intersection LOS: C  
 ICU Level of Service D  
 Intersection Signal Delay: 24.5  
 Intersection Capacity Utilization: 80.1%  
 Analysis Period (min): 15

Splits and Phases: 2: Holland & Wellington.

Lanes, Volumes, Timings  
3: Holland & Tyndall

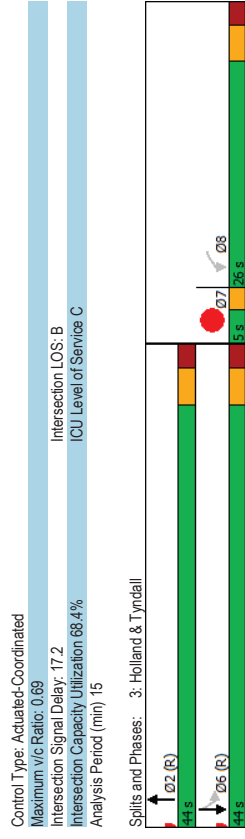
Lanes, Volumes, Timings  
3: Holland & Tyndall

Future Total 2025AM Peak Hour  
1186-1194 Wellington STW

Future Total 2025AM Peak Hour  
1186-1194 Wellington STW

Lane Group	WBL	NBT	SBL	SBT	Ø7
Lane Configurations	W	B	B	B	Ø7
Traffic Volume (vph)	40	492	128	514	
Future Volume (vph)	40	492	128	514	
Lane Group Flow (vph)	207	533	128	514	
Turn Type	Perm	NA	Perm	NA	
Protected Phases		2		6	7
Permitted Phases	8		6		
Detector Phase	8	2	6	6	
Switch Phase					
Minimum Initial (s)	10.0	10.0	10.0	10.0	1.0
Minimum Split (s)	23.5	25.7	15.7	15.7	3.0
Total Split (s)	26.0	44.0	44.0	44.0	5.0
Total Split (%)	34.7%	58.7%	58.7%	58.7%	7%
Maximum Green (s)	20.5	38.3	38.3	38.3	3.0
Yellow Time (s)	3.3	3.3	3.3	3.3	2.0
All-Red Time (s)	2.2	2.4	2.4	2.4	0.0
Lost Time Adjust (s)	0.0	0.0	0.0	0.0	0.0
Total Lost Time (s)	5.5	5.7	5.7	5.7	
Lead/Lag					Lead
Lead-Lag Optimize?	Yes				Yes
Vehicle Extension (s)	3.0	3.0	3.0	3.0	3.0
Recall Mode	None	C-Max	C-Max	C-Max	Max
Walk Time (s)	5.0	10.0			
Pedestrian Calls (#/hr)	38	47			
Act Effr Green (s)	16.2	42.6	42.6	42.6	
Actuated g/C Ratio	0.22	0.57	0.57	0.57	
v/c Ratio	0.69	0.55	0.35	0.52	
Control Delay	38.5	13.6	13.6	13.3	
Queue Delay	0.0	0.0	0.0	0.0	
Total Delay	38.5	13.6	13.6	13.3	
LOS	D	B	B	B	
Approach Delay	38.5	13.6	13.3		
Approach LOS	D	B	B		
Queue Length 50th (m)	26.2	45.3	9.5	43.4	
Queue Length 95th (m)	44.9	78.7	23.4	74.9	
Internal Link Dist (m)	140.7	156.5		23.1	
Turn Bay Length (m)					
Base Capacity (vph)	382	976	364	991	
Starvation Cap Reductn	0	0	0	0	
Spillback Cap Reductn	0	0	0	0	
Storage Cap Reductn	0	0	0	0	
Reduced v/c Ratio	0.54	0.55	0.35	0.52	

Intersection Summary	
Cycle Length:	75
Actuated Cycle Length:	75
Offset:	2 (3%), Referenced to phase 2:NBT and 6:SBTL, Start of Green
Natural Cycle:	60



Control Type: Actuated-Coordinated  
 Maximum v/c Ratio: 0.69  
 Intersection Signal Delay: 17.2  
 Intersection LOS: B  
 Intersection Capacity Utilization: 68.4%  
 Analysis Period (min): 15

Splits and Phases: 3: Holland & Tyndall

Lanes, Volumes, Timings  
4: Parkdale & Armstrong

Future Total 2025AM Peak Hour  
1186-1194 Wellington STW

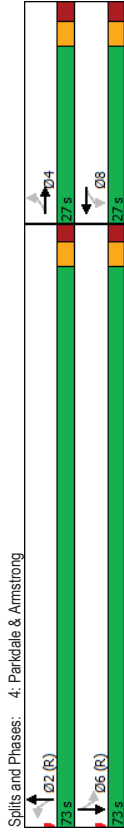
	EBL	EBT	WBL	WBT	NBL	NBT	SBL	SBT
Lane Group	EBL	EBT	WBL	WBT	NBL	NBT	SBL	SBT
Lane Configurations	27	75	12	47	22	366	12	216
Traffic Volume (vph)	27	75	12	47	22	366	12	216
Future Volume (vph)	0	117	0	72	0	411	0	250
Lane Group Flow (vph)	Perm	NA	Perm	NA	Perm	NA	Perm	NA
Protected Phases	4	4	8	8	2	2	6	6
Permitted Phases	4	4	8	8	2	2	6	6
Detector Phase	4	4	8	8	2	2	6	6
Switch Phase								
Minimum Initial (s)	10.0	10.0	10.0	10.0	10.0	10.0	10.0	10.0
Minimum Split (s)	23.5	23.5	23.5	25.2	25.2	25.2	25.2	25.2
Total Split (s)	27.0	27.0	27.0	27.0	73.0	73.0	73.0	73.0
Total Split (%)	27.0%	27.0%	27.0%	27.0%	73.0%	73.0%	73.0%	73.0%
Maximum Green (s)	21.5	21.5	21.5	67.8	67.8	67.8	67.8	67.8
Yellow Time (s)	3.0	3.0	3.0	3.0	3.0	3.0	3.0	3.0
All-Red Time (s)	2.5	2.5	2.5	2.2	2.2	2.2	2.2	2.2
Lost Time Adjust (s)	0.0	0.0	0.0	0.0	0.0	0.0	0.0	0.0
Total Lost Time (s)	5.5	5.5	5.5	5.2	5.2	5.2	5.2	5.2
Lead/Lag								
Lead-Lag Optimize?								
Vehicle Extension (s)	3.0	3.0	3.0	3.0	3.0	3.0	3.0	3.0
Recall Mode	Max	Max	Max	C-Max	C-Max	C-Max	C-Max	C-Max
Walk Time (s)	10.0	10.0	10.0	15.0	15.0	15.0	15.0	15.0
Flash Dont Walk (s)	8.0	8.0	8.0	5.0	5.0	5.0	5.0	5.0
Pedestrian Calls (#/hr)	28	28	25	25	33	33	32	32
Act Effr Green (s)	21.5	21.5	21.5	67.8	67.8	67.8	67.8	67.8
Actuated g/C Ratio	0.22	0.22	0.22	0.68	0.68	0.68	0.68	0.68
v/c Ratio	0.35	0.21	0.36	0.22	0.36	0.22	0.36	0.22
Control Delay	34.7	29.8	29.8	2.2	2.2	6.4	6.4	6.4
Queue Delay	0.0	0.0	0.0	0.4	0.4	0.0	0.0	0.0
Total Delay	34.7	29.8	29.8	2.6	2.6	6.4	6.4	6.4
LOS	C	C	C	A	A	A	A	A
Approach Delay	34.7	29.8	29.8	2.6	2.6	6.4	6.4	6.4
Approach LOS	C	C	C	A	A	A	A	A
Queue Length 50th (m)	18.1	9.9	9.9	4.2	4.2	15.5	15.5	15.5
Queue Length 95th (m)	34.3	21.7	21.7	7.7	7.7	25.0	25.0	25.0
Internal Link Dist (m)	46.6	196.9	196.9	125.2	125.2	312.1	312.1	312.1
Turn Bay Length (m)								
Base Capacity (vph)	336	345	345	1139	1139	1135	1135	1135
Starvation Cap Reductn	0	0	0	333	333	0	0	0
Spillback Cap Reductn	0	0	0	0	0	0	0	0
Storage Cap Reductn	0	0	0	0	0	0	0	0
Reduced v/c Ratio	0.35	0.21	0.21	0.51	0.51	0.22	0.22	0.22

Intersection Summary	
Cycle Length:	100
Actuated Cycle Length:	100
Offset:	52 (52%), Referenced to phase 2,NBTL and 6:SBTL, Start of Green
Natural Cycle:	50

Lanes, Volumes, Timings  
4: Parkdale & Armstrong

Future Total 2025AM Peak Hour  
1186-1194 Wellington STW

Control Type:	Actuated-Coordinated
Maximum v/c Ratio:	0.36
Intersection Signal Delay:	10.4
Intersection LOS:	B
Intersection Capacity Utilization:	54.0%
Analysis Period (min):	15





Lanes, Volumes, Timings  
5: Parkdale & Wellington

Future Total 2025AM Peak Hour  
1186-1194 Wellington STW

EBL	EBT	WBL	WBT	NBL	NBT	SBL	SBT	Ø1	Ø3	Ø5	Ø7
30	263	27	173	72	391	20	254				
30	263	27	173	72	391	20	254				
0	380	27	191	72	476	20	277				
Perm	NA	Perm	NA	pm+pt	NA	Perm	NA				
2	2	6	6	13	4	8	8	1	3	5	7
2	2	6	6	13	4	8	8				
10.0	10.0	10.0	10.0	5.0	10.0	10.0	10.0	1.0	1.0	1.0	1.0
23.4	23.4	23.4	23.4	10.2	15.5	20.5	20.5	3.0	3.0	3.0	3.0
35.0	35.0	35.0	35.0	12.0	55.0	43.0	43.0	5.0	5.0	5.0	5.0
35.0%	35.0%	35.0%	35.0%	12.0%	55.0%	43.0%	43.0%	5%	5%	5%	5%
29.6	29.6	29.6	29.6	6.8	49.5	37.5	37.5	3.0	3.0	3.0	3.0
3.3	3.3	3.3	3.3	3.0	3.0	3.0	3.0	2.0	2.0	2.0	2.0
2.1	2.1	2.1	2.1	2.2	2.5	2.5	2.5	0.0	0.0	0.0	0.0
0.0	0.0	0.0	0.0	0.0	0.0	0.0	0.0	0.0	0.0	0.0	0.0
5.4	5.4	5.4	5.4	5.2	5.5	5.5	5.5				
Lag	Lag	Lag	Lag	Lead	Lead	Lead	Lead				
Yes	Yes	Yes	Yes	Yes	Yes	Yes	Yes				
3.0	3.0	3.0	3.0	3.0	3.0	3.0	3.0	3.0	3.0	3.0	3.0
C-Max	C-Max	C-Max	C-Max	Max	Max	Max	Max	Max	Max	Max	Max
5.0	5.0	5.0	5.0	2.0	2.0	2.0	2.0				
8.0	8.0	8.0	8.0	8.0	8.0	8.0	8.0				
89	89	74	74	65	60	60	60				
29.6	29.6	29.6	29.6	54.8	49.5	37.5	37.5				
0.30	0.30	0.30	0.30	0.50	0.38	0.38	0.38				
0.48	0.48	0.14	0.39	0.16	0.59	0.07	0.44				
21.5	28.1	30.8	3.6	11.5	18.9	22.4	22.4				
0.0	0.0	0.0	0.0	0.2	0.0	0.0	0.0				
21.5	28.1	30.8	3.6	11.7	18.9	22.4	22.4				
C	C	C	A	B	B	C	C				
21.5	30.5	30.5	10.6	22.1	22.1	22.1	22.1				
C	C	C	B	C	C	C	C				
19.0	3.8	29.3	2.0	56.0	2.2	30.9	30.9				
26.2	10.6	48.5	m3.2	84.3	m6.3	45.2	45.2				
56.3	38.0	38.0	26.9	125.2	125.2	125.2	125.2				
30.0	30.0	40.0	40.0	40.0	40.0	40.0	40.0				
785	188	494	440	809	284	629	629				
0	0	0	0	45	0	0	0				
0	0	0	0	0	0	0	0				
0	0	0	0	0	0	0	0				
0.48	0.14	0.39	0.16	0.62	0.07	0.44	0.44				

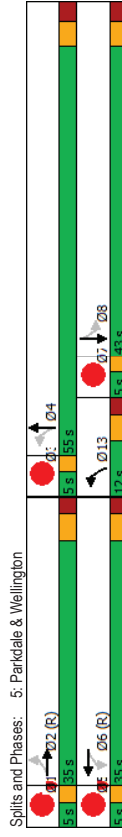
Intersection Summary

Cycle Length: 100
Actuated Cycle Length: 100
Offset: 0 (0%), Referenced to phase 2,EBTL and 6,WBTL, Start of Green
Natural Cycle: 65

Lanes, Volumes, Timings  
5: Parkdale & Wellington

Future Total 2025AM Peak Hour  
1186-1194 Wellington STW

Control Type: Actuated-Coordinated
Maximum v/c Ratio: 0.59
Intersection Signal Delay: 18.9
Intersection LOS: B
Intersection Capacity Utilization: 78.6%
Analysis Period (min): 15
ICU Level of Service: D
m. Volume for 95th percentile queue is metered by upstream signal.



Lanes, Volumes, Timings  
6: Parkdale & Gladstone

Future Total 2025AM Peak Hour  
1186-1194 Wellington STW

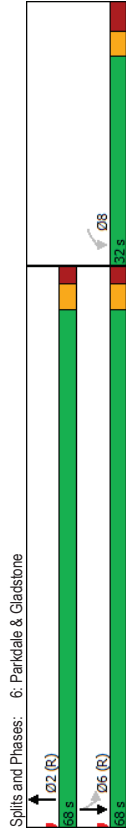
Lane Group	WBL	NBT	SBL	SBT
Lane Configurations	W	B	B	B
Traffic Volume (vph)	134	507	33	371
Future Volume (vph)	134	507	33	371
Lane Group Flow (vph)	165	638	33	371
Turn Type	Perm	NA	Perm	NA
Protected Phases		2		6
Permitted Phases	8		6	
Detector Phase	8	2	6	6
Switch Phase				
Minimum Initial (s)	10.0	10.0	10.0	10.0
Minimum Split (s)	22.7	20.3	15.3	15.3
Total Split (s)	32.0	68.0	68.0	68.0
Total Split (%)	32.0%	68.0%	68.0%	68.0%
Maximum Green (s)	25.3	62.7	62.7	62.7
Yellow Time (s)	3.0	3.0	3.0	3.0
All-Red Time (s)	3.7	2.3	2.3	2.3
Lost Time Adjust (s)	0.0	0.0	0.0	0.0
Total Lost Time (s)	6.7	5.3	5.3	5.3
Lead/Lag				
Lead-Lag Optimize?				
Vehicle Extension (s)	3.0	3.0	3.0	3.0
Recall Mode	Max	C-Max	C-Max	C-Max
Walk Time (s)	7.0	7.0		
Flash Dont Walk (s)	9.0	8.0		
Pedestrian Calls (#/hr)	16	8		
Act Effct Green (s)	25.3	62.7	62.7	62.7
Actuated g/C Ratio	0.25	0.63	0.63	0.63
v/c Ratio	0.41	0.61	0.09	0.34
Control Delay	35.0	12.0	12.4	13.6
Queue Delay	0.0	0.0	0.0	0.0
Total Delay	35.0	12.0	12.4	13.6
LOS	C	B	B	B
Approach Delay	35.0	12.0	13.5	
Approach LOS	C	B	B	
Queue Length 50th (m)	26.7	61.1	2.5	28.1
Queue Length 95th (m)	45.8	74.7	m7.1	65.7
Internal Link Dist (m)	224.2	197.3		88.5
Turn Bay Length (m)				85.0
Base Capacity (vph)	398	1053	349	1094
Starvation Cap Reductn	0	0	0	0
Spillback Cap Reductn	0	0	0	0
Storage Cap Reductn	0	0	0	0
Reduced v/c Ratio	0.41	0.61	0.09	0.34

Intersection Summary	
Cycle Length:	100
Actuated Cycle Length:	100
Offset:	12 (12%), Referenced to phase 2:NBT and 6:SBTL, Start of Green
Natural Cycle:	60

Lanes, Volumes, Timings  
6: Parkdale & Gladstone

Future Total 2025AM Peak Hour  
1186-1194 Wellington STW

Control Type:	Actuated-Coordinated
Maximum v/c Ratio:	0.61
Intersection Signal Delay:	15.6
Intersection LOS:	B
Intersection Capacity Utilization:	60.1%
Analysis Period (min):	15
m:	Volume for 95th percentile queue is metered by upstream signal.



Lanes, Volumes, Timings  
7: Parkdale & 417 WB OR

Lanes, Volumes, Timings  
7: Parkdale & 417 WB OR

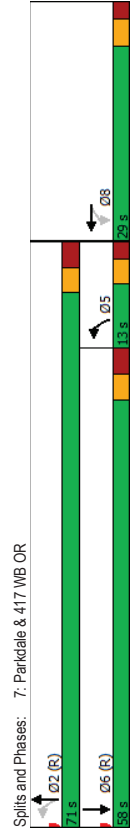
Future Total 2025AM Peak Hour  
1186-1194 Wellington STW

Future Total 2025AM Peak Hour  
1186-1194 Wellington STW

Lane Group	WBL	WBT	NBL	NBT	SBT
Lane Configurations	W	T	T	T	T
Traffic Volume (vph)	345	0	183	347	483
Future Volume (vph)	345	0	183	347	483
Lane Group Flow (vph)	345	544	183	347	750
Turn Type	Perim	NA	pm-pt	NA	NA
Protected Phases	8	5	2	2	6
Permitted Phases	8	8	5	2	6
Detector Phase	8	8	5	2	6
Switch Phase					
Minimum Initial (s)	10.0	10.0	5.0	10.0	10.0
Minimum Split (s)	20.5	20.5	10.2	27.3	21.3
Total Split (s)	29.0	29.0	13.0	71.0	58.0
Total Split (%)	29.0%	29.0%	13.0%	71.0%	58.0%
Maximum Green (s)	23.5	23.5	7.8	64.7	51.7
Yellow Time (s)	3.3	3.3	3.0	3.0	3.0
All-Red Time (s)	2.2	2.2	2.2	3.3	3.3
Lost Time Adjust (s)	0.0	0.0	0.0	0.0	0.0
Total Lost Time (s)	5.5	5.5	5.2	6.3	6.3
Lead/Lag			Lag	Lead	
Lead-Lag Optimize?			Yes	Yes	
Vehicle Extension (s)	3.0	3.0	3.0	3.0	3.0
Recall Mode	None	None	None	C-Max	C-Max
Walk Time (s)	7.0	7.0	7.0	7.0	7.0
Pedestrian Calls (#/hr)	1	1		24	11
Act Effr Green (s)	22.7	22.7	66.6	65.5	62.5
Actuated g/C Ratio	0.23	0.23	0.67	0.66	0.52
v/c Ratio	68.4	12.7	21.6	8.5	35.3
Queue Delay	0.0	0.0	0.0	0.0	0.0
Total Delay	68.4	12.7	21.6	8.5	35.3
LOS	E	B	C	A	D
Approach Delay	34.3		13.0	35.3	
Approach LOS	C		B	D	
Queue Length 50th (m)	64.9	7.1	12.3	26.8	144.7
Queue Length 95th (m)	#113.6	45.0	20.5	40.8	#199.2
Internal Link Dist (m)	462.5		38.8	197.3	
Turn Bay Length (m)					
Base Capacity (vph)	389	721	337	1143	873
Starvation Cap Reductn	0	0	0	0	0
Spillback Cap Reductn	0	0	0	0	0
Storage Cap Reductn	0	0	0	0	0
Reduced v/c Ratio	0.89	0.75	0.54	0.30	0.86

Intersection Summary	
Cycle Length:	100
Actuated Cycle Length:	100
Offset:	26 (26%), Referenced to phase 2, NBL and 6, SBT, Start of Green
Natural Cycle:	90

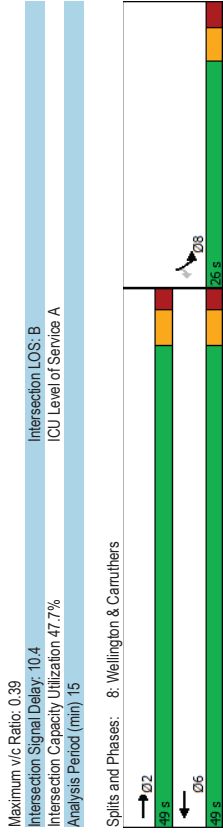
Control Type:	Actuated-Coordinated
Maximum v/c Ratio:	0.92
Intersection Signal Delay:	29.5
Intersection LOS:	C
Intersection Capacity Utilization:	105.0%
Analysis Period (min):	15
# 95th percentile volume exceeds capacity, queue may be longer.	
Queue shown is maximum after two cycles.	



Lanes, Volumes, Timings  
8: Wellington & Carruthers

Lanes, Volumes, Timings  
8: Wellington & Carruthers

Lane Group	EBT	WBT	SBL	SBR
Lane Configurations	←	←	←	←
Traffic Volume (vph)	396	210	63	13
Future Volume (vph)	396	210	63	13
Lane Group Flow (vph)	396	210	63	13
Turn Type	NA	NA	Prot	Perm
Protected Phases	2	6	8	8
Permitted Phases				
Detector Phase	2	6	8	8
Switch Phase				
Minimum Initial (s)	10.0	10.0	10.0	10.0
Minimum Split (s)	15.3	26.3	25.5	25.5
Total Split (s)	49.0	49.0	26.0	26.0
Total Split (%)	65.3%	65.3%	34.7%	34.7%
Maximum Green (s)	43.7	43.7	20.5	20.5
Yellow Time (s)	3.3	3.3	3.0	3.0
All-Red Time (s)	2.0	2.0	2.5	2.5
Lost Time Adjust (s)	0.0	0.0	0.0	0.0
Total Lost Time (s)	5.3	5.3	5.5	5.5
Lead/Lag				
Lead-Lag Optimize?				
Vehicle Extension (s)	3.0	3.0	3.0	3.0
Recall Mode	Max	Max	Max	Max
Walk Time (s)	14.0	15.0	15.0	
Flash Dont Walk (s)	7.0	5.0	5.0	66
Pedestrian Calls (#/hr)	75	66	66	
Act Effr Green (s)	43.7	43.7	20.5	20.5
Actuated G/C Ratio	0.58	0.58	0.27	0.27
v/c Ratio	0.39	0.21	0.14	0.03
Control Delay	9.9	8.1	21.7	11.0
Queue Delay	0.0	0.0	0.0	0.0
Total Delay	9.9	8.1	21.7	11.0
LOS	A	A	C	B
Approach Delay	9.9	8.1	19.9	
Approach LOS	A	A	B	
Queue Length 50th (m)	27.4	12.8	6.7	0.0
Queue Length 95th (m)	44.3	22.4	15.4	3.8
Internal Link Dist (m)	154.4	153.4	73.2	
Turn Bay Length (m)			30.0	
Base Capacity (vph)	1016	1016	453	385
Starvation Cap Reductn	0	0	0	0
Spillback Cap Reductn	0	0	0	0
Storage Cap Reductn	0	0	0	0
Reduced v/c Ratio	0.39	0.21	0.14	0.03
<b>Intersection Summary</b>				
Cycle Length: 75				
Actuated Cycle Length: 75				
Natural Cycle: 55				
Control Type: Semi-Act-Uncoord				



Intersection												
Int Delay, s/veh	0.1											
Movement	EBL	EBR	NBL	NBT	SBT	SBR						
Lane Configurations	W											
Traffic Vol, veh/h	0	9	0	548	368	0						
Future Vol, veh/h	0	9	0	548	368	0						
Conflicting Peds. #/hr	0	0	30	0	0	30						
Sign Control	Stop	Stop	Free	Free	Free	Free						
RT Channelized	-	None	-	None	-	None						
Storage Length	0	-	-	-	-	-						
Veh in Median Storage, #	0	-	-	0	0	-						
Grade, %	0	-	-	0	0	-						
Peak Hour Factor	100	100	100	100	100	100						
Heavy Vehicles, %	2	2	2	2	2	2						
Mvmt Flow	0	9	0	548	368	0						
Major/Minor	Minor2	Major1	Major1	Major2								
Conflicting Flow All	946	398	398	0	-	0						
Stage 1	398	-	-	-	-	-						
Stage 2	548	-	-	-	-	-						
Critical Hdwy	6.42	6.22	4.12	-	-	-						
Critical Hdwy Stg 1	5.42	-	-	-	-	-						
Critical Hdwy Stg 2	5.42	-	-	-	-	-						
Follow-up Hdwy	3,518	3,318	2,218	-	-	-						
Pot Cap-1 Maneuver	290	652	1161	-	-	-						
Stage 1	678	-	-	-	-	-						
Stage 2	579	-	-	-	-	-						
Platoon blocked, %	-	-	-	-	-	-						
Mov Cap-1 Maneuver	277	637	1134	-	-	-						
Mov Cap-2 Maneuver	277	-	-	-	-	-						
Stage 1	652	-	-	-	-	-						
Stage 2	566	-	-	-	-	-						
Approach	EB	NB	SB									
HCM Control Delay, s	10.7	0	0									
HCM LOS	B											
Minor Lane/Major Mvmt	NBL	NBT	EBLn1	SBT	SBR							
Capacity (veh/h)	1134	-	637	-	-							
HCM Lane V/C Ratio	-	-	0.014	-	-							
HCM Control Delay (s)	0	-	10.7	-	-							
HCM Lane LOS	A	-	B	-	-							
HCM 95th %tile Q(veh)	0	-	0	-	-							

Intersection												
Int Delay, s/veh	1.8											
Movement	WBL	WBR	NBT	NBR	SBL	SBT						
Lane Configurations	W											
Traffic Vol, veh/h	2	9	20	7	6	32						
Future Vol, veh/h	2	9	20	7	6	32						
Conflicting Peds. #/hr	0	0	0	10	10	0						
Sign Control	Stop	Stop	Free	Free	Free	Free						
RT Channelized	-	None	-	None	-	None						
Storage Length	0	-	-	-	-	-						
Veh in Median Storage, #	0	-	0	0	-	0						
Grade, %	0	-	0	-	-	0						
Peak Hour Factor	100	100	100	100	100	100						
Heavy Vehicles, %	2	2	2	2	2	2						
Mvmt Flow	2	9	20	7	6	32						
Major/Minor	Minor1	Major1	Major1	Major2								
Conflicting Flow All	78	34	0	0	37	0						
Stage 1	34	-	-	-	-	-						
Stage 2	44	-	-	-	-	-						
Critical Hdwy	6.42	6.22	-	-	4.12	-						
Critical Hdwy Stg 1	5.42	-	-	-	-	-						
Critical Hdwy Stg 2	5.42	-	-	-	-	-						
Follow-up Hdwy	3,518	3,318	-	-	2,218	-						
Pot Cap-1 Maneuver	925	1039	-	-	1574	-						
Stage 1	988	-	-	-	-	-						
Stage 2	978	-	-	-	-	-						
Platoon blocked, %	-	-	-	-	-	-						
Mov Cap-1 Maneuver	914	1031	-	-	1562	-						
Mov Cap-2 Maneuver	914	-	-	-	-	-						
Stage 1	980	-	-	-	-	-						
Stage 2	974	-	-	-	-	-						
Approach	WB	NB	SB									
HCM Control Delay, s	8.6	0	1.2									
HCM LOS	A											
Minor Lane/Major Mvmt	NBT	NBR	WBLn1	SBL	SBT							
Capacity (veh/h)	-	-	1008	1562	-							
HCM Lane V/C Ratio	-	-	0.011	0.004	-							
HCM Control Delay (s)	-	-	8.6	7.3	0							
HCM Lane LOS	A	-	A	A	A							
HCM 95th %tile Q(veh)	-	-	0	0	-							

11: Hamilton & Wellington  
 HCM 2010 TWSC  
 Future Total 2025AM Peak Hour  
 1186-1194 Wellington STW

Intersection													
Int'Delay, s/veh													1.8
Movement	EBL	EBT	EBR	WBL	WBT	WBR	NBL	NBT	NBR	SBL	SBT	SBR	
Lane Configurations													
Traffic Vol, veh/h	13	246	12	11	215	10	12	7	10	6	15	17	
Future Vol, veh/h	13	246	12	11	215	10	12	7	10	6	15	17	
Conflicting Peds. #/hr	0	0	0	0	0	0	0	0	0	0	0	0	0
Sign Control	Free	Free	Free	Free	Free	Free	Free	Free	Free	Free	Free	Free	Free
RT Channelized	-	-	None	-	-	None	-	-	None	-	-	None	-
Storage Length	-	-	-	-	-	-	-	-	-	-	-	-	-
Veh in Median Storage, #	-	0	-	-	0	-	-	0	-	-	0	-	-
Grade, %	-	0	-	-	0	-	-	0	-	-	0	-	-
Peak Hour Factor	100	100	100	100	100	100	100	100	100	100	100	100	100
Heavy Vehicles, %	2	2	2	2	2	2	2	2	2	2	2	2	2
Mvmt Flow	13	246	12	11	215	10	12	7	10	6	15	17	
Major/Minor	Major1	Major2	Minor1	Minor2									
Conflicting Flow All	225	0	0	258	0	0	536	525	252	529	526	220	
Stage 1	-	-	-	278	278	-	242	242	-	-	-	-	
Stage 2	-	-	-	258	247	-	287	284	-	-	-	-	
Critical Hdwy	4.12	-	-	4.12	-	-	7.12	6.52	6.22	7.12	6.52	6.22	
Critical Hdwy Stg 1	-	-	-	-	-	-	6.12	5.52	-	6.12	5.52	-	
Critical Hdwy Stg 2	-	-	-	-	-	-	6.12	5.52	-	6.12	5.52	-	
Follow-up Hdwy	2.218	-	-	2.218	-	-	3.518	4.018	3.318	3.518	4.018	3.318	
Pot Cap-1 Maneuver	1344	-	-	1307	-	-	455	468	787	460	457	820	
Stage 1	-	-	-	-	-	-	728	680	-	762	705	-	
Stage 2	-	-	-	-	-	-	747	702	-	720	676	-	
Platoon blocked, %	-	-	-	-	-	-	-	-	-	-	-	-	
Mov Cap-1 Maneuver	1344	-	-	1307	-	-	427	448	787	442	447	820	
Mov Cap-2 Maneuver	-	-	-	-	-	-	427	448	-	442	447	-	
Stage 1	-	-	-	-	-	-	720	673	-	754	698	-	
Stage 2	-	-	-	-	-	-	709	695	-	696	669	-	
Approach	EB	WB	NB	SB									
HCM Control Delay, s	0.4	0.4	12.4	11.9									
HCM LOS	B				B								
Minor Lane/Major Mvmt	NBLn1	EBL	EBT	EBR	WBL	WBT	WBR	SBLn1					
Capacity (veh/h)	514	1344	-	-	1307	-	-	560					
HCM Lane V/C Ratio	0.056	0.01	-	-	0.008	-	-	0.068					
HCM Control Delay (s)	12.4	7.7	-	-	7.8	-	-	11.9					
HCM Lane LOS	B				A								
HCM 95th %ile Q(veh)	0.2	0	-	-	0	-	-	0.2					

12: Hamilton & Tyndall  
 HCM 2010 TWSC  
 Future Total 2025AM Peak Hour  
 1186-1194 Wellington STW

Intersection													
Int'Delay, s/veh													1.6
Movement	EBL	EBT	EBR	WBL	WBT	WBR	NBL	NBT	NBR	SBL	SBT	SBR	
Lane Configurations													
Traffic Vol, veh/h	10	173	0	3	95	15	0	2	7	21	2	11	
Future Vol, veh/h	10	173	0	3	95	15	0	2	7	21	2	11	
Conflicting Peds. #/hr	0	0	0	0	0	0	0	0	0	0	0	0	0
Sign Control	Free	Free	Free	Free	Free	Free	Free	Free	Free	Free	Free	Free	Free
RT Channelized	-	-	None	-	-	None	-	-	None	-	-	None	-
Storage Length	-	-	-	-	-	-	-	-	-	-	-	-	-
Veh in Median Storage, #	-	0	-	-	0	-	-	0	-	-	0	-	-
Grade, %	-	0	-	-	0	-	-	0	-	-	0	-	-
Peak Hour Factor	100	100	100	100	100	100	100	100	100	100	100	100	100
Heavy Vehicles, %	2	2	2	2	2	2	2	2	2	2	2	2	2
Mvmt Flow	10	173	0	3	95	15	0	2	7	21	2	11	
Major/Minor	Major1	Major2	Minor1	Minor2									
Conflicting Flow All	110	0	0	173	0	0	308	309	173	307	302	103	
Stage 1	-	-	-	-	-	-	193	193	-	198	193	-	
Stage 2	-	-	-	-	-	-	115	116	-	116	116	-	
Critical Hdwy	4.12	-	-	4.12	-	-	7.12	6.52	6.22	7.12	6.52	6.22	
Critical Hdwy Stg 1	-	-	-	-	-	-	6.12	5.52	-	6.12	5.52	-	
Critical Hdwy Stg 2	-	-	-	-	-	-	6.12	5.52	-	6.12	5.52	-	
Follow-up Hdwy	2.218	-	-	2.218	-	-	3.518	4.018	3.318	3.518	4.018	3.318	
Pot Cap-1 Maneuver	1480	-	-	1404	-	-	644	605	871	645	611	952	
Stage 1	-	-	-	-	-	-	809	741	-	896	805	-	
Stage 2	-	-	-	-	-	-	890	800	-	804	741	-	
Platoon blocked, %	-	-	-	-	-	-	-	-	-	-	-	-	
Mov Cap-1 Maneuver	1480	-	-	1404	-	-	630	600	871	634	606	952	
Mov Cap-2 Maneuver	-	-	-	-	-	-	630	600	-	634	606	-	
Stage 1	-	-	-	-	-	-	803	736	-	890	803	-	
Stage 2	-	-	-	-	-	-	876	798	-	790	736	-	
Approach	EB	WB	NB	SB									
HCM Control Delay, s	0.4	0.2	9.6	10.3									
HCM LOS	A				B								
Minor Lane/Major Mvmt	NBLn1	EBL	EBT	EBR	WBL	WBT	WBR	SBLn1					
Capacity (veh/h)	792	1480	-	-	1404	-	-	709					
HCM Lane V/C Ratio	0.011	0.007	-	-	0.002	-	-	0.048					
HCM Control Delay (s)	9.6	7.4	0	-	7.6	0	-	10.3					
HCM Lane LOS	A				A								
HCM 95th %ile Q(veh)	0	0	-	-	0	-	-	0.2					

Lanes, Volumes, Timings  
1: Holland & Spencer

Future Total 2025PM Peak Hour  
1186-1194 Wellington STW

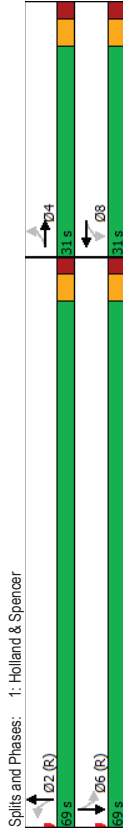
Lane Group	EBL	EBT	WBL	WBT	NBL	NBT	SBL	SBT
Lane Configurations	12	24	153	61	55	361	16	481
Traffic Volume (vph)	12	24	153	61	55	361	16	481
Future Volume (vph)	12	24	153	61	55	361	16	481
Lane Group Flow (vph)	Perm	NA	Perm	NA	Perm	NA	Perm	NA
Protected Phases	4	4	8	8	2	2	6	6
Permitted Phases	4	4	8	8	2	2	6	6
Detector Phase	4	4	8	8	2	2	6	6
Switch Phase	4	4	8	8	2	2	6	6
Minimum Initial (s)	10.0	10.0	10.0	10.0	10.0	10.0	10.0	10.0
Minimum Split (s)	23.5	23.5	23.5	29.3	29.3	29.3	29.3	29.3
Total Split (s)	31.0	31.0	31.0	69.0	69.0	69.0	69.0	69.0
Total Split (%)	31.0%	31.0%	31.0%	69.0%	69.0%	69.0%	69.0%	69.0%
Maximum Green (s)	25.5	25.5	25.5	63.7	63.7	63.7	63.7	63.7
Yellow Time (s)	3.3	3.3	3.3	3.3	3.3	3.3	3.3	3.3
All-Red Time (s)	2.2	2.2	2.2	2.0	2.0	2.0	2.0	2.0
Lost Time Adjust (s)	0.0	0.0	0.0	0.0	0.0	0.0	0.0	0.0
Total Lost Time (s)	5.5	5.5	5.5	5.3	5.3	5.3	5.3	5.3
Lead/Lag								
Lead-Lag Optimize?								
Vehicle Extension (s)	3.0	3.0	3.0	3.0	3.0	3.0	3.0	3.0
Recall Mode	None	None	None	C-Max	C-Max	C-Max	C-Max	C-Max
Walk Time (s)	7.0	7.0	7.0	15.0	15.0	15.0	15.0	15.0
Flash Dont Walk (s)	11.0	11.0	11.0	9.0	9.0	9.0	9.0	9.0
Pedestrian Calls (#/hr)	24	24	23	23	95	95	85	85
Act Effr Green (s)	21.9	21.9	21.9	67.3	67.3	67.3	67.3	67.3
Actuated g/C Ratio	0.22	0.22	0.22	0.67	0.67	0.67	0.67	0.67
v/c Ratio	0.19	0.19	0.82	0.25	0.25	0.25	0.25	0.25
Control Delay	19.7	58.3	58.3	1.1	7.2	7.2	7.2	7.2
Queue Delay	0.0	0.0	0.0	0.0	0.0	0.0	0.0	0.0
Total Delay	19.7	58.3	58.3	1.1	7.2	7.2	7.2	7.2
LOS	B	E	E	A	A	A	A	A
Approach Delay	19.7	58.3	58.3	1.1	7.2	7.2	7.2	7.2
Approach LOS	B	E	E	A	A	A	A	A
Queue Length 50th (m)	5.5	43.0	43.0	1.1	19.2	19.2	19.2	19.2
Queue Length 95th (m)	15.7	#74.6	#74.6	2.5	28.2	28.2	28.2	28.2
Internal Link Dist (m)	151.9	132.2	132.2	211.0	211.0	211.0	211.0	211.0
Turn Bay Length (m)								
Base Capacity (vph)	403	343	343	1803	2062	2062	2062	2062
Starvation Cap Reductn	0	0	0	0	0	0	0	0
Spillback Cap Reductn	0	0	0	0	0	0	0	0
Storage Cap Reductn	0	0	0	0	0	0	0	0
Reduced v/c Ratio	0.16	0.71	0.71	0.25	0.25	0.25	0.25	0.25

Intersection Summary	
Cycle Length:	100
Actuated Cycle Length:	100
Offset:	38 (38%), Referenced to phase 2, NBT, and 6, SBT, Start of Green
Natural Cycle:	55

Lanes, Volumes, Timings  
1: Holland & Spencer

Future Total 2025PM Peak Hour  
1186-1194 Wellington STW

Control Type:	Actuated-Coordinated
Maximum v/c Ratio:	0.82
Intersection Signal Delay:	15.5
Intersection LOS:	B
Intersection Capacity Utilization:	74.6%
ICU Level of Service:	D
Analysis Period (min):	15
# 95th percentile volume exceeds capacity, queue may be longer.	
Queue shown is maximum after two cycles.	



Lanes, Volumes, Timings  
2: Holland & Wellington

Lanes, Volumes, Timings  
2: Holland & Wellington

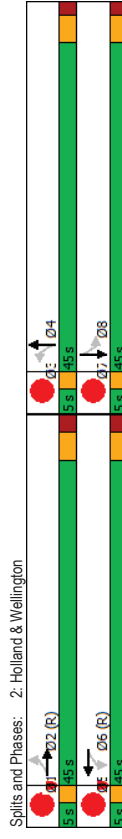
Future Total 2025PM Peak Hour  
1186-1194 Wellington STW

Future Total 2025PM Peak Hour  
1186-1194 Wellington STW

EBL	EBT	WBL	WBT	NBL	NBT	SBL	SBT	Ø1	Ø3	Ø5	Ø7
41B	41B	41B	41B	41B	41B	41B	41B				
21	340	80	486	38	398	26	652				
21	340	80	486	38	398	26	652				
0	442	0	590	0	496	0	742				
Perm	NA	Perm	NA	Perm	NA	Perm	NA				
2	2	6	6	4	4	8	8	1	3	5	7
2	2	6	6	4	4	8	8				
10.0	10.0	10.0	10.0	10.0	10.0	10.0	10.0	1.0	1.0	1.0	1.0
23.6	23.6	24.5	24.5	20.1	20.1	20.1	20.1	3.0	3.0	3.0	3.0
45.0	45.0	45.0	45.0	45.0	45.0	45.0	45.0	5.0	5.0	5.0	5.0
45.0%	45.0%	45.0%	45.0%	45.0%	45.0%	45.0%	45.0%	5%	5%	5%	5%
39.4	39.4	39.4	39.4	39.9	39.9	39.9	39.9	3.0	3.0	3.0	3.0
3.3	3.3	3.3	3.3	3.3	3.3	3.3	3.3	2.0	2.0	2.0	2.0
2.3	2.3	2.3	2.3	1.8	1.8	1.8	1.8	0.0	0.0	0.0	0.0
0.0	0.0	0.0	0.0	0.0	0.0	0.0	0.0				
5.6	5.6	5.6	5.6	5.1	5.1	5.1	5.1				
Lag	Lag	Lag	Lag	Lag	Lag	Lag	Lag	Lead	Lead	Lead	Lead
Yes	Yes	Yes	Yes	Yes	Yes	Yes	Yes	Yes	Yes	Yes	Yes
3.0	3.0	3.0	3.0	3.0	3.0	3.0	3.0	3.0	3.0	3.0	3.0
C-Max	C-Max	C-Max	C-Max	Max	Max	Max	Max	Max	Max	Max	Max
4.0	4.0	4.0	4.0	2.0	2.0	2.0	2.0				
14.0	14.0	14.0	14.0	13.0	13.0	13.0	13.0				
241	241	166	166	165	165	146	146				
39.4	39.4	39.4	39.4	39.9	39.9	39.9	39.9				
0.39	0.39	0.39	0.39	0.40	0.40	0.40	0.40				
0.41	0.41	0.58	0.47	0.63	0.63	0.63	0.63				
23.3	23.3	20.7	20.1	22.6	22.6	22.6	22.6				
0.0	0.0	0.0	0.0	0.0	0.0	0.0	0.0				
23.3	23.3	20.7	20.1	22.6	22.6	22.6	22.6				
C	C	C	C	C	C	C	C				
23.3	23.3	20.7	20.1	22.6	22.6	22.6	22.6				
C	C	C	C	C	C	C	C				
32.0	32.0	33.1	27.4	44.6	44.6	44.6	44.6				
45.1	45.1	m45.2	47.4	66.8	66.8	66.8	66.8				
21.0	21.0	38.8	190.8	211.0	211.0	211.0	211.0				
1082	1082	1009	1048	1170	1170	1170	1170				
0	0	0	0	0	0	0	0				
0	0	0	0	0	0	0	0				
0	0	0	0	0	0	0	0				
0.41	0.41	0.58	0.47	0.63	0.63	0.63	0.63				

Intersection Summary	
Cycle Length:	100
Actuated Cycle Length:	100
Offset:	72 (72%), Referenced to phase 2,EBTL and 6:WBTL, Start of Green
Natural Cycle:	55

Control Type:	Actuated-Coordinated
Maximum v/c Ratio:	0.63
Intersection Signal Delay:	21.7
Intersection LOS:	C
ICU Level of Service:	E
Intersection Capacity Utilization:	68.8%
Analysis Period (min):	15
m:	Volume for 95th percentile queue is metered by upstream signal.





Lanes, Volumes, Timings  
3: Holland & Tyndall

Lanes, Volumes, Timings  
3: Holland & Tyndall

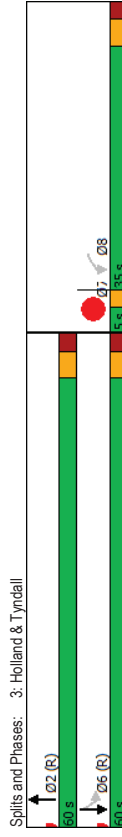
Future Total 2025PM Peak Hour  
1186-1194 Wellington STW

Future Total 2025PM Peak Hour  
1186-1194 Wellington STW

	WBL	NBT	SBL	SBT	Ø7
Lane Group	W	B	B	B	Ø7
Lane Configurations	W	B	B	B	Ø7
Traffic Volume (vph)	46	595	145	585	
Future Volume (vph)	46	595	145	585	
Lane Group Flow (vph)	227	621	145	585	
Turn Type	Perm	NA	Perm	NA	
Protected Phases	8	2	6	7	
Permitted Phases	8	2	6	6	
Detector Phase	8	2	6	6	
Switch Phase					
Minimum Initial (s)	10.0	10.0	10.0	10.0	1.0
Minimum Split (s)	23.5	25.7	15.7	15.7	3.0
Total Split (s)	35.0	60.0	60.0	60.0	5.0
Total Split (%)	35.0%	60.0%	60.0%	60.0%	5%
Maximum Green (s)	29.5	54.3	54.3	54.3	3.0
Yellow Time (s)	3.3	3.3	3.3	3.3	2.0
All-Red Time (s)	2.2	2.4	2.4	2.4	0.0
Lost Time Adjust (s)	0.0	0.0	0.0	0.0	0.0
Total Lost Time (s)	5.5	5.7	5.7	5.7	
Lead/Lag	Lag		Lead	Lead	
Lead-Lag Optimize?	Yes		Yes	Yes	
Vehicle Extension (s)	3.0	3.0	3.0	3.0	3.0
Recall Mode	None	C-Max	C-Max	C-Max	Max
Walk Time (s)	5.0	10.0			
Pedestrian Calls (#/hr)	15	22			
Act Effr Green (s)	20.7	63.1	63.1	63.1	
Actuated g/C Ratio	0.21	0.63	0.63	0.63	
v/c Ratio	0.75	0.57	0.40	0.53	
Control Delay	52.0	14.4	8.1	7.4	
Queue Delay	0.0	0.0	0.0	0.0	
Total Delay	52.0	14.4	8.1	7.4	
LOS	D	B	A	A	
Approach Delay	52.0	14.4	7.5		
Approach LOS	D	B	A		
Queue Length 50th (m)	41.5	63.0	5.6	24.7	
Queue Length 95th (m)	60.9	115.4	m12.1	39.9	
Internal Link Dist (m)	140.4	156.5		23.7	
Turn Bay Length (m)					
Base Capacity (vph)	430	1091	365	1100	
Starvation Cap Reductn	0	0	0	0	
Spillback Cap Reductn	0	0	0	0	
Storage Cap Reductn	0	0	0	0	
Reduced v/c Ratio	0.53	0.57	0.40	0.53	

Intersection Summary	
Cycle Length:	100
Actuated Cycle Length:	100
Offset:	24 (24%), Referenced to phase 2:NBT and 6:SBTL, Start of Green
Natural Cycle:	60

Control Type:	Actuated-Coordinated
Maximum v/c Ratio:	0.75
Intersection Signal Delay:	16.6
Intersection LOS:	B
Intersection Capacity Utilization:	72.9%
Analysis Period (min):	15
m:	Volume for 95th percentile queue is metered by upstream signal.



Lanes, Volumes, Timings  
4: Parkdale & Armstrong

Future Total 2025PM Peak Hour  
1186-1194 Wellington STW

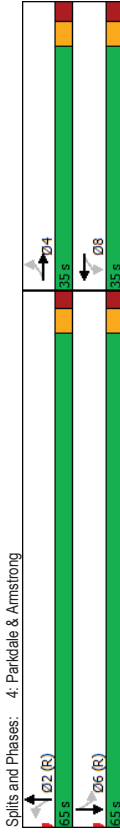
EBL	EBT	WBL	WBT	NBL	NBT	SBL	SBT
4	4	8	8	2	2	6	6
4	4	8	8	2	2	6	6
10.0	10.0	10.0	10.0	10.0	10.0	10.0	10.0
23.5	23.5	23.5	23.5	25.2	25.2	25.2	25.2
35.0%	35.0%	35.0%	35.0%	65.0%	65.0%	65.0%	65.0%
29.5	29.5	29.5	29.5	59.8	59.8	59.8	59.8
3.0	3.0	3.0	3.0	3.0	3.0	3.0	3.0
2.5	2.5	2.5	2.5	2.2	2.2	2.2	2.2
0.0	0.0	0.0	0.0	0.0	0.0	0.0	0.0
5.5	5.5	5.5	5.5	5.2	5.2	5.2	5.2
3.0	3.0	3.0	3.0	3.0	3.0	3.0	3.0
10.0	10.0	10.0	10.0	15.0	15.0	15.0	15.0
8.0	8.0	8.0	8.0	5.0	5.0	5.0	5.0
19	19	22	22	37	37	32	32
29.5	29.5	29.5	29.5	59.8	59.8	59.8	59.8
0.30	0.30	0.30	0.30	0.60	0.60	0.60	0.60
0.47	0.47	0.47	0.47	0.52	0.52	0.35	0.35
25.5	25.5	32.2	32.2	4.9	4.9	11.4	11.4
0.0	0.0	0.0	0.0	0.5	0.5	0.0	0.0
25.5	25.5	32.2	32.2	5.5	5.5	11.4	11.4
C	C	C	C	A	A	B	B
25.5	25.5	32.2	32.2	5.5	5.5	11.4	11.4
C	C	C	C	A	A	B	B
17.0	34.0	34.0	34.0	7.7	7.7	32.3	32.3
32.5	55.7	55.7	55.7	m9.4	m9.4	49.4	49.4
46.6	196.9	196.9	196.9	125.2	125.2	312.1	312.1
442	466	466	466	1021	1021	1006	1006
0	0	0	0	178	178	0	0
0	0	0	0	0	0	0	0
0	0	0	0	0	0	0	0
0.30	0.47	0.47	0.47	0.64	0.64	0.35	0.35

Intersection Summary  
Cycle Length: 100  
Actuated Cycle Length: 100  
Offset: 20 (20%), Referenced to phase 2, NBT, and 6, SBT, Start of Green  
Natural Cycle: 55

Lanes, Volumes, Timings  
4: Parkdale & Armstrong

Future Total 2025PM Peak Hour  
1186-1194 Wellington STW

Control Type: Actuated-Coordinated	Intersection LOS: B
Maximum v/c Ratio: 0.52	ICU Level of Service B
Intersection Signal Delay: 14.0	
Intersection Capacity Utilization: 58.6%	
Analysis Period (min): 15	
m. Volume for 95th percentile queue is metered by upstream signal.	



Lanes, Volumes, Timings  
5: Parkdale & Wellington

Future Total 2025PM Peak Hour  
1186-1194 Wellington STW

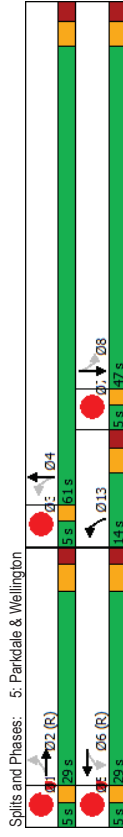
EBL	EBT	WBL	WBT	NBL	NBT	SBL	SBT	Ø1	Ø3	Ø5	Ø7
17	248	47	319	143	548	19	392				
17	248	47	319	143	548	19	392				
0	332	47	345	143	602	19	444				
Perm	NA	Perm	NA	pm-pt	NA	Perm	NA				
2	2	6	6	13	4	8	8	1	3	5	7
2	2	6	6	13	4	8	8				
10.0	10.0	10.0	10.0	5.0	10.0	10.0	10.0	1.0	1.0	1.0	1.0
23.4	23.4	23.4	23.4	10.2	15.5	20.5	20.5	3.0	3.0	3.0	3.0
29.0	29.0	29.0	29.0	14.0	61.0	47.0	47.0	5.0	5.0	5.0	5.0
29.0%	29.0%	29.0%	29.0%	14.0%	61.0%	47.0%	47.0%	5%	5%	5%	5%
23.6	23.6	23.6	23.6	8.8	55.5	41.5	41.5	3.0	3.0	3.0	3.0
3.3	3.3	3.3	3.3	3.0	3.0	3.0	3.0	2.0	2.0	2.0	2.0
2.1	2.1	2.1	2.1	2.2	2.5	2.5	2.5	0.0	0.0	0.0	0.0
0.0	0.0	0.0	0.0	0.0	0.0	0.0	0.0	0.0	0.0	0.0	0.0
5.4	5.4	5.4	5.4	5.2	5.5	5.5	5.5				
Lag	Lag	Lag	Lag	Lead	Lead	Lead	Lead				
Yes	Yes	Yes	Yes	Yes	Yes	Yes	Yes				
3.0	3.0	3.0	3.0	3.0	3.0	3.0	3.0	3.0	3.0	3.0	3.0
C-Max	C-Max	C-Max	C-Max	Max	Max	Max	Max	Max	Max	Max	Max
5.0	5.0	5.0	5.0	2.0	2.0	2.0	2.0				
8.0	8.0	8.0	8.0	8.0	8.0	8.0	8.0				
173	173	157	157	91	97	97	97				
23.6	23.6	23.6	23.6	60.8	55.5	41.5	41.5				
0.24	0.24	0.24	0.24	0.61	0.56	0.42	0.42				
0.59	0.34	0.88	0.36	0.65	0.65	0.07	0.66				
61.0	39.7	62.4	11.0	16.6	15.3	23.0	23.0				
0.0	0.0	0.0	0.0	0.6	0.0	0.3	0.3				
61.0	38.7	62.4	11.0	17.1	15.3	23.3	23.3				
E	D	E	B	B	B	C	C				
61.0	59.7	16.0	16.0	22.9	22.9						
E	E	E	B	C	C						
34.6	7.6	64.8	10.6	56.4	1.8	45.2	45.2				
49.4	18.7	#113.4	m16.9	82.1	m4.9	61.2	61.2				
55.3	29.7	26.9	26.9	125.2	125.2						
30.0	30.0	40.0	40.0	40.0	40.0						
567	140	390	392	931	264	669	669				
0	0	0	0	91	0	29	29				
0	0	0	0	0	0	0	0				
0	0	0	0	0	0	0	0				
0.59	0.34	0.88	0.36	0.72	0.07	0.69	0.69				

Intersection Summary	
Cycle Length:	100
Actuated Cycle Length:	100
Offset:	70 (70%), Referenced to phase 2,EBTL and 6:WBTL, Start of Green
Natural Cycle:	65

Lanes, Volumes, Timings  
5: Parkdale & Wellington

Future Total 2025PM Peak Hour  
1186-1194 Wellington STW

Control Type:	Actuated-Coordinated
Maximum v/c Ratio:	0.88
Intersection Signal Delay:	34.2
Intersection LOS:	C
ICU Level of Service:	F
Intersection Capacity Utilization:	92.4%
Analysis Period (min):	15
# 95th percentile volume exceeds capacity, queue may be longer.	
Queue shown is maximum after two cycles.	
m Volume for 95th percentile queue is metered by upstream signal.	



Lanes, Volumes, Timings  
6: Parkdale & Gladstone

Future Total 2025PM Peak Hour  
1186-1194 Wellington STW

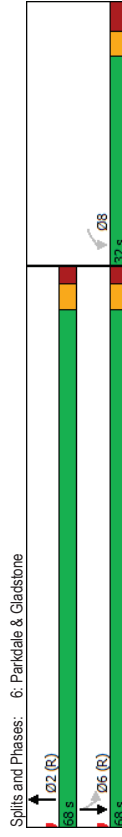
Lane Group	WBL	NBT	SBL	SBT
Lane Configurations	W	T	T	T
Traffic Volume (vph)	216	624	41	396
Future Volume (vph)	216	624	41	396
Lane Group Flow (vph)	282	782	41	396
Turn Type	Perm	NA	Perm	NA
Protected Phases		2		6
Permitted Phases	8	2	6	6
Detector Phase	8	2	6	6
Switch Phase				
Minimum Initial (s)	10.0	10.0	10.0	10.0
Minimum Split (s)	22.7	20.3	15.3	15.3
Total Split (s)	32.0	68.0	68.0	68.0
Total Split (%)	32.0%	68.0%	68.0%	68.0%
Maximum Green (s)	25.3	62.7	62.7	62.7
Yellow Time (s)	3.0	3.0	3.0	3.0
All-Red Time (s)	3.7	2.3	2.3	2.3
Lost Time Adjust (s)	0.0	0.0	0.0	0.0
Total Lost Time (s)	6.7	5.3	5.3	5.3
Lead/Lag				
Lead-Lag Optimize?				
Vehicle Extension (s)	3.0	3.0	3.0	3.0
Recall Mode	Max	C-Max	C-Max	C-Max
Walk Time (s)	7.0	7.0		
Flash Dont Walk (s)	9.0	8.0		
Pedestrian Calls (#/hr)	27	21		
Act Effr Green (s)	25.3	62.7	62.7	62.7
Actuated g/C Ratio	0.25	0.63	0.63	0.63
v/c Ratio	0.74	0.75	0.16	0.36
Control Delay	47.3	15.3	6.0	5.8
Queue Delay	0.0	0.2	0.0	0.1
Total Delay	47.3	15.4	6.0	5.8
LOS	D	B	A	A
Approach Delay	47.3	15.4	5.8	5.8
Approach LOS	D	B	A	A
Queue Length 50th (m)	50.3	69.6	2.0	19.1
Queue Length 95th (m)	#85.7	m104.2	m3.2	25.7
Internal Link Dist (m)	224.2	197.3		88.5
Turn Bay Length (m)			85.0	
Base Capacity (vph)	383	1045	253	1094
Starvation Cap Reductn	0	22	0	0
Spillback Cap Reductn	0	0	0	81
Storage Cap Reductn	0	0	0	0
Reduced v/c Ratio	0.74	0.76	0.16	0.39

Intersection Summary	
Cycle Length:	100
Actuated Cycle Length:	100
Offset:	12 (12%), Referenced to phase 2:NBT and 6:SBTL, Start of Green
Natural Cycle:	60

Lanes, Volumes, Timings  
6: Parkdale & Gladstone

Future Total 2025PM Peak Hour  
1186-1194 Wellington STW

Control Type:	Actuated-Coordinated
Maximum v/c Ratio:	0.75
Intersection Signal Delay:	18.6
Intersection LOS:	B
Intersection Capacity Utilization:	72.7%
ICU Level of Service:	C
Analysis Period (min):	15
# 95th percentile volume exceeds capacity, queue may be longer.	
Queue shown is maximum after two cycles.	
m Volume for 95th percentile queue is metered by upstream signal.	



Lanes, Volumes, Timings  
7: Parkdale & 417 WB OR

Lanes, Volumes, Timings  
7: Parkdale & 417 WB OR

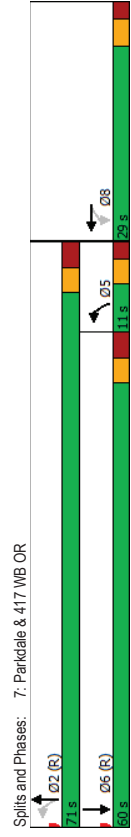
Future Total 2025PM Peak Hour  
1186-1194 Wellington STW

Future Total 2025PM Peak Hour  
1186-1194 Wellington STW

Lane Group	WBL	WBT	NBL	NBT	SBT
Lane Configurations	←	←	←	←	←
Traffic Volume (vph)	334	24	84	596	588
Future Volume (vph)	334	24	84	596	588
Lane Group Flow (vph)	334	537	84	596	822
Turn Type	Perm	NA	pm-pt	NA	NA
Protected Phases	8	5	2	2	6
Permitted Phases	8	5	2	2	6
Detector Phase	8	8	5	2	6
Switch Phase					
Minimum Initial (s)	10.0	10.0	5.0	10.0	10.0
Minimum Split (s)	20.5	20.5	10.2	27.3	21.3
Total Split (s)	29.0	29.0	11.0	71.0	60.0
Total Split (%)	29.0%	29.0%	11.0%	71.0%	60.0%
Maximum Green (s)	23.5	23.5	5.8	64.7	53.7
Yellow Time (s)	3.3	3.3	3.0	3.0	3.0
All-Red Time (s)	2.2	2.2	2.2	3.3	3.3
Lost Time Adjust (s)	0.0	0.0	0.0	0.0	0.0
Total Lost Time (s)	5.5	5.5	5.2	6.3	6.3
Lead/Lag			Lag	Lead	
Lead-Lag Optimize?			Yes	Yes	
Vehicle Extension (s)	3.0	3.0	3.0	3.0	3.0
Recall Mode	None	None	None	C-Max	C-Max
Walk Time (s)	7.0	7.0	7.0	7.0	7.0
Flash Dont Walk (s)	8.0	8.0	14.0	8.0	
Pedestrian Calls (#/hr)	3	3		23	15
Act Effct Green (s)	22.5	22.5	66.8	65.7	56.9
Actuated g/C Ratio	0.22	0.22	0.67	0.66	0.57
v/c Ratio	0.90	0.96	0.29	0.52	0.87
Control Delay	65.0	47.5	11.9	11.2	30.4
Queue Delay	0.0	0.0	0.0	0.0	0.0
Total Delay	65.0	47.5	11.9	11.2	30.4
LOS	E	D	B	B	C
Approach Delay	54.2		11.3	30.4	
Approach LOS	D		B	C	
Queue Length 50th (m)	62.2	50.0	5.3	56.1	150.7
Queue Length 95th (m)	#108.8	#116.3	10.3	82.0	#222.6
Internal Link Dist (m)	462.5		38.8	197.3	
Turn Bay Length (m)					
Base Capacity (vph)	389	570	287	1146	948
Starvation Cap Reductn	0	0	0	0	0
Spillback Cap Reductn	0	0	0	0	0
Storage Cap Reductn	0	0	0	0	0
Reduced v/c Ratio	0.86	0.94	0.29	0.52	0.87

Intersection Summary	
Cycle Length:	100
Actuated Cycle Length:	100
Offset:	39 (39%), Referenced to phase 2, NBL and 6: SBT, Start of Green
Natural Cycle:	90

Control Type:	Actuated-Coordinated
Maximum v/c Ratio:	0.96
Intersection Signal Delay:	33.7
Intersection LOS:	C
Intersection Capacity Utilization:	102.3%
ICU Level of Service:	G
Analysis Period (min):	15
# 95th percentile volume exceeds capacity, queue may be longer.	
Queue shown is maximum after two cycles.	



Lanes, Volumes, Timings  
8: Wellington & Carruthers

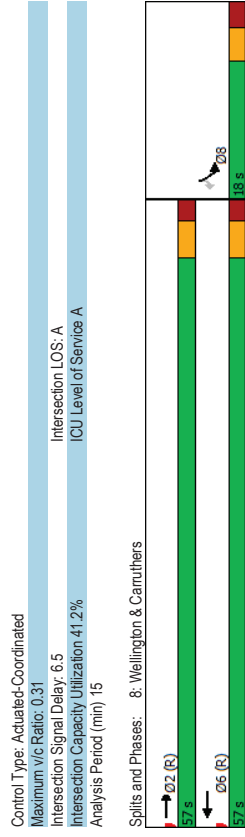
Lanes, Volumes, Timings  
8: Wellington & Carruthers

Future Total 2025PM Peak Hour  
1186-1194 Wellington STW

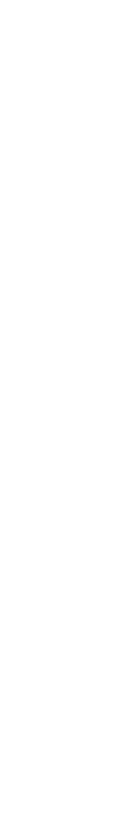
Future Total 2025PM Peak Hour  
1186-1194 Wellington STW

Lane Group	EBT	WBT	SBL	SBR
Lane Configurations	←	←	←	←
Traffic Volume (vph)	395	408	54	20
Future Volume (vph)	395	408	54	20
Lane Group Flow (vph)	395	408	54	20
Turn Type	NA	NA	Prot	Perm
Protected Phases	2	6	8	8
Permitted Phases				
Detector Phase	2	6	8	8
Switch Phase				
Minimum Initial (s)	10.0	10.0	10.0	10.0
Minimum Split (s)	15.3	26.3	17.5	17.5
Total Split (s)	57.0	57.0	18.0	18.0
Total Split (%)	76.0%	76.0%	24.0%	24.0%
Maximum Green (s)	51.7	51.7	12.5	12.5
Yellow Time (s)	3.3	3.3	3.0	3.0
All-Red Time (s)	2.0	2.0	2.5	2.5
Lost Time Adjust (s)	0.0	0.0	0.0	0.0
Total Lost Time (s)	5.3	5.3	5.5	5.5
Lead/Lag				
Lead-Lag Optimize?				
Vehicle Extension (s)	3.0	3.0	3.0	3.0
Recall Mode	C-Mix	C-Mix	None	None
Walk Time (s)	14.0	7.0	7.0	7.0
Flash Dont Walk (s)	7.0	5.0	5.0	5.0
Pedestrian Calls (#/hr)	165	64	64	64
Act Effr Green (s)	57.2	57.2	11.2	11.2
Actuated g/C Ratio	0.76	0.76	0.15	0.15
v/c Ratio	0.30	0.31	0.22	0.10
Control Delay	4.7	4.7	30.1	13.6
Queue Delay	0.0	0.0	0.0	0.0
Total Delay	4.7	4.7	30.1	13.6
LOS	A	A	C	B
Approach Delay	4.7	4.7	25.6	
Approach LOS	A	A	C	
Queue Length 50th (m)	18.1	18.9	6.7	0.0
Queue Length 95th (m)	29.3	30.4	16.1	5.5
Internal Link Dist (m)	163.1	153.4	73.2	
Turn Bay Length (m)				30.0
Base Capacity (vph)	1330	1330	276	227
Starvation Cap Reductn	0	0	0	0
Spillback Cap Reductn	0	0	0	0
Storage Cap Reductn	0	0	0	0
Reduced v/c Ratio	0.30	0.31	0.20	0.09

Intersection Summary	
Cycle Length:	75
Actuated Cycle Length:	75
Offset:	72 (96%), Referenced to phase 2,EBT and 6:WBT, Start of Green
Natural Cycle:	45



Control Type: Actuated-Coordinated	
Maximum v/c Ratio:	0.31
Intersection Signal Delay:	6.5
Intersection LOS:	A
ICU Level of Service A	
Intersection Capacity Utilization:	41.2%
Analysis Period (min):	15



Splits and Phases: 8: Wellington & Carruthers	
EBT	2 s
WBT	6 s
SBL	8 s
SBR	8 s

HCM 2010 TWSC  
9: Parkdale & Rear Lane

Future Total 2025PM Peak Hour  
1186-1194 Wellington STW

Intersection												
Int Delay, s/veh												0
Movement	EBL	EBR	NBL	NBT	SBT	SBR						
Lane Configurations	W											
Traffic Vol, veh/h	0	5	0	745	507	0						
Future Vol, veh/h	0	5	0	745	507	0						
Conflicting Peds. #/hr	0	0	30	0	0	30						
Sign Control	Stop	Stop	Free	Free	Free	Free						
RT Channelized	-	None	-	None	-	None						
Storage Length	0	-	-	-	-	-						
Veh in Median Storage, #	0	-	-	0	0	-						
Grade, %	0	-	-	0	0	-						
Peak Hour Factor	100	100	100	100	100	100						
Heavy Vehicles, %	2	2	2	2	2	2						
Mvmt Flow	0	5	0	745	507	0						
Major/Minor	Minor2	Major1	Major1	Major2								
Conflicting Flow All	1282	537	537	0	-	0						
Stage 1	537	-	-	-	-	-						
Stage 2	745	-	-	-	-	-						
Critical Hdwy	6.42	6.22	4.12	-	-	-						
Critical Hdwy Stg 1	5.42	-	-	-	-	-						
Critical Hdwy Stg 2	5.42	-	-	-	-	-						
Follow-up Hdwy	3,518	3,318	2,218	-	-	-						
Pot Cap-1 Maneuver	182	544	1031	-	-	-						
Stage 1	586	-	-	-	-	-						
Stage 2	469	-	-	-	-	-						
Platoon blocked, %	-	-	-	-	-	-						
Mov Cap-1 Maneuver	174	531	1007	-	-	-						
Mov Cap-2 Maneuver	174	-	-	-	-	-						
Stage 1	573	-	-	-	-	-						
Stage 2	458	-	-	-	-	-						
Approach	EB	NB	NB	SB								
HCM Control Delay, s	11.8	0	0	0								
HCM LOS	B											
Minor Lane/Major Mvmt	NBL	NBT	EBLn1	SBT	SBR							
Capacity (veh/h)	1007	-	531	-	-							
HCM Lane V/C Ratio	-	-	0.009	-	-							
HCM Control Delay (s)	0	-	11.8	-	-							
HCM Lane LOS	A	-	B	-	-							
HCM 95th %tile Q(veh)	0	-	0	-	-							

HCM 2010 TWSC  
10: Rear Lane & Hamilton

Future Total 2025PM Peak Hour  
1186-1194 Wellington STW

Intersection												
Int Delay, s/veh												1.1
Movement	WBL	WBR	NBT	NBR	SBL	SBT						
Lane Configurations	W											
Traffic Vol, veh/h	1	5	29	12	10	57						
Future Vol, veh/h	1	5	29	12	10	57						
Conflicting Peds. #/hr	0	0	0	10	10	0						
Sign Control	Stop	Stop	Free	Free	Free	Free						
RT Channelized	-	None	-	None	-	None						
Storage Length	0	-	-	-	-	-						
Veh in Median Storage, #	0	-	0	0	-	0						
Grade, %	0	-	0	-	-	0						
Peak Hour Factor	100	100	100	100	100	100						
Heavy Vehicles, %	2	2	2	2	2	2						
Mvmt Flow	1	5	29	12	10	57						
Major/Minor	Minor1	Major1	Major1	Major2								
Conflicting Flow All	122	45	0	0	51	0						
Stage 1	45	-	-	-	-	-						
Stage 2	77	-	-	-	-	-						
Critical Hdwy	6.42	6.22	-	-	4.12	-						
Critical Hdwy Stg 1	5.42	-	-	-	-	-						
Critical Hdwy Stg 2	5.42	-	-	-	-	-						
Follow-up Hdwy	3,518	3,318	-	-	2,218	-						
Pot Cap-1 Maneuver	873	1025	-	-	1555	-						
Stage 1	977	-	-	-	-	-						
Stage 2	946	-	-	-	-	-						
Platoon blocked, %	-	-	-	-	-	-						
Mov Cap-1 Maneuver	860	1017	-	-	1543	-						
Mov Cap-2 Maneuver	860	-	-	-	-	-						
Stage 1	969	-	-	-	-	-						
Stage 2	939	-	-	-	-	-						
Approach	WB	NB	NB	SB								
HCM Control Delay, s	8.7	0	0	1.1								
HCM LOS	A											
Minor Lane/Major Mvmt	NBT	NBR	WBLn1	SBL	SBT							
Capacity (veh/h)	-	-	987	1543	-							
HCM Lane V/C Ratio	-	-	0.006	0.006	-							
HCM Control Delay (s)	-	-	8.7	7.3	0							
HCM Lane LOS	A	-	A	A	A							
HCM 95th %tile Q(veh)	-	-	0	0	-							

11: Hamilton & Wellington  
 HCM 2010 TWSC  
 Future Total 2025PM Peak Hour  
 1186-1194 Wellington STW

Intersection													
Int'Delay, s/veh													
1.9													
Movement	EBL	EBT	EBR	WBL	WBT	WBR	NBL	NBT	NBR	SBL	SBT	SBR	
Lane Configurations													
Traffic Vol, veh/h	10	301	31	15	337	13	8	8	18	9	21	31	
Future Vol, veh/h	10	301	31	15	337	13	8	8	18	9	21	31	
Conflicting Peds. #/hr	0	0	0	0	0	0	0	0	0	0	0	0	
Sign Control	Free	Free	Free	Free	Free	Free	Free	Free	Free	Free	Free	Free	Stop
RT Channelized	-	-	-	-	-	-	-	-	-	-	-	-	None
Storage Length	-	-	-	-	-	-	-	-	-	-	-	-	-
Veh in Median Storage, #	-	0	-	-	0	-	-	-	0	-	-	-	0
Grade, %	-	0	-	-	0	-	-	-	0	-	-	-	0
Peak Hour Factor	100	100	100	100	100	100	100	100	100	100	100	100	100
Heavy Vehicles, %	2	2	2	2	2	2	2	2	2	2	2	2	2
Mvmt Flow	10	301	31	15	337	13	8	8	18	9	21	31	
Major/Minor	Major1	Major2	Minor1	Minor2									
Conflicting Flow All	350	0	0	332	0	0	737	717	317	724	726	344	
Stage 1	-	-	-	-	-	-	337	337	-	374	374	-	
Stage 2	-	-	-	-	-	-	400	380	-	350	352	-	
Critical Hwy	4.12	-	-	4.12	-	-	7.12	6.52	6.22	7.12	6.52	6.22	
Critical Hwy Stg 1	-	-	-	-	-	-	6.12	5.52	-	6.12	5.52	-	
Critical Hwy Stg 2	-	-	-	-	-	-	6.12	5.52	-	6.12	5.52	-	
Follow-up Hwy	2.218	-	-	2.218	-	-	3.518	4.018	3.318	3.518	4.018	3.318	
Pot Cap-1 Maneuver	1209	-	-	1227	-	-	334	355	724	341	351	689	
Stage 1	-	-	-	-	-	-	677	641	-	647	618	-	
Stage 2	-	-	-	-	-	-	626	614	-	666	632	-	
Platoon blocked, %	-	-	-	-	-	-	-	-	-	-	-	-	
Mov Cap-1 Maneuver	1209	-	-	1227	-	-	299	346	724	321	342	689	
Mov Cap-2 Maneuver	-	-	-	-	-	-	299	346	-	321	342	-	
Stage 1	-	-	-	-	-	-	670	635	-	641	609	-	
Stage 2	-	-	-	-	-	-	569	605	-	635	626	-	
Approach	EB	WB	NB	SB									
HCM Control Delay, s	0.2	0.3	13.6	14.1									
HCM LOS	B	B	B	B									
Minor Lane/Major Mvmt	NBLn1	EBL	EBT	EBR	WBL	WBT	WBR	SBLn1					
Capacity (veh/h)	455	1209	-	-	1227	-	-	456					
HCM Lane V/C Ratio	0.075	0.008	-	-	0.012	-	-	0.134					
HCM Control Delay (s)	13.6	8	0	0	8	0	0	14.1					
HCM Lane LOS	B	A	A	A	A	A	A	B					
HCM 95th %tile Q(veh)	0.2	0	-	-	0	-	-	0.5					

12: Hamilton & Tyndall  
 HCM 2010 TWSC  
 Future Total 2025PM Peak Hour  
 1186-1194 Wellington STW

Intersection													
Int'Delay, s/veh													
1.9													
Movement	EBL	EBT	EBR	WBL	WBT	WBR	NBL	NBT	NBR	SBL	SBT	SBR	
Lane Configurations													
Traffic Vol, veh/h	15	164	2	2	114	20	3	3	1	26	2	22	
Future Vol, veh/h	15	164	2	2	114	20	3	3	1	26	2	22	
Conflicting Peds. #/hr	0	0	0	0	0	0	0	0	0	0	0	0	
Sign Control	Free	Free	Free	Free	Free	Free	Free	Free	Free	Free	Free	Free	Stop
RT Channelized	-	-	-	-	-	-	-	-	-	-	-	-	None
Storage Length	-	-	-	-	-	-	-	-	-	-	-	-	-
Veh in Median Storage, #	-	0	-	-	0	-	-	-	0	-	-	-	0
Grade, %	-	0	-	-	0	-	-	-	0	-	-	-	0
Peak Hour Factor	100	100	100	100	100	100	100	100	100	100	100	100	100
Heavy Vehicles, %	2	2	2	2	2	2	2	2	2	2	2	2	2
Mvmt Flow	15	164	2	2	114	20	3	3	1	26	2	22	
Major/Minor	Major1	Major2	Minor1	Minor2									
Conflicting Flow All	134	0	0	166	0	0	335	333	165	325	324	124	
Stage 1	-	-	-	-	-	-	195	195	-	128	128	-	
Stage 2	-	-	-	-	-	-	140	138	-	197	196	-	
Critical Hwy	4.12	-	-	4.12	-	-	7.12	6.52	6.22	7.12	6.52	6.22	
Critical Hwy Stg 1	-	-	-	-	-	-	6.12	5.52	-	6.12	5.52	-	
Critical Hwy Stg 2	-	-	-	-	-	-	6.12	5.52	-	6.12	5.52	-	
Follow-up Hwy	2.218	-	-	2.218	-	-	3.518	4.018	3.318	3.518	4.018	3.318	
Pot Cap-1 Maneuver	1451	-	-	1412	-	-	619	587	879	628	594	927	
Stage 1	-	-	-	-	-	-	807	739	-	876	790	-	
Stage 2	-	-	-	-	-	-	863	782	-	805	739	-	
Platoon blocked, %	-	-	-	-	-	-	-	-	-	-	-	-	
Mov Cap-1 Maneuver	1451	-	-	1412	-	-	597	579	879	619	586	927	
Mov Cap-2 Maneuver	-	-	-	-	-	-	597	579	-	619	586	-	
Stage 1	-	-	-	-	-	-	798	731	-	866	788	-	
Stage 2	-	-	-	-	-	-	839	780	-	792	731	-	
Approach	EB	WB	NB	SB									
HCM Control Delay, s	0.6	0.1	10.9	10.3									
HCM LOS	B	B	B	B									
Minor Lane/Major Mvmt	NBLn1	EBL	EBT	EBR	WBL	WBT	WBR	SBLn1					
Capacity (veh/h)	617	1451	-	-	1412	-	-	723					
HCM Lane V/C Ratio	0.011	0.01	-	-	0.001	-	-	0.069					
HCM Control Delay (s)	10.9	7.5	0	0	7.6	0	0	10.3					
HCM Lane LOS	B	A	A	A	A	A	A	B					
HCM 95th %tile Q(veh)	0	0	-	-	0	-	-	0.2					



# Appendix K

Synchro Intersection Worksheets – 2030 Future Total Conditions

Lanes, Volumes, Timings  
1: Holland & Spencer

Future Total 2030AM Peak Hour  
1186-1194 Wellington STW

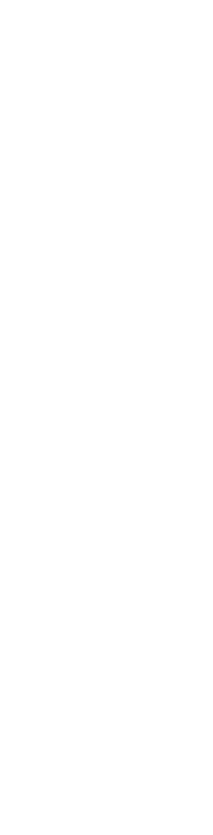
Lane Group	EBL	EBT	WBL	WBT	NBL	NBT	SBL	SBT
Lane Configurations	8	11	57	4	10	535	10	335
Traffic Volume (vph)	8	11	57	4	10	535	10	335
Future Volume (vph)	0	50	0	113	0	566	0	350
Lane Group Flow (vph)	Perm	NA	Perm	NA	Perm	NA	Perm	NA
Protected Phases	4	4	8	8	2	2	6	6
Permitted Phases	4	4	8	8	2	2	6	6
Detector Phase	4	4	8	8	2	2	6	6
Switch Phase								
Minimum Initial (s)	10.0	10.0	10.0	10.0	10.0	10.0	10.0	10.0
Minimum Split (s)	23.5	23.5	23.5	29.3	29.3	29.3	29.3	29.3
Total Split (s)	24.0	24.0	24.0	76.0	76.0	76.0	76.0	76.0
Total Split (%)	24.0%	24.0%	24.0%	76.0%	76.0%	76.0%	76.0%	76.0%
Maximum Green (s)	18.5	18.5	18.5	70.7	70.7	70.7	70.7	70.7
Yellow Time (s)	3.3	3.3	3.3	3.3	3.3	3.3	3.3	3.3
All-Red Time (s)	2.2	2.2	2.2	2.0	2.0	2.0	2.0	2.0
Lost Time Adjust (s)	0.0	0.0	0.0	0.0	0.0	0.0	0.0	0.0
Total Lost Time (s)	5.5	5.5	5.5	5.3	5.3	5.3	5.3	5.3
Lead/Lag								
Lead-Lag Optimize?								
Vehicle Extension (s)	3.0	3.0	3.0	3.0	3.0	3.0	3.0	3.0
Recall Mode	None	None	None	C-Max	C-Max	C-Max	C-Max	C-Max
Walk Time (s)	7.0	7.0	7.0	15.0	15.0	15.0	15.0	15.0
Flash Dont Walk (s)	11.0	11.0	11.0	9.0	9.0	9.0	9.0	9.0
Pedestrian Calls (#/hr)	24	24	17	17	67	67	74	74
Act Effr Green (s)	13.5	13.5	13.5	0.14	0.14	0.14	0.14	0.14
Actuated g/C Ratio	0.22	0.22	0.55	0.24	0.24	0.24	0.15	0.15
v/c Ratio	21.0	21.0	36.6	1.0	3.8	3.8	3.8	3.8
Control Delay	0.0	0.0	0.0	0.0	0.0	0.0	0.0	0.0
Queue Delay	21.0	21.0	36.6	1.0	3.8	3.8	3.8	3.8
Total Delay	21.0	21.0	36.6	1.0	3.8	3.8	3.8	3.8
LOS	C	D	D	A	A	A	A	A
Approach Delay	21.0	21.0	36.6	1.0	3.8	3.8	3.8	3.8
Approach LOS	C	D	D	A	A	A	A	A
Queue Length 50th (m)	3.4	3.4	13.9	1.7	7.0	7.0	7.0	7.0
Queue Length 95th (m)	13.0	29.4	4.8	4.8	14.3	14.3	14.3	14.3
Internal Link Dist (m)	151.9	132.2	211.0	211.0	210.0	210.0	210.0	210.0
Turn Bay Length (m)								
Base Capacity (vph)	296	268	2350	2350	2344	2344	2344	2344
Starvation Cap Reductn	0	0	0	0	0	0	0	0
Spillback Cap Reductn	0	0	0	0	0	0	0	0
Storage Cap Reductn	0	0	0	0	0	0	0	0
Reduced v/c Ratio	0.17	0.42	0.24	0.24	0.15	0.15	0.15	0.15

Intersection Summary	
Cycle Length:	100
Actuated Cycle Length:	100
Offset:	40 (40%), Referenced to phase 2, NBT and 6, SBT, Start of Green
Natural Cycle:	55

Lanes, Volumes, Timings  
1: Holland & Spencer

Future Total 2030AM Peak Hour  
1186-1194 Wellington STW

Lane Group	EBL	EBT	WBL	WBT	NBL	NBT	SBL	SBT
Lane Configurations	8	11	57	4	10	535	10	335
Traffic Volume (vph)	8	11	57	4	10	535	10	335
Future Volume (vph)	0	50	0	113	0	566	0	350
Lane Group Flow (vph)	Perm	NA	Perm	NA	Perm	NA	Perm	NA
Protected Phases	4	4	8	8	2	2	6	6
Permitted Phases	4	4	8	8	2	2	6	6
Detector Phase	4	4	8	8	2	2	6	6
Switch Phase								
Minimum Initial (s)	10.0	10.0	10.0	10.0	10.0	10.0	10.0	10.0
Minimum Split (s)	23.5	23.5	23.5	29.3	29.3	29.3	29.3	29.3
Total Split (s)	24.0	24.0	24.0	76.0	76.0	76.0	76.0	76.0
Total Split (%)	24.0%	24.0%	24.0%	76.0%	76.0%	76.0%	76.0%	76.0%
Maximum Green (s)	18.5	18.5	18.5	70.7	70.7	70.7	70.7	70.7
Yellow Time (s)	3.3	3.3	3.3	3.3	3.3	3.3	3.3	3.3
All-Red Time (s)	2.2	2.2	2.2	2.0	2.0	2.0	2.0	2.0
Lost Time Adjust (s)	0.0	0.0	0.0	0.0	0.0	0.0	0.0	0.0
Total Lost Time (s)	5.5	5.5	5.5	5.3	5.3	5.3	5.3	5.3
Lead/Lag								
Lead-Lag Optimize?								
Vehicle Extension (s)	3.0	3.0	3.0	3.0	3.0	3.0	3.0	3.0
Recall Mode	None	None	None	C-Max	C-Max	C-Max	C-Max	C-Max
Walk Time (s)	7.0	7.0	7.0	15.0	15.0	15.0	15.0	15.0
Flash Dont Walk (s)	11.0	11.0	11.0	9.0	9.0	9.0	9.0	9.0
Pedestrian Calls (#/hr)	24	24	17	17	67	67	74	74
Act Effr Green (s)	13.5	13.5	13.5	0.14	0.14	0.14	0.14	0.14
Actuated g/C Ratio	0.22	0.22	0.55	0.24	0.24	0.24	0.15	0.15
v/c Ratio	21.0	21.0	36.6	1.0	3.8	3.8	3.8	3.8
Control Delay	0.0	0.0	0.0	0.0	0.0	0.0	0.0	0.0
Queue Delay	21.0	21.0	36.6	1.0	3.8	3.8	3.8	3.8
Total Delay	21.0	21.0	36.6	1.0	3.8	3.8	3.8	3.8
LOS	C	D	D	A	A	A	A	A
Approach Delay	21.0	21.0	36.6	1.0	3.8	3.8	3.8	3.8
Approach LOS	C	D	D	A	A	A	A	A
Queue Length 50th (m)	3.4	3.4	13.9	1.7	7.0	7.0	7.0	7.0
Queue Length 95th (m)	13.0	29.4	4.8	4.8	14.3	14.3	14.3	14.3
Internal Link Dist (m)	151.9	132.2	211.0	211.0	210.0	210.0	210.0	210.0
Turn Bay Length (m)								
Base Capacity (vph)	296	268	2350	2350	2344	2344	2344	2344
Starvation Cap Reductn	0	0	0	0	0	0	0	0
Spillback Cap Reductn	0	0	0	0	0	0	0	0
Storage Cap Reductn	0	0	0	0	0	0	0	0
Reduced v/c Ratio	0.17	0.42	0.24	0.24	0.15	0.15	0.15	0.15



Control Type	Actuated-Coordinated
Maximum v/c Ratio:	0.55
Intersection Signal Delay:	6.6
Intersection LOS:	A
ICU Level of Service A	
Intersection Capacity Utilization:	47.7%
Analysis Period (min):	15

Lanes, Volumes, Timings  
2: Holland & Wellington

Future Total 2030AM Peak Hour  
1186-1194 Wellington STW

EBL	EBT	WBL	WBT	NBL	NBT	SBL	SBT	Ø1	Ø3	Ø5	Ø7
38	379	48	257	45	520	24	414				
38	379	48	257	45	520	24	414				
0	480	0	347	0	616	0	464				
Perm	NA	Perm	NA	Perm	NA	Perm	NA				
2	2	6	6	4	4	8	8	1	3	5	7
2	2	6	6	4	4	8	8				
10.0	10.0	10.0	10.0	10.0	10.0	10.0	10.0	1.0	1.0	1.0	1.0
23.6	23.6	24.5	24.5	20.1	20.1	20.1	20.1	3.0	3.0	3.0	3.0
45.0	45.0	45.0	45.0	45.0	45.0	45.0	45.0	5.0	5.0	5.0	5.0
45.0%	45.0%	45.0%	45.0%	45.0%	45.0%	45.0%	45.0%	5%	5%	5%	5%
39.4	39.4	39.4	39.9	39.9	39.9	39.9	39.9	3.0	3.0	3.0	3.0
3.3	3.3	3.3	3.3	3.3	3.3	3.3	3.3	2.0	2.0	2.0	2.0
2.3	2.3	2.3	2.3	1.8	1.8	1.8	1.8	0.0	0.0	0.0	0.0
0.0	0.0	0.0	0.0	0.0	0.0	0.0	0.0				
5.6	5.6	5.6	5.6	5.1	5.1	5.1	5.1				
Lag	Lag	Lag	Lag	Lag	Lag	Lag	Lag	Lead	Lead	Lead	Lead
Yes	Yes	Yes	Yes	Yes	Yes	Yes	Yes	Yes	Yes	Yes	Yes
3.0	3.0	3.0	3.0	3.0	3.0	3.0	3.0	3.0	3.0	3.0	3.0
C-Max	C-Max	C-Max	C-Max	Max	Max	Max	Max	Max	Max	Max	Max
4.0	4.0	4.0	4.0	2.0	2.0	2.0	2.0				
14.0	14.0	14.0	14.0	13.0	13.0	13.0	13.0				
153	153	113	113	123	123	116	116				
39.4	39.4	39.4	39.4	39.9	39.9	39.9	39.9				
0.39	0.39	0.39	0.39	0.40	0.40	0.40	0.40				
0.44	0.44	0.34	0.34	0.55	0.55	0.40	0.40				
23.8	23.8	34.4	34.4	25.4	25.4	20.0	20.0				
0.0	0.0	0.0	0.0	0.0	0.0	0.0	0.0				
23.8	23.8	34.4	34.4	25.4	25.4	20.0	20.0				
C	C	C	C	C	C	C	C				
23.8	23.8	34.4	34.4	25.4	25.4	20.0	20.0				
C	C	C	C	C	C	C	C				
35.2	35.2	29.7	29.7	47.4	47.4	30.1	30.1				
49.0	49.0	43.5	43.5	64.3	64.3	39.0	39.0				
20.2	20.2	43.8	43.8	195.2	195.2	211.0	211.0				
1096	1096	1020	1020	1119	1119	1164	1164				
0	0	0	0	0	0	0	0				
0	0	0	0	0	0	0	0				
0	0	0	0	0	0	0	0				
0.44	0.44	0.34	0.34	0.55	0.55	0.40	0.40				

Intersection Summary	
Cycle Length:	100
Actuated Cycle Length:	100
Offset:	64 (84%), Referenced to phase 2,EBTL and 6:WBTL, Start of Green
Natural Cycle:	55

Lanes, Volumes, Timings  
2: Holland & Wellington

Future Total 2030AM Peak Hour  
1186-1194 Wellington STW

EBL	EBT	WBL	WBT	NBL	NBT	SBL	SBT
38	379	48	257	45	520	24	414
38	379	48	257	45	520	24	414
0	480	0	347	0	616	0	464
Perm	NA	Perm	NA	Perm	NA	Perm	NA
2	2	6	6	4	4	8	8
2	2	6	6	4	4	8	8
10.0	10.0	10.0	10.0	10.0	10.0	10.0	10.0
23.6	23.6	24.5	24.5	20.1	20.1	20.1	20.1
45.0	45.0	45.0	45.0	45.0	45.0	45.0	45.0
45.0%	45.0%	45.0%	45.0%	45.0%	45.0%	45.0%	45.0%
39.4	39.4	39.4	39.9	39.9	39.9	39.9	39.9
3.3	3.3	3.3	3.3	3.3	3.3	3.3	3.3
2.3	2.3	2.3	2.3	1.8	1.8	1.8	1.8
0.0	0.0	0.0	0.0	0.0	0.0	0.0	0.0
5.6	5.6	5.6	5.6	5.1	5.1	5.1	5.1
Lag	Lag	Lag	Lag	Lag	Lag	Lag	Lag
Yes	Yes	Yes	Yes	Yes	Yes	Yes	Yes
3.0	3.0	3.0	3.0	3.0	3.0	3.0	3.0
C-Max	C-Max	C-Max	C-Max	Max	Max	Max	Max
4.0	4.0	4.0	4.0	2.0	2.0	2.0	2.0
14.0	14.0	14.0	14.0	13.0	13.0	13.0	13.0
153	153	113	113	123	123	116	116
39.4	39.4	39.4	39.4	39.9	39.9	39.9	39.9
0.39	0.39	0.39	0.39	0.40	0.40	0.40	0.40
0.44	0.44	0.34	0.34	0.55	0.55	0.40	0.40
23.8	23.8	34.4	34.4	25.4	25.4	20.0	20.0
0.0	0.0	0.0	0.0	0.0	0.0	0.0	0.0
23.8	23.8	34.4	34.4	25.4	25.4	20.0	20.0
C	C	C	C	C	C	C	C
23.8	23.8	34.4	34.4	25.4	25.4	20.0	20.0
C	C	C	C	C	C	C	C
35.2	35.2	29.7	29.7	47.4	47.4	30.1	30.1
49.0	49.0	43.5	43.5	64.3	64.3	39.0	39.0
20.2	20.2	43.8	43.8	195.2	195.2	211.0	211.0
1096	1096	1020	1020	1119	1119	1164	1164
0	0	0	0	0	0	0	0
0	0	0	0	0	0	0	0
0	0	0	0	0	0	0	0
0.44	0.44	0.34	0.34	0.55	0.55	0.40	0.40



Control Type: Actuated-Coordinated	
Maximum v/c Ratio:	0.55
Intersection Signal Delay:	25.3
Intersection LOS:	C
ICU Level of Service D	
Intersection Capacity Utilization:	61.0%
Analysis Period (min):	15

Splits and Phases: 2: Holland & Wellington.

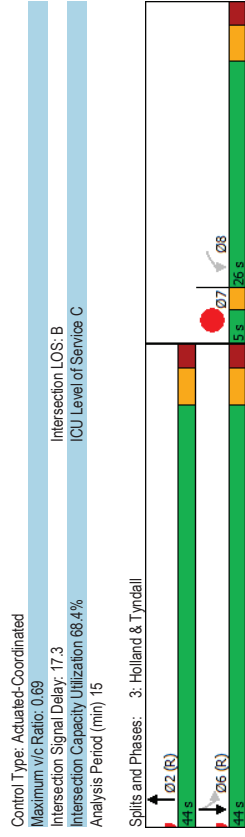
Lanes, Volumes, Timings  
3: Holland & Tyndall

Lanes, Volumes, Timings  
3: Holland & Tyndall

Future Total 2030AM Peak Hour  
1186-1194 Wellington STW

Future Total 2030AM Peak Hour  
1186-1194 Wellington STW

WBL	NBT	SBL	SBT	Ø7
W	R	R	R	
40	492	128	540	
40	492	128	540	
207	533	128	540	
Perm	NA	Perm	NA	
2	2	6	6	7
8	2	6	6	6
10.0	10.0	10.0	10.0	1.0
23.5	25.7	15.7	15.7	3.0
26.0	44.0	44.0	44.0	5.0
34.7%	58.7%	58.7%	58.7%	7%
20.5	38.3	38.3	38.3	3.0
3.3	3.3	3.3	3.3	2.0
2.2	2.4	2.4	2.4	0.0
0.0	0.0	0.0	0.0	0.0
5.5	5.7	5.7	5.7	5.7
Yes	Yes	Yes	Yes	Yes
3.0	3.0	3.0	3.0	3.0
None	C-Max	C-Max	C-Max	Max
5.0	10.0			
13.0	10.0			
38	47			
16.2	42.6	42.6	42.6	
0.22	0.57	0.57	0.57	
0.69	0.55	0.35	0.54	
38.5	13.6	13.6	13.7	
0.0	0.0	0.0	0.0	
38.5	13.6	13.6	13.7	
D	B	B	B	
38.5	13.6	13.7		
D	B			
26.2	45.3	9.5	46.6	
44.9	78.7	23.4	80.4	
139.5	156.5		19.3	
382	976	364	991	
0	0	0	0	
0	0	0	0	
0	0	0	0	
0.54	0.55	0.35	0.54	



Control Type: Actuated-Coordinated  
Maximum v/c Ratio: 0.69  
Intersection Signal Delay: 17.3  
Intersection LOS: B  
Intersection Capacity Utilization: 68.4%  
Analysis Period (min): 15

Control Type: Actuated-Coordinated  
Maximum v/c Ratio: 0.69  
Intersection Signal Delay: 17.3  
Intersection LOS: B  
Intersection Capacity Utilization: 68.4%  
Analysis Period (min): 15

Intersection Summary	
Cycle Length:	75
Actuated Cycle Length:	75
Offset:	2 (3%), Referenced to phase 2:NBT and 6:SBTL, Start of Green
Natural Cycle:	60

Intersection Summary	
Cycle Length:	75
Actuated Cycle Length:	75
Offset:	2 (3%), Referenced to phase 2:NBT and 6:SBTL, Start of Green
Natural Cycle:	60

Lanes, Volumes, Timings  
4: Parkdale & Armstrong

Future Total 2030AM Peak Hour  
1186-1194 Wellington STW

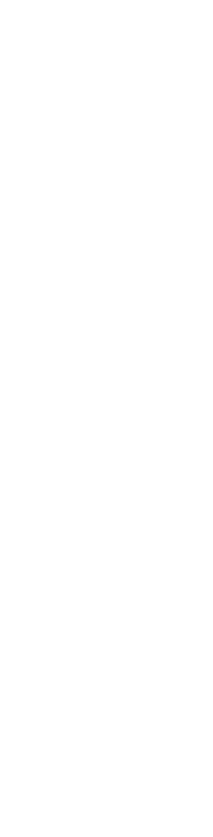
	EBL	EBT	WBL	WBT	NBL	NBT	SBL	SBT
Lane Group	EBL	EBT	WBL	WBT	NBL	NBT	SBL	SBT
Lane Configurations	27	75	12	47	22	370	12	227
Traffic Volume (vph)	27	75	12	47	22	370	12	227
Future Volume (vph)	0	117	0	72	0	415	0	261
Lane Group Flow (vph)	Perm	NA	Perm	NA	Perm	NA	Perm	NA
Turn Type	4	4	8	8	2	2	6	6
Protected Phases	4	4	8	8	2	2	6	6
Permitted Phases	4	4	8	8	2	2	6	6
Detector Phase	4	4	8	8	2	2	6	6
Switch Phase	10.0	10.0	10.0	10.0	10.0	10.0	10.0	10.0
Minimum Initial (s)	23.5	23.5	23.5	23.5	25.2	25.2	25.2	25.2
Minimum Split (s)	27.0	27.0	27.0	27.0	73.0	73.0	73.0	73.0
Total Split (s)	27.0%	27.0%	27.0%	27.0%	73.0%	73.0%	73.0%	73.0%
Total Split (%)	21.5	21.5	21.5	21.5	67.8	67.8	67.8	67.8
Maximum Green (s)	3.0	3.0	3.0	3.0	3.0	3.0	3.0	3.0
Yellow Time (s)	2.5	2.5	2.5	2.5	2.2	2.2	2.2	2.2
All-Red Time (s)	0.0	0.0	0.0	0.0	0.0	0.0	0.0	0.0
Lost Time Adjust (s)	5.5	5.5	5.5	5.5	5.2	5.2	5.2	5.2
Total Lost Time (s)	Lead/Lag							
Lead/Lag	Lead-Lag Optimize?							
Vehicle Extension (s)	3.0	3.0	3.0	3.0	3.0	3.0	3.0	3.0
Recall Mode	Max	Max	Max	Max	C-Max	C-Max	C-Max	C-Max
Walk Time (s)	10.0	10.0	10.0	10.0	15.0	15.0	15.0	15.0
Flash Dont Walk (s)	8.0	8.0	8.0	8.0	5.0	5.0	5.0	5.0
Pedestrian Calls (#/hr)	28	28	25	25	33	33	32	32
Act Effr Green (s)	21.5	21.5	21.5	21.5	67.8	67.8	67.8	67.8
Actuated g/C Ratio	0.22	0.22	0.22	0.22	0.68	0.68	0.68	0.68
v/c Ratio	0.35	0.21	0.36	0.21	0.36	0.23	0.36	0.23
Control Delay	34.7	29.8	29.8	2.2	2.2	6.5	6.5	6.5
Queue Delay	0.0	0.0	0.0	0.4	0.4	0.0	0.0	0.0
Total Delay	34.7	29.8	29.8	2.7	2.7	6.5	6.5	6.5
LOS	C	C	C	A	A	A	A	A
Approach Delay	34.7	29.8	29.8	2.7	2.7	6.5	6.5	6.5
Approach LOS	C	C	C	A	A	A	A	A
Queue Length 50th (m)	18.1	9.9	9.9	4.6	4.6	16.4	16.4	16.4
Queue Length 95th (m)	34.3	21.7	21.7	8.0	8.0	26.2	26.2	26.2
Internal Link Dist (m)	46.6	196.9	196.9	125.2	125.2	312.1	312.1	312.1
Turn Bay Length (m)	336	345	345	1141	1141	1136	1136	1136
Base Capacity (vph)	0	0	0	335	335	0	0	0
Starvation Cap Reductn	0	0	0	0	0	0	0	0
Spillback Cap Reductn	0	0	0	0	0	0	0	0
Storage Cap Reductn	0	0	0	0	0	0	0	0
Reduced v/c Ratio	0.35	0.21	0.21	0.51	0.51	0.23	0.23	0.23

Intersection Summary	
Cycle Length:	100
Actuated Cycle Length:	100
Offset:	52 (52%), Referenced to phase 2; NBT and 6; SBT, Start of Green
Natural Cycle:	50

Lanes, Volumes, Timings  
4: Parkdale & Armstrong

Future Total 2030AM Peak Hour  
1186-1194 Wellington STW

	EBL	EBT	WBL	WBT	NBL	NBT	SBL	SBT
Lane Group	EBL	EBT	WBL	WBT	NBL	NBT	SBL	SBT
Lane Configurations	27	75	12	47	22	370	12	227
Traffic Volume (vph)	27	75	12	47	22	370	12	227
Future Volume (vph)	0	117	0	72	0	415	0	261
Lane Group Flow (vph)	Perm	NA	Perm	NA	Perm	NA	Perm	NA
Turn Type	4	4	8	8	2	2	6	6
Protected Phases	4	4	8	8	2	2	6	6
Permitted Phases	4	4	8	8	2	2	6	6
Detector Phase	4	4	8	8	2	2	6	6
Switch Phase	10.0	10.0	10.0	10.0	10.0	10.0	10.0	10.0
Minimum Initial (s)	23.5	23.5	23.5	23.5	25.2	25.2	25.2	25.2
Minimum Split (s)	27.0	27.0	27.0	27.0	73.0	73.0	73.0	73.0
Total Split (s)	27.0%	27.0%	27.0%	27.0%	73.0%	73.0%	73.0%	73.0%
Total Split (%)	21.5	21.5	21.5	21.5	67.8	67.8	67.8	67.8
Maximum Green (s)	3.0	3.0	3.0	3.0	3.0	3.0	3.0	3.0
Yellow Time (s)	2.5	2.5	2.5	2.5	2.2	2.2	2.2	2.2
All-Red Time (s)	0.0	0.0	0.0	0.0	0.0	0.0	0.0	0.0
Lost Time Adjust (s)	5.5	5.5	5.5	5.5	5.2	5.2	5.2	5.2
Total Lost Time (s)	Lead/Lag							
Lead/Lag	Lead-Lag Optimize?							
Vehicle Extension (s)	3.0	3.0	3.0	3.0	3.0	3.0	3.0	3.0
Recall Mode	Max	Max	Max	Max	C-Max	C-Max	C-Max	C-Max
Walk Time (s)	10.0	10.0	10.0	10.0	15.0	15.0	15.0	15.0
Flash Dont Walk (s)	8.0	8.0	8.0	8.0	5.0	5.0	5.0	5.0
Pedestrian Calls (#/hr)	28	28	25	25	33	33	32	32
Act Effr Green (s)	21.5	21.5	21.5	21.5	67.8	67.8	67.8	67.8
Actuated g/C Ratio	0.22	0.22	0.22	0.22	0.68	0.68	0.68	0.68
v/c Ratio	0.35	0.21	0.36	0.21	0.36	0.23	0.36	0.23
Control Delay	34.7	29.8	29.8	2.2	2.2	6.5	6.5	6.5
Queue Delay	0.0	0.0	0.0	0.4	0.4	0.0	0.0	0.0
Total Delay	34.7	29.8	29.8	2.7	2.7	6.5	6.5	6.5
LOS	C	C	C	A	A	A	A	A
Approach Delay	34.7	29.8	29.8	2.7	2.7	6.5	6.5	6.5
Approach LOS	C	C	C	A	A	A	A	A
Queue Length 50th (m)	18.1	9.9	9.9	4.6	4.6	16.4	16.4	16.4
Queue Length 95th (m)	34.3	21.7	21.7	8.0	8.0	26.2	26.2	26.2
Internal Link Dist (m)	46.6	196.9	196.9	125.2	125.2	312.1	312.1	312.1
Turn Bay Length (m)	336	345	345	1141	1141	1136	1136	1136
Base Capacity (vph)	0	0	0	335	335	0	0	0
Starvation Cap Reductn	0	0	0	0	0	0	0	0
Spillback Cap Reductn	0	0	0	0	0	0	0	0
Storage Cap Reductn	0	0	0	0	0	0	0	0
Reduced v/c Ratio	0.35	0.21	0.21	0.51	0.51	0.23	0.23	0.23





Lanes, Volumes, Timings  
6: Parkdale & Gladstone

Future Total 2030AM Peak Hour  
1186-1194 Wellington STW

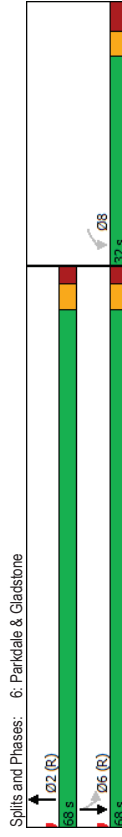
Lane Group	WBL	NBT	SBL	SBT
Lane Configurations	W	B	B	B
Traffic Volume (vph)	134	514	33	389
Future Volume (vph)	134	514	33	389
Lane Group Flow (vph)	165	645	33	389
Turn Type	Perm	NA	Perm	NA
Protected Phases	2	6	6	6
Permitted Phases	8	2	6	6
Detector Phase	8	2	6	6
Switch Phase				
Minimum Initial (s)	10.0	10.0	10.0	10.0
Minimum Split (s)	22.7	20.3	15.3	15.3
Total Split (s)	32.0	68.0	68.0	68.0
Total Split (%)	32.0%	68.0%	68.0%	68.0%
Maximum Green (s)	25.3	62.7	62.7	62.7
Yellow Time (s)	3.0	3.0	3.0	3.0
All-Red Time (s)	3.7	2.3	2.3	2.3
Lost Time Adjust (s)	0.0	0.0	0.0	0.0
Total Lost Time (s)	6.7	5.3	5.3	5.3
Lead/Lag				
Lead-Lag Optimize?				
Vehicle Extension (s)	3.0	3.0	3.0	3.0
Recall Mode	Max	C-Max	C-Max	C-Max
Walk Time (s)	7.0	7.0		
Flash Dont Walk (s)	9.0	8.0		
Pedestrian Calls (#/hr)	16	8		
Act Effr Green (s)	25.3	62.7	62.7	62.7
Actuated g/C Ratio	0.25	0.63	0.63	0.63
v/c Ratio	0.41	0.61	0.10	0.36
Control Delay	35.0	12.0	12.9	14.3
Queue Delay	0.0	0.0	0.0	0.0
Total Delay	35.0	12.0	12.9	14.3
LOS	C	B	B	B
Approach Delay	35.0	12.0	14.1	
Approach LOS	C	B	B	
Queue Length 50th (m)	26.7	62.5	2.6	31.0
Queue Length 95th (m)	45.8	76.0	m/7.0	70.2
Internal Link Dist (m)	224.2	197.3		88.5
Turn Bay Length (m)			85.0	
Base Capacity (vph)	398	1054	345	1094
Starvation Cap Reductn	0	0	0	0
Spillback Cap Reductn	0	0	0	0
Storage Cap Reductn	0	0	0	0
Reduced v/c Ratio	0.41	0.61	0.10	0.36

Intersection Summary	
Cycle Length:	100
Actuated Cycle Length:	100
Offset:	12 (12%), Referenced to phase 2:NBT and 6:SBTL, Start of Green
Natural Cycle:	60

Lanes, Volumes, Timings  
6: Parkdale & Gladstone

Future Total 2030AM Peak Hour  
1186-1194 Wellington STW

Control Type:	Actuated-Coordinated
Maximum v/c Ratio:	0.61
Intersection Signal Delay:	15.8
Intersection LOS:	B
Intersection Capacity Utilization:	60.5%
Analysis Period (min):	15
m:	Volume for 95th percentile queue is metered by upstream signal.



Lanes, Volumes, Timings  
7: Parkdale & 417 WB OR

Lanes, Volumes, Timings  
7: Parkdale & 417 WB OR

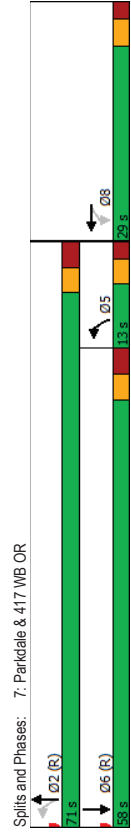
Future Total 2030AM Peak Hour  
1186-1194 Wellington STW

Future Total 2030AM Peak Hour  
1186-1194 Wellington STW

	WBL	WBT	NBL	NBT	SBT
Lane Group	WBL	WBT	NBL	NBT	SBT
Lane Configurations	345	0	202	352	508
Traffic Volume (vph)	345	0	202	352	508
Future Volume (vph)	345	0	202	352	508
Lane Group Flow (vph)	Perim	NA	pm-pt	NA	NA
Turn Type	8	5	2	2	6
Permitted Phases	8	5	2	2	6
Detector Phase	8	8	5	2	6
Switch Phase					
Minimum Initial (s)	10.0	10.0	5.0	10.0	10.0
Minimum Split (s)	20.5	20.5	10.2	27.3	21.3
Total Split (s)	29.0	29.0	13.0	71.0	58.0
Total Split (%)	29.0%	29.0%	13.0%	71.0%	58.0%
Maximum Green (s)	23.5	23.5	7.8	64.7	51.7
Yellow Time (s)	3.3	3.3	3.0	3.0	3.0
All-Red Time (s)	2.2	2.2	2.2	3.3	3.3
Lost Time Adjust (s)	0.0	0.0	0.0	0.0	0.0
Total Lost Time (s)	5.5	5.5	5.2	6.3	6.3
Lead/Lag			Lag	Lead	
Lead-Lag Optimize?			Yes	Yes	
Vehicle Extension (s)	3.0	3.0	3.0	3.0	3.0
Recall Mode	None	None	None	C-Max	C-Max
Walk Time (s)	7.0	7.0	7.0	7.0	7.0
Flash Dont Walk (s)	8.0	8.0	14.0	8.0	8.0
Pedestrian Calls (#/hr)	1	1		24	11
Act Effct Green (s)	22.7	22.7	66.6	65.5	62.5
Actuated g/C Ratio	0.23	0.23	0.67	0.66	0.52
v/c Ratio	0.92	0.77	0.68	0.31	0.92
Control Delay	68.4	13.2	32.5	8.5	41.7
Queue Delay	0.0	0.0	0.0	0.0	0.0
Total Delay	68.4	13.2	32.5	8.5	41.7
LOS	E	B	C	A	D
Approach Delay		34.6		17.2	41.7
Approach LOS		C		B	D
Queue Length 50th (m)	64.9	7.9	13.7	27.3	157.2
Queue Length 95th (m)	#113.6	46.6	#29.2	41.4	#222.1
Internal Link Dist (m)		462.5		38.8	197.3
Turn Bay Length (m)					
Base Capacity (vph)	389	717	299	1143	873
Starvation Cap Reductn	0	0	0	0	0
Spillback Cap Reductn	0	0	0	0	0
Storage Cap Reductn	0	0	0	0	0
Reduced v/c Ratio	0.89	0.76	0.68	0.31	0.92

Intersection Summary	
Cycle Length:	100
Actuated Cycle Length:	100
Offset:	26 (26%), Referenced to phase 2, NBT and 6, SBT, Start of Green
Natural Cycle:	90

Control Type:	Actuated-Coordinated
Maximum v/c Ratio:	0.92
Intersection Signal Delay:	32.9
Intersection LOS:	C
Intersection Capacity Utilization:	109.2%
Analysis Period (min):	15
# 95th percentile volume exceeds capacity, queue may be longer.	
Queue shown is maximum after two cycles.	





Lanes, Volumes, Timings  
8: Wellington & Carruthers

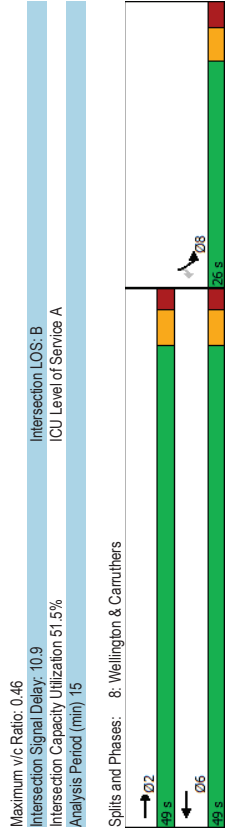
Future Total 2030AM Peak Hour  
1186-1194 Wellington STW

Lane Group	EBT	WBT	SBL	SBR
Lane Configurations	←	←	←	←
Traffic Volume (vph)	465	238	63	13
Future Volume (vph)	465	238	63	13
Lane Group Flow (vph)	465	238	63	13
Turn Type	NA	NA	Prot	Perm
Protected Phases	2	6	8	8
Permitted Phases	2	6	8	8
Detector Phase	2	6	8	8
Switch Phase				
Minimum Initial (s)	10.0	10.0	10.0	10.0
Minimum Split (s)	15.3	26.3	25.5	25.5
Total Split (s)	49.0	49.0	26.0	26.0
Total Split (%)	65.3%	65.3%	34.7%	34.7%
Maximum Green (s)	43.7	43.7	20.5	20.5
Yellow Time (s)	3.3	3.3	3.0	3.0
All-Red Time (s)	2.0	2.0	2.5	2.5
Lost Time Adjust (s)	0.0	0.0	0.0	0.0
Total Lost Time (s)	5.3	5.3	5.5	5.5
Lead/Lag				
Lead-Lag Optimize?				
Vehicle Extension (s)	3.0	3.0	3.0	3.0
Recall Mode	Max	Max	Max	Max
Walk Time (s)	14.0	15.0	15.0	15.0
Flash Dont Walk (s)	7.0	5.0	5.0	5.0
Pedestrian Calls (#/hr)	75	66	66	66
Act Effr Green (s)	43.7	43.7	20.5	20.5
Actuated G/C Ratio	0.58	0.58	0.27	0.27
v/c Ratio	10.7	8.3	21.7	11.0
Control Delay	0.0	0.0	0.0	0.0
Queue Delay	0.0	0.0	0.0	0.0
Total Delay	10.7	8.3	21.7	11.0
LOS	B	A	C	B
Approach Delay	10.7	8.3	19.9	
Approach LOS	B	A	B	
Queue Length 50th (m)	33.9	14.7	6.7	0.0
Queue Length 95th (m)	54.1	25.4	15.4	3.8
Internal Link Dist (m)	154.1	153.4	73.2	
Turn Bay Length (m)			30.0	
Base Capacity (vph)	1016	1016	453	385
Starvation Cap Reductn	0	0	0	0
Spillback Cap Reductn	0	0	0	0
Storage Cap Reductn	0	0	0	0
Reduced v/c Ratio	0.46	0.23	0.14	0.03

Intersection Summary	
Cycle Length:	75
Actuated Cycle Length:	75
Natural Cycle:	55
Control Type:	Semi-Act-Uncoord

Lanes, Volumes, Timings  
8: Wellington & Carruthers

Future Total 2030AM Peak Hour  
1186-1194 Wellington STW



HCM 2010 TWSC  
9: Parkdale & Rear Lane  
Future Total 2030AM Peak Hour  
1186-1194 Wellington STW

Intersection												
Int Delay, s/veh	0.1											
Movement	EBL	EBR	NBL	NBT	SBT	SBR						
Lane Configurations	W											
Traffic Vol, veh/h	0	9	0	553	381	0						
Future Vol, veh/h	0	9	0	553	381	0						
Conflicting Peds. #/hr	0	0	30	0	0	30						
Sign Control	Stop	Stop	Free	Free	Free	Free						
RT Channelized	-	None	-	None	-	None						
Storage Length	0	-	-	-	-	-						
Veh in Median Storage, #	0	-	-	0	0	-						
Grade, %	0	-	-	0	0	-						
Peak Hour Factor	100	100	100	100	100	100						
Heavy Vehicles, %	2	2	2	2	2	2						
Mvmt Flow	0	9	0	553	381	0						
Major/Minor	Minor2	Major1	Major1	Major2								
Conflicting Flow All	964	411	411	0	-	0						
Stage 1	411	-	-	-	-	-						
Stage 2	553	-	-	-	-	-						
Critical Hdwy	6.42	6.22	4.12	-	-	-						
Critical Hdwy Stg 1	5.42	-	-	-	-	-						
Critical Hdwy Stg 2	5.42	-	-	-	-	-						
Follow-up Hdwy	3,518	3,318	2,218	-	-	-						
Pot Cap-1 Maneuver	283	641	1148	-	-	-						
Stage 1	669	-	-	-	-	-						
Stage 2	576	-	-	-	-	-						
Platoon blocked, %	-	-	-	-	-	-						
Mov Cap-1 Maneuver	270	626	1121	-	-	-						
Mov Cap-2 Maneuver	270	-	-	-	-	-						
Stage 1	654	-	-	-	-	-						
Stage 2	563	-	-	-	-	-						
Approach	EB	NB	SB									
HCM Control Delay, s	10.8	0	0									
HCM LOS	B											
Minor Lane/Major Mvmt	NBL	NBT	EBLn1	SBT	SBR							
Capacity (veh/h)	1121	-	626	-	-							
HCM Lane V/C Ratio	-	-	0.014	-	-							
HCM Control Delay (s)	0	-	10.8	-	-							
HCM Lane LOS	A	-	B	-	-							
HCM 95th %tile Q(veh)	0	-	0	-	-							

HCM 2010 TWSC  
10: Hamilton & Rear Lane  
Future Total 2030AM Peak Hour  
1186-1194 Wellington STW

Intersection												
Int Delay, s/veh	1.8											
Movement	WBL	WBR	NBT	NBR	SBL	SBT						
Lane Configurations	W											
Traffic Vol, veh/h	2	9	20	7	6	32						
Future Vol, veh/h	2	9	20	7	6	32						
Conflicting Peds. #/hr	0	0	0	10	10	0						
Sign Control	Stop	Stop	Free	Free	Free	Free						
RT Channelized	-	None	-	None	-	None						
Storage Length	0	-	-	-	-	-						
Veh in Median Storage, #	0	-	0	-	-	0						
Grade, %	0	-	0	-	-	0						
Peak Hour Factor	100	100	100	100	100	100						
Heavy Vehicles, %	2	2	2	2	2	2						
Mvmt Flow	2	9	20	7	6	32						
Major/Minor	Minor1	Major1	Major2									
Conflicting Flow All	78	34	0	0	37	0						
Stage 1	34	-	-	-	-	-						
Stage 2	44	-	-	-	-	-						
Critical Hdwy	6.42	6.22	-	-	4.12	-						
Critical Hdwy Stg 1	5.42	-	-	-	-	-						
Critical Hdwy Stg 2	5.42	-	-	-	-	-						
Follow-up Hdwy	3,518	3,318	-	-	2,218	-						
Pot Cap-1 Maneuver	925	1039	-	-	1574	-						
Stage 1	988	-	-	-	-	-						
Stage 2	978	-	-	-	-	-						
Platoon blocked, %	-	-	-	-	-	-						
Mov Cap-1 Maneuver	914	1031	-	-	1562	-						
Mov Cap-2 Maneuver	914	-	-	-	-	-						
Stage 1	980	-	-	-	-	-						
Stage 2	974	-	-	-	-	-						
Approach	WB	NB	SB									
HCM Control Delay, s	8.6	0	1.2									
HCM LOS	A											
Minor Lane/Major Mvmt	NBT	NBR	WBLn1	SBL	SBT							
Capacity (veh/h)	-	-	1008	1562	-							
HCM Lane V/C Ratio	-	-	0.011	0.004	-							
HCM Control Delay (s)	-	-	8.6	7.3	0							
HCM Lane LOS	A	-	A	A	A							
HCM 95th %tile Q(veh)	-	-	0	0	-							

11: Hamilton & Wellington  
 HCM 2010 TWSC  
 Future Total 2030AM Peak Hour  
 1186-1194 Wellington STW

Intersection													
Int Delay, s/veh													1.8
Movement	EBL	EBT	EBR	WBL	WBT	WBR	NBL	NBT	NBR	SBL	SBT	SBR	
Lane Configurations	↔		↔	↔					↔		↔		
Traffic Vol, veh/h	13	246	12	11	215	10	12	7	10	6	15	17	
Future Vol, veh/h	13	246	12	11	215	10	12	7	10	6	15	17	
Conflicting Peds. #/hr	0	0	0	0	0	0	0	0	0	0	0	0	0
Sign Control	Free	Free	Free	Free	Free	Free	Free	Free	Free	Free	Free	Free	Stop
RT Channelized	-	-	None	-	-	None	-	-	None	-	-	None	-
Storage Length	-	-	-	-	-	-	-	-	-	-	-	-	-
Veh in Median Storage, #	-	0	-	-	0	-	-	-	0	-	-	0	-
Grade, %	-	0	-	-	0	-	-	-	0	-	-	0	-
Peak Hour Factor	100	100	100	100	100	100	100	100	100	100	100	100	100
Heavy Vehicles, %	2	2	2	2	2	2	2	2	2	2	2	2	2
Mvmt Flow	13	246	12	11	215	10	12	7	10	6	15	17	
Major/Minor	Major1	Major2	Minor1	Minor2									
Conflicting Flow All	225	0	0	258	0	0	536	525	252	529	526	220	
Stage 1	-	-	-	278	278	-	242	242	-	-	-	-	-
Stage 2	-	-	-	258	247	-	287	284	-	-	-	-	-
Critical Hdwy	4.12	-	-	4.12	-	-	7.12	6.52	6.22	7.12	6.52	6.22	
Critical Hdwy Stg 1	-	-	-	-	-	-	6.12	5.52	-	6.12	5.52	-	
Critical Hdwy Stg 2	-	-	-	-	-	-	6.12	5.52	-	6.12	5.52	-	
Follow-up Hdwy	2.218	-	-	2.218	-	-	3.518	4.018	3.318	3.518	4.018	3.318	
Pot Cap-1 Maneuver	1344	-	-	1307	-	-	455	468	787	460	457	820	
Stage 1	-	-	-	-	-	-	728	680	-	762	705	-	
Stage 2	-	-	-	-	-	-	747	702	-	720	676	-	
Platoon blocked, %	-	-	-	-	-	-	-	-	-	-	-	-	
Mov Cap-1 Maneuver	1344	-	-	1307	-	-	427	448	787	442	447	820	
Mov Cap-2 Maneuver	-	-	-	-	-	-	427	448	-	442	447	-	
Stage 1	-	-	-	-	-	-	720	673	-	754	698	-	
Stage 2	-	-	-	-	-	-	709	695	-	696	669	-	
Approach	EB	WB	WB	NB	NB	SB							
HCM Control Delay, s	0.4	0.4	0.4	12.4	11.9								
HCM LOS	B	B	B	B	B								
Minor Lane/Major Mvmt	NBLn1	EBL	EBT	EBR	WBL	WBT	WBR	SBLn1					
Capacity (veh/h)	514	1344	-	-	1307	-	-	560					
HCM Lane V/C Ratio	0.056	0.01	-	-	0.008	-	-	0.068					
HCM Control Delay (s)	12.4	7.7	0	-	7.8	0	-	11.9					
HCM Lane LOS	B	A	A	A	A	A	A	B					
HCM 95th %ile Q(veh)	0.2	0	-	-	0	-	-	0.2					

12: Hamilton & Tyndall  
 HCM 2010 TWSC  
 Future Total 2030AM Peak Hour  
 1186-1194 Wellington STW

Intersection													
Int Delay, s/veh													1.6
Movement	EBL	EBT	EBR	WBL	WBT	WBR	NBL	NBT	NBR	SBL	SBT	SBR	
Lane Configurations	↔		↔	↔					↔		↔		
Traffic Vol, veh/h	10	173	0	3	95	15	0	2	7	21	2	11	
Future Vol, veh/h	10	173	0	3	95	15	0	2	7	21	2	11	
Conflicting Peds. #/hr	0	0	0	0	0	0	0	0	0	0	0	0	0
Sign Control	Free	Free	Free	Free	Free	Free	Free	Free	Free	Free	Free	Free	Stop
RT Channelized	-	-	None	-	-	None	-	-	None	-	-	None	-
Storage Length	-	-	-	-	-	-	-	-	-	-	-	-	-
Veh in Median Storage, #	-	0	-	-	0	-	-	-	0	-	-	0	-
Grade, %	-	0	-	-	0	-	-	-	0	-	-	0	-
Peak Hour Factor	100	100	100	100	100	100	100	100	100	100	100	100	100
Heavy Vehicles, %	2	2	2	2	2	2	2	2	2	2	2	2	2
Mvmt Flow	10	173	0	3	95	15	0	2	7	21	2	11	
Major/Minor	Major1	Major2	Minor1	Minor2									
Conflicting Flow All	110	0	0	173	0	0	308	309	173	307	302	103	
Stage 1	-	-	-	-	-	-	193	193	-	198	193	-	
Stage 2	-	-	-	-	-	-	115	116	-	198	193	-	
Critical Hdwy	4.12	-	-	4.12	-	-	7.12	6.52	6.22	7.12	6.52	6.22	
Critical Hdwy Stg 1	-	-	-	-	-	-	6.12	5.52	-	6.12	5.52	-	
Critical Hdwy Stg 2	-	-	-	-	-	-	6.12	5.52	-	6.12	5.52	-	
Follow-up Hdwy	2.218	-	-	2.218	-	-	3.518	4.018	3.318	3.518	4.018	3.318	
Pot Cap-1 Maneuver	1480	-	-	1404	-	-	644	605	871	645	611	952	
Stage 1	-	-	-	-	-	-	809	741	-	896	805	-	
Stage 2	-	-	-	-	-	-	890	800	-	804	741	-	
Platoon blocked, %	-	-	-	-	-	-	-	-	-	-	-	-	
Mov Cap-1 Maneuver	1480	-	-	1404	-	-	630	600	871	634	606	952	
Mov Cap-2 Maneuver	-	-	-	-	-	-	630	600	-	634	606	-	
Stage 1	-	-	-	-	-	-	803	736	-	890	803	-	
Stage 2	-	-	-	-	-	-	876	798	-	790	736	-	
Approach	EB	WB	WB	NB	NB	SB							
HCM Control Delay, s	0.4	0.2	0.2	9.6	9.6	10.3							
HCM LOS	A	A	A	B	B								
Minor Lane/Major Mvmt	NBLn1	EBL	EBT	EBR	WBL	WBT	WBR	SBLn1					
Capacity (veh/h)	792	1480	-	-	1404	-	-	709					
HCM Lane V/C Ratio	0.011	0.007	-	-	0.002	-	-	0.048					
HCM Control Delay (s)	9.6	7.4	0	-	7.6	0	-	10.3					
HCM Lane LOS	A	A	A	A	A	A	A	B					
HCM 95th %ile Q(veh)	0	0	-	-	0	-	-	0.2					

Lanes, Volumes, Timings  
1: Holland & Spencer

Future Total 2030PM Peak Hour  
1186-1194 Wellington STW

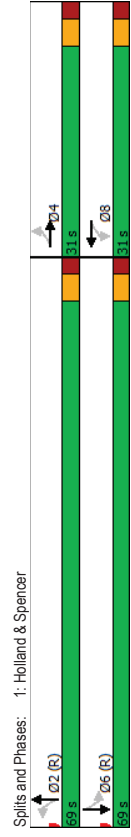
	EBL	EBT	WBL	WBT	NBL	NBT	SBL	SBT
Lane Configurations	12	24	153	61	55	380	16	481
Traffic Volume (vph)	12	24	153	61	55	380	16	481
Future Volume (vph)	0	66	0	244	0	463	0	511
Lane Group Flow (vph)	Perm	NA	Perm	NA	Perm	NA	Perm	NA
Turn Type	4	8	8	2	2	6	6	6
Protected Phases	4	8	8	2	2	6	6	6
Permitted Phases	4	8	8	2	2	6	6	6
Detector Phase	4	8	8	2	2	6	6	6
Switch Phase	4	8	8	2	2	6	6	6
Minimum Initial (s)	10.0	10.0	10.0	10.0	10.0	10.0	10.0	10.0
Minimum Split (s)	23.5	23.5	23.5	29.3	29.3	29.3	29.3	29.3
Total Split (s)	31.0	31.0	31.0	69.0	69.0	69.0	69.0	69.0
Total Split (%)	31.0%	31.0%	31.0%	69.0%	69.0%	69.0%	69.0%	69.0%
Maximum Green (s)	25.5	25.5	25.5	63.7	63.7	63.7	63.7	63.7
Yellow Time (s)	3.3	3.3	3.3	3.3	3.3	3.3	3.3	3.3
All-Red Time (s)	2.2	2.2	2.2	2.0	2.0	2.0	2.0	2.0
Lost Time Adjust (s)	0.0	0.0	0.0	0.0	0.0	0.0	0.0	0.0
Total Lost Time (s)	5.5	5.5	5.5	5.3	5.3	5.3	5.3	5.3
Lead/Lag								
Lead-Lag Optimize?								
Vehicle Extension (s)	3.0	3.0	3.0	3.0	3.0	3.0	3.0	3.0
Recall Mode	None	None	None	C-Max	C-Max	C-Max	C-Max	C-Max
Walk Time (s)	7.0	7.0	7.0	15.0	15.0	15.0	15.0	15.0
Flash Dont Walk (s)	11.0	11.0	11.0	9.0	9.0	9.0	9.0	9.0
Pedestrian Calls (#/hr)	24	24	23	23	95	95	85	85
Act Effr Green (s)	21.9	21.9	21.9	67.3	67.3	67.3	67.3	67.3
Actuated g/C Ratio	0.22	0.22	0.22	0.67	0.67	0.67	0.67	0.67
v/c Ratio	0.19	0.82	0.82	0.26	0.26	0.26	0.26	0.26
Control Delay	19.7	58.3	58.3	1.1	1.1	7.2	7.2	7.2
Queue Delay	0.0	0.0	0.0	0.0	0.0	0.0	0.0	0.0
Total Delay	19.7	58.3	58.3	1.1	1.1	7.2	7.2	7.2
LOS	B	E	E	A	A	A	A	A
Approach Delay	19.7	58.3	58.3	1.1	1.1	7.2	7.2	7.2
Approach LOS	B	E	E	A	A	A	A	A
Queue Length 50th (m)	5.5	43.0	43.0	1.2	1.2	19.2	19.2	19.2
Queue Length 95th (m)	15.7	#74.6	#74.6	2.7	2.7	28.2	28.2	28.2
Internal Link Dist (m)	151.9	132.2	132.2	211.0	211.0	211.0	211.0	211.0
Turn Bay Length (m)								
Base Capacity (vph)	403	343	343	1813	1813	2063	2063	2063
Starvation Cap Reductn	0	0	0	0	0	0	0	0
Spillback Cap Reductn	0	0	0	0	0	0	0	0
Storage Cap Reductn	0	0	0	0	0	0	0	0
Reduced v/c Ratio	0.16	0.71	0.71	0.26	0.26	0.26	0.26	0.26

Intersection Summary	
Cycle Length:	100
Actuated Cycle Length:	100
Offset:	38 (38%), Referenced to phase 2; NBT1 and 6; SBT1, Start of Green
Natural Cycle:	55

Lanes, Volumes, Timings  
1: Holland & Spencer

Future Total 2030PM Peak Hour  
1186-1194 Wellington STW

Control Type:	Actuated-Coordinated
Maximum v/c Ratio:	0.82
Intersection Signal Delay:	15.4
Intersection LOS:	B
Intersection Capacity Utilization:	74.6%
Analysis Period (min):	15
# 95th percentile volume exceeds capacity, queue may be longer.	
Queue shown is maximum after two cycles.	



Lanes, Volumes, Timings  
2: Holland & Wellington

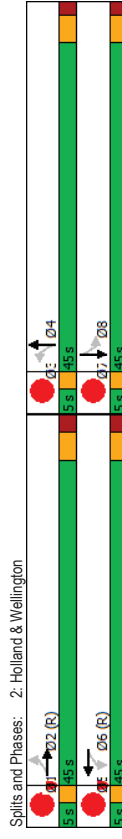
Future Total 2030PM Peak Hour  
1186-1194 Wellington STW

EBL	EBT	WBL	WBT	NBL	NBT	SBL	SBT	Ø1	Ø3	Ø5	Ø7
Lane Configurations											
21	384	80	570	38	419	26	652				
21	384	80	570	38	419	26	652				
Lane Group Flow (vph)											
Perm	NA	Perm	NA	Perm	NA	Perm	NA				
Protected Phases											
2	2	6	6	4	4	8	8	1	3	5	7
Permitted Phases											
2	2	6	6	4	4	8	8				
Detector Phase											
10.0	10.0	10.0	10.0	10.0	10.0	10.0	10.0	1.0	1.0	1.0	1.0
23.6	23.6	24.5	24.5	20.1	20.1	20.1	20.1	3.0	3.0	3.0	3.0
Minimum Split (s)											
45.0	45.0	45.0	45.0	45.0	45.0	45.0	45.0	5.0	5.0	5.0	5.0
Total Split (%)											
45.0%	45.0%	45.0%	45.0%	45.0%	45.0%	45.0%	45.0%	5%	5%	5%	5%
Maximum Green (s)											
39.4	39.4	39.4	39.4	39.9	39.9	39.9	39.9	3.0	3.0	3.0	3.0
Yellow Time (s)											
3.3	3.3	3.3	3.3	3.3	3.3	3.3	3.3	2.0	2.0	2.0	2.0
All-Red Time (s)											
2.3	2.3	2.3	2.3	1.8	1.8	1.8	1.8	0.0	0.0	0.0	0.0
Lost Time Adjust (s)											
0.0	0.0	0.0	0.0	0.0	0.0	0.0	0.0				
Total Lost Time (s)											
5.6	5.6	5.6	5.6	5.1	5.1	5.1	5.1				
Lead/Lag											
Lag	Lag	Lag	Lag	Lag	Lag	Lag	Lag	Lead	Lead	Lead	Lead
Yes	Yes	Yes	Yes	Yes	Yes	Yes	Yes	Yes	Yes	Yes	Yes
Lead-Lag Optimize?											
3.0	3.0	3.0	3.0	3.0	3.0	3.0	3.0	3.0	3.0	3.0	3.0
Vehicle Extension (s)											
C-Max	C-Max	C-Max	C-Max	Max	Max	Max	Max	Max	Max	Max	Max
4.0	4.0	4.0	4.0	2.0	2.0	2.0	2.0				
Recall Mode											
14.0	14.0	14.0	14.0	13.0	13.0	13.0	13.0				
Flash Dont Walk (s)											
241	241	166	166	165	165	146	146				
Pedestrian Calls (#/hr)											
39.4	39.4	39.4	39.4	39.9	39.9	39.9	39.9				
Act Effr Green (s)											
0.39	0.39	0.39	0.39	0.40	0.40	0.40	0.40				
Actuated G/C Ratio											
0.45	0.45	0.67	0.67	0.49	0.49	0.64	0.64				
v/c Ratio											
23.9	23.9	22.8	22.8	20.7	20.7	22.7	22.7				
Control Delay											
0.0	0.0	0.0	0.0	0.0	0.0	0.0	0.0				
Queue Delay											
23.9	23.9	22.8	22.8	20.7	20.7	22.7	22.7				
Total Delay											
C	C	C	C	C	C	C	C				
LOS											
23.9	23.9	22.8	22.8	20.7	20.7	22.7	22.7				
Approach Delay											
C	C	C	C	C	C	C	C				
Approach LOS											
35.7	35.7	42.0	42.0	28.3	28.3	44.6	44.6				
Queue Length 50th (m)											
49.8	49.8	m49.7	m49.7	49.9	49.9	66.8	66.8				
Queue Length 95th (m)											
23.9	23.9	34.4	34.4	195.8	195.8	211.0	211.0				
Internal Link Dist (m)											
1089	1089	1007	1007	1055	1055	1167	1167				
Turn Bay Length (m)											
0	0	0	0	0	0	0	0				
Base Capacity (vph)											
0	0	0	0	0	0	0	0				
Starvation Cap Reductn											
0	0	0	0	0	0	0	0				
Spillback Cap Reductn											
0	0	0	0	0	0	0	0				
Storage Cap Reductn											
0.45	0.45	0.67	0.67	0.49	0.49	0.64	0.64				
Reduced v/c Ratio											
Intersection Summary											
Cycle Length: 100											
Actuated Cycle Length: 100											
Offset: 72 (72%), Referenced to phase 2,EBTL and 6:WBTL, Start of Green											
Natural Cycle: 60											

Lanes, Volumes, Timings  
2: Holland & Wellington

Future Total 2030PM Peak Hour  
1186-1194 Wellington STW

Control Type: Actuated-Coordinated	
Maximum v/c Ratio: 0.67	Intersection LOS: C
Intersection Signal Delay: 22.6	ICU Level of Service F
Intersection Capacity Utilization 92.8%	
Analysis Period (min): 15	
m. Volume for 95th percentile queue is metered by upstream signal.	



Lanes, Volumes, Timings  
3: Holland & Tyndall

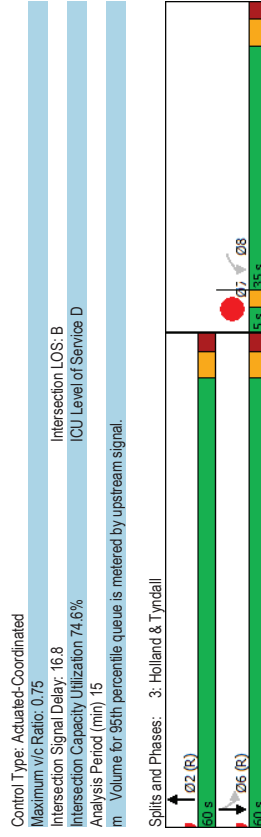
Lanes, Volumes, Timings  
3: Holland & Tyndall

Future Total 2030PM Peak Hour  
1186-1194 Wellington STW

Future Total 2030PM Peak Hour  
1186-1194 Wellington STW

	WBL	NBT	SBL	SBT	Ø7
Lane Group	W	R	L	R	
Lane Configurations	46	625	145	585	
Traffic Volume (vph)	46	625	145	585	
Future Volume (vph)	227	651	145	585	
Lane Group Flow (vph)	Perm	NA	Perm	NA	
Turn Type	2	2	6	7	
Protected Phases	8	2	6	6	
Permitted Phases	8	2	6	6	
Detector Phase					
Switch Phase					
Minimum Initial (s)	10.0	10.0	10.0	10.0	1.0
Minimum Split (s)	23.5	25.7	15.7	15.7	3.0
Total Split (s)	35.0%	60.0%	60.0%	60.0%	5%
Total Split (%)	35.0%	60.0%	60.0%	60.0%	5%
Maximum Green (s)	29.5	54.3	54.3	54.3	3.0
Yellow Time (s)	3.3	3.3	3.3	3.3	2.0
All-Red Time (s)	2.2	2.4	2.4	2.4	0.0
Lost Time Adjust (s)	0.0	0.0	0.0	0.0	0.0
Total Lost Time (s)	5.5	5.7	5.7	5.7	
Lead/Lag					Lead
Lead-Lag Optimize?	Yes				Yes
Vehicle Extension (s)	3.0	3.0	3.0	3.0	3.0
Recall Mode	None	C-Max	C-Max	C-Max	Max
Walk Time (s)	5.0	10.0			
Pedestrian Calls (#/hr)	15	22			
Act Effr Green (s)	20.7	63.1	63.1	63.1	
Actuated g/C Ratio	0.21	0.63	0.63	0.63	
v/c Ratio	0.75	0.60	0.42	0.53	
Control Delay	52.0	15.0	8.6	7.3	
Queue Delay	0.0	0.0	0.0	0.0	
Total Delay	52.0	15.0	8.6	7.3	
LOS	D	B	A	A	
Approach Delay	52.0	15.0	7.5		
Approach LOS	D	B	A		
Queue Length 50th (m)	41.5	68.0	5.7	25.1	
Queue Length 95th (m)	60.9	124.4	12.1	40.0	
Internal Link Dist (m)	143.3	156.5		18.7	
Turn Bay Length (m)					
Base Capacity (vph)	430	1092	348	1100	
Starvation Cap Reductn	0	0	0	0	
Spillback Cap Reductn	0	0	0	0	
Storage Cap Reductn	0	0	0	0	
Reduced v/c Ratio	0.53	0.60	0.42	0.53	

Intersection Summary	
Cycle Length:	100
Actuated Cycle Length:	100
Offset:	24 (24%), Referenced to phase 2:NBT and 6:SBTL, Start of Green
Natural Cycle:	60



Control Type: Actuated-Coordinated  
Maximum v/c Ratio: 0.75  
Intersection Signal Delay: 16.8  
Intersection LOS: B  
ICU Level of Service D  
Analysis Period (min): 15  
Volume for 95th percentile queue is metered by upstream signal.

Splits and Phases: 3: Holland & Tyndall

Lanes, Volumes, Timings  
4: Parkdale & Armstrong

Future Total 2030PM Peak Hour  
1186-1194 Wellington STW

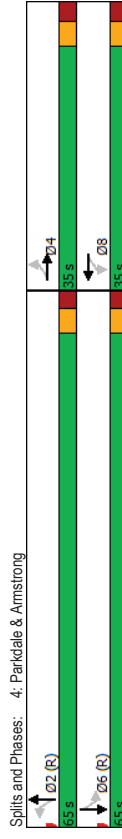
	EBL	EBT	WBL	WBT	NBL	NBT	SBL	SBT
Lane Group	EBL	EBT	WBL	WBT	NBL	NBT	SBL	SBT
Lane Configurations	34	63	39	160	13	527	15	330
Traffic Volume (vph)	34	63	39	160	13	527	15	330
Future Volume (vph)	0	134	0	220	0	562	0	361
Lane Group Flow (vph)	Perm	NA	Perm	NA	Perm	NA	Perm	NA
Turn Type	4	8	8	2	2	6	6	6
Protected Phases	4	8	8	2	2	6	6	6
Permitted Phases	4	8	8	2	2	6	6	6
Detector Phase	4	8	8	2	2	6	6	6
Switch Phase	4	8	8	2	2	6	6	6
Minimum Initial (s)	10.0	10.0	10.0	10.0	10.0	10.0	10.0	10.0
Minimum Split (s)	23.5	23.5	23.5	25.2	25.2	25.2	25.2	25.2
Total Split (s)	35.0	35.0	35.0	35.0	65.0	65.0	65.0	65.0
Total Split (%)	35.0%	35.0%	35.0%	35.0%	65.0%	65.0%	65.0%	65.0%
Maximum Green (s)	29.5	29.5	29.5	29.5	59.8	59.8	59.8	59.8
Yellow Time (s)	3.0	3.0	3.0	3.0	3.0	3.0	3.0	3.0
All-Red Time (s)	2.5	2.5	2.5	2.2	2.2	2.2	2.2	2.2
Lost Time Adjust (s)	0.0	0.0	0.0	0.0	0.0	0.0	0.0	0.0
Total Lost Time (s)	5.5	5.5	5.5	5.2	5.2	5.2	5.2	5.2
Lead/Lag								
Lead-Lag Optimize?								
Vehicle Extension (s)	3.0	3.0	3.0	3.0	3.0	3.0	3.0	3.0
Recall Mode	Max	Max	Max	C-Max	C-Max	C-Max	C-Max	C-Max
Walk Time (s)	10.0	10.0	10.0	15.0	15.0	15.0	15.0	15.0
Flash Dont Walk (s)	8.0	8.0	8.0	5.0	5.0	5.0	5.0	5.0
Pedestrian Calls (#/hr)	19	19	22	22	37	37	32	32
Act Effr Green (s)	29.5	29.5	29.5	29.5	59.8	59.8	59.8	59.8
Actuated g/C Ratio	0.30	0.30	0.30	0.47	0.55	0.55	0.36	0.36
v/c Ratio	0.30	0.47	0.30	0.47	0.55	0.55	0.36	0.36
Control Delay	25.5	32.2	32.2	4.8	11.4	11.4	0.0	0.0
Queue Delay	0.0	0.0	0.0	0.6	0.6	0.6	0.0	0.0
Total Delay	25.5	32.2	32.2	5.4	11.4	11.4	0.0	0.0
LOS	C	C	C	A	A	A	B	B
Approach Delay	25.5	32.2	32.2	5.4	11.4	11.4	0.0	0.0
Approach LOS	C	C	C	A	A	A	B	B
Queue Length 50th (m)	17.0	34.0	34.0	7.1	32.8	32.8	0.0	0.0
Queue Length 95th (m)	32.5	55.7	55.7	m8.9	50.1	50.1	0.0	0.0
Internal Link Dist (m)	46.6	196.9	196.9	125.2	312.1	312.1	0.0	0.0
Turn Bay Length (m)								
Base Capacity (vph)	442	466	466	1024	1005	1005	0	0
Starvation Cap Reductn	0	0	0	177	0	0	0	0
Spillback Cap Reductn	0	0	0	0	0	0	0	0
Storage Cap Reductn	0	0	0	0	0	0	0	0
Reduced v/c Ratio	0.30	0.47	0.47	0.66	0.66	0.66	0.36	0.36

Intersection Summary	
Cycle Length:	100
Actuated Cycle Length:	100
Offset:	20 (20%), Referenced to phase 2; NBT and 6; SBT, Start of Green
Natural Cycle:	55

Lanes, Volumes, Timings  
4: Parkdale & Armstrong

Future Total 2030PM Peak Hour  
1186-1194 Wellington STW

Control Type:	Actuated-Coordinated
Maximum v/c Ratio:	0.55
Intersection Signal Delay:	13.9
Intersection LOS:	B
Intersection Capacity Utilization:	60.0%
Analysis Period (min):	15
m. Volume for 95th percentile queue is metered by upstream signal.	







Lanes, Volumes, Timings  
6: Parkdale & Gladstone

Future Total 2030PM Peak Hour  
1186-1194 Wellington STW

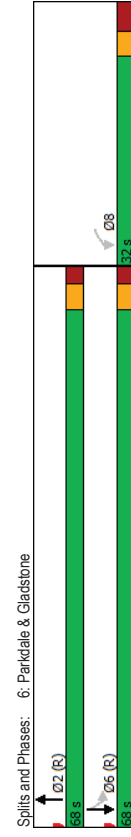
Lane Group	WBL	NBT	SBL	SBT
Lane Configurations	W	T	T	T
Traffic Volume (vph)	216	656	41	401
Future Volume (vph)	216	656	41	401
Lane Group Flow (vph)	282	814	41	401
Turn Type	Perm	NA	Perm	NA
Protected Phases		2		6
Permitted Phases	8	2	6	6
Detector Phase	8	2	6	6
Switch Phase				
Minimum Initial (s)	10.0	10.0	10.0	10.0
Minimum Split (s)	22.7	20.3	15.3	15.3
Total Split (s)	32.0	68.0	68.0	68.0
Total Split (%)	32.0%	68.0%	68.0%	68.0%
Maximum Green (s)	25.3	62.7	62.7	62.7
Yellow Time (s)	3.0	3.0	3.0	3.0
All-Red Time (s)	3.7	2.3	2.3	2.3
Lost Time Adjust (s)	0.0	0.0	0.0	0.0
Total Lost Time (s)	6.7	5.3	5.3	5.3
Lead/Lag				
Lead-Lag Optimize?				
Vehicle Extension (s)	3.0	3.0	3.0	3.0
Recall Mode	Max	C-Max	C-Max	C-Max
Walk Time (s)	7.0	7.0		
Flash Dont Walk (s)	9.0	8.0		
Pedestrian Calls (#/hr)	27	21		
Act Effr Green (s)	25.3	62.7	62.7	62.7
Actuated g/C Ratio	0.25	0.63	0.63	0.63
v/c Ratio	0.74	0.78	0.18	0.37
Control Delay	47.3	15.7	5.9	5.5
Queue Delay	0.0	0.3	0.0	0.1
Total Delay	47.3	16.0	5.9	5.6
LOS	D	B	A	A
Approach Delay	47.3	16.0	5.6	5.6
Approach LOS	D	B	A	A
Queue Length 50th (m)	50.3	72.3	1.9	19.2
Queue Length 95th (m)	#85.7	m104.1	m3.1	25.7
Internal Link Dist (m)	224.2	197.3		88.5
Turn Bay Length (m)			85.0	
Base Capacity (vph)	383	1047	233	1094
Starvation Cap Reductn	0	25	0	0
Spillback Cap Reductn	0	0	0	90
Storage Cap Reductn	0	0	0	0
Reduced v/c Ratio	0.74	0.80	0.18	0.40

Intersection Summary	
Cycle Length:	100
Actuated Cycle Length:	100
Offset:	12 (12%), Referenced to phase 2:NBT and 6:SBTL, Start of Green
Natural Cycle:	65

Lanes, Volumes, Timings  
6: Parkdale & Gladstone

Future Total 2030PM Peak Hour  
1186-1194 Wellington STW

Control Type:	Actuated-Coordinated
Maximum v/c Ratio:	0.78
Intersection Signal Delay:	18.8
Intersection LOS:	B
Intersection Capacity Utilization:	74.4%
Analysis Period (min):	15
# 95th percentile volume exceeds capacity, queue may be longer.	
Queue shown is maximum after two cycles.	
m Volume for 95th percentile queue is metered by upstream signal.	



Lanes, Volumes, Timings  
7: Parkdale & 417 WB OR

Lanes, Volumes, Timings  
7: Parkdale & 417 WB OR

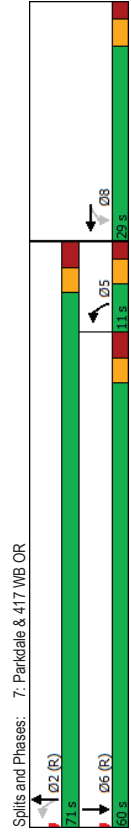
Future Total 2030PM Peak Hour  
1186-1194 Wellington STW

Future Total 2030PM Peak Hour  
1186-1194 Wellington STW

Lane Group	WBL	WBT	NBL	NBT	SBT
Lane Configurations	←	←	←	←	←
Traffic Volume (vph)	360	24	89	626	596
Future Volume (vph)	360	24	89	626	596
Lane Group Flow (vph)	360	576	89	626	845
Turn Type	Perim	NA	pm-pt	NA	NA
Protected Phases	8	5	2	2	6
Permitted Phases	8	5	2	2	6
Detector Phase	8	8	5	2	6
Switch Phase					
Minimum Initial (s)	10.0	10.0	5.0	10.0	10.0
Minimum Split (s)	20.5	20.5	10.2	27.3	21.3
Total Split (s)	29.0	29.0	11.0	71.0	60.0
Total Split (%)	29.0%	29.0%	11.0%	71.0%	60.0%
Maximum Green (s)	23.5	23.5	5.8	64.7	53.7
Yellow Time (s)	3.3	3.3	3.0	3.0	3.0
All-Red Time (s)	2.2	2.2	2.2	3.3	3.3
Lost Time Adjust (s)	0.0	0.0	0.0	0.0	0.0
Total Lost Time (s)	5.5	5.5	5.2	6.3	6.3
Lead/Lag			Lag	Lead	
Lead-Lag Optimize?			Yes	Yes	
Vehicle Extension (s)	3.0	3.0	3.0	3.0	3.0
Recall Mode	None	None	None	C-Max	C-Max
Walk Time (s)	7.0	7.0	7.0	7.0	7.0
Flash Dont Walk (s)	8.0	8.0	14.0	8.0	8.0
Pedestrian Calls (#/hr)	3	3		23	15
Act Effct Green (s)	23.5	23.5	65.8	64.7	55.9
Actuated G/C Ratio	0.24	0.24	0.66	0.65	0.56
v/c Ratio	0.93	1.04	0.34	0.55	0.91
Control Delay	69.1	68.6	14.5	12.1	35.0
Queue Delay	0.0	0.0	0.0	0.0	0.0
Total Delay	69.1	68.6	14.5	12.1	35.0
LOS	E	E	B	B	C
Approach Delay	68.8	68.8	12.4	35.0	
Approach LOS	E	E	B	B	C
Queue Length 50th (m)	68.4	~75.4	5.6	60.5	162.1
Queue Length 95th (m)	#120.5	#140.0	10.9	88.7	#233.7
Internal Link Dist (m)	462.5		38.8	197.3	
Turn Bay Length (m)					
Base Capacity (vph)	389	556	260	1129	929
Starvation Cap Reductn	0	0	0	0	0
Spillback Cap Reductn	0	0	0	3	0
Storage Cap Reductn	0	0	0	0	0
Reduced v/c Ratio	0.93	1.04	0.34	0.56	0.91

Intersection Summary	
Cycle Length:	100
Actuated Cycle Length:	100
Offset:	39 (39%), Referenced to phase 2, NBL and 6, SBT, Start of Green
Natural Cycle:	110

Control Type:	Actuated-Coordinated
Maximum v/c Ratio:	1.04
Intersection Signal Delay:	41.2
Intersection LOS:	D
Intersection Capacity Utilization:	106.6%
ICU Level of Service:	G
Analysis Period (min):	15
~ Volume exceeds capacity, queue is theoretically infinite.	
Queue shown is maximum after two cycles.	
# 95th percentile volume exceeds capacity, queue may be longer.	
Queue shown is maximum after two cycles.	



Lanes, Volumes, Timings  
8: Wellington & Carruthers

Lanes, Volumes, Timings  
8: Wellington & Carruthers

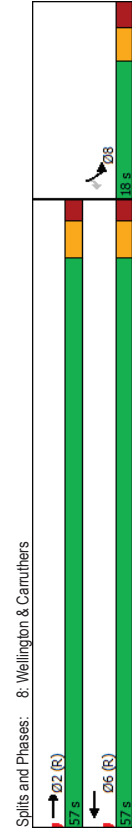
Future Total 2030PM Peak Hour  
1186-1194 Wellington STW

Future Total 2030PM Peak Hour  
1186-1194 Wellington STW

Lane Group	EBT	WBT	SBL	SBR
Lane Configurations	←	←	←	←
Traffic Volume (vph)	446	479	54	20
Future Volume (vph)	446	479	54	20
Lane Group Flow (vph)	446	479	54	20
Turn Type	NA	NA	Prot	Perm
Protected Phases	2	6	8	8
Permitted Phases				
Detector Phase	2	6	8	8
Switch Phase				
Minimum Initial (s)	10.0	10.0	10.0	10.0
Minimum Split (s)	15.3	26.3	17.5	17.5
Total Split (s)	57.0	57.0	18.0	18.0
Total Split (%)	76.0%	76.0%	24.0%	24.0%
Maximum Green (s)	51.7	51.7	12.5	12.5
Yellow Time (s)	3.3	3.3	3.0	3.0
All-Red Time (s)	2.0	2.0	2.5	2.5
Lost Time Adjust (s)	0.0	0.0	0.0	0.0
Total Lost Time (s)	5.3	5.3	5.5	5.5
Lead/Lag				
Lead-Lag Optimize?				
Vehicle Extension (s)	3.0	3.0	3.0	3.0
Recall Mode	C-Mix	C-Mix	None	None
Walk Time (s)	14.0	7.0	7.0	7.0
Flash Dont Walk (s)	7.0	5.0	5.0	64
Pedestrian Calls (#/hr)	165	64	64	64
Act Effr Green (s)	57.2	57.2	11.2	11.2
Actuated g/C Ratio	0.76	0.76	0.15	0.15
v/c Ratio	0.34	0.36	0.22	0.10
Control Delay	4.9	5.1	30.1	13.6
Queue Delay	0.0	0.0	0.0	0.0
Total Delay	4.9	5.1	30.1	13.6
LOS	A	A	C	B
Approach Delay	4.9	5.1	25.6	
Approach LOS	A	A	C	
Queue Length 50th (m)	21.3	23.4	6.7	0.0
Queue Length 95th (m)	34.0	37.3	16.1	5.5
Internal Link Dist (m)	157.3	153.4	73.2	
Turn Bay Length (m)				30.0
Base Capacity (vph)	1330	1330	276	227
Starvation Cap Reductn	0	0	0	0
Spillover Cap Reductn	0	0	0	0
Storage Cap Reductn	0	0	0	0
Reduced v/c Ratio	0.34	0.36	0.20	0.09

Intersection Summary	
Cycle Length:	75
Actuated Cycle Length:	75
Offset:	72 (96%), Referenced to phase 2,EBT and 6:WBT, Start of Green
Natural Cycle:	45

Control Type: Actuated-Coordinated
Maximum v/c Ratio: 0.36
Intersection Signal Delay: 6.5
Intersection LOS: A
Intersection Capacity Utilization: 45.2%
Analysis Period (min): 15



HCM 2010 TWSC  
9: Parkdale & Rear Lane

HCM 2010 TWSC  
10: Hamilton & Rear Lane

Future Total 2030PM Peak Hour  
1186-1194 Wellington STW

Future Total 2030PM Peak Hour  
1186-1194 Wellington STW

Intersection													
Int Delay, s/veh												0	
Movement	EBL	EBR	NBL	NBT	SBT	SBR							
Lane Configurations	W						4						
Traffic Vol, veh/h	0	5	0	773	512	0							
Future Vol, veh/h	0	5	0	773	512	0							
Conflicting Peds. #/hr	0	0	30	0	0	30							
Sign Control	Stop	Stop	Free	Free	Free	Free							
RT Channelized	-	None	-	None	-	None							
Storage Length	0	-	-	-	-	-							
Veh in Median Storage, #	0	-	-	0	0	-							
Grade, %	0	-	-	0	0	-							
Peak Hour Factor	100	100	100	100	100	100							
Heavy Vehicles, %	2	2	2	2	2	2							
Mvmt Flow	0	5	0	773	512	0							
Major/Minor	Minor2	Major1	Major1	Major2									
Conflicting Flow All	1315	542	542	0	-	0							
Stage 1	542	-	-	-	-	-							
Stage 2	773	-	-	-	-	-							
Critical Hdwy	6.42	6.22	4.12	-	-	-							
Critical Hdwy Stg 1	5.42	-	-	-	-	-							
Critical Hdwy Stg 2	5.42	-	-	-	-	-							
Follow-up Hdwy	3,518	3,318	2,218	-	-	-							
Pot Cap-1 Maneuver	174	540	1027	-	-	-							
Stage 1	583	-	-	-	-	-							
Stage 2	455	-	-	-	-	-							
Platoon blocked, %	-	-	-	-	-	-							
Mov Cap-1 Maneuver	166	527	1003	-	-	-							
Mov Cap-2 Maneuver	166	-	-	-	-	-							
Stage 1	570	-	-	-	-	-							
Stage 2	445	-	-	-	-	-							
Approach	EB	NB	SB										
HCM Control Delay, s	11.9	0	0										
HCM LOS	B												
Minor Lane/Major Mvmt	NBL	NBT	EBLn1	SBT	SBR								
Capacity (veh/h)	1003	-	527	-	-								
HCM Lane V/C Ratio	-	-	0.009	-	-								
HCM Control Delay (s)	0	-	11.9	-	-								
HCM Lane LOS	A	-	B	-	-								
HCM 95th %tile Q(veh)	0	-	0	-	-								

Intersection													
Int Delay, s/veh												1.1	
Movement	WBL	WBR	NBT	NBR	SBL	SBT							
Lane Configurations	W						4						
Traffic Vol, veh/h	1	5	29	12	10	57							
Future Vol, veh/h	1	5	29	12	10	57							
Conflicting Peds. #/hr	0	0	0	0	10	10							
Sign Control	Stop	Stop	Free	Free	Free	Free							
RT Channelized	-	None	-	None	-	None							
Storage Length	0	-	-	-	-	-							
Veh in Median Storage, #	0	-	0	0	-	0							
Grade, %	0	-	0	0	-	0							
Peak Hour Factor	100	100	100	100	100	100							
Heavy Vehicles, %	2	2	2	2	2	2							
Mvmt Flow	1	5	29	12	10	57							
Major/Minor	Minor1	Major1	Major1	Major2									
Conflicting Flow All	122	45	0	0	51	0							
Stage 1	45	-	-	-	-	-							
Stage 2	77	-	-	-	-	-							
Critical Hdwy	6.42	6.22	-	-	4.12	-							
Critical Hdwy Stg 1	5.42	-	-	-	-	-							
Critical Hdwy Stg 2	5.42	-	-	-	-	-							
Follow-up Hdwy	3,518	3,318	-	-	2,218	-							
Pot Cap-1 Maneuver	873	1025	-	-	1555	-							
Stage 1	977	-	-	-	-	-							
Stage 2	946	-	-	-	-	-							
Platoon blocked, %	-	-	-	-	-	-							
Mov Cap-1 Maneuver	860	1017	-	-	1543	-							
Mov Cap-2 Maneuver	860	-	-	-	-	-							
Stage 1	969	-	-	-	-	-							
Stage 2	939	-	-	-	-	-							
Approach	WB	NB	SB										
HCM Control Delay, s	8.7	0	1.1										
HCM LOS	A												
Minor Lane/Major Mvmt	NBT	NBR	WBLn1	SBL	SBT								
Capacity (veh/h)	-	-	987	1543	-								
HCM Lane V/C Ratio	-	-	0.006	0.006	-								
HCM Control Delay (s)	-	-	8.7	7.3	0								
HCM Lane LOS	-	-	A	A	A								
HCM 95th %tile Q(veh)	-	-	0	0	-								

HCM 2010 TWSC  
11: Wellington & Hamilton

Future Total 2030PM Peak Hour  
1186-1194 Wellington STW

Intersection													
Int'Delay, s/veh													
1.9													
Movement	EBL	EBT	EBR	WBL	WBT	WBR	NBL	NBT	NBR	SBL	SBT	SBR	
Lane Configurations	↔	↔	↔	↔	↔	↔	↔	↔	↔	↔	↔	↔	↔
Traffic Vol, veh/h	10	301	31	15	337	13	8	8	18	9	21	31	
Future Vol, veh/h	10	301	31	15	337	13	8	8	18	9	21	31	
Conflicting Peds. #/hr	0	0	0	0	0	0	0	0	0	0	0	0	0
Sign Control	Free	Free	Free	Free	Free	Free	Free	Free	Free	Free	Free	Free	Free
RT Channelized	-	-	-	-	-	-	-	-	-	-	-	-	-
Storage Length	-	-	-	-	-	-	-	-	-	-	-	-	-
Veh in Median Storage, #	-	0	-	-	0	-	-	-	0	-	-	0	-
Grade, %	-	0	-	-	0	-	-	-	0	-	-	0	-
Peak Hour Factor	100	100	100	100	100	100	100	100	100	100	100	100	
Heavy Vehicles, %	2	2	2	2	2	2	2	2	2	2	2	2	
Mvmt Flow	10	301	31	15	337	13	8	8	18	9	21	31	
Major/Minor	Major1	Major2	Minor1	Minor2									
Conflicting Flow All	350	0	0	332	0	0	737	717	317	724	726	344	
Stage 1	-	-	-	-	-	-	337	337	-	374	374	-	
Stage 2	-	-	-	-	-	-	400	380	-	350	352	-	
Critical Hdwy	4.12	-	-	4.12	-	-	7.12	6.52	6.22	7.12	6.52	6.22	
Critical Hdwy Stg 1	-	-	-	-	-	-	6.12	5.52	-	6.12	5.52	-	
Critical Hdwy Stg 2	-	-	-	-	-	-	6.12	5.52	-	6.12	5.52	-	
Follow-up Hdwy	2.218	-	-	2.218	-	-	3.518	4.018	3.318	3.518	4.018	3.318	
Pot Cap-1 Maneuver	1209	-	-	1227	-	-	334	355	724	341	351	689	
Stage 1	-	-	-	-	-	-	677	641	-	647	618	-	
Stage 2	-	-	-	-	-	-	626	614	-	666	632	-	
Platoon blocked, %	-	-	-	-	-	-	-	-	-	-	-	-	
Mov Cap-1 Maneuver	1209	-	-	1227	-	-	299	346	724	321	342	689	
Mov Cap-2 Maneuver	-	-	-	-	-	-	299	346	-	321	342	-	
Stage 1	-	-	-	-	-	-	670	635	-	641	609	-	
Stage 2	-	-	-	-	-	-	569	605	-	635	626	-	
Approach	EB	WB	NB	SB									
HCM Control Delay, s	0.2	0.3	13.6	14.1									
HCM LOS	B	B	B	B									
Minor Lane/Major Mvmt	NBLn1	EBL	EBT	EBR	WBL	WBT	WBR	SBLn1					
Capacity (veh/h)	455	1209	-	-	1227	-	-	456					
HCM Lane V/C Ratio	0.075	0.008	-	-	0.012	-	-	0.134					
HCM Control Delay (s)	13.6	8	0	0	8	0	0	14.1					
HCM Lane LOS	B	A	A	A	A	A	A	B					
HCM 95th %ile Q(veh)	0.2	0	-	-	0	-	-	0.5					

HCM 2010 TWSC  
12: Hamilton & Tyndall

Future Total 2030PM Peak Hour  
1186-1194 Wellington STW

Intersection													
Int'Delay, s/veh													
1.9													
Movement	EBL	EBT	EBR	WBL	WBT	WBR	NBL	NBT	NBR	SBL	SBT	SBR	
Lane Configurations	↔	↔	↔	↔	↔	↔	↔	↔	↔	↔	↔	↔	↔
Traffic Vol, veh/h	15	164	2	2	114	20	3	3	1	26	2	22	
Future Vol, veh/h	15	164	2	2	114	20	3	3	1	26	2	22	
Conflicting Peds. #/hr	0	0	0	0	0	0	0	0	0	0	0	0	0
Sign Control	Free	Free	Free	Free	Free	Free	Free	Free	Free	Free	Free	Free	Free
RT Channelized	-	-	-	-	-	-	-	-	-	-	-	-	-
Storage Length	-	-	-	-	-	-	-	-	-	-	-	-	-
Veh in Median Storage, #	-	0	-	-	0	-	-	-	0	-	-	0	-
Grade, %	-	0	-	-	0	-	-	-	0	-	-	0	-
Peak Hour Factor	100	100	100	100	100	100	100	100	100	100	100	100	
Heavy Vehicles, %	2	2	2	2	2	2	2	2	2	2	2	2	
Mvmt Flow	15	164	2	2	114	20	3	3	1	26	2	22	
Major/Minor	Major1	Major2	Minor1	Minor2									
Conflicting Flow All	134	0	0	166	0	0	335	333	165	325	324	124	
Stage 1	-	-	-	-	-	-	195	195	-	128	128	-	
Stage 2	-	-	-	-	-	-	140	138	-	197	196	-	
Critical Hdwy	4.12	-	-	4.12	-	-	7.12	6.52	6.22	7.12	6.52	6.22	
Critical Hdwy Stg 1	-	-	-	-	-	-	6.12	5.52	-	6.12	5.52	-	
Critical Hdwy Stg 2	-	-	-	-	-	-	6.12	5.52	-	6.12	5.52	-	
Follow-up Hdwy	2.218	-	-	2.218	-	-	3.518	4.018	3.318	3.518	4.018	3.318	
Pot Cap-1 Maneuver	1451	-	-	1412	-	-	619	587	879	628	594	927	
Stage 1	-	-	-	-	-	-	807	739	-	876	790	-	
Stage 2	-	-	-	-	-	-	863	782	-	805	739	-	
Platoon blocked, %	-	-	-	-	-	-	-	-	-	-	-	-	
Mov Cap-1 Maneuver	1451	-	-	1412	-	-	597	579	879	619	586	927	
Mov Cap-2 Maneuver	-	-	-	-	-	-	597	579	-	619	586	-	
Stage 1	-	-	-	-	-	-	798	731	-	866	788	-	
Stage 2	-	-	-	-	-	-	839	780	-	792	731	-	
Approach	EB	WB	NB	SB									
HCM Control Delay, s	0.6	0.1	10.9	10.3									
HCM LOS	B	B	B	B									
Minor Lane/Major Mvmt	NBLn1	EBL	EBT	EBR	WBL	WBT	WBR	SBLn1					
Capacity (veh/h)	617	1451	-	-	1412	-	-	723					
HCM Lane V/C Ratio	0.011	0.01	-	-	0.001	-	-	0.069					
HCM Control Delay (s)	10.9	7.5	0	0	7.6	0	0	10.3					
HCM Lane LOS	B	A	A	A	A	A	A	B					
HCM 95th %ile Q(veh)	0	0	-	-	0	-	-	0.2					

# Appendix L

TDM Checklist

**TDM Measures Checklist:**  
*Non-Residential Developments (office, institutional, **retail** or industrial)*

**Legend**

**BASIC** The measure is generally feasible and effective, and in most cases would benefit the development and its users

**BETTER** The measure could maximize support for users of sustainable modes, and optimize development performance

**★** The measure is one of the most dependably effective tools to encourage the use of sustainable modes

TDM measures: <i>Non-residential developments</i>		Check if proposed & add descriptions
<b>1. TDM PROGRAM MANAGEMENT</b>		
<b>1.1 Program coordinator</b>		
BASIC ★	1.1.1 Designate an internal coordinator, or contract with an external coordinator	<input type="checkbox"/>
<b>1.2 Travel surveys</b>		
BETTER	1.2.1 Conduct periodic surveys to identify travel-related behaviours, attitudes, challenges and solutions, and to track progress	<input type="checkbox"/>
<b>2. WALKING AND CYCLING</b>		
<b>2.1 Information on walking/cycling routes &amp; destinations</b>		
BASIC	2.1.1 Display local area maps with walking/cycling access routes and key destinations at major entrances	<input checked="" type="checkbox"/>
<b>2.2 Bicycle skills training</b>		
<i>Commuter travel</i>		
BETTER ★	2.2.1 Offer on-site cycling courses for commuters, or subsidize off-site courses	<input type="checkbox"/>
<b>2.3 Valet bike parking</b>		
<i>Visitor travel</i>		
BETTER	2.3.1 Offer secure valet bike parking during public events when demand exceeds fixed supply (e.g. for festivals, concerts, games)	<input type="checkbox"/>

TDM measures: <i>Non-residential developments</i>		Check if proposed & add descriptions
<b>3. TRANSIT</b>		
<b>3.1 Transit information</b>		
BASIC	3.1.1 Display relevant transit schedules and route maps at entrances	<input checked="" type="checkbox"/>
BASIC	3.1.2 Provide online links to OC Transpo and STO information	<input checked="" type="checkbox"/>
BETTER	3.1.3 Provide real-time arrival information display at entrances	<input type="checkbox"/>
<b>3.2 Transit fare incentives</b>		
<i>Commuter travel</i>		
BETTER	3.2.1 Offer preloaded PRESTO cards to encourage commuters to use transit	<input type="checkbox"/>
BETTER ★	3.2.2 Subsidize or reimburse monthly transit pass purchases by employees	<input type="checkbox"/>
<i>Visitor travel</i>		
BETTER	3.2.3 Arrange inclusion of same-day transit fare in price of tickets (e.g. for festivals, concerts, games)	<input type="checkbox"/>
<b>3.3 Enhanced public transit service</b>		
<i>Commuter travel</i>		
BETTER	3.3.1 Contract with OC Transpo to provide enhanced transit services (e.g. for shift changes, weekends)	<input type="checkbox"/>
<i>Visitor travel</i>		
BETTER	3.3.2 Contract with OC Transpo to provide enhanced transit services (e.g. for festivals, concerts, games)	<input type="checkbox"/>
<b>3.4 Private transit service</b>		
<i>Commuter travel</i>		
BETTER	3.4.1 Provide shuttle service when OC Transpo cannot offer sufficient quality or capacity to serve demand (e.g. for shift changes, weekends)	<input type="checkbox"/>
<i>Visitor travel</i>		
BETTER	3.4.2 Provide shuttle service when OC Transpo cannot offer sufficient quality or capacity to serve demand (e.g. for festivals, concerts, games)	<input type="checkbox"/>

TDM measures: Non-residential developments		Check if proposed & add descriptions
<b>4. RIDESHARING</b>		
<i>Commuter travel</i>		
<b>BASIC</b> ★	4.1.1 Provide a dedicated ride-matching portal at OttawaRideMatch.com	<input type="checkbox"/>
<b>4.2 Carpool parking price incentives</b>		
<i>Commuter travel</i>		
<b>BETTER</b>	4.2.1 Provide discounts on parking costs for registered carpools	<input type="checkbox"/>
<b>4.3 Vanpool service</b>		
<i>Commuter travel</i>		
<b>BETTER</b>	4.3.1 Provide a vanpooling service for long-distance commuters	<input type="checkbox"/>
<b>5. CARSHARING &amp; BIKESHARING</b>		
<b>5.1 Bikeshare stations &amp; memberships</b>		
<b>BETTER</b>	5.1.1 Contract with provider to install on-site bikeshare station for use by commuters and visitors	<input type="checkbox"/>
<i>Commuter travel</i>		
<b>BETTER</b>	5.1.2 Provide employees with bikeshare memberships for local business travel	<input type="checkbox"/>
<b>5.2 Carshare vehicles &amp; memberships</b>		
<i>Commuter travel</i>		
<b>BETTER</b>	5.2.1 Contract with provider to install on-site carshare vehicles and promote their use by tenants	<input type="checkbox"/>
<b>BETTER</b>	5.2.2 Provide employees with carshare memberships for local business travel	<input type="checkbox"/>
<b>6. PARKING</b>		
<i>Commuter travel</i>		
<b>BASIC</b> ★	6.1.1 Charge for long-term parking (daily, weekly, monthly)	<input checked="" type="checkbox"/>
<b>BASIC</b>	6.1.2 Unbundle parking cost from lease rates at multi-tenant sites	<input checked="" type="checkbox"/>
<i>Visitor travel</i>		
<b>BETTER</b>	6.1.3 Charge for short-term parking (hourly)	<input type="checkbox"/>

TDM measures: Non-residential developments		Check if proposed & add descriptions
<b>7. TDM MARKETING &amp; COMMUNICATIONS</b>		
<b>7.1 Multimodal travel information</b>		
<i>Commuter travel</i>		
<b>BASIC</b> ★	7.1.1 Provide a multimodal travel option information package to new/relocating employees and students	<input checked="" type="checkbox"/>
<i>Visitor travel</i>		
<b>BETTER</b> ★	7.1.2 Include multimodal travel option information in invitations or advertising that attract visitors or customers (e.g. for festivals, concerts, games)	<input type="checkbox"/>
<b>7.2 Personalized trip planning</b>		
<i>Commuter travel</i>		
<b>BETTER</b> ★	7.2.1 Offer personalized trip planning to new/relocating employees	<input type="checkbox"/>
<b>7.3 Promotions</b>		
<i>Commuter travel</i>		
<b>BETTER</b>	7.3.1 Deliver promotions and incentives to maintain awareness, build understanding, and encourage trial of sustainable modes	<input type="checkbox"/>
<b>8. OTHER INCENTIVES &amp; AMENITIES</b>		
<b>8.1 Emergency ride home</b>		
<i>Commuter travel</i>		
<b>BETTER</b> ★	8.1.1 Provide emergency ride home service to non-driving commuters	<input type="checkbox"/>
<b>8.2 Alternative work arrangements</b>		
<i>Commuter travel</i>		
<b>BASIC</b> ★	8.2.1 Encourage flexible work hours	<input type="checkbox"/>
<b>BETTER</b>	8.2.2 Encourage compressed workweeks	<input type="checkbox"/>
<b>BETTER</b> ★	8.2.3 Encourage telework	<input type="checkbox"/>
<b>8.3 Local business travel options</b>		
<i>Commuter travel</i>		
<b>BASIC</b> ★	8.3.1 Provide local business travel options that minimize the need for employees to bring a personal car to work	<input type="checkbox"/>
<b>8.4 Commuter incentives</b>		
<i>Commuter travel</i>		
<b>BETTER</b>	8.4.1 Offer employees a taxable, mode-neutral commuting allowance	<input type="checkbox"/>
<b>8.5 On-site amenities</b>		
<i>Commuter travel</i>		
<b>BETTER</b>	8.5.1 Provide on-site amenities/services to minimize mid-day or mid-commute errands	<input type="checkbox"/>



**TDM Measures Checklist:**  
**Residential Developments (multi-family, condominium or subdivision)**

**Legend**

**BASIC** The measure is generally feasible and effective, and in most cases would benefit the development and its users

**BETTER** The measure could maximize support for users of sustainable modes, and optimize development performance

**\*** The measure is one of the most dependably effective tools to encourage the use of sustainable modes

TDM measures: Residential developments		Check if proposed & add descriptions
<b>1. TDM PROGRAM MANAGEMENT</b>		
<b>1.1 Program coordinator</b>		
BASIC	1.1.1 Designate an internal coordinator, or contract with an external coordinator	<input type="checkbox"/>
<b>1.2 Travel surveys</b>		
BETTER	1.2.1 Conduct periodic surveys to identify travel-related behaviours, attitudes, challenges and solutions, and to track progress	<input type="checkbox"/>
<b>2. WALKING AND CYCLING</b>		
<b>2.1 Information on walking/cycling routes &amp; destinations</b>		
BASIC	2.1.1 Display local area maps with walking/cycling access routes and key destinations at major entrances (multi-family, condominium)	<input checked="" type="checkbox"/>
<b>2.2 Bicycle skills training</b>		
BETTER	2.2.1 Offer on-site cycling courses for residents, or subsidize off-site courses	<input type="checkbox"/>

TDM measures: Residential developments		Check if proposed & add descriptions
<b>3. TRANSIT</b>		
<b>3.1 Transit information</b>		
BASIC	3.1.1 Display relevant transit schedules and route maps at entrances (multi-family, condominium)	<input checked="" type="checkbox"/>
BETTER	3.1.2 Provide real-time arrival information display at entrances (multi-family, condominium)	<input type="checkbox"/>
<b>3.2 Transit fare incentives</b>		
BASIC	3.2.1 Offer PRESTO cards preloaded with one monthly transit pass on residence purchase/move-in, to encourage residents to use transit	<input checked="" type="checkbox"/>
BETTER	3.2.2 Offer at least one year of free monthly transit passes on residence purchase/move-in	<input type="checkbox"/>
<b>3.3 Enhanced public transit service</b>		
BETTER	3.3.1 Contract with OC Transpo to provide early transit services until regular services are warranted by occupancy levels (subdivision)	<input type="checkbox"/>
<b>3.4 Private transit service</b>		
BETTER	3.4.1 Provide shuttle service for seniors homes or lifestyle communities (e.g. scheduled mall or supermarket runs)	<input type="checkbox"/>
<b>4. CARSHARING &amp; BIKESHARING</b>		
<b>4.1 Bikeshare stations &amp; memberships</b>		
BETTER	4.1.1 Contract with provider to install on-site bikeshare station (multi-family)	<input type="checkbox"/>
BETTER	4.1.2 Provide residents with bikeshare memberships, either free or subsidized (multi-family)	<input type="checkbox"/>
<b>4.2 Carshare vehicles &amp; memberships</b>		
BETTER	4.2.1 Contract with provider to install on-site carshare vehicles and promote their use by residents	<input checked="" type="checkbox"/>
BETTER	4.2.2 Provide residents with carshare memberships, either free or subsidized	<input type="checkbox"/>
<b>5. PARKING</b>		
<b>5.1 Priced parking</b>		
BASIC	5.1.1 Unbundle parking cost from purchase price (condominium)	<input checked="" type="checkbox"/>
BASIC	5.1.2 Unbundle parking cost from monthly rent (multi-family)	<input checked="" type="checkbox"/>

TDM measures: Residential developments		Check if proposed & add descriptions
<b>6. TDM MARKETING &amp; COMMUNICATIONS</b>		
<b>6.1 Multimodal travel information</b>		
BASIC ★	6.1.1 Provide a multimodal travel option information package to new residents	<input checked="" type="checkbox"/>
<b>6.2 Personalized trip planning</b>		
BETTER ★	6.2.1 Offer personalized trip planning to new residents	<input type="checkbox"/>

**TDM-Supportive Development Design and Infrastructure Checklist:  
Non-Residential Developments (office, institutional, retail or industrial)**

Legend	
REQUIRED	The Official Plan or Zoning By-law provides related guidance that must be followed
BASIC	The measure is generally feasible and effective, and in most cases would benefit the development and its users
BETTER	The measure could maximize support for users of sustainable modes, and optimize development performance

TDM-supportive design & infrastructure measures: Non-residential developments		Check if completed & add descriptions, explanations or plan/drawing references
<b>1. WALKING &amp; CYCLING: ROUTES</b>		
<b>1.1 Building location &amp; access points</b>		
BASIC	1.1.1 Locate building close to the street, and do not locate parking areas between the street and building entrances	<input checked="" type="checkbox"/>
BASIC	1.1.2 Locate building entrances in order to minimize walking distances to sidewalks and transit stops/stations	<input checked="" type="checkbox"/>
BASIC	1.1.3 Locate building doors and windows to ensure visibility of pedestrians from the building, for their security and comfort	<input checked="" type="checkbox"/>
<b>1.2 Facilities for walking &amp; cycling</b>		
REQUIRED	1.2.1 Provide convenient, direct access to stations or major stops along rapid transit routes within 600 metres; minimize walking distances from buildings to rapid transit; provide pedestrian-friendly, weather-protected (where possible) environment between rapid transit accesses and building entrances; ensure quality linkages from sidewalks through building entrances to integrated stops/stations (see <i>Official Plan policy 4.3.3</i> )	<input type="checkbox"/>
REQUIRED	1.2.2 Provide safe, direct and attractive pedestrian access from public sidewalks to building entrances through such measures as: reducing distances between public sidewalks and major building entrances; providing walkways from public streets to major building entrances; within a site, providing walkways along the front of adjoining buildings, between adjacent buildings, and connecting areas where people may congregate, such as courtyards and transit stops; and providing weather protection through canopies, colonnades, and other design elements wherever possible (see <i>Official Plan policy 4.3.12</i> )	<input checked="" type="checkbox"/>

TDM-supportive design & infrastructure measures: Non-residential developments		Check if completed & add descriptions, explanations or plan/drawing references
REQUIRED	1.2.3 Provide sidewalks of smooth, well-drained walking surfaces of contrasting materials or treatments to differentiate pedestrian areas from vehicle areas, and provide marked pedestrian crosswalks at intersection sidewalks (see <i>Official Plan policy 4.3.10</i> )	<input checked="" type="checkbox"/>
REQUIRED	1.2.4 Make sidewalks and open space areas easily accessible through features such as gradual grade transition, depressed curbs at street corners and convenient access to extra-wide parking spaces and ramps (see <i>Official Plan policy 4.3.10</i> )	<input checked="" type="checkbox"/>
REQUIRED	1.2.5 Include adequately spaced inter-block/street cycling and pedestrian connections to facilitate travel by active transportation. Provide links to the existing or planned network of public sidewalks, multi-use pathways and on-road cycle routes. Where public sidewalks and multi-use pathways intersect with roads, consider providing traffic control devices to give priority to cyclists and pedestrians (see <i>Official Plan policy 4.3.11</i> )	<input checked="" type="checkbox"/>
BASIC	1.2.6 Provide safe, direct and attractive walking routes from building entrances to nearby transit stops	<input checked="" type="checkbox"/>
BASIC	1.2.7 Ensure that walking routes to transit stops are secure, visible, lighted, shaded and wind-protected wherever possible	<input type="checkbox"/>
BASIC	1.2.8 Design roads used for access or circulation by cyclists using a target operating speed of no more than 30 km/h, or provide a separated cycling facility	<input type="checkbox"/>
<b>1.3 Amenities for walking &amp; cycling</b>		
BASIC	1.3.1 Provide lighting, landscaping and benches along walking and cycling routes between building entrances and streets, sidewalks and trails	<input type="checkbox"/>
BASIC	1.3.2 Provide wayfinding signage for site access (where required, e.g. when multiple buildings or entrances exist) and egress (where warranted, such as when directions to reach transit stops/stations, trails or other common destinations are not obvious)	<input type="checkbox"/>

TDM-supportive design & infrastructure measures: Non-residential developments		Check if completed & add descriptions, explanations or plan/drawing references
<b>2. WALKING &amp; CYCLING: END-OF-TRIP FACILITIES</b>		
<b>2.1 Bicycle parking</b>		
REQUIRED	2.1.1 Provide bicycle parking in highly visible and lighted areas, sheltered from the weather wherever possible (see <i>Official Plan policy 4.3.6</i> )	<input checked="" type="checkbox"/>
REQUIRED	2.1.2 Provide the number of bicycle parking spaces specified for various land uses in different parts of Ottawa; provide convenient access to main entrances or well-used areas (see <i>Zoning By-law Section 111</i> )	<input checked="" type="checkbox"/>
REQUIRED	2.1.3 Ensure that bicycle parking spaces and access aisles meet minimum dimensions, that no more than 50% of spaces are vertical spaces, and that parking racks are securely anchored (see <i>Zoning By-law Section 111</i> )	<input type="checkbox"/>
BASIC	2.1.4 Provide bicycle parking spaces equivalent to the expected number of commuter cyclists (assuming the cycling mode share target is met), plus the expected peak number of customer/visitor cyclists	<input type="checkbox"/>
BETTER	2.1.5 Provide bicycle parking spaces equivalent to the expected number of commuter and customer/visitor cyclists, plus an additional buffer (e.g. 25 percent extra) to encourage other cyclists and ensure adequate capacity in peak cycling season	<input type="checkbox"/>
<b>2.2 Secure bicycle parking</b>		
REQUIRED	2.2.1 Where more than 50 bicycle parking spaces are provided for a single office building, locate at least 25% of spaces within a building/structure, a secure area (e.g. supervised parking lot or enclosure) or bicycle lockers (see <i>Zoning By-law Section 111</i> )	<input type="checkbox"/>
BETTER	2.2.2 Provide secure bicycle parking spaces equivalent to the expected number of commuter cyclists (assuming the cycling mode share target is met)	<input type="checkbox"/>
<b>2.3 Shower &amp; change facilities</b>		
BASIC	2.3.1 Provide shower and change facilities for the use of active commuters	<input type="checkbox"/>
BETTER	2.3.2 In addition to shower and change facilities, provide dedicated lockers, grooming stations, drying racks and laundry facilities for the use of active commuters	<input type="checkbox"/>
<b>2.4 Bicycle repair station</b>		
BETTER	2.4.1 Provide a permanent bike repair station, with commonly used tools and an air pump, adjacent to the main bicycle parking area (or secure bicycle parking area, if provided)	<input checked="" type="checkbox"/>

TDM-supportive design & infrastructure measures: Non-residential developments		Check if completed & add descriptions, explanations or plan/drawing references
<b>3. TRANSIT</b>		
<b>3.1 Customer amenities</b>		
BASIC	3.1.1 Provide shelters, lighting and benches at any on-site transit stops	<input type="checkbox"/>
BASIC	3.1.2 Where the site abuts an off-site transit stop and insufficient space exists for a transit shelter in the public right-of-way, protect land for a shelter and/or install a shelter	<input type="checkbox"/>
BETTER	3.1.3 Provide a secure and comfortable interior waiting area by integrating any on-site transit stops into the building	<input type="checkbox"/>
<b>4. RIDESHARING</b>		
<b>4.1 Pick-up &amp; drop-off facilities</b>		
BASIC	4.1.1 Provide a designated area for carpool drivers (plus taxis and ride-hailing services) to drop off or pick up passengers without using fire lanes or other no-stopping zones	<input type="checkbox"/>
<b>4.2 Carpool parking</b>		
BASIC	4.2.1 Provide signed parking spaces for carpools in a priority location close to a major building entrance, sufficient in number to accommodate the mode share target for carpools	<input type="checkbox"/>
BETTER	4.2.2 At large developments, provide spaces for carpools in a separate, access-controlled parking area to simplify enforcement	<input type="checkbox"/>
<b>5. CARSHARING &amp; BIKESHARING</b>		
<b>5.1 Carshare parking spaces</b>		
BETTER	5.1.1 Provide carshare parking spaces in permitted non-residential zones, occupying either required or provided parking spaces (see <i>Zoning By-law Section 94</i> )	<input type="checkbox"/>
<b>5.2 Bikeshare station location</b>		
BETTER	5.2.1 Provide a designated bikeshare station area near a major building entrance, preferably lighted and sheltered with a direct walkway connection	<input type="checkbox"/>

TDM-supportive design & infrastructure measures: Non-residential developments		Check if completed & add descriptions, explanations or plan/drawing references
<b>6. PARKING</b>		
<b>6.1 Number of parking spaces</b>		
REQUIRED	6.1.1 Do not provide more parking than permitted by zoning, nor less than required by zoning, unless a variance is being applied for	<input checked="" type="checkbox"/>
BASIC	6.1.2 Provide parking for long-term and short-term users that is consistent with mode share targets, considering the potential for visitors to use off-site public parking	<input type="checkbox"/>
BASIC	6.1.3 Where a site features more than one use, provide shared parking and reduce the cumulative number of parking spaces accordingly (see <i>Zoning By-law Section 704</i> )	<input type="checkbox"/>
BETTER	6.1.4 Reduce the minimum number of parking spaces required by zoning by one space for each 13 square metres of gross floor area provided as shower rooms, change rooms, locker rooms and other facilities for cyclists in conjunction with bicycle parking (see <i>Zoning By-law Section 111</i> )	<input type="checkbox"/>
<b>6.2 Separate long-term &amp; short-term parking areas</b>		
BETTER	6.2.1 Separate short-term and long-term parking areas using signage or physical barriers, to permit access controls and simplify enforcement (i.e. to discourage employees from parking in visitor spaces, and vice versa)	<input type="checkbox"/>
<b>7. OTHER</b>		
<b>7.1 On-site amenities to minimize off-site trips</b>		
BETTER	7.1.1 Provide on-site amenities to minimize mid-day or mid-commute errands	<input type="checkbox"/>

**Legend**

**REQUIRED** The Official Plan or Zoning By-law provides related guidance that must be followed

**BASIC** The measure is generally feasible and effective, and in most cases would benefit the development and its users

**BETTER** The measure could maximize support for users of sustainable modes, and optimize development performance

TDM-supportive design & infrastructure measures: Residential developments		Check if completed & add descriptions, explanations or plan/drawing references
<b>1. WALKING &amp; CYCLING: ROUTES</b>		
<b>1.1 Building location &amp; access points</b>		
BASIC	1.1.1 Locate building close to the street, and do not locate parking areas between the street and building entrances	<input checked="" type="checkbox"/>
BASIC	1.1.2 Locate building entrances in order to minimize walking distances to sidewalks and transit stops/stations	<input checked="" type="checkbox"/>
BASIC	1.1.3 Locate building doors and windows to ensure visibility of pedestrians from the building, for their security and comfort	<input checked="" type="checkbox"/>
<b>1.2 Facilities for walking &amp; cycling</b>		
REQUIRED	1.2.1 Provide convenient, direct access to stations or major stops along rapid transit routes within 600 metres; minimize walking distances from buildings to rapid transit; provide pedestrian-friendly, weather-protected (where possible) environment between rapid transit accesses and building entrances; ensure quality linkages from sidewalks through building entrances to integrated stops/stations (see <i>Official Plan policy 4.3.3</i> )	<input checked="" type="checkbox"/>
REQUIRED	1.2.2 Provide safe, direct and attractive pedestrian access from public sidewalks to building entrances through such measures as: reducing distances between public sidewalks and major building entrances; providing walkways from public streets to major building entrances; within a site, providing walkways along the front of adjoining buildings; between adjacent buildings, and connecting areas where people may congregate, such as courtyards and transit stops; and providing weather protection through canopies, colonnades, and other design elements wherever possible (see <i>Official Plan policy 4.3.12</i> )	<input checked="" type="checkbox"/>

TDM-supportive design & infrastructure measures: <i>Residential developments</i>		Check if completed & add descriptions, explanations or plan/drawing references
REQUIRED	1.2.3 Provide sidewalks of smooth, well-drained walking surfaces of contrasting materials or treatments to differentiate pedestrian areas from vehicle areas, and provide marked pedestrian crosswalks at intersection sidewalks (see <i>Official Plan policy 4.3.10</i> )	<input checked="" type="checkbox"/>
REQUIRED	1.2.4 Make sidewalks and open space areas easily accessible through features such as gradual grade transition, depressed curbs at street corners and convenient access to extra-wide parking spaces and ramps (see <i>Official Plan policy 4.3.10</i> )	<input checked="" type="checkbox"/>
REQUIRED	1.2.5 Include adequately spaced inter-block/street cycling and pedestrian connections to facilitate travel by active transportation. Provide links to the existing or planned network of public sidewalks, multi-use pathways and on-road cycle routes. Where public sidewalks and multi-use pathways intersect with roads, consider providing traffic control devices to give priority to cyclists and pedestrians (see <i>Official Plan policy 4.3.11</i> )	<input checked="" type="checkbox"/>
BASIC	1.2.6 Provide safe, direct and attractive walking routes from building entrances to nearby transit stops	<input checked="" type="checkbox"/>
BASIC	1.2.7 Ensure that walking routes to transit stops are secure, visible, lighted, shaded and wind-protected wherever possible	<input type="checkbox"/>
BASIC	1.2.8 Design roads used for access or circulation by cyclists using a target operating speed of no more than 30 km/h, or provide a separated cycling facility	<input type="checkbox"/>
<b>1.3 Amenities for walking &amp; cycling</b>		
BASIC	1.3.1 Provide lighting, landscaping and benches along walking and cycling routes between building entrances and streets, sidewalks and trails	<input type="checkbox"/>
BASIC	1.3.2 Provide wayfinding signage for site access (where required, e.g. when multiple buildings or entrances exist) and egress (where warranted, such as when directions to reach transit stops/stations, trails or other common destinations are not obvious)	<input type="checkbox"/>

TDM-supportive design & infrastructure measures: <i>Residential developments</i>		Check if completed & add descriptions, explanations or plan/drawing references
<b>2. WALKING &amp; CYCLING: END-OF-TRIP FACILITIES</b>		
<b>2.1 Bicycle parking</b>		
REQUIRED	2.1.1 Provide bicycle parking in highly visible and lighted areas, sheltered from the weather wherever possible (see <i>Official Plan policy 4.3.6</i> )	<input checked="" type="checkbox"/>
REQUIRED	2.1.2 Provide the number of bicycle parking spaces specified for various land uses in different parts of Ottawa; provide convenient access to main entrances or well-used areas (see <i>Zoning By-law Section 111</i> )	<input checked="" type="checkbox"/>
REQUIRED	2.1.3 Ensure that bicycle parking spaces and access aisles meet minimum dimensions, that no more than 50% of spaces are vertical spaces; and that parking racks are securely anchored (see <i>Zoning By-law Section 111</i> )	<input checked="" type="checkbox"/>
BASIC	2.1.4 Provide bicycle parking spaces equivalent to the expected number of resident-owned bicycles, plus the expected peak number of visitor cyclists	<input type="checkbox"/>
<b>2.2 Secure bicycle parking</b>		
REQUIRED	2.2.1 Where more than 50 bicycle parking spaces are provided for a single residential building, locate at least 25% of spaces within a building/structure, a secure area (e.g. supervised parking lot or enclosure) or bicycle lockers (see <i>Zoning By-law Section 111</i> )	<input checked="" type="checkbox"/>
BETTER	2.2.2 Provide secure bicycle parking spaces equivalent to at least the number of units at condominiums or multi-family residential developments	<input type="checkbox"/>
<b>2.3 Bicycle repair station</b>		
BETTER	2.3.1 Provide a permanent bike repair station, with commonly used tools and an air pump, adjacent to the main bicycle parking area (or secure bicycle parking area, if provided)	<input checked="" type="checkbox"/>
<b>3. TRANSIT</b>		
<b>3.1 Customer amenities</b>		
BASIC	3.1.1 Provide shelters, lighting and benches at any on-site transit stops	<input type="checkbox"/>
BASIC	3.1.2 Where the site abuts an off-site transit stop and insufficient space exists for a transit shelter in the public right-of-way, protect land for a shelter and/or install a shelter	<input type="checkbox"/>
BETTER	3.1.3 Provide a secure and comfortable interior waiting area by integrating any on-site transit stops into the building	<input type="checkbox"/>

TDM-supportive design & infrastructure measures: <i>Residential developments</i>		Check if completed & add descriptions, explanations or plan/drawing references
<b>4. RIDESHARING</b>		
<b>4.1 Pick-up &amp; drop-off facilities</b>		
BASIC	4.1.1 Provide a designated area for carpool drivers (plus taxis and ride-hailing services) to drop off or pick up passengers without using fire lanes or other no-stopping zones	<input type="checkbox"/>
<b>5. CARSHARING &amp; BIKESHARING</b>		
<b>5.1 Carshare parking spaces</b>		
BETTER	5.1.1 Provide up to three carshare parking spaces in an R3, R4 or RS Zone for specified residential uses (see <i>Zoning By-law Section 94</i> )	<input type="checkbox"/>
<b>5.2 Bikeshare station location</b>		
BETTER	5.2.1 Provide a designated bikeshare station area near a major building entrance, preferably lighted and sheltered with a direct walkway connection	<input type="checkbox"/>
<b>6. PARKING</b>		
<b>6.1 Number of parking spaces</b>		
REQUIRED	6.1.1 Do not provide more parking than permitted by zoning, nor less than required by zoning, unless a variance is being applied for	<input type="checkbox"/>
BASIC	6.1.2 Provide parking for long-term and short-term users that is consistent with mode share targets, considering the potential for visitors to use off-site public parking	<input type="checkbox"/>
BASIC	6.1.3 Where a site features more than one use, provide shared parking and reduce the cumulative number of parking spaces accordingly (see <i>Zoning By-law Section 104</i> )	<input type="checkbox"/>
BETTER	6.1.4 Reduce the minimum number of parking spaces required by zoning by one space for each 13 square metres of gross floor area provided as shower rooms, change rooms, locker rooms and other facilities for cyclists in conjunction with bicycle parking (see <i>Zoning By-law Section 111</i> )	<input type="checkbox"/>
<b>6.2 Separate long-term &amp; short-term parking areas</b>		
BETTER	6.2.1 Provide separate areas for short-term and long-term parking (using signage or physical barriers) to permit access controls and simplify enforcement (i.e. to discourage residents from parking in visitor spaces, and vice versa)	<input type="checkbox"/>