



**211 ARMSTRONG STREET -
STORMWATER MANAGEMENT AND
SERVICING REPORT**

June 23, 2022

Prepared for:
Lion Trade Ltd.

Prepared by:
Stantec Consulting Ltd.

Project Number:
160401745

211 Armstrong Street - Stormwater Management and Servicing Report

Revision	Description	Author	Date	Quality Check	Date	Independent Review	Date
0	Issued for SPA	MW	2022-06-09	NC	2022-06-23	KK	2022-06-10



211 Armstrong Street - Stormwater Management and Servicing Report

The conclusions in the Report titled 211 Armstrong Street - Stormwater Management and Servicing Report are Stantec's professional opinion, as of the time of the Report, and concerning the scope described in the Report. The opinions in the document are based on conditions and information existing at the time the scope of work was conducted and do not take into account any subsequent changes. The Report relates solely to the specific project for which Stantec was retained and the stated purpose for which the Report was prepared. The Report is not to be used or relied on for any variation or extension of the project, or for any other project or purpose, and any unauthorized use or reliance is at the recipient's own risk.

Stantec has assumed all information received from Lion Trade Ltd. (the "Client") and third parties in the preparation of the Report to be correct. While Stantec has exercised a customary level of judgment or due diligence in the use of such information, Stantec assumes no responsibility for the consequences of any error or omission contained therein.

This Report is intended solely for use by the Client in accordance with Stantec's contract with the Client. While the Report may be provided to applicable authorities having jurisdiction and others for whom the Client is responsible, Stantec does not warrant the services to any third party. The report may not be relied upon by any other party without the express written consent of Stantec, which may be withheld at Stantec's discretion.

Prepared by: 

Signature

Michael Wu, E.I.T.

Reviewed by: 

Signature

Alyssa Gladish, E.I.T.

Printed Name

Approved by: _____
Signature

Neal Cody, P.Eng

Printed Name



Table of Contents

1	INTRODUCTION.....	1.1
1.1	Objective.....	1.2
2	BACKGROUND.....	2.1
3	WATER SERVICING	3.1
3.1	Background	3.1
3.2	Water Demands.....	3.1
3.2.1	Potable (Domestic) Water Demands.....	3.1
3.2.2	Fire Flow Demands	3.1
3.3	Level of Servicing	3.2
3.3.1	Boundary Conditions	3.2
3.3.2	Allowable Domestic Pressures	3.2
3.3.3	Allowable Fire Flow Pressures	3.2
3.4	Proposed Water Servicing.....	3.3
4	WASTEWATER SERVICING.....	4.1
4.1	Design Criteria	4.1
4.2	Wastewater Generation and Servicing Design	4.1
4.3	Proposed Sanitary Servicing	4.2
5	STORMWATER MANAGEMENT AND SERVICING	5.1
5.1	Objectives	5.1
5.2	Stormwater Management (SWM) Criteria	5.1
5.3	Existing Conditions	5.2
5.4	Stormwater Management Design.....	5.3
5.4.1	Allowable Release Rate	5.3
5.4.2	Quantity Control: Storage Requirements	5.4
5.4.3	Quality Control.....	5.7
5.5	Proposed Stormwater Servicing.....	5.7
6	SITE GRADING	6.1
7	UTILITIES.....	7.1
8	APPROVALS.....	8.1
9	EROSION CONTROL DURING CONSTRUCTION.....	9.1
10	GEOTECHNICAL INVESTIGATION	10.1
11	CONCLUSIONS.....	11.1
11.1	Water Servicing	11.1
11.2	Sanitary Servicing.....	11.1
11.3	Stormwater Servicing and Management	11.1
11.4	Grading	11.1
11.5	Utilities	11.2
11.6	Approvals/Restrictions	11.2



211 Armstrong Street - Stormwater Management and Servicing Report

LIST OF TABLES

Table 3-1: Estimated Water Demands	3.1
Table 3-2: Boundary Conditions	3.2
Table 4-1: Estimated Wastewater Peak Flow	4.1
Table 5-1: Pre-Development Release Rates	5.3
Table 5-2: Summary of Subcatchment Areas	5.3
Table 5-3: Target Release Rate	5.4
Table 5-4: Roof Control Areas	5.4
Table 5-5: Peak Post-Development Discharge Rates from the Uncontrolled Areas	5.6
Table 5-6: Comparison of Pre- to Post-Development Release Rate to 213 Armstrong	5.6
Table 5-7: Summary of Total 2-Year and 100-Year Event Release Rates	5.7
Table 5-8 Comparison of Pre- to Post-Development Release Rates	5.7

LIST OF FIGURES

Figure 1: Key Plan of Site	1.1
----------------------------------	-----

LIST OF APPENDICES

APPENDIX A POTABLE WATER SERVICING.....	A.1
A.1 Domestic Water Demand Calculations	A.1
A.2 Fire Flow Requirements Per OFM Guidelines	A.2
A.3 Confirmation of Building Construction: Correspondence with Architect	A.3
A.4 Boundary Conditions	A.4
A.5 Hydraulic Conditions Calculations	A.5
APPENDIX B DRAFT SITE PLAN AND ROOF PLAN BY PROJECT1 STUDIO INC. 18- MAY-2022.....	B.1
APPENDIX C WASTEWATER SERVICING.....	C.1
C.1 Sanitary Sewer Calculation Sheet	C.1
C.2 Confirmation of Sanitary Sewer Capacity	C.2
APPENDIX D STORMWATER SERVICING.....	D.1
D.1 Modified Rational Method Sheet	D.1
D.2 Watts Drainage Adjustable Accutrol Weir Detail (2016).....	D.2
D.3 Storm Sewer Design Sheet	D.3
D.4 Correspondence with the RVCA	D.4
D.5 Correspondence with City of Ottawa on Stormwater Sewer Capacity	D.5
APPENDIX E BACKGROUND STUDIES.....	E.1
E.1 Geotechnical Investigation By Kollaard Associates (January 24, 2022)	E.1
E.2 Plan of Topographic Survey By J.D. Barns Limited (January 20, 2022).....	E.2
E.3 Tree Conservation Report for By ILS Associates (May 17, 2022)	E.3
APPENDIX F CORRESPONDENCES	F.1
F.1 Preconsultation Notes	F.1
APPENDIX G DRAWINGS	G.1



211 ARMSTRONG STREET – STORMWATER MANAGEMENT AND SERVICING REPORT

Introduction
June 15, 2022

1 Introduction

Stantec Consulting Ltd. has been commissioned by Lion Trade Ltd. to prepare the following servicing and stormwater management report in support of a Site Plan Control (SPC) application for the proposed development located at 211 Armstrong Street in the City of Ottawa.

The 0.047 ha site is situated approximately 60 m northeast of the Parkdale Avenue and Armstrong Street intersection. The site is currently zoned R4UD and contains an existing two-storey building (residence), trees, a timber fence, and surface parking. The site is bounded by Armstrong Street to the south, and existing residential developments on the north, west and east, (see **Figure 1** below).

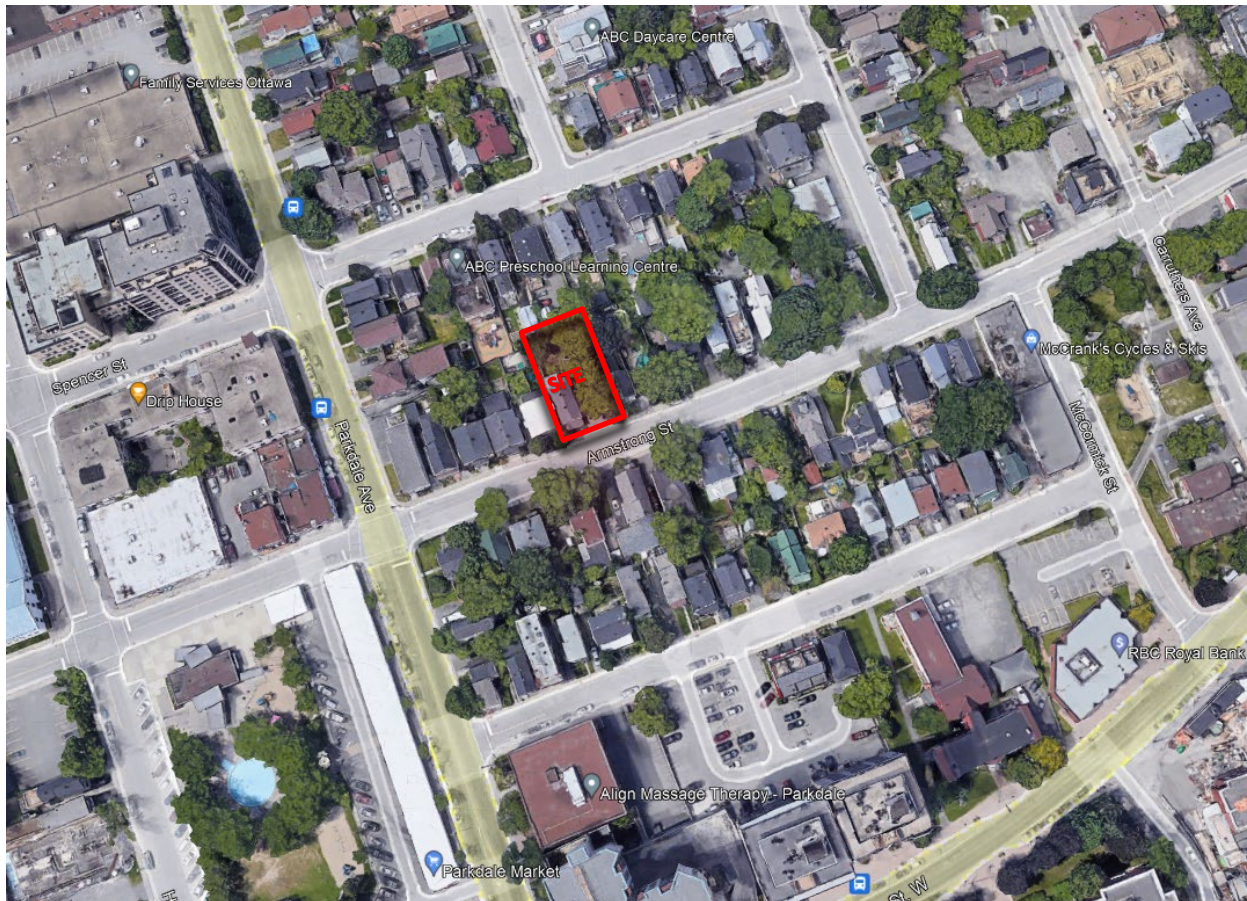

Figure 1: Key Plan of Site

The proposed development is a three-storey apartment building with a basement level, consisting of 12 residential units. The proposed building will include six (6) one-bedroom and six (6) two-bedroom apartment units with a mechanical room located directly beneath the front entrance. Project 1 Studio Inc. has prepared a draft site plan dated May 18, 2022 which defines the proposed development (see **Appendix B**).



Introduction

June 15, 2022

1.1 Objective

This site servicing and stormwater management (SWM) report presents a servicing scheme that is free of conflicts, provides on-site servicing in accordance with City of Ottawa design guidelines, and uses the existing municipal infrastructure in accordance with any limitations communicated during consultation with the City of Ottawa staff. Details of the existing infrastructure located within the Armstrong Street right of way (ROW) were obtained from available as-built drawings and site topographic survey in **Appendix E.2**.

Criteria and constraints provided by the City of Ottawa have been used as a basis for the detailed servicing design of the proposed development. Specific elements and potential development constraints to be addressed are as follows:

- Potable Water Servicing
 - Estimate water demands to characterize the proposed feed for the proposed development which will be serviced from the existing 203 mm diameter watermain within the Armstrong Street ROW.
 - Watermain servicing for the development is to be able to provide average day and maximum day (including peak hour) demands (i.e., non-emergency conditions) at pressures within the acceptable range of 50 to 80 psi (345 to 552 kPa).
 - Under fire flow (emergency) conditions, the water distribution system is to maintain a minimum pressure greater than 20 psi (140 kPa).
- Wastewater (Sanitary) Servicing
 - Define and size the sanitary service lateral which will be connected to the existing 300 mm diameter sanitary sewer within the Armstrong Street ROW.
- Storm Sewer Servicing
 - Define major and minor conveyance systems in conjunction with the proposed grading plan
 - Determine the stormwater management storage requirements to meet the allowable release rate for the site
 - Define and size the proposed storm service lateral that will be connected to the existing 375 mm diameter municipal storm sewer within the Armstrong Street ROW.
- Prepare a grading plan in accordance with the proposed site plan and existing grades.

The accompanying drawings included in **Appendix F** of this report illustrate the proposed internal servicing scheme for the site.



Background
June 15, 2022

2 Background

Documents referenced in preparation of this stormwater and servicing report for 211 Armstrong Street development include:

- *City of Ottawa Sewer Design Guidelines (SDG)*, City of Ottawa, October 2012, including all subsequent technical bulletins.
- *City of Ottawa Design Guidelines – Water Distribution*, City of Ottawa, July 2010, including all subsequent technical bulletins.
- *Design Guidelines for Drinking Water Systems*, Ministry of the Environment, Conservation, and Parks (MECP), 2008.
- *Fire Protection Water Supply Guideline for Part 3 in the Ontario Building Code*, Office of the Fire Marshal (OFM), October 2020.
- *Geotechnical Investigation*, Kollaard Associates Inc., January 2022.
- *Phase I – Environmental Site Assessment Report*, Kollaard Associates Inc., March 2022.
- *Water Supply for Public Fire Protection*, Fire Underwriters Survey (FUS), 2020.
- *Tree Conservation Report*, IFS Associates, May 2022



3 Water Servicing

3.1 Background

The proposed building is in Pressure Zone 1W of the City of Ottawa’s Water Distribution System. The existing dwelling on site is presently serviced by a building service lateral connection to the existing 203 mm diameter watermain on Armstrong Street, which would be removed by City Staff and blanked at the watermain, as shown on the Existing Conditions and Removals Plan (see **Drawing EX-1** in **Appendix G**).

3.2 Water Demands

3.2.1 POTABLE (DOMESTIC) WATER DEMANDS

The proposed three-storey with basement building consists of six (6) one-bedroom units, and six (6) two-bedroom apartments units. The City of Ottawa Water Distribution Guidelines (July 2010) and ISTB 2021-03 technical bulletin were used to determine water demands based on projected population densities for residential areas. The population was estimated using an occupancy of 1.4 persons per unit for a one-bedroom apartment and 2.1 persons per unit for a two-bedroom apartment. The proposed residential apartment building was estimated to have a total projected population of 21 persons.

A daily rate of 280 L/cap/day has been used to estimate average daily (AVDY) potable water demands for the residential units. Table 3-3 of the MECP Water Design Guidelines were used to estimate peak demand rates for the site (i.e., residential areas < 500 equivalent population) as follows: Maximum day (MXDY) demands were determined by multiplying the AVDY demands by a factor of 9.5 for residential areas. Peak hourly (PKHR) demands were determined by multiplying the AVDY demands by a factor of 14.3 (see **Appendix A.1**). The estimated demands are summarized in **Table 3-1**

Table 3-1: Estimated Water Demands

	Population	AVDY (L/s)	MXDY (L/s)	PKHR (L/s)
Residential	21 persons	0.07	0.65	9.25
Total Site		0.07	0.65	9.25

3.2.2 FIRE FLOW DEMANDS

The fire flow demand was calculated in accordance with the Office of the Fire Marshal (OFM) fire protection water supply guidelines for the Ontario Building Code (OBC) methodology. As no on-site watermains or fire hydrants are proposed for the current development, the OFM guidelines are acceptable for this purpose. The OBC estimate is based on a wood-frame building construction with unprotected building openings. Hence the type of construction selected was combustible without fire-resistance ratings. The floor area was estimated as the area of the ground floor and taking into consideration the storeys above and below the ground level for the building volume. It is anticipated that the building will not be sprinklered.



Water Servicing
June 15, 2022

Correspondence with the architects confirmed that these assumptions for the building construction are conservative (see **Appendix A.3**). Required fire flows were determined to be approximately 3600 L/min (60.0 L/s). (See calculations in **Appendix A.2**).

3.3 Level of Servicing

3.3.1 BOUNDARY CONDITIONS

The estimated domestic water demands, and fire flow demands were used to define the level of servicing required for the proposed development from the municipal watermains and hydrants within the Armstrong Street ROW. **Table 3-2** outlines the boundary conditions provided by the City of Ottawa on May 11, 2022 (See **Appendix A.3** for correspondence).

Table 3-2: Boundary Conditions

	Connection @ Armstrong Street
Min. HGL (m)	108.0
Max. HGL (m)	115.0
Max. Day + Fire Flow (150 L/s)	106.6

3.3.2 ALLOWABLE DOMESTIC PRESSURES

The desired normal operating objective pressure range as per the City of Ottawa 2010 Water Distribution Design Guidelines is 345 kPa (50 psi) to 552 kPa (80 psi) and no less than 276 kPa (40 psi) at ground elevation under normal operation conditions. Furthermore, the maximum pressure at any point in the water distribution should not exceed 100 psi as per the Ontario Building/Plumbing Code; pressure reducing measures are required to service areas where pressures greater than 552 kPa (80 psi) are anticipated.

The proposed finished floor elevation at the first floor of 65.27 m will serve as ground floor elevation for the calculation of residual pressures at ground level. As per the Boundary Conditions, the on-site pressures are expected to range from 418 to 488 kPa (60.7 to 70.7 psi) under normal operating conditions. Due to head loss of about 29.4 kPa (4.3 psi) for each storey, it is expected that the upper storey (the third floor) will experience minimum pressure in the range of 360 to 429 kPa (52 to 62 psi). Calculations of the residual pressures have been provided in **Appendix A.5**. These values are within the normal operating pressure range as defined by City of Ottawa design guidelines which requires 276 to 552 kPa (40 to 80 psi). Consequently, we do not anticipate a requirement for booster pumps for the proposed development.

3.3.3 ALLOWABLE FIRE FLOW PRESSURES

The boundary conditions provided by the City of Ottawa indicate that the 203 mm dia. watermain within Armstrong Street is expected to maintain a residual pressure of 41.3 m equivalent to 405 kPa (59 psi) under



211 ARMSTRONG STREET – STORMWATER MANAGEMENT AND SERVICING REPORT

Water Servicing
June 15, 2022

the worst-case fire flow conditions. This demonstrates that the existing watermain and nearby hydrants can provide the required fire flows while maintaining a residual pressure of 20 psi.

In summary, the existing 203 mm diameter watermain on Armstrong Street can provide adequate fire and domestic flows and pressures for the subject site based on City of Ottawa Design Guidelines. An existing hydrant located approximately 22.5 m west of the subject site can be used for fire suppression. The existing hydrant is within 90 m of the building as per the OBC. The proposed water servicing is shown on **Drawing SSP-1** contained in **Appendix F**.

3.4 Proposed Water Servicing

The development will be serviced via a single 50 mm building service connection to the existing 203 mm diameter watermain on Armstrong Street. The sizing of the service connection is to be confirmed by the mechanical consultant. Thermal insulation is required on the water service lateral as there is less than 2.4 m cover provided per W22.



Wastewater Servicing
June 15, 2022

4 Wastewater Servicing

The site will be serviced from the existing 300 mm diameter PVC sanitary sewer in the Armstrong Street ROW. The existing dwelling on site is presently serviced by an existing sanitary service lateral, connecting it to the existing 300 mm diameter sanitary sewer, which will be decommissioned and abandoned by City Staff, as shown in Existing Conditions and Removals Plan (see **Drawing EX-1** in **Appendix G**).

4.1 Design Criteria

As outlined in the City of Ottawa Sewer Design Guidelines and the MECP Design Guidelines for Sewage Works, the following criteria were used to calculate the estimated wastewater flow rates, and to determine the size and location of the sanitary service lateral:

- Minimum velocity = 0.6 m/s (0.8 m/s for upstream sections)
- Maximum velocity = 3.0 m/s
- Manning roughness coefficient for all smooth wall pipes = 0.013
- Minimum size of sanitary sewer service = 135 mm
- Minimum grade of sanitary sewer service = 1.0 % (2.0 % preferred)
- Average wastewater generation = 280 L/person/day (per City Design Guidelines)
- Peak Factor = based on Harmon Equation; maximum of 4.0 (residential)
- Harmon correction factor = 0.8
- Infiltration allowance = 0.33 L/s/ha (per City Design Guidelines)
- Minimum cover for sewer service connections – 2.0 m
- Population density for one-bedroom apartments – 1.4 persons/apartment
- Population density for two-bedroom apartments – 2.1 persons/apartment

4.2 Wastewater Generation and Servicing Design

The proposed 0.047 ha development area will consist of a 3-storey plus basement residential apartment building consisting of six (6) of both one-bedroom and two-bedroom units for a total of 12 units and a projected population of 21. The anticipated wastewater peak flow generated from the proposed development is summarized in **Table 4-1** below:

Table 4-1: Estimated Wastewater Peak Flow

Residential Peak Flows					Infiltration Flow (L/s)	Total Peak Flow (L/s)
	No. of Units	Population	Peak Factor	Peak Flow (L/s)		
Residential	12 units	21	3.502	0.238	0.008	0.246



211 ARMSTRONG STREET – STORMWATER MANAGEMENT AND SERVICING REPORT

Wastewater Servicing
June 15, 2022

Detailed sanitary sewage calculations are included in **Appendix C.1**. A backflow preventer will be required for the proposed building in accordance with the Sewer Design Guidelines and will be coordinated with building mechanical engineers.

The proposed sewage peak flows were provided to City of Ottawa staff to conduct a capacity analysis of the sanitary sewer system in the vicinity of the site and downstream system. Confirmation was obtained that there are no concerns with respect to adding the proposed sanitary peak flows to the existing sewer on Armstrong Street (see correspondence in **Appendix C.2**), however this area is designated as a 2-year level-of-service system.

4.3 Proposed Sanitary Servicing

A 150 mm diameter sanitary building service, complete with full port backwater valve as per City standard S14.1 is proposed for the sanitary sewage from the proposed development. Final sizing of the lateral is to be confirmed by the mechanical consultant. Due to the finished floor elevation of the mechanical room, sanitary sump is required.

The depths of the sewers and watermain in Armstrong Street make the connections challenging for the sanitary and stormwater services. The storm and sanitary sewer services will each have a sump pit and pump to service the proposed development. The sumps will lift the sewage to the lateral invert at the building face. The laterals will have a gravity connection from the building to the municipal sewer. Thermal insulation will be provided for the full length of both stormwater and sanitary sewer laterals to protect from freezing. The sewer is to connect to the main with a riser pipe as per City standard S11.1.



5 Stormwater Management and Servicing

5.1 Objectives

The goal of this stormwater servicing and stormwater management (SWM) plan is to determine the measures necessary to control the quantity and quality of stormwater released from the proposed development to meet the criteria established during the consultation process with City of Ottawa and Rideau Valley Conservation Authority (RVCA) staff, and to provide sufficient details required for approval.

5.2 Stormwater Management (SWM) Criteria

The Stormwater Management (SWM) criteria were established by combining current design practices outlined by the City of Ottawa Sewer Design Guidelines (SDG) (October 2012), review of project pre-consultation notes of the City of Ottawa, and through consultation with City of Ottawa staff. The following summarizes the criteria, with the source of each criterion indicated in brackets:

General

- Use of the dual drainage principle (City of Ottawa SDG).
- Wherever feasible and practical, site-level measures should be used to reduce and control the volume and rate of runoff. (City of Ottawa SDG)
- Assess impact of 100-year event outlined in the City of Ottawa Sewer Design Guidelines on major & minor drainage system (City of Ottawa SDG)
- The proposed site is not subject to quality control criteria due to the small site size and land usage of the development (City of Ottawa SDG).

Storm Sewer & Inlet Controls

- Size storm sewers to convey 2-year storm event under free-flow conditions using City of Ottawa I-D-F parameters (Correspondence with City of Ottawa staff, **Appendix D.5**)
- Site discharge rates for each storm event to be restricted to a 2-year storm event pre-development rates with a maximum pre-development C coefficient of 0.5 (City of Ottawa pre-consultation, **Appendix F.1**)
- Proposed site to discharge into the existing 375 mm diameter storm sewer within Armstrong Street ROW (City of Ottawa pre-consultation, **Appendix F.1**).
- The foundation drainage system is to be independently connected to the storm sewer main unless being pumped with appropriate back up power, sufficient sized pump, and backflow prevention. (City of Ottawa pre-consultation, **Appendix F.1**)
- T_c should be not less than 10 minutes since IDF curves become unrealistic at less than 10 min (City of Ottawa SDG).



Stormwater Management and Servicing
June 15, 2022

Surface Storage & Overland Flow

- Any additional peak flows generated by events greater than the 2-year storm event up to and including the 100-year storm event must be detained on site. Alternatively, City of Ottawa staff noted during pre-consultation that it would be acceptable to control the roof portion of the development only so long as the remainder of the uncontrolled site is directed towards the Armstrong Street ROW (City of Ottawa pre-consultation, **Appendix F.1**).
- Building openings to be a minimum of 0.30 m above the 100-year water level (City of Ottawa)
- Maximum depth of flow under either static or dynamic conditions shall be less than 0.30 m (City of Ottawa SDG)
- Provide adequate emergency overflow conveyance off-site with a minimum vertical clearance of 15 cm between the spill elevation and the ground elevation at the building envelope in the proximity of the flow route or ponding area (City of Ottawa)

The preferred stormwater system outlet for this site is the 375 mm diameter stormwater sewer within the Armstrong Street ROW.

5.3 Existing Conditions

The existing development area (0.047 ha) consists of a two-storey building, a paved driveway, trees, vegetated/sodded areas, and a timber fence at the rear yard. The existing structures, the rear fence, and some trees will be removed to allow for the proposed development, as shown in Existing Conditions and Removals Plan (see **Drawing EX-1** in **Appendix G**).

Two subcatchments (subareas) were delineated in the Existing Conditions Storm Drainage Plan (see **Appendix G** Drawing EXSD-1), the NORTH and SOUTH subcatchments. The catchments are characterized by a mix of paved, roof, and vegetated areas, with the SOUTH subcatchment having more impervious surfaces ($C=0.72$) than the NORTH ($C=0.34$). The NORTH subcatchment constitutes most of the site which drains toward the left rear (northwest) corner and into the adjacent lot to the west (213 Armstrong Street). The EXSD-1 plan was used to establish the overall site pre-development runoff coefficient of $C=0.43$.

The pre-development release rates for the site have been determined using the rational method and the drainage characteristics identified above. A time of concentration for the pre-development area (10 minutes) was assigned based on the small site size and its proximity to the existing drainage outlet. Peak flow rates have been calculated using the rational method as follows:



Stormwater Management and Servicing
June 15, 2022

$$Q = 2.78 (C)(I)(A)$$

Where:

Q = peak flow rate, L/s

C = site runoff coefficient

I = rainfall intensity, mm/hr (per City of Ottawa IDF curves)

A = drainage area, ha

Table 5-1: Pre-Development Release Rates

	C	A (ha)	Peak Discharge (L/s)	
			2-Year Event	100-Year Event
Uncontrolled – Surface (NORTH)	0.34	0.036	2.61	7.59
Uncontrolled – Surface (SOUTH)	0.72	0.011	1.69	4.91
Uncontrolled - Total Site	0.43	0.047	4.30	12.51

5.4 Stormwater Management Design

The Modified Rational Method was employed to assess the rate and volume of runoff anticipated during post-development rainfall runoff events. The site was subdivided into subcatchments (subareas) as defined by the proposed grades and the location, nature, or presence/absence of inlet control devices (ICD's). Each subcatchment was assigned a runoff coefficient. A summary of subareas and runoff coefficients is provided in **Table 5-2** below. Further details can be found in **Appendix D.1**, while **Drawing SD-1** illustrates the proposed subcatchments.

Table 5-2: Summary of Subcatchment Areas

Catchment Areas	C	A (ha)	Flow Type	Outlet Direction
BLDG	0.90	0.024	Controlled	Sewer
NORTH	0.52	0.014	Uncontrolled	Northwest
SOUTH	0.50	0.009	Uncontrolled	South
Total Site	0.71	0.047	-	-

5.4.1 ALLOWABLE RELEASE RATE

Based on consultation with City of Ottawa staff, the peak post-development discharge from the subject site must be limited to the discharge resulting from the 2-year event due to the capacity restrictions of the downstream municipal stormwater infrastructure. The actual pre-development runoff coefficient of 0.43 was utilized for the site as it does not exceed the maximum permissible pre-development runoff coefficient of $C = 0.5$. C coefficient values have been increased by 25 % for the post-development 100-year storm event based on the MTO Drainage Manual recommendations. The pre-development 2-year release rate for the



Stormwater Management and Servicing
June 15, 2022

site, as determined in **Table 5-1**, was calculated using the modified rational method to be 4.32 L/s. Consequently, the target release rate for 211 Armstrong Street under all events up to and including the 100-year event will be 4.32 L/s, as shown in **Table 5-3** below.

Table 5-3: Target Release Rate

Design Storm	Target Flow Rate (L/s)
All Events	4.32

5.4.2 QUANTITY CONTROL: STORAGE REQUIREMENTS

The site requires quantity control measures to meet the restrictive stormwater release criteria. It is proposed that rooftop storage via restricted roof release be used to reduce site peak outflow. A spreadsheet using the Modified Rational Method (MRM) was used to size the roof storage.

5.4.2.1 Rooftop Storage

It is proposed to retain stormwater on the building rooftop by installing restricted flow roof drains. The following calculations assume the roof will be equipped with two standard Watts model roof drains complete with Adjustable Accutrol Weirs. Discharge from the two controlled roof drains will be routed by the mechanical consultant through the building’s internal plumbing to the proposed building storm service lateral on the downstream side of the backwater prevention valve.

Watts Drainage Adjustable Accutrol roof drain weir data (see **Appendix D.3**) and actual rooftop stage-storage data derived from the roof plan (see **Appendix B**) has been used to calculate a practical roof release rate and detention storage volume for the rooftop areas. It should be noted that the Accutrol weir has been used as an example only, and that other products may be specified for use, provided that:

- the peak roof drain release rate is restricted to match the maximum rate of release indicated in **Table 5-4**,
- sufficient roof storage is provided to meet (or exceed) the required volume of detained stormwater indicated in **Table 5-4**, and
- the maximum ponding depth of 150 mm is not exceeded during a design storm event.

The proposed drain release rates and storage volumes have been calculated based on both Adjustable Accutrol roof drain weir set in the closed setting. Rooftop storage volumes and controlled release rates are summarized in **Table 5-4**.

Table 5-4: Roof Control Areas

Design Storm	Storage Depth (mm)	Discharge (L/s)	Volume Stored (m ³)
2-Year (Roof)	72	0.63	3.2
100-Year (Roof)	114	0.63	11.4



211 ARMSTRONG STREET – STORMWATER MANAGEMENT AND SERVICING REPORT

Stormwater Management and Servicing
June 15, 2022

5.4.2.2 Uncontrolled Areas

As per consultation with the City of Ottawa staff, shown in **Appendix D.5**, it has been deemed acceptable to control only the roof portion of the development so long as the remainder of the uncontrolled site is directed towards the Armstrong Street (ROW). These uncontrolled areas have no flow rate restriction component.

The proposed SOUTH subcatchment effectively drains south, uncontrolled, to the Armstrong Street ROW via surface flows. The proposed NORTH subcatchment, however, includes the rear yard, which under existing conditions drains to the rear (northwest) corner of the lot, away from the ROW. Ideally, this site would utilize rear and side-yard infrastructure to capture, detain, and direct the remaining site area (non-roof portion) runoff to the Armstrong Street ROW.

The option of a storage pipe or conveyance pipe along the left (west) side yard was explored and evaluated this scenario for feasibility. Due to the existing site conditions, narrow side yards, the proximity of the adjacent structures to both side yard property lines, and conflicting municipal infrastructure within Armstrong Street, it was found that rear/side yard infrastructure was not a viable stormwater management plan for the remaining site area. The conflicts included:

- the 1.0 m offset of the pipe from the foundation wall could not be met (per Sewer Connection Bylaw 2003-513, GP#19)
- there was insufficient room for the required structures (CB's, etc.),
- the CB lead and WM conflicted (0.28 m clearance), and
- the footings of the adjacent and proposed building would be undermined by the side yard storage pipe.

In the right rear corner of the lot are three large trees (T6, T7, and T8) that are to be retained (all other trees on the site will need to be removed to accommodate the excavation and foundation), as per the Tree Conservation Report in **Appendix E.3**. An alternate method to get the remaining site area to drain south to the ROW is by regrading the rear yard. This would require the construction of a retaining wall at the rear property line and grade changes exceeding 0.3 m. These rear-yard disturbances would be within a significant portion of the critical root zones (CRZ's) of the three trees to be retained and would likely result in the necessary removal of the trees.

The site conditions and the tree retention plan do not allow the stormwater from the NORTH subcatchment to be directed to the Armstrong Street ROW.

The only reasonable and feasible option is to allow the NORTH subcatchment to drain as per existing conditions. Peak discharges from the two uncontrolled subareas have been considered in the overall SWM plan.



211 ARMSTRONG STREET – STORMWATER MANAGEMENT AND SERVICING REPORT

Stormwater Management and Servicing
June 15, 2022

Table 5-5: Peak Post-Development Discharge Rates from the Uncontrolled Areas

Design Storm	NORTH Discharge (L/s)	SOUTH Discharge (L/s)
2-year	1.55	0.96
100-Year	4.52	2.79

We believe that it is acceptable to allow the NORTH subcatchment to drain as per existing conditions for three key reasons:

1. To retain the three large trees in the rear yard.
2. The proposed SWM plan for the site directs most of the subcatchment areas to the Armstrong Street ROW and storm sewer (0.033 ha of the total 0.047 ha, or 70%).
3. The proposed SWM plan significantly reduces the amount of runoff that is directed into the adjacent property (213 Armstrong Street). See **Table 5-6** below for the reductions in the peak discharge released to the adjacent lot.

Table 5-6: Comparison of Pre- to Post-Development Release Rate to 213 Armstrong

	2-Year Peak Discharge @ C=0.34				100-Year Peak Discharge @ C=0.34			
	Pre-Dev.	Post-Dev.	Difference		Pre-Dev.	Post-Dev.	Difference	
	(L/s)	(L/s)	(L/s)	%	(L/s)	(L/s)	(L/s)	%
Uncontrolled – Surface (NORTH)	2.61	1.55	-1.06	-40.6	12.51	4.52	-7.99	-63.9

Correspondence with the City of Ottawa staff did not identify any issues with the proposed release of the NORTH subcatchment as per existing conditions, given the overall drainage improvements on the site and reduction of runoff to the adjacent property, as shown in **Appendix D.5**.

5.4.2.3 Results

The proposed stormwater management plan meets the requirements identified during pre-consultation that it would be acceptable to control the roof portion of the development only. Although not all the remaining site area could be directed to the Armstrong Street ROW, we believe the SWM plan presented provides the best solution for all stakeholders. **Table 5-7** provides a summary of the peak design discharge rates calculated from the MRM analysis, shown in **Appendix D.1**. As the table demonstrates, with a 2-year target rate for control, the 2-year post-development conditions satisfy the design criteria, but there is a minor exceedance in the 100-year peak discharge of 3.62 L/s.



Table 5-7: Summary of Total 2-Year and 100-Year Event Release Rates

Drainage areas	2-year Peak Discharge (L/s)	100-Year Peak Discharge (L/s)
Uncontrolled Areas	2.52	7.31
Controlled Areas	0.63	0.63
Total (L/s)	3.15	7.94
Target (L/s)	4.32	4.32
Exceedance (L/s)	-1.17	3.62

Table 5-8 compares the pre- and post-development peak stormwater release rates from this site. It demonstrates that by developing the site, controlling the rooftop storage, and re-introducing effective permeable/landscaped areas, the overall stormwater release rate from the site will be reduced by 27.1 % for the 2-year event and by 36.5 % for the 100-year event compared to existing conditions. These significant reductions to the release rates justify the 3.62 L/s exceedance of the restrictive target. An exceedance of 3.62 L/s is comparable to the overall 100-year event reduction of the release rate from the site, 4.57 L/s, and consequently, this to be an acceptable deviation from the stormwater management criteria.

Table 5-8 Comparison of Pre- to Post-Development Release Rates

	2-Year Peak Discharge @ C=0.43				100-Year Peak Discharge @ C=0.43			
	Pre-Dev.	Post-Dev.	Difference		Pre-Dev.	Post-Dev.	Difference	
	(L/s)	(L/s)	(L/s)	%	(L/s)	(L/s)	(L/s)	%
Uncontrolled – Surface	4.32	2.52	-1.8	-	12.51	7.31	-5.2	-
Controlled – Rooftop Storage	-	0.63	0.63	-	-	0.63	0.63	-
Total	4.32	3.15	-1.17	-27.1%	12.51	7.94	-4.57	-36.5%

5.4.3 QUALITY CONTROL

Through correspondence with the Rideau Valley Conservation Authority (RVCA), it is confirmed that no additional quality control measures are required for the site based on the Site Plan provided and best management practices are encouraged where possible. Refer to **Appendix D.4** for correspondence with the RVCA.

5.5 Proposed Stormwater Servicing

One 100 mm diameter stormwater building service, complete with full port backwater valve as per City standard S14.1 is proposed for the foundation drain and the roof drain, as per **Drawing SSP-1** in **Appendix G**. A stormwater sump and pump are required for the proposed foundation drain, and the roof drain is to be connected to the service lateral downstream of the sump pump and full port backwater valve. The full length of the storm laterals will be insulated. The laterals are to connect to the main with a riser pipe as per City standard S11.1



Site Grading
June 15, 2022

6 Site Grading

The proposed re-development site measures approximately 0.047 ha in area. A detailed grading plan (see **Appendix G, Drawing GP-1**) has been prepared to satisfy the stormwater management requirements described in **Section 5.0** and to allow for positive drainage away from the face of the building.

The grading plan indicates that the existing site is relatively flat, with a subtle split-grade yard; the rear yard drain toward the rear property line while the front portion of the yard drains toward the Armstrong Street ROW.

An artificial high point is proposed to achieve the split-lot drainage pattern and optimize the area draining to the ROW. The proposed grading respects the existing grades at the property lines, provides an adequate overland flow route, and maintains the existing drainage conditions for the rear portion of the site. The grading approach for the rear yard was governed by the retention of trees T6, T7, and T8 located at the northeast corner of the lot. No retaining walls are required for the proposed development. Insulation will be required along the southeast portions of the foundation wall where the minimum 1.5 m cover over USF could not be provided in the surrounding elevations.

To minimize disturbance and impact to the retained trees, less than 0.3 m in grade changes were proposed within the CRZs to allow the rear yard to drain as per existing conditions. A depressed curb at the central front entrance is proposed to allow for waste management receptacles to be moved to the curb.



Utilities
June 15, 2022

7 Utilities

Overhead (OH) hydro-wires run east-west on the north side of Armstrong Street, and OH telephone wires run east-west along the north property line, north-south parallel to the west property line, and lead diagonally through the rear yard from the east to the north side of the site (telephone pole) and from the existing building to the north telephone pole. All utilities within the work area will require relocation during construction. The existing utility poles are to be protected during construction.

Hydro Ottawa, Bell, Rogers, and Enbridge all have existing utility plants in the area, which will be used to service this site. The exact size, location, and routing of utilities will be finalized after design circulation. Existing overhead wires and utility plants may need to be moved/reconfigured to allow sufficient clearance to the proposed building and the movement of heavy machinery required for construction. The relocation of existing utilities will be coordinated with the individual utility providers upon design circulation.



Approvals
June 15, 2022

8 Approvals

The proposed development lies on a private site under singular ownership; drains to an approved separated sewer outlet; and is not intended to service industrial land or land uses. Therefore, the site is exempt from the Ministry of the Environment, Conservation and Parks (MECP) Environmental Compliance Application (ECA) process under O.Reg. 525/98.

While the building will be founded on shallow bedrock and dewatering will likely not be required, as stated in the geotechnical report for the site, it should be noted that borehole refusal was encountered at a maximum depth of 1.7 m below ground surface, and boreholes were not advanced to the full depth of the services. The proposed mechanical room floor will be located 3.09 m below the average existing grade (AEG) of the site (63.860 m) and the underside of footing will be located 2.19 m below AEG, as indicated in the latest elevation plan (see **Appendix B**). Consequently, groundwater may be encountered when excavation depths exceed the depth of borehole refusal.

For ground or surface water volumes being pumped during the construction phase, typically between 50,000 to 400,000 L/day, it is required to register on the Environmental Activity and Sector Registry (EASR). It is possible that groundwater may be encountered during the foundation excavation on this site. A minimum of two to four weeks should be allotted for completion of the EASR registration and the preparation of the Water Taking and Discharge Plan by a Qualified Person as stipulated under O.Reg. 63/16. An MECP Permit to Take Water (PTTW) which is required for dewatering volumes exceeding 400,000L/day, is not anticipated for the site.



Erosion Control During Construction
June 15, 2022

9 Erosion Control During Construction

To protect downstream water quality and prevent sediment build up in catch basins and storm sewers, erosion and sediment control measures must be implemented during construction. The following recommendations will be included in the contract documents and communicated to the Contractor.

1. Implement best management practices to provide appropriate protection of the existing and proposed drainage system and the receiving water course(s).
2. Limit the extent of the exposed soils at any given time.
3. Re-vegetate exposed areas as soon as possible.
4. Minimize the area to be cleared and grubbed.
5. Protect exposed slopes with geotextiles, geogrid, or synthetic mulches.
6. Provide sediment traps and basins during dewatering works.
7. Install sediment traps (such as SiltSack® by Terrafix) between catch basins and frames.
8. Schedule the construction works at times which avoid flooding due to seasonal rains.

The Contractor will also be required to complete inspections and guarantee the proper performance of their erosion and sediment control measures at least after every rainfall. The inspections are to include:

- Verification that water is not flowing under silt barriers.
- Cleaning and changing the sediment traps placed on catch basins.

Refer to **Drawing ECDS-1** in **Appendix G** for the proposed location of silt fences, sediment traps, and other erosion control measures.



Geotechnical Investigation
June 15, 2022

10 Geotechnical Investigation

A geotechnical investigation report for 211 Armstrong Street was completed by Kollaard Associates on January 24, 2022. Field testing consisting of the advancement of three (3) boreholes to a maximum depth of 1.72 m below existing grade was carried out throughout the subject site on January 19, 2022. The borehole locations are presented in the geotechnical investigation report included in **Appendix E.1**.

Currently, the subject site has an existing ground surface at an approximate geodetic elevation of 64 m. The subsurface profile encountered at the test hole locations consists of fill to depths of about 0.2 m below the existing ground surface (BGS), glacial till spanning depths from 0.2 to 0.6 m BGS, and there was refusal of augers at the bedrock surface at depths of 1.7, 0.5 and 0.9 m BGS, in boreholes BH1, BH2 and BH3, respectively. The fill material generally consists of grey crushed granular stone and asphaltic concrete. The glacial till was a silty sand with traces of clay, gravel, and cobbles. Considering the available geological mapping, the bedrock in the subject area is reported to consist of limestone of the Bobcaygeon formation.

Groundwater levels were not observed in the boreholes before backfilling; however, groundwater levels are subject to seasonal fluctuations. Given that the native soils on site are frost susceptible, it is recommended that the backfill against insulated walls shall consist of free draining, non-frost susceptible material. In addition, granular fill material should be used as backfill of the service trenches.

According to the geotechnical investigation, the site is considered satisfactory for the proposed development. It is recommended that the foundation be conventional pad and strip footings placed either directly on the underlying bedrock or on engineered fill placed on the underlying bedrock. As bedrock is expected to be encountered during excavation, pre-excavation surveys of neighbouring structures and existing utilities shall be completed to reduce the impact of vibrations from the hoe ramming. A combination of earth cover and extruded polystyrene rigid insulation is recommended for foundation elements that do not have adequate soil cover for protection against frost.

Furthermore, Kollaard also recommends line drilling and controlled blasting for the removal of large quantities of bedrock while for small quantities of bedrock or weathered bedrock, hoe-ramming will be sufficient. For the blasting operation, it is advised that it should be planned and completed under the guidance of a professional engineer with experience in blasting operations.



Conclusions
June 15, 2022

11 Conclusions

11.1 Water Servicing

Based on the supplied boundary conditions for existing watermains and calculated domestic and fire flow demands for the subject site, the adjacent watermain on Armstrong Street has sufficient capacity to sustain both the required domestic demands and emergency fire flow demands for the development. The proposed development requires a 50 mm diameter water service which will be connected to the existing 203 mm watermain on Armstrong Street.

11.2 Sanitary Servicing

The proposed sanitary sewer service will consist of a 150 mm diameter sanitary service lateral, a sanitary sump pit and sump pump directing wastewater to the existing 300 mm diameter sanitary sewer on Armstrong Street. Existing connections are to be removed and full port backwater valves installed on the proposed sanitary service within the site to prevent any surcharge from the downstream sewer main from impacting the proposed property. The proposed sanitary lateral for the property will connect to the sump pumps in the mechanical room to pump out sanitary discharges for the basement level and all floors above grade.

11.3 Stormwater Servicing and Management

A single 100 mm diameter storm service lateral is proposed for the building's foundation drain and roof drain, the full-port backwater valve, which will prevent flooding if the storm sewer on Armstrong Street surcharges. The proposed stormwater lateral for the building will be connected to the sump pumps in the mechanical room to provide storm discharge for drains.

Rooftop storage has been proposed to limit the stormwater discharge rate for all rainfall events up to and including the 100-year event to a peak 2-year predevelopment release rate. The controlled/restricted roof drainage is to discharge through the service lateral downstream of the backwater valve and drain to the existing storm sewer within the Armstrong Street ROW. Due to site grading and servicing restrictions, the remainder of the site will drain uncontrolled as per existing conditions (split yard drainage), with the rear yard draining to the northwest corner and the front yard draining to the Armstrong Street ROW.

11.4 Grading

Site grading has been designed to an emergency overland flow route has been provided. The front yard drains uncontrolled to the Armstrong Street ROW, the existing drainage pattern is maintained in the rear yard and the recommendations made in the geotechnical investigation report prepared by Kollaard Associates have been followed. Erosion and sediment control measures and best management practices



211 ARMSTRONG STREET – STORMWATER MANAGEMENT AND SERVICING REPORT

Conclusions
June 15, 2022

outlined in this report and included in the drawing set, will be implemented during construction to reduce the impact on existing facilities. Insulation will be required along the southeast portions of the foundation wall. Given that the native soils on site are frost susceptible, backfill against insulated walls shall consist of free draining, non-frost susceptible material.

11.5 Utilities

The site is situated within an established residential neighbourhood; hence existing utility infrastructure is readily available to service the proposed development. Overhead lines running through the site will need to be relocated during construction. Overhead lines within the Armstrong Street ROW and along the rear property line will need to be protected and accommodated during construction. Utility infrastructure exists within overhead lines running diagonally through the east and north sides of the property and running parallel to the west side of the property, and subsurface plant within the Armstrong Street ROW. It is anticipated that existing infrastructure will be sufficient to provide a means of distribution for the proposed site. Exact size, location and routing of utilities will be finalized after design circulation.

11.6 Approvals/Restrictions

An MECP Environmental Compliance Approval (ECA) is not required for the site, as the development lies on a private site under singular ownership draining to an approved sewer outlet, it does not drain to a combined sewer, and it is not intended to service industrial land or land uses. Therefore, the site is exempt from the Ministry of the Environment, Conservation and Parks (MECP) Environmental Compliance Application (ECA) process under O.Reg. 525/98.

For the expected dewatering needs of 50,000 to 400,000 L/day, the proponent will need to register on the MECP's Environmental Activity and Sector Registry (EASR). A Permit to Take Water will only be required for dewatering needs in excess of 400,000 L/day which is not expected for this site.



June 15, 2022

APPENDICES

June 15, 2022

Appendix A Potable Water Servicing

A.1 Domestic Water Demand Calculations

211 Armstrong St., Ottawa, ON - Domestic Water Demand Estimates

Site Plan provided by Project 1 Studio (2022-03-16)

Project No. 160401745

Densities as per City Guidelines:		
Apartment Units		
1 Bedroom	1.4	ppu
2 Bedroom	2.1	ppu



Building ID	No. of Units	Population	Daily Rate of Demand ¹ (L/cap/day)	Avg Day Demand		Max Day Demand ²		Peak Hour Demand ²	
				(L/min)	(L/s)	(L/min)	(L/s)	(L/min)	(L/s)
Apartment Units									
1 Bedroom	6	8	280	1.6	0.03	15.5	0.26	221.9	3.70
2 Bedroom	6	13	280	2.5	0.04	23.3	0.39	332.8	5.55
Total Site :	12	21		4.1	0.07	38.8	0.65	554.7	9.25

¹ Average day water demand for residential areas: 280 L/cap/d

² As per Table 3-3 from the MECP Water Design Guidelines, the Water demand criteria used to estimate peak demand rates for residential areas are as follows:

maximum day demand rate = 9.5 x average day demand rate

peak hour demand rate = 14.3 x average day demand rate

June 15, 2022

A.2 Fire Flow Requirements Per OFM Guidelines

Fire Flow Calculations as per Ontario Building Code 2006 (Appendix A)

Job# 160401745
Date 09-May-22

Designed by: MW
Checked by: AG
Description: 3-storey residential

$$Q = KVS_{tot}$$

Q = Volume of water required (L)

V = Total building volume (m³)

K = Water supply coefficient from Table 1

S_{tot} = Total of spatial coefficient values from property line exposures on all sides as obtained from the formula

$$S_{tot} = 1.0 + [S_{side1} + S_{side2} + S_{side3} + S_{side4}]$$

1	Type of construction	Building Classification		Water Supply Coefficient
	combustible without Fire-Resistance Ratings	A-2, B-1, B-2, B-3, C, D		23
2	Area of one floor (m ²)	number of floors	height of ceiling (m)	Total Building Volume (m ³)
	219.72	4	3.0	2,637
3	Side	Exposure Distance (m)	Spatial Coefficient	Total Spatial Coefficient
	North	7.13	0.287	2
	East	1.5	0.5	
	South	3.57	0.5	
	West	1.44	0.5	
4	Established Fire Safety Plan?	Reduction in Volume (%)		Total Volume Reduction
	no	0%		0%
5	Total Volume 'Q' (L)			
				121,302
	Minimum Required Fire Flow (L/min)			
				3,600

Notes:

1. Site Plan and Floor Plans provided by Project 1 Studio dated 2022-03-16.
2. Exposure distance based on on the site plan provided.

June 15, 2022

A.3 Confirmation of Building Construction: Correspondence with Architect

Wu, Michael

From: Ryan Koolwine <koolwine@project1studio.ca>
Sent: Wednesday, 4 May, 2022 06:19
To: Gladish, Alyssa; Jason Hiebert
Cc: jack@liontrade.ca; Wu, Michael
Subject: RE: Confirmation of Building Construction - 211 Armstrong Street

Hi Alyssa,

I think we usually call these buildings Type III, the walls along the interior side yard will be steel stud/ non-combustible with a fire rating. The building will not be sprinklered.

Ryan Koolwine

project1studio | 613 884-3939 x1

From: Gladish, Alyssa <Alyssa.Gladish@stantec.com>
Sent: May 3, 2022 3:42 PM
To: Jason Hiebert <hiebert@project1studio.ca>
Cc: Ryan Koolwine <koolwine@project1studio.ca>; jack@liontrade.ca; Wu, Michael <Michael.Wu@stantec.com>
Subject: Confirmation of Building Construction - 211 Armstrong Street

Good day Jason,

Can you please confirm the following information regarding the building construction and provide any additional details that may be pertinent to the building's fire resistivity (i.e., minimum fire-resistance rating of floors/walls/openings, any intentional fire separations) for 211 Armstrong Street. This will support our OFM and FUS fire flow requirement calculations.

- a. Building classification: **C - Residential Occupancy, 3-Storey + full basement apartment building with 12 units. (6 x 1-bed, 6 x 2-bed).**
- b. Type of construction:
 - i. Type I - Fire Resistive Construction Non-Combustible without Fire-Resistance Ratings
 - ii. Type II - Noncombustible Construction / Type IV-A - Mass Timber Construction
 - iii. Type III - Ordinary Construction / Type IV-C - Mass Timber Construction
 - iv. Type IV-B Mass Timber Construction
 - v. **Type V - Wood Frame / Type IV-D - Mass Timber Construction**
- c. **The building will be sprinklered.**

Thank you for your time.

Best Regards,

Alyssa

Alyssa Gladish E.I.T.
Project Manager, Community Development

Direct: 780 917-8567
Mobile: 587 721-1241
Alyssa.Gladish@stantec.com

Stantec
300-1331 Clyde Avenue
Ottawa ON K2C 3G4



The content of this email is the confidential property of Stantec and should not be copied, modified, retransmitted, or used for any purpose except with Stantec's written authorization. If you are not the intended recipient, please delete all copies and notify us immediately.

June 15, 2022

A.4 Boundary Conditions

Wu, Michael

From: Bakhit, Reza <reza.bakhit@ottawa.ca>
Sent: Wednesday, 11 May, 2022 11:43
To: Wu, Michael
Cc: Gladish, Alyssa; Fawzi, Mohammed
Subject: RE: 211 Armstrong Street Boundary Condition Request
Attachments: 211 Armstrong Street May 2022.pdf

Hi Michael,

The following are boundary conditions, HGL, for hydraulic analysis at 211 Armstrong Street (zone 1W) assumed to be connected to the 203 mm watermain on Armstrong Street (see attached PDF for location).

Minimum HGL: 108.0 m

Maximum HGL: 115.0 m

Max Day + Fire Flow (150 L/s): 106.6 m

These are for current conditions and are based on computer model simulation.

Disclaimer: The boundary condition information is based on current operation of the city water distribution system. The computer model simulation is based on the best information available at the time. The operation of the water distribution system can change on a regular basis, resulting in a variation in boundary conditions. The physical properties of watermains deteriorate over time, as such must be assumed in the absence of actual field test data. The variation in physical watermain properties can therefore alter the results of the computer model simulation.

Regards,

Reza Bakhit, P.Eng, C.E.T

Project Manager

Planning, Real Estate and Economic Development Department / Direction générale de la planification, des biens immobiliers et du développement économique

Development Review - Central Branch

City of Ottawa | Ville d'Ottawa

110 Laurier Avenue West Ottawa, ON | 110, avenue. Laurier Ouest. Ottawa (Ontario) K1P 1J1

613.580.2424 ext./poste 19346, reza.bakhit@ottawa.ca

Please note: Given the current pandemic, I will be working from home until further notice; reaching me by email is the easiest. I will be checking my voicemail, just not as frequently as I normally would be.

From: Wu, Michael <Michael.Wu@stantec.com>
Sent: Monday, May 09, 2022 2:28 PM
To: Bakhit, Reza <reza.bakhit@ottawa.ca>
Cc: Gladish, Alyssa <Alyssa.Gladish@stantec.com>
Subject: RE: 211 Armstrong Street Boundary Condition Request

CAUTION: This email originated from an External Sender. Please do not click links or open attachments unless you recognize the source.

ATTENTION : Ce courriel provient d'un expéditeur externe. Ne cliquez sur aucun lien et n'ouvrez pas de pièce jointe, excepté si vous connaissez l'expéditeur.

Hi Reza, yes, I can confirm that the 2020 FUS guidelines were used for the calculations of the fire flow demand.

Please let me know if you have any additional questions or comments.

Best regards,

Michael Wu, EIT

Civil Engineering Intern, Community Development

Mobile: (613) 858-0548
michael.wu@stantec.com

Stantec
300 - 1331 Clyde Avenue
Ottawa ON K2C 3G4



The content of this email is the confidential property of Stantec and should not be copied, modified, retransmitted, or used for any purpose except with Stantec's written authorization. If you are not the intended recipient, please delete all copies and notify us immediately.

From: Bakhit, Reza <reza.bakhit@ottawa.ca>
Sent: Monday, 9 May, 2022 14:25
To: Wu, Michael <Michael.Wu@stantec.com>
Cc: Gladish, Alyssa <Alyssa.Gladish@stantec.com>
Subject: RE: 211 Armstrong Street Boundary Condition Request

Hi Michael,

Thanks for the note. Can you confirm that the latest FUS update (2020) has been used for your calculations?

Regards,

Reza Bakhit, P.Eng, C.E.T

Project Manager

Planning, Real Estate and Economic Development Department / Direction générale de la planification, des biens immobiliers et du développement économique

Development Review - Central Branch

City of Ottawa | Ville d'Ottawa

110 Laurier Avenue West Ottawa, ON | 110, avenue. Laurier Ouest. Ottawa (Ontario) K1P 1J1

613.580.2424 ext./poste 19346, reza.bakhit@ottawa.ca

Please note: Given the current pandemic, I will be working from home until further notice; reaching me by email is the easiest. I will be checking my voicemail, just not as frequently as I normally would be.

From: Wu, Michael <Michael.Wu@stantec.com>
Sent: Monday, May 09, 2022 11:47 AM
To: Bakhit, Reza <reza.bakhit@ottawa.ca>

Cc: Gladish, Alyssa <Alyssa.Gladish@stantec.com>
Subject: RE: 211 Armstrong Street Boundary Condition Request

CAUTION: This email originated from an External Sender. Please do not click links or open attachments unless you recognize the source.

ATTENTION : Ce courriel provient d'un expéditeur externe. Ne cliquez sur aucun lien et n'ouvrez pas de pièce jointe, excepté si vous connaissez l'expéditeur.

As a quick follow-up, Reza, I would like to note that Mohammed Fawzi is the City Project Manager on the 211 Armstrong Street project, and I was directed to contact you from his automatic email reply.

Please let me know if you have any questions or comments.

Thanks,

Michael Wu, EIT

Civil Engineering Intern, Community Development

Mobile: (613) 858-0548
michael.wu@stantec.com

Stantec
300 - 1331 Clyde Avenue
Ottawa ON K2C 3G4



The content of this email is the confidential property of Stantec and should not be copied, modified, retransmitted, or used for any purpose except with Stantec's written authorization. If you are not the intended recipient, please delete all copies and notify us immediately.

From: Wu, Michael
Sent: Monday, 9 May, 2022 11:32
To: Reza.Bakhit@ottawa.ca
Cc: Gladish, Alyssa <Alyssa.Gladish@stantec.com>
Subject: FW: 211 Armstrong Street Boundary Condition Request

Good morning, Reza:

We would like to request boundary conditions for the proposed three-storey development plus basement on 211 Armstrong Street comprising of 12 apartment units (6 one-bedroom units and 6 two-bedroom units) projected to serve 21 residents.

We intend to service the site via a single connection on Armstrong Street.

Estimated domestic demands based on the MECP guidelines and fire flow requirements for the site are as follows:

- Domestic demands:
 - Average Day Demand: 0.07 L/s (4.1 L/min) (5.904 m³/day)
 - Maximum Day Demand: 0.65 L/s (38.8 L/min)
 - Peak Hour Demand: 9.25 L/s (554.7 L/min)
- Fire Flow Demand per FUS methodology: 150.0 L/s (9000 L/min)
- Fire Flow Demand per OBC methodology: 60.0 L/s (3600 L/min)

Attached are the boundary condition map, draft site plan, and water demand and fire flow calculations for your information.

We appreciate your time looking into this for us, and please do not hesitate to contact me if you have any questions or comments.

Best regards,

Michael Wu, EIT

Civil Engineering Intern, Community Development

Mobile: (613) 858-0548

michael.wu@stantec.com

Stantec

300 - 1331 Clyde Avenue

Ottawa ON K2C 3G4



The content of this email is the confidential property of Stantec and should not be copied, modified, retransmitted, or used for any purpose except with Stantec's written authorization. If you are not the intended recipient, please delete all copies and notify us immediately.

This e-mail originates from the City of Ottawa e-mail system. Any distribution, use or copying of this e-mail or the information it contains by other than the intended recipient(s) is unauthorized. Thank you.

Le présent courriel a été expédié par le système de courriels de la Ville d'Ottawa. Toute distribution, utilisation ou reproduction du courriel ou des renseignements qui s'y trouvent par une personne autre que son destinataire prévu est interdite. Je vous remercie de votre collaboration.

This e-mail originates from the City of Ottawa e-mail system. Any distribution, use or copying of this e-mail or the information it contains by other than the intended recipient(s) is unauthorized. Thank you.

Le présent courriel a été expédié par le système de courriels de la Ville d'Ottawa. Toute distribution, utilisation ou reproduction du courriel ou des renseignements qui s'y trouvent par une personne autre que son destinataire prévu est interdite. Je vous remercie de votre collaboration.

June 15, 2022

A.5 Hydraulic Conditions Calculations



Project:	211 Armstrong Street	No.	160401745
SITE PLAN HYDRAULIC ANALYSIS			
Revision:	01	Prepared By:	MW
Revision Date:	24-May-2022	Checked By:	AG

BOUNDARY CONDITIONS (BC)	
Connection at Armstrong Street	
Site Plan Revision Date	16-Mar-2022
Min. HGL (m)	108
Max. HGL (m)	115
Max. Day + Fire Flow (150 L/s)	106.6

Ground Floor Elevation (GFE) (Level 01) (m)	65.18
---	-------

GROUND FLOOR (GF) PRESSURE RANGE				
	GF HGL (m)	GF Pressure (kPa)	GF Pressure (psi)	Outcome
	= BC HGL (m) - FFE (m)	= GF HGL (m) x 9.804 (kPa/m)	= GF Pressure (kPa) x 0.145 (psi/kPa)	If min <50 psi: booster pump If max >100 psi: pressure reducer
Minimum Normal	42.82	419.8	60.9	No Booster Pump Required
Maximum Normal	49.82	488.4	70.8	No Pressure Reducer Required

Number of Floors Above Ground	3
Approximate Height of One Storey (m)	3
Pressure Drop Per Floor (kPa)	29.4
Pressure Drop Per Floor (psi)	4.3

RESIDUAL PRESSURE RANGE IN MULTI-LEVEL BUILDINGS			
	Residual Pressure (kPa)	Residual Pressure (psi)	Outcome
Top Floor Min	361.0	52.3	No Booster Pump Required
Top Floor Max	429.6	62.3	
Maximum Number of Floors Above Ground at Minimum Pressure	4		

RESIDUAL PRESSURE FROM FIRE FLOW			
	Residual HGL (m)	Residual Pressure (kPa)	Residual Pressure (psi)
Ground Floor	41.42	406.1	58.9
Top Floor	35.42	347.3	50.4

Pressure Check		
	Pressure (kPa)	Pressure (psi)
Pressure Below Minimum	<276	<40
Pressure Below Normal	276-345	40-50
Pressure Within Normal Range	345-552	50-80
Pressure Above Normal Range	552-690	80-100
Pressure Above Maximum	>690	>100

June 15, 2022

**Appendix B Draft Site Plan and Roof Plan by Project1
Studio Inc. 18-May-2022**

SURVEYOR'S REAL PROPERTY REPORT
WITH TOPOGRAPHICAL DETAILS
PART 1 - PLAN SHOWING
LOT 24
REGISTERED PLAN 99
CITY OF OTTAWA
J.D. BARNES LIMITED, 2022

SURVEY INFO
SCALE: N.T.S.

SITE PLAN SYMBOLS LEGEND

- BUILDING ENTRANCE
- BUILDING EXIT
- FIRE HYDRANT
- NEW STREET LIGHT
- STREET LIGHT TO BE REMOVED
- BICYCLE PARKING



1 LOCATION PLAN
SP-01 SCALE: 1:1

SYMBOLS LEGEND
SCALE: N.T.S.

- GENERAL ARCHITECTURAL NOTES:
- This drawing is the property of the Architect and may not be reproduced or used without the expressed consent of the Architect.
 - Drawings are not to be scaled. The Contractor is responsible for checking and verifying all levels and dimensions and shall report all discrepancies to the Architect and obtain clarification prior to commencing work.
 - Upon notice in writing, the Architect will provide written/verbal clarification or supplementary information regarding the intent of the Contract Documents.
 - The Architectural Drawings are to be read in conjunction with all other Contract Documents including Project Manuals and the Structural, Mechanical and Electrical Drawings.
 - Positions of exposed or finished Mechanical or Electrical devices, fittings and fixtures are indicated on the Architectural Drawings. Locations shown on the Architectural Drawings shall govern over Mechanical and Electrical Drawings. Mechanical and Electrical items not clearly located will be located as directed by the Architect.
 - These documents are not to be used for construction unless specifically noted for such purpose.

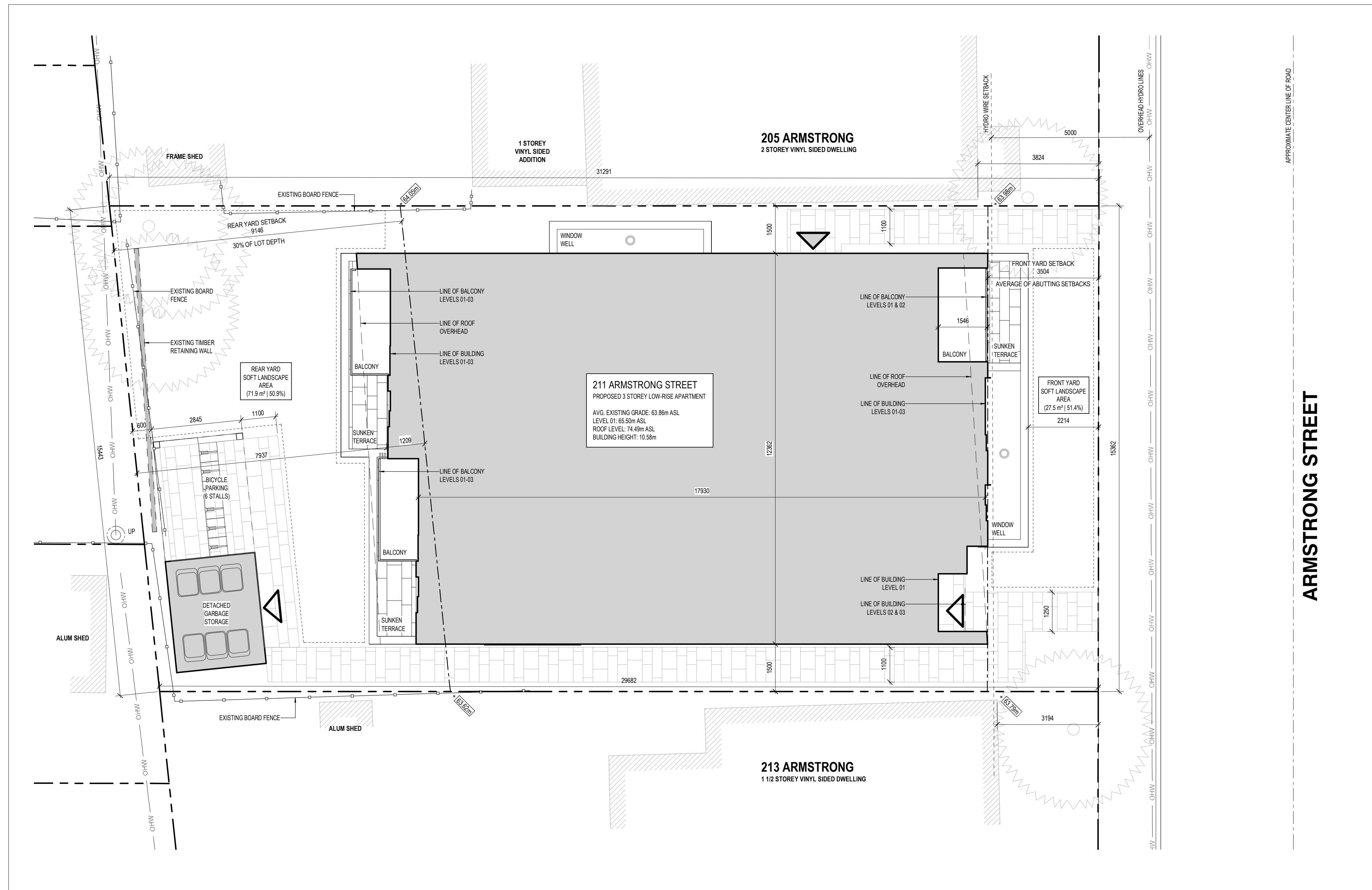

SITE STATISTICS

ZONING MECHANISM [R4-U6]	REQUIRED	PROVIDED
MIN. LOT WIDTH 162(a)	15m	15.262m
MIN. LOT AREA 162(a)	450m ²	468.3m ²
MIN. FRONT YARD SETBACK 144(V)(a)	The front yard setback must align with the average of the setbacks of the existing buildings on the abutting lots.	3.004m
MIN. INTERIOR SIDE YARD SETBACK Table 162A	1.5m	1.5m
MIN. REAR YARD SETBACK Table 144A(iii)	30% of the lot depth (29.682m x 31.231m / 2 = 9.146m)	9.146m
MAX. BUILDING HEIGHT Table 162A	11m	10.79m
PARKING SPACE RATES 161(16)(a)	No motor vehicle parking is permitted on a lot less than 450m ²	0 Spaces
MIN. VISITOR PARKING RATES 161(16)(a)	No motor vehicle parking is permitted on a lot less than 450m ²	0 Spaces
BICYCLE PARKING RATES Table 111A(b)(i)	0.5 per dwelling unit (0.5 x 12 units = 6 spaces)	6 Spaces
SOFT LANDSCAPING 161(15)(b)(ii)	50% of the rear yard area must be softly landscaped.	71.9m ² / 141.24m ² = 50.9%
FRONT YARD SOFT LANDSCAPING Table 161	40% of the front yard area must be softly landscaped.	27.5m ² / 55.53m ² = 51.4%
MIN. 2-BEDROOM UNIT RATES 161(16)(b)(ii)	25% of dwelling units must have at least two bedrooms. (12 units x 25% = 3 two bedroom units)	50% (6 Units)
MIN. GLAZING RATES 161(20)(g)	The front facade must comprise at least 25% windows.	Complies
FAÇADE ARTICULATION / BALCONIES 161(20)(h)	No additional recession of the front facade is required when balconies are provided for every unit facing a public street on the front facade.	Complies
AMENITY AREA Table 137	6m ² per dwelling unit (6m ² x 12 units = 72m ²)	
COMMUNAL AMENITY AREA Table 137	A minimum of 50% of the required total amenity area. (70m ² x 50% = 35m ²)	

ZONING
SCALE: N.T.S.

UNIT BREAKDOWN

FLOOR	1 BEDROOM	1 BED + DEN	2 BEDROOM	TOTAL
LEVEL 00	2		1	3
LEVEL 01	2		1	3
LEVEL 02	1		2	3
LEVEL 03	1		2	3
TOTAL	6	0	6	12

BUILDING EFFICIENCY

FLOOR	BUILDING AREA	RENTABLE AREA	EFFICIENCY
LEVEL 00	2,365 sqft	1,850 sqft	78%
LEVEL 01	2,365 sqft	1,850 sqft	78%
LEVEL 02	2,395 sqft	2,000 sqft	84%
LEVEL 03	2,395 sqft	2,000 sqft	84%
TOTAL	9,520 sqft	7,700 sqft	81%

- 4 ISSUED FOR COORDINATION 22-05-18
- 3 ISSUED FOR COORDINATION 22-05-13
- 2 ISSUED FOR COORDINATION 22-04-29
- 1 ISSUED FOR COORDINATION 22-03-16

ISSUE RECORD

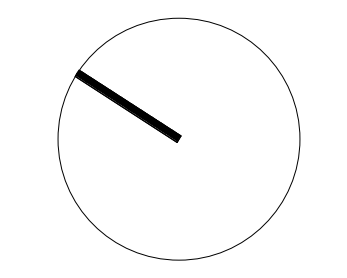

project1 studio

Project1 Studio Incorporated
[613.884.3939 | mail@project1studio.ca]

211 ARMSTRONG
211 Armstrong Street
Ottawa ON
K1Y 2W3

PROJ SCALE DRAWN REVIEWED
2203 NOTED JDH RMK

SITE PLAN

SP-01

2 SITE PLAN
SP-01 SCALE: 1:75

GENERAL ARCHITECTURAL NOTES:

1. This drawing is the property of the Architect and may not be reproduced or used without the expressed consent of the Architect.
2. Drawings are not to be scaled. The Contractor is responsible for checking and verifying all levels and dimensions and shall report all discrepancies to the Architect and obtain clarification prior to commencing work.
3. Upon notice in writing, the Architect will provide written graphic clarification or supplementary information regarding the intent of the Contract Documents.
4. The Architectural drawings are to be read in conjunction with all other Contract Documents including Project Manuals and the Structural, Mechanical and Electrical Drawings.
5. Positions of exposed or finished Mechanical or Electrical devices, fittings and fixtures are indicated on the Architectural Drawings. Locations shown on the Architectural Drawings shall govern over Mechanical and Electrical Drawings. Mechanical and Electrical items not clearly located will be located as directed by the Architect.
6. These documents are not to be used for construction unless specifically noted for such purpose.

4	ISSUED FOR COORDINATION	22-05-30
3	ISSUED FOR COORDINATION	22-05-18
2	ISSUED FOR COORDINATION	22-05-13
1	ISSUED FOR COORDINATION	22-04-29

ISSUE RECORD

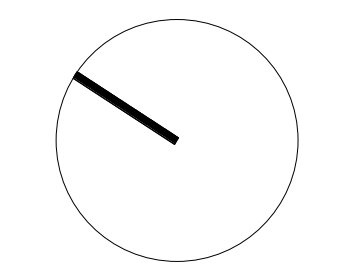

project1 studio

Project1 Studio Incorporated
613.884.9339 | mail@project1studio.ca

211 ARMSTRONG
211 Armstrong Street
Ottawa ON
K1Y 2W3

PROJ	SCALE	DRAWN	REVIEWED
2203	NOTED	JDH	RMK

ROOF PLAN

A105

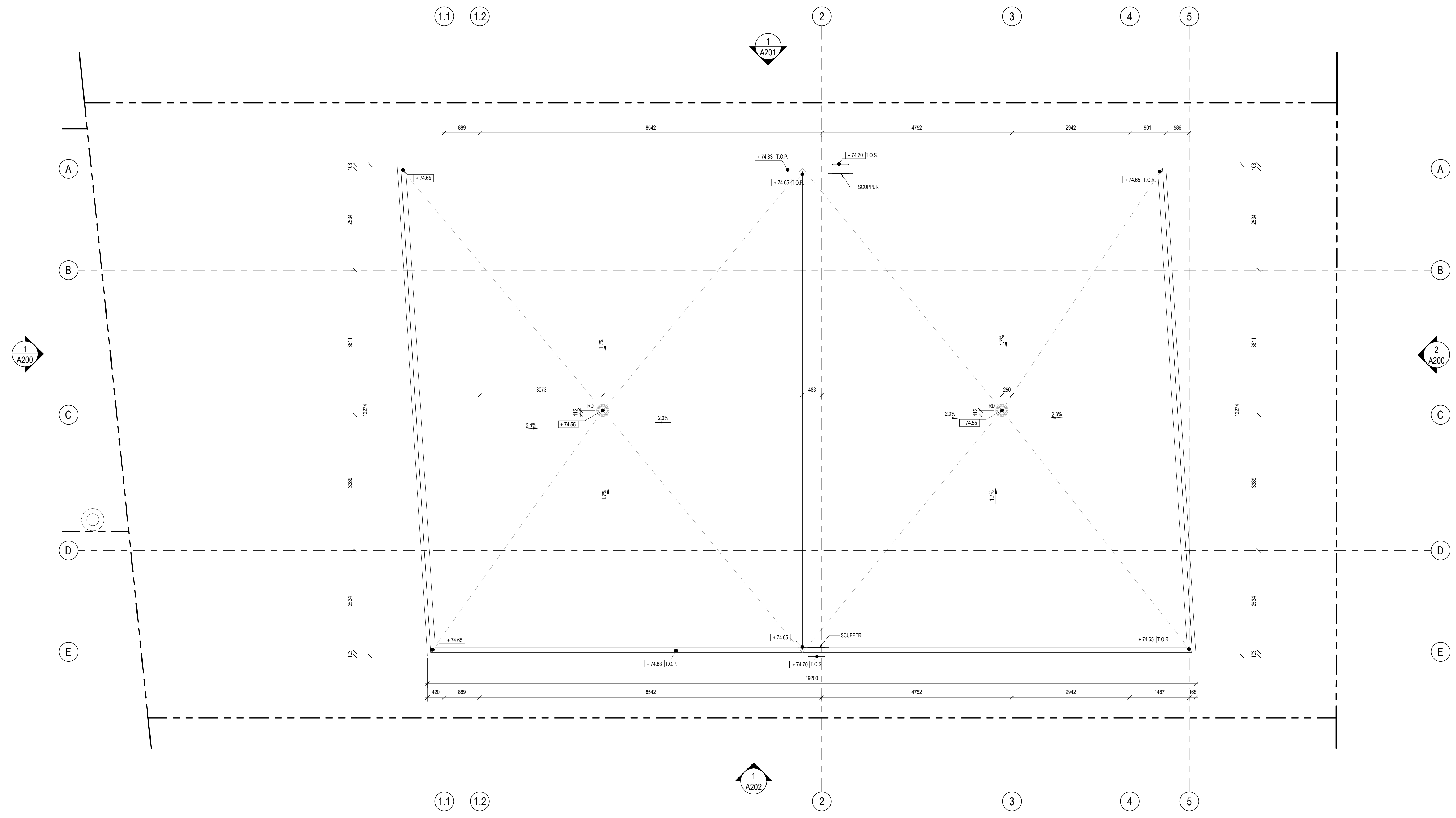

1 ROOF PLAN
A105 SCALE: 1:50

June 15, 2022

Appendix C Wastewater Servicing

C.1 Sanitary Sewer Calculation Sheet



SUBDIVISION:
211 Armstrong Street
 DATE: 2022-05-24
 REVISION: 1
 DESIGNED BY: MW
 CHECKED BY: -

**SANITARY SEWER
 DESIGN SHEET
 (City of Ottawa)**

FILE NUMBER: 160401745

DESIGN PARAMETERS			
MAX PEAK FACTOR (RES.)=	4.0	AVG. DAILY FLOW / PERSON	280 l/p/day
MIN PEAK FACTOR (RES.)=	2.0	COMMERCIAL	28,000 l/ha/day
PEAKING FACTOR (INDUSTRIAL):	2.4	INDUSTRIAL (HEAVY)	55,000 l/ha/day
PEAKING FACTOR (ICI >20%):	1.5	INDUSTRIAL (LIGHT)	35,000 l/ha/day
PERSONS / ONE BEDROOM	1.4	INSTITUTIONAL	28,000 l/ha/day
PERSONS / 2 BEDROOM	2.1	INFILTRATION	0.33 l/s/ha
PERSONS / 3 BEDROOM	3.1		
MINIMUM VELOCITY	0.60 m/s		
MAXIMUM VELOCITY	3.00 m/s		
MANNINGS n	0.013		
BEDDING CLASS	B		
MINIMUM COVER	2.50 m		
HARMON CORRECTION FACTOR	0.8		

LOCATION			RESIDENTIAL AREA AND POPULATION								COMMERCIAL		INDUSTRIAL (L)		INDUSTRIAL (H)		INSTITUTIONAL		GREEN / UNUSED		C+H	INFILTRATION			TOTAL	PIPE												
AREA ID NUMBER	FROM M.H.	TO M.H.	AREA (ha)	1 BED	2 BED	3 BED	POP.	CUMULATIVE AREA (ha)	POP.	PEAK FACT.	PEAK FLOW (l/s)	AREA (ha)	ACCU. AREA (ha)	AREA (ha)	ACCU. AREA (ha)	AREA (ha)	ACCU. AREA (ha)	AREA (ha)	ACCU. AREA (ha)	AREA (ha)	ACCU. AREA (ha)	PEAK FLOW (l/s)	TOTAL AREA (ha)	ACCU. AREA (ha)	INFILT. FLOW (l/s)	FLOW (l/s)	LENGTH (m)	DIA (mm)	MATERIAL	CLASS	SLOPE (%)	CAP. (FULL) (l/s)	CAP. V PEAK FLOW (%)	VEL. (FULL) (m/s)	VEL. (ACT.) (m/s)			
PROPOSED DEVELOPMENT	BLDG	EX. SAN	0.023	6	6		21	0.023	21	3.502	0.238	0.000	0.000	0.000	0.000	0.000	0.000	0.000	0.000	0.000	0.000	0.000	0.023	0.023	0.000	0.023	0.023	0.008	0.246	178.505	150	PVC	SDR 35	1.00	15.3	1.60%	0.86	0.27

June 15, 2022

C.2 Confirmation of Sanitary Sewer Capacity

Wu, Michael

From: Bakhit, Reza <reza.bakhit@ottawa.ca>
Sent: Thursday, 26 May, 2022 13:09
To: Wu, Michael
Cc: Gladish, Alyssa; Fawzi, Mohammed
Subject: RE: Follow up on 211 Armstrong Street Sanitary Sewer Capacity

Hi Michael,

No capacity concern at this location at the moment. Please note that this is a 2-year system.

Regards,

Reza Bakhit, P.Eng, C.E.T

Project Manager

Planning, Real Estate and Economic Development Department / Direction générale de la planification, des biens immobiliers et du développement économique

Development Review - Central Branch

City of Ottawa | Ville d'Ottawa

110 Laurier Avenue West Ottawa, ON | 110, avenue. Laurier Ouest. Ottawa (Ontario) K1P 1J1

613.580.2424 ext./poste 19346, reza.bakhit@ottawa.ca

Please note: Given the current pandemic, I will be working from home until further notice; reaching me by email is the easiest. I will be checking my voicemail, just not as frequently as I normally would be.

From: Wu, Michael <Michael.Wu@stantec.com>
Sent: Thursday, May 26, 2022 11:52 AM
To: Bakhit, Reza <reza.bakhit@ottawa.ca>
Cc: Gladish, Alyssa <Alyssa.Gladish@stantec.com>; Fawzi, Mohammed <mohammed.fawzi@ottawa.ca>
Subject: RE: Follow up on 211 Armstrong Street Sanitary Sewer Capacity

CAUTION: This email originated from an External Sender. Please do not click links or open attachments unless you recognize the source.

ATTENTION : Ce courriel provient d'un expéditeur externe. Ne cliquez sur aucun lien et n'ouvrez pas de pièce jointe, excepté si vous connaissez l'expéditeur.

Hi Reza:

No worries. Please let me know when you have the confirmation of the capacity.

Thanks,

Michael Wu, EIT

Civil Engineering Intern, Community Development

Mobile: (613) 858-0548

michael.wu@stantec.com

Stantec

300 - 1331 Clyde Avenue

Ottawa ON K2C 3G4



The content of this email is the confidential property of Stantec and should not be copied, modified, retransmitted, or used for any purpose except with Stantec's written authorization. If you are not the intended recipient, please delete all copies and notify us immediately.

From: Bakhit, Reza <reza.bakhit@ottawa.ca>
Sent: Thursday, 26 May, 2022 08:49
To: Wu, Michael <Michael.Wu@stantec.com>
Cc: Gladish, Alyssa <Alyssa.Gladish@stantec.com>; Fawzi, Mohammed <mohammed.fawzi@ottawa.ca>
Subject: RE: Follow up on 211 Armstrong Street Sanitary Sewer Capacity

Hi Michael,

Sorry for delay, I will get back to you soon.

Thanks,

Reza Bakhit, P.Eng, C.E.T

Project Manager

Planning, Real Estate and Economic Development Department / Direction générale de la planification, des biens immobiliers et du développement économique

Development Review - Central Branch

City of Ottawa | Ville d'Ottawa

110 Laurier Avenue West Ottawa, ON | 110, avenue. Laurier Ouest. Ottawa (Ontario) K1P 1J1

613.580.2424 ext./poste 19346, reza.bakhit@ottawa.ca

Please note: Given the current pandemic, I will be working from home until further notice; reaching me by email is the easiest. I will be checking my voicemail, just not as frequently as I normally would be.

From: Wu, Michael <Michael.Wu@stantec.com>
Sent: Tuesday, May 24, 2022 10:19 AM
To: Bakhit, Reza <reza.bakhit@ottawa.ca>
Cc: Gladish, Alyssa <Alyssa.Gladish@stantec.com>; Fawzi, Mohammed <mohammed.fawzi@ottawa.ca>
Subject: Follow up on 211 Armstrong Street Sanitary Sewer Capacity

CAUTION: This email originated from an External Sender. Please do not click links or open attachments unless you recognize the source.

ATTENTION : Ce courriel provient d'un expéditeur externe. Ne cliquez sur aucun lien et n'ouvrez pas de pièce jointe, excepté si vous connaissez l'expéditeur.

Good morning, Reza:

Hope you are doing well. I am writing to follow up on the request for confirmation on the capacity of the downstream sanitary sewers on Armstrong Street and Parkdale Avenue.

Is there anything else you need from me or is there a timeline on when we can expect the confirmation?

Best regards,

Michael Wu, EIT

Civil Engineering Intern, Community Development

Mobile: (613) 858-0548
michael.wu@stantec.com

Stantec
300 - 1331 Clyde Avenue
Ottawa ON K2C 3G4



The content of this email is the confidential property of Stantec and should not be copied, modified, retransmitted, or used for any purpose except with Stantec's written authorization. If you are not the intended recipient, please delete all copies and notify us immediately.

'

This e-mail originates from the City of Ottawa e-mail system. Any distribution, use or copying of this e-mail or the information it contains by other than the intended recipient(s) is unauthorized. Thank you.

Le présent courriel a été expédié par le système de courriels de la Ville d'Ottawa. Toute distribution, utilisation ou reproduction du courriel ou des renseignements qui s'y trouvent par une personne autre que son destinataire prévu est interdite. Je vous remercie de votre collaboration.

'

This e-mail originates from the City of Ottawa e-mail system. Any distribution, use or copying of this e-mail or the information it contains by other than the intended recipient(s) is unauthorized. Thank you.

Le présent courriel a été expédié par le système de courriels de la Ville d'Ottawa. Toute distribution, utilisation ou reproduction du courriel ou des renseignements qui s'y trouvent par une personne autre que son destinataire prévu est interdite. Je vous remercie de votre collaboration.

June 15, 2022

Appendix D Stormwater Servicing

D.1 Modified Rational Method Sheet

Stormwater Management Calculations

File No: **160401745**
 Project: **211 Armstrong Street**
 Date: **09-Jun-22**

SWM Approach:
 Post-development to Pre-development flows

Post-Development Site Conditions:

Overall Runoff Coefficient for Site and Sub-Catchment Areas

Runoff Coefficient Table								
Catchment Type	Sub-catchment Area	ID / Description		Area (ha) "A"	Runoff Coefficient "C"		"A x C"	Overall Runoff Coefficient
					Hard	Soft		
Uncontrolled - Non-Tributary	NORTH		Hard	0.006	0.9	0.006	0.00728	0.520
			Soft	0.008	0.2	0.002		
			Subtotal		0.014			
Uncontrolled - Non-Tributary	SOUTH		Hard	0.004	0.9	0.003	0.0045	0.500
			Soft	0.005	0.2	0.001		
			Subtotal		0.009			
Roof	BLDG		Hard	0.024	0.9	0.022	0.0216	0.900
			Soft	0.000	0.2	0.000		
			Subtotal		0.024			
Total				0.047		0.033		
Overall Runoff Coefficient= C:								0.71

	Total Roof Areas	0.024 ha
Total Tributary Surface Areas (Controlled and Uncontrolled)	0.000 ha	
Total Tributary Area to Outlet	0.024 ha	
Total Uncontrolled Areas (Non-Tributary)	0.023 ha	
Total Site	0.047 ha	

Roof Drain Design Calculation Sheet

**Project #160401745, 211 Armstrong Street
Roof Drain Design Sheet, Area BLDG
Standard Watts Roof Drain with Adjustable Accutrol Weir**

Rating Curve				Volume Estimation				Water Depth (m)
Elevation (m)	Discharge Rate (cu.m/s)	Outlet Discharge (cu.m/s)	Storage (cu. m)	Elevation (m)	Area (sq. m)	Volume (cu. m)		
						Increment	Accumulated	
0.000	0.000000	0.0000	0.00	0.000	0	0.00	0.00	0.000
0.025	0.000315	0.0006	0.17	0.025	18	0.17	0.17	0.025
0.050	0.000316	0.0006	1.12	0.050	63	0.95	1.12	0.050
0.075	0.000317	0.0006	3.53	0.075	135	2.41	3.53	0.075
0.100	0.000318	0.0006	8.08	0.100	234	4.55	8.08	0.100
0.125	0.000319	0.0006	13.95	0.125	236	5.87	13.95	0.125
0.150	0.000320	0.0006	19.86	0.150	237	5.91	19.86	0.150

Drawdown Estimate			
Total Volume (cu.m)	Total Time (sec)	Vol (cu.m)	Detention Time (hr)
0.0	0.0	0.0	0
1.0	1501.3	1.0	0.41702
3.4	3796.5	2.4	1.47159
7.9	7145.1	4.6	3.45634
13.8	9189.1	5.9	6.00887
19.7	9222.8	5.9	8.57077

Roof Storage Summary

Total Building Area (sq.m)	240	
Assume Available Roof Area (sq.m)	80%	192
Roof Imperviousness		0.99
Roof Drain Requirement (sq.m/Notch)		232
Number of Roof Notches*		2
Max. Allowable Depth of Roof Ponding (m)	0.15	* As per Ontario Building Code section OBC 7.4.10.4.(2)(c).
Max. Allowable Storage (cu.m)		20
Estimated 100 Year Drawdown Time (h)		5.0

Adjustable Accutrol Weir Flow Rate Settings From Watts Drain Catalogue					
Head (m)	L/s				
	Open	75%	50%	25%	Closed
0.025	0.3154	0.3154	0.3154	0.3154	0.3154
0.05	0.6308	0.6308	0.6308	0.6308	0.3164
0.075	0.9462	0.8674	0.7885	0.7097	0.3174
0.1	1.2617	1.104	0.9462	0.7885	0.3184
0.125	1.5771	1.3405	1.104	0.8674	0.3194
0.15	1.8925	1.5771	1.2617	0.9462	0.3204

* Note: Number of drains can be reduced if multiple-notch drain used.

Calculation Results	2yr	100yr	Available
Qresult (cu.m/s)	0.001	0.001	-
Depth (m)	0.072	0.114	0.150
Volume (cu.m)	3.2	11.4	19.9
Drain time (hrs)	1.4	5.0	

Stormwater Management Calculations

Project #160401745, 211 Armstrong Street Modified Rational Method Calculators for Storage

2 yr Intensity City of Ottawa	$I = a/(t + b)^c$	a =	732.951	t (min)	I (mm/hr)
		b =	6.199	10	76.81
		c =	0.81	20	52.03
				30	40.04
			40	32.86	
			50	28.04	
			60	24.56	
			70	21.91	
			80	19.83	
			90	18.14	
			100	16.75	
			110	15.57	
			120	14.56	

2 YEAR Predevelopment Target Release from Portion of Site

Subdrainage Area: Predevelopment Tributary Area to Outlet
 Area (ha): 0.0470
 C: 0.43

Typical Time of Concentration

tc (min)	I (2 yr) (mm/hr)	Qtarget (L/s)
10	76.81	4.32

2 YEAR Modified Rational Method for Entire Site

Subdrainage Area: NORTH Uncontrolled - Non-Tributary
 Area (ha): 0.01
 C: 0.52

tc (min)	I (5 yr) (mm/hr)	Qactual (L/s)	Qrelease (L/s)	Qstored (L/s)	Vstored (m³)
10	76.81	1.55	1.55		
20	52.03	1.05	1.05		
30	40.04	0.81	0.81		
40	32.86	0.67	0.67		
50	28.04	0.57	0.57		
60	24.56	0.50	0.50		
70	21.91	0.44	0.44		
80	19.83	0.40	0.40		
90	18.14	0.37	0.37		
100	16.75	0.34	0.34		
110	15.57	0.32	0.32		
120	14.56	0.29	0.29		

Subdrainage Area: SOUTH Uncontrolled - Non-Tributary
 Area (ha): 0.01
 C: 0.50

tc (min)	I (5 yr) (mm/hr)	Qactual (L/s)	Qrelease (L/s)	Qstored (L/s)	Vstored (m³)
10	76.81	0.96	0.96		
20	52.03	0.65	0.65		
30	40.04	0.50	0.50		
40	32.86	0.41	0.41		
50	28.04	0.35	0.35		
60	24.56	0.31	0.31		
70	21.91	0.27	0.27		
80	19.83	0.25	0.25		
90	18.14	0.23	0.23		
100	16.75	0.21	0.21		
110	15.57	0.19	0.19		
120	14.56	0.18	0.18		

Subdrainage Area: BLDG Roof Maximum Storage Depth: 150 mm
 Area (ha): 0.02
 C: 0.90

tc (min)	I (5 yr) (mm/hr)	Qactual (L/s)	Qrelease (L/s)	Qstored (L/s)	Vstored (m³)	Depth (mm)
10	76.81	4.61	0.63	3.98	2.39	63.2
20	52.03	3.12	0.63	2.49	2.99	69.4
30	40.04	2.40	0.63	1.77	3.19	71.5
40	32.86	1.97	0.63	1.34	3.22	71.8
50	28.04	1.68	0.63	1.05	3.16	71.2
60	24.56	1.47	0.63	0.84	3.04	69.9
70	21.91	1.32	0.63	0.68	2.88	68.2
80	19.83	1.19	0.63	0.56	2.69	66.3
90	18.14	1.09	0.63	0.46	2.48	64.1
100	16.75	1.01	0.63	0.37	2.25	61.7
110	15.57	0.93	0.63	0.30	2.01	59.2
120	14.56	0.87	0.63	0.24	1.75	56.6

Storage: Roof Storage

Depth (mm)	Head (m)	Discharge (L/s)	Vreq (cu. m)	Vavail (cu. m)
71.81	0.07	0.63	3.22	19.86

SUMMARY TO OUTLET

	Vrequired	Vavailable*	
Tributary Area	0.024 ha		
Total 2yr Flow to Sewer	0.63 L/s	3.22	19.860 m³
Non-Tributary Area	0.023 ha		
Total 2yr Flow Uncontrolled	2.52 L/s		
Total Area	0.047 ha		
Total 2yr Flow Target	3.15 L/s		
Target	4.32 L/s		

Project #160401745, 211 Armstrong Street Modified Rational Method Calculators for Storage

100 yr Intensity City of Ottawa	$I = a/(t + b)^c$	a =	1735.688	t (min)	I (mm/hr)
		b =	6.014	10	178.56
		c =	0.820	20	119.95
				30	91.87
			40	75.15	
			50	63.95	
			60	55.89	
			70	49.79	
			80	44.99	
			90	41.11	
			100	37.90	
			110	35.20	
			120	32.89	

100 YEAR Predevelopment Target Release from Portion of Site

Subdrainage Area: Predevelopment Tributary Area to Outlet
 Area (ha): 0.0470
 C: 0.43

Estimated Time of Concentration after Development

tc (min)	I (100 yr) (mm/hr)	Q100yr (L/s)
10	178.56	10.03

100 YEAR Modified Rational Method for Entire Site

Subdrainage Area: NORTH Uncontrolled - Non-Tributary
 Area (ha): 0.01
 C: 0.65

tc (min)	I (100 yr) (mm/hr)	Qactual (L/s)	Qrelease (L/s)	Qstored (L/s)	Vstored (m³)
10	178.56	4.52	4.52		
20	119.95	3.03	3.03		
30	91.87	2.32	2.32		
40	75.15	1.90	1.90		
50	63.95	1.62	1.62		
60	55.89	1.41	1.41		
70	49.79	1.26	1.26		
80	44.99	1.14	1.14		
90	41.11	1.04	1.04		
100	37.90	0.96	0.96		
110	35.20	0.89	0.89		
120	32.89	0.83	0.83		

Subdrainage Area: SOUTH Uncontrolled - Non-Tributary
 Area (ha): 0.01
 C: 0.63

tc (min)	I (100 yr) (mm/hr)	Qactual (L/s)	Qrelease (L/s)	Qstored (L/s)	Vstored (m³)
10	178.56	2.79	2.79		
20	119.95	1.88	1.88		
30	91.87	1.44	1.44		
40	75.15	1.18	1.18		
50	63.95	1.00	1.00		
60	55.89	0.87	0.87		
70	49.79	0.78	0.78		
80	44.99	0.70	0.70		
90	41.11	0.64	0.64		
100	37.90	0.59	0.59		
110	35.20	0.55	0.55		
120	32.89	0.51	0.51		

Subdrainage Area: BLDG Roof Maximum Storage Depth: 150 mm
 Area (ha): 0.02
 C: 1.00

tc (min)	I (100 yr) (mm/hr)	Qactual (L/s)	Qrelease (L/s)	Qstored (L/s)	Vstored (m³)	Depth (mm)
10	178.56	11.91	0.64	11.28	6.77	92.8
20	119.95	8.00	0.64	7.37	8.84	103.2
30	91.87	6.13	0.64	5.49	9.89	107.7
40	75.15	5.01	0.64	4.38	10.50	110.3
50	63.95	4.27	0.64	3.63	10.89	112.0
60	55.89	3.73	0.64	3.09	11.13	113.0
70	49.79	3.32	0.64	2.68	11.28	113.6
80	44.99	3.00	0.64	2.36	11.35	113.9
90	41.11	2.74	0.64	2.11	11.37	114.0
100	37.90	2.53	0.64	1.89	11.35	113.9
110	35.20	2.35	0.64	1.71	11.30	113.7
120	32.89	2.19	0.64	1.56	11.21	113.4

Storage: Roof Storage

Depth (mm)	Head (m)	Discharge (L/s)	Vreq (cu. m)	Vavail (cu. m)
114.02	0.11	0.64	11.37	19.86

SUMMARY TO OUTLET

	Vrequired	Vavailable*	
Tributary Area	0.024 ha		
Total 100yr Flow to Sewer	0.64 L/s	11.37	19.86 m³
Non-Tributary Area	0.023 ha		
Total 100yr Flow Uncontrolled	7.31 L/s		
Total Area	0.047 ha		
Total 100yr Flow Target	7.95 L/s		
Target	4.32 L/s		

June 15, 2022

D.2 Watts Drainage Adjustable Accutrol Weir Detail (2016)



Adjustable Accutrol Weir

Tag: _____

Adjustable Flow Control for Roof Drains

ADJUSTABLE ACCUTROL (for Large Sump Roof Drains only)

For more flexibility in controlling flow with heads deeper than 2", Watts Drainage offers the Adjustable Accutrol. The Adjustable Accutrol Weir is designed with a single parabolic opening that can be covered to restrict flow above 2" of head to less than 5 gpm per inch, up to 6" of head. To adjust the flow rate for depths over 2" of head, set the slot in the adjustable upper cone according to the flow rate required. Refer to Table 1 below.
 Note: Flow rates are directly proportional to the amount of weir opening that is exposed.

EXAMPLE:

For example, if the adjustable upper cone is set to cover 1/2 of the weir opening, flow rates above 2" of head will be restricted to 2-1/2 gpm per inch of head.

Therefore, at 3" of head, the flow rate through the Accutrol Weir that has 1/2 the slot exposed will be:
 [5 gpm (per inch of head) x 2 inches of head] + 2-1/2 gpm (for the third inch of head) = 12-1/2 gpm.

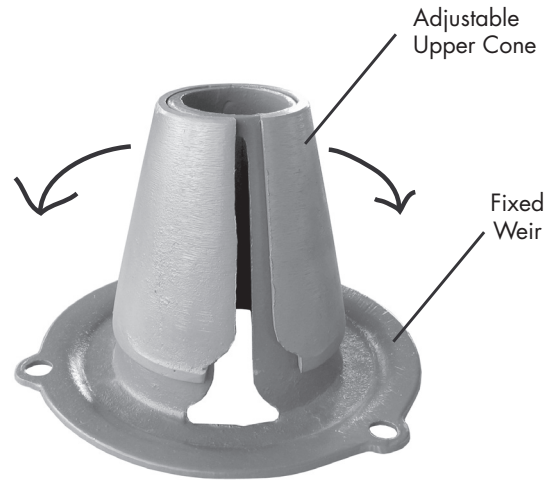
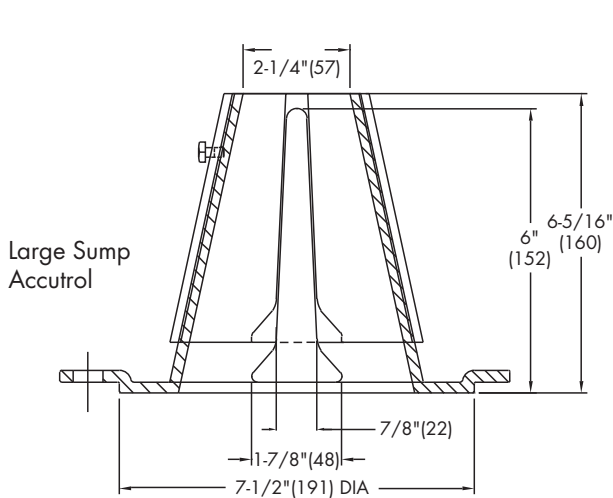

1/2 Weir Opening Exposed Shown Above

TABLE 1. Adjustable Accutrol Flow Rate Settings

Weir Opening Exposed	1"	2"	3"	4"	5"	6"
	Flow Rate (gallons per minute)					
Fully Exposed	5	10	15	20	25	30
3/4	5	10	13.75	17.5	21.25	25
1/2	5	10	12.5	15	17.5	20
1/4	5	10	11.25	12.5	13.75	15
Closed	5	5	5	5	5	5

Job Name _____
 Job Location _____
 Engineer _____

Contractor _____
 Contractor's P.O. No. _____
 Representative _____

Watts product specifications in U.S. customary units and metric are approximate and are provided for reference only. For precise measurements, please contact Watts Technical Service. Watts reserves the right to change or modify product design, construction, specifications, or materials without prior notice and without incurring any obligation to make such changes and modifications on Watts products previously or subsequently sold.

USA: Tel: (800) 338-2581 • Fax: (828) 248-3929 • Watts.com
 Canada: Tel: (905) 332-4090 • Fax: (905) 332-7068 • Watts.ca
 Latin America: Tel: (52) 81-1001-8600 • Fax: (52) 81-8000-7091 • Watts.com



A Watts Water Technologies Company

211 ARMSTRONG STREET – STORMWATER MANAGEMENT AND SERVICING REPORT

June 15, 2022

D.3 Storm Sewer Design Sheet



211 ARMSTRONG STREET

**STORM SEWER
DESIGN SHEET
(City of Ottawa)**

DESIGN PARAMETERS

$I = a / (t+b)^c$ (As per City of Ottawa Guidelines, 2012)

a =	732.951	998.071	1174.184	1735.688	MANNING'S n =	0.013	BEDDING CLASS =	B
b =	6.199	6.053	6.014	6.014	MINIMUM COVER:	2.00	m	
c =	0.810	0.814	0.816	0.820	TIME OF ENTRY	10	min	

FILE NUMBER: 160401745

DATE: 2022-06-10
REVISION: 1
DESIGNED BY: MW
CHECKED BY: AG

LOCATION			DRAINAGE AREA																	PIPE SELECTION																				
AREA ID NUMBER	FROM M.H.	TO M.H.	AREA (2-YEAR) (ha)	AREA (5-YEAR) (ha)	AREA (10-YEAR) (ha)	AREA (100-YEAR) (ha)	AREA (ROOF) (ha)	C (2-YEAR) (-)	C (5-YEAR) (-)	C (10-YEAR) (-)	C (100-YEAR) (-)	A x C (2-YEAR) (ha)	ACCUM AxC (2YR) (ha)	A x C (5-YEAR) (ha)	ACCUM AxC (5YR) (ha)	A x C (10-YEAR) (ha)	ACCUM AxC (10YR) (ha)	A x C (100-YEAR) (ha)	ACCUM AxC (100YR) (ha)	T of C (min)	I ₂ -YEAR (mm/h)	I ₅ -YEAR (mm/h)	I ₁₀ -YEAR (mm/h)	I ₁₀₀ -YEAR (mm/h)	Q _{CONTROL} (L/s)	ACCUM. Q _{CONTROL} (L/s)	Q _{ACT} (CIA/360) (L/s)	LENGTH (m)	PIPE WIDTH OR DIAMETER (mm)	PIPE HEIGHT (mm)	PIPE SHAPE (-)	MATERIAL (-)	CLASS (-)	SLOPE (%)	Q _{CAP} (FULL) (L/s)	% FULL (-)	VEL. (FULL) (m/s)	VEL. (ACT) (m/s)	TIME OF FLOW (min)	
SITE	STUB	EXIST.	0.05	0.000	0.00	0.047	0.024	0.90	0.00	0.00	1.13	0.04	0.04	0.00	0.00	0.00	0.00	0.00	0.05	0.05	10.00	76.81	104.19	122.14	178.56	0.630	0.63	0.630	11.2	100	100	CIRCULAR	PVC	-	1.00	5.3	11.90%	0.66	0.37	0.51

June 15, 2022

D.4 Correspondence with the RVCA

Wu, Michael

From: Eric Lalande <eric.lalande@rvca.ca>
Sent: Thursday, 19 May, 2022 11:34
To: Wu, Michael
Cc: Gladish, Alyssa
Subject: RE: 211 Armstrong Street Stormwater quality control criteria request

Hi Michael,

Based on the site plan, the RVCA has no on-site quality control requirements. Best management practices are encouraged where possible. Sorry for the delay.

Thanks,

Eric Lalande, MCIP, RPP
Planner, RVCA
613-692-3571 x1137

From: Wu, Michael <Michael.Wu@stantec.com>
Sent: Thursday, May 12, 2022 5:06 PM
To: Eric Lalande <eric.lalande@rvca.ca>
Cc: Gladish, Alyssa <Alyssa.Gladish@stantec.com>
Subject: 211 Armstrong Street Stormwater quality control criteria request

Good afternoon, Eric.

I hope you are doing well.

I am writing to request stormwater quality control criteria for a proposed re-development on 211 Armstrong Street in the City of Ottawa.

Below is a list of some key site information:

1. The existing building will be replaced by a 3-storey plus 1 basement building to be serviced through the existing services on Armstrong Street.
2. There is an existing 375 mm diameter PVC storm sewer fronting the site on Armstrong Street.
3. There is no onsite parking at the proposed development.
4. Stormwater quantity control for the site is anticipated to be provided via rooftop storage and the remaining site uncontrolled towards the right of way.
5. The City of Ottawa has indicated that the allowable stormwater release rate is to be calculated using:
 - a. Allowable Runoff Coefficient (C): 0.5
 - b. Allowable flowrate: Control the 100-year storm events to the 5-year predevelopment storm event.

Attached is the storm drainage plan and a site map for your information.

Thank you in advance for your time and assistance. Please let me know if you require any additional information from our end.

Regards,

Michael Wu, EIT

Civil Engineering Intern, Community Development

Mobile: (613) 858-0548

michael.wu@stantec.com

Stantec

300 - 1331 Clyde Avenue

Ottawa ON K2C 3G4



The content of this email is the confidential property of Stantec and should not be copied, modified, retransmitted, or used for any purpose except with Stantec's written authorization. If you are not the intended recipient, please delete all copies and notify us immediately.

June 15, 2022

D.5 Correspondence with the City of Ottawa on Stormwater Sewer Capacity

Wu, Michael

From: Gladish, Alyssa
Sent: Tuesday, 7 June, 2022 11:20
To: Fawzi, Mohammed
Cc: Wu, Michael
Subject: RE: Follow up on 211 Armstrong Street Sanitary Sewer Capacity

Hello Mohammed,

Good to have you back, I hope you had a great vacation.

We really appreciated Reza helping to keep this project moving along. Thank you. We will remove him from future correspondences.

Thank you for the helpful feedback, I will pass it on to the design team. I agree with promoting infiltration at the property line, this is something we would be happy to revisit during detailed design.

Sincerely,
Alyssa

Alyssa Gladish E.I.T.
Project Manager, Community Development

Direct: 780 917-8567
Mobile: 587 721-1241
Alyssa.Gladish@stantec.com

Stantec
300-1331 Clyde Avenue
Ottawa ON K2C 3G4



The content of this email is the confidential property of Stantec and should not be copied, modified, retransmitted, or used for any purpose except with Stantec's written authorization. If you are not the intended recipient, please delete all copies and notify us immediately.

From: Fawzi, Mohammed <mohammed.fawzi@ottawa.ca>
Sent: Tuesday, June 7, 2022 8:55 AM
To: Gladish, Alyssa <Alyssa.Gladish@stantec.com>
Cc: Wu, Michael <Michael.Wu@stantec.com>; Bakhit, Reza <reza.bakhit@ottawa.ca>
Subject: RE: Follow up on 211 Armstrong Street Sanitary Sewer Capacity

Hi Alyssa,

Thank you for bringing this up prior to submission.

Reza (cc'd) has been covering for me while I was on vacation and now that I am back, moving forward please remove Reza from any email correspondences.

Based on the reduction of water going to the rear yard, I don't see an issue with the proposal. The building footprint takes up a majority of the lot and is connected to the mainline sewer. The only

thing I may request is possibly some clear stone near the property line to help with any infiltration – but we can look into that further during detailed design.

Hope this helps. Thanks Alyssa.

Best Regards,

Mohammed Fawzi, P.Eng.

Project Manager

Planning, Infrastructure and Economic Development Department - Services de la planification, de l'infrastructure et du développement économique

Development Review - Central Branch

City of Ottawa | Ville d'Ottawa

110 Laurier Avenue West Ottawa, ON | 110, avenue. Laurier Ouest. Ottawa (Ontario) K1P 1J1

613.580.2424 ext./poste 20120, Mohammed.Fawzi@ottawa.ca

****Please note that due to the current situation, I am working remotely. Email is currently the best way to contact me****

From: Gladish, Alyssa <Alyssa.Gladish@stantec.com>

Sent: June 01, 2022 10:40 AM

To: Bakhit, Reza <reza.bakhit@ottawa.ca>

Cc: Fawzi, Mohammed <mohammed.fawzi@ottawa.ca>; Wu, Michael <Michael.Wu@stantec.com>

Subject: RE: Follow up on 211 Armstrong Street Sanitary Sewer Capacity

CAUTION: This email originated from an External Sender. Please do not click links or open attachments unless you recognize the source.

ATTENTION : Ce courriel provient d'un expéditeur externe. Ne cliquez sur aucun lien et n'ouvrez pas de pièce jointe, excepté si vous connaissez l'expéditeur.

Hello Reza,

Thank you for confirming this is a 2-year system.

I appreciate that we are permitted to control the roof portion only and leave the rest of the site uncontrolled.

We are having difficulty getting the rest of the site to drain towards the ROW. I have attached the existing conditions storm drainage plan. As you can see under existing conditions, most of the site drains toward the left rear of the site, and into the adjacent lot to the northwest.

We explored the option of a storage pipe or conveyance pipe along the left (west) side yard. There simply is not enough room between the proposed foundation wall and the foundation wall of the adjacent dwelling to provide adequate clearance to a pipe without undermining the existing neighbour's foundation. On the right (east) side yard, the adjacent building is situated almost on top of the property line, so there is even less room to accommodate a pipe on this side.

In the right rear corner of the lot are three large trees (T6, T7 and T8) that we are trying to retain (all other trees on the site will need to be removed to accommodate the excavation and foundation. These trees will require noteworthy trimming to provide clearance to the proposed building and will have a portion of their CRZ's disturbed to accommodate the foundation excavation. These disturbances can't be avoided for the proposed development. To retain these trees and minimize disturbance to them, we have proposed minimal grade changes in the rear yard, and to direct the rear-yard

drainage per existing conditions. To get this area to drain south to the ROW would require significant disturbance within the CRZ's of these three trees, including a retaining wall at the rear property line and grade changes would exceed 0.3m, which would likely result in the necessary removal of the trees.

We have attached the proposed stormwater drainage plan for your review. With rooftop control and the proposed grading, this will represent a significant reduction in the runoff that is directed into the adjacent property (213 Armstrong Street). See Table 1 below for the reductions to the adjacent lot. We are requesting that the proposed NORTH sub-catchment be permitted to drain per existing conditions to retain these three large trees. Table 2 shows the overall release rates from the site.

Table 1: Comparison of Pre- to Post-Development Release to 213 Armstrong (Adjacent property)

	2-Year Peak Discharge @ C=0.34				100-Year Peak Discharge @ C=0.34			
	Pre-Dev.	Post-Dev.	Difference		Pre-Dev.	Post-Dev.	Difference	
	(L/s)	(L/s)	(L/s)	%	(L/s)	(L/s)	(L/s)	%
Uncontrolled – Surface (NORTH)	2.61	1.55	-1.06	-40.6	12.51	4.52	-7.99	-63.9

Table 2: Comparison of Pre- to Post-Development Release Rates for Overall Site 211 Armstrong Street

	2-Year Peak Discharge @ C=0.43				100-Year Peak Discharge @ C=0.43			
	Pre-Dev.	Post-Dev.	Difference		Pre-Dev.	Post-Dev.	Difference	
	(L/s)	(L/s)	(L/s)	%	(L/s)	(L/s)	(L/s)	%
Uncontrolled – Surface	4.32	2.52	-1.8	-	12.51	7.31	-5.2	-
Controlled – Rooftop Storage	-	0.63	0.63	-	-	0.63	0.63	-
Total	4.32	3.15	-1.17	-27.1%	12.51	7.94	-4.57	-36.5%
Release Rate Target (2-year)	Target is achieved		-	-	Target is exceeded		+3.62 L/s	

I appreciate your feedback on this matter.

Best,
Alyssa

Alyssa Gladish E.I.T.
Project Manager, Community Development

Direct: 780 917-8567
Mobile: 587 721-1241
Alyssa.Gladish@stantec.com

Stantec
300-1331 Clyde Avenue
Ottawa ON K2C 3G4



The content of this email is the confidential property of Stantec and should not be copied, modified, retransmitted, or used for any purpose except with Stantec's written authorization. If you are not the intended recipient, please delete all copies and notify us immediately.

From: Bakhit, Reza <reza.bakhit@ottawa.ca>
Sent: Monday, May 30, 2022 9:25 AM
To: Gladish, Alyssa <Alyssa.Gladish@stantec.com>; Wu, Michael <Michael.Wu@stantec.com>
Cc: Fawzi, Mohammed <mohammed.fawzi@ottawa.ca>
Subject: RE: Follow up on 211 Armstrong Street Sanitary Sewer Capacity

Hi Alysa,

The AMB confirmed that this is a two year system and not 5 years. However, you can control the roof portion only and leave the rest of the site uncontrolled as long as the uncontrolled portion of the site drains towards the ROW.

Thank,

Reza Bakhit, P.Eng, C.E.T

Project Manager

Planning, Real Estate and Economic Development Department / Direction générale de la planification, des biens immobiliers et du développement économique

Development Review - Central Branch

City of Ottawa | Ville d'Ottawa

110 Laurier Avenue West Ottawa, ON | 110, avenue. Laurier Ouest. Ottawa (Ontario) K1P 1J1

613.580.2424 ext./poste 19346, reza.bakhit@ottawa.ca

Please note: Given the current pandemic, I will be working from home until further notice; reaching me by email is the easiest. I will be checking my voicemail, just not as frequently as I normally would be.

From: Gladish, Alyssa <Alyssa.Gladish@stantec.com>

Sent: Monday, May 30, 2022 9:12 AM

To: Bakhit, Reza <reza.bakhit@ottawa.ca>; Wu, Michael <Michael.Wu@stantec.com>

Cc: Fawzi, Mohammed <mohammed.fawzi@ottawa.ca>

Subject: RE: Follow up on 211 Armstrong Street Sanitary Sewer Capacity

CAUTION: This email originated from an External Sender. Please do not click links or open attachments unless you recognize the source.

ATTENTION : Ce courriel provient d'un expéditeur externe. Ne cliquez sur aucun lien et n'ouvrez pas de pièce jointe, excepté si vous connaissez l'expéditeur.

Good morning Reza,

Thank you for confirming that there is adequate capacity for the proposed sanitary generation from this site.

Regarding your note that this is a 2-year system, I take it this was for the stormwater system. It was our understanding from the pre-consultation notes that the stormwater management was to be controlled to the 1:5-year storm and the sewers on Armstrong Street are separated sewers. Please confirm why this has changed. Is there a stormwater capacity issue in this area?

Thank you,

Alyssa

Alyssa Gladish E.I.T.

Project Manager, Community Development

Direct: 780 917-8567

Mobile: 587 721-1241

Alyssa.Gladish@stantec.com

Stantec

300-1331 Clyde Avenue

Ottawa ON K2C 3G4

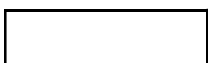

From: Bakhit, Reza <reza.bakhit@ottawa.ca>
Sent: Thursday, May 26, 2022 1:09 PM
To: Wu, Michael <Michael.Wu@stantec.com>
Cc: Gladish, Alyssa <Alyssa.Gladish@stantec.com>; Fawzi, Mohammed <mohammed.fawzi@ottawa.ca>
Subject: RE: Follow up on 211 Armstrong Street Sanitary Sewer Capacity

Hi Michael,

No capacity concern at this location at the moment. Please note that this is a 2-year system.

Regards,

Reza Bakhit, P.Eng, C.E.T

Project Manager

Planning, Real Estate and Economic Development Department / Direction générale de la planification, des biens immobiliers et du développement économique

Development Review - Central Branch

City of Ottawa | Ville d'Ottawa

110 Laurier Avenue West Ottawa, ON | 110, avenue. Laurier Ouest. Ottawa (Ontario) K1P 1J1

613.580.2424 ext./poste 19346, reza.bakhit@ottawa.ca

Please note: Given the current pandemic, I will be working from home until further notice; reaching me by email is the easiest. I will be checking my voicemail, just not as frequently as I normally would be.

From: Wu, Michael <Michael.Wu@stantec.com>
Sent: Thursday, May 26, 2022 11:52 AM
To: Bakhit, Reza <reza.bakhit@ottawa.ca>
Cc: Gladish, Alyssa <Alyssa.Gladish@stantec.com>; Fawzi, Mohammed <mohammed.fawzi@ottawa.ca>
Subject: RE: Follow up on 211 Armstrong Street Sanitary Sewer Capacity

CAUTION: This email originated from an External Sender. Please do not click links or open attachments unless you recognize the source.

ATTENTION : Ce courriel provient d'un expéditeur externe. Ne cliquez sur aucun lien et n'ouvrez pas de pièce jointe, excepté si vous connaissez l'expéditeur.

Hi Reza:

No worries. Please let me know when you have the confirmation of the capacity.

Thanks,

Michael Wu, EIT

Civil Engineering Intern, Community Development

Mobile: (613) 858-0548

michael.wu@stantec.com

Stantec

300 - 1331 Clyde Avenue

Ottawa ON K2C 3G4



The content of this email is the confidential property of Stantec and should not be copied, modified, retransmitted, or used for any purpose except with Stantec's written authorization. If you are not the intended recipient, please delete all copies and notify us immediately.

From: Bakhit, Reza <reza.bakhit@ottawa.ca>
Sent: Thursday, 26 May, 2022 08:49
To: Wu, Michael <Michael.Wu@stantec.com>
Cc: Gladish, Alyssa <Alyssa.Gladish@stantec.com>; Fawzi, Mohammed <mohammed.fawzi@ottawa.ca>
Subject: RE: Follow up on 211 Armstrong Street Sanitary Sewer Capacity

Hi Michael,

Sorry for delay, I will get back to you soon.

Thanks,

Reza Bakhit, P.Eng, C.E.T

Project Manager

Planning, Real Estate and Economic Development Department / Direction générale de la planification, des biens immobiliers et du développement économique

Development Review - Central Branch

City of Ottawa | Ville d'Ottawa

110 Laurier Avenue West Ottawa, ON | 110, avenue. Laurier Ouest. Ottawa (Ontario) K1P 1J1

613.580.2424 ext./poste 19346, reza.bakhit@ottawa.ca

Please note: Given the current pandemic, I will be working from home until further notice; reaching me by email is the easiest. I will be checking my voicemail, just not as frequently as I normally would be.

From: Wu, Michael <Michael.Wu@stantec.com>
Sent: Tuesday, May 24, 2022 10:19 AM
To: Bakhit, Reza <reza.bakhit@ottawa.ca>
Cc: Gladish, Alyssa <Alyssa.Gladish@stantec.com>; Fawzi, Mohammed <mohammed.fawzi@ottawa.ca>
Subject: Follow up on 211 Armstrong Street Sanitary Sewer Capacity

CAUTION: This email originated from an External Sender. Please do not click links or open attachments unless you recognize the source.

ATTENTION : Ce courriel provient d'un expéditeur externe. Ne cliquez sur aucun lien et n'ouvrez pas de pièce jointe, excepté si vous connaissez l'expéditeur.

Good morning, Reza:

Hope you are doing well. I am writing to follow up on the request for confirmation on the capacity of the downstream sanitary sewers on Armstrong Street and Parkdale Avenue.

Is there anything else you need from me or is there a timeline on when we can expect the confirmation?

Best regards,

Michael Wu, EIT

Civil Engineering Intern, Community Development

Mobile: (613) 858-0548
michael.wu@stantec.com

Stantec
300 - 1331 Clyde Avenue
Ottawa ON K2C 3G4



The content of this email is the confidential property of Stantec and should not be copied, modified, retransmitted, or used for any purpose except with Stantec's written authorization. If you are not the intended recipient, please delete all copies and notify us immediately.

,

This e-mail originates from the City of Ottawa e-mail system. Any distribution, use or copying of this e-mail or the information it contains by other than the intended recipient(s) is unauthorized. Thank you.

Le présent courriel a été expédié par le système de courriels de la Ville d'Ottawa. Toute distribution, utilisation ou reproduction du courriel ou des renseignements qui s'y trouvent par une personne autre que son destinataire prévu est interdite. Je vous remercie de votre collaboration.

,

,

This e-mail originates from the City of Ottawa e-mail system. Any distribution, use or copying of this e-mail or the information it contains by other than the intended recipient(s) is unauthorized. Thank you.

Le présent courriel a été expédié par le système de courriels de la Ville d'Ottawa. Toute distribution, utilisation ou reproduction du courriel ou des renseignements qui s'y trouvent par une personne autre que son destinataire prévu est interdite. Je vous remercie de votre collaboration.

,

,

This e-mail originates from the City of Ottawa e-mail system. Any distribution, use or copying of this e-mail or the information it contains by other than the intended recipient(s) is unauthorized. Thank you.

Le présent courriel a été expédié par le système de courriels de la Ville d'Ottawa. Toute distribution, utilisation ou reproduction du courriel ou des renseignements qui s'y trouvent par une personne autre que son destinataire prévu est interdite. Je vous remercie de votre collaboration.

,

,

This e-mail originates from the City of Ottawa e-mail system. Any distribution, use or copying of this e-mail or the information it contains by other than the intended recipient(s) is unauthorized. Thank you.

Le présent courriel a été expédié par le système de courriels de la Ville d'Ottawa. Toute distribution, utilisation ou reproduction du courriel ou des renseignements qui s'y trouvent par une personne autre que son destinataire prévu est interdite. Je vous remercie de votre collaboration.

,

June 15, 2022

Appendix E Background Studies

E.1 Geotechnical Investigation by Kollaard Associated (January 24, 2022)



Kollaard Associates
Engineers

210 Prescott Street, Unit 1
P.O. Box 189
Kemptville, Ontario K0G 1J0

Civil • Geotechnical •
Structural • Environmental •
Hydrogeology

(613) 860-0923

FAX: (613) 258-0475

REPORT ON

**GEOTECHNICAL INVESTIGATION
PROPOSED RESIDENTIAL DEVELOPMENT
211 ARMSTRONG STREET
CITY OF OTTAWA, ONTARIO**

Project # 211169

Submitted to:

Lion Trade Ltd.
4-91 Prince Albert Street
Ottawa, Ontario
K1K 2A2

DISTRIBUTION

4 copies City of Ottawa
2 copies Lion Trade Ltd.
1 copy Kollaard Associates Inc.

January 24, 2022



Professional Engineers
Ontario

Authorized by the Association of Professional Engineers
of Ontario to offer professional engineering services.



TABLE OF CONTENTS

1.0	INTRODUCTION	1
2.0	BACKGROUND INFORMATION AND SITE GEOLOGY	1
2.1	EXISTING CONDITIONS AND SITE GEOLOGY	1
2.2	PROPOSED DEVELOPMENT	2
3.0	PROCEDURE	2
4.0	SUBSURFACE CONDITIONS	3
4.1	GENERAL	3
4.2	TOPSOIL	4
4.3	FILL.....	4
4.4	GLACIAL TILL	4
4.4	BEDROCK	5
4.5	GROUNDWATER	5
4.6	CORROSIVITY ON REINFORCEMENT AND SULPHATE ATTACK ON PORTLAND CEMENT	5
5.0	GEOTECHNICAL GUIDELINES AND RECOMMENDATIONS	6
5.1	GENERAL	6
5.2	FOUNDATION FOR PROPOSED RESIDENTIAL BUILDING.....	7
5.2.1	FOUNDATION EXCAVATION.....	7
5.3	FOUNDATION DESIGN AND BEARING CAPACITY	7
5.4	ENGINEERED FILL.....	8
5.4.2	EFFECT OF FOUNDATION EXCAVATION ON ADJACENT STRUCTURES AND CITY OF OTTAWA SERVICES	9
5.4.3	GROUND WATER IN EXCAVATION AND CONSTRUCTION DEWATERING.....	9
5.4.4	EFFECT OF DEWATERING OF FOUNDATION OR SITE SERVICES EXCAVATIONS ON ADJACENT STRUCTURES.....	9
5.5	FROST PROTECTION REQUIREMENTS FOR SPREAD FOOTING FOUNDATIONS.....	9
5.6	FOUNDATION WALL BACKFILL AND DRAINAGE	10
5.7	BASEMENT FLOOR SLAB.....	11
5.8	SEISMIC DESIGN FOR THE PROPOSED RESIDENTIAL BUILDING	13
5.8.1	SEISMIC SITE CLASSIFICATION.....	13
5.9	NATIONAL BUILDING CODE SEISMIC HAZARD CALCULATION.....	13
5.9.1	POTENTIAL FOR SOIL LIQUEFACTION	13
6.0	SITE SERVICES.....	13
6.1	EXCAVATION.....	13
6.2	PIPE BEDDING AND COVER MATERIALS.....	14
6.3	TRENCH BACKFILL	15
7.0	TREES	15
8.0	CONSTRUCTION CONSIDERATIONS.....	16



RECORD OF BOREHOLE LOG SHEETS

List of Abbreviations

LIST OF FIGURES

FIGURE 1 - KEY PLAN

FIGURE 2 - SITE PLAN

LIST OF ATTACHMENTS

ATTACHMENT A - Laboratory Test Results for Physical Properties

ATTACHMENT B - National Building Code Seismic Hazard Calculation



January 24, 2022

211169

Lion Trade Ltd.
4-91 Prince Albert Street
Ottawa, Ontario
K1K 2A2

RE: GEOTECHNICAL INVESTIGATION
PROPOSED RESIDENTIAL DEVELOPMENT
211 ARMSTRONG STREET
CITY OF OTTAWA, ONTARIO

1.0 INTRODUCTION

This report presents the results of a geotechnical investigation carried out for the above noted proposed residential development at 211 Armstrong Street, City of Ottawa, Ontario (See Key Plan, Figure 1).

The purpose of the investigation was to:

- Identify the subsurface conditions at the site by means of a limited number of boreholes;
- Based on the factual information obtained, provide recommendations and guidelines on the geotechnical engineering aspects of the project design; including bearing capacity and other construction considerations, which could influence design decisions.

2.0 BACKGROUND INFORMATION AND SITE GEOLOGY

2.1 Existing Conditions and Site Geology

The subject site for this assessment consists of about a 0.05 hectare (0.12 acres) rectangular shaped property located at 211 Armstrong Street, City of Ottawa, Ontario (see Key Plan, Figure 1).





For the purposes of this assessment, project north lies in a direction perpendicular to Armstrong Street, which is located immediately south of the site. The site is currently occupied by a single-family dwelling, which is to be demolished prior to construction.

Surrounding land use is residential development. The site is bordered on the west, north and east by residential development and to the south by Armstrong Street followed by residential developments.

The ground surface at the site is currently graded such that surface water drains from the southwest to the northeast, away from Armstrong Street.

Based on a review of the surficial geology map for the site area, it is expected that the site is underlain by shallow bedrock. Bedrock geology maps indicate that the bedrock underlying the site consists of limestone with shaley partings of the Ottawa formation.

Based on a review of available borehole information, the overburden at and near the site likely consists of some 0 to 2 metres of glacial till followed by limestone bedrock.

2.2 Proposed Development

It is understood that preliminary plans are being prepared for the construction of a, 3.5-storey, multi-unit residential building. There is no proposed parking at the site. It is understood that the building will be wood framed with some brick veneer and cast-in-place concrete construction with conventional concrete spread footing foundations and a concrete slab-on-grade ground floor. The proposed building will be serviced by municipal water and sanitary services.

Surface drainage for the proposed building will be by means of swales, nearby catch basins and storm sewers.

3.0 PROCEDURE

The field work for this investigation was carried out on January 19, 2021, at which time three boreholes, numbered BH1 to BH3 were put down at the site using a truck mounted drill rig equipped



with a hollow stem auger owned and operated by CCC Geotechnical & Environmental Drilling of Ottawa, Ontario. The boreholes were put down in the driveway of the existing dwelling.

The subsurface soil conditions encountered at the boreholes were classified based on visual and tactile examination of the samples recovered (ASTM D2488 - Standard Practice for Description and Identification of Soils (Visual-Manual Procedure), standard penetration tests (ASTM D-1586) as well as laboratory test results on select samples. Groundwater conditions at the boreholes were noted at the time of drilling and at a later date. The boreholes were loosely backfilled with the auger cuttings upon completion of drilling.

Sampling of the overburden materials encountered at the borehole location was carried out at regular 0.75 metre depth intervals using a 50 millimetre diameter drive open conventional split spoon sampler in conjunction with standard penetration testing. All of the boreholes were put down to bedrock at the site. The soils were classified using the Unified Soil Classification System.

One soil sample (BH1 – SS2 – 0.8 – 1.4 m) was delivered to a chemical laboratory for testing for any indication of potential soil sulphate attack on concrete and corrosivity to buried steel.

The field work was supervised throughout by members of our engineering staff who located the boreholes in the field, logged the boreholes and cared for the samples obtained. A description of the subsurface conditions encountered at the boreholes is given in the attached Record of Borehole Sheets. The results of the laboratory testing of the soil samples are presented in the Laboratory Test Results section and Attachment A following the text in this report. The approximate locations of the boreholes are shown on the attached Site Plan, Figure 2.

4.0 SUBSURFACE CONDITIONS

4.1 General

As previously indicated, a description of the subsurface conditions encountered at the boreholes is provided in the attached Record of Borehole Sheets following the text of this report. The borehole logs indicate the subsurface conditions at the specific drill locations only. Boundaries between zones on the logs are often not distinct, but rather are transitional and have been interpreted.



Subsurface conditions at locations other than borehole locations may vary from the conditions encountered at the boreholes.

Classification and identification of soil involves judgement and Kollaard Associates Inc. does not guarantee descriptions as exact, but infers accuracy to the extent that is common in current geotechnical practice.

The groundwater conditions described in this report refer only to those observed at the location and on the date the observations were noted in the report and on the borehole logs. Groundwater conditions may vary seasonally, or may be affected by construction activities on or in the vicinity of the site.

The following is a brief overview of the subsurface conditions encountered at the boreholes.

4.2 Topsoil

From the surface, a layer of topsoil measuring about 0.6 metres in thickness was encountered in borehole BH1. The material was classified as topsoil based on the colour and the presence of organic materials. The identification of the topsoil layer is for geotechnical purposes only and does not constitute a statement as to the suitability of this layer for cultivation and sustainable plant growth.

4.3 Fill

Fill materials consisting of asphaltic concrete and grey crushed granular stone were encountered in boreholes BH2 and BH3. The fill materials were encountered from the surface to depths of about 0.2 metres. The fill materials were fully penetrated at both borehole locations.

4.4 Glacial Till

Glacial till was encountered beneath the topsoil in BH1 and beneath the fill materials in boreholes BH2 and BH3, at depths between about 0.2 to 0.6 metres below the existing ground surface. The glacial till consisted of grey brown silty sand, with traces of clay, gravel and cobbles. The results of the standard penetration testing carried out in the glacial till material range from 15 to 22 blows per



0.3 metres, indicating a compact state of packing. The glacial till was fully penetrated in all boreholes where encountered.

4.4 Bedrock

Beneath the glacial till material, boreholes BH1, BH2 and BH3 encountered limestone bedrock at depths of about 1.7, 0.5 and 0.9 metres, respectively, below the existing ground surface. Refusal at the bedrock surface was encountered in all boreholes.

4.5 Groundwater

All boreholes were observed to be dry at time of drilling. It should be noted that the groundwater levels may be higher during wet periods of the year such as the early spring.

4.6 Corrosivity on Reinforcement and Sulphate Attack on Portland Cement

The results of the laboratory testing of a soil sample for submitted for chemistry testing related to corrosivity is summarized in the following table.

Item	Threshold of Concern	Test Result	Comment
Chlorides (Cl)	Cl > 0.04 %	0.00771	Negligible concern
pH	5.5 > pH	7.70	Basic Negligible concern
Resistivity	R < 20,000 ohm-cm	8380	Moderately Corrosive
Sulphates (SO ₄)	SO ₄ > 0.1%	0.0031	Negligible concern

The results of the laboratory testing of a soil sample for sulphate gave a percent sulphate of 0.0031. The National Research Council of Canada (NRC) recognizes four categories of potential sulphate attack of buried concrete based on percent sulphate in soil. From 0 to 0.10 percent the potential is negligible, from 0.10 to 0.20 percent the potential is mild but positive, from 0.20 to 0.50 percent the potential is considerable and 0.50 percent and greater the potential is severe. Based on the above, the soils are considered to have a negligible potential for sulphate attack on buried concrete materials and accordingly, conventional GU or MS Portland cement may be used in the construction of the proposed concrete elements.

The pH value for the soil sample was reported to be at 7.70, indicating a durable condition against corrosion. This value was evaluated using Table 2 of Building Research Establishment (BRE) Digest



362 (July 1991). The pH is greater than 5.5 indicating the concrete will not be exposed to attack from acids.

The chloride content of the sample was also compared with the threshold level and presents negligible concrete corrosion potential.

Corrosivity Rating for soils ranges from extremely corrosive to non-corrosive as follows:

Soil Resistivity (ohm-cm)	Corrosivity Rating
> 20,000	non- corrosive
10,000 to 20,000	mildly corrosive
5,000 to 10,000	moderately corrosive
3,000 to 5,000	corrosive
1,000 to 3,000	highly corrosive
< 1,000	extremely corrosive

The soil resistivity was found to be 8380 ohm-cm for the sample analyzed making the soil moderately corrosive for buried steel within below grade concrete walls. Consideration to increasing the specified strength and/or adding air entrainment into any reinforced concrete in contact with the soil should be given. Consideration should also be given to increasing the minimum concrete cover over reinforcing steel.

5.0 GEOTECHNICAL GUIDELINES AND RECOMMENDATIONS

5.1 General

This section of the report provides engineering guidelines on the geotechnical design aspects of the project based on our interpretation of the information from the test holes and the project requirements. It is stressed that the information in the following sections is provided for the guidance of the designers and is intended for this project only. Contractors bidding on or undertaking the works should examine the factual results of the investigation, satisfy themselves as to the adequacy of the information for construction, and make their own interpretation of the factual data as it affects their construction techniques, schedule, safety and equipment capabilities.

The professional services for this project include only the geotechnical aspects of the subsurface conditions at this site. The presence or implications of possible surface and/or subsurface



contamination resulting from previous uses or activities at this site or adjacent properties, and/or resulting from the introduction onto the site of materials from offsite sources are outside the terms of reference for this report.

5.2 Foundation for Proposed Residential Building

With the exception of the fill materials and topsoil, the subsurface conditions encountered within the test holes are suitable for the support of the proposed apartment building on conventional spread footing foundations. Excavations for the proposed foundations should be taken through the fill materials, topsoil and glacial till to expose the bedrock subgrade.

5.2.1 Foundation Excavation

Any excavation for the proposed structure will likely be carried out through topsoil, fill materials (asphalt and crushed stone) and glacial till to bear upon the limestone bedrock. The sides of the excavations should be sloped in accordance with the requirements of Ontario Regulation 213/91, s. 226 under the Occupational Health and Safety Act. According to the Act, the native soils at the site can be classified as Type 3 soil above bedrock and Type 1 below the bedrock surface, however this classification should be confirmed by qualified individuals as the site is excavated and if necessary, adjusted.

It is expected that the side slopes of the excavation will be stable in the short term provided the walls are sloped at 1H:1V through the fill materials to 1.2 metres or less from the bottom of the excavation and provided no excavated materials are stockpiled within 3 metres of the top of the excavations.

5.3 Foundation Design and Bearing Capacity

It is suggested that the building be founded either directly on the underlying bedrock or on engineered fill placed on the underlying bedrock. The underside of footings can be stepped as necessary to facilitate placement on the bedrock.

The foundation of the proposed residential building may be placed on conventional pad and strip footings. A maximum allowable bearing pressure of 1500 kilopascals using serviceability limit states



design and a factored ultimate bearing resistance of 1500 kilopascals using ultimate limit states design may be used for the design of conventional strip or pad footings, a minimum of 0.6 metres in width, founded on sound bedrock. Sound bedrock consists of a hard relatively level bedrock surface free of loose material, rock shatter and fractured rock.

The foundation of the proposed residential building founded on engineered fill placed on the bedrock may use a maximum allowable bearing pressure of 500 kilopascals using serviceability limit states design and a factored ultimate bearing resistance of 800 kilopascals using ultimate limit states design for the design of convention strip or pad footings, a minimum of 0.6 metres in width.

No maximum allowable landscape grade raise adjacent to the proposed building foundation is required. Total and differential settlement of the footings for the apartment building designed and founded based on the above guidelines should be less than 15 millimetres and 10 millimetres, respectively.

The subgrade surfaces should be inspected and approved by geotechnical personnel prior to placement of any engineered fill or concrete.

5.4 Engineered Fill

It is recommended that the building be founded either on sound bedrock or on engineered fill placed on sound bedrock. It is not recommended that the footings be placed on both bedrock and engineered fill at different locations in the building.

Any fill required to raise the footings for the proposed building to founding level should consist of imported granular material (engineered fill). The engineered fill should consist of granular material meeting Ontario Provincial Standards Specifications (OPSS) requirements for Granular A or Granular B Type II and should be compacted in maximum 300 millimetre thick loose lifts to at least 100 percent of the standard Proctor maximum dry density. It is considered that the engineered fill should be compacted using dynamic compaction with a large diameter vibratory steel drum roller or diesel plate compactor. If a diesel plate compactor is used, the lift thickness may need to be restricted to less than 300 mm to achieve proper compaction. Compaction should be verified by a suitable field compaction test method.



To allow the spread of load beneath the footings, the engineered fill should extend out 0.5 metres horizontally from the edges of the footing then down and out at 1 horizontal to 1 vertical, or flatter. The excavations for the proposed residential building should be sized to accommodate this fill placement.

5.4.2 Effect of Foundation Excavation on Adjacent Structures and City of Ottawa Services

It is expected that bedrock will be encountered during excavating for site services. Small amounts of bedrock removal can most likely be carried out by hoe ramming and heavy excavating equipment. It is considered that where large amounts of bedrock are removed by hoe ramming, the hoe ramming could also introduce significant vibrations through the bedrock. As such it is considered that pre-excavation surveys of nearby structures and existing utilities should also be completed before extensive hoe ramming. It is further recommended that line drilling be used in conjunction with hoe ramming to reduce the effort required to fracture and remove the bedrock.

5.4.3 Ground Water in Excavation and Construction Dewatering

All boreholes were dry at the time of drilling, January 19, 2021. As the building will be founded on shallow bedrock, water intrusion into the excavation is not a concern and dewatering will not be required. As such a permit to take water will not be required prior to excavation.

5.4.4 Effect of Dewatering of Foundation or Site Services Excavations on Adjacent Structures

Since the building is to be founded on shallow bedrock and all adjacent building are also founded on shallow bedrock, dewatering of the foundation will not remove water from any historically saturated soils that are important for the support of any building. As such dewatering of the foundation or site services excavations, if required, will not have a detrimental impact on the adjacent structures.

5.5 Frost Protection Requirements for Spread Footing Foundations

In general, all exterior foundation elements and those in any unheated parts of the proposed building should be provided with at least 1.5 metres of earth cover for frost protection purposes. Isolated, unheated foundation elements adjacent to surfaces, which are cleared of snow cover



during winter months should be provided with a minimum 1.8 metres of earth cover for frost protection purposes.

Where less than the required depth of soil cover can be provided, the foundation elements should be protected from frost by using a combination of earth cover and extruded polystyrene rigid insulation. A typical frost protection insulation detail could be provided upon request, if required.

Where the proposed building foundations are placed on sound bedrock or on engineered fill over bedrock, the subgrade materials would be considered to be non susceptible to frost action and no frost protection for the foundations is required.

5.6 Foundation Wall Backfill and Drainage

Provided the proposed finished floor surfaces are above the exterior finished grade at all locations, the granular materials beneath the proposed floor slab are properly compacted and provided the exterior grade is adequately sloped away from the proposed building, no perimeter foundation drainage system is required.

The native soils encountered at this site are considered to be frost susceptible. As such, to prevent possible foundation frost jacking, the backfill against any unheated or insulated walls or isolated walls or piers should consist of free draining, non-frost susceptible material. If imported material is required, it should consist of sand or sand and gravel meeting OPSS Granular B Type I grading requirements.

Alternatively, foundations could be backfilled on the exterior with native material in conjunction with the use of an approved proprietary drainage layer system (such as Platon System Membrane) against the foundation wall. There is potential for possible frost jacking of the upper portion of some types of these drainage layer systems if frost susceptible material is used as backfill. To mitigate this potential, the upper approximately 0.6 metres of the foundation should be backfilled with non-frost susceptible granular material.

Where the granular backfill will ultimately support a pavement structure or walkway, it is suggested that the wall backfill material be compacted in 250 millimetre thick lifts to 95 percent of the standard



Proctor dry density value. In that case any native material proposed for foundation backfill should be inspected and approved by the geotechnical engineer.

A conventional, perforated perimeter drain, with a 150 millimetre surround of 20 millimetre minus crushed stone, should be provided at the founding level for the cast-in-place concrete basement floor slab and should lead by gravity flow to the City Storm Sewer or to a sump. If the perimeter drain tile is discharged by gravity to the Storm Sewer a backup flow valve must be used. If a sump is used, the sump should be equipped with a backup pump and generator. The sump discharge should be equipped with a backup flow protector

The proposed basement should also be provided with under floor drains consisting of perforated pipe with a surround of 20 millimetre minus crushed stone to reduce the potential for buildup of hydrostatic pressure below the basement floor. The under floor drains should be placed beginning at the inside edge of the foundation wall and should be spaced a maximum of 5 metres apart. The under floor drain should also be directed to the storm sewer or to the sump.

The basement foundation walls should be designed to resist the earth pressure, P , acting against the walls at any depth, h , calculated using the following equation.

$$P = k_0 (\gamma h + q)$$

Where:

- P = the pressure, at any depth, h , below the finished ground surface
- k_0 = earth pressure at-rest coefficient, 0.5
- γ = unit weight of soil to be retained, estimated at 22 kN/m³
- q = surcharge load (kPa) above backfill material
- h = the depth, in metres, below the finished ground surface at which the pressure, P , is being computed

This expression assumes that the water table would be maintained at the founding level by the above mentioned foundation perimeter drainage and backfill requirements.

5.7 Basement Floor Slab

As stated above, it is expected that the proposed building will be founded on bedrock or on an engineered pad placed on bedrock. For predictable performance of the proposed concrete basement floor slab all existing fill material and any otherwise deleterious material should be



removed from below the proposed floor slab areas. The exposed bedrock surface should then be inspected and approved by geotechnical personnel.

The fill materials beneath the proposed concrete basement floor slab on grades should consist of a minimum of 150 millimetre thickness of crushed stone meeting OPSS Granular A immediately beneath the concrete floor slab followed by sand, or sand and gravel meeting the OPSS for Granular B Type I, or crushed stone meeting OPSS grading requirements for Granular B Type II, or other material approved by the Geotechnical Engineer. The fill materials should be compacted in maximum 300 millimetre thick lifts to at least 95 percent of the standard Proctor maximum dry density.

The slabs should be structurally independent from walls and columns, which are supported by the foundations. This is to reduce any structural distress that may occur as a result of differential soil movement. If it is intended to place any internal non-load bearing partitions directly on the slab-on-grade, such walls should also be structurally independent from other elements of the building founded on the conventional foundation system so that some relative vertical movement between the floor slab and foundation can occur freely.

The concrete floor slab should be saw-cut at regular intervals to minimize random cracking of the slab due to shrinkage of the concrete. The saw cut depth should be about one quarter of the thickness of the slab. The crack control cuts should be placed at a grid spacing not exceeding the lesser of 25 times the slab thickness or 4.5 metres. The slab should be cut as soon as it is possible to work on the slab without damaging the surface of the slab. Under slab drainage is not considered necessary provided that the floor slab level is above the finished exterior ground surface level. If any areas of the proposed building are to remain unheated during the winter period or under slab insulation is to be used, thermal protection of the foundation may be required. Further details on the insulation requirements could be provided, if necessary.



5.8 Seismic Design for the Proposed Residential Building

5.8.1 Seismic Site Classification

Based on the limited information from the boreholes, for seismic design purposes, in accordance with the 2012 OBC Section 4.1.8.4, Table 4.1.8.4.A., the site classification for seismic site response for the bedrock is Site Class C.

5.9 National Building Code Seismic Hazard Calculation

The design Peak Ground Acceleration (PGA) for the site was calculated as 0.278 with a 2% probability of exceedance in 50 years based on the interpolation of the 2015 National Building Code Seismic Hazard calculation. The results of the test are attached following the text of this report.

5.9.1 Potential for Soil Liquefaction

As indicated above, the results of the boreholes indicate that the subsurface conditions consist of a thin layer of overburden followed by bedrock. The proposed building will be founded on the bedrock.

The bedrock is not considered to be liquefiable under seismic conditions.

Therefore, it is considered that no damage to the proposed residential building will occur due to liquefaction of the native subgrade under seismic conditions.

6.0 SITE SERVICES

6.1 Excavation

The excavations for the site services will be carried out through topsoil or fill materials (asphalt and crushed stone), glacial till and bedrock. For the purposes of Ontario Regulation 213/91 the soils at the site can be considered to be Type 3 soil above bedrock, and Type 1 below the bedrock surface. Work within an excavation in the bedrock should follow the requirements of Ontario Regulation 213/91 in particular O.Reg 213/91 S230 – S233. Excavation walls within bedrock may be made near vertical. The sides of the excavations in overburden materials should be sloped in accordance with the requirements in Ontario Regulation 213/91 under the Ontario Occupational Health and Safety Act.



It is expected that bedrock will be encountered during excavating for site services. Small amounts of bedrock removal, can most likely be carried out by hoe ramming and heavy excavating equipment. Where larger amounts of bedrock removal are required it may be more economically feasible to use drill and blasting techniques which should be carried out under the supervision of a blasting specialist engineer. Monitoring of the blasting should be carried out throughout the blasting period to ensure that the blasting meets the limiting vibration criteria established by the specialist engineer. Pre-blast condition surveys of nearby structures and existing utilities are essential. It is also considered that were large amounts of bedrock are removed by hoe ramming, the hoe ramming could also introduce significant vibrations through the bedrock. It is recommended that where large amounts of bedrock are to be removed by hoe ramming, line drilling techniques be combined with the hoe ramming. As such it is considered that pre-excavation surveys of nearby structures and existing utilities should also be completed before extensive hoe ramming.

Groundwater was not encountered in the test holes above the bedrock. The test holes however were not advanced into the bedrock to the expected depth of the services. As such it is uncertain where the groundwater elevation is with respect to the service elevations. Based on available information it is unlikely that a permit to take water will be required to dewater the service trench. It is considered however that an ESR may be required.

6.2 Pipe Bedding and Cover Materials

It is suggested that the service pipe bedding material consist of at least 150 millimetres of granular material meeting OPSS requirements for Granular A. A provisional allowance should, however, be made for sub-excavation of any existing fill or disturbed material encountered at sub-grade level. Granular material meeting OPSS specifications for Granular B Type II could be used as a sub-bedding material. The use of clear crushed stone as bedding or sub-bedding material should not be permitted.

Cover material, from pipe spring line to at least 300 millimetres above the top of the pipe, should consist of granular material, such as OPSS Granular A.



The sub-bedding, bedding and cover materials should be compacted in maximum 200 millimetre thick lifts to at least 95 percent of the standard Proctor maximum dry density using suitable vibratory compaction equipment.

6.3 Trench Backfill

The general backfilling procedures should be carried out in a manner that is compatible with the future use of the area above the service trenches.

In areas where the service trench will be located below or in close proximity to existing or future roadway areas, granular fill material should be used as backfill between the roadway sub-grade level and the depth of seasonal frost penetrations (i.e. 1.8 metres below finished grade) in order to reduce the potential for differential frost heaving between the area over the trench and the adjacent section of roadway.

As there is limited native material onsite, imported granular material will likely have to be used. Where imported granular materials are used, suitable frost tapers should be used OPSP 802.013.

To minimize future settlement of the backfill and achieve an acceptable sub-grade for the roadways, sidewalks, etc., the trench should be compacted in maximum 300 millimetre thick lifts to at least 95 percent of the standard Proctor maximum dry density. The specified density may be reduced where the trench backfill is not located or in close proximity to existing or future roadways, driveways, sidewalks, or any other type of permanent structure.

7.0 TREES

The site is underlain by a thin layer of glacial till over bedrock, which is not considered to be susceptible to shrinkage caused by changes to moisture content. As such, it is considered that there are not any increased separation distances or limitations to the type of trees planted onsite.

The effects of existing and future trees on the adjacent buildings, services and other ground supported structures should be considered in the landscaping design.



8.0 CONSTRUCTION CONSIDERATIONS

The engagement of the services of the geotechnical consultant during construction is recommended to confirm that the subsurface conditions throughout the proposed development do not materially differ from those given in the report and that the construction activities do not adversely affect the intent of the design.

All foundation areas and any engineered fill areas for the proposed residential building should be inspected by Kollaard Associates Inc. to ensure that a suitable sub-grade has been reached and properly prepared. The placing and compaction of any granular materials beneath the foundations should be inspected to ensure that the materials used conform to the grading and compaction specifications.

The subgrade for the site services should be inspected and approved by geotechnical personnel. In situ density testing should be carried out on the service pipe bedding and backfill and the pavement granular materials to ensure the materials meet the specifications from a compaction point of view.

The native topsoil and glacial till at this site will be sensitive to disturbance from construction operations, from rainwater or snow melt, and frost. In order to minimize disturbance, construction traffic operating directly on the subgrade should be kept to an absolute minimum and the subgrade should be protected from below freezing temperatures.



We trust this report provides sufficient information for your present purposes. If you have any questions concerning this report or if we may be of further services to you, please do not hesitate to contact our office.

Regards,
Kollaard Associates Inc.

Dean Tataryn, B.E.S., EP.



Steve DeWit, P.Eng.

BOREHOLE BH1

PROJECT: Proposed Residential Development
CLIENT: Lion Trade Ltd.
LOCATION: 211 Armstrong Road
PENETRATION TEST HAMMER: 63.5 kg, Drop, 0.76 mm

PROJECT NUMBER: 211169
DATE OF BORING: 22-1-19
SHEET 1 of 1
DATUM:

DEPTH SCALE (meters)	SOIL PROFILE			SAMPLES			UNDIST SHEAR STRENGTH					DYNAMIC CONE PENETRATION TEST					MOISTURE CONTENT (%)	PIEZOMETER OR STANDPIPE INSTALLATION	
	DESCRIPTION	DEPTH (m)	STRATA PLOT	ELEV. (m)	NUMBER	TYPE	BLOWS/0.3m	x Cu. kPa x					blows/300 mm						
								o Cu. kPa o											
0	0	TOPSOIL	0																
0.5					1	SS	22												
	0.61	Grey brown silty sand, some gravel, cobbles and boulders, trace clay (GLACIAL TILL)																	
1.0					2	SS	15												
1.5																			
	1.72	Practical refusal on bedrock			3	SS	100												

Borehole dry at time of drilling, January 19, 2022.

GEOTECH BH KOLLAARD 211169 BOREHOLES.GPJ GINT STD CANADA.GDT 22-2-4

DEPTH SCALE: 1 to 10 **LOGGED:** CI
BORING METHOD: Power Auger **CHECKED:** SD
AUGER TYPE: 200 mm Hollow Stem

BOREHOLE BH2

PROJECT: Proposed Residential Development
CLIENT: Lion Trade Ltd.
LOCATION: 211 Armstrong Road
PENETRATION TEST HAMMER: 63.5 kg, Drop, 0.76 mm

PROJECT NUMBER: 211169
DATE OF BORING: 22-1-19
SHEET 1 of 1
DATUM:

DEPTH SCALE (meters)	SOIL PROFILE				SAMPLES			UNDIST SHEAR STRENGTH					DYNAMIC CONE PENETRATION TEST					MOISTURE CONTENT (%)	PIEZOMETER OR STANDPIPE INSTALLATION
	DESCRIPTION	DEPTH (m)	STRATA PLOT	ELEV. (m)	NUMBER	TYPE	BLOWS/0.3m	x Cu. kPa x					blows/300 mm						
								o Cu. kPa o											
0	ASPHALTIC CONCRETE	0																	
0.03	Grey crushed granular stone (FILL)	0.03																	
0.23	Grey brown silty sand, some gravel, cobbles, boulders, trace clay (GLACIAL TILL)	0.23			1	SS	100												
0.5	Practical refusal on large boulder or bedrock	0.53																	

Borehole dry at time of drilling, January 19, 2022.

GEOTECH BH KOLLAARD 211169 BOREHOLES.GPJ GINT STD CANADA.GDT 22-2-4

DEPTH SCALE: 1 to 10

LOGGED: CI

BORING METHOD: Power Auger

AUGER TYPE: 200 mm Hollow Stem

CHECKED: SD

BOREHOLE BH3

PROJECT: Proposed Residential Development
CLIENT: Lion Trade Ltd.
LOCATION: 211 Armstrong Road
PENETRATION TEST HAMMER: 63.5 kg, Drop, 0.76 mm

PROJECT NUMBER: 211169
DATE OF BORING: 22-1-19
SHEET 1 of 1
DATUM:

DEPTH SCALE (meters)	SOIL PROFILE			SAMPLES			UNDIST SHEAR STRENGTH					DYNAMIC CONE PENETRATION TEST					MOISTURE CONTENT (%)	PIEZOMETER OR STANDPIPE INSTALLATION		
	DESCRIPTION	DEPTH (m)	STRATA PLOT	ELEV. (m)	NUMBER	TYPE	BLOWS/0.3m	x Cu. kPa x					blows/300 mm							
								o Cu. kPa o												
0	0.03	0.23	0.5	0.91	1	SS	100	0	20	40	60	80	100	0	20	40	60	80	100	
	ASPHALTIC CONCRETE																			
	Grey crushed granular stone (FILL)																			
	Grey brown silty sand, some gravel, cobbles, boulders, trace clay (GLACIAL TILL)																			
	Practical refusal on bedrock																			

Borehole dry at time of drilling, January 19, 2022.

GEOTECH BH KOLLAARD 211169 BOREHOLES.GPJ GINT STD CANADA.GDT 22-2-4

DEPTH SCALE: 1 to 10

LOGGED: CI

BORING METHOD: Power Auger

AUGER TYPE: 200 mm Hollow Stem

CHECKED: SD



LIST OF ABBREVIATIONS AND TERMINOLOGY

SAMPLE TYPES

AS auger sample
CS chunk sample
DO drive open
MS manual sample
RC rock core
ST slotted tube
TO thin-walled open Shelby tube
TP thin-walled piston Shelby tube
WS wash sample

PENETRATION RESISTANCE

Standard Penetration Resistance, N
The number of blows by a 63.5 kg hammer dropped 760 millimeter required to drive a 50 mm drive open sampler for a distance of 300 mm. For split spoon samples where less than 300 mm of penetration was achieved, the number of blows is reported over the sampler penetration in mm.

Dynamic Penetration Resistance
The number of blows by a 63.5 kg hammer dropped 760 mm to drive a 50 mm diameter, 60° cone attached to 'A' size drill rods for a distance of 300 mm.

WH
Sampler advanced by static weight of hammer and drill rods.

WR
Sampler advanced by static weight of drill rods.

PH
Sampler advanced by hydraulic pressure from drill rig.

PM
Sampler advanced by manual pressure.

SOIL TESTS

C consolidation test
H hydrometer analysis
M sieve analysis
MH sieve and hydrometer analysis
U unconfined compression test
Q undrained triaxial test
V field vane, undisturbed and remolded shear strength

SOIL DESCRIPTIONS

Relative Density	'N' Value
Very Loose	0 to 4
Loose	4 to 10
Compact	10 to 30
Dense	30 to 50
Very Dense	over 50

Consistency	Undrained Shear Strength (kPa)
-------------	--------------------------------

Very soft	0 to 12
Soft	12 to 25
Firm	25 to 50
Stiff	50 to 100
Very Stiff	over 100

LIST OF COMMON SYMBOLS

c_u undrained shear strength
 e void ratio
 C_c compression index
 C_v coefficient of consolidation
 k coefficient of permeability
 I_p plasticity index
 n porosity
 u pore pressure
 w moisture content
 w_L liquid limit
 w_p plastic limit
 ϕ^1 effective angle of friction
 γ unit weight of soil
 γ^1 unit weight of submerged soil
 σ normal stress

DRAWING NUMBER:
SITE PLAN, FIGURE 2

LEGEND:



REFERENCE: PLAN SUPPLIED BY
CITY OF OTTAWA EMAPS

SPECIAL NOTE: THIS DRAWING TO
BE READ IN CONJUNCTION WITH
THE ACCOMPANYING REPORT.

REV.	NAME	DATE	DESCRIPTION

 **Kollaard Associates**
Engineers
P.O. BOX 189, 210, PRESCOTT ST (613) 860-0923
KEWATVILLE ONTARIO info@kollaard.ca
K0G 1J0 FAX (613) 258-0475
http://www.kollaard.ca

CLIENT: LION TRADE LTD.

PROJECT: GEOTECHNICAL INVESTIGATION
FOR PROPOSED RESIDENTIAL
DEVELOPMENT

LOCATION:
211 ARMSTRONG STREET
CITY OF OTTAWA, ON

DESIGNED BY: DATE: January 24, 2022
DRAWN BY: CI SCALE: N.T.S.
KOLLAARD FILE NUMBER: 211169

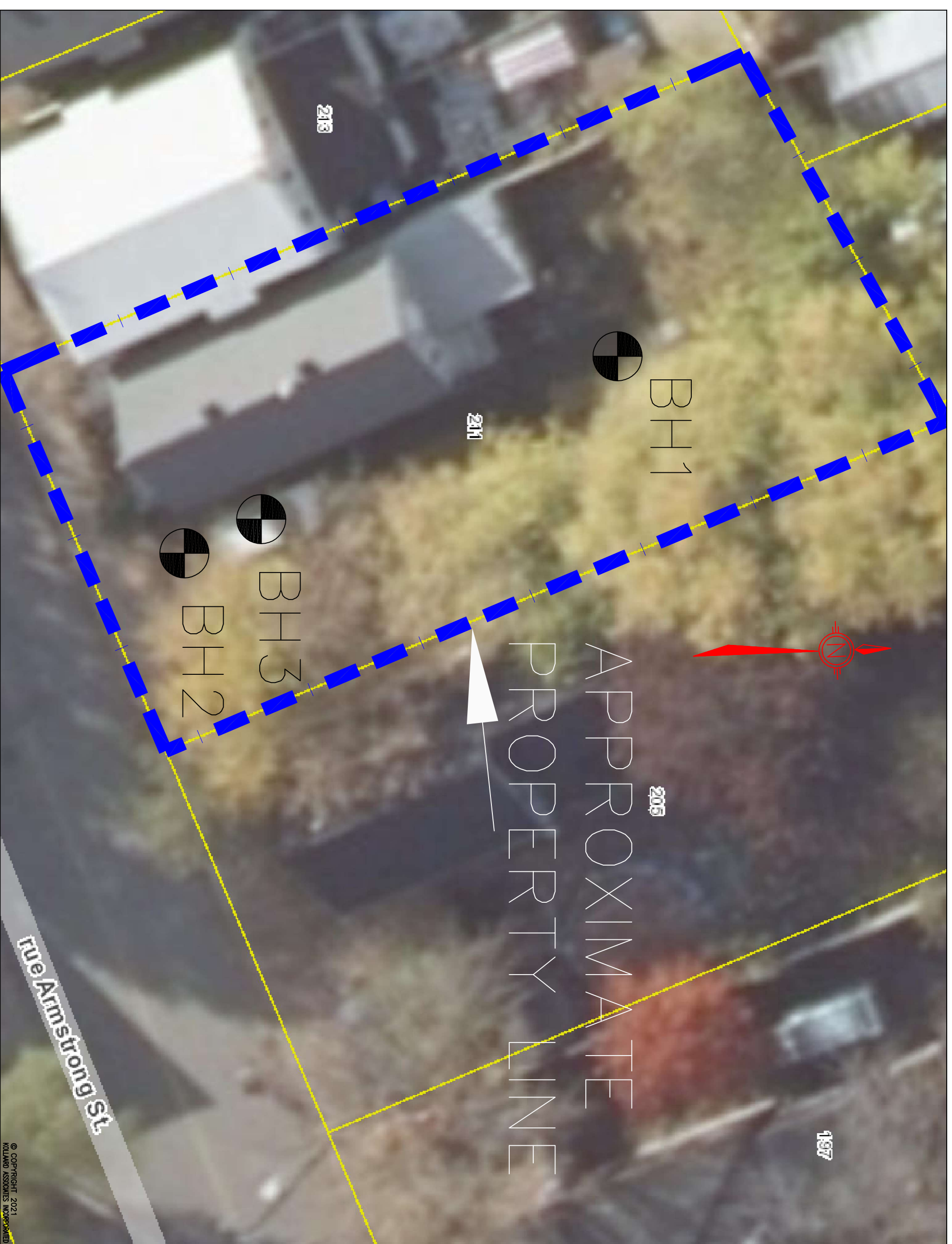



Lion Trade Ltd.
January 24, 2022

Geotechnical Investigation
Proposed Residential Development
211 Armstrong Street
City of Ottawa, Ontario
211169

Laboratory Test Results for Physical Properties



Kollaard Associates (Kemptville)
ATTN: Dean Tataryn
210 Prescott Street Unit 1
P.O. Box 189
Kemptville ON K0G 1J0

Date Received: 25-JAN-22
Report Date: 01-FEB-22 14:26 (MT)
Version: FINAL

Client Phone: 613-860-0923

Certificate of Analysis

Lab Work Order #: L2681336
Project P.O. #: NOT SUBMITTED
Job Reference: 211169
C of C Numbers:
Legal Site Desc:



Costas Farassoglou
Account Manager

[This report shall not be reproduced except in full without the written authority of the Laboratory.]

ADDRESS: 190 Colonnade Road, Unit 7, Ottawa, ON K2E 7J5 Canada | Phone: +1 613 225 8279 | Fax: +1 613 225 2801
ALS CANADA LTD Part of the ALS Group An ALS Limited Company

ALS ENVIRONMENTAL ANALYTICAL REPORT

Sample Details/Parameters	Result	Qualifier*	D.L.	Units	Extracted	Analyzed	Batch
L2681336-1 211169 BH1-SS2 2.5-4.5 FT Sampled By: CLIENT on 19-JAN-22 @ 12:00 Matrix: SOIL							
Physical Tests							
Conductivity	0.119		0.0040	mS/cm		28-JAN-22	R5711559
% Moisture	7.58		0.25	%	26-JAN-22	26-JAN-22	R5709237
pH	7.70		0.10	pH units		27-JAN-22	R5710076
Resistivity	8380		1.0	ohm*cm		28-JAN-22	
Leachable Anions & Nutrients							
Chloride	0.00771		0.00050	%	28-JAN-22	31-JAN-22	R5712341
Anions and Nutrients							
Sulphate	0.0031		0.0020	%	28-JAN-22	31-JAN-22	R5712341

* Refer to Referenced Information for Qualifiers (if any) and Methodology.

Reference Information

Test Method References:

ALS Test Code	Matrix	Test Description	Method Reference**
CL-R511-WT	Soil	Chloride-O.Reg 153/04 (July 2011)	EPA 300.0
5 grams of dried soil is mixed with 10 grams of distilled water for a minimum of 30 minutes. The extract is filtered and analyzed by ion chromatography.			
Analysis conducted in accordance with the Protocol for Analytical Methods Used in the Assessment of Properties under Part XV.1 of the Environmental Protection Act (July 1, 2011 and as of November 30, 2020), unless a subset of the Analytical Test Group (ATG) has been requested (the Protocol states that all analytes in an ATG must be reported).			
EC-WT	Soil	Conductivity (EC)	MOEE E3138
A representative subsample is tumbled with de-ionized (DI) water. The ratio of water to soil is 2:1 v/w. After tumbling the sample is then analyzed by a conductivity meter.			
Analysis conducted in accordance with the Protocol for Analytical Methods Used in the Assessment of Properties under Part XV.1 of the Environmental Protection Act (July 1, 2011).			
MOISTURE-WT	Soil	% Moisture	CCME PHC in Soil - Tier 1 (mod)
PH-WT	Soil	pH	MOEE E3137A
A minimum 10g portion of the sample is extracted with 20mL of 0.01M calcium chloride solution by shaking for at least 30 minutes. The aqueous layer is separated from the soil and then analyzed using a pH meter and electrode.			
Analysis conducted in accordance with the Protocol for Analytical Methods Used in the Assessment of Properties under Part XV.1 of the Environmental Protection Act (July 1, 2011).			
RESISTIVITY-CALC-WT	Soil	Resistivity Calculation	APHA 2510 B
"Soil Resistivity (calculated)" is determined as the inverse of the conductivity of a 2:1 water:soil leachate (dry weight). This method is intended as a rapid approximation for Soil Resistivity. Where high accuracy results are required, direct measurement of Soil Resistivity by the Wenner Four-Electrode Method (ASTM G57) is recommended.			
SO4-WT	Soil	Sulphate	EPA 300.0
5 grams of soil is mixed with 50 mL of distilled water for a minimum of 30 minutes. The extract is filtered and analyzed by ion chromatography.			

** ALS test methods may incorporate modifications from specified reference methods to improve performance.

The last two letters of the above test code(s) indicate the laboratory that performed analytical analysis for that test. Refer to the list below:

Laboratory Definition Code	Laboratory Location
WT	ALS ENVIRONMENTAL - WATERLOO, ONTARIO, CANADA

Chain of Custody Numbers:

GLOSSARY OF REPORT TERMS

Surrogates are compounds that are similar in behaviour to target analyte(s), but that do not normally occur in environmental samples. For applicable tests, surrogates are added to samples prior to analysis as a check on recovery. In reports that display the D.L. column, laboratory objectives for surrogates are listed there.

mg/kg - milligrams per kilogram based on dry weight of sample

mg/kg wwt - milligrams per kilogram based on wet weight of sample

mg/kg lwt - milligrams per kilogram based on lipid weight of sample

mg/L - unit of concentration based on volume, parts per million.

< - Less than.

D.L. - The reporting limit.

N/A - Result not available. Refer to qualifier code and definition for explanation.

Test results reported relate only to the samples as received by the laboratory.

UNLESS OTHERWISE STATED, ALL SAMPLES WERE RECEIVED IN ACCEPTABLE CONDITION.

Analytical results in unsigned test reports with the DRAFT watermark are subject to change, pending final QC review.



Quality Control Report

Workorder: L2681336

Report Date: 01-FEB-22

Page 1 of 3

Client: Kollaard Associates (Kemptville)
210 Prescott Street Unit 1 P.O. Box 189
Kemptville ON K0G 1J0

Contact: Dean Tataryn

Test	Matrix	Reference	Result	Qualifier	Units	RPD	Limit	Analyzed
CL-R511-WT								
	Soil							
Batch	R5712341							
WG3690400-7	CRM	AN-CRM-WT						
Chloride			84.6		%		70-130	31-JAN-22
WG3690400-8	DUP	WG3690400-9						
Chloride		76.9	77.5		ug/g	0.7	30	31-JAN-22
WG3690400-6	LCS							
Chloride			101.2		%		80-120	31-JAN-22
WG3690400-5	MB							
Chloride			<5.0		ug/g		5	31-JAN-22
EC-WT								
	Soil							
Batch	R5711559							
WG3690324-9	DUP	WG3690324-8						
Conductivity		1.57	1.64		mS/cm	4.6	20	28-JAN-22
WG3690324-7	IRM	WT SAR4						
Conductivity			111.8		%		70-130	28-JAN-22
WG3690413-1	LCS							
Conductivity			91.6		%		90-110	28-JAN-22
WG3690324-6	MB							
Conductivity			<0.0040		mS/cm		0.004	28-JAN-22
MOISTURE-WT								
	Soil							
Batch	R5709237							
WG3689411-3	DUP	L2681632-42						
% Moisture		35.0	35.5		%	1.5	20	26-JAN-22
WG3689411-2	LCS							
% Moisture			100.6		%		90-110	26-JAN-22
WG3689411-1	MB							
% Moisture			<0.25		%		0.25	26-JAN-22
PH-WT								
	Soil							
Batch	R5710076							
WG3689463-1	DUP	L2681308-3						
pH		8.04	7.99	J	pH units	0.05	0.3	27-JAN-22
WG3689592-1	LCS							
pH			7.00		pH units		6.9-7.1	27-JAN-22
SO4-WT								
	Soil							
Batch	R5712341							
WG3690400-7	CRM	AN-CRM-WT						
Sulphate			103.8		%		60-140	31-JAN-22
WG3690400-8	DUP	WG3690400-9						



Quality Control Report

Workorder: L2681336

Report Date: 01-FEB-22

Page 2 of 3

Client: Kollaard Associates (Kemptville)
210 Prescott Street Unit 1 P.O. Box 189
Kemptville ON K0G 1J0

Contact: Dean Tataryn

Test	Matrix	Reference	Result	Qualifier	Units	RPD	Limit	Analyzed
SO4-WT	Soil							
Batch	R5712341							
WG3690400-8	DUP	WG3690400-9						
Sulphate		31	31		ug/g	0.9	25	31-JAN-22
WG3690400-6	LCS							
Sulphate			102.3		%		70-130	31-JAN-22
WG3690400-5	MB							
Sulphate			<20		ug/g		20	31-JAN-22

Quality Control Report

Workorder: L2681336

Report Date: 01-FEB-22

Client: Kollaard Associates (Kemptville)
210 Prescott Street Unit 1 P.O. Box 189
Kemptville ON K0G 1J0

Page 3 of 3

Contact: Dean Tataryn

Legend:

Limit ALS Control Limit (Data Quality Objectives)
DUP Duplicate
RPD Relative Percent Difference
N/A Not Available
LCS Laboratory Control Sample
SRM Standard Reference Material
MS Matrix Spike
MSD Matrix Spike Duplicate
ADE Average Desorption Efficiency
MB Method Blank
IRM Internal Reference Material
CRM Certified Reference Material
CCV Continuing Calibration Verification
CVS Calibration Verification Standard
LCSD Laboratory Control Sample Duplicate

Sample Parameter Qualifier Definitions:

Qualifier	Description
J	Duplicate results and limits are expressed in terms of absolute difference.

Hold Time Exceedances:

All test results reported with this submission were conducted within ALS recommended hold times.

ALS recommended hold times may vary by province. They are assigned to meet known provincial and/or federal government requirements. In the absence of regulatory hold times, ALS establishes recommendations based on guidelines published by the US EPA, APHA Standard Methods, or Environment Canada (where available). For more information, please contact ALS.

The ALS Quality Control Report is provided to ALS clients upon request. ALS includes comprehensive QC checks with every analysis to ensure our high standards of quality are met. Each QC result has a known or expected target value, which is compared against pre-determined data quality objectives to provide confidence in the accuracy of associated test results.

Please note that this report may contain QC results from anonymous Sample Duplicates and Matrix Spikes that do not originate from this Work Order.



Chain of Custody (COC) / Analysis Request Form

Canada Toll Free: 1 800 668 98



L2681336-COFC

COC Number: 17 -

Page 1 of 1

Report To Contact and company name below will appear on the final report		Re:		Level Below - Contact your AM to confirm all E&P TATs (surcharges may apply)							
Company:	Kollaard Associates (27196)	Select Report Format:	<input checked="" type="checkbox"/> PDF <input checked="" type="checkbox"/> EXCEL <input type="checkbox"/> EDD (DIGITAL)	Regular [R] <input checked="" type="checkbox"/> Standard TAT if received by 3 pm - business days - no surcharges apply		EMERGENCY					
Contact:	Dean Tataryn	Quality Control (QC) Report with Report:	<input type="checkbox"/> YES <input type="checkbox"/> NO	PRIORITY (Business Days)	4 day [P4-20%] <input type="checkbox"/>	1 Business day [E1 - 100%] <input type="checkbox"/>					
Phone:	613.860.0923, ext.225	<input type="checkbox"/> Compare Results to Criteria on Report - provide details below if box checked		3 day [P3-25%] <input type="checkbox"/>	Same Day, Weekend or Statutory holiday [E2 -200%] <input type="checkbox"/>						
Company address below will appear on the final report		Select Distribution:	<input type="checkbox"/> EMAIL <input type="checkbox"/> MAIL <input type="checkbox"/> FAX	2 day [P2-50%] <input type="checkbox"/>	(Laboratory opening fees may apply)						
Street:	210 Prescott Street, Unit 1 P.O. Box 189	Email 1 or Fax:	dean@kollaard.ca	Date and Time Required for all E&P TATs:							
City/Province:	Kemptville, Ontario	Email 2:		For tests that can not be performed according to the service level selected, you will be contacted.							
Postal Code:	K0G 1J0	Email 3:		Analysis Request							
Invoice To	Same as Report To <input type="checkbox"/> YES <input type="checkbox"/> NO	Invoice Distribution		Indicate Filtered (F), Preserved (P) or Filtered and Preserved (F/P) below							
	Copy of Invoice with Report <input type="checkbox"/> YES <input type="checkbox"/> NO	Select Invoice Distribution:	<input type="checkbox"/> EMAIL <input type="checkbox"/> MAIL <input type="checkbox"/> FAX								
Company:		Email 1 or Fax:	mary@kollaard.ca								
Contact:		Email 2:									
Project Information		Oil and Gas Required Fields (client use):									
ALS Account # / Quote #:	Q71021	AFE/Cost Center:	PO#								
Job #:	71109	Major/Minor Code:	Routing Code:								
PO / AFE:		Requisitioner:									
LSD:		Location:									
ALS Lab Work Order # (lab use only):	L2681336	ALS Contact:	Melanie M.	Sampler:							
ALS Sample # (lab use only)	Sample Identification and/or Coordinates (This description will appear on the report)	Date (dd-mmm-yy)	Time (hh:mm)	Sample Type							
	31/07 B41-552 2.5 4.5 FT	Jan 19, 2022	12:00	Soil							
					Corrosivity (KOLLAARD-CORR-WT) VOC F1-F4 (VOC-ASH-F1-F4) Metals & Inorganics (AST-IMP-10) PAH (PAH-511-WT) BTEX / F1-F4					SAMPLES ON HOLD Sample is hazardous (please provide further detail)	NUMBER OF CONTAINERS
Drinking Water (DW) Samples¹ (client use)		Special Instructions / Specify Criteria to add on report by clicking on the drop-down list below (electronic COC only)			SAMPLE CONDITION AS RECEIVED (lab use only)						
Are samples taken from a Regulated DW System? <input type="checkbox"/> YES <input type="checkbox"/> NO					Frozen <input type="checkbox"/> SIF Observations Yes <input type="checkbox"/> No <input type="checkbox"/>						
Are samples for human consumption/ use? <input type="checkbox"/> YES <input type="checkbox"/> NO					Ice Packs <input type="checkbox"/> Ice Cubes <input type="checkbox"/> Custody seal-intact Yes <input type="checkbox"/> No <input type="checkbox"/>						
					Cooling Initiated <input checked="" type="checkbox"/>						
					INITIAL COOLER TEMPERATURES °C			FINAL COOLER TEMPERATURES °C			
					14.8			3.6			
SHIPMENT RELEASE (client use)		INITIAL SHIPMENT RECEPTION (lab use only)			FINAL SHIPMENT RECEPTION (lab use only)						
Released by:	Date: Jan 24 2022	Time: 11:30	Received by:	Date: 25 JAN 2022	Time: 10:00	Received by:	Date: 26 JAN 2022	Time: 10:30			

REFER TO BACK PAGE FOR ALS LOCATIONS AND SAMPLING INFORMATION

WHITE - LABORATORY COPY YELLOW - CLIENT COPY

SEPT 2017 FRONT

Failure to complete all portions of this form may delay analysis. Please fill in this form LEGIBLY. By the use of this form the user acknowledges and agrees with the Terms and Conditions as specified on the back page of the white - report copy.

1. If any water samples are taken from a Regulated Drinking Water (DW) System, please submit using an Authorized DW COC form.



Lion Trade Ltd.
January 24, 2022

Geotechnical Investigation
Proposed Residential Development
211 Armstrong Street
City of Ottawa, Ontario
211169

National Building Code Seismic Hazard Calculation

2015 National Building Code Seismic Hazard Calculation

INFORMATION: Eastern Canada English (613) 995-5548 français (613) 995-0600 Facsimile (613) 992-8836
Western Canada English (250) 363-6500 Facsimile (250) 363-6565

Site: 45.402N 75.729W

User File Reference: 211 Armstrong Street

2022-01-21 16:57 UT

Probability of exceedance per annum	0.000404	0.001	0.0021	0.01
Probability of exceedance in 50 years	2 %	5 %	10 %	40 %
Sa (0.05)	0.442	0.244	0.146	0.044
Sa (0.1)	0.518	0.296	0.184	0.060
Sa (0.2)	0.435	0.252	0.159	0.054
Sa (0.3)	0.331	0.193	0.123	0.043
Sa (0.5)	0.235	0.137	0.087	0.031
Sa (1.0)	0.117	0.069	0.044	0.015
Sa (2.0)	0.056	0.032	0.020	0.006
Sa (5.0)	0.015	0.008	0.005	0.001
Sa (10.0)	0.005	0.003	0.002	0.001
PGA (g)	0.278	0.161	0.100	0.032
PGV (m/s)	0.195	0.110	0.067	0.021

Notes: Spectral ($S_a(T)$, where T is the period in seconds) and peak ground acceleration (PGA) values are given in units of g (9.81 m/s^2). Peak ground velocity is given in m/s . Values are for "firm ground" (NBCC2015 Site Class C, average shear wave velocity 450 m/s). NBCC2015 and CSAS6-14 values are highlighted in yellow. Three additional periods are provided - their use is discussed in the NBCC2015 Commentary. Only 2 significant figures are to be used. **These values have been interpolated from a 10-km-spaced grid of points. Depending on the gradient of the nearby points, values at this location calculated directly from the hazard program may vary. More than 95 percent of interpolated values are within 2 percent of the directly calculated values.**

References

National Building Code of Canada 2015 NRCC no. 56190; Appendix C: Table C-3, Seismic Design Data for Selected Locations in Canada

Structural Commentaries (User's Guide - NBC 2015: Part 4 of Division B)
Commentary J: Design for Seismic Effects

Geological Survey of Canada Open File 7893 Fifth Generation Seismic Hazard Model for Canada: Grid values of mean hazard to be used with the 2015 National Building Code of Canada

See the websites www.EarthquakesCanada.ca and www.nationalcodes.ca for more information

June 15, 2022

E.2 Plan of Topographic Survey by J.D. Barnes Limited (January 20, 2022)

LOT 24
REGISTERED PLAN 99
CITY OF OTTAWA

J.D. BARNES LIMITED

© COPYRIGHT 2022

SCALE 1 : 100



METRIC DISTANCES AND/OR COORDINATES SHOWN ON THIS PLAN ARE IN METRES AND CAN BE CONVERTED TO FEET BY DIVIDING BY 0.3048.

NOTES

BEARINGS ARE MTM GRID, AND DERIVED FROM GLOBAL NAVIGATION SATELLITE SYSTEMS (GNSS) BY REAL TIME NETWORK (RTN) OBSERVATIONS, MTM ZONE 9, NAD 83, (CSRS) (2010.0).

DISTANCES ARE GROUND.

COMPLIANCE WITH ONTARIO BUILDING CODE SETBACK REQUIREMENTS ARE NOT VERIFIED BY THIS SURVEY.

PART 2 - SURVEY REPORT

- DESCRIPTION

LOT 24 ON REGISTERED PLAN 99, BEING ALL OF

PIN 04094-0261 (LT), IN THE CITY OF OTTAWA

- REGISTERED EASEMENTS AND/OR RIGHTS-OF-WAY

NONE

- BOUNDARY FEATURES

NOTE LOCATION OF THE BOARD FENCE, THE ALUMINUM SHED, THE

CROSSING HYDRO CABLE AND THE EAVES ALONG THE WESTERLY

LIMIT OF THE SUBJECT PROPERTY

NOTE LOCATION OF THE CONCRETE SIDEWALK ALONG THE SOUTHERLY

LIMIT OF THE SUBJECT PROPERTY

NOTE LOCATION OF THE BOARD FENCES, THE TELEPHONE CABLES, THE

FRAME SHED AND THE EAVES ALONG THE EASTERLY LIMIT OF THE SUBJECT

PROPERTY

NOTE LOCATION OF THE BOARD FENCES, THE ALUMINUM SHED, THE

TIMBER RETAINING WALL AND THE OVERHEAD TELEPHONE CABLES ALONG THE

NORTHERLY LIMIT OF THE SUBJECT PROPERTY

LEGEND

■	DENOTES SURVEY MONUMENT FOUND
□	DENOTES SURVEY MONUMENT SET
CC	DENOTES CUT CROSS
SSIB	DENOTES SHORT STANDARD IRON BAR
SIB	DENOTES STANDARD IRON BAR
IB	DENOTES IRON BAR
MEAS	DENOTES MEASURED
WIT	DENOTES WITNESS
OJ	DENOTES ORIGIN UNKNOWN
RP	DENOTES REGISTERED PLAN 99
P	DENOTES PLAN 4R-1122
P1	DENOTES PLAN 4R-25848
P2	DENOTES PLAN 5R-10306
P3	DENOTES SURVEYOR'S REAL PROPERTY REPORT BY ANNIS, O'SULLIVAN, VOLLEBEK LTD., DATED JANUARY 28, 1994
AOC	DENOTES ANNIS, O'SULLIVAN, VOLLEBEK LTD.
990	DENOTES J.G. PAYETTE, O.L.S.
1287	DENOTES FARLEY, SMITH & MURRAY SURVEYING LTD.
1692	DENOTES FARLEY, SMITH & DENIS SURVEYING LTD.
RWA Notes	DENOTES NOTES BY R.W. ARNETT, O.L.S., PROJECT 6-99
—	DENOTES PROPERTY LINE

N=NORTH / S=SOUTH / E=EAST / W=WEST

TOPOGRAPHIC LEGEND

FDN	DENOTES FOUNDATION
CONC	DENOTES CONCRETE
ALUM	DENOTES ALUMINUM
C/L	DENOTES CENTERLINE
N/F	DENOTES NORTH FACE
BF	DENOTES BOARD FENCE
BOL	DENOTES BOLLARD
TP	DENOTES TELEPHONE POLE
GM	DENOTES GAS METER
WK	DENOTES WATER KEY
CB	DENOTES CATCH BASIN
T_IB	DENOTES TELEPHONE JUNCTION BOX
M_WELL	DENOTES MONITORING WELL
MH_STM	DENOTES STORM MANHOLE
MH_SAN	DENOTES SANITARY MANHOLE
E	DENOTES OVERHEAD HYDRO CABLE
T	DENOTES OVERHEAD TELEPHONE CABLE
STM	DENOTES UNDERGROUND STORM SEWER
SAN	DENOTES UNDERGROUND SANITARY SEWER
Tree Symbol	DENOTES DECIDUOUS TREE
Tree Symbol	DENOTES CONIFEROUS TREE

ALL SET SSIB AND PB MONUMENTS WERE USED DUE TO LACK OF OVERBURDEN AND/OR PROXIMITY OF UNDERGROUND UTILITIES IN ACCORDANCE WITH SECTION 11 (4) OF O.REG. 525/91.

ELEVATION NOTE:

1. IT IS THE RESPONSIBILITY OF THE USER OF THIS INFORMATION TO VERIFY THAT THE SITE BENCHMARKS HAVE NOT BEEN ALTERED OR DISTURBED AND THAT ITS RELATIVE ELEVATION AND DESCRIPTION AGREES WITH THE INFORMATION SHOWN ON THIS DRAWING.

2. ELEVATIONS ARE GEODETIC AND ARE REFERRED TO CITY OF OTTAWA CONTROL POINT X HAVING A PUBLISHED ELEVATION OF X METRES (CCVD-1928 DATUM).

SURVEYOR'S CERTIFICATE

I CERTIFY THAT:
1. THIS SURVEY AND PLAN ARE CORRECT AND IN ACCORDANCE WITH THE SURVEYS ACT, THE SURVEYORS ACT AND THE REGULATIONS MADE UNDER THEM.

2. THE SURVEY WAS COMPLETED ON JANUARY 18, 2022.

DATE: _____
GEORGE ZERVOS
ONTARIO LAND SURVEYOR

J.D. BARNES LIMITED
LAND INFORMATION SPECIALISTS
62 STEACIE DRIVE, SUITE 103, KANATA, ON K2K 2A9
T: (613) 731-7244 F: (613) 254-8659 www.jdbarnes.com

DRAWN BY: RP	CHECKED BY: GZ	REFERENCE NO.: 21-10-154-00
PLOTTED: 1/20/2022	DATED: 01/18/22	

TREE SCHEDULE			
TREE No.	TRUNK DIAMETER (m)	CROWN RADIUS (m)	DISTANCE FROM C/L TRUNK TO PROPERTY LINE
T1	0.4	4	0.3 E 2.3 N
T2	0.35	7	0.7 W 6.3 N
T3	0.3	7	0.2 W
T4	0.3	7	1.0 W
T5	0.35	7	0.8 W
T6	0.6	7	1.1 W 1.9 S
T7	0.8	10	0.7 W 1.2 S
T8	0.6	7	1.2 S
T9	0.15	3	1.1 S
T10	0.15	3	0.9 S
T11	0.2	5	0.3 E
T12	0.2	3	1.2 W

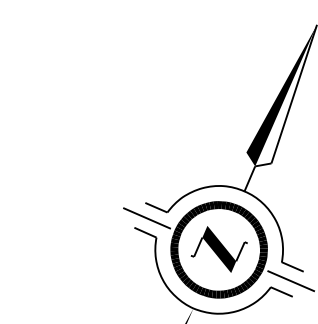
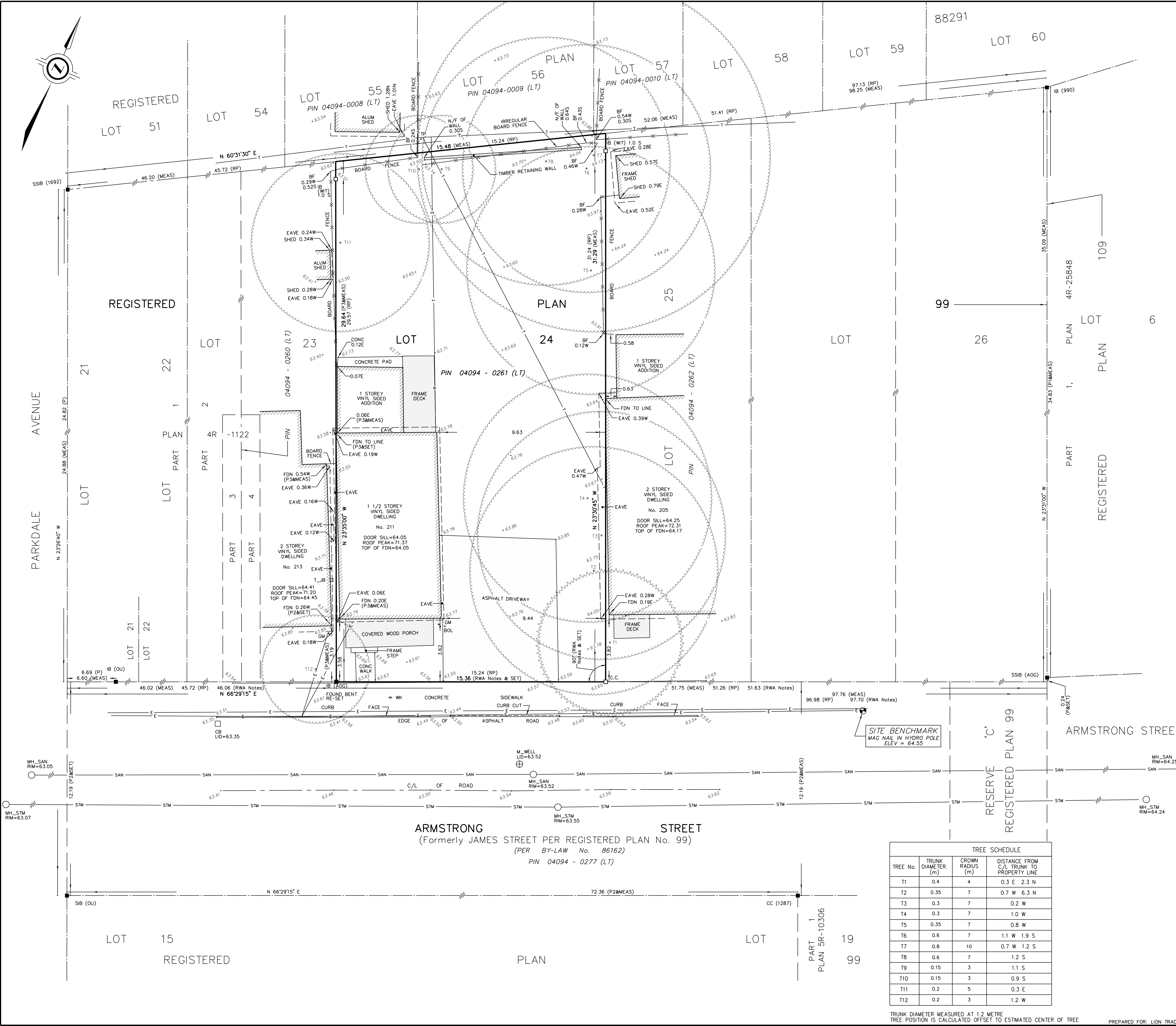

PARKDALE AVENUE

ARMSTRONG STREET

ARMSTRONG STREET
(Formerly JAMES STREET PER REGISTERED PLAN No. 99)
(PER BY-LAW No. 86162)
PIN 04094 - 0277 (LT)

RESERVE 'C'
REGISTERED PLAN 99

PART 1
PLAN 5R-10306

PART 1
PLAN 4R-25848

PART 2
PLAN 109

PART 3
PLAN 6

PART 4
PLAN 26

PART 5
PLAN 99

PART 6
PLAN 25

PART 7
PLAN 57

PART 8
PLAN 58

PART 9
PLAN 59

PART 10
PLAN 60

PART 11
PLAN 19

PART 12
PLAN 99

211 ARMSTRONG STREET – STORMWATER MANAGEMENT AND SERVICING REPORT

June 15, 2022

E.3 Tree Conservation Report for 211 Armstrong Street by IFS Associates (May 17, 2022)



May 17, 2022

Jack Billen, CEO/Co-Founder
Lion Trade Ltd.
4-91 Prince Albert Street
Ottawa, ON
K1K 2A2

RE: TREE CONSERVATION REPORT FOR 211 ARMSTRONG STREET, OTTAWA

This Tree Conservation Report (TCR) was prepared by IFS Associates Inc. (IFS) on behalf of Lion Trade Ltd. in support of their proposed redevelopment of 211 Armstrong Street in Ottawa. The need for this report is related to trees protected under the City of Ottawa’s Tree Protection By-law (By-law No. 2020-340). Presently the subject property is occupied by a one-and-half-storey dwelling with a one-storey rear addition. The proposed redevelopment will include the demolition of the existing dwelling and construction of a three-storey apartment building.

Under the Tree Protection By-law a TCR is required for all Plans of Subdivision, Site Plan Control Applications, Common Elements Condominium Applications, and Vacant Land Condominium Applications where there is a tree of 10 cm in diameter at breast height (DBH) or greater on a site and/or if there is a tree on an adjacent site that has a critical root zone (CRZ) extending onto a development site. Trees of any size on adjacent City lands must also be documented in a TCR. A “tree” is defined in the By-law as any species of woody perennial plant, including its root system, which has reached or can reach a minimum height of at least 450 cm at physiological maturity. The CRZ is calculated as DBH x 10 cm.

The approval of this TCR by the City of Ottawa and the issuing of a permit by them authorize the removal of approved trees. **Importantly, although this report may be used to support the application for a City tree removal permit, it does not by itself constitute permission to remove trees or begin site clearing activities. No such work should occur before a tree removal permit is issued by the City’s General Manager authorizing the injury or destruction of a tree in accordance with the by-law.**

The inventory in this report details the assessment of all individual trees on the subject and adjacent private property. No trees were found on nearby City of Ottawa property. Field work for this report was completed in February 2022.

TREE SPECIES, CONDITION, SIZE AND STATUS

Table 1 on pages 2 and 3 of this report details the species, condition, size (diameter) and status of the individual trees on and adjacent to the subject property. Each of these trees is referenced by the numbers plotted on the tree conservation plan included on page 6 of this report.



Table 1. Species, condition, size, ownership and status of trees at 211 Armstrong Street

Tree No.	Tree species /Tolerance to Construction ¹	DBH ² (cm)	Ownership ³	Condition, age class, tree condition notes & preservation status (to be removed or preserved and protected)
1	Eastern white cedar (<i>Thuja occidentalis</i>) Good	36.3	Neighbour	Fair; mature; mildly divergent form and asymmetric crown towards south east; fair crown density, growth increment and needle colour; native species; to be removed with neighbour's permission (conflicts with site servicing and proposed driveways)
2	Manitoba maple (<i>Acer negundo</i>) Good	34.7	Private	Fair; mature; moderately divergent towards southwest; central stem with two competing laterals towards southwest (both with weak unions); three competing leaders at 5-6m from grade; naturalized species; to be removed (conflicts with proposed walkway)
3	Manitoba maple (<i>Acer negundo</i>) Good	27.6	Private	Fair; mature; moderately divergent towards southwest; competing, divergent leaders at 4m from grade; naturalized species; to be removed (conflicts with proposed walkway)
4	Manitoba maple (<i>Acer negundo</i>) Good	30.8	Private	Fair; mature; heavily divergent towards west; three competing, divergent leaders at 4-5m from grade; naturalized species; to be removed (conflicts with proposed walkway)
5	Manitoba maple (<i>Acer negundo</i>) Good	38.2	Private	Poor; mature; very heavily divergent towards south; central stem with three competing leaders at 5m (near crown apex); to be removed (conflicts with excavation, grading and side of building)
6 & 7	Manitoba maple (<i>Acer negundo</i>) Good	58.7 & 63.2	Private	Fair; very mature; single tree with co-dominant stems from grade - moderately divergent north/south; north stem with major barkless stub at 3m on northeast with decay and three competing leaders at 7m; south stem with competing laterals starting at 6m and three competing leaders at 9m; broad crown; naturalized species; to be preserved and protected
8	Manitoba maple (<i>Acer negundo</i>) Good	49.3	Private	Fair; mature; mildly divergent towards northwest; central stem broken at 6m (stub with decay); leader is epicormic in nature – upright; naturalized species; to be preserved and protected

Table 1. Con't

9	Manitoba maple (<i>Acer negundo</i>) Good	17.8	Private	Fair; maturing; central stem with competing lateral at 3.5m on north; competing leaders at 4.5m; divergent form towards north; naturalized species; to be removed (conflicts with proposed bicycle parking)
10	Cherry (<i>Prunus spp.</i>) Poor-Moderate	14.4	Private	Good; maturing; mildly asymmetric towards north; minor black knot (<i>Apiosporina morbosa</i>); basal spout; cultivar; to be removed (conflicts with proposed bicycle parking)
11	Cherry (<i>Prunus spp.</i>) Poor-Moderate	22 avg.	Private	Very poor; mature; co-dominant stems with multiple basal sprouts; south stem broken at 3m; heavy black knot (<i>Apiosporina morbosa</i>) throughout crown; cultivar; to be removed (conflicts with proposed walkway)
12	Japanese tree lilac (<i>Syringa reticulata</i>) unknown	+/-20	Neighbour	Fair; mature; crown asymmetric due to clearance pruning from private Hydro line; cultivar; to be preserved and protected

¹ as taken from Managing Trees during Construction; 2nd Ed., Fite and Smiley; ² diameter at breast height, or 1.4m from grade (unless otherwise indicated); ³ as determined by topographic survey prepared by J.D. Barnes Ltd. dated 01/18/22

Pictures 1 through 4 on pages 6, 7 and 8 of this report show selected trees on and adjacent to the subject property.

FEDERAL AND PROVINCIAL REGULATIONS

Federal and provincial regulations can be applicable to trees on private property. In particular, the following two regulations have been considered for this property:

- 1) Endangered Species Act (2007): No butternuts (*Juglans cinerea*) were identified on the subject or adjacent properties. This species of tree is listed as threatened under the Province of Ontario's Endangered Species Act (2007) and so is protected from harm.
- 2) Migratory Bird Convention Act (1994): In the period between April and August of each year nest surveys are required to be performed by a suitably trained person no more than five (5) days before trees or other similar nesting habitat are to be removed.

TREE PRESERVATION AND PROTECTION MEASURES

Preservation and protection measures intended to mitigate damage during construction will be applied for the trees to be retained. The following measures are the minimum required by the City of Ottawa to ensure tree survival during and following construction:

1. Erect a fence at the critical root zone (CRZ¹) of trees;
2. Do not place any material or equipment within the CRZ of the tree;
3. Do not attach any signs, notices or posters to any tree;
4. Do not raise or lower the existing grade within the CRZ without approval;
5. Tunnel or bore when digging within the CRZ of a tree;
6. Do not damage the root system, trunk or branches of any tree;
7. Ensure that exhaust fumes from all equipment are NOT directed towards any tree's crown.

¹ The critical root zone (CRZ) is established as being 10 centimetres from the trunk of a tree for every centimetre of trunk diameter at breast height (DBH). The CRZ is calculated as DBH x 10 cm.

This report is subject to the attached Limitations of Tree Assessments and Liability to which the reader's attention is directed.

Please do not hesitate to contact the undersigned with any questions concerning this report.

Yours,



Andrew K. Boyd, B.Sc.F, R.P.F. (#1828)
Certified Arborist #ON-0496A and TRAQualified
Consulting Urban Forester

GENERAL NOTES

- SITE GRADING**
1. ALL GRANULAR BASE & SUB-BASE COURSE MATERIALS SHALL BE COMPACTED AS PER GEOTECHNICAL CONSULTANT RECOMMENDATIONS.
 2. ALL DISTURBED GRASSES SHALL BE RESTORED TO ORIGINAL CONDITION OR BETTER, WITH SOD ON MIN. 100mm TOPSOIL. THE RELOCATION SHRUBS SHALL BE SUBJECT TO APPROVAL BY THE PROJECT LANDSCAPE ARCHITECT OR ENGINEER.
 3. INSPECTIONS: ALL WORK ON THE MUNICIPAL RIGHT OF WAY AND EASEMENTS TO BE INSPECTED BY THE MUNICIPALITY PRIOR TO BACKFILLING. ALL TO WATERMANS AND SEWERS TO BE INSPECTED BY THE MUNICIPALITY WHEN REQUIRED.
 4. REFER TO ARCHITECTURAL SITE PLAN FOR DIMENSIONS AND SITE DETAILS.
 5. CONTRACTOR TO OBTAIN A ROAD OCCUPANCY PERMIT 48 HOURS PRIOR TO COMMENCING ANY WORK WITHIN THE MUNICIPAL ROAD ALLOW BY THE MUNICIPALITY.
 6. EMBANKMENTS TO BE SLOPED AT MAX. 3:1, UNLESS OTHERWISE SPECIFIED.
 7. ALL TREES ON THE RIGHT-OF-WAY ARE TO BE MAINTAINED BEFORE AND AFTER CONSTRUCTION AND ALL TREES WITHIN THE PROPERTY SHALL BE THE "MUNICIPAL TREES AND NATURAL AREAS PROTECTION BY-LAW" AND THE "URBAN TREES CONSERVATION BY-LAW" AS AMENDED FROM TIME T.
 8. ALL NECESSARY CLEARING AND GRUBBING SHALL BE COMPLETED BY THE CONTRACTOR. REVIEW WITH ARCHITECT AND THE CITY OF OTTAWA PRIOR CUTTING.
 9. SUB-EXCAVATE SOFT AREAS & FILL WITH GRANULAR "B" COMPACTED IN 0.15m LAYERS.
 9. NO ALTERATION TO EXISTING GRADES OR DRAINAGE PATTERN ON PROPERTY LINE MAY BE MADE WHERE NO PERMISSION TO ENTER ADJACENT P.
 10. NO EXCESS DRAINAGE, DURING AND AFTER CONSTRUCTION, IS TO BE DIRECTED TOWARDS NEIGHBOURING PROPERTIES.
 11. UNDERSIDE-OF-FOOTING TO HAVE MINIMUM COVER OF 1.5m, WHERE SURFICIENT COVER IS NOT PROVIDED, FOOTINGS ARE TO BE INSULATED TO EQUIVALENT INSULATION.
 12. PAVEMENT REINSTATEMENT FOR SERVICE AND UTILITY CUTS SHALL BE IN ACCORDANCE WITH CITY OF OTTAWA STANDARD R10, 0902-509-010-010-AN.
 13. ALL RETAINING WALLS GREATER THAN 1.0m IN HEIGHT ARE TO BE DESIGNED, APPROVED, AND STAMPED BY STRUCTURAL ENGINEER.
 14. FENCES OR RAILINGS ARE REQUIRED FOR RETAINING WALLS GREATER THAN 0.9m IN HEIGHT. IS. PAVEMENT CONSTRUCTION SHALL BE AS PER GEOTECHNICAL CONSULTANT RECOMMENDATIONS.

GRADING PLANS COMPLETED BY FARLEY, SMITH & DENIS SURVEYING LTD. (12/17/18)

LEGEND

- ORIGINAL GROUND ELEVATION
- PROPOSED ELEVATION
- PROPOSED LOT CORNER ELEVATION
- EXISTING ELEVATION AT LOT CORNER
- FLOW DIRECTION AND GRADE
- FINISHED FIRST FLOOR ELEVATION
- TOP OF FOUNDATION ELEVATION
- UNDERSIDE OF FOOTING ELEVATION
- TERRACING 3:1 SLOPE MAXIMUM (UNLESS OTHERWISE SHOWN)
- PROPOSED SWALE
- DIRECTION OF EMERGENCY OVERLAND FLOW ROUTE
- PROPOSED VALVE BOX
- PROPOSED SANITARY SEWER MANHOLE
- PROPOSED STORM SEWER MANHOLE
- DEPRESSED CURB LOCATION
- PROPOSED DOOR LOCATIONS
- PROPOSED BARRIER CURB AS PER SC.1.1
- TREE

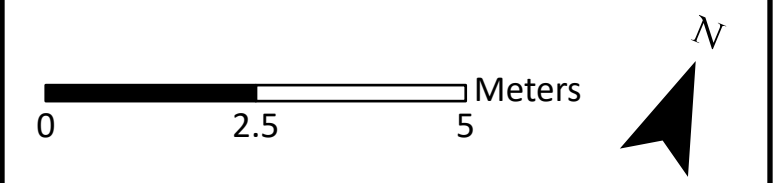

DRAWING: Tree Conservation Plan

PROJECT: 211 ARMSTRONG STREET
CITY OF OTTAWA



Andrew K. Boyd, R.P.F.

SCALE: 1:90	DRAWING NO. 211A
DATE: 2022-05-17	
DRAWN BY: SS	
SHEET NO. 1	

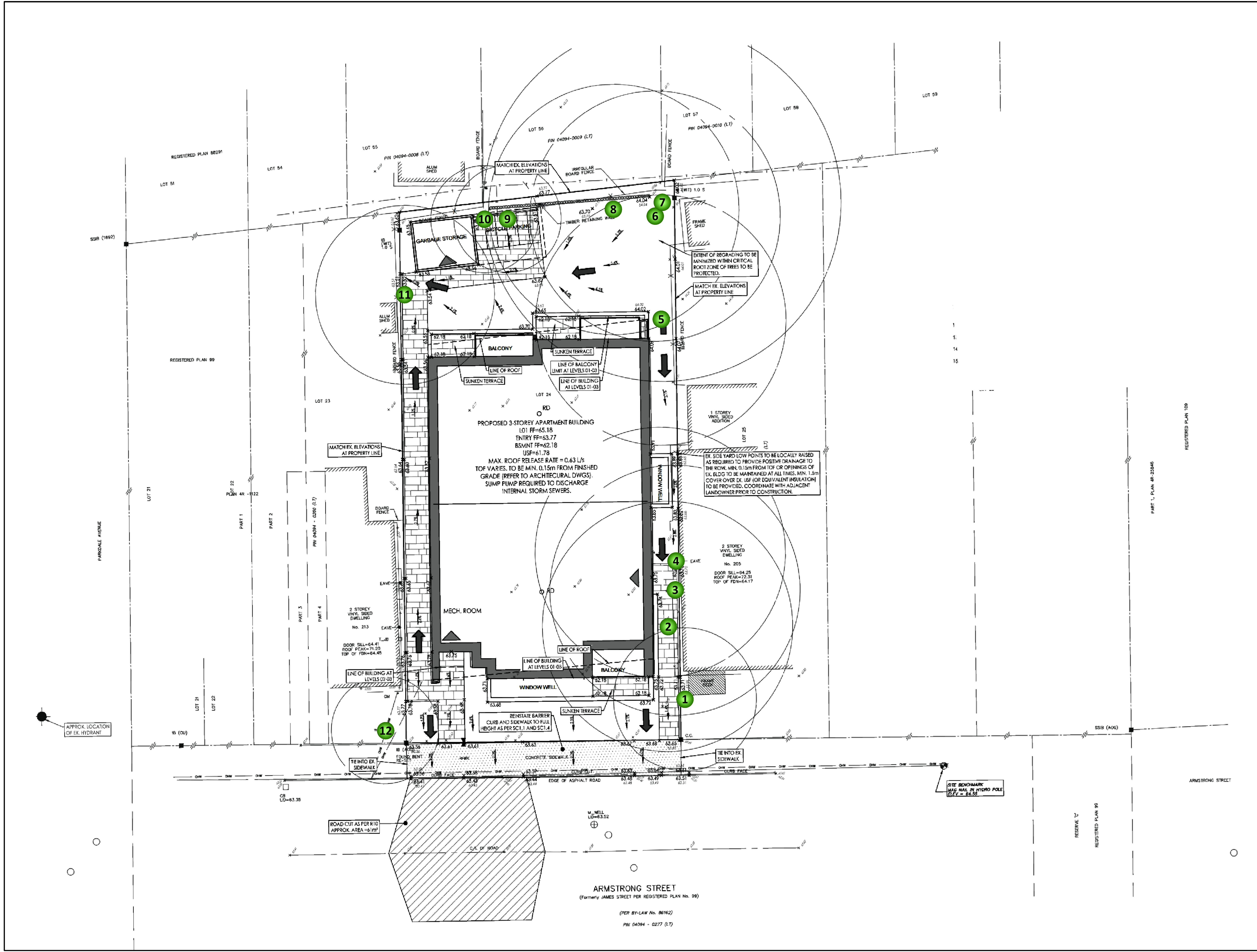

ARMSTRONG STREET
(Formerly JAMES STREET PER REGISTERED PLAN No. 98)
(PER BY-LAW No. 86162)
PIN 04094 - 0277 (L7)



Picture 1. Tree #1, neighbouring white cedar (far right) and Manitoba maples #2, 3 and 4 at 211 Armstrong Street



Picture 2. Trees #9-11 (right to left) at 211 Armstrong Street



Picture 3. Trees #6-8 (right to left) at 211 Armstrong Street



Picture 4. Neighbouring tree #12 adjacent to 211 Armstrong Street

LIMITATIONS OF TREE ASSESSMENTS & LIABILITY

GENERAL

It is the policy of *IFS Associates Inc.* to attach the following clause regarding limitations. We do this to ensure that our clients are clearly aware of what is technically and professionally realistic in assessing trees for retention.

This report was carried out by *IFS Associates Inc.* at the request of the client. The information, interpretation and analysis expressed in this report are for the sole benefit and exclusive use of the client. Possession of this report or a copy thereof does not imply right of publication or use for any purpose by any other than the client to whom it is addressed. Unless otherwise required by law, neither all or any part of the contents of this report, nor copy thereof, shall be conveyed by anyone, including the client, to the public through public relations, news or other media, without the prior expressly written consent of the author, and especially as to value conclusions, identity of the author, or any reference to any professional society or institute or to any initialed designation conferred upon the author as stated in his qualifications.

This report and any values expressed herein represent the opinion of the author; his fee is in no way contingent upon the reporting of a specified value, a stipulated result, nor upon any finding to be reported.

Details obtained from photographs, sketches, *etc.*, are intended as visual aids and are not to scale. They should not be construed as engineering reports or surveys. Although every effort has been made to ensure that this assessment is reasonably accurate, the tree(s) should be reassessed at least annually. The assessment presented in this report is valid at the time of the inspection only. The loss or alteration of any part of this report invalidates the entire report.

LIMITATIONS

The information contained in this report covers only the tree(s) in question and no others. It reflects the condition of the assessed tree(s) at the time of inspection and was limited to a visual examination of the accessible portions only. *IFS Associates Inc.* has prepared this report in a manner consistent with that level of care and skill ordinarily exercised by members of the forestry and arboricultural professions, subject to the time limits and physical constraints applicable to this report. The assessment of the tree(s) presented in this report has been made using accepted arboricultural techniques. These include a visual examination of the above-ground portions of each tree for structural defects, scars, cracks, cavities, external indications of decay such as fungal fruiting bodies, evidence of insect infestations, discoloured foliage, the condition of any visible root structures, the degree and direction of lean (if any), the general condition of the tree(s) and the surrounding site, and the proximity of people and property. Except where specifically noted in the report, the tree(s) examined were not dissected, cored, probed or climbed to gain further evidence of their structural condition. Also, unless otherwise noted, no detailed root collar examinations involving excavation were undertaken.

While reasonable efforts have been made to ensure that the tree(s) proposed for retention are healthy, no warranty or guarantee, expressed or implied, are offered that these trees, or any parts of them, will remain standing. This includes other trees on or off the property not examined as part of this assignment. It is both professionally and practically impossible to predict with

absolute certainty the behaviour of any single tree or groups of trees or their component parts in all circumstances, especially when within construction zones. Inevitably, a standing tree will always pose some risk. Most trees have the potential for failure in the event of root loss due to excavation and other construction-related impacts. This risk can only be eliminated through full tree removal (which is recommended in this case).

Notwithstanding the recommendations and conclusions made in this report, it must be realized that trees are living organisms, and their health and vigour constantly change over time. They are not immune to changes in site conditions, or seasonal variations in the weather. It is a condition of this report that *IFS Associates Inc.* be notified of any changes in tree condition and be provided an opportunity to review or revise the recommendations within this report.

Recognition of changes to a tree's condition requires expertise and extensive experience. It is recommended that *IFS Associates Inc.* be employed to re-inspect the tree(s) with sufficient frequency to detect if conditions have changed significantly.

ASSUMPTIONS

Statements made to *IFS Associates Inc.* in regards to the condition, history and location of the tree(s) are assumed to be correct. Unless indicated otherwise, all trees under investigation in this report are assumed to be on the client's property. A recent survey prepared by a Licensed Ontario Land Surveyor showing all relevant trees, both on and adjacent to the subject property, will be provided prior to the start of field work. The final version of the grading plan for the project will be provided prior to completion of the report. Any further changes to this plan invalidate the report on which it is based. *IFS Associates Inc.* must be provided the opportunity to revise the report in relation to any significant changes to the grading plan. The procurement of said survey and grading plan, and the costs associated with them both, are the responsibility of the client, not *IFS Associates Inc.*

LIABILITY

Without limiting the foregoing, no liability is assumed by *IFS Associates Inc.* for:

- 1) Any legal description provided with respect to the property;
- 2) Issues of title and/or ownership with respect to the property;
- 3) The accuracy of the property line locations or boundaries with respect to the property;
- 4) The accuracy of any other information provided by the client or third parties;
- 5) Any consequential loss, injury or damages suffered by the client or any third parties, including but not limited to replacement costs, loss of use, earnings and business interruption; and,
- 6) The unauthorized distribution of the report.

Further, under no circumstances may any claims be initiated or commenced by the client against *IFS Associates Inc.* or any of its directors, officers, employees, contractors, agents or assessors, in contract or in tort, more than 12 months after the date of this report.

ONGOING SERVICES

IFS Associates Inc. accepts no responsibility for the implementation of any or all parts of the report, unless specifically requested to supervise the implementation or examine the results of activities recommended herein. In the event that examination or supervision is requested, that request shall be made in writing and the details, including fees, agreed to in advance.



June 15, 2022

Appendix F Correspondences

F.1 Preconsultation Notes

211 Armstrong Street – Infrastructure Notes

Available Infrastructure:

Sanitary: 300mm PVC (Install 1992)

Storm: 375mm PVC (Install 1992)

Water: 200mm PVC (Install 1992)

Water Boundary Conditions:

Will be provided at request of consultant. Requests must include the location of the service and the expected loads required by the proposed development. Please provide the following and submit Fire Flow Calculation Sheet per FUS method with the request:

- Location of service
- Type of development and amount of required fire flow (per FUS method – include FUS calculation sheet with request)
- Average Daily Demand (l/s)
- Maximum Hourly Demand (l/s)
- Maximum Daily Demand (l/s)
- Water Supply Redundancy – Fire Flow:
Applicant to ensure that a second service with an inline valve chamber be provided where the average daily demand exceeds 50 m³ / day (0.5787 l/s per day)

Water services larger than 19 mm require a Water Data Card. Please complete card and submit.

Stormwater Management:

- Coefficient (C) of runoff determined **as per existing conditions** but in no case more than 0.5
- TC = To be calculated, minimum 10 minutes
- Any storm events greater than 5 year, up to 100 year, and including 100-year storm event must be detained on site.
- Foundation drains are to be independently connected to sewer main unless being pumped with appropriate back up power, sufficient sized pump and back flow prevention.
- Roof drains are to be connected downstream of any incorporated ICD within the SWM system.

Stormwater management criteria (Quality Control)

Include a section in the SWM report concerning quality control requirements. It is the consultant's responsibility to check with the relevant Conservation Authority for quality control issues and include this information in the SWM report.

Phase I and Phase II ESA:

- Phase I ESA is required; Phase II ESA may be required depending on the results of the Phase I ESA. Phase I ESA must include an EcoLog ERIS Report.
- Phase I ESA and Phase II ESAs must conform to clause 4.8.4 of the Official Plan that requires that development applications conform to Ontario Regulation 153/04.

Required Studies

- Servicing and Stormwater Management Report
- Geotechnical Study
- Phase I ESA
- Phase II ESA (depends on outcome of Phase I)
- Noise Study (proximity to Parkdale Road)

Required Plans

- Site Servicing Plan
- Grade Control and Drainage Plan
- Erosion and Sediment Control Plan (Can be combined with grading plan)

Relevant information

1. The Servicing Study Guidelines for Development Applications are available at the following address: <https://ottawa.ca/en/city-hall/planning-and-development/information-developers/development-application-review-process/development-application-submission/guide-preparing-studies-and-plans#servicing-study-guidelines-development-applications>
2. Servicing and site works shall be in accordance with the following documents:
 - ⇒ Ottawa Sewer Design Guidelines (October 2012)
 - ⇒ Ottawa Design Guidelines – Water Distribution (2010)
 - ⇒ Geotechnical Investigation and Reporting Guidelines for Development Applications in the City of Ottawa (2007)
 - ⇒ City of Ottawa Slope Stability Guidelines for Development Applications (revised 2012)
 - ⇒ City of Ottawa Environmental Noise Control Guidelines (January, 2016)
 - ⇒ City of Ottawa Park and Pathway Development Manual (2012)
 - ⇒ City of Ottawa Accessibility Design Standards (2012)
 - ⇒ Ottawa Standard Tender Documents (latest version)
 - ⇒ Ontario Provincial Standards for Roads & Public Works (2013)
3. Record drawings and utility plans are also available for purchase from the City (Contact the City's Information Centre by email at InformationCentre@ottawa.ca or by phone at (613) 580-2424 x.44455).
4. Any proposed work in utility easements requires written consent of easement owner.

211 ARMSTRONG STREET – STORMWATER MANAGEMENT AND SERVICING REPORT

June 15, 2022

Appendix G Drawings