

Notes:

- 1) Prune plants a min. amount to remove dead or injured members. Maintain natural character and shape of the species. Do not cut the leader branch.

DECIDUOUS TREE PLANTING
section NTS

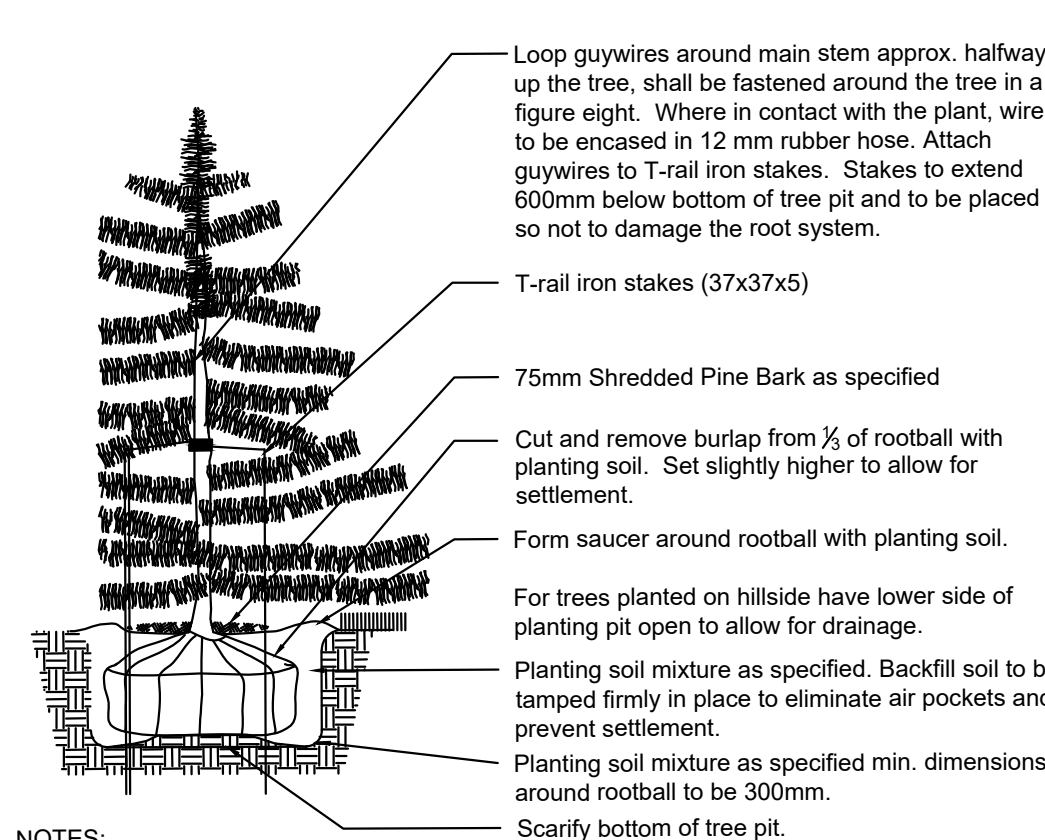

NOTES:

- 1) Prune plants a min. amount to remove dead or injured members. Maintain natural character and or shape of species. Do not cut a leader branch.

CONIFEROUS TREE PLANTING
section NTS

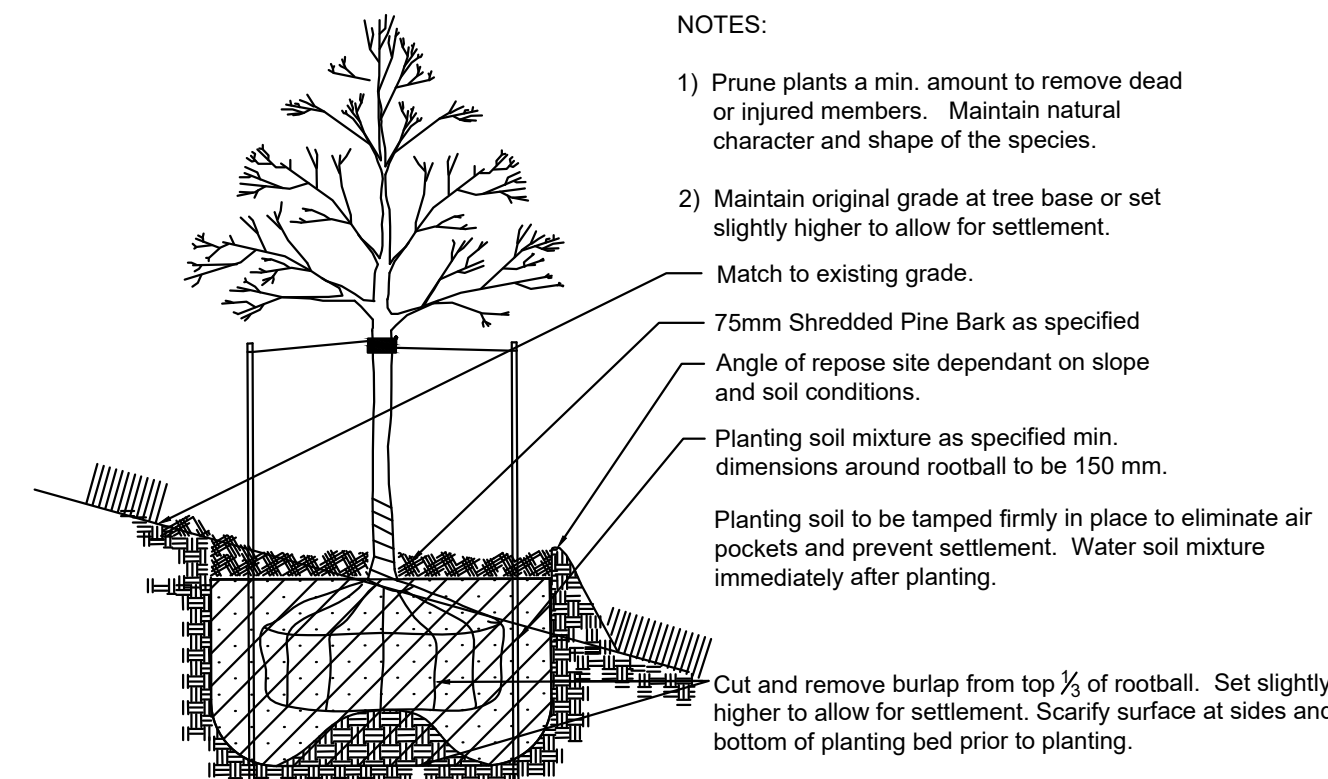

NOTES:

- 1) Prune plants a min. amount to remove dead or injured members. Maintain natural character and shape of the species.
 - 2) Maintain original grade at tree base or set slightly higher to allow for settlement.
- Trees/shrubs planted in groups shall be set in continuous prepared beds

DECIDUOUS TREE ON SLOPE
section NTS

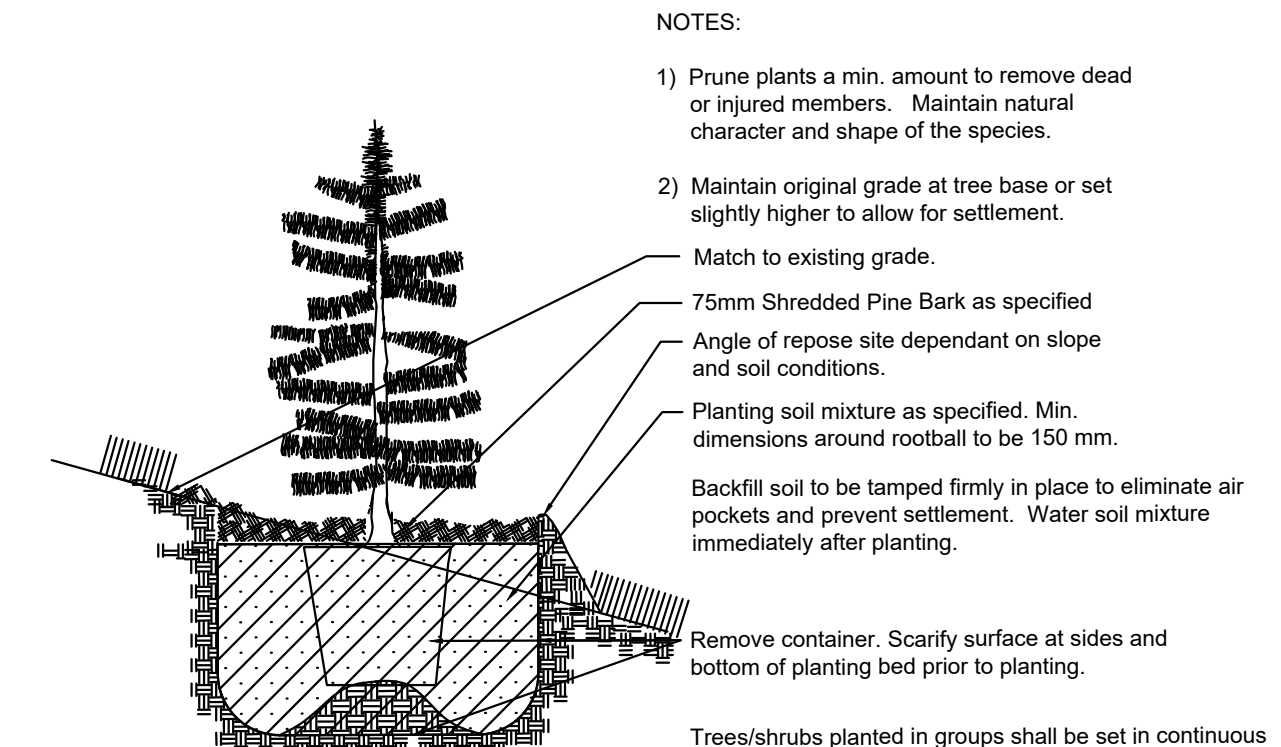

NOTES:

- 1) Prune plants a min. amount to remove dead or injured members. Maintain natural character and shape of the species.
 - 2) Maintain original grade at tree base or set slightly higher to allow for settlement.
- Trees/shrubs planted in groups shall be set in continuous prepared beds

CONIFEROUS TREE ON SLOPE
section NTS

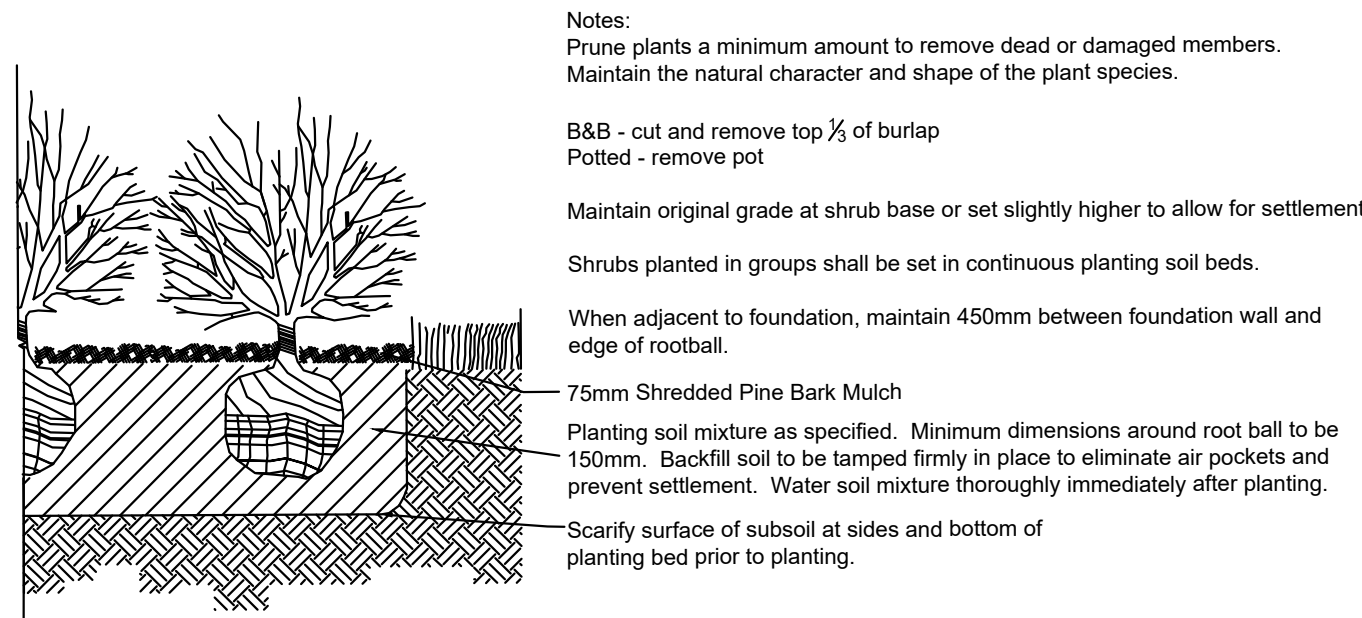

Notes:

- 1) Prune plants a minimum amount to remove dead or damaged members. Maintain the natural character and shape of the plant species.

B&B - cut and remove top 1/2 of burlap
Potted - remove pot

Maintain original grade at shrub base or set slightly higher to allow for settlement

Shrubs planted in groups shall be set in continuous planting soil beds.

When adjacent to foundation, maintain 450mm between foundation wall and edge of rootball.

75mm Shredded Pine Bark Mulch

Planting soil mixture as specified. Minimum dimensions around root ball to be 150mm. Backfill soil to be tamped firmly in place to eliminate air pockets and prevent settlement. Water soil mixture thoroughly immediately after planting.

Scarify surface of subsoil at sides and bottom of planting bed prior to planting.

MULTIPLE SHRUB PLANTING
section NTS

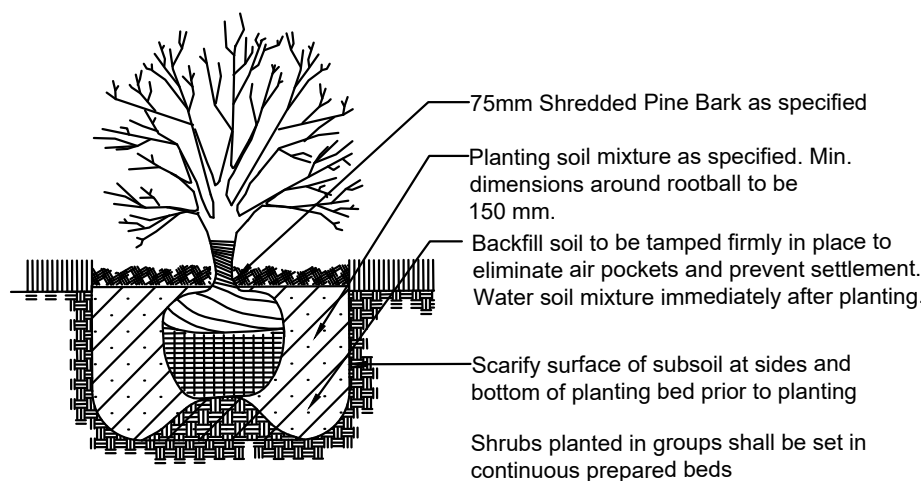

NOTES:

1. Prune plants a min. amount to remove dead or injured members. Maintain natural character and shape of the species.
2. Maintain original grade at tree base or set slightly higher to allow for settlement.
3. When adjacent to foundation, maintain 450mm between foundation wall and edge of rootball.

SHRUB PLANTING
section NTS

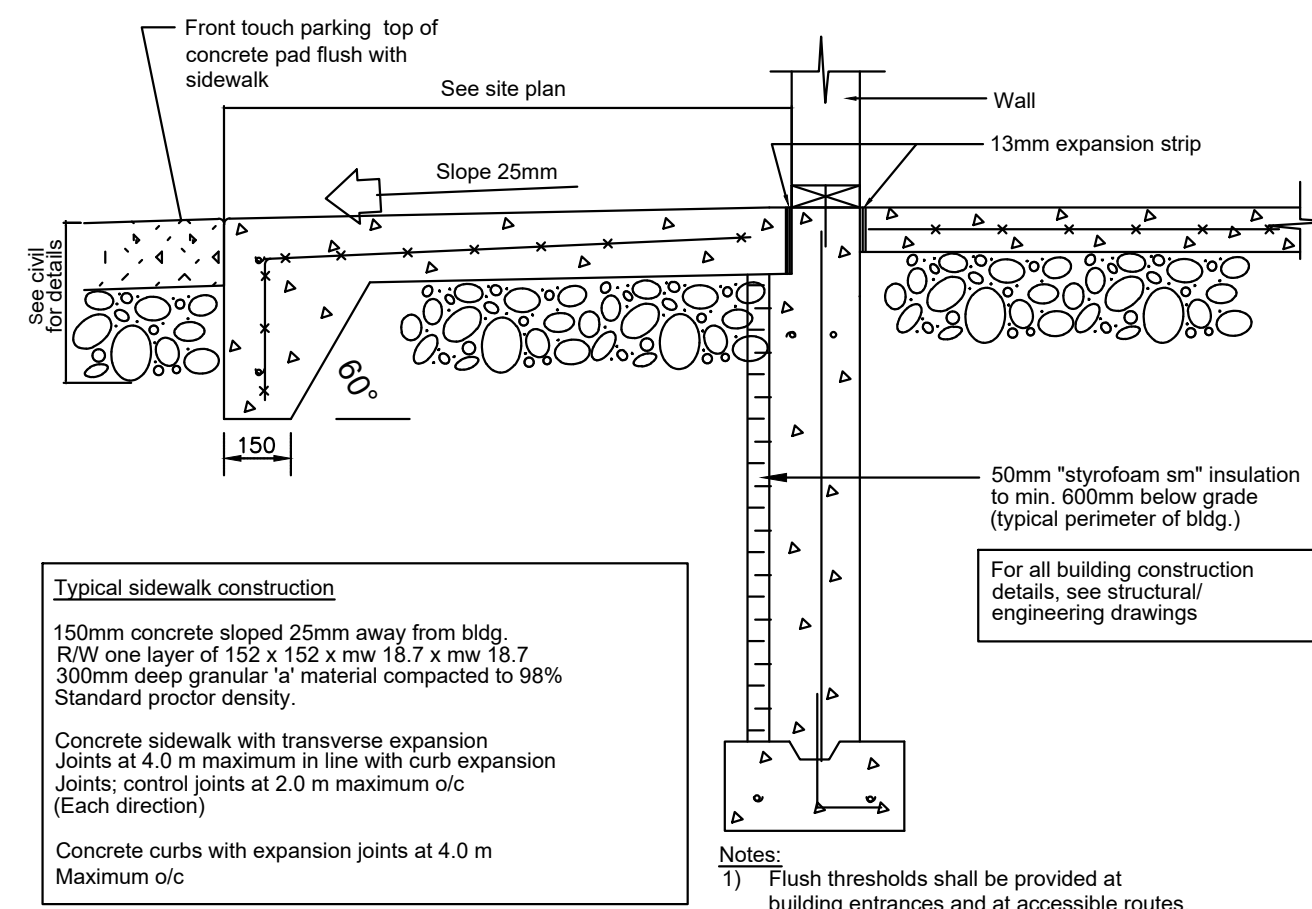

Typical sidewalk construction

150mm concrete sloped 25mm away from bldg. RW one layer of 152 x 152 x mw 18.7 x mw 18.7 300mm deep granular material compacted to 98% Standard proctor density.

Concrete sidewalk with transverse expansion joints at 4.0 m maximum in line with curb expansion joints; control joints at 2.0 m maximum o/c (Each direction)

Concrete curbs with expansion joints at 4.0 m Maximum o/c

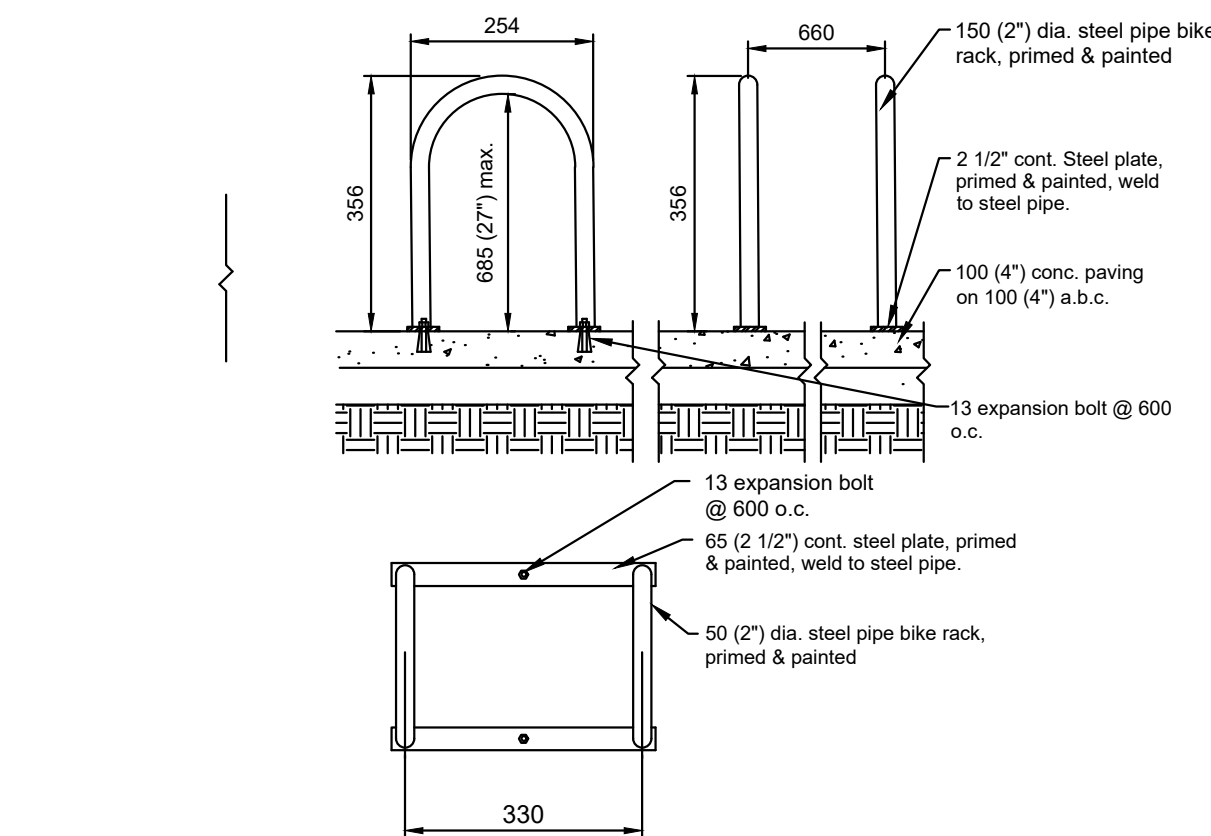

BIKE RACK
section NTS

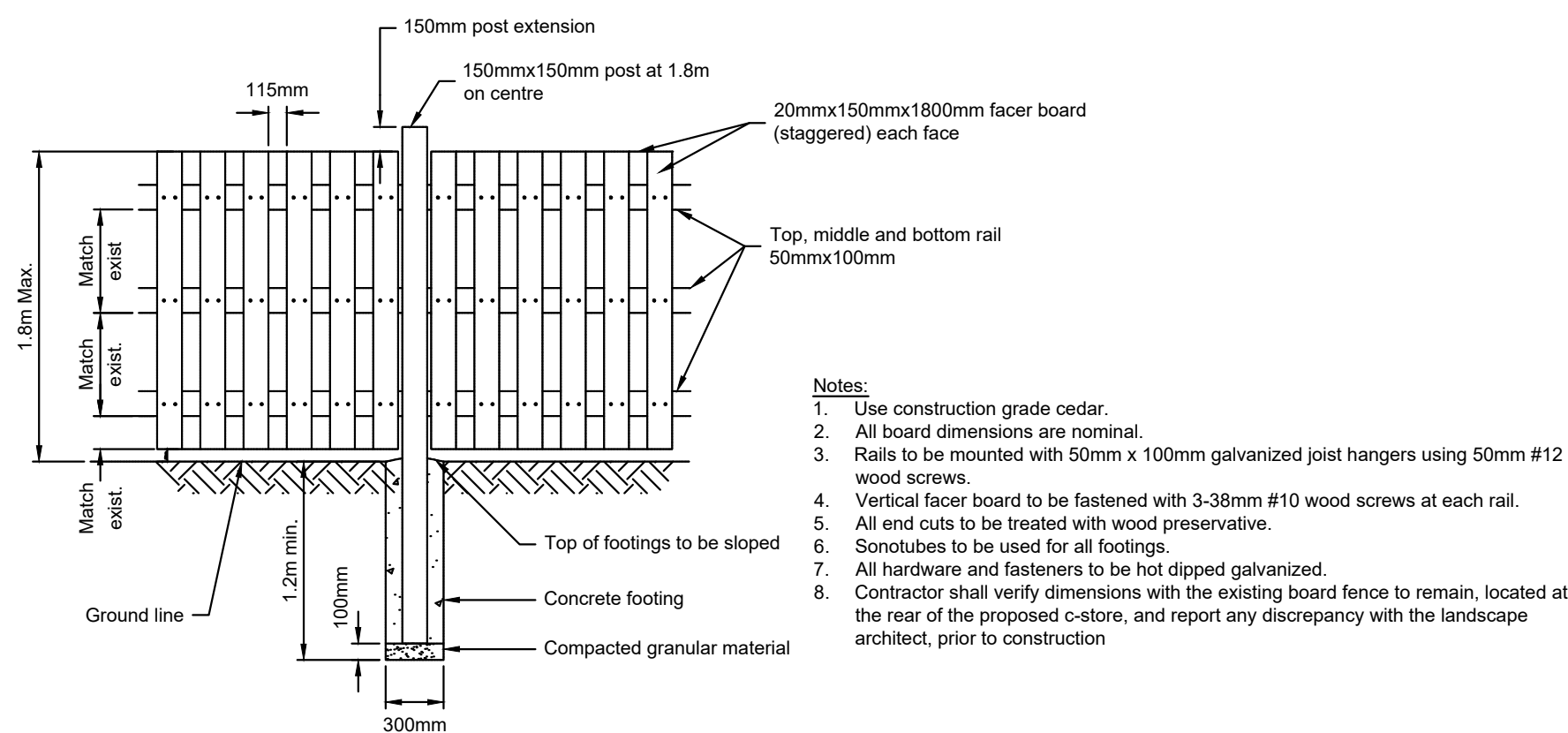

Notes:

1. Use construction grade cedar.
2. All board dimensions are nominal.
3. Rails to be mounted with 50mm x 100mm galvanized joist hangers using 50mm #12 wood screws.
4. Vertical facer board to be fastened with 3-38mm #10 wood screws at each rail.
5. All end cuts to be treated with wood preservative.
6. Snotobes to be used for all footings.
7. All hardware and fasteners to be hot dipped galvanized.
8. Contractor shall verify dimensions with the existing board fence to remain, located at the rear of the proposed fence, and report any discrepancy with the landscape architect, prior to construction

SHADOWBOX WOOD FENCE
section NTS

GENERAL CONSTRUCTION NOTE:

1. USE PLANTING MATERIAL TRUE TO NAME, SIZES, OR GRADES AS SPECIFIED, AND CONFORMING TO THE 'CANADIAN NURSERY TRADES ASSOCIATION METRIC GUIDE SPECIFICATIONS AND STANDARDS'.
2. CHECK ALL QUANTITIES AND REPORT ANY ERRORS/DISCREPANCIES TO THE LANDSCAPE ARCHITECT AND AGREE BEFORE PROCEEDING.
3. MATERIALS AND WORKMANSHIP NOT MEETING SPECIFICATIONS WILL BE REJECTED, AT TIME OF INSPECTIONS.
4. ALL TREES SHALL BE BALLED AND BURLAPPED AND ALL SHRUBS SHALL BE POT GROWN. PLANTING MATERIAL SIZES ARE MINIMUM.
5. WHEN PLANTING MATERIALS IS SUPPLIED IN WIRE BASKETS THE TOP 2/3 OF THE BASKET SHALL BE CUT AND REMOVED FROM THE PIT PRIOR TO BACKFILLING.
6. SPECIFIED MIX FOR TREE / SHRUB PLANTING: TOPSOIL SHALL BE A FERTILE, FRIABLE, NATURAL SANDY LOAM. IT SHALL BE FREE OF STONES, SUBSOIL, REFUSE OR OTHER EXTRANEIOUS MATERIALS, AND CAPABLE OF SUSTAINING HEALTHY PLANT GROWTH. THE CONTRACTOR SHALL NOT USE TOPSOIL WHILE IN A FROZEN OR MUDDY CONDITION. TEN PER CENT PEATMOSS AND TEN PERCENT WELL ROTTED FARMYARD MANURE SHOULD BE MIXED INTO THE TOPSOIL. THE SPECIFIED MIX SHALL BE SUBJECT TO THE APPROVAL OF THE TOWN/CITY'S AUTHORITY.
7. FINISH ALL PLANTING AREAS WITH 100MM OF SHREDDED PINE BARK MULCH. GROW BARK, 519-885-3411; ECONOMY MULCH SUBSTITUTIONS WILL BE REJECTED
8. ALL SOD SHALL CONFORM TO THE 'CANADIAN NURSERY SOD GROWERS SPECIFICATIONS' / NO 1 NURSERY SOD. SOD SHALL BE INSTALLED UPON ARRIVAL, AND SHALL BE SMOOTHLY LAID WITH TIGHT JOINTS ON MINIMUM 10 CM CLEAN TOPSOIL AND RECOMMENDED MINIMUM 30 CM OF CLEAN FILL. SOD SHALL BE COMPOSED OF 90% KENTUCKY BLUEGRASS & 10% CREEPING RED FESCUE, OR APPROVED EQUAL. CONTRACTOR TO PEG SOD ON SLOPES GREATER THAN 3:1. SWALES & DITCHES. CONTRACTOR TO PROVIDE UNIT PRICE FOR SODDING, AREAS DETERMINED ON SITE, AT TIME OF CONSTRUCTION. CONTRACTOR RESPONSIBLE TO MAINTAIN GRASS UNTIL FINAL APPROVAL. ALLOW FOR ONE CUTTING AND REMOVE CLIPPINGS.
9. WARRANTY ON ALL PLANT MATERIAL, (INCLUDING TRANSPLANTED MATERIAL), SHALL BE FOR TWO YEARS FROM DATE OF FINAL ACCEPTANCE OF CONSTRUCTION, REPLACEMENTS WARRANTY SHALL BE FOR AN ADDITIONAL TWO YEARS, (CONTRACTORS RESPONSIBILITY).

CONTRACTOR RESPONSIBLE TO MAINTAIN & WATER PLANTINGS UNTIL FINAL APPROVAL & COORDINATE TAKE OVER OF MAINTENANCE WITH IO DEALER; (CONTRACTOR SHALL MONITOR SITE DURING. TWO YEAR WARRANTY, REPORT ANY CONCERN TO CK)

wood.

Unless otherwise agreed in a written contract between Wood and its client, this document: (i) contains information, data and design that is confidential and may not be copied or disclosed; and (ii) may be used by the client only in the context and for the express purpose for which it was intended. Any use of, or reliance on, this document by any third party is the party's sole risk.

COPYRIGHT NOTICE

This drawing is the property of the above referenced Professional and is not to be used for any purpose other than the specific project and site named herein, and cannot be reproduced in any manner without the express written permission from the Professional

04/21/21 FOR CLIENT REVIEW
04/27/21 ISSUE FOR SPA
09/21/21 RE-ISSUED FOR SPA
12/03/21 RE-ISSUED FOR SPA

PROFESSIONAL SEAL

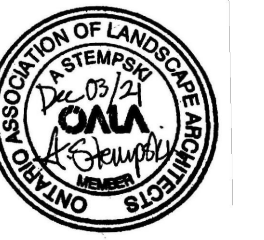

ska
Stempeski Kelly Associates Inc.
Design Landscape Architecture Planning
P.O. Box 359, Fergus, ON, N1M 3E2
Voice (519) 787 4313
stasio@sko-design.ca www.ska-design.ca

PROFESSIONAL IN CHARGE
S. STEMPESKI
PROJECT MANAGER
S. LAWRENCE
QUALITY CONTROL
F. RIVARD
DRAWN BY
J. YI

PROJECT NAME
CIRCLE K STORES INC. R&R No. 52287

NEPEAN ONTARIO

1545 WOODROFFE AVENUE NEPEAN, ON, CANADA K2G 1W2



CIRCLE K STORES INC.

PROJECT NUMBER
BE20207036

SHEET TITLE
LANDSCAPE DETAILS I

SHEET NUMBER
L3.0