



Transportation Noise Assessment

**Salvation Army Multi Purpose Building
102 Bill Leathem Drive**

Ottawa, Ontario

REPORT: GWE15-009 - Transportation Noise

Prepared For:

Michaela Jones
The Salvation Army
2 Overlea Boulevard
Toronto, Ontario
M4H 1P4

Prepared By:

Michael Lafortune, Environmental Technologist
Joshua Foster, P.Eng., Partner

May 2, 2016

EXECUTIVE SUMMARY

This document describes a transportation noise assessment performed for a proposed multi purpose single floor development at 102 Bill Leathem Drive in Ottawa, Ontario. Phases 1 and 2 will rise approximately 9.5 and 10.5 meters above local grade respectively. Figure 1 illustrates a site plan with surrounding context. The major sources of roadway noise are Bill Leathem Drive and Leikin Drive. The site is also situated inside the Airport Operating Influence Zone (Noise Exposure Forecast 30)

The assessment is based on: (i) theoretical noise prediction methods that conform to the Ontario Ministry of the Environment and Climate Change (MOECC) and City of Ottawa requirements; (ii) noise level criteria as specified by the City of Ottawa's Environmental Noise Control Guidelines (ENCG); (iii) future vehicular traffic volumes based on the City of Ottawa's Official Plan roadway classifications; and (iv) architectural drawings received from Vandenberg & Wildeboer Architects.

The results of the current study indicate that noise levels due to roadway traffic over the site will range between 60 and 68 dBA during the daytime period (07:00-23:00) and between 53 and 60 dBA during the nighttime period (23:00-07:00). The highest noise level (i.e. 68 dBA) occurs on the south façade of Phase 1 (Receptor 3), which is nearest and most exposed to Leikin Drive. In addition to surface transportation, the site is also impacted from aircraft noise. The site is situated between NEF/NEP contours of 30 and 35 and the maximum expected sound pressure level is 67 dBA, due to aircraft flyovers.

Minimum building construction in all areas is required to satisfy the Ontario Building Code (2012). In addition, upgraded Sound Transmission Class (STC) ratings are required for building components where noise levels exceed the ENCG criteria for roadway traffic and aircraft traffic noise respectively, as per Section 5.3. In addition to upgraded building components the installation of central air conditioning (or similar mechanical system) will be required for the development. Furthermore, Warning Clauses will be required on all purchase, sale, and lease agreements, as per Section 6

TABLE OF CONTENTS

	PAGE
1. INTRODUCTION	1
2. TERMS OF REFERENCE	1
3. OBJECTIVES	2
4. METHODOLOGY	2
4.1 Background	2
4.2 Roadway Traffic Noise	2
4.2.1 Criteria for Roadway Traffic Noise	2
4.2.2 Roadway Traffic Volumes	5
4.2.3 Theoretical Roadway Noise Predictions	5
4.3 Aircraft Traffic Noise	6
4.3.1 Criteria for Aircraft Traffic Noise	6
4.3.2 Theoretical Aircraft Noise Predictions	7
5. RESULTS AND DISCUSSION	9
5.1 Roadway Noise Levels	9
5.2 Aircraft Noise Levels	10
5.3 Building Components	10
6. CONCLUSIONS AND RECOMMENDATIONS	11
FIGURES	
APPENDICES:	
Appendix A – Architectural Drawings	
Appendix B – STAMSON 5.04 Input and Output Data	
Appendix C – IBANA-Calc Calculations	

1. INTRODUCTION

Gradient Wind Engineering Inc. (GWE) was retained by The Salvation Army to undertake a transportation noise study of a proposed multi purpose single floor building development at 102 Bill Leathem Drive in Ottawa, Ontario. This report summarizes the methodology, results, and recommendations related to a transportation noise assessment. GWE's scope of work involved assessing exterior and interior noise levels generated by local roadway traffic. The assessment was performed on the basis of theoretical noise calculation methods conforming to the City of Ottawa¹ and Ontario Ministry of the Environment and Climate Change² guidelines. Noise calculations were based on architectural drawings received from Vandenberg & Wildeboer Architects (see Appendix A), with future traffic volumes corresponding to the City of Ottawa's Official Plan (OP) roadway classifications.

2. TERMS OF REFERENCE

The focus of this transportation noise assessment is a proposed single-storey, two-phase, multi purpose building, to be used as a place of worship and a community centre. The development is located on the northwest corner of the Bill Leathem Drive & Leikin Drive intersection. The major sources of roadway noise are Bill Leathem Drive and Leikin Drive. The site is surrounded on all sides with mixed-use land, specifically Light Industrial and Parks and Open Space zones. Figure 1 illustrates a complete site plan with surrounding context.

Upon completion, Phases 1 and 2 will rise approximately 9.5 and 10.5 meters above local grade respectively. No Outdoor Living Areas (OLAs) are currently located on, or proposed for the site. Under the guidelines, OLA are areas readily assessable from the building and intended for quiet enjoyment of the outdoor environment. They can include passive recreational areas such as parks. Active areas, such as sports fields would therefore not be considered as OLA.

¹ City of Ottawa, Environmental Noise Control Guidelines, January 2016

² Ontario Ministry of the Environment and Climate Change, Environmental Noise Guideline – Publication NPC-300, August 2013
The Salvation Army – 102 Bill Leathem Drive

3. OBJECTIVES

The main goals of this work are to: (i) calculate the future noise levels on the study building produced by local roadway traffic and aircraft traffic, (ii) ensure that interior noise levels and vibration levels do not exceed the allowable limits specified by the City of Ottawa's Environmental Noise Control Guidelines as outlined in Sections 4.2 and 4.4 of this report.

4. METHODOLOGY

4.1 Background

Noise can be defined as any obtrusive sound. It is created at a source, transmitted through a medium, such as air, and intercepted by a receiver. Noise may be characterized in terms of the power of the source or the sound pressure at a specific distance. While the power of a source is characteristic of that particular source, the sound pressure depends on the location of the receiver and the path that the noise takes to reach the receiver. Measurement of noise is based on the decibel unit, dBA, which is a logarithmic ratio referenced to a standard noise level (2×10^{-5} Pascals). The 'A' suffix refers to a weighting scale, which better represents how the noise is perceived by the human ear. With this scale, a doubling of power results in a 3 dBA increase in measured noise levels and is just perceptible to most people. An increase of 10 dBA is often perceived to be twice as loud.

4.2 Roadway Traffic Noise

4.2.1 Criteria for Roadway Traffic Noise

For vehicle traffic, the equivalent sound energy level, L_{EQ} , provides a measure of the time varying noise levels, which is well correlated with the annoyance of sound. It is defined as the continuous sound level, which has the same energy as a time varying noise level over a period of time. For roadways, the L_{EQ} is commonly calculated on the basis of a 16-hour (L_{EQ16}) daytime (07:00-23:00) / 8-hour (L_{EQ8}) nighttime (23:00-07:00) split to assess its impact on residential buildings. The City of Ottawa's Environmental Noise Control Guidelines (ENCG) specifies that the recommended indoor noise limit range (that is relevant to this study) is 45 dBA for conference rooms and places of worship, as listed in Table 1. Based on GWE's experience, more comfortable indoor noise levels should be targeted toward 42 dBA to control peak noise, and deficiencies in building envelope construction.

TABLE 1: INDOOR SOUND LEVEL CRITERIA (ROAD & RAIL)³

Type of Space	Time Period	L _{EQ} (dBA)	
		Road	Rail
General offices, reception areas, retail stores, etc.	07:00 – 23:00	50	45
Living/dining/den areas of residences, hospitals, schools, nursing/retirement homes, day-care centres, theatres, places of worship, libraries, individual or semi-private offices, conference rooms, etc.	07:00 – 23:00	45	40
Sleeping quarters of hotels/motels	23:00 – 07:00	45	40
Sleeping quarters of residences, hospitals, nursing/retirement homes, etc.	23:00 – 07:00	40	35

Predicted noise levels at the plane of window (POW) and outdoor living area (OLA) dictate the action required to achieve the recommended sound levels. When noise levels at these areas exceed the criteria outlined in Table 2, specific outdoor, ventilation and Warning Clause requirements may apply. In addition, when noise levels exceed the criteria outlined in Table 3, upgraded building components must be designed.

³ Adapted from ENCG – Table 2.2b,c
The Salvation Army – 102 Bill Leathem Drive
Transportation Noise Study

TABLE 2: ROAD & RAIL NOISE COMBINED – OUTDOOR NOISE, VENTILATION AND WARNING CLAUSE REQUIREMENTS⁴

Time Period	L_{EQ} (dBA)	Ventilation Requirements	Outdoor Noise Control Measures	Warning Clause
Outdoor Living Area (OLA)				
Daytime (07:00 – 23:00)	$L_{EQ(16hr)} < 55$	N/A	Not required	Not required
	$55 < L_{EQ(16hr)} \leq 60$	N/A	May not be required but should be considered	Type A [†]
	$L_{EQ(16hr)} > 60$	N/A	Required to reduce the L_{EQ} to below 60 dBA and as close to 55 dBA where feasible	Type B ^{††}
Plane of Window (POW)				
Daytime (07:00 – 23:00)	$L_{EQ(16hr)} < 55$	Not required	N/A	Not required
	$55 < L_{EQ(16hr)} \leq 65$	Forced air heating with provision for central air conditioning	N/A	Type C
	$L_{EQ(16hr)} > 65$	Central air conditioning	N/A	Type D
Nighttime (23:00 – 07:00)	$L_{EQ(8hr)} < 50$	Not required	N/A	Not required
	$50 < L_{EQ(8hr)} \leq 60$	Forced air heating with provision for central air conditioning	N/A	Type C
	$L_{EQ(8hr)} > 60$	Central air conditioning	N/A	Type D

† - Required if resultant L_{EQ} exceeds 55 dBA

†† - Required if resultant L_{EQ} exceeds 55 dBA and if it is administratively, economically and/or technically feasible

TABLE 3: ROAD & RAIL NOISE BUILDING COMPONENT REQUIREMENTS⁵

Source	L_{EQ} (dBA)	Building Component Requirements
Road	$L_{EQ(16hr)} > 65$ (Daytime)	Building components (walls, windows, etc.) must be designed to achieve indoor sound level criteria
	$L_{EQ(8hr)} > 60$ (Nighttime)	
Rail	$L_{EQ(16hr)} > 60$ (Daytime)	
	$L_{EQ(8hr)} > 55$ (Nighttime)	

⁴ Adapted from ENCG 2006 – Table 1.10

⁵ Adapted from ENCG 2006 – Table 1.8

4.2.2 Roadway Traffic Volumes

The ENCG dictates that noise calculations should consider future sound levels based on a roadway's classification at the mature state of development. Therefore, traffic volumes are based on the roadway classifications outlined in the City of Ottawa's Official Plan (OP) and Transportation Master Plan⁶ which provides additional details on future roadway expansions. Average Annual Daily Traffic (AADT) volumes are then based on data in Table 1.7 of the ENCG for each roadway classification. Table 4 (below) summarizes the AADT values used for each roadway included in this assessment.

TABLE 4: ROADWAY TRAFFIC DATA

Roadway	Roadway Class	Speed Limit (km/h)	Official Plan AADT
Bill Leathem Drive	2-UAU	60	12,000
Leikin Drive	2-UCU	60	12,000

4.2.3 Theoretical Roadway Noise Predictions

Noise predictions were performed with the aid of the Ontario Ministry of the Environment and Climate Change (MOECC) computerized noise assessment program, STAMSON 5.04, for road and rail analysis. Appendix B includes the STAMSON 5.04 input and output data.

Roadway noise calculations were performed by treating each road segment as separate line sources of noise, and by using existing building locations as noise barriers. In addition to the traffic volumes summarized in Table 4, theoretical noise predictions were based on the following parameters:

- Truck traffic on all roadways was taken to comprise 5% heavy trucks and 7% medium trucks, as per ENCG requirements for noise level predictions
- The day/night split was taken to be 92% / 8% respectively for all streets
- Absorptive and reflective intermediate ground surfaces based on specific source-receiver path ground characteristics
- The study site was treated as having flat topography

Noise receptors were strategically placed at seven locations around the study area (see Figure 2).

⁶ City of Ottawa Transportation Master Plan, November 2013
The Salvation Army – 102 Bill Leathem Drive
Transportation Noise Study

4.3 Aircraft Traffic Noise

4.3.1 Criteria for Aircraft Traffic Noise

The ENCG outlines the sound level criteria for aircraft noise based on a site's location near the Ottawa International Airport. The Ottawa Airport Vicinity Development Zone (OAVDZ) is a zone around the airport defined by Noise Exposure Forecast (NEF) or Noise Exposure Projections (NEP) contour lines that follow fixed features, such as roads or lot boundaries. NEF/NEP contours reflect the predetermined noise levels which would impact sensitive areas around airports. These contours include the influences of noise levels from aircraft flight, take-off, and ground operations to specific urban areas. Noise generated from aircraft traffic is represented as Effective Perceived Noise Levels (EPNL), a unit of noise measurement that accounts for variations in the human perception of pure tones and noise duration. Recorded noise levels are plotted geographically to generate NEF/NEP contour maps, where lower NEF/NEP levels correspond to lower average outdoor noise levels. The OAVDZ represents the 25 NEF/NEP contour. The Ottawa Airport Operating Influence Zone (OAOIZ) represents the NEF/NEP 30 contour, where commercial aircraft traffic may negatively influence noise-sensitive developments. Within the OAOIZ, noise-sensitive development is not permitted, although infill and redevelopment may occur in specific areas within the zone in keeping with the criteria set out in the Official Plan, and subject to detailed studies.

According to accepted research⁷, Health and Welfare Canada states that people continuously exposed to NEF/NEP values less than 35 will not suffer adverse physical or psychological effects. Sociological surveys⁸ have indicated that negative community reactions to noise levels may start at about 25 NEF/NEP. Table 5 identifies the sound level criteria for relevant outdoor and indoor living spaces exposed to aircraft noise.

⁷ Report of the Special Meeting on Aircraft Noise in the Vicinity of Aerodromes, Montreal ICAO, 1969.

⁸ Noise in Urban and Suburban Areas. Bolt, Beanik and Newman, Inc., Washington, January 1967.

TABLE 5: OUTDOOR AND INDOOR AIRCRAFT SOUND LEVEL CRITERIA⁹

Type of Space	NEF/NEP	Approximate L _{EQ(24Hr)}
Outdoor Point of Reception	30	61-64 dBA
General offices, reception areas, retail stores, etc.	15	46-49 dBA
Individual or semi-private offices, conference rooms, etc.	10	41-44 dBA
Living/dining areas of residences, sleeping quarters in hotels/motels, theatres, libraries, schools, day-care centres, places of worship , etc.	5	36 - 39 dBA
Sleeping quarters of residences, hospitals, nursing/retirement homes, etc.	0	31-34 dBA

4.3.2 Theoretical Aircraft Noise Predictions

The impact of aircraft noise on the local environment was determined using IBANA-CALC, a software package developed by the National Research Council of Canada. This software calculates indoor noise levels for standard roof, wall and window construction details for appropriate aircraft noise source spectra. Since aircraft produce uniform noise levels over large areas, building construction is more carefully considered than specific building location for interior noise level calculations. For this project, an NEF value of 35 has been applied due to the study site location, which is between OAOIZ (NEF 30) and the NEF contour 35 as illustrated in Figure 3. As the study site is inside the OAOIZ limit, outdoor living areas are not currently proposed, nor associated with the development.

The influence of aircraft noise is based on NEF/NEP contours, geographically plotted values that quantify the noise levels from airport traffic on adjacent properties. The ENCG guidelines state that locations corresponding to NEF/NEP 25 or greater require improvements to the typical building envelope components, including exterior walls, roofs, windows and doors, to ensure adequate noise attenuation by the building envelope. In IBANA-CALC, construction elements are rated on the basis of Outdoor-Indoor Transmission Class (OITC). The OITC is a single number rating of the sound insulation (similar to Acoustic Insulation Factor values referred to in the ENCG document) of an exterior partition against typical outdoor noises defined in the ASTM standard E1332. The procedure for determining OITC ratings includes specifying a standard source spectrum corresponding to an NEF/NEP and calculation of the reduction in noise levels to the interior across the wall components.

⁹ Adapted from ENCG – Tables 1.2, 1.3
The Salvation Army – 102 Bill Leathem Drive
Transportation Noise Study

To model the study site using the IBANA-CALC software, building elements were selected around the site to represent typical façades. The resulting interior noise level was then determined using similar construction elements and room dimensions. Calculations were based on a worst-case representation of the most sensitive rooms, comprising the following construction elements: metal sided 2"× 6" walls, wood truss roof, and standard glazing elements. Details of the wall assemblies proposed are included in Appendix A. Acoustically equivalent assemblies which match the available assemblies in IBANA-CALC were chosen for calculations for worship spaces and meeting rooms. Details of the calculations are provided in Appendix C.

5. RESULTS AND DISCUSSION

5.1 Roadway Noise Levels

Appendix B contains the complete set of input and output data from all STAMSON 5.04 calculations. The results of the roadway noise calculations are summarized in Table 6 below.

TABLE 6: EXTERIOR NOISE LEVELS DUE TO ROADWAY TRAFFIC

Receptor Number	Plane of Window Receptor Location	Noise Level (dBA)	
		Day	Night
1	POW – Phase 1 – 7 m – North Façade	63	56
2	POW – Phase 1 – 3.2 m – East Façade	66	58
3	POW – Phase 1 – 7 m – South Façade	68	60
4	POW – Phase 1 – 1.5 m – West Façade	62	55
5	POW – Phase 1 – 1.5 m – West Façade	62	54
6	POW – Phase 2 – 1.5 m – West Façade	60	53
7	POW – Phase 2 – 7 m – South Façade	65	57

The results of the current analysis indicate that noise levels will range between 60 and 68 dBA during the daytime period (07:00-23:00) and between 53 and 60 dBA during the nighttime period (23:00-07:00). The highest noise level (i.e. 68 dBA) occurs on the south façade of Phase 1 (Receptor 3), which is nearest and most exposed to Leikin Drive.

Because of elevated noise levels from traffic, central air conditioning (or similar mechanical system) will be required to allow windows and doors to remain closed to maintain a comfortable and quiet indoor environment. Under the ENCG guidelines, surface transportation and aircraft noise are evaluated separately and aircraft noise was found to be the governing source with an anticipated 24-hour L_{EQ} of up to 67 dBA anticipated. It should also be noted that the indoor criteria for aircraft is more stringent.

5.2 Aircraft Noise Levels

Appendix C contains the complete set of input and output data from all IBANA-Calc calculations. The results of the aircraft noise assessment are summarized in Table 7 below.

TABLE 7: EXTERIOR NOISE LEVELS DUE TO AIRCRAFT

Room Location	Indoor Noise Level $L_{EQ(24 \text{ Hr})}$ (dBA)	
	IBANA-Calc	ENCG Criteria
Worship / Gymnasium (Phase 1)	37	36 - 39
Sanctuary (Phase 2)	37	36 - 39
Multi-Purpose Room	31	41-44

The results of the current analysis indicate that with the proposed wall and standard window assemblies predicted noise levels will be compliant to the ENCG criteria for aircraft noise. Due to aircraft noise, central air conditioning (or similar mechanical system) will be required to allow windows and doors to remain closed to maintain a comfortable and quiet indoor environment.

5.3 Building Components

The noise levels predicted due to roadway traffic and aircraft traffic exceed the criteria listed in the ENCG for outdoor noise levels. Therefore, building components will be designed to meet the indoor sound level criteria. As discussed in Section 4.3 the anticipated STC / OITC requirements for windows have been estimated based on the overall noise reduction required for each intended use of space. As per city of Ottawa requirements, detailed review of wall assemblies will be required to be completed prior to building permit application. The STC requirements for the windows, roof and walls are summarized below:

- **Windows**
 - (i) Windows will have a minimum STC 35 (OITC 29)
- **Exterior Walls**
 - (i) Exterior wall components require a minimum STC of 50 (OITC 37) which will be achieved with brick cladding or an acoustical equivalent according to NRC test data¹⁰

¹⁰ J.S. Bradley and J.A. Birta. Laboratory Measurements of the Sound Insulation of Building Façade Elements, National Research Council October 2000.

- **Roof**

- (i) Roof components require a minimum STC of 45 (OITC 30) which will be achieved with standard roof truss construction according to NRC test data¹¹

Results of the calculations also indicate that the development will require central air conditioning (or similar mechanical system), which will allow occupants to keep windows closed and maintain a comfortable living environment.

6. CONCLUSIONS AND RECOMMENDATIONS

The results of the current study indicate that noise levels due to roadway traffic over the site will range between 60 and 68 dBA during the daytime period (07:00-23:00) and between 53 and 60 dBA during the nighttime period (23:00-07:00). The highest noise level (i.e. 68 dBA) occurs on the south façade of Phase 1 (Receptor 3), which is nearest and most exposed to Leikin Drive. In addition to surface transportation, the site is also impacted by aircraft noise. The site is situated between NEF/NEP contours of 30 and 35 and the maximum expected sound pressure level is 67 dBA, due to aircraft flyovers.

Minimum building construction in all areas is required to satisfy the Ontario Building Code (2012). In addition, upgraded Sound Transmission Class (STC) ratings are required for building components where noise levels exceed the ENCG criteria for roadway traffic and aircraft traffic noise respectively, as per Section 5.3. In addition to upgraded building components, the installation of central air conditioning (or similar mechanical system) will be required for the development. In addition to physical noise control measures, the ENCG typically requires the following Warning Clauses to be applied to purchase and sale and agreements. The following paragraphs provide example text adopted from the ENCG:

¹¹ J.S. Bradley and J.A. Birta. Laboratory Measurements of the Sound Insulation of Building Façade Elements, National Research Council October 2000.

Due to surface Transportation:

Purchasers/occupants are advised that sound levels due to increasing road traffic will interfere with outdoor activities as the sound levels exceed the sound level limits of the City and the Ministry of the Environment. To help address the need for sound attenuation this development includes:

- *multi-pane glass;*
- *brick veneer;*
- *high sound transmission class walls.*

To ensure that provincial sound level limits are not exceeded, it is important to maintain these sound attenuation features. This building has been supplied with a central air conditioning or equivalent system and other measures which will allow windows and exterior doors to remain closed, thereby ensuring that the indoor sound levels are within the sound level limits of the City and the Ministry of the Environment

Due to Aircraft Noise

Purchasers/building occupants are forewarned that this property is located in a noise sensitive area due to its proximity to Ottawa Macdonald-Cartier International Airport. In order to reduce the impact of aircraft noise in the indoor spaces, the building has been designed and built to meet provincial standards for noise control by the use of components and building systems that provide sound attenuation. In addition to the building components (i.e. walls, windows, doors, ceiling-roof), since the benefit of sound attenuation is lost when windows or doors are left open, this building has been fitted with a central air conditioning system or equivalent. Despite the inclusion of noise control features within the building, noise due to aircraft operations may continue to interfere with some indoor activities and with outdoor activities, particularly during the summer months. The building occupant is further advised that the Airport is open and operates 24 hours a day, and that changes to operations or expansion of the airport facilities, including the construction of new runways, may affect the worship environment of the parishioners of this property/area. The Ottawa Macdonald-Cartier International Airport Authority, its acoustical consultants and the City of Ottawa are not responsible if, regardless of the implementation of noise control features, the occupant of this building finds that the noise levels due to aircraft operations continue to be of concern or are offensive.

This concludes our assessment and report. If you have any questions or wish to discuss our findings please advise us. In the interim, we thank you for the opportunity to be of service.

Yours truly,

Gradient Wind Engineering Inc.

A handwritten signature in blue ink, appearing to read 'M. Lafortune'.

Michael Lafortune
Environmental Technologist
GWE15-009 - Transportation Noise



Joshua Foster, P.Eng.
Partner

APPENDIX A

Architectural Drawings

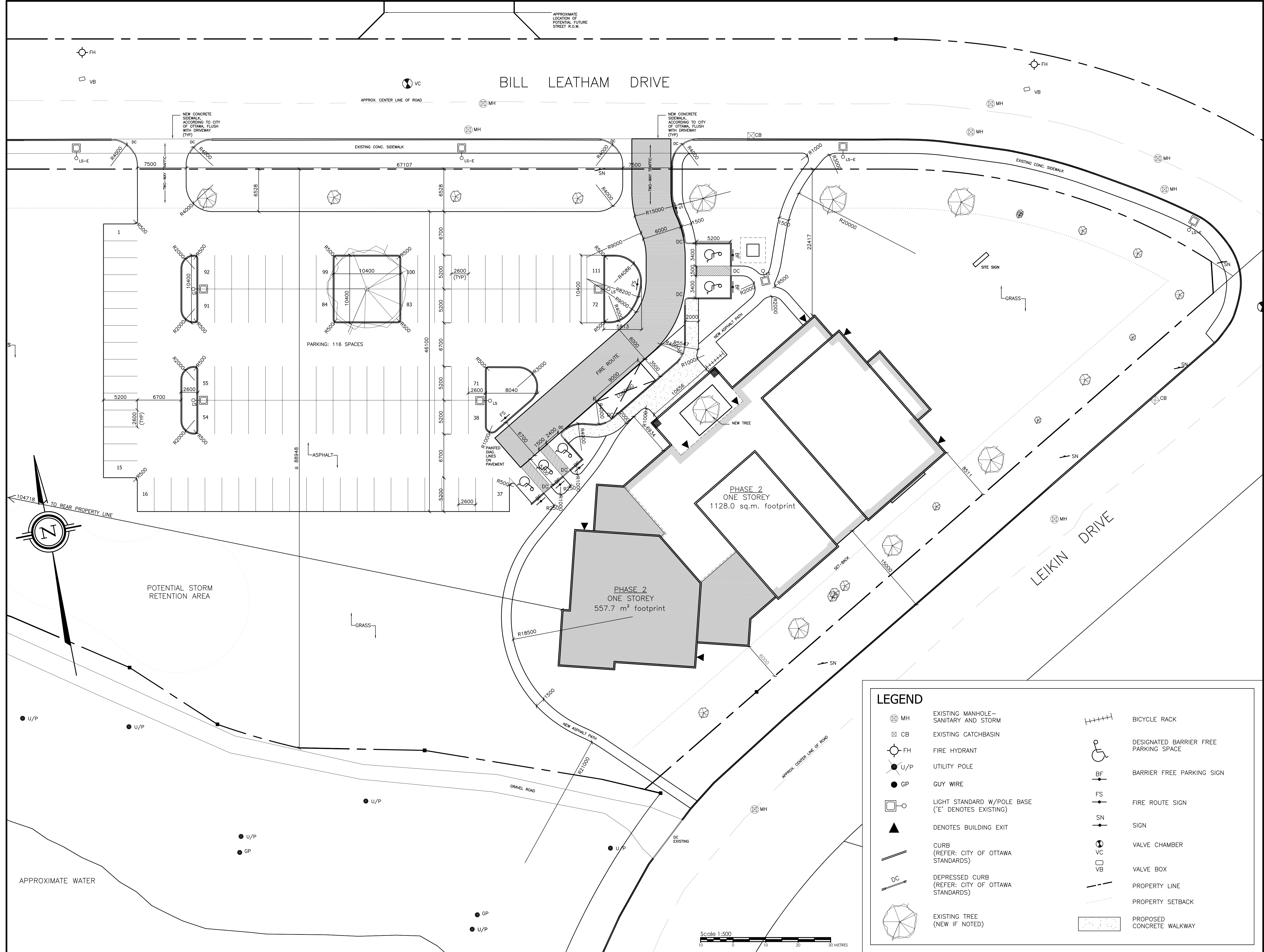

NO.	REVISION	DATE
1	ISSUED FOR SITE PLAN APPLICATION	

KEY PLAN

Property Information:

Legal Description:
 PART OF LOTS 17 & 18
 Concession 1 (Rideau Front)
 (Geographic Township of Nepean)
 City of Ottawa



- GENERAL NOTES:**
1. ALL WALKWAYS TO BE ASPHALT PAVING UNLESS NOTED OTHERWISE.
 2. ALL NEW PARKING AREAS TO BE ASPHALT UNLESS NOTED OTHERWISE.
 3. REFER TO LEGAL SURVEY FOR SITE SPECIFIC LEGAL INFORMATION.
 4. REFER TO CIVIL FOR COMPLETE GRADE INFORMATION.

BUILDING AREA (FOOTPRINT): 1696.2 m²
 LOT AREA: 19578 m²
 ZONE: IL9 - LIGHT INDUSTRIAL

MECHANISM	REQUIRED	PROVIDED
MINIMUM LOT AREA	3000 m ²	1672.2 m ²
MINIMUM LOT WIDTH	50 m	± 89.2 m
MINIMUM FRONT YARD SETBACK	6 m	6 m
MINIMUM CORNER SIDE YARD SETBACK	6 m	22.4 m
MINIMUM REAR YARD SETBACK	6 m	104.7 m
MAXIMUM LOT COVERAGE	60 %	8.66 %
MAXIMUM BUILDING HEIGHT	22 m	10.5 m
MAXIMUM FLOOR SPACE INDEX	2	0.087
MAX. WIDTH LANDSCAPE AREA (AROUND PARKING LOT)	NO MIN.	N.A.
MIN. WIDTH OF LANDSCAPE AREA	3 m	6.5 m
MIN. # OF PARKING SPACES	103	116
MIN. # BICYCLE PARKING SPACES	1 PER 1500 m ² GFA	6
VEHICLE PARKING SPACE SIZE PROVISIONS	2.6m x 5.2m	2.6 m x 5.2 m
MIN AISLE WIDTH	6.7 m	6.7 m
BICYCLE PARKING SPACE SIZE PROVISIONS	0.6m x 1.8m	0.6 m x 1.8 m
LOADING SPACE	1: 3.5m x 9m	1

LEGEND

	EXISTING MANHOLE-- SANITARY AND STORM		BICYCLE RACK
	EXISTING CATCHBASIN		DESIGNATED BARRIER FREE PARKING SPACE
	FIRE HYDRANT		BARRIER FREE PARKING SIGN
	UTILITY POLE		FIRE ROUTE SIGN
	GUY WIRE		SIGN
	LIGHT STANDARD W/POLE BASE ('E' DENOTES EXISTING)		VALVE CHAMBER
	DENOTES BUILDING EXIT		VALVE BOX
	CURB (REFER: CITY OF OTTAWA STANDARDS)		PROPERTY LINE
	DEPRESSED CURB (REFER: CITY OF OTTAWA STANDARDS)		PROPERTY SETBACK
	EXISTING TREE (NEW IF NOTED)		PROPOSED CONCRETE WALKWAY

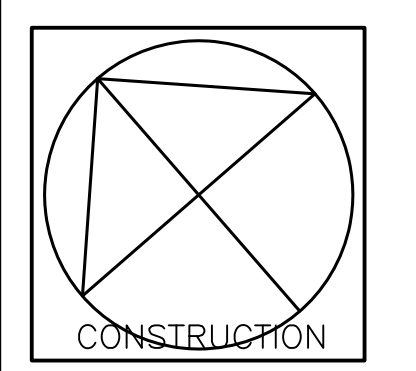

Vandenberg & Wildeboer
 A.R.C.H.I.T.E.C.T.S

www.vandenberg-wildeboer.com Telephone: 613.287.2166 Fax: 613.271.3609 mail@vandenberg-wildeboer.com
 • THE OLD STONE LODGE • 140 PLAINFIELD RD • OTTAWA, ONTARIO • K2E 1P9 •

PROJECT TITLE
 SALVATION ARMY
 BARRHAVEN, NEPEAN

DRAWING TITLE
 PHASE 2: SITE PLAN

DESIGNED BY: RALPH VANDENBERG
 DRAWN BY: LV
 START DATE: 2015
 SCALE: 1:500
 PROJECT NO. 1502

A100

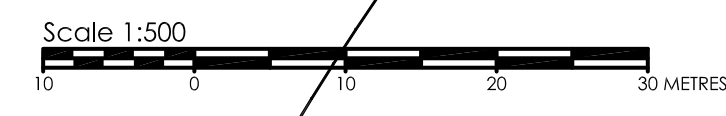

NO.	REVISION	DATE
1	ISSUED FOR SITE PLAN APPLICATION	

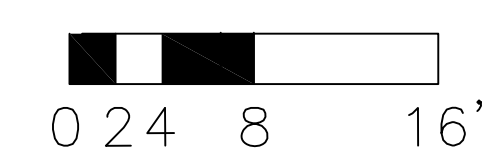
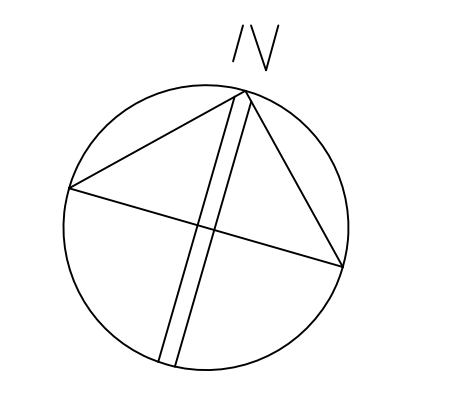
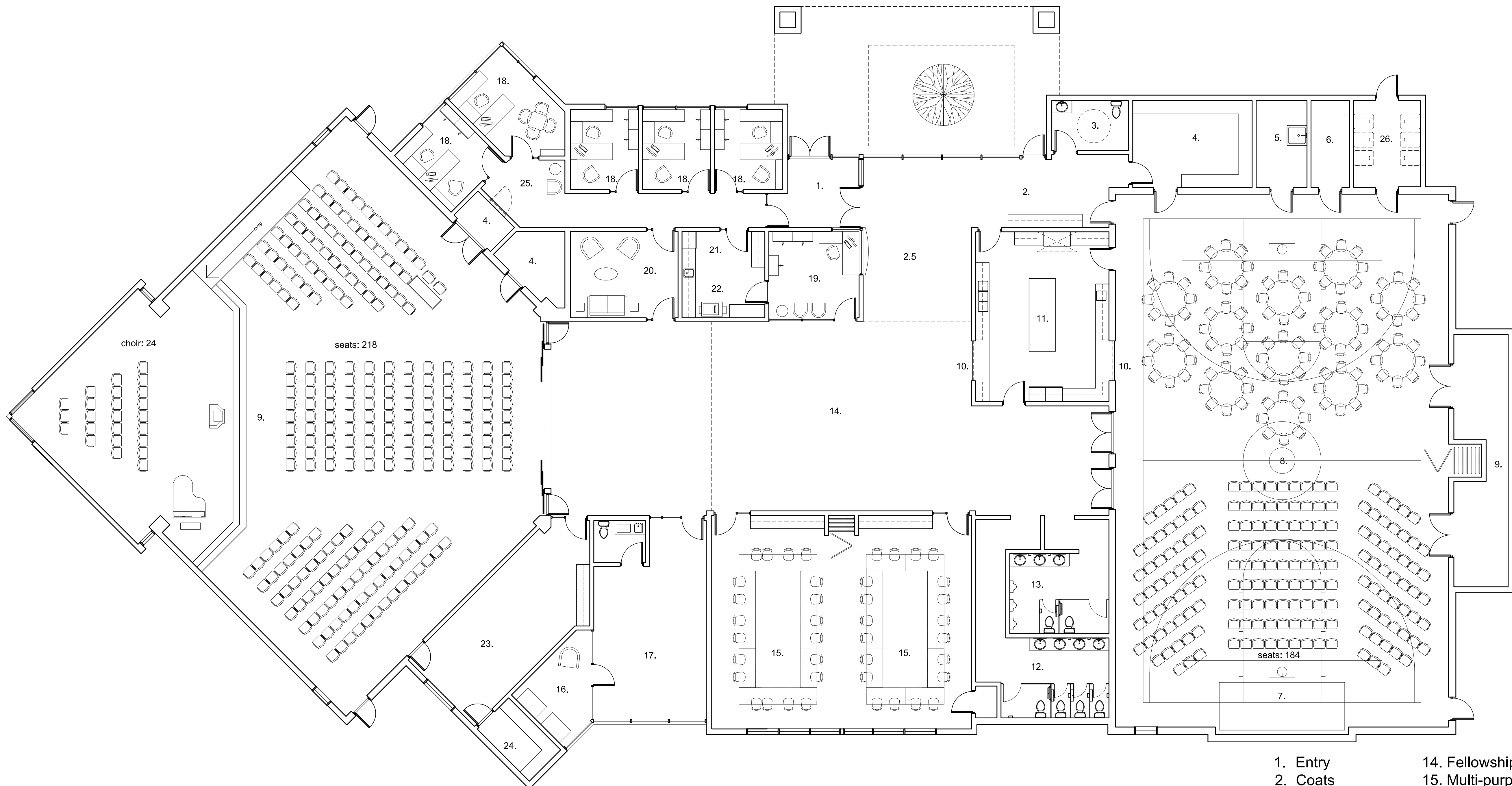

AREA: 18139.7 sq. ft.
1685.2 sq. m.

- | | |
|---------------------------|---------------------------------------|
| 1. Entry | 14. Fellowship |
| 2. Coats | 15. Multi-purpose |
| 2.5 Lobby | 16. Babies |
| 3. Universal w/c | 17. Nursery |
| 4. Storage | 18. Office |
| 5. Janitorial | 18.5 Work Station |
| 6. Electrical | 19. Reception |
| 7. Platform | 20. Waiting, Prayer
& Meeting Room |
| 8. Worship &
Gymnasium | 21. Kitchenette |
| 9. Sanctuary | 22. Work Room |
| 10. Pass Thru | 23. Music |
| 11. Kitchen | 24. Music Storage |
| 12. Women's | 25. Waiting |
| 13. Men's | 26. Recycling/
Refuse |

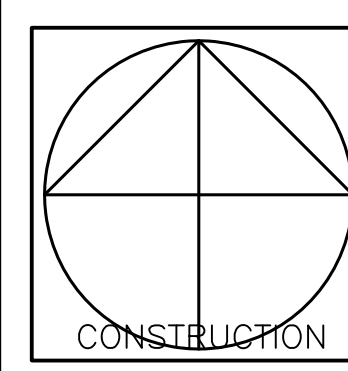

Vandenberg & Wildeboer
A · R · C · H · I · T · E · C · T · S

www.vandenberg.ca Telephone: 613.287.2144 Fax: 613.271.8609 email: vandenberg@vandenberg.ca
• THE OLD STONE LODGE • 140 PLAINFIELD RD • OTTAWA, ONTARIO • K2E 9B9 •

PROJECT TITLE
SALVATION ARMY
BARRHAVEN, NAPEAN

DRAWING TITLE
PHASE 2: PLAN

DESIGNED BY: RALPH VANDENBERG
DRAWN BY: LV
START DATE: 2015
SCALE: 1:100
PROJECT NO. 1502

A101

NO.	REVISION	DATE
1	ISSUED FOR SITE PLAN APPLICATION	



NORTH



SOUTH

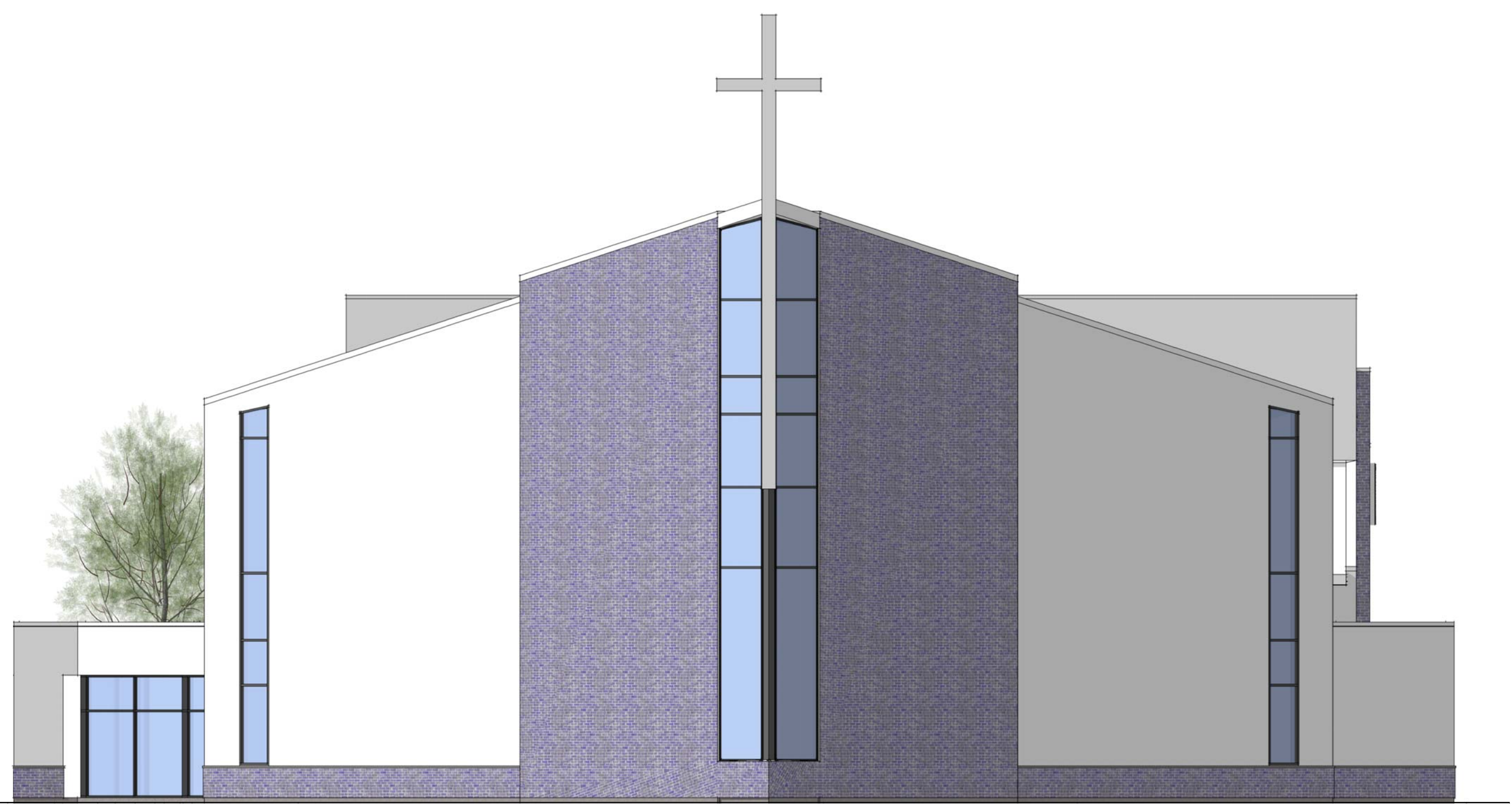

WEST

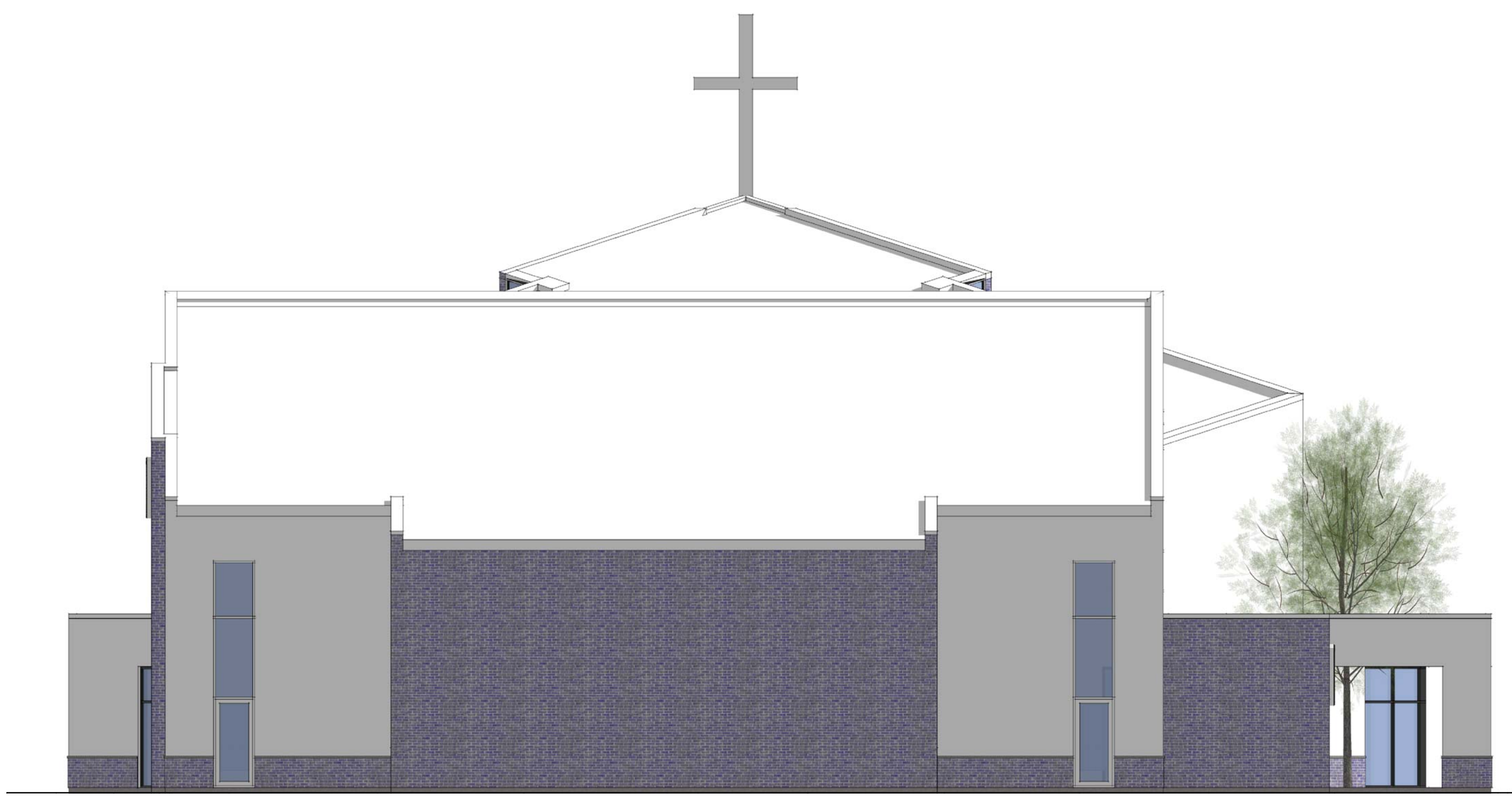

EAST

CONSTRUCTION

Vandenberg & Wildeboer
A·R·C·H·I·T·E·C·T·S

www.vandenberg-wildeboer.com Telephone: 613.287.2144 Fax: 613.271.8699 email: info@vandenberg-wildeboer.com
• THE OLD STONE LODGE • 140 PLAINBOURNE WAY • OTTAWA, ONTARIO • K2E 9B9 •

PROJECT TITLE
SALVATION ARMY BARRHAVEN
NAPEAN

DRAWING TITLE
PHASE 2: ELEVATIONS

DESIGNED BY: RALPH VANDENBERG
DRAWN BY: LV
START DATE: 2015
SCALE: 1:100
PROJECT NO. 1502

A102

TYPICAL CONSTRUCTION ASSEMBLIES
SALVATION ARMY - BARRHAVEN
APRIL 05, 2016

EXTERIOR WALLS:

EX1

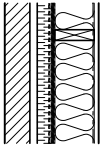

MASONRY VENEER/WOOD STUD
 1 HR FRR PER SB-2 TABLES 2.3.4.A & C

- MASONRY VENEER (SEE ELEVS.)
- AIR SPACE (W/MORTAR CONTROL)
- 50 XPS INSULATION (RSI 1.8 c.i.)
- SHEATHING MEMBRANE (AIR BARRIER-VAPOUR PERMEABLE)
- WOOD SHEATHING (SEE STRUCT.)
- 140 WOOD STUD @ 400 O.C.
- BATT INSULATION (RSI 3.88)
- SHEET POLY VAPOUR BARRIER
- 16 TYPE X GYPSUM BOARD (FRR)

MIN. RSI 2.3+1.8 ci
 (ENERGY EFFICIENCY per SB-10, DIVISION 2, TABLE 5.5-6, WOOD FRAMED/NON-RESIDENTIAL)

EX2

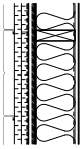

METAL SIDING/WOOD STUD
 1 HR FRR PER SB-2 TABLES 2.3.4.A & C

- 38 PREFIN. METAL SIDING
- 25 XPS INSUL. ON HORIZ. Z-BAR (RSI .9 c.i.)
- 25 XPS INSUL. ON VERT. Z-BAR (RSI .9 c.i.)
- SHEATHING MEMBRANE (AIR BARRIER-VAPOUR PERMEABLE)
- 13 EXT. GYPSUM SHEATHING (STC)
- WOOD SHEATHING (REFER TO STRUCT.)
- 140 WOOD STUD @ 400 O.C.
- BATT INSULATION (RSI 3.88)
- SHEET POLY VAPOUR BARRIER
- 16 TYPE X GYPSUM BOARD (FRR)

MIN. RSI 2.3+1.8 ci
 (ENERGY EFFICIENCY per SB-10, DIVISION 2, TABLE 5.5-6, WOOD FRAMED/(NON-RESIDENTIAL)

EX3

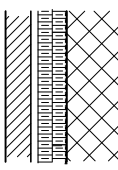

METAL SIDING - CONCRETE BLOCK

- 90 BRICK VENEER
- AIR SPACE
- 50 SEMI-RIGID INSUL. (RSI 1.48 c.i.) ON HORIZ. Z-GIRTS
- 50 XPS INSULATION (RSI 1.48 c.i.) ON VERT. Z-GIRTS
- LIQUID OR MEMBRANE MOISTURE BARRIER (AIR/VAPOUR BARRIER)
- 190 REINFORCED CMU (SEE STRUCT.)

MIN. RSI 2.7ci
 (ENERGY EFFICIENCY per SB-10, DIVISION 2, TABLE 5.5-6, (WALL/MASS/NON-RESIDENTIAL)

EX4

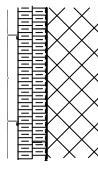

METAL SIDING - CONCRETE BLOCK

- 38 PREFIN. METAL SIDING
- HORIZ. Z-BAR METAL FURRING
- 50 SEMI-RIGID INSUL. (RSI 1.48 c.i.) ON HORIZ. Z-GIRTS
- 50 XPS INSULATION (RSI 1.48 c.i.) ON VERT. Z-GIRTS
- LIQUID OR MEMBRANE MOISTURE BARRIER (AIR/VAPOUR BARRIER)
- 190 REINFORCED CMU (SEE STRUCT.)

MIN. RSI 2.7ci
 (ENERGY EFFICIENCY per SB-10, DIVISION 2, TABLE 5.5-6, (WALL/MASS/NON-RESIDENTIAL)

ROOFS:

R1

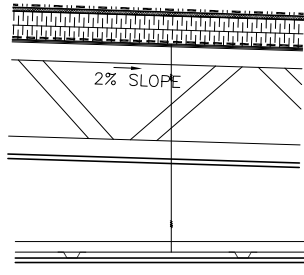

LOW SLOPE - WOOD
 1 HR FRR PER SB-2 TABLES 2.3.4.A & C

- 2 PLY MOD. BIT MEMBRANE ROOFING
- PROTECTION BOARD UNDERLAY
- ROOF INSULATION BD (MIN. RSI 5.3 AGED)
- VAPOUR RETARDER
- WOOD ROOF SHEATHING (SEE STRUCT)
- 2% SLOPED STRUCTURE (SEE STRUCT)
- 16 TYPE X GYPSUM BOARD (FRR)
- SUSPENDED CEILING (ACOUSTIC TILE OR GYPSUM BOARD - SEE REFLECTED CEILING)

MIN. RSI 5.3 ci
 (ENERGY EFFICIENCY per SB-10, DIVISION 2, TABLE 5.5-6, (ROOFS/INSUL ABOVE DECK/NON-RESIDENTIAL)

R2

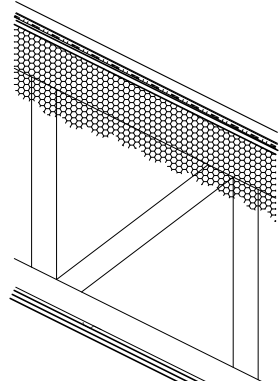

SLOPING FLAT ROOF - WOOD
 1 HR FRR PER SB-2 TABLES 2.3.4.A & C

- PRE-FINISHED METAL ROOFING
- SYNTHETIC FELT SHEET UNDERLAYMENT
- SELF-ADHERED RUBBERIZED MEMBRANE (EAVE PROTECTION, VALLEYS, PENETRATIONS)
- WOOD ROOF SHEATHING (SEE STRUCT)
- SLOPED ROOF TRUSSES (SEE STRUCT)
- TYPE 2 SPRAY FOAM POLYURETHANE INSULATION (MIN. RSI 8.6 AGED)
- RESILIENT CHANNEL @ 400 O.C. (STC)
- 16 TYPE X GYPSUM BOARD (FRR & STC)
- 16 TYPE X GYPSUM BOARD (FRR)

MIN. RSI 8.6
 (ENERGY EFFICIENCY per SB-10, DIVISION 2, TABLE 5.5-6, (ROOFS/OTHER/NON-RESIDENTIAL)

APPENDIX B

STAMSON 5.04 - INPUT AND OUTPUT DATA



Results segment # 1: Bill (day)

Source height = 1.50 m

ROAD (0.00 + 63.33 + 0.00) = 63.33 dBA

Angle1	Angle2	Alpha	RefLeq	P.Adj	D.Adj	F.Adj	W.Adj	H.Adj	B.Adj
--------	--------	-------	--------	-------	-------	-------	-------	-------	-------

SubLeq

-90	49	0.00	69.03	0.00	-4.57	-1.12	0.00	0.00	0.00
-----	----	------	-------	------	-------	-------	------	------	------

63.33

Segment Leq : 63.33 dBA

Total Leq All Segments: 63.33 dBA

Results segment # 1: Bill (night)

Source height = 1.50 m

ROAD (0.00 + 55.73 + 0.00) = 55.73 dBA

Angle1	Angle2	Alpha	RefLeq	P.Adj	D.Adj	F.Adj	W.Adj	H.Adj	B.Adj
--------	--------	-------	--------	-------	-------	-------	-------	-------	-------

SubLeq

-90	49	0.00	61.43	0.00	-4.57	-1.12	0.00	0.00	0.00
-----	----	------	-------	------	-------	-------	------	------	------

55.73

Segment Leq : 55.73 dBA

Total Leq All Segments: 55.73 dBA

TOTAL Leq FROM ALL SOURCES (DAY) : 63.33
(NIGHT) : 55.73



STAMSON 5.0 NORMAL REPORT Date: 01-04-2016 10:20:17
MINISTRY OF ENVIRONMENT AND ENERGY / NOISE ASSESSMENT

Filename: r2.te Time Period: Day/Night 16/8 hours
Description:

Road data, segment # 1: BillL (day/night)

Car traffic volume : 9715/845 veh/TimePeriod *
Medium truck volume : 773/67 veh/TimePeriod *
Heavy truck volume : 552/48 veh/TimePeriod *
Posted speed limit : 60 km/h
Road gradient : 0 %
Road pavement : 1 (Typical asphalt or concrete)

* Refers to calculated road volumes based on the following input:

24 hr Traffic Volume (AADT or SADT): 12000
Percentage of Annual Growth : 0.00
Number of Years of Growth : 0.00
Medium Truck % of Total Volume : 7.00
Heavy Truck % of Total Volume : 5.00
Day (16 hrs) % of Total Volume : 92.00

Data for Segment # 1: BillL (day/night)

Angle1 Angle2 : -41.00 deg 30.00 deg
Wood depth : 0 (No woods.)
No of house rows : 0 / 0
Surface : 1 (Absorptive ground surface)
Receiver source distance : 52.00 / 52.00 m
Receiver height : 3.20 / 3.20 m
Topography : 1 (Flat/gentle slope; no barrier)
Reference angle : 0.00



Road data, segment # 2: BillR (day/night)

Car traffic volume : 9715/845 veh/TimePeriod *
Medium truck volume : 773/67 veh/TimePeriod *
Heavy truck volume : 552/48 veh/TimePeriod *
Posted speed limit : 60 km/h
Road gradient : 0 %
Road pavement : 1 (Typical asphalt or concrete)

* Refers to calculated road volumes based on the following input:

24 hr Traffic Volume (AADT or SADT): 12000
Percentage of Annual Growth : 0.00
Number of Years of Growth : 0.00
Medium Truck % of Total Volume : 7.00
Heavy Truck % of Total Volume : 5.00
Day (16 hrs) % of Total Volume : 92.00

Data for Segment # 2: BillR (day/night)

Angle1 Angle2 : -15.00 deg 73.00 deg
Wood depth : 0 (No woods.)
No of house rows : 0 / 0
Surface : 2 (Reflective ground surface)
Receiver source distance : 58.00 / 58.00 m
Receiver height : 3.20 / 3.20 m
Topography : 1 (Flat/gentle slope; no barrier)
Reference angle : 0.00



Road data, segment # 3: Leikin (day/night)

Car traffic volume : 9715/845 veh/TimePeriod *
Medium truck volume : 773/67 veh/TimePeriod *
Heavy truck volume : 552/48 veh/TimePeriod *
Posted speed limit : 60 km/h
Road gradient : 0 %
Road pavement : 1 (Typical asphalt or concrete)

* Refers to calculated road volumes based on the following input:

24 hr Traffic Volume (AADT or SADT): 12000
Percentage of Annual Growth : 0.00
Number of Years of Growth : 0.00
Medium Truck % of Total Volume : 7.00
Heavy Truck % of Total Volume : 5.00
Day (16 hrs) % of Total Volume : 92.00

Data for Segment # 3: Leikin (day/night)

Angle1 Angle2 : -81.00 deg 0.00 deg
Wood depth : 0 (No woods.)
No of house rows : 0 / 0
Surface : 2 (Reflective ground surface)
Receiver source distance : 23.00 / 23.00 m
Receiver height : 3.20 / 3.20 m
Topography : 1 (Flat/gentle slope; no barrier)
Reference angle : 0.00



Results segment # 1: BillL (day)

Source height = 1.50 m

ROAD (0.00 + 56.11 + 0.00) = 56.11 dBA

Angle1	Angle2	Alpha	RefLeq	P.Adj	D.Adj	F.Adj	W.Adj	H.Adj	B.Adj
--------	--------	-------	--------	-------	-------	-------	-------	-------	-------

SubLeq									
--									
-41	30	0.61	69.03	0.00	-8.69	-4.23	0.00	0.00	0.00
56.11									

Segment Leq : 56.11 dBA

Results segment # 2: BillR (day)

Source height = 1.50 m

ROAD (0.00 + 60.05 + 0.00) = 60.05 dBA

Angle1	Angle2	Alpha	RefLeq	P.Adj	D.Adj	F.Adj	W.Adj	H.Adj	B.Adj
--------	--------	-------	--------	-------	-------	-------	-------	-------	-------

SubLeq									
--									
-15	73	0.00	69.03	0.00	-5.87	-3.11	0.00	0.00	0.00
60.05									

Segment Leq : 60.05 dBA

Results segment # 3: Leikin (day)

Source height = 1.50 m

ROAD (0.00 + 63.70 + 0.00) = 63.70 dBA

Angle1	Angle2	Alpha	RefLeq	P.Adj	D.Adj	F.Adj	W.Adj	H.Adj	B.Adj
--------	--------	-------	--------	-------	-------	-------	-------	-------	-------

SubLeq									
--									
-81	0	0.00	69.03	0.00	-1.86	-3.47	0.00	0.00	0.00
63.70									

Segment Leq : 63.70 dBA



Total Leq All Segments: 65.76 dBA

Results segment # 1: BillL (night)

Source height = 1.50 m

ROAD (0.00 + 48.51 + 0.00) = 48.51 dBA

Angle1	Angle2	Alpha	RefLeq	P.Adj	D.Adj	F.Adj	W.Adj	H.Adj	B.Adj
--------	--------	-------	--------	-------	-------	-------	-------	-------	-------

SubLeq

-41	30	0.61	61.43	0.00	-8.69	-4.23	0.00	0.00	0.00
48.51									

Segment Leq : 48.51 dBA

Results segment # 2: BillR (night)

Source height = 1.50 m

ROAD (0.00 + 52.45 + 0.00) = 52.45 dBA

Angle1	Angle2	Alpha	RefLeq	P.Adj	D.Adj	F.Adj	W.Adj	H.Adj	B.Adj
--------	--------	-------	--------	-------	-------	-------	-------	-------	-------

SubLeq

-15	73	0.00	61.43	0.00	-5.87	-3.11	0.00	0.00	0.00
52.45									

Segment Leq : 52.45 dBA



Results segment # 3: Leikin (night)

Source height = 1.50 m

ROAD (0.00 + 56.10 + 0.00) = 56.10 dBA

Angle1	Angle2	Alpha	RefLeq	P.Adj	D.Adj	F.Adj	W.Adj	H.Adj	B.Adj
--------	--------	-------	--------	-------	-------	-------	-------	-------	-------

SubLeq

--
-81 0 0.00 61.43 0.00 -1.86 -3.47 0.00 0.00 0.00
56.10

--

Segment Leq : 56.10 dBA

Total Leq All Segments: 58.16 dBA

TOTAL Leq FROM ALL SOURCES (DAY) : 65.76
(NIGHT) : 58.16



STAMSON 5.0 NORMAL REPORT Date: 01-04-2016 10:20:23
MINISTRY OF ENVIRONMENT AND ENERGY / NOISE ASSESSMENT

Filename: r3.te Time Period: Day/Night 16/8 hours
Description:

Road data, segment # 1: Bill (day/night)

Car traffic volume : 9715/845 veh/TimePeriod *
Medium truck volume : 773/67 veh/TimePeriod *
Heavy truck volume : 552/48 veh/TimePeriod *
Posted speed limit : 60 km/h
Road gradient : 0 %
Road pavement : 1 (Typical asphalt or concrete)

* Refers to calculated road volumes based on the following input:

24 hr Traffic Volume (AADT or SADT): 12000
Percentage of Annual Growth : 0.00
Number of Years of Growth : 0.00
Medium Truck % of Total Volume : 7.00
Heavy Truck % of Total Volume : 5.00
Day (16 hrs) % of Total Volume : 92.00

Data for Segment # 1: Bill (day/night)

Angle1 Angle2 : 0.00 deg 66.00 deg
Wood depth : 0 (No woods.)
No of house rows : 0 / 0
Surface : 2 (Reflective ground surface)
Receiver source distance : 72.00 / 72.00 m
Receiver height : 7.00 / 7.00 m
Topography : 1 (Flat/gentle slope; no barrier)
Reference angle : 0.00



Road data, segment # 2: LeikinL (day/night)

Car traffic volume : 9715/845 veh/TimePeriod *
Medium truck volume : 773/67 veh/TimePeriod *
Heavy truck volume : 552/48 veh/TimePeriod *
Posted speed limit : 60 km/h
Road gradient : 0 %
Road pavement : 1 (Typical asphalt or concrete)

* Refers to calculated road volumes based on the following input:

24 hr Traffic Volume (AADT or SADT): 12000
Percentage of Annual Growth : 0.00
Number of Years of Growth : 0.00
Medium Truck % of Total Volume : 7.00
Heavy Truck % of Total Volume : 5.00
Day (16 hrs) % of Total Volume : 92.00

Data for Segment # 2: LeikinL (day/night)

Angle1 Angle2 : -83.00 deg 69.00 deg
Wood depth : 0 (No woods.)
No of house rows : 0 / 0
Surface : 2 (Reflective ground surface)
Receiver source distance : 21.00 / 21.00 m
Receiver height : 7.00 / 7.00 m
Topography : 1 (Flat/gentle slope; no barrier)
Reference angle : 0.00

Road data, segment # 3: LeikinR (day/night)

Car traffic volume : 9715/845 veh/TimePeriod *
Medium truck volume : 773/67 veh/TimePeriod *
Heavy truck volume : 552/48 veh/TimePeriod *
Posted speed limit : 60 km/h
Road gradient : 0 %
Road pavement : 1 (Typical asphalt or concrete)

* Refers to calculated road volumes based on the following input:

24 hr Traffic Volume (AADT or SADT): 12000
Percentage of Annual Growth : 0.00
Number of Years of Growth : 0.00
Medium Truck % of Total Volume : 7.00
Heavy Truck % of Total Volume : 5.00
Day (16 hrs) % of Total Volume : 92.00



Data for Segment # 3: LeikinR (day/night)

```

-----
Angle1   Angle2           : -90.00 deg   -79.00 deg
Wood depth           :           0       (No woods.)
No of house rows     :           0 / 0
Surface              :           2       (Reflective ground surface)
Receiver source distance : 15.00 / 15.00 m
Receiver height      :           7.00 / 7.00 m
Topography           :           1       (Flat/gentle slope; no barrier)
Reference angle      :           0.00

```

Results segment # 1: Bill (day)

Source height = 1.50 m

ROAD (0.00 + 57.86 + 0.00) = 57.86 dBA

```

Angle1 Angle2  Alpha RefLeq  P.Adj  D.Adj  F.Adj  W.Adj  H.Adj  B.Adj
SubLeq

```

```

-----
--
--      0      66      0.00  69.03      0.00  -6.81  -4.36      0.00      0.00      0.00
57.86
-----
--

```

Segment Leq : 57.86 dBA

Results segment # 2: LeikinL (day)

Source height = 1.50 m

ROAD (0.00 + 66.83 + 0.00) = 66.83 dBA

```

Angle1 Angle2  Alpha RefLeq  P.Adj  D.Adj  F.Adj  W.Adj  H.Adj  B.Adj
SubLeq

```

```

-----
--
--     -83      69      0.00  69.03      0.00  -1.46  -0.73      0.00      0.00      0.00
66.83
-----
--

```

Segment Leq : 66.83 dBA



Results segment # 3: LeikinR (day)

Source height = 1.50 m

ROAD (0.00 + 56.89 + 0.00) = 56.89 dBA

Angle1	Angle2	Alpha	RefLeq	P.Adj	D.Adj	F.Adj	W.Adj	H.Adj	B.Adj
--------	--------	-------	--------	-------	-------	-------	-------	-------	-------

SubLeq

-90	-79	0.00	69.03	0.00	0.00	-12.14	0.00	0.00	0.00
-----	-----	------	-------	------	------	--------	------	------	------

56.89

Segment Leq : 56.89 dBA

Total Leq All Segments: 67.72 dBA

Results segment # 1: Bill (night)

Source height = 1.50 m

ROAD (0.00 + 50.26 + 0.00) = 50.26 dBA

Angle1	Angle2	Alpha	RefLeq	P.Adj	D.Adj	F.Adj	W.Adj	H.Adj	B.Adj
--------	--------	-------	--------	-------	-------	-------	-------	-------	-------

SubLeq

0	66	0.00	61.43	0.00	-6.81	-4.36	0.00	0.00	0.00
---	----	------	-------	------	-------	-------	------	------	------

50.26

Segment Leq : 50.26 dBA

Results segment # 2: LeikinL (night)

Source height = 1.50 m

ROAD (0.00 + 59.23 + 0.00) = 59.23 dBA

Angle1	Angle2	Alpha	RefLeq	P.Adj	D.Adj	F.Adj	W.Adj	H.Adj	B.Adj
--------	--------	-------	--------	-------	-------	-------	-------	-------	-------

SubLeq

-83	69	0.00	61.43	0.00	-1.46	-0.73	0.00	0.00	0.00
-----	----	------	-------	------	-------	-------	------	------	------

59.23



Segment Leq : 59.23 dBA

Results segment # 3: LeikinR (night)

Source height = 1.50 m

ROAD (0.00 + 49.29 + 0.00) = 49.29 dBA

Angle1	Angle2	Alpha	RefLeq	P.Adj	D.Adj	F.Adj	W.Adj	H.Adj	B.Adj
--------	--------	-------	--------	-------	-------	-------	-------	-------	-------

SubLeq

--
-90 -79 0.00 61.43 0.00 0.00 -12.14 0.00 0.00 0.00
49.29

--

Segment Leq : 49.29 dBA

Total Leq All Segments: 60.12 dBA

TOTAL Leq FROM ALL SOURCES (DAY) : 67.72
(NIGHT) : 60.12



Road data, segment # 2: LeikinL (day/night)

Car traffic volume : 9715/845 veh/TimePeriod *
Medium truck volume : 773/67 veh/TimePeriod *
Heavy truck volume : 552/48 veh/TimePeriod *
Posted speed limit : 60 km/h
Road gradient : 0 %
Road pavement : 1 (Typical asphalt or concrete)

* Refers to calculated road volumes based on the following input:

24 hr Traffic Volume (AADT or SADT): 12000
Percentage of Annual Growth : 0.00
Number of Years of Growth : 0.00
Medium Truck % of Total Volume : 7.00
Heavy Truck % of Total Volume : 5.00
Day (16 hrs) % of Total Volume : 92.00

Data for Segment # 2: LeikinL (day/night)

Angle1 Angle2 : 0.00 deg 56.00 deg
Wood depth : 0 (No woods.)
No of house rows : 0 / 0
Surface : 2 (Reflective ground surface)
Receiver source distance : 24.00 / 24.00 m
Receiver height : 1.50 / 1.50 m
Topography : 1 (Flat/gentle slope; no barrier)
Reference angle : 0.00



Road data, segment # 3: LeikinR (day/night)

Car traffic volume : 9715/845 veh/TimePeriod *
Medium truck volume : 773/67 veh/TimePeriod *
Heavy truck volume : 552/48 veh/TimePeriod *
Posted speed limit : 60 km/h
Road gradient : 0 %
Road pavement : 1 (Typical asphalt or concrete)

* Refers to calculated road volumes based on the following input:

24 hr Traffic Volume (AADT or SADT): 12000
Percentage of Annual Growth : 0.00
Number of Years of Growth : 0.00
Medium Truck % of Total Volume : 7.00
Heavy Truck % of Total Volume : 5.00
Day (16 hrs) % of Total Volume : 92.00

Data for Segment # 3: LeikinR (day/night)

Angle1 Angle2 : 88.00 deg 90.00 deg
Wood depth : 0 (No woods.)
No of house rows : 0 / 0
Surface : 2 (Reflective ground surface)
Receiver source distance : 15.00 / 15.00 m
Receiver height : 1.50 / 1.50 m
Topography : 1 (Flat/gentle slope; no barrier)
Reference angle : 0.00



Results segment # 1: Bill (day)

Source height = 1.50 m

Barrier height for grazing incidence

Source Height (m)	Receiver Height (m)	Barrier Height (m)	Elevation of Barrier Top (m)
1.50	1.50	1.50	1.50

ROAD (47.32 + 39.92 + 0.00) = 48.05 dBA

Angle1	Angle2	Alpha	RefLeq	P.Adj	D.Adj	F.Adj	W.Adj	H.Adj	B.Adj
SubLeq									

-90	-84	0.00	69.03	0.00	-6.93	-14.77	0.00	0.00	0.00
47.32									

-84	-41	0.00	69.03	0.00	-6.93	-6.22	0.00	0.00	-15.96
39.92									

Segment Leq : 48.05 dBA

Results segment # 2: LeikinL (day)

Source height = 1.50 m

ROAD (0.00 + 61.92 + 0.00) = 61.92 dBA

Angle1	Angle2	Alpha	RefLeq	P.Adj	D.Adj	F.Adj	W.Adj	H.Adj	B.Adj
SubLeq									

0	56	0.00	69.03	0.00	-2.04	-5.07	0.00	0.00	0.00
61.92									

Segment Leq : 61.92 dBA



Results segment # 3: LeikinR (day)

Source height = 1.50 m

ROAD (0.00 + 49.48 + 0.00) = 49.48 dBA

Angle1	Angle2	Alpha	RefLeq	P.Adj	D.Adj	F.Adj	W.Adj	H.Adj	B.Adj
SubLeq									

88	90	0.00	69.03	0.00	0.00	-19.54	0.00	0.00	0.00
49.48									

Segment Leq : 49.48 dBA

Total Leq All Segments: 62.33 dBA

Results segment # 1: Bill (night)

Source height = 1.50 m

Barrier height for grazing incidence

Source Height (m)	Receiver Height (m)	Barrier Height (m)	Elevation of Barrier Top (m)
1.50	1.50	1.50	1.50

ROAD (39.73 + 32.32 + 0.00) = 40.45 dBA

Angle1	Angle2	Alpha	RefLeq	P.Adj	D.Adj	F.Adj	W.Adj	H.Adj	B.Adj
SubLeq									

-90	-84	0.00	61.43	0.00	-6.93	-14.77	0.00	0.00	0.00
39.73									

-84	-41	0.00	61.43	0.00	-6.93	-6.22	0.00	0.00	-15.96
32.32									

Segment Leq : 40.45 dBA



Results segment # 2: LeikinL (night)

Source height = 1.50 m

ROAD (0.00 + 54.32 + 0.00) = 54.32 dBA

Angle1	Angle2	Alpha	RefLeq	P.Adj	D.Adj	F.Adj	W.Adj	H.Adj	B.Adj
--------	--------	-------	--------	-------	-------	-------	-------	-------	-------

SubLeq

0	56	0.00	61.43	0.00	-2.04	-5.07	0.00	0.00	0.00
---	----	------	-------	------	-------	-------	------	------	------

54.32

Segment Leq : 54.32 dBA

Results segment # 3: LeikinR (night)

Source height = 1.50 m

ROAD (0.00 + 41.89 + 0.00) = 41.89 dBA

Angle1	Angle2	Alpha	RefLeq	P.Adj	D.Adj	F.Adj	W.Adj	H.Adj	B.Adj
--------	--------	-------	--------	-------	-------	-------	-------	-------	-------

SubLeq

88	90	0.00	61.43	0.00	0.00	-19.54	0.00	0.00	0.00
----	----	------	-------	------	------	--------	------	------	------

41.89

Segment Leq : 41.89 dBA

Total Leq All Segments: 54.73 dBA

TOTAL Leq FROM ALL SOURCES (DAY): 62.33
(NIGHT): 54.73



STAMSON 5.0 NORMAL REPORT Date: 01-04-2016 10:20:41
MINISTRY OF ENVIRONMENT AND ENERGY / NOISE ASSESSMENT

Filename: r5.te Time Period: Day/Night 16/8 hours
Description:

Road data, segment # 1: Bill (day/night)

Car traffic volume : 9715/845 veh/TimePeriod *
Medium truck volume : 773/67 veh/TimePeriod *
Heavy truck volume : 552/48 veh/TimePeriod *
Posted speed limit : 60 km/h
Road gradient : 0 %
Road pavement : 1 (Typical asphalt or concrete)

* Refers to calculated road volumes based on the following input:

24 hr Traffic Volume (AADT or SADT): 12000
Percentage of Annual Growth : 0.00
Number of Years of Growth : 0.00
Medium Truck % of Total Volume : 7.00
Heavy Truck % of Total Volume : 5.00
Day (16 hrs) % of Total Volume : 92.00

Data for Segment # 1: Bill (day/night)

Angle1 Angle2 : -90.00 deg -41.00 deg
Wood depth : 0 (No woods.)
No of house rows : 0 / 0
Surface : 2 (Reflective ground surface)
Receiver source distance : 60.00 / 60.00 m
Receiver height : 1.50 / 1.50 m
Topography : 1 (Flat/gentle slope; no barrier)
Reference angle : 0.00



Road data, segment # 2: LeikinL (day/night)

Car traffic volume : 9715/845 veh/TimePeriod *
Medium truck volume : 773/67 veh/TimePeriod *
Heavy truck volume : 552/48 veh/TimePeriod *
Posted speed limit : 60 km/h
Road gradient : 0 %
Road pavement : 1 (Typical asphalt or concrete)

* Refers to calculated road volumes based on the following input:

24 hr Traffic Volume (AADT or SADT): 12000
Percentage of Annual Growth : 0.00
Number of Years of Growth : 0.00
Medium Truck % of Total Volume : 7.00
Heavy Truck % of Total Volume : 5.00
Day (16 hrs) % of Total Volume : 92.00

Data for Segment # 2: LeikinL (day/night)

Angle1 Angle2 : 0.00 deg 31.00 deg
Wood depth : 0 (No woods.)
No of house rows : 0 / 0
Surface : 2 (Reflective ground surface)
Receiver source distance : 49.00 / 49.00 m
Receiver height : 1.50 / 1.50 m
Topography : 2 (Flat/gentle slope; with barrier)
Barrier angle1 : 0.00 deg Angle2 : 6.00 deg
Barrier height : 4.20 m
Barrier receiver distance : 8.00 / 8.00 m
Source elevation : 0.00 m
Receiver elevation : 0.00 m
Barrier elevation : 0.00 m
Reference angle : 0.00



Road data, segment # 3: LeikinR (day/night)

```

-----
Car traffic volume : 9715/845 veh/TimePeriod *
Medium truck volume : 773/67 veh/TimePeriod *
Heavy truck volume : 552/48 veh/TimePeriod *
Posted speed limit : 60 km/h
Road gradient : 0 %
Road pavement : 1 (Typical asphalt or concrete)

```

* Refers to calculated road volumes based on the following input:

```

24 hr Traffic Volume (AADT or SADT): 12000
Percentage of Annual Growth : 0.00
Number of Years of Growth : 0.00
Medium Truck % of Total Volume : 7.00
Heavy Truck % of Total Volume : 5.00
Day (16 hrs) % of Total Volume : 92.00

```

Data for Segment # 3: LeikinR (day/night)

```

-----
Angle1 Angle2 : 63.00 deg 90.00 deg
Wood depth : 0 (No woods.)
No of house rows : 0 / 0
Surface : 2 (Reflective ground surface)
Receiver source distance : 26.00 / 26.00 m
Receiver height : 1.50 / 1.50 m
Topography : 1 (Flat/gentle slope; no barrier)
Reference angle : 0.00

```

Results segment # 1: Bill (day)

Source height = 1.50 m

ROAD (0.00 + 57.36 + 0.00) = 57.36 dBA

```

Angle1 Angle2 Alpha RefLeq P.Adj D.Adj F.Adj W.Adj H.Adj B.Adj
SubLeq

```

```

-----
--
-90 -41 0.00 69.03 0.00 -6.02 -5.65 0.00 0.00 0.00
57.36
-----
--

```

Segment Leq : 57.36 dBA



Results segment # 2: LeikinL (day)

Source height = 1.50 m

Barrier height for grazing incidence

Source Height (m)	Receiver Height (m)	Barrier Height (m)	Elevation of Barrier Top (m)
1.50	1.50	1.50	1.50

ROAD (0.00 + 34.20 + 55.31) = 55.35 dBA

Angle1	Angle2	Alpha	RefLeq	P.Adj	D.Adj	F.Adj	W.Adj	H.Adj	B.Adj
SubLeq									

0	6	0.00	69.03	0.00	-5.14	-14.77	0.00	0.00	-14.92
---	---	------	-------	------	-------	--------	------	------	--------

6	31	0.00	69.03	0.00	-5.14	-8.57	0.00	0.00	0.00
---	----	------	-------	------	-------	-------	------	------	------

Segment Leq : 55.35 dBA

Results segment # 3: LeikinR (day)

Source height = 1.50 m

ROAD (0.00 + 58.40 + 0.00) = 58.40 dBA

Angle1	Angle2	Alpha	RefLeq	P.Adj	D.Adj	F.Adj	W.Adj	H.Adj	B.Adj
SubLeq									

63	90	0.00	69.03	0.00	-2.39	-8.24	0.00	0.00	0.00
----	----	------	-------	------	-------	-------	------	------	------

Segment Leq : 58.40 dBA

Total Leq All Segments: 61.98 dBA



Results segment # 1: Bill (night)

Source height = 1.50 m

ROAD (0.00 + 49.76 + 0.00) = 49.76 dBA

Angle1	Angle2	Alpha	RefLeq	P.Adj	D.Adj	F.Adj	W.Adj	H.Adj	B.Adj
-90	-41	0.00	61.43	0.00	-6.02	-5.65	0.00	0.00	0.00

SubLeq
49.76

Segment Leq : 49.76 dBA

Results segment # 2: LeikinL (night)

Source height = 1.50 m

Barrier height for grazing incidence

Source Height (m)	Receiver Height (m)	Barrier Height (m)	Elevation of Barrier Top (m)
1.50	1.50	1.50	1.50

ROAD (0.00 + 26.60 + 47.71) = 47.75 dBA

Angle1	Angle2	Alpha	RefLeq	P.Adj	D.Adj	F.Adj	W.Adj	H.Adj	B.Adj
0	6	0.00	61.43	0.00	-5.14	-14.77	0.00	0.00	-14.92

SubLeq
26.60

SubLeq
47.71

Segment Leq : 47.75 dBA



Results segment # 3: LeikinR (night)

Source height = 1.50 m

ROAD (0.00 + 50.80 + 0.00) = 50.80 dBA

Angle1	Angle2	Alpha	RefLeq	P.Adj	D.Adj	F.Adj	W.Adj	H.Adj	B.Adj
--------	--------	-------	--------	-------	-------	-------	-------	-------	-------

SubLeq

63	90	0.00	61.43	0.00	-2.39	-8.24	0.00	0.00	0.00
50.80									

Segment Leq : 50.80 dBA

Total Leq All Segments: 54.38 dBA

TOTAL Leq FROM ALL SOURCES (DAY) : 61.98
(NIGHT) : 54.38



Results segment # 1: Bill (day)

Source height = 1.50 m

ROAD (0.00 + 60.19 + 0.00) = 60.19 dBA

Angle1	Angle2	Alpha	RefLeq	P.Adj	D.Adj	F.Adj	W.Adj	H.Adj	B.Adj
--------	--------	-------	--------	-------	-------	-------	-------	-------	-------

SubLeq

--

-90	4	0.00	69.03	0.00	-6.02	-2.82	0.00	0.00	0.00
-----	---	------	-------	------	-------	-------	------	------	------

60.19

--

Segment Leq : 60.19 dBA

Total Leq All Segments: 60.19 dBA

Results segment # 1: Bill (night)

Source height = 1.50 m

ROAD (0.00 + 52.59 + 0.00) = 52.59 dBA

Angle1	Angle2	Alpha	RefLeq	P.Adj	D.Adj	F.Adj	W.Adj	H.Adj	B.Adj
--------	--------	-------	--------	-------	-------	-------	-------	-------	-------

SubLeq

--

-90	4	0.00	61.43	0.00	-6.02	-2.82	0.00	0.00	0.00
-----	---	------	-------	------	-------	-------	------	------	------

52.59

--

Segment Leq : 52.59 dBA

Total Leq All Segments: 52.59 dBA

TOTAL Leq FROM ALL SOURCES (DAY): 60.19
(NIGHT): 52.59



STAMSON 5.0 NORMAL REPORT Date: 01-04-2016 10:20:52
MINISTRY OF ENVIRONMENT AND ENERGY / NOISE ASSESSMENT

Filename: r7.te Time Period: Day/Night 16/8 hours
Description:

Road data, segment # 1: LeikinL (day/night)

Car traffic volume : 9715/845 veh/TimePeriod *
Medium truck volume : 773/67 veh/TimePeriod *
Heavy truck volume : 552/48 veh/TimePeriod *
Posted speed limit : 60 km/h
Road gradient : 0 %
Road pavement : 1 (Typical asphalt or concrete)

* Refers to calculated road volumes based on the following input:

24 hr Traffic Volume (AADT or SADT): 12000
Percentage of Annual Growth : 0.00
Number of Years of Growth : 0.00
Medium Truck % of Total Volume : 7.00
Heavy Truck % of Total Volume : 5.00
Day (16 hrs) % of Total Volume : 92.00

Data for Segment # 1: LeikinL (day/night)

Angle1 Angle2 : -44.00 deg 37.00 deg
Wood depth : 0 (No woods.)
No of house rows : 0 / 0
Surface : 2 (Reflective ground surface)
Receiver source distance : 24.00 / 24.00 m
Receiver height : 7.00 / 7.00 m
Topography : 1 (Flat/gentle slope; no barrier)
Reference angle : 0.00



Road data, segment # 2: LeikinR (day/night)

```

-----
Car traffic volume : 9715/845 veh/TimePeriod *
Medium truck volume : 773/67 veh/TimePeriod *
Heavy truck volume : 552/48 veh/TimePeriod *
Posted speed limit : 60 km/h
Road gradient : 0 %
Road pavement : 1 (Typical asphalt or concrete)

```

* Refers to calculated road volumes based on the following input:

```

24 hr Traffic Volume (AADT or SADT): 12000
Percentage of Annual Growth : 0.00
Number of Years of Growth : 0.00
Medium Truck % of Total Volume : 7.00
Heavy Truck % of Total Volume : 5.00
Day (16 hrs) % of Total Volume : 92.00

```

Data for Segment # 2: LeikinR (day/night)

```

-----
Angle1 Angle2 : 68.00 deg 90.00 deg
Wood depth : 0 (No woods.)
No of house rows : 0 / 0
Surface : 2 (Reflective ground surface)
Receiver source distance : 15.00 / 15.00 m
Receiver height : 7.00 / 7.00 m
Topography : 1 (Flat/gentle slope; no barrier)
Reference angle : 0.00

```

Results segment # 1: LeikinL (day)

Source height = 1.50 m

ROAD (0.00 + 63.52 + 0.00) = 63.52 dBA

```

Angle1 Angle2 Alpha RefLeq P.Adj D.Adj F.Adj W.Adj H.Adj B.Adj
SubLeq

```

```

-----
--
-44 37 0.00 69.03 0.00 -2.04 -3.47 0.00 0.00 0.00
63.52
-----
--

```

Segment Leq : 63.52 dBA



Results segment # 2: LeikinR (day)

Source height = 1.50 m

ROAD (0.00 + 59.90 + 0.00) = 59.90 dBA

Angle1	Angle2	Alpha	RefLeq	P.Adj	D.Adj	F.Adj	W.Adj	H.Adj	B.Adj
--------	--------	-------	--------	-------	-------	-------	-------	-------	-------

SubLeq

68	90	0.00	69.03	0.00	0.00	-9.13	0.00	0.00	0.00
----	----	------	-------	------	------	-------	------	------	------

59.90

Segment Leq : 59.90 dBA

Total Leq All Segments: 65.09 dBA

Results segment # 1: LeikinL (night)

Source height = 1.50 m

ROAD (0.00 + 55.92 + 0.00) = 55.92 dBA

Angle1	Angle2	Alpha	RefLeq	P.Adj	D.Adj	F.Adj	W.Adj	H.Adj	B.Adj
--------	--------	-------	--------	-------	-------	-------	-------	-------	-------

SubLeq

-44	37	0.00	61.43	0.00	-2.04	-3.47	0.00	0.00	0.00
-----	----	------	-------	------	-------	-------	------	------	------

55.92

Segment Leq : 55.92 dBA



Results segment # 2: LeikinR (night)

Source height = 1.50 m

ROAD (0.00 + 52.30 + 0.00) = 52.30 dBA

Angle1	Angle2	Alpha	RefLeq	P.Adj	D.Adj	F.Adj	W.Adj	H.Adj	B.Adj
--------	--------	-------	--------	-------	-------	-------	-------	-------	-------

SubLeq

68	90	0.00	61.43	0.00	0.00	-9.13	0.00	0.00	0.00
----	----	------	-------	------	------	-------	------	------	------

52.30

Segment Leq : 52.30 dBA

Total Leq All Segments: 57.49 dBA

TOTAL Leq FROM ALL SOURCES (DAY) : 65.09

(NIGHT) : 57.49

APPENDIX C

IBANA-Calc Calculations

Aircraft Noise Sound Insulation - Scenario Calculation Results

Project: Salvation Army

Date: 3/31/2016 | **ProjectID:** GWE15-009

Outdoor level: NEF 35 or Leq24 67 or Ldn 68 dBA

Source Spectrum details:

100% Standard Aircraft

Corrections:

Receiving room:

Floor Area: 360.00 m²

Absorbtion: 90% of floor area

Construction Description:

Element 1: GMEM4_PSMEM0.2_WFB13_INSUL70_PAP0.3_STE0.8_SJ254(1610)_AIR352_CTILE16

Construction Type: Steel Deck

Area: 360.00 m²

Test ID: TLF-99-011a

Test Date: 4/21/1999

Granular membrane and peel and stick membranes, 13 mm wood fibre board, 70 mm thick polyisocyanurate insulation, kraft paper, 0.7 mm steel decking, steel joists on 1610 mm centre, 16 mm ceiling tiles hung from steel decking, no vents installed.

Element 2: VIN1_GFR25_OSB11_WS140(406)_GFB152_RC13(610)_2G13

Construction Type: 2by6 Wall+RC

Area: 691.00 m²

Test ID: TLA-99-089a

Test Date: 2/23/1999

Vinyl siding, 25 mm rigid glass fibre insulation, 11 mm OSB, 140 mm wood studs on 406 mm centre with glass fibre cavity insulation, 2 of 13 mm gypsum board on resilient channels spaced 610 mm on centre.

Element 3: GL6_AIR9_GL8

Construction Type: Glazing

Area: 50.00 m²

Test ID: CMHC177.961.6

Test Date: 11/1/1996

Thermopane only



Aircraft Noise Sound Insulation - Scenario Calculation Results

Project: Salvation Army

Date: 3/31/2016 | **ProjectID:** GWE15-009

Outdoor level: NEF 35 or Leq24 67 or Ldn 68 dBA

Source Spectrum details:

100% Standard Aircraft

Corrections:

Receiving room:

Floor Area: 441.00 m²

Absorbtion: 75% of floor area

Construction Description:

Element 1: GMEM4_PSMEM0.2_WFB13_INSUL70_PAP0.3_STE0.8_SJ254(1610)_AIR352_CTILE16

Construction Type: Steel Deck

Area: 441.00 m²

Test ID: TLF-99-011a

Test Date: 4/21/1999

Granular membrane and peel and stick membranes, 13 mm wood fibre board, 70 mm thick polyisocyanurate insulation, kraft paper, 0.7 mm steel decking, steel joists on 1610 mm centre, 16 mm ceiling tiles hung from steel decking, no vents installed.

Element 2: VIN1_GFR25_OSB11_WS140(406)_GFB152_RC13(610)_2G13

Construction Type: 2by6 Wall+RC

Area: 454.50 m²

Test ID: TLA-99-089a

Test Date: 2/23/1999

Vinyl siding, 25 mm rigid glass fibre insulation, 11 mm OSB, 140 mm wood studs on 406 mm centre with glass fibre cavity insulation, 2 of 13 mm gypsum board on resilient channels spaced 610 mm on centre.

Element 3: GL6_AIR9_GL8

Construction Type: Glazing

Area: 60.00 m²

Test ID: CMHC177.961.6

Test Date: 11/1/1996

Thermopane only

Aircraft Noise Sound Insulation - Scenario Calculation Results

Project: Salvation Army

Date: 3/31/2016 **ProjectID:** GWE15-009

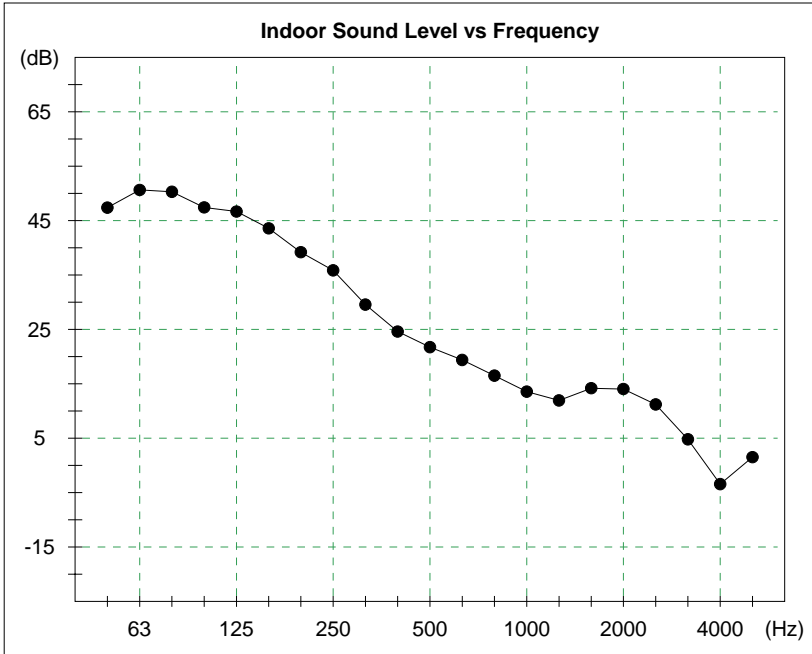

Frequency (Hz)	Sound Level (dB)
50	47.4
63	50.6
80	50.3
100	47.4
125	46.7
160	43.6
200	39.2
250	35.9
315	29.6
400	24.6
500	21.7
630	19.4
800	16.5
1000	13.6
1250	11.9
1600	14.2
2000	14.0
2500	11.2
3150	4.8
4000	-3.4
5000	1.5

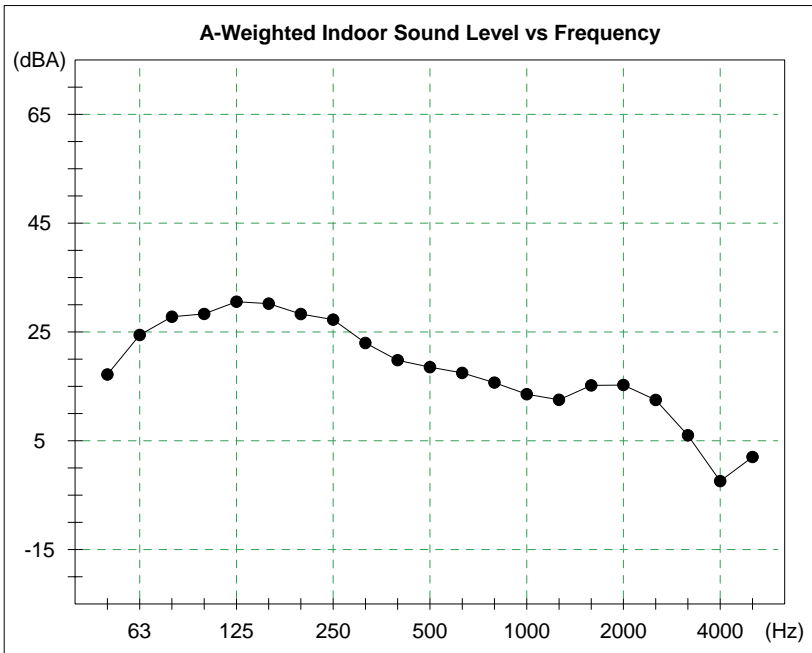

Frequency (Hz)	Sound Level (dBA)
50	17.2
63	24.4
80	27.8
100	28.3
125	30.6
160	30.2
200	28.3
250	27.3
315	23.0
400	19.8
500	18.5
630	17.5
800	15.7
1000	13.6
1250	12.5
1600	15.2
2000	15.2
2500	12.5
3150	6.0
4000	-2.4
5000	2.0

Aircraft Noise Sound Insulation - Scenario Calculation Results

Project: Salvation Army

Date: 3/31/2016 **ProjectID:** GWE15-009

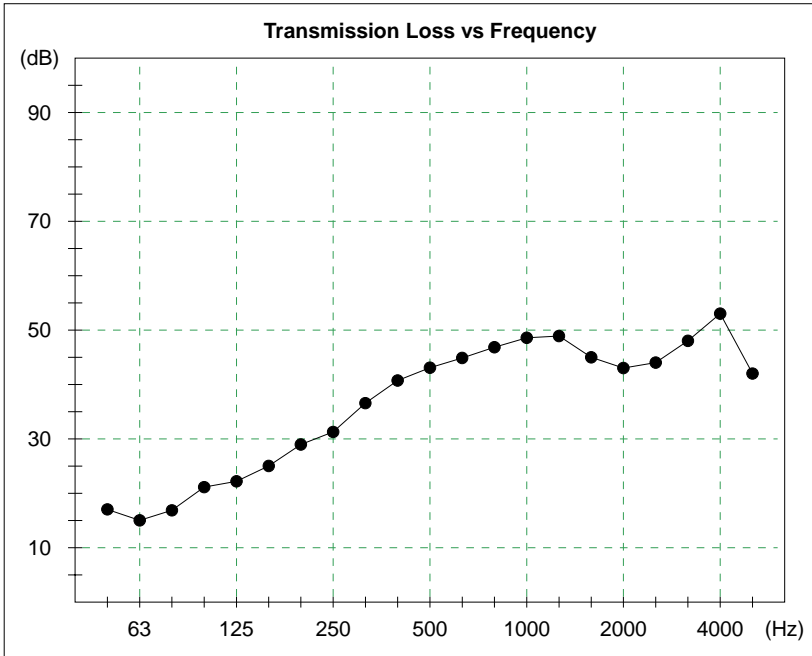

Frequency (Hz)	TL (dB)
50	17
63	15
80	17
100	21
125	22
160	25
200	29
250	31
315	37
400	41
500	43
630	45
800	47
1000	49
1250	49
1600	45
2000	43
2500	44
3150	48
4000	53
5000	42

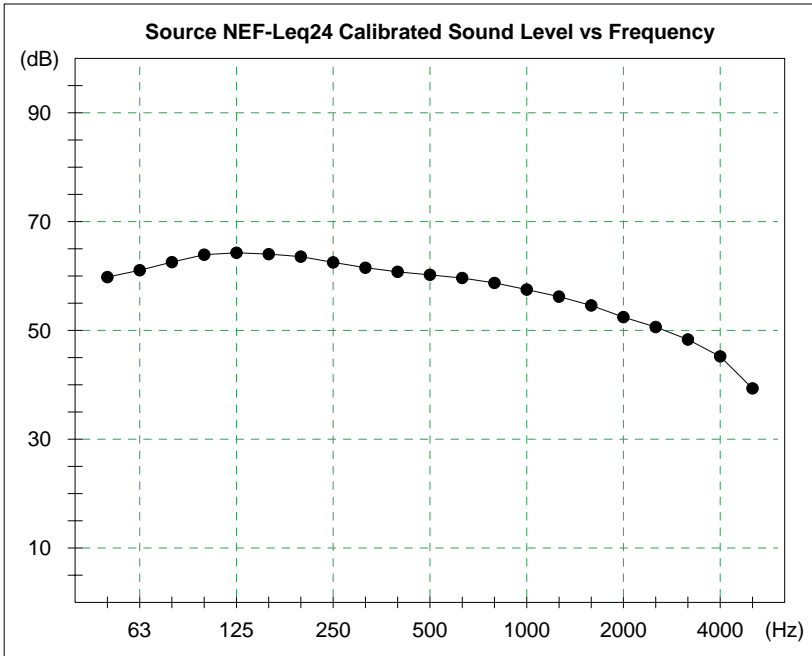

Frequency (Hz)	Sound Level (dB)
50	59.8
63	61.0
80	62.5
100	63.9
125	64.3
160	64.0
200	63.5
250	62.5
315	61.5
400	60.8
500	60.2
630	59.6
800	58.7
1000	57.5
1250	56.2
1600	54.6
2000	52.4
2500	50.6
3150	48.3
4000	45.2
5000	39.3

Single Number Ratings:

Outdoor Sound Level:	67 dBA
Indoor Sound Level:	37 dBA
A-wtd Level Reduction:	30 dB
A-wtd Reduction re Standard Source:	30 dB
OITC Rating:	31 dB

Aircraft Noise Sound Insulation - Scenario Calculation Results

Project: Salvation Army

Date: 3/31/2016 | **ProjectID:** GWE15-009

Outdoor level: NEF 35 or Leq24 67 or Ldn 68 dBA

Source Spectrum details:

100% Standard Aircraft

Corrections:

Receiving room:

Floor Area: 360.00 m²

Absorbtion: 120% of floor area

Construction Description:

Element 1: GMEM4_PSMEM0.2_WFB13_INSUL70_PAP0.3_STE0.8_SJ254(1610)_AIR352_CTILE16

Construction Type: Steel Deck

Area: 114.00 m²

Test ID: TLF-99-011a

Test Date: 4/21/1999

Granular membrane and peel and stick membranes, 13 mm wood fibre board, 70 mm thick polyisocyanurate insulation, kraft paper, 0.7 mm steel decking, steel joists on 1610 mm centre, 16 mm ceiling tiles hung from steel decking, no vents installed.

Element 2: VIN1_GFR25_OSB11_WS140(406)_GFB152_RC13(610)_2G13

Construction Type: 2by6 Wall+RC

Area: 77.25 m²

Test ID: TLA-99-089a

Test Date: 2/23/1999

Vinyl siding, 25 mm rigid glass fibre insulation, 11 mm OSB, 140 mm wood studs on 406 mm centre with glass fibre cavity insulation, 2 of 13 mm gypsum board on resilient channels spaced 610 mm on centre.

Element 3: GL6_AIR9_GL8

Construction Type: Glazing

Area: 41.00 m²

Test ID: CMHC177.961.6

Test Date: 11/1/1996

Thermopane only



Aircraft Noise Sound Insulation - Scenario Calculation Results

Project: Salvation Army

Date: 3/31/2016 **ProjectID:** GWE15-009

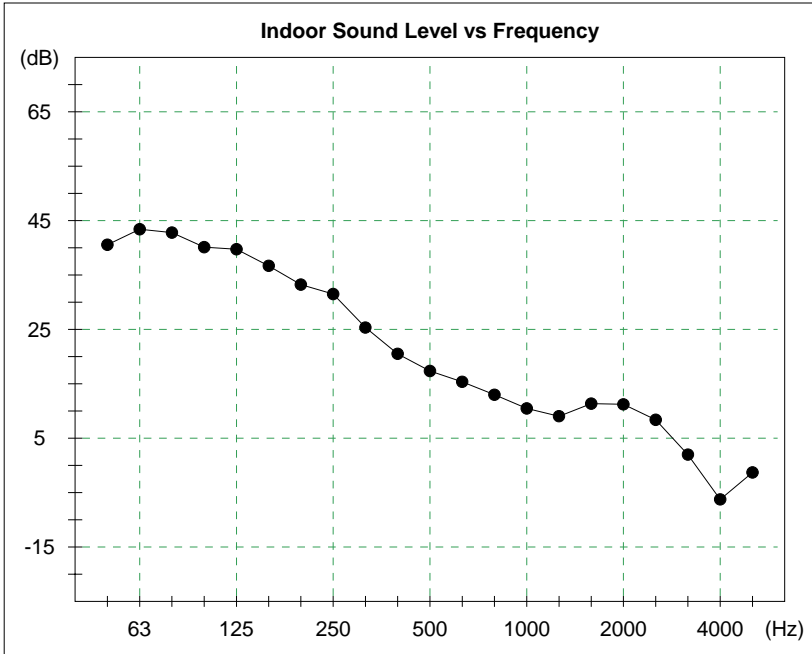

Frequency (Hz)	Sound Level (dB)
50	40.6
63	43.4
80	42.8
100	40.1
125	39.7
160	36.7
200	33.2
250	31.5
315	25.4
400	20.5
500	17.3
630	15.4
800	13.0
1000	10.5
1250	9.0
1600	11.4
2000	11.2
2500	8.4
3150	2.0
4000	-6.3
5000	-1.3

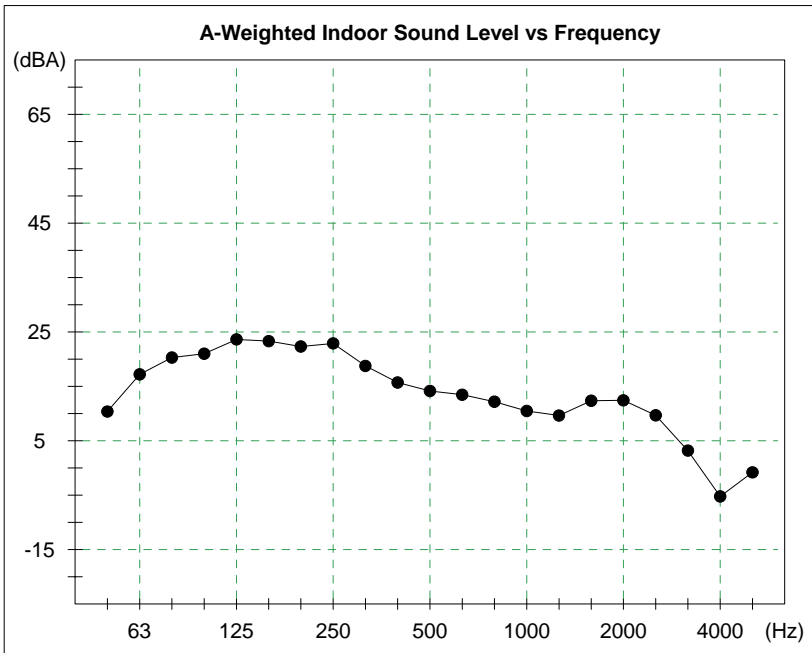

Frequency (Hz)	Sound Level (dBA)
50	10.4
63	17.2
80	20.3
100	21.0
125	23.6
160	23.3
200	22.3
250	22.9
315	18.8
400	15.7
500	14.1
630	13.5
800	12.2
1000	10.5
1250	9.6
1600	12.4
2000	12.4
2500	9.7
3150	3.2
4000	-5.3
5000	-0.8

Aircraft Noise Sound Insulation - Scenario Calculation Results

Project: Salvation Army

Date: 3/31/2016 **ProjectID:** GWE15-009

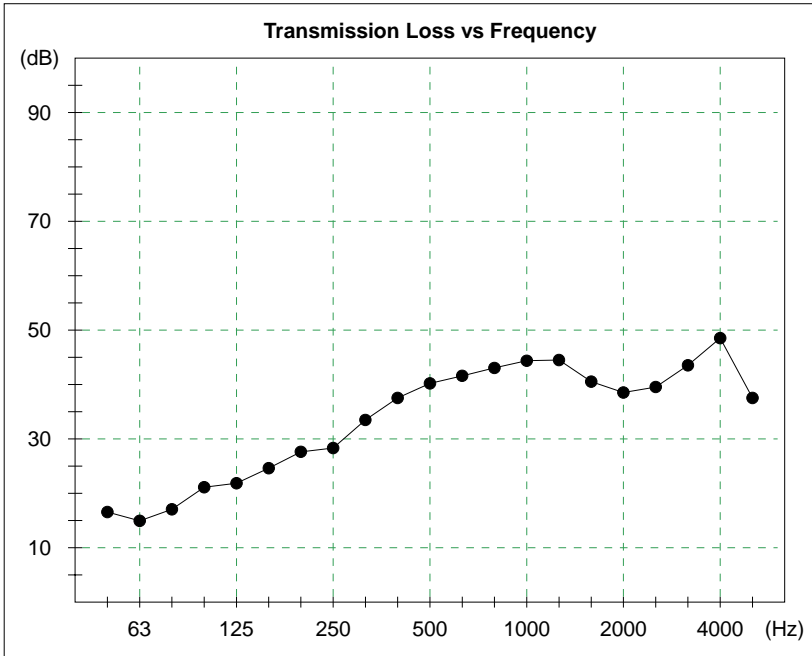

Frequency (Hz)	TL (dB)
50	17
63	15
80	17
100	21
125	22
160	25
200	28
250	28
315	33
400	38
500	40
630	42
800	43
1000	44
1250	44
1600	41
2000	39
2500	40
3150	44
4000	49
5000	38

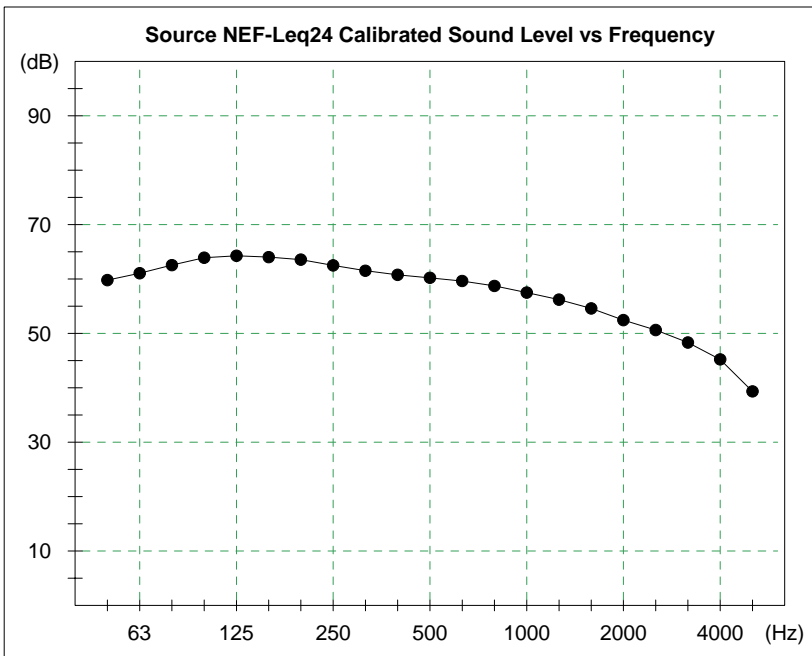

Frequency (Hz)	Sound Level (dB)
50	59.8
63	61.0
80	62.5
100	63.9
125	64.3
160	64.0
200	63.5
250	62.5
315	61.5
400	60.8
500	60.2
630	59.6
800	58.7
1000	57.5
1250	56.2
1600	54.6
2000	52.4
2500	50.6
3150	48.3
4000	45.2
5000	39.3

Single Number Ratings:

Outdoor Sound Level:	67 dBA
Indoor Sound Level:	31 dBA
A-wtd Level Reduction:	36 dB
A-wtd Reduction re Standard Source:	36 dB
OITC Rating:	31 dB

Aircraft Noise Sound Insulation - Scenario Calculation Results

Project: Salvation Army

Date: 3/31/2016 **ProjectID:** GWE15-009

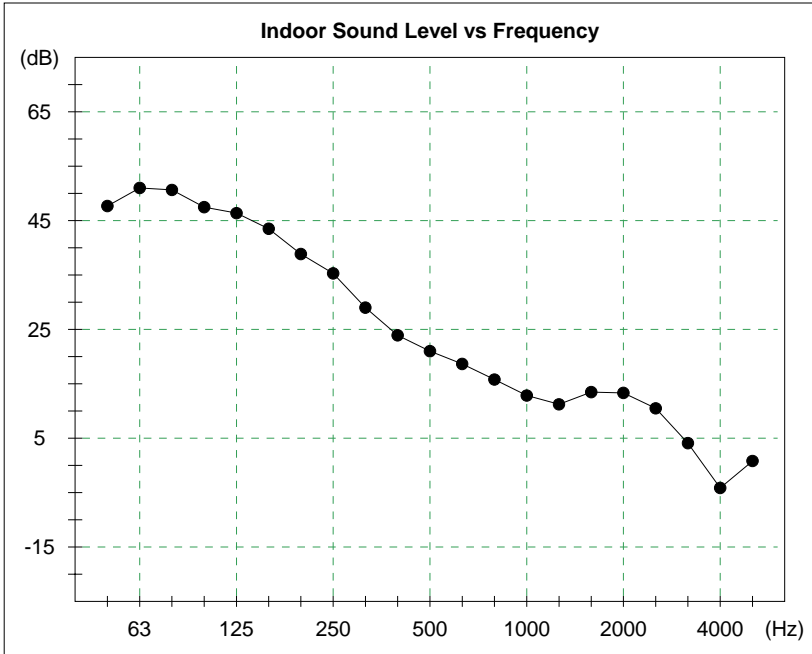

Frequency (Hz)	Sound Level (dB)
50	47.7
63	51.0
80	50.6
100	47.5
125	46.4
160	43.5
200	38.8
250	35.3
315	29.0
400	23.9
500	21.0
630	18.6
800	15.8
1000	12.8
1250	11.2
1600	13.5
2000	13.3
2500	10.5
3150	4.1
4000	-4.1
5000	0.8

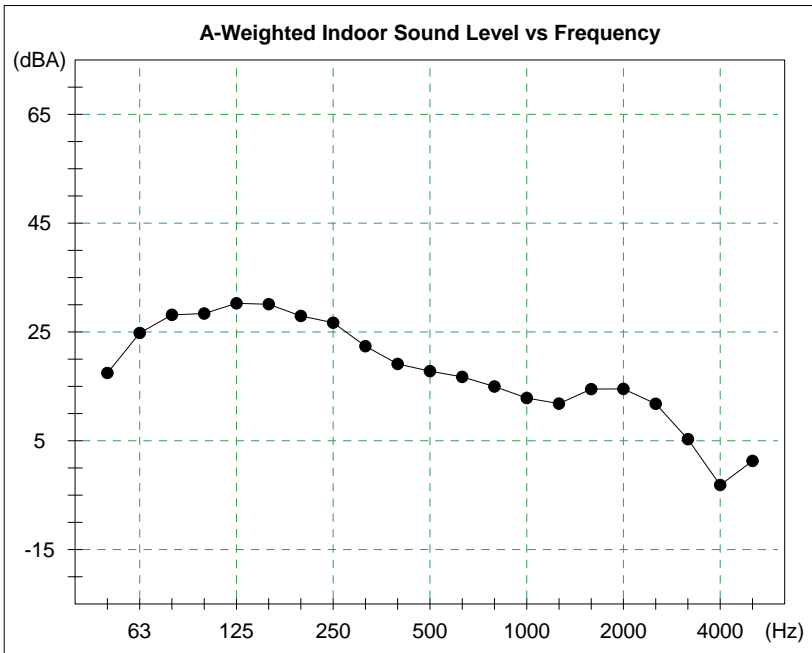

Frequency (Hz)	Sound Level (dBA)
50	17.5
63	24.8
80	28.1
100	28.4
125	30.3
160	30.1
200	27.9
250	26.7
315	22.4
400	19.1
500	17.8
630	16.7
800	15.0
1000	12.8
1250	11.8
1600	14.5
2000	14.5
2500	11.8
3150	5.3
4000	-3.1
5000	1.3

Aircraft Noise Sound Insulation - Scenario Calculation Results

Project: Salvation Army

Date: 3/31/2016 **ProjectID:** GWE15-009

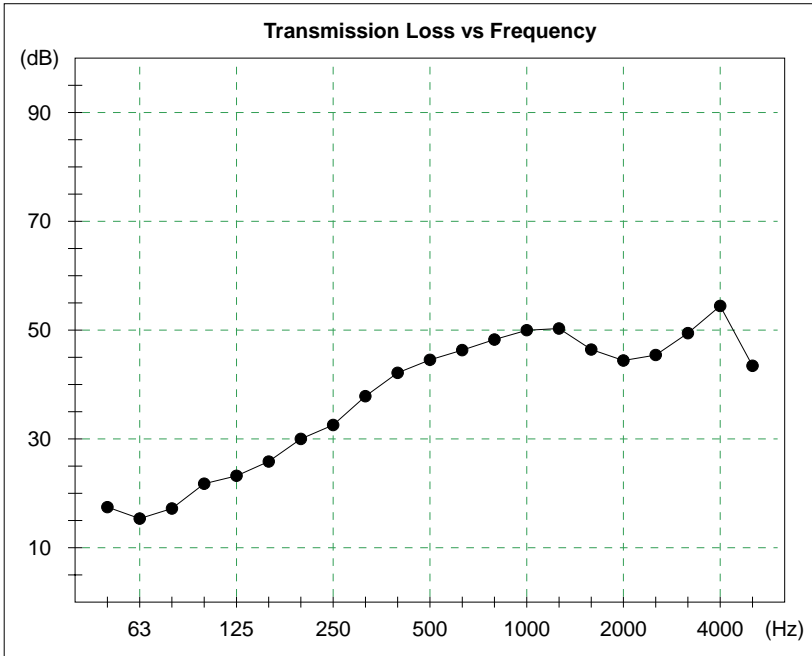

Frequency (Hz)	TL (dB)
50	17
63	15
80	17
100	22
125	23
160	26
200	30
250	33
315	38
400	42
500	45
630	46
800	48
1000	50
1250	50
1600	46
2000	44
2500	45
3150	49
4000	54
5000	43

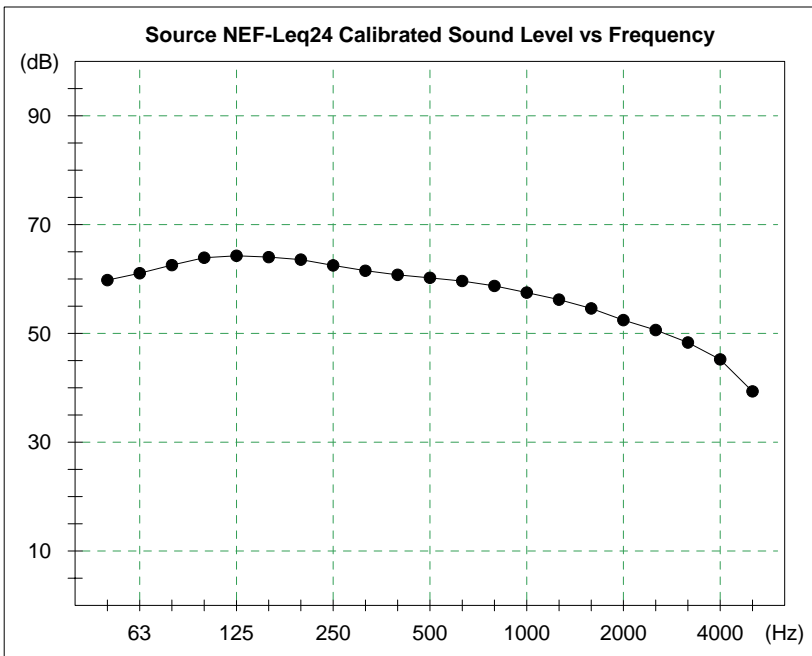

Frequency (Hz)	Sound Level (dB)
50	59.8
63	61.0
80	62.5
100	63.9
125	64.3
160	64.0
200	63.5
250	62.5
315	61.5
400	60.8
500	60.2
630	59.6
800	58.7
1000	57.5
1250	56.2
1600	54.6
2000	52.4
2500	50.6
3150	48.3
4000	45.2
5000	39.3

Single Number Ratings:

Outdoor Sound Level:	67 dBA
Indoor Sound Level:	37 dBA
A-wtd Level Reduction:	30 dB
A-wtd Reduction re Standard Source:	30 dB
OITC Rating:	32 dB