



1047 Richmond Road

TIA Strategy Report

DRAFT

January 2022

1047 Richmond Road

TIA Strategy Report

prepared for:
Fengate Capital Management Ltd.
2275 Upper Middle Rd. E. Suite 700
Oakville, ON
L6H 0C3

prepared by:
 **PARSONS**
1223 Michael Street North
Suite 100
Ottawa, ON K1J 7T2

January 25, 2022

478087-01000

DOCUMENT CONTROL PAGE

CLIENT:	Fengate Capital Management Ltd.
PROJECT NAME:	1047 Richmond Road
REPORT TITLE:	TIA Step 4 Strategy Report
PARSONS PROJECT NO:	478087 - 01000
APPLICATION TYPE:	Zoning By-Law Amendment (ZBLA) and Official Plan Amendment (OPA) Applications
VERSION:	Draft
DIGITAL MASTER:	\\xcca57fs01\data\ISO\478087\1000\DOCS\STEP4-Strategy\1047 Richmond_Strategy Report_2022-01-25.docx
ORIGINATOR	Basel Ansari, E.I.T.
REVIEWER:	Austin Shih, M.A.Sc., P.Eng.
AUTHORIZATION:	
CIRCULATION LIST:	Patrick McMahon, Project Manager Infrastructure Approvals
HISTORY:	<ul style="list-style-type: none"> - TIA Step 1 Screening Form – November 19, 2021 - TIA Step 2 Scoping Report – November 19, 2021 - TIA Step 3 Forecasting Report – December 3, 2021 - TIA Step 4 Strategy Report – January 25, 2022

TABLE OF CONTENTS

1.0	SCREENING FORM	1
2.0	SCOPING REPORT	1
2.1.	EXISTING AND PLANNED CONDITIONS	1
2.1.1.	PROPOSED DEVELOPMENT	1
2.1.2.	EXISTING CONDITIONS.....	4
2.1.3.	PLANNED CONDITIONS	9
2.1.3.1.	Future Transportation Network Changes	9
2.1.3.2.	Other Area Developments	10
2.2.	STUDY AREA AND TIME PERIODS	11
2.3.	EXEMPTION REVIEW	11
3.0	FORECASTING REPORT.....	12
3.1.	DEVELOPMENT GENERATED TRAVEL DEMAND	12
3.1.1.	TRIP GENERATION AND MODE SHARES	12
3.1.2.	TRIP DISTRIBUTION AND ASSIGNMENT	14
3.2.	BACKGROUND NETWORK TRAFFIC	15
3.2.1.	TRANSPORTATION NETWORK PLANS	15
3.2.2.	BACKGROUND GROWTH.....	15
3.2.3.	OTHER DEVELOPMENTS.....	16
3.3.	DEMAND RATIONALIZATION.....	18
4.0	ANALYSIS.....	20
4.1.	DEVELOPMENT DESIGN	20
4.2.	PARKING	21
4.3.	BOUNDARY STREET DESIGN.....	21
4.4.	ACCESS INTERSECTION DESIGN	21
4.5.	TRANSPORTATION DEMAND MANAGEMENT	23
4.5.1.	CONTEXT FOR TDM	23
4.5.2.	NEED AND OPPORTUNITY.....	23
4.5.3.	TDM PROGRAM	24
4.6.	NEIGHBOURHOOD TRAFFIC MANAGEMENT.....	24
4.7.	TRANSIT.....	25
4.8.	REVIEW OF NETWORK CONCEPT.....	26
4.9.	INTERSECTION DESIGN.....	26
4.9.1.	INTERSECTION CONTROL	26
4.9.2.	INTERSECTION DESIGN	26
5.0	FINDINGS, CONCLUSIONS AND RECOMMENDATIONS	30

LIST OF FIGURES

FIGURE 1:	LOCAL CONTEXT.....	2
FIGURE 2:	PROPOSED CONCEPT PLAN	3
FIGURE 3:	STUDY AREA ACTIVE TRANSPORTATION FACILITIES	7
FIGURE 4:	AREA TRANSIT NETWORK.....	7

FIGURE 5: BUS STOP LOCATIONS	7
FIGURE 6: EXISTING PEAK HOUR TRAFFIC VOLUMES	8
FIGURE 7: EXISTING PEAK HOUR AT VOLUMES AT RICHMOND/NEW ORCHARD	8
FIGURE 8: LRT STAGE 2 EXPANSIONS MAP	10
FIGURE 9: STUDY AREA	11
FIGURE 10: PROPOSED DEVELOPMENT SITE-GENERATED TRAFFIC	15
FIGURE 11: FUTURE BACKGROUND 2026 TRAFFIC VOLUMES	16
FIGURE 12: FUTURE BACKGROUND 2031 TRAFFIC VOLUMES	16
FIGURE 13: 1071 AMBLESIDE DR PROPOSED FUTURE DEVELOPMENT	17
FIGURE 14: TOTAL FUTURE BACKGROUND 2026 TRAFFIC VOLUMES	17
FIGURE 15: TOTAL FUTURE BACKGROUND 2031 TRAFFIC VOLUMES	18
FIGURE 16: TOTAL PROJECTED 2026 TRAFFIC VOLUMES	19
FIGURE 17: TOTAL PROJECTED 2031 TRAFFIC VOLUMES	19
FIGURE 18: TOTAL PROJECTED 2031 TRAFFIC VOLUMES, WITH 30% REDUCTION	20
FIGURE 19: PRIVATE APPROACH BY-LAW REQUIRED ACCESS DISTANCES	22
FIGURE 20: BY-LAW CONFORMING ACCESS LIMITS - 300 OR MORE PARKING SPACES	22
FIGURE 21: TAC GUIDELINES, CORNER CLEARANCE (CHAPTER 8, FIGURE 8.8.2)	23
FIGURE 22: TRANSIT RIDERSHIP DATA BUS STOP LOCATIONS	25

LIST OF TABLES

TABLE 1: EXEMPTIONS REVIEW SUMMARY	11
TABLE 2: RESIDENTIAL TRIP GENERATION TRIP RATES	12
TABLE 3: APARTMENT UNITS PEAK PERIOD PERSON TRIP GENERATION	12
TABLE 4: RESIDENTIAL PEAK PERIOD TRIPS MODE SHARES BREAKDOWN	12
TABLE 5: PEAK PERIOD TO PEAK HOUR CONVERSION FACTORS (2020 TRANS MANUAL)	13
TABLE 6: RESIDENTIAL PEAK HOUR TRIPS MODE SHARE BREAKDOWN	13
TABLE 7: RESIDENTIAL LAND USE TRIP GENERATION	13
TABLE 8: RESIDENTIAL PEAK HOUR TRIPS TOD MODE SHARE BREAKDOWN	13
TABLE 9: RESIDENTIAL LAND USE TRIP GENERATION (TOD MODE SHARES)	14
TABLE 10: PERCENT ANNUAL CHANGE AT RICHMOND/NEW ORCHARD	15
TABLE 11: TRANSIT RIDERSHIP DATA (5 JAN 2020 - 16 MAR 2020)	26
TABLE 12: EXISTING CONDITIONS INTERSECTION PERFORMANCE	27
TABLE 13: TOTAL FUTURE BACKGROUND 2026 CONDITIONS INTERSECTION PERFORMANCE	27
TABLE 14: TOTAL FUTURE BACKGROUND 2031 CONDITIONS TRAFFIC VOLUMES	28
TABLE 15: TOTAL PROJECTED 2026 CONDITIONS TRAFFIC VOLUMES	28
TABLE 16: TOTAL PROJECTED 2031 CONDITIONS TRAFFIC VOLUMES	29
TABLE 17: TOTAL PROJECTED 2031 CONDITIONS TRAFFIC VOLUMES, WITH 30% REDUCTION AND MITIGATION MEASURES	29

LIST OF APPENDICES

APPENDIX A: SCREENING FORM AND CITY COMMENTS
APPENDIX B: TRANSIT ROUTE MAPS
APPENDIX C: TRAFFIC DATA
APPENDIX D: BACKGROUND GROWTH ANALYSIS
APPENDIX E: 2031 CITY TRANSPORTATION MODEL
APPENDIX F: TDM CHECKLISTS
APPENDIX G: SYNCHRO AND SIMTRAFFIC ANALYSIS REPORTS

STRATEGY REPORT

Parsons has been retained by Fengate Capital Management Ltd. to prepare a TIA in support of a Zoning By-Law Amendment (ZBLA) and Official Plan Amendment (OPA) Application for a proposed residential development at 1047 Richmond Rd. This document follows the TIA process as outlined in the City of Ottawa's Transportation Impact Assessment (TIA) Guidelines (2017). The following report represents Step 4 – Strategy Report. The Screening Form has been provided in **Appendix A** along with responses to the latest City comments.

1.0 SCREENING FORM

The Screening Form confirmed the need for a TIA Report based on the Trip Generation, Location and Safety triggers. The Trip Generation trigger was met as the development is anticipated to generate more than 60 person trips during peak hours. The Location trigger was met due to the location of the proposed development site in both a Transit-Oriented Development (TOD) zone and a Design Priority Area (DPA) and the designation of Richmond Rd as a Spine Route. The Safety trigger is met due to the proximity of the proposed access within 150m of the signalized Richmond/New Orchard intersection.

2.0 SCOPING REPORT

2.1. Existing and Planned Conditions

2.1.1. Proposed Development

The proposed development is located at the municipal address of 1047 Richmond Rd. The site is currently occupied by a car dealership, which will be replaced by three proposed residential towers that are 36 to 40-storeys high and connected by a 6-storey podium. The buildings will consist of approximately 1,343 apartment units, along with approximately 1,347 m² (14,493 ft²) of first floor retail. Additionally, the development is proposed to provide three truck loading areas, an underground parking garage and a park approximately 1,015 m² (10,925 ft²).

An internal driveway is proposed to be provided with access to Richmond Rd at the east end of the site and access to New Orchard Ave N at the north end of the site. Internally, the driveway provides access to the underground parking garage, three truck loading areas and a drop-off zone.

The full buildout of the development is estimated to be 2026. The site is currently zoned as Traditional Mainstreet TM[2494] H(25). The local context of the site is illustrated in **Figure 1**, while the concept plan for the proposed development is provided in **Figure 2**.

Figure 1: Local Context



Figure 2: Proposed Concept Plan



2.1.2. Existing Conditions

Area Road Network

The following roads are included in the TIA. Description for each road within the study area has been provided below.

Richmond Rd is an east-west municipal arterial road that extends from Baseline Rd in the west (where it continues west as Robertson Rd) to Island Park Dr in the east (where it continues east as Wellington St W). Within the study area, the roadway consists of a two-lane cross-section, with sidewalks on both sides of the road. Bike lanes are provided west of New Orchard Ave N. The posted speed limit is 50 km/h.

Ambleside Dr is a short east-west municipal local road providing access to residential buildings, extending from New Orchard Ave N to McEwen Ave. The roadway consists of a two-lane cross-section, with on-street parking on the south side and a sidewalk on the north side. The speed limit is assumed to be 50 km/h.

New Orchard Ave N is a short (dead-end) north-south municipal local road providing access to the car dealership, a nursing home and low to high-rise residential units. The road extends from Richmond Rd to a cul-de-sac 200m north. The roadway consists of a two-lane cross-section and a sidewalk on the west side, with on-street parking permitted on both sides north of Ambleside Dr. The cul-de-sac at the north end provides access to a series of pathways along Sir John A. Macdonald Pkwy. The speed limit is assumed to be 50 km/h.

McEwen Ave is a short (dead-end) north-south municipal local road providing access to residential buildings. The road extends from Richmond Rd to Ambleside Dr, where it turns left and ends at a cul-de-sac. The road consists of a two-lane cross-section, with sidewalks provided on both sides along most sections and on-street parking permitted on the west side near the north end. Similar to New Orchard Ave N, the cul-de-sac at the north end provides access to a series of pathways along Sir John A. Macdonald Pkwy. The speed limit is assumed to be 50 km/h.

Woodroffe Ave is a north-south municipal arterial roadway that extends from Sir John A. Macdonald Pkwy in the north to south of Cortleigh Dr and Castlestone Way in the south. Within the study area, the roadway consists of a two-lane cross-section, with sidewalks on both sides of the road. The posted speed limit along Woodroffe Ave is 50 km/h.

Existing Study Area Intersections

Richmond/New Orchard

The Richmond/New Orchard intersection is a signalized three-legged “T” intersection. The aerial image provided on the right is outdated as the intersection was recently reconfigured. The new configuration is described as follows.

The eastbound approach consists of a through lane and an auxiliary left-turn lane. The westbound and southbound approaches consist of an all-movement lane. Painted zebra crosswalks are provided on all legs of the intersection. Existing bike lanes have been removed recently to provide space for LRT construction. There are no prohibited movements at the intersection.



Ambleside/New Orchard

The Ambleside/New Orchard intersection is an unsignalized three-legged intersection, with stop control on the eastbound approach only. All approaches of the intersection consist of a single all-movement lane. On the east side, there is a driveway access to the car dealership. No dedicated pedestrian crossings are provided at the intersection.

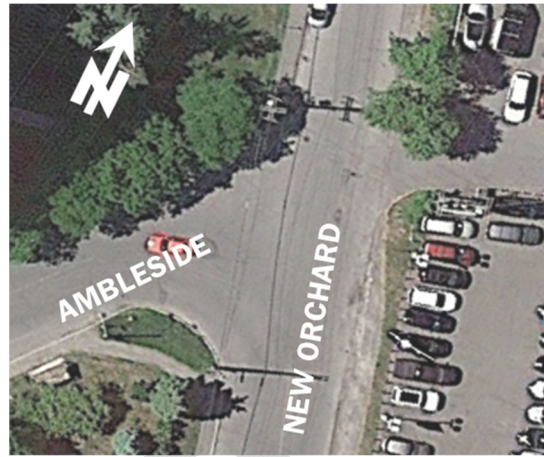

Richmond/McEwen/Edgeworth

The Richmond/McEwen/Edgeworth intersection is a signalized three-legged "T" intersection. The aerial image provided on the right is outdated as the intersection was recently reconfigured. The new configuration is described as follows.

The eastbound and westbound approaches consist of an all-movement lane. The southbound approach consists of a right-turn lane and an auxiliary left-turn lane. At the northbound approach, Edgeworth Ave is designed as a right-turn only onto Richmond Rd. However, this movement has long been blocked off to traffic. All movements to/from Edgeworth Ave are prohibited. Bike lanes and sidewalks are provided on both sides of Richmond Rd and sidewalks are provided on all sides of the intersection. Painted crosswalks are provided on the north, west and south legs.



Richmond/Woodroffe

The Richmond/Woodroffe intersection is a signalized four-legged intersection. The northbound, southbound and eastbound approaches consist of a shared through/right-turn lane and an auxiliary left-turn lane. The westbound approach consists of a through lane, an auxiliary right-turn lane and an auxiliary left-turn lane. There are no restricted movements at this intersection.

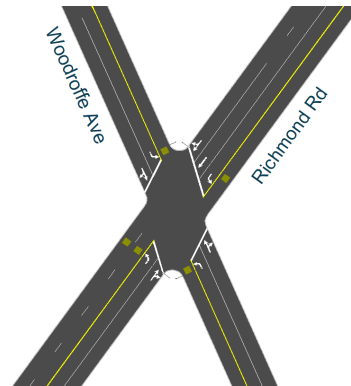

Existing Driveways to Adjacent Developments

Two accesses to the site are proposed to be provided. One access is located along Richmond Rd at the east end of the site and the second access is located along New Orchard Ave N at the north end of the site. Adjacent development accesses located within 200m of the proposed accesses are described below.

New Orchard Ave N Access

- On the west side of New Orchard Ave N, there is a total of 5 adjacent driveways. North of Ambleside Dr, there is an access to a high-rise residential apartment building, an access to a single residential unit and two accesses to low and mid-rise residential buildings. South of Ambleside Dr, there is an outbound driveway to a social services organization.
- On the east side of New Orchard Ave N, there are 2 adjacent driveways, which are all located north of Ambleside Dr. The two accesses are for a nursing home.

Richmond Rd Access

- All adjacent development accesses are located on the north side of Richmond Rd, east of the proposed development. There is a total of 6 adjacent driveways. two accesses are to a residential building at 1025 Richmond Rd, two accesses are to a Tim Hortons, one access is to a car wash and one access is to a car dealership.

Existing Area Traffic Management Measures

Existing area traffic management measures within the study area include pedestrian advance walk phases at the Richmond/New Orchard intersection, along with zebra crosswalks.

Pedestrian/Cycling Network

The active transportation network facilities for pedestrians and cyclists are illustrated in **Figure 3**. As shown, sidewalk facilities are provided on the north side of Ambleside Dr, the west side of New Orchard Ave N, and the north side and some sections on the south side of Richmond Rd. Sidewalks are also provided on both sides of McEwen Ave and Woodroffe Ave. A Pedestrian Crossover was recently provided on Richmond Rd, approximately 200m west of New Orchard Ave N.

For both pedestrian and cyclist usage, major Multi-Use Pathways (MUP) are provided north of the site and run along both sides of Sir John A. Macdonald Pkwy. An underpass is available through the New Orchard Ave N cul-de-sac to access the MUP on the north side of Sir John A. Macdonald Pkwy. A MUP is also available on the south side of Richmond Rd, east of New Orchard Ave N.

Based on the City of Ottawa TMP, Richmond Rd is classified as a Spine Route with regards to the cycling network in the City of Ottawa. Bike lanes are provided along both sides of Richmond Rd from New Orchard Ave N to Carling Ave.

Transit Network

Due to the current circumstances regarding COVID-19, some bus services have been altered by OC Transpo to operate on a different schedule. The following description of OC Transpo routes within the study area reflect the current bus operations:

- **Route #11 (Parliament <-> Bayshore):** identified by OC Transpo as a “Frequent Route”, this route operates all day, 7 days a week and at an average rate of every 15 minutes during weekday peak hours. The nearest bus stop to the site is at the intersection of Richmond/New Orchard.
- **Route #87 (Tunney’s Pasture <-> Baseline):** identified by OC Transpo as a “Frequent Route”, this route operates all day, 7 days a week and at an average rate of every 15-to-30 minutes during weekday peak hours. The nearest bus stop to the site is within 600m at the intersection of Woodroffe/Richmond.
- **Route #153 (Tunney’s Pasture <-> Lincoln Fields):** identified by OC Transpo as a “Local Route”, this route operates with a custom routing to local destinations. The nearest bus stops to the site are at the intersections of Ambleside/New Orchard and Richmond/New Orchard.

The transit network for the study area is illustrated in **Figure 4** and the transit route maps are provided in **Appendix B**. **Figure 5** illustrates the bus stop locations.

Figure 3: Study Area Active Transportation Facilities



Figure 4: Area Transit Network

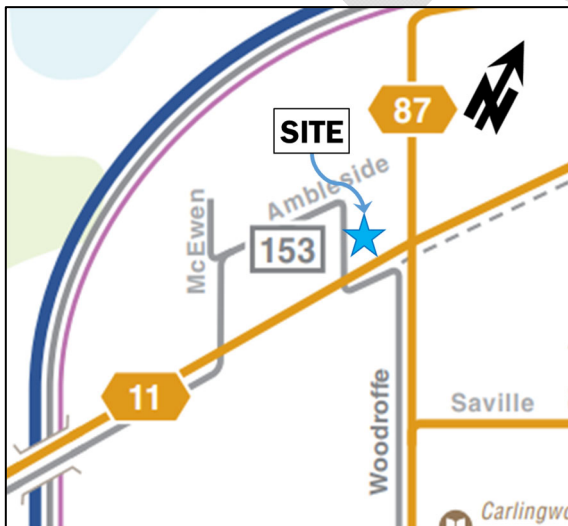
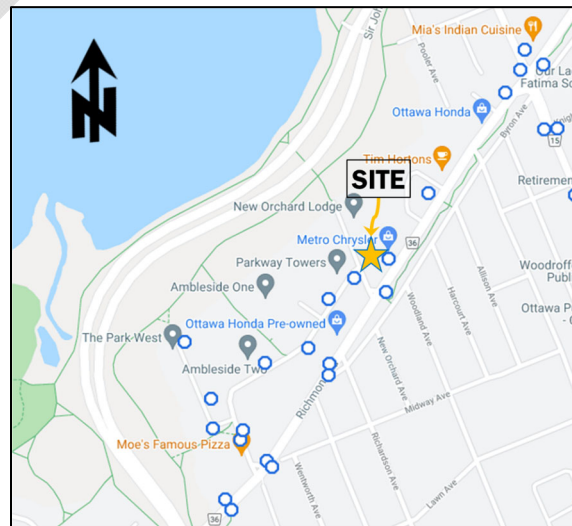

Figure 5: Bus Stop Locations



Peak Hour Travel Demands

The existing peak hour traffic volumes at the signalized intersections within the study area were obtained from the City of Ottawa for the following intersections:

- Richmond/McEwen – Conducted Thursday, August 25, 2016
- Richmond/New Orchard – Conducted Thursday, August 25, 2016
- Richmond/Woodroffe – Conducted Thursday, December 01, 2016

Counts were conducted separately at the intersection of Ambleside/New Orchard on Wednesday, August 11, 2021.

The traffic volumes at study area intersections are illustrated in **Figure 6**, with raw traffic count data provided in **Appendix C**. Pedestrian and Cyclist Volumes at the intersection of Richmond/New Orchard are illustrated in **Figure 7**.

Figure 6: Existing Peak Hour Traffic Volumes

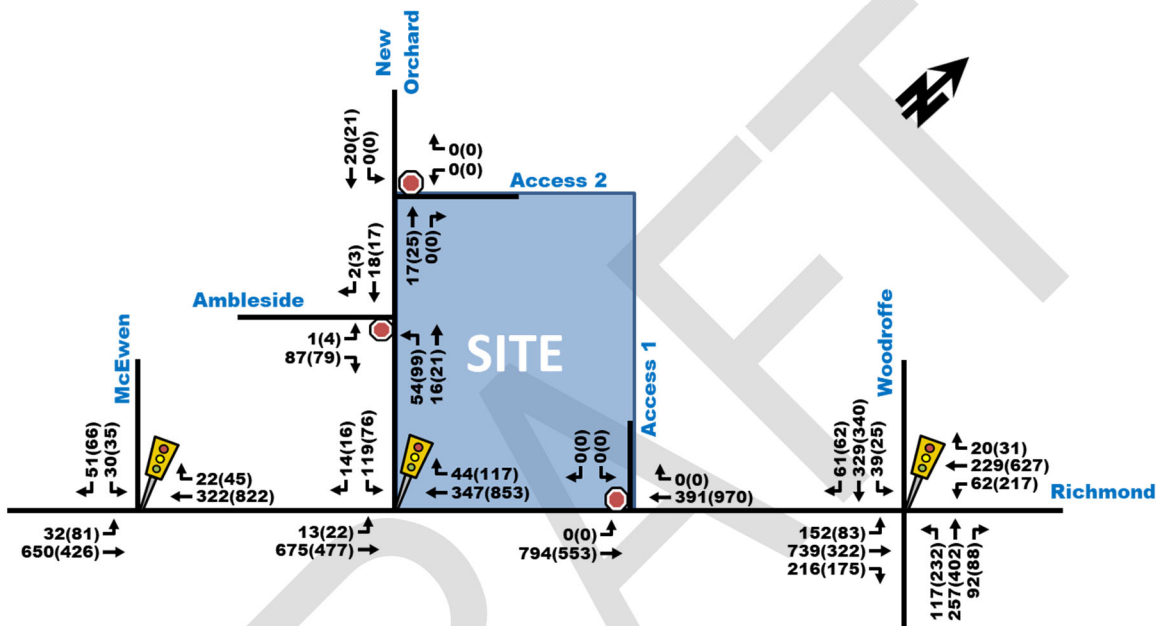
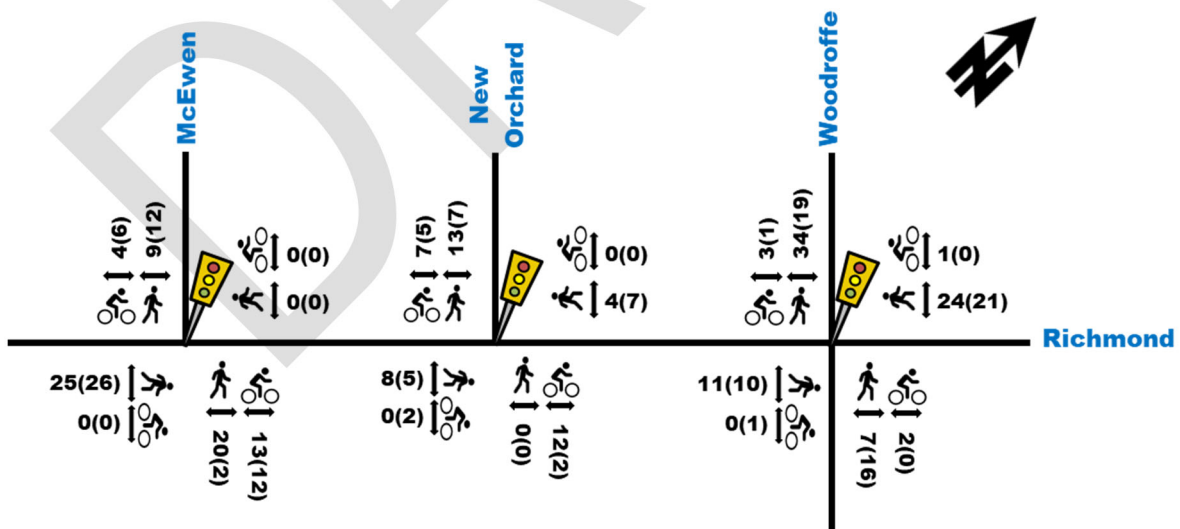

Figure 7: Existing Peak Hour AT Volumes at Richmond/New Orchard



Existing Road Safety Conditions

A five-year collision history data (2015-2019, inclusive) was reviewed using the public online data from the City of Ottawa. Data for all intersections and road segments within the study area was obtained. It was determined

that a total of 73 collisions have occurred at intersections and road segments within the study area. Of the 73 collisions, 26 resulted from rear ends, 17 from turning movements, 13 from angled collisions, 7 from single vehicle (unattended), 3 from single vehicle (other), 3 from sideswipes, 1 from approaching and 2 from “other”. Furthermore, 57 (78%) collisions representing the majority of collisions, resulted in property damage only, while 16 (22%) resulted in non-fatal injuries.

A standard unit of measure for assessing collisions at an intersection is based on the number of collisions per million entering vehicles (MEV). Intersections with a ratio of 1.0 Collisions/MEV or greater are considered to be at a higher risk for collisions. Based on the City of Ottawa TIA Guidelines (2017), a collision pattern is characterized as a sequence of more than six collisions of the same impact type occurring for a specific movement within a five-year period.

At intersections within the study area, reported collisions have historically taken place as follows:

- 0.27 Collisions/MEV at the intersection of Richmond/New Orchard. A total of 8 collisions occurred at this intersection with no particular collision pattern observed.
- 0.25 Collisions/MEV at the intersection of Richmond/McEwen. A total of 7 collisions occurred at this intersection in the five-year period, with no particular collision patterns observed.
- 0.68 Collisions/MEV at the intersection of Richmond/Woodroffe. A total of 39 collisions occurred at this intersection in the five-year period. The only potential collision pattern at this intersection occurred in the northbound approach, where 7 rear end collisions occurred within the five-year period.
- Only 1 collision occurred at the intersection of Ambleside/New Orchard.

With regards to road segments on the development site’s boundary streets, the number of collisions that have occurred in the five-year period are as follows:

- 1 collision occurred along New Orchard Ave N, between Richmond Rd and the north end.
- 13 collision occurred along Richmond Rd, between New Orchard Ave N and Woodroffe Ave.
- 4 collision occurred along Richmond Rd, between McEwen Ave and New Orchard Ave N.

With regards to active transportation (i.e. walking and biking) related collisions, the following collisions are documented out of the total 73 collisions in the study area:

- 1 bicycle collision at the intersection of Richmond/New Orchard and 1 at the intersection of Richmond/Woodroffe, both of which resulted in a non-fatal injury.
- 1 pedestrian collision at the intersection of Richmond/McEwen and 2 at the intersection of Richmond/Woodroffe, all of which resulted in a non-fatal injury. Also, 3 pedestrian collisions occurred along Richmond Rd, between New Orchard Ave N and Woodroffe Ave, which resulted in a non-fatal injury.

Based on the data, there are no major safety concerns within the study area.

2.1.3. Planned Conditions

2.1.3.1. Future Transportation Network Changes

LRT Stage 2

The Light Rail Transit (LRT) in the City of Ottawa has entered Stage 2 of its development, which will include the extending of the LRT corridor in the west, east and south directions. The west extension will include a new station called “New Orchard” within the Byron Linear Park, which will be located within 150m walking distance of the new proposed residential building development. The west extension is expected to be complete by 2025. **Figure 8** illustrates the full expansion of the LRT Stage 2 system.

Figure 8: LRT Stage 2 Expansions Map

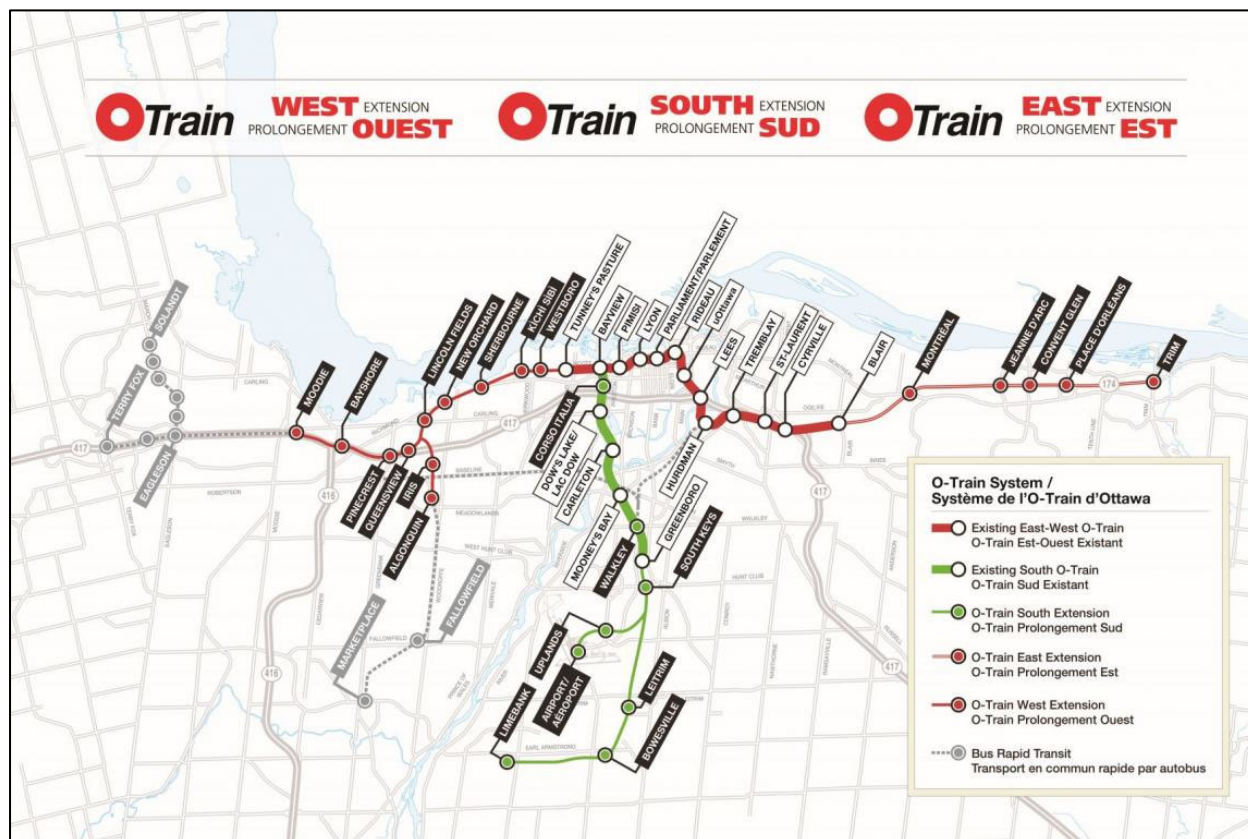

Future Study Area Modifications

Some modifications will be implemented to the study area as part of the LRT Stage 2 project. These modifications include the following:

- Along Richmond Rd, cycle tracks are anticipated to be provided on both sides of the road.
- A new concrete sidewalk will be constructed on the north side of Ambleside Dr and west side of McEwen Ave.
- The intersection of Richmond/New Orchard is expected to operate with a single all-movement lane on all approaches.
- The intersection of Richmond/Woodroffe is expected to operate with an auxiliary left-turn lane and a shared through/right-turn lane on all approaches.
- Bike crossings will also be provided on all approaches of the three Richmond Rd intersections at McEwen Ave, New Orchard Ave N and Woodroffe Ave. All bike crossings are expected to be unidirectional, with a bidirectional crossing at the south leg of the Woodroffe Ave intersection.

2.1.3.2. Other Area Developments

The following section outlines proposed future adjacent developments within the study area. Based on the City of Ottawa's Development Applications search tool, there are two development applications initiated in the area.

100 New Orchard Ave N

A Zoning By-Law Amendment (ZBLA) application has been submitted for a 14-storey high-rise residential building located at 100 New Orchard Ave N. The development will consist of 84 residential units, which did not trigger the need for a TIA report. As such, the development is anticipated to generate a low traffic volume.

1071 Ambleside Dr

A Zoning By-Law Amendment (ZBLA) and Official Plan Amendment (OPA) application has been submitted for a 30-storey residential building housing 293 apartment units that will be replacing the surface parking lot at 1071 Ambleside Dr. The development is anticipated to generate approximately 47 vehicle trips during peak hours by 2023 (full buildout) and 18 vehicle trips during peak hours by 2028 (i.e. post LRT extension).

2.2. Study Area and Time Periods

The proposed development is assumed to be fully constructed by 2026. As such, horizon years 2026 and 2031 (i.e. five-years after development buildout) will be analyzed using the weekday morning and afternoon peak hour time period traffic volumes. Proposed study area intersections are outlined below and highlighted in **Figure 9**.

- Richmond/New Orchard
- Richmond/McEwen
- Ambleside/New Orchard
- Richmond/Woodroffe

Figure 9: Study Area

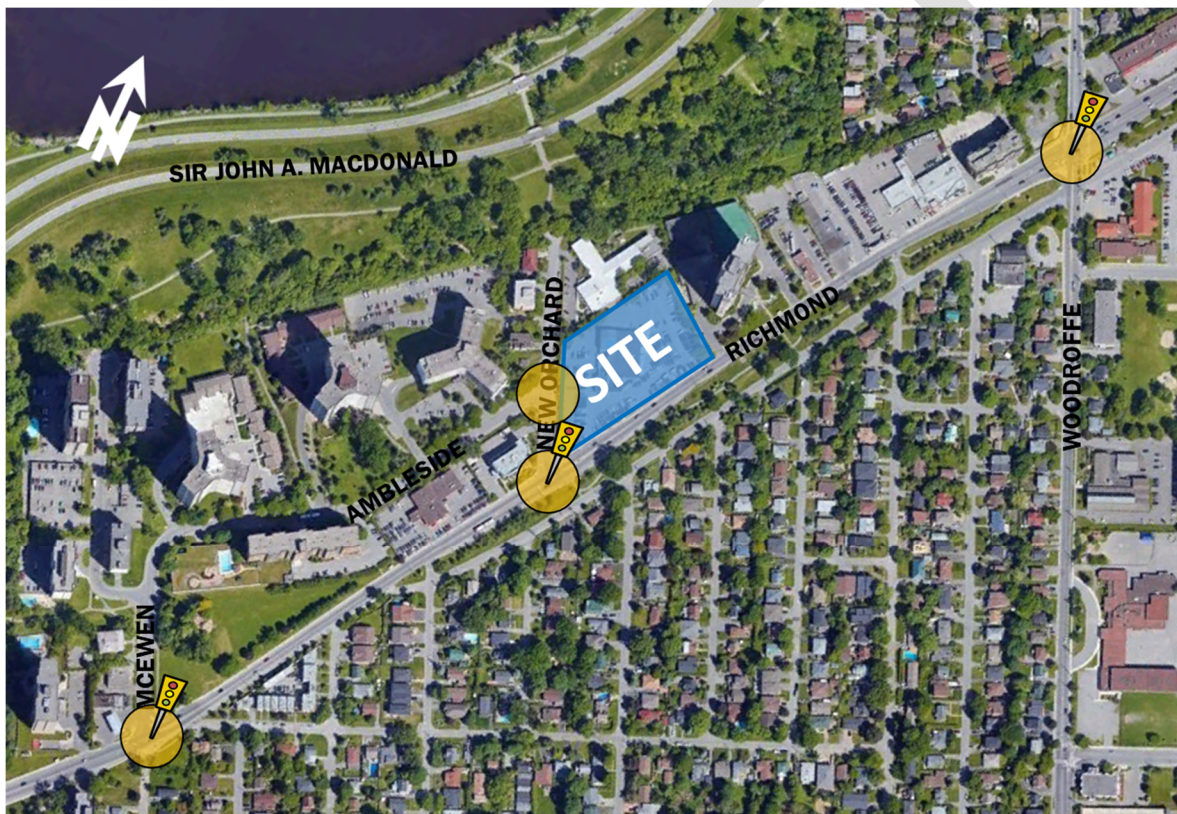

2.3. Exemption Review

The following modules/elements of the TIA process provided in **Table 1** are recommended to be exempt in the subsequent steps of the TIA process, based on the City’s TIA guidelines and the subject site:

Table 1: Exemptions Review Summary

Module	Element	Exemption Consideration
4.1 – 4.4 Design Review Component	All	Not required for applications involving ZBLA. However, a brief description may be provided.

3.0 FORECASTING REPORT

3.1. Development Generated Travel Demand

3.1.1. Trip Generation and mode shares

As mentioned previously, the site currently consists of a car dealership and a surface parking lot. Conservatively, the dealership is assumed to generate a negligible number of trips during peak hours. The proposed development will replace the dealership with three high-rise residential towers containing 1,343 apartment units and 14,493 ft² of first floor commercial space. The commercial space will likely provide ancillary use for the high-density residential units and is expected to be intended for local residents, community and potentially some pass-by traffic. As such, it is not expected to be a regional attraction and is not anticipated to generate new trips.

The appropriate trip generation rates for high-rise apartment land uses were obtained from the 2020 TRANS Trip Generation Manual. The Manual provides person-trip rates during the peak AM and PM periods (7am-9:30am and 3:30PM-6PM). The trip rates are summarized in **Table 2** below.

Table 2: Residential Trip Generation Trip Rates

Land Use	Data Source	Trip Rates	
		AM Peak Period (7-9:30am)	PM Peak Period (3:30-6pm)
High-Rise Apartments	TRANS 2020	T = 0.8(du);	T = 0.9(du);
Notes: T = Average Vehicle Trip Ends du = Dwelling unit			

Using the trip rates provided in **Table 2**, the total number of person trips generated during the morning and afternoon peak periods can be found in **Table 3**. The trips generated by the existing and future buildings are provided separately.

Table 3: Apartment Units Peak Period Person Trip Generation

Land Use	Dwelling Units	AM Peak Period Person Trips	PM Peak Period Person Trips
High-Rise Apartments	1,343	1,074	1,209

The proposed development is anticipated to generate 1,074 and 1,209 person trips during the morning and afternoon peak periods, respectively. The total peak period person trips in **Table 3** are then divided into different travel modes using mode share percentages obtained from the 2020 TRANS Manual for the “Ottawa West” district. **Table 4** provides the travel mode breakdown for the proposed building.

Table 4: Residential Peak Period Trips Mode Shares Breakdown

Travel Mode	Mode Share	AM Peak Period Person Trip	Mode Share	PM Peak Period Person Trips
Auto Driver	28%	306	33%	398
Auto Passenger	11%	123	11%	138
Transit	41%	442	26%	309
Cycling	3%	35	7%	83
Walking	16%	168	23%	281
Total Person Trips	100%	1,074	100%	1,209

Standard traffic analysis is usually conducted using the morning and afternoon peak hour trips as they represent a worst-case scenario. In the 2020 TRANS Manual, Table 4 provides conversions rates from peak period to peak hours for different mode shares. The conversion rates are provided in **Table 5** below.

Table 5: Peak Period to Peak Hour Conversion Factors (2020 TRANS Manual)

Travel Mode	Peak Period to Peak Hour Conversion Factors	
	AM	PM
Auto Driver and Passenger	0.48	0.44
Transit	0.55	0.47
Bike	0.58	0.48
Walk	0.58	0.52

Using the conversion rates in **Table 5** and the peak period person trips for different travel modes in Table 4, the peak hour trips for different travel modes can be calculated as shown in **Table 6**.

Table 6: Residential Peak Hour Trips Mode Share Breakdown

Travel Mode	AM Peak Hour Trips	PM Peak Hour Trips
Auto Driver	147	175
Auto Passenger	59	61
Transit	243	145
Cycling	20	40
Walking	98	146
Total Person Trips	567	567

As shown in **Table 6**, the proposed development is anticipated to generate a total of 567 person trips during the morning and afternoon peak hours. Inbound and outbound percentages were obtained from the 2020 TRANS Manual and applied to each travel mode as shown in **Table 7**.

Table 7: Residential Land Use Trip Generation

Travel Mode	AM Peak (Person Trips/h)			PM Peak (Person Trips/h)		
	In (31%)	Out (69%)	Total	In (58%)	Out (42%)	Total
Auto Driver	46	101	147	101	73	175
Passenger	18	41	59	35	26	61
Transit	75	168	243	84	61	145
Cycling	6	14	20	23	17	40
Walk	30	67	98	85	61	146
Total Person Trips	176	391	567	329	238	567

As shown **Table 7**, the proposed development is anticipated to generate up to 175 vehicle trips, 243 transit trips and 186 Active Transport (walking and cycling) trips, during the morning and afternoon peak hours.

However, the New Orchard LRT Station is expected to be fully constructed at full buildout of the proposed development (2026). As such, transit mode share should be adjusted to reflect the higher number of transit trips. The percentages provided in **Table 8**, are reflective of the City's Transit-Oriented Development (TOD) projections.

Table 8: Residential Peak Hour Trips TOD Mode Share Breakdown

Travel Mode	Mode Share	AM Peak Hour Trips	PM Peak Hour Trips
Auto Driver	15%	85	85
Auto Passenger	5%	28	28
Transit	65%	369	368
Cycling	10%	57	57
Walking	5%	28	28
Total Person Trips	100%	567	567

Using the TOD mode shares in **Table 8**, the breakdown of inbound and outbound trips for the residential land use are provided in **Table 9**.

Table 9: Residential Land Use Trip Generation (TOD Mode Shares)

Travel Mode	AM Peak (Person Trips/h)			PM Peak (Person Trips/h)		
	In (31%)	Out (69%)	Total	In (58%)	Out (42%)	Total
Auto Driver	26	59	85	49	36	85
Passenger	9	19	28	16	12	28
Transit	114	255	369	213	155	368
Cycling	18	39	57	33	24	57
Walk	9	19	28	16	12	28
Total Person Trips	176	391	567	329	238	567

As shown in **Table 9**, the proposed development is anticipated to generate 85 vehicle trips, 369 transit trips and 85 active transport trips during peak hours.

3.1.2. Trip Distribution and Assignment

Based on the 2011 OD Survey (Ottawa West district) and the distribution of background traffic volumes on Richmond Rd, the site-generated commuter traffic (i.e. vehicles travelling to work in the AM peak hour and back from work in the PM peak hour) was estimated as follows:

- 10% to/from the north;
- 25% to/from the south;
- 30% to/from the east; and,
- 35% to/from the west.

For non-commuter site-generated traffic (i.e. inbound traffic during the AM peak hour and outbound traffic during the PM peak hour), it was assumed that traffic would be divided evenly with regards to their travel directions for the primary purpose of reaching major commercial destinations, such as Ikea, Bayshore Mall and Lincoln Fields Mall to the west and the downtown and Hwy 417 to the east and south. The distribution of site-generated traffic volumes was estimated as follows:

- 50% to/from the west on Richmond Rd;
- 25% to/from the east on Richmond Rd; and,
- 25% to/from Hwy 417 via Woodroffe Ave.

Trips travelling to/from the north, south and east will travel east on Richmond Rd, while trips travelling west will travel west on Richmond Rd. The anticipated site-generated auto trips for the proposed building were then assigned to the road networks as shown in **Figure 10**, where vehicles generated were divided evenly between the two site accesses. As mentioned previously, the new proposed building will be accessed via a new access along Richmond Rd (i.e. Access 1), and a second access along New Orchard Ave N (i.e. Access 2).

Figure 10: Proposed Development Site-Generated Traffic

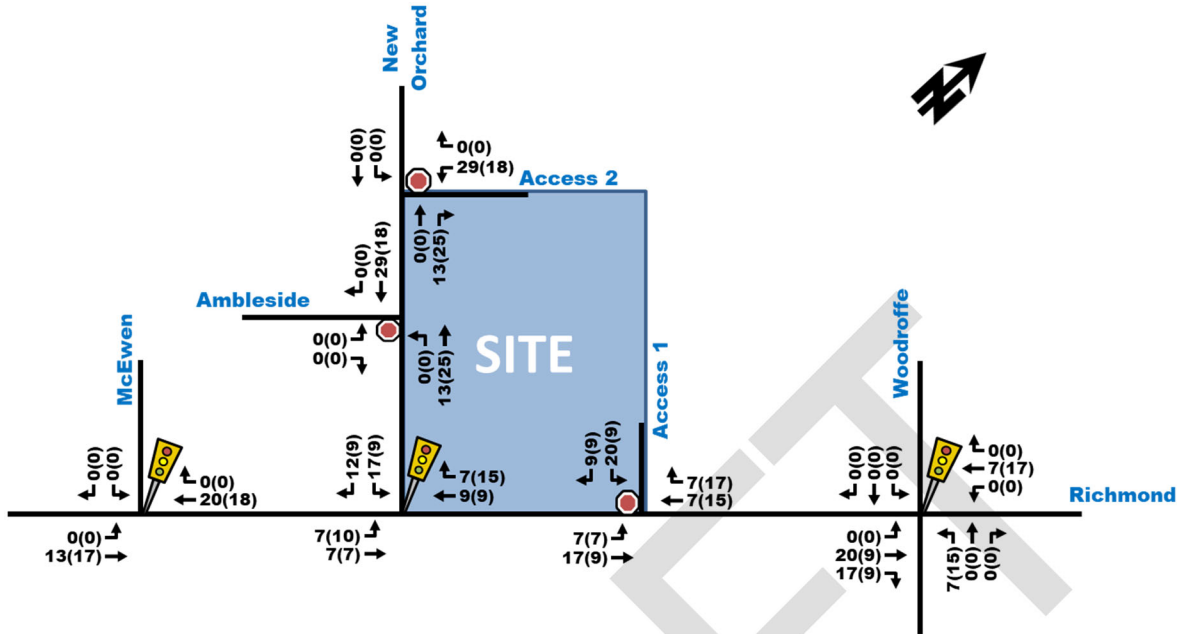

3.2. Background Network Traffic

3.2.1. Transportation network plans

Refer to **Section 2.1.3: Planned Conditions** for a summary of all future modifications anticipated within the study area and along Richmond Rd and the McEwen Ave, New Orchard Ave N and Woodroffe Ave intersections as a result of constructing the New Orchard LRT Station.

3.2.2. Background Growth

A regression analysis was conducted using historic (2009, 2011, 2016) traffic volumes at the intersection of Richmond/New Orchard. A summary of the analysis results is provided in **Table 10** below, with the detailed analysis sheet provided in **Appendix D**.

Table 10: Percent Annual Change at Richmond/New Orchard

Time Period	Percent Annual Change			Overall
	North Leg	East Leg	West Leg	
8 hrs	1.28%	1.86%	1.38%	1.60%
AM Peak	0.64%	0.07%	0.15%	0.15%
PM Peak	2.75%	2.53%	2.06%	2.34%

Based on the results provided in **Table 10**, a background growth rate of 2% was applied to the through movements on Richmond Rd. This growth rate is considered conservative as the AM peak indicates no growth and the 8 hrs period indicates a growth of less than 2%. Although the north leg of the intersection also indicates some growth, there is no background growth rate applied to New Orchard Ave N as it is a short local street with a dead-end, which provides very limited capacity for traffic growth.

A conservative 2% background traffic growth rate was applied only to the through movements of Richmond Rd to account for potential future developments in the area. **Figure 11** provides the future background traffic at horizon year 2026 and **Figure 12** provides the future background traffic at horizon year 2031.

Figure 13: 1071 Ambleside Dr Proposed Future Development

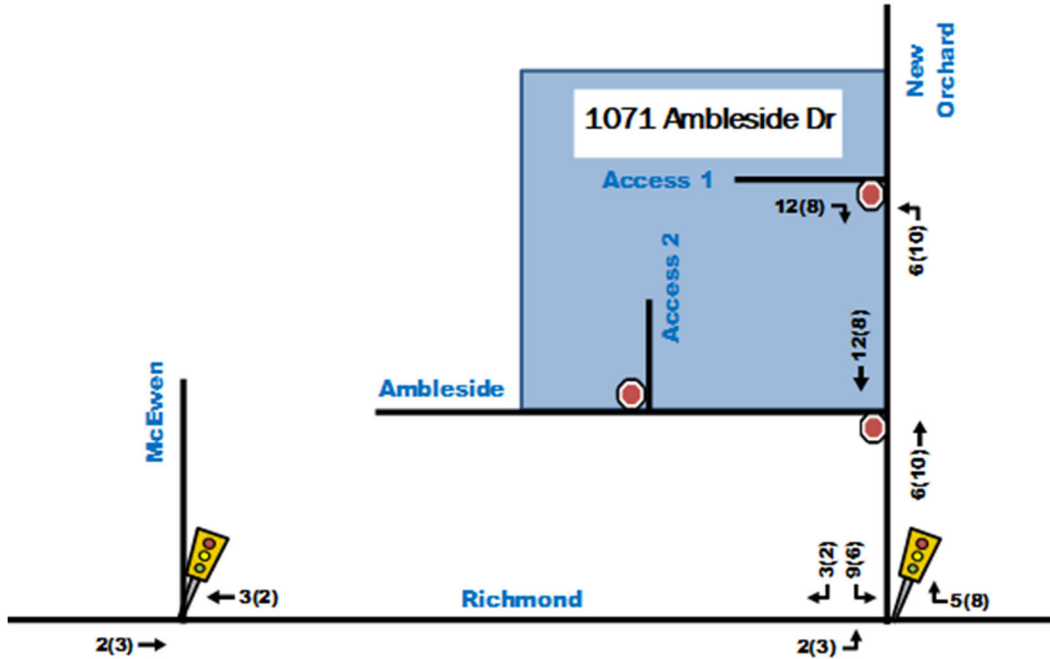

Figure 14: Total Future Background 2026 Traffic Volumes

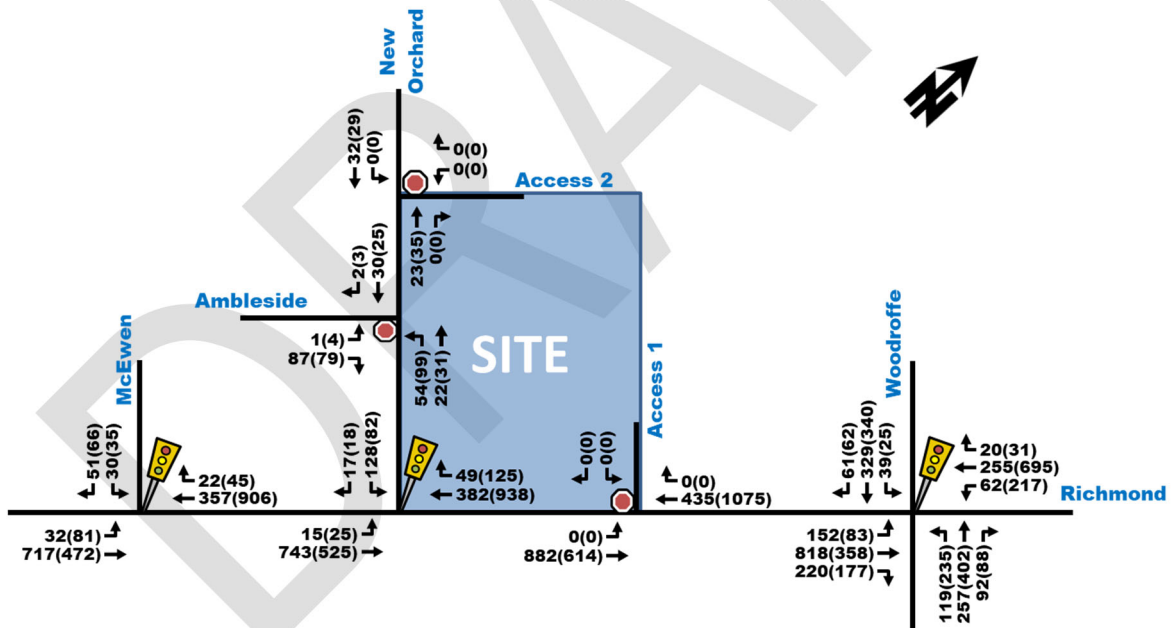
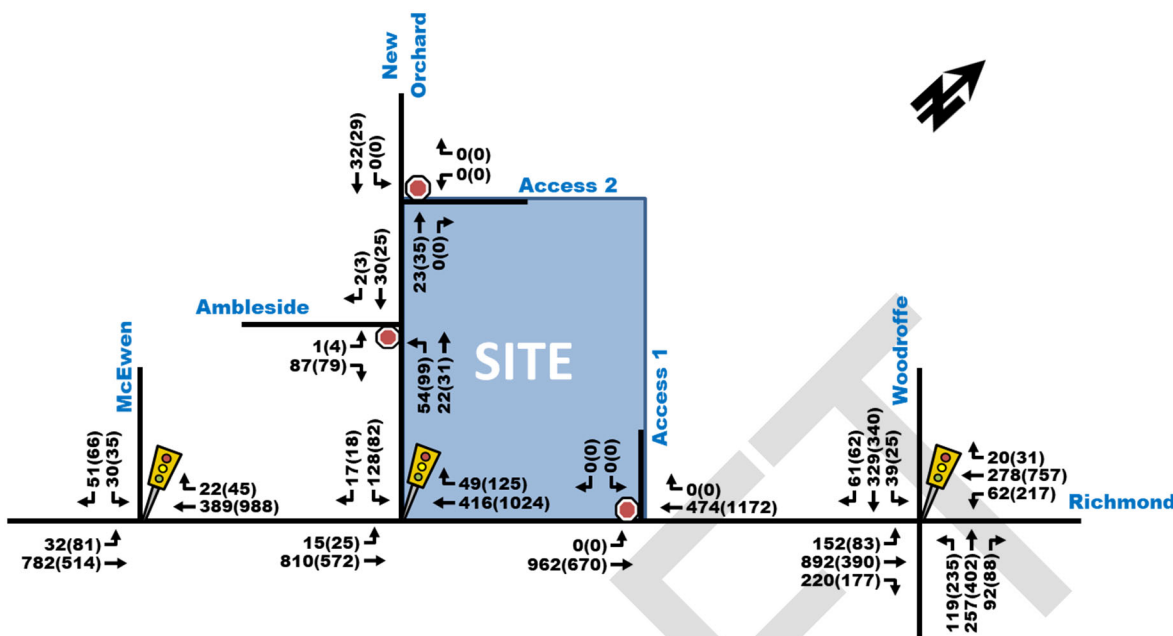

Figure 15: Total Future Background 2031 Traffic Volumes



3.3. Demand Rationalization

The total projected future traffic volumes can be determined by superimposing the site-generated traffic volumes in **Figure 10**, onto the total future background traffic volumes in **Figure 14** and **Figure 15**. The resulting total projected traffic volumes 2026 and 2031 illustrated in **Figure 16** and **Figure 17**. Analysis of study area intersections is provided in **Section 4.9**.

While the proposed development is anticipated to generate a total of 85 vehicles during both peak hours, the traffic will split between two access points, resulting in negligible impacts to existing traffic operations on Richmond Rd.

Potential Future Capacity Issues

The ongoing construction of LRT along Richmond Rd will result in lost operational capacity at study area intersections as existing auxiliary turn lanes are removed to enhance pedestrian and cycling infrastructure along the corridor.

Both the Richmond/McEwen and Richmond/New Orchard intersections will be losing the auxiliary EBL turn lanes, which will potentially result in extended traffic queues forming as left-turning vehicles may block through traffic. However, side street volumes at these intersections are relatively low, and may be resolved via demand rationalizations over time.

The intersection of Woodroffe/Richmond will lose the auxiliary EBR lane and the second EBT and WBT lanes. The current intersection operation is poor and the long-term outlook of this intersection will remain poor since both roadways are major arterial connections, carrying heavy traffic.

Additionally, intersection timings at all three intersections will be adjusted to accommodate new protected intersection designs that provide more time for pedestrians and cyclists, reducing the overall time available for vehicles. The intersection timings in the forthcoming analysis will be adjusted based on the City of Ottawa’s Protected Intersection Design Guide (September 2021).

Figure 16: Total Projected 2026 Traffic Volumes

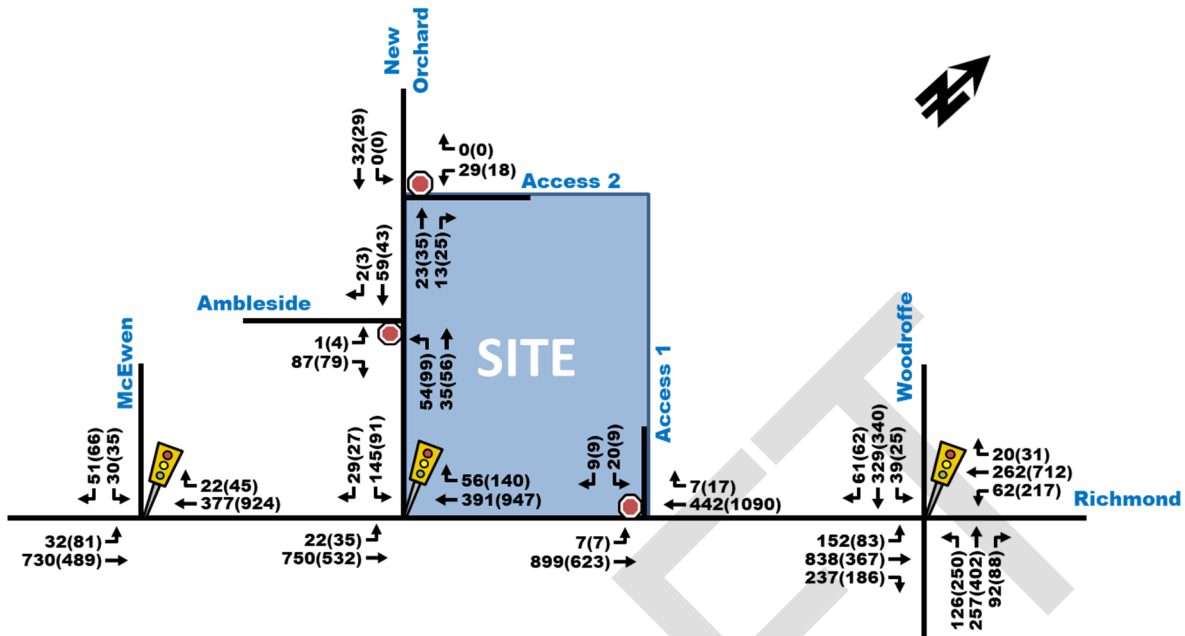
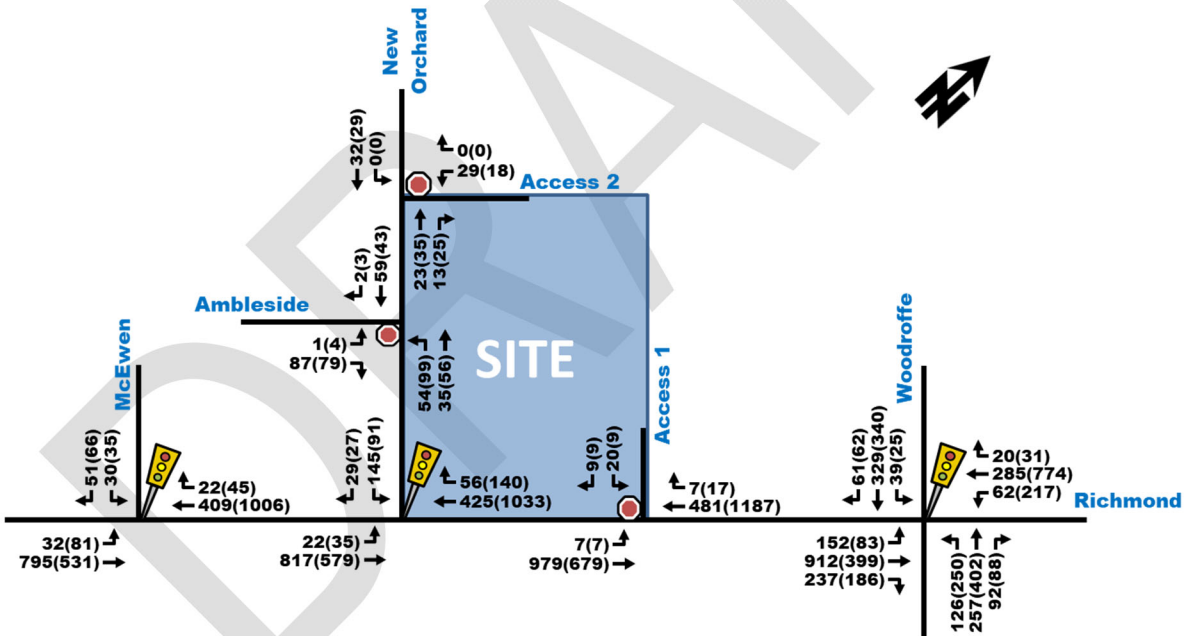

Figure 17: Total Projected 2031 Traffic Volumes



Future Background Traffic Adjustments

In Section 3.2.2 of this TIA, background traffic along Richmond Rd was conservatively expected to continue increasing by 2% per year which aligns with historical growth. However, the implementation of LRT along the corridor and other sustainable initiatives throughout the City are expected to encourage existing drivers to take transit or active travel, and reduce background traffic in the fullness of time. This assumption is supported by the City’s Regional Transportation Model (RTM), which forecasts travel patterns of traffic up to the 2031 horizon year during the AM peak hour. The model suggests Richmond Rd traffic could stagnate or reduce by up to 10% from existing levels. The City’s model outputs have been provided in Appendix E.

A sensitivity analysis was conducted using total projected 2031 traffic volumes in **Figure 17**, where future traffic volumes (without demand rationalizations) have been reduced in increments of 10% to a maximum of 30% for the through movements on Richmond Rd and Woodroffe Ave, which is the estimated limit based on the City’s RTM.

Figure 18 illustrates total projected 2031 traffic volumes with a 30% reduction. The implications of this reduction on the adjacent road network will be discussed in **Section 4.9**.

Figure 18: Total Projected 2031 Traffic Volumes, with 30% Reduction

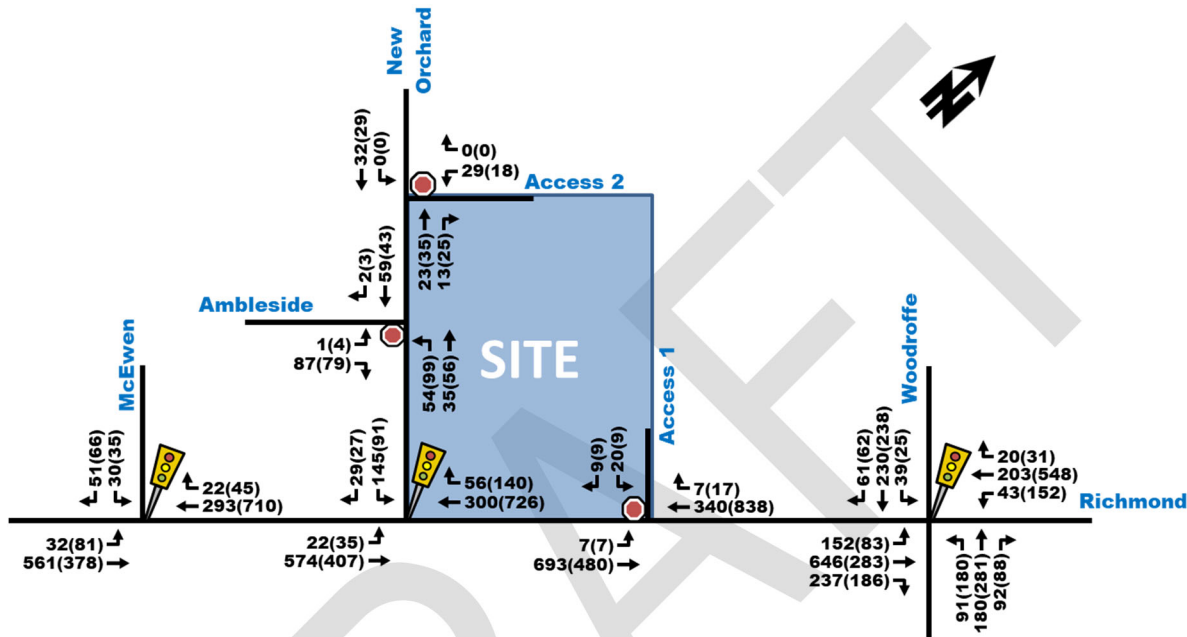

4.0 ANALYSIS

4.1. Development Design

As this is a ZBLA, design related elements will be provided in more detail in the future Site Plan Application (SPA) submission of the proposed development. The City of Ottawa’s TDM-supportive Development Design and Infrastructure checklist has been provided in **Appendix F** and discussed in more detail in **Section 4.5**.

Auto and Bicycle Parking

Vehicle and bicycle parking are proposed to be provided in a three-level underground parking garage. The parking garage, three truck loading entrances and a drop-off area are all located along the site’s proposed internal driveway.

Pedestrian and Cyclist Facilities

Pedestrian sidewalks will be provided at the frontages of the proposed development, along Richmond Rd and New Orchard Ave N. As mentioned previously, bike lanes will be provided along Richmond Rd and New Orchard Ave N (up to Ambleside Dr) as part of the construction work for the west expansion of the LRT. Additionally, bike crossings will be provided on all approaches at the three Richmond Rd intersections with Woodroffe Ave, New Orchard Ave N and McEwen Ave.

Transit Amenities

The New Orchard LRT Station will be located within a 150m walking distance of the proposed development site. The station can be accessed via sidewalk facilities and the crossings at the intersection of Richmond/New

Orchard. The existing bus routes may also continue to operate in the future as indicated in **Section 2.1.2: Transit Network**.

4.2. Parking

The development is proposing to provide a total of 1,343 dwelling units and approximately 1,347 m² (14,493 ft²) retail space, within three residential towers and a six-storey podium. Based on the City of Ottawa Parking Provisions, the proposed development is located in “Area Z”, which consists of the following parking requirements:

- No off-street motor vehicle parking required for tenants.
- Visitor parking is required at a rate of 0.1 per dwelling unit, up to a maximum of 30 spaces per building and excluding the first twelve units. This equates to approximately 90 required spaces for the three proposed towers.
- Bicycle parking is required at a rate of 0.50 per dwelling unit and 1 per 250 m² of retail space, for a total of approximately 678 required spaces.

The development is proposing to provide a total of 762 vehicle parking spaces within three levels of an underground parking garage, which meets the minimum requirements of the City of Ottawa’s Parking Provisions. Additionally, the total number of bicycle parking spaces proposed is 778 spaces, which meets the minimum City requirements as well.

4.3. Boundary Street Design

The detailed Multi-Modal Level of Service (MMLoS) analysis for boundary streets and signalized intersections will be provided in the future Site Plan Application.

4.4. Access Intersection Design

Access to the proposed development will be provided via an internal driveway that connects Richmond Rd and New Orchard Ave N. The Richmond Rd access will be located at the east end of the site, approximately 140m east of the Richmond/New Orchard intersection, while the New Orchard Ave N access will be located at the north end of the site, approximately 90m north of the intersection. Note that both accesses will allow all movements in/out of the site. Along the internal driveway, access will be provided to three truck loading areas, a drop-off area and a three-level underground parking garage.

Given the proximity of the accesses to the signalized intersection of Richmond/New Orchard, the Private Approach By-Law and TAC Guidelines have been reviewed as shown below to ensure the access locations and operations are acceptable.

Private Approach By-Law

The Private Approach By-Law notes the following requirements under Section 25 that are relevant to the subject development:

- The maximum width for a two-way access is 9m,
- The minimum distance between a two-way access and another access to the same property is 9m,
- The minimum distance between the property access and the property line of an adjacent development must be at least 3m. However, it is noted in Section 25, paragraph 1.P, that a distance of 0.3m may be acceptable to City staff if the access is found to be a safe distance from the adjacent property, has adequate sight lines and does not create a traffic hazard,
- For arterial roads (i.e. Richmond Rd), the location of the access is dependent on the number of parking spaces that the access leads to. According to the City Private Approach By-Law (**Figure 19** below), if 300 or more parking spaces are provided, the access must be at least 60m away from the signalized intersection at Richmond/New Orchard and at least 60m away from any other private

accesses to **the same property**. Note that this calculation does not apply to local roads, such as New Orchard Ave N.

Figure 19: Private Approach By-Law Required Access Distances

COLUMN 2 NUMBER OF PARKING SPACES	COLUMN 3 DISTANCE BETWEEN THE PRIVATE APPROACH AND NEAREST INTERSECTING STREET LINE	COLUMN 4 DISTANCE BETWEEN A TWO-WAY PRIVATE APPROACH AND ANY OTHER PRIVATE APPROACH
20 to 99	18 metres	15 metres
100 to 199	30 metres	30 metres
200 to 299	45 metres	45 metres
300 or more	60 metres	60 metres

As the site proposes to provide more than 300 parking spaces, the Richmond Rd access must maintain a 60m distance from the signalized Richmond/New Orchard intersection, along with a 3m distance from the property line of 1025 Richmond Rd. Since there is an approximately 150m site frontage along Richmond Rd, the access may be located within an approximately 87m span towards the east end of the site, as illustrated in **Figure 20**.

Figure 20: By-Law Conforming Access Limits - 300 or More Parking Spaces

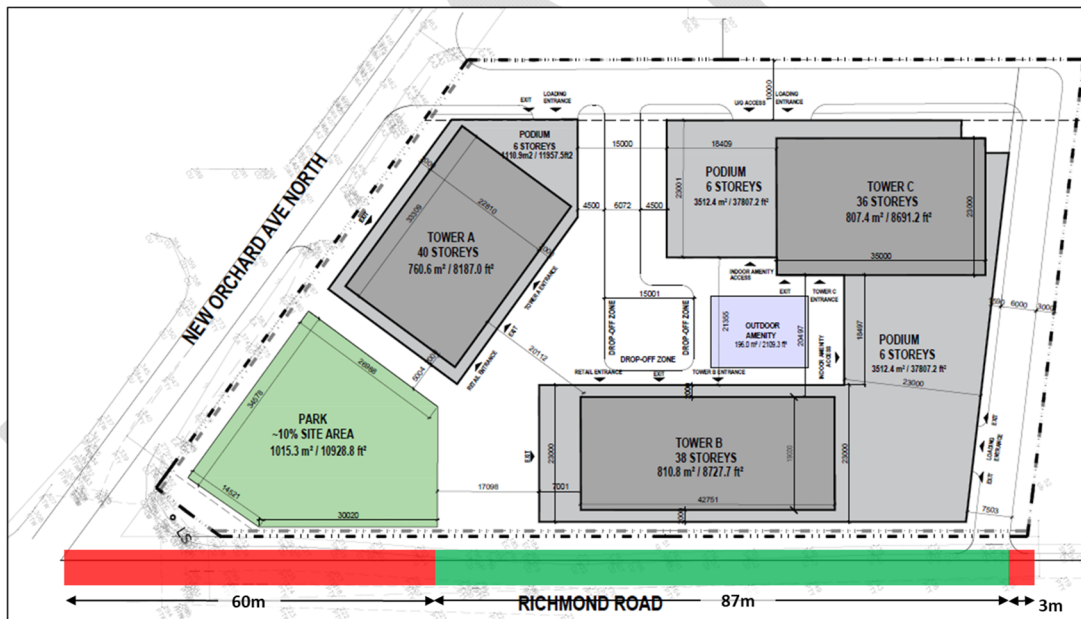

With regards to the New Orchard Ave N accesses, there are no concerns with its proposed locations as a distance of 3m is expected to be maintained from the adjacent property line at 99 New Orchard Ave N.

TAC Guidelines

The TAC Guidelines provide suggested minimum corner clearances from a signalized intersection. **Figure 21** below obtained from TAC Guideline Chapter 8, Figure 8.8.2, summarizes the suggested distances from a signalized intersection.

Figure 21: TAC Guidelines, Corner Clearance (Chapter 8, Figure 8.8.2)

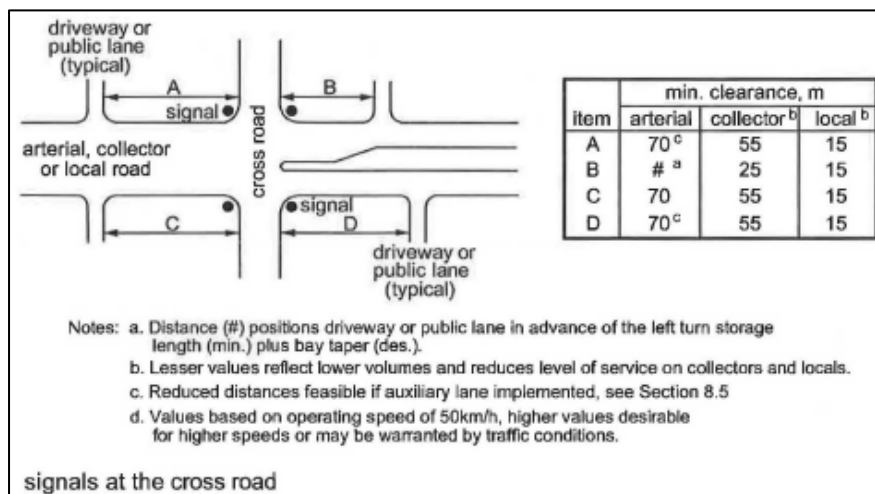

The arterial Richmond Rd access is suggested to be approximately 70m east of the signalized Richmond/New Orchard intersection, while the local New Orchard Ave N access is suggested to be 15m north of the signalized Richmond/New Orchard intersection.

Based on the above, the proposed locations of the Richmond Rd and the New Orchard Ave N accesses are acceptable, given the requirements of the Private Approach By-Law and the suggestions of the TAC Guidelines. Notably, the proposed Richmond Rd access is more critical due to its location on an arterial road. Therefore, it is advantageous for it to be located as far east as possible to maximize the separation distance to the New Orchard Ave intersection, while conforming to the private approach spacing requirements to the adjacent property driveway.

4.5. Transportation Demand Management

4.5.1. Context for TDM

The proposed development is located in both a Design Priority Area (DPA), known as Richmond Traditional Mainstreet, and a Transit-Oriented Development (DPA) zone, where the future New Orchard LRT Station will be located within 150m walking distance. The property is owned and will be managed by the Fengate Capital Management.

Given the proposed land-use of the development as a residential building, it is assumed that most trips generated will be from residents leaving the site in the AM peak to go to work and returning to the site in the PM peak. **Sections 3.1.1** and **3.1.2** describe how many trips are anticipated per travel mode and anticipates the likely locations that they will travel to and from based on the OD-Survey 2011 for Ottawa.

The development is proposing to provide 1,343 apartment units in three residential towers. A breakdown of the unit types indicates that the units provided will consist of 286 studio units, 559 one-bedroom units, 663 two-bedroom units and 35 three-bedroom units.

4.5.2. Need and Opportunity

Transit usage is anticipated to increase greatly in the area as a result of the future New Orchard LRT Station. In addition to the LRT expansions, the active transportation facilities (sidewalks and bike lanes) are anticipated to be improved in the area. Therefore, transit and active transport travel modes are expected to generate the highest number of trips.

The proposed development is expected to utilize Transportation Demand Management (TDM) measures to maintain sustainable transit and active mode shares, as described in more detail in **Section 4.5.3** below.

4.5.3. TDM Program

The TDM Infrastructure and TDM Measures Checklists have been provided in **Appendix F**. The proposed measures in each respective checklists are identified below. It should be noted that some measures are being considered but will be confirmed during the Site Plan Application (SPA).

Proposed measures identified in the TDM-supportive Development Design and Infrastructure Checklist are:

- All ten (10) Required measures related to Walking and Cycling (facilities and bicycle parking) and Vehicle Parking have been satisfied
- Ten (10) out of fourteen (14) basic measures related to Walking and Cycling, Parking and Ridesharing have been satisfied, namely:
 - Locating building close to the street.
 - Locating building entrances to minimize walk distance to sidewalks and transit.
 - Locating building doors and windows to ensure visibility of pedestrians.
 - Providing safe, direct and attractive walking routes to transit.
 - Ensuring walking routes are secure, visible, and lighted.
 - Designing roads for cyclist circulation.
 - Providing lighting, landscaping and benches along walking and cycling routes.
 - Providing wayfinding signage for site access.
 - Provide a designated area for carpool drivers to drop-off or pick-up passengers.
 - Providing parking for long-term and short-term users.
- One (1) out of seven (7) better measures related to Parking have been satisfied, while one Carsharing measure will be considered during Site Plan Application, namely:
 - Provide separate areas for short-term and long-term parking.
 - Providing carshare parking spaces for tenants and the benefit of the surrounding community. (To be confirmed during SPA)

Proposed measures identified in the TDM Measures Checklist are:

- Designate an internal or external coordinator. (To be confirmed during SPA)
- Conduct periodic surveys to identify travel-related behaviors. (To be confirmed during SPA)
- Display walking and cycling information at major entrances.
- Display transit information at major entrances.
- Offer PRESTO cards for one month. (One year measure to be considered during SPA)
- Provide on-site carshare vehicles for residents and carshare memberships. (To be confirmed during SPA)
- Unbundle parking costs from monthly rent.
- Provide multi-modal travel information package to new residents.

4.6. Neighbourhood Traffic Management

This module compares the maximum two-way traffic of a local or collector road during morning and afternoon peak hours, to the respective thresholds suggested by the City of Ottawa TIA Guidelines.

Site-generated traffic of the proposed development are expected to use local road New Orchard Ave N as part of their access route to/from the proposed development. The thresholds suggested in the TIA Guidelines indicate an ideal two-way traffic volume of 120 veh/h for local roads during peak hours. Using the total projected 2031 traffic volumes in **Figure 17**, future traffic volumes along New Orchard Ave N were projected to be as follows:

- A maximum two-way traffic on New Orchard Ave N of approximately 293 veh/h are anticipated during the afternoon peak hour, between Ambleside Dr and Richmond Rd. These volumes are greater than the 120 veh/h ideal threshold of a local road and are approaching a collector road threshold of 300 veh/h. Notably, these volumes also exceed the threshold in existing conditions, with 231 v/h during the afternoon peak hour.

It should be noted that these volumes are exceeding the specified threshold on New Orchard Ave N over a short distance of approximately 60m, as the majority of traffic diverts to/from Ambleside Dr. Additionally, the 60m section of New Orchard Ave N is designed with wider lanes and limited access to developments, which are typical characteristics of a collector road.

The thresholds provided in the TIA Guidelines are only ideal suggestions and not firm requirements for traffic volumes. The City may choose to reclassify this section of New Orchard Ave N as a collector road. However, it is not considered critical at this time.

4.7. Transit

As shown in **Table 9**, the proposed development is anticipated to generate a total of 369 transit trips during both the morning and afternoon peak hours. These trips are expected to utilize both the LRT at the future New Orchard Station along with any bus routes that will be operating in the area. The LRT was created with the purpose of accommodating a substantial number of riders in the future. As such, the future transit network is expected to have sufficient capacity that can easily accommodate the projected number of site-generated transit trips.

Existing conditions (pre-COVID) transit ridership data was obtained from OC Transpo for six bus stops near the proposed development site, as shown in **Figure 22**. The data, provided in **Table 11**, is a summary of average bus boarding, alighting and occupancy information for bus routes at each of the respective stop numbers, during morning and afternoon peak hours.

Figure 22: Transit Ridership Data Bus Stop Locations

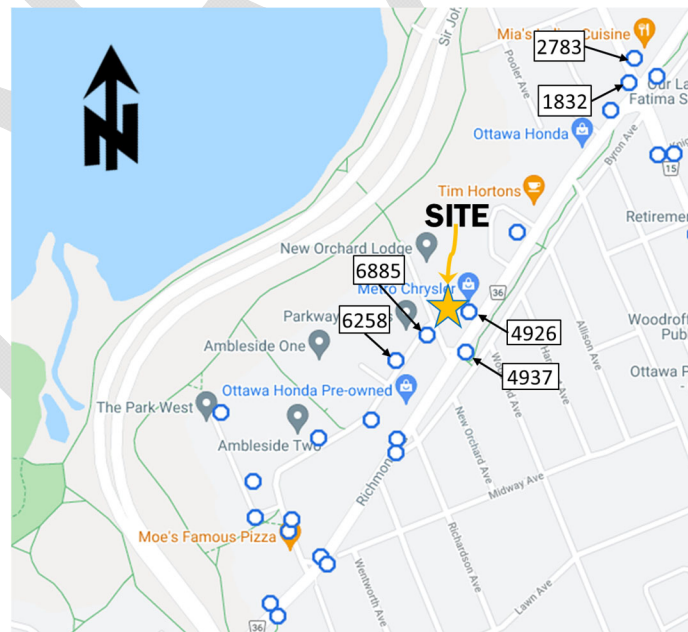

Table 11: Transit Ridership Data (5 Jan 2020 - 16 Mar 2020)

Stop No.	Location	Route	Direction	AM			PM		
				Boarding	Alighting	Avg. Load at Depart.	Boarding	Alighting	Avg. Load at Depart.
1832	Woodroffe / Richmond	87	SB	0	0	4	0	3	17
2783	Woodroffe / Richmond	87	NB	25	0	17	11	14	9
4926	Richmond / New Orchard	11	WB	8	3	6	4	23	11
		153	WB	0	0	1	0	0	7
4937	Richmond / New Orchard	11	EB	30	5	12	12	5	7
		153	EB	0	0	4	0	0	4
6258	Ambleside / New Orchard	153	EB	0	0	4	0	0	4
6885	Ambleside / New Orchard	153	WB	0	0	1	2	1	7

As shown in **Table 11**, the average load of each bus route at its respective bus stop ranges from about 1 to 17 persons during the peak hours. It should be noted that these bus routes serve their respective stops several times during peak hours. Bus route #11 and #87 in particular are “frequent routes” that arrive every 15 minutes or less during peak hours. In the future, the LRT will also be providing service in the area, at the New Orchard Station. It is assumed that the LRT will arrive approximately every 5 minutes or less during peak hours.

Based on information obtained from the OC Transpo website, the person capacity of OC Transpo vehicles, which includes the number of seats on the bus plus the standing capacity, ranges from approximately 65 occupants in its smallest vehicles to approximately 150 occupants in its largest vehicles. The LRT’s capacity is approximately 336 occupants.

Therefore, based on the current average bus loads, the available capacity and frequency of the existing bus routes, and the future anticipated capacity and frequency of the LRT, the proposed development generating approximately 369 transit trips during peak hours is anticipated to be accommodated by the available and future transit services.

4.8. Review of Network Concept

Although the proposed development is projected to generate up to 558 person trips during both peak hours, the majority of the trips are expected to be transit trips, which can be accommodated by the future transit network, as discussed in **Section 4.7**. It is also projected that there will be up to 85 vehicle trips and 85 active transport (walking and cycling) trips, which are not substantial enough to cause a major impact to the local network. The effect of the vehicle trips on the road network and study area intersections is confirmed in **Section 4.9**.

4.9. Intersection Design

4.9.1. Intersection Control

Stop control will be provided for vehicles exiting the site at each of the Richmond Rd and New Orchard Ave N accesses. Both accesses will allow all movements in/out of the site. All other off-site intersection controls in the study area will continue to operate like existing conditions.

4.9.2. Intersection Design

Synchro 10 Trafficware was used to analyze intersection performance of intersections within the study area. Critical movements at each of the intersections were assessed based on either the movement with the highest volume-to-capacity ratio (for signalized intersections), or the movement experiencing the highest average delay

(for unsignalized intersections). It should be noted that, as per the TIA Guidelines, the Peak Hour Factor (PHF) used for analysis was 0.90 in existing conditions and 1.0 in all future scenario conditions.

As mentioned previously, the intersection designs for each of the Richmond Rd intersections at McEwen Ave, New Orchard Ave N and Woodroffe Ave will be modified in the future as part of the LRT construction in the area (see **Section 2.1.3.1**). This will result in modifications in the signal timing plans at each of the signalized intersections. As such, the timing plans have been modified at signalized intersections for both horizon years 2026 and 2031 in accordance with the guidelines of the City of Ottawa’s Protected Intersection Design Guide (September 2021). Additionally, all phase timings in Synchro were optimized, while cycle lengths were unchanged from existing (for scenarios that do not include demand rationalization).

All Synchro and SimTraffic report outputs for existing and future conditions have been provided in **Appendix G**.

Existing Conditions

Table 12 below summarizes the intersection performance of study area intersections, based on existing conditions traffic volumes illustrated in **Figure 6**.

Table 12: Existing Conditions Intersection Performance

Intersection	Weekday AM Peak (PM Peak)					
	Critical Movement			Intersection ‘As a Whole’		
	LOS	max. v/c or avg. delay (s)	Movement	Delay (s)	LOS	v/c
Richmond Rd/McEwen Ave (S)	A(B)	0.55(0.70)	EBT(WBT)	7.3(6.9)	A(B)	0.53(0.65)
Richmond Rd/New Orchard Ave N (S)	A(C)	0.59(0.80)	EBT(WBT)	8.7(14.2)	A(C)	0.58(0.76)
Woodroffe Ave/Richmond Rd (S)	F(F)	1.72(1.11)	EBT(NBL)	167.2(59.6)	F(F)	1.37(1.01)
Ambleside/New Orchard Ave N (U)	A(A)	8.8(8.8)	EB(EB)	6.6(6.6)	A(A)	-
Note: Analysis of signalized intersections assumes a PHF of 0.9 and a saturation flow rate of 1800 veh/h/lane. (S) – Signalized intersection, movement with highest v/c ratio identified as critical movement. (U) – Unsignalized intersection, movement with highest average delay identified as critical movement.						

As shown in **Table 12**, both the critical movement and the intersection ‘as a whole’ at the signalized Richmond/Woodroffe intersection operate at capacity with a LOS ‘F’ during both peak hours, while the other two signalized intersections operate at a LOS ‘C’ or better.

The unsignalized intersection of Ambleside/New Orchard operates at a LOS ‘A’ during both peak hours.

Total Future Background 2026

Table 13 below summarizes the Synchro traffic operations at study area intersections, based on total future background 2026 traffic volumes illustrated in **Figure 14**.

Table 13: Total Future Background 2026 Conditions Intersection Performance

Intersection	Weekday AM Peak (PM Peak)					
	Critical Movement			Intersection ‘As a Whole’		
	LOS	max. v/c or avg. delay (s)	Movement	Delay (s)	LOS	v/c
Richmond Rd/McEwen Ave (S)	A(B)	0.54(0.69)	EBT(WBT)	7.2(7.2)	A(B)	0.52(0.63)
Richmond Rd/New Orchard Ave N (S)	A(C)	0.60(0.79)	EBT(WBT)	8.7(13.3)	A(B)	0.58(0.65)
Woodroffe Ave/Richmond Rd (S)	F(F)	1.49(1.42)	EBT(NBL)	135.5(94.0)	F(F)	1.26(1.09)
Ambleside/New Orchard Ave N (U)	A(A)	8.8(8.8)	EB(EB)	6.0(6.2)	A(A)	-
Note: Analysis of signalized intersections assumes a PHF of 1.0 and a saturation flow rate of 1800 veh/h/lane. (S) – Signalized intersection, movement with highest v/c ratio identified as critical movement. (U) – Unsignalized intersection, movement with highest average delay identified as critical movement.						

As shown in **Table 13**, operations are similar to or slightly better than existing conditions due to increasing the PHF to 1.0. However, the intersection of Woodroffe/Richmond continues to experience congestion.

Total Future Background 2031

Table 14 below summarizes the Synchro traffic operations at study area intersections, based on total future background 2031 traffic volumes illustrated in **Figure 15**.

Table 14: Total Future Background 2031 Conditions Traffic Volumes

Intersection	Weekday AM Peak (PM Peak)					
	Critical Movement			Intersection 'As a Whole'		
	LOS	max. v/c or avg. delay (s)	Movement	Delay (s)	LOS	v/c
Richmond Rd/McEwen Ave (S)	A(C)	0.58(0.75)	EBT(WBT)	7.7(8.8)	A(B)	0.56(0.70)
Richmond Rd/New Orchard Ave N (S)	B(D)	0.66(0.85)	EBT(WBT)	9.2(16.2)	B(C)	0.64(0.71)
Woodroffe Ave/Richmond Rd (S)	F(F)	1.59(1.42)	EBT(NBL)	157.8(102.3)	F(F)	1.33(1.10)
Ambleside/New Orchard Ave N (U)	A(A)	8.8(8.8)	EB(EB)	6.0(6.2)	A(A)	-

Note: Analysis of signalized intersections assumes a PHF of 1.0 and a saturation flow rate of 1800 veh/h/lane.
(S) – Signalized intersection, movement with highest v/c ratio identified as critical movement.
(U) – Unsignalized intersection, movement with highest average delay identified as critical movement.

As shown in **Table 14**, operations at the signalized intersections are anticipated to deteriorate slightly compared to total future background 2026 due to higher congestions and delays.

Total Projected 2026

Table 15 below summarizes the Synchro traffic operations at study area intersections, based on total projected 2026 traffic volumes illustrated in **Figure 16**.

Table 15: Total Projected 2026 Conditions Traffic Volumes

Intersection	Weekday AM Peak (PM Peak)					
	Critical Movement			Intersection 'As a Whole'		
	LOS	max. v/c or avg. delay (s)	Movement	Delay (s)	LOS	v/c
Richmond Rd/McEwen Ave (S)	A(B)	0.55(0.70)	EBT(WBT)	6.5(8.6)	A(B)	0.53(0.64)
Richmond Rd/New Orchard Ave N (S)	C(D)	0.76(0.89)	EBT(WBT)	16.1(23.0)	C(C)	0.75(0.78)
Woodroffe Ave/Richmond Rd (S)	F(F)	1.59(1.52)	EBT(NBL)	155.5(105.7)	F(F)	1.33(1.14)
Ambleside/New Orchard Ave N (U)	A(A)	8.9(8.9)	EB(EB)	5.0(5.3)	A(A)	-
Richmond Rd/Site Access 1 (U)	D(D)	33.8(34.8)	SB(SB)	0.8(0.5)	A(A)	-
New Orchard Ave N/Site Access 2 (U)	A(A)	8.9(8.9)	WB(WB)	2.7(1.5)	A(A)	-

Note: Analysis of signalized intersections assumes a PHF of 1.0 and a saturation flow rate of 1800 veh/h/lane.
(S) – Signalized intersection, movement with highest v/c ratio identified as critical movement.
(U) – Unsignalized intersection, movement with highest average delay identified as critical movement.

As shown in **Table 15**, the signalized Richmond Rd intersections at McEwen Ave and New Orchard Ave N are projected to operate 'as a whole' at a LOS 'C' or better during the morning and afternoon peak hours, while the Woodroffe Ave intersection continues to operate at capacity during peak hours. Critical movements at the signalized Richmond Rd intersections at McEwen Ave and New Orchard Ave N operate at a LOS 'D' or better during peak hours, while the Woodroffe Ave intersection continues to operate at capacity.

With regards to unsignalized intersections, the SB movement at the proposed development access along Richmond Rd is anticipated to operate at a LOS 'D' during both peak hours, with delays up to approximately 35 seconds.

Total Projected 2031 (without Demand Rationalizations)

Table 16 below summarizes the Synchro traffic operations at study area intersections, based on total projected 2031 traffic volumes illustrated in **Figure 17**.

Table 16: Total Projected 2031 Conditions Traffic Volumes

Intersection	Weekday AM Peak (PM Peak)					
	Critical Movement			Intersection 'As a Whole'		
	LOS	max. v/c or avg. delay (s)	Movement	Delay (s)	LOS	v/c
Richmond Rd/McEwen Ave (S)	A(C)	0.59(0.76)	EBT(WBT)	6.9(10.4)	A(C)	0.57(0.72)
Richmond Rd/New Orchard Ave N (S)	D(E)	0.82(0.96)	EBT(WBT)	17.6(31.8)	C(D)	0.80(0.89)
Woodroffe Ave/Richmond Rd (S)	F(F)	1.69(1.52)	EBT(NBL)	178.3(115.2)	F(F)	1.40(1.16)
Ambleside/New Orchard Ave N (U)	A(A)	8.9(8.9)	EB(EB)	5.0(5.3)	A(A)	-
Richmond Rd/Site Access 1 (U)	E(E)	46.0(47.7)	SB(SB)	1.0(0.7)	A(A)	-
New Orchard Ave N/Site Access 2 (U)	A(A)	8.9(9.0)	WB(WB)	2.7(1.5)	A(A)	-
Note: Analysis of signalized intersections assumes a PHF of 1.0 and a saturation flow rate of 1800 veh/h/lane. (S) – Signalized intersection, movement with highest v/c ratio identified as critical movement. (U) – Unsignalized intersection, movement with highest average delay identified as critical movement.						

As shown in **Table 16**, operations are similar to total projected 2026 operations, with higher delays and v/c ratios. The SB movement at the proposed development access along Richmond Rd is anticipated to operate near capacity at a LOS 'E' during both peak hours, with delays up to approximately 48 seconds. However, it is important to note that development generated traffic can also choose to utilize the New Orchard Ave N access if delays appear to be excessively high for left-turning vehicles at the Richmond Rd access.

Although traffic operations at the Richmond/McEwen and Richmond/New Orchard intersections are acceptable, queuing analysis conducted using SimTraffic indicates that excessive queuing (based on both average and 95th percentile queues) occurs in the EB and WB through movements of Richmond Rd as a result of congestion caused by left-turning vehicles and the adjusted timings at the intersections. Similarly, the intersection of Woodroffe/Richmond undergoes excessive queuing in all its movements. As recorded in the SimTraffic reports provided in **Appendix G**, traffic queues are anticipated to cause major spillbacks and extend past their respective storage areas and even the study area limits.

Total Projected 2031 (with Demand Rationalizations)

Table 17 below summarizes the Synchro traffic operations at study area intersections, based on total projected 2031 traffic volumes with the demand rationalization outlined in **Section 3.3.**, i.e. a 30% reduction in background traffic volumes, as illustrated in **Figure 18**. Both cycle lengths and timings have been adjusted to improve traffic operations at all signalized intersections. For coordination purposes, the same cycle length was provided for the Richmond/McEwen and Richmond/New Orchard intersections. Additionally, a permissive/protected EBL turn phase was provided at each of the two intersections.

Table 17: Total Projected 2031 Conditions Traffic Volumes, with 30% Reduction and Mitigation Measures

Intersection	Weekday AM Peak (PM Peak)					
	Critical Movement			Intersection 'As a Whole'		
	LOS	max. v/c or avg. delay (s)	Movement	Delay (s)	LOS	v/c
Richmond Rd/McEwen Ave (S)	A(B)	0.45(0.69)	EBT(WBT)	10.9(15.0)	A(A)	0.43(0.58)
Richmond Rd/New Orchard Ave N (S)	C(E)	0.74(0.97)	SBL(WBT)	19.0(40.0)	A(C)	0.60(0.79)
Woodroffe Ave/Richmond Rd (S)	E(E)	0.99(0.97)	EBT(WBL)	53.2(44.3)	E(D)	0.93(0.85)
Ambleside/New Orchard Ave N (U)	A(A)	8.9(8.9)	EB(EB)	5.0(5.3)	A(A)	-
Richmond Rd/Site Access 1 (U)	C(C)	17.2(20.2)	SB(SB)	0.6(0.4)	A(A)	-
New Orchard Ave N/Site Access 2 (U)	A(A)	8.9(9.0)	WB(WB)	2.7(1.5)	A(A)	-
Note: Analysis of signalized intersections assumes a PHF of 1.0 and a saturation flow rate of 1800 veh/h/lane. (S) – Signalized intersection, movement with highest v/c ratio identified as critical movement. (U) – Unsignalized intersection, movement with highest average delay identified as critical movement.						

As shown in **Table 17**, operations of intersections 'as a whole' have improved as a result of the 30% reduction in traffic and adjustment of timings. All signalized intersections and respective critical movements now operate

at a LOS 'E' or better during peak hours. The critical SB movement at the proposed unsignalized Richmond Rd access of the development improves operations to a LOS 'C' during peak hours.

Queueing analysis conducted using SimTraffic indicated that the 95th percentile traffic queues are reasonable compared to total projected 2031 conditions as most locations do not experience spillback that exceed available storage lengths. The Woodroffe/Richmond intersection is still expected to experience some congestion during the afternoon peak hour, albeit not as excessive without considering demand rationalizations. However, given that both Richmond Rd and Woodroffe Ave are arterial roads that serve high traffic volumes, some congestion that occurs during the critical afternoon peak hour was considered acceptable.

The average queue lengths in this scenario from SimTraffic are significantly lower than the 95th percentile queue lengths, indicating that the 95th percentile queue lengths, which represent a worse-case outcome, may only occur within a short duration of the critical afternoon peak hour.

It is worth noting that even with only a 20% reduction in background traffic (which is equivalent to a 0% background traffic growth rate), traffic congestions and delays at the New Orchard and site access intersections would still operate within City standards. The SB movement at the Richmond Rd access would operate at LOS 'D' or better. Similarly, the intersection of Richmond/New Orchard 'as a whole', operates at LOS 'D' or better during both peak hours. More extensive queuing on Richmond Rd was observed in this scenario, but on average both AM and PM peak hour queues do not exceed available storage capacity.

5.0 FINDINGS, CONCLUSIONS AND RECOMMENDATIONS

Based on the results summarized herein, the following transportation related conclusions are offered:

Proposed Development

- Fengage Capital Management is proposing a residential development to replace the existing car dealership at the northeast corner of the Richmond/New Orchard signalized intersection. The municipal address of the development is 1047 Richmond Rd. The development is anticipated to be constructed in a single phase by horizon year 2026.
- The development will consist of three residential towers that are 36 to 40-storeys high and connected by a 6-storey podium. The buildings are proposed to consist of 1,343 apartment units, along with approximately 1,347 m² (14,493 ft²) of first floor retail. A park approximately 1,015 m² (10,925 ft²) in size is also proposed.
- Approximately 762 vehicle parking spaces and 778 bicycle parking spaces are proposed to be provided in an underground parking garage, which meet the requirements of the City of Ottawa's Parking Provisions.
- The Richmond Rd access will be located at the east end of the site, approximately 140m east of the Richmond/New Orchard intersection, while the New Orchard Ave N access will be located at the north end of the site, approximately 90m north of the intersection. The underground parking garage, a drop-off area and three loading zones will be located along the site driveway. The site accesses will provide stop control for vehicles exiting the site. The access locations were found to meet the requirements of the City of Ottawa's Private Approach By-Law and TAC Guidelines.
- The development is anticipated to generate approximately 567 person trips during peak hours, which includes 85 vehicle trips, 28 passenger trips, 369 transit trips and 85 active transport (walking and cycling) trips.

- The development will be located across from the future New Orchard LRT Station (anticipated to be constructed by 2025), within a 150m walking distance. As a result, transit usage was expected to be very high, with 369 trips anticipated to be generated by the proposed development. A review of the existing and future transit network in the area indicated that these volumes can be accommodated in the future.
- A suite of TDM measures is anticipated to be adopted by the development for the purpose of ensuring sustainable transit and active mode travel patterns are maintained. Additional measures may be considered during SPA. At this time, measures include displaying multi-modal travel information for walking, cycling and transit, and unbundling parking costs from monthly rent. Other key measures include:
 - Providing safe, direct, and attractive walking routes to transit.
 - Offering residents PRESTO cards for one month.
 - Locating buildings close to street.
 - Designing roads to accommodate cyclist circulation.
 - Providing lighting, landscaping and benches along walking and cycling routes.

Future Study Area Modifications

- The LRT west extension will be complete by 2025 and will include a new station within the Byron Linear Park called New Orchard Station.
- Cycle tracks are anticipated to be provided on both sides of Richmond Rd.
- A new concrete sidewalk will be constructed on the north side of Ambleside Dr and west side of McEwen Ave.
- The intersection of Richmond/New Orchard will provide a single all-movement lane on all approaches.
- The intersection of Richmond/Woodroffe will provide an auxiliary left-turn lane and a shared through/right-turn lane on all approaches.
- Unidirectional bike crossings will be provided on all approaches of the three Richmond Rd intersections with McEwen Ave, New Orchard Ave N and Woodroffe Ave, with a bidirectional crossing on the south leg of the Woodroffe Ave intersection.
- Two adjacent developments are anticipated to be constructed at 100 New Orchard Ave N and 1071 Ambleside Dr. The 100 New Orchard Ave N development is anticipated to generate minimal traffic, while the 1071 Ambleside Dr development is anticipated to generate 47 vehicle trips by 2023 and 18 vehicle trips by 2028, which has been included in the future background traffic volumes.

Existing and Future Background Conditions

- In existing conditions, the intersection of Woodroffe/Richmond 'as a whole' operates at capacity with a LOS 'F' during both peak hours. All other intersections provide acceptable traffic operations.
- A review of historical traffic volumes indicated a growth trend at the Richmond/New Orchard intersection of approximately 2% during the afternoon peak hour. Therefore, a 2% background growth rate was conservatively applied to both the morning and afternoon peak hours, to account for any unforeseen future developments that may generate traffic in the study area. The growth rate was only applied only to the through movements of Richmond Rd.
- Given the future modifications of the signalized study area intersections as protected intersections, the signal timing plans were modified in accordance with the City of Ottawa's Protected Intersection Design Guide (September 2021). Both the future designs of the intersections and the modified timing plans

result in increased congestion for traffic as more consideration and time is provided for pedestrians and cyclists.

- Both the total future background 2026 and 2031 conditions indicate that overall study area intersections are anticipated to operate similar to existing conditions, with slightly lower or higher delays and v/c ratios. Note that the Peak Hour Factor (PHF) was increased to 1.0 for all future scenarios in Synchro, as per the requirements of the TIA Guidelines, which results in somewhat better operations compared to existing conditions.
- MMLoS analysis of boundary streets and signalized intersections for existing and future conditions will be provided during SPA.

Projected Conditions

- With regards to neighbourhood traffic management, the two-way traffic volumes along New Orchard Ave N exceeds the 120 veh/h ideal threshold of a local road between Richmond Rd and Ambleside Dr and are approaching the 300 veh/h threshold of a collector road, with up to 293 veh/h during the afternoon peak hour of total projected 2031 conditions. The following is noted:
 - The threshold is also exceeded in existing conditions, with up to 231 veh/h during the afternoon peak hour.
 - The local road threshold is exceeded over a short distance of 60m as the majority of traffic diverts to/from Ambleside Dr. Within this segment of New Orchard Ave N, wider lanes are provided and limited access to developments is available, which are typical characteristics of a collector road.
 - The local and collector road thresholds provided in the TIA Guidelines are only ideal suggestions and not firm requirements for traffic volumes. As such, reclassifying this segment of New Orchard Ave N as collector road is not considered critical.
- In total projected 2026 and 2031 conditions, traffic operations are anticipated to deteriorate slightly compared to the respective total future background conditions. By 2031, the Richmond Rd access to the proposed development is anticipated to encounter delays up to 48 seconds (LOS 'E') in the SB movement. However, it should be noted that there is flexibility with regards to which access residents choose to utilize. If delays at the Richmond Rd access are high, residents may choose to use the New Orchard Ave N access instead.
- Queue lengths within the study area were assessed using SimTraffic to determine the level of congestion caused by the future modifications to the study area, based on total projected 2031 traffic volumes. It was determined that highly excessive queuing would result due to reduced intersection capacities, where traffic extends past available storage lengths and even outside the study area limits.

Demand Rationalizations

- A background growth rate of 2% was applied to through volumes on Richmond Rd to account for potential future development traffic, but it is reasonable to assume that future background traffic would decrease as a result of the ongoing implementation of LRT on Richmond Rd and other sustainable initiatives throughout the City. A reduction up to 30% was supported by the City's Regional Transportation Model forecasts on both Richmond Rd and Woodroffe Ave. Therefore, reductions were applied as follows:
 - 30% reduction of background traffic volumes for the through volumes on Richmond Rd and Woodroffe Ave; and
 - The northbound and westbound left-turns at the intersection of Woodroffe/Richmond.

The reductions resulted in acceptable traffic operations at all study area intersections, including the intersection of Woodroffe/Richmond, which operates at an overall LOS 'E' or better during both peak hours. Additionally, traffic queues were reduced to reasonable levels, with some congestion that can be experienced in short durations at the intersection of Woodroffe/Richmond during the afternoon peak hour.

Overall, based on the preceding report, the proposed development can be supported by the transportation network at the 2026 and 2031 horizon years. The development plan leverages its location in close proximity to the future New Orchard LRT Station with enhanced active transportation facilities and will consider various TDM initiatives to promote sustainable travel choices for its residents and reduce the vehicular impacts on the adjacent network. As a result, the analysis confirmed that no off-site roadway modifications were needed to support the development based on information available at the time of this study. The proposed development is recommended to proceed from a transportation perspective.

DRAFT

DRAFT

Appendix A:

Screening Form and City Comments

21 January 2022

City of Ottawa
Development Review Services
110 Laurier Avenue West
Ottawa, ON K1P 1J1

Attention: Patrick McMahon, Project Manager, Infrastructure Approvals

Dear Patrick:

Re: 1047 Richmond Rd TIA

Step 4 – Response to Forecasting Report Comments

The following document has been prepared in response to City of Ottawa comments received on January 10, 2022. Comments have been noted in black with the corresponding responses from Parsons in **Green**.

Transportation Engineering Services

1. The modal share for the commercial portion of the development is unlikely to meet 65% transit use. However, the 15% auto mode share is accepted. Keep in mind that all transit trips for the commercial portion are really pedestrian trips onto the site.
Agreed. The onsite commercial uses will cater mostly to walking/cycling/transit traffic with a large proportion coming from local residents within the development. Therefore, the updated TIA reflect no external vehicle trips during the peak hour periods, as they will mostly occur during off-peak periods. Even if a 15% auto driver mode share was assumed, it would result in less than 10 commercial vehicle trips generated during peak hours. As such, the implication of the updated assumption is negligible.
2. The modal shares for the residential portion are accepted and should be supported with adequate TDM infrastructure/measures and low auto parking.
Noted. The TDM Checklists supporting modal share assumptions have been provided in Appendix E.
3. The background growth rate of 2% is very conservative and as indicated with future LRT will likely be much lower.
Agreed. The growth rate represents a worst-case scenario for future adjacent developments.
4. Confirm that the expected transit trips can be supported by the LRT Confederation Line and local transit routes within Section 4.7.
Section 4.7 has been updated to provide existing transit ridership data and confirm the future transit network can accommodate the expected transit trips.
5. Consideration should be given to aligning the access on New Orchard with the future access at 1071 Ambleside at site plan application.
Based on the locations of the two proposed developments, there may be geometric constraints to aligning the two accesses.
6. This site should strive to integrate into the LRT designs and support alternative modes through integration of significant TDM measures.
Agreed. Various TDM measures will be considered to support alternative modes, for example preloaded PRESTO cards for residents and unbundling parking costs from monthly rent.

Traffic Signal Operations

7. The ultimate design along Richmond Road will see a reduction in vehicular capacity as well as the removal or shortening of existing auxiliary lanes. Should the targets not be met, the delays and congestion will be considerable given the size of the proposed development.

It is acknowledged that congestion may occur during the AM and PM peak hours should the mode share targets not be met. However, with the close proximity of the development to the future New Orchard LRT Station and the various TDM measures being considered to support alternative travel modes, the development has a very high probability of reaching these targets. It should also be noted that a very conservative background growth rate of 2% was applied to traffic on Richmond Rd. With the future LRT extension, background traffic along Richmond Rd is expected to decline as a result of increasing transit trips, which would extend the operational capacity of Richmond Rd intersections in the fullness of time.

Development Review

8. Depending on the results of the Synchro at the unsignalized access on Richmond Road, some of the demand at peak times may need to be rationalized to the signalized access and/or restrictions may be needed for left turns into and out of the development.

Based on the analysis in the updated TIA, restricting left-turns at the Richmond Rd driveway access is not justified. Residents may adjust their route in response to congestion by utilizing the Richmond/New Orchard intersection. Based on the proposed Site Plan, the parking garage entrance is located closer to the New Orchard Ave N access along the site's internal driveway, increasing the likelihood of residents utilizing the access.

Additionally, the TIA analysis results for future 2031 conditions indicate the Richmond Rd driveway access provides adequate traffic operations (LOS 'E') for the SB movement during both peak hours (without any demand rationalizations) or redirections. Similarly, the signalized intersection of Richmond/New Orchard 'as a whole' operates within City standards (LOS 'D' or better). These results suggest there is sufficient capacity between these two access points is available to accommodate the development generated traffic volumes.

As per a previous City comment, a very conservative growth rate was also assumed for background traffic along Richmond Rd. The TIA report provides a demand rationalization if background traffic growth was stagnant (0%) or decreased (-1%) due to the implementation of LRT along the corridor. With no background traffic growth, delays at the Richmond Rd site access improved to LOS 'D' with less congestion, and with a reduction of 1%, driveway access conditions would significantly improve to a LOS 'C' with only minor congestion during peak hours. These demand rationalizations were also supported by the City's Regional Transportation Model AM peak period traffic forecasts for 2031.

City of Ottawa 2017 TIA Guidelines

Date

16-Nov-21

TIA Screening Form

Project

1047 Richmond Rd

Project Number

477943-01000

Results of Screening	Yes/No
Development Satisfies the Trip Generation Trigger	Yes
Development Satisfies the Location Trigger	Yes
Development Satisfies the Safety Trigger	Yes

Module 1.1 - Description of Proposed Development

Municipal Address	1047 Richmond Rd, Ottawa, ON
Description of location	Northeast corner of the intersection of Richmond/New Orchard
Land Use	Apartment units, with first floor retail
Development Size	Three towers 36-40 storeys and podium, 1,265 units
Number of Accesses and Locations	One on Richmond Rd and one on New Orchard Ave
Development Phasing	1 Phase
Buildout Year	Assumed 2025
Sketch Plan / Site Plan	See attached

Module 1.2 - Trip Generation Trigger

Land Use Type	Townhomes or Apartments	
Development Size	1265	Units
Trip Generation Trigger Met?	Yes	

Module 1.3 - Location Triggers

Development Proposes a new driveway to a boundary street that is designated as part of the City's Transit Priority, Rapid Transit, or Spine Bicycle Networks (See Sheet 3)	Yes
Development is in a Design Priority Area (DPA) or Transit-oriented Development (TOD) zone. (See Sheet 3)	Yes
Location Trigger Met?	Yes

Module 1.4 - Safety Triggers

Posted Speed Limit on any boundary road	<80	km/h
Horizontal / Vertical Curvature on a boundary street limits sight lines at a proposed driveway	No	
A proposed driveway is within the area of influence of an adjacent traffic signal or roundabout (i.e. within 300 m of intersection in rural conditions, or within 150 m of intersection in urban/ suburban conditions) or within auxiliary lanes of an intersection;	Yes	
A proposed driveway makes use of an existing median break that serves an existing site	No	
There is a documented history of traffic operations or safety concerns on the boundary streets within 500 m of the development	No	
The development includes a drive-thru facility	No	
Safety Trigger Met?	Yes	

DRAFT

Appendix B:
Transit Route Maps



11

Fréquent

LINCOLN FIELDS BAYSHORE

PARLIAMENT/ PARLEMENT LAURIER

7 days a week / 7 jours par semaine

All day service

Service toute la journée

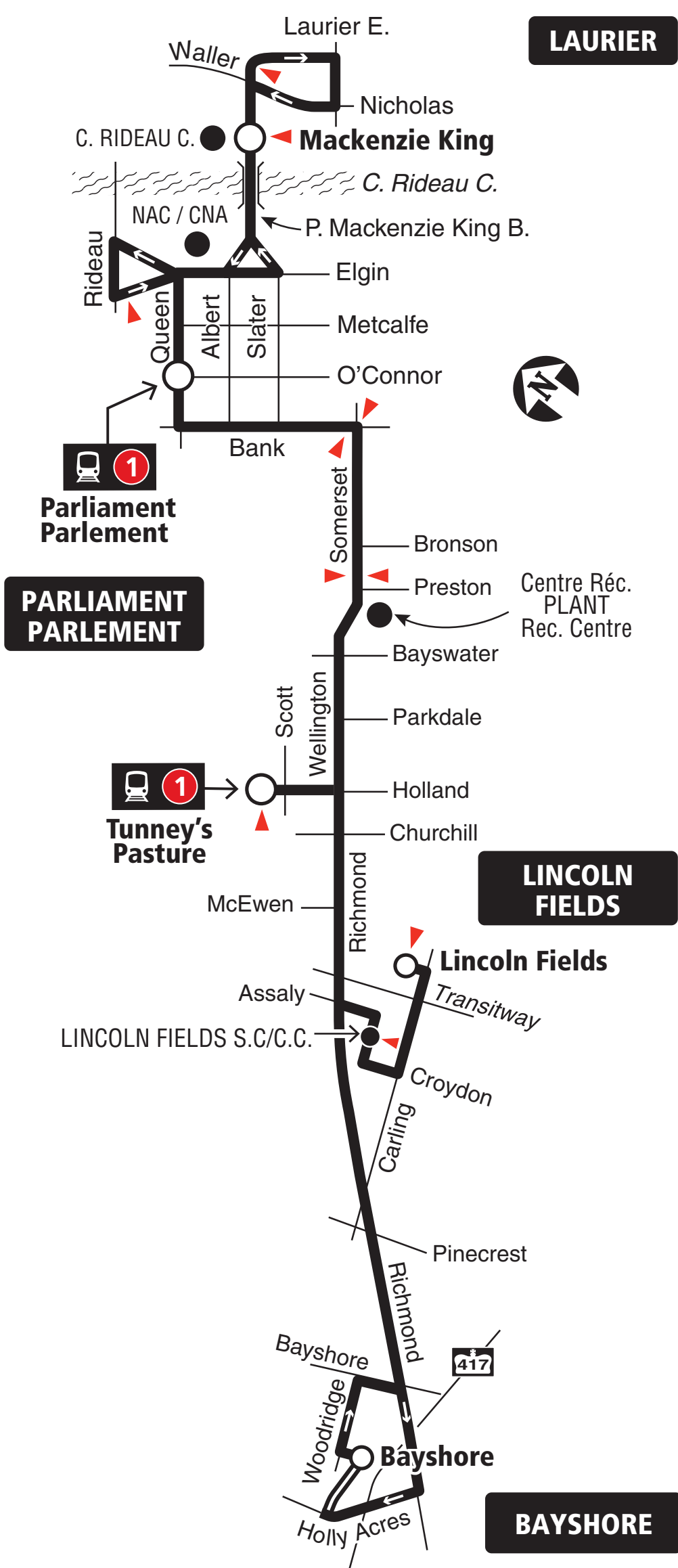

Transitway & Station
 Timepoint / Heures de passage

2021.06



Schedule / Horaire 613-560-1000

Text / Texto* 560560

plus your four digit bus stop number / plus votre numéro d'arrêt à quatre chiffres

*Standard message rates may apply / Les tarifs réguliers de messagerie texte peuvent s'appliquer

Customer Service

Service à la clientèle **613-741-4390**

Lost and Found / Objets perdus **613-563-4011**

Security / Sécurité **613-741-2478**

Effective June 20, 2021

En vigueur 20 juin 2021



INFO 613-741-4390
octranspo.com



87

BASELINE TUNNEY'S PASTURE

Fréquent

7 days a week / 7 jours par semaine

All day service

Service toute la journée

TUNNEY'S PASTURE

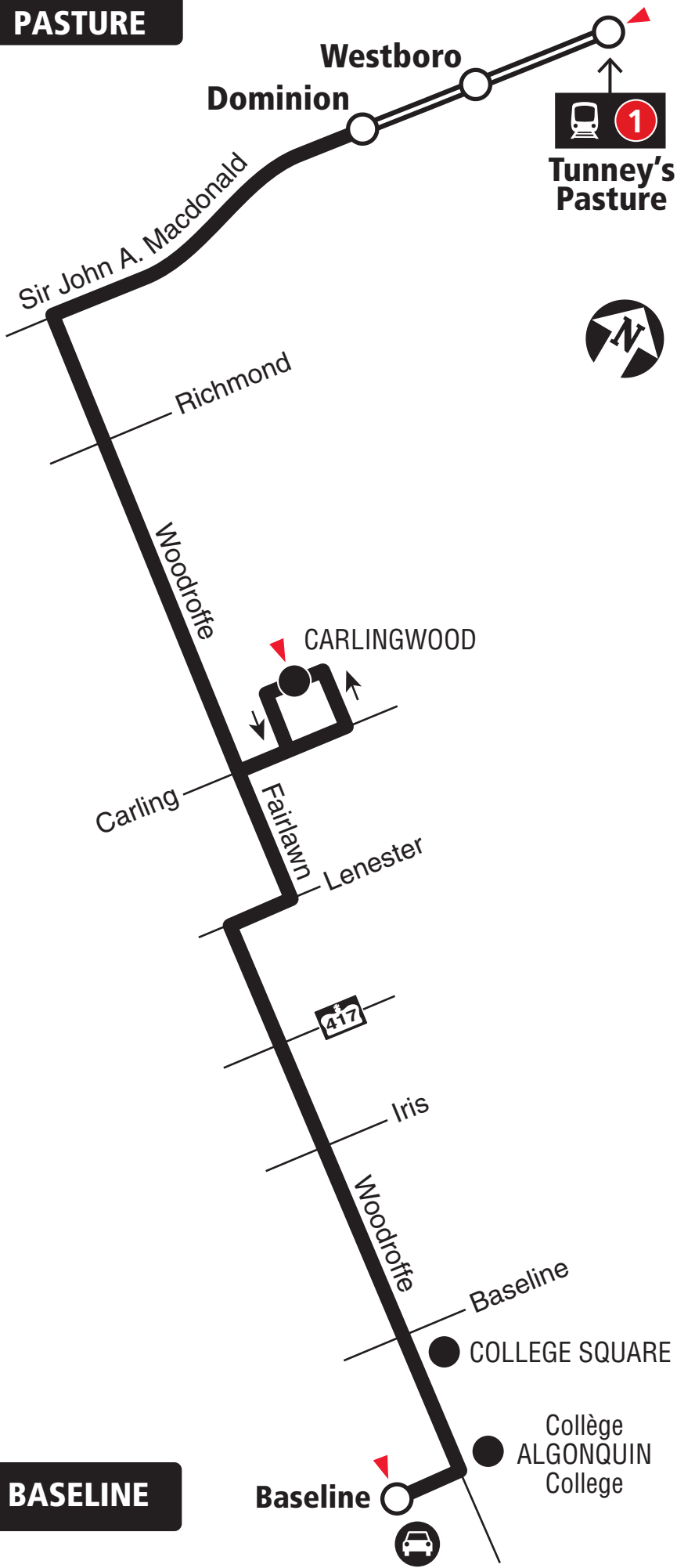

BASELINE



Transitway & Station



Park & Ride / Parc-o-bus



Timepoint / Heures de passage

2019.07



1



**Future route after O-Train Line 1 is open
Trajet du circuit après l'ouverture
de la Ligne 1 de l'O-Train**

Lost and Found / Objets perdus..... **613-563-4011**

Security / Sécurité **613-741-2478**



INFO 613-741-4390
octranspo.com



153

LINCOLN FIELDS TUNNEY'S PASTURE CARLINGWOOD

Local

7 days a week / 7 jours par semaine

Selected time periods only
Périodes sélectionnées seulement



Station



Some trips / Quelques trajets



Timepoint / Heures de passage

2019.10



Schedule / Horaire.....613-560-1000

Text / Texto560560

plus your four digit bus stop number / plus votre numéro d'arrêt à quatre chiffres

Customer Relations

Service à la clientèle **613-842-3600**

Lost and Found / Objets perdus..... **613-563-4011**

Security / Sécurité **613-741-2478**

Effective October 6, 2019

En vigueur 6 octobre 2019



INFO 613-741-4390
octranspo.com

Appendix C:

Traffic Data



Turning Movement Count Summary, AM and PM Peak Hour Flow Diagrams

All Vehicles Except Bicycles



Ambleside Drive & New Orchard Avenue North Ottawa, ON

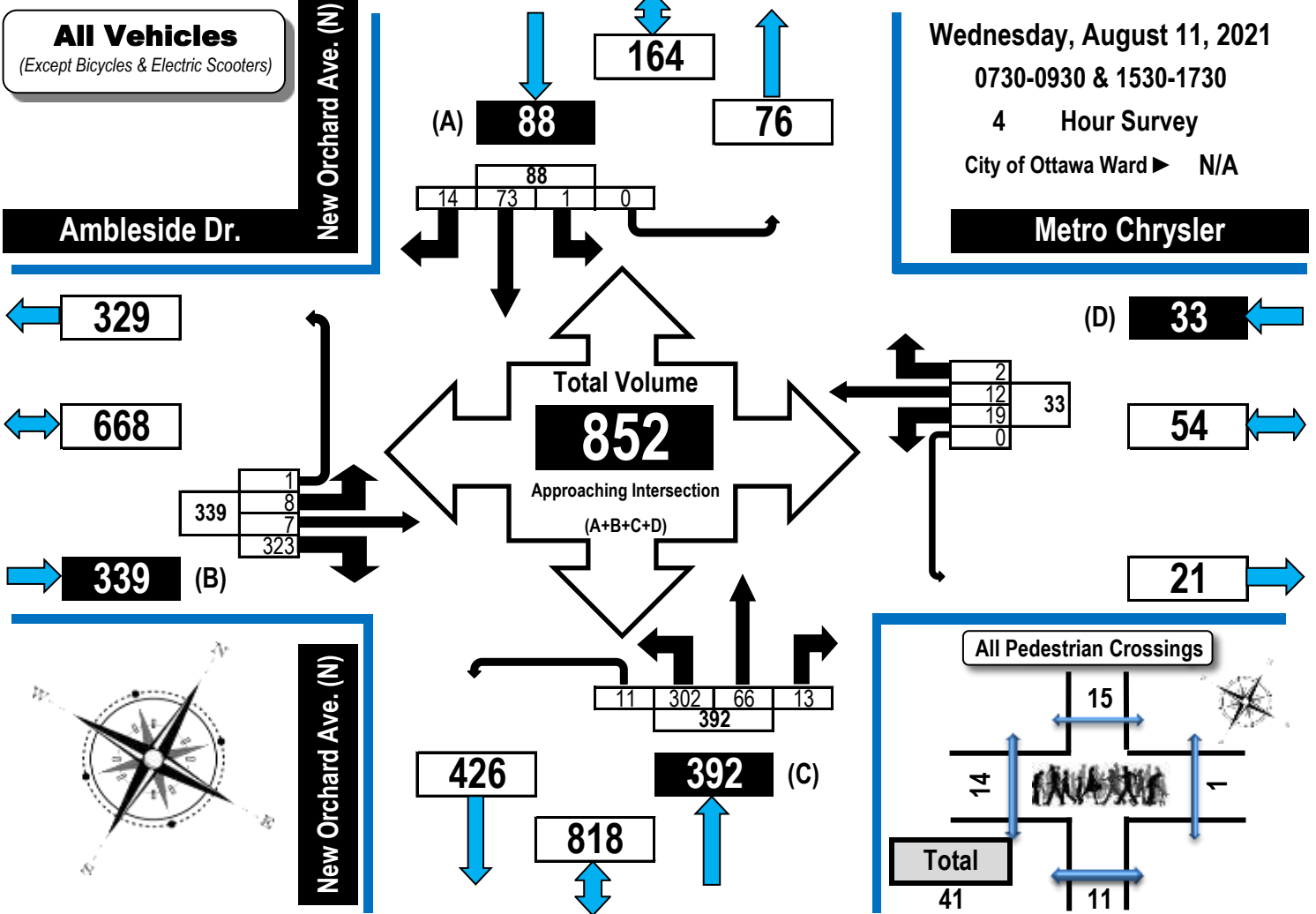

AM Peak Hour Flow Diagram PM Peak Hour Flow Diagram

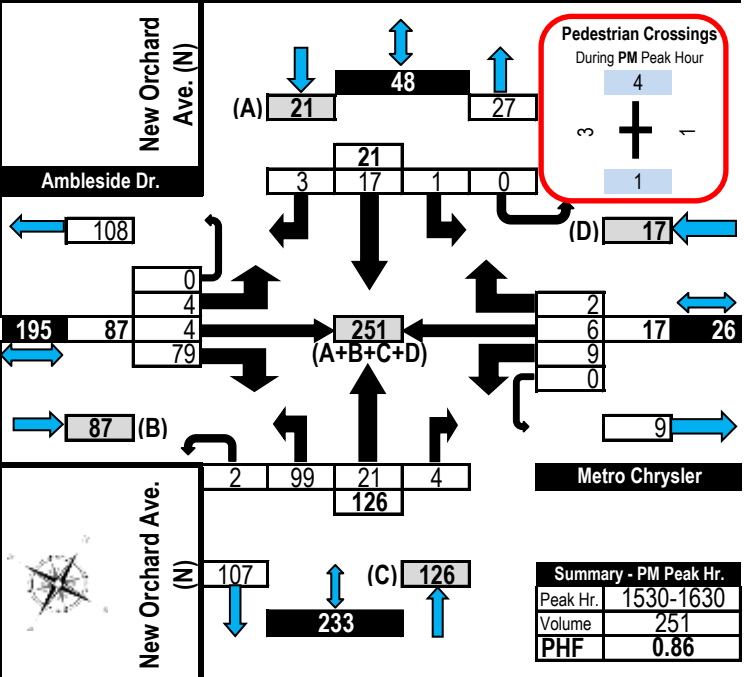
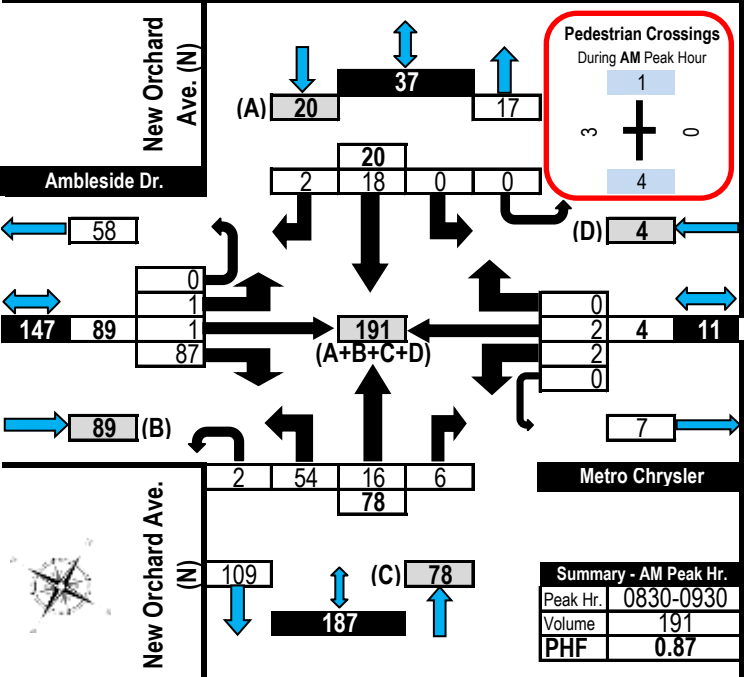

Turning Movement Count - Study Results

NEW ORCHARD AVE @ RICHMOND RD

Survey Date: Thursday, August 25, 2016

WO No: 36256

Start Time: 07:00

Device: Miovision

Full Study Diagram

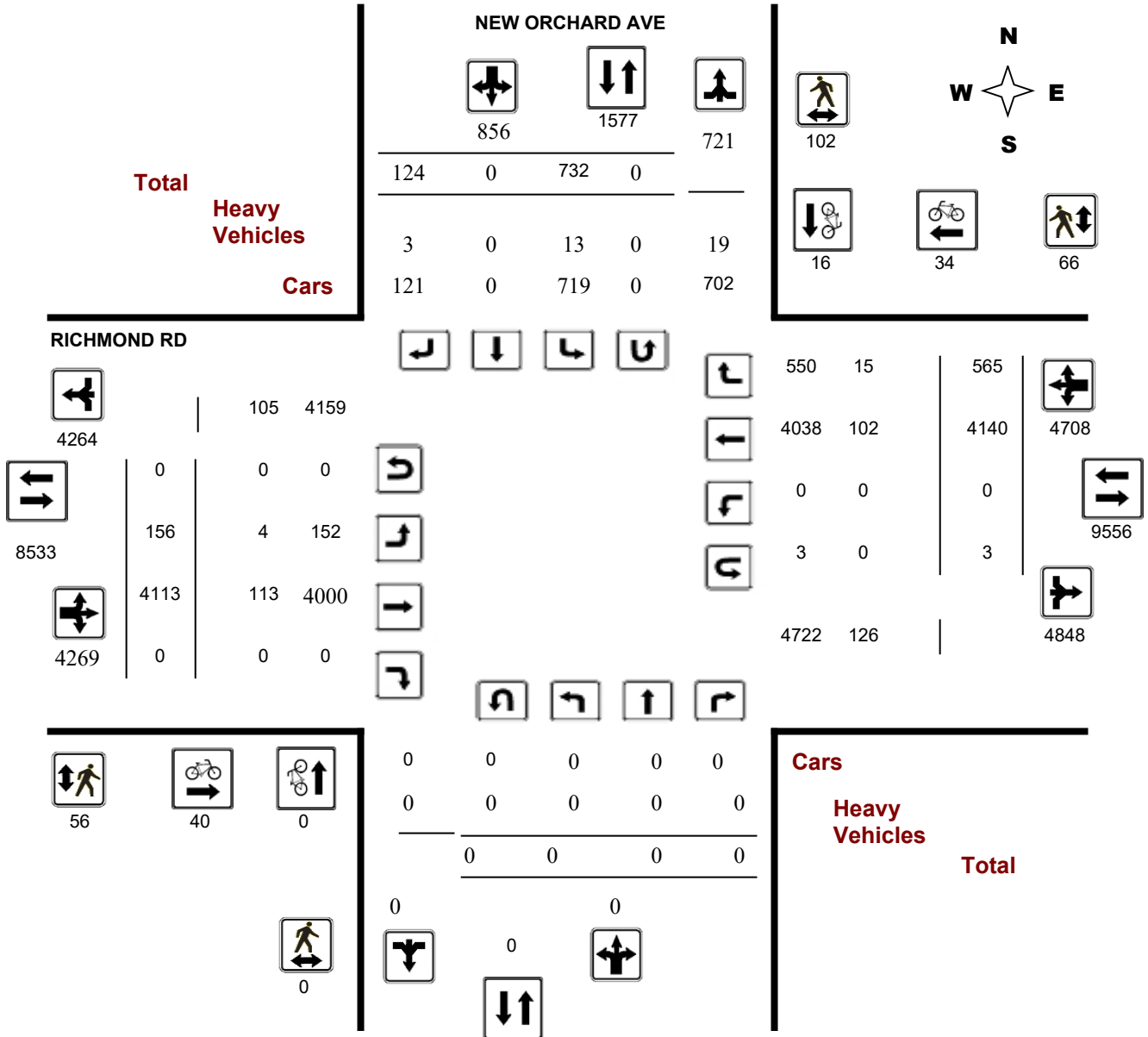



Transportation Services - Traffic Services

Turning Movement Count - Study Results

NEW ORCHARD AVE @ RICHMOND RD

Survey Date: Thursday, August 25, 2016

WO No:

36256

Start Time: 07:00

Device:

Miovision

Full Study Peak Hour Diagram

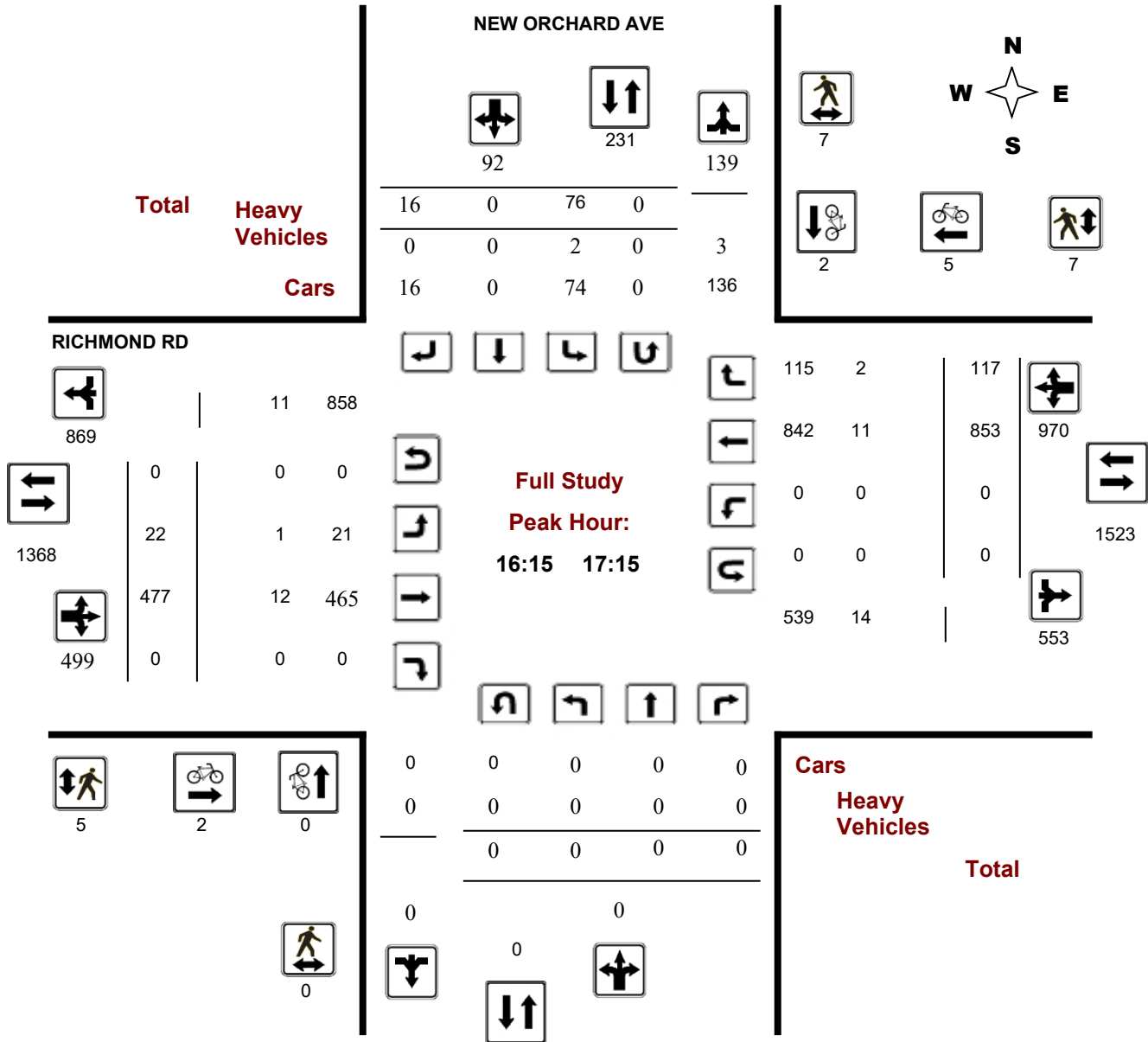

Turning Movement Count - Peak Hour Diagram

NEW ORCHARD AVE @ RICHMOND RD

Survey Date: Thursday, August 25, 2016

Start Time: 07:00

WO No: 36256

Device: Miovision

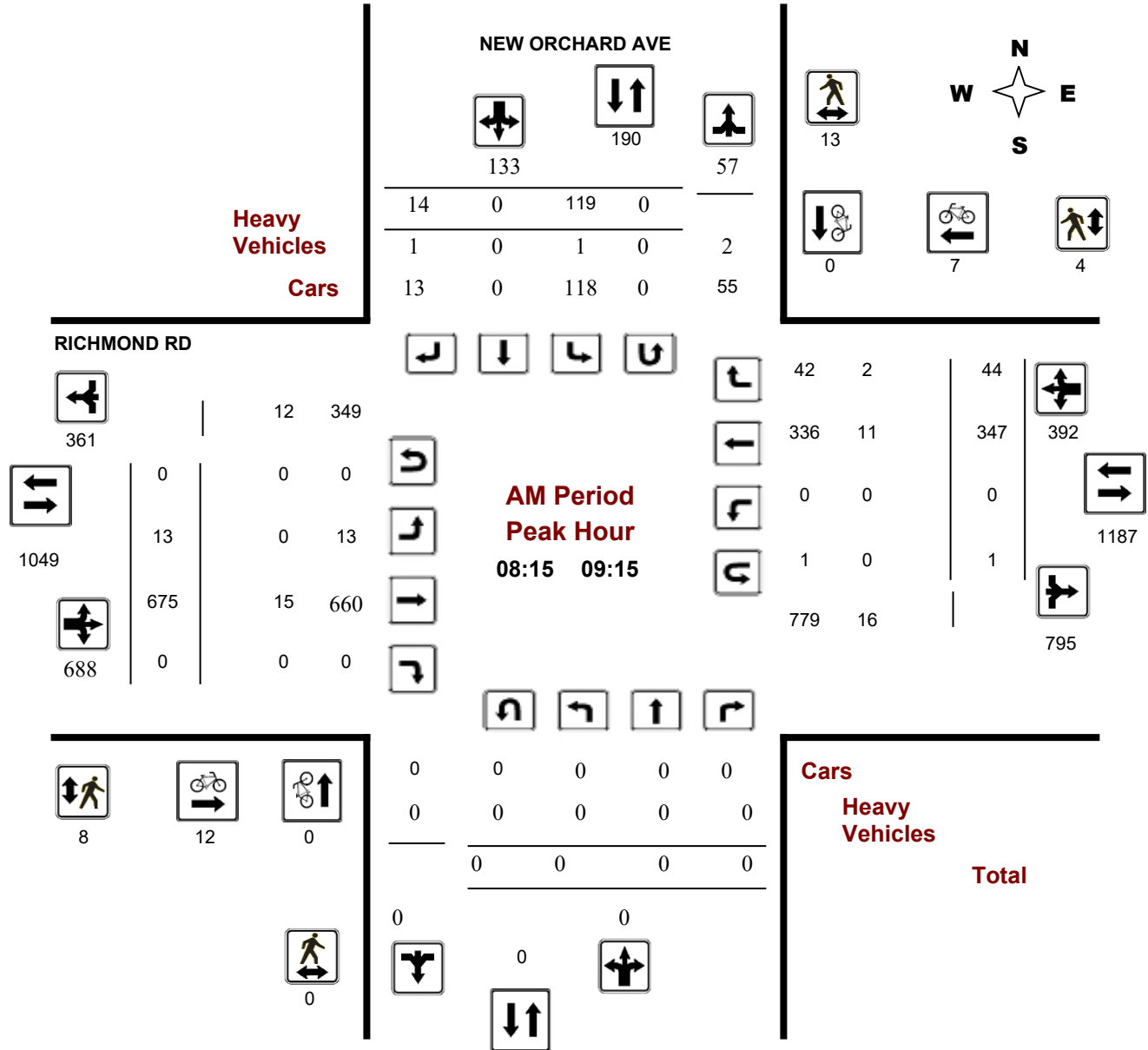

Turning Movement Count - Peak Hour Diagram

NEW ORCHARD AVE @ RICHMOND RD

Survey Date: Thursday, August 25, 2016

Start Time: 07:00

WO No: 36256

Device: Miovision

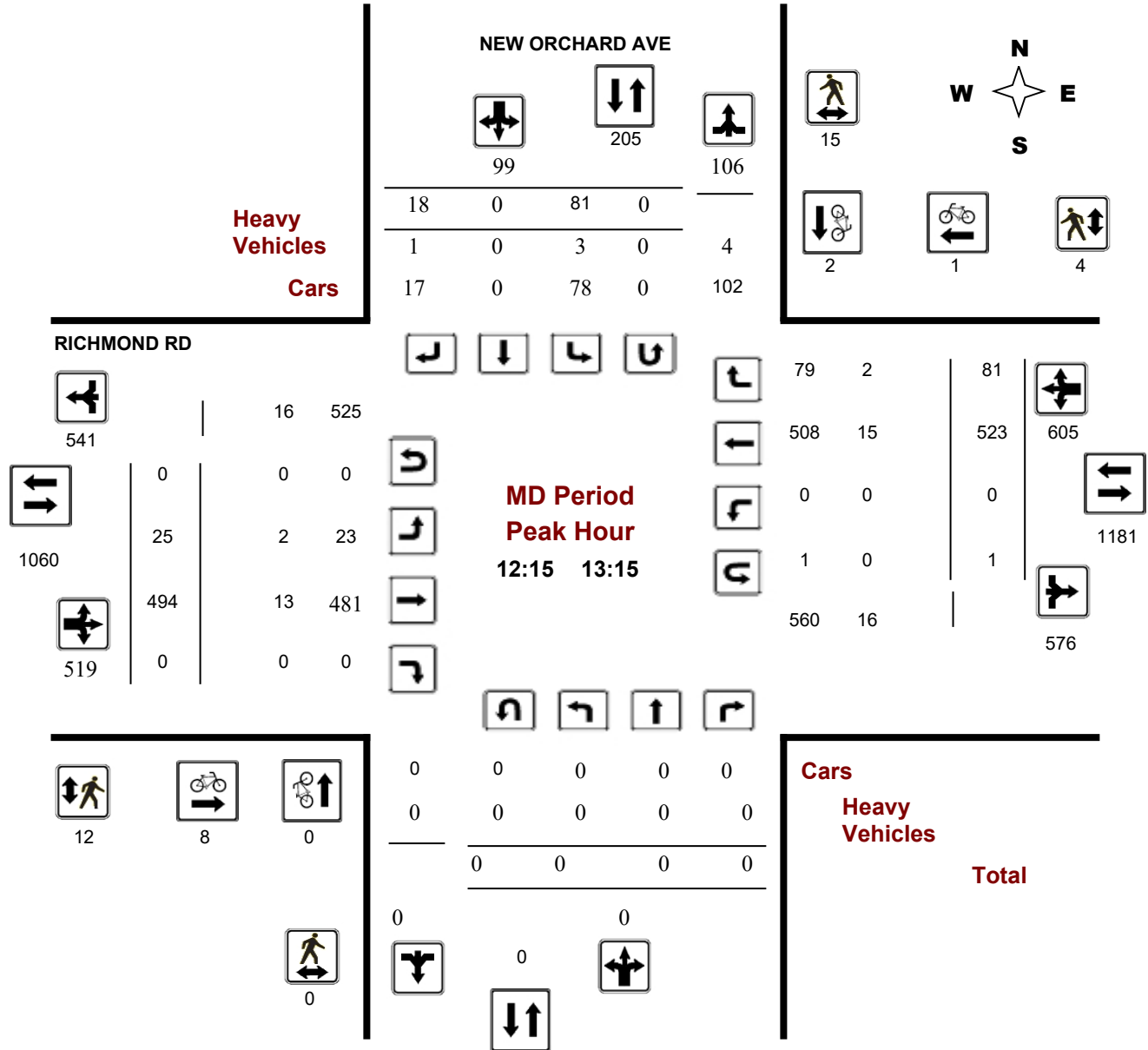

Comments



Transportation Services - Traffic Services

Turning Movement Count - Peak Hour Diagram

NEW ORCHARD AVE @ RICHMOND RD

Survey Date: Thursday, August 25, 2016

Start Time: 07:00

WO No: 36256

Device: Miovision

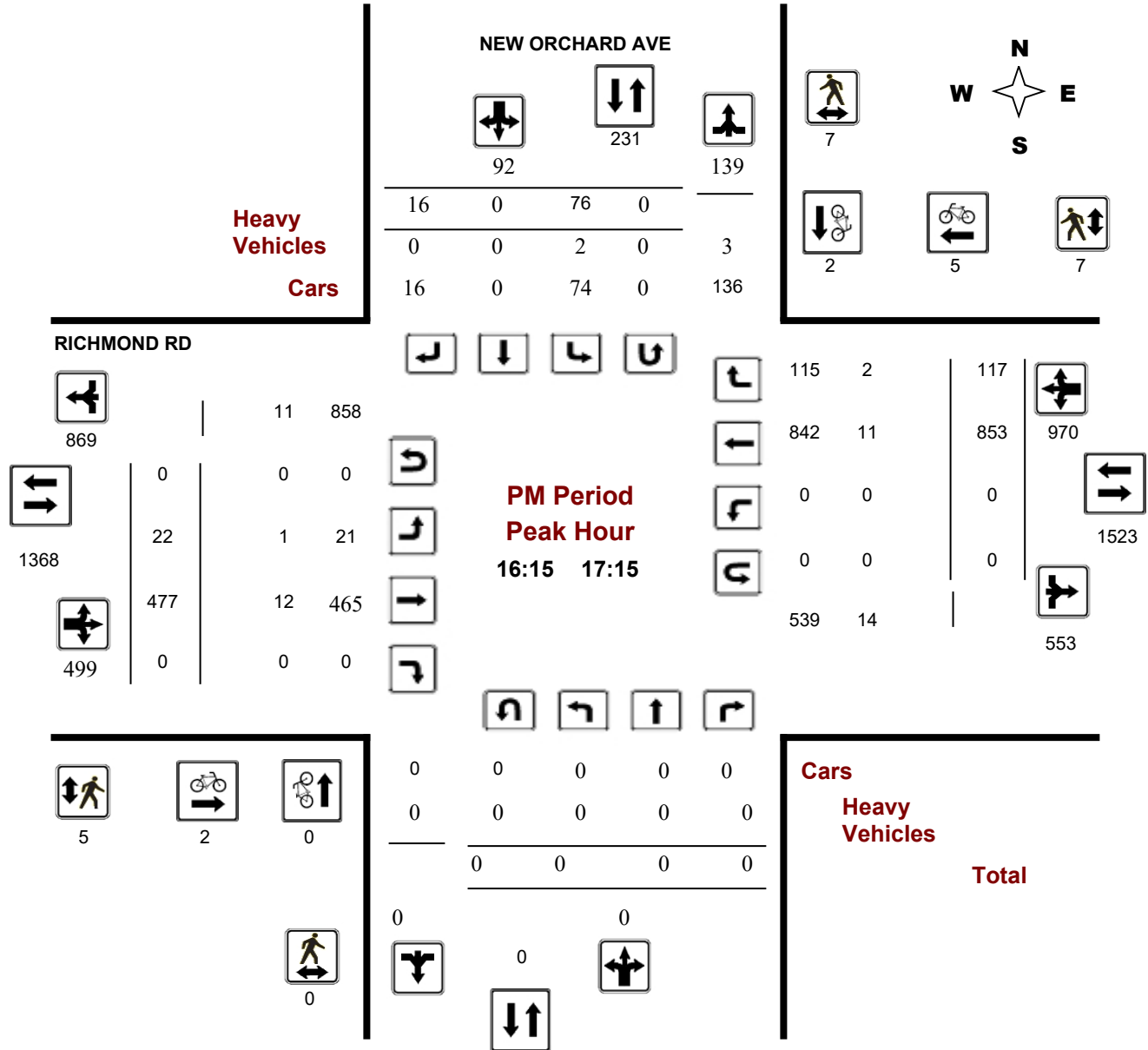



Transportation Services - Traffic Services

Turning Movement Count - Study Results

NEW ORCHARD AVE @ RICHMOND RD

Survey Date: Thursday, August 25, 2016

WO No: 36256

Start Time: 07:00

Device: Miovision

Full Study Summary (8 HR Standard)

Survey Date: Thursday, August 25, 2016

Total Observed U-Turns

AADT Factor

Northbound: 0 Southbound: 0
 Eastbound: 0 Westbound: 3
 .90

NEW ORCHARD AVE

RICHMOND RD

Period	NEW ORCHARD AVE					RICHMOND RD					STR TOT	Grand Total							
	Northbound			Southbound		Eastbound			Westbound										
	LT	ST	RT	NB TOT	LT	ST	RT	SB TOT	STR TOT	LT	ST	RT	EB TOT	LT	ST	RT	WB TOT	STR TOT	Grand Total
07:00 08:00	0	0	0	0	93	0	5	98	98	18	559	0	577	0	191	30	221	798	896
08:00 09:00	0	0	0	0	104	0	15	119	119	13	706	0	719	0	327	43	370	1089	1208
09:00 10:00	0	0	0	0	110	0	11	121	121	19	493	0	512	0	350	49	399	911	1032
11:30 12:30	0	0	0	0	94	0	22	116	116	23	498	0	521	0	475	79	554	1075	1191
12:30 13:30	0	0	0	0	82	0	14	96	96	23	488	0	511	0	489	76	565	1076	1172
15:00 16:00	0	0	0	0	95	0	18	113	113	20	431	0	451	0	696	95	791	1242	1355
16:00 17:00	0	0	0	0	73	0	20	93	93	17	459	0	476	0	819	103	922	1398	1491
17:00 18:00	0	0	0	0	81	0	19	100	100	23	479	0	502	0	793	90	883	1385	1485
Sub Total	0	0	0	0	732	0	124	856	856	156	4113	0	4269	0	4140	565	4705	8974	9830
U Turns	0			0	0			0	0	0			0	3			3	3	3
Total	0	0	0	0	732	0	124	856	856	156	4113	0	4269	3	4140	565	4708	8977	9833
EQ 12Hr	0	0	0	0	1017	0	172	1189	1189	217	5717	0	5934	4	5755	785	6544	12478	13667
Note: These values are calculated by multiplying the totals by the appropriate expansion factor.																	1.39		
AVG 12Hr	0	0	0	0	915	0	155	1070	1070	195	5145	0	5340	4	5180	706	5890	11230	12300
Note: These volumes are calculated by multiplying the Equivalent 12 hr. totals by the AADT factor.																	.90		
AVG 24Hr	0	0	0	0	1199	0	203	1402	1402	255	6740	0	6995	5	6786	925	7716	14711	16113
Note: These volumes are calculated by multiplying the Average Daily 12 hr. totals by 12 to 24 expansion factor.																	1.31		

Note: U-Turns provided for approach totals. Refer to 'U-Turn' Report for specific breakdown.



Transportation Services - Traffic Services

Turning Movement Count - Study Results

NEW ORCHARD AVE @ RICHMOND RD

Survey Date: Thursday, August 25, 2016

WO No: 36256

Start Time: 07:00

Device: Miovision

Full Study 15 Minute Increments

NEW ORCHARD AVE

RICHMOND RD

Northbound

Southbound

Eastbound

Westbound

Time Period	LT	ST	RT	N TOT	LT	ST	RT	S TOT	STR TOT	LT	ST	RT	E TOT	LT	ST	RT	W TOT	STR TOT	Grand Total
07:00 07:15	0	0	0	0	17	0	0	17	17	4	103	0	107	0	32	4	36	143	160
07:15 07:30	0	0	0	0	18	0	1	19	19	4	128	0	132	0	59	7	66	198	217
07:30 07:45	0	0	0	0	26	0	1	27	27	7	157	0	164	0	42	8	50	214	241
07:45 08:00	0	0	0	0	32	0	3	35	35	3	171	0	174	0	58	11	69	243	278
08:00 08:15	0	0	0	0	21	0	4	25	25	5	177	0	182	0	68	9	77	259	284
08:15 08:30	0	0	0	0	22	0	6	28	28	1	161	0	162	0	82	8	90	252	280
08:30 08:45	0	0	0	0	25	0	4	29	29	2	177	0	179	1	90	12	103	282	311
08:45 09:00	0	0	0	0	36	0	1	37	37	5	191	0	196	0	87	14	101	297	334
09:00 09:15	0	0	0	0	36	0	3	39	39	5	146	0	151	0	88	10	98	249	288
09:15 09:30	0	0	0	0	26	0	1	27	27	5	110	0	115	0	87	11	98	213	240
09:30 09:45	0	0	0	0	21	0	5	26	26	4	113	0	117	0	89	15	104	221	247
09:45 10:00	0	0	0	0	27	0	2	29	29	5	124	0	129	0	86	13	99	228	257
11:30 11:45	0	0	0	0	22	0	4	26	26	7	132	0	139	1	116	14	131	270	296
11:45 12:00	0	0	0	0	19	0	5	24	24	5	135	0	140	0	109	24	133	273	297
12:00 12:15	0	0	0	0	32	0	5	37	37	7	115	0	122	0	112	20	132	254	291
12:15 12:30	0	0	0	0	21	0	8	29	29	4	116	0	120	0	138	21	159	279	308
12:30 12:45	0	0	0	0	21	0	4	25	25	13	123	0	136	0	130	29	159	295	320
12:45 13:00	0	0	0	0	19	0	4	23	23	3	124	0	127	0	126	13	139	266	289
13:00 13:15	0	0	0	0	20	0	2	22	22	5	131	0	136	1	129	18	148	284	306
13:15 13:30	0	0	0	0	22	0	4	26	26	2	110	0	112	0	104	16	120	232	258
15:00 15:15	0	0	0	0	26	0	8	34	34	3	95	0	98	0	125	27	152	250	284
15:15 15:30	0	0	0	0	27	0	3	30	30	7	114	0	121	0	155	21	176	297	327
15:30 15:45	0	0	0	0	17	0	5	22	22	6	109	0	115	0	191	26	217	332	354
15:45 16:00	0	0	0	0	25	0	2	27	27	4	113	0	117	0	225	21	246	363	390
16:00 16:15	0	0	0	0	19	0	10	29	29	4	109	0	113	0	188	23	211	324	353
16:15 16:30	0	0	0	0	19	0	5	24	24	3	118	0	121	0	213	26	239	360	384
16:30 16:45	0	0	0	0	22	0	2	24	24	5	120	0	125	0	200	27	227	352	376
16:45 17:00	0	0	0	0	13	0	3	16	16	5	112	0	117	0	218	27	245	362	378
17:00 17:15	0	0	0	0	22	0	6	28	28	9	127	0	136	0	222	37	259	395	423
17:15 17:30	0	0	0	0	22	0	4	26	26	4	121	0	125	0	197	20	217	342	368
17:30 17:45	0	0	0	0	18	0	4	22	22	4	108	0	112	0	207	21	228	340	362
17:45 18:00	0	0	0	0	19	0	5	24	24	6	123	0	129	0	167	12	179	308	332
Total:	0	0	0	0	732	0	124	856	856	156	4113	0	4269	3	4140	565	4708	856	9,833

Note: U-Turns are included in Totals.



Transportation Services - Traffic Services

Turning Movement Count - Study Results

NEW ORCHARD AVE @ RICHMOND RD

Survey Date: Thursday, August 25, 2016

WO No: 36256

Start Time: 07:00

Device: Miovision

Full Study Cyclist Volume

NEW ORCHARD AVE

RICHMOND RD

Time Period		NEW ORCHARD AVE			RICHMOND RD			Grand Total
		Northbound	Southbound	Street Total	Eastbound	Westbound	Street Total	
07:00	07:15	0	0	0	1	1	2	2
07:15	07:30	0	0	0	2	3	5	5
07:30	07:45	0	0	0	2	2	4	4
07:45	08:00	0	0	0	2	3	5	5
08:00	08:15	0	2	2	3	2	5	7
08:15	08:30	0	0	0	3	4	7	7
08:30	08:45	0	0	0	3	1	4	4
08:45	09:00	0	0	0	4	1	5	5
09:00	09:15	0	0	0	2	1	3	3
09:15	09:30	0	0	0	0	0	0	0
09:30	09:45	0	1	1	1	0	1	2
09:45	10:00	0	0	0	2	0	2	2
11:30	11:45	0	0	0	0	1	1	1
11:45	12:00	0	0	0	2	0	2	2
12:00	12:15	0	0	0	0	0	0	0
12:15	12:30	0	1	1	0	1	1	2
12:30	12:45	0	0	0	2	0	2	2
12:45	13:00	0	1	1	5	0	5	6
13:00	13:15	0	0	0	1	0	1	1
13:15	13:30	0	1	1	0	0	0	1
15:00	15:15	0	0	0	0	0	0	0
15:15	15:30	0	1	1	0	0	0	1
15:30	15:45	0	1	1	0	0	0	1
15:45	16:00	0	0	0	0	0	0	0
16:00	16:15	0	0	0	0	2	2	2
16:15	16:30	0	0	0	0	1	1	1
16:30	16:45	0	0	0	0	1	1	1
16:45	17:00	0	1	1	0	1	1	2
17:00	17:15	0	1	1	2	2	4	5
17:15	17:30	0	3	3	2	2	4	7
17:30	17:45	0	0	0	0	3	3	3
17:45	18:00	0	3	3	1	2	3	6
Total		0	16	16	40	34	74	90



Transportation Services - Traffic Services

Turning Movement Count - Study Results

NEW ORCHARD AVE @ RICHMOND RD

Survey Date: Thursday, August 25, 2016

WO No: 36256

Start Time: 07:00

Device: Miovision

Full Study Pedestrian Volume

NEW ORCHARD AVE

RICHMOND RD

Time Period	NB Approach (E or W Crossing)	SB Approach (E or W Crossing)	Total	EB Approach (N or S Crossing)	WB Approach (N or S Crossing)	Total	Grand Total
07:00 07:15	0	2	2	2	0	2	4
07:15 07:30	0	1	1	0	0	0	1
07:30 07:45	0	0	0	0	1	1	1
07:45 08:00	0	1	1	0	2	2	3
08:00 08:15	0	3	3	2	1	3	6
08:15 08:30	0	3	3	2	2	4	7
08:30 08:45	0	4	4	1	0	1	5
08:45 09:00	0	3	3	3	2	5	8
09:00 09:15	0	3	3	2	0	2	5
09:15 09:30	0	6	6	4	4	8	14
09:30 09:45	0	4	4	1	2	3	7
09:45 10:00	0	1	1	3	2	5	6
11:30 11:45	0	1	1	0	3	3	4
11:45 12:00	0	5	5	1	4	5	10
12:00 12:15	0	7	7	0	2	2	9
12:15 12:30	0	4	4	2	1	3	7
12:30 12:45	0	3	3	4	1	5	8
12:45 13:00	0	3	3	2	0	2	5
13:00 13:15	0	5	5	4	2	6	11
13:15 13:30	0	4	4	3	5	8	12
15:00 15:15	0	5	5	1	1	2	7
15:15 15:30	0	11	11	8	7	15	26
15:30 15:45	0	7	7	1	3	4	11
15:45 16:00	0	0	0	2	3	5	5
16:00 16:15	0	2	2	0	5	5	7
16:15 16:30	0	2	2	1	3	4	6
16:30 16:45	0	1	1	2	1	3	4
16:45 17:00	0	3	3	0	2	2	5
17:00 17:15	0	1	1	2	1	3	4
17:15 17:30	0	4	4	1	5	6	10
17:30 17:45	0	1	1	1	0	1	2
17:45 18:00	0	2	2	1	1	2	4
Total	0	102	102	56	66	122	224



Transportation Services - Traffic Services

Turning Movement Count - Study Results

NEW ORCHARD AVE @ RICHMOND RD

Survey Date: Thursday, August 25, 2016

WO No: 36256

Start Time: 07:00

Device: Miovision

Full Study Heavy Vehicles

NEW ORCHARD AVE

RICHMOND RD

Northbound

Southbound

Eastbound

Westbound

Time Period	Northbound			N TOT	Southbound			S TOT	STR TOT	Eastbound			E TOT	Westbound			W TOT	STR TOT	Grand Total
	LT	ST	RT		LT	ST	RT			LT	ST	RT		LT	ST	RT			
07:00 07:15	0	0	0	0	0	0	0	0	0	0	5	0	5	0	0	0	0	5	5
07:15 07:30	0	0	0	0	0	0	0	0	0	0	3	0	3	0	2	0	2	5	5
07:30 07:45	0	0	0	0	0	0	0	0	0	0	3	0	3	0	2	0	2	5	5
07:45 08:00	0	0	0	0	0	0	0	0	0	0	5	0	5	0	4	0	4	9	9
08:00 08:15	0	0	0	0	1	0	0	1	1	1	3	0	4	0	5	0	5	9	10
08:15 08:30	0	0	0	0	0	0	1	1	1	0	3	0	3	0	3	0	3	6	7
08:30 08:45	0	0	0	0	0	0	0	0	0	0	4	0	4	0	2	0	2	6	6
08:45 09:00	0	0	0	0	1	0	0	1	1	0	4	0	4	0	4	2	6	10	11
09:00 09:15	0	0	0	0	0	0	0	0	0	0	4	0	4	0	2	0	2	6	6
09:15 09:30	0	0	0	0	0	0	0	0	0	0	3	0	3	0	3	1	4	7	7
09:30 09:45	0	0	0	0	1	0	0	1	1	0	4	0	4	0	3	1	4	8	9
09:45 10:00	0	0	0	0	2	0	0	2	2	0	3	0	3	0	3	2	5	8	10
11:30 11:45	0	0	0	0	0	0	0	0	0	0	7	0	7	0	9	0	9	16	16
11:45 12:00	0	0	0	0	0	0	1	1	1	0	6	0	6	0	3	3	6	12	13
12:00 12:15	0	0	0	0	0	0	0	0	0	0	6	0	6	0	6	0	6	12	12
12:15 12:30	0	0	0	0	2	0	1	3	3	1	1	0	2	0	4	0	4	6	9
12:30 12:45	0	0	0	0	0	0	0	0	0	1	2	0	3	0	2	1	3	6	6
12:45 13:00	0	0	0	0	1	0	0	1	1	0	4	0	4	0	6	1	7	11	12
13:00 13:15	0	0	0	0	0	0	0	0	0	0	6	0	6	0	3	0	3	9	9
13:15 13:30	0	0	0	0	1	0	0	1	1	0	3	0	3	0	3	0	3	6	7
15:00 15:15	0	0	0	0	1	0	0	1	1	0	5	0	5	0	4	0	4	9	10
15:15 15:30	0	0	0	0	0	0	0	0	0	0	5	0	5	0	5	0	5	10	10
15:30 15:45	0	0	0	0	0	0	0	0	0	0	3	0	3	0	4	0	4	7	7
15:45 16:00	0	0	0	0	0	0	0	0	0	0	3	0	3	0	2	0	2	5	5
16:00 16:15	0	0	0	0	0	0	0	0	0	0	1	0	1	0	2	0	2	3	3
16:15 16:30	0	0	0	0	2	0	0	2	2	0	5	0	5	0	1	0	1	6	8
16:30 16:45	0	0	0	0	0	0	0	0	0	0	2	0	2	0	4	2	6	8	8
16:45 17:00	0	0	0	0	0	0	0	0	0	0	1	0	1	0	2	0	2	3	3
17:00 17:15	0	0	0	0	0	0	0	0	0	1	4	0	5	0	4	0	4	9	9
17:15 17:30	0	0	0	0	1	0	0	1	1	0	2	0	2	0	2	1	3	5	6
17:30 17:45	0	0	0	0	0	0	0	0	0	0	1	0	1	0	2	0	2	3	3
17:45 18:00	0	0	0	0	0	0	0	0	0	0	2	0	2	0	1	1	2	4	4
Total: None	0	0	0	0	13	0	3	16	16	4	113	0	117	0	102	15	117	234	250



Transportation Services - Traffic Services

Turning Movement Count - Study Results

NEW ORCHARD AVE @ RICHMOND RD

Survey Date: Thursday, August 25, 2016

WO No: 36256

Start Time: 07:00

Device: Miovision

Full Study 15 Minute U-Turn Total

NEW ORCHARD AVE

RICHMOND RD

Time Period		Northbound U-Turn Total	Southbound U-Turn Total	Eastbound U-Turn Total	Westbound U-Turn Total	Total
07:00	07:15	0	0	0	0	0
07:15	07:30	0	0	0	0	0
07:30	07:45	0	0	0	0	0
07:45	08:00	0	0	0	0	0
08:00	08:15	0	0	0	0	0
08:15	08:30	0	0	0	0	0
08:30	08:45	0	0	0	1	1
08:45	09:00	0	0	0	0	0
09:00	09:15	0	0	0	0	0
09:15	09:30	0	0	0	0	0
09:30	09:45	0	0	0	0	0
09:45	10:00	0	0	0	0	0
11:30	11:45	0	0	0	1	1
11:45	12:00	0	0	0	0	0
12:00	12:15	0	0	0	0	0
12:15	12:30	0	0	0	0	0
12:30	12:45	0	0	0	0	0
12:45	13:00	0	0	0	0	0
13:00	13:15	0	0	0	1	1
13:15	13:30	0	0	0	0	0
15:00	15:15	0	0	0	0	0
15:15	15:30	0	0	0	0	0
15:30	15:45	0	0	0	0	0
15:45	16:00	0	0	0	0	0
16:00	16:15	0	0	0	0	0
16:15	16:30	0	0	0	0	0
16:30	16:45	0	0	0	0	0
16:45	17:00	0	0	0	0	0
17:00	17:15	0	0	0	0	0
17:15	17:30	0	0	0	0	0
17:30	17:45	0	0	0	0	0
17:45	18:00	0	0	0	0	0
Total		0	0	0	3	3



Turning Movement Count - 15 Minute Summary Report

RICHMOND RD @ WOODROFFE AVE

Survey Date: Thursday, December 01, 2016

Total Observed U-Turns

Northbound: 0 Southbound: 0
Eastbound: 0 Westbound: 1

WOODROFFE AVE

RICHMOND RD

Table with columns for Time Period, Northbound (LT, ST, RT, N TOT), Southbound (LT, ST, RT, S TOT, STR TOT), Eastbound (LT, ST, RT, E TOT), Westbound (LT, ST, RT, W TOT, STR TOT), and Grand Total. Rows represent 15-minute intervals from 07:00 to 18:00.

Note: U-Turns are included in Totals.

Comment:



Transportation Services - Traffic Services

Turning Movement Count - Cyclist Volume Report

Work Order
36566

RICHMOND RD @ WOODROFFE AVE

Count Date: Thursday, December 01, 2016

Start Time: 07:00

Time Period	WOODROFFE AVE			RICHMOND RD			Grand Total
	Northbound	Southbound	Street Total	Eastbound	Westbound	Street Total	
07:00 08:00	0	1	1	1	2	3	4
08:00 09:00	2	1	3	1	1	2	5
09:00 10:00	0	0	0	3	0	3	3
11:30 12:30	0	0	0	0	0	0	0
12:30 13:30	1	0	1	1	0	1	2
15:00 16:00	0	0	0	0	0	0	0
16:00 17:00	0	1	1	0	1	1	2
17:00 18:00	0	2	2	0	2	2	4
Total	3	5	8	6	6	12	20

Comment:

Note: These volumes consists of bicycles only (no mopeds or motorcycles) and ARE NOT included in the Turning Movement Count Summary.

Transportation Services - Traffic Services

Turning Movement Count - Full Study Diagram

RICHMOND RD @ WOODROFFE AVE

Survey Date: Thursday, December 01, 2016

WO#: 36566
Device: Miovision

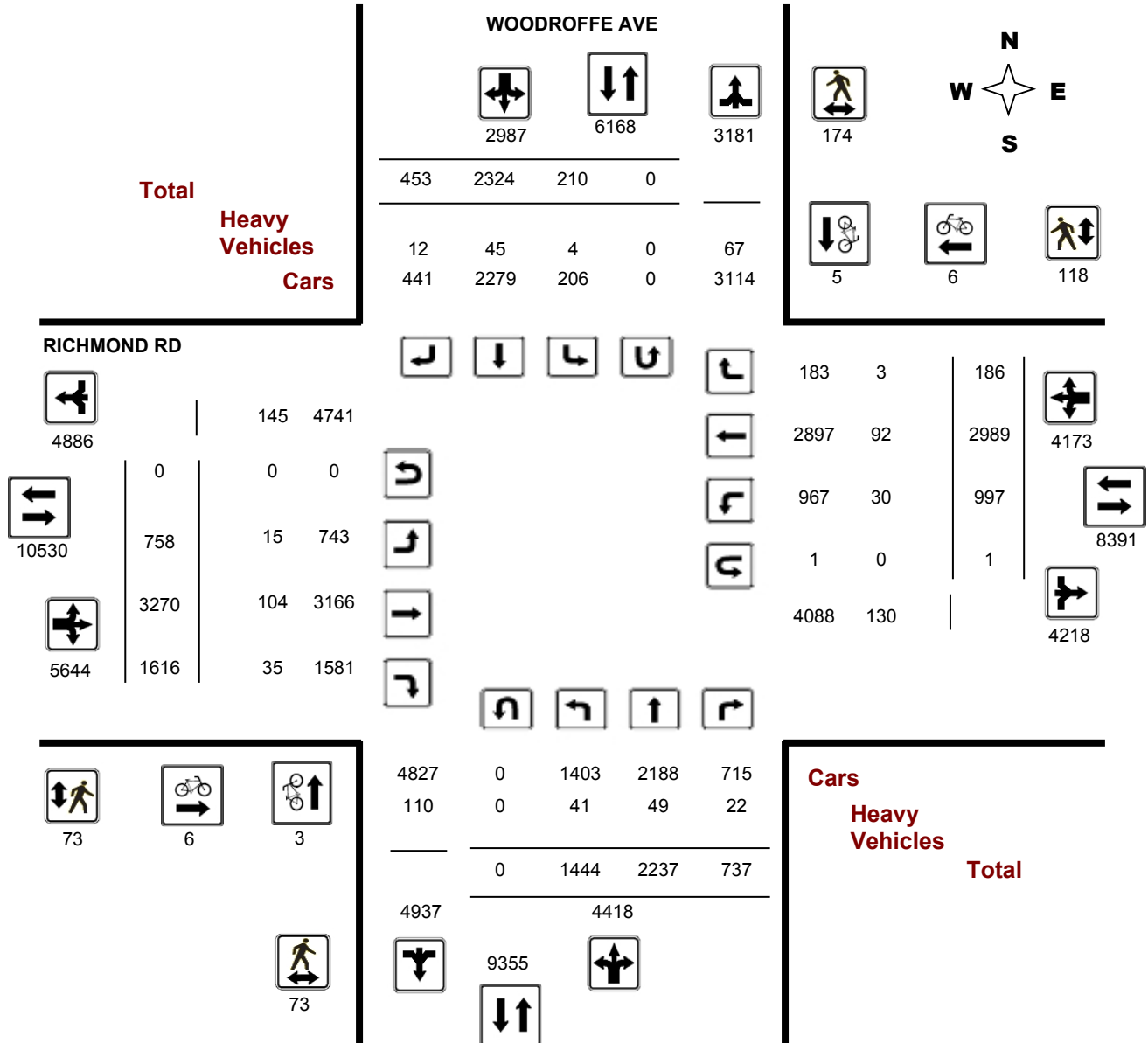

Comments



Transportation Services - Traffic Services

W.O.
36566

Turning Movement Count - Heavy Vehicle Report

RICHMOND RD @ WOODROFFE AVE

Survey Date: Thursday, December 01, 2016

Time Period	WOODROFFE AVE									RICHMOND RD									Grand Total
	Northbound			Southbound			S TOT	STR TOT	Eastbound			Westbound			W TOT	STR TOT			
	LT	ST	RT	N TOT	LT	ST			RT	LT	ST	RT	E TOT	LT			ST	RT	
07:00 08:00	7	6	4	17	2	6	0	8	25	3	25	1	29	0	7	0	7	36	61
08:00 09:00	5	5	4	14	0	6	1	7	21	4	28	9	41	6	17	1	24	65	86
09:00 10:00	7	8	7	22	1	3	2	6	28	1	14	3	18	8	11	1	20	38	66
11:30 12:30	2	8	4	14	0	3	2	5	19	3	6	2	11	3	7	1	11	22	41
12:30 13:30	7	6	1	14	0	7	3	10	24	1	8	6	15	9	16	0	25	40	64
15:00 16:00	3	7	1	11	0	6	4	10	21	0	9	7	16	0	9	0	9	25	46
16:00 17:00	7	6	1	14	1	7	0	8	22	2	8	4	14	1	16	0	17	31	53
17:00 18:00	3	3	0	6	0	7	0	7	13	1	6	3	10	3	9	0	12	22	35
Sub Total	41	49	22	112	4	45	12	61	173	15	104	35	154	30	92	3	125	279	452
U-Turns (Heavy Vehicles)				0				0	0				0				0	0	0
Total	41	49	22	0	4	45	12	61	173	15	104	35	154	30	92	3	125	279	452

Heavy Vehicles include Buses, Single-Unit Trucks and Articulated Trucks. Further, they ARE included in the Turning Movement Count Summary.



Transportation Services - Traffic Services

Work Order

36566

Turning Movement Count - Pedestrian Volume Report

RICHMOND RD @ WOODROFFE AVE

Count Date: Thursday, December 01, 2016

Start Time: 07:00

Time Period	NB Approach (E or W Crossing)	SB Approach (E or W Crossing)	Total	EB Approach (N or S Crossing)	WB Approach (N or S Crossing)	Total	Grand Total
07:00 07:15	1	2	3	1	1	2	5
07:15 07:30	0	5	5	0	4	4	9
07:30 07:45	2	8	10	1	12	13	23
07:45 08:00	3	10	13	1	11	12	25
07:00 08:00	6	25	31	3	28	31	62
08:00 08:15	3	4	7	3	5	8	15
08:15 08:30	0	12	12	3	2	5	17
08:30 08:45	1	8	9	4	6	10	19
08:45 09:00	6	6	12	4	3	7	19
08:00 09:00	10	30	40	14	16	30	70
09:00 09:15	0	8	8	1	2	3	11
09:15 09:30	5	1	6	2	2	4	10
09:30 09:45	2	4	6	1	2	3	9
09:45 10:00	1	4	5	4	8	12	17
09:00 10:00	8	17	25	8	14	22	47
11:30 11:45	2	2	4	2	2	4	8
11:45 12:00	2	4	6	3	6	9	15
12:00 12:15	1	10	11	1	3	4	15
12:15 12:30	1	6	7	1	3	4	11
11:30 12:30	6	22	28	7	14	21	49
12:30 12:45	2	7	9	6	1	7	16
12:45 13:00	2	1	3	2	1	3	6
13:00 13:15	3	3	6	0	1	1	7
13:15 13:30	1	5	6	2	2	4	10
12:30 13:30	8	16	24	10	5	15	39
15:00 15:15	0	5	5	3	0	3	8
15:15 15:30	1	2	3	2	1	3	6
15:30 15:45	1	4	5	5	2	7	12
15:45 16:00	1	3	4	1	3	4	8
15:00 16:00	3	14	17	11	6	17	34
16:00 16:15	2	11	13	2	7	9	22
16:15 16:30	4	1	5	2	2	4	9
16:30 16:45	6	4	10	4	6	10	20
16:45 17:00	4	3	7	2	6	8	15
16:00 17:00	16	19	35	10	21	31	66
17:00 17:15	3	9	12	3	3	6	18
17:15 17:30	2	1	3	0	1	1	4
17:30 17:45	5	14	19	3	5	8	27
17:45 18:00	6	7	13	4	5	9	22
17:00 18:00	16	31	47	10	14	24	71
Total	73	174	247	73	118	191	438

Comment:

Turning Movement Count - Full Study Summary Report

RICHMOND RD @ WOODROFFE AVE

Survey Date: Thursday, December 01, 2016

Total Observed U-Turns

Northbound: 0 Southbound: 0
Eastbound: 0 Westbound: 1

AADT Factor

1.00

Full Study

Period	WOODROFFE AVE									RICHMOND RD									Grand Total
	Northbound				Southbound					Eastbound			Westbound						
	LT	ST	RT	NB TOT	LT	ST	RT	SB TOT	STR TOT	LT	ST	RT	EB TOT	LT	ST	RT	WB TOT	STR TOT	
07:00 08:00	92	232	75	399	28	349	57	434	833	126	567	175	868	50	129	14	193	1061	1894
08:00 09:00	109	249	96	454	41	305	63	409	863	145	753	209	1107	63	241	20	324	1431	2294
09:00 10:00	151	197	81	429	13	218	41	272	701	88	400	231	719	91	244	13	348	1067	1768
11:30 12:30	190	212	109	511	19	207	40	266	777	76	309	245	630	114	293	25	432	1062	1839
12:30 13:30	201	242	101	544	18	203	44	265	809	80	281	240	601	128	318	24	470	1071	1880
15:00 16:00	230	379	90	699	34	346	70	450	1149	82	294	178	554	153	533	37	723	1277	2426
16:00 17:00	232	402	88	722	25	340	62	427	1149	83	322	175	580	217	627	31	875	1455	2604
17:00 18:00	239	324	97	660	32	356	76	464	1124	78	344	163	585	181	604	22	807	1392	2516
Sub Total	1444	2237	737	4418	210	2324	453	2987	7405	758	3270	1616	5644	997	2989	186	4172	9816	17221
U Turns				0				0	0				0				1	1	1
Total	1444	2237	737	4418	210	2324	453	2987	7405	758	3270	1616	5644	997	2989	186	4173	9817	17222
EQ 12Hr	2007	3109	1024	6141	292	3230	630	4152	10293	1054	4545	2246	7845	1386	4155	259	5800	13645	23938
Note: These values are calculated by multiplying the totals by the appropriate expansion factor.													1.39						
AVG 12Hr	2007	3109	1024	6141	292	3230	630	4152	10293	1054	4545	2246	7845	1386	4155	259	5800	13645	23938
Note: These volumes are calculated by multiplying the Equivalent 12 hr. totals by the AADT factor.													1.00						
AVG 24Hr	2629	4073	1342	8045	382	4232	825	5439	13484	1380	5954	2943	10277	1815	5443	339	7599	17876	31360
Note: These volumes are calculated by multiplying the Average Daily 12 hr. totals by 12 to 24 expansion factor.													1.31						

Comments:

Note: U-Turns provided for approach totals. Refer to 'U-Turn' Report for specific breakdown.



Transportation Services - Traffic Services

Turning Movement Count - Full Study Peak Hour Diagram

RICHMOND RD @ WOODROFFE AVE

Survey Date: Thursday, December 01, 2016

Start Time: 07:00

WO No: 36566

Device: Miovision

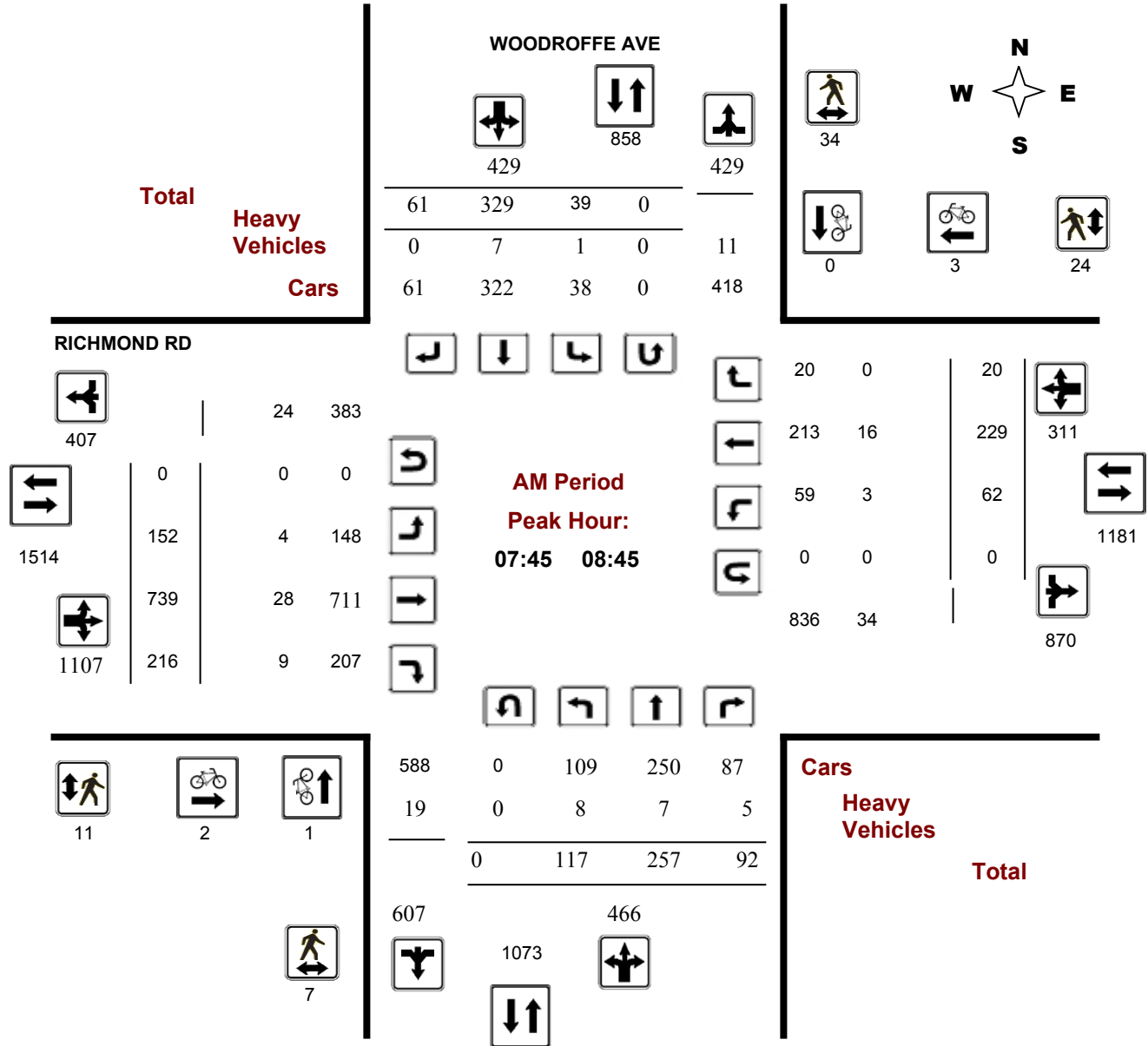

Comments



Transportation Services - Traffic Services

Turning Movement Count - Full Study Peak Hour Diagram

RICHMOND RD @ WOODROFFE AVE

Survey Date: Thursday, December 01, 2016

Start Time: 07:00

WO No: 36566

Device: Miovision

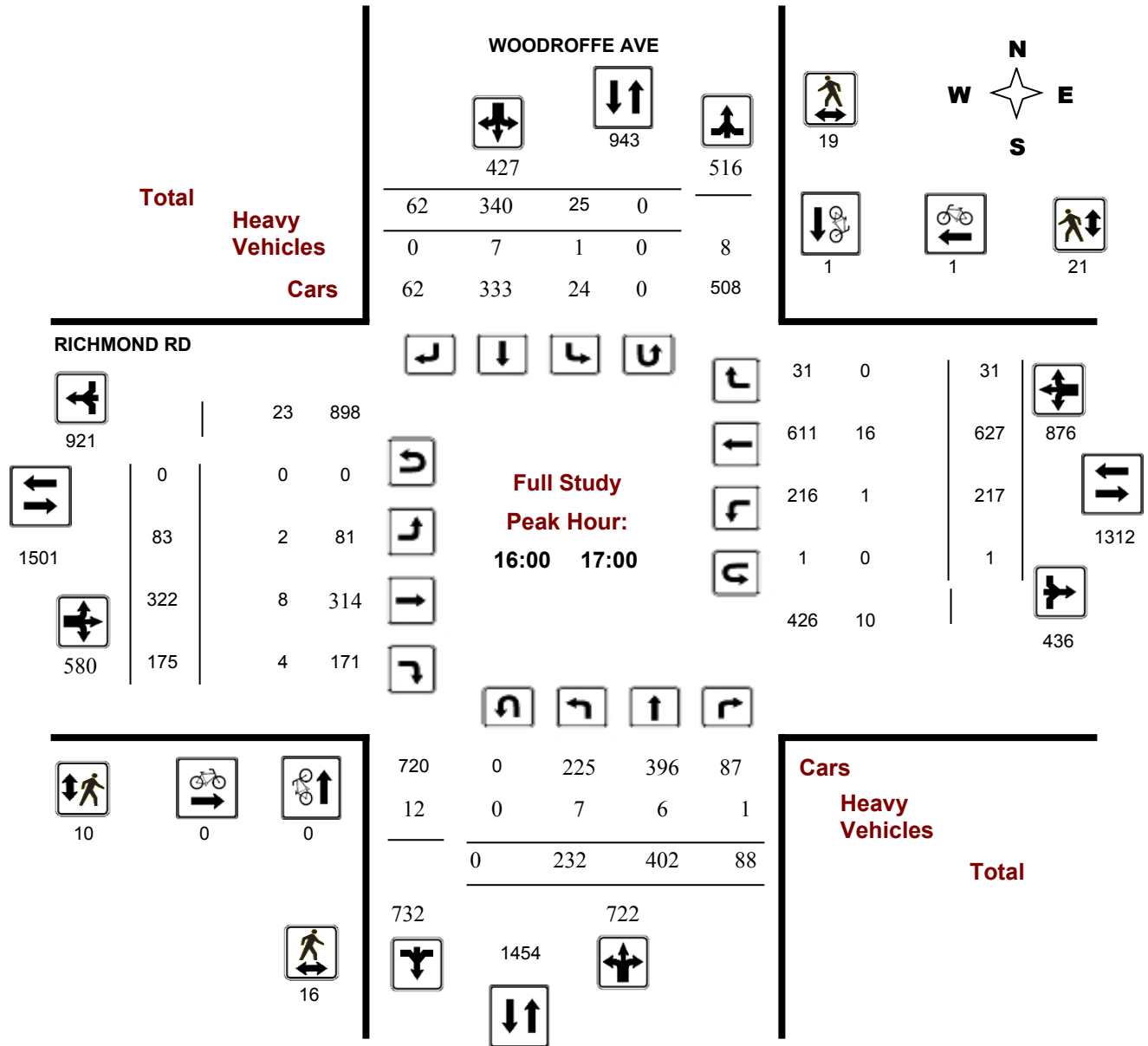

Comments

Survey Date: Thursday, December 01, 2016

Start Time: 07:00

WO No: 36566

Device: Miovision

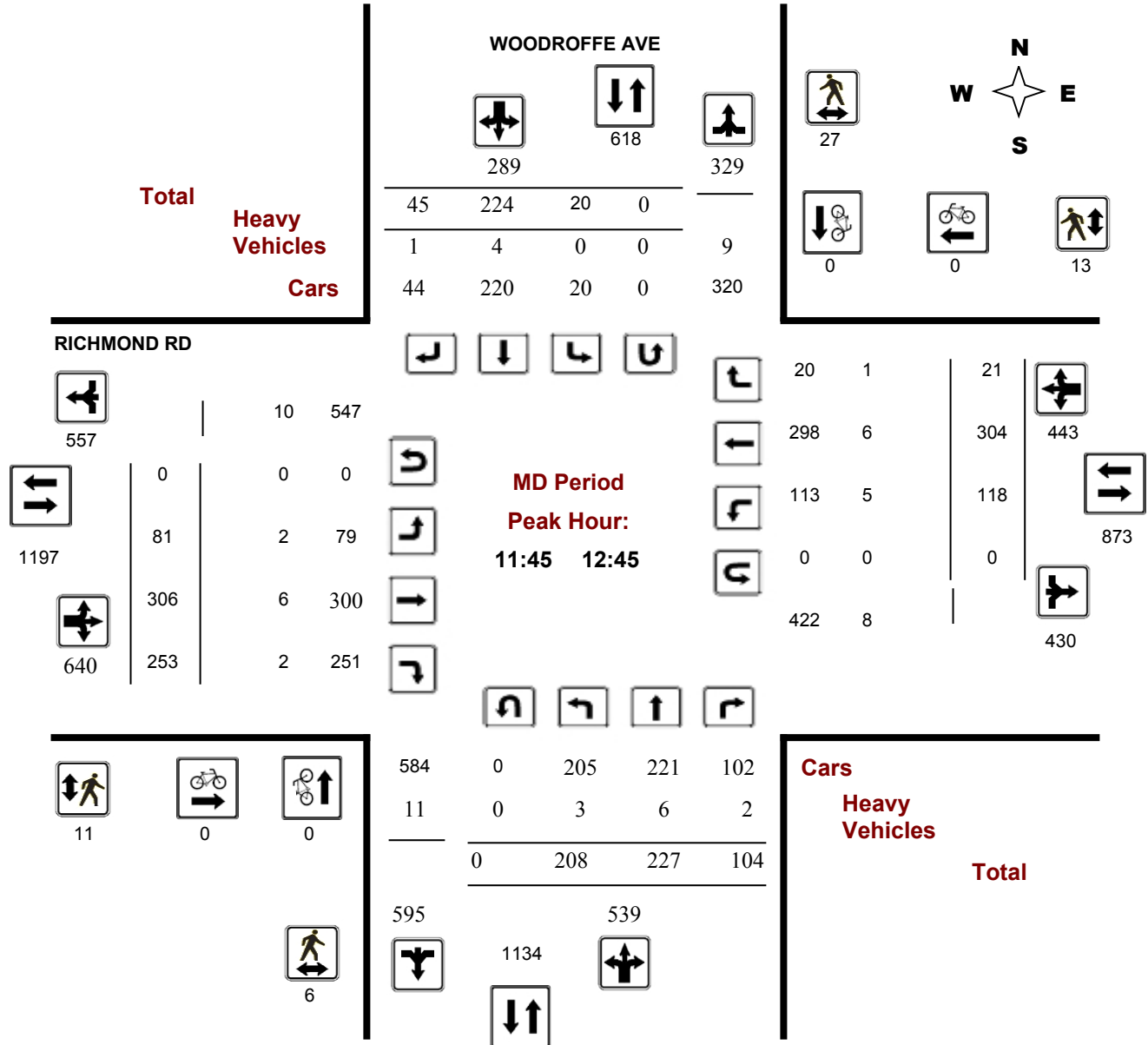



Transportation Services - Traffic Services

Turning Movement Count - Full Study Peak Hour Diagram

RICHMOND RD @ WOODROFFE AVE

Survey Date: Thursday, December 01, 2016

Start Time: 07:00

WO No: 36566

Device: Miovision

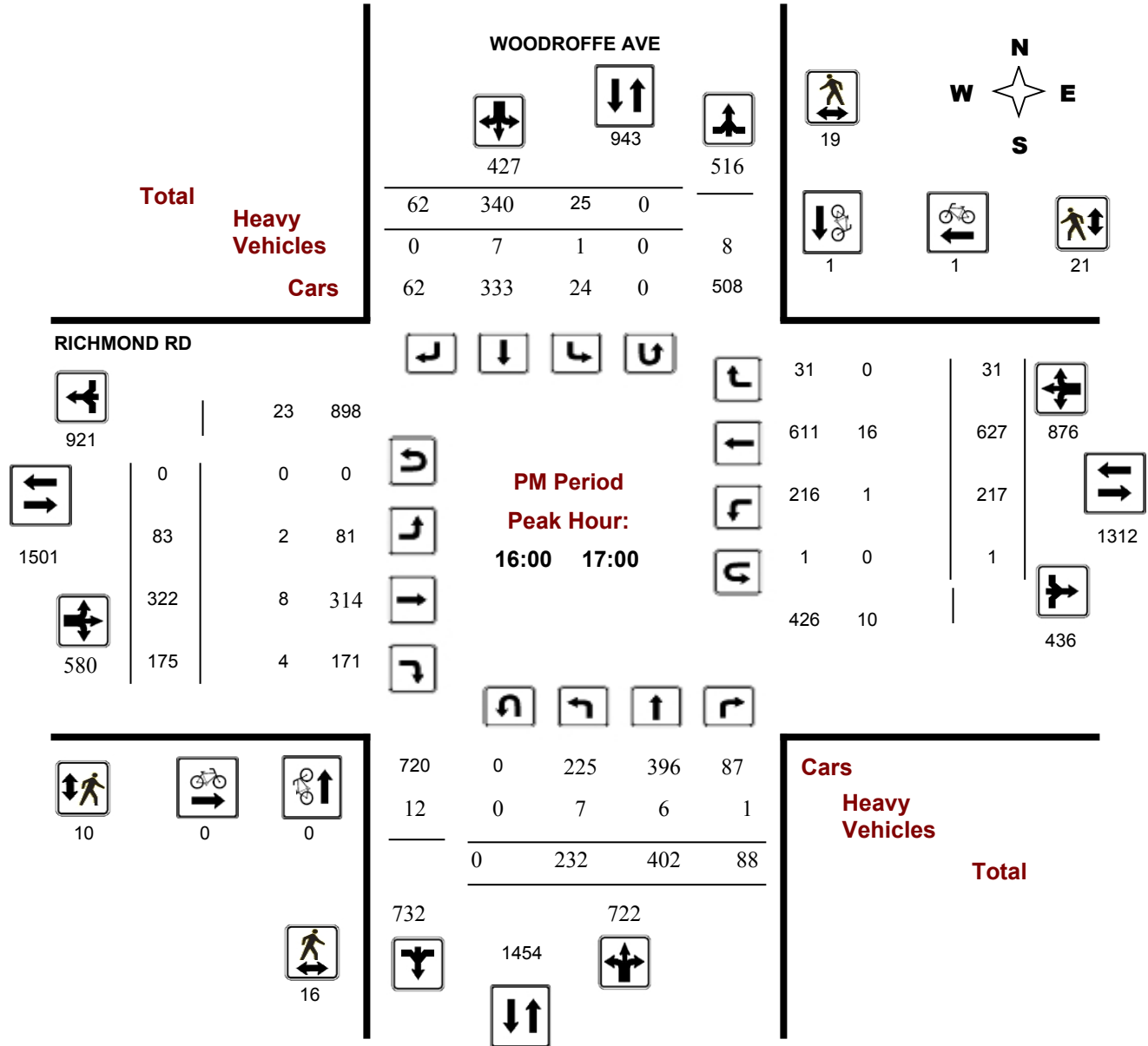

Turning Movement Count - 15 Min U-Turn Total Report

RICHMOND RD @ WOODROFFE AVE

Survey Date: Thursday, December 01, 2016

Time Period		Northbound U-Turn Total	Southbound U-Turn Total	Eastbound U-Turn Total	Westbound U-Turn Total	Total
07:00	07:15	0	0	0	0	0
07:15	07:30	0	0	0	0	0
07:30	07:45	0	0	0	0	0
07:45	08:00	0	0	0	0	0
08:00	08:15	0	0	0	0	0
08:15	08:30	0	0	0	0	0
08:30	08:45	0	0	0	0	0
08:45	09:00	0	0	0	0	0
09:00	09:15	0	0	0	0	0
09:15	09:30	0	0	0	0	0
09:30	09:45	0	0	0	0	0
09:45	10:00	0	0	0	0	0
11:30	11:45	0	0	0	0	0
11:45	12:00	0	0	0	0	0
12:00	12:15	0	0	0	0	0
12:15	12:30	0	0	0	0	0
12:30	12:45	0	0	0	0	0
12:45	13:00	0	0	0	0	0
13:00	13:15	0	0	0	0	0
13:15	13:30	0	0	0	0	0
15:00	15:15	0	0	0	0	0
15:15	15:30	0	0	0	0	0
15:30	15:45	0	0	0	0	0
15:45	16:00	0	0	0	0	0
16:00	16:15	0	0	0	0	0
16:15	16:30	0	0	0	0	0
16:30	16:45	0	0	0	1	1
16:45	17:00	0	0	0	0	0
17:00	17:15	0	0	0	0	0
17:15	17:30	0	0	0	0	0
17:30	17:45	0	0	0	0	0
17:45	18:00	0	0	0	0	0
Total		0	0	0	1	1



Transportation Services - Traffic Services

Turning Movement Count - Study Results

RICHMOND RD @ EDGEWORTH AVE/MCEWEN AVE

Survey Date: Thursday, August 25, 2016

WO No: 36242

Start Time: 07:00

Device: Miovision

Full Study Diagram

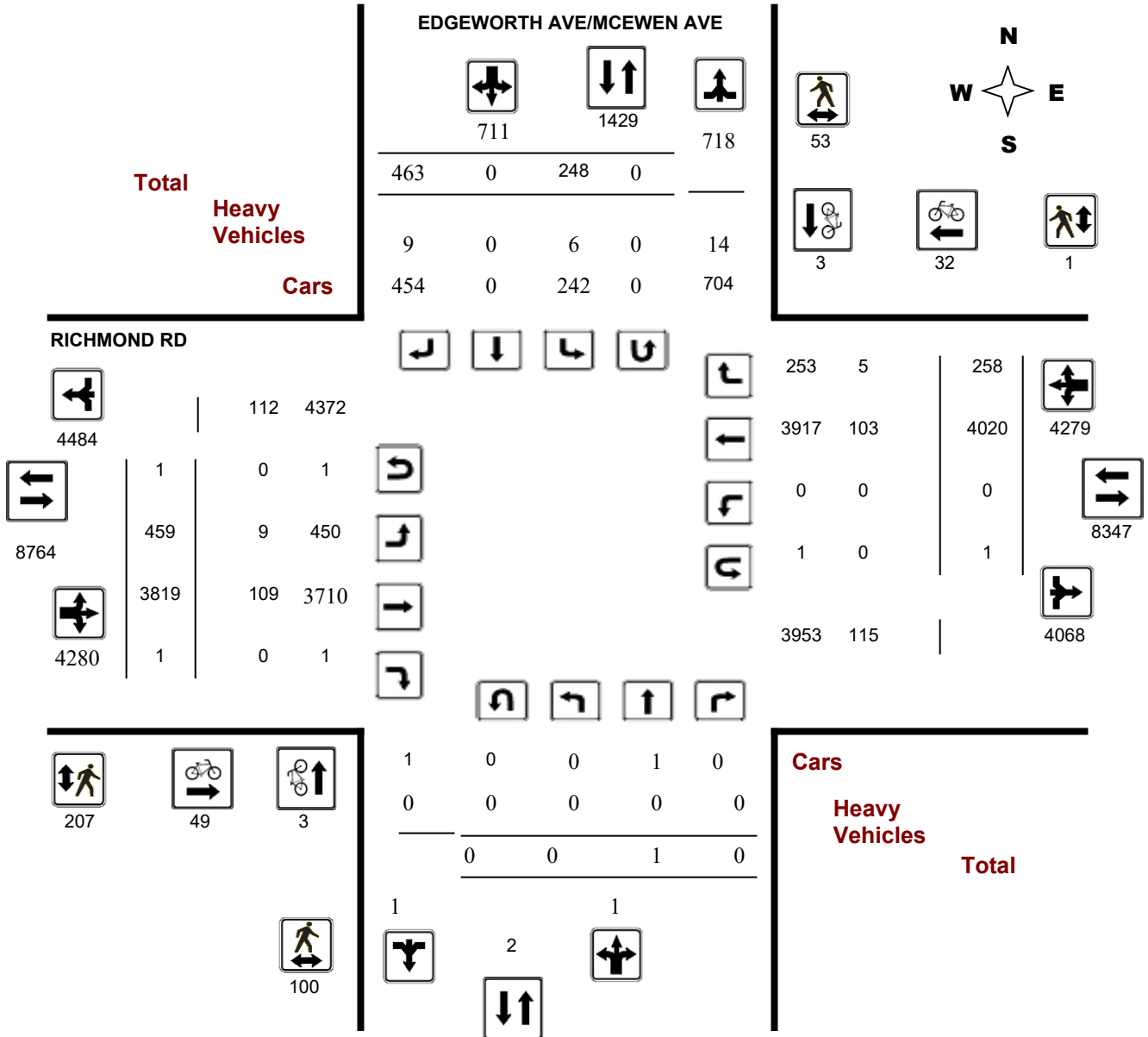

Turning Movement Count - Study Results

RICHMOND RD @ EDGEWORTH AVE/MCEWEN AVE

Survey Date: Thursday, August 25, 2016

WO No: 36242

Start Time: 07:00

Device: Miovision

Full Study Peak Hour Diagram

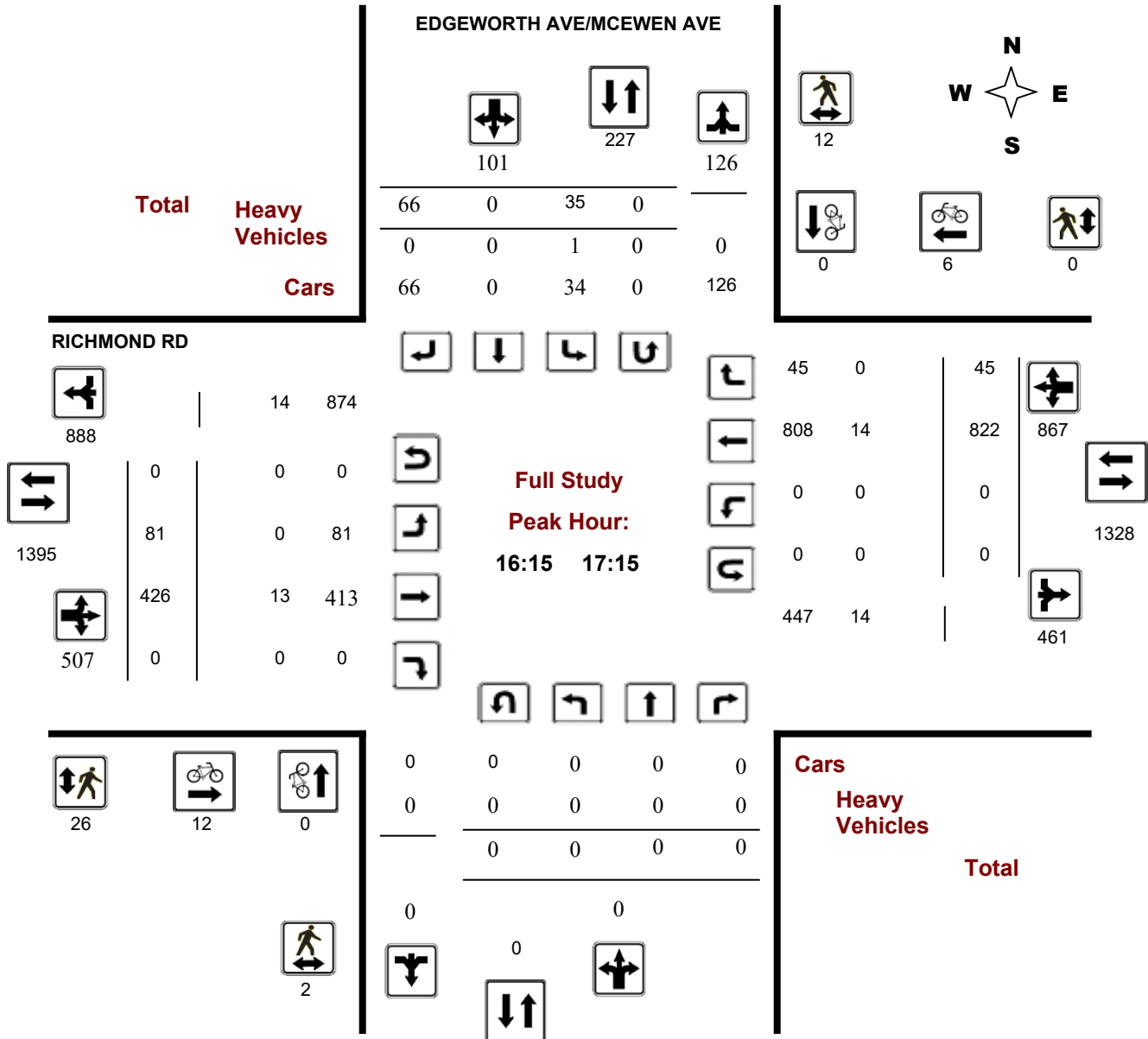



Transportation Services - Traffic Services

Turning Movement Count - Peak Hour Diagram

RICHMOND RD @ EDGEWORTH AVE/MCEWEN AVE

Survey Date: Thursday, August 25, 2016

Start Time: 07:00

WO No: 36242

Device: Miovision

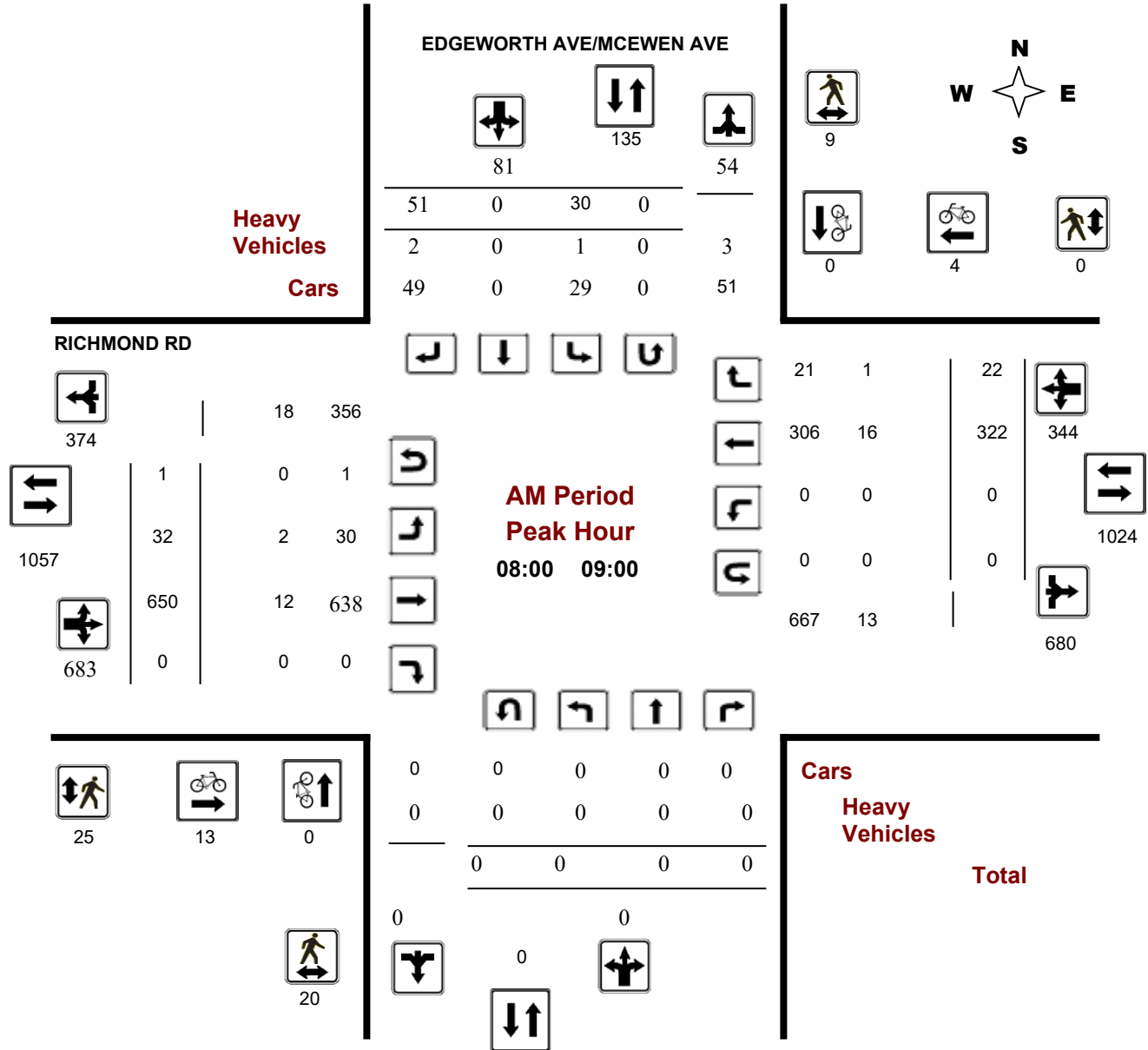

Comments

Turning Movement Count - Peak Hour Diagram

RICHMOND RD @ EDGEWORTH AVE/MCEWEN AVE

Survey Date: Thursday, August 25, 2016

Start Time: 07:00

WO No: 36242

Device: Miovision

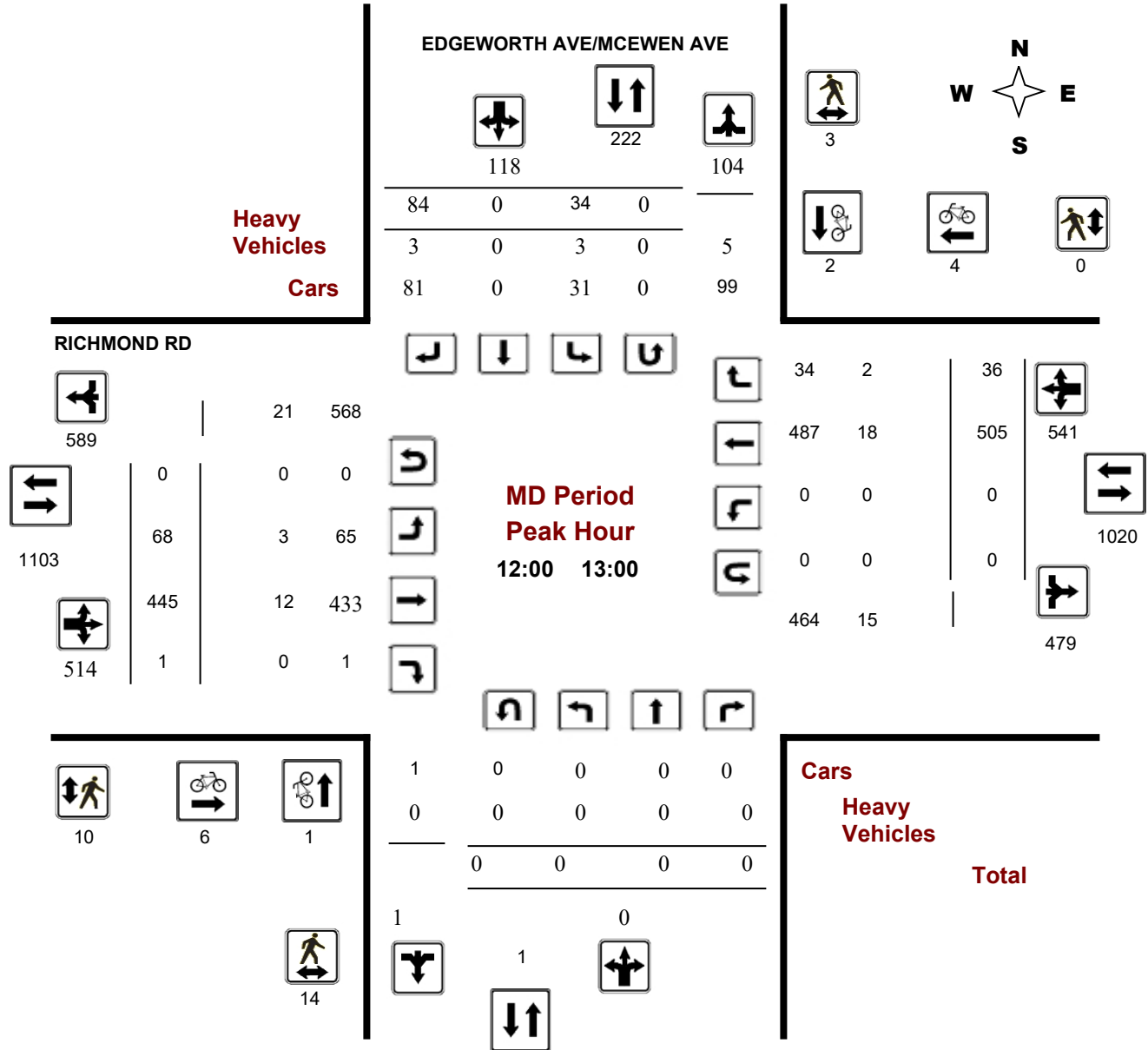

Comments

Turning Movement Count - Peak Hour Diagram

RICHMOND RD @ EDGEWORTH AVE/MCEWEN AVE

Survey Date: Thursday, August 25, 2016

Start Time: 07:00

WO No: 36242

Device: Miovision

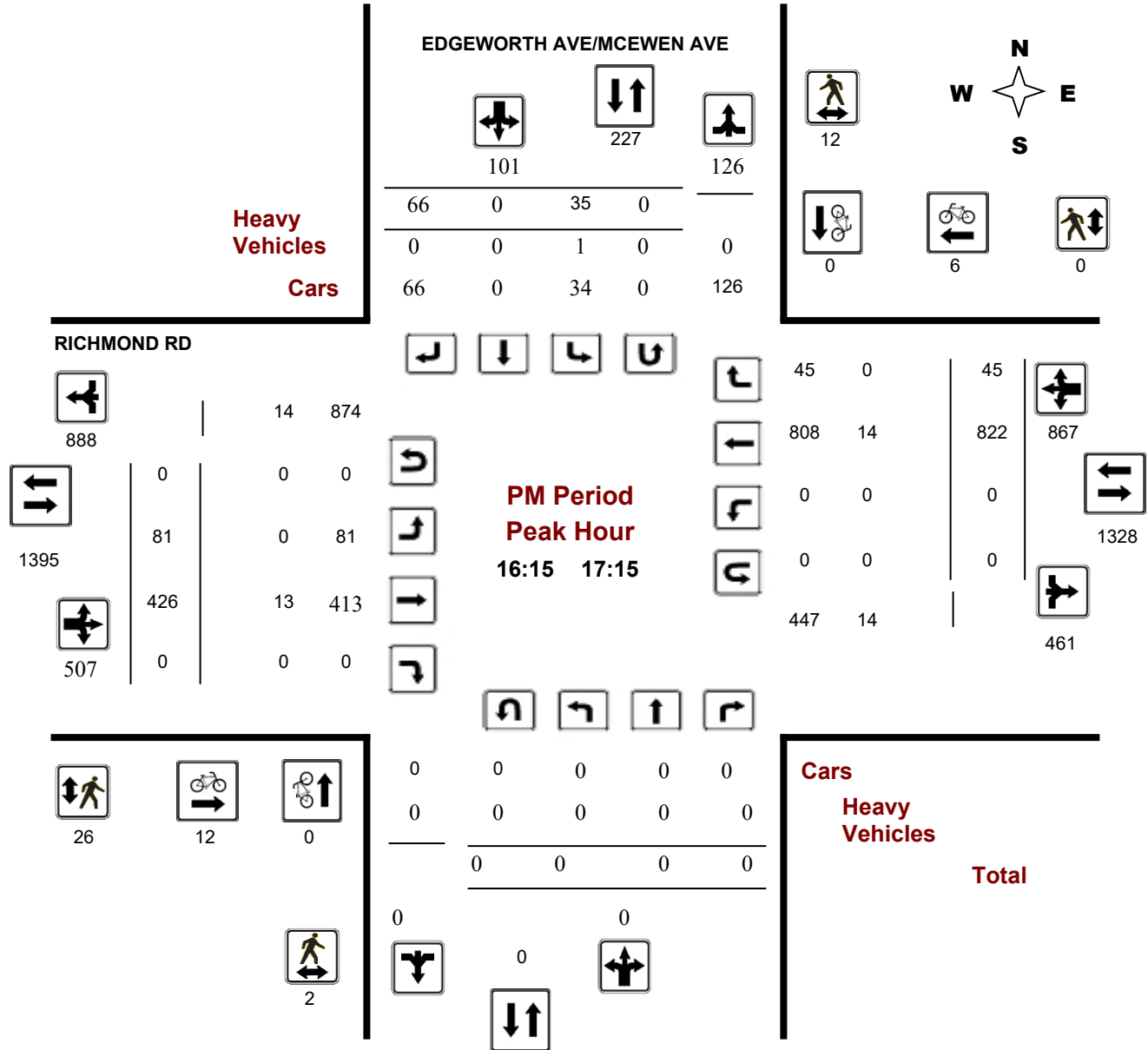



Transportation Services - Traffic Services

Turning Movement Count - Study Results

RICHMOND RD @ EDGEWORTH AVE/MCEWEN AVE

Survey Date: Thursday, August 25, 2016

WO No: 36242

Start Time: 07:00

Device: Miovision

Full Study Summary (8 HR Standard)

Survey Date: Thursday, August 25, 2016

Total Observed U-Turns

AADT Factor

Northbound: 0 Southbound: 0
 Eastbound: 1 Westbound: 1

.90

EDGEWORTH AVE/MCEWEN AVE

RICHMOND RD

Period	Northbound					Southbound					Eastbound					Westbound					Grand Total
	LT	ST	RT	NB TOT	STR TOT	LT	ST	RT	SB TOT	STR TOT	LT	ST	RT	EB TOT	STR TOT	WB TOT	STR TOT				
07:00 08:00	0	0	0	0	64	24	0	40	64	64	26	572	0	598	0	208	187	21	806	870	
08:00 09:00	0	0	0	0	81	30	0	51	81	81	32	650	0	682	0	344	322	22	1026	1107	
09:00 10:00	0	0	0	0	89	30	0	59	89	89	39	428	0	467	0	346	318	28	813	902	
11:30 12:30	0	0	0	0	99	28	0	71	99	99	70	460	1	531	0	499	463	36	1030	1129	
12:30 13:30	0	0	0	0	110	39	0	71	110	110	70	456	0	526	0	494	461	33	1020	1130	
15:00 16:00	0	0	0	0	85	31	0	54	85	85	57	395	0	452	0	742	706	36	1194	1279	
16:00 17:00	0	0	0	0	95	35	0	60	95	95	75	404	0	479	0	836	797	39	1315	1410	
17:00 18:00	0	1	0	1	88	31	0	57	88	89	90	454	0	544	0	809	766	43	1353	1442	
Sub Total	0	1	0	1	711	248	0	463	711	712	459	3819	1	4279	0	4278	4020	258	8557	9269	
U Turns	0			0	0				0	0	1			1	1			2	2		
Total	0	1	0	1	711	248	0	463	711	712	460	3819	1	4280	1	4279	4020	258	8559	9271	
EQ 12Hr	0	1	0	1	989	345	0	644	989	990	639	5308	1	5948	1	5948	5588	359	11896	12886	
Note: These values are calculated by multiplying the totals by the appropriate expansion factor.																1.39					
AVG 12Hr	0	1	0	1	890	310	0	580	890	891	575	4777	1	5353	1	5353	5029	323	10706	11597	
Note: These volumes are calculated by multiplying the Equivalent 12 hr. totals by the AADT factor.																.90					
AVG 24Hr	0	1	0	1	1166	406	0	760	1166	1167	753	6258	1	7012	1	7012	6588	423	14024	15191	
Note: These volumes are calculated by multiplying the Average Daily 12 hr. totals by 12 to 24 expansion factor.																1.31					

Note: U-Turns provided for approach totals. Refer to 'U-Turn' Report for specific breakdown.



Transportation Services - Traffic Services

Turning Movement Count - Study Results

RICHMOND RD @ EDGEWORTH AVE/MCEWEN AVE

Survey Date: Thursday, August 25, 2016

WO No: 36242

Start Time: 07:00

Device: Miovision

Full Study 15 Minute Increments

EDGEWORTH AVE/MCEWEN AVE

RICHMOND RD

Northbound

Southbound

Eastbound

Westbound

Time Period	LT	ST	RT	N TOT	LT	ST	RT	S TOT	STR TOT	LT	ST	RT	E TOT	LT	ST	RT	W TOT	STR TOT	Grand Total
07:00 07:15	0	0	0	0	4	0	7	11	11	3	105	0	108	0	34	4	38	146	157
07:15 07:30	0	0	0	0	3	0	11	14	14	4	149	0	153	0	39	10	49	202	216
07:30 07:45	0	0	0	0	9	0	11	20	20	12	165	0	177	0	53	5	58	235	255
07:45 08:00	0	0	0	0	8	0	11	19	19	7	153	0	160	0	61	2	63	223	242
08:00 08:15	0	0	0	0	5	0	16	21	21	11	142	0	153	0	61	9	70	223	244
08:15 08:30	0	0	0	0	6	0	12	18	18	10	163	0	173	0	80	6	86	259	277
08:30 08:45	0	0	0	0	11	0	9	20	20	4	189	0	193	0	84	3	87	280	300
08:45 09:00	0	0	0	0	8	0	14	22	22	8	156	0	164	0	97	4	101	265	287
09:00 09:15	0	0	0	0	7	0	16	23	23	7	121	0	128	0	74	9	83	211	234
09:15 09:30	0	0	0	0	5	0	14	19	19	16	115	0	131	0	82	9	91	222	241
09:30 09:45	0	0	0	0	12	0	13	25	25	8	95	0	103	0	89	5	94	197	222
09:45 10:00	0	0	0	0	6	0	16	22	22	8	97	0	105	0	73	5	78	183	205
11:30 11:45	0	0	0	0	8	0	16	24	24	13	116	0	129	0	106	9	115	244	268
11:45 12:00	0	0	0	0	5	0	16	21	21	21	139	0	160	0	100	8	108	268	289
12:00 12:15	0	0	0	0	7	0	19	26	26	18	96	1	115	0	129	8	137	252	278
12:15 12:30	0	0	0	0	8	0	20	28	28	18	109	0	127	0	128	11	139	266	294
12:30 12:45	0	0	0	0	8	0	23	31	31	16	116	0	132	0	112	7	119	251	282
12:45 13:00	0	0	0	0	11	0	22	33	33	16	124	0	140	0	136	10	146	286	319
13:00 13:15	0	0	0	0	8	0	11	19	19	14	98	0	112	1	105	9	115	227	246
13:15 13:30	0	0	0	0	12	0	15	27	27	24	118	0	142	0	108	7	115	257	284
15:00 15:15	0	0	0	0	11	0	16	27	27	13	83	0	96	0	130	8	138	234	261
15:15 15:30	0	0	0	0	6	0	16	22	22	17	100	0	117	0	168	8	176	293	315
15:30 15:45	0	0	0	0	6	0	12	18	18	10	112	0	122	0	198	5	203	325	343
15:45 16:00	0	0	0	0	8	0	10	18	18	17	100	0	117	0	210	15	225	342	360
16:00 16:15	0	0	0	0	8	0	9	17	17	14	109	0	123	0	186	7	193	316	333
16:15 16:30	0	0	0	0	8	0	20	28	28	23	93	0	116	0	210	16	226	342	370
16:30 16:45	0	0	0	0	11	0	16	27	27	17	101	0	118	0	180	11	191	309	336
16:45 17:00	0	0	0	0	8	0	15	23	23	21	101	0	122	0	221	5	226	348	371
17:00 17:15	0	0	0	0	8	0	15	23	23	20	131	0	151	0	211	13	224	375	398
17:15 17:30	0	1	0	1	8	0	19	27	28	22	104	0	126	0	182	14	196	322	350
17:30 17:45	0	0	0	0	7	0	10	17	17	24	99	0	123	0	202	11	213	336	353
17:45 18:00	0	0	0	0	8	0	13	21	21	24	120	0	144	0	171	5	176	320	341
Total:	0	1	0	1	248	0	463	711	712	460	3819	1	4280	1	4020	258	4279	712	9,271

Note: U-Turns are included in Totals.



Transportation Services - Traffic Services

Turning Movement Count - Study Results

RICHMOND RD @ EDGEWORTH AVE/MCEWEN AVE

Survey Date: Thursday, August 25, 2016

WO No: 36242

Start Time: 07:00

Device: Miovision

Full Study Cyclist Volume

EDGEWORTH AVE/MCEWEN AVE

RICHMOND RD

Time Period		EDGEWORTH AVE/MCEWEN AVE			RICHMOND RD			Grand Total
		Northbound	Southbound	Street Total	Eastbound	Westbound	Street Total	
07:00	07:15	0	0	0	0	0	0	0
07:15	07:30	0	0	0	2	1	3	3
07:30	07:45	0	0	0	0	0	0	0
07:45	08:00	0	0	0	1	1	2	2
08:00	08:15	0	0	0	5	1	6	6
08:15	08:30	0	0	0	2	2	4	4
08:30	08:45	0	0	0	4	1	5	5
08:45	09:00	0	0	0	2	0	2	2
09:00	09:15	0	0	0	1	1	2	2
09:15	09:30	0	0	0	0	0	0	0
09:30	09:45	0	0	0	3	0	3	3
09:45	10:00	0	0	0	0	0	0	0
11:30	11:45	0	0	0	1	1	2	2
11:45	12:00	0	0	0	1	2	3	3
12:00	12:15	0	1	1	1	2	3	4
12:15	12:30	0	0	0	1	0	1	1
12:30	12:45	0	0	0	1	0	1	1
12:45	13:00	1	1	2	3	2	5	7
13:00	13:15	0	0	0	4	0	4	4
13:15	13:30	0	0	0	0	2	2	2
15:00	15:15	1	1	2	2	0	2	4
15:15	15:30	0	0	0	0	0	0	0
15:30	15:45	0	0	0	0	1	1	1
15:45	16:00	0	0	0	0	0	0	0
16:00	16:15	0	0	0	0	3	3	3
16:15	16:30	0	0	0	2	1	3	3
16:30	16:45	0	0	0	3	2	5	5
16:45	17:00	0	0	0	3	1	4	4
17:00	17:15	0	0	0	4	2	6	6
17:15	17:30	0	0	0	0	1	1	1
17:30	17:45	1	0	1	0	2	2	3
17:45	18:00	0	0	0	3	3	6	6
Total		3	3	6	49	32	81	87



Transportation Services - Traffic Services

Turning Movement Count - Study Results

RICHMOND RD @ EDGEWORTH AVE/MCEWEN AVE

Survey Date: Thursday, August 25, 2016

WO No: 36242

Start Time: 07:00

Device: Miovision

Full Study Pedestrian Volume

EDGEWORTH AVE/MCEWEN AVE

RICHMOND RD

Time Period	NB Approach (E or W Crossing)	SB Approach (E or W Crossing)	Total	EB Approach (N or S Crossing)	WB Approach (N or S Crossing)	Total	Grand Total
07:00 07:15	0	0	0	6	0	6	6
07:15 07:30	0	0	0	8	0	8	8
07:30 07:45	0	0	0	7	0	7	7
07:45 08:00	0	1	1	8	0	8	9
08:00 08:15	6	3	9	7	0	7	16
08:15 08:30	2	1	3	2	0	2	5
08:30 08:45	5	2	7	9	0	9	16
08:45 09:00	7	3	10	7	0	7	17
09:00 09:15	1	2	3	6	0	6	9
09:15 09:30	7	1	8	10	0	10	18
09:30 09:45	5	2	7	6	0	6	13
09:45 10:00	3	0	3	5	0	5	8
11:30 11:45	2	3	5	6	0	6	11
11:45 12:00	5	0	5	8	0	8	13
12:00 12:15	2	0	2	1	0	1	3
12:15 12:30	5	2	7	5	0	5	12
12:30 12:45	3	1	4	3	0	3	7
12:45 13:00	4	0	4	1	0	1	5
13:00 13:15	4	1	5	8	0	8	13
13:15 13:30	3	6	9	4	1	5	14
15:00 15:15	1	0	1	3	0	3	4
15:15 15:30	7	3	10	8	0	8	18
15:30 15:45	2	5	7	10	0	10	17
15:45 16:00	5	1	6	6	0	6	12
16:00 16:15	3	0	3	6	0	6	9
16:15 16:30	1	4	5	2	0	2	7
16:30 16:45	0	2	2	3	0	3	5
16:45 17:00	0	2	2	10	0	10	12
17:00 17:15	1	4	5	11	0	11	16
17:15 17:30	4	1	5	10	0	10	15
17:30 17:45	5	2	7	12	0	12	19
17:45 18:00	7	1	8	9	0	9	17
Total	100	53	153	207	1	208	361



Transportation Services - Traffic Services

Turning Movement Count - Study Results

RICHMOND RD @ EDGEWORTH AVE/MCEWEN AVE

Survey Date: Thursday, August 25, 2016

WO No: 36242

Start Time: 07:00

Device: Miovision

Full Study Heavy Vehicles

EDGEWORTH AVE/MCEWEN AVE

RICHMOND RD

Northbound

Southbound

Eastbound

Westbound

Time Period	Northbound			N TOT	Southbound			S TOT	STR TOT	Eastbound			E TOT	Westbound			W TOT	STR TOT	Grand Total
	LT	ST	RT		LT	ST	RT			LT	ST	RT		LT	ST	RT			
07:00 07:15	0	0	0	0	0	0	0	0	0	0	6	0	6	0	1	0	1	7	7
07:15 07:30	0	0	0	0	0	0	0	0	0	0	2	0	2	0	1	0	1	3	3
07:30 07:45	0	0	0	0	0	0	0	0	0	0	5	0	5	0	5	0	5	10	10
07:45 08:00	0	0	0	0	0	0	0	0	0	0	4	0	4	0	2	0	2	6	6
08:00 08:15	0	0	0	0	0	0	0	0	0	1	2	0	3	0	5	0	5	8	8
08:15 08:30	0	0	0	0	1	0	1	2	2	0	2	0	2	0	4	1	5	7	9
08:30 08:45	0	0	0	0	0	0	0	0	0	1	2	0	3	0	2	0	2	5	5
08:45 09:00	0	0	0	0	0	0	1	1	1	0	6	0	6	0	5	0	5	11	12
09:00 09:15	0	0	0	0	0	0	1	1	1	0	5	0	5	0	2	1	3	8	9
09:15 09:30	0	0	0	0	0	0	1	1	1	0	3	0	3	0	4	0	4	7	8
09:30 09:45	0	0	0	0	0	0	0	0	0	0	4	0	4	0	4	0	4	8	8
09:45 10:00	0	0	0	0	0	0	0	0	0	0	2	0	2	0	1	1	2	4	4
11:30 11:45	0	0	0	0	0	0	0	0	0	0	7	0	7	0	7	0	7	14	14
11:45 12:00	0	0	0	0	0	0	1	1	1	0	8	0	8	0	5	0	5	13	14
12:00 12:15	0	0	0	0	0	0	0	0	0	2	2	0	4	0	8	0	8	12	12
12:15 12:30	0	0	0	0	0	0	1	1	1	0	3	0	3	0	3	0	3	6	7
12:30 12:45	0	0	0	0	0	0	1	1	1	1	5	0	6	0	2	1	3	9	10
12:45 13:00	0	0	0	0	3	0	1	4	4	0	2	0	2	0	5	1	6	8	12
13:00 13:15	0	0	0	0	0	0	0	0	0	1	7	0	8	0	2	0	2	10	10
13:15 13:30	0	0	0	0	0	0	0	0	0	0	3	0	3	0	2	0	2	5	5
15:00 15:15	0	0	0	0	0	0	0	0	0	0	2	0	2	0	3	0	3	5	5
15:15 15:30	0	0	0	0	0	0	0	0	0	1	6	0	7	0	8	0	8	15	15
15:30 15:45	0	0	0	0	1	0	0	1	1	0	3	0	3	0	2	0	2	5	6
15:45 16:00	0	0	0	0	0	0	0	0	0	0	1	0	1	0	1	0	1	2	2
16:00 16:15	0	0	0	0	0	0	0	0	0	1	1	0	2	0	1	0	1	3	3
16:15 16:30	0	0	0	0	0	0	0	0	0	0	3	0	3	0	3	0	3	6	6
16:30 16:45	0	0	0	0	0	0	0	0	0	0	3	0	3	0	4	0	4	7	7
16:45 17:00	0	0	0	0	0	0	0	0	0	0	2	0	2	0	2	0	2	4	4
17:00 17:15	0	0	0	0	1	0	0	1	1	0	5	0	5	0	5	0	5	10	11
17:15 17:30	0	0	0	0	0	0	1	1	1	0	0	0	0	0	1	0	1	1	2
17:30 17:45	0	0	0	0	0	0	0	0	0	0	2	0	2	0	2	0	2	4	4
17:45 18:00	0	0	0	0	0	0	0	0	0	1	1	0	2	0	1	0	1	3	3
Total: None	0	0	0	0	6	0	9	15	15	9	109	0	118	0	103	5	108	226	241



Transportation Services - Traffic Services

Turning Movement Count - Study Results

RICHMOND RD @ EDGEWORTH AVE/MCEWEN AVE

Survey Date: Thursday, August 25, 2016

WO No: 36242

Start Time: 07:00

Device: Miovision

Full Study 15 Minute U-Turn Total

EDGEWORTH AVE/MCEWEN AVE

RICHMOND RD

Time Period	Northbound U-Turn Total	Southbound U-Turn Total	Eastbound U-Turn Total	Westbound U-Turn Total	Total	
07:00	07:15	0	0	0	0	
07:15	07:30	0	0	0	0	
07:30	07:45	0	0	0	0	
07:45	08:00	0	0	0	0	
08:00	08:15	0	0	0	0	
08:15	08:30	0	0	0	0	
08:30	08:45	0	0	0	0	
08:45	09:00	0	0	1	1	
09:00	09:15	0	0	0	0	
09:15	09:30	0	0	0	0	
09:30	09:45	0	0	0	0	
09:45	10:00	0	0	0	0	
11:30	11:45	0	0	0	0	
11:45	12:00	0	0	0	0	
12:00	12:15	0	0	0	0	
12:15	12:30	0	0	0	0	
12:30	12:45	0	0	0	0	
12:45	13:00	0	0	0	0	
13:00	13:15	0	0	0	1	
13:15	13:30	0	0	0	0	
15:00	15:15	0	0	0	0	
15:15	15:30	0	0	0	0	
15:30	15:45	0	0	0	0	
15:45	16:00	0	0	0	0	
16:00	16:15	0	0	0	0	
16:15	16:30	0	0	0	0	
16:30	16:45	0	0	0	0	
16:45	17:00	0	0	0	0	
17:00	17:15	0	0	0	0	
17:15	17:30	0	0	0	0	
17:30	17:45	0	0	0	0	
17:45	18:00	0	0	0	0	
Total		0	0	1	1	2

DRAFT

Appendix D:

Background Growth Analysis

Richmond/New Orchard
8 hrs

Year	Date	North Leg		South Leg		East Leg		West Leg		Total
		SB	NB	NB	SB	WB	EB	EB	WB	
2009	Wednesday, August 19	823	594	1	1	3639	4238	3783	3413	16492
2011	Thursday, July 14	807	746	1	1	4467	5691	5347	4184	21244
2016	Thursday, August 25	856	721	1	1	4708	4848	4269	4264	19668

Year	Counts				% Change			
	NB	SB	NB+SB	INT	NB	SB	NB+SB	INT
2009	594	823	1417	16492				
2011	746	807	1553	21244	25.6%	-1.9%	9.6%	28.8%
2016	721	856	1577	19668	-3.4%	6.1%	1.5%	-7.4%

Regression Estimate 2009 646 812 1458
 Regression Estimate 2016 742 851 1593
Average Annual Change 2.00% 0.69% 1.28%

Year	Counts				% Change			
	EB	WB	EB+WB	INT	EB	WB	EB+WB	INT
2009	3783	3413	7196	16492				
2011	5347	4184	9531	21244	41.3%	22.6%	32.4%	28.8%
2016	4269	4264	8533	19668	-20.2%	1.9%	-10.5%	-7.4%

Regression Estimate 2009 4422 3650 8072
 Regression Estimate 2016 4525 4359 8884
Average Annual Change 0.33% 2.57% 1.38%

Year	Counts				% Change			
	EB	WB	EB+WB	INT	EB	WB	EB+WB	INT
2009	4238	3639	7877	16492				
2011	5691	4467	10158	21244	34.3%	22.8%	29.0%	28.8%
2016	4848	4708	9556	19668	-14.8%	5.4%	-5.9%	-7.4%

Regression Estimate 2009 4812 3873 8685
 Regression Estimate 2016 5078 4802 9879
Average Annual Change 0.77% 3.12% 1.86%

Year	Counts				% Change			
	NB	SB	NB+SB	INT	NB	SB	NB+SB	INT
2009	1	1	2	16492				
2011	1	1	2	21244	0.0%	0.0%	0.0%	28.8%
2016	1	1	2	19668	0.0%	0.0%	0.0%	-7.4%

Regression Estimate 2009 1 1 2
 Regression Estimate 2016 1 1 2
Average Annual Change 0.00% 0.00% 0.00%

**Richmond/New Orchard
AM Peak**

Year	Date	North Leg		South Leg		East Leg		West Leg		Total
		SB	NB	NB	SB	WB	EB	EB	WB	
2009	Wednesday, August 19	142	37	1	1	373	788	662	352	2356
2011	Thursday, July 14	137	55	1	1	388	854	748	364	2548
2016	Thursday, August 25	133	57	1	1	392	795	688	361	2428

Year	Counts				% Change			
	NB	SB	NB+SB	INT	NB	SB	NB+SB	INT
2009	37	142	179	2356				
2011	55	137	192	2548	48.6%	-3.5%	7.3%	8.1%
2016	57	133	190	2428	3.6%	-2.9%	-1.0%	-4.7%

Regression Estimate 2009 43 141 183
 Regression Estimate 2016 59 133 192
Average Annual Change 4.85% -0.87% 0.64%

Year	Counts				% Change			
	EB	WB	EB+WB	INT	EB	WB	EB+WB	INT
2009	662	352	1014	2356				
2011	748	364	1112	2548	13.0%	3.4%	9.7%	8.1%
2016	688	361	1049	2428	-8.0%	-0.8%	-5.7%	-4.7%

Regression Estimate 2009 697 356 1053
 Regression Estimate 2016 702 363 1065
Average Annual Change 0.10% 0.26% 0.15%

Year	Counts				% Change			
	EB	WB	EB+WB	INT	EB	WB	EB+WB	INT
2009	788	373	1161	2356				
2011	854	388	1242	2548	8.4%	4.0%	7.0%	8.1%
2016	795	392	1187	2428	-6.9%	1.0%	-4.4%	-4.7%

Regression Estimate 2009 817 377 1194
 Regression Estimate 2016 806 394 1200
Average Annual Change -0.18% 0.61% 0.07%

Year	Counts				% Change			
	NB	SB	NB+SB	INT	NB	SB	NB+SB	INT
2009	1	1	2	2356				
2011	1	1	2	2548	0.0%	0.0%	0.0%	8.1%
2016	1	1	2	2428	0.0%	0.0%	0.0%	-4.7%

Regression Estimate 2009 1 1 2
 Regression Estimate 2016 1 1 2
Average Annual Change 0.00% 0.00% 0.00%

**Richmond/New Orchard
PM Peak**

Year	Date	North Leg		South Leg		East Leg		West Leg		Total
		SB	NB	NB	SB	WB	EB	EB	WB	
2009	Wednesday, August 19	104	86	1	1	710	502	441	667	2512
2011	Thursday, July 14	97	108	1	1	895	630	597	851	3180
2016	Thursday, August 25	92	139	1	1	970	553	499	869	3124

Year	Counts				% Change			
	NB	SB	NB+SB	INT	NB	SB	NB+SB	INT
2009	86	104	190	2512				
2011	108	97	205	3180	25.6%	-6.7%	7.9%	26.6%
2016	139	92	231	3124	28.7%	-5.2%	12.7%	-1.8%

Regression Estimate 2009 89 102 191
 Regression Estimate 2016 140 91 232
Average Annual Change 6.70% -1.62% 2.75%

Year	Counts				% Change			
	EB	WB	EB+WB	INT	EB	WB	EB+WB	INT
2009	441	667	1108	2512				
2011	597	851	1448	3180	35.4%	27.6%	30.7%	26.6%
2016	499	869	1368	3124	-16.4%	2.1%	-5.5%	-1.8%

Regression Estimate 2009 504 724 1227
 Regression Estimate 2016 524 892 1416
Average Annual Change 0.57% 3.03% 2.06%

Year	Counts				% Change			
	EB	WB	EB+WB	INT	EB	WB	EB+WB	INT
2009	502	710	1212	2512				
2011	630	895	1525	3180	25.5%	26.1%	25.8%	26.6%
2016	553	970	1523	3124	-12.2%	8.4%	-0.1%	-1.8%

Regression Estimate 2009 553 760 1313
 Regression Estimate 2016 573 990 1563
Average Annual Change 0.52% 3.85% 2.53%

Year	Counts				% Change			
	NB	SB	NB+SB	INT	NB	SB	NB+SB	INT
2009	1	1	2	2512				
2011	1	1	2	3180	0.0%	0.0%	0.0%	26.6%
2016	1	1	2	3124	0.0%	0.0%	0.0%	-1.8%

Regression Estimate 2009 1 1 2
 Regression Estimate 2016 1 1 2
Average Annual Change 0.00% 0.00% 0.00%

DRAFT

Appendix E:

2031 City Transportation Model

TRANS Regional Model

Version 2.15 - Assigned Oct, 2021

AM Peak Hour Total Traffic Volume

Richmond Rd. (Cleary to Carling)

2011 Model - Basecase

N/A

User Initials: TIMW

Plot Prepared: Jan, 2022

EMME Scenario: 23713



Legend

AM Peak Hour Total Traffic Volume

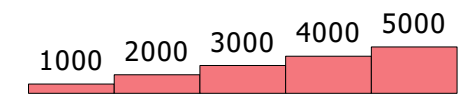

Distance (m)



The TRANS model is continuously refined & maintained, and all information is provided in good faith. However, model outputs are provided "as is", and no warranty or guarantee is provided as to the accuracy, reliability or reasonableness of the results. In using this data, you agree to accept any and all risks arising from any incorrect, incomplete, or misleading information.

Recipients are required to use caution and professional judgement in using and interpreting model outputs. In particular, caution should be used when focusing on a geographically limited area (such as a single road or intersection), as the model is primarily designed to simulate regional-scale phenomena and has been calibrated at a regional level.

As general good practice, it is recommended that the user confirm the network coding within the area of interest, and compare base year forecasts against traffic count data to assess the extent to which the model may be over- or under-estimating the travel demand.

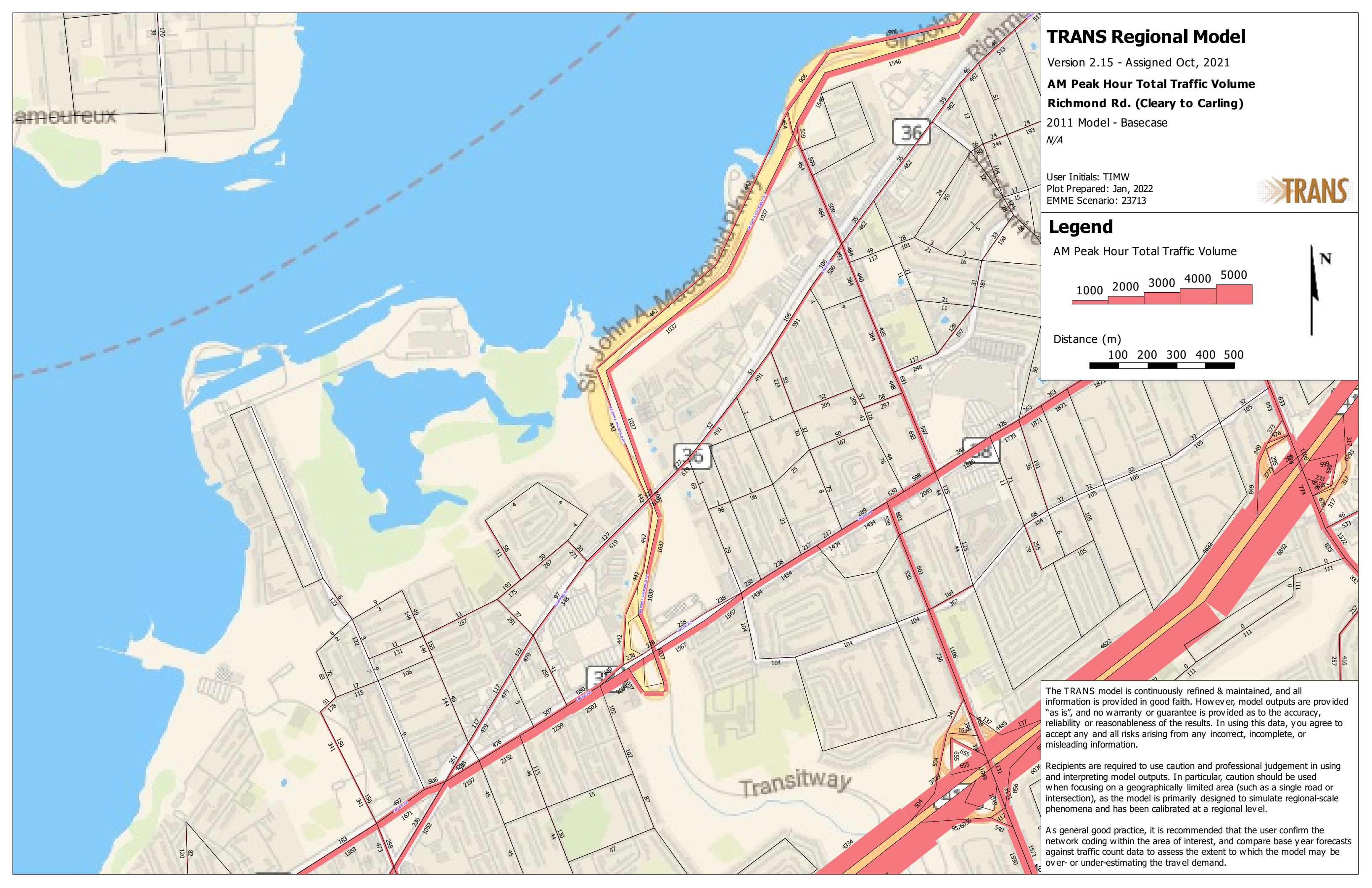

TRANS Regional Model

Version 2.15 - Assigned June 16, 2020

AM Peak Hour Total Traffic Volume

Richmond Rd. (Cleary to Carling)

2031 Model - Basecase

N/A

User Initials: TIMW
Plot Prepared: January, 2022
EMME Scenario: 21711



Legend

AM Peak Hour Total Traffic Volume

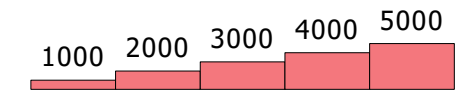

Distance (m)

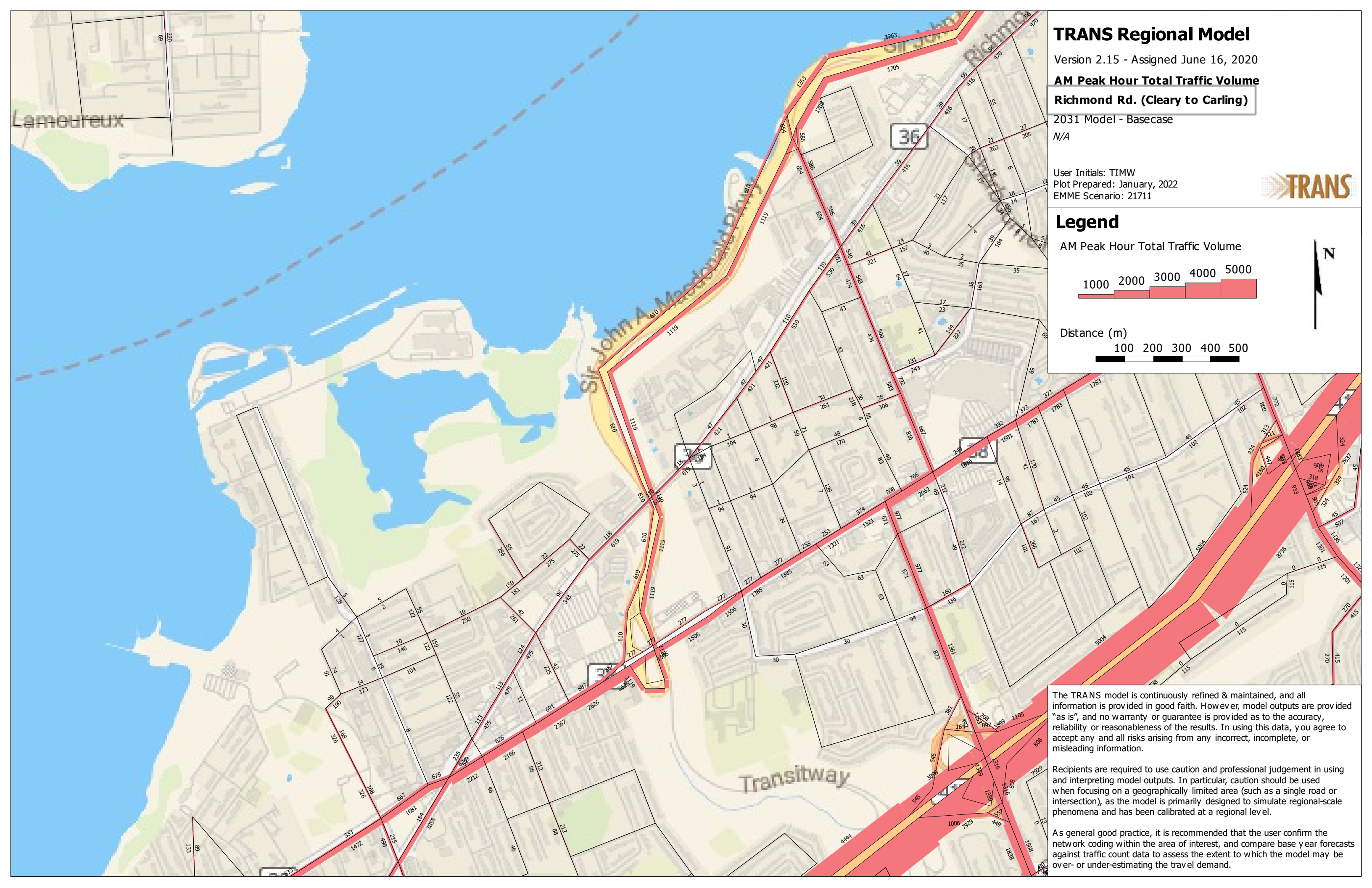
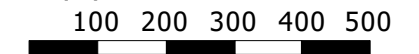

The TRANS model is continuously refined & maintained, and all information is provided in good faith. However, model outputs are provided "as is", and no warranty or guarantee is provided as to the accuracy, reliability or reasonableness of the results. In using this data, you agree to accept any and all risks arising from any incorrect, incomplete, or misleading information.

Recipients are required to use caution and professional judgement in using and interpreting model outputs. In particular, caution should be used when focusing on a geographically limited area (such as a single road or intersection), as the model is primarily designed to simulate regional-scale phenomena and has been calibrated at a regional level.

As general good practice, it is recommended that the user confirm the network coding within the area of interest, and compare base year forecasts against traffic count data to assess the extent to which the model may be over- or under-estimating the travel demand.

DRAFT

Appendix F:
TDM Checklists

TDM-Supportive Development Design and Infrastructure Checklist: *Residential Developments (multi-family or condominium)*

Legend	
REQUIRED	The Official Plan or Zoning By-law provides related guidance that must be followed
BASIC	The measure is generally feasible and effective, and in most cases would benefit the development and its users
BETTER	The measure could maximize support for users of sustainable modes, and optimize development performance

TDM-supportive design & infrastructure measures: <i>Residential developments</i>		Check if completed & add descriptions, explanations or plan/drawing references
1. WALKING & CYCLING: ROUTES		
1.1 Building location & access points		
BASIC	1.1.1 Locate building close to the street, and do not locate parking areas between the street and building entrances	<input checked="" type="checkbox"/>
BASIC	1.1.2 Locate building entrances in order to minimize walking distances to sidewalks and transit stops/stations	<input checked="" type="checkbox"/>
BASIC	1.1.3 Locate building doors and windows to ensure visibility of pedestrians from the building, for their security and comfort	<input checked="" type="checkbox"/>
1.2 Facilities for walking & cycling		
REQUIRED	1.2.1 Provide convenient, direct access to stations or major stops along rapid transit routes within 600 metres; minimize walking distances from buildings to rapid transit; provide pedestrian-friendly, weather-protected (where possible) environment between rapid transit accesses and building entrances; ensure quality linkages from sidewalks through building entrances to integrated stops/stations (<i>see Official Plan policy 4.3.3</i>)	<input checked="" type="checkbox"/>
REQUIRED	1.2.2 Provide safe, direct and attractive pedestrian access from public sidewalks to building entrances through such measures as: reducing distances between public sidewalks and major building entrances; providing walkways from public streets to major building entrances; within a site, providing walkways along the front of adjoining buildings, between adjacent buildings, and connecting areas where people may congregate, such as courtyards and transit stops; and providing weather protection through canopies, colonnades, and other design elements wherever possible (<i>see Official Plan policy 4.3.12</i>)	<input checked="" type="checkbox"/>

TDM-supportive design & infrastructure measures: <i>Residential developments</i>		Check if completed & add descriptions, explanations or plan/drawing references
REQUIRED	1.2.3 Provide sidewalks of smooth, well-drained walking surfaces of contrasting materials or treatments to differentiate pedestrian areas from vehicle areas, and provide marked pedestrian crosswalks at intersection sidewalks (see <i>Official Plan policy 4.3.10</i>)	<input checked="" type="checkbox"/>
REQUIRED	1.2.4 Make sidewalks and open space areas easily accessible through features such as gradual grade transition, depressed curbs at street corners and convenient access to extra-wide parking spaces and ramps (see <i>Official Plan policy 4.3.10</i>)	<input checked="" type="checkbox"/>
REQUIRED	1.2.5 Include adequately spaced inter-block/street cycling and pedestrian connections to facilitate travel by active transportation. Provide links to the existing or planned network of public sidewalks, multi-use pathways and on-road cycle routes. Where public sidewalks and multi-use pathways intersect with roads, consider providing traffic control devices to give priority to cyclists and pedestrians (see <i>Official Plan policy 4.3.11</i>)	<input checked="" type="checkbox"/>
BASIC	1.2.6 Provide safe, direct and attractive walking routes from building entrances to nearby transit stops	<input checked="" type="checkbox"/>
BASIC	1.2.7 Ensure that walking routes to transit stops are secure, visible, lighted, shaded and wind-protected wherever possible	<input checked="" type="checkbox"/>
BASIC	1.2.8 Design roads used for access or circulation by cyclists using a target operating speed of no more than 30 km/h, or provide a separated cycling facility	<input checked="" type="checkbox"/>
1.3 Amenities for walking & cycling		
BASIC	1.3.1 Provide lighting, landscaping and benches along walking and cycling routes between building entrances and streets, sidewalks and trails	<input checked="" type="checkbox"/>
BASIC	1.3.2 Provide wayfinding signage for site access (where required, e.g. when multiple buildings or entrances exist) and egress (where warranted, such as when directions to reach transit stops/stations, trails or other common destinations are not obvious)	<input checked="" type="checkbox"/>

TDM-supportive design & infrastructure measures: <i>Residential developments</i>		Check if completed & add descriptions, explanations or plan/drawing references
2. WALKING & CYCLING: END-OF-TRIP FACILITIES		
2.1 Bicycle parking		
REQUIRED	2.1.1 Provide bicycle parking in highly visible and lighted areas, sheltered from the weather wherever possible (see <i>Official Plan policy 4.3.6</i>)	<input checked="" type="checkbox"/>
REQUIRED	2.1.2 Provide the number of bicycle parking spaces specified for various land uses in different parts of Ottawa; provide convenient access to main entrances or well-used areas (see <i>Zoning By-law Section 111</i>)	<input checked="" type="checkbox"/>
REQUIRED	2.1.3 Ensure that bicycle parking spaces and access aisles meet minimum dimensions; that no more than 50% of spaces are vertical spaces; and that parking racks are securely anchored (see <i>Zoning By-law Section 111</i>)	<input checked="" type="checkbox"/>
BASIC	2.1.4 Provide bicycle parking spaces equivalent to the expected number of resident-owned bicycles, plus the expected peak number of visitor cyclists	<input type="checkbox"/>
2.2 Secure bicycle parking		
REQUIRED	2.2.1 Where more than 50 bicycle parking spaces are provided for a single residential building, locate at least 25% of spaces within a building/structure, a secure area (e.g. supervised parking lot or enclosure) or bicycle lockers (see <i>Zoning By-law Section 111</i>)	<input checked="" type="checkbox"/>
BETTER	2.2.2 Provide secure bicycle parking spaces equivalent to at least the number of units at condominiums or multi-family residential developments	<input type="checkbox"/>
2.3 Bicycle repair station		
BETTER	2.3.1 Provide a permanent bike repair station, with commonly used tools and an air pump, adjacent to the main bicycle parking area (or secure bicycle parking area, if provided)	<input type="checkbox"/>
3. TRANSIT		
3.1 Customer amenities		
BASIC	3.1.1 Provide shelters, lighting and benches at any on-site transit stops	<input type="checkbox"/>
BASIC	3.1.2 Where the site abuts an off-site transit stop and insufficient space exists for a transit shelter in the public right-of-way, protect land for a shelter and/or install a shelter	<input type="checkbox"/>
BETTER	3.1.3 Provide a secure and comfortable interior waiting area by integrating any on-site transit stops into the building	<input type="checkbox"/>

TDM-supportive design & infrastructure measures: <i>Residential developments</i>		Check if completed & add descriptions, explanations or plan/drawing references
4. RIDESHARING		
4.1 Pick-up & drop-off facilities		
BASIC	4.1.1 Provide a designated area for carpool drivers (plus taxis and ride-hailing services) to drop off or pick up passengers without using fire lanes or other no-stopping zones	<input checked="" type="checkbox"/>
5. CARSHARING & BIKESHARING		
5.1 Carshare parking spaces		
BETTER	5.1.1 Provide up to three carshare parking spaces in an R3, R4 or R5 Zone for specified residential uses (see <i>Zoning By-law Section 94</i>)	<input type="checkbox"/> May be considered. To be confirmed during Site Plan Control process.
5.2 Bikeshare station location		
BETTER	5.2.1 Provide a designated bikeshare station area near a major building entrance, preferably lighted and sheltered with a direct walkway connection	<input type="checkbox"/>
6. PARKING		
6.1 Number of parking spaces		
REQUIRED	6.1.1 Do not provide more parking than permitted by zoning, nor less than required by zoning, unless a variance is being applied for	<input checked="" type="checkbox"/>
BASIC	6.1.2 Provide parking for long-term and short-term users that is consistent with mode share targets, considering the potential for visitors to use off-site public parking	<input checked="" type="checkbox"/>
BASIC	6.1.3 Where a site features more than one use, provide shared parking and reduce the cumulative number of parking spaces accordingly (see <i>Zoning By-law Section 104</i>)	<input type="checkbox"/>
BETTER	6.1.4 Reduce the minimum number of parking spaces required by zoning by one space for each 13 square metres of gross floor area provided as shower rooms, change rooms, locker rooms and other facilities for cyclists in conjunction with bicycle parking (see <i>Zoning By-law Section 111</i>)	<input type="checkbox"/>
6.2 Separate long-term & short-term parking areas		
BETTER	6.2.1 Provide separate areas for short-term and long-term parking (using signage or physical barriers) to permit access controls and simplify enforcement (i.e. to discourage residents from parking in visitor spaces, and vice versa)	<input checked="" type="checkbox"/>

TDM Measures Checklist:
Residential Developments (multi-family, condominium or subdivision)

Legend	
BASIC	The measure is generally feasible and effective, and in most cases would benefit the development and its users
BETTER	The measure could maximize support for users of sustainable modes, and optimize development performance
★	The measure is one of the most dependably effective tools to encourage the use of sustainable modes

TDM measures: <i>Residential developments</i>		Check if proposed & add descriptions
1. TDM PROGRAM MANAGEMENT		
1.1 Program coordinator		
BASIC	★	1.1.1 Designate an internal coordinator, or contract with an external coordinator <input type="checkbox"/> May be considered. To be confirmed during Site Plan Control process.
1.2 Travel surveys		
BETTER		1.2.1 Conduct periodic surveys to identify travel-related behaviours, attitudes, challenges and solutions, and to track progress <input type="checkbox"/> May be considered. To be confirmed during Site Plan Control process.
2. WALKING AND CYCLING		
2.1 Information on walking/cycling routes & destinations		
BASIC		2.1.1 Display local area maps with walking/cycling access routes and key destinations at major entrances (<i>multi-family, condominium</i>) <input checked="" type="checkbox"/>
2.2 Bicycle skills training		
BETTER		2.2.1 Offer on-site cycling courses for residents, or subsidize off-site courses <input type="checkbox"/>

TDM measures: <i>Residential developments</i>		Check if proposed & add descriptions
3. TRANSIT		
3.1 Transit information		
BASIC	3.1.1 Display relevant transit schedules and route maps at entrances (<i>multi-family, condominium</i>)	<input checked="" type="checkbox"/>
BETTER	3.1.2 Provide real-time arrival information display at entrances (<i>multi-family, condominium</i>)	<input type="checkbox"/>
3.2 Transit fare incentives		
BASIC ★	3.2.1 Offer PRESTO cards preloaded with one monthly transit pass on residence purchase/move-in, to encourage residents to use transit	<input checked="" type="checkbox"/>
BETTER	3.2.2 Offer at least one year of free monthly transit passes on residence purchase/move-in	<input type="checkbox"/> May be considered. To be confirmed during Site Plan Control process.
3.3 Enhanced public transit service		
BETTER ★	3.3.1 Contract with OC Transpo to provide early transit services until regular services are warranted by occupancy levels (<i>subdivision</i>)	<input type="checkbox"/>
3.4 Private transit service		
BETTER	3.4.1 Provide shuttle service for seniors homes or lifestyle communities (e.g. scheduled mall or supermarket runs)	<input type="checkbox"/>
4. CARSHARING & BIKESHARING		
4.1 Bikeshare stations & memberships		
BETTER	4.1.1 Contract with provider to install on-site bikeshare station (<i>multi-family</i>)	<input type="checkbox"/>
BETTER	4.1.2 Provide residents with bikeshare memberships, either free or subsidized (<i>multi-family</i>)	<input type="checkbox"/>
4.2 Carshare vehicles & memberships		
BETTER	4.2.1 Contract with provider to install on-site carshare vehicles and promote their use by residents	<input type="checkbox"/> May be considered. To be confirmed during Site Plan Control process.
BETTER	4.2.2 Provide residents with carshare memberships, either free or subsidized	<input type="checkbox"/>
5. PARKING		
5.1 Priced parking		
BASIC ★	5.1.1 Unbundle parking cost from purchase price (<i>condominium</i>)	<input type="checkbox"/>
BASIC ★	5.1.2 Unbundle parking cost from monthly rent (<i>multi-family</i>)	<input checked="" type="checkbox"/>

TDM measures: <i>Residential developments</i>		Check if proposed & add descriptions
6. TDM MARKETING & COMMUNICATIONS		
6.1 Multimodal travel information		
BASIC	★ 6.1.1 Provide a multimodal travel option information package to new residents	<input checked="" type="checkbox"/>
6.2 Personalized trip planning		
BETTER	★ 6.2.1 Offer personalized trip planning to new residents	<input type="checkbox"/>

DRAFT

Appendix G:

Synchro and SimTraffic Analysis Reports

Existing Conditions

Lanes, Volumes, Timings
1: Richmond Rd & McEwen Ave

Existing AM
12/12/2021

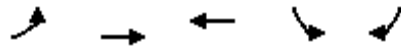

Lane Group	EBL	EBT	WBT	SBL	SBR	Ø9
Lane Configurations		↶	↷	↶	↷	
Traffic Volume (vph)	32	650	322	30	51	
Future Volume (vph)	32	650	322	30	51	
Lane Group Flow (vph)	0	758	382	33	57	
Turn Type	Perm	NA	NA	Perm	Perm	
Protected Phases		4	8			9
Permitted Phases	4			6	6	
Detector Phase	4	4	8	6	6	
Switch Phase						
Minimum Initial (s)	10.0	10.0	10.0	10.0	10.0	3.0
Minimum Split (s)	24.3	24.3	36.3	23.8	23.8	5.0
Total Split (s)	41.0	41.0	41.0	24.0	24.0	5.0
Total Split (%)	58.6%	58.6%	58.6%	34.3%	34.3%	7%
Yellow Time (s)	3.3	3.3	3.3	3.3	3.3	2.0
All-Red Time (s)	3.0	3.0	3.0	3.5	3.5	0.0
Lost Time Adjust (s)		0.0	0.0	0.0	0.0	
Total Lost Time (s)		6.3	6.3	6.8	6.8	
Lead/Lag						
Lead-Lag Optimize?						
Recall Mode	C-Max	C-Max	C-Max	None	None	None
Act Effct Green (s)		56.1	56.1	10.0	10.0	
Actuated g/C Ratio		0.80	0.80	0.14	0.14	
v/c Ratio		0.55	0.27	0.14	0.23	
Control Delay		7.1	5.5	27.9	10.9	
Queue Delay		0.0	0.0	0.0	0.0	
Total Delay		7.1	5.5	27.9	10.9	
LOS		A	A	C	B	
Approach Delay		7.1	5.5	17.1		
Approach LOS		A	A	B		
Queue Length 50th (m)		48.7	31.7	3.9	0.0	
Queue Length 95th (m)		80.8	52.5	11.0	8.9	
Internal Link Dist (m)		155.4	379.9	123.9		
Turn Bay Length (m)				20.0		
Base Capacity (vph)		1389	1417	416	389	
Starvation Cap Reductn		0	0	0	0	
Spillback Cap Reductn		0	0	0	0	
Storage Cap Reductn		0	0	0	0	
Reduced v/c Ratio		0.55	0.27	0.08	0.15	

Intersection Summary

Cycle Length: 70	
Actuated Cycle Length: 70	
Offset: 38 (54%), Referenced to phase 4:EBTL and 8:WBT, Start of Green	
Natural Cycle: 70	
Control Type: Actuated-Coordinated	
Maximum v/c Ratio: 0.55	
Intersection Signal Delay: 7.3	Intersection LOS: A
Intersection Capacity Utilization 86.2%	ICU Level of Service E
Analysis Period (min) 15	

Splits and Phases: 1: Richmond Rd & McEwen Ave



Lanes, Volumes, Timings
2: Richmond Rd & New Orchard Ave N

Existing AM
12/12/2021



Lane Group	EBL	EBT	WBT	SBL	Ø9
Lane Configurations					
Traffic Volume (vph)	13	675	347	119	
Future Volume (vph)	13	675	347	119	
Lane Group Flow (vph)	14	750	435	148	
Turn Type	Perm	NA	NA	Perm	
Protected Phases		4	8		9
Permitted Phases	4			6	
Detector Phase	4	4	8	6	
Switch Phase					
Minimum Initial (s)	10.0	10.0	10.0	10.0	3.0
Minimum Split (s)	24.3	24.3	32.3	28.7	5.0
Total Split (s)	36.0	36.0	36.0	29.0	5.0
Total Split (%)	51.4%	51.4%	51.4%	41.4%	7%
Yellow Time (s)	3.3	3.3	3.3	3.3	2.0
All-Red Time (s)	3.0	3.0	3.0	3.4	0.0
Lost Time Adjust (s)	0.0	0.0	0.0	0.0	
Total Lost Time (s)	6.3	6.3	6.3	6.7	
Lead/Lag					
Lead-Lag Optimize?					
Recall Mode	C-Max	C-Max	C-Max	None	None
Act Effct Green (s)	49.6	49.6	49.6	12.0	
Actuated g/C Ratio	0.71	0.71	0.71	0.17	
v/c Ratio	0.02	0.59	0.35	0.51	
Control Delay	2.2	5.6	6.8	30.4	
Queue Delay	0.0	0.0	0.0	0.0	
Total Delay	2.2	5.6	6.8	30.4	
LOS	A	A	A	C	
Approach Delay		5.5	6.8	30.4	
Approach LOS		A	A	C	
Queue Length 50th (m)	0.2	11.5	21.5	16.9	
Queue Length 95th (m)	m0.4	14.8	44.4	30.6	
Internal Link Dist (m)		379.9	396.9	54.3	
Turn Bay Length (m)	70.0				
Base Capacity (vph)	625	1263	1241	537	
Starvation Cap Reductn	0	0	0	0	
Spillback Cap Reductn	0	0	0	0	
Storage Cap Reductn	0	0	0	0	
Reduced v/c Ratio	0.02	0.59	0.35	0.28	

Intersection Summary

Cycle Length: 70	
Actuated Cycle Length: 70	
Offset: 68 (97%), Referenced to phase 4:EBTL and 8:WBT, Start of Green	
Natural Cycle: 75	
Control Type: Actuated-Coordinated	
Maximum v/c Ratio: 0.59	
Intersection Signal Delay: 8.7	Intersection LOS: A
Intersection Capacity Utilization 59.0%	ICU Level of Service B
Analysis Period (min) 15	

m Volume for 95th percentile queue is metered by upstream signal.

Splits and Phases: 2: Richmond Rd & New Orchard Ave N

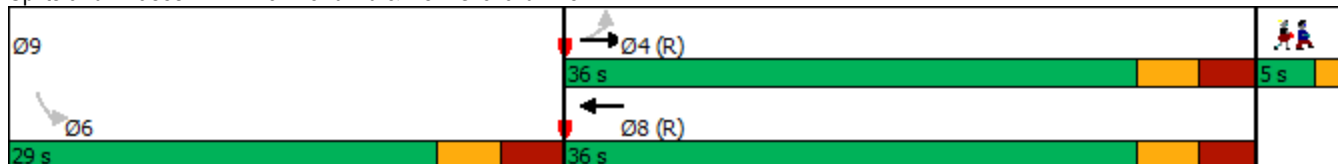

HCM Unsignalized Intersection Capacity Analysis
 3: New Orchard Ave N & Ambleside Dr

Existing AM
 12/12/2021



Movement	EBL	EBR	NBL	NBT	SBT	SBR
Lane Configurations						
Traffic Volume (veh/h)	1	87	54	16	18	2
Future Volume (Veh/h)	1	87	54	16	18	2
Sign Control	Stop			Free	Free	
Grade	0%			0%	0%	
Peak Hour Factor	0.90	0.90	0.90	0.90	0.90	0.90
Hourly flow rate (vph)	1	97	60	18	20	2
Pedestrians						
Lane Width (m)						
Walking Speed (m/s)						
Percent Blockage						
Right turn flare (veh)						
Median type				None	None	
Median storage veh						
Upstream signal (m)	78					
pX, platoon unblocked						
vC, conflicting volume	159	21	22			
vC1, stage 1 conf vol						
vC2, stage 2 conf vol						
vCu, unblocked vol	159	21	22			
tC, single (s)	6.4	6.2	4.1			
tC, 2 stage (s)						
tF (s)	3.5	3.3	2.2			
p0 queue free %	100	91	96			
cM capacity (veh/h)	801	1056	1593			
Direction, Lane #	EB 1	NB 1	SB 1			
Volume Total	98	78	22			
Volume Left	1	60	0			
Volume Right	97	0	2			
cSH	1053	1593	1700			
Volume to Capacity	0.09	0.04	0.01			
Queue Length 95th (m)	2.3	0.9	0.0			
Control Delay (s)	8.8	5.7	0.0			
Lane LOS	A	A				
Approach Delay (s)	8.8	5.7	0.0			
Approach LOS	A					
Intersection Summary						
Average Delay	6.6					
Intersection Capacity Utilization	23.1%			ICU Level of Service	A	
Analysis Period (min)	15					

Lanes, Volumes, Timings
6: Woodroffe Ave & Richmond Rd

Existing AM
12/12/2021

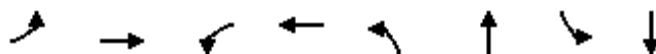

Lane Group	EBL	EBT	WBL	WBT	NBL	NBT	SBL	SBT
Lane Configurations								
Traffic Volume (vph)	152	739	62	229	117	257	39	329
Future Volume (vph)	152	739	62	229	117	257	39	329
Lane Group Flow (vph)	169	1061	69	276	130	388	43	434
Turn Type	pm+pt	NA	pm+pt	NA	pm+pt	NA	Perm	NA
Protected Phases	7	4	3	8	5	2		6
Permitted Phases	4		8		2		6	
Detector Phase	7	4	3	8	5	2	6	6
Switch Phase								
Minimum Initial (s)	5.0	10.0	5.0	10.0	5.0	10.0	10.0	10.0
Minimum Split (s)	11.7	33.9	11.7	33.9	10.3	31.5	31.5	31.5
Total Split (s)	15.0	39.0	15.0	39.0	12.0	46.0	34.0	34.0
Total Split (%)	15.0%	39.0%	15.0%	39.0%	12.0%	46.0%	34.0%	34.0%
Yellow Time (s)	3.3	3.3	3.3	3.3	3.3	3.3	3.3	3.3
All-Red Time (s)	3.4	3.6	3.4	3.6	2.0	3.2	3.2	3.2
Lost Time Adjust (s)	0.0	0.0	0.0	0.0	0.0	0.0	0.0	0.0
Total Lost Time (s)	6.7	6.9	6.7	6.9	5.3	6.5	6.5	6.5
Lead/Lag	Lead	Lag	Lead	Lag	Lead		Lag	Lag
Lead-Lag Optimize?	Yes	Yes	Yes	Yes	Yes		Yes	Yes
Recall Mode	None	C-Max	None	C-Max	None	Max	Max	Max
Act Effct Green (s)	42.4	35.5	39.8	32.2	40.7	39.5	27.5	27.5
Actuated g/C Ratio	0.42	0.36	0.40	0.32	0.41	0.40	0.28	0.28
v/c Ratio	0.37	1.72	0.35	0.26	0.60	0.57	0.17	0.90
Control Delay	18.5	356.0	20.1	25.0	32.0	26.4	29.8	57.7
Queue Delay	0.0	0.0	0.0	0.0	0.0	0.0	0.0	0.0
Total Delay	18.5	356.0	20.1	25.0	32.0	26.4	29.8	57.7
LOS	B	F	C	C	C	C	C	E
Approach Delay		309.6		24.0		27.8		55.2
Approach LOS		F		C		C		E
Queue Length 50th (m)	18.5	~316.8	7.1	20.0	15.9	54.5	6.3	79.4
Queue Length 95th (m)	31.3	#394.7	14.6	30.1	#28.8	83.7	15.2	#134.9
Internal Link Dist (m)		69.5		81.7		167.6		124.8
Turn Bay Length (m)	95.0		75.0		55.0		50.0	
Base Capacity (vph)	459	617	212	1078	216	677	253	483
Starvation Cap Reductn	0	0	0	0	0	0	0	0
Spillback Cap Reductn	0	0	0	0	0	0	0	0
Storage Cap Reductn	0	0	0	0	0	0	0	0
Reduced v/c Ratio	0.37	1.72	0.33	0.26	0.60	0.57	0.17	0.90

Intersection Summary

Cycle Length: 100	
Actuated Cycle Length: 100	
Offset: 35 (35%), Referenced to phase 4:EBTL and 8:WBTL, Start of Green	
Natural Cycle: 150	
Control Type: Actuated-Coordinated	
Maximum v/c Ratio: 1.72	
Intersection Signal Delay: 167.2	Intersection LOS: F
Intersection Capacity Utilization 110.6%	ICU Level of Service H
Analysis Period (min) 15	

Lanes, Volumes, Timings
 6: Woodroffe Ave & Richmond Rd

Existing AM
 12/12/2021

~ Volume exceeds capacity, queue is theoretically infinite.

Queue shown is maximum after two cycles.

95th percentile volume exceeds capacity, queue may be longer.

Queue shown is maximum after two cycles.

Splits and Phases: 6: Woodroffe Ave & Richmond Rd

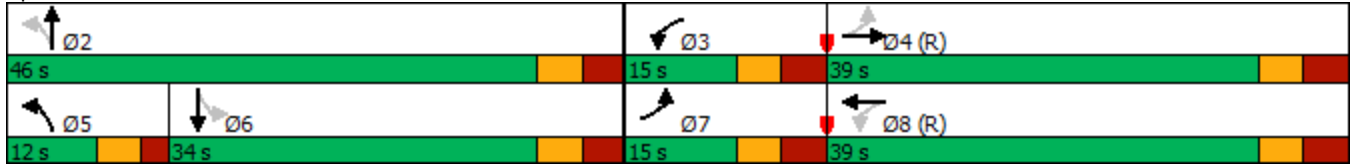

Lanes, Volumes, Timings
1: Richmond Rd & McEwen Ave

Existing PM
12/12/2021



Lane Group	EBL	EBT	WBT	SBL	SBR	Ø9
Lane Configurations		↖	↗	↖	↗	
Traffic Volume (vph)	81	426	822	35	66	
Future Volume (vph)	81	426	822	35	66	
Lane Group Flow (vph)	0	563	963	39	73	
Turn Type	Perm	NA	NA	Perm	Perm	
Protected Phases		4	8			9
Permitted Phases	4			6	6	
Detector Phase	4	4	8	6	6	
Switch Phase						
Minimum Initial (s)	10.0	10.0	10.0	10.0	10.0	3.0
Minimum Split (s)	24.3	24.3	36.3	23.8	23.8	5.0
Total Split (s)	56.0	56.0	56.0	24.0	24.0	5.0
Total Split (%)	65.9%	65.9%	65.9%	28.2%	28.2%	6%
Yellow Time (s)	3.3	3.3	3.3	3.3	3.3	2.0
All-Red Time (s)	3.0	3.0	3.0	3.5	3.5	0.0
Lost Time Adjust (s)		0.0	0.0	0.0	0.0	
Total Lost Time (s)		6.3	6.3	6.8	6.8	
Lead/Lag						
Lead-Lag Optimize?						
Recall Mode	C-Max	C-Max	C-Max	None	None	None
Act Effct Green (s)		66.5	66.5	10.0	10.0	
Actuated g/C Ratio		0.78	0.78	0.12	0.12	
v/c Ratio		0.61	0.70	0.20	0.32	
Control Delay		9.1	3.9	36.6	13.2	
Queue Delay		0.0	0.0	0.0	0.0	
Total Delay		9.1	3.9	36.6	13.2	
LOS		A	A	D	B	
Approach Delay		9.1	3.9	21.3		
Approach LOS		A	A	C		
Queue Length 50th (m)		39.1	19.1	5.8	0.0	
Queue Length 95th (m)		70.8	32.4	14.7	11.6	
Internal Link Dist (m)		155.4	379.9	123.9		
Turn Bay Length (m)				20.0		
Base Capacity (vph)		921	1385	342	339	
Starvation Cap Reductn		0	0	0	0	
Spillback Cap Reductn		0	0	0	0	
Storage Cap Reductn		0	0	0	0	
Reduced v/c Ratio		0.61	0.70	0.11	0.22	

Intersection Summary

Cycle Length: 85	
Actuated Cycle Length: 85	
Offset: 17 (20%), Referenced to phase 4:EBTL and 8:WBT, Start of Green	
Natural Cycle: 100	
Control Type: Actuated-Coordinated	
Maximum v/c Ratio: 0.70	
Intersection Signal Delay: 6.9	Intersection LOS: A
Intersection Capacity Utilization 104.9%	ICU Level of Service G
Analysis Period (min) 15	

Splits and Phases: 1: Richmond Rd & McEwen Ave

Ø9	 Ø4 (R)	
 Ø6	56 s	5 s
24 s	 Ø8 (R)	
	56 s	

Lanes, Volumes, Timings
2: Richmond Rd & New Orchard Ave N

Existing PM
12/12/2021



Lane Group	EBL	EBT	WBT	SBL	Ø9
Lane Configurations					
Traffic Volume (vph)	22	477	853	76	
Future Volume (vph)	22	477	853	76	
Lane Group Flow (vph)	24	530	1078	102	
Turn Type	Perm	NA	NA	Perm	
Protected Phases		4	8		9
Permitted Phases	4			6	
Detector Phase	4	4	8	6	
Switch Phase					
Minimum Initial (s)	10.0	10.0	10.0	10.0	3.0
Minimum Split (s)	24.3	24.3	32.3	28.7	5.0
Total Split (s)	51.0	51.0	51.0	29.0	5.0
Total Split (%)	60.0%	60.0%	60.0%	34.1%	6%
Yellow Time (s)	3.3	3.3	3.3	3.3	2.0
All-Red Time (s)	3.0	3.0	3.0	3.4	0.0
Lost Time Adjust (s)	0.0	0.0	0.0	0.0	
Total Lost Time (s)	6.3	6.3	6.3	6.7	
Lead/Lag					
Lead-Lag Optimize?					
Recall Mode	C-Max	C-Max	C-Max	None	None
Act Effct Green (s)	65.4	65.4	65.4	11.2	
Actuated g/C Ratio	0.77	0.77	0.77	0.13	
v/c Ratio	0.11	0.39	0.80	0.45	
Control Delay	8.3	8.4	15.1	36.1	
Queue Delay	0.0	0.0	0.0	0.0	
Total Delay	8.3	8.4	15.1	36.1	
LOS	A	A	B	D	
Approach Delay		8.4	15.1	36.1	
Approach LOS		A	B	D	
Queue Length 50th (m)	1.4	37.9	99.7	13.9	
Queue Length 95th (m)	m3.5	78.9	#236.5	27.2	
Internal Link Dist (m)		379.9	402.2	54.3	
Turn Bay Length (m)	70.0				
Base Capacity (vph)	219	1372	1347	440	
Starvation Cap Reductn	0	0	0	0	
Spillback Cap Reductn	0	0	0	0	
Storage Cap Reductn	0	0	0	0	
Reduced v/c Ratio	0.11	0.39	0.80	0.23	

Intersection Summary

Cycle Length: 85	
Actuated Cycle Length: 85	
Offset: 1 (1%), Referenced to phase 4:EBTL and 8:WBT, Start of Green	
Natural Cycle: 100	
Control Type: Actuated-Coordinated	
Maximum v/c Ratio: 0.80	
Intersection Signal Delay: 14.2	Intersection LOS: B
Intersection Capacity Utilization 75.7%	ICU Level of Service D
Analysis Period (min) 15	

Lanes, Volumes, Timings
 2: Richmond Rd & New Orchard Ave N

Existing PM
 12/12/2021

- # 95th percentile volume exceeds capacity, queue may be longer.
 Queue shown is maximum after two cycles.
- m Volume for 95th percentile queue is metered by upstream signal.

Splits and Phases: 2: Richmond Rd & New Orchard Ave N



HCM Unsignalized Intersection Capacity Analysis
3: New Orchard Ave N & Ambleside Dr

Existing PM
12/12/2021



Movement	EBL	EBR	NBL	NBT	SBT	SBR
Lane Configurations						
Traffic Volume (veh/h)	4	79	99	21	17	3
Future Volume (Veh/h)	4	79	99	21	17	3
Sign Control	Stop			Free	Free	
Grade	0%			0%	0%	
Peak Hour Factor	0.90	0.90	0.90	0.90	0.90	0.90
Hourly flow rate (vph)	4	88	110	23	19	3
Pedestrians						
Lane Width (m)						
Walking Speed (m/s)						
Percent Blockage						
Right turn flare (veh)						
Median type				None	None	
Median storage veh						
Upstream signal (m)	78					
pX, platoon unblocked						
vC, conflicting volume	264	20	22			
vC1, stage 1 conf vol						
vC2, stage 2 conf vol						
vCu, unblocked vol	264	20	22			
tC, single (s)	6.4	6.2	4.1			
tC, 2 stage (s)						
tF (s)	3.5	3.3	2.2			
p0 queue free %	99	92	93			
cM capacity (veh/h)	675	1057	1593			
Direction, Lane #	EB 1	NB 1	SB 1			
Volume Total	92	133	22			
Volume Left	4	110	0			
Volume Right	88	0	3			
cSH	1032	1593	1700			
Volume to Capacity	0.09	0.07	0.01			
Queue Length 95th (m)	2.2	1.7	0.0			
Control Delay (s)	8.8	6.2	0.0			
Lane LOS	A	A				
Approach Delay (s)	8.8	6.2	0.0			
Approach LOS	A					
Intersection Summary						
Average Delay			6.6			
Intersection Capacity Utilization			25.7%	ICU Level of Service	A	
Analysis Period (min)			15			

Lanes, Volumes, Timings
6: Woodroffe Ave & Richmond Rd

Existing PM
12/12/2021

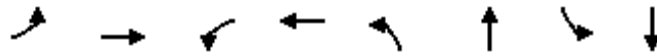

Lane Group	EBL	EBT	WBL	WBT	NBL	NBT	SBL	SBT
Lane Configurations								
Traffic Volume (vph)	83	322	217	627	232	402	25	340
Future Volume (vph)	83	322	217	627	232	402	25	340
Lane Group Flow (vph)	92	552	241	731	258	545	28	447
Turn Type	pm+pt	NA	pm+pt	NA	pm+pt	NA	Perm	NA
Protected Phases	7	4	3	8	5	2		6
Permitted Phases	4		8		2		6	
Detector Phase	7	4	3	8	5	2	6	6
Switch Phase								
Minimum Initial (s)	5.0	10.0	5.0	10.0	5.0	10.0	10.0	10.0
Minimum Split (s)	11.7	33.9	11.7	33.9	10.3	31.5	31.5	31.5
Total Split (s)	14.0	46.0	14.0	46.0	16.0	50.0	34.0	34.0
Total Split (%)	12.7%	41.8%	12.7%	41.8%	14.5%	45.5%	30.9%	30.9%
Yellow Time (s)	3.3	3.3	3.3	3.3	3.3	3.3	3.3	3.3
All-Red Time (s)	3.4	3.6	3.4	3.6	2.0	3.2	3.2	3.2
Lost Time Adjust (s)	0.0	0.0	0.0	0.0	0.0	0.0	0.0	0.0
Total Lost Time (s)	6.7	6.9	6.7	6.9	5.3	6.5	6.5	6.5
Lead/Lag	Lead	Lag	Lead	Lag	Lead		Lag	Lag
Lead-Lag Optimize?	Yes	Yes	Yes	Yes	Yes		Yes	Yes
Recall Mode	None	C-Max	None	C-Max	None	Max	Max	Max
Act Effct Green (s)	46.4	39.1	47.9	41.9	44.7	43.5	27.5	27.5
Actuated g/C Ratio	0.42	0.36	0.44	0.38	0.41	0.40	0.25	0.25
v/c Ratio	0.33	0.91	1.10	0.57	1.11	0.80	0.18	1.02
Control Delay	19.0	53.0	113.6	29.8	119.7	38.9	36.1	88.0
Queue Delay	0.0	0.0	0.0	0.0	0.0	0.0	0.0	0.0
Total Delay	19.0	53.0	113.6	29.8	119.7	38.9	36.1	88.0
LOS	B	D	F	C	F	D	D	F
Approach Delay		48.2		50.5		64.8		84.9
Approach LOS		D		D		E		F
Queue Length 50th (m)	10.4	107.0	~35.1	66.8	~48.1	99.5	4.7	~97.6
Queue Length 95th (m)	19.4	#172.1	#84.2	86.4	#98.3	#145.6	12.8	#161.4
Internal Link Dist (m)		69.3		80.5		174.1		118.0
Turn Bay Length (m)	95.0		75.0		55.0		50.0	
Base Capacity (vph)	285	607	220	1281	232	685	155	440
Starvation Cap Reductn	0	0	0	0	0	0	0	0
Spillback Cap Reductn	0	0	0	0	0	0	0	0
Storage Cap Reductn	0	0	0	0	0	0	0	0
Reduced v/c Ratio	0.32	0.91	1.10	0.57	1.11	0.80	0.18	1.02

Intersection Summary

Cycle Length: 110	
Actuated Cycle Length: 110	
Offset: 0 (0%), Referenced to phase 4:EBTL and 8:WBTL, Start of Green	
Natural Cycle: 120	
Control Type: Actuated-Coordinated	
Maximum v/c Ratio: 1.11	
Intersection Signal Delay: 59.6	Intersection LOS: E
Intersection Capacity Utilization 101.2%	ICU Level of Service G
Analysis Period (min) 15	

Lanes, Volumes, Timings
 6: Woodroffe Ave & Richmond Rd

Existing PM
 12/12/2021

~ Volume exceeds capacity, queue is theoretically infinite.

Queue shown is maximum after two cycles.

95th percentile volume exceeds capacity, queue may be longer.

Queue shown is maximum after two cycles.

Splits and Phases: 6: Woodroffe Ave & Richmond Rd

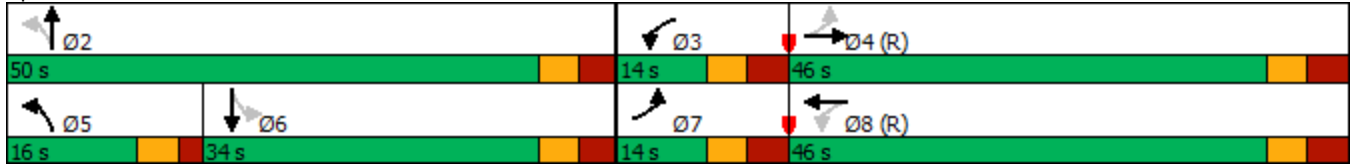

Total Future Background 2026

Lanes, Volumes, Timings
1: Richmond Rd & McEwen Ave

Future Background 2026 AM
01/18/2022



Lane Group	EBL	EBT	WBT	SBL	SBR	Ø3	Ø5	Ø7
Lane Configurations								
Traffic Volume (vph)	32	717	357	30	51			
Future Volume (vph)	32	717	357	30	51			
Lane Group Flow (vph)	0	749	379	30	51			
Turn Type	Perm	NA	NA	Perm	Perm			
Protected Phases		4	8			3	5	7
Permitted Phases	4			6	6			
Detector Phase	4	4	8	6	6			
Switch Phase								
Minimum Initial (s)	10.0	10.0	10.0	10.0	10.0	1.0	1.0	1.0
Minimum Split (s)	24.3	24.3	31.3	23.8	23.8	5.0	5.0	5.0
Total Split (s)	36.2	36.2	36.2	23.8	23.8	5.0	5.0	5.0
Total Split (%)	51.7%	51.7%	51.7%	34.0%	34.0%	7%	7%	7%
Yellow Time (s)	3.3	3.3	3.3	3.3	3.3	2.0	2.0	2.0
All-Red Time (s)	3.0	3.0	3.0	3.5	3.5	0.0	0.0	0.0
Lost Time Adjust (s)		0.0	0.0	0.0	0.0			
Total Lost Time (s)		6.3	6.3	6.8	6.8			
Lead/Lag	Lag	Lag	Lag	Lag	Lag	Lead	Lead	Lead
Lead-Lag Optimize?	Yes	Yes	Yes	Yes	Yes	Yes	Yes	Yes
Recall Mode	C-Max	C-Max	C-Max	None	None	None	None	None
Act Effct Green (s)		56.1	56.1	10.0	10.0			
Actuated g/C Ratio		0.80	0.80	0.14	0.14			
v/c Ratio		0.54	0.27	0.12	0.21			
Control Delay		6.9	5.5	27.7	11.1			
Queue Delay		0.0	0.0	0.0	0.0			
Total Delay		6.9	5.5	27.7	11.1			
LOS		A	A	C	B			
Approach Delay		6.9	5.5	17.3				
Approach LOS		A	A	B				
Queue Length 50th (m)		47.5	31.1	3.5	0.0			
Queue Length 95th (m)		78.5	51.6	10.4	8.6			
Internal Link Dist (m)		155.4	379.9	123.9				
Turn Bay Length (m)				20.0				
Base Capacity (vph)		1395	1417	411	381			
Starvation Cap Reductn		0	0	0	0			
Spillback Cap Reductn		0	0	0	0			
Storage Cap Reductn		0	0	0	0			
Reduced v/c Ratio		0.54	0.27	0.07	0.13			

Intersection Summary

Cycle Length: 70	
Actuated Cycle Length: 70	
Offset: 38 (54%), Referenced to phase 4:EBTL and 8:WBT, Start of Green	
Natural Cycle: 80	
Control Type: Actuated-Coordinated	
Maximum v/c Ratio: 0.54	
Intersection Signal Delay: 7.2	Intersection LOS: A
Intersection Capacity Utilization 89.8%	ICU Level of Service E
Analysis Period (min) 15	

Splits and Phases: 1: Richmond Rd & McEwen Ave

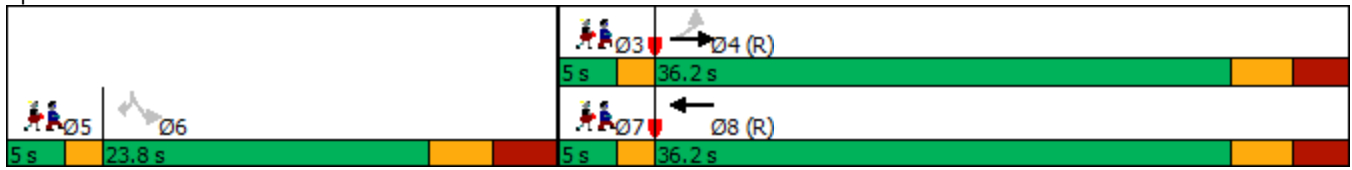

Lanes, Volumes, Timings
2: Richmond Rd & New Orchard Ave N

Future Background 2026 AM

01/18/2022



Lane Group	EBL	EBT	WBT	SBL	Ø3	Ø5	Ø7
Lane Configurations		↕	↔	↗			
Traffic Volume (vph)	15	743	382	128			
Future Volume (vph)	15	743	382	128			
Lane Group Flow (vph)	0	758	431	145			
Turn Type	Perm	NA	NA	Perm			
Protected Phases		4	8		3	5	7
Permitted Phases	4			6			
Detector Phase	4	4	8	6			
Switch Phase							
Minimum Initial (s)	10.0	10.0	10.0	10.0	1.0	1.0	1.0
Minimum Split (s)	24.3	24.3	27.3	28.7	5.0	5.0	5.0
Total Split (s)	31.3	31.3	31.3	28.7	5.0	5.0	5.0
Total Split (%)	44.7%	44.7%	44.7%	41.0%	7%	7%	7%
Yellow Time (s)	3.3	3.3	3.3	3.3	2.0	2.0	2.0
All-Red Time (s)	3.0	3.0	3.0	3.4	0.0	0.0	0.0
Lost Time Adjust (s)		0.0	0.0	0.0			
Total Lost Time (s)		6.3	6.3	6.7			
Lead/Lag	Lag	Lag	Lag	Lag	Lead	Lead	Lead
Lead-Lag Optimize?	Yes	Yes	Yes	Yes	Yes	Yes	Yes
Recall Mode	C-Max	C-Max	C-Max	None	None	None	None
Act Effct Green (s)		49.7	49.7	11.9			
Actuated g/C Ratio		0.71	0.71	0.17			
v/c Ratio		0.60	0.35	0.50			
Control Delay		5.8	6.7	30.1			
Queue Delay		0.0	0.0	0.0			
Total Delay		5.8	6.7	30.1			
LOS		A	A	C			
Approach Delay		5.8	6.7	30.1			
Approach LOS		A	A	C			
Queue Length 50th (m)		11.0	21.1	16.4			
Queue Length 95th (m)		14.3	43.6	29.8			
Internal Link Dist (m)		379.9	124.6	54.3			
Turn Bay Length (m)							
Base Capacity (vph)		1253	1243	530			
Starvation Cap Reductn		0	0	0			
Spillback Cap Reductn		0	0	0			
Storage Cap Reductn		0	0	0			
Reduced v/c Ratio		0.60	0.35	0.27			

Intersection Summary

Cycle Length: 70	
Actuated Cycle Length: 70	
Offset: 68 (97%), Referenced to phase 4:EBTL and 8:WBT, Start of Green	
Natural Cycle: 90	
Control Type: Actuated-Coordinated	
Maximum v/c Ratio: 0.60	
Intersection Signal Delay: 8.7	Intersection LOS: A
Intersection Capacity Utilization 75.7%	ICU Level of Service D
Analysis Period (min) 15	

Splits and Phases: 2: Richmond Rd & New Orchard Ave N

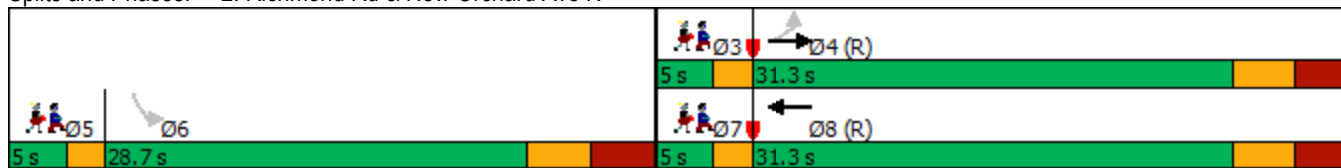

HCM Unsignalized Intersection Capacity Analysis
3: New Orchard Ave N & Ambleside Dr

Future Background 2026 AM
01/18/2022



Movement	EBL	EBR	NBL	NBT	SBT	SBR
Lane Configurations						
Traffic Volume (veh/h)	1	87	54	22	30	2
Future Volume (Veh/h)	1	87	54	22	30	2
Sign Control	Stop			Free	Free	
Grade	0%			0%	0%	
Peak Hour Factor	1.00	1.00	1.00	1.00	1.00	1.00
Hourly flow rate (vph)	1	87	54	22	30	2
Pedestrians						
Lane Width (m)						
Walking Speed (m/s)						
Percent Blockage						
Right turn flare (veh)						
Median type				None	None	
Median storage veh						
Upstream signal (m)	78					
pX, platoon unblocked						
vC, conflicting volume	161	31	32			
vC1, stage 1 conf vol						
vC2, stage 2 conf vol						
vCu, unblocked vol	161	31	32			
tC, single (s)	6.4	6.2	4.1			
tC, 2 stage (s)						
tF (s)	3.5	3.3	2.2			
p0 queue free %	100	92	97			
cM capacity (veh/h)	802	1043	1580			
Direction, Lane #	EB 1	NB 1	SB 1			
Volume Total	88	76	32			
Volume Left	1	54	0			
Volume Right	87	0	2			
cSH	1040	1580	1700			
Volume to Capacity	0.08	0.03	0.02			
Queue Length 95th (m)	2.1	0.8	0.0			
Control Delay (s)	8.8	5.3	0.0			
Lane LOS	A	A				
Approach Delay (s)	8.8	5.3	0.0			
Approach LOS	A					
Intersection Summary						
Average Delay			6.0			
Intersection Capacity Utilization			23.5%	ICU Level of Service	A	
Analysis Period (min)			15			

Lanes, Volumes, Timings
6: Woodroffe Ave & Richmond Rd

Future Background 2026 AM
01/18/2022

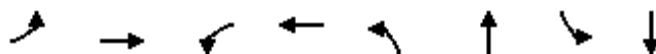

Lane Group	EBL	EBT	WBL	WBT	NBL	NBT	SBL	SBT	Ø9
Lane Configurations									
Traffic Volume (vph)	152	818	62	255	119	257	39	329	
Future Volume (vph)	152	818	62	255	119	257	39	329	
Lane Group Flow (vph)	152	1038	62	275	119	349	39	390	
Turn Type	Prot	NA	Prot	NA	pm+pt	NA	Perm	NA	
Protected Phases	7	4	3	8	5	2		6	9
Permitted Phases					2		6		
Detector Phase	7	4	3	8	5	2	6	6	
Switch Phase									
Minimum Initial (s)	5.0	10.0	5.0	10.0	5.0	10.0	10.0	10.0	1.0
Minimum Split (s)	11.9	28.9	11.7	33.9	11.5	31.5	31.5	31.5	5.0
Total Split (s)	21.3	40.3	11.7	35.7	11.5	43.0	31.5	31.5	5.0
Total Split (%)	21.3%	40.3%	11.7%	35.7%	11.5%	43.0%	31.5%	31.5%	5%
Yellow Time (s)	3.3	3.3	3.3	3.3	3.3	3.3	3.3	3.3	2.0
All-Red Time (s)	3.6	3.6	3.4	3.6	3.2	3.2	3.2	3.2	0.0
Lost Time Adjust (s)	0.0	0.0	0.0	0.0	0.0	0.0	0.0	0.0	
Total Lost Time (s)	6.9	6.9	6.7	6.9	6.5	6.5	6.5	6.5	
Lead/Lag	Lead		Lead	Lag	Lead		Lag	Lag	Lag
Lead-Lag Optimize?	Yes		Yes	Yes	Yes		Yes	Yes	Yes
Recall Mode	None	C-Max	None	C-Max	None	Max	Max	Max	None
Act Effct Green (s)	12.8	40.7	5.0	30.4	36.5	36.5	25.0	25.0	
Actuated g/C Ratio	0.13	0.41	0.05	0.30	0.36	0.36	0.25	0.25	
v/c Ratio	0.70	1.49	0.74	0.51	0.64	0.57	0.16	0.90	
Control Delay	59.3	254.2	92.8	33.5	40.2	29.9	31.6	62.0	
Queue Delay	0.0	0.0	0.0	0.0	0.0	0.0	0.0	0.0	
Total Delay	59.3	254.2	92.8	33.5	40.2	29.9	31.6	62.0	
LOS	E	F	F	C	D	C	C	E	
Approach Delay		229.3		44.4		32.5		59.3	
Approach LOS		F		D		C		E	
Queue Length 50th (m)	28.1	~287.6	12.1	44.8	15.5	53.5	5.9	73.3	
Queue Length 95th (m)	#49.3	#361.4	#33.9	70.2	#32.1	81.5	14.7	#125.9	
Internal Link Dist (m)		341.9		81.7		167.6		124.8	
Turn Bay Length (m)	95.0		75.0		55.0		50.0		
Base Capacity (vph)	244	697	84	534	185	613	239	433	
Starvation Cap Reductn	0	0	0	0	0	0	0	0	
Spillback Cap Reductn	0	0	0	0	0	0	0	0	
Storage Cap Reductn	0	0	0	0	0	0	0	0	
Reduced v/c Ratio	0.62	1.49	0.74	0.51	0.64	0.57	0.16	0.90	

Intersection Summary

Cycle Length: 100	
Actuated Cycle Length: 100	
Offset: 0 (0%), Referenced to phase 4:EBT and 8:WBT, Start of Green	
Natural Cycle: 150	
Control Type: Actuated-Coordinated	
Maximum v/c Ratio: 1.49	
Intersection Signal Delay: 135.5	Intersection LOS: F
Intersection Capacity Utilization 115.4%	ICU Level of Service H
Analysis Period (min) 15	

~ Volume exceeds capacity, queue is theoretically infinite.

Queue shown is maximum after two cycles.

95th percentile volume exceeds capacity, queue may be longer.

Queue shown is maximum after two cycles.

Splits and Phases: 6: Woodroffe Ave & Richmond Rd

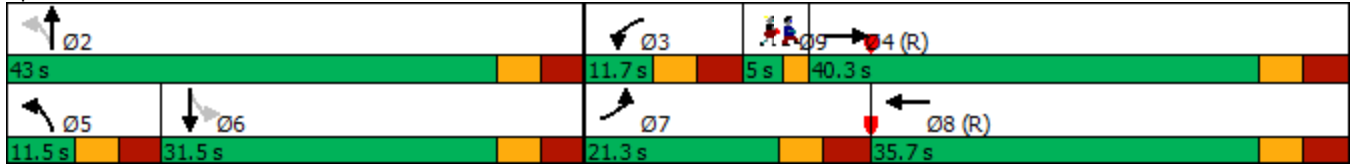

Lanes, Volumes, Timings
1: Richmond Rd & McEwen Ave

Future Background 2026 PM

01/18/2022

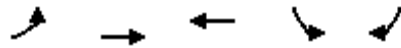

Lane Group	EBL	EBT	WBT	SBL	SBR	Ø3	Ø5	Ø7
Lane Configurations		↖	↔	↗	↗			
Traffic Volume (vph)	81	472	906	35	66			
Future Volume (vph)	81	472	906	35	66			
Lane Group Flow (vph)	0	553	951	35	66			
Turn Type	Perm	NA	NA	Perm	Perm			
Protected Phases		4	8			3	5	7
Permitted Phases	4			6	6			
Detector Phase	4	4	8	6	6			
Switch Phase								
Minimum Initial (s)	10.0	10.0	10.0	10.0	10.0	1.0	1.0	1.0
Minimum Split (s)	24.3	24.3	36.3	23.8	23.8	5.0	5.0	5.0
Total Split (s)	45.0	45.0	45.0	26.0	26.0	7.0	7.0	7.0
Total Split (%)	52.9%	52.9%	52.9%	30.6%	30.6%	8%	8%	8%
Yellow Time (s)	3.3	3.3	3.3	3.3	3.3	2.0	2.0	2.0
All-Red Time (s)	3.0	3.0	3.0	3.5	3.5	0.0	0.0	0.0
Lost Time Adjust (s)		0.0	0.0	0.0	0.0			
Total Lost Time (s)		6.3	6.3	6.8	6.8			
Lead/Lag	Lag	Lag	Lag	Lag	Lag	Lead	Lead	Lead
Lead-Lag Optimize?	Yes	Yes	Yes	Yes	Yes	Yes	Yes	Yes
Recall Mode	C-Max	C-Max	C-Max	None	None	None	None	None
Act Effct Green (s)		66.5	66.5	10.0	10.0			
Actuated g/C Ratio		0.78	0.78	0.12	0.12			
v/c Ratio		0.56	0.69	0.18	0.30			
Control Delay		7.8	5.4	36.2	13.4			
Queue Delay		0.0	0.0	0.0	0.0			
Total Delay		7.8	5.4	36.2	13.4			
LOS		A	A	D	B			
Approach Delay		7.8	5.4	21.3				
Approach LOS		A	A	C				
Queue Length 50th (m)		35.7	31.2	5.2	0.0			
Queue Length 95th (m)		61.8	54.1	13.6	11.1			
Internal Link Dist (m)		155.4	379.9	123.9				
Turn Bay Length (m)				20.0				
Base Capacity (vph)		986	1386	382	365			
Starvation Cap Reductn		0	0	0	0			
Spillback Cap Reductn		0	0	0	0			
Storage Cap Reductn		0	0	0	0			
Reduced v/c Ratio		0.56	0.69	0.09	0.18			

Intersection Summary

Cycle Length: 85	
Actuated Cycle Length: 85	
Offset: 17 (20%), Referenced to phase 4:EBTL and 8:WBT, Start of Green	
Natural Cycle: 110	
Control Type: Actuated-Coordinated	
Maximum v/c Ratio: 0.69	
Intersection Signal Delay: 7.2	Intersection LOS: A
Intersection Capacity Utilization 112.1%	ICU Level of Service H
Analysis Period (min) 15	

Splits and Phases: 1: Richmond Rd & McEwen Ave

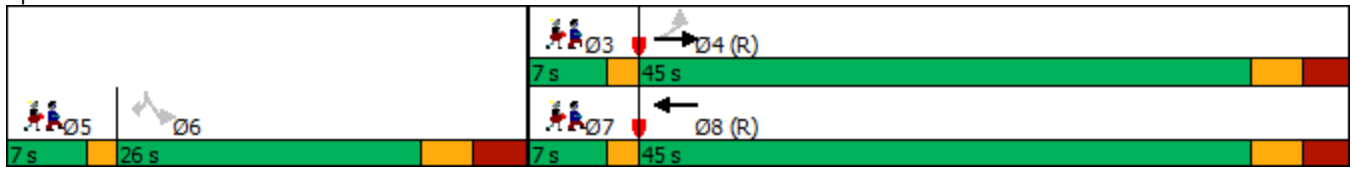

Lanes, Volumes, Timings
2: Richmond Rd & New Orchard Ave N

Future Background 2026 PM
01/18/2022



Lane Group	EBL	EBT	WBT	SBL	Ø3	Ø5	Ø7
Lane Configurations							
Traffic Volume (vph)	25	525	938	82			
Future Volume (vph)	25	525	938	82			
Lane Group Flow (vph)	0	550	1063	100			
Turn Type	Perm	NA	NA	Perm			
Protected Phases		4	8		3	5	7
Permitted Phases	4			6			
Detector Phase	4	4	8	6			
Switch Phase							
Minimum Initial (s)	10.0	10.0	10.0	10.0	1.0	1.0	1.0
Minimum Split (s)	24.3	24.3	27.3	28.7	5.0	5.0	5.0
Total Split (s)	46.3	46.3	46.3	28.7	5.0	5.0	5.0
Total Split (%)	54.5%	54.5%	54.5%	33.8%	6%	6%	6%
Yellow Time (s)	3.3	3.3	3.3	3.3	2.0	2.0	2.0
All-Red Time (s)	3.0	3.0	3.0	3.4	0.0	0.0	0.0
Lost Time Adjust (s)		0.0	0.0	0.0			
Total Lost Time (s)		6.3	6.3	6.7			
Lead/Lag	Lag	Lag	Lag	Lag	Lead	Lead	Lead
Lead-Lag Optimize?	Yes	Yes	Yes	Yes	Yes	Yes	Yes
Recall Mode	C-Max	C-Max	C-Max	None	None	None	None
Act Effct Green (s)		65.5	65.5	11.1			
Actuated g/C Ratio		0.77	0.77	0.13			
v/c Ratio		0.43	0.79	0.44			
Control Delay		7.1	14.5	35.6			
Queue Delay		0.0	0.0	0.0			
Total Delay		7.1	14.5	35.6			
LOS		A	B	D			
Approach Delay		7.1	14.5	35.6			
Approach LOS		A	B	D			
Queue Length 50th (m)		26.9	96.1	13.4			
Queue Length 95th (m)		74.3	#230.6	26.6			
Internal Link Dist (m)		379.9	122.7	54.3			
Turn Bay Length (m)							
Base Capacity (vph)		1282	1348	435			
Starvation Cap Reductn		0	0	0			
Spillback Cap Reductn		0	0	0			
Storage Cap Reductn		0	0	0			
Reduced v/c Ratio		0.43	0.79	0.23			

Intersection Summary

Cycle Length: 85	
Actuated Cycle Length: 85	
Offset: 1 (1%), Referenced to phase 4:EBTL and 8:WBT, Start of Green	
Natural Cycle: 110	
Control Type: Actuated-Coordinated	
Maximum v/c Ratio: 0.79	
Intersection Signal Delay: 13.3	Intersection LOS: B
Intersection Capacity Utilization 80.9%	ICU Level of Service D
Analysis Period (min) 15	

95th percentile volume exceeds capacity, queue may be longer.
 Queue shown is maximum after two cycles.

Splits and Phases: 2: Richmond Rd & New Orchard Ave N

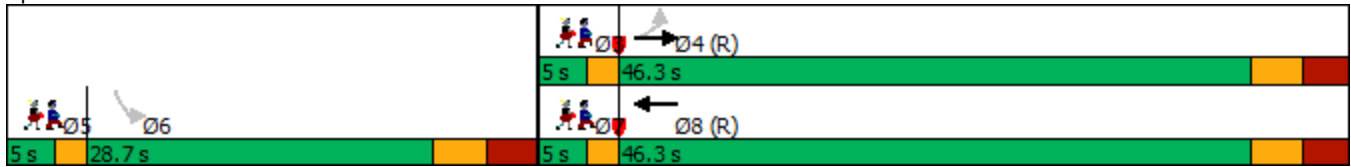

HCM Unsignalized Intersection Capacity Analysis
3: New Orchard Ave N & Ambleside Dr

Future Background 2026 PM
01/18/2022



Movement	EBL	EBR	NBL	NBT	SBT	SBR
Lane Configurations						
Traffic Volume (veh/h)	4	79	99	31	25	3
Future Volume (Veh/h)	4	79	99	31	25	3
Sign Control	Stop			Free	Free	
Grade	0%			0%	0%	
Peak Hour Factor	1.00	1.00	1.00	1.00	1.00	1.00
Hourly flow rate (vph)	4	79	99	31	25	3
Pedestrians						
Lane Width (m)						
Walking Speed (m/s)						
Percent Blockage						
Right turn flare (veh)						
Median type				None	None	
Median storage veh						
Upstream signal (m)	78					
pX, platoon unblocked						
vC, conflicting volume	256	26	28			
vC1, stage 1 conf vol						
vC2, stage 2 conf vol						
vCu, unblocked vol	256	26	28			
tC, single (s)	6.4	6.2	4.1			
tC, 2 stage (s)						
tF (s)	3.5	3.3	2.2			
p0 queue free %	99	92	94			
cM capacity (veh/h)	687	1049	1585			
Direction, Lane #	EB 1	NB 1	SB 1			
Volume Total	83	130	28			
Volume Left	4	99	0			
Volume Right	79	0	3			
cSH	1023	1585	1700			
Volume to Capacity	0.08	0.06	0.02			
Queue Length 95th (m)	2.0	1.5	0.0			
Control Delay (s)	8.8	5.8	0.0			
Lane LOS	A	A				
Approach Delay (s)	8.8	5.8	0.0			
Approach LOS	A					
Intersection Summary						
Average Delay			6.2			
Intersection Capacity Utilization			26.2%	ICU Level of Service	A	
Analysis Period (min)			15			

Lanes, Volumes, Timings
6: Woodroffe Ave & Richmond Rd

Future Background 2026 PM
01/18/2022

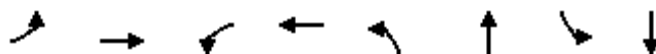

Lane Group	EBL	EBT	WBL	WBT	NBL	NBT	SBL	SBT	Ø9
Lane Configurations									
Traffic Volume (vph)	83	358	217	695	235	402	25	340	
Future Volume (vph)	83	358	217	695	235	402	25	340	
Lane Group Flow (vph)	83	535	217	726	235	490	25	402	
Turn Type	Prot	NA	Prot	NA	pm+pt	NA	Perm	NA	
Protected Phases	7	4	3	8	5	2		6	9
Permitted Phases					2		6		
Detector Phase	7	4	3	8	5	2	6	6	
Switch Phase									
Minimum Initial (s)	5.0	10.0	5.0	10.0	5.0	10.0	10.0	10.0	1.0
Minimum Split (s)	11.9	33.9	11.7	33.9	11.5	31.5	31.5	31.5	5.0
Total Split (s)	12.0	40.5	18.0	51.5	15.0	46.5	31.5	31.5	5.0
Total Split (%)	10.9%	36.8%	16.4%	46.8%	13.6%	42.3%	28.6%	28.6%	5%
Yellow Time (s)	3.3	3.3	3.3	3.3	3.3	3.3	3.3	3.3	2.0
All-Red Time (s)	3.6	3.6	3.4	3.6	3.2	3.2	3.2	3.2	0.0
Lost Time Adjust (s)	0.0	0.0	0.0	0.0	2.0	0.0	0.0	0.0	
Total Lost Time (s)	6.9	6.9	6.7	6.9	8.5	6.5	6.5	6.5	
Lead/Lag	Lead		Lead	Lag	Lead		Lag	Lag	Lag
Lead-Lag Optimize?	Yes		Yes	Yes	Yes		Yes	Yes	Yes
Recall Mode	None	C-Max	None	C-Max	None	Max	Max	Max	None
Act Effct Green (s)	5.1	38.6	11.3	44.6	38.0	40.0	25.0	25.0	
Actuated g/C Ratio	0.05	0.35	0.10	0.41	0.35	0.36	0.23	0.23	
v/c Ratio	1.06	0.92	1.25	1.01	1.42	0.79	0.16	1.02	
Control Delay	171.5	56.9	191.5	70.2	249.2	41.7	37.4	94.1	
Queue Delay	0.0	0.0	0.0	0.0	0.0	0.0	0.0	0.0	
Total Delay	171.5	56.9	191.5	70.2	249.2	41.7	37.4	94.1	
LOS	F	E	F	E	F	D	D	F	
Approach Delay		72.3		98.1		109.0		90.8	
Approach LOS		E		F		F		F	
Queue Length 50th (m)	~19.6	108.9	~58.2	~157.7	~53.8	92.6	4.3	~91.9	
Queue Length 95th (m)	#50.5	#173.0	#104.3	#234.4	#102.1	#135.2	12.0	#150.1	
Internal Link Dist (m)		348.7		80.5		174.1		118.0	
Turn Bay Length (m)	95.0		75.0		55.0		50.0		
Base Capacity (vph)	78	583	174	717	165	624	156	393	
Starvation Cap Reductn	0	0	0	0	0	0	0	0	
Spillback Cap Reductn	0	0	0	0	0	0	0	0	
Storage Cap Reductn	0	0	0	0	0	0	0	0	
Reduced v/c Ratio	1.06	0.92	1.25	1.01	1.42	0.79	0.16	1.02	

Intersection Summary

Cycle Length: 110	
Actuated Cycle Length: 110	
Offset: 0 (0%), Referenced to phase 4:EBT and 8:WBT, Start of Green	
Natural Cycle: 145	
Control Type: Actuated-Coordinated	
Maximum v/c Ratio: 1.42	
Intersection Signal Delay: 94.0	Intersection LOS: F
Intersection Capacity Utilization 106.3%	ICU Level of Service G
Analysis Period (min) 15	

~ Volume exceeds capacity, queue is theoretically infinite.

Queue shown is maximum after two cycles.

95th percentile volume exceeds capacity, queue may be longer.

Queue shown is maximum after two cycles.

Splits and Phases: 6: Woodroffe Ave & Richmond Rd

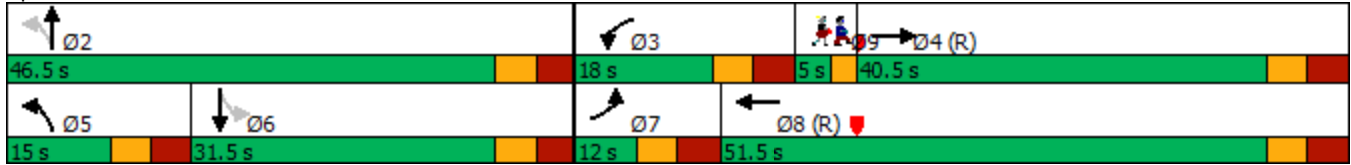

Total Future Background 2031

Lanes, Volumes, Timings
1: Richmond Rd & McEwen Ave

Future Background 2031 AM
01/18/2022



Lane Group	EBL	EBT	WBT	SBL	SBR	Ø3	Ø5	Ø7
Lane Configurations		↶	↷	↶	↷			
Traffic Volume (vph)	32	782	389	30	51			
Future Volume (vph)	32	782	389	30	51			
Lane Group Flow (vph)	0	814	411	30	51			
Turn Type	Perm	NA	NA	Perm	Perm			
Protected Phases		4	8			3	5	7
Permitted Phases	4			6	6			
Detector Phase	4	4	8	6	6			
Switch Phase								
Minimum Initial (s)	10.0	10.0	10.0	10.0	10.0	1.0	1.0	1.0
Minimum Split (s)	24.3	24.3	31.3	23.8	23.8	5.0	5.0	5.0
Total Split (s)	36.2	36.2	36.2	23.8	23.8	5.0	5.0	5.0
Total Split (%)	51.7%	51.7%	51.7%	34.0%	34.0%	7%	7%	7%
Yellow Time (s)	3.3	3.3	3.3	3.3	3.3	2.0	2.0	2.0
All-Red Time (s)	3.0	3.0	3.0	3.5	3.5	0.0	0.0	0.0
Lost Time Adjust (s)		0.0	0.0	0.0	0.0			
Total Lost Time (s)		6.3	6.3	6.8	6.8			
Lead/Lag	Lag	Lag	Lag	Lag	Lag	Lead	Lead	Lead
Lead-Lag Optimize?	Yes	Yes	Yes	Yes	Yes	Yes	Yes	Yes
Recall Mode	C-Max	C-Max	C-Max	None	None	None	None	None
Act Effct Green (s)		56.1	56.1	10.0	10.0			
Actuated g/C Ratio		0.80	0.80	0.14	0.14			
v/c Ratio		0.58	0.29	0.12	0.21			
Control Delay		7.7	5.7	27.7	11.1			
Queue Delay		0.0	0.0	0.0	0.0			
Total Delay		7.7	5.7	27.7	11.1			
LOS		A	A	C	B			
Approach Delay		7.7	5.7	17.3				
Approach LOS		A	A	B				
Queue Length 50th (m)		55.4	34.9	3.5	0.0			
Queue Length 95th (m)		92.9	57.2	10.4	8.6			
Internal Link Dist (m)		155.4	379.9	123.9				
Turn Bay Length (m)				20.0				
Base Capacity (vph)		1395	1419	411	381			
Starvation Cap Reductn		0	0	0	0			
Spillback Cap Reductn		0	0	0	0			
Storage Cap Reductn		0	0	0	0			
Reduced v/c Ratio		0.58	0.29	0.07	0.13			

Intersection Summary

Cycle Length: 70	
Actuated Cycle Length: 70	
Offset: 38 (54%), Referenced to phase 4:EBTL and 8:WBT, Start of Green	
Natural Cycle: 80	
Control Type: Actuated-Coordinated	
Maximum v/c Ratio: 0.58	
Intersection Signal Delay: 7.7	Intersection LOS: A
Intersection Capacity Utilization 93.4%	ICU Level of Service F
Analysis Period (min) 15	

Splits and Phases: 1: Richmond Rd & McEwen Ave

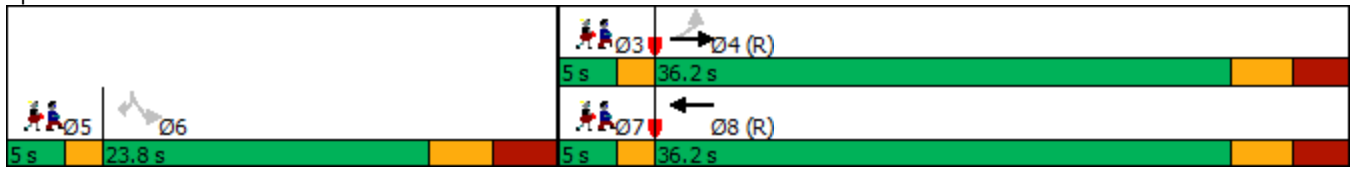

Lanes, Volumes, Timings
2: Richmond Rd & New Orchard Ave N

Future Background 2031 AM

01/18/2022



Lane Group	EBL	EBT	WBT	SBL	Ø3	Ø5	Ø7
Lane Configurations							
Traffic Volume (vph)	15	810	416	128			
Future Volume (vph)	15	810	416	128			
Lane Group Flow (vph)	0	825	465	145			
Turn Type	Perm	NA	NA	Perm			
Protected Phases		4	8		3	5	7
Permitted Phases	4			6			
Detector Phase	4	4	8	6			
Switch Phase							
Minimum Initial (s)	10.0	10.0	10.0	10.0	1.0	1.0	1.0
Minimum Split (s)	24.3	24.3	27.3	28.7	5.0	5.0	5.0
Total Split (s)	31.3	31.3	31.3	28.7	5.0	5.0	5.0
Total Split (%)	44.7%	44.7%	44.7%	41.0%	7%	7%	7%
Yellow Time (s)	3.3	3.3	3.3	3.3	2.0	2.0	2.0
All-Red Time (s)	3.0	3.0	3.0	3.4	0.0	0.0	0.0
Lost Time Adjust (s)		0.0	0.0	0.0			
Total Lost Time (s)		6.3	6.3	6.7			
Lead/Lag	Lag	Lag	Lag	Lag	Lead	Lead	Lead
Lead-Lag Optimize?	Yes	Yes	Yes	Yes	Yes	Yes	Yes
Recall Mode	C-Max	C-Max	C-Max	None	None	None	None
Act Effct Green (s)		49.7	49.7	11.9			
Actuated g/C Ratio		0.71	0.71	0.17			
v/c Ratio		0.66	0.37	0.50			
Control Delay		6.7	7.0	30.1			
Queue Delay		0.0	0.0	0.0			
Total Delay		6.7	7.0	30.1			
LOS		A	A	C			
Approach Delay		6.7	7.0	30.1			
Approach LOS		A	A	C			
Queue Length 50th (m)		11.7	23.6	16.4			
Queue Length 95th (m)		#15.7	48.2	29.8			
Internal Link Dist (m)		379.9	124.6	54.3			
Turn Bay Length (m)							
Base Capacity (vph)		1253	1245	530			
Starvation Cap Reductn		0	0	0			
Spillback Cap Reductn		0	0	0			
Storage Cap Reductn		0	0	0			
Reduced v/c Ratio		0.66	0.37	0.27			

Intersection Summary

Cycle Length: 70	
Actuated Cycle Length: 70	
Offset: 68 (97%), Referenced to phase 4:EBTL and 8:WBT, Start of Green	
Natural Cycle: 90	
Control Type: Actuated-Coordinated	
Maximum v/c Ratio: 0.66	
Intersection Signal Delay: 9.2	Intersection LOS: A
Intersection Capacity Utilization 79.5%	ICU Level of Service D
Analysis Period (min) 15	

95th percentile volume exceeds capacity, queue may be longer.
 Queue shown is maximum after two cycles.

Splits and Phases: 2: Richmond Rd & New Orchard Ave N

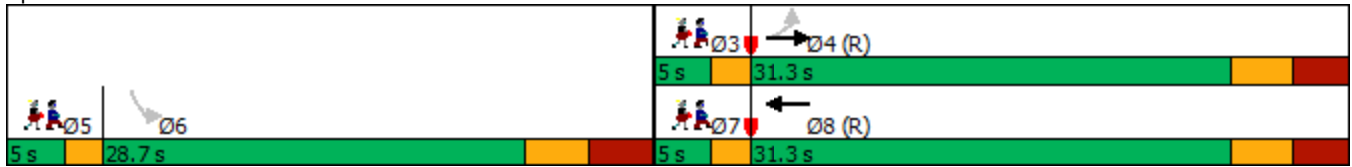

HCM Unsignalized Intersection Capacity Analysis
3: New Orchard Ave N & Ambleside Dr

Future Background 2031 AM
01/18/2022



Movement	EBL	EBR	NBL	NBT	SBT	SBR
Lane Configurations						
Traffic Volume (veh/h)	1	87	54	22	30	2
Future Volume (Veh/h)	1	87	54	22	30	2
Sign Control	Stop			Free	Free	
Grade	0%			0%	0%	
Peak Hour Factor	1.00	1.00	1.00	1.00	1.00	1.00
Hourly flow rate (vph)	1	87	54	22	30	2
Pedestrians						
Lane Width (m)						
Walking Speed (m/s)						
Percent Blockage						
Right turn flare (veh)						
Median type				None	None	
Median storage veh						
Upstream signal (m)	78					
pX, platoon unblocked						
vC, conflicting volume	161	31	32			
vC1, stage 1 conf vol						
vC2, stage 2 conf vol						
vCu, unblocked vol	161	31	32			
tC, single (s)	6.4	6.2	4.1			
tC, 2 stage (s)						
tF (s)	3.5	3.3	2.2			
p0 queue free %	100	92	97			
cM capacity (veh/h)	802	1043	1580			
Direction, Lane #	EB 1	NB 1	SB 1			
Volume Total	88	76	32			
Volume Left	1	54	0			
Volume Right	87	0	2			
cSH	1040	1580	1700			
Volume to Capacity	0.08	0.03	0.02			
Queue Length 95th (m)	2.1	0.8	0.0			
Control Delay (s)	8.8	5.3	0.0			
Lane LOS	A	A				
Approach Delay (s)	8.8	5.3	0.0			
Approach LOS	A					
Intersection Summary						
Average Delay			6.0			
Intersection Capacity Utilization			23.5%	ICU Level of Service	A	
Analysis Period (min)			15			

Lanes, Volumes, Timings
6: Woodroffe Ave & Richmond Rd

Future Background 2031 AM
01/18/2022

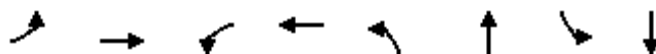

Lane Group	EBL	EBT	WBL	WBT	NBL	NBT	SBL	SBT	Ø9
Lane Configurations									
Traffic Volume (vph)	152	892	62	278	119	257	39	329	
Future Volume (vph)	152	892	62	278	119	257	39	329	
Lane Group Flow (vph)	152	1112	62	298	119	349	39	390	
Turn Type	Prot	NA	Prot	NA	pm+pt	NA	Perm	NA	
Protected Phases	7	4	3	8	5	2		6	9
Permitted Phases					2		6		
Detector Phase	7	4	3	8	5	2	6	6	
Switch Phase									
Minimum Initial (s)	5.0	10.0	5.0	10.0	5.0	10.0	10.0	10.0	1.0
Minimum Split (s)	11.9	28.9	11.7	33.9	11.5	31.5	31.5	31.5	5.0
Total Split (s)	19.4	40.3	11.7	37.6	11.5	43.0	31.5	31.5	5.0
Total Split (%)	19.4%	40.3%	11.7%	37.6%	11.5%	43.0%	31.5%	31.5%	5%
Yellow Time (s)	3.3	3.3	3.3	3.3	3.3	3.3	3.3	3.3	2.0
All-Red Time (s)	3.6	3.6	3.4	3.6	3.2	3.2	3.2	3.2	0.0
Lost Time Adjust (s)	0.0	0.0	0.0	0.0	0.0	0.0	0.0	0.0	
Total Lost Time (s)	6.9	6.9	6.7	6.9	6.5	6.5	6.5	6.5	
Lead/Lag	Lead		Lead	Lag	Lead		Lag	Lag	Lag
Lead-Lag Optimize?	Yes		Yes	Yes	Yes		Yes	Yes	Yes
Recall Mode	None	C-Max	None	C-Max	None	Max	Max	Max	None
Act Effct Green (s)	11.8	40.7	5.0	31.4	36.5	36.5	25.0	25.0	
Actuated g/C Ratio	0.12	0.41	0.05	0.31	0.36	0.36	0.25	0.25	
v/c Ratio	0.76	1.59	0.74	0.54	0.64	0.57	0.16	0.90	
Control Delay	67.0	298.0	92.8	33.1	40.2	29.9	31.6	62.0	
Queue Delay	0.0	0.0	0.0	0.0	0.0	0.0	0.0	0.0	
Total Delay	67.0	298.0	92.8	33.1	40.2	29.9	31.6	62.0	
LOS	E	F	F	C	D	C	C	E	
Approach Delay		270.3		43.4		32.5		59.3	
Approach LOS		F		D		C		E	
Queue Length 50th (m)	28.7	~317.2	12.1	48.0	15.5	53.5	5.9	73.3	
Queue Length 95th (m)	#57.2	#392.2	#33.9	74.0	#32.1	81.5	14.7	#125.9	
Internal Link Dist (m)		341.9		81.7		167.6		124.8	
Turn Bay Length (m)	95.0		75.0		55.0		50.0		
Base Capacity (vph)	211	699	84	551	185	613	239	433	
Starvation Cap Reductn	0	0	0	0	0	0	0	0	
Spillback Cap Reductn	0	0	0	0	0	0	0	0	
Storage Cap Reductn	0	0	0	0	0	0	0	0	
Reduced v/c Ratio	0.72	1.59	0.74	0.54	0.64	0.57	0.16	0.90	

Intersection Summary

Cycle Length: 100	
Actuated Cycle Length: 100	
Offset: 0 (0%), Referenced to phase 4:EBT and 8:WBT, Start of Green	
Natural Cycle: 150	
Control Type: Actuated-Coordinated	
Maximum v/c Ratio: 1.59	
Intersection Signal Delay: 157.8	Intersection LOS: F
Intersection Capacity Utilization 119.5%	ICU Level of Service H
Analysis Period (min) 15	

~ Volume exceeds capacity, queue is theoretically infinite.

Queue shown is maximum after two cycles.

95th percentile volume exceeds capacity, queue may be longer.

Queue shown is maximum after two cycles.

Splits and Phases: 6: Woodroffe Ave & Richmond Rd

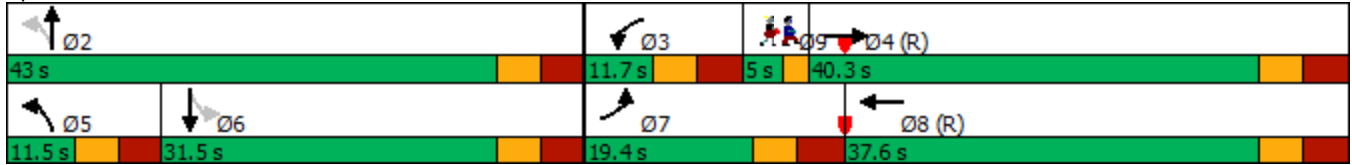

Lanes, Volumes, Timings
1: Richmond Rd & McEwen Ave

Future Background 2031 PM

01/18/2022

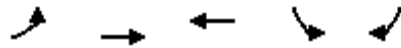

Lane Group	EBL	EBT	WBT	SBL	SBR	Ø3	Ø5	Ø7
Lane Configurations		↕	↔	↕	↕			
Traffic Volume (vph)	81	514	988	35	66			
Future Volume (vph)	81	514	988	35	66			
Lane Group Flow (vph)	0	595	1033	35	66			
Turn Type	Perm	NA	NA	Perm	Perm			
Protected Phases		4	8			3	5	7
Permitted Phases	4			6	6			
Detector Phase	4	4	8	6	6			
Switch Phase								
Minimum Initial (s)	10.0	10.0	10.0	10.0	10.0	1.0	1.0	1.0
Minimum Split (s)	24.3	24.3	36.3	23.8	23.8	5.0	5.0	5.0
Total Split (s)	45.0	45.0	45.0	26.0	26.0	7.0	7.0	7.0
Total Split (%)	52.9%	52.9%	52.9%	30.6%	30.6%	8%	8%	8%
Yellow Time (s)	3.3	3.3	3.3	3.3	3.3	2.0	2.0	2.0
All-Red Time (s)	3.0	3.0	3.0	3.5	3.5	0.0	0.0	0.0
Lost Time Adjust (s)		0.0	0.0	0.0	0.0			
Total Lost Time (s)		6.3	6.3	6.8	6.8			
Lead/Lag	Lag	Lag	Lag	Lag	Lag	Lead	Lead	Lead
Lead-Lag Optimize?	Yes	Yes	Yes	Yes	Yes	Yes	Yes	Yes
Recall Mode	C-Max	C-Max	C-Max	None	None	None	None	None
Act Effct Green (s)		66.5	66.5	10.0	10.0			
Actuated g/C Ratio		0.78	0.78	0.12	0.12			
v/c Ratio		0.66	0.75	0.18	0.30			
Control Delay		10.5	6.6	36.2	13.4			
Queue Delay		0.0	0.0	0.0	0.0			
Total Delay		10.5	6.6	36.2	13.4			
LOS		B	A	D	B			
Approach Delay		10.5	6.6	21.3				
Approach LOS		B	A	C				
Queue Length 50th (m)		44.4	33.7	5.2	0.0			
Queue Length 95th (m)		83.6	m56.8	13.6	11.1			
Internal Link Dist (m)		155.4	379.9	123.9				
Turn Bay Length (m)				20.0				
Base Capacity (vph)		903	1386	382	365			
Starvation Cap Reductn		0	0	0	0			
Spillback Cap Reductn		0	0	0	0			
Storage Cap Reductn		0	0	0	0			
Reduced v/c Ratio		0.66	0.75	0.09	0.18			

Intersection Summary

Cycle Length: 85	
Actuated Cycle Length: 85	
Offset: 17 (20%), Referenced to phase 4:EBTL and 8:WBT, Start of Green	
Natural Cycle: 130	
Control Type: Actuated-Coordinated	
Maximum v/c Ratio: 0.75	
Intersection Signal Delay: 8.8	Intersection LOS: A
Intersection Capacity Utilization 119.0%	ICU Level of Service H
Analysis Period (min) 15	

m Volume for 95th percentile queue is metered by upstream signal.

Splits and Phases: 1: Richmond Rd & McEwen Ave

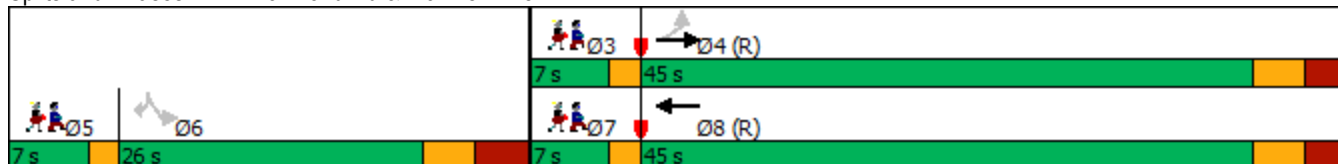

Lanes, Volumes, Timings
2: Richmond Rd & New Orchard Ave N

Future Background 2031 PM
01/18/2022



Lane Group	EBL	EBT	WBT	SBL	Ø3	Ø5	Ø7
Lane Configurations							
Traffic Volume (vph)	25	572	1024	82			
Future Volume (vph)	25	572	1024	82			
Lane Group Flow (vph)	0	597	1149	100			
Turn Type	Perm	NA	NA	Perm			
Protected Phases		4	8		3	5	7
Permitted Phases	4			6			
Detector Phase	4	4	8	6			
Switch Phase							
Minimum Initial (s)	10.0	10.0	10.0	10.0	1.0	1.0	1.0
Minimum Split (s)	24.3	24.3	27.3	28.7	5.0	5.0	5.0
Total Split (s)	46.3	46.3	46.3	28.7	5.0	5.0	5.0
Total Split (%)	54.5%	54.5%	54.5%	33.8%	6%	6%	6%
Yellow Time (s)	3.3	3.3	3.3	3.3	2.0	2.0	2.0
All-Red Time (s)	3.0	3.0	3.0	3.4	0.0	0.0	0.0
Lost Time Adjust (s)		0.0	0.0	0.0			
Total Lost Time (s)		6.3	6.3	6.7			
Lead/Lag	Lag	Lag	Lag	Lag	Lead	Lead	Lead
Lead-Lag Optimize?	Yes	Yes	Yes	Yes	Yes	Yes	Yes
Recall Mode	C-Max	C-Max	C-Max	None	None	None	None
Act Effct Green (s)		65.5	65.5	11.1			
Actuated g/C Ratio		0.77	0.77	0.13			
v/c Ratio		0.50	0.85	0.44			
Control Delay		9.2	18.2	35.6			
Queue Delay		0.0	0.0	0.0			
Total Delay		9.2	18.2	35.6			
LOS		A	B	D			
Approach Delay		9.2	18.2	35.6			
Approach LOS		A	B	D			
Queue Length 50th (m)		42.3	119.0	13.4			
Queue Length 95th (m)		89.1	#262.1	26.6			
Internal Link Dist (m)		379.9	122.7	54.3			
Turn Bay Length (m)							
Base Capacity (vph)		1183	1350	435			
Starvation Cap Reductn		0	0	0			
Spillback Cap Reductn		0	0	0			
Storage Cap Reductn		0	0	0			
Reduced v/c Ratio		0.50	0.85	0.23			

Intersection Summary

Cycle Length: 85	
Actuated Cycle Length: 85	
Offset: 1 (1%), Referenced to phase 4:EBTL and 8:WBT, Start of Green	
Natural Cycle: 130	
Control Type: Actuated-Coordinated	
Maximum v/c Ratio: 0.85	
Intersection Signal Delay: 16.2	Intersection LOS: B
Intersection Capacity Utilization 85.7%	ICU Level of Service E
Analysis Period (min) 15	

95th percentile volume exceeds capacity, queue may be longer.
 Queue shown is maximum after two cycles.

Splits and Phases: 2: Richmond Rd & New Orchard Ave N

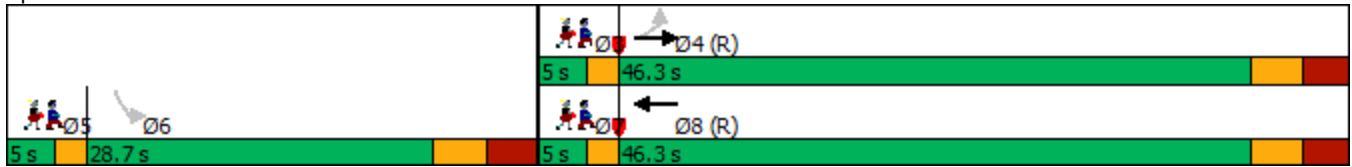

HCM Unsignalized Intersection Capacity Analysis
 3: New Orchard Ave N & Ambleside Dr

Future Background 2031 PM
 01/18/2022



Movement	EBL	EBR	NBL	NBT	SBT	SBR
Lane Configurations						
Traffic Volume (veh/h)	4	79	99	31	25	3
Future Volume (Veh/h)	4	79	99	31	25	3
Sign Control	Stop			Free	Free	
Grade	0%			0%	0%	
Peak Hour Factor	1.00	1.00	1.00	1.00	1.00	1.00
Hourly flow rate (vph)	4	79	99	31	25	3
Pedestrians						
Lane Width (m)						
Walking Speed (m/s)						
Percent Blockage						
Right turn flare (veh)						
Median type				None	None	
Median storage veh						
Upstream signal (m)	78					
pX, platoon unblocked						
vC, conflicting volume	256	26	28			
vC1, stage 1 conf vol						
vC2, stage 2 conf vol						
vCu, unblocked vol	256	26	28			
tC, single (s)	6.4	6.2	4.1			
tC, 2 stage (s)						
tF (s)	3.5	3.3	2.2			
p0 queue free %	99	92	94			
cM capacity (veh/h)	687	1049	1585			
Direction, Lane #	EB 1	NB 1	SB 1			
Volume Total	83	130	28			
Volume Left	4	99	0			
Volume Right	79	0	3			
cSH	1023	1585	1700			
Volume to Capacity	0.08	0.06	0.02			
Queue Length 95th (m)	2.0	1.5	0.0			
Control Delay (s)	8.8	5.8	0.0			
Lane LOS	A	A				
Approach Delay (s)	8.8	5.8	0.0			
Approach LOS	A					
Intersection Summary						
Average Delay			6.2			
Intersection Capacity Utilization			26.2%	ICU Level of Service	A	
Analysis Period (min)			15			

Lanes, Volumes, Timings
6: Woodroffe Ave & Richmond Rd

Future Background 2031 PM
01/18/2022

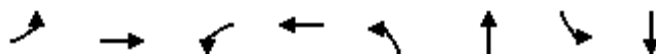

Lane Group	EBL	EBT	WBL	WBT	NBL	NBT	SBL	SBT	Ø9
Lane Configurations									
Traffic Volume (vph)	83	390	217	757	235	402	25	340	
Future Volume (vph)	83	390	217	757	235	402	25	340	
Lane Group Flow (vph)	83	567	217	788	235	490	25	402	
Turn Type	Prot	NA	Prot	NA	pm+pt	NA	Perm	NA	
Protected Phases	7	4	3	8	5	2		6	9
Permitted Phases					2		6		
Detector Phase	7	4	3	8	5	2	6	6	
Switch Phase									
Minimum Initial (s)	5.0	10.0	5.0	10.0	5.0	10.0	10.0	10.0	1.0
Minimum Split (s)	11.9	33.9	11.7	33.9	11.5	31.5	31.5	31.5	5.0
Total Split (s)	12.0	40.5	18.0	51.5	15.0	46.5	31.5	31.5	5.0
Total Split (%)	10.9%	36.8%	16.4%	46.8%	13.6%	42.3%	28.6%	28.6%	5%
Yellow Time (s)	3.3	3.3	3.3	3.3	3.3	3.3	3.3	3.3	2.0
All-Red Time (s)	3.6	3.6	3.4	3.6	3.2	3.2	3.2	3.2	0.0
Lost Time Adjust (s)	0.0	0.0	0.0	0.0	2.0	0.0	0.0	0.0	
Total Lost Time (s)	6.9	6.9	6.7	6.9	8.5	6.5	6.5	6.5	
Lead/Lag	Lead		Lead	Lag	Lead		Lag	Lag	Lag
Lead-Lag Optimize?	Yes		Yes	Yes	Yes		Yes	Yes	Yes
Recall Mode	None	C-Max	None	C-Max	None	Max	Max	Max	None
Act Effct Green (s)	5.1	38.6	11.3	44.6	38.0	40.0	25.0	25.0	
Actuated g/C Ratio	0.05	0.35	0.10	0.41	0.35	0.36	0.23	0.23	
v/c Ratio	1.06	0.97	1.25	1.10	1.42	0.79	0.16	1.02	
Control Delay	171.5	66.5	191.5	96.3	249.2	41.7	37.4	94.1	
Queue Delay	0.0	0.0	0.0	0.0	0.0	0.0	0.0	0.0	
Total Delay	171.5	66.5	191.5	96.3	249.2	41.7	37.4	94.1	
LOS	F	E	F	F	F	D	D	F	
Approach Delay		79.9		116.9		109.0		90.8	
Approach LOS		E		F		F		F	
Queue Length 50th (m)	~19.6	118.6	~58.2	~192.2	~53.8	92.6	4.3	~91.9	
Queue Length 95th (m)	#50.5	#187.7	#104.3	#263.4	#102.1	#135.2	12.0	#150.1	
Internal Link Dist (m)		348.7		80.5		174.1		118.0	
Turn Bay Length (m)	95.0		75.0		55.0		50.0		
Base Capacity (vph)	78	585	174	717	165	624	156	393	
Starvation Cap Reductn	0	0	0	0	0	0	0	0	
Spillback Cap Reductn	0	0	0	0	0	0	0	0	
Storage Cap Reductn	0	0	0	0	0	0	0	0	
Reduced v/c Ratio	1.06	0.97	1.25	1.10	1.42	0.79	0.16	1.02	

Intersection Summary

Cycle Length: 110	
Actuated Cycle Length: 110	
Offset: 0 (0%), Referenced to phase 4:EBT and 8:WBT, Start of Green	
Natural Cycle: 145	
Control Type: Actuated-Coordinated	
Maximum v/c Ratio: 1.42	
Intersection Signal Delay: 102.3	Intersection LOS: F
Intersection Capacity Utilization 109.7%	ICU Level of Service H
Analysis Period (min) 15	

~ Volume exceeds capacity, queue is theoretically infinite.

Queue shown is maximum after two cycles.

95th percentile volume exceeds capacity, queue may be longer.

Queue shown is maximum after two cycles.

Splits and Phases: 6: Woodroffe Ave & Richmond Rd

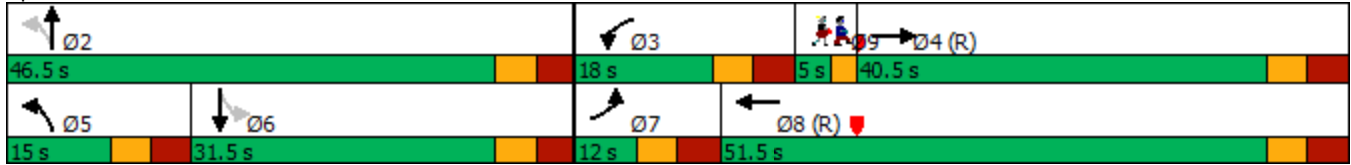

Total Projected 2026

Lanes, Volumes, Timings
1: Richmond Rd & McEwen Ave

Total Projected 2026 AM
01/18/2022

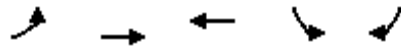

Lane Group	EBL	EBT	WBT	SBL	SBR	Ø3	Ø5	Ø7
Lane Configurations								
Traffic Volume (vph)	32	730	377	30	51			
Future Volume (vph)	32	730	377	30	51			
Lane Group Flow (vph)	0	762	399	30	51			
Turn Type	Perm	NA	NA	Perm	Perm			
Protected Phases		4	8			3	5	7
Permitted Phases	4			6	6			
Detector Phase	4	4	8	6	6			
Switch Phase								
Minimum Initial (s)	10.0	10.0	10.0	10.0	10.0	1.0	1.0	1.0
Minimum Split (s)	24.3	24.3	31.3	23.8	23.8	5.0	5.0	5.0
Total Split (s)	36.2	36.2	36.2	23.8	23.8	5.0	5.0	5.0
Total Split (%)	51.7%	51.7%	51.7%	34.0%	34.0%	7%	7%	7%
Yellow Time (s)	3.3	3.3	3.3	3.3	3.3	2.0	2.0	2.0
All-Red Time (s)	3.0	3.0	3.0	3.5	3.5	0.0	0.0	0.0
Lost Time Adjust (s)		0.0	0.0	0.0	0.0			
Total Lost Time (s)		6.3	6.3	6.8	6.8			
Lead/Lag	Lag	Lag	Lag	Lag	Lag	Lead	Lead	Lead
Lead-Lag Optimize?	Yes	Yes	Yes	Yes	Yes	Yes	Yes	Yes
Recall Mode	C-Max	C-Max	C-Max	None	None	None	None	None
Act Effct Green (s)		56.1	56.1	10.0	10.0			
Actuated g/C Ratio		0.80	0.80	0.14	0.14			
v/c Ratio		0.55	0.28	0.12	0.21			
Control Delay		7.1	3.1	27.7	11.1			
Queue Delay		0.0	0.0	0.0	0.0			
Total Delay		7.1	3.1	27.7	11.1			
LOS		A	A	C	B			
Approach Delay		7.1	3.1	17.3				
Approach LOS		A	A	B				
Queue Length 50th (m)		49.2	32.6	3.5	0.0			
Queue Length 95th (m)		81.1	3.0	10.4	8.6			
Internal Link Dist (m)		155.4	379.9	123.9				
Turn Bay Length (m)				20.0				
Base Capacity (vph)		1392	1413	411	381			
Starvation Cap Reductn		0	0	0	0			
Spillback Cap Reductn		0	0	0	0			
Storage Cap Reductn		0	0	0	0			
Reduced v/c Ratio		0.55	0.28	0.07	0.13			

Intersection Summary

Cycle Length: 70	
Actuated Cycle Length: 70	
Offset: 38 (54%), Referenced to phase 4:EBTL and 8:WBT, Start of Green	
Natural Cycle: 80	
Control Type: Actuated-Coordinated	
Maximum v/c Ratio: 0.55	
Intersection Signal Delay: 6.5	Intersection LOS: A
Intersection Capacity Utilization 90.5%	ICU Level of Service E
Analysis Period (min) 15	

Splits and Phases: 1: Richmond Rd & McEwen Ave

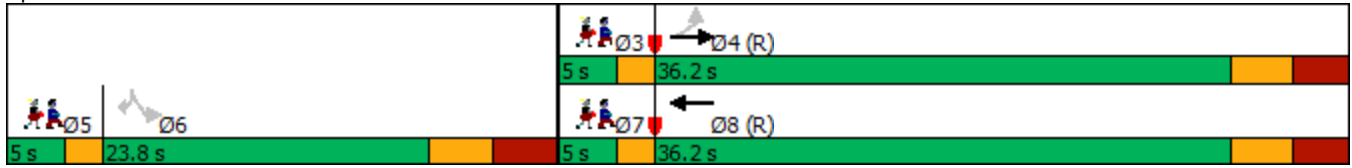

Lanes, Volumes, Timings
2: Richmond Rd & New Orchard Ave N

Total Projected 2026 AM
01/18/2022



Lane Group	EBL	EBT	WBT	SBL	Ø3	Ø5	Ø7
Lane Configurations							
Traffic Volume (vph)	22	750	391	145			
Future Volume (vph)	22	750	391	145			
Lane Group Flow (vph)	0	772	447	174			
Turn Type	Perm	NA	NA	Perm			
Protected Phases		4	8		3	5	7
Permitted Phases	4			6			
Detector Phase	4	4	8	6			
Switch Phase							
Minimum Initial (s)	10.0	10.0	10.0	10.0	1.0	1.0	1.0
Minimum Split (s)	24.3	24.3	27.3	28.7	5.0	5.0	5.0
Total Split (s)	31.3	31.3	31.3	28.7	5.0	5.0	5.0
Total Split (%)	44.7%	44.7%	44.7%	41.0%	7%	7%	7%
Yellow Time (s)	3.3	3.3	3.3	3.3	2.0	2.0	2.0
All-Red Time (s)	3.0	3.0	3.0	3.4	0.0	0.0	0.0
Lost Time Adjust (s)		0.0	0.0	0.0			
Total Lost Time (s)		6.3	6.3	6.7			
Lead/Lag	Lag	Lag	Lag	Lag	Lead	Lead	Lead
Lead-Lag Optimize?	Yes	Yes	Yes	Yes	Yes	Yes	Yes
Recall Mode	C-Max	C-Max	C-Max	None	None	None	None
Act Effct Green (s)		40.9	40.9	16.1			
Actuated g/C Ratio		0.58	0.58	0.23			
v/c Ratio		0.76	0.45	0.68			
Control Delay		14.8	11.1	35.2			
Queue Delay		0.0	0.0	0.0			
Total Delay		14.8	11.1	35.2			
LOS		B	B	D			
Approach Delay		14.8	11.1	35.2			
Approach LOS		B	B	D			
Queue Length 50th (m)		11.3	28.5	19.1			
Queue Length 95th (m)		#159.9	62.3	33.5			
Internal Link Dist (m)		379.9	124.6	54.3			
Turn Bay Length (m)							
Base Capacity (vph)		1020	989	347			
Starvation Cap Reductn		0	0	0			
Spillback Cap Reductn		0	0	0			
Storage Cap Reductn		0	0	0			
Reduced v/c Ratio		0.76	0.45	0.50			

Intersection Summary

Cycle Length: 70	
Actuated Cycle Length: 70	
Offset: 68 (97%), Referenced to phase 4:EBTL and 8:WBT, Start of Green	
Natural Cycle: 90	
Control Type: Actuated-Coordinated	
Maximum v/c Ratio: 0.76	
Intersection Signal Delay: 16.1	Intersection LOS: B
Intersection Capacity Utilization 89.4%	ICU Level of Service E
Analysis Period (min) 15	

Lanes, Volumes, Timings
 2: Richmond Rd & New Orchard Ave N

Total Projected 2026 AM
 01/18/2022

95th percentile volume exceeds capacity, queue may be longer.
 Queue shown is maximum after two cycles.

Splits and Phases: 2: Richmond Rd & New Orchard Ave N

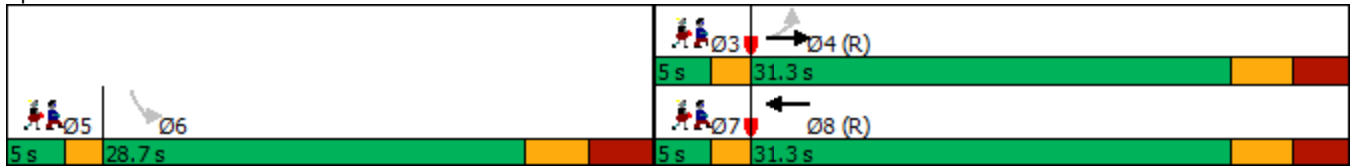

HCM Unsignalized Intersection Capacity Analysis
3: New Orchard Ave N & Ambleside Dr

Total Projected 2026 AM
01/18/2022



Movement	EBL	EBR	NBL	NBT	SBT	SBR
Lane Configurations						
Traffic Volume (veh/h)	1	87	54	35	59	2
Future Volume (Veh/h)	1	87	54	35	59	2
Sign Control	Stop			Free	Free	
Grade	0%			0%	0%	
Peak Hour Factor	1.00	1.00	1.00	1.00	1.00	1.00
Hourly flow rate (vph)	1	87	54	35	59	2
Pedestrians						
Lane Width (m)						
Walking Speed (m/s)						
Percent Blockage						
Right turn flare (veh)						
Median type				None	None	
Median storage veh						
Upstream signal (m)	78					
pX, platoon unblocked						
vC, conflicting volume	203	60	61			
vC1, stage 1 conf vol						
vC2, stage 2 conf vol						
vCu, unblocked vol	203	60	61			
tC, single (s)	6.4	6.2	4.1			
tC, 2 stage (s)						
tF (s)	3.5	3.3	2.2			
p0 queue free %	100	91	96			
cM capacity (veh/h)	758	1005	1542			
Direction, Lane #	EB 1	NB 1	SB 1			
Volume Total	88	89	61			
Volume Left	1	54	0			
Volume Right	87	0	2			
cSH	1002	1542	1700			
Volume to Capacity	0.09	0.04	0.04			
Queue Length 95th (m)	2.2	0.8	0.0			
Control Delay (s)	8.9	4.6	0.0			
Lane LOS	A	A				
Approach Delay (s)	8.9	4.6	0.0			
Approach LOS	A					
Intersection Summary						
Average Delay			5.0			
Intersection Capacity Utilization			24.2%	ICU Level of Service	A	
Analysis Period (min)			15			

HCM Unsignalized Intersection Capacity Analysis
4: Richmond Rd & Access 1



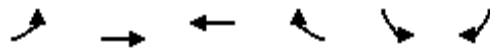





Total Projected 2026 AM
01/18/2022



Movement	EBL	EBT	WBT	WBR	SBL	SBR
Lane Configurations		↖	↗		↘	
Traffic Volume (veh/h)	7	899	442	7	20	9
Future Volume (Veh/h)	7	899	442	7	20	9
Sign Control		Free	Free		Stop	
Grade		0%	0%		0%	
Peak Hour Factor	1.00	1.00	1.00	1.00	1.00	1.00
Hourly flow rate (vph)	7	899	442	7	20	9
Pedestrians						
Lane Width (m)						
Walking Speed (m/s)						
Percent Blockage						
Right turn flare (veh)						
Median type		None	None			
Median storage (veh)						
Upstream signal (m)		149	366			
pX, platoon unblocked	0.92				0.67	0.92
vC, conflicting volume	449				1358	446
vC1, stage 1 conf vol						
vC2, stage 2 conf vol						
vCu, unblocked vol	353				1007	349
tC, single (s)	4.1				6.4	6.2
tC, 2 stage (s)						
tF (s)	2.2				3.5	3.3
p0 queue free %	99				89	99
cM capacity (veh/h)	1105				177	636
Direction, Lane #	EB 1	WB 1	SB 1			
Volume Total	906	449	29			
Volume Left	7	0	20			
Volume Right	0	7	9			
cSH	1105	1700	228			
Volume to Capacity	0.01	0.26	0.13			
Queue Length 95th (m)	0.1	0.0	3.3			
Control Delay (s)	0.2	0.0	23.0			
Lane LOS	A		C			
Approach Delay (s)	0.2	0.0	23.0			
Approach LOS			C			
Intersection Summary						
Average Delay			0.6			
Intersection Capacity Utilization		65.8%		ICU Level of Service		C
Analysis Period (min)		15				

HCM Unsignalized Intersection Capacity Analysis
5: New Orchard Ave N & Access 2

Total Projected 2026 AM
01/18/2022

						
Movement	WBL	WBR	NBT	NBR	SBL	SBT
Lane Configurations						
Traffic Volume (veh/h)	29	0	23	13	0	32
Future Volume (Veh/h)	29	0	23	13	0	32
Sign Control	Stop		Free			Free
Grade	0%		0%			0%
Peak Hour Factor	1.00	1.00	1.00	1.00	1.00	1.00
Hourly flow rate (vph)	29	0	23	13	0	32
Pedestrians						
Lane Width (m)						
Walking Speed (m/s)						
Percent Blockage						
Right turn flare (veh)						
Median type			None			None
Median storage veh						
Upstream signal (m)			108			
pX, platoon unblocked						
vC, conflicting volume	62	30			36	
vC1, stage 1 conf vol						
vC2, stage 2 conf vol						
vCu, unblocked vol	62	30			36	
tC, single (s)	6.4	6.2			4.1	
tC, 2 stage (s)						
tF (s)	3.5	3.3			2.2	
p0 queue free %	97	100			100	
cM capacity (veh/h)	945	1045			1575	
Direction, Lane #	WB 1	NB 1	SB 1			
Volume Total	29	36	32			
Volume Left	29	0	0			
Volume Right	0	13	0			
cSH	945	1700	1575			
Volume to Capacity	0.03	0.02	0.00			
Queue Length 95th (m)	0.7	0.0	0.0			
Control Delay (s)	8.9	0.0	0.0			
Lane LOS	A					
Approach Delay (s)	8.9	0.0	0.0			
Approach LOS	A					
Intersection Summary						
Average Delay			2.7			
Intersection Capacity Utilization		13.3%		ICU Level of Service		A
Analysis Period (min)			15			

Lanes, Volumes, Timings
6: Woodroffe Ave & Richmond Rd

Total Projected 2026 AM
01/18/2022

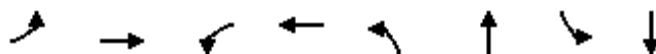

Lane Group	EBL	EBT	WBL	WBT	NBL	NBT	SBL	SBT	Ø9
Lane Configurations									
Traffic Volume (vph)	152	838	62	262	126	257	39	329	
Future Volume (vph)	152	838	62	262	126	257	39	329	
Lane Group Flow (vph)	152	1075	62	282	126	349	39	390	
Turn Type	Prot	NA	Prot	NA	pm+pt	NA	Perm	NA	
Protected Phases	7	4	3	8	5	2		6	9
Permitted Phases					2		6		
Detector Phase	7	4	3	8	5	2	6	6	
Switch Phase									
Minimum Initial (s)	5.0	10.0	5.0	10.0	5.0	10.0	10.0	10.0	1.0
Minimum Split (s)	11.9	28.9	11.7	33.9	11.5	31.5	31.5	31.5	5.0
Total Split (s)	19.4	40.3	11.7	37.6	11.5	43.0	31.5	31.5	5.0
Total Split (%)	19.4%	40.3%	11.7%	37.6%	11.5%	43.0%	31.5%	31.5%	5%
Yellow Time (s)	3.3	3.3	3.3	3.3	3.3	3.3	3.3	3.3	2.0
All-Red Time (s)	3.6	3.6	3.4	3.6	3.2	3.2	3.2	3.2	0.0
Lost Time Adjust (s)	0.0	0.0	0.0	0.0	0.0	0.0	0.0	0.0	
Total Lost Time (s)	6.9	6.9	6.7	6.9	6.5	6.5	6.5	6.5	
Lead/Lag	Lead		Lead	Lag	Lead		Lag	Lag	Lag
Lead-Lag Optimize?	Yes		Yes	Yes	Yes		Yes	Yes	Yes
Recall Mode	None	C-Max	None	C-Max	None	Max	Max	Max	None
Act Effct Green (s)	11.8	40.7	5.0	31.4	36.5	36.5	25.0	25.0	
Actuated g/C Ratio	0.12	0.41	0.05	0.31	0.36	0.36	0.25	0.25	
v/c Ratio	0.76	1.59	0.74	0.52	0.68	0.57	0.16	0.90	
Control Delay	67.0	296.2	92.8	32.5	43.3	29.9	31.6	62.0	
Queue Delay	0.0	0.0	0.0	0.0	0.0	0.0	0.0	0.0	
Total Delay	67.0	296.2	92.8	32.5	43.3	29.9	31.6	62.0	
LOS	E	F	F	C	D	C	C	E	
Approach Delay		267.8		43.4		33.5		59.3	
Approach LOS		F		D		C		E	
Queue Length 50th (m)	28.7	~306.3	12.1	45.0	16.5	53.5	5.9	73.3	
Queue Length 95th (m)	#57.2	#380.9	#33.9	70.1	#35.5	81.5	14.7	#125.9	
Internal Link Dist (m)		341.9		81.7		167.6		124.8	
Turn Bay Length (m)	95.0		75.0		55.0		50.0		
Base Capacity (vph)	211	678	84	546	185	613	239	433	
Starvation Cap Reductn	0	0	0	0	0	0	0	0	
Spillback Cap Reductn	0	0	0	0	0	0	0	0	
Storage Cap Reductn	0	0	0	0	0	0	0	0	
Reduced v/c Ratio	0.72	1.59	0.74	0.52	0.68	0.57	0.16	0.90	

Intersection Summary

Cycle Length: 100	
Actuated Cycle Length: 100	
Offset: 0 (0%), Referenced to phase 4:EBT and 8:WBT, Start of Green	
Natural Cycle: 150	
Control Type: Actuated-Coordinated	
Maximum v/c Ratio: 1.59	
Intersection Signal Delay: 155.5	Intersection LOS: F
Intersection Capacity Utilization 118.6%	ICU Level of Service H
Analysis Period (min) 15	

~ Volume exceeds capacity, queue is theoretically infinite.

Queue shown is maximum after two cycles.

95th percentile volume exceeds capacity, queue may be longer.

Queue shown is maximum after two cycles.

Splits and Phases: 6: Woodroffe Ave & Richmond Rd

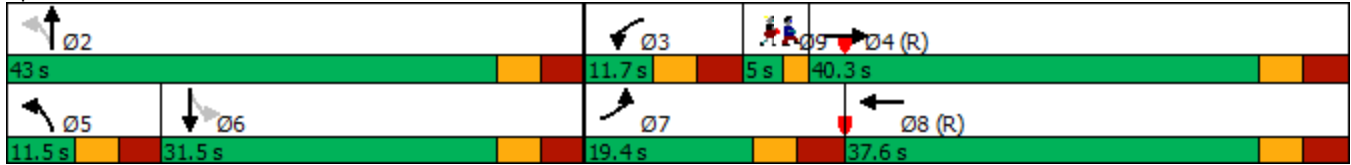

Lanes, Volumes, Timings
1: Richmond Rd & McEwen Ave

Total Projected 2026 PM
01/18/2022



Lane Group	EBL	EBT	WBT	SBL	SBR	Ø3	Ø5	Ø7
Lane Configurations		↕	↔	↕	↕			
Traffic Volume (vph)	81	489	924	35	66			
Future Volume (vph)	81	489	924	35	66			
Lane Group Flow (vph)	0	570	969	35	66			
Turn Type	Perm	NA	NA	Perm	Perm			
Protected Phases		4	8			3	5	7
Permitted Phases	4			6	6			
Detector Phase	4	4	8	6	6			
Switch Phase								
Minimum Initial (s)	10.0	10.0	10.0	10.0	10.0	1.0	1.0	1.0
Minimum Split (s)	24.3	24.3	36.3	23.8	23.8	5.0	5.0	5.0
Total Split (s)	45.0	45.0	45.0	26.0	26.0	7.0	7.0	7.0
Total Split (%)	52.9%	52.9%	52.9%	30.6%	30.6%	8%	8%	8%
Yellow Time (s)	3.3	3.3	3.3	3.3	3.3	2.0	2.0	2.0
All-Red Time (s)	3.0	3.0	3.0	3.5	3.5	0.0	0.0	0.0
Lost Time Adjust (s)		0.0	0.0	0.0	0.0			
Total Lost Time (s)		6.3	6.3	6.8	6.8			
Lead/Lag	Lag	Lag	Lag	Lag	Lag	Lead	Lead	Lead
Lead-Lag Optimize?	Yes	Yes	Yes	Yes	Yes	Yes	Yes	Yes
Recall Mode	C-Max	C-Max	C-Max	None	None	None	None	None
Act Effct Green (s)		66.5	66.5	10.0	10.0			
Actuated g/C Ratio		0.78	0.78	0.12	0.12			
v/c Ratio		0.59	0.70	0.18	0.30			
Control Delay		8.4	7.5	36.2	13.4			
Queue Delay		0.0	0.0	0.0	0.0			
Total Delay		8.4	7.5	36.2	13.4			
LOS		A	A	D	B			
Approach Delay		8.4	7.5	21.3				
Approach LOS		A	A	C				
Queue Length 50th (m)		38.1	39.4	5.2	0.0			
Queue Length 95th (m)		66.9	61.5	13.6	11.1			
Internal Link Dist (m)		155.4	379.9	123.9				
Turn Bay Length (m)				20.0				
Base Capacity (vph)		972	1380	382	365			
Starvation Cap Reductn		0	0	0	0			
Spillback Cap Reductn		0	0	0	0			
Storage Cap Reductn		0	0	0	0			
Reduced v/c Ratio		0.59	0.70	0.09	0.18			

Intersection Summary

Cycle Length: 85	
Actuated Cycle Length: 85	
Offset: 17 (20%), Referenced to phase 4:EBTL and 8:WBT, Start of Green	
Natural Cycle: 120	
Control Type: Actuated-Coordinated	
Maximum v/c Ratio: 0.70	
Intersection Signal Delay: 8.6	Intersection LOS: A
Intersection Capacity Utilization 114.1%	ICU Level of Service H
Analysis Period (min) 15	

m Volume for 95th percentile queue is metered by upstream signal.

Splits and Phases: 1: Richmond Rd & McEwen Ave

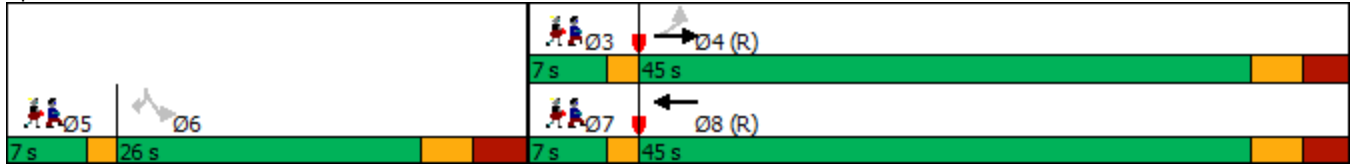

Lanes, Volumes, Timings
2: Richmond Rd & New Orchard Ave N

Total Projected 2026 PM
01/18/2022



Lane Group	EBL	EBT	WBT	SBL	Ø3	Ø5	Ø7
Lane Configurations							
Traffic Volume (vph)	35	532	947	91			
Future Volume (vph)	35	532	947	91			
Lane Group Flow (vph)	0	567	1087	118			
Turn Type	Perm	NA	NA	Perm			
Protected Phases		4	8		3	5	7
Permitted Phases	4			6			
Detector Phase	4	4	8	6			
Switch Phase							
Minimum Initial (s)	10.0	10.0	10.0	10.0	1.0	1.0	1.0
Minimum Split (s)	24.3	24.3	27.3	28.7	5.0	5.0	5.0
Total Split (s)	46.3	46.3	46.3	28.7	5.0	5.0	5.0
Total Split (%)	54.5%	54.5%	54.5%	33.8%	6%	6%	6%
Yellow Time (s)	3.3	3.3	3.3	3.3	2.0	2.0	2.0
All-Red Time (s)	3.0	3.0	3.0	3.4	0.0	0.0	0.0
Lost Time Adjust (s)		0.0	0.0	0.0			
Total Lost Time (s)		6.3	6.3	6.7			
Lead/Lag	Lag	Lag	Lag	Lag	Lead	Lead	Lead
Lead-Lag Optimize?	Yes	Yes	Yes	Yes	Yes	Yes	Yes
Recall Mode	C-Max	C-Max	C-Max	None	None	None	None
Act Effct Green (s)		61.5	61.5	15.1			
Actuated g/C Ratio		0.72	0.72	0.18			
v/c Ratio		0.61	0.89	0.64			
Control Delay		13.6	25.7	42.9			
Queue Delay		0.0	0.0	0.0			
Total Delay		13.6	25.7	42.9			
LOS		B	C	D			
Approach Delay		13.6	25.7	42.9			
Approach LOS		B	C	D			
Queue Length 50th (m)		44.1	137.8	15.5			
Queue Length 95th (m)		90.9	#276.2	29.6			
Internal Link Dist (m)		379.9	122.7	54.3			
Turn Bay Length (m)							
Base Capacity (vph)		932	1217	260			
Starvation Cap Reductn		0	0	0			
Spillback Cap Reductn		0	0	0			
Storage Cap Reductn		0	0	0			
Reduced v/c Ratio		0.61	0.89	0.45			

Intersection Summary

Cycle Length: 85	
Actuated Cycle Length: 85	
Offset: 1 (1%), Referenced to phase 4:EBTL and 8:WBT, Start of Green	
Natural Cycle: 130	
Control Type: Actuated-Coordinated	
Maximum v/c Ratio: 0.89	
Intersection Signal Delay: 23.0	Intersection LOS: C
Intersection Capacity Utilization 91.5%	ICU Level of Service F
Analysis Period (min) 15	

95th percentile volume exceeds capacity, queue may be longer.
 Queue shown is maximum after two cycles.

Splits and Phases: 2: Richmond Rd & New Orchard Ave N

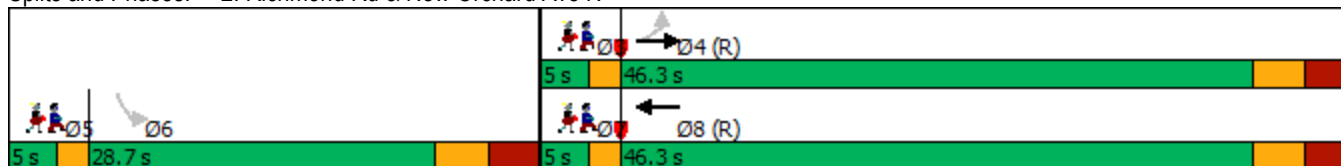

HCM Unsignalized Intersection Capacity Analysis
 3: New Orchard Ave N & Ambleside Dr

Total Projected 2026 PM
 01/18/2022



Movement	EBL	EBR	NBL	NBT	SBT	SBR
Lane Configurations						
Traffic Volume (veh/h)	4	79	99	56	43	3
Future Volume (Veh/h)	4	79	99	56	43	3
Sign Control	Stop			Free	Free	
Grade	0%			0%	0%	
Peak Hour Factor	1.00	1.00	1.00	1.00	1.00	1.00
Hourly flow rate (vph)	4	79	99	56	43	3
Pedestrians						
Lane Width (m)						
Walking Speed (m/s)						
Percent Blockage						
Right turn flare (veh)						
Median type				None	None	
Median storage veh						
Upstream signal (m)	78					
pX, platoon unblocked						
vC, conflicting volume	298	44	46			
vC1, stage 1 conf vol						
vC2, stage 2 conf vol						
vCu, unblocked vol	298	44	46			
tC, single (s)	6.4	6.2	4.1			
tC, 2 stage (s)						
tF (s)	3.5	3.3	2.2			
p0 queue free %	99	92	94			
cM capacity (veh/h)	649	1025	1562			
Direction, Lane #	EB 1	NB 1	SB 1			
Volume Total	83	155	46			
Volume Left	4	99	0			
Volume Right	79	0	3			
cSH	998	1562	1700			
Volume to Capacity	0.08	0.06	0.03			
Queue Length 95th (m)	2.1	1.5	0.0			
Control Delay (s)	8.9	4.9	0.0			
Lane LOS	A	A				
Approach Delay (s)	8.9	4.9	0.0			
Approach LOS	A					
Intersection Summary						
Average Delay			5.3			
Intersection Capacity Utilization			27.6%	ICU Level of Service	A	
Analysis Period (min)			15			

HCM Unsignalized Intersection Capacity Analysis
4: Richmond Rd & Access 1



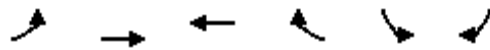





Total Projected 2026 PM
01/18/2022



Movement	EBL	EBT	WBT	WBR	SBL	SBR
Lane Configurations						
Traffic Volume (veh/h)	7	623	1090	17	9	9
Future Volume (Veh/h)	7	623	1090	17	9	9
Sign Control		Free	Free		Stop	
Grade		0%	0%		0%	
Peak Hour Factor	1.00	1.00	1.00	1.00	1.00	1.00
Hourly flow rate (vph)	7	623	1090	17	9	9
Pedestrians						
Lane Width (m)						
Walking Speed (m/s)						
Percent Blockage						
Right turn flare (veh)						
Median type		None	None			
Median storage veh						
Upstream signal (m)		147	373			
pX, platoon unblocked	0.54				0.61	0.54
vC, conflicting volume	1107				1736	1098
vC1, stage 1 conf vol						
vC2, stage 2 conf vol						
vCu, unblocked vol	774				1368	759
tC, single (s)	4.1				6.4	6.2
tC, 2 stage (s)						
tF (s)	2.2				3.5	3.3
p0 queue free %	98				91	96
cM capacity (veh/h)	456				98	220
Direction, Lane #	EB 1	WB 1	SB 1			
Volume Total	630	1107	18			
Volume Left	7	0	9			
Volume Right	0	17	9			
cSH	456	1700	135			
Volume to Capacity	0.02	0.65	0.13			
Queue Length 95th (m)	0.4	0.0	3.4			
Control Delay (s)	0.5	0.0	35.7			
Lane LOS	A		E			
Approach Delay (s)	0.5	0.0	35.7			
Approach LOS			E			
Intersection Summary						
Average Delay			0.5			
Intersection Capacity Utilization			71.6%	ICU Level of Service	C	
Analysis Period (min)			15			

HCM Unsignalized Intersection Capacity Analysis
5: New Orchard Ave N & Access 2

Total Projected 2026 PM
01/18/2022

						
Movement	WBL	WBR	NBT	NBR	SBL	SBT
Lane Configurations						
Traffic Volume (veh/h)	18	0	35	25	0	29
Future Volume (Veh/h)	18	0	35	25	0	29
Sign Control	Stop		Free		Free	
Grade	0%		0%		0%	
Peak Hour Factor	1.00	1.00	1.00	1.00	1.00	1.00
Hourly flow rate (vph)	18	0	35	25	0	29
Pedestrians						
Lane Width (m)						
Walking Speed (m/s)						
Percent Blockage						
Right turn flare (veh)						
Median type	None			None		
Median storage (veh)						
Upstream signal (m)	110					
pX, platoon unblocked						
vC, conflicting volume	76	48			60	
vC1, stage 1 conf vol						
vC2, stage 2 conf vol						
vCu, unblocked vol	76	48			60	
tC, single (s)	6.4	6.2			4.1	
tC, 2 stage (s)						
tF (s)	3.5	3.3			2.2	
p0 queue free %	98	100			100	
cM capacity (veh/h)	927	1022			1544	
Direction, Lane #	WB 1	NB 1	SB 1			
Volume Total	18	60	29			
Volume Left	18	0	0			
Volume Right	0	25	0			
cSH	927	1700	1544			
Volume to Capacity	0.02	0.04	0.00			
Queue Length 95th (m)	0.5	0.0	0.0			
Control Delay (s)	9.0	0.0	0.0			
Lane LOS	A					
Approach Delay (s)	9.0	0.0	0.0			
Approach LOS	A					
Intersection Summary						
Average Delay			1.5			
Intersection Capacity Utilization			13.6%		ICU Level of Service	A
Analysis Period (min)			15			

Lanes, Volumes, Timings
6: Woodroffe Ave & Richmond Rd

Total Projected 2026 PM
01/18/2022

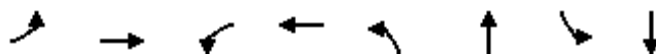

Lane Group	EBL	EBT	WBL	WBT	NBL	NBT	SBL	SBT	Ø9
Lane Configurations									
Traffic Volume (vph)	83	367	217	712	250	402	25	340	
Future Volume (vph)	83	367	217	712	250	402	25	340	
Lane Group Flow (vph)	83	553	217	743	250	490	25	402	
Turn Type	Prot	NA	Prot	NA	pm+pt	NA	Perm	NA	
Protected Phases	7	4	3	8	5	2		6	9
Permitted Phases					2		6		
Detector Phase	7	4	3	8	5	2	6	6	
Switch Phase									
Minimum Initial (s)	5.0	10.0	5.0	10.0	5.0	10.0	10.0	10.0	1.0
Minimum Split (s)	11.9	33.9	11.7	33.9	11.5	31.5	31.5	31.5	5.0
Total Split (s)	12.0	41.5	17.0	51.5	15.0	46.5	31.5	31.5	5.0
Total Split (%)	10.9%	37.7%	15.5%	46.8%	13.6%	42.3%	28.6%	28.6%	5%
Yellow Time (s)	3.3	3.3	3.3	3.3	3.3	3.3	3.3	3.3	2.0
All-Red Time (s)	3.6	3.6	3.4	3.6	3.2	3.2	3.2	3.2	0.0
Lost Time Adjust (s)	0.0	0.0	0.0	0.0	2.0	0.0	0.0	0.0	
Total Lost Time (s)	6.9	6.9	6.7	6.9	8.5	6.5	6.5	6.5	
Lead/Lag	Lead		Lead	Lag	Lead		Lag	Lag	Lag
Lead-Lag Optimize?	Yes		Yes	Yes	Yes		Yes	Yes	Yes
Recall Mode	None	C-Max	None	C-Max	None	Max	Max	Max	None
Act Effct Green (s)	5.1	39.6	10.3	44.6	38.0	40.0	25.0	25.0	
Actuated g/C Ratio	0.05	0.36	0.09	0.41	0.35	0.36	0.23	0.23	
v/c Ratio	1.06	0.97	1.37	1.04	1.52	0.79	0.16	1.02	
Control Delay	171.5	66.7	241.3	77.8	286.3	41.7	37.4	94.1	
Queue Delay	0.0	0.0	0.0	0.0	0.0	0.0	0.0	0.0	
Total Delay	171.5	66.7	241.3	77.8	286.3	41.7	37.4	94.1	
LOS	F	E	F	E	F	D	D	F	
Approach Delay		80.4		114.7		124.3		90.8	
Approach LOS		F		F		F		F	
Queue Length 50th (m)	~19.6	115.5	~61.6	~172.8	~60.6	92.6	4.3	~91.9	
Queue Length 95th (m)	#50.5	#184.4	#107.8	#243.1	#110.3	#135.2	12.0	#150.1	
Internal Link Dist (m)		348.7		80.5		174.1		118.0	
Turn Bay Length (m)	95.0		75.0		55.0		50.0		
Base Capacity (vph)	78	570	158	714	165	624	156	393	
Starvation Cap Reductn	0	0	0	0	0	0	0	0	
Spillback Cap Reductn	0	0	0	0	0	0	0	0	
Storage Cap Reductn	0	0	0	0	0	0	0	0	
Reduced v/c Ratio	1.06	0.97	1.37	1.04	1.52	0.79	0.16	1.02	

Intersection Summary

Cycle Length: 110	
Actuated Cycle Length: 110	
Offset: 0 (0%), Referenced to phase 4:EBT and 8:WBT, Start of Green	
Natural Cycle: 145	
Control Type: Actuated-Coordinated	
Maximum v/c Ratio: 1.52	
Intersection Signal Delay: 105.7	Intersection LOS: F
Intersection Capacity Utilization 108.2%	ICU Level of Service G
Analysis Period (min) 15	

~ Volume exceeds capacity, queue is theoretically infinite.

Queue shown is maximum after two cycles.

95th percentile volume exceeds capacity, queue may be longer.

Queue shown is maximum after two cycles.

Splits and Phases: 6: Woodroffe Ave & Richmond Rd

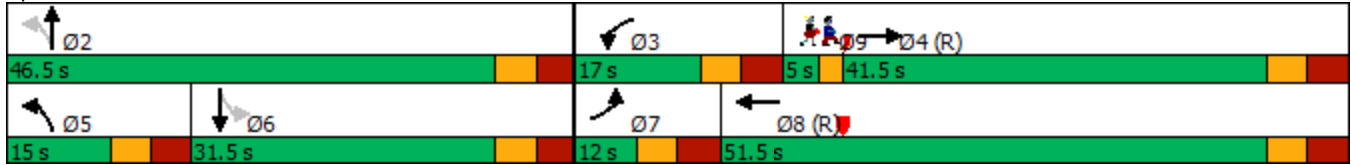

Total Projected 2031

Lanes, Volumes, Timings
1: Richmond Rd & McEwen Ave

Total Projected 2031 AM
01/18/2022

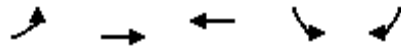

Lane Group	EBL	EBT	WBT	SBL	SBR	Ø3	Ø5	Ø7
Lane Configurations		↕	↔	↕	↕			
Traffic Volume (vph)	32	795	409	30	51			
Future Volume (vph)	32	795	409	30	51			
Lane Group Flow (vph)	0	827	431	30	51			
Turn Type	Perm	NA	NA	Perm	Perm			
Protected Phases		4	8			3	5	7
Permitted Phases	4			6	6			
Detector Phase	4	4	8	6	6			
Switch Phase								
Minimum Initial (s)	10.0	10.0	10.0	10.0	10.0	1.0	1.0	1.0
Minimum Split (s)	24.3	24.3	31.3	23.8	23.8	5.0	5.0	5.0
Total Split (s)	36.2	36.2	36.2	23.8	23.8	5.0	5.0	5.0
Total Split (%)	51.7%	51.7%	51.7%	34.0%	34.0%	7%	7%	7%
Yellow Time (s)	3.3	3.3	3.3	3.3	3.3	2.0	2.0	2.0
All-Red Time (s)	3.0	3.0	3.0	3.5	3.5	0.0	0.0	0.0
Lost Time Adjust (s)		0.0	0.0	0.0	0.0			
Total Lost Time (s)		6.3	6.3	6.8	6.8			
Lead/Lag	Lag	Lag	Lag	Lag	Lag	Lead	Lead	Lead
Lead-Lag Optimize?	Yes	Yes	Yes	Yes	Yes	Yes	Yes	Yes
Recall Mode	C-Max	C-Max	C-Max	None	None	None	None	None
Act Effct Green (s)		56.1	56.1	10.0	10.0			
Actuated g/C Ratio		0.80	0.80	0.14	0.14			
v/c Ratio		0.59	0.31	0.12	0.21			
Control Delay		7.9	3.1	27.7	11.1			
Queue Delay		0.0	0.0	0.0	0.0			
Total Delay		7.9	3.1	27.7	11.1			
LOS		A	A	C	B			
Approach Delay		7.9	3.1	17.3				
Approach LOS		A	A	B				
Queue Length 50th (m)		57.0	36.3	3.5	0.0			
Queue Length 95th (m)		95.8	2.9	10.4	8.6			
Internal Link Dist (m)		155.4	379.9	123.9				
Turn Bay Length (m)				20.0				
Base Capacity (vph)		1394	1413	411	381			
Starvation Cap Reductn		0	0	0	0			
Spillback Cap Reductn		0	0	0	0			
Storage Cap Reductn		0	0	0	0			
Reduced v/c Ratio		0.59	0.31	0.07	0.13			

Intersection Summary

Cycle Length: 70	
Actuated Cycle Length: 70	
Offset: 38 (54%), Referenced to phase 4:EBTL and 8:WBT, Start of Green	
Natural Cycle: 80	
Control Type: Actuated-Coordinated	
Maximum v/c Ratio: 0.59	
Intersection Signal Delay: 6.9	Intersection LOS: A
Intersection Capacity Utilization 94.1%	ICU Level of Service F
Analysis Period (min) 15	

Splits and Phases: 1: Richmond Rd & McEwen Ave

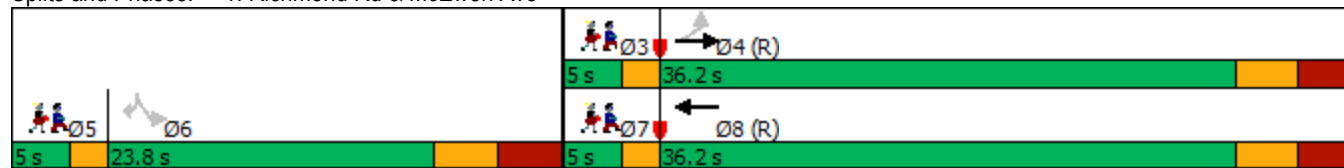

Lanes, Volumes, Timings
2: Richmond Rd & New Orchard Ave N

Total Projected 2031 AM
01/18/2022



Lane Group	EBL	EBT	WBT	SBL	Ø3	Ø5	Ø7
Lane Configurations							
Traffic Volume (vph)	22	817	425	145			
Future Volume (vph)	22	817	425	145			
Lane Group Flow (vph)	0	839	481	174			
Turn Type	Perm	NA	NA	Perm			
Protected Phases		4	8		3	5	7
Permitted Phases	4			6			
Detector Phase	4	4	8	6			
Switch Phase							
Minimum Initial (s)	10.0	10.0	10.0	10.0	1.0	1.0	1.0
Minimum Split (s)	24.3	24.3	27.3	28.7	5.0	5.0	5.0
Total Split (s)	31.3	31.3	31.3	28.7	5.0	5.0	5.0
Total Split (%)	44.7%	44.7%	44.7%	41.0%	7%	7%	7%
Yellow Time (s)	3.3	3.3	3.3	3.3	2.0	2.0	2.0
All-Red Time (s)	3.0	3.0	3.0	3.4	0.0	0.0	0.0
Lost Time Adjust (s)		0.0	0.0	0.0			
Total Lost Time (s)		6.3	6.3	6.7			
Lead/Lag	Lag	Lag	Lag	Lag	Lead	Lead	Lead
Lead-Lag Optimize?	Yes	Yes	Yes	Yes	Yes	Yes	Yes
Recall Mode	C-Max	C-Max	C-Max	None	None	None	None
Act Effct Green (s)		40.9	40.9	16.1			
Actuated g/C Ratio		0.58	0.58	0.23			
v/c Ratio		0.82	0.48	0.68			
Control Delay		17.3	11.6	35.2			
Queue Delay		0.0	0.0	0.0			
Total Delay		17.3	11.6	35.2			
LOS		B	B	D			
Approach Delay		17.3	11.6	35.2			
Approach LOS		B	B	D			
Queue Length 50th (m)		12.0	31.4	19.1			
Queue Length 95th (m)		#181.2	68.8	33.5			
Internal Link Dist (m)		379.9	124.6	54.3			
Turn Bay Length (m)							
Base Capacity (vph)		1020	992	347			
Starvation Cap Reductn		0	0	0			
Spillback Cap Reductn		0	0	0			
Storage Cap Reductn		0	0	0			
Reduced v/c Ratio		0.82	0.48	0.50			

Intersection Summary

Cycle Length: 70	
Actuated Cycle Length: 70	
Offset: 68 (97%), Referenced to phase 4:EBTL and 8:WBT, Start of Green	
Natural Cycle: 90	
Control Type: Actuated-Coordinated	
Maximum v/c Ratio: 0.82	
Intersection Signal Delay: 17.6	Intersection LOS: B
Intersection Capacity Utilization 93.1%	ICU Level of Service F
Analysis Period (min) 15	

Lanes, Volumes, Timings
 2: Richmond Rd & New Orchard Ave N

Total Projected 2031 AM
 01/18/2022

95th percentile volume exceeds capacity, queue may be longer.
 Queue shown is maximum after two cycles.

Splits and Phases: 2: Richmond Rd & New Orchard Ave N

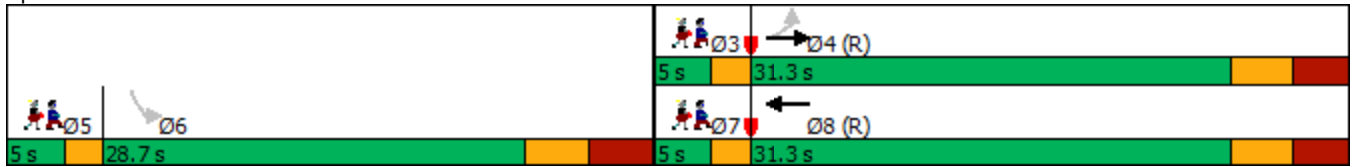

HCM Unsignalized Intersection Capacity Analysis
 3: New Orchard Ave N & Ambleside Dr

Total Projected 2031 AM
 01/18/2022



Movement	EBL	EBR	NBL	NBT	SBT	SBR
Lane Configurations						
Traffic Volume (veh/h)	1	87	54	35	59	2
Future Volume (Veh/h)	1	87	54	35	59	2
Sign Control	Stop			Free	Free	
Grade	0%			0%	0%	
Peak Hour Factor	1.00	1.00	1.00	1.00	1.00	1.00
Hourly flow rate (vph)	1	87	54	35	59	2
Pedestrians						
Lane Width (m)						
Walking Speed (m/s)						
Percent Blockage						
Right turn flare (veh)						
Median type				None	None	
Median storage veh						
Upstream signal (m)	78					
pX, platoon unblocked						
vC, conflicting volume	203	60	61			
vC1, stage 1 conf vol						
vC2, stage 2 conf vol						
vCu, unblocked vol	203	60	61			
tC, single (s)	6.4	6.2	4.1			
tC, 2 stage (s)						
tF (s)	3.5	3.3	2.2			
p0 queue free %	100	91	96			
cM capacity (veh/h)	758	1005	1542			
Direction, Lane #	EB 1	NB 1	SB 1			
Volume Total	88	89	61			
Volume Left	1	54	0			
Volume Right	87	0	2			
cSH	1002	1542	1700			
Volume to Capacity	0.09	0.04	0.04			
Queue Length 95th (m)	2.2	0.8	0.0			
Control Delay (s)	8.9	4.6	0.0			
Lane LOS	A	A				
Approach Delay (s)	8.9	4.6	0.0			
Approach LOS	A					
Intersection Summary						
Average Delay			5.0			
Intersection Capacity Utilization			24.2%	ICU Level of Service	A	
Analysis Period (min)			15			

HCM Unsignalized Intersection Capacity Analysis
4: Richmond Rd & Access 1



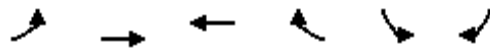





Total Projected 2031 AM
01/18/2022



Movement	EBL	EBT	WBT	WBR	SBL	SBR
Lane Configurations		↔	↔		↔	
Traffic Volume (veh/h)	7	979	481	7	20	9
Future Volume (Veh/h)	7	979	481	7	20	9
Sign Control		Free	Free		Stop	
Grade		0%	0%		0%	
Peak Hour Factor	1.00	1.00	1.00	1.00	1.00	1.00
Hourly flow rate (vph)	7	979	481	7	20	9
Pedestrians						
Lane Width (m)						
Walking Speed (m/s)						
Percent Blockage						
Right turn flare (veh)						
Median type		None	None			
Median storage veh						
Upstream signal (m)		149	366			
pX, platoon unblocked	0.90				0.61	0.90
vC, conflicting volume	488				1478	484
vC1, stage 1 conf vol						
vC2, stage 2 conf vol						
vCu, unblocked vol	373				1088	369
tC, single (s)	4.1				6.4	6.2
tC, 2 stage (s)						
tF (s)	2.2				3.5	3.3
p0 queue free %	99				86	99
cM capacity (veh/h)	1065				145	608
Direction, Lane #	EB 1	WB 1	SB 1			
Volume Total	986	488	29			
Volume Left	7	0	20			
Volume Right	0	7	9			
cSH	1065	1700	190			
Volume to Capacity	0.01	0.29	0.15			
Queue Length 95th (m)	0.2	0.0	4.0			
Control Delay (s)	0.2	0.0	27.3			
Lane LOS	A		D			
Approach Delay (s)	0.2	0.0	27.3			
Approach LOS			D			
Intersection Summary						
Average Delay			0.7			
Intersection Capacity Utilization			70.3%	ICU Level of Service	C	
Analysis Period (min)			15			

HCM Unsignalized Intersection Capacity Analysis
5: New Orchard Ave N & Access 2

Total Projected 2031 AM
01/18/2022

						
Movement	WBL	WBR	NBT	NBR	SBL	SBT
Lane Configurations						
Traffic Volume (veh/h)	29	0	23	13	0	32
Future Volume (Veh/h)	29	0	23	13	0	32
Sign Control	Stop		Free			Free
Grade	0%		0%			0%
Peak Hour Factor	1.00	1.00	1.00	1.00	1.00	1.00
Hourly flow rate (vph)	29	0	23	13	0	32
Pedestrians						
Lane Width (m)						
Walking Speed (m/s)						
Percent Blockage						
Right turn flare (veh)						
Median type			None			None
Median storage (veh)						
Upstream signal (m)			108			
pX, platoon unblocked						
vC, conflicting volume	62	30			36	
vC1, stage 1 conf vol						
vC2, stage 2 conf vol						
vCu, unblocked vol	62	30			36	
tC, single (s)	6.4	6.2			4.1	
tC, 2 stage (s)						
tF (s)	3.5	3.3			2.2	
p0 queue free %	97	100			100	
cM capacity (veh/h)	945	1045			1575	
Direction, Lane #	WB 1	NB 1	SB 1			
Volume Total	29	36	32			
Volume Left	29	0	0			
Volume Right	0	13	0			
cSH	945	1700	1575			
Volume to Capacity	0.03	0.02	0.00			
Queue Length 95th (m)	0.7	0.0	0.0			
Control Delay (s)	8.9	0.0	0.0			
Lane LOS	A					
Approach Delay (s)	8.9	0.0	0.0			
Approach LOS	A					
Intersection Summary						
Average Delay			2.7			
Intersection Capacity Utilization			13.3%	ICU Level of Service		A
Analysis Period (min)			15			

Lanes, Volumes, Timings
6: Woodroffe Ave & Richmond Rd

Total Projected 2031 AM
01/18/2022

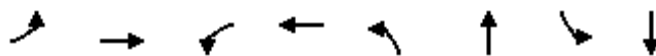

Lane Group	EBL	EBT	WBL	WBT	NBL	NBT	SBL	SBT	Ø9
Lane Configurations									
Traffic Volume (vph)	152	912	62	285	126	257	39	329	
Future Volume (vph)	152	912	62	285	126	257	39	329	
Lane Group Flow (vph)	152	1149	62	305	126	349	39	390	
Turn Type	Prot	NA	Prot	NA	pm+pt	NA	Perm	NA	
Protected Phases	7	4	3	8	5	2		6	9
Permitted Phases					2		6		
Detector Phase	7	4	3	8	5	2	6	6	
Switch Phase									
Minimum Initial (s)	5.0	10.0	5.0	10.0	5.0	10.0	10.0	10.0	1.0
Minimum Split (s)	11.9	28.9	11.7	33.9	11.5	31.5	31.5	31.5	5.0
Total Split (s)	19.4	40.3	11.7	37.6	11.5	43.0	31.5	31.5	5.0
Total Split (%)	19.4%	40.3%	11.7%	37.6%	11.5%	43.0%	31.5%	31.5%	5%
Yellow Time (s)	3.3	3.3	3.3	3.3	3.3	3.3	3.3	3.3	2.0
All-Red Time (s)	3.6	3.6	3.4	3.6	3.2	3.2	3.2	3.2	0.0
Lost Time Adjust (s)	0.0	0.0	0.0	0.0	0.0	0.0	0.0	0.0	
Total Lost Time (s)	6.9	6.9	6.7	6.9	6.5	6.5	6.5	6.5	
Lead/Lag	Lead		Lead	Lag	Lead		Lag	Lag	Lag
Lead-Lag Optimize?	Yes		Yes	Yes	Yes		Yes	Yes	Yes
Recall Mode	None	C-Max	None	C-Max	None	Max	Max	Max	None
Act Effct Green (s)	11.8	40.7	5.0	31.4	36.5	36.5	25.0	25.0	
Actuated g/C Ratio	0.12	0.41	0.05	0.31	0.36	0.36	0.25	0.25	
v/c Ratio	0.76	1.69	0.74	0.56	0.68	0.57	0.16	0.90	
Control Delay	67.0	340.4	92.8	33.6	43.3	29.9	31.6	62.0	
Queue Delay	0.0	0.0	0.0	0.0	0.0	0.0	0.0	0.0	
Total Delay	67.0	340.4	92.8	33.6	43.3	29.9	31.6	62.0	
LOS	E	F	F	C	D	C	C	E	
Approach Delay		308.5		43.6		33.5		59.3	
Approach LOS		F		D		C		E	
Queue Length 50th (m)	28.7	~335.8	12.1	49.4	16.5	53.5	5.9	73.3	
Queue Length 95th (m)	#57.2	#411.6	#33.9	76.0	#35.5	81.5	14.7	#125.9	
Internal Link Dist (m)		341.9		81.7		479.6		301.3	
Turn Bay Length (m)	95.0		75.0		55.0		50.0		
Base Capacity (vph)	211	681	84	547	185	613	239	433	
Starvation Cap Reductn	0	0	0	0	0	0	0	0	
Spillback Cap Reductn	0	0	0	0	0	0	0	0	
Storage Cap Reductn	0	0	0	0	0	0	0	0	
Reduced v/c Ratio	0.72	1.69	0.74	0.56	0.68	0.57	0.16	0.90	

Intersection Summary

Cycle Length: 100	
Actuated Cycle Length: 100	
Offset: 0 (0%), Referenced to phase 4:EBT and 8:WBT, Start of Green	
Natural Cycle: 150	
Control Type: Actuated-Coordinated	
Maximum v/c Ratio: 1.69	
Intersection Signal Delay: 178.3	Intersection LOS: F
Intersection Capacity Utilization 122.6%	ICU Level of Service H
Analysis Period (min) 15	

~ Volume exceeds capacity, queue is theoretically infinite.

Queue shown is maximum after two cycles.

95th percentile volume exceeds capacity, queue may be longer.

Queue shown is maximum after two cycles.

Splits and Phases: 6: Woodroffe Ave & Richmond Rd

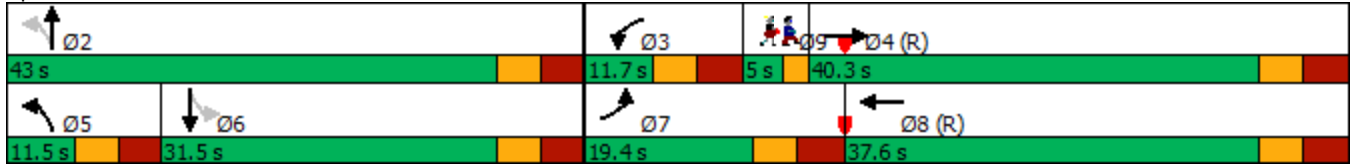

Lanes, Volumes, Timings
1: Richmond Rd & McEwen Ave

Total Projected 2031 PM
01/18/2022



Lane Group	EBL	EBT	WBT	SBL	SBR	Ø3	Ø5	Ø7
Lane Configurations		↕	↔	↕	↕			
Traffic Volume (vph)	81	531	1006	35	66			
Future Volume (vph)	81	531	1006	35	66			
Lane Group Flow (vph)	0	612	1051	35	66			
Turn Type	Perm	NA	NA	Perm	Perm			
Protected Phases		4	8			3	5	7
Permitted Phases	4			6	6			
Detector Phase	4	4	8	6	6			
Switch Phase								
Minimum Initial (s)	10.0	10.0	10.0	10.0	10.0	1.0	1.0	1.0
Minimum Split (s)	24.3	24.3	36.3	23.8	23.8	5.0	5.0	5.0
Total Split (s)	45.0	45.0	45.0	26.0	26.0	7.0	7.0	7.0
Total Split (%)	52.9%	52.9%	52.9%	30.6%	30.6%	8%	8%	8%
Yellow Time (s)	3.3	3.3	3.3	3.3	3.3	2.0	2.0	2.0
All-Red Time (s)	3.0	3.0	3.0	3.5	3.5	0.0	0.0	0.0
Lost Time Adjust (s)		0.0	0.0	0.0	0.0			
Total Lost Time (s)		6.3	6.3	6.8	6.8			
Lead/Lag	Lag	Lag	Lag	Lag	Lag	Lead	Lead	Lead
Lead-Lag Optimize?	Yes	Yes	Yes	Yes	Yes	Yes	Yes	Yes
Recall Mode	C-Max	C-Max	C-Max	None	None	None	None	None
Act Effct Green (s)		66.5	66.5	10.0	10.0			
Actuated g/C Ratio		0.78	0.78	0.12	0.12			
v/c Ratio		0.69	0.76	0.18	0.30			
Control Delay		11.7	8.5	36.2	13.4			
Queue Delay		0.0	0.0	0.0	0.0			
Total Delay		11.7	8.5	36.2	13.4			
LOS		B	A	D	B			
Approach Delay		11.7	8.5	21.3				
Approach LOS		B	A	C				
Queue Length 50th (m)		48.3	50.2	5.2	0.0			
Queue Length 95th (m)		94.4	63.9	13.6	11.1			
Internal Link Dist (m)		155.4	379.9	123.9				
Turn Bay Length (m)				20.0				
Base Capacity (vph)		885	1381	382	365			
Starvation Cap Reductn		0	0	0	0			
Spillback Cap Reductn		0	0	0	0			
Storage Cap Reductn		0	0	0	0			
Reduced v/c Ratio		0.69	0.76	0.09	0.18			

Intersection Summary

Cycle Length: 85	
Actuated Cycle Length: 85	
Offset: 17 (20%), Referenced to phase 4:EBTL and 8:WBT, Start of Green	
Natural Cycle: 140	
Control Type: Actuated-Coordinated	
Maximum v/c Ratio: 0.76	
Intersection Signal Delay: 10.4	Intersection LOS: B
Intersection Capacity Utilization 121.0%	ICU Level of Service H
Analysis Period (min) 15	

m Volume for 95th percentile queue is metered by upstream signal.

Splits and Phases: 1: Richmond Rd & McEwen Ave

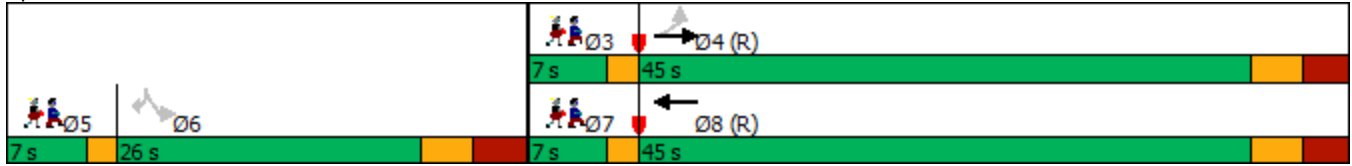

Lanes, Volumes, Timings
2: Richmond Rd & New Orchard Ave N

Total Projected 2031 PM
01/18/2022



Lane Group	EBL	EBT	WBT	SBL	Ø3	Ø5	Ø7
Lane Configurations							
Traffic Volume (vph)	35	579	1033	91			
Future Volume (vph)	35	579	1033	91			
Lane Group Flow (vph)	0	614	1173	118			
Turn Type	Perm	NA	NA	Perm			
Protected Phases		4	8		3	5	7
Permitted Phases	4			6			
Detector Phase	4	4	8	6			
Switch Phase							
Minimum Initial (s)	10.0	10.0	10.0	10.0	1.0	1.0	1.0
Minimum Split (s)	24.3	24.3	27.3	28.7	5.0	5.0	5.0
Total Split (s)	46.3	46.3	46.3	28.7	5.0	5.0	5.0
Total Split (%)	54.5%	54.5%	54.5%	33.8%	6%	6%	6%
Yellow Time (s)	3.3	3.3	3.3	3.3	2.0	2.0	2.0
All-Red Time (s)	3.0	3.0	3.0	3.4	0.0	0.0	0.0
Lost Time Adjust (s)		0.0	0.0	0.0			
Total Lost Time (s)		6.3	6.3	6.7			
Lead/Lag	Lag	Lag	Lag	Lag	Lead	Lead	Lead
Lead-Lag Optimize?	Yes	Yes	Yes	Yes	Yes	Yes	Yes
Recall Mode	C-Max	C-Max	C-Max	None	None	None	None
Act Effct Green (s)		61.5	61.5	15.1			
Actuated g/C Ratio		0.72	0.72	0.18			
v/c Ratio		0.80	0.96	0.64			
Control Delay		23.6	35.0	42.9			
Queue Delay		0.0	0.0	0.0			
Total Delay		23.6	35.0	42.9			
LOS		C	D	D			
Approach Delay		23.6	35.0	42.9			
Approach LOS		C	D	D			
Queue Length 50th (m)		68.9	~205.2	15.5			
Queue Length 95th (m)		#164.9	#307.2	29.6			
Internal Link Dist (m)		379.9	122.7	54.3			
Turn Bay Length (m)							
Base Capacity (vph)		764	1222	260			
Starvation Cap Reductn		0	0	0			
Spillback Cap Reductn		0	0	0			
Storage Cap Reductn		0	0	0			
Reduced v/c Ratio		0.80	0.96	0.45			

Intersection Summary

Cycle Length: 85	
Actuated Cycle Length: 85	
Offset: 1 (1%), Referenced to phase 4:EBTL and 8:WBT, Start of Green	
Natural Cycle: 150	
Control Type: Actuated-Coordinated	
Maximum v/c Ratio: 0.96	
Intersection Signal Delay: 31.8	Intersection LOS: C
Intersection Capacity Utilization 96.2%	ICU Level of Service F
Analysis Period (min) 15	

Lanes, Volumes, Timings
 2: Richmond Rd & New Orchard Ave N

Total Projected 2031 PM
 01/18/2022

~ Volume exceeds capacity, queue is theoretically infinite.

Queue shown is maximum after two cycles.

95th percentile volume exceeds capacity, queue may be longer.

Queue shown is maximum after two cycles.

Splits and Phases: 2: Richmond Rd & New Orchard Ave N

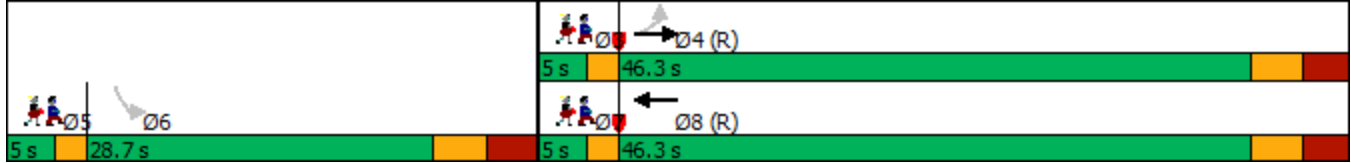

HCM Unsignalized Intersection Capacity Analysis
 3: New Orchard Ave N & Ambleside Dr

Total Projected 2031 PM
 01/18/2022



Movement	EBL	EBR	NBL	NBT	SBT	SBR
Lane Configurations						
Traffic Volume (veh/h)	4	79	99	56	43	3
Future Volume (Veh/h)	4	79	99	56	43	3
Sign Control	Stop			Free	Free	
Grade	0%			0%	0%	
Peak Hour Factor	1.00	1.00	1.00	1.00	1.00	1.00
Hourly flow rate (vph)	4	79	99	56	43	3
Pedestrians						
Lane Width (m)						
Walking Speed (m/s)						
Percent Blockage						
Right turn flare (veh)						
Median type				None	None	
Median storage veh						
Upstream signal (m)	78					
pX, platoon unblocked						
vC, conflicting volume	298	44	46			
vC1, stage 1 conf vol						
vC2, stage 2 conf vol						
vCu, unblocked vol	298	44	46			
tC, single (s)	6.4	6.2	4.1			
tC, 2 stage (s)						
tF (s)	3.5	3.3	2.2			
p0 queue free %	99	92	94			
cM capacity (veh/h)	649	1025	1562			
Direction, Lane #	EB 1	NB 1	SB 1			
Volume Total	83	155	46			
Volume Left	4	99	0			
Volume Right	79	0	3			
cSH	998	1562	1700			
Volume to Capacity	0.08	0.06	0.03			
Queue Length 95th (m)	2.1	1.5	0.0			
Control Delay (s)	8.9	4.9	0.0			
Lane LOS	A	A				
Approach Delay (s)	8.9	4.9	0.0			
Approach LOS	A					
Intersection Summary						
Average Delay			5.3			
Intersection Capacity Utilization			27.6%	ICU Level of Service	A	
Analysis Period (min)			15			

HCM Unsignalized Intersection Capacity Analysis
4: Richmond Rd & Access 1



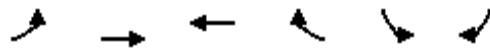





Total Projected 2031 PM
01/18/2022



Movement	EBL	EBT	WBT	WBR	SBL	SBR
Lane Configurations						
Traffic Volume (veh/h)	7	679	1187	17	9	9
Future Volume (Veh/h)	7	679	1187	17	9	9
Sign Control		Free	Free		Stop	
Grade		0%	0%		0%	
Peak Hour Factor	1.00	1.00	1.00	1.00	1.00	1.00
Hourly flow rate (vph)	7	679	1187	17	9	9
Pedestrians						
Lane Width (m)						
Walking Speed (m/s)						
Percent Blockage						
Right turn flare (veh)						
Median type		None	None			
Median storage veh						
Upstream signal (m)		147	373			
pX, platoon unblocked	0.54				0.62	0.54
vC, conflicting volume	1204				1888	1196
vC1, stage 1 conf vol						
vC2, stage 2 conf vol						
vCu, unblocked vol	953				1536	937
tC, single (s)	4.1				6.4	6.2
tC, 2 stage (s)						
tF (s)	2.2				3.5	3.3
p0 queue free %	98				88	95
cM capacity (veh/h)	390				78	174
Direction, Lane #	EB 1	WB 1	SB 1			
Volume Total	686	1204	18			
Volume Left	7	0	9			
Volume Right	0	17	9			
cSH	390	1700	108			
Volume to Capacity	0.02	0.71	0.17			
Queue Length 95th (m)	0.4	0.0	4.4			
Control Delay (s)	0.6	0.0	45.0			
Lane LOS	A		E			
Approach Delay (s)	0.6	0.0	45.0			
Approach LOS			E			
Intersection Summary						
Average Delay			0.6			
Intersection Capacity Utilization			77.0%	ICU Level of Service	D	
Analysis Period (min)			15			

HCM Unsignalized Intersection Capacity Analysis
5: New Orchard Ave N & Access 2

Total Projected 2031 PM
01/18/2022

						
Movement	WBL	WBR	NBT	NBR	SBL	SBT
Lane Configurations						
Traffic Volume (veh/h)	18	0	35	25	0	29
Future Volume (Veh/h)	18	0	35	25	0	29
Sign Control	Stop		Free		Free	
Grade	0%		0%		0%	
Peak Hour Factor	1.00	1.00	1.00	1.00	1.00	1.00
Hourly flow rate (vph)	18	0	35	25	0	29
Pedestrians						
Lane Width (m)						
Walking Speed (m/s)						
Percent Blockage						
Right turn flare (veh)						
Median type	None			None		
Median storage (veh)						
Upstream signal (m)	110					
pX, platoon unblocked						
vC, conflicting volume	76	48			60	
vC1, stage 1 conf vol						
vC2, stage 2 conf vol						
vCu, unblocked vol	76	48			60	
tC, single (s)	6.4	6.2			4.1	
tC, 2 stage (s)						
tF (s)	3.5	3.3			2.2	
p0 queue free %	98	100			100	
cM capacity (veh/h)	927	1022			1544	
Direction, Lane #	WB 1	NB 1	SB 1			
Volume Total	18	60	29			
Volume Left	18	0	0			
Volume Right	0	25	0			
cSH	927	1700	1544			
Volume to Capacity	0.02	0.04	0.00			
Queue Length 95th (m)	0.5	0.0	0.0			
Control Delay (s)	9.0	0.0	0.0			
Lane LOS	A					
Approach Delay (s)	9.0	0.0	0.0			
Approach LOS	A					
Intersection Summary						
Average Delay			1.5			
Intersection Capacity Utilization			13.6%	ICU Level of Service	A	
Analysis Period (min)			15			

Lanes, Volumes, Timings
6: Woodroffe Ave & Richmond Rd

Total Projected 2031 PM
01/18/2022

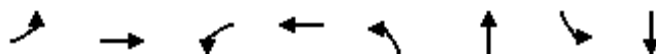

Lane Group	EBL	EBT	WBL	WBT	NBL	NBT	SBL	SBT	Ø9
Lane Configurations	↖	↗	↖	↗	↖	↗	↖	↗	
Traffic Volume (vph)	83	399	217	774	250	402	25	340	
Future Volume (vph)	83	399	217	774	250	402	25	340	
Lane Group Flow (vph)	83	585	217	805	250	490	25	402	
Turn Type	Prot	NA	Prot	NA	pm+pt	NA	Perm	NA	
Protected Phases	7	4	3	8	5	2		6	9
Permitted Phases					2		6		
Detector Phase	7	4	3	8	5	2	6	6	
Switch Phase									
Minimum Initial (s)	5.0	10.0	5.0	10.0	5.0	10.0	10.0	10.0	1.0
Minimum Split (s)	11.9	33.9	11.7	33.9	11.5	31.5	31.5	31.5	5.0
Total Split (s)	12.0	41.5	17.0	51.5	15.0	46.5	31.5	31.5	5.0
Total Split (%)	10.9%	37.7%	15.5%	46.8%	13.6%	42.3%	28.6%	28.6%	5%
Yellow Time (s)	3.3	3.3	3.3	3.3	3.3	3.3	3.3	3.3	2.0
All-Red Time (s)	3.6	3.6	3.4	3.6	3.2	3.2	3.2	3.2	0.0
Lost Time Adjust (s)	0.0	0.0	0.0	0.0	2.0	0.0	0.0	0.0	
Total Lost Time (s)	6.9	6.9	6.7	6.9	8.5	6.5	6.5	6.5	
Lead/Lag	Lead		Lead	Lag	Lead		Lag	Lag	Lag
Lead-Lag Optimize?	Yes		Yes	Yes	Yes		Yes	Yes	Yes
Recall Mode	None	C-Max	None	C-Max	None	Max	Max	Max	None
Act Effct Green (s)	5.1	39.6	10.3	44.6	38.0	40.0	25.0	25.0	
Actuated g/C Ratio	0.05	0.36	0.09	0.41	0.35	0.36	0.23	0.23	
v/c Ratio	1.06	1.02	1.37	1.13	1.52	0.79	0.16	1.02	
Control Delay	171.5	78.8	241.3	106.5	286.3	41.7	37.4	94.1	
Queue Delay	0.0	0.0	0.0	0.0	0.0	0.0	0.0	0.0	
Total Delay	171.5	78.8	241.3	106.5	286.3	41.7	37.4	94.1	
LOS	F	E	F	F	F	D	D	F	
Approach Delay		90.3		135.1		124.3		90.8	
Approach LOS		F		F		F		F	
Queue Length 50th (m)	~19.6	~133.5	~61.6	~200.4	~60.6	92.6	4.3	~91.9	
Queue Length 95th (m)	#50.5	#199.3	#107.8	#272.1	#110.3	#135.2	12.0	#150.1	
Internal Link Dist (m)		348.7		80.5		483.5		273.1	
Turn Bay Length (m)	95.0		75.0		55.0		50.0		
Base Capacity (vph)	78	573	158	714	165	624	156	393	
Starvation Cap Reductn	0	0	0	0	0	0	0	0	
Spillback Cap Reductn	0	0	0	0	0	0	0	0	
Storage Cap Reductn	0	0	0	0	0	0	0	0	
Reduced v/c Ratio	1.06	1.02	1.37	1.13	1.52	0.79	0.16	1.02	

Intersection Summary

Cycle Length: 110	
Actuated Cycle Length: 110	
Offset: 0 (0%), Referenced to phase 4:EBT and 8:WBT, Start of Green	
Natural Cycle: 145	
Control Type: Actuated-Coordinated	
Maximum v/c Ratio: 1.52	
Intersection Signal Delay: 115.2	Intersection LOS: F
Intersection Capacity Utilization 111.6%	ICU Level of Service H
Analysis Period (min) 15	

~ Volume exceeds capacity, queue is theoretically infinite.

Queue shown is maximum after two cycles.

95th percentile volume exceeds capacity, queue may be longer.

Queue shown is maximum after two cycles.

Splits and Phases: 6: Woodroffe Ave & Richmond Rd

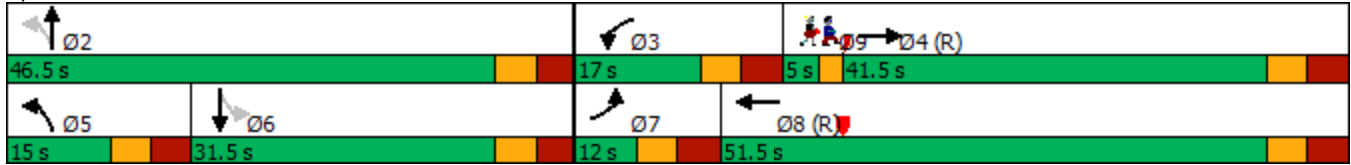

**Total Projected 2031 with Mitigations and 30%
Traffic Reductions**

Lanes, Volumes, Timings
1: Richmond Rd & McEwen Ave

Total Projected 2031 AM (mitigations)
01/18/2022

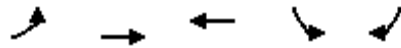

Lane Group	EBL	EBT	WBT	SBL	SBR	Ø3	Ø5	Ø7
Lane Configurations		↶	↷	↶	↷			
Traffic Volume (vph)	32	561	293	30	51			
Future Volume (vph)	32	561	293	30	51			
Lane Group Flow (vph)	0	593	315	30	51			
Turn Type	pm+pt	NA	NA	Perm	Perm			
Protected Phases	9	4	8			3	5	7
Permitted Phases	4			6	6			
Detector Phase	9	4	8	6	6			
Switch Phase								
Minimum Initial (s)	5.0	10.0	10.0	10.0	10.0	1.0	1.0	1.0
Minimum Split (s)	11.3	24.3	31.3	23.8	23.8	5.0	5.0	5.0
Total Split (s)	14.2	46.2	32.0	23.8	23.8	5.0	5.0	5.0
Total Split (%)	17.8%	57.8%	40.0%	29.8%	29.8%	6%	6%	6%
Yellow Time (s)	3.3	3.3	3.3	3.3	3.3	2.0	2.0	2.0
All-Red Time (s)	3.0	3.0	3.0	3.5	3.5	0.0	0.0	0.0
Lost Time Adjust (s)		0.0	0.0	0.0	0.0			
Total Lost Time (s)		6.3	6.3	6.8	6.8			
Lead/Lag		Lag	Lag	Lag	Lag	Lead	Lead	Lead
Lead-Lag Optimize?		Yes	Yes	Yes	Yes	Yes	Yes	Yes
Recall Mode	Max	C-Max	C-Max	None	None	None	None	None
Act Effct Green (s)		60.3	46.1	10.0	10.0			
Actuated g/C Ratio		0.75	0.58	0.12	0.12			
v/c Ratio		0.45	0.31	0.14	0.23			
Control Delay		5.9	17.8	33.1	12.8			
Queue Delay		0.0	0.0	0.0	0.0			
Total Delay		5.9	17.8	33.1	12.8			
LOS		A	B	C	B			
Approach Delay		5.9	17.8	20.3				
Approach LOS		A	B	C				
Queue Length 50th (m)		32.3	18.7	4.1	0.0			
Queue Length 95th (m)		49.7	67.1	11.5	9.4			
Internal Link Dist (m)		307.9	379.9	123.9				
Turn Bay Length (m)				20.0				
Base Capacity (vph)		1310	1009	360	337			
Starvation Cap Reductn		0	0	0	0			
Spillback Cap Reductn		0	0	0	0			
Storage Cap Reductn		0	0	0	0			
Reduced v/c Ratio		0.45	0.31	0.08	0.15			

Intersection Summary

Cycle Length: 80	
Actuated Cycle Length: 80	
Offset: 0 (0%), Referenced to phase 4:EBTL and 8:WBT, Start of Green	
Natural Cycle: 80	
Control Type: Actuated-Coordinated	
Maximum v/c Ratio: 0.45	
Intersection Signal Delay: 10.9	Intersection LOS: B
Intersection Capacity Utilization 81.3%	ICU Level of Service D
Analysis Period (min) 15	

Splits and Phases: 1: Richmond Rd & McEwen Ave

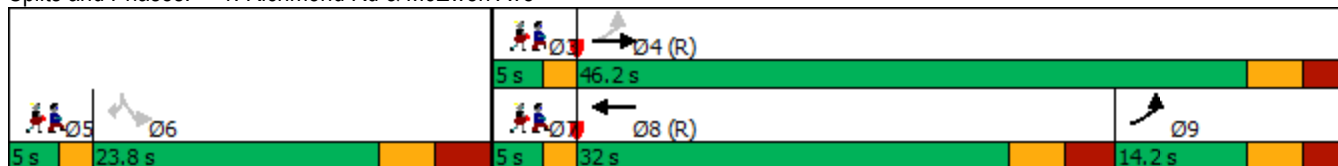

Lanes, Volumes, Timings
2: Richmond Rd & New Orchard Ave N

Total Projected 2031 AM (mitigations)
01/18/2022



Lane Group	EBL	EBT	WBT	SBL	Ø3	Ø5	Ø7
Lane Configurations							
Traffic Volume (vph)	22	574	300	145			
Future Volume (vph)	22	574	300	145			
Lane Group Flow (vph)	0	596	356	174			
Turn Type	pm+pt	NA	NA	Perm			
Protected Phases	9	4	8		3	5	7
Permitted Phases	4			6			
Detector Phase	9	4	8	6			
Switch Phase							
Minimum Initial (s)	5.0	10.0	10.0	10.0	1.0	1.0	1.0
Minimum Split (s)	11.3	24.3	27.3	28.7	5.0	5.0	5.0
Total Split (s)	13.0	41.0	28.0	29.0	5.0	5.0	5.0
Total Split (%)	16.3%	51.3%	35.0%	36.3%	6%	6%	6%
Yellow Time (s)	3.3	3.3	3.3	3.3	2.0	2.0	2.0
All-Red Time (s)	3.0	3.0	3.0	3.4	0.0	0.0	0.0
Lost Time Adjust (s)		0.0	0.0	0.0			
Total Lost Time (s)		6.3	6.3	6.7			
Lead/Lag		Lag	Lag	Lag	Lead	Lead	Lead
Lead-Lag Optimize?		Yes	Yes	Yes	Yes	Yes	Yes
Recall Mode	Max	C-Max	C-Max	None	None	None	None
Act Effct Green (s)		48.4	35.4	18.6			
Actuated g/C Ratio		0.60	0.44	0.23			
v/c Ratio		0.56	0.48	0.74			
Control Delay		11.2	20.0	43.5			
Queue Delay		0.0	0.0	0.0			
Total Delay		11.2	20.0	43.5			
LOS		B	B	D			
Approach Delay		11.2	20.0	43.5			
Approach LOS		B	B	D			
Queue Length 50th (m)		41.1	35.6	22.9			
Queue Length 95th (m)		60.5	71.4	38.3			
Internal Link Dist (m)		379.9	124.6	54.3			
Turn Bay Length (m)							
Base Capacity (vph)		1058	736	293			
Starvation Cap Reductn		0	0	0			
Spillback Cap Reductn		0	0	0			
Storage Cap Reductn		0	0	0			
Reduced v/c Ratio		0.56	0.48	0.59			

Intersection Summary

Cycle Length: 80	
Actuated Cycle Length: 80	
Offset: 0 (0%), Referenced to phase 4:EBTL and 8:WBT, Start of Green	
Natural Cycle: 80	
Control Type: Actuated-Coordinated	
Maximum v/c Ratio: 0.74	
Intersection Signal Delay: 19.0	Intersection LOS: B
Intersection Capacity Utilization 79.8%	ICU Level of Service D
Analysis Period (min) 15	

Splits and Phases: 2: Richmond Rd & New Orchard Ave N

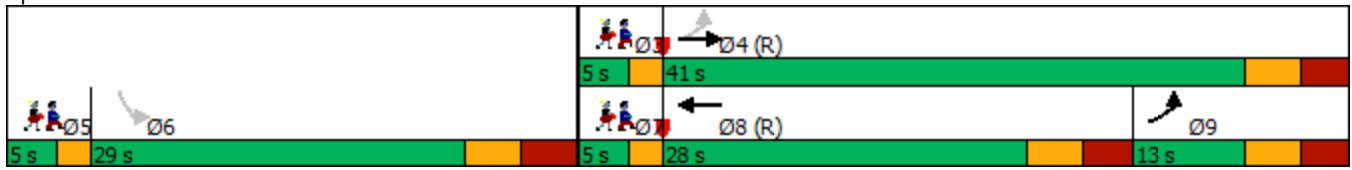

HCM Unsignalized Intersection Capacity Analysis
 3: New Orchard Ave N & Ambleside Dr

Total Projected 2031 AM (mitigations)
 01/18/2022



Movement	EBL	EBR	NBL	NBT	SBT	SBR
Lane Configurations						
Traffic Volume (veh/h)	1	87	54	35	59	2
Future Volume (Veh/h)	1	87	54	35	59	2
Sign Control	Stop			Free	Free	
Grade	0%			0%	0%	
Peak Hour Factor	1.00	1.00	1.00	1.00	1.00	1.00
Hourly flow rate (vph)	1	87	54	35	59	2
Pedestrians						
Lane Width (m)						
Walking Speed (m/s)						
Percent Blockage						
Right turn flare (veh)						
Median type				None	None	
Median storage veh						
Upstream signal (m)	78					
pX, platoon unblocked						
vC, conflicting volume	203	60	61			
vC1, stage 1 conf vol						
vC2, stage 2 conf vol						
vCu, unblocked vol	203	60	61			
tC, single (s)	6.4	6.2	4.1			
tC, 2 stage (s)						
tF (s)	3.5	3.3	2.2			
p0 queue free %	100	91	96			
cM capacity (veh/h)	758	1005	1542			
Direction, Lane #	EB 1	NB 1	SB 1			
Volume Total	88	89	61			
Volume Left	1	54	0			
Volume Right	87	0	2			
cSH	1002	1542	1700			
Volume to Capacity	0.09	0.04	0.04			
Queue Length 95th (m)	2.2	0.8	0.0			
Control Delay (s)	8.9	4.6	0.0			
Lane LOS	A	A				
Approach Delay (s)	8.9	4.6	0.0			
Approach LOS	A					
Intersection Summary						
Average Delay			5.0			
Intersection Capacity Utilization			24.2%	ICU Level of Service	A	
Analysis Period (min)			15			

HCM Unsignalized Intersection Capacity Analysis
4: Richmond Rd & Access 1



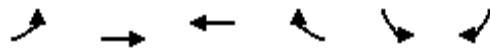





Total Projected 2031 AM (mitigations)
01/18/2022



Movement	EBL	EBT	WBT	WBR	SBL	SBR
Lane Configurations						
Traffic Volume (veh/h)	7	693	340	7	20	9
Future Volume (Veh/h)	7	693	340	7	20	9
Sign Control		Free	Free		Stop	
Grade		0%	0%		0%	
Peak Hour Factor	1.00	1.00	1.00	1.00	1.00	1.00
Hourly flow rate (vph)	7	693	340	7	20	9
Pedestrians						
Lane Width (m)						
Walking Speed (m/s)						
Percent Blockage						
Right turn flare (veh)						
Median type		None	None			
Median storage veh						
Upstream signal (m)		149	366			
pX, platoon unblocked	0.97				0.78	0.97
vC, conflicting volume	347				1050	344
vC1, stage 1 conf vol						
vC2, stage 2 conf vol						
vCu, unblocked vol	313				842	309
tC, single (s)	4.1				6.4	6.2
tC, 2 stage (s)						
tF (s)	2.2				3.5	3.3
p0 queue free %	99				92	99
cM capacity (veh/h)	1212				260	710
Direction, Lane #	EB 1	WB 1	SB 1			
Volume Total	700	347	29			
Volume Left	7	0	20			
Volume Right	0	7	9			
cSH	1212	1700	323			
Volume to Capacity	0.01	0.20	0.09			
Queue Length 95th (m)	0.1	0.0	2.2			
Control Delay (s)	0.2	0.0	17.2			
Lane LOS	A		C			
Approach Delay (s)	0.2	0.0	17.2			
Approach LOS			C			
Intersection Summary						
Average Delay			0.6			
Intersection Capacity Utilization		54.4%		ICU Level of Service		A
Analysis Period (min)		15				

HCM Unsignalized Intersection Capacity Analysis
5: New Orchard Ave N & Access 2

Total Projected 2031 AM (mitigations)
01/18/2022

						
Movement	WBL	WBR	NBT	NBR	SBL	SBT
Lane Configurations						
Traffic Volume (veh/h)	29	0	23	13	0	32
Future Volume (Veh/h)	29	0	23	13	0	32
Sign Control	Stop		Free			Free
Grade	0%		0%			0%
Peak Hour Factor	1.00	1.00	1.00	1.00	1.00	1.00
Hourly flow rate (vph)	29	0	23	13	0	32
Pedestrians						
Lane Width (m)						
Walking Speed (m/s)						
Percent Blockage						
Right turn flare (veh)						
Median type			None			None
Median storage veh						
Upstream signal (m)			108			
pX, platoon unblocked						
vC, conflicting volume	62	30			36	
vC1, stage 1 conf vol						
vC2, stage 2 conf vol						
vCu, unblocked vol	62	30			36	
tC, single (s)	6.4	6.2			4.1	
tC, 2 stage (s)						
tF (s)	3.5	3.3			2.2	
p0 queue free %	97	100			100	
cM capacity (veh/h)	945	1045			1575	
Direction, Lane #	WB 1	NB 1	SB 1			
Volume Total	29	36	32			
Volume Left	29	0	0			
Volume Right	0	13	0			
cSH	945	1700	1575			
Volume to Capacity	0.03	0.02	0.00			
Queue Length 95th (m)	0.7	0.0	0.0			
Control Delay (s)	8.9	0.0	0.0			
Lane LOS	A					
Approach Delay (s)	8.9	0.0	0.0			
Approach LOS	A					
Intersection Summary						
Average Delay			2.7			
Intersection Capacity Utilization		13.3%		ICU Level of Service		A
Analysis Period (min)			15			

Lanes, Volumes, Timings
6: Woodroffe Ave & Richmond Rd

Total Projected 2031 AM (mitigations)
01/18/2022

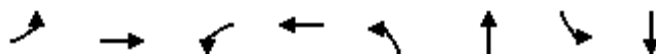

Lane Group	EBL	EBT	WBL	WBT	NBL	NBT	SBL	SBT	Ø9
Lane Configurations									
Traffic Volume (vph)	152	646	43	203	91	180	39	230	
Future Volume (vph)	152	646	43	203	91	180	39	230	
Lane Group Flow (vph)	152	883	43	223	91	272	39	291	
Turn Type	Prot	NA	Prot	NA	pm+pt	NA	Perm	NA	
Protected Phases	7	4	3	8	5	2		6	9
Permitted Phases					2		6		
Detector Phase	7	4	3	8	5	2	6	6	
Switch Phase									
Minimum Initial (s)	5.0	10.0	5.0	10.0	5.0	10.0	10.0	10.0	1.0
Minimum Split (s)	11.9	28.9	11.7	33.9	11.5	31.5	31.5	31.5	5.0
Total Split (s)	27.0	70.3	11.7	60.0	11.5	43.0	31.5	31.5	5.0
Total Split (%)	20.8%	54.1%	9.0%	46.2%	8.8%	33.1%	24.2%	24.2%	4%
Yellow Time (s)	3.3	3.3	3.3	3.3	3.3	3.3	3.3	3.3	2.0
All-Red Time (s)	3.6	3.6	3.4	3.6	3.2	3.2	3.2	3.2	0.0
Lost Time Adjust (s)	0.0	0.0	0.0	0.0	0.0	0.0	0.0	0.0	
Total Lost Time (s)	6.9	6.9	6.7	6.9	6.5	6.5	6.5	6.5	
Lead/Lag	Lead		Lead	Lag	Lead		Lag	Lag	Lag
Lead-Lag Optimize?	Yes		Yes	Yes	Yes		Yes	Yes	Yes
Recall Mode	None	C-Max	None	C-Max	None	Max	Max	Max	None
Act Effct Green (s)	16.3	70.7	5.0	56.9	36.5	36.5	25.0	25.0	
Actuated g/C Ratio	0.13	0.54	0.04	0.44	0.28	0.28	0.19	0.19	
v/c Ratio	0.72	0.99	0.66	0.29	0.59	0.59	0.20	0.88	
Control Delay	73.1	59.0	104.2	25.8	53.4	46.4	47.4	78.9	
Queue Delay	0.0	0.0	0.0	0.0	0.0	0.0	0.0	0.0	
Total Delay	73.1	59.0	104.2	25.8	53.4	46.4	47.4	78.9	
LOS	E	E	F	C	D	D	D	E	
Approach Delay		61.0		38.4		48.2		75.2	
Approach LOS		E		D		D		E	
Queue Length 50th (m)	37.8	~241.0	11.1	36.6	17.8	60.2	8.5	73.3	
Queue Length 95th (m)	59.3	#317.1	#30.6	58.1	#32.8	89.4	19.2	#122.6	
Internal Link Dist (m)		341.9		411.8		472.2		306.4	
Turn Bay Length (m)	95.0		75.0		55.0		50.0		
Base Capacity (vph)	262	889	65	757	154	462	194	329	
Starvation Cap Reductn	0	0	0	0	0	0	0	0	
Spillback Cap Reductn	0	0	0	0	0	0	0	0	
Storage Cap Reductn	0	0	0	0	0	0	0	0	
Reduced v/c Ratio	0.58	0.99	0.66	0.29	0.59	0.59	0.20	0.88	

Intersection Summary

Cycle Length: 130	
Actuated Cycle Length: 130	
Offset: 0 (0%), Referenced to phase 4:EBT and 8:WBT, Start of Green	
Natural Cycle: 150	
Control Type: Actuated-Coordinated	
Maximum v/c Ratio: 0.99	
Intersection Signal Delay: 58.0	Intersection LOS: E
Intersection Capacity Utilization 107.5%	ICU Level of Service G
Analysis Period (min) 15	

~ Volume exceeds capacity, queue is theoretically infinite.

Queue shown is maximum after two cycles.

95th percentile volume exceeds capacity, queue may be longer.

Queue shown is maximum after two cycles.

Splits and Phases: 6: Woodroffe Ave & Richmond Rd

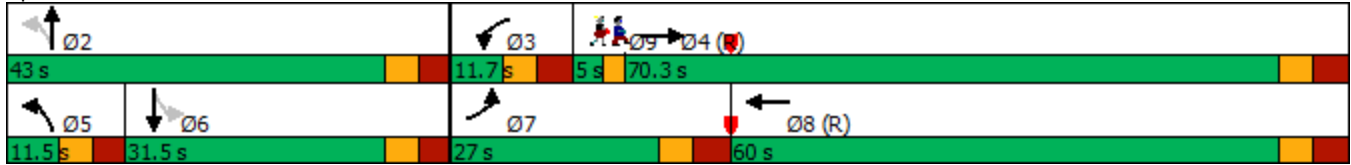

Lanes, Volumes, Timings
1: Richmond Rd & McEwen Ave

Total Projected 2031 PM (mitigations)
01/18/2022

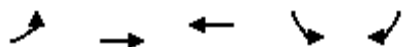

Lane Group	EBL	EBT	WBT	SBL	SBR	Ø3	Ø5	Ø7
Lane Configurations		↶	↷	↶	↷			
Traffic Volume (vph)	81	378	710	35	66			
Future Volume (vph)	81	378	710	35	66			
Lane Group Flow (vph)	0	459	755	35	66			
Turn Type	pm+pt	NA	NA	Perm	Perm			
Protected Phases	9	4	8			3	5	7
Permitted Phases	4			6	6			
Detector Phase	9	4	8	6	6			
Switch Phase								
Minimum Initial (s)	5.0	10.0	10.0	10.0	10.0	1.0	1.0	1.0
Minimum Split (s)	11.3	24.3	36.3	23.8	23.8	5.0	5.0	5.0
Total Split (s)	25.2	86.2	61.0	23.8	23.8	5.0	5.0	5.0
Total Split (%)	21.0%	71.8%	50.8%	19.8%	19.8%	4%	4%	4%
Yellow Time (s)	3.3	3.3	3.3	3.3	3.3	2.0	2.0	2.0
All-Red Time (s)	3.0	3.0	3.0	3.5	3.5	0.0	0.0	0.0
Lost Time Adjust (s)		0.0	0.0	0.0	0.0			
Total Lost Time (s)		6.3	6.3	6.8	6.8			
Lead/Lag		Lag	Lag	Lag	Lag	Lead	Lead	Lead
Lead-Lag Optimize?		Yes	Yes	Yes	Yes	Yes	Yes	Yes
Recall Mode	Max	C-Max	C-Max	None	None	None	None	None
Act Effct Green (s)		100.1	74.9	10.2	10.2			
Actuated g/C Ratio		0.83	0.62	0.08	0.08			
v/c Ratio		0.43	0.69	0.24	0.38			
Control Delay		4.8	18.9	55.8	18.7			
Queue Delay		0.0	0.0	0.0	0.0			
Total Delay		4.8	18.9	55.8	18.7			
LOS		A	B	E	B			
Approach Delay		4.8	18.9	31.5				
Approach LOS		A	B	C				
Queue Length 50th (m)		22.4	82.1	7.9	0.0			
Queue Length 95th (m)		33.3	m95.1	18.1	13.5			
Internal Link Dist (m)		368.1	379.9	123.9				
Turn Bay Length (m)				20.0				
Base Capacity (vph)		1074	1096	240	247			
Starvation Cap Reductn		0	0	0	0			
Spillback Cap Reductn		0	0	0	0			
Storage Cap Reductn		0	0	0	0			
Reduced v/c Ratio		0.43	0.69	0.15	0.27			

Intersection Summary

Cycle Length: 120	
Actuated Cycle Length: 120	
Offset: 0 (0%), Referenced to phase 4:EBTL and 8:WBT, Start of Green	
Natural Cycle: 85	
Control Type: Actuated-Coordinated	
Maximum v/c Ratio: 0.69	
Intersection Signal Delay: 15.0	Intersection LOS: B
Intersection Capacity Utilization 96.1%	ICU Level of Service F
Analysis Period (min) 15	

m Volume for 95th percentile queue is metered by upstream signal.

Splits and Phases: 1: Richmond Rd & McEwen Ave



Lanes, Volumes, Timings
2: Richmond Rd & New Orchard Ave N

Total Projected 2031 PM (mitigations)
01/18/2022



Lane Group	EBL	EBT	WBT	SBL	Ø3	Ø5	Ø7
Lane Configurations							
Traffic Volume (vph)	35	407	726	91			
Future Volume (vph)	35	407	726	91			
Lane Group Flow (vph)	0	442	866	118			
Turn Type	pm+pt	NA	NA	Perm			
Protected Phases	9	4	8		3	5	7
Permitted Phases	4			6			
Detector Phase	9	4	8	6			
Switch Phase							
Minimum Initial (s)	5.0	10.0	10.0	10.0	1.0	1.0	1.0
Minimum Split (s)	11.3	24.3	27.3	28.7	5.0	5.0	5.0
Total Split (s)	21.3	81.3	60.0	28.7	5.0	5.0	5.0
Total Split (%)	17.8%	67.8%	50.0%	23.9%	4%	4%	4%
Yellow Time (s)	3.3	3.3	3.3	3.3	2.0	2.0	2.0
All-Red Time (s)	3.0	3.0	3.0	3.4	0.0	0.0	0.0
Lost Time Adjust (s)		0.0	0.0	0.0			
Total Lost Time (s)		6.3	6.3	6.7			
Lead/Lag		Lag	Lag	Lag	Lead	Lead	Lead
Lead-Lag Optimize?		Yes	Yes	Yes	Yes	Yes	Yes
Recall Mode	Max	C-Max	C-Max	None	None	None	None
Act Effct Green (s)		87.1	65.8	19.9			
Actuated g/C Ratio		0.73	0.55	0.17			
v/c Ratio		0.45	0.97	0.76			
Control Delay		8.1	52.0	71.4			
Queue Delay		0.0	0.0	0.0			
Total Delay		8.1	52.0	71.4			
LOS		A	D	E			
Approach Delay		8.1	52.0	71.4			
Approach LOS		A	D	E			
Queue Length 50th (m)		29.4	190.7	24.2			
Queue Length 95th (m)		49.8	#304.5	42.9			
Internal Link Dist (m)		379.9	122.7	54.3			
Turn Bay Length (m)							
Base Capacity (vph)		985	890	181			
Starvation Cap Reductn		0	0	0			
Spillback Cap Reductn		0	0	0			
Storage Cap Reductn		0	0	0			
Reduced v/c Ratio		0.45	0.97	0.65			

Intersection Summary

Cycle Length: 120	
Actuated Cycle Length: 120	
Offset: 0 (0%), Referenced to phase 4:EBTL and 8:WBT, Start of Green	
Natural Cycle: 120	
Control Type: Actuated-Coordinated	
Maximum v/c Ratio: 0.97	
Intersection Signal Delay: 40.0	Intersection LOS: D
Intersection Capacity Utilization 82.1%	ICU Level of Service E
Analysis Period (min) 15	

Lanes, Volumes, Timings
 2: Richmond Rd & New Orchard Ave N

Total Projected 2031 PM (mitigations)
 01/18/2022

95th percentile volume exceeds capacity, queue may be longer.
 Queue shown is maximum after two cycles.

Splits and Phases: 2: Richmond Rd & New Orchard Ave N



HCM Unsignalized Intersection Capacity Analysis
 3: New Orchard Ave N & Ambleside Dr

Total Projected 2031 PM (mitigations)
 01/18/2022



Movement	EBL	EBR	NBL	NBT	SBT	SBR
Lane Configurations						
Traffic Volume (veh/h)	4	79	99	56	43	3
Future Volume (Veh/h)	4	79	99	56	43	3
Sign Control	Stop			Free	Free	
Grade	0%			0%	0%	
Peak Hour Factor	1.00	1.00	1.00	1.00	1.00	1.00
Hourly flow rate (vph)	4	79	99	56	43	3
Pedestrians						
Lane Width (m)						
Walking Speed (m/s)						
Percent Blockage						
Right turn flare (veh)						
Median type				None	None	
Median storage veh						
Upstream signal (m)	78					
pX, platoon unblocked						
vC, conflicting volume	298	44	46			
vC1, stage 1 conf vol						
vC2, stage 2 conf vol						
vCu, unblocked vol	298	44	46			
tC, single (s)	6.4	6.2	4.1			
tC, 2 stage (s)						
tF (s)	3.5	3.3	2.2			
p0 queue free %	99	92	94			
cM capacity (veh/h)	649	1025	1562			
Direction, Lane #	EB 1	NB 1	SB 1			
Volume Total	83	155	46			
Volume Left	4	99	0			
Volume Right	79	0	3			
cSH	998	1562	1700			
Volume to Capacity	0.08	0.06	0.03			
Queue Length 95th (m)	2.1	1.5	0.0			
Control Delay (s)	8.9	4.9	0.0			
Lane LOS	A	A				
Approach Delay (s)	8.9	4.9	0.0			
Approach LOS	A					
Intersection Summary						
Average Delay			5.3			
Intersection Capacity Utilization			27.6%	ICU Level of Service	A	
Analysis Period (min)			15			

HCM Unsignalized Intersection Capacity Analysis
4: Richmond Rd & Access 1









Total Projected 2031 PM (mitigations)
01/18/2022



Movement	EBL	EBT	WBT	WBR	SBL	SBR
Lane Configurations		↔	↔		↔	
Traffic Volume (veh/h)	7	480	838	17	9	9
Future Volume (Veh/h)	7	480	838	17	9	9
Sign Control		Free	Free		Stop	
Grade		0%	0%		0%	
Peak Hour Factor	1.00	1.00	1.00	1.00	1.00	1.00
Hourly flow rate (vph)	7	480	838	17	9	9
Pedestrians						
Lane Width (m)						
Walking Speed (m/s)						
Percent Blockage						
Right turn flare (veh)						
Median type		None	None			
Median storage veh						
Upstream signal (m)		147	373			
pX, platoon unblocked	0.70				0.74	0.70
vC, conflicting volume	855				1340	846
vC1, stage 1 conf vol						
vC2, stage 2 conf vol						
vCu, unblocked vol	577				1010	565
tC, single (s)	4.1				6.4	6.2
tC, 2 stage (s)						
tF (s)	2.2				3.5	3.3
p0 queue free %	99				95	98
cM capacity (veh/h)	696				196	367
Direction, Lane #	EB 1	WB 1	SB 1			
Volume Total	487	855	18			
Volume Left	7	0	9			
Volume Right	0	17	9			
cSH	696	1700	255			
Volume to Capacity	0.01	0.50	0.07			
Queue Length 95th (m)	0.2	0.0	1.7			
Control Delay (s)	0.3	0.0	20.2			
Lane LOS	A		C			
Approach Delay (s)	0.3	0.0	20.2			
Approach LOS			C			
Intersection Summary						
Average Delay			0.4			
Intersection Capacity Utilization			57.6%		ICU Level of Service	B
Analysis Period (min)			15			

HCM Unsignalized Intersection Capacity Analysis
5: New Orchard Ave N & Access 2

Total Projected 2031 PM (mitigations)
01/18/2022

						
Movement	WBL	WBR	NBT	NBR	SBL	SBT
Lane Configurations						
Traffic Volume (veh/h)	18	0	35	25	0	29
Future Volume (Veh/h)	18	0	35	25	0	29
Sign Control	Stop		Free		Free	
Grade	0%		0%		0%	
Peak Hour Factor	1.00	1.00	1.00	1.00	1.00	1.00
Hourly flow rate (vph)	18	0	35	25	0	29
Pedestrians						
Lane Width (m)						
Walking Speed (m/s)						
Percent Blockage						
Right turn flare (veh)						
Median type	None			None		
Median storage (veh)						
Upstream signal (m)	110					
pX, platoon unblocked						
vC, conflicting volume	76	48			60	
vC1, stage 1 conf vol						
vC2, stage 2 conf vol						
vCu, unblocked vol	76	48			60	
tC, single (s)	6.4	6.2			4.1	
tC, 2 stage (s)						
tF (s)	3.5	3.3			2.2	
p0 queue free %	98	100			100	
cM capacity (veh/h)	927	1022			1544	
Direction, Lane #	WB 1	NB 1	SB 1			
Volume Total	18	60	29			
Volume Left	18	0	0			
Volume Right	0	25	0			
cSH	927	1700	1544			
Volume to Capacity	0.02	0.04	0.00			
Queue Length 95th (m)	0.5	0.0	0.0			
Control Delay (s)	9.0	0.0	0.0			
Lane LOS	A					
Approach Delay (s)	9.0	0.0	0.0			
Approach LOS	A					
Intersection Summary						
Average Delay			1.5			
Intersection Capacity Utilization			13.6%		ICU Level of Service	A
Analysis Period (min)			15			

Lanes, Volumes, Timings
6: Woodroffe Ave & Richmond Rd

Total Projected 2031 PM (mitigations)
01/18/2022

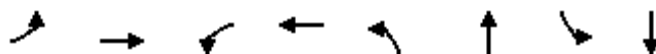

Lane Group	EBL	EBT	WBL	WBT	NBL	NBT	SBL	SBT	Ø9
Lane Configurations									
Traffic Volume (vph)	83	283	152	548	180	281	25	238	
Future Volume (vph)	83	283	152	548	180	281	25	238	
Lane Group Flow (vph)	83	469	152	579	180	369	25	300	
Turn Type	Prot	NA	Prot	NA	pm+pt	NA	Perm	NA	
Protected Phases	7	4	3	8	5	2		6	9
Permitted Phases					2		6		
Detector Phase	7	4	3	8	5	2	6	6	
Switch Phase									
Minimum Initial (s)	5.0	10.0	5.0	10.0	5.0	10.0	10.0	10.0	1.0
Minimum Split (s)	11.9	33.9	11.7	33.9	11.5	31.5	31.5	31.5	5.0
Total Split (s)	14.0	55.0	21.0	67.0	16.0	49.0	33.0	33.0	5.0
Total Split (%)	10.8%	42.3%	16.2%	51.5%	12.3%	37.7%	25.4%	25.4%	4%
Yellow Time (s)	3.3	3.3	3.3	3.3	3.3	3.3	3.3	3.3	2.0
All-Red Time (s)	3.6	3.6	3.4	3.6	3.2	3.2	3.2	3.2	0.0
Lost Time Adjust (s)	0.0	0.0	0.0	0.0	0.0	0.0	0.0	0.0	
Total Lost Time (s)	6.9	6.9	6.7	6.9	6.5	6.5	6.5	6.5	
Lead/Lag	Lead		Lead	Lag	Lead		Lag	Lag	Lag
Lead-Lag Optimize?	Yes		Yes	Yes	Yes		Yes	Yes	Yes
Recall Mode	None	C-Max	None	C-Max	None	Max	Max	Max	None
Act Effct Green (s)	7.1	53.6	13.8	60.1	42.5	42.5	26.5	26.5	
Actuated g/C Ratio	0.05	0.41	0.11	0.46	0.33	0.33	0.20	0.20	
v/c Ratio	0.90	0.74	0.84	0.71	0.82	0.67	0.13	0.86	
Control Delay	130.6	40.9	93.2	34.2	63.4	44.8	44.6	73.9	
Queue Delay	0.0	0.0	0.0	0.0	0.0	0.0	0.0	0.0	
Total Delay	130.6	40.9	93.2	34.2	63.4	44.8	44.6	73.9	
LOS	F	D	F	C	E	D	D	E	
Approach Delay		54.4		46.4		50.9		71.7	
Approach LOS		D		D		D		E	
Queue Length 50th (m)	21.6	101.0	38.7	116.7	34.7	81.2	5.3	74.8	
Queue Length 95th (m)	#53.1	143.2	#74.4	160.3	#68.2	116.1	13.5	#122.7	
Internal Link Dist (m)		348.7		429.3		485.8		318.4	
Turn Bay Length (m)	95.0		75.0		55.0		50.0		
Base Capacity (vph)	92	635	186	810	220	552	189	348	
Starvation Cap Reductn	0	0	0	0	0	0	0	0	
Spillback Cap Reductn	0	0	0	0	0	0	0	0	
Storage Cap Reductn	0	0	0	0	0	0	0	0	
Reduced v/c Ratio	0.90	0.74	0.82	0.71	0.82	0.67	0.13	0.86	

Intersection Summary

Cycle Length: 130	
Actuated Cycle Length: 130	
Offset: 0 (0%), Referenced to phase 4:EBT and 8:WBT, Start of Green	
Natural Cycle: 95	
Control Type: Actuated-Coordinated	
Maximum v/c Ratio: 0.90	
Intersection Signal Delay: 53.4	Intersection LOS: D
Intersection Capacity Utilization 91.7%	ICU Level of Service F
Analysis Period (min) 15	

95th percentile volume exceeds capacity, queue may be longer.
 Queue shown is maximum after two cycles.

Splits and Phases: 6: Woodroffe Ave & Richmond Rd

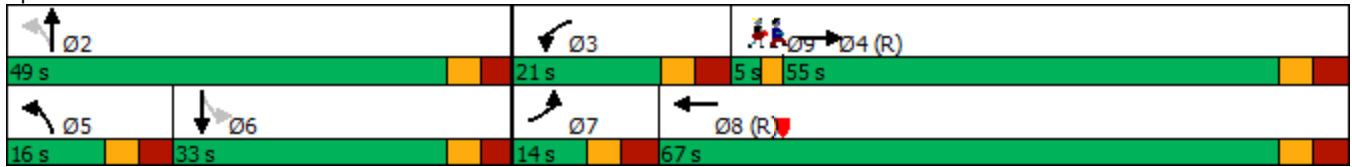

Total Projected 2031 SimTraffic Queuing Analysis

Intersection: 1: Richmond Rd & McEwen Ave

Movement	EB	WB	SB	SB
Directions Served	LT	TR	L	R
Maximum Queue (m)	185.4	39.5	26.6	74.5
Average Queue (m)	174.1	6.0	14.7	20.9
95th Queue (m)	202.4	22.6	31.3	82.4
Link Distance (m)	170.2	381.8		129.9
Upstream Blk Time (%)	93			3
Queuing Penalty (veh)	0			0
Storage Bay Dist (m)			20.0	
Storage Blk Time (%)			37	0
Queuing Penalty (veh)			19	0

Intersection: 2: Richmond Rd & New Orchard Ave N

Movement	EB	WB	SB
Directions Served	LT	TR	LR
Maximum Queue (m)	386.2	105.5	48.2
Average Queue (m)	383.7	52.5	22.3
95th Queue (m)	387.3	91.0	43.3
Link Distance (m)	381.8	125.3	47.3
Upstream Blk Time (%)	29	0	2
Queuing Penalty (veh)	235	0	4
Storage Bay Dist (m)			
Storage Blk Time (%)			
Queuing Penalty (veh)			

Intersection: 3: New Orchard Ave N & Ambleside Dr

Movement	EB	NB	SB
Directions Served	LR	LT	TR
Maximum Queue (m)	19.8	12.8	8.8
Average Queue (m)	7.8	1.1	0.5
95th Queue (m)	14.1	6.6	4.5
Link Distance (m)	109.4	47.3	11.9
Upstream Blk Time (%)			0
Queuing Penalty (veh)			0
Storage Bay Dist (m)			
Storage Blk Time (%)			
Queuing Penalty (veh)			

Intersection: 4: Richmond Rd & Access 1

Movement	EB	WB	SB
Directions Served	LT	TR	LR
Maximum Queue (m)	130.5	1.8	49.0
Average Queue (m)	113.9	0.1	25.2
95th Queue (m)	154.8	1.3	54.1
Link Distance (m)	125.3	335.8	51.5
Upstream Blk Time (%)	8		18
Queuing Penalty (veh)	74		0
Storage Bay Dist (m)			
Storage Blk Time (%)			
Queuing Penalty (veh)			

Intersection: 5: New Orchard Ave N & Access 2

Movement	WB	NB	SB
Directions Served	LR	TR	LT
Maximum Queue (m)	15.5	1.0	1.8
Average Queue (m)	5.2	0.0	0.1
95th Queue (m)	12.5	1.0	1.3
Link Distance (m)	67.4	11.9	77.5
Upstream Blk Time (%)		0	
Queuing Penalty (veh)		0	
Storage Bay Dist (m)			
Storage Blk Time (%)			
Queuing Penalty (veh)			

Intersection: 6: Woodroffe Ave & Richmond Rd

Movement	EB	EB	WB	WB	B10	NB	NB	SB	SB
Directions Served	L	TR	L	TR	T	L	TR	L	TR
Maximum Queue (m)	102.4	340.0	50.3	90.9	4.4	62.1	94.2	57.4	199.5
Average Queue (m)	61.3	336.9	13.0	44.6	0.1	23.6	46.7	19.4	110.1
95th Queue (m)	135.8	356.9	33.3	75.3	2.6	51.3	81.5	57.1	213.5
Link Distance (m)		335.8		78.1	364.5		484.3		306.1
Upstream Blk Time (%)		30	0	1					
Queuing Penalty (veh)		299	0	0					
Storage Bay Dist (m)	95.0		75.0			55.0		50.0	
Storage Blk Time (%)	0	66	0	1		0	5	0	46
Queuing Penalty (veh)	0	100	0	1		0	7	0	18

Network Summary

Network wide Queuing Penalty: 756

Intersection: 1: Richmond Rd & McEwen Ave

Movement	EB	WB	SB	SB
Directions Served	LT	TR	L	R
Maximum Queue (m)	182.2	80.9	26.6	103.3
Average Queue (m)	164.7	40.3	14.5	29.9
95th Queue (m)	220.7	85.5	31.0	103.9
Link Distance (m)	170.2	381.8		129.9
Upstream Blk Time (%)	86			7
Queuing Penalty (veh)	0			0
Storage Bay Dist (m)			20.0	
Storage Blk Time (%)			39	1
Queuing Penalty (veh)			26	0

Intersection: 2: Richmond Rd & New Orchard Ave N

Movement	EB	WB	SB
Directions Served	LT	TR	LR
Maximum Queue (m)	386.3	127.6	43.5
Average Queue (m)	373.5	124.1	15.6
95th Queue (m)	428.4	138.5	34.7
Link Distance (m)	381.8	123.4	47.2
Upstream Blk Time (%)	59	27	1
Queuing Penalty (veh)	333	326	1
Storage Bay Dist (m)			
Storage Blk Time (%)			
Queuing Penalty (veh)			

Intersection: 3: New Orchard Ave N & Ambleside Dr

Movement	EB	NB	SB
Directions Served	LR	LT	TR
Maximum Queue (m)	15.2	11.1	2.8
Average Queue (m)	7.1	0.9	0.1
95th Queue (m)	12.1	5.8	2.0
Link Distance (m)	114.6	47.2	13.9
Upstream Blk Time (%)			0
Queuing Penalty (veh)			0
Storage Bay Dist (m)			
Storage Blk Time (%)			
Queuing Penalty (veh)			

Intersection: 4: Richmond Rd & Access 1

Movement	EB	WB	SB
Directions Served	LT	TR	LR
Maximum Queue (m)	73.0	349.0	29.8
Average Queue (m)	6.8	269.8	11.4
95th Queue (m)	46.3	396.3	31.7
Link Distance (m)	123.4	342.2	43.5
Upstream Blk Time (%)	0	2	4
Queuing Penalty (veh)	2	24	0
Storage Bay Dist (m)			
Storage Blk Time (%)			
Queuing Penalty (veh)			

Intersection: 5: New Orchard Ave N & Access 2

Movement	WB
Directions Served	LR
Maximum Queue (m)	9.2
Average Queue (m)	3.7
95th Queue (m)	10.1
Link Distance (m)	49.8
Upstream Blk Time (%)	
Queuing Penalty (veh)	
Storage Bay Dist (m)	
Storage Blk Time (%)	
Queuing Penalty (veh)	

Intersection: 6: Woodroffe Ave & Richmond Rd

Movement	EB	EB	WB	WB	B10	NB	NB	SB	SB
Directions Served	L	TR	L	TR	T	L	TR	L	TR
Maximum Queue (m)	102.3	275.5	76.6	106.2	415.6	62.5	502.4	57.3	292.2
Average Queue (m)	22.9	88.4	71.3	98.9	402.5	61.3	415.5	20.3	263.1
95th Queue (m)	78.9	237.3	87.8	102.4	447.0	68.4	622.4	59.9	335.0
Link Distance (m)		342.2		76.7	398.8		488.0		277.7
Upstream Blk Time (%)		1	10	58	82		49		70
Queuing Penalty (veh)		8	0	0	0		0		0
Storage Bay Dist (m)	95.0		75.0			55.0		50.0	
Storage Blk Time (%)	0	16	18	57		59	26	0	83
Queuing Penalty (veh)	0	13	147	124		289	64	0	21

Network Summary

Network wide Queuing Penalty: 1380

Intersection: 1: Richmond Rd & McEwen Ave

Movement	EB	WB	SB	SB
Directions Served	LT	TR	L	R
Maximum Queue (m)	83.0	73.3	24.9	45.9
Average Queue (m)	24.6	39.7	8.5	5.2
95th Queue (m)	65.4	66.1	22.2	30.1
Link Distance (m)	322.6	381.8		129.9
Upstream Blk Time (%)				
Queuing Penalty (veh)				
Storage Bay Dist (m)			20.0	
Storage Blk Time (%)			10	0
Queuing Penalty (veh)			5	0

Intersection: 2: Richmond Rd & New Orchard Ave N

Movement	EB	WB	SB
Directions Served	LT	TR	LR
Maximum Queue (m)	137.6	79.9	47.4
Average Queue (m)	70.4	45.1	23.6
95th Queue (m)	117.0	73.7	44.0
Link Distance (m)	381.8	125.8	47.3
Upstream Blk Time (%)			2
Queuing Penalty (veh)			3
Storage Bay Dist (m)			
Storage Blk Time (%)			
Queuing Penalty (veh)			

Intersection: 3: New Orchard Ave N & Ambleside Dr

Movement	EB	NB	SB
Directions Served	LR	LT	TR
Maximum Queue (m)	18.2	11.7	5.0
Average Queue (m)	7.7	1.1	0.3
95th Queue (m)	13.2	6.3	3.6
Link Distance (m)	109.4	47.3	11.9
Upstream Blk Time (%)			0
Queuing Penalty (veh)			0
Storage Bay Dist (m)			
Storage Blk Time (%)			
Queuing Penalty (veh)			

Intersection: 4: Richmond Rd & Access 1

Movement	EB	SB
Directions Served	LT	LR
Maximum Queue (m)	37.6	15.1
Average Queue (m)	2.6	6.0
95th Queue (m)	20.4	13.5
Link Distance (m)	125.8	90.0
Upstream Blk Time (%)		
Queuing Penalty (veh)		
Storage Bay Dist (m)		
Storage Blk Time (%)		
Queuing Penalty (veh)		

Intersection: 5: New Orchard Ave N & Access 2

Movement	WB	SB
Directions Served	LR	LT
Maximum Queue (m)	16.4	0.9
Average Queue (m)	4.7	0.0
95th Queue (m)	12.1	1.0
Link Distance (m)	67.4	77.5
Upstream Blk Time (%)		
Queuing Penalty (veh)		
Storage Bay Dist (m)		
Storage Blk Time (%)		
Queuing Penalty (veh)		

Intersection: 6: Woodroffe Ave & Richmond Rd

Movement	EB	EB	WB	WB	NB	NB	SB	SB
Directions Served	L	TR	L	TR	L	TR	L	TR
Maximum Queue (m)	102.4	327.4	27.9	62.6	57.8	107.4	57.3	184.6
Average Queue (m)	71.0	252.4	9.3	30.0	22.1	49.0	21.1	108.8
95th Queue (m)	132.6	320.9	22.4	52.7	50.8	86.7	57.8	230.7
Link Distance (m)		334.8		417.1		476.9		311.8
Upstream Blk Time (%)		1						4
Queuing Penalty (veh)		10						0
Storage Bay Dist (m)	95.0		75.0		55.0		50.0	
Storage Blk Time (%)	0	48		0	0	8	1	47
Queuing Penalty (veh)	0	72		0	1	7	4	18

Network Summary

Network wide Queuing Penalty: 121

Intersection: 1: Richmond Rd & McEwen Ave

Movement	EB	WB	SB	SB
Directions Served	LT	TR	L	R
Maximum Queue (m)	100.0	112.9	24.4	45.0
Average Queue (m)	39.1	87.1	7.6	4.9
95th Queue (m)	78.5	110.5	20.0	24.0
Link Distance (m)	382.8	381.8		129.9
Upstream Blk Time (%)				
Queuing Penalty (veh)				
Storage Bay Dist (m)			20.0	
Storage Blk Time (%)			7	0
Queuing Penalty (veh)			5	0

Intersection: 2: Richmond Rd & New Orchard Ave N

Movement	EB	WB	SB
Directions Served	LT	TR	LR
Maximum Queue (m)	177.1	127.7	44.2
Average Queue (m)	80.5	125.2	17.1
95th Queue (m)	155.4	127.1	36.5
Link Distance (m)	381.8	123.6	47.2
Upstream Blk Time (%)		39	1
Queuing Penalty (veh)		331	1
Storage Bay Dist (m)			
Storage Blk Time (%)			
Queuing Penalty (veh)			

Intersection: 3: New Orchard Ave N & Ambleside Dr

Movement	EB	NB	SB
Directions Served	LR	LT	TR
Maximum Queue (m)	15.8	12.0	3.3
Average Queue (m)	7.1	1.4	0.2
95th Queue (m)	12.6	7.2	2.3
Link Distance (m)	114.6	47.2	13.9
Upstream Blk Time (%)			0
Queuing Penalty (veh)			0
Storage Bay Dist (m)			
Storage Blk Time (%)			
Queuing Penalty (veh)			

Intersection: 4: Richmond Rd & Access 1

Movement	EB	WB	SB
Directions Served	LT	TR	LR
Maximum Queue (m)	56.4	352.9	42.2
Average Queue (m)	3.6	309.6	13.4
95th Queue (m)	29.1	393.2	36.3
Link Distance (m)	123.6	341.7	89.8
Upstream Blk Time (%)		9	
Queuing Penalty (veh)		70	
Storage Bay Dist (m)			
Storage Blk Time (%)			
Queuing Penalty (veh)			

Intersection: 5: New Orchard Ave N & Access 2

Movement	WB
Directions Served	LR
Maximum Queue (m)	9.1
Average Queue (m)	3.1
95th Queue (m)	9.4
Link Distance (m)	49.8
Upstream Blk Time (%)	
Queuing Penalty (veh)	
Storage Bay Dist (m)	
Storage Blk Time (%)	
Queuing Penalty (veh)	

Intersection: 6: Woodroffe Ave & Richmond Rd

Movement	EB	EB	WB	WB	NB	NB	SB	SB
Directions Served	L	TR	L	TR	L	TR	L	TR
Maximum Queue (m)	102.4	197.1	82.4	302.2	62.4	373.8	57.3	277.3
Average Queue (m)	38.1	98.4	60.7	159.2	53.0	177.1	18.5	162.4
95th Queue (m)	94.1	178.7	100.4	337.3	76.6	414.8	55.9	318.6
Link Distance (m)		341.7		434.6		490.2		323.6
Upstream Blk Time (%)				4		4		6
Queuing Penalty (veh)				0		0		0
Storage Bay Dist (m)	95.0		75.0		55.0		50.0	
Storage Blk Time (%)	0	15	5	29	33	21	0	65
Queuing Penalty (veh)	0	13	31	44	121	38	0	16

Network Summary

Network wide Queuing Penalty: 670
